

electronics

Passive telemetry system finds acceleration of howitzer shells.

Microwave beam is modulated in gun barrel by a transistorized pressure gage mounted in the nose of the shell. See p 68

A McGraw-Hill Publication 75 Cents





50 KC TO 40 KMC

VERSATILE GENERATORS, OSCILLATORS ALSO DRIVE FREQUENCY DOUBLER SETS





















626A/628A shf Signal Generators

Instruments bringing high power, wide range, convenience and accuracy to the 10 to 21 KMC range. Frequencies, output voltage directly set and read. Output 10 to 20 db better than previous spot-frequency sets; SWR better than 1.2 at 0 dbm and lower. High power output provides excellent drive for the  938A/940A Frequency Doubler Sets. Internal pulse, FM or square wave modulation; also external pulsing or FM'ing.  626A, 10 to 15.5 KMC, \$3,250.00;  628A, 15 to 21 KMC, \$3,250.00.



680 Series Sweep Oscillators

Five models offering electronic sweeping for greater flexibility, simplified operation; range from 1 to 18.0 KMC.  686A, 8.2 to 12.4 KMC and  687A, 12.4 to 18.0 KMC, useful for driving  Frequency Doubler Sets.  682A 1-2 KMC, \$3,090.00;  683A, 2 to 4 KMC, \$3,000.00;  684B, 4.0 to 8.1 KMC, \$2,900.00;  686A, \$2,900.00;  687A, \$3,400.00.

Instrument	Frequency Range	Characteristics	Price
 606A	50 KC to 65 MC	Output 0.1 μ v to 3 v. Full feedback loop, low distortion	\$1,200.00 Δ
 608C	10 to 480 MC	Output 0.1 μ v to 1 v into 50 ohm load. AM, pulse, or CW modulation. Direct calibration	1,000.00 ■
 608D	10 to 420 MC	Output 0.1 μ v to 0.5 v. Incidental FM less than 0.001%	1,100.00 ■
 612A	450 to 1,230 MC	Output 0.1 μ v to 0.5 v into 50 ohm load. AM, pulse, CW or square wave modulation. Direct calibration	1,200.00 ■
 614A	800 to 2,100 MC	Output 0.1 μ v to 0.223 v into 50 ohm load. Pulse, CW or FM modulation. Direct calibration	1,950.00 ■
 616B	1,800 to 4,200 MC	Output 0.1 μ v to 0.223 v into 50 ohm load. Pulse, CW or FM modulation. Direct calibration	1,950.00 ■
 618B	3,800 to 7,600 MC	Output 0.1 μ v to 0.223 v into 50 ohm load. Pulse, CW FM or square wave modulation. Direct calibration	2,250.00 ■
 620A	7,000 to 11,000 MC	Output 0.1 μ v to 0.223 v into 50 ohm load. Pulse, FM or square wave modulation. Direct calibration	2,250.00 ■
 626A	10 to 15.5 KMC	Output 10 dbm to -90 dbm. Pulse, FM, or square wave modulation. Direct calibration	3,250.00 ■
 628A	15 to 21 KMC	Output 10 dbm to -90 dbm. Pulse, FM, or square wave modulation. Direct calibration	3,250.00 ■

Δ Rack mounted instruments \$15.00 less.

■ Rack mounted instruments \$20.00 additional.

Data subject to change without notice. Prices f.o.b. factory.

HEWLETT-PACKARD COMPANY

1054A Page Mill Road Palo Alto, California, U.S.A.
Cable "HEWPACK" DAVenport 6-7000

Sales representatives in all principal areas



HEWLETT-PACKARD S.A.

Rue du Vieux Billard No. 1 Geneva, Switzerland
Cable "HEWPACKSA" Tel. No. (022) 26. 43. 36

FULL COVERAGE

hp 606A Standard Signal Generator 50 KC to 65 MC

Output adjustable from 3 v full range to 0.1 μ v rms (+23 to -120 dbm). Feedback assures power into a 50 ohm load constant within \pm 1 db over the frequency range. Reliable internal crystal calibrator permits checking points at 100 KC and 1 MC intervals with an error of less than 0.01%. Very low distortion, broad modulating capabilities. Typical hp speed, ease of operation. hp 606A, \$1,200.00.

VHF SIGNAL GENERATORS

hp 608D—10 to 420 MC

Highest stability, low incidental FM and frequency drift. Calibrated output 0.1 μ v to 0.5 v throughout range. Built-in crystal calibrator provides frequency check accurate within 0.01% each 1 and 5 MC. Master-oscillator, buffer and output amplifier circuit design. Direct calibration, ideal for aircraft communications equipment testing. hp 608D, \$1,100.00.

hp 608C—vhf Signal Generator

High power (1 v max.), stable, accurate generator. 10 to 480 MC. Ideal for testing receivers, amplifiers, driving bridges, slotted lines, antennas, etc. hp 608C, \$1,000.00.

UHF SIGNAL GENERATORS

hp 612A—450 to 1,230 MC

Same high output power, low incidental FM, broad modulation capabilities as hp vhf signal generators. Frequency, output directly set on large precisely calibrated dials. hp 612A, \$1,200.00.

hp 614A—800 to 2,100 MC

Easy to use, direct-reading, one-dial frequency control, high stability and accuracy. Ideal for measuring receiver sensitivity, signal-noise ratio, conversion gain, SWR, transmission line characteristics. hp 614A, \$1,950.00.

hp 616B—1,800 to 4,200 MC

Ruggedly built, compact to save bench space, offers same hp precision, ease of operation, compactness of the other hp uhf instruments. hp 616B, \$1,950.00.

SHF SIGNAL GENERATORS

hp 618B—3,800 to 7,600 MC

hp 620A—7,000 to 11,000 MC

These instruments provide the simple, versatile operation and varied pulsing capabilities common in hp signal generators to the lower regions of the shf range. The 618B and 620A may be synchronized with an external sine wave or with positive or negative pulse signals, as may other hp signal generators. hp 618B, \$2,250.00; hp 620A, \$2,250.00.



Now! GENERATE PRECISE SIGNALS



TO 40 KMC

with these new, inexpensive

FREQUENCY DOUBLER SETS!

For convenient, economical, reliable signal generation to 40 KMC, use these new *hp* Frequency Doubler Sets and either your own existing signal sources or one of the dependable, bench-proven *hp* signal generators on the next pages.

hp Model 938A supplies power from 18 to 26.5 KMC when driven by a 9 to 13.25 KMC source; *hp* Model 940A supplies power from 26.5 to 40 KMC when driven by a 13.25 to 20 KMC source.

The *hp* 938A and 940A have the same output versatility as the driving source. These broadband instruments accept cw, pulsed or swept input signals from signal generators, swept signal sources or klystrons.

Each contains a broadband crystal-harmonic generator, plus a dual rotary vane attenuator, for generating and accurately setting the output level 0 to -100 dbm. Output power depends on input power and is typically 0.5 to 1.0 mw when the driving source is an *hp* 626A or 628A Signal Generator or an *hp* 686A Sweep Oscillator. Output power is known, even though an uncalibrated signal source is used, since the output monitor is accurate to ± 1 to ± 2 db, depending on model and frequency.

hp 938A/940A conversion loss is approximately 17 db at 10 mw input. Maximum input power 200 mw, saturation output 2 mw. Attenuator accuracy $\pm 2\%$ of reading or 0.2 db (whichever is greater). Attenuator range 100 db; output SWR less than 1.2 at 10 db or more attenuation. Sturdy construction permits signal source to be mounted on top of Doubler Set, presents output at convenient bench level. *hp* 938A, \$1,500.00; *hp* 940A, \$1,500.00.

Check these Precision  SIGNAL GENERATORS

electronics

A McGraw-Hill Publication 75 Cents



W. W. MacDONALD, Editor

J. M. CARROLL, Managing Editor
SENIOR ASSOCIATE EDITORS: Samuel Weber, Roland J. Charest. **ASSOCIATE EDITORS:** Frank Leary, Michael F. Tomaino, Sylvester P. Carter, William P. O'Brien, John F. Mason, William E. Bushor, Thomas Emma, Sy Vogel, Leslie Solomon, M. M. Perugini, George J. Flynn. **ASSISTANT EDITORS:** Michael F. Wolff, Nilo Lindgren, Stanley Froud, Stephen B. Gray. **REGIONAL EDITORS:** Harold C. Hood (Pacific Coast, Los Angeles), Thomas Maguire (New England, Boston). **MARKET RESEARCH EDITOR:** Edward DeJongh. **BUYERS' GUIDE EDITOR:** George Sideris. **ART DIRECTOR:** Harry Phillips; Howard R. Berry. **PRODUCTION EDITOR:** John C. Wright, Jr. **EDITORIAL ASSISTANTS:** Gloria J. Filippone, Arlene Schlip, Bernice Duffy, Patricia Martine, Lorraine Rossi, Virginia T. Bastian, Ruth Ayres.

JAMES GIRDWOOD, Publisher

BUSINESS

Navy's "Sage for the Fleet" Opens Market. Business potential big	30
Digital Controls Steal Chicago Show. Sales to reach \$25 million	32
Speeding Up Moon-Bounce Communications. Special techniques	34
Disabled, Electronics Help Each Other. Handicapped show skills	37
New Exchange Stresses Science. Report on stock mart	38
More Medical Tv Planned. Profitable market for manufacturers	40
Crosstalk	4
Comment	6
Electronics Newsletter	11
Washington Outlook	14
Financial Roundup	23
25 Most Active Stocks	23
Marketing	26
Current Figures	26
Meetings Ahead	42

ENGINEERING

Engineer makes final check on missile-mounted telemetry equipment in readiness for firing. See p 68	COVER
New Capacitance-Type Burglar Alarm. Senses 10-pf capacitance changes. By S. M. Bagno	65
Gun Barrel Telemeter Tells Projectile Acceleration During Firing. Reflected microwaves are modulated by acceleration forces. By W. M. Kendrick and L. A. Peters	68
High-Current Solid-State Switch. Energizes falling-sphere accelerometer. By C. H. Price, Jr.	72
Direction Finding at Low Frequencies. Accurate bearings are indicated at 15 Kc. By L. E. Orsak and D. W. Martin	74
Wide-Range Multiple-Pulse Amplifier. Extends usefulness of crystal video receiver. By R. S. Koncen	78
Generator Delivers Constant Current at Voltage Pulses. Determines electrical need of firing circuits. By L. A. Rosenthal	82
Space Capsule Oscillator. Meets stringent requirements. By N. Kling	86

DEPARTMENTS

Research and Development. Recording Multipath Fade Rates	88
Components and Materials. Chopper Stabilizes D-C Amplifier	92
Production Techniques. Projectors Improve Calibration Accuracy	96
New On the Market	100
Literature of the Week	130
New Books	132
People and Plants	136
Index to Advertisers	142

How To Combat Heat

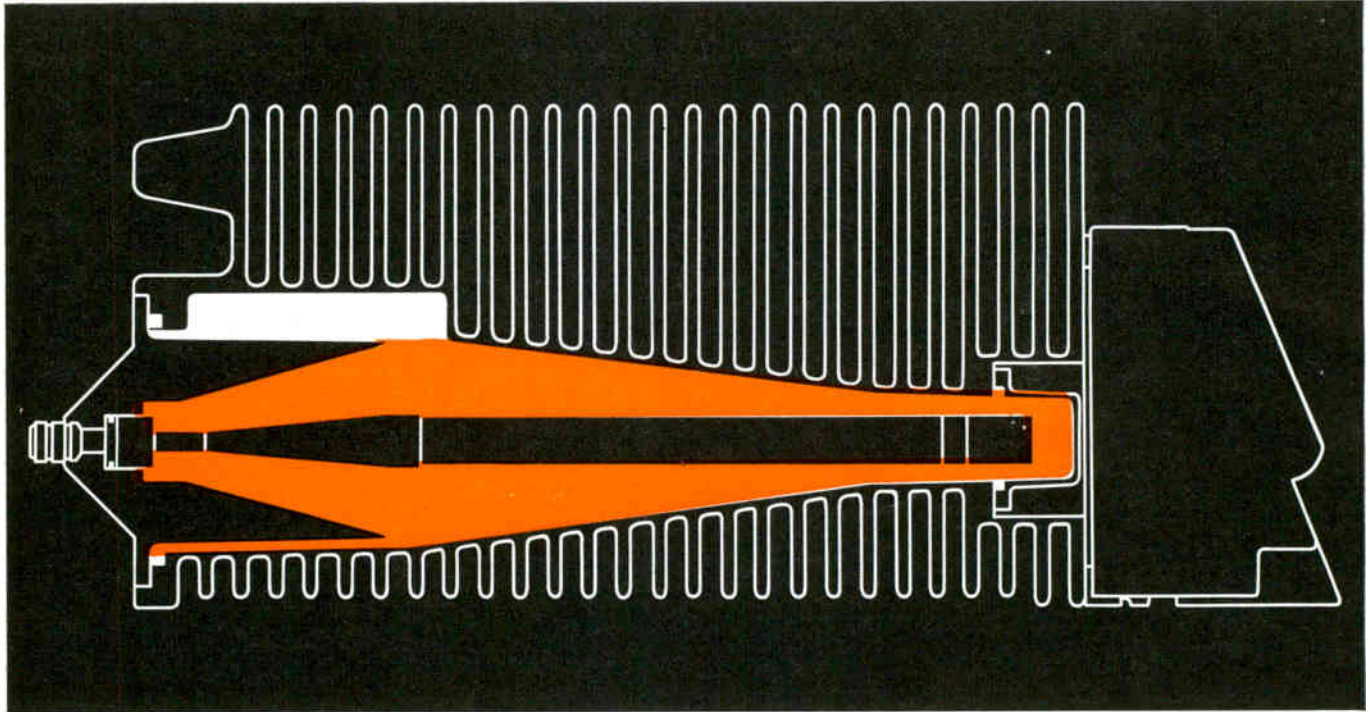

Good heat dissipation with dielectric strength are unique silicone properties

An example: Dow Corning silicone fluids are used as dielectric coolants for rapid dissipation of heat because of their thermal stability and relatively flat viscosity-temperature curves. (See chart below.) They can be pumped at high speeds without breakdown due to shear; maintain consistency from -65 to 250 C; and they will not oxidize or act as corrosives to metals even at high temperatures.

Low vapor pressure is an additional reason why Sierra Electronic Corporation, Menlo Park, California, specifies Dow Corning 200 Fluid as the heat transfer medium in their 100 and 500 watt, 50 ohm coaxial RF loads. Heat losses are dissipated through the dielectric coolant to fins on the cast housing, providing integral liquid cooling without loss of dielectric strength.

These terminations have excellent stability. Prolonged operation within their rating produces no measurable change of characteristics, even with an ambient temperature of 104°F (40°C).

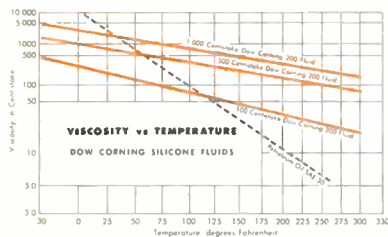

From direct current to 3 kmc these coaxial line loads have a low VSWR ratio of less than 1.2 . . . are compact and light in weight. And Dow Corning 200 Fluid helped Sierra engineers lick the heat problem by providing a dielectric with good heat conduction.



CIRCLE 289 ON READER SERVICE CARD

For "Silicones for the Electronic Engineer", Write Dept. 3509.



Dow Corning

...Specify Silicones

Silastic Jacket for Heat or Cold

Exposed to environmental extremes of blistering heat and bitter cold, the molded jacket of this flexible wave guide is made from Silastic®, the Dow Corning silicone rubber. According to Co-Operative Industries engineers, the Silastic jacket provides a smooth exterior over the corrugated brass of the wave guide, gives added resistance to dents, corrosion and abrasion. It also helps control flexing characteristics. Rubbery parts made of Silastic retain their physical and dielectric properties over the wide temperature span of -90 to 250 C . . . resist ozone, corona and voltage stress. Initial properties remain unchanged despite rapid thermal cycling or long term storage.

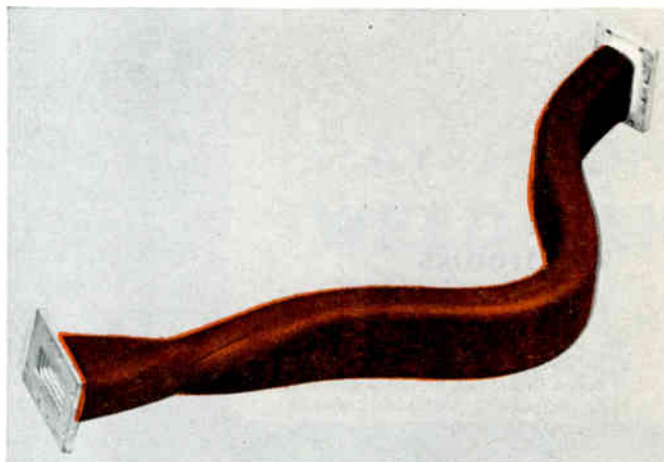

CIRCLE 290 ON READER SERVICE CARD

Silicone Team "Beats" Heat

This solenoid, manufactured by Cannon Electric Company, Los Angeles, California, is subjected to high temperatures and other environmental extremes. One typical use: in pneumatic starters for aircraft turbine engines. To beat the heat, Cannon engineers specify a silicone insulation system consisting of: Dow Corning impregnating varnish; silicone-glass tape; silicone rubber impregnated glass sleeving; silicone fiber glass insulators; silicone compound for sealing terminals; and, Silastic caulking paste. Completed solenoids must withstand environmental tests including salt spray, humidity, high and low temperatures and vibration. Cannon Electric chose the *silicone team* "for its superior characteristics in resisting heat, moisture and abrasion; and, its outstanding dielectric properties."

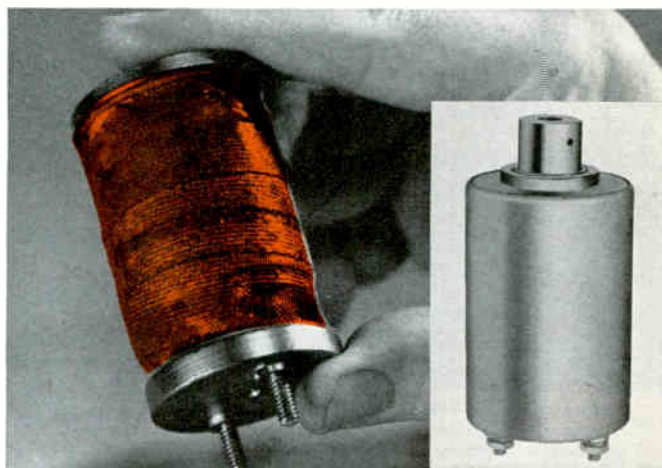

CIRCLE 291 ON READER SERVICE CARD

Heat-Stable Vacuum Pump Fluid

Dow Corning silicone diffusion pump fluids offer a combination of properties that add up to high production rates and long runs without maintenance. These properties provide heat stability, low vapor pressure, high vacua, rapid recovery, quick pump down, inertness to air and metals and resistance to gamma radiation. Silicone diffusion pump fluid is non-toxic and chemically inert . . . pump vacuum can be released without first cooling the boiler . . . decomposition does not occur when hot fluids are exposed to air. To improve the performance of your diffusion pump, specify a Dow Corning diffusion pump fluid . . . They produce vacua in the range of 10^{-3} to 10^{-7} mm of Hg.

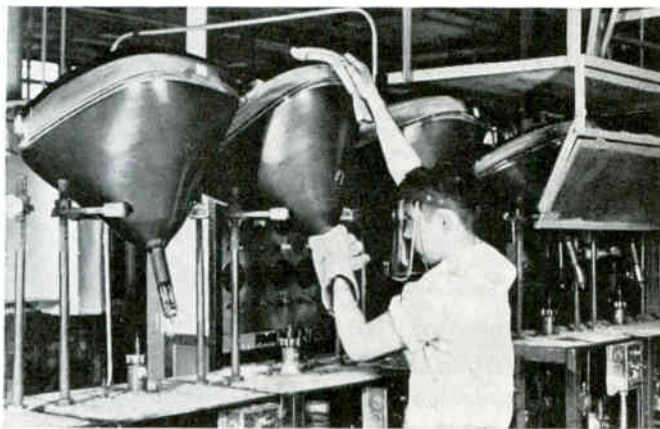

CIRCLE 292 ON READER SERVICE CARD

CORPORATION MIDLAND, MICHIGAN

branches: ATLANTA BOSTON CHICAGO CLEVELAND DALLAS LOS ANGELES NEW YORK WASHINGTON, D.C.

September 16, 1960

3

INDUSTRIAL COMPONENTS DIVISION



MAGNETRON CONNECTORS

by **jettron**®

Specify JETTRON for all types of magnetron connectors for vital military or commercial equipment. Complete facilities for the design and production of "specials" and other precision components including sockets and cable assemblies.

Magnetron Input Connector Cat. 9000-C

Fits 4J52A and similar Magnetrons. Features floating heater contact, eight prong heater-cathode contact of silver plated, heat treated beryllium copper. Molded silicone encloses metal body.



Magnetron Input Connector Cat. 9005-C

Fits 4J52A and similar Magnetrons. Features identical to Cat. 9000-C. In addition has 75 mil thick silicone insulated cables for higher potential applications. Made with 4700 μmf built-in capacitor.



Magnetron Input Connector Cat. 9040

One of the many "Specials" Jettron has made. Basic Input Connector with floating heater contact. Supplied with or without bypass capacitor. Normally potted to the magnetron input end.



Magnetron Input Connector Cat. 9050

Fits Miniature Magnetrons such as L-3028B. Beryllium copper heater and cathode contacts assure dependable contact. Silicone cup fits snugly over magnetron input end. Leads insulated with silicone.



Magnetron Input Connector Cat. 9060

Fits Miniature Magnetrons such as L-3028B. Features similar to Cat. 9050 but supplied less silicone enclosure. Leads extend axially from body of connector. Normally potted to magnetron input end.



Call or write for bulletins on special sockets, magnetron and other connectors

JETTRON PRODUCTS • INC

56 Route 10, Hanover, New Jersey
Telephones: TUcker 7-0571-0572

Sales Engineers in Principal Cities

COMMENT

Radio Blackouts

In the Aug. 5 issue of *ELECTRONICS*, the article on p 35, "Sneaking Through Radio Blackouts," reports investigation of a prominent auroral disturbance which occurred in September 1957.

It so happened that an ARRL amateur radio field-day drill was in process during the auroral display which occurred the following year on June 29, 1958.

The Garden State Amateur Radio Association, radio call W2GSA, set a new record in two-way contacts established (2,590) during the 24-hour period of this contest. This organization had its field-day installation located on Crawfords Hill in Holmdel, N. J., the site presently being used for moon-bounce experiments by the Bell Telephone Laboratories. Worldwide contacts were made using all amateur bands from 3.5 Mc to 145 Mc, on c-w and phone.

I was president of GSARA and had made arrangements to take a periodic count of contacts made by each operating position. A box-score of these contacts is presented in the July 1958 issue of *The Scope*, the GSARA monthly bulletin. I used these data to prepare a series of graphs of contacts vs. time of day. The operating positions were staffed with skilled operators whose experience was peculiar to the frequency band they worked.

It appeared interesting to me how the curves dipped during the auroral display. These curves represent maximum effort towards establishing two-way radio contacts with other stations on the globe from this location at the indicated time as a function of propagation conditions . . .

WATSON P. CZERWINSKI
W2JTJ

SHREWSBURY, N. J.

Dedicated ham Czerwinski sent along a copy of the curves, which show that the frequency of contacts dipped as the visual aurora came into being, recovered rapidly after the aurora disappeared. Voice contacts, interestingly enough, seemed to be less seriously affected than c-w. Worst dip was in the c-w contacts on 7 Mc.

Electronics Probes Nature

The Bushor-Wolff special report ("Electronics Probes Nature," p 53, July 29) is one of the finest writeups of its kind that I have seen in the industry. You deserve and have our congratulations!

I thought the portion by Edgerton and Cousteau was really revelatory, both from the electronics detail standpoint and from the standpoint of human interest. *ELECTRONICS* does not often run quotes, but in this instance they were interesting and illuminating.

ARTHUR F. JOY

RAYTHEON Co.
WALTHAM, MASS.

. . . I think it is all a very valuable piece of work and I am sure it was of the greatest interest to most of the readers of *ELECTRONICS*. I had some favorable letters regarding my own contribution, and I am quite sure you must have had many concerning the whole issue . . .

T. GOLD

CORNELL UNIVERSITY
ITHACA, N. Y.

. . . Most comprehensive . . . The style of writing, together with the references, should make for both interesting and educational reading for amateur and professional worker.

FLOYD DUNN

UNIVERSITY OF ILLINOIS
URBANA, ILL.

. . . Very good review of the work being done in this area, and a real contribution in bringing all these different aspects together into one readable piece.

JAMES E. WHEAT JR.

U. S. DEPARTMENT OF COMMERCE
WASHINGTON, D. C.

Reducing Interference

. . . With reference to "Reducing Interference in Ionospheric Sounding," p 118, May 27, I wish to report that V_s should be a 6AG7, not a 6AU6 as shown . . .

K. PERRY

BRISBANE, QLD.
AUSTRALIA

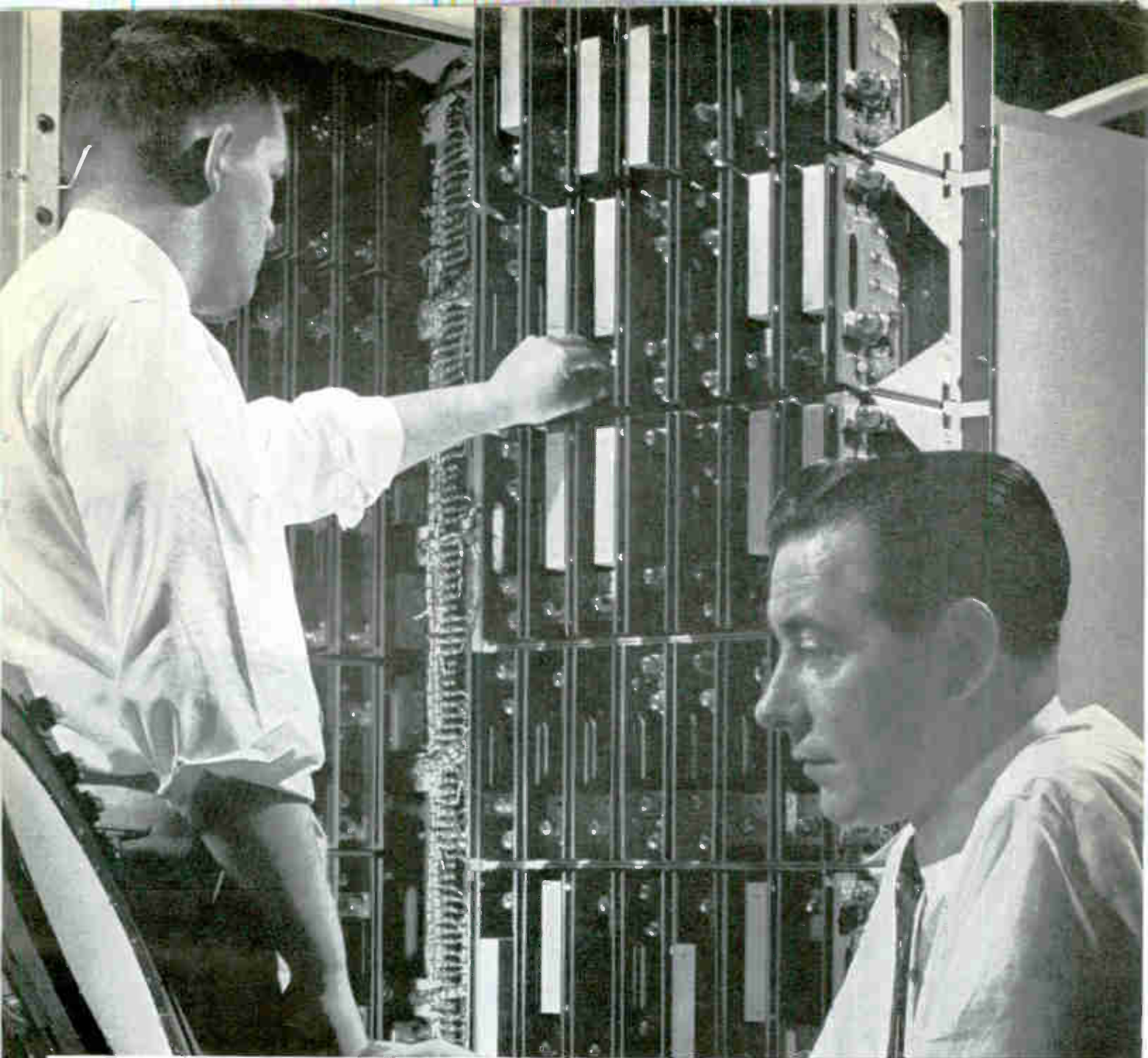

AN ACHIEVEMENT IN DEFENSE ELECTRONICS

AN/FSA-12--First to detect and process 3-D radar data automatically

The first equipment to successfully automate the processing of three-dimensional data direct from a working radar, the AN/FSA-12 (XW-1) has operated since 1958. This detector tracker has enabled General Electric to develop many improved radar techniques and equipment.

New concepts in correlation and smoothing in the track-while-scan method have been demonstrated. Delay lines applied to digital techniques

and plug-in wiring boards have been improved. New ideas in data storage and digital circuitry have been applied.

This experimental model continues to be a proving ground in research and development of advanced military electronics. A completely solid state production version of the AN/FSA-12 will soon be available for many of our nation's air defense radar sites. 17-04

Progress Is Our Most Important Product

DEFENSE ELECTRONICS DIVISION
HEAVY MILITARY ELECTRONICS DEPARTMENT • SYRACUSE, NEW YORK

GENERAL  ELECTRIC

Now Industry's
Major
Semiconductor Source

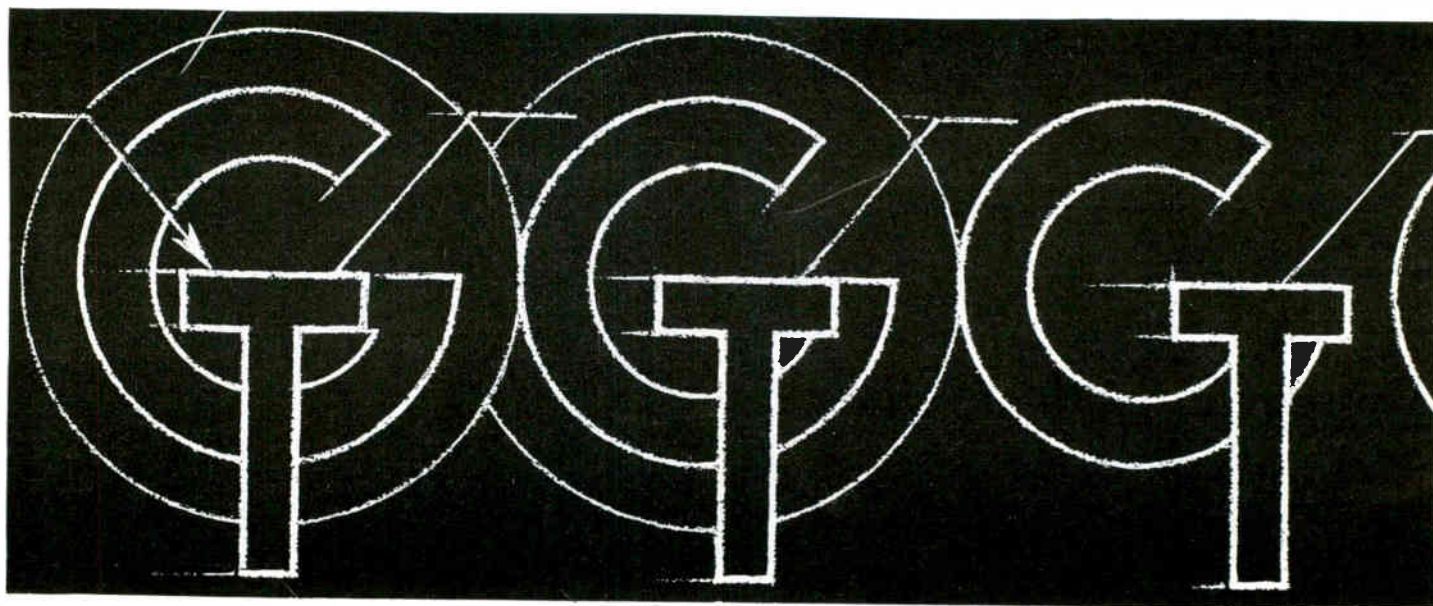

Now available! The broadest
line of high quality

GENERAL INSTRUMENT
GENERAL TRANSISTOR

TRANSISTORS, DIODES, RECTIFIERS

GI SEMICONDUCTOR

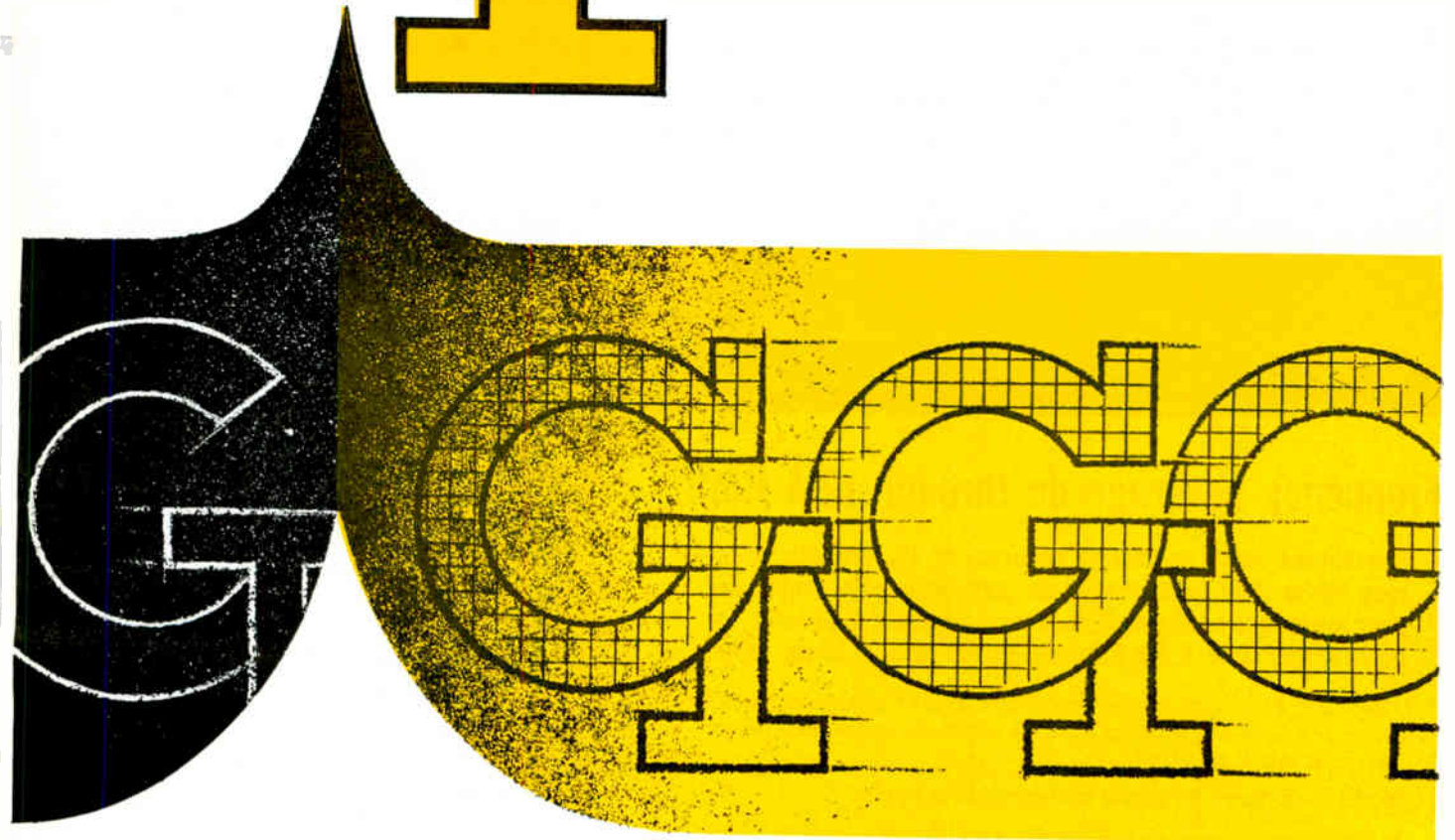

- NOW you can get from **GI** Semiconductor the outstanding **RELIABILITY** for which General Instrument and General Transistor have been recognized . . . **PROVED BY PERFORMANCE!**
- NOW you can get from **GI** Semiconductor the outstanding **CUSTOM QUALITY** for which General Instrument and General Transistor have been recognized . . . **PROVED BY PERFORMANCE!**
- NOW you can get from **GI** Semiconductor the outstanding **AVAILABILITY** of all standard types of semiconductors

for which General Instrument and General Transistor have been recognized . . . **PROVED BY PERFORMANCE!**

- NOW you can get from **GI** Semiconductor the outstanding **PRICE REALISM** for which General Instrument and General Transistor have been recognized . . . **PROVED BY PERFORMANCE!**
- We confidently present this combination of talents to the Industry. **GI** Semiconductor is dedicated to a position of leadership in the dynamic semiconductor market.

GI SEMICONDUCTOR
DIVISION OF GENERAL INSTRUMENT CORPORATION
65 Gouverneur Street, Newark 4, New Jersey

4704

Ready for you now!

Primary standard accuracy for power measurements to 1,000 watts!

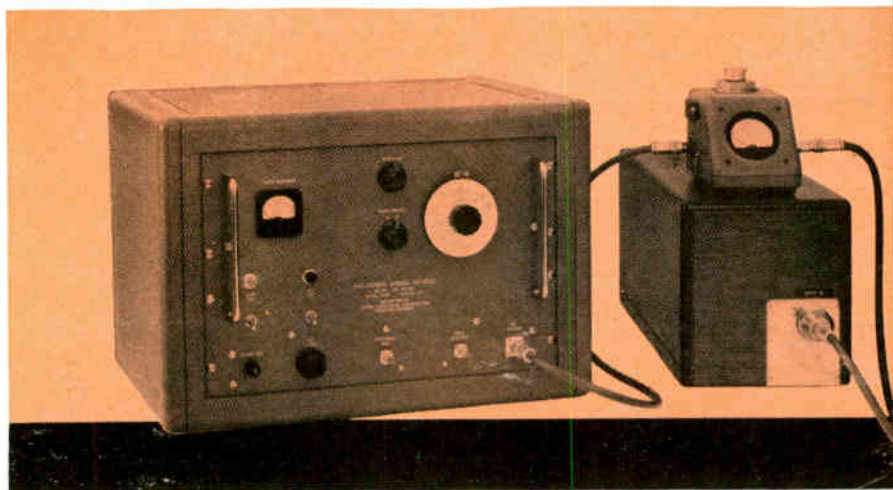

Sierra 290B Test Set

Frequency coverage dc through 12.4 KMC.

Guaranteed power measuring accuracy of 1%. Probable accuracy better than 0.5%. Precise ac wattmeter, calorimeter and heat exchanger in one neat, rack unit. Separate dual loads for dc to 4 KMC, also C, XB, X bands. Direct reading linear scale.

Above are highlights of the new Sierra 290B Calorimetric Wattmeter Test Set—the industry's closest approach to absolute power measurements in this range.

Model 290B measures power in three distinct modes.

1. For power levels 30 to 1,000 watts, a null-balance mode provides measurement accuracies of 1% or better, with probable error as low as 0.5%.
2. For wider range power levels from 10 to 1,500 watts, a direct-reading mode provides excellent linearity in thermal readout and 2% to 3% accuracy. Readout is fast—60 seconds or less.
3. For expanded scale readings of highest resolution, the above two modes may be combined in a third mode to obtain the order of accuracy of the null-balance mode, together with the time-saving convenience of the direct readout mode.

Model 290B, \$4,500.00. (Water loads, extra.)

Data and prices subject to change without notice. Prices f.o.b. factory.

Laboratory setup above shows Sierra Model 215 Power Source being used in conjunction with Model 290B Calorimeter to calibrate Sierra Bi-Directional Power Monitor. Designed specifically for calibration purposes, 215 series Sources include four 50 watt models covering, collectively, 25 to 1,000 MC. Model 215A, 25 to 50 MC; Model 215B, 50 to 150 MC; Model 215C, 150 to 470 MC; Model 215D, 470 to 1,000 MC. Price (any model) \$3,300.00.

For complete details, see your Sierra representative or write direct

SIERRA ELECTRONIC CORPORATION

A Division of Phiico Corporation

6560A BOHANNON DRIVE • MENLO PARK, CALIFORNIA • Davenport 6-2060

Sales representatives in all principal areas

Canada: Atlas Instrument Corporation, Ltd., Montreal, Ottawa, Toronto, Vancouver.

Export: Frazar & Hansen, Ltd., San Francisco, California.

6560



ELECTRONICS NEWSLETTER

Electronics R&D Spending Tops U. S. Industry

CROSS-SECTION of representative U. S. corporations will spend an average of 10.7 percent more for development of new products and processes in 1960 than was spent in 1959, according to a nationwide midyear survey by American Management Association.

AMA surveyed 402 corporations representing 26 industry groups. Of the companies questioned, 66-percent increased R&D budgets, 7-percent cut the budgets and 27 percent reported no change.

Budget changes ranged from decreases of 11.8 percent in mineral and coal mining and 5.2 percent in publishing to increases of 16.8-percent in electronics and 22 percent in miscellaneous machinery and parts.

The 402 corporations spent an average of 3.7 percent of 1959 sales for product development that year, the survey shows. Leading industry was electronics, with 7.7 percent, followed by instruments and controls with 6.1 percent and pharmaceuticals with 5.7 percent. With the 16.8-percent increase in 1960's budget over 1959's 7.7-percent of sales, electronics will continue to lead U. S. industry in percentage of income spent on R&D.

Project Press Takes First Small Step

PROJECT PRESS (Pacific Range Electromagnetic Signature Study)—Defense Department's program for better detection and identification of ballistic-missile warheads—takes a step forward with the award of the first contract for installation of facilities. Army's New York Ordnance District awarded a \$1-million contract to Western Electric for a 55-mile submarine cable to link Kwajalein and Roi Namur in the Marshall Islands.

Press (see *ELECTRONICS* Newsletter, p 11, June 17) is an Army-supervised program supported by Advanced Research Projects Agency, will help ARPA's Project Defender come up with a technique for missile defense beyond the capabilities of the Nike-Zeus

countermissile. Press experiments are concerned with the atmospheric and terminal physics of ballistic-missile flight. Sophisticated data-handling, advanced radar, other sensing devices will be used.

Army is presently constructing facilities in and around Kwajalein with which to test Nike-Zeus against Atlas ICBMs fired from Vandenberg AFB in California. Project Press will use these missiles and other targets of opportunity available on the Pacific Missile Range.

"Voice" Will Build Station in Liberia

CONTRACT FOR engineering design of Voice of America's powerful mid-African radio relay station has been awarded to Page Communications. The station, consisting of six 250-Kw and two 50-Kw transmitters, will be built near Monrovia, Liberia, will cost an estimated \$12.6 million. It will give VOA effective radio coverage of Africa and supplemental coverage of parts of central Europe and the Middle East, besides permitting relays to other VOA stations.

Voice station will operate under international rules despite its high power, will not interfere with other African broadcasts. VOA has two 200-Kw stations operating in the U. S., and three 1,000-Kw transmitters in Germany, the Philippines, and Okinawa. Another giant transmitter—comprising six 500-Kw, six 250-Kw and six 50-Kw transmitters—is currently abuilding near Greenville, N. C. The big station is scheduled for completion in 1962, is designed to be the world's largest shortwave station.

Contracts for construction of the eight transmitters for the Liberian relay will be let shortly, VOA spokesmen said.

Air Force Develops Doppler-Cancel System

TECHNIQUE for cancelling the effects of doppler shift may emerge from Air Force experiments testing the Einstein principle of equivalence. A method developed by Richard

Waetjen at USAF's Cambridge Research Laboratory can be used to cancel first-order doppler effects in signals transmitted from a moving vehicle.

In Waetjen's system, ground-based and airborne transmitters operate at slightly different frequencies. The frequency of the ground transmitter is generated by a ground standard; received at the airborne station with its inevitable doppler shift, it is applied to a detector which determines the shift. The amount of shift is multiplied by the ratio of the two frequencies, then subtracted from the nominal airborne transmitter frequency. Since the shift will be added in the air-to-ground path, the frequency received at the ground terminal will be doppler-free.

Europeans Study Giant Radiotelescope

GIANT RADIOTELESCOPE of cruciform design may be erected by Organization for European Economic Cooperation in the Benelux high country near the city of Luxembourg.

OEEC recently granted \$12,000 for the study of the radiotelescope, which will use a cruciform antenna with arms two miles long and more than 95 ft wide. This would be somewhat larger than the one-kilometer Mills Cross antenna the Soviets are building near Moscow.

Scientists from the U. S., Great Britain, Australia and the Federal Republic of Germany have been invited to lend a hand with the preliminary work.

MIT Working on Infrared Paramp

CYCLOTRON RESONANCE phenomenon detected in semiconductors may lead to the development of a new class of parametric amplifiers called, perhaps, the craser—after its elder cousins maser and laser.

Phenomenon has been observed in germanium and indium antimonide, was disclosed to *ELECTRONICS* last week by Benjamin Lax of MIT's Lincoln Laboratories, who is working on the proposed new amplifier for infrared and millimeter-wave portions of the spectrum.

North Electric opens a whole new chapter in control switching for communications

DATELINE 1960 new north solid state switching technique chosen for 412L air weapons control system

In awarding the contract for the design and manufacture of fixed and mobile electronic communications and switching centers for the U. S. Air Force, General Electric, prime contractor for the "412-L" project, selected North Electric Company, recognizing that a major technological breakthrough in electronic switching has been achieved by North with the development of a unique "Resonant Transfer" technique for generating or detecting pulses in Time Division Multiplex Solid State Switching!

The adoption of this North concept opens a whole new era in communications, a whole new chapter in the history of electronic switching!

It is highly significant that with this development the switching art has reached the state of sophistication demanded by new weapons capabilities. It is equally significant that this development should come from the Company whose history, over better than three-quarters of a century, has been one of continuous progress and development in this field!

As future progress is made—as man reaches further and further into the unknown reaches of the universe—leadership in the highly demanding field of communications and control will continue to come from

ELECTRONETICS DIVISION
NORTH ELECTRIC COMPANY

649 S. MARKET ST. GALION, OHIO



60-S-3

NOW!

an analog output plus control signals from almost any digital input!

**ALL-NEW MOSELEY
MODEL 42
DIGITAL TRANSLATOR**

- 0.1% conversion accuracy
- Permits cartesian plotting of digital data
- Accepts card, perforated tape, magnetic tape, or manual keyboard inputs
- High-speed transistorized control circuits
- Accepts 4 digits and sign per axis; front panel display of matrix contents



Moseley Model 42 Digital Translator allows automatic operation of Autograf or similar X-Y Recorders from digital data supplied by any conventional source. Accuracy of digital-to-analog conversion is 0.1% and the accuracy of Moseley AUTOGRAF recorders, 0.15%, is maintained.

Model 42 is compatible with IBM Summary Punches and Card Readers including Models 514, 519, 523, 524, 526, etc. It may also be driven, without modification to either the Translator or driving equipment, by mechanical punched tape readers such as Friden, Soroban solenoid and Teletype motorized readers.

Model 42 is supplied with a 10-key serial keyboard for manual input. Accessories include magnetic tape adapter, Flexowriter converter, remote decimal contents read-out panel and optical magnetic tape converter. Model 42, including keyboard, \$4,500.00.

Data subject to change without notice. Prices f.o.b. factory.

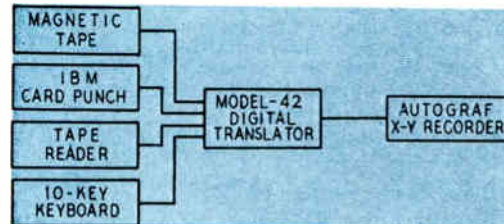

**SEE YOUR MOSELEY REPRESENTATIVE OR
WRITE DIRECT FOR DETAILS**

Pioneer and leader in X-Y and Strip-Chart Recorders



F. L. MOSELEY CO.
Dept. A11, 409 N. Fair Oaks Ave., Pasadena, California
MUrray 1-0208 TWX PASA CAL 7687
Field representatives in all principal areas

BARNSTEAD DEMINERALIZERS FOR ALL INDUSTRIAL APPLICATIONS



DESCRIBED IN NEW CATALOG #160

This NEW 36-page Catalog features the complete line of Barnstead Mixed-Bed, Two-Bed, and Four-Bed Demineralizers with capacities of up to 2500 gallons per hour and more . . . built to your specifications. A special section of interest to Nucleonic and Electronic engineers is devoted to Barnstead "Train" equipment which produces ultra pure water of 18,000,000 ohms resistance at 25° C. This Pure Water equipment connected in series also removes organics, inorganics, bacteria, gases, and submicroscopic particles down to 0.45 micron. Other sections are devoted to Barnstead Tin-Lined Piping, Fittings, Faucets, Purity Meters, Storage Tanks, Sand and Carbon Filters, Submicron® Filters, and other auxiliary equipment.

Installation case histories of Barnstead "Pure Water Specials" are also described and illustrated. Charts, specification drawings and actual on-job installations are detailed. Write for your copy of Catalog #160 Today!

Barnstead
STILL AND STERILIZER CO.
84 Lanesville Terrace, Boston 31, Mass.

BOSTON Jamaica 2-8490	NEW YORK Kingsbridge 8-1557	CLEVELAND ACademy 6-6622
CHICAGO Rogers Park 1-6173	PHILADELPHIA BROADway 9-3146	WASHINGTON, D.C. District 7-1142
LOS ANGELES RYan 1-6663	SAN FRANCISCO TEmplebar 2-5391	DETROIT ENterprise 7422

FIRST IN WATER PURIFICATION
SINCE 1878

WASHINGTON OUTLOOK

ELECTRONIC INDUSTRIES ASSOCIATION has filed another brief here opposing tariff reductions on foreign-made electronic products. The brief comes as general tariff negotiations get under way in Geneva. Washington's view is that the U. S. may get more tariffs lowered abroad than it will have to give as import concessions to foreign producers.

EIA's latest brief supplements an argument made in June against inclusion of germanium diodes and tv tubes for negotiation at Geneva. The association now fears that the government's negotiation plans cover many other electronics industry products.

In its new brief filed here, EIA claims that imports are impeding (electronics) industry expansion and stifling technological advancement. Washington officials, meantime, say confidentially that this country's negotiators are prepared to stand firm against any broad rate reductions that would make it easier for goods to enter this country at lower prices. They also believe we hold the cards to secure lower trade barriers abroad for U. S. products.

Behind their optimism are two key factors. First of these is the serious deficit in the U. S. balance of payments. Foreign countries, interested in preserving the value of the dollar because of its crucial role as an international exchange medium, seem more favorable toward U. S. views. The foreign tariff negotiators also worry about a U. S. swing toward protectionism.

The second factor is the truce between Europe's two rival trading blocs, the six-nation Common Market, and the seven-nation Free Trade Association. The two blocs will be bargaining more seriously among themselves to lower trade barriers. There will be an indirect gain for the U. S., which would automatically receive any trade concessions negotiated between the two blocs.

PENTAGON is pushing for a higher rate of research and development contracting to smaller firms, under pressure from congressional small-business boosters. Orders have gone out for assignment of small-business specialists at major contracting centers to bring facilities of qualified smaller firms to the attention of contracting officers.

Army Signal Corps reports two new policies. Technical requirements in solicitations to bid on R&D contracts are now being prepared in what the service describes as a manner more comprehensible for those small business concerns having the background, experience and personnel to perform the work. Also, large companies are being eliminated from solicitations wherever the procurement is adaptable and the small firms are available.

The new drive is showing up already. In fiscal 1960, just ended, the military services awarded R&D contracts to 844 small companies, an increase of 76 over the previous year. Of this number, 307 of the firms received defense R&D contracts for the first time. Still, the total added up to only about 3½ percent of the value of all R&D contracts placed last year (\$4.3 billion worth).

NATIONAL AERONAUTICS AND SPACE ADMINISTRATION has scheduled special industry conferences at the George Marshall Space Flight Center, Huntsville, Ala., Sept. 27-28, and at Jet Propulsion Laboratory, Pasadena, Calif., Oct. 26, to brief contractors on current and future projects of each installation. Write for invitations if you haven't received one yet.

Inventiveness: indispensable ingredient of **Space Technology Leadership**

In the achievement of Space Technology Leadership, on-the-shelf hardware and the existing state-of-the-art are not always equal to the requirements of advanced missile and space systems. In such challenging situations Space Technology Laboratories responds with the full breadth of its resources • In response to the need for time compression, STL inventiveness produced devices answering urgent requirements of advanced space programs conducted for the Air Force Ballistic Missile Division, National Aeronautics and Space Administration, and Advanced Research Projects Agency. Among these: Telebit, first digital computer to enter space; the first multi-million-mile space communications system of Pioneer V; a continuous-wave radio guidance system and light-weight autopilots for Able-series space vehicles; and a low-thrust multi-start space engine for maneuverable satellites • On this foundation of inventiveness STL continues to broaden in scope, translating creative concept into accomplishment for Space Technology Leadership • Outstanding scientists and engineers seeking such an environment are invited to investigate opportunities available at STL. Resumes and inquiries will receive meticulous attention.

SPACE TECHNOLOGY LABORATORIES, INC. P. O. BOX 95004, LOS ANGELES 45, CALIFORNIA

Los Angeles • Santa Maria • Edwards Rocket Base • Cheyenne

Cape Canaveral • Manchester, England • Singapore • Hawaii

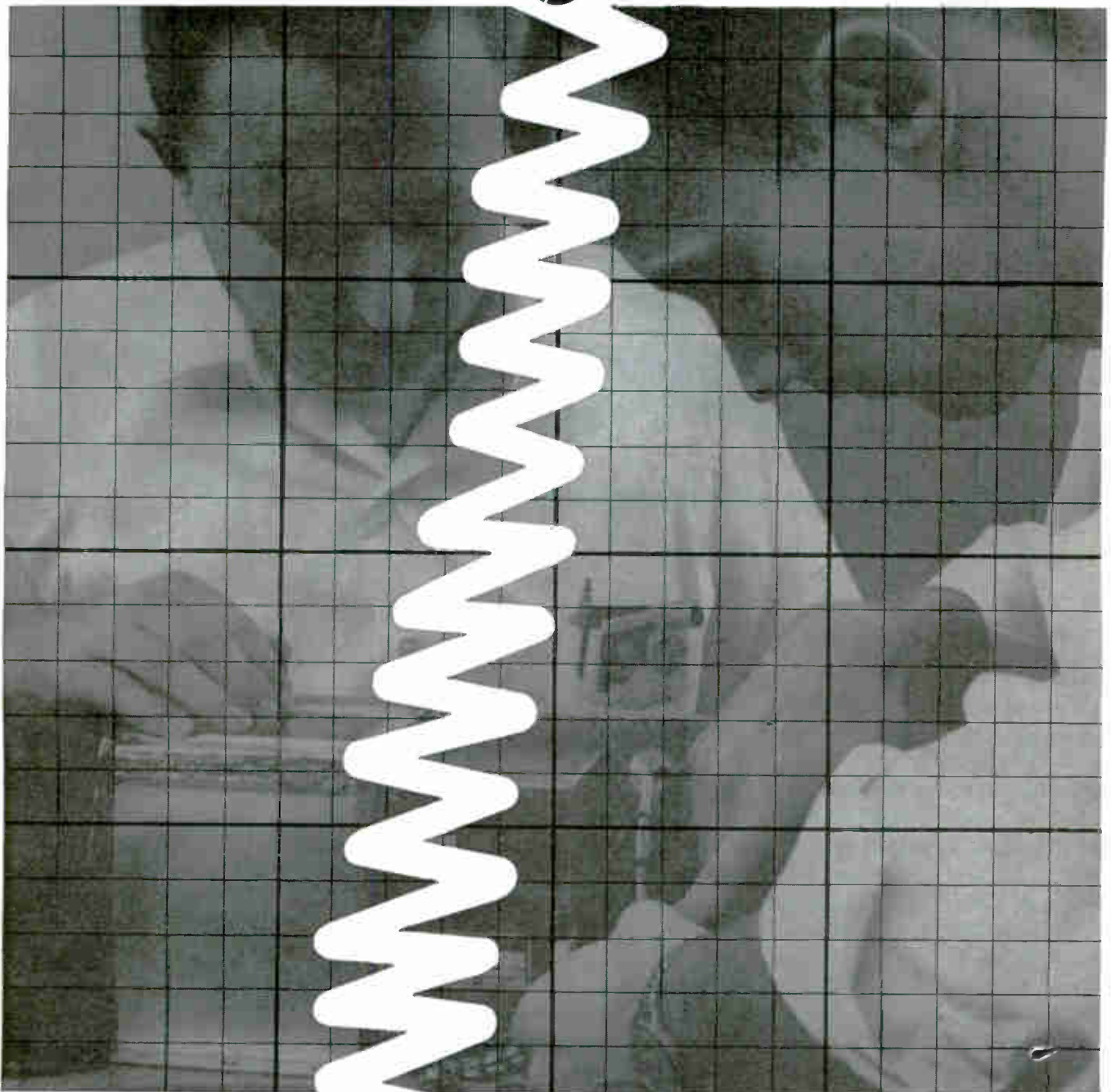

Your most valuable dollars may be life insurance dollars



The dollar value of your estate is not only important to you *now* but to your family in the *future*. Failure to make proper provisions beforehand is costly. The unavoidable expense of taxes, debts, administration and legal fees can shrink the value of an estate by a third or more — money paid to strangers rather than heirs!

But an *Ætna* Life Estate Conservation Plan pinpoints ways to cut tax liability and settlement costs to the minimum. Then it provides adequate cash to cover the unavoidable costs . . . *valuable dollars* that guarantee your heirs all that you intend them to have.

An *Ætna* Life representative, working through your attorney, will gladly review your present arrangements — or establish a plan if you have none — without obligation through your *Ætna* Life office.

Ætna Life's Estate Analysis works for you and your family

- Minimizes tax liability
- Provides money to pay transfer costs
- Assures orderly transfer to heirs
- Protects against forced sale or borrowing against estate assets



ÆTNA LIFE

INSURANCE COMPANY

Hartford 15, Connecticut

Affiliates: *Ætna* Casualty and Surety Company
Standard Fire Insurance Company

this is
the Brush
Mark II . . .

anyone

can
plug
it in

put it
in writing
anywhere

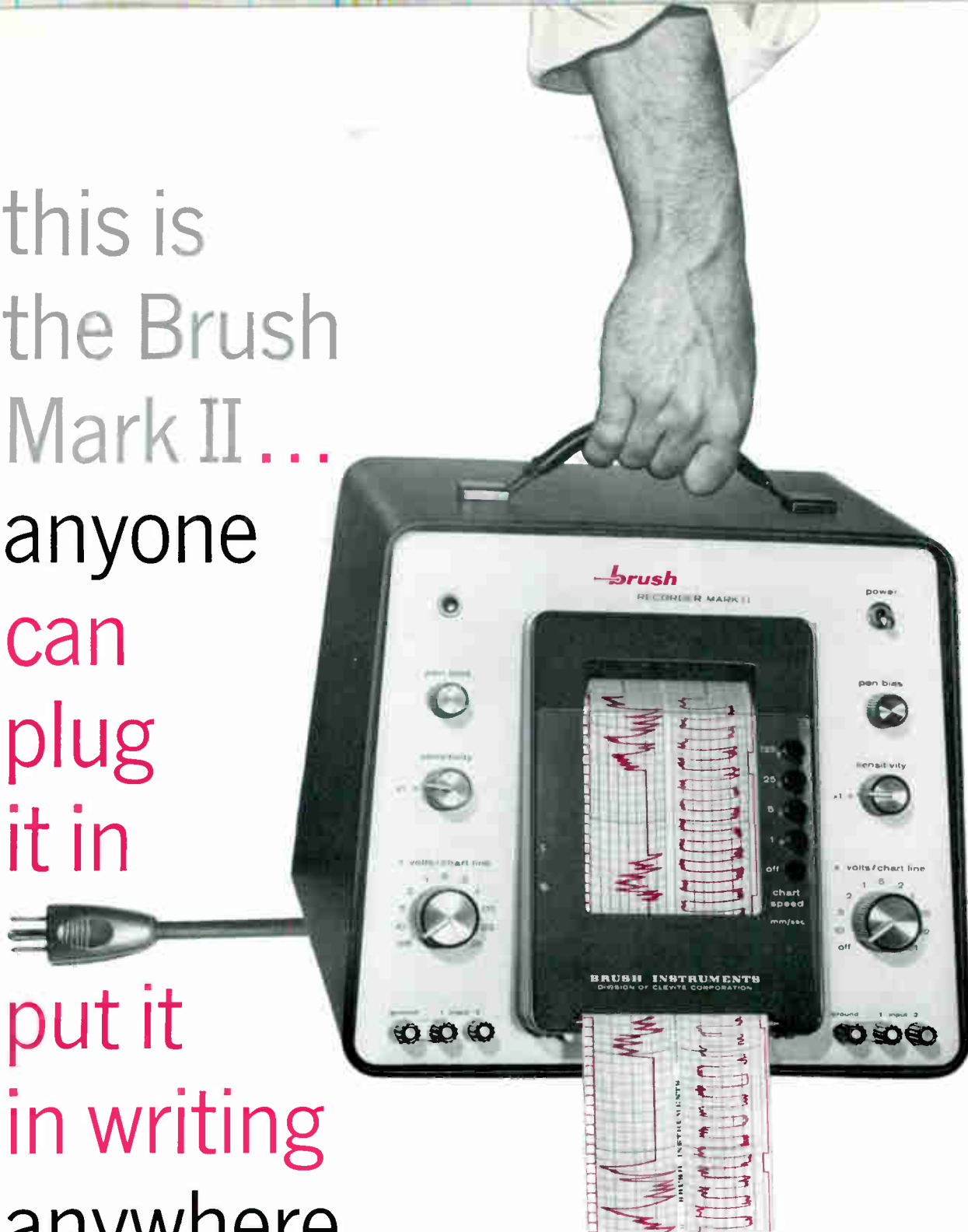

There is no direct writing recorder on the market that approaches the compact Mark II in sheer usefulness. It is a completely integrated engineering tool that can be operated by anyone . . . in the shop or in the field . . . for countless research or design requirements. Every function necessary for uniform, crisp, easily reproduced readouts is "built-in". The Mark II gives you two analog channels plus two event markers; 4 chart speeds; DC to 100 cps response with 40 mm amplitude; 10 mv/mm sensitivity; high input impedance. Immediate shipment from stock. Call, write or wire for complete details.

brush INSTRUMENTS

DIVISION OF

37TH AND PERKINS

CLEVITE
CORPORATION

CLEVELAND 14, OHIO

for direct writing recording systems



no one is as qualified as Brush

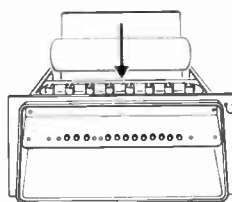
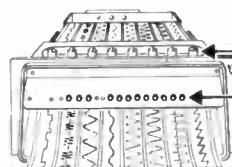

Chart paper loads from top



Trace contrast control

Simple pushbutton speed selection



Why? Simply because Brush recording systems such as this 6-8 channel unit incorporate all of the known refinements in the art of recording by direct writing. No comparable system in existence today is as compact . . . as simplified . . . as reliable . . . as versatile. Note slide-mounted oscillograph and interchangeable "plug-in" signal conditioners that provide four vital functions in addition to amplification: high input impedance, zero suppression, attenuation and calibration.

Instantaneous rectilinear presentation gives clear, uniform and reproducible traces for precise readout of telemetry, computer, ground control and other data gathering operations. Further, this functionally designed system has a "pull-out" horizontal writing table for convenient annotation and reading . . . without turning off the recorder! Check these and many other advanced features for yourself and you'll see why *no one* is as qualified as Brush. Call, write or wire for complete details.

brush INSTRUMENTS

DIVISION OF

37TH AND PERKINS

CLEVITE
CORPORATION

CLEVELAND 14, OHIO

What's missing in your Radar's Performance?

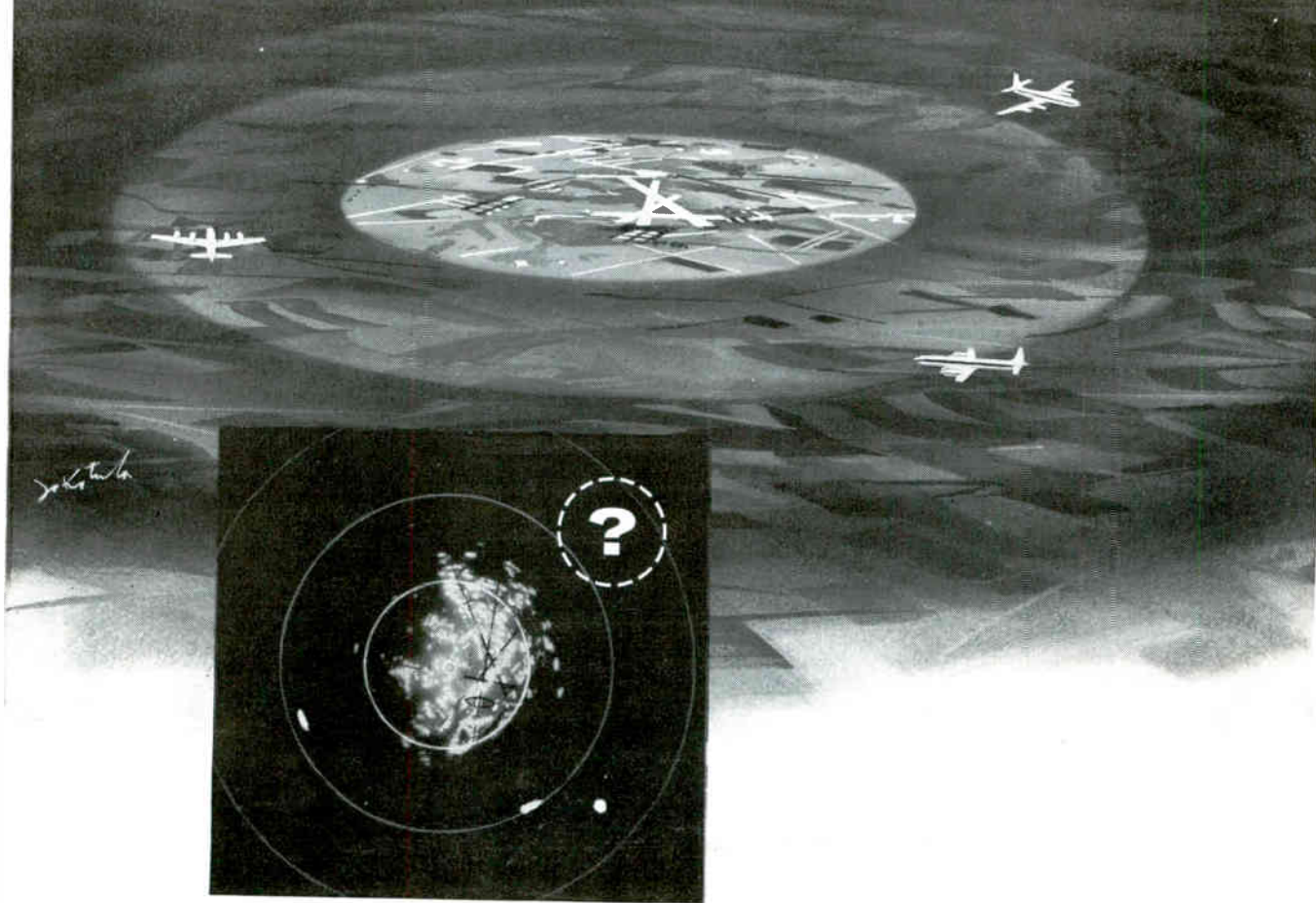

How can a radar operator *know* when system performance gets marginal? How can he assess the reliability of what he sees—not just in the prime performance area, but “out there” on the fringe of his radar’s range?

The FAA signed a contract with Sperry to solve these problems, and the result is the new Sperry Radar Performance Analyzer. This instrument will find and analyze variations in transmitter power, receiver noise, tuning,

sensitivity and subclutter visibility. It will spot performance deterioration and misadjustments on a continuous non-interference basis, indicating the moment-to-moment status of the radar.

One form of the Analyzer is being delivered for use with FAA surveillance radar at a number of airports. Other versions have been developed for missile guidance, tracking and search radars. Evaluation techniques employed are compatible with all modern radar tech-

niques, such as pulse Doppler, MTI, pulse compression, frequency comparison. Whatever your system, the Sperry Radar Performance Analyzer will assure continued performance to spec, or rapid fault location minimizing system “down time.”

Write for technical data or assistance.



SPERRY MICROWAVE ELECTRONICS COMPANY, CLEARWATER, FLORIDA · DIVISION OF SPERRY RAND CORPORATION

←CIRCLE 18 ON READER SERVICE CARD

CIRCLE 19 ON READER SERVICE CARD 19

Introducing mass-produced quality components

Lockheed Electronics supplies *custom quality*
from prototype to *any quantity*

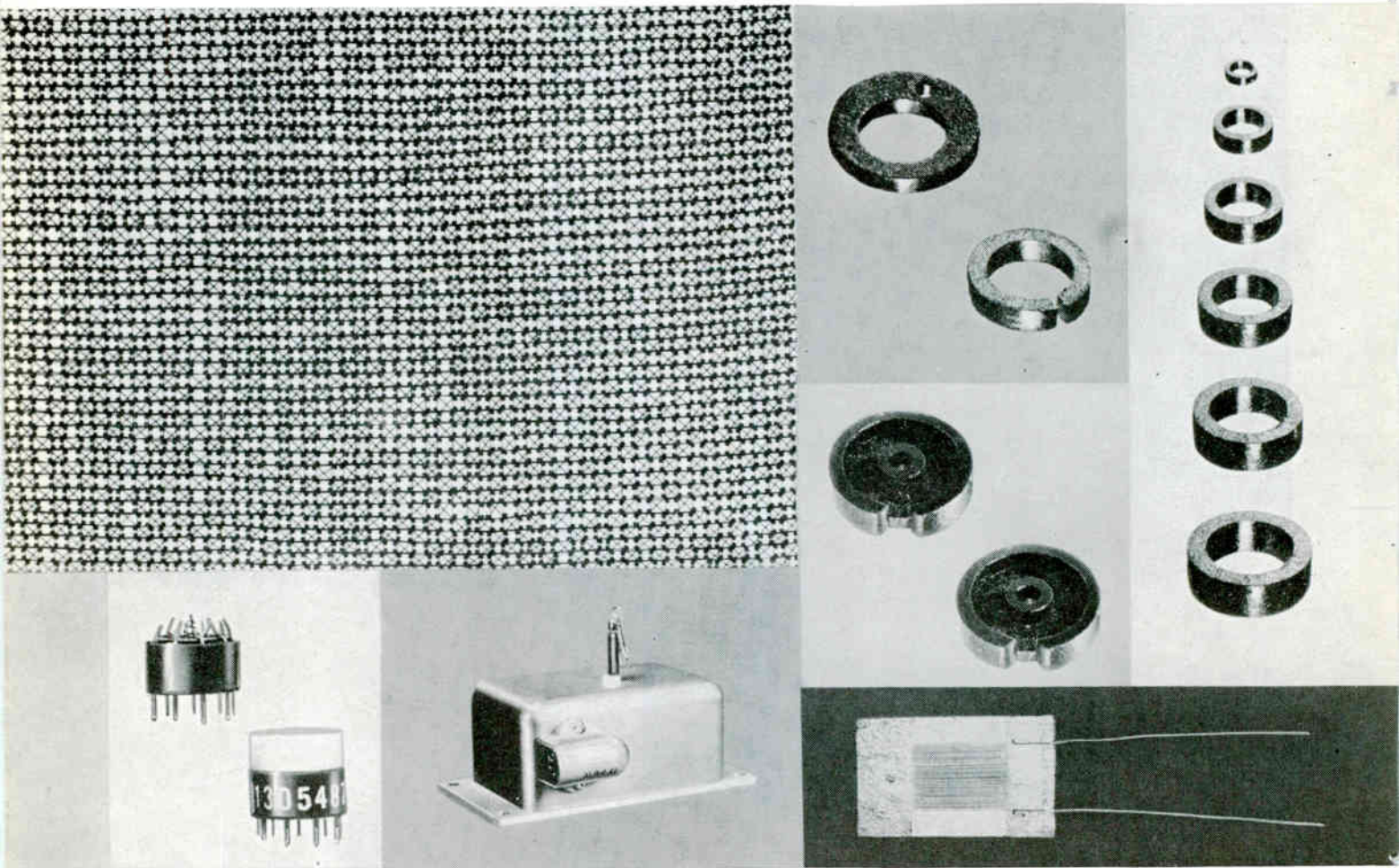

Whatever your need—ten thousand printed circuits or a half million memory cores—Lockheed Electronics offers you years of experience as a user and supplier of components. The complete resources of the Lockheed complex are available to you for prototype development and quantity production.

Mass-produced precision components include printed circuits and assemblies, memory planes, memory cores, logic modules, potentiometers, transformers, transducers, strain gages and force washers. All are produced under the most rigid quality control supervision—and at commercial price levels.

Engineering creativity, experience and a practical outlook come together in Lockheed Electronics' components. Our objective is quality regardless of quantity. The Avionics and Industrial Products Division's extensive facilities can produce any number of units to meet any order requirement. Our design engineering staffs are ready to assist you with special component problems.

FOR DETAILED INFORMATION PLEASE CONTACT:
Marketing Branch, Lockheed Electronics Company
Avionics and Industrial Products Division
6201 East Randolph Street
Los Angeles 22, California

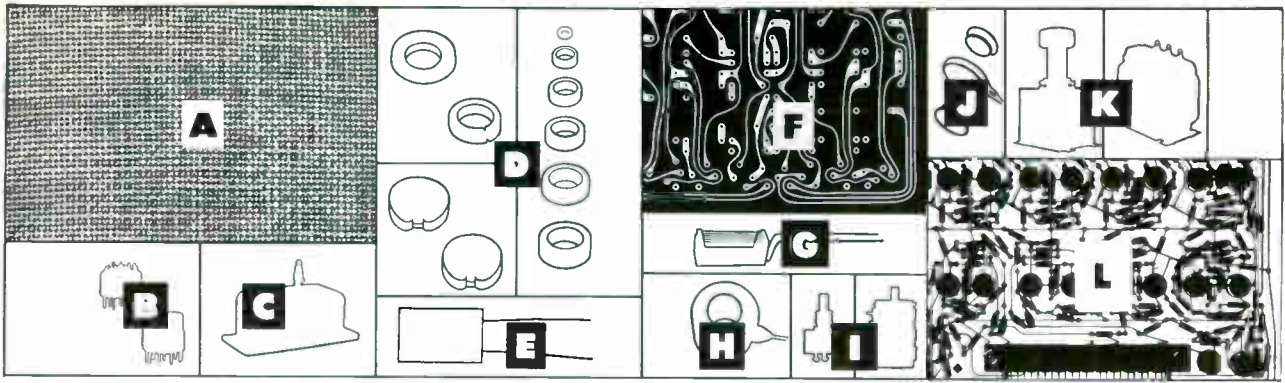

COMPONENTS MADE BY LOCKHEED ELECTRONICS

- A. Memory planes B. Logic modules C. Position transducers D. Electronic ceramics
 E. Strain gages F. Printed circuit boards G. High temperature strain gages H. Load cells I. Potentiometers
 J. Force washers K. Transformers L. Printed circuit assemblies

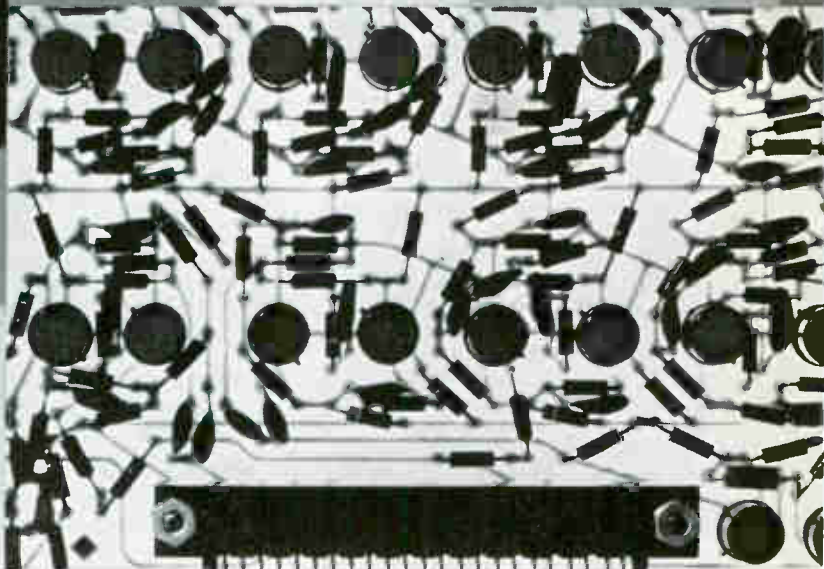
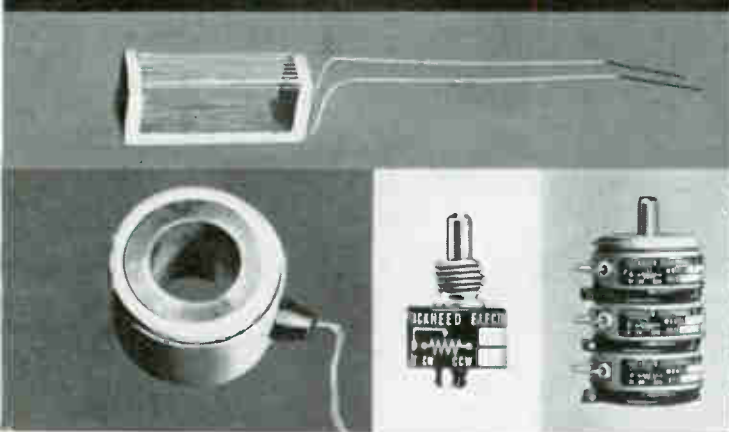
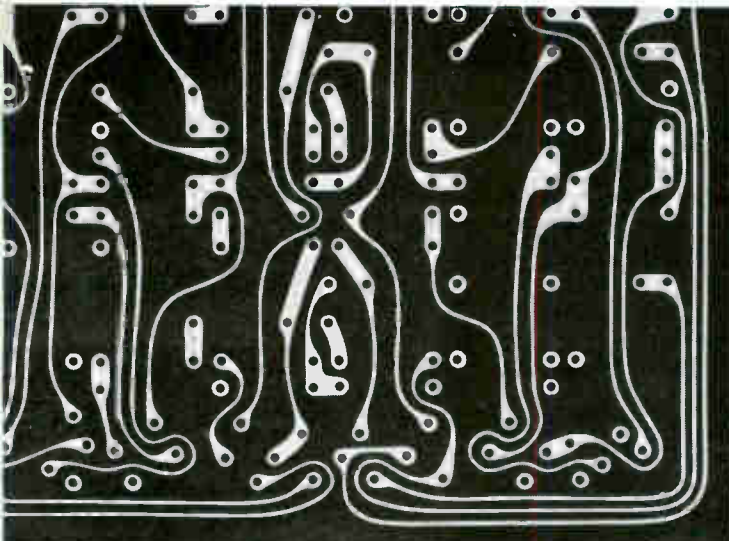

MINDING THE FUTURE

LOCKHEED ELECTRONICS

COMPANY



**AVIONICS AND INDUSTRIAL PRODUCTS DIVISION
 LOS ANGELES, CALIFORNIA**

OTHER LEC DIVISIONS: MILITARY SYSTEMS / STAVID ● INFORMATION TECHNOLOGY ● ENGINEERING SERVICES

ENGINEERS AND SCIENTISTS: For unique position advancement opportunities,
 please contact our Professional Placement Office in Plainfield, N. J.

CIRCLE 21 ON READER SERVICE CARD

ALL UNITS ACTUAL SIZE

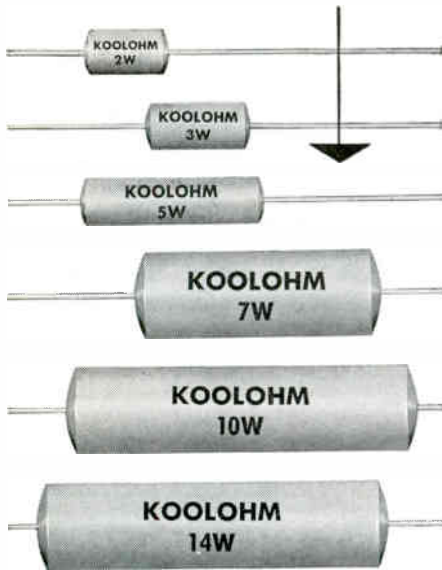

KOOLOHM® INSULATED SHELL POWER RESISTORS

Sprague's Koolohm Resistors are designed to meet military and industrial requirements for insulated power wirewound resistors that will perform dependably.

New axial-lead Koolohm construction features include welded leads and winding terminations. Exclusive Ceron® ceramic-insulated resistance wire, wound on special ceramic core makes possible multilayer non-inductive windings and extra-high-resistance-value conventional windings. Dense, non-porous ceramic outer shells provide both humidity and mechanical protection for resistance elements. All resistors are aged-on-load to stabilize resistance value.

The advanced construction of these improved Koolohm Resistors allows them to operate at "hottest spot" temperatures up to 350°C. You can depend upon them to carry maximum rated load for any given physical size.

Send for Engineering Bulletin 7300A for complete technical data.

SPRAGUE ELECTRIC COMPANY
35 Marshall Street, North Adams, Mass.



FINANCIAL ROUNDUP

First-Half Market Leaders

	VOLUME	HIGH	LOW	RECENT PRICE
General Telephone & Electronics*	3,075,600	34½	27	29½
Ampex*	3,000,500	42½	30	32½
Int'l Telephone & Telegraph	2,653,600	46½	32	42
Radio Corporation of America	2,447,275	78½	58	62½
Sperry Rand	2,162,000	26½	20½	21½
Elect & Musical Industries*	2,140,700	8½	6½	6½
Avco Corporation	2,058,300	17½	11½	16½
Philco Corporation	1,881,700	38½	23½	25½
General Electric	1,772,600	34½	27	29½

* Old and new issues combined

LISTING of the most actively traded electronics stocks for the first six months of this year indicates those which have been on the roster of the 25 most active most consistently. A similar listing prepared in February of this year for the last six months of 1959, ELECTRONICS, p 25, Feb. 26, 1960), contained five names on this year's list: Avco Corp., Sperry Rand, ITT, General Electric, RCA. Not recurring this year are: Universal Controls, Raytheon, General Dynamics. Newcomers to this year's list are Ampex, EMI and Philco.

General trading volumes for the first half of 1960 for the most active stocks were up slightly over the last half of 1959. In the final six-month period last year, the highest volume listed was for Avco Corp. with 2,689,000, as compared with this 1960 half-year leader, General Telephone & Electronics, with a volume of 3,075,600.

At the end of 1959, the lowest volume of the most active issues was scored by General Dynamics with 1,376,500 shares traded. This year's list shows the lowest volume in the group being made by General Electric with 1,772,600 shares traded.

In general, values of the stocks have risen slightly, in all cases.

Electronic Specialty Co., Los Angeles, announces acquisition of Electric Specialty Co., Stamford, Conn. The transaction was made for an undisclosed amount of cash, and company officials say no dilution is created in the 547,440

shares of the California firm. Electric Specialty makes motors and generators for defense and communications applications. It also makes power control equipment. Sales of the newly acquired company exceed \$4 million a year, with a current backlog of about \$3 million. The companies will now identify their products as ESCO equipment.

Radiation Inc., Melbourne, Fla., through its subsidiary, Radiation Service Co., reports acquisition of the assets of the Electronics Services Division of America Bosch

25 MOST ACTIVE STOCKS

	WEEK ENDING SEPTEMBER 2, 1960			
	SHARES (IN 100's)	HIGH	LOW	CLOSE
Telectro Ind	1833	21¾	145½	17½
Gen Tel & Elec	1296	31½	29½	31½
Elec & Mus Ind	1210	79½	63¼	73½
Avco Corp	1141	16½	15½	16
Victoreen Inst	1129	17½	15½	16
Avnet Elec	1060	22¼	19	21¾
Bell Intercom	1045	17½	14¼	147½
Amer Electronics	1004	157½	127½	14¼
Electronic Commun	978	283½	20¼	24¼
Reeves Sndcft	911	9¼	7½	8¾
Ampex	907	31½	30½	30½
U S Indust	656	11¼	9½	10¾
Univ Controls	550	177½	165½	17½
Pentron Elec	536	5¾	37½	47½
Compudyne	498	137½	10¾	127½
Cohu Elec	498	11¼	9½	107½
RCA	481	63¾	60¾	61¾
Bulova Watch	470	233½	213½	23½
Raytheon	469	42¼	38¾	397½
Zenith	468	129¾	1207½	127½
Gen Elec	468	845½	81½	82½
Westinghouse	466	55¾	53¼	53¼
Sperry Rand	442	23¼	22¼	22¾
Int'l Tel & Tel	434	42½	40½	41½
Standard Kollsman	431	25¾	23¾	247½

The above figures represent sales of electronics stocks on the New York and American Stock Exchanges. Listings are prepared exclusively for ELECTRONICS by Ira Haupt & Co., investment bankers.

Arma, which has been responsible for leasing and maintenance of communications gear in Pennsylvania, New Jersey, Delaware and Maryland. Aim of the move, according to Radiation spokesmen, is to promote company growth in nondefense areas.

Loral Electronics, New York, board of directors has voted to recommend for stockholder approval a three-for-one split of common stock. Also voted by the board is a recommendation to issue up to \$5 million in convertible debentures. Approval will be sought from stockholders at the company's annual meeting on Oct. 27.

Communications Control Corp., Van Nuys, Calif., reports sale of \$300,000 of its convertible debentures and long-term notes to Electronics Capital Corp. in the form of \$200,000 worth of 8 percent convertibles and \$100,000 in long-term notes. The debentures are convertible into 54 percent of CCC's total common stock.

San Diego Scientific Corp., San Diego, Calif., has just completed the sale of \$100,000 worth of five-year convertible debentures to Midwest Technical Development Corp, and has retained MTDC's subsidiary, Technical Management Services Corp. as management consultants.

Corson Inc., Plymouth Meeting, Pa., announces acquisition of **Livingston Electronic Corp.**, Essex Falls, N. J., to be operated as a wholly-owned subsidiary. The New Jersey firm manufactures hermetically sealed tube sockets, welding timers and relays. Sales last year amounted to \$250,000.

Espey Mfg. & Electronics Corp., Saratoga Springs, N. Y., reports net sales of \$3,696,853 for the fiscal year ended June 30, 1960. For the fiscal year ended the same date in 1959, sales were \$3,016,418. Net profit before income taxes for the fiscal year just ended was \$340,170. The year before it was \$264,824. Earnings per share in the recent period were \$1.07.

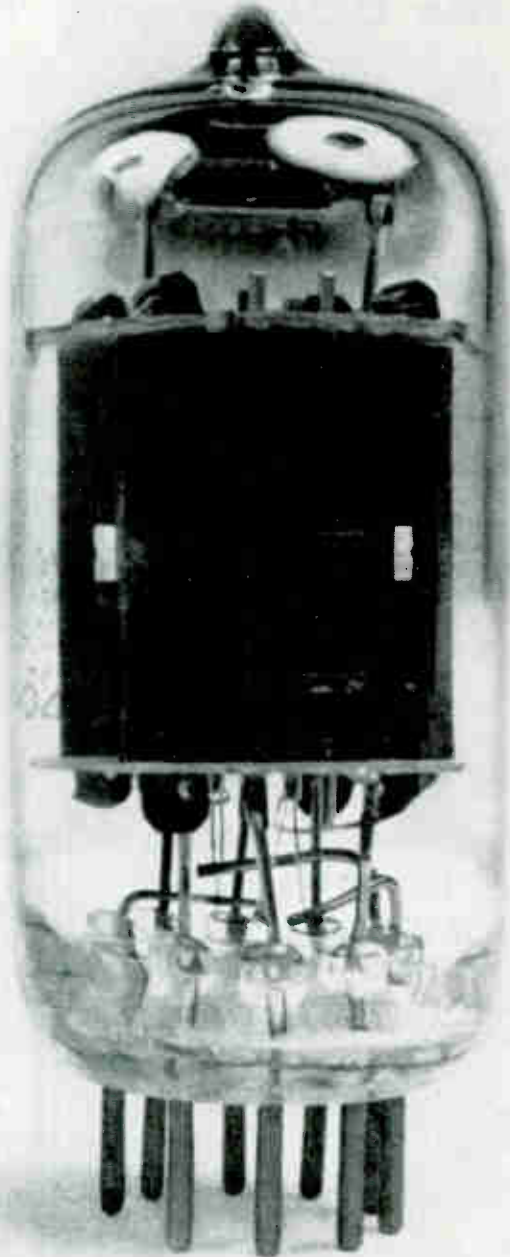

SHIP IT FAST! SHIP IT SAFE! SHIP IT AIR FRANCE JET!

Tubes...condensers...diodes...rectifiers. The fast safe way to ship all electronic parts overseas is Air France Jet. Speed fragile items non-stop to Paris, gateway to all Europe, on 10-mile-a-minute Boeing 707 Jets. Cargo compartments are pressurized...temperature-controlled...perfect for even the most sensitive parts. Total of over 21 jet flights a week—from New York, Chicago, Los Angeles. Fast jet connections throughout Europe, Africa and the Middle East. You save money on crating, shipping weights. Lower insurance costs, too. And no one offers lower jet cargo rates than Air France. Air France speeds cargo to more cities in more countries than any other airline.

DRAWING BOARD NEWS.....No. ①

Published by Chart-Pak, Inc., originator of the tape method of drafting

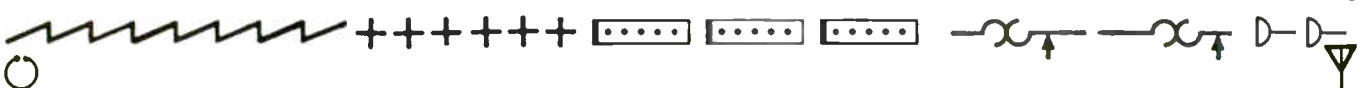

"SYMBLTAK"® — THE EASY WAY TO MAKE DRAWINGS FOR ELECTRONIC SCHEMATICS AND PRINTED CIRCUITS

You don't draw rectifiers...relays...diodes...conductor paths... you stick 'em on...eliminate hours of drudgery

Symbltak is a revolutionary new drafting method using precision-printed, pressure-sensitive materials. It greatly simplifies the production of electronic schematics and printed circuits.

With Symbltak, you no longer have to draw and ink-in circuit symbols and conductor paths. You use pre-printed,

precision-cut Symbltak symbols and tapes that you just press down!

Chart-Pak tapes and Symbltak symbols are accurately scaled; can be positioned with great precision on Precision Grids. They are easily altered by scraping or dissolving surface printing and re-inking; easily repositioned.

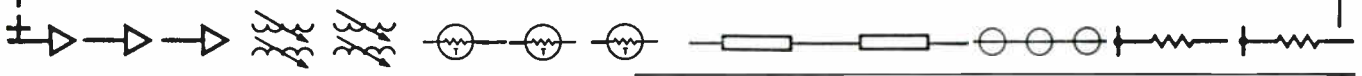
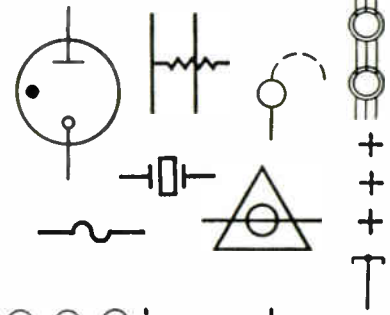

HUNDREDS OF "PRESS-DOWN" SYMBOLS SAVE HOURS OF SLOW PEN-WORK

All are standardized to meet Gov't., Military specifications

328 Symbltak symbols are drawn in accordance with the American Standards Association, ASA Y 32.2 sponsored by the AIEE and ASME; also with MIL-STD-15A for government procurement of electronic drawings. When you press down a Symbltak "Amplifier—Ext. Feedback Path" . . . "Transistor Pentode (LH)" or printed conductor-path "elbow" . . . you know it's right! And it will reproduce beautifully.

NEW DRAFTING FILM WON'T STRETCH, SHRINK, PUCKER

Both expert draftsmen and blueprinters say Chart-Pak's new FUTURA Drafting Film is the most satisfactory medium available. It is made of DuPont Cronar®, for exceptional resistance to heat, cracking, tearing or soiling. It is finished with a mechanically-produced matte surface, on one or both sides — that takes pen and pencil beautifully — reduces smudging or feathering — erases easily. FUTURA has exceptional clarity and dimensional stability. Samples on request.

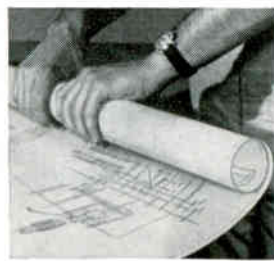

CHART-PAK develops new glare-proof tapes

Now, for the first time — you can get matte-surface acetate-fibre tapes that won't "talk back" to a camera with highlights or glare. These ingenious Chart-Pak tapes provide a non-reflective surface, without excess thickness.

You have a thin, one-piece tape that won't reflect, cast shadows, separate, shrink, yellow or peel — in many colors and widths. Use Chart-Pak *matte-surface* tapes, wherever glare is a problem.

New folder to help you take the drudgery out of printed circuitry

For complete information on the new Chart-Pak system that makes layout easier, write for free folder — "Symbltak."

WRITE WITH AN ORDINARY PEN OR PENCIL TO...

CHART-PAK, INC.

ORIGINATOR OF THE TAPE METHOD OF DRAFTING

161 RIVER ROAD, LEEDS, MASS.

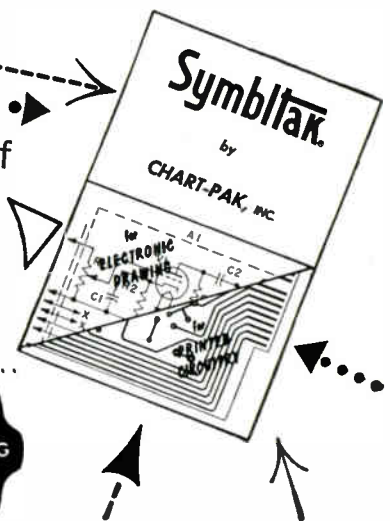

Now Stock as well as Custom!

OAK STOCK SWITCHES

ROTARY LOW-POWER TYPE

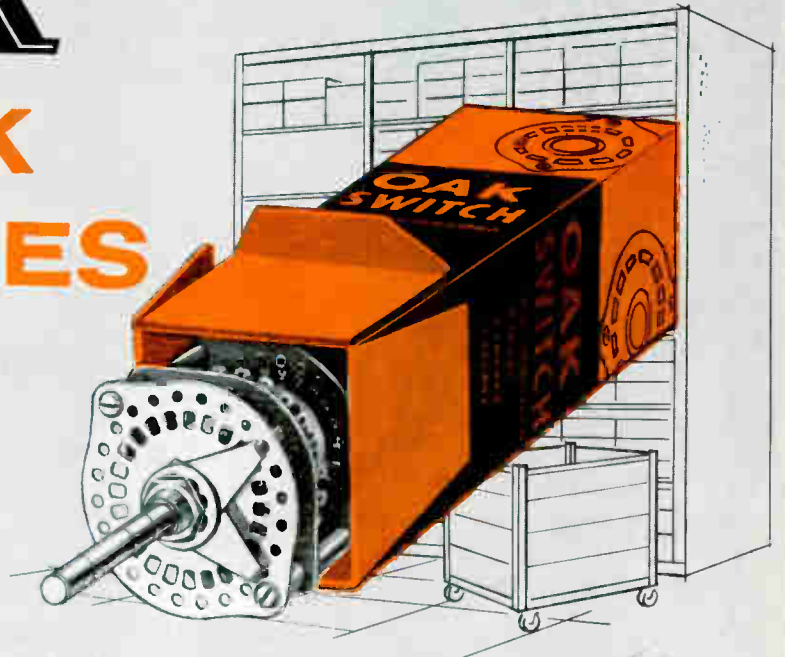

*48-Hour Order Handling Procedures and
Fast Transportation Methods Assure Quick Delivery*



- 124 Different Sizes and Types
- Supplied Fully Assembled or as Subassemblies
- Subassemblies: Sections, Shafts with Index, Strut Screws, Spacers, Miscellaneous Hardware
- Phenolic and Steatite Grade Insulations
- 1 to 4 Sections—2 to 23 Positions
- Shorting and Nonshorting

Now you can get *fast delivery from stock* of popular Oak rotary switches.

Order them as completely assembled units or as sub-assemblies in quantities from 1 to 249. All stock switches have one fixed and one adjustable stop; grooved shafts for "break-off" to desired length; double-wiping contacts of silver-plated brass (shorting and nonshorting types). Finishes withstand the 50-hour salt spray test, enabling the switches to be used in most military as well as commercial applications.

These are the same, quality OEM switches which have formerly been available only as custom units in large production quantities. For years they have been the industry's standard in all types of electronic equipment.

Don't wait, call your Oak representative or the factory for complete details today.

*Send For Catalog 399 Showing Complete
Stock Line and Prices. Quantities
Available on Letterhead Request.*



OAK

MANUFACTURING CO.

1260 Clybourn Ave., Dept. G, Chicago 10, Ill. Phone: MOhawk 4-2222

SWITCHES CHOPPERS VIBRATORS
ROTARY SOLENOIDS TUNERS TIMERS
ELECTRONIC SUBASSEMBLIES

West Coast: Oak Electronics Corp., 11252 Playa Court
Culver City, Calif. Phone: EXmont 1-6367

STROMBERG-CARLSON

**"BB"
SERIES
RELAYS**

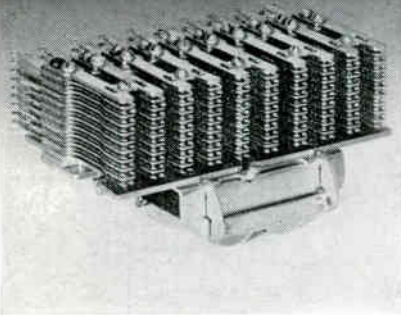

For your automation
... computing ... control
circuit applications ...

"TELEPHONE QUALITY"
at an ordinary price

To meet your needs for precision and durability in automation, computing and control circuitry, here is *telephone quality* at an ordinary price.

The "BB" Series Relay accommodates up to 100 Form A spring combinations. It incorporates such important advantages as twin contacts, knife-edge pivot and special frame-armature construction. Like all Stromberg-Carlson relays, it is built to operate under extreme ranges of temperature and humidity. *Prompt delivery is available on all orders.*

For details, in Atlanta call TRinity 5-7467; Chicago: STate 2-4235; Kansas City: HARRison 1-6618; Rochester: HUbbard 2-2200; San Francisco: OXFord 7-3630. Or write to Telecommunication Industrial Sales, 114 Carlson Rd., Rochester 3, N. Y.

STROMBERG-CARLSON
A DIVISION OF
GENERAL DYNAMICS

MARKETING

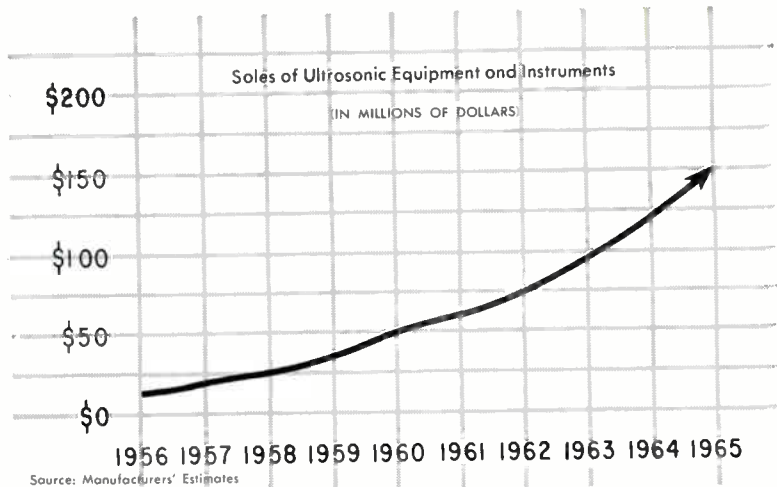

Ultrasonics Companies' Sales Rising

SURGING SALES of ultrasonics firms support the optimistic picture of future ultrasonics industry sales that manufacturers are drawing.

Acoustica Associates report sales of \$8.1 million for the fiscal year ended last February, 60 percent higher than sales in the previous year, and almost eight times sales for fiscal 1958. Branson Instruments sold \$1.5 million worth of ultrasonic testing and cleaning equipment in first six months of this year, 40 percent more than in the first half of 1959.

Market investigators say a number of other manufacturers are experiencing healthy sales gains for their ultrasonics lines; but that specific sales of ultrasonics equipment are obscured by other products in the statements of sales they divulge to the public.

In the past five years sales of the ultrasonics industry have more than trebled—from \$15 million in 1956 to an estimated \$50 million for 1960. In the next five years sales are expected again to treble reaching \$150 million in 1965, manufacturers say.

Cleaning applications are the biggest source of ultrasonics sales today—30 percent of total sales or \$15 million. Test and measuring applications follow with 16 percent of this year's estimated sales or \$8 million. Remainder of the sales pie is divided among a number of applications including welding, alarm systems, grinding and drilling, level

sensing and medical diagnosis.

The first Business Management Institute to study the administration problems of electronics reps opens in Champaign, Ill., next week. Sponsors are the Electronic Representatives Association in cooperation with the University of Illinois.

An error crept into last week's marketing article on thermocouple devices. We stated that annual sales are currently worth \$300 to \$350 million. In fact, this figure won't be achieved until 1965 or 1970.

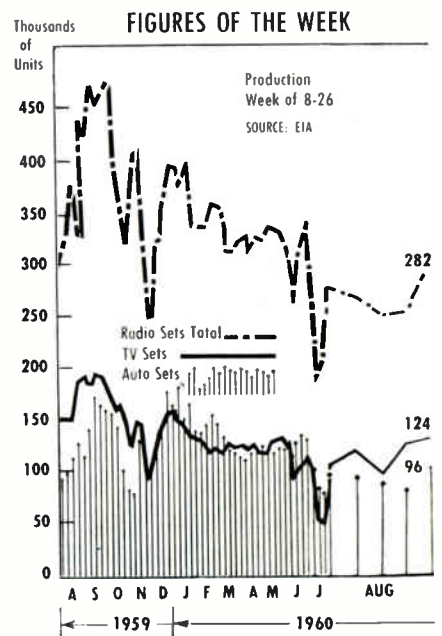

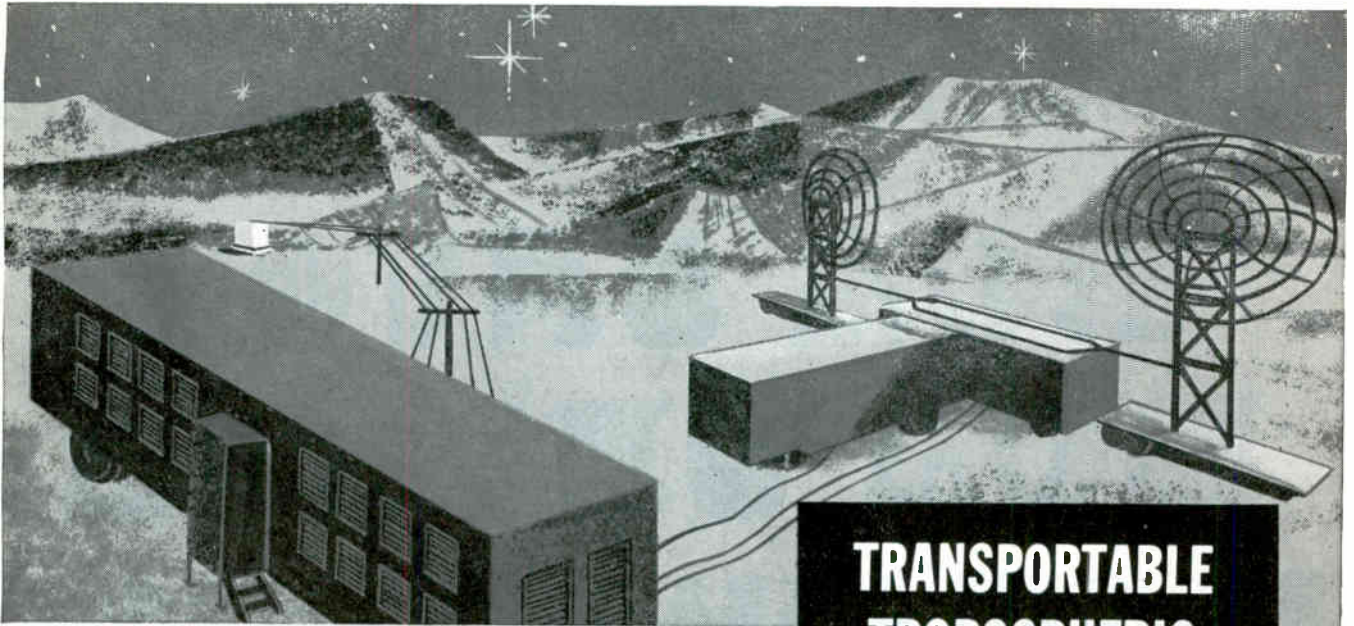

**TRANSPORTABLE
TROPOSPHERIC
SCATTER SYSTEM**

THE BIG **A LEADS THE WAY
TO INTEGRATED COMMUNICATIONS SYSTEMS**

A new concept in continent-spanning tropospheric scatter communications soon will be available to the U.S. Air Force. For the first time, the full multichannel capability and reliability of a large, fixed installation will be provided in a compact, air-ground transportable package. The all-environment, 10kw, AN/MRC-85 is being designed and manufactured by ADLER under subcontract to Page Communications.

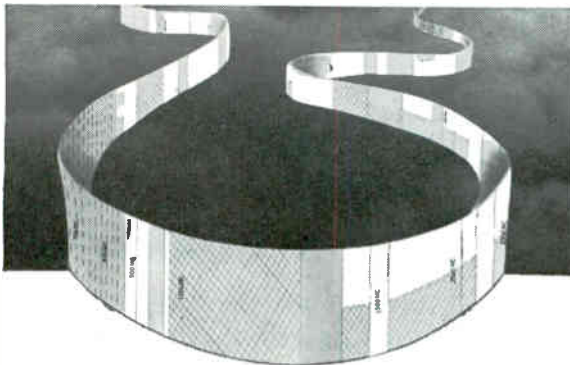

SPECTRUM-STRETCHING COMMUNICATIONS SYSTEM — ADLER heterodyne repeater techniques have opened a wide range of UHF channels for U. S. Army field communications, and prevented obsoleting of millions of dollars of VHF equipment. Developed and manufactured by ADLER, the "F-Head" converter permits the basic AN/TRC-24 VHF system to be used for UHF relaying in areas where VHF spectrum congestion is a problem. Designed for plug-in use, the compact "F-Head" heterodynes the VHF output of the AN/TRC-24 to the available UHF range. ADLER heterodyne techniques also are used in advanced TV microwave and repeater systems, and multichannel communications.

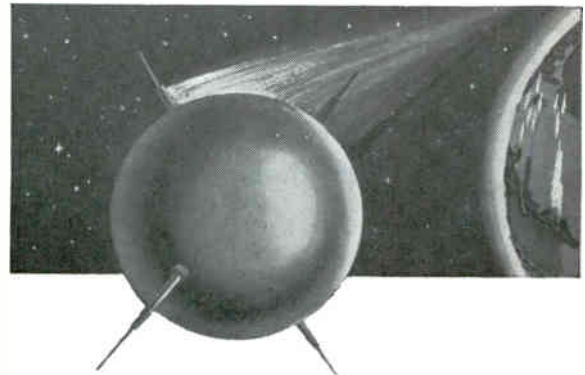

SATELLITE RELAY SYSTEM — A reliable, worldwide network for telegraphy and teletype communications will be realized through PROJECT COURIER of the Advanced Research Projects Agency and U. S. Army Research & Development Laboratories. Each of the Courier's air-ground transportable stations duplex transmit and receive 15 million bits of stored information in the 4-minute contact with the satellite. As subcontractor to ITT Laboratories, ADLER is responsible for design, manufacture and equipment installation of the ground station trailers of this earth-satellite relay system.

Write for all the facts on how ADLER experience can help solve your communications problems.

A ADLER

ADLER ELECTRONICS, INC. New Rochelle, N. Y.

Now, from RCA, the name you know
for reliability in computer transistors

RCA 2N706

RCA 2N706A

SILICON MESA TRANSISTORS

For your high-speed
high temperature military
switching requirements

RCA's stringent internal controls on types 2N706
and 2N706A include these important MIL-S-19500B
requirements:

- 1,000 hour storage life at 300° C.
- 1,000 hour operating life test at maximum rated power.
- Comprehensive mechanical and environmental testing including shock and vibration fatigue.

AVAILABLE THROUGH YOUR RCA DISTRIBUTOR



The Most Trusted Name in Electronics
RADIO CORPORATION OF AMERICA

**AVAILABLE NOW—
IN QUANTITY**

For life test and delivery information,
call your RCA representative at the field
offices listed. For additional technical
data, write RCA Semiconductor and
Materials Division, Commercial Engi-
neering, Sec. I-19-NN-3, Somerville, N.J.

RCA SEMICONDUCTOR & MATERIALS DIVISION FIELD OFFICES

NORTHEAST: 64 "A" Street, Needham Heights 94, Mass., Hillcrest 4-7200.

EAST: 744 Broad Street, Newark 2, N. J., HUmboldt 5-3900.

EAST CENTRAL: 714 New Center Bldg., Detroit 2, Mich., TRinity 5-5600.

CENTRAL: Suite 1154, Merchandise Mart Plaza, Chicago 54, Ill.,
Whitehall 4-2900.

WEST: 6355 E. Washington Blvd., Los Angeles 22, Calif., RAYmond 3-8361,
1838 El Camino Real, Burlingame, Calif., OXFord 7-1620.

SOUTHWEST: 7905 Empire Freeway, Dallas 7, Texas, FLEetwood 7-8167.

GOV'T: 224 N. Wilkinson St., Dayton 2, Ohio, BALDwin 6-2366.

1725 "K" Street, N.W., Washington 6, D. C., FEderal 7-8500.

Unmatched for MIL-R-11 APPLICATIONS

Today's best looking resistors are every bit as good as they look. Going beyond MIL-R-11 requirements, Coldite 70⁺ Resistors give important dividends in terms of load life, moisture resistance and other important characteristics.

Unmatched for EASY SOLDERING

Thanks to an exclusive extra solder coating applied after the usual tin dipping, Coldite 70⁺ Resistors solder readily by any method—dip or iron. Leads stay tarnish-free and solderable even after months in storage.



GET THEM IN 24 HOURS OR LESS

... from These Leading Distributors

BALTIMORE, MD.
Kann-Ellert Electronics, Inc.

BATTLE CREEK, MICH.
Electronic Supply Corp.

BINGHAMTON, N. Y.
Morris Distributing Co., Inc.

BIRMINGHAM, ALA.
MG Electrical Supply Co.

BOSTON, MASS.
Cramer Electronics, Inc.
Sager Electrical Supply

BROOKLYN, N. Y.
Electrical Equipment Corp.

CLEVELAND, OHIO
Pioneer Electronic Supply Co.

DALLAS, TEXAS
Tekko

DAYTON, OHIO
SrepcO, Inc.

DENVER, COLO.
Denver Electronics Supply Co.

GLENDALE, CALIF.
R. V. Weatherford Co.

INDIANAPOLIS, IND.
Radio Distributing Co.

KANSAS CITY, MO.
Burstein-Applebee Co.

MELBOURNE, FLA.
Electronic Supply

MIAMI, FLA.
Electronic Supply

NEW YORK, N. Y.
Electronic Center, Inc.
Harvey Radio Co.
Milo Electronics Corp.
Sun Radio & Electronics Co., Inc.

PHILADELPHIA, PA.
Almo Radio Co.

ROANOKE, VA.
Peoples Radio & TV Supply Co.

SAN DIEGO, CALIF.
Radio Parts Co.

SCRANTON, PA.
Fred P. Pursell

SEATTLE, WASH.
C & G Electronics Co.

ST. LOUIS, MO.
Interstate Supply Co.

SYRACUSE, N. Y.
Morris Electronics of Syracuse, Inc.

TACOMA, WASH.
C & G Electronics Co.

WASHINGTON, D. C.
Electronic Industrial Sales, Inc.

WATERBURY, CONN.
Bond Radio Supply Co. Inc.

WEST PALM BEACH, FLA.
Goddard Distributors, Inc.

WICHITA, KANS.
Interstate Electronic Supply Corp.

WILBRAHAM, MASS.
Industrial Components Corp.

WINSTON-SALEM, N. C.
Dalton-Hege Radio Supply

... and G-C / STACKPOLE, TOO!—Attractively packaged by G-C Electronics for service replacement uses, Coldite 70⁺ Resistors are also available through over 800 G-C distributors.



STACKPOLE

Navy's "Sage for the Fleet" Opens Market

New Naval Tactical Data System (NTDS) will eventually go on every major ship in the fleet, Navy says. Procurement of hardware is still in early stages. R&D contracts to be awarded later for more sophisticated system

By JOHN F. MASON

Associate Editor

EARLY NEXT YEAR, Navy will begin installing a new electronic defense control system capable of welding an entire task force spread out over half an ocean into a single defensive unit.

Consisting of communications, data processing and display, the Naval Tactical Data System (NTDS) will provide a task force commander with a schematic picture showing the enemy targets, their type and movements, the defensive and offensive posture of friendly ships and aircraft, and recommendations for action.

When the commander makes his choice—either the one recommended by NTDS or an alternate choice based on his own judgment—the system transmits the orders to the ship's own fire control equipment or to aircraft that will make the attack.

The system is similar in function to Sage, the continental air defense system.

Business potential for NTDS is big. NTDS will eventually go on every major ship of the fleet, says the Navy Electronics Laboratory.

Navy is already working on a revised NTDS system, more sophisticated than the present version. This will spawn many new R&D contracts as well as production.

Procurement of hardware, BuShips told ELECTRONICS, is in the early stages and will continue for years.

Rate of installation will depend on availability of funds.

Installation priority will be given to ships that direct the task force battle against enemy air attack—such as guided missile ships and

aircraft carriers, the Defense Department says. First ships to get the equipment, early next year, will be tested in the Pacific.

Responsible for the overall system is the Office of the Chief of Naval Operations. The Bureau of Ships is prime executor in system technical design, contract administration and hardware implementation. The Navy Electronics Laboratory, San Diego, is responsible for analysis, test, evaluation, design improvements, and the training of Naval personnel to operate the system.

Remington Rand is prime contractor for data processing. Collins is furnishing high-powered, single-sideband radio stations and data transmission equipment. Alpha Corp., a subsidiary of Collins, is providing systems engineering and management within the company. Collins' divisions at Burbank, Calif., and Cedar Rapids, Iowa, are designing and manufacturing the radio and data transmission equipment. Collins contracts to date total \$28 million.

Hughes is developing the data display system.

Other companies holding prime contracts with BuShips include: Hazeltine for display consoles; Manson Laboratories, Inc., for receiving and transmitting equipment for the communications data link between ships; General Applied Science Laboratories for simulators used for evaluation of the system and for training personnel; and Cornell Aeronautical Laboratories for work still classified.

Stromberg-Carlson is working on an advanced display portion of the system for a later updated version of NTDS.

NTDS was needed, Navy says, to cope with aircraft and missiles that

may approach a task force at speeds of thousands of miles an hour. The Navy must anticipate simultaneous attacks on fleet units from several quarters at several altitudes, in numbers that would saturate the grease pencil and transparency presentations now in use in combat information centers.

The new system can incorporate all anti-air warfare weapons systems now in use or under development by the Navy.

Action information coming from radars, sonars, radio, iff, electronic countermeasures systems, and human sources go into modular-designed data-processing equipment on each ship. Here such functions as identity, size, location, tracking, detection and speed of friendly and enemy vehicles are worked out.

Task force units, which may be widely scattered, will have a data link from computer to computer to provide continuous sharing of target information, coordination of missile power with intercept aircraft, and facilities for immediate, integrated direction of the task force from any ship in the force.

Heart of the NTDS complex is the computer. Remington Rand describes it as "the smallest yet most capable digital computer ever built."

The entire computer measures 3 by 3 by 6 ft.

"Although the computer occupies only about nine sq ft of floor space, it does the work of two Univac 1103 computers, each of which occupies about 1,400 sq ft of floor space," says Remington Rand Univac Military Div. manager, R. E. McDonald.

The computer is a general purpose, stored-program device with a high-speed, random-access memory

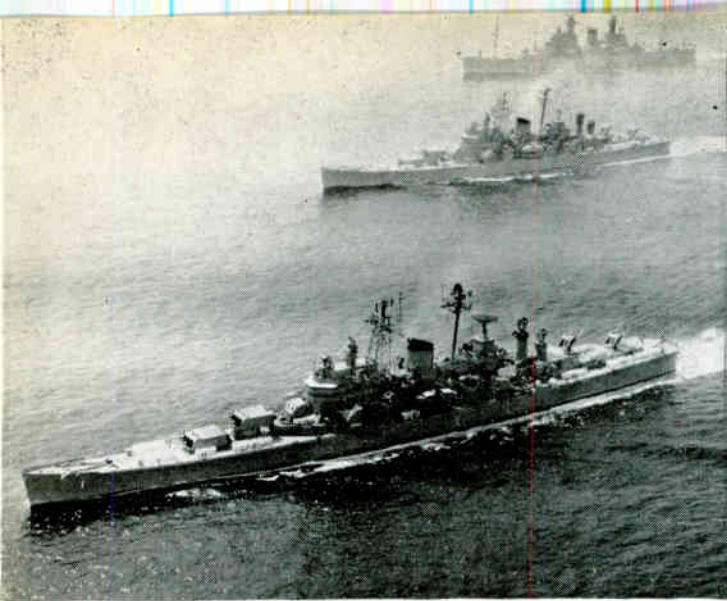

Navy's new electronic defense system will go on cruisers, like these three above, and guided missile ships. System will coordinate an entire task force

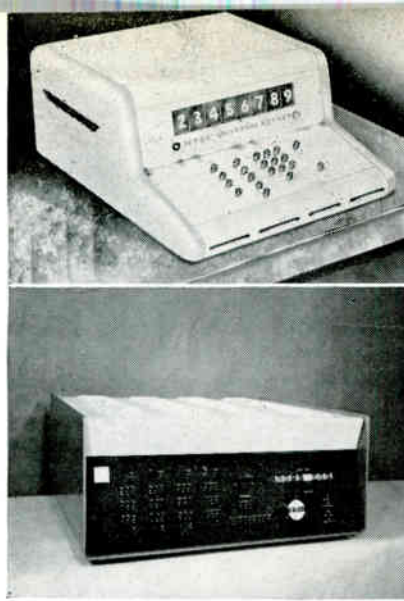

New Naval Tactical Data System (NTDS) equipment includes: (top left) a key set, (bottom left) arithmetic logic unit computer, and (right) the master computer

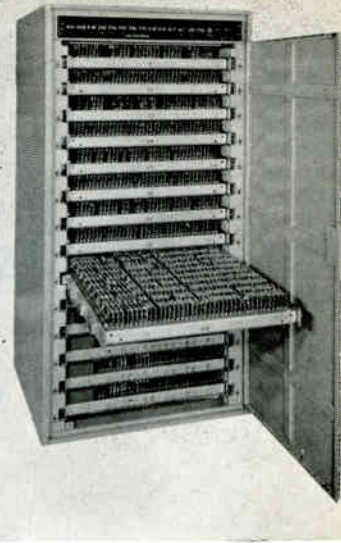

containing 1 million bits of information.

Thirty bits, comprising a single word, may be extracted from any location in the memory in only 2.5 millionths of a second.

Transistor-diode circuits and new packaging techniques—there are 3,776 identically packaged electronic circuit modules—minimize power consumption. Operating power is 2,500 watts.

The computer solves a particular problem by executing instructions stored in its memory. The instruction list consists of 64 operations which the computer is capable of performing, such as: add, subtract, stop, read and store.

A list of instructions, called a program, using combinations of the basic 64 computer instructions, controls machine operation.

The machines can complete an instruction in 20 millionths of a second, or 50,000 instructions a second.

By inserting a new program, the computer can handle new tasks and problems. Thus, the same computer can be used, regardless of the type of ship and its tactical responsibilities, and will be fully adaptable to future changes in tactical environments, McDonald says.

Hughes' data display consists of electronic display consoles which provide concrete pictorial visualizations of an entire tactical situation or selected parts of it. A prototype of the system, installed at the Navy Electronics Laboratory, San Diego, has been successfully checked out.

Hazeltine's general purpose display console contains integral plan-position indicator (ppi) sweep generation, symbol generation and auxiliary readout facilities, all displayed directly on a 12-in. cathode-ray tube. Each console is a completely self sufficient display system element. It functions directly with the Univac digital computer and

any one of many types of radars, processing and displaying data simultaneously from both sources.

A multimegacycle transistorized logic is used throughout and generates a digital sweep. This provides improved range and registration accuracy over that possible through analog techniques, Hazeltine says.

U. S. Defectors Describe Radio Intelligence Network

MOSCOW—Defection to the Soviet Union early this month of cryptanalysts William H. Martin and Bernon F. Mitchell gave the world at large an intimate peek at the operations of one of the biggest electronics customers in the U. S., the National Security Agency.

Long protected from publicity behind its triple barbed-wire fence at Ft. George Meade, Maryland, NSA has over the past twenty years put together one of the country's largest aggregations of digital computers and advanced automatic communications equipment.

According to the defectors, NSA has four main branches: Production, research and development, communications security and security:

The production branch collects intercepted messages of some 40 countries. There are some 2,000 c-w and a small number of radio-teletypewriter and other automatic intercept positions throughout the world manned by some 8,000 com-

munications technicians of the Army, Navy and Air Force communications intelligence activities. Presumably the production branch also operates an efficient communications network of its own.

The research and development branch develops new equipment, studies radio propagation and exploits the use of digital computers in cryptanalysis, probably by statistical analysis of encrypted messages and rapid substitution of postulated clear text.

The communications security branch is responsible for production and security of U. S. cyphers. Here too digital computers play an important role. The security branch investigates NSA personnel. Here too electronic equipment in the form of lie detectors plays a part.

Reportedly the U. S. spends \$500 million a year on communications intelligence, although the NSA budget is never made public. Ten thousand people are said to work at Ft. Meade alone.

DIGITAL CONTROLS STEAL CHICAGO

Sales of numerical controls for machine tools promise to reach \$25 million

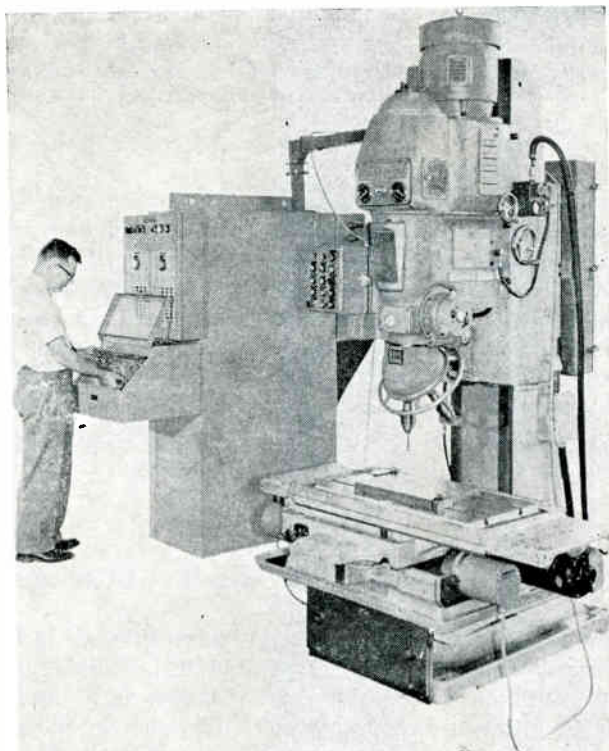

Tape controlled positioning table helps turret drill bore holes automatically

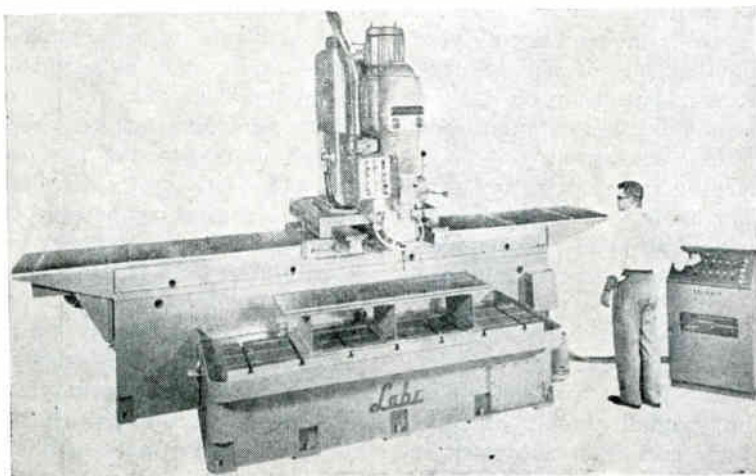

Numerical programmer operates turret drill, point-to-point

SALES OF digital electronic controls for machine tools will total \$25 million at factory-door price over the next year and a half. Numerically controlled tools were a bigger-than-ever attraction at the Chicago Machine Tool Exposition and Production Engineering show which closed today.

Digital positioning systems accounted for 71 of the 85 numerically controlled machines shown in both the Chicago Amphitheatre and Navy Pier sections of the show.

Several of these positioning systems had added provisions this year for cutting slopes and simple contours.

Twenty-six of the digital electronic control systems were shown by General Electric. Digital controls use punched paper or plastic tape to control manufacturing processes step by step.

Cincinnati Milling showed 9 numerical controls, Giddings and Lewis, 6, Bendix and Norden, 5 each.

Aircraft and aircraft parts builders, encouraged by the government to apply numerical controls to contouring, have been heavy users of digital machine controls.

Builders of special industrial machines are now finding electronic numerical controls useful in solving problems of short runs with high tooling costs and spare parts headaches. Many machine tool builders are now using digitally controlled tools in their own plants.

Reduction in direct labor costs has been a big reason for industry's interest in electronic machine controls, closely followed by the value of such equipment in mini-

YOU CAN SEAL

VACUUM

and still get serviceability!

SHOW

during next 18 months

mizing tooling, increasing output and improving quality.

One simple system, exhibited by the Seneca Falls Machine Co., Seneca Falls, N. Y., at the Chicago show operated on variable voltage set by a dial control. Settings by dial or key, rather than by punched paper or plastic tape, were also possible on some machines with Carlton, Fosdick (both of Cincinnati), GE, and Giddings and Lewis controls.

New approaches to machine-tool control included grinding machines that have full contouring systems. Thompson Grinder exhibited one model with a Thompson-Ramo-Wooldridge control and Cincinnati Milling another with its own Acramatic control. An Ex-Cell-O machine was equipped with a cam grinding head using a Bendix contour control. Both Bendix and GE have been concentrating on double-barrelled attempts to reduce the time that must be spent on tape programming and to simplify mechanical operations within each of their systems.

An engine lathe shown by American Tool Works, Cincinnati, combined a GE numerical control for point-to-point cutting with an electronic tracer for contours.

Despite high initial costs, most electronic controls purchasers predict their electronic controls will pay for themselves within three years, although some expect the payoff to take as long as ten years. Three out of four buyers reported they planned to use their electronic machine controls on two production shifts. And nine out of ten users reported they are more than satisfied with performance of their electronic machine tool controls.

Gask-O-Seals meet, or exceed grade A MIL-8484 specifications for hermetic sealing, yet they are mechanical. That means you can seal a vacuum and still achieve full serviceability — easy access for repair, maintenance, re-setting, etc. You can seal components, "black-boxes," instruments, even complete systems — and re-seal them with the same seal!

The seal shown below illustrates the versatility of Gask-O-Seal — one piece seal actually doing the job of ten! Think of the freedom of design such a seal offers. Can they be put to use for your products, too?

The chart at right is an actual reproduction of a test which reveals a leak rate of less than 1 cc/air/inch/year—exceeding top hermetic requirements.

For more information about Gask-O-Seals send for catalog 5800.

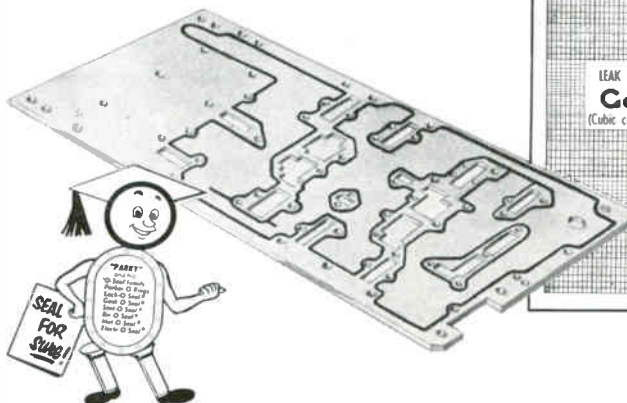
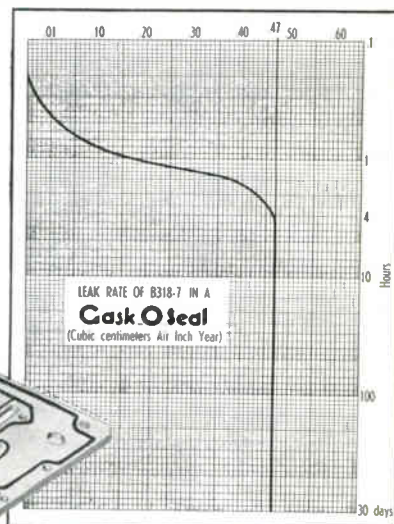

Parker SEAL COMPANY

Culver City, California and Cleveland, Ohio

A DIVISION OF PARKER-HANNIFIN CORPORATION

Parker also makes seals for wave guide flanges that prevent R/F leakage and provide a positive no-leakage seal; a self sealing flush-head rivet called Riv-O-Seal, and many other specialized seals as well as O-Rings and Back-Up Rings. Your inquiry is invited.

CIRCLE 33 ON READER SERVICE CARD →

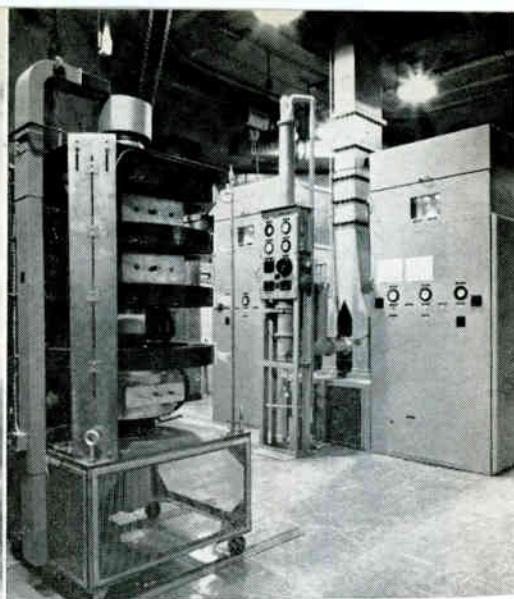

(Left): Facilities use 100-Kw transmitters and 84-ft steerable high-gain (40 db) parabolic antennas. Effective radiated power: $\frac{1}{2}$ billion watts

(Right): Each cabinet houses a 50-Kw klystron, like the spare shown left foreground

Speeding Up Moon-Bounce Communications

By ROBERT L. HENSELL

Moon Relay System Project Manager,
Developmental Engineering Corp.,
Leesburg, Va.

TECHNIQUES USED to achieve the high reliability of Navy's moon-bounce communications system will benefit planners of other long-range passive reflector systems.

Navy's new Communications Moon Relay (CMR) radio system can accept facsimile, multiplexed teletypewriter and binary digit data at a maximum rate of 30,000 bits per minute.

Developed by DECO (Developmental Engineering Corp.), the CMR links Washington, D. C. with Hawaii. The two stations have separate transmitters and receivers.

The reliability of CMR results from freedom from both natural and intentional interference and safeguards against circuit outage.

The earth's atmosphere is not an obstacle to the 135-445 Mc frequencies used and they are above the range of natural interference. In contrast, high-frequency radio systems are vulnerable to ionospheric variations.

Protection against intentional jamming is a strong point of CMR. To jam a moon-reflected transmission, a jamming transmitter and the CMR receiving site must be in the same hemisphere of the earth, as seen from the moon. The periodic monthly oscillation in the

north-south position of this hemisphere severely limits the choice of sites for jamming transmitters.

The highly directional antennas used in CMR and methods for rapid change of frequencies help prevent intentional jamming.

The steerable, equatorially mounted 84-ft reflectors, used for both transmitting and receiving, have a major lobe beamwidth of only 1.75 degrees at the half-power points. This high directivity restricts interference from nearby transmitters to that received by a direct path. The radiating feed portions of the receiver and transmitter antennas are identical. This will permit duplexing the circuit in the future.

Ability to change frequencies in less than a minute to accuracies of within 4 cps can be useful if it becomes necessary to dodge jamming. The temperature-controlled quartz-crystals frequency standards at each installation have a stability of better than 1 part in 10^6 .

The CMR uses full f-m transmission and demodulation to get maximum demodulated signal-to-noise ratio, making it possible to use a wide variety of modes for transmitting intelligence. These modes include multichannel teletypewriter, facsimile and high-speed data transmission.

Use of X602 klystrons having a gain of 50 db permitted simplification of the input driver stages and

power supplies of the custom-built 100-Kw transmitters. Hybrid combiners are used at the outputs of both the driver and power amplifier stages to permit operation at reduced capacity if equipment fails in any of the r-f channels.

Back-up components in the CMR system provide safeguards against circuit outages. There has been complete duplication of all equipment except antennas and transmission-line hardware at the receivers. At the transmitters, all low-level frequency-control elements have been duplicated.

Any spare can be placed in operation on the traffic circuit in 60 seconds.

Since the CMR is a dual-carrier frequency diversity system, it is capable of operating at reduced circuit capacity on a single frequency if the other channel fails.

A signal failure alarm system is actuated by the complete loss of both diversity channels in the receiver i-f amplifier.

This alarm alerts operating personnel to a failure of antenna tracking at either transmitter or receiver.

Other CMR refinements include provision for manual control of transmitter and receiver frequencies to compensate for the doppler shift caused by the relative motion of the moon. Also, circular polarization is provided to compensate for the effects of Faraday shift in the transmission path.



CANOGA IS AT WORK AT EVERY MISSILE RANGE IN THE FREE WORLD!





75 YEARS HONEYWELL
PIONEERING THE FUTURE



(ACTUAL SIZE)

NEW "BOUNCE-FREE" SWITCH

**Eliminates Contact
Bounce in High-Speed
Electronic
Applications**

A new compact switch device has been developed by MICRO SWITCH to eliminate the effects of contact bounce in applications which involve high speed electronic tubes that operate in less than a microsecond.

This new "Bounce-Free" Switch makes it possible for designers to save valuable engineering time otherwise required to develop special circuits to eliminate spurious voltage pulses caused by contact bounce. And, its compactness makes it possible to save valuable cabinet space in control consoles.

The new circuit may be actuated by any switch that has a normally open and normally closed position. It is an electronic switch triggered by a mechanical switch.

Write for Data Sheet 177 which describes the new "1PB2000."

MICRO SWITCH . . . FREEPORT, ILLINOIS
A division of Honeywell

In Canada: Honeywell Controls Limited, Toronto 17, Ontario

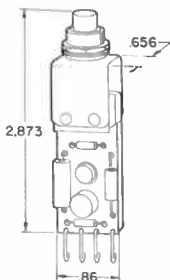

Honeywell

MICRO SWITCH Precision Switches

OPERATING CHARACTERISTICS

There are four circuit types available. One produces a positive output to accommodate resistive loads of 100 to 500 ohms, another produces a positive output for resistive loads of 500 ohms or greater, and two produce

a negative output voltage at these loads. All circuit types have a voltage range of from 5 volts to 25 volts.

The circuits are designed to produce an output voltage which has a maximum rise time of 1/2 microsecond.

DISABLED, ELECTRONICS HELP EACH OTHER

Handicapped workers securing place in industry with determination to prove their abilities

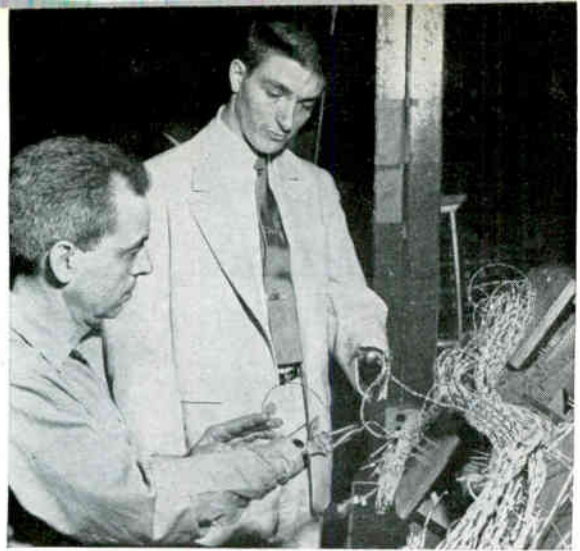

Control harnesses for jet planes, missiles, are among products of Abilities, Inc.

DISABLED electronics workers who built Abilities, Inc., from scratch into a multibranch firm with 400 employees and \$2.9 million in sales during the past eight years dramatize the achievements that have helped handicapped workers win a place in the electronics industry.

Abilities, of Albertson, N. Y., was one of the first all-disabled companies to tackle electronics fabrication and assembly, according to Henry Viscardi, Jr., president, who was born with two underdeveloped legs, himself.

"We could see that servos, computers, sensors and other electronic circuitry would be a growing field back in the early '50's," he said. "Our New York area is involved in all aspects of this field, and we were certain we could prove that if the disabled could build complex electronic equipment, they could build anything else, as well."

Handicapped employees come from all over the city, with every known type of disability and with no, or low levels of skill. Complementing one man's weakness with another's strength, Abilities' training program assigns its skilled people to work side by side with its newer employees. "Our disabled have one special capability," said Viscardi, "they really work to prove themselves."

Paraplegics Manufacturing Inc., of Franklin Park, Ill., has had similar experience, operating with 97 physically handicapped including its president, director of sales and purchasing. Single, double, even quadruple amputees have gained electronic skills over the past ten years, keeping pace with present trends toward miniaturization in controls, sockets, connectors,

*Employing
97 handicapped,
Paraplegics, Inc.,
Franklin Park, Ill.,
specializes in
electronics
contracts*



switches and similar components.

Experienced in turning out computer boards and cables, transistorized garage door controls, microwave assemblies and printed circuits, Paraplegics solicits business solely on its ability to compete at a profit-making price, according to Dwight Guilfoil, president.

Sheltered Workshops, Inc., Santa Monica, Calif. has been training many of its more than 400 skilled, semiskilled and unskilled handicapped for electronics assembly. Since beginning in 1952, Workshops has expanded into a second factory at Inglewood, and is now planning a third.

Abilities was fortunate in cutting its electronic teeth on long-run military contracts during the Korean war, President Viscardi said. "Leaner years have increased the demand for ingenuity, cost-consciousness and the need to run a tighter ship."

Many of Abilities' special solutions to these problems also apply to companies using nonhandicapped workers, he pointed out. A method of flagging wire developed to help an arthritic patient turned out to be patentable.

Completing a contract to build

motors for General Electric, Abilities found equipment needed to balance the motors would have cost \$8,000. Developing its own, the company got patents on them and now sells sensing probes to General Electric for balancing its turbine engines.

More than 5,000 visitors shared Abilities' training and demonstration programs in tours during the past year. Representing every state and 29 foreign countries, visitors from far-away Paris, Bombay, Sao Paulo and other foreign cities have returned to set up disabled companies in their own cities. Viscardi recently dedicated the latest of these in Mexico City.

Directing money saved by its special tax exemptions into a Human Resources division, Abilities recently completed a study on the adaptability of disabled workers based on its own employees.

Telemetry of human factors, the firm's newest research project, awaits a government grant to finance work on a miniaturized transmitter which can be worn in a shirt pocket for dynamic, on-the-job measurements of energy output and expenditure under working conditions.

TWO OUTSTANDING HIGH-TEMPERATURE MAGNET WIRES



Tetroc

FOR CONTINUOUS OPERATION AT
HOTTEST SPOT TEMPERATURES
UP TO 200°C



Ceroc

FOR CONTINUOUS OPERATION AT
HOTTEST SPOT TEMPERATURES
UP TO 250°C

For continuous operation at hottest spot temperatures up to 200°C (392°F) and up to 250°C (482°F) for short periods of time—depend upon TETROC—an all Teflon-insulated wire available in both single and heavy coatings.

CEROC is Sprague's recommendation for continuous operation at hottest spot temperatures up to 250°C (482°F) and up to 300°C (572°F) for short periods of time. Ceroc has a flexible ceramic base insulation with either single silicone or single or heavy Teflon overlays. The ceramic base stops "cut-through" sometimes found in windings of all-fluorocarbon wire. Both Tetroc and Ceroc magnet wires provide extremely high space factors.

Write for Engineering Bulletins 405 (Tetroc Wires) and 400A (Ceroc Wires).

SPRAGUE ELECTRIC COMPANY
35 Marshall Street, North Adams, Mass.

SPRAGUE[®]
THE MARK OF RELIABILITY



National Stock Exchange officers and board. Standing, left to right: J. W. Clagett, pres.; C. C. Denisco, treas.; H. Ahlers, vice chmn.; seated: A. Freundlich, sec.; L. H. Taylor, chmn.; L. Watts, Jr., governor.

New Exchange Stresses Science

Third stock exchange for New York has been authorized. Officials of the new mart say they plan to concentrate on small growth listings in various technical areas.

ELECTRONICS COMPANIES will be of particular interest to the newly authorized National Stock Exchange in New York City, according to L. H. Taylor, board chairman.

Plans for a third stock exchange in New York were hatched back in June of 1958. In November of that year, under the wing of the New York Mercantile Exchange, over 3,000 questionnaires were sent to securities dealers all over the country. The response was such that the new group was formed soon after by application to the New York Mercantile Exchange, with authorization given to officials to seek expressions of interest from corporations regarding their listing in the new mart.

In April of this year, the National Stock Exchange became a reality under the corporation laws of New York state. A scant three weeks ago, the Securities and Exchange Commission franchised the group, making it the first new exchange to be established since pas-

sage of the Securities and Exchange Commission Act of 1934, the third stock exchange in New York and the 14th registered national exchange in the U. S.

In speaking of the new venture, Chairman Taylor told ELECTRONICS the NSE would be actively interested in electronics companies. "We will be trying to populate the exchange with listings that have dynamism and growth potential," he said. "At this time in history, this means the companies involved in new products and research in the sciences. When the New York Stock Exchange first got started, it was sometimes referred to as the Railroad Exchange; perhaps, one day, ours will be referred to as the Science Exchange."

Now at work on memberships, the listings committee will meet shortly to start processing applications already filed. Although corporate names are still being kept confidential, a spokesman for the exchange says there is a liberal

sprinkling of electronics companies.

Present goal of the committee is to have about 50 listings by year's end and to add 50 more each year.

Membership requirements, while firm, will have a greater degree of flexibility than is sometimes encountered. In general, securities listed will be those of companies with 500 or more stockholders, 150,000 shares outstanding and a net worth in excess of \$1 million.

Exchange officials say they may list securities traded here as well as abroad, under certain conditions, with the exception of securities already traded on the New York and American exchanges. They anticipate, however, that the majority of NSE listings will be securities now being traded over-the-counter.

Membership in the new exchange will be limited to members of the NY Mercantile Exchange, which is sponsoring it. Membership in the Mercantile Exchange costs about \$10,000, with the privilege of applying for membership in the National Stock Exchange at no cost except a nominal initial charge.

General counsel for the NSE is James M. Landis, dean emeritus of the Harvard Law School and former chairman of the SEC.

Present plans for the exchange will allow expansion into some four floors of business space as volume increases. Trading data will be processed through a number of specially adapted electronic systems.

Tv Prices Down At London Show

LONDON — TELEVISION receiver prices were down as much as ten per cent at London's 1960 Radio Show. Repair and servicing accessibility received more attention in products shown by 156 exhibitors and ranging from prototype radar to assist the blind to a jewel-studded transistor portable radio receiver priced at \$5,880—plus 49 cents for its battery.

Price reductions of \$20 on 21-inch tv (to \$200) resulted in a sales increase. Twenty-one inch sets now account for 11 percent of total sales during the first half of the year. Sales of 17-inch receivers account for 88 percent of the total. Prices of 17-in. sets dropped to \$182.

Improved Interference Filter Capacitors Have Excellent Environmental and Insertion Loss Characteristics

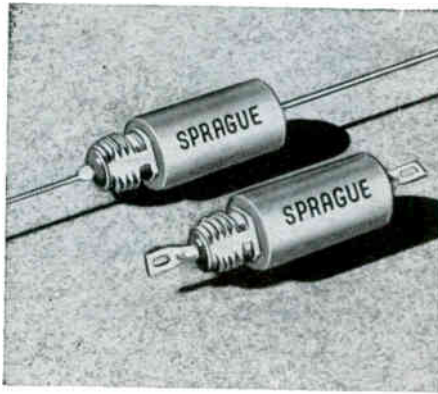

Recent technical data released by the Sprague Electric Company, North Adams, Massachusetts, reveals the unusual environmental and insertion loss characteristics of the company's subminiature Thru-Pass® Filter Capacitors. The performance of these capacitors is said to come closer to that of a theoretically ideal capacitor than any other type of paper capacitor ever made.

When properly installed, these capacitors reduce to a negligible value the effects of external cross coupling. They also provide a minimum length of path to ground for radio interference currents. Thru-Pass Capacitors are designed to meet all the electrical, mechanical, and environmental requirements of Military Specification MIL-C-11693.

Both Type 102P and Type 103P are impregnated with Vitamin Q, Sprague's exclusive inert synthetic impregnant, in order to achieve maximum insulation resistance and minimum capacitance change with temperature. Type 102P units are processed for -55 C to +85 C operation; Type 103P for -55 C to +125 C. Maximum feed-thru current for which both are rated is 5 amperes d-c continuous or equivalent.

For complete data on Thru-Pass Capacitors, write for Engineering Bulletin 8015 to Technical Literature Section, Sprague Electric Company, 35 Marshall Street, North Adams, Massachusetts.

CIRCLE 266 ON READER SERVICE CARD

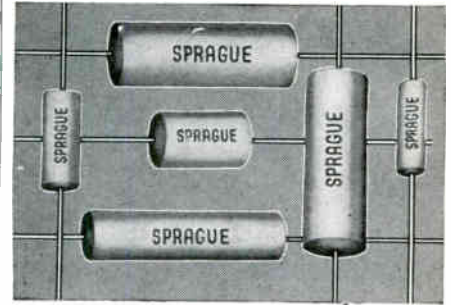

YELLOW- JACKET® CAPACITORS

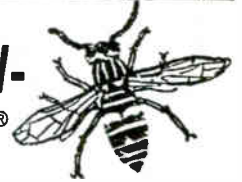

for military and
industrial electronics

Sprague Type 158P Yellow-Jacket Filmite "E" Capacitors are the most reliable "wrap-and-endfill" film capacitors made! Their design is based on the most extensive life test data for polyester film dielectrics available at the present time. They will withstand a 250 hour accelerated life test of 150% of the 85 C rated voltage impressed, or the equivalent derated 125 C voltage. Not more than 1 failure is permitted in 25 samples tested.

Because of their small size and outstanding resistance to humidity, vibration, and shock, Type 158P Yellow-Jacket Capacitors are ideal for such applications as military electronics, computers, and industrial controls. They are particularly well-suited for potting or encapsulating in electronic sub-assemblies, filters, etc.

For complete engineering data on Military-Grade Yellow-Jacket Film Capacitors (Type 158P) write for Engineering Bulletin 2301. Data on Sprague's Commercial and Entertainment Grade Yellow-Jacket Capacitors (Types 148P and 149P) is given in Bulletin 2063A. Both bulletins are available from Technical Literature Section, Sprague Electric Company, 35 Marshall St., North Adams, Massachusetts.



CIRCLE 39 ON READER SERVICE CARD 39

GUDELACE

is engineered
for
problem-free
lacing

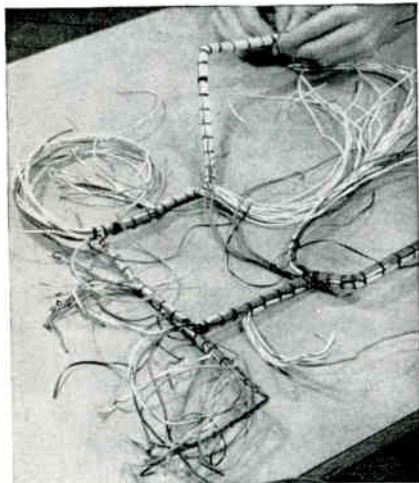

It's no accident that Gudelace is the best lacing tape you can buy. Excellence is *engineered* into Gudelace. A sturdy nylon mesh is meticulously combined with the optimum amount of special microcrystalline wax. Careful selection of raw materials and superior methods of combining them give Gudelace outstanding strength, toughness, and stability. Gudelace is the original *flat* lacing tape which distributes stress evenly over a wide area. It is engineered to stay flat; it will not stretch out of shape when pulled. Gudelace's nonskid surface prevents slipping, eliminating the too-tight pull that causes strangulation and cold flow. Durability and dependability make Gudelace your most economic buy—with no cut insulation, fingers, or feelings.

Write for Data Book with specifications on Gudelace and Gudebrod's complete line of braided lacing tapes and dial cords—Temp-Lace, Stur-D-Lace, and Gude-Glass.

GUDEBROD BROS. SILK CO., INC.

Electronic Division
225 West 34th Street, New York 1, N.Y.

Executive Offices
12 South 12th Street, Philadelphia 7, Pa.

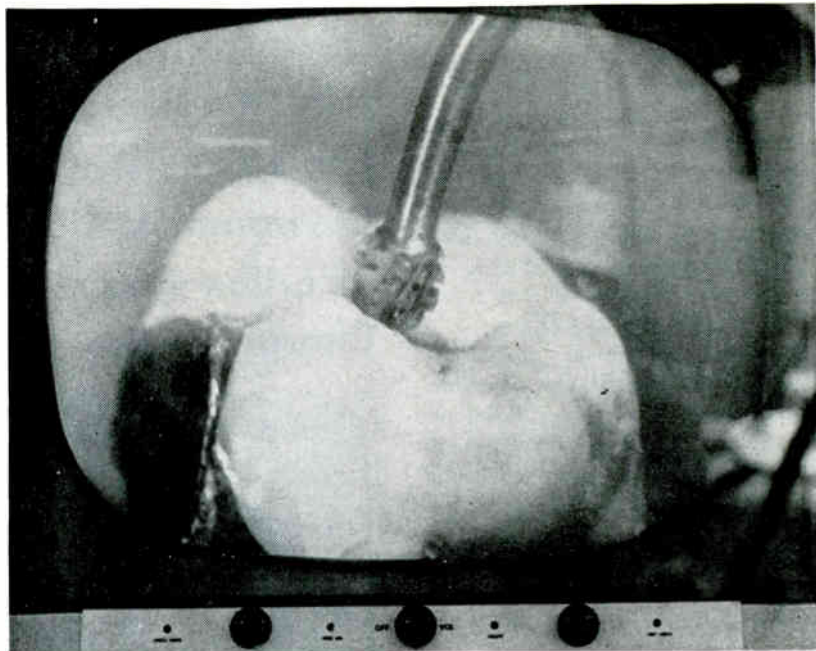

Television monitor picture at University of Pennsylvania School of Dentistry demonstrating use of tv to show detail

Plans Made for More Medical Tv

TWENTY-SIX medical schools in the U. S. are now using closed-circuit tv equipment valued at \$2,500,000 overall. Some hospitals also use tv. Walter Reed Hospital of Washington, D. C., for example, has over a million dollars worth. Many in the health-science field believe there is an important market for closed-circuit television in the nation's 10,356 hospitals and 85 medical schools.

Two roadblocks must be overcome. Some medical personnel still believe that tv equipment is necessarily elaborate and expensive. Also, some tv manufacturers are not yet conversant with health-science problems.

One group working to remedy these conditions is the Council on Medical Television of the Institute for Advancement of Medical Communication. The Council, which has its offices in New York City, is a nonprofit organization interested in making maximum use of tv in the health sciences: medicine, dentistry, nursing and hospital administration. Fifteen electronics firms are represented: Philco, Dage, RCA, Phillips, General Precision Laboratory, Vicon, Blonder-Tongue Laboratories, Ampex Professional Products, Teleprompter Corp., Skia-

tron, CBS Laboratories, Zenith, GE, Jerrold, and International Telemeter.

On October 27 and 28, the Council will present at the University of Florida (Gainesville) a symposium entitled Teaching with Television: An Institute for Medical Educators. Television equipment will be used in practical medical demonstrations. By demonstrating low-cost vidicon equipment, stressing ease of operation, program planners hope to stimulate the use of health-science tv. Hospital television equipment may be grouped into four categories: teaching and medical group demonstration in surgery, pediatrics, obstetrics, dentistry and nurse training; routine applications such as enlargement of view through a microscope, psychiatric observation, and heart catheterization; service-to-patients including master-antenna circuits for program distribution and guard duty at infants ward; protection-of-personnel by viewing of fluoroscope and contrast enhancement to derive maximum information from x-rays. A medical tv system would ideally include a vidicon camera, lens system and one or more television monitors or high definition television receivers.

Vital to your design orbit!



HUDSON PRECISION-DRAWN CLOSURES

Precision Standard Tooling makes the Difference — The HUDSON line provides complete versatility for the designer/engineer. The industry's widest range of round, square and rectangular closures supplied with dozens of modifications to meet unusual applications. Standardized designs assure fast delivery and precision quality — every time! All finishes available on components of mu metal, nickel-silver, aluminum, brass, copper, stainless steel and steel. Call or write for quotations.

Available
faster than
FAST!

Ask for the
HUDSON
CATALCG
— contains
complete data
on HUDSON
Standard
Closures
including MIL
types. Please
make request
on company
letterhead.

Hudson Tool & Die Company • Inc

18-38 Malvern Street, Newark 5, New Jersey

Precision Metal Components for Electronics, Nucleonics, Avionics and Rocketry

Telephone: Market 4-1802
Teletype: NK 1066



Anywhere...

At sea, in the icy cold of the antarctic! S.S. WHITE Molded Resistors in values up to 50,000 megohms retain their characteristics.

in Any Weather

Airborne, in the steaming heat of the tropics! S.S. WHITE Molded Resistors are made of coated, non-hygroscopic material that resists moisture.

S.S. White

"ALL-WEATHER"

**Molded Resistors
Withstand Temperature
and Humidity**

FIXED RESISTANCE VALUES RANGE
FROM 1000 OHMS TO 10,000,000
MEGOHMS!

65X Molded Resistor — 1 watt
80X Molded Resistor — 3 watts

While bargain buys in resistors are wearing out and being replaced, durable S.S. WHITE "All-Weather" Molded Resistors are still giving top performance in hundreds of commercial, industrial and scientific applications.

Our resistors are characterized by low noise level . . . precision . . . stability . . . have negative temperature and voltage coefficients. Compact . . . excellent stability and mechanical strength . . . values do not deteriorate due to age.

We'll be glad to cooperate with you in applying these high-quality resistors to your product. For our Bulletin 5409, just drop a line to Dept. R.

S.S. White

INDUSTRIAL DIVISION

10 East 40th Street
New York 16, New York

MEETINGS AHEAD

Sept. 19-21: Data Transmission, International Symp., PGCS of IRE and Sectie Voor Tele. of Koninklijk Ins. van Ingonieurs, Delft, Neth., Contact B. B. Barrow, Benelux Section, IRE, Postbus 174, Den Haag, Nederland.

Sept. 19-22: Space Electronics and Telemetry, Nat. Symposium, Shoreham Hotel, Washington, D. C.

Sept. 21-22: Industrial Electronics, Annual, PGIE of IRE, AIEE, Sheraton-Cleveland Hotel, Cleveland.

Sept. 23-24: Broadcasting Symposium, PGB of IRE, Willard Hotel, Washington, D. C.

Sept. 23-25: Hi-Fi, Home Entertainment Show, Palmer House, Chicago.

Sept. 26-30: Instrument-Automation Conf. and Exhibit of 1960, ISA Annual Meeting, Coliseum, N. Y. C.

Sept. 27-30: Space Power Systems Conference, ARS, Miramar Hotel, Santa Monica, Calif.

Sept. 27-Oct. 1: Electrostatic Forces and Their Applications, Laboratories D'Electrostatique et Physique du Metal, Institut Fourier, Place du Doyen-Goose, Grenoble, France.

Oct. 3-5: Communications Symposium, PGGS of IRE, Hotel Utica & Utica Memorial Auditorium, Utica, N. Y.

Oct. 4-6: Radio Interference Reduction, PGRFI of IRE, Armour Research Foundation, Chicago.

Oct. 4-7: Instrumentation Symposium, Nat. Inst. of Health, Bethesda, Md.

Oct. 4-9: Data Processing Systems, Large Volume, Fall Meeting, AIEE, New York, N. Y.

Oct. 10-12: National Electronics Conf., Hotel Sherman, Chicago.

Now-from Los Angeles
as well as New York

**CUSTOM
STRIPED
WIRE
IN 24
HOURS**

Alpha is now able to supply you with all your military approved hook-up wire, custom striped to over 40,000 color combinations, from both the East and West coast—and in minimum runs as low as 100'.

For more information on STRIPING write for our new DESIGN ENGINEERING GUIDE TO CUSTOM WIRE STRIPING.



ALPHA WIRE CORPORATION
Subsidiary of LORAL Electronics Corporation
200 VARICK STREET, NEW YORK 14, N. Y.
Pacific Division:
1871 So. Orange Dr., Los Angeles 19, Calif.

For Government Spec Wire the Leaders Specify....

Alpha offers a complete line of Mil- W-16878C Wire from stock for immediate delivery from your local distributor or the factory.

Alpha Military Wire, produced to the highest standards, is used by every major manufacturer engaged in defense projects. Write for your free Alpha Wire catalog

ALPHA  **WIRE**

MIL-W-16878C

MIL-W-16878C	DESCRIPTION (Single conductors)	VOLT RATING	CONDUCTOR SIZE	STOCK COLORS	ALPHA NUMBER
TYPE B UNCOVERED PLASTIC	stranded tinned copper, .010" vinyl thermoplastic insulation. 105°C	600	16-32	*1-19	1850-1858
TYPE B NYLON JACKET	stranded tinned copper, .010" vinyl thermoplastic insulation with clear nylon jacket overall. 115°C	600	16-32	*1-19	1860-1868
TYPE C UNCOVERED PLASTIC	stranded tinned copper, .016" vinyl thermoplastic insulation. 105°C	1000	14-24	Conductors 18-22 Colors *1-19 Conductors 14, 16, 24 Colors 1, 11-19	1830-1835
TYPE C NYLON JACKET	stranded tinned copper, .016" vinyl thermoplastic insulation with clear nylon jacket overall. 115°C	1000	14-24	Conductors 18-22 Colors *1-19 Conductors 14, 16, 24 Colors 1, 11-19	1840-1845
TYPE D UNCOVERED PLASTIC	stranded tinned copper, .032" vinyl thermoplastic insulation. 105°C	3000	6-24	Conductors 18-22 Colors *1-19 Conductors 6-16 & 24 Colors *1, 11-19	1870-1879
TYPE D NYLON JACKET	stranded tinned copper .032" vinyl thermoplastic insulation with clear nylon jacket overall. 115°C	3000	6-24	Conductors 18-24 Colors *1-19 Conductors 6-16 & 24 Colors *1, 11-19	1880-1889
TYPE E EXTRUDED & SPIRAL WRAPPED TEFLON WIRE	stranded silver plated copper, extruded or spiral wrapped Teflon insulation. .010" Wall. 200°C	600	14-30	Conductors 16-30 Colors *1-10 Conductor 14 Colors *1-6	Extruded 2851-2859 Wrapped 2881-2889

- | | | | | |
|----------|-------------|---------------------|------------------|------------------|
| 1. White | 5. Yellow | 9. Gray (slate) | 13. White/Green | 17. White/Orange |
| 2. Black | 6. Lt. Blue | 10. Violet (purple) | 14. White/Yellow | 18. White/Gray |
| 3. Red | 7. Brown | 11. White/Black | 15. White/Blue | 19. White/Violet |
| 4. Green | 8. Orange | 12. White/Red | 16. White/Brown | |

* Alpha can create for you over 40,000 military approved striped color combinations.



ALPHA WIRE CORPORATION Subsidiary of **LORAL** Electronics Corporation
200 Varick Street, New York 14, N. Y.
Pacific Division: 1871 So. Orange Dr., Los Angeles 19, Calif.

No, it's not a transistor...



... it's the new Spectrol ultraminiature trimmer ... the smallest trimming potentiometer on the market! Measuring 1/3" in diameter, weighing only 1 gram, and designed specifically for transistor circuits, the Spectrol Model 80 is a remarkable breakthrough in component technology.

Design engineers can now shrink printed circuit packages in all three dimensions. The single turn adjustment is from the top, rather than the side. It is ideal for printed circuit applications. Sealed construction allows complete package encapsulation.

THE MODEL 80 is approximately one-quarter the size of ordinary trimmers, yet it offers greater resolution and resettability because the resistance element is nearly twice as long. These trimmers meet all applicable military and commercial specifications including the most severe humidity cycling and immersion tests.

AND TWO NEW MINIATURE POTENTIOMETERS, TOO!

Sturdy construction provides reliable operation at a modest price. Only one-half inch in diameter, the new bantam weight Models 140 and 150 rotary potentiometers are well suited to trimming, control and servo applications where space and environmental conditions are critical. Standard linearity is $\pm 1.0\%$ with $\pm 0.5\%$ available on special order. Servo mount ball bearing type units have standard linearity of $\pm 0.5\%$. Slotted shafts are standard on all models.



SPECIFICATIONS

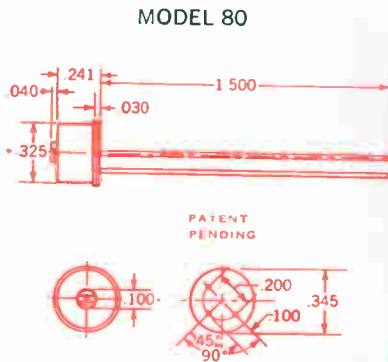

DIAMETER: 0.345"
 STANDARD RESISTANCES (ohms): 50, 100, 200, 500, 1K, 2K, 5K, 10K
 RESISTANCE TOLERANCE: $\pm 5\%$
 NO. TURNS: ONE
 POWER RATING: 1 watt at 70°C
 LINEARITY: $\pm 1.0\%$
 NOISE: 100 Ω ENR per NAS-710
 SHOCK: 50 G
 VIBRATION: 30 G to 2,000 CPS
 HUMIDITY: MIL-E-5272C, Proced. I (10 days, cycling) and MIL-STD-202A, Method 104, Condition A (immersion in hot water)
 SALT SPRAY: MIL-STD-202A, Method 101A, Condition A (96 hours)
 LOAD LIFE: 1000 hours
 WEIGHT: 1 Gram
 PRICE (1-9 units): \$6.00 each

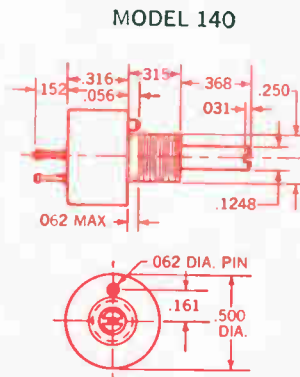

DIAMETER: 0.500"
 STANDARD RESISTANCES (ohms): 50, 100, 200, 500, 1K, 2K, 5K, 10K
 RESISTANCE TOLERANCE: $\pm 5\%$
 NO. TURNS: ONE
 POWER RATING: 2 watts at 70°C
 LINEARITY: $\pm 1.0\%$ standard, $\pm 0.5\%$ special ($\pm 0.5\%$ standard on servo mount)
 NOISE: 100 Ω ENR per NAS-710
 SHOCK: 50 G
 VIBRATION: 30 G to 2,000 CPS
 HUMIDITY: MIL-E-5272C, Proced. I (10 days, cycling)
 SALT SPRAY: MIL-STD-202A, Method 101A, Condition A (96 hours)
 LOAD LIFE: 1000 hours
 WEIGHT: 0.1 oz.
 PRICE (1-9 units): \$10.00 each

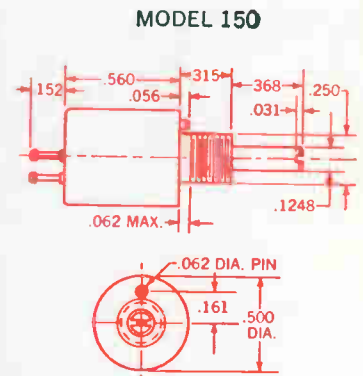

DIAMETER: 0.500"
 STANDARD RESISTANCES (ohms): 20K, 50K, 70K (50 ohms to 20K also available)
 RESISTANCE TOLERANCE: $\pm 5\%$
 NO. TURNS: ONE
 POWER RATING: 2 watts at 70°C
 LINEARITY: $\pm 1.0\%$ standard, $\pm 0.5\%$ special ($\pm 0.5\%$ standard on servo mount)
 NOISE: 100 Ω ENR per NAS-710
 SHOCK: 50 G
 VIBRATION: 30 G to 2,000 CPS
 HUMIDITY: MIL-E-5272C, Proced. I (10 days, cycling)
 SALT SPRAY: MIL-STD-202A, Method 101A, Condition A (96 hours)
 LOAD LIFE: 1000 hours
 WEIGHT: 0.15 oz.
 PRICE (1-9 units): \$12.00 each

The Spectrol name, your assurance of quality. New Spectrol trimmers and miniature potentiometers are produced to the same exacting standards of quality and reliability engineered into the entire Spectrol potentiometer line... the largest selection in the industry.

Available now for immediate delivery. Standard models of Spectrol trimmers and miniature potentiometers, as well as other standard precision potentiometers, are available from your nearby Spectrol distributor. For complete technical information, contact your Spectrol engineering representative or write directly to the factory. Please address Dept. 42.



ELECTRONICS CORPORATION

1704 South Del Mar Avenue • San Gabriel, California
 Phone: ATLantic 7-9761

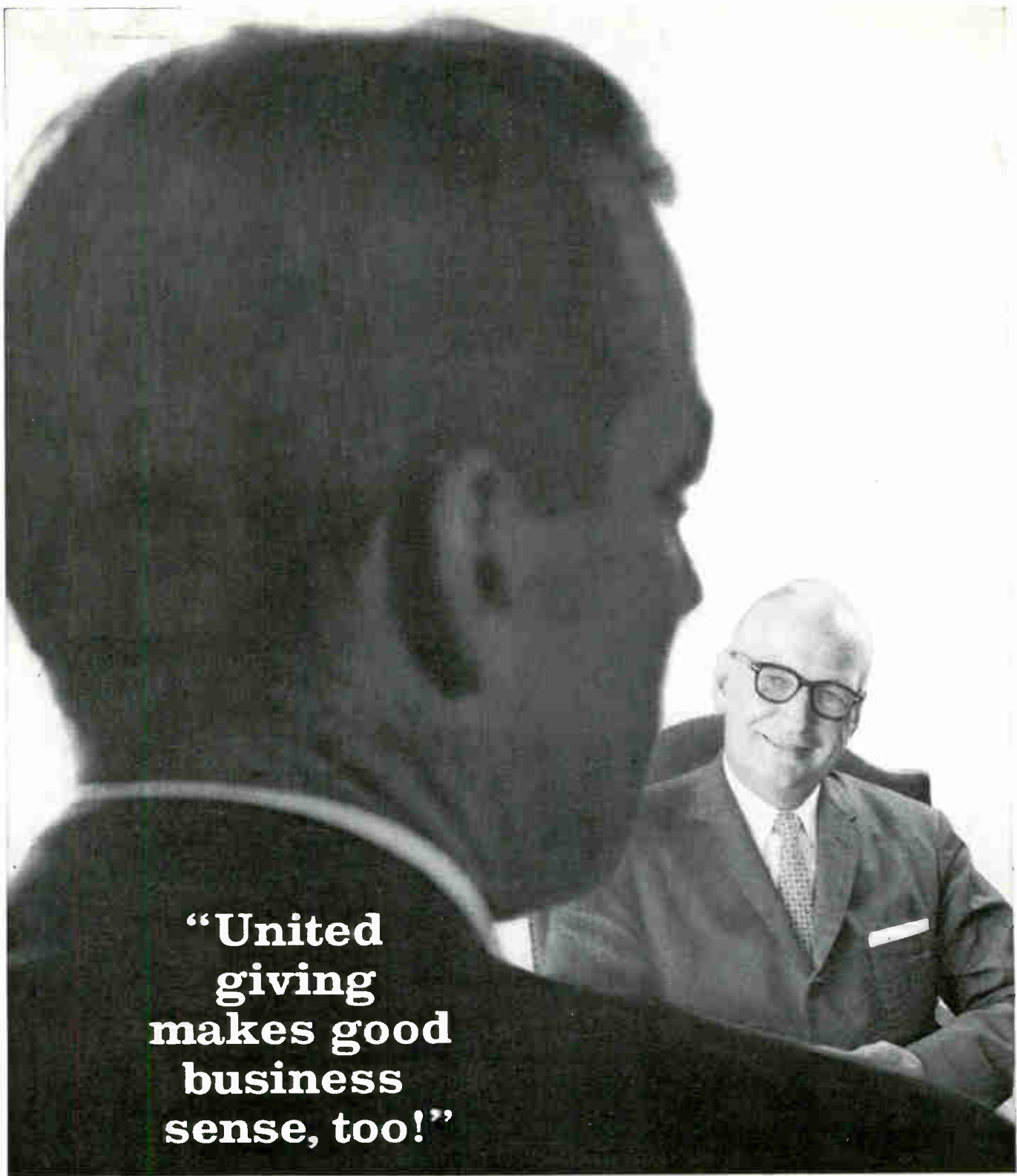

**“United
giving
makes good
business
sense, too!”**

Every business has a vital stake in the welfare of its community. The businesslike way to protect these interests is to support your community The United Way. Your United Fund or Community Chest Campaign takes care of many community needs without the confusion and waste of separate appeals.

Your company can contribute in *three* important ways! ■ Make sure your company makes a generous corporate contribution. It helps protect the welfare of your employees and customers. ■ Help your employees meet their obligations through easy payroll payments. Experience shows this often doubles, even triples, results. ■ Stimulate executive participation in support of your local fund. Such participation helps safeguard the dollar investment made by your company and its employees.

Remember, giving The United Way helps your community *and* your company. **GIVE THE UNITED WAY**

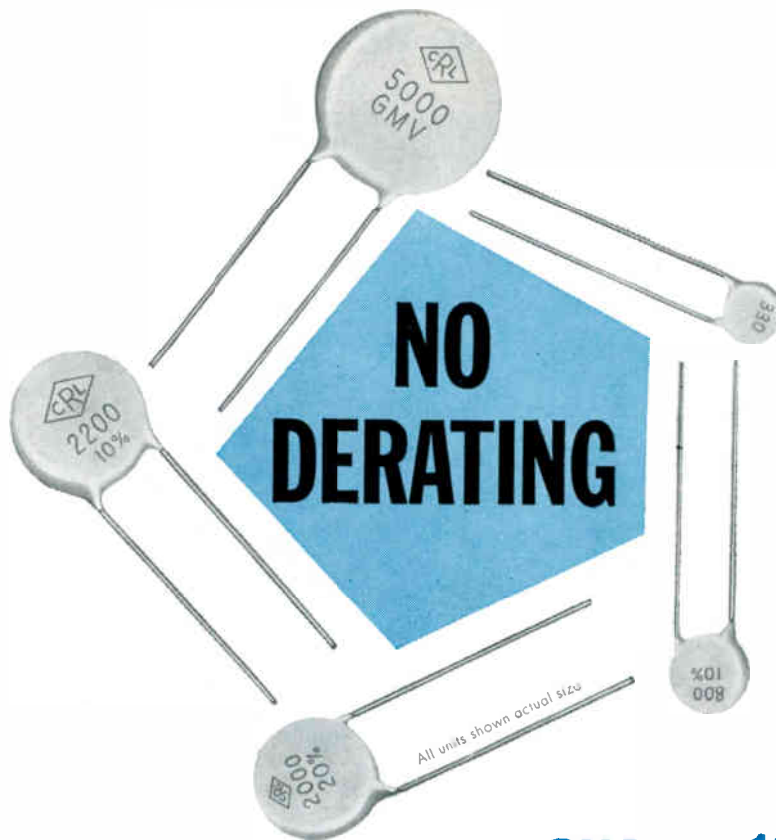

over a 180° C range with Centralab's temperature stable Ceramic Capacitors

These low-cost Type CE ceramic disc Hi-Kaps® have been extensively tested over an 18 month period by prime contractors in the missile and radar fields. Their findings: *the excellence of the CENTRALAB design parameters for standard commercial units permits the identical capacitors to be used in military applications.*

In radio-TV as well as military usage, these units operate from -55°C to $+125^{\circ}\text{C}$ without derating. They last longer than paper or mica capacitors, and their small size makes them economical to work with. Semi-stable Type CF CENTRALAB Hi-Kaps® offer similar advantages.

SPECIFICATIONS

CAPACITIES: 150-6200 mmf

SIZE: .290"-.920" diameter, .156" thick

WORKING VOLTAGE: 500 VDC

LEAKAGE RESISTANCE: Initial, 10,000 Megohms minimum; after humidity test, over 1000 Megohms

POWER FACTOR: 2% Max. at 1KC

TOLERANCES: GMV, $\pm 20\%$, $\pm 10\%$, $+80-20\%$

TYPE CE—% of 25°C Capacity vs. Temperature in °C

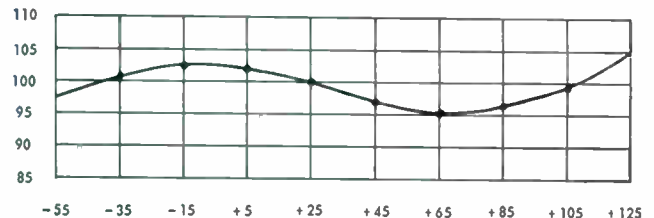

TYPE CF—% of 25°C Capacity vs. Temperature in °C

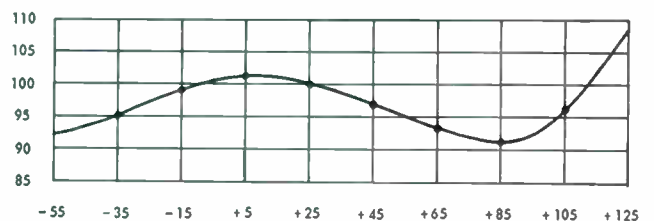

Detailed information on these and many other CENTRALAB ceramic capacitors can be found in Catalog 42-857. Write for your free copy.

Centralab

D-6036 ®

The Electronics Division of Globe-Union Inc.
914J E. Keefe Ave., Milwaukee 1, Wisconsin
Centralab Canada Limited • Ajax, Ontario

ELECTRONIC SWITCHES • VARIABLE RESISTORS • CERAMIC CAPACITORS • PACKAGED ELECTRONIC CIRCUITS • ENGINEERED CERAMICS



THERMOSETTING RESINS

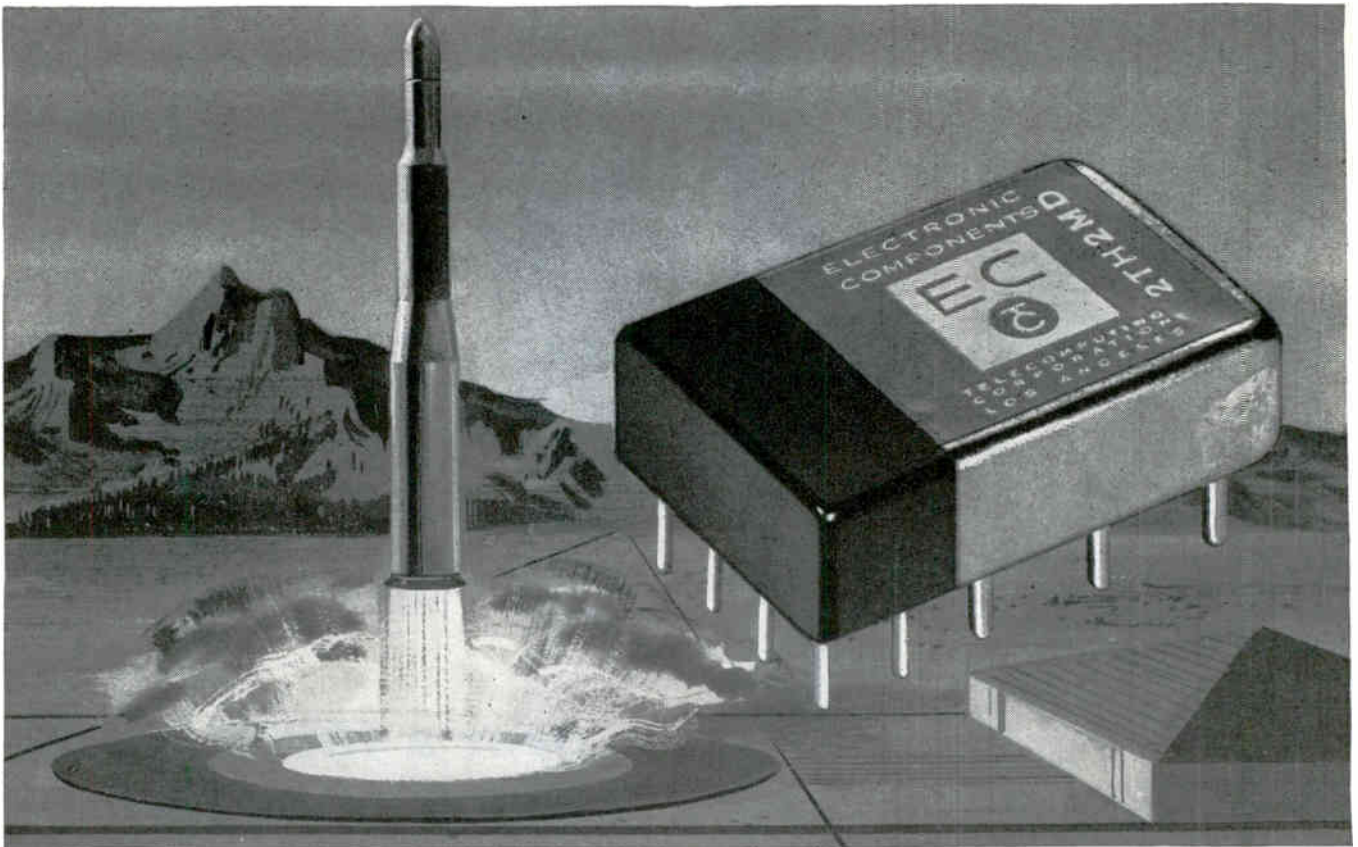

Relay terminal connections, potted with Dow epoxy novolac, help keep the Minuteman missile ready to go!

"Our micro-miniature relay rejects dropped from 25% to . . .

NO REJECTIONS SINCE WE SWITCHED TO DOW EPOXY NOVOLAC!"

"Our customers, the Autonetics Division of North American Aviation, Inc., specified 100,000 ohms insulation resistance for a relay in the guidance system of the Minuteman missile," states H. E. Wardein, Customer Relations Manager of the Electronics Components Division, Telecomputing Corporation. "Our micro-miniature relay had to measure up to this standard. Since the relay is designed as a plug-in unit, it is potted to give the connector mechanical stability, and to assure electrical insulation.

"Using our regular potting materials, we found it necessary to rework about 25% of our production. But with Dow epoxy novolac resin (D.E.N. 438) potting compounds, we have built many thousands of relays and have not experienced a single rejection due to low insulation resistance!"

Dow epoxy novolac resins are preferred by component manufacturers like Telecomputing Corporation for their superior ability to adhere to metal parts; for their heat and chemical resistance—far above that of ordinary epoxy materials; and for their ability to surpass the heat distortion point of ordinary epoxies—even when room-cured rather than oven-cured!

If you are potting, molding, encapsulating, or laminating electronic components, or require an epoxy resin for an application where performance is critical, consider D.E.N. 438 for that extra measure of physical and chemical stability! Call your nearest Dow sales office. Or write: THE DOW CHEMICAL COMPANY, Midland, Michigan, Plastics Merchandising Department 1968JG9-16. See "The Dow Hour of Great Mysteries" on NBC-TV

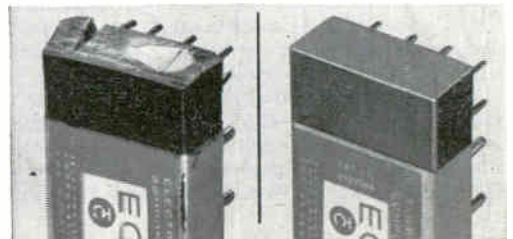

In heat-resistance tests, ordinary epoxy resin compound (left) cracked. Dow epoxy novolac (right) was unharmed!

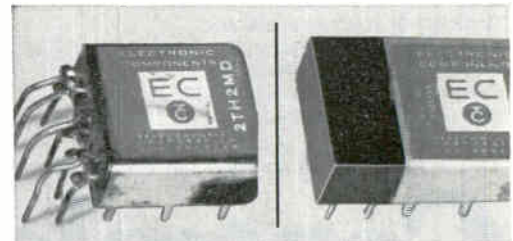

Soaked in an epoxy stripper, ordinary epoxy resin potting (left) dissolved. Dow epoxy novolac (right) showed no change after two weeks' immersion!

THE DOW CHEMICAL COMPANY • MIDLAND, MICHIGAN



±2db TRACKING with CLAROSTAT MATCHED ELEMENT CONTROLS

Now, a degree of accuracy in gain control for two audio channels equaling the accuracy of the associated circuitry. Clarostat now offers the stereo industry matched element controls with tracking in the order of ± 2 db with a range of 80 db. For less precise toler-

ance requirements, Clarostat offers matched element controls in ± 4 db or ± 6 db tracking in 40, 60 and 80 db ranges. Clarostat matched element controls are available in both the famous Clarostat 37 (1-1/8" dia.) or 47 (15/16" dia.) series.

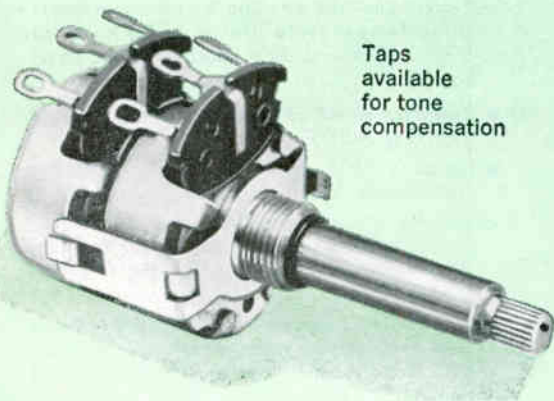

Taps available for tone compensation

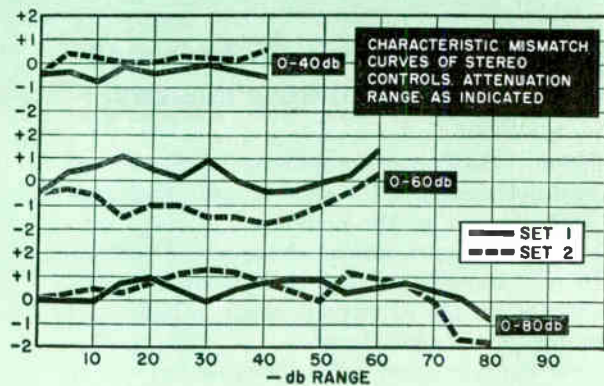

THE COMPLETE HIGH FIDELITY CONTROL LINE

- Single units in both wire-wound and carbon for single channel gain, tone, or balance.
- Dual controls with concentric shafts for individual control of two functions.
- Friction-type dual concentrics with both shafts turning simultaneously, but permitting individual adjustment by holding one and turning other.
- Clutch-type dual concentrics allowing optional operation as dual unit, or by disengaging clutch, individual adjustment.

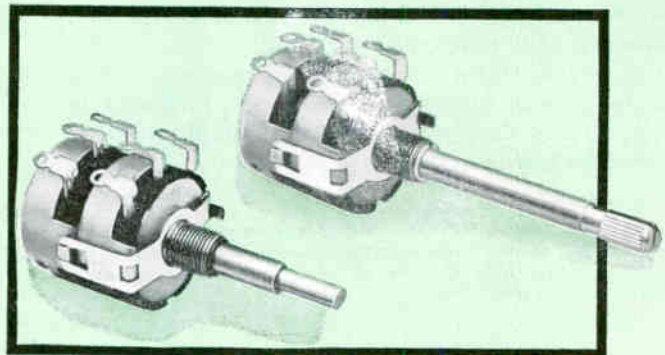

WRITE FOR MANUAL ON STEREO CONTROL —

CLAROSTAT MFG. COMPANY, INC.,
DOVER, NEW HAMPSHIRE

The Future Belongs To Those Who Prepare For It

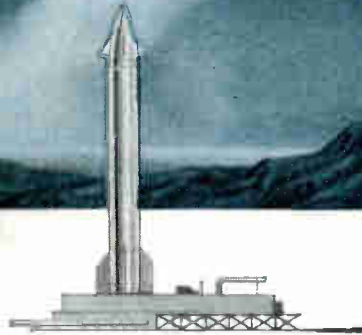

A Superb New Connector, So Advanced It May Rightly Be Called Revolutionary

MIL-C-26500 (USAF) connectors are a revolutionary step forward in the state of the art—bringing true connector reliability out of the conversation stage into practical being. The performance demands of MIL-C-26500 (USAF) have taken the conductor industry boldly into the design of advanced air, missile and space systems for the next decade.

As a participant in these fields, imagine having for your use a connector whose performance is unaffected by 1000 hours of 200°C temperature; a connector that is altitude-moisture resistant, supporting 1500 volts RMS from sea level to 350,000 feet; that is resistant to thermal shock of +260°C to -55°C; that is vibration resistant during temperature cycling.

This is the MIL-C-26500 (USAF) connector—and it is ready today for your use. It is being produced by the AMPHENOL Connector Division of Amphenol-Borg Electronics Corporation.*

**Of importance to manufacturers working to government specifications is the fact that Qualification Approval Listing has been extended to AMPHENOL under MIL-C-26500 (USAF) on the first production connectors in this series.*

AMPHENOL

**MIL-C-26500 (USAF)
CONNECTORS
AMPHENOL 48 SERIES**

PERFORMANCE

- Performance not affected by maximum operating temperature life of 1000 hours at 200°C simultaneously conducting current on all contacts.
- Performance not affected by thermal shock of 260°C to -55°C.
- Supports 1500 volts RMS at high altitudes (sea level to 350,000 feet) fully mated.
- Altitude immersion resistant after 10 contact removal and insertion cycles on all contacts. (Maintains 5000 megohms I.R. after three altitude cycles).
- Environmental and electrical integrity is maintained during and after vibration, 0 to 2000 CPS, 15 g's during exposure to 200°C and -55°C.

DESIGN

- AMPHENOL-developed reversion-resistant silicone inserts.
- Impact extruded aluminum shells.
- Three coupling designs: Push-Pull, Bayonet and Screw type.
- Metal-to-Metal bottoming of mated shells.
- Stress-limited resilient displacement of inserts.
- Face seal, insert rim seal and shell peripheral seal ("O" Ring).
- Integral insert and grommet construction.
- Anti-deflection disk.
- Grommet double sealing risers for wire.
- Visual full engagement indicators.
- MIL-C-26636 (USAF) crimp type "Poke Home" contacts.

AMPHENOL

CONNECTOR DIVISION

1830 S. 54th Ave., Chicago 50, Ill.

Amphenol-Borg Electronics Corporation

TO: DEVICE DEVELOPMENT
ENGINEERS

FROM: TEXAS INSTRUMENTS

SEMICONDUCTOR-COMPONENTS
DIVISION OFFERS YOU

1. A Key Position with the Leader of the Field.
2. Real Opportunity for Personal, Professional Advancement.
3. Relaxed Living in Modern Dallas, Texas.

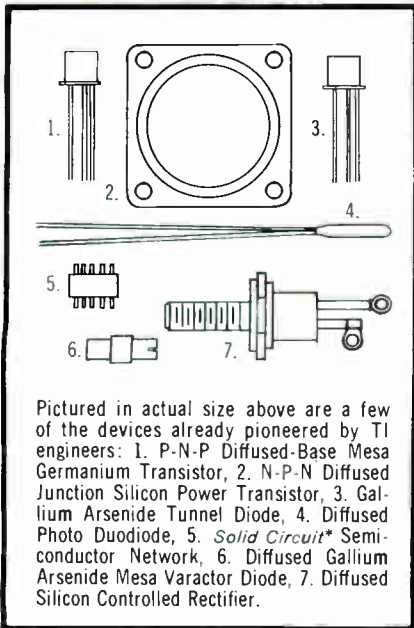

Pictured in actual size above are a few of the devices already pioneered by TI engineers: 1. P-N-P Diffused-Base Mesa Germanium Transistor, 2. N-P-N Diffused Junction Silicon Power Transistor, 3. Gallium Arsenide Tunnel Diode, 4. Diffused Photo Duodiode, 5. Solid Circuit* Semiconductor Network, 6. Diffused Gallium Arsenide Mesa Varactor Diode, 7. Diffused Silicon Controlled Rectifier.

Texas Instruments offers solid state device development engineers the opportunity to pioneer in the application of unique phenomena in semiconductor materials to create specialized components. Studies involve high-speed, high-frequency germanium mesa transistors; tunnel diodes; computer devices; silicon transistors. *Requirements for these key posts:* degree in Electrical Engineering, Physical Chemistry or Physics and experience in semiconductor or related development areas.

INTERVIEWS are scheduled for your area. If the opportunity and challenge of device development at TI intrigues you, please send a confidential summary of your background and your interests to C. A. Besio, Dept. 140.

*Trademark of Texas Instruments Incorporated



TEXAS INSTRUMENTS
INCORPORATED

SEMICONDUCTOR-COMPONENTS DIVISION
POST OFFICE BOX 312 • DALLAS, TEXAS



TEXAS INSTRUMENTS INCORPORATED
Semiconductor-Components Division
Box 312, Dept. 140, Dallas, Texas

Please send me the booklet *TIPS* containing details on career opportunities in my field at TI S-C and information on living in Dallas.

NAME _____

ADDRESS _____

CITY _____ STATE _____

My professional field is _____

My specialty is _____

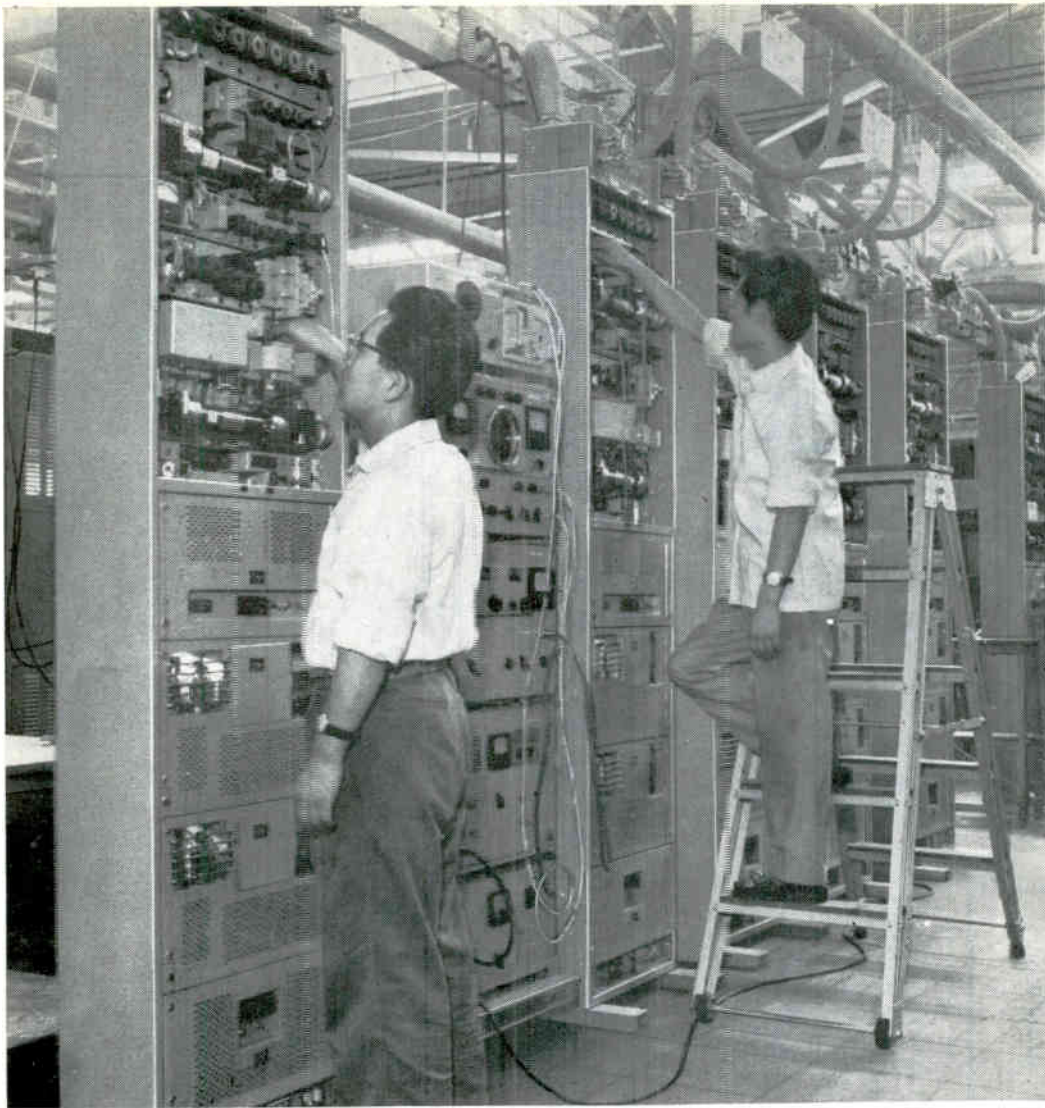

FINAL TEST of 6,000-mc transmitter-receivers at microwave assembly area of NEC factory

Microwave communications systems for 6,000-mc broadband multiplexing

Broadband, long-haul 6,000-mc relay systems are now being installed in Japan. They are the first broadband equipment for commercial use in this band.

NEC is offering this equipment in capacities of 960 and 1,200 telephone channels, and superchannel equipment handling up to 2,400 channels becomes available soon. All meet CCIT requirements for toll-quality transmission.

High stability and reliability are inherent in these features:

- Highly simplified schematic requiring less floor space than any similar equipment.
- Extremely high frequency stability by use of cavity frequency control, eliminating AFC
- Use of microwave diode for receiving frequency converter, improving noise figure

NEC is the only source offering microwave communications systems in all bands from 800 to 14,000 mc. Site engineers are prepared to recommend the most economical system to PTT, military, and commercial users anywhere.

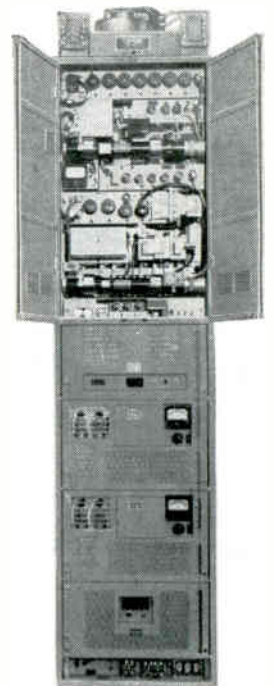

Type 6G-1200 6,000-mc transmitter-receiver provides 1200 telephone channels or 1 color TV channel.



Nippon Electric Company Ltd.

Tokyo, Japan.

Systems / Components

NEW!

HONEYWELL VISICORDER

MODEL 1406*

direct-recording oscillograph



A fourth outstanding instrument has joined the Honeywell Visicorder family—the new Model 1406, an efficient, dependable direct-recording oscillograph capable of recording up to six simultaneous dynamic functions and producing immediately readable permanent records without inks, styli, heat, powders, or chemical processing.

Designed to take full advantage of the ultra-violet Visicorder principle, the 1406 provides today's most advanced recording method at an extremely reasonable price. For only \$1845, you can own a complete six-channel Visicorder, including galvanometers, grid line system, and built-in timer, while a two-channel model is available for just \$1255. Because it is less complex than other Visicorder models, the 1406 greatly reduces the per-channel cost of acquiring and recording data.

* Prices range from \$1145 to \$1845



FEATURES AND SPECIFICATIONS— MODEL 1406 VISICORDER

Now, for the first time, users whose recording requirements lie in the middle frequency range may obtain genuine Visicorder performance without paying a premium for more sophisticated equipment. Depending upon the galvanometers you choose, the 1406 will record variables with frequencies as high as 200 cps, making it the ideal instrument for the majority of applications as found in normal laboratory testing and evaluation. The 1406 is easily tailored to your individual needs; it may be ordered with a choice of galvanometers and record drive speeds, and is available with or without grid line and/or timing systems. In addition, the new Model 1406 provides many user economies—among them, negligible lamp replacement costs and lower power consumption—than upper frequency range instruments.

Use the 1406 for circuit analysis . . . for current studies . . . for a near-infinite number of other applications which you will discover for yourself. As with all Honeywell Visicorders, the 1406's usefulness and versatility are limited only by the imagination of the user.

GALVANOMETERS—Choice of two natural frequencies: 42 or 330 cycles. L42-700—42 cycles; flat within 10% to 25 cycles; sensitivity 30 ua/in \pm 10%; linearity within 5% of full scale deflection (6" peak to peak maximum; 4" single deflection); damping resistance 700 ohm; coil resistance 250 ohm; maximum current 40 ma; may be operated at 500v above ground. L330-120—330 cycle; flat within 10% to 200 cycles; sensitivity 700 ua/in \pm 10%; damping resistance 120 ohm; coil resistance 800 ohm; maximum current 30 ma; other specifications same as L42-700.

BANK—Standard C-type magnet in simple adjustable mount. Dummy filler required for use with less than 6 galvanometers; adjustable reference trace optional for either end of bank.

RECORD PAPER—6" x 100' (standard base) or 6" x 150' (thin base). Uses all popular direct-recording papers.

TIME LINES (Optional)—Flashtube system; instant warm up, no parallax. Full width lines at intervals of 1, .1, and .05 sec., 1, .1, and .05 min., or 1, .1, and .05 hr., depending on choice of record speeds.

RECORD SPEEDS—Standard: 25, 5, 1 and .2"/sec. Also available: 25, 5, 1 and .2"/min.; 25, 5, 1 and 2"/hr.; 100, 50, 25 and 5mm/sec.

GRID LINES (Optional)—Choice of inches or metric. .2" spacing; every 5th line heavier for inch ranges; 5mm spacing with every other line heavier for mm ranges.

WRITING SPEED—to 3500"/sec.; **STATIC TRACE WIDTH**—.03"; **OPTICAL LEVER**—30cm (11.8"); **RECORDING WIDTH**—6" maximum; **LAMP**—70 watt incandescent; **LAMP LIFE**—rated 100 hrs. in high intensity position; **INTENSITY CONTROL**—two-position "high" or "low" switch.

POWER REQUIREMENTS—105-129v AC, 60 cps 200 watt; **OPERATING TEMPERATURE** 32° F to 135° F; **HUMIDITY**—98%; **ALTITUDE**—to 10,000 feet; **DIMENSIONS**—9" x 9" x 12"; **WEIGHT**—25 lbs.

NOW - A VISICORDER FOR EVERY RECORDING NEED

Model 906 Visicorder—906B-1, 14 channels; DC to 5000 cps; 906B-2, 8 channels; DC to 2000 cps. Both on 6" paper.

Model 1108 Visicorder—24 channels from DC to 5000 cps on 8" paper. Many automatic convenience features.

Model 1012 Visicorder—36 channels from DC to 5000 cps on 12" paper. The most versatile recording oscillograph ever made.

Write for your free copy of the 36-page Visicorder Applications Manual, a comprehensive, detailed guide book to many varied uses of the Visicorder.

For further information, including detailed price and delivery data, write:

MINNEAPOLIS-HONEYWELL REGULATOR CO. • INDUSTRIAL PRODUCTS GROUP
Heiland Division, 5200 East Evans Avenue, Denver 22, Colorado

Honeywell

ANOTHER DIAMOND JUBILEE PRODUCT



FROM HONEYWELL



Industrial Products Group



NOW...LOW COST TEST EQUIPMENT PM-FOCUSED TWT'S

Lighter, smaller than solenoid focused versions

For microwave test equipment and other commercial applications, Sylvania now has two S-band PM focused traveling-wave tubes which offer these advantages:

Low Cost Significant price reductions from the level of other PM focused tubes make these units competitive with the price of solenoid, tube, and power supply.

Light Weight These tubes weigh only 3 pounds, compared to the 15 to 35 pounds of a solenoid package.

Small Size The 2 $\frac{1}{4}$ " maximum diameter of these tubes means that they have about half the size, a quarter the volume of solenoids.

Simple Installation Since PM tubes are factory focused, they do not have the installation problems associated with solenoid tubes.

High Performance No electrical performance is sacrificed in attaining the advantages these long-life tubes have over solenoid types: TW-4260 delivers a minimum of 1 watt over the full 2-4 kmc octave, and the TW-4261 achieves 10 mw minimum power and 37 db minimum gain over the same range.

For more information on these or other units in Sylvania's extensive line of TWT's, contact your nearest Sylvania tube sales office or write, wire or phone Sylvania Special Tube Operations, 500 Evelyn Avenue, Mountain View, California.

SYLVANIA

Subsidiary of **GENERAL TELEPHONE & ELECTRONICS**



new
low
prices

**ON WESTINGHOUSE
SILICON POWER
TRANSISTORS**

PRICES
REDUCED
UP TO 40%!

AVAILABLE NOW IN ANY QUANTITY! Now you can have the proven quality and reliability of Westinghouse Silicon Power Transistors at the lowest cost yet. Types 2N1015 and 2N1016 are available in 30, 60, 100, 150 and 200 volt ratings in production quantities to meet your requirements at all times. Because these transistors have **True Voltage Ratings**, they can be operated continuously at full published voltage ratings without risk of failure.

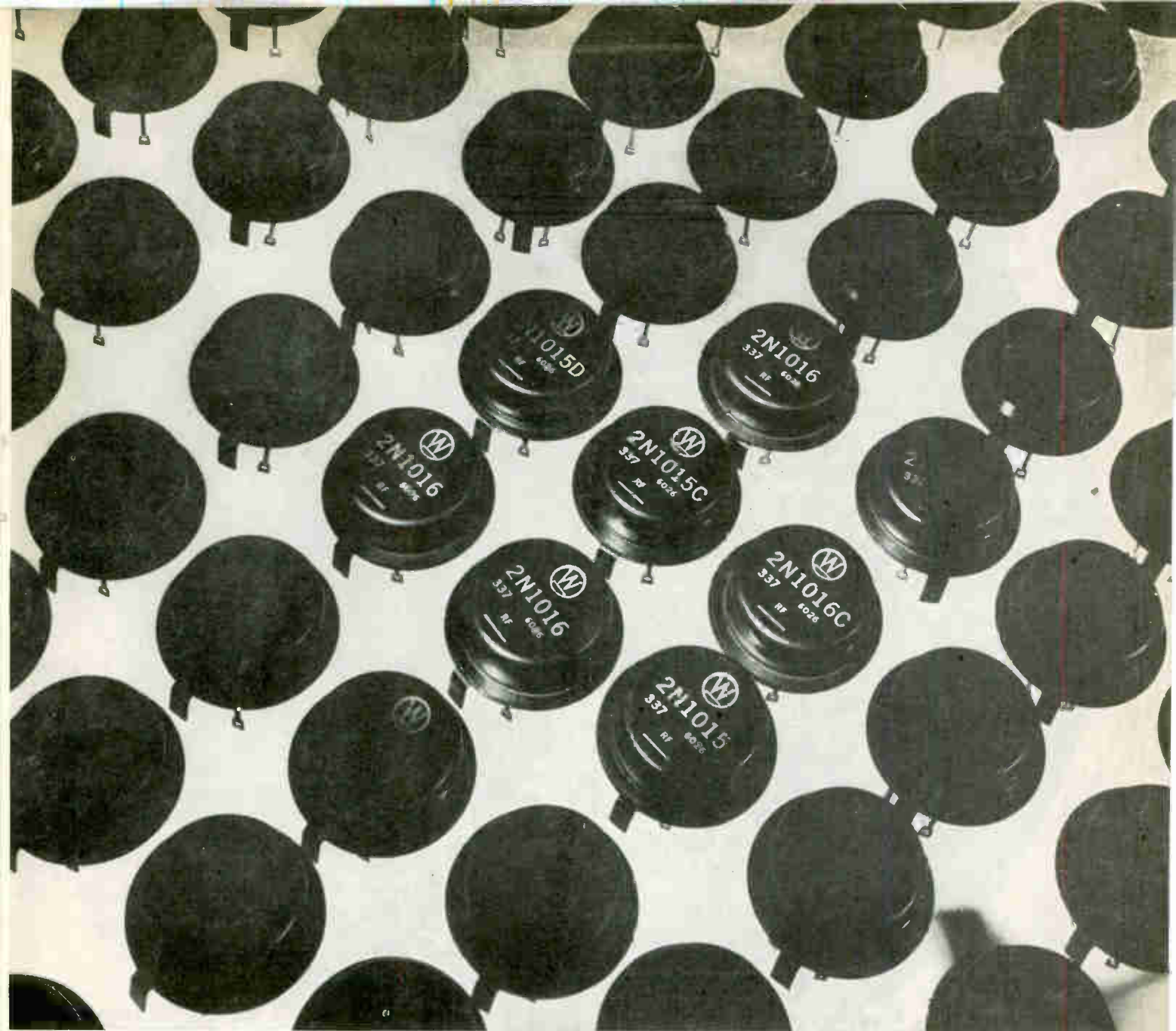

Other Westinghouse Transistor advantages include:

- High Power . . . up to 150 watts
- Collector current to 7.5 amperes
- Junction temperature to 150° C
- Designed to meet or exceed MIL specifications
- Extremely low saturation resistance

Present industrial and military applications include: Inverters • Regulators • Amplifiers • High Power Switching • Telemetry • Guidance • Power supplies.

For additional information, and quotation of new low prices, call your nearest Westinghouse representative or semiconductor distributor. Or write: Westinghouse Electric Corporation, Semiconductor Department, Youngwood, Penna. You can be sure

if it's **Westinghouse** 

SC-1001

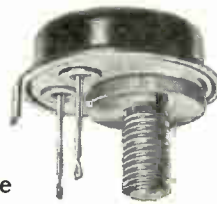

Each Westinghouse Silicon Power Transistor is guaranteed by 100% power testing before shipment.

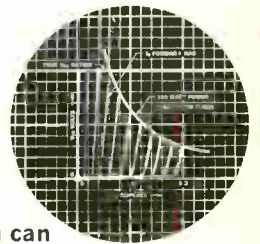

True Voltage Ratings—you can operate Westinghouse Silicon Power Transistors at full rating without risking transistor failure.

For immediate "off-the-shelf" delivery, order from these Westinghouse distributors:

EASTERN

- CAMERADIO Pittsburgh, Pa./EX 1-4000
- CRAMER ELECTRONICS, INC. Boston, Mass./CD 7-4700
- ELECTRONIC SUPPLY Melbourne, Florida/PA 3-1441
- GENERAL RADIO SUPPLY CO., INC. Camden, N.J./WO 4-8560
- KANN-ELLERT ELECTRONICS, INC. Baltimore, Md./TU 9-4242
- MILGRAY ELECTRONICS New York, N.Y./RE 2-4400
- RADIO & ELECTRONIC PARTS CORP. Cleveland, Ohio/UT 1-5060
- SCHWEBER ELECTRONICS Long Island, N.Y./PI 6-6520

MIDWESTERN

- ELECTRONIC COMPONENTS FOR INDUSTRY CO. St. Louis, Mo./WO 2-9917
- INTER-STATE RADIO & SUPPLY CO. Denver 4, Colo./TA 5-8257
- LENERT CO. Houston, Texas/CA 4-2663
- RADIO DISTRIBUTING CO. Indianapolis, Ind./ME 7-5571
- SEMICONDUCTOR SPECIALISTS, INC. Chicago, Ill./HA 2-8860
- UNITED RADIO, INC. Cincinnati, Ohio/MA 1-6530
- WHOLESALE ELECTRONICS SUPPLY Dallas, Texas/TA 4-3001

WESTERN

- ELMAR ELECTRONICS Oakland, Calif./TE 4-3311
- HAMILTON ELECTRO SALES Los Angeles, Calif./BR 2-8453
- NEWARK ELECTRONICS CO. Inglewood, Calif./OR 4-8440



**FIRST
IN
CLASS**

NIKE HERCULES

With deadly accuracy the U.S. Army's new Nike Hercules ground-to-air guided missile streaks out to meet an approaching enemy air force. Its nuclear warhead can wipe out an entire formation.

Western Electric selected Teflon* insulated wire for use in building the alert guidance and control systems of this faster, higher climbing Nike.

As leading specialists in high temperature insulated wires and cables, the men and women at Hitemp are proud of this choice, and the role Teflon wiring plays in giving America a strong new perimeter of defense.

HITEMP WIRES, INC.

1200 SHAMES DRIVE, WESTBURY, NEW YORK

*Du Pont's trade name for Tetrafluoroethylene

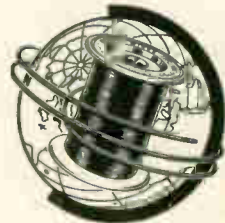

←CIRCLE 57 ON READER SERVICE CARD

CIRCLE 58 ON READER SERVICE CARD

COMPLETE MICROWAVE TELEMETRY SYSTEMS

TRANSMITTERS, RECEIVERS, DISPLAYS, ANTENNAS

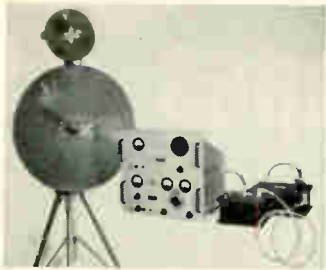

MICROWAVE TRANSMITTER GROUP, 2150 - 2350 mc

The GEL Telemetry Transmitter Group 19A1 features improved frequency stability ($\pm 0.005\%$ under all environmental conditions); true frequency modulation which can operate with FM-FM or PCM data input in accordance with IRIG specifications in addition to voice modulation where required; and operation under severe environmental conditions.

The Transmitter Group consists of 3 components: Basic 4-Watt Transmitter, Power Supply, and 15-Watt Power Amplifier. Installation in airborne vehicles where space is limited mounts these conduction-cooled units on an aluminum plate which in turn is mounted with good thermal contact to the airframe which acts as a heat sink.

FEATURES

- **Frequency Stability:** $\pm 0.005\%$ (all environmental conditions)
- **Modulation:** Operates with FM-FM, FM/PDM FM, PCM
- **Max. Deviation:** ± 0.5 mc
- **Distortion:** Total output distortion not to exceed 1.0%
- **Primary Power:** Either 28 VDC or 110 V, 400 cycles
- **Environmental:** Pressurized for operation up to 80,000 ft.

Operating temperature: -54°C to $+85^{\circ}\text{C}$
 Operation through shock of 100g for 11 milliseconds
 Vibration: 10-500 cps, 10g
 500-2000 cps, 15g



MICROWAVE RECEIVERS, 2150 - 2350 mc

GEL Telemetry Receiver Type 20A1 can be used for reception of FM-FM, PDM-FM, and PCM transmissions at ground installations or in airborne applications.

Operation has been simplified as far as possible; number of operating controls is minimum, compatible with optimum performance. The unit is of the double superheterodyne type with both local oscillators crystal-controlled. Design includes FM capture characteristics, high frequency stability, and variable IF bandwidths. Sub-assembly construction is used for simplicity of servicing in the field. AGC extends dynamic range to 100,000 microvolts or 0.1v of RF signal.

This Receiver provides simultaneous AM and FM video, pre-detection 10 mc IF frequency, signal level recorder, and 60 mc IF for operation of a GEL Type 24A1 Frequency Display Unit.

FEATURES

- **Frequency Stability:** $\pm 0.005\%$ of received frequency using standard MIL CR-33/U crystal without oven
- **Image Rejection:** Greater than 65 db
- **IF Bandwidth:** Plug-in second IF strips with bandwidths of 0.75, 1.5, and 2.0 mc
- **Selectivity:** Response has 60 to 6 db bandwidth of approx. 2.5
- **Interference Immunity:** Highly selective pre-selector for attenuation of interfering signals

FREQUENCY DISPLAY UNIT, SERIES 24

Companion units to GEL Receivers, Types 20A1, 22A1, and 25A1, Series 24 Frequency Display Units feature good resolution, equalization for IF non-linearity ± 3 db, low spurious radiation, edge-lighted scale, and 60 db image rejection. A signal as low as 8 microvolts at the input of the receiver gives full-scale deflection.

Sweep width, center frequency, and gain controls are located below the 3" Cathode Ray Tube. All normally used CRT Controls are front-of-panel screwdriver adjustments protected by an easily removed cover.

FEATURES

- 20 kc Resolution
- Equalization to ± 3 db
- Low Spurious Radiation
- Edge-lighted Scale
- High Sensitivity
- 60 db Image Rejection



MICROWAVE ANTENNAS

The unique GEL Antenna, Model 610-20, is a dual-beamwidth, circularly-polarized receiving antenna with an operating frequency range of 1000 to 2600 mc. This manually operated Antenna consists of two center-fed parabolic reflectors tripod-mounted facing the same direction on a vertical line, with the wide beam reflector above. Both reflectors may be directed simultaneously to any azimuth angle. Tilt adjustment allows elevation angles up to 45 degrees above the horizon. Each reflector is fed by broadband circularly-polarized crossed dipoles. Output of each feed is brought out separately to a 50-ohm Type C female conductor so that either can be connected to an appropriate receiver.



GEL Also Designs and Manufactures a Complete Line of Telemetry Equipment in the VHF Band.

Write for Technical Data Sheets on Compatible GEL Microwave Telemetry Equipment.

ADDRESS ALL INQUIRIES TO:
 General Electronic Labs, Inc.
 8521 Second Avenue
 Silver Spring, Maryland



GENERAL ELECTRONIC
 LABORATORIES, INC.

CAMBRIDGE 42, MASS. SILVER SPRING, MD.

Oscilloscopes

Brilliant Picture
Calibrated Deflection
Stable Triggering

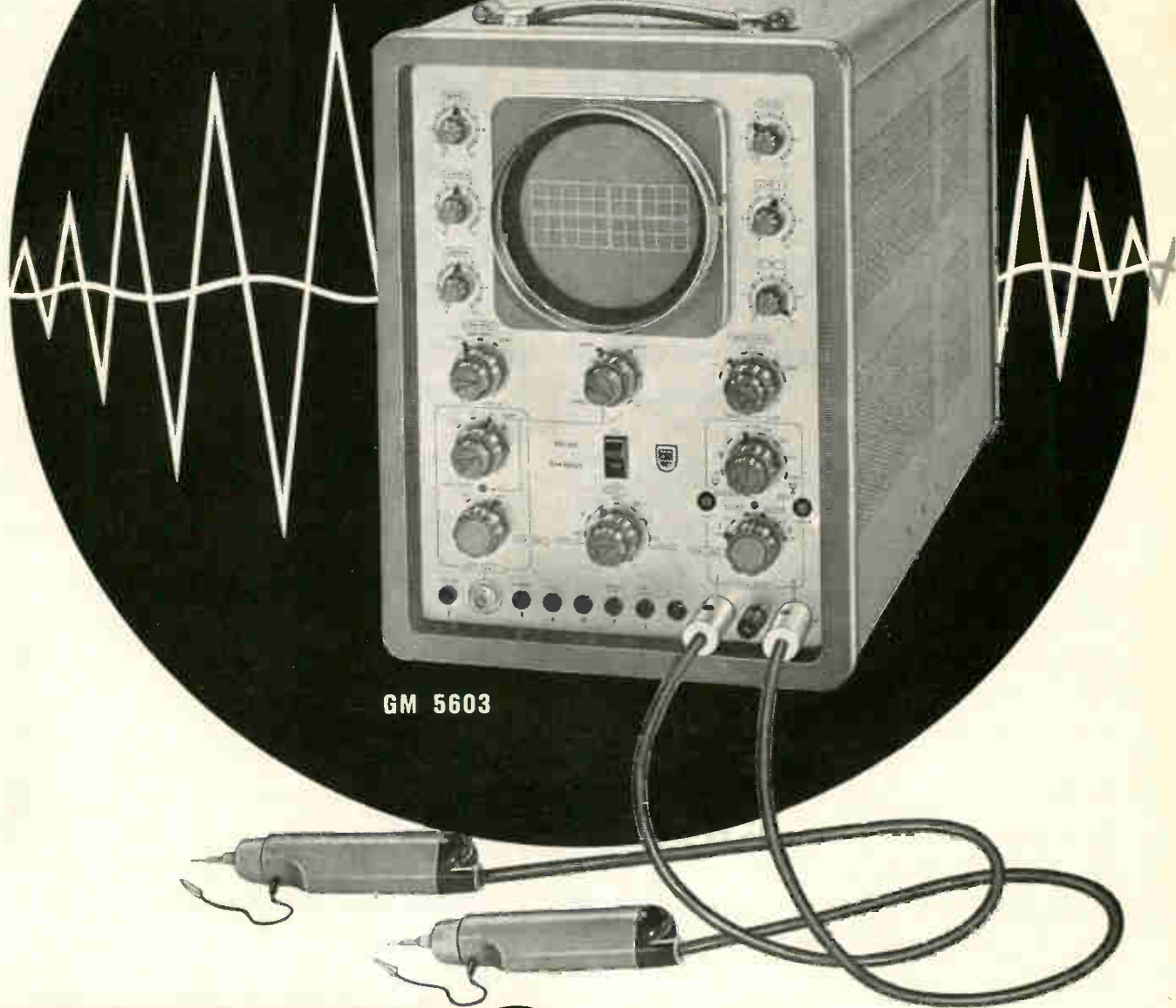

GM 5603

PHILIPS

electronic measuring

Sold and serviced by Philips Organizations all over the world

Further information will gladly be supplied by:

N.V. Philips' Gloeilampenfabrieken, EMA-Department, Eindhoven, the Netherlands

For Canada: Philips Electronics Ind. Ltd., Leaside, Toronto 17, Ont.

HF oscilloscope with differential input, type GM 5603

* Vertical Amplifier

D.C. coupled differential amplifier with a bandwidth up to 15 Mc/s and signal delay

Deflection sensitivity: 50 mV/cm - 5 V/cm in 7 calibrated steps (1 - 2 - 5 sequence) and continuously up to at least 15 V/cm.

Accuracy of calibration: within 3%.

Bandwidth: 0 - 15 Mc/s (AC coupled 2 c/s - 15 Mc/s), rise time: 25 m μ sec.

Signal delay: obtained by a 0.3 μ s symmetrical delay line.

Input: selection of input I or input II single-ended, or I - II differential, all AC or DC coupled.

Input impedance: 1 Megohm in parallel with 25 μ F.

Rejection factor: 1000 for frequencies up to 100 kc/s.

* Probes

Two attenuator- and two DC coupled cathode follower probes are delivered with the instrument

The attenuator probes increase the voltage range up to 600 V at maximum deflection.

Attenuation: 10 : 1.

Input impedance: 5 Megohms in parallel with 9 μ F.

Using the cathode follower probes full sensitivity (50 mV/cm) is maintained.

Input impedance: 0.5 Megohms in parallel with 5 μ F.

* Sweep Generator

* Twenty-one calibrated sweep velocities and calibrated expansion

Sweep range: 0.2 μ s/cm - 1 s/cm in 21 calibrated steps (1 - 2 - 5 sequence) and continuously.

Accuracy of time measurements: within 3%.

Expansion: x2 or x5 (accuracy \pm 5%) and continuously; fastest sweep 40 m μ sec/cm.

* Triggering

Optimum trigger stability up to 2 Mc/s and HF sync up to at least 15 Mc/s

Trigger facilities: internal, external or mains frequency on pos. or neg. slopes.

Trigger requirements: 5 mm at internal or 1 V at external triggering for frequencies up to 2 Mc/s.

* Horizontal amplifier

Bandwidth: 0 - 2 Mc/s (AC coupled 1 c/s - 2 Mc/s).

Deflection sensitivity: 1 V/cm.

Input impedance: 1 Megohm in parallel with 25 μ F.

* Cathode Ray Tube

10 kV E.H.T. applied to the spiral accelerator of the 5" C.R.T.

Tube type DN 13-78 (medium persistence), other phosphors available.

* Mains Supply

From all normal mains supplies between 110 V and 245 V (40 c/s - 100 c/s).

3 others from our range



H.F. OSCILLOSCOPE, TYPE GM 5801

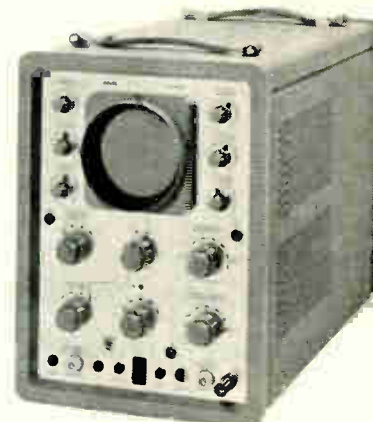

H.F. OSCILLOSCOPE, TYPE GM 5602



L.F. OSCILLOSCOPE, TYPE GM 5606

instruments: quality tools for industry and research

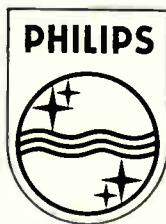

3

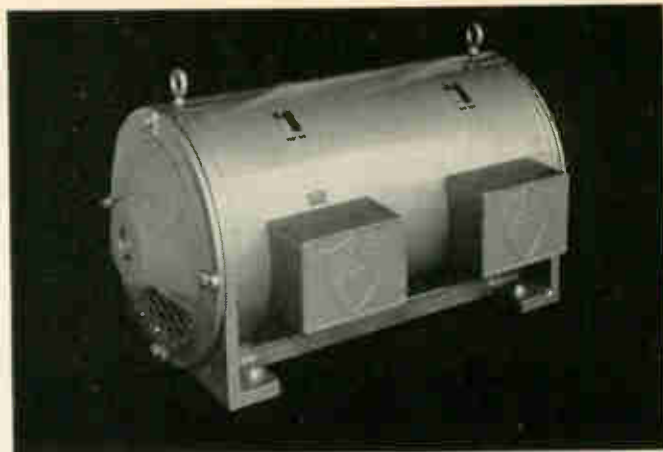

NEW STANDARD 2 BEARING GENERATOR

STANDOUTS IN BRUSHLESS ALTERNATORS

*...for precise H/F power
...compact, trouble-free design
...rugged reliability*

American Electronics' years of motor/generator design and manufacturing experience has resulted in the development of a complete line of inductor alternators with a performance record of maximum efficiency at minimum cost. More than 8000 units in operation today, providing years of dependable service, testify to the quality features engineered into these H/F power supply units by AEI.

More compact in design than units of comparable ratings—versatile in application, and completely reliable in performance—AEI inductor alternators use NO BRUSHES, NO SPRINGS, NO MOVING COILS—operate virtually maintenance free!

AEI standard inductor alternators are available in sizes from 500 watts to 30 kva offering precise 400



TYPICAL GENERATOR FOR H-F INDUSTRIAL INSTALLATIONS



AC-DC SUPPLY FOR AIRCRAFT OR MISSILE COMPONENT CHECK-OUT

cycle single or 3 phase power. Standard designs provide voltages automatically regulated to $\pm 1\%$. Requirement for $\pm 1/2\%$ can also be supplied. Standard voltage adjustment is $\pm 10\%$. Standard rotating field alternators in sizes from 500 watts to 120 kva, with fixed or variable output frequencies ranging from 250 to 10,000 cycles, are in production.

When your high frequency power needs call for precision power delivered with trouble-free reliability, specify alternator units developed by American Electronics, Inc. Write or call for our new *Rotary Power brochure*, which gives the complete story on these and other power supply units.

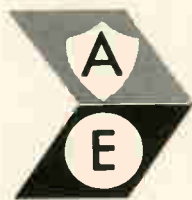

AMERICAN ELECTRONICS, INC.

PRECISION POWER DIVISION

9705 KLINGERMAN STREET, EL MONTE, CALIFORNIA — Cumberland 3-7721

NOW, A PRICE BREAK-THROUGH IN METAL FILM RESISTORS

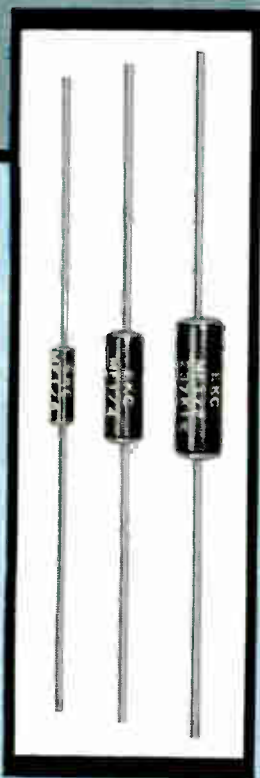

NEW

Electra

**METAL FILM
RESISTOR**

with 0 ± 150 ppm temperature coefficient

Now you can get the extreme precision and extreme ruggedness of a metal film resistor at prices up to 60% lower than former costs. Thanks to advanced production techniques, Electra can now offer you a metal film resistor with 0 ± 150 ppm TC in tolerances of 1% and $\frac{1}{2}\%$ at prices far below those for any other metal film resistor on the market today. This outstanding new resistor is available in the following sizes and ranges:

MF $\frac{1}{8}$ 30 ohms to 500K ohms
MF $\frac{1}{4}$ 50 ohms to 1 megohm
MF $\frac{1}{2}$ 50 ohms to 1.5 megohm

Here is a resistor that gives you precision equal to or exceeding the precision of a wire wound resistor, yet it is smaller in size, gives you better RF performance. And now, it is far, far lower in price. Why not write, wire or call now for complete details. (Available with special molded jacket shown or with exclusive Electra R-5 coating.)

ELECTRA

4051 Broadway Westport 1-6864 Kansas City, Mo.

Manufacturing Company

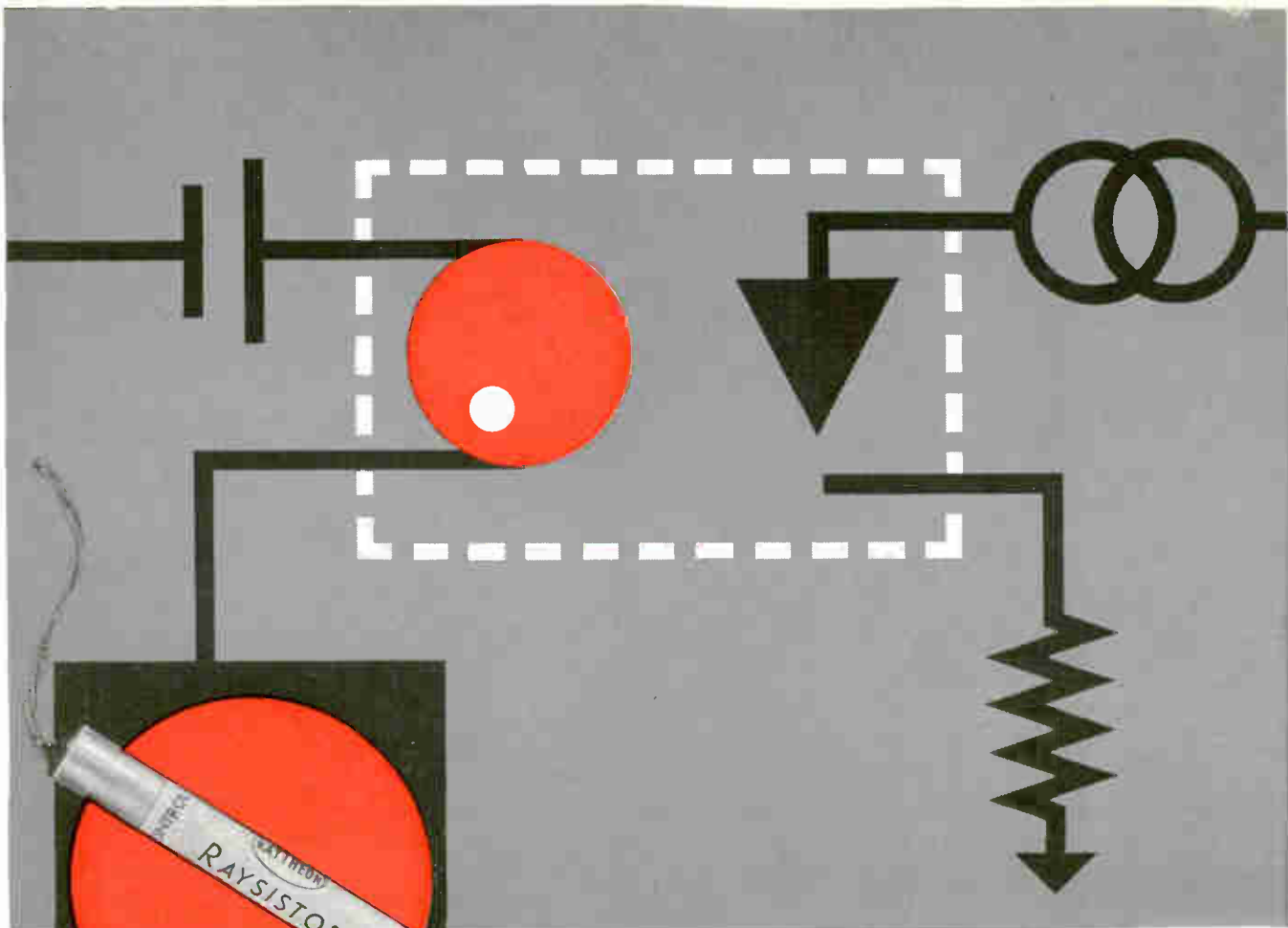

**REPLACES RELAYS,
SWITCHES
AND POTENTIOMETERS
FOR LOW-NOISE
COMMUTATING,
SWITCHING,
AND
CONTROLLING CIRCUITS**

RAYTHEON

RAYTHEON^{*} RAYSISTOR

a new basic circuit component

The Raytheon Raysistor* can turn signals on and off with virtual isolation from switching transients and carriers. The control circuit of the Raysistor* consists of a light source which when excited lowers the resistance of a semiconductor device in the signal circuit allowing an AC or DC signal to pass. This new Raytheon development provides design engineers with the advantages of high signal-to-noise ratio, wide dynamic range, isolation between signal and control circuits, and long life.

For technical information, please write to: Raytheon, Industrial Components Division, 55 Chapel St., Newton 58, Mass.

*TRADEMARK

RAYTHEON COMPANY

.....
INDUSTRIAL COMPONENTS DIVISION

Sensitive Capacitance Intruder Alarm

All-semiconductor alarm detects intruder by sensing his body capacitance. Fail-safe system features bridge, phase-detector and rate-sensitive circuits

By SAMUEL M. BAGNO, Chief Engineer,
Kidde Ultrasonic & Detection Alarms Div.,
Walter Kidde & Co., Inc., Clifton, N. J.



Typical installation shows alarm unit mounted on protected cabinets

THIS alarm system works by sensing the change of capacitance to ground caused by the approach of an intruder to the area protected by the system. The change that is sensed is on the order of 10 pf. A typical cabinet protected by the alarm has a capacitance to ground in the order of 200 pf.

Several features have been designed into this alarm. It is reliable—failing to detect a burglar can be serious; it does not produce false alarms—these are a costly nuisance; it is fail-safe—a malfunction in the system sounds an alert; it detects a 10-pf change in 8,000 pf—this enables it to protect many cabinets.

The alarm circuit is shown in Fig. 1. Oscillator Q_1 feeds 20 Kc to a bridge circuit which contains C_1 , the capacitance-to-ground of the protected cabinet. The parallel capacitance of C_1 and capacitors C_2 and C_3 form one leg of the bridge. Capacitors C_4 and C_5 comprise another bridge leg. The other two legs are formed by the two sections of potentiometer R_1 . When the bridge becomes unbalanced, the bridge feeds a 20-Kc signal to amplifier Q_2 .

The output of Q_2 goes to a phase-sensitive detector which converts the bridge unbalance signal into a d-c voltage, the polarity of which depends on the direction of unbalance. The phase-sensitive detector, which includes diodes D_1 and D_2 , makes the system relatively independent of the power factor of the capacitance in the vicinity of the protected cabinet. Thus the detector is unaffected by humidity or other conditions which might upset the bridge balance by introducing an out-of-phase component. Since the phase-sensitive detector does not respond to an out-of-phase component, its output provides a sharp null. Another advantage of the phase detector is that it is insensitive to external electrical disturbances that might be picked up by the protected cabinets acting as an antenna. This reduces the hazard of false alarms. The d-c output of the phase detector is amplified by Q_3 . This transistor is normally so biased that the 1-ma meter in its

collector circuit reads half scale when the bridge is balanced.

The output of Q_3 is capacitance-coupled to *pnp*-transistor Q_4 and *npn*-transistor Q_5 . The collectors of these transistors are connected in series with relay K_1 . With the bridge balanced, about 1 ma flows through this relay keeping it energized. If an intruder approaches the cabinet, increasing its capacitance, the output of the phase-sensitive detector becomes more negative. This causes the collector voltage of Q_3 to go more positive.

This potential increase is fed through the two 2,000- μ f capacitors (C_6 and C_7) and R_2 to the base of Q_4 . The base of Q_4 is pushed toward its emitter potential. This decreases Q_4 's collector current, causing relay K_1 to drop out and sound an alarm.

If one of the protected cabinets is disconnected, the capacitance of the protected surface decreases. This decrease causes the output of the phase-sensitive detector to increase. Therefore, amplifier Q_3 acts on the base of Q_5 , decreasing its collector current. Consequently, relay K_1 drops out and gives an alarm. Thus, an alarm occurs with either an increase or decrease of the capacitance of C_1 .

The oscillator consists of a tuned oscillating transformer (T_1) wound on a ferrite core. The transformer has four windings, L_1 through L_4 . Winding L_2 is a feedback winding which feeds the base of Q_1 through R_3 and C_{11} . Resistors R_3 and R_1 form a voltage divider to provide the proper bias for Q_1 . Windings L_2 and L_3 provide 20-Kc voltages of opposite polarity to the phase detector. Winding L_4 feeds the bridge circuit.

One end of L_1 is connected to the external capacitance (capacitance-to-ground of the protected surface) through L_5 and a wire that forms a loop. The purpose of the loop is to provide protection against tampering with the protected circuit so that if the loop is cut, the bridge becomes permanently unbalanced by a large amount.

Choke coils L_6 and L_7 , with capacitors C_2 and C_3 , form a filter circuit tending to keep any r-f picked up by the protected line from getting into the base of the amplifier Q_2 . R-f pickup may be caused by powerful radio or television transmitters in the vicinity

of the protected area. Such signals may reach a magnitude of several volts, and unless an effort is made to filter out such signals, they can interfere seriously with the operation of the system by reducing sensitivity or generating false alarms. Since the frequency of such signals are on the order of one megacycle or higher, they are filtered from the 20-Kc capacitance-alarm frequency by the low-pass filter consisting of L_6 , L_7 , C_2 and C_3 .

Output of the bridge is applied to the base of amplifier Q_2 . The output is filtered with a 500-pf capacitor (C_4) to remove any residual r-f pickup and is coupled to the phase detector by capacitor C_{10} and resistor R_4 .

Oscillator coil L_8 , which is also used as part of the oscillator feedback circuit, feeds diode D_1 . Oscillator coil L_9 feeds diode D_2 , 180 degrees out-of-phase with the voltage fed to D_1 . Thus, the two diodes are fed from the oscillator in a push-pull manner. The signal coming from Q_2 also goes to these diodes. Since the signal from Q_2 is in synchronism with the oscillator voltage when the bridge is balanced, it reinforces equally the oscillator-coil signals that feed the diodes. Polarity of these diodes is such that current flow through the paralleled resistor and capacitor (R_6 and C_{11}) combination between the base of Q_3 and ground, is equal in both directions. Therefore, when the bridge is balanced, the voltage at the base of Q_3 remains constant even when unwanted electrical signals are picked up by the protected cabinets, which can act as an antenna; this eliminates a possible cause of false alarm.

If the bridge is so set up that it does not apply voltage to Q_2 , the diode currents cancel and there is no voltage change across the R-C combination between the base of Q_3 and ground.

However, if the bridge is unbalanced, the unbalanced voltage amplified by Q_2 , adds to the signal applied to one rectifier while it subtracts from the other. This causes an unbalance which produces a positive or negative signal, depending on the direction of unbalance. These positive and negative signals are added at the base of Q_3 after passing through the two 10,000-ohm resistors, R_7 and R_8 .

This phase detector does not recognize a signal from Q_2 that is 90 degrees out-of-phase with the signal coming from the two 50-turn windings because such a signal adds equally on both rectifiers and cancels out at the base of Q_3 . Since such a quadrature component stems from resistance and leakage losses, the phase-sensitive detector tends to cancel out effects other than direct changes in capacitance.

The d-c signal from the phase detector is fed to the base of Q_3 and amplified. From Q_3 , the signal is capacitance-coupled to Q_4 and Q_5 as described above. Capacitors C_6 and C_7 are electrolytic types. Excessive d-c leaking through this capacitor to the base of Q_4 , makes Q_4 insensitive to changes in the collector voltage of Q_3 . Such a condition might occur if there were a single coupled electrolytic capacitor between the collector of Q_3 and the base of Q_4 . The circuit used minimizes this possibility because the d-c resistance of C_6 is very high in comparison to 100,000-ohm resistor R_6 shunting the other end of it to ground. Thus any leakage current in C_6 is bypassed to ground through R_6 . However, sudden changes will not be blocked.

To maintain the proper relay current as well as the proper operating current through Q_3 , both Q_3 and Q_4 are temperature regulated. This is accomplished by the circuit which includes thermistor TH_1 and resistor R_{10} as a voltage divider across the battery supply. The tap between the thermistor and R_{10} is fed to the base of Q_3 through R_{11} and to the base of Q_4 through R_{12} . In this way the voltage bias of each transistor is adjusted so as to compensate for temperature changes within the transistors themselves.

The capacitance-alarm housing may be grounded, or connected to the antenna loop to protect the capacitance alarm unit.

A grounded housing is recommended when the unit has to be mounted on a grounded wall or when it is undesirable to make the housing sensitive. (The connection of the cabinet to ground or to the antenna loop may affect the initial balance settings.)

To provide protection of the telephone lines (Fig. 2), the ground terminal of the capacitance alarm unit should be connected to ground

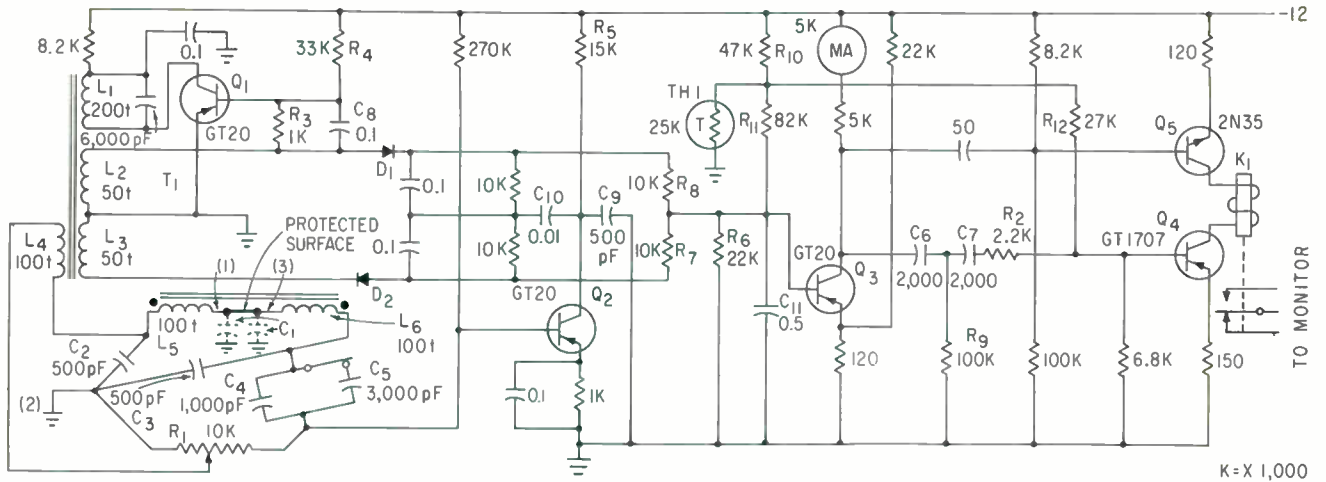

FIG. 1—All active devices of capacitance alarm are semiconductors

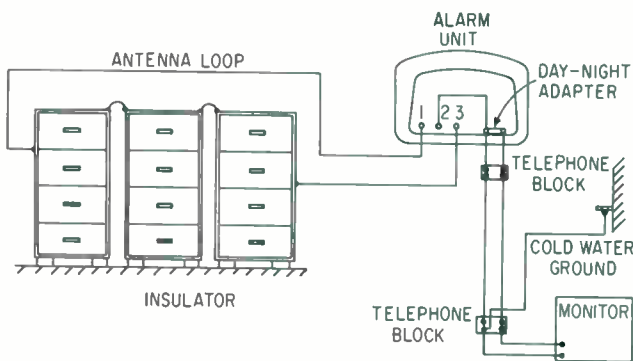

FIG. 2—Alarm system setup. Alarm unit is generally near protected cabinets

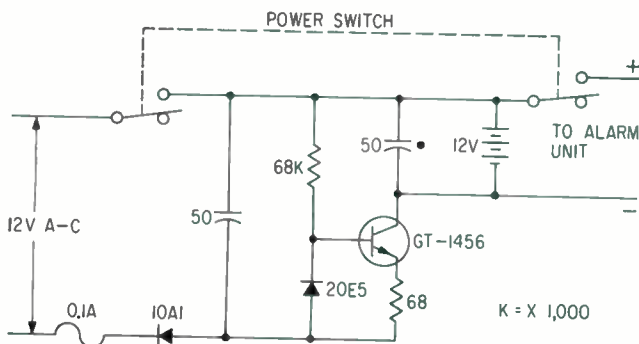
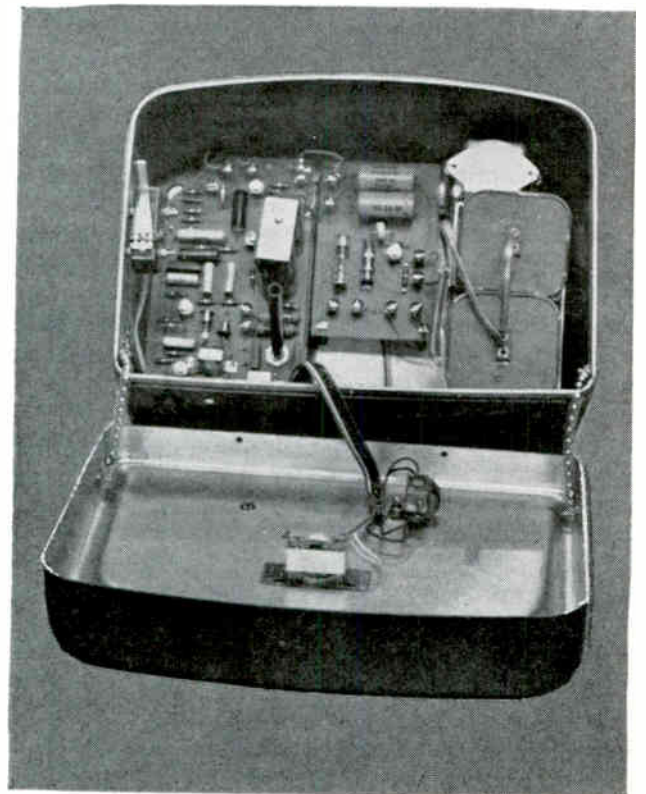

FIG. 3—Power supply has stand-by battery in case of line-power failure



Interior view of alarm unit. The standby batteries are at its right-hand side

through one of the leads connecting the unit to the monitoring equipment.

Some of the more unusual features of this system will now be summarized. External pickup—which had to be eliminated because of the sensitivity of the bridge circuit—was eliminated by using the dual filter and the phase detector. The dual filter presents a negligible impedance to the measuring circuit, but presents a very high impedance to any pickup.

A problem that had to be over-

come was to make the phase detector output insensitive to ambient weather conditions. This is accomplished by using a rate circuit. This rate circuit, which consists of R-C coupling between the bridge output and the relay stage, presented a problem in the original design version. It was quite satisfactory for relatively fast changes in capacitance, but capacitor leakage obviated its use for slow capacitance changes. The effect of leakage was overcome by using a two-stage filter.

If an ordinary detector of a bridge unbalance were used, rather than a phase detector, in conjunction with this rate-distinguishing circuit, the rate discrimination would be limited to a small range around one side of the bridge unbalance. On the other hand, the d-c output of the phase detector varies directly as the capacitance change, making the rate circuit effective over the entire range.

A battery standby circuit (Fig. 3) protects against false alarms caused by power failure.

PROJECTILE TELEMETRY

ONE OF THE CENTRAL problems of interior ballistic instrumentation is the measurement of the pressure on the base of a projectile (or motor pressure in a rocket) and the resultant acceleration developed during firing. Suitable pressure gages can be obtained, but built-in conventional radio-frequency telemeters will not work because their information-bearing radio waves will not propagate up the gun barrel. Microwave generators that can produce frequencies above cutoff for the gun barrel, on the other hand, are not rugged enough to stand the accelerations of 5,000 to 50,000 g's or more which are experienced in conventional gun firings.

One solution for extracting acceleration information uses a wire or coaxial transmission system in the gun barrel to transmit the output of the gages to the recording apparatus'. The method currently in use at BRI is to externally generate a microwave beam and transmit it along the gun barrel to a projectile, where variations in the reflection coefficient of a ferrite device in the projectile nose modulate the reflected microwave signal. The modulated signal reflected from the projectile is then demodulated in the ground station to recover the information.

Transistor oscillator and driver circuits in the projectile convert the output of a variable capacitance gage to an f-m subcarrier signal suitable for modulating the microwave beam. This system has been used successfully in firings of 2.75 inch gun-boostered rockets.

The major elements of the microwave modulation system are shown in Fig. 1A. The transmitter supplies carriers of high enough frequency to allow propagation down gun barrels as small as 37 mm. This requires a frequency of at least 5,000 Mc, but the frequency actually used in these experiments, 24,000 Mc, allows simultaneous high-resolution microwave interferometry.

About 10 milliwatts output power with fluctuations in amplitude and frequency of less than one-percent per millisecond is adequate. The

signal must be equally divided at the magic tee between the antenna arm and the reference signal arm. The reference signal arm uses an attenuator and a phase shifter to produce a signal of controlled amplitude and phase at the detector, as required for correct operation of the interferometer.

The antenna is located about 15 feet in front of the gun with its axis at right angles to the line of fire. The reflector is an aluminum sheet on the line of fire which directs the beam into the gun barrel and is replaced after each round. A 15-inch parabola, constructed and mounted to withstand the shock of gun blast, produces a beam which converges to a focus at the mouth of the gun. It is desired to maintain the width of the beam at focus comparable to the gun barrel diameter, as the net signal loss between antenna and gun must be kept less than 20 db.

The signal level in the gun barrel is a function of position, fluctuating as much as ± 10 db primarily as a result of mode interference and multiple reflection within the gun barrel. Presence of microwave scattering objects near the muzzle can make the fluctuation even larger. The microwave system must be designed and operated to keep these effects within the range level that can be compensated by the automatic gain control and limiting circuits of the discriminator.

The detector input consists of the reflected signal from the projectile with about twenty-percent amplitude modulation, as well as the reference signal for the interferometer. The interferometer output frequency goes from zero to about 150 Kc as the projectile velocity increases from zero to about 3,000 ft/sec, and usually has a magnitude of about 10 mv. The telemetering subcarrier is at about 300 Kc, and is at a 2-millivolt level. Fluctuations in the subcarrier level are caused by mixing with the interferometer signal and also by the effects of mode interference in the gun barrel. That part of the amplitude fluctuation which lies within the 15-Kc pass band of the telemetering receiver must be smoothed by the agc and

limiters of the discriminator amplifier.

The interferometer signal is recorded on film after amplification in a wide-band amplifier and then displayed on an oscilloscope. Fluctuations in signal level are relatively unimportant provided the d-c level does not shift, so agc is not required. The telemetering signal must be shifted to 70 Kc after amplification in the telemetering receiver at 300 Kc, a local oscillator and mixer being used for this purpose. The 70 Kc signal is recorded directly on film or tape, as well as being demodulated in the discriminator, so that a record of fast fluctuations that are smoothed in the discriminator can be obtained.

The components within the projectile are the gage, oscillator, the amplifier and modulator as shown in Fig. 1. The gage is required to produce a frequency shift proportional to pressure (or to acceleration) consistent with the standard fm/fm telemetering system requirements. The maximum allowable deviation of a 70-Kc subcarrier is about 10 Kc, which is a little over three percent of the microwave modulation frequency. A variable capacitance gage can meet this requirement, as well as the need for ruggedness and axial symmetry brought about by the high acceleration and spin of gun-launched projectiles. A further restriction on gage design originates in the need for a characteristic frequency high compared to that of the reciprocal of rise time fluctuations sometimes found in the pressure or acceleration. These fluctuations may have a rise time as short as one-tenth millisecond.

The primary requirement placed on the oscillator, amplifier and modulator is that they must be able to survive the stresses of the projectile acceleration and spin. The oscillator, in addition, must show frequency shifts during firing which are less than five percent of those produced by the gage. A transistor version of the Clapp oscillator using coils of high dimensional stability comes closest to meeting these requirements.

WITH MICROWAVES

To determine projectile acceleration during firing, an externally-generated microwave signal is aimed down the gun barrel and reflected back by a special head on the projectile. Reflected signal contains acceleration data

By W. M. KENDRICK and L. A. PETERS, Ballistic Research Laboratories, Aberdeen Proving Ground, Maryland.

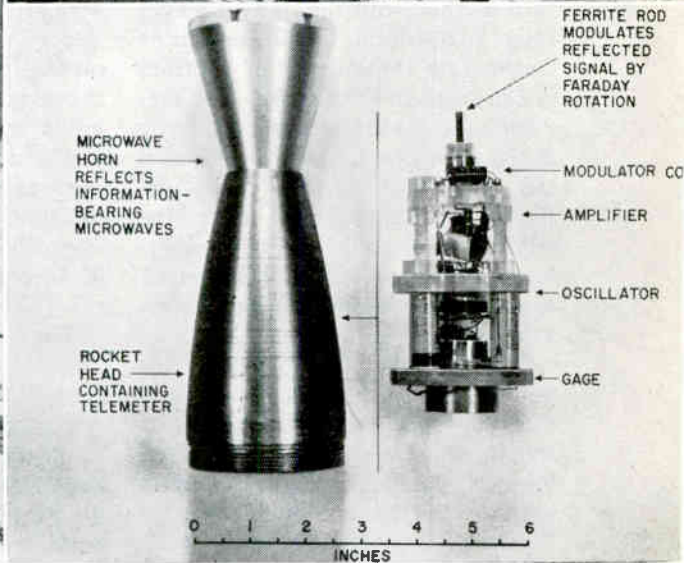
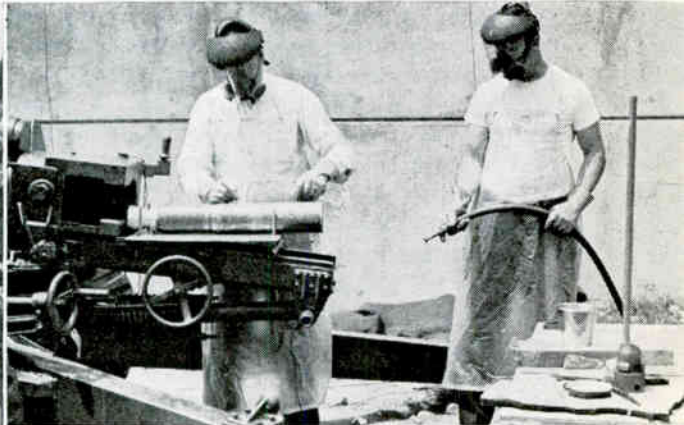
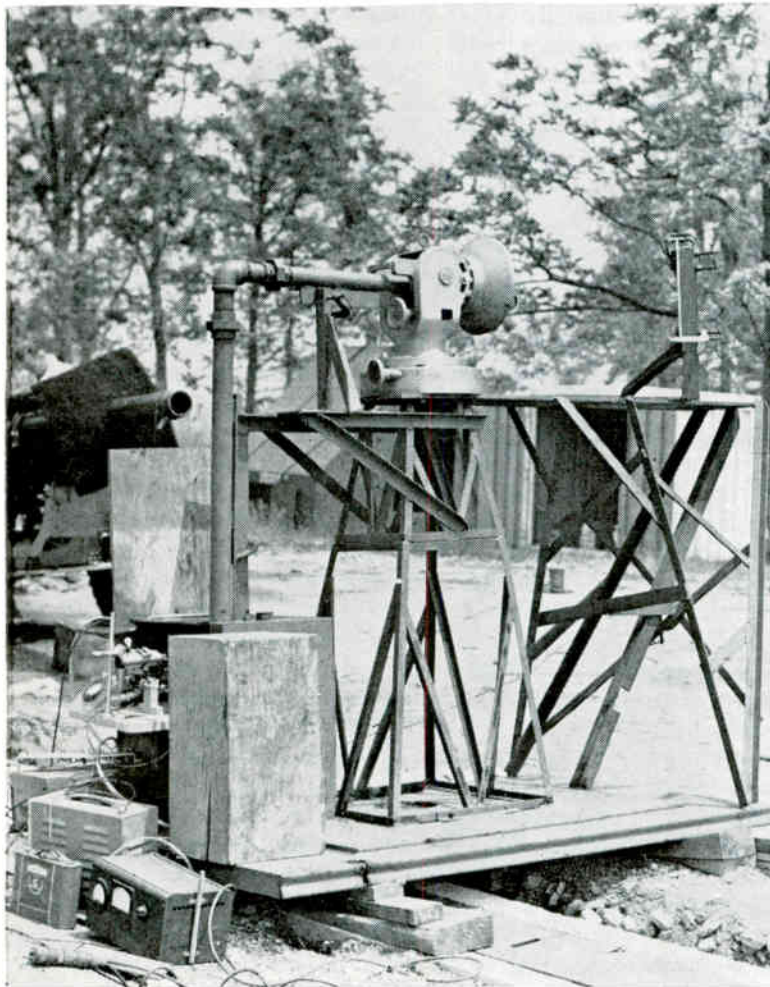

Microwave transmitter with howitzer in background, left; an experimental liquid propellant is loaded into the cartridge case, top right; and a typical projectile showing reflecting horn and un-potted pressure transducer, bottom right

The amplifier converts the low-level oscillator output to a value adequate for the ferrite modulator current requirement of about 50 ma. In addition, it serves as a buffer to isolate the oscillator from the effects of variations in the modulator coil inductance. Transistors of high gain at the operating frequency and having high current capability, such as are found among the diffused or mesa types, are the first choice here.

The ferrite modulator must be capable of operation at the relatively high modulation frequency of approximately 300 Kc. It must have the lowest possible loss at modulation frequency as well as at the microwave frequency. To minimize drain on the battery power supply, it is desirable to minimize current at the expense of some of the other parameters, such as length. The performance of the modulator must be

independent of the polarization of the microwaves, since the spinning projectile makes several rotations while travelling up the barrel. The mechanical properties of the modulator must be such that it can withstand the forces due to spin and acceleration, which may be more than 10,000 g's. In addition, a reasonably high Curie temperature of the ferrite is required.

Modulation of the microwave

beam is obtained through the Faraday rotation effect in a microwave ferrite. When a plane polarized wave is transmitted through a ferrite rod in a circular waveguide, the plane of polarization of the wave can be rotated by varying the strength of a longitudinal magnetic field about the rod. The ferrite in this application is a non-reciprocal device and the sense of rotation will depend only on the direction of the alternating field, while the amount of rotation depends on the strength of the field. A portion of the microwave beam incident on the projectile is transmitted through the ferrite rod with a rotation approaching 45 degrees at maximum. The wave is reflected at the end of the ferrite and transmitted back through the ferrite with an equal rotation in the same sense.

The rotated beam can be resolved into two components at right angles, one of them along the original direction of polarization. Only this component reaches the detector, along with that portion of the beam which was simply reflected from the face of the projectile. These waves form a resultant whose amplitude depends on the amount of rotation of the wave in the ferrite. The frequency of the alternating magnetic field applied to the rod depends on the frequency of the gage-controlled oscillator, and thus the microwave beam is amplitude modulated at a frequency dependent on the gage and ultimately on accelerating pressures.

The amount of rotation of the microwaves in a given ferrite material depends on the dimensions of the ferrite and on the strength of the applied field. The type of ferrite used in the modulator is General Ceramics type R-1, which is suitable for use at the operating frequency of 24,000 Mc. The diameter of the rod must be small enough to prevent multiple-mode propagation, but as the smallest available rod of R-1 was one-eighth inch, this diameter was used. At the operating frequency, it is capable of propagating a second mode, but careful design prevents this. The rod is kept as short as possible to minimize transmission loss and save space.

To get the desired 90-degree rotation at peak current, an adequate magnetic field strength must be developed. Figure 2A shows rotation

versus field strength measured in the R-1 ferrite at 24,000 Mc. For a ferrite length of 1 cm, 15 amp-turns gives 45 degrees rotation to the transmitted wave while an additional 45 degrees is imparted to the reflected wave. To diminish drain on the battery and to operate at a low current level, a coil with the largest possible number of turns per cm is used. A 250-turn coil 1-cm long allows limiting the peak current to 60 ma. This coil has, with the ferrite core, an impedance of about 2,300 ohms at 300 Kc, thus requiring about 140 volts to drive the required current through it. This exceeds the voltage breakdown limit of the amplifier transistors. By making the modulator coil the inductive element of a series resonant circuit, the required voltage can be developed.

The microwave horn used in the nose of the projectile for picking up and reradiating the beam is of conventional design. A plastic cover plate on the front serves as a windshield. The ferrite rod is matched to the horn by a quarter-wave transformer, and before entering the Teflon cylinder about which the modulator coil is wound, passes through a close-fitting metal wave guide which helps suppress undesirable mode phenomena. A typical horn and modulator assembly is illustrated in Fig. 2B. The reflected signal has a modulation percentage of 10 percent or more over a band of ± 200 Mc about 24,000 Mc.

The curve given in Fig. 2A shows that approximately 60 ma peak of current are required to produce 90 degrees rotation of the microwaves propagating in the ferrite. Among the transistors capable of supplying the required output at 300 Kc, we have successfully used the 2N547 and the 2N498. A circuit diagram showing the 2N498 amplifier and a 2N336 oscillator is shown in Fig. 1B. The oscillator shown in this diagram uses the Clapp circuit.² With a coil having a given inductance and Q factor, this circuit has a greater frequency stability than the more familiar Hartley and Colpitts circuits. When projectiles are fired at 10,000 g's peak acceleration using fixed mica capacitors instead of gages, typical drifts of 1 Kc at an operating frequency of 1 Mc are obtained.

The battery is required to supply

40 ma at 16 volts with an operating life of one hour. These requirements are easily met by using four 4-volt mercury batteries in series. These batteries, which are rated at 400 ma-hours and 40 ma maximum drain are composed of three cells with welded connecting straps.

The base pressure gages used in these firings were variable capacitance diaphragm gages of a type especially developed in this laboratory for this application. In the factors that contribute to low cost, such as straightforwardness of design, small amount of close machine work, and ease of assembly and calibration, the variable capacitance gage is comparable to the variable reluctance type.

The design of the gage is controlled by the factors of sensitivity, lowest natural diaphragm resonance frequency and initial capacitance.

The equations customarily used in diaphragm gage design are based on those for deflection of a thin diaphragm clamped at its edges.³ A diaphragm may be considered thin if its thickness is less than one-tenth its radius, which is very far from the case with our gages. The effects of excessive ratio of diaphragm thickness to radius are to make the gage have greater sensitivity and lower resonant frequency than the formulas indicate. The design of the gage is corrected empirically to allow for these effects. The design finally arrived at for a typical pressure gage had a lowest diaphragm resonance of 36 Kc, a sensitivity sufficient to produce an oscillator frequency shift of 2 Kc per 1,000 psi, a range of 10,000 psi and an initial capacitance of 20 pF.

The microwave interferometer is a continuous wave Doppler radar which provides a position-time record of the motion of a projectile. A 24,000 Mc signal of a few milliwatts power is radiated down a gun barrel where it is reflected from a blunt-nosed projectile. As the projectile moves, the reflected signal is shifted in frequency by the amount $f = 2vf/c$, where v is the velocity of the projectile, f is the klystron frequency and c is the velocity of light. The maximum shift of frequency will be 500 Kc. The reflected signal is mixed with a portion of the transmitted signal of controlled amplitude and phase, and the difference frequency is recorded.

The minimum useful received power is dependent on the required bandwidth, which in turn is governed by the characteristics of the telemetered information. The bandwidth may be as much as 10 Kc in the 70 Kc telemetering band. For a range of 1,000 yards, with an antenna gain of 20-db, a c-w transmitter power of approximately one Kw is required. This is available at 3 cm, while for longer ranges, higher power generators are available at lower frequencies.

The above calculations assume that all of the power is available to convey information, which would not be true even with 100-percent amplitude modulation. They also assume that the projectile scatters radiation isotropically, which is much less favorable than the actual case when the projectile beam pickup horn is reasonably large. These two factors tend to cancel, leaving the results of the above calculations substantially unchanged.

The output of the detector is a mixture of the interferometer signal and the telemetering subcarrier. This latter is partially amplitude modulated by the interferometer and requires filtering and amplification in a suitable agc amplifier before going to the discriminator. This unit is a conventional pulse-counting discriminator, and its output, after further filtering is displayed on an oscilloscope for photographic recording. The bandwidth of this much of the system is 50 Kc. It is convenient to convert the 300-Kc subcarrier at the output of the agc amplifier to 70 Kc for direct recording on film and for processing through a commercial subcarrier amplifier and discriminator. The bandwidth for this portion of the system is about 20 Kc. The gages are designed to give deviations within this limit under the anticipated pressures or accelerations, but fluctuations beyond the design limits may occur in experimental firings and the greater bandwidth of the discriminator is desirable in spite of its greater noise level.

The authors were aided in the development of the ferrite modulator by Mr. I. Olin of NRL, who was formerly stationed at BRL during a tour of military service. Mr. P. Sellers of BRL contributed substantially to the electronic and mechanical design.

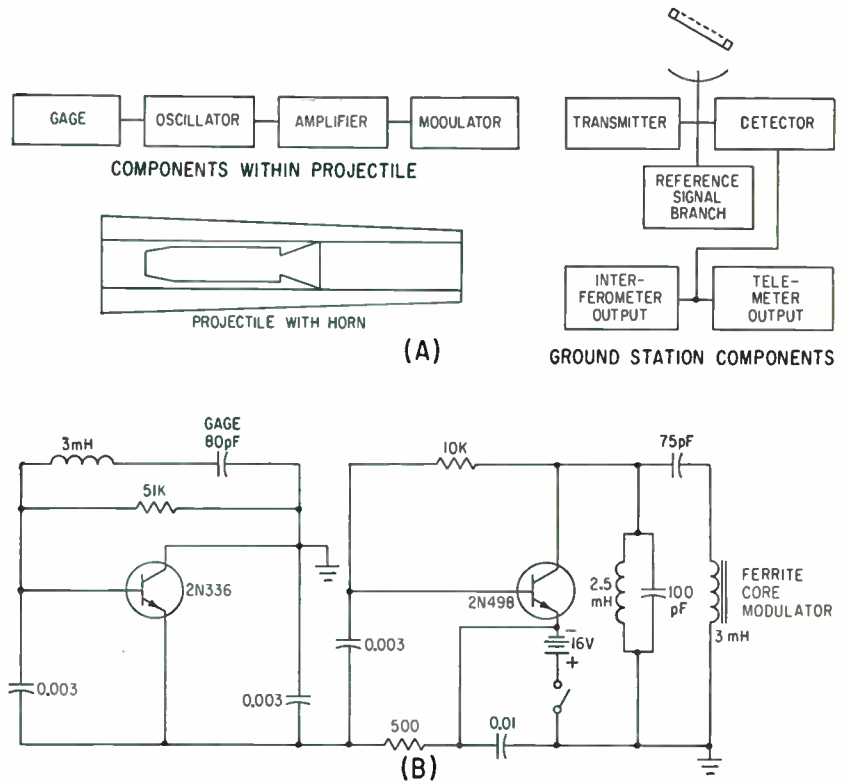

FIG. 1—Projectile contains components that amplitude-modulate the oncoming microwaves according to accelerating force, while ground station extracts information from the reflected signal, (A); encapsulated transducer system modulates the amplitude of reflected microwaves at a frequency dependent on projectile acceleration (B)

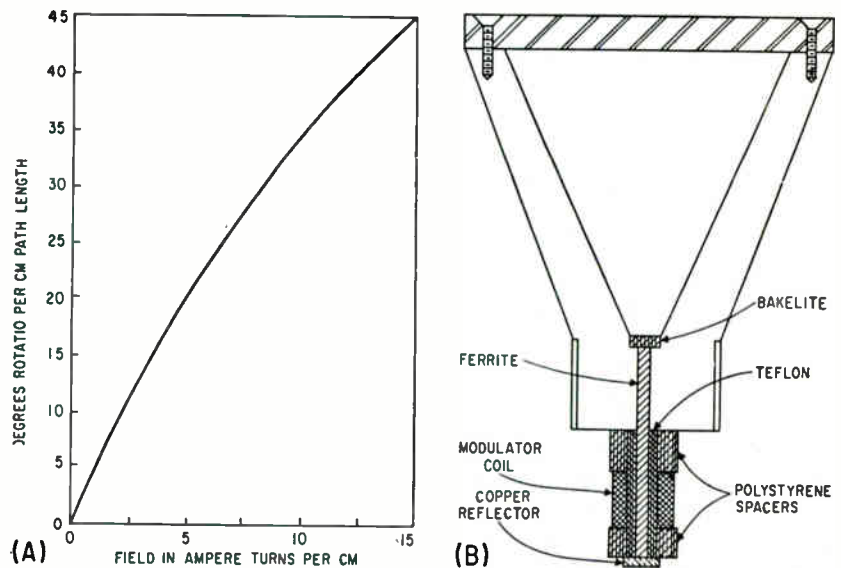
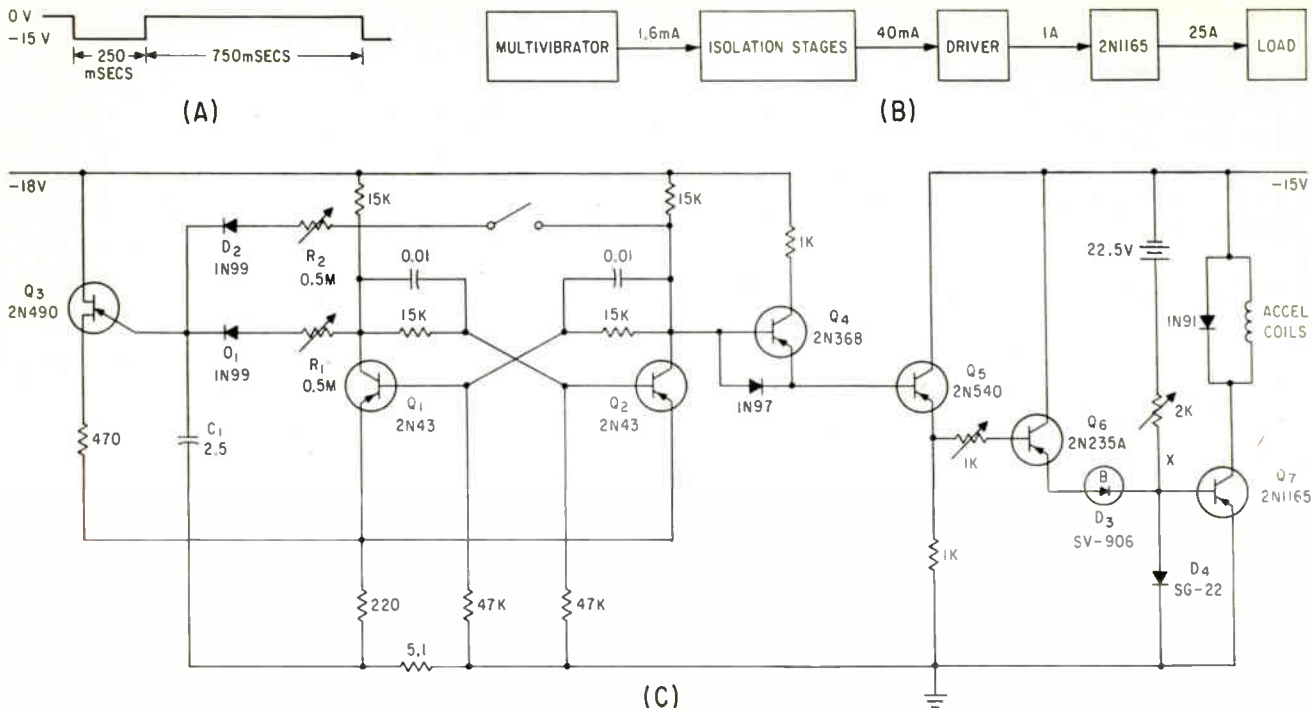

FIG. 2—Sum of forward rotation and that occurring during reflection attain 90 degrees at 15 ampere-turns per cm (A); modulator coil introduces Faraday rotation—hence amplitude modulation of returned signal—at a frequency proportional to the projectile accelerating force (B)

REFERENCES

- (1) W. M. Kendrick and L. A. Peters, Interior Ballistic Telemetering, Aberdeen Proving Ground: BRL Memorandum Report No. 1183, December 1958.

- (2) W. A. Edson, "Vacuum Tube Oscillators", See 8.9, John Wiley and Sons Inc., New York, 1953.
- (3) T. A. Perls, A New Condenser Type Pressure Gage, The David Taylor Model Basin Report No. 629, June 1949.



Waveform (A) shows desired output of high-current switch. Block diagram (B) indicates gain of 25 in each stage. Hybrid multivibrator in switch schematic (C) produces the required unsymmetrical input

By CHARLES H. PRICE, JR., Northeastern University, Boston, Mass.

High-Current Solid-State Switches

Transistor circuit based on hybrid multivibrator energizes falling-sphere accelerometer

SPECIFICATIONS for energizing a density-sensing, falling-sphere accelerometer¹ required a switch capable of handling large currents at 10 to 20 volts. Initially the switching operation was performed by a mechanical switch, driven by a motor and cam at about one revolution per second. The load consisted of four coils in parallel presenting an impedance of $0.561 + j0.033$ ohms. The required output voltage waveform across the coils is seen in Fig. A.

When the coils are deenergized, a large inductive pulse occurs, which is used as a triggering pulse after differentiation. Transient spikes in the arc discharge when the switch is opened often cause erratic triggering before the inductive pulse takes place. Efforts to eliminate the random triggering while retaining the timing pulse were not satisfactory.

A solid-state switch seemed nec-

essary, not only to perform the switching operation, but also to reduce current drain, eliminate arc size. Due to the small load impedance, 0.5 ohm, the switch must exhibit a much lower impedance during conduction, to avoid excessive power dissipation in the switch.

Using a nominal gain figure of 25 per stage, a preliminary block diagram of the circuit was formulated, Fig. B. A hybrid multivibrator² with two *pnp* transistors in a conventional flip-flop and a 2N490 unijunction transistor as a timer and trigger for the flip-flop, was used to obtain the necessary unsymmetrical input. The operation of the unit (Fig. C) is as follows: Assume Q_1 is cut off, then the voltage at the collector of Q_1 equals the supply voltage. Since Q_2 is ON, the potential V_{ce} is small if driven to saturation. Timing capacitor C_1 charges up through R_1 until the potential reaches a value

high enough to fire unijunction transistor Q_3 . The negative pulse developed at the emitters of Q_1 and Q_2 forces Q_2 to cutoff while Q_1 tends to turn ON. The collector of Q_2 drops to the supply potential and this negative pulse is fed to the base of Q_1 , which then turns ON. The collector of Q_1 then rises toward the saturation voltage and this positive-going pulse drives Q_2 further into cutoff. This switching occurs almost instantaneously. The flip-flop remains in this state (250 msec) while C_1 charges up through R_2 and D_2 until Q_3 once more is triggered. The switching action recurs, returning Q_1 and Q_2 to their original states. Diode D_1 isolates R_1 from the timing circuit during this period. During the alternate period, D_2 isolates R_2 from the charging circuit. The adaptation of the hybrid multivibrator produced exactly the type of waveform required. Current drain is only

ABOUT FALLING-SPHERE ACCELEROMETERS

A technique for obtaining the density of the upper air by measuring the drag of a falling sphere caused by atmospheric density was developed by the upper-atmosphere research group in the Department of Mathematics at the University of Michigan, and is described in detail in the first reference at the end of the accompanying article.

Aerodynamic drag and gravitational attraction are the forces acting on a free-falling sphere, the density of which is large compared to that of the atmosphere. The gravitational attraction force on the sphere can be calculated by a computer, leaving only the drag force to be measured, since lateral forces due to spinning and tumbling are considered negligible due to the relatively long periods of spin and tumble.

Sphere acceleration can be measured with respect to various reference bodies. Using a DOVAP

(Doppler velocity and position) system, the earth is the reference body. If the reference body is within the sphere, then in a free fall both bodies will experience the same acceleration of gravity. If the drag of the reference body is made negligibly small, the difference will be the drag acceleration of the sphere. Thus, the relative acceleration of the sphere and the reference body is the difference in their respective drag accelerations. Considerations of aerodynamic and mechanical simplicity, range of measurement, and accuracy led to the choice of the free-falling internal-reference-body system, which constitutes a transit-time accelerometer. Such a system contributes negligible drag to the reference body.

The sensing unit of the transit-time accelerometer is a bobbin which is allowed to free-fall a distance of 0.188 inches, regardless of accelerometer orientation. The bobbin is centered in a cavity by two pick-up fingers, actuated by large currents flowing through pick-up

coils. When the bobbin falls, it experiences the same gravity force as the sphere. However, the drag force acting on the bobbin during the 0.188-inch fall is negligible. Periodically during the free-fall the accelerometer delivers two pulses to a modulator. The first corresponds to bobbin release, the second occurs when the bobbin makes contact with the cavity. When these two pulses are received at the ground station, calculations may then be made to determine the drag acceleration and density experienced by the sphere, and the altitude at which they occurred.

To correlate the density data with altitude, peak time is obtained from tracking radar data. Numerical integration of the equations of motion of the sphere, both forward and backward in time from peak time, yields velocity as a function of flight time. A second integration yields sphere position with respect to flight time. In the vicinity of peak time, a vacuum trajectory is assumed

3.8 ma during OFF time. When the pickup arms of the accelerometer are energized, they do not hold the bobbin securely when the first contact is made. They do, however, bounce away from the bobbin and return to make contact again. A damped oscillation occurs, and experiments have shown that the unit finally stabilizes in 150 to 200 msec, hence the reason for the 250-msec pickup time.

The load placed across the output of Q_5 , consisting of the driver and power amplifier stages Q_6 and Q_7 , causes excessive shunting of Q_5 collector current, which prevents flip-flop operation. A cascaded emitter follower provides isolation between trigger and driver stages.

A 2N540 grounded-emitter is used in the isolation stage Q_5 due to its large current-handling requirement. The diode 1N97 permits both transistors Q_6 and Q_7 to be cut off by permitting the base of Q_5 to become positive and thus provide all of its leakage current. Without the diode, the base current of Q_5 would only approach zero and not reverse, giving amplified leakage current in Q_5 when Q_5 is cut off.³

The output of Q_5 is fed into the

base of Q_6 through a 1,000-ohm potentiometer driver control, then amplified in Q_6 to current levels sufficient to drive Q_7 to saturation. Excessive heating of Q_7 necessitates the use of reverse bias to prevent thermal runaway.⁴ Reverse bias is obtained from the 22.5-volt battery in series with the variable 2,000-ohm potentiometer and the SG-22 stabistor. The drop across the stabistor remains at about +0.65 volts over wide variations in the bias supply voltage, effectively biasing the final stage to cutoff.

The Zener diode D_3 has a dual function in this circuit. A circulating current which tends to flow from the 22.5 volt battery to the junction point X, through the emitter and collector of Q_6 , is blocked by D_3 . The negative ON pulse coming from the emitter of Q_6 is also blocked until the Zener anode-to-cathode potential reaches the avalanche breakdown point (-6.2 to -8 volts). The negative ON pulse then cuts off the stabistor, D_3 , removing the reverse bias from Q_7 , and drives Q_7 to saturation. A large pulse of collector current then flows through the accelerometer coils, providing the ampere-turns needed

to energize the accelerometer.

Using a 2N1165 in the final power switching stage, a saturation resistance of 1/33.8 ohms is obtainable. Such a low resistance across the switch allows current of 33.8 - j 1.37 amps to flow through the load. The useful power to the load is 610 watts, and the saturation resistance is 0.0296 ohms. The power dissipated in the transistor is about 33.85 watts at these values of collector voltage and current.

This solid-state switch is small in size and weight, withstands high acceleration loading, and requires a minimum of standby power.

The author wishes to express his appreciation to Mr. R. B. E. Moren of Wentworth Institute and Professors L. Nardone and A. Bailey of Northeastern University for their technical assistance.

REFERENCES

- (1) L. M. Jones and F. L. Bartman, A Simplified Falling Sphere Method for Upper Air Density, AFCRC-TN-56-497, p 9, June 1956.
- (2) T. P. Sylvan, Transistor Hybrid Timing Circuit, *Electronic Design*, p 22, June 1959.
- (3) Howard T. Mooers, Design Procedures for Power Transistors, Minneapolis Honeywell Regulator Company, TR77C, p 15, 1 Feb. 1956.
- (4) Richard B. Hurley, "Junction Transistor Electronics," John Wiley and Sons, Inc., New York, N. Y., p 162, 1958.

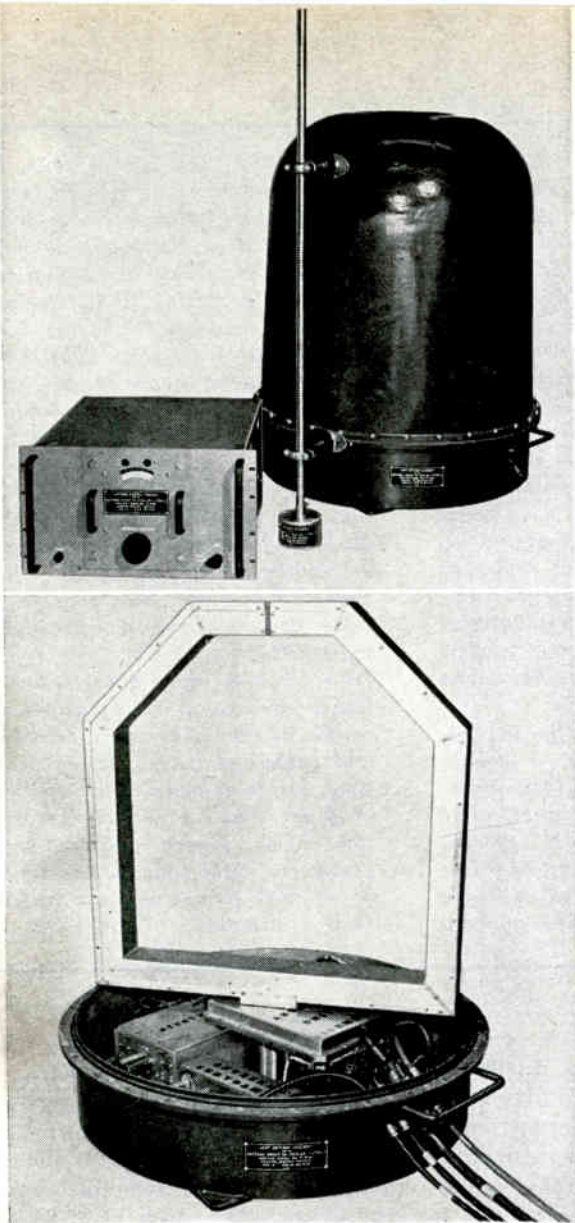

FIG. 1—Loop antenna and associated components are contained within glass fiber radome (top). The loop antenna shield (bottom) has removable covers

Although the antenna of this direction finder has only four square feet of loop area, it indicates bearings with less than one degree of error at frequencies between 15 and 500 Kc

By L. E. ORSAK,

Research Engineer, Stanford Research Inst., Menlo Park, California

D. W. MARTIN,

Project Engineer, Vidar Corp., Palo Alto, California

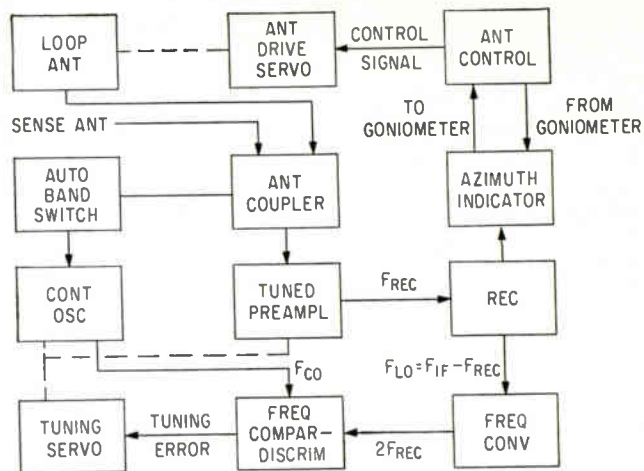

FIG. 2—The radio receiver and azimuth indicator are conventional military equipment. Sense antenna removes ambiguity of bearing indication

Direction Finding

RECENT EMPHASIS placed on the low-frequency radio spectrum by navigation and communication systems has created a need for a radio direction finder capable of operating over the range between 15 and 500 Kc. The direction finder to be discussed uses a physically small rotating loop antenna with only 4 square feet of loop area having a sensitivity of $1 \mu\text{V/m}$ at 500 Kc and $40 \mu\text{V/m}$ at 15 Kc (Fig. 1). Instrument error is less than 1 degree.

In the past, low-frequency radio direction finders operating below about 200 Kc have not been used extensively. However, improved direction finders to operate to as low as 15 Kc and below are now in demand. Most low-frequency radio direction finders use large crossed-loop antenna systems, which require relatively large and permanent complex site installations. The vertical antenna arrays (such as the Adcock system using several masts in a circular configuration) that are used at frequencies above several hundred kilocycles become inoperative at the lower frequencies because of prohibitively high antenna output impedance levels.

The overall system, shown in Fig. 2, also includes a radio receiver and

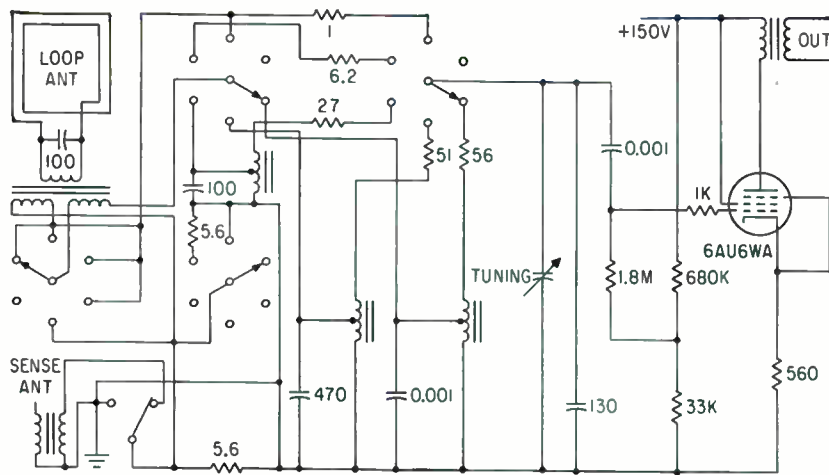

FIG. 3—Preamplifier has resonated loop antenna in grid circuit. Output of preamplifier connects to remainder of system through 100-ohm balanced transmission line, 100-ft long

at Low Frequencies

azimuth indicator which are conventional military equipment and are mentioned only to explain their function in the complete system.

Obtaining satisfactory performance from a small rotating-loop antenna poses several interesting design problems. First, an efficient antenna and antenna coupling circuit must be designed to obtain the maximum antenna gain; second, automatic synchronous tuning of antenna and preamplifier with the receiver is necessary; and third, accurate position control of the antenna must be accomplished to minimize instrument errors in the bearing indication.

From the standpoint of signal-to-noise ratio, maximum tuned-loop antenna gain requires the antenna Q to be the highest allowed by system-bandwidth considerations and also requires a lossless antenna coupling circuit. The desired antenna Q can be obtained, but the lossless coupling circuit is not physically realizable. The problem is to minimize the coupling circuit losses. In addition to the small losses required, the coupling circuit is further complicated by the need for the antenna to rotate freely (slip rings are not feasible due to

the noise introduced). To give efficient operation as well as reasonable bandwidth, the design goal for the overall antenna circuit, as viewed from the tuning capacitor terminals, is Q of 130 at 500 Kc, decreasing as \sqrt{f} to approximately 25 at 15 Kc. Considerable design effort was required to obtain this goal at 500 Kc. After this goal was attained, performance at the lower frequencies was easily achieved.

A shielded antenna was required to take advantage of the isolation afforded by the shielded loop from local effects of static noise, site obstructions and discontinuities. Providing a shield for the loop required careful consideration of a fabrication method that would result in a high Q winding inside a shield. The size (cross-section) and thickness of the shield were determined by the allowable electrical losses in the shield. A polygon configuration was chosen for the antenna instead of the more usual circular configuration, so that the shield could be provided with removable covers for winding a low-loss antenna inside. The antenna winding is supported by spacers placed in the corners of the polygon which allow the turns to be symmetrically spaced from the

shield as well as from each other. This winding configuration minimizes the losses resulting from turn-to-turn conduction and distributed capacitance. Litz wire is used to reduce the conductor losses. The resultant loop has the physical configuration shown in Fig. 1 and a Q of 200 at 500 Kc decreasing to 30 at 15 Kc.

A rotary transformer was devised to efficiently couple the rotating loop to the stationary antenna tuning capacitor and preamplifier. The design criteria for this transformer are very low losses, tight coupling, no resolution (no variation of parameters with antenna rotation), and turns ratio sufficient to transform the high- Q antenna inductance to a value suitable for resonating with the available tuning capacitors. The rotary transformer consists of a two-piece ferrite cup core assembly with the primary and secondary windings wound on concentric nylon bobbins placed inside each cup core. The primary winding and its associated ferrite core are mounted on the antenna drive shaft, which in turn is supported by two precision angular-contact ball bearings. These two bearings are preloaded so that the antenna drive shaft has less than 0.001-in. end play. This eliminates any large gap in the transformer core outer shell and prevents leakage into the surrounding aluminum housing. An air gap of approximately $\frac{1}{8}$ -in. is introduced into the magnetic path in the resulting core assembly by grinding down the center post of each core. The length of this air gap to a large extent determines the Q of the windings and the coefficient of coupling between primary and secondary. This relatively large gap in the center post of the core also appears magnetically in series with the small gap in the outer shell and therefore reduces the effect of possible minor variations in the small gap dimension due to mechanical misalignment.

The resulting rotary transformer allows the high- Q rotating loop antenna to be tuned by a conventional tuning capacitor with no indication of detuning as the antenna is rotated; that is, the rotary transformer has no angular resolution.

The resulting transformer has a coefficient of coupling of 0.9 and winding Q's of 250 at 500 Kc, approximately. The rotary transformer is used exclusively from 125 to 500 Kc. Additional autotransformers are required below 125 Kc to step up the antenna inductance to a value suitable for resonating with the tuning capacitor being used.

The resulting coupling circuit couples the high-Q antenna to the tuning capacitor and preamplifier with only 3 db loss in signal-to-noise ratio. This indicates that the loss in the rotary transformer was no greater than the loss in the high-Q loop antenna. This is found to be the case at 300 Kc where the antenna Q is 200 and the transformer winding Q's are approximately 250.

Sufficient antenna gain results from the use of the high-Q antenna so that noise contributions in the succeeding preamplifier are negligible. The sensitivity of the system is therefore determined entirely by the sensitivity of the high-Q antenna and coupling circuit.

The preamplifier, shown in Fig. 3, is a simple plate-loaded pentode with the resonated loop antenna in its grid circuit. Sufficient gain is provided by the preamplifier so that noise contributions in the receiver are negligible. Stability of preamplifier gain is ensured by negative feedback. The output of the preamplifier is matched to a 100-ohm balanced transmission line by a wideband (15-1,000 Kc) ferrite plate transformer. The received signal can be transmitted over this transmission line from the remote antenna to the receiver. In the system constructed, the distance between the antenna and receiver is 100 feet.

The automatic tuning system was designed for use with a tuned loop antenna physically separated from the receiver. In this system, the first variable local-oscillator frequency indicates the frequency to which the receiver is tuned, while a control oscillator ganged to the antenna tuning capacitor indicates the frequency to which the antenna is tuned. Receiver and antenna tuning are indicated by these two signal frequencies, which can be transmitted to any conveniently located

tuning control servomechanism. Several desirable features of this method include: absence of mechanical connection to the receiver tuning mechanism, the only connection to the receiver is made to the first local oscillator (an existing test jack in the case of the receiver used); there is no problem with finite resolution or non-linearities as would be the case, for example, if wirewound potentiometers were used as pick-off devices; and tracking between antenna tuning and control oscillator is determined primarily by the tracking of two sections of a high-quality variable capacitor. Antenna tuning is therefore accurately indicated by the control oscillator frequency.

The tuning system is shown in Fig. 4. The value of the control oscillator frequency is selected to be twice the antenna tuning frequency so that no interference with the received signal occurs.

The first local oscillator signal from the receiver is fed into a frequency converter, where the signal is first doubled in frequency by passing it through a simple full-wave rectifier. The output of the doubler is heterodyned with the output of a crystal oscillator operating at a frequency of 20 Mc, exactly twice the first i-f of the receiver. The difference signal produced by beating signals equal to twice the first local oscillator frequency and twice the first intermediate frequency is equal to exactly twice the frequency to which the receiver is tuned.

The control oscillator shares a multi-section tuning capacitor with the antenna tuning. These two capacitor sections are accurately tracked. However, the inductor in the oscillator resonant circuit fixes the oscillator frequency at exactly twice the frequency to which the antenna is tuned.

The control oscillator output is coupled to a 100-ohm balanced transmission line by a wideband ferrite transformer (same as the preamplifier plate transformer). The signal is then transmitted to the tuning servomechanism.

The tuning servomechanism functions to keep the output of the frequency converter and the output of the control oscillator very nearly

equal in frequency by proper rotation of the tuning capacitor. These two signals are the inputs to an electronic switch in the tuning system (refer to Fig. 3) which switches between the two inputs in less than one μ sec. The switching action is controlled by the 60-cps line frequency used as excitation for the servo-motor and tachometer generator.

The electronic switch output is amplified then limited by D_1 and D_2 and drives a conventional bucket type pulse-counting discriminator or frequency-to-voltage converter. In this circuit, the current through diode D_1 (and thus through R_1) is equal to the product of the voltage impressed on C_1 each cycle, the value of C_1 , and the number of cycles per second. Capacitor C_2 filters the r-f across R_1 . The voltage across R_1 then is proportional to the frequency-converter output frequency (receiver tuning) for 8.33 milliseconds and proportional to the control oscillator frequency (antenna tuning) for the next 8.33 milliseconds. Another way of describing the output of the frequency-to-voltage converter is to say that superimposed on a d-c component proportional to the average of the two input frequencies is a 60-cps square wave with an amplitude proportional to the difference between these two frequencies. The phase of this square wave is dependent on the sign of the difference between the two frequencies. The d-c component of the output is removed by passing the signal through C_3 .

The error signal from the frequency-to-voltage converter is amplified and then fed to the minor feedback loop containing the servo amplified and a 5-watt motor-tachometer. The tachometer feedback provides electrical damping for the tuning system. Since the frequency range on each band is different, the gain factor of the control oscillator (kilocycles change per revolution of the tuning capacitor) and the overall loop gain of the tuning system depend upon the band to which the system is set. In order to keep a critically damped system on all bands, the gain of the major feedback loop must be appropriately compensated. This is accomplished

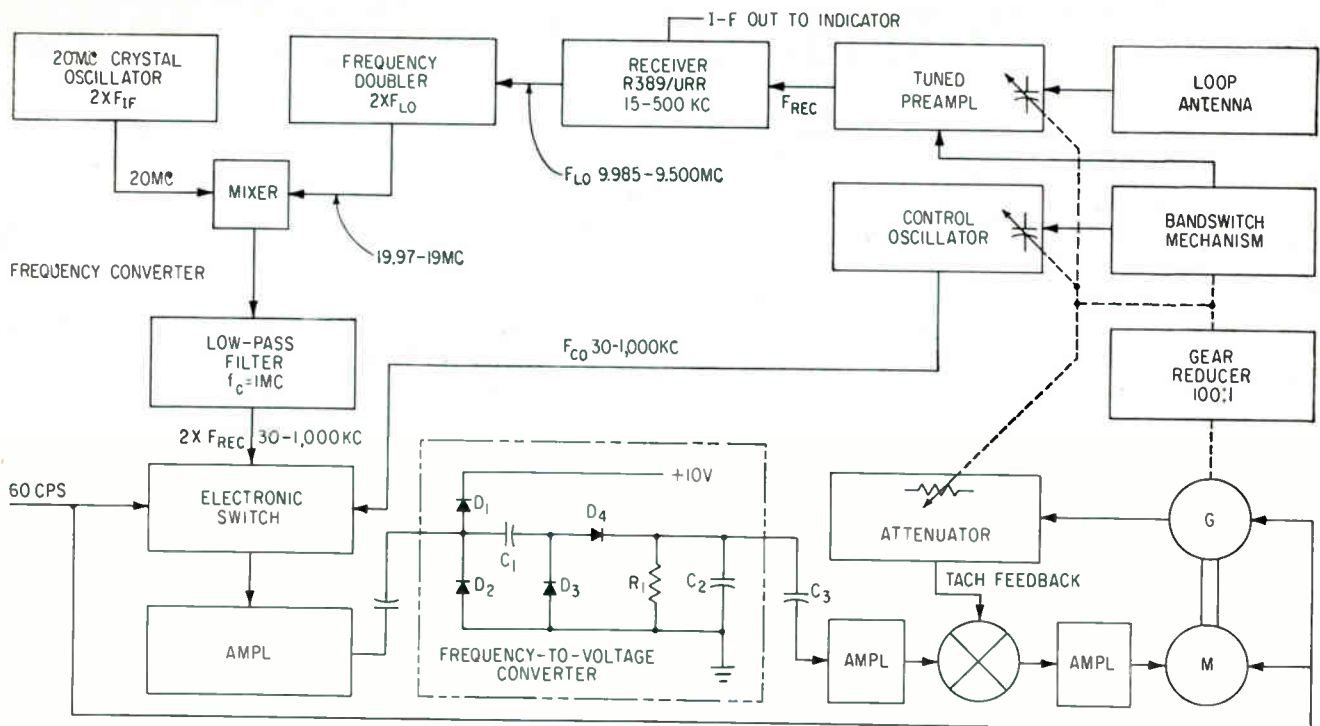

FIG. 4.—Two frequencies are synthesized, one to represent the receiver tuning and one to represent the antenna tuning, and compared by servo circuits to provide the input to an automatic tuning servomechanism

by passing the tachometer output through an attenuator ganged to the bandswitch. The tachometer feedback is varied to change the gain of the minor loop to compensate for the changes in control oscillator frequency range on different bands.

The tuning system keeps the loop antenna and preamplifier tuned to within less than one-half percent of the frequency to which the receiver is set. The circuit feature most responsible for the high accuracy is the time sharing of a single discriminator for both frequency inputs. This provides a first-order cancellation of discriminator drifts and non-linearities, thus providing reliable operation for long time periods without adjustment.

To cover the 15 to 500 Kc frequency range, the antenna tuning and control oscillator operations are broken into five overlapping bands, each with about 2-to-1 frequency range. In the antenna tuning, bands are switched by connecting the secondary windings of the rotary transformer either in series or in parallel for the upper two bands and by switching in autotransformers on the lower bands. The autotransformers step up the loop im-

pedance by a greater amount for each succeeding lower band. In the control oscillator, bands are switched by changing the value of the inductor in the tuned circuit.

Bandswitching is completely automatic, depending only on operation of limit switches on the upper and lower ends of the tuning capacitor travel.

If the upper-limit switch is actuated, the bidirectional rotary bandswitch automatically steps one band higher. When the lower-limit switch is closed, the bandswitch automatically steps one band lower. Other circuits in the bandswitch mechanism provide for switching more than one band if the initial tuning error is greater than one band, and for stopping the tuning motor and de-energizing the bandswitch when the lower or upper limits of the preamplifier tuning are reached. The bandswitch switches both the transformer configuration in the preamplifier and the inductor in the control oscillator.

The antenna and indicator dial at the operator's position are tracked together so that the antenna position is known at all times. Two modes of operation are available—continuous rotation of the

antenna at variable speeds to give a visual presentation of the antenna pattern on a scope, and alternatively, position control of the antenna for aural null operation. The tracking is performed by a positional servomechanism that uses synchros for position indication. The synchros are geared eight-to-one to obtain sufficient accuracy. Instead of using additional synchros that are geared one-to-one to resolve the eight-to-one ambiguity introduced by the gearing (as is done in many applications), a novel arrangement of two photocells in simple circuitry is used. One photocell and its light source are mounted at the antenna so that a hole in the antenna drive gear allows the light to reach the photocell only once each revolution. The other photocell and light source are mounted so that a tab on the indicator dial interrupts the light once each revolution. These photocells are arranged so that in the event that the indicator and antenna are not rotating in synchronism, a relay is operated to stop the indicator dial until the antenna is synchronized with the indicator.

At this time, normal operation is then resumed.

Wide-Range Multiple-Pulse

Progressive development of this negative-pulse amplifier is traced.

Amplifier is suitable for use in command guidance, radar beacon and pulse communication applications that require closely spaced pulse code groups

By **RAYMOND E. KONCEN**, Radar Division, U. S. Naval Research Laboratory, Washington, D. C.

MANY APPLICATIONS exist in which the use of crystal video receivers is advantageous because of considerations such as limited space and power availability, simplicity of operation and maintenance, low cost, and achievement of reliability through simplicity of design. In addition, tuning and instability problems associated with super-heterodyne receivers are eliminated.

The video amplifier described here extends the usefulness and adaptability of the crystal video receiver. This type of receiver could be used economically in command guidance systems and in radar beacon and pulse communication applications requiring closely spaced pulse code groups.

Crystal video receivers used with

passive methods of pulse-group coding and decoding circuits as described by Blake¹ are desirable because of simplicity and reliability. However, limitations in delay-line construction and performance require that the pulses be closely spaced (a few pulse widths) within the code group. Hence a need exists for pulse amplifiers free from recovery problems in the presence of such closely spaced pulses. Other characteristics include the ability to reproduce faithfully pulses having a wide range of amplitudes. A survey of the literature on design of microsecond pulse amplifiers revealed that typical performance characteristics with respect to pulse reproduction, dynamic range and recovery time were inadequate for

amplification of closely spaced pulses.

Design of a wide-range pulse amplifier is determined largely by the characteristics and uses of the pulses to be amplified. Since a pulse can be represented as a discontinuous function, it can be reproduced exactly only by a circuit having a bandwidth approaching infinity. This is obviously impractical and a compromise is required between size, cost, power drain and pulse fidelity.

Performance requirements for the proposed crystal video receiver were as follows: maximum signal level, 0 dbm; dynamic range, 40 db (constant output from 0 dbm to -40 dbm); sensitivity, unity signal-to-noise ratio at -50 dbm or

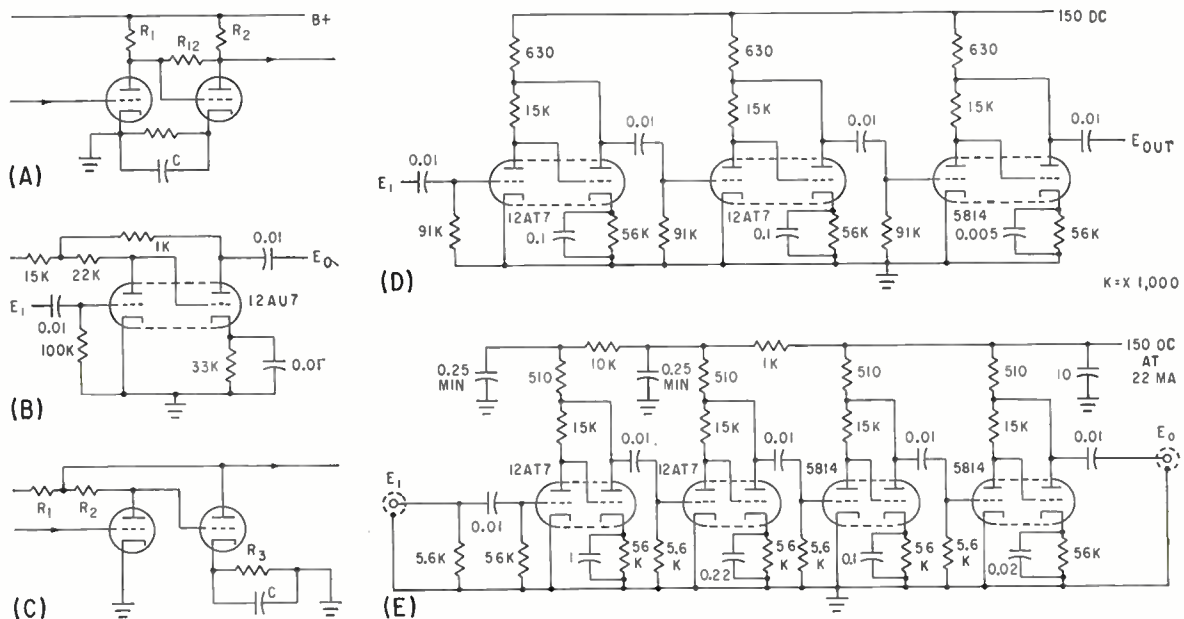

FIG. 1—Basic circuit of direct-coupled inverse-feedback pair (A); modified direct-coupled inverse-feedback pair (B); improved direct-coupled inverse feedback pair (C); three-stage negative-pulse amplifier (D); and final design of four-stage negative-pulse amplifier (E)

Amplifier

lower; bandwidth, 1 Mc minimum; output signal, 10 volts peak to a 5,000-ohm load. A special requirement was that recovery time and pulse stretching should be a minimum, such as to allow reception of 1- μ sec pulses having leading edge separations of 3 μ sec or less.

From these requirements, the design objectives for a pulse amplifier to follow a crystal detector were: voltage gain, 80 db minimum; dynamic range, 60 db or greater; bandwidth, 1 Mc minimum; output signal, 10 volts peak to a 5,000-ohm load; with the special requirement that recovery time and pulse stretching should be negligible compared to that due to the crystal detector.

Excellent reference articles²⁻⁶ have been published on design of similar amplifiers suitable for use in wide dynamic range crystal video receivers. The circuit initially considered best for multiple-pulse amplification is discussed by Van Voorhis⁶ and is shown in Fig. 1A. Several amplifiers were constructed and tested incorporating variations of this basic circuit. Performance of all circuits tested proved to be inadequate. Evaluation criteria used were dependent on requirements for pulse reproduction, recovery time, dynamic range and gain.

The design shown in Fig. 1B was used previously in another application having less stringent requirements. This circuit was tested and found to be incapable of handling closely spaced pulses because of recovery problems and pulse distortion. However, since the over-all frequency response of this circuit appeared satisfactory, a three-stage

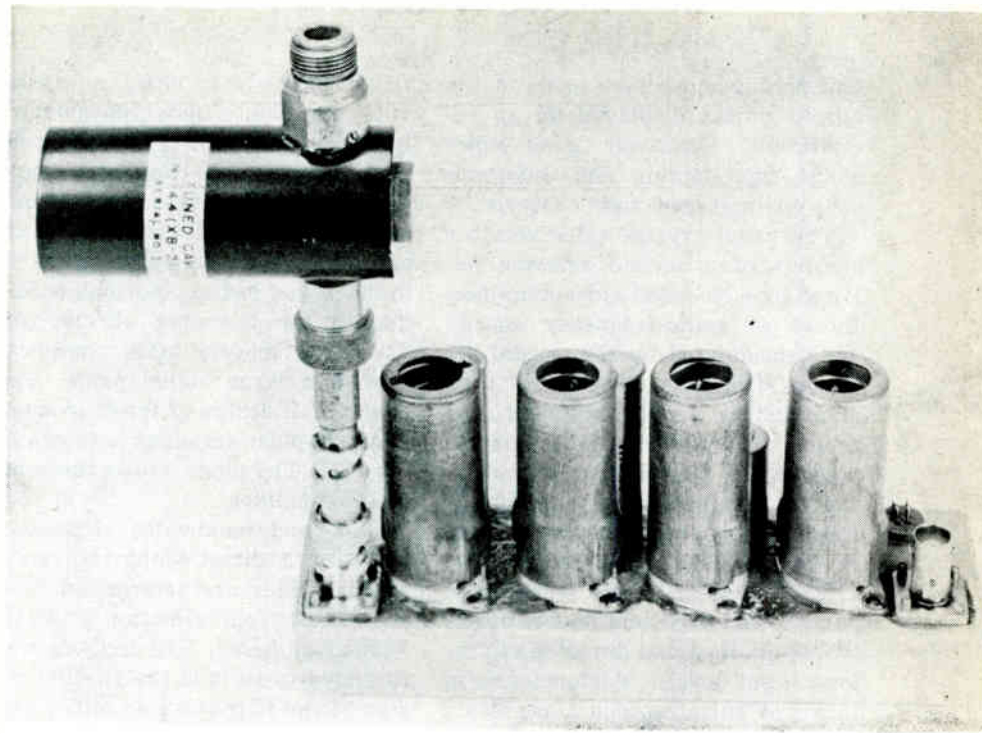

Completed four-stage negative-pulse amplifier

amplifier was constructed using the same circuit. Severe recovery problems were encountered—a relatively long recovery time makes this circuit unsuitable for multiple-pulse code group reproduction.

In designing an improved pulse amplifier, making each amplifier stage an inverse-feedback pair with a 360-degree total phase shift was considered basically sound. Coupling between the two triode sections was examined for possible improvement with respect to apparent second tube overdrive on large signal input. Instead of the usual approach of minimizing overload effects by putting as much gain as possible in the second triode circuit and as little as possible in the first triode circuit, the opposite approach was studied.

Since limiting without pulse distortion rather than maximum amplification was the objective, a form of instantaneous automatic gain control was desired. The instantaneous agc action must be of the delayed type to insure high gain for low-level input signals. These considerations led to a choice of the circuit in Fig. 1C, in which the first triode section acts primarily as a voltage amplifier and the second triode section acts as a phase inverter having considerable negative feedback. The initial experi-

mental circuit parameter optimization was based upon a compromise permitting alternative use of either dual-triode tube types 12AT7 or 5814.

The schematic of an amplifier using three dual-triode inverse-feedback pairs of this type is shown in Fig. 1D. Capacitance coupling is used between the direct-coupled inverse-feedback pairs. The first two pairs have identical component values. In the amplifier constructed, a spurious signal caused by discharge of cathode capacitors, with simultaneous return of the tubes to a conductive state, occurred several hundreds microseconds after the applied pulse. This transient was broadened and suppressed by reducing the value of the cathode bypass capacitor of the final stage to the 0.005 μ f value shown.

Measurements of the frequency response and sinusoidal gain of a single dual-triode amplifier stage were made by connecting a 1.5-volt bias battery between the lower end of the grid resistor and ground to prevent clipping of the positive half cycles during tests. Using an input signal level of 0.01 volt rms, a mid-frequency gain of 28.3 db was measured using 12AT7 dual triodes.

Negative-pulse response of the three-stage amplifier of Fig. 1D using 12AT7 dual triodes was studied

and photographs were made of the output pulses displayed on an oscilloscope. Relatively good pulse shape reproduction and independence of input level were observed.

The usual crystal video receiver consists of a crystal detector followed by a so-called video amplifier. Pulses of radio-frequency energy are demodulated by the crystal detector. The pulse envelope is then amplified by a pulse amplifier. By proper polarization of the crystal detector, a negative pulse output can be obtained. The amplifier of Fig. 1D was coupled to an S-band crystal detector employing a Type 1N21-B crystal. Tests were made using both single and double pulses of one-microsecond duration at various input levels. Performance in terms of pulse reproduction, recovery and dynamic range was quite satisfactory. However, although the gain of the three-stage amplifier was initially thought to be adequate, it did not provide the desired sensitivity when used in connection with the 1N21-B crystal detector. It was therefore decided to change to a four-stage amplifier design, which would provide a higher gain and compensate for crystal detector insensitivity at low signal levels.

As a result of experience with the three-stage amplifier and an approximation analysis of a direct-coupled inverse-feedback pair, effects of circuit parameter changes were considered in determining the design of the four-stage amplifier.

Inasmuch as the three-stage amplifier design was based upon an optimization of the direct-coupled inverse-feedback pair, the four-stage amplifier design was patterned after that of the circuit shown in Fig. 1D. Since the additional gain required was not large, the fourth stage was made low gain and similar to the third stage by using a 5814 type dual triode. Also, to maintain the bandwidth of the four-stage amplifier approximately equivalent to that of the three-stage amplifier, it was necessary to widen the bandwidths of the individual stages somewhat by reducing the value of the common load resistors from 630 ohms to 510 ohms. Grid return resistors were decreased from 91,000 to 5,600 ohms to reduce grid circuit recovery time.

Other changes included a crystal video impedance matching network in the first stage input and decoupling networks in the plate supply circuits of the first and second stages. Values of cathode bypass capacitors were staggered so as to broaden and reduce spurious pulses due to the transient effects produced by recovery after amplification of a large signal pulse. The final circuit design of the four-stage negative-pulse amplifier is shown in Fig. 1E. The photo shows the completed amplifier.

Gain and bandwidth characteristics of a direct-coupled inverse-feedback pair are determined by a process of approximation analysis (not given here). The analysis was extended to include the specific design of the four-stage amplifier and the results verified by experimental measurements. The over-all gain was determined by analysis to be 87db and, using a small input signal, was measured to be 90.4 db. Over-all bandwidth as determined by analysis was 0.9 Mc. Using a method of measurement described by Bryan⁶, pulse rise time from zero to 65 percent amplitude was found to be 0.2 μ sec and the upper 3-db frequency response was calculated to be 0.8 Mc.

In order to determine pulse reproduction and dynamic range in the presence of a dual pulse signal, the amplifier was fed with a dual-pulse signal generated by two Hewlett-Packard Model 212A Pulse Generators, and photographs were taken of the amplifier output pulses on a Tektronix oscilloscope (Model 532) using a sweep speed of 1 μ sec/cm. Input pulse widths were set at 1 μ sec each and the two pulses were spaced 3 μ sec between leading edges. Both input and output waveforms are shown in Fig. 2A and 2B wherein input signal amplitudes are 1 volt and 0.3 millivolt, respectively.

An S-band tuned cavity and crystal holder TN-144 (XB-3) DPN-3 equipped with a 1N21-B crystal was used to test the suitability of the four-stage pulse amplifier for use in crystal video receiver applications. The method of testing was similar to that used for the amplifier alone except for the substitution of r-f input pulses at 2.9 Gc as obtained from a Hewlett-Packard

model 616A signal generator. Dual-pulse modulation of the Model 616A was obtained from the two Hewlett-Packard model 212A pulse generators used in the previous test. As before, the two pulses were each 1 μ sec wide and spaced 3 μ sec between leading edges. Dual-pulse modulation applied to the model 616A and amplifier output waveform photographs were taken for a range of input power levels from 0 dbm to -43 dbm. Approximately 20 microamperes of crystal bias current was used to improve sensitivity through better crystal video impedance matching.

A study of the waveforms (see Fig. 2C and 2D) revealed a relatively large amount of pulse stretching on strong signals. It was concluded that this pulse stretching was due primarily to the rather large crystal holder capacitance. The TN-144 (XB-3) DPN-3 tuned cavity and crystal holder were designed for use in the AN/DPN-3 radar beacon, an application in which pulse stretching was of little importance. The amount by which 1- μ sec pulses are stretched decreases from about 1 μ sec at 0 dbm signal level to 0.2 μ sec at -30 dbm signal level with little or no stretching evident at signal levels of -34 dbm or lower. Although the amount of stretching is not intolerable for 3- μ sec spacings of 1- μ sec pulses, this condition might be improved by use of crystal holders having lower capacitance.

Another possible improvement is the use of a type 1N32 crystal diode designed specifically for video detection at S-band frequencies (or type 1N31 for X-band frequencies). The type 1N32 was not available at the time the waveform photographs were taken. Subsequent tests using the 1N32 revealed a 3 to 6 db improvement in sensitivity over results obtained using the 1N21-B crystal diode.

The dual-pulse output waveforms from the four-stage negative-pulse amplifier and TN-144 (XB-3) DPN-3 tuned cavity and crystal holder assembly with 1N21-B microwave crystal were retaken at different sweep speeds selected to show the pulse shapes and spacing, the characteristics of the spurious pulse produced by recovery transients,

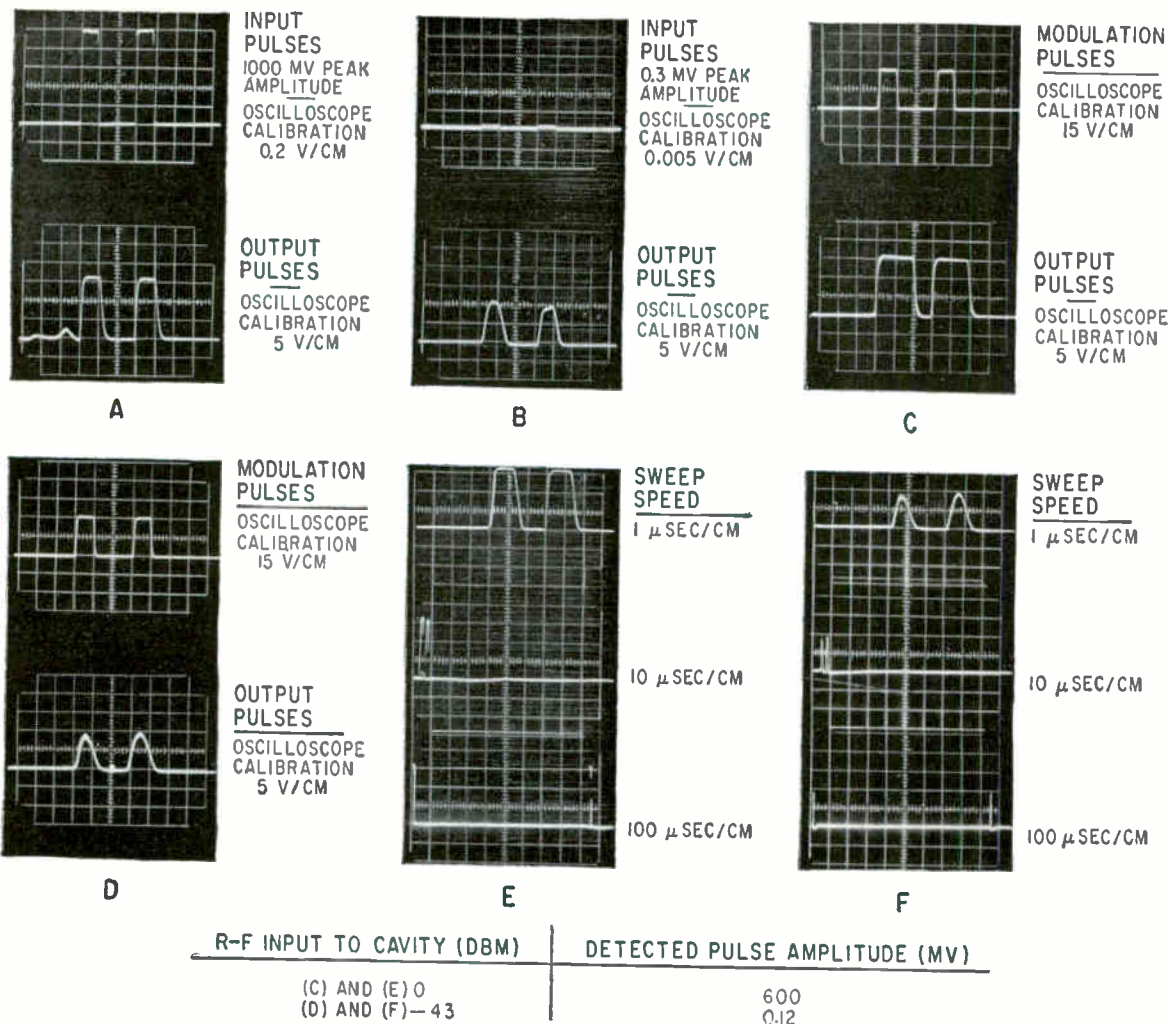

FIG. 2—Pulse reproduction: with dual-pulse signals (A and B); with dual-pulse modulation (C and D); and at different sweep speeds (E and F)

and the absence of other spurious pulses between two recurring pulse code groups. The dual input pulses used were again $1 \mu\text{sec}$ wide and spaced $3 \mu\text{sec}$ between leading edges, with the pair repeated approximately every $1,000 \mu\text{sec}$. Two of the resulting output waveforms are shown in Fig. 2E and 2F for signal levels of 0 dbm and -43 dbm.

These waveform photographs revealed that strong signals produce a single spurious pulse or baseline rise approximately $20 \mu\text{sec}$ wide which occurs about $40 \mu\text{sec}$ after the amplified dual pulses. For an r-f input signal of 0 dbm, the spurious pulse amplitude is approximately one-fourth that of the signal pulses and becomes negligible at signal levels of -30 dbm and lower. Because of the slow rise time and width of the baseline rise, it should

be quite easy to separate pulses for decoding from the undesired signal.

The amplifier has been determined to have a bandwidth approaching 1 Mc, a gain of about 90 db, a dynamic range of 70 db or greater, and the capability of handling closely spaced pulses.

When used with an available S-band tuned cavity and crystal holder, the amplifier functions well as a crystal video receiver. Normal output pulse amplitude is about 15 volts for all r-f input signal levels above -40 dbm and decreases to 10 volts for r-f input signal levels of about -43 dbm to -46 dbm, depending upon the sensitivity of the crystal detector used. Some pulse stretching occurs, primarily due to crystal holder capacitance. Hence, performance as a crystal video receiver is dependent upon the characteristics of the crystal diode de-

tector and crystal holder.

The author acknowledges the guidance and assistance of Paul T. Stine in doing the work of this report and specifically in the preparation of the approximation analysis. John P. Kirwan and Charles F. White also gave valuable assistance in the performance measurements and preparation of the report.

REFERENCES

- (1) Blake, R. F., Pulse Group Coding and Decoding by Passive Networks, Proceedings of National Electronics Conference—1952, 8:760, Jan. 1953.
- (2) Terman, F. E., Radio Engineers' Handbook, New York and London, McGraw-Hill, p 413, 1943.
- (3) Moskowitz, S., and Racker, J., Pulse Techniques, New York, Prentice-Hall, p 120, 1951.
- (4) Radio Research Laboratory, Harvard University, Very-High-Frequency Techniques, New York and London, McGraw-Hill, p 977, 1947.
- (5) Van Voorhis, S. N., ed, Microwave Receivers, New York, Toronto and London, McGraw-Hill, 23, MIT Radiation Laboratory Series, p 504, 1948.
- (6) Bryan, H. E., Square Wave Testing Simplified, *Audio Engineering*, 35 (No. 10), pp 14, 46, Oct. 1951.

Test firing explosive device (in chamber). Scope trace is related to heat capacity and energy input

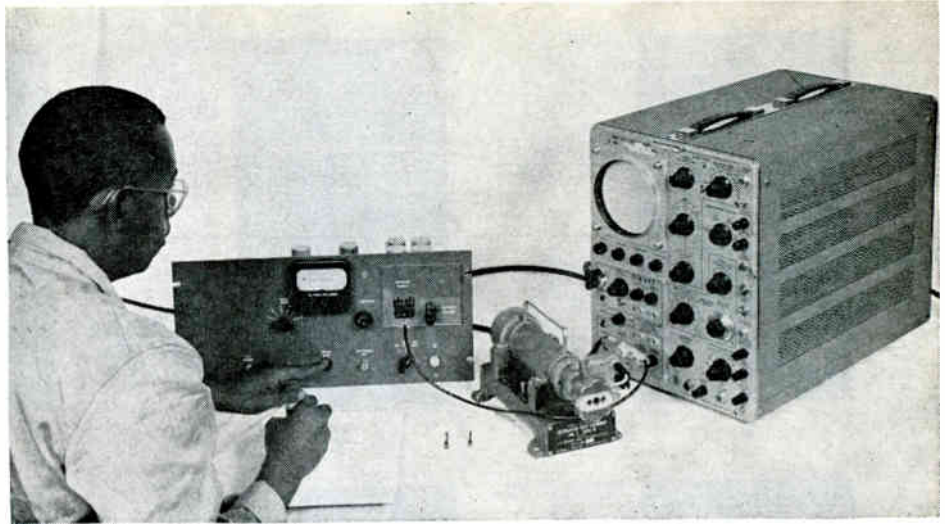

Generator Delivers Constant Current

Rectangular pulses provide means for testing and evaluating electroexplosive

IN THE TESTING and evaluation of electroexplosive devices, it is often necessary to know the energy required to fire 50 percent of the devices being tested (mean firing energy). This establishes a sensitivity parameter in the device being evaluated that can be related to the electrical requirements of the firing circuit.

In these electroexplosive devices (EED), an electrothermal converter, in good thermal contact with an explosive mixture, converts electrical energy into heat. A widely used electrothermal converter is a fine wire (wire bridge).

A popular method used to test the devices that use fine wire converters employs a charged capacitor as the energy source. The energy stored in the capacitor ($CV^2/2$ watt-seconds) is discharged into devices being tested through a mercury switch. Unfortunately, losses in the capacitor under rapid discharge conditions and switch losses introduce some additional variables that may cause errors in measurement.

A new approach uses energy bursts that consist of a constant current or a constant voltage pulse

for a known duration. The form of these bursts is similar to that used in many practical firing systems.

Hard-tube pulsers can provide the bursts but the pulser's physical size becomes impractical when large currents are required. A typical wire bridge could have resistance of one ohm and would require three amperes flowing for 110 microseconds to provide energy. A solid-state thyatron can generate such rectangular waveforms in a wide range of currents, voltages and time durations.¹

Power transistors offer another approach. A simple and compact circuit that employs a thyatron as a pulse generator, a transistor for pulse shaping and an output power transistor as a linear pulse amplifier has been developed (Fig. 1). Output is a constant current or constant voltage pulse with a wide variety of amplitudes (0 to 10 v or 0 to 10 amperes) and time durations (100 to 1,000 microseconds).

The simplified circuit of Fig. 1 illustrates the essential components. Thyatron V_1 , a half-sine wave pulser², provides pulse width tim-

ing as well as base current drive for transistor Q_1 . This driving pulse is easy to generate and has sufficient current, at a high impedance level, to drive Q_1 into saturation. Inductance L and capacitance C determine the pulse width according to $T = \pi(LC)^{1/2}$ and the current amplitude is $I_{max} = E_{bb}/(L/C)^{1/2}$. Since a typical $(L/C)^{1/2}$ would be 1,000 ohms, for plate voltages of 300 volts (E_{bb}), 300 ma peak base current can be expected. Thus Q_1 , by being driven into saturation for time T , places the 10-v regulated power supply voltage across R_1 through the saturation resistance of Q_1 . Transistor voltage drop is negligible and the 10-v pulse has negligible tilt due to a large energy storage capacitance in the power supply.

When the driving pulse ceases, a low base circuit impedance is needed to reduce storage time. This is achieved by placing a small inductor (1 mh) across the base circuit of Q_1 and providing a resonant discharge path. Using a 2N301A as Q_1 , storage time is 10 μ sec. Rise time is 10 μ sec and part of the rise and fall times must be attributed to the finite rate of rise and fall of

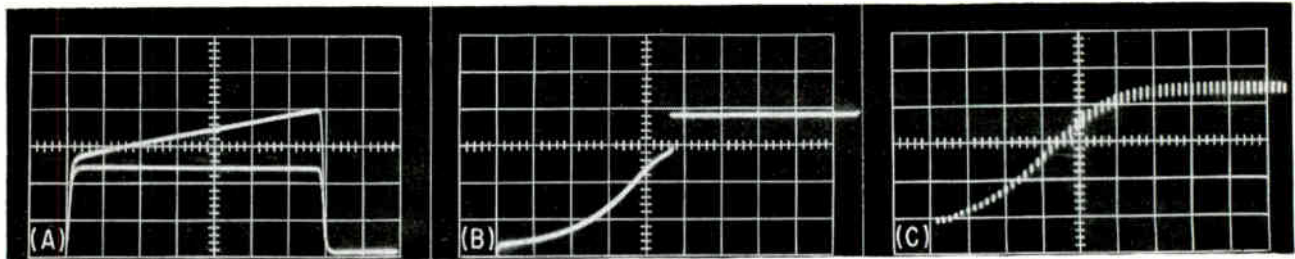

FIG. 3—Constant current waveforms across one-ohm resistor and electroexplosive device (A), burning out of 1/16 amp fuse while passing constant one-amp pulse (B) and thermal stacking resulting from pulsing a pilot lamp (C) show applications of pulser

for the circuit described was about 0.1 ohm. This resistance can be reduced by using transistors in parallel or by using transistors with high β (current gain) values and low intrinsic emitter and base resistances.

The observed internal resistance of 0.1 ohm is sufficiently low for use with most EED devices. At higher pulse currents the value of β is expected to decrease and result in a higher internal resistance (R_e). Voltage gain of the emitter follower at a one amp pulse level is 0.96.

For a device that does not change its resistance with temperature the energy delivered is $E = I^2RT$ watt-sec where R is resistance, I is current, and T is pulse width. For the constant voltage mode of firing, the energy is $E = V^2T/R$ where V is the voltage pulse amplitude measured with a peak voltmeter or oscilloscope.

It is expected that the device will heat up with time during the pulse. For example, in the constant current mode, as the resistance increases more power is dissipated. This regeneration action can increase the energy input. With constant voltage firing an increasing resistance will cause less power dissipation as the pulse time increases.

Consider constant current firing. Voltage drop across the device increases linearly with time as shown by the sloping trace in Fig. 3A. Slope is related to the temperature coefficient of resistivity for the wire α and its lumped heat capacity C_p . From the scope observation it is possible to determine the slope s as $\Delta R/RT$ or per unit change per second. The resistance of the device is changing as $R(t) = R(1 +$

$st)$. The energy input is

$$E = \int_0^T I^2 R(1+st) dt = I^2 R \left(T + \frac{sT^2}{2} \right)$$

$$\text{or } E = I^2 RT \left(1 + \frac{sT}{2} \right)$$

Regeneration has increased the energy delivered by $sT/2$. These equations become simple because the energy discharge is ballistic, or no cooling enters the problem.

For constant voltage firing the analysis for power input is not as direct. As the device heats up the power input decreases. However by monitoring the current waveform or by knowing α , the temperature coefficient of resistivity, a similar energy relationship can be derived.

In addition to the application of delivering a burst of energy to an electroexplosive device and studying the energy requirements or sensitivities, there are other useful extensions of the instrument. One is in the study of the heat capacity of an EED device or thermally sensitive element. The temperature rise (θ) equation for a lumped thermo-electric system under constant current firing conditions is $C_p \frac{d\theta}{dt} + \gamma\theta = I^2 R(1 + \alpha\theta)$ where C_p is the heat capacity in w-sec/C, γ is the heat loss factor in w/C (neglecting radiation losses and nonlinearities), I is the current pulse amplitude, R is the cold resistance of the system, and α is the temperature coefficient of resistance.

This equation can be solved and experimentally checked using the current pulse generator. If the pulse is injected into the system ballistically or adiabatically then the solution is very closely $\theta = I^2 Rt/C_p$ where t is the pulse dura-

tion. By examining the voltage-time relationship on an oscilloscope during the discharge of the current pulse then the slope is

$$\frac{dv}{dt} = IR (I^2 R) \alpha / C_p$$

From this equation and the observed trace it is possible to determine C_p , the lumped equivalent heat capacity of the system with reasonable accuracy. The trace of Fig. 3B shows this type of observed trace for the case of a fuse.

Another application of this apparatus is in the study of thermal stacking; the case where an electrothermal device integrates a series of power pulses and slowly increases its temperature as the heat input exceeds the heat lost per cycle. Eventually the temperature will reach a limiting value as shown in Fig. 3C.

In addition to application to the study of electroexplosive devices, this circuit should be useful wherever electrothermal parameters are under study. Other areas of use include bolometers, fuses and thermoelectric converters. Variations of the basic design can be made to provide pulses of other amplitudes and widths

This work was performed with the U.S. Naval Ordnance Laboratory. The author acknowledges the cooperation of I. Kabik and J. Ayres of the Explosion Dynamics Division of the U.S. Naval Ordnance Laboratories, Silver Spring, Maryland.

REFERENCES

- (1) V. W. Goldie, R. G. Amicone and C. T. Davey, Generating Pulses with Solid-State Thyratrons, *ELECTRONICS*, Aug. 14, 1959.
- (2) L. A. Rosenthal, Energy Source Delivers Half-Sine Pulses, *ELECTRONICS*, Sept. 1956.

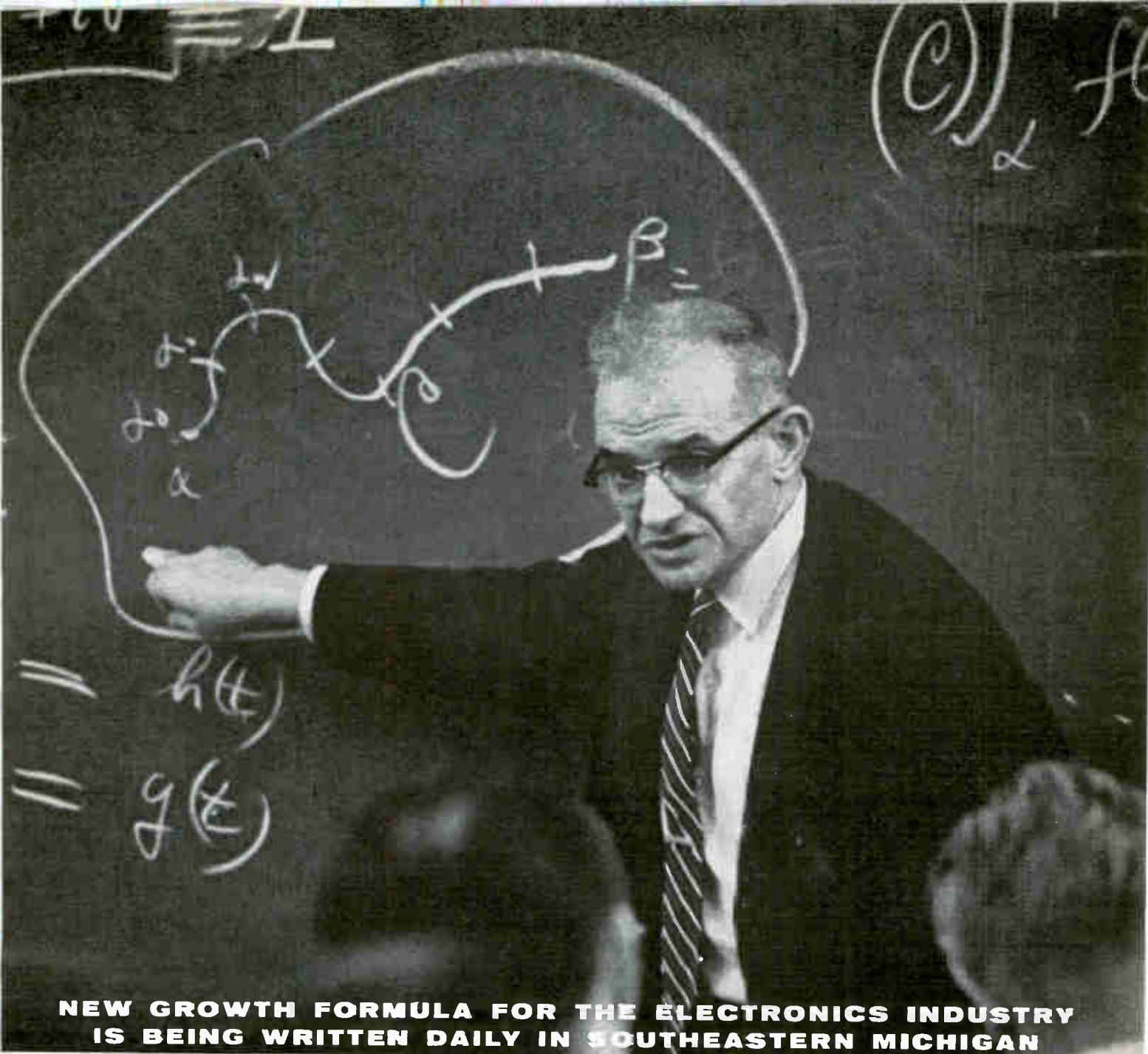

NEW GROWTH FORMULA FOR THE ELECTRONICS INDUSTRY IS BEING WRITTEN DAILY IN SOUTHEASTERN MICHIGAN

Dr. Ben Dushnik, University of Michigan, conducting class in operational mathematics and systems analysis at the Bendix Research Laboratories near Detroit.

Invaluable to the electronics firms in this area is the unusually close relationship between Michigan universities and industry. Faculty members play important roles in industrial programs as researchers, consultants and educators. For example, Dr. Dushnik of the University of Michigan conducts a weekly, off-campus class in advanced mathematics at the Bendix Research Laboratories. All students are Bendix-employed engineers. They attend the lectures for self-improvement, or as candidates for their Master's or Doctorate degrees.

In addition to such unusual teamwork between schools and industry, Southeastern Michigan has other benefits to offer electronics firms. Dozens of progressive communities have planned for their orderly growth. Resident businesses grow, and grow well, in this kind of atmosphere. Acreage has been set aside for new industries. Basic utilities have been provided. Zoning and land use laws have been established. If you are considering moving your plant to a new site with the right "growth formula," write for complete information to Detroit Edison, Plant Location Service, Area Development Division.



DETROIT EDISON

Space Capsule Oscillator

*Tone warns
astronaut that capsule
will soon return
to earth*

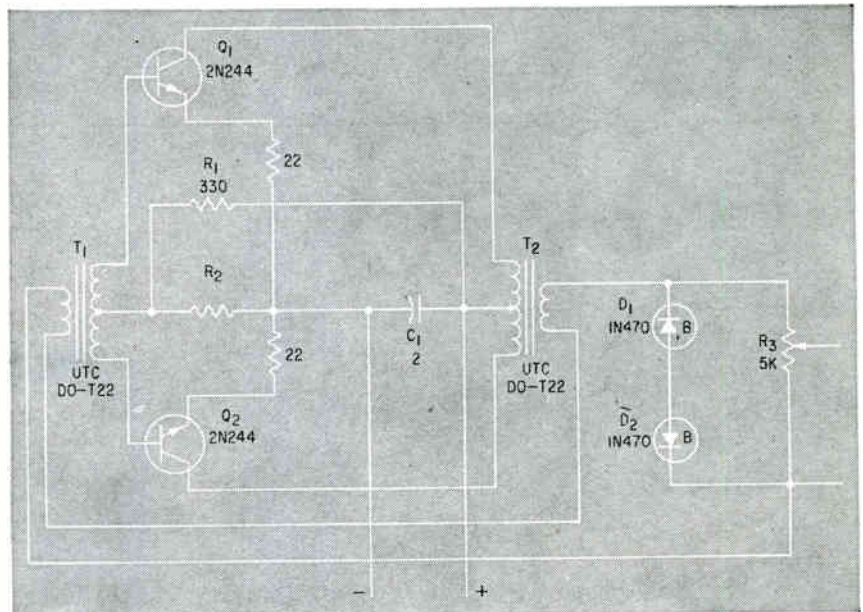

Zener diodes D_1 and D_2 stabilize the output level and also distort the waveform to give a distinctive tone

By NORMAN KLING,
McDonnell Aircraft Corp.,
St. Louis, Missouri

THIS OSCILLATOR was designed for the Project Mercury capsule for manned orbital flight now being developed for the National Aeronautics and Space Administration. The oscillator gives an aural warning to the astronaut several minutes before automatic initiation of his return to earth at the end of his orbital mission. It will also be available for code modulation of the four voice communications transmitters. About 100 pounds of booster, including fuel, are required to place each pound of payload into orbit; therefore, capsule equipment design places special emphasis on lightness. Minimum power consumption is also important because heavy batteries are the source of all electrical power in the capsule. Because of these stringent requirements, available packaged oscillators were not satisfactory.

The oscillator was required to produce at least 50 mw of audio output into a 600-ohm load. The desired frequency was 1,000 cps with a nonsinusoidal waveform to provide distinctive identification above radio signals and noise. The output circuit was to be isolated

from power ground to permit grounding at one point used for all audio signals in the capsule. Input power was to be supplied from capsule batteries having a nominal voltage of 24 v; however, they would start at 30 v and be down to 18 v by the end of the mission. The goal for operating power consumption was one watt at 24 v with zero standby power. Weight and size goals were 0.1 pound and $1 \times 1 \times 1.5$ inches.

A transformer circuit was chosen over an all R-C circuit to meet the requirement for audio output circuit isolation from power ground. Since conventional transformers are heavy and bulky, a push-pull circuit was used to reduce the transformer core size by elimination of the d-c component. This permitted the use of transformers $\frac{1}{8}$ in. in diameter, $\frac{1}{2}$ in. long and weighing 0.1 oz.

Output level was stabilized by Zener-diode clipping to insure an adequate amount of warning tone and to maintain constant modulation level of code transmissions. Since a distinctive nonsinusoidal output was required, the waveform distortion from clipping was desirable. Output clipping also allows some variation in circuit perform-

ance without drastic changes in output level. Consideration was given to Zener regulation of input d-c; however, this would have resulted in power drain of from three to four watts. Using audio clipping the power consumption is one watt at 24 v.

Other warning-tone oscillator characteristics are: maximum output of 80 mw; output constant within one db when set to 50 mw over d-c variation of 30 to 18 v; and a frequency of $1,000 \pm 200$ cps. The unit weighs 0.13 lb. Resistors R_1 and R_2 provide bias stabilization. Tantalum capacitor C_1 is a noise filter on the d-c line. Zener diodes D_1 and D_2 provide output level stabilization and potentiometer R_3 is the output level control. The parts are mounted in a standard MIL-T-27 transformer can $1 \times 1 \times 1\frac{1}{2}$ in. with the two transistor mounting clips fastened to the mounting studs for a heat sink. The voids in the can are filled with a room temperature vulcanizing silicone rubber. Both input d-c and output audio connections are made through a four-terminal hermetic-seal header.

This design has been tested for vibration of 10 g to 500 cps, for shock to 100 g, and over a temperature range of -18 C to 93 C.



Detecting leaks so microscopic that *less than 1 cc of air* (approximately 1/16 of a cubic inch) would require 30 years to pass through . . . this ultra-scientific radioactive test is your assurance that the hermetic seal of the resistance unit is virtually perfect. In the test, resistors go into a tank where the air is evacuated and radioactive Krypton 85 is introduced under pressure. After the resistors have been allowed to "soak" in this atmosphere for several hours, they are removed and individually placed in a shielded chamber equipped with a scintillation counter. If any radioactivity is detected, it indicates a leak in the seal, and the resistor is rejected. You can depend on the Allen-Bradley hermetically sealed resistors—they are what they are *claimed to be!*

Radioactive Tracers

ASSURE

Positive Seal

OF

ALLEN-BRADLEY

TYPE S

CERAMIC ENCASED

RESISTORS



A-B TYPE S HOT MOLDED HERMETICALLY SEALED RESISTORS

Ceramic Encased

Type TS—1/8 Watt (MIL Type RC 08—1/10 Watt)

Type CS—1/3 Watt (MIL Type RC 12—1, 4 Watt)

Type ES—1 Watt (MIL Type RC 22—1/2 Watt)

ACTUAL SIZE

This superior testing technique, which employs radioactive tracers, provides positive proof that the hermetic seal of each and every Allen-Bradley Type S ceramic encased resistor is virtually *perfect*—it guarantees that the unit is completely protected against moisture and humidity.

These Type S resistors have a special carbon composition resistance element and an insulating jacket which are hot molded into one integral unit by an *exclusive* A-B process. The unit is then encased in a ceramic tube with metal seals.

Combining freedom from catastrophic failure with positive protection against humidity, these ceramic encased resistors assure unparalleled performance and absolute reliability. Made in 2% and 5% tolerances in standard EIA values up to 22 megohms and higher, on special order.

For continuous reliability, specify A-B Type S ceramic encased resistors. Send for Technical Bulletin 5003, today.

ALLEN-BRADLEY | Quality Electronic Components

Allen-Bradley Co., 110 W. Greenfield Ave., Milwaukee 4, Wisconsin • In Canada: Allen-Bradley Canada Ltd., Galt, Ont.

Instrument Records Multipath Fade Rates

PROPAGATION studies are being aided by an instrument that records fade rates resulting from multipath transmissions. It provides a permanent record of the number of times per second that a signal envelope rises from below the average signal level to above it. Fade rates almost down to zero and up to 300 per second can be recorded.

The research tool was devised at the Central Propagation Laboratory of the National Bureau of Standards. The project is being conducted under the sponsorship of the U. S. Air Force.

Simultaneous transmission over several paths from transmitter to receiver occur because of irregularities in the atmosphere and the ionosphere. These factors include humidity, temperature, pressure and index of refraction.

Because of the differences in the lengths of the transmission paths of each signal component, times of arrival at the receiver are different. If individual signal components from each path were to arrive at the receiver in phase, level of the received signal would be increased. However, if individual signal components were to arrive at the receiver out of phase, cancellation could occur, resulting in fading of the receiver output signal. This phenomenon is called multipath fading.

Value of recording the rate at which multiple-path transmission results in fading is that it permits comparison with recordings made simultaneously of signal intensity. Comparisons of multipath fading with intensity of the signal at the receiver site are useful in interpreting phenomena associated with simple mode propagation.

The instrument records the rate at which the received signal crosses the average signal level, rather than the rate of median signal crossing. Hence calling the recorded data fading rates may not agree strictly with a frequently used definition of the term. However, these recordings do provide a convenient means

for comparing average fading rates under a variety of propagation conditions and for different transmission frequencies.

Despite the usefulness of these fade-rate recordings, they must be applied cautiously to communications problems. Proper use of the device requires that the nature of the recorded information be understood. Depth of fading, which can vary considerably from amplitude distribution of the envelope, is not indicated by the recorder.

Equipment used in making the recordings includes a receiver through the last intermediate-frequency stage. Time constant of the receiver agc is 12 seconds or longer. The i-f output signal from the receiver is applied to an integrating circuit with a 6-second time constant. Output from the integrating circuit is used to establish the average signal level on which fade rates are based.

The i-f output signal, continuously varying in level, is compared to the average signal level provided by the integrating circuit. When signal level rises above average level, it initiates a Schmitt trigger circuit. When signal level drops below the established average level from the integrating circuit, the Schmitt trigger circuit returns to its original off condition.

The square-wave output produced by the Schmitt trigger each time signal level rises above and then drops below the average level is integrated. The positive pulse resulting from integrating the square wave indicates one crossing of signal level from below to above the average level.

These individual positive pulses are in turn integrated with respect to time, and the resulting voltage is then amplified. Output from the amplifier is the signal that is provided to the strip-chart recorder. Amplitude of the recorded signal is proportional to the number of individual positive pulses per second that are derived from integrating the output of the Schmitt trigger.

Hence the recorded information is a linear function of multipath fading rate.

Operation of the fade-rate recorder has proved to be quite stable after an initial warm-up period and with the condition that power supplied to the equipment be regulated. Although d-c coupling is used between all stages through the Schmitt trigger, the circuits were designed so that drift of critical operating voltages that would invalidate results is negligible.

Several observations have been made using the new fade-rate recorder. Flutter fading at rates as high as 20 per second have been noted in typical recordings for radio transmission paths through the auroral zone. Other recordings show that a change in fading rate occurred when the signal level suddenly changed—probably indicating that the propagation mode had changed during these periods.

Spikes on the fade-rate recordings have occurred even when the transmitter was not operating. These rapid changes in level were probably caused by noise fluctuations. Occasional noise spikes have also been observed on recordings of NBS radio station WWV, which appear to result from impulse noise interference.

Ionosphere Studies May Improve Communications

IONOSPHERIC research stations operating in New Hampshire and Vermont may indicate ways in which long-range radio communications can be improved. Data is being gathered at three locations—a master station and two slave stations.

One aim of the research program is further study of the ionosphere. Specifically, information is being sought about the movements of dense concentrations or clouds of electrons within the ionosphere surrounding the earth.

Another objective of the project

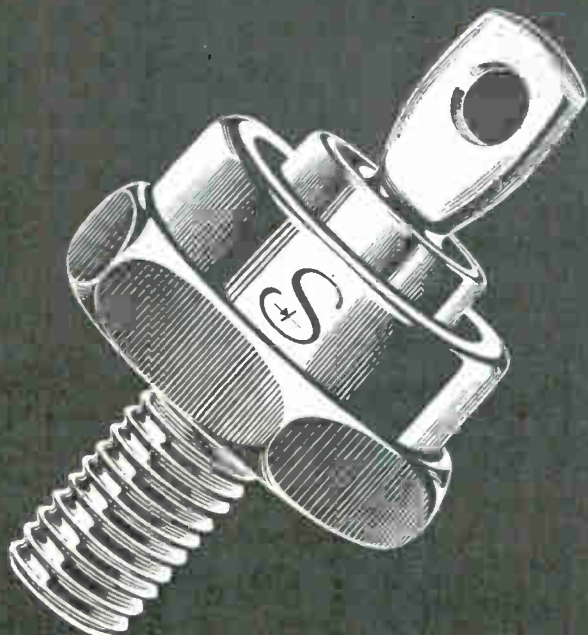

*If safety factors are a
MUST in your application...*

Specify SRC!

An outstanding illustration of SRC quality, reliability and safety is found in its 35 ampere silicon power rectifiers. For example, these hermetically sealed diodes are so conservatively rated that they will withstand **1200 ampere** surges!*

These silicon rectifiers are nominally rated at 35 amperes and are available in a range of 50 to 600 volts. Readily interchangeable with standard existing 35 ampere units, this entire premium rectifier series is now available for immediate delivery at no premium in price!

For further detailed information and technical data send today for your free copy of the new SRC Silicon Rectifier Handbook and Catalog covering the full line up through 400 ampere units.

*As substantiated by United Testing Laboratories



STANDARD OF QUALITY

STANDARD RECTIFIER CORP.

620 East Dyer Road, Santa Ana, California • Kimberly 5-8241

load it...



NEW...THE EASIEST LOADING AND OPERATING RECORDING OSCILLOGRAPH AVAILABLE!

Just ten seconds! That's all it takes to drop in a roll of paper, push the button and you are recording 18 channels of data. No magazine or threading and operation is practically foolproof. Want to change recording speeds?... 1/4, 1, 4, 16, 64 inches per second? Just push a button.

The record is made by the print-out process, so there's nothing to do but watch it happen. No processing. It's right there in front of you. In fact, everything is in front: loading, controls, operating, viewing. And you can tuck it away in a rack without need for top or side clearance.

The 5-124 has 18 individual plug-in inputs to afford you the greatest flexibility in handling your data lines. It's a "big" oscillograph in a very small package. Even with its 7-inch-wide record and regulated power supply, it's portable. Carry it anywhere.

Economical to buy? About \$500 more economical than the basic cost of a comparable unit. And the 5-124 is available with many optional features to meet your knottiest data recording problems.

See the new 5-124 at the ISA SHOW, Sept. 26-30 - Booth 1712.



Five speed transmission of the 5-124 is entirely push button operated. Speeds can be changed while data is being recorded. Write for Bulletin CEC 5124-X1.

Electro Mechanical
Instrument Division

CEC

CONSOLIDATED ELECTRODYNAMICS / pasadena, california

A SUBSIDIARY OF Bell & Howell • FINER PRODUCTS THROUGH IMAGINATION

is determination of the angles at which whistlers enter the atmosphere. This source of radio interference is believed to result from lightning discharges. The released energy resulting from lightning is propagated from one hemisphere to another along the lines of the earth's magnetic field.

A large variety of electronic instruments loaded on movable vans comprise two of the research stations. The permanently located master station is manned by Prof. M. C. Morgan and his associates of Thayer School of Engineering, Dartmouth College. The master station has been situated near Hanover, Vt.

At present, the two portable stations are located about sixty miles from the master station and from each other, forming an almost equilateral triangle. The station at Epsom, N. H. is being monitored by Prof. R. E. Houston, University of New Hampshire. Observations at the remaining station at Brattleboro, Vt., are being made by Prof. J. W. MacArthur.

Progress Indicated for Nuclear Aircraft

ADDITIONAL electronic instruments will be required for aircraft already heavily laden with electronic equipment when nuclear-powered aircraft become a reality. Progress in this direction is indicated by release of some details of design studies of two possible aircraft configurations by the Air Force and Convair Division of General Dynamics.

Information revealed includes drawings of the two swept-wing, atomic-powered aircraft. Each has an assembly of jet-like engines mounted in the tail of the fuselage. This configuration is one of several under study.

Conventional tails have been omitted from the planes. A vertical stabilizer-rudder assembly is mounted at each wing tip, and the horizontal stabilizer-elevator surfaces are far forward on the fuselage.

The direct-air cycle nuclear engine, under development by General Electric, is planned for one aircraft. The plane intended to use this engine has a pair of conventional jet

←CIRCLE 90 ON READER SERVICE CARD

read it!

engines mounted under the wings, in addition to the nuclear power plant. The indirect-cycle engine for the other aircraft is under development by Pratt & Whitney. The engine to be used in the first nuclear-powered aircraft has not been selected.

Nuclear aircraft have been under study for nine years at Convair, which has had actual experience in operating an airborne nuclear reactor in a converted B-36 bomber. The aircraft was test flown for two years with the reactor aboard to study radiation effects on aircraft components and to determine the best methods of protecting the crew from radiation.

High-Temperature Metals Welded by Electron Beam

ELECTRON-BEAM welding process can create temperatures to 6,000 F. Faster fabrication of space vehicles is expected to result from the new technique, which produces high-quality welds of hard-to-handle materials. In addition to faster welding, compared with present methods, the weld is less susceptible to fracturing.

Progress is reported at Republic Aviation, developer of the process, in achieving welds that can withstand 3,000 F. Speeds up to 60 inches per minute are possible, and the technique can be used with metals such as molybdenum alloy and pure tungsten.

The weld-joint is bombarded with a narrow, concentrated beam of high-velocity electrons that generate the intense heat. The electron gun operates in a cylindrical vacuum chamber that provides a contamination-free atmosphere for welding. The resulting deep-penetration, narrow-bead welds are therefore virtually free of contamination, which often makes welded joints brittle and susceptible to fracturing.

Success of the new welding process is expected to accelerate metal working with other new materials. Some such materials are now not being exploited despite desirable characteristics because of the inadequacy of techniques for joining them.

CIRCLE 91 ON READER SERVICE CARD→



NEW... HIGH WRITING SPEED OF 50,000 IPS...

through an exceptionally efficient optical system. Record resolution of the highest order is assured with trace widths of 0.010" or better.

For even faster record access-time than afforded by the standard print-out process, there is the optional DATAFLASH unit, which speeds the print-out process by a factor of 60.

Check this list of standard and optional features. Only the CEC 5-124 can offer them.

STANDARD FEATURES

- 6, 12 or 18 channels
- 15" long x 13" wide x 7 $\frac{3}{8}$ " high
- 115 volts, 50 or 60 cps, 500 watts
- 7" by 200 print-out record capacity
- High intensity mercury-vapor light source
- Intensity control
- Unexposed footage indicator
- Individual input connectors
- Automatically regulated galvanometer lamp circuit

OPTIONAL FEATURES

- Grid lines 1/10" or mm
- Trace identification
- Timing lines
- Galvanometer block heaters

Dataflash—See the new 5-124 at the ISA SHOW, Sept. 26-30—Booth 1712.



Modular construction of the 5-124 allows fast, easy access to all internal components for servicing. Operates with the cover off, too, for dynamic testing. Write for Bulletin CEC 5124-X1.

Electro Mechanical
Instrument Division

CEC

CONSOLIDATED ELECTRODYNAMICS / pasadena, california

A SUBSIDIARY OF Bell & Howell • FINE PRODUCTS THROUGH IMAGINATION

Photoconductor Chopper Stabilizes DC Amplifier

PHOTOSENSITIVE MATERIAL IS EFFECTIVELY SHIELDED FROM MODULATING VOLTAGE TO A LEVEL OF 2 MICROVOLTS

By M. W. P. STRANDBERG

Research Laboratory of Electronics
Massachusetts Institute of Technology

A WIDELY used and generally suitable method of designing stable, high-gain, dc amplifiers is to incorporate one form or another of chopper stabilization. A slowly varying low level potential is chopped or modulated at some frequency convenient for amplification by an ac amplifier. The amplified signal is then demodulated by a synchronous detector to recover the original waveform.

Such an arrangement is convenient when the bandwidth of the varying potential is small. For large bandwidth signals that include a dc component, it is necessary to carry out dual channel amplification. An ac amplifier provides the high frequency gain, and a modulated dc amplifier provides the low frequency and dc gain. The outputs of the two amplifier channels are summed, in some fashion, to obtain the desired gain characteristic as a function of frequency.

A disadvantage of modulated dc amplifiers has been unreliability of mechanical chopping devices. Choppers, vibrators, and reeds can develop mechanical trouble and get out of adjustment.

There are, however, other types of modulators, such as saturable tube reactors, diode or vacuum tube modulators, light-modulated photoconductors, and time varying capacitors that will time modulate a dc potential.

Light modulated photoconductors provide a time varying resistance to modulate a potential. Early photomodulators had large amounts of carrier feed-through, and a limiting sensitivity of a few millivolts.

A photoconductor modulator that overcomes these difficulties is now being manufactured by the Cambridge Electronics Corporation, under the model name M-10.

The design of an effective photo-



Photomodulator package. Design geometry isolates photosensitive material from modulating voltage

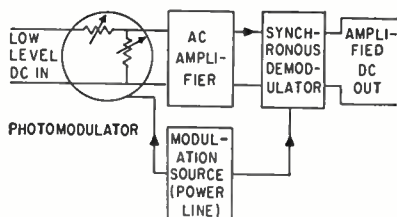

Typical chopper modulated, high gain, dc amplifier. Demodulator restores original wave form

modulator rests upon finding photoconducting materials in which the photoelectric effect is negligible, and in finding a way to shield the photoconductor from the alternating voltages used to modulate the light source.

A neon lamp is modulated by a time varying voltage, such as the power line, in the Cameco modulator, and the photoconductor and lamp are separated in such a geometry that the time varying potentials at the neon bulb are attenuated to a level of 2 microvolts at the photoconductor.

The photomodulator has been applied in a stabilized X-band generator. Conventional mechanical choppers are unsuitable because the mechanical motion of the chopper is transmitted to the chassis, waveguides, and klystron. The transmitted motion leads to an additional frequency modulation of the klystron, which must be corrected in the frequency stabilizing circuit.

A dc amplifier utilizing a 60-cycle

carrier was convenient in this application. The 60-cycle modulated dc signal can be capacitor coupled or transformer coupled to the klystron repeller reference potential, demodulated, filtered, and applied without further loss of gain or stability to the klystron repeller.

Solid state diodes were used in the synchronous detector, demodulator, circuitry. A 60-cycle modulation frequency was of sufficiently high frequency for this application.

If higher frequencies were necessary, to accommodate a limited ac band-width within a single channel amplifier, for example, a dpst photomodulator operating in push-pull could have been used. High efficiency at 400 cps is possible using this configuration.

In most instances, a photoconductor modulator can directly replace any high-stability mechanical chopper. The limitation for their use is that they must be crudely matched in impedance to the source of signal, and the following amplifier. The modulation center impedance of a Cameco photomodulator is 220 kilohms. During the modulation cycle, the photoconduc-

Torture Testing



Technician subjects Minuteman missile precision resistors to extreme environment in tests



Experience is the optimum test for Energy Storage Capacitors...

time-proven Sangamo Type DCM Electrolytic Capacitors exceed operating requirements of practically every application



Sangamo Type DCM Electrolytic Capacitors are housed in seamless, drawn-aluminum containers with a molded thermosetting plastic top that is sealed with a gasket to prevent electrolyte leakage and contamination. Terminal construction insures minimum contact resistance in current-carrying members. Cover design provides an adequate safety vent in case of heavy overload.

Sangamo was the first capacitor manufacturer to produce and establish standards in the manufacture of electrolytic energy storage capacitors. Since 1949, design and manufacturing techniques have been developed to such a scientific degree that Sangamo is still regarded as the leader in the field with the Type DCM. The time-proven characteristics of the DCM more than meet normal requirements of operating temperature, equivalent series resistance and life expectancy. Those techniques mean, too, that maximum capacity can be put in the smallest case size consistent with good engineering practice and performance reliability.

Occasionally applications call for energy-storage capacitors to meet special requirements — including higher temperature, and higher ripple current. Sangamo is uniquely qualified and equipped to engineer and produce to the most exacting specifications. We would appreciate the opportunity of supplying your future needs.

Complete data on capacitance and voltage combinations on Type DCM Capacitors is detailed in Sangamo's Engineering Catalog 2231. Contact your Sangamo Representative, or write us for your copy.

Maximum Capacity in Mfds VS Case Size in Inches								
Rated Voltage	Surge Voltage	D=1-7/16 L=4-1/2	D=1-13/16 L=4-1/2	D=2-1/16 L=4-1/2	D=2-1/16 L=6	D=2-9/16 L=4-1/2	D=3-1/16 L=4-1/2	D=3-1/16 L=6
5	8	14,750	25,500	33,000	48,750	55,500	85,000	125,000
10	15	10,500	18,500	23,500	35,000	40,000	60,000	90,000
15	20	8,000	14,000	18,000	26,500	33,300	46,000	68,500
20	30	6,650	11,700	14,750	22,000	27,000	38,000	56,500
30	40	5,100	9,000	11,400	16,900	19,000	29,000	43,000
35	50	4,000	7,000	9,100	13,500	15,400	23,500	34,800
40	50	4,000	7,000	9,100	13,500	15,400	23,500	34,800
50	75	2,650	4,765	5,900	8,800	10,000	15,300	22,500
75	100	1,350	2,400	3,000	4,500	5,400	7,750	11,450
100	135	1,000	1,790	2,250	3,350	4,000	5,750	8,500
150	185	720	1,250	1,600	2,400	2,800	4,000	6,000
200	250	500	900	1,100	1,650	2,000	2,750	—
250	300	390	690	880	1,300	1,550	2,200	—
300	350	275	490	620	900	1,000	1,500	—
350	400	190	350	440	650	775	1,100	—
400	475	170	300	380	570	680	975	—
450	525	150	260	340	500	600	850	—

NOTE: Case dimensions include insulating sleeve. Subtract 1/16" from diameter and 3/8" from length for overall dimensions of un-insulated case.

SC-60-4

SANGAMO ELECTRIC COMPANY, Springfield, Illinois
—designing toward the promise of tomorrow

WE CAN'T AFFORD A HOLE IN THE NET!

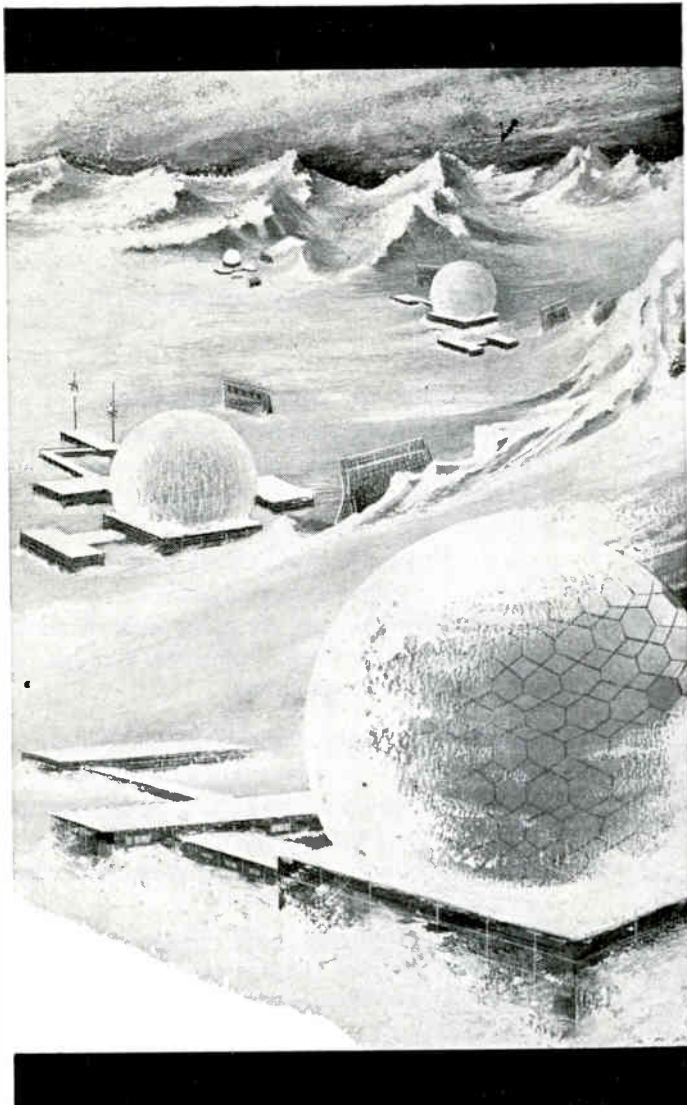

MILLIONS of dollars have been spent in establishing radar early warning protection around our nation. One hole in this system... one inaccurately functioning radar... and the "fish" might slip through.

Determining that this vital radar is accurate and reliable is the job of Remanco.

RADAR TARGET SIMULATION

Remanco is an entire order of magnitude ahead of the field in developing and producing radar target and countermeasures simulation equipment, including single target, multiple target to "n" quantity, video, IF and Microwave target simulators.

Remanco equipment can provide pin-point accuracy in moving target simulation to 0.1% in ranges to 20,000 microseconds. It can be programmed for target velocities up to 75,000 feet per second and acceleration of 50 g's.



Write for folder giving complete details.
Address inquiries to: Remanco, Inc., 1805
Colorado, Santa Monica, California.

REMANCO

tor has a resistance n times less than this with the light on, and n times greater than this with the light off. The factor n depends upon the modulation frequency, but will vary from 10, down to 1.5, in the usable modulation frequency range of dc to 1,000 cps.

Such a modulator is well suited to vacuum tube input impedances. A photomodulator with a modulation center impedance of 1,000 ohms would be more suitable for transistor input impedances.

Some loss in ac output results from replacing a mechanical chopper with a photomodulator; however, the factor is two or less, and is easily compensated for with a slight increase in gain in the following carrier amplifier. This is the price paid for achieving the vibration-free operation, and long life of a photomodulator.

Infrared Eye Monitors Traffic



AN INFRARED traffic monitor that can be installed in minutes has been introduced by the Heiland Div., Minneapolis-Honeywell Regulator Co.

The flexible device will be used by traffic engineers and law enforcement officials in studying and controlling traffic.

The 18-pound unit can be mounted on utility poles, sides of buildings, or other locations up to 50 ft. from the roadway. An infrared beam projects downward onto the road, and is reflected back into the receiver lens. Passing vehicles interrupt the beam, triggering a counting or indicating mechanism.

The manufacturer reports the de-

vice is highly accurate and fool-proof, and can detect and count cars traveling at 80 mph.

Should existing traffic conditions change, the detector can be removed quickly and shifted to another location. This is impossible with conventional magnetic or pressure plate detection systems that are built into the roadway.

The monitor will operate on asphalt, concrete, gravel or dirt roads, and is being marketed under the name Traffitol.

Soviets Note Demand For Cold Cathode Tubes

SOVIET ENGINEERS report that although the cold cathode tube has proved its worth as a cheap and reliable component for use in computers and other apparatus, production has not been up to the level it should be.

Over 200 installations and research institutes are reportedly using the tubes, and the total demand is running in excess of 10 million units a year. Present production figures have not been announced, but the demand is apparently unsatisfied, as existing plants are being enlarged, and a new plant being built.

The conventional Soviet MTX-90 cold cathode tube is about the size of a sunflower seed, and weighs about 1/30 of an ounce. It contains six components and is filled with discharged neon. Unit prices range from 2.5 to 8 cents, and average reported life is about 100,000 hours.

The tubes offer savings in weight and power consumption when used instead of conventional vacuum tubes. Soviets point to a desk computer using 500 MTX-90 tubes that is the size of a home tv set, in contrast with the roughly equivalent "Ural" computer containing over 800 vacuum tubes, and occupying an area of 320 sq. ft.

A second cold cathode tube computer, using 2500 tubes, requires only six half-hour inspection and maintenance checks in six months of operation. The equivalent vacuum tube or transistor computer requires the regular attention of five to ten qualified specialists.

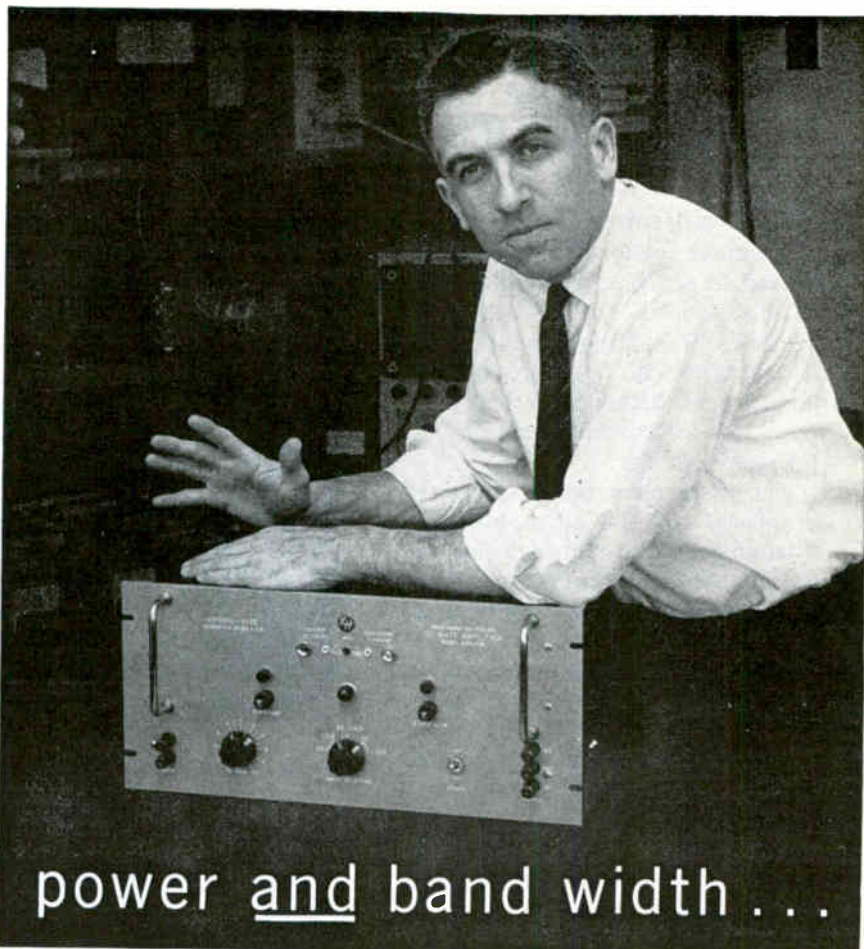

50 watts from dc to 500 kc with this new direct-coupled amplifier!

NEW from Krohn-Hite: this unique combination of high power and bandwidth! The Model DCA-50 offers you the convenience of 50-watt amplification of all sources from dc to one-half megacycle, without the bother of changing amplifiers or bandswitching!

The DCA-50's low distortion—less than 0.2%—makes it the perfect complement for low-distortion, quality oscillators . . . for unexcelled performance over the entire frequency range. And by cascading two DCA-50's, you get a full 100 watts of virtually distortion-free push-pull power!

Output — to 450 volts peak to peak, to 2.5 amps peak to peak. Frequency response is flat to within one db, from dc to 500 kc. Stability is excellent for both output dc level and gain.

So when you need power amplification, with high current, get the real flexibility of dc-through-rf bandwidth. And, because of the DCA-50's low-distortion specifications, this direct-coupled amplifier is ideal for systems where variable frequency power is needed. Write for full information.

Other Krohn-Hite amplifiers include the direct-coupled 10 watt DCA-10, and the ultra-low distortion (0.005%) 50 watt UF-101A. Also, *Krohn-Hite Oscillators, Filters and Power Supplies.*



KROHN-HITE CORPORATION

580 Massachusetts Avenue • Cambridge 39, Mass.
Pioneering in Quality Electronic Instruments

Projectors Improve Calibration Accuracy

OPTICAL PROJECTORS can help make instrument calibration more accurate. In addition to magnification, parallax errors and eyestrain are avoided. Ballantine Laboratories, Inc., Boonton, N. J., reports reading accuracy of better than $\frac{1}{4}$ percent with the instrument scale projector shown in Fig. 1.

The instrument being calibrated is placed on the turntable. The turntable swings through an arc which follows the curvature of the scale, allowing the operator to select small portions of the scale for viewing. Selection is made among parallel scales by shifting the position of the instrument on the turntable. The projectors shown were adapted from war surplus periscopes.

Calibration consoles used by Ballantine have other features which also make the calibration of multirange instruments less tedious and more accurate. These include automatic gain control and level monitoring, and pushbutton selection of test frequencies.

Plan of a typical console for vacuum tube voltmeters is shown in Fig. 2. The pushbuttons are on the high- and low-frequency oscillators. One bank of switches selects base frequencies and the others select multipliers. A series of frequencies are required since the instruments have many steps of high impedance attenuators feeding directly into



Vtvm calibrator watches scale through projector while shifting test frequencies with pushbuttons at his left hand

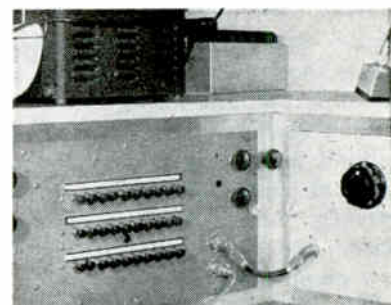
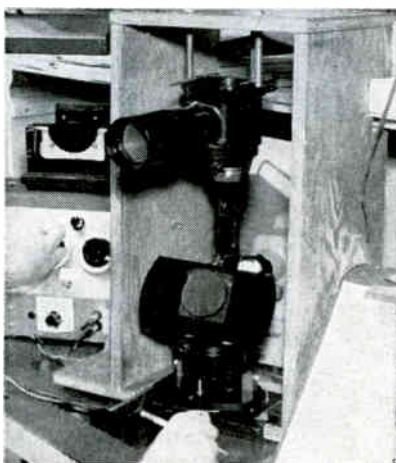

Frequency selection buttons. Rotary switch at right selects voltage

Projector being used to calibrate meter before instrument assembly

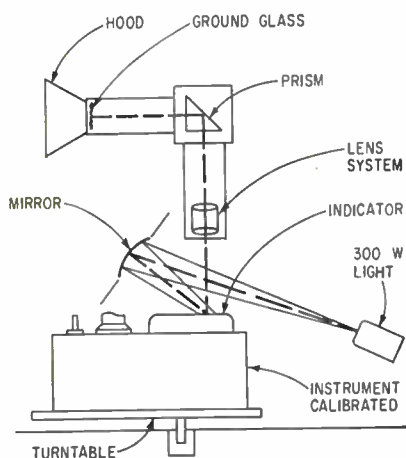

FIG. 1—Meter scale viewing system was adapted from periscope

their amplifiers. Each step is calibrated at critical frequencies.

In Fig. 2, A, B and C are outputs connected to the instruments under calibration. The level meter sensing circuit is built into the power amplifier. Cable D connects the level meter indicator to the sensing circuit. Cable E feeds the control signal (AVC) to the oscillators.

A 6-step test and calibration procedure is followed. Wiring and mechanical operation are inspected. A preliminary performance check is made. The instrument is on-off cycled for a week, including 100 hours of on-time. A detailed calibration is made. The aging cycle is repeated for 24 hours. Another de-

tailed calibration is made by a second operator at a different console. If findings of the calibrators differ beyond specified limits, the instrument is trouble-shooted and put through the procedure again, or rejected.

Generally, a detailed calibration includes the following steps. Absolute accuracy of meter readings is checked at end points on the scale (logarithmic) and at intermediate points. A 1 Kc input is used as reference. All attenuators are also checked against this reference. Higher frequency tests are made with the pushbutton oscillators previously described. Voltage readings are taken at 24 v and down in 1/10

In FLEXIBLE ETCHED CIRCUITS

if it's news, expect it first from IRC

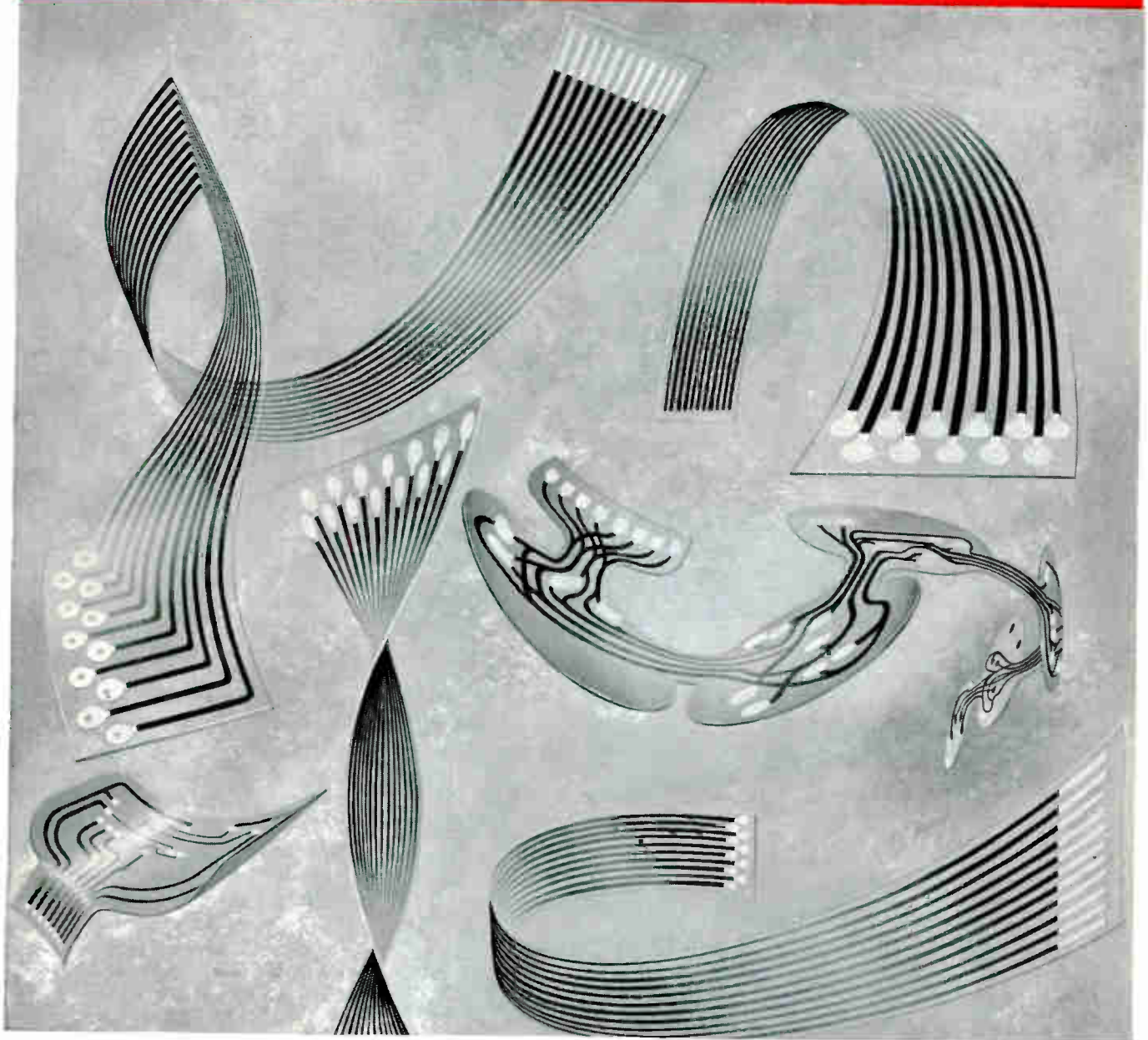

3 DIMENSIONAL FREEDOM OF DESIGN!

IRC LAMOFLEX* FLEXIBLE ETCHED CIRCUITS AND CABLES

**ERROR FREE WIRING AND ASSEMBLINGS • WEIGHT REDUCTION
• GREATER WIRING DENSITY • OPTIMUM ENVIRONMENTAL
PROTECTION • MINIMUM ASSEMBLY TIME • IMPROVED
PRODUCT APPEARANCE •** IRC Lamoflex circuitry consists of a designed pattern of metallic conductors sandwiched between layers of plastic. Conductor and plastic are chosen to give desired combination of voltage and

current rating, heat and dielectric strength, and solderability by automatic or hand methods. Flexible and rigid circuits can be combined, circuits can be stacked as many as six deep, and layers can be selectively bonded. When desired, IRC will wire components into the circuits.

Write for Bulletin S-7 to International Resistance Co., 401 N. Broad St., Philadelphia 8, Pa. *IRC Trademark.



Leading supplier to manufacturers of electronic equipment

BECAUSE
IT'S DIGITALLY
PROGRAMMABLE—
NEW
CON AVIONICS
DC POWER
SOURCE...

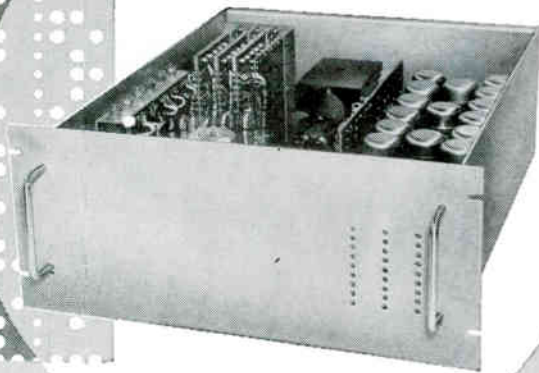

... INSTANTLY PROVIDES ON COMMAND ANY VOLTAGE
FROM 0.1 TO 50 VOLTS DC — UP TO 15 AMPERES

Another first by Con Avionics, this digitally programmable power source translates manual push-button setting or output of your program device into the selected voltage. It can be made to respond to any digital code from sources such as paper or magnetic tape readers, punched card readers, or keyboards. Voltages may be changed from any setting to any other within 300 milliseconds. Voltage is stable and accurate within $\pm 0.1\%$ of the selected value. Ripple is less than 0.05% rms.

The completely self-contained design of the Con Avionics DC Power Source eliminates external rheostats, step switches and other devices.

This unit reduces equipment complexity in data systems, automatic checkout equipment or precision testing applications.

Outstanding results are obtained both in the lab and on production work.

CONSOLIDATED AVIONICS CORPORATION

A SUBSIDIARY OF CONSOLIDATED DIESEL ELECTRIC CORPORATION

800 Shames Drive • Westbury, L. I. • EDgewood 4-8400

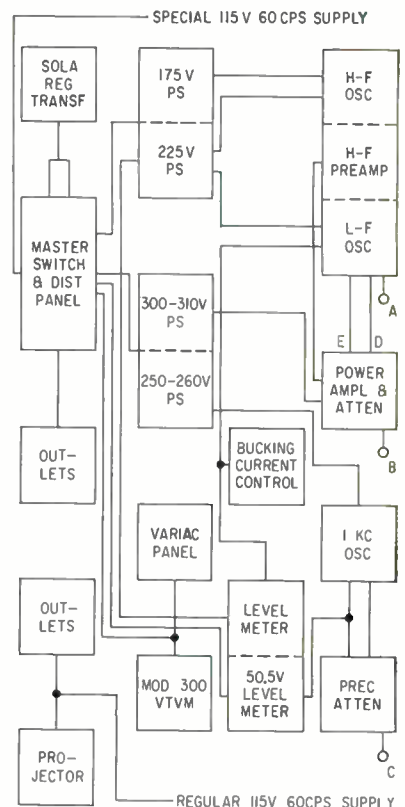

FIG. 2—Layout of typical test console

ranges. Before each reading, the level indicator is inspected and the level corrected if necessary. As frequencies are switched, the meter reading should remain constant at a given voltage. The consoles are also periodically calibrated with secondary standards.

Meters are calibrated before and after temperature cycling, prior to instrument assembly. A precision current source is used. Readings are made with the optical projector.

Coring Drill Shapes Round Crystal Rods

TUBULAR DIAMOND DRILLS are used at Standard Rectifier Corp., Santa Ana, Calif., to prepare round wafers of silicon and germanium crystals. Cylindrical rods, cut from the crystal ingot, are sliced to form the individual crystals.

To make crystals $\frac{3}{8}$ inch in diameter, for example, an ingot $1\frac{1}{2}$ inches long is fixed on a ceramic holder. The holder is fastened under a drill press equipped to water cool the drill. A coring drill with a diamond cutting edge, smooth shank walls and an inside diameter of $\frac{3}{8}$

inch is passed through the ingot. The drill is rotated at 3,000 rpm; feed is manually controlled at 1 inch a minute. Cores are retrieved from the drill, placed on pallets and wafered to desired thickness with a diamond saw on an automatic indexing machine.

The firm also cuts crystals of $\frac{3}{4}$ inch to $1\frac{1}{4}$ inches diameter by this method, using drills obtained from Felker Mfg. Co., Torrance, Calif. Standard Rectifier reports the method is faster than ultrasonic die-cutting for depths of more than $\frac{1}{2}$ inch, reduces material loss and avoids the problem of dies changing shape under abrasive action of slurries.

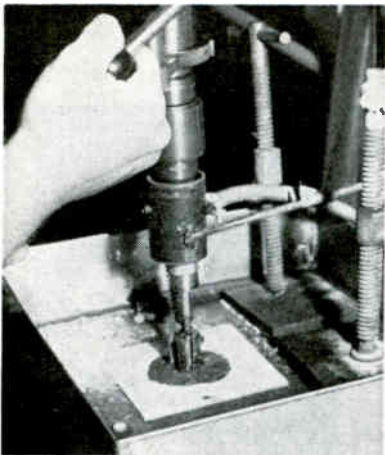

Tubular drill takes several cores from silicon ingot

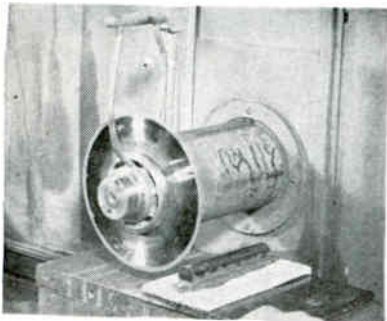

Slicing core into wafers. Diamond wheel is in coolant-distributing hub

Square-cut crystals are produced from bars. An ingot is cut with a diamond saw into slabs the width of the crystal. The slabs are fixed with wax on a pallet and cut on an automatic indexing machine into bars the width of the crystal desired. The machine is then indexed to cut the bars into wafers of the desired thickness, the pallet turned and the bars wafered.

Important facts to know about laminated plastics

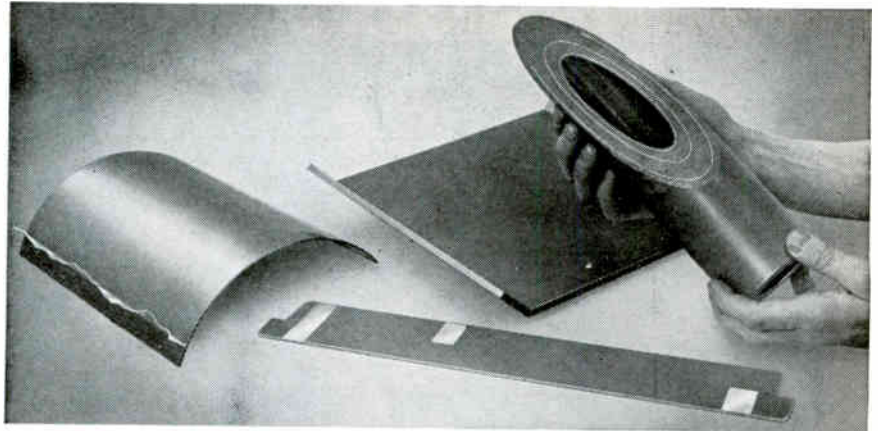

A few Taylor composite laminates (left to right): copper-clad section; sandwiched copper component; Taylorite vulcanized fibre-clad part; laminated tube, copper inserts.

Composite Laminates Open Up New Design Opportunities

While the great variety of commercially available laminated plastics satisfy most electrical and mechanical requirements, there are applications that can benefit from the combination of properties provided by composite laminates. Recent advances in bonding techniques have made it possible to bond virtually any compatible material with a laminate. These can be supplied as clad or as sandwiched materials. And they can be molded into many shapes to fit design requirements. Taylor is presently supplying to order the following composite laminates:

- **Copper and laminated plastics.** Clad for printed circuits and formed shapes. Sandwiched for special applications.
- **Taylorite® vulcanized fibre-clad laminates.** These combine the high strength of laminated plastics with the superior hot-arc-resistance of vulcanized fibre. They are being used in both high and low-voltage switchgear applications. Also in applications where the high impact strength of vulcanized fibre may be advantageous.
- **Rubber-clad laminates.** Almost any type of natural or synthetic rubber may be used as the cladding material. These laminates are widely used for condenser tops in wet condensers to protect the laminate against highly alkaline electrolytes. They also have application in any part where sealing or chemical resistance is needed.
- **Asbestos-clad laminates.** For applications where high heat- and arc-resistance are required.
- **Laminate-clad lead.** Lead sheets sandwiched between Grade XX pa-

per-base laminates have been used for X-ray shields. The laminate provides strength and contributes to the high shielding properties of the lead.

- **Aluminum-clad laminates.** These have been used extensively for engraving stock. They also offer possibilities as printed-circuit material and as plate holders for X-ray machines.
- **Beryllium copper-clad laminates.** Beryllium copper is nonmagnetic and a good conductor—properties that give these laminates possibilities in many applications.
- **Stainless steel-clad laminates.** Applications where nonmagnetic properties are required. Also in certain corrosive environments where the resistance of stainless steel to attack is an asset.
- **Magnesium-clad laminates.** These laminates have been produced in 108-in.-long sheets for use as screens for X-ray operators. Weight was a factor.

Our design and production engineers are constantly developing new materials, new applications, and new procedures for fabricating laminated plastics. Our experience is yours for the asking. And if you have a problem requiring assistance or more information on composite laminates, write us. Also ask for your copy of Taylor's new guide to simplified selection of laminated plastics. Taylor Fibre Co., Norristown 40, Pa.

Taylor
LAMINATED PLASTICS VULCANIZED FIBRE

New On The Market

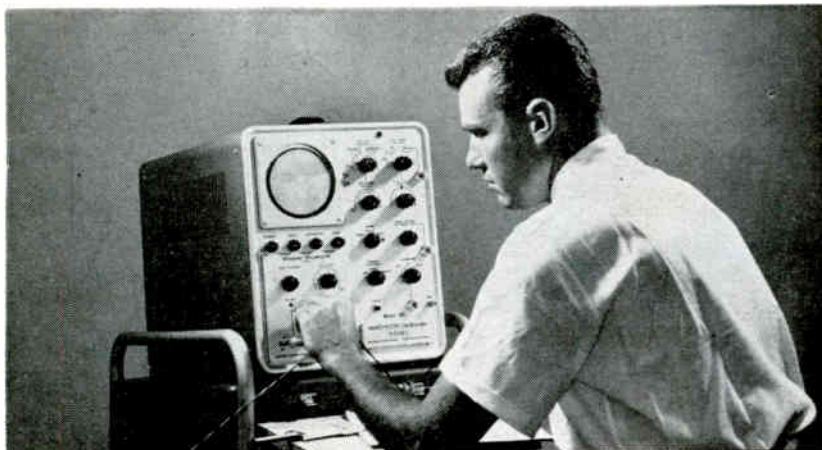

Wideband Storage Scope

WRITING SPEED OF 10^6 INCHES/SEC

A NEW wideband, high frequency storage oscilloscope which features a 10-megacycle bandwidth and a writing speed of 1,000,000 inches a second is available for laboratory and general application. The model 105 Memo-Scope oscilloscope combines the measurement of high frequency waves with storage capacity. Applications are in electronics, medicine, geology, nucleonics and anywhere parameters under test can be transduced to electrical

values.

The scope is designed with plug-in amplifiers, one-shot trigger circuits, delay lines and swing-out circuit boards. Epoxy glass circuit boards are used for circuit stability. Additional information and specifications can be obtained from the Industrial Systems Division, Hughes Aircraft Company, P. O. Box 90904, Airport Station, Los Angeles, Calif.

CIRCLE 301 ON READER SERVICE CARD



Solid State UHF Power Source

MICROWAVE GENERATOR

COMMERCIALY available solid state microwave generator has been announced by Philco Corp., Lansdale Division, Lansdale, Pa. The uhf

power source delivers a minimum of 5 mw at 2.2 Gc.

When compared to conventional, non-solid state power generating

devices for uhf, such as reflex klystron oscillators, the new power source offers an efficiency improvement of up to two orders of magnitude and increased reliability. High efficiency and a minimum number of components are features of the generator.

Only four semiconductor components are used. The first two stages include a field-flow transistor oscillator and a field-flow power amplifier. Two harmonic conversion stages, each using a varactor, take the amplified 116 Mc transistor output to 2.2 Gc. The initial model operates from four 4-volt mercury cells of flashlight battery size; volume will be about 100 cubic inches. Delivery of the solid state uhf generator is within 90 days; unit price is \$2,465.

CIRCLE 302 ON READER SERVICE CARD

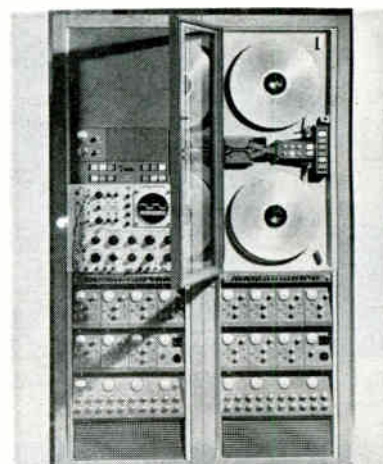

Recorder/Reproducer

VIDEO BAND

MINCOM DIVISION, Minnesota Mining & Manufacturing Co., 2049 So. Barrington Ave., Los Angeles 25, Calif. The new CM-114 extends the advanced capabilities of the original seven-track CM-100 to recording and reproducing 14 tracks of both analog and pulse signals on one-inch magnetic tape. Frequency response on each of the 14 tracks is 400 cps to 1.0 Mc at 120 ips. Pre-detection recording is a feature application of the CM-114, which is designed to incorporate both a receiver and a scope in the unit if desired. This type of recording provides greater system reliability because of the reduction in the number of series elements before data storage. Unit has a selection



COMMUNICATION SYSTEMS . . . *the ultimate integration of the electronic arts*

Among the great names in the telecommunications and electronics industry, Kellogg today is one of the country's strongest sources of advanced communications equipments and systems. We have one major goal — to provide the finest communications that the electronic arts make possible . . . for industrial, commercial and military needs.

The Communication Systems Department of Kellogg, growing by leaps and bounds to keep pace with demands for wholly integrated communications means, provides large-scale communications systems from Alpha to Omega . . . from systems studies through engineering and production. Engineering is concerned with all phases of telephone, radio, data communications and automatic control circuit design. Principal areas of engineering organization include Project Engineering, Applications Engineer-

ing, Development and Systems Evaluation and Utilization and Reliability.

Typical of Kellogg's major systems engineering achievements is the provision of complete ground communications for the firing of Titan and Thor ballistic missiles and Discoverer and Samos space satellites at Vandenberg Air Force Base. Similarly, Kellogg has provided for the Atlas ICBM program nine separate systems for communication, control, maintenance and check-out, count-down, voice-recording and fire alarm — all functioning as an integrated system.

If you seek a dynamic organization in which to further your future, write Manager of Technical Staffing, Communication Systems Department, Dept. M-03(00).

ITT KELLOGG Communications Division, International Telephone and Telegraph Corporation
500 North Pulaski Road, Chicago, Illinois



CIRCLE 381 ON READER SERVICE CARD

of six tape speeds ranging from 7½ to 120 ips, and features higher frequency response at lower tape speeds. At 60 ips, for example, frequency response is up to 500 Kc. Constant phase equalization at all six speeds provides fidelity of pulse

response, and Mincom's exclusive use of direct current for operation of the tape transport eliminates the undesirable effects of outside power line fluctuations.

CIRCLE 303 ON READER SERVICE CARD

Tough, non-interchangeable bases and sockets have no molded center bosses to break, are available in 20- and 11- pin design as well as 7- and 9- pin bases and sockets for miniature and subminiature circuits.

CIRCLE 305 ON READER SERVICE CARD

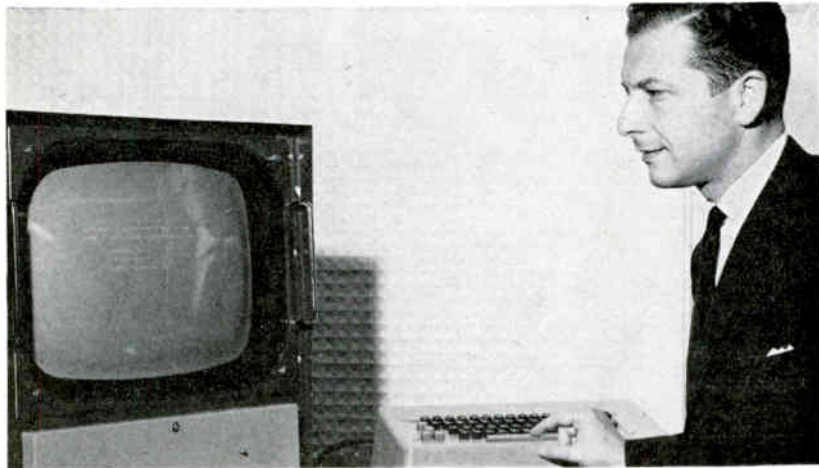

Character Generator

ALPHA-NUMERIC DISPLAY ON CRT

A NEW character generation and display system, called Dotitron, incorporates a new display technique which provides an economical method of generating and displaying alpha-numeric characters or any arbitrary pattern of lines on the face of a crt or other projection tube equipment. The display uses closely spaced luminous dots to generate the required patterns. Character selection and position order are by parallel digital codes.

In generating characters, the blanked electron beam is positioned by X and Y deflection voltages. Dot positions are measured from the suborigin of the character and relative deflection voltages, derived from resistor networks, are added to major deflection voltages. The

beam is unblanked when it has been driven to the desired dot position. The character is thus synthesized by a series of overlapping dots.

This system is flexible in that new characters or symbols can be added with resistor networks. No analyses of wave shapes are necessary nor is a new mask or crt required. The system is also less costly because regular crt's can be used and high precision voltage supplies are not necessary.

Writing speed is faster than raster scanning systems and comparable to systems using masks. The character generator was developed by Link Division, General Precision Inc., Binghamton, New York.

CIRCLE 304 ON READER SERVICE CARD

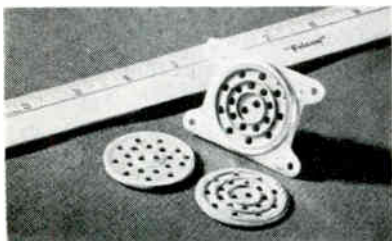

Alkyd Bases and Sockets PREVENT MISMATING

COMPONENT bases and sockets molded from alkyd cut downtime

for digital computers and other electronic equipment. Glass fiber reinforced alkyd is used in the bases and sockets because of its strength, high arc and insulation resistance, in addition to unusual dimensional stability. Molded parts made with Plaskon 540 hold their tolerances during rapid production cycles.

Alden Products, 117 N. Main St., Brockton, Mass., offers a complete series of components specifically designed for plug-in construction.

Storage Oscilloscope

HOLDS TRACES FOR DAYS

OSCILLOSCOPE patterns are frozen instantly on crt face for minutes or days in new StoreScope by Allen B. Du Mont Laboratories Divisions of Fairchild Camera and Instrument Corp. 750 Bloomfield Avenue, Clifton, New Jersey. The new oscilloscope will be priced below other storage scopes now on the market but final prices and delivery dates have not been set.

A P10 phosphor tube is used, producing a dark trace on a light background, with storage time determined by ambient temperature and density of trace. Thus the



image is retained even if there is line voltage failure. Erasure can be accomplished in a maximum of 15 seconds with a recycle every 40 seconds. The StoreScope serves as a storage scope and also a conventional, general purpose oscilloscope. Sweeps range from 50 μ sec/cm to 100 seconds full scale. Tentative specifications for writing speed are 30,000 cm/sec. The scope has an erase warning light and back lighting for photo recording.

In addition to usual applications, the scope finds particular use in displaying low speed phenomena from vibration analysis to medical cardi-



Read this column carefully, because it contains important items of general interest to everyone. Example No. 1: The nine-banded armadillo (*Dasyus novemcintus*) invariably gives birth to a litter of four young, two male and two female. Example No. 2: The Mincom Model C-100 Instrumentation Recorder/Reproducer is one heck of a good system and we are proud of it. Unlike the armadillo, it does not use its long narrow tongue to snare earthworms and insects—but its input requirements are nearly as relaxed and thereby hangs our tale.

Again differing from *Dasyus novemcintus*, the Mincom Model C-100 is all-transistorized. This doesn't mean that you can hold it in your hand at a ball game and listen to what you're already seeing, but lots of Dodger fans are Mincom C-100 fans nevertheless. Because the electronics are transistorized, the power input is remarkably low and figures out to about 1/10 of the power usually needed for systems of this type.

Horrible Thought

Applied to *Dasyus* this would mean one earthworm supplying the energy of ten, and in three years would result in the entire country's being covered to a depth of seven feet ten inches in armadillos. Applied to Model C-100 it means about 500 watts input when the tape is coursing over the pucks in full cry, and has resulted in our selling lots of these fine systems.

Neat, Tidy and Cool

There's something so neat and tidy about Mincom's modular building-block construction when it's all transistorized. Appeals to the housewife in all of us, and it's cool, cool, cool. Those agonizing hours when the brass can't make up their minds (known in the industry as "standby time") have lost their sting. Model C-100 doesn't even have any blowers, it's so cool, and that's fine for us little people who do the work: more locker room in the bottom of the rack, even a place to keep our sandwiches. Good for employee relations. Ask your Chairman of the Board to get you a Mincom Model C-100 for your very own.

Everybody Likes Our DC Top Plate

The armadillo's top plate allows him to curl into a hard tight ball with his head and feet tucked out of harm's way. The top plate on a Mincom Model C-100 is even more ingenious because it's entirely powered by DC, which is something the armadillo never heard of. Not yet, anyway.*

The DC top plate is what makes the Model C-100 (and our CM-100, too) all things to all men. When you have all your transport functions powered by DC, you are approaching the moment of truth in instrumentation recording/reproducing. At Mincom and at 3M we say that Research is the Key to Tomorrow; something like the DC top plate is what gives the key at least a quarter-turn.

*As far as we know.

†Did the Romans use fractions? Did they have a decimal system? We're glad you asked that question . . .

Imagine in your facility a top plate with no nerve-racking mechanical brakes, just smooth easy torque fields that give a stop time under 0.5 seconds at all speeds. If you don't have Dynamic Braking à la Mincom DC Top Plate, your maintenance men are working too hard.

Imagine in your facility a speed control milieu that involves no belt changes. Just look over the brilliantly lighted push buttons on the control panel, pick the speed of your choice (like "30"), think it over and PUSH. Anyone who can read Arabic numerals (Roman like "XXX" available on special order) can change speeds instantaneously on our exclusive DC top plate. Speeds normally supplied on Model C-100 in ips: III.LXXV, VI, VII.V, XV, XXX atque LX.†

Because our top plate runs on DC converted from just any old AC, you are at last independent of the electric company. You will still have to pay your bill, but power line frequency fluctuations will never bother you again.

Mechanical Simplicity

An armadillo is able to hold his or her breath for long periods and sometimes crosses a stream by crawling along the bottom.



... WHERE RESEARCH IS THE KEY TO TOMORROW



MINCOM DIVISION **MINNESOTA MINING AND MANUFACTURING COMPANY**

2049 SOUTH BARRINGTON AVENUE, LOS ANGELES 25, CALIFORNIA • 425 13th STREET N.W., WASHINGTON 4, D. C.

September 16, 1960

CIRCLE 103 ON READER SERVICE CARD 103

How United States
Testing Company helps

CUT COST & TIME OF COMPONENT TESTING 5 WAYS

Engineers who know where a component will "give", and test *there* first... plus complete evaluation facilities... all mean low cost component testing... high reliability... and quick service at United States Testing Company. Here's what you get:

Automated Reliability Testing— machine-recorded, error-free readings of 0.1% accuracy, every 3 seconds.

Complete Environmental Facilities— vibration, acceleration, shock, altitude, humidity, temperature, rain, immersion, fungus, salt spray, sand and dust.

Experienced Evaluation Engineers— who spot weakness and potential failure.

Economical Handling of Your Peak Loads— quick take-over; costs you less than adding permanent staff.

Product Qualification Tests— recognized by government and military for placing your product on the Qualified Products List.

See how United States Testing Company can cut the cost and time of your component testing. Phone or write for quotation.

RESISTORS · TRANSFORMERS · TRANSISTORS · DIODES · CAPACITORS · RELAYS · SWITCHES

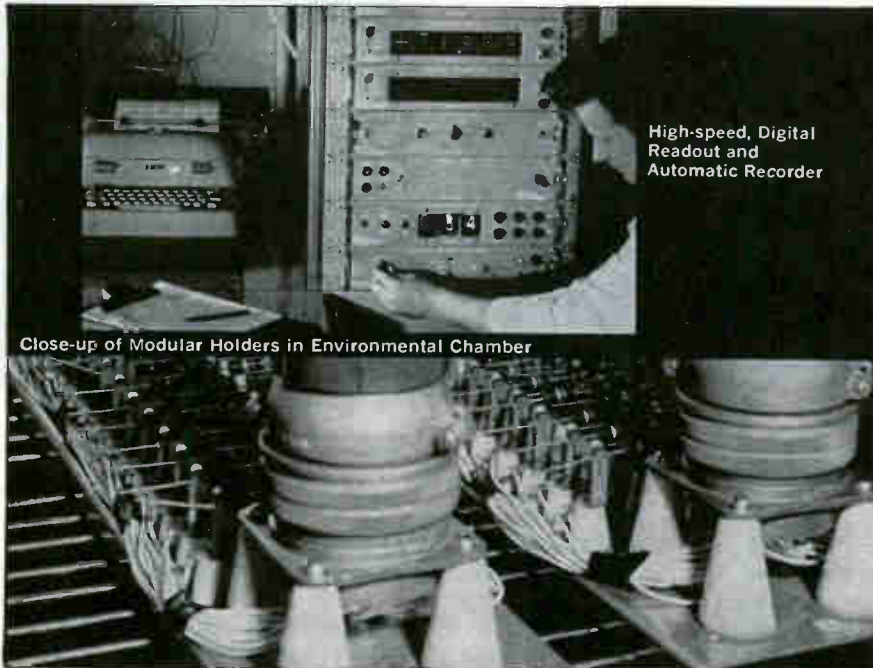

High-speed, Digital
Readout and
Automatic Recorder

Close-up of Modular Holders in Environmental Chamber

17



Send for free bulletin
describing our evaluation
and R/D services

United States Testing Co., Inc.
1415 Park Avenue, Hoboken, N. J.

Branch Laboratories

BOSTON · BROWNSVILLE · DALLAS · DENVER · LOS ANGELES
MEMPHIS · NEW YORK · PHILADELPHIA · TULSA

The
World's Most
Diversified
Independent
Laboratory.



wave Radiation.

The Model B86L1 Sperry Electromagnetic Radiation Meter was developed by Sperry to specifications determined jointly by Sperry and Filtron and is being manufactured by Sperry Microwave Electronics Co., Division of Sperry-Rand, Clearwater, Florida, and will be distributed by the Filtron Co., 131-15 Fowler Avenue, Flushing, New York. Applications include: the determination of power densities for the protection of service personnel and equipment; detection of leakage in shielded areas, waveguides and equipment enclosures; measurement of field intensity patterns of radar and similar types of antennas.

Power density range is from 0 to 20 mw/cm², on four scales, from 400- to 3,000-Mc. An adjustable control provides a red alarm light when the power density of any desired level is reached.

CIRCLE 308 ON READER SERVICE CARD



Taper-Thread Insert

EASY TO USE

FASTENER PRODUCTS, INC., 239 Danbury Road, Wilton, Conn., has developed taper-thread inserts for use in plastic parts after molding, soft metals and wood. They are merely placed in a molded or drilled hole and by the use of tapered threads the screw expands and locks the diamond knurls of the insert in to the hole walls thus preventing rota-

LESA

MADE IN ITALY



**POTENTIOMETERS • POTENZIOMETRI • POTENTIOMETER
POTENTIOMETRES • POTENTIOMETROS**

▼
*Choose from hundreds
of factory models*

▼
*Custom made to your
specifications*

World Renowned Reliability

LESA COSTRUZIONI ELETTROMECCANICHE S. P. A. - VIA BERGAMO, 21 - MILANO ITALY
LESA OF AMERICA 11 WEST 42ND STREET - NEW YORK, 36 - N. Y. - U. S. A.

CIRCLE 201 ON READER SERVICE CARD

Another Arm - The NO. 40
CIRCLE TEMPLATE

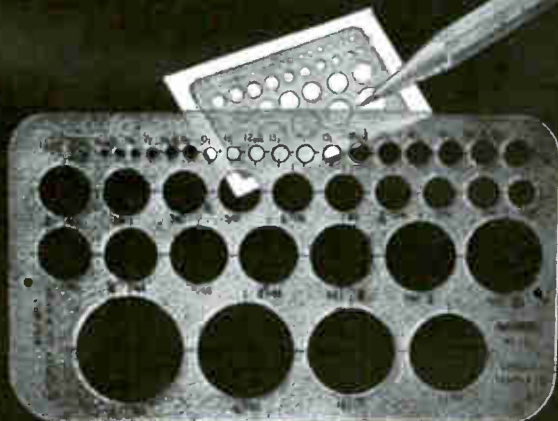

\$1.00 AT YOUR LOCAL DEALER

.030 MATTE FINISH MATHEMATICAL QUALITY DOUBLE-CURED PLASTIC.
ALL HOLES SMOOTH-MILLED TO ENGRAVING MACHINE ACCURACY.

ONE OF MORE THAN 30 RAPIDESIGN TIME-SAVER TEMPLATES - ALL
OF WHICH ARE BETTER MADE, MORE USEFUL AND LESSER PRICED.

CATALOGUE NO. 49 AVAILABLE UPON REQUEST

RAPIDESIGN INC.
P. O. BOX 592 GLENDALE, CALIF.

CIRCLE 202 ON READER SERVICE CARD

September 16, 1960



I have a feeling in the pit of my photocell that you are open to this page. Why not have a look at these data while you are here.

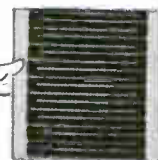

**Cds-
Photo conductive
CELLS**

Capable of dissipating especially high power up to one watt.

• RUGGED • ECONOMICAL

Various standard types with different electrical and physical characteristics available to meet your specifications.

WRITE:

NATIONAL SEMICONDUCTORS LTD.

230 AUTHIER ST. Montreal 9, P. Q.
Phone: RI-4-2946

CIRCLE 107 ON READER SERVICE CARD

107

fabricated
to your exact
specification

BTI

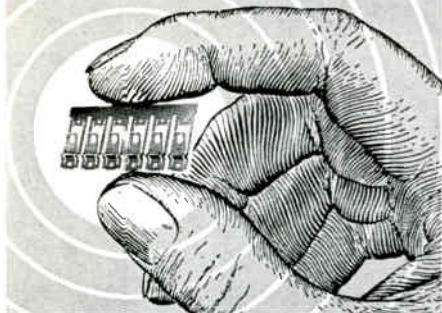

beryllium copper
MULTI-SPRINGS
and **SPRING**
WASHERS

BTI specializes in custom made beryllium copper springs from simple to intricate designs. Engineering assistance is available to design engineers so that quality can be controlled and costs can be minimized through special **BTI** processing.

Multi-springs, a **BTI** development offers parts depending upon design, in continuous coils or strips up to 16 inches which saves money over individual units and affords easy automation in assembly work. Extremely close tolerance can be held and specialized heat treating insures uniformity and flatness to your parts.

Whether you need multi springs or a simple spring washer, consult with the **BTI** experts on your next requirement.

Bulletin No. E 106
shows more specific engineering information.
Write for your copy today.

BTI

BRAUN TOOL & INSTRUMENT COMPANY, INC.

142 Fifth Ave., New York 14, N. Y.

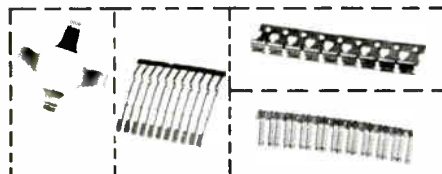

tion and pull-out. Taper-thread inserts can be used in either through or blind holes and require no special tools for installation. They also eliminate the need for extra locking devices and costly tapping operations and do away with the various problems encountered with the use of molded-in inserts. Standard sizes range from 2-56 through 10-32 and they are made of brass and aluminum.

CIRCLE 312 ON READER SERVICE CARD

Time Delay Relay
SUBMINIATURE

BRANSON CORP., 41 S. Jefferson Road, Whippany, N. J. Type MTRH subminiature relay features operate or release delays over a range of 10 millisecc to 1 sec (MTRH-1); 1 sec to 90 sec (MTRH-4); 15 sec to 5 min. (MTRH-8). These hermetically sealed rugged units operate in a temperature range from - 55 C to + 125 C. Added capacity up to 7pdt output is available with identical performance specifications for the type MTHR.

CIRCLE 313 ON READER SERVICE CARD

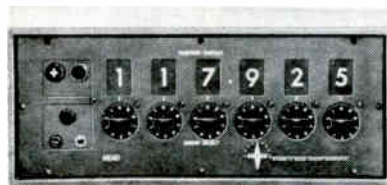

Linear Display System
AUTOMATIC CALCULATION

UNITED AIRCRAFT CORP., Norden Division, Santa Ana, Calif., is producing a modumatic linear display system which features full-range electronic origin selection and absolute display of actual cutting tool or workpiece position. Series 100 numerical control system is specially designed for adaptation to existing as well as new machines. It automatically performs calculations for rotary and linear positioning. It utilizes a unique position feedback transducer, electronic circuitry and a visual display to indicate the actual position of the tool or workpiece. The actual position is displayed in straight decimal form by illuminated numbers that

VERSATILE



HIGH RESISTANCE
MEGOHMMETER

- Up to 50,000,000 Megohms.
- 100-600 vdc Variable Test Voltage.
- Easy-to-read 4½" Meter Scale.
- Provision for Capacitor Discharge.
- Completely Safe Test Terminals.

Designed for use in laboratory and high speed production testing of motor and transformer winding insulation, cable insulation, high value resistors, capacitor insulation, and for the measurement of surface and volume resistivity of insulating materials. Complete line of Type L Megohmmeters for testing in accordance with ASTM-D-257, and Federal Spec. LP-406b, Method 4041. Incorporates many features not found on other instruments selling at twice the price. Choose the model that best fills your needs from this condensed table of specifications...

Model	TEST Voltage	RANGE		POWER Consumption
		Low	High	
L-2A	200 fixed	1 meg.	100,000 meg.	40 Watts
L-4A	200 and 500 fixed	1 meg. 2.5 meg.	100,000 meg. 250,000 meg.	52 Watts
L-68	100 to 600*	1 meg.	100,000 meg.	82 Watts
L-7	100 to 600*	1 meg.	5x10 ¹³ ohms	75 Watts



*Continuously variable, built-in voltmeter for accurate setting.

Industrial Instruments Inc.

89 Commerce Road, Cedar Grove, Essex County, N. J.

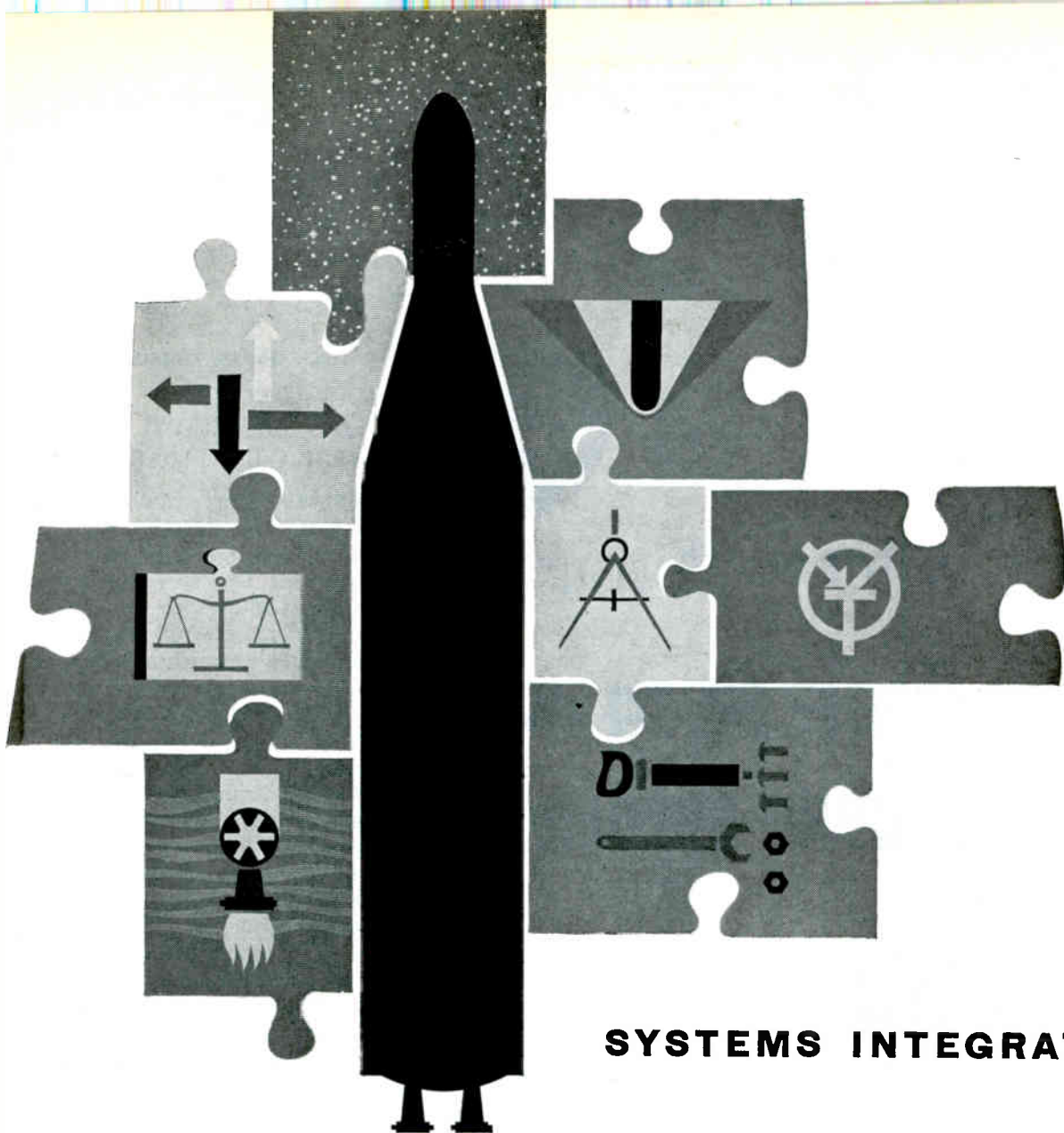

SYSTEMS INTEGRATION

Systems Integration, a major endeavor at Lockheed, involves the responsibility of establishing and maintaining composite system and subsystem characteristics within the parameters necessary for a successful development of weapon and satellite systems.

An outstanding example of this system's engineering approach is illustrated by the Navy POLARIS Fleet Ballistic Missile Weapon System. The Navy gave Lockheed Missiles and Space Division the basic overall weapon system requirements and the required operational date, and requested Lockheed to develop a missile system compatible with the other systems of the weapon system. This demanded an entirely new procedure in missile development: 1) The design had to be based on anticipated advances in the state-of-the-art to meet performance requirements. 2) Simultaneous development of missile subsystems in an independent fashion was required to meet time scale requirements. Not only is Lockheed meeting these requirements—it is delivering an operational missile system three years ahead of the original schedule.

Detailed functions of successful systems integration activities include: Establishment of basic system character-

istics through use of preliminary design and parametric study techniques; sectionalizing the missile and defining interfaces and performance requirements for each subsystem; monitoring and counseling the design activities of subsystems and establishing interfaces and subsystem design parameters and tolerances; assuring and maintaining design compatibility of subsystems throughout the entire development of the missile into the weapon system.

From the development of advanced system proposals into the preliminary design and system requirements, on through to final missile production, demands highly trained engineers and scientists in missile and space technology concerned with the overall systems problems.

Engineers and Scientists: Work in the broad spectrum of systems integration functions provides a constant challenge at Lockheed Missiles and Space Division. If you are experienced in this area, you are invited to write: Research and Development Staff, Department I-22, 962 W. El Camino Real, Sunnyvale, California.

U.S. Citizenship or existing Department of Defense industrial security clearance required.

Lockheed / MISSILES AND SPACE DIVISION

Systems Manager for the Navy POLARIS FBM; the Air Force AGENA Satellite in the DISCOVERER, MIDAS and SAMOS Programs; Air Force X-7; and Army KINGFISHER

SUNNYVALE, PALO ALTO, VAN NUYS, SANTA CRUZ, SANTA MARIA, CALIFORNIA
CAPE CANAVERAL, FLORIDA • ALAMOGORDO, NEW MEXICO • HAWAII

4-4- 4-4- 4-4- 4-4-

the number to remember

4-4- 4-4- 4-4- 4-4-

for faster soldering!

KESTER "44" RESIN-CORE SOLDER



You get the fastest possible soldering action with Kester "44" Resin-Core Solder, created for today's high speed requirements. "44" Resin meets all applicable MIL and Federal specifications, latest amendments, Army, Navy, Air Force. Flux-residue non-corrosive and non-conductive. All alloys, cores and diameters... on 1 lb., 5 lb. and 20 lb. spools.

FREE. WRITE for 78-page Technical Manual "SOLDER... Its Fundamentals and Usage."

Kester Solder COMPANY

4204 Wrightwood Avenue, Chicago 39, Illinois

Newark 5, New Jersey • Anaheim, California • Brantford, Ontario, Canada

Over 61 Years' Experience in Solder and Flux Manufacturing

are readable from 20 ft. The display unit may be located on the machine or remote. This system also offers a full-range electronic origin select so that any desired offset can be quickly and easily dialed in by the operator on manual selector switches.

CIRCLE 314 ON READER SERVICE CARD

Low-Noise TWT FOR C-BAND USE

GENERAL ELECTRIC CO., Schenectady 5, N. Y. Type Z-3028 metal-ceramic tube covers the 4,000 to 8,000 Mc range. It has a maximum noise figure of 10 db with an average integrated noise figure of about 8 db. Minimum small signal gain is 25 db. Power output is 5 mw. Designed primarily as a preamplifier for radar receivers, the tube can also be used in a number of other applications including microwave relay systems, radiometry, counter-measures, radioastronomy, as a limiter and automatic gain control, and as a microwave mixer and frequency divider. It withstands shock up to 50 g and vibration to 15 g; will operate at altitudes as high as 100,000 ft. It uses p-m focusing and is convection cooled.

CIRCLE 315 ON READER SERVICE CARD

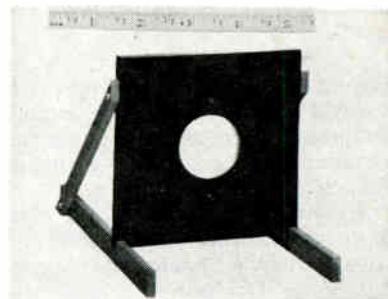

Test Fixture HOLDS SYNCHROS

ANGLER INDUSTRIES, 3 Lexington Drive, Metuchen, N. J. New series of motor generator and motor tachometer test fixtures meets the requirements of ARP-497, and speeds up the testing of motor generators for the following tests: general motor tests, transformation ratio, phase shift, linearity, power input etc. An easy-to-use clamp wrench, fast mounting clamps and hardware are included with this test fixture, necessary for high pro-

PLANNING FUNNEL TYPE EYELETS FOR PRINTED CIRCUIT BOARDS?

this Edward Segal
automatic machine
feeds, inserts and
flares with utmost
reliability!

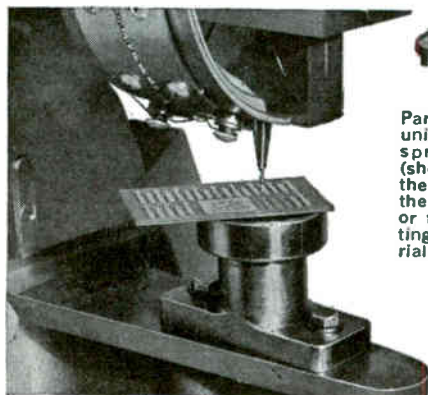
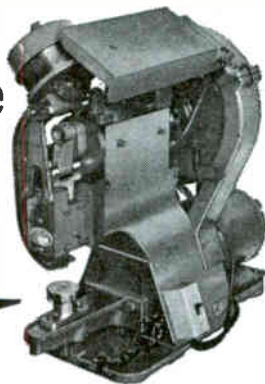

Part of the secret's in Segal's unique anvil tool holder and spring loaded work table (shown at left) which allow the eyelet to pass through the assembly before staking or flaring. Avoids loose settings, compensates for material variations, too.

There's a Segal machine for every eyeletting application. Tell us about yours and we'll gladly look into it without obligation. And write today for new bulletin E-9



Manufacturers of eyeletting machinery,
special hoppers and feeding devices
132 LAFAYETTE STREET, NEW YORK 13, N. Y.

CIRCLE 204 ON READER SERVICE CARD

ELECTRON OPTICS POSTS OPEN IN NEW, ADVANCED PROJECTS OPERATION

New avenues of exploration in non-conventional information recording, storage and display devices under way here have led to formation of a special professional group devoted solely to advance projects.

Position requirements vary in degree of complexity and depend upon the knowledge and experience of the candidate. Electronics and/or physics background with demonstrated experimental and mathematical abilities are prerequisite.

For more information, write informally or forward your resume in strict confidence to Mr. James F. Leete, Dept. 69-WK. Your inquiry will receive prompt review and an early reply.

CATHODE RAY TUBE DEPT.
GENERAL  ELECTRIC

Electronics Park, Syracuse, N. Y.

CIRCLE 378 ON READER SERVICE CARD

September 16, 1960

TV STATION IN YOUR HAND

"MINI-LOOKIE"

Fully Transistorized, Compact,
Economic & Unique
ITV Camera



Operates with conventional
TV receiver

Brief Specification

Electrical:
Horizontal Frequency...15.75 kc/s.
Vertical Frequency...60 or 50 c/s.
SynchronizationSynchronous to power line.
InterlaceRandom interlace.
Pick-up TubeVidicon Tube, Type 6362
R. F. OutputImp. 75 ohms, permits use
of one or more conventional
TV receivers.
Resolution.....Comparable to conventional
ITV camera.
Power Requirement ...117 V, 60/50 cps, 10 VA.
Physical:
Measurements.....3-1/8" x 5-1/8" x 8-7/8"
WeightAbout 7 lbs including stan-
dard 25mm f/1.4 lens.

Other Features:

Lens Mount.....Standard 16mm "C" mount,
but other types are avail-
able on request.
LensStandard 25mm f/1.4 lens,
other lenses are available
at extra cost.
Standard Accessories...33 ft. co-axial cable and
one distribution box.

※ Catalogue on request ※

TOYO TRADING CO., LTD.

P. O. BOX NO. 999 CENTRAL TOKYO
NO. 2 1-CHOME, HONGOKU-CHO, NIHONBASHI,
CHUO-KU, TOKYO, JAPAN.
CABLE ADDRESS "SHININGEAST TOKYO"

CIRCLE 111 ON READER SERVICE CARD

177

Hermetic Seal
transformer co.

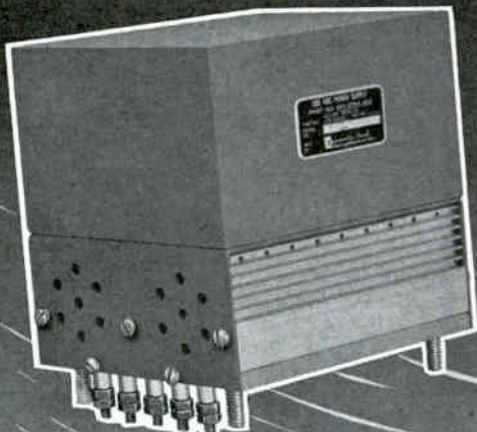

Miniaturized POWER SUPPLIES FOR WIDE LOAD AND LINE VARIATIONS

Designed and manufactured to operate from an auxiliary power source such as an unmanned microwave station, these power supplies provide a wide input frequency range, offer transient and short-term short-circuit protection, and are complete with terminals for external output fusing.

SPECIFICATIONS Model No. PAI-040

ELECTRICAL CHARACTERISTICS:

INPUT: 108 to 132 V, 47 to 420 cycles
 OUTPUT: 200V_{DC} ± 1% of any load between 100 to 200 MA and of any input between 108 to 132 V, 47 to 420 cycles
 RIPPLE: (Max) 300MV_{RMS} @ 47 cycle
 — 200MV_{RMS} @ 60 cycle — 10MV_{RMS} @ 400 cycle

MECHANICAL CHARACTERISTICS:

SIZE: 4 1/4" x 5" x 4 3/4" WEIGHT: Less than 13 lbs. MOUNTING: Four # 1/4-20 Studs

ENVIRONMENT CONDITIONS:

AMBIENT TEMPERATURE: Operating
 — 40°C to + 30°C
 — 30°C to + 55°C with forced air cooling
 ALTITUDE: Operating 10,000 ft. Non-Operating 40,000 ft.
 HUMIDITY: 95% RH 40°C 240 HR (Mil-Std-202 Method 103)
 SHOCK: 30 g's (Mil-S-4456)
 VIBRATION: .060" Total Excursion 10-55 cycles (Mil-Std-202 Method 201A)

WRITE FOR BULLETIN NPB-104

HST Special Products Division specializes in the design and production of power supplies for radar range circuits, tracking circuits, computers, and built-in control or evaluator portions of equipment. Comparable supplies are available in commercial counterparts. Please invite us to quote on your next special production requirements.

Hermetic Seal
transformer co.



**DRESSER
INDUSTRIES
INC.**

MAGNETIC IRON-CORE COMPONENTS
 ENVIRONMENTAL TESTING
 POWER SUPPLIES—SERVO AMPLIFIERS

ELECTRONIC
 OIL • GAS
 CHEMICAL
 INDUSTRIAL

SPECIAL PRODUCTS DIVISION

2925 Merrell Road Dallas 29, Texas Phone Fleetwood 7-4348

CIRCLE 112 ON READER SERVICE CARD

duction testing. Its unique thermal design assures repeatable test results. The complete testing package may be used to test motor generators ranging in sizes from 20 to 34. Price is \$37.50.

CIRCLE 316 ON READER SERVICE CARD



Slotted Section IN HALF-X WAVEGUIDE

TURBO MACHINE CO., Lansdale, Pa., announces a slotted section in Half-X waveguide. Designed to mate commercially available carriages, this device permits accurate measurement of impedance and vswr in 0.900 by 0.200 in. i-d waveguide. Tests which formerly required use of transformer sections can now be performed with minimum incidental error. Slope and distortion are minimized through close tolerance construction. Residual vswr of the section is less than 1.03:1. Flanging consists of a modified UG-39/U configuration.

CIRCLE 317 ON READER SERVICE CARD



Amplifier-Demodulator COMPACT AND LIGHT

KEARFOTT DIVISION, General Precision, Inc., 1150 McBride Ave., Little Falls, N. J., has introduced the lightweight M3102-02 amplifier-demodulator which is designed to convert a 400 cycle signal to d-c. The compact, transistorized unit provides isolation, moderate power gain, high input impedance, and stable, linear operation over an ambient temperature range of -55 C to + 71 C. It consists of a 400 cps

preamplifier followed by a phase sensitive demodulator and is sealed and constructed to meet the applicable shock, vibration, and environmental requirements of MIL-E-5272B.

CIRCLE 318 ON READER SERVICE CARD

Crystal Oscillators TRANSISTORIZED

HUGHES AIRCRAFT CO., International Airport Station, Los Angeles 45, Calif., announces a new line of precision transistorized crystal oscillators especially suited for application in communications systems, airborne electronic equipment, and guided missiles. Those now in production contain a silicon transistor oscillator circuit, and are in the frequency range of 1 Mc to 5 Mc, with a 24-hr frequency stability of $\pm 2 \times 10^{-7}$. Units of other operating frequencies are available on order. They will be added to the firm's existing line of precision crystal filters, with a price of \$240 per unit in lots of 100, and \$350 per unit in lots of 10.

CIRCLE 319 ON READER SERVICE CARD



Capacitor Kits CONTAIN 32 PLUG-INS

ARCO ELECTRONICS INC., 64 White St., New York 13, N. Y. The SS-32 kit consists of a complete set of 32 laboratory standard capacitors ranging from 0.0001 to 0.5 μ f. Units are said to be smaller and lighter than other designs of comparable accuracy, facilitating the use of multiples and combinations. A four position adapter is available for a simple combination of standards to obtain exact values. Any capacitance value accurate to four significant figures with a ± 0.1 per-



INDUSTRIAL PLANTS like Sylvania Electric must maintain rigid quality standards in their precision work. Lint problems have been minimized with uniforms of "Dacron".

LINT-FREE UNIFORMS

start with DACRON® polyester fiber

Lint, often found to be a cause of problems in quality control, is absent with uniforms of "Dacron"® polyester fiber. The smooth surface of "Dacron" just can not generate lint. But that isn't all—uniforms of "Dacron" provide built-in economy and lasting good looks as well.

Plant personnel get a vacation from upkeep problems, too—uniforms of "Dacron" resist wrinkling, endure machine washing and drip drying, need only touch-up ironing.

FOR SPECIAL ADVICE ON UNIFORMS write: Uniform Counseling Service, E. I. du Pont de Nemours & Co. (Inc.), Textile Fibers Dept., Centre Road Building, Wilmington 98, Delaware.



BETTER THINGS FOR BETTER LIVING... THROUGH CHEMISTRY

REG. U.S. PAT. OFF. ENJOY "THE DU PONT SHOW WITH JUNE ALLYSON", THURSDAY NIGHTS, ON CBS-TV. "DACRON" IS DU PONT'S REGISTERED TRADEMARK FOR ITS POLYESTER FIBER. DU PONT MAKES THE FIBERS, NOT THE FABRIC OR UNIFORMS SHOWN.

...Where only a Precision Wirewound
is **Precise** Enough!

Shallcross

"P" type RESISTORS

Exclusive tapered lugs for wrap-around or feed-thru connection

Lug flexing will not destroy hermetic seal

Mineral-filled epoxy resin bobbins & encapsulating coating



Windings of pre-tested wire to meet specific operating needs

Unique contour provides long leakage paths

RADIAL LUG, AXIAL LEAD, and PRINTED CIRCUIT RESISTORS

PRECISION RESISTOR NETWORKS using specially stabilized resistors which may be matched to an accuracy of 0.005% with a tracking temperature coefficient of 5 ppm per °C—for use where voltage or current must be precisely controlled.



As specialists in precision wirewound resistors and resistor assemblies for over 30 years, Shallcross offers unmatched experience in meeting the most exacting matched resistor requirements. Encapsulated "P" Types illustrated are available in over 25 basic types—many to critical MIL-R-93A, MIL-R-93B, and MIL-R-9444 Specifications. Detailed performance comparisons to applicable MIL specs are available for all types.

SHALLCROSS MANUFACTURING CO., 2 Preston St., Selma, N. C.

114 CIRCLE 114 ON READER SERVICE CARD

cent tolerance can be constructed by using only 4 units in conjunction with the adapter. The adapter is calibrated for stray capacitance to maintain accuracy afforded by individual standards, so that the capacitors may be used in decade fashion.

CIRCLE 320 ON READER SERVICE CARD

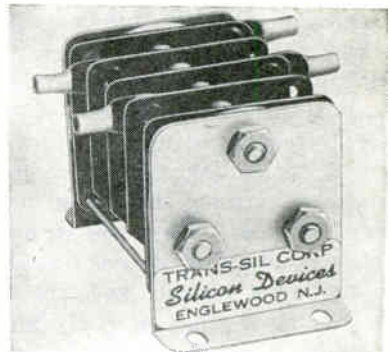

Silicon Rectifiers DOUBLE DIFFUSED

TRANS-SIL CORP., Englewood, N. J., has available the series 1R double diffused silicon rectifiers which are capable of operating at ambient temperatures as high as 150 C. The units, solid stack constructed, will deliver up to 2.5 amperes d-c half wave currents, full wave circuits to 12.5 amperes. Piv is in 50 v multiples. Forward voltage drop and reverse leakage are minimal. The rectifiers have all parts plated to maintain low contact resistance. Melamine insulation is used throughout. Price is \$3 to \$50 depending on voltage and type of circuit.

CIRCLE 321 ON READER SERVICE CARD



A-C Amplifier GENERAL-PURPOSE

HEWLETT-PACKARD CO., 1501 Page Mill Road, Palo Alto, Calif. Model 466A general-purpose, transistorized a-c amplifier has a maximum

electronics

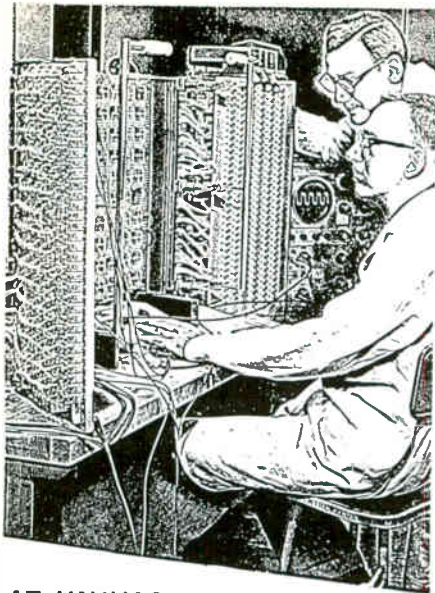

AT UNIVAC...

Atmosphere of Achievement!

Opportunity for personal progress and advancement has never been greater than it is today at Remington Rand Univac. This is your opportunity to advance your career in a satisfying and rewarding *Atmosphere of Achievement*.

In addition to an attractive salary, you will work with engineers and scientists who have made significant advances in solid-state development and computer reliability.

Investigate these immediate openings:

- TRANSISTOR CIRCUIT DESIGNERS
- COMMUNICATIONS ENGINEERS
- SERVO-ENGINEERS
- SYSTEMS ENGINEERS
- MECHANICAL ENGINEERS
- RELIABILITY ENGINEERS
- QUALITY CONTROL ENGINEERS
- PRODUCTION ENGINEERS
- STANDARDS & SPECIFICATIONS ENGINEERS

Send resume of education and experience to:

R. K. PATTERSON, Dept. T-9

Remington Rand
Univac

DIVISION OF SPERRY RAND CORPORATION
2750 West Seventh St., St. Paul 16, Minn.

There are also immediate openings in all areas of digital computer development at our other laboratories. Inquiries should be addressed to:

F. E. NAGLE, Dept. T-9
REMINGTON RAND UNIVAC
1900 West Allegheny
Philadelphia 29, Pa.

R. F. MARTIN, Dept. T-9
REMINGTON RAND UNIVAC
Wilson Avenue
South Norwalk, Conn.

CIRCLE 379 ON READER SERVICE CARD

output voltage of 1.5 v across 1,500 ohms, while input impedance is 1 megohm. It provides either 20 or 40 db gain, ± 0.2 db at 1,000 cps. The instrument's response is flat within 0.5 db from 10 cps to 1 Mc; with the 3 db points at 5 cps and 2 Mc. Distortion is less than 1 percent, and gain is stabilized by considerable negative feedback. Unit measures 4 in. high, 6 in. wide and 6 in. deep, and weighs only 3 lb. Price is \$150.

CIRCLE 322 ON READER SERVICE CARD

Matched Loads COAXIAL, MICROWAVE

MAURY & ASSOCIATES, 10373 Mills Ave., Montclair, Calif. Type ML-2000 microwave coaxial termination features extremely low vswr of 1.03 maximum from 1,000 to 2,000 Mc and is usable to d-c with a vswr of 1.05 max. Type ML-4000 features extremely low vswr of 1.03 max. from 2,000 to 4,000 Mc and is usable to 1,000 Mc with a vswr of 1.05 max. Both types have a nominal impedance of 50 ohms, handle 1 w c-w of power and are supplied with either type N or C connectors. These matched loads are designed for use where an extremely low reflection termination is required.

CIRCLE 323 ON READER SERVICE CARD



Attenuator CONTINUOUSLY VARIABLE

ANTENNA AND RADOME RESEARCH ASSOCIATES, 27 Bond St., Westbury, N. Y., has introduced a miniature S band continuously variable attenuator with an insertion loss of less than 0.5 db. Unit is 3 in. in diameter by 1½ in. high and weighs about 14 oz. Designed primarily for airborne applications, it features a simple locking device and a dial plate calibrated in degrees for easy resetability. Design is of the Pi

LINT-FREE

ACID RESISTANT · STATIC FREE



specify ANGELICA UNIFORMS

Wherever utmost cleanliness is a must, Angelica is the scientific choice! Engineered "down to the last thread" for full protection of delicate assemblies. Smooth monofilament fabrics create no lint—Angelica's superb tailoring allows none to gather. Acid-resistant and static free fabrics in styles for every job—comfortable, easy to launder, long wearing.

Whether you rent or buy, your Angelica representative will help you, as he has others—to choose the right garments for your needs.



1427 OLIVE ST., ST. LOUIS 3, MO.
107 W. 48th ST., NEW YORK 36, N. Y.
177 N. MICHIGAN AVE., CHICAGO 1, ILL.
1900 W. PICO BLVD., LOS ANGELES 6, CALIF.
317 HAYDEN ST. N.W. ATLANTA 13, GA.

CIRCLE 115 ON READER SERVICE CARD

GREEN PANTOGRAPH ENGRAVERS

- ELIMINATE DELAYS!
- KEEP YOUR OPERATING COSTS WHERE THEY SHOULD BE!

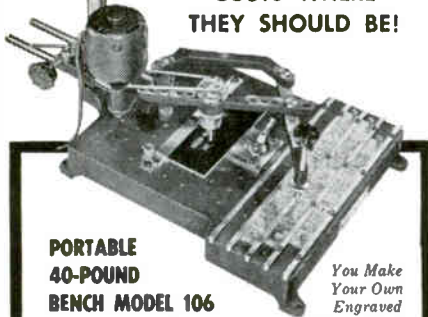

PORTABLE 40-POUND BENCH MODEL 106

*You Make
Your Own
Engraved
Nameplates!*

Here is a speedy, economical 2 or 3-dimensional engraver used by thousands of dollar-conscious companies. It features 5 positive, accurate pantographic ratios; ball bearing spindle with 3 speeds up to 14,000 rpm. Is supplied with one copy carrier that accepts all standard master type sizes. Will actually work up to 10" by any width. Height of pantograph and position of cutter are continuously adjustable.



MODEL D-2 HEAVY-DUTY 2-DIMENSIONAL

Pantograph for milling, drilling and engraving.

Vertical adjustment of copy table automatic with Pantograph. Features: unobstructed on 3 sides to take large work; micrometer adjustment for depth of cut; ball bearing construction throughout; spindle speeds up to 26,000 rpm for engraving or machining; vertical range over 10"; ratios 2 to 1 to infinity — master copy area 26" x 10"

NEW

MODEL D2-201 PNEUMATIC ATTACHMENT



for use with Model D2 Pantograph Engraver to rapidly drill holes in printed circuits by tracing templates. Drills as many as 100 holes per minute. Equipped with foot switch, spindle air cylinder; regulating valve and pressure gauge; filter and oiler. It's ready to use as soon as it's attached to an air compressor

Write or call for full details and prices.

GREEN INSTRUMENT COMPANY, INC.

Dept. 363, 295 Vassar St.,
Cambridge 39, Mass. Tel. Eliot 4-2989

Line Vamp type with full attenuation achieved in less than 180 deg of revolution. Vswr for bandwidths of 15 percent or less is 1.3 maximum on the input end. Total attenuation available is 20 db minimum at about 3,000 Mc. Connectors are type N male. Average power capacity is 10 w. Peak power is 5 Kw.

CIRCLE 324 ON READER SERVICE CARD

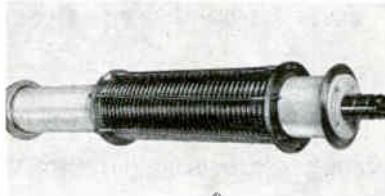

Flexible Coaxial VERY LOW SWR

TELERAD MFG. CORP., 1440 Broadway, New York 18, N. Y., announces 3½ in. flexible coaxial section capable of 3 megawatts peak pulse power. The flexible section encompasses vibration in three planes from 5 to 500 cps and meets all vibration requirements of MIL-E-5422. All Telerad units have a very low swr. The coaxial sections utilize special flanges to reduce r-f leakage.

CIRCLE 325 ON READER SERVICE CARD



Frequency Monitors PRECISION DEVICES

AIRPAX ELECTRONICS INC., Seminole Division, Fort Lauderdale, Fla. Series 4000 precision frequency monitors indicate the frequency of a 400 cps source with an accuracy of 0.01 percent. Cabinet, portable and rack-mounted versions have 4½ in., 50 µa meter movements and anti-parallax mirror scales. Indicating meters have three scale calibrations, each with a 400 cps center reading: 375-425, 395-405 and 399-401 cps. These frequency monitors will also drive recorders having an impedance of approximately 500 K ohms. Power is 60 cps a-c, or units

METROPOLITAN MIAMI

INVITES YOU TO USE ITS INDUSTRIAL DEVELOPMENT SERVICES



If you are considering plant location in Florida, official help in the following areas is available:

- ANALYTICAL STUDIES
- STAFF VISITS
- ON-THE-GROUND EVALUATIONS
- MUNICIPAL CONFERENCES
- SITES, BUILDINGS AND FINANCING
- MANPOWER
- MARKETS
- POWER AND WATER
- TRANSPORTATION
- NATURAL RESOURCES, RAW MATERIALS
- SUPPLIES AND SERVICES
- TAXES, GOVERNMENT REGULATIONS AND SERVICES
- MUNICIPAL COOPERATION

Even if you are only considering the possibility of locating in this area, it will be to your advantage to write for further information. On your letterhead, just request additional details or write for any of the publications listed below. All correspondence will be held in strictest confidence.

- Manufacture in Metropolitan Miami
- Economic Survey of Metropolitan Miami
- Metropolitan Miami Manufacturers' Directory



Write. X. RICHARD WELSH, Director

DADE COUNTY DEVELOPMENT DEPARTMENT

345 NORTHEAST SECOND AVENUE
MIAMI, FLORIDA

An Agency of the Metropolitan Government

may be battery operated. Availability: 4 to 6 weeks; price, \$895 each, quantities 1 to 3.

CIRCLE 326 ON READER SERVICE CARD

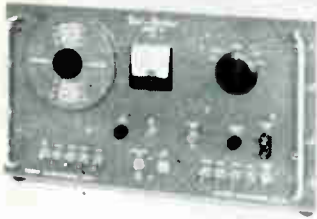

Frequency Marker ALL-ELECTRONIC

KAY ELECTRIC CO., 14 Maple Ave., Pine Brook, N. J. The Vari-Marker model H is a general purpose frequency marker, c-w oscillator, and calibrator providing both continuously variable and "picket fence" harmonic signals over a 1.5 to 230 Mc range. It is designed for use with the Vari-Sweep and Ligna-Sweep oscillators or with any other stable, flat, high output sweeping signal generators. All signals are available either as r-f output or as "birdie pip" audio frequency markers. Frequency dial is direct reading, accurate to ± 1 percent.

CIRCLE 327 ON READER SERVICE CARD



Test Jack CLOSED ENTRY

SEAELECTRO CORP., 610 Fayette Ave., Mamaroneck, N. Y. The SKT-34 test jack is designed to receive a 0.032 in. diameter probe, to a depth of 0.200 in. maximum. The closed entry assures perfect alignment of the probe in test operations. Contacts are beryllium copper, designed for maximum service life. The jack provides a double-turret stud on the reverse side of the chassis for termination of associated circuitry. The Teflon body is 0.148 in. in diameter, with a 0.172 in. diameter above-the-chassis shoulder. The

ACCURACY...

with ac power!

*In laboratory testing,
an electronic ac power source
has an enormous number
of applications . . . but
whatever the voltage delivered,
no matter how good
the regulation and
how low the distortion might be,
accuracy in many cases
is the all-important key.
Behlman's INVERTONS®
provide frequency accuracies
up to 0.00001%!*



*A wide variety of single, two
and three phase models are available
providing from 20-100,000 va and output
frequencies fixed or variable
up to 100 KC.*

*Total harmonic distortion
is only 1% max (lower
on special order);
voltage regulation is
1% no load to
full load standard
(to 0.1% on special order).
The test of the test
is INVERTON.*

BEHLMAN

ENGINEERING COMPANY

2911 Winona Avenue
Burbank, California

*A subsidiary of Electronic
Energy Conversion Corporation*

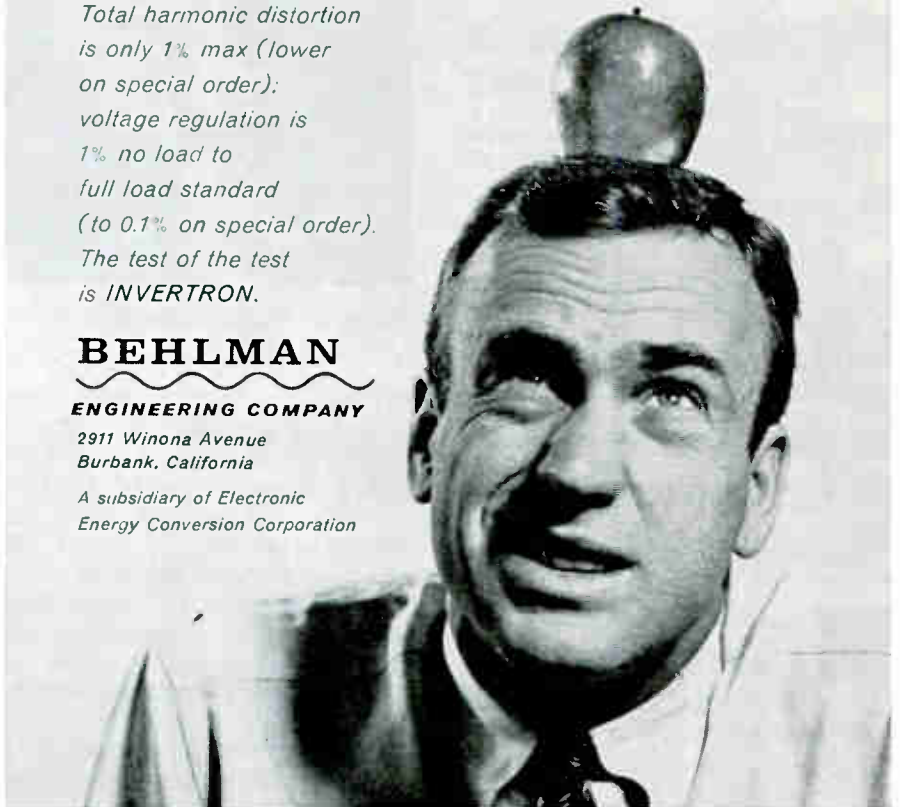

BROADBAND POWER DENSITY METER Model NF-157

For fast, accurate determination of RF power density and location of areas presenting RF hazards to personnel



Description: A broadband device providing direct reading of RF power densities from 1 mw/cm² to 1000 mw/cm² (mid-scale readings), over the continuous frequency range from 200 to 10,000 MC.

Features:

- Direct reading of power density insures immediate awareness of hazardous areas.
- Broad frequency range and high accuracy permit universal application to mapping of high level RF fields from VHF to X-Band.
- Accurate built-in step attenuator provides capability of handling power densities over a dynamic range of 10,000 to 1.
- Three constant-gain calibrated probes permit direct reading in mw/cm² over the continuous frequency range from 200 to 10,000 MC.
- Physical separation of probes from main unit vastly increases flexibility of applications.
- Battery-powered, light-weight design permits complete portability.
- Convenient carrying case simplifies transportation of instrument.
- Efficient shielding prevents stray RF pick-up.
- Conservative design insures resistance to over-load.
- Main unit may be used independently as an accurate, rugged RF power meter over a wide power range.

Send for our Catalog No. 604

emp **EMPIRE DEVICES
PRODUCTS CORPORATION**
AMSTERDAM, N. Y. Victor 2-8400

MANUFACTURERS OF FIELD INTENSITY METERS
DISTORTION ANALYZERS • IMPULSE GENERATORS
COAXIAL ATTENUATORS • CRYSTAL MIXERS

118 CIRCLE 118 ON READER SERVICE CARD

Press-Fit design allows fast, positive insertion through a hole in the metal chassis by merely pressing into place.

CIRCLE 328 ON READER SERVICE CARD

Transistor Tester

FOR NPN AND PNP TYPES

WESTMORE, INC., Fanwood, N. J. Model 200 transistor tester is an economical answer to measuring beta (HFE) on a calibrated scale. Unit also features a provision for measurement of beta at different collector current reference levels, and incorporates a valid I_{co} test leakage reading on a 200 μa meter. The 200 has separate sockets for npn and pnp transistors. Beta calibration accuracy is ± 1 percent, current meter accuracy ± 2 percent. It is designed so that a special industrial socket—available with unit—can be employed for power transistors. Also, provisions have been incorporated for the checking of germanium diodes, selenium and silicon rectifiers.

CIRCLE 329 ON READER SERVICE CARD

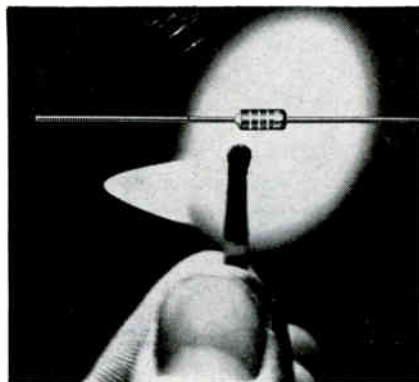

Silicon Zener Diodes SUBMINIATURE

INTERNATIONAL RECTIFIER CORP., 1521 E. Grand Ave., El Segundo, Calif. Types XSZ 5.6 through XSZ27 measure 0.300 by 0.125 in. diameter (not counting leads) and are rated at 200 mw power dissipation. A complete series of 17 types cover the voltage range from 5.6 to 27 v. They demonstrate low Zener impedance values and sharp Zener "knees" assuring optimum voltage regulation. All feature the company's Tri-Seal construction—a 3-barrier sealing process providing high resistance to humidity, shock

THE ELECTRONICS MAN

IDENTIFICATION

R
D
P
M

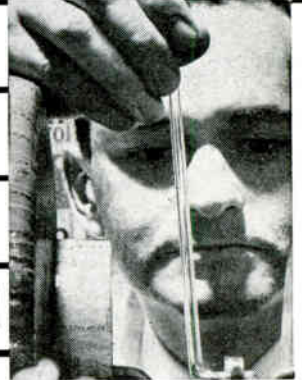

6XK-5XKW

S Q

WHERE TO FIND HIM

The electronics man may be found in any or all of the areas of research, design, production, management.

Your problem: sell him (wherever he is) and keep him sold all year long. Here's the simplified key to this job!

Use electronics to arouse his interest and create acceptance for your products in the magazine's weekly issues.

Use the electronics BUYERS' GUIDE and Reference Issue to be there all year long whenever he is ready to buy.

This is the best selling combination in the electronics industry... and the one that carries the most weight!



THE ELECTRONICS MAN
"BUYS" WHAT HE READS IN...

electronics

A MCGRAW-HILL PUBLICATION
330 West 42nd Street, New York 36, New York

electronics

and vibration over an operating temperature range from -20 to $+130$ C.

CIRCLE 330 ON READER SERVICE CARD



Pulse Height Analyzer FOUR-CHANNEL

INTERSTATE ELECTRONICS CORP., 707 East Vermont Ave., Anaheim, Calif. Model 716 is a four-channel analyzer useful for counting pulses of random spacing and amplitude. Pulses terminating between the settings of the upper limit and lower limit discriminators of each channel are passed to the output of that channel. Channel widths are front panel adjusted from 0 to 10 v or 0 to 20 v and hold constant within 1 percent through a range of 0 to 100 v.

CIRCLE 331 ON READER SERVICE CARD

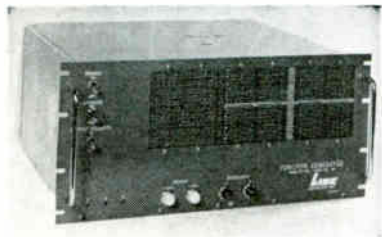

Function Generator LOW DRIFT

LINK DIVISION, General Precision, Inc., Binghamton, N. Y. New analog function generator for multi-variable open or closed loop functions, operates with extremely high speed and accurate resolution, offers new possibilities in solving complex simulation and control problems and widens the computation possibilities of general purpose analog computer installations to an essential degree. The desired functions are programmed on a plug board arrangement which stores 441 discrete voltage values proportional to the output variable on a resistor film in

September 16, 1960

Gertsch MICROWAVE FREQUENCY MULTIPLIER



MODEL FM-4A

-measures 100 to 30,000mc
generates 500 to 30,000mc
with high accuracy and stability

This phase-locked oscillator transfers the accuracy and stability of a VHF driver into the microwave region, giving continuous coverage.

You can drive the unit with Gertsch frequency meters FM-3, FM-6, or FM-7. Fundamental frequency range is 500 to 1000 Mcs, with harmonic output to at least 30,000 Mcs.

Ideal for calibration of cavity wavemeters... for precise measurements, or as an ultra-stable frequency source. Unitized construction. Adaptable for rack mounting.



GERTSCH PRODUCTS, Inc.

3211 South La Cienega Boulevard, Los Angeles 16, California / UPTON 0-2761 - Vermont 9-2201

Complete data
in Bulletin FM-4A.

CIRCLE 207 ON READER SERVICE CARD

RUGGEDIZATION

Huggins HA 20 undergoes
Vibration tests

TRAVELING WAVE TUBES

Tests prove that Huggins TWT's can be provided to operate at 30G shock; 90,000 ft. altitude; 10G vibration to 2000cps with 0.5DB max. amplitude modulation; -55° C to $+71^{\circ}$ C with ± 2 DB variation in gain.

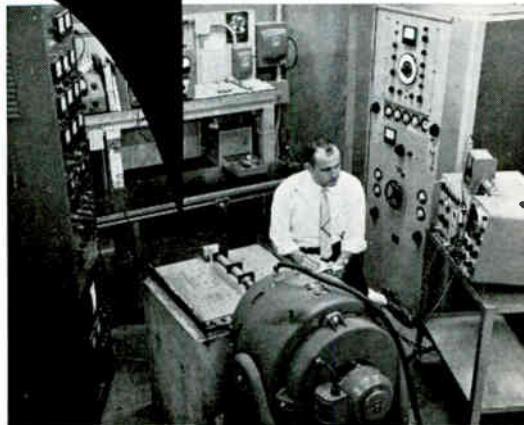

A world leader in research and production of TWT's, the Huggins line is applicable to all phases of military equipment... ground, shipboard, and airborne.

Whatever your project, if it involves TWT's, call an Huggins for complete assistance.



HUGGINS

LABORATORIES INC.

999 East Arques Avenue Sunnyvale, California REgent 6-9330

CIRCLE 119 ON READER SERVICE CARD

119

Who needs feedback? The patented chronometric governor of this standard DC Timing Motor is a tyrant. Without any other circuitry, it holds the motor output speed within $\pm 0.1\%$ while driving charts, cams, contacts, actuators or other devices. It holds the rate even if output shaft load, line voltage, or ambient temperatures change. And that's just the standard model of this little gem. Custom variations can do even better, under special conditions. The A. W. Haydon Co. knows all about timers and timing. If you have a specific timing problem, you ought at least to have our literature. Bulletin MO 802 is yours for the asking. (On 5800 Series chronometrically governed DC Motors)

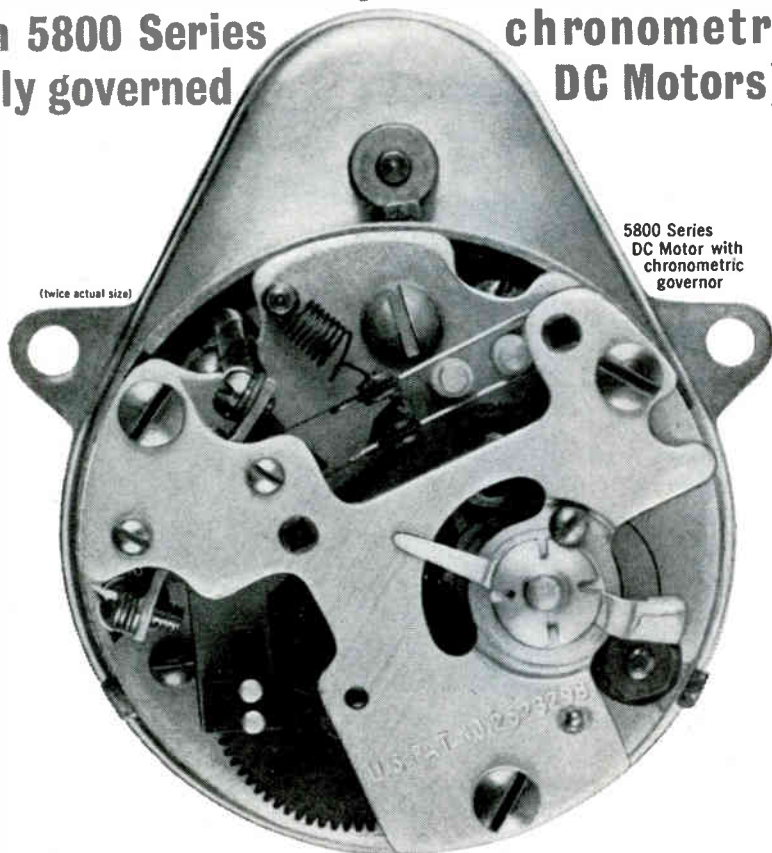

5800 Series
DC Motor with
chronometric
governor

THE AWHAYDON COMPANY

235 North Elm Street, Waterbury 20, Connecticut

a 21 by 21 matrix configuration. The analog function generator provides an overall system accuracy of better than 1 percent and has a frequency response of more than 5 cps over full scale. The maximum resolution is 0.02 percent.

CIRCLE 332 ON READER SERVICE CARD

Traveling-Wave Tubes LOW-NOISE UNITS

GENERAL ELECTRIC CO., Microwave Laboratory, Palo Alto, Calif., announces a family of five packaged, low-noise, metal-ceramic twt's which operate in frequency ranges between 4,000 and 40,000 Mc. Applications include use as front-end r-f amplifiers and i-f amplifiers; in electronic countermeasures, microwave systems, radar mapping, telemetry and radio astronomy.

CIRCLE 333 ON READER SERVICE CARD

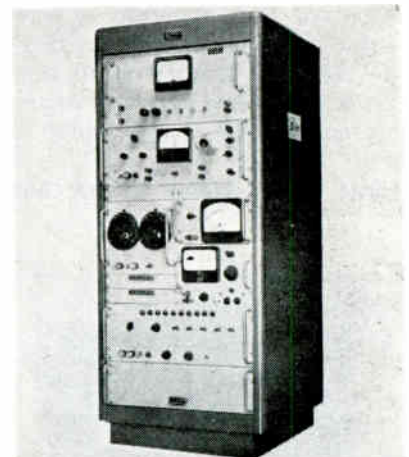

Test Console SYNCHRO & RESOLVER

KEARFOTT DIVISION, General Precision Inc., 1150 McBride Ave., Little Falls, N.J., announces a highly accurate semiautomatic console which performs tests on 400 cycle resolvers, synchro transmitters, differentials, and control transformers. Unit consists of a phase sensitive voltmeter, filtered vtm, relay module, signal module, transformation ratio module, and power supply module. These high-performance modules are rack mounted to provide maximum ease of maintenance, and the console's inherent design flexibility permits removal of the resolver bridge when the unit is to be used only

as a synchro tester. Although the console is designed as a conventional bench type model, a desk-type unit having identical capabilities can be readily produced. Modules incorporated into the console are also available as individual items.

CIRCLE 334 ON READER SERVICE CARD



Subminiature Switch MEETS MIL-S-6743

CROWN ELECTRIC PRODUCTS CO., Box 171, Orange, N. J., has available a complete line of low priced subminiature switches. As a sample of these low prices the new basic type switch CE-100, illustrated, is listed at \$1.30 each net, for quantities of 1 to 9 inclusive. All switches meet MIL-S-6743 requirements. Mica filled Bakelite shell. Guaranteed to break 5 amperes resistance for a minimum of 150,000 cycles.

CIRCLE 335 ON READER SERVICE CARD



Preamplifier MINIATURE SIZE

AD-YU ELECTRONICS LAB., INC., 249-259 Terhune Ave., Passaic, N. J. Sensitivity of a laboratory instrument or electronic device can be increased 100 times simply by plugging a unit of type A102 preamplifier into its input terminals; no need for connection, adjustment or time-consuming setup. Preamplifier, which is basically a two stage transistorized feedback amplifier, features low distortion, small size and light weight. Specifications: 3 db bandwidth from 10 cps to 80 Kc. Distortion is less than 0.5 percent from 10 cps to 80 Kc. Noise level is essentially zero with input terminals shorted, $3\mu\text{v}$ with 10 K

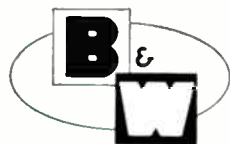

INSTRUMENTS FOR PRECISION CIRCUIT ANALYSIS

Proved in every type of service, these quality instruments are used by experts for FCC "proof-of-performance" tests and supplied as original equipment with many broadcast station installations.

Matchmaster. This versatile test equipment combines three instruments in one self-contained unit. Built-in dummy antenna, standing wave ratio indicator, direct reading RF watt meter. Model 650 (for 52 ohm line) and Model 651 (for 73 ohm line) indicate transmitter output power up to 125 watts directly. Model 52-500 gives direct readings up to 600 watts and is designed for permanent connection into 50 ohm coaxial lines such as RG-8/U.

Model 404 Linear Detector. Combined RF detection and audio bridging circuits for use with any distortion meter. 400 kc to 30 mc range with 20-30 volt RF carrier. Essentially flat frequency response from 20 to 50,000 cps.

Model 300 Frequency Meter. Measures audio frequencies to 30,000 cps in 6 ranges. Integral power supply and input level control.



MODEL 200 AUDIO OSCILLATOR

- Frequency Range: 30 to 30,000 cycles.
- Frequency Response: Better than -1 db. 30 to 15,000 cycles with 500 ohm load.
- Stability: Better than 1%.
- Calibration: $\pm 3.0\%$ of scale reading.
- Voltage Output: 10 volts into 500 ohm load.
- Distortion: Less than .2% at 5 volts output.



MODEL 400 DISTORTION METER

- Frequency Range: Fundamentals from 30 to 15,000 cycles. Measures Harmonics to 45,000 cycles.
- Sensitivity: .3 volts minimum input required for noise and distortion measurements.
- Calibration: Distortion measurements $\pm .5$ db. Voltage measurements: $\pm 5\%$ of full scale at 1000 cycles.
- Residual Distortion: .05%—30—15,000 cycles.
- Residual Noise: .025% or less.



MODEL 600 DIP METER

- Covers 1.75 to 260 mc in 5 bands.
- Monitoring jack & B+ OFF switch.
- Shaped for use in hard-to-get-at places.
- Sturdy, color coded, plug-in coils.
- Adjustable. 500 microamp meter.

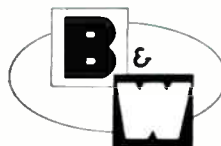

Barker & Williamson, Inc.

Beaver & Canal, Bristol, Penna.

Specialists in Designing and building equipment to operating specifications

B&W also design and manufacture filters for: ANTENNAS • RADIO INTERFERENCE • RADIO RANGE • UHF and VHF as well as many special types designed to performance specifications. Available to commercial or military standards.

CIRCLE 208 ON READER SERVICE CARD



FOR PRINTING of ELECTRONIC COMPONENTS of almost any shape: **REJAFIX MARKING MACHINES**

Hand-operated, semi-automatic and fully automatic models.

Why not send us samples of your products. They will be test-printed and returned to you for your examination!

Est. 1922

POPPER & SONS, INC.
300 Park Ave. South New York 10, N. Y.



COUCH ROTARY RELAYS

Start with a unique and simple design — manufacture within a narrow range of tolerances — specify performance on the *conservative* side — this is how Couch solves the problem of supplying relays that meet the present and future needs of our aircraft and missile programs.

The record shows that this technique is successful: many thousands of Couch CVE type rotary relays are providing consistent flight insurance in complex systems under the most severe environmental conditions.

IMPORTANT SPECIFICATIONS

Contacts: 4PDT (dry circuit to 10 amps)
Size: 1 3/2" D x 1 1/2" H
Weight: 3.2 oz. max.
Pull-in power: 1/2 watt
Ambient temperature: -65° to +125°C
Vibration resistance: 20G's, 5 to 2000 cps
Shock resistance: 75G's operating, 200G's non-operating

Write for complete specifications.



COUCH ORDNANCE, INC.

A Subsidiary of S. H. Couch Company, Inc.

3 Arlington St., North Quincy 71, Mass. Tel.: (Boston) BLuehills 8-4147

input source impedance, and 5 μ v with 100 K input source impedance. Maximum output is 2.5 v rms with 100 K load, and 1.25 v rms with 5,000 ohms load. Input impedance is 35,000 ohms shunted with 15 μ mf. Output impedance is approximately 5,000 ohms. Amplification is 40 db \pm 1 db at 1,000 cps.

CIRCLE 336 ON READER SERVICE CARD

Dry Circuit Contact RESILIENT MESH

METAL TEXTILE CORP., division of General Cable Corp., 730 Third Ave., New York 17, N. Y., has introduced a new line of dry circuit contacts. The Metact... a resilient mesh contact, combining a self-wiping action, multicontact areas and anti-bounce characteristics, insures a greater degree of contact and more performance reliability in relays, switches, choppers and other dry circuit applications. It is available as a gold-plated unit, or in any specified metal which can be drawn into wire. The Metact can be produced in units down to 1/64 in. in diameter.

CIRCLE 337 ON READER SERVICE CARD



Stepping Switch HIGH RELIABILITY

COMAR ELECTRIC CO., 3349 W. Addison St., Chicago 18, Ill. New type ACS stepping switch is designed for sequence controlling, counting and totalizing, scanning, information storage and other switching operations. It is economical in cost, compact and easily mounted. It can be furnished with 2, 3, 4, 8 or 12 single pole continuous rotation, for either shorting or non-shorting steps. Modifications available for a wide range of switching applications. Operating voltages up to 230 v a-c. Voltage range, -15 percent to +10 percent of rated voltage. Nominal power, 20 va a-c minimum. Operating speed, 300 rpm. Rating, 1 ampere at 115 v a-c. Insulation, tested at 1,000 v rms. Impregna-

PEAK POWER



A NEW KIND OF PRECISION ULTRASONIC CLEANING

The new L & R Ultra-Clean '320' has an electronic circuit that transmits peak power directly to the transducerized tank. The transducerized cleaning tank and the rinse tank are 5½" square by 3" deep. Just set the electrical timer to blast away all dirt, grease, foreign particles—get components microscopically clean. . . . Unconditionally guaranteed for 1 year. Write today for complete data on the '320' and other ultrasonic cleaning equipment. . . . \$187.50
Second tank transducerized (at factory), \$74.50.

L & R MANUFACTURING COMPANY

588 Elm Street, Kearny (Arlington), New Jersey

29 EAST MADISON STREET, CHICAGO 2, ILLINOIS

406 SOUTH MAIN STREET, LOS ANGELES 13, CALIFORNIA

CIRCLE 209 ON READER SERVICE CARD

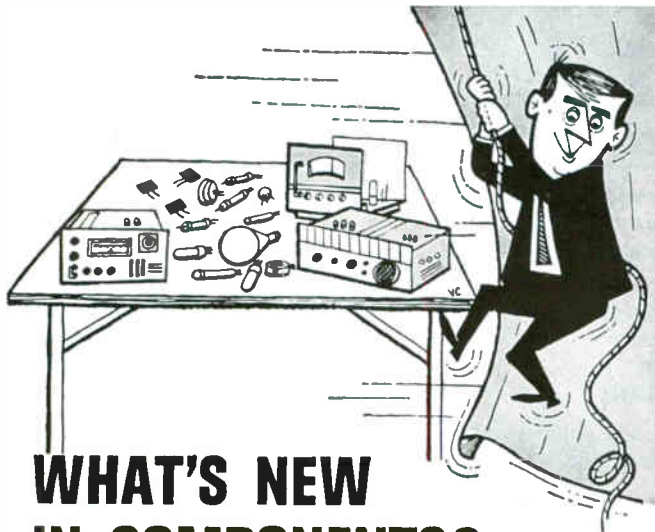

WHAT'S NEW IN COMPONENTS?

What *useable* discoveries are being made on the frontiers of electronic knowledge? Here are a few selected at random: directive long-range sonar transducer . . . high-speed ferrite memory and logic element . . . space-probe telemetry system . . . master preamplifier for X-band radar. You can never tell when one is going *your* way. This is just ONE of the reasons why you should subscribe to electronics (or renew your subscription).

Fill in box on Reader Service Card. Easy to use. Postage free.

**FIND WHAT
YOU NEED IN...**

electronics

Higher Capacity—Smaller Size

OLD

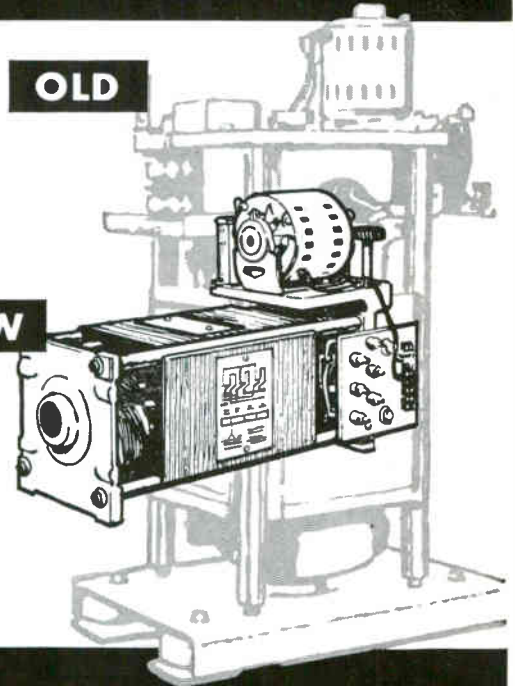

NEW

NEW

COMPACT 3-PHASE INDUCTROL* VOLTAGE REGULATORS

For voltage-sensitive electronic loads
where high capacity and minimum
volume requirements are critical

Ratings up to 15 circuit kva—45 load amperes—208,240,480,600 volts; 3-phase; 50/60 and 400 cycles—automatic or motor-driven.

REGULATOR SIZES (less case and controls)

Width: 14-17 inches Depth: 7½ inches
Height: 11½ inches Weight: 60-80 pounds

FEATURES

- Built to meet MIL specifications
- No brushes
- No harmful waveform distortion
- Drift-free tubeless controls
- ±1% bandwidth accuracy
- Voltage adjustment up to 100%
- Temperature, power factor and frequency compensated

FOR MORE INFORMATION, contact your nearby G-E Apparatus Sales Office, or write Section 457-01, General Electric Company, Schenectady 5, N. Y.

*Registered Trade-mark of General Electric Company.

VOLTAGE REGULATOR PRODUCT SECTION

GENERAL ELECTRIC

PITTSFIELD, MASS.

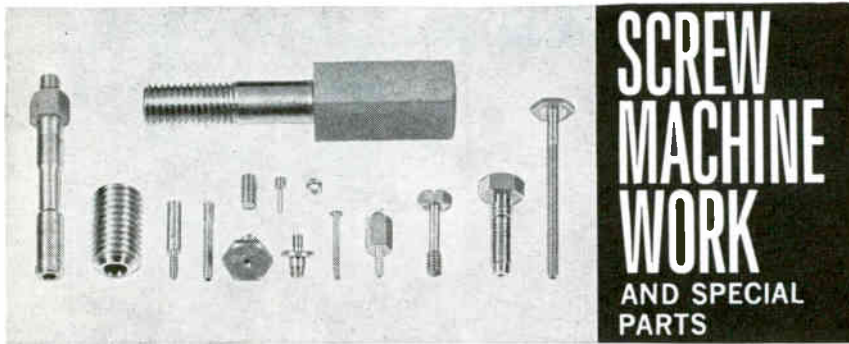
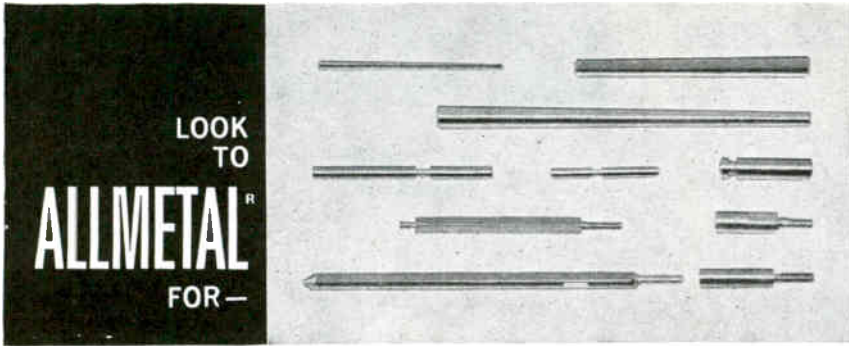

You can look to Allmetal for fine screw machine work in all metals... plus cold heading and hot forging. Complete secondary operations. Prompt production on long or short runs. Intricate shapes, precision tolerances, large, small miniature sizes.

- 30 YEARS OF KNOW-HOW • RIGID QUALITY CONTROL
- SINGLE AND MULTIPLE SPINDLE AUTOMATICS
- BATTERIES OF COLD-HEADERS • TOOL ROOM
- HOT FORGING EQUIPMENT • LARGE MODERN PLANT

For standard stainless steel fasteners, you can depend on Allmetal to provide immediate shipment from "the world's largest stock of stainless fasteners."

REQUEST 132-page catalog #60 (on your letterhead). Packed with helpful fastener data plus stock list.

MANUFACTURERS OF STAINLESS STEEL FASTENERS SINCE 1929

ALLMETAL®
SCREW PRODUCTS COMPANY, INC.

GARDEN CITY, N.Y. PI 1-1200
 NEW YORK, N.Y. FI 3-5800
 NEWARK, N.J. MA 3-1117
 BOSTON, MASS. LA 3-6119
 CHICAGO, ILL. AV 2-3232
 CULVER CITY, CAL. WE 3-9595

821 STEWART AVENUE, GARDEN CITY, NEW YORK

MIDWEST SALES OFFICE
 6424 West Belmont Ave., Chicago 34, Ill.

WEST COAST OFFICE & WAREHOUSE
 5822 West Washington Blvd., Culver City, Calif.

tion available to specifications. All ferrous parts cadmium plated except the armature which is chrome
CIRCLE 338 ON READER SERVICE CARD



**Voltage References
 SOLID STATE**

DYNAGE, INC., 75 Laurel St., Hartford, Conn. Miniature voltage references are available for circuit board, tube socket, and chassis mountings. Printed circuit and 9-pin tube socket types require 1 va at 28 v d-c \pm 20 percent input. Chassis mounted type requires 1 va at 117 v a-c \pm 20 percent input. Output is 6.2 v d-c nominal with a load of 1 ma. Output voltage deviation is less than 0.005 percent for a \pm 20 percent input variation. Temperature stability is better than \pm 0.001 percent/deg C. The p-c board type is conveniently sized to be only $\frac{3}{8}$ in. high by 1 $\frac{1}{2}$ in. diameter.

CIRCLE 339 ON READER SERVICE CARD



**Linear Amplifier
 MULTIPURPOSE**

RADIATION INSTRUMENT DEVELOPMENT LABORATORY, INC., 61 E. North Ave., Northlake, Ill. Model 30-16 multipurpose non-overloading linear amplifier is a versatile and adaptable linear amplifier and precision pulser, designed for pulse amplitude spectroscopy. It is based on the ANLA61 amplifier design. It occupies only 3 $\frac{1}{2}$ in. of rack space. Input pulses from 0 to 80 v are accepted; discriminator output pulses are 15 v negative or 25 v positive. It has a gain of 10,000. Model 30-16 features both positive and negative

Hundreds of standard
JONES
TERMINAL PANELS
Complete equipment for
SPECIALS



Send your specifications for prompt quotation

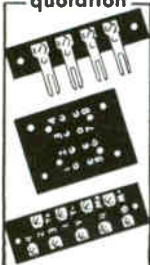

Several pages of Jones Catalog No. 22 illustrate standard and special panels we are constantly producing. Latest special equipment enables us promptly to produce practically any panel required. Send print or description for prices, without obligation. Hundreds of standard terminal strips also listed. Send for Catalog 22 with engineering drawings and data.

JONES MEANS Proven QUALITY



CIRCLE 210 ON READER SERVICE CARD

DYNASERT

**ELIMINATES
COMPONENT
PREPARATION
for PW Boards**

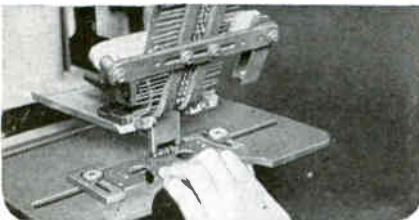

With Dynasert machines, components may be loaded into a self-feeding raceway from card-type packages or fed from a reel. It is no longer necessary to handle components manually.

The Dynasert machine does all the work—takes the chance of error out of component inserting. Operators are easily trained. Changes in production runs can be made quickly. With as little as a few hundred insertions a week Dynasert should be considered. Write for descriptive 12 page booklet.

United

UNITED SHOE MACHINERY CORPORATION
140 Federal Street, Boston, Mass.

CIRCLE 211 ON READER SERVICE CARD

September 16, 1960

B-plus and is Sola regulated. Its internal pulse generator has three operating positions: two fixed positions of + 20 and + 40 v; and a variable output, variable between 0 and 45 v.

CIRCLE 340 ON READER SERVICE CARD

Tunnel Diodes GALLIUM ARSENIDE

PHILCO CORP., Lansdale Division, Church Road, Lansdale, Pa., has available gallium arsenide diodes with peak currents of 10 and 20 ma. The switching speed figure-of-merit (ratio of peak current to capacitance) is $1 \times 10^9 \mu\text{sec}$. Units feature an especially high switching speed when used for millimicrosecond pulse amplifiers. In high speed switching circuits these devices exhibit a signal swing of 1 v, compared to 0.25 v for germanium tunnel diodes, greatly simplifying circuit design. Since shift in bias only slightly affects the new units, more stable high frequency amplifier design is also facilitated.

CIRCLE 341 ON READER SERVICE CARD



D-C Power Supply PLUG-IN TYPE

PLUG-IN INSTRUMENTS, INC., 1416 Lebanon Road, Nashville, Tenn. Model S-94002-PD can be used for outputs from 10 to 35 v d-c with a continuous-current of 0 to 0.5 ampere. Line and load regulation is better than ± 0.75 percent. Ripple is less than 1.5 mv rms. Ambient temperatures as high as 125 F have little effect on operation. Unit is completely self-contained except for transformer and voltage adjustment potentiometer. Filter capacitors, rectifier, regulator amplifier and series regulator transistor are included. It can be individually or

New from **CFI**
ceramics for industry



Stable at 1,000 degrees Centigrade

High-Power Microwave Absorber Ceramics

From CFI's fully integrated ceramics service come the new 1000 Series microwave absorber ceramics.

Typical performance from 1000 Series ceramics shows exceptionally high losses of 9.05 db/cm at 25 deg. C. and "uniform" attenuation over an extremely wide range of frequencies. What's more, these new microwave ceramics are stable in air or vacuum at high temperatures in excess of 1,000 deg. C. in both low and high power systems.

For complete details on the 1000 Series and other custom-designed ceramics and ceramic-to-metal composites for your precise microwave specifications, call CFI today.



Send for free
CFI ceramics data

CFI An Integrated Ceramics Service

CFI Corporation
Department E, Cottage Place
Mineola, New York—Pioneer 6-0571

Gentlemen: Please send me, without obligation, the following literature on CFI ceramics:

- "Custom Ceramic Parts for Industry" Brochure
- Microwave Ceramics Spec Sheet
- Have technical representative contact me.

Name _____

Title _____

Company _____

City _____ Zone _____ State _____

CIRCLE 125 ON READER SERVICE CARD

125



A combination of static components forms a highly accurate, maintenance-free, rotation measuring system.

Airpax tachometers make accurate speed measurement exceedingly simple. Installation can be made in a matter of minutes and no adjustments are required. The combination meter pointer permits viewing at a distance; the mirror scale allows precision readings. The power drawn from the line is approximately 1 watt, less than that required by an electric clock. Rugged construction insures long trouble-free life.

Inherent advantages are:

- No moving parts
- No loading of shaft
- High accuracy
- Instantaneous operation
- No mechanical contact



SEMINOLE DIVISION

FORT LAUDERDALE, FLA.

SB22

guide rail (card file) mounted in chassis and frames available from the company. Seventeen individual power supplies with a total of 8.5 amperes can be mounted in a 3½ by 10 in. panel space using Plug-In mounting assemblies.

CIRCLE 342 ON READER SERVICE CARD

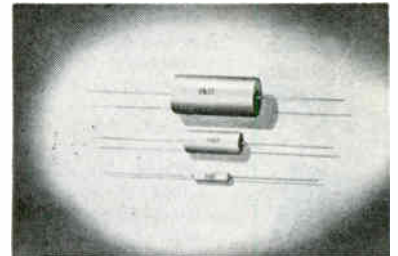

Fixed Capacitors HIGH RELIABILITY

JOHN E. FAST & CO., 3598 Elston Ave., Chicago 18, Ill. A line of improved high reliability fixed capacitors features use of high grade capacitor paper plus a polyester plastic film for the dielectric, together with an advanced synthetic impregnant. Series 134T have wide application in equipment for military electronics, missile guidance, electronic computers, telemetry and industrial electronics. They are hermetically sealed in metal containers and have glass-to-metal solder seal terminals. Capacity range from 0.001 μ f to 1.00 μ f at working voltage ratings of 200, 300, 400, and 600 v d-c are available. Tolerances as low as ± 5 percent are available on special order.

CIRCLE 343 ON READER SERVICE CARD

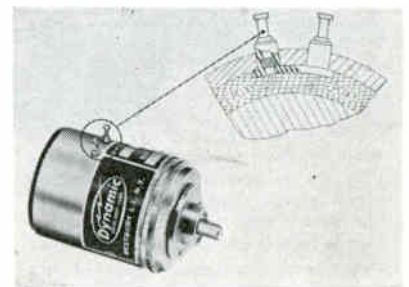

Teflon Terminals MOLDED, NON-TWIST

DYNAMIC INSTRUMENT CORP., 59 New York Ave., Westbury, N. Y. A new mating of Teflon 100, an FEP-fluorocarbon resin, and metal has provided an optimum terminal con-

struction for the company's complete line of magnetic clutches and clutch brakes. It is now virtually impossible for the terminal, positioned from inside the casing, to pull out or twist under the most stringent operating requirements. Because the magnetic clutches are potted components, damage to the terminal prior to the incorporation of the non-twist Teflon type would have rendered the unit, and its function within a system, useless. By eliminating this danger, the company says it can now guarantee that its units will continuously operate in Class H temperatures and under a 500 v interterminal potential, thereby increasing the overall reliability and capability of the clutch.

CIRCLE 344 ON READER SERVICE CARD

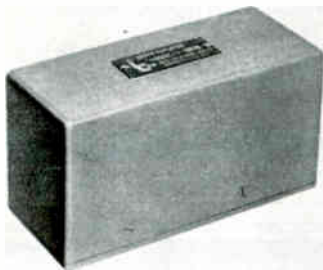

Servo Amplifier HIGH POWER

INDUSTRIAL CONTROL CO., Central Ave. at Pinelawn, Farmingdale, N. Y. The 735D is a high gain, high power, transistorized servo amplifier, which drives 400 cps servo motors requiring up to 18 w per phase. The miniaturized, plug-in package operates directly from the 117 v 400 cps line. Transfer gain is 1,000, with the mating motor's control phase wound for 57 v rms. With the input impedance of 0.5 megohm, higher gains can be obtained with an external step-up transformer. A low output impedance enhances the motor's damping characteristic, and size is only 2 1/2 by 2 1/2 by 5 1/2 in. Unit is recommended for positional and velocity loops using size 18 servo motors. Its high input impedance adapts it to all data systems, including pot, synchro and summing networks. It will operate to 71 C, and is designed for long and reliable service.

CIRCLE 345 ON READER SERVICE CARD

now... find, identify, analyze noise & interference 200cps-25mc FAST!



...just one of the many ways to use

PANORAMIC's
economical
SPA-3/25
SPECTRUM
ANALYZER

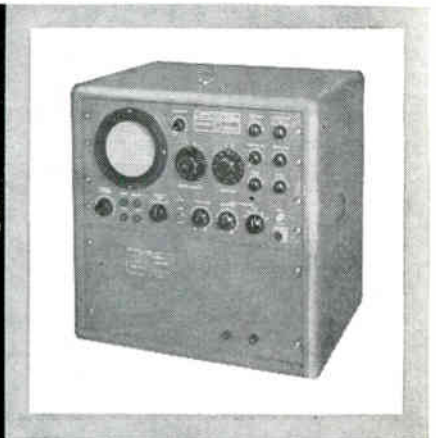

Widely used for high-speed location, identification and analysis of random and discrete signals, the SPA-3/25 automatically separates and measures the frequency and amplitude of signals in spectrum segments up to 3mc wide, selectable anywhere between 200 cps and 25mc. Direct readouts of frequency distributions and amplitudes of signals are provided respectively an calibrated X and Y axes of a 5" long-persistence CRT. The SPA-3/25 samples the spectrum at a 1-60 cps rate.

Panoramic presentation of the Model SPA-3/25

1. permits quick location of signals, minimizes chances of missing weak signals or holes in the spectrum
2. speeds up measurements by eliminating tedious point-by-point plots
3. enables fast, reliable detection of comparatively low level discrete signals present in random spectra through use of adjustable narrow IF bandwidths and correlation techniques
4. allows identification and subsequent analysis of dynamic characteristics of modulated signals and noise.



530 So. Fulton Ave. Mount Vernon, N. Y.

Phone: OWens 9-4600 • TWX: MT-V-NY-5229
Cables: Panoramc, Mount Vernon, N.Y. State

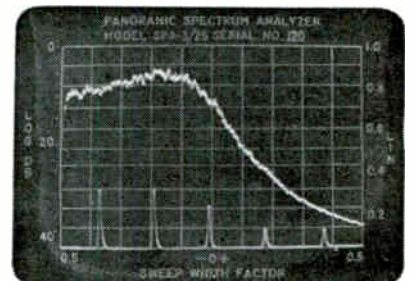

Noise spectrum analysis using internal video smoothing filter presents noise envelope average versus frequency in readily appreciated form. Internal marker pips are 500kc apart.

SPECIFICATIONS:

Frequency Range: 200cps-25mc in 2 bands
Sweepwidth: Variable, calibrated from 0 to 3mc
Center frequency: Variable, calibrated from 0 to 23.5mc
Markers: crystal controlled, 500kc and harmonics to 25mc
Resolution: Variable, 200 cps to 30 kc
Sweep rate: Variable, 1 cps to 60 cps
Amplitude Scales: 20 db linear, 40 db log, 10 db square law (power)
High sensitivity: 20 μ v full scale deflection
Attenuator: 100 db calibrated
Response Flatness: \pm 10% or \pm 1 db
Input impedance: 72 ohms. High impedance probe-PRB-1—Optional
Write, wire or phone NOW for detailed specifications and NEW CATALOG DIGEST.

SEE PANORAMIC'S COMPLETE RANGE OF VERSATILE INSTRUMENTS—in dynamic action-at EIME — 1 pm to 9 pm
Roosevelt Field, L. I., N. Y., Oct. 5 & 6
Treadway Inn, Norwalk, Ct., Oct. 11

SPACE ELECTRONICS & TELEMETRY SYMPOSIUM . . . Booth 46-47
COMMUNICATIONS SYMPOSIUM . . . Booth 52
NEC . . . Booth 261



Sec. 2900

FOR SUPER CLEAN ROOM OPERATIONS



SPECIFY EXCLUSIVE **WORKLON** **LINT-FREE**

100% Dacron* Chemical Resistant **INDUSTRIAL APPAREL**

SHIRTS • TROUSERS • COVERALLS • LAB COATS • CAPS • LADIES UNIFORMS

Reduce product contamination from dust and lint and increase profits with scientifically designed industrial apparel by WORKLON. Lint-free and acid-resistant industrial apparel are available in a variety of special purpose styles for men and women to serve every precision manufacturing requirement.

DESIGNED BY SPECIALISTS FOR EVERY SPECIAL PURPOSE!

- **WRINKLE RESISTANT**
For Longer Wear, Easier Laundering
- **SMARTLY STYLED**
For Wear-With-Pride Appeal
- **ALL STYLES, SIZES, COLORS**
For Immediate Delivery from Stock
- **RESISTALL WEAVE**
For Durability and Year 'Round Comfort

WORKLON Also Features Widest Selection of Acid-Resistant Static-Free Clothing.

For more than a decade, Worklon has been designing and manufacturing Lint-Free garments for industry's most critical operations. Worklon styles are tailored for the specific job, and are your assurance of the highest standards of clean room apparel.

*DuPont's reg. t.m. for its polyester fiber.

SEND FOR NEW FREE CATALOG

Return Coupon TODAY for Latest **WORKLON** Industrial Apparel Catalog **IN COLOR!**



Worklon, Inc., Dept. E-90
253 West 28th St., N.Y. 1, N.Y.

Kindly send new Worklon catalog.

name _____
co. name _____
address _____
city _____ zone _____ state _____

Literature of the Week

ELECTROSTATIC GENERATORS Sorensen & Co., Richards Ave., South Norwalk, Conn. A six-page, illustrated pamphlet describing the **SAMES** line of industrial-type electrostatic generators is now available.

CIRCLE 360 ON READER SERVICE CARD

SERVO MOTOR John Oster Mfg. Co., Avionic Division, Racine, Wisc., has released a technical data sheet on the type 5752-03 size 11 inertially damped servo motor.

CIRCLE 361 ON READER SERVICE CARD

REMOTE CONTROL SWITCHES Automatic Switch Co., 50-56 Hanover Road, Florham Park, N. J. A recent catalog bulletin tells engineers how to select remote control switches for wiring layouts and circuits.

CIRCLE 362 ON READER SERVICE CARD

POWER SUPPLY DESIGN General Electric Co., Schenectady 5, N. Y. Bulletin PT-39, 12 pages, provides circuit designers with information they need to design power supplies for voltage-tunable magnetrons.

CIRCLE 363 ON READER SERVICE CARD

PCM TELEMETRY Epsco Inc., 275 Massachusetts Ave., Cambridge, Mass. A four-page brochure in color describes the company's pulse code modulation airborne telemetry systems and associated ground stations.

CIRCLE 364 ON READER SERVICE CARD

ULTRASONIC GENERATOR National Ultrasonic Corp., 111 Montgomery Ave., Irvington, N. J., has available a data sheet on the model G-310, a 1 Kw ultrasonic generator which is rated at an output of 1,000 w average power and 2,000 w peak power at 38 to 42 Kc and will drive 192 sq in. of barium titanate crystal radiating surface.

CIRCLE 365 ON READER SERVICE CARD

CHOPPERS Airpax Electronics Inc., Cambridge Division, Cambridge, Md. Bulletin C-70 describes series 175 electromechanical choppers, which as industry standards

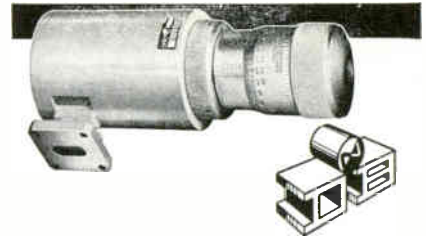

BROAD BAND CAVITY WAVEMETERS

—gas filled for
sustained accuracy

Accuracy is so high these instruments may be used as secondary standards. Units are unaffected by changes in humidity, altitude or barometric pressure. Only 12 sizes serve from 2.6 KMC to 140 KMC. You save budget money on the number of sizes needed. Literature on request.



DE MORNAY-BONARDI
780 SOUTH ARROYO PARKWAY • PASADENA, CALIF.

CIRCLE 212 ON READER SERVICE CARD



FOREMOST
in
**UNDERWATER
SURVEY
DEVICES**

EDO CORPORATION
College Point, L.I., N.Y.
Since 1923

for 60 cps operation, provide highly reliable and trouble-free performance. Typical applications are discussed. Electrical environmental, and mechanical characteristics and typical mounting styles are provided.

CIRCLE 366 ON READER SERVICE CARD

MAGNETIC CORE DATA Telemeter Magnetics Inc., P. O. Box 329, Culver City, Calif. A series of data folders contain complete specifications for a series of storage cores providing a wide range of characteristics.

CIRCLE 367 ON READER SERVICE CARD

SILICON STABISTORS Silicon Transistor Corp., Carle Place, N. Y. A two-page bulletin includes specifications, curves and illustrations for two types of silicon Stabistors which are for use in transistor bias circuits, low level clipping or in reference and regulator service.

CIRCLE 368 ON READER SERVICE CARD

FACSIMILE EQUIPMENT Westrex Corp., 540 W. 58th St., New York 19, N. Y. A 4-page brochure describes and illustrates varied equipment designed for transmitting photos, messages, data, news and other types of graphic information by means of telephone or radio links.

CIRCLE 369 ON READER SERVICE CARD

CONNECTORS Consolidated Electrodynamics Corp., 360 Sierra Madre Villa, Pasadena, Calif., has available bulletin 4004B, a 12-page brochure containing photos and diagrams describing in detail all types of multicontact connectors and their applications.

CIRCLE 370 ON READER SERVICE CARD

PULSE GENERATOR Magnetic Research Corp., 3160 West El Segundo Blvd., Hawthorne, Calif. Details of a new series of 9 Kw solid state pulse generators are contained in a recent engineering data sheet.

CIRCLE 371 ON READER SERVICE CARD

MS PLUGS Cannon Electric Co., 3208 Humboldt St., Los Angeles 31, Calif. A 20-page catalog fully describes the MS-A (solid shell), MS-B (split shell), and MS-C (pressurized) plugs approved to MIL Spec Mil C-5015.

CIRCLE 372 ON READER SERVICE CARD

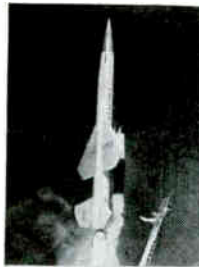

HIGH SIGNAL-TO-NOISE RATIO SIZE 11 MOTOR-GENERATOR

The high performance Size 11 Servo Motor-Generator features 0° phase shift and a signal-to-noise ratio of 300:1. It is designed primarily to replace Size 15 units in high gain damping applications. In-phase speed-sensitive output variations due to temperature variations are stabilized to within 0.2%/°C over the temperature range and speed-sensitive voltage and frequency variation are stabilized to within ±0.2% for voltage and 0.03% cycle for frequency.



KEARFOTT DIVISION
Little Falls, New Jersey



GENERAL PRECISION, INC.
Other Divisions: GPL, Librascope, Link

CIRCLE 214 ON READER SERVICE CARD

ANOTHER IMPORTANT BREAKTHRU!

DUROTHERM Non-freezing Long-Life SOLDERING TIPS

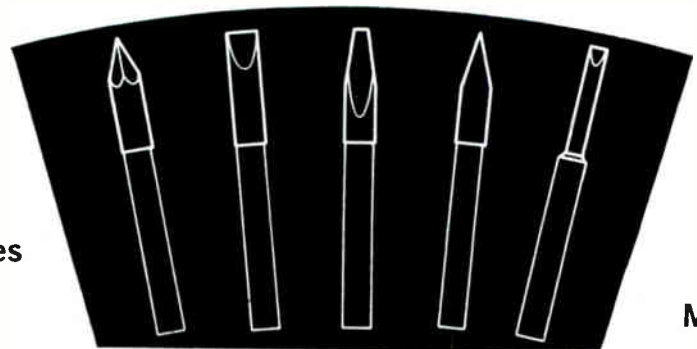

In
ALL
Shapes
and
Sizes

Fit
ALL
Makes

HI-PERFORMANCE Tips for use in HI-PERFORMANCE, HI-TEMPERATURE Irons. Tips positively cannot stick or freeze in any iron—easily removed after months of service. No need to remove tips daily. Minimum loss of heat delivery. Tip shank immunized from solder, except on working surface at end of tip—prevents creeping of solder into element tip hole and spilling of solder on components.



SEND FOR CATALOG—showing the most complete line of industrial Soldering Irons and Long-Life Clad Tips.

HEXAICON ELECTRIC COMPANY

130 West Clay Ave., Roselle Park, New Jersey

SERVING INDUSTRY FOR OVER A QUARTER OF A CENTURY

Slides in only **2** minutes

with this **BEATTIE OSCILLOTRON**

using a Polaroid® Land back

Now you can project transparent slides of oscilloscope traces just minutes after recording with Polaroid® Land Projection Film, Type 46-L, used in this new Beattie Direct View Oscillotron. Also produces 60 sec. paper prints with the new, very fast Polaroid® 3000 Speed Film. Records up to 10 traces on a single frame and offers these many other advantages:

- Direct binocular view of CRT while recording.
- Non-reversed image.
- Camera swings back for easy access to lens and shutter, or lifts off completely. Can be rotated.
- Electric shutter-actuator available.
- Attaches easily to bezel of 5" CRT. Adaptable to other sizes. No special tools.

"Polaroid"® by Polaroid Corp.



1004 N. Olive St., Anaheim, California
Branch: 437 Fifth Ave., New York, N.Y.

Write today
for
full details



CIRCLE 215 ON READER SERVICE CARD

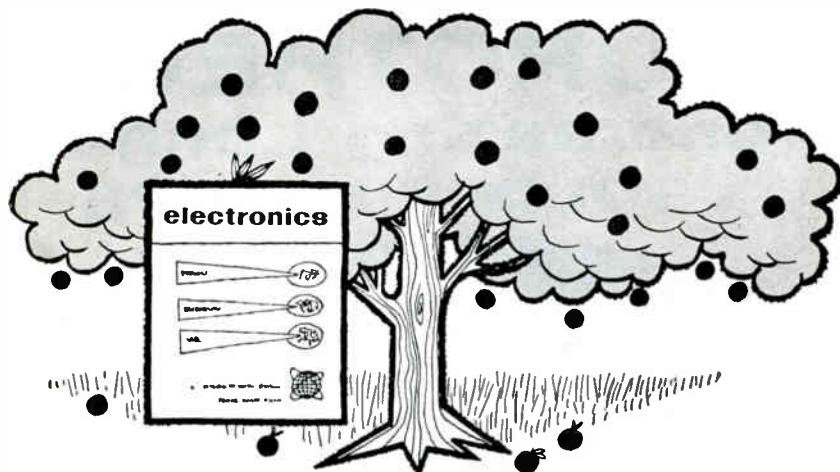

The pick of the crop!

Thumbnail summaries of sales literature on materials, components, equipment, and facilities keep you up-to-date in about 3 minutes of quick, easy reading in "Literature of the Week."

Another reason why it will pay you to subscribe to *electronics* (or renew your subscription) right now. Fill in the box on Reader Service Card. Easy to use. Postage free.

FIND WHAT YOU NEED IN...

electronics

NEW BOOKS

Noise in Electron Devices

Edited by L. D. SMULLIN and H. A. HAUS

Copublished by the Technology Press of the Massachusetts Institute of Technology and John Wiley and Sons, Inc., New York, 413 p., \$12.

NOISE in Electron Devices presents, in book form, material included in a two-week Special Summer Program at the Massachusetts Institute of Technology for people interested in research in the area defined by the title. As outlined in the announcement for the Program, the lectures were concerned with "fundamental thermionic and solid-state noise-producing mechanisms, the mathematical methods of analyzing the noise performance of amplifying devices, fundamental limitations on attainable noise figures, and engineering design parameters for low-noise devices."

The six lecturers who contributed to this book come from industry as well as universities and the value of the book is enhanced by this duality of backgrounds. They have all made significant contributions to the field and describe these against related basic material. Also, some of the classic papers in the literature are covered in a way not found in other books on noise and related topics.

The basic theory of shot noise from thermionic cathodes is presented by Dr. C. F. Quate, well-known in the microwave-tube field for his part in the classic noise standing-wave experiments performed at Bell Telephone Laboratories. Noise in grid-control tubes is covered by Dr. T. E. Talpey, also of BTL and a recognized expert in the field.

Noise in electron beam tubes is treated by two people who made basic and complementary contribution to theory and practice in this area: Prof. H. A. Haus of M.I.T., who established the fundamental noise limitations for these tubes and Dr. R. W. Peter of R.C.A. who successfully developed low-noise types.

Prof. A. van der Ziel of the

University of Minnesota, author of many articles and a well-known book on noise, is responsible for two sections, one on low-frequency noise in electron tubes, and one on noise in semiconductors. Noise in transistors, covered in the Summer Program by Dr. D. O. North, is discussed in the book by Dr. W. H. Fonger, a coworker of North's at R.C.A.

Although all these various aspects of noise have been included, the result has not been a hasty scanning of an extensive field of knowledge. Rather, since the emphasis has been placed on fundamental physical phenomena and has been analytically treated, the result is a unified picture of noise in electron devices.

Parametric amplifiers and masers have been developed since these lectures were prepared and are thus not discussed. However, all of the background needed to understand the noise behavior of these devices is contained in this volume.—
SHIRLEY W. HARRISON, *Sylvania Research Laboratories, Bayside, L. I., N. Y.*

Solid State Physics— Parts A and B

Edited by LARK-HOROVITZ and JOHNSON

Academic Press, New York; Part A—437 p, \$11; Part B—391 p, \$11.80

THIS book on experimental solid state physics edited by Professors Vivan K. Johnson and the late Karl Lark-Horovitz is in two parts. Part A deals with preparation, structure, mechanical and thermal properties, while Part B is concerned with electrical, magnetic and optical properties of importance in this field.

The book is intended to provide "a concise, well-illustrated presentation of the most important methods and general principles used in experimental solid state physics." The volume is intended to be useful to the advanced research worker, graduate student and teacher. This goal is achieved.

While no book on the subject of solid state physics could be sufficiently detailed for highly specialized work in solid state, these books

NEW HIGH PERFORMANCE

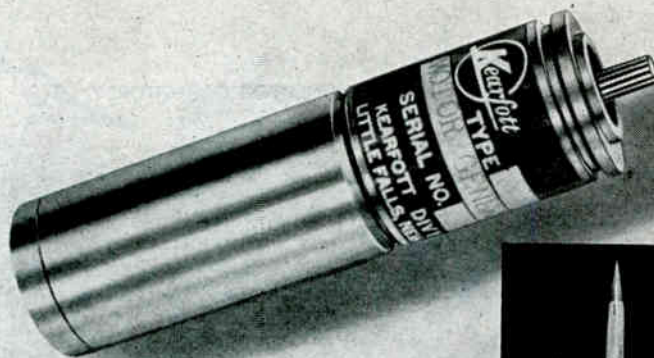

SIZE 8 MOTOR GENERATOR

Kearfott's new Size 8 high performance servo motor-generator features high signal output and extremely low null voltage. The signal-to-noise ratio of 100:1 and linearity of 0.2% make the application of this motor generator to lightweight integrator packages most desirable. Stainless steel construction and thermal stability assure its reliability and long life in the most severe environments.

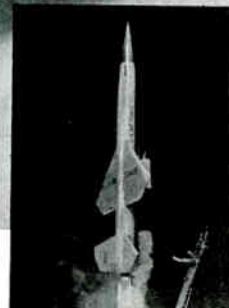

KEARFOTT DIVISION
Little Falls, New Jersey



GENERAL PRECISION, INC.
Other Divisions: GPL, Librascope, Link

CIRCLE 216 ON READER SERVICE CARD

PHAZOR PAT. PEND. PHASE METER

MODEL
200AB

PRICE
\$449⁰⁰



- 2° absolute accuracy
- Readings not affected by noise and harmonics
- Frequency range 15 CPS—30KC
- Accuracy to .01 degree with simple circuit techniques
- High sensitivity on input & reference channels
- Can measure in-phase & quadrature voltage component

For further information contact your nearest representative or write for brochure



INDUSTRIAL TEST EQUIPMENT CO.
55 E. 11th ST. · NEW YORK 3 · GR. 3-4684

VISIT
BOOTH 403
NEC
CHICAGO
Oct. 10, 11, 12
1960

Well, we're
proud as a
peacock
of our JM
capacitors!

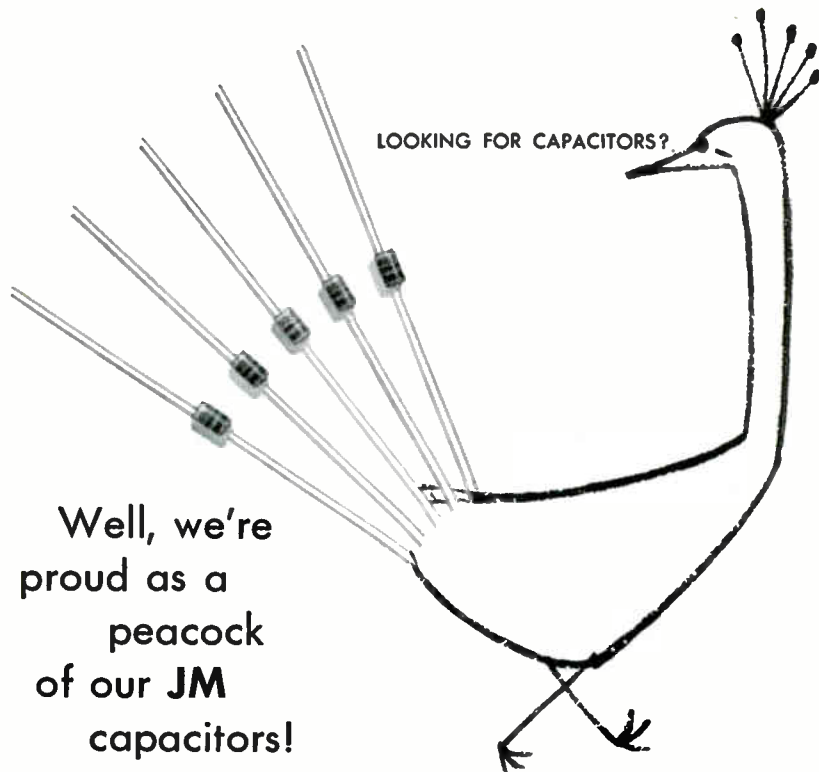

Choose from 49 EIA values. All have these characteristics:

Working voltage: 500 VDC

Insulation Resistance: 50,000 megohms minimum (500 VDC test)

Q Value: 100 minimum

Body Dimensions:

0.1 to 10.0 mmf. .160 ± .005 dia. x .400 max. L

10.0 to 18.0 mmf. .187 ± .005 dia. x .230 max. L

Leads:

No. 20 AWG Copper, heavily tinned to insure good solderability. 1 1/2 ± 1/8 long

Tolerance Color Code:

Under 10.0 mmf	10.0 mmf and Over
20% None	20% Black
10% Silver	10% White
5% Gold	5% Green

Jeffers Fixed Composition JM Capacitors are ideal for a broad range of circuit applications. They offer operating stability, moderate Q—and those other two indispensable characteristics, dependability and economy! Use them as coupling capacitors between RF amplifiers, AVC circuits, oscillators, IF stages—and in many other circuits where low capacitance is a requirement.

The insulated JM body consists of a molded thermosetting resin with a ceramic dielectric material dispersed throughout. The firmly embedded lead wires serve as electrodes.

For all the facts about the Jeffers line of JM Capacitors, write today!



JEFFERS ELECTRONICS DIVISION
Speer Carbon Company
Du Bois, Pennsylvania

Capacitance in mmfd Standard Values in			Color Bands			Max. Body Length
20%	10%	5%	1st	2nd	3rd	
.10	.10		Brown	Black	Gray	.400
.12	.12		Brown	Red	Gray	.400
.15	.15		Brown	Green	Gray	.350
	.18		Brown	Gray	Gray	.281
.22	.22	.20	Red	Black	Gray	.281
	.24	.22	Red	Red	Gray	.281
	.27	.24	Red	Yellow	Gray	.281
	.30	.27	Red	Violet	Gray	.281
.33	.33	.30	Orange	Black	Gray	.281
	.36	.33	Orange	Orange	Gray	.281
	.39	.36	Orange	Blue	Gray	.281
	.43	.39	Orange	White	Gray	.281
.47	.47	.43	Yellow	Orange	Gray	.281
	.51	.47	Yellow	Violet	Gray	.281
	.56	.51	Green	Brown	Gray	.281
	.62	.56	Green	Blue	Gray	.281
	.68	.62	Blue	Red	Gray	.281
	.75	.68	Blue	Gray	Gray	.281
	.82	.75	Violet	Green	Gray	.281
	.91	.82	Gray	Red	Gray	.281
1.0	1.0	.91	White	Brown	Gray	.281
	1.1	1.0	Brown	Black	White	.281
	1.2	1.1	Brown	Brown	White	.281
	1.3	1.2	Brown	Red	White	.281
		1.3	Brown	Orange	White	.281

Capacitance in mmfd Standard Values in			Color Bands			Max. Body Length
20%	10%	5%	1st	2nd	3rd	
1.5	1.5	1.5	Brown	Green	White	.281
	1.6	1.5	Brown	Blue	White	.281
	1.8	1.6	Brown	Gray	White	.281
	2.0	1.8	Red	Black	White	.281
2.2	2.2	2.0	Red	Red	White	.230
	2.4	2.2	Red	Yellow	White	.230
	2.7	2.4	Red	Violet	White	.230
	3.0	2.7	Orange	Black	White	.230
3.3	3.3	3.0	Orange	Orange	White	.230
	3.6	3.3	Orange	Blue	White	.230
	3.9	3.6	Orange	White	White	.230
	4.3	3.9	Yellow	Orange	White	.230
4.7	4.7	4.3	Yellow	Violet	White	.230
	5.1	4.7	Green	Brown	White	.230
	5.6	5.1	Green	Blue	White	.230
	6.2	5.6	Blue	Red	White	.230
6.8	6.8	6.2	Blue	Gray	White	.230
	7.5	6.8	Violet	Green	White	.230
	8.2	7.5	Gray	Red	White	.230
	9.1	8.2	White	Brown	White	.230
10.	10.	9.1	Brown	Black	Black	.230
	12.	10.	Brown	Red	Black	.230
15.	15.	12.	Brown	Green	Black	.230
	18.	15.	Brown	Gray	Black	.230

treat each area with enough detail to be extremely useful to the graduate student and teacher. Further, the research worker in solid state should find the volume an excellent starting reference for work outside of the area of his primary experience. The books are well referenced for more detailed investigations.

For an edited book written by many authors, the volume has a high degree of uniformity. However, some lack of cross-referencing between certain sections exists. For example, it is necessary to examine several sections of the book for information about the diffusion of impurities. In summary, the book should be a valuable addition to any solid state library—GENE STRULL, *Manager, Solid State Advance Development Lab., Westinghouse Electric Corp., Baltimore, Md.*

THUMBNAIL REVIEWS

A Guide to Stero Sound. By David Tardy, Popular Mechanics Press, Chicago, Ill., 192 p., \$4.95. Unlike most present day treatments of the subject, this book emphasizes the basics of stereophonic sound. Two important purposes are served by this approach. First, fundamentals which have been neglected by most people in the field are brought into sharp focus. Second, a good foundation is laid for coping with the dynamic changes taking place in stereo. Text is well written and technically sound; illustrations are unusually good from both the functional and artistic viewpoints. A good buy for the amateur audiophile and the engineer.

Electron Tube Life Factors. Edited by C. Walsh and T. C. Tsao, Engineering Publishers, Elizabeth, N. J., 173 p., \$9.50. Life test data on 11 JAN tube types and a commercial computer tube are presented in great detail. The test program, sponsored by the U. S. Army Signal Research and Development Laboratory, took five years, 35,000 tubes and 6 million measurements. All of this has been analyzed and condensed, mainly in the form of charts and tables. Therefore, this book should be considered as a source of statistical information on the life and reliability which can be expected from various tube types under various operating condi-

tions. It is not a generalized text. It can best be used by electronic equipment designers with sufficient experience to interpret the test results in the light of specific system requirements, operating conditions and differences or improvements in tube design. Since test conditions and data analysis methods are adequately explained, the report might also serve as a guide to other large-scale tube testing programs.

High Productivity in Heavy Engineering. By A. G. Thompson, Iliffe & Sons, Ltd., London, 1960, 339 p, 65s. This book's subtitle, "Production, Inspection and Cost Control in Welded Fabrication," explains its content. Since the book is mainly concerned with fabricating and welding very heavy materials, chiefly for ships and pressure vessels, its value to electronics industry personnel is limited to those seeking up-to-date background material on tooling for extremely massive structures, or those interested in tool control.

Radioisotopes in Science and Industry. By the U. S. Atomic Energy Commission, Government Printing Office, Washington, D. C., 1960. 176 p, \$1.25. This is a summary of the AEC's isotopes development program (fostering peaceful uses of atomic by-products), regulations and related data. Although this report lacks a bibliography and is insufficiently referenced, it is more detailed than most AEC summaries. Persons and firms interested in using or developing applications for radioisotopes will find it a useful starting point.

Basic Ultrasonics. By C. Glickstein, John F. Rider Publisher, Inc., New York, 1960, 137 p, \$3.50. Fundamental nature of ultrasonic energy is explained in very simple terms. Material is primarily descriptive and many of the numerous applications of ultrasonics are touched on briefly. Diagrams are chiefly simplified block diagrams or pictorial explanations.

Nuclear Power Plant. By E. Openshaw Taylor, Philosophical Library, Inc., New York, 184 p, \$7.50. It is not often that a textbook is interesting—this one is. After covering nuclear theory, the content is devoted to power-plant considerations. For example, merits of liquid-metal pumps are analyzed. The book is a primer, not a treatise, thus mathematics are kept at college freshman level.



DUAL CHANNEL BUFFER AMPLIFIER

This small, light-weight unit, a completely transistorized dual channel buffer amplifier, is designed to drive Kearfott's size 11 R980 winding compensated synchro resolvers. The amplifier-resolver combination has stable gain characteristics and negligible phase shift through an ambient temperature range of -55°C to $+85^{\circ}\text{C}$. This unit meets the environmental requirements of MIL-E-5272.

KEARFOTT DIVISION
Little Falls, New Jersey



GENERAL PRECISION, INC.
Other Divisions: GPL, Librascope, Link

CIRCLE 217 ON READER SERVICE CARD

FOR MAXIMUM RELIABILITY

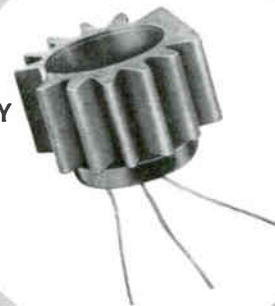

INCREASE TRANSISTOR EFFICIENCY
25% - 27% and prevent thermal runaway

THERE'S A BIRTCHER RADIATOR FOR MOST TRANSISTORS!

Birtcher transistor radiators for most sizes of transistors permit you to get up to 25% to 27% better output efficiency. You can now either increase your input wattage up to 27%, or eliminate up to 27% of the heat with Birtcher radiators.

and thermal runaway is prevented!

To assure circuitry reliability... specify Birtcher radiators. Birtcher qualification tests conducted under MIL standards prove these performance results.

FOR CATALOG and TEST REPORTS write: THE BIRTCHER



CORPORATION industrial division

745 S. Monterey Pass Rd.
Monterey Park, Calif.
Angelus 8-8584

Sales engineering representatives in principal cities.





Magnetic Metals Co. Builds in West

MAGNETIC METALS CO. of Camden, N. J., recently opened a new plant in Newport Beach, Calif., for the manufacture of tape-wound cores and the warehousing of transformer laminations, powdered cores and other magnetic products.

The plant was built to provide nickel-alloy toroidal cores—on overnight service—to the growing southern California electronics industry. The new operation is also equipped to handle the engineering and design of magnetic-core prototypes.

The plant is especially designed to manufacture the company's tape-wound Centricores. It contains complete facilities for winding, annealing, casing, testing, warehousing and shipping of finished cores. In addition, stock is maintained for the company's entire line of transformer laminations, electromagnetic shields and powdered Permalloy, or Filteroid cores.

The extensive annealing facilities include a newly-designed precision electric furnace. The furnace has silicon carbide elements and balancing facilities to adjust the heat input to three separate heating zones, equipment for fast air cooling, and a double-walled retort which is continuously flashed with purging gas. Furnace safety devices include purity control instruments, which guarantee a continuous supply of high purity hydrogen annealing gas, and safety controls designed to flush out the furnace immediately under "fail safe" con-

ditions if power, gas or water supplies fail. A smaller burn-off or heat-clean unit completes the equipment situated in the annealing center.

The new plant is fabricated of tilt-up concrete slabs, has a wooden roof (a type of construction common to the region) and has 5,000 sq ft of floor space.

Gaboriault Joins M-H Boston

NORMAN A. GABORIAULT, formerly president of Atlantic Instrument Corp., Norwood, Mass., has joined the Boston division of Minneapolis-Honeywell as chief methods engineer, it is announced by George J. Schwartz, vice president and general manager of the division.

Before his association with Atlantic Instrument Corp., Gaboriault was president of Techniflex Corp., in Port Jervis, N. Y., and earlier was with Babcock and Wilcox Co. and American Type Founders, Inc.

Fairchild Camera Hires Surbeck

RICHARD U. SURBECK has joined the staff of C. J. O'Donnell, general manager of the Defense Products division of Fairchild Camera and Instrument Corp., Syosset, L. I., N. Y., to coordinate the trend planning activities of the engineering and marketing departments.

In particular, he will be responsible for assisting the general manager in foreign sales activities and in the integration of the newly acquired Allen B. DuMont Laboratories military activities into the Defense Products division. He will also assist in long range planning for the division.

Prior to joining Fairchild, Surbeck was executive assistant to the vice president of Itek Corp. Before that, he was president of Aviquipo, Inc.



Microwave Associates Appoints Hines

APPOINTMENT of Marion E. Hines to the newly created position of senior scientist at Microwave Associates, Inc., Burlington, Mass., is announced. He will coordinate the company's extensive research activities in solid state circuits and will initiate two new programs which will lead to the company's entry into microwave oscillators and microwave amplifier-down converters both using Esaki (tunnel) diode techniques.

Hines was previously associated with the Bell Telephone Laboratories, Inc., at their New York City, Allentown, Pa., and Murray Hill, N. J., laboratories. He has been active in the development of microwave electron tubes, development of telephone transmission systems and in research on solid-state electron devices.

Vogue Instrument Selects V-P

GERALD L. WEINRIB has been named vice president—special products of

TELEMETRY PREAMPLIFIER

for Reliable

LOW NOISE RECEPTION



The LEL TP-5 Telemetry Preamplifier is designed to be installed at a telemetry receiving antenna. The unit is weatherproofed for outdoor use. Ceramic tubes are used to provide a low noise figure and stable performance without forced air cooling.

Specifications:

Gain 23db
Bandpass 215-260mc
Noise Figure 3.5db Typical
Weight 6 lbs.
Size 7-7/8" x 8" x 4-3/4"

LEL INC.

Send for comprehensive Microwave,
IF, RF Amplifier Catalog.
75 AKRON ST., COPIAGUE, N. Y.

CIRCLE 218 ON READER SERVICE CARD

marion
advancement
in instrument
design



VERSATILE MULTI-RANGE METER TESTER

Model M-2

... POWER SUPPLY ... LIMIT BRIDGE

Precise, self-contained unit for laboratory and production use. For DC instrument calibration from 25 μ o full scale to 10 ma full scale, and 0-100 VDC; sensitivity and resistance measurement; DC current-voltage source; limit or bridge measurements from 0-5000 ohms. Regulated power supply. Stepless vacuum tube voltage control. Accuracy exceeds 1/4% (current), 1/2 ohm or 1/2% (resistance). For 115V, 60 cycle AC. Complete — needs no accessories. Bulletin on request. Marion Instrument Division, Minneapolis-Honeywell Regulator Co., Manchester, N. H., U.S.A. In Canada, Honeywell Controls Limited, Toronto 17, Ontario.

Honeywell

75th YEAR
PIONEERING THE FUTURE



First in Control
SINCE 1889

CIRCLE 219 ON READER SERVICE CARD

WHAT'S BEST IN HIGH VACUUM MEASUREMENT?

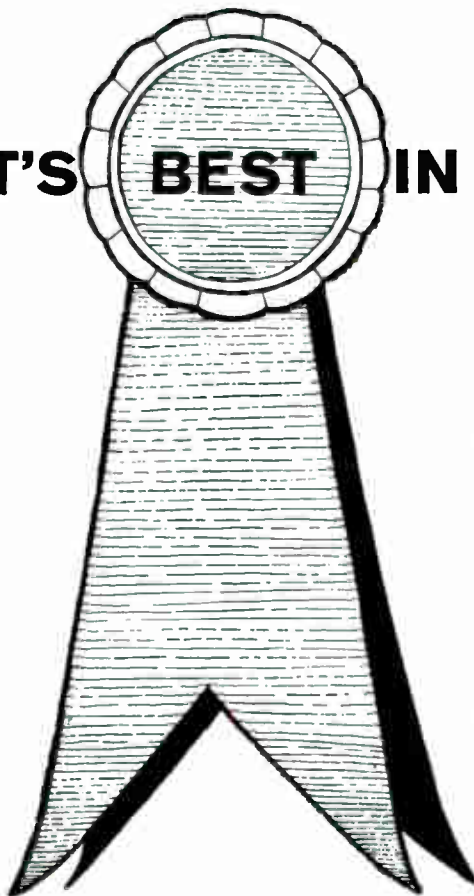

Do you know the specific advantages and disadvantages of 11 different vacuum gages? Improved electronic gage designs are extending measuring range to 10–14 mm Hg. Measurement and control are keys to the success of many production and test applications — **electronics** has the story! (See issue of October 16th, 1959.) Another reason to subscribe to **electronics** (or renew your subscription). Fill in box on Reader Service Card now. Easy to use. Postage free.

**FIND WHAT
YOU NEED IN...**

electronics

McGraw-Hill Book News



INDUCTION HEATING

Just Out. Provides the necessary information for designing, building, and testing induction heating equipment. Commercial and economic considerations are stressed and advantages of each induction heating system are described in detail, with information on many recent applications. By P. G. Simpson, Redifon, Ltd. 308 pp., 188 illus., \$11.50

PRINCIPLES OF CONTROL SYSTEM ENGINEERING

Just Out. Covers such methods of analysis and design as the differential equation approach, the sinusoidal steady-state frequency response, the complex frequency approach, and the electronic computer approach. Discusses operation and characteristics of control system components, and covers the derivation of the transfer function of an inertial guidance system; a guided missile in the pitch axis; an accelerometer; gyroscopes; and others. By V. Del Toro and S. Parker, CCNY. 675 pp., 349 illus., \$14.50

TRAVELING WAVE ENGINEERING

Just Out. Gives full coverage of wave phenomena—develops analogies for electromagnetic waves, vibrating strings, acoustic waves, transverse waves in solids, heat conduction, diffusion, and the wave potential in quantum mechanics. Discusses both transient and steady-state ac waves; plane wave oblique incidence, reflection and spherical waves; lumped parameter models; transmission problems with telephone and power systems; and more. By Richard K. Moore, Univ. of New Mexico. 375 pp., 128 illus., \$11.00

ANALOG AND DIGITAL COMPUTER TECHNOLOGY



Just Out. Covers use and design of both digital and analog computers, the electronic differential analyzer, and the stored-program digital computer. Discusses such recent developments as transistor NOR logic, magnetic core storage systems, and Quine's reduction algorithm for switching circuits. By Norman R. Scott, Univ. of Mich. 550 pp., 361 illus., \$12.75

10 DAYS' FREE EXAMINATION

McGraw-Hill Book Co., Inc., Dept. L-9-16
327 W. 41st St., N. Y. C. 36

Send me book(s) checked below for 10 days' examination on approval. In 10 days I will remit for book(s) I keep, plus few cents for delivery costs, and return unwanted book(s) postpaid. (We pay delivery costs if you remit with this coupon—same return privilege.)

- Simpson—Induction Heating, \$11.50
- Del Toro & Parker—Prin. of Control Sys. Eng., \$14.50
- Moore—Traveling Wave Eng., \$11.00
- Scott—Analog & Digital Comp. Tech., \$12.75

(PRINT)

Name

Address

City Zone State

Company

Position

For price and terms outside U. S.
Write McGraw-Hill Int'l., N. Y. C.

L-9-16

Vogue Instrument Corp., Brooklyn, N. Y., producer of precision potentiometers, gears, gear trains and electromechanical devices for aircraft, missile and computer applications.

Weinrib was formerly vice president of Leemath Industries Corp., works manager and director of manufacturing of Belock Instrument Corp., and chief production engineer of Reeves Instrument Corp.



Martin Co. Appoints Technical Consultant

A. R. Teasdale, Jr., an executive with extensive experience in electronics research and development, has been named technical consultant by the Martin Co., Baltimore, Md.

An authority in missile guidance control, Teasdale joins Martin's corporate engineering staff at Baltimore, where he will head a corporate group of consultants in technical areas of interest to the company.

Before coming to Martin, Teasdale was manager of the electronics division of Temco Electronics and Missiles Co., Dallas, Tex. He was an electronic controls specialist with the Ft. Worth, Tex., facility of the Convair division of General Dynamics Corp. prior to joining Temco in 1954.

Space Electronics Hires Fugate

SPACE ELECTRONICS CORP., Glendale, Calif., recently announced the appointment of Ken Fugate as a member of the technical staff.

Fugate joins the firm from Tridea Electronics Corp. He was

Which of these Craig skills and services can help you?

- ▶ Systems housing — light weight, high strength aluminum shelters, vans and trailers.
- ▶ Systems components — telescoping antenna masts, transit cases, cabinets, equipment racks.
- ▶ Systems installation service — layout and installation of transportable systems, through final checkout.
- ▶ Systems packaging research — engineering design and development for ground support and electronic equipment protection.
- ▶ Complete production facilities — to handle your complete packaging assignment.
- ▶ A unique "aluminum-chemical research" service — engineering "brainpower pool" for solving virtually any problem in aluminum and foamed plastic fabrication.

WRITE TODAY FOR CRAIG'S
CAPABILITIES BROCHURE



Craig

SYSTEMS, INC.

Dept. F-8, 360 Merrimack St., Lawrence, Mass. - Tel. MURdock 8-6961

Business systems and equipment are another Craig specialty through LeFebure Corporation, Cedar Rapids, Iowa — a Craig subsidiary.

CIRCLE 220 ON READER SERVICE CARD



WHO DROPPED THE BINOCULARS?

With everybody watching each other along the DEW line and the Iron Curtain these days, electronics has replaced binoculars.

What's happening in the giant markets for missile controls, radar and communications equipment?

electronics tells how things are going, keeps you informed of developments as they occur. This is a good time to subscribe or renew your subscription. Just fill in box on Reader Service Card. Easy to use. Postage free.

FIND WHAT YOU NEED IN... electronics

previously associated with Gilfillan Brothers and Texas Instruments, Inc.



Underberger Joins Transco Products

GEORGE M. UNDERBERGER has been appointed project engineer at Transco Products Inc., Los Angeles, Calif. In this capacity he will be responsible for the development and expansion of Transco's line of microwave components and sub-systems.

Prior to joining Transco, Underberger was with the Kearfott Division of General Precision, Inc., as manager of the systems engineering laboratory. He has over 10 years of experience in the microwave field.

Photocircuits Corp. Hires Cooper

HOWARD R. COOPER, formerly with Republic Steel Corp., has joined the engineering department of Photocircuits Corp., Glen Cove, N. Y., producer of printed circuitry and electronic equipment.

Cooper also served as an industrial engineer with Ronson Corp. in Stroudsburg, Pa.

Adler Electronics Adds Two Engineers

MERVYN E. SHOPENN, formerly with Tempo Instruments, and Albert M. Waifer, Jr., formerly with International Standard Engineering (ITT), have joined Adler Electronics, Inc., New Rochelle, N. Y.

They come to their new positions at the company's military products division as communication systems project engineers.



METALS and ALLOYS

for use in conjunction with
Semi-Conductor Products

• Doped Gold Wire •

We supply high-purity Gold Wire, accurately doped by the addition of Group III or Group V doping agents such as: Gallium, Antimony, Indium, Arsenic, Aluminum. Where required, objectionable impurities are held to extremely low levels. For example, Copper and Silver can both be kept below a few parts per million. Customarily supplied in sizes .001", .0015", and .002"; other sizes, larger or smaller, are also available.



Write for Catalog Today

SIGMUND COHN CORP.

121 So. Columbus Ave. • Mt. Vernon, N. Y.

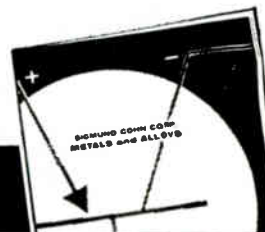

CIRCLE 221 ON READER SERVICE CARD

New 100 kc PLUG-IN CRYSTAL OSCILLATOR

This 100 kc plug-in package, Model CCO-7G, combines a high precision sealed-in-glass quartz crystal with integral temperature control and transistorized circuitry.

Designed to deliver 100 kc output with stability of 2 parts in 10 million over ambient temperatures from 0°C. to 50°C. With fixed ambient conditions and voltage regulation, stability of one part in 10 million can be realized. The standard unit requires 27 volts dc, 12 ma for the oscillator and 27 volts, ac or dc, 10 watts for the crystal oven. Package size, excluding octal base, is 2" x 2" x 4 7/16".

BULLETIN NO. 520 AVAILABLE

BLILEY ELECTRIC COMPANY

UNION STATION BUILDING • ERIE, PENNSYLVANIA

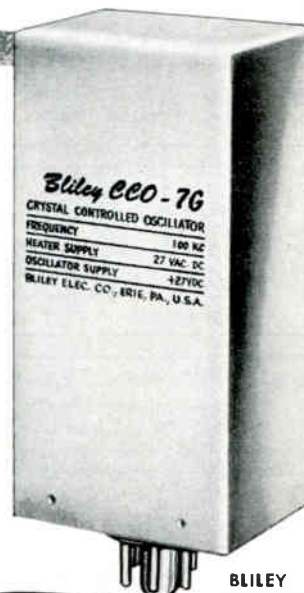

BLILEY CCO-7G



CIRCLE 139 ON READER SERVICE CARD

139

CONTACTS

LIFSCHULTZ
FAST FREIGHT
FASTEST TO BOTH COASTS!

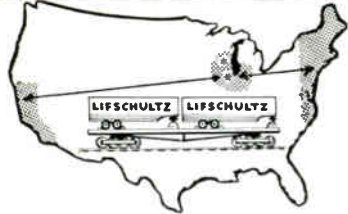

TRUCKLOAD SHIPMENT via LIFSCHULTZ PIGGYBACK

Between Middle West and
Atlantic Seaboard Points

Specify LIFSCHULTZ
and Be Sure It's On Time!

CIRCLE 460 ON READER SERVICE CARD

PROFESSIONAL SERVICES

OFFICE OF JOSEPH R. PERNICE ELECTRONIC and INDUSTRIAL CONSULTANTS

Specializing in electronics, missiles and aviation industries in Europe and United Kingdom; Consultations on military, professional and commercial products; Representation of U. S. companies on technical, industrial and sales matters and on contract negotiations; Investigations and recommendations on manufacturing possibilities, licensing, patents, acquisition of plants and financial industrial interests; Exploration of research & development possibilities; Recommendations on maintenance and repair of equipment and field engineering projects; Organizing and implementing sales promotion programs, market surveys, demonstration and symposiums; Setting up of dealers and sales representatives in Europe.

15 rue de la Faisanderie Paris (16) France
Phone: POINcare 3274

ERCO RADIO LABORATORIES, INC.

Radio Communications Equipment
Engineering - Design - Development - Production
Our 30th Year in Air to Ground
Communication and Radio Beacons
Garden City • Long Island • New York

EUGENE MITTELMANN, E.E., Ph.D.

Consulting Engineer, Physicist
ELECTRONICS FOR INDUSTRY
Analysis, Research and Development
549 West Washington Boulevard
Chicago 6, Illinois
Central 6-2983

TELECHROME MFG. CORP.

Electronic Design Specialists
COLOR TELEVISION EQUIPMENT
Flying Spot Scanners, Color Synthesizers, Keyers,
Monitors, Oscilloscopes and Related Apparatus
Telemetering for Guided Missiles.
J. R. Popkin-Curman, Pres. & Dir. of Eng.
28 Banek Dr. Amityville, L. I., N. Y.

SEARCHLIGHT SECTION

(Classified Advertising)

BUSINESS OPPORTUNITIES
EQUIPMENT - USED or RESALE

DISPLAYED RATE

The advertising rate is \$24.75 per inch for all advertising appearing on other than a contract basis. Contract rates quoted on request. AN ADVERTISING INCH is measured $\frac{1}{8}$ inch vertically on one column, 3 columns—30 inches—to a page. EQUIPMENT WANTED or FOR SALE ADVERTISEMENTS acceptable only in Displayed Style.

UNDISPLAYED RATE

\$2.40 a line, minimum 3 lines. To figure advance payment count 5 average words as a line. PROPOSALS, \$2.40 a line an insertion. BOX NUMBERS count as one line additional in undisplayed ads. DISCOUNT OF 10% if full payment is made in advance for four consecutive insertions of undisplayed ads (not including proposals).

Phone:

Walker 5-6000

Cables:
TELSERSUP

SPECIALS IN • KLYSTRONS •

2K25	\$13.50
2K26	33.50
2K28	27.00
2K29	27.50
2K33A	175.00
2K42	170.00
2K43	144.00
2K44	126.00
2K45	35.00
2K50	72.00
2K56	50.00
X12	475.00

Many other types

See pages 594, 595
of 1960 Electronics
Buyers' Guide for a
more complete listing

LIBERTY
ELECTRONICS
INC.

582 BROADWAY
New York 12, N. Y.

CIRCLE 461 ON READER SERVICE CARD

LOOKING FOR USED/SURPLUS ELECTRONIC EQUIPMENT/COMPONENTS?

For an up-to-date listing of such equipment
see Searchlight Section of September 9th.

SPECIAL SERVICE

Want development—Manufacture—Service—
Installation—Sales of Electrical, Electronic
Products. 30 yrs engineering experience.
Tel—Tech 1110 N.E. 4 Ave. Ft. Lauderdale
Fla.

SEARCHLIGHT Equipment Locating Service

NO COST OR OBLIGATION

This service is aimed at helping you, the reader of "SEARCHLIGHT", to locate Surplus new and used electronic equipment and components not currently advertised. (This service is for USEFULNESS only).

How to use: (Check the dealer ads to see if what you want is not currently advertised. If not, send us the specifications of the equipment wanted on the coupon below, or on your own company letterhead to:

Searchlight Equipment Locating Service
c/o ELECTRONICS
P. O. Box 12, N. Y. 36, N. Y.

Your requirements will be brought promptly to the attention of the equipment dealers advertising in this section. You will receive replies directly from them.

Searchlight Equipment Locating Service
c/o ELECTRONICS, P.O. Box 12, N.Y. 36, N.Y.
Please help us locate the following equipment components.

NAME
TITLE
COMPANY
STREET
CITY 9/16/60

EMPLOYMENT OPPORTUNITIES



The advertisements in this section include all employment opportunities—executive, management, technical, selling, office, skilled, manual, etc.

— RATES —

DISPLAYED: The advertising rate is \$34.33 per inch for all advertising appearing on other than a contract basis. Contract rates quoted on request. An advertising inch is measured $\frac{1}{8}$ inch vertically on a column—30 inches—to a page.

Subject to Agency Commission.

UNDISPLAYED: \$2.40 per line, minimum 3 lines. To figure advance payment count 5 average words as a line.

Box numbers—count as 1 line.

Discount of 10% if full payment is made in advance for 4 consecutive insertions.

Not subject to Agency Commission.

Send New Ads on ELECTRONICS
Class. Adv., P. O. Box 12, N. Y. 36, N. Y.

WANTED CAPACITOR ENGINEERING Project Leader

For development and production of resin dipped capacitors.

Will be responsible for specifying encapsulating materials, manufacturing equipment and production procedures.

Attractive salary and benefits with unlimited future in this multi-company electronic organization.

Reply in strict confidence to
Mr. William S. Franklin, V-P, Chg. Eng.

JOHN E. FAST & CO.
3580 N. Elston Ave., Chicago 18, Ill.
JUUniper 8-2715
subsidiary of the Victoreen Instrument Co.

CIRCLE 384 ON READER SERVICE CARD COMPUTER PROGRAMMING

\$10,000
Choice of three prime spots each having specific advantages toward future growth and progress. Educational advantages and suburban living working with companies selected for heavy back log of contracts. Three to five years computer programming exp. utilizing modern machines.
Contact Lew Musgrave, MONARCH PERSONNEL
28 East Jackson Chicago 4, Illinois

CIRCLE 385 ON READER SERVICE CARD

CHIEF INDUSTRIAL ENGINEER SALARY \$15,000

Experience with an Electronic Company. Extremely helpful knowledge of Military specifications and demonstrated success as a Manager. Your file is handled in strictest confidence. No fee.

ESQUIRE PERSONNEL SERVICE, Inc.
202 South State St. Chicago 4, Illinois
Phone Harrison 7-6337

CIRCLE 386 ON READER SERVICE CARD

ELECTRONIC ENGINEER

Ground floor opportunity for expanding electronics department of an Engineering Services organization. Presently engaged in transistor digital circuits development and test equipment design and fabrication.

MODERN DESIGN

Vestal Parkway Vestal, N. Y.

CIRCLE 387 ON READER SERVICE CARD

An employment advertisement in this EMPLOYMENT OPPORTUNITIES section will help you find the engineers you need. It's an inexpensive, time saving method of selecting competent personnel for every engineering job.

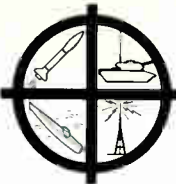

OPENINGS IN

*Systems Analysis
Design & Development
Evaluation*

Systems Analysis

Weapons Systems analysts with BS or MS in mathematics or physics, or BSEE, to work on weapons system and component lethality, evaluations, optimization studies, feasibility studies, and concept synthesis. Also a BSEE or MSEE with a minimum of 3 years in electronic systems with emphasis on remote control, data handling, signal processing.

Design and Development

A number of openings now exist for experienced design and development engineers with the following qualifications:

BSEE or MSEE, minimum 3 years experience in any of these fields: Solid state circuit design, including amplifiers and switching circuitry; RF techniques, including circuit design; antenna design, propagation studies, modulation techniques. Signal processing and data handling, including techniques for encoding, decoding, storage, digital data processing, display, system integration. Also: openings for BSEE with minimum one year in synthesis servo analysis or servo application.

Evaluation

BSEE. Prefer 1-8 years in test, design, or related areas. Work involves testing specific unit systems, parts, or materials. May involve designing and building non-standard testing equipment; field or simulated field testing; tests on production instruments.

All above openings are in Minneapolis area. For complete information, write Allan J. McInnis, Professional Manpower Staff, Ordnance Division, Honeywell, 600 Second St. North, Hopkins, Minn.

Honeywell



Military Products Group

To explore professional opportunities in other Honeywell operations, coast to coast, send your application in confidence to H. D. Eckstrom, Honeywell, Minneapolis 8, Minn.

SCIENTISTS • ENGINEERS • BS, MS • PhD

Name Your Field in Electronics

...you'll find it at Electronics Park

At General Electric's headquarters for electronics in Syracuse, New York, you'll discover projects in every phase of modern electronics, aimed at every kind of application—Consumer, Industrial, Military.

These projects are distributed over research laboratories, development and design groups, manufacturing facilities and field service centers. Different operations are structured to provide independent, localized management yet all offer technical cooperation to each other. In the next building—or the next office—you'll be able to pinpoint a technical expert for consultation on any electronic problem.

THE CHART BELOW offers a broad indication of areas in which we are actively engaged. Check off those areas that are of interest to you—fill in the coupon—and mail to the address below. We will advise you of specific opportunities now available at General Electric's Electronics Park.

TECHNICAL AREAS	Applied Research	Systems Engineering	Advanced Development	Design	Technical Writing	Field Service
RADARS (Antenna, Components)	•	•	•	•	•	•
Ground, Ship, Air	•	•	•	•	•	•
Missile, Satellite	•	•	•	•	•	•
COMMUNICATIONS						
Multiplex Microwave	•	•	•	•		•
SSB Radio				•		•
DSB Transmitters	•		•	•	•	
Synchronous Receivers	•		•	•	•	
Data Links		•				•
DATA RECORDING & DISPLAY				•		•
Equipments		•	•	•	•	•
Advanced Techniques i.e. Thermoplastic Recording	•	•	•		•	
DEFENSE SYSTEMS — Underwater	•	•	•			
Missile Guidance & Navigation	•	•	•	•	•	•
Air Weapons Control	•	•	•	•	•	•
COMPUTERS (Digital) Applications	•	•	•	•	•	•
MATERIALS & PROCESSES (Electrochemical, etc.)	•		•		•	
SEMICONDUCTORS—Circuitry, Devices	•		•	•	•	
PHYSICS (Military & Commercial Applications)						
Space	•	•	•		•	
Acoustics	•	•	•	•	•	•
Electron Optics	•	•	•		•	
Electromagnetics	•	•	•	•	•	•
TELEVISION (Broadcast & Industrial)						
Receivers	•	•	•	•	•	•
Transmitters (AM, FM & TV)			•	•	•	•
HF Video & Audio Techniques	•		•	•	•	
TUBES — Cathode Ray	•		•		•	
AUTOMATED MACHINE CONTROLS		•	•		•	

To: GENERAL ELECTRIC COMPANY
Electronics Park, Div. 69-WK
Syracuse, New York

Att: Technical Personnel Dept.

I am interested in Technical Areas I have checked.

My name: _____

Address: _____

Degree: _____ Date: _____

All communications held in strict confidence.

GENERAL  ELECTRIC



SQUARE-LOOP TAPE CORES TO MEET YOUR TOUGHEST SPECIFICATIONS

Speed your specs to Dynacor when you want square-loop tape cores to exact requirements—fast! Here you'll find a dependable combination of personnel, experience and facilities—the know-how to deliver parameters to your very tightest tolerance requirements for switching time, flux, and noise.

Dynacor Square-Loop Tape Cores are manufactured with the high permeability alloys—Grain-Oriented 50-50 Nickel Iron, 4-79 Molybdenum Permalloy, and Grain-Oriented 3% Silicon Iron . . . with fully guaranteed uniformity . . . under rigid standards of control and inspection.

Look to Dynacor for reliable production and swift delivery of your tape core requirements. For your convenience a full line of standard units are stocked for immediate off-the-shelf delivery—Send for bulletins DN 2000, DN 2001, DN 2002.



DYNACOR
DYNACOR, INC.
A SUBSIDIARY OF SPRAGUE ELECTRIC CO.

1006 Westmore Ave.
Rockville, Maryland

INDEX TO ADVERTISERS



Audited Paid Circulation

Adler Electronics, Inc.	27	General Electronic Laboratories, Inc.	59
Aetna Life Insurance Company	16	* General Instrument Co. Semiconductor Div.	8, 9
Air France	23	Gertsch Products, Inc.	119
* Airpax Electronics Inc.	126	* Green Instrument Co.	116
Allen-Bradley Co.	87	* Gudebrod Bros. Silk Co., Inc.	40
* Allmetal Screw Products Co., Inc. . .	124	Haydon Co., A. W.	120
* Alpha Wire Corp.	42, 43	* Heiland Division, Minneapolis- Honeywell Regulator Co.	53, 54
* American Electronics Inc.	62	Hermetic Seal Transformer Co.	112
* Amphenol-Borg Electronics Corp., Connector Division	50	* Hewlett-Packard Company Inside Front Cover	
Angelica Uniforms	115	Hexacon Electric Co.	131
Barker & Williamson, Inc.	121	* Hitemp Wires Inc.	58
* Barnstead Still & Sterilizer Co. . . .	14	* Hudson Tool & Die Company, Inc. . .	41
Beattie-Coleman Inc.	132	Huggins Laboratories, Inc.	119
* Behlman Engineering Co.	117	Industrial Instruments, Inc.	108
* Birtcher Corporation, The.	135	* Industrial Test Equipment Co.	133
* Bliley Electric Co.	139	International Electric Corp.	105
Braun Tool & Instrument Co., Inc. . . .	108	International Resistance Co.	97
* Brush Instruments, Div. of Clevite Corp.	17, 18	* ITT Kellogg Communications Div., International Telephone and Telegraph Corp.	101
Canoga Corp.	35	* Jettron Products Inc.	6
* Centralab, A Div. of Globe-Union Inc.	47	Jones, H. B., Div. of Cinch Mfg. Co. . .	125
Ceramics for Industry Corp.	125	* Kearfott, Div. of General Precision Inc.	131, 133, 135
Chart-Pak, Inc.	24	* Kester Solder Co.	110
* Clarostat Mfg. Co.	49	* Kintel, A. Division of Cohu Elec- tronics Inc.	3rd Cover
* Cohn Corp., Sigmund.	139	* Krohn-Hite Corp.	95
Consolidated Avionics Corp.	98	L&R Mfg. Co.	123
Consolidated Electrodynamics Corp.	90, 91	Lesaf of America.	107
* Couch Ordnance, Inc.	122	LEL, Inc.	137
Craig Systems Inc.	138	Lockheed Electronics Company.	20, 21
Dade County Development Dept.	116	Lockheed Missiles and Space Div.	109
* DeMornay-Bonardi	130	Marion Instrument Co.	137
Detroit Edison Co.	85	* Markem Machine Co.	144
Dow Chemical Co.	48	* McGraw-Hill Book Co.	138
* Dow Corning Corp.	2, 3	* Microswitch, Div. of Minneapolis- Honeywell Reg. Co.	36
du Pont de Nemours & Co. Inc., E. I. Textile Fibre Dept.	113	Minnesota Mining & Mfg. Co. Min Com Division.	103
Dynacor Div. of Sprague Electric Co. . .	142	* Moseley Co., F. L.	13
Edo Corporation	130	General Dynamics Corp. Stromberg-Carlson Electronics Div.	26
* Electra Mfg. Co.	63	* General Electric Co. Cathode Ray Tube Dept.	111
* Empire Devices Products Corp.	118	Defense Electronics Div.	7
General Dynamics Corp. Stromberg-Carlson Electronics Div.	26	Voltage Regulator Prod. Dept.	123
* General Electric Co. Cathode Ray Tube Dept.	111		

*See Advertisement in the July 20, 1960 issue of Electronics Buyers' Guide for complete line of products or services.

WHITNEY-JENSEN MARSHALLTOWN CAM PRESSES

FOR ASSEMBLING
FOR STAKING
FOR PUNCHING
FOR FORMING
FOR SIZING
FOR RIVETING



No. 102
ADJUSTO-GAP
CAM PRESS



No. 101
MULTIPURPOSE
PRESS

CAPACITY
THREE
THOUSAND POUNDS

DIE SPACE
No. 101 4 1/4"
No. 102 1" to 14"

Write Us Now
For Complete Information and Prices

WHITNEY METAL TOOL CO.
722 Forbes St., Rockford, Ill.

CIRCLE 222 ON READER SERVICE CARD

New . . .

LABORATORY STANDARD R. F. VOLTMETERS



- Flat response to 100 megacycles/sec.
- Ideal for checking V T V M's
- Calibrate on D.C. or 60 cycles/sec.
- Can be certified by Bureau of Standards
- Separate thermocouple units available in ranges 1 volt, 3 volts and 10 volts
- Also units for 30 volts and 100 volts with less frequency range

Write for Bulletin 800.

Rawson
ELECTRICAL INSTRUMENT CO.
fine instruments since 1918

111 Potter Street • Cambridge, Mass.

CIRCLE 223 ON READER SERVICE CARD

September 16, 1960

National Semiconductor Ltd. 107
Nippon Electric Co. 52
North Electric Co. 12

• Oak Mfg. Co. 25

• Panoramic Radio Products, Inc. 129
Parker Seal Company. 33

Philips Gloeilampenfabrieken,
N. V. 60, 61
Popper & Sons, Inc. 121

• Radio Corporation of America 28-
4th Cover

Rapidesign Inc. 107

• Rawson Electrical Instrument Co. 143

• Raytheon Company 5, 64

Remanco Inc. 94
Remington Rand Univac, Div. of
Sperry Rand Corp. 115

Sangamo Electric Co. 93

Sarkes Tarzian Inc. 104

Segal, Edward 111

• Shallcross Mfg. Co. 114

• Sierra Electronic Corp. 10

Space Technology Laboratories, Inc. 15

Spectrol Electronics Corp. 44, 45

Speer Carbon Co.
Jeffers Electronics Div. 134

• Sperry Microwave Electronics Co.,
Division of Sperry Rand Corp. 19

Sprague Electric Co. 22, 38, 39

Stackpole Carbon Co. 29

Standard Rectifier Corp. 89

• Sylvania Electric Products, Inc.,
Special Tube Operations 55

Taylor Fibre Co. 99

• Television Utilities Corp.
Div. of Nord. 143

• Texas Instruments, Incorporated
Semiconductor-Components Division 51

Toyo Trading Co. Ltd. 111

United Shoe Machinery Corp. 125

United States Testing Co., Inc. 106

• Westinghouse Electric Corp. 56, 57

Whitney Metal Tool Co. 143

White, S. S. 42

Worklon Inc. 130

CONTACTS

Lifschultz 140

Professional Services 140

CLASSIFIED ADVERTISING
F. J. Eberle, Business Mgr.

EMPLOYMENT OPPORTUNITIES 140, 141

SPECIAL SERVICES 140
EQUIPMENT
(Used or Surplus New)

For Sale 140

*See Advertisement in the July 20, 1960 issue
of Electronics Buyers' Guide for complete line of
products or services.

SCAN-A-GRAPH®

DISTORTION-FREE
CLOSED CIRCUIT TV
WITHOUT CAMERA OR LIGHT...

to as many as
500 MONITORS
simultaneously!



Yes, without camera or light, Scan-a-graph, a self-contained TV transmitter provides instant, accurate visual communication with as many as 500 locations simultaneously. Scan-a-graph guarantees needle sharp, telescopic brightness essential for closed circuit systems in science, industry, and education.



VIDEO LINE AND DISTRIBUTION AMPLIFIER
Versatile, one chassis unit with internal switching permits use as distribution or line amplifier or a combination of both- Adjustable frequency compensation-Electronically regulated power supply.

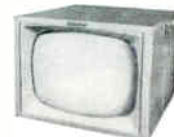

VIDEO MONITORS

800 L. definition, aluminized CRT for brightness and detail. Exclusive "syncrace" for perfect interlace. Sizes: 8, 14, 17, 21, 24, 27 inches.



SYNC GENERATOR

Self contained, regulated unit with exclusive sync pulse mixing for perfect interlace. Separate H and V and mixed H and V outputs.



KINESCOPE RECORDER

A high quality kinescope recorder, completely self contained, providing an inexpensive method for the filming of telecasts.



PULSE CROSS MONITOR

Inputs permit viewing both remote and local sync signals simultaneously. Provides a visual check of signal.

Also manufacturers of "OFF THE AIR" tuners
and "REGULATED POWER SUPPLIES"

TELEVISION UTILITIES CORP. DIVISION OF NORD

New Hyde Park, L.I., N.Y.

Twining 8-1000 • Cable Address: NORDNEWHYDEPARK

CIRCLE 143 ON READER SERVICE CARD 143

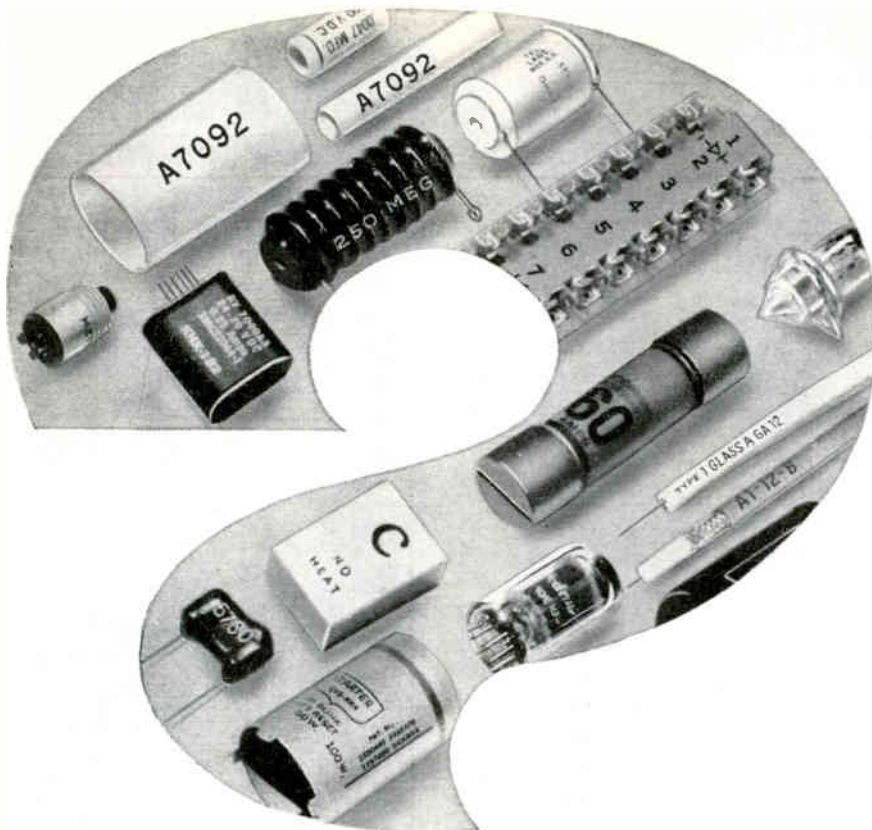

practical answers to your marking problems



This 12-page booklet explains how the electrical or electronic product *you* make can be marked — at production speeds — with clear imprints that hold. Are you looking for a way to mark odd shapes — a *practical* short-run marking method — an ink that will hold on an unusual surface, or withstand temperature, handling, moisture or other conditions? This catalog describes machines, printing elements and inks that will meet *your* requirements in the marking of products ranging from subminiature components to panels and chassis. There are special sections with practical answers to color banding, Underwriters' Laboratories manifest label legend marking, tape and label printing, wire and tube marking, efficient "in-line" marking. For your copy of the Markem Electrical Catalog, write Markem Machine Co., Electrical Division, Keene 5, New Hampshire.

MARKEM

EVERYTHING INDUSTRY NEEDS . . . FOR PROFITABLE MARKING . . . SINCE 1911

144 CIRCLE 144 ON READER SERVICE CARD

ADVERTISERS INDEX

Esquire Personnel Service Inc.....	140
Fast & Co., John E.....	140
General Electric Co.....	141
Honeywell	141
Liberty Electronics Inc.....	140
Modern Design	140
Monarch Personnel	140

This index and our Reader Service Numbers are published as a service. Every precaution is taken to make them accurate, but ELECTRONICS assumes no responsibilities for errors or omissions.

electronics



Audited Paid Circulation

BRUCE A. WINNER,
Advertising Sales Manager

R. S. QUINT, Assistant Advertising Sales Manager and Buyers' Guide Manager; FRED STEWART, Promotion Manager; RICHARD J. TOMLINSON, Production Manager; GEORGE E. POMEROY, Classified Manager; HUGH J. QUINN, Circulation Manager.

ADVERTISING REPRESENTATIVES: NEW YORK Donald H. Miller, Henry M. Shaw, George F. Werner; BOSTON William S. Hodgkinson, Donald R. Furth; PITTSBURGH David M. Watson; PHILADELPHIA Warren H. Gardner, William J. Boyle; CHICAGO Harvey W. Wernecke, Martin J. Gallay; CLEVELAND P. T. Fegley; SAN FRANCISCO T. H. Carmody, R. C. Alcorn; LOS ANGELES Carl W. Dysinger, D. A. McMillan, Marshall Freeman; DENVER J. Patten; ATLANTA M. Miller; DALLAS Robert T. Wood; LONDON Edward E. Schirmer; FRANKFURT Stanley R. Kimes; GENEVA Michael R. Zeynel.

BRANCH OFFICES: National Press Bldg., Washington 4, D.C.; 350 Park Square Bldg., Boston 16; Four Gateway Center, Pittsburgh 22; Six Penn Center Plaza, Philadelphia 3; 520 North Michigan Avenue, Chicago 11; 55 Public Square, Cleveland 13; 68 Post Street, San Francisco 4; 1125 West Sixth St., Los Angeles 17; 1740 Broadway, Denver 2; 1301 Rhodes-Haverty Bldg., Atlanta 3; 901 Vaughn Bldg., Dallas 1; McGraw-Hill House, London E.C.4; B5 Westendstrasse, Frankfurt/Main; 2 Place de Port, Geneva.

OFFICERS OF THE PUBLICATIONS DIVISION: Nelson L. Bond, President; Shelton Fisher, Wallace F. Traendly, Senior Vice Presidents; John R. Callahan, Vice President and Editorial Director; Joseph H. Allen, Vice President and Director of Advertising Sales; A. R. Venezian, Vice President and Circulation Coordinator.

OFFICERS OF THE CORPORATION: Donald C. McGraw, President; Joseph A. Gerardi, Hugh J. Kelly, Harry L. Waddell, Executive Vice Presidents; L. Keith Goodrich, Vice President and Treasurer; John J. Cooke, Secretary.

electronics

(picture of a KIN TEL differential amplifier at work)

6 volts of 60 ν common-mode noise and
6 millivolts of signal in here

2 microvolts of 60 ν noise (equivalent input)
and 6 volts of signal out here

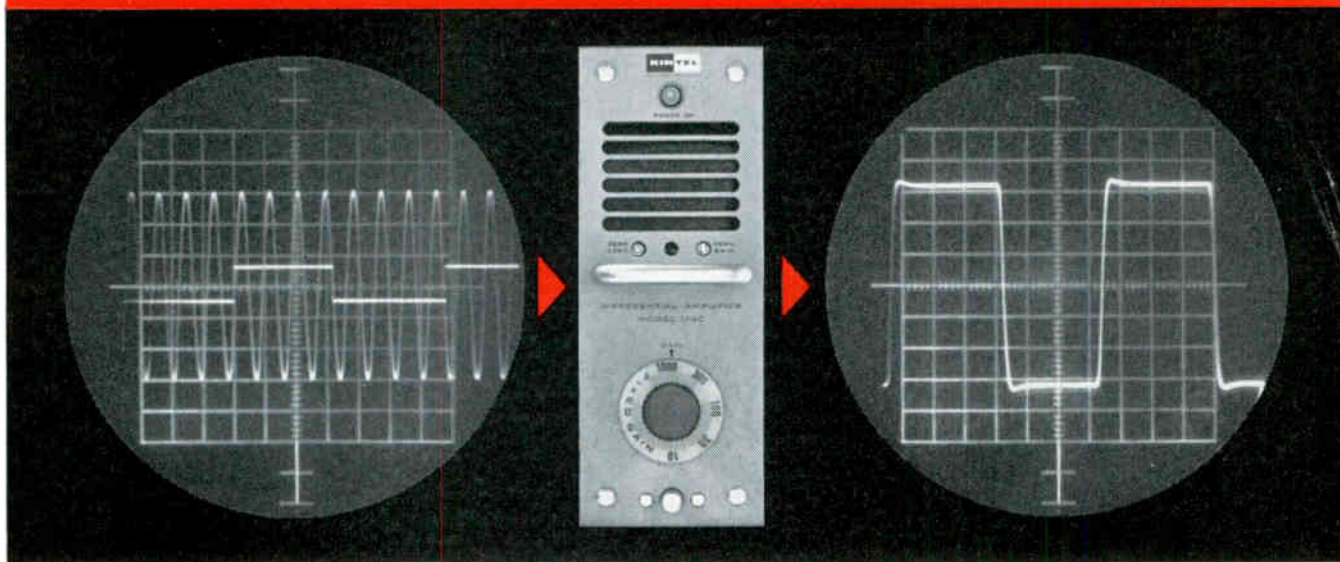

If you measure the output of thermocouples, and the thermocouples are bonded to a rocket engine or almost any other grounded object, and the distance between thermocouples and amplifiers is more than a few feet, you should consider the above illustration carefully. While we'll admit your thermocouples probably aren't producing square waves, nine chances out of ten you *do* have a problem with 60-cycle common-mode noise. Nearly everybody does.

What can be done about it? Well, KIN TEL differential amplifiers reject ruinous 60-cycle common-mode hum and noise by a factor of 3,000,000 to 1 with any unbalance up to 1000 ohms in series with either side of the input, 1,000,000 to 1 with 10,000 ohms unbalance. Rejection for DC is practically infinite and both input and output can be floated up to ± 300 volts DC or peak AC. The secret of this exceptionally high common-mode rejection in the presence of high input unbalance is isolation. Input signal terminals are isolated from chassis ground by 10,000,000 megohms and 0.6 micromicrofarads. Input and output signal terminals are completely isolated from each other. Output signal terminals are isolated from ground to almost the same extent as the input. With this virtually perfect isolation, you can rescue microvolt level signals from volts of common-mode noise, regardless of whether load and transducer are floating or grounded, balanced or unbalanced.

Before you send us that letter... the input scope photo is a double exposure. The square wave input signal was taken with the scope connected across points 1 and 2 (see drawing below) with 5 mv/division sensitivity. To show the noise, the scope was connected between points 2 and 3, and sensitivity was 1 v/division. The scope on the output was set for 1 v/division sensitivity and, of course, no noise is evident.

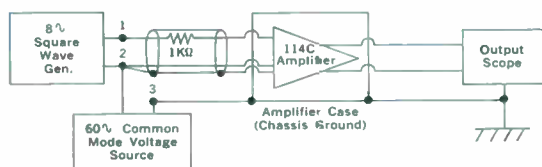

Specifications other than common-mode rejection are equally impressive. Linearity is 0.01% of full scale (10 volt) output for either polarity, 0.02% of full scale for plus-to-minus or minus-to-plus polarities. Equivalent input drift is less than $2\mu\text{v}$; noise at full amplifier bandwidth is less than $6\mu\text{v}$. Input impedance is 30 megohms, output impedance less than 0.25 ohms. Standard bandwidth is less than 3 db down at 80 cps, and the amplifier settles to within 99.9% of final value within 50 milliseconds for an output change of 5 volts. Plug-in input and output filters allow bandwidth options from 3 cps to 120 cps, transient response as good as 25 milliseconds. Gain is 10 to 1000 in 5 steps. A front panel vernier control provides 1 to greater than 3.3 times continuous adjustment of each gain step. Gain stability is $\pm 0.05\%$. Output capability is 10 volts at 10 milliamps. Amplifiers have integral power supplies. Enclosures include six-amplifier and single-amplifier 19-inch rack modules, and portable single amplifier cabinets.

To meet your exact requirements at minimum cost, two models are now available: the 114A at \$775, and the 114C (described) at \$875. Delivery on both models is currently from stock. Write for detailed technical data or a demonstration. Engineering representatives in all major cities.

KIN TEL
A DIVISION OF
COHU
ELECTRONICS, INC.

5725 Kearny Villa Road, San Diego 11, California
Phone: BRowing 7-6700

He sells you
dependability...
'off the shelf''

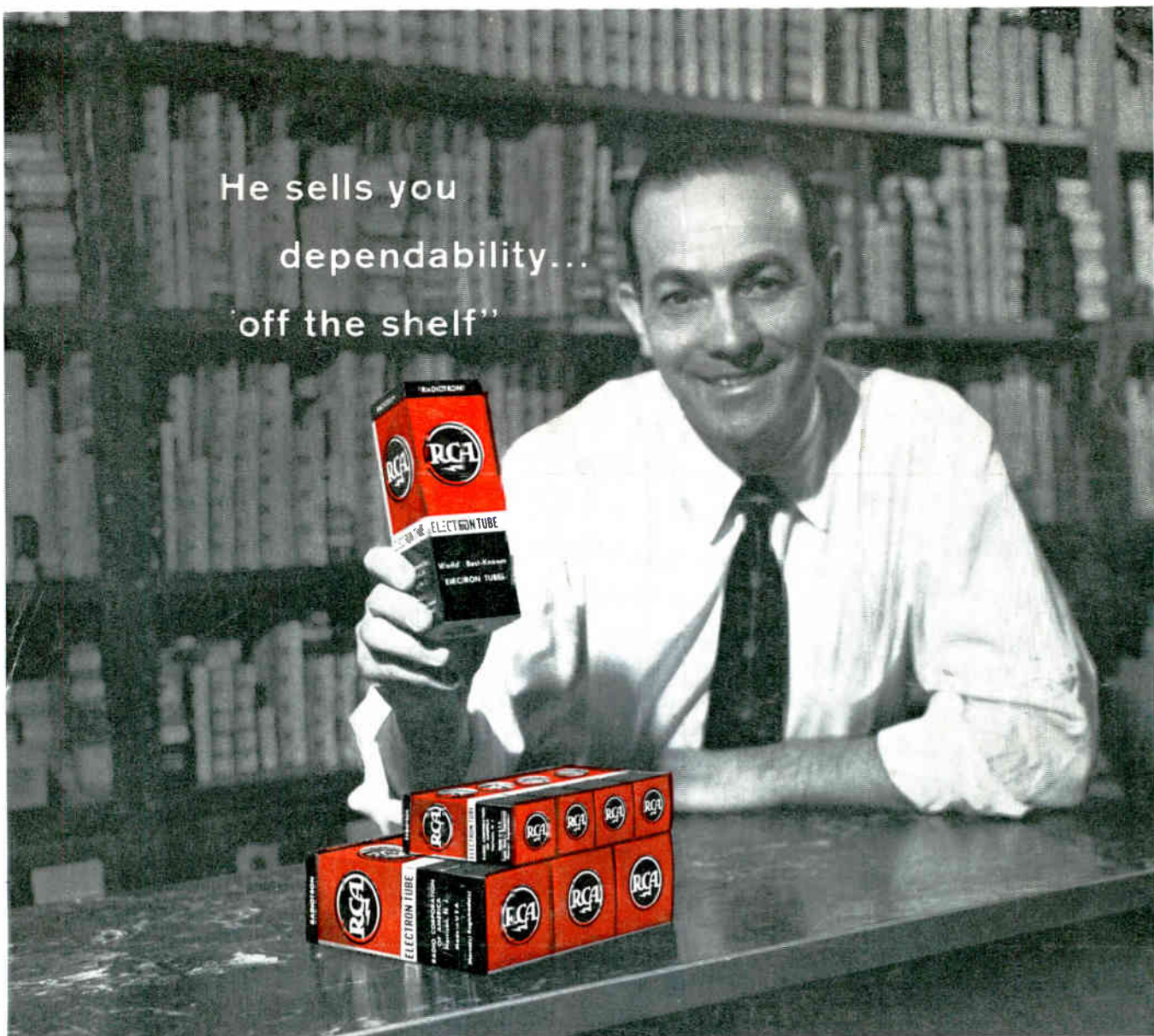

You get immediate delivery of factory-fresh tubes from your
RCA INDUSTRIAL TUBE DISTRIBUTOR

The most efficient industrial-tube service you can find is available locally through your RCA Industrial Tube Distributor. And he's as close to you as your telephone. Whether you need power tubes, gas tubes, photosensitive devices, cathode-ray tubes, industrial receiving tubes—in fact, almost any RCA industrial type—you'll get prompt, often same-day delivery of dependable RCA tubes—just by giving him a call.

Now your RCA Industrial Tube Distributor can offer the designer and manufacturer of electronic equipment

immediate delivery of factory-fresh tubes to meet limited production requirements. And check these "bonus" services for your convenience:

- immediate delivery of *new* RCA-developed types
- practical product information whenever you need it
- technical assistance to help you solve tough problems

Find out for yourself how many ways your RCA Industrial Tube Distributor can assist you. Give him a call today. *RCA Electron Tube Division, Harrison, N. J.*



The Most Trusted Name in Electronics
RADIO CORPORATION OF AMERICA