

September 9, 1960

electronics

Television camera (below) overcomes transistor low-frequency noise problems, permits variation in characteristics. See p 72
Design of a practical high-speed magnetic-film memory. See p 78

A McGraw-Hill Publication 75 Cents

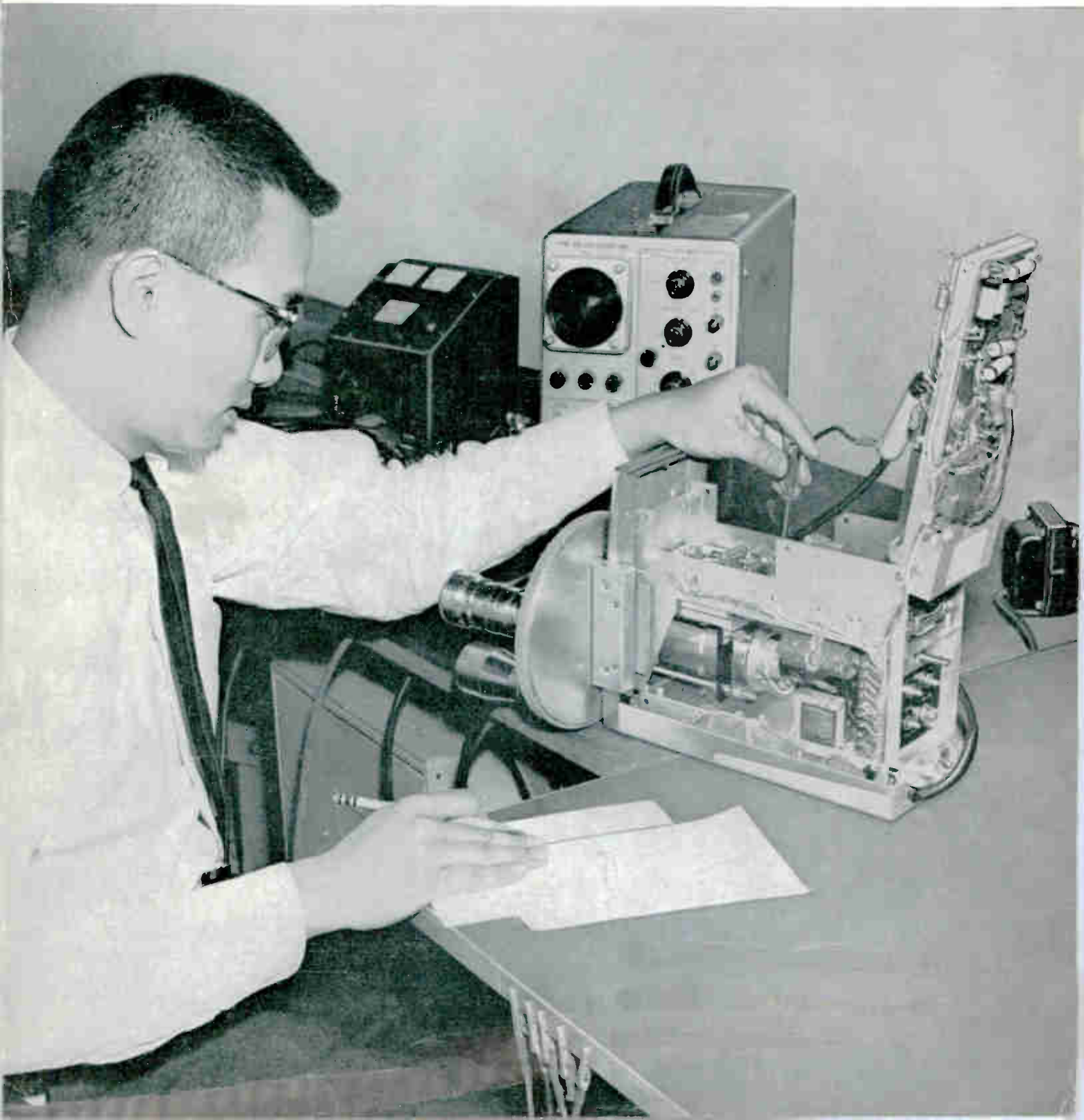



SPECIAL FILTERS

TO YOUR REQUIREMENTS

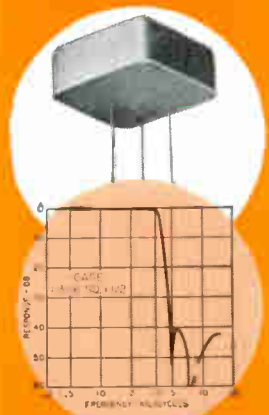

Miniaturized 3.5 KC low pass filter. 10K ohms to 10K ohms. Within 1 db up to 3500 cycles. Greater than 40 db beyond 480 cycles.

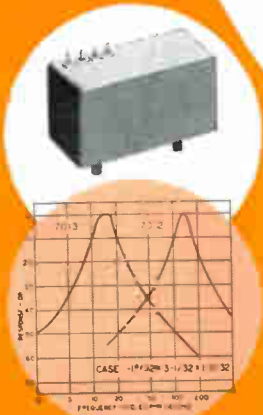

Fifteen cycle and 135 cycle filters for Tacan. 600 ohms to high impedance. Extreme stability -55 C. to +100 C.

Almost thirty years of experience in the design and production of special filters have resulted in UTC being a first source for difficult units. Present designs incorporate a wide variety of core structures, winding methods, and capacitors to provide maximum performance, stability, and reliability. The units illustrated show a few of the thousands of specials produced by UTC, to customers' requirements, and only slightly indicate the possibilities in present special filter design. Range of frequencies on special units is from .1 cycles to 400 MC.

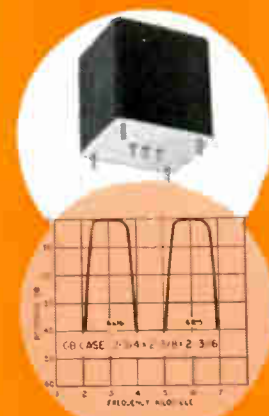

Three KC and 6 KC flat top band pass filters. 400 ohms to 20K ohms. MIL-T-27A; each filter 1.7 lbs.

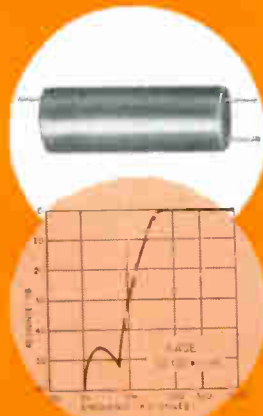

High frequency Mini-filters. 33 ohm. MIL-T-27A Grade 5. 150 KC High Pass 3 db to 150 KC. down 45 db below 85 KC. 7500 ohms.

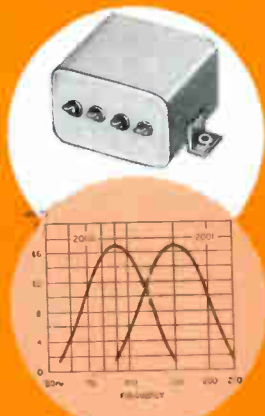

Curves of our miniaturized 90 and 150 cycle filters for glide path systems. 1 1/2" x 1 3/4" x 1 3/4".

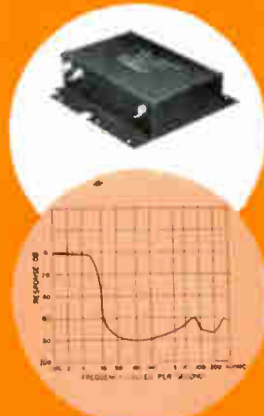

Power line filter from sources of 50 to 400 cycles. Attenuation from 14 KC to 400 MC. 29 cubic inches.

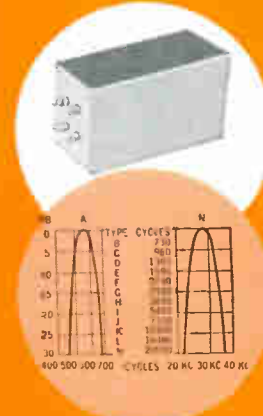

Multi-channel telemetering band pass filters for 400 cycle to 40 KC. Miniaturized units for many applications.

Plus over 1,000 STOCK ITEMS with UTC High Reliability from your local distributor



write for catalog

UNITED TRANSFORMER CORP.

150 VARICK STREET, NEW YORK 13, N. Y.

PACIFIC MFG. DIVISION: 4008 W. JEFFERSON BLVD., LOS ANGELES 16, CALIF.
EXPORT DIVISION: 13 EAST 40th STREET, NEW YORK 16, N. Y. CABLES: "ARLAB"

electronics

A McGraw-Hill Publication 75 Cents



W. W. MacDONALD, Editor

J. M. CARROLL, Managing Editor
SENIOR ASSOCIATE EDITORS:
 Samuel Weber, Roland J. Charest.
ASSOCIATE EDITORS: Frank Leary,
 Michael F. Tomaino, Sylvester P.
 Carter, William P. O'Brien, John
 F. Mason, William E. Bushor,
 Thomas Emma, Sy Vogel, Leslie
 Solomon, M. M. Perugini, George
 J. Flynn. **ASSISTANT EDITORS:**
 Michael F. Wolff, Nilo Lind-
 gren, Stanley Froud, Stephen B.
 Gray. **REGIONAL EDITORS:** Har-
 old C. Hood (Pacific Coast, Los
 Angeles), Thomas Maguire (New
 England, Boston). **MARKET RE-
 SEARCH EDITOR:** Edward DeJongh.
BUYERS' GUIDE EDITOR: George
 Sideris. **ART DIRECTOR:** Harry
 Phillips; Howard R. Berry. **PRO-
 DUCATION EDITOR:** John C. Wright,
 Jr. **EDITORIAL ASSISTANTS:** Gloria
 J. Filippone, Arlene Schilp, Bernice
 Duffy, Patricia Martine, Lorraine
 Rossi, Virginia T. Bastian, Ruth
 Ayres, Mildred Scott.

JAMES GIRDWOOD, Publisher

BUSINESS

| | | | |
|--|----|-----------------------|----|
| Active vs Passive Communications Satellites? Big business either way | 40 | | |
| VHF Translators Win Approval. "Illegal" boosters can become legitimate | 42 | | |
| No Magnetic Field Around Moon? Report on Stockholm space conference | 45 | | |
| New Ground Radar Upgrades Hercules. How two missiles kill one another | 46 | | |
| Photo Engineers Demand More Speed. Want nanosecond exposure times | 48 | | |
| More Grants for Universities. Military research still prime mover | 50 | | |
| Crosstalk | 4 | 25 Most Active Stocks | 20 |
| Comment | 6 | Marketing | 26 |
| Electronics Newsletter | 11 | Current Figures | 26 |
| Washington Outlook | 14 | Meetings Ahead | 52 |
| Financial Roundup | 20 | | |

ENGINEERING

| | |
|--|-------|
| Transistorization of a tv camera raises interesting problems. How these problems were solved is described on p 72 | COVER |
| Sound Velocity Measurement in Liquids.—Instrument has many possible industrial uses. By W. D. Wilson and D. D. Taylor | 69 |
| Designing Transistorized Television Cameras. Overcoming problems resulting from transistorizing equipment. By D. G. Carreon | 72 |
| Variable-Program Triggering Source. Automatic variable-program triggering source. By B. E. Bourne | 76 |
| Making Reproducible Magnetic-Film Memories. Progress beyond the laboratory demonstration stage. By E. M. Bradley | 78 |
| Use of Reflex Klystrons as Millimeter-Wave Detectors. At 58,000 Mc, reflex klystron detector has 12-db gain over crystal detector. By K. Ishii | 82 |
| Practical Approach to Interference Prediction and Suppression. Careful planning in initial design reduces problem. By P. B. Wilson, Jr. | 84 |
| Digital Time Code Identifies Recordings. Provides unique identification of tape as short as 30 inches. By V. B. Morris, Jr. | 88 |

DEPARTMENTS

| | | | |
|--|-----|----------------------|-----|
| Research and Development. High-Accuracy Pulse-Measuring Technique | 92 | | |
| Components and Materials. Cu-Zr Alloy For High Temperature Devices | 96 | | |
| Production Techniques. Making Connections First Speeds Har- nessing | 104 | | |
| New On the Market | 110 | People and Plants | 126 |
| Literature of the Week | 124 | Index to Advertisers | 135 |

JONES & LAMSON OPTICAL COMPARATORS

the man who needs
a new machine tool is
already paying for it

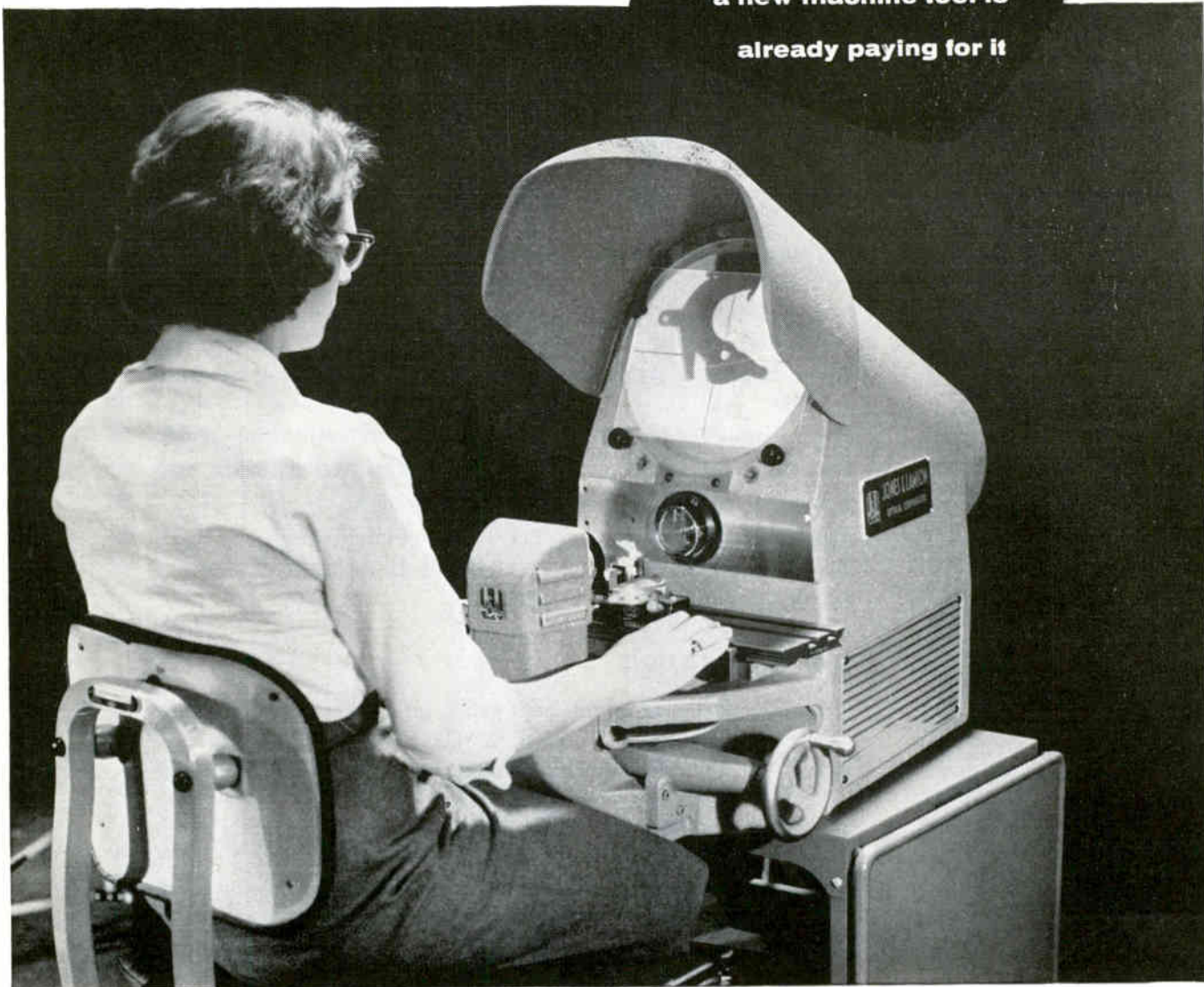

Now... an Economy-size Optical Comparator with "Big Machine" Features

Here is a fine optical inspection and measuring instrument of brand-new design. It is the first small-screen comparator to offer such BIG performance. It is equally suitable for production-line operation or job-shop work, and is extremely flexible in application.

The J&L TC-10 is of precision machine tool construction. This provides a solid base for precise inspection and measurement.

Three different table styles are available, including a fixed table for straight comparison work, a plain table, and a measuring table which gives you 6 square inches of measuring

area. All measurements are read directly to .0001", without computation.

Among other things, the TC-10 is adaptable for *reflection inspection*. Reflected images are extremely sharp—even at high magnifications.

Other "big machine" features include Angle Measuring; Quick-Change Lens Mount; Vertical Staging; Tracing Inspection. And there's a big bonus in the 5X, 2" aperture lens, which gives inspection capacity and accuracy hitherto unattainable on a machine of this size. Write for folder. Jones & Lamson Machine Company, 539 Clinton St., Springfield, Vt.

Turret Lathes • Automatic Lathes • Tape Controlled Machines • Thread & Form Grinders • Optical Comparators • Thread Tools

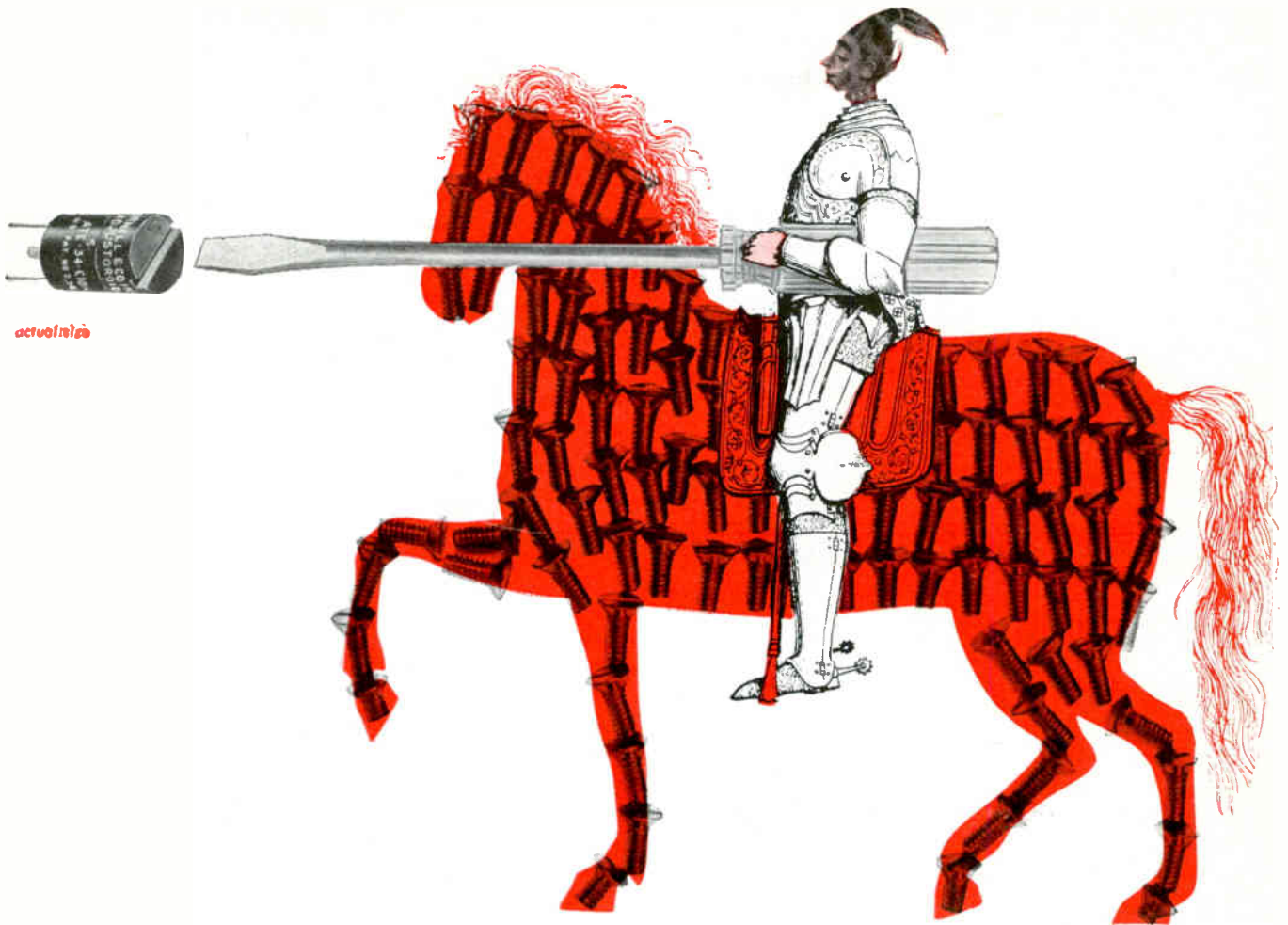

TAMING OF THE SCREW

Newest additions to the Burnell Adjustoroid® line, the microminiaturized Kernel ATE 34 and the miniatures ATE 11, ATE 0, ATE 4, represent an important contribution to printed circuit design.

These new Adjustoroids possess the exclusive advantage of flush-slotted heads which serve to eliminate adjusting screws — provide maximum economy of height — insure ease of adjustment. Besides high Q, they also offer high stability of inductance versus dc.

The new microminiature Kernel ATE 34 and the miniature ATE 11, ATE 0 and ATE 4 Adjustoroids are variable over a 10% range of their inductance. Fully encapsulated, they will withstand high acceleration and vibration environments. These Adjustoroids meet specifications MIL-T 27 Grade 4, Class R and MIL-E 15305 A as well as MIL-E 5272 for humidity and thermal shock. Write for Adjustoroid Bulletin ATE-7.

SEND NOW FOR HANDY 24" x 36" TOROIDAL INDUCTOR WALL REFERENCE CHART

Lists more than 100 types of toroidal inductors and adjustoroids. Gives performance characteristics, mechanical specifications, including case sizes, types of sealing, etc. Attach coupon to company letterhead. And if you haven't already done so — send for your free membership in the Space Shrinkers Club.

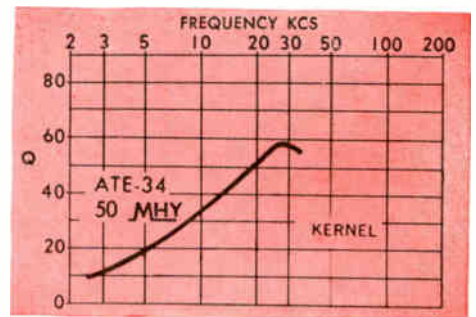

PAT. 2,782,020

COPYRIGHT BURNELL & CO. INC. 1960

Burnell & Co., Inc.

PIONEERS IN microminiaturization OF
TOROIDS, FILTERS AND RELATED NETWORKS

Eastern Division
Dept. E-39
10 Pelham Parkway
Pelham, N. Y.
PEIham 8-5000
Teletype Pelham 3633



Pacific Division
Dept. E-39
720 Mission St.
South Pasadena, Cal.
MURray 2-2841
Teletype Pasadal 7578

Burnell & Co., Inc. Dept. E-38
10 Pelham Parkway, Pelham, New York

Gentlemen:

- I am interested in your new universal toroidal reference chart.
 I am interested in a Space Shrinkers Club membership.

name.....

title.....

company.....

address.....

CROSSTALK

electronics

Sept. 9, 1960 Volume 33 Number 37

Published weekly, with Electronics Buyers' Guide and Reference annually, by McGraw-Hill Publishing Company, Inc. Founder: James H. McGraw (1860-1948).

Executive, editorial, circulation and advertising offices McGraw-Hill Building, 330 West 42nd Street, New York 36, N. Y. Telephone Longacre 4-3000. Teletype TWX N.Y. 1-1636. Cable McGrawhill, N.Y. Printed in Albany, N. Y.; second class postage paid.

Subscription price U.S. and possessions \$6 per year; single copies 75¢, Buyers' Guide \$3. Other countries, and longer periods, on request. Subscriptions solicited only from those actively engaged in the field of the publication and in a manner served by its contents; position and company should be indicated.

Subscribers: Please address all correspondence, change of address notices, subscription orders or complaints to Fulfillment Manager, Electronics, at above address. Change of address notices should provide old as well as new address, including postal zone number if any. If possible, attach address label from recent issue. Allow one month for change to become effective.

Title registered U.S. Patent Office; Copyrighted 1960, McGraw-Hill Publishing Company, Inc. All rights reserved, including the right to reproduce the contents of this publication, in whole or in part.

Postmaster: Please send Form 3579.

REFLEX KLYSTRONS. This issue brings another in a series of informative articles by K. Ishii of Marquette University on the subject of reflex klystrons. In this his latest *ELECTRONICS* article, which begins on p 82, Ishii analyzes the behavior of the QK-295 reflex klystron as a millimeter-wave regenerative detector.

Previous articles by Ishii, who is an assistant professor in Marquette's electrical engineering department, have dealt with reflex klystrons in X-band receiving amplifiers (p 202, April 1955 and p 56, Jan. 8, 1960), in M-band amplifiers (p 71, Mar. 18, 1960) and reflex klystron amplifiers with hybrid-T coupling (p 64, June 10, 1960).

COMMUNICATIONS. Technological progress sometimes means new life to some and doom to others. The invention of the locomotive killed the stage coach business outright. The communications satellite, however, is not expected to leave much bankruptcy in its wake. The expanded facilities provided by these orbiting microwave relay stations will be used up by the normally expanding need for communications. Some changes in equipment are nevertheless inevitable. Gear developed as weapons systems—ballistic missiles and radar—will move into the communications field. And much existing communications equipment will be converted. Progress in many specific areas is urgently needed. Associate Editor John Mason reports on p 40 how the communications satellite will affect the communications equipment maker.

LONG-STANDING THORN in the side of FCC and some broadcasters has been the operation of unlicensed booster stations that take television signals off the air for the benefit of communities isolated from conventional reception. The Commission's latest move is to authorize establishment of vhf-tv translator stations. In the past, FCC tried to deal with boosters by approving uhf translators. (These stations receive vhf broadcasts and transmit them on a uhf channel.) Since many boosters were already operating on vhf frequencies, there was no great stampede to adopt the Commission's uhf plan, although many boosters did change over. Remaining to be seen now is whether or not the vhf translators will win the boosters over, and what, if any, interference problems will arise. For news in this area, see Associate Editor Emma's story on p. 42.

Coming In Our September 16 Issue

MICROWAVE TELEMETRY. Measuring the acceleration of a projectile being fired is a central problem of interior ballistic instrumentation. Telemetry systems for this task are subject to special requirements imposed by accelerations over 10,000 g's and by the high cutoff frequency of the gun barrel.

Next week, W. M. Kendrick and L. A. Peters of Ballistic Research Laboratories, Aberdeen Proving Ground, describe a technique for using a microwave beam to transmit data up the gun barrel from a projectile during firing. A ferrite modulator within the projectile modulates the externally generated beam; the modulated signal reflected from the projectile is then demodulated in the ground station to recover the information.

IN ADDITION. The variety of interesting feature articles scheduled to appear next week includes: A sensitive capacitance intruder alarm by S. M. Bagno of Kidde Ultrasonic & Detection Alarms.

See What Tubular Capacitor leads all others in MOISTURE RESISTANCE!

MOISTURE RESISTANCE COMPARISON CHART
FOR TUBULAR CAPACITORS

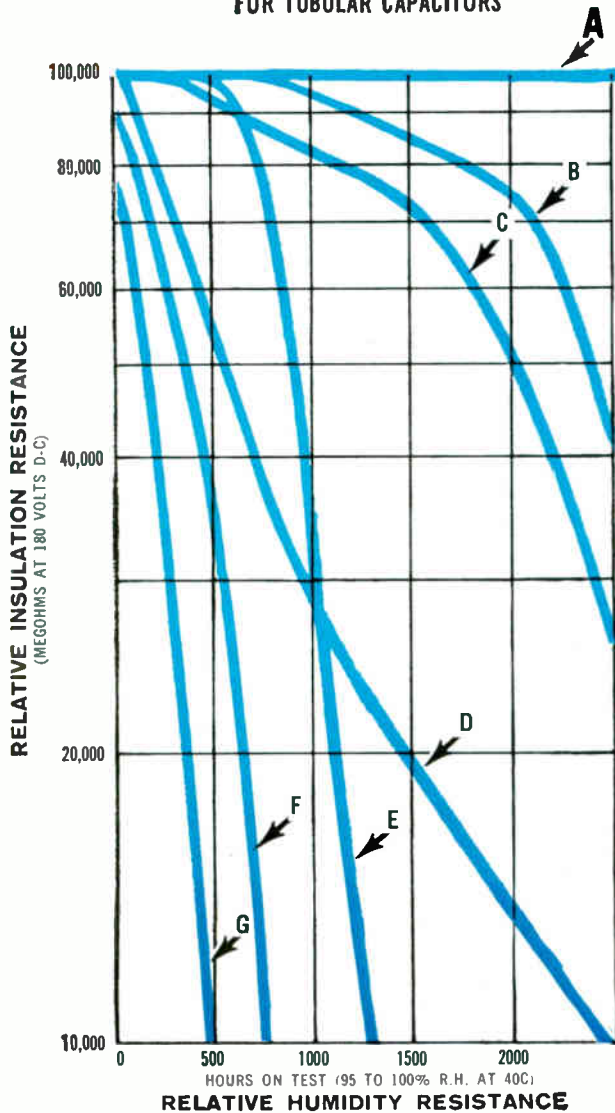

- A DIFILM® DUAL DIELECTRIC (PAPER and POLYESTER FILM) with HCX® solid impregnant and molded phenolic case
- B PAPER DIELECTRIC with HCX solid impregnant and molded phenolic case
- C DIFILM DUAL DIELECTRIC (PAPER and POLYESTER FILM) with HCX solid impregnant and dipped epoxy resin coating
- D PAPER DIELECTRIC with wax or oil impregnant and molded phenolic case
- E POLYESTER FILM DIELECTRIC with molded case
- F PAPER DIELECTRIC with HCX solid impregnant and waxed cardboard jacket
- G PAPER DIELECTRIC with wax or oil impregnant and waxed cardboard jacket

The graph tells the story simply and to the point!

DIFILM® BLACK BEAUTY® MOLDED TUBULAR CAPACITORS withstand more than 2500 hours (95 to 100% R.H. at 40 C) with no change in humidity resistance!

No other tubular comes even close to this performance. Difilm Capacitors are the true answer to moisture problems in entertainment and commercial electronics.



For complete technical data on Difilm Black Beauty Capacitors, write for Engineering Bulletin 2025 to Technical Literature Section, Sprague Electric Co., 35 Marshall St., North Adams, Mass.

SPRAGUE®
THE MARK OF RELIABILITY

SPRAGUE COMPONENTS:

CAPACITORS • RESISTORS • MAGNETIC COMPONENTS • TRANSISTORS • INTERFERENCE FILTERS • PULSE NETWORKS • HIGH TEMPERATURE MAGNETIC WIRE • CERAMIC-BASE PRINTED NETWORKS • PACKAGED COMPONENT ASSEMBLIES

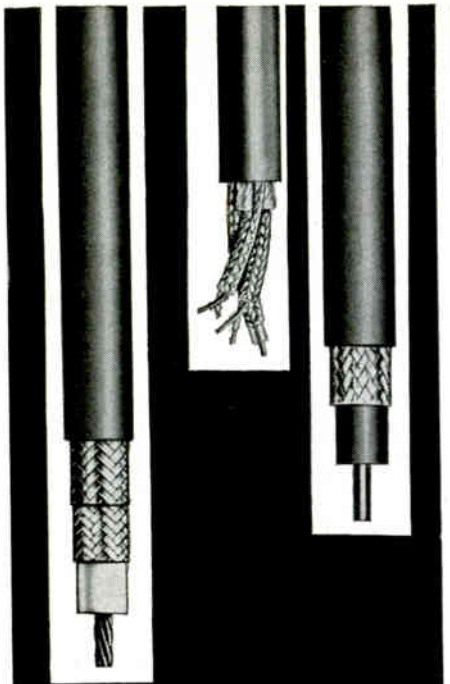

ROYAL COAXIAL CABLES

Royal has the skills and capacities to satisfy your coaxial or multi-conductor cable requirements . . . for electronic equipment, military applications, or community TV installations. Take a look at the Royal line . . . write for Bulletin 4C-3-L listing stock constructions. Or let us quote on your special requirements.



ROYAL ELECTRIC CORPORATION
301 Saratoga Avenue
PAWTUCKET • RHODE ISLAND

in Canada: Royal Electric Company (Quebec) Ltd.,
Pointe-Claire, Quebec

ROYAL
ELECTRIC
... an associate of **ITT**

COMMENT

Electronics Probes Nature

(Ref. "Electronics Probes Nature," special report on p 53, July 29 . . .)

I was very glad that I was able to contribute to your coverage of this most important area.

The report was very well done, demonstrating a masterful editorial effort. I should imagine that the material in the article represents the consolidation of a considerable mass of literature, comments, reports, and so forth. The article accomplished what I believe you intended it to: that is, to establish a framework which shows the related nature of several important scientific areas with a small indication of what is going on in each.

I do, however, have one criticism to make. There wasn't enough of it, which is understandable when publication space is at a premium. Therefore I would like to make a suggestion. Using the present article as a guide, further develop each section so that you can present a full comprehensive report of one part in each issue of *ELECTRONICS*.

I would like to further suggest that in each part, a section be devoted to the geopolitical aspects of that particular part. I do not restrict this facet of an area to the short-range international scene, but refer to the long-range effects.

As an example, what will be the long-range effects of the knowledge we are accumulating about the oceans? What will happen in agriculturally poor countries when food reaped from the oceans will be plentiful? What technical steps are being taken now to make the most of these opportunities? Science-fiction? No, a glimpse into things to come based on wellfounded guesses.

Again, thank you for . . . the article. I sincerely believe it was well done, timely, and with about as much content as the space would permit.

JOHN H. NEWMAN

DAYSTROM INC.
POUGHKEEPSIE, N. Y.

I do not have time to write you a full letter of comment on "Electronics Probes Nature" at the present moment . . .

From my perusal of the articles so far, I was very much impressed with both the high quality of the technical writing (I except my own contribution) and the comprehensive nature of the information.

ROBERT A. FROSCH

COLUMBIA UNIVERSITY
DOBBS FERRY, N. Y.

Researcher Frosch need not except his own contribution, which certainly helped make the report the excellent thing we feel it is.

Reader Newman's suggestion would be difficult to implement, and might take us far afield from our proper concern, which is electronics. There are many subjects of scientific interest that we would like to present, and sometimes we let our eclectic nature carry us away—but always we return to the point that a cobbler is a flop unless he sticks to his last. Electronics, rather than agronomy (for instance), is our business. But we're happy to promise that developments in the various areas covered in the special report will be reported as they occur.

Help Wanted

We are trying to find out the present whereabouts of International Scientific Industries Corp., which was located at 3101 E. 42nd St., Minneapolis, several years ago. An inquiry to the Minneapolis Chamber of Commerce bore no fruit.

If this company has gone out of business, we would like to be able to contact one of the principals; therefore if any of your readers know—or are—any of the principals, we would appreciate hearing from them.

Hope you can help. Perhaps you could print this letter in your Department of Missing Companies.

GERALD SHIRLEY

ALDSHIR MFG. CO.
TUCKAHOE, N. Y.

Inquiries directed to our several records and files of such data also bore no fruit, and we hope that someone in our readership will be able to help reader Shirley find his missing company.

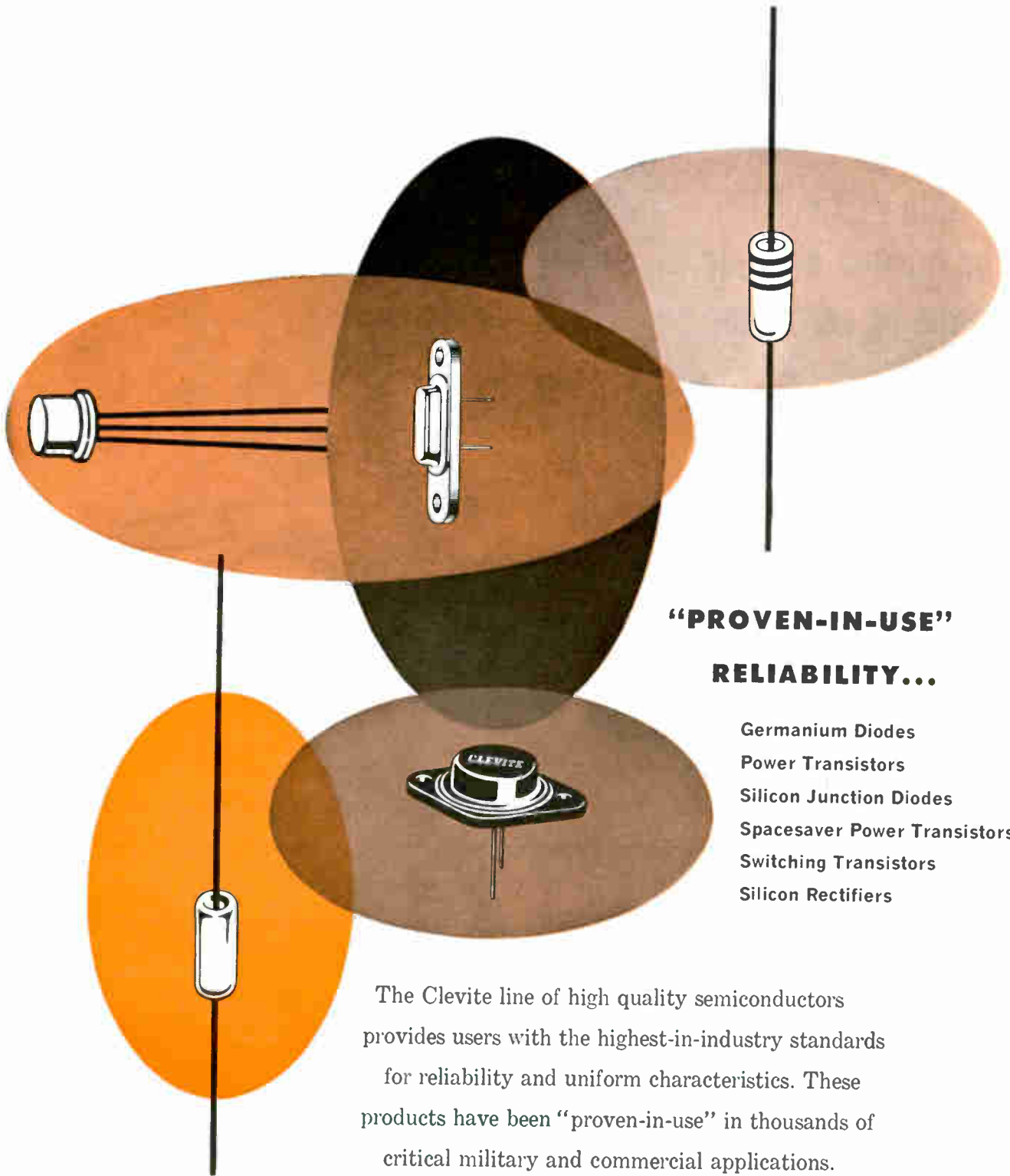

**“PROVEN-IN-USE”
RELIABILITY...**

- Germanium Diodes
- Power Transistors
- Silicon Junction Diodes
- Spacesaver Power Transistors
- Switching Transistors
- Silicon Rectifiers

The Clevite line of high quality semiconductors provides users with the highest-in-industry standards for reliability and uniform characteristics. These products have been “proven-in-use” in thousands of critical military and commercial applications.

Write now for complete data and detailed specifications.



Reliability In Volume . . .
CLEVITE TRANSISTOR

254 Crescent Street Waltham 54, Mass. Tel: TWinbrook 4-9330



hp 456A AC CURRENT PROBE

Converts ac current to
ac voltage directly
(1 amp = 1 volt)
for reading on your
scope or voltmeter

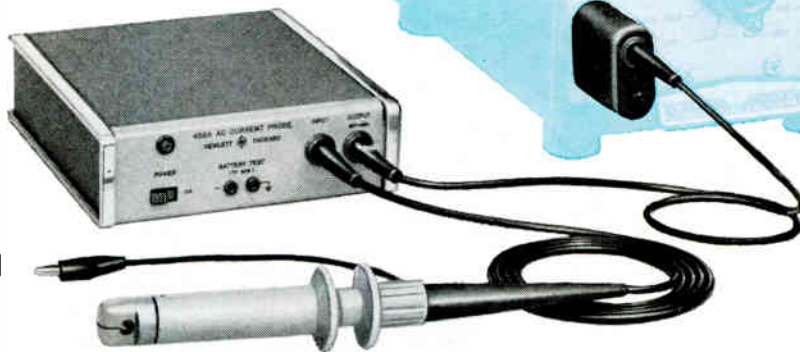

Just clamp around
and read:

Tube circuits view current on your scope or measure it with a VTVM

Transistor circuits measure small signals dynamically, without clipping leads or circuit loading; study diodes at breakdown

Logic circuits measure ac current in presence of dc current

Impedance measuring . . with a dual-channel scope, measure current, voltage magnitude; phase angle

Power measuring with dual-channel scope read current, voltage directly, calculate power

Frequency counting use 456A with counter for clip-on frequency access

And, how about these? . . phase comparisons of ac carrier waveforms; instrument fuse current ratings; cable identification, response of magnetic cores; magnetic field sensing; silicon rectifier peak currents

SPECIFICATIONS

Sensitivity: 1 mv/ma $\pm 1\%$ at 1 KC
Frequency Response: $\pm 2\%$, 100 cps to 3 MC
 $\pm 5\%$, 60 cps to 4 MC
 -3 db at 25 cps and above 20 MC
Maximum Input: 1 amp rms; 1.5 amp peak.
100 ma rms above 5 MC
Maximum dc current: Dc up to 0.5 amp has no appreciable effect
Input Impedance: Probe adds to test circuit only approx. 0.05 ohms in series with 0.05 μ h
Equivalent Input Noise: Less than 50 μ a rms (100 μ a ac powered)
Power: 10 radio mercury cells; approx. 400 hours service normally supplied. Ac supply available
Size: 5" wide, 1 $\frac{1}{2}$ " high, 6" deep, weight 3 lbs.
Price: \$190.00; for ac operation \$210.00.
hp 456-95A ac supply for field installation \$32.00
Data subject to change without notice
Prices F.O.B. Factory

Just clamp the hp 456A probe around a wire under test and view or read ac current directly on an indicating device. Model 456A's 1 mv to 1 ma unity conversion permits direct readings up to 1 ampere rms. The instrument's wide bandwidth permits use with oscilloscopes to view complex current waveforms with rise times to 0.017 μ sec. No direct circuit connection is required; there is no loading, no appreciable impedance change in the circuit under test, and the impedance of the test circuit is immaterial.

HEWLETT-PACKARD COMPANY

1028K Page Mill Road, Palo Alto, California, U. S. A.
Cable "HEWPACK" • Davenport 5-4451



HEWLETT-PACKARD S. A.

Rue du Vieux Billard No. 1, Geneva, Switzerland
Cable "HEWPACKSA" • Tel. No. (022) 26.43.36

hp offers almost 400 precision test instruments



Approximately actual size

This 3 lbs. of transistorized new AC amplifier gives you 20 or 40 db gain, increases scope or VTVM sensitivity 10 or 100!

This new  466A AC Amplifier is just 4" high, 6" wide and 6" deep. Yet it can become one of the most helpful instruments on your bench, or in the field. It is ac or battery powered; battery operation gives you hum-free performance and easy portability. Response is flat within approximately 1/2 db over the broad range of 10 cps to 1 MC, distortion is

less than 1%, and gain is stabilized by substantial negative feedback to virtually eliminate effects of transistor characteristics and environment.

For a demonstration on your laboratory or field application, call your  representative or write direct.

Specifications

| | | | |
|----------------------------|---|--------------------|--|
| Gain: | 20 and 40 db, ± 0.2 db at 1000 cps. | Distortion: | Less than 1%, 10 to 100,000 cps. |
| Frequency Response: | ± 0.5 db, 10 cps to 1 MC; ± 3 db, 5 cps to 2 MC. | Power: | Ac line power normally supplied, but battery operation available. (12 radio type mercury cells, battery life about 160 hours.) Specify battery operation if desired. |
| Output Voltage: | 1.5 v rms across 1500 ohms. | Dimensions: | 6 1/4" wide, 4" high, 6 1/4" deep. Weight: approx. 3 lbs. |
| Noise: | 75 μ v rms referred to input, 100,000 ohm source. | Price: | \$150.00 f.o.b. factory. (Either ac or battery operation.) |
| Input Impedance: | 1 megohm shunted by 25 μ mf. | | |
| Output Impedance: | Approximately 50 ohms. | | |

Data subject to change without notice.

HEWLETT-PACKARD COMPANY

1027A Page Mill Road, Palo Alto, California, U.S.A.
Cable "HEWPACK" • DAVenpart 6-7000



HEWLETT-PACKARD S.A.

Rue du Vieux Billard No. 1, Geneva, Switzerland
Cable "HEWPACKSA" • Tel. No. (022) 26. 43. 36





Field Representatives in all principal areas

Get immediate delivery from stock from **MALLORY** **INDUSTRIAL** **DISTRIBUTORS**

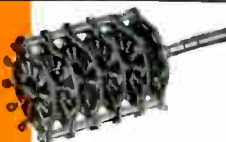

When your research, short runs or maintenance calls for short orders of electronic components in a hurry . . . call your Mallory industrial distributor. He makes a specialty of supplying electronic parts to industrial users. He carries selected lines of Mallory components—identical to those which you would receive on direct factory order. He'll keep your schedules safe with fast delivery from stock . . . *at factory prices.*

Check these Mallory lines for the electronic components to meet your tight schedules:

| | | |
|----------|---|--|
| 1 |  | TANTALUM CAPACITORS broadest line in the industry. 0.33 to 1300 mfd. Sintered, solid and foil types; temperatures —55°C to +200°C. |
| 2 |  | SELECTOR SWITCHES Push-button, lever action, rotary, wafer, multi-section; phenolic or ceramic insulation. |
| 3 |  | VITREOUS ENAMEL RESISTORS complete line of wire-wounds. Fixed and adjustable; 5 to 200 watts, to 100,000 ohms. Also a full line of military types. |
| 4 |  | CERAMIC DISC CAPACITORS made by Radio Materials Company, a Mallory Division. From 50v general purpose to 6000v high-voltage types. |
| 5 |  | SUB-MINIATURE SNAP-ACTION SWITCHES Milli-Switch® line of precision push-buttons, toggles and auxiliary actuators for slide or cam action. Temperature ranges to 300°F. Also hermetically sealed units. |
| 6 |  | HIGH-CAPACITY, HEAVY-DUTY ELECTROLYTICS Types HC (high-capacity) and NP (non-polarized). Plastic-case; compact, leak-proof design; rated for high ripple currents, cool operation; self-insulated. From 3v, 6700 mfd. to 450v, 88 mfd. |

P. R. MALLORY & CO. INC.
Distributor Division
P.O. Box 1558
Indianapolis 6, Indiana



| Mallory Industrial Distributors | |
|--|--------------------------------|
| Standard Radio Parts | 1 Tucson, Ariz. |
| Newark Electronics | 2 Inglewood, Calif. |
| California Electronics | 1 2 6 Los Angeles, Calif. |
| Federated Purchaser | 2 6 Los Angeles, Calif. |
| Kierulff Electronics | 1 2 4 5 6 Los Angeles, Calif. |
| Radio Product Sales | 1 2 6 Los Angeles, Calif. |
| Brill Electronics | 6 Oakland, Calif. |
| Elmar Electronics | 1 2 4 6 Oakland, Calif. |
| Zack Radio | 1 2 3 5 6 Palo Alto, Calif. |
| Elwyn W. Ley | 2 6 Paramount, Calif. |
| Electronic Supply | 1 2 3 4 6 Pasadena, Calif. |
| Shanks & Wright | 4 6 San Diego, Calif. |
| Peninsula Electronics | 5 San Jose, Calif. |
| Denver Electronics | 1 Denver, Colo. |
| Westconn Electronics | 1 Bridgeport, Conn. |
| Capitol Radio | 6 Washington, D.C. |
| Electronic Indus. Sales | 1 2 6 Washington, D.C. |
| Electronic Equipment | 6 Miami, Fla. |
| East Coast Radio | 1 3 4 6 Orlando, Fla. |
| Thurow Distributors | 1 Tampa, Fla. |
| Specialty Dist. | 3 Atlanta, Ga. |
| Allied Radio | 1 2 6 Chicago, Ill. |
| Chauncey's, Inc. | 2 4 6 Chicago, Ill. |
| Newark Electronics | 1 2 6 Chicago, Ill. |
| Melvin Electronics | 6 Oak Park, Ill. |
| Bruce Electronics | 3 Springfield, Ill. |
| Graham Electronics | 1 2 3 4 5 6 Indianapolis, Ind. |
| Radio Supply | 5 Wichita, Kansas |
| D & H Distributing | 2 4 6 Baltimore, Md. |
| Kann-Ellert Electron. | 2 Baltimore, Md. |
| Radio Elec. Serv. | 1 5 Baltimore, Md. |
| Cramer Electronics | 1 2 3 4 6 Boston, Mass. |
| DeMambro Rad. Sup. | 1 2 5 6 Boston, Mass. |
| Lafayette Radio | 1 2 6 Boston, Mass. |
| Radio Shack | 2 Boston, Mass. |
| Northwest Radio | 1 2 4 Minneapolis, Minn. |
| Burstein-Applebee | 1 2 6 Kansas City, Mo. |
| Olive Electronics | 1 5 St. Louis, Mo. |
| General Radio | 1 2 6 Camden, N. J. |
| Eastern Radio | 2 6 Clifton, N. J. |
| Atlas Electronics | 1 2 6 Perth Amboy, N. J. |
| Federated Purchaser | 1 2 6 Mountainside, N. J. |
| Aaron Lippman & Co. | 1 2 Newark, N. J. |
| Lafayette Radio | 1 6 Newark, N. J. |
| State Electronics | 2 4 6 Whippany, N. J. |
| Federal Electronics | 1 2 6 Binghamton, N. Y. |
| Stack Electronics | 1 Binghamton, N. Y. |
| Acme Electronics | 2 Brooklyn, N. Y. |
| Radio Equipment | 2 Buffalo, N. Y. |
| Wehle Electronics | 1 6 Buffalo, N. Y. |
| Bruno-New York | 6 New York, N. Y. |
| Electronic Center | 2 6 New York, N. Y. |
| Harrison Radio | 1 2 3 4 5 6 New York, N. Y. |
| Harvey Radio | 1 2 6 New York, N. Y. |
| Hudson Radio | 1 2 6 New York, N. Y. |
| Lafayette Radio | 1 2 3 6 New York, N. Y. |
| Milo Electronics | 2 6 New York, N. Y. |
| Terminal Electronics | 1 2 6 New York, N. Y. |
| Higgins & Sheer Elec. | 2 Poughkeepsie, N.Y. |
| Morris Electronics | 6 Syracuse, N. Y. |
| Valley Indus. Elec. | 2 Utica, N. Y. |
| Westchester Elec. | 1 2 White Plains, N.Y. |
| Dalton-Hege Radio | 1 Winston-Salem, N.C. |
| Akron Electronic Sup. | 2 Akron, Ohio |
| United Radio | 1 3 4 Cincinnati, Ohio |
| Pioneer Electronics | 1 6 Cleveland, Ohio |
| Thompson Radio | 4 Columbus, Ohio |
| Whitehead Radio | 3 Columbus, Ohio |
| Allied Supply | 1 3 4 5 Dayton, Ohio |
| Srepcu, Inc. | 2 Dayton, Ohio |
| Servex Electronics | 4 Marion, Ohio |
| Engineering Supply | 1 Tulsa, Okla. |
| Television Parts | 3 4 New Brighton, Pa. |
| Cameradio Co. | 5 Pittsburgh, Pa. |
| Radio Parts | 1 2 6 Pittsburgh, Pa. |
| Almo Radio | 6 Philadelphia, Pa. |
| Herbach & Rademan | 1 Philadelphia, Pa. |
| Phila. Electronics | 1 2 6 Philadelphia, Pa. |
| Radio Elec. Serv. | 2 6 Philadelphia, Pa. |
| Geo. D. Barbey Co. | 6 Reading, Pa. |
| Electra Distrib. | 1 2 Nashville, Tenn. |
| Engineering Supply | 1 4 6 Dallas, Texas |
| Harrison Equip. | 1 6 Houston, Texas |
| Lenert Co. | 1 6 Houston, Texas |
| F. B. Connelly Co. | 1 2 3 4 5 Seattle, Wash. |
| Radio Parts | 5 Milwaukee, Wis. |
| Canadian Elec. Sup. | 1 Montreal, Que. |
| Wackid Radio | 1 Ottawa, Ont. |
| Alpha Aracon Radio | 1 Toronto, Ont. |
| Electro Sonic Sup. | 1 Toronto, Ont. |
| Wholesale Radio | 1 Toronto, Ont. |

ELECTRONICS NEWSLETTER

Bank Check Sorter Prints Electrostatically

NEXT THURSDAY an electronic sorter with visual print out at 1,560 lines a minute and a magnetic tape output for computers will go into operation at the First Pennsylvania Banking and Trust Co., Philadelphia. Input to the Burroughs equipment is from MICR (Magnetic Ink Character Recognition) characters imprinted on the checks. The equipment produces magnetic tapes for off-line use with model 220 computers.

The unit also uses four electrostatic printers, two with 27-character lines, two with 17-character lines. The printers are all solid state. Print out is on plastic-coated paper tape. An electron beam deposits a charge pattern on the tape; the tape picks up rosin-based ink powder that is fixed by heat. This is the first commercial application of this printer, although the Signal Corps is using the device for military communications.

Two Electronics Firms Team Up With Jewelry Maker

ELECTRONIC JEWELRY is the term being applied to a line of bracelet charms introduced yesterday in New York City by Sylvania, P. R. Mallory and Marchal Jewelers.

Using the recently developed Sylvania Mite-T-Lite powered by specially designed Mallory batteries, the jewelers have devised such charms as a television set with a glowing screen, tiny sports cars with lighted headlamp, a Statue of Liberty with lighted torch and other designs.

Distribution will be through jewelers who will also carry batteries for replacements. A Sylvania spokesman says the demand for the tiny lamps for jewelry will account for most of those produced for the remainder of this year.

Electronic System to Automate Naval Fleets

SECURITY WRAPS are now off some aspects of Navy's new multimillion dollar tactical data system in which

Remington Rand, Collins Radio and Hughes Aircraft have the major shares.

Navy officials say the new system which provides coordinated data processing and communications facilities will permit an entire naval task force to be coordinated almost to the point of operating as one ship against virtually any type of military attack or opposition that may be encountered.

Designed to deal with manned aircraft, guided missiles, submarines and surface vessels, all task force units will share all input data simultaneously. RemRand is providing the computing systems, Collins Radio's Alpha division is providing the data transmission and communications gear, and Hughes is developing the data display system.

International Investment Firm Plans Being Formulated

NEW INVESTMENT COMPANY is being formed in California, according to West Coast sources, that will aim at international financings.

Formed by C. E. Salik and R. Silberman of Electronics Capital Corp., the new organization will start life with a \$25-million underwriting to be handled by Bear, Stearns, New York City as principle underwriters.

The company, to be called Electronics International Capital, Ltd., will be incorporated in Bermuda and will seek controlling interest in privately held electronics companies in Britain, Germany, Japan and other countries.

Thermal Cooling Seen for Trailers

THERMOELECTRIC cooling of trailer trucks looks like one early commercial application of the Peltier effect in semiconductors, at least that appears to be the wager of one semiconductor company.

Transitron, Inc., of Wakefield, Mass., is negotiating acquisition of Thermo-King of Minneapolis, supplier of refrigeration equipment for truck trailers.

Best guess is that Transitron,

which has been concentrating on thermoelectric materials for two years, sees the merger as a profitable diversification move, expecting that economically practicable direct-conversion systems will be marketable—if not the day after tomorrow, at least the day after that.

Electronics Hitched to Production Control

ELECTRONIC impulse generators link production control center to machines on factory floor in Production Control system introduced by Farrington Manufacturing Co., Needham Heights, Mass., in New York and at Chicago Machine Tool Exposition and Production Engineering Show.

Data is gathered by photocell, pressure transducer, microphone, decade counter, linear measure or voltage relay. Information is reported to a lamp field and to a linear counter which displays and records running situation, including idle machines and causes for them.

Massachusetts company meanwhile has North American leasing rights, with deliveries taking about six months.

Maser Helps Astronomers Measure Solar System

HARVARD UNIVERSITY'S hydrogen-line maser (ELECTRONICS, Jan. 15, 1960, p. 71) is being used to help astronomers define the scale of the solar system more precisely, particularly the distance from the earth to the sun. Information is crucial for deep space probes. Earth's orbital velocity can be computed by comparing the doppler shift when the earth is travelling toward a radio star with the shift, six months later when it is speeding away from the star.

From these measurements, a computer program can solve the earth-sun distance. At 21-cm wavelength, the maser is also helping to detect the weak magnetic fields in interstellar space. Presently, researchers are looking for weak magnetic fields near Cassiopeia, strongest source thus far located.

A*nnouncing*
the formation of
AEROSPACE
CORPORATION
a new and vital force
engaged in
accelerating
the advancement
of space science
and technology

Aerospace Corporation has been brought into being to serve the United States government by concentrating the full resources of modern science and technology on rapidly achieving those advances in space systems indispensable to the national security.

The corporation is non-profit, will share the findings of its research and laboratory experiments with all appropriate organizations involved in the government's missile-space program, and is not organized for manufacturing purposes.

The immediate responsibility of Aerospace Corporation is to aid the United States Air Force in bringing about the best possible ballistic missiles and military space systems on a continuing basis and within the shortest possible time.

In addition, it may furnish the National Aeronautics and Space Administration and other governmental agencies appropriate services whenever its participation in space exploration and related activities is desired.

THE MISSION of Aerospace Corporation, according to the Secretary of the Air Force, encompasses "the field of ballistic missile and space programs. Within this complete area, it has the responsibility for advanced systems analysis, research and experimentation, and initial systems engineering. It will also exercise such general technical supervision of ballistic systems as is appropriate. In special cases, and with the consent of the Secretary of the Air Force, Aerospace Corporation may assume broader responsibility for an Air Force military system."

The new corporation also provides support to the Air Force in its effort to achieve maximum interchange of knowledge with other military services and among universities, research foundations, and the scientific community in general.

THE FUNCTIONS of Aerospace Corporation in carrying out its

responsibilities for the Air Force's missile-space programs include the performance of a wide range of scientific, technical, and administrative tasks.

The corporation will conduct extensive laboratory and field activities aimed at advancing the state-of-the-art and will augment these research and development activities by coordination with industry, universities, laboratories, and other agencies. It is intended that this combined effort will push forward the boundaries of technology on a broad front to fulfill military and other national requirements.

Aerospace Corporation will study the application of the advancing technology to military weapons, support systems, and other systems serving the national need. These studies will culminate in preliminary design and in recommendations for development programs.

Aerospace Corporation will then assist the Air Force or other appropriate government agencies in establishing space programs and in bringing the force of American industry to bear in carrying them out. Once development is initiated, Aerospace Corporation will assume responsibilities for the broad technical aspects of these new programs through their critical phases.

THE FACILITIES of Aerospace Corporation include a research and development center located near the Los Angeles International Airport and within easy reach of several attractive residential communities.

They constitute a modern administrative, scientific, and engineering headquarters which house some of the world's most advanced instrumentation and experimental apparatus.

In addition, the operations of Aerospace Corporation will be directly supported around the globe by a vast array of resources created by the government over the past six years.

These will include: The Atlantic Missile Range in Florida; The Pacific Missile Range in California; The Rocket Engine Test Site at Edwards Air Force Base in California; and numerous other missile test facilities sponsored by the government in cooperation with private industry.

THE PEOPLE who make up Aerospace Corporation have been selected from industry, universities, and government. They constitute a cross-section of highly-developed engineering and scientific skills in the missile and space fields.

Extensive recruiting will continue as the new corporation assumes more and more responsibility. From the outset, the corporation is built on a foundation of proven scientific competence, imagination, and objectivity.

THE OPPORTUNITY awaiting those scientists and engineers who qualify to join Aerospace Corporation is equalled only by the magnitude of the corporation's mission — magnitude mirrored by the highly advanced nature of the programs in which Aerospace Corporation is engaged.

Typical systems projects include: advanced ballistic missiles; advanced military space boosters; recoverable boosters and satellites; space defense systems; early-warning satellites; reconnaissance satellites; communications satellites; and manned satellite systems.

Typical research programs concern: nuclear propulsion; astrodynamics; magnetohydrodynamics; inertial elements; millimeter waves; hypersonics; combustion kinetics; and materials research.

Those capable of contributing to state-of-the-art advances in these and related areas are invited to consider the advantages of becoming a part of the new Aerospace Corporation. Their resumes should be directed to: Mr. James M. Benning, P. O. Box 95081-F, Los Angeles 45, California.

AEROSPACE CORPORATION



2400 East El Segundo Boulevard • El Segundo, California

Another of a series of files on precision products by ALINCO

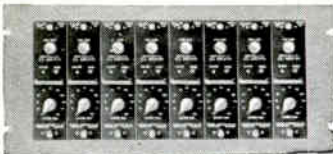

DIFFERENTIAL DC AMPLIFIER Model 516

- WIDE FREQUENCY RESPONSE
- HIGH OUTPUT
- TOTALLY TRANSISTORIZED

Designed to meet a need for a flexible general-purpose differential dc amplifier, the ALINCO Model 516 is a solid state wide band instrument. Chopper stabilized, the Model 516 features low noise of 14 microvolts rms over the full bandwidth. It has a common mode rejection of 130 db at dc and 90 db at 60 cps. The gain factor is continuously variable from 10-2000 with an accuracy of 0.5%; overload recovery time is less than 1 second and the chopper intermodulation 0.1%. Maximum output is 80 ma at 10 v. The amplifier can faithfully reproduce signals from dc to 40 kc. Available as a single channel portable unit, or in an 8 channel module for rack mounting. Size: 2½" x 7" x 18¼". Is ideally suited for driving high frequency galvanometers from a low level source such as resistance strain gages and thermocouples.

For additional information on the Model 516 amplifier or for the answer to a specific amplifier requirement, write:



ALLEGANY INSTRUMENT CO.

A Division of
Textron Electronics, Inc.

Cumberland, Maryland
Regional Sales Offices:
Palo Alto, Calif. • Washington, D. C.

Wide Frequency, High Output — ALINCO

WASHINGTON OUTLOOK

AIR FORCE is fighting to put the B-70 project back on a weapon-system basis. This would mean reinstating subcontracts for development of electronic subsystems terminated in last year's economy drive.

The Administration's recent decision to earmark an extra \$100 million for the B-70 does not imply resuming subsystem development. Instead, the funds are to be used to get faster delivery of two stripped-down prototype models of the Mach 3 aircraft for flight testing.

But the Air Force would prefer to build just one prototype, using the extra funds for what one Air Force official describes as partial resumption on an austere basis of the subsystems. The \$100 million would not go far, however.

Among the subsystems cancelled last year, which the Air Force would like to reinstate: IBM's bombing-navigation; Sperry's auxiliary gyro platform; Westinghouse's defensive subsystem; Motorola's mission and traffic control; and Autonetics' automatic flight control.

In addition, plans were also cancelled last year to build a programmer-comparator; and bomb-nav, defense operator, and flight simulator trainers.

In all, Air Force now has slightly over \$200 million for B-70 development this year. This includes the basic development budget of \$175 million and applied research funds for the bomb-nav subsystem and money carried over from last year to start production of the second prototype plane.

Congress added an additional \$100 million that the Administration so far refuses to release to the Air Force.

Sperry Gyroscope, meantime, has proposed a substantial cut in B-70 costs through use of a modified version of its B-58 bomb-nav system for the Mach 3 aircraft to substitute for development of a brand-new system.

RENEGOTIATION BOARD study of 25 major defense contractors in 1959 shows an average 10.4 percent profit on military sales per company prior to renegotiation. The profit rate ranged from 4.9 percent on contracts with cost plus fixed or incentive fees, 5.3 percent on terminated contracts, 8.8 percent on fixed-price incentive contracts, 10.6 percent on price redetermination awards, to 18.3 percent on fixed-price contracts.

MILITARY PROCUREMENT laws require no legislative changes. That's the conclusion of the Senate Armed Services Committee which recently made a wide-ranging inquiry into defense contracting policies.

The Committee has put the kibosh on enactment of two highly-touted bills pushed during the past session of Congress. One, the Vinson Bill, already passed by the House, is aimed to force the Pentagon into more formal advertised contracting and less negotiated procurement and to put the lid on cost estimates and profit allowances in incentive-type contracts.

The other measure, which the Committee's ranking Republican, Sen. Leverett Saltonstall of Mass., is promoting aims to make it easier for the military to award negotiated contracts, to encourage incentive-type contracts, and to centralize greater weapon development and production powers with prime contractors.

Though supporting the general thesis that more formal advertised procurement is desirable, the Senate Committee conceded that open advertised bidding involves serious problems for contracting officers in many types of weapon projects and pointed out that negotiated contracting does not necessarily mean the absence of price competition among potential suppliers.



TO-18 Case

For unprecedented efficiency at low signal levels plus extreme temperature stability...

HOFFMAN NOW OFFERS YOU SILICON UNI-TUNNEL* DIODES

These unique devices, sometimes referred to as "backward" diodes, utilize the tunneling effect to achieve high forward conductance at very low voltage levels. When they are biased in the reverse direction, the familiar tunnel diode current characteristic appears as a leakage current measurable in microamperes.

TYPICAL APPLICATIONS

Ability of the Uni-Tunnel diode to operate efficiently at low voltage levels eliminates the complex circuitry previously required for low-level operations, resulting in lower cost, greater reliability and decreased space requirements (see modulator circuit at left). Benefits like these also make Hoffman Uni-Tunnel diodes ideal in:

- computer logic
- detectors ■ choppers ■ clampers
- tunnel diode circuitry

SPECIFICATIONS

Twelve types available with minimum forward currents as high as 10 mA (at .25V) and maximum reverse currents as low as 5.0 μ A (at 0 to 0.5V). Operating and storage temperature range is -85°C to $+200^{\circ}\text{C}$.

STANDARD AND CUSTOM-ENGINEERED UNITS AVAILABLE IMMEDIATELY IN QUANTITY

Contact factory, El Monte, California, or your local Hoffman sales office for further information. Ask for Technical Data Sheet, 131-760 UTD.

Hoffman

ELECTRONICS CORPORATION
Semiconductor Division

1001 Arden Drive, El Monte, California
TWX: El Monte 9735

Plants: El Monte, California and Evanston, Illinois



*Trademark Hoffman Electronics Corporation

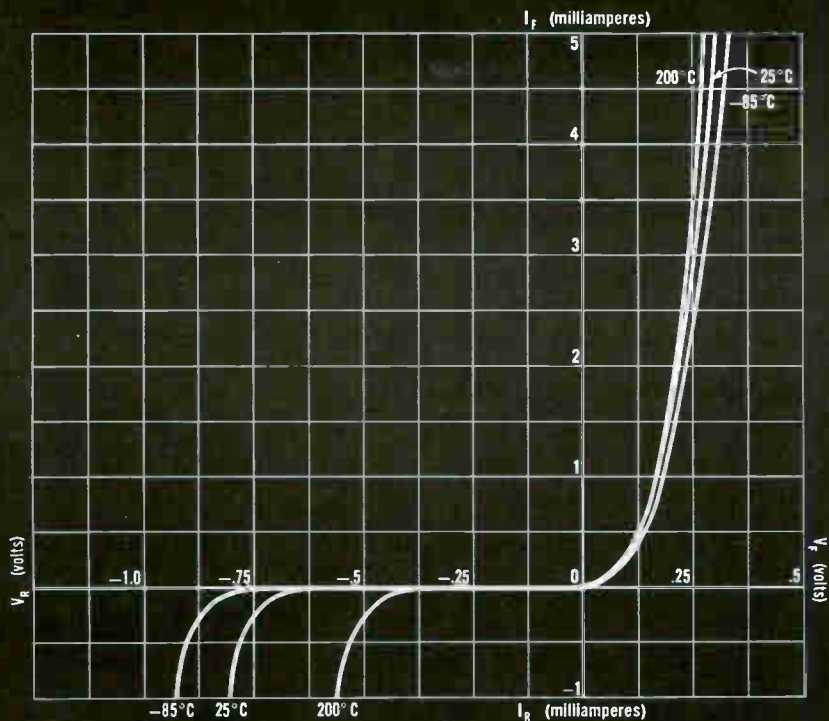

TYPICAL UNI-TUNNEL DIODE CHARACTERISTICS

HOW HOFFMAN UNI-TUNNEL DIODES SIMPLIFY AND IMPROVE MODULATOR CIRCUITRY DESIGN

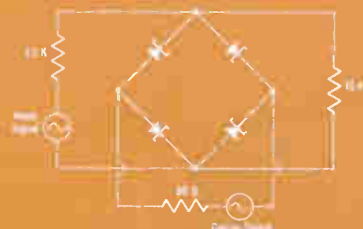

BRIDGE MODULATOR CIRCUIT UTILIZING FOUR HOFFMAN UNI-TUNNEL DIODES

These Graphs Illustrate Typical Operating Characteristics of the Modulator Circuit Above

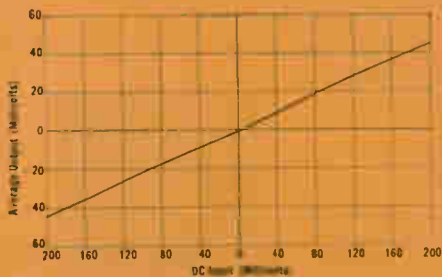

MODULATOR LINEARITY
Average Output Voltage Versus DC Input Voltage

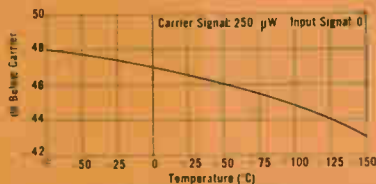

DRIFT VERSUS TEMPERATURE
Change of Output Power (db) Versus Temperature

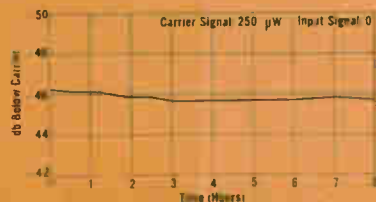

DRIFT VERSUS TIME
Change of Output Power (db) Versus Time (25°C)

Write for details in Hoffman Application Notes - Volume II, Number 1

This announcement is neither an offer to sell nor a solicitation of an offer to buy these securities.
The offer is made only by the Prospectus.

New Issue

135,000 Shares
Electro-Tec Corp.

Common Stock
(\$10 Par Value)

Price \$16.50 per share

Copies of the Prospectus are obtainable in any State from only such dealers
or brokers, including the undersigned, as may lawfully
offer these securities in such State.

Harriman Ripley & Co.
Incorporated

August 31, 1960.

CIRCLE 16 ON READER SERVICE CARD

DIGGING FOR IDEAS?



If you're buying electronic equipment and components the best place to look is where the selection is the largest. Maybe there's a product or service you don't know about that will solve your problem.

The BUYERS' GUIDE is packed with ideas and facts that give you a better basis of buying judgment.

From accurate, up-to-date facts on current designs, materials and markets to detailed catalog information on new product types—the GUIDE puts you in a strong position to make the best buying choice for yourself and your company.

And there are the names and addresses of 4,000 manufacturers and their local offices so you can make your move most easily.

C.B.A.

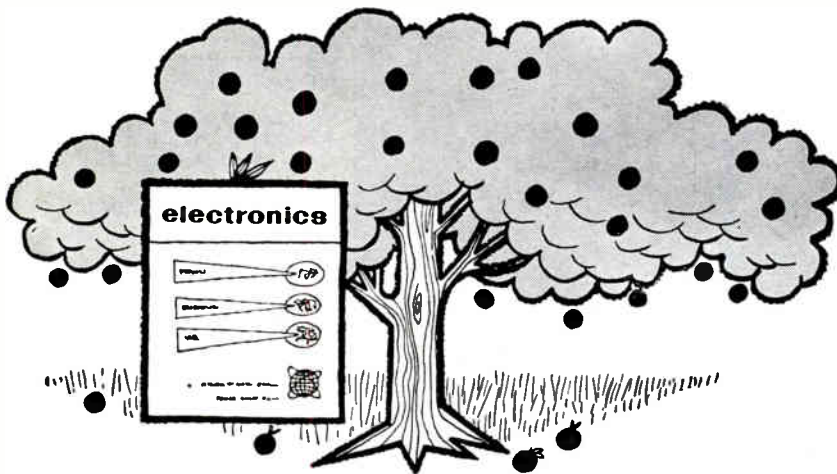

The pick of the crop!

Thumbnail summaries of sales literature on materials, components, equipment, and facilities keep you up-to-date in about 3 minutes of quick, easy reading in "Literature of the Week."

Another reason why it will pay you to subscribe to *electronics* (or renew your subscription) right now. Fill in the box on Reader Service Card. Easy to use. Postage free.

FIND WHAT YOU NEED IN...
electronics

**FIND
WHAT
YOU
NEED
IN
THE**

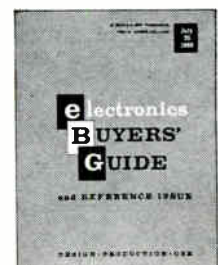

**electronics
BUYERS' GUIDE**



Navy & Air Force Bullpup



Air Force Mace



Army Lacrosse



Army Pershing



Air Force Titan

*At 00^h00^m01^s GMT,
September 1, 1960,
Titan logged its
658,008,000th mile
of space flight*

*Five major U.S. missiles developed
and built by Martin*

MARTIN

OZALID NEWSLETTER

NEW IDEAS TO HELP YOU WITH ENGINEERING REPRODUCTION AND DRAFTING



A simple sponge with new Duratrace is your quickest way to renew soiled drawings.

New washable, scrubbable Duratrace® gives you indestructible masters you can sponge new!

If ever there was a drafting film that "is forever," Duratrace is it. New Ozalid Duratrace, when used with modern plastic pencils, can be wiped clean and thereby restored to new condition at the sweep of a sponge. Drawings, originally done in regular pencil or India ink, can also be cleaned, although a bit more care might be necessary.

Just combine this cleanability with

the fact that Duratrace never yellows or ghosts, and you've got a winner that's hard to match on any count. And how about *this?* Duratrace either exceeds or equals any other tracing material as far as dimensional stability is concerned!

Want even more? Just check Duratrace on acceptability of a pencil image! Never has a drafting film equaled New Ozalid Duratrace on

pencil acceptability. But the proof is really in the doing. There are intangibles that exist between a draftsman and his materials that are hard to fully describe. Only your own experience with Duratrace can completely convince you. We think that Duratrace has a certain "feel" that makes it a delight and a joy to work with. Hundreds of draftsmen agree with us. Why not try Duratrace today? Someday, someone might improve on this. Bet we'll be the ones to do it. On every count, doesn't it make sense to try Duratrace?

If you like 'em stacked for speed...

Just check our Ozalid Streamliner 200 Direct Copy Machine.

Fast? A neat 14 feet per minute. Perfect for medium-sized operations and easy feeding.

Wide? A roomy 42 inches that takes four 8½ x 11 sheets in a row, does them as fast as smaller machines do a single sheet.

And the new close-up controls of the 200 cuts operator fatigue; means anyone can learn to operate it in minutes.

New stacking system cuts work time considerably while the new cooling system means greater comfort for everyone in the office.

But these are just the basic facts of operation. How about versatility? The Streamliner 200 is specifically designed as a double-duty unit equally suitable for both engineering and general office work.

Just invest in one Streamliner 200 and get both an engineering and an office unit in one. You get the benefits of engineering speeds and width in your technical work plus a super high-efficiency unit for office copying and order invoicing.

One last plug. The Streamliner 200 costs a lot less than you would imagine. It costs less to operate and virtually nothing to maintain. Sold? Just contact your local Ozalid representative for a demonstration.

Ozalid, Johnson City, New York. A Division of General Aniline & Film Corp.

Transitron

introduces

an exciting new device for simpler, more reliable, more economical switching circuitry

BINISTOR

(BY-NIS-TOR)

The Silicon NPN Tetrode binistor is a new component and a new concept for the circuit designer!

The key parameters of this bi-stable, negative resistance device are determined by external circuitry in contrast to existing devices. The significant reduction of peripheral circuitry results in outstanding savings in cost, space, weight and solder connections. For example, a typical flip-flop requires at least 13 components versus only 4 in an equivalent binistor stage. Very large current and voltage gains are realized in both on and off directions. Inputs and output are compatible in level with typical transistor and diode circuits. The tetrode binistor can operate from -80°C to $+200^{\circ}\text{C}$.

To learn more of this important new development — THE BINISTOR — and how it works — write for Bulletin No. TE-1360.

CONDENSED SPECIFICATIONS TRANSITRON BINISTOR

| | |
|--|--|
| Typical Turn-off Current Gain | 50 @ 15ma Collector Current |
| Operating Collector Current Range | $50\mu\text{a}$ to 15ma |
| I_b critical | 0.5ma @ 5ma Collector Current |
| Operating Temperature Range without Temperature Compensation | -65°C to 150°C |

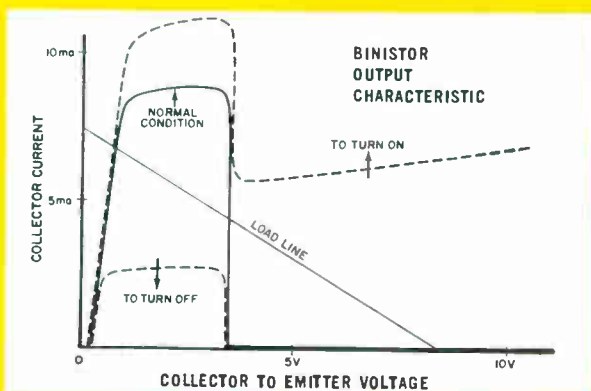
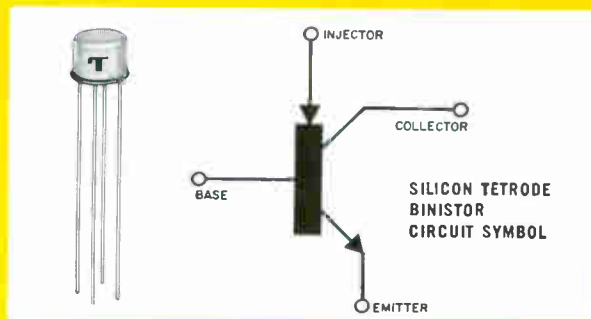

Transitron



electronic corporation

wakefield, melrose, boston, mass.

SALES OFFICES IN PRINCIPAL CITIES THROUGHOUT THE U.S.A. AND EUROPE • CABLE ADDRESS: TRELCO

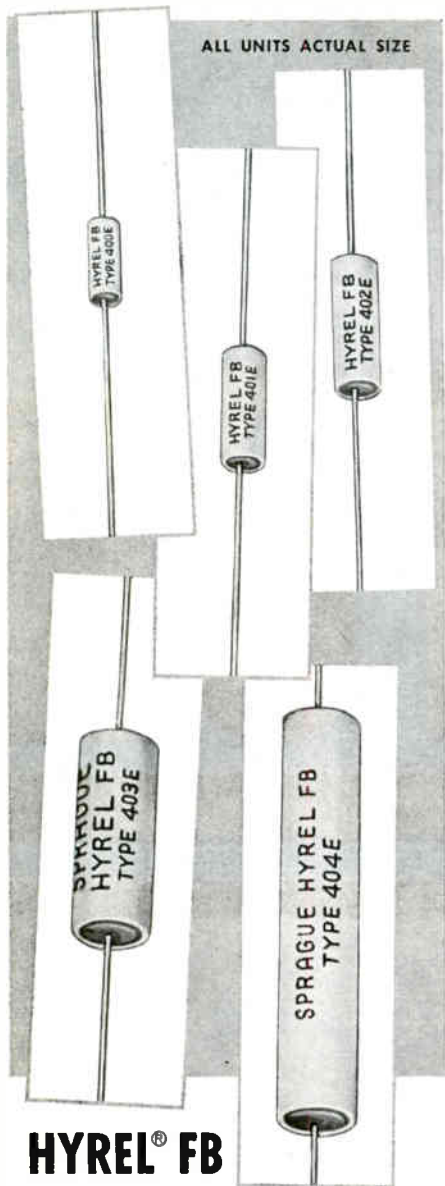

HYREL® FB

DEPOSITED CARBON RESISTORS

UNMATCHED FOR PERFORMANCE

... hermetically sealed in ceramic jackets against moisture and vapor ... safely protected against mechanical abuse.

The Hyrel FB series is intended for applications in military, commercial and telephone equipment where long life under high humidity, small size, and stability of electrical characteristics are important.

WRITE FOR ENGINEERING BULLETIN 7010B

SPRAGUE ELECTRIC COMPANY

35 Marshall Street, North Adams, Mass.

Made to far exceed MIL-R-10509C Specifications



FINANCIAL ROUNDUP

New Mergers Emphasize Diversity

Minnesota Mining and Manufacturing and Warner-Lambert Pharmaceutical Co., Morris Plains, N. J., report they are engaged in negotiations to combine the two companies. W. L. McKnight, 3M board chairman, and E. H. Bobst, Warner-Lambert chairman, emphasize that the respective boards and stockholders of the two companies will be consulted before any plans are finalized. The two men commented that the mutual interest both firms have in chemical and other products, plus marketing and distribution facilities owned by each, would be of mutual benefit to both companies.

Consolidated Electronics Industries Corp., majority owner of Philips Electronics and Pharmaceutical Industries Corp., announces plans by its Philips subsidiary to acquire Columbus Pharmacal Co., Columbus, O. In the same announcement, P. van den Berg, Consolidated president, said net sales of the parent company for the six-month period ended June 30, 1960, totaled \$46,487,749 with consolidated net income of \$2,009,811, equivalent to 72 cents per share on more than two million shares outstanding. Net sales for Philips E&P for the same period were \$17,385,904. Net income is counted at \$851,896, or 43 cents a share on 1,993,275 shares outstanding.

International Telephone and Telegraph Corp. reports acquisition of L. C. Miller Co., Los Angeles manufacturer of vibration test equipment, for an undisclosed amount. An ITT spokesman says the acquisition represents a step in the corporation's intent to grow in the test equipment field. ITT second quarter sales and revenues for this year increased to \$203,523,000 from \$189,851,000 in the same period last year. Net income in this year's second quarter was \$8,383,000, equal to 54 cents a share. In the equivalent period

last year, this figure was \$7,862,000 or 52 cents a share.

Tenney Engineering Co., Union, N. J., manufacturer of environmental test gear and refrigeration and air conditioning components, announces it has contracted to acquire the assets of Communication Measurements Labs., Inc., Plainfield, N. J. CML produces electronic generators, space instruments and science and industry test gear. S. S. Schiffman, Tenney board chairman, describes the move as an expansion of his company in the electronics field, and expects to add a million dollars a year to company sales volume. The acquisition was effected through an exchange of Tenney stock. CML had been a privately held company.

Laboratory for Electronics, Inc., Boston, Mass., reports acquisition of an interest in the Florence, Italy firm, Segnalemento Marittimo ed Aereo. The Italian company was established in 1943 by ar-

25 MOST ACTIVE STOCKS

| | WEEK ENDING AUGUST 26, 1960 | | | |
|-------------------|-----------------------------|---------------------------------|---------------------------------|---------------------------------|
| | SHARES (IN 100's) | HIGH | LOW | CLOSE |
| Elec & Mus Ind | 1470 | 7 ³ / ₈ | 6 ¹ / ₂ | 7 ¹ / ₈ |
| Avco Corp | 1395 | 17 ¹ / ₈ | 16 ¹ / ₈ | 16 ¹ / ₈ |
| Gen Tel & Elec | 1280 | 30 ³ / ₈ | 29 ¹ / ₄ | 29 ³ / ₈ |
| Univ Controls | 1202 | 18 ¹ / ₈ | 16 ¹ / ₈ | 17 ¹ / ₂ |
| Sperry Rand | 1094 | 23 ³ / ₈ | 21 ³ / ₈ | 23 ¹ / ₈ |
| Victoreen Inst | 926 | 16 ¹ / ₂ | 14 ¹ / ₄ | 15 ¹ / ₈ |
| Ampex | 918 | 33 ³ / ₈ | 30 ⁷ / ₈ | 31 ³ / ₈ |
| Avnet Electronics | 918 | 20 ³ / ₄ | 18 ⁵ / ₈ | 19 ¹ / ₈ |
| RCA | 901 | 65 ¹ / ₈ | 62 ¹ / ₈ | 64 ¹ / ₄ |
| Bulova Watch | 825 | 23 ³ / ₄ | 20 ⁷ / ₈ | 23 ¹ / ₈ |
| Westinghouse | 581 | 56 ¹ / ₄ | 54 ⁵ / ₈ | 55 ³ / ₈ |
| Edo Corp A | 557 | 29 ¹ / ₄ | 26 ⁵ / ₈ | 27 ³ / ₈ |
| Standard Toolsmn | 554 | 26 ¹ / ₄ | 23 ³ / ₈ | 23 ⁷ / ₈ |
| Int'l Tel & Tel | 518 | 43 ¹ / ₈ | 41 ¹ / ₈ | 42 |
| Audio Devices | 509 | 23 ¹ / ₈ | 20 ³ / ₈ | 22 ¹ / ₄ |
| Gen Electric | 496 | 85 ¹ / ₄ | 82 ³ / ₈ | 84 ³ / ₈ |
| Philco Corp | 395 | 27 ¹ / ₄ | 25 | 25 ⁵ / ₈ |
| Gen Dynamics | 383 | 46 ⁵ / ₈ | 44 ³ / ₈ | 44 ⁷ / ₈ |
| Reeves Sndcrft | 353 | 8 ¹ / ₂ | 7 ⁵ / ₈ | 7 ³ / ₄ |
| Cenco Inst | 328 | 52 ¹ / ₄ | 48 | 52 ¹ / ₄ |
| National Video A | 303 | 23 ³ / ₈ | 21 | 23 ¹ / ₈ |
| Siegler Corp | 303 | 37 | 34 | 36 ⁵ / ₈ |
| Fairchild Camera | 302 | 201 ³ / ₄ | 185 ¹ / ₄ | 185 ¹ / ₂ |
| Burroughs | 271 | 37 ³ / ₈ | 36 ¹ / ₄ | 36 ⁵ / ₈ |
| Beckman Inst | 260 | 99 ³ / ₈ | 94 | 97 |

The above figures represent sales of electronics stocks on the New York and American Stock Exchanges. Listings are prepared exclusively for ELECTRONICS by Ira Haupt & Co., investment bankers.

rangement of the Italian Ministry of Defense to produce marine and airborne communications gear. The company now produces navigation radar, infrared devices and signalling equipment. Company officials at LFE say the purchase is in line with a program to step up worldwide marketing and manufacturing facilities. In addition to these plans, LFE stockholders will vote Tuesday on a proposed charter amendment to raise the number of authorized shares of common stock (par value \$1 per share) from 750,000 to 1,250,000.

Branson Instruments, Stamford, Conn., reports acquisition of **Colin Campbell Co., Inc.**, Danbury, Conn., through exchange of stock. Also acquired by Branson, by cash payment, is a half interest in **Radionics, Inc.**, Norristown, Pa. The Danbury firm manufactures transformers, toroids and other components for defense and industrial applications. The Norristown company makes gamma radiography thickness gages and flaw detectors.

Transitron Electronic Corp., Wakefield, Mass., and **Thermo King Corp.**, Minneapolis, have arrived at a preliminary agreement to combine. The surviving company name would be Transitron, which would issue nine shares of common stock for each 10 shares of Thermo King stock outstanding. The Minnesota firm manufactures transport temperature control equipment and had a sales volume last year in excess of \$18 million.

Nova-Tech, Inc., Manhattan Beach, Calif., manufacturer of two-way aircraft radios and navigation equipment, reports a net profit of \$37,413 for the fiscal year ended Mar. 31. Profits equal 14 cents a share on 270,000 shares outstanding, compared with \$23,909, or 9 cents a share for the previous year.

Midwest Technical Development Corp., Minneapolis, Minn., announces it has doubled its common stock outstanding with a new issue of 561,500 shares of \$1 par value stock. Existing shareholders bought some 75 percent of them.

ACTUAL



SIZE

20 TO 30 VOLTS DIRECT CURRENT

TIMING FOR RELIABILITY of systems, sub-systems and modules is accurate, dependable with Houston Fearless "Alert" sub-miniature Elapsed Time Indicators. Measure life expectancy, provide operational warnings to prevent overuse failure. Tested for severe environmental use. Exceeds MIL-E-5272C. 1,000 and 10,000 hour models. Weight, 2 oz., 1" dia., 1¼" depth. Write for specifications.



HOUSTON FEARLESS
DIVISION OF HOUSTON FEARLESS CORPORATION
11801 West Olympic Blvd., Los Angeles 64, California

SCOPE OF KOVAR ALLOY STOCK ITEMS

| FORM | RANGE OF STOCK SIZES | NOTES |
|-----------------|---|---|
| Strip | .005" to .030" x 6½" wide | In coils, annealed for deep draw |
| Sheet | .010" to .020" x 6½" x 72" long .030" to .125" x 13" wide x 72" long | In flat lengths, annealed for deep draw |
| Wire | .005" to .080" diameter | Spooled or coiled |
| Rod | .040" to .390" diameter | "As drawn" finish, straight lengths |
| Ground Rod | .030" to 3.0" diameter | Centerless ground finish, straight lengths. |
| Tubing | .030" O.D. x .005" wall to 1.125" O.D. x .030" wall | Seamless, "as drawn" finish, straight lengths |
| Cups | .360" to 5.53" O.D. x .020" to .100" wall | Drawn — flat or rounded bottom |
| Flanged Cups | .672" to 3.375" range diameter x .020" to .030" wall | Drawn — straight tapered sides |
| Flanged Eyelets | .220" to 1.250" range diameter x .010" to .020" wall | Drawn — open straight or tapered sides |

Details of standard sizes, price lists and quotations on non-standard sizes and special finishes are furnished on request.

Engineering hints from Carborundum

Check stock forms of KOVAR® Alloy to simplify production problems

KOVAR®, the original iron-nickel-cobalt alloy for making seals with several hard glasses comes in a variety of forms, sizes and parts available as *stock* items for immediate shipment.

The table above summarizes the breadth of these stocks. It does not, of course, cover the wide range of available sizes. For example, over forty sizes of seamless KOVAR alloy tubing are maintained as stock items. Complete, up-to-date data sheets giving specifications, dimensions, surface finishes, tolerances and other details sent on request.

For applications that cannot be served satisfactorily by

stock items, specials can be supplied. Complete technical service is offered to help in solving particular processing and application problems. Just write The Carborundum Company, Refractories Division, Dept. E-90, Latrobe Plant, Latrobe, Pa.

FIND OUT ABOUT KOVAR— WHERE IT IS USED AND WHY

Bulletin 5134 gives data on composition, properties and applications of KOVAR alloy. Supplementary technical, dimensional and price data sheets are available to you on specific request.



For permanent vacuum and pressure-tight sealing . . . count on

CARBORUNDUM®

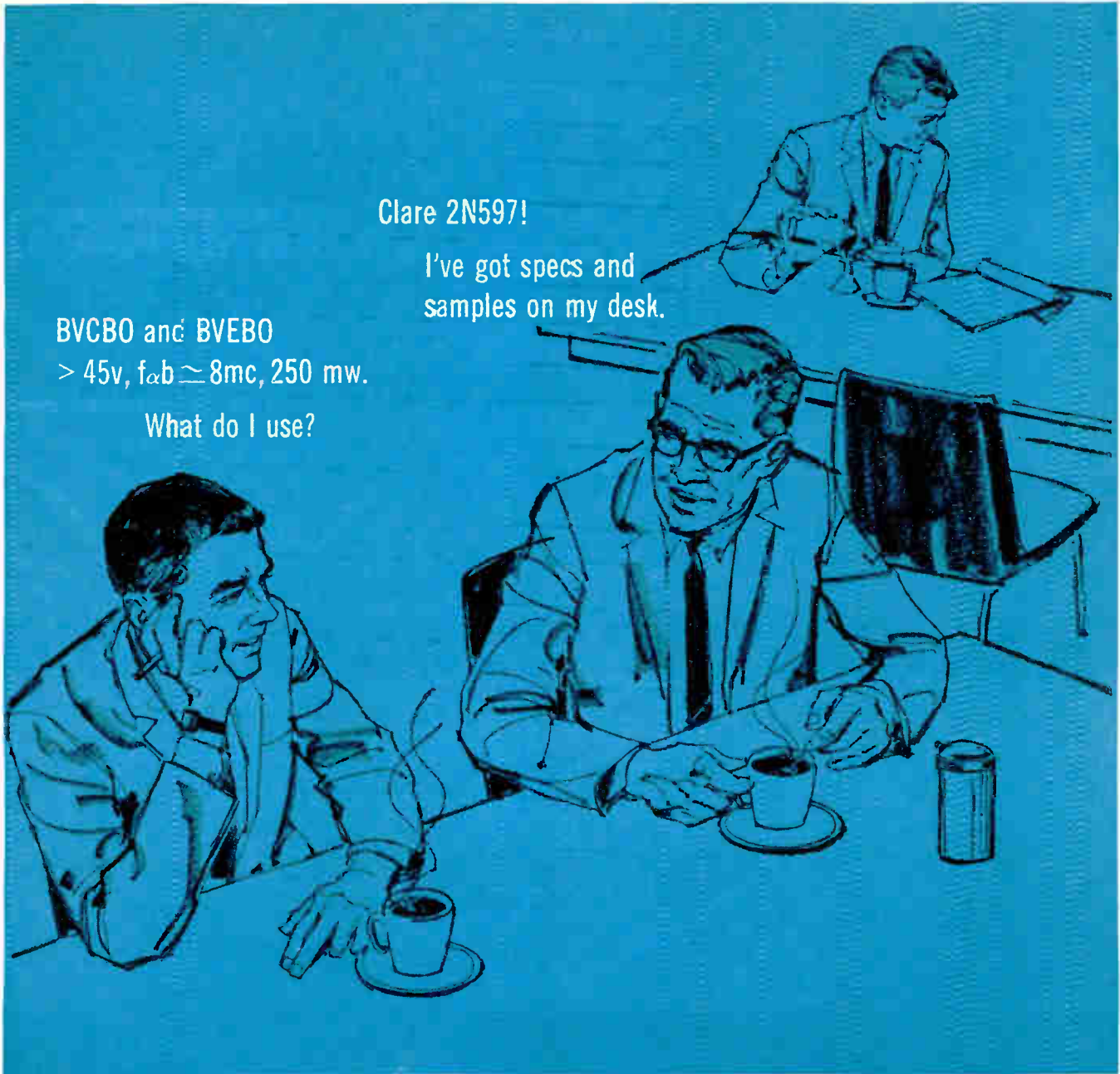

Clare 2N597!

I've got specs and samples on my desk.

BVCBO and BVEBO
 $> 45v$, $f_{\alpha b} \approx 8mc$, 250 mw.

What do I use?

LOW I_{CBO} , MEDIUM FREQUENCY, MEDIUM POWER—these and other characteristics make 2N597-598-599 really valuable to the circuit designer. Prompt delivery in excellent quality, at reasonable prices. Clare talents and production capabilities combined... make these "hard-to-make" PNP germanium alloy devices easy to buy. Get started now... ask for specifications today. Contact your nearest C. P. Clare and Company Sales Office or C. P. CLARE TRANSISTOR CORPORATION, 260 GLEN HEAD ROAD, GLEN HEAD, L. I., NEW YORK.



2N597, 2N598, 2N599—Characteristics at 25°C

| | $f_{\alpha b}$ | | Max. Diss. | Min. H_{FE} $I_C = -100mA$ | Max. Rated V_{CB} | Max. I_{CBO} $V_{CB} = -15Vdc$ |
|-------|----------------|------|------------|---------------------------------|---------------------|-------------------------------------|
| | min. | typ. | | | | |
| 2N597 | 3mc | 8mc | 250mw | 40 | -45Vdc | -5 μA |
| 2N598 | 6.5mc | 10mc | 250mw | 70 | -35Vdc | -5 μA |
| 2N599 | 12mc | 18mc | 250mw | 100 | -30Vdc | -5 μA |

CIRCLE 23 ON READER SERVICE CARD

CIRCLE 24 ON READER SERVICE CARD →

HEDGEHOPPING AT MACH 1

Lockheed radar shows pilot how to miss what he can't see

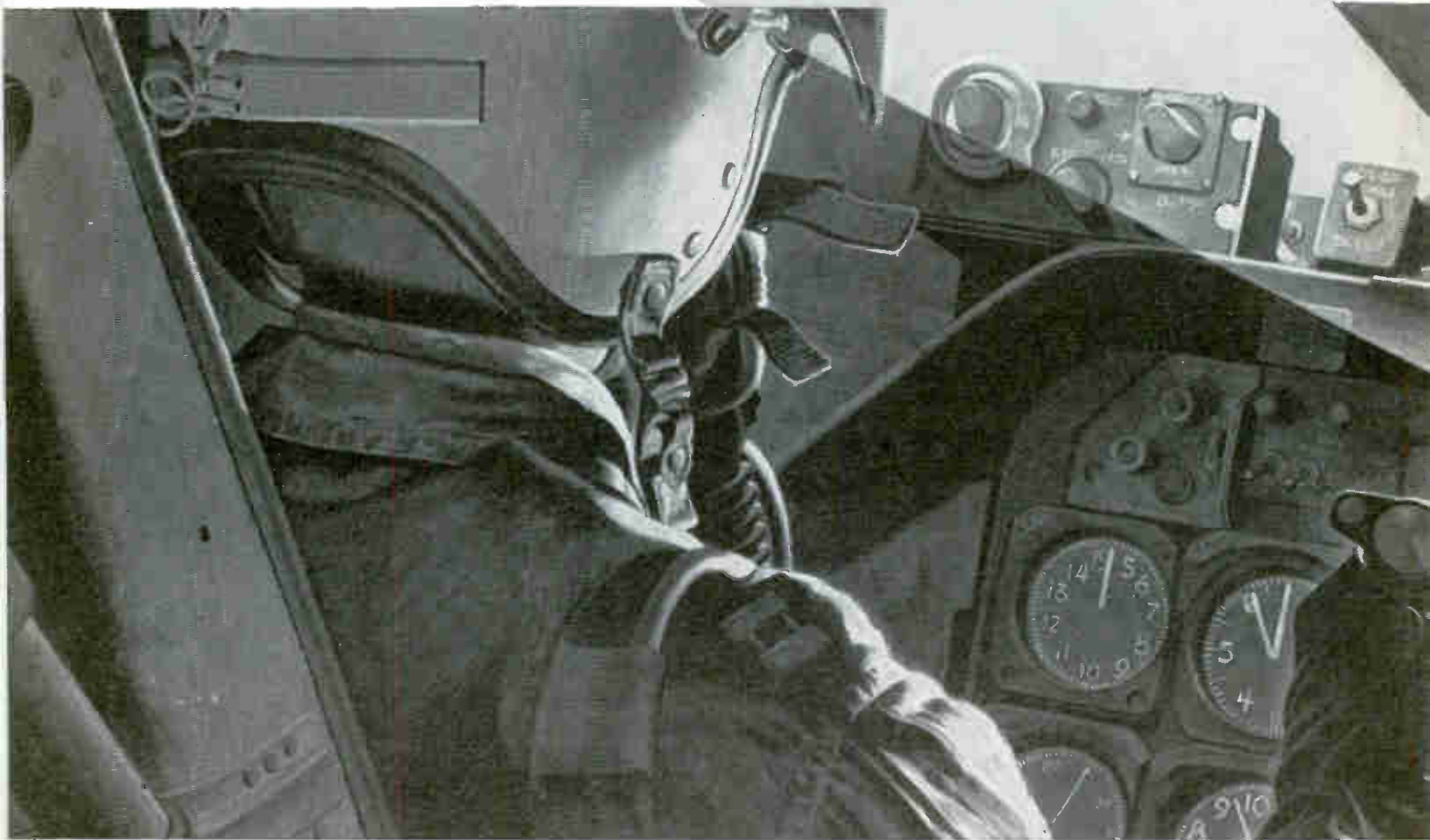

When a pilot hugs the deck traveling a mile *every four seconds*, his route is the world's most dangerous obstacle course. Hills, bridges and other hazards can be in his lap before he has time to maneuver safely over them. He needs information well in advance, particularly in poor visibility or at night.

And now he gets it—from Lockheed Electronics terrain avoidance radar. A compact display shows him obstacles, his position in relation to them, and the maneuvers necessary to avoid them—in time.

Lockheed Electronics systems engineers have created in one group of modules the most versatile airborne radar in flight test today. Equally effective as a map-

ping, bombing or navigational radar, this lightweight, transistorized unit is typical of the sophisticated equipments developed by Lockheed Electronics to help strengthen the nation's defense.

CAPABILITIES—MILITARY SYSTEMS/STAVID DIVISION

RADAR SYSTEMS—search, bombing, navigation devices and displays, missile guidance and control, automatic detection and data processing

COUNTERMEASURES—ECM, ECCM, active and passive

UNDERSEA WEAPON CONTROL AND DETECTION—ASW, electromagnetic detection, location and communication

SIMULATION AND TRAINING DEVICES

OPERATIONS ANALYSIS—offensive and defensive systems, war operations, undersea warfare, electronics in space

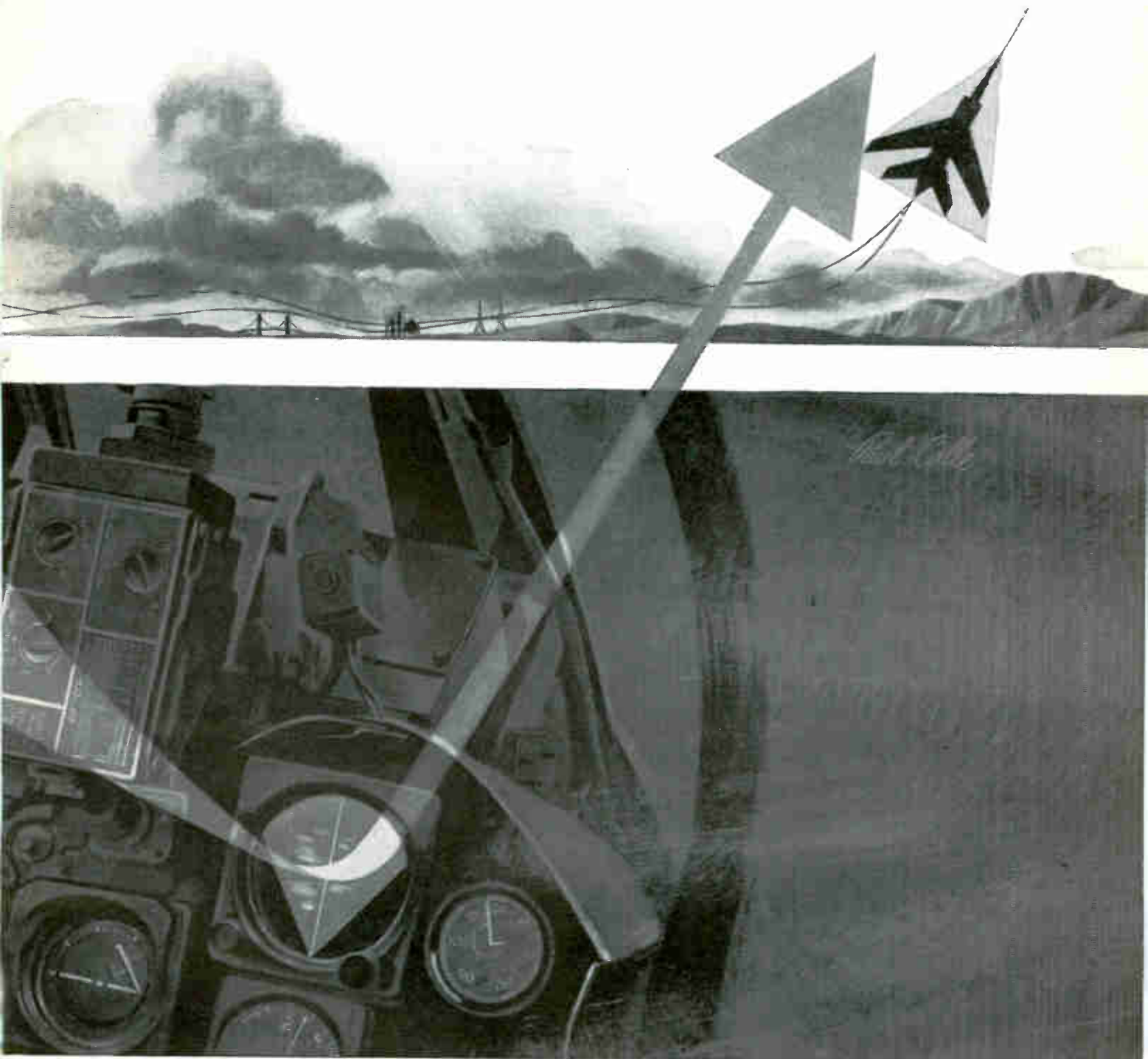

MINDING THE FUTURE

LOCKHEED ELECTRONICS

COMPANY

**MILITARY SYSTEMS / STAVID DIVISION
PLAINFIELD, NEW JERSEY**

OTHER LEC DIVISIONS: INFORMATION TECHNOLOGY ● ENGINEERING SERVICES ● AVIONICS AND INDUSTRIAL PRODUCTS

ENGINEERS AND SCIENTISTS: For unique position advancement opportunities,
please contact our Professional Placement Office in Plainfield, N. J.



now means top quality rare earth and related products for

- ELECTRONICS
- NUCLEAR ENERGY
- METALLURGY

How can these help your production and R&D efforts—

- CERIUM CHEMICALS
- THORIUM-MAGNESIUM MASTER ALLOY
- SCANDIUM CHEMICALS
- GADOLINIUM OXIDE
- EUROPIUM OXIDE
- YTTRIUM PRODUCTS
- ORGANIC-SOLUBLE RARE EARTHS
- RARE EARTH-MAGNESIUM ALLOYS
- THORIA

For further information, check items of interest, and clip this ad.

If you'd like industry's newest technical brochure on rare earth metals, chemicals and alloys, check here

Your Name _____
 Position _____
 Company _____
 Street _____
 City and State _____

**CLIP THIS AD and SEND TO:
 DEPT. 36**

VITRO CHEMICAL COMPANY
 A SUBSIDIARY OF VITRO CORPORATION OF AMERICA
 342 MADISON AVENUE
 NEW YORK 17, NEW YORK

MARKETING

Growing Thermocouple Sales Foreseen

SALES OF THERMOCOUPLE DEVICES are expected to achieve major proportions in the not too distant future, according to industry market researchers who have been studying the market for bismuth telluride, a basic material used in making thermocouples.

These studies show sales of Bi₂Te₃ amounted to 6,000 lb last year; are expected to reach 20,000 lb this year and 300,000 lb in 1965 or 1970. Price of Bi₂Te₃ today is about \$350 per lb, but is expected to drop to less than \$30 when the 300,000-lb sales level is achieved. Annual sales of the material alone would then be worth \$80 to \$90 million.

Today it's estimated annual sales of thermocouple devices are between \$350 and \$300 million, three times the value of the material consumed.

National Aeronautics and Space Administration will spend approximately \$600 million in fiscal year 1961 to speed up space exploration, Aerospace Industries Association reports. Actual appropriation is \$915 million, but most of funds will be spent in future years on programs still in the research and development stage.

Electronic component vibration and calibration testing equipment sales currently amount to more than \$25 million annually and show excellent growth potential, says Frederick H. Gutterman, president of ITT's Industrial Products division.

Capacitor sales will increase 59 percent over the 1959 level by 1965, reports the market research department of Corning Glass Works. Opinions on total value of capacitor sales in 1959 vary between \$234 million and \$267 million. First figure comes from Business and Defense Services Administration, latter from Electronic Industries Association's Fact Book. Depending on which of the two bases is used, projected 1965 sales come to \$372 million or \$424 million.

We hear that sales of vitreous enamel capacitors are booming, but sales figures are not available.

Important key to military markets is the right source of information. A guide to defense industry sources of information has been prepared by Edmund J. Richards, manager of market research for Thiokol Chemical Co. The guide lists sources both within the military establishment and industry. Copies of the guide may be obtained from Richards by writing to him at his office in Bristol, Pa.

Association directories are another important market research source tool. The new 715-page Encyclopedia of American Associations is now available. It lists 8,892 national organizations which are grouped in 18 sections.

Here is a sampling of the number of organizations listed in sections of special interest: 2,314 in trade and commerce; 163 public administration, military and legal groups; 293 scientific and technical groups; 2,693 chambers of commerce.

The encyclopedia is published by Gale Research Co., Book Tower, Detroit 26, Mich., at a price of \$20.

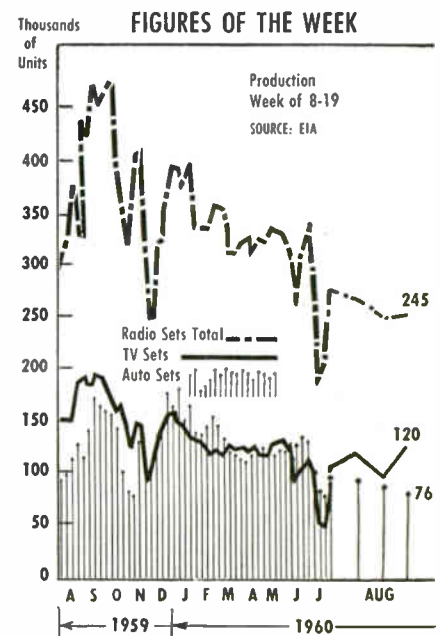

SIEGLER:

...outstanding performance through a family of talents

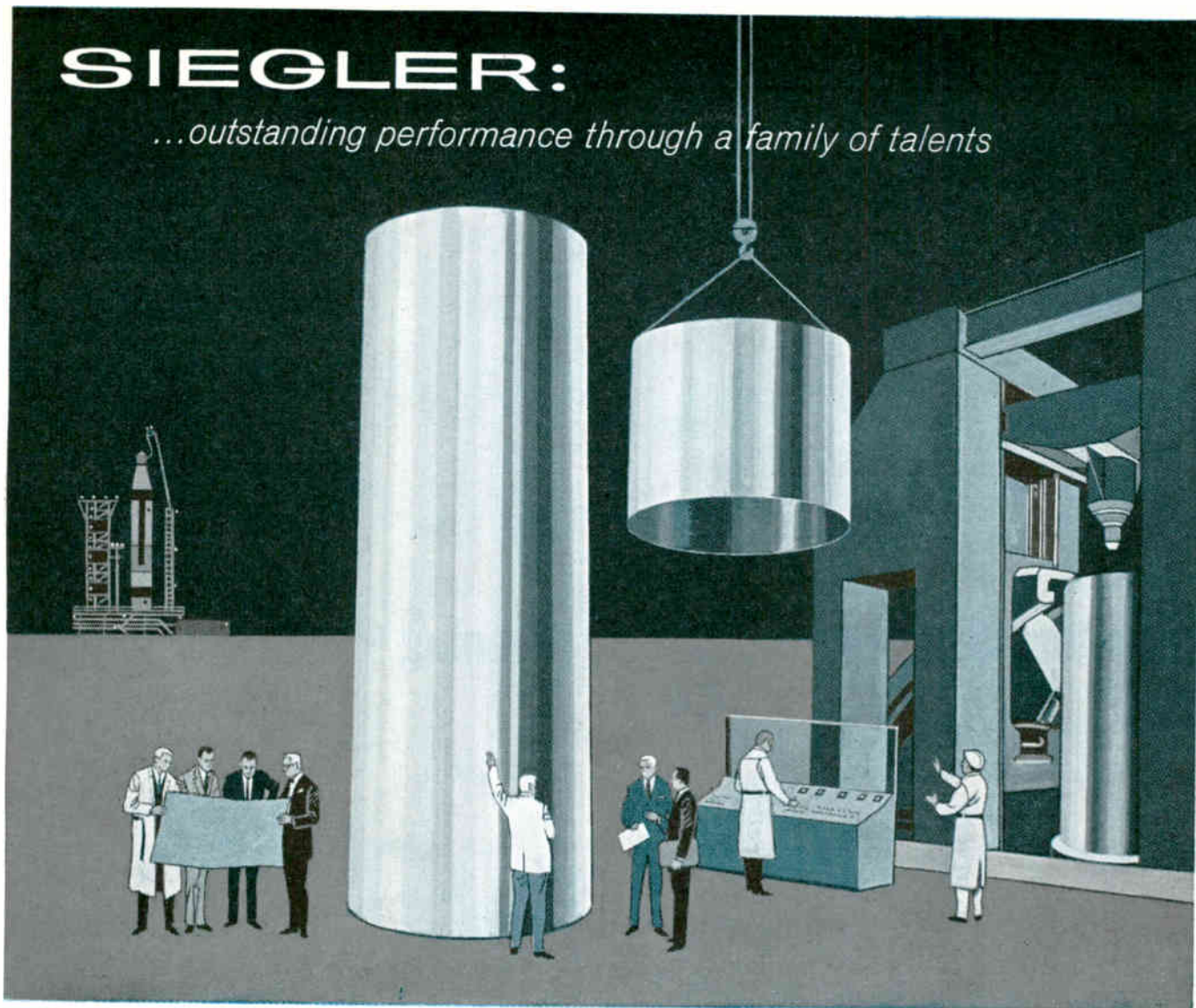

*—forms giant units
to precision tolerances...
with no metal waste!*

Siegler's Hufford Division, long a leader in metal forming techniques, announces the installation of its 120" Spin Forge Machine, entirely paid for from corporate funds at a cost of \$1,250,000. This giant machine, augmented by the existing 72" Spin Forge, comprises the largest and most complete Spin Forging facility in the world. It enables aerospace scientists to design well beyond previous limitations.

The Hufford Division Spin Forge facility is capable of producing precision surface-of-revolution parts from 4 inches to 120 inches in diameter, to 25 feet long, and with wall thicknesses from forty thousandths of an inch to one inch — out of all metals, including space age exotic materials. The giant Spin Forges can exert a pressure exceeding a million pounds per square inch — to flow metal to the desired shape quickly, with great accuracy, and with little or no metal lost to machining. Hufford Division also produces Spin Forges for the aerospace industry.

The outstanding performance of every Siegler division derives from divisional coordination under the Siegler basic corporate concept: *Progressive management of diverse activities with outstanding military, industrial, commercial and consumer capabilities — in order to bring to each of these fields the strengths of the others.*

CAREER OPPORTUNITIES
are available for
engineers and scientists.
Write for complete information.



THE SIEGLER CORPORATION

610 South Harvard Boulevard, Los Angeles 5, California

PLANT LOCATIONS: HUFFORD DIVISION, EL SEGUNDO, CALIFORNIA • HALLAMORE ELECTRONICS DIVISION, ANAHEIM, CALIFORNIA • OLYMPIC RADIO AND TELEVISION DIVISION, LONG ISLAND CITY, NEW YORK • MAGNETIC AMPLIFIERS DIVISION, NEW YORK CITY, NEW YORK • BOGEN-PRESTO DIVISION, PARAMUS, NEW JERSEY • SIEGLER HEATER DIVISION, CENTRALIA, ILLINOIS • HOLLY-GENERAL DIVISION, PASADENA AND BURBANK, CALIFORNIA • VAC-U-LIFT DIVISION, SALEM, ILLINOIS • COMET MANUFACTURING DIVISION, LOS ANGELES, CALIFORNIA • COMMUNITY ANTENNA DIVISION, RENO, NEVADA

We promise you a reply
within one week

The complexity of modern technology...the rapid increase in the number of specializations...and the frequent shifts in technological emphasis all have combined to require a staff of alert, aggressive, creative teams of engineering specialists. Their responsibility is to assist management in the formulation of plans for future efforts.

For our purposes the teams should be staffed by graduate Electronic Engineers and Physicists who have acquired several years of experience with radar, guided missiles, computers, infrared detection, nuclear radiation equipment, micro-electronics, underwater

Opportunities in:

Exploratory Studies • Advanced Planning • Systems Analysis

detection, space propulsion systems or related areas. Several of the positions require the ability to present contract proposals to both technical and non-technical officials. Other positions require the ability to do preliminary systems design. There are twenty-three openings in the above areas at the present time.

All of the positions involve close associations with senior engineers. All of the salaries reflect the unusual backgrounds required.

Please airmail your resume to

Mr. Robert A. Martin
Supervisor, Scientific Employment
Hughes Engineering Division
Culver City, California

Creating a new world with ELECTRONICS

HUGHES

ENGINEERING DIVISION

AEROSPACE GROUP
HUGHES AIRCRAFT COMPANY

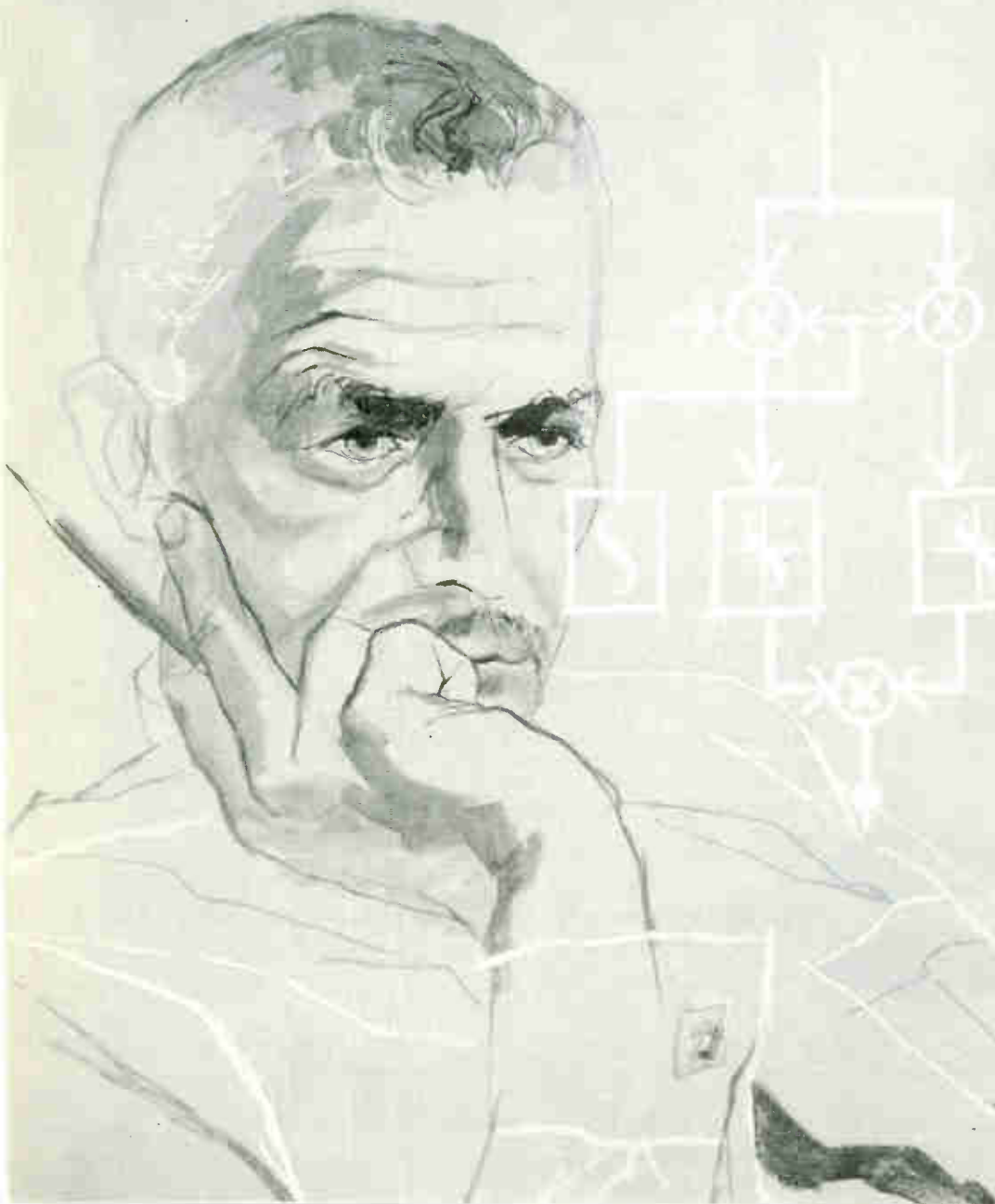

NEW

TRANSISTOR - REGULATED

- *Five-Year Warranty*
- *Transient-Free Output*
- *Exclusive Regulator Circuit*

Two new lines of power supplies — one high and one low voltage line — are available now from POWER SOURCES, INC. Both lines feature the exclusive POWER SOURCES regulator circuit that provides full protection for the transistors *without* DC fuses. Both lines are warranted for *five full years*. Warranty includes all semi-conductor components. Cooling systems of advanced design insure long life and trouble-free operation.

For prices and complete specifications on POWER SOURCES high and low voltage solid state power supplies, write, wire or phone today.

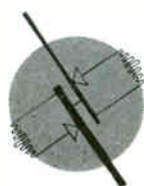

Specify POWER SOURCES BY

POWER SOURCES, INC. Burlington, Massachusetts



Model PS4232M
115-325 volts DC out
at 1.5 amp maximum



Model PS4315M
0-36 volts DC out
at 15 amp maximum

POWER SUPPLIES

High Voltage Supply Specifications

| | PS4222 | PS4230 | PS4232 |
|--------------------|---|----------------------------|-----------------------------|
| DC Output Range | 35-215 volts 0-1.5 amps | 90-300 volts 0-1.5 amps | 115-325 volts 0-1.5 amps |
| AC Input | 105-125 volts, 50-60 cps*, all models | | |
| Regulation (line) | Better than 0.1% or 0.2 volts over entire input range (whichever is greater) | | |
| Regulation (load) | Better than 0.1% or 0.2 volts for no-load to full load (whichever is greater) | | |
| Transient Response | Output remains within regulation limits for step-function change of ± 10 volts in 105-125 volt input range Output remains within regulation limits for changes from no-load to full-load or full-load to no-load | | |

Low Voltage Supply Specifications

| | PS4305 | PS4315 | PS4330 |
|--------------------|--|-------------------------|-------------------------|
| DC Output Range | 0-36 volts 0-5 amps | 0-36 volts 0-15 amps | 0-36 volts 0-30 amps |
| AC Input | 105-125 volts, 50-60 cps*, all models | | |
| Regulation (line) | Better than 0.025% or 3 mv over input range (whichever is greater) | | |
| Regulation (load) | Better than 0.05% or 5 mv, no-load to full-load variation (whichever is greater) | | |
| Transient Response | Output remains within regulation limits for line voltage steps of ± 10 volts within input range Output recovers in 100 usec for no-load to full-load or full-load to 50% load step changes. | | |

*400 cps available on order

DRAMATIC BREAKTHROUGH IN



Industrial Products Division

INTERNATIONAL TELEPHONE & TELEGRAPH CORPORATION
1519th BLED SOE STREET • SAN FERNANDO, CALIFORNIA

for vibration testing the ITT Model 1201 is a completely self-contained console built around the ST-100 fifty force pound Vibration Exciter.

for vibration and shock testing the ITT Model 1205 offers all the features of the vibration console, plus shock test equipment. Both systems are particularly suited to accelerometer calibration as is seen in the graph below.



MODEL 1201

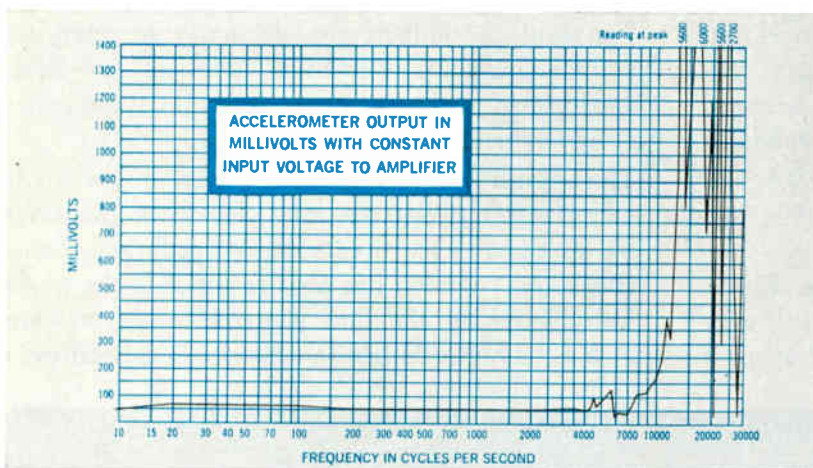

MODEL 1205

VIBRATION AND SHOCK TESTING

THE ITT MODEL ST-100 AIR-SUSPENDED VIBRATION EXCITER

- no measureable distortion to 10 KC
- first major resonance above 12 KC
- shock testing to over 3,000 g
- simple to operate—even by unskilled personnel
- useful frequency range exceeds 50 KC
- 50 force-pound rated output
- handles test samples up to 5 lbs.

The ITT Model ST-100 is the first shaker table of its type designed to be used for both vibration and shock testing. In either application, its greatly advanced design and performance features make it ideal, not only for production testing, but as an R & D tool as well. In addition, its "flat" response to 10,000 cps, with negligible distortion, provides *an exact method of accelerometer calibration.*

With the ST-100, force levels at the table are always accurately known. Thus, unnecessary test failures are eliminated and the failure of sub-standard specimens is assured. This, com-

bined with a useful frequency range in excess of 50,000 cps and the simple, one-man operation of the ST-100 greatly expands areas of practicable testing...substantially reduces testing time and expense.

After 7 years of development, the ITT Model ST-100 Vibration Exciter is now available to reliably upgrade your vibration and shock testing results, while it cuts your testing costs.

For complete technical data and applications information, contact your ITT Instruments representative. Or write us direct for Data File E-1291-1.

FROM EIMAC:

Breakthrough in tube technology opens up new range of reliability

You are looking at a major advance in tube design. This ceramic envelope is made with *beryllium oxide*—an amazing insulating material now introduced by Eimac for electron tubes. It offers thermal conductivity *ten times* greater than any other material in use today. It provides low losses, high breakdown strength and a comparatively low dielectric constant for improved bandwidth in critical applications such as output windows.

With the introduction of beryllium oxide, Eimac breaks through the problem of dissipating ever larger amounts of heat in dielectrics. And opens a

new chapter in power-output capabilities of high power microwave and certain negative grid tubes. The result: a whole new spectrum of tube reliability and performance. Beryllium oxide is now being used in several Eimac production tube types generating ten kilowatts and above.

This significant advance in the state of the art of manufacturing electron tubes has been pioneered by an Eimac sponsored research program. Eimac sponsored research has also resulted in the recent introduction of the first practical quartz-to-metal seal. Eitel-McCullough, Inc., San Carlos, California.



Voltage Regulator and Power Supply Users: RAYTHEON ESTABLISHES PROGRAM 2020

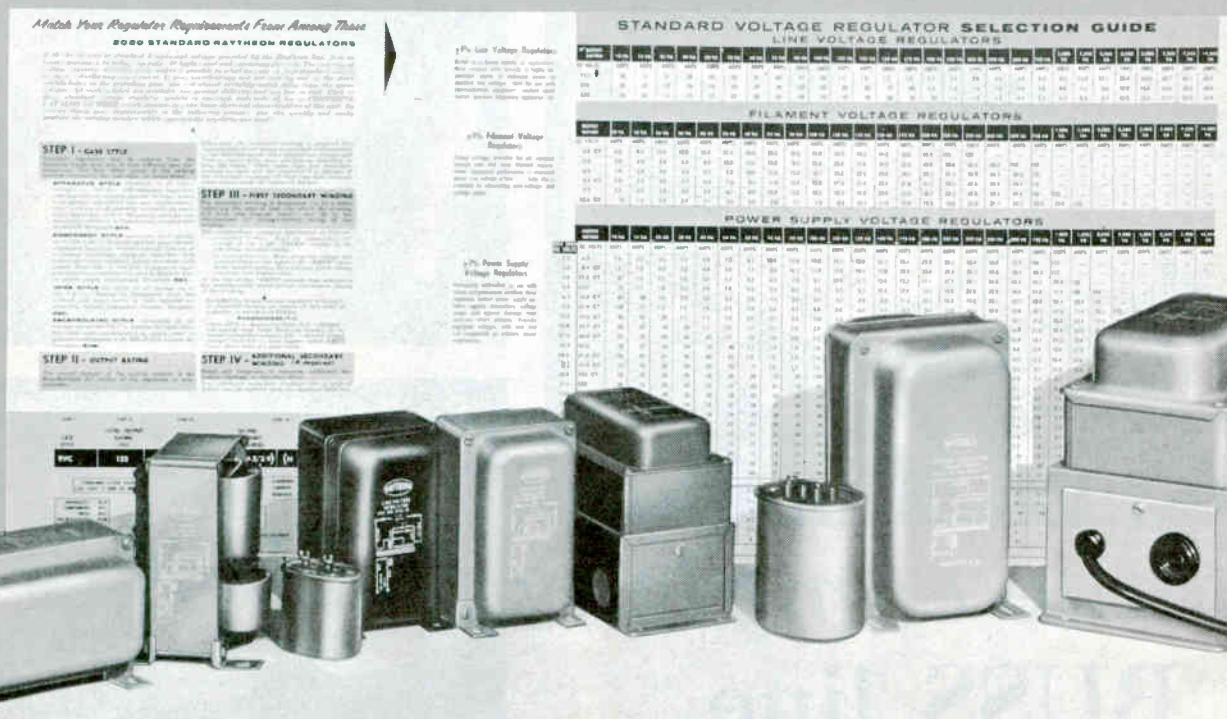

New Raytheon Standard Voltage Regulator Models include Component Style Units with External Capacitors for convenient upright or horizontal installation on electronic equipment chassis Apparatus Style Units for use where a completely self-contained installation is desired • Open Style Units (without end bells) • Cord and Receptacle Plate for line applications
Regulator Selection Guide lets you choose from 2,020 different units!

Now, Raytheon provides 2,020 standard magnetic voltage regulator models for AC loads and DC power supply applications with easier selection, faster delivery, lower cost.

It's the easiest, most economical way yet devised to assure you of exactly the voltage regulator you need.

Raytheon's Regulator Selection Guide provides a simple, reliable means of selecting input and output voltages, volt-ampere rating and type of mounting. By using the Guide included in the new Raytheon voltage regulator catalog you can quickly determine size, weight and other pertinent data to aid you in selecting the unit that best suits your requirements. Your selection is made from 2,020 standard voltage regulator models, all available for prompt delivery.

In addition to their use in countless AC applications, these new regula-

tors provide many significant advantages for the DC power supply designer. Using the Selection Guide, he can readily select the appropriate regulator model directly on the basis of DC output voltage and power requirements.

An extremely wide range of AC voltage ratings is available from 2.3 to 1,055 volts and up to 10,000 volt amperes. Regulation on all models is $\pm 1\%$ for line voltage variations of $\pm 15\%$.

Fill in the coupon and receive your copy of our VOLTAGE REGULATOR SELECTION GUIDE AND CATALOG No. 4-265.

- CHECK THESE BENEFITS OF
NEW RAYTHEON VOLTAGE REGULATORS**
- Lower prices and prompt delivery of 2,020 standard models
 - Isolated secondaries on all models
 - Negligible external field
 - Output stabilization to $\pm 1\%$
 - No tubes or moving parts to service
 - Self protecting against short circuits and surges

RAYTHEON COMPANY
Power Supply & Voltage Regulator Operations
Keeler Avenue, South Norwalk, Connecticut

Gentlemen:
Please send by return mail my copy of Raytheon's
VOLTAGE REGULATOR SELECTION GUIDE & CATALOG.

Name _____
Title _____
Company _____
City _____ State _____



RAYTHEON COMPANY
Power Supply & Voltage Regulator Operations
Keeler Avenue, South Norwalk, Connecticut

Excellence in Electronics Raytheon voltage regulators are also available from your local Raytheon distributor and in Canada through Raytheon Canada, Ltd., P.O. Box 152, Waterlax, Ontario

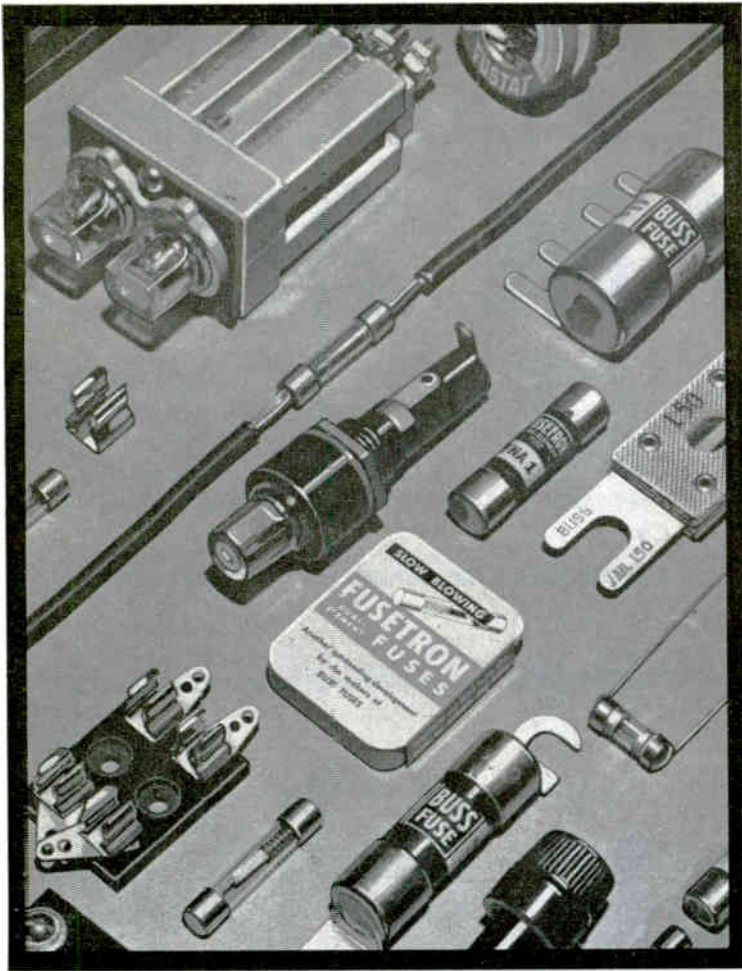

In the complete BUSS line...

*you can quickly find the right fuse and
fuseholder to meet every demand!*

Dual-element "slow-blowing", single-element "quick-acting" and signal or visual indicating type fuses . . . plus a companion line of fuse clips, blocks and holders . . . are available from one source — BUSS. You'll save time and trouble by turning first to BUSS when you need fuses and fuseholders.

To safeguard against 'kicks' or complaints, every BUSS fuse is tested in a sensitive electronic de-

vice. Any fuse not correctly calibrated, properly constructed and right in all physical dimensions is automatically rejected to assure dependable protection under all service conditions.

Save engineering time on special problems in electrical protection. At your request, the BUSS fuse engineers are at your service to help you determine the fuse or fuse mounting best suited to your needs.

In many cases it is possible to find, in the complete BUSS line, a fuse and fuse mounting already available in local wholesalers' stocks, so that your device can be easily serviced.

For more information on BUSS and FUSETRON small dimension fuses and fuseholders . . . Write for bulletin SFB.

860

BUSSMANN MFG. DIVISION,
McGraw-Edison Co.
University at Jefferson, St. Louis 7, Mo.

BUSS fuses are made to protect - not to blow, needlessly.

BUSS makes a complete line of fuses for home, farm, commercial, electronic, electrical, automotive and industrial use.





This is a cutaway of an Epoxy encapsulated stator wound with Epoxy magnet wire. All-Epoxy—an ideal combination for severe applications.

EPOXY MAGNET WIRE... IDEAL FOR ENCAPSULATED SYSTEMS UP TO 130° C

A magnet wire must offer you *all* these important advantages when used in encapsulated systems.

The wire must have outstanding compatibility—a requirement for good bond strength at elevated temperatures—high dielectric strength under adverse moisture conditions.

The ideal magnet wire must also have excellent thermal and high-impact shock resistance. And—it must be able to resist corrosive and abrasive atmospheres.

Anaconda Epoxy meets all these requirements and more. For this 130°C (AIEE Class B) magnet wire is compatible with virtually every encapsulating compound tested to date. Equally important, Anaconda Epoxy contains no polyester modifiers—therefore offering greater resistance to hydrolysis.

In addition, Anaconda Epoxy costs no more than most

Class A magnet wires—which means you can often thermally upgrade your components to Class B without additional cost. It's readily available, too—in a full range of round, square and rectangular sizes.

Epoxy can also be furnished in combination with Vitrotex (glass-served) for added thermal overload protection.

So you can see how it offers you many interesting possibilities for cutting costs and simplifying production through standardization.

Our technical staff and Research and Development Laboratory facilities are available to give you assistance in your encapsulating and other magnet wire problems. See the Man from Anaconda. Or write: Anaconda Wire & Cable Company, 25 Broadway, New York 4, N. Y.

60252

ASK THE MAN

FROM **ANACONDA**[®] FOR EPOXY MAGNET WIRE

ANATHERM 155°C (AIEE Class F)
high temperature resistance

NYFORM 105°C (AIEE Class A)
superior windability

PLAIN ENAMEL 105°C (AIEE Class A)
low-cost enameled magnet wire

FORMVAR 105°C (AIEE Class A)
proven dependability

ANALAC 105°C (AIEE Class A)
solderable magnet wire





There's really not much to custom-designing rotary switches...

It's a matter of routine . . . when you have talented engineers with lots of experience . . . first quality materials . . . and advanced manufacturing techniques.

Fortunately, The Gamewell Company has all three. When customers' specifications come in, our engineers get busy. The precious metal ring, heart of a Gamewell Rotary Switch, is designed with as many segments as required. Brushes are provided which assure smooth, trouble-free action with either MAKE-BEFORE-BREAK or BREAK-BEFORE-MAKE contacts. Then a highly versatile arrangement of terminals connecting to ring segments is devised for the periphery of the switch housing. And so on, depending on requirements.

The end result is a highly versatile, reliable switching component. Cased in special plastic, it's inherently fungus resistant and stable at high temperatures. It can be used with confidence over a wide range of environmental conditions.

Gamewell is well qualified to design rotary switches for circuit sampling, programming, digital generators and various electronic data processing systems. *Your specs will receive prompt attention.*

Write to **THE GAMEWELL COMPANY**, 1379 Chestnut Street, Newton Upper Falls 64, Massachusetts. *A Subsidiary of E.W. Bliss Company.*



The Gamewell SG-270 Switch is available with diameters of $\frac{5}{8}$ ", $1\frac{1}{4}$ ", $1\frac{3}{8}$ ", 2", 3" and 5" in various mounting styles.

BLISS
**Gamewell**[®]

PRECISION POTENTIOMETERS

"INTEGRALS OF
HIGH PERFORMANCE"

ACTUAL SIZE



CANNON MINIATURE PLUGS

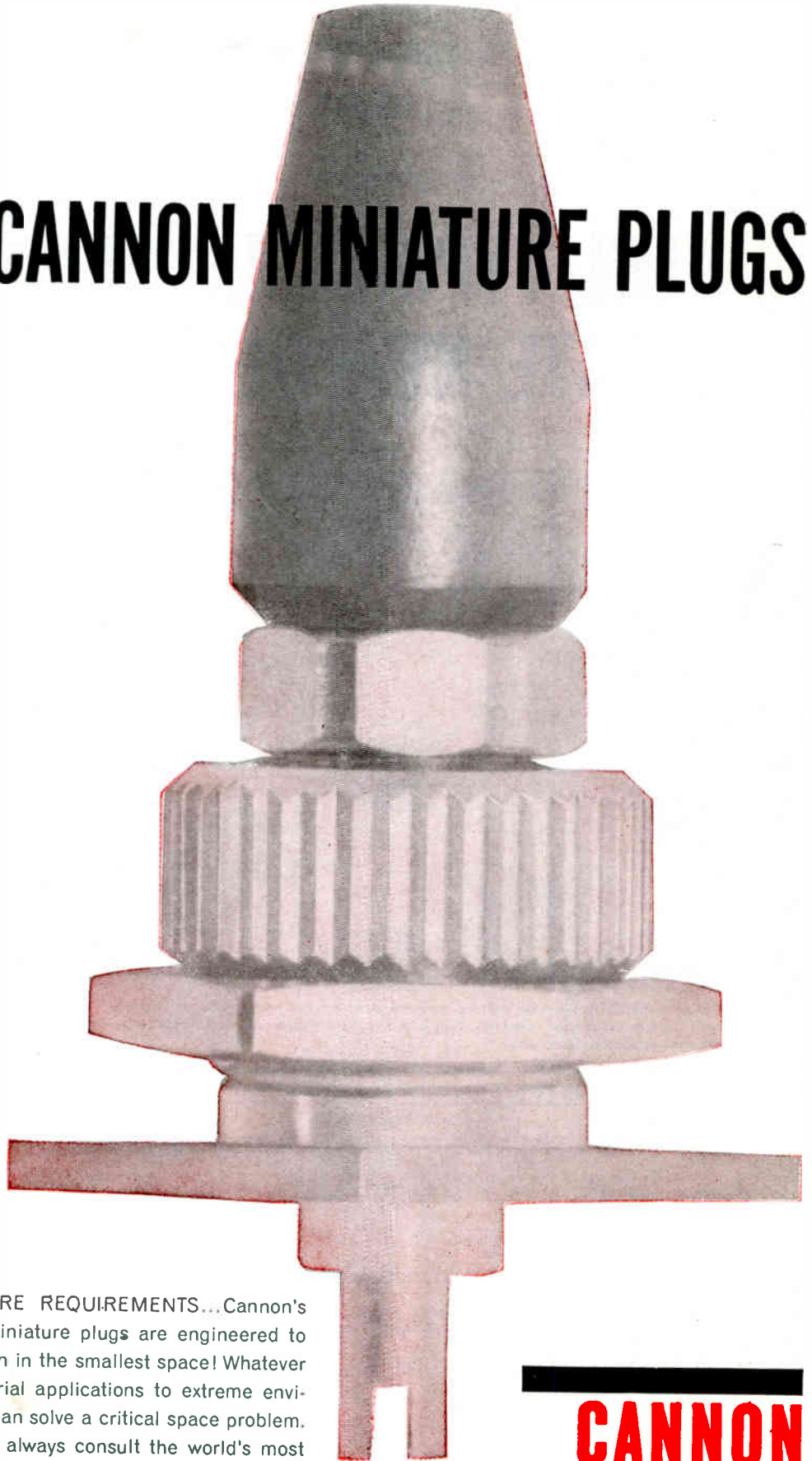

SCALED TO YOUR MINIATURE REQUIREMENTS...Cannon's full line of miniature and subminiature plugs are engineered to provide safe electrical connection in the smallest space! Whatever your requirements — from industrial applications to extreme environmental conditions — Cannon can solve a critical space problem. Another reason why you should always consult the world's most experienced plug manufacturer...why you should consult Cannon for all your plug requirements. Write for literature to:

CANNON ELECTRIC COMPANY, 3208 Humboldt St., Los Angeles 31, Calif.

September 9, 1960



CANNON PLUGS

CIRCLE 37 ON READER SERVICE CARD 37



EXTRA QUALITY AT NO EXTRA COST WITH BENDIX TRANSISTORS

Bendix Bulletin



Up-to-the-minute news about transistors and rectifiers

MIL-TYPE SEMICONDUCTORS CREATE NEW DESIGN FREEDOM

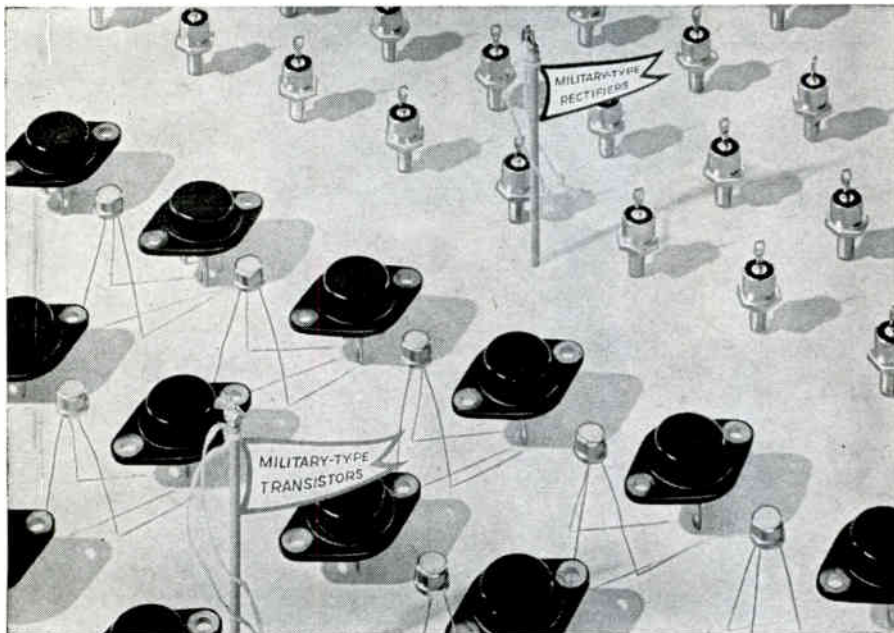

DESIGN ENGINEERS find Bendix military-type power transistors and rectifiers a virtual "parade" of ruggedness and reliability. They also find Bendix engineers most helpful with circuitry and application problems.

Broad Bendix line meets both electrical and environmental military specs.

Here, in Bendix* Power Transistors 2N297A, 2N331, 2N1011, and 2N1120, and Bendix* Power Rectifiers 1N1614, 1N1615, and 1N1616, is a versatile line completely designed to meet military specifications. This combination — most extensive series of its type — permits unusual design latitude on military equipment applications. All units feature outstanding ruggedness and reliability to meet both electrical and environmental conditions.

The four transistors are especially suited to high-current switching, audio amplification, small motor and servo driver applications. The three rectifiers, with their low forward drop and low reverse leakage current, are ideal for magnetic amplifier and DC blocking circuits, in addition to power rectification.

Write today for NEW BENDIX SEMICONDUCTOR CATALOG on our complete line of power transistors and power rectifiers. Bendix offers engineers many challenging opportunities in semiconductors. Write Personnel Manager for full details.

*REG. U.S. PAT. OFF.

MAXIMUM RATINGS AND TYPICAL OPERATION OF MILITARY POWER TRANSISTORS

| TYPE NUMBER | MIL-T-19500 | MAXIMUM RATINGS | | | | | | TYPICAL OPERATION | |
|-------------|-------------|---------------------|---------------------|--------------------|------------------|-------------------|--------------|-------------------|-----------------------|
| | | V _{ce} Vdc | V _{cb} Vdc | I _c Adc | P _c W | T _j °C | T storage °C | h _{FE} | at I _c Adc |
| 2N297A | /36A (SigC) | -50 | -60 | 5 | 35 | 95 | -65 to +95 | 70 | 0.5 |
| 2N331 | /4A | -12 | -30 | 0.2 | 0.075 | 85 | -65 to +85 | 50 | 0.001 |
| 2N1011 | /67 (Sig C) | -70 | -80 | 5 | 35 | 95 | -65 to +95 | 55 | 3.0 |
| 2N1120 | /68 (Sig C) | -70 | -80 | 10 | 45 | 95 | -65 to +95 | 35 | 10.0 |

Ideal for such applications as:

**HIGH CURRENT SWITCHING • AUDIO AMPLIFICATION
SMALL MOTOR AND SERVO DRIVERS**

MAXIMUM RATINGS OF MILITARY POWER RECTIFIERS

| TYPE NUMBER | MIL-E-1 | I _o at 150°C | PRV Vdc | I _{lb} at 25°C | E _{pp} | I _{lb} at 150°C |
|-------------|---------|-------------------------|---------|-------------------------|-----------------|--------------------------|
| 1N1614 | /1240 | 5 Adc | 200 | 50 μAdc | 140 | 750 μAdc |
| 1N1615 | /1241 | 5 Adc | 400 | 50 μAdc | 280 | 750 μAdc |
| 1N1616 | /1242 | 5 Adc | 600 | 50 μAdc | 420 | 750 μAdc |

Ideal for such applications as:

**MAGNETIC AMPLIFIERS • DC BLOCKING CIRCUITS
POWER RECTIFICATION**

SEMICONDUCTOR PRODUCTS
Red Bank Division
LONG BRANCH, N. J.



West Coast Sales Office:
117 E. Providencia Avenue, Burbank, California

Midwest Sales Office:
2N565 York Road, Elmhurst, Illinois

New England Sales Office:
4 Lloyd Road, Tewksbury, Massachusetts

Export Sales Office: Bendix International Division,
205 E. 42nd Street, New York 17, New York

Canadian Affiliate: Computing Devices of Canada, Ltd.,
P. O. Box 508, Ottawa 4, Ontario, Canada

Specialists in precision displays

Celco YOKES

Celco YOKES FOR CHARACTER DISPLAYS & HIGH RESOLUTION APPLICATIONS

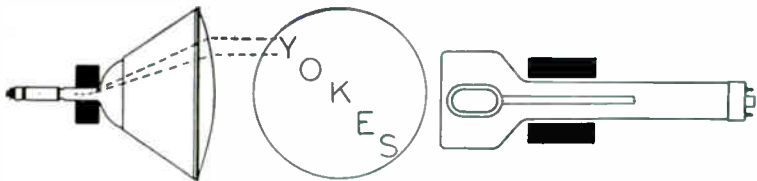

Deflection yokes for difficult character displays and high resolution problems are another achievement in advanced design and engineering at Celco.

Celco Deflection Yokes permit rapid presentation of random character and alpha numeric displays. Low hysteresis, high accuracy and fast Recovery time with emphasis on spot approach to absolute zero, assures highest performance of magnetic deflection character displays.

Celco High Sensitivity Yokes minimize the deflecting currents required from the deflection drivers, resulting in high efficiency for your system.

For best utilization of the New High Resolution CRT's CELCO YOKES assure minimum defocusing at large deflections.

The construction of our yokes makes it possible to achieve sensitivities, linearities, responses and distortion-free deflecting fields not possible with the usual types of yoke.

Celco FOR STANDARD, COMMERCIAL & MILITARY APPLICATIONS

Single units or production quantities immediately available in wide range of inductance - resistance - Recovery time - pin cushion corrected or optimum focus as required. Also available 2-1/8" and 2-1/2" neck CRT yokes.



TYPE BY

Transistorized encapsulated yokes for 70° 7/8" neck CRT and 1" neck image storage tubes.



TYPE AY

Push-pull or single ended yokes for 52°, 70° and 90° deflections for 1-7/16" neck CRT.



TYPE RY

Rotating deflection yokes for PPI displays. Gears, bearings, slip rings and contact assembly included.



TYPE CF

Electromagnetic focusing coil for 7/8", 1" and 1-7/16" neck CRT.

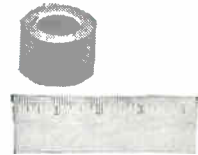

TYPE MY

Miniature light weight deflection yoke coils or assemblies for incorporation into customer housings.

Celco ENGINEERED YOKES FOR PRECISION DISPLAYS



TYPE DP

Dual purpose yoke custom designed. Deflection system plus axial off-centering coils.



TYPE HS

Special high sensitivity deflection yoke with critical damping provisions.



TYPE PI

Plug in type encapsulated deflection yoke for rapid insertion.



TYPE ER

Encapsulated rotating, 4 axis slip ring precision deflection yoke.



TYPE MS

Miniature deflection yoke for rotating or fixed coil radar system.

✉ Write for CELCO DEFLECTION YOKE Catalogue & Design Sheets or for assistance Call your nearest CELCO Plant listed below.



Constantine Engineering Laboratories Company

Main Plant: MAHWAH, N. J. DAVIS 7-1123

• Pacific Division - Cucamonga, Calif. - YUkon 2-2688

Active vs Passive Communications

Either way equipment makers for both military and civilian use will have to

By JOHN F. MASON,
Associate Editor

WHEN THE OFTEN-DELAYED Courier active communications satellite finally joins passive communications satellite Echo I in orbit, communications experts will be able to contrast the actual performance of these protagonists of different satellite communications concepts.

Either system will bring big changes to communications equipment makers, both civilian and military. Present equipment is being converted, new gear is on the drafting board and work on new components is proceeding apace.

Least affected by the new era in communications are makers of consumer products. Whether a telephone conversation from New York to London is by undersea cable or satellite will not affect the design of the telephone instrument nor the local telephone network. Transoceanic tv relayed by satellite will still be transmitted to the home screen by the same local transmitters—though eventually, homes may be equipped with directional antennas that can receive directly from a satellite.

The big change lies in the equipment connecting local conventional communications centers. Equipment once alien to communications is now part of that industry. Devices originally developed for weapon systems and for the exploration of space will become standard production-line items for global networks. Long-range ballistic missiles and related equipment will be the construction gear for installing the satellite relay stations in space.

Specific communications equipment to be used in the new global networks depends on the kind of satellite systems ultimately selected.

Present possibilities include low-altitude passive reflectors, like

NASA's 100-ft balloon, Echo I, now successfully operating; high-altitude hovering reflectors of various shapes, proposed by NASA; UASF's reflective cloud of orbiting frangible needles; low-altitude delayed repeater satellites, like the Advanced Research Projects Agency's Courier, to be launched Sept. 30; and ARPA's 24-hour equatorial, real-time, hovering satellite, Advent, scheduled for test firings in 1963.

All these systems are scheduled for testing. Staying power of each remains to be seen.

The general feeling at the recent Globcom symposium in Washington seemed to favor active rather than passive satellites. Passive reflectors require larger antennas and more powerful transmitters, thus upping cost and complexity.

"The passive satellite is a highly valuable R&D tool which will provide needed information concerning the near-earth space communications environment," James S. Shaw, Senior Vice Pres., Radiation, Inc., told ELECTRONICS. "The bandwidth or intelligence it can reflect is limited to narrow increments such as a telephone channel. Transmission of very high frequency signal components, such as required by tv, will be subject to phase distortions. This is particularly true of a reflective cloud of needles."

Shaw points out another disadvantage to putting clouds of needles into orbit. "The indiscriminate distribution of needles or chaff in the earth space can reduce present day vhf and uhf communications, including tv and radar, to a modern tower of Babel."

Rome Air Development Center, however, sees a big military advantage in passive satellites. They can't be jammed and the operating frequency can be changed on the ground.

Generally accepted as the ultimate satellite relay station is the

active hovering satellite, hanging in a circular, equatorial orbit, 22,400 miles high. Three such satellites—stationary with respect to a point on the earth—could blanket the earth with high frequency radio, telegraph and tv signals.

ITT estimates such a 3-satellite system could be set up, operated for ten years—including satellite replacement every two years—for \$180 million.

AT&T has proposed a commercial network of low-altitude, active repeater satellites in random orbit. AT&T's system calls for 26 ground stations, providing 600 telephone circuits between each pair of terminals, at a total cost of \$115 million. Adding tv to the network would boost the cost to \$170 million.

The keynote for ground equipment is sensitivity, says Walter Glomb, Radio Systems, ITT.

Ground equipment for both passive and active satellites includes high power transmitters, sensitive automatic-scan receivers, multiplex equipment and power supply. (Ground equipment for Courier, ELECTRONICS, p 38, July 22).

Each ground station for AT&T's active repeater satellite station will consist of two 60-ft dish transmitting antennas, two 50-ft by 50-ft horn reflector receiving antennas, two beacon tracking units for directing the antenna systems, and a standby transmitter and receiver.

Radiation's Shaw says: "The low altitude repeater will require expensive, complex programmed antennas. The high altitude active repeater will require the simplest antenna of all. It may be as small and as inexpensive as a fringe-area tv antenna installation.

"The high altitude active satellite will require appreciable power aboard for retransmission to earth. High power, however, will result in the ability to relay contiguous bandwidth suitable for video use together with the radical re-

Satellites?

raise their sights towards outer space

duction in receiving antenna complexity and costs," Shaw says.

"Automatic tracking is probably more economical than highly sophisticated programming," Shaw says, "particularly if the higher frequencies are used. This is because the ground antenna beamwidth reduces with increasing frequency to the extent that accurate programming would be necessary. And of course atmospheric bending is 'unprogrammable'."

Passive satellites require greater transmitter power and more highly sensitive receivers than active. Collins used a 10 kw 28-ft parabolic antenna transmitting system to bounce signals off the 1,000-mi high Echo I balloon. A 40-ft dish was used for receiving. Bell Telephone Laboratories used a 50-ft horn-shaped antenna, with a ruby maser amplifier to receive reflected signals.

To bounce a signal off a passive satellite at 22,400 mi altitude, some 16,000 times as much power as that required for Echo I would be required says Glomb.

The satellite payload is a complete relay station in extremely reduced form: Microwave receivers, transmitters, antennas, data storage and power supply equipment. (For Courier's payload, see *ELECTRONICS*, p. 26, Sept. 2).

Main design goal for satellite payload equipment is reliability, ITT's Glomb says. Unreliable equipment requires a replacement of spares carried in the satellite and eventually the costly replacement of the satellite itself. Miniaturization—weight and size—is also a big requirement. But with more powerful boost vehicles, payload dimensions will become less critical.

Hans Ziegler, Chief Scientist, Army Signal Research and Development Laboratory, Ft. Monmouth, told *ELECTRONICS* he foresees no functional problems in obtaining satellite communications equip-

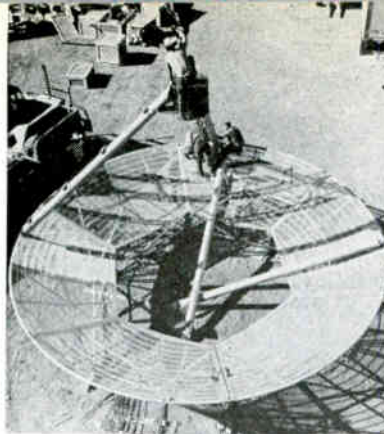

Courier's 28-ft tracking and communications antenna, designed by Radiation, Inc., going up in Puerto Rico

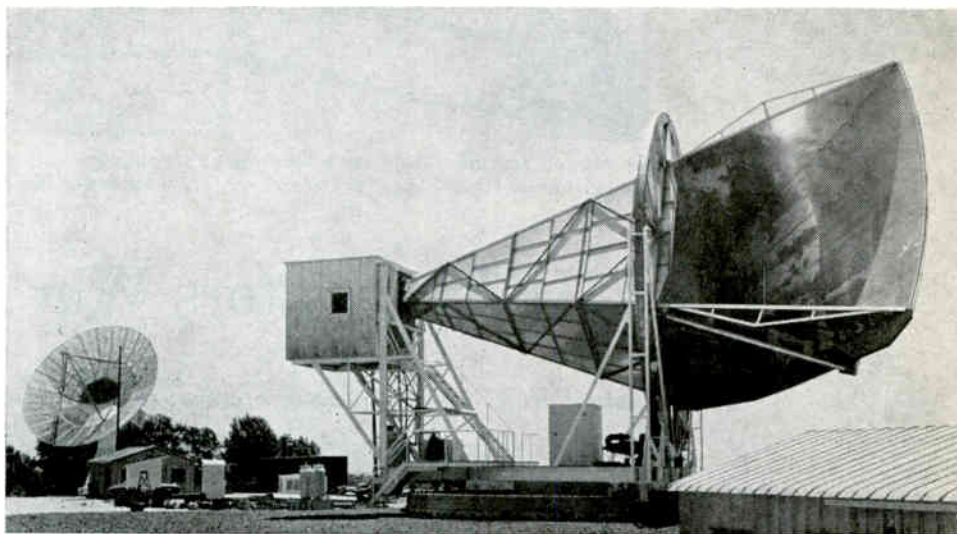

Horn reflector antenna, developed by BTL, listens to Echo reflected signals. Left is D. H. Kennedy's 60-ft transmitter dish

ment. An important portion of a satellite system is the series-to-parallel and parallel-to-series converter for rapid transmission of telegraph and facsimile messages.

Greater reliability and longer life will be demanded of microwave generators, Ziegler said. Failure is now resolved by redundancy, "but we will need at least a life time of several years."

Bell Telephone Laboratories is working on a 1-watt traveling-wave tube with an expected life of 10 years or more. Using such low power is possible by using a broadband modulation method, such as wide deviation f-m and an f-m with feedback receiver.

BTL is also working on a broadband satellite receiver and transmitter made entirely out of long-life solid-state components. Success is dependent on the feasibility of using Esaki tunnel diodes or transistor harmonic generators as

6,000 Mc local oscillators.

Other areas pointed out by Louis Pollack, Space Communications, ITT, include: doppler shift corrective schemes, modulation schemes that make the best use of bandwidth versus information, and large antennas with full theoretical gain at reasonable costs.

Glomb stressed the need for work on low noise amplification: parametric diodes, parametric beam devices, traveling wave tubes, tunnel diodes, and maser devices.

NASA says new methods of information coding and processing are needed which permit compact reliable low-power drain communications links capable of handling much more complex information than at present. NASA is also interested in studying anisotropic passive reflectors and chaff. Ryan Aeronautical has proposed a number of anisotropic designs for passive satellites.



In rugged terrain like this, where an experimental Adler Electronics translator was tested, conventional reception is often impossible

VHF Translators Win Approval

Latest FCC move to block continued operation of unlicensed television boosters is authorization of vhf repeaters to relay on changed frequency

AUTHORIZATION of vhf television translators by Federal Communications Commission becomes effective this week.

The ruling will largely effect mountainous regions in the far west and certain areas of the middle Atlantic states. In many locations, audiences cut off from regular tv stations have been relying exclusively on unlicensed boosters or uhf translators to relay programs into their areas.

FCC has no objection to the operation of properly licensed uhf translators which arrange with local stations to rebroadcast programs on uhf channels. Booster operators, however, who take the station signal off the air and relay it on the same or on some adjacent frequency have long been a problem to the FCC.

For slightly more than two years, booster operators have been urged to exchange their equipment for uhf translator gear. Although some operators complied, others were reluctant to do so because they had viewing audiences equipped with

vhf receivers only. Often the translator had power requirements different from the booster.

In an attempt to improve the situation, FCC set up new regulations this July authorizing low-power translator stations in the vhf band providing they meet technical requirements and protect regular tv broadcast stations from interference. Maximum power for the vhf translators is limited to one watt.

Although the effective date of the new ruling is Sept. 6, boosters constructed prior to July 7, 1960 will have until Oct. 31 to identify themselves to the Commission, and until Oct. 31, 1961 to make the changeover.

From the office of Commissioner R. E. Lee, ELECTRONICS learns that no additional FCC field men will be used to enforce the changeover. "We don't anticipate any great resistance to the new vhf rules," commented one spokesman. "A good number of booster groups have been seeking just the legalization that these new rules provide. There are even areas where people have chosen

to do without television rather than establish an unlicensed booster operation. We expect full cooperation from such groups."

Informal conversations with Commission personnel reveal, however, that the uhf translator operation is dearer to the official heart than the vhf set-up. Some commissioners are fearful that spectrum crowding in the vhf band will develop if any great number of translators go to vhf frequencies. The largely unused uhf television band, in the official opinion, is a preferred spectrum for translator operation.

Predictions by ELECTRONICS in December 1957 that translators would increase have proven valid. At that time there were about 135 translators in use. Present estimates by Adler Electronics, a major supplier of translator equipment, are about 350.

Although no exact count of booster stations is possible since they are not licensed, their number is guessed to be about 700. The majority of these are vhf installations that will be able to modify their

equipment without too much difficulty to meet the new FCC standards of frequency and power. The new rules dispense with the requirement for a licensed operator and require only on-off control from an accessible location and automatic cut-off protection for both vhf and uhf.

While uhf translators must meet prescribed mileage separation from regular tv stations, no equivalent restrictions are placed on vhf translators. The new rules require that the translator be able to transmit identifying call letters.

As in the case of uhf translators, the vhf installations cannot retransmit signals on the same channel as the one on which they receive the station signal. In addition, permission of the station must also be obtained. Power, according to the Commission, will be strictly limited to one watt for the vhf operators. Those who wish to use more power will be allowed to apply for uhf translator operation where the upper limit is 100 watts.

Groups purchasing new translators in preference to modifying existing equipment will be spending about \$1,500 for the gear exclusive of buildings and antennas. Equipment manufacturers, who have up to now been producing equipment primarily for the uhf band, say they will have vhf equipment available.

Argentine Output Sales Dip in '59

OUTPUT AND SALE of consumer electronic equipment in Argentina dropped in 1959, the Electronics Division of Business & Defense Services Administration reports. Production of radio receivers declined from 350,000 units in 1958 to 250,000 last year; tv receiver production dropped from 100,000 units to 80,000.

Higher retail prices resulting from increased production costs are blamed for the dropoff, with the price of imported components sharing part of the blame. Despite high duties, 1,381 tv sets were imported by Argentines from the U. S. during the year, and 648 more from Italy. No Argentine consumer electronic products were exported last year.

3 Steps TO EXCELLENCE IN PW BOARDS

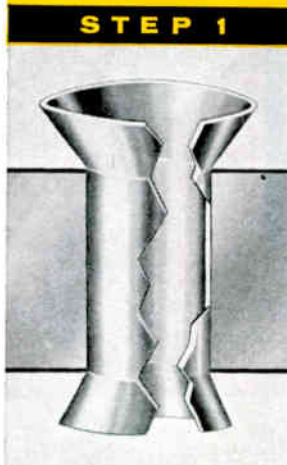

**FUNNEL FLANGE
EYELETS**

Only the United Funnel Flange Eyelet contributes that greater mechanical strength, improved reliability and uniform circuitry so necessary for achieving a superior PW or Etched Circuit Board. Wide range of sizes and lengths meet all board needs.



**AUTOMATIC EYELETING
MACHINES**

Only United offers such a complete line of Eyelet Setting Machines. These are backed by more than 50 years' experience in the design and manufacture of precision production machinery for industry. The United Model G Eyeletting Machine feeds eyelets automatically, and is equipped to compensate for variations in board thicknesses for more dependable production.

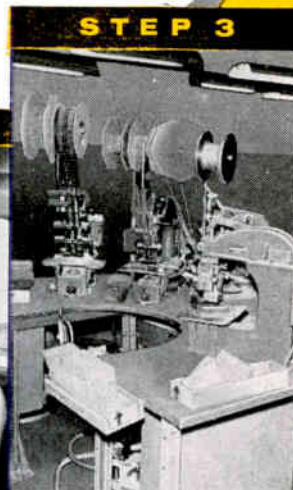

**COMPONENT INSERTING
MACHINES**

Only from United can you get a complete line of high precision DYNASERT Component Inserting Machines that cut component inserting costs up to 80%! If you insert only a few hundred components a week DYNASERT machines should be considered. DYNASERT Component Inserting Machines automatically feed, trim, bend leads, insert components and clinch with uniform results. Highly engineered single or multi-stage machines available.

These "3 Steps to Excellence" — Funnel Flange Eyelets, Automatic Eyeletting Machine, and Component Inserting Machines . . . can provide that vital extra margin of dependability and value in your PW or Etched Boards. And the investment is surprisingly small. Call or write for complete details.

United

UNITED SHOE MACHINERY CORPORATION
140 Federal Street, Boston, Mass. • Liberty 2-9100



Transistor circuits and low power applications need this safety feature!

IRC PW Resistors are available with special resistance windings, designed to act as a standard resistor at normal operating wattages and fuse at some specific overload condition. Thus they provide an ideal solution—resistor and fuse in one unit—a great advantage in circuits which tend to short or where overloading of a component creates a fire hazard.

These double-duty resistors come in six sizes—3, 5, 7, 10, 15 and 20 watts. And, no derating is required even at high ranges.

For additional information on IRC Power Wire Wound Resistors, write for Bulletin P-2, International Resistance Co., 401 N. Broad St., Philadelphia 8, Pa.

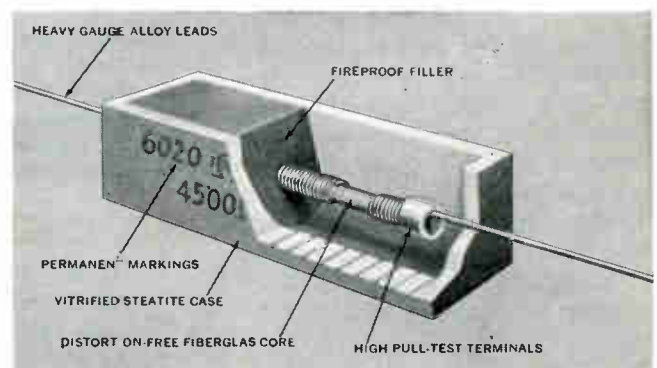

Leading supplier to manufacturers of electronic equipment

No Magnetic Field Around Moon?



Russia's Leonid Sedov, president of the International Astronautical Federation and the man behind the Sputnik, exchanges smiles with Dr. and Mrs. Wernher von Braun in Stockholm

STOCKHOLM—Russian scientists now reveal their Space Probe II, while circling the moon, established there were no radiation belts—which would prove that the moon has no magnetic field.

This disclosure came during the XIth Astronautical Congress held here recently, McGraw-Hill World News reports.

But the Reds said little else.

Only a few summaries of papers presented by the Soviet delegates were available. They mainly concerned probing of meteoric matter, radiation belts and similar investigations.

The United States, meanwhile, walked off with "proof-in-hand" honors by giving more tangible evidence of its space achievements. On display was a full-size replica of the Discoverer XIII capsule, first ever recovered from space.

One highlight of the sessions was Wernher von Braun's lecture on the U. S. space program and particularly the Saturn project. Von Braun said that the possible, future Saturn C2—to follow upon the C1 operational by 1964—would not only be capable of placing small manned space stations, cargo ships and propellant tankers into orbit, but could also place a shorter version of the space station into a circumlunar trajectory.

Such a manned circumlunar spaceship would have the same escape capsule as the space station, he said. Preliminary estimates indicate the manned spaceship would weigh about 15,000 lb (including 6,000 lb for the capsule with its in-

struments and control systems.)

This capsule may well be fitted with lifting devices for use during the reentry maneuver prior to the time the parachutes are deployed.

In addition to the 6,000-lb reentry capsule, 4,000 lb would be devoted to the "caboose", the section where the scientific payload, cargo, etc., would be carried.

Finally, some 5,000 lb would have to be allotted to a combination abort and midcourse control (and possibly reentry deceleration) propulsion system.

Ernst Stuhlinger, from Redstone Arsenal in Huntsville, another of the invited lecturers at the propulsion session made a comparison between electrical systems and conventional chemical ones, stressing that the former are still in their infancy but will certainly become of special interest.

He distinguished between three electrical systems: electrothermal, electrostatic and electrodynamic and said that the electrical methods of propulsion would be particularly important by transfer between different orbits and trajectories.

On the other hand, he said, chemical propulsion systems were to be preferred when defying gravity and propelling a vehicle from the surface of a planet out into space.

A team from the Lockheed Aircraft Corp. presented a paper on studies into a nuclearthermionic propulsion system.

A combination of a rather small reactor with a mass of 42 kg, a vacuum-diodes thermionic power generator and an ion motor with

germanium power transistors, would result in a total mass of the propulsion system without propellant weighing only 80 kg.

Interplanetary trajectory studies indicate, the authors said, that with 50 kg of propellant the system could transport 50 kg of payload to Jupiter in two years, starting from an orbit in the vicinity of the Earth.

A subject of less dramatic scope was that treated at the Small Sounding Rockets symposium. Six papers were read by Americans, but rocket research from other countries, including Belgium, India, Italy, Japan and the Netherlands, was also presented.

A common trend in most countries was the effort to cut the cost of sounding rockets and make them smaller although more efficient and capable of carrying a fairly large payload. India reported having tabulated comparative studies to show the efficiency of the smaller ones.

Scientist J. Gustavson of the Grand Central Rocket Co., Calif., submitted an analysis of the effects of important propulsion system parameters on performance. The calculations were made on relatively low-cost electronic computers.

Various University of Michigan scientists described experiments with aerodynamically stabilized sounding rockets.

A proposed autopilot system with only one moving part and weighing approximately 5-10 lb was said to be capable of controlling attitude of a 500-1,000-lb rocket during and after powered flight in a vacuum.

New Ground Radar Upgrades Hercules

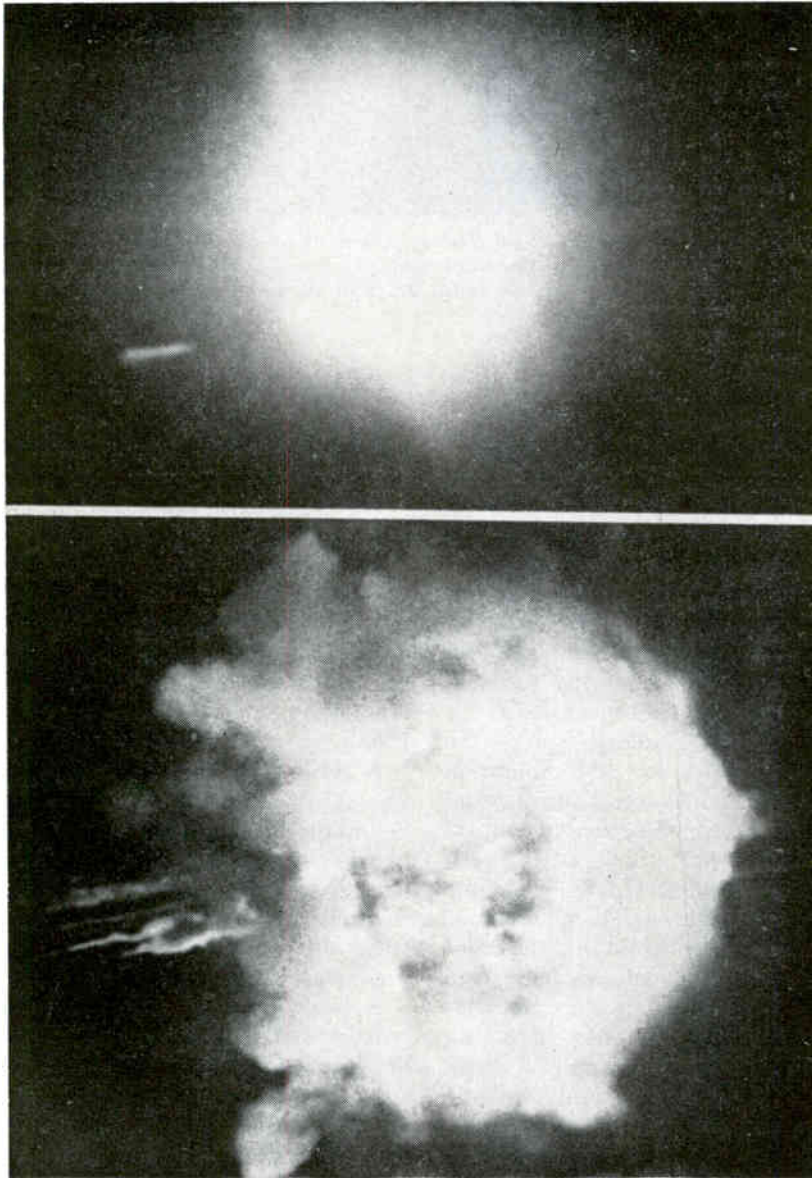

Nike-Hercules target missile (light streak left of explosion in top photo) moves into detonated attacking missile (another Hercules) and is destroyed

NIKE-HERCULES GAINED a stronger foothold in the nation's weapons arsenal recently when it successfully killed another ground-to-air Nike-Hercules in flight.

The Hercules target missile was fired from the northern end of the 100-mi White Sands Missile Range, New Mex., and the defending missile from the southern. The kill occurred some 32 miles from the southern end, 11 miles high. Rate of closure of the missiles was in excess of Mach 7.

Hercules' performance adds a new dimension to the weapon's ca-

pability; defense against air-to-ground missiles like Hound Dog. Earlier this summer, Hercules proved its ability to destroy field artillery ballistic missiles, when it knocked down a Corporal in ballistic flight.

The Hercules missile was originally designed to protect the U. S. against enemy bombers and is now deployed around major cities.

Responsible for reinforcing the Nike-Hercules' position as a continuing weapon system, and thus continuing business for its producers and suppliers, is improved

ground equipment for the missile.

Used in the White Sands test was the prototype of a high-power, long-range acquisition radar, called Hipar, that more than triples the defensive capabilities of the present Hercules system. The new radar was developed by the General Electric Heavy Military Electronics Dept. under a subcontract with the Bell Telephone Laboratories. Western Electric is prime contractor for the Hercules system, with Douglas supplying the missiles.

In addition to longer range, the high gain, narrow beam antenna used by Hipar provides high angle coverage. The extremely precise azimuth data obtained by Hipar permits the narrow beam target tracking radars built by Western Electric to lock on to high performance targets. Moving target indicator and receiver circuits are used with Hipar to counter jamming. A new multimegawatt klystron tube is used to produce the high power, pulsed r-f energy transmitted by Hipar.

GE has just received a new \$14,455,000 contract for production of Hipar.

Oil Company Brings Stereo to Mid-East

REGULARLY SCHEDULED STEREOCASTS now reach Arab listeners for the first time. Arabian American Oil Co. has started regular programs over the company's a-m and f-m network, as an employee service.

Stereocasts are made on one f-m and three a-m stations. A-M broadcasts are dual-frequency; the f-m uses one r-f channel at 99.7 Mc with the two sound channels multiplexed. Network uses Erco 100-w transmitters for a-m, with special modulation transformer for full a-m; and Gates 200-w for f-m.

Aramco is also planning electronic remote control of unattended gas-oil separator plants in Saudi oil fields. Under study are turbine metering of the pipeline flow with electronic counting and integration, and a process analyzer at the Ras Tanura refinery.

Design Engineers:

KEEP AHEAD WITH HAVEG

HAVELEX[®]

(formerly G. E. Mycalex)

Haveg's Precision Molded Rigid Inorganic Insulating Material offering these unique advantages

- Dimensional Stability
- 1000° F. Continuous Temperature Resistance
- Dielectric Strength
- Mechanical Strength
- Low Loss Factor
- Low Power Factor
- Arc Resistance
- No Moisture Absorption

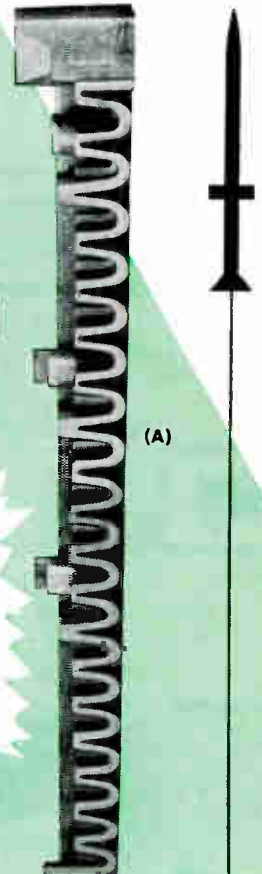
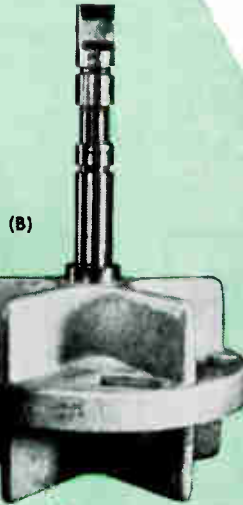
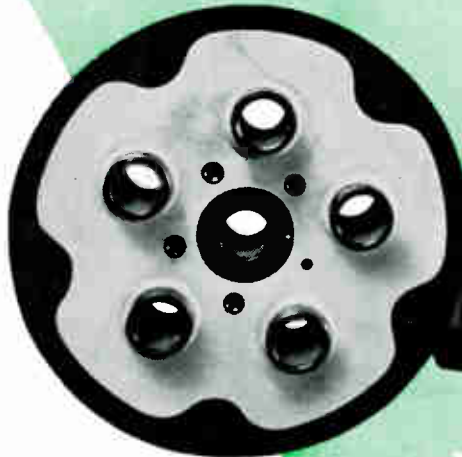
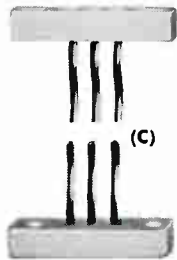

JUST ANNOUNCED

Haveg Industries has achieved a significant milestone in its Research and Development Laboratory with a new Havelex molding.

Five metal inserts (three terminals, a mounting post, and the outer ring) are hermetically sealed with the Havelex body. Engineers may now consider hitherto unexplored design concepts wherein intricate part designs and close tolerances offered by Havelex are enhanced with hermetically sealed metal inserts.

Recent noteworthy applications of Havelex pictured here are:

(A) Ianzler Components — air filter unit for home heating system.

(B) Disconnect Assembly nearly 5 inches in diameter with massive inserts — Havelex provides the electrical insulating "heart" of this disconnect device used in "on the ground" service to military jet aircraft. If for any reason the power disconnection is made while the aircraft is drawing its electrical power from the airport installation, an instantaneous disconnection is insured by this device; hence, protection against personnel injury or equipment damage.

(C) Transistor Test Socket — three stainless steel tubes (.010" wall) integrally molded into Havelex body. A key component in reliability testing of transistors in high ambient temperatures.

Havelex is composed of special glass reinforced with mica. Grey to white in color, this dense stone-like material provides an ideal insulator for wide ranges of ambient operating conditions and electrical stresses. The unusual combination of properties in Havelex plus Haveg's ability to provide precision molded tolerances and intricate shapes permit unlimited design possibilities. Complex metal inserts can be permanently molded in position, facilitating component assembly and assuring end product reliability.

Our forty years experience in custom molding Havelex to stringent specifications, include an extremely wide range of applications... such as Lightning Arrestors, Circuit Breakers, Potentiometers, Vacuum Tubes, Switchgear, Terminal Strips, Arc Barriers, Actuators, Armatures, and Transistor Test Sockets.

Haveg engineers welcome the opportunity to work with customers to assure the most efficient and economical component designs. For technical data on Havelex send for your copy of our new informative brochure.

Keep Ahead with

HAVEG[®]
FIRST IN *Engineered* PLASTICS

TAUNTON DIVISION
HAVEG INDUSTRIES, INC.
336 Weir Street • Taunton, Massachusetts

Other Operating Divisions: Blow Molding Division — Bridgeport, Connecticut • Chemical Materials Division — Wilmington, Delaware • Haveg Corporation — Wilmington, Delaware
Reinhold Engineering & Plastics Co., Inc. — Norwalk, California • American Super-Temperature Wires, Inc. — Burlington, Vermont • Hemisphere Products Corporation — Rio Piedras, Puerto Rico

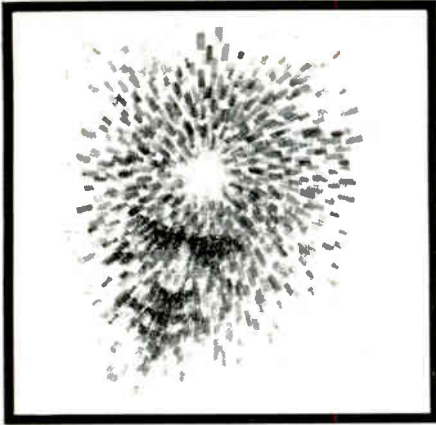

"TIMING UNLIMITED", VIA SOLID STATE ELECTRONICS

From subminiature logic blocks to complete programming and sequencing systems, Tempo applies advanced techniques of solid state electronics to the design and manufacture of precision timing devices and controls. The inherent flexibility of Tempo's unique Solid State Timing Module makes it possible to satisfy a wide range of timing requirements where precision and a high degree of reliability are of paramount importance.

FLASHERS

No-moving-parts design, available with a wide range of flashing rates, on time to off time ratios, accuracy ratings, and output types. Custom-engineered to meet specific application requirements.

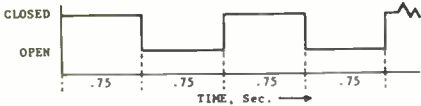

INTERVALOMETERS

Typical operation: 300 seconds after application of 28 vdc, output relay energizes. 3 seconds later, relay de-energizes. Cycle repeats itself until supply voltage is removed.

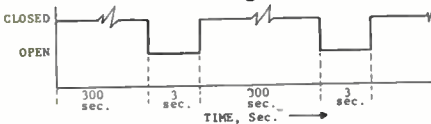

PROGRAMMERS

Available with combined functions of time delays, signal pulses, output switching, etc. Single unit can provide a complete timing and control program covering more than 5000 seconds from start.

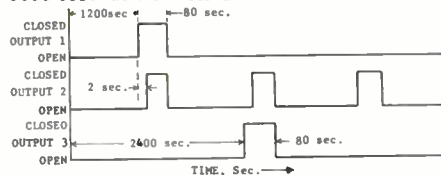

TIMING DESIGNS TO YOUR SPECS

The units shown above are typical — you are invited to submit your specifications for our review and preparation of appropriate engineering and cost proposals. Direct your inquiry to Tempo, or contact the Tempo Field Engineer nearest you.

TEMPO INSTRUMENT INCORPORATED
48 Commercial St., Hicksville, L. I., N. Y.

Photo Engineers Demand More Speed

Modern instrumentation requires nanosecond exposure times. Devices at meeting include high speed shutters

HIGHLIGHTING the Society of Photographic Instrumentation Engineers Convention at Los Angeles last month were demands for faster photographic techniques, more sensitive instrumentation, and reliable reconnaissance systems for outer space and underwater.

Mechanical shutters have maximum speed limits imposed by inertia of moving parts and time delays in actuators and linkages. Two electrooptical shutters, of different design, seem to have the best potential for ultrahigh speed operation, extending to nanosecond exposure times.

The Kerr cell is a hermetically sealed glass container filled with high-purity nitrobenzine in which two planar electrodes are immersed. The cell is placed between two polarizers, oriented to stop transmission of light. When about 35 Kv is applied across the cell electrodes, the direction of polarization of light from the first polarizer is changed, permitting it to pass through the second polarizer. The duration of transmission depends on the pulse duration. A Kerr cell developed by Electro-Optical Instruments Inc., Pasadena, Calif., has a 5 nanosec exposure time.

A second device, the stressed

plate shutter, is a mechanical analog of the Kerr cell. A glass plate is mounted between stacks of piezoelectric drivers. Voltage applied to the drivers causes them to expand or contract, stressing the glass plate, and altering the direction of polarization of light passing through the plate.

The shutter is mounted between two polarizers oriented to stop transmission. Although the speed of the stressed plate shutter is on the order of 100 microseconds, the voltage requirement is much lower than that of a Kerr cell. A shutter developed by Electro-Optical Systems, Inc., Pasadena, Calif., requires a 3,000 volt signal.

L. Frederick of Lowell Observatory reported that 70 percent of all astronomical investigations depend upon photoinstrumentation. He said the Carnegie Committee recommends that low-cost instrumentation be developed and made available to small astronomical laboratories that do not possess elaborate telescopes.

This recommendation highlights the importance of photo image intensifiers that have quantum efficiencies of 25 percent versus photographic film plate efficiencies of 0.1 percent. An image intensifier

Pair of Pooches are Space Pioneers

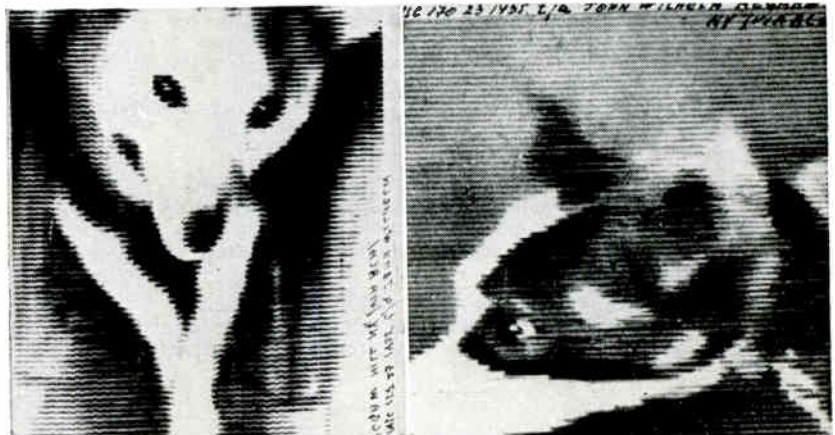

Photograph of tv monitor receiving transmission from the recently recovered Soviet orbiting menagerie spaceship

could increase the speed of a small research telescope up to 16 fold.

Dr. Frederick and his associates have constructed an inexpensive phosphor-window cathode - type image intensifier using single and multiple electrostatic stages. Resolution of the tube operating at 12 to 25 Kv is 56 lines per mm visually or 36 lines per mm on Kodak Plus-X film.

A new Ansco automatic recording microdensitometer was suggested for astronomical photoinstrumentation. The device can measure the size of a star image to determine the star's brightness. Other applications include determination of the width of cathode-ray tube scan lines as a function of brightness, and measurement of transient phenomena displayed on an oscilloscope.

Future outer space and underwater studies will depend heavily on electronic photoinstrumentation. The cancellation of U-2 reconnaissance flights make the development of sensitive satellite reconnaissance systems a necessity.

Over 1,000 of the 6,000 photographs taken by the twin tv cameras of the Tiros satellite were described as good, and could be used for reconnaissance.

Recent photographs of the ocean bottom taken at 19,000 feet below sea level appeared similar to photographs taken by Tiros. Undersea reconnaissance systems using high intensity light sources and tv cameras have been suggested for use with bathyscaphs for future hydro-space underwater research.

Geomagnetic Log to Provide True Speed

GEOMAGNETIC LOG will be developed by Edo Corp., College Point, L. I., to record the speed of vehicles over the ground or, in the case of ships, over the bottom. Navy is funding the development contract.

Although details are classified, it is known that the log will electronically determine true velocity in relation to the earth's surface and magnetic field. Edo's device will provide the ship or aircraft navigator with instantaneous indication of actual true speed, unaffected by wind or water currents.

Another in a series of thoughtful observations on the topic of Time

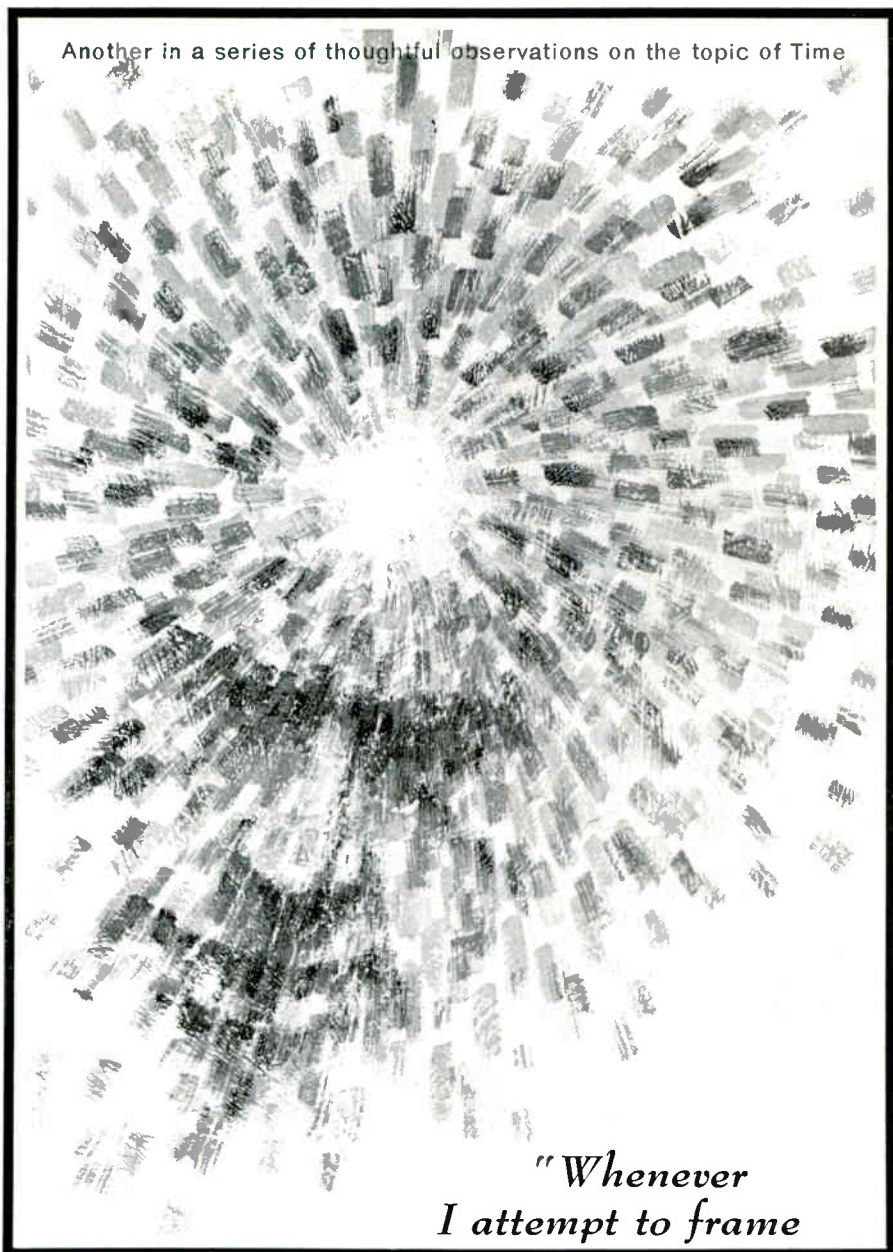

*"Whenever
I attempt to frame*

*a simple idea
of Time,
abstracted
from the succession of ideas
in my mind,
I am lost and embrangled
in inextricable
difficulties"*

GEORGE BERKELEY, English Metaphysical Philosopher, 1685-1753

TEMPO INSTRUMENT INCORPORATED, HICKSVILLE, L.I., NEW YORK
DESIGN AND MANUFACTURE OF PRECISION ELECTRONIC TIMING DEVICES AND CONTROLS



More Grants for Universities

FEDERAL GOVERNMENT continues to finance the biggest share of research and development costs carried on by engineering schools as academic year 1960-61 gets under way, according to latest reports on research grants.

The government gave U. S. engineering schools \$48.6 million of the total \$71 million they spent for sponsored research and development during 1958, says the National Science Foundation.

A comprehensive Foundation survey of 129 schools revealed that industrial sources contributed \$10.3 million to the total. Schools spent \$10.5 million of their own funds on R&D, plus an additional \$3.5 million to cover indirect costs of outside grants and contracts.

UNIVERSITY OF MICHIGAN researchers are measuring the star-like twinkle caused by air turbulence effect on a powerful light beamed across Lake Michigan, to help study evaporation losses from the Great Lakes.

Variations in wind and water temperatures cause variations in intensity of the light as it crosses a mile and a half of lake to reach the lens of telescope located on a point of land below the city. A photocell at the rear of the scope translates these fluctuations into graphic form.

Readings from instruments stationed in the light's path will be correlated with the graphic fluctuations in this new data-gathering technique, usable almost anywhere over water. Mathematical formulas considering molecular transfer between air and water will help evaluate findings.

U. S. AIR FORCE has awarded 39 contracts and 19 grants totaling \$3,958,821 since June 1 for basic scientific research to universities, nonprofit institutions and industrial laboratories in the United States and South America, according to Col. A. P. Gagge, commander of Air Force Office of Scientific Research. AFOSR has also negotiated contracts for other

defense department agencies—three with **University of California** at Berkeley for a total of \$924,113; one with **California Institute of Technology** for \$395,193 and one with **University of Michigan** for \$200,000.

NATIONAL SCIENCE FOUNDATION has awarded grants totaling \$2,153,710 to 54 colleges and universities to help improve their graduate research laboratories, according to Alan T. Waterman, director of NSF. Grants have been made to alleviate obsolescence and inadequacy and to help schools keep pace with rapid growth of graduate science and engineering enrollments and the complexities of modern science, Waterman said. Institutions must provide at least 50 percent of funds needed to construct, convert or modernize laboratory facilities, according to terms of the grants.

POLYTECHNIC INSTITUTE OF BROOKLYN has received a \$700,000 grant from the Ford Foundation to establish a new honors program in science and engineering. Exceptional students may receive their doctorates in six years of full time study under the new program, compared to eight to ten or more years it presently takes for science and engineering students to receive doctorates. Approximately six percent of the Institute's September freshman class will be enrolled in the new program, according to Polytechnic president Ernst Weber.

UNIVERSITY OF COLORADO faculty members Frank S. Barnes, Donald G. Burkhard and Masataha Mizushima have received a \$40,795 research grant from the U. S. Army Signal Corps to investigate the feasibility of developing a new frequency standard in the regions from 100 to 400 Gc. Using electrical resonance in molecules, the proposed instrument could be as much as ten times more accurate than present atomic frequency standards.

S
E
E
I
T
I
L
I
B
A
P
A
C
A
H
A
P
H
A
L
L

Systems competence in design, implementation, structural construction, installation, operation, training, and maintenance of:

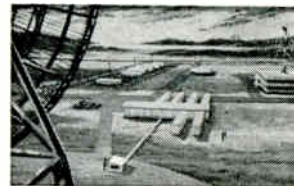

1. Space surveillance systems



2. Transportable electronics systems



3. Instrumentation, control, and switching systems



4. Telecommunications systems

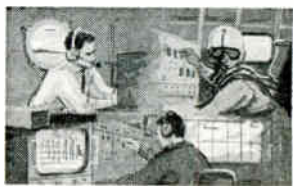

5. Integrated land, sea, and air communications systems



6. Data systems



CABLE • ALPHA DALLAS
CIRCLE 50 ON READER SERVICE CARD
electronics



Alpha provides positive systems project execution

Alpha's Project Executive deals directly with the customer and has complete authority, responsibility, and accountability for the timely execution of the project. This unique organization structure provides complete coordination of systems management and engineering within the assigned project division. It provides your executive and Alpha management with quick, direct access to the facts on project status and performance.

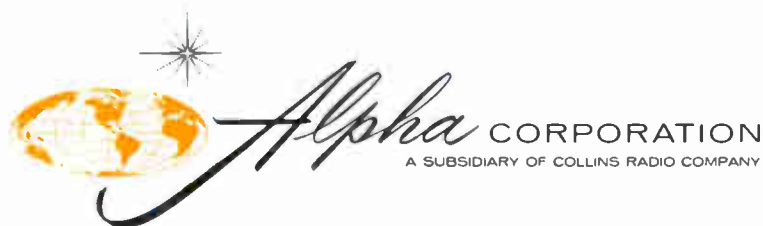

SYSTEMS DESIGNERS, ENGINEERS, CONSTRUCTORS, WORLD-WIDE • RICHARDSON, TEXAS • TELEPHONE DALLAS ADams 5-2331

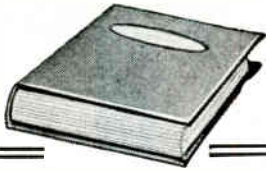

ANALOG COMPUTATION IN ENGINEERING DESIGN

Just Out. Practical working reference for solving problems in engineering design with modern analog computers. Shows how computers are efficiently and economically applied to a wide range of industrial fields—chemical processes and process control, feedback-control systems, nuclear reactors, problems involving statistical phenomena, and other vital areas. By A. E. Rogers, Electronic Associates, Inc.; and T. W. Connolly, Sperry Gyroscope Co. 450 pp., 275 illus., \$16.00

BASIC MATHEMATICS FOR ELECTRONICS

Just Out—2nd Ed. Covers fundamental mathematics applied specifically to electric and electronic circuits. Includes a review of basic arithmetical computations, and takes up algebra, trigonometry, and logarithms. Relates these mathematical processes directly to electrical and electronic applications. By N. Cooke, President, Cooke Engineering Co. 2nd Ed., 785 pp., 348 illus., \$10.75

WAVE GENERATION AND SHAPING

Just Out. Gives you the essential features and techniques of practical wave-generating and -shaping circuits. It applies break point analysis and time sequential solutions to nonlinear circuits—permitting the use of transistors and tubes almost interchangeably. By Leonard Strauss, Polytechnic Institute of Brooklyn. 516 pp., 456 illus., \$12.50.

Proceedings of the Fifth Conference on

MAGNETISM AND MAGNETIC MATERIALS

Just Out. Describes recent work in magnetism performed in such fields as physics, chemistry, metallurgy, and crystallography. Topics range from simple test techniques for the evaluation of materials, to metallurgical and physical principles in magnetic materials, and sophisticated theoretical studies. Spons. by Am. Inst. of Elec. Eng. 419 pp., 310 illus., \$10.00

Proceedings of the Fourth Conference on MAGNETISM AND MAGNETIC MATERIALS. Spons. by Am. Inst. of Elec. Eng. 323 pp., 233 illus., \$10.00

See These Books 10 Days Free

McGraw-Hill Book Co., Inc., Dept. L-9-9
327 W. 41st St., N.Y.C., 36

Send me book(s) checked below for 10 days' examination on approval. In 10 days I will remit for book(s) I keep, plus few cents for delivery costs, and return unwanted book(s) postpaid. (We pay delivery costs if you remit with this coupon—same return privilege.)

- Rogers & Connolly—Analog Comp. in Eng. Design, \$16.00
- Cooke—Basic Math. for Elec., \$10.75
- Strauss—Wave Generation & Shaping, \$12.50
- AIP—5th Conf., Magnetism & Magnetic Materials, \$10.00
- AIP—4th Conf., Magnetism & Magnetic Materials, \$10.00

(PRINT)

Name

Address

City Zone State

Company

Position

For price and terms outside U. S. write McGraw-Hill Int'l., N. Y. C.

L-9-9

MEETINGS AHEAD

Sept. 9-10: Communications: Tomorrow's Techniques—A Survey, IRE, Roosevelt Hotel, Cedar Rapids, Ia.

Sept. 13-14: Bionics Symposium, Applying Biological Principles to Engr. Design, ARDC, Wright Air Devel. Div., Dayton Biltmore Hotel, Dayton, O.

Sept. 14-15: Industrial Electronic Test Equipment Symposium, Armour Research Foundation, Chicago.

Sept. 15-16: Engineering Management Conf., IRE, Morrison Hotel, Chicago.

Sept. 15-17: Upper Midwest Electronic Conf., Twin Cities Elec. Wholesalers, Civic Auditorium, Minneapolis.

Sept. 19-21: Data Transmission, International Symp., PGCS of IRE and Sectie Voor Tele. of Koninklijk Ins. van Ingonieurs, Delft, Neth. Contact B. B. Barrow, Benelux Section, IRE, Postbus 174, Den Haag, Nederland.

Sept. 19-22: Space Electronics and Telemetry, Nat. Symposium, Shoreham Hotel, Washington, D. C.

Sept. 21-22: Industrial Electronics, Annual, PGIE of IRE, AIEE, Sheraton-Cleveland Hotel, Cleveland.

Sept. 23-24: Broadcasting Symposium, PGB of IRE, Willard Hotel, Washington, D. C.

Sept. 23-25: Hi-Fi, Home Entertainment Show, Palmer House, Chicago.

Sept. 26-30: Instrument-Automation Conf. and Exhibit of 1960, ISA Annual Meeting, Coliseum, New York City.

Sept. 27-30: Space Power Systems Conference, ARS, Miramar Hotel, Santa Monica, Calif.

Sept. 27-Oct. 1: Electrostatic Forces and Their Applications, Laboratoire D'Electrostatique et Physique du Metal, Institut Fourier, Place du Doyen-Gosse, Grenoble, France.

Oct. 10-12: National Electronics Conf., Hotel Sherman, Chicago.

12

TRANSISTORS REPLACED BY

2

2N698-2N699 from FAIRCHILD

EAST

CRAMER ELECTRONICS INC.
811 Boylston St., Boston 16, Massachusetts
Copley 7-4700, WUX: FAX Boston, Mass.

PHILA. ELECTRONICS, INC.
1225 Vine St., Philadelphia 7, Pennsylvania
LOcust 8-7444

SCHWEBER ELECTRONICS
60 Herricks Road, Mineola, L. I., New York
Pioneer 6-6520, TWX: G CY NY 580

VALLEY ELECTRONICS INC.
1735 East Joppa Road, Towson, Maryland
VALley 5-7820, TWX: TOWS 564

VALLEY INDUSTRIAL ELECTRONICS,
INCORPORATED
1417 Oriskany Street W., Utica, New York
RANDolph 4-5168, WUX: FAX Utica, New York

EASTERN SALES OFFICES

JENKINTOWN, PENNSYLVANIA
100 Old York Road, Turner 6-6623
TWX: JENKINTOWN PA 1056

WASHINGTON 6, D. C.
1027 Cafritz Building, National 8-7770

GARDEN CITY, L. I., NEW YORK
600 Old Country Road, Pioneer 1-4770
TWX: G CY NY 5391

SYRACUSE, NEW YORK
731 James Street, Room 304, Granite 2-3391
TWX: SS 94

MARBLEHEAD, MASSACHUSETTS
19 Preston Beach Road
NEptune 1-4436

SOUTH

SCHWEBER ELECTRONICS, FLORIDA
P. O. Box 1491, Melbourne, Fla.
PARKway 3-4461

CENTRAL

SEMICONDUCTOR DISTRIBUTOR
SPECIALISTS, INC.
5706 West North Avenue, Chicago 39, Illinois
National 2-8860

CENTRAL SALES OFFICE

OAK PARK, ILLINOIS
6957 West North Avenue, Village 8-5985
TWX: OAK PARK 2820

WEST

HAMILTON ELECTRO SALES
12308 Wilshire Blvd., Los Angeles 25, Calif.
EXbrook 3-0441, BRadshaw 2-8453
TWX: W LA 66 37

KIERULFF ELECTRONICS INC.
820 West Olympic Blvd., Los Angeles 15, Calif.
Richmond 8-2444, TWX: LA 46

SCHAD ELECTRONIC SUPPLY, INC.
499 South Market St., San Jose 13, Calif.
CYpress 7-5858

WESTERN SALES OFFICES

LOS ANGELES 46, CALIFORNIA
8833 Sunset Boulevard, OLeander 5-6058
TWX: BV 7085

MOUNTAIN VIEW, CALIFORNIA
545 Whisman Road, YOrkshire 8-8161
TWX: MN VW CAL 853



CIRCLE 201 ON READER SERVICE CARD
electronics

12

TRANSISTORS
REPLACED BY

2

SMALL SIGNAL SILICON "MESAS"



FROM FAIRCHILD

Improve your small-signal performance, simplify specifying, and get the inherent advantages of the Fairchild silicon mesa configuration — greater mechanical and electrical reliability; tighter control of parameter spreads; minimal saturation resistance; high frequency capabilities.

Why carry twelve separate small-signal transistors and specifications in stock and on file? Just two types — the 2N698 and 2N699 from Fairchild — offer superior characteristics in every parameter.

SMALL-SIGNAL PARAMETERS, FAIRCHILD 2N698 AND 2N699 SILICON MESA TRANSISTORS.

| | $I_E=1\text{mA}, V_C=5\text{V}, f=1\text{kc}$ | | $I_E=5\text{mA}, V_C=10\text{V}, f=1\text{kc}$ | | |
|-----------------------|---|------|--|------|----------------------|
| | MIN. | MAX. | MIN. | MAX. | |
| 2N698 - h_{fe} | 18 | 60 | 20 | — | |
| 2N699 - h_{fe} | 35 | 100 | 45 | — | |
| 2N698 and 2N699 | h_{ib} | 20 | 30 ohms | — | 10 ohms |
| | h_{rb} | — | 250×10^{-6} | — | 300×10^{-6} |
| | h_{ob} | 0.1 | 0.5 | — | $1.0 \mu\text{ mho}$ |



A wholly owned subsidiary of
Fairchild Camera and Instrument Corp.

545 Whisman Road / Mountain View, Calif. / Yorkshire 8-8161



“WOW!”

**Waters new PT $\frac{3}{4}$ meets MIL-R-19A
and MIL-R-19/1A at half the cost!”**

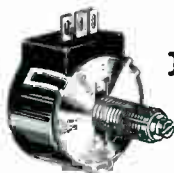

At less than half the cost of the only other comparable unit, Waters introduces a new $\frac{3}{4}$ " plastic case pot completely meeting MIL-R-19A and MIL-R-19/1A specifications! A true military pot at a commercial pot price! "O" ring shaft seal and complete internal sealing virtually eliminate humidity, salt spray and similar environmental problems. Provides the same protection as encapsulation in less space. Resistance range (ohms), $\pm 5\%$, 1 to 20,000. Electrical and functional rotation, 355° without stops; 300° with stops. Dissipates 1.5W at 40°C. Torque, .3 to 6 oz./in. Weight, .02 lbs. Available with split or plain bushings, $\frac{1}{4}$ " or $\frac{3}{8}$ " in diameter. Write for Bulletin PT 760.



POTENTIOMETERS • COIL FORMS • POT HOOK® PANEL MOUNTS • TORQUE WATCH® GAUGES • C'TROL® METER/CONTROLLER • INSTRUMENTS

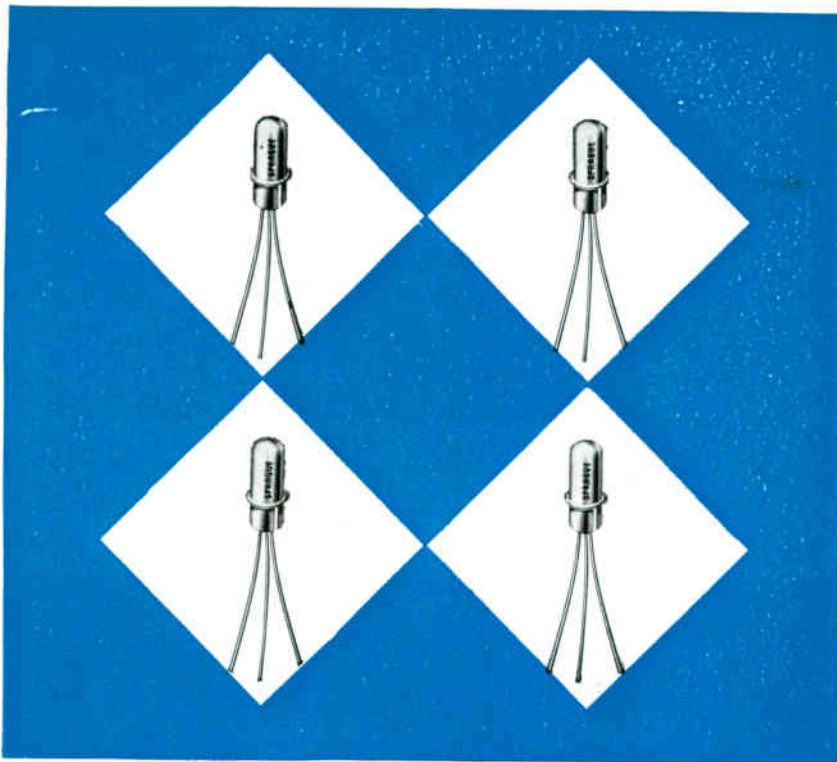

AVAILABLE NOW IN MASS PRODUCTION

- the highest r-f operating frequency
- the fastest switching time
- storage temperatures up to 100°C

YOU CAN GET SPRAGUE* MADT® TRANSISTORS AT SENSIBLE PRICES

Sprague Germanium Micro-Alloy Diffused-Base Transistors, well-known for their rugged vhf performance, are now *priced below other transistors* with comparable electrical characteristics. In many areas, this permits designers to improve circuit techniques without necessarily increasing costs. Expanded production facilities enable us to *ship quantity orders on short notice*. Add to this their *ultra-fast switching time*, and you have three good reasons why Sprague MADT® Transistors have achieved their high level of acceptance.

With Sprague Transistors, circuits in vhf amplifiers and oscillators can now operate with collector currents as high as 50 ma . . . with power dissipation up to 50 mw . . . with collector to base voltages to 15 v. They have been application tested through the entire military electronics vhf spectrum.

The application table may well suggest the use of one or more Micro-Alloy Diffused-Base Transistor types in your latest circuit designs.

For complete engineering data on the types in which

• • •

**Sprague micro-alloy, micro-alloy diffused-base, and surface barrier transistors are fully licensed under Philco patents. All Sprague and Philco transistors having the same type numbers are manufactured to the same specifications and are fully interchangeable.*

SPRAGUE COMPONENTS:

CAPACITORS • RESISTORS • MAGNETIC COMPONENTS • TRANSISTORS • INTERFERENCE FILTERS • PULSE NETWORKS
HIGH TEMPERATURE MAGNET WIRE • CERAMIC-BASE PRINTED NETWORKS • PACKAGED COMPONENT ASSEMBLIES

MICRO-ALLOY DIFFUSED-BASE TRANSISTOR APPLICATIONS

| Type | Application |
|--------|---|
| 2N499 | Amplifier, to 100 mcs |
| 2N501 | Ultra High Speed Switch (Storage Temperature, 85 C) |
| 2N501A | Ultra High Speed Switch (Storage Temperature, 100 C) |
| 2N504 | High Gain IF Amplifier |
| 2N588 | Oscillator, Amplifier, to 50 mcs |

you are interested, write Technical Literature Section, Sprague Electric Co., 35 Marshall St., North Adams, Massachusetts.

You can get off-the-shelf delivery at factory prices on pilot quantities up to 999 pieces from your local Sprague Industrial Distributor.

SPRAGUE®
THE MARK OF RELIABILITY



For more than a quarter century, Hallicrafters has worked in close partnership with our armed forces on fast solutions to critical military electronics problems. Out of this priceless experience are emerging startling new ideas and hard-hitting, fast-moving techniques to keep our country one jump ahead in electronic warfare . . .



B-52 and other military aircraft will be protected by the most potent Electronic Countermeasures equipments yet devised. These equipments were developed in close teamwork with the Air Force under Hallicrafters' QRC (Quick Reaction Capability) program. Now qualified to meet full environmental specifications, they are in quantity production.



New levels of speed and efficiency are being reached in equipment modernization, retrofit and technical support programs with Hallicrafters' radical new "Blue Streak" project. Specially-trained Maintenance and Technical Support Teams, close-knit and flexible, can be tactically deployed to accomplish maintenance, installation and testing of electronics weapons systems anywhere in the world.

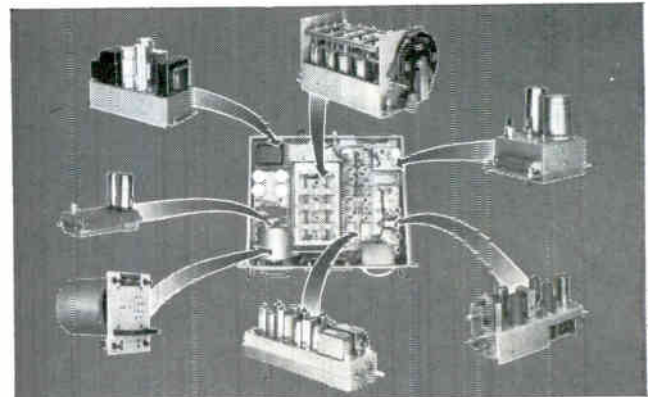

Hallicrafters communications leadership is exemplified by new high frequency Single Sideband receiver, (model no. SX-116). 100% modular design permits simple modification for compatibility with existing and future communications systems. Stability, with proper available plug-ins, is better than one part in 10,000,000 per month. Hallicrafters also offers an existing capability in receiving and transmitting techniques up to frequencies of 50,000 megacycles.



Hallicrafters participation in the Atlas missile project helped to develop capability for many areas of the complex missile field, including code translator data systems; ground support equipment; ECM testing and antenna systems. Current explorations involve latest Infra Red techniques.

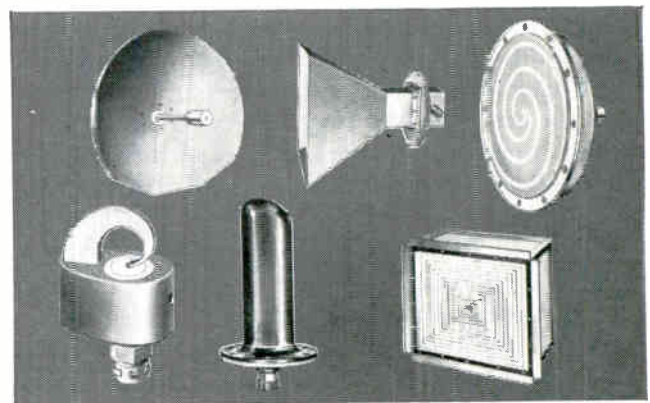

Airborne antennas and micro-wave components with power capability in excess of 1,000 watts, can be made available to solve tomorrow's very high power handling requirements. Testing of microwave components is possible with special high power generators, designed and built by Hallicrafters.

Looking for a challenging new opportunity? We are interested in qualified engineers at all levels. For full details in confidence, contact William F. Frankart, Director of Engineering.

For further information on Hallicrafters facilities and experience in military electronics research, development and production, please write to:

hallicrafters  company

Military Electronics Division,
Chicago 24, Illinois



RELIABILITY

IS AN OUTSTANDING CHARACTERISTIC OF ALSIMAG[®] CERAMICS

AlSiMag Ceramics offer exceptional resistance to heat and erosion. They have marked electrical and physical stability at elevated temperatures and in varying environments. Chemically inert. Good strength. Can be accurately fabricated in micro-miniatures.

AlSiMag Ceramics include many special purpose ceramics, some especially adapted to hermetic sealing. Widest choice of materials, more than half a century of specialized experience. Send blue print and operating conditions.

AlSiMag pioneered micro-miniature ceramics . . . some as thin as 0.005". Relatively high strength, superior performance at high temperatures, high frequencies. Excellent record for withstanding fatigue, heat, shock, vibration.

The AlSiMag Ceramics in these multiple pin headers may be safely used up to 2800°F. The metal components are the limiting factors.

These tantalum pins with nickel braze alloy operate around 1000° F. All materials are rugged. Strong hermetic seal. Low vapor pressure. High temperature bake-out is practical.

A Subsidiary of
Minnesota Mining and
Manufacturing Company



**AMERICAN LAVA
CORPORATION**

CHATTANOOGA 5, TENN.
58TH YEAR OF CERAMIC LEADERSHIP

For service, contact American Lava representatives in Offices of Minnesota Mining & Manufacturing Co. in these cities (see your local telephone directory): Boston, Newton Center, Mass. • Chicago, Bedford Park, Ill. • Cleveland, O. • Dallas, Texas • Los Angeles, Cal. • New York • Ridgefield, N. J. • Philadelphia, Pa. • St. Louis, Mo. • St. Paul, Minn. • San Francisco, Cal. • Seattle, Wash.
All other export: Minnesota Mining & Manufacturing Co., International Division, 99 Park Ave., New York, N. Y.



NOW! WESTINGHOUSE IN FULL PRODUCTION ON FAMILY OF TUNABLE X-BAND MAGNETRONS

Westinghouse announces a family of tunable X-Band Magnetrons available now for airborne radar service—and new production facilities to meet your requirements at all times. These high-performance magnetrons feature improved stability, minimum frequency drift, excellent spectrums, high efficiency and low voltage operation. The new family not only features Type WL-7008, but also includes Types 7110, 7111, 7112 and 6865A. Some of their typical performance characteristics are as follows:

- Frequency range: 8500 to 9600mc
- Peak power output: 220 Kilowatts
- Pulse widths: up to 2.8 microseconds
- Heater voltage: 13.75 volts
- Frequency range excursion: 7 seconds at 1500 rpm shaft speed

For full information, contact your nearest Westinghouse industrial tube representative, or write: Westinghouse Electric Corporation, Electronic Tube Division, Elmira, N.Y.



YOU CAN BE SURE...IF IT'S **Westinghouse**
Electronic Tube Division Elmira, N.Y.

NEW! from ELECTRO INSTRUMENTS

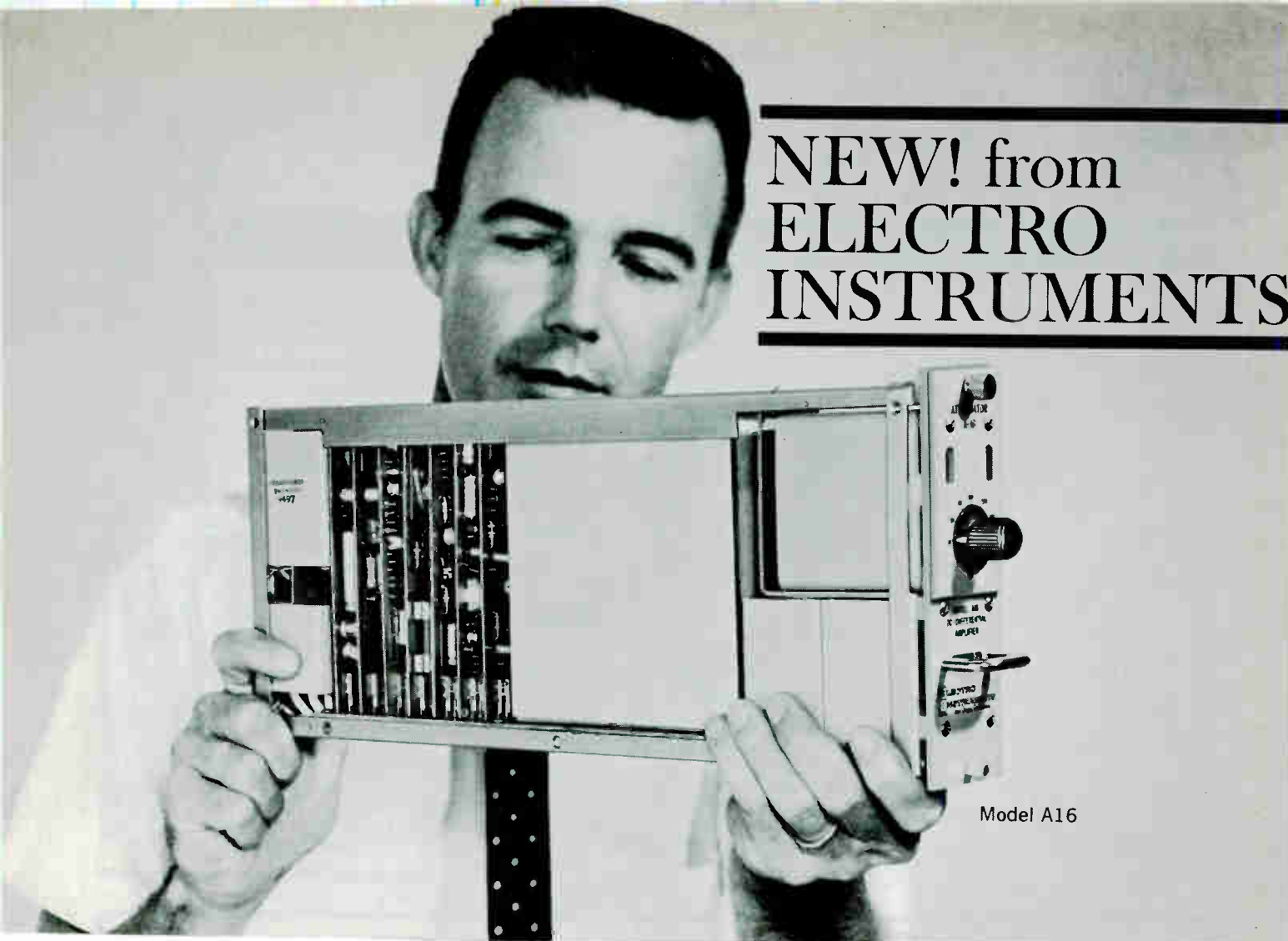

Model A16

8 fit into a 19" rack!

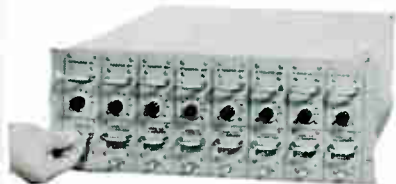

A WIDEBAND DIFFERENTIAL AMPLIFIER

that combines wide bandwidth, high common mode rejection, and high input impedance!

NOW 4 precision, low level, wideband DC instruments to meet every amplifier requirement!

Entirely new in concept and design this new family of "second generation" instruments provides more of everything you want in precision, low level, wideband DC amplifiers. New design techniques represent major breakthroughs in all areas of amplifier design. Performance and versatility are unmatched. Circuits are totally transistorized to eliminate heat dissipation problems, to assure high reliability, and to minimize size and weight. Plug-in, etched circuit boards and internal modular construction simplify troubleshooting and eliminate lengthy downtimes. An actual comparative maintenance report by a major ICBM manufacturer showed the operational

reliability record of EI amplifiers to be better than competitive instruments by 8 to 1!

Let your EI field engineer show you how this new family of amplifiers can meet your needs. EI's nationwide staff of factory sales and service men assures you of the most for your money—before, during and after the sale.

Model A14—For operational, computer and control system applications. Operates at gains of from 1 to 100 with 0.01% stability.

Model A15—A general-purpose, single-ended or differential amplifier with a noise level less than 3 microvolts rms

wideband over the gain range of 10 to 1000.

Model A16—A wideband differential amplifier that combines a 3 microvolts rms noise level, 120 db common mode rejection at 60 cps with up to 1,000 ohms unbalance in either line, DC to 50 KC bandwidth and 100 megohms input impedance.

Model A17—A low-cost, wideband differential amplifier with basically the same performance as the Model A16, including high 160 db common mode rejection at DC. Gain of 1 to 100. Substantial saving in cost through a reduction in input impedance.

Write for new EI Amplifier catalog!

Electro Instruments, Inc.



3540 AERO COURT,
SAN DIEGO 11, CALIF.



PRECISION ILLUMINATION WITH A. C. M. I. MINIATURE LAMPS

HOODED TYPE LAMPS

OPEN TYPE LAMPS

All A.C.M.I. miniature lamps are made to the most meticulous standards of physical dimension and candlepower, and can be relied on for excellent illumination and reliable service.

Miniature lamps are available in sizes from .036" to 1.125" in diameter and in voltages from 1.5 volts to 48 volts.

We invite inquiries for all types of miniature lamps. You can be sure of precision illumination with A.C.M.I. miniature lamps.

American Cystoscope Makers, Inc.

Producers of the world's smallest miniature lamps

8 PELHAM PARKWAY
PELHAM MANOR, N. Y.

FREDERICK J. WALLACE, President



CIRCLE 206 ON READER SERVICE CARD

GREAT BRITAIN & EUROPEAN ELECTRONIC SALES

Well known British electronics company, wishes to contact leading manufacturers to arrive at an exclusive sales arrangement.

We are particularly interested in the sale of laboratory instruments and digital devices for research, production and servicing purposes. We have production and assembly facilities available should they be required.

Manufacturers interested in being represented are requested to contact the advertiser with full information on their product lines.

MICROCELL LTD. *ELECTRONICS DIVISION*

BLACKWATER, Nr. CAMBERLEY, SURREY, ENGLAND



MODELS AND PRICES

(Digits preceding dash in model number indicate output voltage; those following, indicate current.)

| 2 WATT | | 4 WATT | | 8 WATT | | 15 WATT | | 30 WATT | |
|------------|-------|------------|-------|-------------|-------|------------|-------|-------------|-------|
| QM 3.0-.66 | \$115 | QM 3.0-1.3 | \$130 | QM 3.0-2.6 | \$170 | QM 3.0-5.0 | \$210 | | |
| QM 4.4-.45 | 95 | QM 4.4-.90 | 120 | QM 4.4-1.8 | 160 | QM 4.4-3.5 | 195 | | |
| QM 6.3-.32 | 80 | QM 6.3-.64 | 108 | QM 6.3-1.28 | 140 | QM 6.3-2.4 | 176 | QM 6.3-4.75 | \$212 |
| QM 9.0-.22 | 78 | QM 9.0-.44 | 105 | QM 9.0-.88 | 137 | QM 9.0-1.7 | 172 | QM 9.0-3.33 | 207 |
| QM12 -.16 | 76 | QM12 -.32 | 102 | QM12 -.64 | 134 | QM12 -1.25 | 168 | QM12 -2.56 | 202 |
| QM16 -.13 | 74 | QM16 -.25 | 100 | QM16 -.50 | 131 | QM16 -.94 | 164 | QM16 -1.87 | 197 |
| QM21 -.10 | 72 | QM21 -.19 | 98 | QM21 -.38 | 128 | QM21 -.71 | 160 | QM21 -1.43 | 195 |
| QM28 -.07 | 70 | QM28 -.14 | 95 | QM28 -.28 | 125 | QM28 -.53 | 160 | QM28 -1.07 | 195 |
| QM36 -.06 | 70 | QM36 -.11 | 95 | QM36 -.22 | 125 | QM36 -.43 | 160 | QM36 -.83 | 195 |

Intermediate voltages available at slightly higher cost.

Fits in like a midget... regulates like a giant

... and now 7 new Sorensen QM's give you **43 models to choose from!**

These compact completely transistorized d-c power supplies regulate to $\pm 0.05\%$ for line and load variations—and solder right into your equipment to save you engineering and production costs.

They're Sorensen QM series, highly-regulated, miniature d-c supplies. These compact, completely tubeless units are packaged to mount in your equipment like a standard component. They feature instant starting, extremely low ripple (1 mv max) and fast response. They work equally well on 50, 60 or 400 cps input. See table for standard voltages, currents and powers.

Every component is selected and rated for maximum reliability under continuous duty—can't be damaged by momentary overloads or output shorts.

You'll find further data on QM supplies in Sorensen's 32-page "Power Supply Handbook and Catalog"... plus specifications on more than 400 other d-c power supplies, a-c line voltage regulators, frequency changers (variable frequency power sources), and high-voltage (to 600kv) a-c and d-c supplies. Write for your copy today.

Sorensen & Company, Richards Ave., South Norwalk, Conn.

0.32

Sorensen CONTROLLED
POWER
PRODUCTS

A SUBSIDIARY OF RAYTHEON COMPANY

...THE WIDEST LINE MEANS THE WISEST CHOICE

Here's why the NEW AO TRACE-MASTER is the world's finest 8-channel direct writing recorder!

American Optical Company, famous for precision instrumentation for 138 years, introduces an electronic direct-writing recorder of unique design, in which ultra-precise electromechanics has been combined with advanced electronics to achieve *truly superior performance*.

Finest Writing Method Ever

Unique direct-carbon-transfer writing method. Trace is uniformly black and up to four times thinner than that made by any other recorder. Minute variations in phenomena measured are more faithful, meaningful. Carbon trace cannot fade... may be easily reproduced.

Finest Frequency-Amplitude Performance

TRACE-MASTER'S multiple-feedback wide-range Driver circuitry, combined with the advanced pen-motor design, produces wider frequency response at larger amplitudes than any other recorder. TRACE-MASTER response is flat—within 1%—from dc to 110 cps at 40 mm!

Band Amplitude Product (i. e. Bandwidth times Amplitude) is 5600...140 cps (3 db point) x 40mm!

Finest Chart-Drive Facilities

TRACE-MASTER provides widest chart-speed range...0.1 to 500 mm/sec...of any direct-writing recorder! Convenient

push-button selection. Take-up reel automatically stores full 1000 ft. record. Writing table tilts for easy chart annotations. Guide rails permit quick, easy paper-roll changes. Low cost chart paper makes practical protracted recording at high speeds.

Finest Resolution, Linearity, Stability

Thin carbon trace (thinner by 4 to 1 over most recorders) and high Band Amplitude Product (higher by 6 to 1 over other recorders) provide up to 24 times the resolving power or ability to detect short, sharp variations in the record. The superior linearity ($\pm 1\%$) and stability in rectilinear presentation permit full use of this unexcelled resolution.

Finest Systems Oriented Compatibility

Fully transistorized circuitry...application of combined dc level and signal multiple feedback...complete interchangeability of modular signal-conditioning elements... are some of the features that make the AO TRACE-MASTER the world's finest 8-channel direct writing recorder.

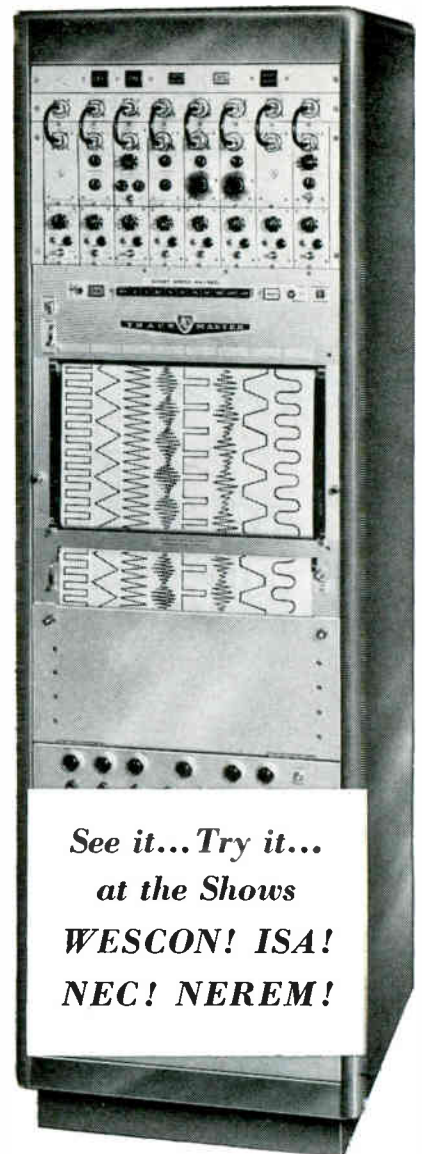

Entire channel easily accessible and completely interchangeable as single unit.

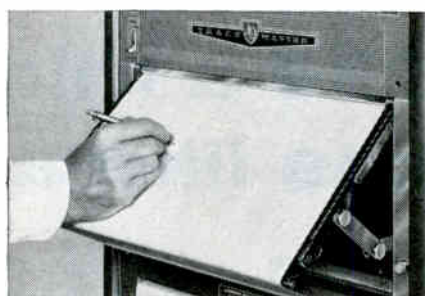

Platen tilts to convenient writing angle.

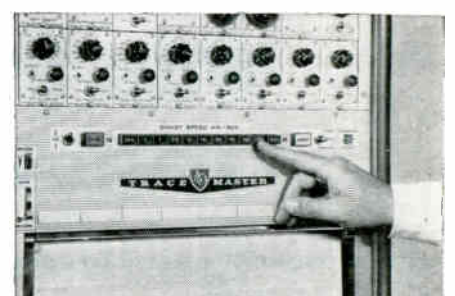

Widest range chart speed... push-button selection through 0.1 mm/sec to 500 mm/sec.

WRITE, WIRE, TELEPHONE TODAY
FOR COMPLETE INFORMATION!

Complete Engineering Bulletins available.
Field Sales Engineers at your service everywhere.

American  Optical
COMPANY

INSTRUMENT DIVISION, BUFFALO 15, NEW YORK

PROJECT "ECHO"

2000-MILE MICROWAVE LINK

USES UNIQUE
VARIAN AMPLIFIER SYSTEM

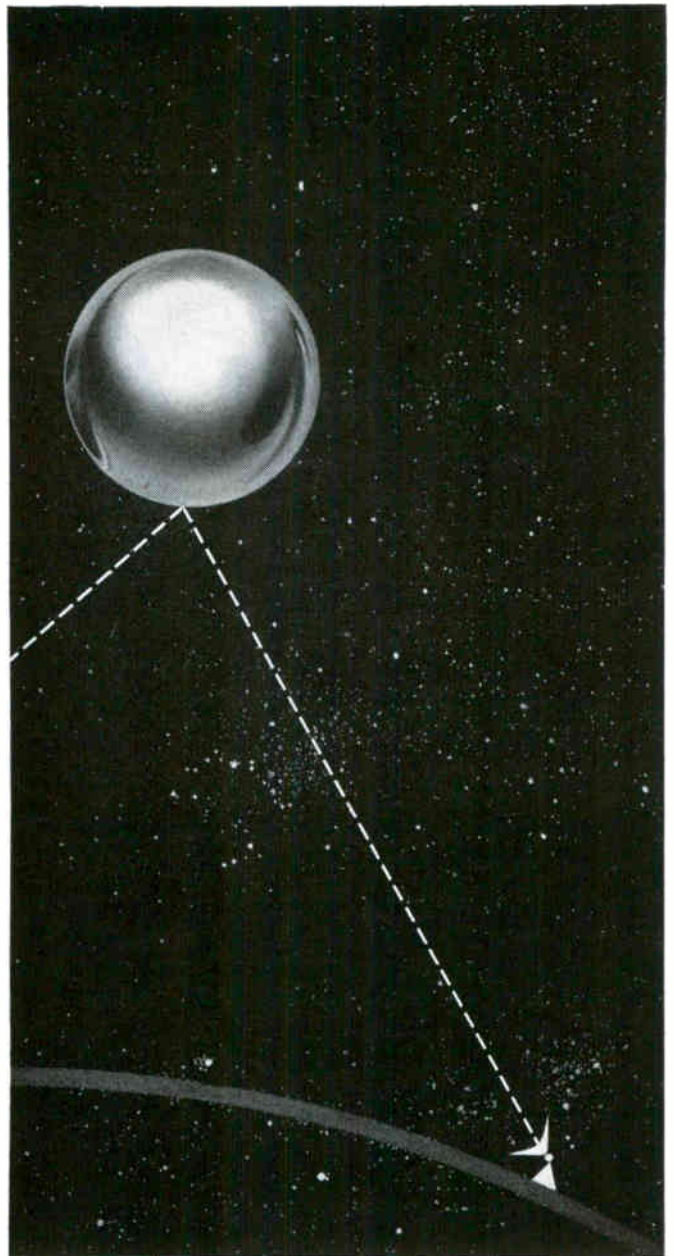

Project "Echo"— using a passive, 100-foot diameter, inflated sphere orbiting the earth to reflect signals— is investigating the feasibility of reliable and efficient long-range microwave communication. Radio and voice signals were bounced off the sphere between California and the East Coast. This followed earlier successful "moon-bounce" signalling between the same locations using the same transmitter.

Varian was contracted by the Jet Propulsion Laboratory (JPL)* to develop the unique klystron amplifier system built right into the 85-foot diameter parabolic transmitter antenna. To assure maximum success in "echo transmission," the system was designed around the proved and reliable Varian VA-800 C Klystron, to provide 10kw output at the desired 2390 megacycle frequency.

*Jet Propulsion Laboratory, a research and development facility of the NASA

Representatives thruout the world

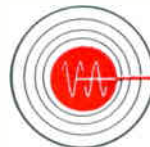

VARIAN associates

PALO ALTO 1, CALIFORNIA

KLYSTRONS, WAVE TUBES, GAS SWITCHING TUBES, MAGNETRONS, HIGH VACUUM EQUIPMENT, LINEAR ACCELERATORS, MICROWAVE SYSTEM COMPONENTS, NMR & EPR SPECTROMETERS, MAGNETS, MAGNETOMETERS, STALOS, POWER AMPLIFIERS, GRAPHIC RECORDERS, RESEARCH AND DEVELOPMENT SERVICES

the

42

most popular
 ® **REGATRON**
POWER
SUPPLIES
 are programmable



MODEL 212A \$129 WITHOUT METERS

| 0.1% REGULATION MODELS | DC OUTPUT | | 0.01% REGULATION MODELS |
|------------------------------|-----------|---------|-------------------------------|
| | VOLTS | MA | |
| 220A | 0-50 | 0-500 | 220AK |
| 213A | 0-50 | 0-1000 | 213AK |
| 215A | 0-50 | 0-3000 | 215AK |
| 225A | 0-75 | 0-2000 | 225AK |
| 212A ¹ | 0-100 | 0-100 | 212AK ¹ |
| 2-212A ^{1, 3} | 0-100X2 | 0-100X2 | 2-212AK ^{1, 3} |
| 224A ¹ | 0-100 | 0-200 | 224AK ¹ |
| 221A | 0-100 | 0-500 | 221AK |
| 214A | 0-100 | 0-1000 | 214AK |
| 226A | 0-100 | 0-2000 | 226AK |
| 218A | 0-100 | 0-3000 | 218AK |
| 229A | 0-150 | 0-300 | 229AK |
| 228A | 0-150 | 0-1000 | 228AK |
| 230A | 0-200 | 0-1000 | 230AK |
| 231A ² | 0-300 | 0-100 | 231AK ² |
| 232A ² | 0-300 | 0-200 | 232AK ² |
| 233A ² | 0-300 | 0-300 | 233AK ² |
| 234A | 0-300 | 0-500 | 234AK |
| 237A | 0-300 | 0-1000 | 237AK |
| 236A ² | 0-600 | 0-200 | 236AK ² |
| 235A | 0-600 | 0-500 | 235AK |

¹ Has modulation input.

² Has additional 0-150 V DC output and 6.3 V AC CT output.

³ Equivalent to two Model 212A's.

Why programmable? Because Regatron Programmable Power Supplies give the design engineer an extra margin of versatility. For example, in automatic test work, the programmable feature reduces control circuitry. In critical laboratory application, the programmable feature permits near-perfect reproducibility of test voltages.

There are other advantages too. The programmable feature provides for remote sensing. This provision eliminates the effect of voltage drops in power leads... places the point of regulation at the load terminals. And there's more.

For complete descriptions and specifications ask for Specification Sheets 3010B and 3023B.

® Registered U.S. Pat. Off. Patents Issued and Pending.

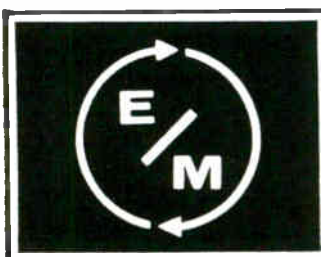

ELECTRONIC

MEASUREMENTS

COMPANY, INCORPORATED
 EATONTOWN • NEW JERSEY

THREE UNCONVENTIONAL COPPERS...



1 HIGH CONDUCTIVITY AND FORMABILITY

OFHC Brand Copper: Conductivity of over 100% IACS... Excellent hot and cold formability... Immunity to hydrogen embrittlement... Soundness and high density... Low volatility under high vacuum... Adherent oxide scale.

IMPACT RESISTANCE OF OFHC AND TOUGH PITCH COPPER

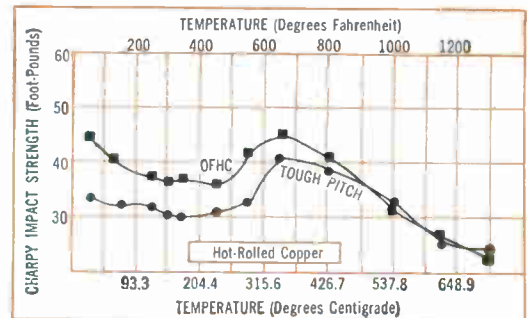

2 HIGH CONDUCTIVITY AND HIGH STRENGTH AT HIGH TEMPERATURES

AMZIRC Brand Zirconium-Copper Alloy: Room temperature conductivity of over 90% IACS... Retains strength at elevated temperatures: 52,000 psi at 400 C... Good notch toughness... Transverse properties equal to longitudinal... Hardness... Exceptional hot and cold workability.

TENSILE STRENGTH AT VARIOUS TEST TEMPERATURES

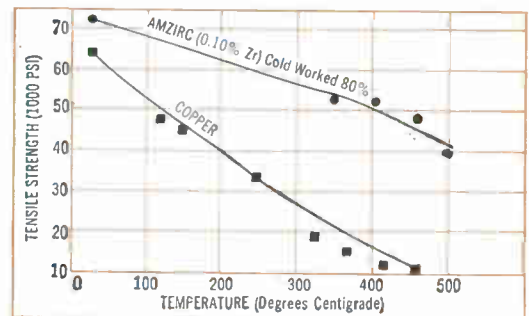

3 HIGH CONDUCTIVITY AND MACHINABILITY

AMSULF Brand Sulfur-Copper Alloy: Conductivity of 96% IACS... Machinability rating of 90... Freedom from hydrogen embrittlement... Good hot and cold workability.

RELATIONSHIP OF ELONGATION, REDUCTION OF AREA, AND TENSILE STRENGTH

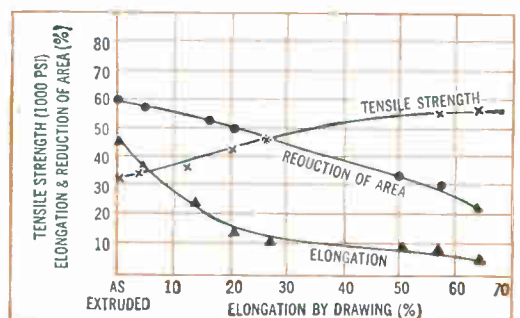

AMCO's Unconventional Coppers are available in rod, wire, strip, sheet, extruded, and forged forms from leading fabricating mills. For applications-engineering assistance, contact AMCO's Technical Service Section.

AMCO DIVISION

AMERICAN METAL CLIMAX, INC., Rockefeller Center, New York 20, N. Y.

OFHC, AMZIRC, and AMSULF are trade marks of American Metal Climax, Inc. AMZIRC is also known as N-4 Alloy.



“And we can still be at the new plant before nine!”

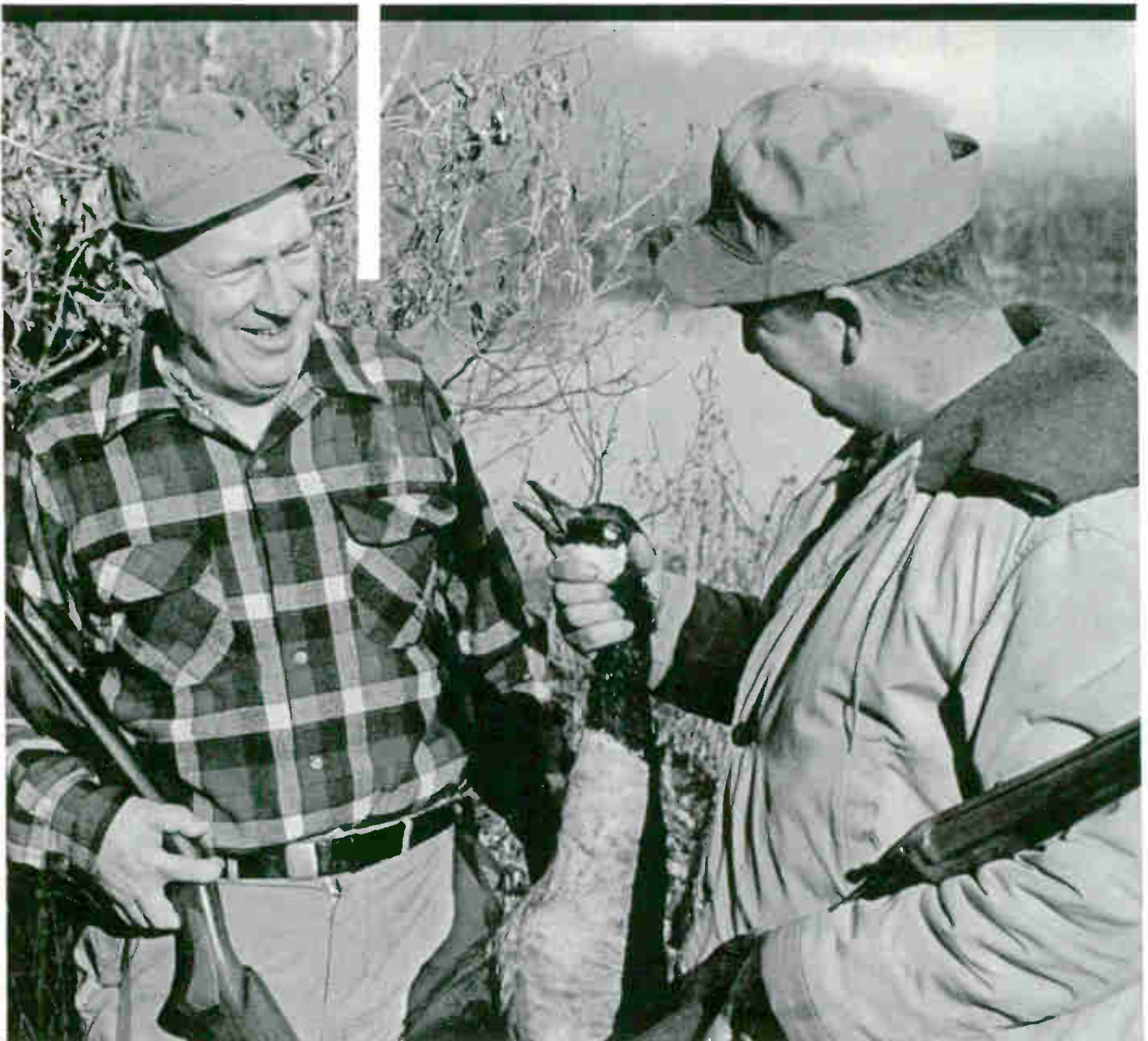

A couple of hours in a duck blind before the plant opens? That's perfectly feasible when your industry is located in northeastern North Carolina. For the same rivers and lakes that mean plentiful industrial water also mean fine shooting, fishing, and summer water sports. ■ Ask VEPCO about the abundant timber, mild climate and many other advantages of this key area . . . including the

fact that North Carolina home-grows two willing, trainable workers for every one who retires or moves away. For a list of available locations, or free confidential site finding help in this land of cordial government and friendly communities, write, wire or phone VEPCO today.



VIRGINIA ELECTRIC and POWER COMPANY

Clark P. Spellman, Manager—Area Development, Electric Building, Richmond 9, Virginia • MIlton 9-1411

SERVING THE TOP-OF-THE-SOUTH WITH 1,990,000 KILOWATTS — DUE TO REACH 2,580,000 KILOWATTS BY 1962



NOW—Ketay “packaged” Gyro components

- safeguard system accuracy
- save testing and machining

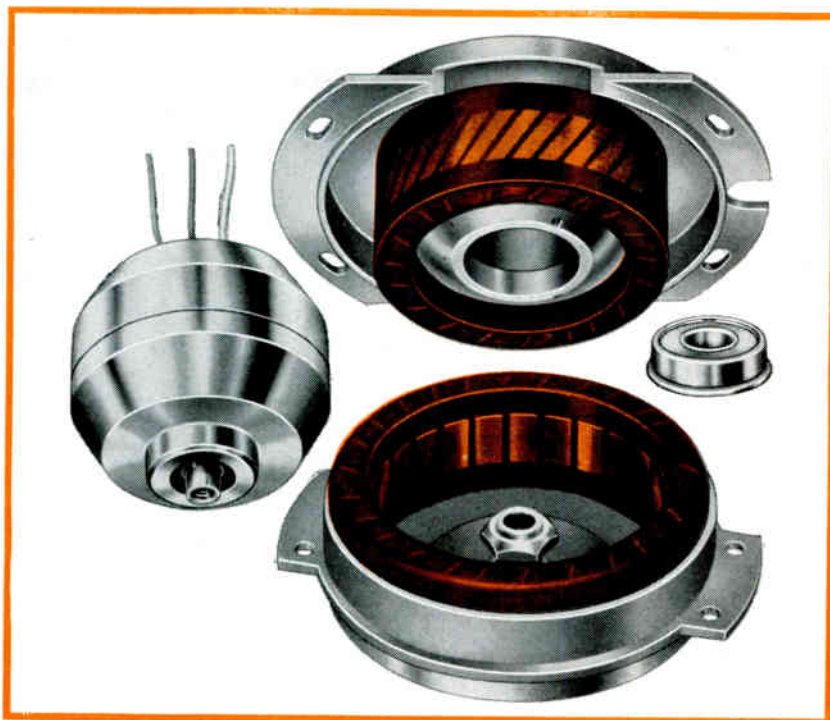

Norden's Ketay Department, an acknowledged leader in the rotating component field, is now able to deliver gyro component "packages" tailored to your specifications . . . ready for installation. This precision pre-assembly saves you expense and problems because:

TESTING, simulating *your* application, is handled by Ketay.

MACHINING of mounts and fittings is accomplished at Ketay . . . saving you machine time and engineering time. RELIABILITY is further ensured, for the gyro "package"

is an entity wholly tailored to a pre-determined function . . . not an assembly of individually modified components. In addition, sets of such packages can be perfectly matched.

Components shown above—Synchro, Torquer and Spin Motor—are typical. Their specifications are tabled below. Other Ketay gyro component "packages" are Induction Pickoffs, Pancake Resolvers, D.C. Spin Motors and a unique D.C. Voice Coil Torquer giving a linear force of .55 grams per milliamper of current.

TYPICAL SPECIFICATIONS

SYNCHRO TRANSMITTER TYPE SP-152

| | |
|---|----------|
| Input Voltage (to Rotor)— 400 cps—volts | 26 |
| Input Power—watts | 1.0 |
| Input Impedance (stator shorted) | 110+j 36 |
| Input Impedance (stator open) | 89+j 230 |
| Transformation Ratio | .454 |
| Output Impedance (Rotor open)—ohms | 27+j 44 |
| Output Voltage—volts (line to line) | 11.8 |
| Voltage Gradient—volt/degree | 0.206 |
| Total Null Voltage (mv. max.) | 30 |
| Electrical Accuracy (Max. Error from E.Z.)—minutes | ±3.0 |

(Tighter accuracy tolerances available for applications requiring limited ranges of rotation.)

A. C. TORQUER MOTOR TYPE SP-170

| | Fixed Phase | Control Phase |
|---|----------------|------------------|
| Rated Excitation Voltage—volts | 26 | 40 |
| Frequency (cps) | 400 | 400 |
| Current—(mv.) | 230 | 226 |
| Power—watts | 3.1 | 4.6 |
| Power Factor | .517 | .505 |
| Resistance—ohms | 58.5 | 89.3 |
| Reactance—ohms | 85.5 | 152.5 |
| Impedance—ohms | 113 | 177 |
| Effective Resistance—ohms | 218 | 348 |
| Capacitor for Unity Power Factor—mfd | 1.35 | 2 |
| Torque at stall (min.)—oz.in. | 1.0 | |

Operating Temperature Range—minus
55°C to plus 125°C

A. C. SPIN MOTOR TYPE SP-167

| | |
|---|---------|
| Input Voltage (line to line)—volts | 26 |
| Frequency—(cps) | 400 |
| Input Line Current (mv.) at stall condition | 350 |
| Total Input Power (watts) at stall condition (max.) | 10 |
| Input Line Current (mv.) at 24,000 rpm. | 300 |
| Total Power (watts) at 24,000 rpm. (nominal) | 5.5 |
| Stall Torque—(min.) in.oz. | .34 |
| No-load Speed (rpm.)—(in air) | 24,000 |
| Run-up time with rated voltage (in air) to NLS—sec. max. | 90 |
| Moment of Inertia Gm.Cm ² | 190 |
| Angular Momentum Gm.Cm ² /Sec. at 24,000 rpm. | 475,000 |
| Dynamically balanced to within 10x10 ⁻⁶ oz.in. max. unbalance | |
| Coasting time (in air) (min.) | 2½ |
| Total weight—gms. | 151 |

Ambient Temperature Range—
Minus 55°C. to Plus 125°C.



KETAY DEPARTMENT
NORDEN DIVISION
UNITED AIRCRAFT CORPORATION
COMMACK, LONG ISLAND, NEW YORK

WORLD'S FASTEST SWITCH

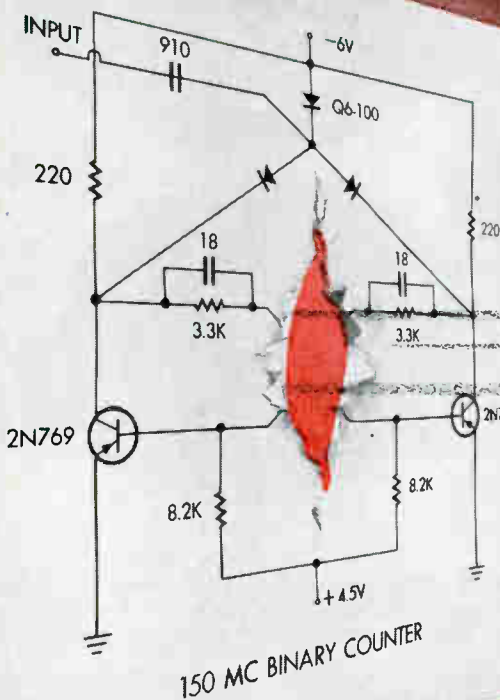

NEW PHILCO 2N769 (IN TO-18 CASE)

THE TRANSISTOR FOR 100 mc COMPUTER CIRCUITS

Philco's new 2N769 is the world's fastest commercially available switching transistor! This new addition to the Philco line of MADTs features an 800 mc gain bandwidth product, low hole storage factor, and low emitter and collector diode capacities. It is intended for use in saturated switching circuits at switching rates up to 300 mc. For complete information, write Dept. E9960

ABSOLUTE MAXIMUM RATINGS

| | |
|------------------------------|-----------|
| Storage Temperature | 100°C |
| Collector Voltage, V_{CB0} | -12 volts |
| Collector Voltage, V_{CES} | -12 volts |
| Collector Voltage, V_{CEO} | -7 volts |
| Emitter Voltage, V_{EBO} | -2 volts |
| Collector Current, I_C | -100 ma |
| Device Dissipation @ 25°C | 35 mw |

ELECTRICAL CHARACTERISTICS (T=25°C)

| Characteristics | Condition | Min. | Typ. | Max. |
|---|-----------------------------------|-------|------|---------------|
| Collector Cutoff Current, I_{CBO} | $V_{CB} = -5v$ | | | -3 μa |
| Current Amplification Factor, h_{FE} | $V_{CE} = -0.5v, I_C = -20 ma$ | 25 | | |
| Collector Saturation Voltage, $V_{CE(SAT)}$ | $I_C = -10 ma, I_B = -1 ma$ | | | -0.24 volt |
| Base Input Voltage, V_{BE} | $I_C = -10 ma, I_B = -1 ma$ | -0.30 | | -0.45 volt |
| Output Capacitance, C_{OB} | $V_{CB} = -5v, I_E = 0$ | | 1.5 | 3 μf |
| Gain Band-Width Product, f_T | $V_{CE} = -5v, I_E = 7 ma$ | 600 | 800 | mc |
| Hole Storage Factor, $K's$ | $I_B = -2 ma$ | | 15 | 30 $m\mu sec$ |
| Emitter Transition Capacitance, C_{TE} | $V_{EB} = -1v, I_C = 0, f = 4 mc$ | | 5 | 8 μf |

Immediately available from your Philco Industrial Semiconductor Distributor.

PHILCO



Famous for Quality the World Over

LANSDALE DIVISION • LANSDALE, PENNSYLVANIA



Sound Velocity Measurement in Liquids

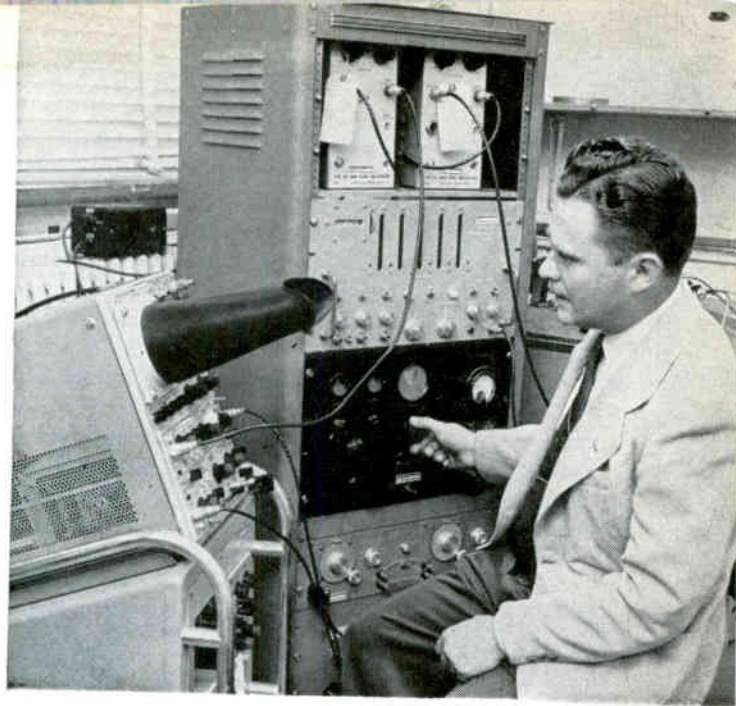

Pulse and waveforms generated in the velocimeter are observed on an oscilloscope

Instrument for direct measurement of velocity of sound in sea water has many possible industrial applications—it will detect impurities to one part in 100,000 by weight when impurity is in solution

By WAYNE D. WILSON,
DUDLEY D. TAYLOR*,
U. S. Naval Ordnance Laboratory,
White Oak, Silver Spring, Maryland

TABLES FOR velocity of sound in sea water were developed in 1939 by S. Kuwahara.¹ However, advances in the field of ultrasonics, particularly since World War II, have shown these tables to be inadequate for pressures corresponding to sea level conditions.² This discovery prompted the design of an instrument capable of measuring directly the velocity of sound for the conditions of temperature, pressure and salinity found in the ocean. Although the instrument was initially designed for this purpose, it has been found suitable for similar measurements in other liquids. The general principles of this instrument were initially developed by M. Greenspan and C. Tschiegg³ at the National Bureau of Standards.

The velocity of sound is obtained by measuring the time required for a pulse to traverse twice the length

*Also affiliated with High Pressure Engineers, Inc., Beltsville, Md.

of the velocimeter. The velocimeter test chamber is bounded by a transmitting and a receiving crystal. The transmitting crystal is driven by a series of pulses, each of 0.05 μ sec duration. When a pulse is applied to the transmitting crystal, a wave train is transmitted through the liquid and is reflected back and forth between the two crystals. The repetition frequency of the 0.05 μ sec pulses is adjusted so that a new pulse is initiated each time the reflected wave returns to the transmitting crystal. In this manner all wave trains move through the liquid in phase. To provide a visual indication that the waves are superimposed, the waves are picked up by the receiving crystal and displayed on an oscilloscope. Thus, the reciprocal of the pulse repetition frequency represents the time required for the sound waves to travel twice the length of the acoustic path. Sound velocity in the liquid is computed from this time and from the known distance between crystals.

The velocimeter, shown in Fig. 1A and 1B, is a stainless steel cylindrical housing 4.997934 inches

long with a $\frac{1}{2}$ -inch bore. Each end of the cylinder is terminated by a 5-Mc gold-plated quartz crystal attached to Mycalex disks. The Mycalex disks are seated on springs located in cylindrical end blocks which are attached to the cylindrical housing. When the instrument is assembled, the springs force the quartz crystals against the ends of the cylindrical housing. Care must be taken to machine the two ends of the housing plane parallel and perpendicular to the axis of the tube. Otherwise, the crystals may be distorted and the sound paths from different portions of the crystal will not be equal. One end block is used for electrical terminations; the other end block has a bellows attached for the transmission of pressure from the hydrostatic pressure field outside the velocimeter to the liquid inside the housing.

Optimum size of the velocimeter depends on the crystal frequency and the delay time of the sound waves in the test liquid. The diameter of the test chamber should be at least 12 times the wave length of sound in the crystal to prevent

viscous effects of the tube walls from affecting the velocity appreciably. Since a wave train is propagated in the liquid, the length of the chamber must be sufficient to prevent the trailing portions of the wave train from overlapping the leading edge when coincidence is established. If this should occur, the wave velocity would interfere with the group velocity being measured.

Velocity of sound in liquids varies with temperature, pressure and composition. Therefore, it is neces-

sary to control these variables. A schematic of the instrumentation required for monitoring and controlling the environment of the velocimeter is shown in Fig. 1C. The velocimeter is placed in a pressure vessel and submerged in a 110-gallon constant-temperature bath. The temperature of the bath is controlled by a mercury thermo-regulator connected to the bath heating elements and an external refrigeration unit for obtaining low temperatures. A thermistor is used to sense temperature gradients in

the bath; such gradients were eliminated by installing pumps to circulate the liquid. During operation, the thermistor is used to detect the variations in bath temperature as a function of time. Absolute temperature is measured with the platinum resistance thermometer.

The pressure gage in Fig. 1C is actually a coil of manganin wire wrapped on a core and positioned in a separate pressure vessel. Communication of pressure between the pump, the gage vessel and the vessel containing the velocim-

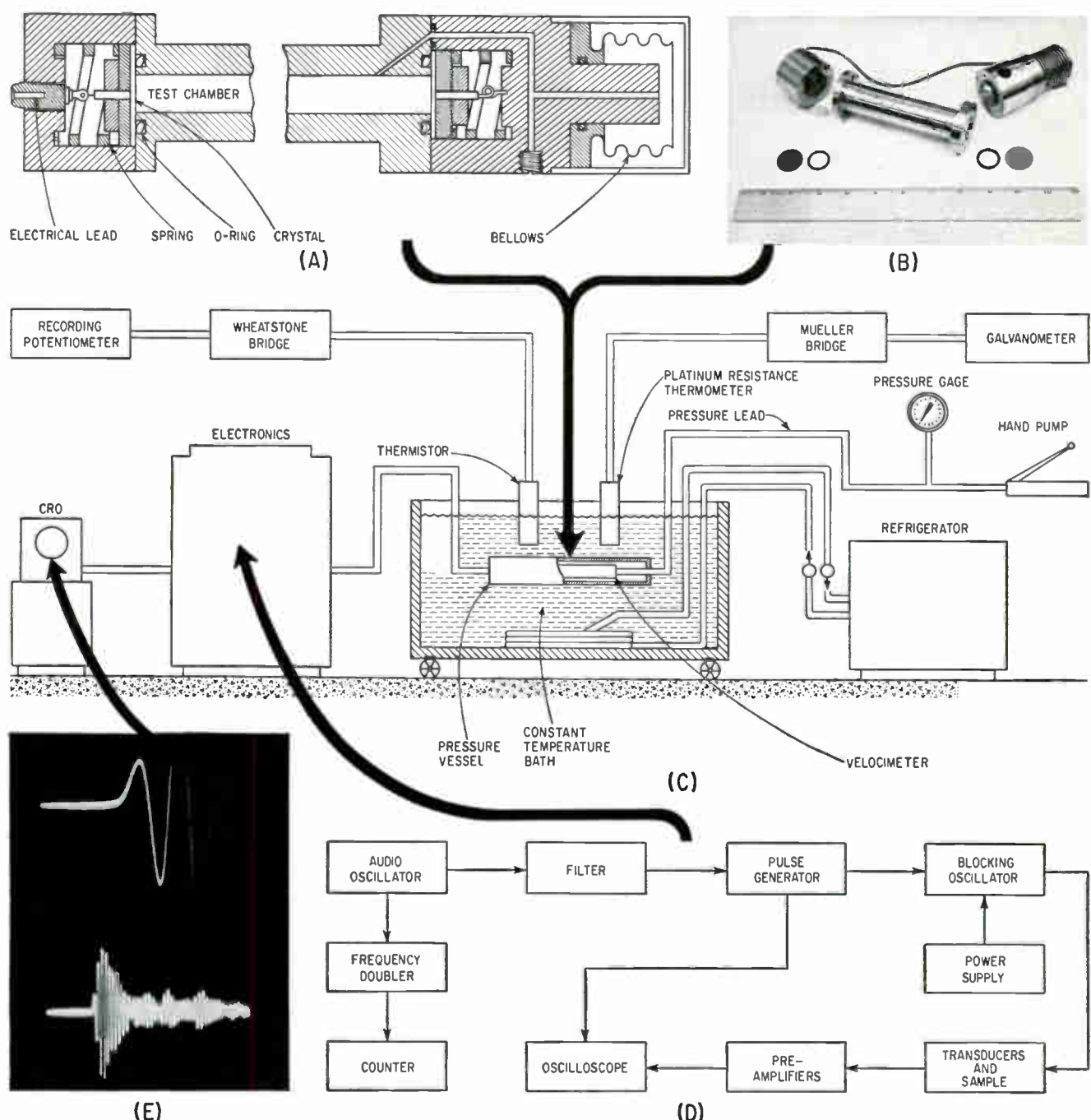

Fig. 1—Velocimeter design (A and B), laboratory setup of instrumentation required for monitoring and controlling the environment of velocimeter (C), the electronics package (D) and oscillograms of wave train (E)

eter is through high-pressure tubing. The resistance of the manganin wire varies with pressure; it is consequently located in one arm of a temperature-regulated Mueller bridge. Bridge output is fed into a photoelectric galvanometer which in turn drives a second galvanometer that indicates bridge balance. The resistance of the coil was initially calibrated as a function of pressure against a free piston gage. In constructing the manganin resistance gage care must be taken to select connecting wires and terminals that will not produce contact voltages at the junctions. In addition, to obtain a coil which is stable and whose resistance depends linearly on pressure, the coil must be thoroughly temperature and pressure seasoned. For work requiring less accuracy than that required for these precision measurements, a sensitive Heise gage is recommended.

The electronics shown in Fig. 1C is expanded in Fig. 1D. The audio oscillator is equipped with a fine frequency control. It is not necessary to filter the oscillator output; however, it may be desirable. A band pass filter is used to reduce harmonic frequencies and line noise. The oscillator signal is fed to a pulse generator and a blocking oscillator before it is applied across the transmitting crystal in the velocimeter. The signal detected by the receiving crystal is amplified before displaying the trace on the oscilloscope. Figure 1E is an oscillogram of the waveform photographed on different time scales to show the detail of the leading edge of the wave train.

The external triggering sweep of the oscilloscope is obtained from the output of the pulse generator. The pulse generator is essentially a multivibrator with the sine wave synchronizing voltage applied to the grid. Output of the multivibrator is rectified by a 1N34 diode to give a positive pulse; R-C coupling between the multivibrator and sub-positive pulse. The R-C coupling between the multivibrator and subsequent amplifiers differentiates the signal to sharpen the pulse. Since the synchronizing frequency is higher than the natural frequency of the multivibrator, the repetition frequency of the pulses is controlled by the sine wave input. One

output of the last amplifier stage is used to drive the external triggering sweep on the oscilloscope and the other output drives the blocking oscillator. The action of the blocking oscillator circuit is standard. Its purpose is to provide a symmetrical pulse of narrow width to drive the transmitting crystal of the velocimeter. When taking measurements with the velocimeter, the first half-cycle of the wave train is normally used to determine when coincidence occurs. If other peaks of the wave train are used, it is necessary to rectify the output of the blocking oscillator to give consistent results between measurements taken at the different peaks. Blocking oscillator output was rectified by a 643 low-capacitance diode.

Velocity data, along with supporting tables for density, can be used to compute all thermodynamic quantities of interest. Once calibrated for a particular liquid, the velocimeter can be used as a sensitive temperature gage or, for a given temperature, as an accurate pressure gage. Also, owing to discontinuities in velocity at phase boundaries, the velocimeter can be used to determine freezing and boiling points of solutions as a function of temperature and pressure.

One interesting industrial application of the velocimeter is in quality control. Where purity of sample is important, the measurement of sound velocity will detect impurities to one part in 100,000 by weight when the impurity is in solution. For bulk production of solutions the velocimeter, with suitable electronic systems, could drive servo mechanisms that control the proportions of the constituents. The petroleum industry, for instance, could use the velocimeter to identify and evaluate for purity the products from distillation and cracking processes. Mixing of anti-knock gasoline blends could be controlled. One application in the food industry is the measurement of sound velocity to determine the carbohydrate and butter fat content in milk.

Instrumentation similar to that described has also been used for the measurement of longitudinal and shear velocities in solids. These measurements are sufficient to determine Young's modulus, Poisson's ratio, and the coefficients of com-

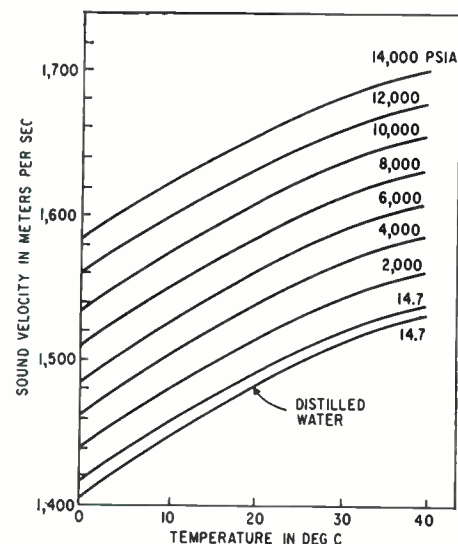

FIG. 2—Typical results obtained with velocimeter in 9 parts per thousand NaCl solution

pressure. Because velocity depends on the past history of the solid, the velocity can determine the temperature at which a specimen has been annealed. Very little information is available at the present time on the variation in velocity with composition. It is possible, however, that when such data are available, the velocity in a particular specimen could be used as a method for identifying the specimen.

Typical results obtained from the velocimeter are shown in Fig. 2. The points representing the sound velocity in a sodium chloride solution (9 grams of salt per 1,000 grams of solution) were used to plot curves of sound velocity versus temperature for the different pressures considered (in pounds per square inch absolute). A plot of the velocities at atmospheric pressure for distilled water is shown to demonstrate the effect of salt concentration. From these curves it may be seen that the pressure, temperature, and salt content coefficients of sound velocity are approximately 0.012 m/sec/psi, 4.3 m/sec/deg C, and 1.2 m/sec/parts per thousand, respectively. With respect to other liquids, water and its derivatives are abnormal. In most liquids the sound velocity decreases with increasing temperature.

REFERENCES

- (1) S. Kuwahara, *Hydrographic Review*, 16, p 126, 1939.
- (2) R. T. Beyer, *J Marine Research* (Sears Foundation), 13, p 113, 1954.
- (3) M. Greenspan and C. Tschiegg, *J Research NBS No. 59*, p 249 1957; also *J Acoustical Soc of Am*, 31, p 75 1959.

Designing

Special circuits and techniques are needed if at all the advantages of transistorizing a tv camera are to be realized

Portable camera uses vidicon and 28 germanium transistors

HIGH RELIABILITY, long life, mechanical compactness and low power drain have been the strongest factors to give impetus to the transistorization of equipment. There are several interesting problems in transistorizing a tv camera to gain all these advantages.

Low-frequency noise of transistors raises problems in video amplifiers and difficulties presented by the use of transistors in crystal oscillators must be overcome. It is also difficult to achieve blocking oscillator frequency stability. In all cases the design should allow for the wide variation in transistor characteristics.

The block diagram of a transistorized tv camera that overcomes these problems is shown in Fig. 1. The camera is designed to use a tipless, 1-in. vidicon, preferably types 7038, 7038A or 7325. The regulated -20 v supply follows conventional design practice, and will not be discussed here. Attention will be focused only on special circuits and their design.

Transistors exhibit a rising noise figure with decreasing frequency. This has been called $1/f$, semiconductor or excess noise in the literature. On a tv picture, this type of noise appears as random horizontal streaks compared to the usual snow from Johnson or thermal noise.

This noise problem is solved by selection of the transistor for the first two stages and adjusting the R-C time constant of the coupling

network between stages to cut off low frequencies beyond that required to reproduce the horizontal scanning interval without tilt.

The video amplifier uses nine 2N384 (or 2N1225) drift transistors. A 2N270 provides the video agc voltage. Response is flat from 15 Kc to 8 Mc with a peak at 7.5 Mc.

An input network introduces a peak to the response at 7.5 Mc. This pi network, shown in Fig. 2A, consists of the output capacitance C_o of the vidicon, L_1 shunted by R_1 , and the input capacitance C_i of the video amplifier. The network produces partial aperture correction. Peaking at this point produces a minimum of h-f noise.

Input stage of the video amplifier is designed for minimum noise figure partly compromised with temperature stability. Lower quiescent collector current gives less noise, but the stage is more sensitive to I_{co} variation with temperature. The 2N384 transistor for this stage is selected for lowest noise (particularly $1/f$ noise) and the stage uses emitter peaking.

A 330-pf mica coupling capacitor minimizes leakage from the high impedance target circuit. For a similar reason, metallized paper capacitors couple the video stages.

Figure 2B shows the automatic video gain control circuit. Potentiometer R_2 adjusts the low-frequency gain of the video amplifier. Gain control over the whole video band is achieved by the nonlinear

dynamic impedance characteristic of diodes D_1 and D_2 . Varying the current through the diodes varies the dynamic impedance and hence, the amount of degeneration in this stage. Since the quiescent current through Q_1 has not changed, output capability and frequency response are independent of video gain. Transistor Q_1 is also selected for low noise, but the noise level may be higher than that of the first stage.

Automatic video gain control is provided for in the following manner. The video signal appearing at the collector of Q_2 is integrated. A d-c voltage proportional to the average video signal appears at the collector of Q_3 . This is the biasing voltage for D_1 and D_2 . Because of the low currents being drawn by D_1 and D_2 , capacitors C_1 to C_4 must be tantalum types. Otherwise, leakage currents would alter the operating point of the diodes.

The third stage (Fig. 1) is the high peaker. A low load resistance in the collector of the third video transistor plus a shunt peaking inductance compensates for h-f roll-off in the input resulting from the high output impedance of the vidicon. Compensation for the vidicon output R-C time constant is possible only if the fourth stage has a high input impedance. Hence, the fourth stage is connected as an emitter follower. The peaking coil of this stage affects the lower midband gain of the video amplifier.

The aperture correcting circuit is

Transistorized Television Cameras

By DANIEL G. CARREON, Project Engineer, Blonder-Tongue Electronics, Newark, N. J.

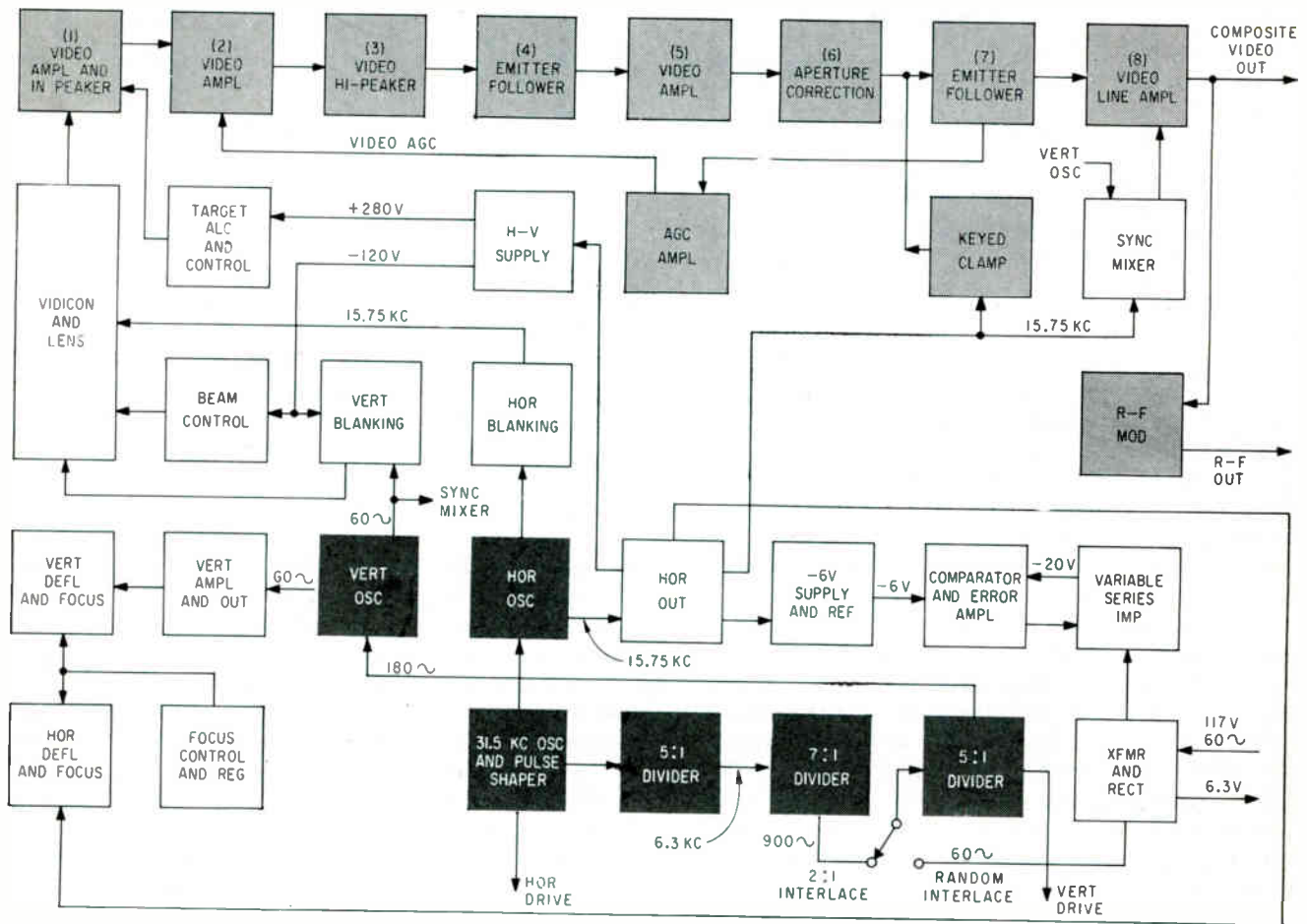

FIG. 1.—Shaded blocks include circuits which are discussed in detail

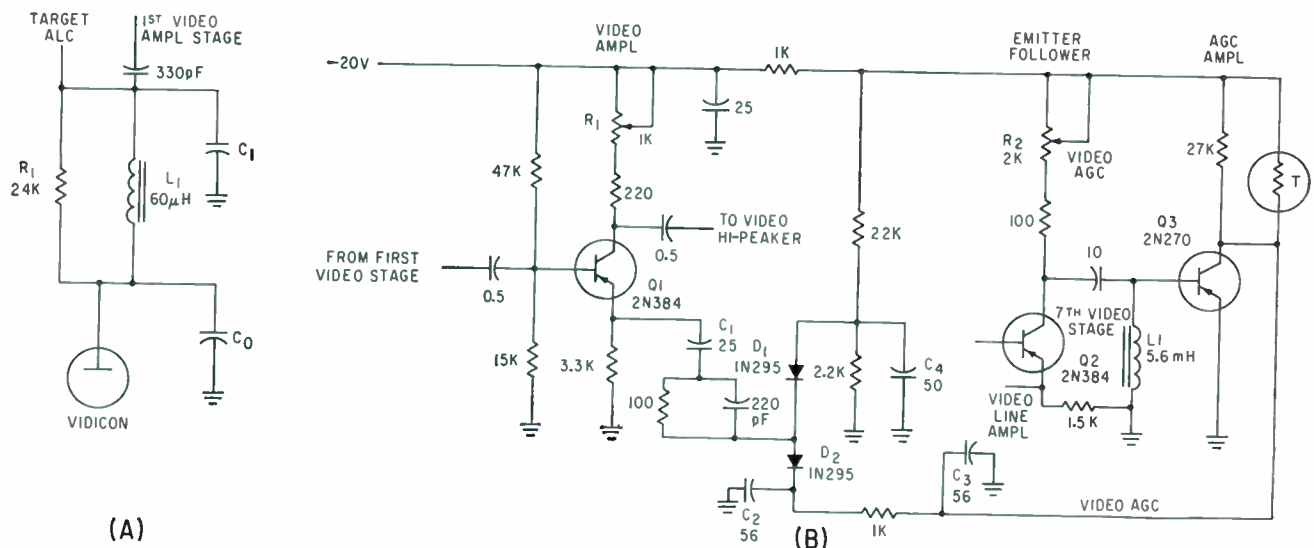

FIG 2.—Input circuit (A) peaks response at 7.5 Mc. Circuit (B) provides automatic video gain control

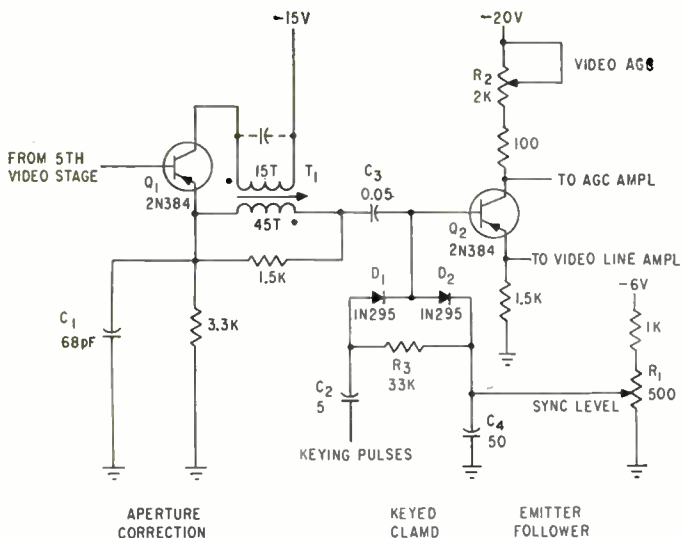

FIG. 3—Diode D_1 of keyed clamp acts as a conventional peak rectifier $d-c$ restorer

shown in Fig. 3. Because of the finite spot size and bandwidth limitation of the video amplifier, video response to a square pulse is rounded. The pulse is sharpened by the combined action of T_1 and C_1 . Capacitor C_1 increases the initial swing at the collector which is opposite in phase with respect to the input. The collector winding then rings with the stray and/or distributed capacitance across it. The emitter pulse is in phase with the base input but slightly delayed because of C_1 . The ringing pulse at the collector is coupled to the transformer secondary and added to the emitter waveform. In the resultant waveform, initial swing at the collector causes an undershoot.

To generate the required frequency, the horizontal and vertical deflection circuits use the blocking oscillator shown in Fig. 4A. The same circuit is used in the frequency dividers for 2:1 interlace. Transistor Q_1 is ON only during the narrow pulse intervals or flyback time. Capacitor C_1 charges during this interval and discharges through R_1 during the sweep periods. The R-C network in the emitter performs both timing and integrating functions.

The oscillator can be synchronized at the base, emitter, or collector. Frequency can be changed by varying either R_1 or C_1 . Pulse width is a function of transformer primary inductance, base circuit resistance and capacitor C_1 .

Although other blocking oscillator circuits are possible, this cir-

cuit has the best frequency stability and the minimum number of parts. Base circuit impedance is low and since the time constant is in the emitter circuit, the frequency is independent of the I_{cbo} component of base cut-off current which is temperature dependent.

For the oscillator frequency to be stable with temperature variation, the net effect of the following factors must be compensated for:

1. The electrical characteristics of the transformer and resistors can be assumed to be temperature invariant. However, the value of emitter capacitor C_1 , whether it be an aluminum electrolytic, tantalum or metallized paper, increases with temperature. This tends to decrease the frequency.

2. The Zener diode used to obtain the 6-v bias has a positive temperature coefficient. Increasing the base bias increases the frequency.

3. The collector supply voltage tends to decrease with temperature because of I_{cbo} variation in the error amplifier of the series regulator (Fig. 1). Decreasing the collector supply increases the frequency.

4. Heating of the transistor increases the frequency due to the change in β and conduction point with temperature.

5. For blocking oscillators used as frequency dividers, input pulse amplitude must be stabilized.

In the design of this transistorized camera, three thermistors are used to stabilize the frequency-dividing chain that gives a 2:1 interlaced picture. The blocking oscil-

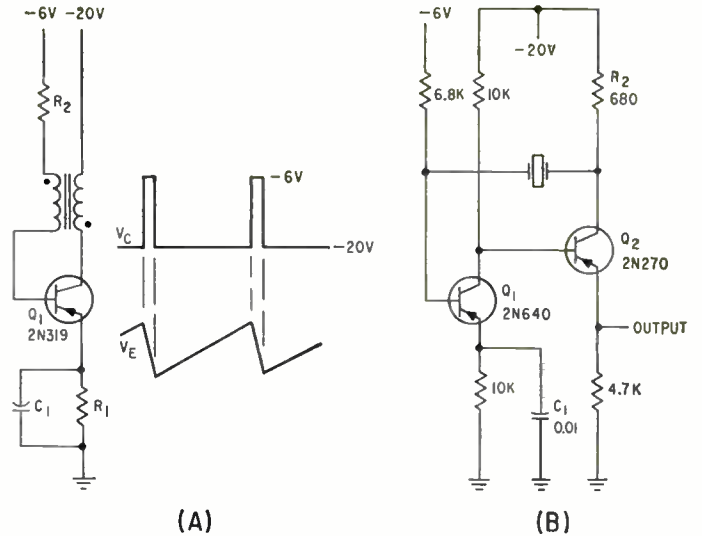

FIG. 4—Blocking oscillator (A). Oscillator in (B) provides sync signals for sweeps.

lator has been found to have only a small drift in its natural frequency of oscillation. This is because the increase in frequency from heating of the transistor is counter-balanced by an increase in capacitance of the metallized paper capacitor used. Three external factors—collector supply voltage, base bias voltage and amplitude of the input pulses—remain to be compensated.

The I_{cbo} of the error amplifier in the voltage regulating circuit changes the -20v collector supply. A thermistor with -5.4-percent temperature coefficient is shunted across the base-to-ground resistor of this transistor. Another thermistor is used to compensate for the positive temperature coefficient of the Zener diode for base bias. It is interesting to note that since the same Zener diode is used as a reference in the error amplifier of the voltage regulator, the increase in Zener voltage tends to increase the collector supply voltage and partially cancel the I_{cbo} effect. A third thermistor keeps the amplitude of the input pulses to the first counter constant. These pulses increase in amplitude with temperature because of the increase in β of the transistors in the crystal oscillator and pulse shaper.

The clamp circuit (Fig. 3) allows a-c coupling into the video amplifier. Low-frequency response of the video amplifier is adjusted to reproduce adequately a square wave at half the horizontal frequency. The low input impedance

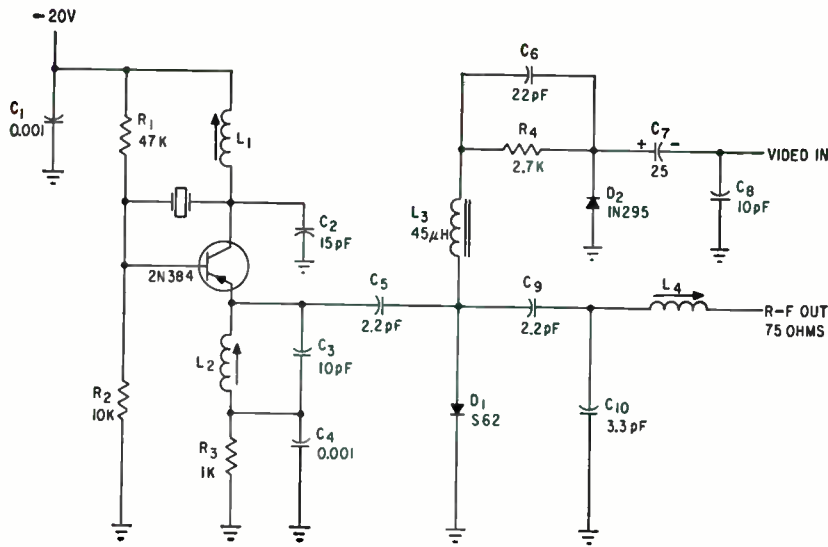

FIG. 5—R-f output is 50 mv into 75-ohm load. Resistors R_1 and R_3 form bleeder network for base bias

of common-emitter transistor amplifiers make it necessary to use coupling capacitors much larger than those used with vacuum tubes to give a long enough time constant.

The driven clamp works in the following manner: the output of Q_1 is video negative. A positive keying pulse makes diodes D_1 and D_2 conduct, fixing the potential of the base of Q_2 at the start of each horizontal line. This potential is set by R_1 and controls the height of the sync pulses in the video output. At the end of the pulse the diodes stop conducting. Resistor R_3 discharges C_2 slightly during the sweep period, making D_1 and D_2 conduct more heavily when the clamping pulse is applied.

The clamping pulse is about 4.5 v positive and is narrower than the retrace period (width is about 5 μ sec). This amplitude is large enough to charge C_2 to a voltage that keeps the diodes cut-off during the horizontal sweep period. Capacitor C_2 is large enough to have a long discharge time, yet small enough relative to C_1 to absorb most of the pulse voltage.

The crystal used in the 31.5 kc oscillator vibrates in the flexural mode, the lowest frequency natural mode of vibration of long thin bars. This cut resonates at one of the lowest frequencies attainable from a homogeneous piece of quartz. At low frequencies like 31.5 kc, the flexural mode is most suitable to use. This design, however, results in a high impedance, leading to design problems.

A high impedance makes it difficult to excite the crystal. It could also lead to oscillation at unwanted harmonics of the crystal frequency. Series resonant operation is much easier to use than parallel resonant operation, even with vacuum tubes. For such a crystal, it is difficult to build an oscillator using one transistor or a single vacuum triode, tetrode or pentode. The camera uses the symmetrical, collector-coupled multivibrator type of oscillator shown in Fig. 4B.

Transistors Q_1 and Q_2 are connected in a positive feedback loop with the base of Q_2 direct coupled to the collector of Q_1 and the crystal forming the feedback from the collector of Q_2 to the base of Q_1 . Assume Q_1 conducts when the equipment is turned on. Its collector voltage drops, cutting off Q_2 and bringing the collector voltage of Q_2 to -20 v. The crystal is excited, the voltage across it decreases, the collector voltage of Q_2 moves in the positive direction. This is coupled to the base of Q_1 , making it draw less current. The negative swing at the collector of Q_1 and the base of Q_2 drives Q_2 out of cut-off.

With Q_2 drawing current, its collector moves in the positive direction. The 31.5 Kc component of this positive going pulse is coupled to the base of Q_1 , by the crystal to complete the positive feedback loop at this frequency. Transistor Q_1 cannot be driven to cut-off because of direct-coupling to the base of Q_2 which cannot go more negative than its collector. During this interval

Q_2 is in saturation. When the crystal voltage decreases, the base of Q_1 is driven more negative and Q_1 starts drawing more current. The collector of Q_1 goes less negative making Q_2 draw less current. Positive feedback around the loop results in Q_1 being driven to saturation and Q_2 being cut off, completing the cycle of oscillation.

To keep the dissipation in the crystal below the 0.1 mw maximum rating, the voltage excursion at the collector of Q_2 is not allowed to exceed about 5 v. This is achieved by keeping the value of R_2 low. Furthermore, the input impedance at the base of Q_1 is made high to reduce the crystal power required to drive it.

The r-f modulator is shown in Fig. 5. Crystal frequency is half the desired r-f. The parallel combination of L_2 and C_3 is tuned to the second harmonic of the crystal frequency to give the desired r-f channel. Inductor L_2 provides the tuning adjustment.

In the r-f oscillator the crystal operates between the series resonant point and the parallel resonant point. In this narrow region, the crystal is inductive. The circuit of the r-f oscillator can be simplified since L_2 and C_3 present a low impedance at a frequency half its resonant point. For the circuit to oscillate, the L_1 and C_2 combination should be tuned below the crystal frequency presenting a capacitance matching impedance from collector to ground at crystal frequency. With this condition the voltage at the base is 180 degrees out of phase from the voltage at the collector. Since there is a 180-degree phase shift between transistor base and collector the total phase shift around the loop is 360 degrees, and oscillation is sustained.

Power consumption, size, and weight are factors in which the transistorized camera may be favorably compared to an equivalent vacuum tube version. Power consumption is about 90 percent less and almost one third of the power consumed by this transistorized camera is in the vidicon heater. Size and weight is reduced about two-thirds.

This camera was designed under the direction of I. Horowitz with valuable assistance from B. Tongue. W. Sampson was responsible for the mechanical engineering.



Relay contacts are brought out to plug on front panel

Variable-Program

Automatic variable-program triggering source was designed to vary camera exposure rates and durations. The triggering rate can be constant and adjustable, or variable for a selected period between predetermined initial and final rates

THIS TRANSISTORIZED instrument was designed to provide a predetermined variable-rate triggering source for instrumentation cameras. Its heart is a unijunction transistor and time-constant circuits.

A bank of charged capacitors is the source of potential for a unijunction transistor acting as a relaxation oscillator. Each capacitor, with its discharge resistance, is diode coupled to the emitter of the unijunction. The capacitor-resistor networks determine, sequentially, the potential applied to the unijunction emitter. By selecting capacitors and resistors, a wide range of triggering-rate decay characteristics can be had.

To provide alternate pulse spacing, a bistable multivibrator circuit, which adds and subtracts capacitance, is coupled to the unijunction emitter.

In the circuit diagram Q_1 is a unijunction transistor. Type 2N489 was used, although any of the types from 2N489 to 2N494 are suitable. Switch S_1 in the FIXED position connects the emitter of the unijunction to the arm of S_{21} and through resistances to the 20-v supply. If S_1 is in the EQUAL position as shown, C_1 , C_2 , C_3 , and C_4 will be connected from the emitter to ground. As the capacitor bank charges, the voltage on the emitter rises. When it has reached about 10 v the resistance between emitter and base B_1 decreases, a small current flows and the cumulative action results in a low resistance between E and B_1 . This does not discharge the capacitors completely, but to a value determined by R_1 . Here it is 4 v, at which the unijunction ceases to conduct. The voltage on the emitter

will slowly rise again to 10, when the action will be repeated. The voltage to which the emitter will rise before it breaks down is determined by R_2 and R_3 , and the supply voltage. The triggering rate is variable from two a second to one a minute. The variable resistance R_2 is for recalibrating the device, so that intervals will correspond with the dial settings if the unijunction is replaced or if the components change value. The control is inside the chassis to prevent inadvertent adjustment.

The signal fed into B_2 of the unijunction has an interesting function. As the emitter voltage increases slowly because of the charging of the capacitors, the emitter draws negligible current until it reaches the firing voltage. At this point it requires about 2 μ a to trigger the unijunction. If the value of the charging resistor in the emitter circuit is too high, this current is not available and the emitter will remain at about 10 v without firing. To overcome this difficulty, a square wave of 60 cps and 1 v peak-to-peak is applied to B_2 through capacitor C_5 . This square wave is available from the 12-v winding of the power transformer through R_4 where it is maintained at constant amplitude by diodes D_1 and D_2 . This jiggle voltage is sufficient to trigger the unijunction when the emitter reaches the threshold voltage. The circuit continued to operate with 52 megohms as the value of the charging resistor, and with 64 μ f capacitance. The recurrence rate with this time constant was once every 22 minutes. The accuracy of repetition was about 0.3 percent. However, a repetition rate of once a minute fills the

requirement for which this instrument was built.

When the unijunction fires, it produces a positive pulse at B_1 of less than 10 v. This has two uses. First, it triggers the monostable multivibrator Q_2 - Q_3 , lengthening the pulse to Q_4 , that operates relay K_1 . The duration of operating time will vary from 0.1 to 0.5 second, depending on the setting of R_5 . One set of contacts on the relay operates a glow lamp. Two sets are for external use.

The second use of the pulse from B_1 of the unijunction is to trigger bistable multivibrator Q_5 - Q_6 . This action indirectly alters the time constant of the unijunction, which produces alternate long and short intervals between pulses. To obtain this effect, switch S_2 is set in the L & S position, while S_1 remains in the FIXED position. This connects capacitors C_6 , C_7 , C_8 , C_9 , and C_{10} in parallel from the emitter through diode D_3 to the collector of Q_7 . Capacitor C_7 is connected directly from the emitter to ground. Consider a pulse from B_1 of the unijunction. It triggers bistable multivibrator Q_5 - Q_6 and leaves it with Q_5 conducting and Q_6 cut off. The collector of Q_6 will go to ground potential, which is the negative side of the supply. This provides a negative voltage at the base of Q_7 through R_6 and R_7 . Transistor Q_7 will conduct, which will make the collector about 20 v positive. Diode D_3 will be back-biased and the bank of capacitors C_6 , C_7 , C_8 , C_9 , C_{10} will be disconnected. The only charging capacitor for the emitter of Q_1 will be C_5 . This will charge more rapidly than before and will trigger the unijunction sooner. When Q_1 fires, the positive

Triggering Source

By B. E. BOURNE,
National Research Council, Canada

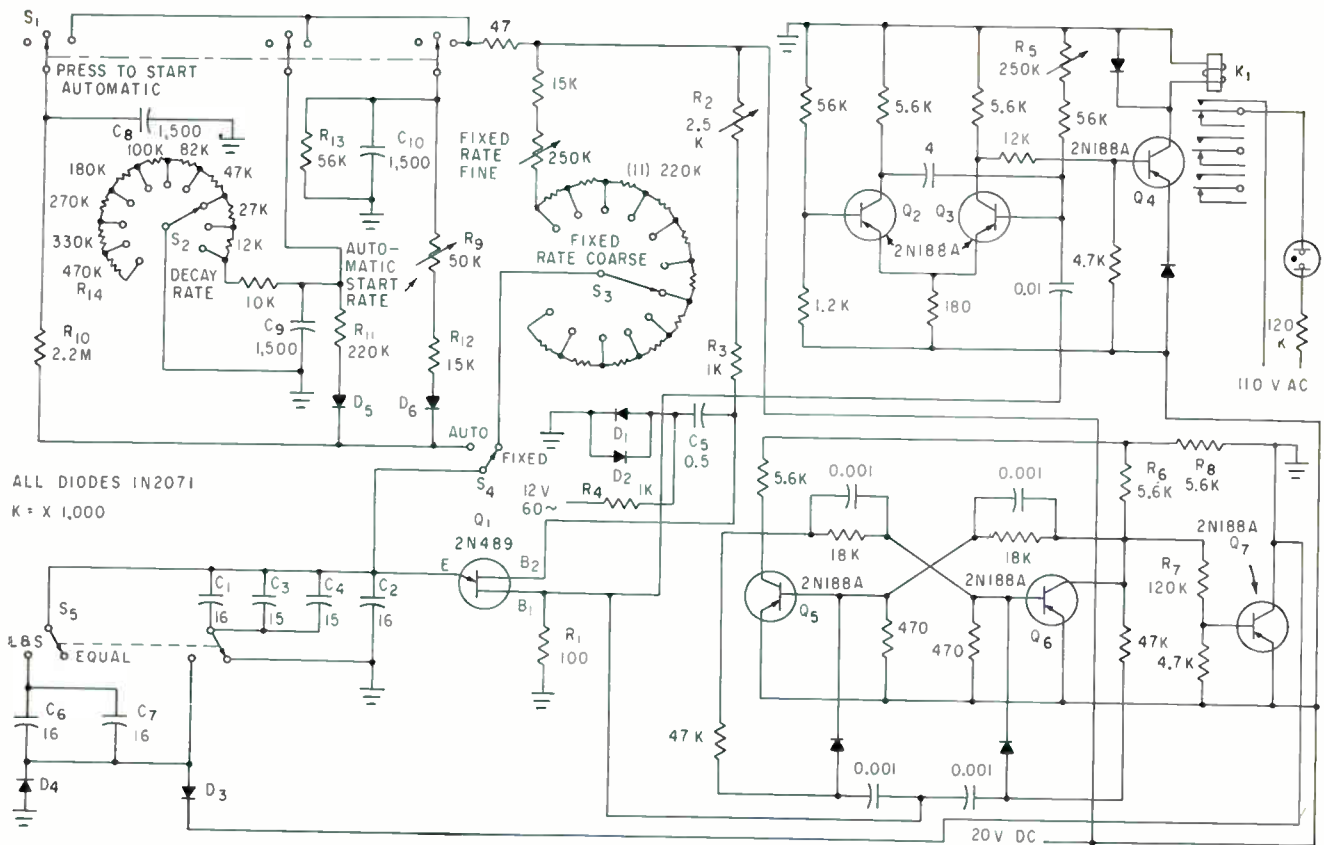

Monostable multivibrator Q_2 - Q_3 determines length of triggering pulse that operates relay K_1 . Bistable multivibrator Q_4 - Q_5 produces alternate long and short intervals between pulses when switch S_5 is in L & S position

pulse from B_1 , will trigger Q_5 and Q_4 again, which will leave Q_5 biased to cutoff and Q_4 conducting. Transistor Q_7 will be nonconducting with the collector at ground potential. The common point of the charging capacitors will now be grounded through R_8 and D_3 . When the emitter of Q_4 rises in potential the entire bank of capacitors must be charged. When Q_4 fires, the bank of five capacitors is discharged through diode D_4 . The pulse from Q_4 again flips Q_5 and Q_4 , and the bank of charging capacitors will be out of the circuit for the next interval. The space between alternate pulses will be in the ratio of about 5 to 1, as determined by the ratio of C_2 to the bank of five capacitors. To go back to equal pulse intervals, switch S_5 is moved to EQUAL.

To obtain an automatic decrease in the triggering rate of Q_1 , switch S_1 is moved to AUTO. This disconnects S_2 and connects into the circuit a new source of voltage obtained from C_8 , C_9 , and C_{10} . Switch

S_1 is a spring-return, lever-action switch that normally remains in an open position. To start the action the switch is pressed down and held for a few seconds. This charges the three storage capacitors C_8 , C_9 , and C_{10} to 20 v. While holding the key down R_9 is adjusted until the desired starting rate is obtained. This is variable from 2 a second to 0.5 a second. When S_1 is released, the triggering rate decreases automatically. The storage capacitors C_8 , C_9 , and C_{10} , are connected to the emitter of Q_1 through R_{10} , R_{11} , D_5 , and R_{12} , R_{12} , D_6 , respectively. The resistor-capacitor network that has the greatest effect in determining the starting recurrence frequency of Q_1 is C_{10} , R_{10} , and R_{12} , because R_9 and R_{11} are much smaller in value than R_{10} and R_{12} . However, C_{10} will be discharged by the load and R_{10} in about 1 minute to a value where it will no longer contribute anything. Diode D_6 will also prevent C_{10} from presenting a load to the remainder of the circuit.

Capacitor C_8 remains charged to approximately 20 v, while the potential of C_9 will be reduced depending on the setting of S_2 . At this point the recurrence frequency will be reduced by a factor of 10 in the circuit illustrated. In the next few minutes C_9 will also be discharged, leaving C_8 in the circuit. The recurrence rate by this time will be about once a minute. Resistor R_{10} is of high value, and C_8 will supply voltage to the emitter of Q_1 for more than one hour. By this time the recurrence frequency will be reduced to about once in five minutes. The interval in which the rate will decrease from twice a second to once a minute can be varied from three minutes to fifteen minutes by DECAY RATE switch S_2 . The decreasing recurrence rate is not linear but approaches linearity when S_2 is near center position. It is possible to alter the linearity of the discharge curves by combinations of load resistors across capacitors C_8 , C_9 , and C_{10} .

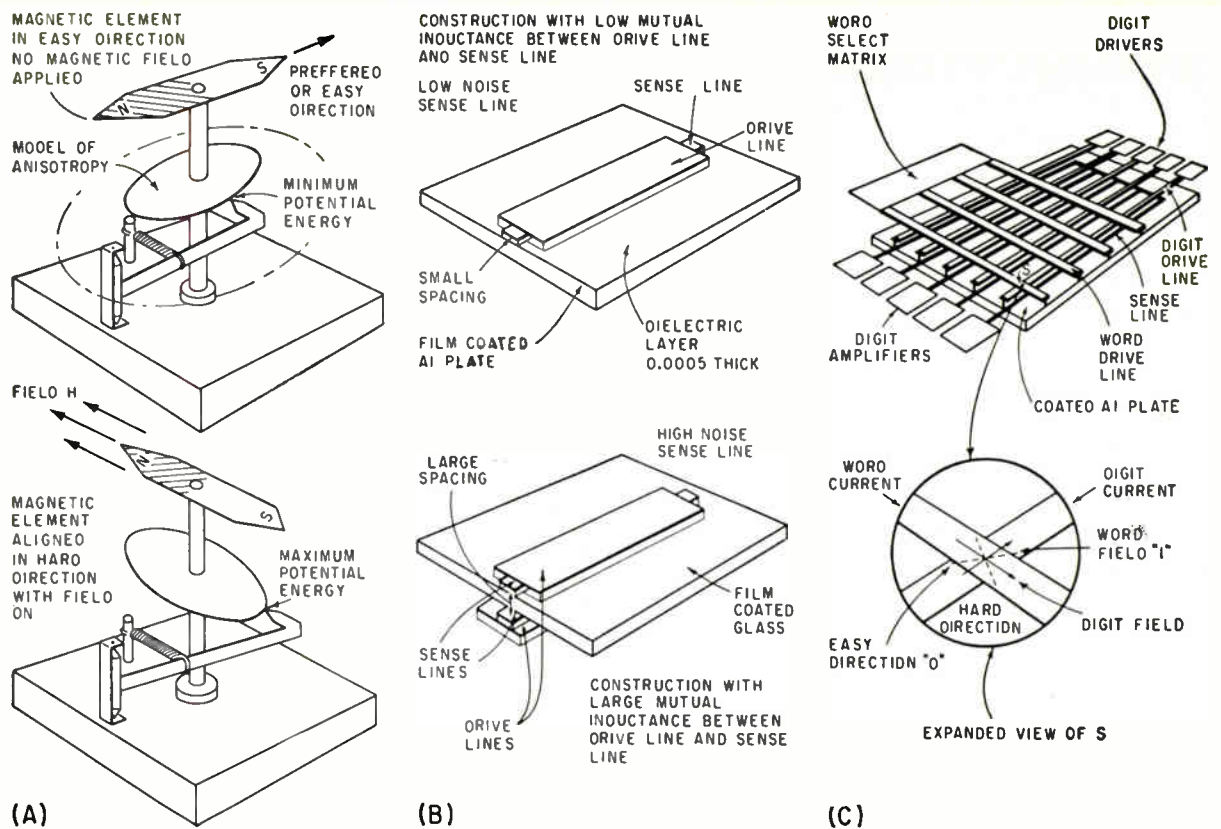

FIG. 1—Model of switching mechanism showing EASY and HARD directions of magnetic polarization (A); aluminum substrate in upper diagram of (B) has much lower noise value than lower glass substrate; expanded view (C) of memory system shows orientation of the various magnetic axes

Making Reproducible Magnetic-Film

Aluminum substrate permits low-noise readout and good reproductibility of memory units. Single memory stores 1,250 bits, while continuous film, not dot pattern, provides rotation switching process

DEVELOPMENT of high-speed computer logical circuits using transistors has to date outstripped the development of storage devices to go with these circuits. Magnetic films, layers of Permalloy less than 20 micro-inches thick, have been shown to be a promising storage medium with nanosecond access times^{1,2}. However, large scale use of magnetic film storage elements, exploiting the potential low cost and high speed of this medium, has not previously been attempted because of associated practical difficulties.

The major difficulty in constructing magnetic film stores has been the problem of reproducibility of the magnetic properties of the film³. It has been known for some time

that the rectangular hysteresis loop, obtained when the drive magnetic fields are applied in the preferred direction, cannot be controlled with respect to coercive force at the accuracy required by the coincident current storage system. Furthermore, switching time can be long because the mechanism of switching is predominantly magnetic domain-wall movement, in which the individual magnetic dipoles caused by the spinning electrons rotate into the opposite direction consecutively⁴.

Magnetic films can be prepared which behave differently from other soft magnetic materials^{5,6}. In these films, the magnetization reversal occurs mainly as a coherent rotation

process in which magnetic dipoles rotate together. The process is therefore extremely fast. This only occurs in thin films if the magnetic field is applied at a large angle to the preferred direction, that is, the direction where the rectangular loop is found.

The rotational operation can best be illustrated by the drawing in Fig. 1A, which shows that the magnet in this model has two stable positions at minimum potential energy. The magnet, if in either of these positions, is pointing in the preferred direction. These two positions represent the ZERO and ONE stored information states. The magnet has a potential energy maximum if it points at right

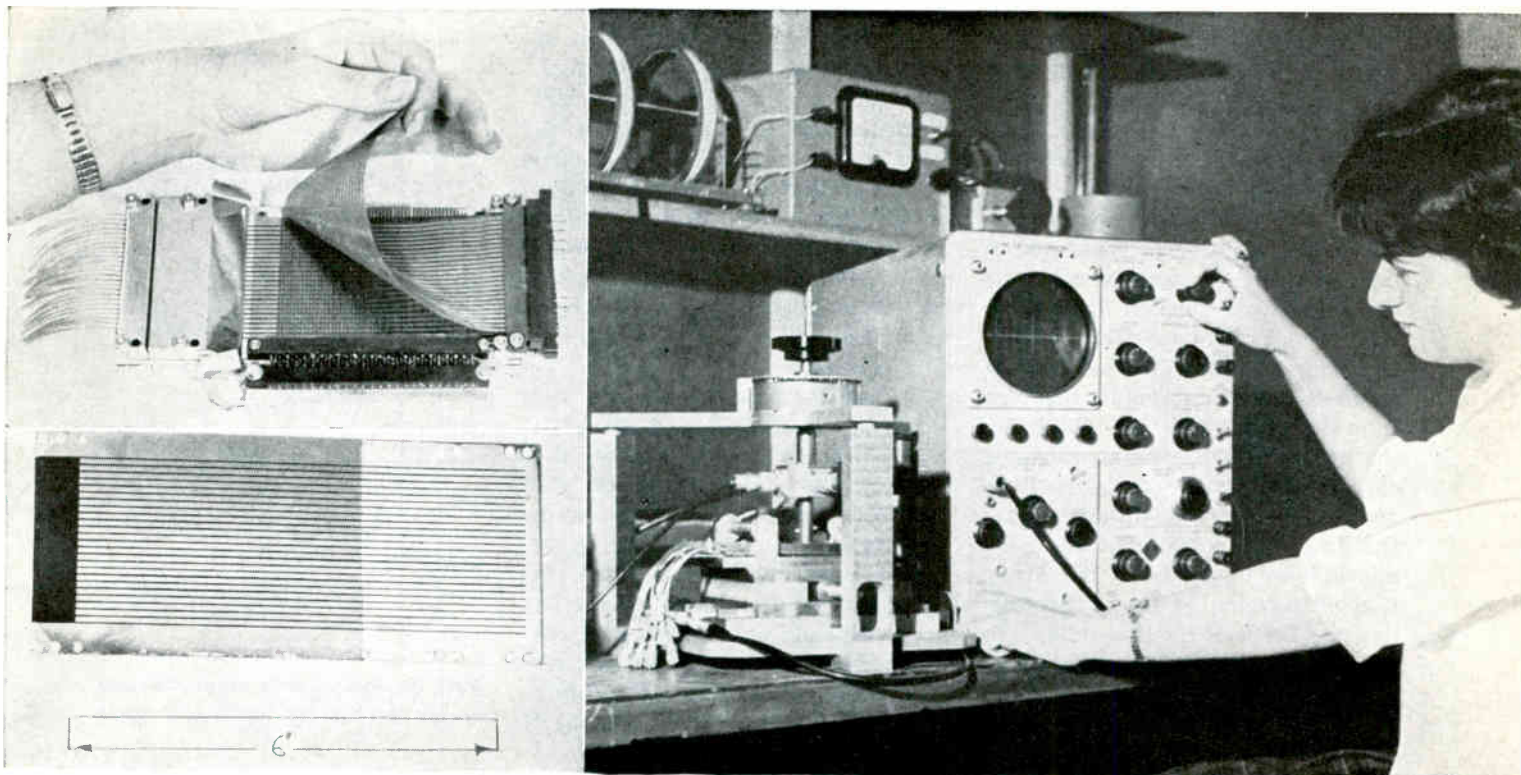

Near-complete 2,500 bit magnetic memory unit (top left), coated aluminum memory plate with electro-deposited sense lines in place (bottom left). Photograph on right shows the equipment specially developed to measure the spread of the EASY magnetic axis

Memories

By E. M. BRADLEY, International Computers and Tabulators Ltd., Stevenage, Herts, England

angles to the preferred direction, so that if magnetic fields are applied in suitable directions, the magnet rotates over the hump and clicks into the preferred direction of the opposite sense.

This model has been used to conceive new storage devices, but films made from Permalloy have not followed the model accurately enough for it to be of use in the design of a large scale memory. It has been found that films made from an alloy called Gyrallloy follow the model more accurately and large sheets of film can be made sufficiently uniform in size 4 by 3 inches permitting 1,250 bits to be stored in a single sheet. It is important to use a complete sheet, to obtain the rotational property, and not a film etched or masked into a dot pattern.

A further difficulty in the design of film memories has been the poor signal to noise ratio. The increased noise is due to induction of a voltage into the sense circuit by the

drive currents. The scale of difficulty can be seen if it is realized that a magnetic film storage element contains about one thousandth of the flux produced in a ferrite memory core, but requires about the same current to drive it. The stray mutual inductance between the sense and drive lines must therefore be reduced by 1,000 times of that obtained in ferrite core memories. Such reduction has been achieved in this film memory by depositing the magnetic film by vacuum evaporation onto an aluminum plate and separating the sense line from the plate with an insulator less than 0.0005-in. thick (Fig. 1B). Thus the sense line and the plate behave like a transmission line of very low impedance because of their close spacing. The mutual inductance between the sense circuit and the drive circuit is sufficiently low.

The memory described in this paper is made from two coated aluminum plates, and stores 2,500

bits organized into 50 words.

Use of an aluminum plate as substrate for the film allows many plates to be connected together to form large stores with capacities up to tens of thousands of words. The read-write cycle time can be a fraction of a microsecond and is not so much limited by the reversal time of the film element as by the driving circuits. Contrary to early suspicions, rotation of the magnetic dipole moment of the element is not damped by eddy currents induced in the aluminum plate or the drive strips.

The elements of the memory are organized as shown in Fig. 1C. In this device, the rows of the matrix are arranged to intersect each bit of a word, and the columns a particular digit position in every word. In the write process it is necessary to select the word row into which it is desired to write, and to pass a suitable current pulse along it through the word drive line. The

chosen word is then primed and a small current pulse is passed down each column or digit drive line into which it is desired to write ONE. This current is sufficient to place the primed elements into the ONE state but not those which have not been primed.

The read process is similar except that a read amplifier is connected to lines running in parallel with the digit drive line and no digit drive lines are activated. The desired word line is again activated and the magnetic elements are all reversed into the ZERO state. In doing so, the magnetization rotates, causes a change in flux cut by the sense lines and thus induces a voltage across the line. The polarity of the voltage induced depends on the direction of rotation of the magnetization and hence of the magnetic state prior to the word select pulse.

Magnetic film memory operation (using the coherent rotational mode of switching) has been proposed before on a small experimental scale but in the matrix to be described here the operation is somewhat different. The inset in Fig. 1C shows how the magnetic fields are applied to an individual memory element and Fig. 2 shows the behavior of the magnetization vector at various stages in the write ONE cycle.

The field caused by a current pulse along the word line is arranged to be at right angles to the field caused by the digit line, which in turn is arranged to be at a small angle, about 5 degrees to the preferred magnetization direction. If the element is storing a ONE the magnetization vector points downwards in Fig. 2; if ZERO, it points upwards.

In the write ONE process, the digit field is switched ON first but is of insufficient amplitude to switch the element to the ONE state by itself (Fig. 2b). With the digit field still ON, the word field is turned ON causing the magnetization to rotate nearly into line with the word field against the torque acting in the opposite direction (which is a result of the magnetic anisotropy of the material). The word field is then switched OFF and the digit field by itself is able to exert sufficient torque on the magnetization to rotate it past the direction where the sign of the anisotropy torque

changes. The magnetization then rotates very nearly into the ONE state easy direction under the action of the anisotropy torque and the digit field torque. When the digit field is turned OFF the magnetization rotates into line with the easy axis.

The write ZERO process is similar except that no digit field is applied, and thus at the end of the word pulse the magnetization rotates back to the ZERO state easy direction under the action of the anisotropy torque alone.

During the read process only the word field is applied, and since the magnetization can be in either the ONE or ZERO state, it rotates into line with the word field and then back again into the ZERO state ready for the next write process. The direction of rotation of the magnetization depends on the state of the film before the word pulse. Therefore if a loop is arranged to cut flux in the same direction as the digit field (Fig. 3) then the polarity of the voltage pulse generated in the loop at the leading edge of the word pulse depends on the previous state of the film element. At the end of the pulse the magnetization rotates into the ZERO state in both cases, resulting in the same output polarity.

It has been shown that a small angle must be maintained between the EASY axis and the word drive line (referred to as tilt angle) and it has been found that the widest tolerances in this angle can be allowed if the nominal value is 5 degrees. Actually, satisfactory operation can be achieved if the tilt angle is 5 ± 3 degrees.

One of the difficulties in designing thin film memories is that the changing field generated by the selection pulses induced a large voltage in the sense loop. This is due to the large area of the sense loop which encloses the glass substrate as well as the film (Fig. 1B lower). It is not practicable to reduce the thickness of glass to smaller than 0.1 mm and it has been found difficult to make magnetic film of the desired properties on thin mica or on plastic. Evaporated sense lines are also unsuccessful because they have too large a resistance and form a poor substrate for the magnetic film.

In this present film memory, aluminum sheet is used as the sub-

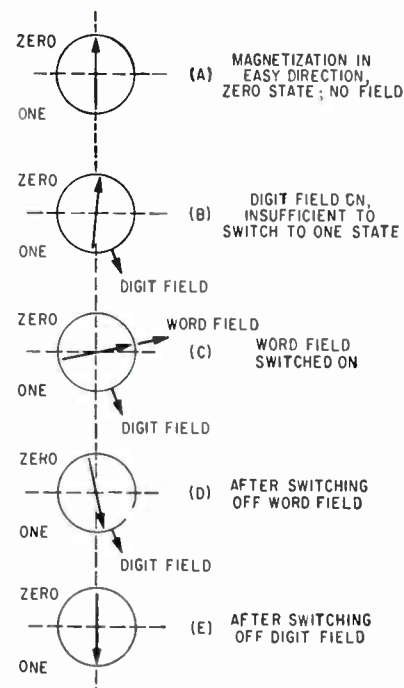

FIG. 2—Behavior of magnetization vector during the write ONE cycle

strate for the magnetic film, and forms an earth return for the sense line, which can then be close to the film. This results in a sense loop of small effective area as shown in the upper diagram of Fig. 1B. The sense line itself can be a thick electroplated layer, eliminating attenuation difficulties.

There are two further advantages in using an earthed plate. First, the magnetic field due to a current passing through a strip line near to the film is doubled because of eddy current image effects. Second, the inductance of the drive line is reduced so that back voltage generated during current change is reduced thus limiting the drive power required.

It has been suggested⁷ that if metal conductors are placed near to the magnetic film, rotation of the magnetic dipole will be damped by eddy currents induced by this rotation. However, magnetic elements deposited on aluminum have been switched successfully in a time as short as 10 nanosec with no evidence of eddy current damping.

Specifications for the magnetic film are as follows: (1) each storage element must perform closely to the simple coherent rotational model; (2) each film element must have its easy axis placed within ± 3 degrees of the design angle; (3)

the anisotropy energy should be of such a value that the drive currents can be generated conveniently.

A test apparatus was built to test the properties of small film areas, using current pulses of rise time and duration similar to that to be used in a storage system. This apparatus determines the angle between the easy axis and the edge of the plate. In the test shown in the photo two drive conductors placed at right angles to each other are turned together to any angle with respect to the edge of the plate. Any point of the plate can be placed under the drive head, so that variations over the area of the plate may easily be studied.

During the measurement, the drive head is rotated while a current pulse train generates magnetic field pulses near the hard direction of the film element. The head is moved so that the field is swept past the hard direction. When this occurs, the voltage response observed in the sense line, which cuts flux at nearly right angles to the hard direction, is observed to change polarity, as expected from the simple model. It is possible to identify the easy axis by this test, for those films which are a good approximation to the simple model. Most thin magnetic films, however, unless specially prepared, do not behave according to the model. Instead of magnetization reversal occurring mainly by rotation, it occurs mainly by wall motion, with the consequence that very little change of flux is cut by the sense line, thus yielding small output.

It has been shown in an earlier paper that low frequency hysteresis loops of a specimen of a film 2 cm square prepared from 81:19 nickel-iron alloy approximated the characteristics expected from the simple rotation model⁵. It has been found that large sheets of film prepared from 81:19 alloy are not sufficiently consistent in their rotational behaviour and in the position of the easy axis to be of use in a large computer memory.

However, films of an alloy called Gyrallloy 1, can be made to fulfill the memory requirements, even over areas of 4 by 3 inches for a film thickness of about 1,000 Å.

These properties are only found in a complete film sheet where individual storage elements are de-

finied by the magnetic field pattern generated by the drive line.

The field in the plane of the film falls off rapidly beyond the strip if the film is spaced close to the strip. The field normal to the film has no effect because it is four orders of magnitude smaller than the demagnetizing field in this direction.

Previously proposed storage devices have used masked or etched dot patterns. Storage plates have been tested before and after etching into a dot pattern of 2.5-mm diameter dots. It was found that the flux rotating due to a field applied near the hard direction was very much reduced and the tolerances available in the drive currents in the memory are also reduced using the etched dot pattern.

After it had been shown that films of the necessary properties could be made, the next step was to find out the packing density that could be achieved. This was done by using an etched copper circuit pattern on which there were 16 conductors each 0.020 inch wide spaced 0.005 inch apart. Activation of suitable conductors could then simulate various strip widths and spacings. This experiment showed that it was possible to use drive strips of 1 mm width and the word drive strips should be spaced by 0.5 mm and the digit drive strips by 1.5 mm. The currents required were 1.2 amp-turns word current, 0.5 amp-turns digit current. The output voltage was about 3 mv for word pulses having a rise time of 40 nanosec.

The prototype store, having 50 words each of 50 bits, was built in the following way. A magnetic film of Gyrallloy 1 of about 1,000 Å thickness was deposited onto a plate of aluminum 7 inch × 3 inch with the film coating confined to one end of size about 4 inch × 3 inch. The plates were tested for

rotational switching properties and for angle of tilt of the film at many spots over the total area.

Satisfactory plates were then coated with a thin layer of cellulose lacquer and a layer of copper was evaporated onto the lacquer. The copper was built up to a thickness of 0.001 inch by electro-plating and the required sense strip pattern was etched out using conventional printed circuit techniques. This process results in a sense line pattern in which each line is spaced about 0.0005 inch from the coated aluminum, as shown by the photograph of the plate at this stage. Two plates were then mounted back to back and the word drive strips were wound over the plates. Each word drive strip consisted of 4 turns of enamelled copper strip 0.010 inch wide, 0.002 inch thick and the spacing between the strips was equivalent to 2 turns of this wire.

The next stage of the process was to connect each sense line to a miniature coaxial cable and then to place a screening box over these joints. The final stage was to fix the digit drive line pattern over the assembly. This pattern was made by the usual printed circuit technique from a thin 0.005 inch plastic copper clad. Figure 4 shows a photograph of the store before the digit line pattern was fixed to the plate.

The performance of the store can best be summarized by the following measured characteristics: word drive 0.3 amp < I_w < 3 amp (not tested above this value), digit drive current 0.6 amp < I_d < 0.8 amp, word drive inductance 0.6 μH at 0.5 amp (0.2 μH contributed by the film).

This means that, for a pulse of rise time 100 nsec, back voltage generated is 6 volts at $I_w = 0.5$ amp.

Acknowledgment is given to Journal of British Institution of Radio Engineers for permission to use some of the data contained in a paper to be published.

REFERENCES

- (1) J. I. Raffel, *J Appl Phys*, 30, p 60S, 1959.
- (2) E. E. Bittman, Using Thin Films in High-Speed Memories, *ELECTRONICS*, p 55, June 5, 1959.
- (3) Ferrite Films In Logic and Storage, *ELECTRONICS*, p 104, May 20, 1960.
- (4) E. M. Bradley and M. Prutton, *J Appl Phys*, 31, p 258S, 1960.
- (5) D. O. Smith, *J Appl Phys*, 29, p 264, 1958.
- (6) E. M. Bradley and M. Prutton, *J Electronics and Control*, 6, p 81, 1959.
- (7) J. S. Eggenberger, *J Appl Phys*, 31, p 287S, 1960.

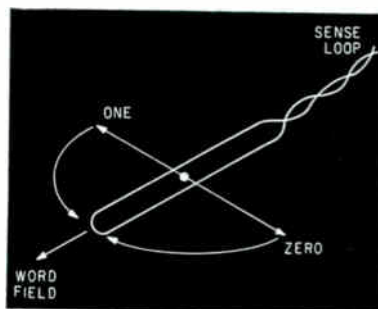

FIG. 3 Orientation of sensing conductors for information readout

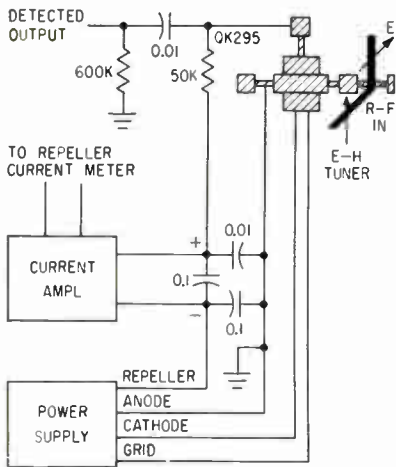

FIG. 1—Reflex klystron regenerative detector uses QK-295 klystron

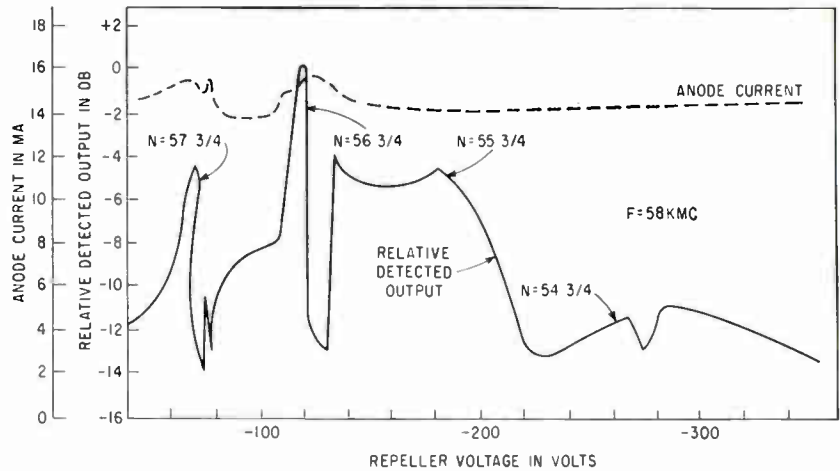

FIG. 2—Repeller characteristics of QK-295 reflex klystron detector having an anode voltage of 3,000 v and a grid voltage of -131 v

Use of Reflex Klystrons

By feeding 58,000 Mc signals to the cavity resonator of this reflex klystron regenerative detector, output signals at repeller are 12 db greater than those of conventional crystal detector. Study of repeller current suggests detection is caused by electrons striking repeller

By KORYU ISHII, Dept. of Electrical Engineering, Marquette University, Milwaukee, Wis.

SUPERHETERODYNES have the highest sensitivity in receiving systems. However, this type of receiver has two problems—circuit complexity and image response. To solve these problems, a backward-wave amplifier and a reflex klystron were proposed for microwave autodyne reception^{1,2}. Both these tube types showed successful results in X-band.

The reflex klystron approach is simple and economical. In this article, the behavior of the QK-295 reflex klystron as a millimeter-wave regenerative detector is analyzed.

A schematic diagram of a QK-295 regenerative detector is shown in Fig. 1. The repeller voltage is

adjusted so that the electrons can reach the repeller.

The input signal, which is a 58,000-Mc wave modulated by a 1-Kc square wave, is fed into the reflex klystron through an E-H tuner. The detected output is taken from the repeller circuit, measured with a vacuum-tube voltmeter and observed on a cathode-ray oscilloscope. Repeller current is measured by a microammeter with a transistorized current amplifier.

When the 1-Kc square-wave modulated 58,000-Mc signals are fed to the reflex klystron detector, the detected output varies as a function of the repeller voltage as shown in Fig. 2. The anode current increases

when the detected output peaks.

This characteristic is similar to oscillation or amplification³. This suggests that when the detected output is optimized by electronic tuning with the repeller voltage, the electron behavior is similar to regenerative amplification.

Electronic tuning for detection can be achieved by adjusting the anode voltage. Only one mode— $N = 56\frac{3}{4}$ —was clearly observed. When the anode voltage decreased, the beam current decreased. The $N = 57\frac{3}{4}$ mode will occur theoretically at $V_a = 2,925$ v if the beam current is sufficient. At this voltage, the current was so low that this mode had degenerated. The anode

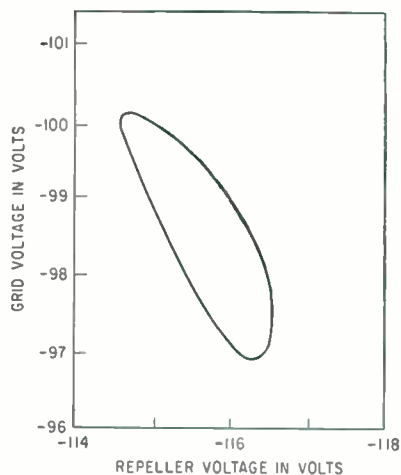

FIG. 3—Combination of repeller and grid voltages to produce same detected output in $N=56\frac{1}{4}$ mode

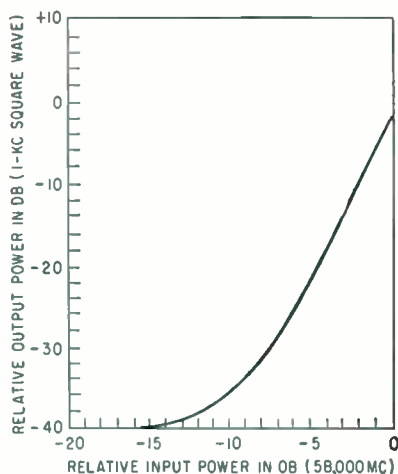

FIG. 4—Input versus output power level characteristics of QK-295 reflex klystron detector

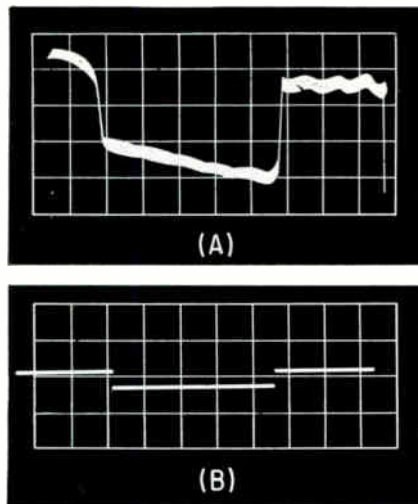

FIG. 5—Klystron detector output (A) is 12 db greater than conventional crystal detector output (B)

As Millimeter-Wave Detectors

voltage could not be raised much above the specified voltage, so the experiment involving mode $N = 55\frac{3}{4}$ was not carried out. For similar reasons, only one mode was observed when the electronic tuning was done by grid-voltage variations.

Optimum output can be obtained within a range of grid voltage in the $N = 56\frac{3}{4}$ mode if the repeller voltage is adjusted as shown in Fig. 3. Repeller and grid voltages were adjusted to give 0.7 mv detected output.

The linearity of the detector is good within the range of operating power levels as shown in Fig. 4. The relative detected output level is plotted against the relative input power level and zero db of input power does not correspond to the zero db level of the output power. The scales of input and output are independent and both represent relative values.

Investigation of the standing-wave ratio suggested how the mechanism of electron motion of the reflex klystron detector might be described.

The vswr on the input waveguide line was adjusted to 1.2 with the detector tube inoperative. The vswr increased to 2.7 with the detector

operating. When detection started, strong reflected waves were observed in the input waveguide. One interpretation of this phenomena is that these waves are amplified waves resulting from regenerative amplification by the reflex klystron tube⁸.

When the QK-295 is used as a regenerative detector, d-c repeller current flows in a direction opposite to that of the 2K25 reflex klystron detector. With the 2K25, d-c repeller current flowed toward the repeller²; with the QK-295 repeller current flowed toward the power supply as if the repeller were emitting electrons.

Repeller current increased when the input r-f intensity increased indicating that the speed of the electrons contributing to the repeller output signal increases when the r-f intensity increases.

When the anode voltage decreased, the repeller current decreased. Again, the repeller current depends on the speed of the electrons. The repeller current is controlled by the grid voltage, which controls total emission as well as the repeller current.

Details of the 58,000-Mc, 1-Kc square-wave modulated waveforms

are shown in Fig. 5. The reflex klystron output (5A) is 12 db greater than that of the matched DBB-319 crystal detector (5B). Although the klystron has much greater output, its pulse response is not as good as that of the crystal detector.

The author thanks the Raytheon Co. for contribution of the klystron tubes. Acknowledgments are made to J. Tsui, J. A. Stefancin, J. E. Billo, A. Treder, S. Krupnik and J. D. Horgan of Marquette University, and to the University Committee on Research.

REFERENCES

- (1) J. K. Pulfer, Application of Backward Wave Amplifier to Microwave Autodyne Reception, *IRE Trans. MTT-7*, p 356, July 1959.
- (2) K. Ishii, Detector Uses Reflex Klystron, *Electrical Industries*, 18, p 77, Nov. 1959.
- (3) K. Ishii, X-Band Receiving Amplifier, *ELECTRONICS*, 28, p 202, April 1955.

BIBLIOGRAPHY

- K. Ishii, Oneway Circuit by the Use of a Hybrid T For the Reflex Klystron Amplifier, *Proc IRE*, 45, p 687, May 1957.
- C. F. Quate, R. Komfner and D. A. Chisholm, The Reflex Klystron as a Negative Resistance Type Amplifier, *IRE Trans of PGED*, ED-5, p 173, July 1958.
- K. Ishii, Impedance Adjustment Effects on Reflex Klystron Amplifier Noise, *Micro-wave Jnl*, 2, p 43, Nov. 1959.
- K. Ishii, Reflex Klystrons as Receiver Amplifiers, *ELECTRONICS*, 33, p 56, Jan. 8, 1960.
- K. Ishii, Using Reflex Klystrons as Millimeter-Wave Amplifiers, *ELECTRONICS*, 33, p 71, March 18, 1960.

Practical Approach To Interference

Information is provided on circuit interference problems and on

By PAUL B. WILSON, Jr.,

Interference Testing & Research Laboratory,
Inc., Boston, Mass.

MUCH TIME AND MONEY can be saved by carefully planning the means of reducing interference in the initial phases of system design. This article presents methods of estimating interference and preventing it. The problem is examined by first considering circuit cards, then sub-assemblies, then the combining of sub-assemblies into a system package.

Figure 1 shows circuit cards containing circuits chosen only to illustrate interference problems. They show incorrect (A) and correct (B) layout methods. The positions of components in the schematics approximate their actual physical layout. The circuits have high gain and contain many of the circuit elements which are sources of electromagnetic radiation.

Inspection indicates the following possible sources of radiation: delay line DL_1 , which could be located in any portion of an actual circuit; stage-input coils L_1 and L_2 ; the tuned circuit at the collector of Q_1 ; peaking coils L_3 and L_4 ; Zener diodes D_1 and D_2 , and relay K_1 . The obvious sources of radiation having been determined, the problem becomes one of determining how much attenuation and shielding is necessary. Since the characteristics of shielding and filtering are such that the shields and filters are least effective at the lowest frequency encountered, the first design criteria involves this frequency.

Assume the frequency interval of interest to be between 0.15 and 1,000 Mc. In considering the energy radiated by the tuned circuit for Q_1 ,

(the same procedure would be followed for the other circuits), a knowledge of the characteristics of the incoming signal is necessary. The incoming signal is a pulse type which can be represented to a first approximation by a square wave having an amplitude of 5 volts, a width of 1 μ sec, and a repetition rate of 5 Kc. Since various amplitudes will be encountered throughout the circuitry, assuming pulse-width preservation, a family of radiated-interference curves can be drawn for various amplitudes (A_ω) based on a plot of the solution to $A_\omega = 2 E t \Delta f f \left(\frac{1,000 \text{ Mc}}{0.15 \text{ Mc}} \sin \pi t f / \pi t f \right)$. Such a plot is shown in Fig. 2 where E is the amplitude of the pulse in volts, t is pulse width in μ sec, Δf is the prf of the pulse train, and f is the frequency at which the amplitude A_ω occurs. It can be seen that at 150 Kc and for the assumed input conditions (using curve D), approximately 48 mv of radiation will exist at the tuned circuit. When using this data, space attenuation and component configuration must be taken into account. The radiated level to which it is desired to reduce this signal is 5 μ v; this reduction represents approximately 80-db attenuation.

Given a requirement of 80-db attenuation of the radiated energy, we now proceed to determine what material shall be used to enclose the tuned circuit of Q_1 , and how thick this material shall be. Since weight is a factor, aluminum, magnesium or some other lightweight metal must be used. From the theory and design data given by C. S. Vasaka¹, we determine the minimum thickness necessary to achieve 80-db attenuation. Using a conservative value of 2.5-db-per-mil thickness for

aluminum, it is seen that an aluminum box constructed from 0.030-in. aluminum and having an 0.002-in. cadmium plating, or other similar type of plating to permit soldering of grounds, provides the necessary attenuation at 150 Kc.

Having now chosen the shielding material, we next determine the filter that will produce the desired attenuation. The filter-attenuation requirement is that the signal level at the line side of the filter shall be less than 1.5 mv at 150 Kc, thus giving an attenuation requirement of approximately 30 db at 150 Kc. Figure 1B shows the modification of Fig. 1A for interference suppression. Since effective decoupling must be achieved within the circuit configuration, the d-c voltage lines have rather large capacitors; therefore L-type filter networks are adequate. To achieve the highest amount of attenuation at the upper frequencies, (above 20 Mc), a feed-through type of capacitor having three terminals is best; this type has a terminal external to the package which permits the soldering of lead wires from the cable harness and provides maximum available attenuation as a filter. To complete this filter, we now must connect a choke (L_6) between the feed-through capacitor (C_{17}) and the decoupling capacitor (C_{10}).

Design of L_6 is governed by the amount of attenuation that is required between the points in the frequency spectrum where the decoupling attenuation drops and the feed-through capacitor attenuation begins. (Fig. 3)². The resultant attenuation curve, which is found by drawing a line joining all three curves, becomes the effective attenu-

Prediction And Suppression

proper grounding techniques to aid in system design

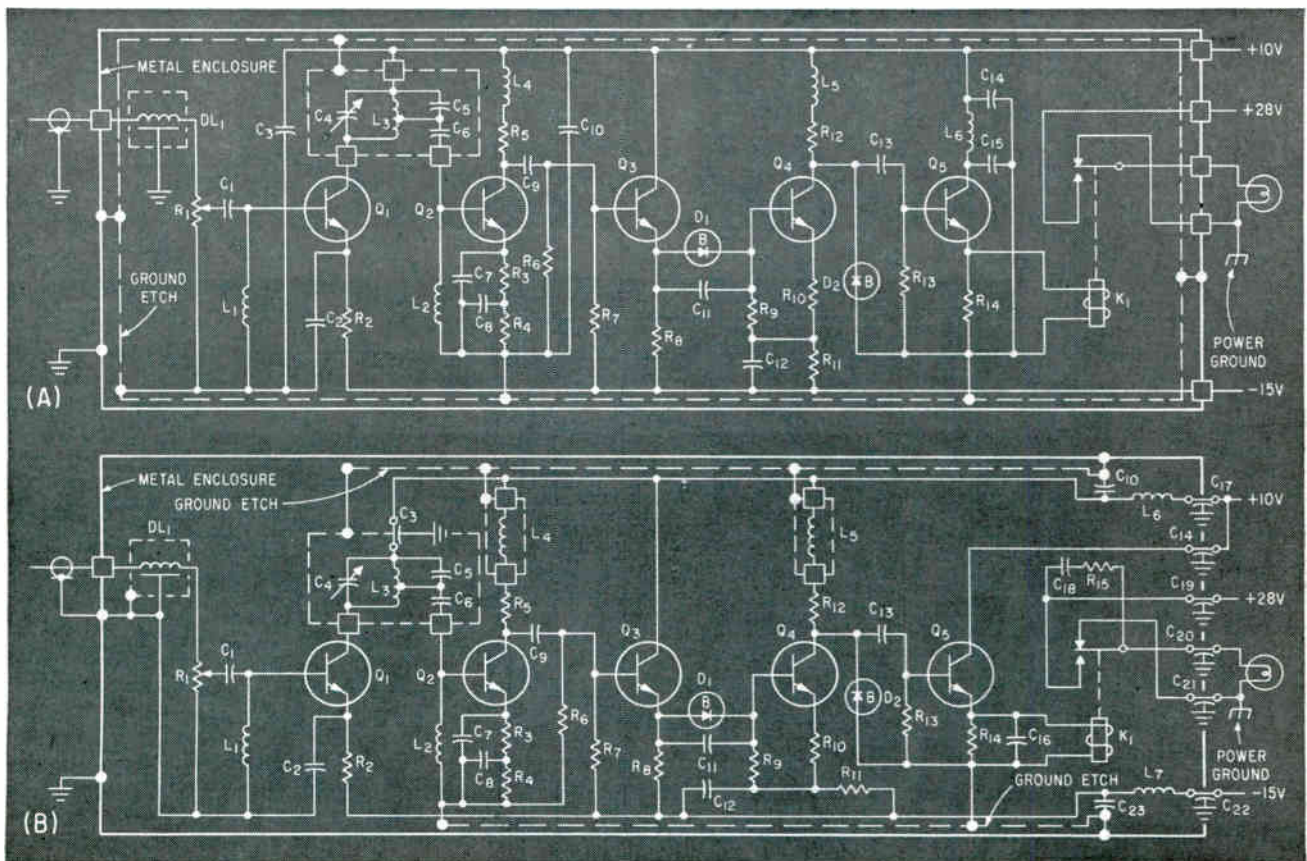

FIG. 1—These circuit cards show examples of incorrect (A) and correct (B) layout methods

ation of the filter. Similar calculations for other circuits will determine the shields and filter sizes that are necessary to confine interference within the enclosure.

When discussing ground-voltage gradients (commonly known as ground currents), it is necessary to define a ground reference point from which all voltage gradients are measured. Here is a definition for the ground reference point: given an infinite conductive plane, the ground reference point is the point at which the difference of potential between it and any other electrical

point within the plane is zero, regardless of how far apart they may be. Zero volts cannot be attained in most practical cases, where $10 \mu\text{v}$ is probably a typical value; the requirement set for Fig. 1B was $5 \mu\text{v}$. When specifying how much voltage above this theoretical zero the system can tolerate, bear in mind that the amplitude of any detectable voltage gradient becomes, to a first approximation, the amplitude of the radiated energy detected at very short distances from the ground plane. This, of course, points up the present need for meas-

urement equipment capable of being calibrated to a standard based on this definition, and usable up to and including, the Gc region at sensitivities of a μv or less.

In reducing these ground-voltage gradients, let us consider the physical layout of the circuit. Our first thought is to the placement of decoupling capacitors C_{10} and C_{23} in Fig. 1B. These capacitors should be placed in the circuit where the heaviest r-f current is drawn and their ground leads should be as short as possible. The input circuit should have all grounded compo-

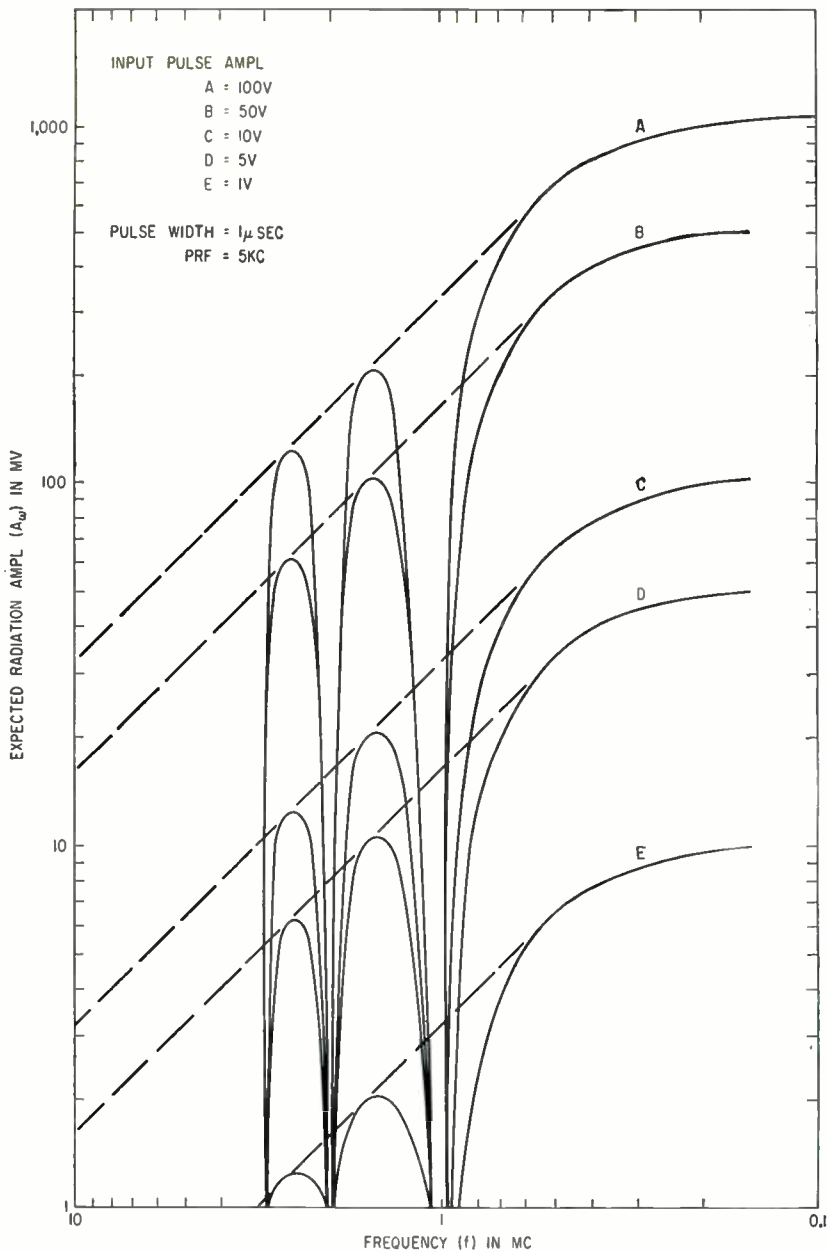

FIG. 2—Expected radiated-interference levels for various input voltages

nents brought to the physical input ground. This prevents the circulation of ground-voltage gradients. All tuned circuits and peaking coils should be completely enclosed and the shield made a part of the ground etch. The ground etch should be made at least three times the width of the other interconnecting etches. The ground etch should not pass near the high-level signal-carrying etches, nor should the ground etch make a complete loop around the periphery of the circuit board. If it becomes necessary to carry the ground etch around the outside of most of the board, there should be

a considerable break between the start of the etch and the end of the etch. This ground etch should be fastened to the shield which comprises the outside cover of the box housing the printed circuit card at the points where the maximum r-f current flows. In the example, these points are near C_{10} and C_{23} ; generally, they are determined empirically. This prevents heavy r-f currents from passing through the lower-level signal paths, thus minimizing the circulation of ground current. Note that when ground-voltage gradients exist, the entire enclosure of the circuit may radiate

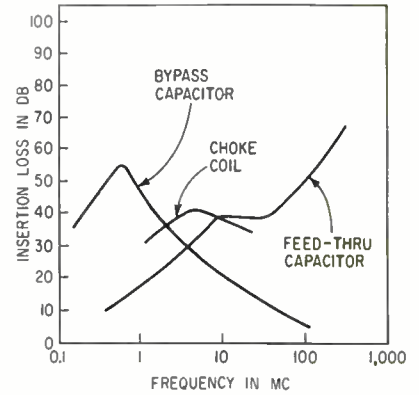

FIG. 3—Attenuation curves of individual filter components

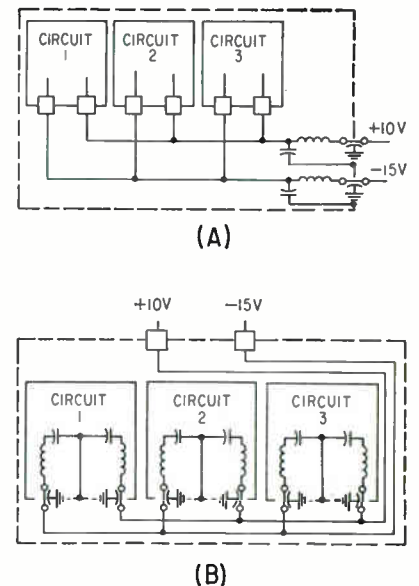

FIG. 4—Incorrect (A) and correct (B) methods of filtering for sub-assemblies powered by a common supply

energy and contaminate other packages within the system.

The dynamic impedance of the system's power supply should be kept as low as possible, preferably in the order of less than 100 milliohms; this further prevents circulation of ground currents within the supply, and materially aids the amount of suppression achieved at lower frequencies.

Figure 1A illustrates the type of layout often encountered when circuit designers do not take into consideration the factors outlined above. It shows a composite of many of the mistakes encountered

in practice. Any of these can cause trouble, not only from the point of view of interference, but also from that of circuit operation. Often, circuits which fail to operate as the designer intends, can be made to perform properly when laid out with correct interference principles in mind.

In Fig. 1A, for instance, the input signals can pass through the output ground. This creates a feedback situation which may cause unintended oscillations. Note that since the ground etch is located at a point other than where the heaviest r-f signal currents flow, a potential difference is set up which may improperly bias one or more of the transistor bases. Another possible cause of trouble is the positioning of filter choke L_a . The choke's leads must be short to prevent radiation of the signal before filtering. This effect is especially pronounced at higher frequencies.

Input circuits should be located at the opposite end of the card from the output circuit.

Another example is shown in Fig. 4, where several amplifiers are fed from the same power source. In Fig. 4A, which shows the incorrect method, there is only one filter between the three cards and the power supply. The three cards interact and thus create a high noise level. In Fig. 4B, each card correctly has its own filter to prevent interaction between amplifiers.

Up to this point, the problems incident to the design and construction of a single sub-assembly have been discussed. Consider now the combining of a group of sub-assemblies into an operating system. Assume that each system sub-assembly is interference-free within the specification limits.

In laying out the wiring harness, unshielded signal-carrying wires must not run in close proximity to any unfiltered power lines.

Electrical ground (known as power ground) continuity and massive (that is, more than point-contact) ground continuity for signal grounding must be maintained. In most aircraft installations, the system is contained in a box which slides into a rack, like a drawer, and grounds must be set up to provide continuity between the box and air

frame (Fig. 5). For this reason, there are usually two grounds, one for power and one for signal circuits. The power ground usually passes through a filter located in the back of the rack, as in Fig. 5, and continues on as a wire to the aircraft power generator where it is grounded to the air frame. The signal ground is usually maintained by finger stock or r-f gasket material which provides an intimate bond between the system box and the rack. If the rack frame contains more than one box, it is grounded to the air frame at a single point, the nearest point possible, to prevent the circulation of ground currents within the rack frame.

In determining the amount of shielding required for the signal-carrying leads within the system box, remember that at the lower frequencies, that is, 150 Kc to 10 Mc, the attenuation afforded by a single-shield 90-percent braid is approximately 40 db—this level being equivalent to a 100 μ V/meter attenuation with a 50-ohm load. Consequently, it may be necessary to go to a double braid or a solid shield. Thus, attenuation limits the type of connectors which may be used. If current levels are extremely high, causing the filters to be large, it may be necessary to use shielded leads from the sub-assembly to the

power supply or other termination. In this case, use a double-shielded wire.

The mechanical construction or layout of the system box (Fig. 5) should locate the power supply at one end, preferably near the output end, so that there is a shield between the power supply and the output, with the power supply sufficiently far away from the input circuit so that any radiation due to the power supply is not picked up by the lower-level signal circuits.

The metal finish should provide good conductivity when the sub-assemblies are bonded to the box frame. For this purpose, finishes such as metal plating or iridite, which give a relatively high conductive surface, should be used. A grounding pressure of about 40 lb/in² should be achieved by the mating surface. This pressure usually ensures intimate ground contact. If an irregular shape is necessary and good metal-to-metal contact is difficult to achieve, use r-f gasket material to take up the differences between the two metal surfaces.

REFERENCES

(1) C. S. Vasaka, Problems in Shielding Electronic Equipment, *Proc of the Conf on Radio Interference Reduction*, p 88, Dec. 1954.

(2) Cornell-Dubilier Electric Corp., Bulletin No. 166, p 11, and Bulletin No. 172, p 4.

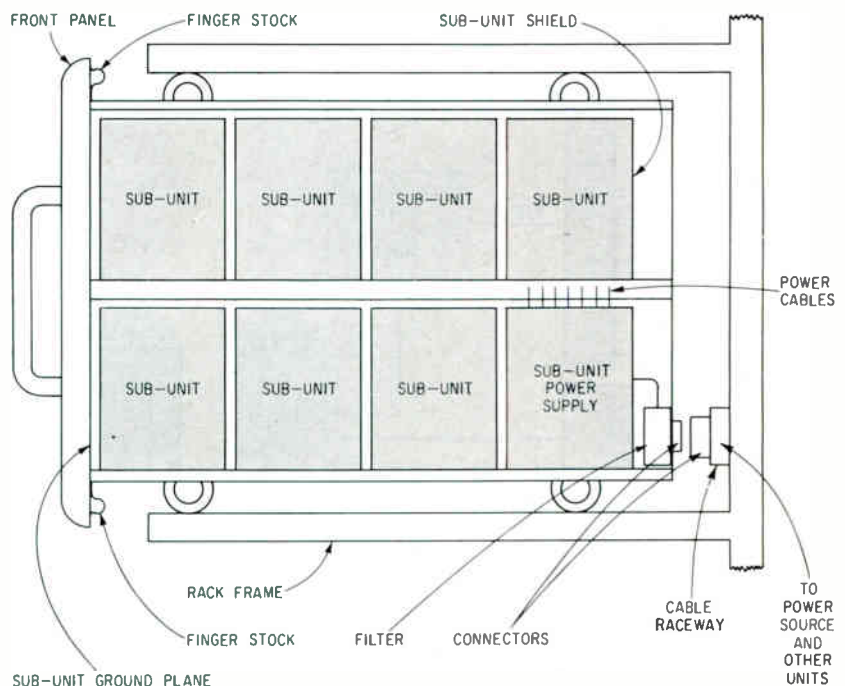

FIG. 5—Grounding scheme for subassemblies



Staircase voltage generator provides a five-digit time code for unique identification and correlation of data on magnetic tape loops as short as 30 inches

Display equipment of B-66 radar development instrumentation system shows at left the remote repeater for the cockpit

Digital Time Code Identifies Recordings

By **VERNON B. MORRIS, JR.**,
Senior Engineer, Air Arm Division,
Westinghouse Electric Corp.
Baltimore, Md.

A RECORDED TIME CODE is often needed in instrumentation magnetic tape and oscillographic recording. Whenever it is desired to determine accurately the time between recorded events, or when two or more recorders must be correlated, a recorded time code becomes essential. In many applications a cyclic timing signal is recorded on one track of each recorder in the instrumentation system. Typical timing signals are one-second pulses on

a 100-cycle note. However, the recorded time signal does not identify uniquely any portion of the record. To determine times between events or to correlate two recorders requires counting. Where lengthy recording periods occur or accurate time resolution is required, simple time-pulse recording is not satisfactory. The difficulties may be accentuated by inability to determine exact beginning and end of record and by pulses missed while the recorders are coming up to speed. When portions of the records must be removed for data analysis or editing, the portions removed cannot be identified in time, and corrections

to the record must be noted.

The shortcomings of periodic time and correlation pulse recording are overcome by a time-code and data-correlation system that generates a unique output for each time period. Digital timing units that produce unique outputs for each time period are commercially available. These equipments fill the timing and correlation requirements but due to cost and complexity they are not found in many installations. The commercially available units usually require an entire track of magnetic tape, and the output may not be suitable for recording on oscillographs. The recovery on play-

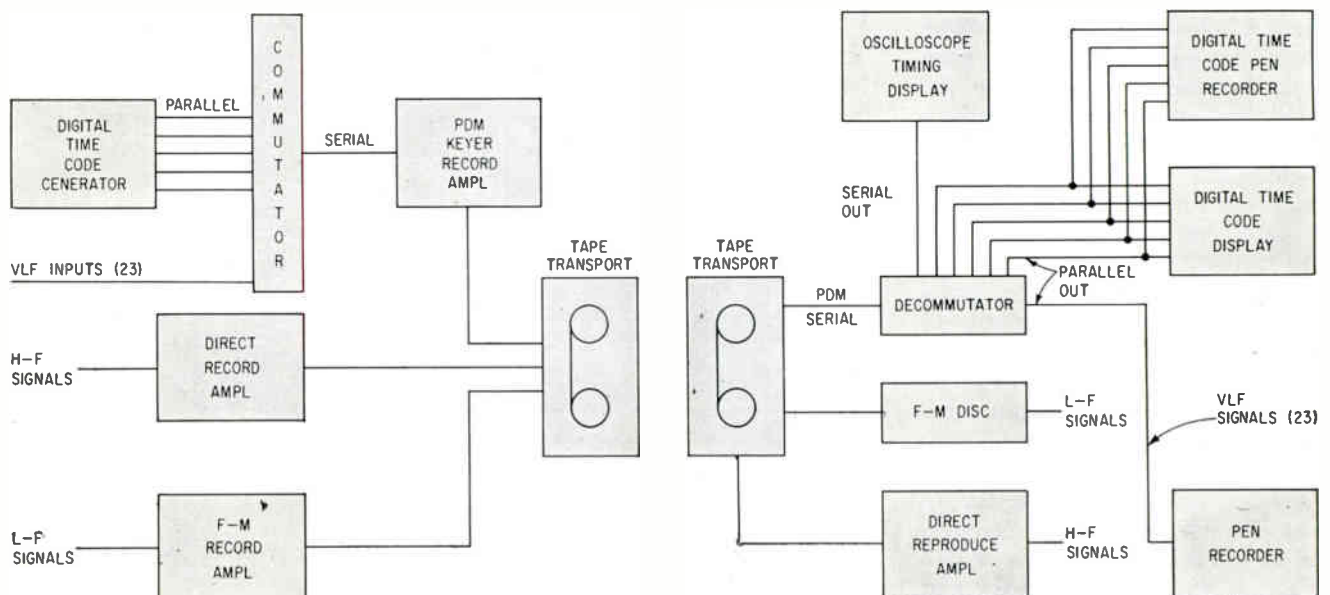
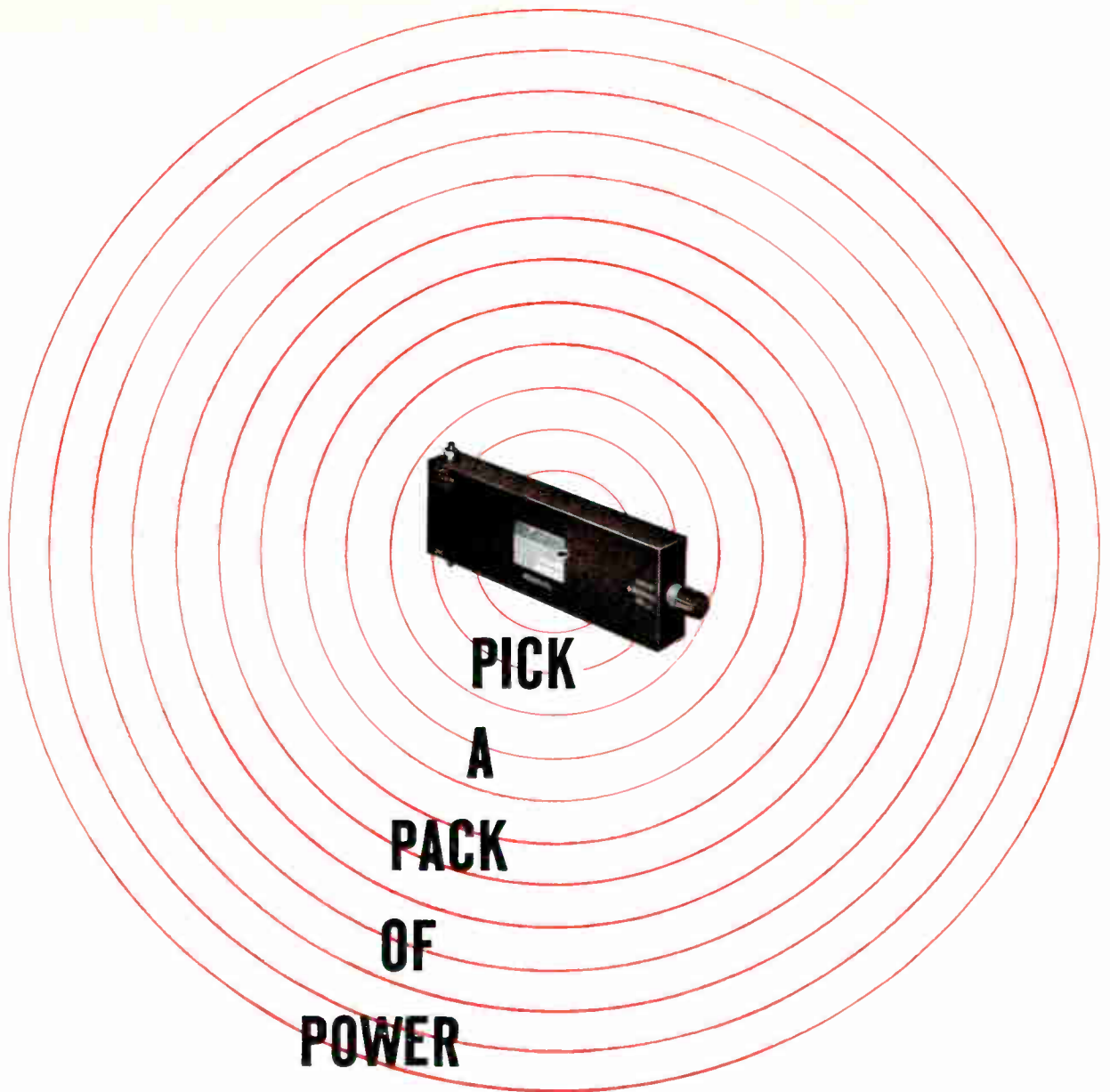

FIG. 1—Block diagrams of record portion (left) and reproduce portion (right) show digital time code equipment added to magnetic tape system



When it comes to High Voltage power packages—boosting power or shrinking size or both together—AMP's Capatron Division is completely equipped to tackle your toughest design and production problem. It has skilled personnel and research facilities—has the exclusive AMPLI-FILM dielectric for tremendous power in smaller packages—has, too, extensive production facilities to give you High Volume and complete quality control.

And, for off-the-shelf power packages, Capatron has developed keep-alive, indicator and modulator power supply packages that set new standards for high output and small cube. Whether your requirement concerns low ripple voltage, close regulation, minimum size or rugged construction, see Capatron first. Engineering facilities are also available for designing AC/DC input transistorized supplies for missile or other applications. For more information, write today.



HA/HV LEADS

For 12,000, 25,000 and 35,000 volts at 5 amps, these new—and much smaller—high altitude, high voltage, high temperature leads offer corona free operation to 23 KV peak pulse and meet radio-noise specifications.

CAPITRON DIVISION

AMP INCORPORATED

Elizabethtown, Pennsylvania

Capatron products and engineering assistance are available in Canada through Aircraft-Marine Products of Canada, Ltd., Toronto, Canada

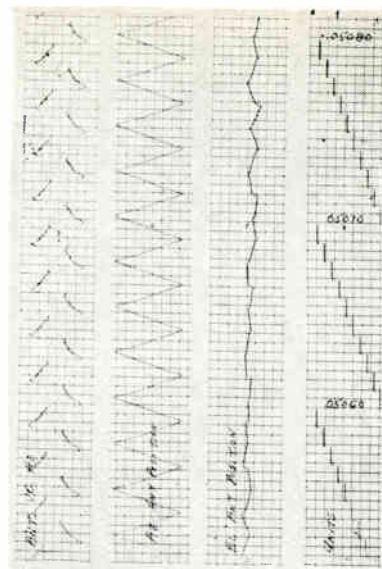
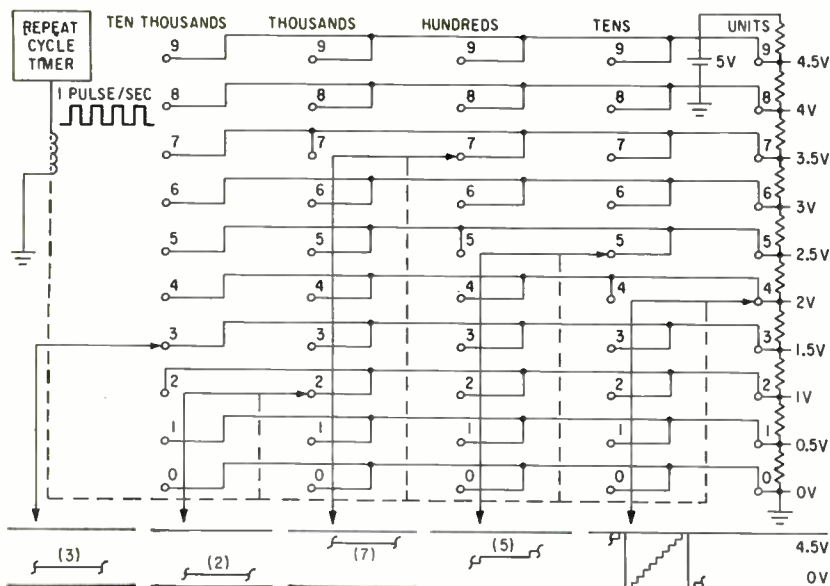

FIG. 2—Repeat cycle timer in digital timing code generator (left) advances the units wiper of the counter, which advances mechanically the higher order wipers at one-tenth the frequency of the next lower order. Strip chart recording (right) displays only unit seconds

back of the digital timing code generated by these systems also requires costly, complex equipment.

A simple, relatively inexpensive digital timing code and data correlation system (Fig. 1) has been devised that does not require an entire track of the magnetic tape and may be played back on equipment available in many magnetic tape facilities. Several channels of a pulse-duration modulation (pdm) magnetic-tape track are used. Pulse-duration modulation designates the time multiplex system used in magnetic-tape recording. This time multiplex system is also known as pulse-width modulation (pwm). A number of low-frequency signals are time-shared using either electronic or electromechanical commutators. The output of the commutator is fed into a pdm keyer that converts the amplitude pulse train to pulse-width information. Keyer output is recorded on magnetic tape.

The time-code system consists of a repeat-cycle timer, the output of which is used to advance periodically a switch-readout electromechanical counter. The output of the counter is a decimal time code. A diagram of the system is shown in Fig. 2 (left). A one-second unit time has been shown. Also the staircase voltage output of each wiper of the counter is shown as zero to +4.5 volts to match the pdm system input of 0 to +5 volts. The voltage on each wiper of the counter is re-

corded on a separate channel of the pdm system. The wiper output voltages may also be recorded on separate channels of a multichannel oscillograph. Unit time used and the number of decades recorded will depend upon the application. The electromechanical counter also has a visual display which provides a continuous indication of the time code.

When the magnetic tape is played back and the pdm information decommutated, the decimal time code is reconstituted. The played-back time code may be recorded on a strip chart or displayed on a meter panel. A neon lamp array may also be used to display the digital time code. In short records, difficulties may arise with the neon lamp display due to transients on the pdm playback when starting or stopping the playback tape transport. These transients cause flashing of the neon lamps. The pdm decommutator monitor oscilloscope is usually provided with a pdm playback system to give a readily interpreted visual display of the digital time code. The complete digital time code may be recorded on a strip chart at playback. To conserve stripchart capacity, it may be desirable to record directly only seconds on the chart and note the complete time code from the playback visual display as shown in Fig. 2 (right).

Each second of the entire record is uniquely identified. By inter-

polating it is possible to determine the times of events more accurately than to one second. For a 30×30 commutator (30 channels each sampled 30 times a second) the resolution is one-thirtieth second. Better resolution may be obtained by recording the units output of the counter on more than one channel of the pdm commutator. For example, resolution of one-ninetieth second is achieved by recording units on three equally-spaced channels of the commutator.

An advantage of the pdm recorded digital time code over commercially available serial time code systems is that short lengths of magnetic tape may be uniquely identified. Where spectrum analyses are made of signals recorded either directly or by f-m, it is possible to identify the time of recording of tape loops cut from the continuous recording. Loops as short as 30 inches may be uniquely identified. With a serial time-code recording at one pulse a second and a tape speed of 60 ips, the length of tape required for unambiguous identification is at least 900 inches.

The playback of the pdm recorded digital time code requires expensive and complex decommutating equipment but in a great many magnetic-tape installations decommutating equipment is already available. The repeat-cycle timer and the switch readout counter are the only new equipment required.

15 THOUSANDTHS OF A SECOND IS A VERY LONG TIME

It's much faster than you can wink an eye, yet time enough for Bell Laboratories' new high-speed switching terminal to transfer your voice to another channel while you are talking by telephone.

The new terminal—recently introduced on the transatlantic cable—uses the idle time in the conversations of talkers on a group of channels to provide paths for other talkers. This time-sharing technique, called Time Assignment Speech Interpolation, permits the sending of 72 simultaneous phone conversations over this deep-sea system where only 36 could be sent before.

TASI takes advantage of the fact that in a normal telephone conversation you actually talk less than half the time. You do not talk when you are listening, and even when you do talk there are pauses between sentences, words, and syllables. When there are more talkers than channels, TASI puts this idle time to use.

Scanning each circuit thousands of times a second, TASI instantly notices when you aren't talking, then quickly switches in someone who is. TASI also notices when you resume talking, immediately finds a channel not in use that moment and switches you to it. Your voice may be switched many times during a single conversation in a time too fast—about 15 milliseconds—for your ear to perceive.

The TASI switching terminal was rendered feasible by the transistor—an invention of Bell Telephone Laboratories. More than 16,000 transistors are employed to achieve the compact, dependable, high-speed circuitry required. TASI is another example of how Bell Laboratories works to keep your telephone service the world's finest.



BELL TELEPHONE LABORATORIES

WORLD CENTER OF COMMUNICATIONS RESEARCH AND DEVELOPMENT

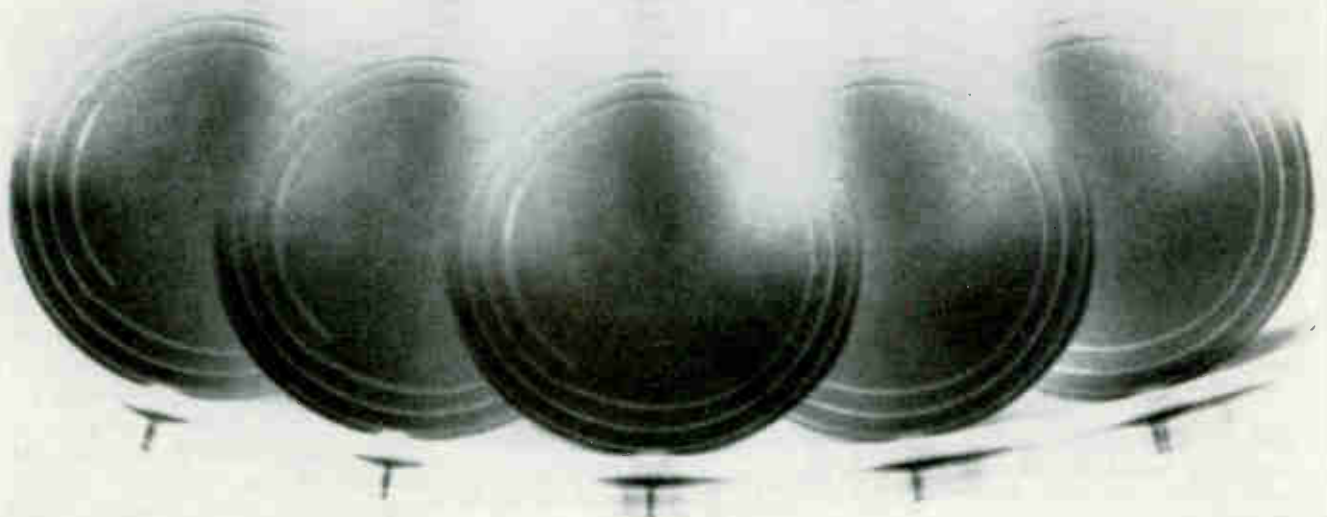

High-Accuracy Pulse-Measuring Technique

By L. M. TIBBETTS, Jr.,
Commercial Engineering Dept.,
Sylvania Electric Products, Inc.,
Emporium, Pa.

EVALUATING special pulse-type tubes requires accurate, repeatable measurements of tube performance. Because of the rapidly increasing use of pulse circuits, such measurements are also needed for proper selection of tubes.

A method has been developed that can measure tube input and output pulse voltages from zero to 500 volts to four significant figures. Cumulative errors are less than 0.5 percent, a ten-fold increase over some conventional methods. Key to the high accuracy is use of choppers for oscilloscope comparison of pulse amplitudes with d-c references, which eliminates reading absolute values from the display.

Limitations of past methods have often led to reliance on a calibrated oscilloscope to set input and measure output voltages. Accuracy is usually assumed to be only 5 percent because of zero drift, calibration shift, vertical nonlinearity and parallax. Using the same oscilloscope for both voltage measurements can compound the error. Bias must be subtracted from a display of total input to determine

pulse voltage, which can also lead to error. To measure both grid-to-cathode voltage and cathode current pulse across a current-viewing resistor would require two oscilloscopes.

A simplified version of the new method displays output across a one-ohm cathode resistor as shown in Fig. 1. Internal triggering of the oscilloscope alternately displays the pulse and the leading edge of the d-c reference as shown at the left of Fig. 3 by synchronizing it with the chopper. Need for oscilloscope calibration and maintaining the zero level are eliminated. Since both pulse and reference are amplified similarly during the first few microseconds, errors from incorrect adjustment of bandpass trimmers are eliminated.

A decade divider is used for low-level outputs. A standard 10,000-ohm decade divider shunting the one-megohm oscilloscope input resistance results in a 0.1 percent error when set at 1 volt. This error can be reduced by a lower resistance decade.

The oscilloscope in the complete system in Fig. 2 must be d-c coupled and have flat frequency response because it is triggered by the driving pulse. With adequate bandpass,

the leading edge of the d-c pulse from the chopper can be used to check and adjust input trimmers for flat frequency response. The oscilloscope must also have sufficient gain and it must incorporate a dual-channel, alternate-sweep pre-amplifier.

Choppers are connected in phase so that input and output pulses are measured at the same time. Since the oscilloscope is grounded to measure output, input must be measured from grid to ground. However, grid-to-cathode voltage can be determined by returning the negative lead of the input reference supply to the positive end of the cathode resistor.

Voltage drop across the cathode resistor is superimposed on the d-c reference line. By making input pulse voltage from grid to ground coincide with the d-c reference line plus the pulse on the oscilloscope, grid-to-cathode pulse voltage will equal the d-c value only. External triggering permits positioning the cathode pulse on the input reference line and also brightens the trace.

The negative lead of the floating input reference can be returned to the cathode end of the one-ohm resistor without adversely affecting cathode wave shape. If applied voltage is specified from grid to ground, this lead can also be returned to ground. Since pulse voltage above zero bias is usually specified, bias level is not critical. However, if total input pulse voltage must be measured, the input d-c reference lead must be returned to the negative lead of the bias supply.

Stability of d-c reference supplies is 0.1 percent with 5 mv maximum ripple. Proper shielding, grounding and lead dress avoid pickup and distortion. A reversing switch in the input to the decade divider permits measurement of plate and grid current pulses across one-ohm resistors in the negative supply returns. Incorporating a reversing switch on the input of the oscilloscope permits inverting grid

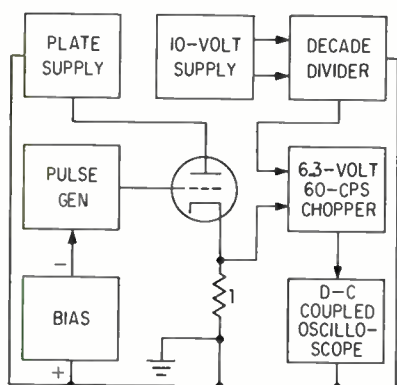

FIG. 1—Output pulse voltage is compared with stable reference on internally triggered oscilloscope

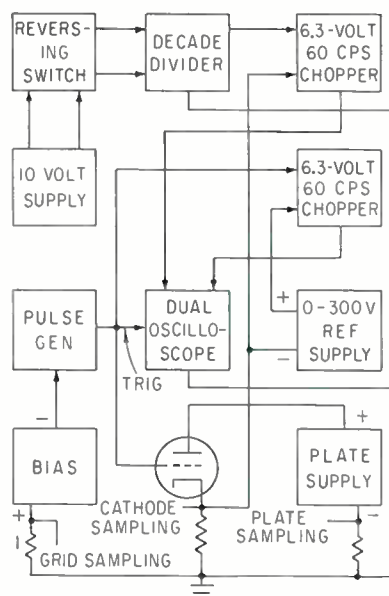

FIG. 2—Both input and output pulses are compared with reference lines using externally triggered, dual-channel oscilloscope



How to use a 4-megacycle instrumentation tape recorder

Ampex's new AR-300 and FR-700 answer a whole new range of needs

For video-bandwidth phenomena

Radar, for instance, can now be tape recorded off receiver and played back repeatedly to scopes, analytical devices or radar guided equipment. Radar testing, reconnaissance and tracking are enormously aided by tape's live-playback capabilities. And for simulation and training, elusive transient phenomena now become repeatable at will.

For predetection recording and communications monitoring

The recorder's bandwidth catches everything at once — any 4-megacycle band of radio frequencies or the IF stage off a telemetering receiver. This simplifies on-site equipment. One kind of recording serves for all usual types of communications and telemetered data. Later you can play back through detector, discriminator and other equipment as many times as necessary to separate and process the desired channels of information.

For 5,000,000 binary bits per second

Super-efficient acquisition and reduction systems can be developed around serial pulse-coded data put directly on tape. One reel lasts 60 minutes — holds over seven billion binary bits. Compare this with previous PCM techniques on tape limited to less than 1,000,000 bits per second even at much higher tape speeds and proportionately shorter recording time.

The essential data

The Models: AR-300 Mobile or airborne record only; FR-700 single-rack laboratory record/playback. Response: 10 cps to 4 mc (± 3 db). Tape speeds: 12½ and 25 ips. Playing time: 60 minutes. Tape: 1.0-mil Mylar, 2-inch width, 10½-inch reels. Data tracks: two wideband plus two auxiliary. Electronics: all solid state. Environmental (AR-300): 10g vibration; 50,000 ft. alt.; -54°C to +55°C. Tape interchangeability: yes, among all AR-300/FR-700 recorders.

Write for full information

AMPEX DATA PRODUCTS COMPANY
Box 5000 • Redwood City, California • EMerson 9-7111



AMPEX

and plate waveshapes.

At the center of Fig. 3, waveshapes are shown below their d-c reference lines for clarity. Only the top of the input waveshape at the bottom of the display is shown. Gain of both channels can be increased to show only the tops of the waveshapes for better resolution.

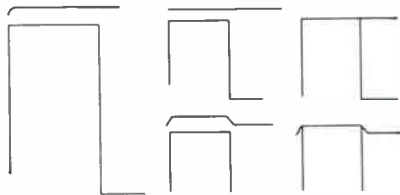

FIG. 3—Cathode pulse at left is compared with reference line using setup in Fig. 1. Grid pulse is also displayed at bottom of center display for comparison with reference plus pulse developed across cathode resistor. Display at right shows correct coincidence with references

Correct coincidence is shown in the display at the right. For go-no go production testing, the output d-c reference may be set to the specified minimum.

This technique permits simultaneous measurement of input and output voltages with different ground potentials on the same oscilloscope and prevents the bias supply from being a source of error. Parallax is avoided because the oscilloscope graticule is not used with this method and waveshapes and d-c reference lines are displayed on the same plane.

Although a flat-topped driving pulse is assumed, voltage at the leading edge or other desired parts of other waveshapes can be measured. The setup is not limited to pulse measurements.

Fission Heat Produces Electricity Directly

THERMIONOC converter using a cesium cell produced 90 watts of electrical power directly from the heat of nuclear fission. Conversion efficiencies as high as 10 percent were achieved at an operating temperature of about 3,500 F.

This performance was achieved in a series of tests at General Atomic Div. of General Dynamics Corp. The cesium cell converter

contained a nuclear fuel element of uranium carbide and zirconium carbide. Power density of 21 watts per square centimeter was delivered into an external load. Overall efficiency of the experimental system of converting fission heat to electrical energy was measured outside the reactor.

The reactor tests are the first step in a series of experiments to determine the feasibility of a nuclear thermionic reactor system as a space and land-based power source. The tests demonstrated that the cesium cell converter can produce electrical energy at high power levels and at adequate voltages in an actual reactor environment. It also has the capability for high temperature operation. Optimizing dimensions and temperatures of the cesium cell could apparently permit further increases in efficiency.

More than 12 cycles totaling several hours of operation at temperatures between ambient and incandescent were conducted during the test series. No attempt was made to use waste heat rejected by the converter, which could increase electrical output and over-all efficiency.

The thermionic-emitter element of the cesium cell used fully enriched U-235. It was made using the carbide fabrication technique developed by General Atomic. In the cesium cell, electrons are released from the emitter because of the heat from the fissioning of the uranium. An electric current collector, which surrounds the emitter element, receives the electrons. Cesium vapor present in the gap between emitter and collector of the converter cell enhances power production.

The entire assembly was housed in an aluminum cladding tube. Two heavy electrical conductors deliver power from the cesium cell to an instrumented load.

The tests were part of General Atomic's program of research and development in direct conversion. This program is being carried out with support from the Rocky Mountain-Pacific Nuclear Research Group, composed of eight western utility companies and the San Diego Gas & Electric Co.

• Premium Quality Switching Transistor

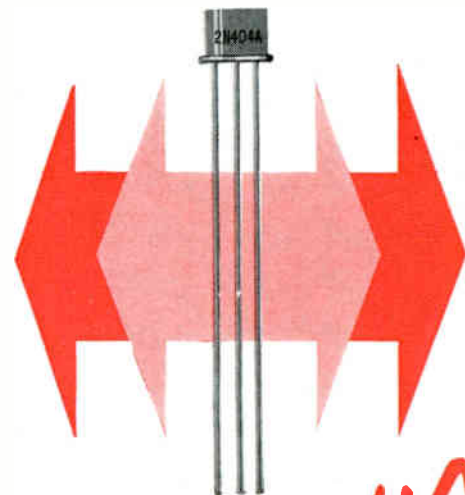

SYLVANIA
2N404A

immediately
available at
OEM prices 1 to 999

through your
SYLVANIA
franchised
Semiconductor
DISTRIBUTOR
today!

New! Switching Transistor

SYLVANIA 2N404A

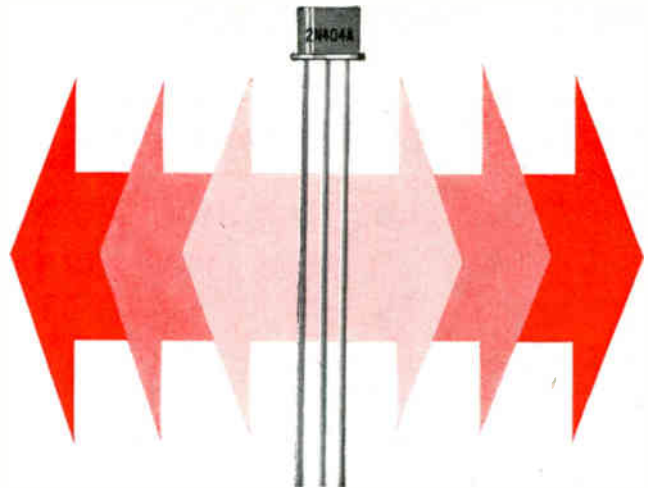

features improved

- ELECTRICAL STABILITY ASSURED BY TIGHT AQLs
- POWER DISSIPATION OF 150mW
- VOLTAGE RATINGS OF -40V
- OPERATING TEMPERATURE CAPABILITIES OF 100°C

| ABSOLUTE MAX RATINGS AT 25°C | 2N404 | 2N404A |
|------------------------------|-----------------|-----------------|
| Collector to Base Voltage | -25V | -40V |
| Emitter to Base Voltage | -12V | -25V |
| Collector to Emitter Voltage | -24V | -35V |
| Collector Current | 100mA | 150mA |
| Power Dissipation at 25°C | 150mW | 150mW |
| Power Dissipation at 55°C | 90mW | 90mW |
| Power Dissipation at 70°C | 60mW | 60mW |
| Junction Temperature | -65°C to +100°C | -65°C to +100°C |

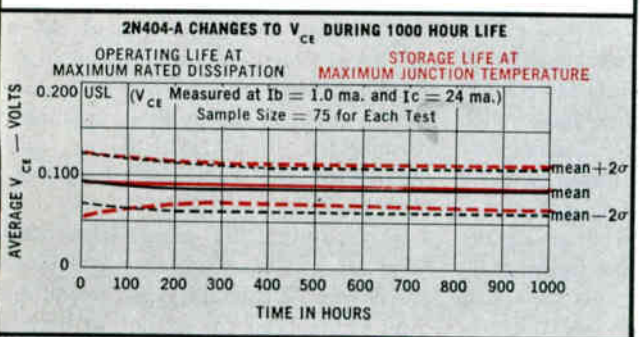
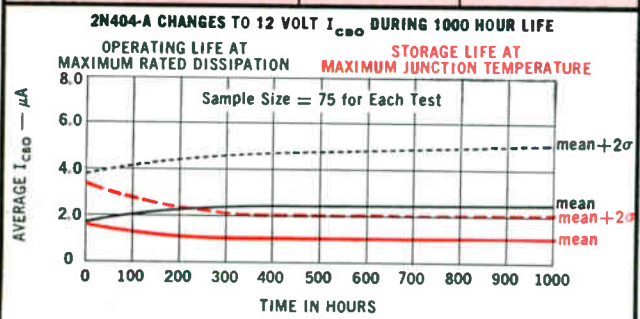

Sylvania introduces the 2N404A, PNP germanium-alloy switching transistor—unilaterally interchangeable with the popular 2N404. A medium-speed switching transistor, Sylvania-2N404A is recommended for service where high reliability, electrical stability and resultant long-life expectancy are prime performance considerations. Reliability is assured by a tighter AQL. Sylvania-2N404A must meet a 1% combined AQL for the following parameters: collector cutoff current at 25°C and 80°C; emitter cutoff current; emitter floating potential; saturation voltage at 12mA and 24mA; input voltage at 12mA and 24mA; and stored base charge.

Designing now? Sylvania-2N404A is available now! Contact your Sylvania Field Office or your local franchised Sylvania Semiconductor Distributor for price and delivery information. For technical data, write Semiconductor Division, Sylvania Electric Products Inc., Dept. 229, Woburn, Massachusetts.

SYLVANIA

Subsidiary of **GENERAL TELEPHONE & ELECTRONICS** 

Cu-Zr Alloy for High Temperature Devices

ALLOY HAS HIGH CONDUCTIVITY AND STRENGTH
AT ELEVATED OPERATING TEMPERATURES

A new copper-zirconium alloy that retains low temperature hardness and strength at extended operating temperatures, and during manufacturing processes, may soon replace pure copper as the conventional material for power rectifier and power diode stud bases.

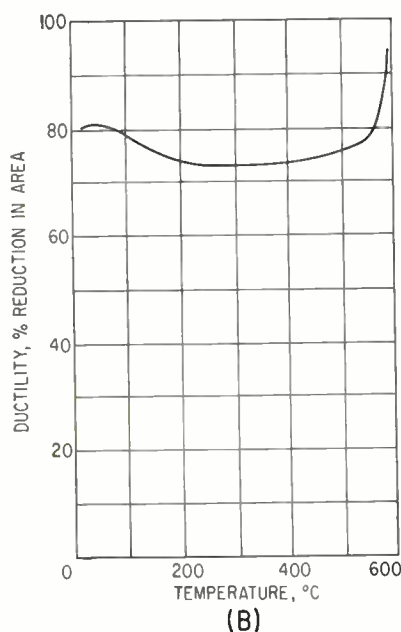
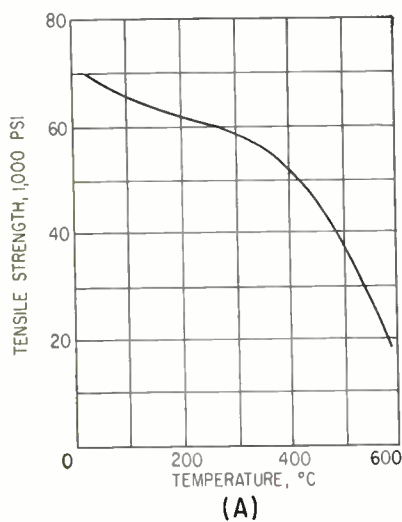

Graphs show tensile strength (A) and ductility (B) for Cu-Zr alloy at 375 C

Called Amzirc, the alloy, containing 0.15 percent Zr, is produced by American Metal Climax, Inc. It combines high strength, at prolonged temperatures up to 750 F, with electrical conductivity of 90-96 percent on the International Annealed Copper Standard scale.

Efficient heat transfer from power rectifiers and diodes requires the stud base to have a flat bottom and accurate threads of uniform size. Base material must be hard enough to withstand a tightening torque sufficient to insure good seating, without deformation and breaking of the base, or stripping of the stud threads.

Manufacturers report that oxygen free high conductivity copper, although hard at the beginning of base processing, becomes heat treated during the manufacturing steps, and is softened. In particular, the copper bases become annealed when a welding ring, used to fasten the case cap to the base, is brazed to the base.

After exposure to manufacturing temperatures of 750 F, the strength of Amzirc is 2 to 3 times greater than pure copper.

One large electrical equipment manufacturer is about to release for production 1-1/16 in. bases with 1/2 in. threaded studs. Laboratory tests on 1-1/16 in. bases with 3/8 in. studs are almost completed.

Initial test data and manufacturing experience have been sufficiently encouraging so that the manufacturer plans to use the new alloy across the board in six different stud sizes.

The company estimates that once production is rolling, 1 million copper-zirconium rectifier bases will be produced annually.

Other potential applications of the alloy include resistance welding wheels and tips, fine wire, high temperature magnet wire, commutators, collector rings, canned mo-

tor windings, rotor wedges, soldering tips, studs for x-ray tubes, and electron tube side rods.

For many years, a copper-0.7 percent chromium alloy was used in applications of this nature. High temperature performance was satisfactory, but the alloy is notch sensitive, and its properties are poor in the transverse direction compared to the longitudinal direction.

The introduction of oxygen free high conductivity copper, with negligible hydrogen penetration, eliminated embrittlement typical of ordinary copper.

The Battelle Memorial Institute was asked to develop an alloy which would have equal or better conductivity than OFHC copper, and would possess greater strength at high temperatures.

Battelle suggested the use of zirconium as an alloying element, but recommended a Zr concentration of 0.23-0.25 percent. Although this alloy possessed the desired properties, considerable difficulty was encountered in melting and in component fabrication.

Through the development of a series of phase diagrams, American Metal Climax found that 0.15 percent max Zr provided optimum properties for fabrication, and possessed the required characteristics.

An outstanding property of the new alloy is the high strength level it develops through cold working and aging, and the extent to which it retains this strength at elevated temperatures.

A typical bar of the alloy, cold worked 85 percent, and aged for one hour at 375 C, has the following mechanical properties at room temperature:

Ultimate tensile strength: 65-70,000 PSI
Yield strength: 57-62,000 PSI
Elongation: 10-12 percent

How to compensate for temperature variation in a transistorized flip-flop

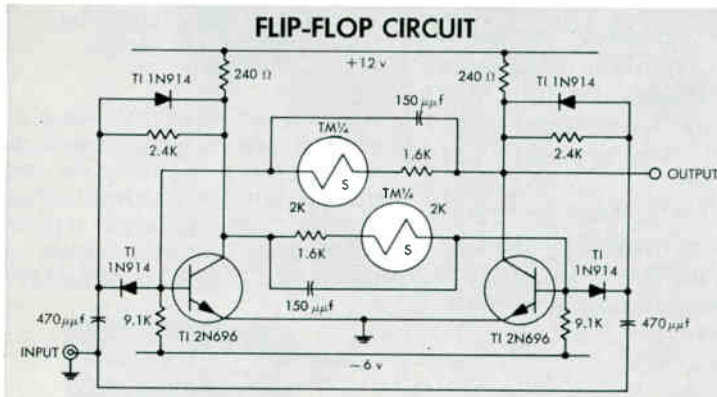

SENSISTOR SILICON RESISTORS
 Positive TC of +0.7%/°C for temperature compensation and sensing.
 Standard available resistances ±10% @ 25°C:
 68, 82, 100, 120, 150, 180, 220, 270, 330, 390, 470, 500, 560, 680, 820, 1000, 1200, 1500, and 1800 ohms.
 Additional resistance values and tolerances available on special order.

| Type No. | Wattage Rating | Body Dimensions | |
|----------|----------------|-------------------------|----------|
| TM 1/4 | 1/4 | Length | Diameter |
| TM 1/2 | 1/2 | 0.585" | 0.200" |
| TC 1/4 | 1/4 | 0.406" | 0.140" |
| P-100† | — | TO-5 Transistor Package | 0.078" |

† Hermetically sealed glass package for instrumentation and temperature control available in resistances of 100 ohms, 500 ohms and 1000 ohms ±10% measured at 25°C

This flip-flop circuit, designed by Texas Instruments, uses *sensistor*® silicon resistors in the cross-coupling network to compensate for increases in h_{FE} with temperature. At 125°C, it resolves 100 mμsec input pulses arriving at a 5 mc rate whereas a fixed resistor version was limited to 3.6 mc. In addition, at +125°C the circuit will operate at a resolution rate greater than 5 mc if the input pulse can be greater than 10 volts when the pulse width is decreased from 100 mμsec.

Another advantage of *sensistor* silicon resistors in a flip-flop using high h_{FE} transistors is the reduction in input voltage required to trigger at high temperatures. For instance, the *sensistor* silicon resistor circuit requires only 10 volts to trigger whereas the fixed resistor circuit required 14 volts.

Sensistor silicon resistors are temperature-sensitive devices that feature a positive temperature coefficient of +0.7% per °C. This predictable rate of resistance change makes *sensistor* resistors ideal for temperature compensation from -50°C to +200°C at frequencies up to 250 mc.

The *sensistor* silicon resistor, developed by TI, provides circuit design engineers with a lightweight temperature compensating and sensing device. Commercially available for over two years, the devices have been used successfully for bias stabilization in a-c coupled stages and in the first stages of d-c amplifiers; and have found wide application in amplifiers, power supplies, servos, telemetry, magnetic amplifiers, computer switching, and thermometry.

In addition, specify from this complete line of TI precision film resistors.

MOLDED

TI-1E
CDM1/2

±1% tol

| TI type number | wattage rating watts | MIL designation | standard resistance ranges | max. recommended voltage volts |
|----------------|----------------------|-----------------|----------------------------|--------------------------------|
| CDM 1/4 | 1/4 | RN60B | 10 Ohm-1 Meg | 350 |
| CDM 1/2 | 1/2 | RN65B | 10 Ohm-1 Meg | 500 |
| CDM 1 | 1 | RN70B | 10 Ohm-5 Meg | 750 |
| CDM 1 | 1 | RN75B | 10 Ohm-10 Meg | 1000 |
| CDM 2 | 2 | RN80B | 50 Ohm-50 Meg | 2000 |

MIL-LINE

TI-1E
CDL1/2

±1% tol

| TI type number | wattage rating watts | MIL designation | standard resistance ranges | max. recommended voltage volts |
|----------------|----------------------|-----------------|----------------------------|--------------------------------|
| CD 1/4 R | 1/4 | — | 10 Ohm-1 Meg | 350 |
| CD 1/4 PR | 1/4 | RN10X | 10 Ohm-1 Meg | 500 |
| CD 1/2 PR | 1/2 | RN15X | 10 Ohm-3 Meg | 650 |
| CD 1/2 MR | 1/2 | RN20X | 10 Ohm-5 Meg | 750 |
| CD 1/2 SR | 1/2 | — | 50 Ohm-10 Meg | 850 |
| CD1R | 1 | RN25X | 10 Ohm-10 Meg | 1000 |
| CD2R | 2 | RN30X | 50 Ohm-50 Meg | 2000 |

HERMETICALLY SEALED LINE

TI-1Z

±1% tol

| TI type number | wattage rating watts | MIL designation | standard resistance ranges | max. recommended voltage volts |
|----------------|----------------------|-----------------|----------------------------|--------------------------------|
| CDH 1/4 M | 1/4 | — | 10 Ohm-500K | 250 |
| CDH 1/4 | 1/4 | RN60B | 10 Ohm-1 Meg | 350 |
| CDH 1/2 | 1/2 | RN65B | 10 Ohm-1 Meg | 500 |
| CDH 1/2 P | 1/2 | — | 10 Ohm-3 Meg | 650 |
| CDH 1/2 A | 1/2 | RN65B | 10 Ohm-3 Meg | 650 |
| CDH 1/2 M | 1/2 | RN70B | 10 Ohm-5 Meg | 750 |
| CDH 1/2 S | 1/2 | — | 50 Ohm-10 Meg | 850 |
| CDH 1 | 1 | RN75B | 10 Ohm-10 Meg | 1000 |
| CDH 2 | 2 | RN80B | 50 Ohm-50 Meg | 2000 |



Write on company letterhead for your copy of "Transistor Bias Compensation with *sensistor*® Silicon Resistors."

TEXAS  **INSTRUMENTS**
INCORPORATED
 SEMICONDUCTOR-COMPONENTS DIVISION
 POST OFFICE BOX 312 • DALLAS, TEXAS



for
printed
wiring
applications

PRECISION wire-wound resistors

Improved design in Cinema's CE400 resistors offer superior performance characteristics and greater ease of installation in printed-wiring boards. Microminiature in size these precision units are ideal for use in critical applications where space is at an absolute premium.

Encapsulated in epoxy, the meniscus effect of this material is used to excellent advantage at the terminal wires to prevent the resistor from being drawn flush to the printed-wiring board and eliminates the possibility of capillary-effects experienced in soldering and high humidity environments. Performance characteristics as per MIL-R93B and MIL-R-9444. CE400 resistors are available in the following sizes and ratings:

| TYPE | WATTAGE RATING | DIA. | LENGTH | MAX. RESISTANCE |
|--------|----------------|------|--------|-----------------|
| CE444E | .25 | 1/4" | 5/8" | 600K |
| CE445E | .25 | 1/4" | 1/2" | 900K |
| CE446E | .5 | 1/4" | 3/4" | 1.7 Meg. |
| CE447E | .5 | 3/8" | 3/4" | 5 Meg. |
| CE451E | .6 | 1/2" | 5/8" | 6.5 Meg. |

Also available in axial lead types as CE200 Series. Write for complete technical details to...



**CINEMA
ENGINEERING**
DIVISION AEROVOX CORPORATION
1100 Chestnut, Burbank, California

Electrical Conductivity: 90-96 percent ICAS
High temperature properties of the alloy are shown in the graphs.

Temperature Compensated Traveling Wave Tubes

Two temperature compensated, magnetically shielded traveling wave tubes have been announced by Sylvania Electric Products Inc. The tubes are designed for close quarter applications in missiles and aircraft.

Designated TW-4002F and TW-956H the new components employ periodic permanent focusing eliminating the need for solenoids. Both tubes are designed for pulse or CW operation.

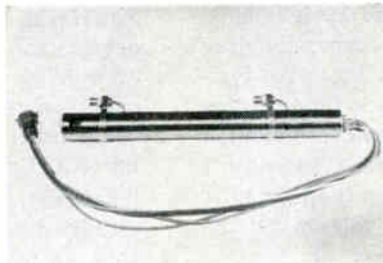

Magnetic shields on new tw tubes permit close quarter applications

The tubes are reported to operate without heater blankets from -65 C to 72 C with minimum performance degradation. Frequency response is relatively flat over an octave, from 2.0 to 4.0 KMc. Each tube weighs approximately 3 lbs., is 15 in. long, and has a 1.4 in. capsule diameter.

Specifications at room temperature are:

Type TW-4002F: 37db minimum small signal gain; 10 mw minimum rf power output at saturation.

Type TW-956H: 37db minimum gain with 0.1 mw input; 2-5 watts CW rf power output at saturation.

Ammonia Batteries for Standby-By Power Supply

Ammonia electrochemical systems have been suggested as stand-by power supplies for outer space vehicles and satellites. The auto-



WAVEGUIDE
BARRETTOR
MOUNT

Broadband—covers complete waveguide frequency range; fixed-tuned mounts; designed for average and peak power measurements; barretter replacement without returning mount; light-weight precision cast aluminum. Covers the complete frequency range, 2.6-12.4 kmc. \$70 to \$150.



COAXIAL THERMISTOR MOUNT—Model 33B2
COAXIAL BARRETTOR MOUNT—Model 33B3

Here are 2 wide frequency range instruments, with low-SWR whose elements are easily replaceable by user. Specially designed for the Microline 31A1. May also be used with any standard power meter.

SPECIFICATIONS

Frequency Range 0.1-10 kmc less than 1.5 over .1-10 kmc
Connectors Male type N input, Female BNC output



TUNABLE DETECTOR MOUNTS

Tunable detector mounts are used extensively in microwave setups with crystals, barretters, and thermistors to detect, monitor, and measure microwave energy. Full waveguide bandwidth coverage, they have a wide tuning range for impedance matching. Same frequencies as waveguide barretter mounts, \$75 to \$180.



BARRETTORS
AND THERMISTORS

Sperry also stocks a complete line of Sperry Microline barretters and thermistors for use with these instruments.



SPERRY MICROWAVE ELECTRONICS COMPANY,
Clearwater, Fla., Division of Sperry Rand Corp.

CIRCLE 202 ON READER SERVICE CARD
electronics

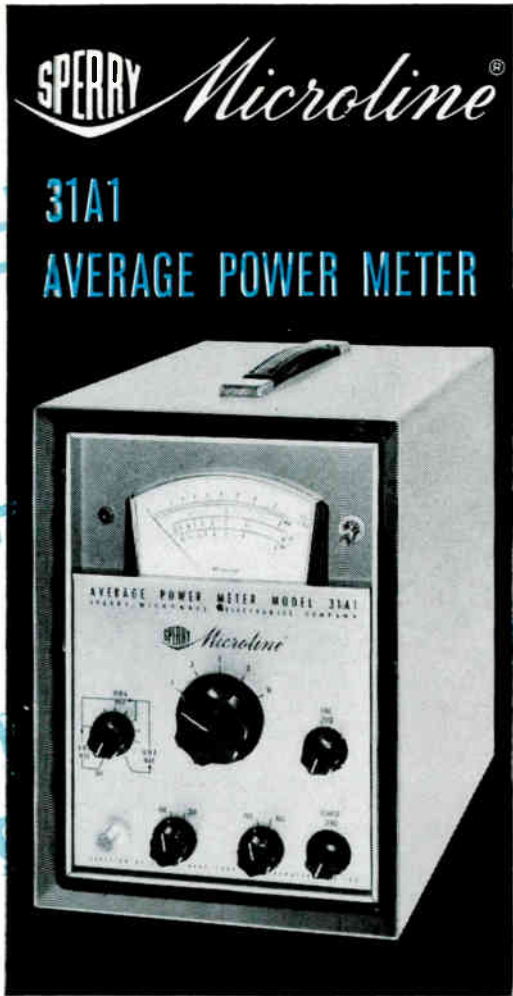

NOW!

MEASURE POWER TO $\pm .03$!

MOST ACCURATE instrument of its kind on the market. Has unmatched stability. Sperry Microline 31A1 can be used to measure pulsed or C-W power of radar, radio, television, microwave and microwave relay equipment and components. Priced competitively low.

EASY TO BALANCE. In addition, two scales (0-10 db and 5-15 db) permit its use for direct attenuation measurements. Its frequency coverage is limited only by the range of the bolometer and mount used. D-C bias adjustment is set by a 12-position switch.



| | |
|------------------------------|---|
| Scales: | Five ranges, front panel selection: 0-1, 0-3, 0-1.0, 0-3.0, 0-10 milliwatts full scale. Two ranges 0-10, 5-15 db full scale. Higher power levels by using directional couplers and/or calibrated attenuators. |
| Accuracy: | 3% of full scale reading. |
| Power: | 105-125 volts, 210-230 volts, 50-60 cps. |
| Bolometer: | Temperature coefficient: positive or negative, front panel selected. Resistance: 100 or 200 ohms, front panel selected. |
| Bias Current: | 0-16 ma d-c |
| Recorder Output: | 0-1 ma, 1500 ohms, one side ground |
| Oscillator Frequency: | 10.7 kc. |
| Weight: | Approximately 13 lbs. |
| Price: | \$240. |

TRY THE SMALL ECONOMY

SIZE... when you're pinched for pennies and panel space! This miniature precision pot is priced at \$10.75 and down; the dial at \$7.75 and down!

Here's togetherness that makes sense... when an application cries out for a low-price pot & dial in $\frac{7}{8}$ " of panel space!

Pencil your way out of this design dilemma by simply specifying Helipot's new economy pair: the $\frac{7}{8}$ " diameter, 10-turn 7216 pot and 2600 series dial. We've restricted the size (and price)... not the designer!

The bushing mount 7216 gives you $\pm 0.5\%$ standard linearity, 10 to 125,000-ohm resistance ranges, and plenty of environmental strength. In short, all the virtues of a precision pot at a price near that of a tolerable trimmer!

The dial is a miniature version of the RB DUODIAL® that counts up to 15 full turns and hundreds of each! It accommodates $\frac{1}{4}$ " shaft and $\frac{3}{8}$ "-32 bushing or $\frac{1}{8}$ " shaft and $\frac{1}{4}$ "-32 bushing with shafts extending as much as 43.64" from the panel!

Whenever your thoughts turn to pots (or dials)... turn to Helipot. We've got a full line of single- and multi-turn pots, linear or non-linear models, with temperature ranges to 85°C, 125°C, and 150°C.

There's much more to tell, so help us. So help yourself and ask for Data File P-10 today.



Beckman®/Helipot®

POTS : MOTORS : METERS

Helipot Division of
Beckman Instruments, Inc.
Fullerton, California



©1960 B.I.I. 61003

matically activated batteries have a long storage life, and operate over a temperature range from well below -65 F to 160 F. The cells demonstrate short time, high rate discharges with good recovery from large transient currents.

Long unactivated storage periods are practical because of hermetically sealed cases and a reserve system of electrolyte distribution. The ammonia filling system is contained within the battery case, and requires only an electrical pulse, or mechanical motion transmitted through a diaphragm or bellows, to activate.

Cell construction is rugged, and the units can survive any stresses or shocks experienced during launch or later impacts. The hermetically sealed cases are capable of withstanding space conditions.

Prototype units are under development at Eastman Kodak Co., and G. & W. H. Corson, Inc.

Precision Resistors In Crystal Cases

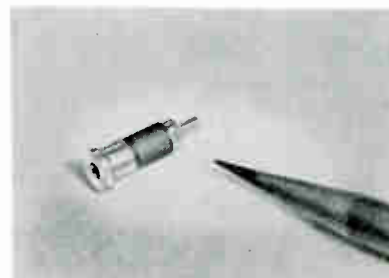

Deposited metal film is coated with impervious material for protection

Crystal type resistors designed to replace crystals during equipment checks with an equivalent impedance are being manufactured by Filmohm Corp., New York.

The devices are made by vacuum depositing a thin metal resistance film on a conventional 1N21 or 1N23 crystal body. The film is immediately sealed with an impervious protective coating.

Available values range between 25 and 400 ohms with standard 2 or 5 percent tolerance. Closer tolerances are available on special order.

Rated power, based on 100 C ambient temperature, is 1 watt average.

Get the
facts
together
quickly

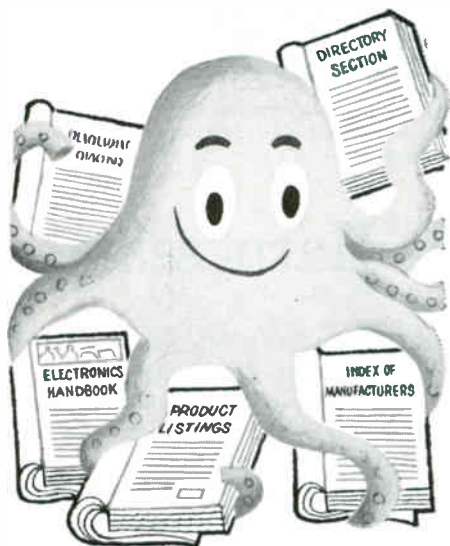

Buying is easier when you've got all the facts in *one* place.

The BUYERS' GUIDE tells who makes it. Gives detailed catalog-type product information and specs. Gives choices in mechanical and electrical characteristics. Gives more choices in terms of materials and design. Also objective and authoritative facts about markets . . . materials . . . design . . . in an exclusive 64-page reference section.

That's why the GUIDE will put you in the *strongest* position to make the best buying choice for yourself and your company.

It's *all* between the covers of one volume. The accurate, complete and authoritative electronics BUYERS' GUIDE and Reference Issue. O.S.E.



FIND
WHAT
YOU
NEED
IN
THE **electronics**
BUYERS' GUIDE

September 9, 1960



CIRCUIT DESIGN

If this is your career interest, we have projects involving digital computers of extremely small size. Let us tell you more about this—confidentially. Write to Mr. S. L. Hirsch, Head, Research and Engineering Staff.



LITTON INDUSTRIES Electronic Equipments Division
Beverly Hills, California

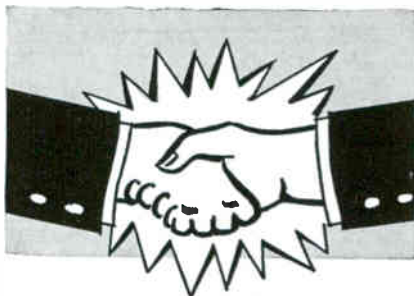

35 YEARS of PROVEN
DEPENDABILITY

COSMIC

**ELECTROLYTIC
AND
PAPER TUBULAR
CONDENSERS**

COSMIC CONDENSER CO.
853 WHITTIER STREET, BRONX, N. Y.
LUdlow 9-3360

CIRCLE 203 ON READER SERVICE CARD



Antenna Systems, Inc., is devoted exclusively to the design, fabrication and installation of antenna systems in the fields of scatter communications, missile tracking, space tracking, radar and surveillance, radio astronomy, and special antenna products.

We invite your inquiry, whatever your antenna problem may be. Write for our folder.

ANTENNA SYSTEMS INC.
HINGHAM, MASS.

CIRCLE 103 ON READER SERVICE CARD 103

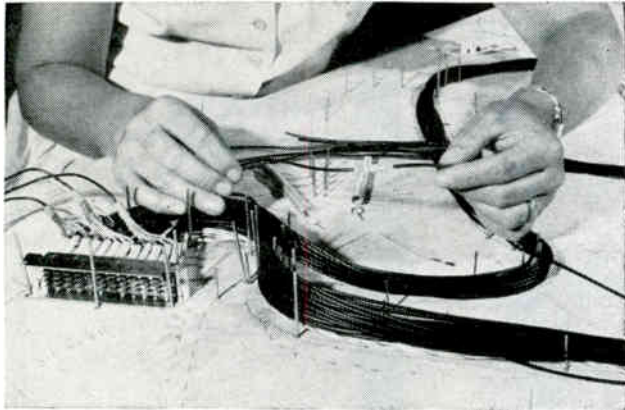

With connector in position, wires are routed. Code marker, seen directly above spring in center, is slid along wire as it is put in place

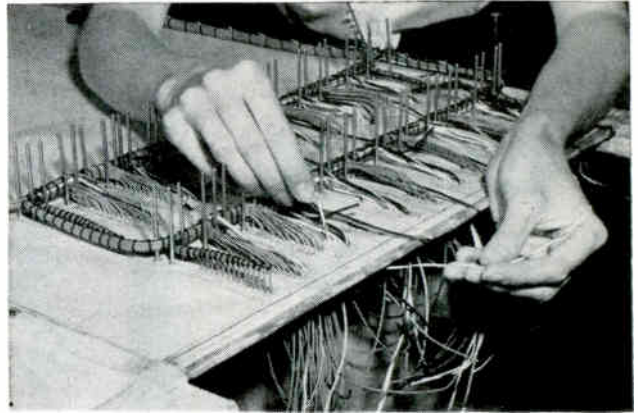

Putting wire ends through holes in harness board allows them to be laced in position for fastening to printed circuit type connectors

Making Connections First Speeds Harnessing

LARGE WIRING HARNESSSES often have several hundred wire ends attached to multipin connectors. As the harness is built, color-coding, tagging, fastening ends in coil springs and similar methods are generally used to segregate wire ends for later attachment to connectors.

Electronic Associates Inc., Long Branch, N. J., has found that in many cases, up to half the time and materials costs of identifying wire ends can be saved by assembling wires to connectors before harnessing. The method also reduces harnessing lead time.

First, all wires are soldered into connectors at a bench, using fixtures. Half the ends, therefore, do not require identification. If the wires are the same color, the free end is identified with E-Z Code tags on Teflon rings. The rings are run down the wire when it is put in place. Wires and terminating plugs also can be prepared in advance.

The harness assembler places the connector in position on a harness board and routes the wires. Harness diagrams include identification and outlines of connectors to avoid confusion. Additional connector-wire assemblies and loose wires are placed as required and the harness laced. One analog computer harness made by this method has 200 wires soldered in advance to four 50-pin connectors, plus 150 wires routed individually.

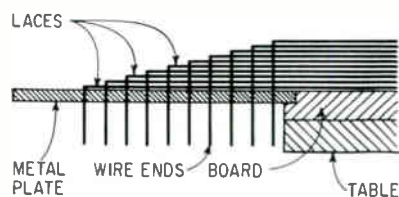

Sketch of in-line lacing method

Another technique to avoid tagging or special color-coding is used when a large number of ends are to be fastened to printed circuit board edge connectors or similar in-line connectors.

The harness board is provided with metal plates in the areas where the wires terminate (see sketch). After the diagram is pasted over the board, holes are drilled in the metal at wire end positions. The metal plates extend over the edge of the worktable.

Working with a spool of wire, the harnesser pushes a few inches of wire through a hole, which is drilled small enough to hold the wire loosely. The wire is routed. If the other end also goes to an in-line connector, the wire is cut long enough to be pushed through a hole at the second end.

After all wires are positioned, the ends are laced as shown to give each wire a 90-degree breakout bend. When the harness is pulled from the board, the ends are ready for hand-

cutting and stripping, and soldering to connectors at a bench.

If precut and stripped wires are to be used, the harness board is mounted above the table on legs so the wire can be pushed through the holes only the distance desired after the 90-degree bend. This method is particularly useful when the wires have been assembled to a connector in advance.

Combinations of these and conventional procedures are used, depending on the judgment of the lead harnesser. By dividing harness preparation into several stages, assemblers can be assigned work at which they are most adept: preassembling wires and connectors, routing and lacing, or assembling connectors to laced harness. The latter is frequently done while the harness is still on the board.

EIA's harnessers have found it easier to work on flat harnessing tables rather than tilted easels. Each table is placed in a clear floor space so harnessers can walk around while routing long wires and lace without stretching.

Wire end identification can also be reduced on small harnesses. If a pair of wires of the same color end at the same point, the harnesser hand strips one end and not the other. Harnesses for small panel assemblies are prepared after the wires have been soldered to panel component terminals. The panel is

4

reasons why you should buy Hughes high voltage silicon cartridge rectifiers

To meet your requirements for IN1730-34, IN2382-85, IN596-98 and IN1406-13 rectifiers... Hughes offers you a universal series with the following advantages over competitive devices:

1 Better High Altitude Performance—
Since the case is insulated and provides a long leakage path between leads, the probability of flashover or corona at high altitudes is reduced.

2 Improved Circuit Performance—
Fewer diodes are required in each unit to obtain the PIV ratings...thereby lowering losses, which in turn, provide better voltage regulation and higher efficiencies.

3 Savings In Space.
The case material is a plastic of high dielectric strength, making it possible to mount units in close proximity to each other.

4 Greater Dependability—These assemblies utilize series strings of Hughes hermetically sealed glass diodes...packaged in a non-combustible cartridge. All internal connections are welded together to insure shock and vibration resistance.

These standard Hughes units are available in voltage ratings from 600 to 10,000 volts. In addition, Hughes offers you many custom assemblies designed to meet your special requirements.

ORDER TODAY! To obtain delivery of Hughes Cartridge Rectifiers just call or write the Hughes Semiconductor Sales Office or Distributor nearest you. Or, for a complete Cartridge Rectifier data sheet (Number: D.S. 82) please write Hughes, Semiconductor Division, Marketing Department, Newport Beach, California.

For export write: Hughes International, Culver City, Calif.



Creating a new world with ELECTRONICS

HUGHES

©1960 HUGHES AIRCRAFT COMPANY
SEMICONDUCTOR DIVISION

**Where do you go for
replacement tubes in
Microwave Relay Equipment?**

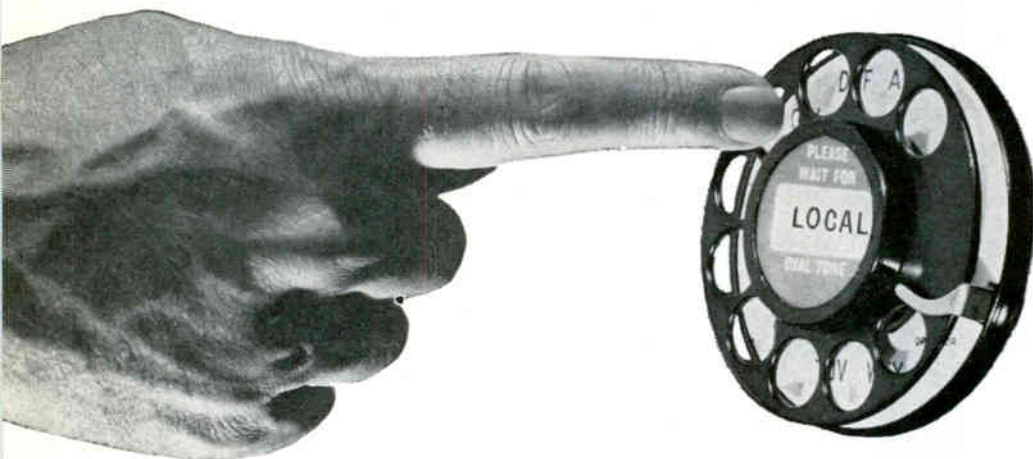

**To the telephone! And call your
local RAYTHEON distributor.**



**Quality Products at Factory Prices
Plus Complete Technical Data
Available from the Raytheon Distributor
Nearest You . . .**



RAYTHEON COMPANY

DISTRIBUTOR PRODUCTS DIVISION • WESTWOOD, MASS.

RECEIVING AND INDUSTRIAL TUBES • SEMICONDUCTOR PRODUCTS
MECHANICAL COMPONENTS • RAYTHEON/MACHLETT POWER TUBES
VOLTAGE REGULATORS • MICROWAVE TUBES • CAPTIVE HARDWARE

CIRCLE 106 ON READER SERVICE CARD

**Raytheon
Distributors
Serving Key
Markets Include:**

Alabama
Birmingham
Forbes Distributing Company
AL 1-4104
MG Electrical Equipment Company
FAirfax 2-0449

Mobile
Forbes Electronic Distributors, Inc.
HE 2-7661

Arizona
Phoenix
Radio Specialties & Appl. Corp.
AL 8-6121

Tucson
Standard Radio Parts, Inc.
MA 3-4326

California
Burbank
Valley Electronic Supply Co.
Victoria 9-3944

Glendale
R. V. Weatherford Co.
Victoria 9-2471

Hollywood
Hollywood Radio Supply, Inc.
HO 4-8321

Inglewood
Newark Electronics Company
ORchard 7-1127

Los Angeles
Graybar Electric Company
ANgelus 3-7282
Kierulff Electronics, Inc.
RiChmond 8-2444

Oakland
Brill Electronics
TE 2-6100
Elmar Electronics
TEmplar 4-3311

Palo Alto
Zack Electronics
DA 6-5432

San Diego
Radio Parts Company
BE 9-9361

San Francisco
Fortune Electronics
UN 1-2434

Santa Monica
Santa Monica Radio Parts Corp.
EXbrook 3-8231

Colorado
Denver
Ward Terry Company
AMherst 6-3181

Connecticut
East Haven
J. V. Electronics
HObart 9-1310

District of Columbia
Electronic Industrial Sales, Inc.
HUdson 3-5200
Kenyon Electronic Supply Company
DEcatur 2-5800

Florida
Miami
East Coast Radio & Television Co.
FRanklin 1-4636
Electronic Equipment Co., Inc.
NEwton 5-0421

West Palm Beach
Goddard Distributors, Inc.
TEmples 3-5701

Illinois
Chicago
Allied Radio Corporation
HAYmarket 1-6800
Newark Electronics Corp.
STate 2-2944

Indiana
Indianapolis
Graham Electronics Supply Inc.
MEIrose 4-8486

Maryland
Baltimore
Wholesale Radio Parts Co., Inc.
MUIberry 5-2134

Massachusetts
Boston
Cramer Electronics, Inc.
COpley 7-4700
DeMambro Radio Supply Co., Inc.
AL 4-9000
Lafayette Radio Corp. of Mass.
HUbbard 2-7850

Cambridge
Electrical Supply Corporation
UNiversity 4-6300

Michigan
Ann Arbor
Wedemeyer Electronic Supply Co.
NORMandy 2-4457

Detroit
Ferguson Electronic Supply Co.
WOOdward 1-2262

Minnesota
Minneapolis
Electronic Expeditors, Inc.
FEderal 8-7597

Mississippi—Jackson
Ellington Radio, Inc.
FL 3-2769

Missouri
Kansas City
Burstin-Applebee Company
Baltimore 1-1155
St. Louis
Graybar Electric Company
Jefferson 1-4700

New Hampshire—Concord
Evans Radio
Capital 5-3358

New Jersey
Camden
General Radio Supply Co.
WO 4-8560 (in Phila.: WA 2-7037)

New Mexico
Alamogordo
Radio Specialties Company, Inc.
HEmlock 7-0307
Albuquerque
Radio Specialties Company, Inc.
AM 8-3901

New York
Binghamton
Stack Industrial Electronics, Inc.
RA 3-6326
Buffalo
Genesee Radio & Parts Co., Inc.
DElaware 9661
Whele Electronics Inc.
TL 4-3270
Elmira
Stack Industrial Electronics, Inc.
RE 3-6513
Ithaca
Stack Industrial Electronics, Inc.
Ithaca 2-3221
Mineola, Long Island
Arrow Electronics, Inc.
Pioneer 6-8686
New York City
H. L. Dalis, Inc.
EMpire 1-1100
Milo Electronics Corporation
BEekman 3-2980
Sun Radio & Electronics Co., Inc.
OREgon 5-8600
Terminal Electronics, Inc.
CHelsea 3-5200

Ohio
Cincinnati
United Radio Inc.
CHerry 1-6530
Cleveland
Main Line Cleveland, Inc.
EXpress 1-4944
Pioneer Electronic Supply Co.
SUPERior 1-9411
Columbus
Buckeye Electronic Distributors, Inc.
CA 8-3265
Dayton
SrepcO, Inc.
BAldwin 4-3871

Oklahoma—Tulsa
S & S Radio Supply
LU 2-7173

Oregon—Portland
Lou Johnson Company, Inc.
CApitol 2-9551

Pennsylvania
Philadelphia
Aimo Radio Company
WAInut 2-5918
Radio Electric Service Co.
WAInut 5-5840
Pittsburgh
Marks Parts Company
FAirfax 1-3700
Reading
The George D. Barbey Co., Inc.
FR 6-7451

Tennessee
Knoxville
Bondurant Brothers Company
3-9144

Texas
Dallas
Graybar Electric Company
Riverside 2-6451
Houston
Busacker Electronic Equipment Co.
JAckson 6-4661
Harrison Equipment Company
CApitol 4-9131
Utah—Salt Lake City
Standard Supply Company
EL 5-2971
Virginia—Norfolk
Priest Electronics
MA 7-4534
Washington—Seattle
Western Electronic Company
AT 4-0200
West Virginia—Bluefield
Meyers Electronics, Inc.
DAvenport 5-9151
Wisconsin—Milwaukee
Electronic Expeditors, Inc.
WOodruff 4-8820

placed on a harness board and the harness prepared by methods similar to that first described.

Cased Coil Brazes Alumina to Monel

WHEN UNIFORM heating and controlled temperature rise are required for brazing, they can be obtained by placing an induction heating coil in an oven. The setup illustrated is employed at John Gombos Co., Inc., Clifton, N. J., to braise a Monel tube to an alumina dome for a missile application. The dome can be fractured by conventional metal brazing methods.

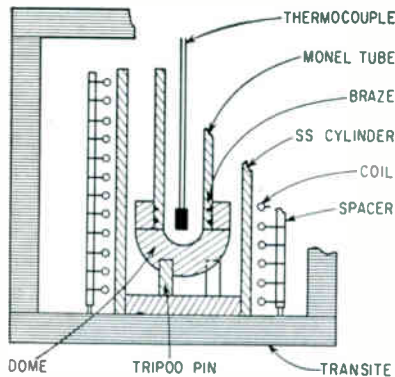

Insulated case and steel heating cylinder raise temperature uniformly

The mating surface of the dome is metallized with 42 percent nickel-iron alloy to match the Monel's coefficient of expansion. The tube is grooved at the joint area to accept silver alloy brazing rings and to allow the brazing material to expand. The dome is pushed over the tube and the assembly placed, dome down, on a tripod of stainless steel rod. Since the assembly is balanced, no other holding fixture is required.

A stainless steel cylinder is placed between the assembly and the surrounding coil. The cylinder, 3.5 inches in diameter, heats the assembly evenly and keeps the tube uniform. The coil has an outside diameter of 4 3/8 inches, is 7 inches high and is made of 12 turns of 1/2-inch copper tubing. Each turn is soldered to a washer. The washers are positioned on a tie rod and insulated by asbestos composition spacers. The coil is also coated with an insulating compound. The entire setup is contained in an asbestos



SEAMLESS METAL TUBE... SOLID DIELECTRIC... SOLID INNER CONDUCTOR

Widely accepted for its performance-proved characteristics over a wide range of applications.

COAXITUBE in Electronics assures lower attenuation and a minimum of false signal pickup... is electrically equivalent to all RG/U cables.

COAXITUBE in electro-mechanics guarantees complete weather-proofing with minimum weight.

The center conductor is a solid or stranded copper wire, dielectric may be teflon or polyethylene. Outer conductor may be copper, aluminum or other non-ferrous alloy to meet requirements of weight, tensile strength or fatigue factors.

COAXITUBE is available in straight random lengths or coils to 40 feet... some in coils to 200 feet. It can also be furnished straightened, cut, stripped and formed in accordance with your sketch or drawing. Write for full technical details to—

PRECISION TUBE COMPANY, INC.
North Wales, Pa.



CIRCLE 204 ON READER SERVICE CARD

September 9, 1960

CIRCLE 107 ON READER SERVICE CARD

107

Install
Coaxial Cable
Faster and for
Less Cost!



HICKORY BRAND[®]
I. M.
Coaxial Cable
needs no separate
messenger!

When you install Hickory Brand I. M. Coaxial Cable, the need for spinning or supporting the cable to a separate messenger is completely eliminated! The high-strength, galvanized solid steel messenger is an integral part of the cable jacket and can be gripped, pulled and tensioned using standard techniques without breaking!

Conductor insulation and dielectric material is polyethylene for maximum operation efficiency making these cables especially adaptable to applications requiring high, very high and ultra-high frequencies.

If Hickory Brand Supported Coaxial Cables spark an idea for you, write us for advice and complete information today!



4643

For *FREE SAMPLE*, send request
on your letterhead to

HICKORY BRAND
Electronic Wires and Cables

Manufactured by
SUPERIOR CABLE CORPORATION, Hickory, North Carolina

composition case with a removable cover.

The coil is designed to heat slowly during the initial, critical warmup. After 8 minutes, the assembly is at 300 F. Temperature is then increased to 1,300 F, the brazing temperature, after 32 minutes. A thermocouple is inserted in the tube and positioned at the braze point for monitoring and control. After the braze is made, the case cover is opened and the assembly allowed to cool down.

Flaws in Welded Metal Show in Plastic Film

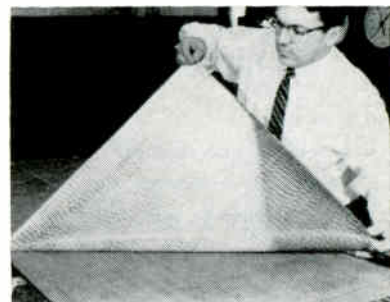

Spotwelding pattern is captured in strippable film

MAGNETIC PARTICLE inspection system that provides a reproducible pattern of welds and flaws in metals is being offered by the Instruments Division, The Budd Co., Phoenixville, Pa. Budd has been using the system, called Recordflux, for non-destructive testing of spotwelds as well. It shows the diameter of spotwelds, which can be used to interpret weld strength. Magnetic particles in a solution are sprayed or poured on the surface of a part. The particles are free to migrate in the solution until it sets up, after 8 or 20 minutes depending on the solution, into a plastic film. The films can be washed from the part, or stripped off for reference and reproduction. In addition to the solutions, magnetizers provide a relatively uniform magnetic field over an area, allowing sensitive detection of faint local differences in magnetic properties over the working area of the field. The system can also be applied, the company reports, to magnetic field studies and determination of grain direction in sheet metal and sectional forgings.

...IT GLOWS when
the FUSE BLOWS!

NEW INDICATING 3AG FUSE POSTS

EXAMINE THESE FEATURES



ACTUAL
SIZE

- 1 New patented knob design to assure high degree of illumination for instant blown fuse indication.
- 2 Positive finger grip for knob extraction.
- 3 Quick service bayonet lock.
- 4 Constant tension beryllium copper coil & leaf spring for positive contact & lower millivolt drop.
- 5 Optional—at extra cost—neoprene "O" ring to assure splash-proof feature.
- 6 New high degree vacuum neon lamp for greater brilliance & visibility.
- 7 Impact black phenolic material in accordance with MIL-M-14E type CFG.
- 8 One piece brass hot tin dipped non-turning bottom terminal.
- 9 Double flats on body to permit mounting versatility.

SPECIFICATIONS:



| PART # | VOLTAGE RANGE |
|------------------|----------------|
| 344006 | 2½- 7 volts |
| 344012 | 7 - 16 volts |
| 344024 | 16 - 32 volts |
| 344125 | 90 -125 volts |
| 344250 | 200 -250 volts |

Maximum current rating 20 amps.

PHYSICAL CHARACTERISTICS—Overall length 2⅞" with fuse inserted • Front of panel length 1⅜" • Back of panel length 1⅞" • Panel area front 1⅜" dia. • Panel area back 1⅜" dia. • Mounting hole size (D hole) ⅝" dia. flat at one side.

TERMINAL—Side—one piece, .025 brass—electro-tin plated • Bottom—one piece, lead free brass, hot tin dipped.

KNOB—High temperature styrene (amber with incandescent bulbs—2½ thru 32 volts—and clear with high degree vacuum neon bulbs—90 thru 250 volts) • Extractor Method—Bayonet, spring grip in cap.

HARDWARE—Hexagon nut—steel, zinc cronak or zinc iridium finish • Interlock lock washer—steel, cadmium plated • Oil resistant rubber washer.

MILITARY SPECIFICATIONS—MIL-M-14E type CFG. Fungus treatment available upon request per Jan-T-152 & Jan-C-173.

TORQUE—Unit will withstand 15 inch lbs. mounting torque.

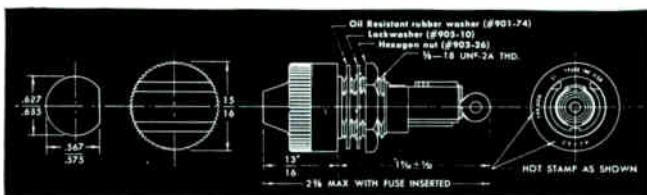

LITTELFUSE

DES PLAINES, ILLINOIS
CIRCLE 205 ON READER SERVICE CARD



LONG-LIFE, IRONCLAD TIPS (¼" to 3/16") provide pinpoint soldering. Both chisel and pyramid types are available.

THIN SHANK (5/16" diameter) allows easy access to close-quarter, hard-to-reach solderjoints.

Iron shown approximately ⅓ actual size.

This
General Electric
Production-line
Soldering Iron
Is...

AS EASY TO USE AS A PENCIL

LIGHTWEIGHT IRON PROVIDES HIGH-SPEED SOLDERING WHERE OTHER IRONS CAN'T REACH

For electronic, instrument, and communication equipment production lines, and for maintenance—where hard-to-reach joints must be soldered in a hurry—General Electric's Lightweight Soldering Iron offers the ideal solution.

It weighs only 8½ ounces, and handles like a pencil. A thin shank and small tip sizes let you solder in tight places where regular-size irons won't go. Rated 120 volts, 60 watts, the iron features extremely fast heat recovery to provide reliable, uniform solderjoints in seconds.

Want more information? Contact your General Electric distributor or nearby G-E Apparatus Sales Office, or write Section 758-02, General Electric Co., Schenectady 5, N. Y.

GENERAL  ELECTRIC

New On The Market



Solid-State Transducer OBVIATES AMPLIFIER

A NEW KIND of solid-state strain gage pressure transducer that obviates the need for an amplifier and that has only two mechanically-functioning parts and that is claimed to combine the best overall characteristics of both strain gage and potentiometer-type transducers without the inadequacies of either has been developed by Fairchild Controls Corp., 225 Park Ave., Hicksville, N. Y., a subsidiary of Fairchild Camera and Instrument Corp. The transducer, designated 3S-G uses a semiconductor strain gage sensor, has unusual accuracy and environmental capabilities, and produces a high-level d-c output signal that eliminates the need for impedance-matching or signal amplification. Responsive to both static and high-frequency dynamic pressures, the device is compatible with existing military ground, telemetry and industrial systems, and is interchangeable with devices now in use.

The transducer incorporates a resistive calibration device that produces an output signal equivalent to half-scale pressure input, enabling the user to determine at will the integrity and scale factor of associated equipment.

The 3S-G transducer consists of three modules, all contained in a rugged anodized aluminum case 1½ inches in diameter and 3 inches long, weighing 5 ounces. These modules perform the functions of energy conversion, signal conditioning and calibration.

Energy conversion is accomplished by several microminiature piezoresistive semiconductor ele-

ments coupled to a resilient high-alloy steel, low mass diaphragm. These elements form the conducting paths of a four-arm Wheatstone Bridge.

Applied pressures deflect the diaphragm, creating an unbalance in the bridge and producing a d-c signal proportional to the deflection. The diaphragm will fit the selected pressure range—from 0-100 psig to 0-10,000 psig full scale. Pressure ranges below 100 psig will be available shortly.

Input excitation to the transducer is from 10-25 volts d-c nominal, and it can take up to 30 volts d-c without damage. Input impedance is approximately 700 ohms. Output impedance is less than 4,500 ohms. Input pressures up to 150 percent of rated have a negligible effect on instrument calibration. Pressures in excess of 200 percent of rated cause no damage.

Signal conditioning: A transistorized amplifier receives the differential signal generated in the sensing element and produces the output signal. The transducer transfer function is 25 percent. Thus, a full-range change in pressure at 20 volts d-c (rated excitation) results in a 5-volt d-c output signal.

The calibrator is an internally-contained shunt resistor. When it is keyed across one leg of the Wheatstone Bridge (by shorting two connector pins) the transducer produces an output signal equivalent to one-half full scale rating.

Frequency response is limited by the design of plumbing that conducts the measured pressure media

to the 3S-G pressure port, and by the nature of the media itself.

Accuracy: better than plus or minus 0.1 percent linearity and 0.1 percent hysteresis over a temperature range of minus 65 F to plus 250 F; it has infinite resolution. Both zero and full range sensitivity change less than plus or minus 0.5 percent over any 100 F temperature excursion within the rated temperature range. It can withstand 50 G's vibration to 2,000 cps without damage and can measure all gaseous and liquid media, including liquid oxygen, strong alkalis, corrosive acids such as red fuming acids, and nitrozene.

CIRCLE 301 ON READER SERVICE CARD

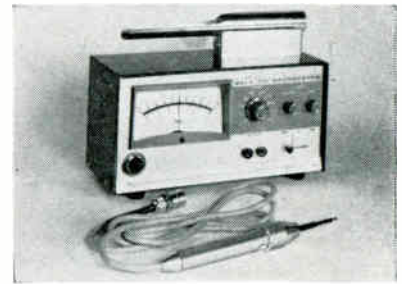

Gaussmeter Features FEATURES PORTABILITY

A DIRECT-READING, completely transistorized gaussmeter, combining portability with high sensitivity, has been developed by F. W. Bell, Inc., 1356 Norton Ave., Columbus, Ohio. Measuring direction and magnitude of magnetic flux density, the instrument reads from 1 gauss, full scale, to 30,000 gauss, full scale, in 10 ranges. An innovation in this Model (No. 110) is the zero center meter which indicates immediately the direction being read and eliminates the necessity for a reversing switch.

Model 110 is designed with an integral carrying handle that serves also as a probe rest providing protection of the vital probe when the instrument is not being used. Built-in probe calibration speeds interchanging of different types of probes. A thin wafer of indium arsenide, operating on the Hall Effect, is the sensing element of the instrument. This material has a temperature coefficient of 0.1 percent per degree C.

Included in applications of the new gaussmeter are: readout of magnetic ink and magnetic tape,

**COMPREHENSIVE
MICROWAVE COMPONENT
CAPABILITIES**

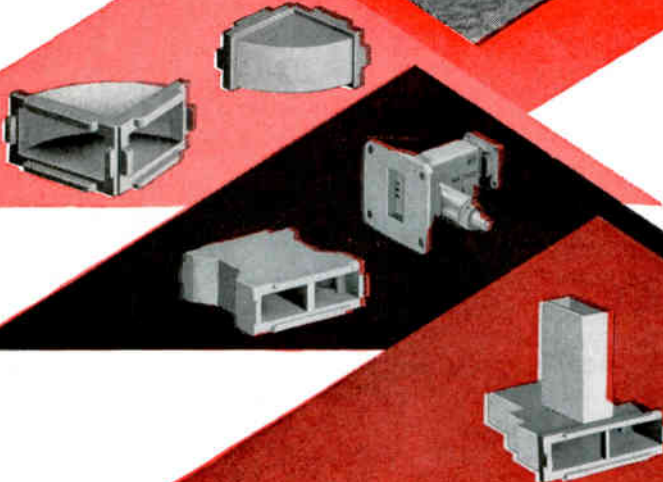
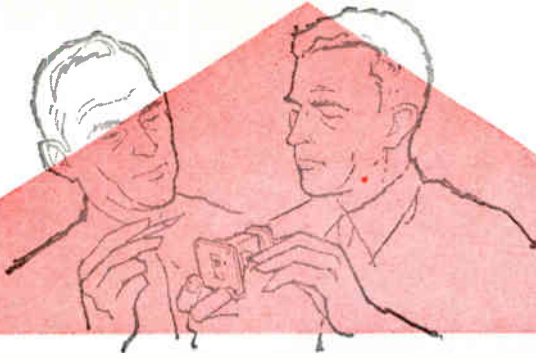

This modern three-quarter-acre plant has significantly expanded the services and production capabilities of Microwave Associates' experienced Waveguide Components Division. This new research and production facility is one of the most completely equipped on the east coast. A large 3' x 2' capacity dip-brazing unit as well as complete plating and other shop facilities are now handling both large volume and custom-engineered orders. Components are precision-machined and produced in beryllium-copper, cast and fabricated aluminum, and cast magnesium.

Over 500 microwave components for applications from 1.12 to 90.0 kMc/s are standard items. Our Sales Engineers will gladly discuss current work in sophisticated components and RF packaging with you.

A FEW OF THE MANY COMPONENTS MANUFACTURED HERE

New High-Power Varactor Harmonic Generators — excellent suppression of unwanted harmonics and record power levels are available from these solid-state harmonic generators.

New Cast Bends — Zero bend radius — 90° E and H plane bends in S through Ka bands... Each bend is compensated to a VSWR of 1.05 over its entire waveguide band.

Sidewall Hybrid Couplers (3db) and H-Plane Folded Hybrid Tees — Cast in aluminum and beryllium-copper are available in S through Ka-band models.

Two New Catalogs — Waveguide Components Short-form Catalog (CSF-60) gives data on over 500 items of waveguide components and test equipment.

Pressure Window Catalog (12 pages) contains electrical and mechanical data on a complete line of glass-kovar, mica, and special pressure windows plus valuable installation and testing tips.

MICROWAVE ASSOCIATES, INC. Burlington, Mass. • Western Union FAX • TWX: Burlington, Mass. 942 • BRowning 2-3000
Export Sales: Microwave International Corporation, 36 West 44th St., New York, New York

measuring and plotting the earth's magnetic field, meters, vibration pickups, d-c motors, magnets, tachometers, relay testing, solenoid and polarized relays.

Standard axial and transverse

(radial) probes are available from stock. Other types of probes, as well as test fixtures for special applications, can be made to order.

CIRCLE 302 ON READER SERVICE CARD

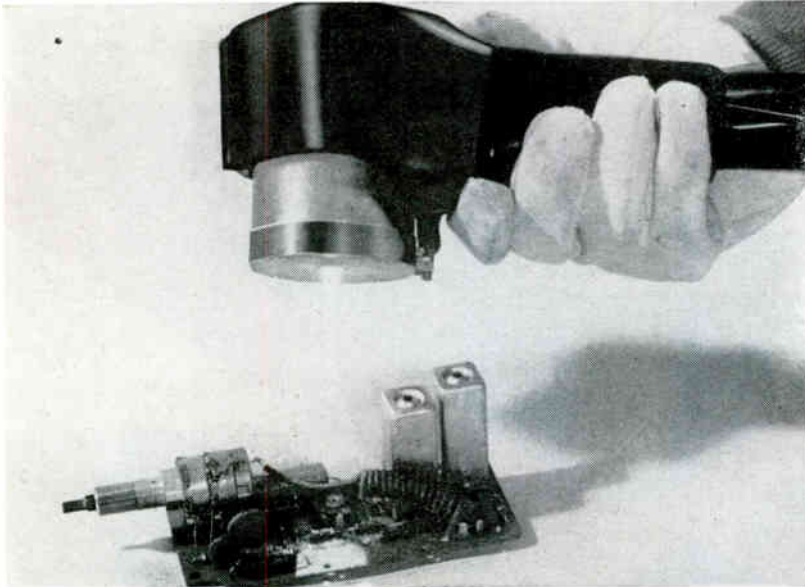

Thinner Epoxy Coatings BY SPRAY GUN

A HAND-HELD plasmatron plasma jet spray gun, capable of spray depositing epoxy resins onto any surface for coatings of any desired thickness, has been introduced by Plasmatron Corp., 3839 S. Main St., Santa Ana, Calif., a subsidiary of Giannini Scientific Corp. Epoxy

coating deposited by this technique is extremely durable and does not need further curing. The technique produces extreme penetration of the resin—an important factor in coating complex devices such as electric motor stators and rotors.

CIRCLE 303 ON READER SERVICE CARD

Weather Radar LIGHT-WEIGHT UNIT

A NEW approach in lightweight airborne weather radar is offered by Collins Radio Company, P. O. Box 1891, Dallas, Texas, in the WP-103 weather radar system which will be available early next year. The small size and weight (under 50 pounds) and power economy are possible because of the extensive use of transistorized, printed circuitry. The WP-103 is about one-sixth as big and only one-eighth as heavy as the WP-101.

The WP-103 covers the general sky area with a stabilized antenna up to 150 nautical miles ahead of the aircraft. The antenna makes a 120 degree sweep with 60 scans per minute using either the 12- or 18-

inch dish antenna. It can sweep a full 360 degree area with the 30-inch antenna. Simplified circuitry has eliminated the need for a sweep resolver or a servo driven rotating yoke. The presentation of weather conditions is on the indicator in terms of range and azimuth.

Five basic units comprise the WP-103. They include: the 374A-3 receiver/transmitter housed in a $\frac{3}{4}$ Short ATR Case; 776C-3 synchronizer contained in a $\frac{3}{4}$ Short ATR Case; 561G-3 control kit; 493A-4 indicator and 537F-7 12-inch dish antenna. The 18-inch and 30-inch antennas are offered as optional equipment. Picture presentation in the 493A-4 indicator uses a $3\frac{1}{2}$ inch sweep line in a box with a $4\frac{1}{4}$ inch square face. A polarized filter permits dimming for night operation.

A pulse-modulated radar system operating in the X-band frequency range, the WP-103 requires 320 watts a-c. The narrow beamwidth of the X-band radar provides the pilot with a sharp definition of targets.

CIRCLE 304 ON READER SERVICE CARD

High-Speed Transistor FOR COMPUTERS

DEVELOPMENT of a computer mesa transistor capable of handling 100,000,000 signals a second has been announced by the Radio Corporation of America, Semiconductor and Materials Division, Somerville, N. J. The device, which will be in commercial production soon, is available for engineering sampling.

Designated TA 1882, the new transistor is a double-diffused germanium *nnp* mesa type, with a 500 megacycle gain-bandwidth product, minimum beta of 40, and a switching speed of 10 millimicroseconds. It is housed in the TO 18 case.

CIRCLE 305 ON READER SERVICE CARD

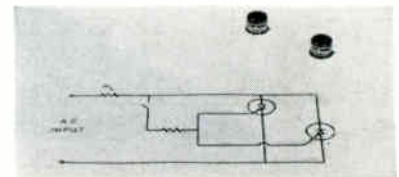

Complimentary SCR's REDUCE COMPLEXITY

AVAILABILITY of a line of complementary silicon controlled rectifiers is announced by the Semiconductor Division, Hoffman Electronics Corp., Los Angeles, Calif. The new line features both *pnpn* and *nnpn* types. The *nnpn* types use negative gate current triggering, a characteristic previously unavailable in controlled rectifiers, according to Hoffman. The *pnpn* types are triggered by positive gate currents. Allowing direct positive and/or negative operation in controlled rectifier circuits, the devices reduce circuit complexity, resulting in decreased system cost, space, and weight requirements and increased reliability.

Encased in TO-5 transistor packages, the new units consist of five *nnpn* types and seven *pnpn* types. All units are rated at 1 amp, aver-



How many

of these



**Electronic
Chemicals**

do you need?

Check your requirements against General Chemical's extensive line of B&A® "Electronic Grade" chemicals. Principal products are listed here—and there are many others too! You'll find that "B&A"—America's leading line of "Electronic Grade" chemicals—is your best single source for *all* your high purity chemical needs!

As America's foremost producer of laboratory and custom chemicals, General Chemical has the wide range of products, the versatile production facilities, and the specialized experience to meet virtually every electronic chemical need! Write today for our free information folder, "B&A Electronic Chemicals." Gives specifications plus other valuable information.



GENERAL CHEMICAL DIVISION

40 Rector Street, New York 6, N.Y.

Baker & Adamson® "Electronic Grade" Chemicals

For Etching

- Acetic Acid—Reagent, A.C.S.
- Ammonium Bifluoride—Technical
- Ammonium Fluoride—Reagent
- Bromine—Reagent, A.C.S.
- Glycerin—Reagent, A.C.S.
- Hydrochloric Acid—Reagent, A.C.S.
- Hydrofluoric Acid—Electronic Grade
- Hydrogen Peroxide (Stab.)—Electronic Grade
- Nitric Acid—Reagent, A.C.S.
- Potassium Hydroxide Pellets and Solution—Electronic Grade
- Sodium Carbonate—Electronic Grade
- Sodium Hydroxide Pellets and Solution—Electronic Grade
- Sulfuric Acid—Reagent, A.C.S.

As Solvents:

- Acetone—Electronic Grade
- Alcohol, Ethyl—Reagent
- Carbon Tetrachloride—Electronic Grade
- Ether—Electronic Grade
- Methyl Alcohol—Electronic Grade
- Propyl Alcohol Iso—Electronic Grade
- Trichloroethylene—Electronic Grade
- Xylene—Reagent, A.C.S.

In the Production of TV Tubes:

- Barium Acetate—Electronic Grade
- Barium Nitrate—Electronic Grade
- Calcium Nitrate—Electronic Grade
- Strontium Nitrate—Reagent, A.C.S.
- Aluminum Nitrate—Electronic Grade

For Semiconductor Production:

- Germanium Dioxide—Electronic Grade
- Germanium Metal—Electronic Grade
- Nickel Chloride—Reagent, A.C.S.
- Nickel Sulfate—Reagent, A.C.S.
- Sodium Hypophosphite—N.F.

For Post Treatment of Semiconductors:

- Hydrogen Peroxide—Electronic Grade

For Capacitors:

- Ammonium Hydroxide—Reagent, A.C.S.
- Boric Acid—Reagent, A.C.S.
- Manganous Nitrate—Reagent, A.C.S., Electronic Grade
- Oxalic Acid—Reagent, A.C.S.

For Phosphor Production:

- Zinc Sulfide

For Gaseous Insulation:

- Sulfur Hexafluoride

BIRD

"Termaline" 50 ohm Coaxial Line 5-WATT LOAD RESISTORS



Model
80-M



Model
80-F



Model
80-CM



Model
80-CF



Model
80-BNCF



Model
80-BNCF

A Known Factor

In measurements of 50-ohm coaxial systems, the Bird 5-watt coaxial terminations provide a known factor.

As primary test equipment in field or laboratory, they are used as . . .

- 50-ohm impedance standards;
- terminations for slotted lines;
- measurements of filter characteristics.
- terminations for insertion loss measurements, and;
- other measurements where an accurate and reliable 50-ohm termination is required.

The low VSWR of the 5-watt "Termaline" resistors, their ability to withstand vibration, and their compactness in size makes their use applicable to a variety of electronic systems where a reliable 50-ohm termination is required.

SPECIFICATIONS

POWER RATING: 5 Watts Max.

NOMINAL IMPEDANCE: 50 ohms

USEFUL FREQUENCY RANGE: 0 to 11,000 mc

VSWR: 1.2 Max. to 4000 mc
1.1 Max. under 1000 mc

SPECIAL VSWR: Can be provided

OPERATING POSITION: Any

CASE: Brass **FINISH:** Silver Plated

LENGTH: 3-3/8" Max.

WIDTH: 11/16 Hex.

WEIGHT: 4 ounces

OTHER BIRD PRODUCTS



"Termaline"
RF Load
Resistors



Coaxial
RF Filters



"Thurline"
Directional
RF Wattmeters



Coaxial
RF Switches



"Termaline"
RF Absorption
Wattmeters



BIRD

ELECTRONIC CORP.

Churchill 8-1200

30303 Aurora Road, Cleveland 39, Ohio

Western Representative:

VAN GROOS COMPANY, Woodland Hills, Calif.

age rectified forward current, and 1.4 amp, d-c, at plus 80 C. Voltages for the *npn* devices range from 30 to 200 volts; for the *pnp* units, 30 to 400 volts. Operating and storage temperature range for all types is from minus 65 C to plus 150 C. Maximum junction temperature is plus 150 C.

Prices for the *npn* devices range from \$8.40 to \$22.50 in quantities of 1 to 99, and from \$5.60 to \$15 in quantities from 100 to 999. The *pnp* units are priced from \$5.60 to \$60 (1-99) and \$3.70 to \$40 (100-999). All are available for immediate delivery in sample quantities.

CIRCLE 306 ON READER SERVICE CARD

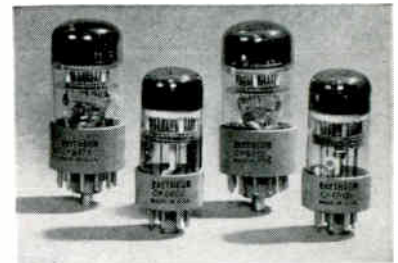

Electron Tubes

FOR COUNTING USES

ELECTRON TUBES that count up to 100,000 units per second and visually display the total on their faces have been announced by Raytheon Company. Industrial Components Division, 55 Chapel St., Newton, Mass. Possible applications are in assembly-line packaging, in measuring pipeline flow and in programming elapsed-time intervals, such as sequency welding, and in nucleonics, for plotting the spectrum of isotopes over a time-period or the energy level of radiation impinging on such nuclear energy detecting devices as scintillometers.

Called decade counters, the tubes record and indicate the count on ten glowing cathodes in luminescent dials within the tubes. With numbered face-plates, placed on series connected decade counters, the total can be read visually in units, tens, hundreds, etc., during operation.

The CK6909 and CK6910 decade counters operate up to 100 Kc and the CK6802 and CK6476 operate up to 4 Kc. The tubes are a cold cathode, bidirectional, ring-stepping de-

IT'S
WHAT'S
IN
HERE
THAT
COUNTS

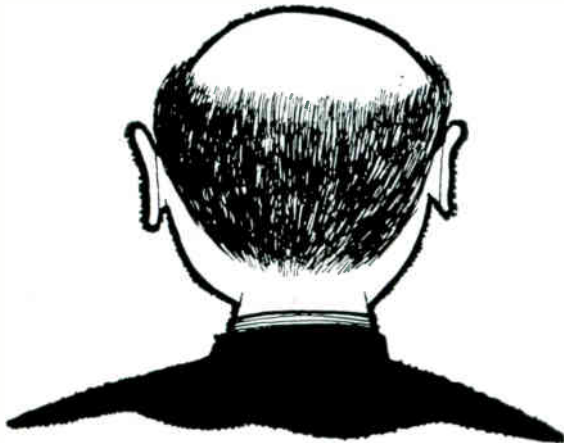

Do you know, for instance... which electronic stocks are hottest? Who's in the news and why? About "Three Approaches to Microminiaturization"? About the newest product ideas hitting the market? What's up in production? Opportunities overseas? What's going on in Washington?

It pays to know more than the next man! The questions above are just 6 reasons why you should subscribe to *electronics*.

IF YOU'RE ON THE TAG END OF A ROUTING SLIP, get your own subscription. Knowing what's going on is the first step to going up.

Fill in the coupon below right now... it will pay big dividends.

FIND WHAT YOU NEED IN... electronics

____ Renew my subscription for 3 more years.

____ Enter my new subscription.

U.S. Subscription Rates: ____ 3 years \$12. ____ 1 year \$6
Canadian rates \$10 for 1 year. Foreign rates \$20 for 1 year.

Name _____

Street _____

City _____ Zone _____ State _____

Company _____

Street _____

City _____ Zone _____ State _____

Your Title _____ Department _____

Product Manufactured or Service Performed _____

Mail reply to: *electronics*, 330 West 42nd Street, New York 36, N. Y.

September 9, 1960

PROVEN, DEPENDABLE... REAR-PROJECTION TYPE

IN-LINE DIGITAL DISPLAYS

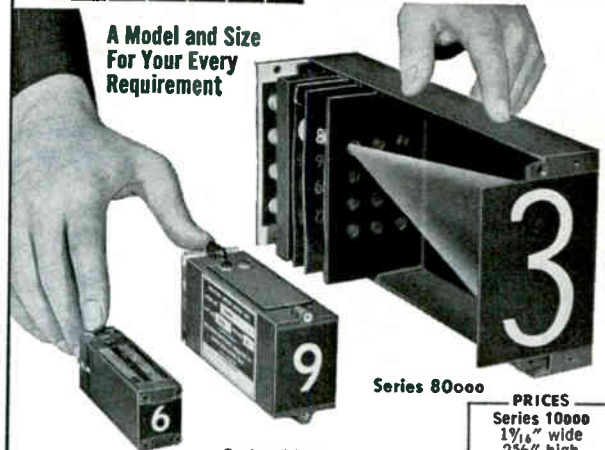

A Model and Size
For Your Every
Requirement

Series 120000

Series 10000

Series 80000

PRICES
Series 10000
1 1/4" wide
2 5/8" high
5 5/8" long
\$18.00 each

Series 80000
3 1/4" wide
5 1/4" high
11 1/4" long
\$33.00 each

Series 120000
1" wide
1 1/4" high
3 3/8" long
\$35.00 each
Quantity Prices
On Request

OUTSTANDING FEATURES

- All digits displayed on front viewing screen
- All digits uniform in size and intensity
- High-contrast viewing screen
- Digit style of your choice
- Colored digits of your choice
- Individual units may be group assembled for panel mounting

WRITE TODAY FOR COMPLETE DETAILED SPECIFICATIONS
Representatives in principal cities



INDUSTRIAL ELECTRONIC ENGINEERS, INC.

5528 Vineland Avenue, North Hollywood, California

CIRCLE 212 ON READER SERVICE CARD



START WITH A PERFECT FINISH...

Specify CAMBION® panel handles



You can be certain of flawless finishes on CAMBION Panel Handles when you install them. They're buffed before plating to remove every surface imperfection... color buffed after plating for lasting luster. Then they're packaged in individual envelopes... positive protection against damage no matter how often they're handled, or how long they're stored before use. Available in 36 different *standard* combinations: rigid, adjustable, and folding types. Finishes of polished nickel, black oxide, semi-frost and black alumilite. Base metal: aluminum or brass. Write Cambridge Thermionic Corporation, 437 Concord Avenue, Cambridge 38, Mass., for full details on these and other products in the wide line of

CAMBION®

The guaranteed electronic components

CIRCLE 115 ON READER SERVICE CARD

115

This One **EA**

EVENT RECORDER

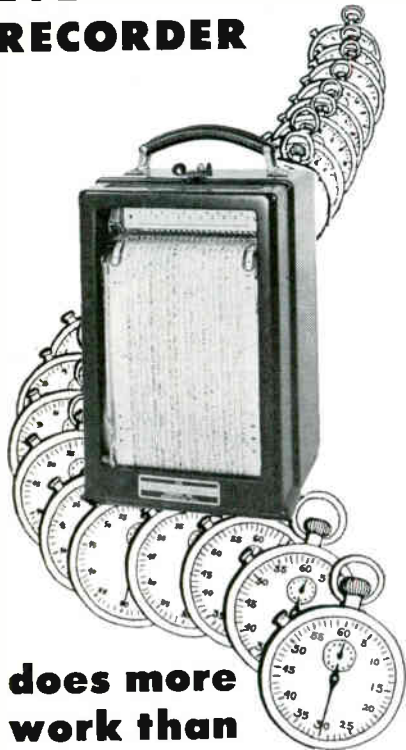

does more work than
20 STOP WATCHES

Each of the 20 pens, writing on a moving, time-calibrated chart can give you split-second, stop watch timing of individual events.

In addition, the time relationships of the events are also recorded. With an E-A Event Recorder, you can have a permanent, indisputable record of such things as:

- Productive and idle time.
- Flow of materials.
- Position of gates and dampers.
- Time of failure in destruction tests.
- Sequence of switching as in
 - appliance control testing,
 - electrical substation monitoring,
 - missile firing.

You save time and costs with these versatile recorders which "picture" both sequence and duration of events—in production and processing . . . in research . . . in plant safety.

Send for Catalog Section 50 for full information.

The
ESTERLINE-ANGUS
Company

No. 1 In fine Recording Instruments
for more than 50 years

DEPT E, BOX 596, INDIANAPOLIS 6, INDIANA

116 CIRCLE 116 ON READER SERVICE CARD

vice featuring low dissipation and short resolution time. The CK6476 and CK6910 offer electrical readout from any cathode lead while the CK6802 and the CK6909 offer electrical readout at th 0, 5, 8, and 9 cathode leads.

CIRCLE 307 ON READER SERVICE CARD



Power Supply ULTRAMINIATURE

VICTORY ELECTRONICS, INC., 50 Bond St., Waterbury, L. I., N. Y., announces a new line of tiny, lightweight, plug-in power supplies, actuated by sources as small as a 1.5-v penlight cell or a 1.3-v mercury cell, and delivering output voltages as high as 20,000 v. Output currents range as high as 120 μ a, depending on the model and the external circuit parameters. This power is capable of operating high-voltage instruments used in both terrestrial and in spaceborne, telemetered instrumentation and control, including: Geiger tubes, infrared detectors, ionization chambers, scintillation counters, maser frequency meters, cathode ray tubes and photomultipliers.

CIRCLE 308 ON READER SERVICE CARD



Synthetic Material REDUCES VIBRATION

LOWELL INDUSTRIES, INC., Allston Station, Boston 34, Mass., is producing Vibra-Check, a highly efficient anti-vibrational material designed to be placed under the base or feet

SPECIFY RAPIDLY AND ACCURATELY WITH SPERRY'S SPECI-FILE



Now you can have Sperry's complete family of klystron and traveling wave tubes right at your fingertips for faster, more accurate tube selection. Attractively packaged and comprehensively indexed, the Sperry Spec-File gives you complete electronic and physical characteristics of every tube in the Sperry line.

TO GET YOUR FREE

Speci-File, use this coupon:

Section C-103
SPERRY
ELECTRONIC TUBE DIVISION
Gainesville, Fla.

Please send me a FREE Sperry Spec-File:

Name _____

Title _____

Company _____

Address _____

City _____

State _____



GAINESVILLE, FLORIDA
A Division of Sperry Rand Corporation

CIRCLE 207 ON READER SERVICE CARD
CIRCLE 117 ON READER SERVICE CARD →

NEW LIGHT is shed daily on microwave tube state-of-the-art by the engineers and scientists at Sperry's Gainesville, Florida plant. If existing hardware doesn't readily solve your tube application problem, call Gainesville, FRanklin 2-0411 collect, for full information about Sperry capabilities.

SPERRY

**ELECTRONIC
TUBE
DIVISION**

Gainesville, Florida • A Division of Sperry Rand Corporation

A COMPLETE LINE of klystron tubes is manufactured and marketed by Sperry Electronic Tube Division, Gainesville, Fla. The division also performs extensive research and development toward advances in klystron state-of-the-art.





Model PS-216-D
16-channel
digital recorder

**PRECISION
instrumentation
magnetic tape
recorders**

for space-conscious applications

PRECISION recorders are fast becoming the standard for the most critical and demanding applications in the age of space. Advanced mechanical concepts and solid-state circuitry provide full-size performance in less than 1/4 the space required by conventional recorders. Up to 14 channels of analog or 16 channels of digital recording in a wide range of models for rack mounting or portable use. Write for detailed new brochure #55A.



Two complete
14-channel
P.I. recorders
require
only 51"
of rack
space



PRECISION INSTRUMENT COMPANY
1011 COMMERCIAL STREET • SAN CARLOS, CALIFORNIA
Phone: LYtell 1-44 41 • TWX: SCAR BEL 30

REPRESENTATIVES IN PRINCIPAL CITIES THROUGHOUT THE WORLD

of machines to prevent their transmission of vibration and noise to surrounding areas. Actual service conditions have proved this material will eliminate up to 90 percent of vibration. Vibra-Check is very simple to install. No lagging or cementing to the floor is necessary. Creeping or crawling of vibrating machinery is impossible on Vibra-Check pads because of the high coefficient of friction (0.8) and the vacuum suction cup pattern of Vibra-Check's surface. The material conforms to rough or uneven floors.

CIRCLE 316 ON READER SERVICE CARD

Multiplexer

SOLID STATE

EPSCO INC., 275 Massachusetts Ave., Cambridge, Mass., announces the TMX841 multiplexer, a solid state high speed switching instrument used for scanning a multiplicity of channels. Transfer accuracy of ± 0.01 percent, crosstalk down 120 db, and flexibility of channel capacity provided by plug-in printed circuit cards, make this unit ideal for precision instrumentation systems. Its utility for the system designer is further enhanced by patch board programming and high input impedance.

CIRCLE 317 ON READER SERVICE CARD

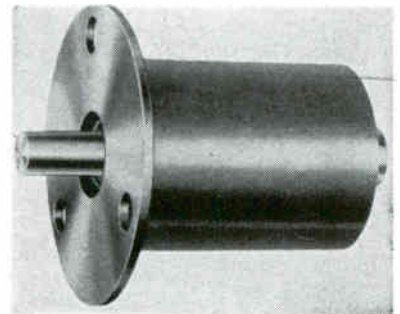

Ratio Drives

SMALL, PRECISE

JAN HARDWARE MFG. CO. INC., 38-01 Queens Blvd., Long Island City 1, N. Y. This new series employs unique mechanical principles utilizing combinations of ball-bearings to replace conventional gears. Small, precision ratio drives are useful in servomechanisms and electronic instruments. Ruggedly built and permanently lubricated, these units provide rotary control

between input and output shafts which are directly in-line. Models with concentric shafts are especially useful to meet critical space problems. These units are available in a range of driving ratios from 2.66:1 up to 19.65:1. Panel mounting is provided by an integrally cast flange.

CIRCLE 318 ON READER SERVICE CARD



Precision Pot SUBMINIATURE

NEW ENGLAND INSTRUMENT CO., INC., 1334 Main St., Waltham, Mass. New 55M precision subminiature 10-turn pot features all metal construction with sleeve or instrument ball bearings. The mechanical stop, a special rugged, stainless steel device, will withstand up to 15 lb in. of torque. Company will furnish servo, bushing or special mount to customer's specifications. The unit is available in resistance values of from 25 ohms to 200 K ohms with linearities as close as ± 0.15 percent.

CIRCLE 319 ON READER SERVICE CARD

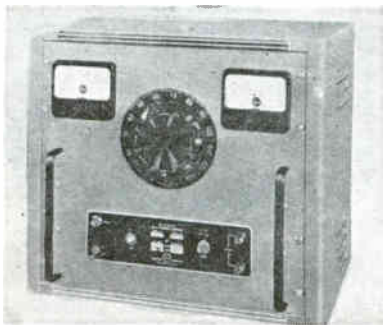

Power Supply NEW RATINGS

OPAD ELECTRIC CO., 43 Walker St., New York 13, N. Y. The d-c output voltage range of the model RS40B has been extended to cover 0-125 v at the full load rating of 20 amperes. Maximum rms ripple is held to within 1 percent of the average d-c output. The voltage regulation has also been reduced to



for -100°F to 500°F applications

Select the right Temp-R-Tape for your job from a variety of types which combine some foam of Teflon, Fiberglass or Silicone Rubber backing with a silicone polymer adhesive. Temp-R-Tapes possess high dielectric strength, thermal stability, excellent moisture resistance, non-aging characteristics and many other desirable properties.

CLASS H INSULATION USES: slot lining; interlayer and interphase insulation; harness bundling; splicing; wrapping for microwave components, transformer coils, capacitors and high voltage cables.

NON-STICK USES: non-stick facings for film guides in electronic instruments, heat sealing bars, forming dies, chutes, guide rails, etc.

AVAILABLE FROM STOCK: 1/4" to 2" widths, 18 yd. and 36 yd. rolls and 12" width on liner by lineal yard. Sold through distributors.

FREE SAMPLE and folder — write, phone or use inquiry service.

ELECTRICAL AND INDUSTRIAL SPECIALTY TAPES

CHR CONNECTICUT HARD RUBBER CO.

*duPont TM

Main office: New Haven 9, Connecticut

CIRCLE 208 ON READER SERVICE CARD



**any size
panels**
engraved in your own plant

- Engrave 1-inch nameplates or 6-foot panels by unskilled labor.
- Spindle covers $18\frac{1}{4}'' \times 6''$ in one set-up — more than any other machine of its kind.
- Bench type model I-R — \$685.

Send for complete catalog ZR-4 illustrating other models from \$325 up

new hermes

ENGRAVING MACHINE CORP.
154 WEST 14TH STREET, NEW YORK 11, N. Y.
IN CANADA: 359 St. James Street West, Montreal, P. Q.

CIRCLE 209 ON READER SERVICE CARD

send for this

FREE

**EICO
Electronics
Catalog**



you save 50% on Top-Quality
Test Instruments
HI-FI • Ham Gear

KITS AND WIRED

for professional and home use

TEST INSTRUMENTS

battery eliminators
battery testers
bridges
decade boxes
electronic switch
flyback tester
oscilloscopes
probes
signal and
sweep generators
tube testers
transistor tester
vacuum tube
voltmeters
volt-ohm-
milliammeters

HI-FI

stereo and monaural
tuners
preamplifiers
power amplifiers
integrated amplifiers
speaker systems

HAM GEAR

cw transmitter
modulator-driver
grid dip meter

OVER 2 MILLION
EICO instruments in
use throughout
the world.

LIFETIME service and calibration guarantee.
IN STOCK at your neighborhood EICO dealer.
Send now for FREE catalog E-9

EICO

33-00 N. Blvd., L. I. C. 1, N. Y.

... praised by the experts
as **BEST BUYS IN ELECTRONICS**

©1960 ELECTRONIC INSTR. CO., INC.

CIRCLE 121 ON READER SERVICE CARD

CO-AX

4 mmf/ft

★ **ULTRA LOW** capacitance & attenuation

WE ARE SPECIALLY ORGANIZED TO HANDLE DIRECT ORDERS OR ENQUIRIES FROM OVERSEAS SPOT DELIVERIES FOR U.S. BILLED IN DOLLARS—SETTLEMENT BY YOUR CHECK CABLE OR AIRMAIL TODAY

| TYPE | $\mu\mu$ F/ft | IMPED. Ω | O.D. |
|------|---------------|-----------------|------|
| C1 | 7.3 | 150 | .36 |
| C11 | 6.3 | 173 | .36 |
| C2 | 6.3 | 171 | .44 |
| C22 | 5.5 | 184 | .44 |
| C3 | 5.4 | 197 | .64 |
| C33 | 4.8 | 220 | .64 |
| C4 | 4.6 | 229 | 1.03 |
| C44 | 4.1 | 252 | 1.03 |



NEW 'MX and SM' SUBMINIATURE CONNECTORS
Constant 50 Ω -63 Ω -70 Ω impedances

TRANSRADIO LTD. 138A Cromwell Rd. London SW7 ENGLAND CABLES: TRANSRAD, LONDON

CIRCLE 210 ON READER SERVICE CARD

METALS for ELECTRONIC APPLICATION

rolled ULTRA THIN

by OUR SPECIAL ROLLING TECHNIQUE

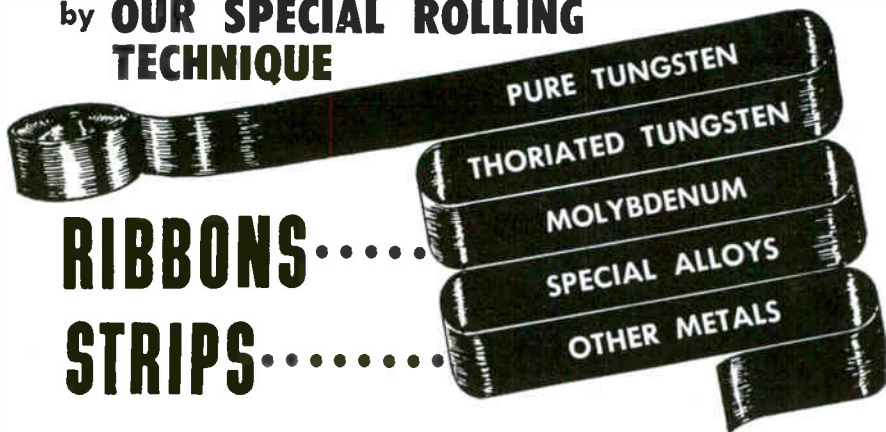

RIBBONS.....
STRIPS.....

TOLERANCES CLOSER THAN COMMERCIAL STANDARDS

Note: for highly engineered applications—strips of TUNGSTEN and some other metals can be supplied

rolled down to .0003 thickness

- Finish: Roll Finish—Black or Cleaned
- Ribbons may be supplied in Mg. weights if required

Developed and Manufactured by

H.CROSS CO. 3229 BERGENLINE AVE., UNION CITY, NEW JERSEY
Tele: Union City, N. J.: UN. 3-1134
N. Y. C., N. Y.: BR 9-4425

122 CIRCLE 122 ON READER SERVICE CARD

provide a maximum change of 6 v when the load current changes from 2 to 20 amperes. A proportionally smaller output voltage change results for a lesser load current swing.

CIRCLE 320 ON READER SERVICE CARD

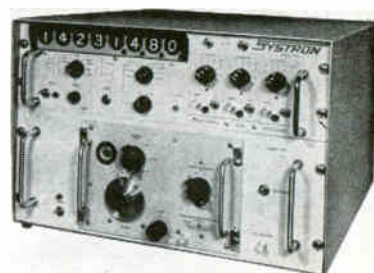

Frequency Extender
FOR LABORATORY USE

SYSTRON-DONNER CORP., 950 Galindo St., Concord, Calif., announces the model 1290 extender which permits frequency measurements to 220 Mc when used with the model 1039 solid state counter-timer and existing plug-in units. The model 1039 provides fully transistorized circuitry, 0.1 v rms sensitivity, 1 megohm input impedance on three d-c amplifiers and Nixie in-line read-out. The model 1039-1290 can be utilized for measurements of frequency-period-time-ratio-phase as a universal laboratory instrument.

CIRCLE 321 ON READER SERVICE CARD



Double Scaler
FAST RESOLVING TIME

RADIATION INSTRUMENT DEVELOPMENT LABORATORY, INC., 61 East North Ave., Northlake, Ill. Model 49-15 double scaler, which occupies 8 $\frac{1}{2}$ in. of rack space, has two scales of 10', each followed by a four digit electrically reset Sodeco register. The two scaling sections may be operated individually or simultaneously. The fast resolving time of 0.8 μ sec permits counting rates in excess of one million counts

per minute. It includes a linear non-overloading amplifier with a gain of 25. Provision is made for remote control of count and of reset operations. The revised model 49-15 uses a single electronically regulated low voltage power supply.

CIRCLE 322 ON READER SERVICE CARD

Gold Alloy Preforms FOR SEMICONDUCTORS

ALPHA METALS, INC., 56 Water St., Jersey City 4, N. J., has available gold 99.99+ percent pure alloyed with antimony, silicon, germanium, gallium or tin and fabricated into spheres, foil, washers, disks, rectangles and squares for semiconductor devices. Dimensions of these materials are as follows: spheres range from 0.005 in. with tolerances as close as 0.0001 in.; disks, from 0.005 in. up; foil, from 0.0005 in. thin; rectangles, from 0.040 in. to 0.015 in.; squares, 0.020 in.; washers from 0.020 in. i-d and a land of 0.005 in.

CIRCLE 323 ON READER SERVICE CARD



Sensitive Relay CLOSE DIFFERENTIAL

ELECTRO-MECHANICAL SPECIALTIES CO., INC., 528 West Lambert Road, Whittier, Calif. Series No. 10,000 relay has been designed to meet stringent requirements for airborne and missile applications per MIL-R-6106C and MIL-R-5757C. Relays are available in spdt or dpdt configurations with contacts rated at 2 amperes. The unit shown operates at 22 v d-c \pm 1 v d-c and the release voltage is 16 v d-c \pm 1 v d-c. Other operate and release voltages are available from 5 to 150 v d-c with accuracy maintained throughout temperature extremes of - 65 F to + 200 F. Units will withstand vibration of 20 g's from 10-2,000 cps, and 50 g's shock with only one watt operating power.

CIRCLE 324 ON READER SERVICE CARD

Kodak Recognizes . . . Proper Color Control Requires PRECISE Timing

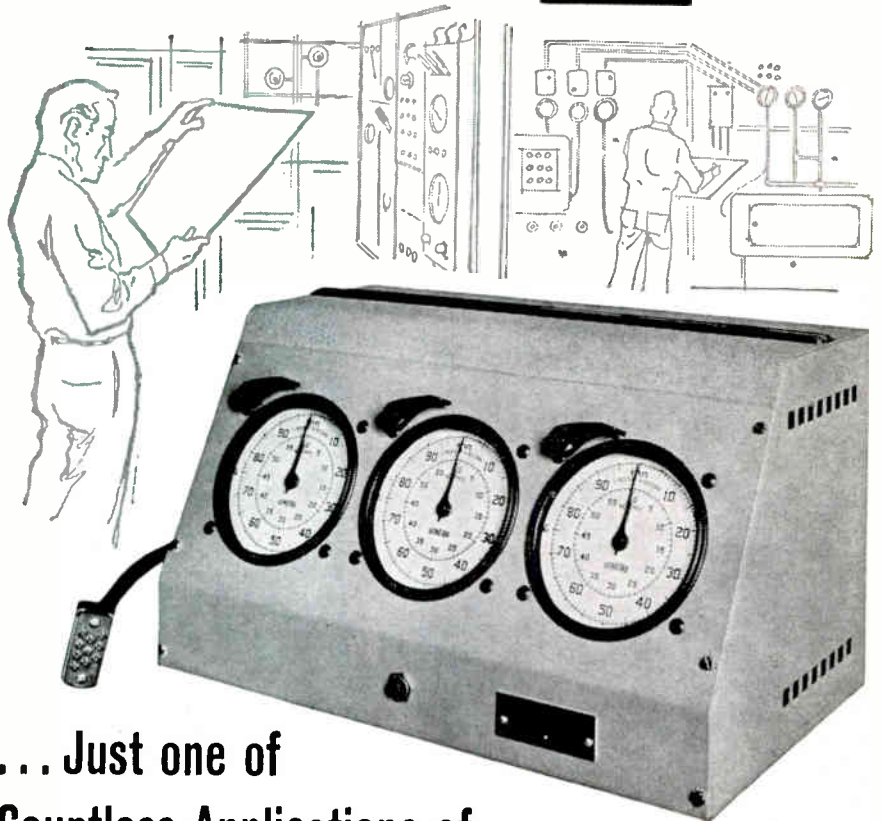

. . . Just one of Countless Applications of **SPECIAL TIMERS** by Standard

What's your timing need? For precise printer time measurements—as used with Kodak IV-C and 5S Color Printers? Accurate test timing (to tolerances of \pm .001 seconds)—as with numerous electronics and missile manufacturers?

For these and countless other applications, STANDARD stands ready to develop the exact elapsed time indicator to meet the most stringent requirements. Inquire today.



Request Catalog No. 198A covering the full line of Standard Precision Timers . . . portable or panel mounted.



**THE STANDARD
ELECTRIC TIME COMPANY**

89 LOGAN STEET • SPRINGFIELD, MASSACHUSETTS

"Splitting the Split Second . . . Precisely"

The
Latest
Data
On

Tantalum Capacitor

RELIABILITY

In these

5

**FANSTEEL
BULLETINS**

... Bring your files up-to-date with these latest bulletins describing Fansteel Tantalum Capacitors for any application from well logging equipment to missiles—wherever reliable performance is essential. Each new bulletin contains the latest complete specifications, ratings, curves, dimensions, application data and ordering references. Write today for the copies you need.

Advertising Department
**FANSTEEL
METALLURGICAL
CORPORATION,**
North Chicago, Illinois

FANSTEEL

where reliability dictates standards

**JUST OFF
THE PRESS**

Ask your Fansteel
salesman for
new Bulletin
6.100-5 on "pp"
type capacitors.

Specification
6CA-101
Gold-Cap*—
individually
tested,
registered,
certified.

Bulletin 6.111-2
HP Type—high
temperature
application.

Bulletin 5.112-5
S-T-A Type—
solid tantalum
capacitor

Bulletin 6.120-1
Blu-Cap*—
utility with
maximum
economy.

*Trademark

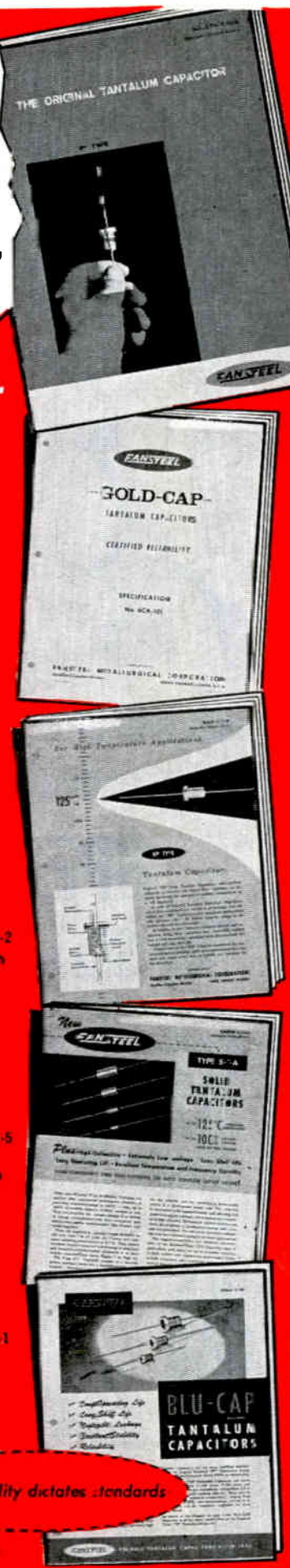

Literature of

CONTROL PANELS Bodnar Products Corp., 238 Huguenot St., New Rochelle, N. Y. A four-page folder illustrates and describes illuminated plastic control panels for the aviation, electronics and computer industries qualified to MIL-P-7788A.

CIRCLE 363 ON READER SERVICE CARD

THREE-WAY DATA CONVERTER Electronic Engineering Co. of California, 1601 East Chestnut Ave., Santa Ana, Calif., has published a bulletin describing the ZA-753 all solid state three-way data converter (paper-to-magnetic tape, magnetic-to-paper tape, paper-to-paper tape).

CIRCLE 364 ON READER SERVICE CARD

LOW CAPACITY BRIDGE Marconi Instruments, 111 Cedar Lane, Englewood, N. J. Data sheet 1342 illustrates and describes a low capacity bridge that measures capacities down to 0.002 $\mu\mu\text{f}$ with speed and 0.2 percent accuracy.

CIRCLE 365 ON READER SERVICE CARD

COMPUTING RESOLVERS Theta Instrument Corp., 520 Victor St., Saddle Brook, N. J. A recently issued 16 page, illustrated monograph describes the characteristics of computing resolvers. Such definitive properties as function error and axis error are explained and the techniques of measurement are set forth in great detail.

CIRCLE 366 ON READER SERVICE CARD

SHIELDED CHAMBERS Emerson & Cuming, Inc., Canton, Mass., has published a 24-page brochure on Eccoshield r-f shielded chambers and describing the complete service which the company is prepared to furnish in connection with shielded chambers from engineering design through erection and testing.

CIRCLE 367 ON READER SERVICE CARD

MICROWAVE PRODUCTS Sylvania Electric Products Inc., 1100 Main St., Buffalo, N. Y., has available a new brochure listing 250 available microwave products by frequency band.

CIRCLE 368 ON READER SERVICE CARD

ACCELERATION SWITCHES The Instrument Division of W. L. Maxson Corp., 475 Tenth Ave.,

the Week

New York 18, N. Y., has available a new bulletin covering eight damped-type acceleration switches. Both unidirectional and bidirectional switches are included with complete technical description, test and performance data.

CIRCLE 369 ON READER SERVICE CARD

TERMINAL BLOCKS Excellex Electronics Inc., 88-06 Van Wyck Blvd., Jamaica 18, N. Y., has available catalog XLX-7a describing a complete line of terminal blocks for all purposes with information on how to specify.

CIRCLE 370 ON READER SERVICE CARD

RTV SILICONE RUBBERS General Electric Co., Silicone Products Department, Waterford, N. Y. A new publication describing product and application data on the complete family of RTV (room temperature vulcanizing) silicone rubber compounds is now available.

CIRCLE 371 ON READER SERVICE CARD

R-F CONNECTORS General RF Fittings, Inc., 702 Beacon St., Boston 15, Mass. A 32-page catalog is a comprehensive effort to provide complete information on TNC and TM series r-f connectors. For a copy, write on your letterhead.

CIRCLE 372 ON READER SERVICE CARD

SILVER-ZINC BATTERIES Yardney Electric Corp., 40-50 Leonard St., New York, N. Y., has issued a new, 10-page illustrated brochure on the compact Silvercel secondary batteries.

CIRCLE 373 ON READER SERVICE CARD

SPECTRUM COVERAGE PRD Electronics, Inc., 202 Tillary St., Brooklyn 1, N. Y. Four page, 2 color, bulletin 400 categorizes hundreds of the company's products by frequency range, waveguide size, and price.

CIRCLE 374 ON READER SERVICE CARD

VHF POWER GENERATOR Pacific Semiconductors, Inc., 10451 W. Jefferson, Culver City, Calif. Circuit details of a high-power solid state vhf power generator are disclosed in a new publication now available.

CIRCLE 375 ON READER SERVICE CARD

MORE NEW FANSTEEL SILICON POWER RECTIFIERS

1N Series

5 Amp.

Type 9A

12 Amp.

Type 7B

20 Amp. 35 Amp.

Type 6B

Type 4B

50 Amp. 70 Amp.

Type 10A

Type 8B

Fansteel's silicon power rectifiers are produced in a new Fansteel semiconductor plant that is considered one of the most spotless, dust-free buildings to be found anywhere in the world. Pictured below is its "white room", where the units are assembled and where cleanliness is most critical. Because it takes only one lint speck to destroy a rectifier's reliability, this environment is kept as sterile as possible through such means as triple air filtering, strict personnel controls and special wall and work surfaces. Result: *consistent reliable performance* from Fansteel silicon power rectifiers.

Write for latest technical data on Fansteel Silicon Power Rectifiers.

Advertising Department

FANSTEEL METALLURGICAL CORPORATION

North Chicago, Illinois, U. S. A.

FANSTEEL

where reliability dictates standards

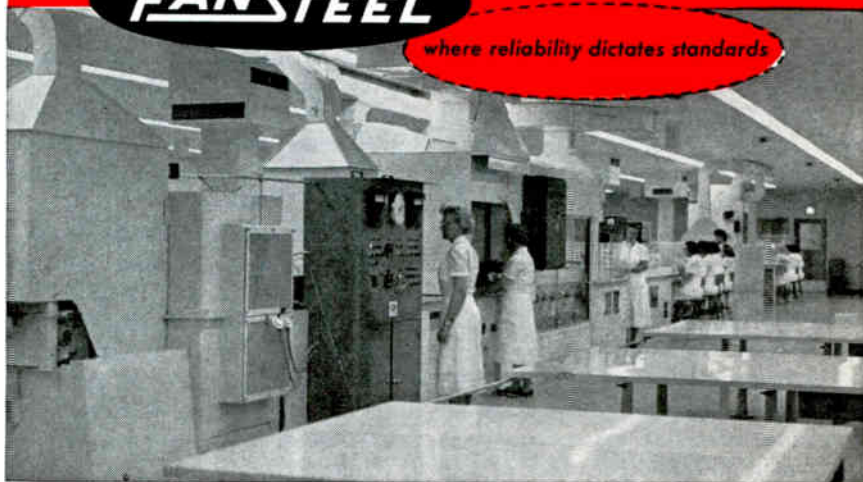

E606A



Carpenter: Solve, don't trample

YOU CAN'T TELL IT from his youthful appearance, but John J. Carpenter has spent more than 20 years untangling production snarls in the electronics industry.

Named to a vice presidential post early this year by Bulova's board chairman Gen. Omar N. Bradley, Carpenter now runs the company's industrial and defense operations, is a director of Bulova Research & Development Laboratories, and of the firm's subsidiary, American Time Products.

Born in Newark, N. J., in 1918, his grade school career was an active one in that he attended "about eleven of them" because of frequent family moves.

An interest in ham radio at an early age gave him a taste for electronics, taught him perseverance. From this interest, the path led to the Newark College of Engineering where he studied electrical engineering at night, worked days gaining practical experience.

In 1937, Carpenter took a job at Bell Laboratories, working on crystal units for frequency controls which at that time were still laboratory-produced devices. It was during this phase of his career that he evolved an axiom that has served him well since: "Solve your problems, don't trample them to death."

During his 15-year stay at Bell Labs, he took on the job of teaching representatives of other companies the techniques and practices he and

his fellow engineers had evolved in the laboratories. Besides this, he also began teaching engineers some functions of accounting in the electronics industry and teaching accountants enough about engineering processes to allow the two groups to understand each other.

During the war years, crystal filter work took on added importance because these devices were needed in combat tank radio gear. The main task was to beef up production. It was during these years that Carpenter developed his approach to unsnarling production lines.

In 1952, Carpenter took a job with Bulova to set up a crystal production facility, only to run head on into problems arising from the Korean emergency. That year he helped set up production lines for quartz crystals and communications devices needed by the Signal Corps.

Carpenter's next challenge came with the missile age. Initially, his attentions were devoted to crystal production. Soon his group began producing ovens for the crystals, then crystal oscillators, finally entire filter assemblies.

The men who work with him seem to share his enthusiasm for hard jobs. Some say this is because of his ability to hand them a challenge and rely on them to see it through. "In this group, when we have nothing to worry about, we're worried," says one of his associates.

Summers still find him spending

vacations at the Jersey shore. The rest of the year is spent at home in Lynbrook, N. Y., where he and his wife, Pat, live with their three sons aged 16, 12, and 3. To ease off from professional strains, Carpenter lives up to his name: his hobby is wood-working.

Polarad Sets Up French Subsidiary

FORMATION of a French manufacturing facility of Polarad Electronics Corp., Long Island City, N. Y., has been announced. The new company, located in Montrouge, a suburb of Paris, will manufacture Polarad's industrial line of microwave instrumentation for the European Common Market and maintain close contact with the new techniques under development in France in the millimeter range.

Formation of the new French subsidiary is in line with an overall expansion program which envisages an increase in the demand for microwave instruments abroad. At the present time, a substantial portion of Polarad's sales of industrial products are foreign. Such sales are handled by 70 sales engineers resident abroad.

Polarad will have a substantial majority interest in the new subsidiary with minority interests represented by French sales, management and technical personnel



Herman Sondov Takes Board Chairman Post

HERMAN SONDOV, executive vice president of Specialty Electronics Development Corp., Syosset, N. Y., manufacturer of communications equipment, radiation detectors and

Precise

DELTA PORTABLE TEMPERATURE CHAMBERS

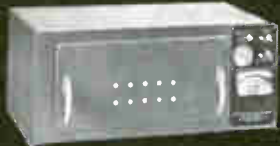

Model 1060W
Test Volume 16" x 7" x 7"



Model 1060R,
Rack Mounted
Test Volume 10" x 7" x 7"

Temperature Control

$\pm 1/2^\circ$ F From
-100°F to +500°F

ACCURATE TEMPERATURE CONTROL, without overshoot and without drift.

SAVES TIME by bringing the environment to the engineer instead of scheduling time in large, slow chambers.

VERSATILE—test for high and low temperatures in the same chamber.

AUTOMATIC CYCLING timer is available as auxiliary equipment.

Other chamber sizes and models are also available.



DELTA DESIGN, Inc.

San Diego

Sales Office
7460 GIRARD AVENUE
LA JOLLA, CALIF.

Glencourt 4-1185 TWX: LAJ 6453

CIRCLE 211 ON READER SERVICE CARD

Take no chances

Specify
SEYMOUR
for NICKEL SILVER
PHOSPHOR BRONZE
Stainless Steel
BRASS • COPPER
Anodes • Bright Nickel

Write for Seymour's
Alloy Selection Chart



The **SEYMOUR**
Manufacturing Co.
21 Franklin St., Seymour, Conn.

CIRCLE 214 ON READER SERVICE CARD

Large production gives you low prices!
— that's why ...

Over 100 O.E.M.s
have standardized
on

AMPERITE

Thermostatic DELAY RELAYS

2 to 180 Seconds

Actuated by a heater, they operate on A.C., D.C., or Pulsating Current.

Hermetically sealed. Not affected by altitude, moisture, or climate changes. SPST only—normally open or closed.

Compensated for ambient temperature changes from -55° to $+80^\circ$ C. Heaters consume approximately 2 W. and may be operated continuously. The units are rugged, explosion-proof, long-lived, and—inexpensive!

TYPES: Standard Radio Octal, and 9-Pin Miniature . . . List Price, \$4.00.



Also — Amperite Differential Relays: Used for automatic overload, under-voltage or under-current protection.

PROBLEM? Send for Bulletin No. TR-81

BALLAST REGULATORS

Amperite Regulators are designed to keep the current in a circuit automatically regulated at a definite value (for example, 0.5 amp.) . . . For currents of 60 ma. to 5 amps. Operate on A.C., D.C., or Pulsating Current.

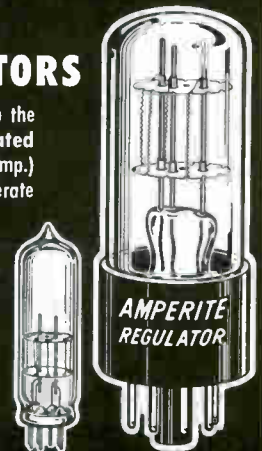
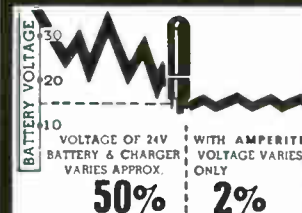

Hermetically sealed, they are not affected by changes in altitude, ambient temperature (-50° to $+70^\circ$ C.), or humidity . . . Rugged, light, compact, most inexpensive . . . List Price, \$3.00.

Write for 4-page Technical Bulletin No. AB-51

AMPERITE

561 Broadway, New York 12, N. Y. . . . CAnal 6-1446
In Canada: Atlas Radio Corp., Ltd., 50 Wingold Ave., Toronto 10

CIRCLE 127 ON READER SERVICE CARD

127

Weller

MAGNASTAT®

CONTROLLED TEMPERATURE SOLDERING IRONS



... with advanced features for greater efficiency, longer life.

- **VARIOUS TIP TYPES AVAILABLE.** Made of copper for fast heat transfer and premium iron plating for long life—with built-in Magnastat sensing device.
- **NEW TIP RETAINING NUT MINIMIZES FREEZING.** Seals tip receptacle from flux fumes.
- **NEW RUBBER SHOCK ABSORBER.** Also prevents iron from sliding off bench.
- **NEW, RUGGED, NON-ARCING SNAP SWITCH.** Guarantees continuous, reliable service.
- **PLASTIC HANDLE.** Extra strong—cooler handling.
- **ADVANCED CORD CONNECTION.** Locks cord securely in place, yet permits easy replacement.
- **2 or 3-WIRE CORDS NOW AVAILABLE** for all models. Cords are flexible and light in weight.

Remember, too, Weller Magnastat Soldering Irons automatically maintain the correct soldering temperature—never overheat. They weigh only half as much as uncontrolled irons and give greater heat efficiency with lower wattage. This means more reliable soldering, less down time.

Model TC-552 provides

2 SOLDERING TEMPERATURES

... low heat for heat-sensitive soldering ... higher heat for regular work. Accomplished by interchanging high and low heat tips. 55 watts.

\$900
list

2 other Magnastat Soldering Irons are available

MODEL TC-602. 60 watts, for light to medium electrical soldering. **\$1000** list

MODEL TC-1202. 120 watts, for medium to heavy electrical soldering. **\$1150** list

Prices shown are for Magnastat Iron including tip and two wire cord.

Send for NEW Magnastat Soldering Iron literature.

WELLER ELECTRIC CORP. 601 STONE'S CROSSING ROAD
EASTON, PA.

related electronic devices, has been named chairman of the board, a post that had not been filled before. He continues as executive vice president, while H. Russell Cammer continues as president and chief executive officer.

Sondov was a partner in Specialty's predecessor firm, Specialty Engineering and Electronics Co., before a merger last year resulted in formation of the present company.



Magnetico Appoints Works Manager

STANLEY L. RUBIN has been named works manager of Magnetico, Inc., East Northport, N. Y.

He had previously been the senior engineer in charge of methods and packaging for ITT Kellogg, communications division.

Since 1933 Rubin has had continuous and progressive management experience in the transformer and amplifier fields. In his new position he will be responsible for intensifying Magnetico's production engineering and control for their new developments in the magnetic and control fields and their recently expanded toroidal winding facility.

Vitramon Names Three Officers

VITRAMON, INC., Bridgeport, Conn., electronic components manufacturer, has named three of its key managers as officers of the company.

Alexander J. Groves, former plant manager, has been advanced to vice president, manufacturing; William Osowski, assistant treasurer, to treasurer; and Clifford H. Tuttle, Jr., sales manager, to vice

president, sales.

The appointments coincide with the opening of a new 48,000 sq ft production and administration facility in Monroe, Conn. The firm manufactures several types of capacitors, all of which are extensively used in missile, rocket and satellite programs.



J. A. Maurer, Inc. Picks Engineering V-P

APPOINTMENT of James M. McCarty as vice president in charge of engineering of J. A. Maurer, Inc., Long Island City, N. Y., has been announced. He has had many years of extensive experience with photo reconnaissance systems. Most recently he served in the capacity of chief engineer and marketing manager of Chicago Aerial Industries, Chicago, Ill.

J. A. Maurer, Inc., manufactures aerial reconnaissance and missile guidance systems.

ITA Appoints Head Engineer

JOSEPH ROBERTS, formerly transmitter project engineer for RCA, Camden, N. J., has been appointed chief engineer of Industrial Transmitters & Antennas, Inc., Lansdowne, Pa.; manufacturer of f-m broadcast and communications equipment.

He will be responsible for the design and development of high power f-m transmitters, and for expansion of engineering facilities at the new plant in Lansdowne, where other transmitter activities are contemplated.

Before joining ITA, Roberts was active for several years in a-m, f-m, and tv transmitter design, and also has served as broadcast chief engineer.

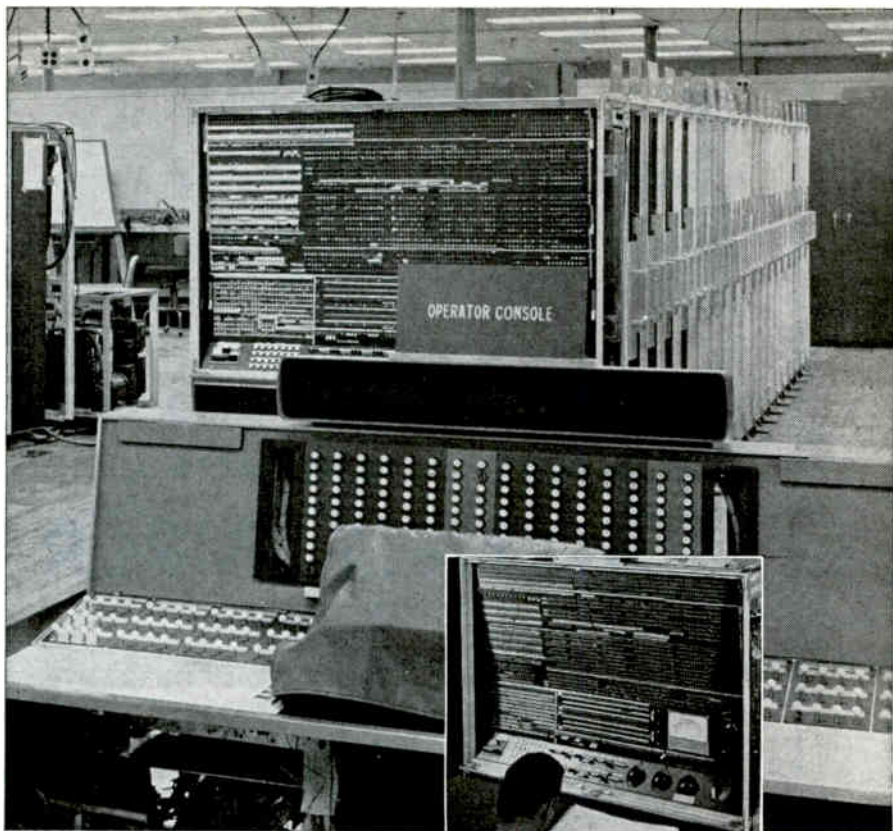

| STRETCH SYSTEM | | | |
|----------------|--------------------------|--------------------------|--------------------------|
| | ENTR | ACTIV | RELE |
| MEM BUS | <input type="checkbox"/> | <input type="checkbox"/> | <input type="checkbox"/> |
| 1-UNIT | <input type="checkbox"/> | <input type="checkbox"/> | <input type="checkbox"/> |
| LOOK AHEAD | <input type="checkbox"/> | <input type="checkbox"/> | <input type="checkbox"/> |
| SERIAL UNIT | <input type="checkbox"/> | <input type="checkbox"/> | <input type="checkbox"/> |
| PARALLEL UNIT | <input type="checkbox"/> | <input type="checkbox"/> | <input type="checkbox"/> |
| EXCHANGE | <input type="checkbox"/> | <input type="checkbox"/> | <input type="checkbox"/> |
| MEMORY | <input type="checkbox"/> | <input type="checkbox"/> | <input type="checkbox"/> |

STRETCH, the world's fastest and most versatile computer, will soon be added to the array of research tools at Los Alamos Scientific Laboratory. This multi-million dollar machine, built by IBM, is 50 to 75 times faster than the IBM 704.

STRETCH can complete more than 75 billion arithmetic operations a day. The system can execute as many as 2 million instructions per second.

A "look ahead" device anticipates instructions and data requirements, thus increasing the effective memory speed to make use of the enormous speed of the arithmetic units.

*For employment information write:
Personnel Director Division 60-83*

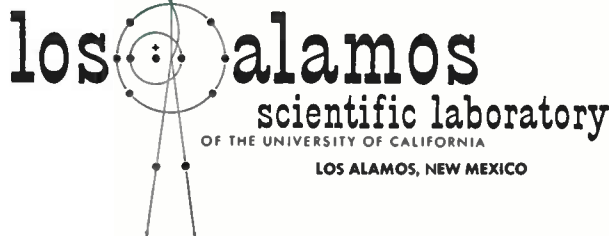

Interested in

helitronics*

a challenging new field of opportunity
for electronic engineers at

SIKORSKY AIRCRAFT

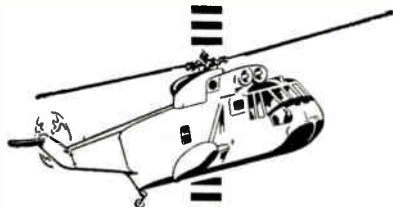

* To describe this unique field, only a brand new word would do, a word with two live roots: *helicopters* and *electronics*. These roots penetrate deeply into some of the most stimulating soil in modern technology.

In broad terms, helitronics embraces practically every phase of avionics, electronics, computer, feedback and systems analysis work. Specifically, helitronics means the integration of communication systems, specialized electronic search and detection equipment to enhance the mission capability of the helicopter, specialized sensors and automatic controls to increase its versatility, and automatic navigation, into an optimum military weapon system or commercial carrier with VTOL capability. Many assignments call for the ability to advance the state-of-the-art in testing and in instrumentation.

If you would like to enter this challenging new field, the time is *now*. The place? Sikorsky Aircraft—pioneer and leading manufacturer of rotary-wing aircraft, the company that leads again with many opportunities for *you* in HELITRONICS.

SIKORSKY AIRCRAFT

DIVISION OF UNITED AIRCRAFT CORPORATION

STRATFORD
CONNECTICUT

For further information, submit your resume or make inquiry to J. L. Purfield, Personnel Department.

CIRCLE 380 ON READER SERVICE CARD

ARE YOU WILLING TO GAMBLE ON YOUR OWN ABILITY —

If Successful—participation in ownership is yours. We are willing to provide Capital—Guaranteed Min. Salary and Guidance to Imaginative, Industrious young man to research and develop new ideas in Electronic and Allied Fields. Give detailed background, previous experience, references and recent photo in first letter to C. M. Tierney, 612 3rd Ave. South, Fort Dodge, Iowa.

CIRCLE 382 ON READER SERVICE CARD



MANUFACTURERS' REPRESENTATIVES

IN THE ELECTRONIC INDUSTRY

SAMUEL K. MACDONALD, INC.

Manufacturers representatives over 25 years
1531 SPRUCE STREET, PHILA. 2, PA.

Territory:
Pennsylvania • New Jersey
Delaware • Maryland
Virginia • West Virginia
District of Columbia

Other Offices:
Pittsburgh
Baltimore
Washington, D.C.

CIRCLE 383 ON READER SERVICE CARD

MANUFACTURERS REPRESENTATIVES WANTED

for high temperature magnet wire

Unusual opportunity for sales representation in some territories of the U.S.A. to handle a full line of high temperature magnet wire produced by a leading manufacturer. Please provide information on the territories which you cover as well as other product lines handled.

RW-5179, Electronics

Class. Adv. Div., P. O. Box 12, N. Y. 36, N. Y.

CIRCLE 381 ON READER SERVICE CARD

POSITIONS VACANT

Engineers wanted, degree preferred, experience required to do research and development in airborne communication and solid-state application. Also, engineer of similar qualification who shows aptitude and desire towards sales engineering. SunAir Electronics, Inc., P. O. Box 8053, Ft. Lauderdale, Fla.

Need Engineers?

Contact them through this

EMPLOYMENT OPPORTUNITIES section

CLASSIFIED

SEARCHLIGHT SECTION

ADVERTISING

BUSINESS OPPORTUNITIES

EQUIPMENT - USED or RESALE

DISPLAYED RATE

The advertising rate is \$24.75 per inch for advertising appearing on other than a contract basis. Contract rates quoted on request. AN ADVERTISING INCH is measured 7/8 inch vertically on one column, 3 columns—30 inches—to a page. EQUIPMENT WANTED or FOR SALE ADVERTISEMENTS acceptable only in Displayed Style.

The publisher cannot accept advertising in the Searchlight Section, which lists the names of the manufacturers of resistors, capacitors, rheostats, and potentiometers, or other names designed to describe such products.

Send NEW ADS or inquiries to Classified Adv Div. of Electronics P. O. Box 12, N. Y. 36, N. Y.

UNDISPLAYED RATE

\$2.40 a line, minimum 3 lines. To figure advance payment count 5 average words as a line.

BOX NUMBERS count as one line additional in undisplayed ads.

DISCOUNT of 10% if full payment is made in advance for four consecutive insertions of undisplayed ads (not including proposals.)

FOR INFORMATION

About Classified Advertising
Contact The McGraw-Hill Office
Nearest You.

| | |
|---|--|
| ATLANTA, 3 1301 Rhodes-Haverty Bldg. | Jackson 3-6951 M. MILLER |
| BOSTON, 16 350 Park Square | Hubbard 2-7160 M. J. HOSMER |
| CHICAGO, 11 520 No. Michigan Ave. | MOhawk 4-5800 W. J. HIGGENS |
| CLEVELAND, 13 1164 Illuminating Bldg. | SUperior 1-7000 W. B. SULLIVAN |
| DALLAS, 2 1712 Commerce St., Vaughn Bldg. | Riverside 7-5117 J. GRANT |
| DENVER, 2 1700 Broadway, Tower Bldg. | Alpine 5-2987 J. PATTEN |
| DETROIT, 26 856 Penobscot Bldg. | WOodward 2-1793 |
| HOUSTON, 25 Prudential Bldg. Holcombe Blvd. | Room W-724 JA 6-1281 G. HOLLAND |
| LOS ANGELES, 17 1125 W. 6 St. | HUntley 2-5450 W. C. GRIES |
| NEW YORK, 36 500 Fifth Ave. R. P. LAWLESS, T. W. BENDER | Oxford 5-5959 H. T. BUCHANAN |
| PHILADELPHIA, 3 Six Penn Center Plaza | LOcust 8-4330 H. W. BOZARTH H. NICHOLSON |
| PITTSBURGH, 22 4 Gateway Center | EXpress 1-1314 P. PIERCE |
| ST. LOUIS, 8 3615 Olive St. | JEfferson 5-4867 |
| SAN FRANCISCO, 4 68 Post St. | DOuglas 2-4600 S. HUBBARD |

0.1% SORENSEN Line Voltage Regulator

±50005. Brand new at low surplus price! Input 95-130 V, 1 ph., with taps for 50 or 60 cy. Use for any power up to 5000 watts. Output adjustable 110-120 V and holds to ±0.10% at line frequency, or to ±0.25% if line frequency drifts 5%. Regulates against line changes of 95-130 V and against load changes from 0 to 5 KVA. Maximum harmonics less than 3%! Recovery time 0.15 seconds. Input to the control section can be moved to the point where you will use the power, thus compensating for line drop. In rack cabinet 28" h, 22" wd, 15" dp. Net wt 190 lbs. Ship wt 285 lbs FOB Utica, N. Y. In original factory pack suitable for export, including SPARE PARTS group. Sorensen catalog net price is \$695.00 \$349.50 less spares. Our price, WITH SPARES...



It is smart planning to buy this 5 KVA capability even if your present need is for lower power, because: 1. It works just as well at lower power. 2. Price is as low as a 1 KVA unit! (Sorensen's prices, LESS SPARES, are \$320.00 for 1 KVA, \$460.00 for 2 KVA, \$520.00 for 3 KVA, and \$695.00 for 5 KVA.)

MEASUREMENTS CORP. Pulse Generator

MEAS. CORP. MOD. 79-B PULSE GENERATOR, 60, 100,000 cy - pulses 1/2-40 usecs wd., and 1 sync pulses delayed 1/2 period. Can pulse modulate an external RF source and can be synched by an external sine source. This is the model preceding the current catalog model which sells for \$495.00. Brand new in original packing with instruction book, 40 lbs fob Harrisburg, Pa. . . . \$97.50

Circle Readers Service Card for our new listing of budget stretchers selected for you from surplus.

R. E. GOODHEART CO.
P. O. Box 1220-E Beverly Hills, Calif.

CIRCLE 461 ON READER SERVICE CARD



the Country's largest and most dependable supplier of

CONNECTORS FITTINGS & CLAMPS

We stock more than 5,000,000 MS/AN CONNECTORS . . . 50,000 variations!

These include . . .

- "MS" (AN) • 89 • MRE
- "MS"-E • DPD • TBF
- W • 164 • K-KR
- K • 126 • GS

"MS" (AN) CONNECTORS, CLAMPS and FITTINGS are available at "O.E.M." PRICE . . . and LOWER . . . in PRODUCTION QUANTITIES.

AMPHENOL — BENDIX — CANNON — WIN-CHESTER — CONTINENTAL — DEJUR — AMSCO — H. H. BUGGIE — IPC KINGS — CINCH — JONES — OAGE — DIAMOND

Send for FREE . . . latest brochure and list price chart

Wilgreen Industries, Inc.

100 Warren Street, New York 7, N. Y.
WOrth 4-2490-1-2 Wire: FFK

CIRCLE 462 ON READER SERVICE CARD

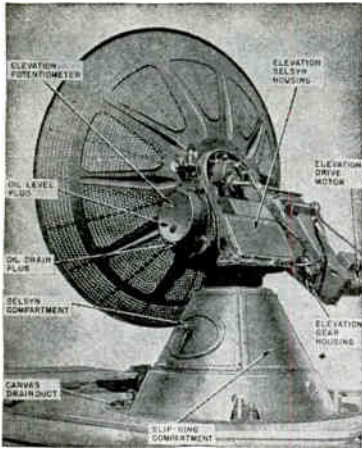

ANTENNA PEDESTAL SCR 584—MP 61B

Full azimuth and elevation sweeps, 360 degrees in azimuth, 210 degrees in elevation. Accurate to 1 mil, or better over system. Complete for full tracking response. Angle acceleration rate: AZ, 9 degrees per second squared EL, 4 degrees per second squared. Angle slewing rate: AZ, 20 degrees per sec. EL, 10 degrees per sec. Angle tracking rate: 10 degrees per sec. Includes pedestal drives, selsyns, potentiometers, drive motors, control amplifiers. Excellent condition. Quantity in stock for immediate shipment. Ideal for missile & satellite tracking, antenna pattern ranges, radar systems, radio astronomy, any project requiring accurate response in elevation and azimuth. Complete description in McGraw-Hill Radiation Laboratory Series, Volume 1, page 284 and page 209, and Volume 26, page 233.

AUTOMATIC TRACKING RADAR

SCR 584 is in like new condition, ready to go, and in stock for immediate delivery. Ideal for research and development, airway control, CCA, missile tracking, balloon tracking, weather forecasting, antiaircraft defense, tactical air support. Write us Fully Desc. MIT Rad. Lab. Series, Vol. 1, pps. 207-210, 238, 284-286.

AN/FPN-32 GCA RADAR

Lab. for Electronics "Quad" type portable ground control approach radar system. 3cm. search and precision approach. Complete systems in used, good condition. A very late type system—in stock \$5500 ea. Exc. cond.

WESTINGHOUSE 3CM RADAR

Complete X band system oper. from 115v 60cy ac with 40kw power output 2f55 magnetron. Ranges 0-1.5, 4, 16, 40 miles. Includes installation waveguide. An ideal system for lab school, demonstration or shipboard. \$1800. New with spares.

RADIO RESEARCH INSTRUMENT CO.
550 FIFTH AVE. NEW YORK JUDSON 6-4691

AN/TPS-1D RADAR

500 KW. 1220-1350 MCS. 160 nautical mile search range P.P.I. and A Scopes. MTI. Thyatron Mod. 5J26 Magnetron. Like new. Complete system incl. Spare parts and gas generator field supply.

TS 731/URM SUMMATION BRIDGE

1000 to 4000 mcs. RF power measuring Bolometer wheatstone bridge wattmeter. Complete set of % coax. calibrated attenuators and bolo. mt. AN/URM-20 c/ots 731/URM wattmeter, MX 1806/URM-20 waveguide kit factory new. Your price \$395.00.

1 MEGAWATT PULSER

MIT Radiation Lab Model 9 pulser. Desc. in "Rad Lab Series" Vol. 5 pps. 152-160. Supplies 1 megawatt output using 6C21 tubes. Complete modulator 115v 60 cycle input enclosed in single cabinet. Also 22000v power supply for magnetron in second cabinet. As new condition. In stock for immediate delivery.

AN/APS-10 3 CM. X BAND RADAR

Complete RF head including transmitter, receiver, modulator. Uses 2J42 magnetron. Fully described in MIT Rad. Lab. Series Vol. 1, pps. 616-625 and Vol. 11, pps. 171-185, \$37500. Complete X band radar system also avail. Includ. 360-deg antenna, PPI, syn pwr supply. Similar to \$47,000 weather radar now in use by airlines, \$750 complete.

10 CM. WEATHER RADAR SYSTEM

US Navy Raytheon 275 KW peak output S band. Rotating yoke Plan position Indicator. Magnetron supplied for any S band frequency specified, incl. Weather Band, 3, 20 and 80 mile range, 360 degree azimuth scan. Sensitive revr using 2K28/707B and 1N21B. Supplied brand new complete with instruction books and installation drawings. Can be supplied to operate from 32VDC or 115 volts. Price \$950. Ideal for weather work. Has picked up clouds at 50 miles. Weight 488 lbs.

100 FT. STEEL TOWER

Self supporting, rect. 14 ft. platform atop. New \$1500.

COLLINS MICROWAVE LINK

MW 103 Microwave Link, 7000 MC common carrier handl. Very late type. Sets and parts. 7 terminals in stock. Will sell part as one lot.

BROAD BAND BAL MIXER

Using short slot hybrid. Pound type broad band dual balanced crystal holder. 1x5 wa. size. \$25 new.

2C40 LIGHTHOUSE CAVITY

AN/APW-11A transmitter cavity for 2C40. Complete S band coverage at max. power. Temperature compensated. New \$77.50 ea.

CP 204/GMD-2 COMPUTER

Mfg. Gen'l. Mills. Met. data computer and recorder. Readout: ltel. Humid, Press., Altitude, etc. Direct. \$1500 ea.

AN/AAS-6 Infra Red Detection System Complete. New. \$5500.

VD-2 PPI REPEATER

Floor standing console with rotating yoke PPI. 7BP7CRT. 4, 20, 80, 200 mile ranges. Will display or repeat any PPI info locally for remote. New & complete. With inst. book. \$375 ea.

VG-2 PPI REPEATER

Desk top size projection type PPI Repeater - plotting board. As new. \$325.

EQUIPMENT VANS

Fully insulated, wired for 110vac with lights and outlets. Includes heater thermostat controls, 20 ft. long apx, 8 ft. wide, 10 ft. high. Fifth wheel for hauling by std. truck tractor. Buttressed walls for handling high roof torsion. 1 entrance door, 2 equipment doors, 4 wheel rear axle. Will hold 10 tons of equipment. Elevator from van floor to roof incl. in some units. Exc. condition \$1500 ea. Mfg. Preuheuf. Large quantity in stock.

CIRCLE 463 ON READER SERVICE CARD

SALE NEW RELAYS IN LARGE QUANTITIES AT FRACTION OF COST

| Maker | Type | Contact Arrangement | Resistance | Voltage | Price |
|------------------|--------------------|---------------------|------------|---------|-------|
| Advance | #A8769-ly | 3A | 39 Ohm | 6VDC | 1.50 |
| | | 2A2C | 39 Ohm | 6VDC | 1.50 |
| Sigma | 52JOCA-80110 | 1A1C | 16,000 Ohm | 28VDC | 3.00 |
| Sigma | 7-JOZ-80030 | SPDT | 5000 Ohm | 28VDC | 2.50 |
| | None Pile Up Cont. | | | | |
| | | 3A3B | 144 Ohm | 12VDC | 1.00 |
| | | 3B | 144 Ohm | 12VDC | 1.00 |
| | | 1A1B2C | 39 Ohm | 6VDC | 1.50 |
| Phillips Control | 2QA316A | 1A1C | 200 Ohm | 12VDC | 1.00 |
| | | SPST | 300 Ohm | 24VDC | 1.50 |
| Clare | B65369 | 1A1B | 125 Ohm | 12VDC | 1.50 |
| RBM | RB22300-14 | 1A1B | 280 Ohm | 28VDC | 1.50 |
| Potter-Bromfield | KF-1012-4 | SP5T | 200 Ohm | 12VDC | 1.50 |

LIBERTY ELECTRONICS, INC.

582 Broadway New York 12, N. Y.
Phone: WA 5-6000 Cables: Telsersup

CIRCLE 464 ON READER SERVICE CARD

Antique TELEPHONES

As is complete, decorative purpose \$12.00. Working order, inter-comm. \$15.00. Ext. on dial \$17.50, talking circuit only. Write for complete list. All shipments FOB, Simpson, Pa.
TELEPHONE ENGINEERING CO.
Dept. E-90, Simpson, Pa.



CIRCLE 465 ON READER SERVICE CARD

SEARCHLIGHT"

IS
Opportunity Advertising

—to help you get what you want—to
help you sell what you no longer need.

Take Advantage Of It

For Every Business Want

"Think Searchlight First"

SAVE TIME & EXPENSE
ON PURCHASING

RELAYS

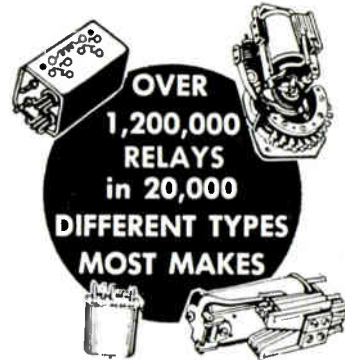

OVER
1,200,000
RELAYS
in 20,000
DIFFERENT TYPES
MOST MAKES

- PRODUCTION QUANTITIES IN STOCK
- DELIVERY ON OFF-THE-SHELF ITEMS WITHIN 48 HOURS. DELIVERY WITHIN ONE WEEK ON RELAYS REQUIRING ASSEMBLY AND/OR ADJUSTMENT.

WE DELIVER RELAYS
NOT PROMISES

SEND FOR CATALOG E

Universal RELAY CORP.

42A White St., New York 13, N. Y. • WAlker 9-5257

CIRCLE 468 ON READER SERVICE CARD

- TS 36 X BAND POWER METER. . . \$ 14.95
- TS 45A X BAND SIGNAL SOURCE . . . 19.95
- TS 76A/APN 3 TEST METER. . . 9.95
- TS 102A CALIBRATOR. 14.95
- TS 173 FREQUENCY METER. . . 124.50
- TS 196 BRIDGE 24.95
- TS 247 WAVE METER. 14.95

STANDARD LABORATORY RECEIVER

APR-4 w/4 Tuning Units. Frequency 38-2200 MC.

Checked out 239.50

MEASUREMENTS CORP. 79-B PULSE

GENERATOR. Checked out. . . 39.50

GEN. ELECT. COMPUTER TESTER.

New 29.95

ARC 3 RECEIVER 100-156 MC. . . 14.95

ARC 3 TRANSMITTER 100-156 MC 16.95

ART-13 TRANSMITTER with tubes

and meters. Checked out. . . 49.50

Large quantity G.E. 955's Orig. cartons.

Write for prices.

REGULAR TERMS TO RATED COMPANIES

Write for Bargain Flyer

R W ELECTRONICS

2430 S. MICHIGAN AVE.,
CHICAGO 16, ILLINOIS
CaLumet 5-1281

CIRCLE 467 ON READER SERVICE CARD

GLASS TUBING

PYREX - NONEX - URANIUM
BULB & CYLINDERS
WRITE FOR FREE MONTHLY LIST

HOUE GLASS COMPANY

PHONE COLFAX 4-4800

P.O. Box 206

Keyport, N. J.

CIRCLE 466 ON READER SERVICE CARD

ELECTRONIC

WAR TERMINATION INVENTORIES

WRITE OR WIRE FOR INFORMATION ON OUR COMPLETE LINE OF SURPLUS ELECTRONIC COMPONENTS. ALL PRICES NET F.O.B. PASADENA, CALIFORNIA



C&H
SALES CO.
2176-E East Colorado St.
Pasadena 8, California
MUrray 1-7393

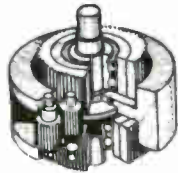

SIMPLE DIFFERENTIAL WITH BALL-BEARING SUN GEARS

The 1:1 reverse ratio spur gears are 48-tooth, 32 pitch brass with 3/16" available face. On one side, the shaft is 23.64" dia. for 11/16" and has a pin hole, then increases in dia. to .377" for the remaining 3/16" of length. On the other side, the shaft is .377 dia. 1/4" lg. 2-13/16" dia. is required to clear the body. Stock no. A6-115.....each \$15.00



SIMPLE DIFFERENTIAL WITH SPACED-OUT SUN GEARS

1:1 reverse ratio spur gears are aluminum, 3/32" face, 32 pitch, 32 tooth on one side, 48 tooth on the other. The body is 3/4" thick, but the sun gears are spaced out so that they are 1/2" apart. 1/4" dia. shaft on each side is 23/32" long. OA length 3 1/8". Requires 1-23/32" dia. to clear the body. Stock no. A6-124.....each \$4.50

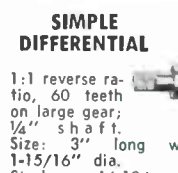

SIMPLE DIFFERENTIAL

1:1 reverse ratio, 60 teeth on large gear; 1/4" shaft. Size: 3" long with 1-15/16" dia. Stock no. A6-104.....each \$3.95



DUAL SIMPLE DIFFERENTIAL

1:1 reverse ratio on both. Size: 3 1/4" long x 1-7/16" dia. Shaft size: 1/8" and 5/32". Stock no. A6-107.....each \$7.50



SPERRY VERTICAL GYRO

Part #673073, Motor 115 volts, 3 phase, 400 cycle, 8 watts, 20,000 RPM. 3-minute runup, synchro pickoffs, roll 360°, pitch 85°. Synchro excitation 26 volts, 400 cycle, 150 m.a. Vertical accuracy ±1/2". Weight 3 1/2 lbs. Approx. dim. 5 3/4" L., 4 1/2" W., 4 1/2" H. Price \$35.00



MINNEAPOLIS-HONEYWELL RATE GYRO (Control Flight)

Part no. JG7005A, 115 volts A.C., 400 cycle, single phase potentiometer take off resistance 530 ohms. Speed 21,000 r.p.m. Angular momentum 2 1/2 million, CM²/sec. Weight 2 lbs. Dimensions 4-7/32 x 3-29/32 x 3-31/64. Price \$22.50

VARIABLE SPEED BALL DISC INTEGRATORS

(All Shafts Ball Bearing Supported)

No. 145 Forward & Reverse 2 1/4-0-2 1/4. Input shaft spline gear 12 teeth 9/32" dia. 3/8" long. Output shaft 15/64" dia. x 15/32" long. Control shaft 11/32" x 3/8" long. Cast aluminum construction. Approx. size 3" x 3" x 2 3/4". \$17.50

No. 146 Forward & Reverse 4-0-4. Input shaft 5/16" dia. x 3/4" long; Output shaft 15/64" dia. x 9/16" long. Control shaft 11/64" dia. x 11/16" long. Cast aluminum construction. Approx. \$18.50 ea. size 4 1/2" x 4 1/2" x 4".

SMALL DC MOTORS

- (approx. size overall 3 3/4" x 1 1/4" dia.)
- 5067043 Delco 12 VDC PM 1" x 1" x 2", 10,000 rpm. \$7.50
 - 5067126 Delco PM, 27 VDC, 125 RPM, Governor Controlled 15.00 ea.
 - 5069600 Delco PM 27.5 VDC 250 rpm 12.50
 - #5069625 120 rpm, mfr. Delco, 27 VDC governor controlled \$15.00
 - 5069230 Delco PM 27.5 VDC 145 rpm 15.00
 - 5068750 Delco 27.5 VDC 160 rpm w. brake 6.50
 - 5068571 Delco PM 27.5 VDC 10,000 rpm (1x1x2") 5.00
 - 5069790 Delco PM, 27 VDC, 100 RPM, Governor Controlled 15.00 ea.
 - #5069800 575 rpm, mfr. Delco, 27 VDC, PM reversible governor controlled, equipped with 27 VDC clutch \$17.50
 - 5072735 Delco 27 VDC 200 rpm governor controlled. 15.00
 - 5BA10A118 GE 24 VDC 110 rpm 10.00
 - 5BA10AJ37 GE 27 VDC 250 rpm reversible 10.00
 - 5BA10AJ52 27 VDC 145 rpm reversible 12.50
 - 5BA10AJ50, G.E., 12 VDC, 140 rpm 15.00
 - 5BA10FJ401B, G.E. 28 VDC, 215 rpm, 10 oz. in., .7 amp. contains brake 15.00
 - 5BA10FJ421, G.E. 26 VDC, 4 rpm, reversible, 6 oz. in., .65 amp 15.00

400 CYCLE PM GENERATOR

Mfgd. by T K M Electric Corp. Model #A-12 120/208 volts, 400 cycle, 1 or 3 phase, 1 kva, pf 0.8, rpm 8,000. Approx. dim. 6" x 5 1/2". Internal spline drive. Price \$100.00

400 CYCLE 1/3 PHASE GENERATOR

115 VAC. 3 KVA. Mfg. Bogue Elect. Mod. 2800S. External excitation 107 VDC. 1.1 amp. 3450 rpm. 1" shaft. \$200.00

TACHOMETER OR RATE GENERATORS

- J-36 E.A.D.; 2 volts per 100 rpm; max. rpm 5000.....\$22.50
- PM-1 Elinco; 2 volts per 100 rpm; max. rpm 3000.....\$17.50
- PM-2 Elinco; 2 volts per 100 rpm; max. rpm 3000.....\$17.50
- B-35 Elinco; 2 volts per 100 rpm; max. rpm 10,000.....\$22.50
- B-68 Elinco; 1.2 V.A.C. per 100 rpm; max. rpm 10,000.....\$17.50

SELSYNS-SYNCHROS



- 1CT cont. Trans 90/55V 60 cy.....\$27.50
- 1DG Diff. Gen. 90/90V 60 cy.....34.50
- 1F Syn. Mtr. 115/90V 60 cy.....34.50
- 1G Gen. 115V 60 cy.....34.50
- 1HDC.....37.50
- 1HCT.....12.50
- 23TF Syn. Mtr. 115/90V 400 cy.....34.50
- 23TR4 torque receiver.....37.50
- 23TR6 torque receiver.....37.50
- 23CT4 control transformer.....34.50
- 23CT6 control transformer.....37.50
- 23CX6 control transmitter.....37.50
- 7DG differential generator.....37.50
- 2J1F1 Gen. 115/57.5V 400 cy.....7.50
- 2J1F3 Gen. 115/57.5V 400 cy.....10.00
- 2J1F4 Gen. 115/57.5V 400 cy.....7.50
- 2J1G1 57.5/57.5V 400 cy.....5.00
- 2J1H1 Diff. Gen. 57.5V.....7.50
- 2J5D1 Cont. Trans. 105/55V 60 cy.....17.50
- 2J5F1 Cont. Trans. 105/55V 60 cy.....17.50
- 2J5H1 Gen. 115/105V 60 cy.....17.50
- 2J15M1 Gen. 115/57.5V 400 cy.....17.50
- 3CT Cont. Trans. 90/55V 60 cy.....34.50
- 5D Diff. Mtr. 90/90V 60 cy.....34.50
- 5DG Diff. Gen. 90/90V 60 cy.....34.50
- 5F Syn. Mtr. 115/90VAC 60 cy.....34.50
- 5G Syn. Gen. 115/90VAC 60 cy.....34.50
- 5HCT Cont. Trans. 90/55V 60 cy.....37.50
- 5SDG Diff. Gen. 90/90V 400 cy.....12.50
- 6DG Diff. Gen. 90/90V 60 cy.....25.00
- 6G Syn. Gen. 115/90VAC 60 cy.....34.50
- 7G Syn. Gen. 115/90VAC 60 cy.....42.50
- C56701 Type 11-4 Rep. 115V 60 cy.....20.00
- C69405-2 Type 1-1 Transm. 115V 60 cy.....20.00
- C69406 Syn. Transm. 115V 60 cy.....20.00
- C69406-1 Type 11-2 Rep. 115V 60 cy.....20.00
- C78248 Syn. Transm. 115V 60 cy.....12.50
- C78410 Repeater 115V 60 cy.....20.00
- FTE 49-7 Diehl servo motor. 115 volts, 60 cycle, 10 watts.....30.00

400 CYCLE, 3 PHASE GENERATOR

BY MASTER ELECTRIC Type AG, frame 364Y, 7.5 kw, 3428 rpm, pf .95 Star connected 120/208 3 phase, 22 amps. Delta connected 120 volt single phase 66 amps. Self excited. Complete with control box, voltage regulator, AC voltmeter and frequency meter. Shaft 1" dia., 2" long; overall dim. of unit: 21" x 18" x 20". Price \$395.00 each

400 CYCLE PM GENERATOR

115/200 volts A.C. 1- or 3-phase, 200 watts. 4,000 r.p.m. Approx. dimensions: 4 3/4" dia.; 3" long; 1/2" shaft; AN connector. \$75.00

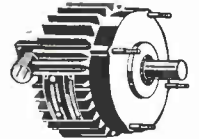

400 CYCLE MOTOR GENERATOR

Mfgd. by General Electric Model #5ATB324E5 Output 120/208 volts AC, 400 cycle, 11.75 kw, 32.6 amp., pf .85. Input 220/440 volts AC, 60 cycle, 3 phase, 15 h.p. Unit complete with motor starter and controls. Price \$750.00

ONAN MOTOR GENERATOR SET

MG 075-G-1 Generator 115 VAC, 480 cycle; 5.3 amps; .6KW; PF 1.0; also 26 VDC; 100 watt; 3.8 amps; Driven by 115-230 VAC —2hp motor; 60 cycle; single phase; 3450 rpm; 10.5 amps. Price \$135.00

16mm SINGLE FRAME CAMERA

mfgd. by Bell & Howell (200 series) 50 ft. magazine load operates on 12 volt DC, has rotary solenoid, standard C mount, lens and view finder; excellent for photographing records, nature study, etc. Price \$35.00 each

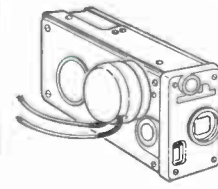

SPECIAL PURPOSE TUBES

| | | | | | | | | | |
|----------|--------|---------|--------|-----------|--------|-------------|--------|--------------|--------|
| OA2 | .70 | 4X150A | 8.85 | 348A | 2.50 | 5528/C6L | 1.50 | 5896 | 1.50 |
| OA3 | .85 | 4X250B | 30.00 | 349A | 2.00 | 5545 | 12.50 | 5899A | 2.50 |
| OB2 | .50 | 5BP1A | 12.50 | 350A | 3.50 | 5552/FG-235 | 45.00 | 5902 | 2.35 |
| OB3 | .70 | 5C22 | 16.00 | 350B | 3.50 | 5557/FG-17 | 4.25 | 5903 | 4.00 |
| OC3 | .50 | 5CP1A | 10.50 | 352A | 6.50 | 5558/FG-32 | 7.50 | 5932/6L6WGA | 5.00 |
| OD3 | .30 | 5LP1A | 20.00 | 354A | 10.00 | 5559/FG-57 | 10.00 | 5948/1754 | 150.00 |
| 1A04 | 1.25 | 5R4GY | 1.00 | 355A | 10.00 | 5560/FG-95 | 15.00 | 5956/E36A | 10.00 |
| 1B24A | 8.85 | 5R4WGY | 2.50 | 393A | 3.50 | 5586 | 100.00 | 5963 | .75 |
| 1B35A | 3.00 | 5RP1A | 10.00 | 394A | 2.50 | 5632/C3J | 8.50 | 5964 | .85 |
| 1B63A | 12.50 | 5Y3WGT | 1.15 | 396A/2C51 | 2.50 | 5636 | 1.25 | 5965 | .75 |
| CIK | 6.00 | 6AC7W | .35 | 398A/5603 | 4.00 | 5639 | 2.00 | 5975 | 2.00 |
| 1P21 | 25.00 | 6AG7Y | 1.00 | 401A/5590 | 1.50 | 5642 | 1.25 | 5977/6K4A | 1.50 |
| 1P25 | 10.00 | 6AK5W | 1.00 | 403A/6AK5 | 1.00 | 5643 | 4.50 | 5981/5650 | 25.00 |
| 1P28 | 20.00 | 6AN5WA | 3.00 | 403B/5591 | 3.00 | 5644 | 2.50 | 5992 | 2.00 |
| 2-O1C | 12.50 | 6AS7G | 2.35 | 404A/5847 | 10.00 | 5646 | 2.00 | 5993 | 4.00 |
| 2AP1A | 2.50 | 6BL6 | 30.00 | 407A | 3.50 | 5647 | 2.25 | 6005/6AQ5W | 1.25 |
| 2BP1 | 7.00 | 6BM6 | 30.00 | 408A/6028 | 2.00 | 5651 | .70 | 6012 | 5.00 |
| 2C36 | 25.00 | 6BM6A | 30.00 | 409A/6A56 | 2.00 | 5654/6AK5W | 1.00 | 6021 | 2.00 |
| 2C39 | 2.50 | 6C21 | 10.00 | 412A | 4.00 | 5656 | 3.50 | 6032 | 25.00 |
| 2C39A | 7.50 | 6CJ | 12.50 | 415A | 3.00 | 5665/C16J | 28.50 | 6037/QK-243 | 25.00 |
| 2C40 | 7.00 | 6J4WA | 1.50 | 416B/6280 | 30.00 | 5670WA | 1.35 | 6045 | 1.25 |
| 2C43 | 7.50 | 6J6W | .60 | 417A/5842 | 10.00 | 5675 | 7.50 | 6072 | 1.75 |
| 2C50 | 5.00 | 6L6GAY | 1.00 | 418A | 15.00 | 5676 | 1.25 | 6073 | .80 |
| 2C51 | 1.50 | 6L6WGB | 1.75 | 420A/5755 | 5.00 | 5678 | 1.25 | 6080 | 2.85 |
| 2C52 | 1.75 | 6L6Y | 1.25 | 421A/5998 | 7.50 | 5684/C3J A | 11.80 | 6080WA | 5.00 |
| 2C53 | 8.50 | 6Q5G | 2.50 | 422A | 10.00 | 5685/C6J A | 15.00 | 6080WB | 10.00 |
| 2D21 | 5.00 | 6S17WGT | 1.00 | 423A/6140 | 5.00 | 5686 | 1.85 | 6082 | 3.00 |
| 2D21W | 1.00 | 6S17WGT | 1.00 | 429A | 9.00 | 5687WA | 2.50 | 6087/5Y3WGTB | 3.00 |
| 2E24 | 2.50 | 65N7WGT | .75 | 450TH | 30.00 | 5691 | 5.00 | 6099 | .75 |
| 2E26 | 2.85 | 6V6GTY | .75 | 450TL | 30.00 | 5692 | 2.00 | 6100/6C4WA | 1.25 |
| 2J42 | 35.00 | 6X4W | .75 | 575A | 12.50 | 5693 | 3.50 | 6101/6J6WA | 1.00 |
| 2J51 | 50.00 | 6X5WGT | 1.00 | 631-PI | 4.25 | 5702WA | 2.75 | 6111A | 2.00 |
| 2K25 | 7.50 | 5RL7F-H | 150.00 | 673 | 12.50 | 5703WA | 3.00 | 6112 | 2.50 |
| 2K26 | 25.00 | 7MP7 | 17.50 | 676 | 27.50 | 5704 | 1.00 | 6115/QK-351 | 50.00 |
| 2K29 | 25.00 | 10KP7 | 25.00 | 677 | 32.50 | 5718 | 1.00 | 6130/3C45 | 8.50 |
| 2K30 | 75.00 | HK-24 | 1.00 | 714AY | 10.00 | 5719A | 1.50 | 6136/6AU6WA | 1.25 |
| 2K34 | 100.00 | 25T | 7.50 | 715C | 10.00 | 5720/FG-33 | 17.00 | 6137/6SK7WA | 1.50 |
| 2K35 | 250.00 | 2625W | 1.25 | 719A | 7.50 | 5721 | 125.00 | 6146 | 3.75 |
| 2K41 | 25.00 | 35T | 7.50 | 721B | 3.00 | 5725/6A56W | 1.00 | 6152 | 4.50 |
| 2K42 | 125.00 | 35TG | 2.50 | 723A/B | 2.50 | 5726/6ALS5W | .75 | 6186/6AG5WA | 1.75 |
| 2K43 | 125.00 | FG-105 | 33.35 | 725A | 5.00 | 5727/2D21W | 1.00 | 6189/12AU7WA | 1.50 |
| 2K44 | 125.00 | FG-172 | 17.50 | 726B | 3.25 | 5728/FG-67 | 7.50 | 6197 | 1.75 |
| 2K47 | 125.00 | 212E | 25.00 | 750TL | 87.50 | 5740/FP-54 | 50.00 | 6199 | 35.00 |
| 2K50 | 65.00 | 244A | 2.50 | 802 | 3.50 | 5744WA | 2.75 | 6201/12AT7WA | 1.50 |
| 2X2A | 1.00 | 245A | 3.50 | 804 | 15.00 | 5749/6BA6W | .75 | 6202/6X4WA | 1.50 |
| 2X1000A | 95.00 | 249B | 10.00 | 805 | 3.00 | 5750/6BE6W | 1.35 | 6211 | .65 |
| 3AP1A | 10.00 | 249C | 5.00 | 807 | 1.25 | 5751/12AX7W | 1.35 | 6216 | 2.50 |
| 3B24W | 3.50 | 250R | 7.50 | 809 | 3.75 | 5763 | 1.50 | 6263 | 9.00 |
| 3B25 | 3.00 | 250TH | 25.00 | 810 | 12.50 | 5777 | 100.00 | 6264 | 9.00 |
| 3B28 | 4.00 | 252A | 6.00 | 811A | 4.75 | 5778 | 150.00 | 6265 | 2.25 |
| 3BP1A | 7.50 | 254A | 2.00 | 813 | 8.50 | 5783 | 2.00 | 6282/BL-11 | 50.00 |
| 3C22 | 30.00 | 257A | 3.50 | 814 | 1.50 | 5784WA | 3.50 | 6299 | 37.50 |
| 3C23 | 4.50 | 259A | 3.50 | 815 | 1.50 | 5787 | 2.50 | 6336 | 7.50 |
| 3C24/24G | 2.50 | 262B | 3.50 | 816 | 1.75 | 5799/VX-21 | 3.00 | 6336A | 10.00 |
| 3C45 | 3.00 | 267B | 7.50 | 828 | 7.00 | 5800/VX-41 | 3.50 | 6352 | 8.50 |
| 3D22 | 9.50 | 271A | 10.00 | 829B | 7.25 | 5801/VX-33A | 3.00 | 6364 | 150.00 |
| 3E29 | 3.50 | 272A | 4.00 | 832 | 2.00 | 5802/VX-32B | 3.50 | 6390 | 175.00 |
| 3J21 | 35.00 | 274A | 2.50 | 833A | 33.00 | 5803/VX-55 | 1.50 | 6438 | 4.00 |
| 3J31 | 50.00 | 275A | 4.00 | 836 | 1.00 | 5814A | 1.25 | 6463 | 1.25 |
| 3K21 | 150.00 | 283A | 3.50 | 837 | .90 | 5819 | 45.00 | 6517/QK358 | 500.00 |
| 3K22 | 150.00 | 287A | 2.50 | 845 | 7.50 | 5824 | 2.50 | 6533 | 6.50 |
| 3K23 | 250.00 | 293A | 4.50 | 866A | 1.95 | 5828 | 3.00 | 6544 | 250.00 |
| 3K27 | 185.00 | 300B | 5.00 | 872A | 1.75 | 5829WA | 1.50 | 6550 | 4.25 |
| 3K30 | 75.00 | 304TH | 30.00 | 884 | 1.00 | 5836 | 60.00 | 6626/OA2WA | 2.00 |
| 3KP1 | 10.00 | 304TL | 30.00 | 913 | 7.50 | 5837 | 60.00 | 6627/OB2WA | 2.00 |
| 4-65A | 9.50 | 310A | 3.50 | 927 | 1.25 | 5839 | 2.50 | 6655 | 40.00 |
| 4-125A | 20.00 | 311A | 2.50 | 931A | 3.00 | 5840 | 2.00 | 6754 | 10.00 |
| 4-250A | 30.00 | 313C | 1.00 | 959 | .50 | 5845 | 4.85 | 6784 | 250.00 |
| 4-400A | 32.50 | 323A | 6.50 | 1000T | 97.50 | 5852 | 2.50 | 6897 | 18.75 |
| 4-1000A | 100.00 | 328A | 2.50 | 1500T | 150.00 | 5854 | 1.50 | 6901 | 10.00 |
| 4AP10 | 10.00 | 329A | 3.50 | 1603 | 4.75 | 5876 | 5.00 | 8005 | 5.00 |
| 4B31 | 15.00 | 336A | 2.50 | 1614 | 2.50 | 5879 | 1.00 | 8013A | 3.00 |
| 4C35 | 15.00 | 337A | 3.50 | 1620 | 3.50 | 5881/6L6WGB | 1.75 | 8020 | 1.50 |
| 4E27 | 7.50 | 339A | 4.00 | 1624 | .75 | 5886 | 3.00 | 9002 | .35 |
| 4J52 | 25.00 | 347A | 1.50 | 2050 | 1.10 | 5894 | 15.00 | 9005 | 3.00 |

ALL TUBES ARE NEW, INDIVIDUALLY CARTONED, FULLY GUARANTEED

Prices are FOB shipping point

western engineers

Orders for less than \$10 cannot be processed

ELK GROVE, CALIFORNIA

SUPPLIERS OF ELECTRON TUBES SINCE 1932



OUR NEWEST ARRIVAL . . .
Just off the press . . . the new edition of

New 1960 Mid-Summer/Fall BARRY'S *GREENSHEET.

* A complete catalog of specialized industrial ELECTRONIC TUBES and COMPONENTS . . . featuring BARRY ELECTRONICS savings to industry. Write for your copy.

Send for your copy today . . . by circling 471 on the Reader Service Card.

We'll also purchase your equipment and unused tubes. Send details to: Dept. E-9

BARRY ELECTRONICS CORP.
512 BROADWAY, NEW YORK 12, N. Y.
Walker 5-7000 TWX: NY1-3731

CIRCLE 471 ON READER SERVICE CARD

CIRCLE 470 ON READER SERVICE CARD

AN/APT-5 Transmitters, 50 watt CW-RF 300-1625MC, 115v60cy filis (send for data), new surplus sld pkg, \$185.00; used svcb1 \$135.00.

AN/SPT-6A Navy version of AN/APT-5 with built-in 115v60cy plate & fil supply, new surplus in sealed packing w/accys & manual \$285.00.

AN/APT-9 Transmitter, 200-2500MC (2-2C39A's, etc.), cavity motorized for remote tuning, new surplus sld pkg \$185.00, used svcb1 \$135.00.

CHOPPERS, Stevens-Arnold CH-268, octal base 0-500cy, interchangeable with CH-364, now priced \$51.30, our price new surplus sld pkg \$18.00.

ATTENUATORS, Daven RFA-541 0-70DB in 10DB steps 0-225MC, 50 ohms coax "N" connectors, now priced \$50, our price new surplus sld pkg \$20.00.

Military and commercial TEST EQUIPMENT—specify your needs.

ENGINEERING ASSOCIATES
434 Potterson Road Doyton 19, Ohio

CIRCLE 472 ON READER SERVICE CARD

TRANSEAL® . . .

TIME SAVER FOR DRAFTSMEN AND ENGINEERS



The Superior Pressure-Sensitive Printed Plastic Drafting Aid

TRANSEAL® the improved Title Blocks, Bill of Materials, Change Blocks, Technical Symbols, Electronic Symbols, Illustrating Aids, etc. for use by engineers and draftsmen on drawings and tracings. They are known to industry as "TRANSEAL"® a thin transparent printed plastic sheet with pressure-sensitive adhesive coating, protected by a removable waxed paper sheet. Transeals eliminate rubber stamps and time-consuming hand lettering, symbol drawing and ruling usually required for engineering drawings on paper, vellum, or cloth. Furnished for application to either the reverse side or the face of drawings, Transeals are easily applied by slight hand pressure without use of heat, and can be conveniently stored for future use.

Coydon M. Johnson Co.,

Write for Information & Samples

ROUTE 107, BETHPAGE, N. Y. WElls 8-4600
CIRCLE 473 ON READER SERVICE CARD

SEARCHLIGHT Equipment Locating Service

NO COST OR OBLIGATION

This service is aimed at helping you, the reader of "SEARCHLIGHT", to locate Surplus new and used electronic equipment and components *not currently advertised.* (This service is for USER-BUYERS only).

How to use: Check the dealer ads to see if what you want is not currently advertised. If not, send us the specifications of the equipment wanted on the coupon below, or on your own company letterhead to:

Searchlight Equipment Locating Service

c/o ELECTRONICS

P. O. Box 12, N. Y. 36, N. Y.

Your requirements will be brought promptly to the attention of the equipment dealers advertising in this section. You will receive replies directly from them.

Searchlight Equipment Locating Service

c/o ELECTRONICS

P. O. Box 12, N. Y. 36, N. Y.

Please help us locate the following equipment components.

NAME

TITLE

COMPANY

STREET

CITY 9/9/60

INDEX TO ADVERTISERS



Audited Paid Circulation

| | | | |
|--|-----------|--|--------------|
| * AMP Incorporated | 89 | Mallory and Co., Inc., P. R. | 10 |
| Aerospace Corporation | 12, 13 | Martin Co. | 17 |
| * Allegany Instrument Co. | 14 | * McGraw-Hill Book Co. | 52 |
| * Allied Chemical Corp., Baker & Adamson Products, General Chemical Div. | 113 | Microcell Ltd. | 60 |
| Alpha Corporation | 50, 51 | Microwave Associates Inc. | 111 |
| American Cystoscope Makers, Inc. | 60 | * New Hermes Engraving Machine Corp. | 121 |
| * American Lava Corp. | 57 | * Ozalid, A Div. of General Aniline & Film Corp. | 18 |
| * American Metal Climax, Inc. | 65 | * Philco Corp. | 68 |
| * American Optical Co. | 62 | Power Sources, Inc. | 29 |
| Amperite | 127 | Powertron Ultrasonics Corp. | 136 |
| Ampex Data Products Co. | 93 | Precision Instrument Co. | 118 |
| Anaconda Wire & Cable Co. | 35 | * Precision Tube Company | 107 |
| Bell Telephone Laboratories | 91 | * Radio Corporation of America, 4th Cover | |
| * Bendix Corporation Red Bank Division | 38 | * Raytheon Company | 33, 106, 107 |
| * Bird Electronic Corp. | 114 | Royal Electric Corp. | 6 |
| * Burnell & Co., Inc. | 3 | Seymour Mfg. Co., The | 127 |
| * Bussman Mfg. Co. | 34 | Siegler Corp., The | 27 |
| * Cambridge Thermionic Corp. | 115 | * Sorensen & Co. | 61 |
| Cannon Electric Co. | 37 | * Sperry Electronic Tube Div., Sperry Rand Corp. | 116, 117 |
| * Carborundum Company, The | 22 | * Sperry Microwave Electronics Co., Div. of Sperry Rand Corp. | 98, 99, 135 |
| * Celco-Constantine Engineering Laboratories | 39 | Sprague Electric Co. | 5, 20, 55 |
| Cinema Engineering | 98 | Standard Electric Time Co., The | 123 |
| Clare & Co., C. P. | 23 | Superior Cable Corp. | 108 |
| * Clevite Transistor, A Div. of Clevite Corp. | 7 | * Sylvania Electric Products, Inc. Semiconductor Division | 94, 95 |
| Connecticut Hard Rubber Co. | 121 | * Tempo Instrument Inc. | 48, 49 |
| * Constantine Engineering Laboratories | 39 | * Texas Instruments Incorporated Semiconductor-Components Division | 97 |
| * Cosmic Condenser Co. | 103 | * Transatron Electronic Corp. | 19 |
| * Cross Co., H. | 122 | Transradio, Ltd. | 122 |
| * Curtiss Universal Joint Co., Inc. | 136 | United Aircraft Corp. Ketay Dept. | 67 |
| * Daven Company, The | 3rd Cover | United Shoe Machinery Corp. | 43 |
| * Delta Design, Inc. | 127 | * United Transformer Corp. | 2nd Cover |
| * Eitel-McCullough, Inc. | 32 | * Varian Associates | 63 |
| Electro Instruments Inc. | 59 | Virginia Electric & Power Co. | 66 |
| * Electronic Instrument Co., Inc. (EICO) | 121 | Vitro Chemical Company | 26 |
| Electronic Measurements Co. Inc. | 64 | * Waters Manufacturing, Inc. | 54 |
| Esterline-Angus Company | 116 | * Weller Electric Corp. | 128 |
| * Fairchild Semiconductor Corp. | 52, 53 | * Westinghouse Electric Corp. Electronic Tube Div. | 58 |
| Fansteel Metallurgical Corp. | 124, 125 | * See Advertisement in the July 20, 1960 issue of Electronics Buyers' Guide for complete line of products or services. | |
| * Gamewell Co., The | 36 | MANUFACTURERS' REPRESENTATIVES | |
| * General Electric Co. Apparatus Sales Dept. | 109 | MacDonald Inc., Samuel K. | 131 |
| * Hallcrafters Company | 56 | CLASSIFIED ADVERTISING | |
| Harriman Ripley & Co., Inc. | 16 | F. J. Eberle, Business Mgr. | |
| Haveg Industries, Inc. | 47 | EMPLOYMENT OPPORTUNITIES. | 130, 131 |
| Helipot Division of Beckman Instruments, Inc. | 100 | SPECIAL SERVICES | 131 |
| * Hewlett Packard Company | 8, 9 | EQUIPMENT | |
| Hoffman Electronics Corp. Semiconductor Div. | 15 | (Used or Surplus New) | |
| Houston Fearless Corp. | 21 | For Sale | 131-134 |
| * Hughes Aircraft Co. | 28, 105 | | |
| * Industrial Electronic Engineers | 115 | | |
| International Resistance Co. | 44 | | |
| * International Telephone and Telegraph Corp. Industrial Products Div. | 30, 31 | | |
| Jones & Lamson Machine Co. | 2 | | |
| Littelfuse | 109 | | |
| Litton Industries | 103 | | |
| Lockheed Electronics Co. | 24, 25 | | |
| Los Alamos Laboratories | 129 | | |

SPERRY *Microline*[®] highly accurate IMPEDANCE INSTRUMENTS



**UNIVERSAL
CARRIAGE 21A1**

This carriage is machined to a high degree of accuracy and carefully designed for long life and low wear of parts. Extreme rigidity and factory adjustment assure precision travel of probe within waveguide walls enabling the most accurate of SWR measurement.



SLOTTED SECTIONS

(for use in Universal Carriage 21A1 above)

These sections fit precisely into the Microline 21A1 Universal Carriage assuring perfect positioning with respect to travel of the probe tip. Each slot is tapered at both ends to reduce secondary slot effects.

| SPECIFICATIONS | | |
|---------------------------|---------------------|-------|
| Model | Frequency Range Kmc | Price |
| 21A1 (Universal Carriage) | 3.95-18.0 | \$160 |
| 21C1 | 3.95-5.85 | 110 |
| 21G1 | 5.2-8.2 | 110 |
| 21H1 | 7.05-10.0 | 110 |
| 21X1 | 8.2-12.4 | 90 |
| 21U1 | 12.4-18.0 | 110 |

Residual VSWR (Max), 1.01



SLOTTED LINES

These are precision built units for applications in S and L bands, machined and manufactured to the same fine tolerances as the 21A1 Universal Carriage. Precision slotted waveguide casting is integral with the carriage.



BROADBAND PROBE 21B1

For use with all of the above units we recommend the Microline 21B1 Broadband Tunable Probe. This probe is outstanding because of its unique dual action repeatable tuning adjustments, and its complete freedom from any type of erratic operation.



SPERRY MICROWAVE ELECTRONICS COMPANY,
Clearwater, Fla., Division of Sperry Rand Corp.

300% FASTER ULTRASONIC CLEANING*

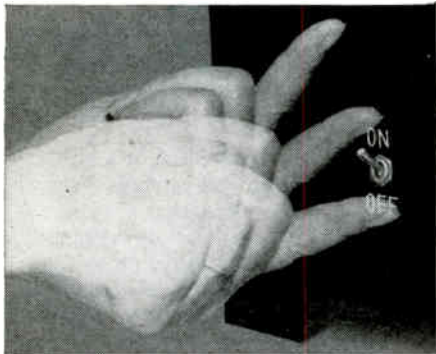

with SELF-TUNING

Self-tuning Autosonic cleaners by Powertron clean faster, better and cheaper because they: Eliminate operator training and monitoring; Release labor for other work; Reduce rejects; Save on solvents.

HERE'S HOW IT'S DONE

The Autosonic is electronically self-tuned by its exclusive feedback transducer and requires no tuning knobs or meters. A simple switch is the only control.

Only Autosonic cleaners give you consistent peak performance cleaning regardless of load, solution level or temperature, contamination or operator inattention.

Powertron's complete line of Autosonic generators, tanks, cabinet models, degreasers and immersible transducers is immediately available from stock. Ask for free demonstration by Sales Engineer.

*Case Histories on File.



WRITE FOR
FREE BULLETIN 60-1
"HOW TO CLEAN
ULTRASONICALLY
WITH SELF TUNING"

POWERTRON ULTRASONICS CORP.

DEPT. E-9

PATTERSON PLACE • ROOSEVELT FIELD
GARDEN CITY, L.I., NEW YORK • PIONEER 1-3220

ADVERTISERS INDEX

| | |
|---|-----|
| Barry Electronics Corp..... | 134 |
| C & H Sales Co..... | 133 |
| Engineering Associates | 134 |
| Goodheart Co., R. E..... | 131 |
| Houde Glass Co..... | 132 |
| Johnson Co., Inc., Corydon M..... | 134 |
| Liberty Electronics Inc..... | 132 |
| RW Electronics | 132 |
| Radio Research Instruments Co..... | 132 |
| Sikorsky Aircraft, Div. of United Aircraft Corp. | 130 |
| Telephone Eng. Co..... | 132 |
| Tierney, C. M..... | 131 |
| Universal Relay Corp..... | 132 |
| Western Engineers | 134 |
| Wilgreen Industries Inc..... | 131 |

This index and our Reader Service Numbers are published as a service. Every precaution is taken to make them accurate, but ELECTRONICS assumes no responsibilities for errors or omissions.

electronics



Audited Paid Circulation

BRUCE A. WINNER,
Advertising Sales Manager

R. S. QUINT, Assistant Advertising Sales Manager and Buyers' Guide Manager; FRED STEWART, Promotion Manager; RICHARD J. TOMLINSON, Production Manager; GEORGE E. POMEROY, Classified Manager; HUGH J. QUINN, Circulation Manager.

ADVERTISING REPRESENTATIVES: NEW YORK Donald H. Miller, Henry M. Shaw, George F. Werner; BOSTON William S. Hadgkinson, Donald R. Furth; PITTSBURGH David M. Watson; PHILADELPHIA Warren H. Gardner, William J. Boyle; CHICAGO Harvey W. Wernecke, Martin J. Galloway; CLEVELAND P. T. Fegley; SAN FRANCISCO T. H. Carmady, R. C. Alcorn; LOS ANGELES Carl W. Dysinger, D. A. McMillan, Marshall Freeman; DENVER J. Patten; ATLANTA M. Miller; DALLAS Robert T. Wood; LONDON Edward E. Schirmer; FRANKFURT Stanley R. Kimes; GENEVA Michael R. Zeynel.

BRANCH OFFICES: National Press Bldg., Washington 4, D.C.; 350 Park Square Bldg., Boston 16; Four Gateway Center, Pittsburgh 22; Six Penn Center Plaza, Philadelphia 3; 520 North Michigan Avenue, Chicago 11; 55 Public Square, Cleveland 13; 68 Post Street, San Francisco 4; 1125 West Sixth St., Los Angeles 17; 1740 Broadway, Denver 2; 1301 Rhodes-Haverty Bldg., Atlanta 3; 901 Vaughn Bldg., Dallas 1; McGraw-Hill House, London E.C.4; B5 Westendstrasse, Frankfurt/Main; 2 Place de Port, Geneva.

OFFICERS OF THE PUBLICATIONS DIVISION: Nelson L. Bond, President; Shelton Fisher, Wallace F. Traendly, Senior Vice Presidents; John R. Callahan, Vice President and Editorial Director; Joseph H. Allen, Vice President and Director of Advertising Sales; A. R. Venezian, Vice President and Circulation Coordinator.

OFFICERS OF THE CORPORATION: Donald C. McGraw, President; Joseph A. Gerardi, Hugh J. Kelly, Harry L. Waddell, Executive Vice Presidents; L. Keith Goodrich, Vice President and Treasurer; John J. Cooke, Secretary.



CURTIS HELPS THIS SWITCH LIVE TO A RIPE OLD AGE

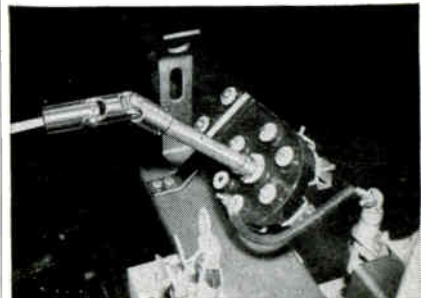

Pad-mounted transformers for underground power distribution systems are built to last a lifetime. They require a minimum of maintenance. Settings are changed infrequently. But when a change is required, this switch must operate smoothly and surely. To insure a long, dependable life, without freeze-ups or rust-outs, the manufacturer equipped it with a Curtis C-646 1" O.D. Stainless Steel double universal joint.

This kind of dependability is the stock-in-trade of Curtis joints — size for size the strongest universal joints designed for industry. Selected materials, precision engineering, continuous testing, inspection and quality control at every stage of manufacture — these are some of the things that make Curtis joints your most dependable buy.

14 SIZES ALWAYS IN STOCK
3/8" to 4"

Not sold through distributors. Write or phone Republic 7-0281 for latest catalog, free engineering data and price list.

CURTIS

UNIVERSAL JOINT CO., INC.

199 Birnie Ave., Springfield 7, Mass.

As near to you as your telephone. Exclusively a manufacturer of universal joints since 1919

CIRCLE 213 ON READER SERVICE CARD
electronics

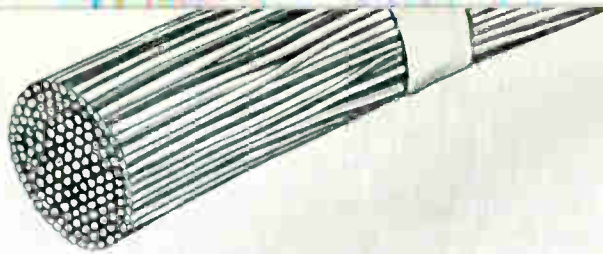

**Reduce costs,
increase reliability**

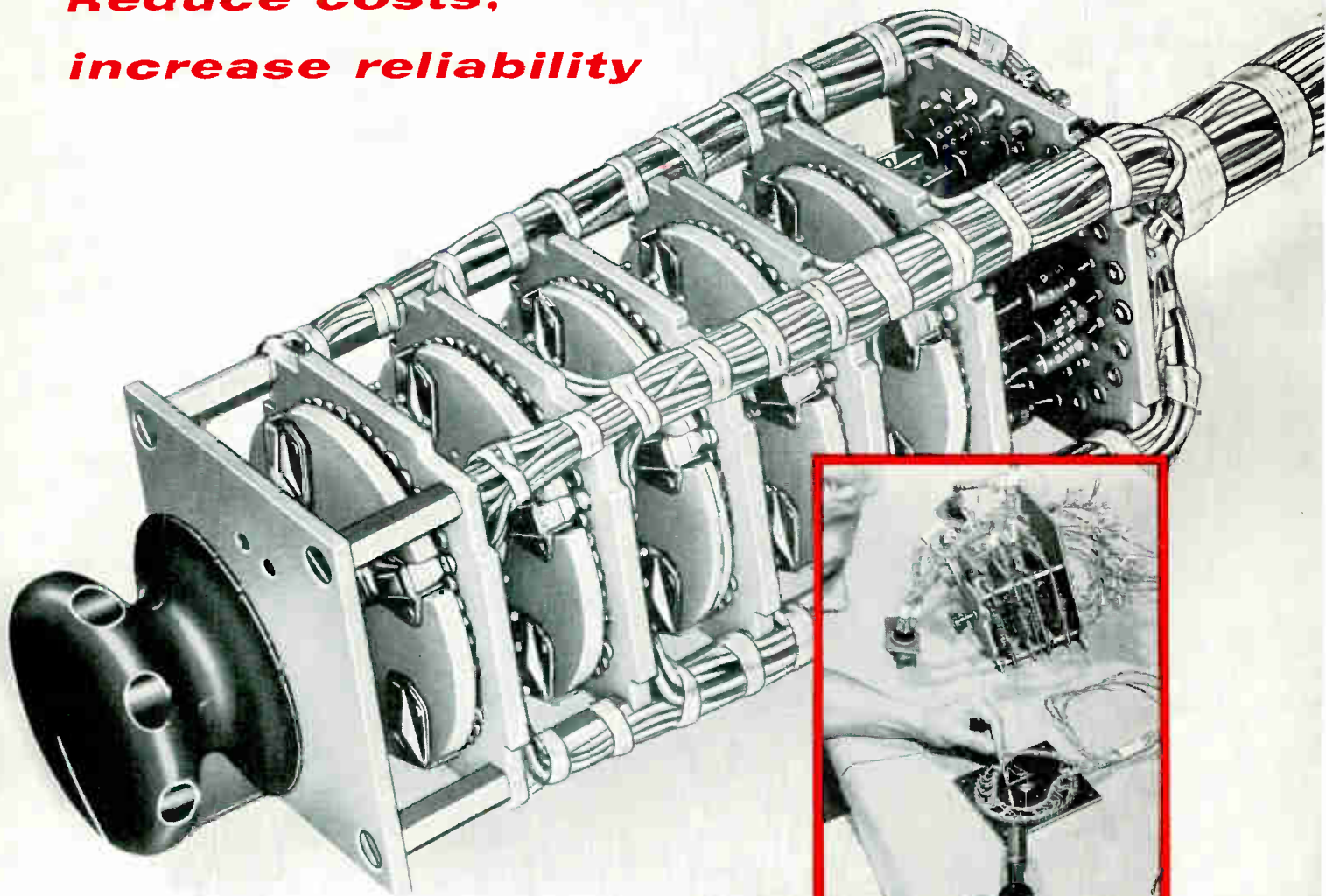

...with

PRE-WIRED Daven switch assemblies

Daven has established a completely new Packaged Assembly Department. This group assembles various components on Daven rotary switches, does all internal wiring, any external cabling necessary, and pre-tests the entire package. In switch wiring, it is very often easier and less time consuming to wire and make connections to switch decks before they are stacked as a complete unit.

Thus, you can now have a completely tested sub-

assembly, instead of a mixed group of components and switches which ordinarily would have to be individually checked, assembled, soldered, and tested. Daven takes complete responsibility for the design, fabrication, testing and overall reliability of this assembly package.

For more information about Daven's new Packaged Assembly Service, write today.

THE **DAVEN** CO.



LIVINGSTON, NEW JERSEY

TODAY, MORE THAN EVER, THE DAVEN © STANDS FOR DEPENDABILITY

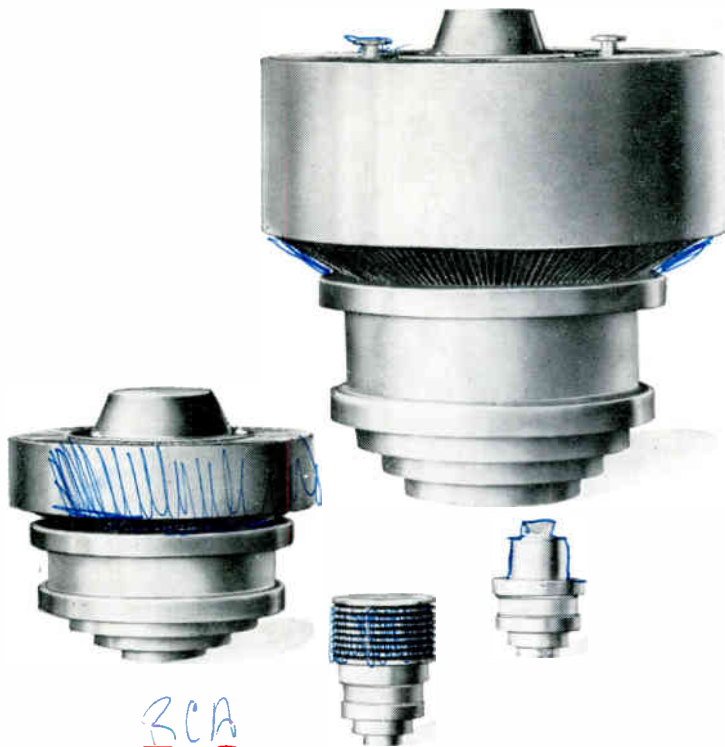

RCA
RCA
CERMOLOX
TUBES

A NEW CONCEPT IN BEAM POWER TUBE TECHNOLOGY
a new concept in Beam Power Tube technology

To meet the increasing demand for dependable UHF power, RCA has developed Cermolox Tubes, a wide line of coaxial, ceramic-metal beam power tubes with precision-aligned grids. These Cermolox tubes are especially well suited to the requirements of aircraft, missile and guidance applications in CW, Pulse, and Hard-Tube-Modulator service.

Already they have set an enviable record of performance in such exacting applications. In Pioneer V, for instance, Cermolox tubes were used in the guidance systems, and in the satellite's high-power transmitter.

Some outstanding features of RCA Cermolox tubes which contribute to long life and reliability are:

- Precise alignment of grids for outstanding efficiency.
- Coaxial-electrode structure adaptable for use either in coaxial-cylinder or parallel-line circuits.
- Exceptionally sturdy structure.
- Low rf-loss ceramic insulation.
- High temperature operation.
- Brazed construction involves no spot welding and assures low rf losses and low internal stresses.
- Compact, ceramic-metal construction.
- Flexibility of cooling techniques: conduction, liquid, and forced air (with RCA's high-efficiency radiator).

The family of RCA Cermolox tubes is shown in the adjacent table. For more information, contact the RCA Field Office nearest you.



The Most Trusted Name in Elec.
The Most Trusted Name in Electronics
 RADIO CORPORATION OF AMERICA

| RCA CERMOLOX BEAM POWER TUBES | | | | |
|--|------------------------|----------------------------|------------------------|----------------------|
| Type | Max. Plate Input Watts | Max. Freq. at Max. Ratings | Max. Plate Diss. Watts | Heater Volts/Amperes |
| CW APPLICATION | | | | |
| A-2678* | 50 | 3,000 | 25 | 6.3/1 |
| A-2582-A* | 50 | 3,000 | 25 | 12.6/49 |
| 6816 | 180 | 1,215 | 115 | 6.3/2.1 |
| A-2261* Conduction Cooled | 180 | 1,215 | 115 | 6.3/2.1 |
| A-2673* Ruggedized Conduction Cooled | 180 | 1,215 | 115 | 6.3/3.0 |
| 7457 Ruggedized | 180 | 1,215 | 115 | 6.3/3.0 |
| A-2635* Conduction Cooled | 180 | 2,000 | 115 | 26.5/52 |
| 6884 | 180 | 1,215 | 115 | 26.5/52 |
| 7650 | 1,250 | 1,215 | 600 | 6.3/7.5 |
| A-2663* Conduction Cooled | 1,250 | 1,215 | 600 | 6.3/7.5 |
| 7213 | 2,500 | 1,215 | 1,500 | 5.5/17.5 |
| A-2545-A* | 28,000 | 400 | 10,000 | 6/8 |
| PULSED RF APPLICATION | | | | |
| A-2587-A* | 3,750 | 3,000 | 25 | 12.6/41 |
| 7649 Ruggedized | 9,000 | 1,215 | 115 | 6.3/3.0 |
| 7651 | 72,000 | 1,215 | 600 | 6.3/7.5 |
| 7214 | 180,000 | 1,215 | 1,500 | 5.5/17.5 |
| A-2581-A* | 2,000,000 | 600 | 10,000 | 18/12 |
| HARD-TUBE-MODULATOR APPLICATION | | | | |
| A-2638* | 8,000 | — | 115 | 6.3/3.0 |
| A-2624* Ruggedized | 60,000 | — | 600 | 6.3/7.5 |
| A-2627-A* Ruggedized Conduction Cooled | 300,000 | — | 1,500 | 5.5/17.5 |
| A-2625* Conduction Cooled | 1,500,000 | — | 10,000 | 18/12 |
| SSB APPLICATION | | | | |
| A-2681* | 650 | 500 | 250 | 6.3/2.6 |

*Development Type—Available on Sampling Basis

RCA ELECTRON TUBE DIVISION FIELD OFFICES

INDUSTRIAL TUBE PRODUCTS SALES: NEWARK 2, N. J., 744 Broad St., Humboldt 5-3900 • DETROIT 2, MICHIGAN, 714 New Center Building, TRinity 5-5600 • CHICAGO 54, ILLINOIS, Suite 1154, Merchandise Mart Plaza, Whitehall 4-2900 • BURLINGAME, CALIF., 1838 El Camino Real, Oxford 7-1620 • LOS ANGELES 22, CALIF., 6355 E. Washington Blvd., Raymond 3-8361. **GOVERNMENT SALES:** NEWARK, N. J., 744 Broad St., Humboldt 5-3900 • DAYTON 2, OHIO, 224 N. Wilkinson St., Baldwin 6-2366 • WASHINGTON 6, D.C., 1725 "K" St., N.W., Federal 7-8500.