

July 15, 1960

electronics

In microcircuits, deposited-film layers may be precisely formed by electron-beam machining, below. Tape control of beam is on the way. Insert shows complete machine. See p 59

A McGraw-Hill Publication 75 Cents



HOLAND KISSLER
BOX 956
MOSES LAKE WASH



FOR YOUR SPECIAL APPLICATIONS

The bulk of UTC production is on special units designed to specific customers' needs. Illustrated below are some typical units and some unusual units as manufactured for special applications. We would be pleased to advise and quote to your special requirements.

FILTERS

All types for frequencies from .1 cycle to 400 MC.



400 \sim telemetering, 3 db at $\pm 7.5\%$, 40 db at 230 and 700 \sim
 $5/8 \times 1\frac{1}{4} \times 2"$



15 \sim BP filter, 20 db at 30 \sim , 45 db at 100 \sim phase angle at \sim less than 3° from -40 to +100°C.



LP filter within 1 db to 49 KC, stable to .1 db from 0 to 85°C., 45 db at 55 KC.



LP filter less than .1 db 0 to 2.5 KC, 50 db beyond 3 KC.

PULSE TRANSFORMERS

From miniature blocking oscillator to 10 megawatt.



Wound core unit .01 micro-second rise time.



Pulse current transformer 100 Amp.



Pulse output to magnatron, bifilar filament.



Precise wave shape pulse output, 2500 V. 3 Amps.

HIGH Q COILS

Toroid, laminated, and cup structures from .1 cycle to 400 MC.



Tuned DO-T servo amplifier transformer, 400 \sim .5% distortion.



Toroid for printed circuit, Q of 90 at 15 KC.



Dual toroid, Q of 75 at 10 KC, and Q of 120 at 5 KC.



HVC tapped variable inductor for 3 KC oscillator.

SPECIALTIES

Saturable reactors, reference transformers, magnetic amplifiers, combined unit.



RF saturable inductor for sweep from 17 MC to 21 MC.



Voltage reference transformer .05% accuracy.



Multi-control magnetic amplifier for airborne servo.



Input, output, two tuned interstages, peaking network, and BP filter, all in one case.

POWER COMPONENTS

Standard and high temperature... hermetic, molded, and encapsulated.



Multi-winding 140 VA, 6 KC power transformer $1\frac{1}{4} \times 1\frac{1}{4} \times 1"$



200° C. power transformer, 400 \sim , 150 VA.



400 \sim scope transformer, 20 KV output.



60 \sim current limiting filament transformer, Sec. 25 Mmfd., 30 KV hipot.

plus
OVER 1,000
STOCK ITEMS
with UTC
High Reliability



write for catalog

UNITED TRANSFORMER CORP.

150 VARICK STREET, NEW YORK 13, N. Y.

PACIFIC MFG. DIVISION: 4008 W. JEFFERSON BLVD., LOS ANGELES 16, CALIF.
EXPORT DIVISION: 13 EAST 40th STREET, NEW YORK 16, N. Y. CABLES: "ARLAB"

electronics

A McGraw-Hill Publication 75 Cents



W. W. MacDONALD, Editor

J. M. CARROLL, Managing Editor
 SENIOR ASSOCIATE EDITORS:
 Samuel Weber, Roland J. Charest.
 ASSOCIATE EDITORS: Frank Leary,
 Michael F. Tomaino, Sylvester P.
 Carter, William P. O'Brien, John
 F. Mason, William E. Bushar,
 Thomas Emma, Sy Vogel, Leslie
 Solomon, M. M. Perugini, George
 J. Flynn. ASSISTANT EDITORS:
 Michael F. Wolff, Nilo Lind-
 gren, Stanley Froud. REGIONAL
 EDITORS: Harold C. Hood (Pacific
 Coast, Los Angeles), Thomas Ma-
 guire (New England, Boston).
 MARKET RESEARCH EDITOR: Ed-
 ward DeJongh. BUYERS' GUIDE
 EDITOR: George Sideris. ART DI-
 RECTOR: Harry Phillips; Howard
 R. Berry. PRODUCTION EDITOR:
 John C. Wright, Jr. EDITORIAL
 ASSISTANTS: Gloria J. Filippone,
 Arlene Schilp, Bernice Duffy, Pa-
 tricia Martine, Lorraine Rossi, Vir-
 ginia T. Bastian, Ruth Ayres.

JAMES GIRDWOOD, Publisher

BUSINESS

| | |
|--|-----|
| New Vlf to Reach All Polaris Subs. Worldwide underwater range | 34 |
| Raising the Ante for Electronics Firms. Report on acquisitions | 36 |
| Pacific Scatter System Completed. Links Hawaii to Philippines | 39 |
| Hearing Aid Sales Hit \$70 Million. 40% increase in next decade? | 41 |
| Training Computer Customers. How new digital trainer works | 42 |
| Courier Satellite Ready for Launch. Delayed repeater prototype | 44 |
| Wall Street and the News | 126 |
| Crosstalk | 4 |
| Comment | 6 |
| Electronics Newsletter | 11 |
| Washington Outlook | 14 |
| Financial Roundup | 21 |
| 25 Most Active Stocks | 21 |
| Market Research | 26 |
| Current Figures | 26 |
| Meetings Ahead | 48 |

ENGINEERING

| | |
|--|-------|
| Electron-beam machining using Hamilton-Zeiss equipment. May use technique in forming evaporated films of microcircuits. See p 59 | COVER |
| Electron Beam Processes for Microcircuit Fabrication. Review of Boston symposium By T. Maguire | 59 |
| Hall-Effect Multipliers. Design of the Hall generator and its transistor amplifiers By W. A. Scango, A. R. Hilbinger and C. M. Barrack | 64 |
| Wind Velocity Telemetry System. Uses tone-modulated transmitter By R. Beaulieu and G. Neal | 68 |
| Feedback Stabilizes Signal Generator. Test signal constant within ± 1 db from 50 Kc to 65 Mc By A Fong | 71 |
| Automatic Test Equipment Checks Missile Systems. Multipurpose unit checks most missile types By D. B. Dobson and L. L. Wolff | 74 |
| Noise Suppression for Digital Signals. Digital signal triggers pulse-forming circuit By F. W. Kear | 80 |

DEPARTMENTS

| | |
|---|-----|
| Research and Development. Generating Millimeter Waves | 82 |
| Components and Materials. Liquid State Control Device | 86 |
| Production Techniques. Boards Cut Computer Lead Time | 90 |
| New On the Market | 94 |
| Literature of the Week | 116 |
| People and Plants | 118 |
| Index to Advertisers | 125 |

**BASIC
BUILDING
BLOCKS
FROM KEARFOTT**



**NEW
HIGH
PERFORMANCE**

Size 8 Motor Generator

This new Size 8 high performance servo motor-generator features high signal output and extremely low null voltage. The signal-to-noise ratio of 100:1 and linearity of 0.2% make the application of this motor generator to light-weight integrator packages most desirable. Stainless steel construction and thermal stability of this component assure its reliability and long life in the most severe environments.

**ELECTRICAL
CHARACTERISTICS**

| Motor Section | Generator Section | | |
|---------------------|-------------------|---------|------------|
| | Phase 1 | Phase 2 | Excitation |
| Voltage (volts) | 26 | 40 | 26 |
| Frequency (cps) | 400 | 400 | 400 |
| Current (ma) | 110 | 77 | 72 |
| Power Input (watts) | 2.3 | 2.3 | 1.3 |

**GENERATOR SECTION
OUTPUT**

| | |
|---------------------------|------------|
| Volts at RPM (mv) | 10 |
| Volts at 1000 RPM (volts) | 1.1 |
| Output Impedance (ohms) | 21 + j2500 |
| Rated Load (ohms) | 100,000 |

**MECHANICAL
CHARACTERISTICS**

| | |
|--|--------|
| No Load Speed (RPM) | 6500 |
| Stall Torque (In. Oz.) | 0.25 |
| Rotor Moment of Inertia (gm-cm ²) | 1.2 |
| Theoretical Acceleration (Rad/Sec ²) | 14,400 |
| Weight (Oz.) | 3.9 |

Write for complete data.

**BASIC
BUILDING
BLOCKS
FROM KEARFOTT**



**QUADRATURE
REJECTION
CIRCUIT**

Kearfott's quadrature rejection circuit is designed to operate from a pre-amplifier or gain controlled amplifier into a transistor servo amplifier. This small, light and rugged device rejects the component of the input wave which is 90° from the reference input. The component of the input sine wave which is in-phase with the reference will produce a square wave whose magnitude is proportional to load and magnitude of in-phase signal. Kearfott's high-performance rejection circuit is designed to operate in an ambient temperature range of -55°C to +115°C at unlimited altitudes.

**TYPICAL
CHARACTERISTICS
#D4816-01**

Input Impedance — In phase signal component (ohms)/5000 + R_L / Quadrature component (ohms)/5000 (min)

Signal Frequency (cps)/400
Max. Signal Input (volts RMS)/6
Bandwidth (cps)/6

Quadrature Rejection Ratio:
Rejection Ratio (min)/50:1/
35:1/35:1

Signal Input/0.15 to 4/4 to 6/
0.005 to 0.15

Meets environmental requirements of MIL-E-5272.

Write for complete data.

**BASIC
BUILDING
BLOCKS
FROM KEARFOTT**



**TWO
AXIS
ACCELER-
OMETERS**



Highly precise and accurate, Kearfott two axis accelerometers are pendulous devices which sense airframe acceleration forces acting on them in aircraft and missile guidance systems, navigational computers and wherever acceleration must be measured precisely and translated into electrical output signals.

The pendulum is anchored to a housing by means of a unique Hooke's joint type spring suspension. Whenever there is relative motion between pendulum and housing due to acceleration, an AC excited, air-core differential transformer type pickoff produces a voltage which is a servo error signal that is fed into an AC to DC amplifier. Feedback signal in form of a DC current transmitted to a restoring coil produces a force that exactly balances force of any accelerations acting on pendulous mass.

**TYPICAL
CHARACTERISTICS**

Range of Measurement: ± 25g (can be adjusted upward within amplifier limits.)

Scale Factor (Output): 5.0000 MA/g of applied acceleration.

Operating Temperature: Performance is optimized within any 20°F range between +50°F and +160°F.

Linearity (Output): Within ± 0.005% of the applied acceleration.

Threshold: Less than 2 x 10⁻⁷g.

Zero Stability: ± .00005g day to day; less than ± .00002g over any continuous time interval.

Vibration: Up to ± 5g peak from 20 to 2000 CPS.

Storage Temperature: -60°F to +170°F.

Scale Factor Variation: ± 0.01% randomness.

Write for complete data.

KEARFOTT DIVISION
Little Falls, New Jersey



GENERAL PRECISION, INC.
Other Divisions: GPL, Librascope, Link

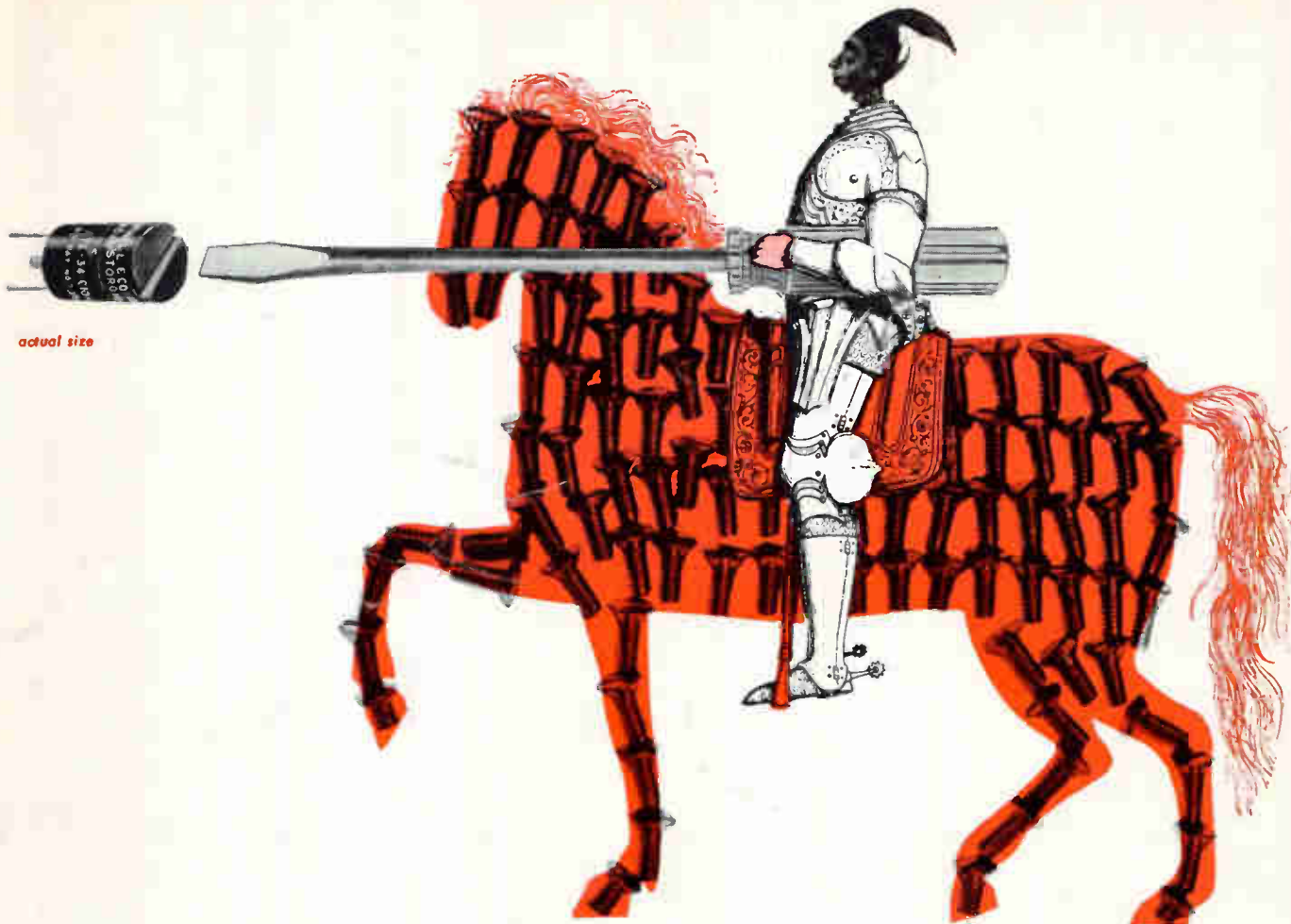

TAMING OF THE SCREW

Newest additions to the Burnell Adjustoroid® line, the microminiaturized Kernel ATE 34 and the miniatures ATE 11, ATE 0, ATE 4, represent an important contribution to printed circuit design.

These new Adjustoroids possess the exclusive advantage of flush-slotted heads which serve to eliminate adjusting screws — provide maximum economy of height — insure ease of adjustment. Besides high Q, they also offer high stability of inductance versus dc.

The new microminiature Kernel ATE 34 and the miniature ATE 11, ATE 0 and ATE 4 Adjustoroids are variable over a 10% range of their inductance. Fully encapsulated, they will withstand high acceleration and vibration environments. These Adjustoroids meet specifications MIL-T 27 Grade 4, Class R and MIL-E 15305 A as well as MIL-E 5272 for humidity and thermal shock. Write for Adjustoroid Bulletin ATE-7.

SEND NOW FOR HANDY 24" x 36" TOROIDAL INDUCTOR WALL REFERENCE CHART
Lists more than 100 types of toroidal inductors and adjustoroids. Gives performance characteristics, mechanical specifications, including case sizes, types of sealing, etc. Attach coupon to company letterhead. And if you haven't already done so send for your free membership in the Space Shrinkers Club.

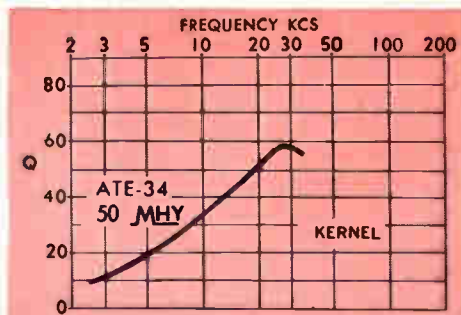

PAT. 2,762,020

COPYRIGHT BURNELL & CO., INC 1960

Burnell & Co., Inc.

PIONEERS IN microminiaturization OF
TOROIDAL, FILTERS AND RELATED NETWORKS

Eastern Division
Dept. E-37
10 Pelham Parkway
Pelham, N. Y.
PEIhom 8-5000
Teletype Pelhom 3633



Pacific Division
Dept. E-37
720 Mission St.
South Pasadena, Cal.
Murray 2-2841
Teletype Pasocal 7578

Burnell & Co., Inc. Dept. E-37
10 Pelham Parkway, Pelham, New York

Gentlemen:

- I am interested in your new universal toroidal reference chart.
 I am interested in a Space Shrinkers Club membership.

name.....

title.....

company.....

address.....

Published weekly, including the ELECTRONICS BUYERS' GUIDE and REFERENCE Issue in mid-July as part of the subscription, by McGraw-Hill Publishing Company, Inc., James H. McGraw (1860-1948) Founder.

Executive, Editorial, Circulation and Advertising Offices: McGraw-Hill Building, 330 W. 42 St., New York 36, N. Y. Longacre 4-3000. Publication Office: 99-129 North Broadway, Albany 1, N. Y. See panel below for directions regarding subscriptions or change of address.

OFFICERS OF THE PUBLICATIONS DIVISION: Nelson L. Bond, President; Shelton Fisher, Wallace F. Traendly, Senior Vice Presidents; John R. Callahan, Vice President and Editorial Director; Joseph H. Allen, Vice President and Director of Advertising Sales; A. R. Venezian, Vice President and Circulation Coordinator. **OFFICERS OF THE CORPORATION:** Donald C. McGraw, President; Joseph A. Gerardi, Hugh J. Kelly, Harry L. Waddell, Executive Vice Presidents; L. Keith Goodrich, Vice President and Treasurer; John J. Cooke, Secretary.

Subscriptions are solicited only from persons engaged in theory, research, design, production, management and use of electronic equipment. **POSITION and COMPANY CONNECTION** must be indicated on subscription orders. Subscription rates for individuals within the field of the Publication: United States and United States Possessions, \$6.00 one year; \$9.00 two years; \$12.00 three years. Canada, \$10.00 one year. All other countries \$20.00 one year. Single Copies, United States, United States Possessions and Canada 75¢; Buyers' Guide \$3.00; Single Copies all other countries \$1.50; Buyers' Guide \$10.00.

Our primary aim is to provide subscribers with a useful, valuable publication. Your comments and suggestions for improvement are encouraged and will be most welcome. The publisher, upon written request from any subscriber to our New York Office, agrees to refund the part of the subscription price applying to copies not yet mailed.

Second class postage paid at Albany, N. Y. Printed in U.S.A. Copyright 1960 by McGraw-Hill Publishing Co., Inc.—All Rights Reserved. Title registered in U. S. Patent Office.

BRANCH OFFICES: 520 North Michigan Avenue, Chicago 11; 68 Post Street, San Francisco 4; McGraw-Hill House, London E. C. 4; 85 Westendstrasse, Frankfurt/Main; National Press Bldg., Washington 4, D. C.; Six Penn Center Plaza, Philadelphia 3; Four Gateway Center, Pittsburgh 22; 55 Public Square, Cleveland 13; 856 Penobscot Bldg., Detroit 26; 3615 Olive St., St. Louis 8; 350 Park Square Bldg., Boston 16; 1301 Rhodes-Haverty Bldg., Atlanta 3; 1125 West Sixth St., Los Angeles 17; 1740 Broadway, Denver 2; 901 Vaughn Bldg., Dallas 1. **ELECTRONICS** is indexed semiannually, in July and December, and regularly in The Engineering Index.

Subscriptions: Send subscription correspondence and change of address to Fulfillment Manager, Electronics, 330 West 42nd Street, New York 36, N. Y. Subscribers should notify Fulfillment Manager promptly of any change of address, giving old as well as new address, and including postal zone number, if any. If possible, enclose an address label from a recent issue of the magazine. Since copies are addressed one to two issues in advance, please allow one month for change of address to become effective.

Postmaster: please send form 3579 to Electronics, 330 W. 42nd St., New York 36, N. Y.



Audited Paid Circulation

CROSSTALK

MICROCIRCUITS. Fabrication of microelectronic circuits with electron-beam techniques is a subject of intensive R&D effort in many organizations. To bring you the latest developments in this field, New England Regional Editor Maguire attended the Alloyd Corporation symposium on electron beam processes. His report this week on the Boston symposium describes the progress being made toward the goal of forming complete semiconductor circuits within a vacuum system. You'll also learn about laboratory work in the relatively new art of microminiature machining by electron beams. A demonstration of electron-beam metal-working equipment was reported upon in our issue of Feb 26 (p 86).

UNDERWATER COMMUNICATIONS. When one forest comes down and another goes up is, normally, of no interest to us. But when a wood forest is replaced with an electronic one, we investigate quickly and in detail. This is what has just happened in Cutler, Me., where reports the Navy, the largest and most powerful vlf radio transmitting system in the world is being installed. The \$70-million facility is the newest addition to Navy's complex of vlf stations for communicating with surface ships and submerged submarines throughout the world. Associate Editor Mason's story, "New Vlf to Reach All Polaris Subs," appears on p 34.

ANTE UP. In last few years electronics companies that wanted to expand through acquisition and firms outside our industry that wanted to buy into the industry have found that prices of electronics companies have risen steeply and that competition for acquisitions is intense.

This trend has much significance for anyone with an interest in trading in the securities of electronics companies or in financing them, as well as for potential selling and acquiring companies, because Wall Street activities strongly influence the electronics acquisition market.

For further details—and for help in making an electronics acquisition—see the story that begins on p 36.

Coming In Our July 22 Issue

LEARNING MACHINES. Development of electronic learning methods has long been a goal of researchers. One approach to the learning machine is the Perceptron concept (ELECTRONICS, p 159, Mar. 11).

In our issue of June 24 (p 43), Associate Editor Bushor brought you the news of the first public demonstration of a working model extension of the Perceptron concept, previously simulated on high-speed digital computers. Next week, a feature article by Bushor explains the Perceptron circuit operation. You'll learn how the logic portion of the brain concerned with memory and recognition is simulated through electronics.

WHISTLER RESEARCH. Rather than wait until whistlers are produced naturally in the course of an electric storm, some researchers have been generating them artificially. In our next issue, M. M. Newman, J. R. Stahmann and J. D. Robb of the Lightning & Transients Research Institute in Minneapolis and E. A. Lewis of the Air Force Cambridge Research Center, describe a sea-going artificial lightning generator being used for vlf propagation studies. The million-volt generator uses an 8,000-ft helicopter-supported antenna to produce high-power, low-frequency pulses similar to lightning atmospherics.

MADT[®] transistors from Sprague*



for the highest r-f operating frequency of all mass-produced transistors



for the fastest switching time of all mass-produced transistors



for storage temperatures up to 100°C

DESIGN AROUND SPRAGUE MICRO-ALLOY DIFFUSED-BASE TRANSISTORS

available now at sensible prices you can afford!

Sprague Germanium Micro-Alloy Diffused-Base Transistors, well-known for their rugged vhf performance, are now priced below other transistors with comparable electrical characteristics. In many areas, this permits designers to improve circuit techniques without necessarily increasing costs. Expanded production facilities enable us to ship quantity orders on short notice. Add to this their ultra-fast switching time, and you have three good reasons why Sprague MADT[®] Transistors have achieved their high level of acceptance.

With Sprague Transistors, circuits in vhf amplifiers and oscillators can now operate with collector currents as high as 50 ma . . . with power dissipation up to 50 mw . . . with collector to base voltages to 15 v. They have been application tested through the entire military electronics vhf spectrum.

The application table may well suggest the use of one or more Micro-Alloy Diffused-Base Transistor types in your latest circuit designs.

*Sprague micro-alloy, micro-alloy diffused-base, and surface barrier transistors are fully licensed under Philco patents. All Sprague and Philco transistors having the same type numbers are manufactured to the same specifications and are fully interchangeable.

MICRO-ALLOY DIFFUSED-BASE TRANSISTOR APPLICATIONS

| Type | Application |
|--------|---|
| 2N499 | Amplifier, to 100 mcs |
| 2N501 | Ultra High Speed Switch (Storage Temperature, 85 C) |
| 2N501A | Ultra High Speed Switch (Storage Temperature, 100 C) |
| 2N504 | High Gain IF Amplifier |
| 2N588 | Oscillator, Amplifier, to 50 mcs |

For complete engineering data on the types in which you are interested, write Technical Literature Section, Sprague Electric Co., 35 Marshall St., North Adams, Massachusetts.

You can get off-the-shelf delivery at factory prices on pilot quantities up to 999 pieces from your local Sprague Industrial Distributor.

SPRAGUE[®]

THE MARK OF RELIABILITY

SPRAGUE COMPONENTS:

CAPACITORS • RESISTORS • MAGNETIC COMPONENTS • TRANSISTORS • INTERFERENCE FILTERS • PULSE NETWORKS
HIGH TEMPERATURE MAGNET WIRE • CERAMIC-BASE PRINTED NETWORKS • PACKAGED COMPONENT ASSEMBLIES

EMERGENCY LIGHTING & POWER

Anywhere Automatically

with **ATR**

EMERGENCY LIGHTING & POWER UNIT



Illustrates ATR Emergency Lighting and Power Unit, Model ETS complete with lamps.



for PA SYSTEMS, INTERCOMS and SWITCHBOARDS



for TIME CLOCKS and OTHER RECORDING CLOCKS



for HOSPITAL OPERATING ROOMS

Completely Automatic Standby-Power Units Specially Designed to Permit the Instantaneous Continued Operation of Critical Lighting Equipment, PA Systems, Amplifiers, Intercom Systems, Burglar Alarms, Fire Alarms, Synchronous Electric Clocks, Electric Time and Recording Clocks, Incubators, Gas Valves, Telephone and Test Equipment, and Similar Critical Devices in the Event of 115 Volt AC Commercial Power Line Failure. For Use: In Hospitals, Banks, Hotels, Theatres, Factories, Office Buildings, Schools, Homes, and Many Other Areas of Operation.

SEE YOUR JOBBER OR WRITE FACTORY

• "A" Battery Eliminators • DC-AC Inverters • Auto Radio Vibrators

ATR

AMERICAN TELEVISION & RADIO CO.
Quality Products Since 1931
SAINT PAUL 1, MINNESOTA, U. S. A.

COMMENT

Ions and Health

We have been intrigued by your article entitled "Ions Affect Health, Behavior," in the issue of Feb. 26 (p 45), and as I note from recent comment others are also . . .

What an excellent job you have done here!

HOMER DUDLEY

BELL TELEPHONE LABORATORIES
MURRAY HILL, N. J.

International Electronics

I wish to commend **ELECTRONICS** for the article in the June 24 edition having as its subject the recent British exhibit at the New York Coliseum ("British Show Industrial Gear," p 46). This piece is, I feel, in keeping with the continued interest your magazine shows in international electronics.

The common language of engineering, the common interests among scientists of many nations, need to be reiterated again and again with the dignity and depth shown by articles of this type. Well done.

G. HAELTERS

PALISADES, N. J.

A Little Time

We, the majority of the Japanese, felt very unhappy with the situation that Mr. Kishi had to withdraw the invitation to your President. What I thought was "give them a little time"—meaning that the only possible way to cool off the heat from some groups of students, political parties and agitators is by giving them time.

I can assure you that we businessmen and good citizens of Japan believe and wish still closer and more friendly cooperation between government, industry and people of the two nations. In this connection, I sincerely hope your President will visit Japan in the very near future after the heat has cooled down . . .

S. MATSUMOTO

MATSUSHITA ELECTRONICS CORP.
OSAKA, JAPAN

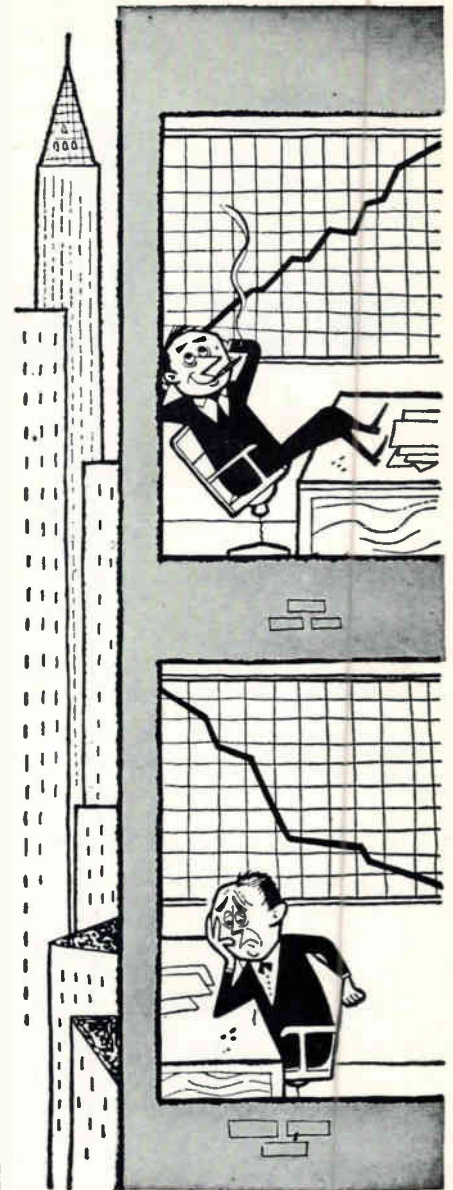

WHO'S MAKING OUT BEST?

A quick, 3-minute Financial Round-up that names electronics companies that have achieved substantial financial gains. Tells where they are and what they make.

Fast visual summary of active stocks each week in the electronics industry. New public issues. Stock price averages.

This highly readable score card helps keep you informed on what counts most on the financial front. This is just one more reason why you should subscribe to **electronics** (or renew your subscription). Fill in box on Reader Service Card. Easy to use. Postage free.

FIND WHAT YOU NEED IN...

electronics

electronics

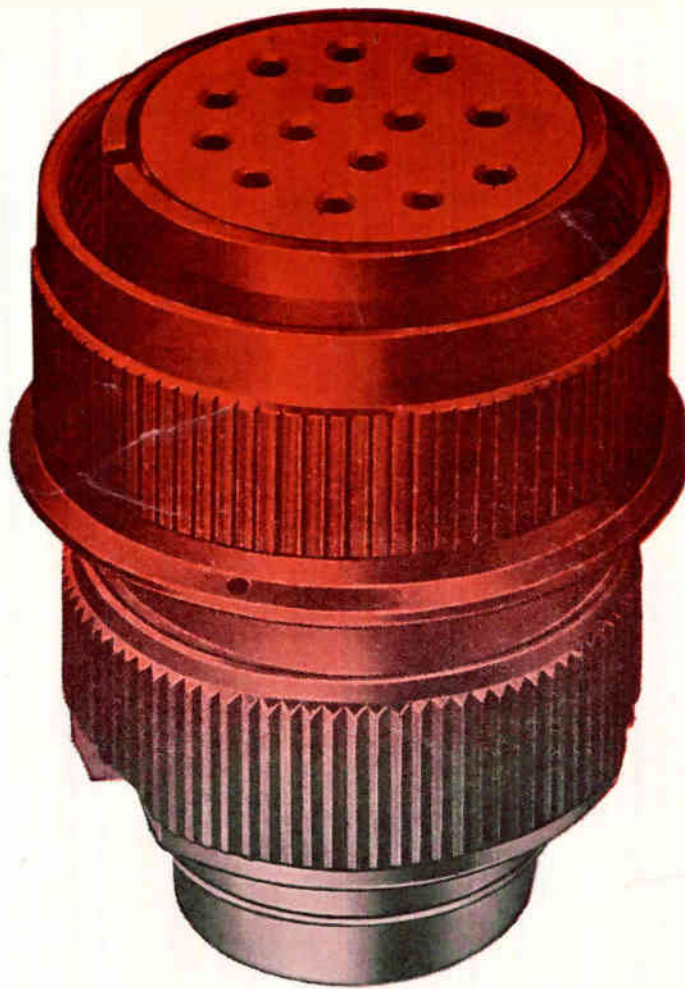

HIGH TEMPERATURE CANNON PLUGS

Whatever the application, Cannon's broad line of heat-resistant plugs provides the optimum protection to vital electrical circuits. Continuous or specified operation from 200°F to 2000°F—at aircraft firewalls or industrial facilities...for missiles or the most advanced spacecraft—we have a plug to solve your temperature problem. Another reason why you should consult the world's most experienced plug manufacturer... why you should consult Cannon for all your plug requirements!

CANNON ELECTRIC COMPANY, 3208 Humboldt St., Los Angeles 31, Calif.

*Write for literature on
high-temperature plugs, or
other Cannon products to:*

**CANNON
PLUGS**



Fastest,
easiest
way
yet devised to

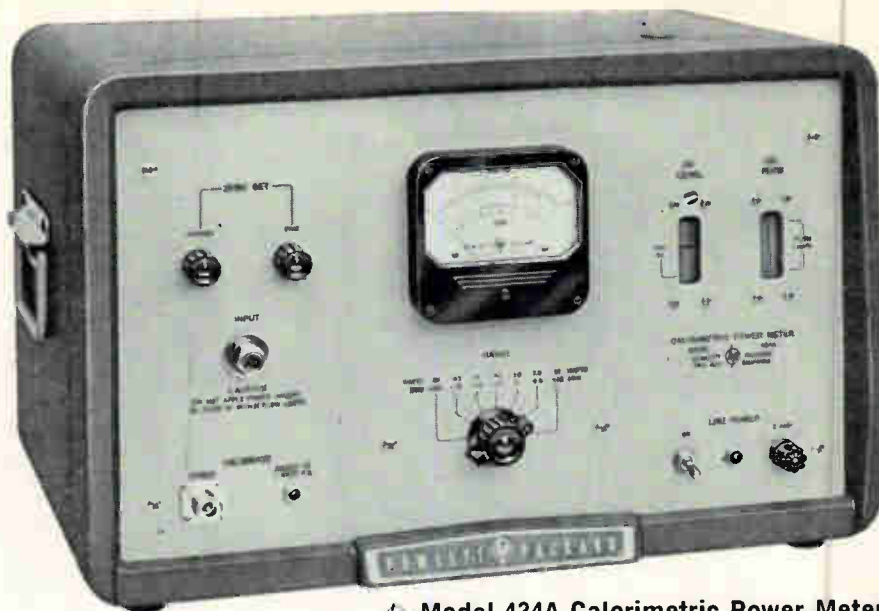

hp Model 434A Calorimetric Power Meter

MEASURE POWER 10 MW TO

without external terminations or

Now you can quickly and confidently measure power to 10 watts average, 1 Kw peak! With the hp Model 434A, simply connect power to be measured to the 50-ohm type N front-panel coaxial connector . . . and read power directly in watts and DBW.

This precision instrument fills the important range between bolometer type microwave power meters (such as the popular hp 430C) and conventional calorimeters whose lower range is approximately 10 watts. The 434A is useful for measuring AM power, pulsed power, cw power and dc power.

Just two operating controls, range switch and zero set. No other adjustments are necessary to make power measurements at any frequency, dc to 12.4 KMC. The 434A requires no barretter, thermistor or external power termination. Directional couplers or similar external equipment can be used to extend the 434A power range above 10 watts. An internal calibrator assures

that the 434A is always operating at peak performance.

Rapid response time—high stability

The 434A contains a self-balancing bridge and high-efficiency heat transfer system using an oil stream to provide a full scale response time of 5 seconds or less. This fast response, a fraction of the response time of ordinary calorimeters, means the 434A quickly follows small adjustments in input tuning circuits. A new high in stability is achieved through the use of twin power-sensitive elements immersed in a single oil stream, making the 434A independent of variations in oil flow rate and temperature.

Operating in 7 meter ranges, the Model 434A has a specified accuracy of $\pm 5\%$ of full scale. Even greater accuracy is achievable through appropriate techniques. Typical techniques are briefly described in the hp Journal, Volume 9 Number 12, August 1958.

World leader in precision test instrumentation

Just connect, then read power
 Direct reading in watts, DBW
 Only two operating controls
 Measure cw or pulsed power
 Compact, self-contained
 Fast reading — 5 sec. response maximum
 Internal 1% calibrator

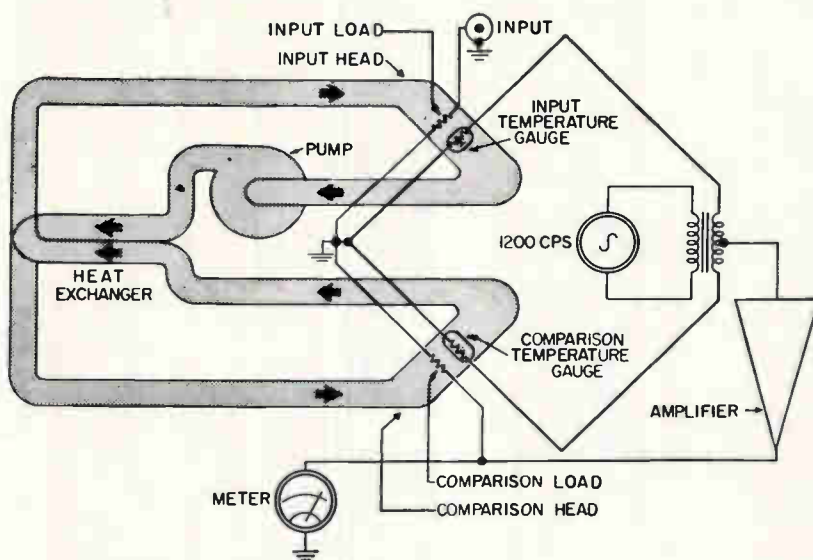

10 WATTS, DC TO 12.4 KMC

equipment

SPECIFICATIONS

Input power range: Seven meter ranges. Full-scale readings of 0.01, 0.03, 0.1, 0.3, 1.0, 3.0 and 10 watts. Meter scale also calibrated from -10 to 0 DBW, providing continuous readings from -30 to +10 DBW. Power range can be extended upward with attenuators or directional couplers.

Peak input power: 1 kilowatt, maximum

Frequency range: Dc to 12.4 KMC

Dc input impedance: 50 ohms \pm 5 ohms at type N input jack

Input VSWR: Dc to 5 KMC, less than 1.3. 5 to 10 KMC, less than 1.5. 10 to 12.4 KMC, less than 1.7.

Meter response time: Less than 5 seconds for full scale deflection.

Accuracy: Within \pm 5% of full scale. Includes dc calibration and termination efficiency, but not mismatch loss. Greater accuracy can be achieved through appropriate techniques.

Power supply: 115/230 volts \pm 10%, 50/60 cycles, approximately 155 watts with no input. 175 watts with 10 watts input.

Price: Model 434A (cabinet), \$1,400.00; Model 434AR (rack mount), \$1,385.00.

Data subject to change without notice.

Prices f.o.b. factory.

Circuitry Basically, the Model 434A consists of a self-balancing bridge which has identical temperature-sensitive resistors (gauges) in two legs, an indicating meter and two load resistors, one for the unknown input power and one for the comparison power. The input load resistor and one gauge are in close thermal proximity so that heat generated in the input load resistor heats the gauge and unbalances the bridge. The unbalance signal is amplified and applied to the comparison load resistor which is in close thermal proximity to the other gauge, so that the heat generated in the comparison load resistor is transferred to its gauge and rebalances the bridge.

The meter measures the power supplied to the comparison load to rebalance the bridge. Characteristics of the gauges are the same and heat transfer characteristics from each load are the same, so the power dissipated in each load is the same, and the meter may be calibrated directly in input power.

The power measurement is accurate, because the flow rate through the input head and comparison head (see diagram) is the same and the oil enters the heads at nearly the same temperature. To insure constant temperature and to bring the streams to nearly the same temperature, they are passed through a parallel-flow heat exchanger just prior to entering the heads. Identical flow rates are obtained by placing all elements of the oil system in series.

HEWLETT-PACKARD COMPANY

1047A Page Mill Road Palo Alto, California, U.S.A.

Cable "HEWPACK" Davenport 6-7000

Field representatives in all principal areas

HEWLETT-PACKARD S. A.

Rue du Vieux Billard No. 1 Geneva, Switzerland

Cable "HEWPACKSA" Tel. No. (022) 26. 43. 36



6369

*Another new Hydro-Aire product
for the aircraft, missile support,
missile and electronics industries*



Ready Now! A Reliable Family of Transistorized Time Delay Devices —available on time from Hydro-Aire

These fully-transistorized time delay devices are but nine of a widely diversified family including relays, sequence timers, computer timing modules and time-programmed, system supervising units—all custom-designed, built and on-time delivered by Hydro-Aire. Perhaps one of these proven designs meets your specifications. If not, we will custom-design to your requirement. All of our time delay devices are compactly designed, available for AC or DC operation, and conform to applicable Mil Specs. These devices typify the many reliable electronic products being designed, developed, produced and on-time delivered by Hydro-Aire.

CHARACTERISTICS: TIME DELAY RELAY MODEL 50-085

Size— $2\frac{3}{8}$ " x $1\frac{1}{2}$ " x $1\frac{1}{2}$ "

Weight—4 oz.

Time delay range—adjustable over one decade; 6 to 60 seconds with $\pm 5\%$ accuracy

Life: 100,000 operations at rated contact load

Maximum power required: 50 ma at 24-31 VDC

Temperature range: -55°C to $+71^{\circ}\text{C}$ as standard; to $+125^{\circ}\text{C}$ available on special request

WRITE FOR ELECTRONICS CATALOG. A note on your letterhead brings a free copy, containing detailed facts and specifications. If you have a time delay device requirement, include your specifications for a prompt quote.



CIRCLE 10 ON READER SERVICE CARD

Just connect, then read power
Direct reading in watts, DBW
Only two operating controls
Measure cw or pulsed power
Compact, self-contained
Fast reading — 5 sec. response maximum
Internal 1% calibrator

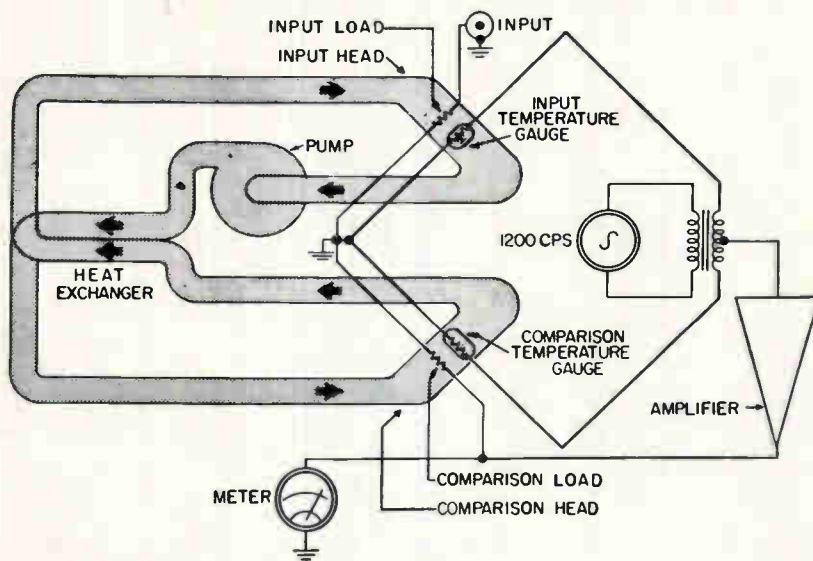

10 WATTS, DC TO 12.4 KMC

equipment

SPECIFICATIONS

Input power range: Seven meter ranges. Full-scale readings of 0.01, 0.03, 0.1, 0.3, 1.0, 3.0 and 10 watts. Meter scale also calibrated from -10 to 0 DBW, providing continuous readings from -30 to +10 DBW. Power range can be extended upward with attenuators or directional couplers.

Peak input power: 1 kilowatt, maximum

Frequency range: Dc to 12.4 KMC

Dc input impedance: 50 ohms \pm 5 ohms at type N input jack

Input VSWR: Dc to 5 KMC, less than 1.3. 5 to 10 KMC, less than 1.5. 10 to 12.4 KMC, less than 1.7.

Meter response time: Less than 5 seconds for full scale deflection.

Accuracy: Within \pm 5% of full scale. Includes dc calibration and termination efficiency, but not mismatch loss. Greater accuracy can be achieved through appropriate techniques.

Power supply: 115/230 volts \pm 10%, 50/60 cycles, approximately 155 watts with no input. 175 watts with 10 watts input.

Price: Model 434A (cabinet), \$1,400.00; Model 434AR (rack mount), \$1,385.00.

Data subject to change without notice.

Prices f.o.b. factory.

Circuitry Basically, the Model 434A consists of a self-balancing bridge which has identical temperature-sensitive resistors (gauges) in two legs, an indicating meter and two load resistors, one for the unknown input power and one for the comparison power. The input load resistor and one gauge are in close thermal proximity so that heat generated in the input load resistor heats the gauge and unbalances the bridge. The unbalance signal is amplified and applied to the comparison load resistor which is in close thermal proximity to the other gauge, so that the heat generated in the comparison load resistor is transferred to its gauge and rebalances the bridge.

The meter measures the power supplied to the comparison load to rebalance the bridge. Characteristics of the gauges are the same and heat transfer characteristics from each load are the same, so the power dissipated in each load is the same, and the meter may be calibrated directly in input power.

The power measurement is accurate, because the flow rate through the input head and comparison head (see diagram) is the same and the oil enters the heads at nearly the same temperature. To insure constant temperature and to bring the streams to nearly the same temperature, they are passed through a parallel-flow heat exchanger just prior to entering the heads. Identical flow rates are obtained by placing all elements of the oil system in series.

HEWLETT-PACKARD COMPANY

1047A Page Mill Road Palo Alto, California, U.S.A.

Cable "HEWPACK" Davenport 6-7000

Field representatives in all principal areas

HEWLETT-PACKARD S. A.

Rue du Vieux Billard No. 1 Geneva, Switzerland

Cable "HEWPACKSA" Tel. No. (022) 26. 43. 36



6369

*Another new Hydro-Aire product
for the aircraft, missile support,
missile and electronics industries*



Ready Now! A Reliable Family of Transistorized Time Delay Devices —available on time from Hydro-Aire

These fully-transistorized time delay devices are but nine of a widely diversified family including relays, sequence timers, computer timing modules and time-programmed, system supervising units—all custom-designed, built and on-time delivered by Hydro-Aire. Perhaps one of these proven designs meets your specifications. If not, we will custom-design to your requirement. All of our time delay devices are compactly designed, available for AC or DC operation, and conform to applicable Mil Specs. These devices typify the many reliable electronic products being designed, developed, produced and on-time delivered by Hydro-Aire.

CHARACTERISTICS: TIME DELAY RELAY MODEL 50-085

Size— $2\frac{3}{8}$ " x $1\frac{1}{2}$ " x $1\frac{1}{2}$ "

Weight—4 oz.

Time delay range—adjustable over one decade; 6 to 60 seconds with $\pm 5\%$ accuracy

Life: 100,000 operations at rated contact load

Maximum power required: 50 ma at 24-31 VDC

Temperature range: -55°C to $+71^{\circ}\text{C}$ as standard; to $+125^{\circ}\text{C}$ available on special request

WRITE FOR ELECTRONICS CATALOG. A note on your letterhead brings a free copy, containing detailed facts and specifications. If you have a time delay device requirement, include your specifications for a prompt quote.

HYDRO-AIRE

BURBANK, CALIFORNIA
Division of CRANE CO

Solid-state devices include
time delay devices, voltage
regulators, power supplies,
inverters.

CIRCLE 10 ON READER SERVICE CARD

ELECTRONICS NEWSLETTER

Defense Agencies Buy Missile Systems, Radar

ELECTRONIC SYSTEMS for guiding, controlling and coordinating missiles of all kinds continue to make up a big part of military buying in electronics, with radar, navigation and direction-finding equipment also looming large.

USAF is buying \$26-million worth of Athena command-guidance computer systems from Remington Rand Univac. The computers, prototype models of which have been used to put the Titan ICBM on target in its 16 flight tests, will go into hard-stand Titan operational bases currently being set up at four sites in the West.

Navy has given Ryan Electronics a follow-on order of \$17 million for more AN/APN-122 doppler radar navigation systems.

Martin Co. will develop and build compact air-defense coordination systems for the Army under an \$8.8-million contract from Army Signal Supply Agency. Systems are patterned after the more complex Missile Master, five of which are now coordinating Nike battery operations in the continental U. S., with five more going in by yearend.

Army missilemen at Huntsville, Ala., are spending \$5 million for simulators used to train operators of the radar and controls for the Hawk beam-riding ground-to-air missile. Simulator systems will be built by Belock Instruments, will reproduce battle situations using all of the Hawk system excepting the bird itself.

Servo Corp. copped a \$1-million contract for AN/GRD-11 uhf doppler direction-finding equipment from USAF's Rome office, and another \$300,000 contract to provide test sets for AN/ASA-14 dead-reckoning tracer equipment.

Net to Link Soviet Bloc From Korea to Germany

PLANS TO LINK the Communist world with a vast international television network were described recently in *Slaboproudy Obzor*, Czech technical journal. Intervision, as the network is called, now includes

facilities for program exchange between Communist East Germany, Poland, Hungary and Czechoslovakia. Immediate future plans call for connection of the tv networks of the Soviet Union and the Balkan nations into the Intervision net.

Long-range plans, described in the article by Czech engineer V. Svoboda, are being formulated to extend the network into the Peoples Republic of China and to North Korea.

Brazilian Company Starts Producing Transistors

THREE-YEAR-OLD Elnabra (Electronica Nacional Brasileira) S. A., Sao Paulo, Brazil, has been assembling transistors from alloyed subassemblies since February, this month will incorporate fusing and alloying operations. Hydrogen furnace is now being set up at Elnabra's plant.

Early in 1961, the company will begin to grow and cut its own crystals and will then have a completely homegrown transistor production facility. Transistor production, developed under a patent agreement with a U. S. firm and said to be Brazil's first, now totals 35,000 monthly in 28 different types, may top an annual rate of a million units by mid-1961. Only entertainment types are covered by the patent agreement.

Tiros I Proves Point, Gives Up Assignment

OPERATING LIFETIME of Tiros I, meteorological satellite launched on April 1, came to an end late last month when a fault—probably an inoperative relay in the wide-angle camera system—made turning the camera off impossible. This drained the batteries and eventually caused the wide-angle camera transmitter to quit.

Narrow-angle camera is still working, but meteorologists cannot orient photographs from this camera without the other pictures. During its 78-day effective lifetime (until June 17, when interrogation was first suspended), the satellite transmitted 22,952 frames to re-

ceiving stations at Fort Monmouth and Kaena Pt., Hawaii, of which over 60 percent are said to represent "good quality cloud-cover photographs useful to meteorological research."

National Aeronautics and Space Administration figures the 270-lb satellite demonstrated the feasibility of observing the mechanics of the atmosphere by satellite, notes that meteorologists will be analyzing Tiros data for months to come, says the satellite's most significant contribution was in showing that highly organized cyclonic storm systems occur more frequently and extend more widely than hitherto realized. Tiros II is scheduled for launching later this year.

Cut-rate Tubes May Stagger Canadian Manufacturers

CUT-RATE electron tubes unloaded on the Canadian market by Japanese manufacturers have sent Canada's tubemakers howling to the government for protection.

Industry spokesmen, meeting at an Electronic Industries Association of Canada conference in Toronto recently, pointed this comparison: a representative Japanese tube type now entering the Canadian market costs the importer 46.9 cents, including a factory sales price of 31 cents, 6.2 cents duty, sales tax of 4.1 cents and excise tax of 5.6 cents. Identical Canadian tube bears a factory price tag of \$1, to which is added 15 cents excise tax and 11 cents sales tax.

Canadian industry representatives point out to ELECTRONICS that the Japanese price is half that calculated by Japan's Ministry of International Trade & Industry as average receiving-tube price for 1959-60 (ELECTRONICS, p 66, May 27). Informed sources indicate that either a shuffling of fiscal allocations by the Japanese government is subsidizing manufacturers to undercut the Canadian market, or a big trading firm is job-shopping production which is being unloaded on the market.

Canada's EIA will ask the Japanese government to cut the Canadian export quota for tubes and to set a quota of 155,000 radio sets (compared against 395,000 exported to Canada last year).

What do these 38 prod



Representing only a few of the many items produced by VTP, these 38 products (and others like them now in research, development and manufacturing stages) offer you "built-in" reliability and highest quality—at competitive prices. These products break down into five broad categories:

Storage Tubes: World's most complete line of 21 different types. Screen diameters: 3" to 21". Electrostatic focusing. Electrostatic or magnetic deflection. *Tonotron** Half-tone Display Tubes. *Typotron*® Character Display Tubes. *Memotron*® Image-retention Tubes.

Special Purpose CRTs: Special configurations, phosphors, electrical characteristics—or for *special* environmental conditions. Screen diameters: 1" to 18". Electrostatic or magnetic deflection and focusing. Packaged, shielded versions are available. A choice of 28 different phosphors to meet your exact needs.

Vacuum Gauge Tubes & Equipment: Most complete line of high vacuum gauge tubes and controls (including: ionization, cold discharge and thermocouple gauge tubes; electronic ultra-high-vacuum pumps.) Single source supply for all of your high-vacuum requirements.

Welders, Controls & Accessories: Complete line of precision electronic welding equipment for joining thin metal parts (.0001" to .08"). Half and full-cycle AC power supplies, stored energy power supplies, inert-gas shielded-arc welder controls—plus welding heads and accessories.

Rectifiers & Transmitting Tubes: Heavy-duty rectifiers, xenon thyratrons, clipper diodes and triode transmitting tubes are now available in production quantities to fill all of your requirements. **See the complete Vacuum Tube Products lines on display at WESCON, Booths 2826-2827.**

Products have in common?

Basically, 3 things—

- *They are all electronic in nature.*
- *They are all available in production quantities for commercial and military applications.*
- *They are all produced by Hughes Vacuum Tube Products Division.*

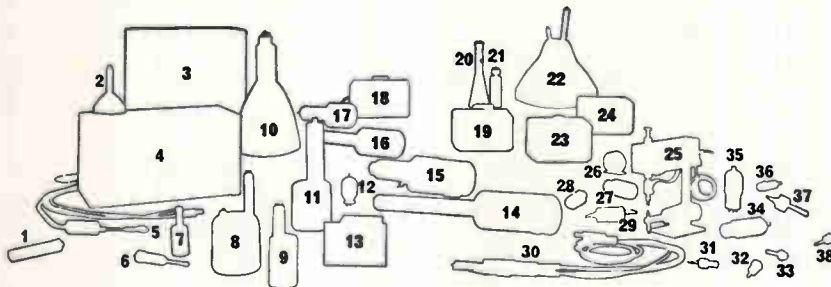
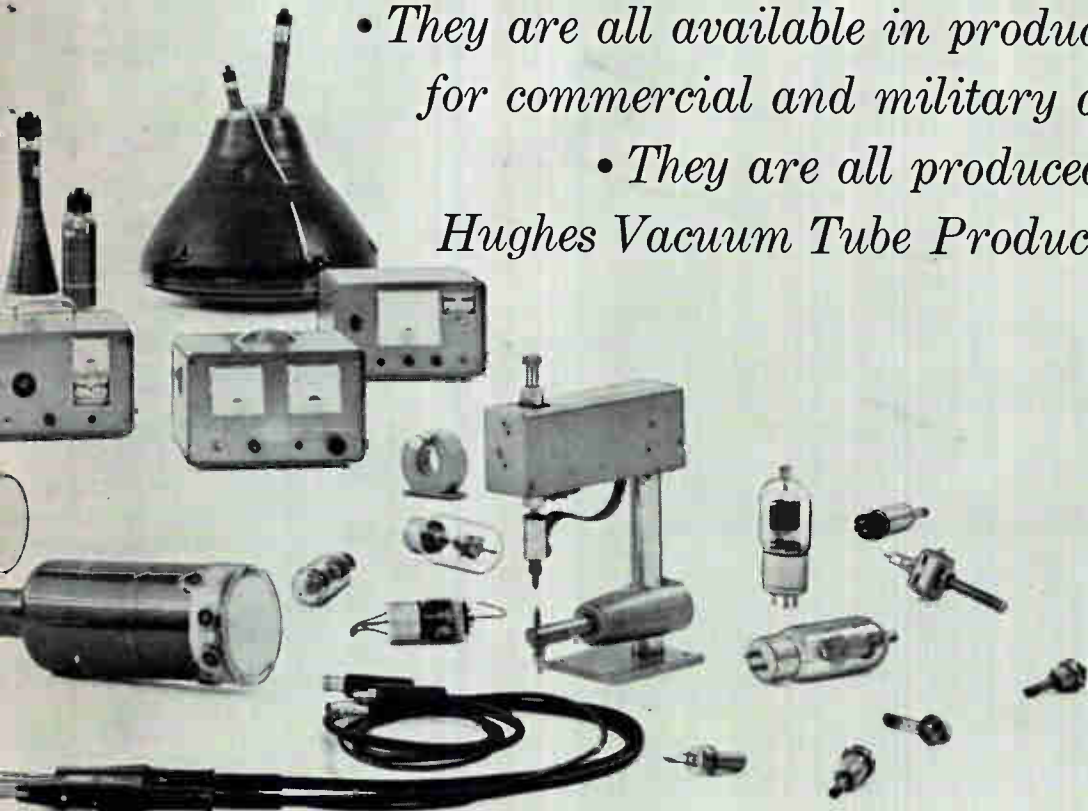

(1) Monoscope (2) 5" CRT (3) Capacitor Welding Power Supply (4) Thermocouple/Ionization Vacuum Gauge Control (5) Seam Welding Handpiece (6) Thermocouple Vacuum Gauge Tube (7) Ionization Gauge Tube (8) (9) 5" & 3" Tonotron Tubes (10) 17" CRT (11) 5" Tonotron Tube (12) High Vacuum Diode (13) Thermocouple Vacuum Gauge Control (14) 5" Typotron Tube (15) 5" Shielded CRT (16) 5" Memotron Tube (17) 5" Tonotron Tube (18) (19) Electrolytic Welding Power Supplies (20) (21) 5" & 3" CRTs (22) 21" Tonotron Tube (23) Thermocouple Vacuum Gauge Control (24) Philips Vacuum Gauge Control (25) Precision Welding Head (26) Ion Pump (27) Power Triode (28) High Vacuum Diode (29) Xenon Thyatron (30) Welding Handpiece (31) High Vacuum Diode (32) Thermocouple Vacuum Gauge Tube (33) High-Voltage Vacuum Switch (34) High Vacuum Diode (35) Clipper Diode/Rectifier (36) Halogen Vacuum Leak Detector (37) Philips Vacuum Gauge Tube (38) Thermocouple Vacuum Gauge Tube.

For full information on reliable, high-quality products in any of these fields, write or wire today: HUGHES, Vacuum Tube Products Division, 2020 Short Street, Oceanside, Calif. For export information, write Hughes International, Culver City, Calif.

Creating a new world with ELECTRONICS

HUGHES

VACUUM TUBE PRODUCTS DIVISION

HUGHES AIRCRAFT COMPANY

*Trade-mark of Hughes Aircraft Company

CIRCLE 13 ON READER SERVICE CARD

VARIAN Potentiometer RECORDERS

Used by the thousands
because ...

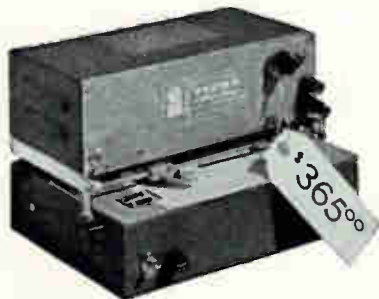

2. PERFORMANCE AT LOW COST

As little as \$365 for a sensitive, rugged potentiometer recorder. Varian Recorders are accurate to 1% and rugged enough to do round-the-clock production-line checkout or round-the-calendar monitoring of long-term laboratory experiments.

Full-scale balancing time 1 or 2½ seconds; weight 15 pounds; ranges from 0.9 millivolts to 0-100 volts; wide choice of speeds, accessories and charts. Full specifications and description of models available by writing the Instrument Division.



VARIAN
associates
PALO ALTO 1, CALIFORNIA

WASHINGTON OUTLOOK

THE AIR FORCE PROGRAM to develop Midas early-warning and Samos reconnaissance satellites has caused a Pentagon-State Dept. feud. A high-level Pentagon official gripes that State Dept. interference is holding back work on the projects.

The State Dept. has insisted on restricted orbits for the first few test shots of the satellites to avoid going over Soviet territory. State is also trying to restrict the performance of ground tracking and computing equipment—and perhaps even gear inside the prototype satellites.

A plan to set up special antennas in Pakistan to read out satellite signals has been shelved.

The State Dept. is still sensitive over the recent U-2 case and is trying to avoid new incidents. Pentagon R&D officials are furious, and want to get State Dept. influence out of the military satellite program.

ELECTRONICS CONTRACTORS for the B-70 aircraft project, Polaris submarine and missile, Minuteman missile, Midas and Samos satellites, and Army communications equipment may get more business from the new defense appropriation that just went through Congress in final form.

Congress added roughly \$700 million to the administration's military budget. It added \$190 million to the \$85-million fund for B-70 development, enough to resume work on cancelled electronic subsystem projects; \$241 million to the \$1.5-billion request for Polaris missiles and submarines, enough for two extra vessels; \$83.8 million extra for development of Minuteman missile and Midas and Samos satellites; and \$332 million to the Army's \$1-billion procurement budget.

But at the same time, Congress approved a 3-percent cut in each procurement appropriation, a total reduction of some \$400 million. Purpose is to make contractors reduce prices and profits. But Pentagon fiscal experts warn the effect will be to cut quantities of materiel bought.

The Eisenhower administration is still cool about using the extra sums voted by Congress. The outlook for expansion of the B-70 project, for instance, is uncertain.

THE ARMY HAS SPELLED out its procurement requirements over and above the new administration budget. The total communications and electronics sum is \$157.5 million. If allowed to spend the extra money voted by Congress, much of the money would presumably go to buy such equipment as: a field-army mobile air-defense fire-direction system; 310 combat surveillance drones; 19 radar flight-control systems for drones and aircraft; division-corps forward-area communications systems; 45 electronic countermeasure sets for enemy artillery fuzes; 3,331 f-m command radio sets for tactical vehicles; 4,671 tactical generators for combat units; and battlefield intelligence analyzers.

CONGRESS HAS PASSED a bill legalizing television booster stations that carry signals to homes in remote communities in the west. Broadcasters opposed the measure, since boosters pick up signals without permission from the originating station. But western legislators prevailed. The issue has caused controversy for two years.

RESOLUTION CALLING for a study of frequency allocations has been introduced by Sen. Vance Hartke (D-Ind.), member of the Senate communications subcommittee. Hartke proposes a five-member study commission named by the Senate, House and FCC. The proposal is not likely to get far, however. A similar effort in the House failed. Feeling was that the subject has already been studied to death and that only a study by someone with power to act would be worthwhile.

NEW TI GENERAL-PURPOSE SILICON MESA TRANSISTORS

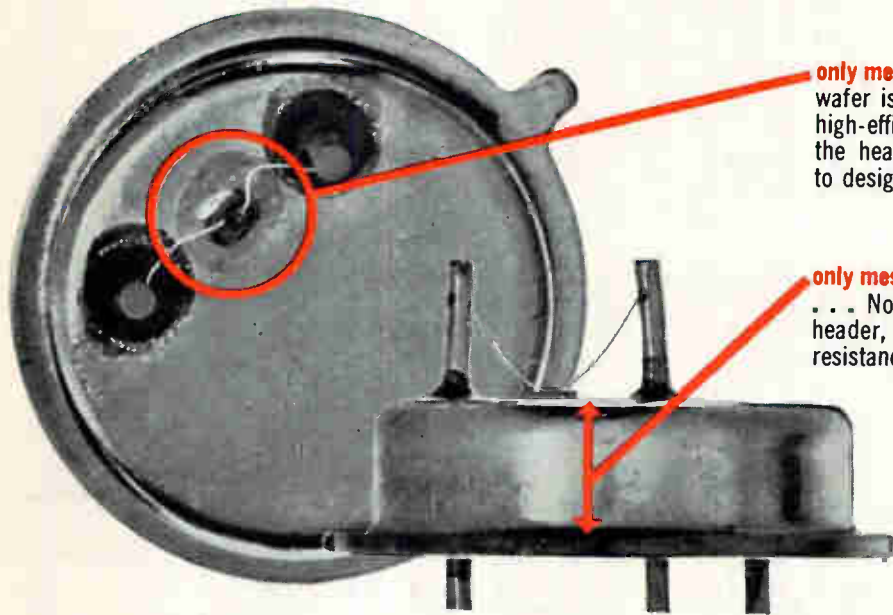

only mesas give you maximum dissipation... Note how wafer is bonded directly to header, forming a direct, high-efficiency metal-to-metal thermal path through the header. High dissipation capabilities permit you to design conservatively for maximum reliability!

only mesas give you maximum mechanical ruggedness... Note how active element is bonded directly to header, close to unit's center of gravity—for maximum resistance to vibration and shock.

TI 2N1564 series **GUARANTEES** -55°C beta, 600-mw dissipation and gain at 30mc

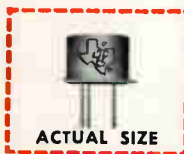

Design now with industry's first small-signal silicon mesa transistors... the new TI 2N1564-series! Take advantage of guaranteed -55°C betas of 12, 20 and 40... guaranteed 600-mw free-air dissipation... guaranteed current gain at 30 mc. Apply the design flexibility of 1 to 50 ma collector current operating range; 20-50, 40-100 and 80-200 beta spreads at 25°C and 60-v collector-emitter breakdown voltage to your audio, medium-power and higher frequency amplifier and switching designs... Specify the new TI 2N1564-series.

absolute maximum ratings at 25°C ambient (unless otherwise noted)

| | |
|---|-----------------|
| Collector-Emitter Voltage (see note 1) | 60 v |
| Emitter-Base Voltage | 5 v |
| Total Device Dissipation at 25°C Case Temperature (see note 2) | 1.2 w |
| Total Device Dissipation at 25°C Ambient Temperature (see note 3) | 0.6 w |
| Collector Junction Temperature | 175°C |
| Storage Temperature Range | -65°C to +200°C |

Note 1: The voltage at which h_{FE} approaches one when the emitter-base diode is open circuited. This value can be exceeded in applications where the dc circuit resistance (R_{BE}) between base and emitter is a finite value.
 Note 2: Derate linearly to 175°C case temperature at the rate of 8.0 mw/°C.
 Note 3: Derate linearly to 175°C ambient temperature at the rate of 4.0 mw/°C.

Available TODAY in production quantities through all TI Sales Offices and Authorized TI Distributors.

| Parameter | Test Conditions | 2N1564 | | | 2N1565 | | | 2N1566 | | | Unit |
|--|--|--------|------|------|--------|------|------|--------|------|------|---------------|
| | | Min. | Typ. | Max. | Min. | Typ. | Max. | Min. | Typ. | Max. | |
| I_{CBO} Collector Reverse Current | $V_{CB} = 40 \text{ v}$ $I_E = 0$ | | | 1 | | | 1 | | | 1 | μa |
| BV_{CBO} Collector-Base Breakdown Voltage | $I_C = 10 \mu\text{a}$ $I_E = 0$ | 80 | | | 80 | | | 80 | | | volt |
| BV_{CEO}^* Collector-Emitter Breakdown Voltage | $I_C = 10 \text{ ma}$ $I_E = 0$ | 60 | | | 60 | | | 60 | | | volt |
| h_{FE} A-C Common-Emitter Forward Current Transfer Ratio | $V_{CE} = 5 \text{ v}$ $f = 1 \text{ kc}$ $I_E = -5 \text{ ma}$ | 20 | | 50 | 40 | | 100 | 80 | | 200 | |
| | $V_{CE} = 5 \text{ v}$ $T_A = -55^\circ\text{C}$ $f = 1 \text{ kc}$ $I_E = -5 \text{ ma}$ | 12 | | | 20 | | | 40 | | | |
| | $V_{CE} = 5 \text{ v}$ $f = 30 \text{ mc}$ $I_E = -5 \text{ ma}$ | 1 | 4 | | 2 | 4.5 | | 2 | 5.0 | | |

 the **FIRST** silicon transistor manufacturer

TEXAS



INSTRUMENTS
INCORPORATED

SEMICONDUCTOR COMPONENTS DIVISION
13500 N. CENTRAL EXPRESSWAY
POST OFFICE BOX 312 · DALLAS, TEXAS

3/8 actual size

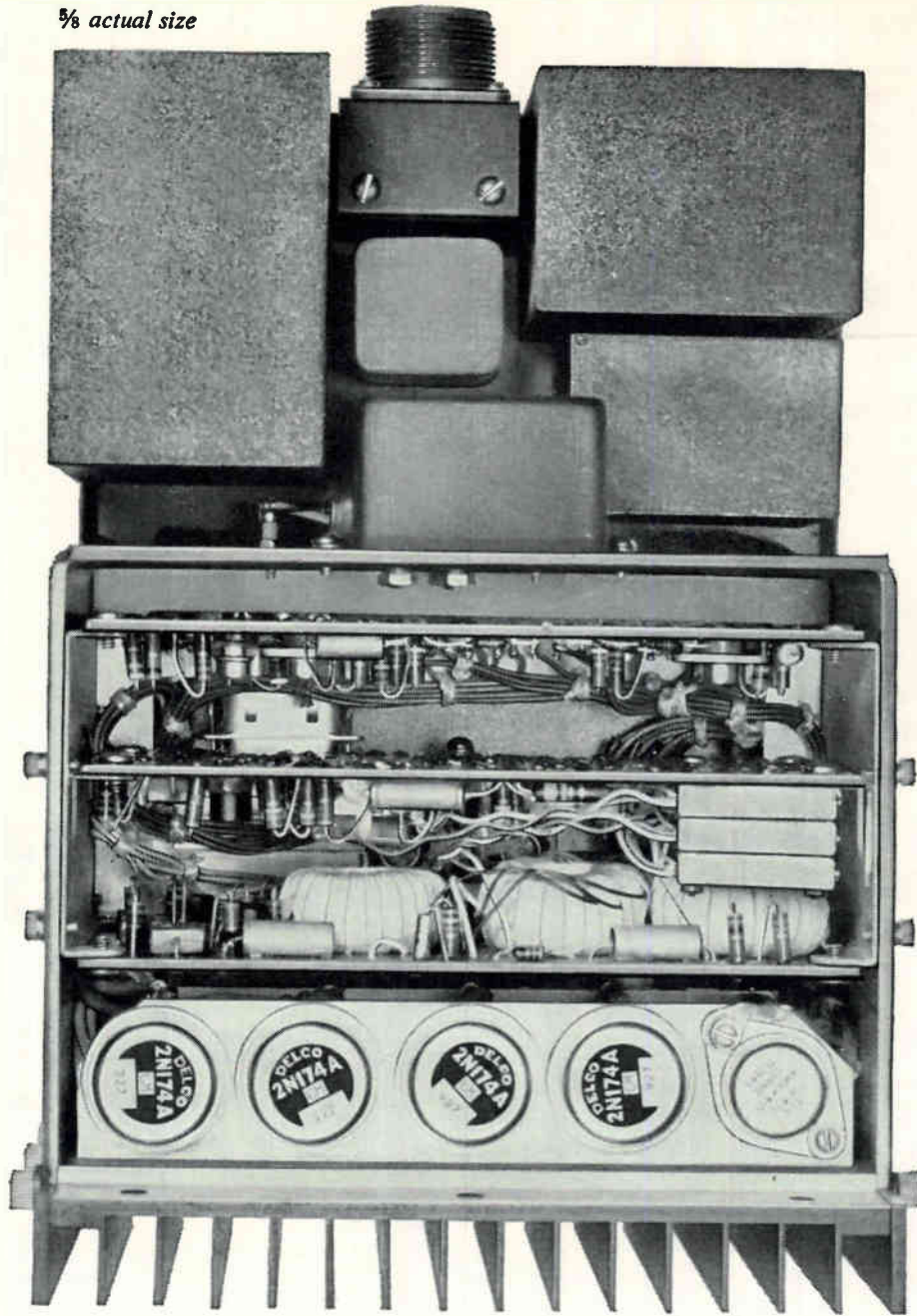

FROM DELCO RADIO NEW IDEAS FOR DEFENSE

HIGH CAPACITY STATIC INVERTERS WITH NO MOVING PARTS

Delco Radio's high capacity Static Inverters and Converters fill a critical need in missile guidance and control—offering extremely reliable, very highly regulated power of precise frequency. The Static Inverters use direct crystal-frequency control and digital logic circuits to produce accurate, single or polyphase power output. They have no moving parts. There is nothing that can get out of adjustment. Electrical characteristics are: High Capacity—150 to 4,000 volt-amperes. High Efficiency—65 to 90% depending on power and control (precision and regulation) required. Accurate Phase Angle Control—to 0.5 degree. Precise Frequency Control—up to 6 parts per million maximum variation under all load and environmental conditions. Voltage Amplitude Control—to $\pm 1\%$ no load to full load. Low Distortion—typically 2% total harmonic distortion. Delco Radio has developed and produced power supplies for missiles such as the Air Force's Ballistic Intermediate Range Thor, Intercontinental Titan, and the pilotless aircraft Mace. For further information on military electronics, write to our Sales Department. *Physicists and electronics engineers: Join Delco Radio's search for new and better products through Solid State Physics.*

PIONEERING PRECISION PRODUCTS THROUGH SOLID STATE PHYSICS

Division of General Motors • Kokomo, Indiana

DELCO
EXPERIENCE
RADIO
RELIABILITY

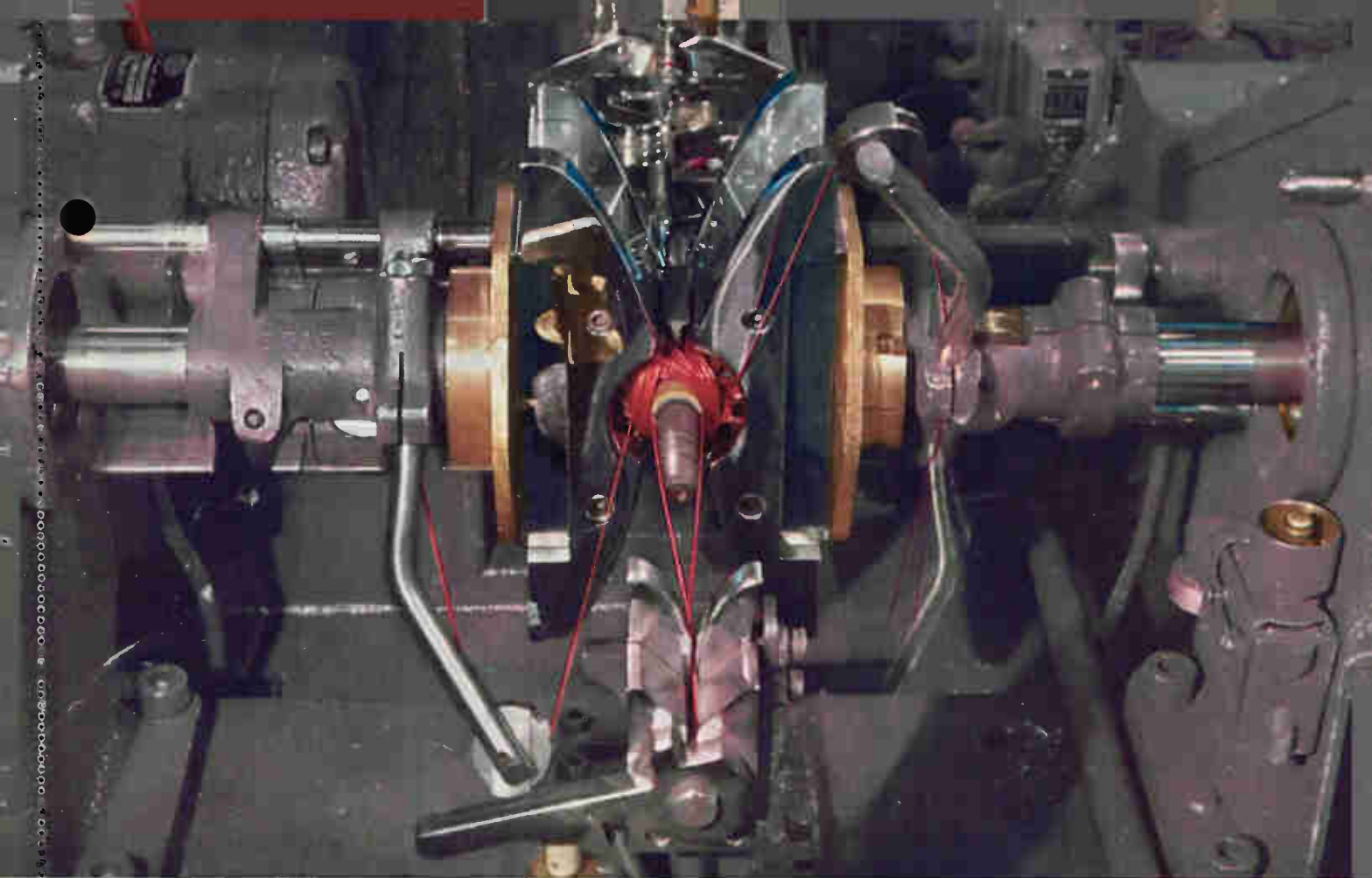

For more details on Anaconda Nylac's unique combination of useful characteristics, please turn the page—

When you must wind fast, tight, and meet high temperatures, too, **SPECIFY NYLAC SOLDERABLE MAGNET WIRE**

The faster you wind and the tighter your space factor—the more you should consider the advantages offered you by Anaconda Nylac Magnet Wire.

For Nylac is Anaconda Analac with a tough, Nylon film outer covering. The Nylon provides outstanding slipperiness and abrasion resistance—these tight-winding characteristics enable you to make compact, easily shaped, uniform coils.

Yet Nylac incorporates many features of Analac. For example, it gives you easy, fast solderability without stripping. It also has excellent moisture resistance.

In addition, Nylac offers you high dielectric strength, high thermoplastic flow temperatures, excellent flexibility, resistance to hot varnishes and potting compounds. *And—it meets all 130°C (AIEE Class B) requirements.*

So by combining Nylon, an old and industry-accepted insulation, with a newer but thoroughly proven film covering—*Analac*—Anaconda's *Nylac* is a new solderable Class B Magnet

Wire especially designed to overcome the strains of today's high-speed winding equipment and tight space factors.

The next time you face these and other winding problems, contact your nearest Anaconda Wire & Cable Sales Office. Our technical staff and Research and Development Laboratory facilities are available to give you every assistance possible. See the Man from Anaconda. Or write: Anaconda Wire & Cable Company, 25 Broadway, New York 4, N. Y.

60258

Ask the man from

ANACONDA[®]

about

NYLAC MAGNET WIRE

ANATHERM 155°C (AIEE Class F)
high temperature resistance

EPOXY 130°C (AIEE Class B)
superior compatibility

PLAIN ENAMEL 105°C (AIEE Class A)
low-cost enameled magnet wire

FORMVAR 105°C (AIEE Class A)
proven dependability

ANALAC 135°C (AIEE Class A)
solderable magnet wire

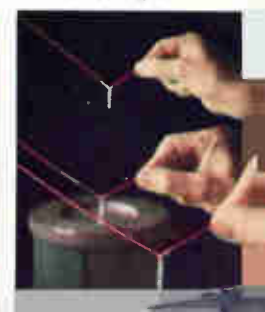
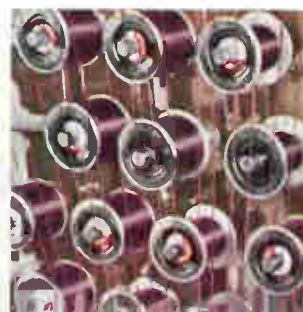



Important Facts about NYLAC MAGNET WIRE

Anaconda® Nylac film-coated magnet wire has a Nylon enamel outer surface over a film of Anaconda Analac (polyurethane) insulation. Nylac is a solderable wire that meets 130°C (AIEE Class B) thermal test requirements. It has outstanding windability and varnishability for severe process conditions, and exhibits excellent heat shock characteristics.

TECHNICAL PROPERTIES

ELECTRICAL PROPERTIES

Nylac has high dielectric strength. It has excellent electrical properties for all applications except high "Q" coils where dissipation factor should be as low as possible.

DIELECTRIC STRENGTH

| Moisture environment of sample | Volts per mil of insulation |
|--|-----------------------------|
| Dry | 3580 |
| Room Conditions | 2560 |
| Six hours at 100% relative humidity at 100°F | 1310 |

DIELECTRIC CONSTANT AND DISSIPATION FACTOR

(Measured with capacitance bridge)

| Frequency Cycles Per Second | Dielectric Constant | | % Dissipation Factor | |
|-----------------------------|---------------------|-------|----------------------|-------|
| | 35°C | 100°C | 25°C | 100°C |
| 10 ² | 3.5 | 10.7 | 2.4 | 11.4 |
| 10 ³ | 3.4 | 8.9 | 2.2 | 21 |
| 10 ⁴ | 3.5 | 6.2 | 2.8 | 18 |
| 10 ⁵ | 3.3 | 4.8 | 2.8 | 6 |

MECHANICAL PROPERTIES

Nylac is a strong flexible insulation. It adheres well to the conductor. Nylac wire survives severe abrasion, stretch and flex-

ing in high-speed, high-tension winding operations due to the tough Nylon overcoat. The wire will take short radius corner bends without cracking.

CHEMICAL PROPERTIES

Nylac has outstanding resistance to chemical attack. It will withstand 24 hours' immersion at room temperature in solvents including naphtha, Xylol, ethyl alcohol, chloroethene, methanol, and in 5% sulfuric acid and 1% potassium hydroxide.

THERMAL PROPERTIES

THERMAL STABILITY

Nylac meets the 130°C (AIEE Class B) requirement. Graph 1 indicates 20,000 hours' life at 135°C for unvarnished samples. Varnished sample data, available on request, indicates over 30,000 hours at 130°C.

Nylac is not recommended for use where severe thermal overloads may be encountered.

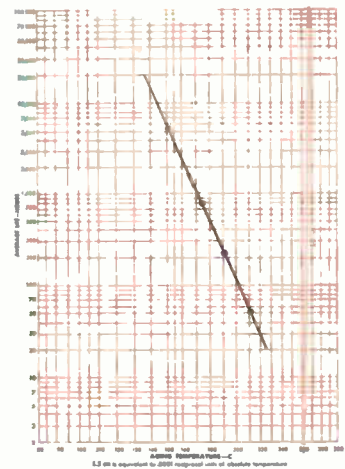

NYLAC MAGNET WIRE
UNVARNISHED AIEE 57 TEST

HEAT SHOCK 1 HR. AT 155°C

Mandrel Diameter (Multiple of Wire Diam.)

| Prestretch | 1x | 3x | 5x | 10x |
|------------|------|------|------|------|
| 0% | pass | pass | pass | pass |
| 10% | pass | pass | pass | pass |
| 15% | pass | pass | pass | pass |
| 20% | pass | pass | pass | pass |
| 25% | pass | pass | pass | pass |

Thermoplastic flow temperature

265°C using 5°C per minute rate of rise

SOLDERABILITY

Nylac wires solder without pre-stripping at practical solder temperatures.

| Wire Size | Time-Seconds | Solder Temperature | Sample |
|-----------|--------------|--------------------|-------------------------|
| 15-18 | 15 | 360°C | Twisted Pair |
| 19-25 | 10 | 360°C | Twisted Pair |
| 26-30 | 4 | 360°C | Wrap on 20 gage mandrel |
| 31-46 | 4 | 360°C | Wrap on 20 gage mandrel |

New Nylac Booklet—yours for the asking. Latest information—full technical data. Mail coupon for your copy.



ANACONDA WIRE & CABLE COMPANY
25 Broadway, New York 4, N. Y.

I am interested in learning more about the excellent properties of Nylac Magnet Wire. Please send me your new technical booklet DM5928.

NAME & TITLE.....
COMPANY.....
ADDRESS.....
CITY.....ZONE.....STATE.....



KENNEDY

CYCLOCONIC MOUNTING

*an advanced concept
in antenna mounting*

KENNEDY *Cycloconic* mounting has several significant advantages over conventional two-axis arrangements. With the *Cycloconic* method of mounting reflectors, two axes are provided, one vertical (azimuth) and one non-orthogonal (inclined) to the vertical. The reflector axis is at an angle to the inclined axis. By combination of rotations any direction of pointing may be achieved.

Cycloconic mounting eliminates the need for mechanical stops or limit switches. The large working diameters on *both* axes insure high angular accuracy. Continuous unidirectional motion about the azimuth and inclined axes provides meridian scanning with simple harmonic motion of the antenna beam.

The inclined axis of the *Cycloconic* mount provides a convenient "Vernier" for measurement of true elevation angle. For example, in satellite tracking low angle passes of short duration can yield quite precise elevation data.

The inherent stability and absence of mechanical limits of the *Cycloconic* mount result in a high survival capability under extreme environmental conditions. This extra ruggedness and rigidity make it ideal for mounting large antennas for radio telescopes. Dishes from 300 feet in diameter up may be *Cycloconic* mounted with total dependability. Loads on the antenna from dead weight, inertia and wind are handled with positive reliability.

KENNEDY *Cycloconic* mounts may be custom made to meet your specific requirements. They are the products of D. S. KENNEDY & CO., designers and builders of more tracking antennas, tropo-scatter systems and radio telescopes than anyone else in the field. The backlog of structural design and antenna technology gained through more than 15 years of activity in antenna installations has been applied to the design of this advanced mounting technique. You can consider *Cycloconic* mounting for your application with complete confidence. It will meet your highest performance standards.

Kennedy gives you experience you can't buy elsewhere.



D. S. KENNEDY & CO.

Antenna Division, Cohasset, Mass.
EVERgreen 3-1200 Twx COH 311

Anchor Metals Division, Hurst, Texas
(Fort Worth) ATlas 4-2583

3

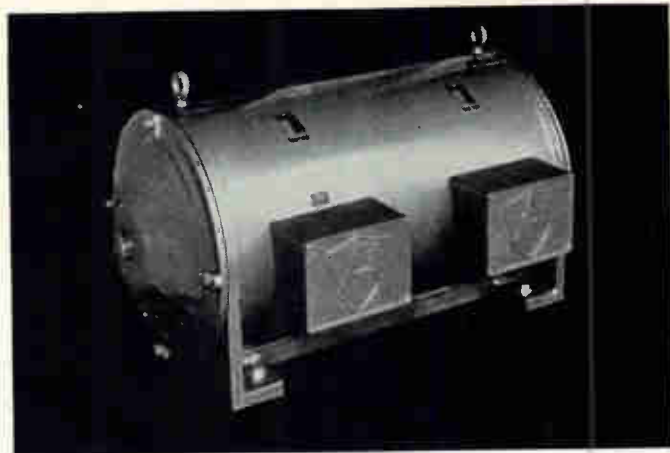

NEW STANDARD 2 BEARING GENERATOR

STANDOUTS IN BRUSHLESS ALTERNATORS

*...for precise H/F power
...compact, trouble-free design
...rugged reliability*

American Electronics' years of motor/generator design and manufacturing experience has resulted in the development of a complete line of inductor alternators with a performance record of maximum efficiency at minimum cost. More than 8000 units in operation today, providing years of dependable service, testify to the quality features engineered into these H/F power supply units by AEI.

More compact in design than units of comparable ratings—versatile in application, and completely reliable in performance—AEI inductor alternators use NO BRUSHES, NO SPRINGS, NO MOVING COILS—operate virtually maintenance free!

AEI standard inductor alternators are available in sizes from 500 watts to 30 kva offering precise 400



TYPICAL GENERATOR FOR H-F INDUSTRIAL INSTALLATIONS



AC-DC SUPPLY FOR AIRCRAFT OR MISSILE COMPONENT CHECK-OUT

cycle single or 3 phase power. Standard designs provide voltages automatically regulated to $\pm 1\%$. Requirement for $\pm 1/2\%$ can also be supplied. Standard voltage adjustment is $\pm 10\%$. Standard rotating field alternators in sizes from 500 watts to 120 kva, with fixed or variable output frequencies ranging from 250 to 10,000 cycles, are in production.

When your high frequency power needs call for precision power delivered with trouble-free reliability, specify alternator units developed by American Electronics, Inc. Write or call for our new *Rotary Power brochure*, which gives the complete story on these and other power supply units.

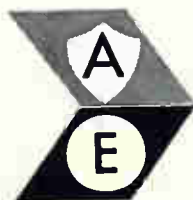

AMERICAN ELECTRONICS, INC.

PRECISION POWER DIVISION

9705 KLINGERMAN STREET, EL MONTE, CALIFORNIA — CUMBERLAND 3-7721

Proposes Investment Company Change

INVESTMENT COMPANIES licensed by Small Business Administration will be allowed to provide equity capital to small concerns by purchasing any classes of their stocks or bonds, if a proposed regulatory change is approved. Present rules limit funding transactions to purchase of convertible debentures. Philip McCallum, SBA administrator, invites comment from interested persons on the proposed change.

Calling 3½ percent convertible subordinated debentures by Radio Corporation of America is slated for Aug. 3, 1960, according to company spokesmen. This is being done to create an expanded base for future growth, particularly in electronic data processing, they say. Additional comment indicates that because of the unique leasing nature of the edp business, profits have been committed to this area with the promise of large returns in the future.

Ampex Corp., Redwood City, Calif., and Telemeter Magnetics, Culver City, Calif., are studying merger possibilities, according to a joint announcement. Proposed merger would be on the basis of two shares of Telemeter for one share of Ampex, with Ampex as the surviving company. Telemeter had sales of \$4.6 million last year. Ampex sales for the fiscal year ended April 30, 1960, exceeded \$68 million.

Secoe Corp., San Francisco manufacturer of selective signalling gear, announces approval by state authorities to acquire 100 percent of the stock of C. A. Rypinski Co., of Pasadena, Calif., which specializes in audio and r-f filters for missile and space communications equipment. Secode sales for the fiscal year ended June 30 this year were more than \$900,000. Current backlog of orders totals \$700,000.

Metropolitan Telecommunications Corp., Brooklyn, N. Y., reports acquisition of Coil Winders, Inc., Plainview, N. Y. The transaction was negotiated through an ex-

change of one share of Metropolitan stock for each three of Coil Winders. Metropolitan is the surviving company.

Litton Industries, Beverly Hills, Calif., discloses purchase of a majority interest in the West German firm of Fritz Hellige & Co. which manufactures medical and industrial electronic equipment. The German firm has annual sales of about \$2 million, and will produce Litton products for the German market. Among these, according to Litton, will be advanced air navigation systems.

Houston Fearless, Los Angeles, announces acquisition of Marchetti Associates, Boston, formerly affiliated with Avco Corp. in the Crosley division's electronics research laboratory. The group's past efforts have involved development of radar antenna steering, voice links for meteor scatter systems and, recently, random access microphotographic files for storage of one million pages of data within a cubic foot area. Terms of the acquisition have not been disclosed.

25 MOST ACTIVE STOCKS

| | WEEK ENDING JULY 1 | | | |
|-------------------|----------------------|------|------|-------|
| | SHARES (IN 100's) | HIGH | LOW | CLOSE |
| Ampex | 2,353 | 41 | 37 | 39½ |
| RCA | 1,340 | 68½ | 64½ | 65½ |
| Avco Corp | 1,320 | 15¼ | 14¼ | 14¼ |
| Gen Tel & Elec | 1,267 | 31½ | 30 | 30½ |
| Du Mont Labs | 1,200 | 12½ | 11½ | 12¼ |
| Sperry Rand | 1,150 | 24½ | 22½ | 24¼ |
| Standard Kollsman | 1,100 | 24¼ | 21½ | 22½ |
| Int'l Tel & Tel | 1,033 | 45¼ | 40¼ | 40½ |
| Gen Instrument | 983 | 50¾ | 44½ | 48¾ |
| Univ Controls | 810 | 18 | 16½ | 17 |
| Victoreen Inst | 726 | 14¾ | 12½ | 13¼ |
| Raytheon | 701 | 44¾ | 41¾ | 42¼ |
| Cohu Electronics | 688 | 12¾ | 10½ | 12 |
| Gen Electric | 637 | 95¾ | 91¾ | 93½ |
| Amer Tel & Tel | 618 | 90¼ | 88¾ | 89¼ |
| Westinghouse | 600 | 60½ | 56¼ | 58¼ |
| Edo Corp | 596 | 23¼ | 17¼ | 22½ |
| Gen Transistor | 583 | 33¼ | 28¾ | 30½ |
| Philco Corp | 553 | 30¾ | 28½ | 28¾ |
| Lear Inc | 540 | 22¼ | 20¼ | 21¾ |
| Litton Ind | 517 | 95¼ | 88¾ | 94 |
| Sterling Precis | 507 | 3½ | 3¼ | 3¾ |
| Collins Radio | 494 | 73¾ | 70¾ | 72¾ |
| Zenith Radio | 442 | 127¾ | 121¼ | 123¼ |
| Int'l Resistance | 414 | 37¾ | 33 | 35¾ |

The above figures represent sales of electronics stocks on the New York and American Stock Exchanges. Listings are prepared exclusively for ELECTRONICS by Ira Haupt & Co., investment bankers.

WHAT
do
you need to know
about...

**PURE
FERRIC
OXIDES**
**MAGNETIC
IRON
OXIDES**
**MAGNETIC
IRON
POWDERS**
?

Since final quality of your production of ferrites, electronic cores, and magnetic recording media depends on proper use of 3 specialized groups of magnetic materials... you'll find it mighty helpful to have all the latest, authoritative technical data describing the physical and chemical characteristics of each. This information is available to you just for the asking. Meanwhile, here are highlights of each product group.

PURE FERRIC OXIDES—For the production of ferrite bodies, we manufacture a complete range of high purity ferric oxide powders. These are available in both the spheroidal and acicular shapes, with average particle diameters from 0.2 to 0.8 microns. Impurities such as soluble salts, silica, alumina and calcium are at a minimum.

MAGNETIC IRON OXIDES—For magnetic recording—audio, video, instrumentation etc.—we produce a group of special magnetic oxides with a range of controlled magnetic properties. Both the black ferroso-ferric and brown gamma ferric oxides are available.

MAGNETIC IRON POWDERS—For the fabrication of magnetic cores in high-frequency, tele-communication, and other magnetic applications, we make a series of high purity iron powders.

If you have problems involving any of these materials, please let us go to work for you. We maintain fully equipped laboratories for the development of new and better inorganic materials. Write... stating your problem... to C. K. Williams & Co., Dept. 25, 640 N. 13th St., Easton, Penna.

WILLIAMS
COLORS & PIGMENTS

C. K. WILLIAMS & CO.
EAST ST. LOUIS, ILL. • EASTON, PA.
EMERYVILLE, CAL.

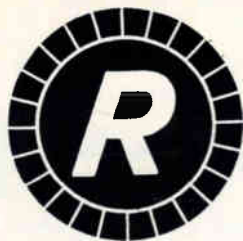

Editorial Reprints Still Available... If You Act Now...

Following are editorial reprints available from stock. However, reprints of any editorial that has appeared in electronics in past or current issues may be ordered. For reprints not listed below prices will vary depending upon the length of the article.



R-2

Instruments for Design and Production, December 4, 1959; Key No. R-2: a 16-page report on Voltage, Current and Power Measurement; Impedance Measurement; Frequency Measurement; Waveform Measurement; Tube and Semiconductor Testing; Automatic Testing. Profusely illustrated with charts and graphs.



R-4

1959 Index to electronics, December 25, 1959; Key No. R-4: a handy 32-page index to the 3,000-plus pages of technical and technically interpreted business information that appeared in electronics during 1959.



R-5

The Electronics Market: "Looking into the 60's", January 1, 1960; Key No. R-5: is the result of one year's intensive research effort to reveal the U. S. Market, the Manpower Picture, Precise breakdown of the Military, Industrial, Consumer and Replacement Parts Markets with charts, graphs, tables, Buying and Selling Abroad and new approaches in Getting Goods to Market.



R-6

Designing High-Power Transistor Oscillators, January 8, 1960; Key No. R-6. 50c each: reprint of a 4-page article by W. E. Roach, Pacific Semiconductors, Inc. New high-power transistors are usable at over 300mc. Oscillator design is simplified with step-by-step procedure.



R-7

Research & Development Around The World, February 12, 1960; Key No. R-7: a 24-page roundup in the countries covered within this report by men recognized as expert . . . men who were approached personally in electronics' behalf by McGraw-Hill's unique World News Bureau, and we are particularly indebted to representatives in London, Paris, Milan, Stockholm, Zurich, Tel Aviv, Tokyo and Melbourne for the result.

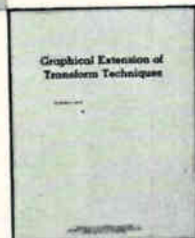

R-8

Graphical Extension of Transform Techniques, April 1, 1960; Key No. R-8. 50c each: a 6-page reprint of a feature article that deals with those engineering problems solved more readily with functional - transformation methods. The article reviews Fourier and convolution integrals and presents a graphical convolution technique.



R-9

What's New in Electron Tubes, April 29, 1960; Key No. R-9. 50c each: 36-page illustrated report of the latest advances and developments in a classic field of electronics. Thorough analysis of Receiving-Type Tubes, High Vacuum Power Tubes, Gas Filled Tubes, Linear-Beam Microwave Tubes, Crossed-Field Microwave Tubes, Cathode-Ray Tubes, Storage, Counting and Phototubes.

Prices: Reprints on items above are 1-10 copies, 75c each; 11-24 copies, 60c each; 25 copies or more 50c each unless otherwise noted.

Fill in, clip out and mail to:

electronics Reprint Service Dept., 330 W. 42nd Street, New York 36, N. Y.

electronics REPRINT ORDER FORM

For Reprints of all Key Numbers listed above fill in below:

Send me _____ Reprints of Key No(s). _____ at _____ c ea.

*For Reprints of other editorial articles in this issue, fill in below:

Send me _____ reprints of article entitled _____
_____ on page(s) _____ (Minimum order 100 copies)

*For Reprints of other editorial articles in past issues, fill in below:

Send me _____ reprints of article entitled _____
_____ on page(s) _____ of issue dated _____ (Minimum order 100 copies)

Check one box *First advise me of costs Mail immediately and bill me later.

Name _____

Number and Street _____

City, Zone No., State _____

PRINTS 3,000 WORDS/MIN

FROM REMOTE POINTS

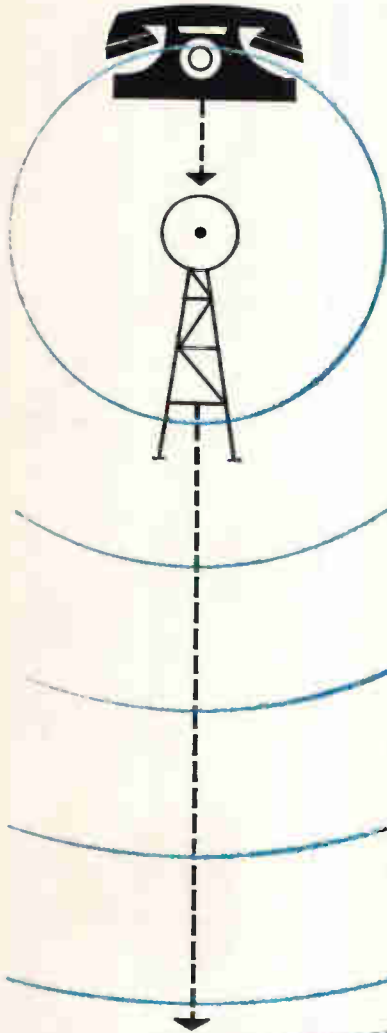

The U.S. Army Corps of Engineers is using Stromberg-Carlson—San Diego's new S-C 3000 High Speed Communications Printer to print 3000 words a minute from remote sources. The equipment can print out over great distances, using standard wire or radio links.

The S-C 3000 is compatible with most available data link systems, including the Collins Kineplex data transmission system and the Stromberg-Carlson Binary Data Link. Printing is accomplished through a unique combination of the Stromberg-Carlson CHARACTRON® shaped beam tube and Haloid Xerox, Inc.'s, electrostatic printing process. The S-C 3000 prints without impact on untreated paper or lithographic masters.

This new communications printer answers the need for equipment that can keep pace with today's high speed communications systems. It is designed for military, government, news service, business and public communications systems where speed and reliability are essential. The S-C 3000 accepts data via wire or radio link from computers located at a distant point and prints out copy of outstanding readability.

If you are interested in high-speed printing of data received from a distant point, don't fail to investigate the S-C 3000. Write for free booklet to Stromberg-Carlson-San Diego, Dept. A-58, P.O. Box 2449, San Diego 12, California. Telephone BRowning 6-3911

STROMBERG-CARLSON-SAN DIEGO
A DIVISION OF **GENERAL DYNAMICS CORPORATION**

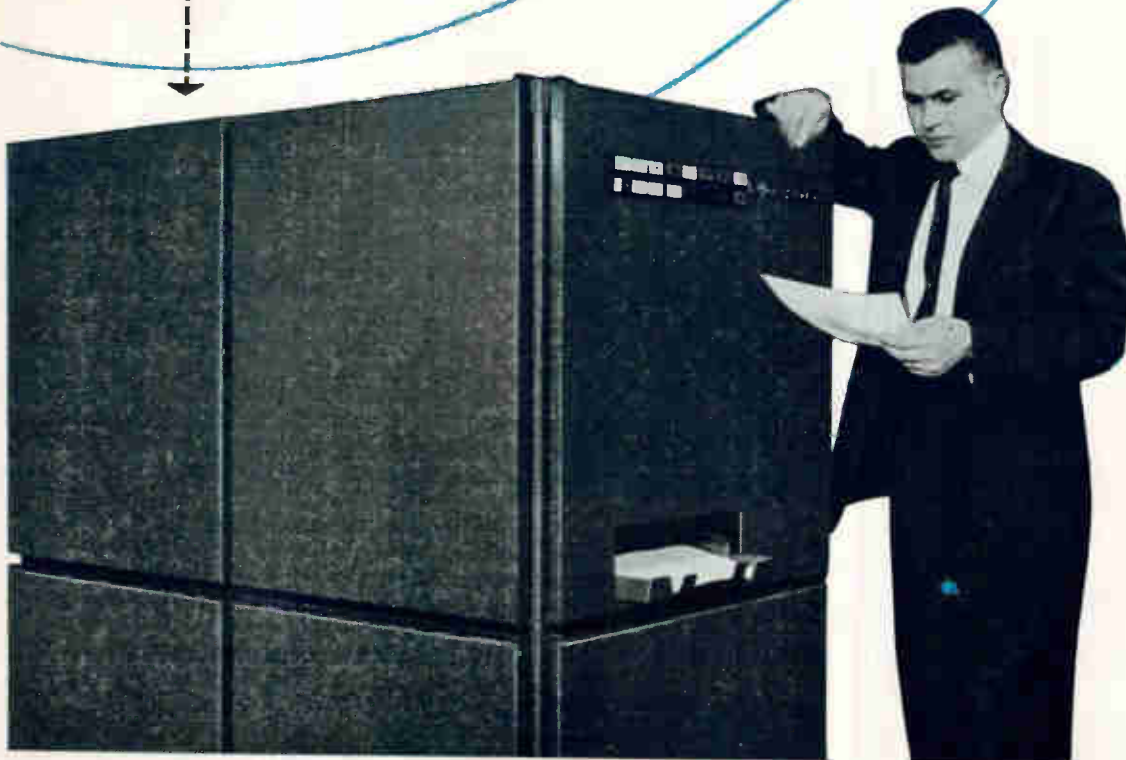

General Electric takes the tubulation



General Electric transistors hold the record in rate-grown reliability

General Electric has manufactured millions of rate-grown transistors in the past seven years. As a result of this experience, G.E.'s parameters are exceptionally stable and a vast amount of reliability data has been accumulated, some of which is shown here. These curves cover 29 lots of General Electric 2N167, tested to MIL-T-19500/11.

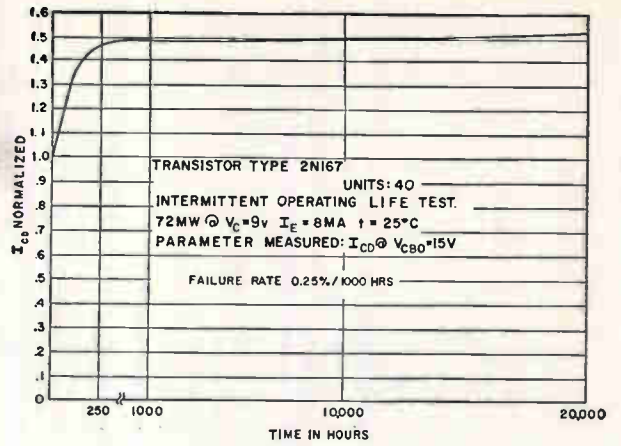
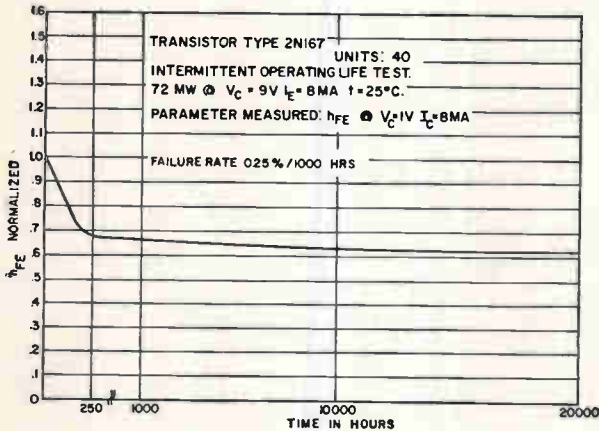

The rate-grown process produces a small, clean junction which exhibits almost no drift or deterioration at high voltages and offers the user low I_{CO} and I_{BO} . Two new types, the 2N1510 and 2N1217, will be useful for low-level switch and neon indicator applications. Both the 2N1217 and 2N167 operate at extremely low current and leakage levels, making them ideal for starvation circuits of 2 ma or less.

off rate-grown NPN transistors!

Remove the tubulation (pinch-off) from rate-grown transistors without sacrificing reliability? General Electric has done just that and even improved reliability with stabilized beta and collector cutoff current. Prices have been reduced on some types up to 20%.

Removal of the tubulation was made possible by adding a sieve or getter. Improved beta and collector cutoff current results from a 125-hour 85°C bake, which also improves the paint's resistance to solvents and chipping. Pellet, pellet mount and processing are identical to the previous process before encapsulation. Then a sieve is added rather than evacuation and subsequent pinch-off. The sieve is the same used and proved for years on G.E.'s PNP low-frequency 2N525 and PNP high-frequency 2N396 lines.

The high-reliability 2N78A and 2N167A have guaranteed 71°C I_{CO} and tight AQL's. The 2N78A also features a 20 volt BV_{CEO} rating compared with the 2N78's 15 volts. The 2N167A, in addition to 71°C I_{CO} , has a lower I_{EO} . For more information, see your G-E Semiconductor Sales Representative or Authorized Distributor. General Electric Company, Semiconductor Products Dept., Electronics Park, Syracuse, N. Y.

| ADVANTAGES TO YOU: 40% lower height • Reduced prices • Stabilized I_{CO} and h_{FE} . All units baked 125 hours at 85°C • Greater resistance of paint to solvents, chipping, and salt spray • Improved low-temperature performance and reliability. | Type No. | Maximum Ratings | | | | Electrical Parameters | | | | | |
|---|---------------------------------|------------------|------------------------|----------------|------------------|-----------------------|------------|-----|----|-----|----|
| | | P_{cmw} @ 25°C | BV_{CE} BV_{CB} | I_C ma | T_J °C | MIN | | MIN | | MAX | |
| | | h_{FE} | @ I_C ma | f_{β} mc | $G_{\text{c}db}$ | I_{CO} (μ a) | @ V_{CB} | | | | |
| | 2N78 | 65 | 15 | 20 | 85 | 45 | 1 | 5 | 27 | 3 | 15 |
| | 2N78A | 65 | 20 | 20 | 85 | 45 | 1 | 5 | 29 | 3 | 15 |
| | 2N78A (Cert) | 65 | 20 | 20 | 85 | 45 | 1 | 5 | 29 | 3 | 15 |
| | 2N167 | 65 | 30 | 75 | 85 | 17 | 8 | 5 | — | 1.5 | 15 |
| | 2N167A | 65 | 30 | 75 | 85 | 17 | 8 | 5 | — | 1.5 | 15 |
| | USAF2N167A (per MIL-S-19500/11) | 65 | 30 | 75 | 85 | 17 | 8 | 5 | — | 1.5 | 15 |
| | 2N169A | 65 | 15 | 20 | 85 | 34 | 1 | — | 27 | 5 | 15 |
| | 2N1198 | 65 | 25 | 75 | 85 | 17 | 8 | 5 | — | 1.5 | 15 |
| | 2N1217 | 65 | 20 | 20 | 85 | 40 | 2 | 5 | — | 1.5 | 15 |
| | 2N1510 | 75 | 75 | 20 | 85 | 8 | 1 | — | — | 5 | 75 |

IN STOCK FOR FAST DELIVERY FROM YOUR AUTHORIZED GENERAL ELECTRIC DISTRIBUTOR

GENERAL ELECTRIC

**NEW
STROMBERG-CARLSON
TELEPHONE
HANDSET
CRADLE**



... for positive retention in all mobile applications

There's no jump, no sway—when a telephone handset is in the firm grip of this new handset cradle by Stromberg-Carlson.

Retaining clip spring assembly assures positive retention in any mobile application on land or sea, or in the air. Even extremely severe jars, jolts and vibrations fail to dislodge the handset.

The cradle is strong and resilient, fits any Stromberg-Carlson handset. Different models provide varying switch combinations with 2 or 4 Form C contacts. All models available with or without the clip assembly.

Specifications on request. In Atlanta call TRinity 5-7467; Chicago: STate 2-4235; Kansas City: HARRison 1-6618; Rochester: HUBbard 2-2200; San Francisco: OXFord 7-3630. Or write to Telecommunication Industrial Sales, 114 Carlson Road, Rochester 3, New York.

STROMBERG-CARLSON
A DIVISION OF
GENERAL DYNAMICS

New Distributors Enter Electronics

DISTRIBUTOR SALES of electronic parts to industrial accounts are expected to exceed \$400 million annually in the 1960-1961 period, up from \$350 million in 1959, reported C. E. Woodhouse, president of Brady Supply Co. of Elmira, N. Y., at the recent national convention of the National Association of Electrical Distributors.

Woodhouse was one of four electrical distributors who recommended that association members investigate the opportunities available to them in industrial electronic distribution.

Electronic devices and components are playing a constantly increasing role in the industrial engineer's thinking, said Woodhouse. Demands by management to decrease production costs have resulted in automation of production lines and processes. Consequently, computers, dielectric heating, power converters, ultrasonic welding, closed circuit tv, telemetering, sensing devices and electronic controls are coming into increasing industrial use and a growing market for maintenance components is developing.

Manufacturers of industrial electronic equipment have discovered that volume is increasing so rapidly they can no longer serve the market from a remote point. They are looking for local distributors who can have their products in stock, readily accessible to the customer in the marketing area.

"Electrical distributors have the industrial contacts, the know-how and the organization needed to serve the industrial market," said Woodhouse. "I feel you are missing an opportunity to expand into an industry which is compatible with ours, if you do not take steps to analyze the market."

The profit rate is good and competition is less severe than in the electrical business, said J. W. Saladine, president of Electrical Supplies Inc., of Hartford, Conn. "Our profit rate on industrial electronics is about four points better than on our electrical apparatus and sup-

plies business. Our industrial electronics sales increased well over 150 percent in the past four years."

Thomas E. Becker, president of John A. Becker Co. of Dayton, O., said his firm decided to expand into industrial electronics to get a line where service ability was of greater importance than price. "We found that our service approach strongly appealed to our industrial customers. Today, our electronics volume equals one-fourth of our total distributor business," he reported.

E. M. Blumberg, vice president of Cadillac Electric in Detroit, said: "There is a great future in the industrial electronics distributing business, but distributors should be aware of some of the special problems.

"The two main problems are inventory and manufacturer-distributor relationships. Because of the constantly changing demand for products and the tremendous number of individual items to be stocked, constant inventory control is mandatory. Choose your suppliers carefully and constantly work with them to try and improve your relations on territorial protection and on protection from direct selling," he said.

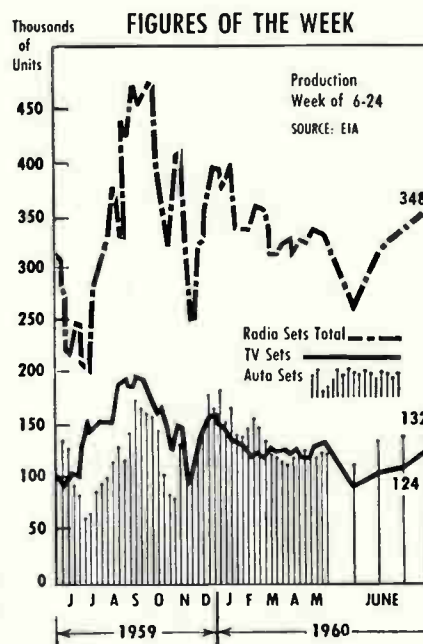



**QUADRUPLED POWER
IN THE SAME CUBE
THE CAPITRON
RADAR PULSE
MODULATOR**



**HA/HV LEADS AND
TERMINALS**

Insulated and corona free to .23 KV peak pulse, the AMP shielded magnetron cable assembly #836547 is a high voltage, high temperature unit that fits exceptionally confined spaces.

To see through peaseoup fog or moonless night, the Navy F8U2N Jet interceptor required a quadruple-power radar modulator that would fit in the same volume as the original power units.

The problem was a natural for AMP's Capatron personnel and facilities. New transformer design standards were developed, new high temperature insulations tested, new components created. The unit was packaged and tested in record time. Capatron is now in volume production of this unit . . . the AMP #855053.

Specifications: delivers 600 KW of pulse power to transmitter . . . 22,000 volts . . . requires only three inputs—DC voltage, system triggers, and AC for filaments . . . internal temperature range from -70°C to $+150^{\circ}\text{C}$. . . conforms to mil specs.

Complete specifications available. Send for them today.

**CAPITRON DIVISION
AMP INCORPORATED
Elizabethtown, Pennsylvania**

Capatron products and engineering assistance are available in Canada through Aircraft-Marine Products of Canada, Ltd., Toronto, Canada

**extreme
sensitivity
10 mc to
44,000 mc**



**PANORAMNIC'S
SPA-4
SPECTRUM
ANALYZER**

MORE USEABLE SENSITIVITY

| BAND | RF SENSITIVITY* |
|------------------|-----------------|
| 10 — 420 MC | —95 to —105 dbm |
| 350 — 1000 MC | —90 to —100 dbm |
| 910 — 2200 MC | —90 to —100 dbm |
| 1980 — 4500 MC | —80 to — 90 dbm |
| 4.5 — 10.88 KMC | —80 to — 95 dbm |
| 10.88 — 18.0 KMC | —70 to — 90 dbm |
| 18.0 — 26.4 KMC | —60 to — 85 dbm |
| 26.4 — 44.0 KMC | —55 to — 85 dbm |

*measured when signal and noise equal 2X noise.
Using one tuning head which contains one triode and two Klystron oscillators, Model SPA-4 offers more exclusive advantages for applications demanding extreme sensitivity, stability, versatility, accuracy.

- Three precisely calibrated amplitude scales—40 db log, 20 db linear, 10 db power.
- Two independent frequency dispersion ranges—continuously adjustable—0-70 mc and 0-5 mc. Negligible internal frequency modulation permits narrow band analysis of FM problems.
- Variable I.F. bandwidth from 1 kc to 80 kc.
- Push-button frequency selector.
- Synchroscope output with 40 db gain.
- Accurate measurement of small frequency differences. A self-contained marker oscillator, modulated by a calibrated external generator, provides accurate differential marker pips as close as 10 kc.

Tremendous flexibility and many unique advances of Panoramnic's compact SPA-4 make it unsurpassed for visually analyzing FM, AM and pulsed signal systems; instabilities of oscillators; noise spectro; detection of parasites; studies of harmonic outputs; radar systems and other signal sources.

Write, wire or phone today for detailed SPA-4 bulletin.



530 So. Fulton Ave., Mount Vernon, N.Y.
OWens 9-4600 • TWX: MT-V-NY-5229
Cable: Panoramnic, Mt. Vernon, N.Y. State

WHAT'S UP IN WASHINGTON?

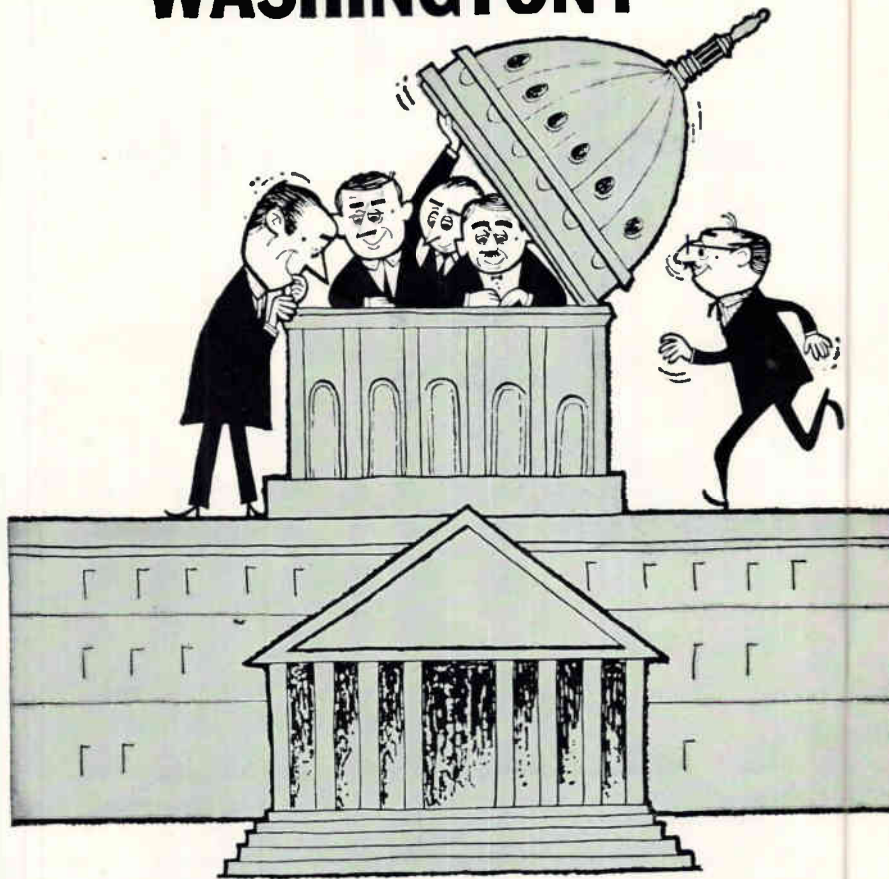

Powerful individuals in Congress, The Pentagon, the State Department and elsewhere can influence the business plans of scores of electronics manufacturers.

electronics reports on policy makers who influence decisions on guided missiles, basic scientific research, government communications policy and many other sensitive subjects.

The highlights are summed up in 3 minutes reading time. More detailed reports on particularly important subjects are specially edited for quick and easy reading.

electronics names names... tells the implications of new developments... keeps you informed. See "Washington Outlook" — a regular, weekly report. Act now! For a new subscription or a renewal, fill in box on Reader Service Card. Easy to use. Postage free.

FIND WHAT YOU NEED IN... electronics

Raytheon Transformer Talk

**Applying the
unit construction
technique to
high voltage
power supplies**

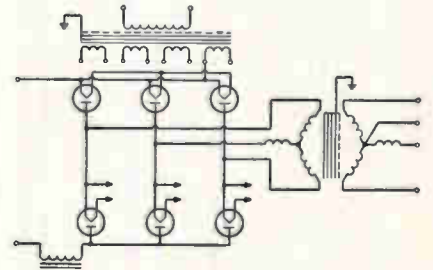

The trend to unitization of power supply construction is not limited to low voltage supplies. The unit at left was designed and built by Raytheon for the main power supply of the FAA Vortac System—the guidance system for aircraft throughout the United States.

This is a complete high-voltage rectifier, including plate transformer, filament transformer and filter reactor in one compact housing with integral mounting of rectifier tubes (circuit diagram above). All magnetic components are capable of withstanding 51 KV RMS hi-pot test. Oil-filled high voltage terminals are corona-free. Input = 3 phase, 208 volts \pm 15% 60 cycle \pm 10%. Output at nominal line voltage is 24,000 volts DC \pm 2% at 200 MA.

Write for complete data on Raytheon magnetic components.

RAYTHEON COMPANY

Magnetics Operations
Commercial Apparatus & Systems Div.
1415 Boston-Providence Turnpike
Norwood, Massachusetts

Solving critical transformer design problems for key missile, radar and communications system contracts has been an important Raytheon activity for over 20 years.

Recent expansion in production facilities now makes many of these advanced designs available in quantity, with prompt delivery.



CIRCLE 29 ON READER SERVICE CARD

AN EXTRAORDINARY PUBLISHING ACHIEVEMENT OF OUR TIME!

Here Are the Many Fields Covered:

ACOUSTICS
 AERONAUTICAL AIRFRAMES
 AGRICULTURE & SOILS
 ANIMAL ANATOMY
 PLANT ANATOMY
 ANIMAL SYSTEMATICS
 ASTRONOMY
 ATOMIC, MOLECULAR AND NUCLEAR PHYSICS
 BIOCHEMISTRY
 BIOPHYSICS
 CHEMICAL ENGINEERING
 ANALYTICAL CHEMISTRY
 INORGANIC CHEMISTRY
 ORGANIC CHEMISTRY
 PHYSICAL CHEMISTRY
 CIVIL ENGINEERING
 COMMUNICATIONS
 CONSERVATION
 CONTROL SYSTEMS
 CYTOLOGY
 ANIMAL ECOLOGY
 PLANT ECOLOGY
 ELECTRICAL ENGINEERING
 ELECTRICITY
 ELECTRONICS
 FLIGHT SCIENCE
 FOOD ENGINEERING
 FORESTRY
 GENETICS & EVOLUTION
 GEOCHEMISTRY
 PHYSICAL GEOGRAPHY
 SURFICIAL AND HISTORICAL GEOLOGY
 GEOPHYSICS
 GRAPHIC ARTS
 GROWTH AND MORPHOGENESIS
 HEAT
 INDUSTRIAL AND PRODUCTION ENGG.
 LOW TEMPERATURE PHYSICS
 MACHINE DESIGN
 MATHEMATICS
 MECHANICAL POWER
 CLASSICAL MECHANICS
 METALLURGICAL ENGINEERING
 METEOROLOGY AND CLIMATOLOGY
 MICROBIOLOGY
 MEDICAL MICROBIOLOGY
 MINERALOGY AND PETROLOGY
 MINING ENGINEERING
 NAVAL ARCHITECTURE AND MARINE ENGG.
 NUCLEAR ENGINEERING
 OCEANOGRAPHY
 OPTICS
 PALEONTOLOGY
 ANIMAL PATHOLOGY
 PLANT PATHOLOGY
 PETROLEUM CHEMISTRY
 PETROLEUM ENGINEERING
 GENERAL PHYSIOLOGY
 PLANT PHYSIOLOGY
 SOLID STATE PHYSICS
 THEORETICAL PHYSICS
 PLANT TAXONOMY
 PROPULSION
 PHYSIOLOGICAL AND EXPERIMENTAL PSYCHOLOGY
 INVERTEBRATE ZOOLOGY

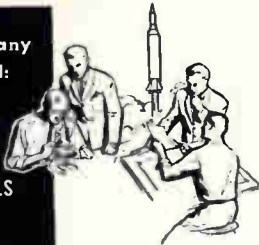

The Entire Span of Today's Scientific, Engineering and Technical Knowledge Encompassed in a Monumental Reference Work Containing 8,500 pages of Text, 800 Index Pages, 7,200 Articles and 9,700 Illustrations.

includes developments so recent they are still major news!

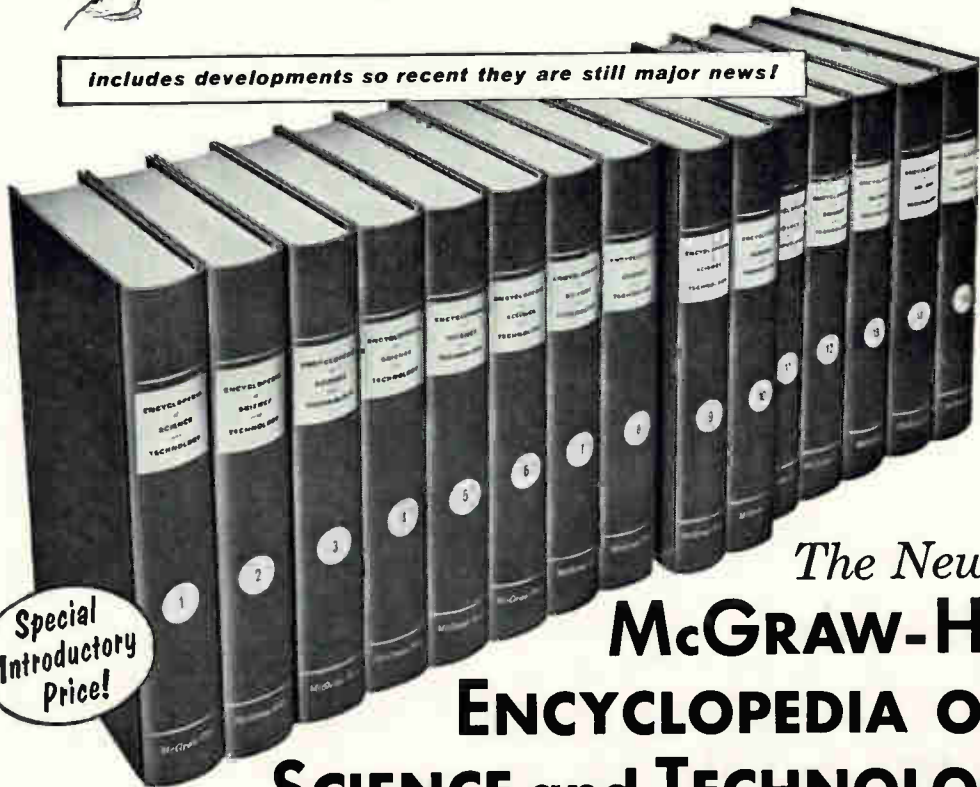

Special Introductory Price!

The New McGRAW-HILL ENCYCLOPEDIA OF SCIENCE and TECHNOLOGY

2,015 Contributors, including Nobel Prize Winners, Respected Leaders of Research and Industry . . . Over 6,000,000 Words — from Concise Articles to Amazingly Comprehensive Treatments . . . 100,000-Entry Index . . . a Wealth of Maps, Charts, Diagrams, Drawings, Photographs . . . many more than in any comparable work of reference.

An epoch-marking publishing venture — providing up-to-date, authoritative information on all the sciences of our day — is being completed. The new McGRAW-HILL ENCYCLOPEDIA OF SCIENCE AND TECHNOLOGY will make readily accessible within its 15 volumes a vast fund of knowledge covering hundreds upon hundreds of subjects dealing with the whole spectrum of the physical sciences, life sciences, earth sciences, and engineering.

This major work fulfills a prime need of the scientist, the engineer, the technician — whether concerned with pure research or practical applications — whether his work is of a design or operating nature — whether he wants to review or keep abreast of the vastly enlarged knowledge of his own field or must bridge the gap between his specialty and unfamiliar areas into which his work leads him.

Unequaled in Timeliness, Clarity, Depth

This unique library makes it possible for you to have as near as your office, laboratory, plant, or home an all-knowing corps of specialists to which you can turn for precise, authoritative information. You can get answers to specific questions raised through daily professional activities or simply explore in a random way the universe of today's scientific, engineering, and technical knowledge — distilled into 7,224 comprehensive articles. Whatever your own field, whatever field your work is related to, you will find it here.

A Work of Unsurpassed Authority

The names of the contributors read like a "Who's Who" of the world's scientific community. All are recognized specialists — in many instances, articles

were written by the very person credited with new discoveries and developments in a given field. Among them are Nobel Prize Winners and others who have distinguished themselves for their original and significant work.

Nothing comparable in breadth of conception, in authority, in usefulness, has ever before been offered in a reference work of this kind. As an all-embracing general reference or a practical working tool, this Encyclopedia belongs in the home and professional library of everyone with an interest in science and engineering. An annual Supplement Volume keeps it always up to date.

By reserving your first edition set now, you will enjoy the benefit of a special money-saving introductory price. Mail the coupon for full details.

MAIL THIS COUPON

McGraw-Hill Book Company, Dept. L-7-15
 327 West 41 Street,
 New York 36, New York

Please send me without obligation your pre-view brochure on the new McGRAW-HILL ENCYCLOPEDIA OF SCIENCE AND TECHNOLOGY in 15 volumes; also details of your introductory price offer and terms of payment. (No salesman will call.)

Name.....

Address.....

City & Zone.....

State.....

L-7-15

Optional Chopper Stabilization



Chopper Stabilization Unit Only,
Installed or in Kit Form . . . \$75

ONLY[®] REGATRON PROGRAMMABLE POWER SUPPLIES HAVE IT!

0.01% or 0.003 V from no load to full load . . . this is the conservative regulation specification for Regatron Programmable Power Supplies equipped with chopper stabilization. And just as important, chopper stabilization assures a higher order of regulation and stability at every output voltage, even at fractions of one volt.

There are other advantages too: Chopper stabilization provides for exceptionally high repeatability of voltage control settings . . . enhances

remote control operation.

And chopper stabilization can be specified at any time. The compact plug-in unit can be installed at the factory as an original accessory, or it can be installed in the field. A complete kit is available for field installations. Instructions and all hardware are included.

Ask your local E/M representative for more information, or write . . .

© REGISTERED U.S. PATENT OFFICE. PATENTS ISSUED AND PENDING.

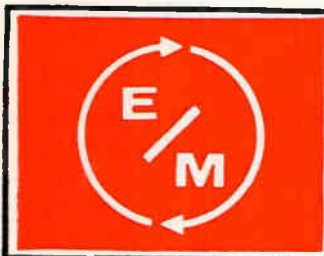

ELECTRONIC

MEASUREMENTS

COMPANY, INCORPORATED
EATONTOWN • NEW JERSEY

*Sylvania introduces
a new concept in*

MICROMINIATURIZATION

• wafer thin! • feather light!

"PANCAKE" TRANSISTORS

*Now...
a new
dimension
in packaging
that offers...*

- * exceptional volumetric efficiency*
- * correct pin-circle geometry for 100-mil
automation grid-system*
- * performance equal to that of prototypes*
- * increased ruggedness*

*SYLVANIA PANCAKE TRANSISTORS
SYL-1986 and SYL-1987 shown actual size*

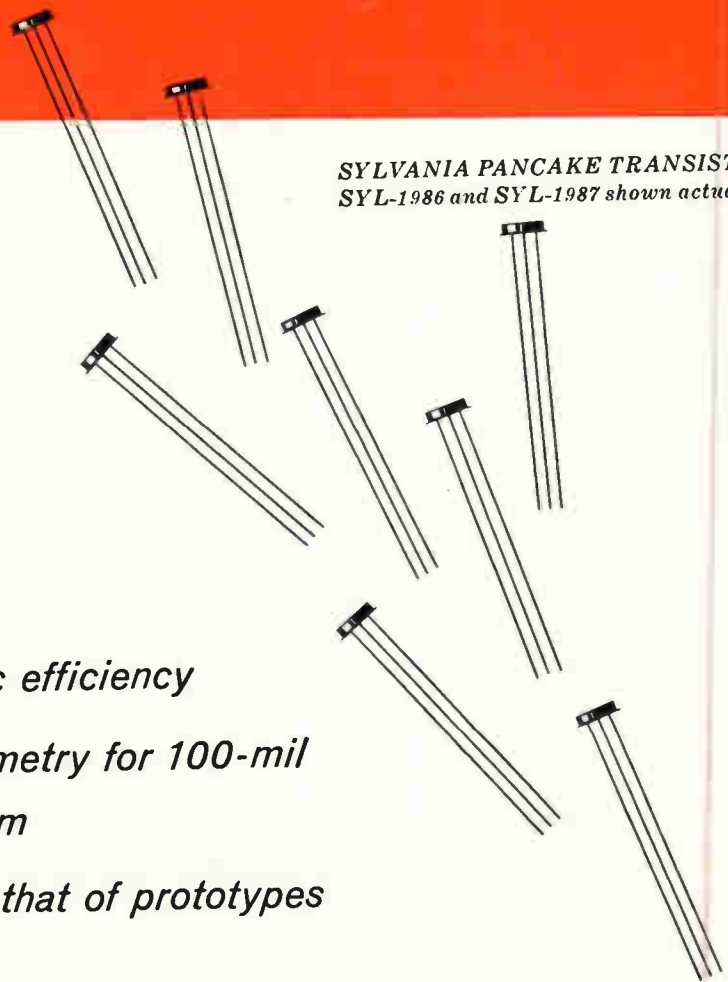

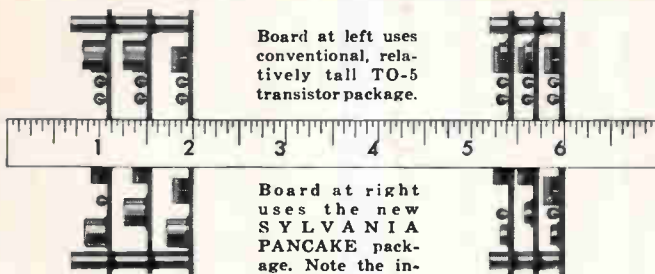
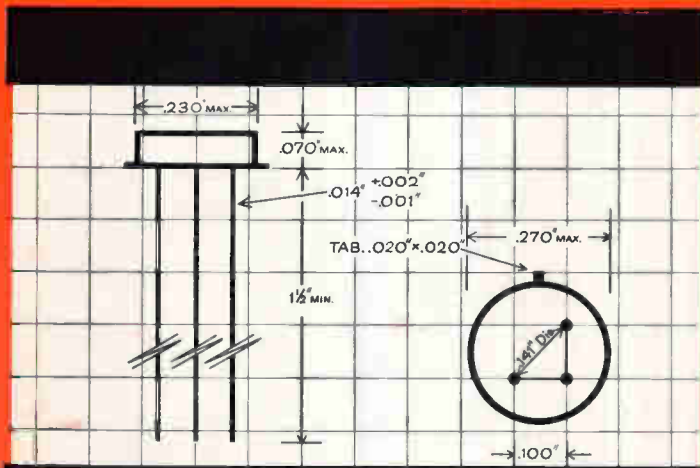

Board at left uses conventional, relatively tall TO-5 transistor package.

Board at right uses the new SYLVANIA PANCAKE package. Note the increased volumetric efficiency.

PANCAKE TRANSISTORS — a SYLVANIA development — herald a new era in the art of designing subminiaturized electronic equipment. PANCAKE TRANSISTORS are 85% smaller, 85% lighter in weight than their larger electrical counterparts. PANCAKE TRANSISTORS are shorter in height than the diameter of conventional ½-watt resistors, flatter than conventional silvered-mica capacitors.

PANCAKE TRANSISTORS are equipped with leads spaced to fit the 100-mil grid-system for automated installation. PANCAKE TRANSISTORS feature clear-glass stress-free matched seals, true chemical bonds that offer exceptional hermetic reliability and strength, excellent resistance to thermal shock. PANCAKE TRANSISTORS withstand atmospheric pressure as high as 200 p.s.i., enabling high-pressure leakage tests for military and industrial quality-assurance.

SYLVANIA launches its PANCAKE program with two germanium alloy switching types: PNP type SYL-1986 (electrically similar to 2N404) and NPN type SYL-1987 (electrically similar to 2N388). Many other types utilizing drift, mesa, and alloy-junction techniques are under development at Sylvania.

FOR CONSULTATION on PANCAKE transistor value to your circuit developments, contact your Sylvania Representative. For technical data, write Semiconductor Division, Sylvania Electric Products Inc., Dept. 198, Woburn, Mass. Sylvania PANCAKE TRANSISTORS also available through Sylvania franchised Semiconductor Distributors.

Tentative data

| MAXIMUM RATINGS AT 25°C | SYL-1986 | SYL-1987 |
|--------------------------------|-----------------|-----------------|
| Collector to Base Voltage | 25V | 25V |
| Collector Current | 100mA | 200mA |
| Power Dissipation | 100mW | 100mW |
| Temperature Range | -55°C to +100°C | -55°C to +100°C |
| Alpha Cutoff Frequency (min.)* | 4Mc | 5Mc |

* $(V_{cb} = 6V, I_e = 1.0mA)$ $(V_{cc} = 6V, I_c = 1.0mA)$

SYLVANIA

Subsidiary of **GENERAL TELEPHONE & ELECTRONICS** 

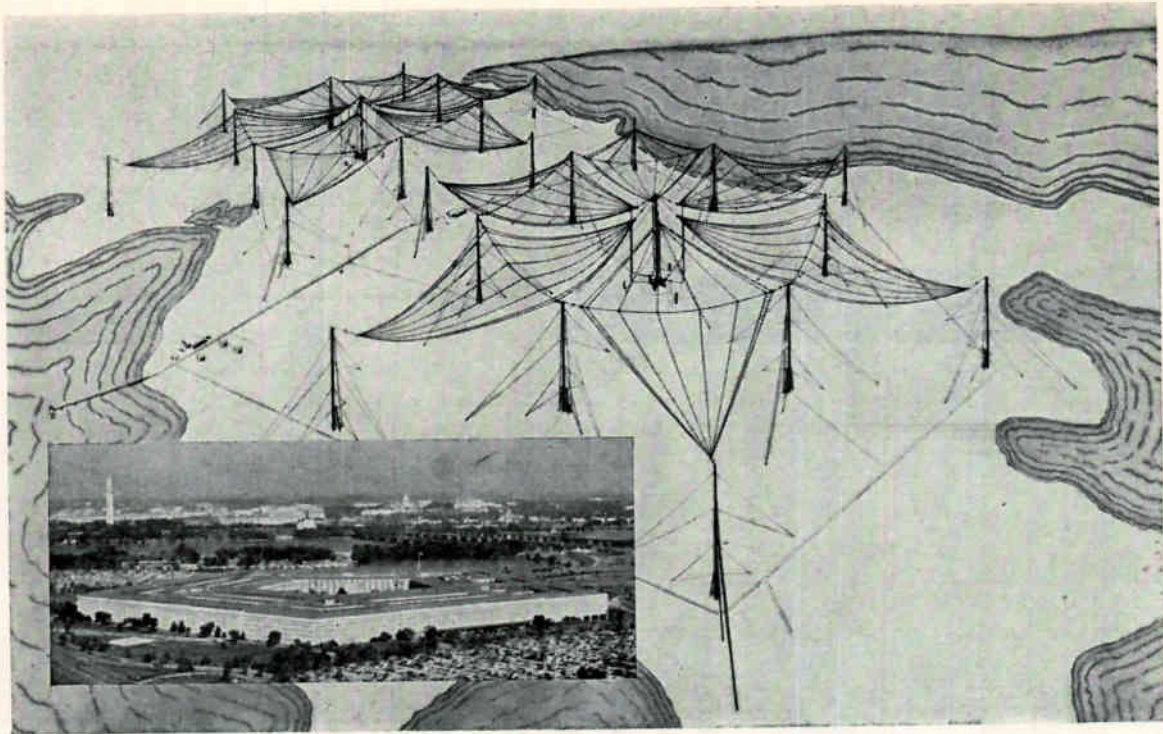

Area of 2 vlf antenna arrays in Cutler, Me., is big enough (715 acres) for 22 Pentagons (inset)

New Vlf to Reach All Polaris Subs

Brute force plus the peculiar fortitude of vlf radio waves in water will give Navy's new Cutler station worldwide underwater range

CUTLER, MAINE—The 3,000-acre peninsula here in Machias Bay has been leveled and shaved clean of its thick pine forest. Now, a new forest—electronic—just as vast as the natural wilds and far higher, is rapidly rising to take its place.

By January, the largest and most powerful vlf radio transmitting system in the world, according to the Navy, will be ready to test. This \$70 million installation is the latest addition to Navy's complex of vlf stations for communicating with surface ships and submerged submarines throughout the world.

Main mission of the Cutler station is to give Polaris submarines in the northern polar waters battle orders in case of attack. The transmitter's enormous power, however, enables it to accomplish more. Radio waves from Cutler will hug the surface of the earth, penetrating the oceans to reach submerged and waiting submarines, as well as surface ships, anywhere in the world.

This long-hoped-for capability has been achieved by brute force

and the fact that very low radio frequencies will penetrate sea water. Water particles do not absorb all of the very slow vibrations—or vlf radio waves—whereas they do absorb higher vibrations. Frequencies from Cutler will range from 14 Kc to 30 Kc. Messages will be c-w.

Nominal output power at Cutler will be 2-million watts. The radiated power will be 1-million watts. (If the radiated power doesn't reach 1 million watts, prime contractor Continental Electronics Manufacturing Co., a division of Ling Altec Electronics Corp. of Dallas, Texas, will, in compliance with a warranty clause in the contract, pay the Navy one half million dollars.)

Most of Navy's vlf stations were constructed prior to, or at the beginning of, World War II. These are located at Annapolis, Md., Balboa, Canal Zone; Pearl Harbor, Hawaii; and a Japanese-owned and operated station in Yoshami, Japan which is used by the U. S. Navy on a lease basis. Built since the war,

is the station at Jim Creek, Wash. This facility, activated in 1952, is rated at 1,000 kw—half the power of the new Cutler facility.

Redundancy in number and locations of transmitters is important due to the enormous size of a vlf station and therefore its vulnerability to nuclear attack. Hardening such facilities for protection would be a tremendously expensive undertaking.

The threat of enemy jamming will be offset by the great signal power, by use of alternate stations, frequencies, and signaling systems in the program.

Prime contractor Continental's responsibilities include erection of all construction as well as design, manufacture, installation and test of the transmitter. Total dollar amount for the work will be \$40 million to \$45 million, the firm says.

Responsibility for design of the antenna and ground system was subcontracted to Developmental Engineering Corp. (DECO), Leesburg, Va. The full antenna and

ground system were designed, developed and then modeled on a scale ratio of 100 to 1. Complete electrical performance data were obtained from the antenna model—such as radiation resistance, effective electrical height, antenna Q, antenna resonant frequency, antenna tophat capacitance, charge distribution from the individual antenna conductors, the E and H field distribution under the tophat, and the distribution of ground currents throughout the ground system.

Finding an area large enough and with the special conditions required for vlf transmission is no mean feat. Vlf transmitters require gigantic antenna arrays and miles of wire underground, preferably in highly conductive earth. The peninsula filled the bill—in spite of the fact that it took a year to get rid of the pine trees—because of its large unpopulated area and the fact that it is surrounded by water on three sides.

When completed, the antenna will look like two giant six-pointed stars. From point to point, the distance is 6,200 ft. Each half of the antenna will cover an area equal to 11 Pentagon buildings.

The antenna array will be supported by 26 towers—24 of which are already up. In each half of the array there will be a central tower, 980 ft high; six intermediate towers, each 875 ft high; and six outer towers, each 800 ft high.

Midway between the two halves of the antenna will be the transmitter building, a structure with 25,000 sq ft of floor space. At the base of each central tower will be a smaller building called the helix house which will contain the antenna tuning and coupling components and de-icing switch gear.

The transmitter has four final amplifier units, of 500 kw each. The output of all four will be combined for full output. Any combination of the four units and the two halves of the antenna is possible. This will enable full flexibility of output and maximum ease of maintenance. Transfer of power from the amplifiers to the helix houses will be by way of large coaxial cables in tunnels.

According to the Bureau of Ships, who in cooperation with the Bureau of Yards and Docks are supervising the program, each an-

tenna panel will be counter-weighted at all supporting towers except the center one. These weights will roll on stub towers beside the main towers. The maximum tension on each halyard, at peak wind load, will be 110,000 lb.

Electric hoists at each tower make it possible to lower and raise each panel individually for maintenance. The panels can be switched onto a de-icing circuit capable of freeing the wires of 3-in. radial ice. Diesel engine-driven generators will furnish 11,000 kilowatts for operation of the station, including the transmitter, station lighting and power, electric hoists, tower lighting, and the de-icing circuits.

A large and elaborate system of buried ground wires will collect the r-f displacement currents and return them to the helix houses. Since earth is a relatively poor

electrical conductor, and sea water is a very good conductor, the ground system will consist of buried copper wires, radiating from the array centers to the sea water surrounding the peninsula.

According to DECO, a ½-in. diameter shore bus is placed around the periphery of the peninsula and serves as a termination for the many buried No. 6 copper wire radials used in the ground system. Approximately 250 sea terminals connect from the shore bus to the sea water and are designed to be in contact with the sea water over the complete tidal ranges. Over 2,000 miles of No. 6 copper wire will be used with as many as six radials per degree in some areas.

If testing takes only two months, as planned, the Cutler station should be operational by March, 1961.

Preparing Report On Contract Rights

WASHINGTON—A House Small Business Subcommittee is working on a set of recommendations which it hopes will resolve the thorny question of proprietary rights involved in government contracts. The report is expected in about four weeks.

An informed source said both industry and the defense department agree that a solution of the problem is possible if both sides give a little, and that the mood on both sides is conciliatory.

The subcommittee contemplates a half dozen recommendations aimed at protecting the legitimate business secrets of small business

while permitting the Defense Department to get as much information as it actually has to have to seek bids and let contracts.

One provision would be to set up machinery giving the company its "day in court" in a dispute over proprietary rights.

Defense Dept. "standards" say the department is entitled to get all the technical information it needs to maintain equipment it buys or to let production contracts to other companies. In the latter case, of course, the department has to buy the technical information.

Businessmen complain that the standards are too broad. They say the department in effect tries to get information of a trade secret nature without actually negotiating for proprietary rights.

The department replies that the standards are only a guide, that the actual contract is the effective document, and that no more information can be required under the standards than the contract specifies.

Under the reform contemplated by the subcommittee, if a company feels the department is demanding information which actually involves proprietary rights some sort of machinery will be provided to decide the issue.

Directing Weapon



New Sperry system for Navy's surface-to-air missiles evaluates targets and fires appropriate missile batteries

Raising the Ante for Electronics Firms

*Competition for acquisitions and rising prices benefit selling companies.
Acquisition seekers develop more intensive finding techniques*

By EDWARD DE JONGH,
Market Research Editor

IT IS GETTING HARDER and harder to acquire an electronics firm at any price, said Warren B. Riley, partner of William E. Hill & Co., recently upon returning from a long trip devoted to interviewing electronics executives on acquisition problems. Riley is in charge of electronics industry consulting for his firm. He has aided in many acquisition searches and evaluations.

Behind the intense competition for acquisitions is widespread interest in the electronics industry as a profitable investment for both individuals and corporations. In the past 10 years electronics sales have been increasing at greater than 10 percent a year, as against 3 to 4 percent for all business.

Not only are electronics firms seeking to acquire other firms in the industry, but also members of other industries are seeking to better their prospects through acquisition of an electronics firm.

Investment bankers, private investors, conventional venture capital groups and small-business investment companies compete with acquisition-seekers for the same electronics firms. The financial groups are not seeking to merge a firm or purchase its assets. However, a firm sold by a stock issue or tied up with a venture capital loan is at least temporarily removed from the list of acquisition prospects.

So-called Ivy League investment bankers, big name firms, which only a few years ago used to turn up their noses at all but the largest electronics firms, are cultivating small and medium-size companies. Private placements for a firm with good prospects can be arranged in a few hours. There have even been instances where firms with a minus net worth position have been able to get financial backing, Riley says.

Prices obtainable for electronics firms are at an all-time high, 30 to

50 times earnings for popular firms, as compared with 15 to 20 times earnings a few years ago.

Electronics industry companies have a competitive advantage over firms from outside the industry when acquisition is based on exchange of stock. Stock of the acquiring electronics firm, may be valued at 20-50 times earnings, which is closer to the times-earnings ratio of the organization to be acquired. This situation contrasts with that of an outside firm whose stock may be selling at 10 to 15 times earnings, and who may have to give up a substantial interest in its own business to acquire an electronics company.

Companies that rarely if ever received acquisition offers in past years are now being courted as stiff competition and high prices has resulted in buyers lowering their sights. One aviation company told ELECTRONICS, "We look for electronics firms that have good technical abilities, but which may have run into difficulties through mis-

takes or some mismanagement".

The tough competition today for electronics acquisitions has required acquisition-seeking firms to develop new and more intensive methods of making acquisitions.

Several years ago it was common for a firm to operate with a casual approach, letting friends and contacts in the industry know of their acquisition interest. This approach no longer works. Organization and planning are necessary to assure success. The firms that have been most successful in their acquisition efforts recommend an acquisition program along the following lines:

(1) Set up an acquisition program aimed at firms in special fields of electronics. Otherwise a company wastes too much time in blind alleys. Also, the acquiring firm is able to operate more efficiently through knowledge and contacts it develops in its fields of special interest. Telex, Inc., Gertsch Products and Benson-Lehner all told Riley this is a key

Anechoic Room Tests Antenna Design



Radio wave absorbing lining in Republic Aviation's 40-ft anechoic chamber minimizes interference in advanced antenna performance tests

point in a successful acquisition program.

(2) Organize a professional acquisition staff with both technical and financial skills and a company vice president in charge who can speak with authority. Example of such an organization is Textron Electronics, headed by John Bishop, executive vice president who has both EE and MBA degrees.

(3) Make full use of publicity to get your name and interests around in the industry, give talks before industry groups. Seek mentions of your firm in industry and general business publications.

(4) Create a network of people for developing as many acquisition leads as possible. Use executives of affiliate companies, directors, banks and any others that can be of help to you. It's a big country and big industry, and you need all the help you can get. Some larger firms have set up regional representatives for their acquisition departments to do a more effective job.

(5) Before making a formal approach to any company, work out a tentative program to show the acquisition prospect why the proposed combination will be worth more than the individual parts. Most worthwhile companies do not aim to sell out. They have to be convinced of benefits such as new markets, higher sales and profits, improved technical operations, better distribution systems and other values.

(6) Recognize the natural fears of the head of a company that may be acquired. In the negotiation phase assure him there will be a minimum of control and a maximum of autonomy after the merger. Some companies even consider things like promising the president of the firm to be acquired that he won't have to have his expense accounts approved after selling out.

(7) Avoid over studying the situation. While a competent appraisal of technical skills, management ability and market position is vital, too many accountants and too lengthy an examination of the books can kill the deal. One way of controlling the risk of important facts being overlooked is to defer part of the payment for the firm, the deferred payment to be pegged to future earnings, says Riley.

NEW MINIATURE RF FILTERS

$\frac{1}{2}$ Space ..
 $\frac{1}{2}$ Weight ..

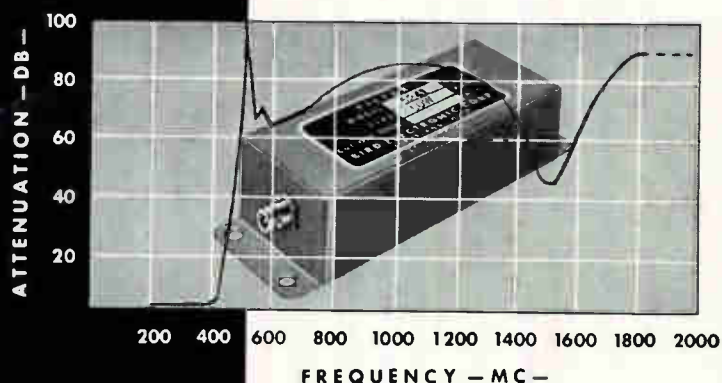

Model 524

DESIGNED TO REJECT INTERFERENCE IN "L" BAND

When size and weight are important factors in your rf filter selection, turn to Bird Electronic for your source of supply. Our engineers will design an rf filter to serve your exact requirements with particular attention to component density, accuracy, ease of application and long-life performance.

Our physical facilities to produce and deliver quantity orders dependably can be relied upon to meet your production schedules.

SPECIFICATIONS

Model 524I

SIZE: 4- $\frac{3}{4}$ " x $\frac{3}{4}$ " x 1- $\frac{1}{4}$ "

WEIGHT: 5 ounces

PASS BAND: 225 to 400 mc

CUT-OFF FREQUENCY: 400 mc

POWER RATING: 50 watts

RF INPUT IMPEDANCE: 50-ohm nominal

ATTENUATION: Less than $\frac{1}{2}$ in pass band; 80 db in stop band

VSWR: Insertion loss and VSWR are very low in pass band

CONNECTORS: Most miniature types



BIRD

ELECTRONIC CORP.

CHurchill 8-1200
30303 Aurora Road, Cleveland 39, Ohio
Western Representative:
VAN GROOS COMPANY, Woodland Hills, Calif.

Unmatched for MIL-R-11 APPLICATIONS

Today's best looking resistors are every bit as good as they look. Going beyond MIL-R-11 requirements, Coldite 70+ Resistors give important dividends in terms of load life, moisture resistance and other important characteristics.

Unmatched for EASY SOLDERING

Thanks to an exclusive extra solder coating applied after the usual tin dipping, Coldite 70+ Resistors solder readily by any method—dip or iron. Leads stay tarnish-free and solderable even after months in storage.



GET THEM IN 24 HOURS OR LESS

... from These Leading Distributors

BALTIMORE, MD.
Kann-Ellert Electronics, Inc.

BATTLE CREEK, MICH.
Electronic Supply Corp.

BINGHAMTON, N. Y.
Morris Distributing Co., Inc.

BIRMINGHAM, ALA.
MG Electrical Supply Co.

BOSTON, MASS.
Cramer Electronics, Inc.
Sager Electrical Supply

BROOKLYN, N. Y.
Electrical Equipment Corp.

CLEVELAND, OHIO
Pioneer Electronic Supply Co.

DALLAS, TEXAS
Tekko

DAYTON, OHIO
Srepco, Inc.

DENVER, COLO.
Denver Electronics Supply Co.

GLENDALE, CALIF.
R. V. Weatherford Co.

INDIANAPOLIS, IND.
Radio Distributing Co.

KANSAS CITY, MO.
Burstein-Applebee Co.

MELBOURNE, FLA.
Electronic Supply

MIAMI, FLA.
Electronic Supply

NEW YORK, N. Y.
Electronic Center, Inc.
Harvey Radio Co.
Milo Electronics Corp.
Sun Radio & Electronics Co., Inc.

PHILADELPHIA, PA.
Almo Radio Co.

ROANOKE, VA.
Peoples Radio & TV Supply Co.

SAN DIEGO, CALIF.
Radio Parts Co.

SCRANTON, PA.
Fred P. Pursell

SEATTLE, WASH.
C & G Electronics Co.

ST. LOUIS, MO.
Interstate Supply Co.

SYRACUSE, N. Y.
Morris Electronics of Syracuse, Inc.

TACOMA, WASH.
C & G Radio Supply Co.

WASHINGTON, D. C.
Electronic Industrial Sales, Inc.

WATERBURY, CONN.
Bond Radio Supply Co. Inc.

WEST PALM BEACH, FLA.
Goddard Distributors, Inc.

WICHITA, KANS.
Interstate Electronic Supply Corp.

WILBRAHAM, MASS.
Industrial Components Corp.

WINSTON-SALEM, N. C.
Dalton-Hege Radio Supply

... and G-C / STACKPOLE, TOO!—Attractively packaged by G-C Electronics for service replacement uses, Coldite 70+ Resistors are also available through over 800 G-C distributors.



STACKPOLE

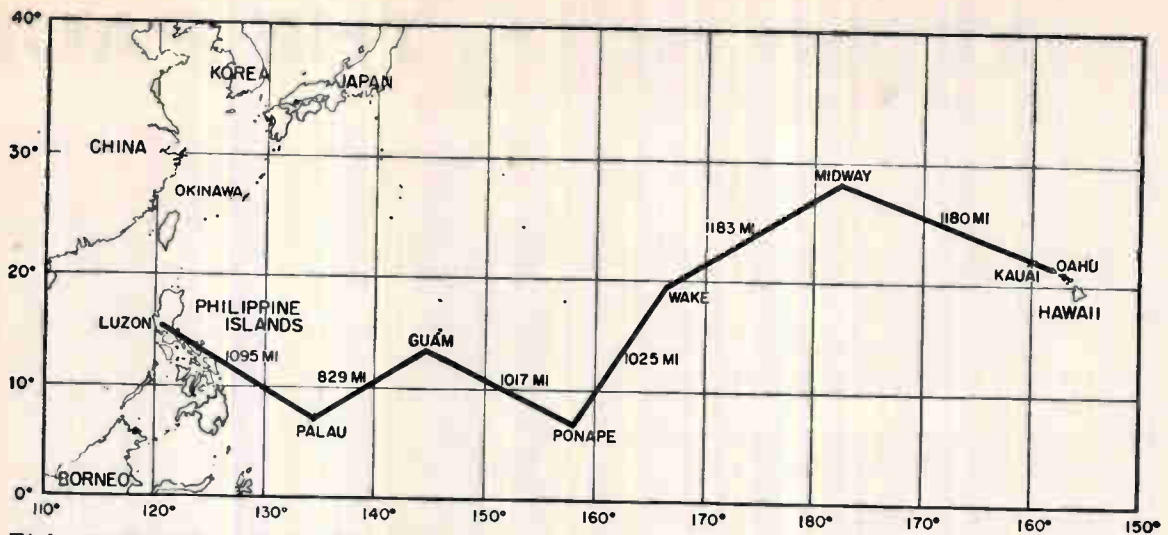

Eight stations from Oahu, Hawaii to Luzon, Philippines relay Army communications 6,500 mi

Pacific Scatter System Completed

Army's new ionospheric and tropospheric scatter communications system links Hawaii to the Philippines. Further extension is underway

A RECENTLY COMPLETED 6,500-mi. communications system, making use of ionospheric and tropospheric scatter propagation, now assures the armed forces of reliable communications between this country and the Far East.

The system, completed by the Army and Page Communications Engineers, Inc., a subsidiary of Northrop, permits reliable communications between transmitters and receivers 600 to 1,300 miles apart.

The Pacific Scatter Communication System is one of the largest of its kind in the world, Army says. It has eight interconnected stations. The stations, six of which are operated by the Army and two by the Navy, extend from Oahu, Hawaii, via Kauai, Midway, Wake, Ponape, Guam and Palau to Luzon in the Philippines. Local communication centers at several of these relay points provide entry to the system for military activities in their areas.

The system is managed by the

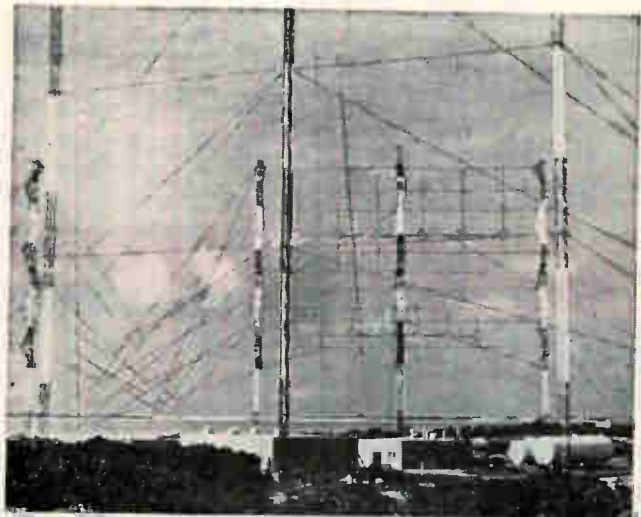

Antenna arrays (400-ft and 200-ft high) composed of stacked dual frequency corner reflectors on Wake Island are part of Army's new scatter system

Army Signal Corps as part of the world-wide Strategic Army Communications Network (STARCOM) and will be part of the Defense Communication System.

Supplementing the basic ionoscatter channels between the system's stations are other types and means of communication. Local communication centers at Midway, Wake, Guam and Luzon are linked to the ionoscatter stations by radio and cable facilities. The communications center at Oahu is connected to the station at Kauai, Hawaii by troposcatter communications.

Between all adjacent Pacific stations, high capacity communication

channels which can handle separate teletypewriter messages up to 100 words a minute are continuously maintained.

Each station has a duplicate set of units in continuous operation with automatic devices which switch alternate or reserve equipment and circuits to reduce to a minimum the possibility of human error.

Extension of the Pacific system to other points in the Far East is underway.

More than 100 industrial firms have contributed to the system so far. RCA, Army says, supplied 29 high-power transmitters.



ROYAL COAXIAL CABLES*

Dependable performance is the greatest asset of Royal coaxial and multi-conductor cables. They are made to exacting standards for exacting applications. Whatever your requirements . . . for electronic equipment, the military, or community TV applications, Royal can supply stock or special constructions with built-in satisfaction.

Ask for Bulletin 4C-3-L (stock constructions) or let us quote on your needs . . . representatives coast to coast.



ROYAL ELECTRIC CORPORATION
301 Saratoga Avenue
PAWTUCKET • RHODE ISLAND

In Canada: Royal Electric Company (Quebec) Ltd.,
Pointe-Claire, Quebec

ROYAL
ELECTRIC 
... an associate of



Naval students study a function of computer they are to maintain

Training Computer Customers

Manufacturers may use digital trainers to teach customers to maintain special computers

By NEAL HESS

Research Scientist
Missile Systems Division
Lockheed Aircraft Corp.
Sunnyvale, Calif.

SIMPLE TRAINING AIDS—similar to the four plug-in types developed by Lockheed to teach fundamentals of the Polaris missile system and its computer to naval personnel—may be used by manufacturers to train customers to maintain special-purpose digital computers.

The naval students were first and second class electronics technicians and missilemen who would be responsible for computers on board naval vessels.

Although lectures would give the student an understanding of digital techniques, laboratory exercises were also felt to be essential. Use of a complete computer was not feasible due to the cost, and not practical for showing elementary techniques.

Four plug-in type training aids were built so the students could assemble a simple computer using the basic logic elements of the computer they were to maintain.

The training aids were designed so the student would learn basic machine timing, arithmetic and decision-making procedures by using the flip-flops, AND gates, OR gates and inverters which are the basic elements of the computer. Using these elements and the plug-in trainer, the students will be able to simulate most commands of the operational computer in its patch-board counterpart.

Each plug-in unit has capacity for six flip-flops, several two, three and five legged AND gates and OR gates, and inverters. The inputs and outputs from each basic element are brought to a plug on the panel of the trainer. The output of each flip-flop drives a neon bulb on the trainer panel. The trainer may be operated in a single or continuous clock mode of operation.

The students work on each trainer and are able to mechanize counters, shift registers and circulating registers. By observing the neon bulbs, the student can determine whether his mechanization was correct. Understanding of

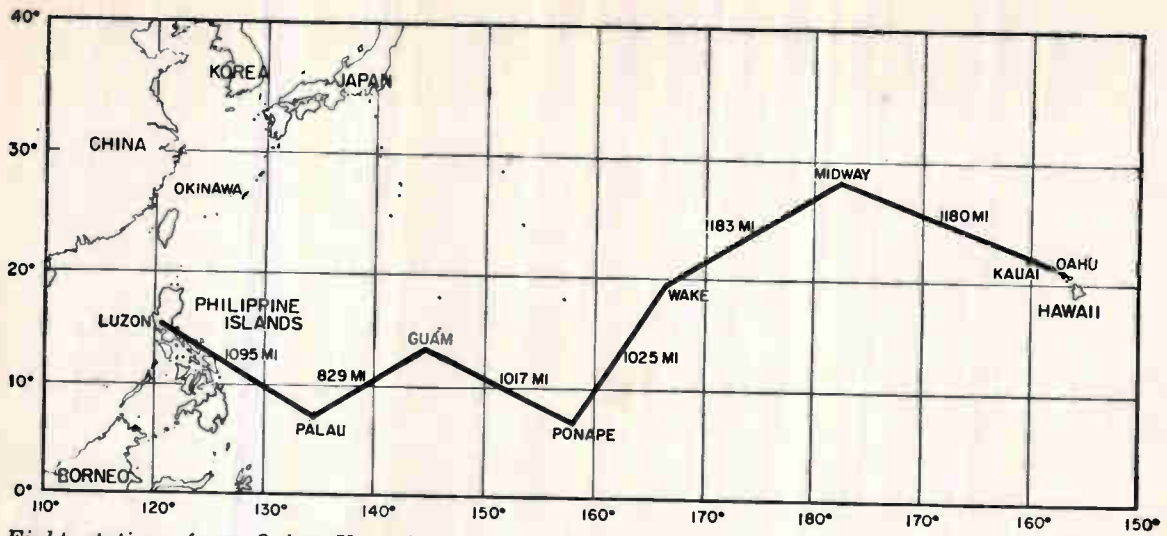

Eight stations from Oahu, Hawaii to Luzon, Philippines relay Army communications 6,500 mi

Pacific Scatter System Completed

Army's new ionospheric and tropospheric scatter communications system links Hawaii to the Philippines. Further extension is underway

A RECENTLY COMPLETED 6,500-mi. communications system, making use of ionospheric and tropospheric scatter propagation, now assures the armed forces of reliable communications between this country and the Far East.

The system, completed by the Army and Page Communications Engineers, Inc., a subsidiary of Northrop, permits reliable communications between transmitters and receivers 600 to 1,300 miles apart.

The Pacific Scatter Communication System is one of the largest of its kind in the world, Army says. It has eight interconnected stations. The stations, six of which are operated by the Army and two by the Navy, extend from Oahu, Hawaii, via Kauai, Midway, Wake, Ponape, Guam and Palau to Luzon in the Philippines. Local communication centers at several of these relay points provide entry to the system for military activities in their areas.

The system is managed by the

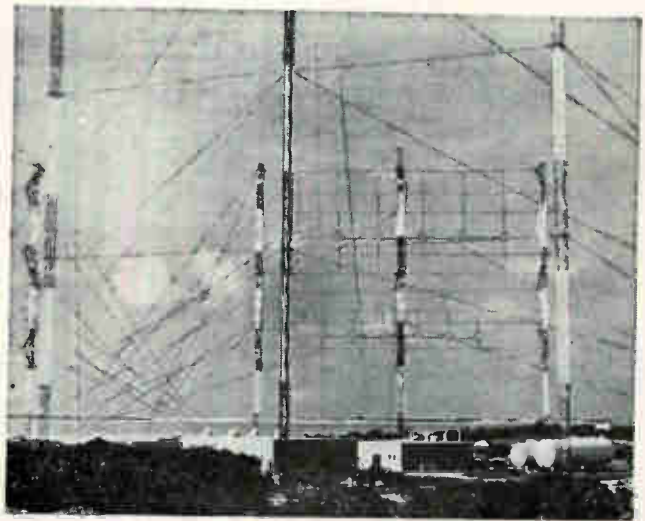

Antenna arrays (400-ft and 200-ft high) composed of stacked dual frequency corner reflectors on Wake Island are part of Army's new scatter system

Army Signal Corps as part of the world-wide Strategic Army Communications Network (STARCOM) and will be part of the Defense Communication System.

Supplementing the basic ionoscatter channels between the system's stations are other types and means of communication. Local communication centers at Midway, Wake, Guam and Luzon are linked to the ionoscatter stations by radio and cable facilities. The communications center at Oahu is connected to the station at Kauai, Hawaii by troposcatter communications.

Between all adjacent Pacific stations, high capacity communication

channels which can handle separate teletypewriter messages up to 100 words a minute are continuously maintained.

Each station has a duplicate set of units in continuous operation with automatic devices which switch alternate or reserve equipment and circuits to reduce to a minimum the possibility of human error.

Extension of the Pacific system to other points in the Far East is underway.

More than 100 industrial firms have contributed to the system so far. RCA, Army says, supplied 29 high-power transmitters.

POTTER SETS THE PACE

WITH...THE ONLY PERFORATED STRIP READER IN ITS CLASS

A single speed, unidirectional, photo-electric, perforated strip reader, the Potter 909 is

OBEDIENT...stops on the stop character at speeds up to 600 characters per second and it can be stepped one character at a time where synchronous readout is needed.

VERSATILE...output is a timed, shaped pulse for input to a computer, high speed printer, or control system.

...parallel NPN, PNP amplifier output circuit supplies up to 40 ma to loads returned to any bias voltage.

FAST...operates at speeds up to 1000 characters per second with complete dependability.

SENSITIVE...a broad image light source eliminates the effects of filament variations in the lamp.

COMPACT...fits into a 10½ in. case—with its own power supply and amplifiers.

The Potter 909 perforated tape reader includes a tape transport system, tape reading system, power system, and control system. It is designed for panel, rack, or cabinet mounting. Accessories available include tape spoolers and tape bin, cooling fan, mounting adapters and extension frames.

WRITE FOR DETAILED SPECS AND LATEST PRICE AND DELIVERY INFORMATION

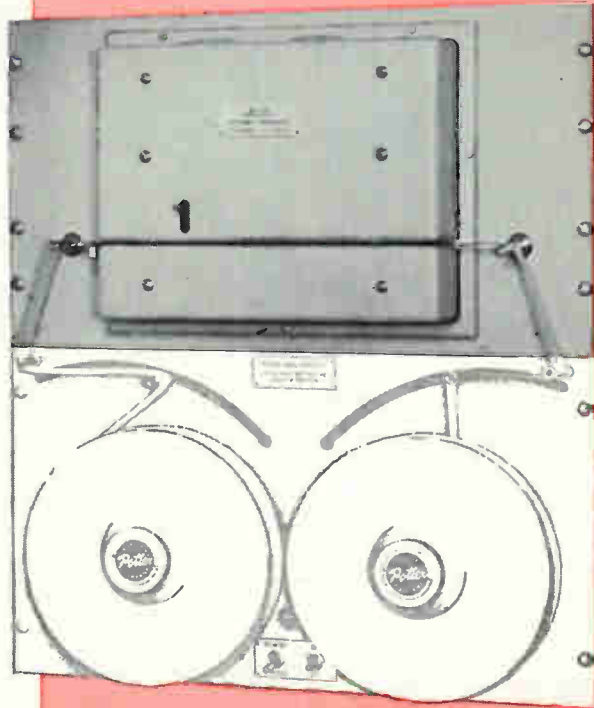

MODEL 909 PERFORATED STRIP READER WITH MODEL 3299 SPOOLER

WITH...THE MOST TAPE HANDLER FOR YOUR MONEY

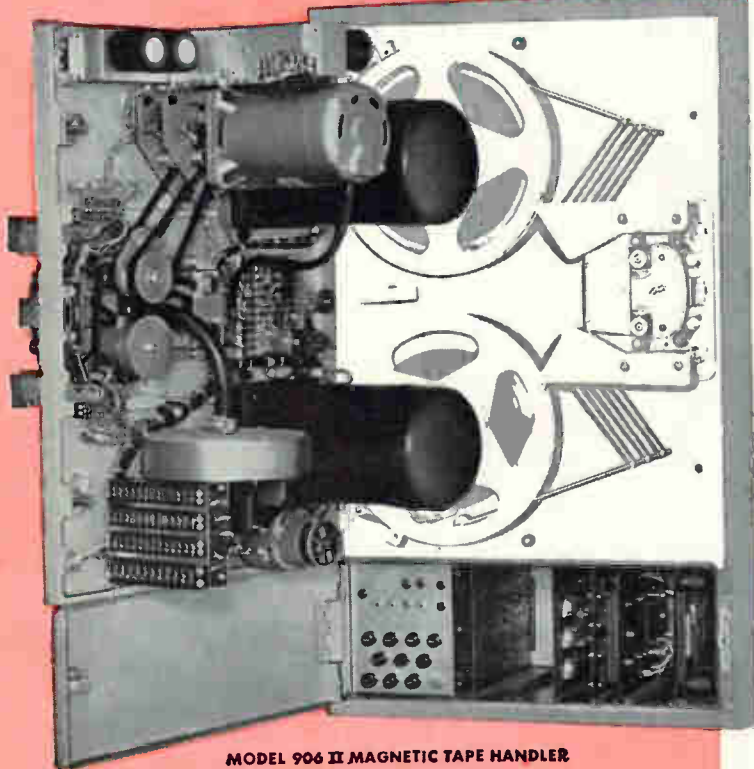

MODEL 906 II MAGNETIC TAPE HANDLER

The Potter 906 II is the high speed digital magnetic tape handler that gives you higher performance, greater reliability, and lower cost than any other tape handler on the market—bar none.

Only with the 906 II do you get such advantages as:

...full forward reverse cycling at 120 ips with 1 inch tape.

...low skew tape guide that permits conventional recording at 400 bpi density.

...1500 bpi recording densities which are made possible by using the 906 II with the Potter Contiguous Double Transition System. 450,000 8-bit characters per second can be recorded on 1 inch tape.

...transistorized control of all functions that simplifies computer design.

...simplified packaging for easy maintenance.

...a price—far below other makes—that proves the economy of superior design.

Compare them any way you like—spec for spec, dollar for dollar, space for space—and you'll agree that the high performance, low cost Potter 906 II is the most tape transport at any price.

WRITE FOR DETAILED SPECS AND LATEST PRICE AND DELIVERY INFORMATION

POTTER INSTRUMENT CO., INC.

Potter

Sunnyside Boulevard, Plainview, L. I., N.Y.
OVERbrook 1-3200

CIRCLE 40 ON READER SERVICE CARD

Hearing Aid Sales Hit \$70 Million

Assembly worker at Dictograph Products' Acousticon division holds the chassis into which miniature hearing aid components will be fitted

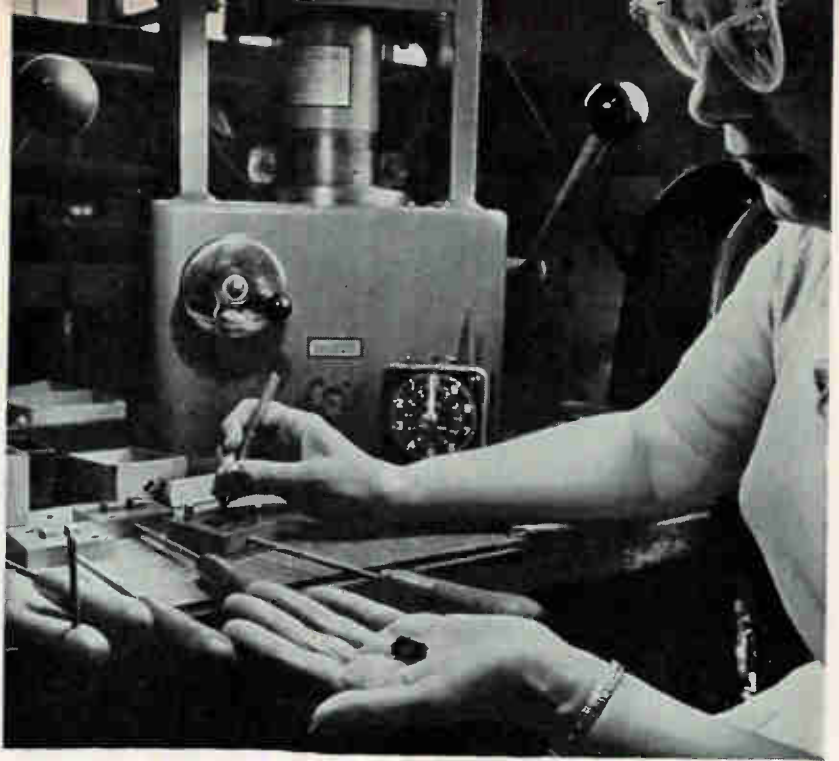

"SMALL COMPONENTS and big business" are the words a hearing aid manufacturer used this week in describing a field whose retail sales are estimated at \$70 million this year. (For factory sales figures see **ELECTRONICS**, p 28, Mar. 18.)

Although exact figures are usually kept under tight wraps by the 15 to 20 main hearing aid manufacturers, figures from the Hearing Aid Industry Conference point to an even high volume next year.

The average price of a hearing aid is considered to be about \$250, with present sales running 275,000 to 350,000 units a year. The HAIC estimates there are presently about 2½ million hearing aid users in the U. S. Individual manufacturers say that 8½ to 9 million more people should be using them.

Growth of the hearing aid business may be seen in the formation of a special panel to collect market figures, sales information and other statistics. This group was established in New York last May.

Sales aspects of the hearing aid business are among the most complicated in consumer electronics. "Our main problem is consumer vanity," a spokesman for Telex tells **ELECTRONICS**.

"A hearing aid is not the sort of thing that can be sold over the counter in the ordinary retail store. The prosthetic nature of the device means the appearance of the establishment, the type of salesman and

the means of advertising and other consumer contact must be delicately handled."

It's estimated about one-half of a hearing aid's price is used to pay for sales. Most companies sell their equipment through franchised dealers who are trained in fitting and hearing problems.

Another aspect that consumer vanity introduces into the manufacturer's problem is the intense interest in miniaturization. One company, pointing out that hearing aids were the first consumer devices to use transistors, says this emphasis on small size can work to the detriment of the user and the manufacturer.

"Manufacturers could easily come up with equipment that would improve hearing even beyond what is now possible with a good hearing aid, but the customer won't buy anything but the smallest unit he can find. Obviously, something has to be given up for the sake of size."

One example of miniaturization accomplished may be seen in a new Sonotone hearing aid. It contains 153 parts in slightly less than ½ cu in. space. It is concealed behind the ear or in the frame of a set of spectacles.

Also using the spectacle mounting is Telex's new unit which has in the frames a transmitter able to "broadcast" its signal to the wearer's ear receiver with no wire or connecting tube. Company engi-

neers say they hope to increase the range of the tiny transmitter to allow further separation between signal pickup and the earpiece.

Another area being probed is the binaural hearing aid. In many cases, loss of hearing in both ears would require double correction in much the same way eyeglasses are worn over both eyes. To date, however, most hearing aids are used in only one ear.

Manufacturers say there is no technical difficulty in producing binaural equipment, but add that the price factor must be solved before full-scale binaural sales efforts can be initiated.

Latest reports from Raytheon (which produces more than half a dozen special transistors for hearing aids) indicate that since 1954 practically no tube models of hearing aids have been made. There is now some demand for replacement tubes, but most users have switched to transistors.

Manufacturers speaking with **ELECTRONICS** are quick to point out their business has had an unbroken yearly rise in sales from its start.

Industry estimates are that this year's sales volume has risen 40 percent over the equivalent figure five years ago. Future growth figures vary, with some manufacturers predicting a 40 percent rise in 10 years, and others forecasting some 15 to 20 percent rise in 1960.



ROYAL COAXIAL CABLES*

Dependable performance is the greatest asset of Royal coaxial and multi-conductor cables. They are made to exacting standards for exacting applications. Whatever your requirements . . . for electronic equipment, the military, or community TV applications, Royal can supply stock or special constructions with built-in satisfaction.

Ask for Bulletin 4C-3-L (stock constructions) or let us quote on your needs . . . representatives coast to coast.



ROYAL ELECTRIC CORPORATION
301 Saratoga Avenue
PAWTUCKET • RHODE ISLAND

In Canada: Royal Electric Company (Quebec) Ltd.,
Pointe-Claire, Quebec

ROYAL
ELECTRIC
... an associate of **ITT**



Naval students study a function of computer they are to maintain

Training Computer Customers

Manufacturers may use digital trainers to teach customers to maintain special computers

By NEAL HESS

Research Scientist
Missile Systems Division
Lockheed Aircraft Corp.
Sunnyvale, Calif.

SIMPLE TRAINING AIDS—similar to the four plug-in types developed by Lockheed to teach fundamentals of the Polaris missile system and its computer to naval personnel—may be used by manufacturers to train customers to maintain special-purpose digital computers.

The naval students were first and second class electronics technicians and missilemen who would be responsible for computers on board naval vessels.

Although lectures would give the student an understanding of digital techniques, laboratory exercises were also felt to be essential. Use of a complete computer was not feasible due to the cost, and not practical for showing elementary techniques.

Four plug-in type training aids were built so the students could assemble a simple computer using the basic logic elements of the computer they were to maintain.

The training aids were designed so the student would learn basic machine timing, arithmetic and decision-making procedures by using the flip-flops, AND gates, OR gates and inverters which are the basic elements of the computer. Using these elements and the plug-in trainer, the students will be able to simulate most commands of the operational computer in its patch-board counterpart.

Each plug-in unit has capacity for six flip-flops, several two, three and five legged AND gates and OR gates, and inverters. The inputs and outputs from each basic element are brought to a plug on the panel of the trainer. The output of each flip-flop drives a neon bulb on the trainer panel. The trainer may be operated in a single or continuous clock mode of operation.

The students work on each trainer and are able to mechanize counters, shift registers and circulating registers. By observing the neon bulbs, the student can determine whether his mechanization was correct. Understanding of

digital techniques requires a knowledge of binary counting and an understanding of gating by clock pulses.

Both of these may be comprehended by the student when he mechanizes and builds a basic 0-7, return-to-0 counter. Three flip-flops designated T_1 , T_2 , and T_3 , (to follow actual computer nomenclature), are used and the logic given to the student is as follows: $1T_1 = \bar{T}_1$; $0T_1 = T_1$; $1T_2 = \bar{T}_2 T_1$; $0T_2 = T_2 T_1$; $1T_3 = \bar{T}_3 T_2 T_1$; and $0T_3 = T_3 T_2 T_1$.

The student mechanizes the logic and sees the result of his mechanization in the single-clock mode of operation. Observation of the neon lights changing state appears to give him the basic appreciation of digital counting and gating. The student broadens his confidence by building a 0-23, return-to-zero

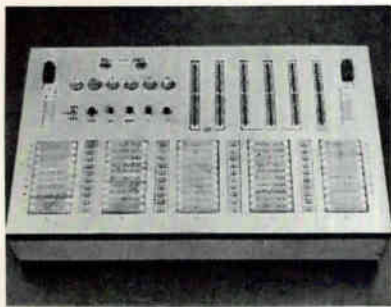

Plug-in type training aid

counter, which is used in the actual computer he will be maintaining.

In a second laboratory period, the basic trainer may be connected to form a shift register. Connecting the output of the shift register to the flip-flop for the most significant bit forms a circulating register. Four units are interconnected to produce a 24-bit circulating register like the one used in the actual computer.

The third laboratory period enables the student to understand the basic addition-subtraction commands including use of signs. The class is divided into four groups for this session. One group of students produces a six flip-flop circulating register; the second group a six flip-flop shift register; the third group produces a zero-to-six counter; and the fourth group the control logic. The four circuits can then be integrated as a working adder-subtractor unit.

Important facts to know about laminated plastics

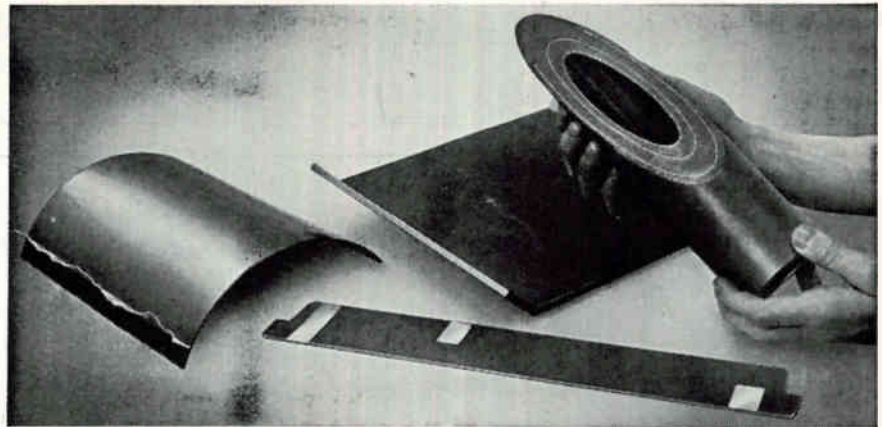

A few Taylor composite laminates (left to right): copper-clad section; sandwiched copper component; Taylorite vulcanized fibre-clad part; laminated tube, copper inserts.

Composite Laminates Open Up New Design Opportunities

While the great variety of commercially available laminated plastics satisfy most electrical and mechanical requirements, there are applications that can benefit from the combination of properties provided by composite laminates. Recent advances in bonding techniques have made it possible to bond virtually any compatible material with a laminate. These can be supplied as clad or as sandwiched materials. And they can be molded into many shapes to fit design requirements. Taylor is presently supplying to order the following composite laminates:

- **Copper and laminated plastics.** Clad for printed circuits and formed shapes. Sandwiched for special applications.
- **Taylorite® vulcanized fibre-clad laminates.** These combine the high strength of laminated plastics with the superior hot-arc-resistance of vulcanized fibre. They are being used in both high and low-voltage switchgear applications. Also in applications where the high impact strength of vulcanized fibre may be advantageous.
- **Rubber-clad laminates.** Almost any type of natural or synthetic rubber may be used as the cladding material. These laminates are widely used for condenser tops in wet condensers to protect the laminate against highly alkaline electrolytes. They also have application in any part where sealing or chemical resistance is needed.
- **Asbestos-clad laminates.** For applications where high heat- and arc-resistance are required.
- **Laminate-clad lead.** Lead sheets sandwiched between Grade XX pa-

per-base laminates have been used for X-ray shields. The laminate provides strength and contributes to the high shielding properties of the lead.

- **Aluminum-clad laminates.** These have been used extensively for engraving stock. They also offer possibilities as printed-circuit material and as plate holders for X-ray machines.
- **Beryllium copper-clad laminates.** Beryllium copper is nonmagnetic and a good conductor—properties that give these laminates possibilities in many applications.
- **Stainless steel-clad laminates.** Applications where nonmagnetic properties are required. Also in certain corrosive environments where the resistance of stainless steel to attack is an asset.
- **Magnesium-clad laminates.** These laminates have been produced in 108-in.-long sheets for use as screens for X-ray operators. Weight was a factor.

Our design and production engineers are constantly developing new materials, new applications, and new procedures for fabricating laminated plastics. Our experience is yours for the asking. And if you have a problem requiring assistance or more information on composite laminates, write us. Also ask for your copy of Taylor's new guide to simplified selection of laminated plastics. Taylor Fibre Co., Norristown 40, Pa.

Taylor

LAMINATED PLASTICS VULCANIZED FIBRE

superb new NULL DETECTOR

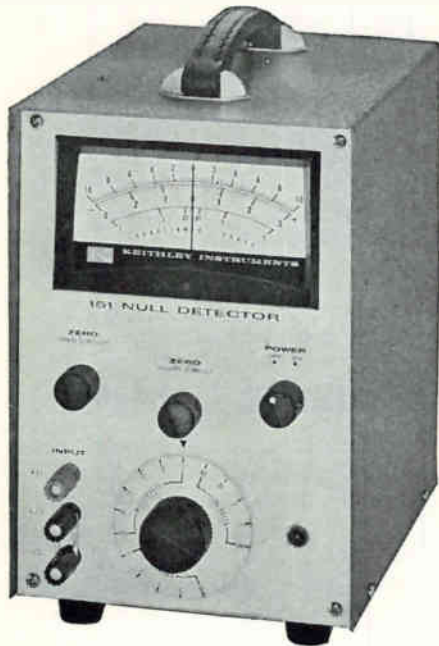

The new Keithley 151, incorporating a unique photo-conductive modulator of Keithley design, is useful wherever a suspension galvanometer can be used, and where a galvanometer is not sufficiently sensitive, fast or rugged. Currents as low as 2×10^{-18} ampere can be detected.

Ranges: 11 linear ranges in 1x and 3x steps, from 100 μ v to 10 v f.s.; 5 non-linear ranges, 0.001 to 10 v f.s., each covering three decades.

Accuracy: Linear ranges, $\pm 3\%$ of f.s.; non-linear, $\pm 10\%$ of input.

Input Resistance: 10 megohms on all ranges. Max. power sensitivity over 10^{-17} watt.

Response Speed: On 100 μ v range, 2.5-sec.; 1-sec. on all others.

Noise: Below 2% f.s. all ranges.

Zero Drift: Less than 10 μ v per day.

Output: 10 volts at 1 ma f.s.

Price: 151 Cabinet Model . \$395.00
151R Rack Model . \$385.00

For full details write:



**KEITHLEY
INSTRUMENTS**

12415 EUCLID AVENUE
CLEVELAND 6, OHIO

Courier Satellite Ready for Launch

Prototype is first step toward network for global communications by delayed-repeater satellites

WITHIN the next few days, Army will attempt to put Courier, the delayed repeater communications satellite, into a circular orbit. If this first try fails, there are two more Courier satellites ready for later firings. (See photo of Courier mock-up, *ELECTRONICS*, p 52, Sept. 11, 1959.)

Project Courier, forerunner of a global microwave satellite communications network, is under direction of the Advanced Research Projects Agency (ARPA). Technical direction is by the U. S. Army Signal Research and Development Laboratory, Fort Monmouth, N. J.

Prime function of Courier is to receive, store, and transmit on command, teletypewriter and voice messages. Here's how the system works:

As the satellite passes over a ground station information is transmitted by that station to the satellite, which stores it on magnetic tape. Later, when the satellite passes over or near the ground station to which traffic is addressed, that ground station triggers the relay with a coded command signal and the satellite broadcasts the traffic stored on its tape.

The first shot, powered by a Thor-Able-Star booster, will go due east from the Atlantic Missile

Range, Fla. The satellite will be injected into a 650-nautical-mile-altitude orbit at $28\frac{1}{2}$ degrees inclination to the equator.

The payload, prime contracted by Philco, will weigh 475 lb. It will require no special orientation, although it will spin to equalize temperature caused by solar radiation.

Powered by solar cells, the satellite will receive coded commands to open its two-way data channel operating in the microwave region. Each of five tape recorders—two of which are spares—will be able to store six million bits of information—at the rate of 25,000 bits per second — during a four-minute "read-in/read-out" period.

During each four-minute burst of operation about $\frac{1}{2}$ million words can be exchanged— $\frac{1}{4}$ million words to the satellite for storage and $\frac{1}{4}$ million transmitted from the satellite for reception on the ground. "Read-in" and "read-out" can occur simultaneously, using two different frequencies and separate tape recorders. Between 20 and 24 teletypewriter channels and four voice channels can be used.

Feasibility of the system will be proved by using two communications tracking stations—one at the Army's Salinas Training Area near Ponce, Puerto Rico, and the second at Army Signal Corps' Astro-Observation Center at Fort Monmouth.

ITT is prime contractor for the ground installations, with Radiation, Inc., supplying the ground antennas and associated control consoles.

Both antennas are 28-ft tracking type data transmission and reception systems with low-noise receivers and one-kilowatt transmitters.

Once the antenna has picked up the signal from the satellite, it tracks automatically. The antenna for Courier is similar in principle to the 60-ft TLM-18 tracking telemetry antennas used for the Tiros weather satellite (*ELECTRONICS*, p 57, Apr. 15).

Units Control Heat



Electronic temperature controllers made by Hagan Chemicals & Controls help produce fiber glass yarn

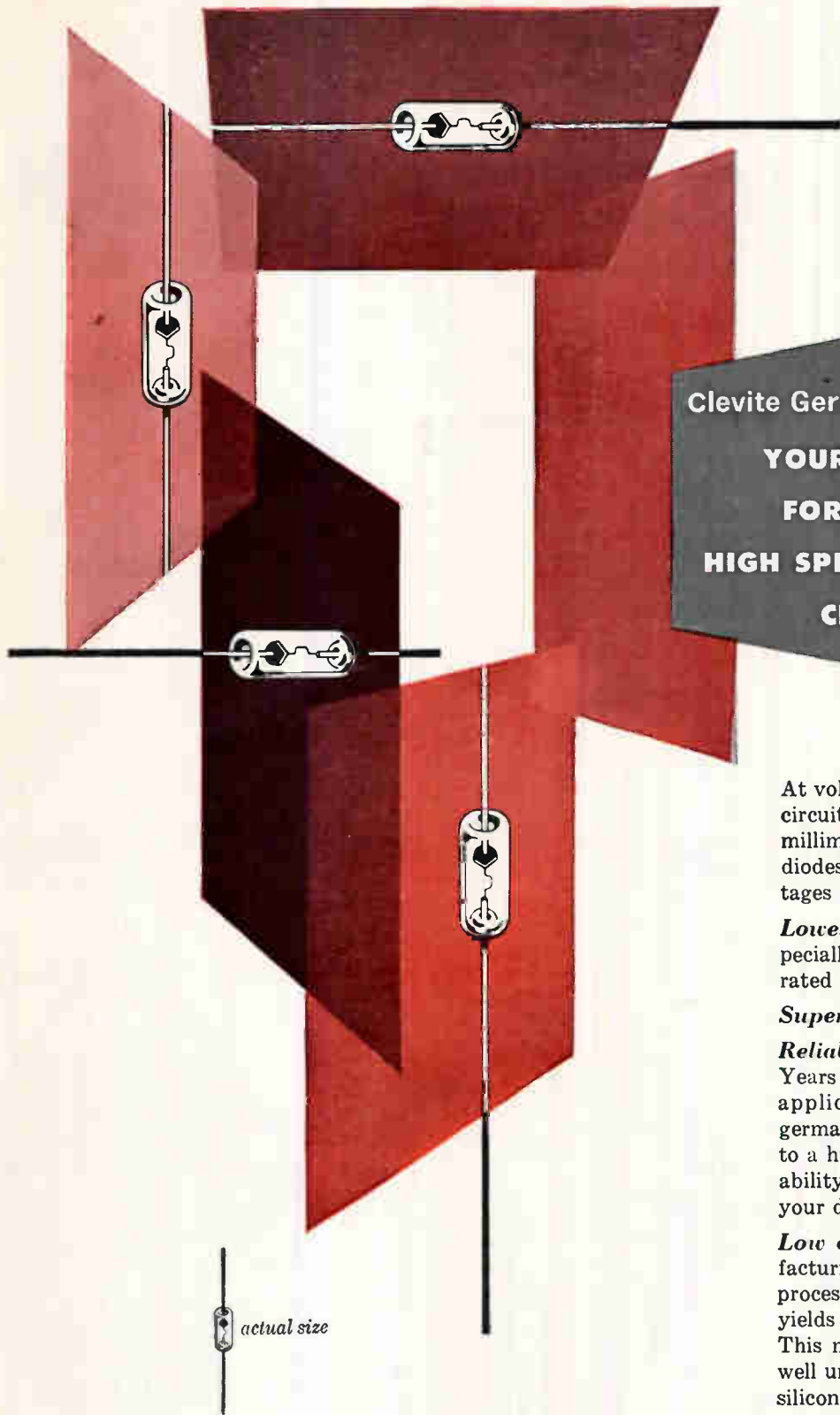

Clevite Germanium Diodes . . .

**YOUR BEST BUY
FOR TODAY'S
HIGH SPEED SWITCHING
CIRCUITS**

At voltages typical of solid state switching circuitry . . . and recovery times in the millimicrosecond range Clevite *germanium* diodes offer several outstanding advantages over costly silicon types:

Lower forward voltage drop. An especially valuable characteristic for saturated circuitry applications.

Superior forward transient response.

Reliability, availability, uniformity. Years of experience in the production and application of hundreds of millions of germanium diodes have brought these types to a high state of perfection and predictability. They take the gamble factor out of your design and production problems.

Low cost. Thoroughly developed manufacturing techniques utilizing automated processes and close controls result in high yields and high production efficiencies. This means top quality product at prices well under the present cost of comparable silicon types.

Take a close look at germanium . . . for fast switching at low voltages, it may well be your best buy!

Send for bulletin B-213-2

A DIVISION OF
CLEVITE
CORPORATION

Reliability In Volume . . .

CLEVITE TRANSISTOR

254 Crescent Street Waltham 54, Mass. Tel: TWinbrook 4-9330



NEW LONG-LIFE MALLORY ALKALINE

TECHNICAL DATA

*Mallory Alkaline Manganese Battery—
"AA" Penlite Size**

Nominal voltage 1.5 v.

Capacity (to 0.8 v.)

Transistor radios . . . 1800 ma-hours

Flashlights (0.2 amp) 900-1000
ma-hours

Photoflash . . . over 1000 flashes at 6
amps in .01 ohm circuit

Shelf life up to 2 years
at room temperature

*"C" and "D" sizes will be available soon.



MALLORY LEADS THE WAY IN BATTERY SYSTEMS



MERCURY BATTERIES—un-
matched for small size, long
life, stable voltage . . . for
hearing aids, transistor radios,
portable instruments, missiles.



**MERCURY ZINC-CARBON
BATTERY**—high capacity, low
drain, non-gassing . . . devel-
oped specifically for electronic
clocks.



SOLIDION® BATTERIES—solid
state batteries with 15-year
storage life; high voltage, tiny
size. For radiation counters,
capacitor charge circuits.

MANGANESE BATTERY

gives extra appeal to your new products

You can add new customer appeal to your battery-powered equipment by putting the unique properties of the Mallory Alkaline Manganese Battery to work in your new designs. A new chemical system, using the basic construction of Mallory Mercury Batteries, gives you these outstanding features:

Versatility—The first truly all-purpose dry battery, the Mallory Alkaline Manganese Battery fits low, moderate and high drain applications. It works equally well in flashlights, radios, photoflash, portable shavers, toys, games, surgical equipment.

Long life—excelled only by that of mercury batteries. In portable radios, it outlasts conventional zinc-carbon dry batteries by three to four times. It lasts twice as long in photoflash service and five to ten times as

long in flashlights, depending upon drain. Unlike conventional dry cells, it never needs a "rest period" to recover its power. The voltage discharge curve, while not approaching the constant high level of mercury batteries, is far superior to that of zinc-carbon batteries.

Can't leak—The cell is inherently non-gassing. Electrolyte is securely contained in a double steel case sealed with a molded plastic grommet. No bulging or leaking, even at solar radiation temperatures up to 165°F.

Long shelf life—stays fresh for over two years on the shelf—more than twice as long as conventional dry cells.

Our application engineers will be glad to discuss how you can capitalize on this new battery in your designs. Write today for technical data and consultation.

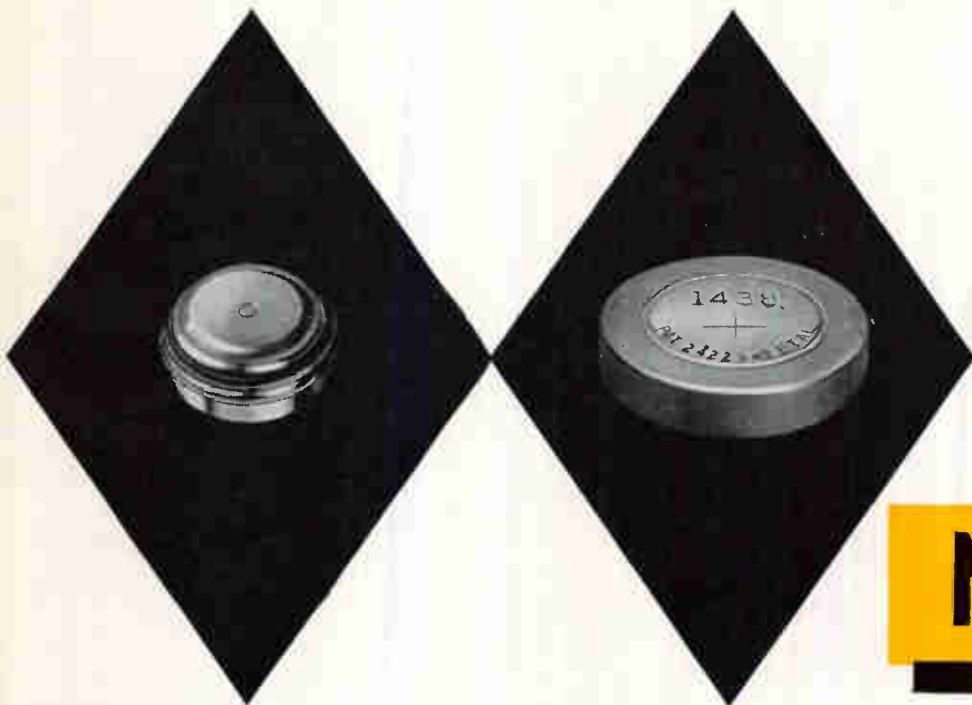

LEAD OXIDE SILVER CELL
—chargeable when ready for service; can be stored indefinitely in inactive condition.

LOW TEMPERATURE MERCURY BATTERIES—stay full of power even below freezing . . . ideal for radio beacons.

Mallory Battery Company
Cleveland, Ohio
a division of

P. R. MALLORY & CO. Inc.
MALLORY

*In Canada: Mallory Battery Company
of Canada Limited, Toronto 4, Ontario*

The A. W. Haydon Co. designed this series of repeat cycle timers for engineers with tricky timing problems and tight budgets. The low unit price on quantity runs will surprise you...and the savings we can offer on very large volume production sometimes surprises us! ■ Yet there has been no sacrifice in quality...it's all in the design. Special spring switches are supported in molded contact blocks; cams, cam followers and gears are molded nylon for long service life and extremely quiet operation. Two printed circuit cables supply internal wiring to 12 output circuits, and parallel cam shafts provide two cycling speeds. ■ The A. W. Haydon Co. has designed this repeat cycle timer to operate continuously

LONG LIFE LOW COST REPEAT CYCLE TIMERS

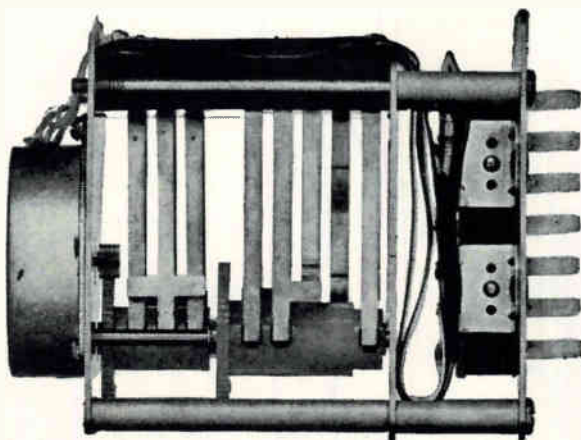

AWH HAYDON
THE COMPANY
235 North Elm Street, Waterbury 20, Connecticut

for at least one year, but it will actually run for much longer. ■ The unit shown operates at 115V, 60 CPS, 2.5 watts power input. Its switch has been tested for 2 years (125 million cycles at 2 amps resistive 10VAC, 60 CPS) and is rated for 2.5 amp or a 7.0 amp inrush lamp load. ■ To be sure, other variations are available. A. W. Haydon will be delighted to quote these long life, low cost repeat cycle timers in any one of 125 standard speeds, 5 voltage ratings and 3 power supplies.

All have Jones type terminal plugs for fast installation, and a quick-change motor mounting forease of motor replacement. A clear plastic dust cover helps reduce noise level to a whisper. Write for information on your particular requirement.

MEETINGS AHEAD

July 21-27: Medical Electronics, International Conf., Inst. of Electrical Engineers, Olympia, London.

Aug. 1-3: Global Communications Symposium, PGCS of IRE, U. S. Sig. Corps, Statler-Hilton Hotel, Washington, D. C.

Aug. 1-4: Photo-Instrumentation Symposium, Soc. of Photo Instr. Engineers, Ambassador Hotel, Los Angeles.

Aug. 8-11: American Astronautical Society, Western National, Olympic Hotel, Seattle, Wash.

Aug. 9-12: American Institute of Electrical Engineers, Pacific General, San Diego, Calif.

Aug. 15-19: High-Speed Photography, Stroboscopic Light Laboratory, MIT, Cambridge, Mass.

Aug. 18-19: Electronic Circuit Packaging Symposium, Univ. of Colorado, Boulder, Colo.

Aug. 22: Scientific Apparatus Makers Assoc., Market Managers, SAMA, Statler-Hilton, San Francisco.

Aug. 22-26: Thermonuclear Plasma Physics Symposium, Oak Ridge, U. S. Atomic Energy Commission, Gallinburg, Tenn.

Aug. 23-26: Association for Computing Machinery, Nat. Conf., Marquette Univ., Milwaukee.

Aug. 23-26: Western Electronic Show and Convention, WESCON, Memorial Sports Arena, Los Angeles.

Sept. 7-9: Automatic Control, Joint Conf., ASME, IRE, AIEE, ISA, Massachusetts Institute of Technology, Cambridge, Mass.

Oct. 10-12: National Electronics Conf., Hotel Sherman, Chicago.

COOL



Standby time is no problem with the new, cool (all-transistorized) Mincom C-100. No blowers necessary — and the new **Mincom Model C-100 Instrumentation Recorder/Reproducer** is particularly new in its simplicity and reliability. Six speeds record frequencies from 50 cps to 100 kc. Only 500 watts input for 14-track system. No mechanical brakes. Only 0.1% flutter and wow. Instant push-button speed control, no belt changes. Interested? Write Mincom for specifications today.



... WHERE RESEARCH IS THE KEY TO TOMORROW

MINCOM DIVISION **MINNESOTA MINING AND MANUFACTURING COMPANY**

2049 SOUTH BARRINGTON AVENUE • LOS ANGELES 25, CALIFORNIA • TELETYPE: WEST LOS ANGELES 6742

Best solution to custom design potentiometer problems...



Merely write to **The Gamewell Company**, stating your requirements.

Gamewell engineers will take it from there. They've been designing high precision potentiometers and rotary switches for a good many years. And a great many of them have been custom-designed.

Naturally, this experience pays off. Take selection of the best resistance material for a given application as just one example. Here, Gamewell makes full use of all available alloys. And, backed by extensive files of in-service data, assures the best design of the resistance element in conjunction with the most compatible wiper-contact material.

When necessary, of course, Gamewell's complete development and test facilities are put to use. Salt spray, humidity, extreme temperature, altitude, acceleration, vibration and many more test facilities are available to insure *exact* matching of pot to requirements.

In production, Gamewell facilities give custom-designed "pots" and rotary switches the benefits of today's

most advanced methods and machines. Extensive metal working machinery, and refined dimensional checking devices assure production of every component to high precision tolerances. All "pots" are wound on precision machines, designed and built by Gamewell. And both winding and assembly are carried out in surroundings *automatically* kept spotlessly clean.

Thus it is that "pots" with even the most unusual electrical characteristics or mechanical features can be precisely produced in a minimum of time at Gamewell. Simplify your custom-designed potentiometer problems. Write **THE GAMEWELL COMPANY**, 1377 Chestnut St., Newton Upper Falls 64, Massachusetts. *A Subsidiary of E.W. Bliss Company.*



PRECISION POTENTIOMETERS

"INTEGRALS OF
HIGH PERFORMANCE"

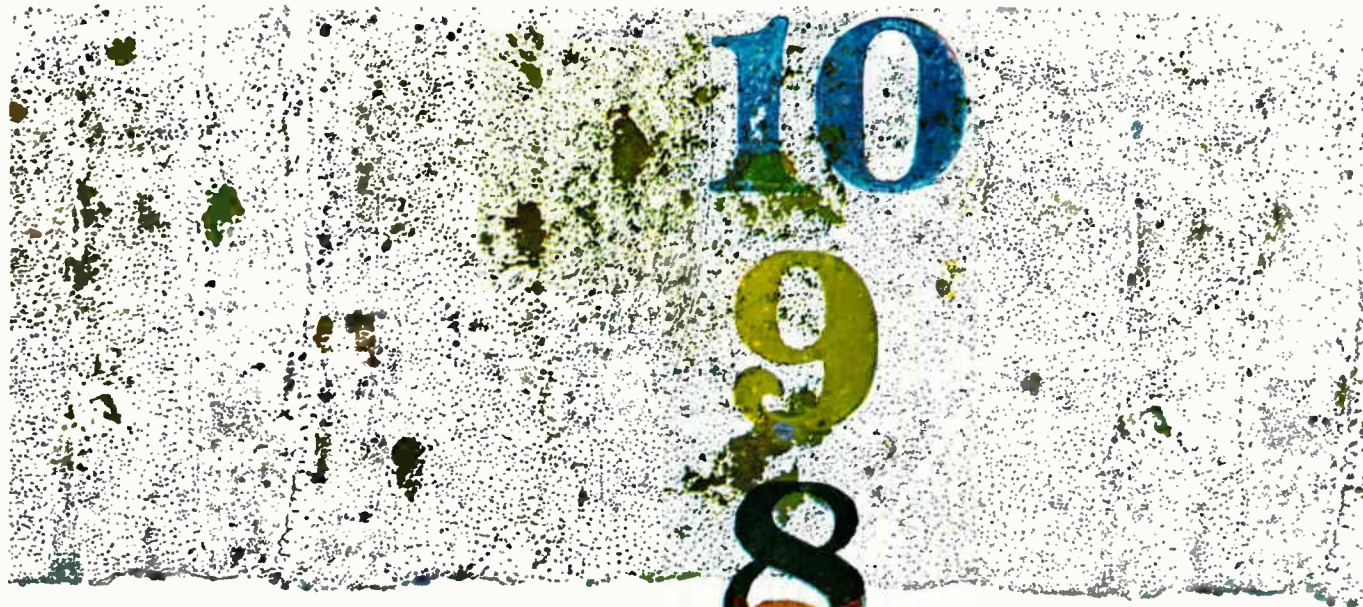

10

9

8

7

6

5

4

3

2

1

WHERE DOES BEYOND BEGIN? Today, the answer changes so fast there is no answer. At Martin-Denver, scientists, physicists, mathematicians in a great many fields are among those pushing beyond in the concepts and vehicles of space. They work in a climate that fosters advancement in the state of the art and professional status. If you would like to join them, write: N. M. Pagan, Director of Technical and Scientific Staffing, Martin-Denver, P.O. Box 179Y, Denver, Colorado.

DESIGN: ALDCROFTT



MARTIN
DENVER DIVISION



**SOLVING MATERIAL
DESIGN PROBLEMS**
BOND STRENGTH

The trick is in the adhesive. CDF's Di-Clad® printed circuit boards are tested for bond strength in this precision machine.

CDF has developed special adhesives for bonding copper foil to laminated plastic boards. These adhesives produce high peel strength, have excellent hot solder resistance, etch cleanly, and provide high insulation resistance.

In addition to its own adhesives, CDF makes resins and papers. This extends quality control several steps beyond simple pressing operations . . . provides you with Di-Clad boards of excellent and uniform properties.

CDF manufactures the largest selection of grades to meet every major civilian and military requirement.

In addition to Di-Clad printed circuit boards, CDF has special combination materials to solve extra troublesome problems. Example: asbestos bonded vulcanized fibre for circuit breaker arc chutes where the fibre quenches the arc and the asbestos guarantees fire resistance.

If you don't see the grade you want in CDF's catalog in Sweet's PD file, write us.



CONTINENTAL-DIAMOND FIBRE

A SUBSIDIARY OF THE *Built* COMPANY • NEWARK 16, DEL.
In Canada, 46 Hollinger Road, Toronto 16, Ont.

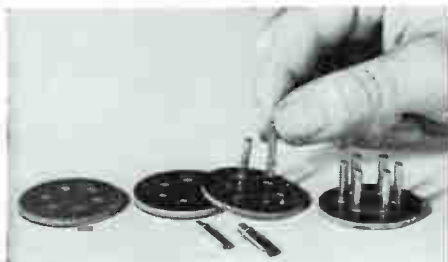

Vibration-free plug bases, fabricated by CDF. A special bond of CDF Dilecto laminated plastic and rubber.

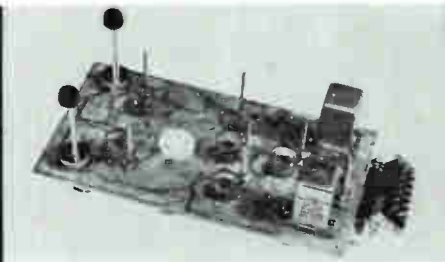

High reliability printed circuits for military applications. Made from CDF's glass-base Di-Clad laminated plastic.

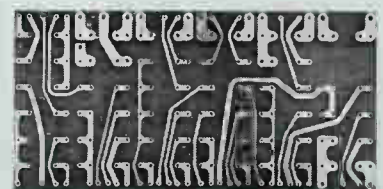

Low-Cost commercial circuits. Made from CDF's paper-based Di-Clad copper-clad laminate.

ANALOGUE

Data Handling Systems

DIGITAL



The DIDAS transmitter

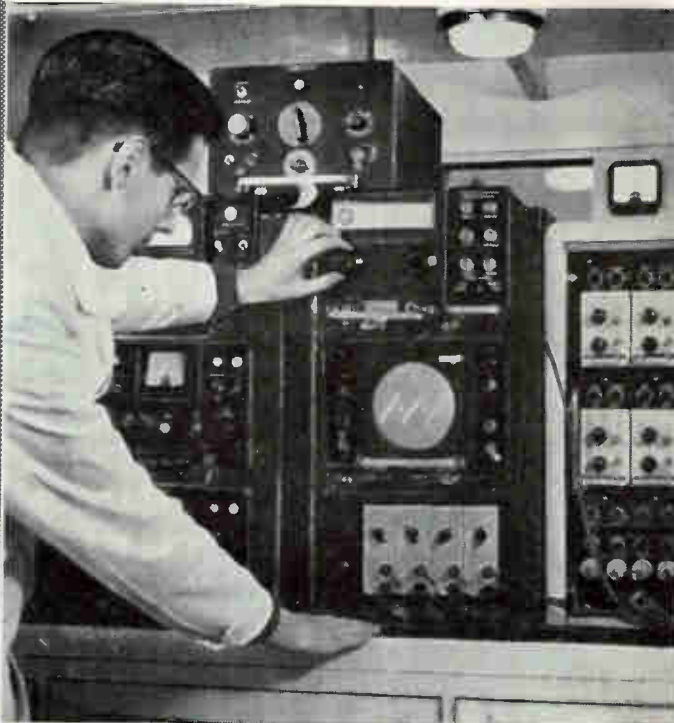

DIDAS receiving and recording in laboratory conditions

| | |
|--------|--------|
| 891362 | 108572 |
| 243895 | 925841 |
| 239810 | 189463 |
| 654958 | 194857 |
| 193847 | 237583 |
| 901205 | 867493 |
| 294736 | 910485 |
| 271057 | 839120 |
| 984752 | 856321 |
| 379824 | 658493 |
| 105447 | 539582 |
| 459233 | 937562 |
| 811278 | 423038 |
| 532485 | 902475 |
| 114857 | 521054 |
| 984735 | 284731 |
| 927411 | 883746 |
| 210473 | 937561 |
| 567482 | 109235 |
| 665820 | 991375 |
| 857395 | 274837 |
| 948573 | 198573 |
| 195847 | 958473 |
| 248571 | 984421 |
| 125434 | 103425 |
| 354321 | 978679 |
| 748275 | 213486 |
| 859483 | 210084 |
| 942106 | 330198 |
| 772689 | 921006 |

- Fully Transistorized
- Extremely High Speed
- Compact
- Reliable
- Modern Construction
- Rugged but light

Speedy measurement and analysis of data has become a necessity in modern industry.

Armstrong Whitworth Aircraft have developed data handling systems for measurement and remote control.

The data can be transmitted at the speed of light by radio, or by cable link, with extreme accuracy.

In one system (the DIDAS vehicle system), over 250,000 different readings can be obtained in one minute. Analogue/digital and digital analogue converters, working at over 50,000 conversions a second, eliminate processing bottlenecks. Systems can be engineered to customers' requirements.

ARMSTRONG WHITWORTH AIRCRAFT LIMITED, Baginton, Coventry, England
(A member of Hawker Siddeley Aviation)

*Who's the local rep?
What's his number?*

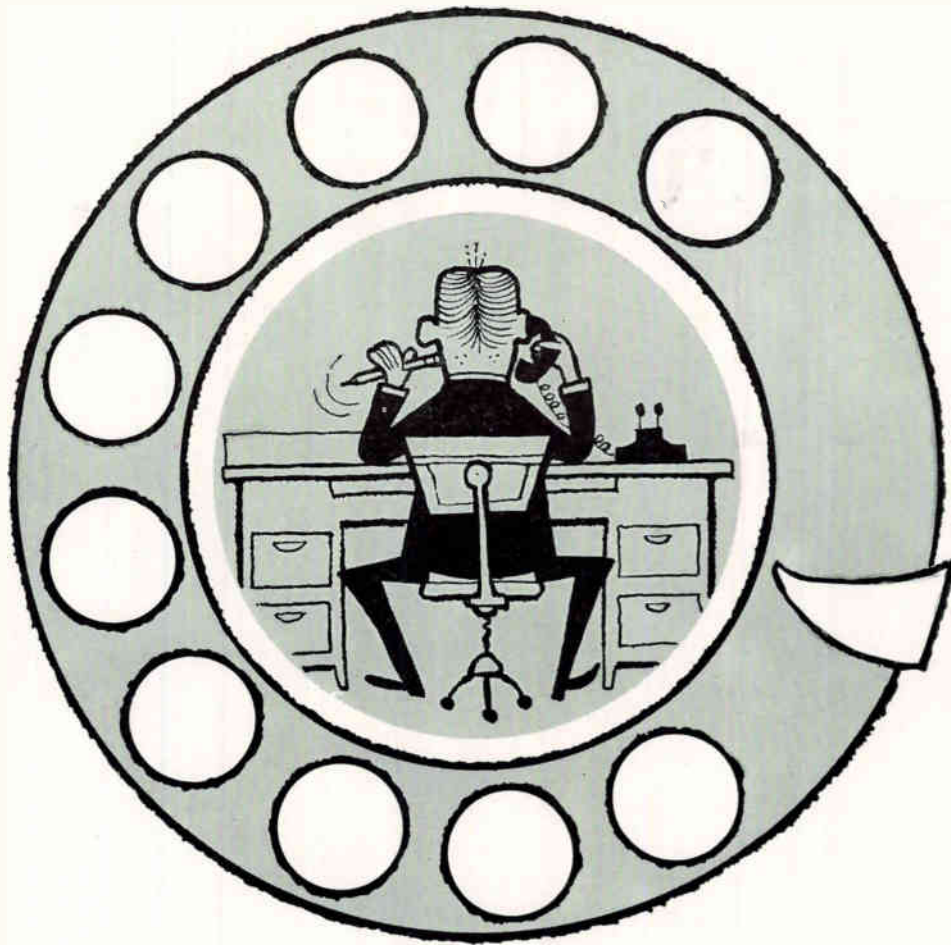

LOOK IN THE NEW **electronics BUYERS' GUIDE**

You'll find the local representative . . . his name, telephone number . . . his address. You'll find such detailed information about more than 25,000 local sales offices of more than 4,000 major manufacturers.

There's also a wealth of reference data about markets, materials, components and applications that make buying easier. Catalog informa-

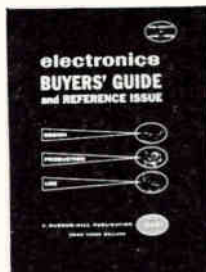

tion on nearly 700 different advertised products (that's about 42% more than you'll find anywhere else). Also complete lists of manufacturers . . . registered trade names . . . and also, of course, the most complete listing of electronic and related products. Tells what you want to know . . . *when you're ready to buy.*



A McGraw-Hill Publication • 330 West 42nd Street, New York 36, New York



THERMOSETTING RESINS

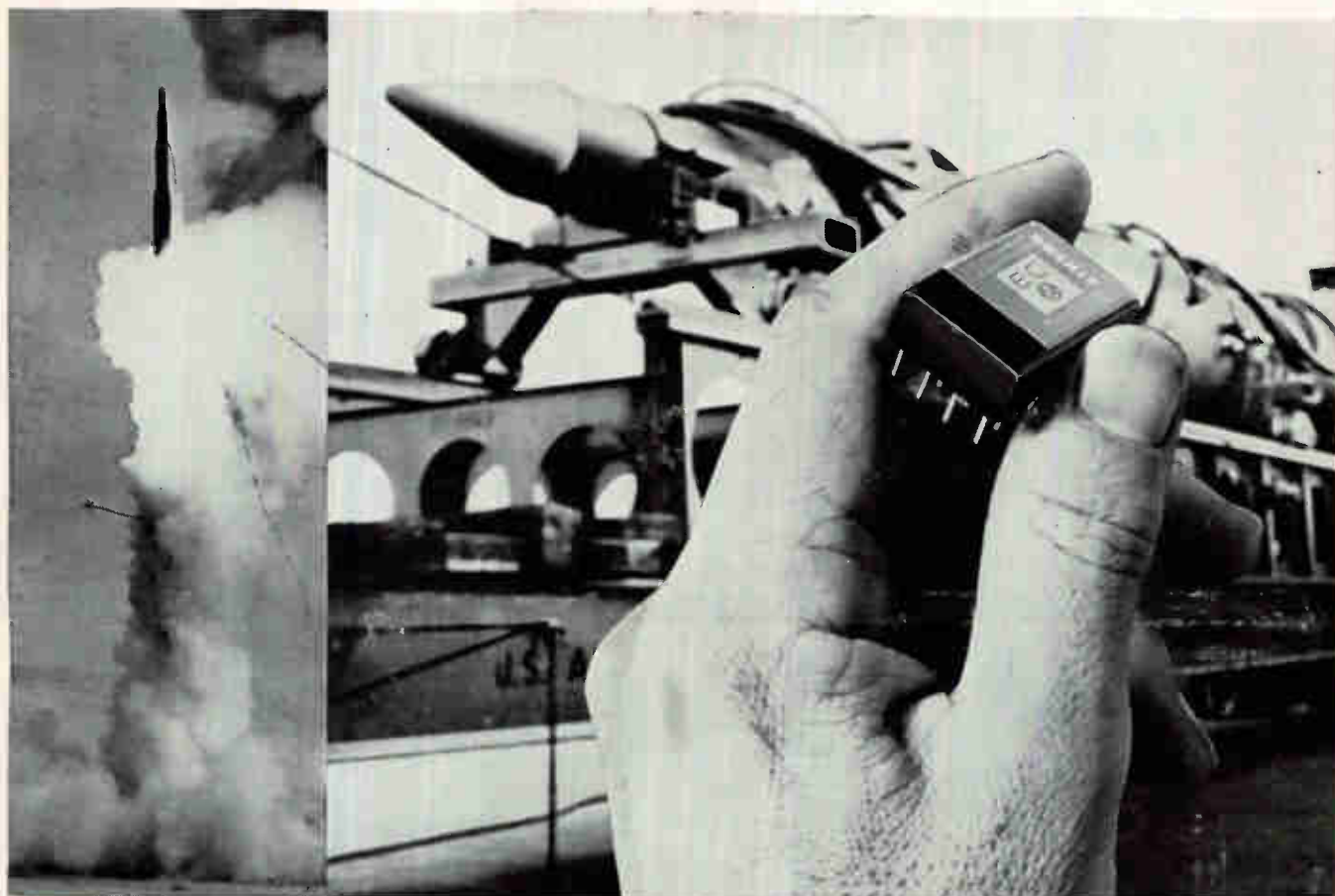

"For insulating relays in the guidance system of the Minuteman . . .

WE RELY ON DOW EPOXY NOVOLAC FOR POTTINGS!"

"Our micro-miniature relays are an important part of the ground checkout system for the Air Force's Minuteman intercontinental ballistic missile," states H. E. Wardein, Customer Relations Manager of the Electronics Components Division of Telecomputing Corporation. "So to be sure of the mechanical stability and insulation resistance of the terminal connector potting, we ran a series of heat and chemical endurance tests. The results convinced us that Dow Epoxy Novolac (D.E.N. 438) was by far the best potting compound for this highly critical application!" Telecomputing supplies the relays to the Autonetics division of North American Aviation, Inc., associate prime contractor for the Minuteman's guidance and flight control systems.

The tests used by Telecomputing Corporation to determine the effects of a prolonged, intense heat on relay terminal pottings took place in a 180°C. oven. After five hours, a terminal potted with an ordinary epoxy resin compound cracked. But after 100 hours, the terminal potted with Dow Epoxy Novolac was unharmed!

A chemical resistance test compared the ability of potting compounds to withstand the action of high-powered degreasing solvents. An ordinary epoxy resin was completely dissolved after only 48 hours in the stripper. But the Dow Epoxy Novolac showed no significant change, even after two weeks immersed in the same stripper!

These results prove once again that if you're potting, molding, encapsulating, or laminating in an application where performance is critical, use Dow Epoxy Novolac (D.E.N. 438) for that extra meas-

ure of physical and chemical stability. For full information, call your nearest Dow sales office, or write to THE DOW CHEMICAL COMPANY, Midland, Michigan, Plastics Merchandising Department 1969JG7-15.

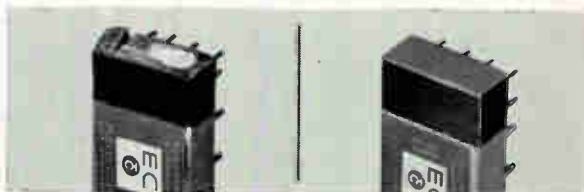

In heat resistance tests, ordinary epoxy resin (left) cracked. Dow Epoxy Novolac (right) was unharmed!

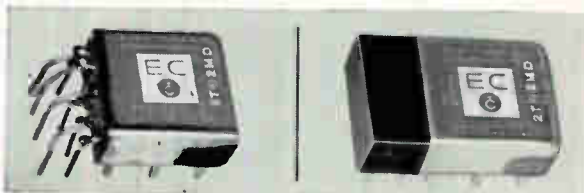

Soaked in a solvent stripper, epoxy resin (left) dissolved. Dow Epoxy Novolac (right) showed no change!

THE DOW CHEMICAL COMPANY • MIDLAND, MICHIGAN



semiconductors

ACCENT RELIABILITY

- FOR GOVERNMENT
- INDUSTRIAL
- ENTERTAINMENT USE

Reliability is the outstanding characteristic of CBS semiconductor products. The comprehensive line particularly emphasizes dependable diodes and transistors for data processing. Check the tables for types you need. Write or ask for complete technical bulletins listed for specific types. Order CBS semiconductors direct . . . from your local sales office . . . or your Manufacturers Warehousing Distributor.

Male and female industrial types are also available with leads, as in case D and F



NPN SWITCHING TRANSISTORS

| TYPE | Min. V_{CB0} (Volts) | Typical fab Mc. | Case | Bulletin |
|--------|------------------------|-----------------|------|----------|
| 2N306 | 20 | 1 | A | E-354 |
| 2N312 | 15 | 2 | A | E-346 |
| 2N356 | 20 | 3 | A | E-297A |
| 2N356A | 30 | 3 | A | E-372 |
| 2N357 | 20 | 6 | A | E-297A |
| 2N358 | 20 | 9 | A | E-297A |
| 2N377 | 25 | 5 | A | E-335 |
| 2N385 | 25 | 6 | A | E-335 |
| 2N388 | 25 | 8 | A | E-335 |
| 2N438 | 30 | 4 | A | E-336 |
| 2N438A | 30 | 4 | A | E-336 |
| 2N439 | 30 | 8 | A | E-336 |
| 2N439A | 30 | 8 | A | E-336 |
| 2N440 | 30 | 12 | A | E-336 |
| 2N440A | 30 | 12 | A | E-336 |
| 2N444 | 15 | 1 | A | E-354 |
| 2N445 | 15 | 3 | A | E-354 |
| 2N446 | 15 | 8 | A | E-354 |
| 2N447 | 15 | 10 | A | E-354 |
| 2N556 | 25 | 1 | A | E-346 |
| 2N558 | 15 | 3 | A | E-346 |
| 2N634 | 20 | 8 | A | E-349 |
| 2N635 | 20 | 12 | A | E-349 |
| 2N636 | 20 | 17 | A | E-349 |
| 2N1000 | 40 | 9 | A | E-346 |
| 2N1012 | 40 | 5 | A | E-346 |

PNP POWER TRANSISTORS

| TYPE | Max. W Diss.† | Max. V_{CB0} | Case | Bulletin |
|-------|---------------|----------------|------|----------|
| 2N101 | 17 | -30 | E | 2N101 |
| 2N143 | 17 | -60 | E | 2N143 |

| TYPE | Max. W Diss.* | Max. V_{CB0} | Case | Bulletin |
|--------|---------------|----------------|------|----------|
| 2N155 | 20 | -30 | B | E-341 |
| 2N156 | 20 | -30 | G | E-259A |
| 2N157 | 20 | -60 | B | E-288A |
| 2N157A | 20 | -100 | B | E-288A |
| 2N158 | 20 | -60 | G | E-259A |
| 2N158A | 20 | -80 | G | E-259A |
| 2N235A | 25 | -50 | B | E-345 |
| 2N235B | 25 | -50 | B | E-345 |
| 2N236A | 25 | -50 | B | E-345 |
| 2N236B | 25 | -50 | B | E-345 |
| 2N242 | 25 | -45 | B | E-345 |
| 2N257 | 25 | -40 | B | E-345 |
| 2N285A | 25 | -40 | B | E-345 |
| 2N297A | 35 | -60 | B | E-345 |
| 2N301 | 35 | -40 | B | E-345 |
| 2N301A | 35 | -60 | B | E-345 |
| 2N399 | 25 | -40 | B | E-385 |
| 2N1078 | 20 | -60 | E | E-360 |
| 2N1291 | 20 | -35 | B | E-355 |
| 2N1293 | 20 | -60 | B | E-355 |
| 2N1295 | 20 | -80 | B | E-355 |
| 2N1297 | 20 | -100 | B | E-355 |
| 2N1320 | 20 | -35 | C | E-360 |
| 2N1322 | 20 | -60 | C | E-360 |
| 2N1324 | 20 | -80 | C | E-360 |
| 2N1326 | 20 | -100 | C | E-360 |
| 2N1328 | 20 | -35 | E | E-360 |
| 2N1331 | 20 | -80 | E | E-360 |
| 2N1333 | 20 | -100 | E | E-360 |
| 2N1433 | 35 | -80 | C | E-370 |
| 2N1434 | 35 | -80 | C | E-370 |
| 2N1435 | 35 | -80 | C | E-370 |
| 2N1437 | 20 | -100 | E | E-381 |
| 2N1438 | 20 | -100 | C | E-381 |
| 2N1453 | 40 | -30 | E | E-386 |
| 2N1455 | 40 | -60 | E | E-386 |
| 2N1457 | 40 | -80 | E | E-386 |
| 2N1461 | 40 | -30 | C | E-382 |
| 2N1463 | 40 | -60 | C | E-382 |

| TYPE | Max. W Diss.† | Max. V _{ceo} | Case | Bulletin |
|---------|------------------|--------------------------|------|----------|
| 2N1465 | 20 | -120 | C | E-383 |
| 2N1466 | 20 | -120 | E | E-383 |
| 2N1504 | 20 | -80 | G* | E-384 |
| LT-5026 | 20 | -30 | E | E-288A |
| LT-5027 | 20 | -30 | C | E-288A |
| LT-5028 | 20 | -30 | B | E-288A |
| LT-5032 | 20 | -60 | E | E-288A |
| LT-5033 | 20 | -60 | C | E-288A |
| LT-5034 | 20 | -60 | B | E-288A |
| LT-5045 | 20 | -120 | B | E-288A |
| LT-5091 | 40 | -30 | E | E-288A |
| LT-5092 | 40 | -30 | C | E-288A |
| LT-5100 | 40 | -60 | E | E-288A |
| LT-5101 | 40 | -60 | C | E-288A |
| LT-5108 | 40 | -80 | B | E-288A |
| LT-5153 | 20 | -60 | E | E-288A |

†25°C Base mounting temperature.

*Special male version with 8-32 stud.

NPN POWER TRANSISTORS

| TYPE | Max. W Diss.† | Max. V _{ceo} | Case | Bulletin |
|--------|------------------|--------------------------|------|----------|
| 2N102 | 17 | 30 | E | 2N102 |
| 2N144 | 17 | 60 | E | 2N144 |
| 2N326 | 7 | 35 | B | E-355 |
| 2N1292 | 25 | 35 | B | E-355 |
| 2N1294 | 25 | 60 | B | E-355 |
| 2N1296 | 25 | 80 | B | E-355 |
| 2N1298 | 25 | 100 | B | E-355 |
| 2N1321 | 25 | 35 | C | E-360 |
| 2N1323 | 25 | 60 | C | E-360 |
| 2N1325 | 25 | 80 | C | E-360 |
| 2N1327 | 25 | 100 | C | E-360 |
| 2N1329 | 25 | 35 | E | E-360 |
| 2N1330 | 25 | 60 | E | E-360 |
| 2N1332 | 25 | 80 | E | E-360 |
| 2N1334 | 25 | 100 | E | E-360 |

†25°C Base mounting temperature.

DIFFUSED-SILICON DIODES

| TYPE | Min. Reverse V @ 100μA | Min. Avg. Forward @ 1v mA @ 25°C | Case | Bulletin |
|-------|------------------------------|--|------|----------|
| 1N482 | -40 | 100 | H | E-373 |
| 1N483 | -80 | 100 | H | E-373 |
| 1N484 | -150 | 100 | H | F-373 |
| 1N485 | -200 | 100 | H | E-373 |
| 1N625 | -35 | 20 | H | E-374 |
| 1N626 | -50 | 20 | H | E-374 |
| 1N627 | -100 | 20 | H | E-374 |
| 1N628 | -150 | 20 | H | E-374 |
| 1N629 | -200 | 20 | H | E-374 |

INDIUM-BONDED DIODES

| TYPE | Peak Reverse Volts | Min. Forward MA, +1V | Case | Bulletin |
|-------|--------------------------|----------------------------|------|----------|
| 1N95 | -75 | 10 | H | E-314R |
| 1N96 | -75 | 20 | H | E-314R |
| 1N97 | -100 | 10 | H | E-314R |
| 1N98 | -100 | 20 | H | E-314R |
| 1N99 | -100 | 10 | H | E-314R |
| 1N100 | -100 | 20 | H | E-314R |
| 1N107 | -15 | 150 | H | E-314R |
| 1N108 | -60 | 50 | H | E-314R |

| TYPE | Peak Reverse Volts | Min. Forward MA, +1V | Case | Bulletin |
|-----------|--------------------------|----------------------------|------|----------|
| 1N117 | -75 | 10 | H | E-314R |
| 1N118 | -75 | 20 | H | E-314R |
| 1N273 | -30 | 100 | H | E-314R |
| 1N276 JAN | -75 | 40 | H | E-314R |
| 1N278 | -60 | 20 | H | E-314R |
| 1N279 | -35 | 100 | H | E-314R |
| 1N281 | -75 | 100 | H | E-314R |
| 1N283 | -20 | 200 | H | E-314R |
| 1N287 | -60 | 20 | H | E-314R |
| 1N288 | -85 | 40 | H | E-314R |
| 1N289 | -85 | 20 | H | E-314R |
| 1N298 | -85 | 30 @ 2V | H | E-314R |
| 1N447 | -25 | 25 | H | E-314R |
| 1N497 | -30 | 100 | H | E-314R |
| 1N498 | -50 | 100 | H | E-314R |
| 1N499 | -65 | 100 | H | E-314R |
| 1N500 | -75 | 100 | H | E-314R |
| 1N631 | -70 | 100 | H | E-314R |
| 1N634 | -115 | 50 | H | E-314R |
| 1N699 | -105 @ 70°C | 100 | H | E-314R |
| 1N770 | | 15 @ 0.5V | H | E-314R |
| LD-70 | -15 | 100 | H | E-314R |
| LD-71 | -15 | 2 @ 0.4V | H | E-314R |
| LD-123 | -35 | 100 | H | E-314R |
| LD-125 | -75 | 10 | H | E-314R |
| LD-141 | -80 | 20 | H | E-314R |
| LD-143 | -75 | 40 | H | E-314R |

GENERAL-PURPOSE DIODES

| TYPE | Peak Reverse Volts | Min. Forward MA, +1V | Case | Bulletin |
|-------------|--------------------------|----------------------------|------|----------|
| 1N34/A | -75 | 5 | H, I | E-217A |
| 1N35 | -75 | 7.5 | H | E-217A |
| 1N38/A/B | -120 | 4 to 25 | H, I | E-217A |
| 1N39A | -225 | 5 | I | E-217A |
| 1N48 | -85 | 4 | H, I | E-217A |
| 1N51 | -50 | 2.5 | H, I | E-217A |
| 1N52 | -85 | 4 | H, I | E-217A |
| 1N54/A | 50/75 | 5 | H, I | E-217A |
| 1N55/A | -170 | 4 | I | E-217A |
| 1N56/A | -50 | 15 | H, I | E-217A |
| 1N58/A | -120 | 5 | H, I | E-217A |
| 1N60 | -30 | 3 | H | E-217A |
| 1N63 | -125 | 4 | H, I | E-217A |
| 1N64 | -20 | — | H, I | E-217A |
| 1N65 | -85 | 2.5 | H, I | E-217A |
| 1N67/A | -100 | 4 | H, I | E-217A |
| 1N68/A | -130 | 3 | H | E-217A |
| 1N69/A | -75 | 5-25 | I | E-217A |
| 1N70/A | -125 | 3-25 | I | E-217A |
| 1N75 | -125 | 2.5 | H, I | E-217A |
| 1N81/A | -50 | 3-25 | I | E-217A |
| 1N82 | -5 | — | I | E-217A |
| 1N82A | -5 | — | H, I | E-217A |
| 1N90 | -75 | 5 | H | E-217A |
| 1N116 | -75 | 5 | H | E-217A |
| 1N126/A JAN | -75 | 5-25 | H | E-217A |
| 1N127/A JAN | -125 | 3-25 | H | E-217A |
| 1N128 JAN | -50 | 3 | H | E-217A |
| 1N191 | -105 | 5 | H | E-217A |
| 1N192 | -80 | 5 | H | E-217A |
| 1N198 JAN | -100 | 4 | H | E-217A |
| 1N290 | -120 | 5 | H | E-217A |
| 1N294 | -70 | 5 | H | E-217A |
| 1N295 | -50 | — | H | E-217A |
| 1N541 | -30 | 1.5 | H | E-217A |
| 1N636 | -60 | 2.5 | H | E-217A |
| LD-47 | Det. | FM, AM | H | E-217A |
| LD-145 | -60 | 5 | H | E-217A |

NEW PRODUCTS COMING

- CBS MADT transistors
- CBS MAT transistors
- CBS high-power NPN and PNP transistors
- Watch for them



semiconductors

Reg. Philco Trademark

CBS ELECTRONICS, Semiconductor Operations • A Division of Columbia Broadcasting System, Inc.

Sales Offices: Lowell, Mass., 300 Chelmsford St., GLENVIEW 4-0446 • Newark, N. J., 231 Johnson Ave., TAILOF 4-3499 • Meigs Park, Ill., 1990 N. Mannheim Rd., ESTABROOK 9-2100 • Los Angeles, Calif., 2120 S. Garfield Ave., RAYMOND 3-9081 • Atlanta, Ga., Cary Chapman & Co., 672 Whitehall St., JACKSON 4-7388 • Minneapolis, Minn., The Heilmann Co., 1711 Hawthorne Ave., FEDERAL 2-5457 • Toronto, Ont., Canadian General Electric Co., Ltd., LEXNER 4-4311

GREATEST PERFORMANCE PER DOLLAR



PHILCO SILICON HIGH FREQUENCY TRANSISTORS

Philco SATs and SADTs have established the industry's greatest history of reliability in high frequency silicon transistors. They were the first of this type to be made available in production quantities and have been used extensively in thousands of critical military and commercial applications. Philco also has led the industry in the development of high-speed automatic production methods which have made possible a steady reduction of prices. This leadership in both reliability and low price results in the greatest performance per dollar in the high-frequency silicon field. For complete data, application information and prices on any of these silicon types, write Department E71560.

SAT®... SILICON SURFACE ALLOY TRANSISTORS

| | APPLICATIONS | FREQ. (MIN.) | SPECIAL PROPERTIES |
|----------|----------------------------|------------------|---|
| 2N495 | Amplifier, Switch, Control | f_{max} -8 mc | V_{CE} =25v, TO-1 case |
| 2N496 | Switch | f_T -7.2 mc | very low V saturation, TO-1 case |
| 2N1118 | Amplifier, Switch, Control | f_{max} -8 mc | electrical equivalent of 2N495, TO-5 case |
| 2N1118 A | Amplifier, Switch, Control | f_{max} -8 mc | high beta version 2N1118 |
| 2N1119 | Switch | f_T -7.2 mc | electrical equivalent of 2N496, TO-5 case |
| 2N1428 | Amplifier, Switch, Control | f_{max} -18 mc | low cost, high beta, TO-1 case |
| 2N1429 | Amplifier, Switch, Control | f_{max} -18 mc | low cost, high beta, TO-5 case |

SADT®... SILICON SURFACE ALLOY DIFFUSED-BASE TRANSISTORS

(All TO-9 cases)

| | APPLICATIONS | FREQ. (MIN.) | SPECIAL PROPERTIES |
|--------|--------------------------|-------------------|---------------------------------------|
| 2N1199 | Switch | f_T -75 mc | superior temperature stability |
| 2N1267 | Med. Frequency Amplifier | f_{max} -43 mc | low beta (video amplifier) |
| 2N1268 | Med. Frequency Amplifier | f_{max} -43 mc | medium beta |
| 2N1269 | Med. Frequency Amplifier | f_{max} -43 mc | high beta |
| 2N1270 | High Frequency Amplifier | f_{max} -125 mc | low beta (video amplifier) |
| 2N1271 | High Frequency Amplifier | f_{max} -125 mc | medium beta |
| 2N1272 | High Frequency Amplifier | f_{max} -125 mc | high beta |
| 2N1472 | Switch | f_T -75 mc | very low V saturation |
| | | | superior temperature stability |
| 2N1663 | Switch | f_T -100 mc | superior temp. stability... high beta |

Immediately available in quantities 1-999 from your local Philco Industrial Semiconductor Distributor

PHILCO®



Famous for Quality the World Over

LANSDALE DIVISION • LANSDALE, PENNSYLVANIA

CIRCLE 58 ON READER SERVICE CARD



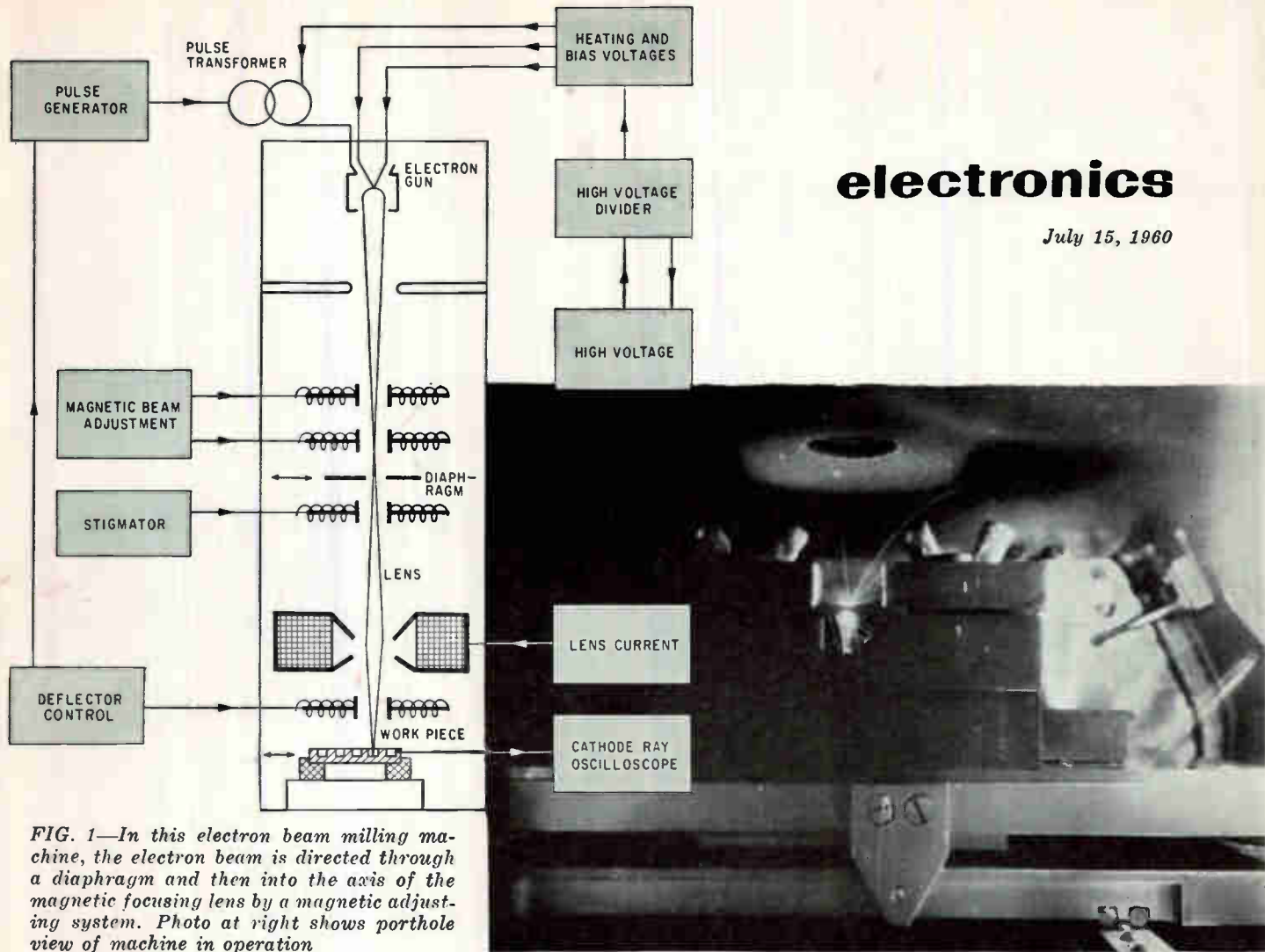

FIG. 1—In this electron beam milling machine, the electron beam is directed through a diaphragm and then into the axis of the magnetic focusing lens by a magnetic adjusting system. Photo at right shows porthole view of machine in operation

Electron Beam Processes

FOR MICROCIRCUIT FABRICATION

New fabrication tools and techniques are needed in the development of micro-electric circuits. Electron-beam equipment may provide a major breakthrough

By THOMAS MAGUIRE,
New England Regional Editor

ELECTRON BEAM techniques may provide a real breakthrough in the development of microelectronic circuits. Such techniques might eventually allow formation of complete semiconductor circuits within a vacuum system.

For initial development efforts, however, reasonably priced, basic machines are needed. According to G. J. Selvin of Sylvania, such machines "must have the growth potential of permitting many accessories and attachments and refinements to be added at a later date without forcing the user to throw

away his original investment."

Selvin outlined the needs of users in the microelectronics field at the Alloyd Corporation's Second Symposium on Electron Beam Processes, held in Boston.

Also discussed were applications of electron beams as a heat source for microminiature machining, melting, evaporation, welding and sintering.

Semiconductor devices may eventually be created by vacuum deposition and material transformation completely within the vacuum system without the requirement of

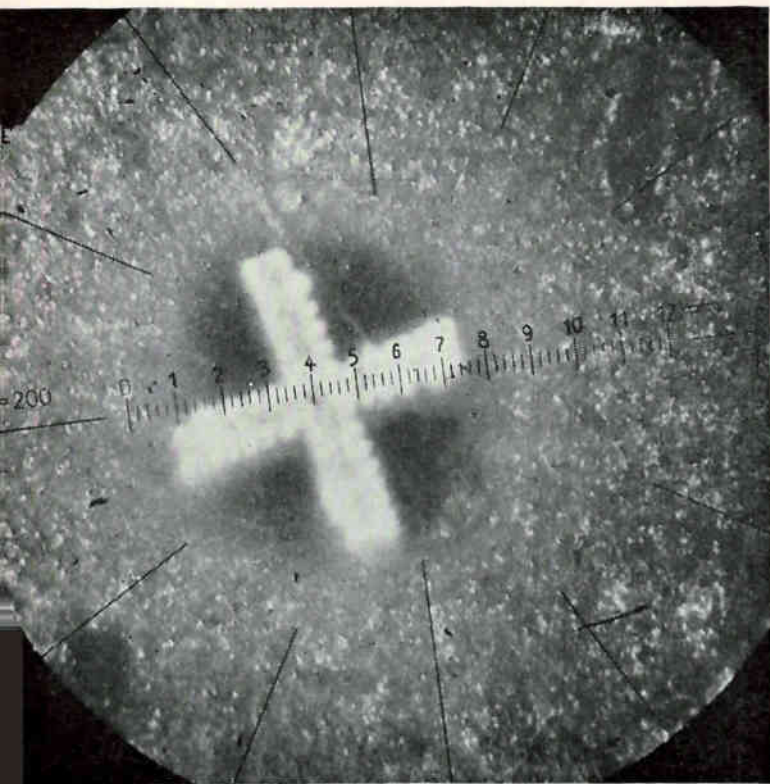

FIG. 2—Spinnerette with cross profile cut by electron beam. It can be applied to a variety of dies and masks

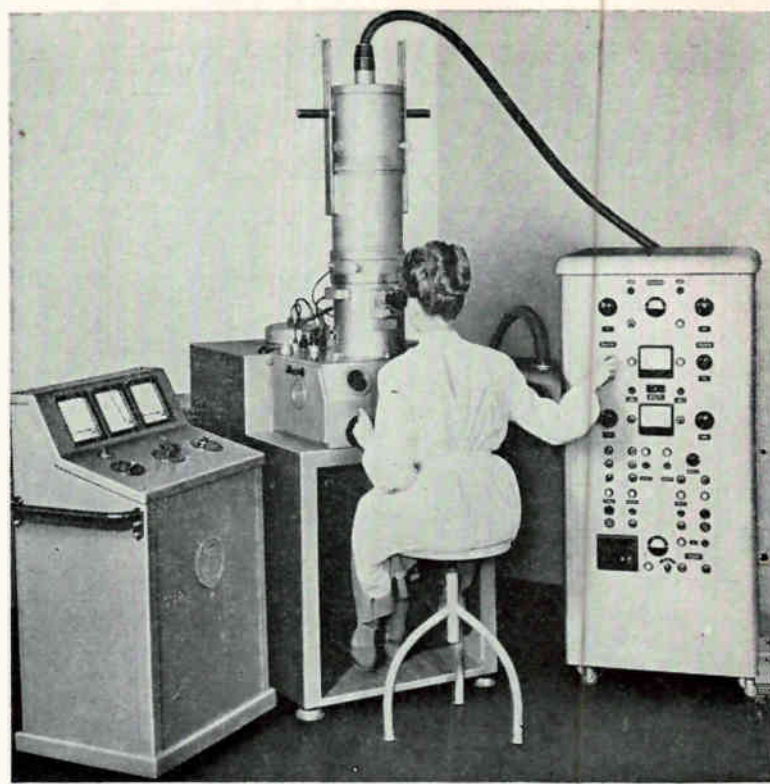

FIG. 3—Zeiss system including high-voltage power control, electron optical column, and beam and vacuum controls

mechanical operation to create the semiconductor device.¹ The circuit will enter the chamber as a base material with a supply of raw or source materials and will be removed as a complete, hermetically sealed, functioning, adjusted, measured and tested circuit.

Intensive R&D effort is now underway in many organizations to determine how electron-beam machines can be applied to the formation of such complete semiconductor devices. The possibility is foreseen of preparing the substrate surface in such a way as to enhance the chance of crystal film deposition, perhaps with seeding required. Coarse electron beams would be used for bulk material evaporation, and fine beams for precise remelting and recrystallization. Secondary alloying and the addition of impurity materials would take place by selective evaporation, and the fine beam would be employed to treat the films in place by thermal diffusion techniques or direct molten alloying.

The problem of forming conductive terminations to the semiconductor rectifying junctions may be solved by the deposition of an insulating film, followed by defined-deposition of conducting films to

make contact with the junctions and to terminate the junctions at other portions of the electron-beam evaporated and patterned circuit materials.

Suggested as a basic design for electron-beam equipment is a metal horizontal tank-type machine rather than the usual vertical glass bell jar. The horizontal tank vacuum chamber would be of alloy steel or stainless steel, with tank diameter in the order of 24-30 in. and a depth of 30-40 in. Many flanged ports would permit installation of power feed-throughs, movable work tables, gas ports, internal vessel wall heaters, and high voltage beam heads without the necessity of tearing down the tank and sending it out for remachining, welding and vacuum testing at a later date.

Since vacuum work will probably be done ultimately at pressures considerably lower than the present 1×10^{-6} mm, and probably range down to 1×10^{-10} mm, all seals or gaskets would probably need to be of the double seal or double gasket variety to permit differential pumping or any of the other advanced techniques for ultrahigh vacuum in single-wall vessels.

A versatile and high-speed vacuum pumping system is considered

the prime requisite for any film evaporation process, conventional or electron beam. The pumping system should be capable of expansion.

For initial development efforts, the equipment would probably be used as a conventional vacuum evaporator using hot tungsten filament heat sources. In the near future, a coarse electron beam for vacuum evaporation heat source work would be added. Still later, a high resolution electron beam gun of small spot diameter and lower total power would be needed for film machining.

Electron beam developers are currently debating the relative merits of high and low beam voltages—in the order of 100 Kv or in the 20-25 Kv range. The debate is, of course, only of indirect interest to electronic industry users. They are interested in characteristics and results, specifically in beam power control and beam spot diameter control, variables which they cannot predict in advance of extensive development work.

Also being weighed are methods of beam positioning that will allow the beam to be located at any precise point reproducibly within approximately a $\frac{3}{8}$ -in. diameter working circle. Manufacturers will

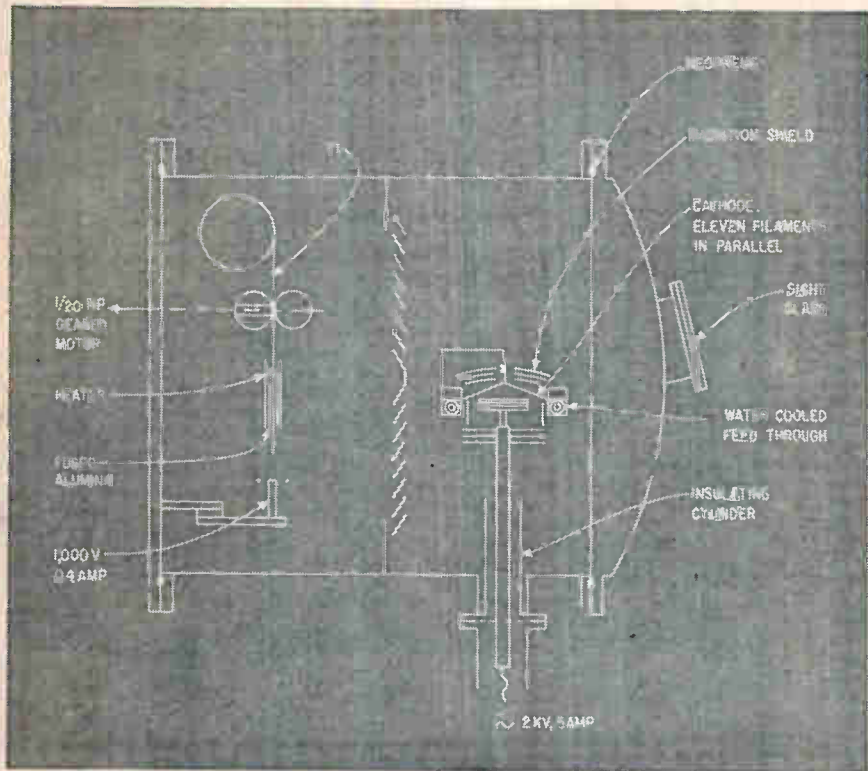

FIG. 4—Shield baffle assembly near center keeps sintering chamber of furnace tank free from titanium vapor

material. In this application, the beam is essentially a source of heat, but it is applied to the circuit working surface to cause reevaporation from that surface. This could eliminate the need for evaporation masks, or pattern etching by chemical or electrochemical techniques and could give fine line definition.

Since more and more circuit materials will be fabricated in the vacuum system, more than one material will be deposited on the substrate. The electron beam will be of value in joining or alloying materials of different compositions while they are still in the chamber. Joints achieved in this manner should be good in terms of contamination control and precision of joint area definition.

The fine electron beam would also heat-treat vacuum-deposited metal and dielectric films to give the desired surface perfection and material crystal structure.

Laboratory developments now underway promise large improve-

probably offer precision steering of the beam and/or a moving work table within the vacuum chamber.

Coarse electron beams, with diameters of 30 to 100 thousandths of an inch, can be used as an evaporation heat source. This would permit vaporization and therefore vacuum-deposition of films of conventional materials as well as of refractory materials which are presently impossible to evaporate with conventional tungsten filament or hot-crucible techniques. Vacuum evaporation would apply not only to metallic materials, but also to other materials that have excellent dielectric properties as thin films.

Coarse high-power electron beams can also be used for surface preparation, such as the fusion of the substrate or film-receiving surface to achieve the ultimate in molecular cleanliness and surface activation as well as ultra-smooth fused surfaces.

With fine beam spot diameters—1 to 3 thousandths of an inch down to perhaps one ten-thousandth—microelectronics possibilities begin to expand. Primary application of an ultra-fine diameter electron beam is in machining vacuum-deposited films to define precisely the shape or pattern of residual film

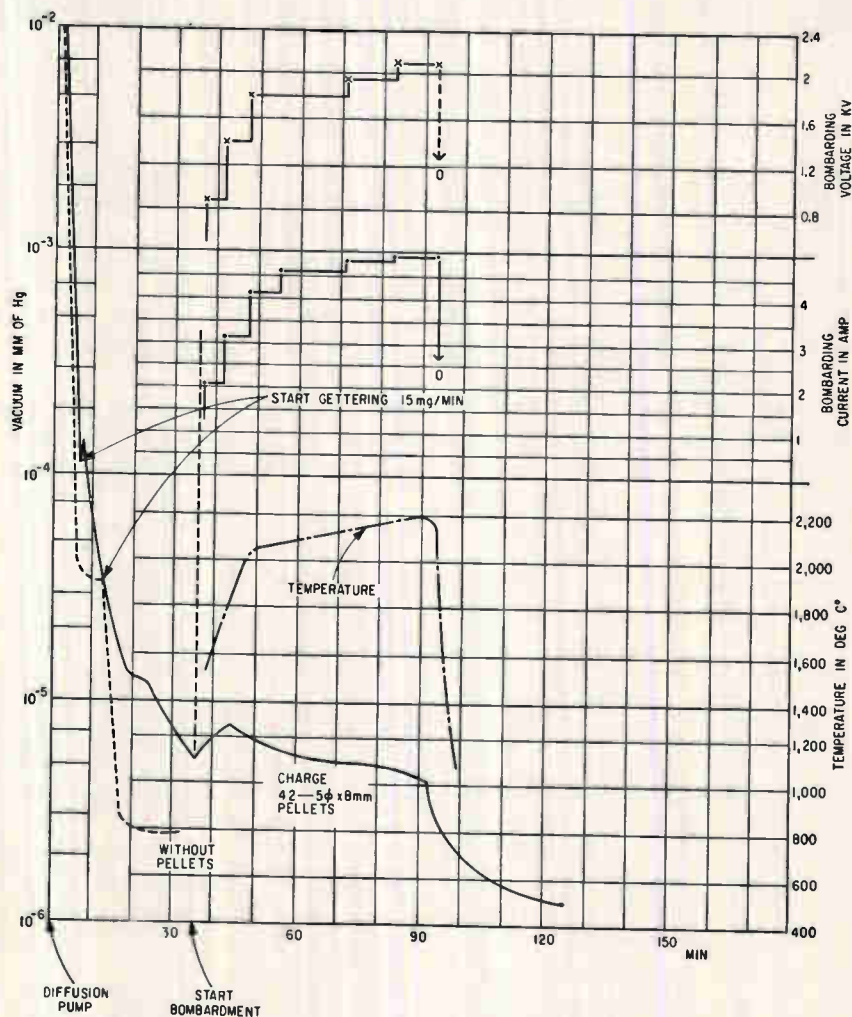

FIG. 5—Test data from operation at plant of electron-beam furnace maker

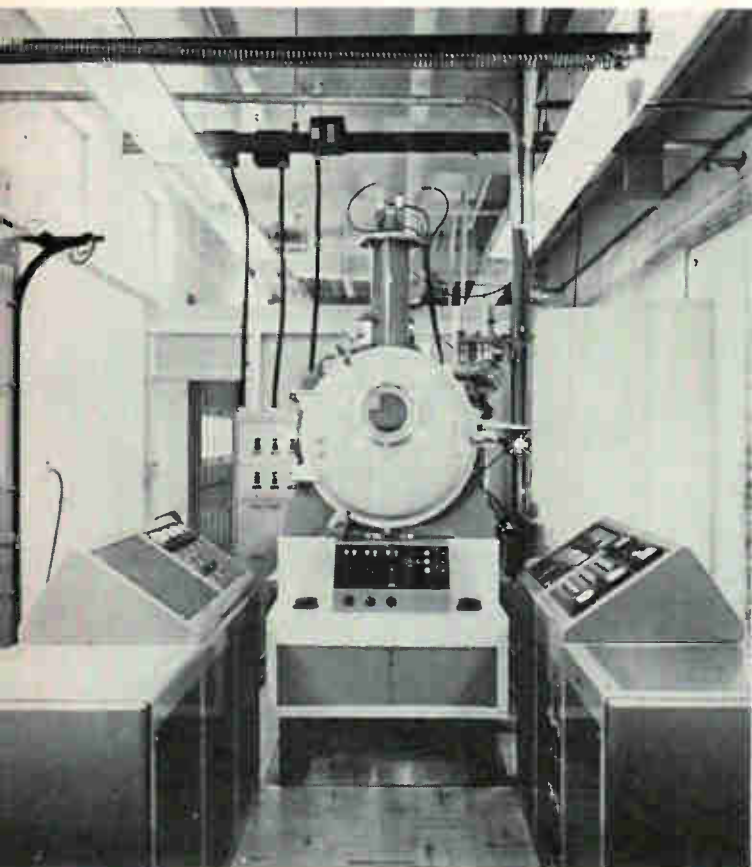

FIG. 6—Modular electron-beam laboratory unit. This facility for research projects is designed for versatility

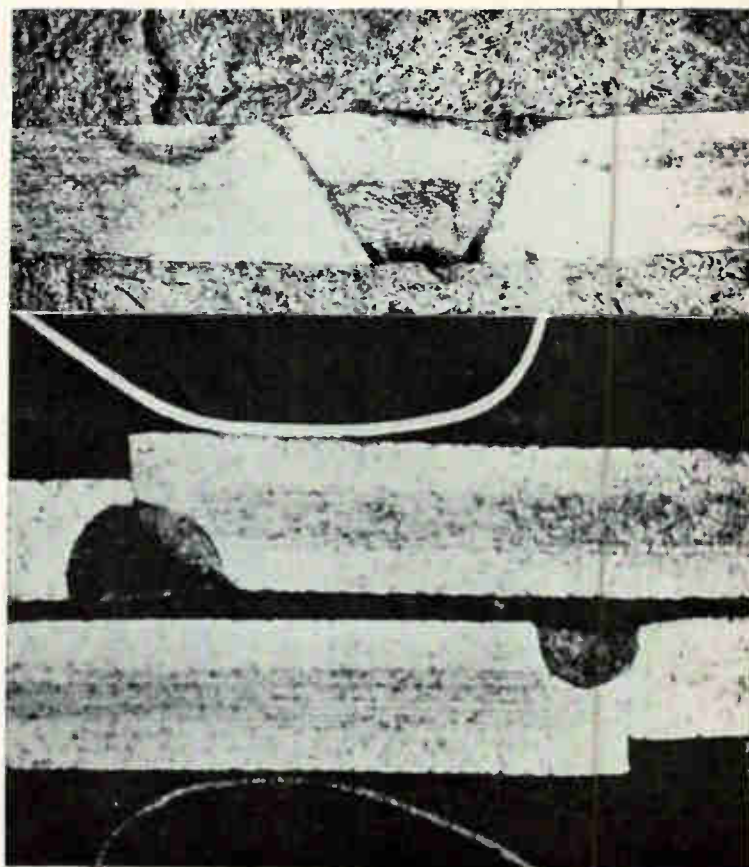

FIG. 7—Weld (top) made with early electron-beam gun contrasts with weld (bottom) made with other equipment

ments in the relatively new art of microminiature machining by electron beams, one of the more advanced techniques in fabrication of electronics microcircuitry.² The electron optical column of a basic Hamilton-Zeiss milling machine is sketched in Fig. 1. The photo is a porthole view of the Hamilton-Zeiss machine during a typical operation.

The technique is also used for machining miniature spinnerettes, dies, masks. Figure 2 shows a spinnerette with cross profile.

Beam deflector control by pre-programmed magnetic tape is expected to result in unlimited choice of shape, higher accuracy, and better control of machining depth. First-generation electron-beam cutting machines use a relay system for beam deflection control to shape the work-piece profile. Magnetic-tape control of pulse sequence, power, density and duration would also increase speed of operation and provide more versatility.

Laboratory work is also aimed at achieving narrower beam cross-sections, resulting in higher power

concentration, improved design of deflectors, including incorporation of ring-shaped magnetic cores, to help cut down the spherical aberration of electron-optical elements; wider range of operation; and increased stability and dependability.

Fabrication of microelectronic components offers one of the most fertile fields for electron beam techniques. In transistor production, for instance, dicing has been accomplished by beam-cutting a fine ditch, 1 mil deep, through the junction. Also being explored is the machining of ferrite materials for memory cells.

In the Zeiss electron-beam milling machine used in this country for the past year, programming is done by imposing various waveforms on a set of deflection coils at the foot of the electron-beam column.³ Figure 3 gives an overall view of a Zeiss system. With a 4-pole deflector, the coils are arranged 90 degrees apart with their axes pointing inward at a common center. If two of these coils 180 degrees apart are connected in

series and a sawtooth voltage is applied to them, the electron beam which passes through the common intersection of the axes will then be deflected at right angles to the field and be swept back and forth in a straight line at a speed determined by the frequency of the sawtooth wave. If a square wave is imposed on the other set of coils, the resultant field from this waveform will deflect the beam back and forth across the straight line formed by the sawtooth wave. If the two waveforms are not synchronized, the beam will eventually pass over all points of a rectangle. But if an automatic relay system is connected in such a manner that the waveforms are interchanged between the sets of coils at intervals, the rectangle will be turned 90 degrees each time and a simple cross will be generated. Using sawtooth, square-wave and sine-wave forms, and a 4-pole and 6-pole deflector system, a variety of figures and many patterns of dots can be made.

The beam can be pulsed off and

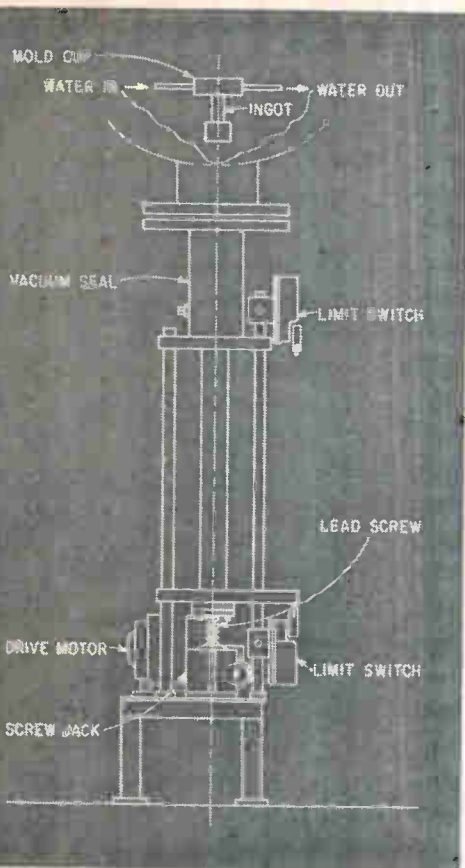

FIG. 8—Ingot withdrawal mechanism in melting modulus

on at 50 to 5,000 cps and with a pulse duration of 100 to 5 microseconds. With pulsing, a high-intensity beam of short duration can be used for cutting so as to prevent heat from seriously affecting the zones immediately adjacent to the cut.

The electron bombardment furnace is used in Japan as a small-scale production unit for sintering pellets made from tantalum powder; such pellets are used in tantalum capacitors for miniaturized electronic circuits.⁴

Inner assembly of the furnace tank is shown in Fig. 4. The horizontal furnace tank is divided into two parts, the gettering chamber and the sintering chamber. A shield baffle assembly near the center keeps the sintering chamber free of titanium vapor. The electron bombardment sintering assembly is a simple diode type. Pressed pellets are put on a tantalum plate 5 cm wide and 10 cm long to make a single layer. Four hundred 1.5-mm long cylindrical pellets (or two hundred 3.5 mm long) could be put

on the plate. To support the tantalum plate, which is the anode, a post comes through the electrically insulated bottom flange of the furnace tank.

The cathode is composed of eleven 1-mm tungsten or tantalum wires put in parallel to cover the anode homogeneously. To prevent excessive heat loss, anode and cathode are surrounded by a set of radiation shield plates. With a cathode emission of 3 to 5 amp and a voltage ranging from 1,000 v to 2,000 v., a temperature of 2,000 deg C to 2,200 deg C can be obtained. Temperature is read on an optical pyrometer through the sight glass.

The pumping system is composed of a gettering pump, ten-inch oil diffusion pump, two-inch booster and 20-cfm rotary pump. Speed of the diffusion pump measured at its inlet mouth is 3,000 liters a second at 0.1 micron Hg. Speed of the gettering pump for active gases is over 20,000 liters a second at 0.001 micron Hg.

Figure 5 shows results of a test operation at the furnace manufacturer's plant.

A modular type electron-beam facility for research projects, designed for versatility in the use of electron beams as heat sources for welding, melting, zone refining and evaporation, is shown in Fig. 6.⁵ A ten-inch diffusion pump is backed up by a roughing pump, holding pump and a refrigerated cold trap. The main chamber, 24 in. in diameter and 24 in. deep, is water-jacketed at the front end on the door. Four flanges diametrically opposed every 90 degrees permit attachment of electron guns, actuators and windows. Around the bottom, at the rear of the chamber are 8 tubes capped with O-ring seals for introducing high-voltage insulators, thermocouples, vacuum gauges and other leads.

For flexibility, three power supplies are used: one 12 Kv and two 5 Kv, all at 1 amp. They can be connected to provide any desired combination of voltages for acceleration, deflection or power. In addition, a 1 Kv supply is incorporated to provide bias and repelling voltages.

High-voltage equipment has been responsible for most of the success

of electron beam techniques in developing optimum mechanical properties in butt welds: thin, deep welds having minimum heat-affected and fusion-zone widths. Fine beam focusing is a prerequisite for high depth-to-width penetration, and focusing is less of a problem at high voltages due to the inherently greater repellent space charge effect that may be utilized by a focusing system. On the other hand, narrow beams at low voltages would be desirable to reduce both x-radiation and equipment cost.

In the lab facility described here, two programs of electron optics design are being followed: design of a low voltage (22Kv) welding gun with improved focusing, and development of a higher voltage gun configuration, using a 75 Kv x-ray power supply. Control circuits and power supply are being installed for a 125 Kv, 0.015 amp unit. A separate high-voltage welding chamber will be added to the present pumping system. Linear actuators will permit welding speeds up to 150 in. per min.

Features of the advanced low-voltage gun are linear-accelerator type of beam collimation with magnetic focusing. Figure 7 (top) shows the cross-section of a weld made in 1/16 in. stainless steel by an early prototype of this gun. The weld is much more straight-sided, has less fusion structure than weld made with other equipment of comparable voltage (Fig. 7, bottom).

Melting modules that will permit drip melting of ingots up to 1 in. in diameter and 15 in. long are being used for research. The ingot withdrawal mechanism is shown in Fig. 8. In addition to drip melting, the module can be used for zone refining, heat-treating and sintering.

REFERENCES

- All papers delivered at Alloyd Corp.'s Second Symposium on Electron Beam Processes, Boston, Mass.
- (1) G. J. Selvin and W. J. MacDonald, Sylvania Electronic Systems, The Future of Electron Beam Techniques in Micro-electronic Circuitry.
- (2) W. Opitz, Carl Zeiss Corp., Germany, Electron Beam Machining Laboratory Developments.
- (3) Morgan Rider, L. R. Industries, Mount Vernon, New York, A Commercial Electron Beam Machining Facility.
- (4) C. Hayashi, I. Umezumi, H. Takei, J. Imachi, Japan Vacuum Engineering Co., Ltd., Yokohama, An Electron Beam Furnace for Sintering Tantalum Capacitor Buttons.
- (5) Robert Bakish, The Alloyd Corp., Cambridge, Mass., A Versatile Electron Beam Laboratory Facility.

HALL-EFFECT MULTIPLIERS

Here is a clear description of a Hall generator and how it and transistor amplifiers have been combined into useful computing equipment

By WILLIAM A. SCANGA, ALBERT R. HILBINGER and CARROLL M. BARRACK,
Aircraft Armaments, Inc., Cockeysville, Md.

THREE important properties of a multiplier are its accuracy, bandwidth and cost. High-accuracy multipliers (0.1 percent or better) can be realized by several different methods but signal bandwidths are usually small and the cost is great. Similarly, low-accuracy multipliers (at most 1 percent, usually 3 to 5 percent) are available and have relatively wide bandwidths; their cost is usually appreciably less than the cost of a high-accuracy multiplier. However, for operation above several Kilocycles, even the low-accuracy multipliers become expensive.

The experimental Hall-effect multiplier discussed in this article has moderate accuracy, 0.1 to 1 percent.

It has a wide bandwidth, several Kc, and is relatively inexpensive.

The active element in a Hall-effect device, or Hall generator, is a rectangular semiconductor wafer (Fig. 1A). When a control current, I_c , is applied through the long dimension of the element and a magnetic field, B , through its thin dimension, a voltage is produced across the width of the wafer. This voltage (V_H), called the Hall voltage, is proportional to the product of control current I_c and magnetic flux density B .

$$V_H = R_H I_c B \times 10^{-8}/t \quad (1)$$

where V_H is in volts, R_H is the Hall coefficient in $\text{cm}^2/\text{coulomb}$, I_c is in amperes, B is in gauss, and t is element thickness in cm.

The flux density, B , in a magnetic circuit containing an air gap is given approximately by

$$B = 0.4\pi N I_c / L \quad (2)$$

where B is in gauss, I_c is the coil current in amperes, N is the number of turns in the winding and L is air-gap length in cm. In deriving Eq. 2, it is assumed that the reluctance of the magnetic material is insignificant compared to the reluctance of the air gap. The loss in flux density due to fringing is also neglected since this loss is small for small air gaps.

If Eq. 2 is substituted for B in Eq. 1 and all constant terms combined in one constant, k , Eq. 1 becomes

$$V_H = k I_c I_c \quad (3)$$

Equation 3 shows that a Hall generator can produce an output, V_H , which is proportional to the product of two inputs, I_c and I_c .^{1, 2, 3}

Prime consideration in the design of the experimental Hall multiplier was simplicity of electrical design and operation. Since the Hall generator was selected from commercially available types and since transistor amplifiers of simple design employing inexpensive transistors are used, the performance of the multiplier is probably not optimum in all respects.

There is no presently available semiconductor material which is ideal for use as the multiplying element in a Hall multiplier. Some of the relative characteristics of four semiconductors, silicon, germanium, indium arsenide and indium antimonide, will be compared here. Multipliers using three of these materials (germanium¹, silicon², and indium arsenide³) have been described.

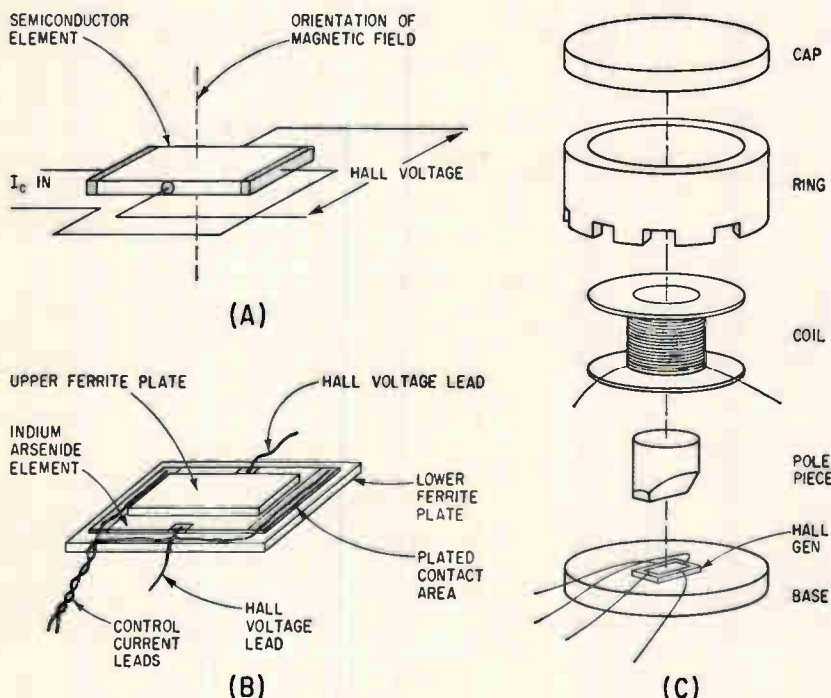
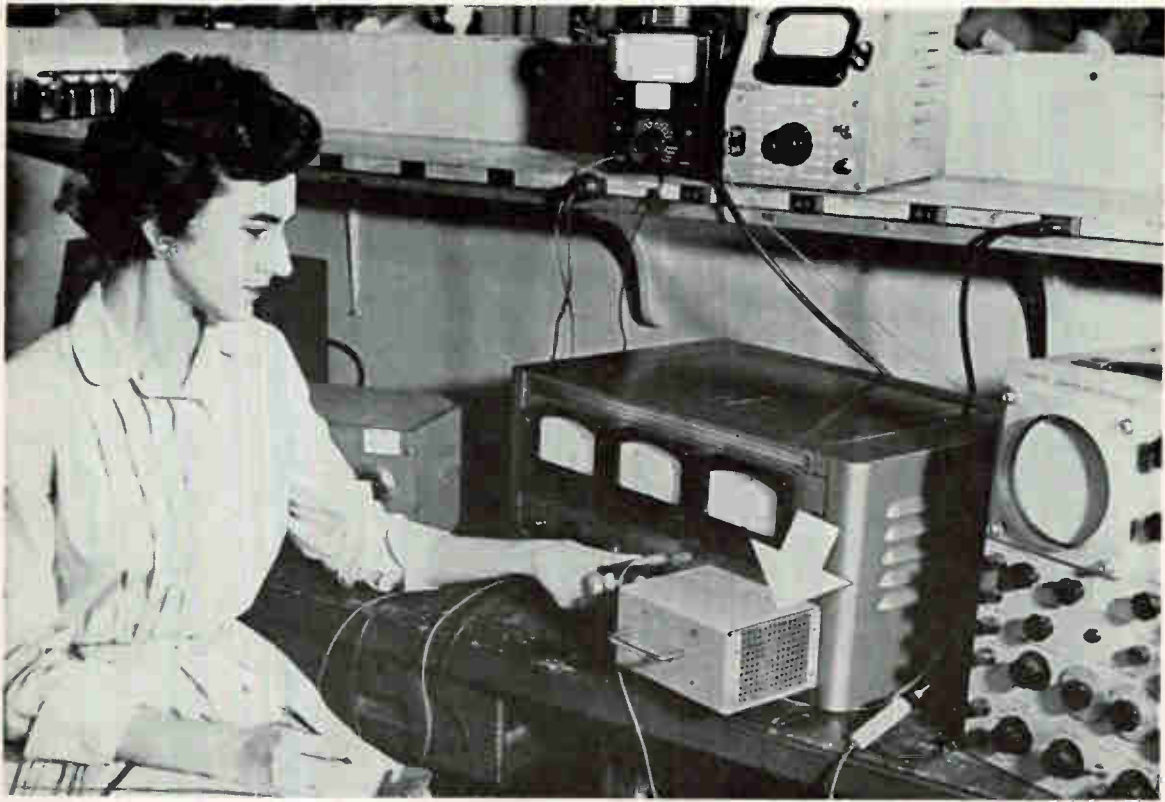

FIG. 1—Basic Hall generator is shown in (A), details of construction (B) and its assembly to supporting components (C)



Checking operation of the multiplier (arrow)

For maximum Hall voltage for given input levels, the semiconductor material having the highest Hall coefficient would be desired. The Hall coefficient, R_H , is described by the equation:

$$R_H = \mu_H \rho \quad (4)$$

where μ_H is Hall mobility in sq cm per volt-sec and ρ is resistivity in ohm-cm. Of the four materials mentioned, silicon and germanium are available in resistivity ranges which yield the highest Hall coefficient. Indium arsenide and indium antimonide have considerably higher Hall mobilities but are available in low resistivities only. Indium arsenide has the lowest temperature coefficient of the four.

Since the selection of a Hall generator for the experimental multiplier was made from commercially available types, the choice of semiconductor materials was limited to indium antimonide and indium arsenide. Indium arsenide was chosen on the basis of its superior temperature characteristics. Two basic Hall generator types were considered. One type consists of a variety of ceramic- and plastic-encased elements requiring air gaps of 0.025 to 0.040 in., while the second type

consists of an indium arsenide element sandwiched between two ferrite plates such that the package becomes an integral part of the magnetic circuit. One of the ferrite types has an air gap length of approximately 0.012 in. and another an air gap of approximately 0.002 in. The latter unit was the Hall generator used in the experimental multiplier. A sketch of this Hall generator is shown in Fig. 1B; Fig. 1C shows the Hall generator assembly. This type of construction permits electrical connection to be made to the semiconductor element without requiring additional air gap length; hence, the air gap is limited only by the thickness of the element. Equation 2 shows that, for a given flux density, gap length L is directly proportional to the required coil current and number of turns; therefore, low L minimizes coil driving power and inductance. On the other hand, since d-c hysteresis error is inversely proportional to air gap length, the gap must not be made too small.

Ferrite was chosen as the magnet core material to achieve wide-band operation; another reason for using a ferrite rather than an iron core

is that the ferrite in the Hall generator limits the maximum flux density attainable regardless of the core material used. The disadvantages of ferrite as compared to many iron core materials are low saturation flux density and high d-c hysteresis error.

The maximum control current rating of the Hall generator is 400 ma and its internal resistance is approximately 1.50 ohms. These two characteristics indicate that it would be more practical to supply the Hall generator control current from a transistor amplifier rather than a vacuum-tube amplifier. The maximum magnetomotive force for linear operation of the magnetic circuit of the Hall generator is approximately 30 ampere turns. Since the inductance should be kept to a minimum for broadband operation, the field amplifier should supply a fairly large field current to a low-turn coil. A transistor amplifier is best suited for this application.

With 300-ma control current and 100-ma field current through a 300-turn coil, the Hall-generator output voltage is approximately 70 mv. The input and output voltage levels are arbitrarily chosen as ± 5 volts maxi-

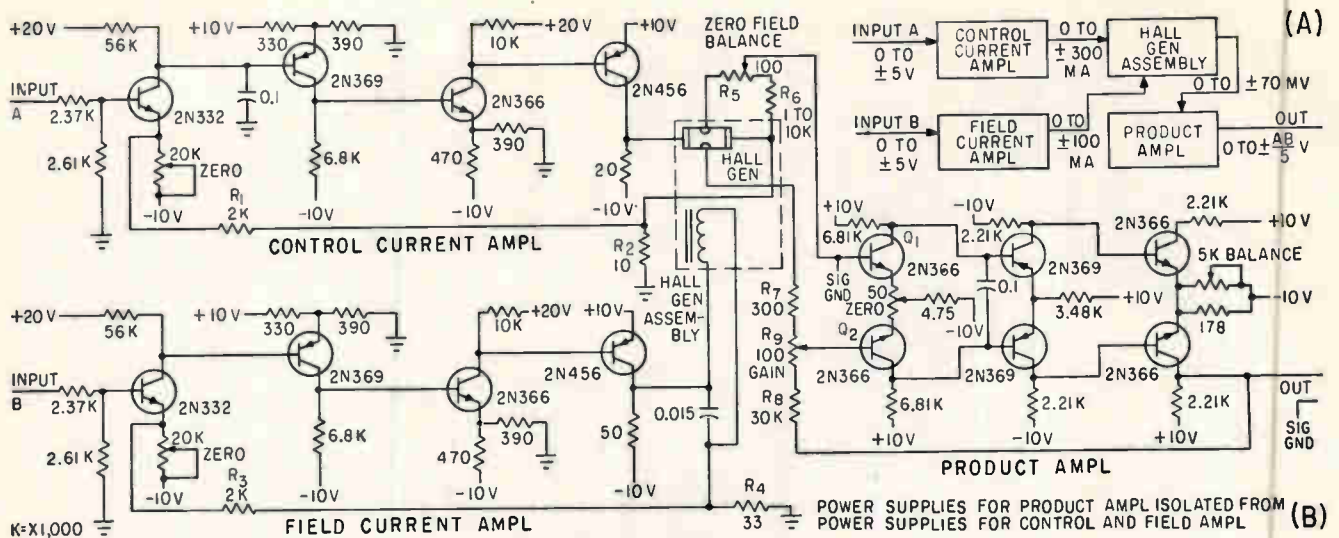

FIG. 2—Hall-effect multiplier is shown in block diagram (A) and schematic (B)

num. These parameters determine the requirements of the amplifiers; these amplifiers, and their inputs and outputs, are shown in Fig. 2A. The 300-ma output of the control current amplifier was later reduced to approximately 280 ma to reduce power dissipation in the output stage; the resulting reduction in Hall voltage was compensated by increasing the gain of the product amplifier.

The control and field current amplifiers are identical, except for their final stages, which differ because of load requirements. These amplifiers are four-stage direct-coupled feedback amplifiers and operate from +10 volts, -10 volt and +20 volt power supplies (Fig. 2B). The input stage in each amplifier uses a silicon transistor to minimize drift due to temperature variations. The product amplifier is a three stage direct-coupled differential amplifier which operates from +10 and -10 volt supplies.

Direct-coupled amplifiers were required because the multiplier had to respond to d-c signals as well as higher frequencies. Because of linearity and accuracy considerations, feedback stabilization of all the multiplier amplifiers were required.

To achieve the closed-loop gain required of the input amplifiers, four stages of amplification are used. Stability for the control-current and field-current amplifiers was achieved by drastically reducing the frequency response of one

stage of each amplifier with 0.1- μ f and 0.015- μ f shunt capacitors, respectively.

This technique proved to be satisfactory.

Depending on the magnetic circuit and the Hall generator that are used, amplifier gains can be adjusted by varying the typical values shown for R_1 , R_2 , R_3 and R_4 . Resistors R_5 and R_6 must be capable of dissipating relatively large amounts of power since the full amplifier load current flows through each.

Since the product amplifier must have a voltage gain of about 37 db, drift in this amplifier proved more of a problem. In fact, most of the drift in the multiplier can be traced directly to the output amplifier. A few temperature-compensation schemes were investigated, but it was decided that the improvement realized by any of these methods was not worth the required extra circuits. Best performance was achieved by matching the characteristics of the input transistors Q_1 and Q_2 as closely as possible. Silicon transistors were also tried in the input stages of the amplifier with some slight improvement in performance. Because of the gain required of this amplifier, three stages of amplification are needed, thus causing a stability problem. An 0.1- μ f shunt capacitor satisfactorily stabilizes the product amplifier. Gain of the amplifier depends on the values of R_7 and R_8 and the setting of R_9 . Since a voltage gain in the vicinity of 100 is required, the ratio

of R_7 to R_8 is 100, typical values being 300 ohms and 30,000 ohms, respectively. By varying R_9 , the gain can be varied from about 75 to 100.

Resistors R_5 and R_6 comprise a single balancing arrangement which is used to eliminate the effect of the unbalance present in the Hall-generator output. With no magnetic field applied, but with a current flowing through the Hall element, a voltage will exist across the two output terminals if the terminals are not placed on the same equipotential line on the Hall element. If the resistivity of the element is absolutely uniform, the two connections must be exactly opposite one another. Practically, this is impossible to achieve. With the Hall elements used, this unbalance is small, amounting to about 1 percent of full-scale output. Unbalance is eliminated by adjusting R_5 until zero output is observed. The values of R_5 and R_6 are not critical. The combined resistance should not appreciably load the Hall element, but since the resistance of a typical element is only an ohm or two, if $R_5 + R_6$ is greater than 1,000 ohms, negligible loading will exist. Typical values would be 100 ohms for R_5 and 1,000 to 10,000 ohms for R_6 .

This multiplier is an experimental unit and therefore does not represent an optimum design. Improvements in several of the characteristics could certainly be achieved with some design effort. Drift and frequency response could be considerably improved by modi-

fication of the amplifier designs. One of the major disadvantages of the multiplier is that the product and input amplifiers must have separate grounds; hence, in its present form, two or more units cannot be cascaded. This difficulty could be eliminated by using a chopper amplifier as the product amplifier. In some instances, one characteristic would have to be sacrificed to improve another. For instance, d-c hysteresis error could be reduced considerably at the expense of frequency response by using a magnet core material such as Supermalloy or Supermendur.⁴ Power consumption could be reduced at the expense of temperature characteristics by the use of semiconductor elements with higher Hall coefficients, for example, indium antimonide, germanium, silicon. With suitable temperature compensation, it is conceivable that a considerably improved Hall multiplier could be designed using one of these materials.

The curves of Fig. 3A show the total static error of the multiplier. The error due to d-c hysteresis must be added to the total static error to obtain the maximum possible total error. Hysteresis error will be maximum when either of

the two multiplier inputs are near zero and it will be minimum when the two inputs are near full scale. The maximum d-c hysteresis error is 0.5 percent of full scale, and zero drift after warmup is less than 0.5 percent of full scale per hour. Total error has never been observed to be greater than 1 percent. The overall temperature coefficient over a 10-deg-C range around room temperature is less than 0.1 percent per deg C without the use of temperature-compensation networks.

Figure 3B shows the dynamic-accuracy characteristic of the multiplier. The phase shift and amplitude curves are measured at the output of the multiplier for the values of input signals shown. Phase shift is the total phase shift through the multiplier. In measuring these curves, when the frequency of input A was varied, input B was a d-c signal and conversely. In input channel A, it was observed that the amplitude and phase-shift characteristics of the channel were independent of the input-signal amplitude for levels equal to or less than full-scale input, which is 5 v d-c.

No error would be introduced by shifting the phase of the input sig-

nals since the multiplier yields the product of the instantaneous input signals. Although multiplier output changes as the phases of the input signals change, the maximum value of the output does not change.

The multiplier is a four-quadrant multiplier; its output gives the algebraic product of the two inputs.

Note that outputs due to an input-B signal of 3.5 v rms decrease with frequency and outputs due to an input-B signal of 1.25 v rms rise with frequency. The field-current amplifier supplies a current to the field winding of the ferrite core that is proportional to the signal applied to input B. This proportionality is maintained through the use of load-current feedback in the amplifier. Thus, if the frequency of the signal applied to the amplifier is increased while maintaining a constant amplitude, the current through the field winding will remain constant. The voltage across the winding, however, will not remain constant. As the frequency increases, the inductive reactance of the coil increases; therefore, the total voltage across the coil and feedback resistor will increase. When this voltage becomes greater than that which can be supplied by the amplifier, the B+ voltage imposing the primary limitation, the current through the coil must decrease. The larger the input signal, the greater the output current; hence, the lower the frequency at which this reduction of signal occurs. For a 3.5-v rms input signal, this point is attained at about 600 cps. For smaller inputs, this frequency will increase. However, at higher frequencies, the frequency response of the amplifier itself will begin to become important. The slight rise in amplitude (less than 0.5 db) observed for a 1.25-v-rms signal is the normal characteristic of a feedback amplifier with a large amount of feedback.

REFERENCES

- (1) G. L. Keister, A Compact Multiplier Puts the Hall Effect to Work, *Con Eng*, Nov. 1955.
- (2) L. Lofgren, Analog Multiplier Based on the Hall Effect, *J App Phys*, Feb. 1958.
- (3) R. P. Chasmer and E. Cohen, An Electrical Multiplier Utilizing the Hall Effect in Indium Arsenide, *Electron Eng*, Nov. 1958.
- (4) N. P. Milligan, The Magnetic Circuit—The Key to Successful Application of the Hall Effect, 1959 Proc. of Special Tech. Conference on Nonlinear Magnetics and Magnetic Amplifiers.

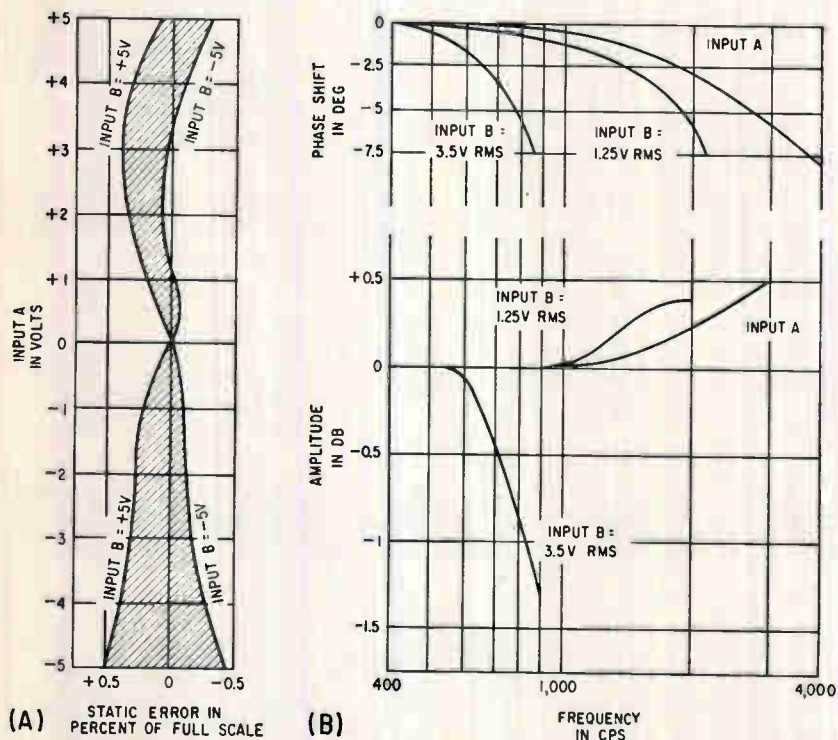

FIG. 3—Static accuracy curves (A) and frequency responses (B) of multiplier. In (B), one input is varied, other held constant

Wind Velocity



Avalanches are predicted by telemetering wind direction and velocity from a mountain pass (left). Since a-c power is available at the receiving site only, transistors were required for the tone-modulating transmitter to permit maximum battery economy

By R. BEAULIEU and G. NEAL,
Radio and Electrical Engineering Division,
National Research Council, Canada

PART of the Trans-Canada Highway is being built through the Selkirk mountain range in Glacier Park, British Columbia, an area having the most intense avalanche activity in North America.

To insure safe passage along this highway, it is necessary to determine when the snow level on the mountain slopes has reached a certain height. It may then be triggered prematurely by an explosive charge or other means before it reaches dangerous avalanche proportions. The snow level may be accurately estimated if the wind speed and direction are known over a sufficient period of time at the upper mountain slopes and ridges where the avalanche snow accumulates.

Thus the problem is to send the wind velocity information down from one of these areas to some convenient point in the valley where the analysis of it may be made, and work crews dispatched to take the necessary measures or to close the road to traffic until the danger has passed. It was decided to employ a radio link instead of a cable, for reasons of economy and ease of servicing.

An unheated cabin on Balu Pass (altitude 6,691 ft) was chosen as the site for the transmitter and anemovane while the receiving equipment was installed in a partially heated cabin at a Parks

Dept. camp (altitude about 4,100 ft.). Airline distance between the two is about 4 miles. A line-of-sight path is blocked by Mt. Cheops.

Since the portion of the system on the mountain must operate on stored energy, the use of transistors throughout this unit was indicated to conserve power. Their usage, however, plus the lack of a line-of-sight path placed an upper limit on the frequency to be used. The final choice of 1,650 Kc was a compromise, giving the maximum power output using currently available transistors, yet at the same time permitting an antenna of reasonable dimensions. The transmitter (Figs. 1 and 2A) is made up of a 2N247 crystal-controlled oscillator, feeding a 2N417 class-C buffer, feeding a 2N417 class-C buffer that couples into a pair of class-C common-collector 2N417s in parallel acting as an r-f power amplifier. Resistors of 33 ohms are placed in the emitter circuits of the

pair of 2N417's to prevent thermal runaway. This output is fed to a 2N656 power amplifier which drives a 2N1049 class-C r-f stage link-coupling 2 watts into the antenna.

The modulator consists of 9 completely separate 2N366 feedback audio oscillators of conventional design working into a 2N369 class-A buffer stage. The signal is transformer-coupled into a 2N387 class-A final audio power amplifier. Collector modulation of the r-f final is accomplished through 60-cycle filament transformer T_1 (Fig. 2A).

For stability, the oscillators and buffer have their supply voltages regulated by Zener diode D_1 .

Through the use of thermistors in their feedback loops, the nine audio oscillators hold their frequencies within ± 2 percent over the temperature range ± 30 C. A thermistor in the input circuit of the

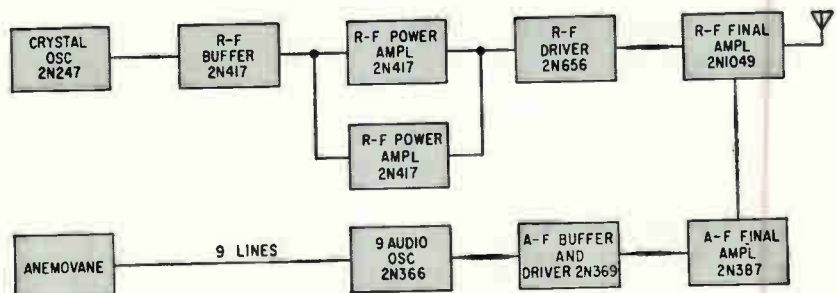

FIG. 1—Transmitting equipment uses 9 tone-modulating oscillators

Telemetry System

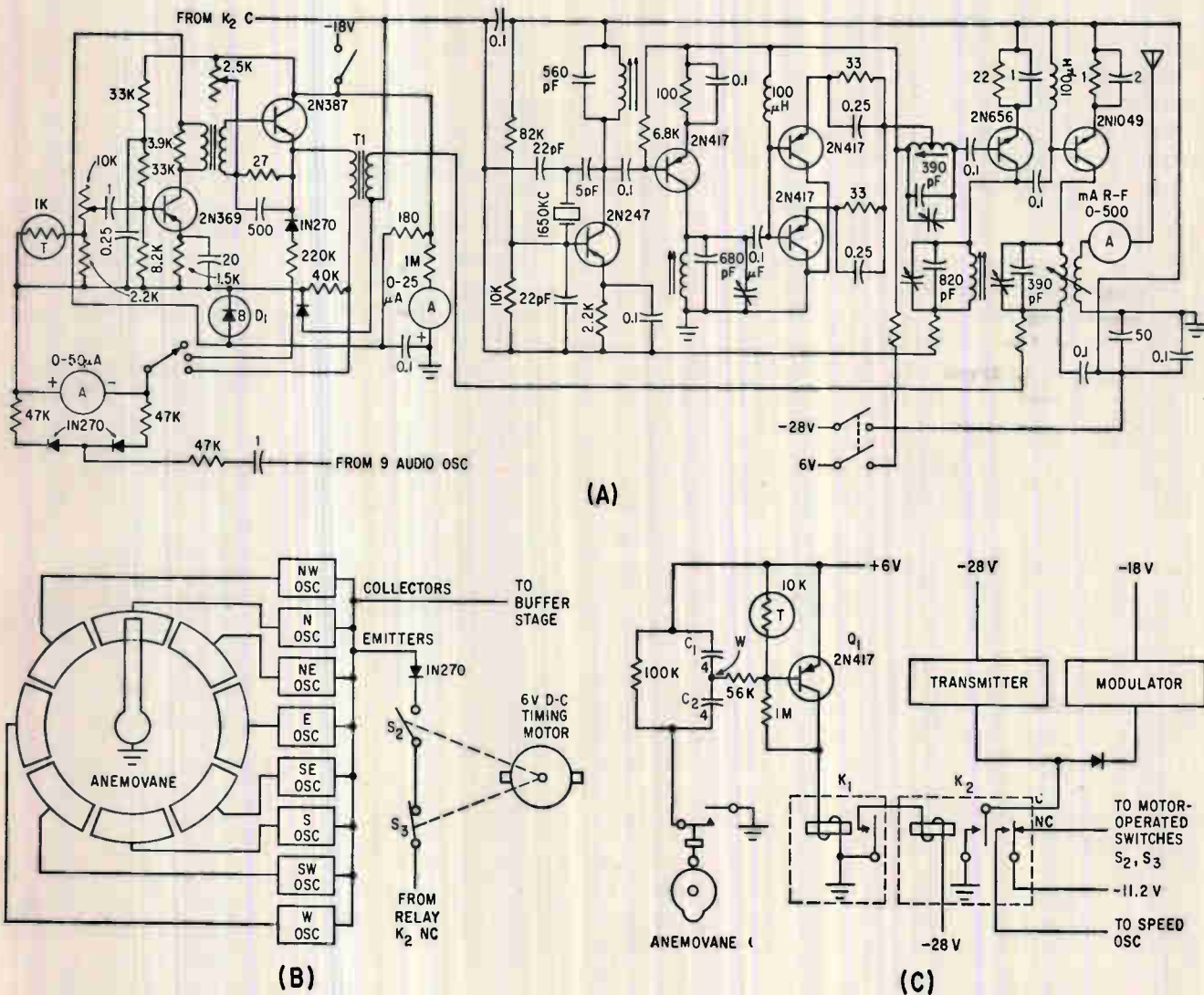

FIG. 2—The a-f buffer, a-f final amplifier and transmitter (A) all use transistors; anemovane and wind direction oscillators (B) are sampled for 5 sec every 5 min; wind-speed circuit (C) shows action of anemovane

buffer stage maintains a relatively constant percentage of modulation over the same range of temperature.

The nine different tones used in the modulator are spaced so that a ratio of 5:4 exists between adjacent channels. The oscillators can be adjusted individually to give a predetermined output level by the 100,000-ohm potentiometer in the feedback loop (circuit not shown).

Wind direction is measured in 45-deg segments and transmitted for 5 seconds every 5 minutes. Eight audio oscillators with frequencies of 967 to 4,577 cps (Fig. 2B) operate one at a time through

the wiper-arm switch driven by the anemovane to amplitude-modulate the transmitter. The timing sequence is produced by a low-drain 6-v 10-ma d-c motor operating two pressure sensitive switches wired in series.

Another audio oscillator is controlled by the anemometer cups to transmit speed. Every time a mile of wind passes the cups, a pressure sensitive switch is closed by a cam (Fig. 2c) and applies voltage to capacitors C_1 and C_2 in series. Point W goes to +3v at once, causing Q_1 to conduct, and then slowly approaches +6v where it is well into the cutoff region, produc-

ing a pulse which closes K_1 . Relay K_1 in turn energizes K_2 , applying power to the speed oscillator, transmitter and modulator. Every mile of wind produces a 3-sec burst of r-f energy, amplitude-modulated at a specific frequency (725 cycles). This circuit is necessary to conserve battery power when the wind speed is slow, in which case the cam-operated switch might stay closed for a long period of time.

Provision is made through K_2 for wind speed to over-ride direction should the two pulses occur together during a period when the direction is being sampled. Greater accuracy of wind speed measure-

ment is obtained with little sacrifice in direction information.

Monitoring circuits including front panel meters are built into the transmitter and modulator chassis, to facilitate final adjustment at the remote site where no other test gear is available.

Cipel AD-524 cells are the power source at the mountain site. These batteries contain a sal ammoniac electrolyte and use air as a depolarizer instead of chemicals, increasing their useful life on intermittent service such as occurs in this application. At the anticipated drains of 25 amp hr from -28 v, 100 amp hr from -18 v and 75 amp hr from +6 v, the bank of batteries provided should easily supply the load for seven-month avalanche season.

The transmitting antenna is a

quarter-wave bent-top type with a 26-ft vertical and a 116-ft horizontal portion. Since the ground wave is the only useful propagation medium at 1,650 Kc, a long vertical antenna, giving a vertically polarized wave, is required. Difficulties in construction and a resultant high cost ruled out the use of high towers to support a long vertical antenna (142 ft). Instead, short wooden poles were set into the ground and braced to support the bent-top antenna. Because of the low antenna impedance, only $\frac{1}{4}$ w would be coupled to the antenna.

At the receiving site the signal from the antenna is fed into a standard fixed-tuned crystal-controlled superheterodyne receiver (Fig. 3A). The demodulated output is amplified and sent to the nine

decoder circuits in parallel. Each of these drives a thyatron having a relay in its plate circuit through which appropriate voltages are fed to the recording pens of a conventional anemograph.

The decoder circuit is shown in Fig. 3B. Each plug-in channel selector has a notch filter so that when an audio signal at other than its resonant frequency is applied, it passes through and is rectified by a diode. At the same time, the signal is also rectified by another diode producing no drop between points Y and Z. However, at the resonant frequency of the filter the audio signal is blocked through that branch, resulting in Y going positive with respect to Z. This fires the thyatron for a portion of every cycle of its plate supply voltage. The resulting pulsating d-c closes a sensitive relay in the thyatron plate circuit, operating the pen of the anemograph.

Rectified 6.3 v fed through the 1,000-ohm bias potentiometer serves as a d-c bias to advance or retard the firing point of the thyatron. Thus this potentiometer acts as a threshold control. In actual use at the receiving site, it is advanced to just under the firing point of the thyatron operated by the highest modulation frequency so that any additional signal will operate the correct pen.

A tubeless magnetic regulator is used to regulate the 110-v 60-cycle input to the receiver, protecting it from voltage fluctuations of the diesel alternator which supplies a-c power to the camp.

On the anemograph there are only four pens (N,E,S,W) so to record intermediate directions such as NE it is necessary to energize two pens at once. Diodes (Fig. 3A) are therefore used in the relay circuits to prevent the operation of other than the desired pens.

This system could be used for wind velocity telemetry in many inaccessible areas. The range could be increased perhaps by changing to tube transmitters operating from transistorized inverters, going to higher frequencies over flat terrain for more efficient performance with short antennas, or by erecting a tower to support a higher vertical portion of the antenna to increase the radiation resistance.

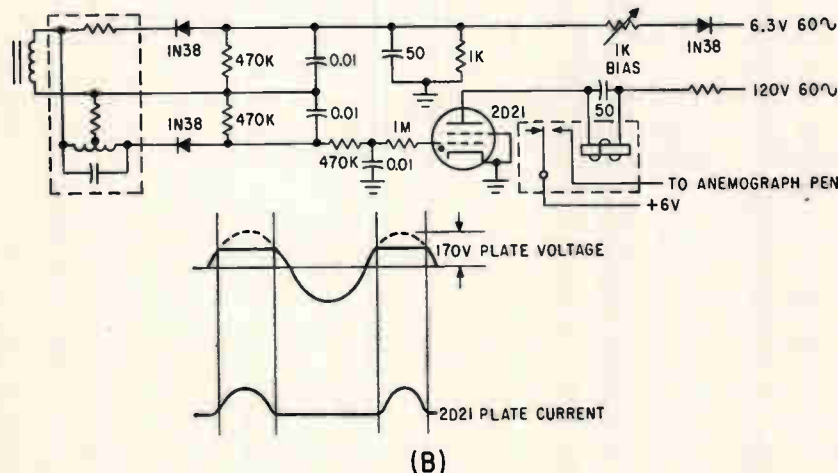
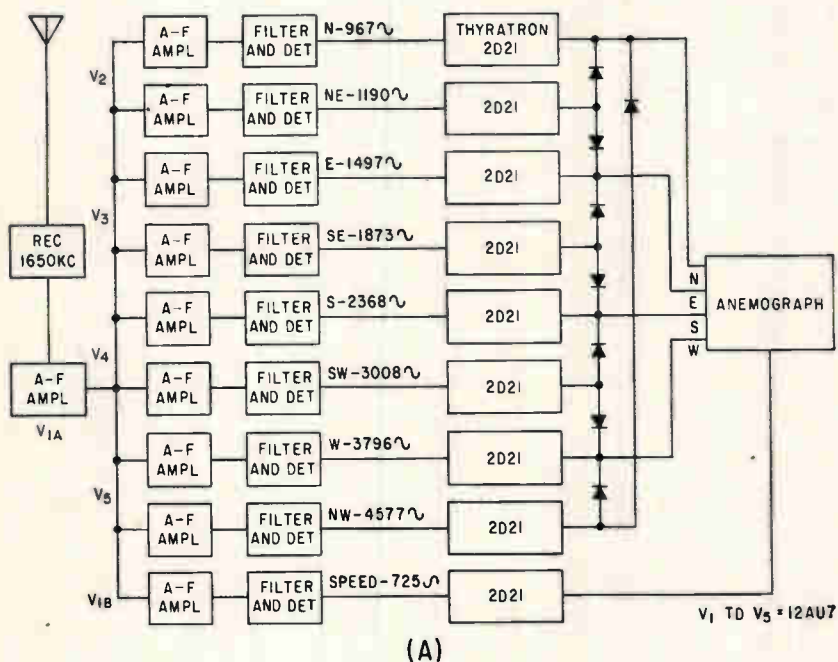

FIG. 3—Receiving equipment (A) includes tone filters; decoder circuit (B) uses thyatron

Feedback Stabilizes Signal Generator



Output of production unit is within ± 1 db from 50 Kc to 65 Mc

Automatic amplitude stabilization of r-f test signals by using negative feedback provides engineers with a signal generator that permits rapid and accurate response measurements over a wide range

By **ARTHUR FONG**,
Group Leader, Hewlett-Packard Co.,
Palo Alto, Calif.

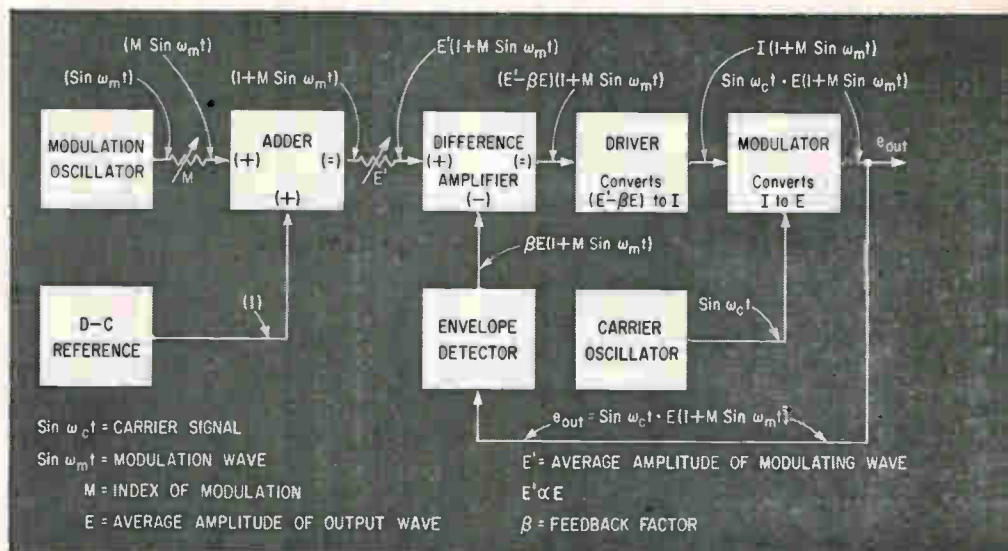

FIG. 1—Diagram defines terms and gives expressions for various outputs

USING conventional signal generators in the 50 Kc to 65 Mc range, approximately 30 percent of an engineer's time is used in resetting the signal level to the input of the device under test. Now, with a single channel negative feedback system, both carrier level and modulation can be detected and compared with the original modulation voltages. Output signal levels can be controlled to variations of less than ± 0.5 db over a 3 to 1 frequency range and less than ± 1 db over a 1,300 to 1 frequency range. Modulation fidelity enhancement can be expected to provide typical distortion of less than 1 percent at 30 percent index, for modulation frequencies of 0 to 15 Kc.

Before a system of feedback can be applied to a single channel, the relationship between carrier level and modulation index must be defined. The system logic is described in Fig. 1.

In this figure, the term $E'(1 + M \sin \omega_m t)$ is shown as an amplitude multiplier. The d-c reference of the modulating wave is established as 1 and the intelligence is provided in the modulating wave $M \sin \omega_m t$. An adder combines the d-c reference and modulation signal giving $(1 + M \sin \omega_m t)$. A level control adjusts amplitude of combined wave to $E'(1 + M \sin \omega_m t)$.

With all the modulating circuits designed for flat response from d-c to the upper audio limit, the output

wave of the system becomes

$\sin \omega_c t E (1 + M \sin \omega_m t)$
 Note that the amplitude control varies the carrier level without changing the modulation index.

The detection process in the feedback loop removes the carrier and provides a d-c component proportional to the average peak carrier. The detector also provides an audio voltage which is a replica of the modulating wave. This composite signal is compared in a differential amplifier to the original modulating signal. Since 35 to 40 db of loop gain exists in the system, amplitude variation is almost eliminated when the carrier frequency, modulation frequency or modulation index is changed. Noise and hum within the

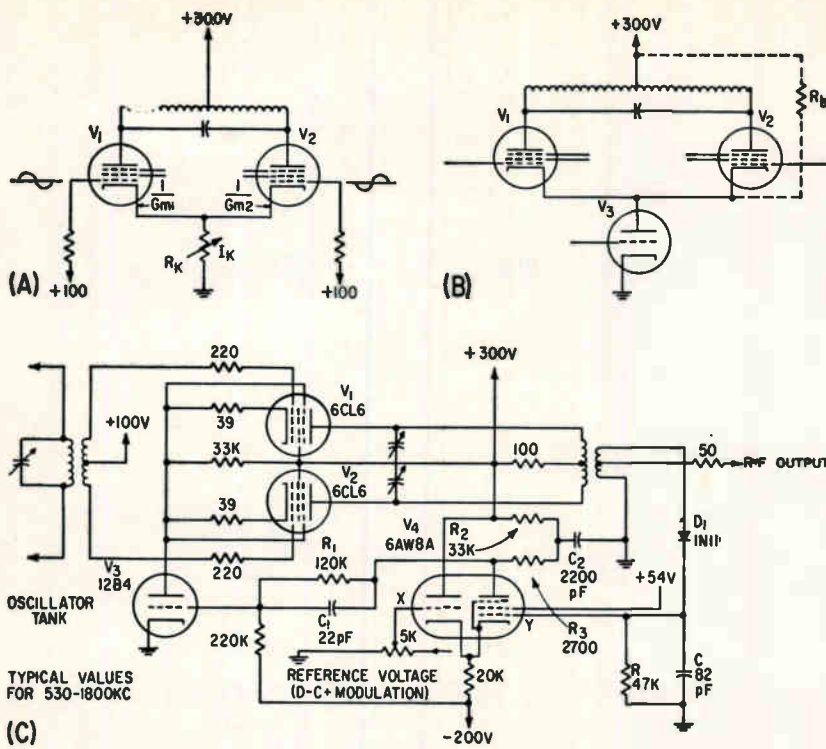

FIG. 2—Cathode resistor in r-f amplifier (A) is replaced by triode (B) to obtain better linearity. Details of modulator and feedback system (C)

loop are also reduced.

The system requires an r-f amplifier capable of linear operation. Figure 2A shows the basis for obtaining this capability. Operating points of the tubes are selected so that V_1 is cut off before grid current is drawn in V_2 , and conversely. In a balanced condition, the two tubes are conducting equally. Upon application of a rising signal, V_1 increases its current at the expense of V_2 . The cathode load for V_1 is $1/g_{m2}$; for V_2 , it is $1/g_{m1}$. A negatively directed signal on V_2 will cut off V_2 before the grid of V_1 becomes positive. The cathode load on V_1 suddenly becomes R_k , which is at least 20 times higher than $1/g_{m2}$. Thus, V_1 is now considerably degenerated. This cathode now follows the grid voltage with a little increase in current. Meanwhile, the maximum current which is specified in V_1 is determined by R_k or $I_{max} = E_k/R_k$. In the last half cycle V_2 is conducting and V_1 is cut off. Thus the tank circuit current is well balanced. Its r-f output voltage is proportional to the current determined by R_k .

If R_k is replaced by a triode as in Fig. 2B, a linear modulating system is obtained. Further enhancement in linearity may be obtained by

allowing a small portion of the triode current which is nonlinear current near cutoff, to flow continually (through R_k). A modulating system of this type could be expected to give distortion of about 8 percent at 100 percent modulation index. Further improvement, however, is achieved by the application of feedback.

Figure 2C shows the differential amplifier, V_4 . Two inputs, X and Y, are available. Input X requires a positive signal for upward modulation and Y requires a negative signal for upward modulation. Therefore, using detector D_1 at the output of the r-f amplifier and applying its demodulated voltage to grid Y, gives inverse feedback. The detector and its R-C load are adjusted so that the carrier is recovered as a d-c potential and the modulation sidebands are recovered as an a-c voltage. If the modulating system and detector are distortionless, then the modulated voltage is identical to the original modulating signal except for phase. Any distortion occurring in the amplification loop is minimized by feeding it back.

However, any distortion caused by the detector or the feedback loop itself will be present in the r-f output. In using a germanium diode

this detector distortion is about 0.5 percent for modulation levels less than 90 percent, and about 1.25 percent for levels of 100 percent. Fortunately, the distortion caused by the diode is in the nature of deepening of the trough of modulation. This is in the opposite direction of the distortion caused by the clipping of the trough of modulation because of nonlinearity of the modulator at low levels. The combined effects result in minimum total distortion.

The gain-phase characteristics of the entire feedback system must be controlled to prevent self-oscillation. There are phase shifts in the tank circuit, the detector, the plate load of the modulator driver and the plate load of the differential amplifier.

The gain-phase characteristics of the wide range tunable tank circuit are by far the most elusive, though not entirely unpredictable. Power delivered to a load can be depicted by a shunt equivalent resistance across a tank circuit. Loading by the amplifier tube and crystal detector can also be represented by a shunt load. This type of loading has a constant impedance with frequency and a bandwidth which varies as the square of frequency.

Ohmic losses in the coils and capacitor are equivalent series losses. Series losses alone in a parallel tuned circuit cause an impedance rise which is proportional to the square of frequency. The bandwidth of this configuration is constant with frequency.

In a practical system, both types of loading are present. Inductors in the 50-Kc to 500-Kc range have series losses which are proportionally higher than inductors for the 0.5 to 65-Mc range. Series losses in variable capacitors of normal construction (20 to 450 pf) are generally higher at the higher frequencies. Therefore, with combinations series and shunt losses, condition between the two extremes may be expected. When the series losses and the shunt losses are equal, the circuit Q is virtually constant with frequency and both the circuit impedance and bandwidth increase proportionately as frequency. Fortunately, this condition is a compromise for a wide range of tuning.

For the computation of gain-

phase, the modulator tank circuit followed by detection can be considered as a single resistance-capacitance cutoff with a 3-db point at the $\frac{1}{2}$ power bandwidth frequency.

The phase shift of the detector is important at higher modulation frequency. For the detector to follow the modulation without distortion, the detector time constant must have a greater slope than any part of the modulating wave. This condition is met when the expression for the time constant is $RC = (1 - M^2)^{1/2}/M\omega$, where M is the modulation index and $\omega = 2\pi f$.

Output of the detector is a modulating wave with a superimposed sawtooth corresponding to the carrier frequency. After the composite wave has passed through the differential amplifier, the sawtooth is removed but the resultant wave is slightly delayed with respect to the original wave. Maximum delay is $\frac{1}{2}$ the period of the carrier wave when using a half-wave detector. If the modulation frequency is less than 1 percent of the carrier frequency, the delay is negligible. Using a full-wave rectifier will reduce this delay by one-half.

Tube V_3 of Fig. 2C is the modulator driver. Its load consists of the parallel combination of the r-f amplifier cathodes. This is close to $1/(2g_m)$ where g_m is the average transconductance during the modulation cycle. Since carrier level is controlled by the current through the modulator tube, its average g_m is different for various currents.

The capacitances associated with the plate circuit of V_3 consists of the cathode-to-heater capacitance of V_1 and V_2 and stray capacitances. In a typical case (using 6CL6's current controlled by a 12B4), the parallel cathode impedance of V_1 and V_2 is about 500 ohms and the heater-cathode capacitances are 13 pf each. The 12B4 plate resistance is in the order of 1,200 ohms. Other capacitances are approximately 9 pf. The aggregate is about 300 ohms and 35 pf, giving a 3-db point of about 14 Mc. Where the maximum modulation frequency is less than 100 Kc, this factor is negligible.

The plate circuit of differential amplifier V_4 is composed of two parts—a voltage divider and the plate load. It is necessary to d-c

couple the plate signal at more than 100 volts d-c to the grid of the modulator driver, which is near ground. This is accomplished by placing a resistive divider between the amplifier plate and -200 volts. High-frequency compensation is attained with a capacitive shunt, C_1 , across R_1 . This combination results in a loss of 4 db in total loop gain. However, the response can be made flat to several megacycles, so for modulation bandwidths of less than 100 Kc this combination is not involved in phase considerations.

The primary portion of the plate load R_2 , R_3 and C_2 can be made flexible. This permits controlling the phase to overcome deficiencies in other portions of the gain loop. Figure 3 shows the tuned circuit, differential amplifier and overall open-loop response of the system. Assuming the frequency response of the other portions of the circuit are wide, the overall response is approximately that of the tuned circuit combined with the differential amplifier. A properly adjusted overall response is shown by a solid line crossing zero gain at 6 db per octave (Fig. 3A).

As a tank circuit is tuned across

the band, its bandwidth shifts by about 3 to 1. Figure 3B shows the result when the tuned circuit is adjusted to a lower frequency where the bandwidth becomes narrower. The result when the adjustment is at a higher frequency is shown in Fig. 3C. For normal sinusoidal modulation the last two responses do not affect the operation. With square wave modulation, however, the rise time, overshoot and ringing are somewhat affected.

One answer to this problem lies in making a tracking device which alters the plate load of the differential amplifier to follow the response of the tuned circuit. Another possibility is to design the tuned circuit to have as little change in bandwidth as possible. The compromise solution giving the responses as shown in Fig. 3A to C has by far the simplest circuits. Control of these gain-phase traits permits linear operation of the modulator with little distortion.

The author wishes to express appreciation for assistance received from the design group which includes H. Asper, J. Blokker, H. L. Halverson, E. C. Hurd, Jr., W. A. Klingman and F. Meyers.

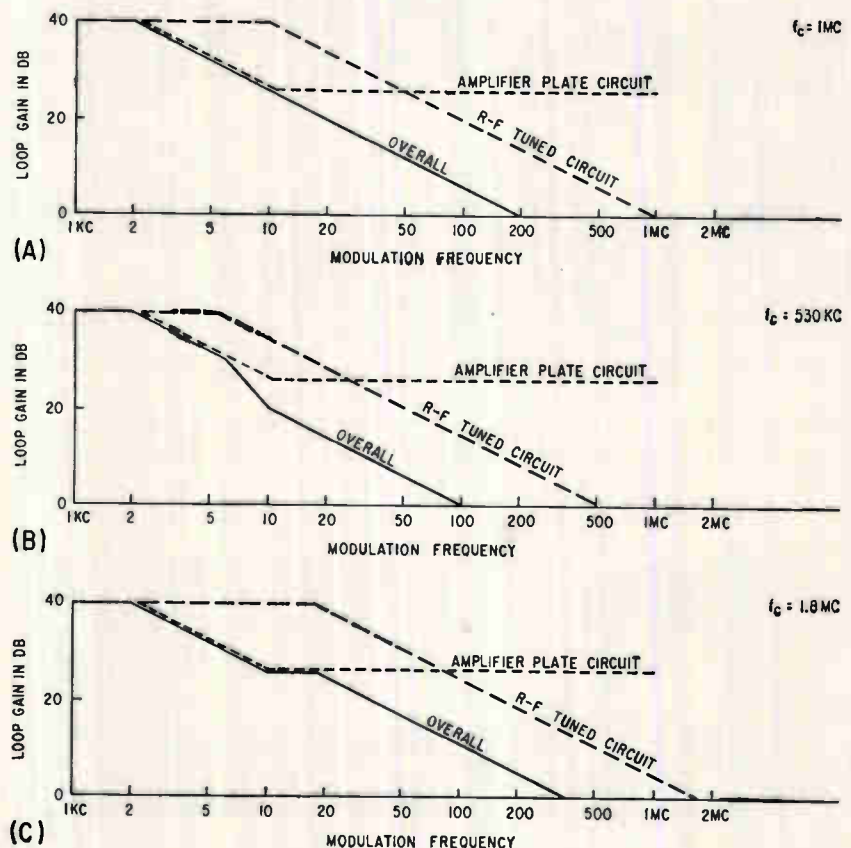

FIG. 3—Typical loop gain for midband (A), low end (B) and high end (C) show effects of tuned circuit adjustments

Automatic Test Equipment

Test program for each missile is held in magnetic memory; test results are automatically printed out on paper tape

By D. B. DOBSON
L. L. WOLFF

Radio Corporation of America,
Camden, New Jersey

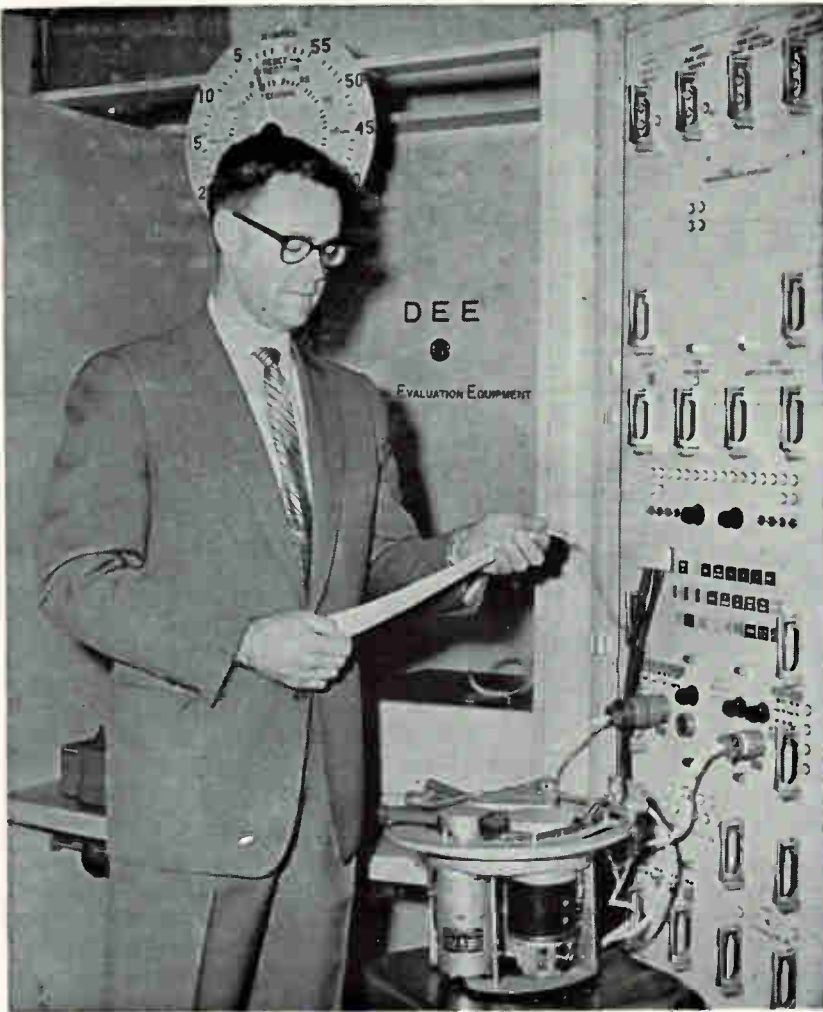

THE MULTI-PURPOSE missile system test equipment, named DEE (Digital Evaluation Equipment) checks the electronic subassemblies of the Hawk, Nike family, Corporal and Lacrosse missile systems and their associated ground launch and control equipment. The system replaces the individual test sets formerly used for each missile type.

Use of this multi-purpose system eliminates hundreds of nonstandard parts and equipments in logistic channels by consolidation of test equipment design, spare parts and procedures. The change from manual to automatic testing requires fewer operators of less skill, and as a by-product, significantly reduces laborious and error-susceptible interpretation methods. The improved use of manpower means that individual systems specialists who are expert in one single-application equipment will be able to operate multi-purpose automatic test equipment without retraining.

The simplified block diagram (Fig. 1A) presents the basic functions of the DEE and its major subunits and illustrates the operation of the system.

The test program is punched on paper tape by typing it on the logistics data printer (an automatic typewriter that operates the tape punch). The paper tape is then processed through the tape reader which transfers the program to the core memory through the distribution register. The core memory acts as a timer and buffer storage unit between the memory and the magnetic tape file. The program stored on the magnetic tape is then used for testing.



Engineer (top) reads-out test data for typical missile unit; complete installation (bottom) shows equipment being tested

Checks Missile Systems

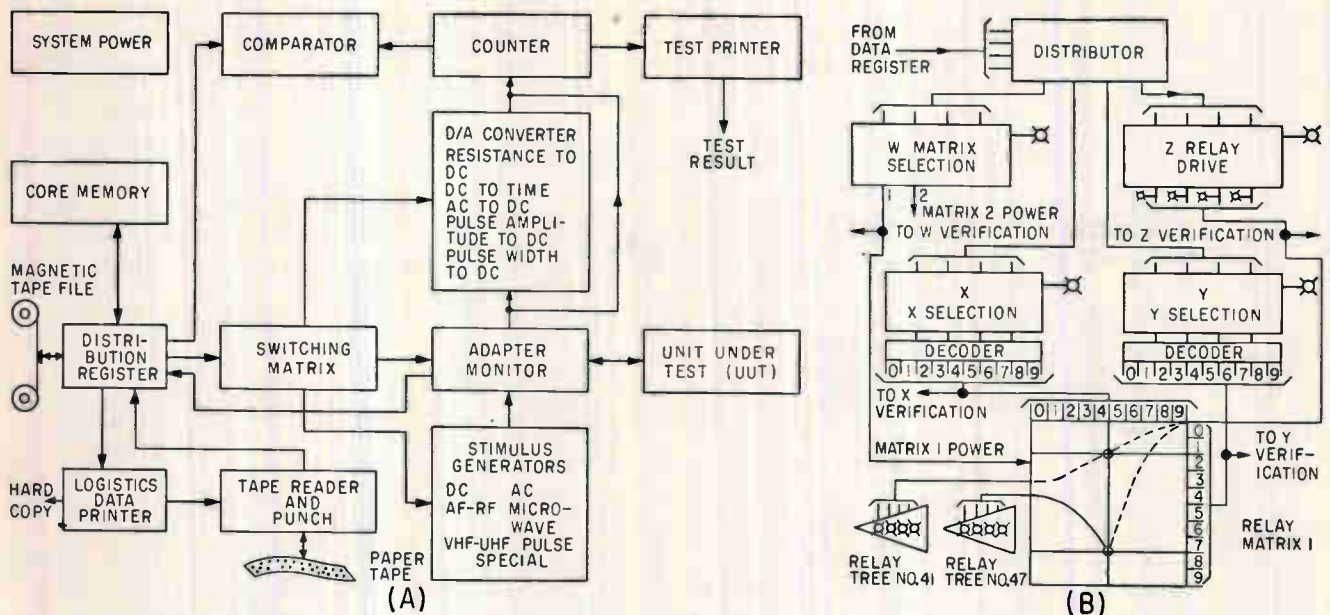

FIG. 1—Sequence of test instructions is fed into magnetic memory by punched paper tape (A); switching system connects power and stimuli inputs to unit under test, and provides path for readout of results (B)

The unit to be tested (UUT for Unit Under Test) is connected to the system through an adapter and cable which sets up the UUT address code in binary coded decimal form. The address code is routed to the distribution register for comparison with the test numbers from the magnetic tape. When the correct address is reached on the magnetic tape the test cycle begins.

Information is fed from the magnetic tape to the core memory and is then transferred in real time through the distribution register to the switching matrix. This matrix, in turn, connects stimulus generators to the UUT and the UUT outputs to the digital-to-analog converter and the counter. All analog signals are converted to time equivalent digital signals in the converter and then go on to the counter; measurements involving time are received directly by the counter.

The UUT outputs are measured and compared in the comparator with the upper and lower limits obtained from the magnetic tape by the distribution register. The results are printed out by the test printer.

When there is a NO-GO response,

the cause of failure together with analysis and repair instructions for that test are transferred from the magnetic tape to the logistic data printer.

Programming of the DEE begins with the preparation of unit test procedures. This is done by establishing a test plan to determine how the UUT will operate in accordance with its specifications.

Such a test plan provides fault isolation to the module, circuit, or component level. However, automatic fault isolation to the component level depends on the design of the UUT and test points. In preparing a test program, the programmer translates the unit test procedures into machine language for DEE. Using the logistic data printer, the programmer's translation of a test procedure is punched on paper tape, which is then entered into the DEE magnetic tape memory. The number and types of tests required vary according to the complexity of the UUT.

A simple test might consist of determining impedances between connector pins. More complicated tests require the application of stimuli to the UUT and the evaluation of the output. A typical test

may involve application of filament voltage, providing a warmup period, applying d-c power, injecting an r-f signal, setting up evaluating circuits to monitor the UUT output, and printing out repair information on the logistic data printer.

The switching subsystem controls, through programmed instructions, the inputs and outputs of the unit under test, the comparator-evaluator and all other functions that must be switched outside of the logic portion of the equipment. The functions consist of the stimuli control which selects the stimuli to be applied to the UUT and determines the magnitude, frequency, and pulse width of the stimuli; the inputs to which the stimulus is to be connected; the test points to be monitored by the comparator evaluator and applicable termination impedances and selects the range and type of measurement.

The switching subsystem operation can be illustrated by the block diagram shown in Fig. 1B. The system uses relay trees to control each function as selected by relay matrices. First *W* information selects one of two matrices, and *X* and *Y* data select the crosspoint re-

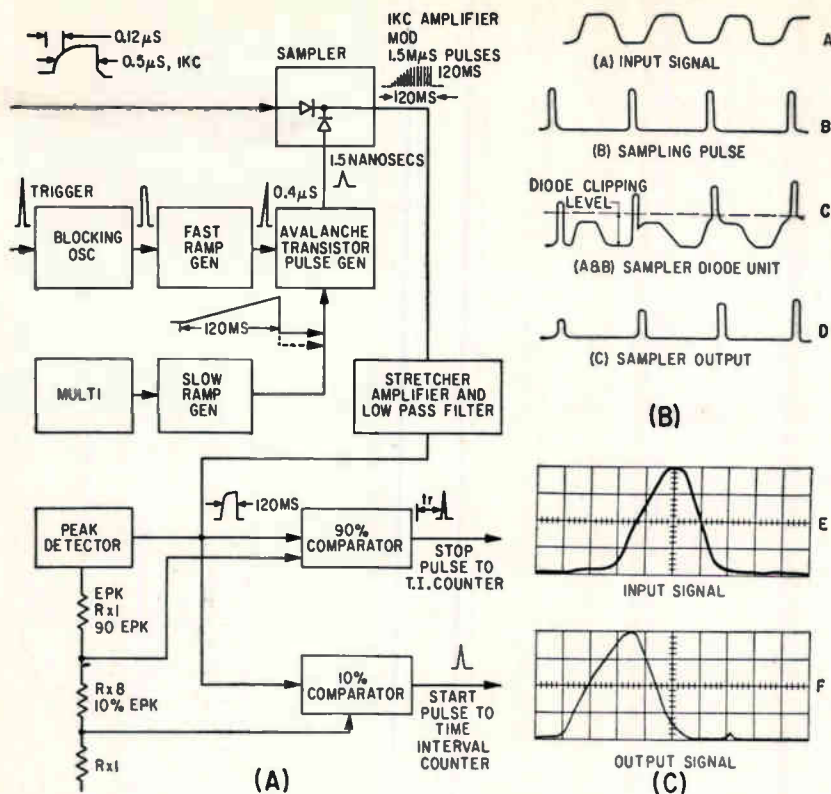

FIG. 2—Sampling amplifier measures waveform rise times and compares circuit performance with its original specifications (A); waveforms produced by analyzer (B); typical input and output waveforms (C)

lay within a matrix. Using this system, any one of 200 relay trees can be selected by *W*, *X* and *Y* information. The selection of a relay tree allows *Z* information to control the setting of that relay tree. Once a relay tree has been selected and is set up, it remains in that condition until it is readdressed with new *Z* information. This allows any number of functions to be controlled during a test.

A command character first notifies the switching subsystem that switching information will follow. This command resets the *W*, *X*, *Y* and *Z* selectors and the switching distributor control, thus readying the switching subsystem for the first character of switching information. The *W*, *X*, *Y* and *Z* switching data is received from the distribution register as 4-bit binary characters. No distinctive identifying code is associated with the 4-bit word, since the switching distributor accepts the characters in the *W*, *X*, *Y*, *Z* sequence. As the word is received, the distributor routes each character to the selection circuits which control the setting of a relay tree. After one relay tree is set up, the switching subsystem may receive four more

characters to set up another relay tree. This process can be repeated as many times as required to set up a number of functions. The system shown in Fig. 1B has already set relay tree 41 and is setting up relay tree 47.

Setting of each relay tree is controlled by the *Z* data, which in turn controls *Z* functions. These functions can use various types of control, such as 1 out of 15 selection of d-c output voltages, on-off control and 2 out of 4 selection. Therefore, the relay trees assure different configurations as required by each function. Standard relay tree configurations have been adopted, but other configurations are possible.

When a particular relay tree is chosen by the *W*, *X*, *Y* coordinates, the *Z* information is routed to the tree by the crossover relay in the matrix. Normally the crossover relay and the relay tree are both physically located with the function they control. The exception is the input and output control of the unit under test. Then they are located in the control unit. The reliability of the relays in the feasibility model has been found to be excellent, and in over six months of op-

eration (millions of cycles), no random relay failures have been encountered.

The switching logic circuits in the DEE constitute a central point from which all relay trees in the system are energized. Therefore, every step of a switching operation must be verified before the equipment proceeds to the next step. Every switching character that actuates a relay tree is encoded from parallel relay contacts. Such encoded characters are routed to the switching comparator where they are compared with the original character. This check assures that the proper relays have been actuated before the equipment goes to the next switching operation.

The switching verification check not only prevents erroneous switching, but also aids in troubleshooting relay circuits. When a relay tree is actuated, a lamp associated with that tree is momentarily lit. If a failure occurs, this lamp remains lit indicating the location of the defective relay tree.

Typical self-checking methods are used in the DEE as follows: when incorrect parity occurs in the transfer of information, operation of the equipment is immediately stopped at that point to prevent improper testing or damage to the UUT or DEE. To evaluate its own performance, the DEE system is programmed to route the outputs of its stimulus generators to the input of the evaluator. The evaluator then checks the stimulus generators and if any one is faulty, the cause for the malfunctioning stimulus generator is typed out by the logistic data printer. A program for checking all or any one of the stimulus generators permits a check of the entire system.

The electrical design philosophy for the DEE equipment was to produce an adaptable, reliable and relatively small system that is easy to maintain. Wherever possible, solid-state devices were used, permitting compact modularization of the hardware. The circuits are mounted on plug-in boards which fit into plug-in modules inserted into the equipment racks. With this arrangement, a circuit can be isolated without disrupting the system.

The stimulus generators are connected to the digital logic only

through the switching function to give the equipment extreme versatility. Hence, any function or testing capability can be added to the system by adding new stimulus generators and their program switches. Such additions do not affect the remainder of the system.

Transistorized logic circuits are encapsulated in miniature color-coded blocks. Since these blocks are functional digital logic circuits, they can be formed into logical configurations by following a logic diagram. Only six basic circuits are used throughout the digital portion of the equipment. Their various combinations yield all digital functions such as counters, shift registers, decoders and storage registers.

Stimulus generators are electronic units that provide the input signals and loads for the units under test. Each stimulus module or group of modules contains only one function to increase the system's adaptability to changes. The stimulus units use advanced components. Typical DEE stimulus generator units are a power amplifier capable of delivering 12 v rms into a 15-ohm load with the output waveforms 90 degrees apart, a transistorized a-f-r-f oscillator with variable frequency and amplitude, a time delay unit, an r-f signal generator with c-w or pulse c-w outputs ranging from 0.03 μ v to 1 v and a frequency range of 19.5 Mc to 37 Mc in 191 increments, programmable transistorized power supplies which are magnetic amplifier-controlled (a typical unit is

programmable in 0.1 v steps from 6 to 6.7 v with 18 amperes capability, another unit can be programmed in 0.5 v steps from 24 to 31.5 v with 20 amperes capability), and a microwave generator-modulator which uses a backward wave oscillator as an r-f source and whose frequency is digitally programmed through 4,096 steps in one portion of the X-band.

The equipment measures unit performance and compares the test results electronically with the limits prescribed in the program for the unit. Waveforms are analyzed automatically. Two automatic waveform analyzers, the *Rise Time Analyzer* (RTA) and the *Waveform Analyzer* (WA) are provided.

The RTA measures rise times of 4 to 150 nanoseconds from 10-percent to the 90-percent amplitude points. Fast rise times (20 nanoseconds) are not subject to deterioration resulting from oscilloscope amplifier bandwidth limitations. In addition the RTA measures aperiodic as well as periodic pulses. All readings are provided in decimal form. Measurement of pulse rise time in the RTA (Fig. 2A block diagram) is accomplished as follows:

A typical pulse whose rise time is 0.5 μ sec and has a 1-K-c repetition rate triggers a blocking oscillator, which in turn triggers a fast ramp (sawtooth) generator. The duration of this ramp is 0.4 μ sec and the output is fed into an avalanche transistor pulse generator. Concurrently, a multivibrator triggers a slow (120 ms) ramp gener-

ator, the output of which is also fed into the pulse generator. In the pulse generator, the combination of the slowly rising base voltage and the 0.4- μ sec trigger pulse combine to produce a 1.5-nanosecond pulse. When this 1.5 nanosecond pulse is superimposed on the original pulse in a pulse sampler, the pulse appears to move across the input pulse and, at each point in time, is superimposed on a different portion of the input pulse, as shown in Fig. 2B.

Diode clipping provides output pulses that are the sum of the input pulse and the sampling pulse referenced to a new base level. The envelope of these output pulses then represents the input pulse magnified by a factor of 10^6 . These output pulses are fed through a stretcher amplifier and filter to a peak detector and to a 10 percent and 90 percent comparator. In the comparator, the output pulse is compared to the 10 percent and 90 percent levels of the peak level of the pulse as detected by the peak detector and triggers start and stop pulses for the counter, thus permitting the pulse width to be read directly. The result is compared with the programmed value, and the measurement is printed on the DEE test data printer.

The waveform analyzer (Fig. 3A) measures the linearity of a sawtooth waveform and the tilt of a square wave. The unit detects sawtooth nonlinearity with extremely high accuracy. Measurement range extends from 0.1 v peak-to-peak to 30 v peak-to-peak

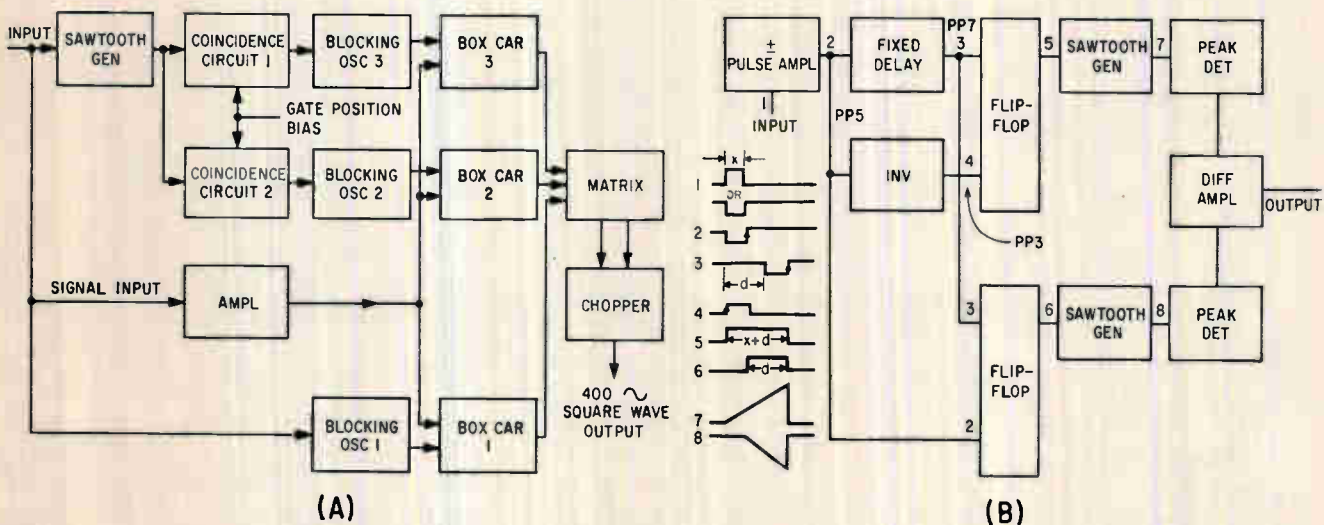
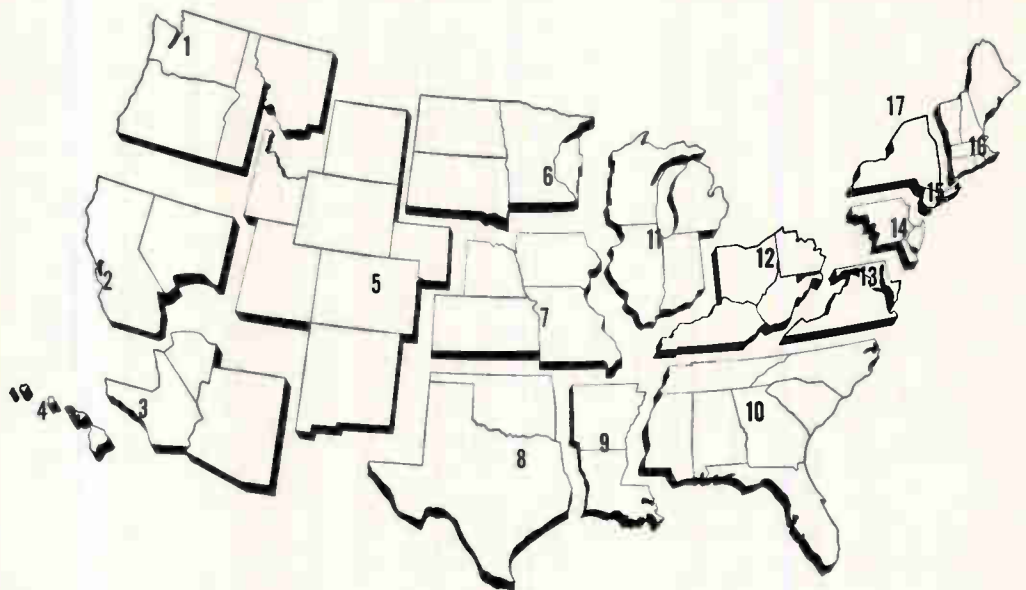

FIG. 3—Analyzer measures linearity of test waveforms (A); pulse width measurement is also carried out (B)

Your TWT requirements designed into rugged new Eimac X778

To meet your application requirements, the advanced new X778 ceramic-metal TWT has been especially designed to operate under severe environmental conditions. Its unique features include exceptionally wide frequency range—5.0 to 11.0 KMc., small signal power gain of 55-60db, and light-weight permanent-magnet focusing.

Ask your nearest Eimac Sales Engineer about complete product specifications and data on this new X778 one-watt CW tube. Ask him, too, about any specific application problems. He is your direct link with Eimac's Research and Development Program. And, at Eimac, *your* needs directly affect product planning and production.



EIMAC FIELD ENGINEERS

- | | | | |
|--|--|--|--|
| 1—RUSH S. DRAKE ASSOC. 1817 Norman Seattle 44, Washington Phone: EAsT 3-8545 | 7—MAURY E. BETTIS CO. CLYDE H. SCHRYVER ASSOC. 3706 Broadway Kansas City 11, Missouri Phone: LOfan 1-0772-3 | 12—TECHNICAL ASSOC., INC. 4475 Lander Road Chagrin Falls, Ohio Phone: TErrace 1-9884 | CANADA: 17—R. D. B. SHEPPARD 2036 Prince Charles Road Ottawa 3, Ontario, Canada Phone: PArkway 2-7152 |
| 2—JAMES S. HEATON CO. 413 Lathrop Street Redwood City, California Phone: EMerson 9-5278 | 8—HOWELL SALES, INC. P. O. Box 747 Grand Prairie, Texas Phone: DAllas— ANDrew 2-5153 Ft. Worth— CRestview 4-4530 | 13—JAMES R. EBERLY CO. Bank of Commerce Bldg. 1700 "K" Street, N.W. Washington 6, D. C. Phone: DIstrict 7-2667 | DAYTON, OHIO, AREA GOVERNMENT ONLY: ROBERT G. SIFF & ASSOC. INC. 22 Oxford Avenue Dayton 7, Ohio Phone: CRestview 8-4779 |
| 3—EIMAC LOS ANGELES OFFICE 3402 West Century Blvd. Inglewood, California Phone: ORchard 3-2710 | 9—DICK BELLEW SALES CO. 314 Melrose El Dorado, Arkansas Phone: UNion 3-8325 | 14—FRED F. BARTLETT & CO. 18 West Avenue P. O. Box 126 Wayne, Pennsylvania Phone: MURray 8-7325 & 8-7326 | ROME, N. Y., AREA GOVERNMENT ONLY: T. "PHIL" RIZZUTI R. F. D. #1 Blossvale, New York Phone: Rome FF 6-6109 |
| 4—JIM HASTIN SALES CO. P. O. Box 2098 Honolulu 5, Hawaii Phone: 511-755 | 10—J. E. JOYNER & ASSOC. 2258 Cascade Rd. S.W. P. O. Box 10821, Stn. A Atlanta 10, Georgia Phone: PLaza 5-4336 | 15—ADOLPH SCHWARTZ 15 Exchange Place Jersey City 2, New Jersey Phone: New Jersey DElaware 3-2424 New York: WOrth 4-1757 | SANDIA REPRESENTATIVE BOWDEN ENGINEERING & SALES CO. 8900 Snowheights Blvd. Albuquerque, New Mexico Phone: AXtel 9-0473 |
| 5—MCLLOUD & RAYMOND CO. 5403 East Evans Denver 22, Colorado Phone: SKYline 6-1589 & 6-1580 | 11—EIMAC CHICAGO OFFICE 10105 S. Western Ave. Chicago 43, Illinois Phone: BEverly 3-3895 | 16—COAKLEY SALES OFFICE 148 Needham Street Newton Highlands Boston 61, Massachusetts Phone: DEatur 2-4800 | |
| 6—H. M. RICHARDSON & CO. 9 East 22nd Street Minneapolis 4, Minnesota Phone: FEderal 6-4078 | | | |

EITEL-McCULLOUGH, INC. • San Carlos, California



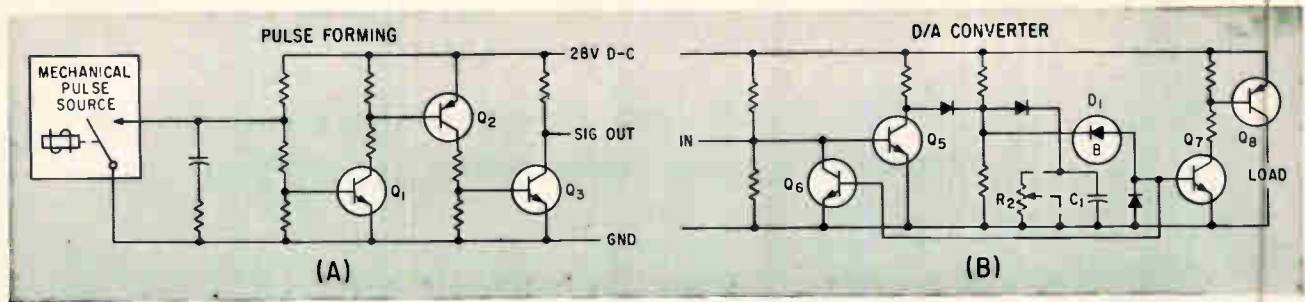

FIG. 1—Noisy pulse from relay or other source is used to trigger pulse-forming circuit (A). Digital to analog conversion circuit (B) can be used as pulse-rate circuit by adding R_2

Noise Suppression for Digital Signals

By FRED W. KEAR,

Lytle Corp., Albuquerque, New Mexico

A TROUBLESOME PROBLEM in electro-mechanical analog to digital convertor systems is brush noise. Most pulse counting and integrating systems are sensitive to noise spikes; accuracies are governed by the ability to control this noise while maintaining sharp rise and fall times. Inductive spikes riding on power buses can also cause errors.

A typical electromechanical to transistor switching circuit is illustrated in Fig. 1A. The mechanical pulse generator is an inductive pulse source, a commutator and brush assembly and associated wiring, such as relays and accelerometers. Noise is injected into the circuit through both output and power terminals of the pulse generator.

Output of the pulse generator must be filtered for the maximum expected noise pulse width. This will be a time interval of about 100 μsec , which is much less than normal switching pulse duration. The base bias and filter circuit of Q_1 will remove all noise pulses of less than 100 μsec duration. The filter circuit for this input will cause poor rise time on the output of Q_1 , about 200 or 300 μsec . Rise times of this order are not acceptable in missile accelerometer and similar circuits.

Transistors Q_2 and Q_3 , are pulse-forming amplifiers; they select portions of the output of Q_1 to cause saturation and to reject the slow rise time caused by the filter circuit. By using the sharp portion of the pulse as the trigger and letting the less acceptable portion fall in the saturation region, the original noisy pulse generates an acceptable signal.

For accurate timing and acceleration measurements it is necessary to standardize the width of the pulses from Q_3 . This is accomplished with the integrating circuit in the emitter of the unijunction transistor of Fig. 2. Standard width of the pulses out of this circuit is determined by R_1 , which is a part of the integrator circuit receiving the pulse train from the pulse-forming circuit. The resistance setting determines the charge and discharge time of the integrator circuit. Firing voltage of unijunction

transistor Q_4 is determined by its base voltages; emitter bias is set to enable the integrated pulse to fire the transistor each time. Duration of the output pulse of this circuit will be the time during which the integrated pulse voltage exceeds the firing voltage of the unijunction transistor.

The standardized pulse train from Q_4 is used either in digital readout equipment or in digital to analog conversion circuits. One typical D/A conversion circuit is shown in Fig. 1B. When the voltage on C_1 reaches the firing voltage of Zener diode D_1 , Q_6 and Q_7 fire; Q_6 clamps the circuit while Q_7 saturates Q_8 , thus energizing the load. Pulse rate can be detected by adding R_2 . Whether used as a pulse rate measuring circuit or pulse counter, the clamping transistor will cause the circuit to remain fired once the capacitor charge voltage reaches the level necessary to fire the Zener diode. Clamping is accomplished by shorting the base of Q_6 to ground.

All power buses are filtered by capacitor-diode L filters to prevent injection of inductive spikes into amplifiers and pulse formers. Most in-circuit generated noise can be filtered in this manner. Noise generated externally, such as in the power source or through radiation, should in general be eliminated by external filter and noise-suppression circuits.

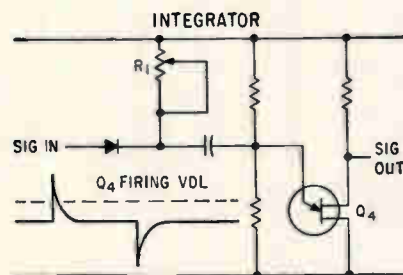
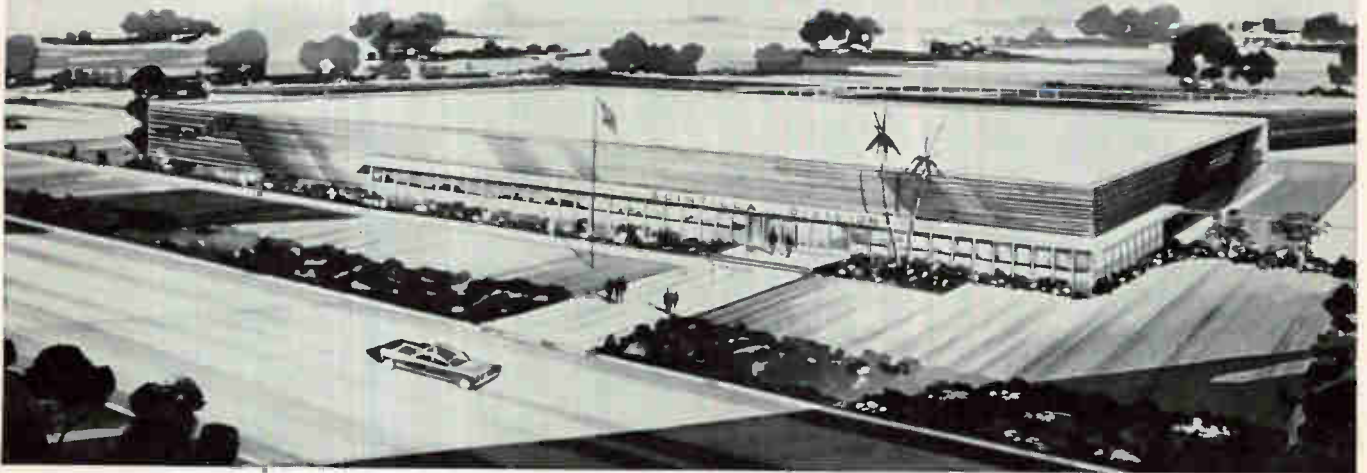

FIG. 2—Unijunction transistor fires only when emitter voltage is above a specified level

BENDIX ANNOUNCES NEW AND EXTENSIVE WEST COAST FACILITY



FOR CABLING USED ON GROUND BASED ELECTRONIC EQUIPMENT

Scintilla Division of Bendix has scheduled for September completion this new 30,000-square-foot plant at 1001 S. Grand Ave., Santa Ana, Calif. It will offer West Coast users the finest, most complete facilities in the area devoted exclusively to development and manufacture of cabling used on ground based electronic equipment.

West Coast missile industry producers, particularly, will benefit by having this new facility "on their doorstep," bringing them the latest and best in cabling for missiles and supporting ground equipment.

Sales and service for *all* Scintilla Division products—including cables and connectors—will continue to be handled out of 117 E. Providencia Ave., Burbank, Calif.

Scintilla Division
SIDNEY, NEW YORK



GaAs Reactance Generates Millimeter Waves

By G. H. HEILMEIER, RCA Laboratories, Princeton, N. J.

EXPERIMENTS have demonstrated the feasibility of generating coherent waves of 6.25 mm using the nonlinear capacitance of a back-biased semiconductor diode. Performance is superior to the nonlinear resistance multiplier in which fairly typical conversion loss is -18 db for the second harmonic of a 12.5-mm fundamental.¹

A power relation exists² for three linear circuits coupled by nonlinear reactance and resonant individually at ω_1 , ω_2 and $\omega_1 + \omega_2$. It states that $P_{12}/(\omega_1 + \omega_2) = -P/\omega_1 = -P/\omega_2$, where P_{12} , P_1 , and P_2 are average powers into reactor at $\omega_1 + \omega_2$, ω_1 and ω_2 . Because power flows from the reactor at the lower frequencies at the expense of the higher frequency, pump power is indicated by minus signs, although the relations could be written with all signs reversed.

If pumped at the two lower frequencies, power should flow from the reactor at the higher frequency. Using the same frequency for both pumps permits harmonic generation. Since nonlinear reactance is essentially lossless, conversion efficiency should be high.^{3,4}

Conversion loss using a back-biased diode in a coaxial circuit⁵ was -6.8 db in doubling 3,300 Mc, but extension to millimeters is difficult. Minimum conversion loss⁶ was -15.8 db in doubling 24 Gc. Main

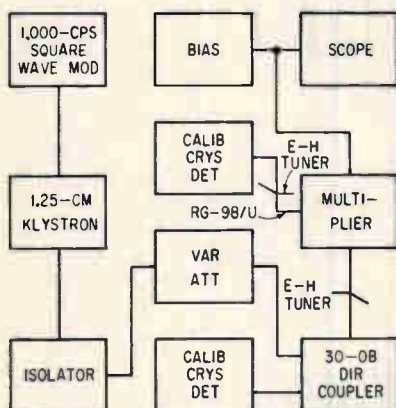

FIG. 1—Test setup compared nonlinear resistance diodes with published data

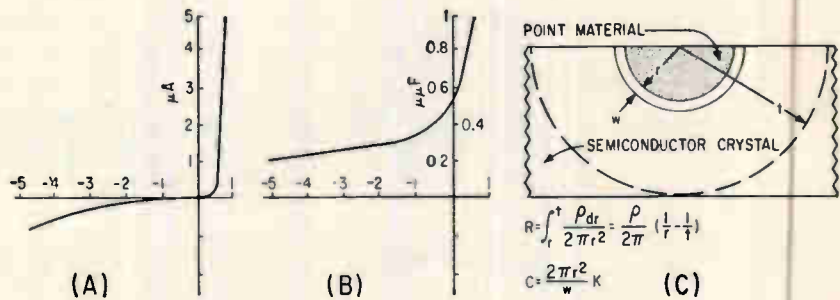

FIG. 2—Current-voltage (A) and capacitance-voltage (B) characteristics are typical for GaAs point-contact diode. Equations (C) permit finding RC product

problems are obtaining suitable materials and a high-performance microwave system. In the present experiments, results were compared for nonlinear-resistance diodes with published data to verify test setup performance.

A 2K33 klystron provided modulated input in Fig. 1, and power was measured with calibrated crystals. Short-circuit plungers and E-H tuners provided adequate matching. The harmonic generator is a fundamental waveguide (18-26 Gc) crossed by an RG-98/U harmonic guide (45-75 Gc). The fundamental guide is tapered in height over a few wavelengths for smooth transition to the smaller guide.

The harmonic guide is a high-pass filter below fundamental cut-off. The crystal of interest is mounted flush with the bottom at the junction of the guides on an easily rotated stud. R-f bypass permits use of d-c bias. A differential screw on top of the guide has effective pitch of 364 turns per in., permitting very low pressure contacts to the crystals. Point material is electrolytically etched, silver-plated platinum.

Measurements on some nonlinear resistance germanium and silicon crystals compared favorably with published results.¹ Input was about 20 mw and 24 Gc was doubled. Conversion efficiencies were -16.6 and -16.4 db for silicon and germanium respectively.

Conversion loss with an *n*-type germanium point-contact nonlinear capacitor was -14.7 db, a 1.7-db improvement. The conversion mechanism is assumed to be the nonlinear reactance because bias was negative where nonlinearity of resistance is small and poor efficiency would be expected.

In at least one case, shifting bias forward from -0.8 v decreased conversion efficiency, then increased it slightly to -20.8 at -1 v. With further bias increases, it fell off rapidly. This behavior is attributed to the nonlinear resistance mechanism.

Thus both mechanisms were clearly observed in the same crystal in this case, with nonlinear reactance being superior. Germanium crystal resistivity was 0.013 ohm/cm.

In magnesium-doped *n*-type gallium arsenide crystals with 0.003 ohm/cm resistivity, conversion efficiency was -9 db in doubling 24 Gc. It was found necessary to form the point immediately after crystal etching, believed needed because otherwise a stable gallium oxide may be formed on the surface. Self bias or a small negative voltage gave best results. Because conversion efficiency was relatively insensitive to small bias shifts about optimum values, it is felt that both mechanisms were acting.

A typical gallium arsenide diode had back current less than 1 μamp in the region of nonlinear capaci-

There've been some

CHANGES....

A new name and a new organization have been established for a well known defense team!

Bell Aircraft's military and government products operations, founded 25 years ago, now form the new Bell Aerospace Corporation, a wholly-owned autonomous subsidiary of Textron Inc.

Each division of Bell Aerospace takes on new breadth under this new arrangement... new capacity for research and development, new operational stability and new resources with which to work efficiently and economically with civilian and military contractors.

Bell Aerospace has strengthened its management and improved its production capabilities while retaining the scientific and technical personnel and facilities of the three former Bell Aircraft defense operations. These divisions, each prominent in its own right, are:

Bell Aerosystems Company (Formerly Bell Aircraft's Niagara Frontier Division), Buffalo, New York, a recognized leader in the diversified fields of rocket propulsion, avionics, aircraft and space techniques and systems.

Bell Helicopter Company, (Formerly Bell Helicopter Corporation) Fort Worth, Texas pioneer developer and one of the world's largest producers of rotary wing aircraft.

Hydraulic Research and Manufacturing Company, Burbank, California, outstanding designer and builder of electro-hydraulic servo control systems and valves for advanced aircraft, missiles and satellite projects.

BELL AEROSPACE CORPORATION

BUFFALO, NEW YORK

recording history at the bottom of the sea



Far below the surface, in a sealed steel ball on the *Trieste* bathyscaphe, a new chapter in undersea history is being recorded—on magnetic tape. Operating in an environment of 99% relative humidity, a high-performance instrumentation tape recorder captures a permanent record of depth, temperature, ambient noise, and voice.

The recorder, Precision Model PS-207 as shown at right, was modified for the application by Lockheed Aircraft Corporation, Sunnyvale, Calif., and supplied by them to the Naval Electronics Laboratory, San Diego, for the *Trieste* installation.

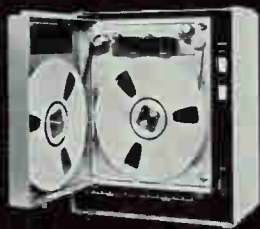

For details on Precision PS-200 series analog and digital recorders for other applications, write:



PRECISION INSTRUMENT COMPANY

1011 Commercial Street • LYtel 1-4441 • San Carlos, California

Cable: PRINCO, San Carlos, California • TWX: SCAR BEL 30

Representatives in principal cities throughout the world

tance. At zero bias, capacitance was about 0.58 pf and rapidly increased as bias approached +1 v.

Superiority stems partly from the higher electron mobility of gallium arsenide, which results in lower spreading resistance. Lower capacitance yields higher cutoff frequency (Q falls to 1) than germanium or silicon units. Higher band gap provides a voltage-current characteristic that increases more slowly in the forward direction than germanium. Thus wider forward voltage excursions are possible where capacitance nonlinearity is greatest before diode current deteriorates Q .

To find first order effect of crystal thickness on frequency, the point is assumed to form a hemispherical junction of the crystal surface. RC product can be calculated from Fig. 2 where w is depletion layer thickness, t is crystal thickness and r is assumed radius. Since r is the controlling geometrical factor and is usually small, t is not of primary importance in the RC product.

Small capacitance is generally desirable for broadband high-frequency operation, but it means high impedance and higher pump voltage. There is more d-c flow and hence more power loss in shunt and series diode resistances. Efficiency drops at high input power because of excursions in the forward-bias region, breakdown over part of the cycle and loss of power in harmonics. Ideals are high harmonic rejection, high diode breakdown voltage and slowly increasing current in the forward direction.

The gallium arsenide crystals were supplied by C. F. Stocker, and the author acknowledges the assistance of K. K. N. Chang and W. O. Eckhardt. The work was sponsored in part by the Air Research and Development Command, Air Force Cambridge Research Center.

REFERENCES

- (1) Johnson, Slager and King, Millimeter Waves from Harmonic Generators. *Rev. Sci. Instr.*, March 1954.
- (2) J. M. Manley and H. E. Rowe, Some General Properties of Nonlinear Elements, *Proc IRE*, 44, p. 904, July 1956.
- (3) A. Uhlir, Potential of Semiconductor Diodes in High-Frequency Communications, *Proc IRE*, 46, p. 1099, June 1958.
- (4) D. Leenov and A. Uhlir, Generation of Harmonics and Subharmonics at Microwave Frequencies with P-N Junction Diodes, *Proc IRE*, 47, p. 1724, October 1959.
- (5) K. K. N. Chang, Harmonic Generation

with Nonlinear Reactances, *RCA Rev.* September 1958.
(6) S. Kita, A Harmonic Generator by Use of the Nonlinear Capacitance of Germanium Diode, *Proc IRE.* 46, p 1307, June 1958.

Improved Spectrograph Controls Oil Quality

PETROLEUM QUALITY CONTROL using a 100-Kv x-ray spectrograph is saving time and money. The highly sensitive system was designed and built by Philips Electronic Instruments and is now in operation at Gulf Research & Development Company's Refinery Technology Laboratory in Philadelphia. The system detects and analyzes elements in oil samples for all the company's products.

Refinery catalytic cracking and molecular reforming processes require determination of potential catalyst poisons, particularly when expensive catalysts are used. Iron, nickel and vanadium, for example, are present in varying amounts in all crude oil. Submicroscopic traces of such elements, even one or two parts per million, are harmful to catalysts and impair their use.

The time required for chemical analysis to spot these catalyst-destroying elements was 24 hours. The x-ray spectrograph enables scientists to take a quick sample of charge stock and catalyst. They can then advise refinery management, within 15 minutes, the time a catalyst needs replenishing and amount of fresh material.

The 100-Kv x-ray spectrograph provides continuous output, unlike the pulsed output of the 60-Kv instruments often used in petroleum laboratories. The 60-Kv units detect elements when there are three parts per million; the new spectrograph detects them down to one-half part per million.

The new instrument was designed for high-speed operation, overcoming some time-consuming mechanical problems. An operator need not spend a great amount of time changing and realigning instrument components when analyses of different elements are required. Mechanical innovations incorporated in the new spectrograph permit these changes to be made in a few seconds.

alpha is an experienced systems organization



How Much Systems Experience Do You Have?

Alpha's facilities consist of its collection of top system management and technical talents together with the physical facilities necessary to most effectively design, engineer and implement systems of high reliability.

Alpha technical experience, know-how and creative talent is exemplified by the fact that more than eighty percent of Alpha project employees hold degrees in science or engineering. Alpha systems management talent is exemplified by the Alpha Project Directors whose average age is 40 and average years of systems experience is more than 10.

Would your capabilities be more significant in a completely systems-oriented organization where facilities must be measured in terms of talent? Do you have technical talent with the specialized capabilities needed to select system parameters; integrate a complex of equipments; direct a team of subsystem suppliers?

Write:

C. P. Nelson
Employment Manager



Alpha CORPORATION
A SUBSIDIARY OF COLLINS RADIO COMPANY

SYSTEMS DESIGNERS, ENGINEERS, CONSTRUCTORS, WORLD-WIDE • RICHARDSON, TEXAS • TELEPHONE DALLAS ADams 5-2331

Status of Liquid-State Control Device

IN LATE 1959 the Ovitron Corporation received considerable publicity about their revolutionary new Liquid-State control, which has characteristics much like those of a saturable reactor or controlled rectifier. In addition to on-off switching of alternating currents up to ten amperes, as the early publicity suggested, the unit also provides modulated control of alternating current throughout its operating range. The rather premature publicity has been somewhat misleading, for, while the switch does offer smooth control of alternating current, it still cannot be made to last indefinitely as was originally believed. (ELECTRONICS Aug. 14, 1959, p. 76).

The cell is an electrochemical device with two main current carrying electrodes hermetically sealed, together with an electrolyte, into a walnut-sized container. Located between the two main electrodes, and also immersed in the electrolyte, is a third electrode to which the control signal is applied. This control electrode is only lightly rated since the current it carries is small relative to the main current. It acts somewhat like the base of the familiar transistor.

Right now the source of cell failure is gassing. Like other electrochemical devices, the passage of current through the electrolyte causes emission of gas and consequent depletion of electrolyte. If the cell is hermetically sealed, build-up of gas pressure will bring failure due to cell rupture. Alternatively, if the gas is allowed to escape, loss of electrolyte will ultimately be the cause of cell failure.

It was originally planned that a catalyst would be sealed into each cell where it would reconstitute the gases, returning them to the electrolyte in a closed cycle of operation. In this way no gas would be lost, and disruptive pressure avoided, thereby conferring indefinite life on the cell. Unfortunately none of the catalysts have worked perfectly due to slow poisoning

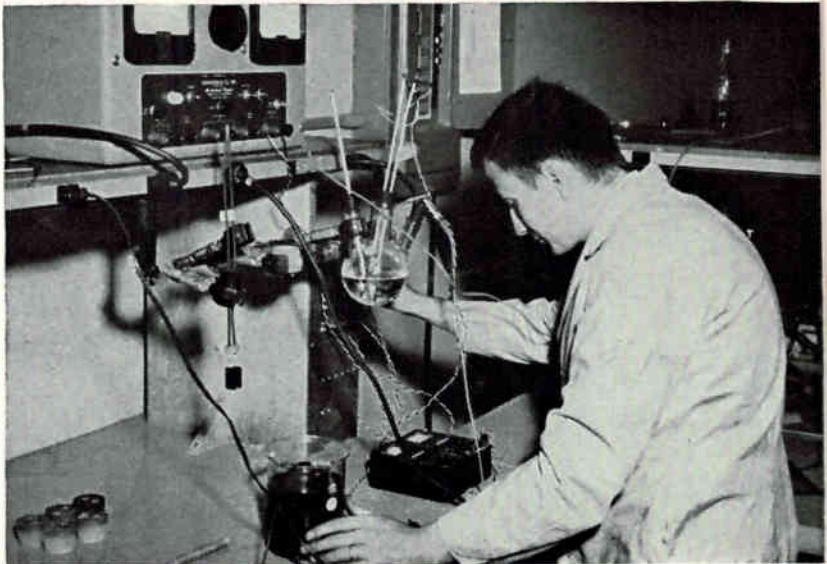

Research engineer at Ovitron works to cure gassing problem

caused by electrochemical by-products.

Currently, Ovitron has a six man scientific team working on the gassing problem. They are still experimenting with some catalysts that seem promising. Their ultimate goal, however, is to create a device utilizing reversible chemical reactions which will not gas at all. Some promising results have recently come out of work with non-aqueous solutions. To date, the Corporation has spent over \$300,000.00 on this development project.

At the present time, Richard Hexter, Ovitron Vice President states that his company could manufacture a cell with 60 volt operating potential and a capacity of 2.5 amperes. The cell would offer a control of alternating current over the working range, by varying the control circuit impedance from one ohm to 2000 ohms. On a light duty cycle the cell would last several months, but this life is shortened if the hermetically sealed unit carries continuous high current. These specifications are given, not so much to offer such cells to the market as yet, but to clarify the position in regard to them.

There are other possibilities for

the cell aside from direct competition with the transistor and control rectifier. Since the cell gasses, why not make it do so and replenish the electrolyte as necessary? We are accustomed to doing this with an automobile battery so it is not inconceivable that it could be done with this unit. Following this argument, a logical application could lie in control of battery charging from an alternating supply in which case the cell would act as a current regulator and receive the same maintenance that the battery receives.

By increasing the area of the main electrodes, the current carrying capacity will also be increased. This suggests an application for the device in the control of wound rotor induction motors, where the cell would adjust the resistance in the rotor circuit and so control the motor speed. Existing motor controls using an electrolyte as a resistance element suffer from the necessity of a mechanical device to raise and lower one of the electrodes so that its contact area—hence resistance—can be altered. Obviously, if the resistance could be varied with the static unit, it would offer some simplicity.

With a possible solution to the

Take a closer look at contacts

They're the most important part of a low-power switch . . .



Oak contacts are the main reason why builders of MILITARY and quality INDUSTRIAL equipment prefer Oak switches.

7X Magnification Shows the Unique Precision and Intricacy of Typical Oak Contacts



Test and Compare Oak Contacts Yourself

Compare them with any other switch made for low-power switching. In many cases, the results will be dramatic. First, you will note that *all* Oak contacts are double wiping (to stay clean and eliminate maintenance) and that each has the longest possible spring length for extra life. Then you will discover that extra contact pressure holds circuit resistance and noise to lower levels over a longer span of life.

Because of unique design and manufacturing subtleties, Oak switch contacts will test out superior in practically every characteristic. They are the finest contacts produced today for low-power, dry circuit switching.

In Oak contacts, you also get the widest selection of forms and materials (many of them exclusive) which are custom engineered to the exact requirements of your application.

Write for New
STOCK CATALOG 399

Prices and specifications on 124 stock rotary switches for Military and other applications.



ONLY THE FINEST IN LOW-POWER SWITCHES

OAK

MANUFACTURING CO.

1260 Clybourn Ave., Dept. G, Chicago 10, Ill. • Phone: MOhawk 4-2222
West Coast Div.: Oak Electronics Corp.
11252 Playa Court, Culver City, Calif. • Phone: EXmont 1-6367

SWITCHES CHOPPERS VIBRATORS
ROTARY SOLENOIDS TUNERS
SUBASSEMBLIES VARIABLE CAPACITORS

CONTENTS:

accuracy in pressure measurement

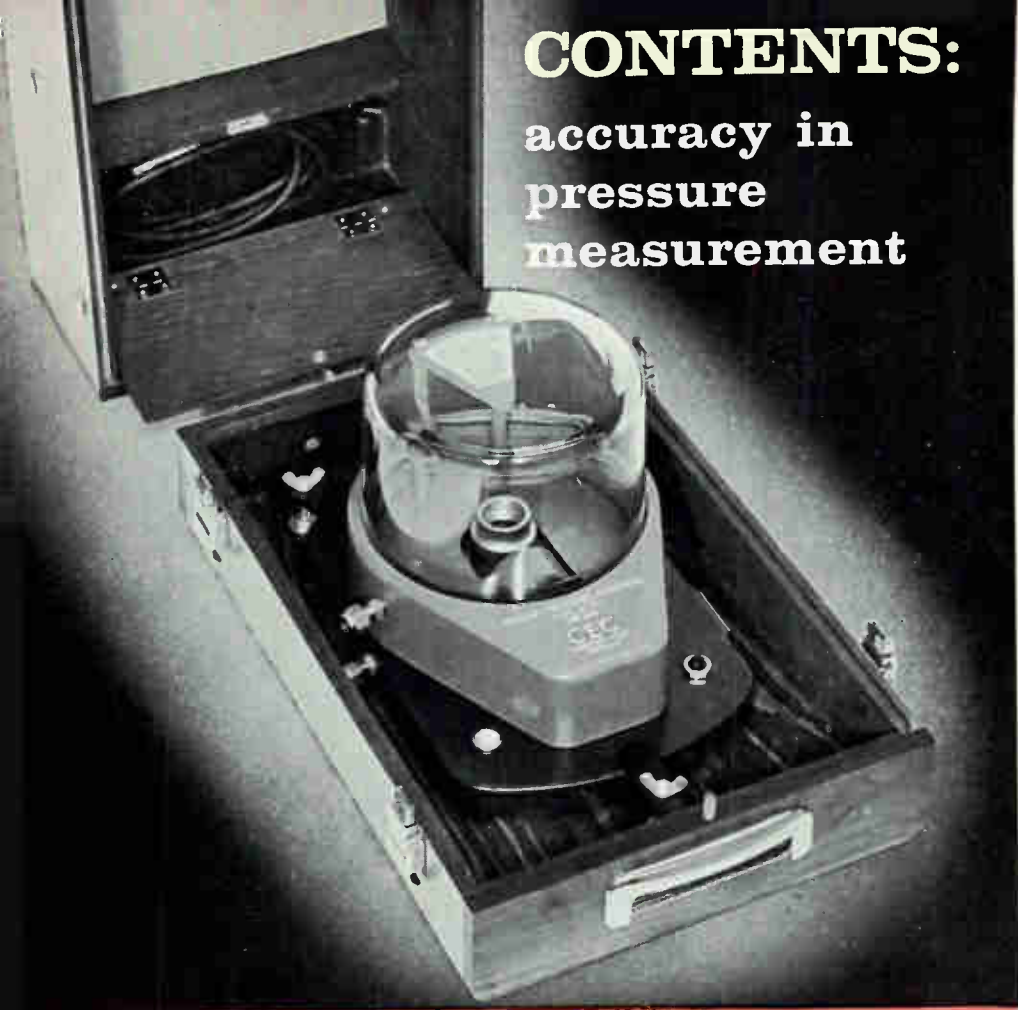

Here's the starting point for precision calibration of pressure measuring instruments... here's where accuracy begins. It's CEC's portable 6-201 Primary Pressure Standard, a pneumatic dead-weight piston gage that assures resolution of 0.005% of reading.

This lightweight instrument is so simple to operate that its accuracy of gage and absolute calibrations is all but independent of operator technique.

The 6-201 covers six pressure ranges between 0.3 and 500 psi, with accuracy of 0.015% of full scale in the 1.5, 5.0, 15 and 50 psi ranges and 0.025% of full scale in pressure ranges of 150 and 500 psi.

Because the 6-201 relies only on fundamental dimensions for measurements, it is independent of any other instrument for its calibration. It uses mass, length and time for its references.



For complete information on the 6-201, write for Bulletin CEC 1581B-X26. For data on CEC's integrated line of instrumentation and pressure measurement devices, ask for Bulletin CEC 1308-X16.

Transducer Division

CEC

gassing problem in the offing, Ovitron engineers are also working to improve the cell's electrical characteristics and reduce its overall size. Basic studies on the cell's mechanism have changed some earlier misconceptions about its method of operation and have already resulted in a two-fold reduction in size of the unit over that originally announced. If these developments are successful, Ovitron, now at Long Island City, N. Y., hopes to supply evaluation units within the year.

Silicon Mesa Transistors

MILITARY TYPE silicon mesa transistors (USA) 2N696 and (USA) 2N697 per MIL-S-19500/99A (Sig-C) are now available from Rheem Semiconductor Corporation.

Types 2N696 and 2N697 are the first silicon mesa transistors available per a military specification. Manufacturers can now use these transistors in equipment for the military without having to obtain "non-standard part approval."

These types, without an individual military specification, have been available from Rheem since October 1959.

Type 2N696 and 2N697 are immediately available in production quantities on orders referencing military contracts. No increase in price.

Forming Bonded Coating On Ultra-Hard Metals

A NEW PLASMA SPRAY coating and fabrication process which can deposit nearly any material on metals, ceramics, and certain plastics brings many new, rare and hard to handle metals and materials within reach of designers and metalworkers and is now industrially available from Harper-Leader, Inc., of Waterbury, Conn.

The process, harnessing controlled temperatures up to 30,000 F., makes possible mass production and custom fabrication of ultra-hard materials which have been considered practically unworkable by conventional metal-working methods.

CONSOLIDATED ELECTRODYNAMICS/pasadena, california

CIRCLE 88 ON READER SERVICE CARD

A SUBSIDIARY OF Bell & Howell • FINER PRODUCTS THROUGH IMAGINATION

Big Performance in a Small Package with CEC's New Portable Recorder

Applied to the basis material by the plasma jet process, the refractory metals and their compounds, oxides, nitrides, borides, and the precious metals and their alloys form a firm chemical and mechanical bonded coating. The number of combinations of compositions and physical properties of coatings applied with the process is almost infinite and opens many new avenues in materials engineering.

The building-up of worn parts such as dies, application of wear-resistant sections to mechanical parts at critical points, corrosion-resistant and non-oxidizing surface treatment are all possible with the process. Almost limitless utility in all metalworking fields and types of industry is seen for the plasma process which not only utilizes hitherto unworkable materials, but with more common materials produces generally superior coatings to those created by conventional methods.

High-Frequency Diodes

TUNNEL DIODES with peak currents in the range of five to 20 amperes with peak to valley ratios of five to 10 have been developed by the Delco Radio Division of General Motors Corp., Kokomo, Indiana.

The high frequency devices are being investigated for use with thermoelectric generators where low voltages are normally encountered. They also may be useful in high frequency oscillators and in high voltage power supplies having very low voltage and high current inputs. They also may be used for switching.

The tunnel diode series developed ranges from units with a capacity of a few milliamperes to units capable of switching 20 amperes. Units in the high current range have peak current of 20 amperes and valley currents of two amperes.

The new units are relatively insensitive to temperature changes and to radiation damage. They have a low noise figure.

Developed as a part of the experimental program of Delco Radio, the units may be made available commercially.

CIRCLE 89 ON READER SERVICE CARD



The all-new PR-2300 is at home in the lab or in the field, aboard a submarine, or with larger systems from missile checkout and back-up to industrial control. In or out of its carrying case it mounts in a standard 19" rack... accepts 10 1/2" reels with all standard hubs and tape widths... provides simplified, fool-proof pushbutton control of any function in any sequence in either direction. The PR-2300 uses all solid-state electronics... gives gentle, controlled tape handling... packs complete 14-channel record and reproduce capability in a 30-inch vertical rack space.

There is much more to the PR-2300 that can change your thinking about tape recorders, and the modest price tag is a feature, too. Call your nearest CEC sales and service office for detailed information, or write today for Bulletin CEC 2300-X2.

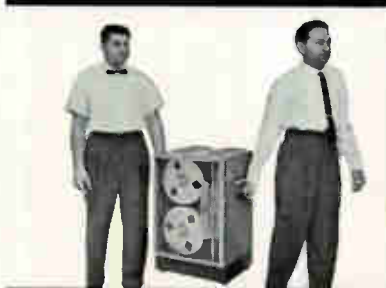

Portability demands little compromise in performance. Flutter, tracking, overall performance and reliability approach or equal the most elaborate and expensive instrumentation tape recorders.

DataTape Division **CEC**

CONSOLIDATED ELECTRODYNAMICS / pasadena, california

A SUBSIDIARY OF Bell & Howell • FINER PRODUCTS THROUGH MAXIMIZATION

Universal Boards Cut Computer Lead Time

By LANE WOLMAN,
Director of Systems Engineering,

ELMER ZUEHLKE, Staff Engineer,
Special Devices Eng. Dept., Librascope Div.,
General Precision, Inc., Glendale, Calif.

DESIGN AND PRODUCTION tasks mushroom as the size and capacity of digital computers increase. Normal evolution through design, breadboarding, design refinement and packaging may take a prohibitive amount of time, particularly if a prototype or limited production run is planned. A shortcut which enables partial production before final design is the ideal solution.

A "universal" circuit board developed by Librascope permits the majority of board assembly and testing to be completed beforehand. This approach has drastically reduced lead time on a giant, reservations type computer designed for the Federal Aviation Agency's new air traffic control system.

A NOR logic concept was selected for the computer. In addition to operational advantages, the circuitry is relatively simple. It lends itself to a single gate module which can be used with minor variations throughout the system, facilitating

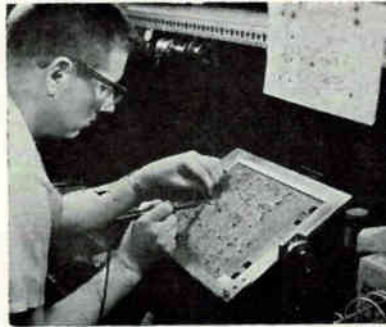

Board assembly. Board is tested and stored pending interconnection of modules

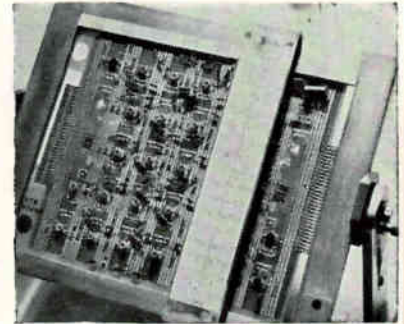

Assembly jig has sliding scale to locate interconnections on preassembled board

preassembly. When modules are interconnected later, the boards are ready for use.

Two boards were designed. The original design is used in the data processor. The second design employs the same basic modules, but has improvements in the etched wiring pattern to overcome some production problems experienced with the first board. The second design is used in the buffer equipment.

The first board is double-sided, carries 15, 20 or 25 transistor modules and has 31 pins duplicated at each of the 2 terminal strips.

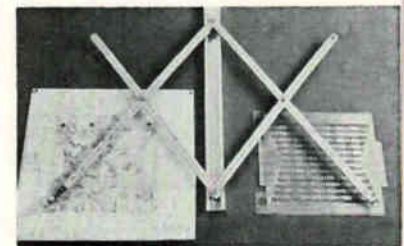

Pantograph transfers eyelet positions from layout to board. A drop of ink guides drilling of each selected pad

All circuitry is run to terminal pins at either end of the board. The latter facilitates checking without removing the board from equipment and enables a special monitor panel to be used in maintenance.

Each transistor position is surrounded by 2 rectangular "rings". Each transistor base lead connects to the inner ring and each collector to the outer ring. The collector has possible intersections with half the signal leads between connectors. A collector resistor and a base bias resistor provide appropriate currents to the rings. The emitter lead goes to a ground bus. A nylon collar at the lead and of each transistor protects the wires from damage, speeding assembly.

A gate circuit is formed by bridging connector buses and base rings with 1 to 7 resistors. The switched signal is fed to the connectors through an eyelet. Two modules connected back to back form a flip-flop. Base and collector

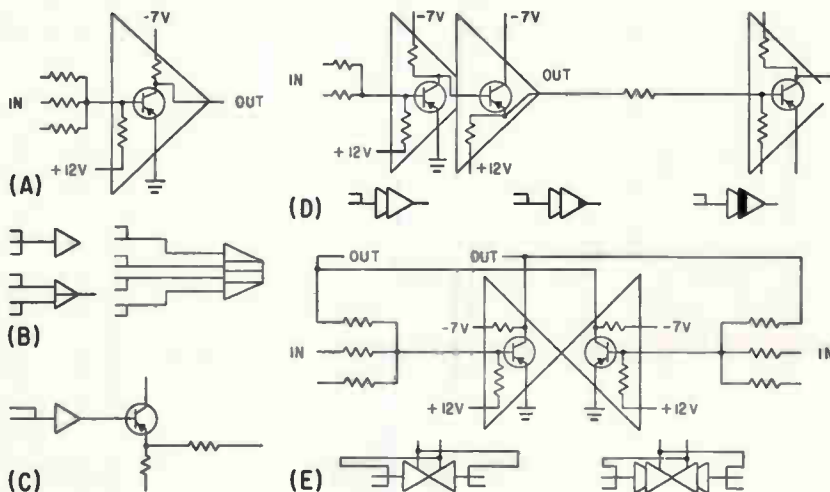
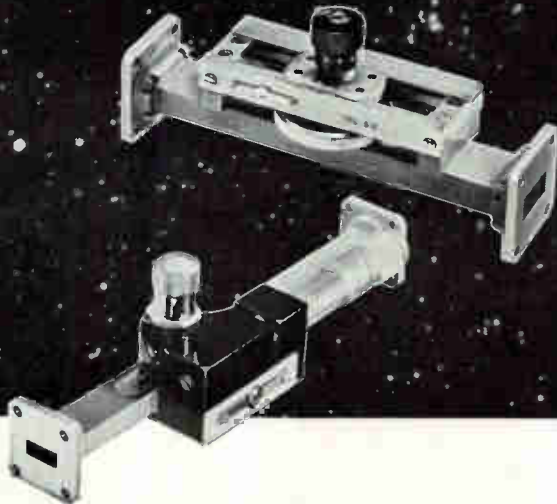

FIG. 1—Schematic diagrams are reduced to symbols, speeding drafting. Shown are schematic of basic nor gate module (A), symbols for 1, 2 and 4-transistor modules (B), symbol combined with conventional symbols (C), emitter follower schematic and symbols for basic emitter follower and emitter followers with higher output transistors (D), schematic of flip-flop and symbols for flip-flop and emitter follower flip-flop (E)

what
is the
frequency
standard
for the
U.S.A.?



ANSWER: By act of Congress, the U.S. Bureau of Standards determines the primary standard, based on the revolution of the earth. All DeMornay-Bonardi microwave instruments are calibrated at frequencies which are verified by our secondary standard, which, in turn, is periodically calibrated, point for point, by the U.S. Bureau of Standards.

One way to properly match a microwave transmission line is by using a D-B Stub Tuner to reduce mismatch losses and utilize the total energy available.

D-B stub tuners in the 2.6 to 18 KMC range have a new scale and vernier that gives precise resettability in longitudinal travel. A new micrometer scale on the probe meas-

ures penetration with very high accuracy.

Probe wobble is eliminated, and no resonances can occur under any conditions. You can correct VSWR as high as 20:1 with amazing accuracy (1.02). You can tune with precision... reset to original settings with certainty that phase and magnitude have been duplicated.

Ditto for higher frequencies. D-B tuners in the 18 to 90 KMC range are not simply scaled-down units—they're engineered for ultramicrowave® use. All the above features are available, plus micrometer positioning which provides readability to .0001".

Write for data sheets—they detail all features, applications, dimensions, sizes. Bulletin DB-919.



780 SOUTH ARROYO PARKWAY • PASADENA, CALIFORNIA

Aboard an Atomic Sub...

PRECISE CONTROL OF TORPEDO FIRING AND MISSILE GUIDANCE OPERATIONS



Atomic Submarine U.S.S. Seadragon

Several STANDARD timers of special design coordinate time between the several operating stations in the "Seadragon's" integrated missile guidance and torpedo fire control system.



Another of Numberless Applications of **SPECIAL TIMERS** by **STANDARD**

What's your need in special timers? For precise process timing... accurate test timing... precision coordination?

Whatever the application, STANDARD has the engineering skill and experience... and the ample production facilities... to develop the timer you need.

Accuracies to $\pm .001$ second are available in standard models. Write today requesting descriptive catalog or outlining your special requirements.

Catalog 198A covers the complete line of Standard precision timers... portable and panel mounted.



**THE STANDARD
ELECTRIC TIME COMPANY**

89 LOGAN STREET • SPRINGFIELD, MASSACHUSETTS

"Splitting the Split Second... Precisely"



rings are connected with 2 resistors, 2 resistors feed in set and reset signals, and 8 eyelets make interconnections.

The boards carry up to 33 modules. The use of fewer modules provides adequate space for emitter followers, which use larger transistors. The holes drilled for standard transistors are enlarged and a portion of the base ring removed. The emitter lead is connected to the collector ring and the collector lead to the voltage bus. An eyelet brings the signal to the connector. From conductors running parallel to the connector busses, an eyelet joins a gate collector ring to the emitter follower base ring.

Approximately 75 percent of assembly and testing is completed before the computer design is finished.

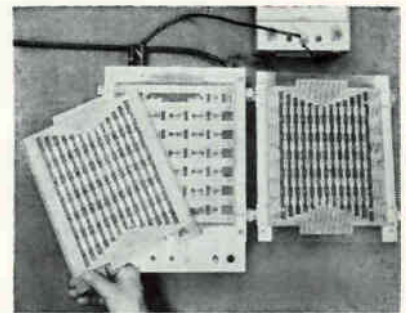

Hi-pot test at 1,500 v d-c is given each board with this test fixture

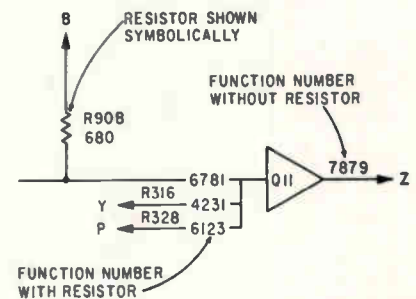
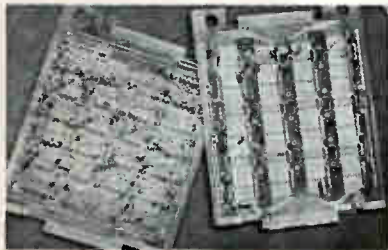

FIG. 2—Example of resistor and function numbering methods

The boards used in the buffer equipment have a different etched pattern to simplify assembly. They have 12, 16, 20 and 24 modules for greater versatility. Instead of parallel conductors for busses, which required jumpers, a conductor is provided which intersects with practically all the modules on the board. The conductor can be cut to isolate interconnections. Eyelet locations were replanned and

increased in number. Base and collector rings were opened up and a jumper pattern laid out between adjacent transistor positions.



Redesigned board used in buffer. Other photos show original design

Buffer boards also permit component bodies to act as insulation between adjacent resistors, making sleeving unnecessary. Component height is limited to $\frac{1}{4}$ inch from the board surface to permit minimum center positioning of the boards in the terminal bays.

Since each board passes through several production stages and inspections, circuit identification is provided by a tagging and numbering system. The code includes the number of the assembly print and its final revision. Conductors and pins are lettered.

During preparation of the boards, it was discovered that the uniformity of module types made it possible to use operational symbolism with the standard IRE symbols used on the nor schematic diagrams. Since only 5 standard gate modules, 3 emitter follower configurations and 3 flip-flops were required, an operational amplifier symbology is used. These symbols, shown in Fig. 1, eliminate repetitive drawing of most transistors and their bias and load resistors. Drafting time is reduced and drawings clarified. The operational symbol can be used with standard IRE symbols to indicate special circuitry.

An interesting development of these symbols is the use of functional numbers for fan-in and cross-steering resistors. Function numbers are also used, as in Fig. 2, to designate specific line functions as well as the presence of a physical resistor in the circuit. All resistors are given series numbers to indicate their use. These numbers are keyed on the final circuit board design.

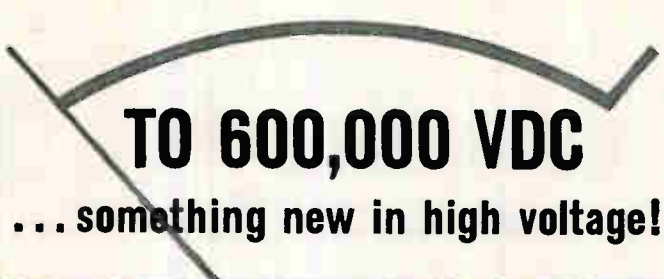

TO 600,000 VDC

... something new in high voltage!

ELECTROSTATIC GENERATORS

FOR INDUSTRY

SAMES Electrostatic Generators, producing substantial amounts of output power at voltages up to 600 kv, are the first such generators ever designed for day-to-day industrial use. They're marketed in the U.S. exclusively by Sorensen.

Output voltage is very nearly pure d-c, marked by the almost complete absence of ripple or other a-c components. Voltage regulation ranges from 4% to 0.33% for medium stability models and from 0.1% to 0.001% for high stability models.

You'll find these advanced high-voltage d-c sources described in the new 6-page SAMES brochure. A new 32-page Sorensen catalog is also available which lists more than 400 models of high-precision power supply equipment and gives valuable selection and application data. Write for your copies today. Sorensen & Company, Richards Avenue, South Norwalk, Conn. c.5

- * 18 models available
- * Voltages up to 600,000 volts
- * Substantially pure d-c output
- * Powers to 2.4 kw
- * Outstanding safety:
 - Low output capacitance
 - Low overload current



Wide selection of portable models - to 100 kv.

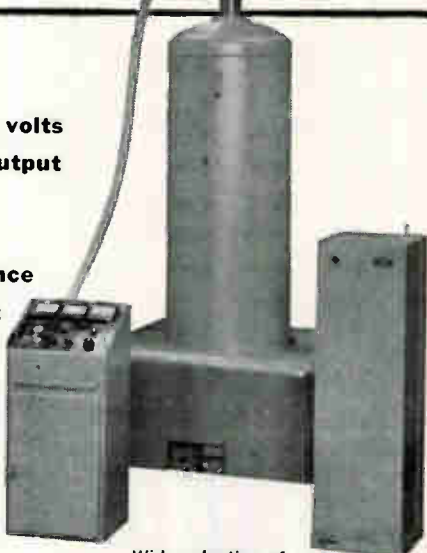

Wide selection of floor-mounted models - to 600 kv.



**CONTROLLED
POWER
PRODUCTS**

A SUBSIDIARY OF RAYTHEON COMPANY

... THE WIDEST LINE MEANS THE WISEST CHOICE

New On The Market

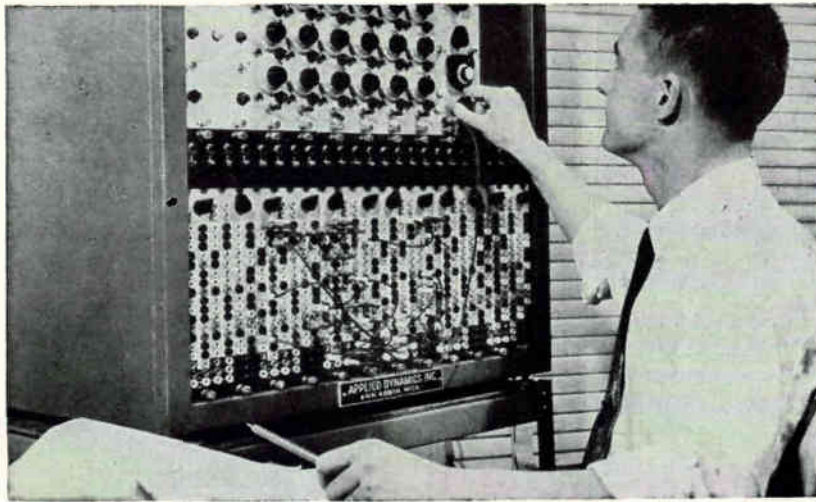

Expandable Analog Computer

LOW-COST DESKTOP UNIT

MODULAR construction is used in the design of an analog computer that can be expanded in size and complexity as computing needs increase. Priced to sell as low as \$2,000, the AD-1 computer is manufactured by Applied Dynamics, Inc., Ann Arbor, Michigan, a subsidiary of Bowmar Instrument Corporation.

The computer is designed to expand with the needs of small, growing firms. However, even after all necessary components have been added, the unit's cost will still remain less than half of that of stand-

ard console equipment, which sell for \$50,000 and up. The computer lends itself to de-centralizing of computation facilities thus speeding the research and analysis process. The computer can be expanded in utility and capability by plugging in additional modules or an entire additional cabinet.

The basic desktop unit can be expanded to a complex floor model, with a pre-programmed, removable patchboard system, up to 64 amplifiers, electronic multipliers and diode function generators.

CIRCLE 301 ON READER SERVICE CARD

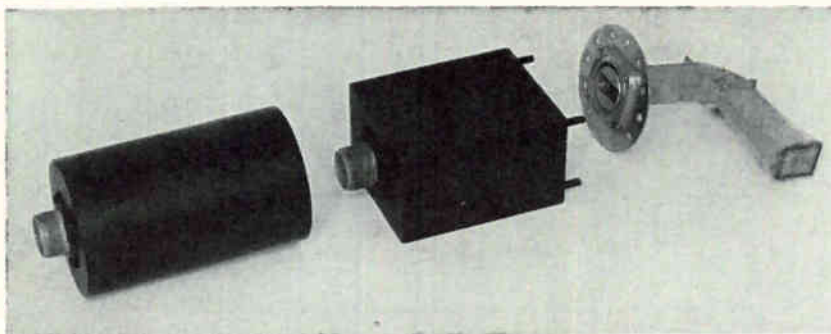

Radar Augmenter

AND DOPPLER SIMULATOR

RADAR range can be increased with augmenter and doppler simulator announced by Emerson Electric Mfg. Co., St. Louis, Missouri. Also, detection of objects with small

radar cross-sections is made more certain. Equipment simulates a 30 sq meter target at X-band with 45 x 20 degree coverage in pulse operation, and 100 sq. meters with

OMNI coverage for c-w operation. The augmenter displays similar performance at other bands.

The device functions as a phase coherent repeater and/or precise frequency translator with 35 db gain for 1 μ sec pulses and over 60 db gain for c-w signals.

Simulated Doppler output (from 10 cps to over 1 Mc) can cause stationary or slow moving targets to assume ICBM or other velocity characteristics.

Bandwidth is ± 20 Mc from center; tuning over a 10 percent band is easily accomplished.

With wide hemisphere search capability, unit qualifies as anti-collision radar, is suitable for missiles, drones, or laboratory use.

CIRCLE 302 ON READER SERVICE CARD

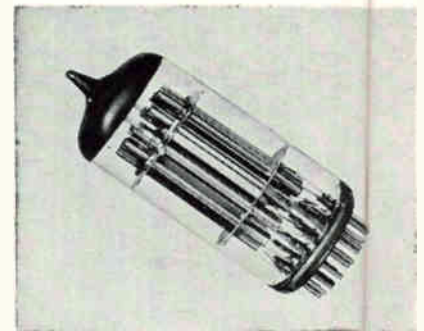

New Beam-X Tube

SHIELD GRID

A FOURTH electrode, called the shield grid, has been added to the Beam-X Switch, giving three new characteristics. The structure provides straight-line or constant switching input requirements unaffected by output level, permits target operation over a wide range of output voltages and allows operation of non-linear devices such as gas discharge tubes, relays and pulse transformers. The tube can operate at zero cathode potential during dynamic switching without affecting stability.

The electronic decimal device is adaptable to multiposition counting, distributing and multiplexing functions and can eliminate many components of comparable binary log circuits.

Electrical features include: switching speeds of over 1 Mc, constant current output from each position, memory in each position, positive switching elements in each position, ability to switch sequen-

CIRCLE 95 ON READER SERVICE CARD →



RELIABILITY

IS AN OUTSTANDING CHARACTERISTIC OF

ALSiMAG[®] CERAMICS

ALSiMag Ceramics offer exceptional resistance to heat and erosion. They have marked electrical and physical stability at elevated temperatures and in varying environments. Chemically inert. Good strength. Can be accurately fabricated in micro-miniatures.

ALSiMag Ceramics include many special purpose ceramics, some especially adapted to hermetic sealing. Widest choice of materials, more than half a century of specialized experience. Send blue print and operating conditions.

ALSiMag pioneered micro-miniature ceramics . . . some as thin as 0.005". Relatively high strength, superior performance at high temperatures, high frequencies. Excellent record for withstanding fatigue, heat, shock, vibration,



The ALSiMag Ceramics in these multiple pin headers may be safely used up to 2800°F. The metal components are the limiting factors.

These tantalum pins with nickel braze alloy operate around 1000° F. All materials are rugged. Strong hermetic seal. Low vapor pressure. High temperature bake-out is practical.

A Subsidiary of
Minnesota Mining and
Manufacturing Company



AMERICAN LAVA CORPORATION

CHATTANOOGA 5, TENN.
58TH YEAR OF CERAMIC LEADERSHIP

For service, contact American Lava representatives in Offices of Minnesota Mining & Manufacturing Co. in these cities (see your local telephone directory): Boston, Newton Center, Mass. • Chicago, Bedford Park, Ill. • Cleveland, O. • Dallas, Texas • Los Angeles, Cal. • New York, Ridgefield, N. J. • Philadelphia, Pa. • St. Louis, Mo. • St. Paul, Minn. • So. San Francisco, Ca. • Seattle, Wash.
All other export: Minnesota Mining & Manufacturing Co., International Division, 99 Park Ave., New York, N. Y.

tially or at random, ability to be preset to any position and reset in less than 1 μ M sec, and ability to operate Nixie indicator tubes at remote locations.

The BX-1000 weighs 1½ ounces,

occupies 3 cubic in., costs \$24.50 in single quantities; is available from Burroughs Corporation, Electronic Tube Division, P. O. Box 1226, Plainfield, N. J.

CIRCLE 303 ON READER SERVICE CARD



Elapsed Time Indicator

ELECTROPLATING PRINCIPLE

THE SIZE of a small fuse, and requiring only 1 ma, this expendable elapsed time indicator will monitor the ON time of electrical equipment up to 10,000 hours. Called a Chronistor, the low cost device is manufactured by Bergen Laboratories, Inc., 60 Spruce St., Paterson, N. J.

The timer operates on the electroplating principle in that the current flowing through the cell plates copper off the anode (making it shorter) and onto the cathode. A scale calibrated in hours gives a direct reading of how long current

has been applied. Current required is approximately 1 ma (depending on full scale hours) at any voltage greater than 6 v d-c.

The unit fits into any ordinary 3AG cartridge fuse clip and requires no major modification of equipment. Full scale hours from 100 to 10,000 are available from stock.

Operating temperature is from 0 to + 55 C, with wider temperature range units available on special order. A half wave rectifier in series converts it to a-c operation.

CIRCLE 304 ON READER SERVICE CARD

UHF Isolators

STRIP TRANSMISSION LINE

SERIES OF miniature uhf strip transmission line isolators can be used in telemetry, radar, communications systems, missiles, aircraft, and laboratory equipment. Advantages are excellent electrical performance, small size and weight, and relative insensitivity to external magnetic influence.

The units can be designed for operation from below 300 to above 1,000 Mc. The two basic units designed for operation at J- and P-

bands, models D44J7 and D44P1-5 respectively, operate over 10 percent bandwidths. They have isolations of 10 and 20 db and insertion losses of 1.0 and 1.2 db for the 400-450 and 870-990 Mc band, respectively. Dimensions are 1.5 x 3.0 x 7-37/64 inches; weight is 2½ lb. each.

The design technique has been used in a laboratory model to obtain 10 db to 1 db attenuation ratio over a 30 percent bandwidth cen-

tered at 450 Mc, with a peak performance of 25 db isolation and 0.5 db insertion loss at 425 Mc.

The two models are available for delivery from stock in small quantities, or in production quantities with delivery beginning 30-60 days after order from Sperry Microwave Electronics Co., Clearwater, Fla. They are also available in other frequency bands and over broader bandwidths on special order. The stock units are intended for applications up to 10 w c-w although higher power units can be designed.

CIRCLE 305 ON READER SERVICE CARD

Tapered Cable Jacket

SPEEDS CABLING JOBS

ZIPPERTUBING with a tight fitting jacket for cables of decreasing diameters is announced by The Zippertubing Company, 752 S. San Pedro St., Los Angeles, Calif.

Wires are pulled through perforations of the tapered Zipper-tubing for attachment to termi-

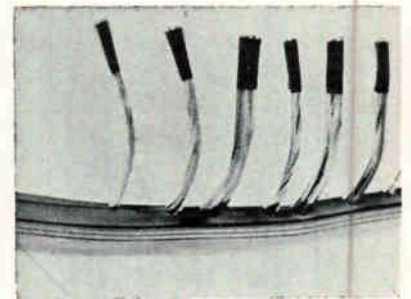

nation points. One man can apply tapered Zippertubing and no special tools are required. Time and labor savings in jacketing cables of tapering diameters may be as high as 50 percent. The tubing is supplied according to customers' specifications and can be furnished in colors to match all types of cable jackets.

CIRCLE 306 ON READER SERVICE CARD

Super-Sensitive Tv Yoke

CUTS POWER NEED

SUPER-SENSITIVE tv yokes use a special form of toroidal vertical winding, retain the Sickles-designed saddle-shaped horizontal winding (for horizontal scanning) to maintain good focussing characteristics. Vertical sensitivity of the yoke is

Time-Sharing Problem?

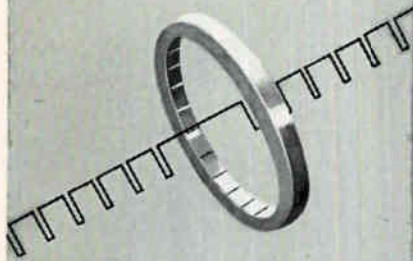

IDL MAY HAVE A SOLUTION -

Your data handling system, whether RF carrier or wire transmission line, may require time-sharing to increase its capacity and efficiency.

In the past, the advantages of motor driven switches used for multiplexing were outweighed by their disadvantages. They were smaller, lighter and simpler but, because of high contact resistance, bounce and short life, they contaminated data.

Then IDL introduced multi-fingered brushes traveling on the inner periphery of cylindrical sections to minimize resistance and bounce and extend trouble-free life to hundreds of hours. These concepts have been successfully applied to missiles in sampling 900 data points per second for more than 500 hours without signal contamination even in the milli-volt signal level ranges.

For example, Switch No. 500660 is a complete unit within a compact case, available at reasonable cost and capable of sampling up to 180 transducers. It combines 2 poles of 30 data channels with 2 poles of 60 data channels, each operating at 5 rps.



For further information, write for Technical Bulletin No. 500660; or let us propose a solution to your Time-Sharing Problem.

INSTRUMENT DEVELOPMENT LABORATORIES
INCORPORATED
Subsidiary of Royal McBee Corporation

51 MECHANIC STREET, ATTLEBORO, MASS.

CIRCLE 200 ON READER SERVICE CARD



for -100° F to 500° F applications

Select the right Temp-R-Tape for your job from a variety of types which combine some form of Teflon, Fibreglas or Silicone Rubber backing with a silicone polymer adhesive. Temp-R-Tapes possess high dielectric strength, thermal stability, excellent moisture resistance, non-aging characteristics and many other desirable properties.

CLASS H INSULATION USES: slot lining; interlayer and interphase insulation; harness bundling; splicing; wrapping for microwave components, transformer coils, capacitors and high voltage cables.

NON-STICK USES: non-stick facings for film guides in electronic instruments, heat sealing bars, forming dies, chutes, guide rails, etc.

AVAILABLE FROM STOCK: 1/4" to 2" widths, 18 yd. and 36 yd. rolls and 12" width on liner by lineal yard. Sold through distributors.

FREE SAMPLE and folder — write, phone or use inquiry service.

ELECTRICAL AND INDUSTRIAL SPECIALTY TAPES

CHR CONNECTICUT HARD RUBBER CO.

*duPont TM

Main office: New Haven 9, Connecticut
CIRCLE 201 ON READER SERVICE CARD



★ ULTRA LOW capacitance & attenuation

| TYPE | μm F/ft | IMPED.Ω | O.D. |
|------|---------|---------|------|
| C1 | 7.3 | 150 | .36 |
| C11 | 6.3 | 173 | .36 |
| C2 | 6.3 | 171 | .44 |
| C22 | 5.5 | 184 | .44 |
| C3 | 5.4 | 197 | .64 |
| C33 | 4.8 | 220 | .64 |
| C4 | 4.6 | 229 | 1.03 |
| C44 | 4.1 | 252 | 1.03 |

WE ARE SPECIALLY ORGANIZED TO HANDLE DIRECT ORDERS OR ENQUIRIES FROM OVERSEAS
SPOT DELIVERIES FOR U.S.
BILLED IN DOLLARS—
SETTLEMENT BY YOUR CHECK
CABLE OR AIRMAIL TODAY



NEW MX and SM SUBMINIATURE CONNECTORS
Constant 50Ω-63Ω-70Ω impedances

TRANSRADIO LTD. 138A Cromwell Rd. London SW7 ENGLAND CABLES: TRANSRAD, LONDON



WHAT THIS UNUSUAL AC-DC "PLUG-IN" TRANSISTORIZED POWER SUPPLY DESIGN GIVES YOU...

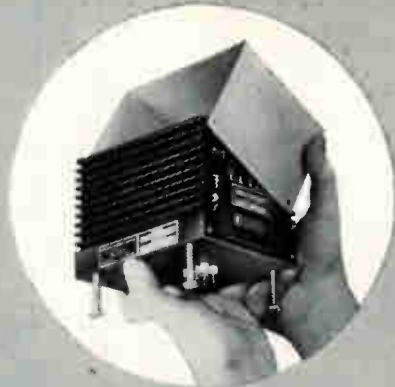

One piece finned aluminum extrusion, achieving high heat dissipation. Most units need no external heat sink to 55° C ambient.

All units have adjustable output. Platform mounted standardized subassemblies and components enable quick delivery of a wide range of voltages and currents.

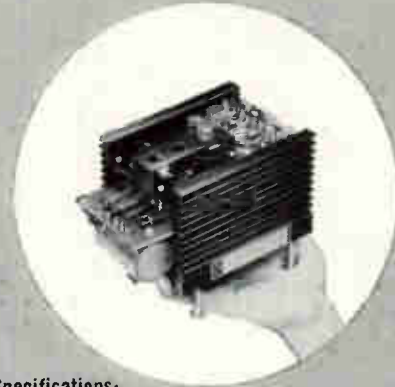

Specifications:

Input: 105 to 125V AC, 45 to 420 cps, single phase
Regulation: 0.1% (line or load)
Stability: Better than 0.25% for 8 hours
Ripple: 0.02% rms
Response time: less than 100 microseconds
Low dynamic impedance

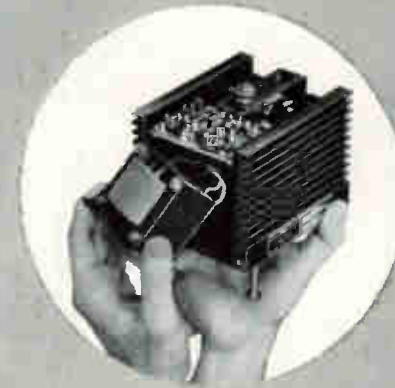

Designed primarily as a component power supply, units are widely used in computers, electronic instrumentation, production test equipment, and quality control check out systems. Best of all, the unique design makes these units available at the lowest possible cost to you.

(Unit pictured above: Model #1R 90-1; 85-95 V; 0-100 ma; Price \$145.00) Prices on other units range from \$100 to \$200.

All solid state — zener diode reference; transistor amplifiers and regulator
Output Voltages: from 2.0 to 300V DC
Output Power to 30 Watts
Reliable short circuit protection
All components readily accessible

CONSOLIDATED AVIONICS CORPORATION

A SUBSIDIARY OF CONSOLIDATED DIESEL ELECTRIC CORPORATION

800 Shames Drive • Westbury, L. I. • Edgewood 4-8400

30 to 40 percent greater than conventional units.

The new yokes—the first of their kind produced in the U. S.—are available in a wide range of sizes and types, and the General Instrument Corp., Sickles Division, Chicopee, Mass. plant is tooled up for large-scale production. Primarily for battery powered transistorized television sets, the yokes



reduce the power requirements for the deflection circuit and thereby add to battery life. In non-transistorized tv sets the lower power requirements mean smaller and less expensive associated components, thus providing a cost saving. The new yokes will be competitively priced with conventional units.

CIRCLE 307 ON READER SERVICE CARD

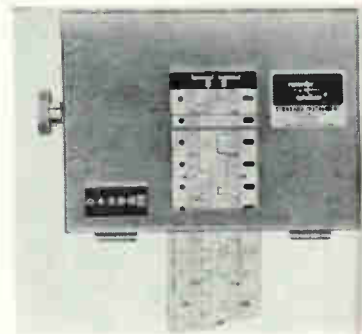

On-Off Time Recorder TWO-CHANNEL MONITOR

ANY TWO processes can be recorded simultaneously on this inexpensive strip-chart recorder. It can be used to analyze operations, to compare productivity of two machines, to measure productive time and idling time. The recorder is manufactured by Standard Instrument Corp., 657 Broadway, N. Y. 12, N. Y.

A read-out counter continuously totalizes productive time in hours and tenths, or minutes and tenths. Time totalizing is a guide to preventive maintenance, overhaul of equipment, parts replacement and

THE ELECTRONICS MAN

IDENTIFICATION

R
D
P
M



6XK-5XKW

S Q

WHERE TO FIND HIM

The electronics man may be found in any or all of the areas of research, design, production, management.

Your problem: sell him (wherever he is) and keep him sold all year long. Here's the simplified key to this job!

Use **electronics** to arouse his interest and create acceptance for your products in the magazine's weekly issues.

Use the **electronics BUYERS' GUIDE** and Reference Issue to be there all year long whenever he is ready to buy.

This is the best selling combination in the electronics industry... and the one that carries the most weight!

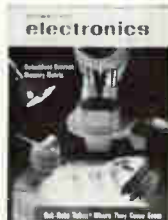

THE ELECTRONICS MAN
"BUYS" WHAT HE READS IN...

electronics

A McGRAW-HILL PUBLICATION

330 West 42nd Street, New York 36, New York

July 15, 1960

VERSATILE VOLTAGE-CURRENT CALIBRATOR



CAPABILITY... measures a-c, d-c or pulse signals from 1 mv to 10 v.
STABILITY... from temperature compensated cascaded zener diodes.
ACCURACY... 0.1% fs. Chopper mounts at oscilloscope input.
CONVENIENCE... calibrator slips into instrument slot of scope dolly.

Model 1082 Precision Voltage-Current Calibrator... immediately available. Write for Bulletin 60-C.

rese



engineering, inc.

731 ARCH ST., PHILADELPHIA 6

MAGNETIC CORE TESTERS • HIGH SPEED MEMORIES • LOGIC CIRCUIT PLUG-INS

CIRCLE 203 ON READER SERVICE CARD

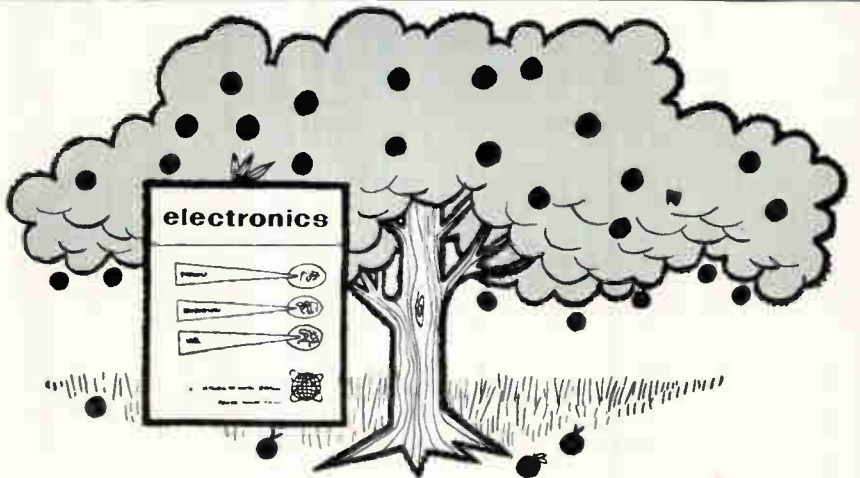

The pick of the crop!

Thumbnail summaries of sales literature on materials, components, equipment, and facilities keep you up-to-date in about 3 minutes of quick, easy reading in "Literature of the Week."

Another reason why it will pay you to subscribe to **electronics** (or renew your subscription) right now. Fill in the box on Reader Service Card. Easy to use. Postage free.

FIND WHAT YOU NEED IN...

electronics

Get the facts together quickly



Buying is easier when you've got all the facts in *one* place.

The BUYERS' GUIDE tells who makes it. Gives detailed catalog-type product information and specs. Gives choices in mechanical and electrical characteristics. Gives more choices in terms of materials and design. Also objective and authoritative facts about markets . . . materials . . . design . . . in an exclusive 64-page reference section.

That's why the GUIDE will put you in the *strongest* position to make the best buying choice for yourself and your company.

It's *all* between the covers of one volume. The accurate, complete and authoritative electronics BUYERS' GUIDE and Reference Issue.

O.S.E.

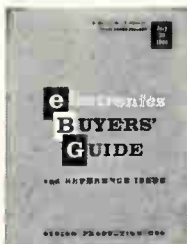

FIND
WHAT
YOU
NEED
IN
THE

electronics BUYERS' GUIDE

production information. An access window permits notations on the chart.

Installation is simple, and the instrument can be mounted remotely or at the point of production. Standard chart speeds are 1, 4, 12 and 60 inches per hour.

The 2-channel time recorder, with built-in time totalizer, is priced at \$95. for 110 or 220 v a-c.

CIRCLE 308 ON READER SERVICE CARD

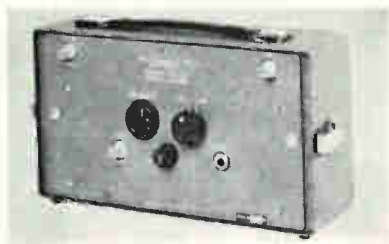

Frequency Converter TRANSISTORIZED

GERTSCH PRODUCTS, INC., 3211 So. La Cienega Blvd., Los Angeles, Calif., announces a fully transistorized frequency converter designed for use with models FM-6 or FM-7 vhf frequency meters, or other meters, to extend the frequency range downward to 10 Kc. Accuracy from 10 Kc to 20 Mc is 0.0001 percent ± 20 cycles. Accuracy from 20 Mc to 1,000 Mc is 0.0001 percent. Model FC-1 is a compact instrument using all miniature components, and a self-contained regulated power supply. Resettability is 0.0005 percent ± 10 cycles. Sensitivity: 1 mv. Beat indication is given both aurally and visually. Delivery: 30 days. Price: \$425.

CIRCLE 309 ON READER SERVICE CARD

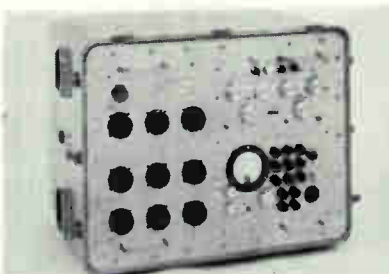

Cable Tester MILITARIZED

CALIFORNIA TECHNICAL INDUSTRIES,
1421 Old County Road, Belmont,

for immediate delivery of

GENERAL INSTRUMENT semiconductors

at factory prices

call your authorized
stocking distributor

CALIFORNIA

Electronic Supply Corp.
Pasadena
Newark Electronics Co., Inc.
Inglewood
Pacific Wholesale Co.
San Francisco
San Delco
San Diego
Valley Electronic Supply Co.
Burbank

COLORADO

Interstate Radio and Supply Co.
Denver

CONNECTICUT

Sun Radio & Electronics Co., Inc.
Stamford
The Bond Radio Supply, Inc.
Waterbury

FLORIDA

Electronic Supply
Melbourne; branches in Miami,
Orlando, St. Petersburg

ILLINOIS

Merquip Company
Chicago
Newark Electronics Corp.
Chicago

INDIANA

Brown Electronics, Inc.
Fort Wayne
Graham Electronics Supply, Inc.
Indianapolis

IOWA

Deeco, Inc.
Cedar Rapids

MARYLAND

Radio Electric Service Co.
Baltimore

MASSACHUSETTS

The Greene-Shaw Co., Inc.
Newton

NEW YORK

Delburn Electronics, Inc.
New York City
Sun Radio & Electronics Co., Inc.
New York City
Standard Electronics, Inc.
Buffalo, N. Y.

OHIO

Buckeye Electronics Distributors
Columbus
The Mytronic Co.
Cincinnati
Pioneer Electronics Supply Co.
Cleveland

OKLAHOMA

Oil Capital Electronics
Tulsa

PENNSYLVANIA

D & H Distributing Co.
Harrisburg
Herbach & Rademan, Inc.
Philadelphia

TEXAS

Scooter's Radio & Supply Co.
Fort Worth

WASHINGTON

Seattle Radio Supply Co.
Seattle

WISCONSIN

Radio Parts Co., Inc.
Milwaukee

CANADA

Soule's Magnetics Ltd.
Willowdale, Ont.



Distributor Division

GENERAL INSTRUMENT
CORPORATION

240 Wythe Avenue
Brooklyn 11, N. Y.

CIRCLE 204 ON READER SERVICE CARD

electronics

Depend on the best from **GENERAL INSTRUMENT**

SILICON VOLTAGE REGULATOR DIODES

- Low zener impedance
- Low reverse leakage up to the point of breakdown

PLUS the highest degree of reliability proved by controlled life tests and outstanding performance in actual circuitry.

STUD TYPES



1N1589
1N1590
1N1591
1N1592
1N1593
1N1594
1N1595
1N1596
1N1597
1N1598

AXIAL LEAD TYPES



1N1765
1N1767
1N1770
1N1771
1N1773
1N1776
1N1780
1N1788
1N1795
1N1802

GLASS ENCASED



1N704
1N708
1N713
1N718
1N725
1N730
1N735
1N738
1N745
1N761

Hermetically sealed, ruggedly constructed and small in size and weight, General Instrument voltage regulator diodes are produced in volume quantities under rigid quality control. Their excellence is recognized by leading manufacturers and they are specified in an increasingly wide variety of circuits now in production. The types listed here are just a sampling of the complete line. Detailed technical information is available upon request.



Semiconductor Division

GENERAL INSTRUMENT CORPORATION

65 Gouverneur Street, Newark 4, N. J.

Midwest office: 5249 West Diversey Ave., Chicago 39

Western office: 11982 Wilshire Blvd., Los Angeles 25

GENERAL INSTRUMENT CORPORATION INCLUDES F. W. SICKLES DIVISION, AUTOMATIC MANUFACTURING DIVISION, SEMI-CONDUCTOR DIVISION, RADIO RECEPTOR COMPANY, INC., THE HARRIS TRANSDUCER CORPORATION, MICAMOLO ELECTRONICS MANUFACTURING CORPORATION AND GENERAL INSTRUMENT — F. W. SICKLES OF CANADA LTD. (SUBSIDIARIES)

HIGH QUALITY CONSTRUCTION

Assures

DEPENDABLE PERFORMANCE

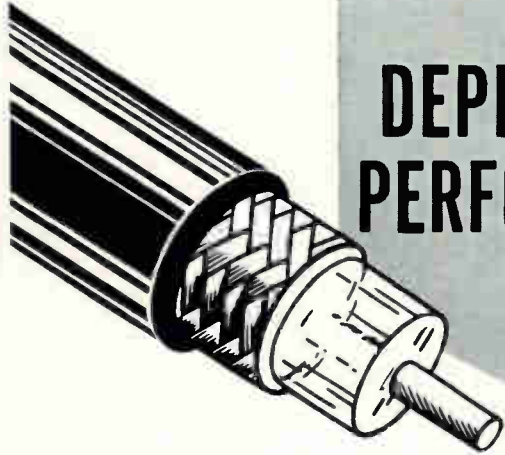

OF

HICKORY BRAND Coaxial Cables

Hickory Brand RF Cables consist entirely of high-quality components fabricated to uniformly high standards.

Conductor insulation and dielectric material is polyethylene for maximum operating efficiency, making these cables especially adaptable to applications requiring high, very high and ultra-high frequencies.

Typical examples of Hickory Brand Coaxial Cables:

| Army-Navy Type No. | Dia. of Dielectric In. | Nom. IMP. OHMS | Attenuation DB/100 ft. 400 Mc 3000 | | Shielding Braid | Nom. Overall Dia. In. |
|--------------------|------------------------|----------------|------------------------------------|------|-----------------|-----------------------|
| RG-8A/U | .285" | 52 | 6 | 19 | Single Copper | .405 |
| RG-9B/U | .280" | 50 | 6.1 | 21.8 | Double Copper | .420 |
| RG-11A/U | .285" | 75 | 5.2 | 18.5 | Single Copper | .405 |
| RG-13A/U | .280" | 75 | 5.7 | | Double Copper | .420 |
| RG-17A/U | .680" | 52 | 2.8 | 11 | Single Copper | .870 |
| RG-59A/U | .146" | 75 | 9 | 30 | Single Copper | .242 |
| RG-74A/U | .370" | 50 | 4.3 | 14 | Double Copper | .615 |

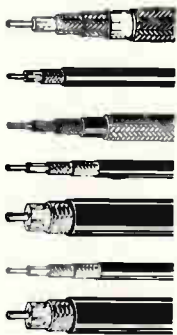

All Hickory Brand Electronic Wires and Cables are quality-engineered and precision-manufactured to meet the exacting requirements of the industry.

Write for complete information on the full line of

HICKORY BRAND Electronic Wires and Cables

Manufactured by
SUPERIOR CABLE CORPORATION, Hickory, North Carolina



4424

Calif. Model 196 militarized cable harness analyzer allows simple and complex branch circuits to be high-potted and measured for leakage to all other circuits. Simultaneously with the leakage test, continuity (conductor resistance) is measured. In automatic operation the wires under test are checked at a maximum rate of five wires per sec. When a fault occurs the tester stops and indicates the circuit and type of fault. Unit will check 150 simple circuits, 75 main circuits with any combination or number of branch circuits to a total of 75 branches, or any intermediate combination of main and branches up to a total of 150. Measurements are made on precision bridges which combine accuracy with fail-safe operation. Continuity testing can be made from 0.3 to 10.0 ohms at 0.5 to 3 amperes. High-pot testing can be made up to 1,000 v d-c.

CIRCLE 315 ON READER SERVICE CARD



Tiny Rectifiers

ENCAPSULATED

RADIO RECEPTOR CO., INC., 240 Wythe Ave., Brooklyn 11, N. Y., announces low cost subminiature encapsulated rectifiers in center tap, bridge and doubler assemblies. All are designed for operation in ambient temperatures from -50 C to +100 C without derating and are protected against atmospheric conditions by the plastic encapsulation. They will withstand peak surge currents up to 250 mils for 1 sec duration and can be operated in circuits at frequencies up to 25 Kc. All types are color coded for simple identification and polarity indication. Maximum case length is 0.480 in. for all types, widths ranging to 0.480 in. maximum. Center tap assemblies have a d-c output rating of 25 ma and a-c input voltage range to 99 v rms; bridge assemblies are rated at 25 ma with voltage to 82 v d-c; and doubler units

are rated at 12.5 ma with piv range from 50 to 150 v, per section.

CIRCLE 316 ON READER SERVICE CARD



Broadband Attenuators

DIRECT READING

PRD ELECTRONICS, INC., 202 Tillary St., Brooklyn 1, N. Y. Type 101 broadband direct reading attenuators are of the rotary vane type. Covering the frequency range of 3,950 to 40,000 Mc in 9 models, they have an attenuation range of 60 db and a maximum vswr of 1.15. Value of attenuation is determined by the angular position of a resistive film with respect to the waveguide and, therefore, is essentially independent of frequency. All nine units feature unusually small insertion length; 60 db range; tape readout; built-in height adjustment; compact size and low insertion loss.

CIRCLE 317 ON READER SERVICE CARD

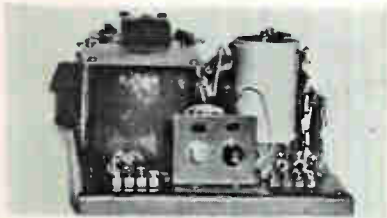

D-C Power Supply

MILITARIZED

PERKIN ENGINEERING CORP., 345 Kansas St., El Segundo, Calif. Model M-1560 militarized d-c power supply has an output of 28 v at a continuous-duty rating of 7½ amperes. It features magnetic amplifier regulation with no vacuum tubes or moving parts. Intended for missile ground support operation, the unit is constructed with base-plate mounting, making it suitable for inclusion into almost any module or rack mount. Hermetically sealed silicon rectifiers are used for high-temperature operation. Regulation is ±1 percent for combined variations of

now!

try Retrievable Miniaturization for size in your reproduction department!

THE IDEA. Retrievable Miniaturization is a new ingenious method for reducing the size of prints yet keeping them large enough to be completely readable and usable. Developed by Paragon-Revolute, this method is acknowledged as one of the significant advancements in reproduction.

HOW IT WORKS. In Paragon-Revolute's unique Continuous Reducing Printer and Processor, reduced-size transparencies are made from original drawings for immediate reproduction in blueprint or diazoprint equipment. Reductions can be made as positives or negatives on paper or film. The Printer takes drawings up to 42" wide by any length at speeds up to 30 fpm.

THE ADVANTAGES. Retrievable Miniaturization fits in with existing facilities, calls for no drastic changes in present drafting standards or print-making systems. It enables savings in materials up to 300% . . . increases capacity of blueprint or diazo-type equipment up to 4 times . . . slashes print handling time, filing space, and mailing costs. Most importantly, it provides readable, usable reduced-size prints without the problems and high cost of blow-back systems.

You owe it to yourself and your company to investigate the advantages and savings offered by this great new concept in reproduction. Use the coupon to get more information or to arrange for demonstration.



The Paragon-Revolute Continuous Reducing Printer is the heart of Retrievable Miniaturization. Really a giant movie camera, it takes pictures of drawings while they move through the machine at speeds variable from 3 fpm to 30 fpm. Camera feeds as easily as blueprint and whiteprint machines.

**PARAGON
REVOLUTE**

DIVISION
OF
CHARLES BRUNING CO., INC.

BRUNING

77 South Avenue
Rochester 4, New York

Paragon-Revolute Advertising Department Dept. P7-Z
1800 Central Rd., Mt. Prospect, Illinois

- Please send me more information about Retrievable Miniaturization.
 Please arrange for one of your representatives to contact me about a demonstration.

Name _____ Title _____

Company _____

Address _____

City _____ State _____

ZERO DRIFT

Accuracy in d-c amplifiers is fundamentally dependent on zero drift. This error, defined as any zero offset appearing at the amplifier output but not present in the input, is indistinguishable from the d-c input signal, and varies more or less sporadically with time and/or ambient temperature. Elimination of zero drift is a prime d-c amplifier design objective.

Evaluation of the amplifier zero drift characteristic is quite simple, but elimination of the effect is not. For example, any direct-coupled stage of amplification will drift due to the inability of circuit operating levels to remain constant. The use of inverse feedback does not have any beneficial effect on drift. The best generally accepted method of drift elimination is to make all amplification drift-free through a-c coupling, and converting the incoming d-c to a-c directly by means of a low-level modulator, such as a chopper or magnetic converter. After amplification, the a-c is demodulated into d-c which may be further amplified at high levels without appreciable zero error. This system is used in both the so-called chopper amplifier (where the band pass is limited by the chopper frequency) and the chopper-stabilized amplifier (where the chopper amplifier is combined with a wide band amplifier to give frequency responses well beyond the chopper excitation frequency).

Testing Amplifiers for Zero Drift

Zero drift is measured at the amplifier output with a strip chart potentiometer such as the Honey-

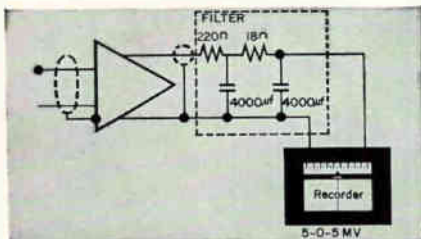

well ElectroniK Recorder connected through a low pass filter as shown. The amplifier input should be shorted. Equivalent input drift is the absolute amount recorded at the output divided by the amplifier gain measured under known conditions of temperature and line voltage, and, if necessary, for a specified time. There do not seem to be agreed-upon definitions of short or long-term time periods. For further details, write for Bulletin BE AN122.

Zero Drift Less Than 0.002 Per Cent at 10 mv

The AccuData II, Honeywell's all-transistor, wide-band, differential input, chopper-stabilized, d-c amplifier, has the lowest drift of any amplifier in its field — something less than 0.5 microvolts at reasonably constant ambient temperature, or less than 2 μv with a 10°F change in ambient. The effect of line voltage never exceeds 1 μv for a $\pm 10\%$ change, hence, under conditions most frequently advertised for amplifiers, its zero error on a 10mv input range would be less than 0.002%

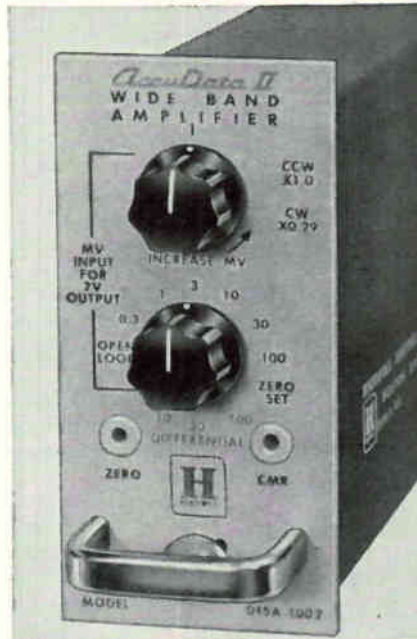

The AccuData II has single-ended as well as differential input ranges, input impedance of 2 megohms differential (20 megohms single-ended), and power output sufficient to drive the highest frequency galvanometer oscillograph to its maximum deflection. In addition to excellent drift characteristics, the AccuData II offers exceptional linearity, very low noise, and frequency response to 20kc. Write for Bulletin BS DISA-1000 to Minneapolis-Honeywell, Boston Division, Dept. 7, 40 Life Street, Boston 35, Mass.

Honeywell

H First in Control
SINCE 1885

line and load. Ripple is 5 percent rms maximum. Unit meets specifications of MIL-E-4970.

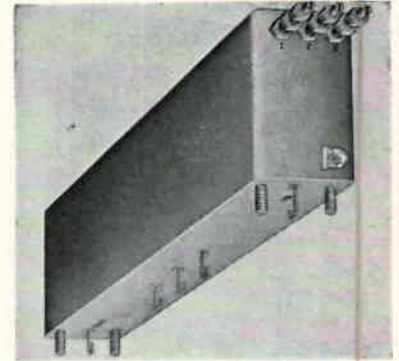

Variable Delay Line

TRIPLE OUTPUT

ESC CORP., 534 Bergen Blvd., Palisades Park, N. J. Model 72-22 special triple output variable delay line, which has particular applications in variable coding systems, provides three variable taps over a total delay of 1.5 μsec . The taps can be individually adjusted over the delay range, with a resolution of 0.025 μsec . Impedance is 300 ohms. Pulse rise time and attenuation for full delay are 0.07 μsec and 2 db (max.) respectively. Variations of the model 72-22 to meet individual specifications are available.

CIRCLE 318 ON READER SERVICE CARD



Power Supply

TRANSISTOR TYPE

HARRISON LABORATORIES, INC., 45 Industrial Road, Berkeley Heights, N. J. Model 855 transistor power supply is continuously variable from 0 to 18 v at any output current from 0 to 1.5 amperes. Regulation for load or line is less than 5 mv, and ripple is below 500 μv . The units are fully protected from all overload conditions including direct short across output terminals; there is no voltage overshoot

ACE PLASTIC EXTRUSIONS

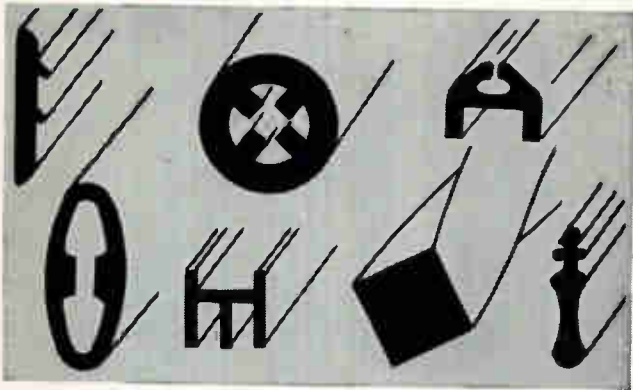

SHAPES • CHANNELS • SPLINES • PROFILES
CORNER MOLDINGS • RODS • TUBES

IN THESE PLASTICS

ACRYLICS • ACETATE • BUTYRATE • POLYCARBONATE
POLYPROPYLENE • METHYL STYRENE • ETHYL CELLULOSE
POLYETHYLENE • STYRENE • VINYL-ELASTOMERIC & RIGID



FAST DELIVERY

ACE PLASTIC COMPANY

91-33 Van Wyck Expwy., Jamaica 35, N. Y., JAMAICA 3-5500

CIRCLE 205 ON READER SERVICE CARD



WHAT'S NEW IN COMPONENTS?

What *useable* discoveries are being made on the frontiers of electronic knowledge? Here are a few selected at random: directive long-range sonar transducer . . . high-speed ferrite memory and logic element . . . space-probe telemetry system . . . master preamplifier for X-band radar. You can never tell when one is going *your* way. This is just ONE of the reasons why you should subscribe to electronics (or renew your subscription).

Fill in box on Reader Service Card. Easy to use. Postage free.

**FIND WHAT
YOU NEED IN...
electronics**

July 15, 1960

PEAK POWER



A NEW KIND OF PRECISION ULTRASONIC CLEANING

The new L & R Ultra-Clean '320' has an electronic circuit that transmits peak power directly to the transducerized tank. The transducerized cleaning tank and the rinse tank are 5½" square by 3" deep. Just set the electrical timer to blast away all dirt, grease, foreign particles—get components microscopically clean. . . . Unconditionally guaranteed for 1 year. Write today for complete data on the '320' and other ultrasonic cleaning equipment. . . . \$187.50
Second tank transducerized (at factory), \$74.50.

L & R MANUFACTURING COMPANY

588 Elm Street, Kearny (Arlington), New Jersey

29 EAST MADISON STREET, CHICAGO 2, ILLINOIS

406 SOUTH MAIN STREET, LOS ANGELES 13, CALIFORNIA

CIRCLE 206 ON READER SERVICE CARD

Precise

DELTA PORTABLE TEMPERATURE CHAMBERS



Model 1060W
Test Volume 16" x 7" x 7"



Model 1060R,
Rack Mounted
Test Volume 10" x 7" x 7"

**Temperature
Control**
±½° F From
-100°F to +500°F

ACCURATE TEMPERATURE CONTROL, without overshoot and without drift.

SAVES TIME by bringing the environment to the engineer instead of scheduling time in large, slow chambers.

VERSATILE—test for high and low temperatures in the same chamber.

AUTOMATIC CYCLING timer is available as auxiliary equipment.

Other chamber sizes and models are also available.



DELTA DESIGN, Inc.
San Diego

Sales Office
7460 GIRARD AVENUE
LA JOLLA, CALIF.
Glencourt 4-1185 TWX: LAJ 6453

CIRCLE 105 ON READER SERVICE CARD 105

THE TWT WITH A BIFILAR HELIX...

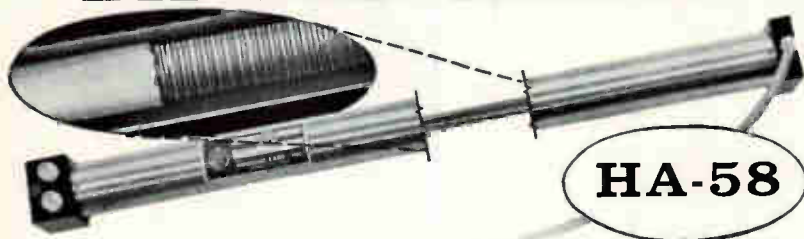

HA-58

An Electrostatic focused 1 watt Traveling Wave Tube is the latest addition to the Huggins line of TWT's.

The HA 58 operates on a frequency range of 500 to 1000 MCS, with a small signal gain of 30 DB minimum, and a saturation gain of 28 DB minimum. Substantial savings in weight and size have been effected in this

tube which measures 1 1/4" in diameter and 18" in length. Weight is 1 3/4 lb. The tube is unusually rugged. No magnetic structure either solenoid or permanent magnet is needed by the HA 58.

Write for complete characteristics and prices.



HUGGINS

LABORATORIES INC.

999 East Arques Avenue Sunnyvale, California REgent 6-9330



CIRCLE 216 ON READER SERVICE CARD

Which of these Craig skills and services can help you?

- ▶ Systems housing — light weight, high strength aluminum shelters, vans and trailers.
- ▶ Systems components — telescoping antenna masts, transit cases, cabinets, equipment racks.
- ▶ Systems installation service — layout and installation of transportable systems, through final checkout.
- ▶ Systems packaging research — engineering design and development for ground support and electronic equipment protection.
- ▶ Complete production facilities — to handle your complete packaging assignment.
- ▶ A unique "aluminum-chemical research" service — engineering "brainpower pool" for solving virtually any problem in aluminum and foamed plastic fabrication.

WRITE TODAY FOR CRAIG'S CAPABILITIES BROCHURE



Craig

SYSTEMS, INC.

Dept. F-7, 360 Merrimack St., Lawrence, Mass. - Tel. MURdock 8-6961
Business systems and equipment are another Craig specialty through LeFebvre Corporation, Cedar Rapids, Iowa — a Craig subsidiary.



WHO DROPPED THE BINOCULARS?

With everybody watching each other along the DEW line and the Iron Curtain these days, electronics has replaced binoculars.

What's happening in the giant markets for missile controls, radar and communications equipment?

electronics tells how things are going, keeps you informed of developments as they occur. This is a good time to subscribe or renew your subscription. Just fill in box on Reader Service Card. Easy to use. Postage free.

FIND WHAT YOU NEED IN... electronics

on either turn-on or turn-off. The compact unit also features low internal impedance over a wide frequency band and fast transient response. Remote programming is another feature (100 ohms/v). Line input is 105-125 v a-c, 50-440 cps. Price is \$175 including case.

CIRCLE 319 ON READER SERVICE CARD



D-C/A-C Chopper MICROMINIATURE

RAWCO INSTRUMENTS, INC., 3527 West Rosedale, Fort Worth 7, Texas. Type 40 d-c/a-c chopper housed in a 7/8 by 1/2 by 3/8 in. metal case incorporates a rugged taut band armature suspension and an armature action exerting over 50 times more contact force than the earlier type 20 model. The improved armature suspension, greater drive and increased contact area enable this chopper to withstand higher environmental conditions. Choppers are available in the following driving ranges: 20 cps to 150 cps, 400 cps to 600 cps, and 1,000 cps to 1,500 cps with coil excitation voltages from 3 to 28 v square or sine wave.

CIRCLE 320 ON READER SERVICE CARD



Microwave Sub-System FOR C & X BANDS

MERRIMAC RESEARCH AND DEVELOPMENT, INC., 517 Lyons Ave., Irvington 11, N. J. New coaxial line sub-system package, designed for use in both C and X bands, provides sampling, filtering, and level control. Unit contains an octave wide directional coupler, two band pass filters of unique design with broad pass bands and very sharp skirt

selectivity, and a standard Merrimac flat coaxial attenuator. The C band package incorporates an AE-6 IL attenuator, while the X-band unit contains the AF-6 IL attenuator. Both units are continuously-variable zero initial loss attenuators with flat attenuation versus frequency characteristics over octave bands. Package weight is only 5 lb and over-all dimensions are 17 in. by 3½ in. by 2½ in.

CIRCLE 321 ON READER SERVICE CARD

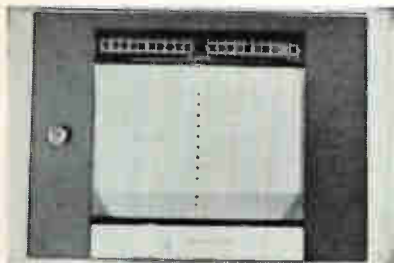

Strip-Chart Recorders FLUSH-MOUNTING

TEXAS INSTRUMENTS INCORPORATED, Geosciences and Instrumentation Division, 3609 Buffalo Speedway, Houston 6, Texas, announces flush-mounting models of the "recti-riter" galvanometric recorders for panel installations. They are available in both single and dual-channel models. The new instruments have swing-out chart carriages and a slide-out chassis for extra accessibility. They have an illuminated scale for greater visibility at a distance. A zero adjustment provides for zero settings over the entire scale as well as zero suppression above or below scale.

CIRCLE 322 ON READER SERVICE CARD



Transistor Clip SUBMINIATURE

ATLEE CORP., 47 Prospect St., Woburn, Mass. A rugged, subminiature transistor clip, suitable for vertical or horizontal mounting, has unusual holding and cooling

New

Model CRB-1B

Gertsch Complex Ratio Bridge

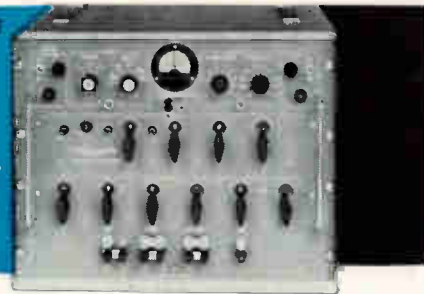

—measures both in-phase and quadrature
voltage ratios — with high accuracy

This instrument cancels quadrature effects, giving a sharp, true null.

In eliminating quadrature voltage, this Gertsch bridge achieves an in-phase ratio accuracy as good as 0.001%. Quadrature voltage ratios are read as rectangular coordinates, tangent of phase-shift angle, or magnitude of phase-shift angle in degrees directly.

Write for complete data in Bulletin CRB.

- SELF-CONTAINED PHASE-SENSITIVE DETECTOR
- SIX-PLACE RESOLUTION
- TWO FREQUENCY RANGES
 - 30 TO 1000 CPS
 - 50 TO 3000 CPS

Gertsch

GERTSCH PRODUCTS, Inc.

3211 South La Cienega Boulevard, Los Angeles 16, California
UPon 0-2761 — VErmont 9-2201

CIRCLE 208 ON READER SERVICE CARD

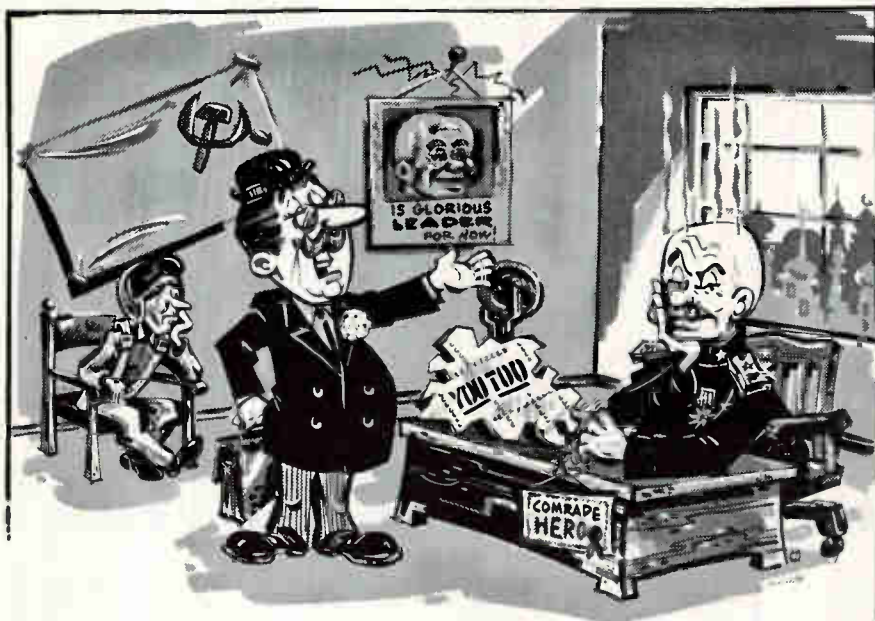

"Honest, Ivan, he wasn't spying.
He was going to Texas and his guidance system went haywire!"

Guidance or communications system failures can cause problems! Guard against them with Reeves-Hoffman oscillator reliability. Get the whole story.

WRITE FOR BULLETINS S-1159 AND TGD/300-OC.



PS/160

DIVISION OF
DYNAMICS CORPORATION OF AMERICA
CARLISLE, PENNSYLVANIA

THERMISTORS

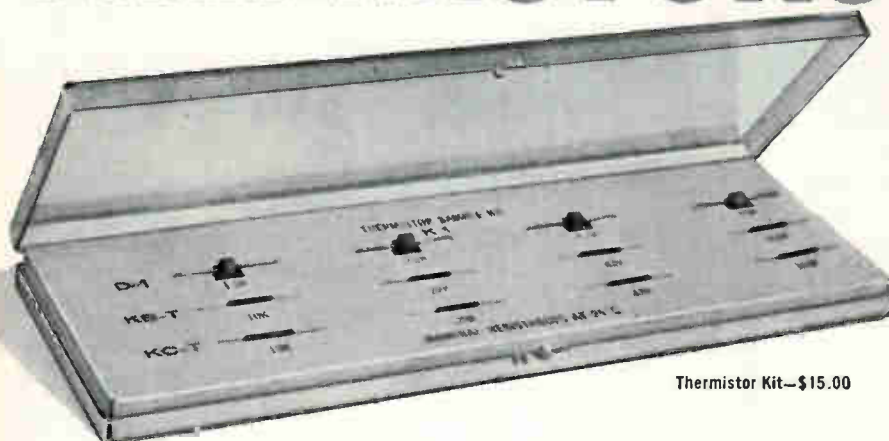

Thermistor Kit—\$15.00

Now—Kidde experience sets the standard for quality and performance!

Kidde experience. For more than ten years, Kidde has manufactured thermistors for use in sensitive aircraft fire detectors. Now, by using the experience gained in this demanding field, Kidde makes available a complete selection of thermistor components for general use.

Kidde performance. First developed to meet the rigid specifications of the military, Kidde thermistors have been *proven in performance*. In temperature control, compensation, time delay or voltage regulation, you can be sure of the stabilized characteristics and high temperature capabilities of Kidde thermistors.

Kidde quality. By utilizing unique automated manufacturing techniques in the production of thermistors, Kidde can now offer the utmost in thermistor uniformity and quality at the lowest possible price. And, in addition to a wide off-the-shelf selection, Kidde also offers engineering help in the application of thermistors toward the solution of special problems. For more details on Kidde thermistors, and their application to special problems, write today.



ELECTRONICS DEPARTMENT

Kidde Aero-Space Division

Walter Kidde & Company, Inc., 850 Brighton Road, Clifton, N. J.

CIRCLE 209 ON READER SERVICE CARD

properties. Formed of tempered beryllium copper and finished with a flat black matte, the clip has a case of 0.300 to 0.324-in. diameter. It is available in two lengths, to accommodate most styles of medium-power TO-5 transistor cases. A small, turned-up tab at one end is designed to catch the rim of the transistor and force the top against a large flat back-plate which serves as a heat sink and radiation member. Another small tab on the bottom is designed to be depressed into the mounting surface, providing a firm grip and preventing the clip from twisting. The entire clip is formed from one piece of material, and its total weight is 3/100 of an oz, yet its holding power and ability to dissipate heat are said to be unprecedented for a unit of this size.

CIRCLE 323 ON READER SERVICE CARD

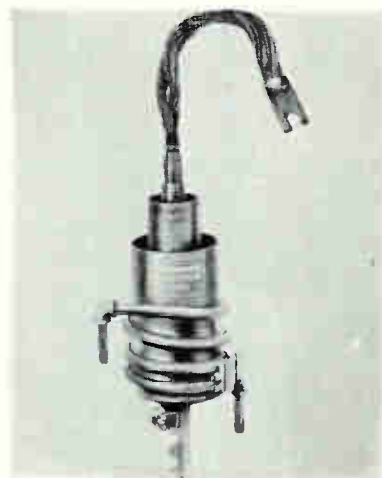

Ignitron

REDUCED ARC-BACK

AMPEREX ELECTRONIC CORP., 230 Duffy Ave., Hicksville, Long Island, N. Y. Type 7585 ignitron features a unique spiral cooling coil so distributed as to concentrate cooling action around the discharge chamber to promote condensation at the bottom of the tube and thus reduce the problem of arc-back. It has been designed for single phase welding control and similar applications. It is completely compatible and interchangeable with all existing C-size tubes. Its electrical characteristics are identical with the standard type 5552A. The temperature sensing plate of the type 7585 fits all existing thermo-

Hot House

Call Air Conditioning Expert

'Cool' Transistors

Call Semiconductor Specialists

Orders Shipped From Stock Same Day

. . . Exact Factory Prices . . .

Selection and Application Assistance



MOTOROLA INC.
Semiconductor
Products Division

ZENER REGULATORS
RECTIFIERS
POWER TRANSISTORS

Semiconductor

DISTRIBUTOR



Specialists INC.

5706 WEST NORTH AVENUE • CHICAGO 39, ILLINOIS • TELEPHONE NATIONAL 7-8860

stats. When equipped with suitable thermostatic switches, the 7585 has the added advantage of needing reduced amounts of cooling water, while simultaneously protecting the tube and associated equipment from overloads.

CIRCLE 324 ON READER SERVICE CARD

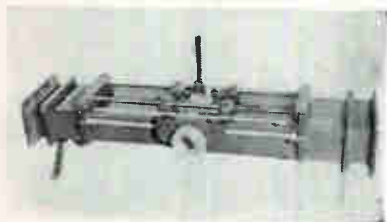

Impedance Meters SLOTTED LINE

SCHUTTER MICROWAVE CORP., 80 E. Montauk Highway, Lindenhurst, N. Y., announces a new line of precision instruments to provide reliable and accurate vswr measurements on the larger waveguides including the WR2300 and WR2100 types. The instruments are designed with adjustable mounts for ease of alignment, incorporate ball bearing carriages for smooth probe travel and are rugged in construction to insure long-life operation.

CIRCLE 325 ON READER SERVICE CARD



Resistivity Bridge FOR ULTRA-PURE WATER

INDUSTRIAL INSTRUMENTS, INC., 89 Commerce Road, Cedar Grove, N. J. A new Solu-Bridge for checking the resistivity of hot, ultra-pure water has been announced. Model RD-336 has wide application in the components manufacturing field where washing of transistors and semiconductor materials is essential. The instrument covers the range of

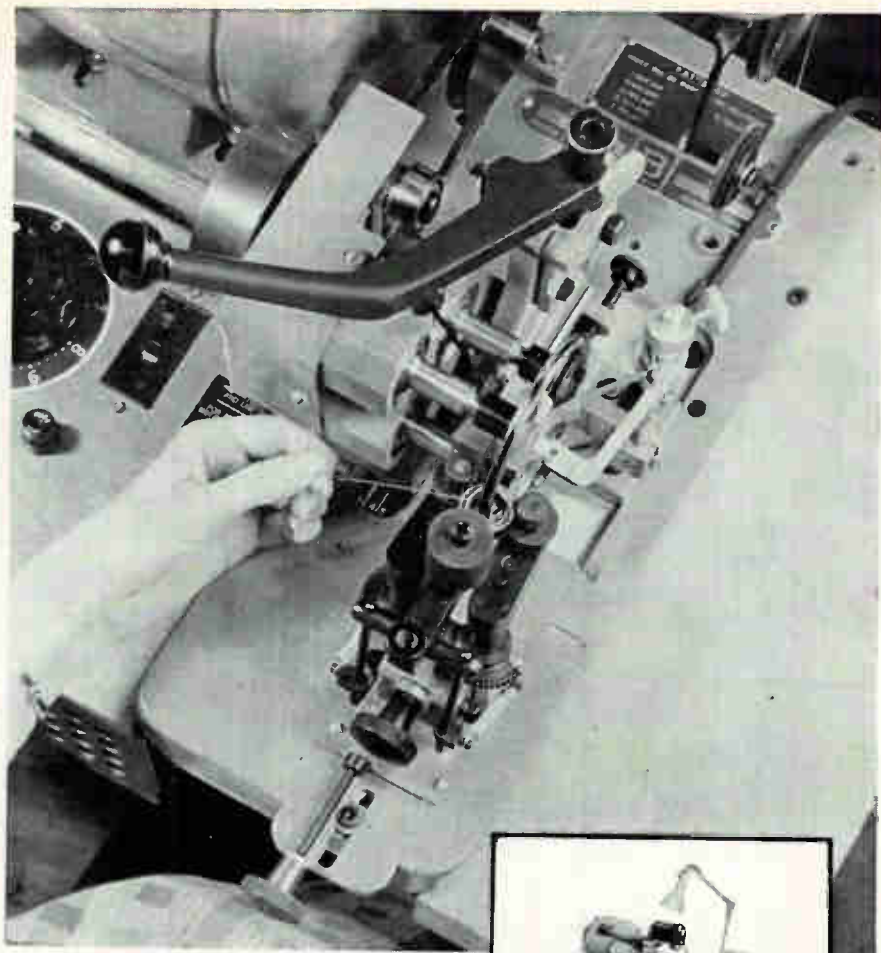

BOESCH *semi-automatic toroidal winders*

- Wind #20 to #42 AWG wire with constant uniformity at speeds up to 1200 RPM.
- Finished coils from 7/32" ID through 5" OD.

Low cost, high production winders. Core oscillated manually, clamped manually. Both machines wind standard size cores without additional attachments — use interchangeable shuttle heads. Capabilities identical except that TW-251 has built-in turns counter and variable speed motor.

Accessory, electronic, predetermined turns counters available for both machines . . . automatically stop winding at a preset number of turns — results in faster winding because operator does not have to watch counter. Both the TW251 and TW201 are bench-type machines with the following standard equipment: motor, core holder, shuttle opening lever, wire tension device, predetermined mechanical linear counter, reversing switch, 3" shuttle head, choice of 3" standard or 3S shuttle with slider.

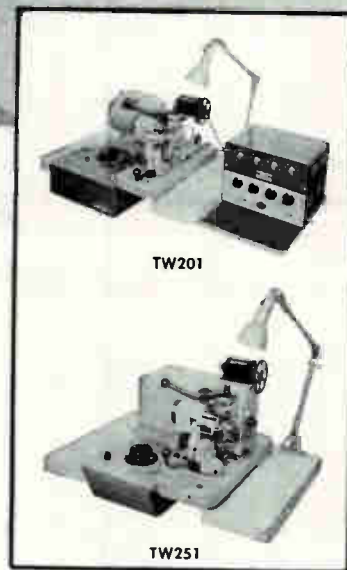

Write for complete data.

B BOESCH MANUFACTURING
COMPANY, INCORPORATED
BOESCH DANBURY, CONNECTICUT

Look what



EVENT RECORDERS
are doing to
improve operations
and cut costs!

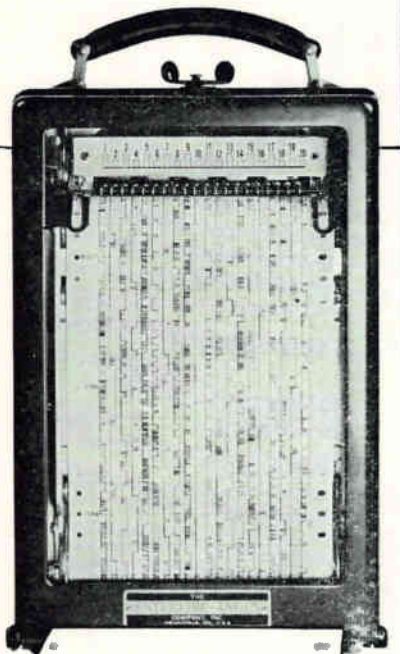

Check Switch
Assemblies.

Monitor Plastic or
Metal Molding
Operations.

Plot Movement
of Conveyors.

Show Idle Time
of Automatic
Machines.

Monitor Electrical
Substation Operation.

See how E-A Event Recorders can help you with accurately recorded, unbiased information.

Send for Catalog Section 50.

The
ESTERLINE-ANGUS
Company

No. 1 in fine Graphic Instruments
for more than 50 years.

DEPT. E, BOX 596, INDIANAPOLIS 6, INDIANA

112 CIRCLE 112 ON READER SERVICE CARD

1-18 megohm-cm specific resistance and has a manual temperature compensator calibrated at 70-100 C incorporating the characteristics of ultra-pure water.

CIRCLE 326 ON READER SERVICE CARD



Tape Recorder

MINIATURE UNIT

PACIFIC ELECTRO MAGNETICS Co., 942 Commercial St., Palo Alto, Calif. Wideband multichannel recording under rugged environmental conditions is the primary application for the new model PMR-300. Unit measures 10 in. by 6 in. by 4½ in., weighs only 4½ lb, and requires less than 18 w from a 24 v d-c source. Recording bandwidth has been extended to 100 Kc at 30 ips, and lower speeds with proportionately reduced bandwidths are available. Modular electronics for up to seven channels on ½ in. tape are also furnished.

CIRCLE 327 ON READER SERVICE CARD



Potentiometer

LINEAR MOTION TYPE

COMPUTER INSTRUMENTS CORP., 92 Madison Ave., Hempstead, L. I., N. Y. Model 111 linear motion pot, designed for operation with an a-c or d-c input, provides, without amplification, outputs as great as 350 v/in. of displacement. Capability to detect a motion as small as 0.000005 in., coupled with its life rating of up to 30,000,000 strokes, depending on circuitry, will make it of prime interest to those involved in the design of programmed machine tools or other devices requiring precise knowledge of linear po-

**THERE'S A
BETTER
WAY...**



Although ice cubes can be used to keep transistors cool enough to operate at full rated load, there are those who maintain that ice cubes serve a better purpose in a long cool drink. This is the school of thought that leans toward Birtcher Heat Radiators for preventing thermal runaway and for getting maximum performance from semiconductor devices. If you would like to investigate before choosing sides in this debate, write for the Birtcher Transistor Radiator Catalog... it comes complete with all sorts of test reports and other technical looking papers.

Address your inquiry to: Charles F. Booher, Secretary, There's a Better Way Society of America, Inc.

THE BIRTCHER CORPORATION

Industrial Division

4371 Valley Boulevard
Los Angeles 32, California

Sizes available for every commonly used transistor. If we don't have what you want, we'll probably make one.

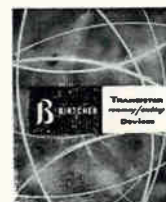

Cool!
Write for
new Transistor
Radiator Catalog



CIRCLE 210 ON READER SERVICE CARD
electronics

TOROIDAL COIL WINDER — \$1250 COMPLETE

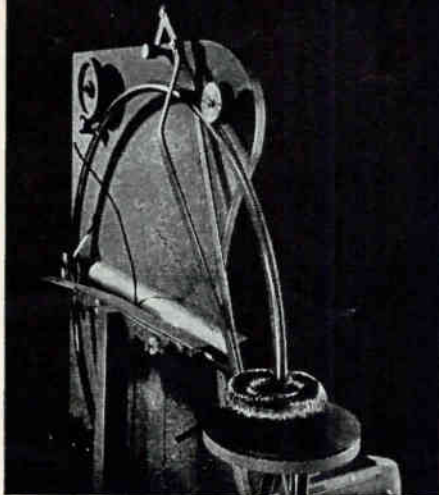

2-lb. loading capacity

This is the largest of the Harder Toroidal Coil Winders. Its big, 24-inch diameter winding ring will handle coil stacks 6-inches high and 6-inches in diameter. Up to two pounds of wire may be stored in the oversize winding ring. Smaller rings are available when maximum fill is required. This machine is an outstanding buy priced at only \$1250 complete.

Harder Coil Winding Machines are made in five models to handle ring sizes from 3 through 24 inches. This permits the production of coils ranging in size from miniature to heavy duty. The design was developed in Government Laboratories and accepted by the Navy as outstanding in its field. Hundreds in use at leading companies. Write for free booklet. Donald C. Harder Company, 2580 "K" Street, San Diego 2, Calif.

 **HARDER CO.**

CIRCLE 211 ON READER SERVICE CARD
July 15, 1960

sition. It is one in. square with the length depending upon the desired stroke. The unit is ruggedized and is designed with a self-aligning shaft for ease in mounting.

CIRCLE 328 ON READER SERVICE CARD



Capacitors

STACKED-FOIL

SPRAGUE ELECTRIC CO., North Adams, Mass. Rugged protective epoxy castings house the new type 210M high temperature Fabmika capacitors. These capacitors are particularly suited for use at temperatures up to 125 C in airborne electronic equipment, pulse-forming networks, corrosive atmospheres, and in high-voltage applications in high-powered transmitters and similar devices. Standard capacitance ratings are available in values from 0.01 μf to 1.0 μf at voltage ratings from 300 up to 6,000 v d-c.

CIRCLE 329 ON READER SERVICE CARD



Power Amplifier

LOW-DISTORTION

KROHN-HITE CORP., 580 Massachusetts Ave., Cambridge 39, Mass. Model DCA-10 power amplifier features a power output of 10 w, continuous, from d-c to 1 Mc, with frequency response flat within ± 1 db, throughout the entire fre-

Reliability

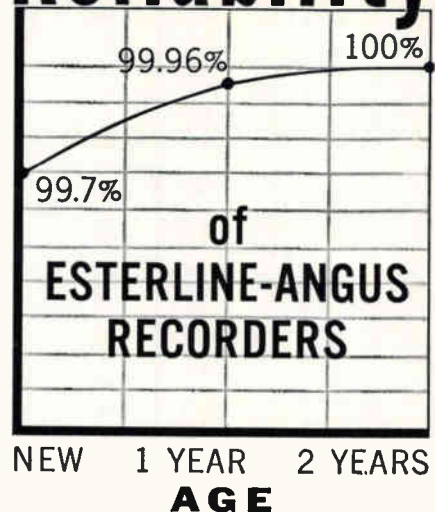

● All E-A Recording Instruments are now guaranteed for two years.

The above reliability curve covering the past several years, shows why. The reliability which starts quite high in a new instrument, increases to practically 100% at the end of two years—and stays there. E-A instruments are designed and built to give ten years of trouble-free service.

Reliability like this is not quickly nor easily achieved. It takes years of development, testing and improvement . . . production know-how resulting from long experience . . . plus conscientious quality control, to attain this enviable record for reliability. Our one goal for over five decades has been to produce this one product—the reliable Esterline-Angus recording instrument.

In today's space-age technology, reliability of a high order is more important than ever before. Reliability Engineers stress that simplicity increases reliability. Simplicity also pays dividends in ease of operation and the ability to keep operating. Since the E-A recorder has simplicity and reliability, it is a proven choice for today's requirements.

Yes, proven by years of use in thousands of successful applications. We invite you to learn more about these applications. Representatives in all principal cities and in many foreign countries.

The
ESTERLINE-ANGUS
Company

*No. 1 in fine Recording Instruments
for more than 50 years.*

DEPT. E, BOX 596, INDIANAPOLIS 6, INDIANA

CIRCLE 113 ON READER SERVICE CARD 113

HELITRIM® 1/2" SQUARE TRIMMING POTS... Now available from Helipot at the lowest price in history! Model 70 with Teflon leads, \$4.95 and down; Model 71 with pins, \$5.45 and down.

Take your pick: Model 70 with leads... Model 71 with pins. They'll solve your trimming and space problems and see you through adverse environmental conditions, too!

They should. They're the best pair of square trims on today's market... at this or any price!

The reasons? Elementary... they offer special features (such as Teflon leads on the 70) as standard! And both standard models incorporate a unique slip clutch stop that positively prevents the wiper from going off the end of the coil and into dead space. (Continuous units are available as special.)

The specs tell the story! Standard resistance ranges of 10 to 50,000 ohms... resolution from 1.01% at 10 ohms to 0.083% at 50K ohms... 1 watt power input at 50°C derating to zero at 150°C!

And all this performance is packed into a 1/2" square all-metal housing that's sealed against humidity.

Convinced? If not, there are more persuaders in our catalog. Ask for it.

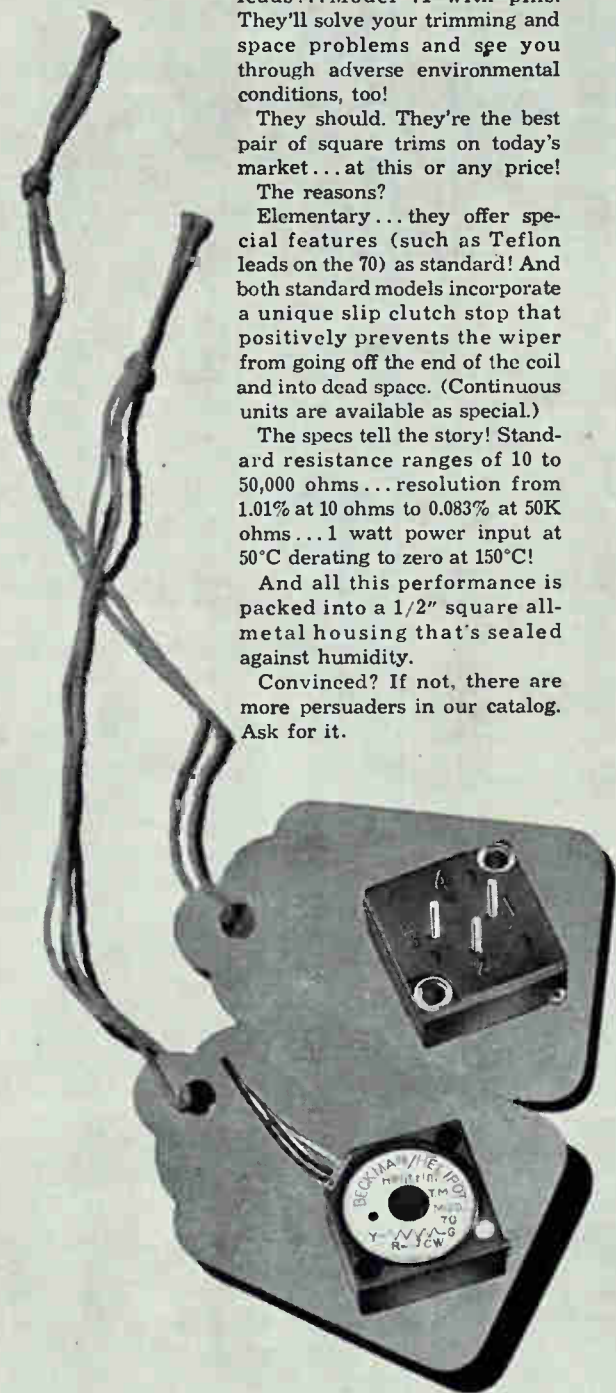

Beckman Helipot®

POTS : MOTORS : METERS
Helipot Division of
Beckman Instruments, Inc.
Fullerton, California



© 1960 B.I.I. 61004

quency range. Voltage gain is continuously variable, maximum of 10; with a fixed gain of 10 or fixed gain of 1, as determined by the input selector switch. Harmonic distortion is less than 0.1 percent; output hum and noise, less than 10 mv (input shorted). Unit offers excellent d-c level stability, low output impedance, and good output regulation.

CIRCLE 330 ON READER SERVICE CARD



**Solder Terminal
DOUBLE TURRET**

CAMBRIDGE THERMIONIC CORP., 445 Concord Ave., Cambridge 38, Mass. The No. 1026 solder terminal has a double turret and mounts in a 0.094 in. hole (0.237 in. high when mounted). Width of terminal shoulder is 0.125 in. diameter. Terminal is brass per QQ-B-626a, Comp. 22, 1/2 hard. It is finished with 0.0003 in. silver plate plus water dip lacquer. New terminal conforms with specifications of NAS 705. It is available with shank lengths for mounting in panels from 1/8 in. to 3/8 in. thick.

CIRCLE 331 ON READER SERVICE CARD

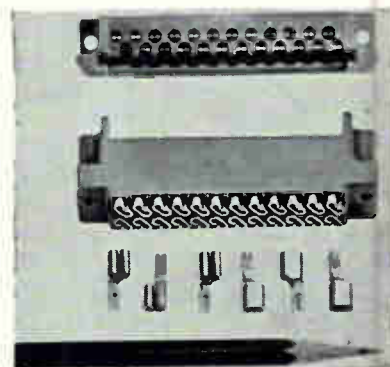

**P-C Connector
24 CONTACT UNIT**

ELCO CORP., "M" St. below Erie Ave., Philadelphia 24, Pa. Series 7009 p-c connector is known as the

Varitwin-Pin because of its twin taper-pin wire terminations. Connection to the printed-circuit board is accomplished via the Varicon mating principle, offering fork-like contacts with four coined mating surfaces; and resulting in very high contact reliability and low contact resistance. The one-piece molded insulator of glass-filled dialyl phthalate is ruggedized in design and incorporates board guides for easy mounting. Contact terminations feature dual connections on each contact and accept series 53 taper pins. Polarization of the 24-contact unit may be utilized in one or more of eleven positions by insertion of a polyethylene polarizing tab; a corresponding slot having been milled or stamped in the p-c module card.

CIRCLE 332 ON READER SERVICE CARD



Materials Tester PORTABLE INSTRUMENT

CIRCO ULTRASONIC CORP., 51 Terminal Ave., Clark, N. J. The Circo-sonic model CM100 ultrasonic materials tester is a precision engineered instrument used for non-destructive inspection of material which can support ultrasonic waves, such as metals, plastics, ceramics, etc. Uses include: flaw detection, either surface or internal, thickness measurement from one side, and determination of physical and structural properties. Components are a generator and receiver for high frequency vibrations sent in a pulsed beam through material to be inspected and discontinuities, as well as the opposite end, reflect vibrations back to receiver indicating size and location of reflecting areas on the viewing screen.

CIRCLE 333 ON READER SERVICE CARD

July 15, 1960

The future . . . from your point of view

A good day's growth for a hard day's work.

A position to suit your talents, experience and ambition.

Opportunity to exercise full initiative in Research, Radar, Doppler Navigational Systems, Magnetic Memory Systems, Microwave and Computers.

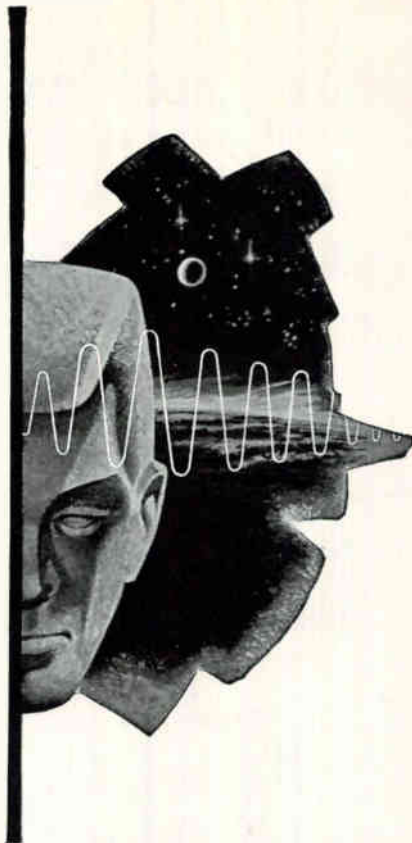

PLUS

Management awareness encouraging exploration beyond the range of present knowledge.

APPOINTMENTS NOW AVAILABLE:

DESIGN ENGINEER

Radar Circuitry

Experience and state-of-the-art knowledge in one or more of these: oscillators, cw or pulse modulators, video, IF or microwave amplifiers, differentiators, integrators, power supplies, pulse coders and decoders, phase detectors, MTI cancellers. Projects include: R&D of advanced techniques; ground, airborne, space equipment.

PHYSICIST

Applied Research

Advanced degree in physics or engineering physics, plus an appreciation of theory. To design a series of experiments in plasma physics, taking responsibility for equipment specification and installation plus all other experimental considerations.

For a confidential discussion, please write:

Eugene Rust
Laboratory for Electronics
75 Pitts Street, Boston 14, Massachusetts



Laboratory for Electronics

HIGH PRECISION HIGH STABILITY ULTRASONIC DELAY LINES

- DELAY TIME TEMPERATURE COEFFICIENT 20 ppm PER DEGREE C.
- DELAY TIME TOLERANCE $\pm .003$ usec AT 25° C.



Bliley

BLILEY ELECTRIC CO.
UNION STATION BUILDING
ERIE, PENNSYLVANIA

Ring types supplied in range 2-40 usec. Absorber types supplied in range 2-20 usec. Available in either single ended or double ended designs. Center frequencies may be specified in range 10 to 100 mc. When supplied with center frequency specified in range 10-60 mc, bandwidths up to 40% are realizable. Bandwidths up to 30% are available in range 60-100 mc.

Ring types have exceptionally uniform decay rates with negligible undulation on decay envelope. Both types can be furnished with integral temperature control for ultra high stability requirements.

Bliley ultrasonic delay lines are custom built to specifications over the complete range from 2 to 4500 usec. Send your specifications or prints for prompt quotation.

CIRCLE 212 ON READER SERVICE CARD

Literature of

CONTROLLED ATMOSPHERE SYSTEMS Kewaunee Scientific Equipment, Adrian, Mich. A 4-page folder illustrates and describes controlled atmosphere systems for the manufacture of semiconductors.

CIRCLE 350 ON READER SERVICE CARD

SNAP-ACTION SWITCHES Cherry Electrical Products Corp., 1650 Deerfield Rd., Highland Park, Ill. A 16-page booklet contains definitions of technical terms and illustrated descriptions of a line of precision snap-action switches.

CIRCLE 351 ON READER SERVICE CARD

THERMISTOR MANUAL Fenwal Electronics, Inc., 51 Mellen St., Framingham, Mass., has released thermistor manual EMC-3. This 24-page book describes what thermistors are and what they do, gives several examples of how they are used, tells how to solve thermistor problems, and contains a listing and ratings of the company's thermistor line.

CIRCLE 352 ON READER SERVICE CARD

BOBBIN WINDERS Geo Stevens Mfg. Co., Inc., Pulaski Road at Peterson, Chicago 46, Ill., offers a two-color catalog page illustrating and describing the model 39-AM miniature bobbin winder and model 315-AM 5,000 rpm 3-in. stroke 5-in. o-d bobbin-solenoid-repeater-resistor coil winder designed for greater operating convenience.

CIRCLE 353 ON READER SERVICE CARD

HIGH-VOLTAGE PENTODE The Victoreen Instrument Co., 5806 Hough Ave., Cleveland 3, Ohio. Form 2157-9 is a four-page illustrated brochure describing the type 6842 electron tube as a beam-type pentode designed for use with plate voltages up to 4 Kv. Tube described is well suited for use as the amplifier or regulator tube in series or shunt regulator circuits.

CIRCLE 354 ON READER SERVICE CARD

KLYSTRON AND PLANAR TRIODE Sylvania Electric Products Inc., 1100 Main St., Buffalo 9, N. Y. Characteristics and applications of a wide range of klystron oscillators

SYNCHRO NEWS!

VERNITRON 3-MINUTE CONTROL SYNCHROS DELIVERED ON REGULAR PRODUCTION BASIS

ALL SIZES—11 through 23

ALL TYPES—Transformers, Transmitters, Differential Transmitters—Thru-Bore and Standard

ALL ENGINEERED & MANUFACTURED TO: MIL-S-2335, MIL-S-12472, MIL-S-16892, MIL-S-20708 A, FXS-1066

ALL AVAILABLE WITH MAXIMUM ELECTRICAL ERROR OF ± 3 MINUTES! A major breakthrough, made possible by VERNITRON specialization in precision synchro component design and manufacture.

WRITE, WIRE, PHONE NOW for complete price, delivery and specification data.

Write today for Vernitron Bulletin

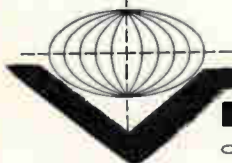

VERNITRON

C O R P O R A T I O N

THE QUALITY NAME IN PRECISION SERVO COMPONENTS

129 Old Country Rd.,
Carle Place, N. Y.
Pioneer 1-4130
TWX: G-CY-NY-1147

the Week

and "rocket" planar triodes are described in a new brochure. Listed is information on the SK-220 and SK-222 series which operate with one watt output in the 6,125 to 8,100 Mc range.

CIRCLE 355 ON READER SERVICE CARD

MAGNET WIRES General Electric Co., Bridgeport 2, Conn. A 50-page catalog covering a complete line of magnet wires includes full product descriptions with dimensional data and application information.

CIRCLE 356 ON READER SERVICE CARD

FREQUENCY DISCRIMINATOR Magnetic Research Corp., 3160 West El Segundo Blvd., Hawthorne, Calif., has published an engineering data sheet containing complete details on its 115-v, 400-cycle, 0-5 v d-c range frequency discriminator model 91-105-0.

CIRCLE 357 ON READER SERVICE CARD

COIL CATALOG Chicago Standard Transformer Corp., 3501 W. Addison St., Chicago 18, Ill. A new 28-page catalog on a complete line of Stancor coils gives detailed electrical and physical specifications on over 600 units, as well as complete application information.

CIRCLE 358 ON READER SERVICE CARD

TANTALUM CAPACITORS Tantor Electronics, Inc., West Road, Bennington, Vt., has available a condensed catalog sheet on a line of wire anode, foil and some solid electrolyte tantalum capacitors.

CIRCLE 359 ON READER SERVICE CARD

TEST CONSOLE Sensitive Research Instrument Corp., New Rochelle, N.Y. Volume 28 No. 3 of *Electrical Measurements* illustrates and describes the model LTC laboratory standardizing test console.

CIRCLE 360 ON READER SERVICE CARD

SYSTEM BUILDING BLOCKS Digital Equipment Corp., Maynard, Mass. A color-coded eight-page folder contains logic diagrams and complete description, including input, output, and price data on all 35 of the 5 Mc line of plug-in system building blocks.

CIRCLE 361 ON READER SERVICE CARD



Talos fired at sea, prime armament for missile-age cruisers.

GO MIDDLE WEST . . . for a prime opportunity in missiles!

Go Midwest for outstanding career opportunities with Bendix Mishawaka, prime contractor for the U.S. Navy Talos—first line anti-aircraft weapon aboard missile-age cruisers. Take advantage of the wide range of engineering opportunities Bendix Mishawaka offers you right in America's heartland! . . .

The established success of Talos by Bendix Mishawaka, its prime contractor, not only assures permanence of the present program but has opened the door to other advanced missile projects that offer new and challenging job opportunities in design, development, testing, and manufacturing.

Bendix Mishawaka, in addition to its

direct responsibility for Talos and other advanced missile projects, is a key division of The Bendix Corporation. The corporation-wide activities of Bendix cover practically every phase of advanced technology with particular emphasis on systems design and development. Participation in this highly diversified corporation effort is your further assurance of a more secure future.

Enjoy living in the Midwest and find unmatched job opportunities with Bendix Mishawaka. Grow professionally as well as financially. Take the first step today. Mail the coupon for your copy of the interesting booklet "Opportunities Abound at Bendix Missiles."

Bendix Mishawaka Division



PRIME CONTRACTOR FOR THE TALOS MISSILE



Bendix Mishawaka Division

400F So. Beiger St., Mishawaka, Ind.

Gentlemen: I would like more information concerning opportunities in guided missiles. Please send me the booklet "Opportunities Abound at Bendix Missiles."

NAME _____

ADDRESS _____

CITY _____ STATE _____



IERC Sets Up New Headquarters

A NEW half-million-dollar building, covering 30,000 sq ft, was recently dedicated in Burbank, Calif., as headquarters for the International Electronic Research Corp. on the eve of its 10th anniversary.

Harvey Riggs, IERC president, announces the new facility enables the firm to consolidate certain corporate functions and offers improved and expanded quarters for all the corporation's divisions.

In combination with previous holdings, the new building brings IERC's total space to 70,000 sq ft, a two-fold expansion. The structure is adjacent to the majority of the company's other facilities.

The building's ground floor provides ample covered parking area for cars and includes the main entrance and lobby. Electronic assembly, part of the corporation's Components division, will occupy the second floor.

The third floor houses the purchasing, general accounting and production control departments, plus other general offices. Executive offices and sales departments for all divisions are situated on the top floor.

The new space, plus shifting within existing facilities, provides a 100-percent increase of floor space for both the Electronic Instruments

and Components divisions. Millrich Engineering, a third division of IERC, has gained 25 percent more space for its operations, Riggs reports.

International Electronic Research Corp. developed a heat dissipating shield for electron tubes and now manufactures a complete line of such devices, company says. The firm presently has overseas licensees in France and England for the manufacture and sales of these units in the European Common Market and in the British Commonwealth.

IERC also manufactures electronic precision a-c power supplies and amplifiers, as well as nuclear instruments including single and multi-channel radiation detection units. In addition, it engages in precision machine work for the aircraft/missile industry and manufactures a patented mass flow meter through its Millrich division.

The company now employs about 350 people and has a sales volume of about \$6 million, Riggs reports.

GPL Announces Three Appointments

FRANCE B. BERGER has assumed the position of director of research at

GPL division, General Precision, Inc., Pleasantville, N. Y. Formerly he was director of planning and requirements.

Harry J. Reed and Raymond Klemmer have taken the respective positions of director and associate director of planning.

Both Berger and Reed came to GPL in 1946, and were among the organization's original group of scientists. Klemmer came to GPL in 1958. Prior to his new appointment, he was a member of Berger's planning and requirements staff.



Equipto Electronics Hires Plant Manager

EQUIPTO ELECTRONICS CORP., Naperville, Ill., has appointed Robert L. Golz plant manager. Company manufactures electronic hardware such as enclosures, racks, panels, chassis and associated equipment.

Golz was formerly assistant to the plant manager at Emcor-Ingersoll Products, division of Borg-Warner.



Hazeltine Electronics Elects Vice President

DIRECTORS of Hazeltine Corp., Little Neck, N. Y., have announced the election of Victor J. Young as vice

USE THE BUYERS' GUIDE AS A MARKETING TOOL

You'll find key information from the marketing viewpoint in the electronics **BUYERS' GUIDE**. It will help you to see the *whole* picture of industry activity *clearly*.

You'll find facts about the markets ... materials ... design—available nowhere else.

You'll find *who* makes which products and *where* they are located.

You'll find a reflection of the size, interests and stature of more than 4,000 companies.

Best of all, the **BUYERS' GUIDE** and Reference Issue is accurate, complete and authoritative. You can *act* on the information it gives you. O.B.B

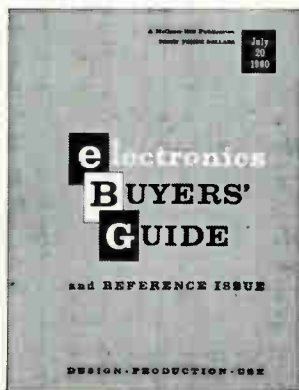

FIND
WHAT
YOU
NEED
IN
THE

**electronics
BUYERS' GUIDE**

CIRCLE 119 ON READER SERVICE CARD→

ac **POWER!**

... controlled to a frequency accuracy of 0.00001%
The Behlman **INVERTRON** is synonymous with electronic AC power ... single, two or three phase with output from milliwatts to kilowatts.

INVERTRON is available in both fixed and variable frequencies with extremely high stability and extremely low harmonic content. The test of the test is **INVERTRON**

Complete specifications will be sent on request.

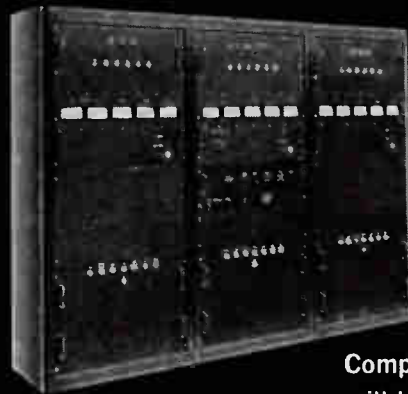

BEHLMAN

ENGINEERING COMPANY

2911 Winona Avenue Burbank, California

METALS for ELECTRONIC APPLICATION

rolled ULTRA THIN

by **OUR SPECIAL ROLLING TECHNIQUE**

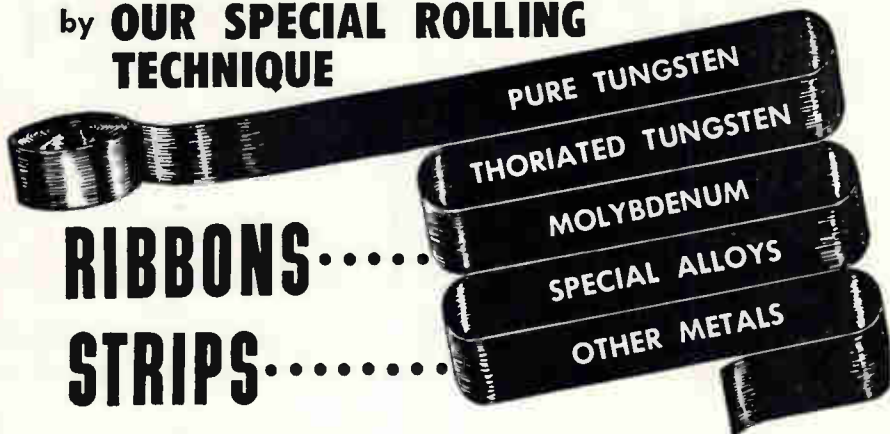

RIBBONS.....
STRIPS.....

TOLERANCES CLOSER THAN COMMERCIAL STANDARDS

Note: for highly engineered applications—strips of TUNGSTEN and some other metals can be supplied

rolled down to .0003 thickness

- Finish: Roll Finish—Black or Cleaned
- Ribbons may be supplied in Mg. weights if required

Developed and Manufactured by

H.CROSS CO.

15 BEEKMAN ST., N. Y. 38, N. Y.

TELEPHONE: WOrth 2-2044
COrtlandt 7-0470

CIRCLE 213 ON READER SERVICE CARD

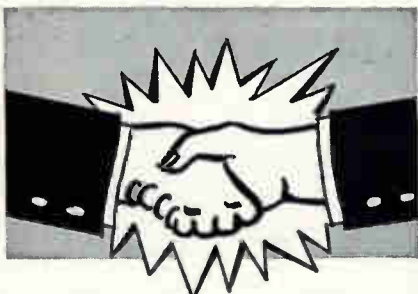

35 YEARS of PROVEN DEPENDABILITY

COSMIC

ELECTROLYTIC AND PAPER TUBULAR CONDENSERS

COSMIC CONDENSER CO.

853 WHITTIER STREET, BRONX, N. Y.
LUdlow 9-3360

send for this

FREE

EICO Electronics Catalog



you save 50% on Top-Quality Test Instruments
HI-FI • Ham Gear

KITS AND WIRED

for professional and home use

TEST INSTRUMENTS
battery eliminators
battery testers
bridges
decade boxes
electronic switch
flyback tester
oscilloscopes
probes
signal and sweep generators
tube testers
transistor tester
vacuum tube voltmeters
volt-ohm-milliammeters

HI-FI
stereo and monaural tuners
preamplifiers
power amplifiers
integrated amplifiers
speaker systems

HAM GEAR
cw transmitter
modulator-driver
grid dip meter

OVER 2 MILLION
EICO Instruments in use throughout the world.

LIFETIME service and calibration guarantee.
IN STOCK at your neighborhood EICO dealer.
Send now for FREE catalog E-7

EICO 33-00 N. Blvd., L. I. C. 1, N. Y.
...praised by the experts as BEST BUYS IN ELECTRONICS

CIRCLE 214 ON READER SERVICE CARD

president of Hazeltine Electronics Division. He is in charge of the electrical engineering department of the 36-year old electronics firm. He had been an assistant vice president of the electronics division since 1956.

Prior to joining Hazeltine in 1949, Young was in charge of radar, undersea detection and recorder projects for Melpar, Inc., and the Sperry Gyroscope Co.



Tung-Sol Picks Board Member

ALFRED K. WRIGHT, vice president of operations, Tung-Sol Electric Inc., Newark, N. J., has been elected to the company's board of directors.

With the company since 1937, Wright was elected vice president in charge of engineering in 1951. In 1958 he was given the broadened responsibilities of his present position.



Whitford Heads Sperry Division

APPOINTMENT of John R. Whitford as manager of Sperry Gyroscope Company's Electronic Tube Division has been announced.

The Sperry division is a major source of special electronic tubes

DYNASERT

**Increase
Hourly Output
up to 10 Times Over
Hand Inserting**



If you insert only a few hundred components a week, Dynasert component inserting machines should be considered. Big or small boards, long or short runs, Dynasert handles all.

Automatically feeds, trims, bends leads, inserts component, and clinches with uniform results. Little operator training. Highly engineered single or multi-stage production machines available. Write for descriptive 12 page booklet.

United

UNITED SHOE MACHINERY CORPORATION
140 Federal Street, Boston, Mass.

CIRCLE 215 ON READER SERVICE CARD

CONTACTS

**FOR THE FIELD OF
ELECTRONICS**

**LIFSCHULTZ
FAST FREIGHT**
FASTEST TO BOTH COASTS!

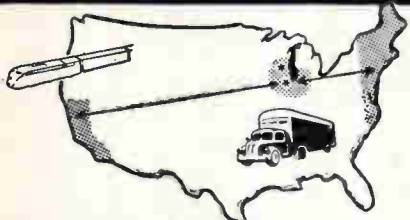

**2nd DAY SERVICE
between NEW ENGLAND STATES
and CHICAGO**

SPEED—DEPENDABILITY SINCE 1899

**Specify LIFSCHULTZ
and Be Sure It's On Time!**

for microwave radars, electronic countermeasures, and microwave communications systems used by the Armed Forces and industry.

Whitford joined Sperry in 1949 as project engineer for microwave instruments and components and later advanced through a series of sales positions.

GI Elects President, Vice Chairman

ELECTION of Moses Shapiro as president and Monte Cohen as vice chairman of the board of General Instrument Corp., Newark, N. J., has been announced by board chairman Martin H. Benedek.

Shapiro has been executive vice-president since June 1955.

Cohen, president of General Instrument since December 1953, retains his active operating post as chairman of the operations committee and in addition, will devote himself more fully to long-range planning for the company's future growth, Benedek stated.



Appoint Zneimer Section Manager

JOEL ZNEIMER was recently appointed manager of the ferrite materials section of Airtron, a division of Litton Industries, Beverly Hills, Calif. He will be responsible for production of polycrystalline ferrite materials for microwave applications. His section will continue Airtron's activity in this field which was started in 1955.

Before joining Airtron, Zneimer was in charge of development and production of microwave materials for Kearfott Co. He also was responsible for the company's ferrite material development program.

PRECISION DEFLECTION WITH COSSOR YOKES



Slip Ring Yoke

Two Axis Fixed Yoke

Component Development Engineering at its BEST!

- ADVANCED ELECTRICAL DESIGN
- PRECISION MECHANICAL DESIGN
- ACCURATE PRODUCTION METHODS

Custom Built to the most
Exacting Specifications
by Cossor Engineers

In Mumetal Cores for Optimum Geometry
In Ferrite Cores for Speed and Sensitivity
In Non-magnetic Cores for Perfection of Response

Any of Cossor's Three Core Types can be made in single or double axis with single or push-pull windings, and encapsulated for fixed or slip ring (rotating) use

Normal characteristics of yokes for 1-1/2 in neck tubes are:

Positional accuracy - the spot position will conform to the yoke current co-ordinates within 0.25% of tube diameter. For deflection angles less than $\pm 25^\circ$ better accuracy can easily be achieved

Memory - 0.5% max without over swing
0.1% or less with controlled over swing

Complete encapsulation in epoxy (stycast) or silicone resins is standard for all Cossor deflection yokes, and is done with special moulding tools ensuring accurate alignment of the yoke axis. When slip rings are added, solid silver rings are mounted in encapsulating resin. The finished slip ring yoke is precision turned to centre bore, and can include bearing mounting surfaces with dimensional tolerances approaching those associated with high quality metal parts.

Settling Time (Micro sec.) -

$120 \sqrt{\text{Inductance in Henries}}$

Sensitivity degrees/milliampere is

$0.098 \sqrt{\frac{\text{Inductance} \cdot \text{millihenries}}{\text{Accelerator Voltage} \cdot \text{kV}}}$



Complete
Rotational
Systems

COMPONENTS DIVISION.

**E.M.I
COSSOR**
Electronics Limited

WOODSIDE, DARTMOUTH, N. S.
2005 Mackay St., Montreal, Que.
3077 Bathurst St., Toronto, Ont.
Corporation House, 160 Laurier West, Ottawa, Ont.

**NATIONAL
COVERAGE**

EMPLOYMENT OPPORTUNITIES

The Advertisements in this section include all employment opportunity—executive, management, technical, selling, office, skilled, manual, etc.

Positions Vacant
Positions Wanted
Part Time Work

Civil Service Opportunities
Selling Opportunities Wanted
Selling Opportunities Offered

Employment Agencies
Employment Services
Labor Bureaus

DISPLAYED

The advertising rate is \$14.00 per inch for all advertising appearing on other than a contract basis. Contract rates quoted on request. An advertising inch is measured 7/8" vertically on a column—3 column—30 inches to a page. Subject to Agency Commission.

RATES

\$2.40 per line, minimum 3 lines. To figure advance payment count 5 average words as a line. Box Numbers—counts as 1 line. Discount of 10% if full payment is made in advance for 4 consecutive insertions. Not subject to Agency Commission.

UNDISPLAYED

Send **NEW ADS** to **CLASSIFIED ADV. DIV. of ELECTRONICS**, P.O. Box 12, N. Y. 36, N. Y.

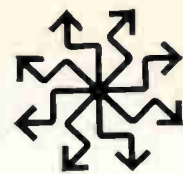

**New
Horizons
for Creative
Engineers**

Dictaphone Corporation . . . the greatest name in dictation for office communication has broadened its base to meet new challenges in sound recording.

Indicative of this product diversification is the development of the Dictatape 5 channel recorder — the "double check" element for monitoring communications to and from dispatching control centers.

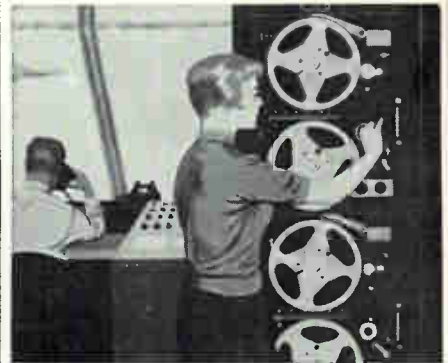

The Dictatape recording machine records up to five voice channels on 1/4 inch magnetic tape and is designed to give 16 hours unattended service.

This is just one of many areas where Dictaphone Corporation has applied advanced, practical research to the growing needs of business, industry and government for recording and reproducing machines.

Write tonight to:
Mr. Lloyd R. Jones
Assistant to the Vice President
Engineering & Research Division

 **Dictaphone
CORPORATION**

375 Howard Avenue, Bridgeport, Conn.
DICTAPHONE and DICTATAPE ARE REGISTERED
TRADEMARKS OF DICTAPHONE CORPORATION

ACF ELECTRONICS DIVISION

ELECTRO-PHYSICS LABORATORIES

**OUR NEW NAME
REFLECTS . . .**

. . . the ever-growing importance of this unit of ACF—a major, multi-division organization . . . the bringing together of our talents into a highly-regarded, cohesive force in Electronics . . . the expansion of activities simultaneously in a number of broad areas of research, design and development, in modern new facilities.

**TO THE ENGINEER,
IT MEANS . . .**

. . . diversification, with choice assignments in the fields of RF Communications Systems, Digital Data Processing Systems and Data Transmission Systems . . . and identification of your contributions to challenging projects of unusual interest.

**OUR
IMMEDIATE
NEEDS
ARE FOR:**

Research Consultants . . . PhD or MSEE degree, with up to 5 years' experience including background in data transmission, solid-state electronics, data systems development, and systems and circuit design.

—Advanced degree in EE, with experience in communications packaging, including: micro-miniaturization, thin-film, and other solid-state development.

SENIOR ELECTRONIC ENGINEERS

—MSEE or BSEE with background or interest in data transmission, solid-state development, systems and circuit design, or communications packaging.

—MSEE or BSEE with background in miniaturization and transistorization of RF circuitry.

**ELECTRONIC
ENGINEERS**

—EE degree, for solid-state digital circuits and systems design. Background in data processing and wireline transmission desirable.

The Electro-Physics Laboratories are located in the suburban Washington, D.C. area, where post-graduate study is available in several nearby universities. Housing is plentiful in attractive, well-established neighborhoods. Our relocation allowance is liberal.

Please send resume to:
PROFESSIONAL EMPLOYMENT DEPARTMENT

ACF ELECTRONICS DIVISION

acF

**INDUSTRIES, INCORPORATED
RIVERDALE, MARYLAND**

**TECHNICAL WRITER
\$10,000**

Needs to originate, prepare and edit technical reports and hand books covering electronic equipment such as, radar, ECM and ASW systems and components. Should have knowledge of milspecs and have a bachelors degree with three to five years exp. Fine growth company located in desirable surroundings. Fee paid. See Lew Musgrave.

MONARCH PERSONNEL

28 East Jackson Chicago 4, Illinois

SALES REPS WANTED

New and expanding corporation requires sales representatives for its G-10 product—a copper-clad epoxy glass base material—used for etching, printed, flush and plated circuits. Many territories open. Inquire immediately to:

PRECISION LAMINATES

7 East Franklin St. Danbury, Connecticut

ENGINEERS
SCIENTISTS

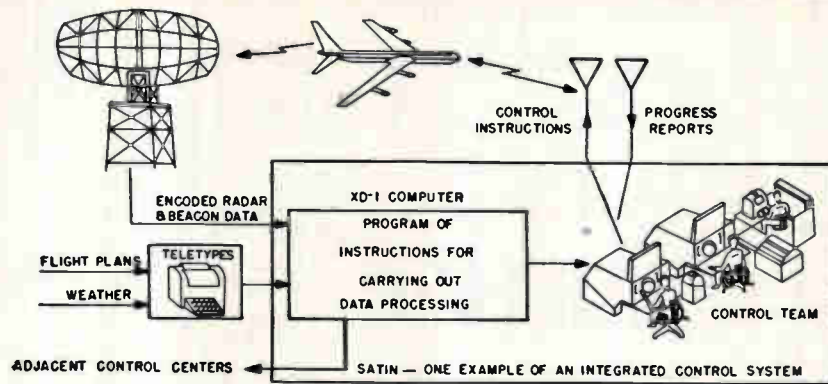

The HUMAN CATALYST

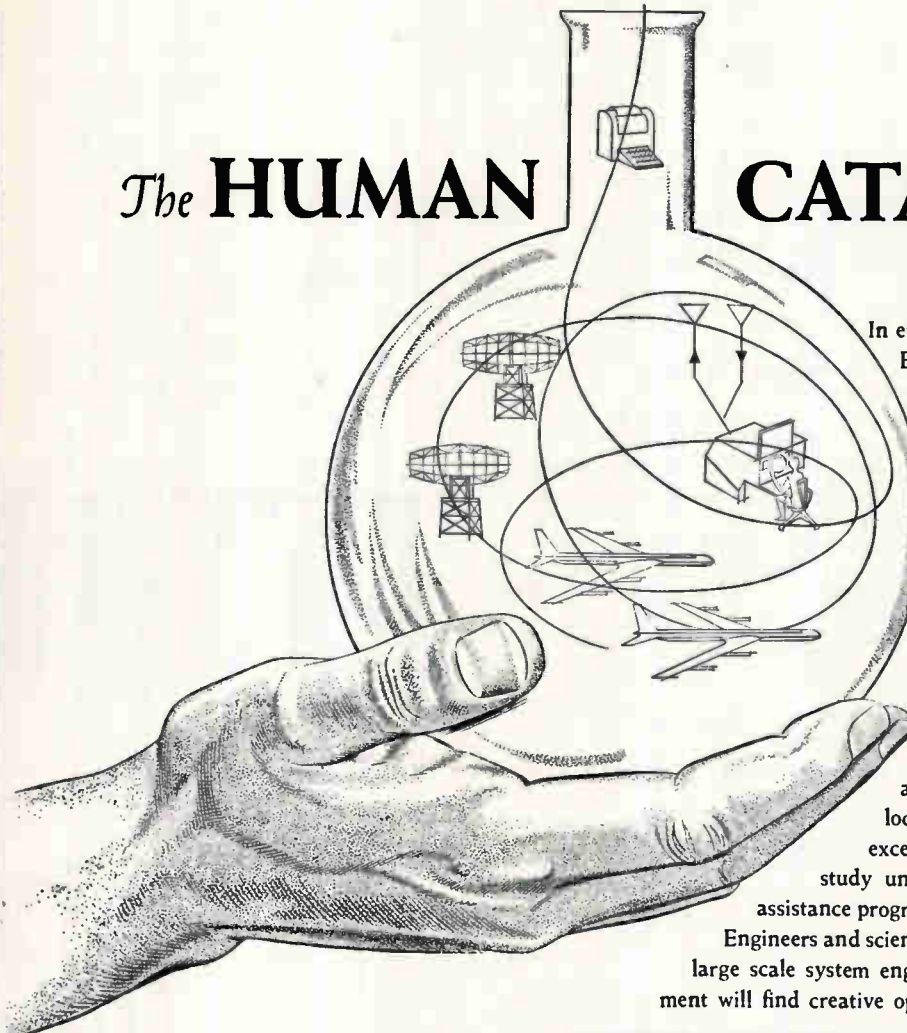

In effect, this is the role of the System Engineer at MITRE.

His technical competence and objectivity must maximize the effectiveness of complex interacting communications networks, radar systems, digital computers and countermeasures. The end result must be an integrated command and control system.

MITRE, a system engineering organization, is engaged in the design, development and evaluation of large scale command and control systems. Its convenient location in suburban Boston offers excellent opportunities for advanced study under MITRE's liberal educational assistance program.

Engineers and scientists with an interest in combining large scale system engineering with electronic development will find creative opportunities with MITRE in:

- COMPUTER TECHNOLOGY • RADAR SYSTEM DEVELOPMENT •
- AIR TRAFFIC CONTROL SYSTEM DEVELOPMENT • HUMAN FACTORS •
- ADVANCED SYSTEM DESIGN • COMMUNICATION SYSTEMS •
- OPERATIONS RESEARCH • ELECTRONICS COUNTERMEASURES •

Inquiries may be directed in confidence to:
VICE PRESIDENT — TECHNICAL OPERATIONS

THE
MITRE
CORPORATION

Post Office Box 31, 17-WO, Lexington, Massachusetts

electrical or mechanical engineers
**INTERESTING
 DIVERSIFIED
 HIGH-LEVEL
 POSITIONS**

Honeywell introduced the first successful autopilot of World War II—the C-1. Since then we have produced more flight control systems than any other company. Today we are engaged in producing the automatic flight control system and the rate stabilization control system for Project Mercury, the flight reference system for the Titan, the solid state autopilot for the F-104, and the adaptive autopilot which controls flight through aerodynamic surfaces and reaction nozzles for the X-15.

One result of our X-15 Adaptive Autopilot effort has been the creation of a permanent reaction control system and development section which has been assigned to our Components Design Department.

Because of our expansion in this area we now have openings for engineers with the following background and experience.

**REACTION CONTROL
 SYSTEMS ENGINEERS**

Requires background in missile propulsion systems analysis as it relates to reaction controls. Must be able to establish reaction control requirements by analysis of vehicle dynamics and have an understanding of propellant fuels and oxidizers for specific systems; handle heat transfer problems to optimize and compare several concepts for a given duty cycle; determine optimum over-all performance characteristics, thrust response with given inputs, and chamber pressure and oxidizer-fuel ratios for various nozzle heat sink designs; assist on all proposal efforts requiring propulsion system analysis.

**REACTION CONTROL
 DEVELOPMENT ENGINEERS**

Requires background in rocket engine design, specifically bipropellant type. Must be capable in valving design techniques for injection mixing, oxidizer to fuel ratio adjustment, positive shut-off and valve actuation methods, determining thrust at sea level and vacuum with various fuels and combustion chamber designs. Must have working knowledge of high temperature materials and materials compatible with exotic fuels and oxidizers; ability to determine the optimum configuration (nozzle, valves, torque motor, injectors, etc.) for given applications; ability to work with design and layout draftsmen, model makers, and evaluation engineers in following through with a design development.

If you are a qualified engineer, we would like to hear from you. Just drop a line including pertinent information on your background, interests, and accomplishments to Mr. James C. Burg, Dept. 731B, Honeywell Aeronautical Division, 1433 Stinson Blvd. N.E., Minneapolis 13, Minn.

Honeywell



To explore professional opportunities in other Honeywell operations coast to coast, send your application in confidence to H. K. Eckstrom, Minneapolis 8, Minnesota.

**ELECTRONIC
 ENGINEER**

Large financial institution seeks combination Electronics Engineer and financial analyst. Assignment requires broad electronics background as well as bank credit. Salary commensurate with experience. Please submit complete resume to:

P-4784, Electronics
 Class. Adv. Div., P.O. Box 12, N.Y. 36, N.Y.

SECTION HEAD . . . \$18,000

Will be responsible for design & acceptance of Communications eqpt. Will assist Chief Eng. in administration of all projects. B.S.E.E. min. 3 or more years exp. in above will warrant an interview. Client location ideal. Agency fee, interviewing and moving expenses paid by client. Send resume in complete confidence.

ESQUIRE PERSONNEL
 202 State St. Chicago 4, Ill.



**MANUFACTURERS'
 REPRESENTATIVES**

IN THE ELECTRONIC INDUSTRY

SAMUEL K. MACDONALD, INC.

manufacturers representatives over 25 years
 1531 SPRUCE STREET, PHILA. 2, PA.

Territory: Pennsylvania • New Jersey
 Delaware • Maryland
 Virginia • West Virginia
 District of Columbia
 Other Offices: Pittsburgh
 Baltimore
 Washington, D.C.

**SEARCHLIGHT
 SECTION**

(Classified Advertising)
BUSINESS OPPORTUNITIES
 EQUIPMENT - USED or RESALE

**SPECIALS IN
 • KLYSTRONS •**

| | | |
|-------|-------|---------|
| 2K25 | | \$13.50 |
| 2K26 | | 33.50 |
| 2K28 | | 27.00 |
| 2K29 | | 27.50 |
| 2K33A | | 144.00 |
| 2K42 | | 170.00 |
| 2K43 | | 144.00 |
| 2K44 | | 126.00 |
| 2K45 | | 35.00 |
| 2K50 | | 72.00 |
| 2K56 | | 50.00 |
| X12 | | 475.00 |

Many other types
 See pages 622, 23 & 24 of
 the 1959 Electronics Buyers'
 Guide for a more
 complete listing.

Phone:
 Walker 5-6000

Cables:
 TELSERSUP

**LIBERTY
 ELECTRONICS, INC.**

582 BROADWAY
 New York 12, N. Y.
CIRCLE 460 ON READER SERVICE CARD

**Antique
 TELEPHONES**

As is complete, decorative purpose
 \$12.00. Working order, inter-comm.
 \$15.00. Ext. on dial \$17.50, talking
 circuit only. Write for complete list.
 All shipments FOB, Simpson, Pa.
TELEPHONE ENGINEERING CO.
 Dept. E-70, Simpson, Pa.



CIRCLE 461 ON READER SERVICE CARD

United Shoe Machinery Corp. 121
 United Transformer Corp. 2nd Cover

Varian Associates 14
 Vernitron Corporation 116

Williams & Co., C. K. 21

CLASSIFIED ADVERTISING
 F. J. Eberle, Business Mgr.

EMPLOYMENT OPPORTUNITIES 122, 123, 124
EQUIPMENT
 (Used or Surplus New)
 For Sale 124

ADVERTISERS INDEX

ACF Electronics 122
 Dictaphone Corporation 122
 Esquire Personnel 124
 Honeywell, Aeronautical Div. 124
 Liberty Electronics Inc. 124
 Mitre Corp., The 123
 Monarch Personnel 122
 Precision Laminates 122
 Telephone Engineering Co. 124

This index and our Reader Service Numbers are published as a service. Every precaution is taken to make them accurate, but ELECTRONICS assumes no responsibilities for errors or omissions.

BRUCE A. WINNER, Advertising Sales Manager. **R. S. QUINT**, Assistant Advertising Sales Manager and Buyers' Guide Manager.
FRED STEWART, Promotion Manager. **RICHARD J. TOMLINSON**, Production Manager. **GEORGE E. POMEROY**, Classified Manager. **HUGH J. QUINN**, Circulation Manager.

ADVERTISING REPRESENTATIVES

NEW YORK: Donald H. Miller, Henry M. Shaw, George F. Werner.
BOSTON: William S. Hodgkinson.
PITTSBURGH: David M. Watson.
PHILADELPHIA: Warren H. Gardner, William J. Boyle.
CHICAGO: Harvey W. Wernecke, Martin J. Gallay.
CLEVELAND: P. T. Fegley.
SAN FRANCISCO: T. H. Carmody, R. C. Alcorn.
LOS ANGELES: Carl W. Dysinger, D. A. McMillan, Marshall Freeman.
DENVER: J. Patten.
ATLANTA: M. Miller.
DALLAS: Robert T. Wood.
LONDON: Edward E. Schirmer.
FRANKFURT: Stanley R. Kimes.
GENEVA: Michael R. Zeynel.

Wall Street and the News



WITH EXPANSION of the electronics industry has come a new awareness of Wall Street and the stock market. The past two or three years in particular have seen merger after merger, new stock issue after new stock issue. The newspapers now cover electronics as a daily diet, not only in the science and financial columns but often on page one.

There's a rush for glamor, a rush for top billing, such as we've never known before. It's not good. Top companies, old timers, are vying with newcomers for publicity. Who has the most, who has the latest? "Breakthroughs" are mentioned so often they are becoming commonplace. And definitely not all of them are breakthroughs.

Recently a New York newspaper headline read "Components Outdated". Now this just isn't so. Most of them have been continuously improved and are not even obsolescent, unless you want to be academic. Certainly, semiconductors are wonderful components. We've seen solid-state devices combined to achieve near miraculous results, and some combinations don't use components as we have known them. But we're a long way from the universal, or even predominant use of solid-state circuits at reasonable prices.

Too much glamorizing is dangerous for our industry. You can't kid the public continuously and forever about electronics. Time, perhaps, for a sober checkup on publicity releases? Time to handle them in a manner which will be believable even by engineers and scientists? We think so.

James Gidwood

PUBLISHER

A large, rectangular LC filter component is shown on the left, and a white egg is on the right. Both are set against a background of a red dashed grid. The filter has a textured top surface with small protrusions and a smoother bottom surface with mounting holes.

**Better shape factor
over wider frequency range**

Daven's new EGG CRATE LC filters...

Center frequency: covers the range from 0.4 MC to 60.0 MC depending upon specific requirements. Center frequency stability: ± 1.0 KC per MC from -55°C to $+105^{\circ}\text{C}$. Shape factor: BW_{60}/BW_6 to 2.1. Shape factors can be modified for optimum time delay.

In addition to these outstanding specifications, Daven's new LC filters offer a unique type of construction which makes them the most rugged filters ever built. Small cells are welded

together to form the partitioned shield compartment...making this the first filter with truly continuous mechanical and electrical bond...providing a high degree of inter-circuit shielding.

Daven's new LC filters are ideal for shaping the pass band of AM/FM or FM/FM data link receivers, double or single side band receivers and generators, direction finding receivers, communication and telemetering receivers, and spectrum analyzers. So versatile, in fact, that applications are almost limitless. Write today for complete, newly-published technical data.

THE **DAVEN** CO.  **LIVINGSTON, NEW JERSEY**

TODAY, MORE THAN EVER, THE DAVEN © STANDS FOR DEPENDABILITY

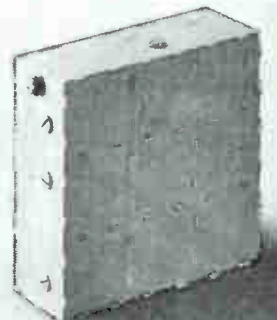

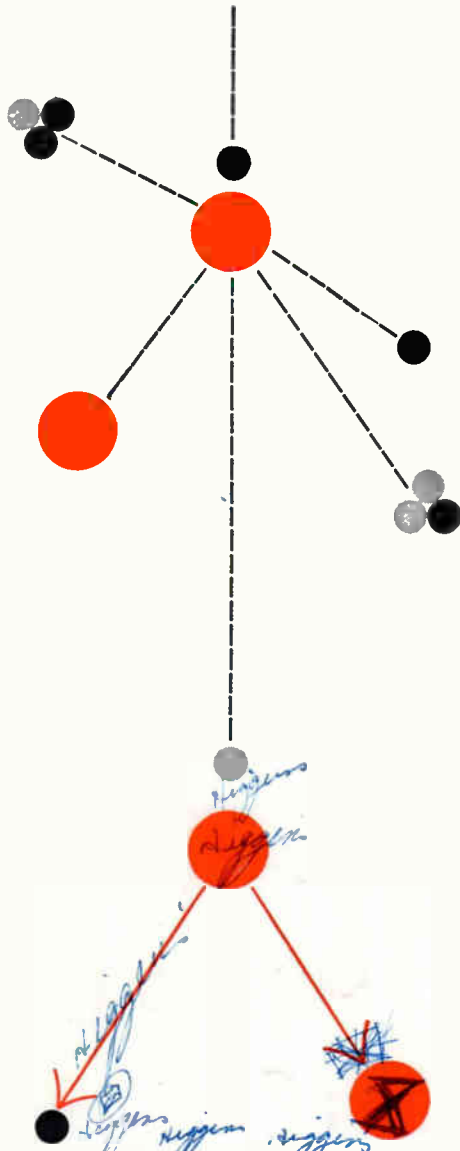

New RCA-7746
Multiplier Phototube with

GUARANTEED
GUARANTEED
Pulse-Height
PULSE-HEIGHT
Resolution
RESOLUTION
UNDER 9%
under 9%

RCA-7746 is a new 10-stage head-on type multiplier phototube especially suited for application in scintillation counters and in nuclear "time-of-flight" measurements. In addition to its excellent pulse-height resolution, this tube shows very good stability, and is remarkably fast. Its spherical photocathode surface makes possible an extremely small spread in electron transit time.

Another important design innovation is the enclosed in-line dynode structure which prevents both light and ion feedback within the tube, and provides internal electrostatic and light shielding. Together with the spherical photocathode and the focusing electrode, this new dynode structure enables RCA-7746 to achieve a typical pulse-height resolution of 8.5%. The pulse-height resolution is 100% factory tested using Cesium 137 and a Thallium-activated Sodium-iodide crystal, and is *guaranteed* not to exceed 9%.

RCA-7746 is capable of an essentially linear current amplification of 16,000,000 when operated at a supply voltage of 2,000 volts. Spectral response covers the range from about 3,000 to 6,500 angstroms, with maximum response in the blue region at approximately 4,400 angstroms.

For further information on RCA-7746, or any of RCA's broad line of high quality multiplier phototubes, get in touch with the RCA field office nearest you. If you would like a technical bulletin on RCA-7746, write RCA Commercial Engineering, Section G-19-Q-2, Harrison, N. J.

RCA ELECTRON TUBE DIVISION FIELD OFFICES... Industrial Tube Products Sales: Detroit 2, Michigan, 714 New Center Building, TRinity 5-5600 • Newark 2, N. J., 744 Broad St., HUmboldt 5-3900 • Chicago 54, Illinois, Suite 1154, Merchandise Mart Plaza, WHitehall 4-2900 • Los Angeles 22, Calif., 6355 E. Washington Blvd., RAymond 3-8361 • Burlingame, Calif., 1838 El Camino Real, OXFord 7-1620 • Government Sales: Harrison, N. J., 415 S. 5th Street, HUmboldt 5-3900 • Dayton 2, Ohio, 224 N. Wilkinson St., BAldwin 6-2366 • Washington 7, D.C., 1725 "K" St., N.W., FEderal 7-8500



The Most Trusted Name in Electronics
RADIO CORPORATION OF AMERICA