

electronics

A MCGRAW-HILL PUBLICATION

APRIL 1, 1960

PRICE SEVENTY-FIVE CENTS

Rocket Sled Camera Control

page 63

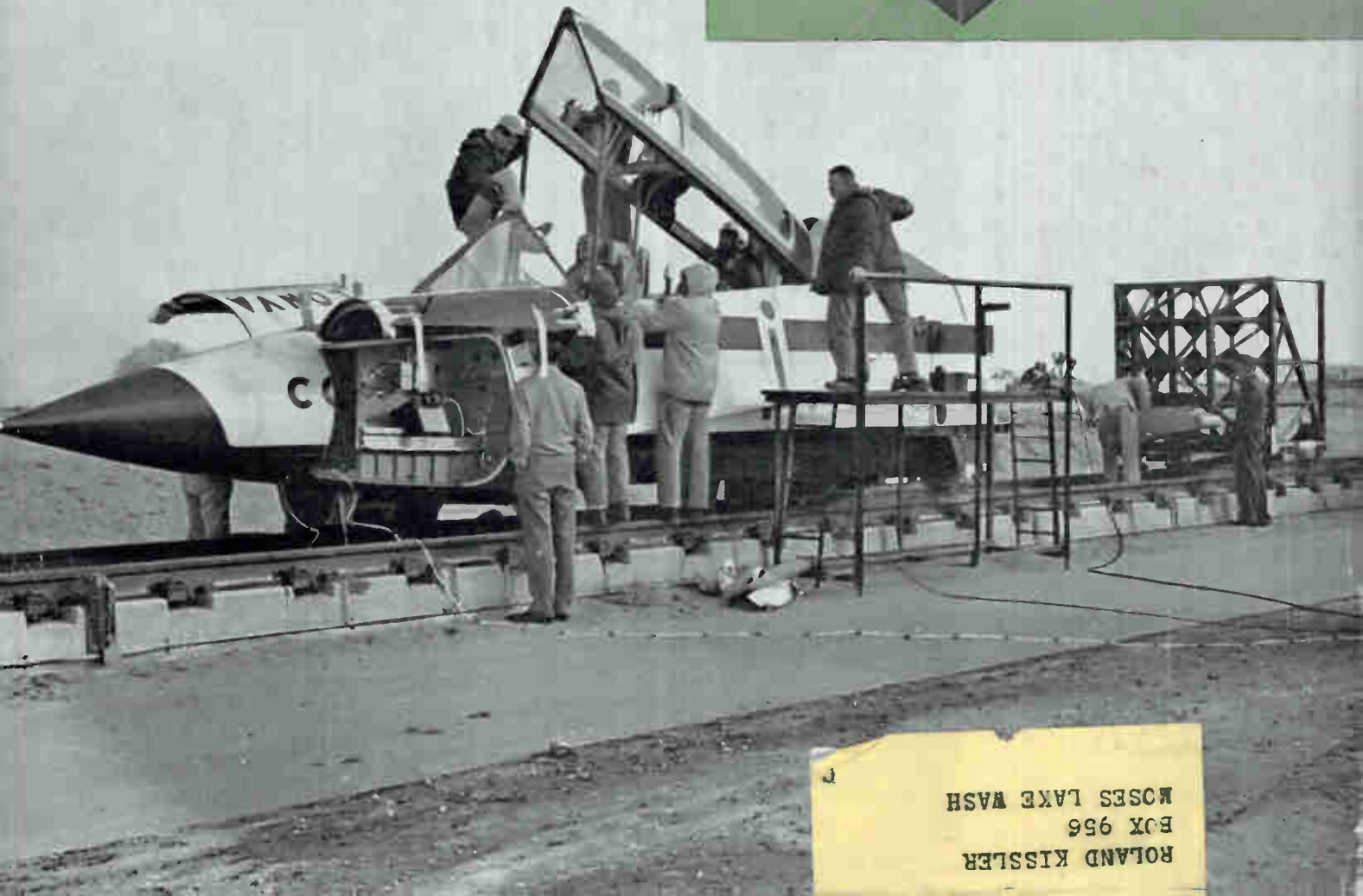
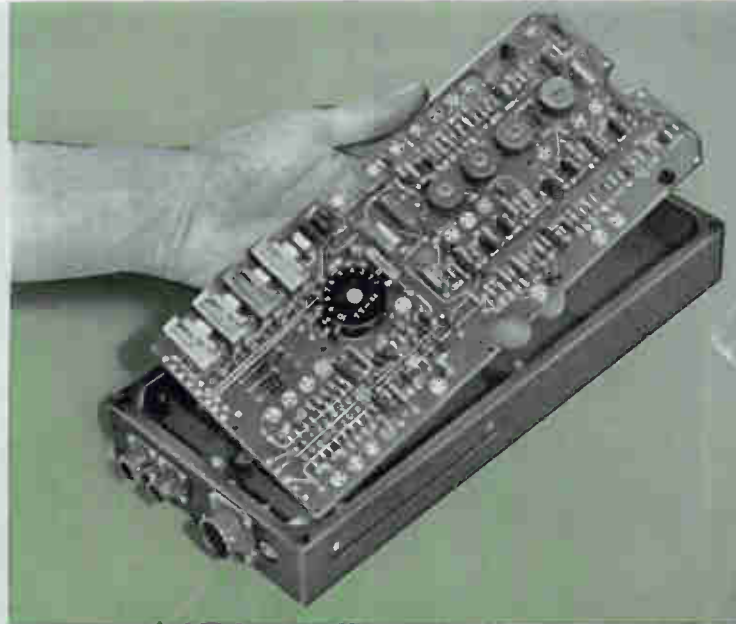

ROLAND KISSLER
BOX 956
ROSES LAKE WASH



Approximately actual size

This 3 lbs. of transistorized new AC amplifier gives you 20 or 40 db gain, increases scope or VTVM sensitivity 10 or 100!

This new 466A AC Amplifier is just 4" high, 6" wide and 6" deep. Yet it can become one of the most helpful instruments on your bench, or in the field. It is ac or battery powered; battery operation gives you hum-free performance and easy portability. Response is flat within approximately 1/2 db over the broad range of 10 cps to 1 MC, distortion is

less than 1%, and gain is stabilized by substantial negative feedback to virtually eliminate effects of transistor characteristics and environment.

For a demonstration on your laboratory or field application, call your representative or write direct.

Specifications

Gain:	20 and 40 db, ± 0.2 db at 1000 cps.	Output Impedance:	Approximately 50 ohms.
Frequency Response:	± 0.5 db 10 cps to 1 MC.	Distortion:	Less than 1%, 10 to 100,000 cps.
Output Voltage:	1.5 v rms across 1500 ohms.	Power:	12 radio type mercury cells; battery life about 160 hours; or ac line power.
Noise:	75 μ v rms referred to input, 100,000 ohm source.	Dimensions:	6 1/4" wide, 4" high, 6 1/4" deep. Weight: approx. 3 lbs.
Input Impedance:	1 megohm shunted by 25 μ f.	Price:	\$150.00 f.o.b. factory.

Data subject to change without notice.

HEWLETT-PACKARD COMPANY
1027A Page Mill Road, Palo Alto, California, U.S.A.
Cable "HEWPACK" • Davenport 5-4451



HEWLETT-PACKARD S.A.
Rue du Vieux Billard No. 1, Geneva, Switzerland
Cable "HEWPACKSA" • Tel. No. (022) 26. 43. 36

Field Representatives in all principal areas

electronics

A MCGRAW-HILL PUBLICATION

APRIL 1, 1960

PRICE SEVENTY-FIVE CENTS

Rocket Sled Camera Control

page 63

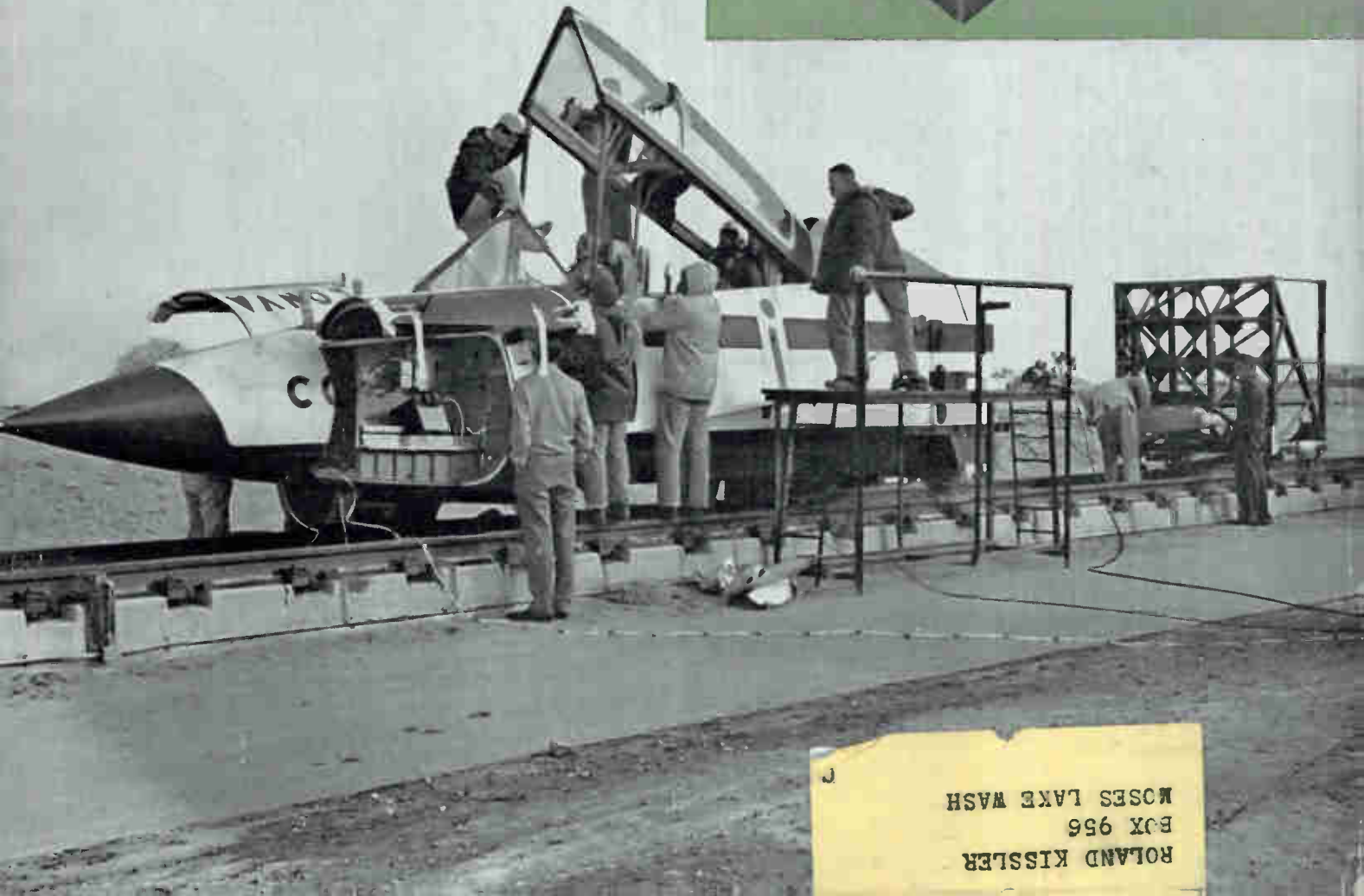
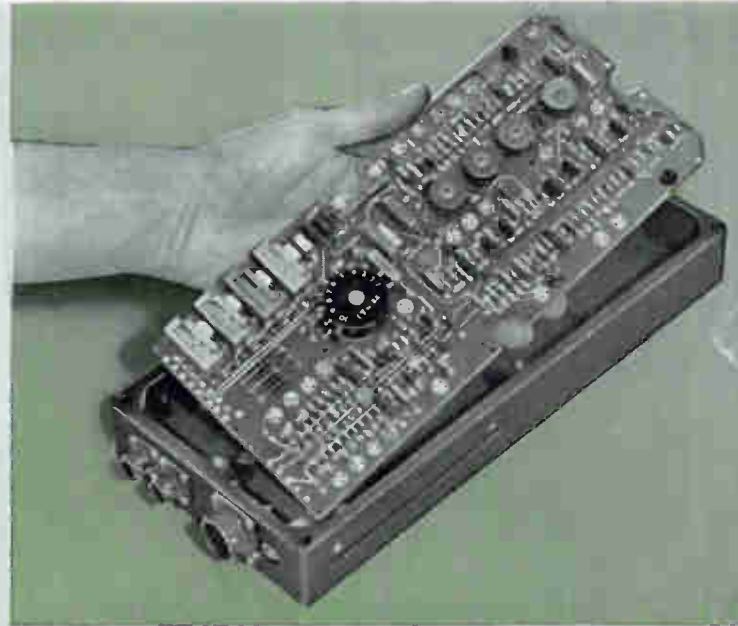

J
ROLAND KISSLER
BOX 956
MOSES LAKE WASH

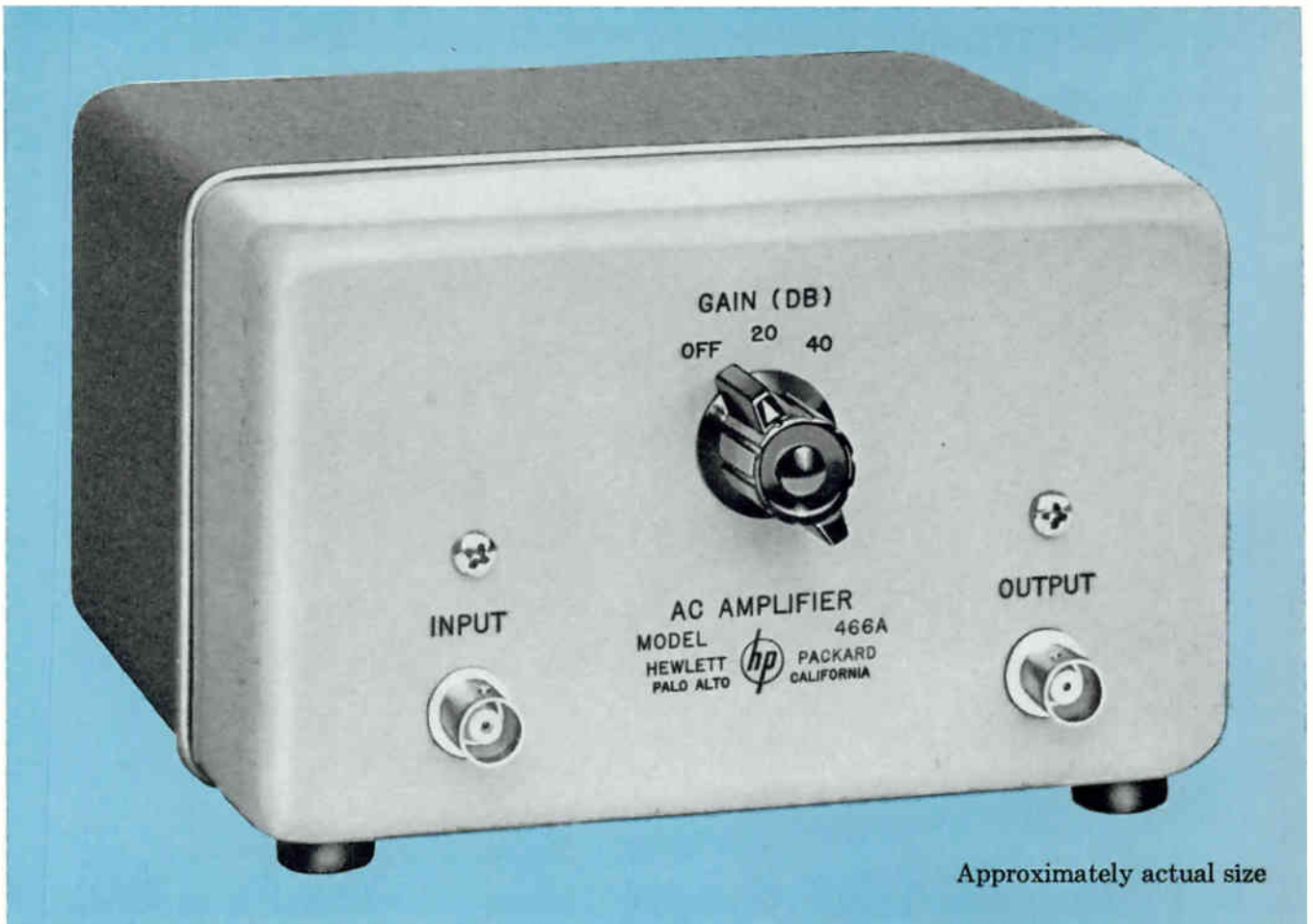

Approximately actual size

This 3 lbs. of transistorized new AC amplifier gives you 20 or 40 db gain, increases scope or VTVM sensitivity 10 or 100!

This new Φ 466A AC Amplifier is just 4" high, 6" wide and 6" deep. Yet it can become one of the most helpful instruments on your bench, or in the field. It is ac or battery powered; battery operation gives you hum-free performance and easy portability. Response is flat within approximately $\frac{1}{2}$ db over the broad range of 10 cps to 1 MC, distortion is

less than 1%, and gain is stabilized by substantial negative feedback to virtually eliminate effects of transistor characteristics and environment.

For a demonstration on your laboratory or field application, call your Φ representative or write direct.

Specifications

Gain:	20 and 40 db, ± 0.2 db at 1000 cps.	Output Impedance:	Approximately 50 ohms.
Frequency Response:	± 0.5 db 10 cps to 1 MC.	Distortion:	Less than 1%, 10 to 100,000 cps.
Output Voltage:	1.5 v rms across 1500 ohms.	Power:	12 radio type mercury cells; battery life about 160 hours; or ac line power.
Noise:	75 μ v rms referred to input, 100,000 ohm source.	Dimensions:	6 $\frac{1}{4}$ " wide, 4" high, 6 $\frac{1}{4}$ " deep. Weight: approx. 3 lbs.
Input Impedance:	1 megohm shunted by 25 μ f.	Price:	\$150.00 f.o.b. factory.

Data subject to change without notice.

HEWLETT-PACKARD COMPANY
1027A Page Mill Road, Palo Alto, California, U.S.A.
Cable "HEWPACK" • DAVenport 5-4451



HEWLETT-PACKARD S.A.
Rue du Vieux Billard No. 1, Geneva, Switzerland
Cable "HEWPACKSA" • Tel. No. (022) 26. 43. 36

Field Representatives in all principal areas

A McGRAW-HILL PUBLICATION
Vol. 33 No. 14

JAMES GIRDWOOD, *Publisher*

W. W. MacDONALD, *Editor*

JOHN M. CARROLL, *Managing Editor*

Senior Associate Editors: Samuel Weber, Roland J. Chorest

Associate Editors: Frank Leary, Michael F. Tomaino, Howard K. Janis, Sylvester P. Carter, William P. O'Brien, John F. Mason, William E. Bushor, Thomas Emma, Sy Vogel, Leslie Solomon, M. M. Perugini, George J. Flynn

Assistant Editors: Michael F. Wolff, Nilo Lindgren, Stanley Froud.

Regional Editors: Harold C. Haad (Pacific Coast, Los Angeles), Thomas Maguire (New England, Boston)

Market Research Editor: Edward DeJongh

Buyers' Guide Editor: George Sideris

Art Director: Harry Phillips, Howard R. Berry

Production Editor: John C. Wright, Jr.

Editorial Assistants: Gloria J. Filippone, Arlene Schilp, Bernice Duffy, Patricia Landers, Marian L. Freed, Dolores A. Fornara, Lorraine Rossi, Virginia T. Bastian

BRUCE A. WINNER, *Advertising Sales Manager.* R. S. Quint, *Assistant Advertising Sales Manager and Buyers' Guide Manager.* Fred Stewart, *Promotion Manager.* Richard J. Tomlinson, *Production Manager.* George E. Pomeroy, *Classified Manager.* Hugh J. Quinn, *Circulation Manager*

Advertising Representatives: New York: Donald H. Miller, Henry M. Shaw, George F. Werner. Boston: Wm. S. Hodgkinson. Pittsburgh: David M. Watson. Philadelphia: Warren H. Gardner, William J. Boyle. Chicago: Harvey W. Wernecke, Martin J. Gally, Cleveland: P. T. Fegley. San Francisco: T. H. Carmady, R. C. Alcorn. Los Angeles: Carl W. Dysinger, D. A. McMillan, Marshall Freeman. Denver: J. Patten. Atlanta: M. Miller. Dallas: Gordon L. Jones, Robert T. Wood. Frankfurt: Stanley Kimes. Geneva: Michael R. Zeynel

Issue at a Glance

Business

Strength of Japan's Industry. Meet typical production workers...	36
How Satellites Work With Radar. Midas fills BMEWS blind spots..	42
Highlights of Last Week's IRE Show. Business looks promising...	47
Broadcasters Meet Next Week. Advance report on NAB convention	48
We'll Get 17% of Defense Budget. That's the minimum for 1970..	53
Crosstalk	4
25 Most Active Stocks.....	27
Business This Week.....	11
Market Research	30
Washington Outlook	14
Current Figures	30
Financial Roundup	27
Meetings Ahead	54

Engineering

Personnel at Edwards AFB check out specially-packaged solid state receiver-controller (inset) used to control cameras during rocket sled test of seat injector. See p 63.....	COVER
Camera Control System for Rocket Sled Tests. Receiver-controller operates four cameras from uhf radio link signals. By F. M. Gardner and L. R. Hawn	63
Finding Spectral Response of Electro-Optical Materials. Monochromatic system for photoelectric testing.....	By S. J. Roth 66
Graphical Extension of Transform Techniques. A method of graphical convolution in the frequency domain.....	By R. S. Smith 68
Characteristics of Infrared Detectors. Four types analyzed By S. F. Jacobs	72
Mass Spectrometer Tests Tightness of Seals. Uses penetrating properties of helium gas.....	By J. L. Peters 74
Measuring Fluid Velocity by Nuclear Resonance. Laboratory phenomenon in practical application.....	By J. R. Singer 77
Cold Cathode Ring Counter Drives Numerical Indicator. Combines reliability with economy.....	By P. G. Hodgson 80

Departments

Research and Development. Strobe Displays High-Speed Pulses...	82
Components and Materials. Mesa's Push for Power and Speed....	86
Production Techniques. Mold Cable Covering at Junctions.....	90
On the Market.....	94
Plants and People.....	124
Literature of the Week.....	120
Backtalk	128

Index to Advertisers.....137

AME

new economy adding machine by **adolo-x**



economy priced to save you money—continuous-duty design for long trouble-free service—interlocked keyboard—direct-action function keys—direct subtract—repeat add and subtract—7/8 cap. "addo-x" stands for a family of versatile adding-calculating machines—backed by nation-wide service and repair parts facilities see your dealer or write: "addo-x" 300 Park Avenue, New York 22

Centralab
 CERAMIC CAPACITORS
 FOR SEMI-CONDUCTOR
 CIRCUITS

COST
 UP TO
40%
LESS
 THAN PAPERS OR
 ELECTROLYTICS

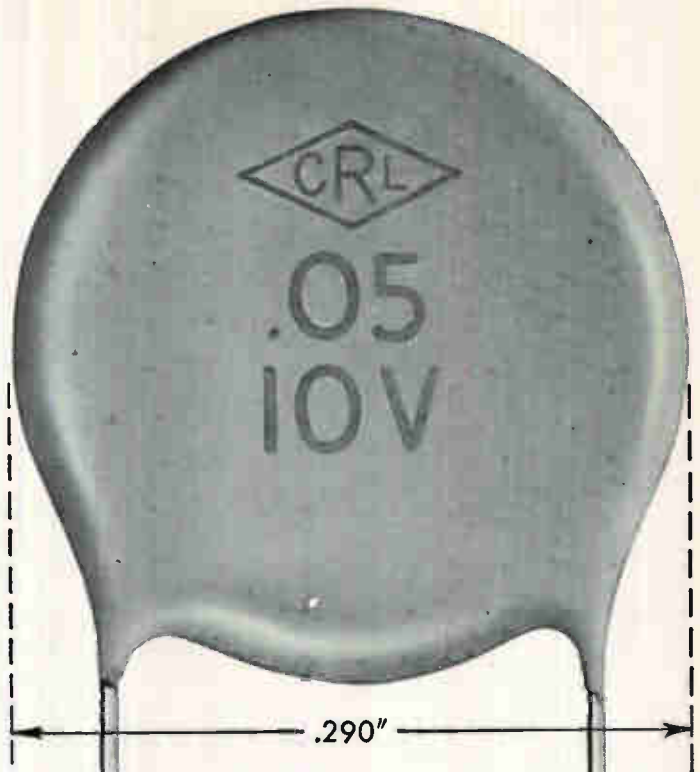

These are Ultra-Kaps*—
 ultra-miniature ceramic capacitors for any low voltage use requiring extremely high capacities, low power factor and small size.

Ultra-Kaps have excellent stability from -55°C to $+85^{\circ}\text{C}$... and there has *never* been a case of electrical failure among the millions of them now in the field.

SPECIFICATIONS

10 VDCW Ultra-Kaps

Capacitance Range05 to .47 mfd.
 Sizes290" to .840" diam.
 Thickness156"
 Power Factor at 1 KC 10%

3 VDCW Ultra-Kaps

Capacitance Range02 to 2.2 mfd.
 Sizes125" to .840" diam.
 Thickness156"
 Power Factor at 1 KC 3%

For complete technical data write for Bulletins EP-594R and EP-746 or contact your CENTRALAB representative.

Centralab

The Electronics Div. of Globe-Union Inc.
 914D E. Keefe Ave. • Milwaukee 1, Wis.
 In Canada: P. O. Box 400, Ajax, Ontario

*Trademark

D-6015

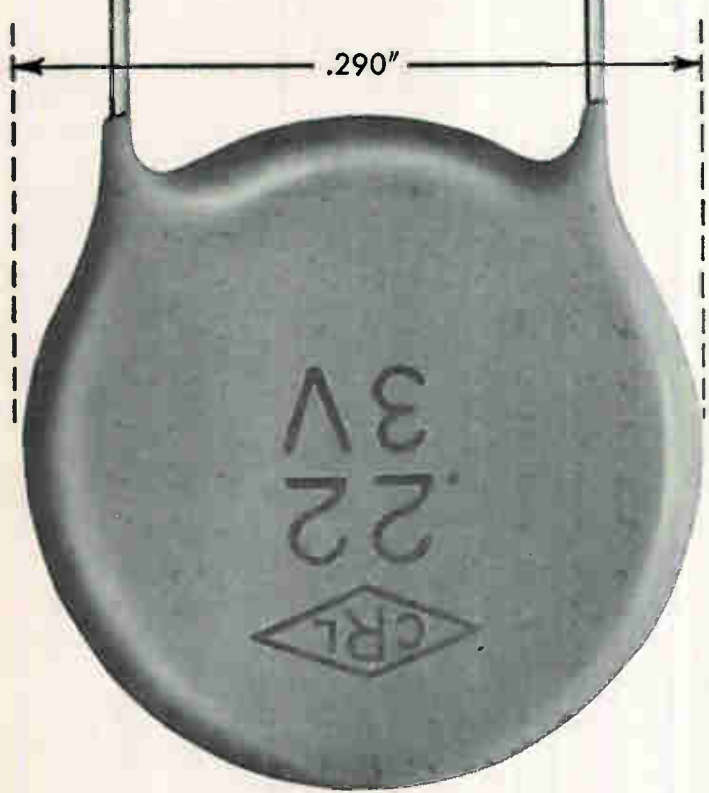



Member ABP and ABC

Published weekly, including the ELECTRONICS BUYERS' GUIDE and REFERENCE Issue in mid-July as part of the subscription, by McGraw-Hill Publishing Company, Inc., James H. McGraw (1860-1948) Founder.

Executive, Editorial, Circulation and Advertising Offices: McGraw-Hill Building, 330 W. 42 St., New York, 36, N. Y. Longacre 4-3000. Publication Office: 99-129 North Broadway, Albany 1, N. Y. See panel below for directions regarding subscriptions or change of address.

OFFICERS OF THE PUBLICATIONS DIVISION: Nelson L. Bond, President; Shelton Fisher, Wallace F. Traendly, Senior Vice Presidents; John R. Callahan, Vice President and Editorial Director; Joseph H. Allen, Vice President and Director of Advertising Sales; A. R. Venezian, Vice President and Circulation Coordinator. **OFFICERS OF THE CORPORATION:** Donald C. McGraw, President; Joseph A. Gerardi, Hugh J. Kelly, Harry L. Waddell, Executive, Vice Presidents; L. Keith Goodrich, Vice President and Treasurer; John J. Cooke, Secretary.

Subscriptions are solicited only from persons engaged in theory, research, design, production, management and use of electronic equipment. **POSITION and COMPANY CONNECTION** must be indicated on subscription orders. Subscription rates for individuals within the field of the Publication: United States and United States Possessions, \$6.00 one year; \$9.00 two years; \$12.00 three years. Canada, \$10.00 one year. All other countries \$20.00 one year. Single Copies, United States, United States Possessions and Canada 75¢; Buyers' Guide \$3.00; Single Copies all other countries \$1.50; Buyers' Guide \$10.00.

Our primary aim is to provide subscribers with a useful, valuable publication. Your comments and suggestions for improvement are encouraged and will be most welcome. The publisher, upon written request from any subscriber to our New York Office, agrees to refund the part of the subscription price applying to copies not yet mailed.

Second class postage paid at Albany, N. Y. Printed in U.S.A. Copyright 1960 by McGraw-Hill Publishing Co., Inc.—All Rights Reserved. Title registered in U. S. Patent Office.

BRANCH OFFICES: 520 North Michigan Avenue, Chicago 11; 68 Post Street, San Francisco 4; McGraw-Hill House, London E. C. 4; 85 Westendstrasse, Frankfurt/Main; National Press Bldg., Washington 4, D. C.; Six Penn Center Plaza, Philadelphia 3; 1111 Henry W. Oliver Bldg., Pittsburgh 22; 55 Public Square, Cleveland 13; 856 Penobscot Bldg., Detroit 26; 3615 Olive St., St. Louis 8; 350 Park Square Bldg., Boston 16; 1301 Rhodes-Haverty Bldg., Atlanta 3; 1125 West Sixth St., Los Angeles 17; 1740 Broadway, Denver 2; 901 Vaughn Bldg., Dallas 1.

ELECTRONICS is indexed regularly in The Engineering Index and annually in a December issue.

Subscriptions: Send subscription correspondence and change of address to Fulfillment Manager, Electronics, 330 West 42nd Street, New York 36, N. Y. Subscribers should notify Fulfillment Manager promptly of any change of address, giving old as well as new address, and including postal zone number, if any. If possible, enclose an address label from a recent issue of the magazine. Since copies are addressed one to two issues in advance, please allow one month for change of address to become effective.

Postmaster: please send form 3579 to Electronics, 330 W. 42nd St., New York 36, N. Y.

CROSSTALK . . .

OUR 30TH ANNIVERSARY. It wasn't the only by-line in the book, back there in April, 1930. But it was the first. And it was prominent: Thomas A. Edison.

The opening article in this magazine's first issue was headlined "The Future Service of Electronics to Mankind." Along with it were pieces by Lee De Forest, J. Ambrose Fleming and R. A. Millikan. The McGraw-Hill publication ELECTRONICS was a reality, pioneering a new and strange word. Six months before, Wall Street had crashed. But the magazine's eye was on tubes, not ticker tapes.

In the first issue pains were taken to point out important characteristics of the pentode tube, then just coming over the horizon. In the news section mention was made of a new set of equations from Prof. Einstein, still in Berlin, relating gravitation and magnetism.

When it started, ELECTRONICS was "a paper devoted to the design, manufacture and application of all things using a radio tube or an electric eye." Electronics, the industry, was largely radio. Since then we have persisted in setting a course for an expanding art which has revolutionized many lives and will revolutionize many more.

Even a partial list of authors who have written for our pages reads like a Who's Who in the Electronics Industry. V. J. Andrew, W. R. G. Baker, S. Ballantine, A. B. Dumont, D. G. Fink, R. K. Gessford, L. J. Giascoletto, A. N. Goldsmith, A. Hazeltine, C. F. Kettering, P. W. Klipsch, W. E. Kock, E. A. Laport. And many, many others.

We've published a great deal of truly significant material. During World War II alone, we published 17 feature articles that dealt specifically with major problems troubling the military in our field. We have also published many articles which anticipated important developments and will publish many more in the years ahead. These range from report of a "mysterious ray" ("Microwaves to Detect Aircraft," Sept. 1935), the forerunner of radar, to first publication of the Smith Chart, now a standard tool in all microwave labs.

We published the earliest detailed design article on tunnel diodes. We have printed many articles on microminiaturization—and more are coming. We have carried perhaps more details than anyone else about satellites' electronic payloads. And special reports, long an ELECTRONICS hallmark, continue to attract wide readership. Typical were: "The Challenge of Space" (April 24, '59), "Modern Communications Methods" (Oct. 23, '59), "Electronics Research & Development Around the World" (Feb. 12, '60).

Our articles have led to books: Coblenz and Owens, "Transistors: Theory and Applications"; W. R. Bennett, "Electrical Noise" (to be published shortly). And books have been written by staff members.

The growth of our industry is reflected in the growth of ELECTRONICS. Before the first issue appeared 30 years ago this month, 5,000 subscribers signed up. Circulation has grown in steady—and bigger—steps. In 1940, it was 18,000 (up 13,000 over 1930); 1950—33,000 (up 15,000); 1960—52,000 (up 19,000).

For three decades ELECTRONICS has been a feeder of specialized knowledge to research, design, production and management men. To meet editorial needs, we have expanded from monthly to weekly.

Coverage has expanded, too. In addition to the many engineering and business feature articles carried each week, today's issues offer special departments for research and development, components and materials, production techniques, new products, finance, and so on.

Editorial alertness is recognized, too. In just one year, ELECTRONICS editorial pages have generated more than 7,000 individual news stories in the American press.

W W Mac Donald

Editor

Sharper Definition... Improved Gray Scale... with **RAYTHEON "KILOLINE"** **RECORDING STORAGE TUBES**

A Raytheon-designed tetrode gun insures higher resolution — 1,000 TV lines at 50% modulation — and improved control over beam cut-off in Raytheon's new CK7571/QK685 and CK7575/QK787 recording storage tubes. A new multiple collimating lens improves background uniformity and results in a signal-to-shading ratio of ten.

These advanced design features, plus low noise and stable operating characteristics, make Raytheon recording storage tubes ideal for frequency and scan conversion. Among the applications where these tubes play an important role are:

- Scan conversion for bright display and target trails.
- Slow-down video for transmission of still pictures over telephone lines.
- Stop motion to permit analysis of production machinery or to stop action in a sporting event.
- Signal-to-noise improvement of radar or other still pictures by integration.
- Conversion of television pictures from one transmission standard to another.
- Indication of moving targets by electrical comparison of pictures taken at different times.

For scan conversion applications, both r.f. read-out and video cancellation techniques have proved equally effective with Raytheon single- and dual-gun storage tubes.

Raytheon's single-gun CK7571/QK685 and dual-gun CK7575/QK787 recording storage tubes are available from stock in sample quantities. Detailed technical data bulletins are yours for the asking — write direct to Dept. 2527.

TYPICAL OPERATING CHARACTERISTICS CK7571/QK685 and CK7575/QK787

Anode Voltage.....	4,000 Vdc
Magnetic Focus Resolution.....	1,000 Lines (nominal)
Electrostatic Resolution.....	700 Lines (nominal)
Output capacitances:	
CK7571/QK685.....	12 $\mu\mu\text{f}$ (nominal)
CK7575/QK787.....	27 $\mu\mu\text{f}$ (nominal)
Maximum Deflection Angle.....	30 Degrees

TYPICAL RESOLUTION CURVE

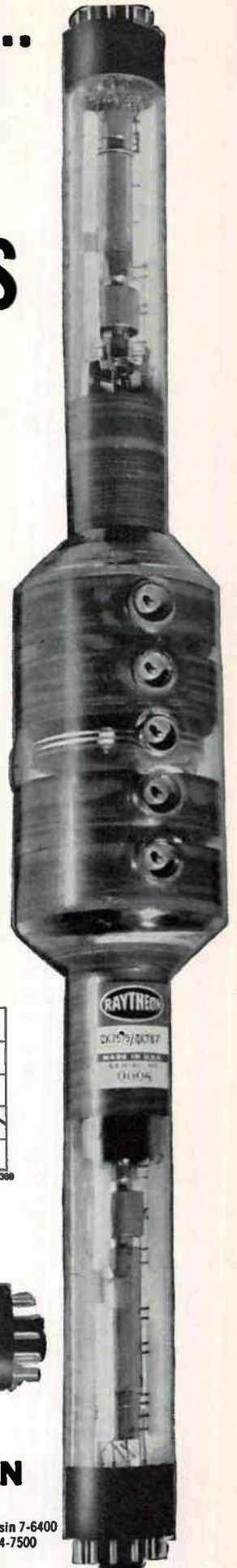
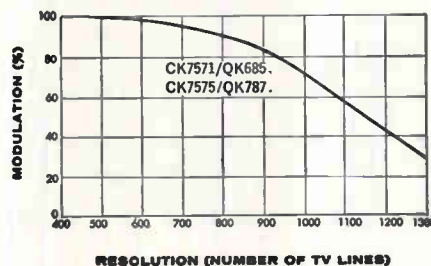

INDUSTRIAL COMPONENTS DIVISION

51 Chapel Street, Newton 58, Massachusetts

Los Angeles — Normandy 5-4221 Dallas — Fleetwood 1-4185 Chicago — National 5-4009 Orlando — Garden 3-1553 New York — Wisconsin 7-6400
 San Francisco — Fireside 1-7711 Kansas City — Plaza 3-5330 Cleveland — Winton 1-7716 Baltimore — Southfield 1-0450 Boston — Bigelow 4-7500
 GOVERNMENT SALES: Boston — Bigelow 4-7500 • Washington, D.C. — Metropolitan 8-5205 • Dayton — Baldwin 3-8128

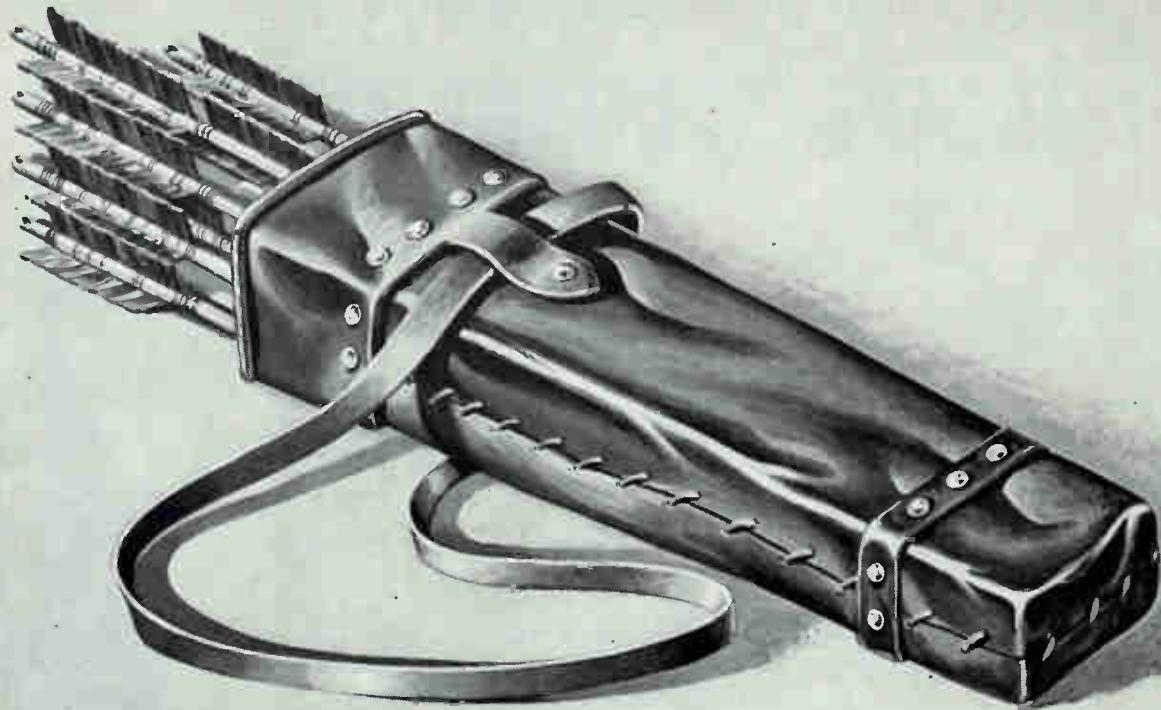

MIDDLE AGE MISSILE PACKAGE.....

Progress in Systems packaging... for the Missile Age

Craig's missile packages are a prime example of the skillful combination of **MOBILITY** and **RELIABILITY**. The missile section pictured above, for instance, is a warbird which travels first class in a transit case custom designed by Craig for maximum strength and minimum weight. Every detail of design is calculated to provide extra protection — from the tough, lightweight aluminum shell to the special shock absorbing vibration isolators of foamed-in-place polyurethane — a unique Craig development.

It is this kind of attention to detail that insures both **MOBILITY** and **RELIABILITY**. This art of aluminum fabrication explains why Craig handles the accommodations for so many of America's warbirds, including such systems as Hawk, Thor, Jupiter and Bullpup, as well as for computer components, communications equipment, optical instruments, and a host of other fragile items.

This specialty is one small facet of our over-all capability . . . the integration of **MOBILITY** and **RELIABILITY** in complete missile and electronic systems.

CRAIG SKILLS AND SERVICES

- Systems housings— light weight, high-strength aluminum shelters, vans and trailers for mobile, transportable ground support and electronic systems.
- Systems components — including telescoping antenna masts, transit cases, spare parts boxes, equipment racks, and cabinets.
- Systems installation service — layout and installation of complete systems, through final checkout for maximum mobility and reliability. Includes all cabling, shock & vibration isolation,

ENGINEERING AND RESEARCH SERVICES



FOAMED PLASTIC RADOMES

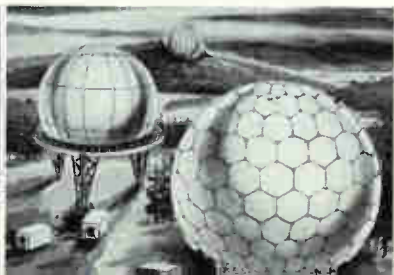

AIR TRANSPORTABLE SHELTERS



MOBILE GROUND SUPPORT

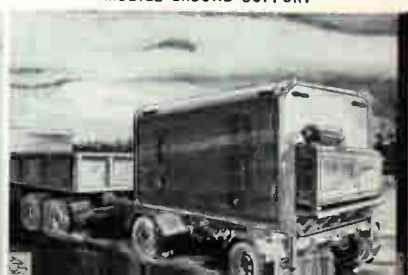

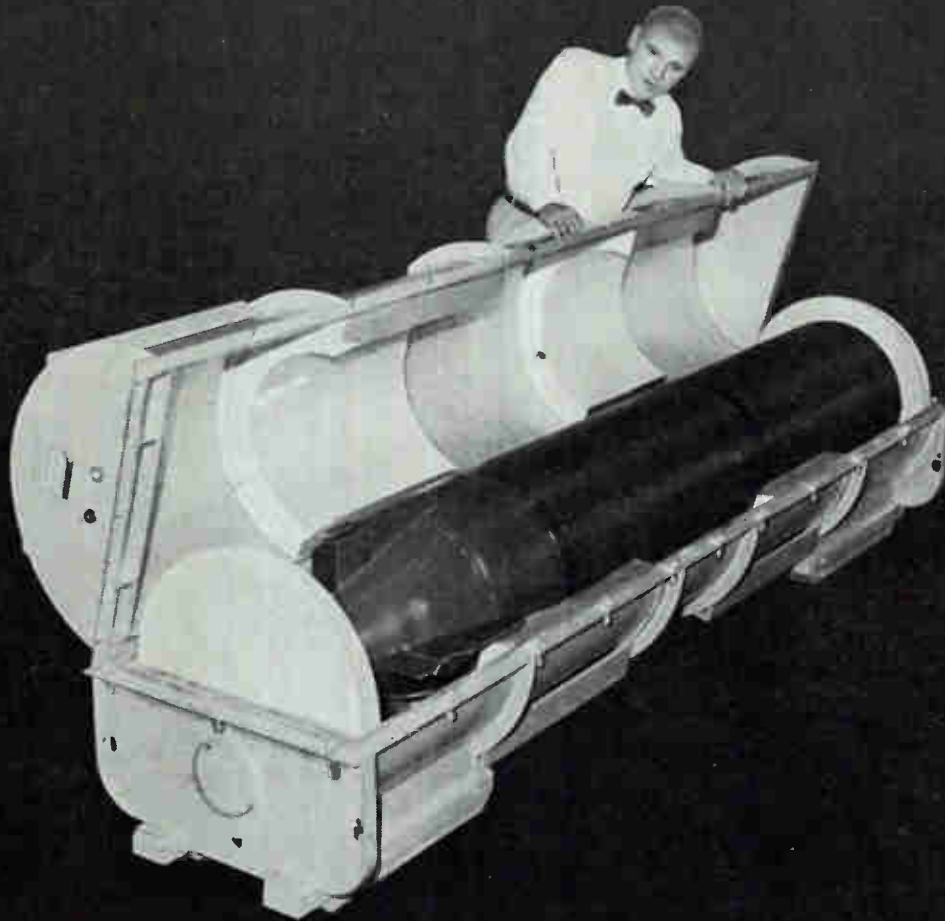

..... MISSILE AGE MISSILE PACKAGE

human engineering, environmental control, testing, and repackaging.

- **Systems packaging research** — engineering design and development for ground support and electronic equipment protection.
- **Complete production facilities** — all the manpower, all the tools, all the space required to handle the complete packaging assignment.
- **A unique "aluminum-chemical research" service** — a highly versatile "brainpower pool" for solving virtually any problem in aluminum and foamed plastic fabrication.



Craig's complete 16 page capabilities brochure will be sent on request. Write to Dept. E-2

Craig

SYSTEMS, INC.

360 MERRIMACK ST., LAWRENCE, MASS. - TELEPHONE: MUrdock 8-6961
Boston, Mass., CApital 7-7794

WASHINGTON, D. C.,
The LaSalle Suite, 815
1028 Connecticut Ave., N. W.
District 7-1575

DALLAS, TEXAS
6300 North Central Expressway
EMerson 1-5522

LOS ANGELES 45,
CALIFORNIA
6214 W. Manchester Ave.
SPring 6-0025

Business systems and equipment are another Craig specialty through Lefebure Corporation, Cedar Rapids, Iowa — a Craig subsidiary

MISSILE SUPPORT



ELECTRONIC SYSTEM INSTALLATIONS

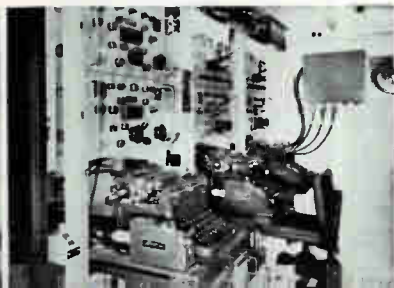

TELESCOPING MASTS AND CONTROL TOWERS



ENGINEERED TRANSIT CASE UNDER TEST

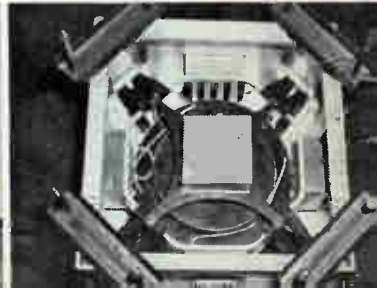

**IMMEDIATE
SHIPMENT!**

from *PSI*...

**Fast Recovery Diodes Featuring
Mil Approved Types...
Low Capacitance Types...
High Conductance Types...
Low Leakage Types...
High Voltage Types**

*All types immediately available
in production quantities...the broadest
line in the industry!*

There are PSI silicon diodes for every application in advanced computer design. Listed below are but a few of hundreds of special and standard cataloged types.

Highlights of the extensive PSI line are the now widely used Military Types IN643, IN662 and IN663...the new extremely fast recovery/low capacitance series IN925

thru IN928...and IN789 thru IN804 high conductance diodes which replace older types.

REGIONAL SALES OFFICES:

NEW YORK—870 Broadway, Newark 4, N. J. • HUmboldt 4-5616
TWX: NK 1010

PHILADELPHIA—350 Huntingdon Pike, Rockledge
• Pilgrim 2-8089 TWX: ROCKLEDGE PA 1064

CHICAGO—6957 W. North Ave., Oak Park, Illinois
• Village 8-0750 • TWX: OKP 1547

LOS ANGELES—8271 Melrose Avenue • OLive 3-7850

Phone, wire or write for complete specifications, prices and delivery schedules.

PSI Authorized Distributors from coast-to-coast can supply up to 999 units of any type at factory prices.



SILICON DIFFUSION COMPUTER DIODES

Military Types

IN643-662-663

TYPE NO.	VOLTAGE* @ 100 μ a (volts)	MIN. FWD. CUR. @ +1.0 volt (mA)	MAX. REVERSE CURRENT (μ a)		REVERSE RECOVERY CHARACTERISTICS	
			25°C	100°C	REVERSE RESIST. (Ohms)	MAX. RECOV. TIME (μ s)
IN643†	200	10	.025 (10v) 1 (100v)	5 (10v) 15 (100v)	200K	0.3
IN662‡	100	10	1 (10v) 20 (50v)	20 (10v) 100 (50v)	100K	0.5
IN663*	100	100	5 (75v)	50 (75v)	200K	0.5

†Mil-E-1/1171 (SigC)

‡Mil-E-1/1139 (SigC)

*Mil-E-1/1140 (SigC)

Extremely Fast

Low Capacitance Types

IN925 thru IN928

TYPE NO.	MIN. SAT. VOLTAGE @ 100 μ a (volts)	MIN. FWD. CUR. 1.0 volt (mA)	MAX. REVERSE CURRENT (μ a)		REVERSE RECOVERY CHARACTERISTICS			MAX. CAP. @ ZERO VOLTS (μ mf)
			25°C	100°C	REVERSE RESIST. (Ohms)	MAX. RECOV. TIME* (μ s)	TYPICAL RECOV. TIME** (M μ s)	
IN925	40	5	1.0 (10v)	20 (10v)	20K	0.15	5.0	4.0
IN926	40	5	0.1 (10v)	10 (10v)	20K	0.15	5.0	4.0
IN927	65	10	0.1 (10v) 5.0 (50v)	10 (10v) 25 (50v)	20K	0.15	5.0	4.0
IN928	120	10	0.1 (10v) 5.0 (50v)	10 (10v) 25 (50v)	20K	0.15	5.0	4.0

*Switching from 5mA to -10 volts ($R_L=1K$, $C_L=10\mu$ mf)

**Switching from 5mA to -10 volts
($R_{loop}=100$ ohms, $C_L=8\mu$ mf including diode capacitance)

*Maximum DC working inverse voltage is 85% of minimum saturation voltage

OTHER SPECIFICATIONS:

Peak Pulse Current, 1 μ sec, 1% duty cycle: 3.0 Amps

Storage and Operating Temperature Range -65°C to 200°C

New High Conductance Types

IN789 thru IN804

TYPE NO.	MIN. SAT. VOLTAGE* @ 100 μ a (volts)	MIN. FWD. CUR. @ +1.0 volt (mA)	MAX. REVERSE CURRENT (μ a)		REVERSE RECOVERY CHARACTERISTICS	
			25°C	100°C	REVERSE RESIST. (Ohms)	MAX. RECOV. TIME (μ s)
IN789	30	10	1 (20v)	30 (20v)	200K	0.5
IN790	30	10	5 (20v)	30 (20v)	200K	0.25
IN791	30	50	5 (20v)	30 (20v)	200K	0.5
IN792	30	100	5 (20v)	30 (20v)	100K	0.5
IN793	60	10	1 (50v)	30 (50v)	200K	0.5
IN794	60	10	5 (50v)	30 (50v)	200K	0.25
IN795	60	50	5 (50v)	30 (50v)	200K	0.5
IN796	60	100	5 (50v)	30 (50v)	100K	0.5
IN797	120	10	1 (100v)	30 (100v)	200K	0.5
IN798	120	10	5 (100v)	30 (100v)	200K	0.25
IN799	120	50	5 (100v)	30 (100v)	200K	0.5
IN800	120	100	5 (100v)	30 (100v)	100K	0.5
IN801	150	10	1 (125v)	30 (125v)	200K	0.5
IN802	150	50	5 (125v)	50 (125v)	200K	0.5
IN803	200	10	5 (175v)	50 (175v)	200K	0.5
IN804	200	50	30 (175v)	50 (175v)	200K	0.5

Study these specifications! You'll find a decided dollar advantage because you can select exactly the specifications you require... and have the added assurance of reliability standards unsurpassed in the industry!

Pacific Semiconductors, Inc.

12955 CHADRON AVENUE, HAWTHORNE, CALIFORNIA
(A SUBSIDIARY OF THOMPSON RAMO WOOLDRIDGE, INC.)

TRANSFORMERS YOU CAN COUNT ON*

*with calculated reliability

Reliability is much more than just a feature of Electro's transformers. It begins as an integral design consideration; and many bold design innovations have been pioneered by Electro to make transformers inherently more reliable. Among them: new developments in the use of epoxy resins for encapsulation and coil protection; thinner coils with greater exposed surface area for faster heat transfer; a unique terminal design that is much more rugged; special filling compounds for hermetically sealed transformers that eliminate the thermal expansion problem and provide better thermal conductivity. Reliability in Electro's transformers is also the result of painstaking testing and rigid quality control. Electro's complete facilities include in-plant equipment approved for qualification testing in accordance with MIL-T-27A. Environmental tests are conducted to assure resistance to humidity, temperature, shock and vibration. Electro reliability begins with the design, continues through development, manufacture and qualification, and results in a better product. If you need a more reliable transformer—talk to the Electro people. ▣

ELECTRO

from microwatt to megawatt... high reliability transformers

ELECTRO ENGINEERING WORKS / 401 PRED A STREET, SAN LEANDRO, CALIFORNIA

BUSINESS THIS WEEK

Reports New Techniques for Producing Micro-Alloy Diffused Base Transistor

Improved fabrication of its micro-alloy diffused base transistor (MADT) through the use of a new technique is reported by the Lansdale division of Philco Corp. The technique is known as ETL (for Etching by Transmitted Light).

In the ETL process, high-intensity light is focused on one side of a wafer of semiconductor material and a jet of electrochemical solution is directed on the opposite side. Light diffuses through the material and makes hole-electron pairs available at the surface being etched, thus greatly increasing the speed and accuracy of etching. Philco says the technique makes possible extremely flat surfaces 120 mils in diameter and larger.

New transistors made through the ETL technique and now commercially available have dissipation ratings as high as 500 mw, compared to 75 mw for earlier precision-etched units. At a clock rate of 10 Mc, the new transistors can switch currents as high as 400 ma. The company says an even more dramatic result of the ETL technique is under development: an MADT capable of dissipating 15 watts and switching 1 amp at a clock rate of 5 Mc.

Microminiature Tube Circuits Are Offered, Feature Resistance to Nuclear Radiation

Nuclear radiation resistance was a big selling point for a large number of companies at this year's IRE show, particularly in the field of miniature devices. GE's Receiving Tube Department, Owensboro, Ky., for example, demonstrated its thermionic integrated micro-modular (TIMM) circuits, which it says will continue operating at least 50 miles from the source of the initial gamma pulse created by a one-megaton nuclear bomb explosion. The GE tube men claim transistorized digital computer circuits would fail when exposed to conditions equivalent in space to an explosion of the same force 1,400 miles away.

The company says TIMM circuits open new possibilities such as: a cigarette pack-size 100-tube digital computer and a telephone book-size airplane guidance system. The circuits would permit space vehicle installation of six times as much electronic circuitry as with presently-used components, GE adds.

In the circuits, tube-parts—cathodes, grids and anodes—are combined with resistors, coils and capacitors. Thermal insulating material surrounds the circuits, permitting them to heat themselves from the same electrical energy source by which they operate after an initial application of heat from an external source starts cathode emission. A free-running multivibrator, an "and-gate" and a bistable multivibrator

Increased Production, Marketing Activity Forecast for Electroluminescent Devices

Electroluminescent devices are forging ahead technically in a number of companies, with a corresponding boost in production plans and marketing activity. Sylvania has just introduced a group of low-power display devices which it says makes possible "substantial progress in the design of electronic equipment used in data processing, radar, countermeasures, medicine, air and sea traffic control and entertainment." The company says miniaturized photoconductive-electroluminescent switches may eliminate the need for bulky and complicated switching matrices in complex logic circuits.

ELECTRONICS NEWSLETTER

Thermoelectric developments and capabilities were shown during the IRE show by several companies. RCA showed a thermoelectric refrigeration unit for submarines built under a BuShips contract; Westinghouse showed spot-cooling devices; Borg-Warner showed a generator. General Instrument Corp. announced availability of "Evaluation samples" of its one-foot high, 10 lb generator for \$5,000. Company says semiconductor thermopiles convert 85 of the heat of the burning gas into 5 watts of power, adds that unattended unit will run for a year on \$10 worth of ordinary propane gas.

Broadband data link for transmitting up to 10 Mc of video data is announced by Texas Instruments. System is designed to handle information gathered by airborne radar mappers. The 15-lb 2-watt output transmitter reportedly improves picture quality at the ground-based receiver by simplifying the transmission procedure, gives more information and saves more than 100 lbs by eliminating several components.

Two new thin-film devices—one for logic circuits, the other for memory systems—are being developed by Eiichi Goto of Tokyo University. Aim of this work is to raise the frequency limitations of the basic parametron computer element.

Micron-thick permalloy plated onto copper wire is the basis for both devices, one of which replaces the wound ferrite in the parametron. Plated wire is used as the inductance core in the parametron tank with coil wound around it. Goto figures the winding can be printed on so that manufacture will be a continuous process: Plated wire is coated with insulating material and then copper, which is subsequently etched away, leaving winding.

Memory system use of thin-film wire uses wires woven into a matrix. Such a system presumes the use of a parametron or other phase-locked oscillator as both input and output since it relies on a circuit that both amplifies and discriminates among various harmonics.



AN ACHIEVEMENT IN DEFENSE ELECTRONICS

WHAT'S BEHIND A BMEWS RADAR?

Years of experience—for as early as 1954, General Electric had conceived and developed radar equipment capable of detecting ballistic missiles at 1,000 miles. This was the forerunner of the AN/FPS-50 surveillance radar being provided by General Electric under subcontract to RCA for the Air Force Ballistic Missile Early Warning System (BMEWS).

The AN/FPS-50 radar equipment, with a range in excess of 2,000 miles, is a singular example of achievement in defense electronics. It is another milestone in General Electric's sustained engineering effort to develop and produce equipment to meet the unprecedented detection problems posed by ICBM's.

176-01

Progress Is Our Most Important Product

GENERAL  ELECTRIC

DEFENSE ELECTRONICS DIVISION
HEAVY MILITARY ELECTRONICS DEPARTMENT
SYRACUSE, NEW YORK

REGATRAN[®]

SEMICONDUCTOR

POWER SUPPLIES...

Here's reliability . . . Since their introduction, over ~~18~~³⁰ months ago, not one Regatran has lost a series transistor due to short circuits or overloading.



MODEL T036-5M

NOW... higher current REGATRANS

WIDE RANGE MODELS

MODEL NUMBER	D-C OUTPUT	
	VOLTS	AMPS
T060-15	0-60	0-15
T036-30	0-35	0-30
T032-30	0-32	0-30
T014-30	0-14	0-30
T07-30	0-7	0-30

Brief Specifications (all models)

REGULATION, LINE OR LOAD: 0.03% or 0.01 V
(0.01% or 0.003 V available).

RIPPLE: Less than 1 millivolt rms.

CIRCUIT PROTECTION: (1) electronic circuit breaker plus (2) electromagnetic circuit breaker plus (3) input line fused.

NARROW RANGE MODELS ALSO AVAILABLE

REQUEST BULLETIN 721A (Revised) FOR COMPLETE SPECIFICATIONS

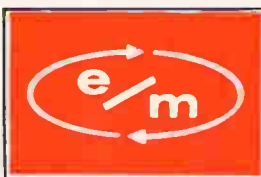

ELECTRONIC
MEASUREMENTS
COMPANY OF RED BANK
RED BANK • NEW JERSEY

® Registered U. S. Patent Office. Patents Issued and Pending.

- transistorized
- short circuit proof
- super-regulated
- overload protected
- low output impedance
- lowest ripple
- High-speed regulation
- null balance control

- sensing termination
- front panel calibration
- any grounding arrangement
- small size, light weight

BARNSTEAD ENGINEERED WATER PURIFICATION EQUIPMENT

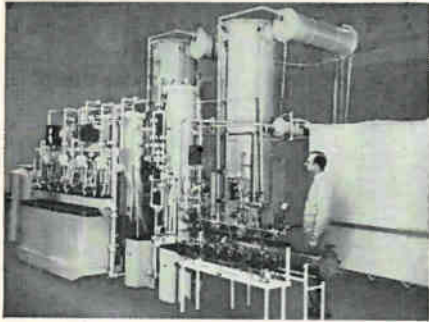

18,000,000 OHM WATER

This Barnstead equipment engineered in series consists of sand and carbon filter, high-capacity four-bed demineralizer, two Barnstead High-Purity Stills, Tin-lined tank, Mixed-Bed Demineralizer, MF Sub-micron Filter, Tin-lined Heater. Produces 18,000,000 ohm water in production quantities, completely free of minerals, organics, bacteria, and submicroscopic particles down to 0.45 micron.

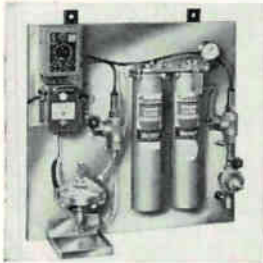

COOLING WATER RE-PURIFYING SYSTEM

adds thousands of hours to UHF transmitting tube life. Saves additional hours of maintenance ordinarily spent in citric acid cleaning procedures within the cooling system. Write for detailed Bulletin 149.



TRANSISTOR WASHER

Rinses transistors, diodes, and other small components in hot, ultra pure water. System filters out particles to 0.45 micron. Continuous re-purification system conserves water resulting in substantial savings. Write for Bulletin 146.

Barnstead

TRADE MARK REG. U.S. PAT. OFF.

STILL AND STERILIZER CO.

84 Lanesville Terrace, Boston 31, Mass.

BOSTON Jamaica 4-3100	NEW YORK Kingsbridge 8-1557	CLEVELAND ACademy 6-6622
CHICAGO Rogers Park 1-6173	PHILADELPHIA LOCust 8-1796	WASHINGTON, D.C. District 7-1142
LOS ANGELES RYan 1-6663	SAN FRANCISCO TEmplebar 2-5391	DETROIT ENTERprise 7422

WASHINGTON OUTLOOK

THE EISENHOWER ADMINISTRATION is mulling over a plan to expand the number of Atlas and Titan ICBMs by 18 percent. The Air Force has proposed that the Atlas-Titan force be increased from 270 missiles to 312 by 1963. The proposal calls for erection of additional launching pads at bases now under construction or scheduled, rather than the building of new ICBM installations. The extra missiles would be all-inertial guidance types capable of salvo launching from underground sites.

At press time, there was no sign of an Administration decision on the proposal. The Budget Bureau wants the Defense Dept. to offset the cost of the proposal—some \$400 million would probably be involved—by trimming other weapon projects. Defense Secretary Gates argues that such cuts should not be forced on the Pentagon, that the cost should be borne by a supplemental appropriation request to Congress this spring. The Navy, like the Air Force, has proposed an increase for its key strategic weapon system. It wants funds to build six Polaris submarines in addition to the three authorized in the fiscal 1961 budget, plus funds to produce the missiles required by the additional vessels.

The Navy plea for more money faces tougher sledding than the Air Force proposal. Defense Secretary Gates, though a former Navy Secretary and a long-time Polaris proponent, still feels the present program of three subs a year is about as far as the Pentagon should go "until we get more confirmation (of the system's capabilities) and increase our confidence."

The Navy will get a chance to sell its plan soon with a series of full-scale Polaris tests. If the tests prove out impressively, it's likely the submarine-missile program will be sharply accelerated. Washington strategists—including the Air Force—are excited over the Polaris concept and its theoretical invulnerability to an enemy attack.

- The debate over the missile gap continues. Defense Secretary Gates, who has become the storm center in the latest round of controversy, was put on the griddle two weeks ago by the Senate Preparedness-Space Committees headed by Senator Lyndon B. Johnson (D., Tex.).

Gates was asked to clear up the apparent disagreement between his claims on the so-called "gap" and a secret report on the issue by CIA Director Allen Dulles. Gates has told Congress the gap between the U. S. and Russia has "narrowed." Dulles reportedly said Soviet ICBM "launching capability has increased."

Gates said it is "unwise, misleading, and difficult" to get into "ratios and specific numbers" comparing U.S. and Soviet missile capabilities. But he reiterated his belief that "Russian missile superiority is not as great as previously estimated." He said there's "evidence" that the Russians are not engaged in an ICBM "crash" program. The committee's ranking Democrats—presidential aspirants Johnson and Stuart Symington—were not convinced.

- A new twist in the squabble over patent policies has developed. Senator Joseph C. O'Mahoney, chairman of the Senate Patents Subcommittee, has introduced a bill which aims at free distribution of patent rights stemming from basic research on government contracts. The bill is a product of a special study by the subcommittee.

Another provision in the bill would authorize the National Science Foundation to recommend disposition of patent rights on basic research projects financed by the government.

Under the present system, the Defense Department—by far the largest contracting agency—generally allows the contractor to keep any patent rights that develop and demands only a royalty-free license to use the invention.

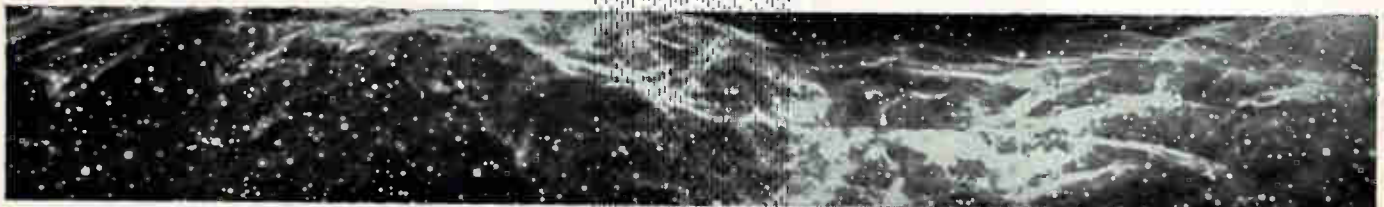
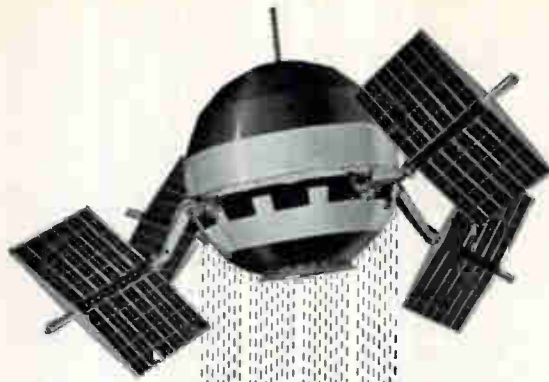

**Pioneer V
Paddlewheel Planetoid
Is Vaulting
Through Unexplored Space
Toward The
Orbital Path of Venus**



At this moment Pioneer V, one of the most advanced space probe vehicles ever launched, is on a course toward the path of Venus—26 million miles from earth. Blasted aloft March 11 by a Thor Able-4 rocket booster, this miniature space laboratory will reach its destination in about 130 days.

The project, carried out by Space Technology Laboratories for the National Aeronautics and Space Administration under the direction of the Air Force Ballistic Missile Division, may confirm or disprove long-standing theories of the fundamental nature of the solar system and space itself.

Energy from the sun—captured by almost 5,000 cells mounted in the four paddles—is used to supply all of the electrical power to operate the sophisticated array of instrumentation packed into the 94-pound spacecraft which measures only 26" in diameter.

By combining a phenomenal digital electronic brain (telebit) with a powerful radio transmitter inside the satellite, STL scientists and engineers expect to receive communications from Pioneer V at their command over interplanetary distances up to 50 million miles.

STL's technical staff brings to this space research the same talents which have provided over-all systems engineering and technical direction since 1954 to the Air Force missile programs including Atlas, Thor, Titan, Minuteman, and related space programs.

Important positions in connection with these activities are now available for scientists and engineers with outstanding capabilities. Inquiries and resumes are invited.

SPACE TECHNOLOGY LABORATORIES, INC.



Los Angeles • Santa Maria • Edwards Rocket Base • Cheyenne
Cape Canaveral • Manchester, England • Singapore • Hawaii

P. O. Box 95004, Los Angeles 45, California

Important facts to know about Laminated Plastics.

LAMINATED PLASTICS *What they are, where they can be used*

Taylor laminated plastics, also known as reinforced plastics, are thermosetting-type materials formed by impregnating paper, cotton cloth, asbestos, glass cloth, nylon or other base materials with synthetic resins and fusing them into sheets, rods, tubes and special shapes under heat and pressure. These materials exhibit a valuable combination of characteristics, including high electrical insulation resistance, structural strength, strength-to-weight ratio, and resistance to chemical reaction; also adaptability to fabricating operations.

Types of laminated plastics made by Taylor

There are four basic types of Taylor laminated plastics commonly specified and used throughout industry today. They are as follows:

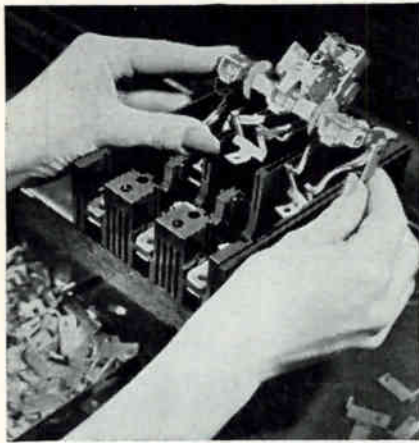

Phenolic Laminates. Paper, cotton fabric or mat, asbestos, glass cloth or nylon bases impregnated with phenol formaldehyde resins. These provide strength and rigidity, dimensional stability, resistance to heat, chemical resistance, and good dielectric characteristics. Some Taylor grades are excellent basic materials for gears, cams, pinions, bearings and other mechanical applications. Others are widely used in terminal boards, switchgear, circuit breakers, switches, electrical appliances and motors. Also in radios, television equipment and other electronic devices; and in missiles as nose cones, exhaust nozzles, and combustion chamber liners.

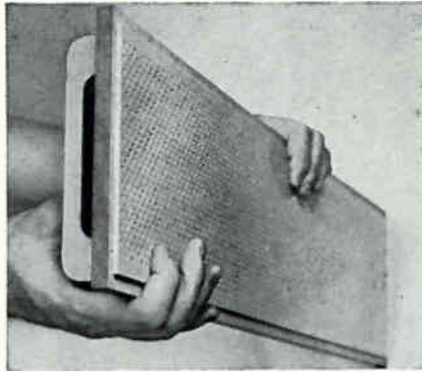

Melamine Laminates. Glass cloth or cotton fabric impregnated with melamine formaldehyde resin. Taylor melamine laminates have superior mechanical strength and are especially desirable for their arc-resistant qualities. Good flame and heat resistance, good resistance to the corrosive effects of alkalis and most other common solvents, besides other favorable characteristics. Typical applications include arc barriers, switchboard panels, and circuit-breaker parts in electrical installations.

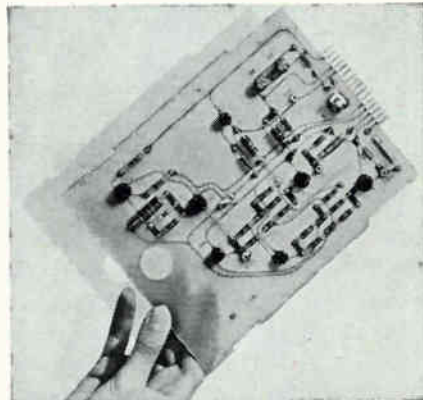

Silicone Laminates. Continuous-filament woven glass fabric impregnated with a silicone resin. These laminates combine high heat resistance (up to 500°F. continuous) with excellent electrical and mechanical properties. They are primarily used in high-temperature electrical applications and high-frequency radio equipment.

Epoxy Laminates. Continuous-filament woven glass fabric or paper impregnated with epoxy resin. Glass-fabric grades are designed for use in applications requiring high humidity-resistance, good chemical resistance,

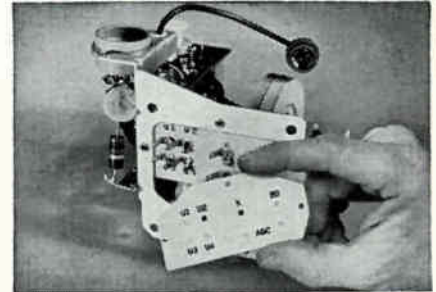

and strength retention at elevated temperatures. Paper grades are used under high-humidity conditions where resistance to acids and alkalis is required. Both grades are characterized by good dielectric strength, low dielectric losses, and high insulation resistance even following severe humidity conditions.

Recent technical advances in the bonding of various metallic and nonmetallic materials to laminated plastics have opened up new design opportunities. It is now possible to bond virtually any compatible material with a laminated plastic to form a composite which combines the advantages of both. One of the first composite materials was a copper-clad laminate used for printed circuits. More recent composite laminates, usually manufactured to customer specification, include the following: Taylorite® vulcanized fibre-clad, rubber-clad, asbestos-clad, aluminum-clad, beryllium-copper-clad, stainless-steel-clad, magnesium-clad, and silver and gold-clad. Any one of these materials can be sandwiched between sheets of laminates, too, and can be molded to fit specific requirements.

Send for complete information about any or all of these Taylor laminates. And remember Taylor's new selection guide will simplify your problems in choosing the right laminate for your specific application. Taylor Fibre Co., Norristown 40, Pa.

Taylor
LAMINATED PLASTICS VULCANIZED FIBRE

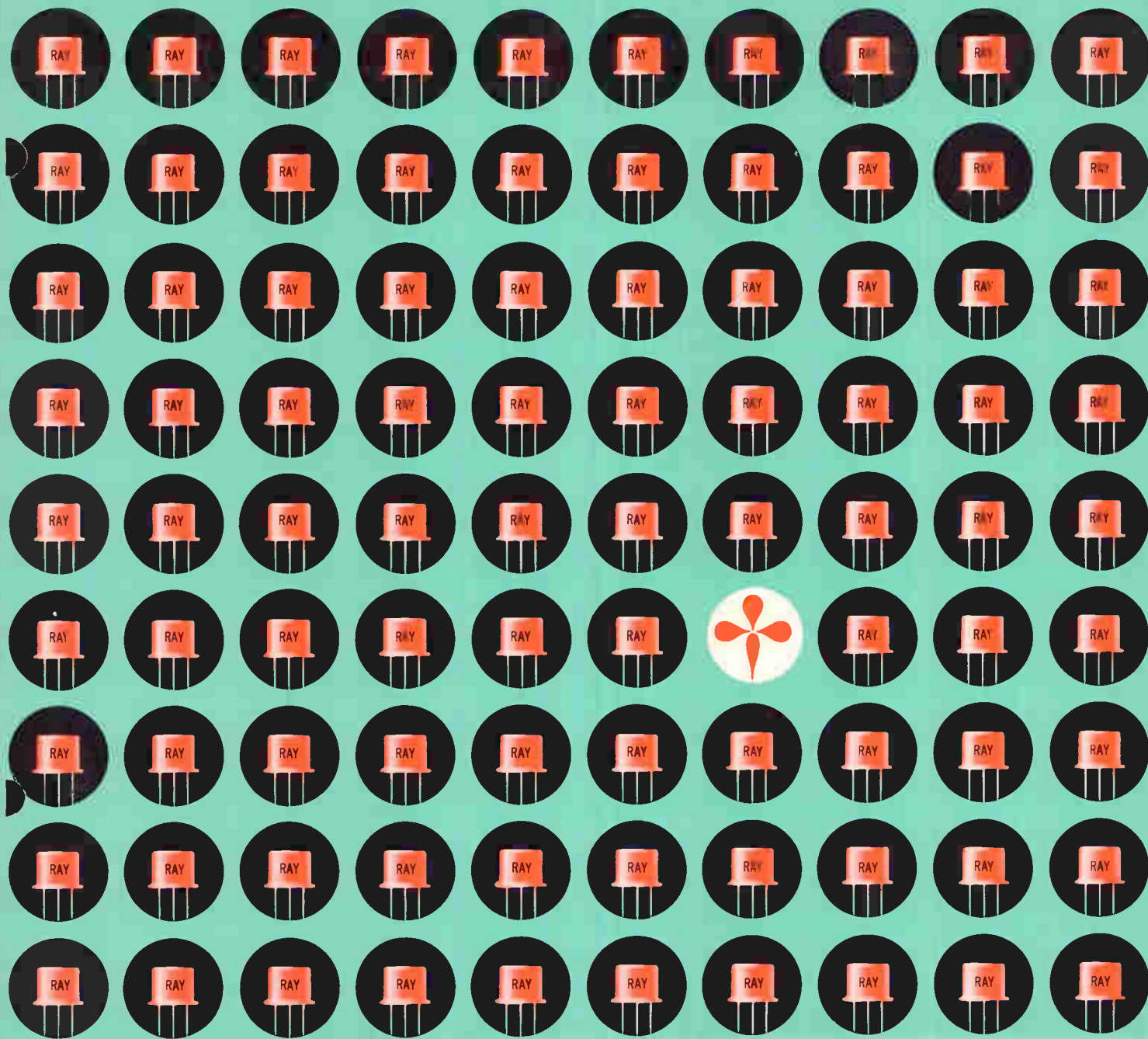

Reliability in Semiconductors

Semiconductor technology has advanced to the point where reliability can be predicted accurately, rather than "guesstimated" on the basis of extrapolation from previous data. The Raytheon transistors, diodes and rectifiers listed in this condensed catalog have been subjected to thorough reliability analysis, which is now available for your study and reference. Use of this new reliability data will help in the selection of many Raytheon

Semiconductor products where reliability is a controlling condition.

In this handy guide you will find basic data on a wide range of Raytheon transistors, diodes, and rectifiers. You will want to keep it on file for ready reference whenever your circuit designs call for semiconductor products of demonstrated reliability.



RAYTHEON SEMICONDUCTORS

Your Condensed Guide

TRANSISTORS

GERMANIUM TRANSISTORS COMPUTER SWITCHING

†	Type	V _{YPT} Max. Volts	I _{CB} Mc	H _{FE1}	H _{FE2}	R _{SAT} ohms	Applications
NPN Temp. Range -65°C to +85°C Case A (TO-5)	2N438	25	2.5	25	—	3.0	Medium Current High Frequency High Gain Switches
	2N439	20	5.0	45	—	3.0	
	2N440	15	10.0	70	—	3.0	
	2N1090	18	5.0	50	—	3.0	
	2N1091	15	10.0	70	—	3.0	
PNP Temp. Range -65°C to +85°C Case A (TO-5)	2N658	-18	5	50	45	1 Ampere High Frequency High Gain Switches	
	2N659	-16	10	70	65		
	2N660	-14	15	90	70		
	2N661	-9	20	120	100		
	2N662	-14	8	30 MIN	20 MIN		
PNP Temp. Range -65°C to +85°C Case A (TO-5)	2N404	-24	12	See Data Sheet For Characteristics		Medium Current High Frequency	
	2N425	-30	4	30	15		
	2N426	-25	6	40	18		
	2N427	-20	11	55	20		
	2N428	-15	17	80	30		
	2N1017	-12	20	100	30		
PNP Temp. Range -65°C to +100°C Case A (TO-5)	2N395	15	4.5	40	12	Medium Current High Frequency	
	2N396	20	8.0	60	20		
	2N397	15	12.0	80	35		

† Values shown are average parameter measurements unless otherwise indicated. For individual list conditions, refer to the respective technical specifications available upon request.

GERMANIUM TRANSISTORS SUBMINIATURE

†	Type	V _{CE} Max. Volts	I _{CB} Mc	h _{FE}	C _{ob} (f=1mc μμf)	r _b ^m ohms
PNP RF AMP Temp. Range -65°C to +85°C	CK13	-18	2.5	30	12	40
	CK14	-15	7	60	12	55
	CK16	-12	10	80	12	65
	CK17	-10	18	140	12	100
	CK13A CK14A CK16A CK17A					

†	Type	V _{CE} Max. Volts	h _{FE}	Power Gain Class A DB	I _{CO} μA	Noise Factor DB
PNP GP AUDIO Temp. Range -65°C to +85°C	CK22	-20	90	44	2	8.5 Max.
	CK64	-29	22.5	40	2	
	CK65	-24	45	42	2	
	CK66	-20	90	44	2	
	CK67	-15	180	45	2	
	CK22A CK64A CK65A CK66A CK67A					

†	Type	V _{YPT} Max. Volts	I _{CB}	H _{FE1}	H _{FE2}	R _{SAT}	Applications	
								Case B-1
PNP RF SWITCH Temp. Range -65°C to +85°C	CK25	-30	4	30	15	2.2	Medium Current High Frequency High Gain Switches	
	CK26	-25	6	40	18	2.2		
	CK27	-20	11	55	20	x.x		
	CK28	-15	17	80	30	1.1		
	CK4	-24	12	See Data Sheet for Characteristics				
	CK25A CK26A CK27A CK28A CK4A							

GERMANIUM TRANSISTORS GENERAL PURPOSE AUDIO

†	Type	V _{CE} Max. Volts	h _{FE}	Power Gain Class A DB	I _{CO} μA	Noise Factor DB
PNP Temp. Range -65°C to +85°C Case A (TO-5)	2N422	-20	50	40	6	6.5 Max.
	2N464	-40	26	40	6	
	2N465	-30	45	42	6	
	2N466	-20	90	44	6	
	2N467	-15	180	45	6	
	2N422 2N464 2N465 2N466 2N467					

GERMANIUM TRANSISTORS GENERAL PURPOSE RADIO FREQUENCY

†	Type	V _{CE} Max. Volts	I _{CB} Mc	h _{FE}	C _{ob} f=1 Mc μμf	r _b ^m ohms
PNP Temp. Range -65°C to +85°C Case A (TO-5)	2N413	-18	2.5	30	12	40
	2N414	-15	7	60	12	55
	2N416	-12	10	80	12	65
	2N417	-10	20	140	12	100
	2N413 2N414 2N416 2N417					

GERMANIUM TRANSISTORS AUDIO CIRCUITS, ENTERTAINMENT

†	Type	Supply Max. Volts	Circuit Usage	Class A Amplifier		Class B Amplifier	
				Gain DB	Distortion %	Gain DB	Distortion %
PNP Temp. Range -65°C to +85°C Case A (TO-5)	2N359	22	Output	37*	5*	30†	8†
	2N360	22	Output	34*	5*	27†	8†
	2N361	22	Output	30*	5*	24†	8†
	2N362	9	Driver	42	—	—	—
	2N363	9	Driver	40	—	—	—
	2N631	22	Output	35**	8**	—	—
	2N632	22	Output	—	—	25††	8†
	2N633	22	Output	—	—	25††	8†

*Class A P_o = 50 mW, †Class B P_o = 450 mW, **Class A P_o = 30 mW
††Class B P_o = 150 mW. 9V supply for all ratings.

SILICON TRANSISTORS SWITCHING

†	Type	I _{EO} μA	I _{CO} μA	V _{CE} Max. Volts	H _{FE}	V _{SAT} * Volts	C _{ob} f=100KC μμf	I _{CB} Mc
PNP Temp. Range -65°C to +160°C Case A (TO-5)	2N327A	0.005	0.005	-40	15	0.3	55	100
	2N328A	0.005	0.005	-35	30	0.5	55	200
	2N329A	0.005	0.005	-30	60	0.6	55	250
NPN Temp. Range -65°C to +160°C Case A (TO-5)	2N619	0.005	0.005	40	15	0.5	30	200
	2N620	0.005	0.005	35	30	0.5	30	250
	2N621	0.005	0.005	30	60	0.5	30	300
NPN Temp. Range -65°C to +175°C Case A (TO-5)	2N1386	0.006	0.006	25	60	0.6	4.0	25
	2N1387	0.006	0.006	30	30	0.6	4.0	25
	2N337	0.05	0.05	45	35	1.5	2.0	10
	2N338	0.05	0.05	45	60	1.5	2.0	20

*See data sheet for test conditions.

SILICON TRANSISTORS SMALL SIGNAL

†	Type	I _{CO} μA	I _{EO} μA	V _{CE} Max. Volts	h _{FE}	h _{ie} Max. ohms	h _{oe} Max. μmhos	Noise Factor DB	C _{ob} f=100KC μμf	I _{CB} Mc
PNP Temp. Range -65°C to +160°C Case A (TO-5)	2N1623	0.005	0.005	-20	14	1000	20	18	70	100
	2N1034	0.005	0.005	-40	15	3000	70	30	65	200
	2N1035	0.005	0.005	-35	30	3000	85	30	65	300
	2N1036	0.005	0.005	-30	60	3000	100	30	65	400
	2N1037	0.005	0.005	-35	30	3000	85	15	65	250
NPN Temp. Range -65°C to +160°C Case A (TO-5)	2N1074	0.005	0.005	40	15	3500	15	30	35	200
	2N1075	0.005	0.005	35	28	3500	20	30	35	350
	2N1076	0.005	0.005	30	60	3500	30	30	35	500
	2N1077	0.005	0.005	35	25	3500	20	15	35	300

SILICON TRANSISTORS HIGH FREQUENCY, GENERAL PURPOSE

†	Type	I _{EO} μA	I _{CO} μA	V _{CE} Max. Volts	h _{FE} 6mc	r _b ^m 6mc ohms	P.G. Uniter- alized DB	C _{ob} f=140KC μμf	I _{CB} Mc
NPN Temp. Range -65°C to +175°C Case A (TO-5)	2N1388	0.01	0.01	45	10.0	100	20	4.0	75
	2N1389	0.01	0.01	50	7.0	100	15	4.0	25
	2N1390	0.01	0.05	20	4.0	150	10	4.0	12
	2N1528	0.01	0.01	25	4.0	150	13	4.0	15

All are established... All a

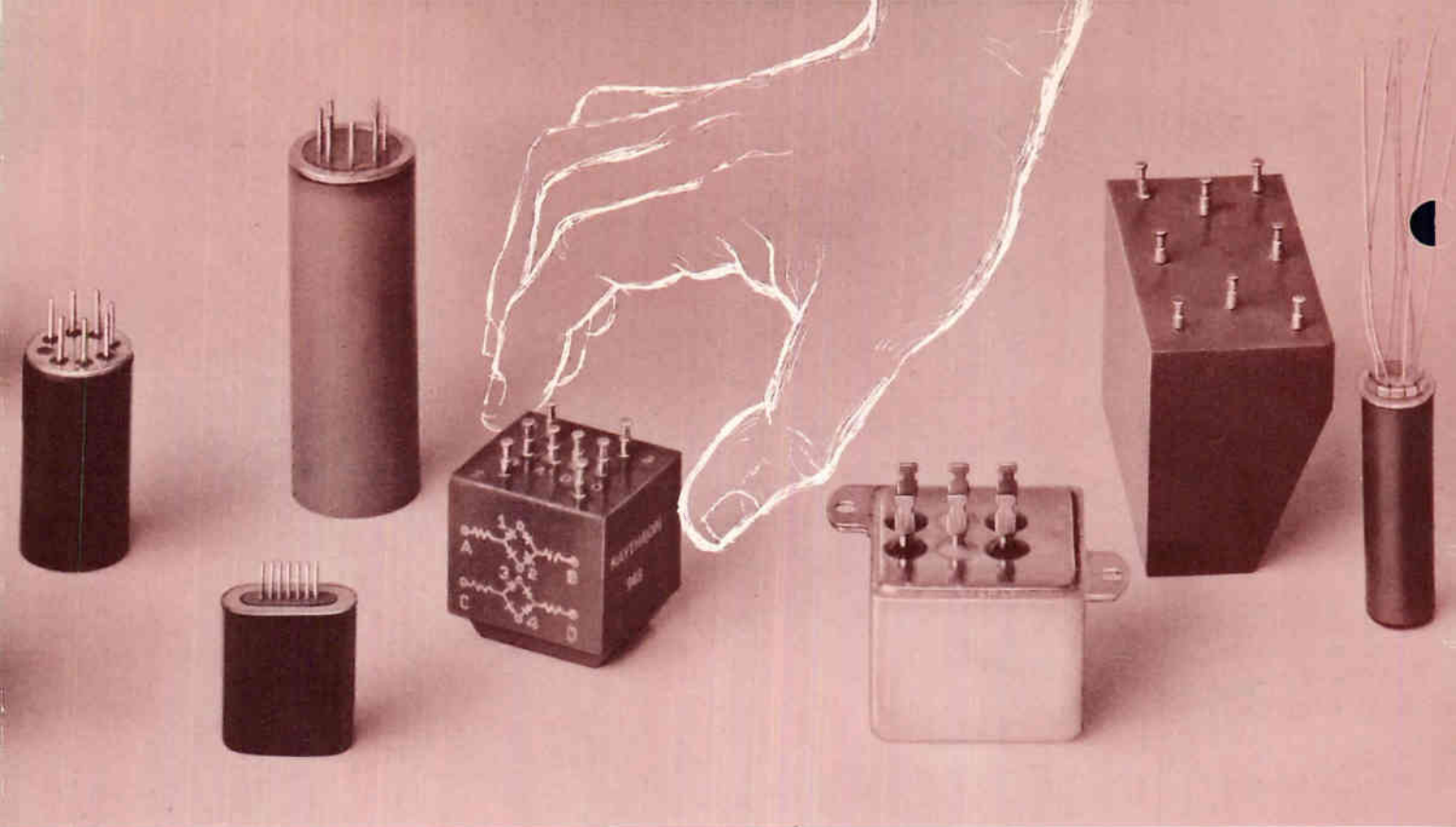

NOW, Raytheon's **CIRCUIT-PAKS** for greater reliability in circuits space savings, off-the-shelf economy!

Circuit-Paks, compact encapsulated circuits, extend the reliability of Raytheon semiconductors to standard and custom circuits. Internal construction advantages, reduced insulation requirements, and important space savings are provided.

Circuit-Pak applications such as bridges, flip-flops, phase comparators, etc., are avail-

able from stock or to your specifications. It is possible to specify and qualify the complete Circuit-Pak as a special or nonstandard item ("black-box") rather than the individual constituent components. Circuit-Paks, 100% tested for circuit reliability, offer within a single minimal size encapsulation the multiple advantages of:



** Pretested components of a stated quality level * Devices economically matched and selected for electrical parameters * Shock and vibration resistance * Minimal surface leakage * Predictable heat dissipation * Economy of pretested, off-the-shelf packages*

RAYTHEON COMPANY SEMICONDUCTOR DIVISION

COMMERCIAL SALES OFFICES—Boston (Needham Heights), Mass.—215 First Ave. Hillcrest 4-6700 • Englewood Cliffs, N.J.—Lowell 7-4911 (Manhattan phone, Wisconsin 7-6400) • Chicago (Franklin Park)—9501 Grand Ave. National 5-4000 • Los Angeles 29, Calif.—5236 Santa Monica Blvd. Normandy 5-4221 • Syracuse, N.Y.—1054 James St. Granite 2-7751 • Orlando, Fla.—1612 E. Colonial Dr. Garden 3-0518 • Baltimore (Glen Burnie), Md.—100 Roesler Rd. Southfield 1-1237 • Cleveland, Ohio—3076 W. 117th St. Winton 1-7716 • San Francisco (San Mateo), Calif.—44 W. 41st Ave. Fireside 1-7711 • Canada (Waterloo, Ontario)—61 Laurel St. Sherwood 3-5281 • GOVERNMENT SALES OFFICES—Boston (Needham Heights), Mass.—215 First Ave. Hillcrest 4-6700 • Washington 6, D.C.—1000 Sixteenth St., N.W., Metropolitan 8-5205.

DIODES

SILICON TRANSISTORS—SUBMINIATURE

†	Type	I _{EO} μA	I _{CO} μA	V _{CE} Max. Volts	H _{FE}	V _{SAT} Volts	C _{ob} f=100KC μμf	f _{αb} Mc
NPN Temp. Range -55°C to +175°C Case B (Subminiature)	2N745	0.05	0.05	45	35	1.5	2.0	10
	2N746	0.05	0.05	45	60	1.5	2.0	10
	2N747	0.006	0.006	25	60	0.6	4.0	25
	2N748	0.006	0.006	30	30	0.6	4.0	25
	2N749	0.01	0.01	45	10*	—	4.0	60
	2N750	0.01	0.01	50	7*	—	4.0	25
2N751	0.01	0.05	20	4*	—	4.0	12	

*h_{fe}, @ 6 mc

SILICON TRANSISTORS HIGH VOLTAGE

†	Type	I _{EO} μA	I _{CO} μA	V _{CE} Volts	H _{FE}	Noise Factor DB	C _{ob} μμf	f _{αb} Mc
PNP Temp. Range -65°C to +160°C Case A(TO-5)	2N1275	0.005	0.005	-80	15	18	60	200
	CK798	0.005	0.005	-80	30	18	60	200
	CK799	0.005	0.005	-125	15	18	60	200
	CK800	0.005	0.005	-125	30	18	60	200

SILICON TRANSISTORS AVALANCHE MODE

†	Type	I _{EO} μA	V _{CB} Volts	V _{CE} Volts	t _r μsec
NPN Temp. Range -65°C to +160°C Case A(TO-5)	2N1468	0.01	70	70	4.0

SILICON TRANSISTORS HIGH POWER

†	Type	B _V CE Min. Volts	B _V EB0 Min. Volts	I _{CE} R Min. Amp	SAT RES Max. ohm	h _{FE}
NPN Temp. Range -65°C to +200°C Case G	2N389	60	10	1.5	5.0	35
	2N424	80	10	0.75	10.0	35
	2N1470*	60‡	3	—	3.0	50

*Case J ‡B_VCE

All measurements at ambient of T = 25°C unless otherwise indicated

DISSIPATION COEFFICIENTS

	In Air	Infinite Sink
For All Silicon Types	See Individual Data Sheets	—
For All Germanium Submin Types	0.75°C/mW	0.35°C/mW
For All Germanium PNP TO-5 Types	0.35°C/mW	0.18°C/mW
For All Germanium NPN TO-5 Types	0.6°C/mW	—

MILITARY QUALIFIED PRODUCTS

The following Raytheon types have received JAN Approval:

Type	Specification
JAN1N198	MIL-E-1/700
JAN1N253	MIL-E-1/1024A
JAN1N254	MIL-E-1/989B
JAN1N255	MIL-E-1/990B
JAN1N256	MIL-E-1/991B
JAN1N538	MIL-E-1/1084A
JAN1N540	MIL-E-1/1085A
JAN1N547	MIL-E-1/1083A

The following Raytheon types have received Signal Corps Approval:

Type	Specification
2N416	MIL-T-19500/56A(Sig. C.)
2N417	MIL-T-19500/57A(Sig. C.)
2N425	MIL-T-19500/41A(Sig. C.)
2N426	MIL-T-19500/42A(Sig. C.)
2N427	MIL-T-19500/43A(Sig. C.)
2N428	MIL-T-19500/44A(Sig. C.)
2N464	MIL-T-19500/49B(Sig. C.)
2N465	MIL-T-19500/50A(Sig. C.)
2N466	MIL-T-19500/51A(Sig. C.)
2N467	MIL-T-19500/52B(Sig. C.)

The following Raytheon type has received Air Force Approval:

Type 2N404 Specification MIL-T-19500/20 (USAF)

Other military approvals are pending.
Consult your Raytheon representative for latest additions.

GERMANIUM DIODES—GLASS GOLD BONDED

	Type	PIV Max.	I ₀ Max. mA	Peak Rect. Current Max. mA	Max. Reverse Currents in μA			I _F mA 1V
					10V	20V	50V	
GERMANIUM DIODES Temp. Range -65°C to +90°C Case F (Glass)	1N270	100	60	325	—	—	100	200
	1N273	35	60	300	—	—	—	100
	1N276	100	40	150	20	—	100	40
	1N277	125	50	270	10	—	50	100
	1N281	75	75	270	30	—	500	100
	1N283	25	70	350	20	—	—	200

GERMANIUM DIODES— METAL CASE, GOLD BONDED

	Type	Peak Inverse Volts Max.	I ₀ Max. mA	Peak Rectified Max. mA	Max. Reverse Currents in μA			I _F mA	
					at 10V	at 50V	at 100V	at 0.8V	at 1.0V
GOLD BONDED GERMANIUM DIODES Temp. Range -10°C to +90°C Case D (Metal and Glass)	1N306	15	150	300	2.0	—	—	100▲	—
	1N305	60	125	300	2.0	—	—	100▲	—
	1N307	125	50	300	5.0	—	20	—	100▲

▲At 70°C

SILICON DIODES—BONDED JUNCTION HIGH RELIABILITY GENERAL PURPOSE

	Type	PIV	IF Min. at 1v mA	IREV Max. at 10v μA	IREV Max. uA at specified voltage			10 Max. mA	
					volts	25°C	150°C	25°C	150°C
BONDED SILICON DIODES Temp. Range -65°C to +150°C	1N300	15	15	.001	10	0.001	2.0	65	18
	1N300A	15	30	.001	10	0.001	2.0	80	25
	1N300B	15	50	.001	10	0.001	2.0	100	30
	1N432	40	10	.005	10	0.005	3.0	55	15
	1N432A	40	20	.005	10	0.005	3.0	70	22
	1N432B	40	50	.005	10	0.005	3.0	85	30
Case D (Metal and Glass)	1N301	70	5	.01	50	0.05	8.0	45	12
	1N301A	70	18	.01	50	0.05	8.0	65	20
	1N301B	70	50	.01	50	0.05	8.0	75	25
	1N460	90	5	.01	75	0.1	10.0	45	12
	1N460A	90	15	.01	75	0.1	10.0	60	18
	1N460B	90	50	.01	75	0.1	10.0	70	25
BONDED SILICON DIODES Temp. Range -65°C to +150°C	1N303	125	3	.01	100	0.1	14.0	40	10
	1N303A	125	12	.01	100	0.1	14.0	55	16
	1N303B	125	50	.01	100	0.1	14.0	65	20
	1N433	145	3	.01	125	0.1	16.0	40	10
	1N433A	145	10	.01	125	0.1	16.0	50	16
	1N433B	145	50	.01	125	0.1	16.0	60	20
Case D (Metal and Glass)	1N434	180	2	.01	150	0.1	18.0	35	10
	1N434A	180	7	.01	150	0.1	18.0	45	15
	1N434B	180	20	.01	150	0.1	18.0	60	20
	1N302	225	1	.01	200	0.2	20.0	30	8
	1N302A	225	5	.01	200	0.2	20.0	40	13
	1N302B	225	20	.01	200	0.2	20.0	55	20
C K863A C K863B	300	1	.01	275	0.3	30.0	20	6	
	300	3	.01	275	0.3	30.0	30	8	
	300	20	.01	275	0.3	30.0	50	15	

Ratings at 25°C unless otherwise indicated

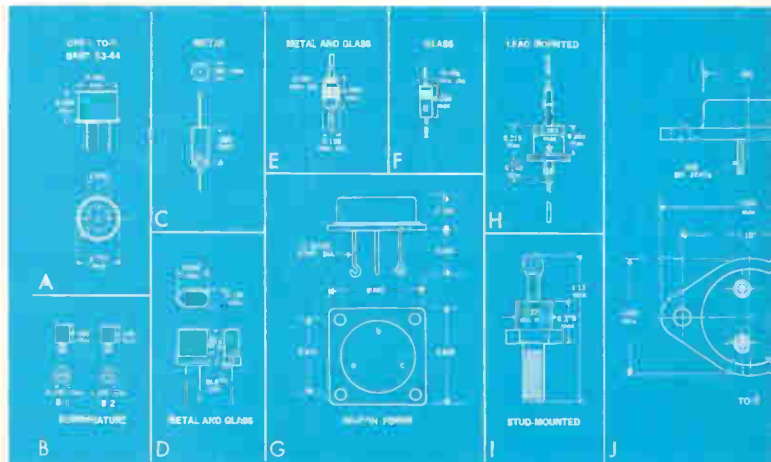

semiconductor Family

RECTIFIERS

GERMANIUM DIODES—GLASS GENERAL PURPOSE

	Type	Working Voltage Max. Volts	I _f Min. at 1.0V mA	I ₀ Max. mA	I _{rev} Volts	I _f μA
GERMANIUM GLASS DIODES	1N55B	150	5	30	150	500
	1N63A	100	4	30	50	50
	1N66A	60	5	30	10	50
	1N67A	80	4	30	50	50
	1N68A	100	3	30	100	625
	1N89	80	3.5	30	50	100
	1N90	60	5	30	50	500
	1N95	60	10	30	50	500
	1N97	80	10	30	50	100
	1N99	80	10	30	50	50
	1N116	60	5	30	50	100
	1N117	60	10	30	50	100
	1N126	60	5	30	10	50
	1N126A	60	5	30	10	50
	1N127	100	3	30	10	25
	1N127A	100	3	30	10	25
	1N128	40	3	30	10	10
	1N128A	40	3	30	10	10
	1N294A	60	5	30	10	10
	1N297A	80	3.5	30	50	100
	1N298A	70	30*	30	40	250†
COMPUTER	1N191	75	5	30	10	25
	1N192	60	5	30	50	250▲
VHF-UHF HIGH TEMPERATURE	1N295A	40	3	30	10	200
	1N198	80	4	30	10	75‡
	1N198A	80	4	30	10	10
	1N198JAN	80	4	30	10	75‡

*at +2v. †at 50°C Includes recovery time test. ‡at 75°C ▲ at 55°C

GERMANIUM DIODES—METAL

	Type	Working Voltage Max. volts	I ₀ Max. mA	Peak Rectified Current Max. mA	Reverse Current, Max., in μA		I _f at 1.0V mA
					at 50V	at 100V	
GERMANIUM METAL DIODES	1N66	60	50	150	800	—	5.0
	1N67	80	35	100	50	—	4.0
	1N68	100	35	100	—	625	3.0
	1N294	60	50	150	800	—	5.0
	1N297	80	35	100	100	—	3.5
	1N298	70	50	150	‡250 at -40v	—	30 at 2v
	1N295*	40	35	125	200 at -10v	—	—

*VHF and UHF

†T_a=50°C

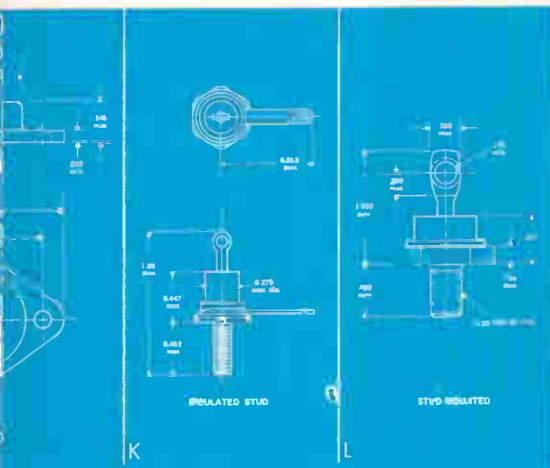

SILICON DIFFUSED JUNCTION RECTIFIERS—GLASS

	Type	Peak Operating Voltage -65°C to +150°C Volts	Avg. Rectified Current		Reverse Current (Max.) in μA at Specified Voltage		
			25°C	150°C	Volts	25°C	100°C
			mA	mA			
SILICON RECTIFIERS	1N645	225	400	150	225	0.2	15
	1N646	300	400	150	300	0.2	15
	1N647	400	400	150	400	0.2	20
	1N648	500	400	150	500	0.2	20

SILICON DIFFUSED JUNCTION RECTIFIERS—LOW CURRENT

	Type	Peak Operating Voltage -65°C to +165°C Volts	Avg. Rectified Current		Reverse Current (Max.) in μA at Specified Voltage		
			50°C	150°C	Volts	25°C	150°C
			mA	mA			
DIFFUSED JUNCTION SILICON RECTIFIERS	1N536	50	750	250	50	2	400
	1N537	100	750	250	100	2	400
	1N538	200	750	250	200	2	300
	1N539	300	750	250	300	2	300
	1N540	400	750	250	400	2	300
	1N1095	500	750	250	500	2	300
	1N547 (1N1096)	600	750	250	600	2	300

SILICON DIFFUSED JUNCTION RECTIFIERS—MEDIUM CURRENT

	Type	Peak Operating Voltage -65°C to +165°C Volts	Avg. Rectified Current		Reverse Current (Max.) in μA at Specified Voltage		
			30°C	150°C	Volts	25°C	150°C
			Amps	Amps			
DIFFUSED JUNCTION SILICON RECTIFIERS	1N253	95*	3.0	1.0*	95	10	100*
	1N254	190*	1.5	0.4*	190	10	100*
	1N255	380*	1.5	0.4*	380	10	150*
	1N256	570*	0.95	0.2*	570	20	250*
	CK846	100	3.5	1.0	100	2	250
	CK847	200	3.5	1.0	200	2	250
	CK848	300	3.5	1.0	300	2	300
	CK849	400	3.5	1.0	400	2	300
	CK850	500	3.5	1.0	500	2	350
	CK851	600	3.5	1.0	600	2	400
NON-INSULATED CATHODE TO STUD	1N2512	100	4.0	1.0	100	2	250
	1N2513	200	4.0	1.0	200	2	250
	1N2514	300	4.0	1.0	300	2	300
	1N2515	400	4.0	1.0	400	2	300
	1N2516	500	4.0	1.0	500	2	350
	1N2517	600	4.0	1.0	600	2	400
NON-INSULATED ANODE TO STUD	1N2512R	100	4.0	1.0	100	2	250
	1N2513R	200	4.0	1.0	200	2	250
	1N2514R	300	4.0	1.0	300	2	300
	1N2515R	400	4.0	1.0	400	2	300
	1N2516R	500	4.0	1.0	500	2	350
	1N2517R	600	4.0	1.0	600	2	400
INSULATED STUD	1N2518	100	4.0	1.0	100	2	250
	1N2519	200	4.0	1.0	200	2	250
	1N2520	300	4.0	1.0	300	2	300
	1N2521	400	4.0	1.0	400	2	300
	1N2522	500	4.0	1.0	500	2	350
	1N2523	600	4.0	1.0	600	2	400

*Ratings at 135°C; operating ambient temperature range -65°C to +150°C

SILICON DIFFUSED JUNCTION RECTIFIERS—HIGH CURRENT

	Type	Peak Operating Voltage -65°C to +165°C Volts	Average Rectified Current @ 150°C Amps	Max. Avg. Reverse Current @ 150°C mA
DIFFUSED JUNCTION SILICON RECTIFIERS	1N248A	50	20	5
	1N249A	100	20	5
	1N250A	200	20	5
	1N1191A	50	22	5
	1N1192A	100	22	5
	1N1193A	150	22	5
	1N1194A	200	22	5
	1N1195	300	18	10
	1N1196	400	18	10
	1N1197	500	18	10
	1N1198	600	18	10

ou Raytheon reliability

These basic types of **RAYTHEON SEMICONDUCTORS** fulfill a wide variety of applications

TRANSISTORS

	Audio High Temp.	Audio Amplifier	Audio Pre amp Low Noise	Computer Switching	DC & Servo Amplifier	IF & RF Amplifier	Wide Band High Temp. Amplifier	Chopper	Flip-Flop	Multi-Vibrator	High Speed Switch	Converter & Oscill.	Core Driver	High Voltage Amplifier	Relay Driver
Germanium—Computer Switching				•				•	•	•			•		•
Germanium—General Purpose Audio		•	•												
Germanium—General Purpose RF						•									
Germanium—Audio Circuits Entertainment		•				•						•			
Germanium—Subminiature		•	•	•		•		•	•	•					
Silicon—Switching	•			•	•	•	•	•	•	•	•				
Silicon—Small Signal	•	•	•												
Silicon—High Frequency General Purpose						•	•								
Silicon—Subminiature				•		•	•		•	•	•				
Silicon—High Voltage	•				•				•	•				•	•
Silicon—Avalanche Mode Switching											•		•		
Silicon—High Power	•	•			•								•	•	•

RECTIFIERS
DIODES

	Transient Protection	Gates				Modulators	Clamping Circuits	Power Supplies		
		Low Current	High Current	Magnetic Amplifiers	Low Current			Medium Current	High Current	
Germanium—Glass General Purpose		•				•	•			
Germanium—Glass Gold-Bonded	•	•				•	•			
Germanium—Metal Case Gold-Bonded	•	•				•	•			
Silicon—Bonded Junction, High Reliability General Purpose	•	•		•	•	•	•			
Silicon—Diffused Junction, Rectifiers—Glass	•		•	•	•	•	•			
Silicon—Diffused Junction Rectifiers—Low Current	•		•	•	•	•	•	•		
Silicon—Diffused Junction Rectifiers—Medium Current			•	•	•	•		•	•	
Silicon—Diffused Junction Rectifiers—High Current				•	•	•				•

Reliable Raytheon Semiconductors

PUTTING MAGNETICS TO WORK



Open your eyes to new amplifier designs!

See how to combine tape wound cores and transistors
for more versatile, lower-cost, smaller amplifiers

Tie tape wound cores and transistors into a magnetic-transistor amplifier, and open your eyes to new design opportunities.

To start with, these are static control elements—no moving parts, nothing to wear or burn out. Next thing you find is that you reduce components' size—your amplifier is smaller and costs less. That's because between them the core and the transistor perform just about every circuit function . . . and then some.

For instance? The core has multiple isolated windings. Thus you can feed many inputs to control the amplifier. The core also has a square hysteresis loop, and thus acts as a low loss transformer. That means you save power. In addition, the core can store and remember signals—so time delay becomes simple.

There's no need for temperature stabilization, either. The transistor acts only as a low loss, fast, static switch—and in this function it has no peer.

How do you want to use this superb combination? As a switching amplifier—or a linear one? In an oscillator? A power converter (d-c to d-c or d-c to a-c)? You'll have ideas of your own—and if they involve tape wound cores, why not write us? Ours are Performance-Guaranteed. *Magnetics, Inc., Dept. E-81, Butler, Pennsylvania.*

**MAGNETICS inc.**[®]

←CIRCLE 22 ON READER SERVICE CARD

CIRCLE 23 ON READER SERVICE CARD

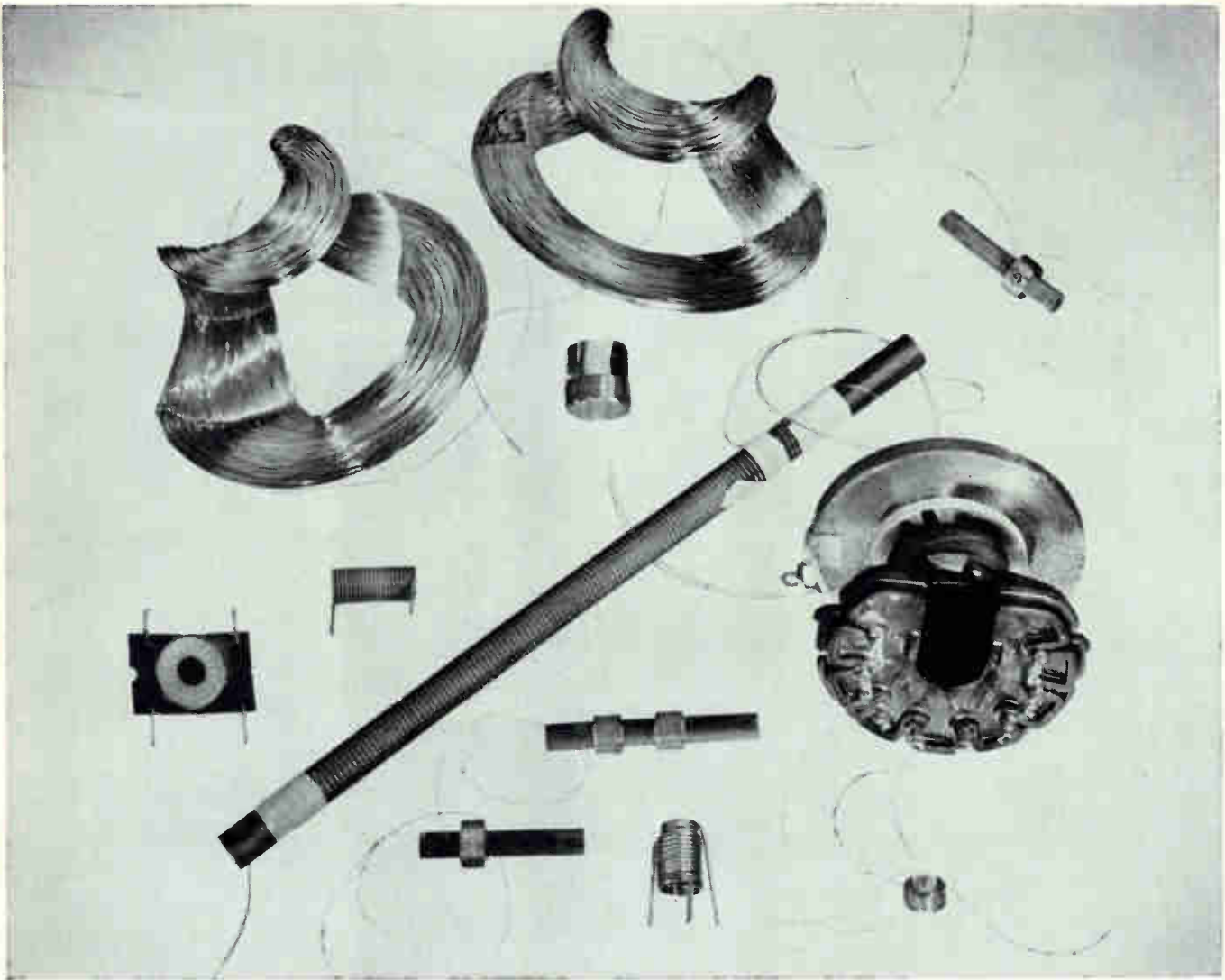

General Electric has whatever you need in magnet wire

When it comes to buying fine or ultra-fine magnet wire for the electronic industries, just name your specs and General Electric can match them. For example:

What sizes do you need? G-E magnet wire is available in sizes No. 4 Awg to No. 50 Awg round. These wires meet NEMA standards in every particular yet in many of the smaller sizes General Electric offers maximum overall diameters which are smaller than applicable NEMA standards. G. E. also offers several ultra-fine sizes in addition to the standard Awg series.

What temperature range do you need? Operating temperatures for General Electric ultra-fine magnet wire range from 105 C through 200 C.

What properties do you need? There's a G-E type to meet any property specification. Here are a few:

- Solderable:** Polyurethane
Polyurethane nylon, polyurethane Butvar
- Self-bonding:** Formex* Butvar
Polyurethane Butvar
- Complementary properties:**
Formex nylon, polyurethane nylon

When do you need it? You can get most types and sizes of G-E magnet wire right out of stock, at G-E warehouses spotted all over the country. G-E Plants on both coasts can usually make special types and sizes to order, promptly.

Any more questions? Send for the newest, most comprehensive magnet wire catalog available. To get your copy, simply fill in and mail the coupon below.

**General Electric Company
Wire and Cable Department
Section W249-299, Bridgeport 2, Connecticut**

Please send me the brand-new G-E magnet wire catalog—the most complete book of its kind available.

Attached is a description of my problem—what do you suggest?

Name _____ Title _____

Company _____

Address _____

City _____ Zone _____ State _____

*Reg. Trade-Mark General Electric Co.

Progress Is Our Most Important Product

GENERAL  ELECTRIC

NEED MORE THAN FOUR?

Use the Only Voltmeter with the Factual Fifth Figure



WHEN FOUR-DIGIT ACCURACY JUST ISN'T ENOUGH, specify the five-digit NLS V35 — world's most accurate digital voltmeter. Only the V35 gives you the "factual fifth figure" . . . full five-digit resolution of 0.001%. Here is the instrument for your measuring jobs demanding maximum accuracy — automatic missile checkout, readout and printout in data logging and computer systems, critical production inspection. Only the V35 offers you the benefits of "no-needless-nines" logic — greater reliability, increased speed, longer parts life. Contact NLS today for the full story.

V35 Specifications: Measures DC voltage from ± 0.0001 to ± 999.99 ; DC voltage ratio from $\pm 0.0001\%$ to $\pm 99.999\%$. . . DC voltage accuracy is $\pm 0.01\%$ of reading or ± 1 digit . . . overall accuracy for voltage ratio is $\pm 0.005\%$ of reading or ± 1 digit . . . "factual fifth figure" — 0.001% resolution . . . transistorized "no-needless-nines" logic . . . plug-in modular construction . . . simple external connections for AC/DC converter, pre-amplifier and data logging accessories . . . one-package design — $5\frac{1}{4}$ " high — for standard rack mount . . . automatic selection and indication of range and polarity . . . interchangeable plug-in stepping switch-resistor assemblies sealed in oil . . . \$3,750.00, complete. Available in four-digit model for \$3,150.00, complete.



Originator of the Digital Voltmeter

non-linear systems, inc. DEL MAR (SAN DIEGO), CALIFORNIA

NLS — The Digital Voltmeter That Works . . . And Works . . . And Works!

This announcement is under no circumstances to be construed as an offer to sell or as a solicitation of an offer to buy any of these securities. The offering is made only by the Prospectus.

NEW ISSUE

March 17, 1960

225,000 Shares

**LAFAYETTE RADIO ELECTRONICS
CORPORATION**

Common Stock
(Par Value \$1 per Share)

Price \$5.00 per Share

Copies of the Prospectus may be obtained from the undersigned only in States in which the undersigned is qualified to act as a dealer in securities and in which the Prospectus may legally be distributed.

D. A. LOMASNEY & Co.

39 Broadway, New York 6, N. Y.

WHitehall 4-5885

CIRCLE 26 ON READER SERVICE CARD



**WHAT'S BEST IN HIGH VACUUM
MEASUREMENT?**

Do you know the specific advantages and disadvantages of 11 different vacuum gages? Improved electronic gage designs are extending measuring range to 10–14 mm Hg. Measurement and control are keys to the success of many production and test applications — **electronics** has the story! (See issue of October 16th, 1959.) Another reason to subscribe to **electronics** (or renew your subscription). Fill in box on Reader Service Card now. Easy to use. Postage free.

**FIND WHAT
YOU NEED IN...**

electronics

New Rule for Small Firms?

SMALL BUSINESS ADMINISTRATION has proposed amendments to its regulations which would permit SBA-licensed investment companies to issue stock to individuals for services and in exchange for tangible assets to be used in operations of the investment company.

The proposed amendment would also permit the granting of stock options in lieu of salary or payment for services rendered. The amendment is now being studied by a committee of the House of Representatives.

A spokesman for SBA told ELECTRONICS the amendments are intended to act as incentives for the formation of investment companies, and that some of the possible ramifications of passage may work for the good of small electronics companies. Presently, SBA investment companies are limited to long-term convertible debentures as the only means of regaining their investment.

• **Telechrome Mfg. Corp.**, Amityville, L. I., announces purchase of **Hammarlund Mfg.**, New York City. Purchase price reported was \$800,000, which covers all assets and property of Hammarlund. The purchase is expected to triple Telechrome's sales to about \$6 million for next year. No changes in personnel will be made.

• **Dynamics Corp. of America** reports acquisition of **Winston Electronics, Ltd.**, Shepperton, England, which manufactures military, commercial and medical electronic equipment in a 200-employee plant. The British company will provide a sales and manufacturing base for DCA's present products, particularly tropospheric scatter communications equipment. The acquisition will also permit the American company to broaden its product line in the U. S. Together with DCA's recently created Latin America-Far East division, the British company gives Dynamics Corp. the nucleus of a world-wide organization.

• **Avien, Inc.**, reports agreement has been reached for its acquisition of **Colvin Laboratories, Inc.** and **Pressure Elements, Inc.**, both of East Orange, N. J. Avien, located in Woodside, L. I., is a leading designer and manufacturer of instrumentation systems for temperature control, fluid flow and automatic checkout. Colvin produces electromechanical instrumentation for automated industrial applications. Pressure Elements makes pressure capsules used in a wide variety of transducers. The acquisitions reportedly will be carried out by an exchange of stock. L. A. Weiss, Avien president, said the proposed acquisitions are "a first step" in company expansion plans.

• **Ironrite, Inc.**, Mt. Clemens, Mich., producer of home automatic ironing equipment, announces the acquisition of **Warren Mfg. Co.**, Littleton, Mass., producer of telephone, teletype and telemetering gear.

25 MOST ACTIVE STOCKS

	WEEK ENDING MARCH 18			
	SHARES (IN 100's)	HIGH	LOW	CLOSE
Philco Corp	845	35 $\frac{3}{8}$	33 $\frac{3}{8}$	34 $\frac{1}{4}$
Siegler Corp	784	37 $\frac{1}{4}$	34 $\frac{1}{2}$	37
Ampex	728	39 $\frac{3}{8}$	37 $\frac{1}{8}$	38 $\frac{1}{4}$
Avco Corp	679	14 $\frac{1}{4}$	13	13 $\frac{3}{4}$
RCA	671	67 $\frac{3}{8}$	65 $\frac{1}{8}$	66 $\frac{1}{8}$
Westinghouse	561	50 $\frac{1}{2}$	49 $\frac{1}{8}$	50
Gen Electric	555	88 $\frac{1}{4}$	86	88 $\frac{1}{8}$
Gen Tel & Elec	451	74 $\frac{3}{8}$	73 $\frac{3}{8}$	74
Dynamics Corp Amer	415	13	11 $\frac{1}{8}$	11 $\frac{3}{4}$
Transitron	391	47 $\frac{1}{8}$	45 $\frac{1}{8}$	45 $\frac{3}{8}$
Collins Radio	372	61 $\frac{3}{8}$	56 $\frac{3}{8}$	57 $\frac{1}{8}$
Int'l Tel & Tel	370	36 $\frac{1}{4}$	35 $\frac{1}{8}$	35 $\frac{3}{4}$
Clarostat Mfg	349	15 $\frac{1}{4}$	12 $\frac{1}{8}$	13 $\frac{1}{4}$
Litton Ind	344	71	67 $\frac{1}{8}$	69 $\frac{1}{4}$
Burroughs Corp	298	30 $\frac{3}{8}$	29 $\frac{3}{8}$	29 $\frac{3}{8}$
Raytheon	290	46 $\frac{3}{8}$	43 $\frac{3}{8}$	44 $\frac{3}{8}$
Univ Control	251	15	13 $\frac{1}{8}$	14 $\frac{1}{8}$
Varian Assoc	247	47 $\frac{1}{8}$	45 $\frac{1}{8}$	45 $\frac{3}{4}$
Compydne	235	11 $\frac{3}{8}$	8 $\frac{3}{8}$	10 $\frac{3}{8}$
Beckman Inst	235	70 $\frac{3}{8}$	68	68 $\frac{3}{4}$
Texas Inst	225	174	171 $\frac{1}{4}$	172 $\frac{1}{4}$
Gen Inst	221	27 $\frac{3}{8}$	25	27 $\frac{3}{8}$
Sterling Precision	215	3	2 $\frac{3}{4}$	3
Gen Dynamics	206	45 $\frac{3}{8}$	44 $\frac{1}{4}$	44 $\frac{3}{8}$
Int'l Bus Mach	193	426 $\frac{1}{2}$	419 $\frac{1}{4}$	423

The above figures represent sales of electronics stocks on the New York and American Stock Exchanges. Listings are prepared exclusively for ELECTRONICS by Ira Haupt & Co., investment bankers.

ROHN COMMUNICATION TOWER

No. 60

for height up to 630 feet!

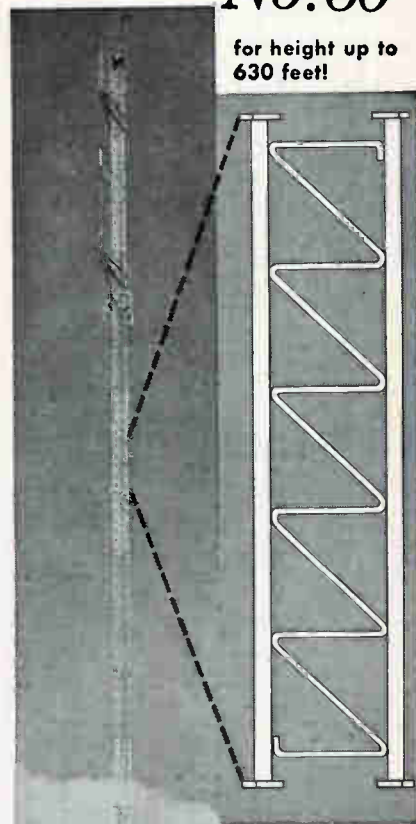

★ This extremely heavy duty tower is designed for a wide variety of communications of all kinds.

★ This No. 60 ROHN tower is suitable for height up to 630 feet when properly guyed and installed.

★ Completely hot-dipped zinc galvanized after fabrication.

★ Designed for durability, yet economical — easily erected and shipped. ROHN towers have excellent workmanship, construction and design. Each section is 10 feet in length.

Shown here is a ROHN No. 60 tower installed to a height of 200 feet with 3 five-foot side arms, mounting antenna for police radio communications.

FREE

Details and complete engineering specifications gladly sent on request. Also ROHN representatives are coast-to-coast to assist you.

Write-Phone-Wire Today!

ROHN Manufacturing Co.

116 Limestone, Bellevue, Peoria, Illinois
Phone 7-8416

"Pioneer Manufacturers of Towers of All Kinds"



People believe most *completely* in the things that work best for them. That's why 52,000 readers of **electronics** pay more than \$300,000 each year to get the information it gives them.

Use **electronics** to create interest and acceptance for your products, materials or services. The **electronics BUYERS' GUIDE** gets you there when your customers are making buying decisions . . . actually sells for you.

Exclusive! There is clear evidence that the "GUIDE" carries the most weight: it has 42% more advertisers than any other electronics directory.

**PICK
THE ONE
THAT CARRIES
THE MOST
WEIGHT**





GALLAGHER COTTON MILLS

BEE BEE TOGS, Inc.



ELECTRONIC COMMUNICATIONS Inc.

CONTINENTAL OPTICAL COMPANY
THE **HEROHOME** INSTRUMENT CORP.
Metal Industries, Inc.

Hood

THE BABY BUTLER ELEVATORIZED

CIRCUIT



RADER AND ASSOCIATES ENGINEERS AND ARCHITECTS

THE HOUSTON CORPORATION

ALLSTATE INSURANCE COMPANY

FLORIDA FISHING TACKLE Mfg. Co. Inc. **Barracuda** BRAND

GENERAL NUCLEAR ENGINEERING CORPORATION

AMP

"TAPECO"

CREST DIVISION OF JACQUES-KREISLER CO.

SPERRY

ROY

Carousal Fashions

RABCOCK & WILCOX

Smith and Gillespie

Be in Good Company

Here's one of the few areas in America where it is possible to attract personnel in every category without difficulty.

Why?—No executive or employee need be more than 15 minutes away from home and garden, from fresh and salt water, fishing, bathing, boating, water skiing . . . no more than 15 minutes away from schools, churches, shopping centers, recreational and social activities.

All this, plus a favorable business climate . . . and SUN-sational living all year, in this enchanting land of flora and fauna.

Executive decisions, after extensive site location surveys in many areas of the nation, have resulted in major companies locating here. Their managements will gladly give you the result of their findings.

NOTE: Persons seeking positions please write Florida State Employment Service, 1004 First Avenue North, St. Petersburg.

Communicate in confidence with:

GREATER ST. PETERSBURG CHAMBER OF COMMERCE

Jack Bryan, Industrial Director

Dept. E

St. Petersburg, Florida

IN LESS THAN 4 SECONDS

FROM THIS

TO THIS

OR THIS

WITH THE REVOLUTIONARY PRODUCTION AID TOOL!

"PIG-TAILOR"[®]



Foot operated
No accessories
3 minute set up

\$125.00

'PIG-TAILORING'

o revolutionary new mechanical process for higher production at lower costs. Fastest PREPARATION and ASSEMBLY of Resistors, Capacitors, Diodes and all other axial lead components for TERMINAL BOARDS, PRINTED CIRCUITS and MINIATURIZED ASSEMBLIES.

PIG-TAILORING eliminates: • Diagonal cutters • Long nose pliers • Operator judgment • 90% operator training time • Broken components • Broken leads • Short circuits from clippings • 65% chassis handling • Excessive lead tautness • Haphazard assembly methods.

PIG-TAILORING provides: • Uniform component position • Uniform marking exposure • Miniaturization spacing control • "S" leads for terminals • "U" leads for printed circuits • Individual cut and bend lengths • Better time/rate analysis • Closer cost control • Invaluable labor saving • Immediate cost recovery.

Pays for itself in 2 weeks

"SPIN-PIN"[®]

Close-up views of "SPIN-PIN" illustrate fast assembly of tailored-lead wire to terminal.

- No Training
- No Pliers
- No Clippings
- Uniform Crimps
- 22 Sizes

PAYS FOR ITSELF THE FIRST DAY!

\$500 EACH



Write for illustrated book to Dept. E-4



BRUNO-NEW YORK INDUSTRIES CORP.

DESIGNERS & MANUFACTURERS OF ELECTRONIC EQUIPMENT
460 WEST 34th STREET • NEW YORK 1, N. Y.

MARKET RESEARCH

ELECTRONIC INDUSTRY'S SHARE OF DOD OPERATION & MAINTENANCE AUTHORIZATIONS

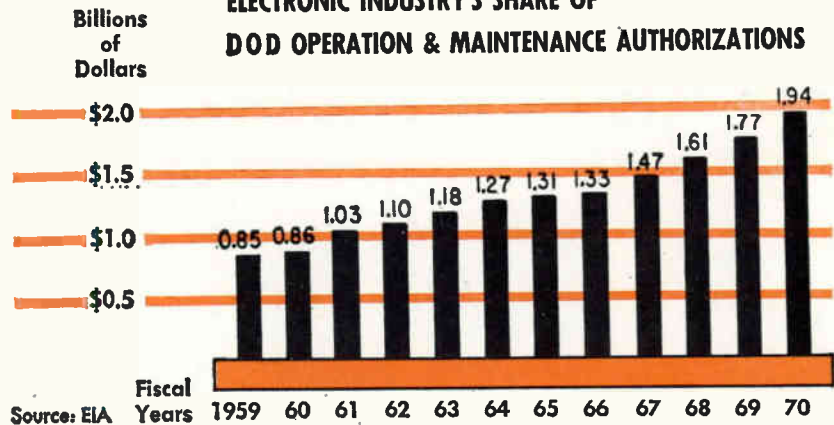

Military Upkeep \$900 Million

PAST PURCHASES of electronic equipment by the Armed Services are building a sizable amount of business for electronics firms in the form of replacement parts, repairs and modifications.

Money comes from the Operations & Maintenance category of the Department of Defense budget.

Although no great rise in total Operations & Maintenance expenditures is foreseen, the electronics industry's share of the total is moving up sharply.

Our Share to Rise

For instance, Electronic Industries Association estimates total O&M expenditure authorizations will increase from about \$10 billion to \$12 billion between 1960 and 1970. But the electronics portion will rise from about \$900 million to nearly \$2 billion over the same period, EIA estimates. Its prediction assumes our share will climb from nine percent of the total in 1960 to 16 percent in 1970.

One force behind the rising trend of O&M spending for electronics is the growing amount of electronic equipment in use by the military. Advancing average age of this equipment requires larger expenditures to keep it in operational condition. Fast rate of technical obsolescence of military equipment, and the trend toward use of higher-performance and higher-priced components in military gear, are other

factors.

Air Force spending in this area currently far exceeds that of the other two services. Of \$860 million of O&M electronics expenditure by DOD in 1960, about \$650 million is coming from the Air Force and \$100 million each from the Army and the Navy, according to estimates by Arthur D. Little, Inc.

LATEST MONTHLY SALES TOTALS

(Source: EIA)
(Add 000)

	Jan. 1960	Dec. 1959	Change From One Year Ago
Rec. Tubes, Value	\$26,872	\$32,401	+2.2%
Rec. Tubes, Units	31,367	37,248	+7.7%
Pic. Tubes, Value	\$15,835	\$15,941	+4.1%
Pic. Tubes, Units	795	817	+1.3%
Transistors, Value	\$24,715	\$22,820	+86.6%
Transistors, Units	9,607	7,826	+84.9%

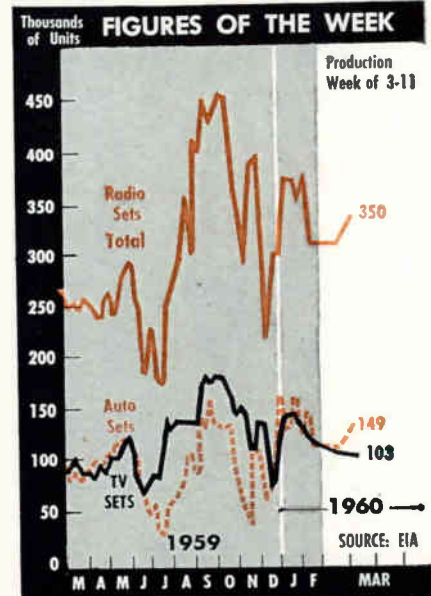

OHMITE RESISTORS



THE EXACT RESISTOR YOU NEED—WHEN YOU NEED IT—FOR EVERY INDUSTRIAL AND MILITARY REQUIREMENT

Fixed . . . adjustable . . . tapped . . . noninductive . . . precision metal film and encapsulated wire-wound . . . thin type . . . high-current—practically any resistor you need, you can find in the Ohmite line.

WORLD'S LARGEST STOCK FOR IMMEDIATE DELIVERY—Chances are Ohmite's huge stock of several million resistors in more than 2000 sizes and types contains a unit that fits your requirements. Many types are also available through Electronic Parts Distributors located across the Nation.

YOUR CUSTOMERS KNOW THE VALUE OF OHMITE QUALITY—When a purchaser sees Ohmite resistors in a piece of equipment, he knows that equipment is designed and built for dependability.

OHMITE ENGINEERING ASSISTANCE ASSURES THE RIGHT UNIT—Selecting the right resistor for the job is sometimes a tough problem. Why not call on Ohmite application engineers to help out. Take advantage of their specialized skills and background.

Write on Company Letterhead for Catalog and Engineering Manual 58

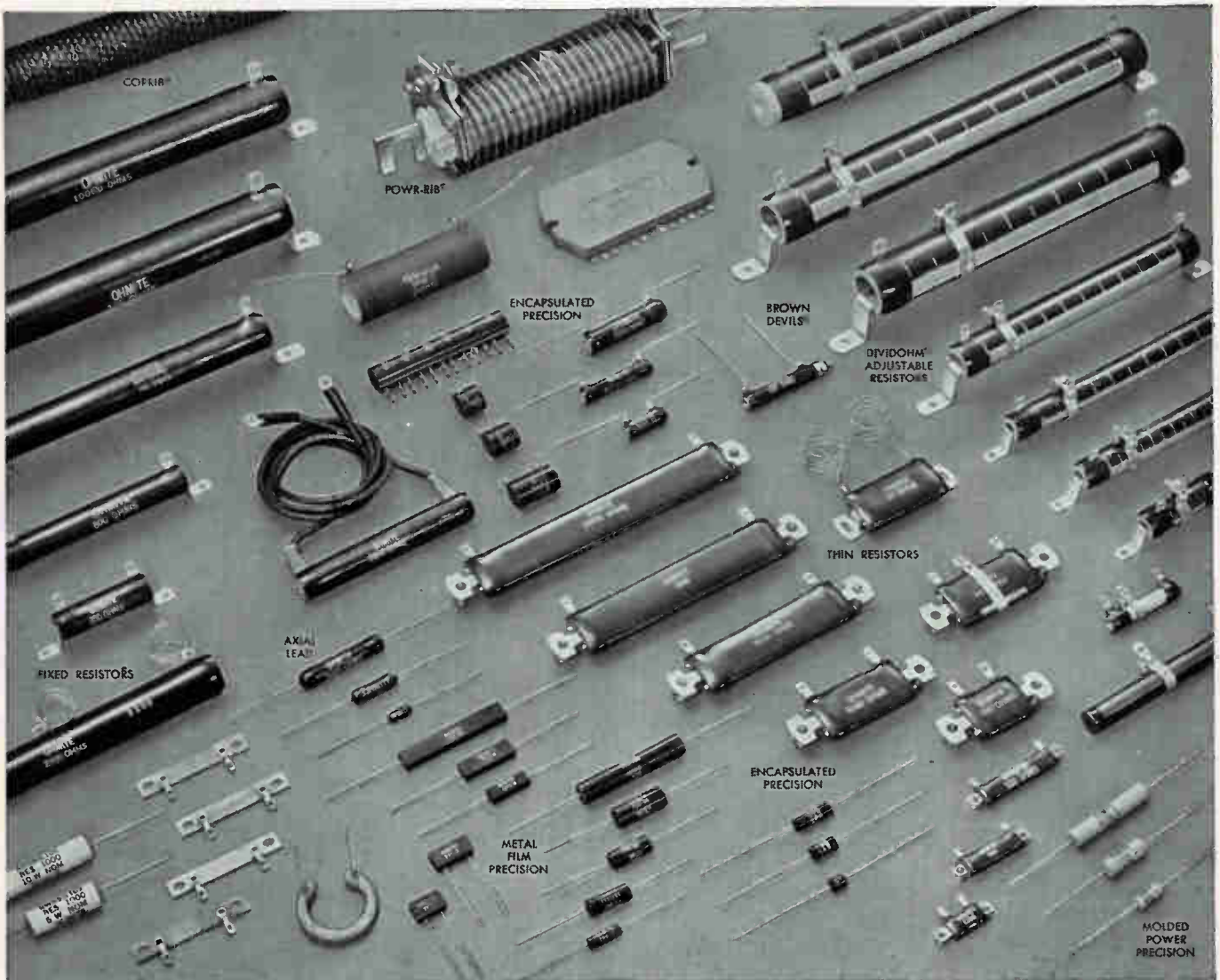

OHMITE

**OHMITE MANUFACTURING COMPANY
3610 Howard Street, Skokie, Illinois**

Quality Components

**• RHEOSTATS • RESISTORS • TAP SWITCHES
• RELAYS • R.F. CHOKES • TANTALUM CAPACITORS
• VARIABLE TRANSFORMERS • GERMANIUM DIODES**

SYLVANIA—BASIC SUPPLIER TO THE ELECTRONICS INDUSTRY

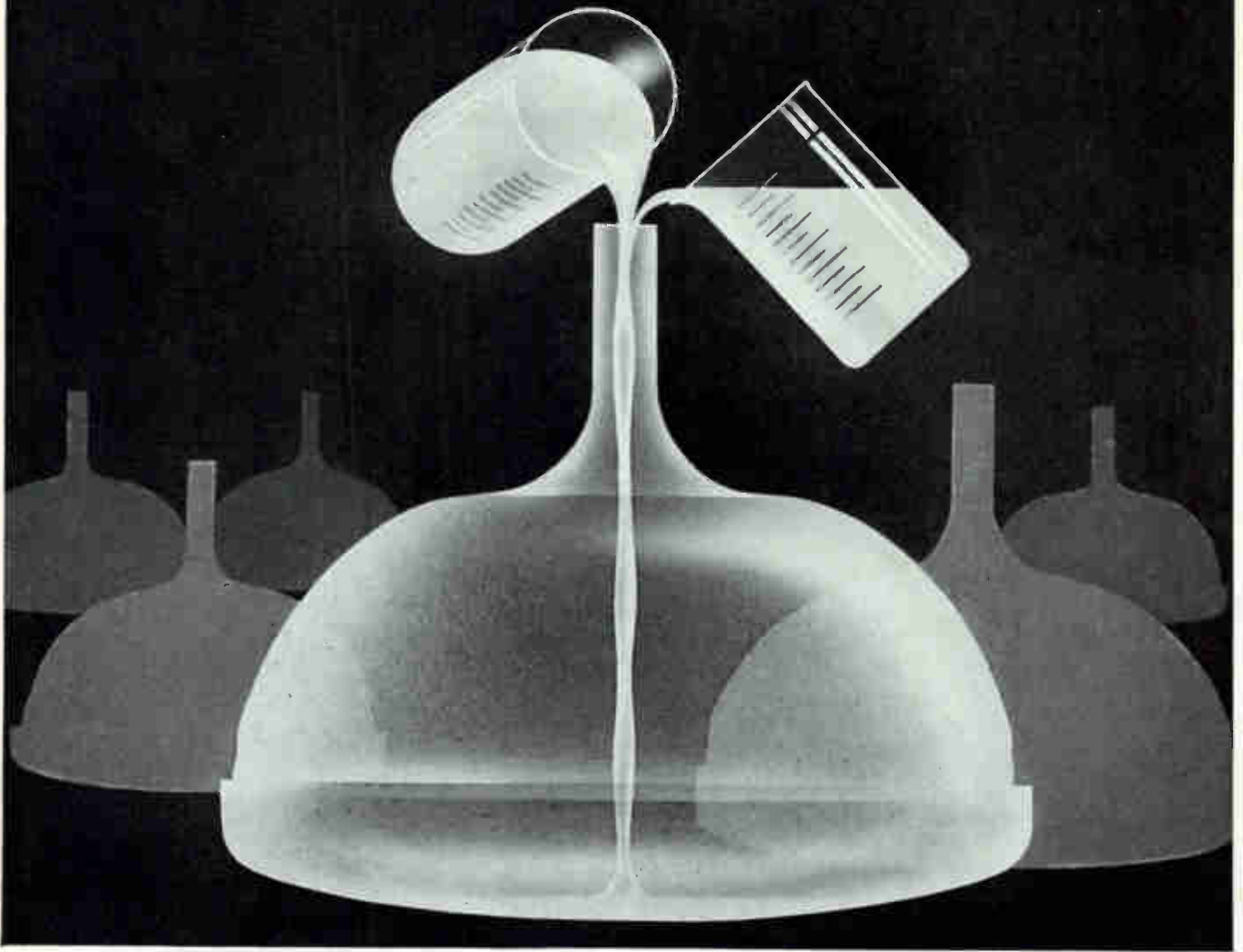

FIRST WORD IN PHOSPHORS AND SILICATES—

*For brighter,
longer-lasting
TV pictures*

Throughout the electronics industry, you hear the name "Sylvania" when phosphors and silicates are discussed.

Sylvania scientists are constantly improving screening materials for cathode-

ray tubes. Example: development of new phosphors with superior brightness, color and stability. In competitive tests, the new Sylvania phosphors surpassed all other commercial picture-tube phosphors tested, maintaining at least 93% of initial brightness after 1,500 hours under electron bombardment.

Another example: In 1959 Sylvania introduced a new electronic grade potassium silicate containing 35% solids. The cathode-ray-tube manufacturers previ-

ously could obtain material containing only 29.5% solids. Thus, the new potassium silicate offers the industry significant savings in material, transportation and storage costs.

Progress in phosphors and silicates is another reason why Sylvania has become the first word—and the last word—in basic supplies for the electronics industry. Chemical & Metallurgical Division, Sylvania Electric Products Inc., Towanda, Pa.

SYLVANIA

Subsidiary of **GENERAL TELEPHONE & ELECTRONICS**



A SIGNAL SUCCESS IN 200 B.C.

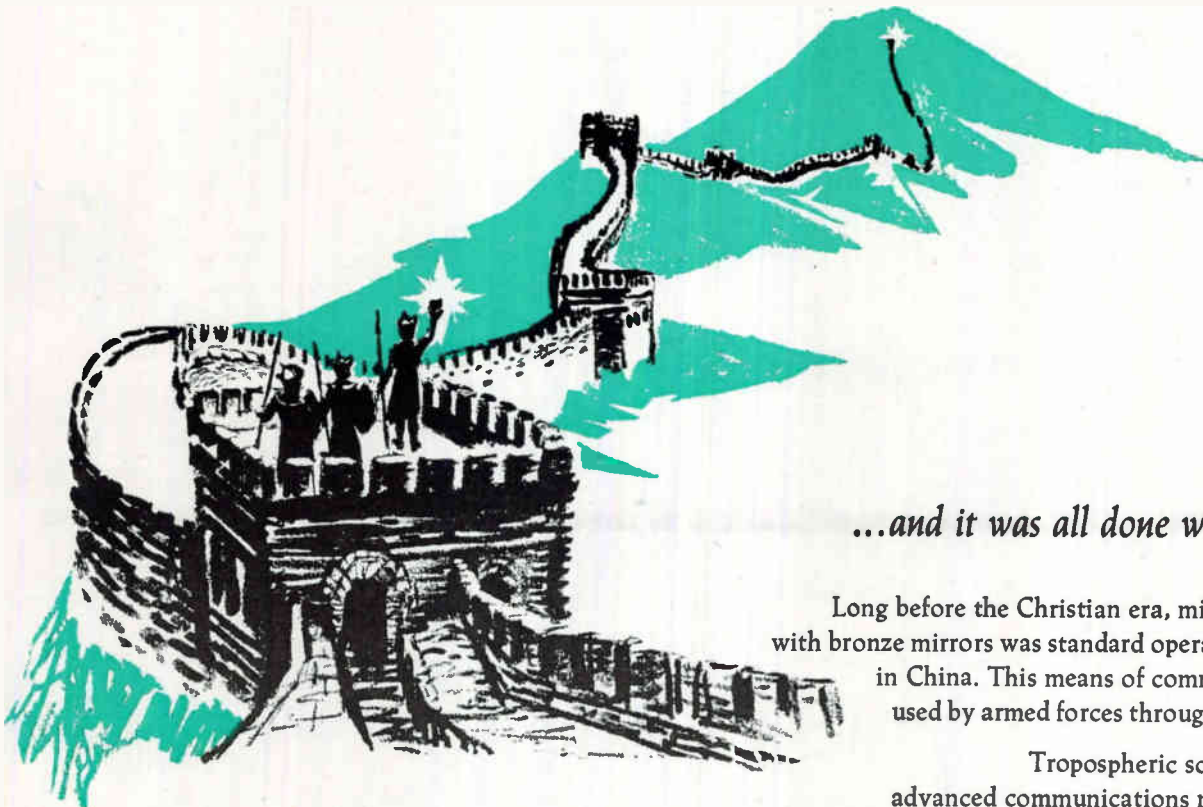

...and it was all done with mirrors!

Long before the Christian era, military signaling with bronze mirrors was standard operating procedure in China. This means of communication was used by armed forces through the centuries.

Tropospheric scatter—the most advanced communications method today—is not done with mirrors. But it *is* magical how this ultra high frequency radio technique hops mountains, oceans and other geographical barriers to carry its messages far beyond the horizon with unprecedented reliability.

The name Radio Engineering Laboratories, too, has been carried afar. REL is a pioneer in the design and construction of tropo scatter communications equipment. You'll find its name on the radio apparatus in use or on order by eight out of nine major tropo networks.

REL's a name you'll want to remember when you need experienced solutions to your commercial or military radio communications problems.

Radio Engineering Laboratories • Inc

A subsidiary of Dynamics Corporation of America

Dept. E • 29-01 Borden Ave • Long Island City 1, NY



Creative careers at REL await a few exceptional engineers. Address résumés to James R. Day, Vice President, Engineering.

HELICOPTER



WITH A HIGH IQ

With new Hamilton Standard flight control—combining autopilot, amplifier-coupler in one package—Sikorsky S-61 cruises, climbs and hovers “hands off”

An advanced flight control, designed and built by Hamilton Standard in cooperation with Sikorsky Aircraft, helps make the S-61 the “brightest” helicopter flying today. It is the first helicopter flight control to combine an autopilot and amplifier-coupler in one package, and gives the S-61 completely automatic control for any pre-set flight mode, plus automatic stabilization for all flight regimes—yaw, pitch, roll, or collective.

The unit itself is fully transistorized; employs redundant circuitry for reliability and has separate plug-in modules. Compact and lightweight, this new control is typical of the sound design and engineering that Hamilton Standard is applying to a variety of projects in the flight control field.

ADAPTIVE FLIGHT CONTROLS for re-entry bodies, space-probes and gliders are now in advanced stages of study at Hamilton Standard. This program involves the development of a self-adaptive system that will not only compensate for aerodynamic changes, but will also compensate for failure of its own components.

MISSILE FLIGHT CONTROL. Hamilton Standard has also created a new concept in digital flight control and guidance systems for advanced missiles. This system offers significant reductions in weight and component complexity.

FLIGHT CONTROL is just one of the many areas of electronics in which Hamilton Standard is working today. The company's experience also includes instrumentation, electrical control, and static power conversion. These activities, plus the technologies developed in producing electronic controls for environmental conditioning systems, starters, turbine and rocket fuel controls, propellers, and ground support equipment, establish Hamilton Standard as a dependable source of widely diversified electronics capabilities.

FOR COMPLETE INFORMATION on how Hamilton Standard Electronics can go to work for you, phone or write: Hamilton Standard Electronics Department, 50 Main St., Broad Brook, Connecticut.



“CEREBELLUM” of the S-61's automatic stabilization and flight control system is this compact control unit, designed and built by Hamilton Standard. It has separate plug-in modules which are completely interchangeable in any of the four major channels. The control takes inputs from pilot command settings, flight parameter sensors, and sonar coupler signals. Error signals for yaw, pitch, roll, and collective pitch are computed and amplified to drive the craft's hydraulic flight-control actuators.



HAMILTON STANDARD

DIVISION OF UNITED AIRCRAFT CORPORATION

WINDSOR LOCKS, CONNECTICUT

SOME OF THE MANY FIELDS OF GROWTH AT HAMILTON STANDARD



ENVIRONMENTAL CONDITIONING SYSTEMS for space vehicles and such advanced aircraft as the B-58, 880, B-70 are important aspects of Hamilton Standard diversification.

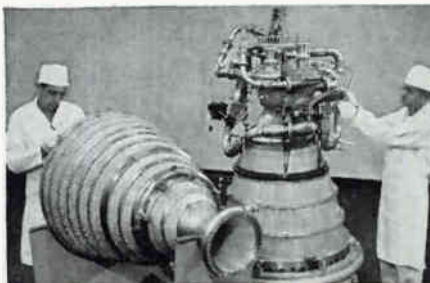

ENGINE CONTROLS for over 20,000 aircraft gas turbines have been produced by Hamilton Standard. The company's latest control work involves advanced rocket engines.

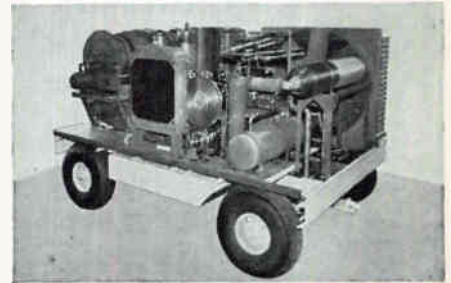

GROUND SUPPORT EQUIPMENT. Hamilton Standard is presently producing a wide range of GSE for both missiles and aircraft—from special tools to complete systems.

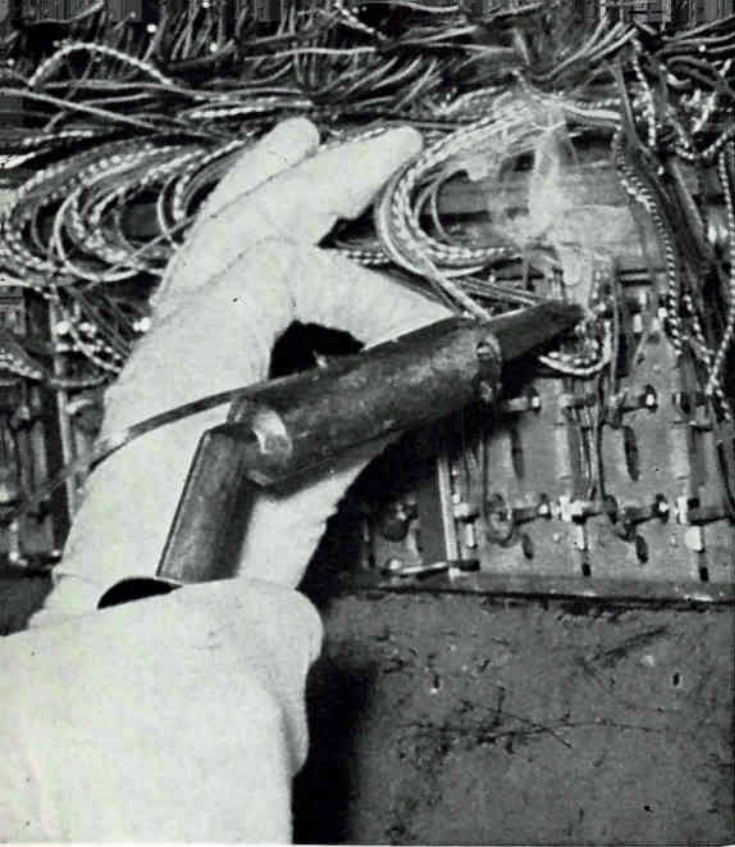

The hands of Tatsuko Noji

Tatsuko and Kayoko

Japanese

More than half of Japan's electronics workers are young women between school and marriage. Here's the picture of how two of these girls live

By FRANK LEARY, Associate Editor

TOKYO—MUCH OF THE STRENGTH of Japan's electronics industry is in hands like the ones pictured above, the hands of Tatsuko Noji, 22-year-old assembler in the Totsuka works of Hitachi Ltd.

Hitachi, one of Japan's Big Five electronics producers, makes everything from heavy power-generating systems (including nuclear equipment) to transistors.

The Totsuka plant in Yokohama is one of Hitachi's 20-odd production facilities, and makes communications and computer equipment.

Tatsuko Noji and Kayoko Otsu are typical of Hitachi's production workers.

Hitachi Girls

Kayoko Otsu, born in the Fukushima prefecture some 200 miles north of Tokyo, came to Yokohama ten years ago with her family (three brothers and a sister, ranging in age from Kayoko's 22 to her youngest brother's 10). Her father joined Hitachi, and the family moved into a company-owned house.

When she finished junior high school in 1952, she took advantage of Hitachi's policy of preferential treatment to employee relatives to go to work at the Totsuka works.

Tatsuko Noji is a Yokohama girl, also came to work for Hitachi at the age of 14 when she finished

junior high school. Tatsuko's father is dead, and with her mother and brother she is responsible for maintaining a household. Her mother works for the prefectural police, and her brother, just turned 18 and now finished high school, has taken a job at Tokyo's Haneda Airport.

By local Yokohama standards, Hitachi pays the girls fairly well and treats them generously. More than half of the 3,500 workers at the Totsuka works are young women, about normal for a Japanese electronics firm. The women are paid substantially less than men, who are generally solely responsible for a family and so treated more handsomely.

Tatsuko's monthly salary is 13,000 yen (\$36) plus a monthly transportation allowance of 540 yen (\$1.50); her bonus last year was 45,000 yen (\$125). Kayoko's salary is 12,500 yen (\$34.72), from which 800 yen (\$2.22) is deducted as her share of the housing charge; most of the rent for the company house is paid by her father and a younger brother who works at another Hitachi plant in Yokohama. Kayoko's bonus last year was also 45,000 yen (\$125).

Both girls are heavily dependent on their employer, not only for income, but also for much of their social life.

Their day starts at about six, and for both girls begins with household chores: cleaning up the sleeping quarters and sweeping the floor. Kayoko walks to work, and Tatsuko takes a streetcar for which expense the firm reimburses her. They arrive at about 8, and the working day begins at 8:05.

There are coffee breaks at 10:05 and 2:30, and at 12:05 a 45-minute lunch period. Lunch is served by a company canteen at less than half what it would cost outside. At 4:20 the assembly line closes down, and the gates open at 4:30.

Of the 3,500 employees at the Totsuka works, few pass through those gates at 4:30. The bachelor engineers (most young college graduates cannot afford the responsibility of a family on 20,000 (\$55.55) or 30,000 yen (\$83.33) a month), generally live on the grounds in company bachelor quarters. The executives usually haven't finished their working day. And for production workers, there is more diversion on factory grounds than they will find outside.

Hitachi, for instance, subsidizes 16 cultural activities and 16 sports for its employees. A fully equipped gymnasium is alive with pingpong, badminton, basketball, gymnastics, wrestling, fencing and other sports by 5 p.m. At various places on the

Production Workers: A Close-up

factory grounds, the girls can study flower arranging, dressmaking, cooking and other domestic arts. Dancing classes in Western style and traditional Japanese forms are held. Introspective young men can play go or chess.

Both Tatsuko and Kayoko play pingpong and badminton, though rarely together (Kayoko, inclined by nature to be rather domestic, usually loses to her friend). Kayoko is studying flower arranging and dressmaking, next month will take on cooking lessons.

Tatsuko learned dressmaking from her elder sister (now married) and had to learn to cook in order to backstop her working mother; her interests lie elsewhere. A sporting type, she plays volleyball and handball, can still put the shot a fair distance. She never misses company-sponsored symphony concerts and plays, goes occasionally to the company movie.

Kayoko takes in the movies on Sundays and has developed a definite taste for American films (with a special warm spot for Montgomery Clift); Tatsuko doesn't care one way or the other about films but definitely likes Western classical music and regards the Fifth Beethoven symphony most highly (she calls it *Unmei*—"Destiny").

What with sports, schools and recreation, neither of the girls leaves the plant much before 6:30. They get home in time for dinner—

when her mother works late, Tatsuko gets home in time to *make* dinner—and by the time they've finished eating and cleaning up the dishes it's time for bed. Tatsuko admits that she sneaks in some reading in the evening; Kayoko sometimes sews a bit.

The Weekend

Saturday is usually a half-day; Sunday is the day traditionally associated by the Japanese with outings. The whole population will be on the move of a bright Sunday morning, and the trains are jammed. Tatsuko and Kayoko go on frequent outings with their friends—both boys and girls—from the plant. These outings are paid for by the company.

Some go to Nikko, the great necropolis of the Tokugawa shoguns and a national shrine; some to the hot springs at Atami; some to the seashore or the mountains for skiing or swimming. Tatsuko and Kayoko say they're not much for skiing or swimming, but Tatsuko likes to climb mountains (she's been up Fuji) and Kayoko likes hiking.

A few times a year, the company schedules a longer outing, perhaps to the old imperial capital at Kyoto or to the northern islands. On these occasions, which require overnight trips, Saturday is added in as a holiday, again at company expense.

Thus the bald salary figures tell only part of the story. Translated

into dollars at the going exchange rate (360 yen to the dollar) they look meagre indeed, and for this reason it becomes deceptively easy to think of Japan's millions of Tatsukos and Kayokos as cheap labor.

But as a matter of fact, the purchasing power of these salaries is not too far out of line with many European standards, and is higher than some. And the cost of labor to Hitachi and other Japanese firms does not end with salaries, transportation allowances and bonuses.

Kayoko could buy a pretty Western-style dress in Yokohama for less than 3,500 yen (\$9.72), about a week's salary. Better than that, she can make her own dress clothes for far less. Work clothes are provided for her by the company, eliminating a major expense. The evening meal, the one big meal a day that the worker has to pay for, can be prepared for three people for about 200 yen (56 cents), less than half Tatsuko's daily wage. And for these workers, major sports or entertainment expenses are unnecessary.

Aside from salaries and bonuses, transportation allowances and the costs of company housing, Hitachi spent about 35 million yen (\$972,000) last year on the diffuse package of employee activities at its Totsuka plant. Besides this, about 30 million yen (\$833,000) a month went toward operating the schools, a hospital, etc., for employees.

Tatsuko performs an intricate series of wiring jobs on automatic switchboard assembly line



Kayoko Otsu on the assembly line for carrier relay equipment





NEED PRODUCT INFO? LOOK IN THE NEW



electronics BUYERS' GUIDE

You'll find detailed facts about the products of almost 700 different advertisers — that's 42% more than you'll find in any other electronics directory.

There's also 64 pages of reference data about markets, materials and design — vital information for all working in electronics. Also local sales offices of man-

ufacturers . . . the names, addresses and phone numbers of representatives . . . complete lists of manufacturers . . . registered trade names . . . and also, of course, the most complete listing of all electronic and related products. Tells what you want to know . . . *when you're ready to buy.*



A McGraw-Hill Publication • 330 West 42nd Street, New York 36, New York

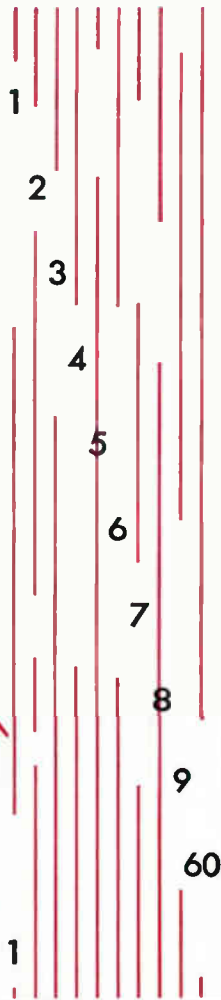

insight at 4 milliseconds

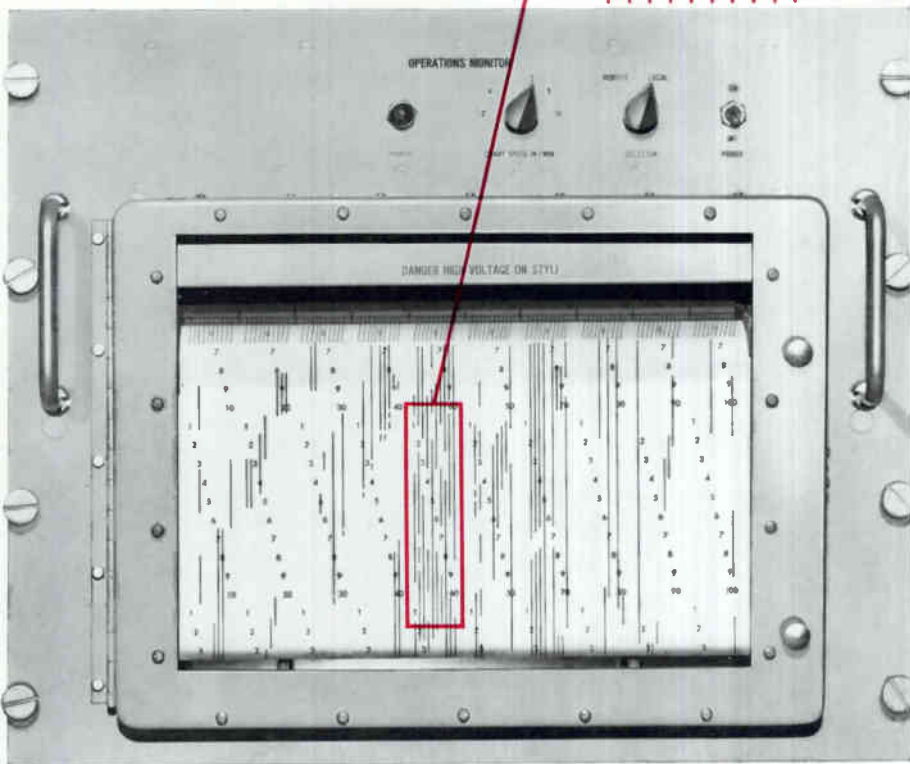

recorded with Brush operations monitors. Multiple high-speed events are reported in writing within 4 milliseconds of occurrence—to establish the basis for split-second, million dollar decisions necessary in today's complex control systems. Up to 120 separate "on-off" event signals are monitored and permanently recorded on a chart only 12" wide. Fixed-stylus electric writing provides sharp, reproducible traces of uniform clarity. Chart speeds from one to 250 mm/sec permit a precise interpretation of all events, with resolution up to 500 signal changes per second. For military or industrial analysis and control, no direct writing recording system can match the capabilities of Brush Operations Monitors. Write today for complete specifications and application data.



in direct
writing
systems

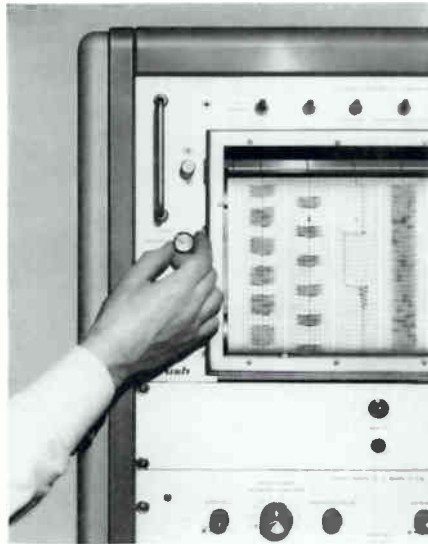

only Brush
eliminates
compromise



Avoid a "second best" choice. Get exactly what you need. Only Brush permits selection of . . . **Writing Method** . . . ink, electric or thermal . . .

Trace Presentation . . . curvilinear or rectilinear . . . **Configuration** . . . vertical or horizontal, rack mounted or portable models. Also . . . chart speeds from 50"/sec to 10"/day . . . functionally designed control panels . . . readily accessible components for fast inspection, simple adjustment . . . complete, easy to understand operating manuals. Get the industry's most advanced design concepts. You never need compromise when you specify Brush. Complete information at your request.

brush INSTRUMENTS

DIVISION OF

37TH AND PERKINS

CLEVITE
CORPORATION

CLEVELAND 14, OHIO

our business is communications and control systems...

For over 75 years North Electric has been designing, engineering and manufacturing "systems" designed on the dual functions of communications and control.

Today, North Systems speed man's thoughts and words over vast distances, between continents and over oceans in seconds.

Today, North Systems control the flow of light, heat, power and water for homes and industry, petroleum products for the wheels of America and chemicals for industry.

Today, North Systems are at work on land, sea and in the air as integral cogs in our vast transportation network.

Today, North Systems make possible high speed data processing complexes functioning through highly efficient switching centrals.

Today, North Systems automate production tools and production lines, handle packaging and pricing chores, perform scientific testing, measuring, weighing and analysis, and hosts of similar functions.

Today, North Systems help BMEWS guard our frontiers, add to our missile capability in projects THOR and JUPITER and help keep our nation safe and strong in many other defense programs.

At North Electric, the engineering team represents a cadre of professional competence with the solid background that comes from long experience in the application of system concepts.

To learn what North can do for you, systemwise, today and tomorrow, write for your copy of "North System Concepts" booklet—now.

ELECTRONETICS DIVISION

NORTH ELECTRIC COMPANY

644 S. Market St.

Galion, Ohio

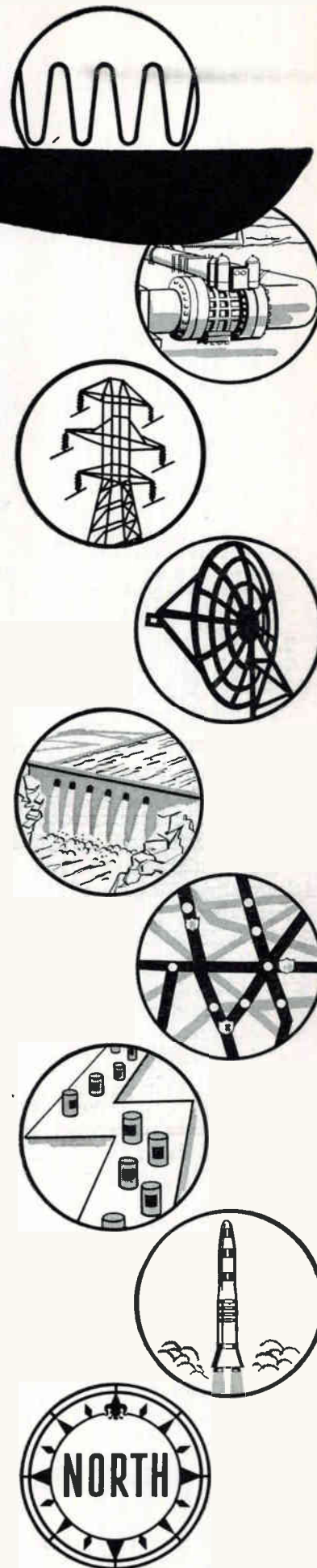

This Is How Midas Satellite Fills BMEWS Radar Blind Spots

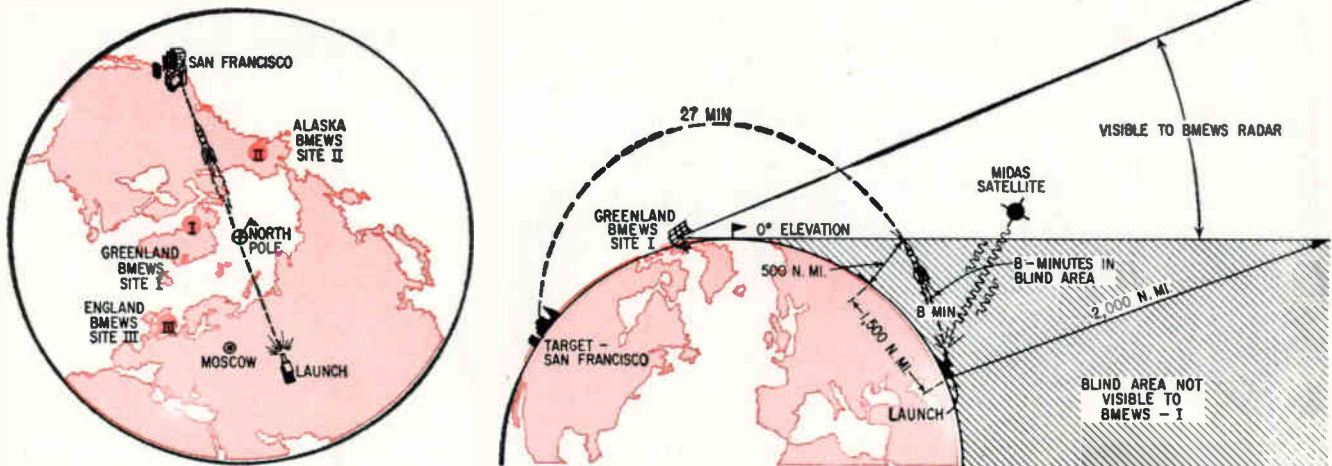

Theoretical enemy missile firing (left) will be detected at three BMEWS radar sites from six to 10 minutes after launch. Midas satellite (right) detects enemy missile's heat one minute after blast-off—while rocket is still in radar blind spots—then tells BMEWS missile is on the way

How Satellites Work With Radar

THE PRIORITY STATUS of Project Midas—this country's heat-seeking missile defense satellite—is being debated in the Pentagon this week.

The debate itself has been assigned "highest priority," says Secretary of Defense Thomas S. Gates.

Many top USAF brass hope this priority label will soon be transferred to the project itself.

Lockheed currently has a \$60-million contract for R&D but the feeling in many military quarters is that this is not enough.

USAF believes one obstacle is due to the misunderstanding that Midas will supersede the Ballistic Missile Early Warning System (BMEWS) — our 3,000-nautical-mile-range ground radar installations at Thule, Greenland (Site I), Clear, Alaska (Site II), and Fylingdale Moor, Yorkshire, England (Site III).

In fact, the two systems are complementary and, as a team, will greatly strengthen our defense position in the northern polar region, experts say.

Ground radar, though long in range, is line-of-sight and consequently does not see below the horizon. A Soviet missile launched deep in the Soviet Union would be in-

visible to BMEWS radars for from five to 10 minutes.

Midas, however, in orbit directly over the launch can pick up the blast one minute after firing. Midas then alerts the North American Defense Command headquarters in Colorado Springs of a firing and warns the BMEWS sites to be prepared for a suspicious object that will appear at a certain time in a specific sector.

Though the Soviet Union is known to have many launch sites and would hardly launch a single missile just to test our reaction, the following simplified example shows how the two systems operate as a team.

What Happens

A Soviet ICBM is launched from a pad southeast of Moscow, Kapustin Yar (47°N—62°30'E). The target is San Francisco, a distance over the earth of about 5,800 nautical miles. The BMEWS radar at Thule, Greenland, some 3,160 n. mi. from Kapustin Yar, will leave a blind area over the launch site of about 2,000 miles altitude—even if BMEWS' elevation angle is 0°.

Assuming the Soviet missile is programmed to follow a medium elevation trajectory, it will tilt over

toward its target soon after launch. Before Thule radar has picked up the missile it will have traveled an earth distance of 1,500 n.mi. toward its target and be at an altitude over the earth of 500 n.mi. Time elapsed will be about eight minutes. This leaves 27 more minutes to San Francisco.

Site III, which is closer geographically, should detect it in less time. Site II, farther away, should take longer than eight minutes.

A series of four to six strategically spaced Midas satellites, traveling in a circular, polar orbit, will be able to detect the missile launch while still invisible to BMEWS. The satellites' infrared sensors will pick up rocket exhausts as soon as they emerge from the atmosphere (water content of the atmosphere filters out infrared). This will only take about one minute—seven minutes before Site I radar picks up this missile. An advantage to setting the sensors so that the earth's atmosphere becomes a barrier is in blanking out heat sources such as blast furnaces, fires, and other irrelevant phenomena.

Midas' tracking of a missile will last for only five minutes or so until the rocket engine shuts down. By the time BMEWS detects the mis-

sile, it will be in free flight. The missile passing through the two horizontal beams radiated by the fixed surveillance radar provides two coordinates. This permits almost instant calculation of trajectory and impact point.

Soviets Changing Research Setup

THE USSR Academy of Sciences, the top science and technology agency responsible for Soviet scientific achievements, is changing some of its research approaches and is integrating the scientific organizations of other Communist states into its program.

A Tass report received in Vienna recently said future work of the Academy would differ in two ways from work done up to now: First, the report said, research subjects would be limited to a relatively small number; second, commissions and councils will be established all over the country for each research project. Tass indicated that additional scientific centers would be built in newly developed industrial areas, especially in the Ural and Volga areas and the Eastern parts of the country.

Seek Coordination

The Soviet news agency said the overall aim is to coordinate scientific research within the Communist bloc by incorporating the scientific research institutes within the Soviet system.

A start towards integration of all Communist research facilities was reportedly made during 1959 with the signing of bilateral agreements with Albania, Bulgaria, Czechoslovakia, East Germany, Hungary, Poland and Rumania. The report did not mention an agreement with Red China.

The statements about the future work and organization of the Academy of Sciences were part of a dispatch on the annual general conference of the Academy devoted to "Results of Scientific Research in 1959." Academy president Alexander Nesmeyanov asserted that the USSR leads the world in cosmic research.

FIRST Navy Militarized SSB Transmitter Generates Cleaner Signal Using HERMES CRYSTAL FILTERS

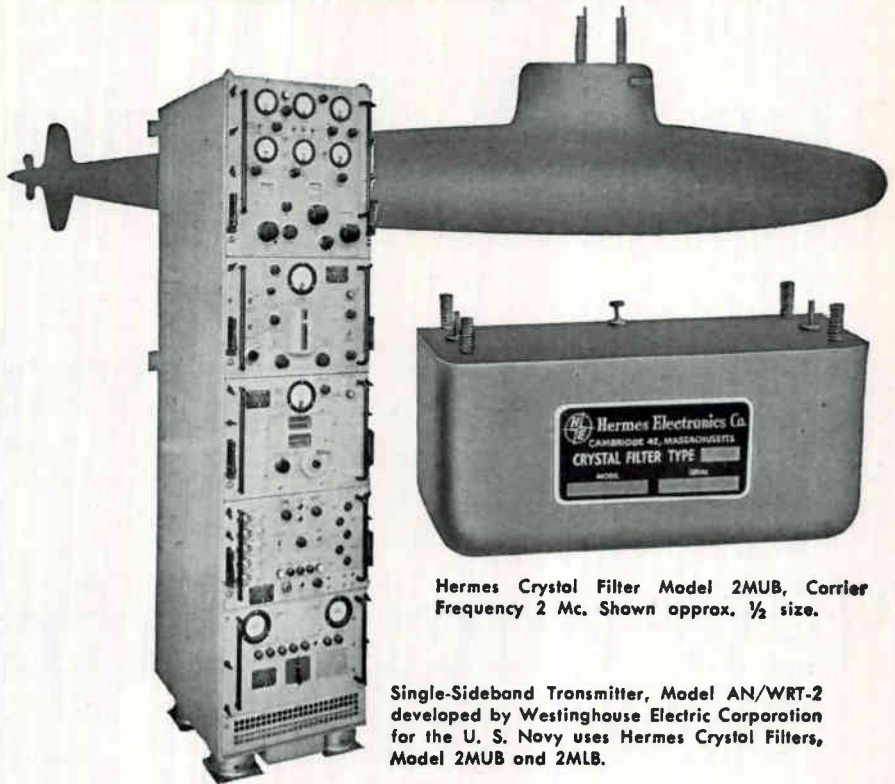

Hermes Crystal Filter Model 2MUB, Carrier Frequency 2 Mc. Shown approx. 1/2 size.

Single-Sideband Transmitter, Model AN/WRT-2 developed by Westinghouse Electric Corporation for the U. S. Navy uses Hermes Crystal Filters, Model 2MUB and 2MLB.

Recently installed on the atomic submarine SKIPJACK (SSN585), the Westinghouse Electric AN/WRT-2 SSB Transmitter is now standard Navy equipment.

Single sideband signals are generated in the AN/WRT-2 by the selective filter method employing Hermes 2MUB and 2MLB Crystal Filters. These 2.0 Mc Crystal Filters not only offer all the basic advantages of the filter SSB generation method, but reduce the number of heterodyning stages required to translate the modulated signal to the required output frequency. The attendant decrease in unwanted signal generation results in a cleaner signal. The AN/WRT-2 is also a more reliable transmitter because fewer components are used.

In addition to the 2.0 Mc Crystal Filters, Hermes has also supplied SSB units at 87 Kc, 100 Kc, 137 Kc, 1.4 Mc, 1.75 Mc, 3.2 Mc, 6 Mc, 8 Mc, 10 Mc and 16 Mc. These Crystal Filters are presently installed in airborne HF, mobile VHF and point to point UHF SSB systems.

Whether your selectivity problems are in transmission or reception, AM or FM, mobile or fixed equipment, you can call on Hermes engineering specialists to assist in the design of circuitry and the selection of filter characteristics best suited to your needs. Write for Crystal Filter Short Form Catalog.

Hermes



ELECTRONICS CO.

75 CAMBRIDGE PARKWAY, CAMBRIDGE 42, MASSACHUSETTS

Nothing is NEWER than like G-E Shadow Grid... anode... New products New engineering: direct-

MEANS LOWEST-NOISE PENTODE!

The new Shadow Grid tube is an advanced concept applied by General Electric. It makes possible high-gain pentode performance at a low noise level found up to now only in triodes. Electron flow is channeled *between* the wires of the screen grid. There is minimum contact of electrons with grid. Consequently, noise-producing screen current is held to a minimum. A plate-to-screen current ratio of 25 to 1 can be obtained with new General Electric Type 6FG5 for TV tuners.

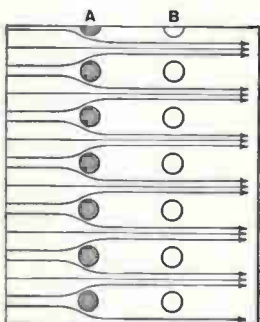

Electron flow from cathode past control grid is guided by electrostatic field in the vicinity of

Shielding grid (A) into streams passing between the wires of Screen Grid (B), thus bypassing the screen grid and continuing to the plate.

ACTUATES RELAYS DIRECTLY!

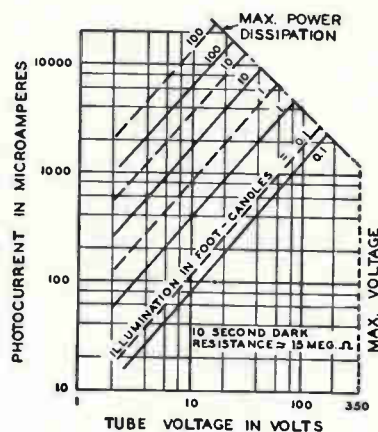

General Electric's new 7427 cadmium-sulphide photoconductive tube is so sensitive to light variations, and can handle so much current (400 mw max dissipation), that the tube will operate a relay without amplification. Your costs are reduced. Spectrum of the 7427 matches the human eye. Check performance below:



Left: average characteristics, Type 7427

— AC (RMS) operation
- - - DC operation

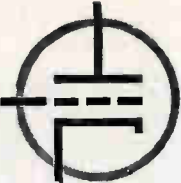
Note this new tube's high sensitivity to light, with large current capacity. In series with a relay, the G-E 7427 helps form a simple, economical circuit which will handle scores of lighting, industrial, other control functions.

tubes . New concepts
 New materials like 5-ply
 like 7427  phototube.
 heated cathode in 3DG4.

CUTS HEAT IN TV RECEIVERS!

Less heater power...less total power for set...less heat generated! The new General Electric 3DG4 power rectifier tube with direct-heated cathode brings you all three benefits. Special 3-ply cathode requires no filament, teams up with a new high-internal-reflectance plate material for maximum efficiency. Total power required is 42% less than the 5V3. Compare:

	NEW 3DG4	5V3
Heater power	12.5 w	19.0 w
Total watts in tube	29	50
Bulb temperature	171 C	206 C
Output current	350 ma	350 ma

NO "HOT SPOTS" ON ANODES!

General Electric has pioneered the use of 5-ply bonded material for tube anodes. Greatly superior in heat conduction and radiation, the new material prevents the formation of "hot spots" when tubes are running full-load. Gives sustained top-performance capability to a large and growing list of G-E receiving types.

Copper promotes the even distribution and faster dissipation of anode heat. Iron for strength. Aluminum for surface protection.

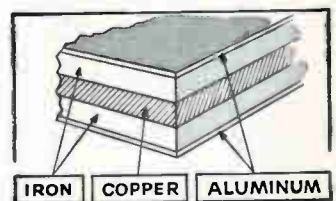

RECEIVING TUBE DEPARTMENT OFFICES:

New York, WI 7-4065, 6, 7, 8.... Boston, DE 2-7122.... Washington, EX 3-3600.... Chicago, SP 7-1600
 Dallas, RI 7-4296.... Los Angeles, GR 9-7765, BR 2-8566.... San Francisco, DI 2-7201.

Progress Is Our Most Important Product

GENERAL  ELECTRIC

CHRISTIE

Specialists in Power Supplies for 30 Years

D-C POWER



WITH ENGINEERED AND CONTROLLED

RELIABILITY

- Static-Tubeless
- All Silicon
- Built to MIL-E-4970
- Overload and Short Circuit Protection
- 500% Overload Capability

Write for new D-C Power Supply Bulletin AC-60

CHRISTIE ELECTRIC CORP.

3400 W. 67th Street, Los Angeles 43, California

300 AMP. POWER SUPPLY

Model MH32-300KP4

Electrical Specifications:

NOMINAL D-C OUTPUT:
28 v. @ 300 amp. (continuous)
VOLTAGE ADJUSTMENT RANGE:
22 to 32 v. d-c
VOLTAGE REGULATION:
±0.5% — combination of rated
load and a-c input variations
(Sensing: local or remote)

VOLTAGE RIPPLE:
1% rms. (-20°C to +55°C)
VOLTAGE RECOVERY (63%):
0.1 sec.— full load application
or removal

D-C CURRENT OVERLOAD
CAPACITY:
125% for 5 min. every 20 min.
250% for 5 sec. every 20 sec.
350% for 1 sec., 500% peak

A-C INPUT:
400-490 v., 3-ph., 57-63 cps.
(other voltages available)
A-C CURRENT AT 440 V.:
25 amp.

AMBIENT TEMPERATURE RANGE:
Operating: -55°C to +55°C
Storage: -62°C to +70°C

ENVIRONMENT, SHOCK,
VIBRATION:
Built to MIL-E-4970
RADIO INTERFERENCE:
Built to MIL-I-26600

Mechanical Specifications:

CABINET STYLE: STATIONARY
Also other styles below
SIZE & WEIGHT:
19" W x 19" D x 31" H.— 355 lbs.

Standard Features:

VOLTMETER & AMMETER:
3½" ruggedized (MIL-M-10304)
Recessed behind removable panel

OVERLOAD PROTECTION:
Magnetic & thermal

PARALLEL OPERATION:
Includes load sharing provision

OTHER FEATURES:
Input Contactor, Pilot Light, Fan,
Fan Failure Protection.

Over 200 Models in
6 Cabinet Styles



Stationary



19" Rack



2-Wheel



Caster



Lab Cabinet



3-Wheel

←CIRCLE 45 ON READER SERVICE CARD

CIRCLE 46 ON READER SERVICE CARD

Highlights of the IRE Show

The Broad View: Interest Is Strong

In New Components and Instruments

Components dominated last week's IRE show, with instruments a close second. Interest was strong in test equipment, including automatic controls for production testing. Space and aviation electronics—from components and instruments to heavy equipment—received greater attention than before, but the military field in general got less emphasis than last year.

Crowds were heavy around exhibits that showed products that were both new and highly sophisticated in their implications for design engineers. While attendance appeared to reach a record 65,000, there seemed to be a heavy sprinkling of chemists, physicists, medical men, and metallurgists.

Growth markets on the minds of marketing men at the show were: industrial electronics, space gear, educational tv, telemetry, infrared, tunnel diodes, solid slug type capacitors, and computers.

Components and Microcircuits Picture:

As seen through our eyes, the components exhibits were oriented towards two major areas: microwave components of all types and sizes, including plumbing, and microcircuitry. Microminiaturization was everywhere, even extending to mechanical items such as gears. Micromodules vied with off-the-shelf miniature devices. In addition, there was new attention to millimeter wave work with hardware such as couplers, attenuators and harmonic generators in evidence.

Some companies believe that an underlying reason for the quickening microminiaturization trend is an accelerated adaptation of military electronics know-how for commercial use.

One example of attention-getting microminiaturization was the display of solid circuit semiconductor networks by the Components division of Texas Instruments Inc. Each network is a complete functioning electronic circuit fabricated with a piece of high-purity semiconductor crystal the size of a match head.

Big push in Esaki tunnel diodes was noted, with the list of companies showing and demonstrating low-priced units reading like a Who's Who in the Semiconductor Field. Most of the firms are in pilot production, but a few are mass-producing units. Even as additional firms announced their entry into the field with germanium and silicon units, earlier entries indicated they were offering gallium arsenide units or bearing down heavily on development of GaAs.

Tubes were far from being shunted out of view by the general emphasis on semiconductor miniaturization. Demonstrations of special tubes still had plenty of crowd appeal. A few examples:

High-speed direct electronic printing on non-sensitized dielectric material was demonstrated by Litton. System uses the electrons in the beam of a Printapix writing tube to produce a charge pattern on a dielec-

tric surface (such as paper) through a mosaic printing head. Picture is developed by dusting the latent image on the paper with a pigmented powder and can be fixed by heating.

Another crowd-drawing tube display was the Westinghouse Permachon pick-up storage tube, a 1-in. tube designed for high resolution, long storage continuous readout application. Available as a vidicon or orthicon, firm says it can retain an image for 24 hours.

Where Instruments Are Going:

Most striking thing about measuring instruments displayed this year is the fact that microwave power is now being measured with an accuracy that was virtually unknown last year. One example is a relatively simple method of X-band radar measurement of standing voltage wave ratio and attenuation.

Digitized instruments such as microwave frequency meters were prominent. Show revealed a continuing emphasis on analog-to-digital converters and readouts, as well as on digital-to-analog gear. Some 72 companies were promoting microwave and radar test equipment. Several firms showed their use of measuring instruments for automatic testing of devices along a production line.

Here are some of the individual instrument highlights:

DuMont digital readout oscilloscope was given its first public showing. Display demonstrated how numerical readings made on the instrument are automatically transferred to a key punch for permanent record and later statistical analysis. DuMont claims that where a variety of tests are made, information from a number of the oscilloscopes can be printed on a single card with consequent cost savings.

Eight-pound probe-type detector for making quick tests for presence of gas was shown by Houston Instrument Corp. Probe tip can be inserted in or around area to be inspected; elaborate procedures or sampling systems are not required.

Uhf Q meter Type 280-A introduced by Boonton Radio Corp. measures r-f characteristics of components in the 200 to 600 Mc range. It differs from conventional Q meters in that it measures the actual percentage bandwidth of the resonance curve, and then computes and reads out circuit Q.

Production Equipment:

Among observations we made on production gear were these: Most equipment had familiar outlines, but many of the exhibitors have made modifications to step up speed and utility. Axial lead component taping equipment made by Universal Instruments Corp., for example, can now be fitted between the hopper and the taper with a section which will automatically test the components.

(For more news of the IRE show, see p 11.)

TOUGH



... AS A TURTLE'S BACK

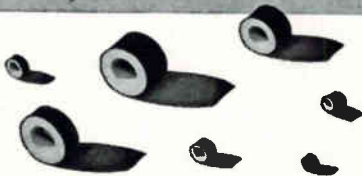

**ARMAG*-PROTECTED
DYNACOR®
BOBBIN CORES
AT NO EXTRA COST!**

Tough-as-tortoise-shell Armag armor is an exclusive Dynacor development. It is a thin, non-metallic laminated jacket for bobbin cores that replaces the defects of nylon materials and polyester tape with *very definite advantages*—and, you pay no premium for Armag extra protection.

Tough Armag is suitable for use with normal encapsulation techniques on both ceramic and stainless steel bobbins. It withstands 180°C without deterioration—is completely compatible with poured potted compounds—has no abrasive effect on copper wire during winding—fabricates easily to close-tolerance dimensions—inner layer is compressible to assure tight fit on bobbin—does not shrink, age or discolor.

Write for Engineering Bulletins DN 1500, DN 1000A, DN 1003 for complete performance and specification data covering the wide range of Dynacor low cost Standard, Special and Custom Bobbin Cores—all available with Armag non-metallic armor.

*TRADEMARK

DYNACOR

DYNACOR, INC.
A SUBSIDIARY OF SPRAGUE ELECTRIC CO.

1006 Westmore Ave. • Rockville, Maryland

Broadcasters Meet Next

NAB convention in Chicago will highlight new equipment for automation and stereo

CHICAGO — HARD-CORE REALITIES rather than blue-sky futures will highlight next week's 38th annual convention of the National Association of Broadcasters here.

ELECTRONICS' talks with a number of broadcasters indicate the group meeting here from April 3 to 6 will give its prime attention to the hardware and operating methods made available by manufacturers today.

Stereocasting

Heavy attendance is expected at a talk to be given by C. Graydon Lloyd of General Electric, on the present status of stereophonic broadcasting.

Ten days ago, the Federal Communications Commission marked the final day for receiving comment on this subject. Prior to this, the National Stereophonic Radio Committee adopted a decision to suspend its work of drawing up recommendations on the adoption of standards.

Broadcasters see a considerable possibility of expansion in their operations if and when stereo standards are adopted. Until such adoption comes about, large-scale manufacture of broadcast and receiver equipment will most likely be held in abeyance.

Station automation for both radio and television has long occupied the attention of broadcasters. This year will be no exception. Talks on this subject will be made by manufacturers and users alike. One speaker, F. F. McNicol (RCA) will speak on tv station automation. His discussion will concern the broad outlines of program assembly functions that can be performed automatically. Methods for automatic gain control, for synchronizing film sources and slide projectors, as well as other program functions, will be dealt with. McNicol told ELECTRONICS his talk will stress theory and method, rather than any particular manufacturer's hardware.

Automatic logging will be discussed by Granville Klink, Jr., of WTOP, Washington, D. C. This station has been obtaining logging data for several months with automatic equipment designed by Minneapolis-Honeywell. This data has been taken side-by-side with the manual record required by FCC.

The station operates a-m, f-m and tv transmitters, all of which are now equipped for automatic logging. It is likely that after the convention the FCC will be petitioned to allow adoption of such equipment, and cutting down or abandoning of manual logging.

Aural program automation techniques will be discussed in a talk by Paul Shafer of Shafer Custom Engineering, Burbank, Calif.

From the Federal Communications Commission, James E. Barr, Assistant Chief of the Broadcast Bureau, will present a talk on recent FCC rule changes.

Barr told ELECTRONICS his talk will deal with broad outlines of broadcast rules rather than details

Russian Device



Martin Co. vice president J. D. Routh, (right) and nuclear division head M. E. Talaat study Russian-built device for converting heat of kerosene lamp into electricity for radios in remote Asian-USSR provinces

Week

and particulars. He will bring out the purposes and objectives of rule changes now coming into being, as well as those of the recent past.

Barr will also discuss the UHF-VHF situation in television broadcasting, and subsidiary communications rule-making.

One convention highlight of particular interest to broadcast engineers will be presentation of the latest NAB handbook by Prose Walker, NAB manager of engineering. This revised edition will reflect an updating of the past five years of engineering information pertinent to broadcasting.

Exhibits

Exhibits at the Conrad Hilton Hotel will demonstrate some of the latest broadcast equipment now available. In addition to the many electronics companies now servicing broadcasters, exhibitors will include companies supplying lighting, mechanical hardware and towers.

In the area of non-electronic station automation will be Century Lighting's "Punch" system which permits presetting of stage lighting conditions for television studios. This system is described as fully automatic.

The automatic logging equipment mentioned earlier in connection with station WTOP will be demonstrated by Minneapolis-Honeywell, along with other developments in automatic logging. Program automation equipment will be displayed by Visual Electronics. Gear is for use in radio broadcast stations as well as television installations.

Full-time and spot programming equipment, as well as spot recorders, turn-tables and other equipment suitable for automatic operation, will be shown by Gates Radio. Programmatic Broadcasting Service, a division of Muzak, will show a fully-automatic radio programming service in action.

Compatible stereophonic a-m broadcast system will be exhibited by Kahn Research Laboratories. This system, which operates by frequency offset of two a-m receivers, is now being studied by Canadian broadcasters.

New Film Dielectric Displays Unusual Stability

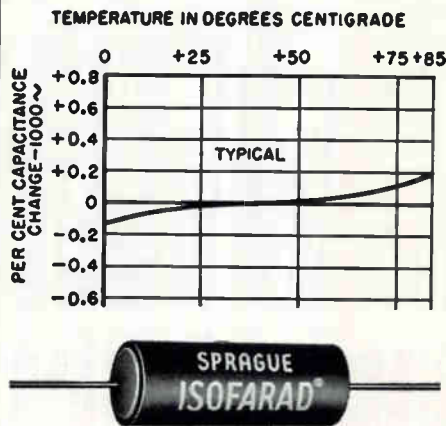

A new duplex plastic film dielectric developed and patented by the Sprague Electric Co. displays practically a zero temperature coefficient of capacitance over operating ranges up to +85 C. The retrace on return to room temperature is within $\pm 0.10\%$.

This new dielectric is currently being used in Sprague Electric's ISOFARAD Capacitors which are finding wide application in critical circuits of color TV receivers. The insulation resistance and dielectric absorption characteristics of these capacitors approach those of polystyrene film capacitors. ISOFARAD capacitors also are said to be superior to silvered mica capacitors in insulation resistance. Their tubular shape makes them more adaptable than silvered mica units for machine insertion on printed wiring boards. For practical purposes, their capacitance stability is equivalent to the more expensive silvered mica units.

Capacitor sections are of extended-foil design and are housed in pre-molded phenolic shells with plastic-resin end seals for protection against moisture and mechanical damage. Standard ISOFARAD Capacitors are rated at 500-volts d-c and are available with capacitance tolerances as close as $\pm 5\%$.

For complete technical data on ISOFARAD Capacitors (Type 145P), write for Engineering Bulletin 2073A to Technical Literature Section, Sprague Electric Company, 35 Marshall Street, North Adams, Massachusetts.

CIRCLE 216 ON READER SERVICE CARD

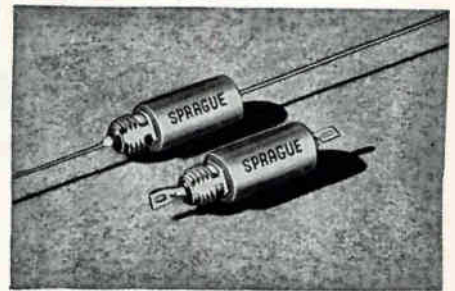

SPRAGUE SUBMINIATURE THRU-PASS® CAPACITORS

solve noise
filtering problems

Sprague THRU-PASS Capacitors display insertion loss characteristics that are truly remarkable, especially at very high frequencies.

THRU-PASS Capacitors reduce to a negligible value the effect of external connection inductance on the capacitor. They also provide a minimum length of internal path for radio interference currents. Their performance is closer to that of a theoretically ideal capacitor than that of any other paper capacitor ever made! THRU-PASS Capacitors are designed to meet all the electrical, mechanical, and environmental requirements of MIL-C-11693.

Both Type 102P and Type 103P are impregnated with Vitamin Q, Sprague's exclusive inert synthetic impregnant, in order to provide maximum insulation resistance and minimum temperature/capacitance change. Type 102P units are processed for -55 C to 85 C operation; Type 103P for -55 C to 125 C. Maximum feed-thru current for which both are rated is 5 amperes d-c continuous or equivalent.

For complete data on THRU-PASS Capacitors, write for Engineering Bulletin 8015 to Technical Literature Section, Sprague Electric Company, 35 Marshall St., North Adams, Mass.



*For the highest
standard of
Accuracy
and Reliability*

MARCONI INSTRUMENTS

for Precise Measurement



LOW CAPACITANCE BRIDGE Model 1342

- * Capacitance range: 0.002 μF to 1,111 μF , $\pm 0.2\%$ accuracy.
- * Shunt-resistance range: 1 to 1,000 $\text{M}\Omega$.
- * Suitable for in-situ measurements.
- * Decade switching and readout.
- * Independent indication of resistive component.

Capacitances down to 0.002 μF can be measured with speed and precision by means of this three-terminal transformer ratio-arm bridge. Its exceptional discrimination and stability make it suitable for such applications as the measurement of the temperature coefficient of capacitors or changes in tube interelectrode capacitance. The bridge measures the capacitance between any two terminals of a 3-terminal network and is virtually unaffected by the impedance between either of these terminals and the third point. Connection to the component under test can be made via long leads without affecting measurement accuracy. Remote or wired-in components can be measured in-situ without the need to disconnect associated circuits.

20-MC SWEEP GENERATOR Model 1099

Can be used in conjunction with any oscilloscope for direct display of video response characteristics up to 20 MC. Frequency is indicated by crystal-controlled marker pips, and a special circuit provides for differential amplitude measurements, enabling relative response to be determined with a discrimination better than 0.01dB. **Frequency Swept Output:** Frequency Range: Lower limit 100 kc, Upper limit 20 MC. Output level: Continuously variable from 0.3 to 3 volts. Output Impedance: 75 Ω . Time Base: Repetition Rate: 50 to 60 cps. Output for c.r.o. X deflection: 250 volts. **Frequency Markers:** At 1 MC intervals; every fifth pip distinctive and crystal controlled.

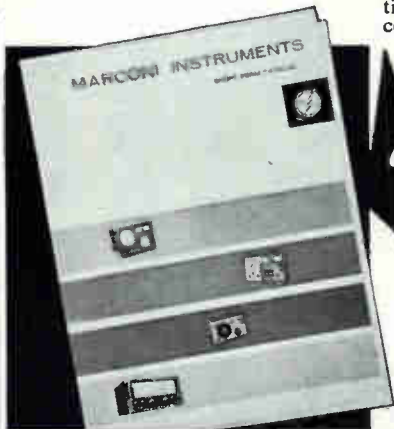

*Available
Now*

SHORT-FORM CATALOG OF MARCONI INSTRUMENTS

Keeps you up to date. Facilitates the rapid identification of the Marconi instrument most suitable for a prescribed purpose. More detailed information freely available.

**Marconi Instruments wide range
of test equipment covers VLF
to EHF. The latest short-form
Catalog is now freely available.**

Designers and Manufacturers of
AM & FM SIGNAL GENERATORS
AUDIO & VIDEO OSCILLATORS
FREQUENCY METERS · VOLTMETERS
POWER METERS · DISTORTION METERS
FIELD STRENGTH METERS
TRANSMISSION MONITORS
DEVIATION METERS · OSCILLOSCOPES
SPECTRUM & RESPONSE ANALYZERS
Q METERS & BRIDGES

Model 1064A/2 for MOBILE RADIO

This FM Signal Generator provides RF outputs of 30 to 50, 118 to 185, and 450 to 470 MC, with FM at one fixed deviation and 0-15 kc variable; IF crystal outputs at five spot frequencies, (xtals not supplied) and also an AF output. High frequency stability, quick warm up and accurate FM have been obtained by use of modern semi-conductor components. FM is produced by a varactor and the power supply is transistor stabilized with zener diode reference.



Q METER Model 1245

**Here for the first time is a
single Q Meter covering
the range AF to VHF.**

Frequency Range: 1 kc to 300 MC. Measures Q: 5 to 1,000; accuracy 5% at 100 MC. Q Multiplier: $\times 0.9$ to $\times 2$. Delta Q: 25-0-25. Test Circuits: separate LF and HF test circuits have ranges of 1 kc to 50 MC and 20 to 300 MC. Capacitance Range: 7.5 to 110 μF with 1-0-1 μF incremental, for either test circuit: 20 to 500 μF for LF test circuit. Shunt Loss: 12 M Ω at 1 MC, 0.3 M Ω at 100 MC. External Oscillators: Model 1247, 20 to 300 MC. Model 1246, 40 kc to 50 MC. Model 1101, 20 cps to 200 kc.

MARCONI INSTRUMENTS

111 CEDAR LANE · ENGLEWOOD · NEW JERSEY

Telephone : LOwell 7-0607

CANADA : CANADIAN MARCONI CO · MARCONI BUILDING · 2442 TRENTON AVE · MONTREAL 16
MARCONI INSTRUMENTS LTD · ST. ALBANS · HERTS · ENGLAND



Greater bandwidth at a given speed—in six words that's the story of Mincom's newest system, the **Mincom Model CM-100 Magnetic Tape Instrumentation Recorder/Reproducer**. There's more, too: one-rack compactness, no belt changes, dynamic braking, complete compatibility, modular construction. For versatile and reliable performance in any instrumentation application, the CM-100 stands alone. Interested? Write today for brochure.



... WHERE RESEARCH IS THE KEY TO TOMORROW

MINCOM DIVISION MINNESOTA MINING AND MANUFACTURING COMPANY

2049 SOUTH BARRINGTON AVENUE • LOS ANGELES 25, CALIFORNIA

We'll Get 17% of Defense Budget

Electronics' share seen rising \$2.4 billion in 10 years even if total defense budget remains static

WASHINGTON—An increase in the electronics industry's share of defense money over the next several years (while some other industries may get less) is forecast by John M. Sprague, Deputy Assistant Secy. of Defense.

Express Views

Rear Admiral L. D. Coates, director of development planning, Office of Chief of Naval Operations, sees a possible increase of 20 percent in the electronics industry's share of the defense budget during the next 10 years. Electronics' share would rise from 14 percent (last year's figure) to almost 17 percent of all defense expenditures.

An increase of 20 percent in our share would amount to \$2.4 billions of additional business to this industry, he said, even if the total defense budget remains constant.

These were among views expressed here recently during a one-day seminar at the Electronic Industries Association's spring conference.

'Spread the Risks'

With indications of further growth and expansion in non-military markets for electronics, Coates urges the industry to increase its efforts in marketing to "spread the risks and hazards of business. There are too many companies that are narrow in their range of products and too easily hurt by minor readjustments in military programs or by changing technology."

Coates gave these guidelines for keeping abreast of advanced planning in naval programs: use bureau contracts, increase your visits to Navy laboratories, read what the services have told Congress. New business, he says, is found not by wearing out shoe leather looking for it but rather by developing it through research.

In pointing out some areas of potential growth, he mentioned that

low frequency which has been used for a long time in communicating with submerged submarines will become increasingly important with further developments. Soon artificial satellites will be used for long-range communications, he said, as well as for accurate navigation of ships by electronic means. There must be improvements in means of detecting and tracking satellites, which will increase greatly in number, he said.

Calls for New Ideas

Touching on anti-submarine warfare, Coates calls for new ideas in electronics—including sonar, sonobuoys, bathythermographs and related communications, navigation, data processing, and display equipment. In electronic warfare, countermeasures and counter-countermeasures must be improved, he said.

Emphasis was placed on the "small war" weapons by Harold Wilcox, director of research and engineering in the Defense Systems division of GM.

Drone aircraft, he said, can be designed to fly over the battlefield and transmit back by code signals the intelligence they get. If destroyed, the cost is not great. Also, he called for better detection devices for use in chemical and biological warfare.

75,000 Units

Brig. Gen. Elmer L. Littell, commanding general, U. S. Army Signal Supply Agency, Philadelphia, points out that about 85 percent of the communications-electronic end-items and components used by the Army are planned and managed by the Army Signal Corps. He estimates that the field Army of the 60's will be equipped with upwards of 75,000 Army-operated electronic emitters—about 2½ times the number used at the end of World War II.

Let us show you how our precision wire forms CUT COSTS!



TERMINAL LEADS FOR RESISTORS, DIODES, TRANSISTORS, CAPACITORS, ETC.

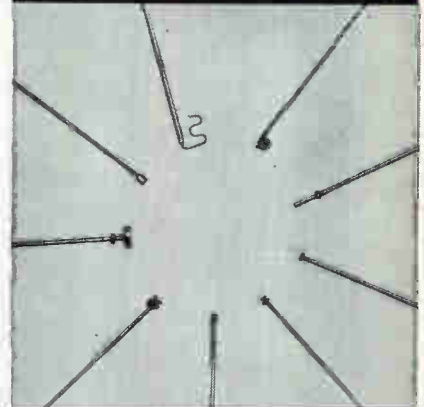

FOR THE HERMETIC SEAL INDUSTRY

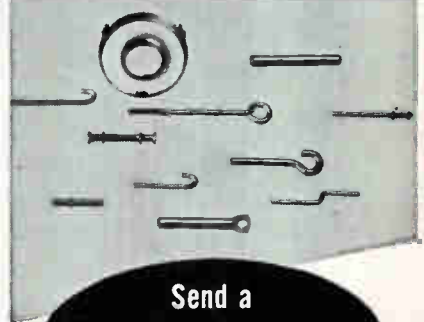

Send a sample or blue print for estimates.

When Art Wire tackles the job, big gains in precision and uniformity are possible on small components . . . resulting in big savings in time and production costs. In addition, Art Wire's modern production methods produce a wide variety of components more economically.

Art Wire specializes in wire forms designed for today's automatic production lines . . . manufactured to assure the economy of an uninterrupted work flow.

ART WIRE AND STAMPING CO.

18 Boyden Place, Newark 2, N. J.

the first complete line of
**TRANSISTOR
VOLTMETERS . . .**



6 ALL-TRANSISTOR MIL TRVMs

- miniature, panel-mounting, for build-in applications
- power supplies included—no battery replacement or checks needed
- isolated inputs • low power consumption
- compact (as small as 2.85" diameter by 6" deep including terminals)
- lightweight • longer life

Model	Meter	Description	Price
301-1 AC TRVM	3½"	zero-left, from 10MV range	\$250.00
302-1 AC TRVM	3½"	zero-center, phase sensitive, from ± 10MV	275.00
303-1 AC TRVM	2½"	50% less panel area than Model 301-1	275.00
304-1 AC TRVM	2½"	zero-center, phase sensitive, from ± 10MV	300.00
305-1 DC TRVM	3½"	zero-center, no zero-set, ± 100MV range	225.00
305-2 DC TRVM	3½"	zero-left version of 305-1, 250MV range	225.00

Note: Due to heavy demand, present delivery of most models is 6-8 weeks. For complete literature, write to Dept. E-4.



TRIO LABORATORIES, INC.
Plainview, Long Island, New York
OVerbrook 1-0400 • TWX HKVL 1166

© 1960, Trio Laboratories, Inc.

MEETINGS AHEAD

Apr. 3-6: National Assoc. of Broadcasters, Engineering Conf. Committee, NAB, Conrad Hilton Hotel, Chicago.

Apr. 3-8: Nuclear Congress, EJC, PGNS of IRE, New York Coliseum, New York City.

Apr. 4-7: Nuclear Congress, EJC, Coliseum, New York City.

Apr. 11-13: Space Conference, Engineering Technology, AIEE, Baker Hotel, Dallas.

Apr. 11-14: Weather Radar Conference, American Meteorological Society and Stanford Research Institute, San Francisco.

Apr. 12-13: Protective Relay Engineers, Annual, A&M College of Texas, College Station, Tex.

Apr. 12-13: Electronic Data Processing, IRE, ARS, Hotel Alms, Cincinnati, O.

Apr. 12-13: Static Relay Symposium, USA Signal R&D Lab., Hexagon Auditorium, Ft. Monmouth, N. J.

Apr. 18-19: Automatic Techniques, Annual Conf., ASME, IRE, AIEE, Cleveland-Sheraton Hotel, Cleveland.

Apr. 19-21: Active Networks & Feedback Systems, International Symposium, Department of Defense Research Agencies, IRE, Engineering Societies Bldg., N. Y. C.

Apr. 20: Quality Control Clinic, ASQC, Univ. of Rochester, Rochester, N. Y.

Apr. 20-22: Medical Electronics, National Conf., PGME of IRE, Shamrock-Hilton Hotel, Houston, Tex.

Apr. 20-22: Southwestern IRE Conf. & Electronics Show, SWIRECO, PGME of IRE, Shamrock-Hilton Hotel, Houston, Tex.

Aug. 23-26: Western Electronic Show and Convention, WESCON, Memorial Sports Arena, Los Angeles.

Oct. 10-12: National Electronics Conf., Hotel Sherman, Chicago.

There's more news in ON the MARKET, PLANTS and PEOPLE and other departments beginning on p 94.

How to determine high-frequency characteristics of precision film resistors

Specify with confidence from this complete line of time-proved TI resistors

MOLDED †

TI type number	wattage rating watts	MIL designation	standard resistance ranges	max. recommended voltage volts
CDM 1/4	1/4	RN60B	10 Ohm-1 Meg	350
CDM 1/4	1/4	RN65B	10 Ohm-1 Meg	500
CDM 1/2	1/2	RN70B	10 Ohm-5 Meg	750
CDM 1	1	RN75B	10 Ohm-10 Meg	1000
CDM 2	2	RN80B	50 Ohm-50 Meg	2000

MIL-LINE †

TI type number	wattage rating watts	MIL designation	standard resistance ranges	max. recommended voltage volts
CD 1/4 R	1/4	—	10 Ohm-1 Meg	350
CD 1/4 R	1/4	RN10X	10 Ohm-1 Meg	500
CD 1/2 PR	1/2	RN15X	10 Ohm-3 Meg	650
CD 1/2 MR	1/2	RN20X	10 Ohm-5 Meg	750
CD 1/2 SR	1/2	—	50 Ohm-10 Meg	850
CD1R	1	RN25X	10 Ohm-10 Meg	1000
CD2R	2	RN30X	50 Ohm-50 Meg	2000

HERMETICALLY SEALED LINE †

TI type number	wattage rating watts	MIL designation	standard resistance ranges	max. recommended voltage volts
CDH 1/4 M	1/4	—	10 Ohm-500K	250
CDH 1/4	1/4	RN60B	10 Ohm-1 Meg	350
CDH 1/4	1/4	RN65B	10 Ohm-1 Meg	500
CDH 1/2 P	1/2	—	10 Ohm-3 Meg	650
CDH 1/2 A	1/2	RN65B	10 Ohm-3 Meg	650
CDH 1/2 M	1/2	RN70B	10 Ohm-5 Meg	750
CDH 1/2 S	1/2	—	50 Ohm-10 Meg	850
CDH 1	1	RN75B	10 Ohm-10 Meg	1000
CDH 2	2	RN80B	50 Ohm-50 Meg	2000

† All values available in 1% tolerance; nominal lead length 1.5 in.

silicon* SILICON RESISTORS

Type No.	Wattage Rating	Body Dimensions	Average Temperature Coefficient	Resistance Tolerance
TM 1/4	1/4	Length: 0.385" Diameter: 0.200"	+0.7	±10
TM 1/4	1/4	Length: 0.435" Diameter: 0.140"	+0.7	±10
TC 1/4	1/4	YG-5 Transistor	+0.7	±10

* TRADEMARK OF TEXAS INSTRUMENTS INCORPORATED
 † Other resistance values and tolerances available on special order



For a more detailed discussion of this subject, contact your nearest TI sales office for a copy of "High-Frequency Characteristics of Precision Film Resistors."

In high frequency applications, precision film resistors are superior to composition or wirewound resistors; skin effect of the thin film is negligible.

OHMIC VALUE vs FREQUENCY

Precision film resistors of a given physical size have the same distributed capacitances regardless of their ohmic value. As the frequency increases, the shunting effect of the distributed capacitance causes the effective parallel resistance to decrease. The reactance of the stray capacitance becomes a relatively good shunt when it approximates the ohmic value of the resistor. The smaller the ohmic value of a precision film resistor (for a given physical size), the higher its usable frequency range.

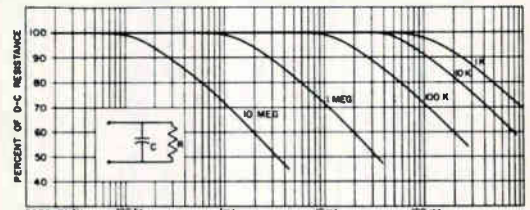

HIGH FREQUENCY RESISTANCE OF PRECISION FILM RESISTORS

INDUCTANCE CONSIDERATIONS

The inductance caused by helixing the higher value resistors is negligible throughout the "useful" range of frequencies at which the resistance is greater than 60% of its d-c value.

When resistors under 500 ohms are measured using high frequency meters, the reactive component of the equivalent parallel circuit appears inductive because of lead and binding post inductance. However, the resistor itself is capacitive.

CAPACITANCE CONSIDERATIONS

The average measured capacitance of Texas Instruments Precision Film Resistors is determined primarily by the end cap-to-cap capacitance which is proportional to the dielectric constant of the core and encapsulating material.

TI TYPE	SIZE (WATT RATING)				
	1/4	1/4	1/2	1	2
MIL-LINE (CD)	0.2	0.1	0.25	0.5	0.6
MOLDED (CDM)	0.3	0.25	0.45	0.7	0.7
HERMETICALLY SEALED (CDH)	0.3	0.25	0.45	0.75	0.8

CAPACITANCE IN pF OF TI PRECISION FILM RESISTORS

MOUNTING

Precision film resistors of 200 ohms or less perform satisfactorily at 5000 mc and higher if placed in a well-designed coaxial mount. A coaxial mount constructed from a standard UG-18B/U Type N plug can be used effectively. In conventional terminals, correct mounting of the body of the resistor off the circuit chassis and the use of short leads will minimize the stray capacitance and lead inductance.

Specify TI precision resistors!

TEXAS  INSTRUMENTS
 INCORPORATED
 SEMICONDUCTOR-COMPONENTS DIVISION
 13500 N. CENTRAL EXPRESSWAY
 POST OFFICE BOX 312 · DALLAS, TEXAS

*Who's the local rep?
What's his number?*

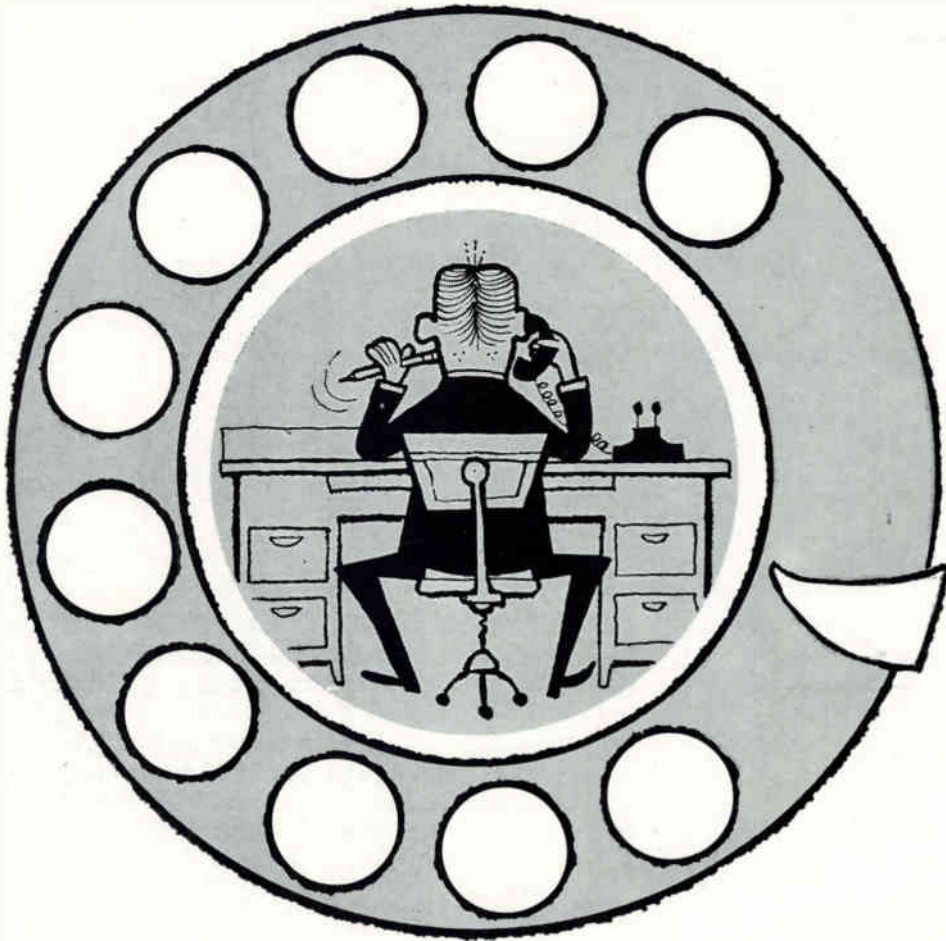

**LOOK IN THE NEW
electronics BUYERS' GUIDE**

You'll find the local representative . . . his name, telephone number . . . his address. You'll find such detailed information about more than 25,000 local sales offices of more than 4,000 major manufacturers.

There's also a wealth of reference data about markets, materials, components and applications that make buying easier. Catalog informa-

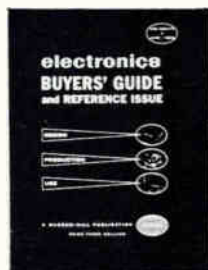

tion on nearly 700 different advertised products (that's about 42% more than you'll find anywhere else). Also complete lists of manufacturers . . . registered trade names . . . and also, of course, the most complete listing of electronic and related products. Tells what you want to know . . . *when you're ready to buy.*



A McGraw-Hill Publication • 330 West 42nd Street, New York 36, New York



**THE
DIRECT
RECORDING
VISICORDER...
THE
NEW WAY
TO RECORD
THE
ADVANCEMENTS
OF SCIENCE**



HONEYWELL DEVELOPERS OF THE ULTRA-VIOLET PRINCIPLE OF OSCILLOGRAPHY, PRESENT THREE VERSATILE VISICORDER MODELS AND ASSOCIATED SIGNAL-CONDITIONING EQUIPMENT...

Honeywell

MODEL 906 VISICORDER

... pioneer in the field of Ultra-Violet direct recording

Two models of the 906 Series Visicorder give you a choice of recording capacity on 6" paper. The Model 906 B-1 uses high-sensitivity Series M sub-miniature plug-in type galvanometers that are directly interchangeable among all Honeywell oscillographs of the sub-miniature galvanometer type. Optical arms, therefore galvanometer sensitivities, are an identical 11.8 inches in all instruments.

The 906 B-1 provides for 14 channels of recording including two static reference traces—each channel operating at frequencies from DC to 5000 cps. It has provisions for recording intensity control; trace identification; grid line system (either inches or millimeters) and selectable record speeds (a choice of 5 interchangeable systems, each covering 4 speeds).

The Model 906 B-2 is identical to the 906 B-1, except that it uses solid-frame galvanometers with a capacity of 8 channels, including 2 timing or event-marking channels.

Accessories available for both models of the 906 B include a record take-up unit; record takeup and latensifier; relay rack adapters; and the Visicorder Timing Unit.



Honeywell

MODEL 1108 VISICORDER

... newest of the Honeywell direct-recording oscillographs

The Model 1108 delivers direct-writing Visicorder oscillography at the lowest cost per channel. Intermediate in size between the 14-channel 906 and the 36-channel 1012, the 1108 simultaneously records up to 24 channels of data on a record 8 inches wide. This instrument, like other Visicorders, records at frequencies from DC to 5000 cps with unparalleled galvanometer sensitivities.

Pushbutton controls give a choice of 15 record speeds from .05 to 80 inches per second, and time line intervals of 1, .1 and .01 seconds. Such built-in features as automatic record length control, grid-line intensity control, galvanometer spot intensity control, record numbering, reversible record drive, trace identification, provision for remote operation, and many others contribute to maximum convenience in recording high-speed analog data.

As in all Honeywell Visicorders, paper loading, access to the interior, and galvanometer adjustment is easy and convenient.



Honeywell

MODEL 1012 VISICORDER

... the most complete, convenient multi-channel oscillograph on the market today

The Model 1012 has been accepted as "the most versatile instrument ever devised for converting dynamic data into immediately visible read-out." It will record up to 36 channels of data simultaneously on 12" wide paper. It gives complete push-button control of 15 different paper speeds, from 0.1 to 160 in./sec., with automatic recording intensity control. Designed into the 1012 are many other convenience features: daylight paper loading; reversible record drive choice; switch selection of 5 different timing intervals (.001 to 10.0 seconds); simultaneous recording of amplitude reference (grid) lines; trace identification; automatic record length control; record numbering; jump-speed control and provisions for remote and/or multiplexed operation.

Like other Visicorders, the 1012 makes use of the sub-miniature galvanometer. All instruments are readily adaptable to rack and shock-mounting.



Honeywell

SIGNAL-CONDITIONING SYSTEMS

A. The Model 119 Amplifier System ... a simple and accurate 6-channel carrier amplifier, for use in oscillographic recording, which may be converted to a linear/integrating system simply by installing linear/integrating channels in the same case. The carrier amplifier is designed to amplify signals from resistive, variable-reluctance, differential-transformer, and capacitive transducers. The linear/integrate amplifier is used in conjunction with self-generating transducers such as vibration pickups, etc. The carrier system provides recordings in the 0-1000 cps range at galvanometer amplitudes of 8" peak-to-peak. The linear-integrate system accommodates frequencies from 5-5000 cps.

B. The Model 130-2C Carrier Amplifier ... a two-channel unit for use with resistance, reluctance, differential transformer, and capacitive transducers. Produces 8-inch (peak-to-peak) galvanometer deflections up to 1000 cps from as little as 0.5 mv gage output.

C. The Model 82-6 Bridge Balance and Strain Indicator ... a simple, accurate 6-channel unit for calibrating, balancing, controlling, and measuring static and dynamic phenomena from resistive transducers. All three of these units are suitable for convenient rack mounting.



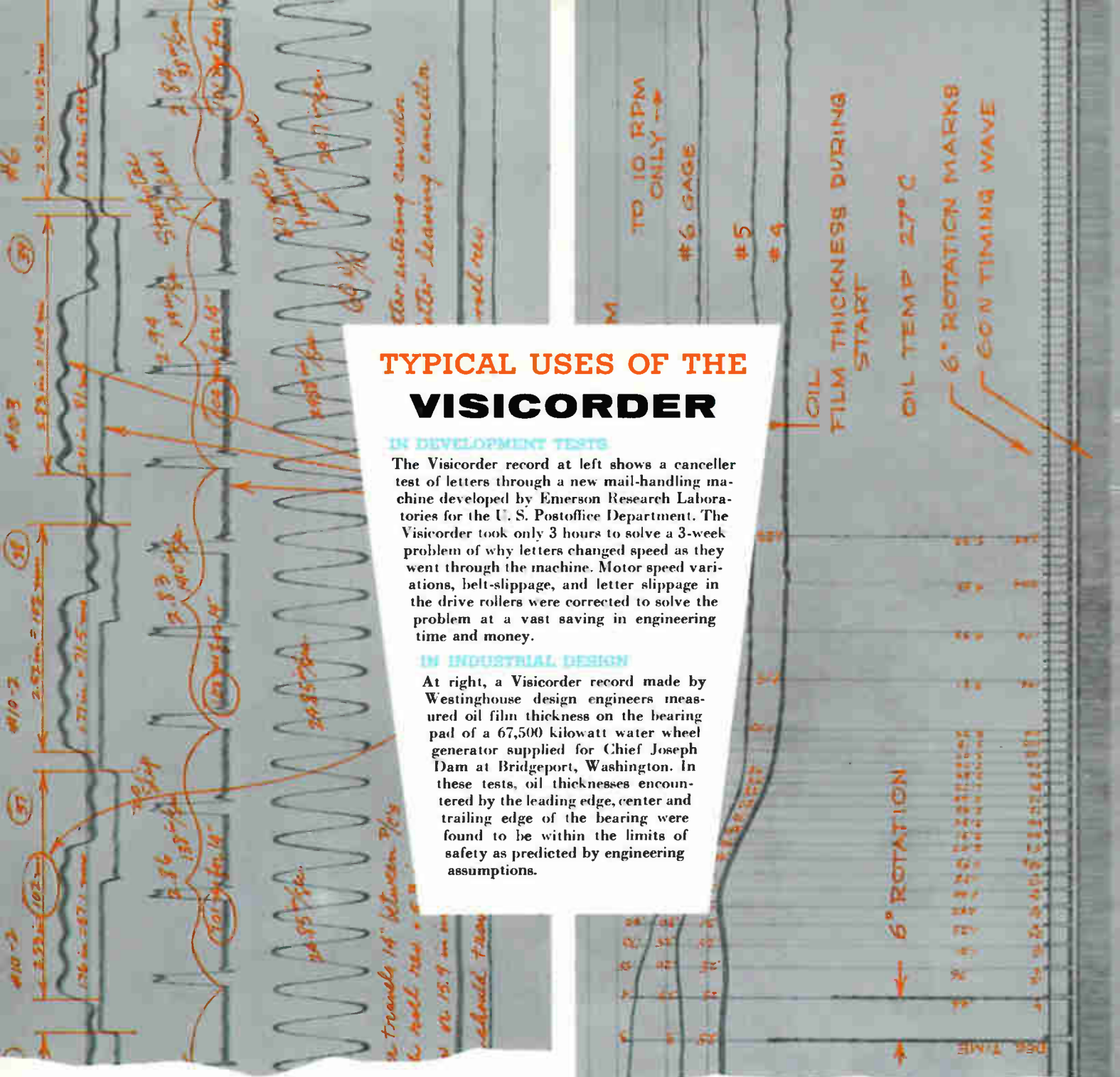

TYPICAL USES OF THE VISICORDER

IN DEVELOPMENT TESTS

The Visicorder record at left shows a canceller test of letters through a new mail-handling machine developed by Emerson Research Laboratories for the U. S. Postoffice Department. The Visicorder took only 3 hours to solve a 3-week problem of why letters changed speed as they went through the machine. Motor speed variations, belt-slippage, and letter slippage in the drive rollers were corrected to solve the problem at a vast saving in engineering time and money.

IN INDUSTRIAL DESIGN

At right, a Visicorder record made by Westinghouse design engineers measured oil film thickness on the bearing pad of a 67,500 kilowatt water wheel generator supplied for Chief Joseph Dam at Bridgeport, Washington. In these tests, oil thicknesses encountered by the leading edge, center and trailing edge of the bearing were found to be within the limits of safety as predicted by engineering assumptions.

OTHER USES of the Visicorder . . . as a direct readout unit **IN RECORDING AND MONITORING SYSTEMS** . . . **IN MISSILE AND ENGINE ANALYSIS** for test stand recording . . . for analog recording **OF TELEMETERED SIGNALS** . . . **IN CONTROL** to monitor reference and error signals . . . **IN NUCLEAR TEST** to record temperatures, pressures, impacts, etc. . . **IN LABORATORIES** for all-purpose analysis . . . **IN PRODUCTION** for final dynamic inspection . . . **IN COMPUTING** for immediately-readable analog records . . . **IN PILOT COMPONENT TESTS** for rapid evaluation of prototypes . . . **IN ALL TESTS** which are non-repetitive in sequence, making oscilloscopes impractical.

Write for your *free* copy of the new 36-page Visicorder Applications Manual, a comprehensive, detailed guidebook to many varied uses of the Visicorder.

Honeywell



Industrial Products Group

For further information including prices and delivery, write
 Minneapolis-Honeywell Regulator Company, Industrial Products Group, Heiland Division, 5200 E. Evans Ave., Denver 22, Colorado.

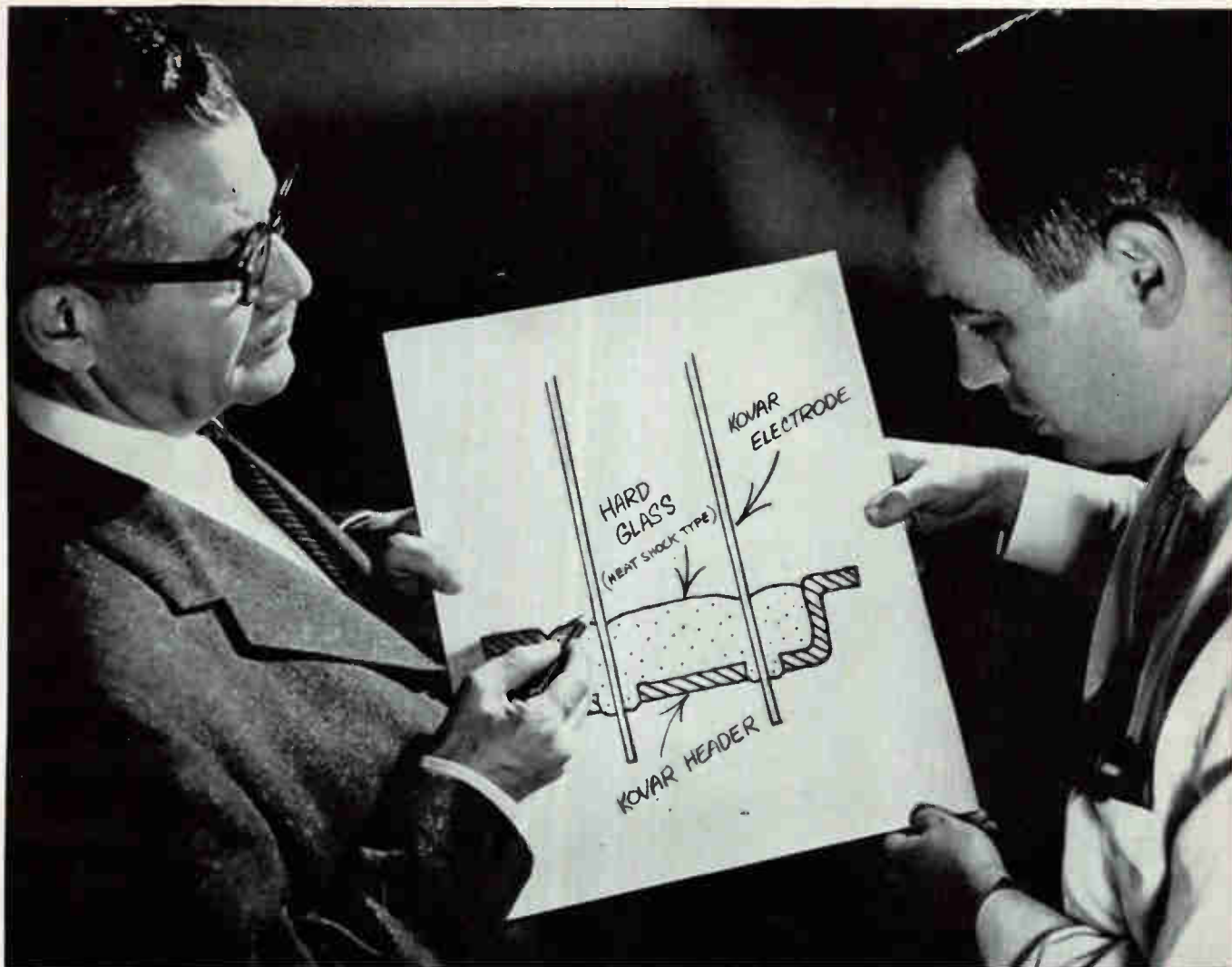

Engineering hints from Carborundum

Why use KOVAR[®] Alloy in Semi-Conductors?

KOVAR, an iron-nickel-cobalt alloy, has a thermal expansion curve that matches almost perfectly that of several hard glasses—making an ideal glass-to-metal seal. For years, it has been used to make vacuum and pressure tight seals for large size electron tubes.

But why use KOVAR for less exacting requirements of semi-conductors? Wouldn't less expensive alloys serve as well? Actually, three reasons justify KOVAR alloy's use:

1. Only an oxide-bonded seal of the matched type, such as you get with KOVAR, gives vacuum tightness over so wide a temperature range—minus 80C to over 200C.
2. Its thermal expansion not only matches certain high thermal shock glasses, but also matches the expansion of germanium and silicon—therefore insuring dimensional stability of the entire unit.
3. In KOVAR alloy you get *uniformity* of all required properties—such as expansion, freedom from phase

transformation down to minus 80C, oxidation rate and plateability with other metals.

KOVAR can be welded, brazed or soldered—also plated with other metals—either by electrolytic or chemical methods. KOVAR, either oxide bonded to hard glass, or brazed to metallized ceramic insulators, makes a rugged permanent seal... even under the most severe conditions of temperature, vibration and handling. Technical service is available to help you solve processing and application problems. Contact The Carborundum Company, Refractories Division, Dept. E-40, Latrobe Plant, Latrobe, Pa.

FIND OUT ABOUT KOVAR WHERE IT IS USED AND WHY

New book gives data on composition, fabrication techniques and applications. Send for your free copy today.



For permanent vacuum and
pressure-tight sealing . . . count on

CARBORUNDUM[®]

Camera Control System For Rocket Sled Tests

Sled-mounted uhf receiver-controller converts radio link signals into camera control commands. Receiver uses bandpass filter made of etched-board transmission line. Camera control unit is transistorized and specially packaged to withstand the severe shock and vibration encountered at supersonic speeds

By **FLOYD M. GARDNER**, Associate Director of Research

LEONARD R. HAWN, Project Engineer, Interstate Electronics Corp., Anaheim, Calif.

PHOTOGRAPHIC recording of ejection seat performance during rocket sled tests at Edwards AFB has been improved using on-board rather than conventional ground-mounted cameras. To make a sled-borne system practical, the existing radio control installation had to be utilized. This article describes the transistorized camera control system developed to meet this requirement.

SYSTEM OPERATION—A block diagram of the system is shown in Fig. 1. Data to be transmitted to the sled consists of camera start and timing pulses which are amplitude-modulated onto 3.5-Kc and 12-Kc subcarriers, respectively. These subcarriers are frequency-modulated and transmitted on a 460-Mc radio link.

At the receiver, the signal is detected and the two subcarriers separated. Pulses are then reconstituted; start pulses operate the camera relays and timing pulses flash neon lamps.

INPUT FILTER—Since the receiver used has an open front end, it is the function of the input filter to pass the required signal frequencies of 459, 460, and 461 Mc and to attenuate other signals, especially the image frequency of 350 Mc. The input bandpass filter is of the etched-board transmission-line type.

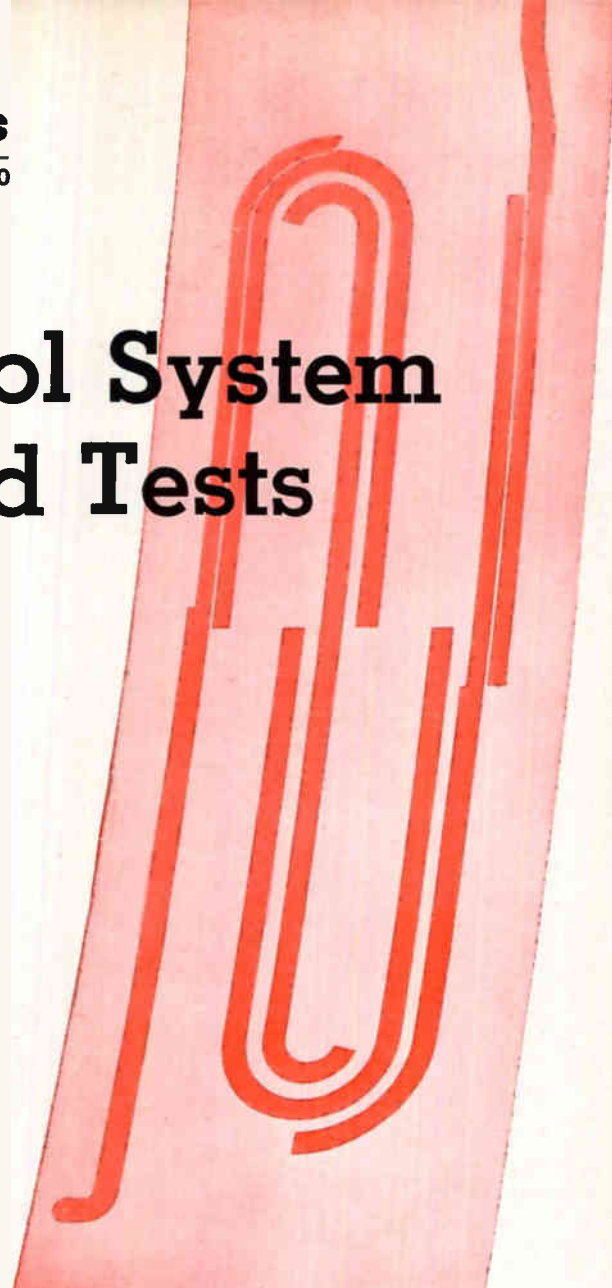

Input bandpass filter is made of etched-board transmission line

It consists of a series of half-wavelength resonant strips folded into an S shape to reduce the physical size and sandwiched between two $\frac{1}{8}$ -inch pieces of metal-clad Rexolite dielectric material. (See photo.)

The design differs from the usual end-coupled strip configuration in that successive strips are parallel-coupled along a distance of a quarter wavelength. The resulting coupling is partly electric and partly magnetic.

RECEIVER—The transistorized f-m receiver is a double-conversion superheterodyne type tunable by crystal substitution in the 457- to 462-Mc band. It has a sensitivity of approximately $6 \mu\text{v}$ for 20 db of noise quieting. A schematic diagram of the receiver is shown in Fig. 2.

A total of 13 germanium transistors are used. The transistors in the i-f amplifiers are *pnp* drift type (2N384) with an alpha cutoff of 100 Mc; the tran-

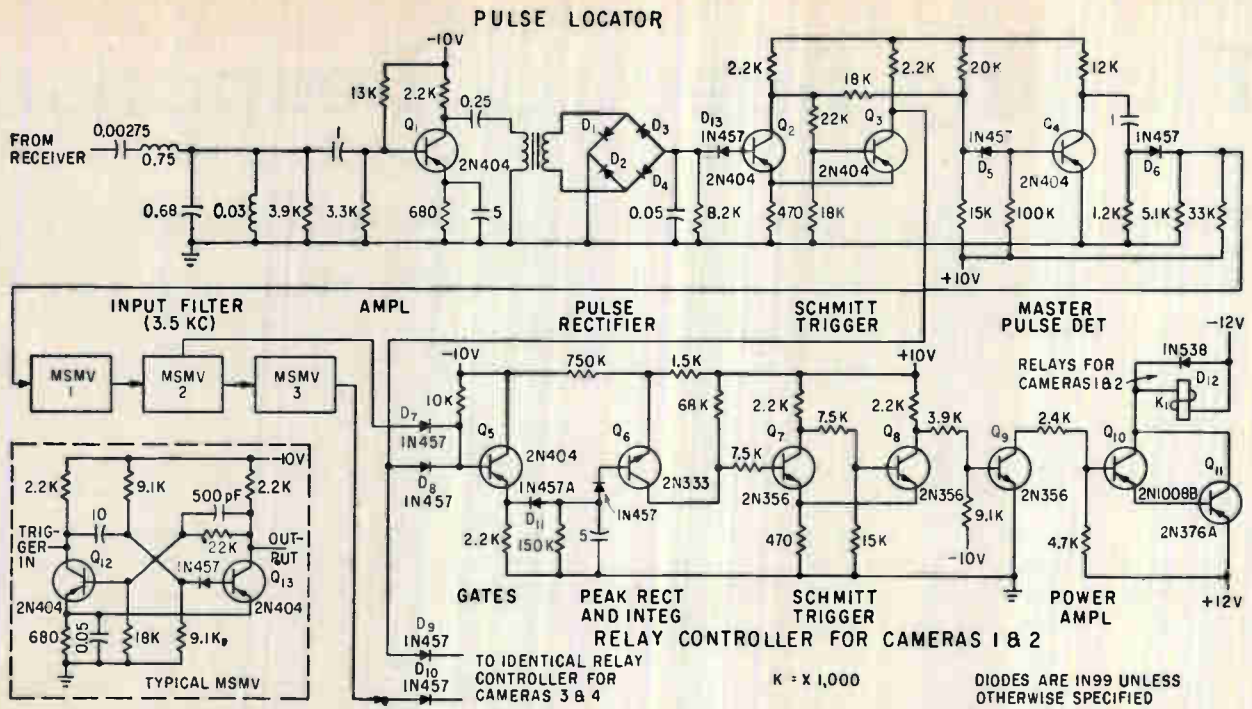

FIG. 3—Camera control circuit has two identical relay controllers: one for cameras 1 and 2 and one for cameras 3 and 4 (not shown)

devices with corresponding low dissipation and are not sensitive to large temperature changes. The Schmidt triggers are used to speed the switching time of following transistors. This speed prevents the transistors from taking too long a time, from a heat standpoint, to switch from either state.

The integrator circuit with transistor Q_5 uses a silicon junction diode in the emitter to isolate the low emitter resistance necessary for I_{c0} control from the integrator capacitor. Transistor Q_6 is the only silicon type used in the camera control circuit and is necessary because of the low leakage requirement of that portion of the circuit.

Output relay K_1 is of the balanced armature type, specially designed for operation under high shock and vibration conditions. The circuit in which this relay is employed allows relay operation from the unregulated 24 v d-c.

TIMING LIGHT CIRCUIT—A schematic diagram of the timing light circuit is shown in Fig. 4. The input filter and amplifier separate the 12-Kc pulses from the other subcarrier pulses. The pulses are rectified and then amplified by Q_2 . Capacitor C_1 and resistor R_1 constitute a pulse-length discriminator circuit. When the capacitor is in the circuit the integrated output voltage of the transistor stays below the triggering level of the Schmidt trigger for short (1 millisecc) pulses, but allows longer pulses to go through.

The voltage used on the neon lamps is considerably higher than can be safely applied to a transistor. To circumvent the difficulty, silicon transistors Q_7 and Q_8 are connected in series. A type 2N498 is used, rather than one of lower rating, because each neon lamp might draw as much as 30-ma.

PACKAGING—Supersonic sleds generate severe

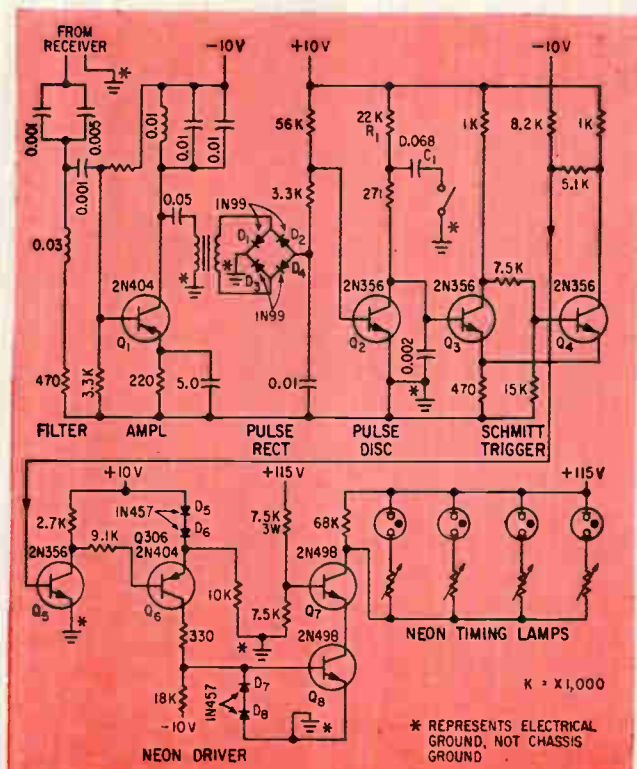

FIG. 4—Timing light circuit provides properly synchronized flash illumination for cameras

shock and vibration and any on-board equipment must be packaged with care. The receiver-decoder is mounted on etched-circuit boards which are firmly nested in an aluminum casting. All components are cemented to the board in order to avoid any strains on the leads.

The equipment described was developed for the high-speed track at Edwards AFB under Contract AF 04(611)-4300.

Finding Spectral Response

Allowing accurate determination of response or sensitivity, this monochromator system aids research into phototube materials and phosphors for the visible, infrared and ultraviolet regions

By SYDNEY J. ROTH, Allen B. Du Mont Laboratories, Inc., Clifton, New Jersey

MATERIALS INTENDED FOR the active surfaces of light sensitive devices must be carefully evaluated for spectral response. In the visual wavelength band, materials are desired for cathode-ray tubes, photomultipliers, photoemission devices and luminescence applications. Outside the visual range, spectral response problems range from ultraviolet to longwave infrared.

Shown in the photograph is an automatic spectroscopic system for determining the spectral response of photosensitive devices. The system can also be used to find the wavelength emission of phosphors and for checking the transmission and absorption of light filters. The system is flexible enough to be used in both research and quality control work.

System Operation

Major elements of the system are shown in Fig. 1A. The units required are a power supply to operate the various light sources, a double monochromator—containing the optics, radiation detector, and an electromechanical drive to scan the spectrum—and the amplification and recording equipment. The combination of an optical system to produce radiation of high spectral purity with an electronic system to detect, amplify and record the findings, results in an accurate measurement of spectral response.

The three primary sources of light are lamps: mercury-xenon arc, hydrogen discharge and tungsten filament.

The heart of the system is the monochromator, the source or selector of the single wavelength—

or very narrow bandwidth—light. Light of the desired wavelength can be selected manually—by a micrometer adjustment—or a spectrum can be generated by driving the micrometer with an electrically operated drive mechanism. The monochromatic light is then chopped or interrupted at a frequency of 13 cps.

A reference signal—for comparison with the material being tested—is generated by allowing the 13 cps light beam to fall on a high-speed thermocouple. The thermocouple has a response that is virtually independent of the wavelength of the light. The minute signal from the thermocouple is amplified at the monochromator and further amplified at the output rack. Final

display of the information is on a recorder, as a chart of waveform versus amplitude.

Response of Phototubes

The multiplier phototube to be tested is placed in the light-tight housing indicated in the block diagram, Fig. 1A. Depending on which region of the spectrum is to be investigated, the tungsten filament or hydrogen discharge lamp is then activated. At the phototube a voltage divider network applies the stage-to-stage dynode voltages required for proper multiplication. The circuit, shown in Fig. 1B, is used for tubes with end windows from $\frac{1}{2}$ to 5 inches in diameter. Voltage of the focusing electrode is adjusted—between cathode and the first

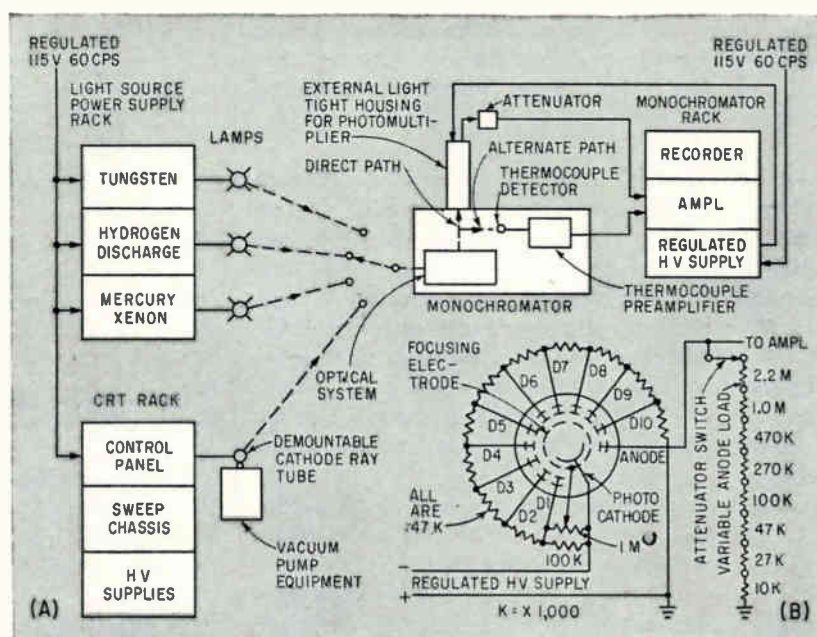

FIG. 1—Fast-acting thermocouple, with a response nearly independent of wavelength, serves as a calibrating standard for amplitude measurements (A). The adjustment between photocathode and the first dynode allows optimum phototube operation (B)

Of Electro-Optical Materials



Monochromator is at right in the photo; at left are power supplies for the lamps; recorder and amplifier are in the center

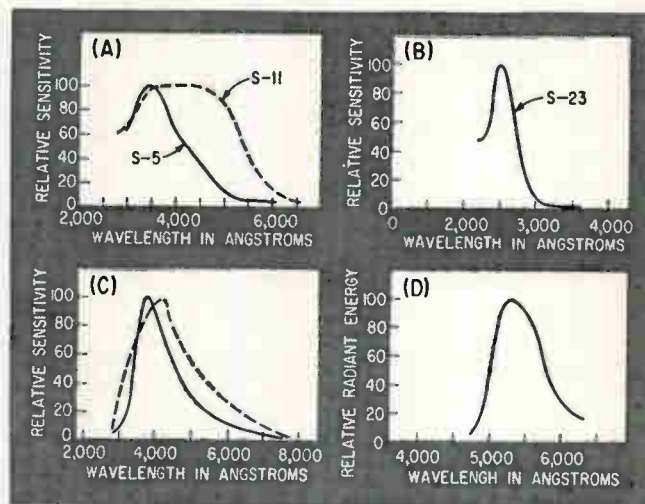

FIG. 2—In (A), the dotted line illustrates how the addition of manganese broadens the response of a ten-stage photomultiplier tube

dynode—for optimum photoelectron collection efficiency.

When placed in the light-tight housing, the end window of the photocathode surface is normal to the path of the monochromatic light. Phototube output is then fed to the amplifier-recorder through an attenuator network. The recorder plots the signal output for the selected light source. Another spectral run is then made with the thermocouple to establish a reference level for comparison.

Response Curves

The response of the multiplier phototube is divided by the response of the thermocouple detector throughout the wavelength range under study. This final curve compensates for the varying response of the light source and results in an accurate response curve of the phototube.

A typical application is shown in Fig. 2A. The solid line curve represents the S-5 spectral response curve of a ten-stage photomultiplier tube. This response was obtained by using a cesium-antimony surface in an ultraviolet transmitting envelope.

The response of another phototube is shown by the dotted curve of the same Fig. 2A. In this instance, the photocathode material is S-11, a composite surface of cesium,

antimony, and manganese. The photoemissive energy has been greatly increased by the introduction of the manganese. The peak response has broadened and shifted toward the visible range.

A rubidium-telluride photocathode S-23 surface is plotted in Fig. 2B. This photomultiplier is sensitive to ultraviolet radiation but is unaffected by visible light.

The curves shown in Fig. 2C are spectral responses of two tri-alkali surfaces. The variation in response is due to differences in the application or laydown of the photocathode surface.

Response of Phosphors

A demountable cathode-ray tube has been incorporated into the monochromator system to investigate the spectral response of cathode-ray phosphors. The faceplate of the cathode-ray tube can be removed to permit the insertion of a phosphor slide near the face of the tube. After this is done, the faceplate is replaced and the vacuum pumping equipment mounted under the demountable tube is started up.

The electronics rack required for the demountable cathode-ray tube consists of a metering and control panel, a sweep deck to provide deflection voltages and high voltage supplies for accelerating potentials.

Synchronizing signals are introduced into the sweep deck to permit a standard 525 line television raster to excite the phosphor screen. Gain and centering controls permit adjustment of raster size and position. The light output of the phosphor is then directed into the monochromator.

Since the light level of the cathode-ray phosphor is relatively low, a photomultiplier tube is used as a detector. The light energy follows the direct path to the phototube. The recorded output is then divided by the response of the phototube, which has been determined by the method outlined above. This calculation yields the spectral distribution curve of the phosphor. A curve for a P-1 phosphor is shown in Fig. 2D.

Applications

In addition to the use of the monochromator for spectral analysis of photocathode surfaces and cathode-ray tube phosphors, it has proved a valuable tool in the determination of optical filter characteristics. Accurate measurements of filter pass bands and percentage transmittance are readily accomplished.

At the present time, work is in progress which will extend the range of the monochromator system into the far ultraviolet region.

Transform Techniques

and phases equal to the resulting positive frequency spectral lines. Using this method for the transformation of the function in Fig. 1 it can be seen that the resulting time function is equal to $\cos(\omega_0 t + \theta)$. This of course is the original function.

The unfolded Fourier series is thus one class of the Fourier integral. To convert a Fourier series into the equivalent Fourier integral in the frequency domain, each term of the Fourier series is unfolded into two half-amplitude spectral lines at plus and minus the frequency (and phase) of the term. If a sine and cosine term exist in the Fourier series at the same frequency, the two should be vectorially added to obtain a single cosine term before unfolding.

In general, it is seldom necessary to evaluate the Fourier integral since it already has been evaluated for many functions.^{1, 2, 3}

The Convolution Integral

If:

$$f_0(t) = f_1(t)f_2(t); \text{ then:} \quad (5)$$

$$F_0(f) = \int_{-\infty}^{\infty} F_1(\lambda) F_2(f-\lambda) d\lambda \quad (6)$$

where $F_N(f)$ (in which $N = 0, 1, 2$) is the Fourier transform of $f_N(t)$ and λ is a dummy variable equivalent to f . The integral in Eq. 6 is called the convolution integral.

Equations 5 and 6 say in words: if a time function is equal to the product of two other time functions, its Fourier transform is equal to the convolution integral of the Fourier transforms of the other two time functions. These equations are symmetrical; that is, multiplication in the frequency domain corresponds to convolution in the time domain. However, only convolution in the frequency domain will be discussed here.

The convolution integral can in general be evaluated mathematically; however, graphical techniques offer advantages in many cases.

As an example of graphical evaluation of the convolution inte-

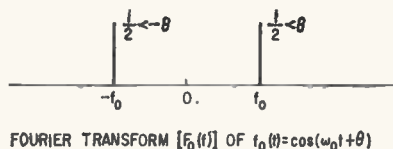

FOURIER TRANSFORM $[F_0(f)]$ OF $f_0(t) = \cos(\omega_0 t + \theta)$

FIG. 1—Spectral lines are conventionally shown with amplitudes equal to the areas of the lines; however, function itself is infinite at the frequency of the spectral lines

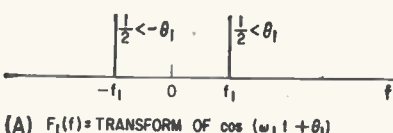

(A) $F_1(f) = \text{TRANSFORM OF } \cos(\omega_1 t + \theta_1)$

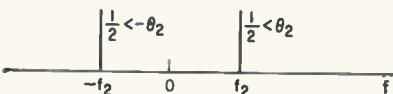

(B) $F_2(f) = \text{TRANSFORM OF } \cos(\omega_2 t + \theta_2)$

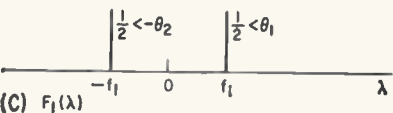

(C) $F_1(\lambda)$

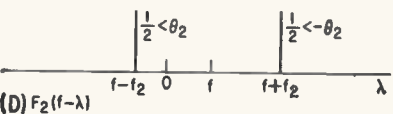

(D) $F_2(f-\lambda)$

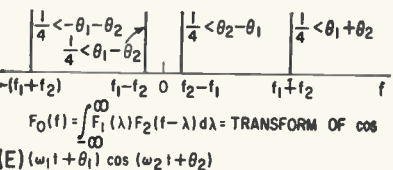

(E) $(\omega_1 + \theta_1) \cos(\omega_2 t + \theta_2)$

FIG. 2—Graphical convolution in the frequency domain

gral, consider the function:

$$f_0(t) = f_1(t)f_2(t) = \cos(\omega_1 t + \theta_1)\cos(\omega_2 t + \theta_2)$$

The equivalent Fourier transforms of $f_1(t)$ and $f_2(t)$ are plotted in Fig. 2A and 2B respectively. The problem is to obtain $F_0(f)$ using the convolution integral (Eq. 6).

In evaluating this integral, f is constant and λ a dummy variable which is equivalent to f . Thus f is assigned specific values (such as 0, f_1 , f_2 and other values) and the integral evaluated at each value of f considering it to be a constant.

$F_1(\lambda)$ is plotted in Fig. 2C. This

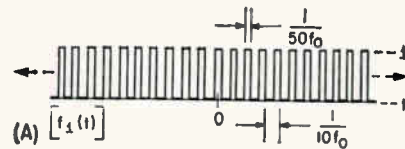

(A) $[f_1(t)]$

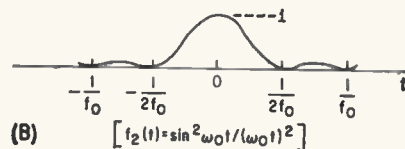

(B) $[f_2(t) = \sin^2 \omega_0 t / (\omega_0 t)^2]$

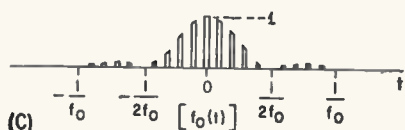

(C) $[f_0(t)]$

FIG. 3—Radar return from search-lighted target (A); dynamic antenna pattern (B); and return from scanned target for which spectrum is desired (C)

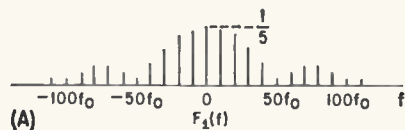

(A) $F_1(f)$

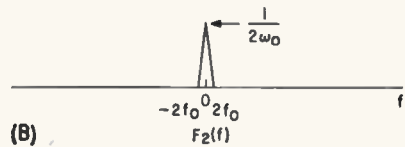

(B) $F_2(f)$

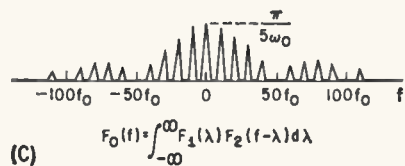

(C) $F_0(f) = \int_{-\infty}^{\infty} F_1(\lambda) F_2(f-\lambda) d\lambda$

FIG. 4—Spectra of functions of Fig. 3: transform of 3A (A); transform of 3B (B); and transform of 3C (C)

is plotted for completeness although it is not necessary since it is identical to $F_1(f)$. $F_2(f-\lambda)$ is obtained by folding $F_2(\lambda)$ about the zero frequency axis and moving the function a distance equal to the chosen f . It is plotted in Figure 2D. As an aid to remembering this step, the following procedure may be helpful. (1) Plot $f(x) = x$; (2) Plot $f(1-x) = 1-x$; (3) Note that plot 2 consists of plot 1 folded and moved one unit along the x axis.

The integral is then evaluated at discrete values of f . This is easily

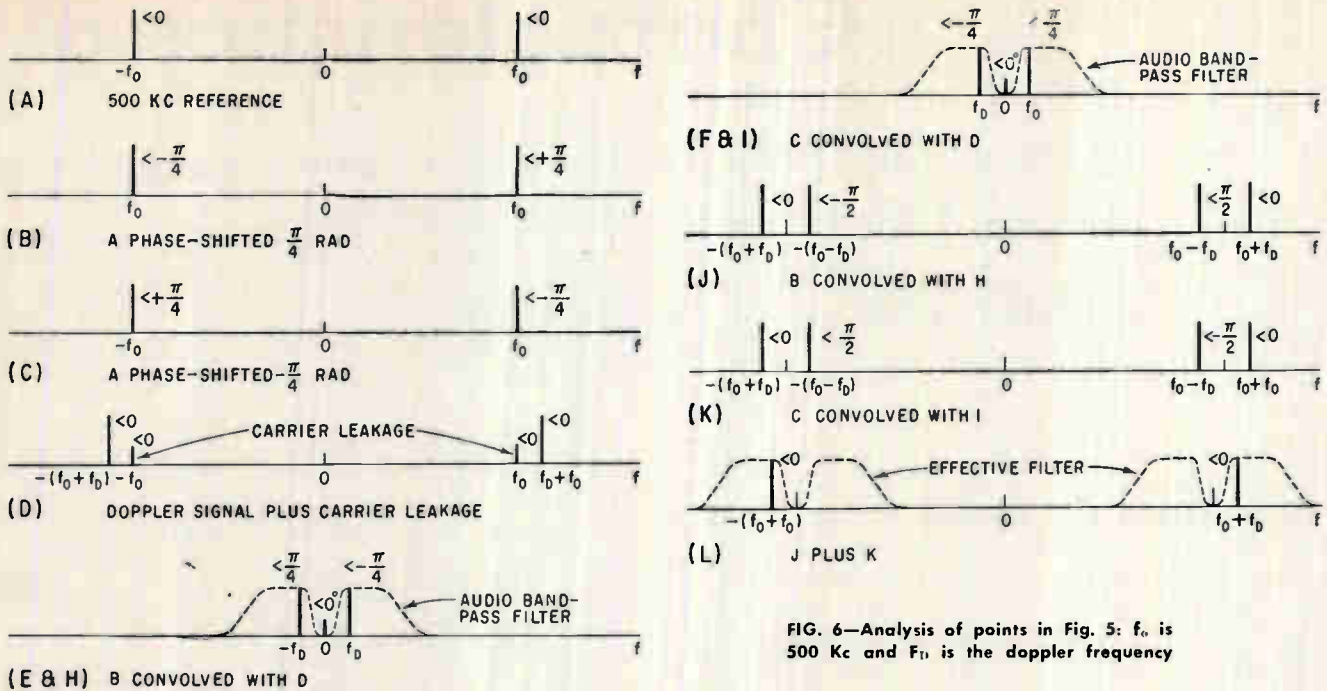

FIG. 6—Analysis of points in Fig. 5: f_0 is 500 Kc and F_D is the doppler frequency

been phase shifted $\pm\pi/4$ radians (B and C). (Convolution results in frequency terms near twice the reference frequency. However, since a filter follows which eliminates these terms, they are not shown.) The demodulated signals are then passed through an audio bandpass filter with a lower cut-off frequency of $\frac{1}{2}$ cps (H and I). It will be noted that the carrier leakage term is eliminated by these filters.

The outputs of the filters are then remodulated (convolved) with the original phase-shifted reference frequency that demodulated each channel originally (J and K). It will be noted that an extra side band occurs in each channel. If these two outputs are added vectorially (L), the unwanted sidebands cancel while the desired sidebands add. Thus the original signal is preserved while eliminating the unwanted leakage component. If other signal frequencies are considered, it will be seen that in effect the audio filter is converted into an i-f filter with the identical characteristics of the audio filter.

A clear picture of the operation of a quadrature detector can be obtained through the graphical convolution technique because of the visual-mathematical feature of this technique. The effects of unequal channel gain, non-quadrature phase shifts and other non-ideal circuit

characteristics on operation can readily be evaluated.

Some other areas where the graphical convolution technique is useful are listed below.

Modulation and remodulation (or detection) problems: The above mentioned problems are essentially in this class as are many in the radar field. Other examples are: (1) Reception of vestigial side band television signals; (2) Generation and reception of multiplexed stereo signals (fm-fm and am-am); (3) Reception of multiplexed signals in general.

Spectrum analysis: As an example of this type of problem consider the derivation of the spectrum of the function depicted in Fig. 7. This function can be considered to be the product of a pure cosine function and a rectangular waveform both of whose Fourier transforms should be well known. The answer can be found by graphically convoluting the transforms of the two functions.

Sampling problems: Effectively, sampling consists of multiplying a

function by unity for a short interval and then by zero for a longer interval and repeating this periodically. Thus graphical convolution is applicable. The sampling theorem can easily be shown by convoluting the Fourier transform of the sampling waveform with the spectrum of an arbitrary signal with varying bandwidth and noting at what bandwidth overlapping of frequencies occur. This corresponds to the bandwidth defined in the sampling theorem.

Other fields: Another field in which graphical convolution may be applied (although not in the frequency domain) is in the area of probability analysis. The probability density function of the sum of two independent quantities is equal to the convolution integral of the probability density functions of the two quantities.⁴ That is, if the quantity z is equal to the sum of quantities x and y with probability density functions of $p_1(x)$ and $p_2(y)$, respectively; then:

$$p(z) = \int_{-\infty}^{\infty} p_1(x)p_2(z-x)dx$$

which is the convolution integral.

REFERENCES

- (1) G. A. Campbell and R. M. Foster, "Fourier Integrals for Practical Applications," Van Nostrand Publ. Co., 1947.
- (2) S. Goldman, "Frequency Analysis, Modulation and Noise" McGraw-Hill Book Company, 1948.
- (3) Hewlett-Packard Journal, 5, No. 3-4, Nov.-Dec., 1953.
- (4) W. R. Bennett, Methods of Solving Noise Problems. *Proc IRE*, May 1956.



FIG. 7—Because this function can be treated as a product of a pure cosine function and a rectangular waveform, its frequency spectrum can be analyzed by graphical convolution techniques

Characteristics of

Operating principles and characteristics for thermal, photoconducting, photovoltaic and photoelectromagnetic detectors are tabulated

By **STEPHEN F. JACOBS**, Perkin-Elmer Corp., Norwalk, Connecticut*

FOUR DISTINCT TYPES of infrared detector are in general use: thermal, photoconducting (PC), photovoltaic (PV) and photoelectromagnetic (PEM). The operating principle of each is summarized in table.

In many detectors noise is reduced by cooling below room temperature. At present, these detectors have the greatest sensitivity and, in many cases, both short time constant and broad response. Unfortunately, the cooling requirements get more severe as the spectral coverage is extended to longer wavelengths.

Room-temperature thermal detectors combine broad spectral coverage with moderate sensitivity but they are slow. A PEM indium antimonide detector that has submicrosecond response time and covers the spectral region out to seven microns has been developed for room-temperature operation.

SENSITIVITY — A common basis for comparing different detectors, which relates to the properties of the detector material itself, is provided by the quantity D^* (area-normalized detectivity).¹ This factor is defined as the square root of the sensitive area divided by the noise equivalent power, and is usually expressed in units of $\text{cm} \cdot (\text{cps})^{1/2} / \text{WATT}$.

Factors that may limit detectivity are the inability to convert all the incident radiation completely into signal and the presence of excess noise. Excess noise is any type of noise above photon noise. Photon noise is caused by the inherent fluctuations in photon arrival—a process randomly distributed in time about some average rate. This noise is unavoidable and is no fault of the detector (except insofar as the detector's spectral sensitivity determines whether it sees fewer or more fluctuating photon arrivals).

When a small source appears against a d-c background at, for example, room temperature, the photons coming from the background far outnumber those coming from the source. It is then the photon fluctuations in the d-c background that limit the signal-to-noise ratio of any radiation detector. (Conceivably the source could be so big that no background is seen. Then it is the signal photon noise that ultimately limits detectivity.)

The limiting peak D^* for an ideal, photon-noise-limited photoconductor, whose long wavelength cutoff wavelength is λ_0 , is discussed by Petritz² and

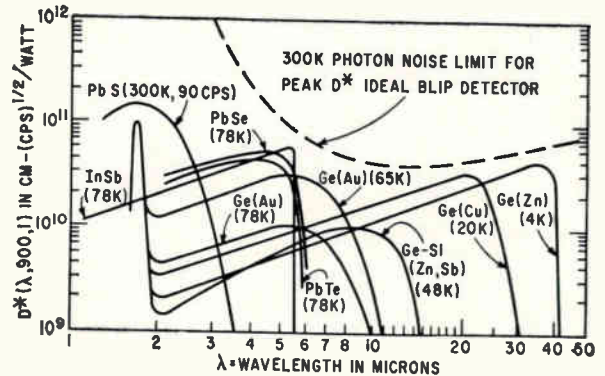

FIG. 1—Spectral responses of nine commercially-available photoconductors are compared with that of ideal background-limited infrared photoconductor

Characteristics of Thermal, Photoconducting,

Type	Primary Operating Principle
Thermal	Thermal change in resistance
	Heat transport accompanied by charge transport
	Thermal expansion of a gas
PC	Photoionization produces current carriers thereby changing electrical conductivity
PV	Photoionization produces electron-hole pairs separated by internal electric field at junction, thus establishing potential difference
PEM	As hole-electron pairs produced by photoionization diffuse into material, they are separated by external magnetic field, thus establishing potential difference

(a) λ where sensitivity falls to 50 percent max (b) Excludes intrinsic peak of Ge photoconductors (c) Approx 60-deg field of view (d) Monochromatic peak, 900-cps chopping rate, 1-cps bandpass (e) Response to 500 K blackbody, 900-cps chopping rate, 1-cps bandpass (f) Limited only by

* Now with Technical Research Group, Inc., Syosset, N. Y.

Infrared Detectors

others². The detectivity limit is given by

$$\text{Limiting photoconductor } D^*(\lambda_c) = \lambda_c / 2hc(N_B)^{1/2}$$

where N_B is the rate of arrival of background photons with wavelengths in the spectral region to which the detector is sensitive, h is Planck's constant and c is the speed of light. The factor 2 comes into the derivation through the dual random processes of generation and recombination.

In the photovoltaic and PEM cases, however, there is relatively little recombination and the corresponding detectivity limit is

$$\text{Limiting photovoltaic and PEM } D^*(\lambda_c) = \lambda_c / hc(2N_B)^{1/2}$$

This means that, in principle, it should be possible to achieve greater detectivity with photovoltaic or PEM than with photoconductive detectors.

Finally, for thermal detectors the limit is also set by the photon noise (that is, thermal fluctuations caused by photon fluctuations).

$$\text{Limiting thermal } D^* = (16\sigma kT^3)^{-1/2}$$

or about 1.8×10^{10} cm-(cps)^{1/2}/w for room temperature operation. Here σ is the Stefan-Boltzmann constant, k the Boltzmann constant and T the absolute temperature. The detector sensitive area is assumed⁴ to

be one side of a flake with surface emissivities $\epsilon_1 = 1$ and $\epsilon_2 = 0$, coupled to its surroundings purely through radiative exchange.

For any photon-noise-limited detector the greatest detectivity will be achieved by surrounding the detector with a cold chamber whose only opening is an aperture just large enough to admit the signal beam.

DETECTOR PERFORMANCE—Figure 1 shows the actual spectral response performance of a group of commercially available photoconductors. For comparison, the limiting peak D^* is also shown as a function of long wavelength cutoff. The limiting D^* is calculated assuming 300 K background and 2π (hemisphere) steradian acceptance angle. The actual performance curves are for detectors whose cooled apertures allow approximately 60-degree acceptance angles. With this restriction on the angle, the limiting D^* is increased by a factor of two over the limit shown.

REFERENCES

- (1) *Proc IRIS*, p 83, Dec. 1957.
- (2) R. L. Petritz, *Proc IRE*, 47, p 1,458, 1959.
- (3) K. M. van Vliet, *Proc IRE*, 46, p 1,004, 1958.
- (4) Smith, Jones and Chasmar, "The Detection and Measurement of Radiation", p 214, Oxford Press.

Photovoltaic and Photoelectromagnetic Infrared Detectors

Example	λ_c (microns)	Peak ^{b,c,d} $D^*(\lambda, 900, 1)$ (cm-cps ^{1/2} /W)	λ_{peak} (microns)	$D^*(500^\circ, 900, 1)$ ^{b,c,e} (cm-cps ^{1/2} /W)	Impedance (ohms)	Time Constant (μ sec)	Operating Temp (deg K)	Remarks
Thermistor bolometer	Flat energy response ^f	$1.6 \times 10^{10} \tau^{1/2}$ ($f = \frac{1}{2}\pi\tau$)	$1.6 \times 10^8 \tau$	$0.25-30 \times 10^6$	200-20,000	300	Typical
Thermocouple	Flat energy response ^f	8×10^8 ^l ($f = 13$ cps)	8×10^8 ^l ($f = 13$ cps)	1-30	~8,000	300	Selected
Golay Cell	Flat energy response ^f	4.2×10^9 ^m ($f = 13$ cps)	4.2×10^9 ^m ($f = 13$ cps)	<i>g</i>	~8,000	300	Selected
PbS	3	15×10^{10} ($f = 90$ cps)	2	7.5×10^8	$0.1-10 \times 10^6$	10-1,000	300 ^a	Typical
PbSe	6	5×10^{10}	5	1.4×10^{10}	$1-50 \times 10^6$	10-50	77 ^c	Selected
PbTe	5.5	4×10^{10}	4.5	8.1×10^9	$50-200 \times 10^6$	10-100	77	Selected
In Sb	5.5	5×10^{10}	5.5	1.1×10^{10}	$6-20 \times 10^3$	<1	77 ^c	Selected
P-type Ge(Au)	9	1×10^{10}	6	4×10^9	$0.05-5 \times 10^6$	<1	77 ^j	Selected
Ge-Si(Zn, Sb)	14	1×10^{10}	10	5.2×10^9	$50-100 \times 10^6$	<1	48	Typical
Ge(Cu)	30	3×10^{10}	20	1.4×10^{10}	$\sim 100 \times 10^3$	<1	20	Selected
Ge(Zn)	40	4×10^{10}	37	1.1×10^{10}	$0.3-30 \times 10^6$	<0.01	4	Selected
InSb	5.5	6×10^{10}	5.4	1.2×10^{10}	50-1,500	<1	77	Selected ^k
InAs	3.7	7.5×10^9	3.6	1×10^9	30-250	<2	300	Selected ^k
InSb	7	1.0×10^8	6.5	5×10^7	5-40	<1	300	Typical ^k

blackness of coating (g) Golay cell converts radiant energy into mirror motion; impedance is that of photocell used to monitor motion (h) Lowering temp extends cutoff farther into IR (at 77 K, cutoff is 4 microns); peak D^* relatively unaffected; time constant (τ) and impedance increased (i)

Operates at 300 K with shorter τ , smaller impedance, reduced D^* (j) At optimum temp of 65 K, sensitivity and impedance are 3 and 10 times greater, respectively (k) Transformer-coupled, no bias required (l) Extrapolated from 0.004 cm² area (m) Extrapolated from 0.179 cm² area

Mass Spectrometer Tests Tightness of Seals

Production-line leak-detecting mass spectrometer is usable in electron-tube manufacturing. Unit achieves high precision with two magnetic analyzers in series. It determines leak size by measuring quantity of helium escaping

By J. L. PETERS, Crosby-Teletronics Corp., Vacuum Research Division, Syosset, New York

IN recent years, mass spectrometry has developed from a field of limited application in the laboratory to one of wide-spread use in many phases of electronics, chemistry, geology, biology and medicine. Its industrial uses include process control, routine chemical analysis, and detecting and locating leaks in vacuum, pressure, or hermetically sealed devices and components. The Manhattan Project, in the last war, saw the dramatic introduction of the mass spectrometer as a leak detector with tremendous savings in time, skilled manpower and materials.

The mass spectrometer is basically an instrument which continuously separates ions of a specific element from a nonhomogeneous stream of ions, in a manner similar to the separation of light into its component colors by a prism. It analyzes, separates or sorts positive ions of different atomic weights.

Operation

Figures 1A and 1B show operational schematic diagrams of a typical mass spectrometer leak detector. The component under test is evacuated to a pressure of about 50 microns (0.05 mm Hg) and at this pressure it is disconnected from the auxiliary vacuum pump. Next, the component is connected to the spectrometer ready for the actual test. (Both connection to the auxiliary vacuum pump and spec-

trometer are accomplished by airtight valves.)

If, when the evacuated component is connected to the spectrometer, a source of helium gas is applied to the component's outside surface, leaks that are present will permit the ingress of some of the helium. Since the component is now connected to the spectrometer (which is permanently evacuated) the helium will disperse throughout the volume available to it—which includes the spectrometer ionization chamber—and become ionized. Once ionized, the helium will be urged by electrostatic fields through the spectrometer resolving system where it is detected at the spectrometer output collector.

Should it be undesirable to evacuate the component, it can be filled with helium under pressure, with alternative means as shown in Figs. 1C and 1D to detect escaping helium.

In both the above cases, the principle of mass separation is used to distinguish between helium and other gases that may be present. The basic apparatus is shown in Fig. 2. Gases from the evacuated equipment being tested are communicated to the spectrometer, where they are ionized by an electron beam. The resulting ions are accelerated by an electrostatic field and then passed between the pole pieces of the analyzer magnet. The effect of the magnetic field of the analyzer magnet is to bend the

beam of ions into a circular path.

The radius of each ion path is related to the mass of the ion, so that ions heavier and lighter than helium will travel in wider or narrower arcs, respectively. Baffles are placed so that only ions of a particular mass (helium) are accepted; the remaining ions are intercepted by these baffles or by the inner walls of the equipment and do not reach the ion detecting apparatus. The radius of the ion orbit is also a function of the accelerating voltage. Thus, by varying the accelerating voltage, the orbit of any particular ion type may be adjusted so that that particular ion reaches the ion-collector.

Ideal Performance

Figure 3 shows the ideal relation between accelerating voltage and collection of ions. In this graph, the helium ions are shown as arriving at a discrete value of accelerating voltage. In practice, the curve is flattened due to ion collision and to the presence of other types of ions inadvertently collected.

On hitting the collector plate, the ions give up their charge through a high value resistor (10^{11} ohms) and the signal so developed provides the input to a following amplifier. Amplifier output is proportional to the number of helium ions hitting the collector plate, and is therefore a measure of the size of the leak.

Output of the leak detector

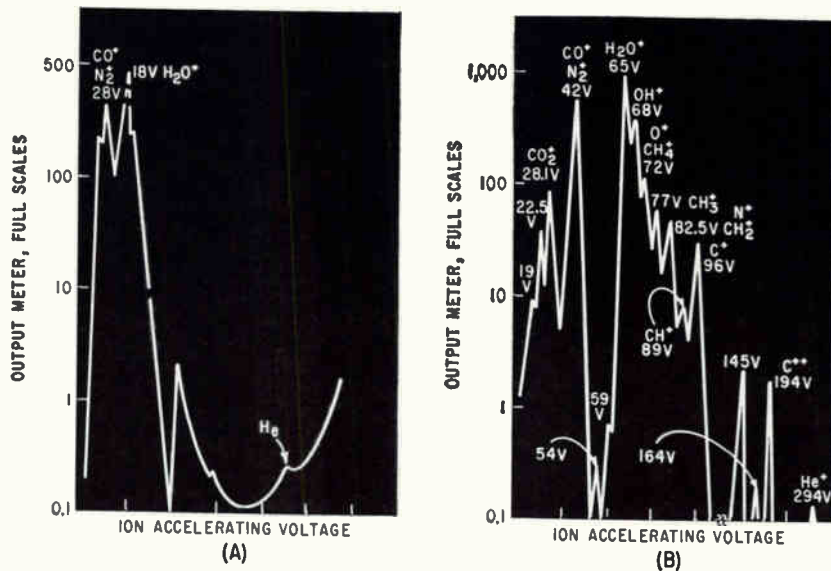

FIG. 4—Resolution obtained by single-stage spectrometer (A) is surpassed by resolution of twin-stage spectrometer (B)

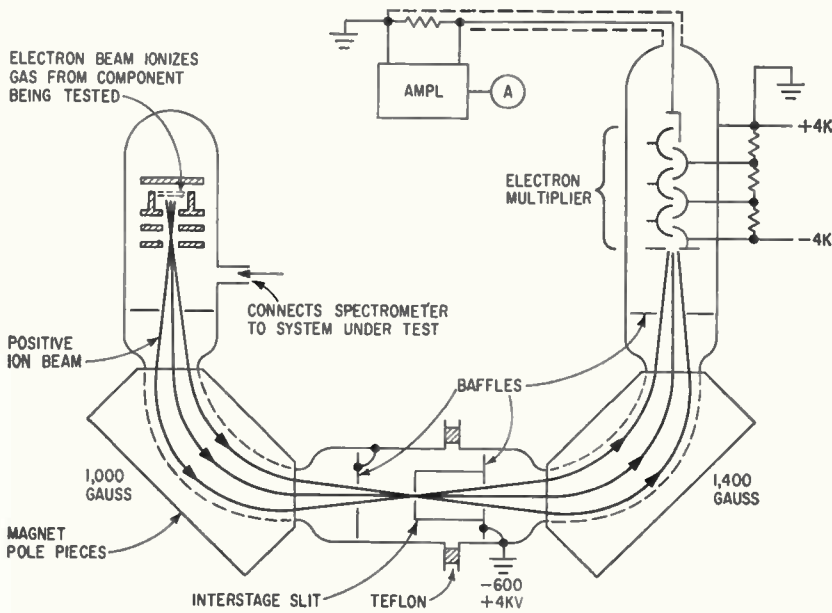

FIG. 5—After the first stage of separation, the ions are accelerated and then passed through a second analyzer for greatly improved resolution

gas scattering in the first spectrometer are resolved into separate peaks by the second analyzer. Also, those ions which had corresponding momentum, although their masses were different and consequently formed a spurious single peak in the first analyzer, will be separated into discrete peaks in the second analyzer. Another feature in addition to the two analyzers is the interstage slit where all ions are accelerated. This acceleration tends to bring about improved separation of different peaks in the spectrometer output because acceleration adds different amounts of momentum to

ions of different masses. This action separates the false peaks and refocuses the scattered ions.

The reduction in background realized with this improved instrument is so great (three orders of magnitude) that a specially designed electron multiplier is advantageously employed as the ion detector. The multiplier has a first dynode which provides nearly 100-percent conversion efficiency of bombarding positive ions to secondary electrons. The secondary electrons from the first dynode are focused and multiplied in the remaining stages of the multiplier

and provide the input signal for the high stability negative feedback amplifier. The amplifier section features a CK5886 electrometer tube in the input stage followed by a high stability d-c amplifier with cathode follower output to the indicating meter.

Fig 4A shows the output signal from a standard leak detector when it was operated as an analytical instrument. Output is plotted against ion acceleration voltage. Helium, water vapor and the mass 28 peak, which may be due to both carbon monoxide and nitrogen, are shown, Fig 4B shows considerably more detail due to sharper resolution of individual peaks obtained on using the improved leak detector for analysis. The same slit widths were used in both cases.

Industrial Use

One of the causes of vacuum tube failure results from insufficient sensitivity of present day leak detection equipment. For example: if a small power tube (of 100cc volume) passes a test for tightness on any standard leak detector (sensitivity 10^{-10} cubic centimeter per second at standard temperature and pressure) the tube may nevertheless become inoperative in less than a week from undetectably small leaks. See Fig. 6. This assumes an end point pressure of 10^{-4} mm Hg. By comparison, similar tubes tested on equipment having a sensitivity of 10^{-13} cubic centimeter a second at standard temperature and pressure are assured a shelf life of more than 10 years.

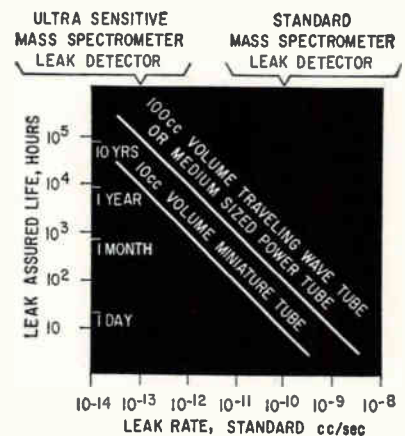

FIG. 6—Graph shows how an ultrasensitive leak detector can locate the vacuum tubes that will take years to become faulty

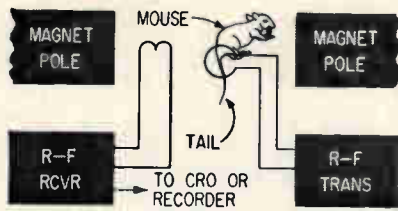

FIG. 1—Measuring blood flow rate in a mouse tail by nuclear resonance

nance is $f = 4.26 H$ where f is in Mc and H is in kilo-oersteds. Early experiments used a 14 kilo-oersted field and a 60-Mc frequency. Future experiments are planned using a 3,000-oersted field. Lower frequencies do not provide as good a signal-to-noise ratio but does simplify the problem of obtaining homogeneous magnetic fields over large volumes.

Flow Rate Studies

Early studies of flow rates^{3,4} utilized the following procedure. A mechanical pump having a known (and variable) pumping rate circulated water through plastic tubing. A portion of the tubing was in a magnetic field H and perpendicular to another coil as in the Singer and Johnson apparatus⁵.

By providing r-f energy of the appropriate frequency and intensity, the resonance absorption signal was saturated.

After time T_1 , which is a characteristic of the material, the absorption signal may be observed to be about two-thirds of its maximum value.

Since the observed substance is flowing away from the observational point, the characteristic time T_1 is shortened by the inflow of fluid with unsaturated nuclei. Hence the difference between the time T_1 measured with a static fluid and the observed time of relaxation when the fluid is flowing is a measure of the flow of the fluid.

Equipment

The method is applicable to oils and most other fluids in addition to water.

The equipment needed is a good magnet or solenoid, an r-f transmitter and receiver and an oscilloscope or recorder for observing the resonances and measuring the relaxation times. The observation does

not disturb the flow of the fluid, but the observation is simplest if the pipe or tube is made of a non-ferromagnetic material preferably non-metallic. This simple system for measuring oil flow rates without breaking the pump lines is also readily applicable to chemical processing plants where monitoring and control of fluid flows is important.

A modification of this system allows measuring the velocity of blood flow in the tails of mice as shown in Fig. 1. The r-f absorption decreases with increased signal strength in a given sample. The rate of decrease is well known quan-

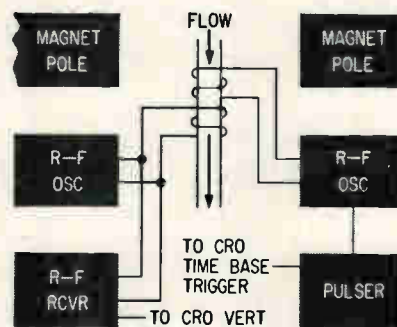

FIG. 2—Improved flow meter presently under development

tatively and is described by a saturation factor. However, if the sample flows through the observation region, the partially saturated nuclei are replaced by unsaturated nuclei; hence the r-f absorption is greater for flowing fluids than static ones, and the relative absorption under certain conditions can be described by a simple equation². The flow velocity may then be determined by using the relationship $v = L(A_s - A)/AT_1$ where v is the average flow velocity, L is the length of fluid in the r-f field, A is the amplitude of the r-f absorption without flow and A_s is the amplitude with flow. Thus flow velocity in a mouse tail is readily measured by determining the amplitude of r-f absorption when the flow is stopped with a tourniquet and the amplitude without the tourniquet. In addition, it is necessary to measure T_1 , which is a simple procedure². For mice blood in vivo the protons have a relaxation time of approximately four tenths of a second.

Present efforts are directed towards an improved system of flow measurement with the prospect of monitoring human blood flow velocities. The improved design is shown in Fig. 2. Here the nuclei are inverted (or saturated) at one point and observed at another point downstream. The flow velocity is found by noting the time between the disturbed pulse and the time when the r-f absorption is decreased.

The distance between the coils is divided by the observed time to give the flow velocity directly.

Methods Used

The general philosophy utilized is to induce a tracer (in this case, inverted water protons) into the blood (or other fluid) for a time T_1 which is characteristic of the fluid.

The tracer may be detected downstream at a later time and thus the flow velocity is ascertained. The above may be termed a short-time tracer.

If a flow path is to be investigated over a longer time, the injection of specific nuclei with a significant and unusual nuclear resonance spectrum is recommended.

Such substances are common and harmless and provide a useful tracers for flow velocities and channel determination. A multitude of such tracer materials is readily available.

It would appear that many of the tasks now being performed by radioactive tracers can be done more easily with nuclear paramagnetic substances or even with electron paramagnetic materials by using a different frequency.³

REFERENCES

- (1) F. Bloch, W. Hansen and M. Packard, Nuclear Induction Experiment, *Physical Review*, 70, p 460, Oct. 1, 1946.
- (2) N. Bloembergen, M. Purcell and R. V. Pound, Relaxation Effects in NMR Absorption, *Physical Review*, 73, p 679, April 1, 1948.
- (3) J. R. Singer, Flow Rates Using Nuclear or Electron Paramagnetic Resonance Techniques with Applications to Biological and Chemical Processes, *Journal of Applied Physics*, 31, p 125, Jan. 1960.
- (4) J. R. Singer, Blood Flow Rates by Nuclear Magnetic Resonance Measurements, *Science*, 130, p 1652, Dec. 11, 1959.
- (5) J. R. Singer and S. Johnson, Transistorized Nuclear Magnetic Resonance Field Probe, *Rev of Scientific Instruments*, 30, p 92, Feb. 1959.

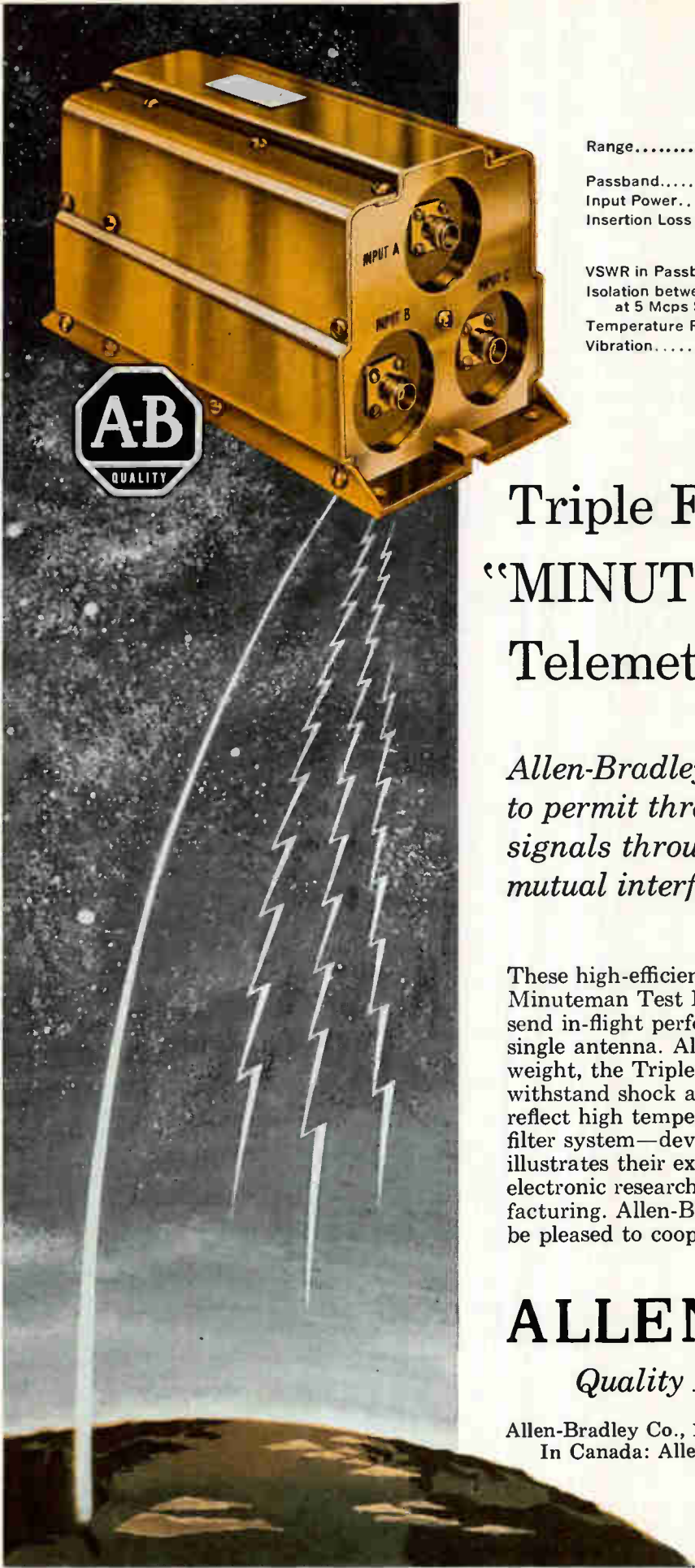

SPECIFICATIONS

Range.....	Telemetry Band (216—260 Mcps)
Passband.....	±0.300 Mcps
Input Power.....	50 Watts max
Insertion Loss in Passband.....	≤1.25 DB at 125°C ≤1.15 DB at room temperature
VSWR in Passband.....	≤1.20
Isolation between Adjacent Channels at 5 Mcps Spacing.....	≥20 DB
Temperature Range.....	-65°C to +125°C
Vibration.....	For use in guided missiles; meets mili- tary vibration specs

Other power levels and higher frequency ranges can also be provided.

Triple Filter for "MINUTEMAN" Missile Telemetry System

Allen-Bradley Triplexer is designed to permit three simultaneous telemetry signals through one antenna without mutual interference.

These high-efficiency triple filters—employed in the Minuteman Test Program—enable three transmitters to send in-flight performance data simultaneously from a single antenna. Although extremely compact and light in weight, the Triplexer is ruggedly constructed to withstand shock and vibration—and it is gold plated to reflect high temperatures. This highly sophisticated filter system—developed and built by Allen-Bradley—illustrates their extensive experience in advanced electronic research, and capabilities in precision manufacturing. Allen-Bradley scientists and engineers will be pleased to cooperate in solving your problems.

ALLEN - BRADLEY

Quality Electronic Components

Allen-Bradley Co., 110 W. Greenfield Ave., Milwaukee 4, Wis.
In Canada: Allen-Bradley Canada Ltd., Galt, Ontario

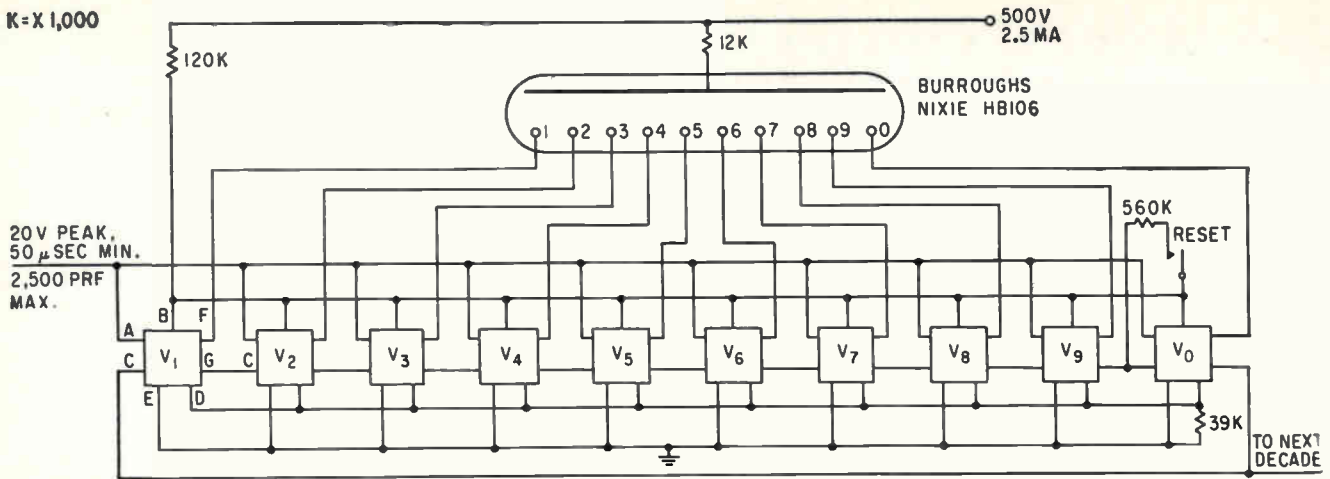

FIG. 1—Count registered in the ring counter is displayed as a numeral by Nixie tube

Cold-Cathode Ring-Counter Drives Numerical Indicator

Gas tubes in both indicator and counter circuits for medium-speed applications provide reliable operation at economical power consumption

By P. G. HODGSON, Radio and Electrical Engineering Division, National Research Council, Ottawa, Canada

IT IS USUAL to drive numerical indicator tubes with thermionic tubes or transistors. The transistors used for this application are usually expensive because of the high voltage rating needed. Cold-cathode trigger tubes, when used for low and medium-speed logic operations, have some advantages over both thermionic tubes and transistors. They are inexpensive compared with most thermionic tubes and transistors, and since there are no heaters, no warm-up time is necessary. Heat dissipation is not usually a problem since power consumption is low. In each decade of a trigger tube counter, only one tube conducts at a time, with a consumption of about 1.25 watts. Furthermore, trigger tubes are rugged and have a long life¹.

Circuit Operation

The ring counter described uses Philips Z70U trigger tubes in a decade counter with a maximum

speed of 2,500 pps. The readout display is on a Burroughs Nixie HB106. Other types of trigger tubes and numerical indicators are available commercially and could probably be used in a similar circuit.

Operation of the trigger tube

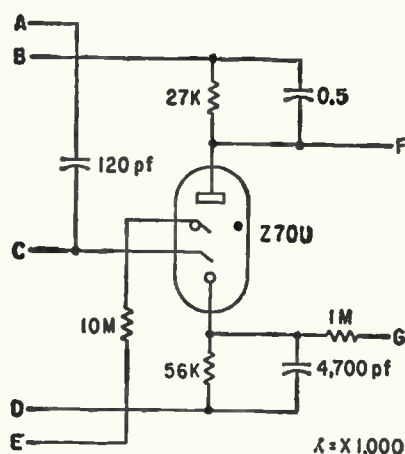

FIG. 2—Single stage of ring counter. Bias developed at cathode is fed by way of G to prime following stage

ring counter is well known², and depends upon the conducting tube to prepare the following tube for advance of count, which occurs with each positive input.

In this case a conducting tube produces a voltage-drop across its load resistor causing the appropriate section of the indicator tube to ignite. Conversely, when the trigger tube extinguishes due to the advance of count, that section of the indicator tube also extinguishes.

The Nixie tube has relatively long ionization and de-ionization times which would normally limit the speed of counting. However, the 0.5-μf capacitor across each trigger tube load resistor enables the counter to switch at higher speeds without being affected by the indicator tube parameters.

REFERENCES

1. C. D. Florida and R. Williamson, A Cold-Cathode Scaling Unit, *Electronic Eng.* 26, No. 315 p 186, 1954.
2. "Tubes for Computers," *Electronic Tubes Book 12*, Philips Technical Library, p 46, 1956.

Strobe Displays High-Speed Pulses

ELECTRICAL stroboscope has rise time of about 10^{-10} sec and overall sensitivity of 3 mv/cm. It was described by W. M. Goodall and A. F. Dietrich of Bell Telephone Laboratories at the National Symposium of the Professional Group on Microwave Theory and Techniques of the IRE.

Operation

In Fig. 1, the gate blocks input except when it is opened by a strobe pulse. If strobe prf were equal to signal prf, filter output would be d-c of signal amplitude. However, strobe frequency is lower than signal frequency by a small constant amount, δ . After one cycle of δ frequency, one complete high-frequency wave has been scanned.

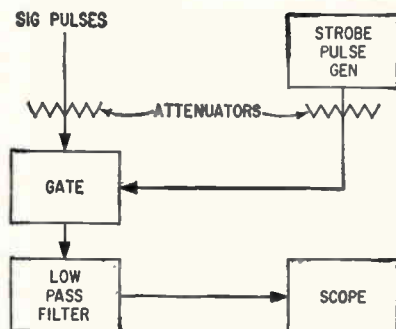

FIG. 1—Basic strobe circuit passes signal amplitudes only when a strobe pulse is applied to gate

The wave has been effectively slowed by the ratio δ/f , where f is recurrent signal frequency. Theoretical filter cut-off is $f/2$, which is an upper limit. If the high-frequency signal requires a band of nf , where n is number of harmonics of recurrent frequency, $n\delta < f/2$. Thus it can be ensured that the number of harmonics required to represent the slowed signal will be transmitted by the low-pass filter.

Experimental work required an oscilloscope to display pulses of about 3×10^{-10} sec. Signal pulses repeated regularly and pulse groups repeated at 10 Mc (determined by a crystal oscillator). The strobe pulse was generated from a second

crystal oscillator. One-hundred cycles was chosen for δ when f is 10 Mc. Because the oscilloscope has a 300-Kc band, its transmission is limited at 10 Mc requiring only a simple low-pass filter. The two critical broadband elements are the strobe pulse generator and the gate.

High-amplitude sine waves are clipped to generate the short timing pulses. The 10-Mc strobe frequency is multiplied in a series of harmonic generators to 320 Mc. A 320-Mc sine wave is applied to the grid of a special ceramic tetrode. Negative pulses with half-amplitude duration of 3 nsec and 10-Mc prf (controlled by the strobe oscillator) are applied to the cathode of the tetrode. Delays are adjusted so that each 10-Mc pulse occurs at positive maximum of one of the sine-wave cycles.

Proper negative grid bias causes the tetrode to act as an AND gate, conducting only when pulse and positive maximum occur simultaneously. One of every 32 sine-wave cycles produces an output. A train of pulses occurs at the plate at a

10-Mc rate with half-amplitude duration less than 3×10^{-10} sec.

The gate uses a gallium arsenide point contact rectifier mounted between inner and outer conductors of a 50-ohm coaxial line. A capacitor between the ground side of the crystal and the outer conductor presents low impedance to strobe and signal frequency harmonics and high impedance to gate output. This capacitor and the shunt resistance in the gate output form a low-pass filter.

The gate functions as a peak detector and low-pass filter output is the envelope of the product of the strobe and signal pulses. When this gate is used in the stroboscope, signal power is dissipated in an attenuator between the gate and the strobe pulse generator, while strobe pulser power is dissipated in an attenuator in the signal input branch.

The wideband performance of the gallium arsenide crystal adds clipping of the strobe pulse in the gate, and the effective strobe pulse is even shorter than provided by the strobe pulse generator.

Hemispherical Antenna Reflector

GENERAL purpose radio telescopes usually use steerable parabolic reflectors. For operation at the hydrogen line (1,420 Mc) the parabola must not deviate from its theoretical shape by more than one inch.

With the large parabolas being built, maintaining sufficient rigidity is a difficult problem.¹ A. K. Head, Commonwealth Scientific and Industrial Research Organization, University of Melbourne, describes a possible solution.² He investigated alternate focusing systems that might be simpler and cheaper to fabricate.

Two-Reflector System

The main distortion of a parabolic reflector is the changing sag under its own weight as it is moved. The proposed system reduces this

effect by using two reflectors: a large fixed hemisphere and a small movable barrel-shaped reflector. An incoming signal from a direction parallel to the axis of the barrel is reflected by part of the hemisphere into the barrel, which reflects it into the final focus. To receive a signal from another direction it is only necessary to rotate the barrel about the center of the hemisphere, another portion of which is then used.

In Fig. 1 a ray through the system is shown. To produce a point focus from a parallel incident beam, the second mirror must have the shape given by the following parametric equations in which ρ and ϕ are polar coordinates of the mirror about focus F : $\phi = 2\theta + 2 \arctan f(\theta)$ and $\rho = \frac{1}{2}R(\sin \theta - C \sin 2\theta)[f(\theta) + 1/f(\theta)]$, where $f(\theta) = (\sin$

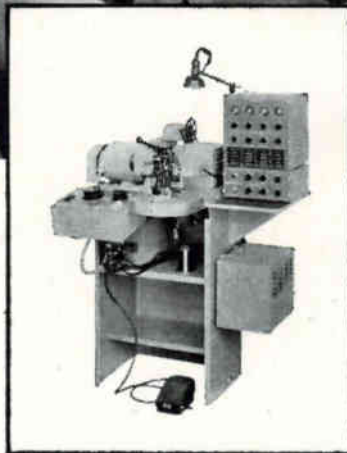
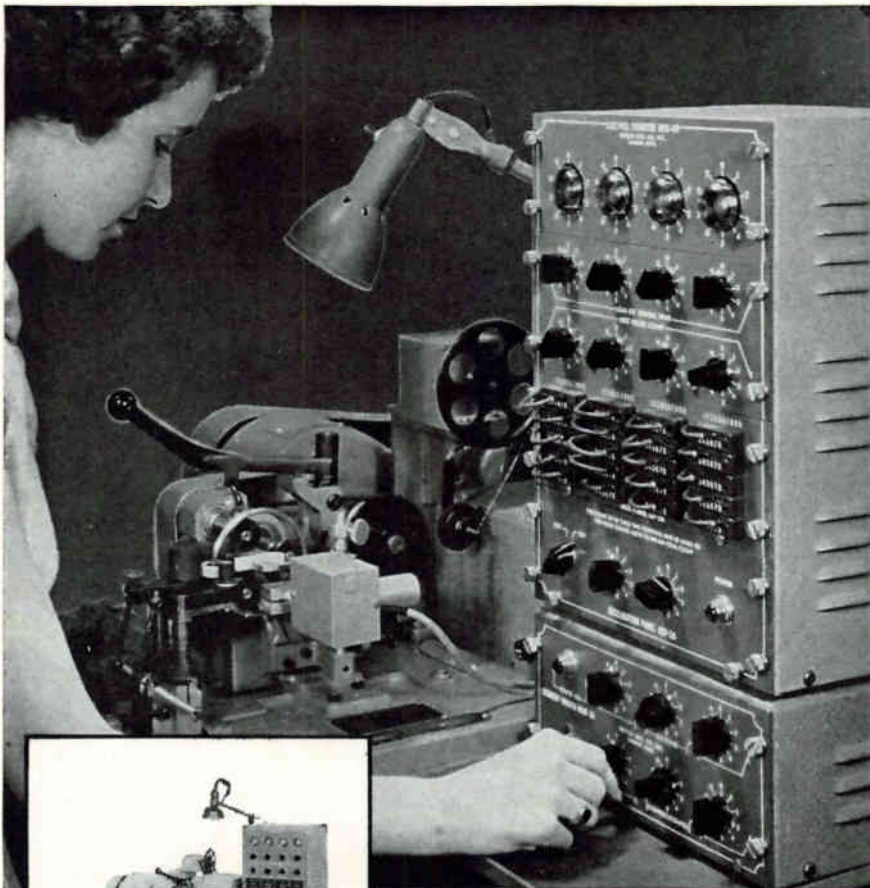

BOESCH

*electronically
controlled
toroidal winder*

- *speeds up to 2000 turns per minute*
- *4-digit, 2- or 7- position predetermined counting*

The entirely NEW electronic system of the TW 300 provides unmatched features in a toroidal winder . . . proximity pick-up for use with any size wire without physical contact . . . 100% accurate turns counting . . . controlled slow-start, slow-stop driving motor . . . automatic segmental winding with perfect repeatability . . . progressive winding of segments or continuous coils in either direction.

The TW 300, designed for easy servicing and maintenance, cuts production time and operator fatigue to the bone. Flexibility in production of new coil types with superior electrical characteristics is unlimited because of the new control system with automatic winding features. This machine is a significant advance toward complete automation of toroidal winding.

WRITE FOR COMPLETE DATA



**BOESCH MANUFACTURING
COMPANY, INCORPORATED
DANBURY, CONNECTICUT**

$\theta = C \sin 2\theta / (K - 2 \cos \theta + C \cos 2\theta)$, θ is a parameter, R is radius of hemisphere, CR is distance of focus from center of hemisphere and K is an adjustable constant.

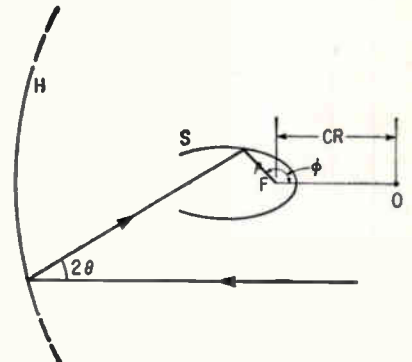

FIG. 1—Parallel incident beam reflected by hemisphere (H) to second reflector (S) comes to point focus (F). Center of hemisphere is (O)

A model radio telescope designed on this principle has angular coverage of 60 degrees down from vertical in any direction and operating wavelength from 21 cm to 3 meters. The spherical 250-ft reflector is partly sunk in the ground as an alternative to building a complete hemisphere. Only a section of that part of the hemisphere above ground is constructed, but that part can be moved on a circular track as needed. This arrangement is possible since only a circular area of the hemisphere is in use at any one time.

Performance

Colleagues of Head considered design of a suitable feed. Preliminary results include a gain factor of 71 percent and first side lobes of 13 percent amplitude compared with the main lobe. Other side lobes are negligible, and it is probable that amplitude of the first side lobe can be reduced.

They have also shown that for wavelengths longer than 3 meters, diffraction in the mouth of the second mirror may modify calculated performance. However at 3 meters or longer the spherical reflector is a sufficiently close approximation to a parabola for operation with 250 ft diameter. Thus a suitable feed placed at the mouth of the second mirror extends operating range to longer wavelengths.

Gain and side lobes are similar to

those of a parabola and both can operate over the same wavelengths. This system also provides good shielding of the focus from interference and an equatorial mount can easily be provided. A disadvantage is that, in correcting spherical aberration, the second mirror introduces coma, so that operating with a displaced feed is impracticable.

REFERENCES

- (1) Noises From Outer Space, *ELECTRONICS*, 32, p 46, October 23, 1959.
 (2) A. K. Head, A New Form For A Giant Radio Telescope, *Nature*, 179, p 692, April 6, 1957.

Indicator to Direct Astronaut Return

REVOLVING globe of the world may help astronauts to return safely to earth. Called an Earth Path Indicator, it will show where an orbiting capsule is over the earth.

Developed by Minneapolis-Honeywell Regulator Co., it could be the prime source of position information for landing if the astronaut loses contact with ground tracking stations. Capsule position becomes critical when the rockets are fired that will return it to earth. The capsule is designed to land safely in water, but a miscalculation of position could cause it to hit land.

The globe is viewed through a window on the instrument panel. Globe markings show longitude, latitude, continents, topography and major cities. A sight on the window pinpoints capsule location over the earth, and other markings show the spot where the capsule would land if ejected from orbit.

The indicator will be set by the astronaut after he reaches orbit, using information relayed to him from ground tracking stations. Four adjustments correspond to capsule orbit and speed. The globe revolves around a north-south axis like the earth; at the same time it revolves around a second axis that duplicates capsule travel. Resolution of the two movements indicates capsule position.

The device will supplement electronic navigation equipment on the ground and in the space capsule. It is mechanically powered to operate independently of the capsule electrical system.



A fascinating project at Martin-Denver and one which offers to the truly creative engineer or scientist a personal esteem and professional recognition unequalled in today's opportunities. Please do consider being a part of this or other creative involvements at Martin-Denver and inquire of N. M. Pagan, Director of Technical and Scientific Staffing, (Dept. JJ 4), The Martin Company, P. O. Box 179, Denver 1, Colorado.

MARTIN
DENVER DIVISION

MARTIN-DESIGNED CIRCULAR SPACE COMPUTERS ARE AVAILABLE FREE TO INTERESTED PERSONS BY WRITING TO THE SAME ADDRESS.

Mesa's Push for Power and Speed

A TRANSISTOR DEVELOPMENT program at Pacific Semiconductors, Inc., Culver City, California, was planned to investigate a 10, 20, 50, and 100 amp series of silicon power units. The mesa construction was used. This work was sponsored under contract AF (600)-35088 and monitored by the Electrical Technology Laboratory of Wright Air Development Division and resulted in the recent delivery of sample units of the transistor to the Air Force.

Samples for Industry

The 10-ampere model is now in pilot production, and PSI is ready to supply electronics men with engineering samples for circuit development. According to Mason Clark, head of the PSI Development Department, the 20, 50 and 100 ampere models require further process development before manufacturing plans are initiated.

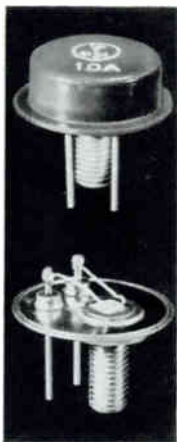

Fast and powerful

Engineering samples of the 10-amp transistors now available, types PT900 and PT901, are designed for high-frequency, or fast switching applications. These units are characterized by a power dissipation of 125 watts at 25 C case temperatures; 50-Mc alpha cut-off frequency; 10-amp continuous collector current and 0.2-ohm saturation resistance.

The low-frequency, large-signal power gain as an amplifier is greater than 20 db. One kilowatt can be switched with an input power less than three watts.

High temperature, triple diffusion of donors and acceptors form the emitter, base and collector regions. With the layer of original material, these are four-region transistors but are not to be confused with the four-region pnpn de-

Table I—Characteristics of the New Power Transistors (25 C)

Symbol	Characteristics	Test Conditions	Typical	Max
I_{cbo}	Collector Cut Off Curr	$V_{cb} = 10v, I_E = 0$ $V_{cb} = 60v, I_E = 0$	10 ma 40 ma	30 ma 120 ma
$V_{BE SAT}$	Base Saturation	$I_C = 10a, I_B = 1a$		2.5
$V_{CE SAT}$	Collector Saturation	$I_C = 10a, I_B = 1a$		2
h_{FE}	D-c Current Gain, min	$V_{CE} = 2v, I_C = 10a$	10	
h_{fe}^*	Small Signal Current Gain	$V_{CE} = 10v, I_C = 3a$	3	
h_{ie}^*	Short Circuit In Imped	$V_{CE} = 10v, I_C = 3a$	5 ohm	
h_{oe}^*	Open Circuit Out Admit	$V_{CE} = 10v, I_C = 3a$	$2-j60)10^{-8}$ mho	
$f_{\alpha b}$	Alpha Cut Off Freq	$V_{CE} = 10v, I_C = 3a$	50 Mc	
C_{ob}	Collector Cap	$V_{CE} = 10v, I_E = 0$	0.001 μF	

* Measured at 10 Mc

vices. The diffused structure is N+-P-N-N+.

The emitter and base regions are designed with an interdigitated structure shaped like a comb. This comb structure gives a junction edge that is one meter long—the length necessary to attain the required characteristics.

Where They Will Be Used

Commercial demand for these high-power units point up many possible applications. They will be used in power converters and inverters operating at frequencies as high as one megacycle with reduction in weight and size as compared to present low-frequency converters. But there will be other uses: radar pulse generation, high-power

video amplifiers, core drivers for computers, ultrasonic generators, and compact r-f generators for induction heating. They will be used for communications systems, radio transmitters, marine and aircraft distress signaling, and in fast-response power-supply regulation.

At this date, PSI has no manufacturing plans for the other units. The 20-amp Air Force model is characterized by 300 watts dissipation, 25 Mc amplification and 0.1 μ sec switching. The 50-amp Air Force model has 750 watts dissipation and 20 Mc amplification with a switching time of 0.2 μ sec. The 100-amp Air Force model has a range of 1,500 watts dissipation and a 0.2 μ sec switch for 20 Mc.

Emitter and base combs of all

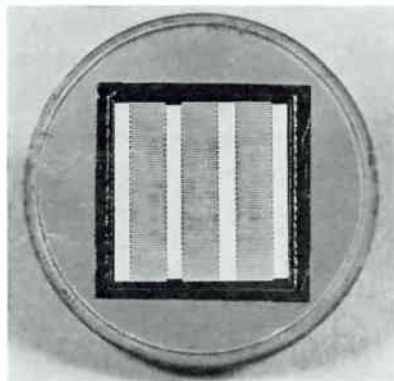

Comb structure between emitter and base gives a meter-long edge

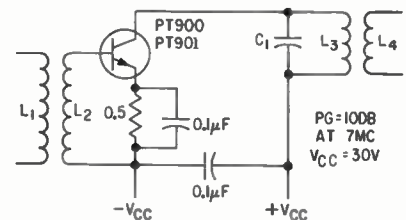

f (MC)	L ₁ (μ H)	L ₂ (μ H)	L ₃ (μ H)	L ₄ (μ H)	C ₁ (μ F)
7	*	0.1	0.085	2.2	0.0070
10	*	0.1	0.075	1.2	0.0033

* AS REQUIRED FOR IMPEDANCE MATCHING

f (MC)	P ₀ (R _T =2°C/W)	P ₀ (R _T =1°C/W)	EFF (%)
10	20W	42W	30
7	65W	125W	50

FIG. 1—Circuit with values shows how the new high-power, high-frequency mesa transistors can be hooked up as an r-f amplifier for class C service

DAPON® SERVES COMMUNICATION



DAPON (diallyl phthalate) RESIN GIVES A LIFETIME SHRINKAGE VALUE OF .001 IN THIS AMPHENOL CONNECTOR

This connector routes many circuits in the Bell System's multi-line "Call Director" at a great saving of space and weight.

About the size of a cigarette lighter, an Amphenol-Borg Electronic Corporation connector is used in the Bell System's "Call Director." This versatile telephone can handle as many as 29 outside lines or extensions. The working members of this connector are fifty gold plated bronze contacts held firmly in a body molded from DAPON (diallyl phthalate) Resin.

Chosen by Amphenol for this application because of its dimensional stability and insulating properties, DAPON's superior moldability accommodates the thick and very thin sections and lateral cavities of the connector's body. DAPON molds easily around metal inserts; there is no cracking and little or no after-shrinkage of DAPON molded parts after years of service, even under elevated temperatures.

Specify DAPON (diallyl phthalate) Resin when you need:

- Low dielectric loss
- High dielectric strength
- Superior dimensional stability
- Excellent arc resistance
- High volume and surface resistance after high humidity-high temperature conditioning

Write to the address below for FMC's data sheet containing technical information about DAPON, suggested uses for this resin, and the name of the DAPON compounder nearest you.



FOOD MACHINERY AND CHEMICAL CORPORATION
Dapon Department

161 East 42nd Street, New York 17, New York

ACOUSTICA ULTRASONIC CLEANING REPLACES OLDER METHODS!

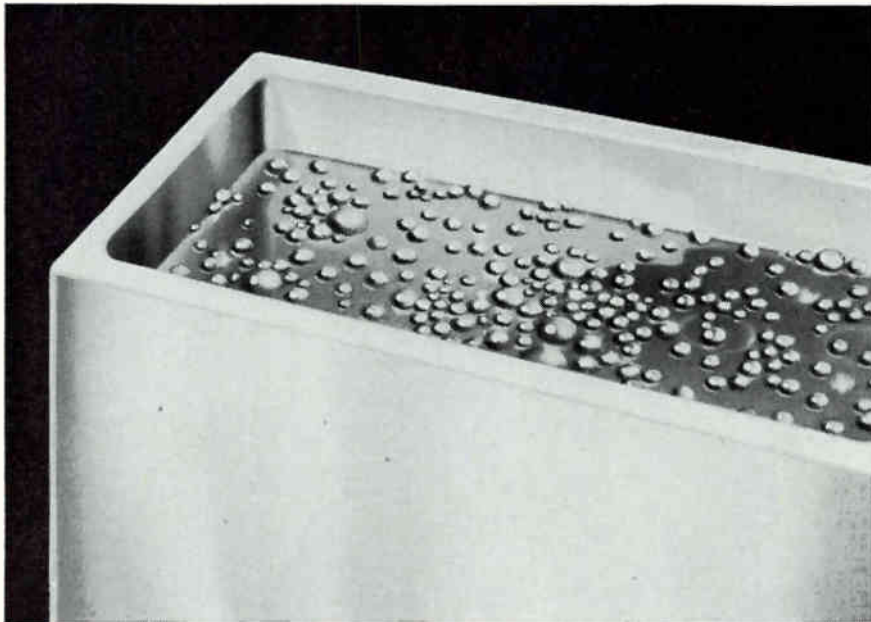

Texas Instruments, Martin Company, Bell Telephone Laboratories and many other firms are turning to Acoustica for better cleaning ultrasonically!

Now you can clean better and faster. In seconds—all dirt, dust, and soils are “cavitated” away ultrasonically. No scrubbing, no disassembling, maintenance costs are sharply reduced. Acoustica ultrasonic systems are application tested and *certified* for your particular needs. Send for details of complete Acoustica line of the most advanced ultrasonic equipment and cleaning chemicals. Acoustica Associates, Inc., Fairchild Court, Plainview, N. Y., 10400 Aviation Blvd., Los Angeles, Calif.

CERTIFIED
APPLICATIONS

acoustica
ULTRASONIC CLEANING SYSTEMS

models are metalized to carry high currents. Collectors are attached to headers for good heat transfer.

Figure 1 shows a schematic of a unit used as an r-f amplifier.

All units are hermetically sealed in a welded case and a threaded copper stud is provided for heat transfer to an internal heat sink, as shown in the photo.

The PT900 and the PT901 transistors now cost about \$155 and \$195 respectively when asked for in small quantities.

Platinum Wire Defines Microwave Standards

A WISP OF PLATINUM wire in a gold-plated mount was recently carried from Tokyo to Boulder to be tested at the Boulder Laboratories of the National Bureau of Standards—part of an international program to intercompare national standards of measurement.

Bolometer Mount

This tiny platinum thread, 30 times thinner than a human hair, is the heart of a Japanese bolometer mount, an instrument used to measure microwave power. The mount itself is gold plated to improve its stability. At the Boulder Laboratories the staff of the Microwave Power Group, directed by Glenn F. Engen, carefully checked the fragile device against U. S. Standards and found that agreement between the two was better than one percent. For microwave power standards this precision is exceptional.

In fast-growing electronics, microwave energy (power times time) is being used to transmit television signals, to control long-range rockets in space, and to pinpoint the position of radio stars. In every case, accurate measurements of power are essential to know the amount of energy involved.

For both research and defense, it is also important to know that the measurement standards of different countries agree with each other. During the International Geophysical Year, scientists all over the world recorded radio energy from the stars and planets; the value of these studies lies in the accuracy

with which each country measured this energy. When an aircraft or ship needs a radar set repaired overseas, the test instruments of the other country must be comparable to those in the United States.

The efficiency of a bolometer mount is tested by measuring the amount of power absorbed in the instrument by a combination of two techniques (bolometric and calorimetric), or by measuring the power reflected from the mount as the resistance of the platinum wire is changed (impedance technique). The Japanese instrument was tested by both methods—the first time impedance techniques have been used in this country for an international intercomparison. The impedance method is the more difficult technique. It demands more measurements, with complex equipment of great stability and sensitivity. There is also a ever-present danger of bolometer burnout.

These measurements by the Microwave Power Group completed the third international intercomparison by calorimetric methods—a Japanese bolometer mount was compared in Boulder in the fall of 1957, and a U. S. mount was compared in England in the summer of 1958. All of these measurements were made at a frequency of 9,375 mc and one-hundredth of a watt.

Delicate Thread

The tiny section of platinum wire which is used in these mounts is so delicate that it can be burned in two by a spark of static electricity from a person's finger. The international intercomparisons accent this fragility. In two cases it has been impossible to complete an intercomparison because the thread of platinum was broken after the measurement was completed in one country and before a test could be made in another.

These intercomparisons of microwave power standards result from a recommendation of the International Scientific Radio Union which held its Twelfth General Assembly in Boulder in 1957. At that meeting the Union reaffirmed its recommendation that national laboratories intercompare their standards of power measurement at about 3,000 and 10,000 mc.

AIRPAX

MAGNETIC AMPLIFIERS

60 CPS



PREAC®

Fifty db power gain and full linear output with but milli-microwatt input power are inherent characteristics of the PREAC magnetic amplifier. Thermocouples, strain gauges, pressure transducers or high impedance sources may supply the input signal. Null drifts are as low as 1.0 micro-microwatt. Other applications include null and error detection, integration and summing, and use in sensitive micro-voltmeter and micro-ammeter circuits.

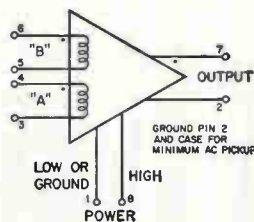

ELECTRICAL CONNECTIONS
TRANSFER CHARACTERISTICS

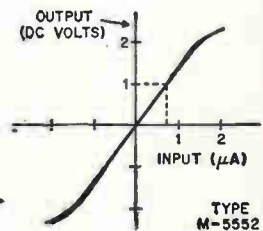

SPECIFICATIONS FOR 60 CPS PREAC AMPLIFIERS

TYPE	DC Microamperes Input for 1 DC Volt Output, 5K Load		Control Winding Resistance—Ohms		Bandwidth—CPS, with Tabulated Input Loop Resistance	
	Winding A	Winding B	Winding A	Winding B	Winding A	Winding B
M-5549	4.8	7.4	65	188	0.26 CPS/0.1K	0.6 CPS/0.1K
M-5550	1.2	7.4	980	188	0.32 CPS/2K	0.6 CPS/0.1K
M-5551	2.4	2.4	490	490	0.5 CPS/1K	0.5 CPS/1K
M-5552	0.7	7.4	2600	310	0.13 CPS/3K	0.6 CPS/0.1K

AIRPAX also produces a complete line of 400 CPS PREAC magnetic amplifiers.



SEMINOLE DIVISION

FORT LAUDERDALE, FLA

SM33

Mold Cable Covering at Junctions

By GENE M. LE FAVE, Director of Research, ROBERT GAMERO and DUKE WITHROW, Coast Pro-Seal & Mfg. Co., Compton, Calif.

SUCCESSFULLY MOLDING cable junctions, connectors and terminations with cast-in-place solid elastomers is strongly dependent on design, selection of materials and molding techniques. Suitable molding materials, depending on properties desired, include polyurethanes, vinyl plastisols, polysulfides and silicones.

Molds may be made of aluminum for long-run production, of fiberglass-epoxy or fiberglass-polyester for short runs, or of castable elastomer for a few parts. They should be provided with adequate vent and injection ports. Dimensions should be adequate for complete impregnation and reinforcement of the part produced and its design should assure precise positioning of the splice. A smooth finish assures good mating of mold halves, prevents ribbing and air entrapment and gives the part an attractive appearance.

Making Molds

Heaters can be built into metal molds to avoid oven curing and increase heat transfer efficiency. The principal pitfall of metal molds is air entrapment caused by insufficient or improperly placed venting, or sharp corners. Fiberglass-based molds are built on wood or plaster patterns which have been cut in half. The mold is smoothed with lacquer and wax and covered with a jell coat of the mold resin. After mold halves are cured, voids are filled, surfaces smoothed, the mold trimmed and match points or index pins installed. To prepare elastomer molds, the pattern is left whole. The pattern is coated with a parting agent and the elastomer. After curing, the mold is split and carefully removed. Injection pressure must be kept low to avoid distortion of the flexible mold.

Mold release agents must be kept from contact with the workpiece to avoid loss of adhesion. Metal molds may be coated with Teflon to eliminate the need for release agents and avoid contamination. Life of the Teflon coat will be increased many



Molding a junction. Compound is injected from bottom to top to permit air to escape. Note direction of threaded ports in mold (insert)

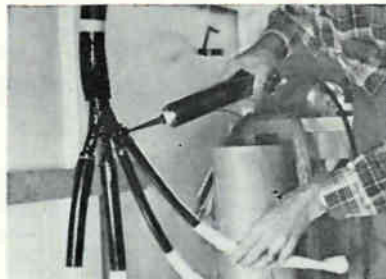

Prepainting with molding compound

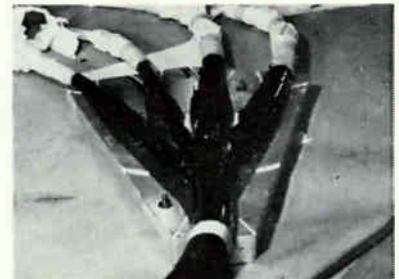

Port is coated to remove air from wires

fold by applying wax before each use.

Leads, cable, harness, connectors and other parts of the cable system must be carefully prepared before molding. Cable jacketing surface is completely broken by abrading with a high-speed grinding wheel. The surfaces are cleaned by brushing, a blast of filtered, compressed air and wiping with a lint-free towel dampened with clean solvent.

A thin, uniform coating of primer is applied, following the elastomer manufacturer's recommendations. Areas contacting the mold are pre-painted with a brush coat of molding compound. The part is installed in the half-shell of the mold and coated with a layer of the compound to remove air from the wires in the cable. The mold is then closed.

Molds are filled from the bottom to the top, working in easy stages

BOURNS TRIMPOT® WITH BUILT-IN TEMPERATURE STABILITY

Stable settings under extreme temperature conditions is an outstanding feature of the Trimpot® potentiometer. This thermal stability is built-in through all phases of design and production—

MATCHED COEFFICIENTS OF THERMAL EXPANSION

Resistance wire and mandrels have matched coefficients of thermal expansion to reduce the "strain gage effect." Linear expansion rates for the mandrel and wire match so closely that the temperature coefficient value for the entire wirewound element approximates that of the wire itself.

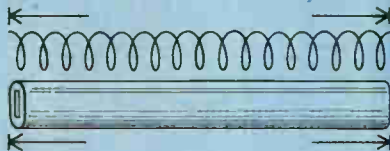

THERMALLY STABLE CERAMIC MANDRELS

Bourns takes advantage of high thermal stability of ceramic materials for element mandrels. Today, all Bourns Trimpot potentiometers provide the improved performance and reliability afforded by ceramic materials.

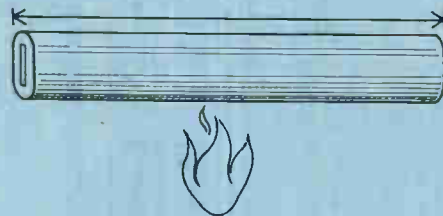

EXCLUSIVE SILVERWELD® TERMINATION

Silverweld is an actual metal-to-metal fusion of element wire and external terminal. In doing away with mechanical or soft-solder joints, Bourns eliminates potential hot spots thus extending the potentiometer's temperature range. The fusion of the Silverweld terminal to many turns of wire on the resistance element avoids the problem of single wire termination. Silverweld is virtually indestructible under thermal stresses.

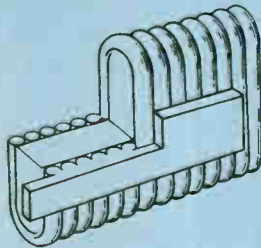

EXCLUSIVE TENSION CONTROL EQUIPMENT

Bourns has developed specialized winding equipment that provides constant and precise control of wire tension during winding operations. "Necking" of the wire or resistance-altering stresses never occur. Instead the wire remains uniform—well able to withstand temperature variations with no appreciable change in resistance.

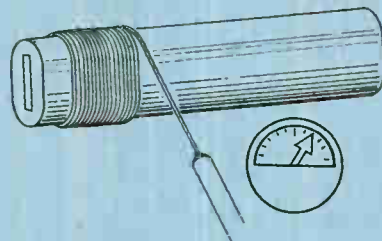

Specify Trimpot—the original leadscrew-actuated potentiometer with reliability on which you can depend. 20 basic models—4 terminal types—3 mounting styles.



BOURNS

BOURNS, INC., TRIMPOT DIVISION
6135 MAGNOLIA AVE., RIVERSIDE, CALIF.
PLANTS: RIVERSIDE, CALIF. AND AMES, IOWA

Write for new Trimpot summary brochure and list of stocking distributors.

Exclusive manufacturers of Trimpot®, Trimit® and E-Z-Trim®. Pioneers in transducers for position, pressure and acceleration.

ACCURACY IN PRESSURE MEASUREMENT

*begins with CEC's
6-201 Primary Pressure Standard*

For solutions to pressure measurement problems, depend on the experience and know-how of Consolidated Electro-dynamics—the only single source for all your pressure instrumentation needs. The integrated CEC line ranges from rugged transducers, readout, and other related precision equipment to primary calibration instruments.

Accuracy begins with CEC's 6-201 Primary Pressure Standard, a calibration instrument used to ensure the accuracy of pressure measurement devices.

This pneumatic dead-weight piston gage offers a resolution of better than 0.005% of reading... covers six pressure ranges from 1.5 to 500 psi, with a minimum pressure of 0.3. It assures accuracy that is conservatively rated at 0.015% of full scale in pressure ranges to 150 psi and at 0.025% of full scale in pressure ranges of 150 to 500 psi.

The 6-201 is a true primary standard that utilizes mass, length and time for its references. Its accuracy depends only upon the dimensional accuracy of its component parts. Write for Bulletin CEC 1581-X23 for detailed specifications.

For complete information on CEC pressure instrumentation and pressure measurement devices, write today for Bulletin CEC 1308-X13.

Transducer Division

CEC

CONSOLIDATED ELECTRODYNAMICS / pasadena, california

A SUBSIDIARY OF Bell & Howell • FINER PRODUCTS THROUGH IMAGINATION



on large parts or with a single injection on small parts. Injection ports, $\frac{1}{8}$ to $\frac{3}{8}$ inch in diameter, are threaded so they can be closed with a screw after each injection. The compound is injected with a gun until it appears at the next highest port. The gun is removed, the port plugged and the procedure repeated at each port until compound appears through the upper vent holes.



Flash on molded part will be cut or ground off



Finished cable junction



Multipin connector was molded to cable by similar process

The mold is allowed to stand at room temperature about 30 minutes to settle the compound and release entrained air. The last port is unplugged and a final shot of compound injected to fill any voids. Adequate mold venting is essential since it is easier to remove flash than rework voids. When molding a backshell, the receptacle should be at the top of the mold to keep the compound out of the pins. A gap of 0.01 inch is left between plug and mold for venting.

After curing, by integral heaters, oven or at room temperature, the workpiece is removed from the mold. Flash is removed with a sharp

knife or hand grinder. Small surface voids are filled by buffing, applying primer and compound, buffing level and curing. Compound can be thickened by standing at room temperature if a large area is to be reworked. In some cases, the repaired area can be covered with a sheet of polyethylene during curing, giving a smooth surface without finish buffing.

Chassis Becomes Jig For Fungus-Proofing

BY USING completed chassis as dipping fixtures, Consolidated Avionics Corp., Westbury, N. Y., has reduced the time required to fungus-proof plug-in circuit cards for a mobile military data-processing system.

Instead of dipping each card before final assembly, the cards are dipped 50 at a time after installation. The dipping tank is sized so that the chassis can be inverted and lowered deep enough into the tank to submerge the cards. Liquid level is maintained by an overflow cut-out in the tank side.

After immersion, each chassis is hung up by wires to dry overnight. Drying is also more convenient since the chassis serves as a holder and separator for the card. The technique may also be used to apply other protective compounds.



Chassis is inverted to submerge circuit cards in tank



Chassis becomes holder and separator during draining and drying

VERSATILITY IN PRESSURE MEASUREMENT

with CEC's advanced line of precise sensing devices

From the only single source for all your pressure instrumentation needs... three new sensing devices that are typical of CEC advancements designed to solve problems in measurement and control applications:

4-332 MINIATURE PRECISION PRESSURE BALANCE

Less sensitive to acceleration and vibration... more stable than larger pressure balances—that's the record of this miniature device that's easier to use in wind tunnel pressure measurement and control applications. This device can be held in your hand... measures a scant 4" x 3" x 2½". CEC also offers pressure balances in high speed and standard models. *For complete information, write for Bulletin CEC 1547-X5.*



4-326 STRAIN GAGE PRESSURE TRANSDUCER

In such demanding applications as rocket test stands, this small but rugged transducer measures high-frequency gage or absolute pressures to 10,000 psi. It stands up to severe acoustical noise... maintains low acceleration response... is extremely stable at 1,000 g's at temperatures from -320°F to +300°F. The 4-326 is just one of 13 types of CEC transducers. *For details on this finest achievement in strain gage transducers, write for Bulletin CEC 1620-X9.*



4-380A LOW PRESSURE POTENTIOMETER

Put this pot to work in your toughest environment—it takes 25 g, 2 KC vibrations for hours, with negligible change in calibration. The 4-380A covers a pressure range of ±1 psi to 100 psi. When operated over most pressure ranges at -65°F to +200°F, it shows a temperature effect of less than 1%. Choose from absolute, gage and differential models. CEC high pressure pots are also available. *For specifications, write for Bulletin CEC 1604-X2.*



Transducer Division

CEC

CONSOLIDATED ELECTRODYNAMICS / pasadena, california

A SUBSIDIARY OF Bell & Howell • FINER PRODUCTS THROUGH IMAGINATION

On The Market



Surge Protectors nine types

VICKERS INC., 1815 Locust St., St. Louis 3, Mo. Type SP surge protectors protect silicon power rectifiers from breakdown due to transient high voltage. Nonlinear resistance, decreasing with increase in voltage, plus built-in capacitance,

absorbs intermittent surge energy up to 3,000 w, limiting voltage to safe value for silicon rectifier. Consumes less than 5 w under steady-state conditions. Nine standard types cover range of 50 to 600 v normal piv rating. Field tested for more than a year; lab surge tested for more than 5 million cycles.

CIRCLE 301 ON READER SERVICE CARD

Waveguide Adapter flexible unit

DOUGLAS MICROWAVE CO., INC., 252 E. Third St., Mt. Vernon, N. Y. No. 105 waveguide adapter is bendable and twistable; stretches and contracts; and boasts an unusually long life. It covers the 8,000-10,000 Mc frequency range and will



bend 30 deg and twist 45 deg. It compresses $\frac{1}{8}$ in. and expands $\frac{1}{8}$ in. for each 3 in. of length, and is available 3 $\frac{1}{2}$ in., 8 in. and 12 in. long. Maximum vswr for all of the above is 1.08 to 1 or better throughout the band. Units permit increased twist and bend maintaining same electrical characteristics.

CIRCLE 302 ON READER SERVICE CARD

Coax Terminations small-size

RADAR DESIGN CORP., 1004 Pickard Drive, Syracuse 11, N. Y. The RDL-3 series of compact, wide-range, low power coaxial terminations feature an unusually low vswr over a broad usable frequency

range. Model RDL-3N, illustrated, covers 0-4,000 Mc with a vswr at 1.05 or less. Available from stock in standard connectors HN, N, TNC, BNC, LC and LT, these small sized models also incorporate precious metal resistors on a rugged ceramic base, and can be used satisfactorily with up to 2 w of power.



Prices vary from \$30 to \$75 according to type of connector desired.

CIRCLE 303 ON READER SERVICE CARD

P-C Resistors vertical mounted

DALE PRODUCTS, INC., Columbus, Nebr. The PRS series of vertically mounted p-c resistors are silicone coated and will meet applicable paragraphs of MIL-R-26C. Space

saving design has 2 parallel leads at one end of the resistor treated to facilitate easy soldering. Available in 4 sizes: 2, 5, 7 and 10 w, size range is from $\frac{1}{8}$ in. by $\frac{3}{8}$ in. to $\frac{3}{8}$ in. by 1 $\frac{1}{2}$ in. Operating temperature range - 55 to + 275 C. Temperature coefficient is 0.00002/deg

C. Resistance range is from 10 ohms to 175 K ohms with tolerances of 0.05 percent, 0.1 percent, 0.25 percent, 0.5 percent, 1 percent and 3 percent. Resistors feature complete welded construction from terminal to terminal.

CIRCLE 304 ON READER SERVICE CARD



Waveform Synthesizer flexible unit

EXACT ELECTRONICS, INC., P.O. Box 552, Portland 7, Ore. Type 200 waveform synthesizer permits the operator to create a stable output waveform of almost any shape imaginable. This is achieved by separately controlling the characteristics of small segments of the total waveform, using different

plug-in units. With type A variable slope plug-in, the synthesizer provides an almost limitless number of wave shapes. The amplitude and slope of each of the 50 increments may be independently varied without interaction to create the desired waveform; and the overall amplitude and waveform duration may then also be varied over a wide range. When used with type C variable width plug-in, the synthesizer

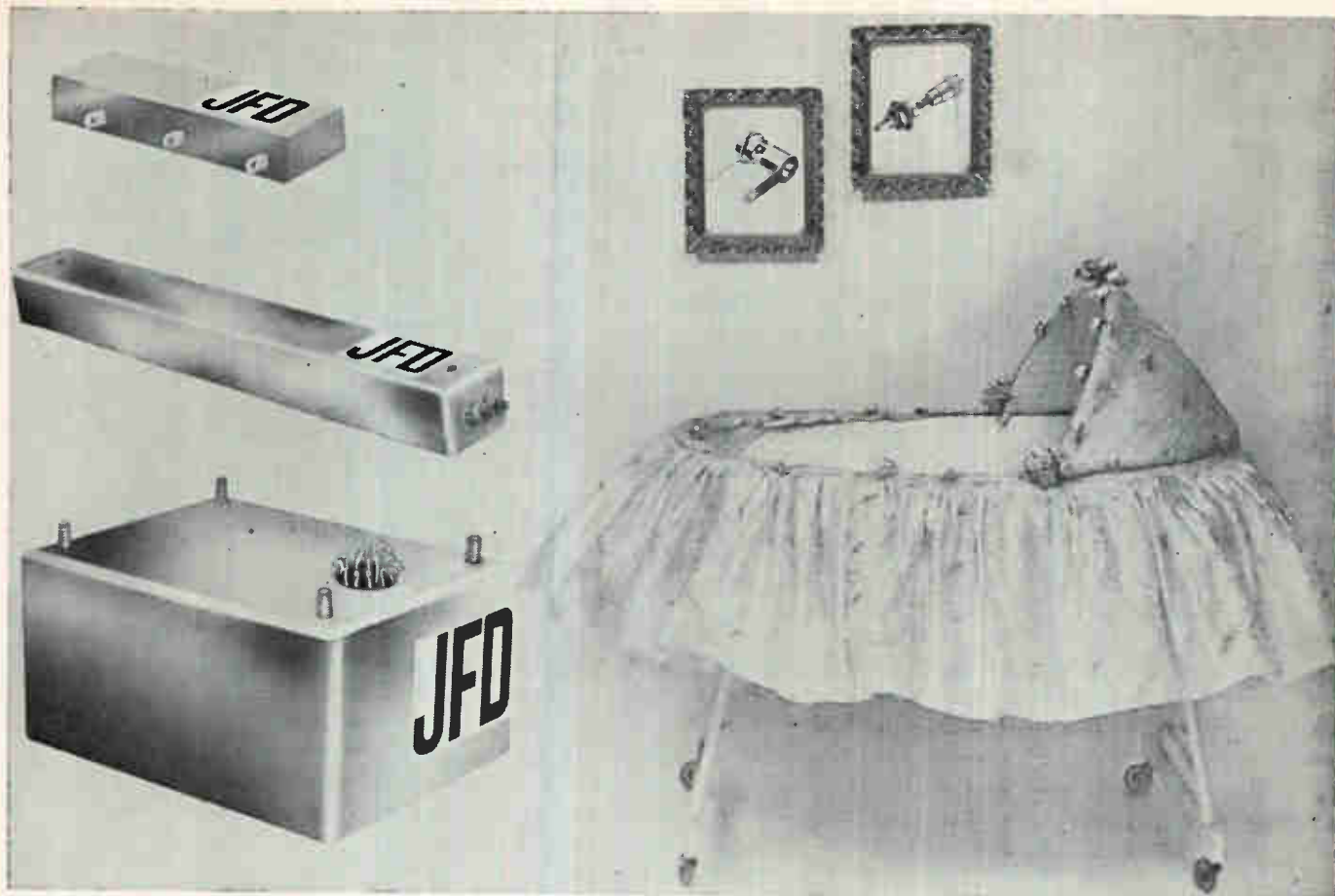

NEW FROM JFD LUMPED CONSTANT DELAY LINES

Meet the newest addition to the growing family of JFD precision electronic components.

Designed with compactness, ruggedness and reliability in mind, new JFD lumped constant Delay Lines upgrade your prototype or production project.

Compare the advantages of the standard JFD lumped constant delay lines:

- High delay-to-rise time ratio with minimum signal attenuation.
- Tolerance of $\pm 5\%$ max. on delay and characteristic impedance.
- Temperature range of -55°C to $+125^\circ\text{C}$.
- Delay time thermal stability of 50 parts per million per degree centigrade.
- Up to 25 Mc bandwidth.
- Virtually linear phase shift.
- Hermetically sealed metal cases for maximum resistance to shock, vibration and humidity.
- Meet all applicable MIL specs.

Whether your application calls for standard or custom-built lumped constant or distributed constant delay lines, our engineering staff will be glad to review your needs and

Typical Standard Delay Line Characteristics

Delay Time 5 μ sec.		10 μ sec.		25 μ sec.	
Rise Time	Size	Rise Time	Size	Rise Time	Size
1.0	1 $\frac{1}{8}$ x1 $\frac{1}{8}$ x2 $\frac{1}{4}$	2.0	1 $\frac{1}{2}$ x1 $\frac{1}{2}$ x3	5.0	1 $\frac{3}{4}$ x1 $\frac{3}{4}$ x2 $\frac{7}{8}$
.5	1 $\frac{1}{4}$ x1 $\frac{1}{4}$ x2 $\frac{5}{8}$	1.0	1 $\frac{5}{8}$ x1 $\frac{5}{8}$ x3 $\frac{1}{4}$	2.5	1 $\frac{3}{4}$ x1 $\frac{3}{4}$ x3 $\frac{1}{2}$
.3	1 $\frac{3}{8}$ x1 $\frac{3}{8}$ x2 $\frac{3}{4}$.6	1 $\frac{3}{4}$ x1 $\frac{3}{4}$ x3 $\frac{1}{2}$	1.5	2 $\frac{1}{4}$ x2 $\frac{1}{4}$ x4 $\frac{7}{8}$
.15	2 $\frac{1}{4}$ x2 $\frac{1}{4}$ x4 $\frac{1}{2}$.3	2 $\frac{1}{4}$ x2 $\frac{1}{4}$ x4 $\frac{1}{2}$.75	2 $\frac{3}{4}$ x2 $\frac{3}{4}$ x5 $\frac{1}{2}$

Range of characteristic impedance: 50 ohms to 2000 ohms $\pm 5\%$.

Attenuation: Less than 1db per μ sec. up to 3 μ sec. delay; 6db max. up to 50 μ sec. delay.

Temperature stability: 50 parts per million per degree C from -55° to $+125^\circ\text{C}$.

submit recommendations. Closer tolerance delays and impedances are available, in forms, sizes and terminal designs to match your needs. Write for Bulletin No. 213A.

JFD

Pioneers in electronics since 1929
ELECTRONICS CORPORATION

1462 62nd Street, Brooklyn, New York

JFD International, 15 Moore Street, New York, New York

JFD Canada Ltd., 51 McCormack Street, Toronto, Ont., Canada

produces 50 output pulses with independently variable width as well as amplitude.

CIRCLE 305 ON READER SERVICE CARD



Cardiac Resuscitator pocket size

MEDTRONIC, INC., 818—19th Ave. N. E., Minneapolis 18, Minn. Designed for external application, the pocket cardiac resuscitator stimulates ventricular function in cardiac arrests due to drug and anesthesia reactions and those that occur spontaneously as in Stokes-Adams syndrome. The instrument employs a transistorized circuit which completely removes the hazards and nuisance associated with a-c pow-

ered instruments. The battery that operates the instrument may be recharged with a small battery charger, which is supplied with the unit.

CIRCLE 306 ON READER SERVICE CARD

Data System geophysical

SOUTHWESTERN INDUSTRIAL ELECTRONICS Co., 10201 Westheimer Road, Houston 27, Texas. The MS-12 GeoData geophysical data processing system handles both SIE f-m and direct recorded a-m magnetic tapes to produce a pen recorded time cross-section on paper which can be photographically reproduced. These time cross-sections can be isopached, or set to a desired reference plane for presentation in geologically oriented form. The corrected information on these final records is also recorded on magnetic tape for other uses, such as making additional cross-sections with other filtering or mixing.

CIRCLE 307 ON READER SERVICE CARD

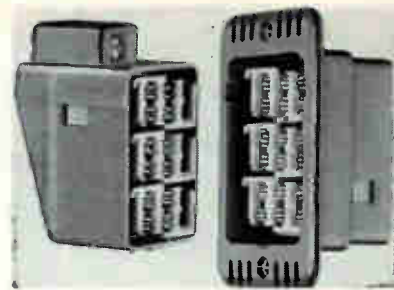

Connectors hermaphrodite type

CANNON ELECTRIC Co., 3208 Humboldt St., Los Angeles 31, Calif. The Morpho, series MH, represents a new concept in plug design and development. It features hermaphrodite contacts and insulators which fit both plugs and receptacles. Design of the plugs makes them easily adaptable to many configurations and a variety of layouts is possible within each shell style. Snap-in crimp-type contacts cut assembly time and facilitate maintenance. Plug is especially suited to commercial applications such as business machines, computers, communications equipment, and the like. The versatility of these low cost plugs

SPECTROL PRECISION POTENTIOMETERS



Two valid reasons why **SPECTROL**
delivers better non-linear pots *faster!*

REASON

1

COMPUTER DESIGNED



Spectrol uses an IBM 610 computer to turn out complex non-linear precision pots in record time, both single-turn and multi-turn. This in itself saves weeks of time, assures more accurate performance. Spectrol alone maintains a computer on the premises for this purpose.

How It Works. Design information in the form of X and Y coordinates or mathematical equations describing the particular parameters of a given non-linear function is entered in the computer. Previously programmed general equations automatically compute from these data points manufacturing directions in terms of winding equipment settings, cam angle and radii. An electric typewriter prints out winding machine set-up information on a form which is sent to production. Simultaneously, a punched tape is made to store data for repeat requirements.

will make them useful in many other military and civilian applications.

CIRCLE 308 ON READER SERVICE CARD

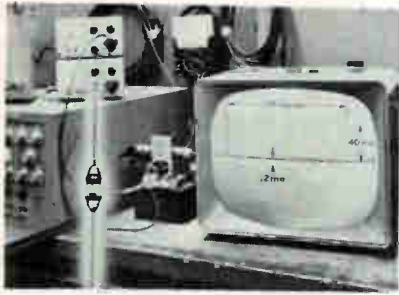

Switching Diode extremely fast

SYLVANIA ELECTRIC PRODUCTS INC., Woburn, Mass., has developed a switching diode capable of performing up to 500,000,000 logic functions in a fraction of a sec. It is designed for use in high speed military computers such as missile guidance and tracking systems, and in commercial equipment. Guaranteed maximum speed is 0.8 billionths of a sec, and a typical rating is 0.3 billionths of a sec. Type

D-4121 silicon diode is hermetically sealed and capable of operation at 150 C. It offers superior performance despite extreme conditions of vibration, shock, temperature change and moisture. It is also capable of operation in the microwave range (1,000 Mc and upward).

CIRCLE 309 ON READER SERVICE CARD

NPN Transistor miniature package

FAIRCHILD SEMICONDUCTOR CORP., 545 Whisman Road, Mountain View, Calif. The 2N717 is a high speed general purpose silicon transistor. Saturated switching times are tenths of a μ sec at $\frac{1}{2}$ ampere. Typical gain-bandwidth is 100 Mc. In low level amplifier service 2N717 provided 15 db neutralized gain at 30 Mc. Current gain is essentially flat over a two decade range of current. JEDEC TO-18 package permits 1.5 w dissipation at room temperature. Transistor is designed to meet the environmental specifications of MIL-S-19500B.

CIRCLE 310 ON READER SERVICE CARD

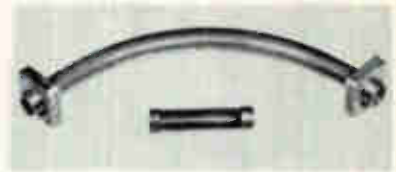

Circular Waveguide for 60,000-75,000 Mc

TRG, INC., 9 Union Square, Somerville, Mass. Simple and complex bends in millimeter-band waveguide are now being fabricated. They are made by first corrugating the inside of lengths of straight copper waveguide and then bending them to the desired shape. New method of construction was developed to make use of the TE_{01} mode in circular waveguide, preferred because of its circular symmetry and low loss. The corrugations overcome the problem of deviations from straightness, and the resultant mode conversion to the degenerate TE_{11} mode. New method also allows complicated bends to be made with little or no machining. A typical 90 deg bend made with the new method, model V-BMM1, has a 3-in. inside radius. The waveguide i-d is

REASON

2

LIBRARY OF TAPES



Spectrol also maintains an extensive library of tapes with programs for the solution of general non-linear potentiometer design equations, saving hours of calculation time and providing error free results. Again, you receive a superior product sooner.

Let us know your design requirements. With Spectrol's time-saving techniques, you can expect a quote within a few days.

Contact your Spectrol representative for more details about Spectrol linear and non-linear precision potentiometers, or write direct. A 4-page specifications brochure is yours for the asking. Please address Dept. 42

SPECTROL

**ELECTRONICS
CORPORATION**

1704 South Del Mar Avenue • San Gabriel, California

This is not and is under no circumstances to be construed as an offer to sell, or as an offer to buy, or as a solicitation of an offer to buy, any of the securities herein mentioned. The offering is made only by the Prospectus.

March 18, 1960

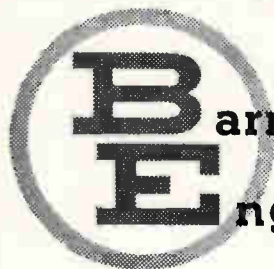

Barnes

Engineering Company

50,000 Shares Common Stock

Price \$26.25 per share

Copies of the Prospectus may be obtained from the undersigned and the other underwriters only in states in which they are qualified to act as dealers in securities and in which the Prospectus may legally be distributed.

HAYDEN, STONE & CO.

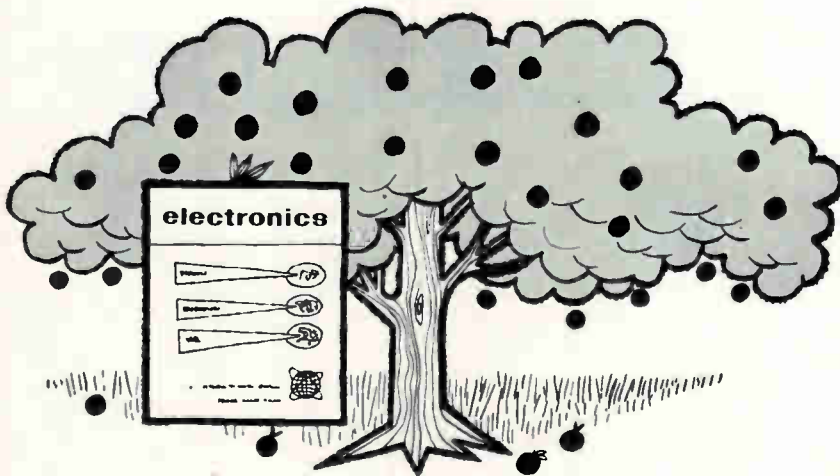

The pick of the crop!

Thumbnail summaries of sales literature on materials, components, equipment, and facilities keep you up-to-date in about 3 minutes of quick, easy reading in "Literature of the Week."

Another reason why it will pay you to subscribe to *electronics* (or renew your subscription) right now. Fill in the box on Reader Service Card. Easy to use. Postage free.

FIND WHAT YOU NEED IN...

electronics

0.353 in. Loss in this particular section is less than 0.2 db.

CIRCLE 311 ON READER SERVICE CARD



Hot Plate

3 1/2 in. diameter top

THERMO ELECTRIC MFG. Co., 465 Huff St., Dubuque, Iowa. Type 2300 Thermolyne hot plate is especially recommended for lab and shop uses where a small single or multiple precision heat source is needed. It incorporates a thermostatic control unit. Stepless selection of temperature from 6 C above ambient to 370 C (700 F) is provided. A built-in anticipatory sensing device results in negligible overshoot in initial heat-up, and temperature variation thereafter falls within ± 3 C. There is automatic compensation for wide fluctuation in voltage and ambient temperature to maintain a uniform watt-hr input with consequent even temperatures. From a cold start, the plate reaches 370 C in less than 9 minutes and reserve power at that point is a substantial 46 percent.

CIRCLE 312 ON READER SERVICE CARD



Transformers

current sampling

VALOR INSTRUMENTS, INC., 13214 Crenshaw, Gardena, Calif. The IST series of seven pulse current sampling transformers delivers synchronizing voltage pulses for use with radar transmitters or other devices which develop high pulse

currents. The voltage pulses have the same shape as the high current pulses. No resistance is added to the circuit because the transformer is not connected to the current-carrying conductor; voltage pulses are developed by simply passing the conductor through the hole in the transformer. This approach eliminates bulky resistive networks. Size is $\frac{1}{8}$ in. by $\frac{1}{2}$ in. by $\frac{3}{8}$ in.; weight $\frac{1}{4}$ oz; ratio 20:1 to 150:1; pulse widths 0.4 to 3.0 μ sec at 50 v; inductance 0.12 to 6.0 mh; optimum load 50 to 500 ohms; meets MIL-T-27A.

CIRCLE 313 ON READER SERVICE CARD



Ultrasonic Cleaner transistorized

BRANSON ULTRASONIC CORP., 40 Brown House Road, Stamford, Conn. Model LGT-40 self-contained cleaning unit is ideal for cleaning precision parts, electronic components and small subassemblies. It takes advantage of the latest advances in semiconductors to achieve a powerful, rugged, compact arrangement, for long life with little or no maintenance. Design is simple, an on-off switch being the only generator control required. A second switch controls integral heating elements, to keep the cleaning solution at the proper temperature. Both housing and inner tank are of 300-series stainless steel. To simplify drainage of spent cleaning solution, the $\frac{1}{2}$ -gallon tank is completely removable; there is no need to disconnect or move the entire cleaning unit. Generator output is 40 w average, 80 w on peaks. Power input is 120 v, at 115 v, 50/60 cycle

MARK TIME

TO AN ACCURACY OF 1 SECOND A MONTH

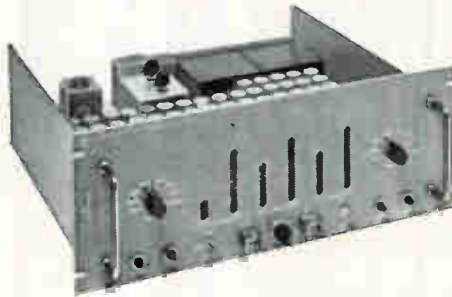

You time-correlate data within 3 parts in 10^8 per day...when you design your instrumentation timing system around an EECo Time Code Generator.

More accuracy per dollar... Use Model ZA 801 for BCD output (24 digits), \$7650⁰⁰... Model

ZA 802 for Binary Coded output (17 digits), \$7050⁰⁰... both with accuracy and stability equal to a secondary standard. Other minor code format variations available.

Compact... sized for standard rack mounting... complete unit including power supply measures 7" x 19" x 16".

Furnishes as output both time-of-day code (24-hour recycling) and any two of eight pulse rates. Suitable for oscillographs, strip chart, recorders, magnetic tape, or driver for neon flash lamps.

Applications in lab or field. Use an EECo TCG as a clock, for time correlation. Use it as the heart for your own system... incorporate it wherever you need time pulses. Or call on EECo's specialized experience in developing complete timing and synchronization systems.

For benefits and full specs write for Data Sheet ZA 801/802.



Electronic Engineering Company of California

1601 E. Chestnut Ave., Santa Ana, Calif. • Klmbery 7-5501 • TWX: S ANA 5263

EE 0-1

MISSILE AND AIRCRAFT RANGE INSTRUMENTATION • DIGITAL DATA PROCESSING SYSTEMS
COMPUTER LANGUAGE TRANSLATORS • SPECIAL ELECTRONIC EQUIPMENT

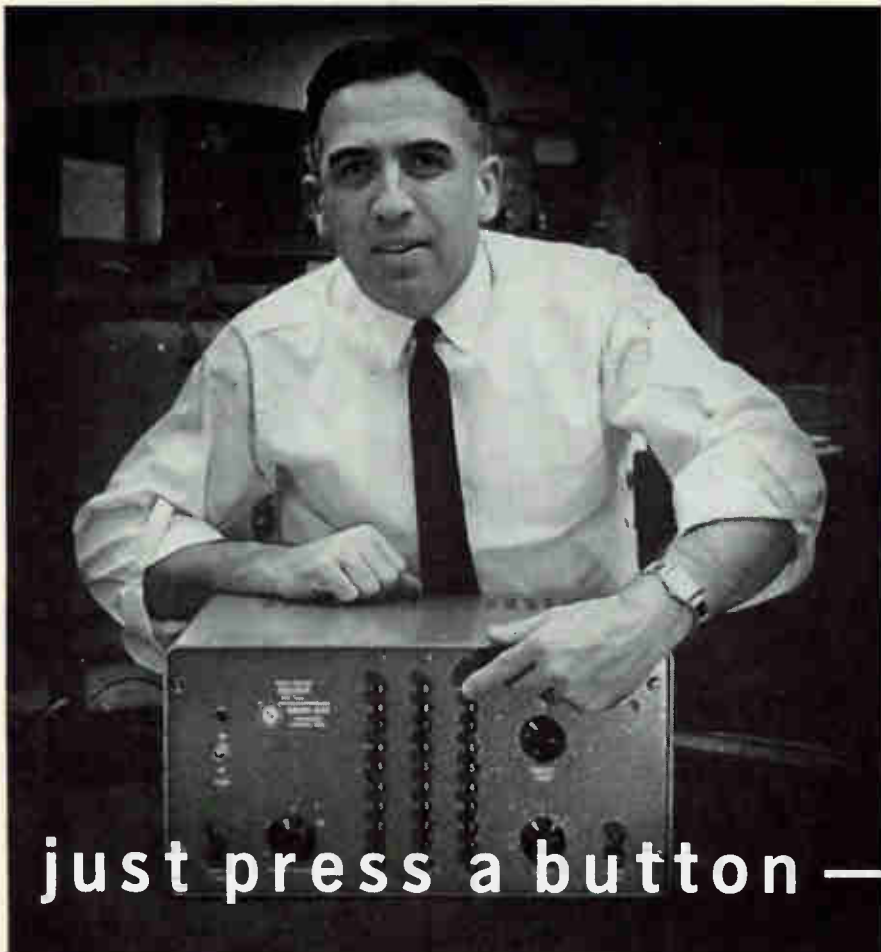

on this oscillator and you cover a
frequency range from 0.001 cps to 100 kc!

Here's a combination of wide frequency range (0.001 to 100,000 cps), low distortion (less than 0.1%), and high stability (less than 0.05% drift per hour) — in one highly convenient oscillator. The Model 440-A also provides both sine and square waves *simultaneously* over this entire frequency range.

Three banks of push-button switches give positive control of frequency with ease, and reset accuracy of better than 0.01%. The frequency multiplier switch covers the entire range in six decade steps. A vernier control varies the frequency continuously by an amount equal to the increment between adjacent third-bank buttons. This time-saving push button feature insures freedom from error, and enables use of untrained personnel for routine checking.

The 440-A's wide range offers more measurement flexibility. Its constant signal-to-noise ratio allows effective use of small signals in low level applications. Its low distortion eliminates troublesome harmonics in precise measurements.

Other Krohn-Hite oscillators include log dial-tuning Models 400-A (0.009-1,100 cps); 420-A (0.35-52,000 cps); 430-AB (4.6-520,000 cps) and others. *Write for full information on Krohn-Hite Oscillators, as well as Krohn-Hite Amplifiers, Filters and Power Supplies.*



KROHN-HITE CORPORATION

580 Massachusetts Avenue • Cambridge 39, Mass.

Pioneering in Quality Electronic Instruments

a-c. Unit is 14 in. deep, 7 in. wide, and 13 in. at its highest point.

CIRCLE 314 ON READER SERVICE CARD

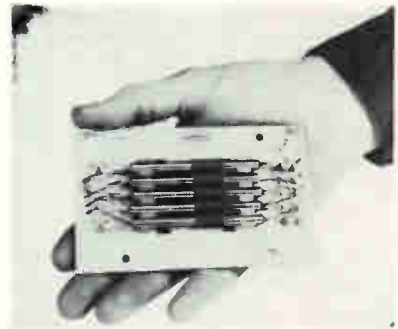

Bandpass Filter magnetostriction

RAYTHEON Co., 55 Chapel St., Newton, Mass. New magnetostriction bandpass filter enables unlimited combinations of parallel bandpass filter arrays to be constructed easily with center frequencies spaced one bandwidth apart anywhere in the 45 to 50 Kc range. Filters provide a half-power bandwidth of 3 cps with resonant frequencies between 45 and 50 Kc. At 50 Kc center frequency can be adjusted within 0.3 cps. Units are designed for applications requiring multiple, narrow-band filter channels for frequency analysis or as frequency determining elements. Typical uses are in shock and vibration test equipment, spectrum analyzers, sonar equipment, telemetering equipment, and wireless paging systems. Input and output impedances of 15 and 600 ohms, respectively, are ideally suited to transistor circuits.

CIRCLE 315 ON READER SERVICE CARD

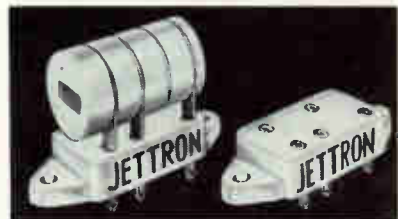

Tube Sockets for triode No. 7296

JETTRON PRODUCTS, INC., 56 Route 10, Hanover, N. J. Catalog No. 8715 ultrahigh temperature socket can be operated continuously at 1,000 F (538 C). A high alumina ceramic is employed as the insula-

T.R. CHECKER

STEREO LEVEL INDICATOR

PLASTIC EDGEWISE METER

PLASTIC PANEL METER

AC VOLTS

PLASTIC EDGEWISE METER

KEW

Around the world it's **KEW**

KYORITSU ELECTRICAL INST. WORKS, LTD.

NO. 120, Nakane-cho, Meguro-ku, Tokyo, Japan.
Cable Address "KYORITSUKEIKI TOKYO"

CIRCLE 200 ON READER SERVICE CARD



Low Noise
VHF and UHF
Amplifiers and Preamplifiers
SERIES 1000

For application as receiver preamplifiers or wide band i. f. amplifiers . . . in scatter communications systems, laboratory, or nuclear research. Eight standard models cover VHF and UHF to 900 mc. High gain, low noise. Special pass bands available.

Advanced techniques permit modification of standard units at minimum cost.

Write for complete details:

COMMUNITY ENGINEERING CORPORATION
P. O. BOX 824 STATE COLLEGE, PA.
CIRCLE 213 ON READER SERVICE CARD
ELECTRONICS • APRIL 1, 1960

the ultimate in bandpass filters

Model HFF-4
(Quadruple Tuned)

$f_0 = 400$ mcs
B.W. = 45 mcs
Insertion loss = 0.9 db

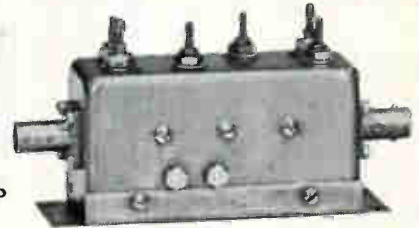

SPECIFICATIONS

MODEL HFF BANDPASS FILTERS

Center Frequency: 30 to 1000 mcs (factory preset to customer specifications)
Bandwidth: 5% to 25% of center frequency (factory preset)
Impedance: 50 ohms
V.S.W.R.: ≤ 1.2 in pass band (consistent with peak to valley ratio)
Insertion Loss: ≤ 1 db
Peak to Valley Ratio: $\leq .5$ db
Selectivity: Defined by number of resonant elements
Doublets to sextuplets available
Power Rating (CW): 25 watts
Connectors: BNC or Type N
Finish: Silver Plate; Rhodium Flash

Model HFF-T-3
(Triple Tuned)

$f_0 = 425$ mcs
B.W. = 50 mcs
Insertion loss = 0.15 db

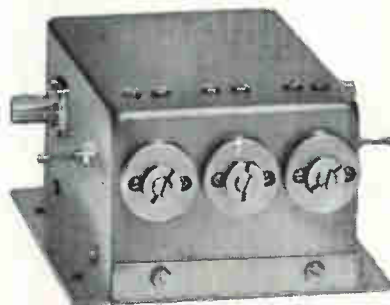

SPECIFICATIONS

MODEL HFF-T BANDPASS FILTERS

Center Frequency: 200 to 2000 mcs (factory preset to customer specifications)
Bandwidth: 1% to 15% of center frequency (factory preset)
Impedance: 50 ohms
V.S.W.R.: ≤ 1.2 in pass band (consistent with peak to valley ratio)
Insertion Loss: ≤ 1 db
Peak to Valley Ratio: $\leq .5$ db or less
Selectivity: Defined by number of resonant elements
Doublets to sextuplets available
Power Rating: 100 watts
Connectors: BNC or Type N
Finish: Silver Plate; Rhodium Flash

Model HFF and Model HFF-T bandpass filters are available at other frequencies, bandwidths, power ratings and to customer specifications. Also available are temperature compensated filters for maximum stability.

SEND FOR BROCHURE

Applied Research inc.

76 S. Bayles Avenue Port Washington, N. Y.

CIRCLE 101 ON READER SERVICE CARD 101

The most complete single-turn pot line

Pick the single-turn pot to suit your circuit from the complete HELIPOT standard line... scaled from a compact 1/2" to a high resolution 3" diameter.

These singular single-turns come in both economy and all-metal models... so name your temperature... to 80°C... to 125°C... to 150°C.

Most models allow 8 cups to be ganged... standard linearity is ±0.5%, with ±0.10% available for most... and, of course, you can have non-linears and spec models.

To help you single out the single-turn you need, we have prepared Data File A122. Write for it today.

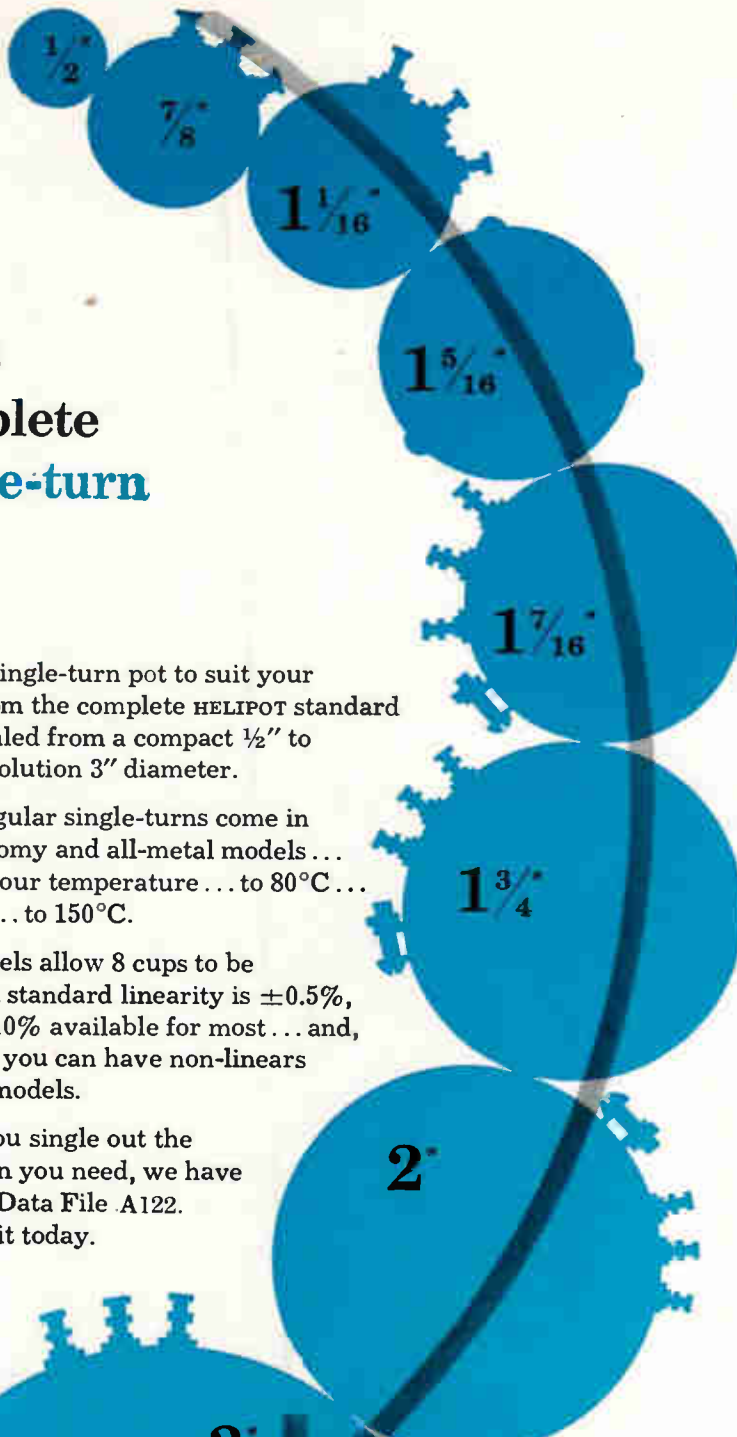

Beckman Helipot®

Helipot Division of Beckman Instruments, Inc. Fullerton, California
Engineering representatives in 29 cities

- potentiometers
- dials
- delay lines
- expanded scale meters
- servomotors
- breadboard parts

tor, and the contacts are made of spring tempered Inconel-X, nickel plated and then gold plated. Two holes are provided on 1.172 in. centers for mechanical fastening of the socket to a chassis or print-board. The contact terminals are suitable for soldering to a print-board or for conventional wiring. A steel bracket (not shown) is included with each socket for shock mounting of the No. 7296 tube.

CIRCLE 316 ON READER SERVICE CARD

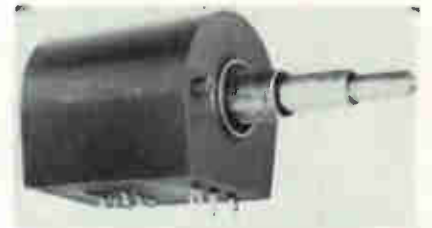

Potted Potentiometer and switch system

CLAROSTAT MFG. CO., INC., Dover, N. H. A completely encapsulated unit provides two independent switching actions plus a potentiometer. The assembly consists of a molded-carbon pot, series 53 M, a switch activated by end-rotation of potentiometer, and a second switch that may be activated at any point of rotation of potentiometer by push-pull action of the shaft. Switches rated 7 v d-c 7 amperes (resistive). Entire assembly is encapsulated in a high dielectric plastic compound.

CIRCLE 317 ON READER SERVICE CARD



Heater-Buttons 2, 5 and 10 w ratings

MINCO PRODUCTS, INC., 740 Washington Ave. North, Minneapolis 1, Minn. These miniature electric heaters, only 3/8 in. in diameter and 0.15 in. thick, have a center hole for No. 2 screw mounting to any flat surface. Six-inch long lead wires, No. 28 Teflon insulated, are

IT'S WHAT'S IN HERE THAT COUNTS

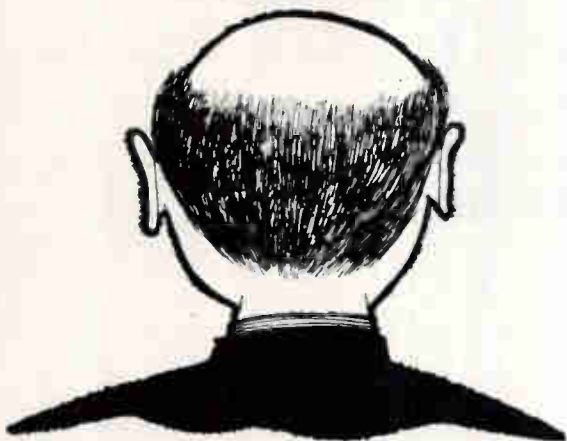

Do you know, for instance... which electronic stocks are hottest? Who's in the news and why? About "Three Approaches to Microminiaturization"? About the newest product ideas hitting the market? What's up in production? Opportunities overseas? What's going on in Washington?

It pays to know more than the next man! The questions above are just 6 reasons why you should subscribe to *electronics*.

IF YOU'RE ON THE TAG END OF A ROUTING SLIP, get your own subscription. Knowing what's going on is the first step to going up.

Fill in the coupon below right now... it will pay big dividends.

FIND WHAT YOU NEED IN... **electronics**

____ Renew my subscription for 3 more years.
____ Enter my new subscription.

U.S. Subscription Rates: ____ 3 years \$12. ____ 1 year \$6
Canadian rates \$10 for 1 year. Foreign rates \$20 for 1 year.

Name _____
Street _____
City _____ Zone _____ State _____
Company _____
Street _____
City _____ Zone _____ State _____
Your Title _____ Department _____
Product Manufactured or Service Performed _____
Mail reply to: *electronics*, 330 West 42nd Street, New York 36, N. Y.



VERSATILE
MULTI-RANGE
METER TESTER

Model M-2

... POWER SUPPLY ... LIMIT BRIDGE

Precise, self-contained unit for laboratory and production use. For DC instrument calibration from 25 μ a full scale to 10 ma full scale, and 0-100 VDC; sensitivity and resistance measurement; DC current-voltage source; limit or bridge measurements from 0-5000 ohms. Regulated power supply. Stepless vacuum tube voltage control. Accuracy exceeds $\frac{1}{4}\%$ (current), $\frac{1}{2}$ ohm or $\frac{1}{2}\%$ (resistance). For 115V, 60 cycle AC. Complete — needs no accessories. Bulletin on request. Marion Instrument Division, Minneapolis-Honeywell Regulator Co., Manchester, N. H., U.S.A. In Canada, Honeywell Controls Limited, Toronto 17, Ontario.

Honeywell

PIONEERING THE FUTURE



First in Control
SINCE 1886

CIRCLE 201 ON READER SERVICE CARD



For electronics, aircraft and
missile manufacturers...

AN UNLIMITED SOURCE OF SKILLED LABOR



Impartial analyses show Metropolitan Miami to be the nation's last unlimited source of skilled, technical labor. Let us show you how this factor, combined with the area's other many advantages, can mean a profitable plant location for *your* firm.

SEND FOR 300 PAGE SURVEY OF THIS DYNAMIC AREA

This important study will be mailed to you, in strictest confidence, if you write, on your letterhead, to the address listed below.

RICHARD J. WELSH, Director

Dade County Development Department

CHAMBER OF COMMERCE BUILDING
345 NORTHEAST SECOND AVENUE • MIAMI 32, FLORIDA
An agency of the Metropolitan Miami government

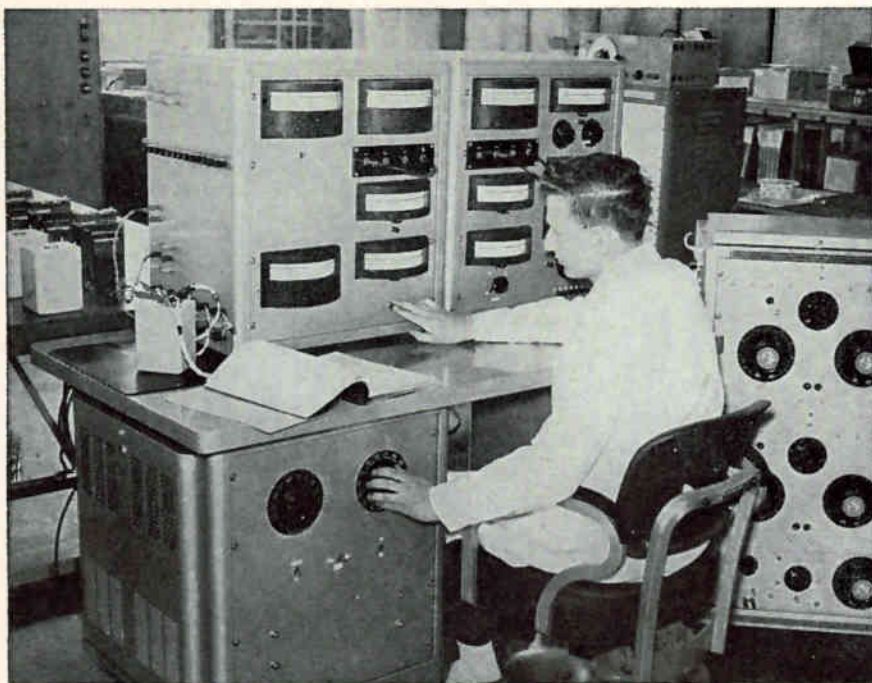

It costs less to RENT AN ELECTRONICS LABORATORY than to buy one

You can save costly investment in laboratory equipment and staff... and still get top-quality R/D services... by using the complete product testing and evaluation facilities of United States Testing Company. Since 1880 thousands of clients in all industries have used our services to get:

Improved Product-Design Through Testing

Our test engineers will set up an evaluation program that "locks in" with each step of your product development from design to prototype to finished product.

An Independent Laboratory

We present a completely objective, unbiased approach to your design evaluation problems. All reports to clients are impartial, factual and confidential.

Economical Handling of Peak Loads

We are equipped to take over your peak loads *immediately* at a fraction of what it would cost your company to maintain a staff of the necessary calibre.

Product Qualification

Tests run by United States Testing Company are recognized by military and government procurement agencies in placing a product on the Qualified Product list.

Facilities and Services

Electronic Laboratory—evaluates electronic components and systems in communications and industrial fields; includes automated facilities for low-cost collection of reliability data.

Environmental Laboratory—simulates high-low temperatures, humidity, altitude, immersion, salt spray, sand and dust, rain, fungus, vibration, shock, acceleration, etc.

Materials Testing Laboratory—conducts tension, compression and transverse tests on metals, ceramics, plastics, rubber and wood materials; spectrographic analysis and X-ray also available.

Mechanical Laboratory—evaluates mechanical, electro-mechanical hydraulic and pneumatic devices.

Chemical Laboratory—covers all fields including physical and biological chemistry; also infrared spectrophotometry.



Send for your free copy of bulletin 5801 describing our complete services and facilities.

United States Testing Co., Inc.
1415 Park Avenue, Hoboken, N. J.

Branch Laboratories

BOSTON • BROWNSVILLE • DALLAS • DENVER • LOS ANGELES
MEMPHIS • NEW YORK • PHILADELPHIA • PROVIDENCE • TULSA

The
World's Most
Diversified
Independent
Laboratory.



provided for electrical connections. Leads emerge from the upper side of the heater through special glass to metal seals. The heaters are completely enclosed in a metal case, flat on the under side for maximum heat transfer to the surface being treated. Heater internal temperatures to 500 F are permissible. To aid in applications engineering, a special temperature-sensitive heater is available for determining internal temperatures, thus assuring that the heater is operated within its ratings in a given installation.

CIRCLE 318 ON READER SERVICE CARD

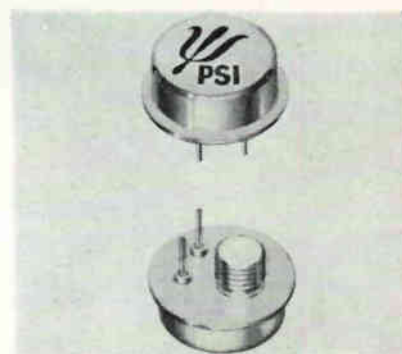

Silicon Transistors very high power

PACIFIC SEMICONDUCTORS, INC., 10451 W. Jefferson Blvd., Culver City, Calif. Types PT900 and PT901 diffused, mesa transistors are characterized by a power dissipation of 125 w at 25 C case temperature; 5 Mc alpha cut off frequency; 10 ampere continuous collector current and 0.2 ohm saturation resistance. It is expected they will find applications as power converters and inverters operating at frequencies as high as 1 Mc. Other applications are fast-response power supply regulation; marine and aircraft radio transmitters; ultrasonic generators; compact r-f generators for induction heating; computer core-drivers, high-speed switches; radar pulse generators and high power video amplifiers.

CIRCLE 319 ON READER SERVICE CARD

Test Chamber hyper-environment

TENNEY ENGINEERING, INC., Union, N.J., has developed a hyper-en-

INCREASED RELIABILITY PLUS HIGHER OPERATING TEMPERATURES with Westinghouse Silicon POWER Transistors*



2N1015—2 amp
2N1016—5 amp

Westinghouse 2N1015 and 2N1016 Silicon Power Transistors offer positive, *proved* benefits to designers of inverters, series regulators, and A.C. Amplifiers.

INVERTERS...

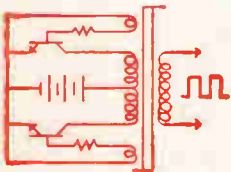

Extremely low saturation resistance (typical .3 ohms)

minimizes power losses in the transistor. High temperature (150°C T_j max.) operation permits compact inverter designs for missiles, aircraft, and other military equipment.

SERIES REGULATORS

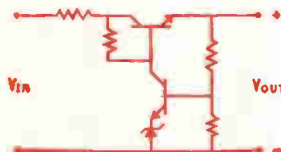

High voltage ratings and high temperature

operation, plus internal power dissipation of 150 watts made possible by low thermal resistance of .7°C/watt make the 2N1015 and 2N1016 an ideal choice for constant voltage and constant current regulators.

A.C. AMPLIFIERS...

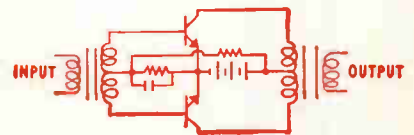

Perfect choice for high power audio and A.C. Amplifier applications, thanks to their high power dissipation capabilities and common emitter frequency response to 20KC.

PLUS TRUE VOLTAGE RATINGS...

guaranteed by 100% power testing. Means you can operate these transistors continuously at the V_{CE} listed for each rating without the risk of transistor failure.

Westinghouse Silicon Power Transistors are available in 2 and 5 ampere collector ratings. Both are available in 30, 60, 100, 150, and 200 volt ratings for immediate applications. Contact your local Westinghouse Apparatus Sales Office, or write directly to Westinghouse Electric Corp., Semiconductor Department, Youngwood, Penna.

*Designed to meet or exceed military specifications and currently being used in many military, industrial, and commercial applications.

Type	V_{CE}^*	β (min)	R_s (max)	I_C A (max)	T_j max. operating	Thermal drop to case (max)
2N1015	30	10 @ $I_C=2$ amp	.75 ohms @ $I_C=2$ amp $I_B=300$ ma	7.5	150°C	.7°C/W
2N1015A	60					
2N1015B	100					
2N1015C	150					
2N1015D	200					
2N1016	30	10 @ $I_C=5$ amp	.50 ohms @ $I_C=5$ amp $I_B=750$ ma	7.5	150°C	.7°C/W
2N1016A	60					
2N1016B	100					
2N1016C	150					
2N1016D	200					

*TRUE voltage rating (The transistors can be operated continuously at the V_{CE} listed for each rating.)

YOU CAN BE SURE...IF IT'S **Westinghouse**

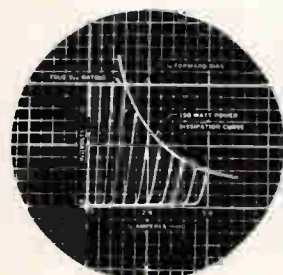

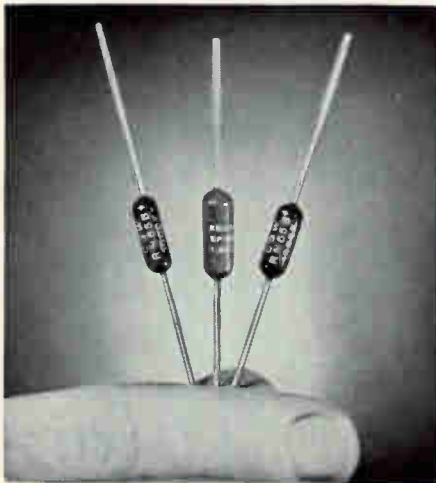

Miniature

or
Monster

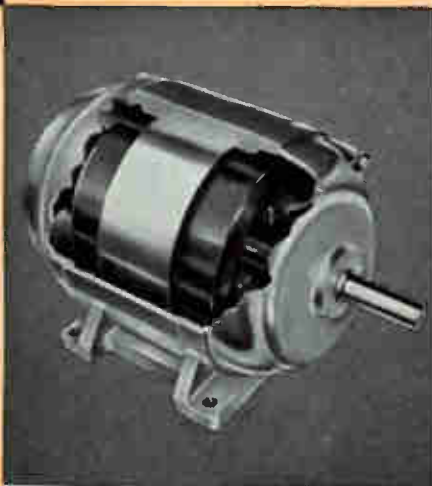

HYSOL epoxy compounds can solve
your insulation problems

For over a decade HYSOL chemists and engineers have been helping manufacturers solve unique and intricate problems of insulation. As a result of this experience, Hysol has developed a complete line of epoxy encapsulating compounds. For superior insulation, for outstanding moisture, chemical and abrasion resistance, for dependable performance . . . there's a Hysol epoxy to meet your specifications. Write for the HYSOL "Systems Selector."

HYSOL CORPORATION • OLEAN, NEW YORK
Formerly Houghton Laboratories, Inc.

HYSOL OF CALIFORNIA HYSOL (CANADA) LTD.
Los Angeles, California Toronto, Ontario

vironmental test facility combining three extreme conditions for state-of-the art testing of rocket and satellite components. Chamber can produce at least 1,200 F of radiant heat under altitude conditions of at least 500,000 ft of 1×10^{-6} mm Hg absolute. Also featured is a vapor trap operating in the range of -120 F, and an automatic hot gas defrost. Exterior dimensions of the chamber, including machinery and instrumentation, are approximately 4 ft by 8 ft by 7 ft high. Inside work space is a cylinder 30 in. in diameter and 30 in. deep.

CIRCLE 320 ON READER SERVICE CARD

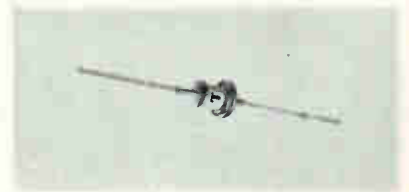

Rectifiers
silicon-carbide

TRANSITRON ELECTRONIC CORP., 168 Albion St., Wakefield, Mass., has developed commercially - available high temperature, radiation-resistant, silicon-carbide rectifiers. They can withstand temperatures of 500 C and are 10 times less subject to radiation damage than silicon. New units will permit reliable operation at temperatures in excess of 200 C. Typical reverse currents are less than 100 μ a at 50 v at 400 C.

CIRCLE 321 ON READER SERVICE CARD

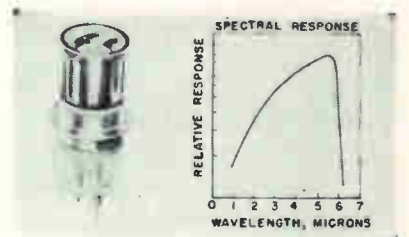

Infrared Detector
high-speed

RADIATION ELECTRONICS Co., 5600 Jarvis Ave., Chicago 48, Ill., announces an infrared detector of extremely small area (0.1×0.1 mm²). Utilizing the photovoltaic effect in indium antimonide at liquid nitrogen, the model J-02 detector ex-

hibits typical NEP values of 2×10^{-12} w at 5 microns and 7×10^{-12} w for 500 K Blackbody. It responds from the visible region to 5.7 microns with a time constant of less than 1 μ sec. It permits the design of infrared systems with high optical gain, high resolution, and very rapid scanning rates. Having an impedance between 1,000 and 40,000 ohms, the J-02 is efficiently coupled to both transistor and vacuum tube preamplifiers. Linear arrays of detection elements can be fabricated for special applications.

CIRCLE 322 ON READER SERVICE CARD

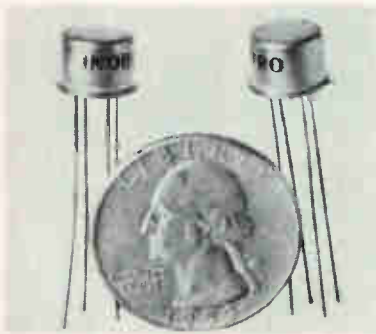

Reference Amplifier miniaturized

INDUSTRO TRANSISTOR CORP., 35-10 36th Ave., Long Island City 6, N. Y. The Mini Ref-Amp, consisting of a bi-polar Zener diode (voltage reference) and a silicon amplifying transistor, is manufactured as one unit and packaged in the TO-5 transistor case. About four components used in ordinary reference amplifiers are eliminated with this configuration. Ease of handling is promoted by using a standard transistor case (4 leads) with index tab for automatic handling equipment. It may be used for printed circuit applications or in conventional chassis. For maintenance purposes, the entire unit may be replaced as easily as inserting a transistor. Because of its design, it may be mounted in any position, and used wherever a transistor can go.

CIRCLE 323 ON READER SERVICE CARD

Double-Beam Scope portable unit

SOLARTRON ELECTRONIC Co LTD., Thames Ditton, Surrey, England,

ELECTRONICS • APRIL 1, 1960

Millions of tiny parts are made from shaped, special alloy wire

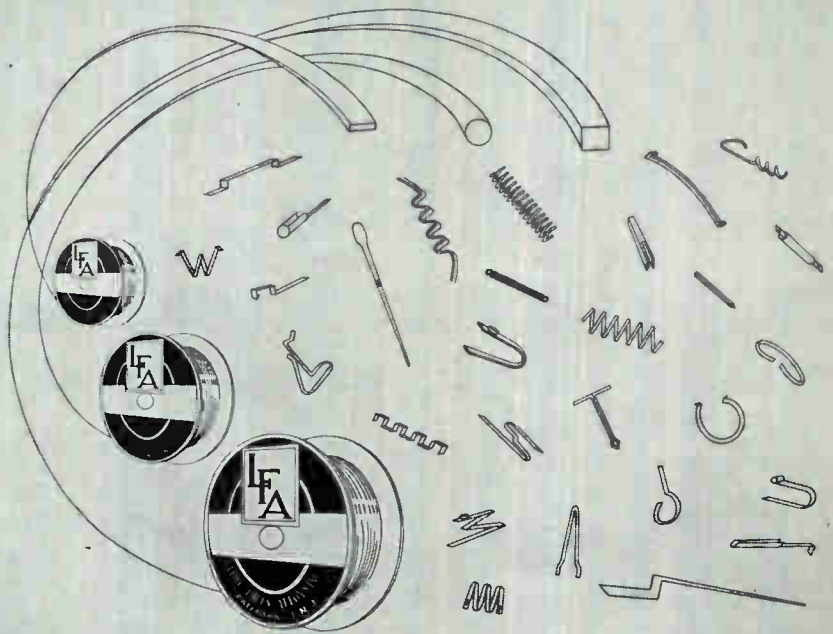

... supplied by LFA in precision sizes,
round - square - flat - rectangular shapes

Tons of beryllium copper, bronze and other special non-ferrous alloy wire today provide millions of tiny formed parts for industry.

Modern production applications (printed circuit, spring, connectors, terminals, tabs) require all types, shapes and finishes (solder dipped and plated, etc.) of special alloy wire for production of miniature and sub-miniature formed parts.

These new production techniques reduce costs, more importantly, are a guarantee of better quality control, positive size holding and elimination of finish problems.

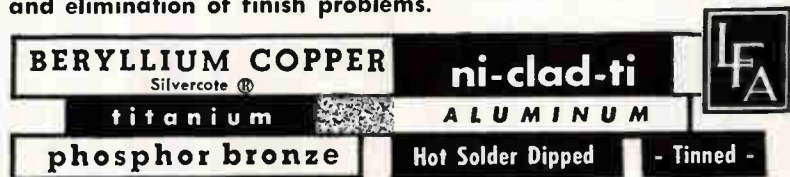

LITTLE FALLS ALLOYS, INC.

194 CALDWELL AVENUE, PATERSON 1, NEW JERSEY

CIRCLE 109 ON READER SERVICE CARD

NEW IDEAS FOR SALE!

Words and pictures tell you about the top new product ideas each week in "On the Market". Who makes 'em and what they'll do for you. Easy way to keep in touch with the latest and best.

Another reason why it will pay you to subscribe to *electronics* (or renew your subscription) right now. Fill in the box on Reader Service Card. Easy to use. Postage free.

FIND WHAT
YOU NEED IN...

electronics

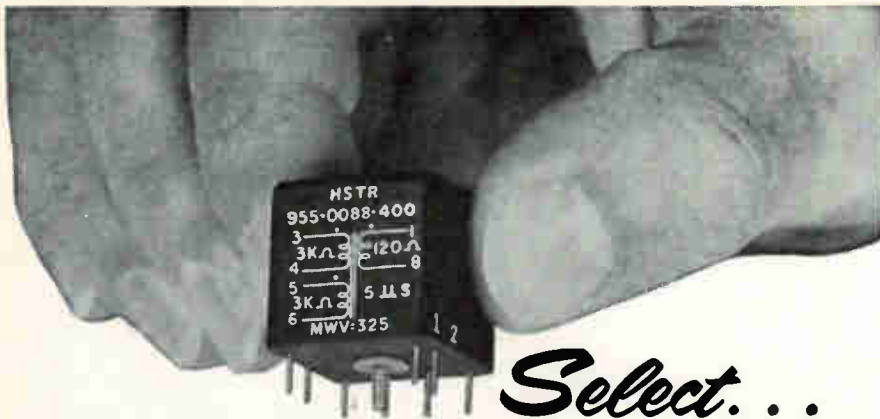

Select...

HERMETIC SEAL PULSE TRANSFORMERS

designed — tested — manufactured for *reliability!*

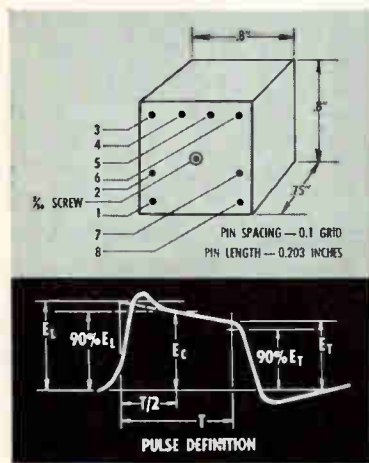

Special emphasis on control of all design and manufacturing processes enables HST to offer *ultra-high reliability* pulse transformers for computer, missile and other airborne applications. HST *reliability* programs are managed by *reliability* specialists from receipt of order to shipment. All transformers are acceptance tested by HST's environment division. Advise us now of your *reliability* problems for prompt solution.

Write for Bulletin NPB-105

	PT-00	PT-01	PT-02	PT-03	PT-04
INDUCTANCE					
Terminals 3-4	42.2 MH	3.8 MH	5.5 MH		9.75 MH
1-8	0.188 MH	0.152 MH			
5-6	42.2 MH	3.8 MH		1.47 MH CT	
1-3				1.47 MH CT	
6-8					
TURNS RATIO	15:1:15	8:1:5	1:3	1:1	1:16
LEAKAGE INDUCTANCE					
1-8 Ref. 3-4	360 μH	35 μH			
1-8 Ref. 5-6	400 μH	30 μH			
3-4 Ref. 1-2			40 μH		
3-4 Ref. 3-4					
1-3 Ref. 1-3				10 μH	
6-8					
3-4 Ref. 1-2					900 μH
3-4 Ref. 3-4					
PULSE CHARACTERISTICS					
Risetime	0.27 μs	0.1 μs	0.1 μs	.05 μs	.25 μs
Drop	30% in 5 μs	50% in 5 μs	63% in 3 μs	25% in 4 μs	25% in 5 μs
Fall	0.25 μs	0.2 μs	0.1 μs	.05 μs	0.25 μs
Backswing	75% E _L	160% E _T	170% E _T	75%	
Overshoot	5% E _C	5% E _C	5% E _C	5% E _C	5% E _C
Output Amplitude	89% E _L	89% E _L	70% E _L	86% E _L	

has developed portable test gear which combines high accuracy and durability with low weight. Type CD1014 is a true double-beam instrument using a double-gun crt. Weighing only 22 lb, it is ideal for general development, field service, and educational uses. Bandwidth is from d-c to 5 Mc (3 db) with maximum time base sweep speed of 10 cm per μsec. The device has accurate X and Y calibration and stabilized extra high tension power supply.

CIRCLE 324 ON READER SERVICE CARD



Shaped Battery dual output

COOK BATTERIES, A Subsidiary of Telecomputing Corp., 3850 Olive St., Denver 7, Colo. A special, "shaped" electric APU power source containing two separate battery sections provides dual output for missile and spacecraft power requirements. The two battery sections in the model P68A provide two different voltage levels. One section provides a current of 8 amperes at 28 v. Maximum current is 25 amperes, with a discharge time of 40 minutes at 8 amperes. Capacity is 5.5 ampere-hr. Second section supplies 6.3-v power at 3 amperes. Discharge time is 40 minutes. Maximum current is 25 amperes. Capacity is 5.5 ampere-hr. Both sections are activated automatically. Model P68A will withstand shock to 50 g, acceleration to 20 g and vibration to 10 g, along all three major axes. Temperature range is 50 F to 150 F.

CIRCLE 325 ON READER SERVICE CARD



MAGNETIC IRON-CORE COMPONENTS
ENVIRONMENTAL TESTING
POWER SUPPLIES—SERVO AMPLIFIERS



DRESSER INDUSTRIES INC.
ELECTRONIC
OIL • GAS
CHEMICAL
INDUSTRIAL

TEXAS COMPONENTS DIVISION
555 N. Fifth St. P. O. Box 978
Garland, Texas
Dallas phone BRoadway 6-5141

PACIFIC COMPONENTS DIVISION
18151 Napa St. P. O. Box 161
Northridge, California
Phone Dickens 5-2250

Germanium Transistors high speed

PHILCO CORP., Lansdale, Pa., announces development of germanium Micro Alloy Diffused-base Transistors (MADT) having cadmium electrodes and featuring high speed and high power dissipation. De-

signed in response to industry's demand for high current, high power, high frequency switching performance, the new MADT devices have applications which primarily include incorporation into data processing systems (memory drivers, transmission line drivers), oscillators and communications equipment. The new transistors include types 2N1495, 2N1204, 2N1494 and 2N1496, all of which are capable of switching 400 ma.

CIRCLE 326 ON READER SERVICE CARD



Pressure Generator digital type

WIANCKO ENGINEERING Co., 255 N. Halstead, Pasadena, Calif., announces a fully automatic method of performing complete calibration of a pressure instrumentation system. Pressure in a reservoir is measured by a secondary pressure standard, the output of which is a precision frequency. This frequency is compared in a frequency comparator with a selected reference frequency. The output of the comparator, indicating the magnitude and direction of the difference in frequencies, regulates the pressure in the reservoir. Result—accurate pressure source. Unique digital concepts allow resolution to be set as fine as required without sacrificing the response characteristic. Accuracy—0.05 percent full scale.

CIRCLE 327 ON READER SERVICE CARD

Gold Alloy Strip precision rolled

ACCURATE SPECIALTIES Co., INC., 37-11 57th St., Woodside 77, N. Y., has available gold alloy strip precision rolled to tolerances down to ± 0.0001 in. for use in a wide variety of components where its properties of conductivity, solderability, ductility and chemical cor-

BALLANTINE'S MODEL 305A VOLTMETER measures peak, or peak to peak

PULSES

0.5 μ s

as short as

AT PULSE RATES AS LOW AS 5 pps
... VOLTAGES OF 1 mv TO 1000 v

Also measures

Complex Waveforms

having fundamental of 5 cps to 500 kc with harmonics to 2 mc.

Accuracy

is 2% to 5% OF INDICATED VOLTAGE, depending upon waveform and frequency.

Scale

is the usual Ballantine log-voltage and linear db, individually hand-calibrated for optimum precision.

Input Impedance

is 2 meg, shunted by 10 pf to 25 pf.



Price: \$395.

THIS "A" MODEL is the result of improvements and new features AFTER 11 YEARS OF MANUFACTURING THE VERY SUCCESSFUL MODEL 305

Write for brochure giving many more details

— Since 1932 —



BALLANTINE LABORATORIES INC.

Boonton, New Jersey

CHECK WITH BALLANTINE FIRST FOR LABORATORY AC VACUUM TUBE VOLTMETERS, REGARDLESS OF YOUR REQUIREMENTS FOR AMPLITUDE, FREQUENCY, OR WAVEFORM. WE HAVE A LARGE LINE, WITH ADDITIONS EACH YEAR. ALSO AC/DC AND DC/AC INVERTERS, CALIBRATORS, CALIBRATED WIDE BAND AF AMPLIFIER, DIRECT-READING CAPACITANCE METER, OTHER ACCESSORIES.

How To Get Things Done Better And Faster

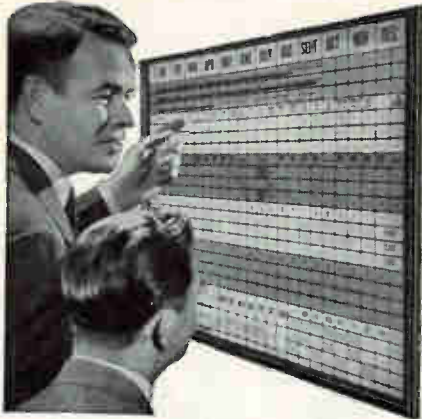

BOARDMASTER VISUAL CONTROL

- ☆ Gives Graphic Picture—Saves Time, Saves Money, Prevents Errors
- ☆ Simple to operate—Type or Write on Cards, Snap in Grooves
- ☆ Ideal for Production, Traffic, Inventory, Scheduling, Sales, Etc.
- ☆ Made of metal Compact and Attractive. Over 500,000 in Use

Full price **\$49⁵⁰** with cards

FREE

24-PAGE BOOKLET NO. C-40
Without Obligation

Write for Your Copy Today

GRAPHIC SYSTEMS

Yanceyville, North Carolina

CIRCLE 202 ON READER SERVICE CARD

FREE!

416-PAGE

**PIC
MASTER
CATALOG**

#21

Lists over 12,000

**PRECISION INSTRUMENT PARTS
and ASSOCIATED COMPONENTS**

Available From **STOCK!**

GEARS • SHAFTS • COLLARS • CLUTCHES •
BEARINGS • COUPLINGS • DIFFERENTIALS
• SPEED REDUCERS and many other Pre-
cision Engineered Parts
& Components.

Send For Your
Copy Today.

PIC DESIGN CORP.

Subsidiary of **BENRUS WATCH COMPANY, Inc.**

477 Atlantic Ave., East Rockaway, L.I., N.Y.

rosion resistance are necessary. The material is available in strip to 4.00 in. maximum width, in thicknesses down to 0.0005 in.

CIRCLE 328 ON READER SERVICE CARD



TV Camera Tube 4 1/2-in. face

RADIO CORP. OF AMERICA, Harrison, N. J. New image orthicon camera tube, 7389-A, is intended to provide superior black-and-white tv pictures within the framework of existing tv standards. The superior quality of the picture signal from the 7389-A permits the making of successive recordings which retain good broadcast picture quality. Tube is capable of providing pictures that have great sharpness, more realistic tonal values, wider range of contrast, and greater freedom from edge effects, noise and redistribution effects. It features a very high signal-to-noise ratio, greater resolution, and a higher capacitance target. Characteristics are controlled within close tolerances to permit ease of camera-tube set-up and to facilitate operation in cameras designed for high stability.

CIRCLE 329 ON READER SERVICE CARD

Laminates high heat resistant

CONTINENTAL - DIAMOND FIBRE CORP., Newark 100, Del., announces a line of laminates that are designed for exceptionally high heat applications. These include graphite fabric and asbestos base laminates that are designed for short-

time applications at 5,000 F. The use of these materials is for missile and rocket applications where the materials will ablate or wear away at a slow enough rate to permit them to accomplish their intended function.

CIRCLE 330 ON READER SERVICE CARD

Scope Cart all-aluminum

HUGHES INDUSTRIAL SYSTEMS DIVISION, International Airport Station, Los Angeles 45, Calif., has available an all-aluminum scope cart designed to fit all popular oscilloscope models. It is equipped with large full-swivel casters and a bottom tray for storage of auxiliary equipment and accessories. It also has a pull-out leaf for use as a writing desk, and a drawer for manuals, instruction books, tools, parts and miscellaneous items. The cart contains a six-ft retractable power cord with duplex outlet, mounting provisions for two spare amplifiers, and snap clips for storing probes.

CIRCLE 331 ON READER SERVICE CARD



Cathode Ray Bulb high-speed printing

CORNING GLASS WORKS, Corning, N. Y. A cathode ray bulb with 35,000 separate wire conductors embedded in face plate only 3 by 1/4 in. in size has been developed for high-speed electronic printing. The new process is capable of printing 20,000 characters a second. It also can be used to transmit by microwave or wire systems facsimiles of graphic and printed materials—

documents, records, maps—even mail. Each conductor in the rectangular matrix of the face plate is 0.001 in. in diameter—half the thickness of a strand of human hair. Nominal space between conductors is 0.003 in. These conductors serve to transfer an electrostatic charge from an electron beam to moving paper. The information can be obtained from a computer or from magnetic tape.

CIRCLE 332 ON READER SERVICE CARD



Power Supply double regulation

VALOR INSTRUMENTS, INC., 13214 Crenshaw Blvd., Gardena, Calif. Double regulation in model PS102M provides high regulation and low ripple. Other features are excellent transient response with a controlled under and overshoot, high stability and a floating output. Output is 6-30 v d-c at 0.5 ampere; input 105-125 v, 60-400 cps; transient response 30-50 mv typical for 50 μ sec; ripple 1 mv rms typical; line regulation 5 mv typical; load regulation 50 mv typical for 0-0.5 ampere load change; output impedance 0.08 ohm typical; voltage and current metering; price \$235.

CIRCLE 333 ON READER SERVICE CARD

Wrapping Tape abrasion-resistant

DIXON CORP., Bristol, R. I. Rulon abrasion barrier wrapping tape is available in thicknesses from 0.004 in. up and widths from $\frac{1}{4}$ in. to 12 in. It finds application for TFE-insulated wires rated for 500 F up, and currently is being used on missile electrical wire. Best results are obtained with a Teflon primary insulation, the Rulon tape on top

IF relays cause you as much trouble as they do us, you will undoubtedly welcome information on how to get rid of them. Probably the most fashionable way to do the switching is to use transistors, and as a public service Sigma hereby offers some application data toward this end. The Search for Truth must go on.

Right off the bat, it must be conceded that transistors have the edge in several important physical and dynamic respects. Relays are certainly bigger, heavier and slower, and their useful life is nowhere near infinite—primarily because they all have such old-fashioned things as moving parts. Nor are relays immune to unlimited shock and vibration (the best we've been able to do on a subminiature type, and keep it operating within spec, is 30 g's to 5000 cycles).

There are a few things relays are good for, however, even though "Relayized" may never sell a single product. For instance: signal circuits can be isolated from load circuits . . . signal and load can be AC or DC, in

any combination . . . circuits with high voltage to ground present no particular problems, and relatively high voltage loads can be handled . . . inductive loads can be switched "off" when they're supposed to be off. On "sliding" or slowly varying signals, the right relay will also provide clean, positive switching and it won't fry if the circuit develops a mild defect. It is true, if not grammatical, to say that a relay is many orders more "off" and several orders more "on" than those other things.

The fact that relay contacts more closely approximate the ideal switch—no ohms one way and infinite ohms the other way—also means something when dry circuit switching is your problem. With loads in the order of 0.1 microwatt, a properly designed relay can provide dependable switching.

Further, if 3-position, polar, center-stable switching (Sigma "Form X") is needed, a single relay will do the job. And if the requirement calls for having the switch "remember" and stay in the last switched position, a polarized, magnetic latching relay (our "Form Z") will do just that without stand-by power.

There are also such considerations as cost (where the switching is of the pinball machine variety), stability as a function of temperature, and amplification (10,000:1 load to signal ratio), that lean in favor of relays. But the main ones are those mentioned earlier—which we're banking on to keep us from going bankrupt this year. In the meantime, we're looking around for diversification possibilities—something in a good solid state, perhaps.

*or, Ten Easy Steps to Utopia.

SIGMA INSTRUMENTS, INC.
62 Pearl St., So. Braintree 85, Mass.
An Affiliate of The Fisher-Pierce Co. (since 1939)

HOW TO AVOID RELAYS*



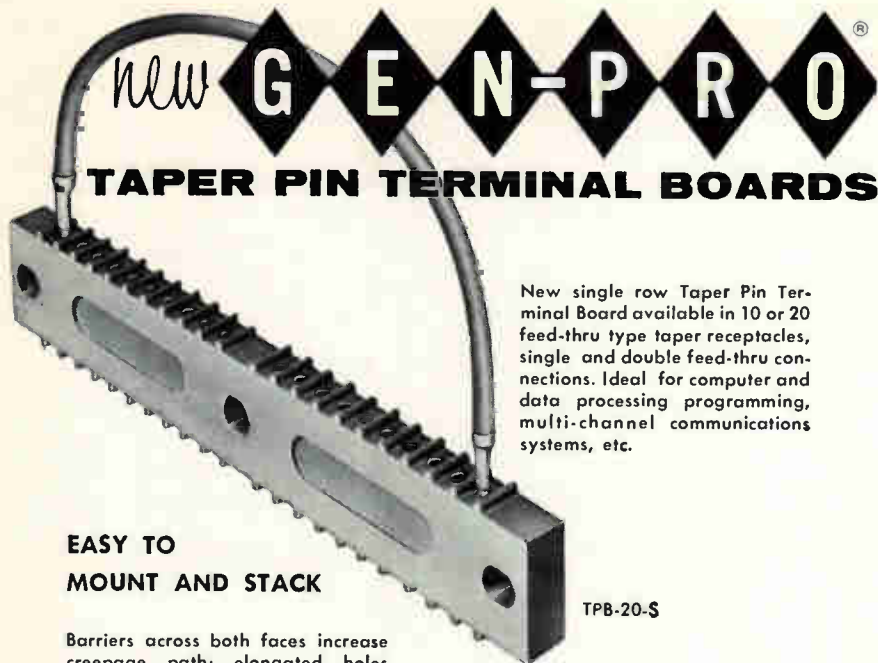

new GEN-PRO[®]

TAPER PIN TERMINAL BOARDS

New single row Taper Pin Terminal Board available in 10 or 20 feed-thru type taper receptacles, single and double feed-thru connections. Ideal for computer and data processing programming, multi-channel communications systems, etc.

EASY TO MOUNT AND STACK

Barriers across both faces increase creepage path; elongated holes facilitate mounting; nesting projection and recess aid stacking. Brass receptacles provide low contact resistance. 14 lbs. min. pull out with standard solderless taper pins. Molding compound is MAI-60 (Glass Alkyd) of MIL-M-14E.

TPB-20-S

Gen-Pro boards have passed Navy 2,000 ft. lb. high shock requirements as specified by MIL-S-901B.

WRITE NOW FOR FURTHER DETAILS

GENERAL PRODUCTS CORPORATION

Over 25 Years of Quality Molding

UNION SPRINGS, NEW YORK

TWX No. 169

CIRCLE 203 ON READER SERVICE CARD

of primary, and an outer layer of braided fiberglass impregnated with Teflon. A No. 20 gage wire constructed in this fashion to a finished o.d. of 0.091 in. provided a minimum of 36 in. abrasion resistance when tested according to MIL-T-5438. After heat aging 96 hours at 750 F, the abrasion resistance increased by 20 percent and dielectric strength by 1,000 v.

CIRCLE 334 ON READER SERVICE CARD



Tester-Monitor automatic

ITI ELECTRONICS, INC., 369 Lexington Ave., Clifton, N. J. Automatic testing is provided by Model IT-213 tester. Designed for high-speed limit testing, the device can perform go-no-go tests on wired resistors, capacitors, inductors, diodes and transistors. Also make hi-pot, wiring error and wiring resistance checks. The basic unit is adaptable to limit monitoring of any parameter which may be converted to a voltage by a transducer.

CIRCLE 335 ON READER SERVICE CARD



Tiny Protector for small motors

TEXAS INSTRUMENTS INC., Metals & Controls Division, 34 Forest St., Attleboro, Mass. The Klixon 5891 overtemperature protector is designed specifically for subfractional h-p motors 1 in. in diameter and larger, and is equally suitable for

"SPOOLY" SAYS...

Super-Temp

HAS EVERYTHING!

Super-Temp offers a complete line of high temperature wire with fastest production and quickest delivery. Don't lose time! . . . standardize on Super-Temp.

Magnet Wire, Airframe Wire, Hook-up Wire
Coaxial Cables, Miniature & Jumbo Cables, Tapes
Teflon* or Silicone Rubber Insulations

*DUPONT'S TFE RESIN



Save Time WITH Super-Temp

American Super-Temperature Wires, Inc.

8 West Canal Street, Winooski, Vermont • UNIVERSITY 2-9636

General Sales Office: 195 Nassau St., Princeton, N. J. • WALnut 4-4450

A Subsidiary of Haveg Industries, Inc.

Free! Send for 1960 Catalog. 88 pages of valuable data.

small solenoids and transformers. Responsive to both current and temperature, the protector is designed with a compensating heating element to ensure that the snap-acting, disk-type sensing element will follow closely the temperature changes of the component to be controlled. Temperature levels of protection are 150, 175 and 200 C. Maximum contact capacity is 5 amperes at 27 v d-c or 120 v a-c. Units conform to MIL-M-7969 and MIL-M-8609, and when mounted in equipment they comply with MIL-E-5272.

CIRCLE 336 ON READER SERVICE CARD



Telemetry Amplifier small-size

UNITED ELECTRODYNAMICS, INC., 200 Allendale Road, Pasadena, Calif., announces a telemetry power amplifier designed to amplify a 2-w signal to as high as 100 w. The PA-15 operates in the 225 to 260 Mc telemetry band. Power output up to 100 w is achieved by using an Eimac 4CX300A stacked ceramic triode. A self-contained 400 cps blower is provided to deliver sufficient cooling air for conditions of maximum r-f output. PA-15 operates over a temperature range of -67 F to 176 F. It withstands vibration of 10 g from 20 to 2,000 cps . . . shock and acceleration of 100 g each.

CIRCLE 337 ON READER SERVICE CARD

Monitoring Scopes rugged and compact

SIERRA ELECTRONIC CORP., 3885 Bohannon Drive, Menlo Park, Calif. Model 218 monitoring oscilloscopes are especially designed for continuous function monitoring of as many as seven channels simultaneously in one rack unit. The scopes provide

At Los Alamos, the mysteries of the universe provide the dynamics for projects ranging from space propulsion to nuclear research.

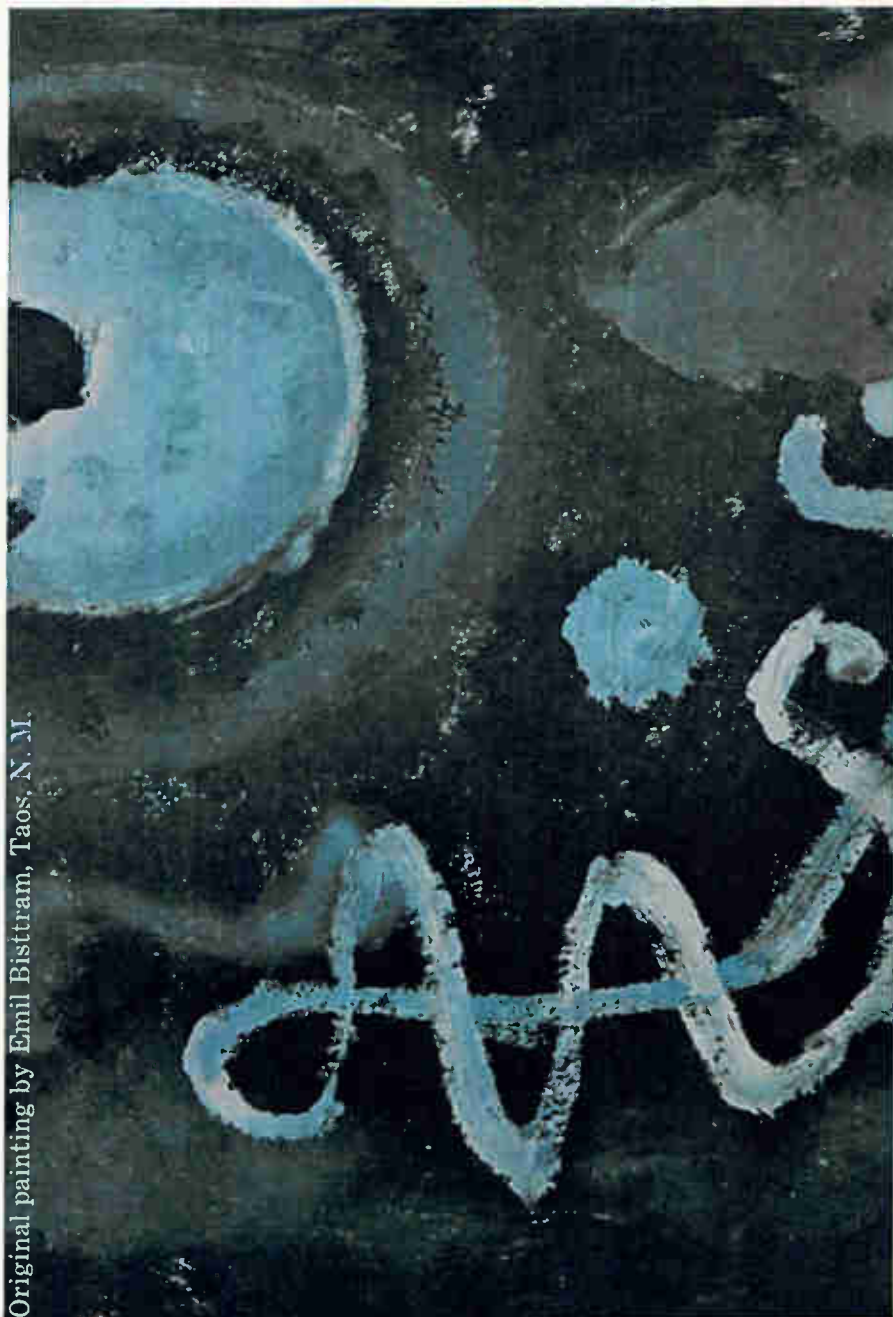

Original painting by Emil Bisttram, Taos, N. M.

For employment
information write:
Personnel Director
Division 60-33

los alamos
scientific laboratory
OF THE UNIVERSITY OF CALIFORNIA
LOS ALAMOS, NEW MEXICO

send for this

FREE

EICO Electronics Catalog



you save 50% on Top-Quality Test Instruments
Hi-Fi • Ham Gear
KITS AND WIRED
 for professional and home use

<p>TEST INSTRUMENTS battery eliminators battery testers bridges decade boxes electronic switch flyback tester oscilloscopes probes signal and sweep generators tube testers transistor tester vacuum tube voltmeters volt-ohm-milliammeters</p>	<p>HI-FI stereo and monaural tuners preamplifiers power amplifiers integrated amplifiers speaker systems</p>	<p>HAM GEAR cw transmitter modulator-driver grid dip meter</p>	<p>OVER 2 MILLION EICO instruments in use throughout the world.</p>
---	--	--	---

LIFETIME service and calibration guarantee. IN STOCK at your neighborhood EICO dealer. Send now for FREE catalog E-4

EICO 33-00 N. Blvd., L. I. C. 1, N. Y. . . . praised by the experts as BEST BUYS IN ELECTRONICS

CIRCLE 204 ON READER SERVICE CARD

AVAILABLE
424
Industrial Sites



in **Minnesota**

Free
112-page Book

filled with photos and facts about latest industrial data on 123 Minnesota cities, their available sites, and names of local contact. A gold-mine of site-finding facts! For your copy of "Minnesota Welcomes New Industry," write on your firm's letterhead:

Dept. of Business Development, State Capitol, Dept. 422, St. Paul 1,

Minnesota

116 CIRCLE 116 ON READER SERVICE CARD

a convenient means for viewing and evaluating complex voltages. Designed primarily for tape recording and data handling systems, model 218 series is well suited for measuring and analyzing mechanical quantities through a transducer.

CIRCLE 338 ON READER SERVICE CARD

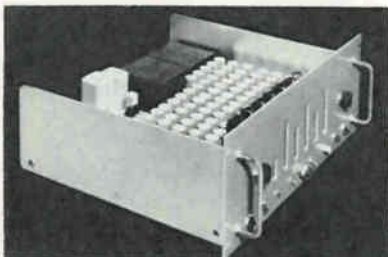

Time Code Generator two models

ELECTRONIC ENGINEERING CO. OF CALIFORNIA, 1601 E. Chestnut Ave., Santa Ana, Calif. Two all solid-state circuit time code generators having an accuracy and stability equal to a secondary standard are being manufactured for field instrumentation timing systems or for laboratory use. Outputs are suitable for recording on oscillographs, strip chart recorders, magnetic tape, or as drivers for neon flash lamps. Time-of-day code (24-hr recycling) and eight pulse rates are produced. A serial binary code is supplied as a d-c level shift and a-m carrier. The ZA-801 is a binary-coded-decimal readout unit and the ZA-802 is a straight binary readout unit. Accuracy is three parts in 10⁶ per day or equivalent to 1 sec per month.

CIRCLE 339 ON READER SERVICE CARD

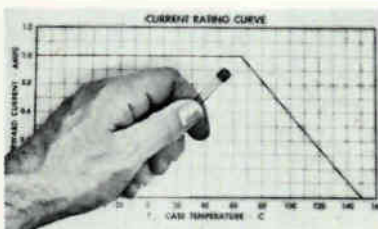

Controlled Rectifiers diffused silicon

TEXAS INSTRUMENTS INC., Box 312, Dallas, Texas. The TI-110 series of *mpn* diffused silicon controlled rectifiers are rated at 1 ampere from 50 to 400 v, and packaged in

a JEDEC TO-5 case. Their light weight, small size and high current and voltage ratings make them extremely well suited for printed circuitry, high-temperature switching, military airborne systems, and many other applications. Functions performed by the devices such as triggering and firing enable them to replace thyratron tubes, relays, and magnetic amplifiers. Units are also ideally suited for use in servomotor control circuits and other low power control systems, and as a protective device in power output circuits.

CIRCLE 340 ON READER SERVICE CARD



I-F Preamplifier transistorized

LEL, INC., 380 Oak St., Copiague, New York. Model I.F.86 preamplifier for missile, space and telemetry applications, has a bandwidth of 20 Mc centered at 60 Mc and designed to be used with microwave receiver mixers having an i-f source impedance of 300 ohms and 18 μ f. Noise figure is better than 4.25 db. Unit is also available at other center frequencies and for other source impedances.

CIRCLE 341 ON READER SERVICE CARD

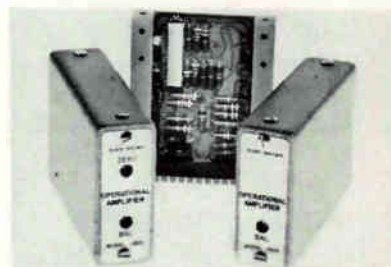

Amplifiers operational type

BURR-BROWN RESEARCH CORP., Box 6444, Tucson, Ariz., announces the 1300 series transistorized amplifiers. Basic units are high gain dif-

APRIL 1, 1960 • ELECTRONICS

ferential d-c amplifiers designed to be used with external feedback. Stable with any resistive feedback, the user may select the "closed-loop" performance best suited to his application. Typical units feature gains of 10,000 and input impedance of 100 K. Outputs to ± 10 v at 200 ma are available. Both germanium and silicon units are packaged in a case measuring 1 in. by 2½ in. by 3½ in. Prices range from \$65 to \$98 for germanium to \$310 for silicon.

CIRCLE 342 ON READER SERVICE CARD

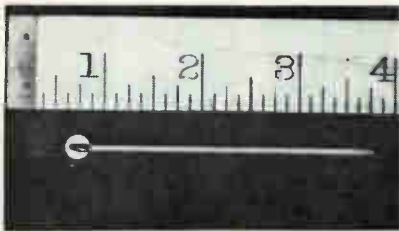

Temperature Probe fast-reacting

FENWAL ELECTRONICS, INC., 51 Mel-
len St., Framingham, Mass. The
G312 surface temperature probe
consists of a thermistor bead
mounted on an aluminum disk 0.25
in. diameter by 0.005 in. thick. All
G312's have identical RT curves
from 0 F to 350 F, and all meet the
Fenwal EMD-31 curve (4,000 ohms
at 25 C). They are supplied with a
48-in. Teflon insulated ribbon wire,
and can be cemented, taped, potted
or held on to any surface.

CIRCLE 343 ON READER SERVICE CARD



Electronic Counters versatile

HEWLETT-PACKARD Co., 275 Page
Mill Rd., Palo Alto, Calif. Models
521D and 521E counters quickly



WHAT THIS UNUSUAL AC-DC "PLUG-IN" TRANSISTORIZED POWER SUPPLY DESIGN GIVES YOU...



One piece finned aluminum extrusion,
achieving high heat dissipation. Most units
need no external heat sink to 55° C ambient.
All units have adjustable output.
Platform mounted standardized subassemblies
and components enable quick delivery of
a wide range of voltages and currents.



Specifications:

Input: 105 to 125V AC, 45 to 420 cps, single phase
Regulation: 0.1% (line or load)
Stability: Better than 0.25% for 8 hours
Ripple: 0.02% rms
Response time: less than 100 microseconds
Low dynamic impedance

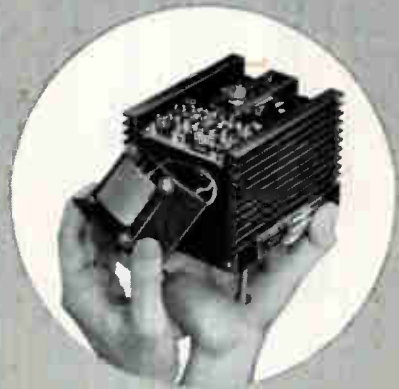

All solid state — zener diode reference,
transistor amplifiers and regulator
Output Voltages: from 2.0 to 300V DC
Output Power to 30 Watts
Reliable short circuit protection
All components readily accessible

Designed primarily as a com-
ponent power supply, units
are widely used in computers,
electronic instrumentation,
production test equipment,
and quality control check out
systems. Best of all, the
unique design makes these
units available at the lowest
possible cost to you.

(Unit pictured above: Model
=1R 90-1; 85-95 V; 0-100 ma;
Price \$145.00) Prices on other
units range from \$100 to \$200.

CONSOLIDATED AVIONICS CORPORATION

A SUBSIDIARY OF CONSOLIDATED DIESEL ELECTRIC CORPORATION

800 Shames Drive • Westbury, L. I. • EDGWOOD 4-8400

ULTRA HIGH PRECISION OVENS

.0033°C Stability
per Degree C



THE
PM
SERIES

Ambient temperature range — 20°C to within 10°C of operating temperature. Standard cavity temperatures 65°C, 75°C, or 85°C (other temperatures on special request). Temperature stability $\pm .0033^\circ\text{C}$ per degree centigrade ambient temperature change. Frequency stability with a 1MC Monitor crystal ± 3 parts 10^6 . Dimensions: $1\frac{7}{16} \times 1\frac{7}{8} \times 4$ " seated height. Optional features available upon request.

Pioneers in crystal ovens designed
and built to customer specifications! Send for NEW, detailed Brochure!

MONITOR PRODUCTS COMPANY

815 Fremont Ave. • South Pasadena, Calif.
MUrray 2-1174 • TWX PASA CAL 7616

CIRCLE 205 ON READER SERVICE CARD

and directly measure frequency and random events per unit of time. With transducers converting mechanical into electrical phenomena, they measure speed, rpm, rps, weight, pressure, temperature and acceleration. The 521E has 5-place readout (99,999 count), the 521D, 4-place readout. The counters have range of 1 cps to 120 Kc. A front-panel switch selects automatic gate time. Both counters also have a manual gate position to allow counts over long time intervals. The 521D is priced at \$675.00, the 521E at \$875.00.

CIRCLE 344 ON READER SERVICE CARD

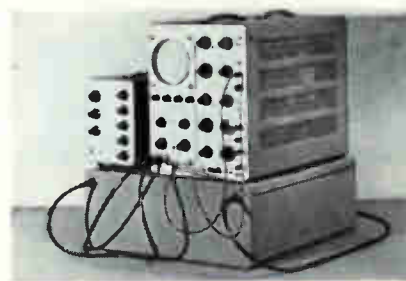

Pulse Sampling System bright display

TEKTRONIX, INC., P. O. Box 831, Portland 7, Ore. Recurrent signals faster than the normal capabilities of Tektronix type 530, 540 and 550 series oscilloscopes can be observed with this pulse sampling system. Risetimes to approximately 0.6 nsec (bandwidth to 600 Mc) can be investigated. Displays with apparent sweep times of as little as 1 nsec can be provided (with magnifier, 100 psec/cm). System also provides general purpose medium and low speed service, convenient trigger takeoff, precise pulse generator with repetition rate of 720 pps nominally and risetime less than 0.25 nsec, ample signal delay, superior synchronizing, and high basic repetition rate to 100 Kc.

CIRCLE 345 ON READER SERVICE CARD

Magnetic Amplifier second harmonic

COLDSTREAM ENGINEERING Co., Box 1893, Tulsa, Okla. Model 300 Magnetor provides temperature compensation to operate over the range of 0 to 100 C. Maximum sensitivity



Who's going to get together and *what* are they going to talk about?

Electronics men are meeting all over the country to talk about everything from ultrasonics to quantum electronics.

electronics tells you where and when "Meetings Ahead" ... gives you the highlights later on.

Another reason why it will pay you to subscribe to *electronics* (or renew your subscription) right now. Fill in the box on Reader Service Card. Easy to use. Postage free.

FIND WHAT YOU NEED IN...

electronics

THE ELECTRONICS MAN

IDENTIFICATION

R
D
P
M



6XK-5XKW **S** **Q**

WHERE TO FIND HIM

The electronics man may be found in any or all of the areas of research, design, production, management.

Your problem: sell him (wherever he is) and keep him sold all year long. Here's the simplified key to this job!

Use electronics to arouse his interest and create acceptance for your products in the magazine's weekly issues.

Use the electronics BUYERS' GUIDE and Reference Issue to be there all year long whenever he is ready to buy.

This is the best selling combination in the electronics industry... and the one that carries the most weight!

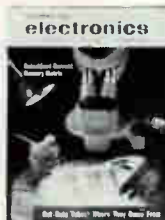

THE ELECTRONICS MAN
"BUYS" WHAT HE READS IN...

electronics

A MCGRAW-HILL PUBLICATION
330 West 42nd Street, New York 36, New York

of 0 to 1 mv input. Conversion gain of 70. Long term zero stability drift is the equivalent of 1 μ v input. Units are internally shielded and shock mounted. Drawn metal case, 1 $\frac{1}{4}$ by 1 $\frac{1}{2}$ by 2 $\frac{1}{2}$ in.

CIRCLE 346 ON READER SERVICE CARD

Miniature Chopper for airborne use

THE BRISTOL Co., Waterbury 20, Conn., announces the C1425 series Syncroverter chopper for use in airborne servo systems. It features an 83 deg nominal phase-lag (at 400 cps) which eliminates space-consuming phasing networks. Chopper is of Bristol's basic nonresonant design, and it exhibits the high reliability and shock and vibration resistance of previous models. It measures 1 $\frac{3}{8}$ by $\frac{7}{8}$ in. and is available with a variety of mountings.

CIRCLE 347 ON READER SERVICE CARD

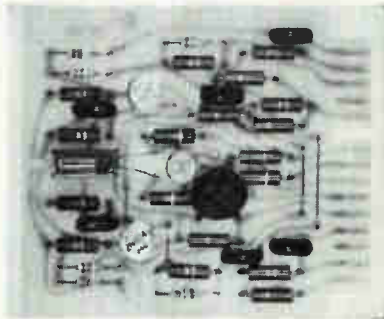

Digital Modules transistorized

CONTROL EQUIPMENT CORP., 19 Kearney Road, Needham Heights 94, Mass. Features of this new line include neon indicators on flip flops and shift registers and allowance for use of a remote indicator. They are economically priced and completely compatible. The modules are designed for operation within a temperature range of -45 C to +65 C. They have an overall size of 3 $\frac{1}{8}$ in. by 3 $\frac{3}{8}$ in., with an approximate weight of 1.5 oz. Among the types available are flip flops, shift registers, multivibrators, one-shots, d-logic and many others. Among applications are digital systems, automation, timing and control, data processing, test equipment, instrumentation and digital servos.

CIRCLE 348 ON READER SERVICE CARD



FOREMOST

in

SONAR

EDO CORPORATION

College Point, L.I., N.Y.

Since 1925

CIRCLE 206 ON READER SERVICE CARD

Heyco Nylon BUSHINGS

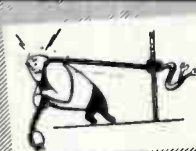

STRAIN RELIEFS
The insulating bushing that anchors a cord set to an electrically operated machine or appliance.



JUNCTION-TERMINAL BUSHINGS

Eliminate "pig-tails" - Miniature size. Snap-in assembly, color or number coded. Can be used as plug-in receptacle. Simple quick disconnect.

ACCORDIAN TYPE
Fit curved surfaces
Nylon bushing - brass tab

HEYCO NYLON Snap Bushings

10 Sizes for holes from $\frac{3}{16}$ " to $1\frac{1}{2}$ " dia. - various inside diameters. Snap locks into panels up to $\frac{1}{8}$ " thick.



FREE SAMPLES! BUSHINGS OF YOUR CHOICE

HEYMAN
MANUFACTURING COMPANY
KENILWORTH 2, NEW JERSEY

CIRCLE 119 ON READER SERVICE CARD 119

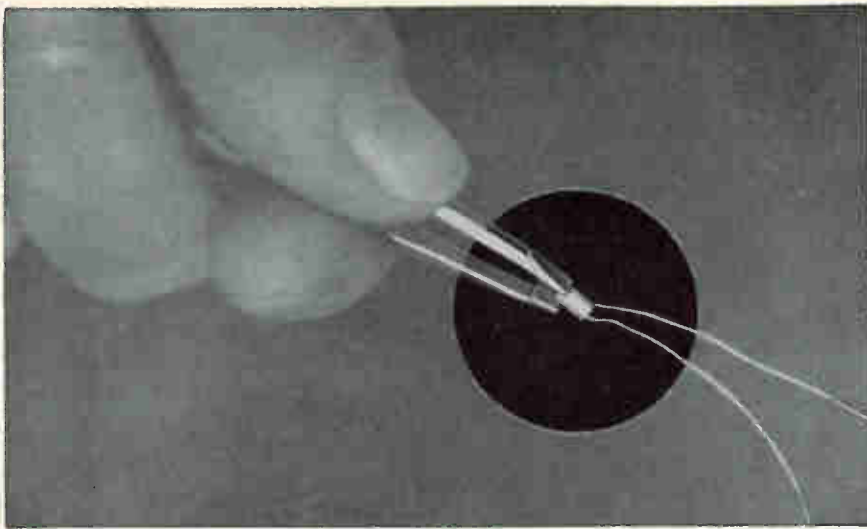

**NOW - 48-56 Gauge Wire Coils
built to YOUR specifications**

Whatever your application—from hearing aids to missile systems—Deluxe Coils' new fine wire plant can supply the miniature coils you need . . . built to your specifications for precision and accuracy.

Deluxe Coils' newest facility spans 15,000 sq. ft. It is air and sound conditioned and completely equipped to produce all types of miniature fine wire coils, 40-47 gauge, ultra fine wire coils, 48-56 gauge, and components.

Write for information on Deluxe Coils' fine wire production capabilities—and how they can be put to work for you, right away.

DELUXE COILS, INC.
POST OFFICE BOX 318 • WABASH, INDIANA

CIRCLE 207 ON READER SERVICE CARD

*Safe . . . Accurate
Controlled Area Heat!*
with Sherman HF Induction Heaters . . .

New Sherman Induction Heaters provide an extremely versatile tool for all manufacturing operations requiring controlled area heating. Modern 3 megacycle units supply instantaneous pin-point heat with no contamination and no pre-heating, permitting a safer, more accurate and reliable method of sealing semiconductors, diodes and transistors, as well as soldering, brazing and heat treating. All Sherman Induction Heaters are designed for use on regular factory voltages and completely automatic units can be built to satisfy individual requirements.

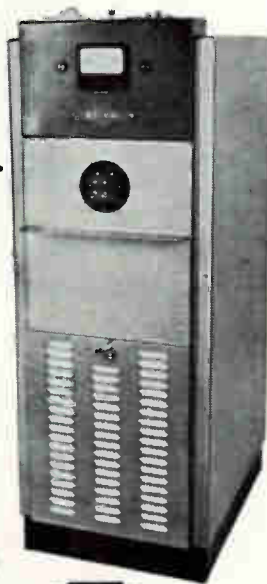

Silver Soldering



Production Brazing



Automatic Production Unit

*Write
for
detailed
literature.*



SHERMAN INDUSTRIAL ELECTRONICS
Division of HF Induction and Dielectric Heaters
ELECTRONICS DEVELOPMENT, INC./STATE COLLEGE, PENNSYLVANIA

120 CIRCLE 120 ON READER SERVICE CARD

**Literature of
the Week**

PRESSURE INSTRUMENTATION. Ultradyne, Inc., 2630 San Mateo, N. E., Albuquerque, N. M. Pressure instrumentation of the variable reluctance and d-c/d-c types is shown and described in a 4-page brochure.

CIRCLE 380 ON READER SERVICE CARD

P-C GRID BOARDS. Corning Electronic Components, Corning Glass Works, Bradford, Pa. Fotoceram printed circuit grid boards are described in new data sheets—CE-3.01—now available.

CIRCLE 381 ON READER SERVICE CARD

FILM-TYPE RESISTOR. Kidco Inc., P. O. Box 178, Medford, N. J. Bulletin 104 describes the SM $\frac{1}{2}$, M $\frac{1}{2}$ and EM $\frac{1}{2}$ Metal-istors (precision metal-film resistors).

CIRCLE 382 ON READER SERVICE CARD

D-C MOTORS. General Electric Co., Schenectady 5, N. Y. GEC-1539 is a two-page illustrated bulletin listing ratings and frame sizes of a line of open and totally enclosed fractional h-p d-c motors.

CIRCLE 383 ON READER SERVICE CARD

PRINTED CIRCUITS. Whitney Blake Co., New Haven 14, Conn. A two-color bulletin discusses the benefits accruing from the use of printed circuits and provides a list of information needed by the manufacturer when quotations are to be made.

CIRCLE 384 ON READER SERVICE CARD

PRECISION METERS. Greibach Instruments Corp., 319 North Ave., New Rochelle, N. Y. An all-inclusive Meter Master Chart, for quickly determining the one meter that combines up to 23 ranges to meet individual measuring needs, is among the many highlights of a recently released 20-page catalog.

CIRCLE 385 ON READER SERVICE CARD

THERMOSTAT METAL. Texas Instruments Inc., Metals & Controls Division, 34 Forest St., Attleboro, Mass. How thermostat metal elements can be stacked to satisfy performance specifications in space that prohibits the use of a

single element with sufficient material volume is the subject of a new 2-page data bulletin, TRU-11.
CIRCLE 386 ON READER SERVICE CARD

AIRCRAFT TEST SET. Airpax Electronics Inc., Seminole Division, Fort Lauderdale, Fla. Bulletin F-71 describes the model 4B aircraft test set which incorporates in one instrument a highly accurate means of measuring frequency as well as a-c and d-c voltage.

CIRCLE 387 ON READER SERVICE CARD

METAL NAMEPLATES. Hallmark Nameplate, Inc., 19 Gazza Blvd., Farmingdale, N. Y., has available a mailing piece describing Perf-i-Kal nameplates which range in thickness from 0.003 to 0.125 aluminum.

CIRCLE 388 ON READER SERVICE CARD

ENCODER TRANSLATOR. Datex Corp., 1307 S. Myrtle Ave., Monrovia, Calif. Bulletin No. 122 covers a compact, solid state translator that will translate up to 14 bits of Gray code to binary code, producing at the same time not only the binary signal but its complement as well.

CIRCLE 389 ON READER SERVICE CARD

ROUND DRAWN CASES. Olympic Products Co., Inc., Alpha, N. J. A 4-page data sheet features more than 200 new standard sizes of round drawn cases made from aluminum, copper, steel, brass, and mu metal.

CIRCLE 390 ON READER SERVICE CARD

DIRECTIONAL COUPLERS. Waveline Inc., Caldwell, N. J. A 6-page folder illustrates and describes cross guide, narrow wall general purpose, and broad wall precision directional couplers.

CIRCLE 391 ON READER SERVICE CARD

SERVO MOTOR. Helipot Division of Beckman Instruments, Inc., 2500 Fullerton Road, Fullerton, Calif., has available a new data sheet describing the Size 18 velocity-damp servo motor. It shows photos of the model 18 VM 460, as well as dimensional drawings, torque-speed curves, electrical and mechanical characteristics.

CIRCLE 392 ON READER SERVICE CARD

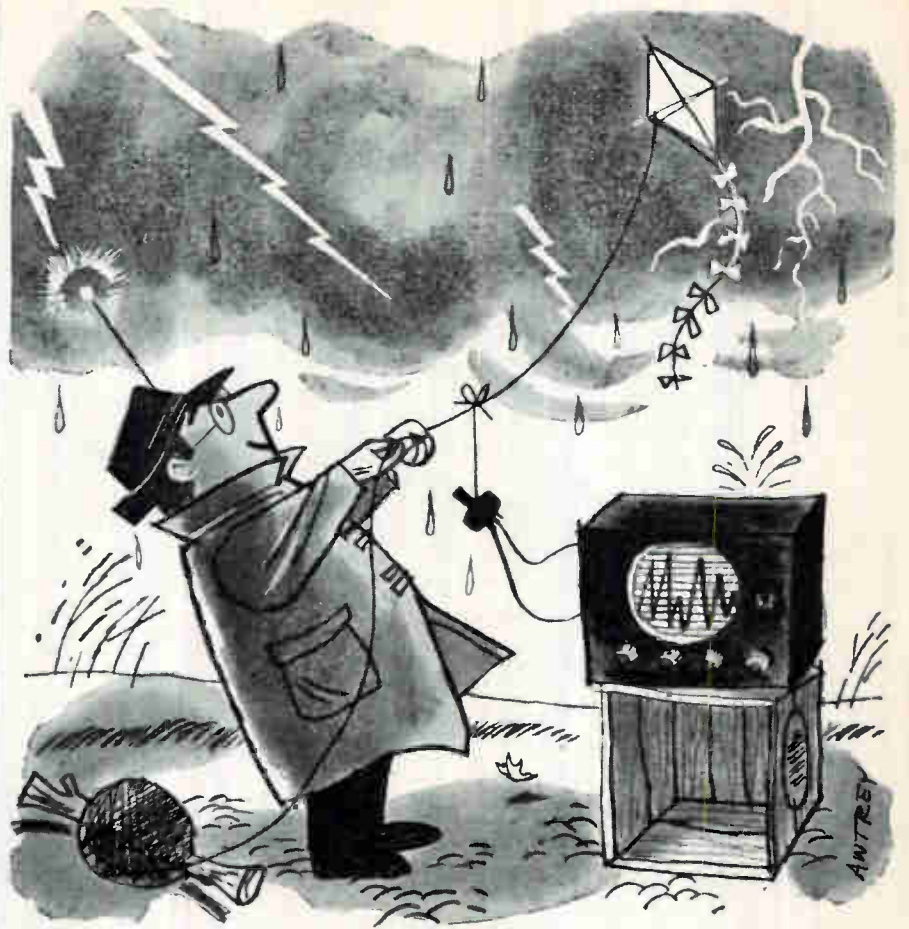

test . . . test . . . test . . .

If you feel you *must* make your own pots to get exactly what you need, don't overlook quality control along the way! And this can be a messy business, what with special, elaborate techniques to quality-check *every* production stage! Oh, you'll get involved in maddening bouts with visual comparitors, ratiometers, environmental testing labs — and when you've finished — *and* made a few hundred revisions — you *might* have the quality you want!

So, before you go fly a kite — consider Ace. We've been all through this before, and have what is regarded to be the finest quality control system in the industry. It enables us to keep our final costs down, by rejecting sub-standards at each stage, without waiting for the final inspection. Although it's more work this way, we can offer a higher degree of resolution and linearity at a lower price. So, for precision-at-price, see your ACErep!



Here's 0.3% linearity in a 1/2" pot: the Series 500 ACEPOT®. Single-turn, -55° to 125°C range. As with all Ace components, tested in every stage of its manufacture!

ACE ELECTRONICS ASSOCIATES, INC.
99 Dover Street, Somerville 44, Mass.
Somerset 6-5130 TMX SMVL 181 West. Union WUX

Acepot® Acetrim® Aceset® Aceohm® *Reg. Appl. for



PI Remodels, Expands Plant

COMPLETION of remodeling and new additions to existing administration and manufacturing facilities has been announced by Precision Instrument Co., San Carlos, Calif., maker of magnetic tape instrumentation recording equipment.

The expanded plant now includes a total of 12,500 sq ft of manufacturing, engineering and administrative space for the three-year-old firm, president Konrad Schoebel says.

Features of the new building include high density lighting, air-conditioned engineering and production areas, and complete facilities for the development, fabrication and assembly of all items in the Precision Instrument product line.

In three years, Precision Instrument has grown from two persons to 100 employees. The company's line of portable, transistorized instrumentation tape recorders is now widely used for military, scientific and industrial applications, especially where space is at a premium.

Precision Instrument recorders range from 2-channel models weighing 2½ lb, to 16-channel record/reproduce models weighing 100 lb and using 250 w of power.

Sperry Appoints Department Head

HERBERT O. BOELLHOFF has been named methods and procedure supervisor by Sperry Semiconductor,



South Norwalk, Conn. This division of Sperry Rand Corp. manufactures silicon diodes and transistors.

Before joining Sperry, Boellhoff served as industrial engineering supervisor at Clevite Transistor, as plant manager at Marine Optical Co., and as industrial engineering superior at Wheeler Electronics.

Alpha Metals Promotes Two

THE DIRECTORS of Alpha Metals, Inc., Jersey City, N. J., announce the election of Harold A. Cohn as vice president in charge of the Alpha-Loy Division, Chicago. Join-

ing the firm in 1953, he assisted in setting up the midwest plant he now heads.

Fredrick C. Disque, Jr., was named director of research. He was formerly chairman of the department of chemistry, Pratt Institute. Before joining Alpha Metals in 1953, he acted as one of their technical consultants, specializing in research and development of solders, fluxes and high-purity metals for the semiconductor industry.



Chance Vought Hires Ciscel

VOUGHT ELECTRONICS, division of Chance Vought Aircraft, Inc., recently appointed Benjamin H. Ciscel as general manager. The 400 man division is currently active in several major missile and aircraft programs.

Before joining Vought Electronics, Ciscel was senior vice president and member of the board of directors of Electronic Specialty Co. and had also been manager of weapons systems with RCA.

Name Fishman Consultant

HERBERT FISHMAN was recently appointed consulting engineer to the transistor advance and design engineering subsection in General Electric's Semiconductor Products Department, Syracuse, N. Y.

Immediately prior to his promo-

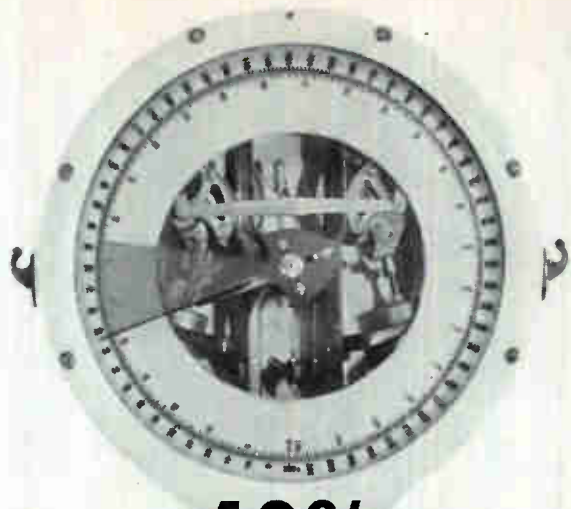

**42%
HEAVIER
IN
ADVERTISER
CONFIDENCE!**

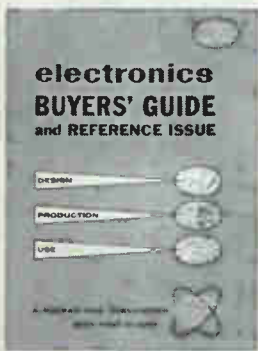



Advertisers, being practical, like things that work! That's why the **electronics BUYERS' GUIDE and Reference Issue** has 42% more advertisers than the nearest competition. With the "GUIDE" advertisers reach more of the right people . . . readers

get a correspondingly bigger choice of products and services to select from. Clear evidence that the "GUIDE" carries the most weight in advertiser confidence and acceptance.

Exclusive! 64-page Reference Section that gives buyers basic market, materials, and design data that buyers refer to again and again. The only directory in the field that contains this valuable reference data, Accurate, authoritative, easy to read.

9.62



electronics Buyers' Guide and Reference Issue
THE ELECTRONICS MAN'S BASIC BUYING BOOK
A MCGRAW-HILL PUBLICATION
330 West 42nd St., New York 36, N. Y.  

1960 Issue Closing Dates: Published July 20; Complete Plates May 1

Greatly
Improved
**POWER
RELAY**
from
Line Electric

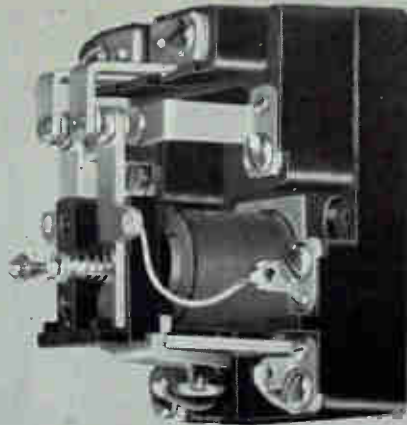

New Series ST Power Relay ideally suited for starting motors up to 1 horsepower, elevator controls, and many other applications requiring high current or high voltage switching with maximum dependability.

The Series ST is presently available in DPDT models only, and features:

- One piece molded Bakelite base which provides high barriers between electrical connections.
- Gold flashed Fine Silver contacts 5/16" in diameter. Rated 15 amps /115/60.
- Screw type electrical connections mounted conveniently on base.
- Available voltage ranges 6-110 VDC and all standard A.C. voltage to 440 VAC.

Engineering specifications and other electrical characteristics are found in Bulletin #80, available from Line Electric on request.



LINE ELECTRIC COMPANY

271 SOUTH 6TH STREET, NEWARK, N. J.

AFFILIATE • INDUSTRIAL TIMER CORPORATION

CIRCLE 208 ON READER SERVICE CARD



**NEW Beattie
"Minute Man"
Oscillotron***

Polaroid® Slides or Prints in Minutes!

This ONE new Beattie Oscillotron answers your *every* need in oscilloscope photography. Project new Polaroid® transparent slides minutes after recording or have prints in 60 secs. with new 3000 Speed Film. Object to image ratio - 1 to 0.9. Record up to 9 traces on a single frame. 75mm f/2.8 Wollensak lens. Instantly converted for a wide range of instrumentation photography.

"Polaroid" ® by Polaroid Corp.

*Trade Mark

\$250 Basic Camera

ACCESSORIES: Binocular viewing hood; Data card to record in frame; Data chamber; f/1.9 lens; Electric remote shutter control.

B BEATTIE-
C COLEMAN inc.

1000 NORTH OLIVE STREET, ANAHEIM, CALIFORNIA • BRANCH: 437 FIFTH AVENUE, NEW YORK, N. Y.

126 CIRCLE 126 ON READER SERVICE CARD

tion, Fishman was a design engineer in the department's advance process engineering unit.



**Huyck Systems
Names Stuart**

AUSTIN F. STUART has been appointed chief engineer of the Airborne Equipment department of Huyck Systems Co. (formerly Waldorf Electronics), Huntington Station, N. Y. He will be in charge of all engineering programs in airborne computers, navigation systems, instrumentation and displays.

Stuart had previously held staff positions with Servomechanisms Inc. and the Norden Laboratories Co.



**S. T. Coffin Joins
Dynamic Controls**

STEWART T. COFFIN has joined the staff of Dynamic Controls Co. of

APRIL 1, 1960 • ELECTRONICS

Cambridge, Mass., as chief engineer. During the past seven years he has been associated with MIT Lincoln Laboratory and its offshoot, Mitre Corp., as designer of digital circuits and power supplies.

In his move, Coffin again joins J. J. Gano, with whom he developed the power systems for a series of large scale digital computers at Lincoln Laboratory.

GI Expands Department

A MAJOR expansion of the Research and Development department of General Instrument Corporation's Semiconductor Division, involving addition of key scientific and engineering personnel and tripling of laboratory space at the division's Newark, N. J., facility is announced by Maurice Friedman, vice president and general manager of the division.

Frank S. Stein, formerly manager of device development at Westinghouse Electric Corporation's Semiconductor Department, has joined GI as manager of the Semiconductor R&D Department, under over-all direction of Friedman. Active in semiconductor work for approximately 10 years, Stein previously had taught physics at the University of Buffalo.

Functioning under Stein will be R. W. Hull, as director of semiconductor research, and Stanley Pessok, as chief of development, a new post.

Bendix Red Bank Appoints Two

RED BANK DIVISION of the Bendix Aviation Corp., Eatontown, N. J., recently appointed two sales engineers for the Electron Tube Products department.

Dwight L. Umstead, Jr. will be working out of the West Coast office in Burbank, Calif.

William Connaughton, Jr. will work out of the New England office, temporarily situated in Mattapan, Mass.

WHAT'S UP IN WASHINGTON?

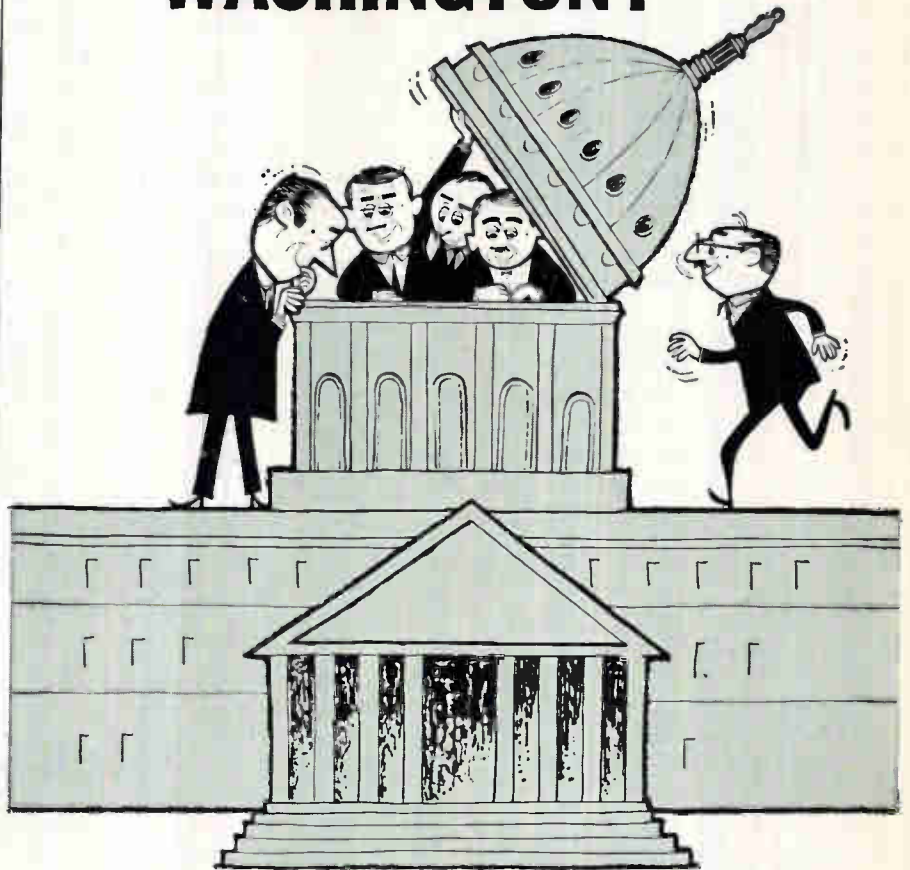

Powerful individuals in Congress, The Pentagon, the State Department and elsewhere can influence the business plans of scores of electronics manufacturers.

electronics reports on policy makers who influence decisions on guided missiles, basic scientific research, government communications policy and many other sensitive subjects.

The highlights are summed up in 3 minutes reading time. More detailed reports on particularly important subjects are specially edited for quick and easy reading.

electronics names names...tells the implications of new developments...keeps you informed. See "Washington Outlook" — a regular, weekly report. Act now! For a new subscription or a renewal, fill in box on Reader Service Card. Easy to use. Postage free.

FIND WHAT YOU NEED IN... electronics

LEARN THE
**INDUSTRIAL
 ADVANTAGES**
 OF
**HOLLYWOOD
 FLORIDA**

- Ideal living and working conditions
- Abundant, contented, skilled and unskilled labor
- Modern industrial buildings available
- Excellently located industrial sites
- Rail, truck, air, water transportation
- Adjoining deep water Port Everglades
- Convenient to U.S. and Latin American markets
- Hub of Florida's fastest growing market

Write for Industrial Brochure
 Inquiries held in strict confidence

**INDUSTRIAL DIVISION, DEPT. E
 CHAMBER OF COMMERCE
 HOLLYWOOD, FLORIDA**

CIRCLE 209 ON READER SERVICE CARD



**WHO
 DROPPED
 THE BINOCULARS?**

With everybody watching each other along the DEW line and the Iron Curtain these days, electronics has replaced binoculars.

What's happening in the giant markets for missile controls, radar and communications equipment?

electronics tells how things are going, keeps you informed of developments as they occur. This is a good time to subscribe or renew your subscription. Just fill in box on Reader Service Card. Easy to use. Postage free.

**FIND WHAT
 YOU NEED IN...
 electronics**

BACKTALK

Orders of Magnitude

Thanks for your sanction and support of the new prefixes for orders of magnitude, as discussed in Crosstalk on page 4 of your March 4 issue. Editorial support such as yours should hasten the day when *tera*, *giga*, *nano*, and *pico* become commonplace and can be used without frequent explanation or amusement.

Your help is still needed in linguistic circles. How are the new prefixes pronounced? *Tera* is fairly obvious. *Pico* has been uttered with long *e*, as in "picot", or long *i*, as in "pike", or short *i*, as in "pick". *Nano* usually has a long *a*, as in "name", although the shorter *a* of "nap" also sounds forth. *Giga* seems to have the widest possibilities; it can have a soft *g* and long *i*, as in "gigantic" (Did it come from this word?), or a soft *g* and short *i*, a la "gigolo", or a hard *g* and short *i*, as in "giggle".

Any authoritative guidance you can render would be most welcome by those of us who must occasionally resort to vocal justification of our technology.

JAMES B. ANGELL
 HUNTINGDON VALLEY, PA.

We'll go along with you that there's not much you can do with *tera* besides a treatment similar to that we give terror. The other three, however, are tricky. Trying to render them vocally in a language as unphonetic as English can produce a variety of sounds. We are willing to settle for the following: *Giga*—the "gig" stem here should be pronounced to rhyme with "gig" rather than "jig." This prefix derives from mathematical parlance rather than any foreign language origin. *Pico*—the "i" here should be pronounced as "ee" making the word "peeko." The origin of this prefix is most probably Latin, meaning diminution. A ready example is "piccolo," Italian sired out of Latin, meaning small. There is a Javanese word "pikul" meaning a small weight, but we've no proof there is a connection here, nor can anyone on the staff claim to know how to pronounce Javanese. *Nano*—this prefix derives from the

Greek word for "dwarf" then on to Spanish "enano". It is pronounced like "piano."

Foreign Authors

I've been pleased to notice an increasing number of bylined articles by foreign authors in *ELECTRONICS* over the past few months. Is this by accident or plan?

FRANK JENNINGS

BOLTON, MISS.

By plan. We feel that special developments in electronics are important no matter where they originate. Reader K. Perry from Australia agrees with us (see below). Our far-flung foreign news bureaus are constantly on the lookout for new ideas that will be of help to our readers—domestic and foreign. The growing importance of the electronics industry in Japan has taken Associate Editor Frank Leary to the Far East for a thorough look at the industry there. We can expect a number of technical articles carrying Japanese by-lines, as well as reports written by Leary himself, to come out of his trip.

Foreign Comment

A word of praise for your excellent magazine. I could not estimate the amount of time saved when designing equipment, by looking through my back issues. I can on almost every occasion find an article relating to the problem on hand.

K. PERRY

DEPT. OF PHYSICS
 UNIVERSITY OF QUEENSLAND
 BRISBANE, AUSTRALIA

Sonar Systems

The article, "Determining Sonar System Capability," by George Rand on p 41 of the Feb. 19 issue of *ELECTRONICS*, presents many complex analyses of the problem in a direct and easily understood manner.

We are distributing the article to all our corps of sonar field engineers.

C. W. WILKINSON
 RAYTHEON COMPANY
 BURLINGTON, MASS.

**HIGH
INFORMATION**

**NO
ACTION**



ACTION

**LOW
INFORMATION**

Placing the man in a man-machine system

The operator shown above is on duty at the radar display console of an air defense system.

How effective would this system be if the operator were unable to detect the direction of movement of a target because of flickering noise pips?

Interestingly enough, this was the case. The solution to the problem came from fundamental studies by IBM systems engineers and engineering psychologists.

Data was collected on the performance of individuals at the display in relation to the rate at which the radar trails were presented. The display was redesigned by systems engineers to present radar trails at a much higher rate—making the radar data clearly visible at all times by reducing its “on-off” character.

Engineering and human factors

At IBM, when an engineering team first

meets to set up the requirements for a system, the possible extent and nature of human participation are carefully analyzed. Before a prototype is built and tested, design recommendations are made based on simulation research. Task and system function analysis are employed to develop and improve total system operability and reliability.

New theories answer future questions

The IBM systems specialist has ample opportunity to investigate general theories which might answer future questions concerning the characteristics of man communicating with machines.

Studies are being conducted on decision-making, memory and learning processes, and constrained handwriting as a data processing technique.

Opportunities for achievement

But perhaps human factors engineer-

ing is not your primary interest. You might be more interested in what IBM people are doing in semiconductors, inertial guidance, or microwaves. Or the advances they are making in cryogenics and optics. In all these fields, you'll find IBM offers a world of opportunity for engineering achievement.

Right now, there are several key openings in IBM's expanding research and development staff. If you have a degree in engineering, mathematics, or one of the sciences—plus experience in your field—please write, describing your qualifications, to:

**Manager of Technical Employment
IBM Corporation, Dept. 554P1
590 Madison Ave.
New York 22,
New York**

INTERNATIONAL BUSINESS MACHINES CORPORATION

IBM®

ENGINEERS

Join Sanders Associates
and combine
PLEASANT COUNTRY LIVING
with a **TOP FLIGHT**
ENGINEERING CAREER

At Sanders Associates—located in the friendly New England community of Nashua, N. H.—you will find a variety of engineering programs that probe deeply into advanced areas of electronic and electromechanical systems and components for industry and defense.

Here in the fresh clean world of the country, away from the soot and strain of heavily populated areas, you will discover that Sanders can offer you a wide range of opportunities—at fully competitive salaries.

You will enjoy diversified assignments on technically advanced projects in Radar, ECM, Navigation, ASW systems & devices, Industrial Automation techniques, working with the engineers who originated such products as Panar® radar, Dare target-seeker system, Flexprint® flexible printed circuits, Tri-Plate® microwave products and other Sanders "firsts."

The cost of living is low in Nashua; schools are excellent and attractive homes are available. Downtown Boston is less than an hour away, as are the recreations of mountains, oceans, lakes.

Openings available for:

SYSTEMS ENGINEERS

Through Project Engineer level. Need not be specialists, but must have creative abilities and backgrounds of VHF transmitters and receivers, communications systems in general, data processing techniques, propagation and must be capable of translating this knowledge into complex integrated systems.

RECEIVER DESIGN ENGINEERS

VHF electronically scanned airborne receivers, filters, problems in spurious response reduction and multiplexing.

CIRCUIT DESIGN ENGINEERS

With particular emphasis on transistor application to analog and digital techniques; data handling equipment; audio, video, RF circuitry and switching.

MANUFACTURING ENGINEERS

10 to 15 years experience in the successful manufacture of complex military electronic systems and instruments.

TRANSMITTER & MAGNETIC
DESIGN ENGINEERS

GYRO & SERVO DESIGN ENGINEERS

To learn more about opportunity for YOU at Sanders, send a resume to Lloyd Ware, Staff Engineer, Dept. 906



SANDERS ASSOCIATES, INC.

NASHUA, NEW HAMPSHIRE

©registered trademark

PROJECT ENGINEERS

America's leading manufacturer of silver-zinc batteries has openings for project engineers with 5-10 years' experience. Must know "weapons systems" concept, be able to assume complete project responsibility. Battery experience helpful but not required.

Salary commensurate with ability. Liberal employee benefits.

Send resume, salary desired to
Director of Professional Employment
YARDNEY ELECTRIC CORP.
40-50 Leonard St., New York 13, N. Y.

We need REPS.

to sell our printed circuit services to industry. We offer a comprehensive electronic background plus an experienced staff and adequate facilities. We have a lot to offer. Ours is an electronic firm of long standing. We do a good business right now. We want to expand this segment of our work. Do you want to work with us? Why not write and tell us about yourself.

Charles Allegri, Treas.

ALLIED ALLEGRI CO., INC.

141 River Road Nutley 10, N. J.

ELECTRONIC ENGINEER

Opening in growing concern located in university town in southwest. 2 to 8 years experience in circuit design, telemetering, transistor circuitry, or data handling required. Pleasant working and living conditions.

DORSETT LABORATORIES, INC.

P. O. Box 862 Norman, Oklahoma

SALES ENGINEERS

Well known electronics firm in process of adding experienced sales engineers to their organization. This firm is broadening their territories and strengthening their present sales installations. Good salary and fringe benefits. Interesting and promising future. Please reply to

P-3956, Electronics

Class. Adv. Div., P. O. Box 12, N. Y. 36, N. Y.

ADDRESS BOX NO. REPLIES TO: Box No.

Classified Adv. Div. of this publication.

Send to office nearest you.

NEW YORK 36: P. O. Box 12

CHICAGO 11: 520 N. Michigan Ave.

SAN FRANCISCO 4: 68 Post St.

SELLING OPPORTUNITY WANTED

Manufacturer's representative organization established eleven years in engineering sales, desire to represent electronic component manufacturer for Military and Industrial application. Northern Illinois and Northern Indiana. Twin Cities, Minneapolis and St. Paul, Minn. RA-3909, Electronics.

**Your Inquiries to Advertisers
Will Have Special Value . . .**

—for you—the advertiser—and the publisher, if you mention this publication. Advertisers value highly this evidence of the publication you read. Satisfied advertisers enable the publishers to secure more advertisers and—more advertisers mean more information on more products or better service—more value—to YOU.

Men

who refuse to get lost in the crowd. Engineers with a yen for challenge . . . who *intend* to see their ideas put into motion. These are the special breed of determined, creative, thinking individuals who staff the government and industrial division of the Magnavox Company. And Magnavox needs more people like them . . .

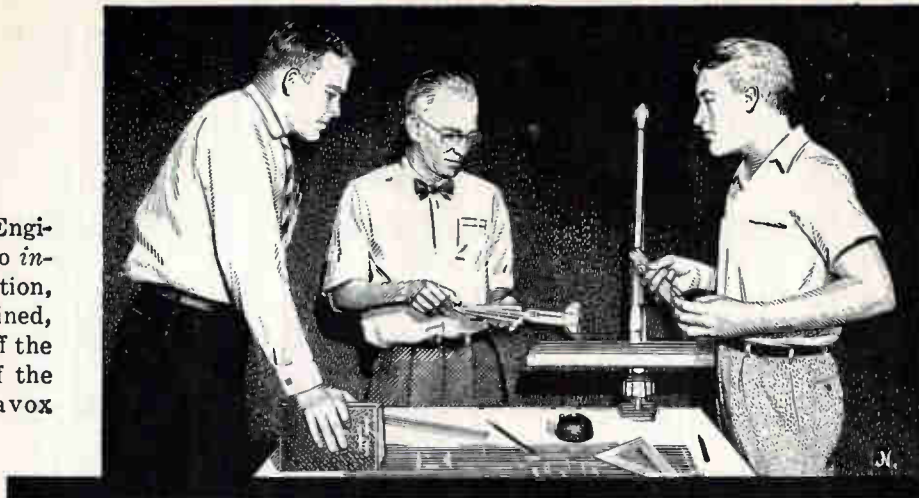

To

fill present openings at the three Magnavox military and industrial plants. In Fort Wayne, Indiana, where families enjoy the good life of a growing Mid-Western community. In Urbana, Illinois, home of the University of Illinois which has one of the largest communications, physics and radar research centers. Or in America's largest electronic community, Los Angeles, California.



Do

engineering to develop advanced anti-submarine warfare systems in conjunction with the Navy Department. Projects on tap for the future offer experiences just as challenging and rewarding—not only in ASW, but in Communications, Missiles, Airborne Radar and Data Processing Equipment as well.

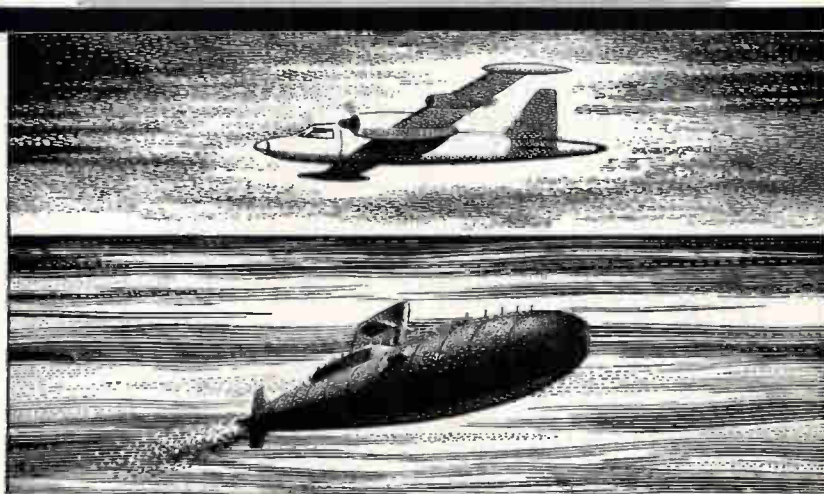

Phone Dick Eary (collect, of course) at Eastbrook 9721 in Fort Wayne or write him for complete information.

Magnavox



THE MAGNAVOX CO. • DEPT. 215 • Government and Industrial Division • FORT WAYNE, IND.

ELECTRONICS ENGINEERS

for Application Engineering at

ELECTRIC BOAT

Pioneer Designer & Builder
of Nuclear Submarines

The Electrical Design Department of Electric Boat Division of General Dynamics has immediate openings for Electronics Engineers in application engineering of radio, radar, sonar, counter-measures, computing and data handling systems and components. This includes re-design of existing systems and components and the development of new electronics systems and components to satisfy the latest military and commercial needs.

Positions are available for men with 2 to 4 years experience in the design and/or development of electronic systems and components—with experience in solid state desirable but not essential.

These positions provide an opportunity to live and work on the Connecticut shore, just half way between New York and Boston. Convenient interviews will be arranged. Please send resumes to James P. O'Brien.

ELECTRIC BOAT

A DIVISION OF

GENERAL DYNAMICS

Groton,

Connecticut

ANALOG COMPUTER ENGINEER

The Standard Ohio Company (Ohio) has an immediate opening for an Analog Computer Engineer. A minimum of a B.S. in Electrical Engineering or Physics and 2-5 years analog experience is required. Applications are in the field of simulation and study of chemical and refining processes and process control systems. Salary commensurate with experience.

Apply To: Mr. C. A. Bruggers
THE STANDARD OIL COMPANY (OHIO)
1737 Midland Building • Cleveland 16, Ohio

*"Put Yourself in the
Other Fellow's Place"*

TO EMPLOYERS

TO EMPLOYEES

Letters written offering Employment or applying for same are written with the hope of satisfying a current need. An answer, regardless of whether it is favorable or not, is usually expected.

MR. EMPLOYER, won't you remove the mystery about the status of an employee's application by acknowledging all applicants and not just the promising candidates.

MR. EMPLOYEE you, too, can help by acknowledging applications and job offers. This would encourage more companies to answer position wanted ads in this section.

We make this suggestion in a spirit of helpful cooperation between employers and employees.

This section will be the more useful to all as a result of this consideration.

Classified Advertising Division

**McGRAW-HILL
PUBLISHING CO., INC.**

330 West 42nd St.,
New York 36, N. Y.

DISENCHANTED ENGINEERS

If your present employer has failed to utilize your full potential, why not permit us to explore the parameters for your personal qualifications with the many dynamic young companies in aviation, electronics, missiles and rockets. We now have in excess of 4,000 openings in the \$8,000 to \$40,000 bracket, all of which are fee paid. Why wait? Send resume in duplicate at once indicating geographical preferences and salary requirements.

FIDELITY PERSONNEL
1530 Chestnut Street, Philadelphia 2, Pa.
Established 1943

DESIGN ENGINEERS

America's leading manufacturer of silver-zinc batteries has openings for engineers with 5-10 years' experience in mechanical and/or electrochemical design.

Salary open. Liberal company benefits.

Send resume, salary requirements to
Director of Professional Employment

YARDNEY ELECTRIC CORP.
40-50 Leonard St., New York 13, N. Y.

PROFESSIONAL SERVICES

ERCO RADIO LABORATORIES, INC.

Radio Communications Equipment
Engineering - Design - Development - Production
Our 30th Year in Air to Ground
Communication and Radio Beacons
Garden City • Long Island • New York

TELECHROME MFG. CORP.

Electronic Design Specialists
COLOR TELEVISION EQUIPMENT
Flying Spot Beanners, Color Synthesizers, Keyers,
Monitors, Oscilloscopes and Related Apparatus
Telemetering for Guided Missiles.
J. R. Popkin-Curman, Pres. & Dir. of Eng.
28 Ranick Dr. Amityville, L. I., N. Y.

WHEN TIME IS SHORT

put the solution of your problems up to a specialized Consultant. His broad experience may save you months of costly experimentation.



STIMULATING!

Motorola engineers are the most stimulated and enthusiastic individuals you'll find anywhere. And, for sound reasons.

First, the work. Electronics—challenging fields that plead for vision, creativeness and imagination.

Secondly, the company, An "engineers' company"—developed by technical minds dedicated to engineering excellence. A rewarding company—quick to recognize and advance skill. A secure, diversified company—not wholly dependent on one single market.

Thirdly, the place, Chicago—exciting and quiet. Cosmopolitan and suburban. Mid-America's nucleus of culture, education and entertainment—where everyone can find the perfect environment.

- Radar transmitters and receivers
- Radar circuit design
- Electronic countermeasure systems
- Military communications equipment design
- Pulse circuit design
- IF strip design
- Device using klystron, traveling wave tube and backward wave oscillator
- Display and storage devices
- Transistor applications
- Crystal engineering
- Sales engineering
- Design of VHF & UHF FM communications in portable or subminiature development
- Microwave field engineers
- Transistor switching circuit design
- Logic circuit design
- T.V. circuit design engineering
- Home radio design
- New product design
- Auto radio design
- Mechanical engineering
- Semi-conductor device development
- Semi-conductor application work

Also Splendid Opportunities in:
Phoenix, Arizona and Riverside, California

Send Complete Resumé to:

MR. L. B. WRENN
Engineering Personnel Mgr.
Dept. D
4501 Augusta Blvd.
Chicago 51, Illinois



MOTOROLA Inc.



ELECTRONIC ENGINEERS

STAVID

offers all 3 most important positions considerations

CAREER OPPORTUNITIES
based on solid, long-term growth . . .

TOP EARNINGS
fully commensurate with experience . . .

CHALLENGING ASSIGNMENTS
made possible by project diversification.

STAVID has immediate openings available at all levels in research, design, development and field service engineering in the following areas:

- Sonar
- High-Power Modulation
- UHF & VHF Development
- Antennas
- Receivers & Transmitters
- Transistor Applications
- Microwave Development
- Digital Techniques
- Electro-Mechanical Packaging
- Pulse Circuit Techniques
- Telemetry
- I.F. & Video Circuitry
- Environmental Testing

STAVID'S facilities in Plainfield, New Jersey, at the foothills of the Watchung Mountains, are near excellent schools, modern shopping facilities and ample housing accommodations. With New York City just 45 minutes away, and the New Jersey shore within one hour's drive, the Plainfield area provides an ideal environment for work, recreation and comfortable suburban living.

*For Complete Information,
Please Send Detailed Resume To:*

J. R. CLOVIS
Personnel Dept. E-4

LOCKHEED ELECTRONICS COMPANY

STAVID DIVISION

U. S. Highway 22, Plainfield, N. J.

PLAINFIELD 7-1600

Electronic Engineers • Physicists

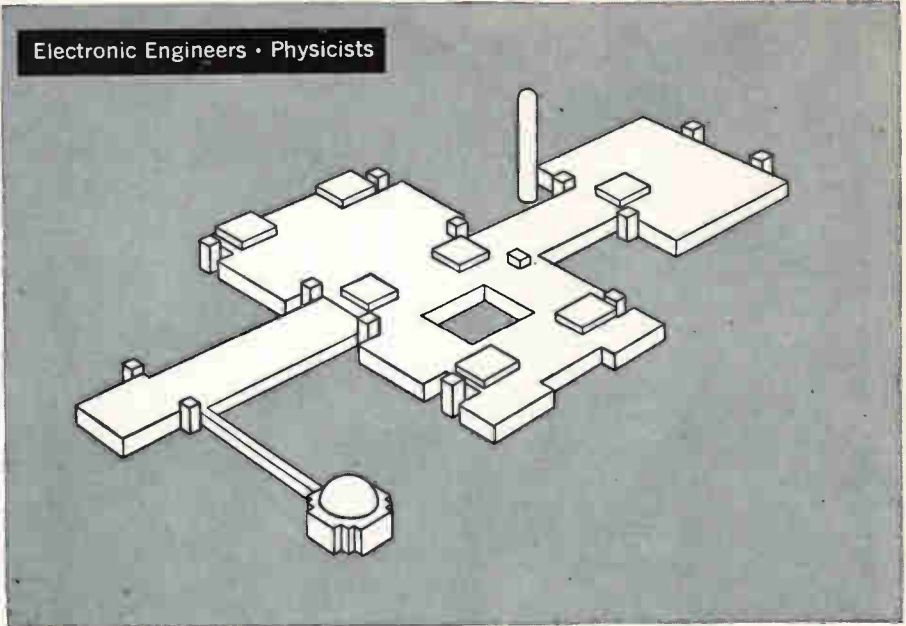

COMMUNICATIONS PHYSICIST
Plan applied research in such areas as telemetry and radar detection as affected by plasma sheaths. Interpret space communication needs and problems. MS or PhD in EE or applied physics.

SYSTEMS ENGINEER COMMUNICATIONS
EE or Physicist with 10 years' experience in systems design of airborne communications; to work on design of communication systems to meet requirements for future space vehicles.

ENGINEER-NAVIGATION AND GUIDANCE
To conduct analytical studies on inertial guidance and control for space vehicles. Should have background in closed-loop systems with 10 years of applicable experience and degree in EE or physics.

SYSTEMS ENGINEER NAVIGATION & CONTROL
EE with control systems background. Required are five years' experience in design of control and navigation systems, preferably in space vehicle systems.

ENGINEER ADVANCED ANTENNA & PROPAGATION STUDIES

To provide high level theoretical and experimental studies of antennas, propagation and target reflectors for all radio frequency bands, leading to new and improved concepts of equipment. BS, EE (advanced degree desirable). Six years' experience in above fields required.

ANALYSIS AND SYNTHESIS ENGINEER
Responsible for synthesis of new instrumentation and communication systems to meet missile and satellite requirements. Analytical knowledge in the field of instrumentation, communication and data processing with BS or MS EE essential.

INSTRUMENTATION SYSTEM TEST & EVALUATION ENGINEER
Coordinate tests on missile and satellite instrumentation systems. Requires experience in instrumentation and communication test and ground station equipment with BS, EE.

Other significant opportunities exist in the following areas:

Systems Engineering • Aerodynamics • Space Mechanics • Arming & Fuzing Systems • Airframe Structural Design • Materials Studies • Flight Test Analysis • Vibration Engineering • Producibility Engineering • Human Factors • Plasma Physics • Gas Dynamics • Applied Mathematics • Ground Support Equipment • Reliability Engineering • Project Engineering

For further information regarding opportunities here, write Mr. Thomas H. Sebring, Div. 69WD. You will receive an answer within 10 days.

MISSILE & SPACE VEHICLE DEPARTMENT

GENERAL  ELECTRIC

3198 Chestnut Street, Philadelphia 4, Pa.



RESOURCES FOR THE CHALLENGE OF SPACE

...General Electric's New \$14,000,000 Space Research Center, to be built near Valley Forge Park 17 miles from Philadelphia

General Electric is carrying its tradition of pace-setting electronics research into the field of space vehicle applications, primarily through the agency of its Missile and Space Vehicle Department.

Qualified engineers interested in working in these areas are invited to review the opportunities described on this and the opposite page. Those who join us will work in a professional atmosphere with other highly trained and competent people who have taken part in such G-E achievements as the FIRST demonstration of effective space vehicle stabilization control and navigation, and the FIRST measurements in space of earth's magnetic field and infrared radiation.

Upon completion of the Department's Space Research Center in suburban Valley Forge, new and unique facilities will be available to our staff, to further long range programs in space electronics.

ENGINEER-TRANSISTOR CIRCUIT DESIGN

BS, EE or Physics with advanced degree desired. Five years' experience in circuit design, information theory and circuit philosophy.

ENGINEER-TELEMETRY DESIGN

Will design and evaluate airborne and ground telemetry, voice and video circuits and components. Thorough knowledge of both transmitter and receiver design, five years' experience; BS, EE required.

DIGITAL CIRCUIT DESIGN

To provide high level technical evaluation of digital techniques as applied to airborne digital and pulse circuitry, EE with five years' experience in this field.

ENGINEER-CONTROLS

Will be responsible for analytical studies in adapted controls, non linear systems and analogue and digital computation. Requires ten years of controls background with BS, EE or related degree.

ENGINEER-DYNAMICS

To conduct analytical studies in the dynamics of rigid bodies as applicable to navigation and control systems. Requires eight years of experience with MS degree in mechanics or physics.

ENGINEER-SYSTEMS ANALYSIS

Requires eight to ten years experience in analytical studies of complex systems, with some control experience. Background in analogue and digital equipment also desirable.

Check additional openings listed to the left, and write to Mr. Thomas H. Sebring, Div. 69WD.

MISSILE & SPACE VEHICLE DEPARTMENT

GENERAL  **ELECTRIC**

3198 Chestnut Street, Philadelphia 4, Pa.

GROW with Kollsman

Kollsman's leadership and continuing growth in the field of automatic navigation and flight instrumentation assures excellent opportunities for qualified men. Send resumes to Mr. T. A. DeLuca.



kollsman INSTRUMENT CORPORATION

80-00 45th AVENUE, ELMHURST, NEW YORK • SUBSIDIARY OF Standard COIL PRODUCTS CO. INC.

Opportunities in:

FLIGHT DATA INSTRUMENTS & SYSTEMS

Senior Project Engineers, EE & ME

For aircraft and missile instrumentation. 5 to 10 years project experience in precision electromechanical devices.

AUTOMATIC ASTRO TRACKING SYSTEMS

Project Engineers, EE

For automatic astro tracking systems. Up to 5 years related experience.

STAFF ENGINEERS & SPECIALISTS

- a. Experience in the research and development of transistors in servo, digital and instrumentation application. Minimum 3 years experience desired in transistor circuit design for military applications.
- b. Experienced with IR to UV radiation properties and applications, noise theory and detectors.
- c. Optics — IR through visual optical design, lens design, materials.
- d. Digital computers — logic or packaging experience.
- e. Theoretical mechanics — inertial and trajectory studies.

SEARCHLIGHT SECTION

(Classified Advertising)

BUSINESS OPPORTUNITIES

EQUIPMENT - USED or RESALE

DISPLAYED RATE

The advertising rate is \$24.75 per inch for all advertising appearing on other than a contract basis. Contract rates quoted on request. An ADVERTISING INCH is measured 3/4 inch vertically on one column, 3 columns—30 inches—to a page. EQUIPMENT WANTED or FOR SALE ADVERTISEMENTS acceptable only in Displayed Style.

UNDISPLAYED RATE

\$2.40 a line, minimum 3 lines. To figure advance payment count 5 average words as a line. BOX NUMBERS count as one line additional in undisplayed ads.

BUSINESS OPPORTUNITY

Small Successful Manufacturer in the Detroit area wishes to expand. Financing and stock option available to a man who can head up a team to produce and sell in the transistor and semi-conductor field. Send resume with qualifications, experience and proposal. BO-4029, Electronics, Class. Adv. Div., 520 N. Michigan Ave., Chicago 11, Ill.

PLATING SPECIALISTS

for the **ELECTRONICS INDUSTRY**

Gold, Silver, Nickel, Tin, Cadmium PLATING to any thickness.

PALUMBO BROS., INC.
347 Ferry St. Newark 5, N. J.
Market 2-5060 Est. 1915

LOOKING FOR

USED/SURPLUS ELECTRONIC EQUIPMENT/COMPONENTS?

For an up-to-date listing of such equipment see Searchlight Section of March 11th.

SELECTION and APPLICATION OF METALLIC RECTIFIERS

Provides quick, reliable answers to rectifier and transformer circuit problems—all necessary data on filters and transformers—and the essential mathematical tools to deal with circuit design. By developing together a clear idea of circuits and cell characteristics the book shows design procedures for such uses as pulse circuits, industrial and electroplating power supplies, battery charging, and others. **By Stuart P. Jackson, Gen. Elect. Co., 326 pp., 216 illus., \$8.00**

FEEDBACK CONTROL SYSTEMS

Clearly develops techniques and theory for the full range of feedback problems—including those involved in process controls, servomechanisms, traffic, economics, and conservation. Precisely correlates such areas as phase plane, statistical methods, log gain plots, transient and steady state responses. **By Otto J. M. Smith, Prof. of Elec. Engrg., U. of Cal. 671 pp., 343 illus., \$13.50**

SEE ANY BOOK 10 DAYS FREE

McGraw-Hill Book Co., Dept. FL-4-1
327 W. 41st St., New York, 36, N. Y.

Send me book(s) checked below for 10 days' examination on approval. In 10 days I will remit for book(s) I keep plus few cents for delivery costs, and return unwanted book(s) postpaid. (We pay delivery costs if you remit with this coupon—same return privilege.)

- Jackson—Sel. & App. of Metal. Rect., \$8.00
- Smith—Feedback Control Sys., \$13.50
- Kuh & Pederson—Princ. of Circ. Syn., \$8.50
- DeWitt & Rossoff—Trans. Elec., \$8.00
- Ginzton—Microwave Meas., \$12.50

Name Address

City Zone State

Position Company

For price and terms outside U.S., write McGraw-Hill Int'l. N. Y. C. FL-4-1

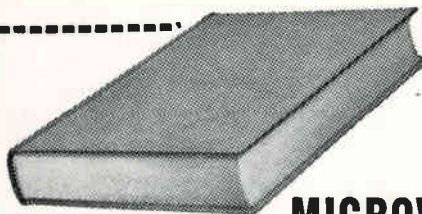

MICROWAVE MEASUREMENTS

Modern microwave measuring techniques that help you accurately determine the behavior of electromagnetic waves. Covers the full scope of the field, starting with the generation and detection of microwave signals and progressing through measurement of impedance, wavelength, frequency, and other major topics. **By Edward L. Ginzton, Professor of Applied Physics and Electrical Eng., Stanford U. 514 pp., 375 illus., \$12.50**

Practical working aids in the electronics field

PRINCIPLES OF CIRCUIT SYNTHESIS

Introduces the principles of modern circuit synthesis together with the key aspects of classical filter theory. The topic of synthesis is introduced with a discussion of typical communication and control systems. A discussion of the approximation problems and basic concepts and techniques of network realization follows. **By E. S. Kuh and D. O. Pederson, Assoc. Professors, U. of California, Berkeley. 244 pp., 300 illus., \$8.50**

TRANSISTOR ELECTRONICS

Brings you a profitable working knowledge of quantitative transistor circuit design, based on a clear-cut understanding of the internal workings of the transistor device. Assures useful design accuracy without requiring a prior knowledge of quantum mechanics. **By David DeWitt, IBM Data Proc. Div., and Arthur L. Rossoff, Radio Receptor Co. 381 pp., illus., \$8.00**

INDEX TO ADVERTISERS

● Ace Electronics Associates, Inc.	123	Hollywood, City of, Fla. Chamber of Commerce	128
● Acoustica Associates, Inc.	88	● Hydro-Alre, Inc.	81
● Addo-X	2	● Hysol Corporation	108
● Ad-Yu Electronics	138	● J F D Electronics Corp.	95
● Airpax Products Co.	89	● Kintel, A Division of Cohn Electronics Inc.	3rd Cover
● Allen-Bradley Co.	79	● Krohn-Hite Corp.	100
● American Super-Temperature Wires, Inc.	114	● Kyoritsu Electrical Instruments	101
● Applied Research, Inc.	101	● Line Electric Co.	126
● Art Wire & Stamping Co.	53	● Little Falls Alloys, Inc.	109
● Ballantine Laboratories, Inc.	111	● Lomasney & Co., D. A.	26
● Barnstead Still & Sterilizer Co.	14	● Los Alamos Scientific Laboratories, Inc.	115
● Beattie-Coleman Inc.	126	● Magnetics, Inc.	23
● Beckman Instruments, Inc., Hellipot Div.	102	● Marechal Instruments, Ltd.	50, 51
● Boesch Mfg. Co., Inc.	84	● Martin Co.	85
● Courns Laboratories, Inc.	91	● Marion Instrument Division Minneapolis-Honeywell Regulator Co.	165
● Bruno-New York Industries Corp.	30	● Minnesota Mining & Mfg. Co. Min Com. Division	52
● Brush Instruments Div. of Clevite Corp.	39, 40	● Minnesota, State of	116
● Carborundum Co.	61	● Monitor Products Co.	118
● Centralab a Div. of Globe-Union, Inc.	3	● Non-Linear Systems, Inc.	25
● Christie Electric Corp.	46	● North Electric Co.	41
● Community Engineering Corp.	101	● Ohmite Mfg. Co.	31
● Consolidated Avionics Corp.	117	● PRD Electronics Co.	83
● Consolidated Electro-dynamics Corp.	92, 93	● Pacific Semiconductors, Inc.	8, 9
● Craig Systems, Inc.	6, 7	● Ptc Design Corp.	112
● Dade County Development Dept.	105	● Radio Corporation of America ...	4th Cover
● Deluxe Colls, Inc.	120	● Radio Engineering Laboratories, Inc.	33
● Edo Corporation	119	● Raytheon Company ..	5, 17, 18, 19, 20, 21, 22
● Electro Engineering Works	10	● Reed Roller Bit, Cleco Div.	62
● Electronic Engineering Co. of California	99	● Rohn Mfg. Co.	27
● Electronic Instrument Co., Inc. (EICO)	116	● Sherman Industrial Electronics	120
● Electronic Measurements Co., Inc.	13	● Sigma Instruments, Inc.	113
● Food Machinery and Chemical Corp.	87	● Space Technology Laboratories, Inc.	15
● General Electric Co. Construction Dept.	24	● Spreetrol Electronics Corporation ..	96, 97
● Military & Industrial	12	● Sprague Electric Co.	48, 49
● Power tubes	44, 45	● Sylvania Electric Products, Inc.	32
● General Products Corp.	114	● Hamilton Standard, Division of United Aircraft Corporation	34, 35
● Graphic Systems	112	● Hayden, Stone & Co.	98
● Hermes Electronics Co.	43	● Heiland Div.—Minneapolis-Honeywell 57, 58, 59, 60	
● Hermetic Seal Transformer Co.	110	● Hermes Electronics Co.	43
● Hewlett Packard Co.	2nd Cover	● Hermetic Seal Transformer Co.	110
● Heyman Mfg. Co.	119	● Hewlett Packard Co.	2nd Cover
		● Heyman Mfg. Co.	119
		● See advertisement in the June, 1959 Mid-Month ELECTRONICS BUYERS GUIDE for complete line of products or services.	

do you know
what's expected
from
semi-conductor
materials?

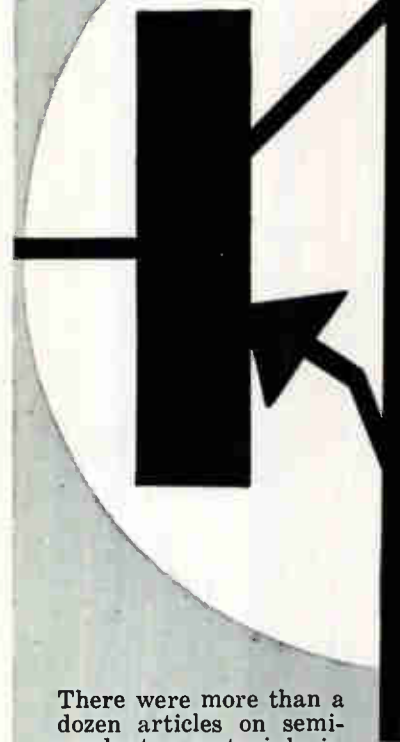

There were more than a dozen articles on semi-conductor materials in **electronics** in recent months. Each was specially edited to give you all key facts, ideas or trends—and there's more coming! Accurate **electronics'** reporting tells you what's happening now... what's *expected* in materials and components. Don't miss dozens of articles on basic subjects edited to keep you informed, help make your research, development, sales and marketing plans pay off. It pays to subscribe to **electronics** (or renew). Fill in box on Reader Service Card now. Easy to use. Postage free.

**FIND WHAT
YOU NEED IN
electronics**

PHASERS METERS TO 1000 MEGACYCLES DELAYS LINES

RISE DELAY \leq 0.02

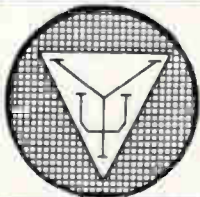

AD-YU ELECTRONICS LAB, Inc.
Formerly Advance
249 TERHUNE AVENUE
PASSAIC, NEW JERSEY



Plotting Phase and Amplitude Characteristics of Crystal Filter.



Type 305 RF Phase and Ratio Meter: Automatic plotting of transfer characteristics of an unknown network up to 100 mc; sensitivity down to 50 mv.

Type 205B1-B2: Frequency 15 mc to 1000 mc. Resolution time 0.01 μ s. Accuracy $\pm 0.05^\circ$.

Type 405 Series: Frequency 1 cps to 500 kc. Direct reading in degrees. Accuracy $\pm 0.25^\circ$.

Type 202: 1° full scale sensitivity; 0.005° deviation can be detected. Accuracy $\pm 0.05^\circ$.

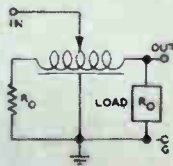

611 Series: Total delay 8 μ s to 128 μ s; impedance 150 ohms to 1300 ohms; resolution time down to μ s.

521 Series: Total delay 6 μ s to 21 μ s; impedance 500 ohms to 1200 ohms; resolution time down to μ s.

602-3 Series: Equal input and output impedance, 50 ohms to 500 ohms; total delay 0.1 μ s to 27.5 μ s.

Fixed & Tapped Delay Lines: 6C, 7C, 5T, 6T, 7T, 8T, 9T & 10T Series: Delay 0.1 μ s to 1000 μ s; impedance 50 ohms to 4000 ohms.

Special delay lines meet Mil specifications.

- Taylor Fibre Co. 16
- Texas Instruments Incorporated
Semiconductor Division 55
- Trio Laboratories, Inc. 54

United States Testing Co., Inc. 106

Westinghouse Electric Corp. 107

CLASSIFIED ADVERTISING
F. J. Eberle, Business Mgr.

- EMPLOYMENT OPPORTUNITIES. 129-136
- PROFESSIONAL SERVICES. 133
- SPECIAL SERVICES 136
- BUSINESS OPPORTUNITIES. 136

ADVERTISERS INDEX

- Allied Allegri Machine Company, Inc. 130
- Dorsett Laboratories, Inc. 130
- Fidelity Personnel 133
- General Dynamics, Electric Boat Division 132
- General Electric Company 134-135
- International Business Machines Corp. 129
- Kollsman Instrument Corporation 136
- Lockheed Electronics Company,
Stavid Division 134
- Magnavox Company,
Government & Industrial Div. 131
- Motorola Inc. 133
- Palumbo Brothers, Inc. 136
- Sanders Associates, Inc. 130
- Standard Oil Company of Ohio 132
- Yardney Electric Corporation 130-133

• See advertisement in the June, 1959 Mid-Month ELECTRONICS BUYERS GUIDE for complete line of products or services.

This Index and our Reader Service Numbers are published as a service. Every precaution is taken to make them accurate, but ELECTRONICS assumes no responsibilities for errors or omissions.

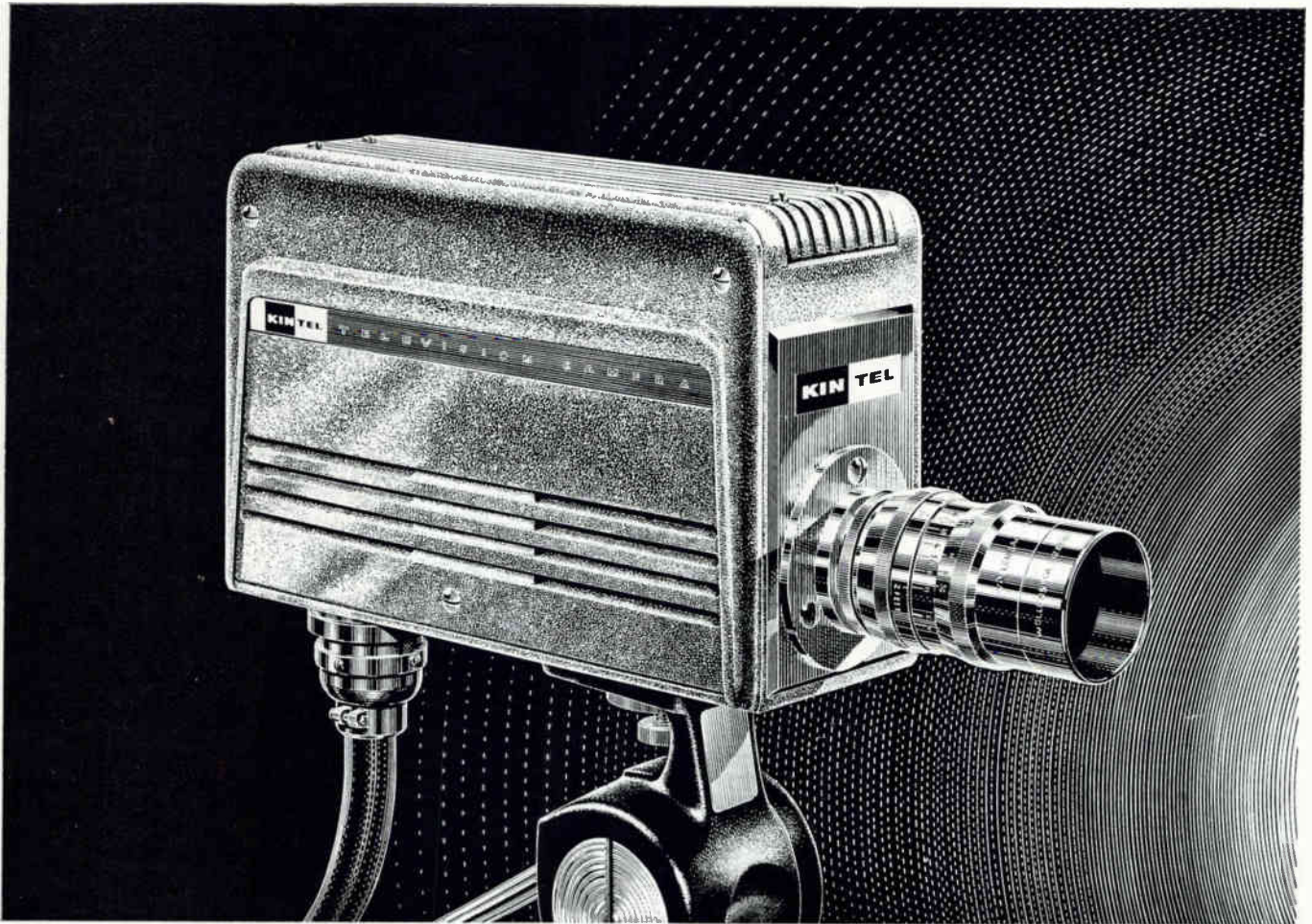

For laboratory performance...in rugged field applications

LOCKHEED AND HUNDREDS OF OTHER FIRMS CHOOSE KIN TEL...THE QUALITY-LEADER IN CLOSED CIRCUIT TV

Hundreds of leading firms specify KIN TEL Closed Circuit TV Systems when they *can't* compromise on quality...when they *must* observe operations that are tedious, difficult, or even impossible for men to watch.

Why a KIN TEL System? First, it is designed to work continuously, faultlessly even under extreme environmental conditions. Second, it is fully automatic...provides 1% linearity and continuous self-adjustment for light-level variations up to 2000:1. Third, it features crisp, photoprint picture quality—*twice* the resolution of the best home TV reception.

This basic TV system, consisting of camera, camera control, and receiver, is surprisingly low in cost, easy to operate, and simple to maintain. A complete line of housings and accessories permits observation of nearly every kind of operation, under all kinds of conditions.

Nationwide factory-trained engineering representatives can show you how a KIN TEL TV System can be put to profitable use in your business. Write direct for TV catalog 6-103 and the name of your nearest representative.

Partial List of KIN TEL Closed Circuit TV Customers

GENERAL MOTORS
E. I. DUPONT DE NEMOURS
WESTINGHOUSE
EASTMAN KODAK
PHILLIPS PETROLEUM
LOCKHEED
CONVAIR
DOUGLAS
U. S. STEEL
LOS ANGELES DEPT. OF WATER & POWER
RAYTHEON
AMERICAN POTASH AND CHEMICAL
SANDIA CORPORATION
JOHNS HOPKINS UNIVERSITY
SHELL DEVELOPMENT
PHILCO
SAN FRANCISCO NAVAL SHIPYARD
PACIFIC TELEPHONE AND TELEGRAPH
REDSTONE ARSENAL
MELLON INSTITUTE

*KIN TEL manufactures closed circuit TV. and electronic instruments
for measurement and control. Representatives in all major cities.*

5725 Kearny Villa Road, San Diego 11, California • BRowning 7-6700



Communications



Instruments

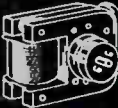

Controls



Radar



Avionics



Missiles



Mobile Electronics



New RCA Intermediate Power Transistors feature JEDEC TO-8 case with removable heat-sink mounting flange



6 NEW RCA INTERMEDIATE POWER TRANSISTORS

New germanium units offer unique design flexibility for a wide variety of industrial and military applications

Now—in production quantities—six new RCA PNP germanium alloy junction transistors designed primarily for intermediate-power switching and audio-frequency industrial and military applications. Featuring 100°C maximum junction temperature and a unique case design, these new types can be used with or without the heat-sink mounting flange. With mounting flange in place, these types can dissipate 7.5 watts at 25°C case temperature; without flange, one watt at 25°C ambient temperature.

These new RCA intermediate-power transistors provide a choice of voltage ratings and beta ranges for design flexibility. They feature low saturation resistance and low leakage current.

They are particularly useful in power switching circuits such as dc-to-dc converters, inverters, choppers, solenoid drivers, and relay controls; oscillator, regulator, and pulse-amplifier circuits, and as class A and class B push-pull amplifiers for servo and other audio-frequency applications.

RCA intermediate-power germanium transistors were developed in cooperation with the U. S. Army Signal Corps on an Industrial Preparedness Measure for military devices.

Call your nearest RCA field office today for particulars on these new intermediate-power transistors. For further technical information write RCA Commercial Engineering Section D-19-NN1, Somerville, N. J.

ELECTRICAL CHARACTERISTICS					
Type	Min. V _{CE} S (I _C = —50 ma)	Min. V _{CE} O (I _C = —50 ma)	Min. V _{CB} O (I _{CB} O = —250 μa)	Min. V _{EB} (I _E = —100 μa)	h _{FE} (I _C = —400 ma)
2N 1183	—35v	—20v	—45v	—20v	20-60
2N 1183A	—50v	—30v	—60v	—20v	20-60
2N 1183B	—60v	—40v	—80v	—20v	20-60
2N 1184	—35v	—20v	—45v	—20v	40-120
2N 1184A	—50v	—30v	—60v	—20v	40-120
2N 1184B	—60v	—40v	—80v	—20v	40-120

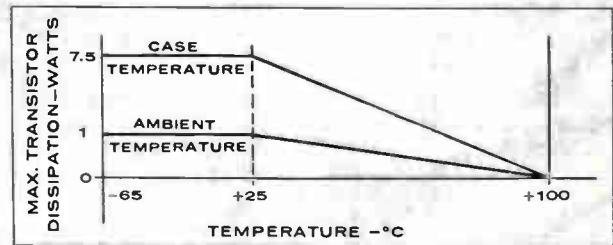

ANOTHER WAY RCA SERVES YOU THROUGH ELECTRONICS



RADIO CORPORATION OF AMERICA
SEMICONDUCTOR AND MATERIALS DIVISION
SOMERVILLE, N. J.

East: 744 Broad St., Newark, N. J., HUmboldt 5-3900 • Northeast: 64 "A" St., Needham Heights 94, Mass., HILLcrest 4-7200 • East Central: 714 New Center Bldg., Detroit 2, Mich., TRinity 5-5600 • Central: Suite 1154, Merchandise Mart Plaza, Chicago, Ill., WHitehall 4-2900 • West: 6355 East Washington Blvd., Los Angeles, Calif., RAYmond 3-8361 • Southwest: 7905 Empire Freeway, Dallas 7, Texas, FLEetwood 2-8663 • Gov't: 224 N. Wilkinson Street, Dayton, Ohio, BAIdwin 6-2366; 1625 "K" Street, N.W., Washington, D.C., DIstrict 7-1260

AVAILABLE, TOO, THROUGH YOUR AUTHORIZED RCA DISTRIBUTOR