

NOVEMBER 6, 1959

electronics

A MCGRAW-HILL PUBLICATION

VOL. 32, No. 45

PRICE SEVENTY-FIVE CENTS

11/4

Braiding Harness Wiring Mechanically

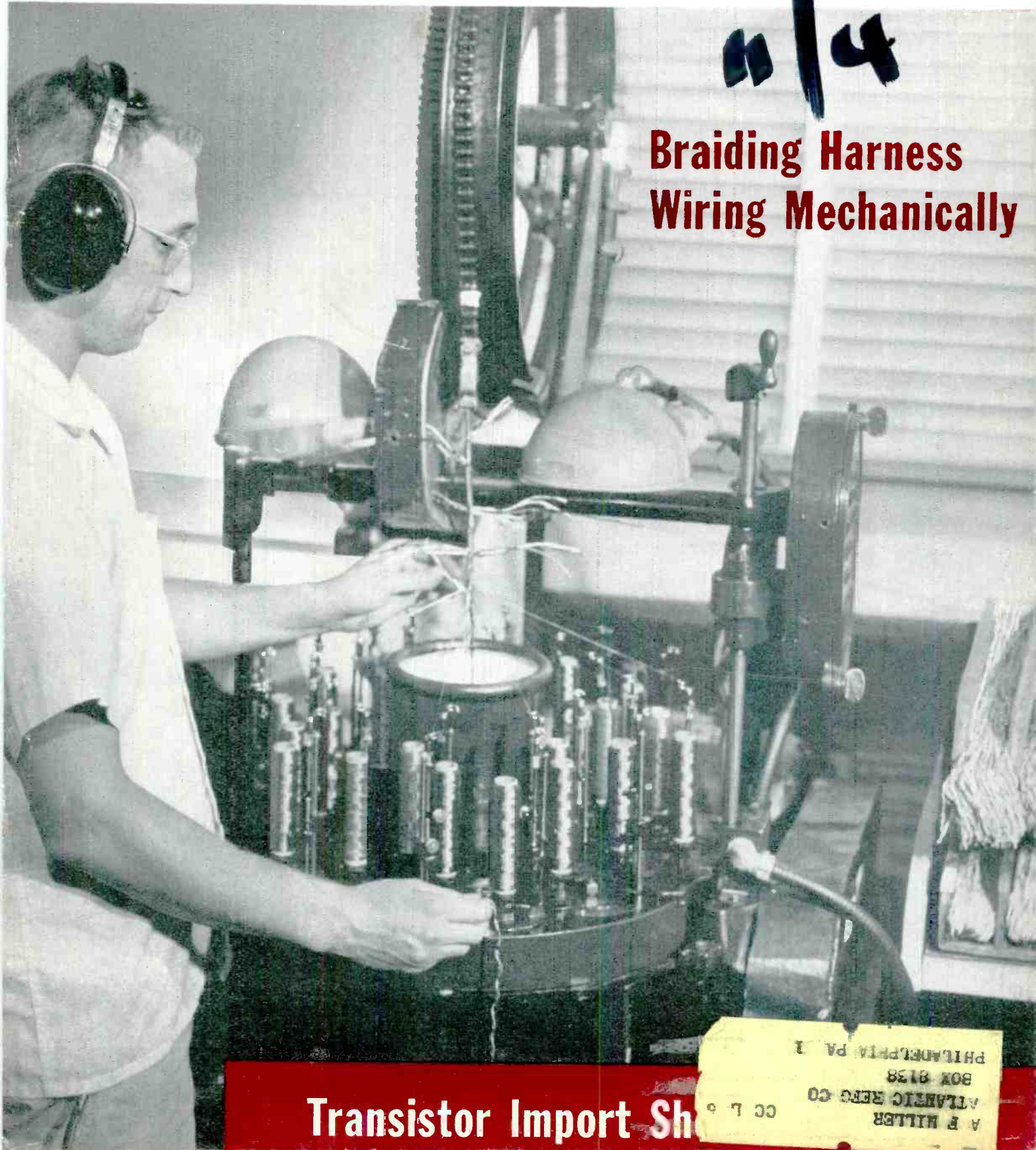

Transistor Import Sh

A & MILLER
ATLANTIC REFRIG CO
BOX 8138
PHILADELPHIA PA 19104



FIRST CHOICE FOR RELIABILITY

Designers of complex military and industrial equipment fully appreciate the need for extremely reliable components. For over a decade, UTC has been devoting constantly increasing manpower and dollars in the search for increased transformer and filter dependability. Investigation and analysis have been related to

the life testing of large numbers of units to failure, plus thousands of wire-insulation-impregnant-potting and encapsulating systems. This program has resulted in proven materials, methods of structure and full quality controls which assure in UTC units an overall degree of reliability unequaled in our industry.



RELIABILITY UNDER ADVERSE ENVIRONMENT

As a leader in the production of extremely miniaturized components, UTC is a natural source for missile applications. Add to this the need for top reliability under adverse environmental conditions, and one can see why UTC units have been chosen for almost every missile from the Sidewinder to the Jupiter to the Atlas; our satellites, and project Mercury.



Special Units to Your Specifications
or 1000 Stock Items
... with UTC
High Reliability



General Catalog G Filter Catalog F

RELIABILITY TO DESTROY

A vital factor in second generation missiles is the sure ability to destroy the missile should something go wrong. UTC high reliability transformers were first choice for Ramo-Wooldrige in the design and production of their 4 pound AN/DRW-11 "command destruct" receiver which provides UHF FM signals to three command channels.



RELIABILITY TO NAVIGATE... CONTROL... COMMUNICATE

Manufacturers providing principal electronic gear for the B-58 chose UTC for optimum miniaturization with maximum reliability under adverse environment. In general aircraft use UTC high reliability units are found in virtually all applications such as Tacan omnirange, intercommunication equipment, and fire control. The high inherent quality level of UTC airborne components is illustrated by over 13,000 units being shipped to one customer... than fully tested... with zero rejects.



UNITED TRANSFORMER CORP.
150 Varick Street, New York 13, N. Y.

PACIFIC MFG. DIVISION: 4008 W. JEFFERSON BLVD., LOS ANGELES 16, CALIF.
EXPORT DIVISION: 13 EAST 40th STREET, NEW YORK 16, N. Y. CABLES: "ARLAB"

A McGRAW-HILL PUBLICATION
Vol. 32 No. 45

JAMES GIRDWOOD, *Publisher*

W. W. MacDONALD, *Editor*

JOHN M. CARROLL, *Managing Editor*

Associate Editors: Frank Leary, Michael F. Tomaino, Howard K. Janis, Sylvester P. Carter, Roland J. Charest, William P. O'Brien, George Sideris, John F. Mason, William E. Bushor, Thomas Emma, Samuel Weber, Sy Vogel, Leslie Solomon, M. M. Perugini, George J. Flynn

Assistant Editors: Michael F. Wolff, Nilo Lindgren, Harold M. McKean

Regional Editors: Harold C. Hood (Pacific Coast, Los Angeles), Harold Harris (Midwestern, Chicago), Thomas Maguire (New England, Boston)

Market Research Editor: Edward DeJongh

Art Director: Harry Phillips

Production Editor: John C. Wright, Jr.

Editorial Assistants: Gloria J. Filippone, Arlene Schilp, Bernice Duffy, Patricia Landers, Carol Weaver, Marian L. Freed, Dolores A. Fornaro, Lorraine Rossi

BRUCE A. WINNER, *Advertising Sales Manager*. R. S. Quint, *Assistant Advertising Sales Manager and Buyers' Guide Manager*. Fred Stewart, *Promotion Manager*. Richard J. Tomlinson, *Production Manager*. George E. Pomeroy, *Classified Manager*. Hugh J. Quinn, *Circulation Manager*

New York: Donald H. Miller, Henry M. Shaw, George F. Werner.
Boston: Wm. S. Hodgkinson.
Philadelphia: Warren H. Gardner, William J. Boyle. *Chicago:* Harvey W. Wernecke, Martin J. Gallay.
Cleveland: P. T. Fegley, David M. Watson. *San Francisco:* T. H. Carmody, R. C. Alcorn. *Los Angeles:* Carl W. Dysinger, D. A. McMillan. *Denver:* J. Patten. *Atlanta:* M. Miller. *Dallas:* Gordon L. Jones, Robert T. Wood. *London:* E. E. Schirmer, Norman Strick. *Frankfurt:* Michael R. Zeynel

Issue at a Glance

Business

Space Agency Expanding. Exclusive roundup on NASA.....	28
Import Study Nears Countdown. Japan sends industry delegation....	32
Manned Interceptors' Role. Report on World-Wide Weapons Meet....	35
Dr. Esaki Goes Sightseeing. And ELECTRONICS joins in the fun.....	38
Stratovision: New Business. First year's cost is \$7 million.....	42
Shoptalk	4
Electronics Newsletter	11
Washington Outlook	14
Financial Roundup.....	21
25 Most Active Stocks.....	21
Market Research.....	22
Current Figures.....	22
Meetings Ahead	44

Engineering

Instrument harnesses are prepared by General Radio Co on cable-braiding machine modified by adjustable stops and variable speed controls. Improved quality, 40-percent labor savings result. See p 49	COVER
Electronics Production: Methods for Modernization. How typical electronics firms are improving facilities.....By G. Sideris	49
The Tunnel Diode—Its Action and Properties. Here's an explanation of tunneling theory.....By B. Sklar	54
Finishes for Magnesium Electronic Components. Tables describe primers, paints, chemical and plating finishes....By J. A. Stevens	58
Infrared Detector Trains Tank Gunners for Combat. System keeps track of direct hits.....By W. P. Battista, I. Roth and R. Rachlis	60
Pre-receiver Attenuator Reduces Intermodulation. Six to eight db improvement is realized.....By S. L. Robinette	64
Function Generation With Operational Amplifiers. Precision switching and function generation.....By H. Koerner and G. A. Korn	66

Departments

Research and Development. Subaudio Tunable Amplifier.....	72
Components and Materials. Achieving Precise Frequency Control....	76
Production Techniques. Arc Method Simplifies Glassworking.....	80
On the Market.....	84
New Books	126
Literature of the Week.....	130
Plants and People.....	132
News of Reps.....	135
Comment	136

Index to Advertisers.....146

3.5-millimicrosecond risetime

with these

TWO NEW OSCILLOSCOPES



TYPE 581

The Tektronix Type 581 is a new laboratory oscilloscope with many of the capabilities needed in the current rapid advancement of the electronic art. Its 3.5-m μ sec risetime, 0.1-v/cm sensitivity, and 0.01- μ sec/cm sweep time are excellent features for modern high-speed pulse applications. In addition to these unique features, the Type 581 also has the slow sweeps, versatile triggering, and dc-coupled vertical-deflection system needed for most general-purpose laboratory work. A new series of Tektronix plug-in preamplifiers promises outstanding signal-handling versatility for an oscilloscope with a vertical passband of dc to approximately 100 mc.

With the Type 80 Plug-In Preamplifier and Type P80 Probe the basic vertical-deflection factor is 0.1 v/cm with input impedance of 10 μ m Ω paralleled by 100 kilohms. Five snap-on probe attenuator heads provide deflection factors of 0.2, 0.5, 1, 2, and 5 v/cm at input impedances ranging up to 1.5 μ m Ω paralleled by 5 megohms. A fixed balanced delay line is incorporated in the main vertical amplifier.



The cathode-ray tube is a lumped-constant traveling-wave type with 10-kv accelerating potential.

The wide sweep range of the Type 581 includes sweeps fast enough to take advantage of its risetime capabilities. Calibrated range is 0.05 μ sec/cm to 2 sec/cm in 24 steps, with 5-x magnifier to increase calibrated range to 0.01 μ sec/cm. Sweep time is continuously adjustable between steps. Versatile triggering includes amplitude-level control, and preset stability for operating convenience. Lockout-reset circuitry provides for one-shot sweep operation.

TYPE 585

The Tektronix Type 585 has, in addition to the identical general specifications of the Type 581, a second time base generator. This time-base generator, designated TIME BASE B, acts as a delay generator, providing a wide range of calibrated sweep delay. Two modes of sweep delay are available—triggered (delayed sweep is started after the

delay period by the signal under observation), and conventional (delayed sweep is started at the end of the delay period by the delayed trigger). Calibrated sweep delay is continuously variable over the range of 1 μ sec to 10 sec. Color-correlated controls eliminate confusion, making this new high-performance oscilloscope easy to operate.

- TYPE 581, without plug-in units \$1375
- TYPE 585, without plug-in units 1675
- TYPE 80 Plug-In Preamplifier 50
- TYPE P80 Probe, with 5 attenuator heads. 100

(Both Preamplifier and Probe are needed to operate the Type 581 and Type 585.)

Other Plug-In Preamplifiers are currently in development. Prices f.o.b. factory.

ENGINEERS—Interested in furthering the advancement of the oscilloscope? We have openings for men with creative ability in circuit and instrument design, cathode-ray tube design, and semiconductor research. Please write Richard Rapiquet, V.P., Eng.

Tektronix, Inc.

P. O. Box 831 • Portland 7, Oregon
Phone CYpress 2-2611 • TWX-PD 311 • Cable: TEKTRONIX

TEKTRONIX FIELD OFFICES: Albertson, L.I., N.Y. • Albuquerque • Annandale, Va. • Atlanta Ga. • Buffalo • Cleveland • Dallas • Dayton • Elmwood Park, Ill. • Endwell, N.Y. • Houston Lathrup Village, Mich. • Lexington, Mass. • East Los Angeles • West Los Angeles • Minneapolis Mission, Kansas • Orlando, Fla. • Palo Alto, Calif. • Philadelphia • San Diego • St. Petersburg, Fla. • Scottsdale, Ariz. • Stamford, Conn. • Syracuse • Towson, Md. • Union, N.J. • Willowdale, Ont.

TEKTRONIX ENGINEERING REPRESENTATIVES: Hawthorne Electronics, Portland, Oregon, Seattle, Wash.; Hytronic Measurements, Denver, Colo.; Salt Lake City, Utah.

Tektronix is represented in 20 overseas countries by qualified engineering organizations.

SPACE SHRINKERS

MICROIDS AND MONKEYS -- Burnell & Co. welcomes the assistance of their simian friends in the task of gathering data vital to space shrinking. By shrinking toroids, filters and related networks for guidance and communication systems, Burnell helps space vehicles carry bigger payloads -- more instrumentation, animals -- eventually man. Typical of our accomplishments is the **MTT MICROID**® telemetering band pass filter. Significantly, the combined weight of 23 **MICROIDS** -- plus the monkey -- is less than the single non-miniaturized telemetering band pass filter pictured here. **MICROID** band width is 15% at 3 db + 60% -40% at 40 db. Frequency coverage is from .4 kcs to 70 kcs.

Sizes

Channels 1-6 2x27/32x1/2
 Channels 7-10 1-5/16x11/16x11/16
 Channels 11-18 15/16x19/32x1/2
 Alternates A-E 15/16x19/32x1/2

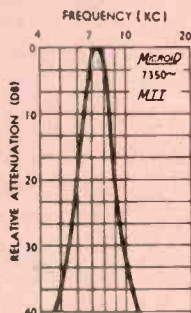

2/3 actual size

Write for Filter Bulletin MTT 23.

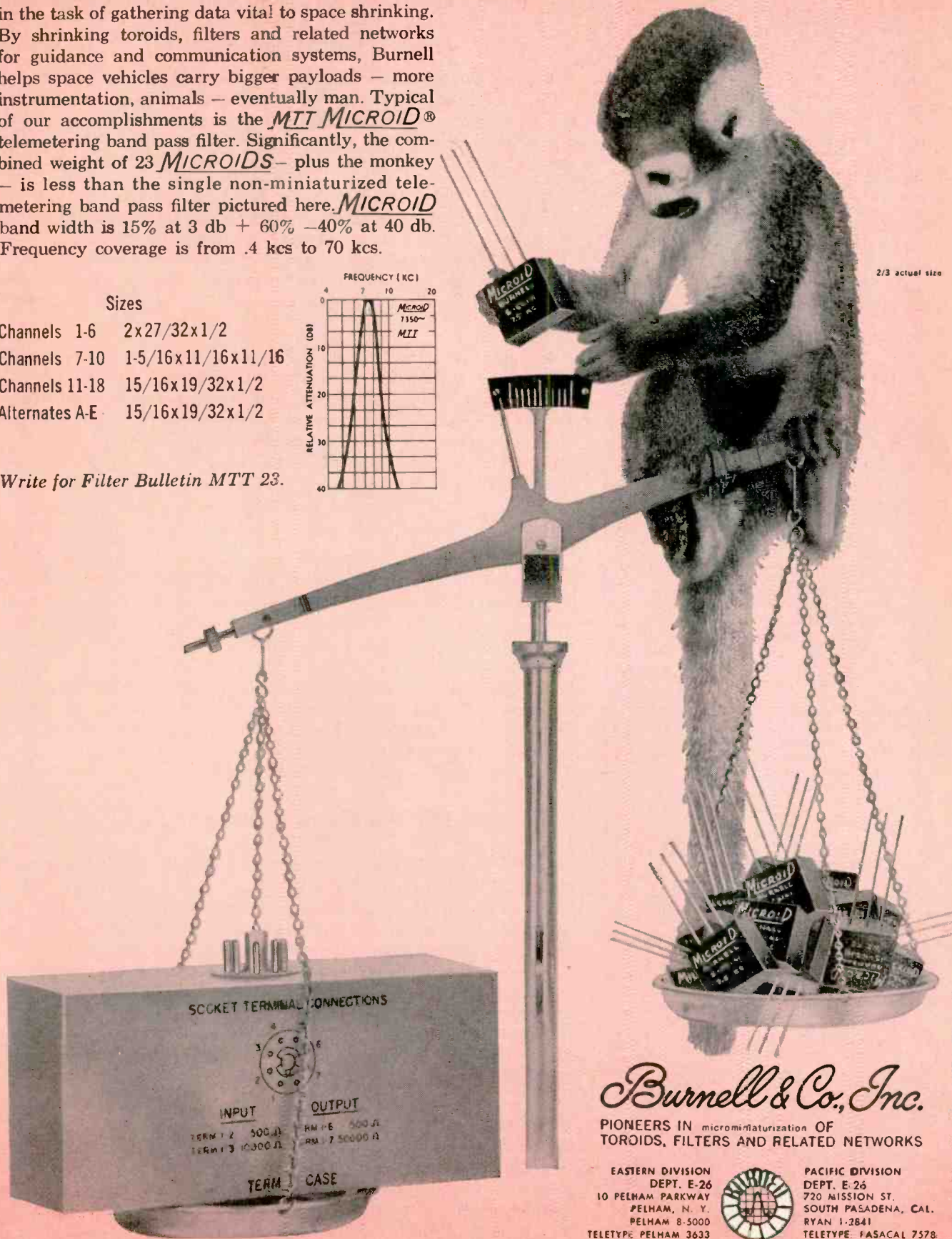

Burnell & Co., Inc.

PIONEERS IN microminiaturization OF TOROIDS, FILTERS AND RELATED NETWORKS

EASTERN DIVISION
 DEPT. E-26
 10 PELHAM PARKWAY
 PELHAM, N. Y.
 PELHAM 8-5000
 TELETYPE PELHAM 3633



PACIFIC DIVISION
 DEPT. E-26
 720 MISSION ST.
 SOUTH PASADENA, CAL.
 RYAN 1-2841
 TELETYPE PASACAL 7578

electronics

November 6, 1959 Vol. 32, No. 45

Published weekly, including the ELECTRONICS BUYERS' GUIDE and REFERENCE Issue in mid-June as part of the subscription, by McGraw-Hill Publishing Company, Inc., James H. McGraw (1860-1948) Founder.

Executive, Editorial, Circulation and Advertising Offices: McGraw-Hill Building, 330 W. 42 St., New York 36, N. Y. Longacre 4-3000. Publication Office: 99-129 North Broadway, Albany 1, N. Y.

See panel below for directions regarding subscriptions or change of address. Donald C. McGraw, President; Joseph A. Gerardi, Executive Vice President; L. Keith Goodrich, Vice President and Treasurer; John J. Cooke, Secretary; Nelson L. Bond, President, Publications Division; Shelton Fisher, Senior Vice President; John R. Callahan, Vice President and Editorial Director; Joseph H. Allen, Vice President and Director of Advertising Sales; A. R. Venezian, Vice President and Circulation Coordinator.

Single copies in the United States, U. S. possessions & Canada 75¢; \$1.50 for all other foreign countries. Buyers' Guide in the United States, U. S. possessions & Canada \$3.00; all other foreign \$10.00. Subscription rates—United States and possessions, \$6.00 a year; \$9.00 for two years; \$12.00 for three years. Canada, \$10.00 a year; \$16.00 for two years; \$20.00 for three years. All other countries, \$20.00 a year; \$30.00 for two years; \$40.00 for three years. Second class postage paid at Albany, N. Y. Printed in U.S.A. Copyright 1959 by McGraw-Hill Publishing Co., Inc.—All Rights Reserved. Title registered in U. S. Patent Office. BRANCH OFFICES: 520 North Michigan Avenue, Chicago 11; 8 Post Street, San Francisco 4; McGraw-Hill House, London E. C. 4; 85, Westendstrasse, Frankfurt/Main; National Press Bldg., Washington 4, D. C.; Six Penn Center Plaza, Philadelphia 3; 1111 Henry W. Oliver Bldg., Pittsburgh 22; 55 Public Square, Cleveland 13; 856 Penobscot Bldg., Detroit 26; 3615 Olive St., St. Louis 8; 350 Park Square Bldg., Boston 16; 1301 Rhodes-Haverty Bldg., Atlanta 3; 1125 West Sixth St., Los Angeles 17; 1740 Broadway, Denver 2; 901 Vaughn Bldg., Dallas 1. ELECTRONICS is indexed regularly in The Engineering Index.

Subscription: Address correspondence to: Fulfillment Manager, Electronics, 330 W. 42nd St., New York 36, N. Y. Allow one month for change of address, stating old as well as new address, including postal zone if any. Subscriptions are solicited only from persons engaged in theory, research, design, production, management, maintenance and use of electronics and industrial control components, parts and products. POSITION and COMPANY CONNECTION must be indicated on subscription orders.

Postmaster: please send form 3579 to Electronics, 330 W. 42nd St., New York 36, N. Y.



Member ABP and ABC

SHOE LEATHER. One guiding principle passed down by James H. McGraw, Sr., founder of the McGraw-Hill Publishing Co., is that a good editor wears out the soles of his shoes rather than the seat of his pants. Today, ELECTRONICS editors travel mostly by air. They have to, covering this widespread, fast-growing industry.

● **Item.** Covering the Japanese transistor import situation (p 32), Associate Editor Emma traveled to Washington, D. C. There he interviewed officers of the Electronic Industries Association, officials of the Office of Civil and Defense Mobilization and of the Commerce Dept.'s Business and Defense Services Administration.

● **Item.** Frank Leary flew to Langley Field, Va., toured the National Aeronautics and Space Administration research center with aeronautical experts representing military and civil arms of the U. S. and foreign governments and U. S. industry. The tour uncovered interesting developments in electrical propulsion systems for space craft as well as new thoughts on communicating through plasma, all reported on p 28.

● **Item.** Traveling in an Air Force RC-121, an ex-radar picket plane, John Mason flew from Stewart AFB, N. Y., to Tyndall AFB, Fla., by way of Byrd AFB, Va. and Warner-Robbins AFB, Ga. At Tyndall, he watched what could be the last World-Wide Weapons Meet. As crack Air Force pilots fired their Sidewinder, Genie and Falcon missiles at jet target drones high over the Gulf of Mexico, Mason got some sobering views from top Air Force brass on the probable future of manned interceptor aircraft in continental air defense. For these views, and what they mean to our industry, see p 35.

● **Item.** Other staff men were simultaneously active in Chicago. New York editors Solomon and Perugini joined forces with Midwestern Editor Hap Harris. They attended engineering sessions of the National Electronics Conference and then visited plants in the area, encouraging authors, rounding up opinions and renewing friendships. One bond of friendship immediately stretched from Chicago to New York. Leo (tunnel diode) Esaki told Solomon of plans to get a tourist's look at New York. A few days later the distinguished Japanese visitor and Solomon were reunited—as tourists. For a picture of Leo Esaki at ease, see p 38.

Coming In Our November 13 Issue . . .

DIRECT CONVERSION. Research on direct conversion of heat into electricity without use of moving parts is growing rapidly. Military research and development centers, as well as firms in the electronics, airframe, appliance, automotive and power distribution industries, are investigating thermionic and thermoelectric converters.

The promise of high-efficiency, small-weight and maintenance-free operation makes thermionic generation of electricity commercially attractive, according to G. N. Hatsopoulos and J. Welsh of MIT, and E. Langberg of the Thermo Electron Engineering Corp. in Cambridge, Mass. They describe devices currently under development, including gas-diode, magnetic-triode and vacuum-diode thermionic engines.

DIGITAL ENCODER. As the volume of data gathered by high-speed multichannel recorders increases, the readout task becomes more and more imposing. R. J. Sullivan, I. Eastman and I. C. Chanock of Edgerton, Germeshausen & Grier, Inc. in Boston, Mass., describe a method of generating time scales for magnetic tape and paper charts in a form that permits quick interpretation.

EXTENDED-LIFE TUBULAR



ELECTROLYTICS

... the newest and most
reliable miniature tubular aluminum
electrolytic capacitors made!

Now... *for the first time*... an extended-life electrolytic in miniature tubular case styles. Sprague's New Type 40D Extended-Life Electrolytics are designed to give more than 10 years of service under normal operating conditions in actual circuit applications.

○ Broader Application

Though similar in many respects to Sprague's famous extended-life electrolytics for telephone and communications systems, these capacitors have the added advantage of low temperature characteristics previously unavailable in an aluminum electrolytic. As a result, Type 40D offers much broader industrial and military application.

○ Special Construction

Type 40D capacitors are specially constructed to assure freedom from open circuits even after extended periods of operation in the millivolt signal range. Ultra-low leakage currents are the result of special design and processing techniques based on the use of the highest purity anode and cathode foils.

○ Hand or Machine Assembly

For applications which require an insulated case, Sprague furnishes an outer insulation of either flexible plastic for hand assembly or rigid phenolic for machine insertion on printed wiring boards.

Get details on Type 40D Extended-Life Electrolytics by writing for Bulletin 3205 to Technical Literature Section, Sprague Electric Co., 35 Marshall St., North Adams, Mass.

SPRAGUE®
THE MARK OF RELIABILITY

SPRAGUE COMPONENTS:

CAPACITORS • RESISTORS • MAGNETIC COMPONENTS • TRANSISTORS • INTERFERENCE FILTERS • PULSE NETWORKS
HIGH TEMPERATURE MAGNET WIRE • CERAMIC-BASE PRINTED NETWORKS • PACKAGED COMPONENT ASSEMBLIES

keyed for automation

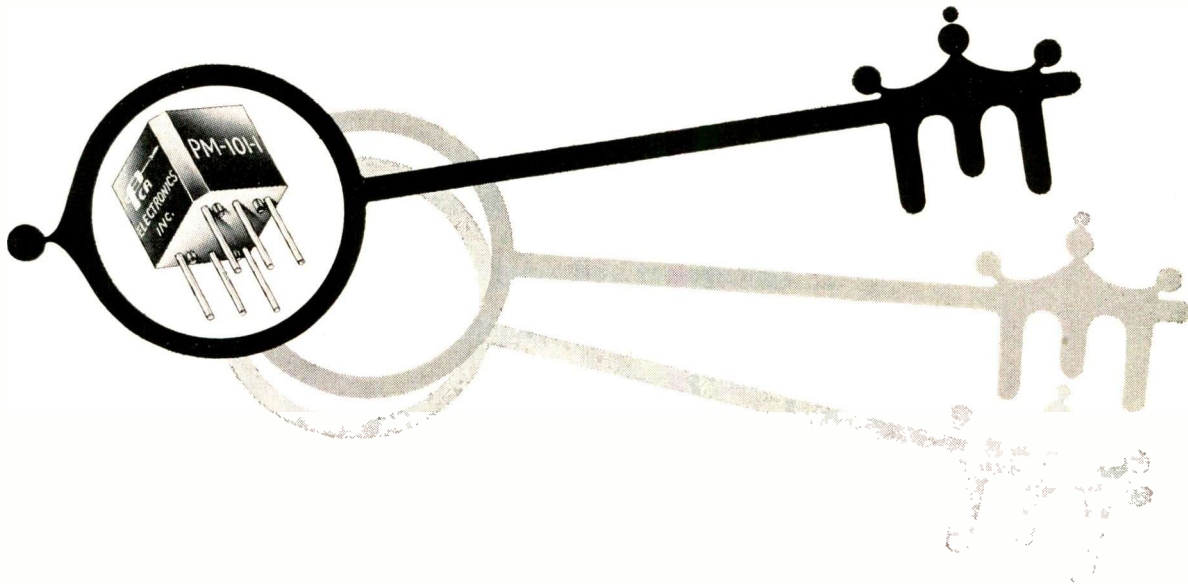

Applicable specs: MIL-T-27... MIL-T-21038, Case H

PM STYLE PULSE TRANSFORMERS by PCA ELECTRONICS enable installation by automation! Precision molded, with a chamfered edge .062 inch in width, this highly miniaturized transformer features a core of grain oriented silicon steel. A vacuum impregnated internal assembly and case material in glass alkyd, combine to eliminate shock and vibration problems. Mounted by soldering on etched circuit boards, it has four bosses to prevent moisture condensation between unit and board.

PM STYLE PULSE TRANSFORMERS by PCA ELECTRONICS are designed to serve a wide range of applications.

A few typical applications are usage in:

- DC isolation circuits
- Blocking oscillator circuits
- Low voltage inter-stage coupling
- As wide band input and output transformers
- Impedance matching and phase inversion
- Low-voltage and counting circuits
- Triggering circuits
- Pulse shaping circuits

PM Size	2 Wndg.	3 Wndg.	4 Wndg.
.400 x .400 x .400 ht.	PM-101—0.1 and under	PM-111—0.1 and under	Not available
.562 x .562 x .500 ht.	PM-101—0.2 to PM-101—5	PM-111—0.2 to PM-111—5	PM-1111—0 to PM-1111—4
.700 x .700 x .650 ht.	PM-101—6 to PM-101—25	PM-111—6 to PM-111—25	PM-1111—5 to PM-1111—25

DESIGN APPLICATIONS

The number following the dash (box left) represents an approximate pulse width obtained in a coupling circuit. If, for example, a 2 micro-second pulse is desired, a PCA transformer MPT-101-2 is suggested as an approximation. Should a third winding be required, an MPT-11X-2 may be used where X is the desired winding ratio.

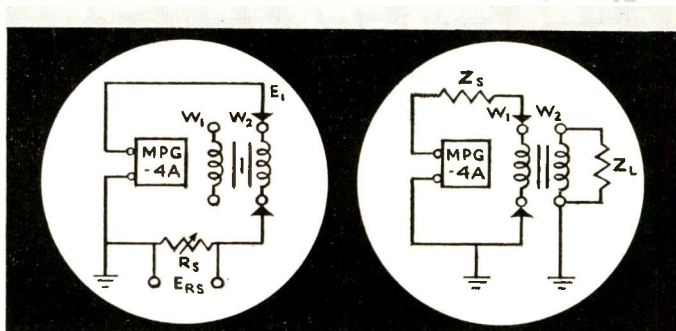

Write Today For Complete Pulse Transformer Catalog

PCA
ELECTRONICS, INC.

Leading Manufacturers of Pulse Transformers and Delay Lines

16799 SCHOENBORN STREET, SEPULVEDA, CALIFORNIA

- ▶ **DIRECT USE** *without auxiliary amplification*
- ▶ **DIRECT WRITING** *without servos or linkage drives*
- ▶ **DIRECT SATISFACTION** *with famous, "use-proved," E/A quality*

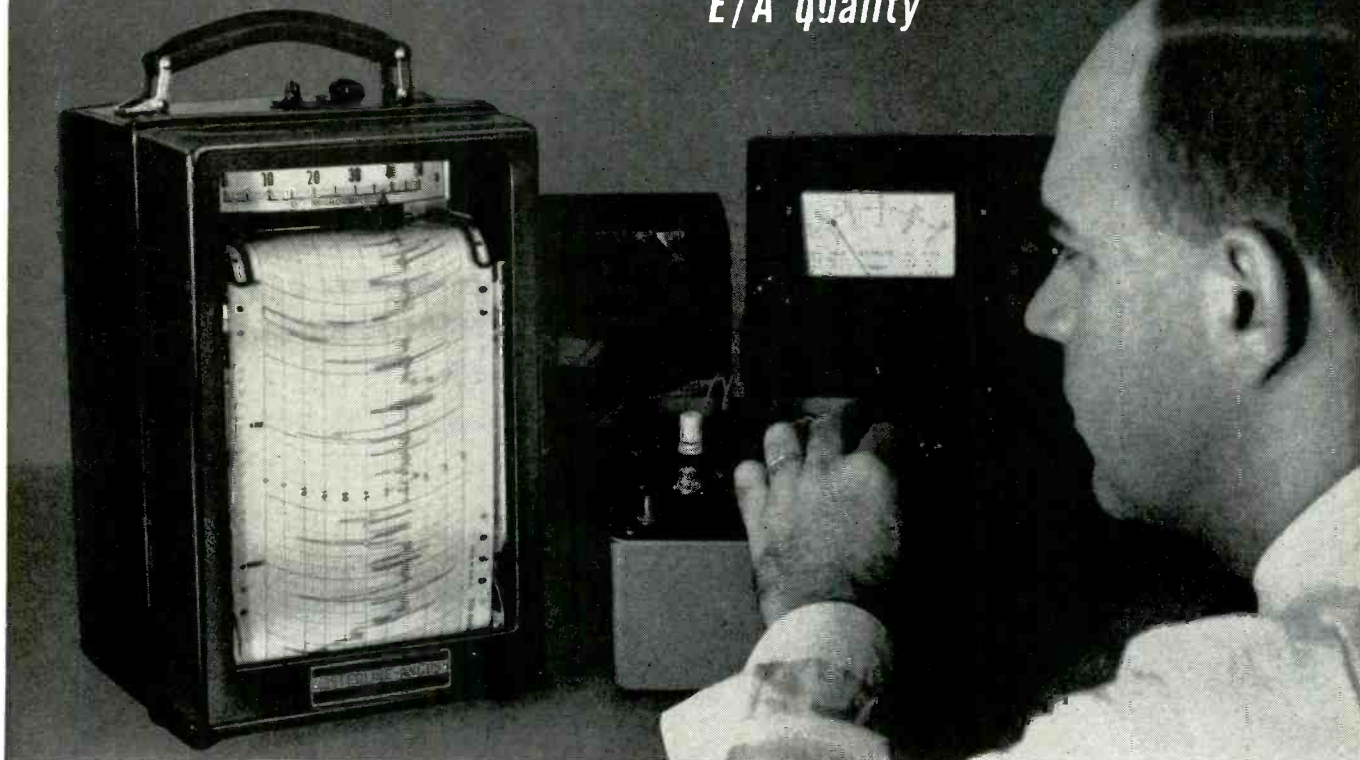

You get them ALL with the new Esterline-Angus
RECORDING D.C. MICROAMMETER

Here's the recording instrument designed for universal use, with basic ranges common to numerous applications:

Ranges: 0 to 50 microamperes D. C. with approximately 200 ohms input resistance.
 Also 0-10/50/200 millivolts D. C.

Power Supply: 120 volts, 60 cycles.

Response: 1 second, independent of external circuit resistance.

Here's the recording instrument with high stability, linearity, long-lasting reliability, and freedom from zero drift—desirable for most instrument applications . . . and here's why:

Direct writing eliminates maintenance of servo motors

and linkage drives. Combines the famous E-A rugged, "use-proved" permanent-magnet moving-coil movement with a highly durable magnetic amplifier built with wide safety margins.

Extremely high sensitivity for direct use, without auxiliary amplification, in most electronic circuits.

Ruggedly built for continuously reliable results in rough use. Quickly and easily set up. Simple to maintain.

This new E/A D.C. MICROAMMETER is the recording instrument of a *thousand and one uses*—in every field of research and production.

Send for Catalog Section No. 41 and see how it can help you.



No. **1** in fine Graphic Instruments for more than 50 years

The Esterline-Angus Company

DEPT. E, P.O. BOX 596
 INDIANAPOLIS 6, IND.

NOW! 4 new microwave sweep oscillators

*speed, simplify
measurements
2.0 to 18.0 KMC*

Covers full band, or any part
Use with 'scope or recorder
All electronic; no mechanical sweep
Direct reading, independently
adjustable sweep range
and rate controls

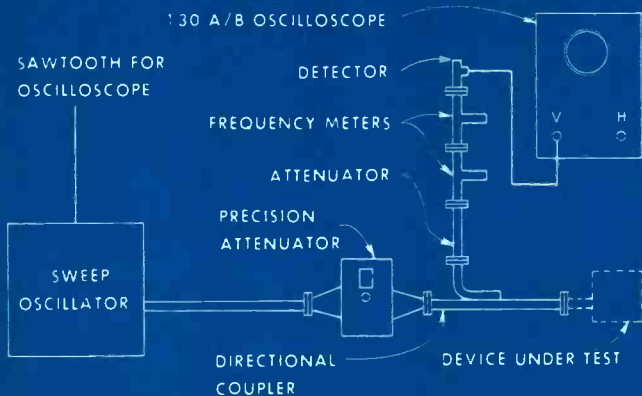

◀ Figure 1. Arrangement for high speed microwave measurement to provide rapid visual display with ϕ 130A/B oscilloscope.

hp Dependable, quality

Hewlett-Packard Electronic Sweep Oscillators are new measuring tools deliberately designed to give you simpler, faster microwave measurements. Four models are provided, covering frequencies 2.0 to 18.0 KMC as follows: Model 683A, 2.0 to 4.0 KMC; Model 684B, 4.0 to 8.1 KMC; Model 686A, 8.2 to 12.4 KMC and Model 687A, 12.4 to 18.0 KMC.

These instruments make possible microwave investigations and evaluations with a convenience previously associated only with lower frequency measurements. These oscillators provide a wide range of sweep speeds so that measurements of reflection, attenuation, gain etc., can be displayed on an oscilloscope or recorded in permanent form on X-Y or strip-chart recorders.

Electronic Sweeping

Specifically, the new oscillators provide either a CW or swept rf output throughout their individual bands. The instruments employ new backward wave oscillator tubes whose frequency is shifted by varying an applied potential. Thus, troublesome mechanical stops and tuning plungers are eliminated. Sweep range is continuously adjustable and independently variable; sweep rate is selected separately, and either can be changed without interrupting operation. The full band width can be covered in time segments ranging from 140 seconds (very slow for mechanical recorder operation) to 0.014 seconds (high speed for clear, non-flickering oscilloscope presentation).

Linear Frequency Change

The swept rf output from the sweep oscillator is linear with time, and a linear sawtooth voltage is provided concurrent with each rf sweep to supply a linear time base for an oscilloscope or recorder. In addition, for convenience in recording and other operations, rf sweeps can be triggered electrically externally and single sweeps can be triggered by a front panel push button. The rf output can also be internally AM'd from 400 to 1,200 cps and externally AM'd or FM'd over a wide range of frequencies.

Rapid Visual Presentation

The variety of sweep rates and band widths available from the new oscillators insures convenience and accuracy for reflection and transmission coefficient measurements and many other production line and laboratory tests. For maximum speed, an oscilloscope such as 130A/B may be used as indicated in the diagram on opposite page. For maximum information and a permanent record, an X-Y or strip chart recorder may be used.

Complete details of a rapid visual method using an oscilloscope or a maximum-data, permanent record method using a recorder may be obtained from your field engineer. Detailed discussions of these methods are also contained in the Journal, Vol. 8, No. 6, and Vol. 9, No. 1-2, available on request.

TYPICAL SPECIFICATIONS

Below are specifications for -hp- 686A Sweep Oscillator, 8.2 to 12.4 KMC. Specifications for -hp- 683A, 684B, and 687A (P band) are similar except for frequency range and other minor variations.

Types of Outputs: Swept Frequency, CW, FM, AM.

Single Frequency Operation

Frequency: Continuously adjustable 8.2 to 12.4 KMC.

Power Output: At least 10 milliwatts into matched waveguide load. Continuously adjustable to zero.

Swept Frequency Operation

Sweep: Recurrent; externally triggered; also manually triggered single sweep. Rf sweep linear with time.

Power Output: At least 10 MW into matched waveguide load. Output variation less than 3 db over any 250 MC range; less than 6 db over entire 8.2-12.4 KMC range.

Sweep Range: Adjustable in 7 steps 4.4 MC to 4.4 KMC.

Sweep Rate-of-Change: Decade steps from 32 MC/sec. to 320 KMC/sec.

Sweep Time: Determined by sweep range and rate; from 0.014 to 140 seconds over full-band.

Sweep Output: +20 to +30-volt-peak sawtooth provided at a front-panel connector concurrent with each rf sweep.

Modulation

Internal Amplitude: Square wave modulation continuously adjustable from 400 to 1200 cps; peak rf output power equals cw level ± 1 db.

External Amplitude: Direct coupled to 300 KC; 20 volt swing reduces rf output level from rated cw output to zero.

External Pulse: +10 volts or more, 5 millisecond maximum duration.

External FM: Approx. 350 v peak to modulate full frequency range.

General

Input Connectors, Impedances: BNC; above 100,000 ohms.

Output Connector: Waveguide cover flange (686A, 687A); Type N, female (683A, 684B).

Power Requirements: 115/230 volts $\pm 10\%$, 50/60 cps; approximately 540 watts.

Price: 683A (2.0 to 4.0 KMC) \$3,000.00.

684B (4.0 to 8.1 KMC) \$2,900.00.

686A (8.20 to 12.40 KMC) \$2,900.00.

687A (12.40 to 18.00 KMC) \$3,400.00.

(Prices above are f.o.b. factory for cabinet models. Rack mount instruments \$15.00 less.)

Data subject to change without notice.

HEWLETT-PACKARD COMPANY

4478A Page Mill Rd. • Palo Alto, California, U.S.A.

Field Representatives in All Principal Areas

Cable "HEWPACK" Davenport 5-4451

4478-R

instruments that speed and simplify your work

How a 150 watt triode 25 years ago led to super power klystrons today

In 1934, two radio amateurs, unhappy with existing final amplifier tubes, formed a company to make their own. Their first tube, the Eimac 150T, established a new standard of electron tube performance and reliability.

Other important Eimac tube developments were:

150T—The first Eimac tube in 1934, was designed primarily for the amateur and established Eimac tube characteristics for the future — clean, hard vacuums, simplified design, lower driving power, high mutual conductance and superior overload capability.

450T—Only two years later practically every major airline was using Eimac tubes. The 450T fulfilled the critical needs of aviation and was first choice in ground-to-air communications.

3X2500A3—By the time Major Armstrong had won his battle for FM, Eimac internal anode triodes were in nearly every experimental FM broadcast station. In 1945 the external anode triode 3X2500A3 was introduced and used in the world's most powerful FM transmitter.

304T—In 1940 Eimac introduced multi-unit triodes — which operate efficiently up to 200mc, and as high as 10 times rated voltage. The 304T, four triodes in one, is still acclaimed as a top linear amplifier tube.

VT 127—In 1939, Eimac 100T triodes powered the first Navy radar, prototype of the first radar to see action in the Pacific. Eimac's 15E met the higher frequency operation needs of airborne radar and made possible 26,000 Navy radar sets. Many of the renowned VT series tubes were other Eimac contributions.

4-125A Family (5 tubes) — In 1945 Eimac introduced the 4-125A, first radial-beam tetrode. Today, Eimac's five internal anode

tetrodes are famous for low driving power requirements, low grid emission, low gridplate capacitances, minimized neutralization requirements and dependable VHF performance.

4X150A—Compact, rugged external anode radial-beam tetrodes were introduced by Eimac in 1946. The 4X500A and 4X150A led to smaller, high power, high frequency equipment and coaxial cable circuits.

Amplifier Klystron—Eimac saw the shortcomings of grid tubes for UHF in 1948, started developing amplifier klystrons. Today Eimac klystrons are the most widely used tubes in tropospheric communications.

4CX300A, 4CX250B, 4CX1000A, 4CX5000A — Today, over 40 Eimac tubes feature ceramic envelopes. More compact than glass, these advanced tubes can withstand thermal and physical shock never before possible.

X626—Super power, 1.25 megawatts of long-pulse power, at UHF is now available with the Eimac X626. This tube powered the record 56,000,000 mile radar contact with Venus.

TWT—Now, microwave in the form of ceramic traveling wave tubes and reflex klystrons. Eimac is engaged in the development and manufacture of new electron devices to propagate the uncrowded spectrum at Super High Frequencies and above.

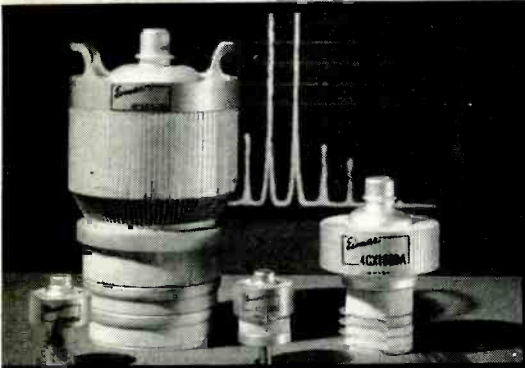
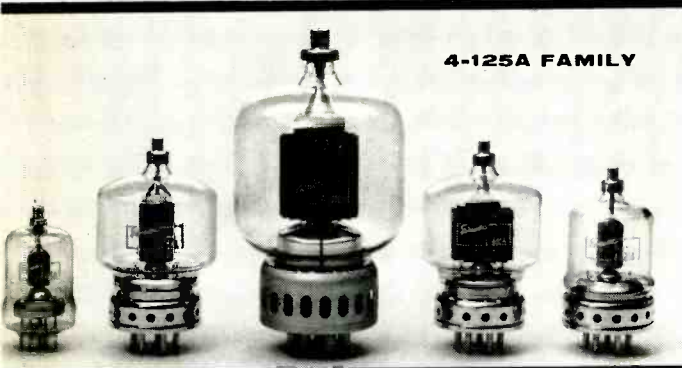
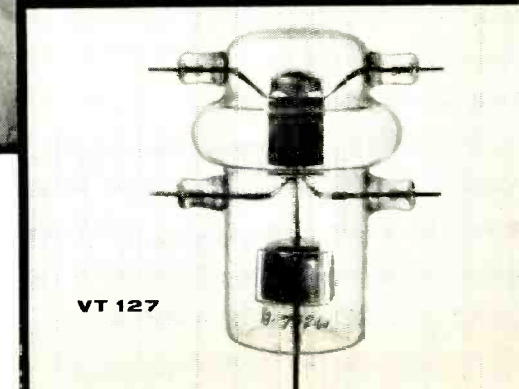
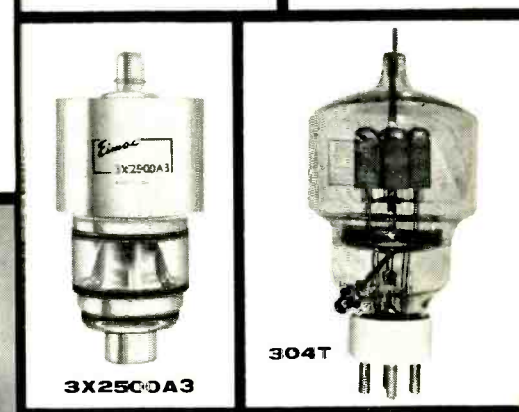
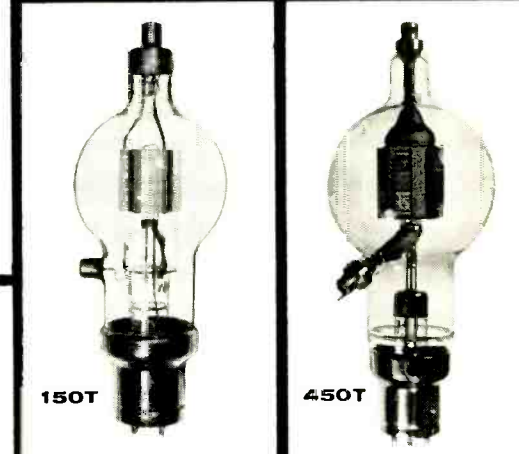
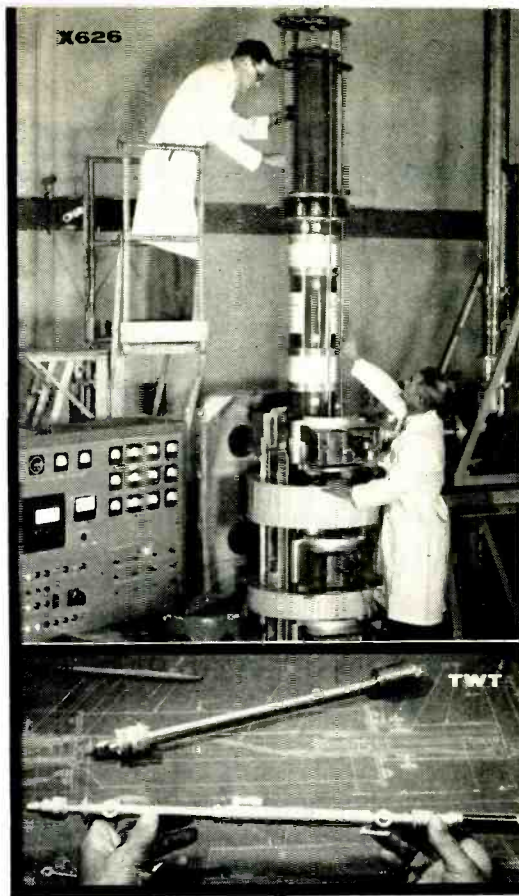

The dependable tubes of yesteryear have not been forgotten. They are constantly improved. Most of the oldtimers on review here are still available and many are replacements for originals that have finally given in after years and years of service.



EITEL-McCULLOUGH, INC., San Carlos, California

ELECTRONICS NEWSLETTER

MAGNETOHYDRODYNAMIC GENERATOR has been successfully demonstrated by General Electric's missiles & space vehicle department in Philadelphia. Breakthrough in space-age power generation uses an air plasma as the electrical conductor that is passed through a magnetic field, produces d-c at high power levels with no moving parts. Plasma is produced by an air arc, passed down a rectangular quartz channel about three inches wide and an inch high. An electromagnet produces a strong magnetic field normal to the direction of plasma flow. Graphite electrodes on the sides of the channel pick up the current. In one set of experiments, magnet field strength was in the 10-to-20 kilogauss range, voltage (which varies as the square of plasma velocity) was 16 v, and the generator produced 900 w.

STIFFENING OF TARIFF RESTRICTIONS on European and Asian imports—requested by Electronic Industries Association—looks less likely in view of U. S. actions before GATT (General Agreement on Tariffs & Trade) in Tokyo last week. Douglas Dillon, Undersecretary of State, told GATT that trade barriers are contributing to U. S. balance-of-payments deficit, demanded that other nations end these barriers. Informed Washington sources told **ELECTRONICS** that U. S. can't, in the face of these demands, raise its own tariff barriers higher.

Electronically controlled color-photo enlarger was disclosed to the annual conference of the Society of Photographic Scientists and Engineers in Chicago by inventor Dwin R. Craig of LogElectronics Inc., Alexandria, Va. Enlarger uses "electronic scanning light source," combined with a phototube that modulates the brightness of the source. Phototube provides automatic dodging (print correction) by dimming light source for shadowed areas and brightening it for highlights. Each primary color is measured and relative exposure time is controlled to provide correct color balance and print density.

NAVY LOGISTICS will be aided by RCA-501 now being used by Navy's newly organized Bureau of Naval Weapons (which replaces BuOrd and BuAer on Jan. 1). The big transistorized data-processing system, renting for \$20,000 monthly, will keep track of stocks of every type of weapon and ammunition, will also know where every ship in each fleet is at all times.

SWEDEN is getting \$4.2-million worth of new Marconi radar air-defense equipment, whose heart is a high-speed computer for solving many interception problems at once. System was designed in collaboration with the Swedish Air Force, is said to discriminate between types of aircraft and to provide full position and height information. Automatic tracking methods are said to render the

system proof against disorganization by saturation attacks. Computer reportedly reduces human error to a minimum, bringing correct defense weapons into action at the right instant. Both color and monochrome tv are used. Besides synthetic and tabular displays and televised pictures of ancillary operational data, a large-screen color tv displays the entire air situation.

Countercountermeasures trainers developed by Sylvania are being installed at Air Defense Command radar sites throughout the U. S. and Canada. Air Force is buying some 100 of the trainers. Equipment provides realistic simulation of aircraft and missile jamming of radars. Field reports indicate operators cannot distinguish simulated countermeasures from real jamming by airborne vehicles, Sylvania says.

ELECTRONIC VOTING SYSTEM has been proposed by RCA's V. K. Zworykin in a lecture before the British Institution of Radio Engineers. Zworykin proposes that radio, tv and other media be used to address voting questions to the public, and that the popular vote be registered by means of a vote-recording system using the telephone. He proposes that each voter record his vote on a "televoter," which he describes as a box provided with a series of yes-no pushbuttons and attached to a telephone. There would be one televoter for a household, with a set of buttons for each voter in the household. Each voter would unlock his set of buttons by inserting his individual coded voting card. When the voting period ends, all telephones would receive interrogating pulses that would trigger transmission of signals corresponding to the switch positions in the televoter. These could be tabulated at the exchange and the results sent to a central station.

Canada has completed evaluation of a four-chain Decca Navigator system of continuous radio-position fixing for shipping, and is recognizing it as an official radio aid to marine navigation. Canada's Department of Transport purchased the system for \$2.35 million from Computing Devices of Canada, licensee of British Decca Navigator Co. The system's evaluation encompassed 400 Canadian and foreign ships operating in the Atlantic and up the St. Lawrence River.

NATIONAL BUSINESS SHOW this year featured more electronic equipment than ever, including data-processing systems, office intercoms, automatic telephone switchboards, dictating-transcribing machines, duplicating equipment. Trend toward transistorization continues, as reflected in DeJur-Amsco's little Stenorette dictating machine, increasing use of transistorized switchboards. Reasons given: space and power savings, reliability. Besides, as one spokesman put it, "it's the thing to do—it's new." Also shown at the show was American Electronics' data integrator, a peripheral unit to link data inputs with computers.

AIR LIFT

for mobile teleprinter center



Interior view of mobile teleprinter center

Kleinschmidt super-speed teletypewriters provide world's fastest printed combat communications for the U. S. Army!

Taking the jolts and jars of movement by air in stride, the new Kleinschmidt telecommunications units handle *printed* messages at speeds up to 750 words a minute! Using these machines, developed in cooperation with the U. S. Army Signal Corps, information on enemy movements could move accurately and rapidly to friendly units widely

dispersed under nuclear battlefield conditions. In recognition of Kleinschmidt's high standards of quality, equipment produced for the U. S. Army is manufactured under the Reduced Inspection Quality Assurance Plan. Today, the advanced commercial application of electronic communications is unlimited.

KLEINSCHMIDT



DIVISION OF SMITH-CORONA MARCHANT INC., DEERFIELD, ILLINOIS
Pioneer in teleprinted communications systems and equipment since 1911

From Detroit, Camden, or L. A.

TEXAS INSTRUMENTS SEMICONDUCTORS

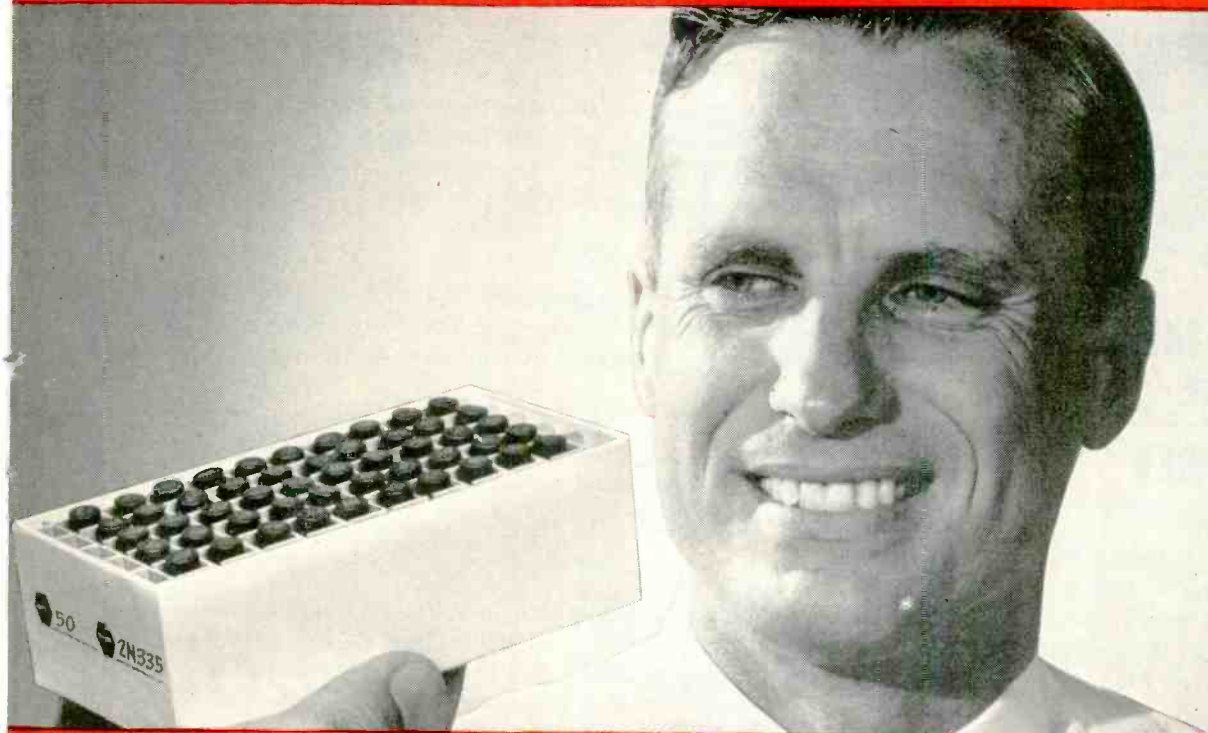

DELIVERED OFF-THE-SHELF OVERNIGHT

RADIO PRODUCTS SALES

LOS ANGELES

**FERGUSON ELECTRONIC
SUPPLY CO.**

DETROIT

**GENERAL RADIO
SUPPLY CO., INC.**

CAMDEN

Ready to give you fast, time saving local service, these three authorized TI distributors are backed by the pioneering leader with the greatest semiconductor experience — Texas Instruments — to deliver to you the most advanced, dependable semiconductor and component products available anywhere.

If you have an electronic component requirement, contact one of these three listed distributors for overnight delivery at factory prices from his complete line of TI stock.

Order today in the following quantities:

1-999:

silicon transistors, germanium transistors, silicon diodes and rectifiers, carbon film resistors

1-499:

silistor silicon resistors

1-99:

tan-TI-cap tantalum capacitors



Your Authorized TI Distributor



RADIO PRODUCTS SALES INC.

1501 South Hill Street
Los Angeles 15, California
Richmond 9-7471

Ferguson
Electronic Supply *Company*

2306 Puritan • Detroit 38, Michigan
UNiversity 1-6700



**GENERAL RADIO
SUPPLY COMPANY, Inc.**

600 Penn Street • Camden 2, New Jersey
(Phila. • WALnut 2-7037) • WOODlawn 4-8560

WASHINGTON OUTLOOK

WASHINGTON—TRANSFER OF ARMY'S SPACE LABORATORY at Redstone Arsenal, Huntsville, Ala. to National Aeronautics and Space Administration may reduce the civilian space agency's dependence on electronic and other industrial contractors for design and development of astronautic systems and components.

One NASA official points out that the agency's in-house development operations will be greater in scope than before the acquisition of the Army's Huntsville facilities—where Wernher Von Braun and his team of German rocket scientists hold forth.

The Germans, about 100 in number, form the nucleus of a 2,000-man staff of civil service scientists and engineers. The Huntsville space facilities consist of ten laboratories valued at well over \$58 million.

Among the Huntsville laboratories' specialties are guidance and control development, computation, systems analysis and reliability studies, and feasibility research.

The Huntsville switch to NASA, which is subject to congressional approval, is a step towards insuring full utilization of the government's facilities there. Previously the Army had the facilities while NASA and the Air Force had been given full control over space efforts. The Huntsville research center was in danger of becoming an idle and costly white elephant.

In assignment of mission, NASA is responsible for all space projects not tied to specific weapon system development. This includes the super-rocket boosters producing 1 million lb of thrust and over, smaller exotic boosters, scientific satellites, lunar probes and deep space probes.

Air Force controls all rocket booster development of a lesser size for use in weapon systems, is responsible for development of the Midas early-warning and Samos reconnaissance satellites. Lockheed is prime contractor on both.

The Navy is in charge of the Transit navigation satellite (John Hopkins' Applied Physics Lab is prime) and the Army on the Notus satellite-borne communications system (Philco, GE, Bendix Aviation, ITT and Radiation, Inc.).

U. S. Radio astronomers fear a squeeze in the negotiations on international radio frequencies now going on in Geneva. The astronomers held a meeting in Washington under the auspices of the National Academy of Science and then made their wishes known to government officials conducting the negotiations.

At present there are no frequencies set aside internationally solely for radio astronomy. Each radio astronomy installation has to scrounge around for whatever frequencies are vacant. But the scientists say their instruments are so sensitive they need channels that have no interference anywhere in the world. One difficulty international radio frequency negotiators face is that astronomers in different countries are not agreed on which frequencies they should have. They can use frequencies from 5 mc through television bands.



COMPLETE LINE + FAST SERVICE

= HIPERSIL CORES

Westinghouse stocks all types and sizes of Hipersil cores in three locations to serve you better

COMPLETE LINE includes the new EIA, RS-217 standard sizes.

- Type C: 12, 4, 2 and 1 mil sizes, in single- and 3-phase, from a fraction of an ounce to 300 pounds.
- Ring Cores: with new polyclad treatment—assure best magnetic performance of any Epoxy resin-coated core ready to receive windings.
- Special Cores: to any specification and shape requirement—rectangular, triangular and others.

FAST SERVICE is assured by complete stocks at Greenville, Pa.; Boston, Mass.; and Los Angeles, Calif.

Performance of Hipersil® cores in "iron-core" components is guaranteed to meet or exceed specifications.

For more facts, write for Price List 44-520 and Descriptive Bulletin 44-550 to Westinghouse Electric Corporation, P.O. Box 868, Pittsburgh 30, Pa. J-70920

YOU CAN BE SURE...IF IT'S

Westinghouse

WATCH WESTINGHOUSE LUCILLE BALL-DESI ARNAZ SHOWS*
CBS TV FRIDAYS

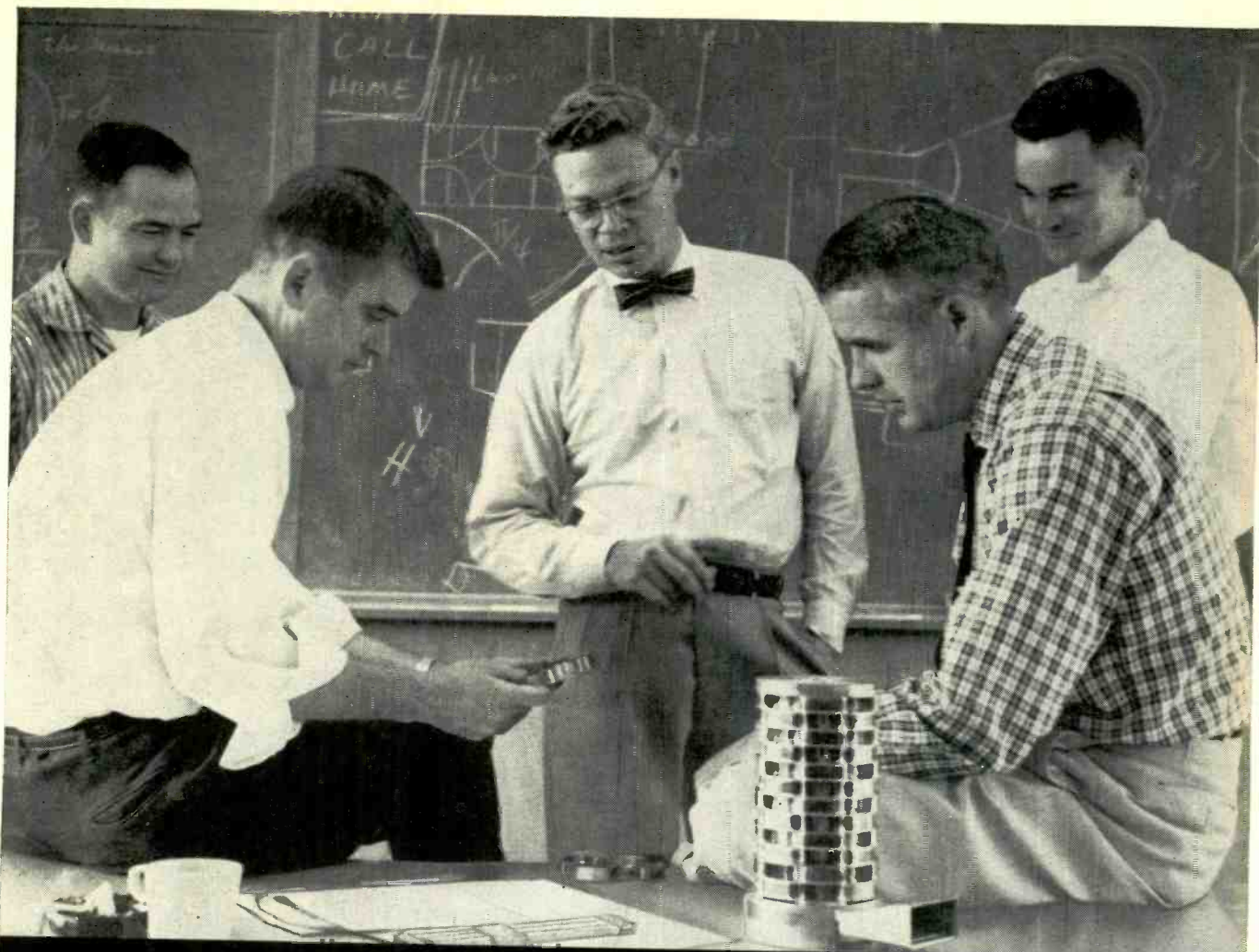

A few of Varian's large research team on wave tubes confer on new design features.

TOP TEAM IN WAVE TUBES

Varian has become the world's leader in the development and production of microwave tubes. With a greatly expanded wave tube team and larger manufacturing facilities, new tubes for advanced applications are being offered at an accelerated pace. From the small X-Band BWO's to the megawatt TWT, there is a Varian wave tube to meet your requirements.

Over 100 Varian Klystrons and Wave Tubes are pictured and described in our new catalog. Write for copy — address Tube Division.

VA-125A, B TWT	2.65 to 3.25 kMc 2 megawatt peak output
VA-161 BWO	8.2 to 12.4 kMc
VA-162 BWO	12.4 to 18.0 kMc
VA-128 TWT	2.6 to 3.2 kMc 10 kw peak output

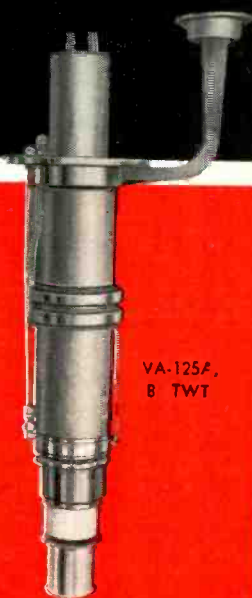

VA-125A,
B TWT



VARIAN associates
PALO ALTO 1, CALIFORNIA
Representatives throughout the world



VA-128 TWT



VA-161
VA-162
BWO's

KLYSTRONS, WAVE TUBES, GAS SWITCHING TUBES, MAGNETRONS, HIGH VACUUM EQUIPMENT, LINEAR ACCELERATORS, MICROWAVE SYSTEM COMPONENTS, NMR & EPR SPECTROMETERS, MAGNETS, MAGNETOMETERS, CALOS, POWER AMPLIFIERS, GRAPHIC RECORDERS, RESEARCH AND DEVELOPMENT SERVICES

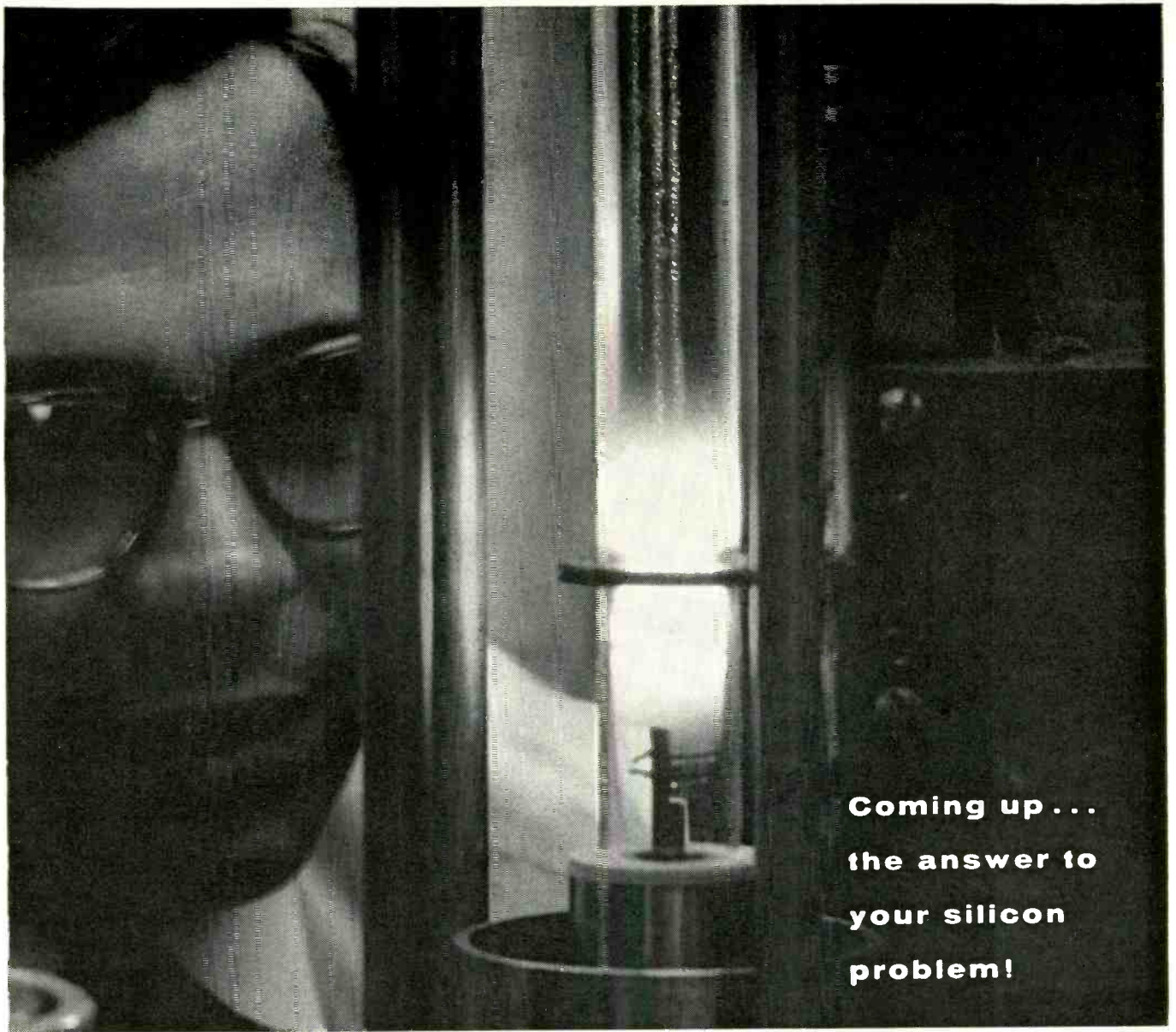

**Coming up . . .
the answer to
your silicon
problem!**

Du Pont . . . manufacturer of Hyperpure Silicon offers the services of technical specialists

When you specify Du Pont HYPERPURE Silicon, you get a product of highest dependability as well as expert technical assistance, when needed. Experienced Du Pont Technical Specialists will gladly discuss techniques of crystal growing and materials processing with you. What's more, you can take advantage of Du Pont's new \$3,000,000 Technical-Service Laboratory designed for researching customer problems.

Floating zone single crystals of Du Pont HYPERPURE Silicon are available in a wide range of resistivities. Du Pont HYPERPURE Silicon is also supplied in densified cut rods . . . and rods suitable for float zone refining. They're offered in several grades with care-

fully controlled purity levels.

Here's more news: Du Pont's new Brevard, N. C., plant has a capacity of 70,000 lbs. of HYPERPURE Silicon per year. That means you're assured of a prompt supply of high-purity silicon in the form you need. For more information, write Du Pont . . . pioneer producer of semiconductor-grade silicon.



Free booklet is available upon request. It describes the manufacture, properties and uses of HYPERPURE Silicon. E. I. du Pont de Nemours & Co. (Inc.), Pigments Dept., Silicon Development Group, Wilmington 98, Delaware.

HYPERPURE SILICON



BETTER THINGS FOR BETTER LIVING
. . . THROUGH CHEMISTRY



MICRO SWITCH Precision Switches

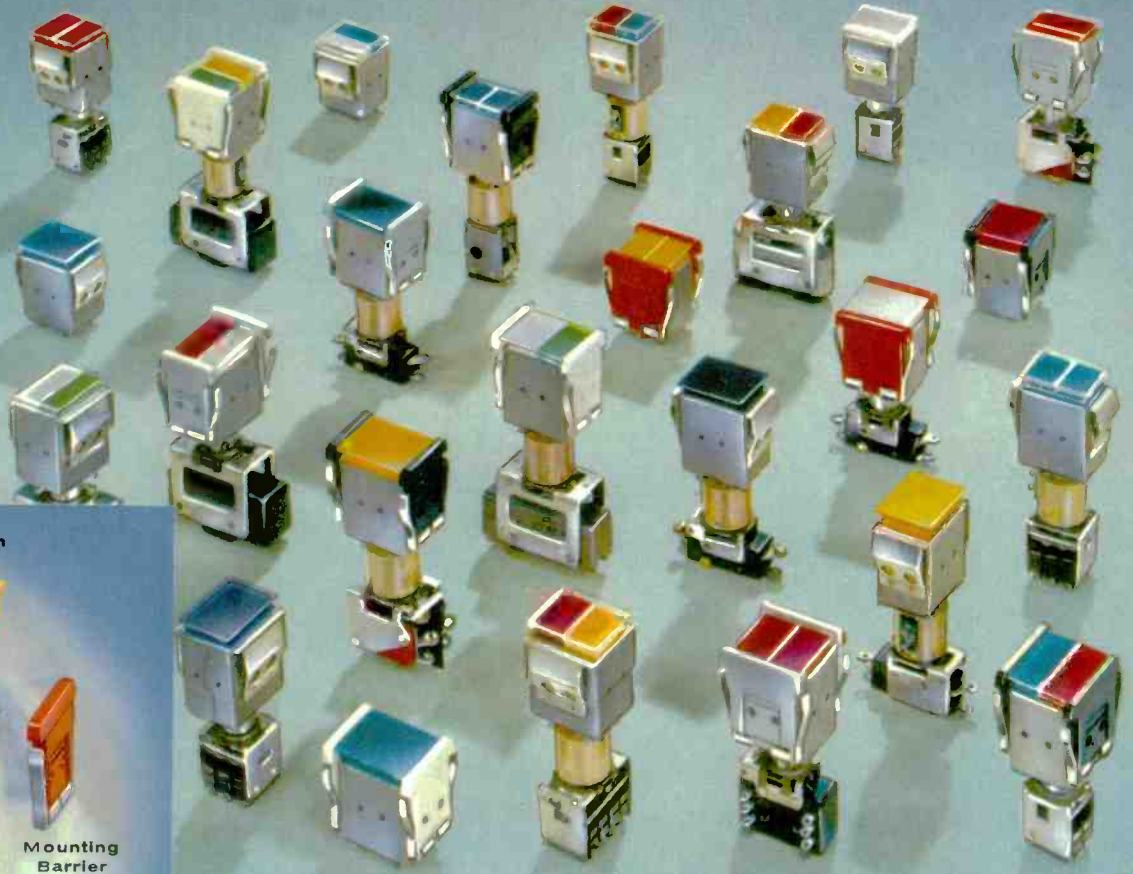

Display Screen

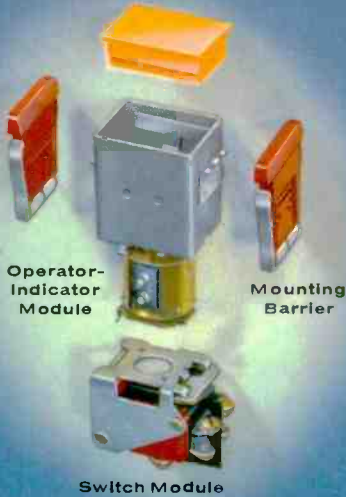

Modular concept allows wide choice of combinations. Parts snap together and into panels without tools.

Just 25 of the hundreds of switch and indicator combinations

Build your own lighted pushbutton switches and indicators with Series 2 modules

No tools are needed to put together Series 2 modular assemblies that provide a choice of hundreds of different control and display functions.

From our Catalog 67, you select modules from 48 different operator-indicator units, 12 indicators, 18 switch units, 16 mounting barriers differing in size and color, 40 color display screens, and 4 filters.

Up to 4 lamps in each Series 2 indicator module provide improved signal reliability, and choice of transmitted or projected signal color.

Catalog 67 describes Series 2 devices and switching units in detail . . . contains helpful information and application data for human factors engineers and for electrical engineers. Catalog 67 and application assistance are available on request from the MICRO SWITCH branch office near you. Or write for your copy.

MICRO SWITCH . . . FREEPORT, ILLINOIS
A division of Honeywell

In Canada: Honeywell Controls Limited, Toronto 17, Ontario

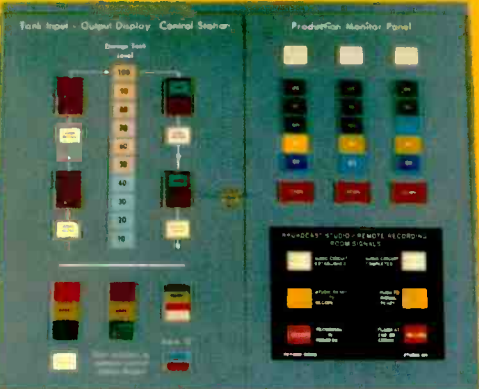

Four Series 2 mounting types permit mounting singly or in columns or rows, provide panel design freedom.



Honeywell

MICRO SWITCH Precision Switches



Pushbutton switches with built-in "One-Shot" circuit generate one square pulse per operation

These MICRO SWITCH snap-action pushbutton assemblies incorporate a special circuit which produces a single square wave pulse, regardless of the speed of operation.

Advantages are: pulse widths from 0.1 to 10.0 microseconds • output voltages up to 180 volts • can drive loads as low as 5 ohms • no constant power drain • produce positive or negative pulse, as required • potted circuit for physical and environmental protection • operate at temperatures from -65° to +185° F.

By providing a pre-engineered, compact package, "One-Shot" switches help speed up equipment design by eliminating the need for time-consuming custom circuit development to accomplish a shaped wave output. Typical output curves are illustrated below:

Three of the many available "One-Shot" switch assemblies



The "One-Shot" switch can be supplied as an integral unit with any MICRO SWITCH pushbutton device. Applications include computer and radar consoles, keyboards, electronic test equipment, checking ring counters, setting and resetting flip-flops, and reflected pulse systems. Ask for data sheet 150.

Engineering assistance on switch application is available from the MICRO SWITCH branch office near you. Consult the Yellow Pages.

MICRO SWITCH . . . FREEPORT, ILLINOIS
A division of Honeywell
In Canada: Honeywell Controls Limited, Toronto 17, Ontario



Honeywell

MICRO SWITCH Precision Switches

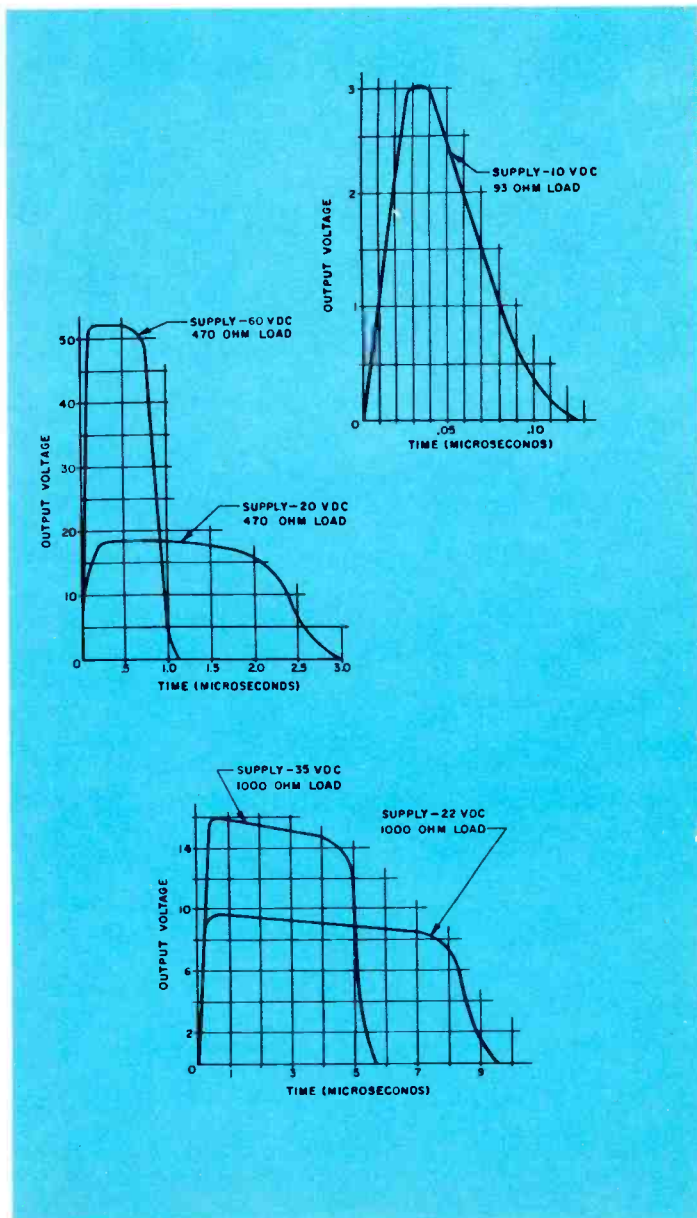

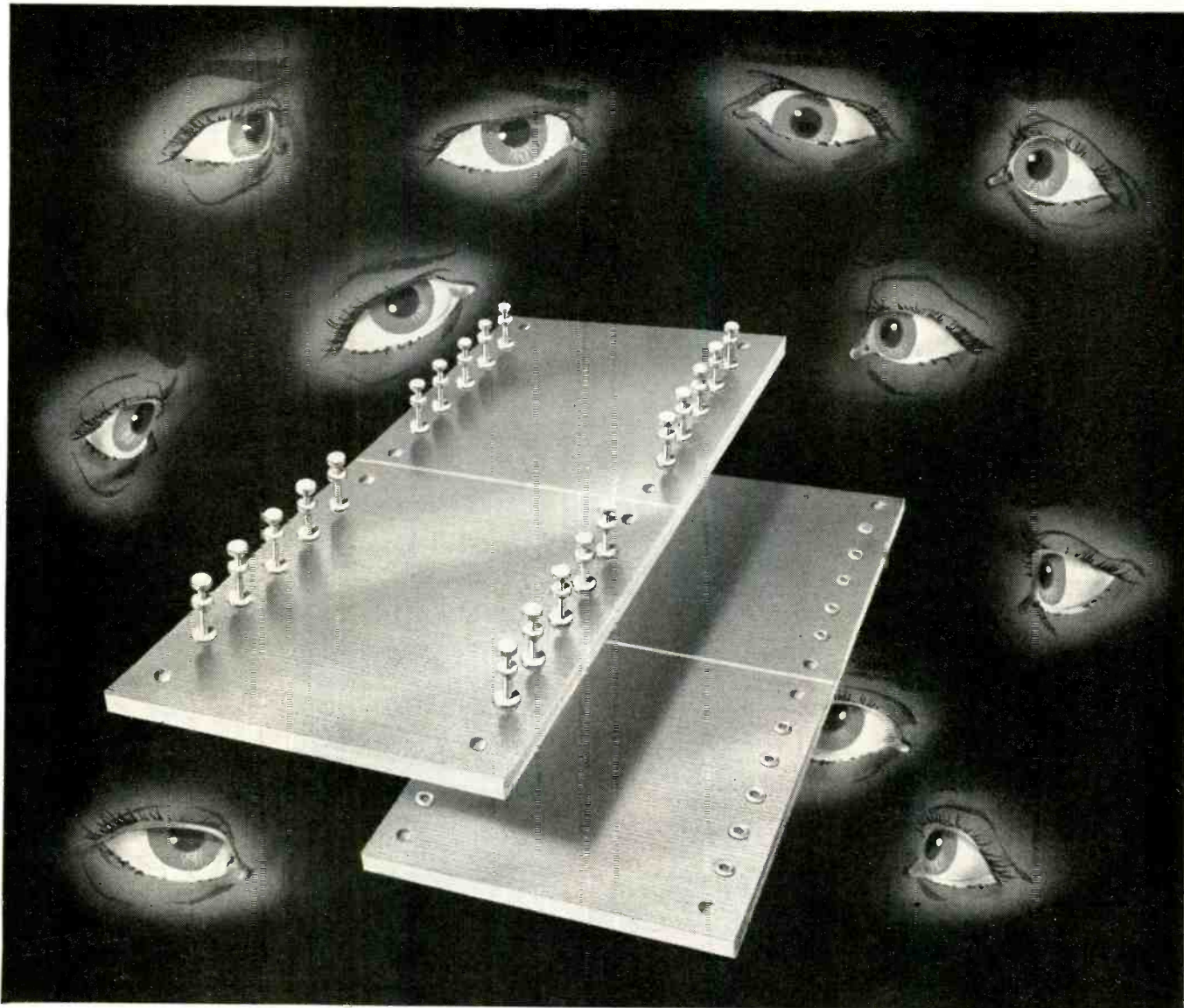

CAMBION terminal boards are available in standard all-set, miniature all-set, standard ceramic and custom-made types. Materials include paper, cloth, nylon or glass laminates, bonded with phenolic, epoxy, melamine or silicone resins. Boards are moisture-proofed and fungus-proofed. Standard or special components are assembled as required.

Our "private eyes" protect you from delinquents

You won't find a single weak spot in any CAMBION® terminal board. We've already made sure there are no cracks in board or terminals; no strain, chips or sunbursts; no insecurely mounted terminals. In fact, such defects are the rarest discoveries, even in our own thorough inspections. That's because the stock used in CAMBION boards is certified top grade . . . CAMBION tooling is specially engineered to prevent product damage . . . and CAMBION workmanship is true craftsmanship.

Quality control like this is standard in every step of CAMBION production — in any quantity. That's why you can count on the complete CAMBION line — terminal boards, solder terminals, insulated terminals, coils, coil forms, capacitors, swagers, hardware — for the trouble-free performance you expect and need. And every CAMBION component is *guaranteed*.

Available locally through authorized CAMBION distributors. Or write to Cambridge Thermionic Corporation, 437 Concord Avenue, Cambridge 38, Massachusetts. On the West Coast: E. V. Roberts and Associates, Inc., 5068 West Washington Blvd., Los Angeles, California. In Canada: Cambridge Thermionic of Canada, Limited, Montreal, P. Q.

CAMBION solder terminals are made of silver plated brass, coated with water displacquer. There are 65 different types available in bulk in unlimited quantity or in individual packages of 100. Mounting information and CAMBION tools required are listed on the package.



CAMBRIDGE THERMIONIC CORPORATION
CAMBION®

The guaranteed electronic components



AUTOMOBILES
RADIO'S TELEVISIONS
HERE

TAPE RECORDERS

COMPUTERS

JUKE BOXES

VENDING MACHINES

X-RAY MACHINES

BUSINESS MACHINES

MOTORS

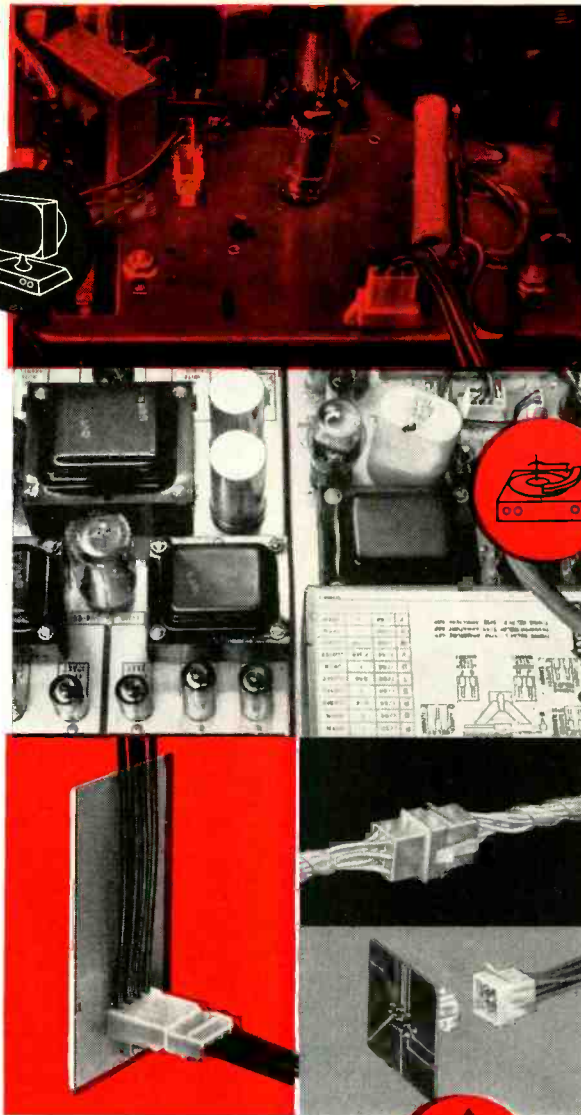

AIR CONDITIONERS

TRAFFIC APPLIANCES

ELECTRIC REFRIGERATORS

THERE

HI-FI EQUIPMENT

PHONOGRAPHS

ELECTRIC WASHERS

ELECTRIC RANGES

ELECTRIC DRYERS

EVERYWHERE

You won't have to look far to find an AMP-lok Multiple Circuit Connector. AMP-lok connectors have been used for the most diverse applications . . . for disconnecting multiple leads on—television deflection yokes, phonograph turn tables, electric ranges, washer and dryer control panels, and automotive instrument panels.

There are good reasons for the growing use of AMP-lok: It is available in 3, 4, 6, 9, or 12 circuit combinations. Attachment and assembly speeds run to thousands per hour. Uniform, reliable electrical characteristics are assured through AMP's compression crimp method. Automated techniques reduce total installed cost.

Versatility, reliability, economy and outstanding assembly speed—these factors explain why millions of AMP-lok connectors are being used everywhere. If you aren't using them for your circuit requirements, send today for more information.

AMP INCORPORATED

GENERAL OFFICES: HARRISBURG, PENNSYLVANIA

AMP products and engineering assistance are available through subsidiary companies in: Australia • Canada • England • France • Holland • Japan

Nine Stocks Set Sales Pace

	SHARES (in 100's)	HIGH	LOW	CLOSE (Oct. 2)	PER- FORMANCE
Sperry Rand	12,432	27 1/2	21 7/8	22 1/8	- 5 3/8
Avco Manufacturing	11,740	15 7/8	11 1/2	12 3/8	- 3 1/2
Int'l Tel & Tel	10,052	40 3/4	30 1/8	33 1/2	- 7 1/4
General Tel & Elec	9,476	79	69	69 1/2	- 9 1/2
Raytheon	7,634	57 7/8	43 1/2	45	- 12 7/8
General Electric	7,515	84 3/4	74	79 1/8	- 5 5/8
Radio Corp of Amer	7,132	70 3/8	54 3/4	57	- 13 3/8
General Dynamics	6,787	56 3/8	44	45 7/8	- 10 1/2
Universal Control	6,429	20 1/8	15 3/4	16 3/8	- 3 3/4

THIS TABLE shows the nine electronics stocks which have consistently been among the 25 most actively traded electronics stocks for the period of July 6 to Oct. 2 this year.

The performance column reflects the market easing which occurred during the period and shows that the two most actively traded, as well as the one least actively traded of the nine securities, maintained the smallest range during the period indicated. These figures were compiled for ELECTRONICS by the statistical research department of Ira Haupt & Co., New York investment bankers.

• **Telechrome Manufacturing Corp.**, Amityville, L. I., reports acquisition of 50 percent of the stock of **Hammarlund Manufacturing Corp.**, New York, by purchase of stock. Purchase of the remaining 50 percent, now held within the Hammarlund family, is being negotiated. Based on current operations, acquisition of complete control of Hammarlund would boost Telechrome sales volume to approximately \$5 million, a rise of about 300 percent. Telechrome manufactures monochrome and color tv broadcast equipment, tv test gear and telemetering devices. Hammarlund produces high-quality radio receivers and control equipment, and has 25,000 sq ft of plant facilities in Mars Hill, N. C., as well as a New York installation of 18,000 sq ft. During the past year, Telechrome has also acquired **Encapsor Products** and a substantial interest in **Universal Transistor**.

• **Eitel-McCullough**, San Carlos,

Calif., power tube manufacturer, is awaiting approval from Securities and Exchange Commission on its filing for registration of \$5 million of convertible subordinated debentures due Nov. 1, 1974. The bond issue will be offered for sale by an underwriting group headed by Schwabacher & Co. Proceeds from the sale will be used to retire current bank borrowings and to aid in financing expansion.

25 MOST ACTIVE STOCKS

WEEK ENDING OCTOBER 23

	SHARES (IN 100'S)	HIGH	LOW	CLOSE
Lear	2,322	19 3/8	15 1/2	19 3/8
Varian Assoc	1,586	42	34	40 3/8
Int'l Tel & Tel	1,059	38 5/8	36 5/8	38
Ampex	777	98 7/8	89	98 7/8
Sperry-Rand	707	22 3/8	21 1/8	21 1/8
Raytheon	687	51 3/4	48 5/8	50 1/2
Avco	661	13 3/4	13	13 3/8
Texas Inst	547	163	146 3/4	160 3/4
Gen. Elec	543	78 7/8	75 3/4	78
Gen Tel & Tel	487	72 3/8	70 5/8	71 3/4
Univ Control	406	18 1/2	17 1/4	17 3/8
Gen Dynamics	395	46 1/2	41 7/8	45 1/2
Elec & Mus Ind	378	8 1/8	7 7/8	8
Siegler Corp	374	32 1/8	28 5/8	30 7/8
Burroughs	366	30 3/8	28 3/4	29 1/4
RCA	365	61 3/8	59	59 3/4
Philco Corp	354	26 7/8	25 1/4	25 7/8
Westinghouse	348	96 1/2	93	95 1/2
Cons Elec'dynmcs	333	39 7/8	35 1/8	39 3/4
Amer Bosch Arma	320	28 1/2	27	28 3/8
Beckman Inst	294	60 5/8	55 1/2	60 1/2
DuMont	293	8 3/4	7 7/8	8 3/4
Reeves Sndcrft	282	8	7 3/8	7 5/8
Gen Inst Corp	281	27 3/8	25 3/8	26 5/8
Litton Ind	230	126 3/8	117	125 3/8

The above figures represent sales of electronics stocks on the New York and American Stock Exchanges. Listings are prepared exclusively for ELECTRONICS by Ira Haupt & Co., investment bankers.

NEW PUBLIC ISSUES

	No. of Shares	Issue Price
Audio Dynamics	200,000	1 1/2
BM Harrison Elecsncs	133,000	3
Electronics Devel	115,459	1
Electrosonic Labs	100,000	3
Gertsch Products	107,143	0
Mid-Eastern Elecsncs	60,000	2 1/2
Hycon Mfg	126,316	2 3/8
Met'plyn Telecmctns	99,933	3
Nat'l Stnd Elecsncs	300,000	1
Radio Frequency Co	100,000	3
Raub Elecsncs Resch	100,000	8 1/2
Wellinton Electronic	240,000	6

*to be announced

a new concept...

ELECTRONICS CAPITAL CORPORATION

A \$16,500,000 institution devoted to the management and capital needs of the electronics industry. Electronics Capital Corporation is the first and largest Small Business Investment Company specifically licensed to provide long-term capital for the growth and expansion of electronics companies throughout the United States.

OFFICERS AND DIRECTORS

Charles E. Salik, *President*
President, Electronics Investment Corporation

Richard T. Silberman, *Executive Vice President*

Dr. Neil H. Jacoby
Dean of the Graduate School of Business Administration
University of California, Los Angeles

Dr. Joseph M. Pettit
Dean of the School of Engineering,
Stanford University

Louis J. Rice, Jr.
Vice President, Director, First National Bank
San Diego

Donald C. Duncan
Director, Contract Sales
Beckman Instruments

Alfred J. Coyle
Partner, Hayden, Stone & Co

David Salik
Industrialist

Bernard Koteen, *Secretary*
Partner, Koteen & Burt

Send for informative brochure
"Long-Term Capital for
the Electronics Industry"
ELECTRONICS CAPITAL
CORPORATION,
1400 Fifth Ave., San Diego, Calif

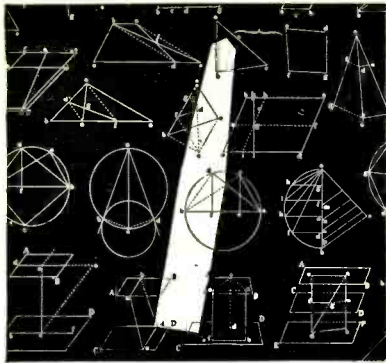

If *you* are or would like to become a space veteran...

DOUGLAS AIRCRAFT COMPANY MISSILES AND SPACE SYSTEMS

has immediate openings in the following fields—

Electrical and Electronics:

- Control System Analysis & Design
- Antenna & Radome Design
- Radar System Analysis and Design
- Instrumentation
- Equipment Installation
- Test Procedures
- Logic Design
- Power System Design

Mechanical Engineering —

Analysis and Design of the following:

- Servo Units
- Hydraulic Power Systems
- Air Conditioning Systems
- Missile Launcher Systems
- Propulsion Units and Systems
- Auxiliary Power Supplies

Aeronautical Engineering:

- Aerodynamic Design
- Advanced Aerodynamic Study
- Aerodynamic Heating
- Structural Analysis
- Strength Testing
- Dynamic Analysis of Flutter and Vibration
- Aeroelasticity
- Design of Complex Structure
- Trajectory Analysis
- Space Mechanics
- Welding
- Metallurgy

Physics and Mathematics:

- Experimental Thermodynamics
- General Advanced Analysis in all fields
- Computer Application Analysis
- Computer Programming and Analysis
- Mathematical Analysis

For full information write to:

Mr. C. C. LaVene
Box F-620
Douglas Aircraft Company, Inc.
Santa Monica, Calif.

MARKET RESEARCH



RCA's Wendell R. Smith predicts . . .

'Industrial Electronics to Spurt'

OVER THE NEXT five years industrial electronics will grow faster than any other segment of the electronics industry, predicts Wendell R. Smith, RCA's new director of marketing research and development.

Rapidly rising research and development expenditures, need of America to modernize its industrial plants, plus the necessity of meeting foreign competition by lowering production costs, all point to more automation and more use of electronics by industry, Smith says.

Smith was appointed to his new position earlier this year. He is responsible for developing corporate marketing research policies and programs and for the market research programs in approximately 15 units in the RCA organization.

More than a facts and figures man, he is also responsible for developing new market research methods and works closely with the firm's new product development program. Reporting directly to Fred M. Farwell, new staff vice-president of marketing, Smith has a close relationship to RCA top management, reflecting the growing importance electronics firms pay to the marketing research job.

Previous to joining RCA, Smith

was vice president of Alderson Associates, Inc., management consultants. A former professor, he holds a Ph.D from the U. of Iowa.

• **Figures of the Week**, beginning with this issue, come to you in chart rather than tabular form

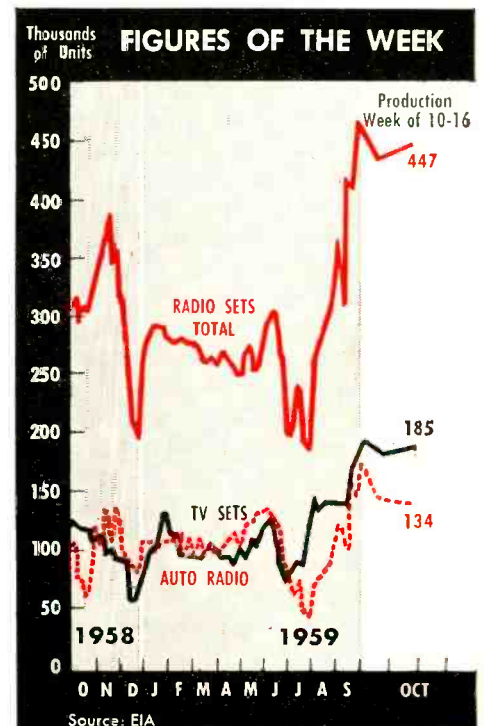

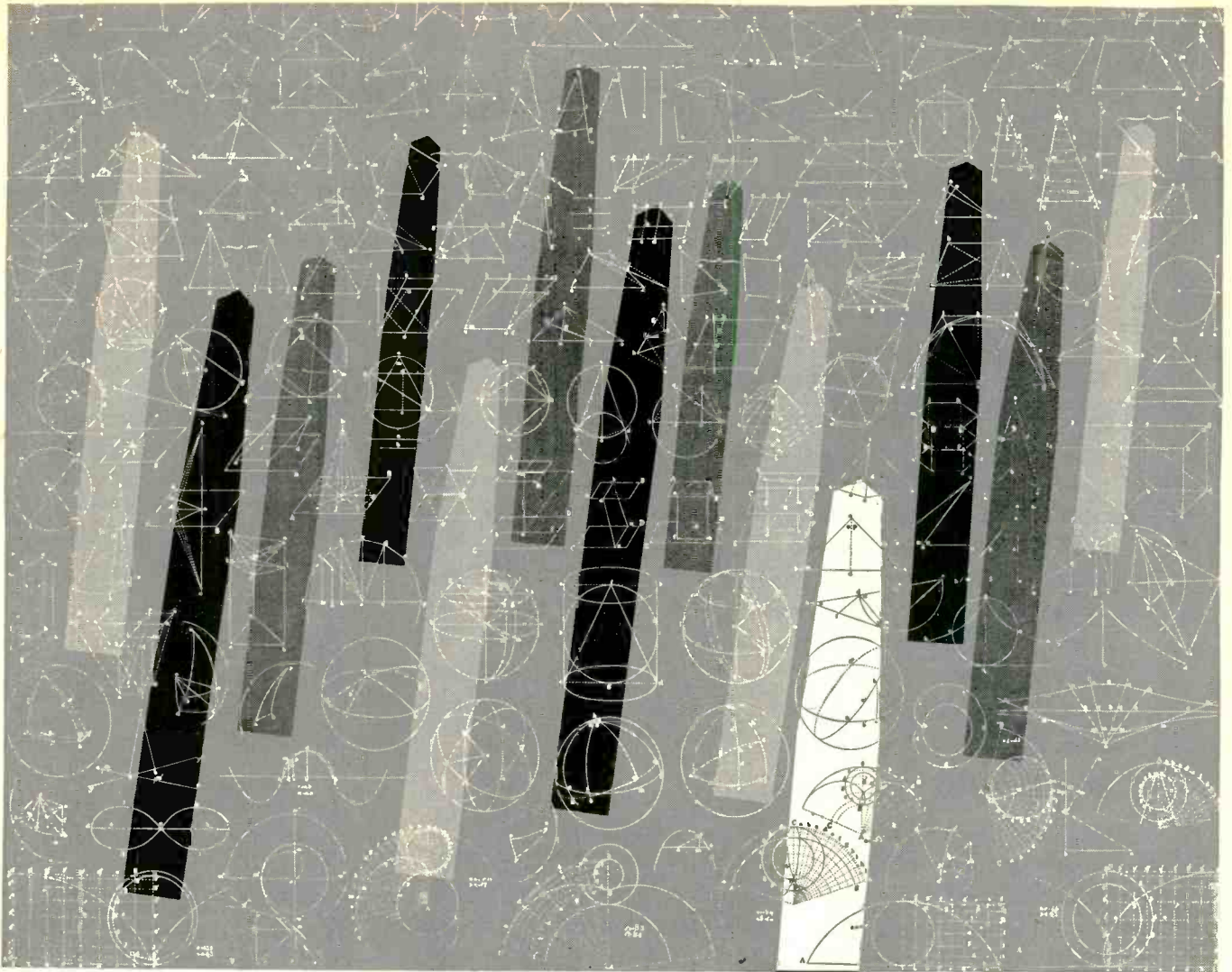

Space veteran at the age of two



The Air Force THOR, built by Douglas and three associate prime contractors, shows how well a down-to-earth approach to outer space can work. Since its first shoot early in 1957, it has had more than *forty* successful launchings...at a variety of jobs from re-entry vehicle testing at ICBM ranges to placing satellites in orbit. Initial planning for THOR included volume production tooling, ground handling equipment and operational systems. This typical Douglas approach made the giant IRBM available in quantity in record time, and THOR has performed with such reliability that it has truly become the workhorse of the space age. Douglas is now seeking qualified engineers and scientists for new projects with even more exciting prospects. Some immediate openings are described on the facing page.

Robert Johnson, Missile and Space Systems Chief Engineer, reviews results of a THOR-boosted 5000 mile flight with **DOUGLAS**
Donald W. Douglas, Jr., president of

MISSILE AND SPACE SYSTEMS ■ MILITARY AIRCRAFT ■ DC-8 JETLINERS ■ CARGO TRANSPORTS ■ AIRCOMB ■ GROUND SUPPORT EQUIPMENT

3 good ways to make dc measurements

KEITHLEY ELECTROMETERS have up to 64 voltage, resistance and current ranges

1 Model 610A, 64 ranges

The line-operated 610A is a refinement of the popular 610, covering virtually every dc laboratory test. It measures nine voltage ranges from 0.01 to 100 volts full scale with 2% accuracy, current from three amperes to 1×10^{-13} ampere full scale, and resistance from 10 ohms to 10^{14} ohms full scale. The 610A also serves as a useful dc pre-amplifier with precise gains to 1000 and outputs for driving scopes and recorders. Input resistance is variable from one ohm to over 10^{14} ohms. The instrument checks its own resistance standards. Zero drift is within two millivolts per hour.

\$480.00

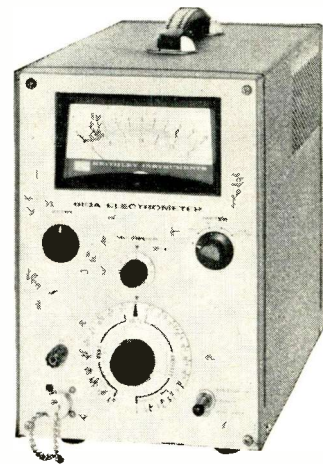

2 Model 600A, 54 ranges

This portable instrument is a battery-operated counterpart of the 610A. Its ranges cover 10 mv to 10 volts, 3 amperes to 10^{-13} ampere, and 10^4 to 10^{13} ohms full scale. Like the 610A, it has selectable input resistance, a dc to 100 cps bandwidth, and output sufficient to drive recorders directly. Battery life is 500 hours; condition may be checked on the panel meter.

\$380.00

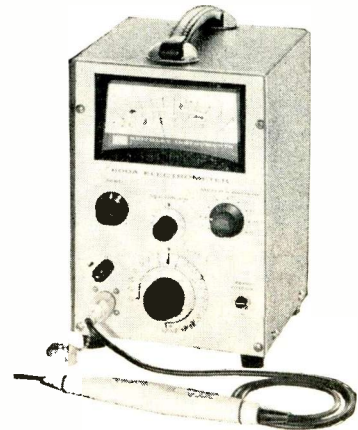

Three accessory probes and test shield are available to facilitate measurements and extend voltage ranges to 30 kv (Model 610A) or 10 kv (Model 600A).

3 Model 603, differential input

This instrument is a wide-band dc amplifier, with an extremely high input impedance, high voltage and current sensitivity, and a remote differential input. Its separate input head permits measurements up to 24 feet from the amplifier. The 603 has nine ranges from 2.5 to 1000 mv, with precise gains up to 4000, and a 10-volt output at 10 ma. Bandwidth is dc to 10 kc on the 2.5 mv range, rising to 30 kc on the 1000 mv range.

\$650.00

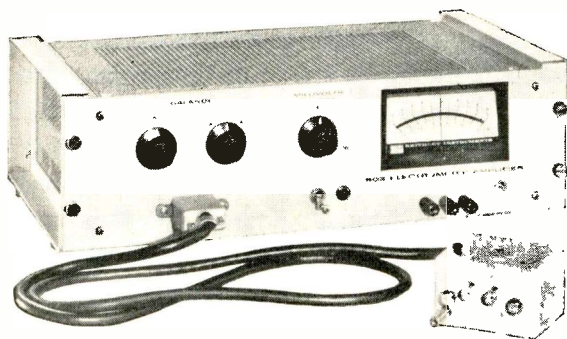

KEITHLEY INSTRUMENTS, INC.
12415 EUCLID AVENUE • CLEVELAND 6, OHIO

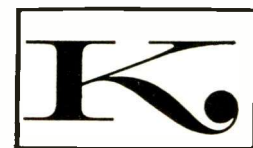

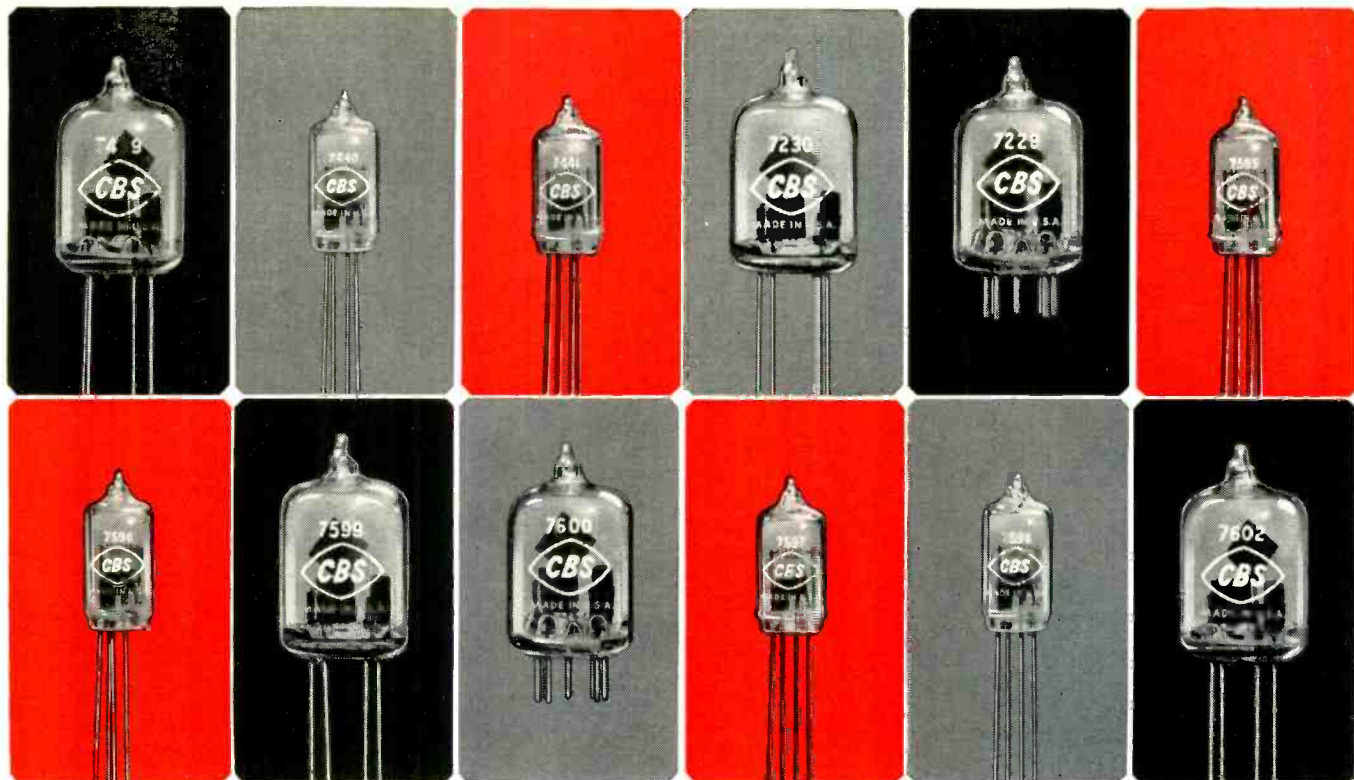

MORE NEW KRYTRONS

Advanced Electronic Devices for Triggers • Timers • Regulators • Pulsers • Etc.

This original, advanced and still growing family of CBS cold-cathode triggering, timing, regulating and pulsing devices now includes six subminiature and six miniature types. Designers are discovering virtually unlimited applications for these Krytrons. Efficient, accurate and dependable, they offer particular advantages in military and industrial equipment.

CBS Krytrons are as reliable and rugged as the most stable circuit elements. They provide conservative safety margins for extreme conditions of heat (+85°C), cold (-55°C), shock (2000-2800G), and vibration (10G at 0-5000 cycles). Their compact modern design fits neatly into potted and printed-circuit packages.

Check the features . . . the wide ranges of the major characteristics. Write for complete Technical Bulletin E-337A. Order from your local Manufacturers Warehousing Distributor, or from any CBS Electronics sales office.

FEATURES

- Very high hold-off voltages
- Low grid driving current
- Very high instantaneous pulse current
- Short anode delay time
- Negligible jitter
- Wide ambient temperature range
- Very rugged and reliable
- Compact and light
- Silent and cool
- Stable inert gas fill
- Instant-firing keep-alive
- Sure dark/cold starts

MAJOR CHARACTERISTICS

SUBMINIATURE

Type	Hold-off Voltage (V)	Grid Firing Current (μamps)	Anode Delay (μsecs)	Anode Delay Variation (μsec)	Peak Anode Current (amps)	Test Specification
7440	1500	20	4.0	0.4	100	Commercial
7441	1500	20	1.6	0.4	100	Reliable
7595	3000	8	1.0	0.15	400	Reliable
7596	5000	15	—	—	100	Commercial
7597	5000	15	1.0	0.15	100	Reliable
7598	4000	15	1.0	0.15	500	Commercial

MINIATURE

7439	2000	40	4.0	0.4	500	Com., flying leads
7229	2000	40	4.0	0.4	500	Com., base pins
7230	3000	10	2.0	0.2	500	Rel., flying leads
7599	6000	7	1.5	0.2	500	Com., flying leads
7600	6000	7	1.5	0.2	500	Com., base pins
7602	6000	7	1.5	0.2	500	Rel., flying leads

Repetition rate is determined by allowable dissipation and by constants of gas fill.



*Reliable products
through Advanced
Engineering*

CBS ELECTRONICS, DANVERS, MASSACHUSETTS

A Division of Columbia Broadcasting System, Inc.

The new concept of electronic equipment manufacture ●

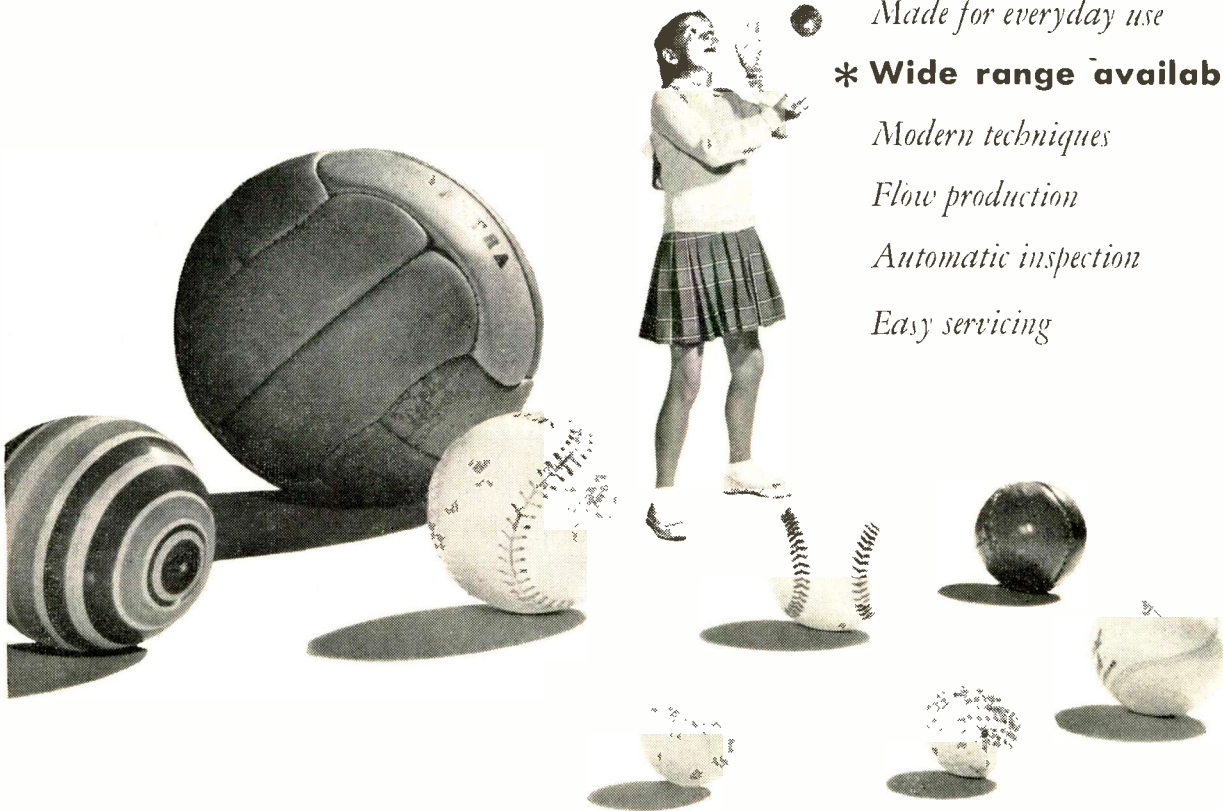

A new philosophy:

Made for everyday use

*** Wide range available**

Modern techniques

Flow production

Automatic inspection

Easy servicing

***Not too big; not too little: just right for the job.**

Yet another of the advantages of the flow-produced Philips tools for the electronic industry is that, within the wide range available, there is the electronic tool possessing exactly the right characteristics for each job which has to be done.

And why the word tool? Because these instruments are in fact tools hardy and reliable in daily use, simple to operate, with service facilities available all over the world.

Dependable **PHILIPS** tools 
for the electronic industry

Sold and serviced by Philips Organizations all over the world

Further information will gladly be supplied by:

N.V. Philips' Gloeilampenfabrieken, Eindhoven, the Netherlands

26 CIRCLE 26 ON READER SERVICE CARD

GM 6014

Broadband HF-Millivoltmeter

Measuring range: in 10 steps from 1 mV up to 30 V full scale deflection, dB scale from -80 dB . . . +32 dB (0 dB = 1 mW into 600Ω)

Frequency range: 1 kc/s . . . 30 Mc/s

Input impedance:

400 kΩ . . . 50 MΩ // 7pF . . . 2 pF

Overall accuracy: 3% with no respect to variations in the frequency response curve, which variations are limited within 5% of the gain at the calibration frequency.

Mains supply: 110 . . . 245 V; 40 . . . 100 c/s

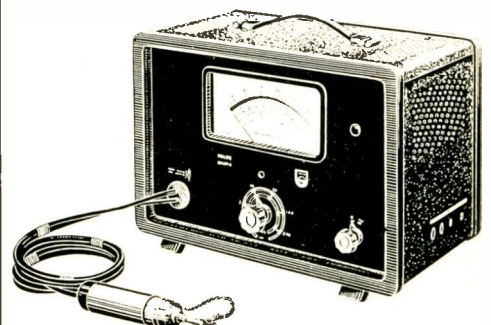

The price - a pleasant surprise

NOVEMBER 6, 1959 • ELECTRONICS

Important news for owners of CEC's 5-114 recording oscillograph

NEW RAPID-ACCESS DATARITE MAGAZINE

*provides developed, dried, fully visible
records almost instantly*

Here is the DATARITE Magazine many of you owners of CEC's 5-114 Recording Oscillograph have been waiting for: The new 5-047. This DATARITE Magazine attaches directly to your 5-114. The result is a data-processing tool with all the capabilities needed for modern dynamic tests—especially attractive for low-budget programs.

RAPID-ACCESS . . . THE 5-047 DATARITE Magazine provides the shortest access time of any known process, and yields records of high trace contrast and permanency. The Magazine automatically develops and dries oscillograms as quickly as data are recorded. Ready-to-read test results are available almost simultaneously with the occurrence of events under study.

The 5-047 recording speeds are variable from .45 to 28.8 ips. Fully developed and visible record is available in 0.7 second at 28.8 ips record speed. There is a generous capacity of 400 feet of conventional thin-base recording paper, combined with writing speeds up to 20,000 ips. Power requirement is 115 v, 60 cps, 1500 watts for the combination of the 5-047 and the 5-114.

For complete details call your nearest CEC sales and service office, or write for Bulletin CEC 1500-X26.

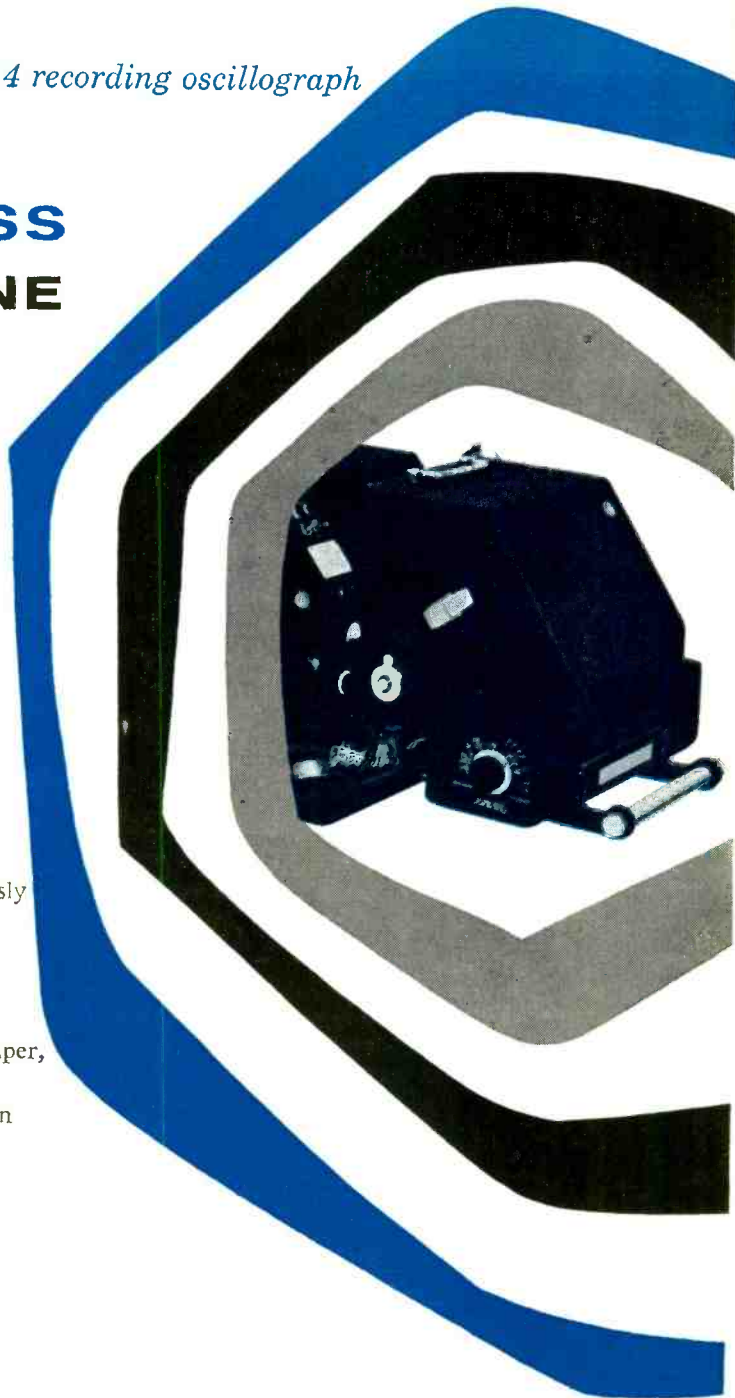
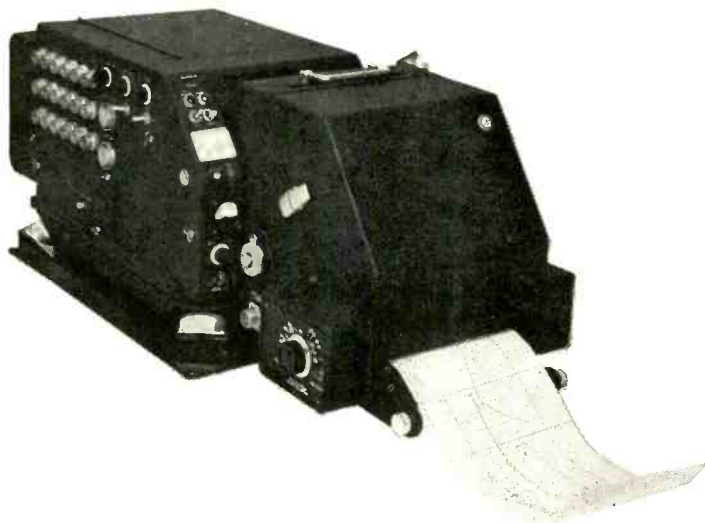

Electro Mechanical Instrument Division

CEC

CONSOLIDATED ELECTRODYNAMICS 360 Sierra Madre Villa, Pasadena, California

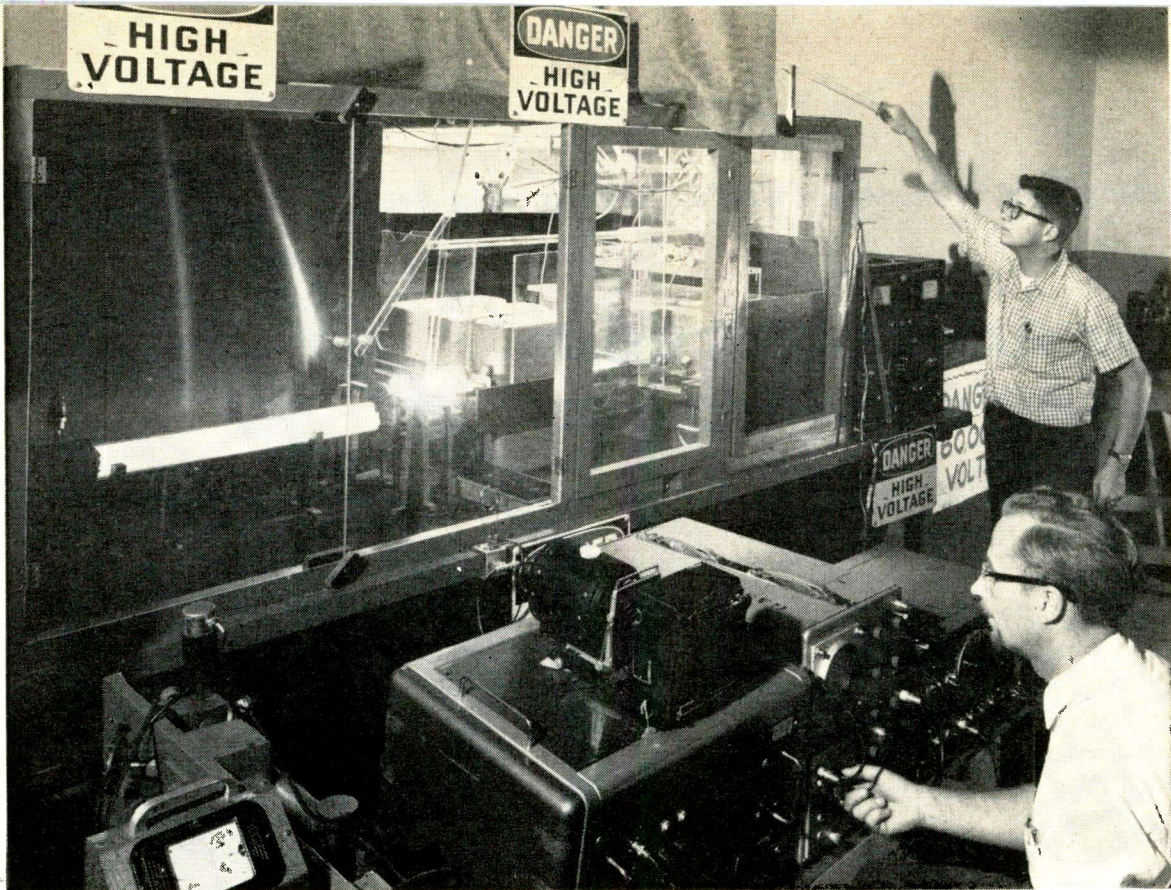

At Langley Research Center, instruments and sequence camera record experiment in MPD (magnetoplasmadynamics) labs

Space Agency Expanding

NASA takeover of Redstone missile group reflects top support being given to civilian space agency. Here's an on-the-spot progress report

TRANSFER of control over functions of Army Ballistic Missile Agency at Huntsville, Ala., to National Aeronautics & Space Administration highlights the support the federal government is giving NASA's long- and short-range plans. The transfer also indicates the progress made thus far by NASA, now only a little more than a year old.

ABMA, whose 2,300 scientists and technicians are headed by rocketeer Wernher von Braun, is working on the 1.5-million-pound-thrust Saturn rocket engine. The huge engine will be capable of throwing a 15-ton payload into orbit 300 miles overhead; since this is bigger than anything Army needs for missile work, the Pentagon had cut down funds for it. NASA control will allow the Redstone group to keep working at such long-range projects.

Meanwhile, at NASA's Langley

Research Center, ELECTRONICS joined international aeronautical experts in looking over the space agency's plans and progress.

Progress

During its first year, NASA fired three probes into deep space and sent three earth satellites aloft. These instrumented payloads sent back valuable data on meteorology, cosmic rays, earth magnetism, solar energy and the space environment.

Additional satellites and space probes now planned will gather information on micrometeorites, electromagnetic radiation, high-energy particles in space and planetary environments.

Launch vehicles such as Scout, Delta, Vega and Centaur make up NASA's biggest effort. Until they arrive, U. S. programs must rely on existing missiles as launchers; Mercury, for example, will be

launched on a modified Atlas. Scout will be flight-tested next month at Wallops Island, Va., and Delta will also get its first trials before year-end. Vega and Centaur are scheduled for test firings within two years. Saturn is still further off, and the Nova, with a cluster of Saturn-type engines developing 6 million pounds of thrust, will follow, to become the first U. S. vehicle capable of carrying men to the moon and back.

Magnetoplasmadynamics

Big research effort for NASA is in the area of plasma physics, especially the behavior of plasmas in electromagnetic fields. Magnetoplasmadynamics—MPD—interacts with research aimed at finding out how to communicate through the plasma sheath that forms on the bow end of a vehicle reentering atmosphere at hypersonic speeds. The

electrically conductive plasma sheath increases the apparent size of the vehicle to radar detection (thereby aiding the radar); but it also blacks out the vehicle for communications purposes.

One hot project at Langley arises from the theory that plasma collisions in outer space, and interactions between plasmas and planetary or stellar magnetic fields, generate radio waves. Following this idea, Langley researchers are experimenting with colliding plasma streams as a possible means of generating superhigh-powered radio signals for advanced space communications.

Control systems for plasma streams and thermonuclear fusion reactions rely entirely on electronics. A magnetic shock tube speeds up plasma bursts in a microsecond to tens of thousands of miles per hour. Microwave techniques are also used; radiation pressure pushes the plasma down a fiat-plate waveguide at speeds near the group velocity. Speed attained is a function of the guide length: researchers have achieved plasma velocities of 25×10^6 mph using a guide 40λ long.

Both magnetic and microwave accelerators can speed up only small plasma masses for very brief periods. A steady plasma accelerator requires a technique for introducing plasma into a steady repellent field, or ionizing gases emitted by a source which also produces a continuous repellent field.

Plasma experiments involving radio transmission at Langley introduced seeded potassium vapor at 1,800 F into an oxygen-cyanogen flame. The 8,200-F flame ionizes the vapor to produce a sheath, into which a transmitting antenna is placed. These experiments have confirmed the steady exponential drop in absorptivity as higher frequencies are used, permit prediction of radiated power loss through plasmas of varying density, temperature and depth.

Other Research Centers

Goddard Space Flight Center in Greenbelt, Md., is investigating basic space science, specifically in rocket astronomy, ionospheric physics and tracking and data systems.

Mercury satellite and Delta booster are also Goddard's concern.

Emphasis in rocket astronomy is aimed at mapping stellar ultraviolet by sounding rockets. Ultraviolet emission patterns have upset a couple of theories on the source of u-v; the hottest parts of the sky are not necessarily the ones with the hottest stars.

Goddard is also probing earth's ionosphere, trying to pin down its distribution in space, variations with time, currents, and magnetic interactions with radiation particles and the Van Allen belts.

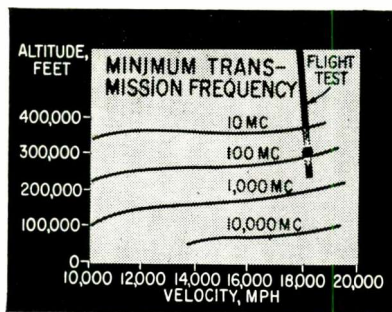

Special NASA vehicle fired three-stage rocket directly at earth from 100 mi over Wallops Island, Va., in plasma sheath study. Rocket radio on 109 mc cut off at about 300,000 ft, agreeing with theoretically derived data

The center will be prime NASA authority on vehicle instrumentation, telemetry, tracking systems and the reduction of data. Its Greenbelt headquarters are not yet finished, and in the meantime its functions are spread all over Washington, with fragments at Langley and other NASA centers.

Lewis Research Center in Cleveland is pursuing ion propulsion. What Lewis calls "electric propulsion systems"—using ions under electronic control—can achieve an acceleration of about 0.001 g, but are limited in jet velocity only by relativistic considerations. Jet velocities of 216,000 mph are feasible for space journeys, Lewis scientists feel.

An ion engine that can develop an ounce of thrust at 10 kv and 120 ma has already been built. Cesium, which ionizes relatively easily, is boiled under pressure, and the vapor ionized by being passed over hot tungsten grids. The ion stream is then accelerated electrically.

Electrons are drawn off electronically and fired into the emerging ion stream, reneutralizing the engine exhaust and contributing slightly to the thrust.

A rocket equipped with such an engine would be assembled in an earth orbit, could make the round trip to Mars in 1,070 days. A chemical engine would make the same trip in 970 days (saving the accelerating and decelerating time required by the slow-start ion engine), but would have to weigh 6 times as much and require 6 times the booster power to put it into its parking orbit for assembly.

CalTech's Jet Propulsion Laboratories, which developed the Microlock telemetry system for NASA, is principally concerned with the Vega project. Vega will use an Atlas for a first stage, a modified Atlas for a second stage, and a JPL-developed third stage of 6,000-pound thrust using hydrazine and nitrogen tetroxide, which ignite on contact and can be prepared long in advance. Vega will be able to throw several tons into earth orbit or half a ton into deep space. JPL is developing the guidance system too; guidance will be contained in the top stage, which can be second or third depending on mission.

Super Sensitive

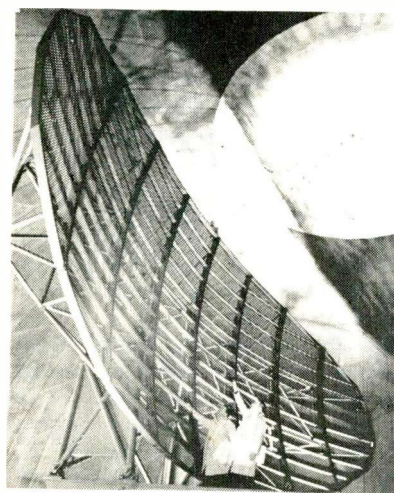

Seven-ton, 40 x 18-ft antenna will soon become part of the Sage defense system. Capable of rotating 360 deg at four speeds, the antenna will help provide faster target data on approaching aircraft. It is being tested by GE, which developed antenna and new long-range multibeam radar with USAF's Rome Air Development Center

RELIABILITY
INSIDE
THE
BLACK BOX*

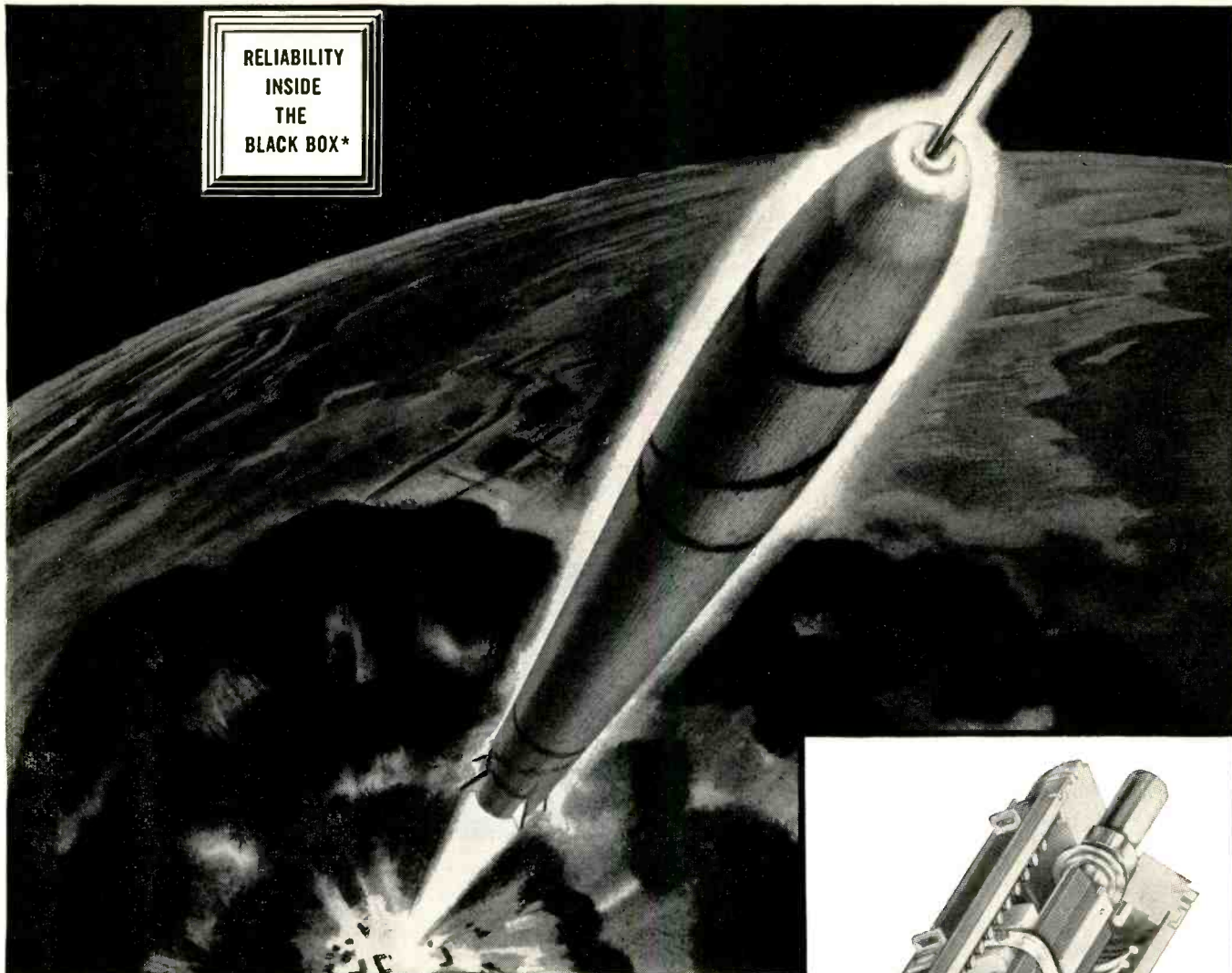

The Pot Thor's thunder couldn't shake!

Only Fairchild's "Pot" Could Meet the Specs for a Big 15G Jolt
... Then Took 12G's More as a Safety Factor*

When the prime contractor on the first guidance system for the Air Force Thor missile required a potentiometer that could take punishment Fairchild was called in. Fairchild's sales engineer working with one of Fairchild's Customer Engineering Groups and the contractor's Standards Engineers, developed the rugged 1" diameter precision 10-turn potentiometer on your right.

This "pot" features a unique mechanical wiper tab drive perfected by Fairchild which is separate from the helical coil of resistance wire. This minimizes winding wear and electrical backlash thereby extending life and accuracy. Fairchild's de-

sign also offers tight linearity tolerance, high temperature performance, low noise levels and is available in resistance ranges between 1K ohms and 2 megohms, and in diameters of 3/8", 1" and 1-13/16".

The Fairchild potentiometer line is complete. It is the result of careful research and design, of rigid incoming materials inspection, of sub-assembly and final inspection plus performance testing and environmental testing to destruction of random samples.

Write or call for the new condensed catalog — Fairchild Controls Corporation, Components Division, Dept. 24 ED.

*Fairchild's Built-in SAFETY FACTORS Beyond the Specs for Reliability in Performance.

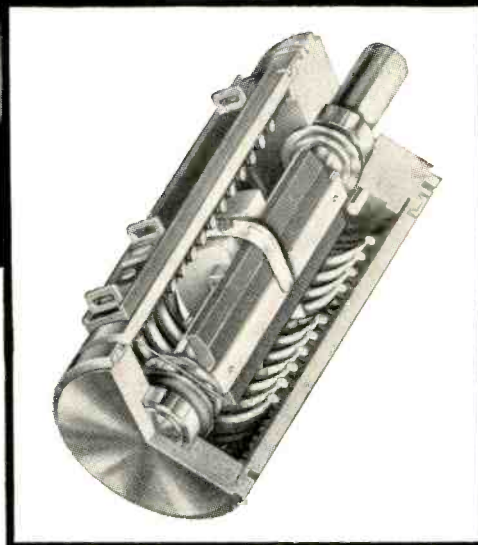

THE PROBLEM: A small, multi-turn potentiometer was required for the "black box" in the Thor missile which had to withstand severe environmental conditions, and have characteristics of low noise with no discontinuity under vibration, shock and acceleration.

THE SOLUTION: A special high-reliability design of the Fairchild standard type 920, 10-turn potentiometer, a design demanding the closest tolerances, selected materials, and special assembly techniques. The result — a "pot" which delivered a safety factor beyond the specs that helps to assure reliability.

Environmental Tests	Contractors Specification	Fairchild Performance
Vibrations	2-2000 cps—15G	2-2000 cps—30G
Shock	100G	125G
Acceleration	Constant 17G	Constant 50G

In addition, the units were vibrated at resonant peaks between 2-2000 cps from 25G to 50G for 15 minutes without electrical or mechanical degradation.

Potentiometers
Rate Gyros
Pressure Transducers
Accelerometers

RELIABILITY
INSIDE
THE
BLACK BOX*

FAIRCHILD
CONTROLS CORPORATION

COMPONENTS DIVISION

225 Park Avenue
Hicksville, L. I. N. Y.

6111 E. Washington Blvd.
Los Angeles, Cal.

COORS PRODUCES CERAMIC TO MEET YOUR REQUIREMENTS!

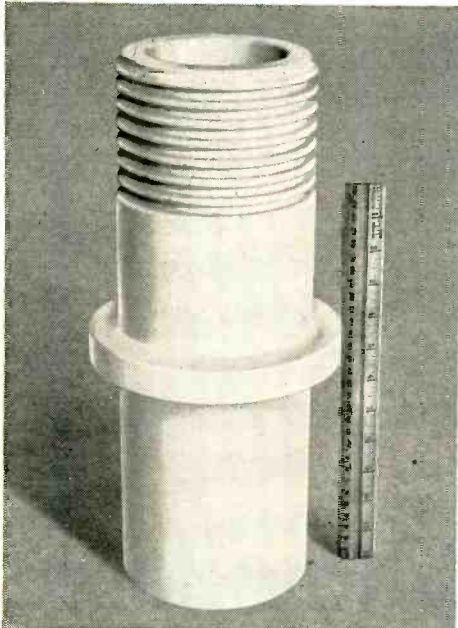

Eighteen years ago, this insulator was the answer to a need for a new ceramic for use on an early atomic project—Coors first production run of large ceramic parts using the isostatic technique.

Coors precision finishing improves accuracy of electrical characteristics—this window for a traveling wave tube has thickness tolerances of $\pm .0005''$, and a flatness of 2 to 3 light bands.

Brazing temperatures of 1083°C were used in making this hermetic ceramic-to-metal assembly, permitting high operating temperatures in the final use of this design.



New ceramic compositions, and new techniques have been introduced many times by Coors. Eighteen years ago Coors met the requirements of engineers in an early atomic project by supplying both a new ceramic composition and a new isostatic technique for forming ceramic components. The result—a new, mechanically strong, completely homogenous ceramic having excellent electrical properties.

Demands for better, stronger materials have been answered by Coors throughout the 47 years of their experience. Continuous re-

search assures future developments. For example, Coors AD-99 is only one of several ceramic materials recently developed to meet the new needs of the electronic industry.

Parallel with the development of new ceramic compositions is the research for new and better techniques. For example, a completely new department for metalizing and brazing was installed and recently enlarged. Ceramic-to-metal assemblies can be furnished where brazing temperatures go as high as 1083°C —bonds have tensile strengths as high as 9,000 to 12,000 psi.

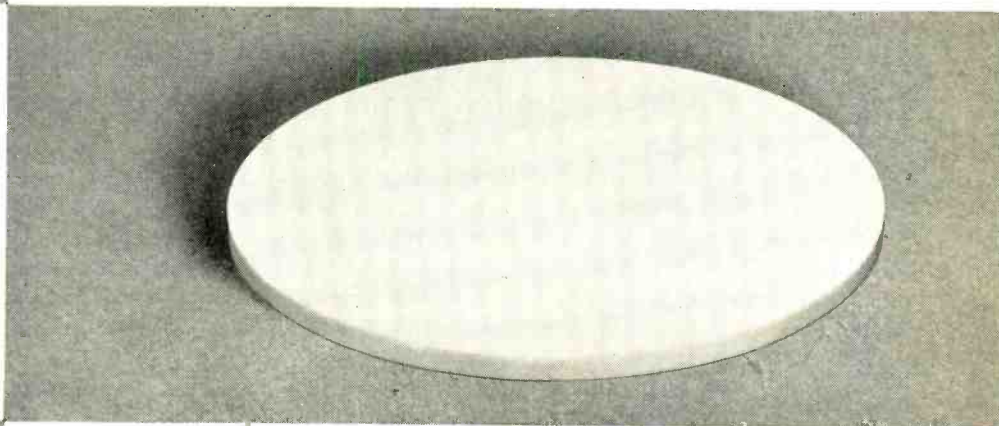

Ceramic compositions or production techniques are of little value without precise control. You need close tolerances—you obtain them from Coors in production runs, or experimental prototypes. Customary, careful work by over 600 skilled workers permits holding tolerances of 30 millionths of an inch on production runs.

To meet increased demands, additional engineers are being assigned to the field—Coors engineers in your neighborhood give

you on-the-spot ceramic design service. They need only your invitation to help you with your ceramic problems.

For information concerning our facilities and for data about Coors high alumina ceramics, please write for bulletin 858.

Coors

**COORS PORCELAIN
COMPANY**

600 Ninth Street, Golden, Colorado

CIRCLE 31 ON READER SERVICE CARD

JAPANESE EXPORTS OF REPRESENTATIVE ELECTRONIC PRODUCTS TO U.S.

		1956	1957	1958	1959 — Jan to Jun
Radio Receivers	Units	368,000	641,000	2,507,000	2,183,000
	*Dollar Value	\$2,646,000	\$5,294,000	\$17,904,000	\$17,584,000
Transistors	Units	Less than 500	1,000	11,000	823,000
	Dollar Value	\$4,000	\$1,000	\$7,000	\$521,000
Microphones	Units	33,000	137,000	80,000	80,000
	Dollar Value	\$73,000	\$276,000	\$177,000	\$156,000
Speakers	Units	40,000	113,000	129,000	132,000
	Dollar Value	\$75,000	\$293,000	\$420,000	\$453,000
Capacitors	Units	281,000	1,974,000	6,166,000	3,454,000
	Dollar Value	\$26,000	\$169,000	\$288,000	\$203,000
Electron Tubes	Units	3,000	14,000	1,238,000	2,268,000
	Dollar Value	\$7,000	\$8,000	\$314,000	\$558,000

Source: Electronics Division Business & Defense Services Administration Dept. of Commerce

*Manufacturer's Sales Price

Import Study Nears Showdown

Investigation to determine effects of Japanese transistor imports on U.S. defense effort begins next week as statements hit Washington

JAPANESE TRANSISTOR import situation heads for a showdown in Washington shortly. As the showdown nears:

- A Japanese delegation is already in Washington to present its side of the issue.

- Within ten days, the Office of Civil and Defense Mobilization will close phase one (of three phases), the filing of preliminary statements. The next phase will consist of accepting rebuttals to these statements by Dec. 17, with the final wrap-up of all comment and rebuttal slated for Jan. 2.

What Can Result

OCDM is conducting an investigation of Japanese transistor imports at the petition of Electronic Industries Association. EIA has requested a determination as to whether or not these imports are affecting U. S. transistor manufacturers' potential ability to respond to a national emergency.

If OCDM finds that Japanese imports are a threat to production ca-

capacity needed for national defense, it will pass this opinion on to the White House. The President could then, if he saw fit, fix import quotas, set protective tariffs, or take any other action that seemed appropriate.

If OCDM finds that the imports pose no threat to the nation's security, it will so inform EIA and close the matter from its agenda.

EIA's general counsel, J. B. Olverson, told ELECTRONICS that, should a negative decision be reached, EIA plans no additional action on the subject at this time.

Defense Department's Electronics Production Resources Agency recently concluded a study which informed OCDM that adequate capacity exists for both present and long-range military transistor needs. A top OCDM spokesman says that the Defense Department study is bound to have an impact on the OCDM decision.

U. S. and Japanese transistor manufacturers and makers of transistorized items are keeping a close

watch on developments. Many major American electronics companies have a stake in Japanese industry by way of licensing agreements, subsidiary companies or part ownership of Japanese firms. For example, GE owns 7.4 per cent of Toshiba, IT&T operates subsidiary Nippon Electric, Westinghouse owns 4 per cent of Mitsubishi Electric.

Some firms use Japanese facilities to manufacture products such as transistor radios for the export market outside the U. S. An increasing number are importing Japanese transistors for incorporation into domestic-made assemblies.

H. Imai, of Tokyo Shibaura Electric Co. (Toshiba), points out that "American manufacturers of scientific and technical equipment have a vital stake in overseas trade . . . with exports from the U. S. amounting to more than \$231 million last year, of which Japan accounted for \$17 million." Last year's total exports to Japan from U.S. were \$829,488,593 for all commodities.

Imports from Japan came to \$673,-951,285, a balance in our favor of more than \$155 million. Fears have been expressed that the imposition of excessive tariffs would endanger the present favorable balance.

Possible Answers

Some members of the interested groups indicate that the answer to Japanese competition lies not in government action alone, but in American technical sophistication, consumer preference for known brand-names, and superior service and distribution facilities.

Some firms feel that more reliance should be placed in stepped-up automation. Westinghouse Electric took this approach in its transistor radio manufacturing. The result: a personal radio priced competitively with Japanese models. Admiral Corporation's answer to "Japan's competitive challenge" is a 7-transistor pocket radio which will carry a list price of \$29.95.

Automation at the assembly level is not the sole answer, however. C. J. Urban, Westinghouse manager of marketing, points out that one result of Japanese competition has been a stepped-up effort on the part of component suppliers to find ways of reducing their production costs. Such items as miniature loudspeakers and tuning assemblies, which appeared to be endangered by competing Japanese equipment, are now available from American suppliers who have found more efficient production methods.

Compromise Likely

The Japanese delegation plans to stress that they do not wish to pose any threat to American defense. Interviews with representatives of the group indicate that the Japanese have no immediate plans to go after the markets for highly specialized transistors. One spokesman says that, based on present rate of expansion of the entertainment market, there is adequate room for foreign competition there.

It appears likely that the group would consent to voluntary quotas and other negotiated agreements. The Japanese spokesmen appear willing to go to considerable lengths to avoid the loss of the American market.

BALLANTINE VOLTMETER

Model 300-D

Price: \$245.

gives you
utmost

Accuracy,

Stability

and

Reliability

... plus
these
features

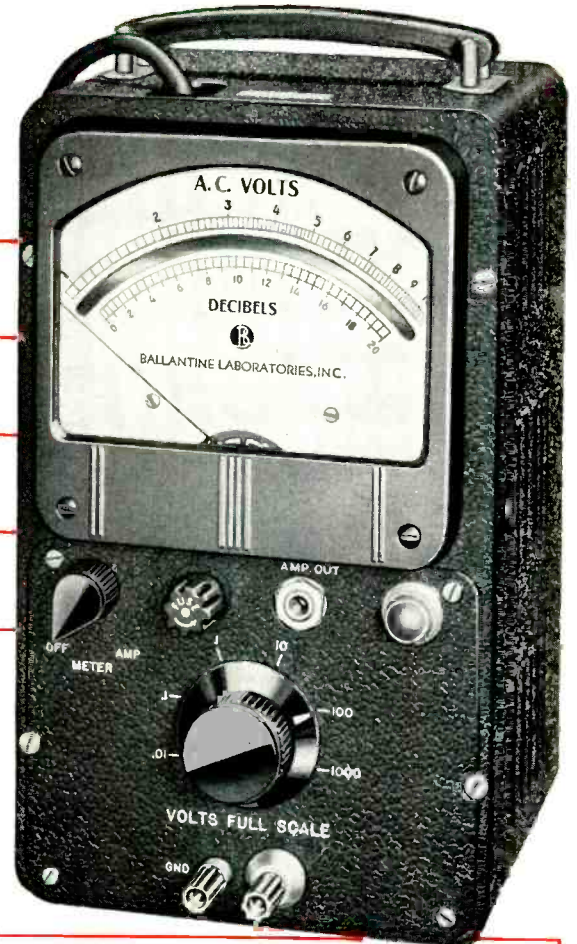

- Long life • High input impedance • Wide voltage range
- Large easy to read meter with overlap • High accuracy at any point on the scale • Light, compact, rugged

SPECIFICATIONS

VOLTAGE RANGE: 1 millivolt to 1000 volts rms. in 6 decade ranges (.01, .1, 1, 10, 100 and 1000 volts full scale).

FREQUENCY RANGE: 10 to 250,000 cps.

ACCURACY: 2% throughout voltage and frequency ranges and **at all points on the meter scale.**

INPUT IMPEDANCE: 2 megohms shunted by 15 μf except 25 μf on lowest range.

DECIBEL RANGE: -60 to +60 decibels referred to 1 volt.

STABILITY: Less than 1/2% change with power supply voltage variation from 105 to 125 volts.

SCALES: Logarithmic voltage scale reading from 1 to 10 with 10% overlap at both ends; auxiliary linear scale in decibels from 0 to 20.

AMPLIFIER CHARACTERISTICS: Maximum voltage gain of 60 DB; maximum output 10 volts; output impedance is 300 ohms. Frequency response flat within 1 DB from 10 to 250,000 cps.

POWER SUPPLY: 115/230 volts, 50-420 cps, 35 watts approx.

Write for catalog for complete information.



BALLANTINE LABORATORIES, INC.
Boonton, New Jersey



It's Mr. Fortin's job to be hard to please...

Bob Fortin isn't the easiest person in the world to get along with. He's in charge of RCA's Current Product Design Group...and he's never content to let well enough alone. No matter how well a tube performs, Bob is always sure it can be improved...and he's usually right. He keeps a watchful eye on manufacturing to spot problem areas; he helps devise and develop more accurate testing and inspection methods. Working with the Life Test and Rating Laboratory, Bob and his staff determine the limits within which tube types perform with maximum reliability. He constantly reviews tube design to make sure the best available methods and materials are used. Recently, for instance, Bob Fortin and his staff suggested the use of RCA's new vacuum-melt cathode material, N-132, in the RCA-5654/6AK5-W. This change substantially reduced leakage, extended tube life, and increased operating stability. With men like Bob Fortin on the job, you can always count on quality performance when you design around RCA Industrial Receiving Tubes. Make sure you specify the best...get in touch with your RCA Field Representative today.



RADIO CORPORATION OF AMERICA
Electron Tube Division **Harrison, N. J.**

ANOTHER WAY RCA SERVES YOU THROUGH ELECTRONICS

EAST: 744 Broad Street, Newark 2, New Jersey
Humboldt 5-3900
MIDWEST: Suite 1154, Merchandise Mart Plaza
Chicago 54, Illinois—Whitehall 4-2900
WEST: 6355 E. Washington Blvd.
Los Angeles 22, California—Raymond 3-8361

Manned Interceptors' Role

TYNDALL AFB, FLA.—How much business—and what kind—can the electronics industry expect from the Air Defense Command in the immediate and near future?

How soon will manned interceptors give way to ground-to-air missiles? When will all defense, both manned and unmanned, against enemy bombers be scrapped?

Answers to these questions were not self-evident at the 10-day World-Wide Weapons Meet that wound up here recently. The dazzling spectacle, put on by crack U.S. interceptor pilots from Germany, Alaska, the Pacific and the U.S., was almost too impressive to permit questioning the actual defense value of the supersonic, missile-shooting planes.

Thousands Watch

The mood was that of a jet-age Arthurian tournament. Thousands of spectators milled about the ramp watching pilots dressed in red, baby blue, or yellow flight suits riding out to their supersonic jets in rickshaws. Mingling with the crowd, off-duty pilots from Germany—wearing leder hosen, green vests and Tyrolian hats—watched on closed-circuit tv as the actual shoot went on 100 miles out over the Gulf. F-89J's, F-100's, F-102A's and F-104's fired Genies, Sidewinders and Falcons at radio-controlled drones released from a B-26.

According to some pilots questioned, manned interceptors will go on forever. Some believe Congress will soon see the light and restore the recently cancelled F-108.

Reasoning is that "only a man has the capability of making a decision at the last moment to attack or not to attack." One top official says: "There will be a need for manned interceptors to handle identification missions as long as there is an air-breathing threat."

This point loses strength, however, in view of two facts: the weapons have all-weather capabilities, thus requiring identification

by electronic means during bad weather as would a ground-to-air missile; and secondly, the rate of closure of an approaching enemy bomber and an interceptor makes visual identification and consequently a "human decision" a difficult task.

The Strategic Air Command's need for last-minute decision making is more convincing. Opportunity of calling off a long-range bombing mission would be handy in the event a fast peace were declared after take-off.

Several electronics company tech reps revealed less enthusiasm for the future of manned interceptors than ADC officials: "Manned interceptors are dying ducks. ADC just doesn't want to lose a going concern." Several ADC officers admitted this weapons meet might well be the last.

Official ADC stand gives manned interceptors from eight to ten years, depending, of course, on what the Soviets do. If the Russians relax on bombers, then our present interceptors will suffice. If it's learned they're working on a Mach 2 bomber, then something like the F-108 would be required.

The fate of the manned interceptor in ADC finally boils down to how long a potential enemy maintains an air-breathing threat.

As of today, no new money is allocated for manned interceptors in the 1960 budget. F-101's and F-106's, already ordered, will be trickling in for another year. ADC plans a total of eight F-101 and four F-106 squadrons.

ADC now has 21 F-102 and 4 F-104 squadrons. The F-102's will be phased down when all F-106's become operational.

With no new aircraft in sight, ADC will be doubly anxious to update subsystems in its existing inventory. A continued market can be expected for improved fire control systems, search radar, missile launchers, new air-to-air missiles and target drones.

Ground equipment will also be

needed. Radar, computers for Sage, communications and test equipment will still be required.

Missile Business

Bomarc and Nike-Hercules missiles are still being produced and sites are under construction. The missiles and support equipment will be salable for a long time to come.

Only two of the 12 planned Bomarc launching sites are completed.

As far as is known, the 400 to 450-mi range Bomarc B is the ultimate in ground-to-air interceptor missiles against air-breathing targets. Its range and accuracy should be able to take care of any existing Soviet bombers. If the Bomarc misses, Army's Nike-Hercules can get out to 75 miles and the Nike-Ajax to 25 mi. U.S. now has about 240 Nike sites. More are under construction for Nike-Hercules.

From the Bomarc B, defense requirements jump to anti-ICBM's and anti-air and submarine-launched ballistic missiles.

The interceptor pilot's star might rise again with Dynasoar, the vehicle that will orbit the earth, enabling a pilot to destroy enemy satellites and other space craft.

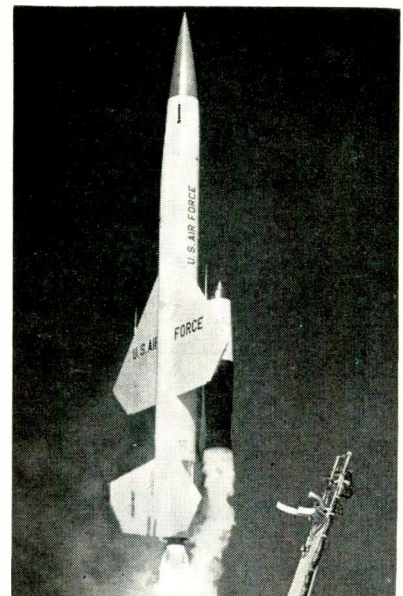

Ground-to-air Bomarc missile

population -



Even in the most remote areas, wings aloft are guided on their way by AeroCom's new medium range N.D. Beacon Transmitter. This transmitter was designed and built to provide long, trouble-free service with no attendants...even where the total population is Zero.

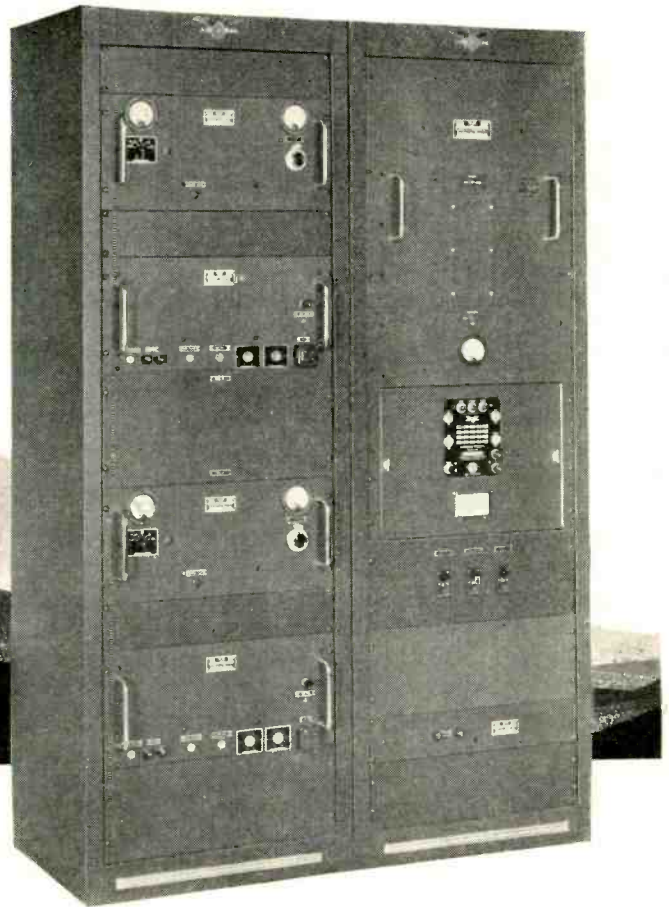
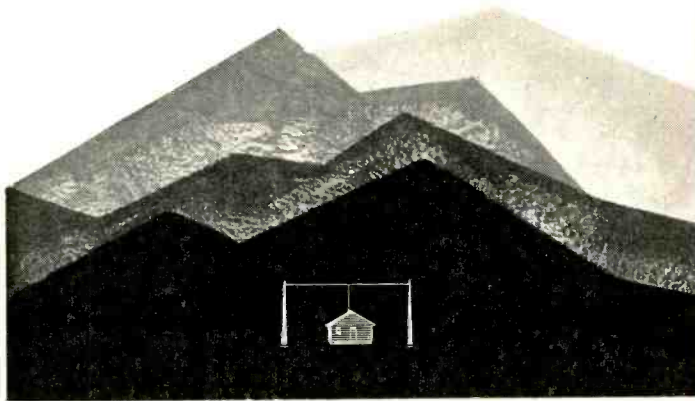

AEROCOM'S **Dual Automatic** **Package-Type Radio Beacon**

for completely unattended service. This N.D. Beacon (illustrated) consists of two 100 watt (or 50 watt) transmitters with 2 keyers, automatic transfer and antenna tuner. (Power needed 110 or 220 volts 50/60 cycles, 465 V.A. for 50 watt, 675 V.A. for 100 watt.)

Frequency range 200-500 kcs.: available with either crystal or self excited oscillator coil. High level plate modulation of final amplifier is used, giving 97% tone modulation. Microphone P-T switch interrupts tone, permitting voice operation.

The "stand-by" transmitter is selected when the carrier or modulation level of main transmitter drops 3 db or more, in case of failure to transmit the identification signal or if carrier frequency changes 5 kcs. or more. Audible indication in monitoring receiver tells which transmitter is in operation.

Unit is ruggedly constructed and conservatively rated, providing low operating and maintenance costs.

Also available in 400 watt, 1 K.W. and 4 K.W. Models, 200-415 kcs.

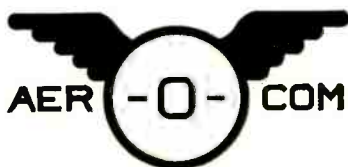

3090 S. W. 37th AVENUE • MIAMI 33, FLORIDA

Wide Bandwidth

with True Differential Input

► Only Epsco
Instrumentation
Amplifiers give you
all these features...

- WIDE BANDWIDTH . . . dc to 150 kc at gain of 100
- TRUE DIFFERENTIAL INPUT . . . true balance, low capacity
- HIGH COMMON MODE REJECTION . . . 200,000 to 1 dc . . . 50,000 to 1 ac
- HIGH GAIN . . . selectable gains of 100, 200, 500, 1000, 2000
- HIGH STABILITY . . . drift less than $2\mu\text{v}$ per day; less than $5\mu\text{v}$ long term cumulative drift
- LOW NOISE . . . less than $3\mu\text{v rms}$ to 50 cps
- HIGH POWER OUTPUT . . . ± 20 volts, up to 40 ma
- 100,000 OHM INPUT IMPEDANCE
- FAST RISE TIME . . . 2.3 $\mu\text{sec.}$ for full scale step input at gain of 100
- WIDE DYNAMIC RANGE . . . unsaturating at twice nominal output
- NO ADJUSTMENTS OR CALIBRATIONS
- NO BATTERIES

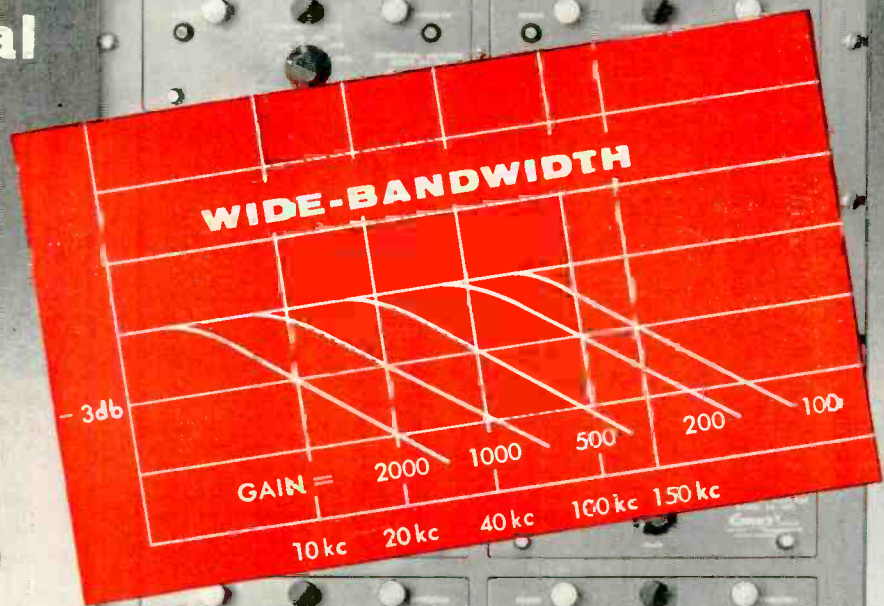

With the ever-increasing need for greater accuracy in dynamic instrumentation the demand for an expanding bandwidth in signal amplification becomes more and more urgent. Epsco Instrumentation Amplifiers not only meet the bandwidth challenge, but they also provide true differential input.

Available rack-mounted or in portable units. Write for Bulletin 105801 for complete technical information and options available.

Epsco

First in data control

Epsco, Inc., Instruments & Equipment Division, 275 Massachusetts Ave., Cambridge, Massachusetts

(Advertisement)

On the Market . . .

Cold Cathode Trigger-Timer-Gap Tube

switches 1000 amperes

The KP-130 is a subminiature, cold cathode tube, capable of switching pulse circuits with currents in excess of 1000 amperes.

The KP-130 is one of a family of "Krytrons" announced recently by KIP ELECTRONICS CORPORATION, manufacturer of electron tubes in Stamford, Connecticut.

The KP-130 is a T-3 size (see cut) capable of controlling pulse discharges as high as 1100 amps at 2500 volts. The anode delay time (time from the application of signal until conduction) averages 0.2 microseconds. The variation in delay ("jitter") is barely measureable, averaging less than 0.05 usec.

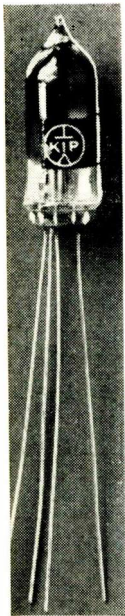

Actual Size

Hold-off voltage is in the 3000-4000 volt range, with higher voltage models in development.

With its high-voltage, high-current handling capabilities, the KP-130 will replace timer tubes

and spark gaps, thereby eliminating circuit components and improving equipment reliability.

A low-level radioactive material is included for light and dark stability, but no external radiation results therefrom.

Tubes are available from stock. For further details, contact KIP ELECTRONICS CORPORATION, Dept. 917, Box 562, Stamford, Connecticut.

Dr. Leo Esaki Goes

Electronics plays host as famous delineator of tunnel diode effect visits New York City

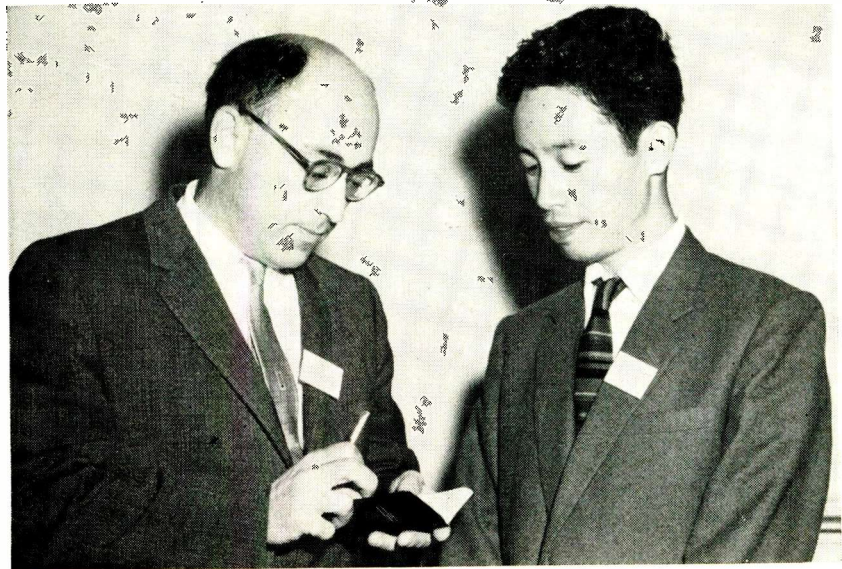

Before sightseeing in New York: Associate Editor Solomon interviews Esaki in Chicago

NEW YORK—Fame didn't matter, really.

There was this big city to see and new friends to enjoy. Leo Esaki, tourist, was ready.

Quickly he finished his breakfast of eggs (sunny side up), toast and coffee. He asked his companions for the day, Electronics Associate Editor and Mrs. Leslie Solomon, to come to his room for a minute; had to get his movie camera. (He carries it everywhere.)

Esaki — world-famous delineator of the tunnel diode effect that bears his name—is 34 but looks only 20. He dresses well. He wears Japanese-made suits of English wool.

Well-educated (Ph D from Tokyo University), he speaks English quite fluently. But if the right English word doesn't come quickly, he stutters a bit. Now, though, he didn't hesitate. Obviously, the words had been selected years ago.

"Please," Esaki said, "I would like to visit Hayden Planetarium."

No explanation was necessary, but he offered one:

"The last time I went to a planetarium was in Kyoto, Japan. I was only eight years old. I have always wished to see the one in New York."

On the way over, he was all tourist. The Solomons' tiny foreign car

intrigued him. He inspected it closely. He explained Sony provides him with a car in Tokyo.

Esaki was impressed by the tall buildings. Frequently he took pictures through the car's windows. He smiled and chatted and relaxed.

"I have been so busy—busy every minute—since arriving in America," he explained. He didn't have to add: one day off, cloaked in anonymity, was wonderful.

Home-Cooked Meal

It also reminded him, fleetingly, of just one year before when obscurity was Esaki's traveling companion. He had stopped briefly here while en route to the Brussels Conference. He could have wandered to his heart's content.

This Sunday was different. It was his only free day. One is better than none; he was thrilled.

At the planetarium, he strained his neck to see the overhead star display. He smiled. He peered. And he laughed. This was fun.

Outside, Solomon asked Esaki if he'd like to visit Solomon's two aunts in the Bronx and have a home-cooked meal. Quickly, he said yes.

The four-flight walk up to the aunts' apartment didn't bother Esaki. He found the meal delightful

Touring

—potted meat balls, mushrooms and barley soup. He had taken his jacket off. Now, contentedly, he was sipping American coffee.

The conversation turned to clothes. One of Solomon's aunts is an expert seamstress.

"Is this suit well made?" asked Esaki. The aunt examined it closely and said it was. Esaki asked her how much the suit cost. She said about \$125. Esaki smiled.

"I guess my tailor in Japan told me the truth. He said it was worth the price. I paid \$100 for it." Everyone laughed.

'Same In Tokyo'

By now, day had turned to night. But the conversation hippity-skipped along.

No, New York's traffic and wandering pedestrians didn't bother him. "Same in Tokyo," he said.

Time and again he took out his pen (he carries several) to explain something by drawing, as if he felt his English needed support. Always, he was polite, genial, friendly.

He discussed his hectic schedule and, sense of humor showing, summed it up: "I am getting to be quite an expert on eating."

The talk turned to labor unions. Esaki pointed out cheap labor (by American standards) is not the only reason Japan produces products more cheaply. "Japanese manufacturers are always trying to better their production techniques to further reduce prices," he explained.

For no reason (pleasant conversations never need one), the talk turned to Esaki's coming wedding this month. It will be a modern, Western-type one, he said. "Yes," he added, "I'm nervous."

It was time for him to return to his hotel. On the way, he counted hotel signs. He was surprised at the number of hotels in New York.

This little incident, like so many others during the day, spoke louder than words: here is a personable young man who doesn't seem aware his name is world-famous.

This day of touring had helped him feel that way.

Leo Esaki had talked about everything but the tunnel diode.

customize efficiency & accuracy
with trio labs' **BUILD-IN** instruments

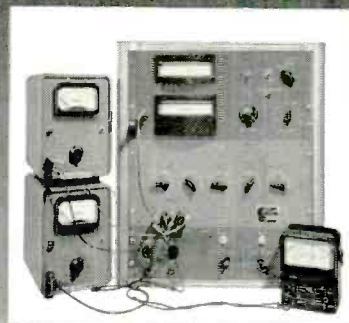

BEFORE . . . 3 external instruments were used to measure AC and DC voltages . . . cluttered, tedious, wasteful, subject to error.

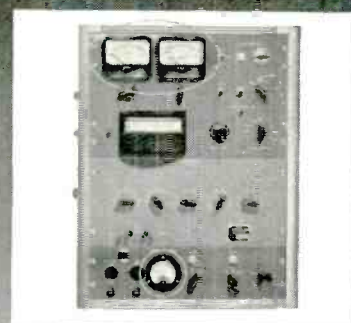

AFTER . . . 3 trio labs' miniature VTVMs integrally built-in now are always on hand to measure just the parameters you designate.

the industry's
pioneer & complete line of
MINIATURIZED ELECTRONIC INSTRUMENTS

MILITARY
for MIL-E-5400A & MIL-T-945A applications.



B Series ruggedized single-range AC VTVMs \$160.



D Series ruggedized multi-range AC VTVMs \$272.

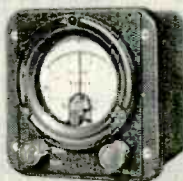

G Series ruggedized single or multi-range DC VTVMs \$136.



J Series ruggedized low-level multi-range DC VTVMs \$450.

COMMERCIAL



E Series Single-range AC VTVMs \$99.50

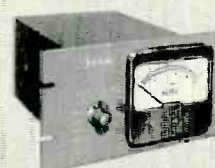

Model 109-1 low-level multi-range AC VTVM \$199.

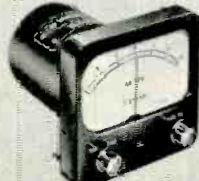

F Series single-range DC VTVMs \$84.50

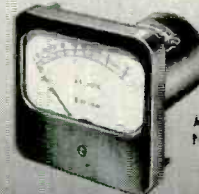

Model 125-1 Null Meter \$125.

By building-in trio labs' panel-mounting instruments you . . . customize test systems, set-ups and instruments; save space (average model is 4" x 4" x 4"); save time with at-a-glance monitoring; save money; make monitoring foolproof "go-no go"; improve system reliability; increase overall design freedom. Choose from many "standard" or "special" models — or consult us for new designs for your needs. Write for free "How-to" Engineering Guide to Dept. E-11



© 1954, TRIO LABORATORIES, INC.

Trio Laboratories, Inc., Great Neck, Long Island, New York

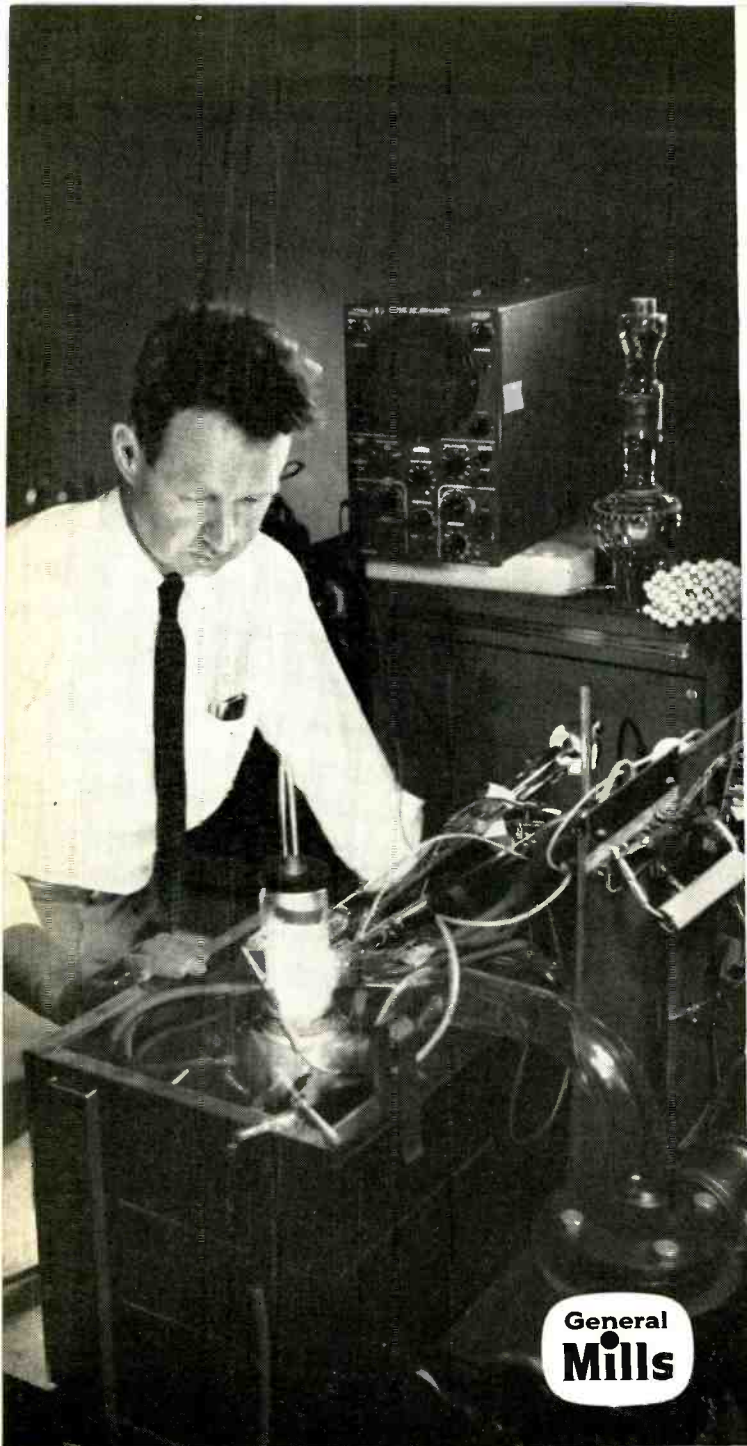

This scientific pioneer is our Dr. G. K. Wehner, designer of the "space chamber" which he uses here to determine the "sputtering" or disintegration rate of molybdenum under

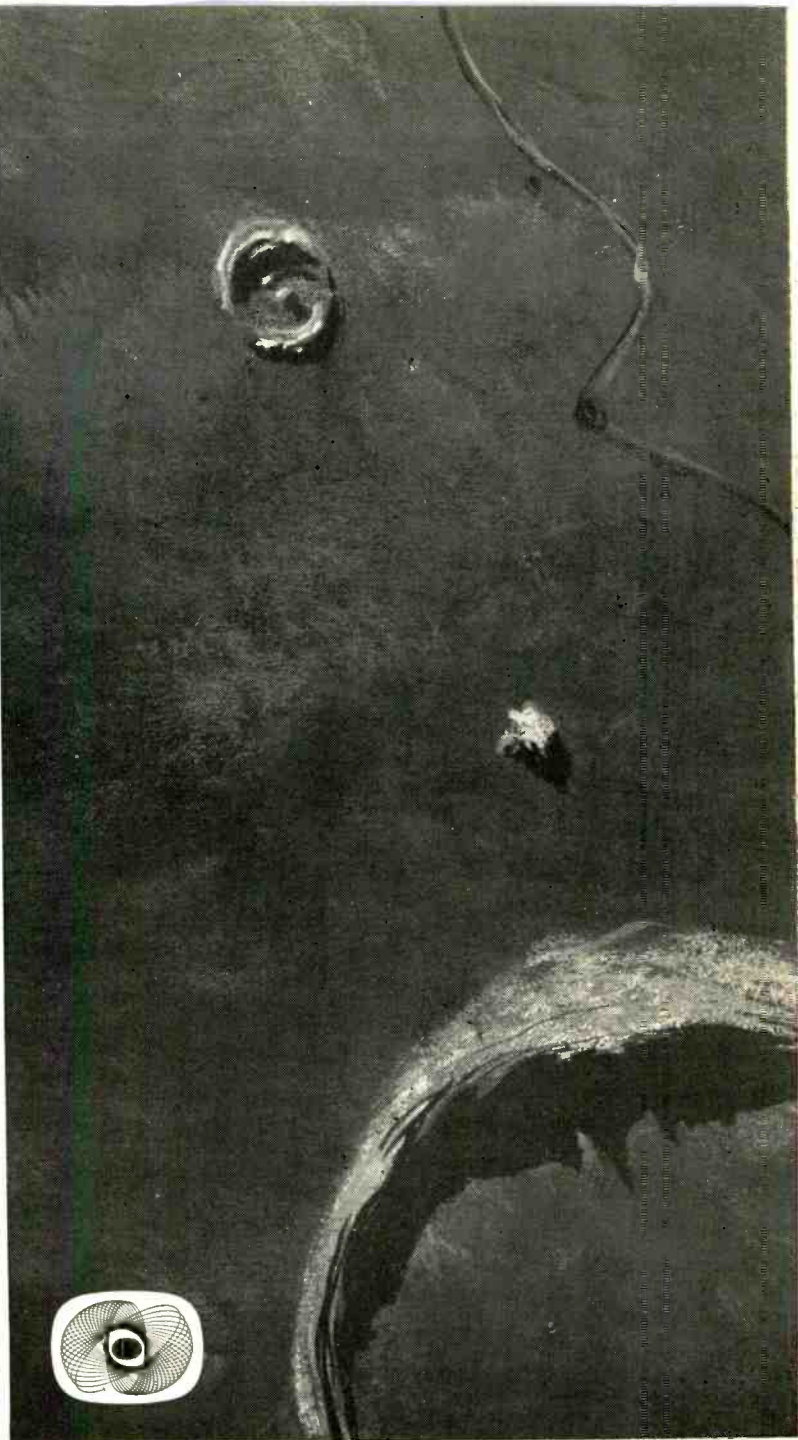

bombardment from atoms moving at 25,000 mph hundreds of miles above the earth. His studies can have bearing on materials which will be used in future space vehicles.

General Mills scientists are helping today to

The Mechanical Division of General Mills is contributing to man's knowledge of space through work in the vast field of geophysics. Important effort is directed toward increased knowledge of space phenomena vital to the future of space travel.

Our research activities cover broad areas in physics, chemistry, mechanics, electronics and mathematics. Some of the studies repre-

sentative of these activities are: ions in vacuum, deuterium sputtering, dust erosion, magnetic materials, stress measurements, surface friction and phenomena, trajectory data and infrared surveillance.

In our engineering department, current projects include: airborne early warning systems, micro wave radar test equipment, antennas and pedestals, infrared and optics, inertial

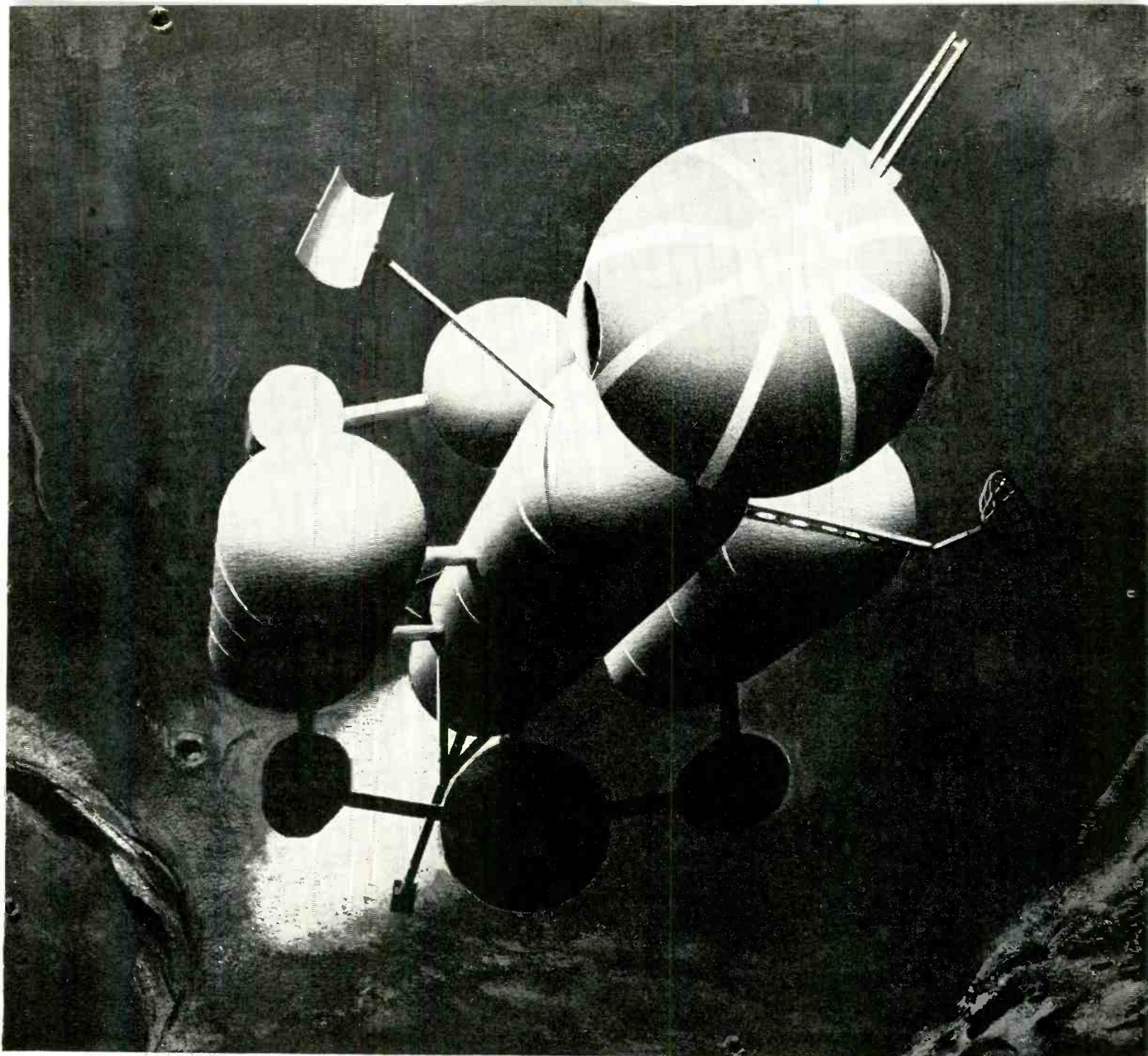

man reaches the moon . . . illustration from a book written for General Mills by Willy Ley.

pave the way for tomorrow's trip to the moon

guidance and navigation, digital computers. Our entire manufacturing department is geared to produce systems, sub-systems and assemblies to the most stringent military requirements. Our people have a wealth of

experience in complex military projects. We will be happy to discuss with you the many ways in which our research, engineering and manufacturing capabilities can serve you. Write for more information.

MECHANICAL DIVISION

1620 Central Avenue, Minneapolis 13, Minnesota

To wider worlds—through Intensive Research • Creative Engineering • Precision Manufacturing



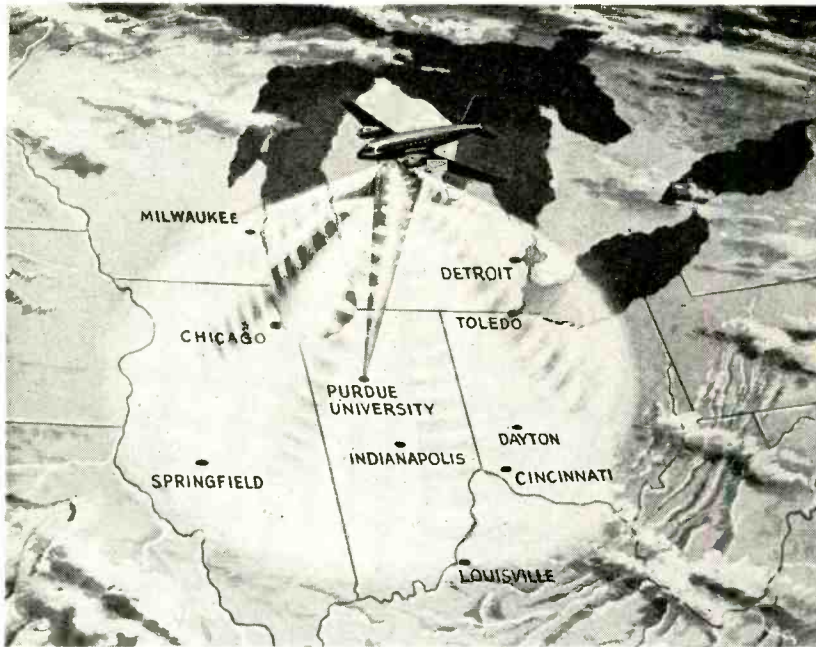

Five million students in 17,000 locations in six states are expected to be within range of educational courses telecast from high-flying airplane

Stratovision: New Business

Televising courses from an airplane will cost \$7 million the first year for program, gear

MIDWEST COUNCIL ON AIRBORNE TELEVISION plans to put a converted DC-7 in the air over Purdue University, Ind., to televise high school and grade school courses to a six-state area encompassing 5 million students.

Telecasting is expected to start next September. Meanwhile, equipment will be tested and programs taped.

The move means added business for the electronics industry. Overall costs of the experiment and equipment will be \$7 million the first year.

Programs will be prepared on video tape in advance by teachers on the ground.

The craft will cruise in a 10-mi circle at 23,000 to 27,000 ft near West Lafayette, Ind. The tv courses will be beamed initially on two channels covering a great circle extending to Detroit, Milwaukee, Springfield, Ill., and Louisville, Ky.

Schools Equip Selves

Schools using the voluntary programs will have to equip themselves with uhf receivers.

Early transmission on standard-band uhf will be backstopped later

by experimentation with narrow-band uhf (3-mc wide) allowing more programs without using any more channels.

"Stratovision" technique of re-broadcasting tv signals from high-flying airplanes was originated in 1944 by Charles E. Nobles, manager of surveillance radar projects, Air Arm division, Westinghouse, Baltimore.

Two planes will be used—one for immediate use, the other a reserve unit.

The experimental aircraft will use an antenna 30 ft. long which will be a two-element turnstile omnidirectional horizontal unit. This will be streamlined later into a cylindrical tube shape with slots so it can work omnidirectionally in a horizontal plane.

Each plane will have 4 transmitters (12 kw each).

Experiment gets under way this month when Purdue University applies to the FCC for channels. Instructors and lecturers will be put on video tape beginning in January.

The planes will fly six hours per day and broadcast twelve ½-hour programs on each of the two channels.

for immediate
delivery of
**General
Instrument
semiconductors**
at factory prices
call your
stocking distributor

The authorized distributors listed below carry a full stock of all General Instrument semiconductors — and can give you immediate delivery from stock:

**SILICON RECTIFIERS
SILICON DIODES
GERMANIUM
DIODES**



CALIFORNIA: Newark Electric Co., 4747 W. Century Blvd., Inglewood; Pacific Wholesale Co., 1850 Mission St., San Francisco; Shanks & Wright, Inc., 2045 Kettner Blvd., San Diego; Valley Electronic Supply Co., 1302 W. Magnolia Blvd., Burbank

CONNECTICUT: The Bond Radio Supply, Inc., 439 W. Main St., Waterbury

DISTRICT OF COLUMBIA: Silberne Industrial Sales Corp., 3400 Georgia Ave., N.W.

ILLINOIS: Merquip Co., 5904 W. Roosevelt Rd., Chicago; Newark Electric Co., 223 W. Madison St., Chicago

INDIANA: Brown Electronics, Inc., 1032 Broadway, Fort Wayne; Graham Electronics Supply, Inc., 122 S. Senate Ave., Indianapolis

MARYLAND: Radio Electric Service Co., 5 N. Howard St., Baltimore

MASSACHUSETTS: The Greene-Shaw Co., Inc., 341-347 Watertown St., Newton

NEW YORK: Hudson Radio & Television Corp., 37 W. 65th St., NYC; Sun Radio & Electronics Co., Inc., 650 Sixth Ave., NYC

OHIO: Buckeye Electronics Distributors, 236-246 E. Long St., Columbus; The Mytronic Co., 2145 Florence Ave., Cincinnati; Pioneer Electronic Supply Co., 2115 Prospect Ave., Cleveland

OKLAHOMA: Oil Capitol Electronics, 708 S. Sheridan, P. O. Box 5423, Tulsa

PENNSYLVANIA: D & H Distributing Co., 2535 N. 7th St., Harrisburg; Herbach & Rademan, Inc., 1204 Arch St., Philadelphia

WASHINGTON: Seattle Radio Supply Co., 2115 2nd Ave., Seattle

WISCONSIN: Radio Parts Co., Inc., 1314 N. 7th St., Milwaukee

AUTOMATIC MINIATURIZED silicon power rectifiers

SMALL TO FIT YOUR SPACE REQUIREMENTS

JEDEC TYPE NO.	MAXIMUM RATINGS			ELECTRICAL CHARACTERISTICS			
	PEAK INV. VOLT- AGE (V)	MAX. AVG. RECTIFIED CURRENT (mA)*		MINIMUM SATURA- TION VOLTAGE @ 100° C. (VOLTS)	MAXIMUM REVERSE CURRENT @ PIV (μA)		MAXIMUM VOLTAGE DROP @ 400 ma DC @ 25° C. VOLTS DC
		@ 25° C.	@ 150° C.		@ 25° C.	@ 100° C.	
1N645	225	400	150	275	0.2	15	1.0
1N646	300	400	150	360	0.2	15	1.0
1N647	400	400	150	480	0.2	20	1.0
1N648	500	400	150	600	0.2	20	1.0
1N649	600	400	150	720	0.2	25	1.0

* Resistive or inductive load

We've shrunk the size, but not the quality. All the outstanding characteristics and reliability you expect of products from General Instrument Corporation are present in these miniaturized units. Data sheets on these and other Automatic silicon rectifiers are available upon request.



Semiconductor Division

GENERAL INSTRUMENT CORPORATION

65 Gouverneur Street, Newark 4, N. J.

GENERAL INSTRUMENT CORPORATION INCLUDES F. W. SICKLES DIVISION, AUTOMATIC MANUFACTURING DIVISION, RADIO RECEPTOR COMPANY, INC. AND MICAMOLD ELECTRONICS MANUFACTURING CORPORATION (SUBSIDIARIES)

GENERAL INSTRUMENT DISTRIBUTORS: Baltimore: D & H Distributing Co. • Chicago: Mesquip Co. • Cleveland: Pioneer Electronic Supply • Los Angeles: Valley Electronics Supply Co. • Burbank: Radio Parts Co., Inc. • New York City: Hudson Radio & Television Corp. • Sun Radio & Electronic Co. • Philadelphia: Herbach & Rademan, Inc. • San Diego: Shanks & Wright Inc. • San Francisco: Pacific Wholesale Co. • Seattle: Seattle Radio Supply • Tulsa: Oil Capitol Electronics

BIRD

"Termaline" DIRECT READING RF LOAD- WATTMETERS SERIES 6100



MODEL 612

Models 61 and 611
are identical in
appearance

These popular direct reading instruments measure and absorb power in 50 ohm coaxial line systems through the range of 30 to 500 mc.

They are portable and extremely useful for field or laboratory testing . . . checking installation of transmitters . . . trouble shooting . . . routine maintenance . . . production and acceptance tests . . . transmitter tune-ups . . . measuring losses in transmission lines . . . testing coaxial line insertion devices such as, connectors, switches, relays, filters, tuning stubs, patch cords and the like . . . accurately terminating 50 ohm coaxial lines, and . . . monitoring modulation by connecting phone, amplifier or audio voltmeter to the DC meter circuit.

Power scales for Model 61 Special are made to meet your requirements.

WRITE FOR BULLETIN TW606

SPECIFICATIONS

RF INPUT IMPEDANCE: 50 ohm nominal.

VSWR: Standard specification 1.1 to 1 maximum over operating range.

ACCURACY: 5% of full scale.

INTERNAL COOLANT: Oil.

POWER RANGE: Model 611—0-15, 0-60 watts full scale. Model 612—0-20, 0-80 watts full scale.

INPUT CONNECTOR: Female "N".

EXTERNAL COOLING METHOD: Air Convection.

RADIATOR STRUCTURE: All Aluminum.

FINISH: Bird standard gray baked enamel.

WEIGHT: 7 pounds.

OPERATING POSITION: Horizontal.

OTHER BIRD PRODUCTS

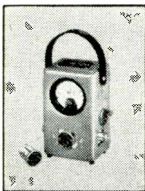

"ThruLine"
Directional
RF Wattmeters



"Termaline"
RF Load Resistor

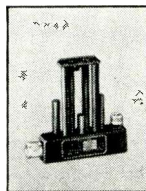

Coaxial
RF Filters

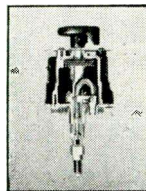

Coaxial
RF Switches



BIRD ELECTRONIC CORP.
Churchill 8-1200 (Cleveland)
30303 Aurora Road, Solon, Ohio
Western Representative:
VAN GROOS COMPANY, Woodland Hills, Calif.

MEETINGS AHEAD

Nov. 9-11: Radio Fall Meeting, IRE, EIA, Hotel Syracuse, Syracuse, N. Y.

Nov. 9-11: Instrumentation Conf., PGI of IRE, Biltmore Hotel, Atlanta.

Nov. 10-12: Electrical Techniques in Medicine & Biology, AIEE, ISA, PGME of IRE, Sheraton Hotel, Philadelphia.

Nov. 16-20: American Rocket Society, Annual Meeting, Washington, D. C.

Nov. 16-20: Magnetism & Magnetic Materials, AIEE, AIM, APS, IRE, ONR, Sheraton-Cadillac Hotel, Detroit.

Nov. 17-19: Northeast Electronics Research and Engineering Meeting, NEREM, Annual, Commonwealth Armory, Boston.

Nov. 23-24: Solid Facts About Solid State, Symposium, ISA, IRE, Ben Franklin Hotel, Philadelphia.

Dec. 1-2: Circuit Theory, Mid-West Symposium, PGCT of IRE, Brooks Memorial Union, Marquette Univ., Milwaukee.

Dec. 1-3: Eastern Joint Computer Conf., AIEE, ACM, PGEC of IRE, Hotel Statler, Boston.

Dec. 3-4: Vehicular Communications, Annual Meeting, PGEC of IRE, Colonial Inn & Desert Ranch, St. Petersburg, Fla.

Dec. 8-10: Electrical Insulation, Applications, Nat. Conf., AIEE, NEMA, Shoreham Hotel, Cleveland.

Jan. 11-13: Reliability & Quality Control, National Symposium, ASQC, IRE, EIA, AIEE, Statler Hotel, Washington, D. C.

Jan. 31-Feb. 5: Comparison of Control Computers, Winter General Meeting, AIEE, New York City.

Feb. 3-4: Military Electronics, Winter Convention, Biltmore Hotel, Los Angeles.

Mar. 21-24: Institute of Radio Engineers, National Convention, Coliseum & Waldorf-Astoria Hotel, N. Y. C.

There's more news in ON the MARKET, PLANTS and PEOPLE and other departments beginning on p 84.

Solitan

the truly dry
tantalum
capacitor!

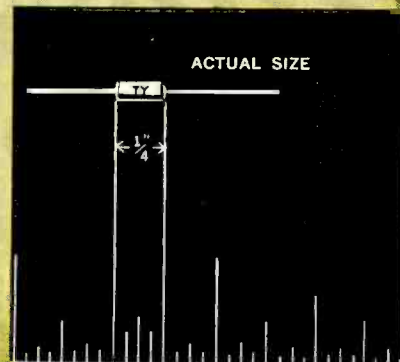

NEW SOLID-STATE ELECTROLYTE CAPACITORS BY CORNELL-DUBILIER • SOLITAN capacitors are specifically designed for transistor application in computer and military circuits. Solid electrolyte tantalum assures extreme resistance to shock and vibration, wider useful temperature characteristics, stability of capacitance in spite of aging or temperature variations, freedom from corrosion or leakage. Cornell-Dubilier has SOLITAN tantalum capacitors in production quantities. Write for 4-pg. Bulletin No. 537 to Dept. E-11, Cornell-Dubilier Electric Corp., South Plainfield, N.J.

SOLITAN

Specifications and Features

- Ratings up to 6.0 mfd. at 35 volts DC Working, or 60.0 mfd. at 6 volts
- Wider useful temperature characteristics within range of: -80°C to $+85^{\circ}\text{C}$
- Freedom from corrosion and leakage
- Extremely small size
- Remarkable stability of capacitance with time and temperature
- Metal cased, hermetically sealed



Consistently

Dependable

CORNELL-DUBILIER
CAPACITORS

Microfarads

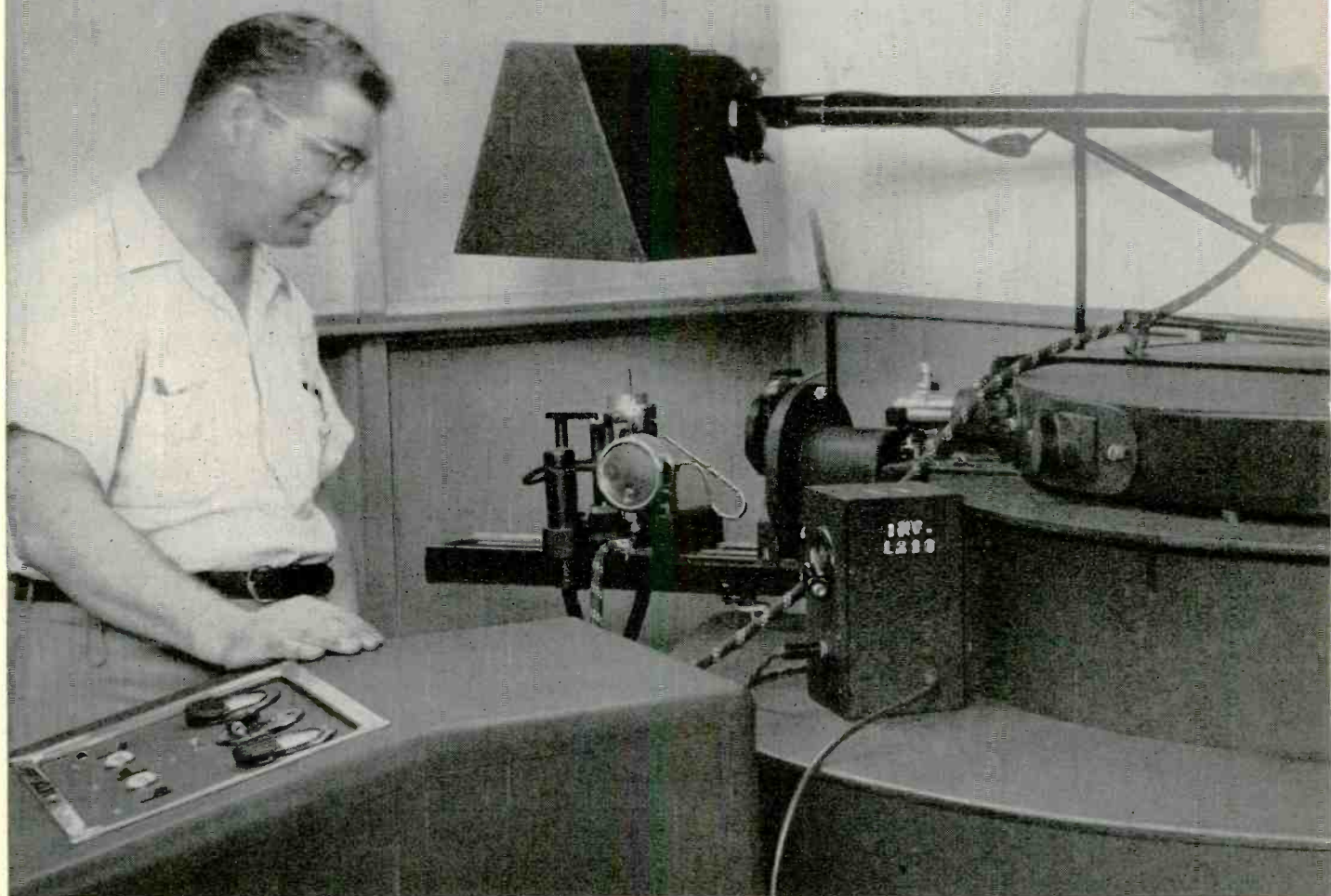

Research In Depth Makes The Difference In Mallory Components



New Types of Resistors, made by depositing materials in vacuum of 0.1 micron, are being investigated. From Mallory resistor research have been developed techniques for producing carbon elements to high uniformity that makes possible the ganged control of dual stereo amplifiers shown at right.

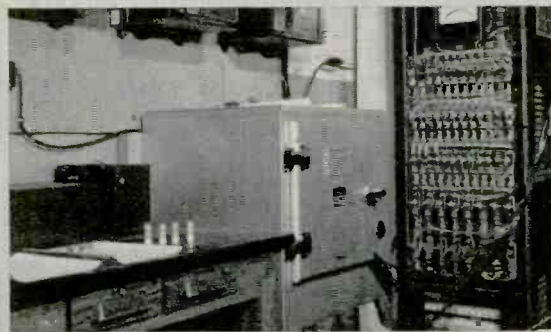

6-Year Storage Test on Mallory Mercury Batteries shows that this unique portable energy system stays practically "factory-fresh" many times longer than ordinary batteries. Pioneered by Mallory, Mercury Batteries lead in long life, steady output, miniature size.



and Metallurgy...

... Mallory Research In Depth Applies Metallurgical Science to Improve Capacitor Performance

One of the reasons why you're sure of long life and high uniformity with Mallory capacitors is the specialized metallurgical know-how that goes into them.

Take electrolytic capacitors, for example. Characteristics such as DC leakage current, life expectancy and capacitance stability depend to a considerable extent on the purity of aluminum foil. Developing specifications for high purity foils, and checking quality of foil being used in production is a joint effort of Mallory capacitor and metals specialists. Scientific tests in our laboratories, using the latest spectrographic equipment, enable us to analyze metals and detect impurities to a precision measured in parts per million.

In tantalum capacitors, too, Mallory experience with unusual metals has been the foundation for design and production innovations that have made extreme temperature ratings possible. The sintered pellet construction... still the only 200°C capacitor design... grew from our long background in powder metallurgy techniques.

That is what "Research in Depth" by Mallory puts into the components you use. A combination of ingenuity and knowledge in the basic sciences of electronics, special metallurgy, electrochemistry, and semiconductors, all in one organization constantly works to improve present components and to make tomorrow's products even better.

SPECTROGRAPHIC ANALYSIS of metals, in Mallory Corporate Research Laboratories, assures high-purity foil for long life in electrolytic capacitors... aids testing of powder for tantalum capacitors... contributes to research in special alloys for resistors... as well as metallurgical contacts, welding electrodes and high density metals.

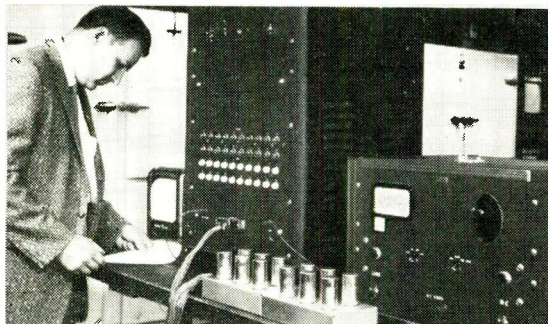

Checking Capacitor Characteristics, using automatic test apparatus like this to eliminate human error, gives Mallory engineers data vital to analysis of new developments. One of the most recent products of this program is the new THR capacitor shown here... a miniature unit with the high stability and life qualities of Mallory computer grade capacitors.

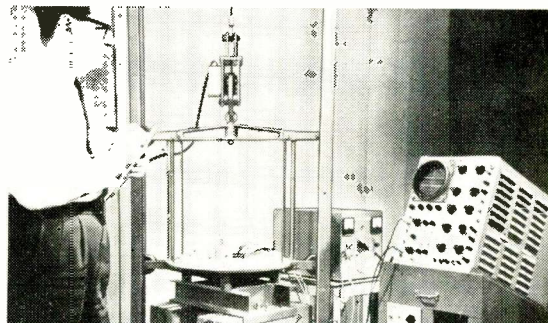

Shock Tests at accelerations of 50 G and more evaluate the ruggedness of new products from the Electromagnetic Department of Mallory's Elkon Division. Typical of new developments in this line is the miniature 1900 Series Vibrator, which has survived shocks of 9000 G and up.



FROM PHILCO...

2 NEW

SURFACE ALLOY

SILICON TRANSISTORS



**For Proven Performance
in High Speed Circuits
at High Temperatures**

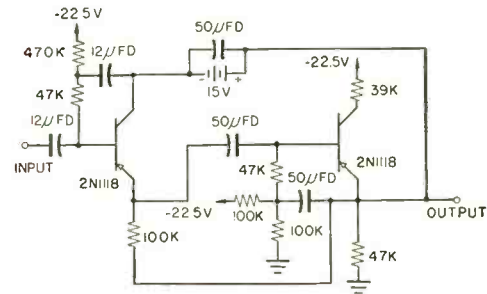

High Input Impedance Amplifier— $Z_{IN} > 2$ megohms ($25^{\circ}\text{C} - 125^{\circ}\text{C}$)

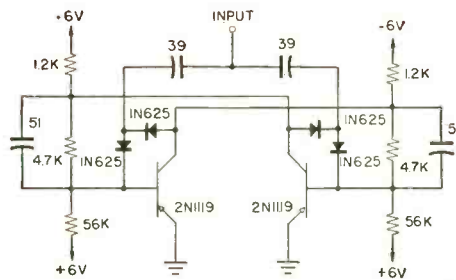

2 MCS Binary Counter—(-55°C to $+125^{\circ}\text{C}$)

SAT* 2N1118 and 2N1119
offer 4 outstanding features:

1. Low Leakage Current
2. Very Low Saturation Resistance (Choppers, Switches)
3. High Base-emitter Breakdown Region
4. Controlled Input Characteristics

2N1428 and 2N1429 are Lower-priced Units with Comparable Characteristics for Low Voltage, High Beta Application.

*Trademark Philco Corp. for Surface Alloy Transistors

Philco continues its leadership in the Silicon high speed PNP field with these highly reliable field-proven SATs. In addition to their other superior characteristics, they have adequate frequency response to fill a large percentage of silicon transistor applications in both military and commercial circuits operating at high ambient temperatures. They are environmentally tested in accordance with MIL-T-19500 A. These two new types supplement and are the electrical equivalents of the widely used 2N495 and 2N496, offering the designer a choice of packages (TO-1 and TO-5). For very high speed switching applications, designers should consider Philco's NPN Diffused-base Transistor 2N1199. Write for complete information, Dept. E 1159.

Immediately Available in Production Quantities . . . and 1-99 from your Philco Industrial Semiconductor Distributor.

PHILCO®

LANSDALE TUBE DIVISION • LANSDALE, PENNSYLVANIA



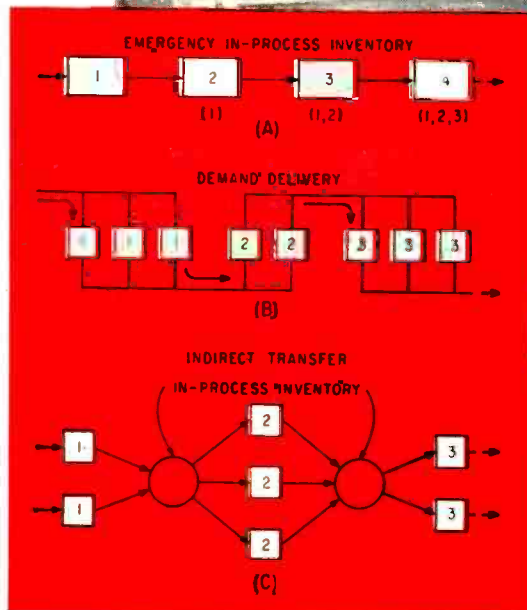
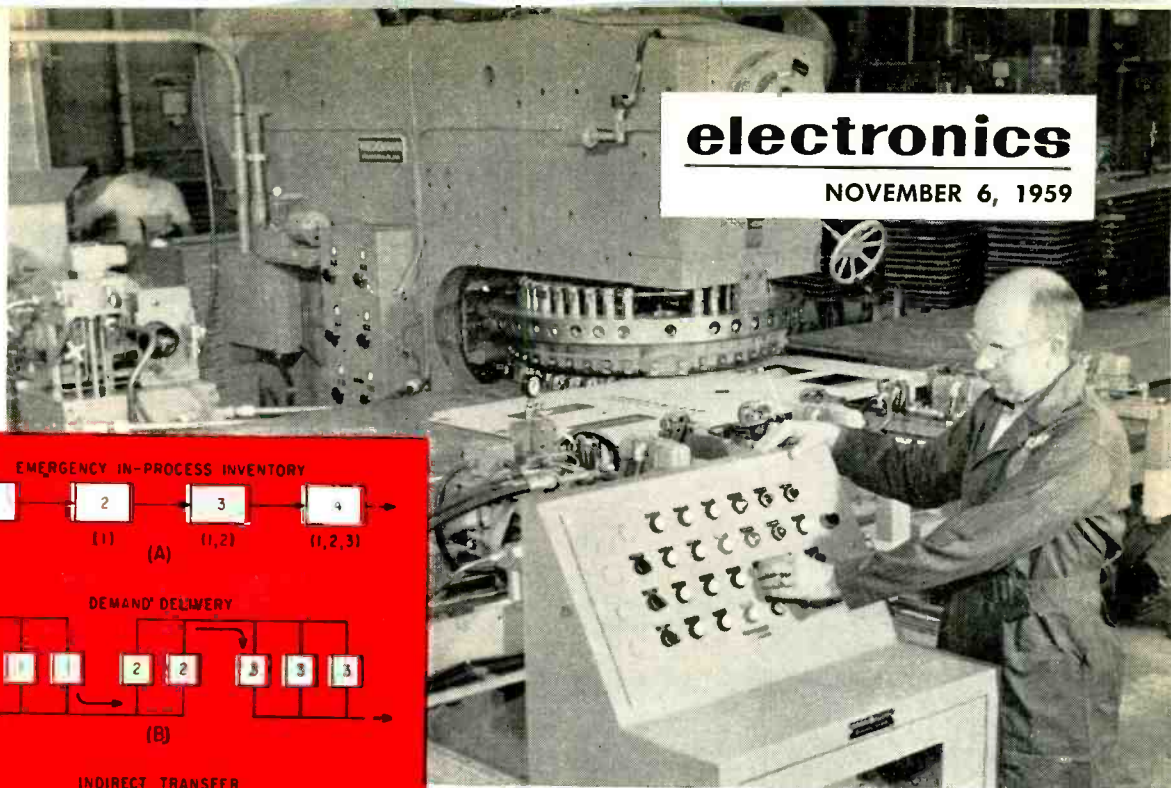

Tape-controlled turret punch press used by General Electric punches 30 holes a minute and automatically changes punches

FIG. 1—The effects of machine breakdown on plant operation can be avoided by not putting all the eggs in one basket. Numbered squares indicate machine work stations. Method (A) employs a standby inventory of partially-completed units; in (B) work goes to the machines ready to accept it; (C) is similar to (B) except that a pool of workpieces is built up between stations

Electronics Production. Methods for Modernization

Planning to invest in new plant, new equipment? Here's how typical electronics firms raise capital, mechanize equipment, use new techniques and organize plant space for greater efficiency

By **GEORGE SIDERIS**, Associate Editor

IMPACT OF NEW PRODUCTS, new technologies and increasing sales on the electronics industry shows up in the amount of capital being spent on plant and equipment modernization and expansion.

While capital expansion in all U. S. industry is seven percent more this year than in 1958, the electrical and electronics industries are spending 16 percent more. A McGraw-Hill survey shows that electrical equipment firms (including most electronics firms surveyed) spent \$459 million in 1958, will spend \$532 million this year and \$591 million in 1960.¹

CAPITAL FINANCING—Plowing back profits, establishing depreciation reserves, selling stock, renting, selling and leasing back plant or equipment, and combinations of these methods are used to raise capital.^{2, 3}

One medical electronics firm which wanted to expand its product line acquired a new plant on a 25-year lease with purchase option. All office equipment, including a computer, was rented to preserve cash for production equipment and inventory.

International Rectifier's present policy is to rein-

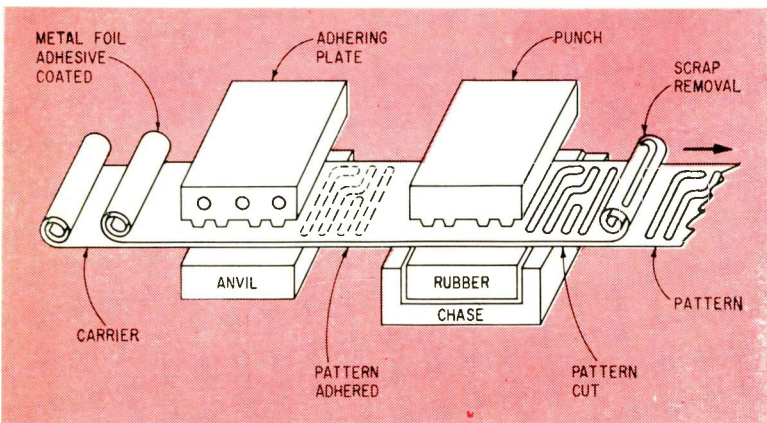

FIG. 2—Die-stamping of printed circuits permits feed of continuous strip of printed circuit boards to component insertion machine

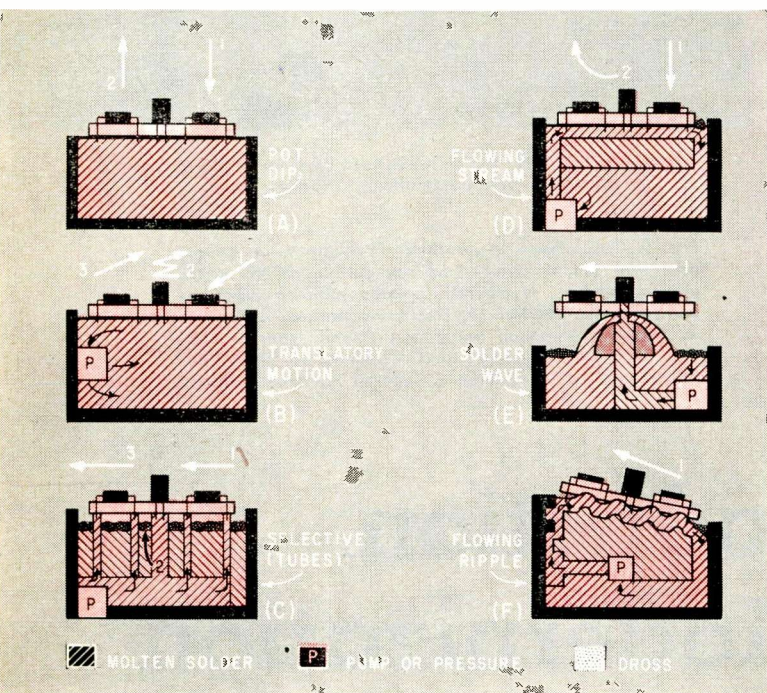

FIG. 3—Six dip soldering methods. Arrows indicate motion of circuit board, or (A) and (C) pot motion. Methods (A) and (B) require wiping of dross; (C) is selective without masking; (A), (C), (E) and (F) work well with conveyors

vest earnings. Last year, it also sold stock. Capital is used only for production facilities and offices. The firm leases its plants. As much modernization money as possible is allocated to new product lines. To avoid obsolescence, new product modernization must generally pay out in three months.

WHEN TO MECHANIZE—Reasons given for mechanization include: competition, avoidance of human errors, production speedup, lower manpower cost, conservation of plant space, safety, inventory reduction, product consistency. These are weighed against flexibility desired, product complexity, a need for in-process inspection or adjustment, product obsolescence, finances, sales potential and the time it may take to acquire a machine. These general considerations may in turn be influenced by a large variety of

specific considerations.^{4, 5, 6, 7}

WHAT TO MECHANIZE—One large data-processing equipment firm looks for mechanization clues in three places: operations with highest labor content, inconsistent results from a production operation and the employees' suggestion box.

Next, it determines if existing methods are being used to fullest advantage, whether mechanization would require product redesign and whether this is practical, if market potential is sufficient, how much the machine and support equipment would cost.

If a machine is economically justified, possible savings are whittled away by making the machine more flexible. If parts are costly, methods of stopping fabrication of a faulty assembly are considered. The effect of a breakdown on plant operation is weighed and an avoidance method, like those shown in Fig. 1, may be used.

HOW TO MECHANIZE—Mechanized equipment can be purchased, purchased and modified, or built to order. It is common practice in the electronics industry to home-build some specialized equipment to facilitate debugging and fully employ the firm's tool-makers.

Mechanisms which transfer the workpiece from point to point in a machine exist in a variety of forms.⁸ Rotary index machines are popular when several operations are to be performed on a single piece. One operator can handle a critical loading operation and also act as overseer or inspector.⁹ In-line machines are often favored when there are many individual operations and locations of the work area on the workpiece vary widely.

Mechanization and flexibility can be compatible. Machines whose operations are controlled by magnetic tape, punched tape or cards and other programming methods are inherently flexible.^{10, 11, 12, 13} Automated test equipment can also be flexible and less costly than hand methods.^{14, 15, 16}

CIRCUIT BOARD ASSEMBLY—Mechanization of component insertion and related operations have received major attention during the past decade.^{17, 18, 19} One way to make these machines more flexible and reduce investment is to use inserters as single station machines. Librascope, for example, has 13 inserters on its computer production line. Boards are automatically positioned by magnetic fixtures and one operator tends and loads three machines.

Lenkurt uses a multistation machine which does not require etched or plated boards. Staples and components are inserted in bare board. Component leads are wrapped on the staple legs and circuit paths are completed by strapping wire from staple to staple.²⁰

Stamped out circuit paths may also shortcut board plating and etching. One process²¹ is shown in Fig. 2. Some miniaturization techniques eliminate boards by using connecting wiring as a cage to support the components.^{22, 23}

BONDING METHODS—Six of the various dip solder methods are shown in Fig. 3. The wave²¹ and ripple²² do not require a conveyor dwell time. Translatory motion²³ simulates hand jiggling and is suited to small lot production.

A recently-developed method of spot welding is now being adapted to circuit board assembly.²⁷ Cold soldering, or molecular adhesion of clean surfaces under pressure, seals small cases and metal tubes. A magnetic arc method of welding high temperature glass and ceramics is reported in this issue of **ELECTRONICS**. Radio-frequency sealing allows multiple seals to be made in one operation.

MACHINE TOOLS—Vibratory, centrifugal or tumble hoppers will enable continuous feeding of many of the machine tools used to finish small piece parts. With suitable tracks, vibratory feeders size-segregate small parts or align them for other operations.

Programmed control, established in drilling, milling and similar tools, has recently been applied to a turret punch press by GE and Weidemann. The machine will punch 30 holes a minute. Other machines will work on a piece with a variety of cutting tools.

AMP, Inc. keeps its strip terminal punch presses in continuous operation by butt welding short strip stock into long strips. The welds are smoothed and the strips slit and fed to as many as 12 supply spools. Coiling the strip on the spools allows them to hold five times as much as pancake spools.

Another firm converts a 150-ton press brake into a production line by mounting progressive dies along the blade. Men stationed along the line feed material into the blade to form, notch and punch holes in large computer frame members.

PLANT LAYOUT—Layout of a plant is usually dictated by the type of production and the amount of immovable equipment required. Assembly firms, however, try to keep a substantial portion of the plant relatively free of structures so that assembly line setup can be conveniently rearranged.

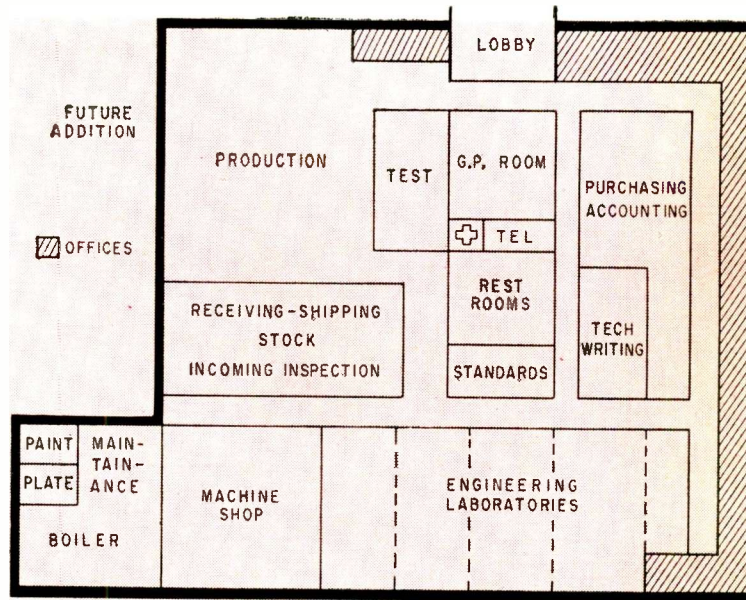

FIG. 4—CGS Laboratories plant is laid out to reduce intramural travel

MAXIMUM FLEXIBILITY—Electronics Associates' plant in West Long Branch, N. J., emphasizes quick change in space use, clear span work areas and easy expansion. The layout of the plant has been changed over a single weekend.

Offices have semipermanent walls. Security between shipping, stock and manufacturing areas is provided by floor-to-ceiling wire fence panels. Supervisors' offices on the plant floor are big boxes on skids, rest rooms are up under raised portions of the roof. Bus ducts permit 80 percent of total electrical power to be concentrated in any part of the plant. Equipment and lights are powered from trolley ducts.

Hot air heat, or fresh air is aimed along the walls and ceiling by large, independent blower units mounted under the roof.

The plant is being built in quarter sections of about

Portion of clean room built in former textile mill by Sanders Associates



New instrument production area at Assembly Products is pressurized to keep out dust. Area covers 9,600 square feet in plant addition

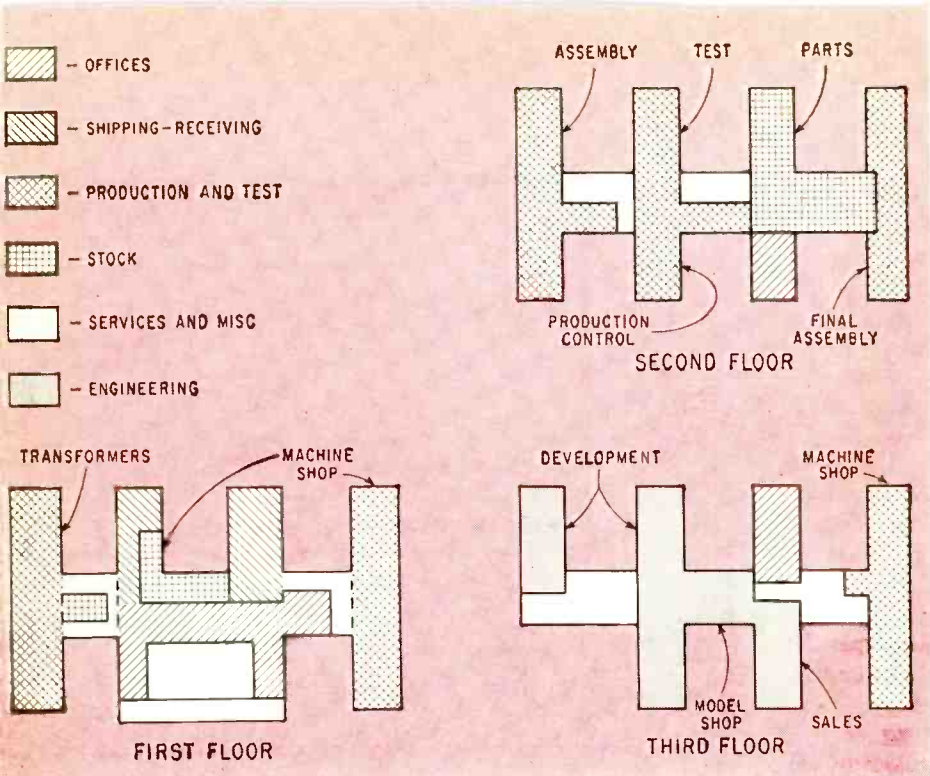

FIG. 5—H-shapes improve natural lighting, help separate functional groups

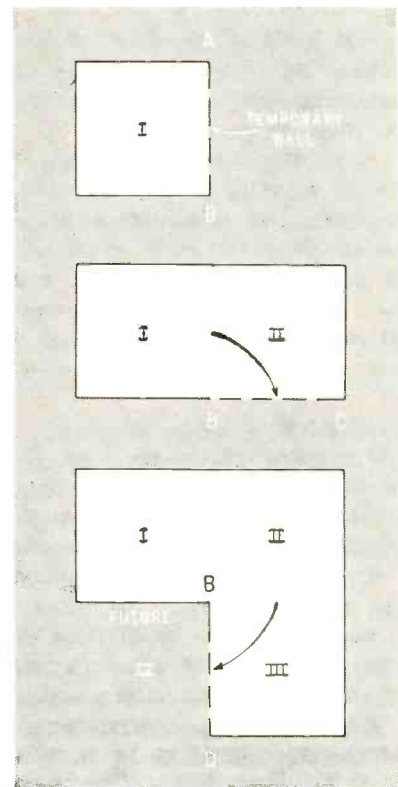

FIG. 6—Prefab wall is moved as plant expands

57,000 square feet. Two sections are in use and two more laid out. Only outside walls of the final building are permanent. One wall made of prefab panels is moved as new sections are built (Fig. 6), saving construction cost and move-in time.

MINIMUM SHUTTLING—Constant shuttling of men and materials among a firm's five buildings in Stamford, Conn., was costly. A new plant keeps shuttling to a minimum. Areas with a common purpose—stockrooms, washrooms, instruments, standards—are centrally located (Fig. 4).

The plant can be expanded from 35,000 square feet to 100,000 by building out from the production area. To promote flexibility, walls in offices are semipermanent and walls in the engineering area are movable.

PROCESS NEEDS—Clevite's transistor products division is getting a new plant designed for semiconductor processing. Since 1952, it has used a former watch factory in Waltham, Mass. The new plant will have controlled environment areas, acid-resistant plumbing, more production mechanization, data processing equipment in the office. Cost will be \$10 a square foot more than renovating the old plant, but the company feels the advantages of a specially designed plant will be worth the difference.

GROUP ORGANIZATION—A plant in West Concord, Mass., is built in a series of H shapes (Fig. 5) to provide functionally related areas. The first section was occupied in 1952, the second in 1958 and the last two this year.

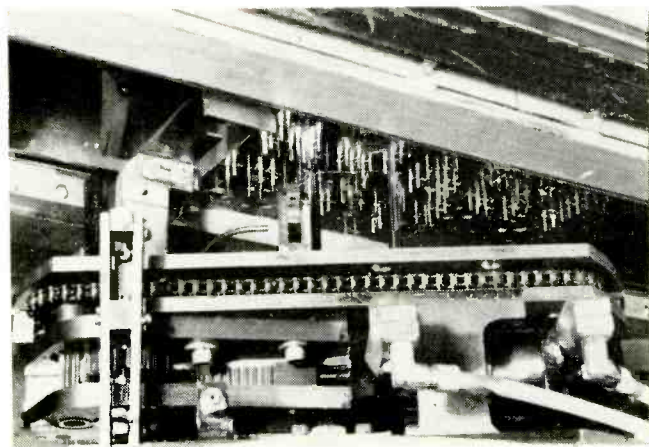

Wire strapping station (viewed from underneath) of Lenkurt's stitched wiring assembly machine



Single-station insertion machines at Librascope. Magnetic stops position boards to accept components

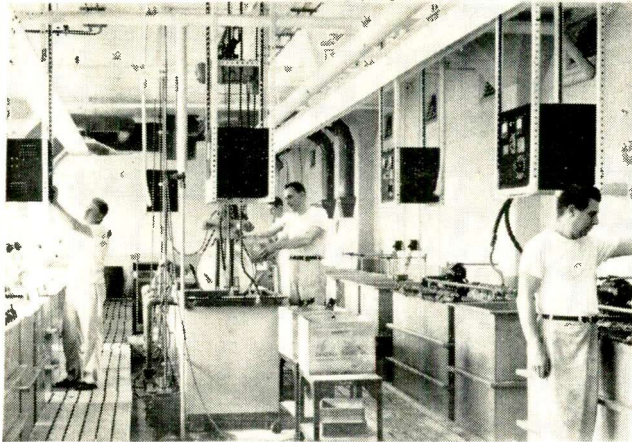

Plating room at General Radio. Acid tanks at right rear have individual exhausts. Emergency shower and eyebath are nearby

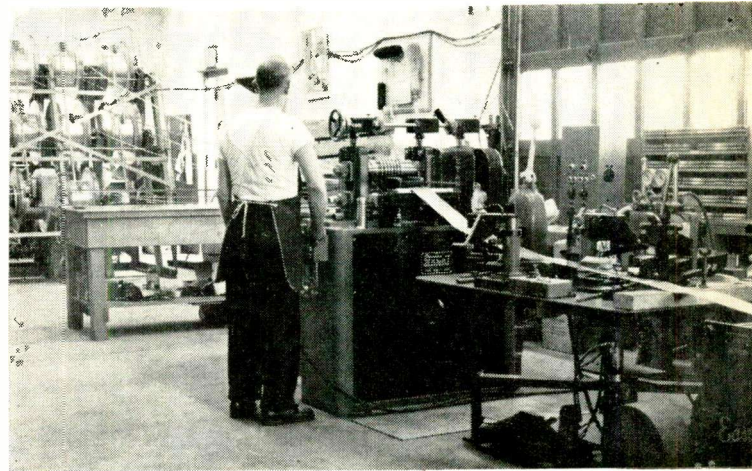

Strip preparation equipment at AMP. Butt welder is at right, slitter in center and spooling racks at left

One group handles metals receiving, shearing and stocking. Another does all plating, finishing, cleaning and soldering. In the machine tools area, a cabinet can be punched, drilled, formed and welded all in one end of the department. Assembly is grouped with its stockroom and test areas. The only exception is transformer production, which is grouped on the first floor because of weight considerations.

Economies from improved methods in a single plant will, we are told, recapture the cost of the 290,000-square-foot building in less than five years.

RENOVATIONS—A plant in Nashua, N. H., was a 33-year-old textile mill when an electronics firm moved in during 1952. The mill was built, however, with relatively clear floor areas and its 500,000 square feet provided plenty of room for growth.

Not all of this space is in use yet. The top floors were occupied first and the company has been growing down, reshuffling facilities as required. The mill's floors readily support heavy equipment.

Major renovations included rewiring the plant for modern lighting and improving the electrical distribution system. An annex—the mill's former waste house—was converted to an environmental lab and

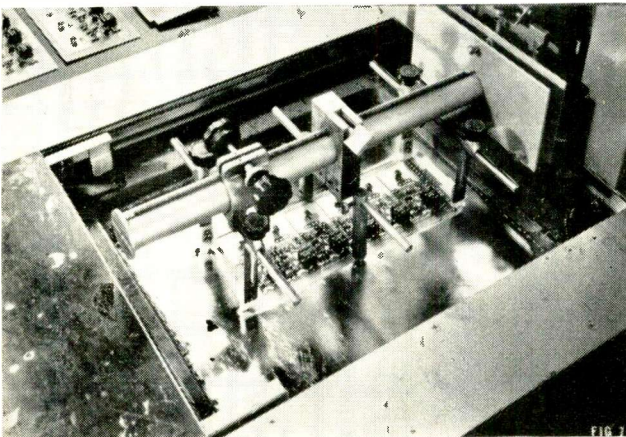

Dip soldering machine. Fluoroplastic fingers hold boards during dipping cycle

provided with generating equipment.

Last fall, an 11,000-square-foot area was converted to a clean room for precision assembly. The two exterior walls, which are solid concrete with double windows, were refinished and new floors, a false ceiling with special lighting, and air-conditioning were installed.

REFERENCES

- (1) McGraw-Hill Department of Economics, *Business' Plans for New Plants and Equipment, 1959-1962*, New York, 1959.
- (2) Financing for Tomorrow, *ELECTRONICS*, p 16, Oct. 24, 1958.
- (3) Your Plant—Lease or Buy?, *ELECTRONICS*, p 144, Jan. 17, 1958.
- (4) G. E. Johnson, Better Decisions on Mechanizing, *Factory*, p 62, July, 1959.
- (5) K. R. Bennett, et al, Developing Automation for Flexibility of Output, *Automation*, p 38, April, 1959.
- (6) P. Carroll, Cost Control, Past, Present and Future, *Factory*, p 62, March, 1959.
- (7) J. R. Bright, Myths and Fallacies of Automation, 1957 Annual Meeting, Society of Automotive Engineers, New York.
- (8) L. L. Lee, Types of Automatic Assembly Equipment, Paper 22, Vol. 58, American Society of Tool Engineers, Detroit.
- (9) Air Cylinders Operate Assembler, *ELECTRONICS*, p 84, May 8, 1959.
- (10) J. D. Cooney and B. K. Ledgerwood, 31 Numerically-Controlled Point-to-Point Positioning Systems, *Control Engineering*, Jan., Feb. and March, 1958.
- (11) W. F. Maynard, et al, "Automatology," General Electric Co., Utica, N. Y.
- (12) G. Sideris, Production Machinery for the Electronics Industry, *ELECTRONICS*, p 73, Oct. 24, 1958.
- (13) W. M. Hancock and J. C. Souter, Mechanized Assembly of Carrier Equipment, *Western Electric Engineer*, p 34, April, 1957 (see also back cover, April, 1958).
- (14) G. M. Shumway and N. R. Brown, Testing Subassemblies in Large and Small Lots, *Control Engineering*, p 78, Dec., 1958.
- (15) L. S. Klivans, Five Examples Show Versatility of Automatic Testing, *Control Engineering*, p 81, August, 1958.
- (16) W. E. Bushor, Instruments for Design and Production, *ELECTRONICS*, p 89, Sept. 11, 1959.
- (17) Same as Ref. 12.
- (18) J. Markus, Mechanized Production of Electronic Equipment, *ELECTRONICS*, p 137, Sept., 1955.
- (19) A. R. Gray, Automation for Electronics—A 1956 Status Report, *Trans. IRE-PGPT*, Institute of Radio Engineers, April, 1957.
- (20) J. M. Coffin, The Lenkurt Automatic Wiring Process, 1959 *IRE Wescon Conv Rec*, p 64, Pt. 6.
- (21) P. L. Anderson and J. A. Zagusta, The Molded Circuit, 15th *An Tech Conf*, Society of Plastics Engineers, New York, 1959.
- (22) Machine Assembles Circuit Modules, *ELECTRONICS*, p 70, July 10, 1959.
- (23) E. C. Hall and R. M. Jansson, Miniature Packaging in Three Dimensions, *ELECTRONICS*, p 63, Oct. 9, 1959.
- (24) Solder Wave in Pot Replaces Dip Soldering, *ELECTRONICS*, p 144, Jan. 17, 1958.
- (25) W. L. Oates, Automatic Soldering Machine for Printed Circuit Board Assemblies, *Proc 1958 IRE Nat Conf*.
- (26) A. S. King and W. H. Hough, Dip Solder Machine Uses Solder Pumps, *ELECTRONICS*, p 108, Jan. 3, 1958.
- (27) J. S. Gellatly, et al, Low-Voltage Percussion Welding, *Western Electric Engineer*, p 22, July, 1959.

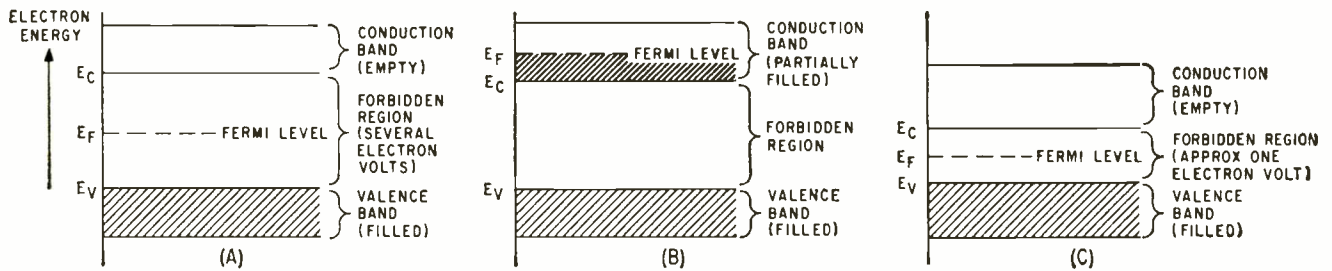

FIG. 1—Electron energy band diagram for an insulator (A), a conductor (B) and a pure semiconductor (C)

The Tunnel Diode—

DURING October of 1957 Leo Esaki, a young Japanese physicist, revealed the results of his research on the tunneling effect in thin semi-conductor junctions. This effect has recently been utilized in the development of the tunnel diode. The new device has many advantages over the transistor—it is smaller, cheaper, more reliable, more resistant to radiation, has a greater temperature range and a much higher cutoff frequency.

Operating Principle

The tunnel diode gets its name from the quantum-mechanical tunneling which characterizes its unique operation. In highly doped *p-n* junctions, the majority charge carriers can tunnel through the

junction barrier and appear with the speed of light at the other side. The device exhibits a voltage-controlled negative conductance which suits it for many applications as an oscillator, amplifier, or switching element, and has a predicted operating range beyond 10,000 mc.

To understand the operation of the highly doped tunnel diode, the energy band diagrams of various types of crystalline material and the formation of a moderately doped ordinary *p-n* junction must be examined. Figures 1 and 2 show how available energy levels in a crystalline lattice are split into bands.

Insulator Energy Levels

In an insulator, the highest energy band containing electrons is

filled and separated from the empty band above it by a forbidden region of several electron volts as shown in Fig. 1A. There are no available states for electrons within this forbidden region. A large amount of energy is required to raise an electron from the top of the filled band (valence band) to the bottom of the empty band (conduction band). Once in the conduction band, the electron is disassociated from its atom and is free to move through the lattice.

Fermi level is defined as that energy level where the probability of an available state being occupied by an electron is equal to 50 percent. For an insulator, the probability of occupancy of the conduction band states is zero and the probability of

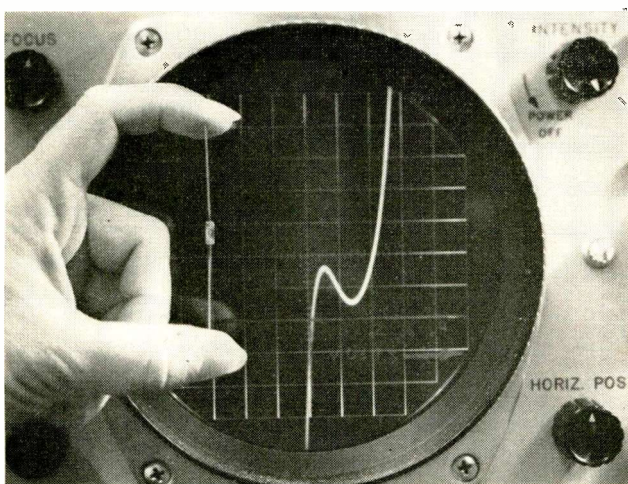

Tunnel diode held by fingers exhibits breakdown characteristics shown on scope

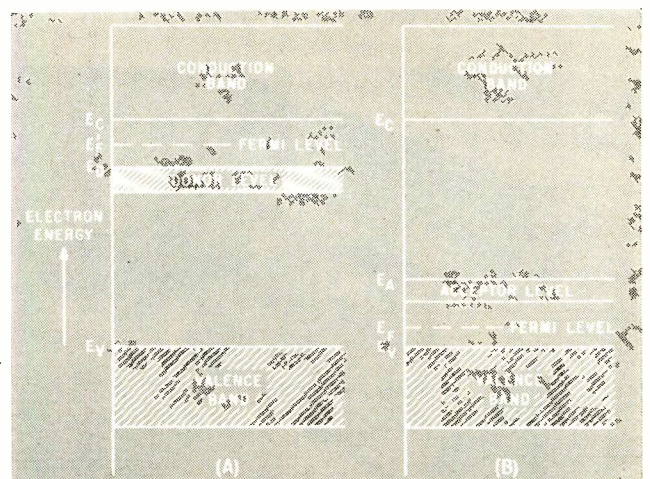

FIG. 2—Electron energy band diagram for *n*-type (A) and *p*-type (B) materials

Negative conductance property of new diode is explained using fundamental electron energy band diagrams. Breakdown characteristics of tunnel and ordinary diodes are compared. Operation of tunnel diode in an amplifier is described with equivalent circuit

By **BERNARD SKLAR**, Member of Technical Staff, Hughes Aircraft Co., Culver City, Calif.

Its Action and Properties

occupancy of the valence band states is unity; therefore, the Fermi level must exist at the center of the forbidden region.

Conductor Energy Levels

In a conductor, the highest band containing electrons overlaps the first empty band as shown in Fig. 1B. This partially filled band can be considered the conduction band and the filled band below it, the valence band.

The electrons in the conduction band require little energy to move to an empty level. In so doing the electrons become disassociated from their atoms and are free to move.

For a conductor, the energy level that corresponds to a 50 percent probability of electron occupancy (Fermi level) is also the maximum possible energy that an electron may have in the crystal at a temperature of absolute zero. The Fermi level of a conductor always appears in the conduction band.

Pure Semiconductor Energy Level

The energy band diagram shown in Fig. 1C for an intrinsic (pure) semiconductor is similar to the insulator diagram. However, instead of the forbidden region extending over several electron volts, the gap in the semiconductor has a much smaller value equal to approximately one electron volt. Since this is a relatively small energy gap, some electrons have sufficient thermal energy at room temperature to

surmount the forbidden region and appear in the conduction band.

The result of a valence electron crossing this gap is referred to as the formation of an electron-hole pair. That is, a negatively charged electron becomes free to move in the conduction band and a positively charged hole (the absence of an electron) is correspondingly free to move in the valence band. Each of these charged particles contribute to current flow and are generally referred to as carriers. The Fermi level for the intrinsic semiconductor is at the center of the forbidden region.

Doped Semiconductor Energy Level

Extrinsic (doped) semiconductor materials are either *n*-type (excess of electrons) or *p*-type (excess of holes). Figure 2A illustrates the energy-band diagram for *n*-type material. This diagram reveals a new energy level, E_D , corresponding to the donor doping material and appearing slightly below the bottom of the conduction band, E_C . A small amount of energy is necessary for donor electrons to escape from the donor level and rise to the conduction band.

At absolute zero there is no thermal energy available for any donor electrons to appear at E_C , thus the Fermi level is found midway between E_C and E_D , since it prescribes total occupancy below that level and total vacancy above it. As the temperature increases and electrons

EARLY TUNNELING THEORIES

Calculations showing that the tunnel effect was possible were made independently by Gamow, and Gurney and Condon in 1929. These physicists based their theories on the quantum-mechanical approach.

It was thought that, because of the wave nature of matter, particles of a given potential probably could penetrate barriers of higher potential. This probability was expected to decrease rapidly as the barrier got thicker and as the barrier potential increased.

Theoretical calculations of the tunneling effect in high-impurity germanium semiconductors were made by P. Aigrain in 1954.¹ This study pointed out that band problems with random potentials were not impossible to handle. Also, it showed that vanishing activation energies for high impurity concentrations can be understood as an overlap between the impurity and conduction bands

gain enough thermal energy to escape into the conduction band, the Fermi level falls until at a high enough temperature it approaches the intrinsic case.

Figure 2B illustrates the energy band diagram for *p*-type material. This diagram reveals an energy level, E_A , corresponding to acceptor doping and appearing slightly above the top of the valence band.

It can be shown that the Fermi level in *p* material is found midway between E_V and E_A at absolute zero and rises with increasing tempera-

ture until in the limit it also approaches the intrinsic case.

Junction Phenomena

If *p*-type material is joined to *n*-type material in the formation of an ordinary diode, Fig. 3 indicates the phenomenon that takes place at the junction. Figure 3A shows the *p* and *n* materials before the junction is formed.

At the instant of junction, there is a higher concentration of holes in the *p* material than in the *n* material resulting in a diffusion of holes into the *n* material as shown in Fig. 3B. Simultaneously, there is a diffusion of electrons into the *p* material. The diffusive flow quickly results in a net negative charge caused by immobile acceptor ions at the *p* surface and a net positive charge caused by immobile donor ions at the *n* surface. The boundary region between the *p* and

to *n*-type material. Since at equilibrium the average energy of each half of the resulting slab must be equal, the Fermi levels E_F and $E_{F'}$ must line up at the same energy level. Consequently, we can consider the *p*-type diagram moving up and the *n*-type diagram moving down with respect to each other. The resulting diagram for the diode is shown in Fig. 3C.

The hill at the depletion region represents the potential barrier which opposes the flow of holes from left to right and the flow of electrons from right to left. If the diode is forward-biased, the barrier height decreases and current is allowed to flow in the forward direction. If the diode is reverse-biased, the barrier height increases and only a small reverse saturation current can flow. If reverse bias is continuously increased, a breakdown voltage will be reached where

concentration increases to about 6×10^{20} atoms per cc (for silicon), the semiconductor begins to resemble an alloy and the characteristic is in the breakdown condition at zero and even slightly positive bias as shown in Fig. 4B.

For all back biasing, the diode is highly conducting in the reverse direction; for small forward biasing, the current increases linearly with voltage in the forward direction until it reaches a peak. With increased forward bias, the forward current then drops to a minimum, thereby manifesting the negative conductance peculiar to the tunnel diode. This forward current at low forward bias, which disappears with increased bias, is called the Esaki current.

With still larger positive bias the characteristic increases like that of an ordinary diode. Unlike the usual breakdown curve which occurs over a range of reverse bias, the breakdown region here extends from a small positive bias (approximately 50 to 100 millivolts for germanium) to all negative biases. As the tunnel diode goes into breakdown, the current flow decreases until reversal takes place. This is so different from the usual breakdown condition, that probably the term breakdown is not applicable.

Two important criteria for making a tunnel diode are heavy doping in the order of 10^{20} atoms per cc (for silicon) and an extremely thin depletion region in the order of 100 angstroms. Since the depletion width of an abrupt junction is an inverse function of the doping concentration, a high enough impurity concentration and an abrupt junction will satisfy the latter criterion.

Tunnel Effect

Figure 5 is an energy band diagram for a highly doped *p-n* junction. The cause for the negative conductance is now obvious. First, the semiconductor is so highly doped that it is degenerate and resembles an alloy (it is sometimes called a semimetal); second, unlike the moderately doped semiconductors, the Fermi level, E_F in the degenerate case is in the conduction band for *n*-type material and in the valence band for *p*-type material. Therefore, when the junction is

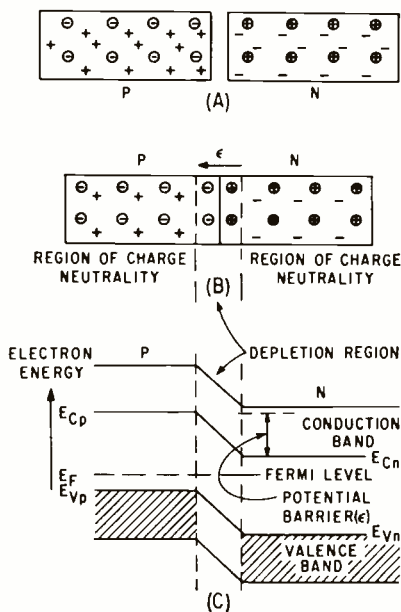

FIG. 3—Moderately doped *p*- and *n*-type materials (A) when junctioned (B) form a diode having energy band diagram (C)

n sides becomes devoid of holes and electrons, and is known as the depletion region.

A potential difference or barrier, ϵ , is established at the junction because of the field generated by the exposed charges. The Fermi level can be considered as a level depicting the average energy associated with the electrons of the crystal.

With reference to Fig. 2, assume that *p*-type material is to be joined

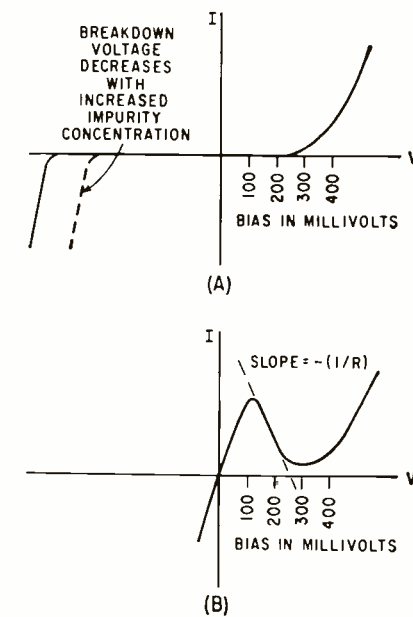

FIG. 4—Breakdown characteristic of ordinary germanium diode (A) and of germanium tunnel diode (B)

the reverse current suddenly rises to a large value because of the avalanche effect.

Tunnel Diode Characteristics

Figure 4 illustrates the difference between ordinary diode and tunnel diode characteristics. As the impurity concentration is increased in the ordinary diode, the breakdown voltage decreases as shown in Fig. 4A. When the impurity con-

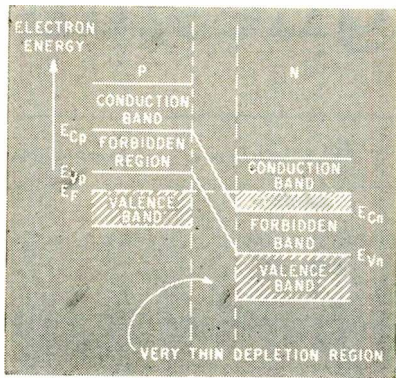

FIG. 5—Electron energy band diagram for highly doped p - n junction. Note difference from conventional diode (Fig. 3)

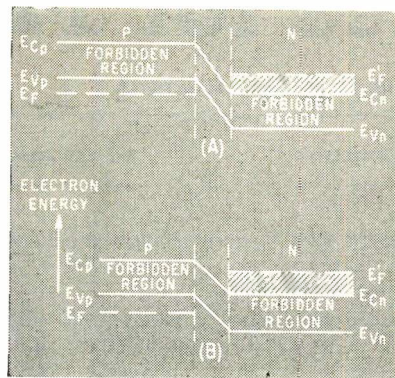

FIG. 6—Electron energy band diagrams for tunnel diode with small positive bias (A) and increased positive bias (B)

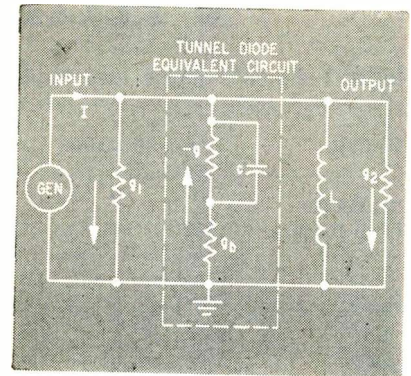

FIG. 7—Equivalent circuit of linear amplifier using a tunnel diode. Input is constant current source

formed and the Fermi levels line up, the diagram is different than that of an ordinary diode. In the case of the highly doped p - n junction, there are some electrons in the n -material conduction band that have the same amount of energy as some electrons in the p -material valence band.

With a small amount of positive bias, figure 6A, the junction barrier is decreased and n -material conduction electrons are situated opposite p -material available states at the same level of energy. Quantum-mechanics dictates that under this condition there is a finite probability that an electron originally on one side of the junction can appear on the other side at the same energy level by tunneling through the barrier at the speed of light. The tunneling probability can be made high enough to support large currents.

With increased positive bias the junction barrier is further decreased and the n -material conduction electrons are opposite the p -material forbidden region as shown in Fig. 6B. Therefore, there are no available states to which the electrons can tunnel and the current (theoretically zero) is small as indicated by the valley in the characteristic shown in Fig. 4B. The current has decreased with increased positive voltage, thus demonstrating negative conductance. Further increase of positive bias results in sufficiently decreasing the junction barrier so that carriers can surmount it and contribute to current flow as in ordinary diodes.

Tunnel Diode Amplifier

An equivalent circuit for a tunnel

diode amplifier is shown in Fig. 7.² The input is a constant current source supplying a current, I , and having a shunt conductance, g_1 . The tunnel diode equivalent circuit is a negative conductance, $-g$, shunted by the junction capacitance, C . The parallel combination is in series with a dissipative conductance, g_2 , resulting from the ohmic contacts. The inductance, L , is added to tune out the diode capacitance. The output conductance is g_2 .

Without the tunnel diode, current I divides between g_1 and g_2 . When the diode is inserted, the current through it will be in such a direction as to increase the currents through g_1 and g_2 . Neglecting g_2 and L , the power gain for the amplifier can be shown to equal $4g_1g_2/(g_1 + g_2 - g)^2$.

The concept of amplification by the use of negative conductance is not new. In 1918, A. W. Hull disclosed the dynatron (a voltage controlled negative conductance device) and in 1935, E. W. Herold pointed out the possibility of using its unusual characteristic for amplification. However, the lack of a convenient device has made the use of such amplifiers unattractive. It now appears that the simple, inexpensive tunnel diode will reawaken interest in negative conductance amplifiers.

Advantages of Tunnel Diodes

Tunnel diode amplifiers have gain-bandwidth products and noise factors considerably better than those of grid-controlled electron tubes. One of the most impressive features is the wide temperature range over which the negative char-

acteristic can be obtained—from 4.2 K (liquid helium) to over 400 C for silicon devices. Also, in a radioactive environment a conventional transistor is badly degraded because radiation shortens the lifetime of the minority carriers; however, since tunnel-diodes operate by the flow of majority carriers, they are particularly resistant to radiation effects. Many circuits have already been built with tunnel diodes including i-f amplifiers, oscillators, converters, r-f detectors, limiters, flip-flops, and various switching devices which respond within a fraction of a millimicrosecond and require very little power.

Considering all the accolades that have been heaped upon the tunnel diode, it is only fair to mention the device's one drawback. It is not yet possible to couple several stages with ease and obtain a unidirectional circuit. The dilemma of isolating output from input is inherent to all two-terminal devices. It remains to the ingenuity of the circuit designer to overcome this difficulty and make the tunnel diode a prodigious building block.

REFERENCE

- (1) P. Aigrain, Theory of Impurity Bands with Randomly Distributed Centers, *Physica*, XX, No. 11, p 978, 1954.
- (2) K. K. N. Chang, Negative Conductance Amplifier, *Proc IRE*, July, 1959.

BIBLIOGRAPHY

- H. S. Sommers, Jr., Tunnel Diodes as High Frequency Devices, *Proc IRE*, July, 1959.
- H. S. Sommers, Jr., Tunnel Diodes for Low Noise Amplification, *IRE Wescon Conv. Record*, Part 3, 1959.
- I. A. Lesk, Germanium and Silicon Tunnel Diodes—Design, Operation and Application, *IRE Wescon Conv. Record*, Part 3, 1959.
- R. D. Middlebrook, "An Introduction to Junction Transistor Theory", J. Wiley & Sons, Inc., New York, 1957.
- D. Dewitt and A. L. Rossoff, "Transistor Electronics", McGraw-Hill Book Co., New York, 1957.

Finishes for Magnesium

Table I—Paint Primers and Finishes and Their Characteristics

Finish	Specification	Comments	Advantages	Disadvantages	Application
PRIMERS					
Wash Primer	MIL-C-15328A MIL-C-8514 (Aer)	recommended with chemical surface treatments on magnesium ^d	improves adhesion; use up to 500 F	two component material	brush or spray
Modified Vinyl	MIL-P-15930A	recommended for magnesium	good alkali resistance; good adhesion	not serviceable above 250 F	dip, brush or spray
Epoxy	proprietary ^c		excellent at high temp; good adhesion, alkali resistance		brush or spray
Zinc chromate	MIL-P-6889A	performance inferior to MIL-P-15930A & epoxy	good adhesion	poor alkali resistance	dip, brush or spray
API0 (Poly-Vinyl Butyral)	proprietary ^a		alkali-resistant when baked; good adhesion	baking preferred	dip, brush or spray
405 P (Vinyl)	proprietary ^a		air dried	not serviceable above 250 F	dip, brush or spray
TOP COATS					
Vinyl Alkyd	MIL-P-15936A	excellent service experience	air dried; good adhesion, alkali resistance	poor high temperature resistance	dip, brush or spray
Acrylics	proprietary ^b		good adhesion and salt-spray resistance		dip, brush or spray
Alkyd Enamels	TTE-485 TTE-489	used with MIL-C-15328A & MIL-P-15930A	good exterior durability	poor alkali and high temp resistance	dip, brush or spray
Epoxies	proprietary ^c	used successfully on wave-guides	good adhesion, high temp and abrasion resistance		brush or spray

Table II—Chemical Treatments Used as Paint Bases and Plated Finishes for Magnesium Alloys and Their

Finish	Specification	Comments	Advantages
Chrome pickle	Dow 1; MIL-M-3171 (Type I) AMS 2475	use of wash primer promotes paint adhesion; good touch up	provides acid surface and pebble etch for paint adhesion; low treatment time; low resistance for grounding; protects parts in storage
Iridite 15	proprietary ^e	good touch up when rinsed well	low treatment time
Dichromate (acid or alkaline)	Dow 7: acid Dow 8: alkaline MIL-M-3171 (Type III) AMS 2475	7: good adhesive bond base; 8: black surface, for interior of sealed components; both: wash primer promotes paint adhesion	{acid surface; virtually no effect on dimensions of parts; excellent corrosion resistance
Galvanic Anodize	Dow 9 MIL-M-3171 (Type IV)	use wash primer to promote paint adhesion	acid surface; almost no dimensional change; for M-1, Mg-Th, Mg-Al alloys; good black surface
Caustic Anodize	Dow 12 MIL-M-3171 (Type V)	wear-resistant coating	no "croaking"; good wear resistance and dielectric properties
Acidic Anodize	Dow 17 MIL-F-14072, AMS 2478, FCS 155	thickness and color of coating vary with voltage	acid surface; excellent resistance to salt water, high temp, wear; alkali-resistant
HAE	MIL-F-14072, MIL-C-13335, AMS 2476	thickness and color of coating vary with voltage	alkali-resistant; excellent resistance to salt water, high temp; abrades less than Dow 17
Electroplate	proprietary ^f process ^g	decorative wear-resistant finish and solder base	permits application to magnesium of any metal that can be electroplated
Electroless Nickel	proprietary ^f process	wear-resistant finish; solder or electroplating base ^h	simple equipment used; uniform thickness; no masking of dissimilar metals

(a) Metal and Thermite Corp. (b) E. I. DuPont de Nemours & Co. and Rinsheed-Mason Co. (c) Examples include: Nubelon S (Glidden); Aero Catl-Coat (Sherwin-Williams); PT 201 (baked) and PT 401 (air dried) (Prod-

ucts Techniques); Chemfast (Truscon Laboratories); Copon (Coast Paint & Lacquer); Cat-A-Lac (Finch Paint & Chemical); Permagro (Grand Rapids Varnish); V-570 (Midland Industrial Finishes). (d) 0.0002 to 0.0003 inch

Electronic Components

Properties of paints, chemical conversion coatings and electroplated finishes suited to varying environmental and electrical requirements

By JOHN A. STEVENS, Technical Service and Development, Dow Metal Products Co., Midland, Michigan

MAGNESIUM ELECTRONIC COMPONENTS are finished to provide corrosion resistance. For this purpose, organic finishes are preferred. Plating is used when solderability, solder wettability, r-f grounding or hermetic sealing is desired. An electroplate plus paint is used to achieve maximum corrosion resistance.

In general, organic finishing systems for magnesium consist of chemical pretreatment, primer and paint. Primers are usually, but not always, required for good paint adhesion. Interiors of components generally are chemically treated only.

Finishing requirements for magnesium electronic components are covered in government specifications. Choice of a particular finishing system varies with service conditions. The chief considerations are whether the exposure is indoor or outdoor and whether it is at room or elevated temperature.

Tables I and II show the properties and uses of

various finishes. Surface resistance of the paints listed is generally high, varying with the thickness. Manufacturers' recommendations on thickness should be followed.

As a rule, vinyl paints can be used for exposures ranging from room temperature to 250-300 F. For exposures at higher temperatures, other paints are used in the following order as temperature increases: modified vinyls, epoxies, modified epoxies, epoxy-silicones and silicones.

In the case of plating, a tin, tin-zinc or tin-lead plate is used for solderability or hermetic sealing, gold plate for solder wettability and silver plate for r-f grounding. These may be applied by the conventional zinc immersion method or over electroless nickel which has been plated directly onto bare magnesium.

Most finishes can be applied by dipping, brushing, or with a conventional spray gun.

Physical, Chemical and Electrical Properties

Disadvantages	Application Method	Surface Resistance	Thickness (inches)	Operating Temp
not alkali-resistant; must allow for etching in machining tolerances; nonuniform; subject to powdering and staining	dip or brush	300 μ ohms	negligible	up to 450 F
not alkali-resistant; residues must be thoroughly removed by rinsing	dip or brush		less than 0.0001	up to 550 F
not alkali-resistant; cannot be used on alloys which do not contain aluminum or zinc	dip	0.5-1 ohm	less than 0.0001	up to 550 F
	dip	0.5-1 ohm	less than 0.0001	up to 550 F
not alkali-resistant; decomposes on long exposure to 500 F; racking required	dip	0.5-1 ohm	0.0002-0.0003	up to 680 F
requires racking, post treatment for paint adhesion	anodize — racking and dipping	high (200-300 voltage breakdown)	ultra-thin: 0.0001 thin: 0.0001-0.0003 full: 0.001-0.0015	stable above melting point of metal
requires racking; dissimilar materials except aluminum alloys 220, 5052, & 5056 need masking				
requires post treatment or sealing for paint adhesion; all dissimilar metals need masking				
large areas of steel must be masked				
must tin plate if solder rosin-cored; must stress relieve part to be soldered or subject to thermal shock			0.0008-0.001 minimum for interior use; 0.002-0.0025 for exterior use	

thick (e) Allied Research Products Corp. (f) Licensed by Dow Chemical Co. (g) Zinc immersion coating, copper strike and electroplate. Painting adds corrosion resistance and reduces required thickness; tin top plate is

most popular paint base. Corrosion resistance depends on part geometry; thickness depends on geometry and alloy. (h) Nickel surface better than electroplated; all common electroplates can be applied over nickel.

Infrared Detector Trains Tank Gunners for Combat

Remote controlled moving target system simulates battle conditions for training gunners in tank warfare. Infrared detector senses projectile passing within target area and relays signal for use as hit indication

By **WILLIAM P. BATTISTA**, U. S. Naval Training Device Center, Port Washington, N. Y.,

IRVING ROTH and ROBERT RACHLIS, Bulova Research and Development Laboratories, Woodside, N. Y.

TRAINING IN THE accurate firing of tank weapons requires practice with erratically-moving targets. Present systems use moving targets which are mounted on self-propelled or towed vehicles traveling on a straight or closed track. Such systems are subjected to rapid target destruction, with a resulting need for comparatively expensive replacements, and limitations on the sizes and characteristics of the rounds that can be fired.

The target system to be described

eliminates the above drawbacks and has other features that increase combat effectiveness. Although designed to meet the marksmanship requirements of tank and antitank weapons, the system can be adapted to other weapon range needs.

Main elements of this system are a portable control console and a vehicle carrying a six-foot high trapezoidal target. Passive infrared hit sensing circuits detect passage of rounds through the target which roughly represents the vul-

nerable portions of an enemy tank and defines marksmanship skill for successful tank combat. Figure 1 is the basic block diagram of the system.

Vehicular motion is under continuous radio control of an operator stationed at the control console at a convenient point behind the firing line. Supplementary controls are provided at the vehicle itself to permit its guidance takeover as required.

All hits are telemetered to a conventional counter on the control console. For realism, hits by main armament rounds, such as 76 mm and 90 mm, are also indicated by smoke clouds automatically released by equipment carried on the target vehicle.

The smoke generator contains pressurized liquid titanium tetrachloride which forms a dense white smoke when sprayed out as a mist.

Hit Detection and Scoring

If the target area can be defined optically, then a signal from the infrared transducer can be used as the hit indication. The target area is defined by three telescopes located as shown in Fig. 2.

The requirements of the optical components introduce several conflicting parameters. The system

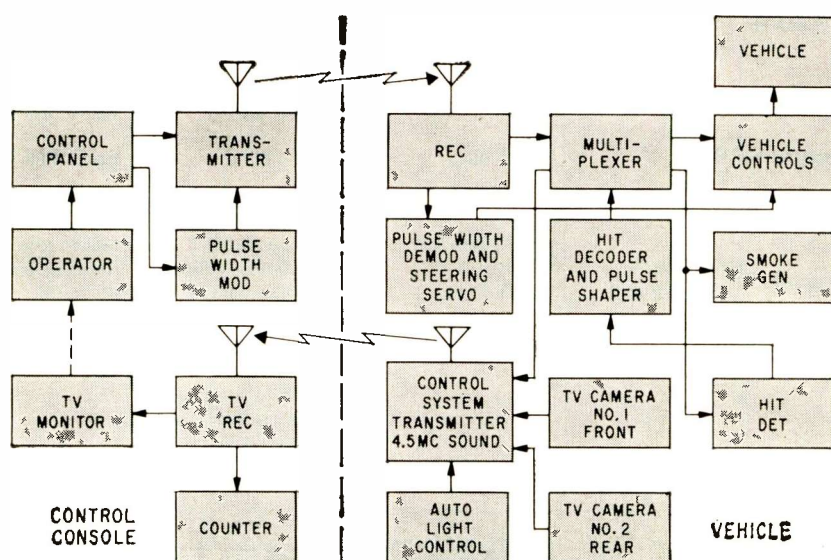
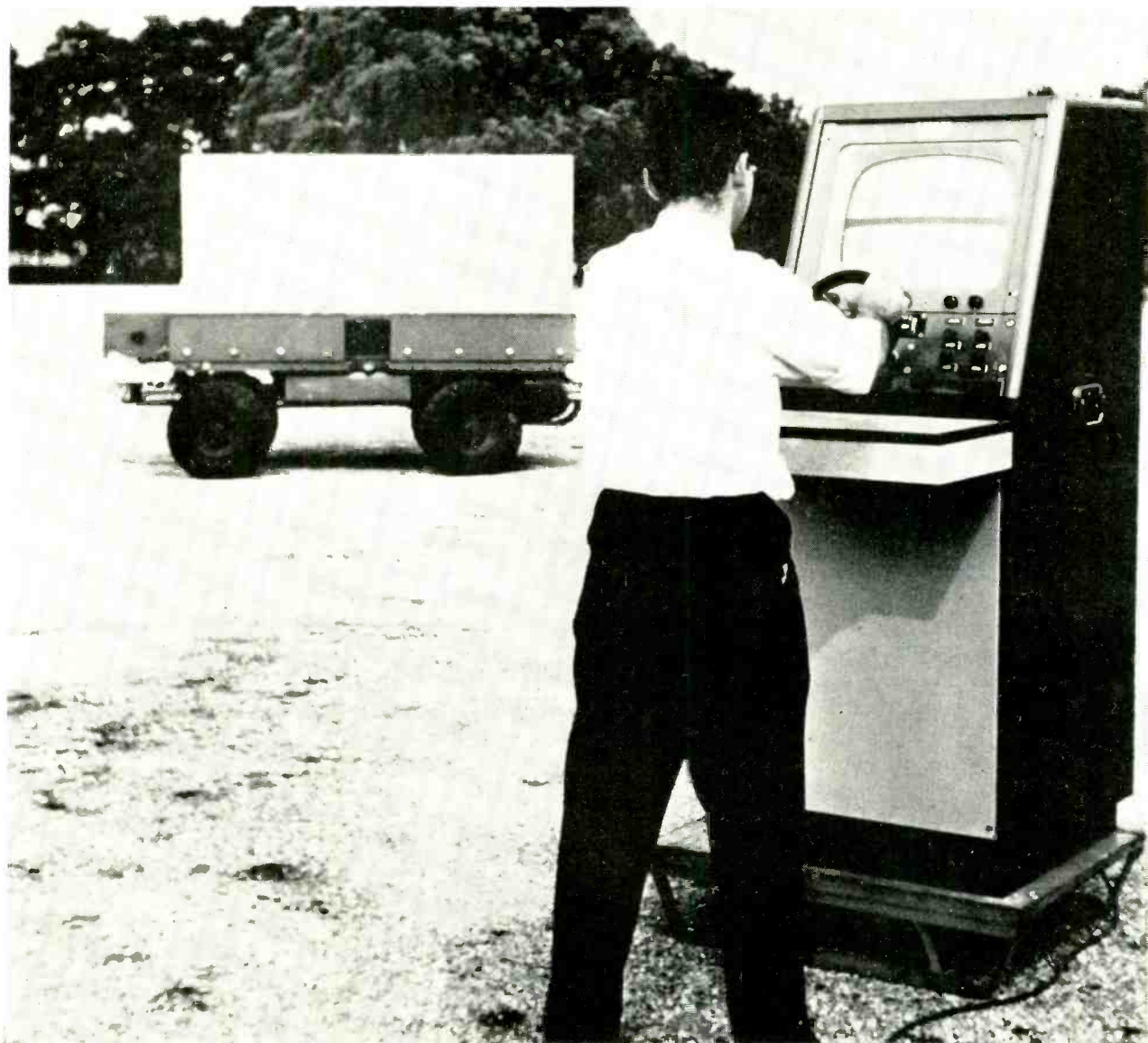

FIG. 1—Infrared detector system telemeters hits to control console



Target vehicle is steered from control console and monitored on television screen

must have a short focal length, in order to maintain a small detector size, and a large aperture to collect enough infrared energy to provide a positive signal from the detector. The target area definition requires that the optical system have a wide angle (approximately 65 deg).

Solution of these optical requirements was found in the use of a Schmidt system using a 4-inch radius-of-curvature mirror and a 5-inch diameter, uncorrected cover plate. Although the resolution of this system is low, it is sufficient for defining the target area on a go, no-go basis.

The signal from the lead sulfide

detector cell is amplified in a hybrid amplifier using one vacuum tube to provide the high input impedance and first stage low noise amplification, and three transistor stages. The output of the three amplifiers is fed into an AND gate to detect coincidence and hence the appearance of a round in the target area.

Hit Sensing

Output of the AND gate operates a flip-flop which in turn triggers a smoke generator and provides a pulse which is transmitted to the firing line and is registered on a counter, shown in Fig. 3.

Only a pulse input is detected. As

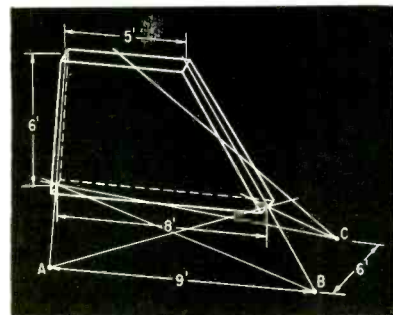

FIG. 2—Three telescopes define target area

a result, the background daylight level, which is effectively d-c, has no effect on the detection capabilities of the system. However, it is necessary to protect the lead sulfide cell from possible saturation and overheating due to direct sunlight. A germanium infrared transmission

filter is therefore deposited on the cover plate of each telescope. For secondary cooling of the cell it is possible to circulate air through the telescope, using the adjusting hole in the center of mirror.

Remote Controlled Vehicle

The target-carrying vehicle is a half-ton weapons carrier capable of forward and reverse motion at speeds of 8 and 16 miles per hour. It can turn left or right with varying radii over terrain having a gradient up to five degrees. The controls are operated by electromechanical systems actuated by the remote control system. All controls are on-off controls except for the steering, which is a proportional control, and the gearshift which has three positions: forward, neutral and reverse.

The vehicle is controlled by radio telemetry from a remote position at a maximum distance of 2,000 yards. This is done with the aid of the drone Q 19 Receiver-Transmitter Set. The transmitter is an audio tone amplitude-modulated transmitter operating in the vhf range. The receiver is a superregenerative detector with individual tuned tone amplifiers. The set is modified to transmit three channels simultaneously.

Since the receiver has only five channels, the relay output is multiplexed to give a minimum of 11 separate control signals. All commands are of the digital type except the steering command which is analog. The multiplexer provides 10 operation commands. These are: smoke, counter, start, stop, high, low, forward, neutral, reverse and spare. The command signals are self-latching and are interconnected to assure proper operation of the vehicle.

Remote steering of the vehicle is accomplished using radio transmission of steering commands, a steering servo on the vehicle, and visual feedback to the operator via a television system. A detailed block diagram of the system is shown in Fig. 4, and the mechanical components of the steering servo are seen in Fig. 5.

The system input device is a spring-loaded steering wheel coupled to a potentiometer for electrical position pickoff. The spring

loading provides steering feel or torque feedback to the operator. The potentiometer output voltage pulse width modulates a sub-carrier channel which in turn modulates the transmitter signal.

The radio signal is received at the vehicle, detected, filtered and demodulated. The demodulated signal is used to cut off a normally conducting transistor. Thus, the off time of the transistor is proportional to the steering angle. The transistor output is then filtered to provide the servo input signal. The servo consists of a transistorized error amplifier and compensator feeding into magnetic clutches with appropriate gearing to effect steering control. Steering angle feedback is provided by a potentiometer mounted at the steering column. Stabilization is provided by a d-c tachometer mounted at the magnetic clutch output shaft.

Television System

Since it is not practical visually to steer a vehicle from a distance of 2,000 yards, a television system is used to establish the position of the vehicle. The system used is a commercially available, closed-loop system which is specially constructed

and mounted to withstand vibration and shock. The outputs of two cameras are combined to provide a simultaneous front and rear split view on the receiver. An audio sub-carrier is used to transmit hit data to the control console where it is recorded.

The basic concept of design is to provide the operator with automotive type controls. The presentation of the television receiver simulates the view through a windshield and a rear view mirror. All general system controls are located on the right side of the control panel. These controls start and stop the system and choose the method of hit indication. Commonly used controls such as speed and gearshift are placed on the left side.

The operator is also provided with a steering wheel and a brake pedal. All control buttons are illuminated to provide visual indication of the activated controls. The control console contains the television monitor, the control signal multiplexer, the pulse width modulation circuit for proportional steering control, the Q 19 radio transmitter set, and a power supply for the transmitter.

A lead sulfide photoconducting

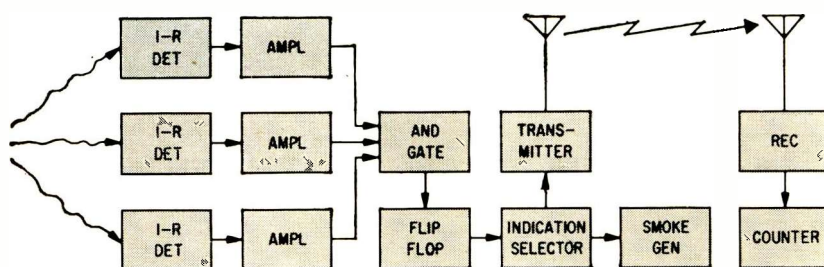

FIG. 3—Hit sensing circuit employs lead sulfide sensor

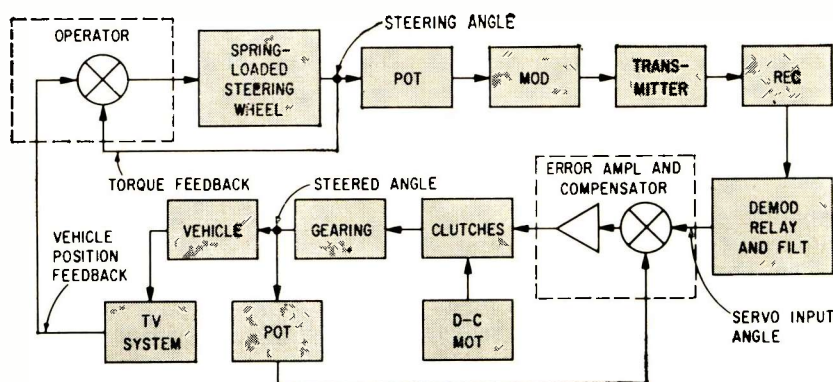

FIG. 4—Steering system uses closed circuit television

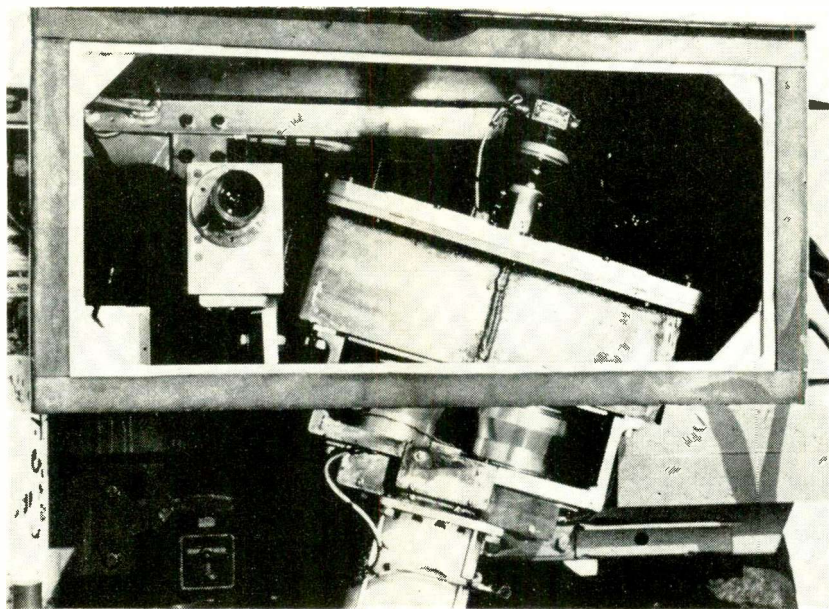
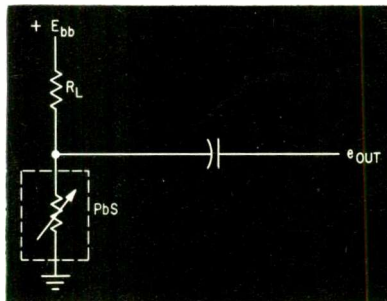

FIG. 5—Front view of vehicle shows forward tv camera at left of steering servo area box. Tachometer above gear box provides damping; two magnetic clutches below control steering direction

FIG. 6—Lead sulfide cell is one leg of potential divider



sensor was chosen because of its high sensitivity. As with other semiconductors, electrons can be raised to the conduction band by incident electromagnetic radiation. For lead sulfide, the threshold wavelength is in the vicinity of 4μ . The cell has the effect of a 0.5 megohm variable resistor.

Cell Sensitivity

Incidence of radiation on the cell causes a differential decrease in resistance. The cell is used as one leg of a potential divider shown in Fig. 6, and the signal is taken from the divider as a voltage variation. Cell sensitivity is a function of many parameters, but for a working figure it can be assumed that it will be better than 10^{-8} w noise equivalent power for incident radiation shorter than 3.5μ .

Feasibility of this detection technique was shown by analyzing the most critical situation—detection of a 0.30-caliber bullet fired at machine-gun rate.

The bullet was approximated as

a black body source with a radiating area of 0.0001 sq in. This area was chosen as an estimate of the worst possible condition. A value of 267 C was obtained for the limiting temperature by computing the stagnation temperature of a cone. In this calculation a value of Mach 2 was used for muzzle velocity and 27 C for ambient temperature.

A 1 cu cm cell with five sensitized faces was placed in the focal region of a parabolic reflector from a stroboscopic tachometer. The reflector had a 2.5-inch focal length and a 9-inch diameter. A black body with a 0.094-inch aperture set at 210 C was placed 6.5 feet from the detecting system. Using a readily available transistor preamplifier, amplifier and oscilloscope, a signal-to-noise ratio of 10:1 was observed for a chopping frequency of 700 cps. Further experiments were performed at Fort Tilden, N. Y. with a 5-inch sniper scope infrared filter placed above the reflector to protect against sunlight and variation in visible radiation.

The detecting system was placed approximately 8 feet below the bullseye of a standard A target. Shots were fired into and above the target from a range of 200 yards with a 0.30-caliber rifle. In all cases a positive signal was recorded. Laboratory tests indicated the energy equivalent of the bullet at a range of 8 to 12 feet from the detector is a black body, set at 350 C with a 0.25-inch aperture at 7 feet from the detector.

Power Calculations

Power radiated by a black body at 350 C into π steradians in the wavelength region from 1μ to 3.5μ equals 0.084 w per sq cm. The radiating area is 0.0707 sq in., or, 0.456 sq cm.

Radiating power of the source is $0.084 \text{ w/sq cm} \times 0.456 \text{ sq cm}/\pi$ which equals 0.0122 w per steradian. The solid angle subtended by the mirror at the detector is $\pi \times (2.5 \text{ in.})^2 / (7 \text{ ft} \times 12 \text{ in.})^2$ which equals 0.00278 steradian. Total radiant power incident on the filter is $0.0122 \text{ w per steradian} \times 0.00278 \text{ steradian}$ which equals $33.9 \times 10^{-6} \text{ w}$. The transmission factor of the filter is $\frac{1}{3}$. Thus, the total power entering the optical system is $11.3 \times 10^{-6} \text{ w}$. An optical system efficiency of 50 percent is assumed, giving $5 \times 10^{-6} \text{ w}$ total energy incident on the detector. This is compared with the noise equivalent power of the cell of 10^{-8} w . The results of these tests were corroborated by further tests performed at Fort Knox, Ky. using the integral weapons of a 90 mm tank at a range of 1,000 yards.

The authors acknowledge the following persons for their valuable contributions to the development of this system: Major Thomas J. Peterson, U. S. Army, who was the military project officer, N. Alpert, J. Beller, T. Sullivan, W. Mueller-Herget, J. Cioffi, E. Greenberg, O. Heller, R. Weinberger, F. Piscopo and A. Lubin. The authors also wish to recognize the assistance provided by the U. S. Army Armor School, Fort Knox, Ky. and the commander and staff of Fort Tilden, N. Y. Project was sponsored by the U. S. Continental Army Command and carried out under contract with U. S. Naval Training Device Center, Port Washington, N. Y.

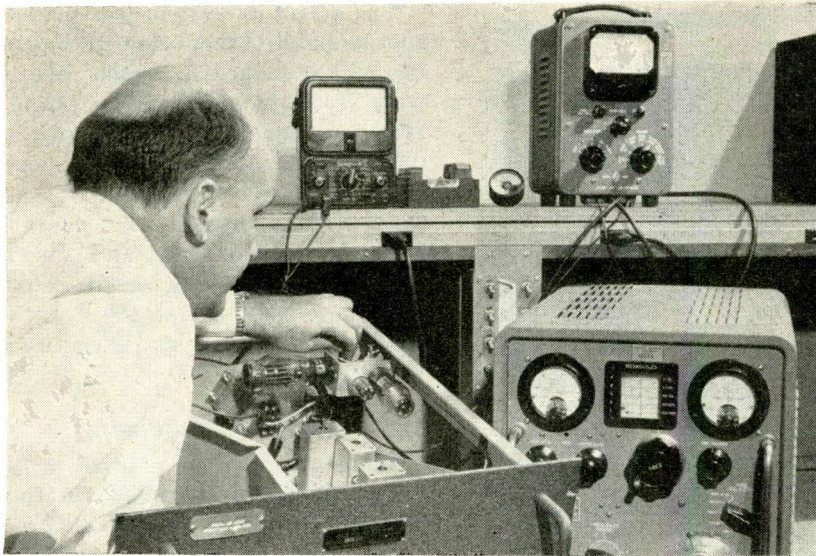

Intermodulation tests were made on R-361A/GR receiver to evaluate pre-receiver avc. Vacuum tubes are used as d-c amplifiers to drive the attenuator

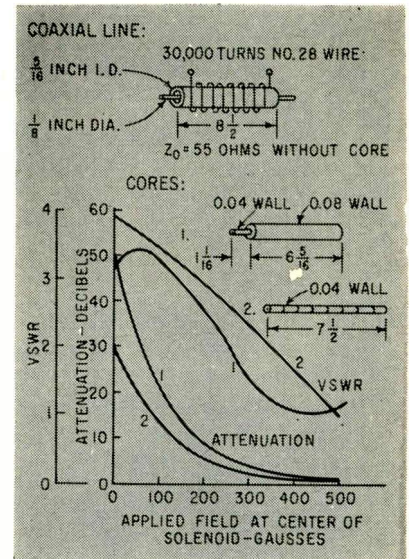

FIG. 1—Attenuation characteristics of coaxial ferrite attenuator

Pre-receiver Attenuator

Magnetically-controlled ferrite attenuators used between antenna and receiver reduce intermodulation and cross-modulation interference

WHEN UHF RECEIVERS and transmitters are operated in close geographical and spectrum proximity, intermodulation and cross-modulation interference are produced, primarily by nonlinear mixing of signals in the r-f amplifier tubes and in the first mixer tube¹. More nearly linear operation can be realized in a tube if the input signals are kept small.

Intermodulation and cross-modulation interference can be reduced if the receiver automatic volume control acts through a controlled attenuator located between the antenna and the receiver. An attenuator ahead of a receiver reduces intermodulation interference because the interference arises from high-order nonlinearities in the characteristics of the r-f amplifier tubes. In the case of third-order intermodulation, for instance, the interference is generated as a product of one voltage times the square of another voltage. Attenuation of the total input signal therefore effects a greater reduction in the

intermodulation than the desired signal.

The possibility of desensitization is present in any receiver with avc, but in a conventional receiver the avc does not serve to inhibit intermodulation. Pre-receiver attenuation thus makes better use of avc. The input tubes of a receiver are the chief offenders in the production of intermodulation. If attenuation is to reduce intermodulation it must precede these nonlinearities.

Pre-receiver avc also permits fixed-bias operation of the r-f amplifier tubes. It has been shown that the intermodulation rejection of a tube can be optimized by operation at a particular, fixed bias¹.

Coaxial Attenuator

Coaxial ferrite attenuators, which are controlled through applied magnetic fields, have been reported in the literature^{2, 3}. The device has a sleeve of Ferramic Q over the inner conductor, with the sleeve located in the magnetic field of the control coil. The curves of

Fig. 1 show attenuation plotted against applied field and Fig. 2 shows how the maximum and minimum attenuations vary over the uhf region.

The pre-receiver attenuator must be a linear circuit element if it is to reduce the effects of nonlinearities in the tubes which follow. Tests made with the attenuator showed no measurable intermodulation produced from 0.5-v input signals.

A block diagram of the experimental pre-receiver avc system is shown in Fig. 3. The plot of the avc characteristic shows that a signal of 1.0 v at the antenna was reduced to 0.005 v at the receiver input. The attenuated signal was small enough to allow fixed-bias operation of the r-f amplifier tubes. If the range of the attenuator had been increased from 40 db to 80 db, the whole receiver could have been operated with bias set for minimum distortion¹.

The control coil power required for minimum signal loss through

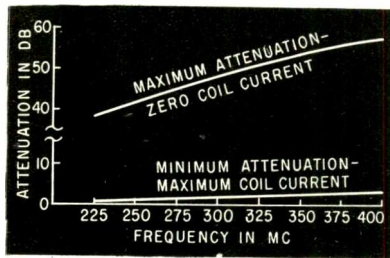

FIG. 2—Attenuator characteristics plotted against frequency

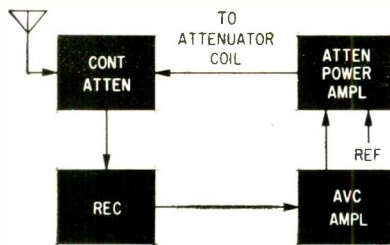
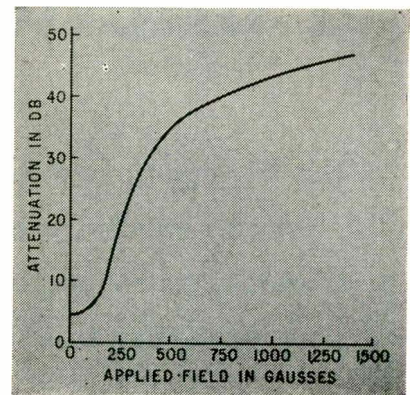

FIG. 3—Experimental pre-receiver avc system uses linear attenuator

FIG. 4—Attenuation characteristics of toroidal-core ferrite transformer attenuator are plotted against applied field at 230 mc



By SPURGEON L. ROBINETTE, Research Engineer, Georgia Institute of Technology, Atlanta, Ga.

Reduces Intermodulation

the attenuator was 80 watts. This high power requirement and the large physical size of the coaxial attenuator render it impractical in many cases.

Transformer Attenuator

Another attenuator, which is small and which shows promise of a greatly reduced power demand, is a transformer whose primary and secondary are single turns, and whose core is a ring of Ferramic H. When the degree of magnetization in the ferrite is changed by the control field, the primary-to-secondary coupling of the transformer is also varied. Minimum attenuation (maximum coupling) occurs when the control field is zero. This is desirable because the idling power will be low.

Figure 4 shows that an attenuation of 4.7 db was obtained when the applied field was zero. The maximum power required was about ten watts. Refined techniques will probably reduce the power requirement.

Ferrite Characteristics

The low-field losses are the chief magnetic loss characteristics in ferrites at uhf. Gyromagnetic resonances are not strong effects below

microwave frequencies. For the coaxial attenuator, a material with a high effective saturation magnetization ($4\pi M_s$) is desired, since a high zero-field loss is then indicated.^{1,2} The value of $4\pi M_s$ in Ferramic Q is 6,500 gauss at microwave frequencies.³ Another desirable quality would be complete saturation in an applied field of about 100 oersteds. Ferramic Q was found to saturate at 500 oersteds.

For the transformer, a high incremental permeability at zero applied field is desired, as well as complete saturation (or zero incremental permeability) in a field of about 100 oersteds. A low value of $4\pi M_s$ is desired, because a low zero-field loss is implied, and hence also a reduced minimum insertion loss in the transformer.

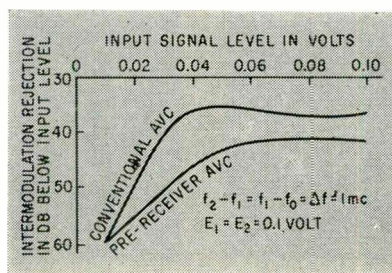

FIG. 5—Pre-receiver avc compared with conventional avc intermodulation rejection

Intermodulation tests were made on a R-361A/GR receiver to evaluate pre-receiver avc.

Evaluation

The resulting curves in Fig. 5 show that an improvement of six to eight db in intermodulation rejection was realized.

The bulk of the work was performed for USAF Rome Air Development Center under Contract No. AF-30(602)-1638, as part of a study of methods for reducing interference effects in uhf communication equipment.

REFERENCES

- (1) B. L. Blanks, et al, Investigation and Study of Communication Interference Reduction Techniques, Final Report, Project A-312, Engineering Experiment Station, Georgia Institute of Technology, Atlanta, Georgia, 1958.
- (2) F. Reggia, and R. W. Beatty, Characteristics of the Magnetic Attenuator at UHF, *Proc. IRE* 41, p 93, 1953.
- (3) P. Fire, and P. H. Vartanian, An Amplitude Regulator for Microwave Signal Sources, *IRE Conv. Rec.* 4, Pt. 5, p 166, 1956.
- (4) Benjamin Lax, Frequency and Loss Characteristics of Microwave Ferrite Devices, *Proc. IRE* 44, p 1368, 1956.
- (5) C. Lester Hogan, The Elements of Nonreciprocal Microwave Devices, *Proc. IRE* 44, p 1345, 1956.
- (6) Samuel Sensiper, Resonance Loss Properties of Ferrites in 9 KMC Region, *Proc. IRE* 44, p 1323, 1956.

Function Generation With

Use of high-gain d-c amplifiers and voltage feedback to design accurate electronic switches is applied to precision limiters, gates, comparators, multi-vibrators, timers and integrator resetting circuits. Present and future applications make the technique an important design tool

By H. KOERNER and G. A. KORN,

Dept. of Electrical Engineering, University of Arizona, Tucson, Arizona

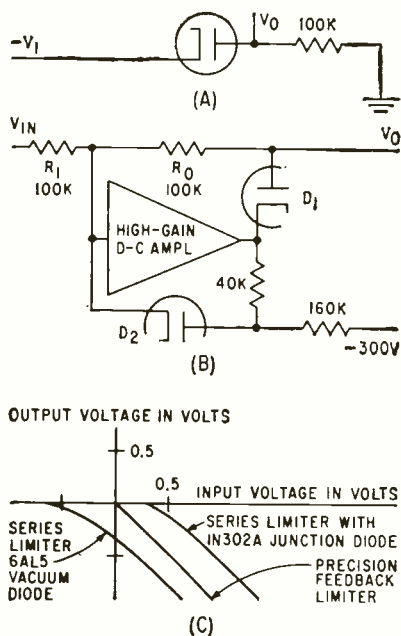

FIG. 1—Conventional series limiter (A) and precision feedback limiter (B) characteristics are compared (C)

MODERN ELECTRONIC ANALOG computers can add, subtract and integrate d-c voltages with component accuracies considerably better than 0.05 v. Such performance is obtainable at relatively low cost with the aid of chopper-stabilized d-c amplifiers and precision network components. In addition, modern time-division multipliers permit multiplication of d-c voltages with comparable accuracy.

This accuracy is not matched by the diode series, shunt and feedback limiters commonly used to implement various nonlinear system characteristics in electronic analog computers.^{1, 2, 3} Finite forward and back resistance of diodes and bias circuits as well as breakpoint-voltage variations can produce errors as large as 1 v.

The precision limiter circuit shown in Fig. 1B employs voltage feedback to realize a vastly im-

proved limiter characteristic. For positive input voltages, D_1 conducts, and the circuit acts like any phase-inverting operational amplifier of gain $-R_0/R_1$. Diode forward resistance and contact potentials are effectively divided by the high loop gain of the feedback circuit.

As the input voltage becomes negative, D_1 begins to cut off. This opens the feedback loop through R_0 , so that the high amplifier gain cuts D_1 off sharply by increasing its cathode voltage. Diode D_2 limits the amplifier output voltage to some positive value; and feedback through D_2 keeps the summing-point voltage, and hence the limiter output voltage, accurately at zero.

Figure 1C compares the actual 0.01-cps transfer characteristics of a precision limiter with those of conventional series limiters.

Figure 2 shows two modified precision limiters that do not re-

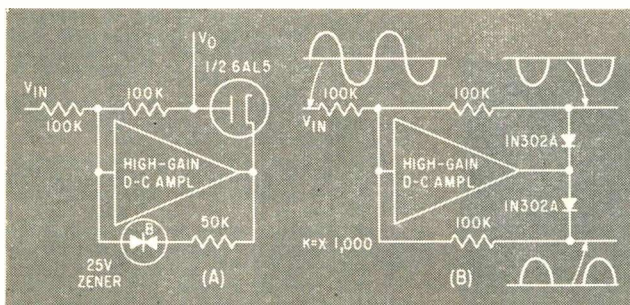

FIG. 2—Modified precision limiters (A) and (B) do not require a bias supply. The 50-k resistor limits Zener current

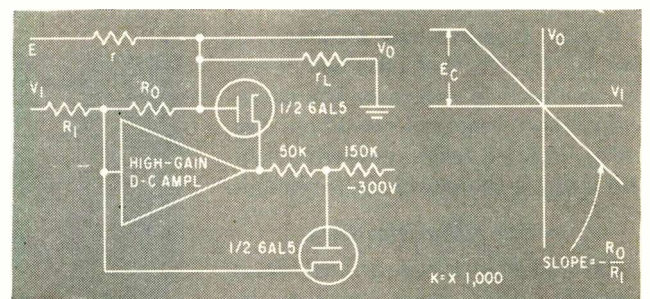

FIG. 3—Diodes and bias voltage of new precision limiter can be reversed to obtain a lower limit

Operational Amplifiers

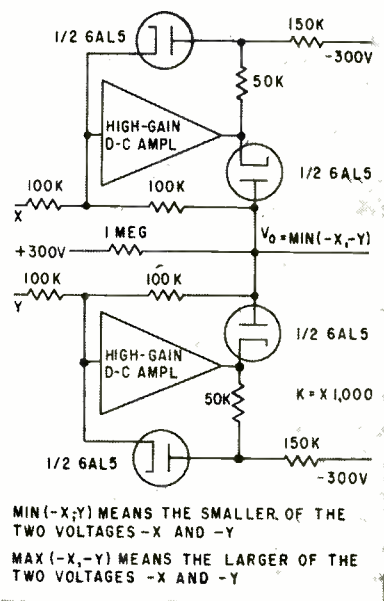

FIG. 4—Reversal of diodes and bias provides output of max (-X, -Y)

quire a bias supply. In Fig. 2A, D_2 of Fig. 1B and its bias circuit have been replaced by a Zener diode.

In Fig. 2B the built-in 0.2-v bias of the silicon-junction diodes yields two different limiter characteristics from the same circuit. The small bias for the second diode is sufficient for precision-limiter action and the built-in bias is not evident in the limiter output, since there it is effectively divided by the loop gain.

Instead of limiting at zero, the new limiter circuit of Fig. 3 limits at a precisely adjustable level $E_c = R_o r_L E / (R_o r + r_L + R_o r_L)$. Voltage E can be positive or negative and

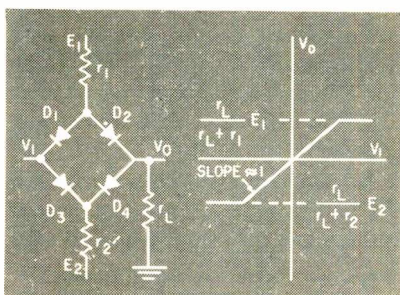

FIG. 5—Diode-bridge defines upper and lower limits

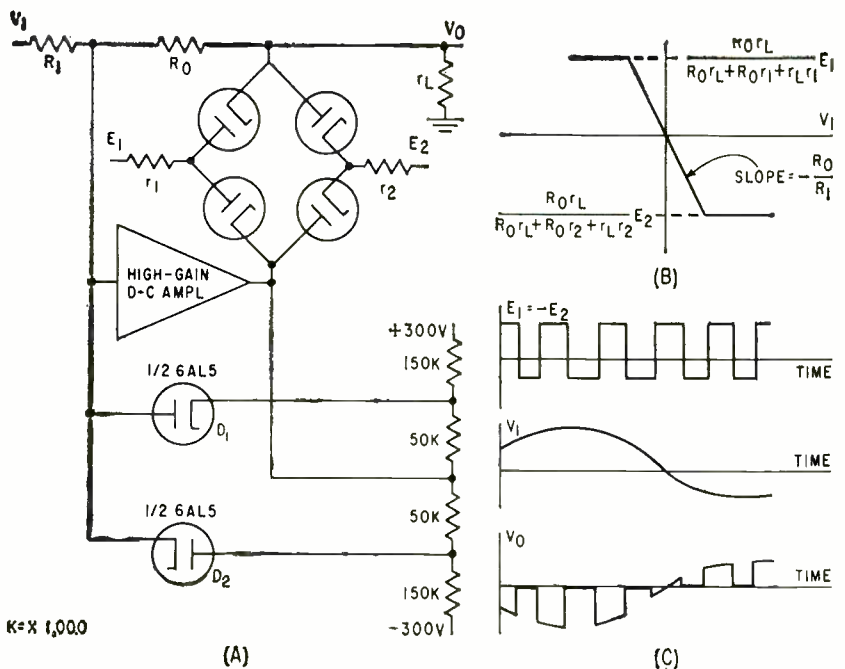

FIG. 6—Dual precision limiter (A) has a sharply defined characteristic (B). Application of push-pull gate pulses results in precision switch action (C)

may, indeed, be a variable voltage. The output voltage will always be the smaller of the two voltages $-R_o V_1 / R_1$ and E_c (amplitude-selector circuit). Note that E_c depends on the load resistance r_L .

As with all precision limiters, the output impedance is low only in the linear part of the characteristic. If r_L and R_o are sufficiently large, r may be replaced by a diode to reduce the output impedance when limiting.

The accurate amplitude-comparison circuit of Fig. 4 combines two precision limiters to yield $V_o = \min(-X, -Y)$ at very low output impedance. The circuit is related to Howe's amplitude-comparison circuit¹ which depends on the saturation limiting of d-c amplifiers without chopper stabilization. This new circuit permits chopper stabilization and thus substantially better accuracy. It may be used as a gate to turn either input voltage off and on. Reversing the diodes and bias voltages in Fig. 1 to 4 reverses the limiter characteristics.

The diode-bridge limiter shown in Fig. 5 is used in some commercial analog computers to establish

upper and lower limits in a single operation. Thus, if the input voltage V_1 exceeds the upper limiting level $r_L E_1 / (r_L + r_1)$, diodes D_1 and D_2 are off while D_3 and D_4 are on. This action is reversed if $V_1 < r_L E_2 / (r_L + r_2)$. Series pairs of diodes conduct in the linear portion of the characteristic. Since the diode-bridge limiter is a series limiter, its limiting action is much better than that of the more familiar dual-shunt and feedback limiters.² By applying positive and negative gate pulses, this circuit can be used as an electronic switch (bridge modulator).³

The dual precision limiter of Fig. 6 combines a diode bridge and precision-limiter action. In the linear portion of the characteristic, the circuit acts like an accurate phase-inverting feedback amplifier essentially unaffected by the bridge circuit. As soon as the bridge begins to limit, the feedback loop opens. The high-gain amplifier drives the bridge decisively into its limits, and a sharply-defined limiter characteristic is obtained. Diodes D_1 and D_2 constitute a conventional shunt limiter to keep the summing

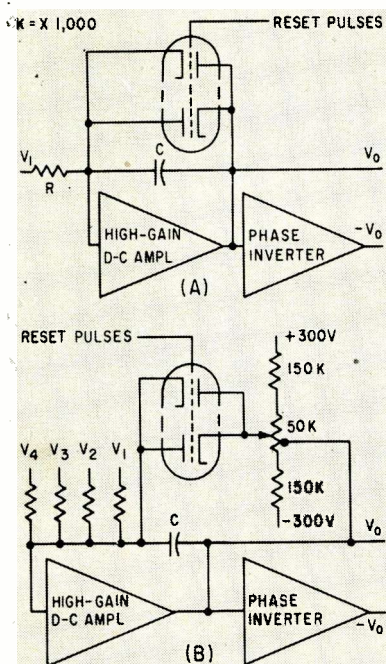

FIG. 10—Resetting circuit (A) is modified (B) to double capacity of computer

tion; the new circuit uses four instead of two diodes in an attempt to shunt diode-leakage currents from the bias supplies to ground.

Performance

With suitable chopper-stabilized d-c amplifiers, reference-voltage supplies and precision network components, the limiter circuits of Fig. 1 to 3 yield static accuracies better than 0.05 volt, as exemplified by the limiter characteristic shown in Fig. 1C.

As in the case of electronic multipliers, the static accuracy of a nonlinear operational-amplifier circuit may be compromised by frequency-response requirements. The sharp break characteristics of precision limiter circuits depend on high open-loop gain and may deteriorate somewhat above 2 cps because of wiring and patchbay capacitances in multipurpose computers. The situation is much more favorable in circuits with short leads.

The high capacitance ($25 \mu\text{F}$) of most silicon-junction diodes capable of standing 100 v inverse voltage may necessitate the use of vacuum diodes that have low capacitances ($5 \mu\text{F}$) but relatively large plate resistances (1,000 ohms). In this connection, Lofgren⁹ has suggested the use of two vacuum diodes and two junction diodes

in each bridge circuit.

Figure 12 shows a simple precision limiter and its transfer characteristic at 5 kc. The separation between forward and return traces is due to phase shift, not hysteresis. Optional diode D_3 reduces the output impedance when limiting. Using Philbrick K2-X d-c amplifiers, the ideal limiter characteristics, are approximated to within 0.5 v at 5 kc for sinusoidal input of 40 v peak-to-peak. The switching step shown in Fig. 12 is minimized by small back bias (0.2 to 0.5 v) on D_2 .

Applications

Nonlinear operational-amplifier circuits of the type described permit analog-computer representation of nonlinear characteristics (dead space, limit tops, backlash and hysteresis) in dynamic systems and simulated modulation systems with excellent accuracy. The new circuits can frequently replace operational relays and thus permit faster computer operation.

These accurate analog switching and comparison techniques can be used in various automatic checkout and quality-control devices. In the laboratory the new circuits have proved extraordinarily useful in the design of the following special computing elements: quadrant switches for trigonometric function generators¹⁰, electronic decommutators¹¹, analog-to-digital converters¹¹, simple and remarkably accurate triangle-integration multipliers¹¹

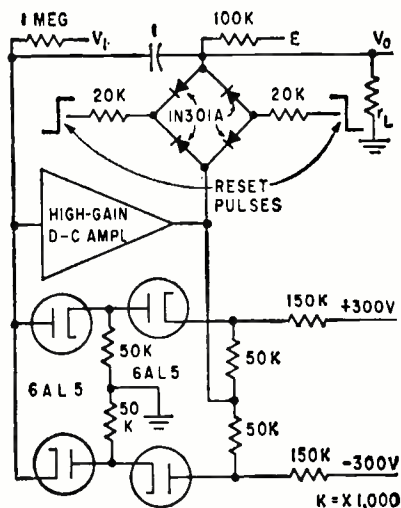

FIG. 11—Accurate resetting circuit uses new voltage divider to minimize effects of limiter-diode leakage and contact voltage

and a novel amplitude-distribution analyzer for estimation of probability densities.¹² Related switching techniques can be applied to analog computers with automatic-programming features such as automatic scale-factor changes, analog storage or memory circuits and sample-hold circuits. Higher frequency versions of these circuits

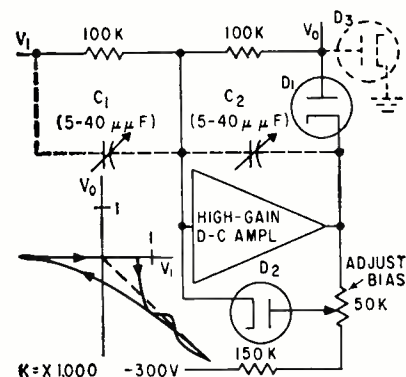

FIG. 12—For h-f operation of precision limiter, capacitors are adjusted to obtain best frequency response without ringing

will make possible new applications in storage and sampling devices.

The writers are grateful to the Electrical Engineering Department of the University of Arizona and to P. E. Russell, Department Head, for their continuing support of this work. The writers thank R. Bell, K. Hanson, W. Herndon, H. Shavet and S. Jurich, all students at the University of Arizona for their help.

REFERENCES

- (1) C. D. Morrill and R. V. Baum, Diode Limiters Simulate Mechanical Phenomena, *ELECTRONICS*, p 122, November, 1952.
- (2) C. L. Johnson, "Analog Computer Techniques," McGraw-Hill, N. Y., 1956.
- (3) G. A. Korn and T. M. Korn, "Electronic Analog Computers," 2nd Ed, McGraw-Hill, N. Y., 1956.
- (4) R. M. Howe, Representation of Non-linear Functions By Means of Operational Amplifiers, *Trans. IRE-PGEC*, Dec. 1956.
- (5) R. J. Medkett and R. J. Parent, A Diode Bridge Limiter For Use With Electronic Analog Computers, *Proc. AIEE* 70, Sec. T-1-170, 1951.
- (6) N. D. Diamantides, A Multipurpose Electronic Switch for Analog Computer Simulation and Autocorrelation Applications, *Trans. IRE-PGEC*, Dec. 1956.
- (7) J. Millman and H. Taub, "Pulse and Digital Circuits," McGraw-Hill, N. Y., 1956.
- (8) G. A. Philbrick Researches, Boston, Massachusetts, Specification Sheet For Type K2-J Integrating Component, 1952.
- (9) L. Lofgren, Predictors in Time-shared Analog Computers, *Proc. Int. Analog Computation Meeting*, Brussels, Belgium, 1956.
- (10) N. D. Tomlinson, Fundamental Circuits and Techniques Used With Electronic Analog Computers, Report AP-77079, Goodyear Aircraft Company, Akron, Ohio, 1956.
- (11) G. A. Korn, Analog-computer Development Projects 1958/9, *ACL Memo No. 2*, Electrical Engineering Department, University of Arizona, Tucson, Arizona, 1959.
- (12) W. F. Caldwell, G. A. Korn, V. R. Latorre and G. R. Peterson, A Precision Amplitude-distribution Analyzer, *ACL Memo No. 6*, Electrical Engineering Department, University of Arizona, Tucson, Arizona, 1959.



Amperex 6939
5 watts
total anode
dissipation



Amperex 6360
14 watts
total anode
dissipation



Amperex 6907
20 watts
total anode
dissipation



Amperex 5894
40 watts
total anode
dissipation

Compatibility

an **Amperex**® concept in tube design

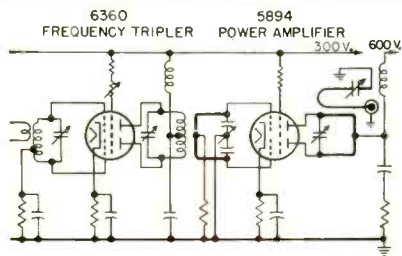
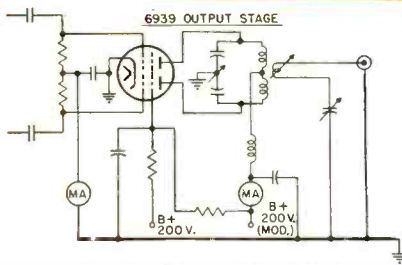

Presenting a Compatible Family of 4 Twin Tetrodes,
Specifically Designed to Simplify Circuitry in Mobile
VHF/UHF Transmitter Design

These four AMPEREX twin tetrodes, designed from the ground up as a compatible group, complement one another in electrical and mechanical characteristics. The designer of light VHF and UHF transmitting equipment in the 5 to 85-watt category can draw on this group for all of his power amplifier, oscillator, frequency multiplier and modulator requirements, with considerable benefit in design efficiency. He can (1) save entire stages in his transmitter, (2) reduce power consumption requirements and (3) generally optimize transmitter design. The superior performance and reliability of the AMPEREX twin tetrodes, particularly in the 460 Mc band, have made them the most widely accepted small transmitting tubes in the world for amateur, professional, military and airborne applications.



ask **Amperex**

about tubes and useful circuitry
for VHF/UHF transmitters

1
2
3
4

Type	Max. Power Input (watts)	Max. Power Output (watts)
6939	14 ICAS 12 CCS	7.5 ICAS 5.8 CCS
6360	30 ICAS 22.5 CCS	18.5 ICAS 14.5 CCS
6907	112 ICAS 90 CCS	67 CCS
5894	150 ICAS 120 CCS	96 ICAS 90 CCS

Subaudio Tunable Amplifier

By J. M. REECE, Naval Research Lab., Washington, D. C.

ONE METHOD of analyzing low-frequency components of complex waveforms is to pass them through a tunable, narrow-band amplifier. Design and performance of such an amplifier, tunable from 0.5 to 100 cps, is presented.

Amplifier Unit

The unit in Fig. 1 consists of a mixing circuit, inverting operational d-c amplifier and twin-tee tuning element. There are two negative feedback paths around the d-c amplifier: R_f reduces gain to the desired maximum and provides stability, and the twin-tee network degenerates all but the desired frequency.

A 5-megohm potentiometer at the output of the twin-tee allows Q to be reduced without affecting overall gain. Maximum Q available is determined by R_f .

The resistance arms of the twin-tee consist of three ganged 10-turn potentiometers that are trimmed and have their shaft couplings adjusted until a resistance bridge measurement indicated that they tracked with less than 0.2 percent error from 5,000 to 100,000 ohms. The three associated capacitors

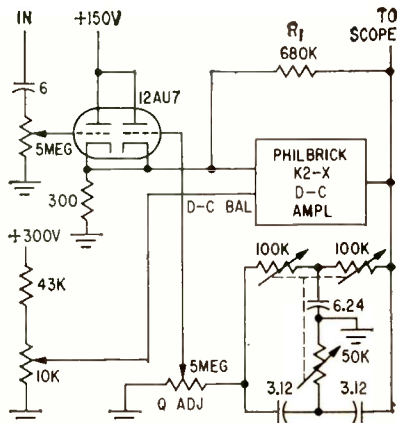

FIG. 1—Commercial d-c amplifier with twin-tee feedback added tunes from 0.5 to 100 cps

were measured on an impedance bridge and matched in a deviation bridge to within 0.1 percent. As a result the twin-tee alone exhibits a notch of more than 45 db from 0.5 to 20 cps and more than 30 db through 100 cps.

Single-knob control provides continuous tuning from 0.5 to 100 cps with a Q of 50 from 0.5 to 20 cps. Above 20 cps, gain and Q decrease because of tracking errors in the twin-tee. However, a Q of over 100 can easily be reached by changing

the value of R_f , without danger of oscillation. Gain is about 200. Input level must be kept low enough to prevent distortion from overdrive (in this case 0.1 v).

Time Constant

At these low frequencies the effect of the time constant is very pronounced. At one cps, input can be removed and output will take about a half minute to die down to noise level.

By experiment, the constant relating time constant (TC) and Q was found to be

$$k = (TC) f/Q \approx 0.32 \quad (1)$$

The time constant was measured at frequencies below 2 cps by abruptly removing the signal and measuring with a stop watch the time for the output to fall to one-half maximum. After output had fallen to noise level, the signal was abruptly applied and the time measured for output to reach this half amplitude point again. (At one cps, this time can be 6 or 7 sec.). Since universal time constant curves cross at half amplitude for 0.73 time constant, either time as measured above can be divided by 0.73 to give the circuit time constant.

For higher frequencies short pulses were applied at a prf about one-twentieth the frequency of the twin-tee. An exponentially decaying sine wave appeared at the output. On the scope, time taken for amplitude to fall to $1/\epsilon$ of maximum was measured. This value is a time constant by definition.

Measuring Q

The Q was found by measuring gain (A) of the d-c amplifier and feedback loop and applying the formula $Q = A/4$. Another method was to vary input frequency until output amplitude fell to 0.707 of maximum, since $Q = f_o/(f_2 - f_1)$, where f_o is center frequency, f_2 is upper frequency at 0.707 maximum amplitude and f_1 is lower frequency at 0.707 maximum amplitude.

The value of $k = 0.32$ obtained

Courier Communications Link

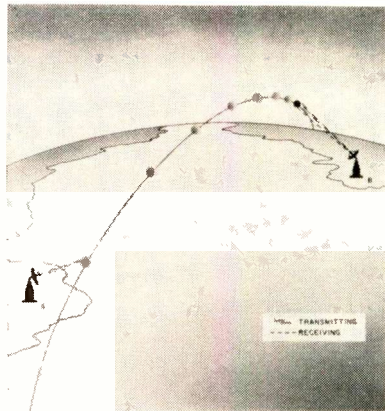
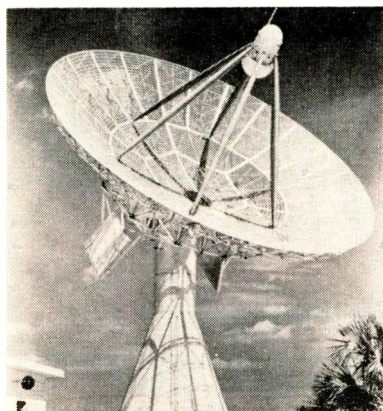

Communications-tracking system for Project Courier (Electronics, Sept. 25) uses Radiation, Inc. 28-ft tracking antenna at left. Station A at right triggers readout of data stored on tape A in satellite as it passes over, and data is recorded and processed on ground. Station A then triggers satellite tape B and transmits data for station B. Process is repeated at each ground station

KEEPS *Total* COST DOWN

IF INSTALLED-COST IS A DESIGN PROBLEM

Look at the KA general purpose RELAY

What do your relays cost *installed*? Initial cost is never the whole story.

Our KA Relays are engineered for modern production methods. They're available with printed circuit, taper tab, quick-disconnect or hook solder terminals . . . are simple, economical to install. This fact, combined with low original cost, keeps your total cost down.

Another source for savings! All standard KA ac relays bear U/L and Canadian Standard Association seals of approval.

Write or call for more information or see the complete P&B catalog in Sweet's Product Design File.

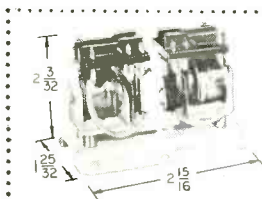

KB LATCHING RELAY consists of two KA Relays, forming a mechanical latching relay, featuring a large number of contact arrangements.

KA ENGINEERING DATA

GENERAL:

Insulation Resistance: 100 megohms min.
Breakdown Voltage: 1500 V. rms between all elements.

Temperature Range:
-55° C. to +85° C. DC
-55° C. to +70° C. AC

Weight: 2.0 ozs.
Pull-In: DC 75% of nominal voltage.
AC 78% of nominal voltage.

Terminals: Taper tabs.
Printed circuit.
Quick-disconnect.
Pierced solder lugs.

Enclosures: Dust Cover
(max. 55° C. ambient for AC relays)
(max. 70° C. ambient for DC relays)

CONTACTS:

Arrangements: 3 Form C (3PDT) max.
Material: Movable— $\frac{1}{8}$ " silver; stationary— $\frac{3}{32}$ " wide silver overlay.

Load: 5 amps @ 115 V. AC 60 cps res.
COILS:

Resistance: 16,500 ohms max.
Power: 1.2 watts (DC), 2 volt amps (AC)
Duty: Continuous AC or DC (DC coils will stand 4.5 watts at 25° C.)

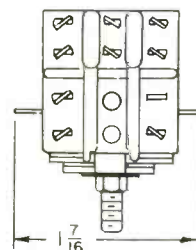
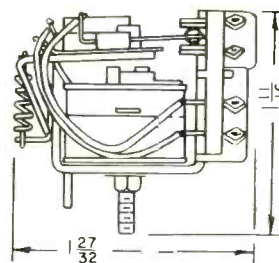

P&B STANDARD RELAYS ARE AVAILABLE AT YOUR LOCAL ELECTRONIC PARTS DISTRIBUTOR



POTTER & BRUMFIELD

DIVISION OF AMERICAN MACHINE & FOUNDRY COMPANY, PRINCETON, INDIANA

IN CANADA: POTTER & BRUMFIELD CANADA LTD., GUELPH, ONTARIO

CIRCLE 73 ON READER SERVICE CARD



He's found the cable
he needs!

It's Hickory Brand intercommunicating and sound system cable!

- LONG SERVICE LIFE
- EXCELLENT MECHANICAL CHARACTERISTICS
- EXCELLENT ELECTRICAL PROPERTIES

Use Hickory Brand for balanced intercom systems, annunciators, telephones, control circuits, electronic computers and multiple speaker and signal systems.

Quality-engineered Hickory Brand Electronic Wires and Cables are precision manufactured and insulated and sheathed in modern plastics.



Write for complete information on
the full line of HICKORY BRAND
Electronic Wires and Cables

HICKORY BRAND Electronic Wires and Cables

Manufactured by
SUPERIOR CABLE CORPORATION, Hickory, North Carolina

by inserting measured values of TC and Q in Eq. 1 agrees with the following mathematical derivation. The solution of the differential equation for a high Q - L - C - R circuit yields:

$$E_1 = E_0 \epsilon^{-Rt_1/2L} \quad (2)$$

where E_1 is amplitude at time t_1 and E_0 is amplitude at time t_0 . Since $Q = 2\pi fL/R$,

$$L/R = Q/2\pi f \quad (3)$$

Substitution of Eq. 3 in Eq. 2 gives:

$$E_1 = E_0 \epsilon^{-\pi f t_1 / Q} \quad (4)$$

If t_1 is selected equal to TC , $E_1 = E_0/\epsilon$, so that Eq. 4 becomes $E_0/\epsilon = E_0 \epsilon^{-\pi f (TC)/Q}$. Solving: $f(TC)/Q = 1/\pi \approx 0.32$.

If pulses are applied to the circuit with a prf of $1/t_1$, $Q = -\pi f / (\text{prf}) \ln (E_1/E_0)$. Since E_1 and E_0 can be measured on a scope and the other values are known, Q can be calculated. This was also in agreement with the other methods used.

If random noise is applied to the circuit, a sine wave output appears at the frequency to which the twin-tee is tuned, since the unit accepts only that frequency component of the noise. A one-cps square wave was analyzed for frequency components up to its 15th harmonic (down 23 db from the fundamental). The two abrupt changes per second contained in a one-cps square wave cause a ringing at 2 cps that is of

Satellite Checkout Instrumentation

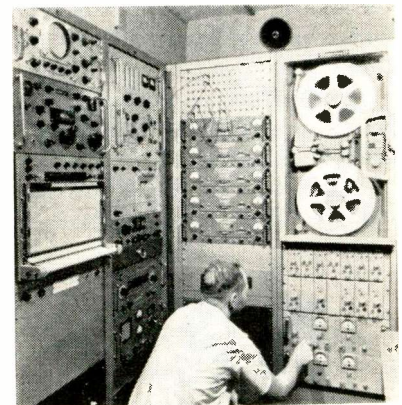

Two trailers provide Redstone Arsenal's Army Ballistic Missile Agency with mobile test facility to telemeter data from earth satellites and listen in on satellites after they are launched. Minneapolis-Honeywell recorder-reproducer (right) records six channels on half-inch magnetic tape and up to five items on telemetering channel alone

sufficient amplitude to hinder measurements above the 15th harmonic, although harmonics as high as the 50th can be seen.

It appears feasible to use this type circuit with higher Q's, lower frequencies, greater dynamic range or wider tuning range if desired.

The background information for this paper was obtained from Naval Research Lab. report 4444 and from unpublished papers by the author.

Boxcar Radar Antenna For Defense Network



Rotating 50-ton radar antenna 104 ft long was developed for the Air Force by Raytheon. New antenna is designed for use with high power radars now undergoing final test

Electronic Timer Monitors Outboards

ELECTRONIC system monitors performance of boats powered by Mercury outboard motors at Kiekhaefer Corp. lake near St. Cloud, Florida.

Small oscillator in each boat provides identifying frequency to underwater loop in plastic-covered cable. The cable carries the signal to a receiver-filter unit in the control tower. After amplification, the signal actuates a printer that records boat identification and time on tape.

The transistorized clocks used in the system are accurate within ± 1 sec in 15 days. The system is interference-free in the most active thunder-storm belt in the U. S. The electronic timing arrangement has also been found not susceptible to the false indications encountered using light beams and optical equipment.

Texas Instruments roof prism—viewer for photographic system used in the Douglas A3D-2P—helped photo map the landing flight path for North American's X-15

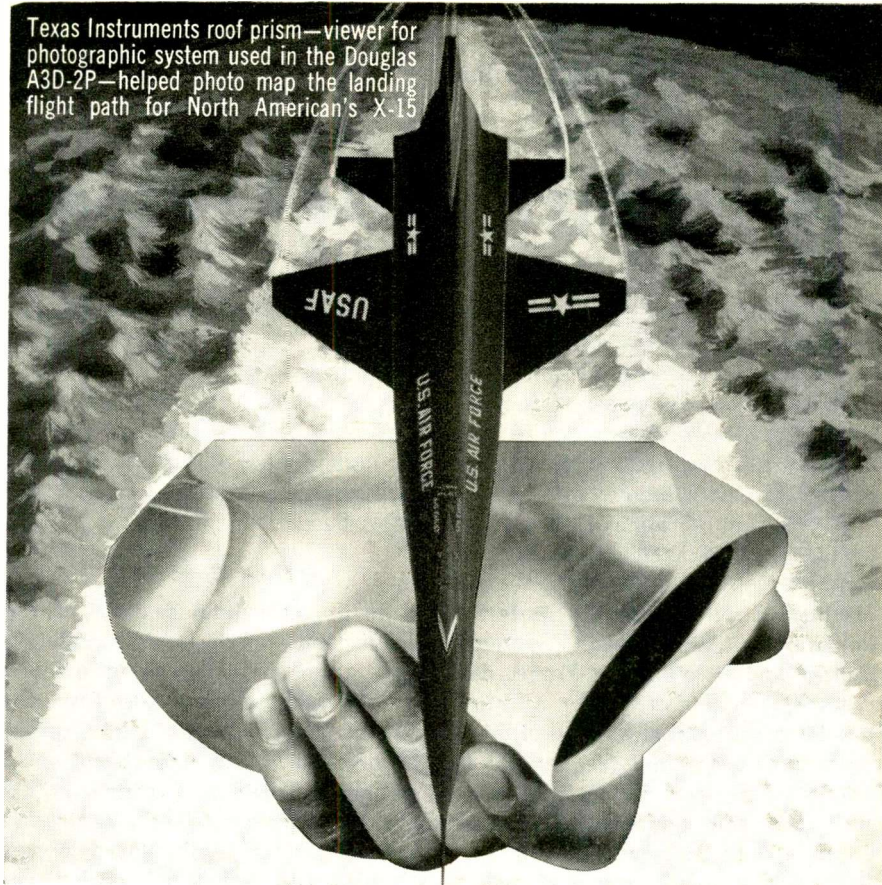

ROAD MAPPER FOR THE X-15

Texas Instruments roof prisms share a vital role in mapping a safe landing course for the first manned spacecraft. Installed in a photographic system aboard a Douglas A3D-2P, these prisms recorded landmarks that will guide the X-15 pilot in his return to earth. Accurate photo mapping at 600 miles per hour requires exceptionally high quality optical components. This roof prism, for example, has angles that must be held within seconds of arc. Difficult to manufacture? Not for TI craftsmen... tolerances such as these are met everyday at TI in production quantities.

Leading designer and producer of silicon, germanium, quartz and other optics for military and commercial uses, TI has intimate familiarity with unusual materials suited to specific portions of the spectrum. In one of the nation's best equipped facilities, TI craftsmen grind, polish and coat precision optics with the same care that goes into a "road mapper" prism. This team — backed by a full-time engineering service and high-speed computers — can meet *your requirements in any quantity* from idea to completion. For detailed information about this technology, send for booklet "Precision Optics at Texas Instruments" or contact SERVICE ENGINEERING:

TEXAS  OPTICS DEPARTMENT
INSTRUMENTS
INCORPORATED
6000 LEMMON AVENUE
DALLAS 9, TEXAS

Achieving Precise Frequency Control

WITH ENORMOUS INCREASE in use of the frequency spectrum, military specifications for crystal oscillator units have become more stringent. Quartz crystal oscillator units are used to achieve precise frequency control of electronic circuits.

A program of fabricating crystal units, accomplished through the combined efforts of Manufacturing Methods Division of Air Materiel Command's Aeronautical Systems Center and Dayton Air Force, has resulted in the fabrication of high precision quartz crystal oscillator units with a nominal frequency tolerance of plus or minus 0.002 percent for the temperature range from -55 to 90 degrees C. Previously, crystal units, operating in

this range, contained frequency deviation of ± 0.005 from the nominal frequency.

A frequency tolerance of 0.002 percent had been possible, but only through use of constant temperature ovens, regulated to ± 5 degrees C.

New Concept

As an additional feature of the production process, a completely new philosophy has been evolved which eventually will lead to elimination of ovens used to control crystal temperature during operation in airborne weapon systems. This means a direct dollar saving and elimination of complicated power circuits, reduction of power re-

quirements and decrease in size and weight of oscillator units.

A secondary result is increase in reliability. Without need for ovens to keep quartz crystals on a precise frequency, there will be less of a supply problem. Supply problems also were aggravated because of non-interchangeability of temperature controlling ovens.

To accomplish the production refinement program, several groups of units at various frequencies from 3 to 17 megacycles on the fundamental thickness shear mode and from 20 to 30 mc on the third overtone were fabricated by utilizing standard machinery. Rejection rates were about 15 percent, which was considered quite normal.

Further work showed that angular tolerance of one degree of arc was adequate. However, this angle had to be checked just before the rounding operation. Following this, the blank thickness could not be reduced by lapping more than 0.015 inches because of the effect lapping has on the blank orientation.

Stabilized Frequency

In addition to more careful surveillance of blank orientation, one additional heat treatment was employed in fabricating these precision units. This reduced to a minimum further aging of units and stabilized the frequency. A final adjustment of units to frequency was necessary, which required a small increase in finishing time.

In summing up the program, K. P. Dale of the Manufacturing Methods Division, estimated, "As a result of this program, less than five percent and not more than 10 percent additional finishing time was required. This produces precision units, 0.002 percent or better, with percentage yields comparable to yields obtainable on currently available crystal units, 0.005 percent, and eventually crystal ovens will not be necessary.

Since completion of this program,

Transducer Logs Explosive Force

AN IMPROVED transducer configuration, designed at Stanford Research Institute, Menlo Park, California, eliminates the complexities usually associated with diaphragm resonance in a pressure transducer.

The basic transducer element is a barium titanate piezoelectric ceramic disc (below), polarized in the thickness mode with silver electrodes deposited on the major surfaces. A brass backing column

forms one electrical contact and also provides an acoustical impedance match to the crystal. Elastic wave reflections resulting from the crystal-backing interface are greatly reduced by the column.

The steel guard ring serves transducer protection from bomb fragments and protection from radial compression of the crystal by the incident shock wave. As reported by Douglas D. Keough, the styrofoam insert provides a sufficient mismatch in acoustical impedance between it and the guard ring so that the intensity of the radial compression wave is greatly reduced¹. The styrofoam is also used to position the pressure-sensing area of the crystal in the plane of the upper surface of the guard ring.

The effectiveness of the beveled ring was verified experimentally by observing transducer output with and without the guard when placed three feet from an explosive source.

REFERENCE

(1) Douglas D. Keough, Transducer Equipment for Measuring Pressure, Poulter Laboratories Technical Report 002-59, Stanford Research Institute, Menlo Park, California, Jan. 6, 1959.

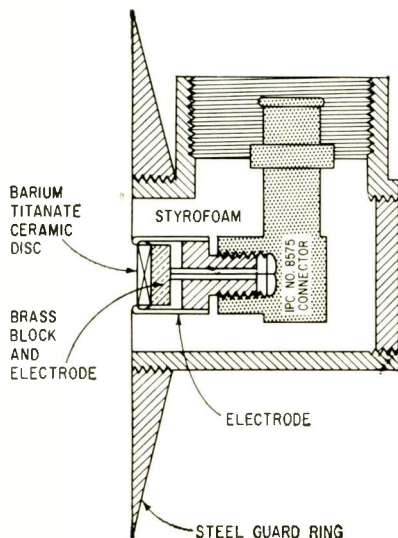

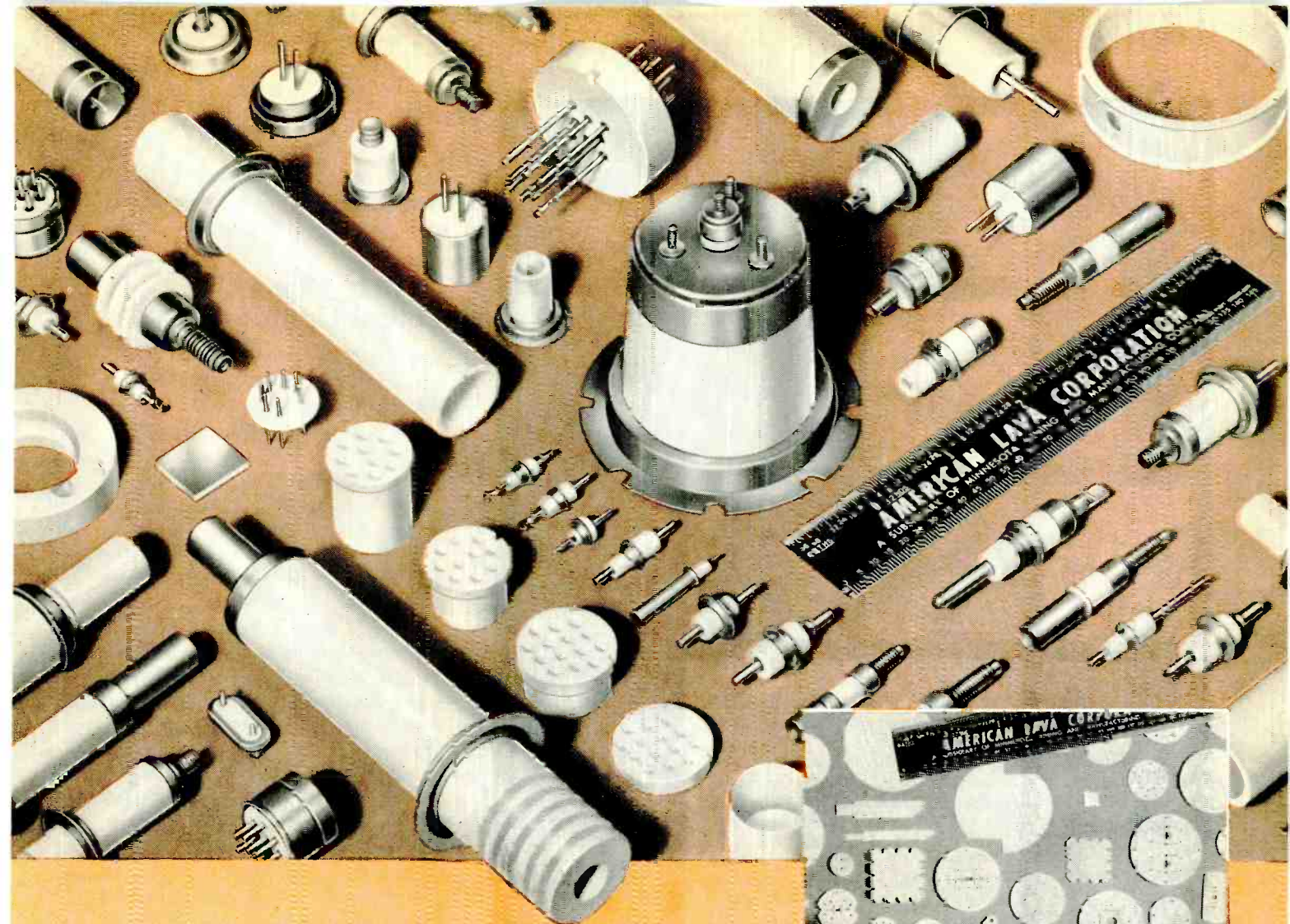

RELIABILITY

IS AN OUTSTANDING CHARACTERISTIC OF ALSiMAG® CERAMICS

ALSiMag Ceramics offer exceptional resistance to heat and erosion. They have marked electrical and physical stability at elevated temperatures and in varying environments. Chemically inert. Good strength. Can be accurately fabricated in micro-miniatures.

ALSiMag Ceramics include many special purpose ceramics, some especially adapted to hermetic sealing. Widest choice of materials, more than half a century of specialized experience. Send blue print and operating conditions.

ALSiMag pioneered micro-miniature ceramics . . . some as thin as 0.005". Relatively high strength, superior performance at high temperatures, high frequencies. Excellent record for withstanding fatigue, heat, shock, vibration.



The ALSiMag Ceramics in these multiple pin headers may be safely used up to 2800°F. The metal components are the limiting factors.

These tantalum pins with nickel braze alloy operate around 1000° F. All materials are rugged. Strong hermetic seal. Low vapor pressure. High temperature bake-out is practical.

A Subsidiary of
Minnesota Mining and
Manufacturing Company



AMERICAN LAVA CORPORATION

CHATTANOOGA 5, TENN.
58TH YEAR OF CERAMIC LEADERSHIP

For service, contact American Lava representatives in Offices of Minnesota Mining & Manufacturing Co. In these cities (see your local telephone directory): Boston: Newton Center, Mass. • Chicago: Bedford Park, Ill. • Cleveland, O. • Dallas, Texas • Los Angeles, Cal. New York: Ridgefield, N. J. • Philadelphia, Pa. • St. Louis, Mo. • St. Paul, Minn. • San Francisco, Cal. • Seattle, Wash. All other export: Minnesota Mining & Manufacturing Co., International Division, 99 Park Ave., New York, N. Y.



Multi-turns?

We got 'em!

Multi-turn potentiometer connoisseurs...the men who buy them...turn to Helipot to succor their circuits.

They make their choice from the nineteen separate and distinct series of HELIPOT multi-turns, each with a myriad of models, scaled from 7/8" dia. x 1-1/2" up to 3-5/16" dia. x 6".

They find it easy to pick the pot that suits their circuit...linear or non-linear...high temperature or standard range...with resolution from a three-turn 0.164% up to a forty-turn 0.00073%...and linearities to $\pm 0.01\%$!

Join the well-informed 7 out of 10* who turn to Helipot. Get the complete story on this profusion of multi-turns (plus a delineation of the HELIPOT single-turn line). Write for Data File A452.

**Based on a well-known national trade publication's own survey of thousands of pot specifiers and buyers.*



Beckman® Helipot®

Helipot Division of Beckman Instruments, Inc., Fullerton, California
Engineering representatives in 29 cities

60010 © 1959 B.I.I.

potentiometers: trimmers: delay lines: expanded scale meters: servomotors: breadboard parts

crystal oscillator units have been flight tested in operational environments and have proved successful.

How to Reclaim Potted Components

YOU MAY HAVE the answer to another problem being asked by the Manufacturing Methods Division of AMC (see above). The question is: "How do you de-pot a potted electronic component so that the unit can be reclaimed?" Potted components, those encased in resinous or epoxy-type substances, now usually are discarded because it is too expensive to reclaim them.

Some of these complex potted assemblies may now cost hundreds and thousands of dollars, and have to be scrapped because of a fault that occurs to one relatively inexpensive component.

In some instances, wiring circuits for control or switching of impulses generated to gunsights, radar units, and communication equipment, usually are encapsulated in the resinous substance to protect them from environmental conditions and for a host of other reasons. One individual item on the circuit board can go bad and destroy usefulness of the entire circuit system.

Normal practice is for field units to replace the whole circuit board or the sealed component and forward the discard to one of Air Materiel Command's depots for repair. There the unit is subjected to reclamation, but usually the individual bad item cannot be pried or forced out of the sealant substance without damage to other elements.

Answer Will Save Millions

Several weeks ago, in an attempt to find answers to some of these questions, Manufacturing Methods Division of AMC sent out a questionnaire to industries working in the field, requesting suggestions as to what processes might overcome this problem. G. E. Lehr Ritter of Electronics Branch, Manufacturing Methods Division noted in his letter that, "At present, there appears to be no standard acceptable method of de-potting encapsulated electrical components which have been found to be de-

fective. They are either scrapped or repaired by a slow, tedious chipping process which often damages or destroys components other than the ones to be repaired."

This week, in a discussion with G. E. Lehritter, *ELECTRONICS* finds that AMC has received about 60 replies to the questionnaire that asked for specific suggestions.

The answer to the potting material must conform to certain requirements: impervious to shock, the unit must be sealed against the atmosphere, with the desired insulation resistance and heat transfer characteristics.

A Simple Powder?

Will the answer to this potting problem be discovered in a simple powder that can be poured into the component or assembly, sealed, and poured out at will?

If so, this powder should be capable of withstanding high temperatures without melting and should not possess significant expansion-contraction characteristics.

Perhaps such a simple approach might be the answer that would save millions of military dollars now spent because it is now too expensive to reclaim potted circuitry components.

Rotating Anode Crt

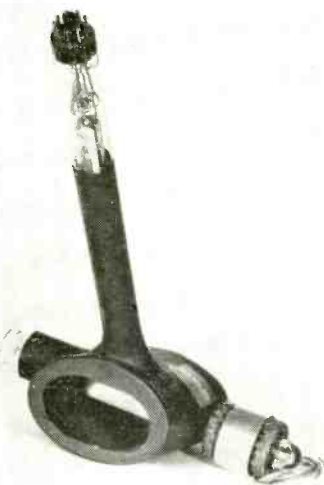

This line scan cathode-ray tube, developed by CBS Laboratories, Stamford, Conn., utilizes a rotating anode that spins at 1,600 rpm which scans one line at a time with high resolution.

The tube provides a high-intensity, small area light source for applications in data transmission, and flying spot scanning

GALVANOMETERS

for Precise Null Indication



Type 1965
table model

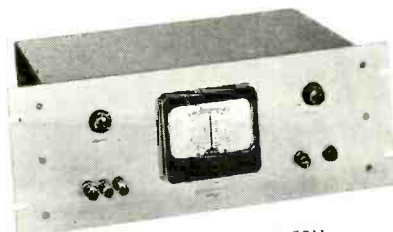

Type 1965RM
rack mounting model

ELECTRONIC

Shallcross Electronic Galvanometers are mechanically and electrically designed for rapid, maintenance-free laboratory and production testing. The extremely high sensitivity detects the balance point immediately . . . minute deflections are registered instantly. Meter becomes balanced in less than one second. Adjustments are quickly made from front of panel.

Current sensitivity is greater than 1×10^{-10} amps. Voltage sensitivity is greater than 0.5 μv /scale division.

Electronic galvanometers are available in both table and rack-mounting models. Delivery is immediate. Ask for Bulletin L-47.

MOVING COIL

These rugged Shallcross taut-suspension galvanometers are widely used in potentiometer and bridge circuits where precise balance indication is needed at low cost.

Complete instruments or their systems are available in sensitivities of 0.5, 1, 2, or 4 μa /mm scale division. Complete specifications are in Bulletin L-47.



Type 315

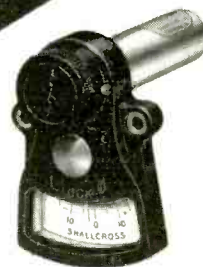

Type 1951
system

Shallcross

SHALLCROSS MANUFACTURING CO., Selma, N. C.

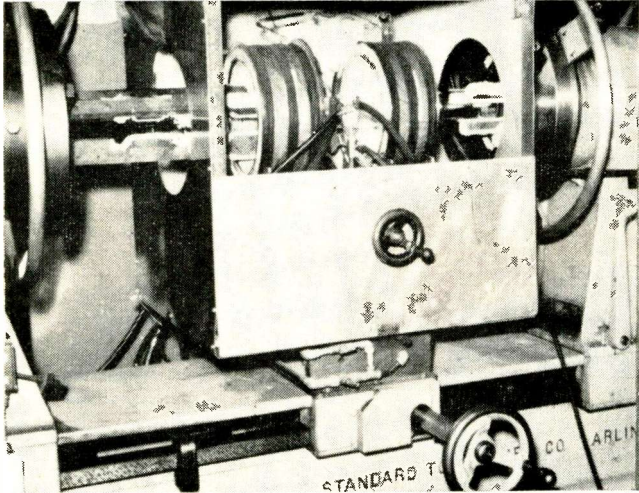

Magnetic arc welder mounted on glass sealing lathe. Workpiece need not be rotated during welding operation

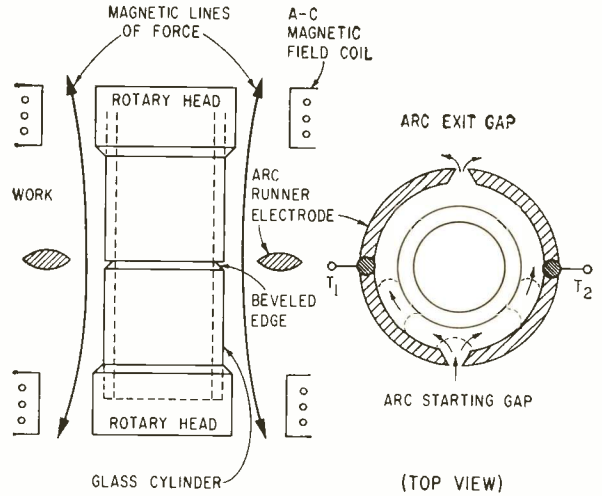

FIG. 1—Basic setup for creating hot arc plasma and confining it in slot between workpieces to be joined

Arc Method Simplifies Glassworking

By E. M. GUYER, Corning Glass Works, Corning, N. Y.

FABRICATING NEW GLASSES and ceramics for high temperature applications requires powerful and versatile glassworking tools. The limitations of flame heating were overcome by electric heating methods,¹ but these in turn pose other problems.

Electric methods now widely used for fabricating glassware for electronic applications generally require the glass be preheated by flames or electrically via conductive paints. These methods complicate welding machines and procedures and raise the cost.

Magnetic arc methods developed by Corning have the advantages of other electric methods. In addition, they do not require special preheaters, paint nor rotating machinery. Large, irregular workpieces can be

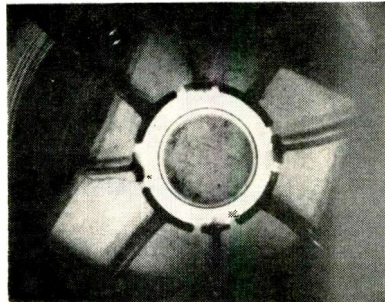

Overhead view of paired arc runners in sequential operation around large diameter workpiece

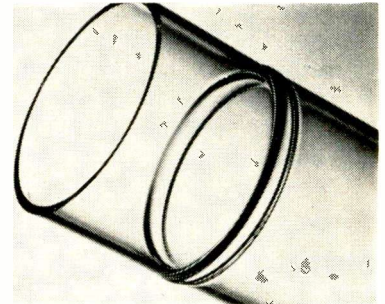

Glass cylinder welded on lathe-mounted arc. Welds can be made in high-temperature glasses or ceramics

welded on stationary jigs. More important, the arcs will rapidly melt conventional glasses and will effectively weld such materials as ceramics and fused silica. The arc can be confined to a specific heating zone, can be shut off instantly and its intensity can be varied at will.

There are limitations at present, however. Care must be taken in preparing the mating edges of workpieces. Reduction in heating rates is necessary with materials sensitive to heat shock or materials which lose volatile components at high temperatures.

Basic Arc Setup

High voltage electric arcs are made to travel in oriented magnetic

fields, over arc runners encircling the edges of parts to be welded. Arc runner electrodes, in cross-section in Fig. 1, cause magnetic lines of force to pass through the welding zone normal to the plane of the arc runners. Constant current, high voltage a-c supplied T₁ and T₂ forms a short arc at the starting gap. The arc is deflected into the tapered slot at the junction of the workpiece. The central section of the arc plasma is forced into the slot. The magnetic field drives the terminal sections of the arc in opposite directions over the surfaces of the arc runners.

The arc is stretched into an elongated ribbon tightly girdling the parts to be welded. The arc sections

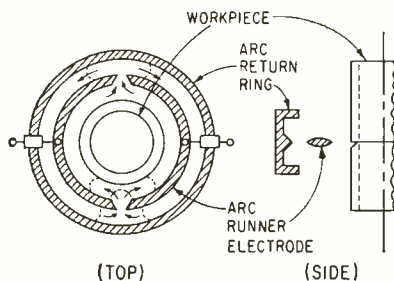
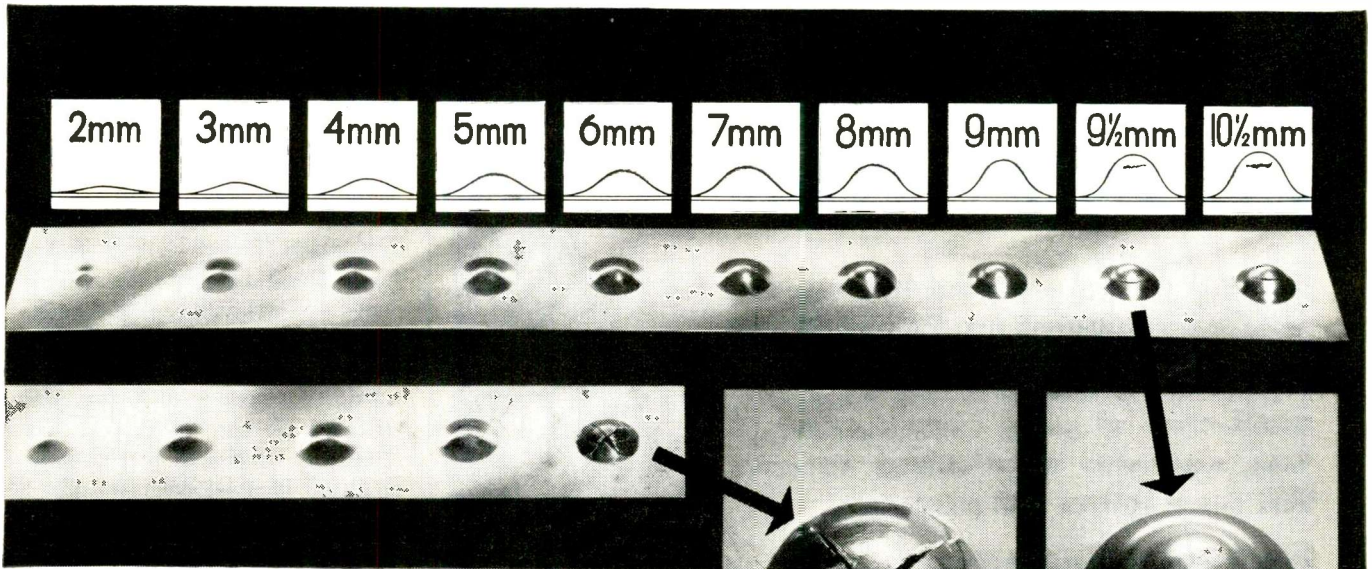

FIG. 2—Coaxially-mounted arc return rings provide repetitive heating cycle

Now you can deep draw and bend molybdenum sheet at room temperature!

... with General Electric's new High-Ductility (HD) Molybdenum Sheet



ERICKSON CUP TEST on 0.060" sheet demonstrates high ductility of new G-E "HD" Moly Sheet. Both test samples of molybdenum were at room temperature. Depth of the draw was increased by 1 millimeter at each progression. The ordinary moly sheet (at bottom) "exploded" at 6mm depth—while the new G-E "HD" sheet showed no evidence of a fissure until 9 1/2mm. Note the reduced tendency of the "HD" sheet to explode. And there's less tendency, also, to delaminate on punching, stamping and shearing than with ordinary commercial grades of molybdenum.

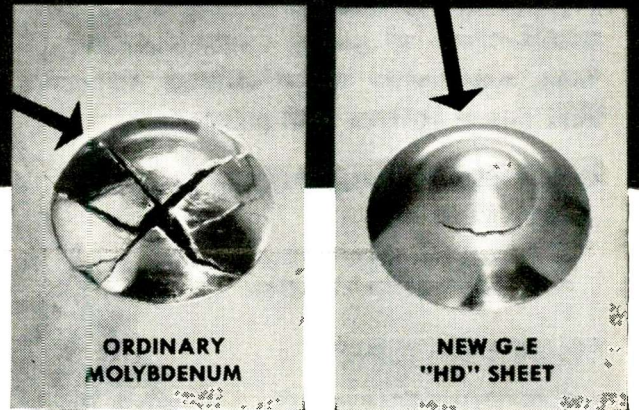

DRAW IT! FORM IT! PUNCH IT!—all without preheating! General Electric's new "HD" Moly Sheet can take it—and you can do all these operations in thicknesses previously impossible . . . or requiring up to 1000°F preheating. Even in cases where small amounts of heat may be needed, it's always less than with ordinary molybdenum sheet.

TIME SAVER, MONEY SAVER! The improved ductility of General Electric's new "HD" Molybdenum Sheet is of particular significance in sheet thicknesses of 0.020" to 0.125"—as used in electronic tubes and semiconductor

diodes, rectifiers and similar products. It has a high melting point (2622°C, 4752°F), low vapor pressure, and excellent strength at elevated temperatures. So it will be of great value to any company using refractory metals.

PLAN ON G-E "HD" SHEET Available in commercial quantities, so there's no better time than right now to get all the facts about this new kind of molybdenum. Write: General Electric Co., Lamp Metals and Components Dept. E-11, 21800 Tungsten Road, Cleveland 17, Ohio.

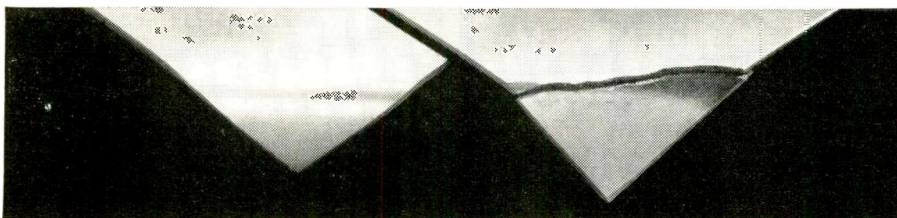

**BENDS WITHOUT CRACKING . . .
EVEN WITH NO PREHEATING!**

Ordinary 0.060" thick molybdenum broke at a 20° bend (see photo at left). The G-E "HD" sheet of same thickness shows no sign of cracking at 90°. Actually this new G-E Moly Sheet is so ductile you can bend it up to 180° without damage!

Progress Is Our Most Important Product

GENERAL  ELECTRIC

PHILCO

TECHREP DIVISION

ANNOUNCES NEW GROUND-FLOOR OPPORTUNITIES IN ENGINEERING

As the pioneer in electronic field services, PHILCO is now moving into the broader field of Electronics . . . researching . . . engineering . . . designing and performing engineering modifications of global communication systems, world-wide radar defense networks, and missile systems and components.

OUR NEW FLEXIBLE POLICY LETS YOU —

- Choose Your Own Field of Interest
- Choose Your Own Location

WHILE PROVIDING

— constant career guidance
... professional growth ...
top compensation and the
very best in employee
benefits.

WRITE TODAY

Let us review your professional experience and desires, so that we may arrange a confidential consultation in your city.

MR. CLIFFORD F. GRAEBE, *Personnel Manager*

PHILCO TECHREP DIVISION, Dept. 39-A

22nd & Lehigh Ave., Philadelphia 32, Pa.

NAME: _____

ADDRESS: _____

CITY: _____ STATE: _____

P.S. Please Enclose Resume.

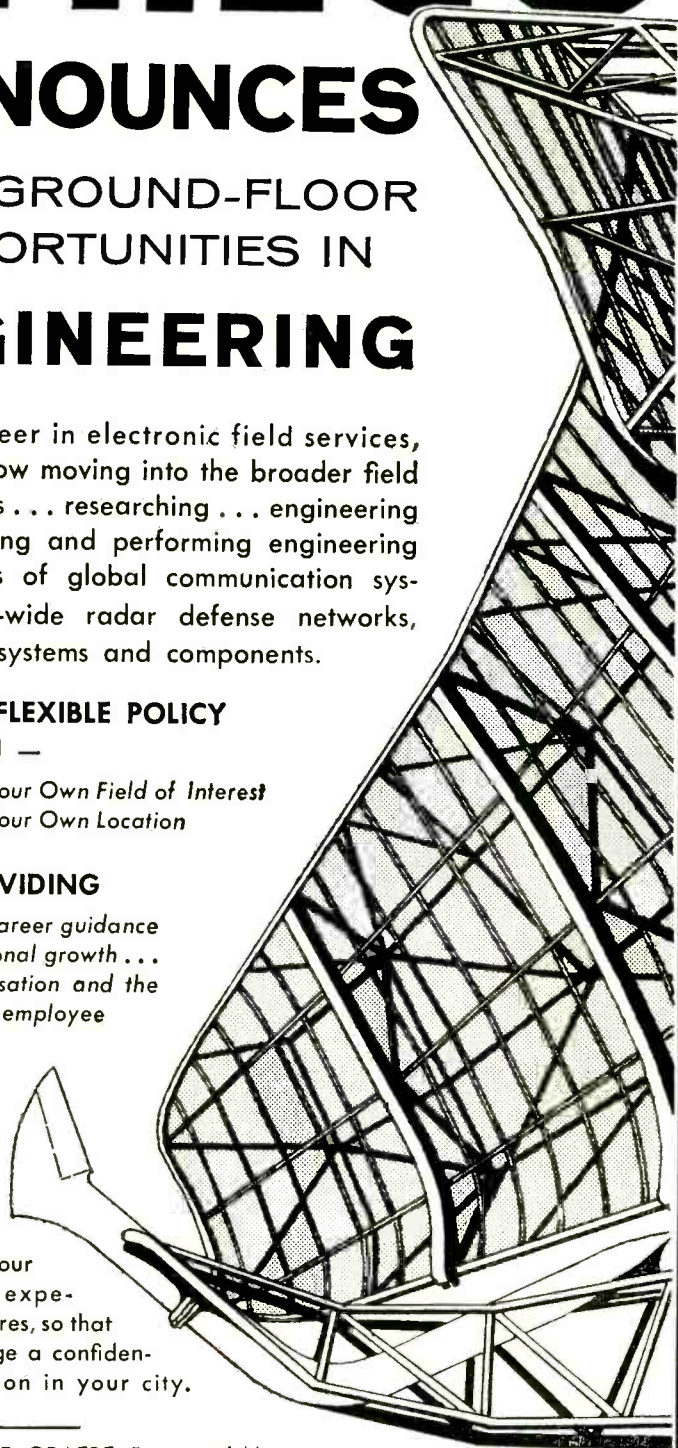

reunite at the exit gap and pass out of the operating area. A repeating cycle is set up by mounting arc return rings as in Fig. 2. Relatively little heat is generated in the return, which has shorter arcs and lower voltage drops.

The arc can be made to oscillate by reversing the field magnet phase, with respect to arc current, as the traveling arc terminals reach the runner ends. Heat transfer may be accelerated by causing the arc to hold at optimum heat transfer.

Resistance Welding

When the glass is hot enough to conduct, it can be resistance welded by forcing the arc current to transfer to the glass. Arc current is reduced and arc voltage increased until current flows in the glass. Or, increasing current and decreasing voltage enables welding by contact with hot plasma.

Large, irregular pieces may be mounted in stationary fixtures and girdled with arc runners in a conforming shape. Periodic reversal of the magnetic field, with respect to arc current, makes the arc flow back and forth, uniformly heating the workpiece. Sequentially-excited pairs of arc runners may be needed for large diameter parts.

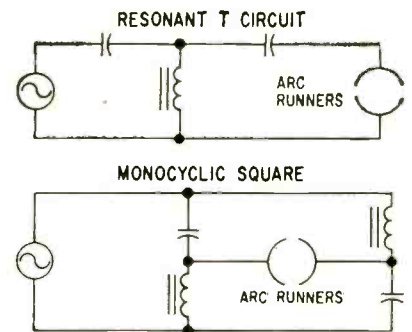
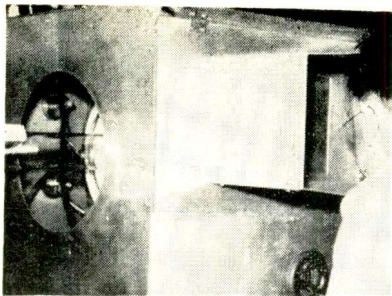

FIG. 3—Position of arc runners in constant current power systems

Efficient operation requires that the slot between mating edges of workpieces be wide enough to permit application of full field strength, but not so wide that the plasma escapes through the slot. Slots 5 to 10 mils wide are best. Part edges must be free from flaws which create excessive variations in the slot. This problem is minimized by curving or bevelling one edge to form a tapered slot (Fig. 1), which traps the plasma.

Power supply must provide sev-



Welder on lathe, with operator's viewing panel in place

eral kilovolts from a constant current generator (Fig. 3). Proper phase relations between arc current and magnet current must be maintained. Coil construction and magnetic materials may vary with the application. Arc runner shape will depend on workpiece shape.

REFERENCE

(1) E. M. Guyer, Electronic Welding of Glass, *ELECTRONICS*, p 92, June, 1945.

Sleeving and Wire Cutters Modified

IMPROVEMENTS of their sleeving cutters and wire cutters and strippers are announced by Technical Devices Co., Santa Monica, Calif. A new 4:1 gear ratio enables the sleeving cutters to cut lengths of sleeving, solder and No. 16 or smaller wire in lengths from $\frac{1}{4}$ inch to 8 inches. Present models with 2-inch length capacity can be modified to obtain 8-inch capacity. Cart-ridge kits for the cutter-stripper machine permit users to change-over rapidly for various wire gages, strip lengths and wire types.

Big Balloons Cushion Shipments in Trucks

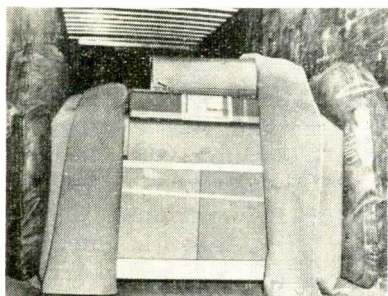

Inflatable cushions made by United States Rubber Co. prevent excessive swaying of data processing systems shipped by truck from IBM, Endicott, N. Y. Cushions are placed around shipments and inflated to 1 psi



Now you can record test data on-the-spot. In both lab and field you get accuracies equal to or better than big, rack mounted units. Just pick up and move a multi-channel (up to 14) PI recorder/reproducer as you would any other item of test equipment.

Instead of 1,000-lb. cabinets, requiring 1000 watts, you're working with recorders 10 times smaller and lighter, using 250 watts or less.

In the field, you get laboratory performance under the most difficult environments. PI fits many places where 19-inch racks won't go. One man can carry a rugged PI recorder to virtually any test site.

How did PI put precision in a small package? By combining transistorized electronics with unique stacked reel tape magazines. PI recorders use standard tapes and heads, are compatible in every way with standard recording practices and other recording equipment.

KEY SPECIFICATIONS (Model PS-207 Series unit)

FM SYSTEM: Frequency response $\pm 1/2$ db 0-10 kc, S/N ratio 43 db, better than 1.5% total harmonic distortion, less than 2% drift 40° to 120°F., linearity 1%.

DIRECT SYSTEM: Response ± 3 db 50-100,000 cps.

POWER: 115 vac, 48-62 cps or 24 vdc.

FLUTTER: Less than 0.1% rms dc to 300 cps or .5% peak-to-peak at 30 ips.

PS-207 shown contains electronics for 7 record/reproduce channels.

After you note these key specs, may we suggest you call your PI representative to arrange a demonstration? If you are uncertain who he is, please write direct. Address Dept. 1811

Precision Is Portable



PRECISION INSTRUMENT COMPANY

1011 COMMERCIAL STREET • SAN CARLOS, CALIFORNIA • PHONE: LYTELL 1-4441

On The Market

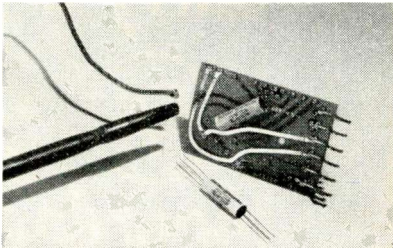

Ultrasmall Relay flexible unit

GENERAL ELECTRIC Co., Schenectady 5, N. Y. Less than 1 in. long and approximately $\frac{1}{4}$ in. in diameter, the new spdt general purpose Unimite relay has a 1-millisecond operating time and a 3-millisecond re-

lease time. It can be cycled at 10,000 operations per minute. The contact chamber is hermetically sealed and isolated from the coil and contains only inorganic and chemically inert materials. As a result, contamination of the contacts has been virtually eliminated.

CIRCLE 301 ON READER SERVICE CARD

Q Meter 1 kc to 300 mc

MARCONI INSTRUMENTS, 111 Cedar Lane, Englewood, N. J. Model 1245 Q meter has a range of 1 kc to 300 mc. Q measurement range is 4 to 1,000 Q with delta Q range of ± 50

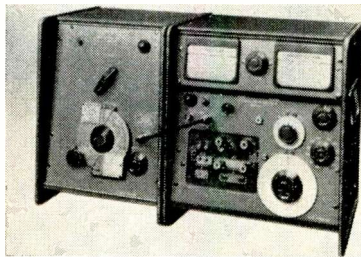

Q. Accuracy to 100 mc is ± 5 percent. Injection resistance is reduced to 20 milliohms for frequencies to 50 mc and to 0.1 $m\mu h$ for all frequencies above. A full range of test jigs and coils are available.

CIRCLE 302 ON READER SERVICE CARD

Mating Jack & Plug microminiature

SEAELECTRO CORP., 610 Fayette Ave., Mamaroneck, N. Y. Specifically designed for multiple jack-plug connections on an ultra-miniaturized scale, the Press-Fit SKT-31 jack and PR-10 plug have general breakaway-connector usages. The

PR-10 is 0.040 in. diameter, while the SKT-31 is designed to accept a 0.040 in. diameter. Both are provided with solder cups so that straight leads can be attached in very close quarters without wrapping. The terminals can be mounted very close together; specifically, on 0.187 in. centers, minimum, plus/minus normal tolerances, and are

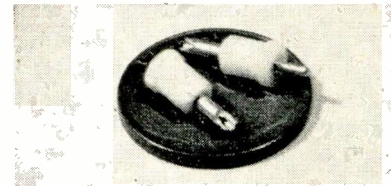

exceptionally rugged. Descriptive literature is available.

CIRCLE 303 ON READER SERVICE CARD

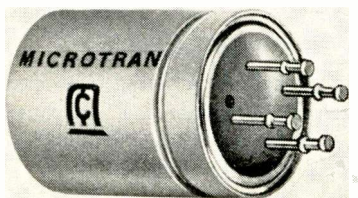

Tiny Transformers hermetically sealed

MICROTRAN Co., INC., 145 E. Mineola Ave., Valley Stream, N. Y., has a line of Veri-Miniature transistor transformers in hermetically

sealed construction to MIL-T-27A, Grade 4, Class R, 10,000 hr life. Size is 0.600 in. diameter by $\frac{1}{8}$ in. high, weight 0.32 oz. Designed for clamp mounting, they may also be obtained with 4-40 stud.

CIRCLE 304 ON READER SERVICE CARD

Soldering System fully automated

ELECTROVERT, INC., 124 E. 40th St., New York 17, N. Y. Faster, higher quality soldering of p-c boards or other electronic and machine component assemblies is possible with the Flowsolder production line soldering system. Product conveying, flux application, solvent removal, flux and board preheating and soldering are completely integrated.

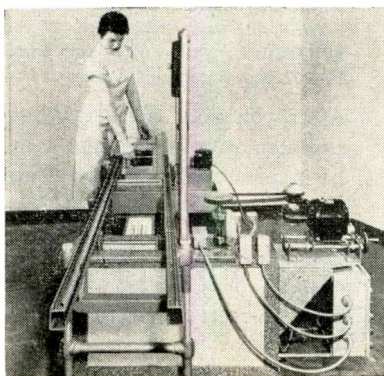

Heart of the system is the Flow-solder machine which brings the molten solder up to the under surface of the assembly rather than dipping the work into a static solder bath. Solder is forced, by means of an impeller pump, through an elongated nozzle so that it forms a standing laminar wave. This standing wave allows straight-line processing and has resulted in production speeds of up to 15 ft per minute. One firm is currently proc-

CIRCLE 85 ON READER SERVICE CARD →

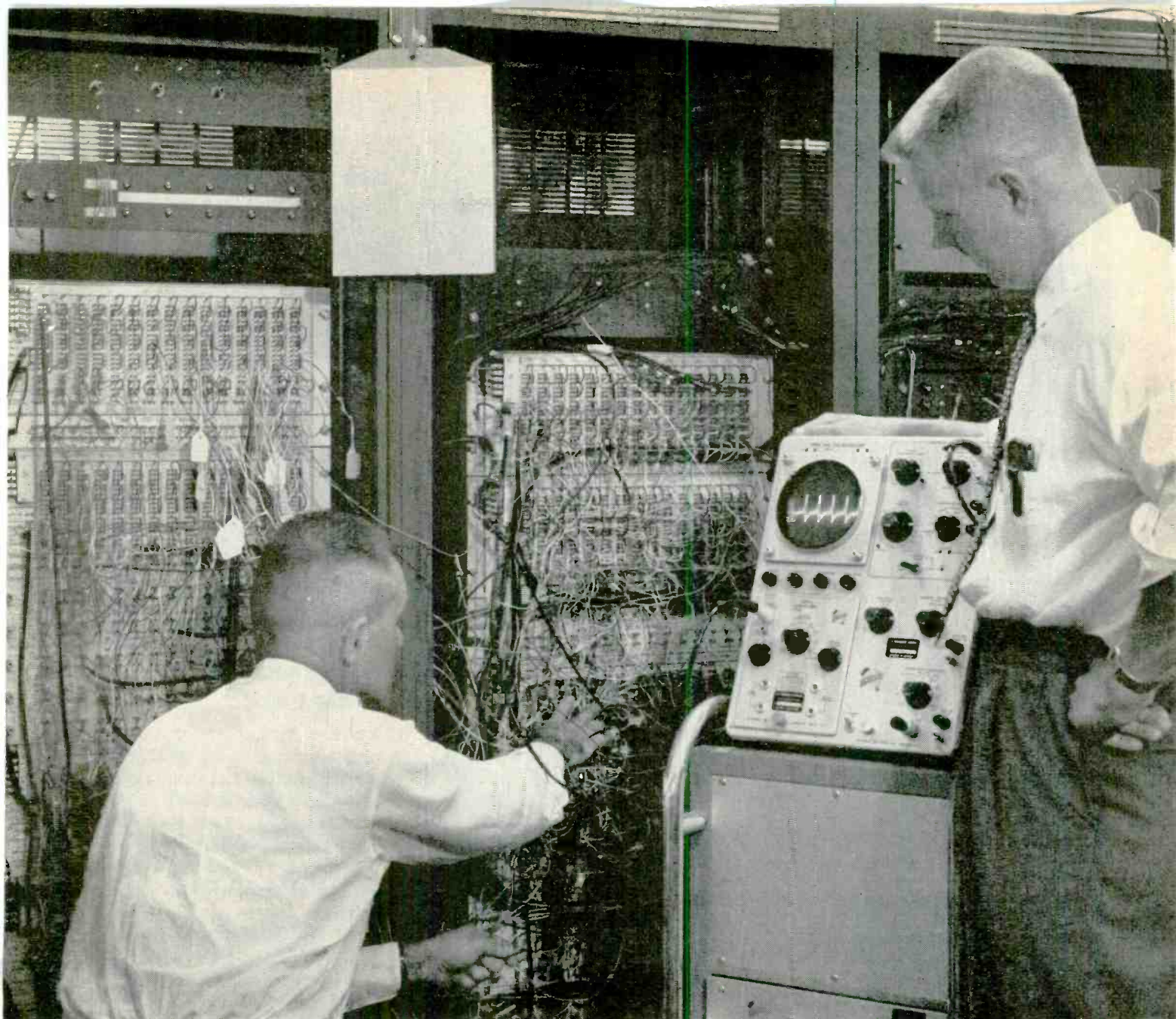

The University of Michigan's Dr. Norman Scott (left) demonstrates the Michigan Instructional Computer—only unit of its kind in the world—to Strand Engineering Company's Robert Carson who is working for his Ph. D.

IN SOUTHEASTERN MICHIGAN: A SCIENTIFIC CLIMATE FOR THE ELECTRONICS INDUSTRY

Electronics companies in Southeastern Michigan have an invaluable asset right from the start. Their personnel find advanced schooling readily accessible. In the area are conveniently located science schools whose postgraduate and extension facilities and faculties are comparable with the best available anywhere.

Within easy reach of these competent schools are communities which have carefully organized and blueprinted their prosperous

growth. Done by skilled professional land-use planners, it's the kind of planning which reassures management people concerned with plant location. Such communities can be particularly confident when they extend an invitation to the electronics industry to look them over. We, too, would welcome the opportunity to discuss communities and plant sites with you on a completely confidential basis.



(Left) Analog computer, Michigan State University. (Center) One of the modern College of Engineering buildings, Wayne State University. (Right) University of Detroit engineering students conduct electronic experiments in the characteristics of gravity.

Write to Plant Location Service,
Area Development Division

DETROIT EDISON

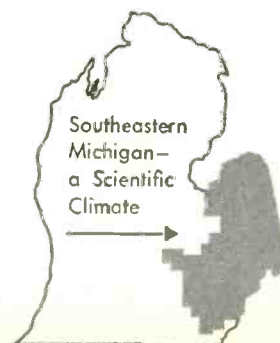

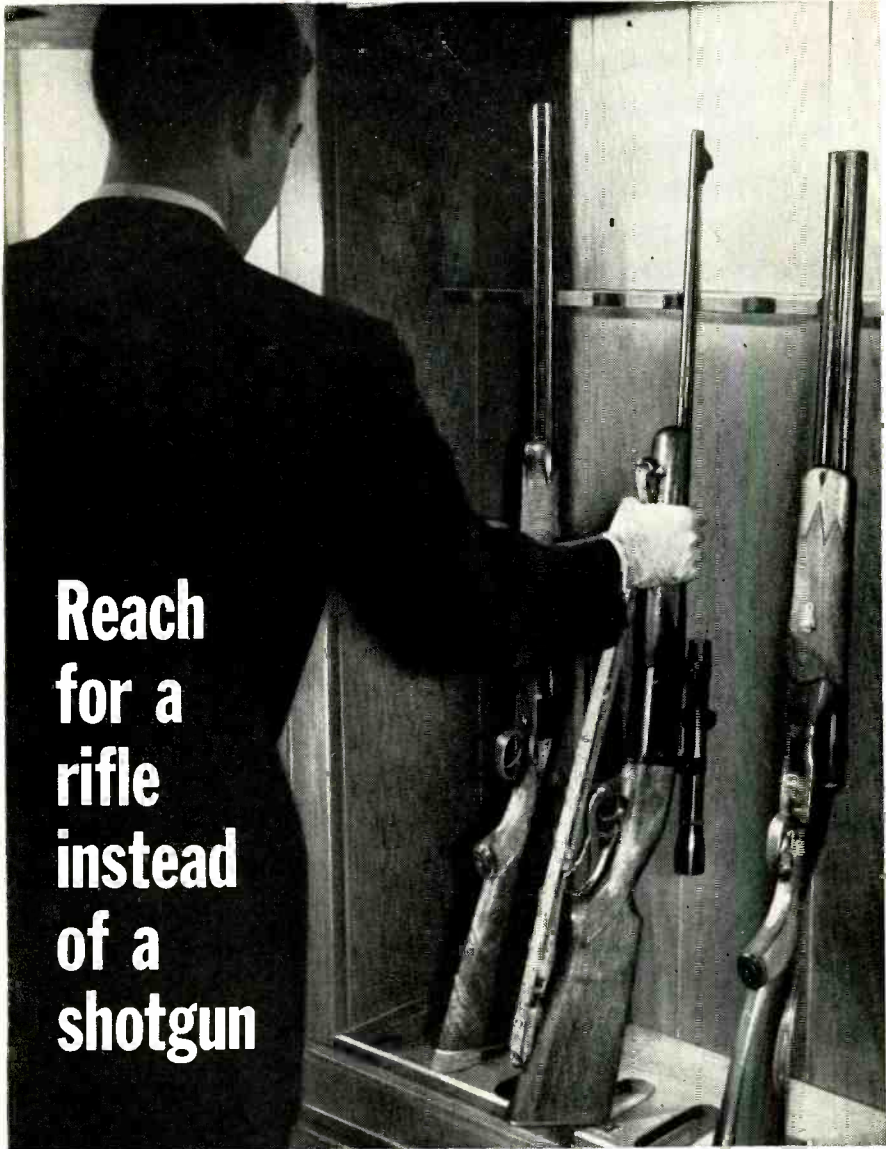

Reach
for a
rifle
instead
of a
shotgun

GPU *Site-Service* puts you on target for the plant location to fit your needs!

Take the "scatter-shot" out of site-seeking with GPU *Site-Service*! This complete, centralized service has complete details on more than 600 separate listings of available buildings and sites. It can do your screening for you and match *your* requirements in one of the nation's finest industrial areas.

To make sure your next plant is placed *exactly* right for most profitable operation, contact GPU *Site-Service* today! Your inquiry will receive prompt, *confidential* attention.

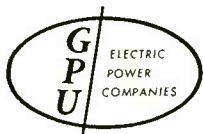

Metropolitan Edison Co.
Pennsylvania Electric Co.
New Jersey Power & Light Co.
Jersey Central Power & Light Co.

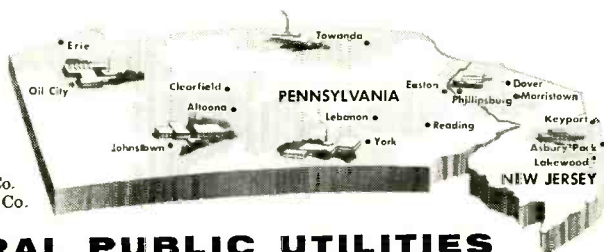

GENERAL PUBLIC UTILITIES CORPORATION

Att: Wm. J. Jamieson, Area Development Director, Dept. E-8
67 Broad St., New York 4, N. Y. Whitehall 3-5600

essing boards at a rate of 800 per hr.

CIRCLE 305 ON READER SERVICE CARD



Power Rheostats explosion-proof

CLAROSTAT MFG. CO., INC., Dover, N. H., has announced metal-cased power rheostats that meet the explosion-proof requirements of MIL-E-5272A, Par. 4, 13, 2. Units have many industrial applications aside from military requirements, or wherever an explosive-gas hazard is present.

CIRCLE 306 ON READER SERVICE CARD



Potentiometers panel mount

BOURNS LABORATORIES, INC., P. O. Box 2112, Riverside, Calif. A complete line of panel mount Trimpot potentiometers require only $\frac{1}{2}$ sq in. or less of panel area. Units feature a self-locking shaft which does away with cumbersome lock nuts. The multiturn adjustment provides up to 9,000 deg of rotation to speed up and simplify the adjustment or balancing of circuits. Stainless steel construction assures compliance with military specs. Screwdriver adjustment is easily

CIRCLE 87 ON READER SERVICE CARD →



Engineers Make the Best Fathers

Engineers make the best fathers because they encourage curiosity and experimentation—"pinning things down" to what they really are, instead of what somebody wants them to be. Engineers lead their children to the greater rewards of basing decisions in life on realities rather than wishes—facts rather than fiction.

We know engineers make the best fathers, because most of us at General Transistor are engineer-fathers... and so are most of our customers. Engineers practice what they preach. They base their decisions on facts, which explains why they write us asking for the facts about General Transistor products.

We encourage them.



... helping engineers make the best, by supplying the best

GENERAL TRANSISTOR CORPORATION

91-27 138th Place, Jamaica 35, New York

Raytheon relies on **COUCH** RELAYS*

for
the
Sparrow III



* CVE type

SERVICE: U. S. NAVY
STATUS: Operational
TYPE: Air to Air
POWERPLANT: Solid Propellant
SPEED: Supersonic
LENGTH: 12 feet
WEIGHT: 350 lbs.
GUIDANCE: Radar homing

Developed by the Raytheon Company, the U.S. Navy's Sparrow III is notable for a new radar guidance system which insures effective attacks on evasive targets. For this highly advanced missile, Raytheon chose Couch Relays. Other leading missile builders also rely on Couch Relays . . . and for the same reason. Couch has coupled stringent quality control techniques with simple, rugged design to assure performance of proven reliability under severest environmental extremes. In the broad Couch line, there's a dependable relay ready to work for you. Write today for complete specifications.

Write for our new catalog on the full Couch line of rugged rotary relays.



ORDNANCE INC.

A subsidiary of S. H. Couch, Inc.

3 Arlington Street

North Quincy, Mass.

made from the front of the panel, and the recessed head prevents accidental changing of the setting. Units are available in resistances from 10 ohms to 1 meg with wire-wound or carbon resistance elements.

CIRCLE 307 ON READER SERVICE CARD



Tetrode Transistors r-f, i-f amplifiers

GENERAL ELECTRIC Co., Syracuse, N. Y. The 3N36 and 3N37 germanium tetrode transistors are designed for use as wide band r-f amplifiers, radar i-f amplifiers, and h-f mixers and oscillators. The 3N36 has an operating range of 30 to 100 mc; the 3N37 is recommended for use from 100 to 300 mc. Both are capable of attaining maximum gain at power levels as low as 5 mw. Typical I_{co} for both is 3 μ a. Features include extreme ruggedness and stability of gain with a change of ambient temperature.

CIRCLE 308 ON READER SERVICE CARD

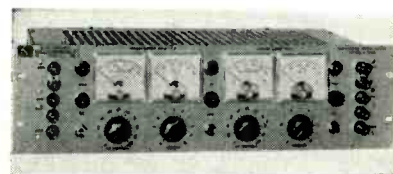

Dual Power Supply programmable

ELECTRONIC MEASUREMENTS Co., INC., Eatontown, N. J. Model 2-212A Regatron power supply offers two independent sources of 0-100 v d-c at 0-100 ma on one rack-mounted chassis. Load regulation is 0.1 percent or 0.05 v, line regulation 0.15 percent or 0.05 v, ripple less than $\frac{1}{2}$ mv for each output independently. Remote control terminals for programming may be had on either the front panel or rear of

CONTINENTAL CONNECTOR announces...

two new sub-miniature plug & socket connectors

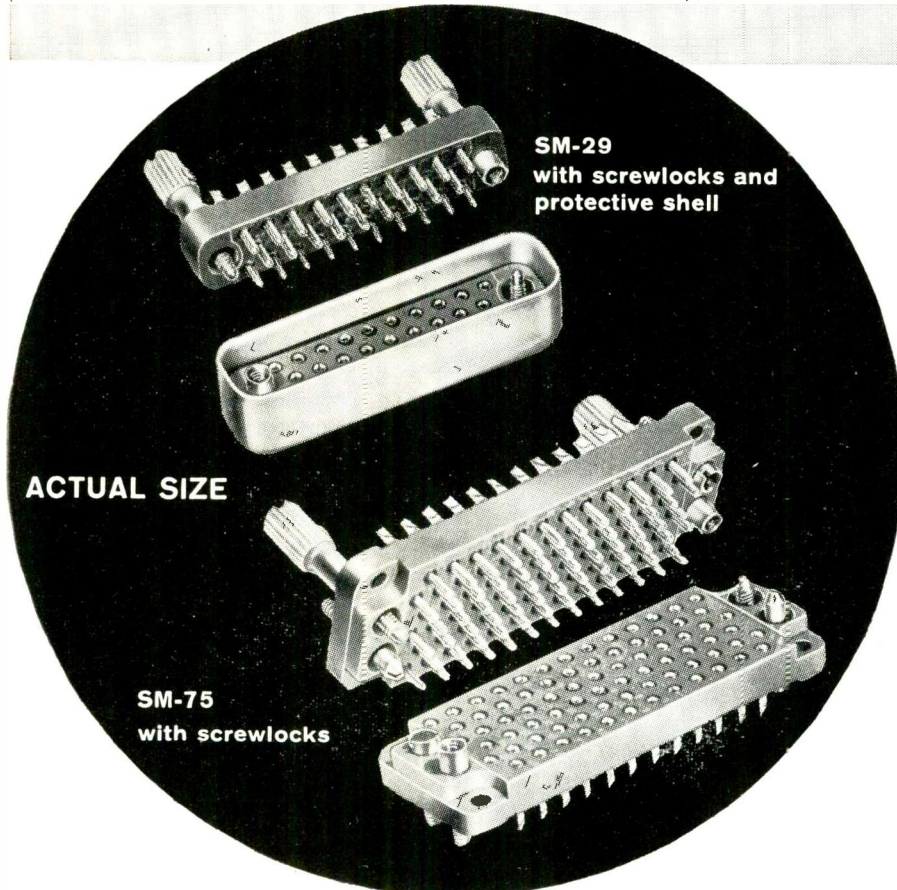

SM-29
with screwlocks and
protective shell

ACTUAL SIZE

SM-75
with screwlocks

SERIES SM-20

- Floating contact design insures positive self-alignment of each contact
- Precision machined phosphor bronze contacts... gold plate over silver plate
- Also available with 5, 7, 9, 11, 14, 20, 26, 34, 42 or 50 contacts
- Reversed guides or screwlocks* provide positive polarization of plug and receptacle

Small size and rugged construction make these Continental Sub-Miniature Connectors practical for aircraft and instrumentation applications requiring extreme miniaturization without loss of high precision. Body material is glass filled Diallyl Phthalate (MIL-M-19833, Type GDI-30). Other molding compounds can be supplied on order.

SM-11 with hood

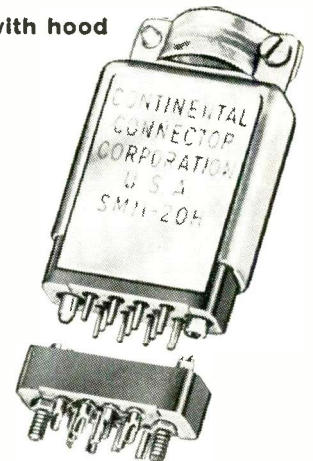

ELECTRICAL AND MECHANICAL RATINGS

Voltage Breakdown:
 At Sea Level.....1900 Volts RMS
 At 60,000 Ft..... 700 Volts RMS
 Current Rating.....5 Amps.
 Minimum Creepage Path Between Contacts..... $\frac{5}{64}$ "
 Minimum Air Space Between Contacts..... $\frac{3}{64}$ "
 Contacts Center-to-Center..... $\frac{1}{8}$ "
 Pin Diameter......040
 Solder Cup..... #20 AWG wire

Ratings meet MIL-C-5015 and MIL-C-8384 Specifications
 shock tested (MIL-STD-202)...vibration tested (MIL-E-5272)

OTHER TYPES AVAILABLE

Aluminum hoods, protective shells and solder core contacts, pre-filled with a solder alloy of any specified composition, are available on order for this series. In addition to the two sizes illustrated, Series SM-20 can be supplied with 10 other contact arrangements between 5 and 50.

*PAT. NO. 2,746,022

SPECIFY... ORDER

Continental Connectors

For complete specifications on Continental Connector's sub-miniature series write to: Electronic Sales Division
 DeJUR-AMSCO CORPORATION, 45-01 Northern Boulevard, Long Island City 1, N. Y. (Exclusive Sales Agent)

MANUFACTURED BY CONTINENTAL CONNECTOR CORPORATION, AMERICA'S FASTEST GROWING LINE OF PRECISION CONNECTORS

GM TACHOMETER-GENERATORS

Built to all applicable Government Specifications.
In production—available for prompt delivery.



BuOrd Mark 12 Mod 0 SERVO MOTOR Tachometer Generator 115 volts / phase, 4500 RPM (min).

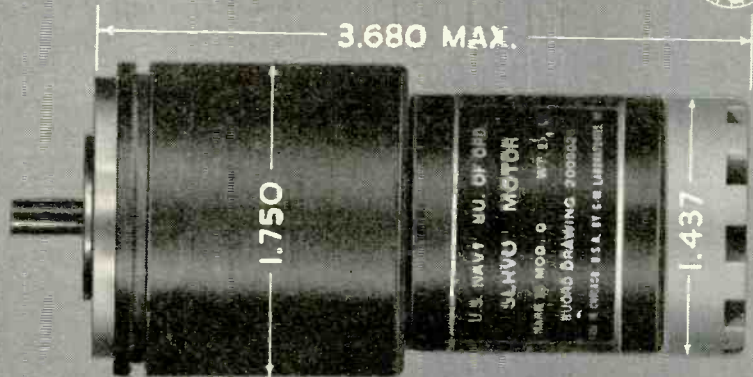

BuOrd Mark 16 Mod 0 SERVO MOTOR Tachometer Generator 115 volts / phase, 4500 RPM (min).

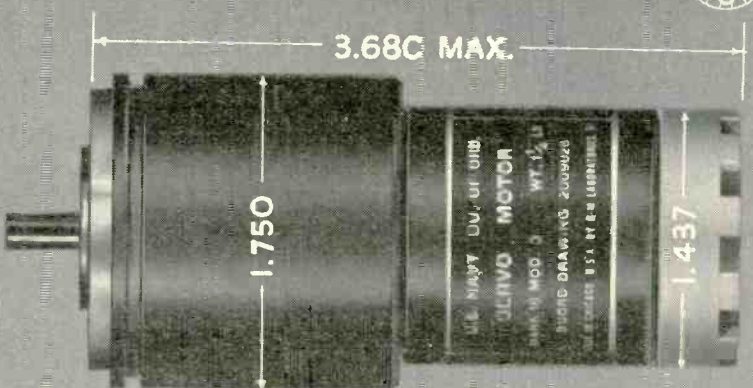

BuOrd Mark 16 Mod 3 SERVO MOTOR Tachometer Generator for transistor operation 115 volts fixed phase 36/18 volts control phase, 4500 RPM (min).



GM
G-M Servo Motors
Manufactured by the Components Division of
G-M LABORATORIES, INC.
4336 N. Knox Avenue • Chicago 41

For complete information on these and all SERVO MOTORS, write for G-M PROCUREMENT SPECIFICATION NO. 665 and Catalogue

the unit, with provision for remote sensing to maintain regulation at the load. Chopper stabilization is optional.

CIRCLE 309 ON READER SERVICE CARD



Card Receptacles meet MIL-C-21097

METHODS MFG. CORP., 7447 W. Wilson Ave., Chicago 31, Ill. Designers can now utilize the added strength characteristics of $\frac{3}{16}$ in. and $\frac{1}{8}$ in. p-c boards and still employ direct plug-in construction with the $\frac{3}{16}$ in. and $\frac{1}{8}$ in. capacity Reli-Acon card receptacles. Units are available with optional threaded mounting inserts and with vibration resistant card locking clips, with which a screw driver or similar instrument is employed to release the latch.

CIRCLE 310 ON READER SERVICE CARD

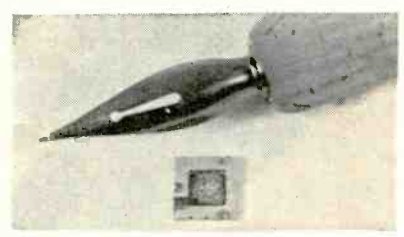

Tiny Capacitor solid-tantalum

SPRAGUE ELECTRIC Co., North Adams, Mass., has developed a solid-electrolyte Tantalex capacitor embedded in a notched phalanx-shaped ceramic wafer 0.3 in. sq for use in micromodule circuitry. Capacitances as high as 30 μ f at 1 v or 10 μ f at 3 v are contained in a wafer only 25 mils thick.

CIRCLE 311 ON READER SERVICE CARD

H-V Power Supplies regulated units

FXR, INC., 26-12 Borough Place, Woodside 77, N. Y., adds to its line three continuously variable h-v

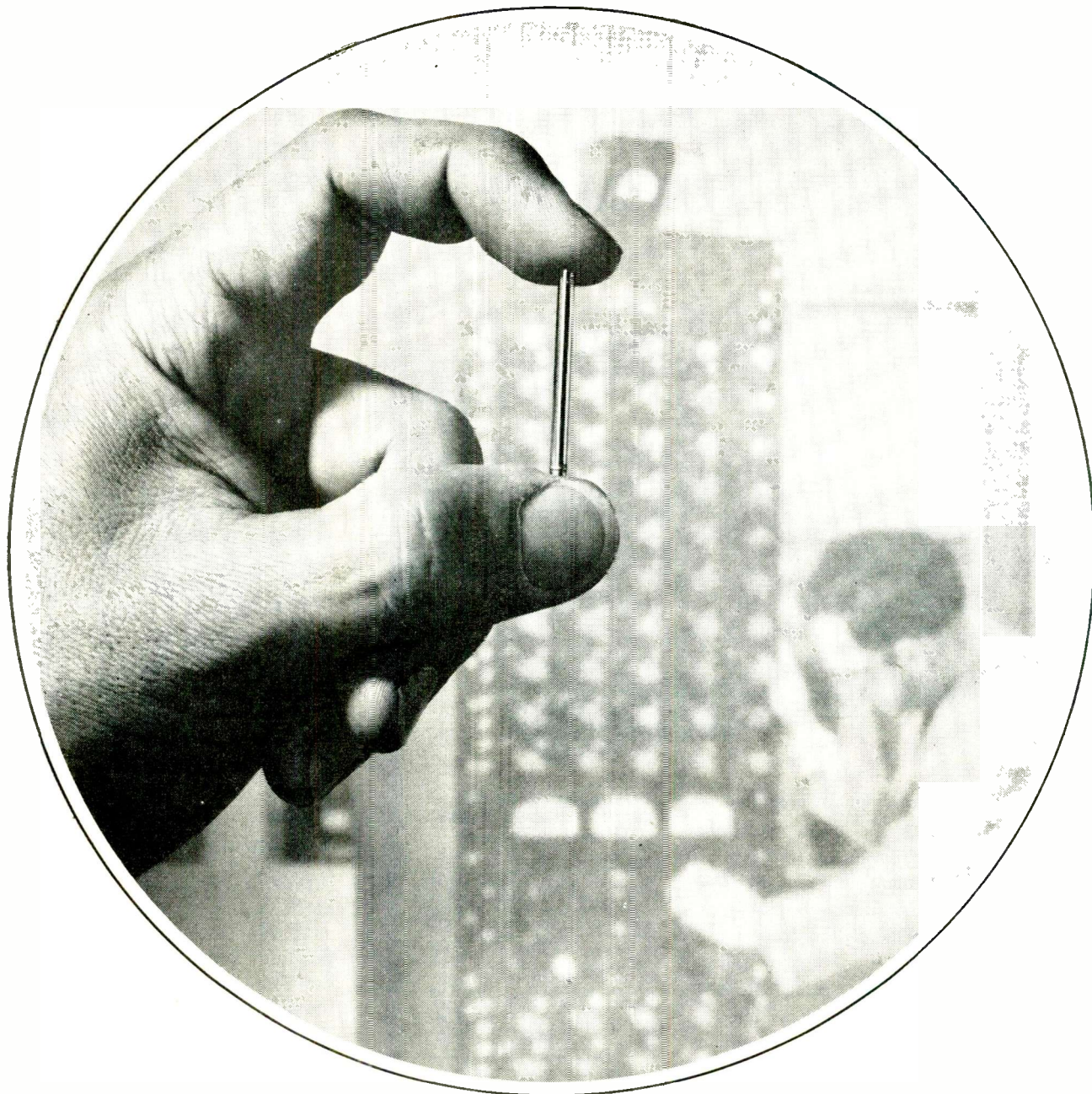

Superior Probes Deeper into Cathode Metallurgy

VACUUM MELTED CATHODE MATERIALS AND VACUUM ANNEALED CATHODES

There has been considerable interest lately in vacuum melted and vacuum annealed cathodes. On the part of Superior Tube, too—its engineers have been probing the subject for almost 10 years.

Today Superior offers vacuum annealed cathodes in more than a dozen cathode alloys in Seamless/Weldrawn® form. In addition, vacuum melted heats of Superior's Cathaloy® materials are available in all cathode forms . . . Seamless/

Weldrawn, Lockseam,* and Lapseam. The full benefits to users of electron tubes await further exploration and testing.

Why not investigate these alloys in your own laboratory. Cathodes can be supplied in any desired size for pilot testing or in quantity lots. Superior engineers will be glad to work with you in comparing laboratory findings and in providing analysis information. Superior Tube Company, 2500 Germantown Ave., Norristown, Pa. **Manufactured under U.S. patents*

Superior Tube

The big name in small tubing

NORRISTOWN, PA.

Johnson & Hoffman Mfg. Corp., Mineola, N.Y.—an affiliated company making precision metal stampings and deep-drawn parts

MARCONI FM SIGNAL GENERATOR

Covers 10 to 470 mc on fundamentals



Model 1066A offers a unique combination of features essential to the exacting tasks required of a precision fm generator.

Its wide range is covered with the complete absence of spurious sub-harmonics. Directly calibrated stepped and continuous incremental tuning, supported by exceptional frequency stability, bring new ease and accuracy to bandwidth measurement. Deviation up to ± 100 kc is produced at either of two modulation frequencies by a ferrite modulator. Other major features are the Marconi-patented contactless range turret, and a piston attenuator giving a high-quality 50-ohm output.

MARCONI FM SIGNAL GENERATOR MODEL 1066A

Abridged Specifications

FREQUENCY RANGE: 10 to 470 mc in five bands—all on fundamentals. FREQUENCY STABILITY: Better than 0.0025% per 10-minute period after warm-up. INCREMENTAL FREQUENCY CONTROLS: Variable, 0 to ± 20 and 0 to ± 100 kc. Stepped, ± 5 , 10 and 15 kc. MODULATION: 0 to 20 and 0 to 100 kc deviation monitored and continuously variable; amplitude modulation at any depth up to 40% is also obtainable. MODULATION FREQUENCIES: 1 and 5 kc. OUTPUT: 0.1 μ v to 100 mv across a 50 Ω termination. OUTPUT ACCURACY: Incremental, 0.2 db: within 2 db overall. LEAKAGE: Negligible; allows full use of 0.1 μ v output. TUBES: 5Z4G, 6AK6, 6CD6G, 6AK5, 5861, 6C4, 6L6G, 12AT7, 6X2, 5651. Marconi FM Deviation Meters 791D and 934/2 are companion instruments.

Send for leaflet B159 for full details.

**MARCONI
INSTRUMENTS**

*Marconi
for fm
test gear*

111 CEDAR LANE · ENGLEWOOD · NEW JERSEY Tel: LOwell 7-0607
Canada: Canadian Marconi Co. Marconi Building, 2442 Trenton Ave., Montreal 16
MARCONI INSTRUMENTS LTD · ST. ALBANS · HERTS · ENGLAND

regulated power supplies. Voltage ranges are 0 to 10 kv, 0 to 12 kv and 0 to 18 kv, respectively. Units supply beam, focus, filament and magnet voltages for backward wave oscillators, t-w amplifiers, stable local oscillators and other frequency sensitive tubes requiring the beam voltages within the ranges designated. Voltage regulation is better than 0.1 percent with a 10 percent variation of primary power. Maximum ripple is 4 or 5 mv, depending upon the model.

CIRCLE 312 ON READER SERVICE CARD



Relay microminiature

FILTERS, INC., Port Washington, N. Y. A new microminiature Powr-mite relay guarantees 50 g's vibration and 250 g's shock. Featuring the Sensi-Tork rotary relay motor, the 0.200 grid space relay gives the "golden G" outstanding overall performance characteristics.

CIRCLE 313 ON READER SERVICE CARD

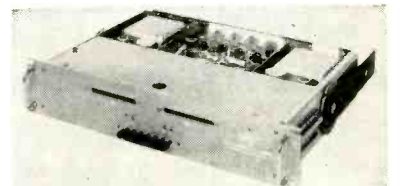

Gate-Pulse Generator adds versatility

ARNOUX CORP., 11924 W. Washington Blvd., Los Angeles 66, Calif. A gating unit designed to generate sequential gate pulses is immediately adaptable to any ArnoUX de-commutator, or it may be adapted to any system requiring sequential timing pulses, such as digital computers, a-to-d converters, d-to-a converters, etc. Operation is con-

Here is the
fascinating field of

BIO-MEDICAL ELECTRONICS

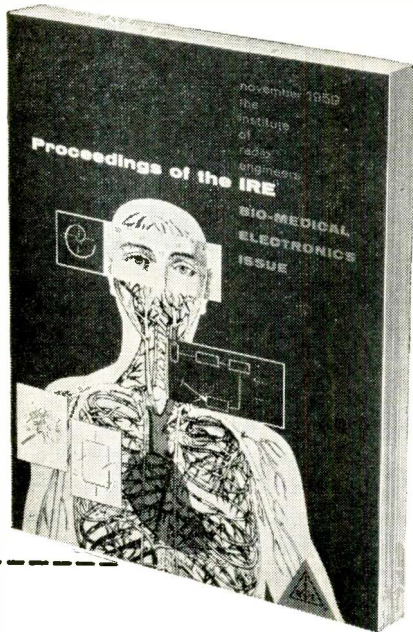

The purpose of this special November issue of *Proceedings*, as outlined in the guest editorial by J. W. Moore, National Institute of Health, is "to provide its readers with some interesting, informative and perhaps provocative examples of various weddings of electronic art and concepts to some of the life sciences. This collection of articles is not intended to delineate Bio-Medical Electronics, but rather to illustrate the breadth of the field of interest of the Professional Group on Medical Electronics, which, by constitutional definition, is the study of biological and medical systems." Thus begins one of *Proceedings'* most fascinating issues — one that presents the scope of the broad new avenues of experimentation in biological measurements opened up by the speed, versatility and precision of modern electronics. This special issue is not only the current record of the progress in Bio-Medical Electronics, it is fascinating reading for radio-electronics engineers in general.

26 ARTICLES BY LEADERS IN THE BIO-MEDICAL ELECTRONIC FIELD

Below is just a partial listing of the articles this special issue covers. For example, the development of a broadband electrometer is described in the article by Gesteland, Howland, Lettvin and Pitts on "Microelectrodes and Their Use." This issue gives considerable emphasis to basic biological research. And, because the recruitment and training of personnel to work in the bio-medical instrumentation area is probably the most pressing problem to be faced by the PGME, there are supplementary articles in this area. This special November issue of *Proceedings of the IRE* on Bio-Medical Electronics is only one of the many services offered members of the IRE. If you are a non-member and wish a copy of this vital link in the record of radio-electronics, return the coupon below, today, to reserve it for yourself or your company.

PARTIAL CONTENTS OF THIS NOVEMBER BIO-MEDICAL ELECTRONICS ISSUE:

- "An Analog Computer to Stimulate Systems of Coupled Bimolecular Reactions," by E. F. MacNichol, John Hopkins University
- "Electron Transfer in Biological Systems," by B. Chance, University of Pennsylvania
- "Alternating Current Spectroscopy of Biological Substances," by H. P. Schwan, University of Pennsylvania
- "Comments on Microelectrodes," by R. C. Gesteland, B. Howland & J. Lettvin, Massachusetts Institute of Technology
- "Some Functions of Nerve Cells in Terms of an Equivalent Network," by W. H. Freygang, National Institutes of Health
- "Electronic Control of Some Active Bioelectric Membranes," by J. W. Moore, National Institutes of Health
- "Measurement of Mechanical Properties of Muscle under Servo Control," by M. Lubin, Harvard University
- "Scanning Microscopy in Medicine and Biology," by L. E. Flory, RCA Laboratories
- "Instrumentation for Automatically Pre-Screening Cytological Smears," by R. C. Bostrom, H. S. Sawyer & W. E. Tolles, Airborne Instruments Laboratory
- "A Magnetic Flowmeter for Recording Cardiac Output," by H. W. Shirer, R. B. Shackelford & K. E. Jochim, University of Kansas
- "The Use of an Analog Computer for Analysis of Control Mechanisms in the Circulation," by H. R. Warner, Latterday Saints Hospital
- "Some Engineering Aspects of Modern Cardiac Research," by D. Baker, R. M. Ellis, D. L. Franklin & R. F. Rushmer, University of Washington
- "Stability, Oscillations, and Noise in the Human Pupil Servomechanisms," by L. Stark, Yale University
- "What the Frog's Eye Tells the Frog's Brain," by J. Y. Lettvin, H. R. Maturana, W. S. McCullough & W. H. Pitts, Massachusetts Institute of Technology
- "Repetitive Analog Computer for Analysis of Sums of Distribution Functions," by F. W. Noble, J. E. Hayes, Jr. & M. Eden, National Heart Institute
- "Medical Ultrasonics," by J. F. Herrick, Mayo Clinic; H. P. Schwan & J. M. Reid, University of Pennsylvania
- "The Use of Electronic Computers to Aid Medical Diagnosis," by R. S. Ledley & L. B. Lusted, National Academy of Sciences
- "New Instrumentation Concepts for Manned Flight," by L. J. Fogel, Convair
- "The Origin of the Professional Group on Medical Electronics," by L. H. Montgomery, Vanderbilt Medical School
- "Instrumentation in Bio-Medical Research," by P. E. Klopsteg, National Academy of Sciences
- "On the Role of the Engineer in Bio-Medical Instrumentation," by J. P. Hervey, Rockefeller Institute
- "Medical Electronics Center—Interdisciplinary Coordination," by V. K. Zworykin, Rockefeller Institute

Enclosed is \$3.00

Enclosed is company purchase order for the November, 1959, issue on Bio-Medical Electronics.

All IRE members will receive this November issue as usual. Extra copies to members, \$1.25 each (only one to a member).

THE INSTITUTE OF RADIO ENGINEERS
1 East 79th Street
New York 21, New York



Proceedings of the IRE

1 East 79th Street, New York 21, New York

Name _____

Company _____

Address _____

City & State _____

C.E.C.

FILTERS AND SONIC DELAY LINES

ANSWER CHALLENGING ASSIGNMENTS*

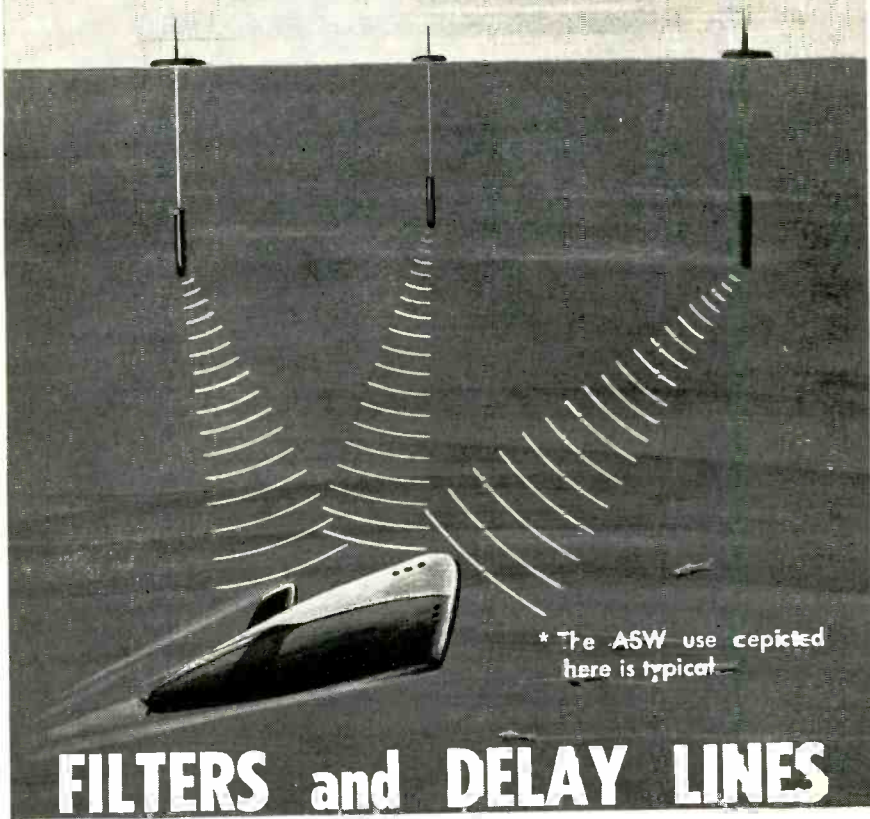
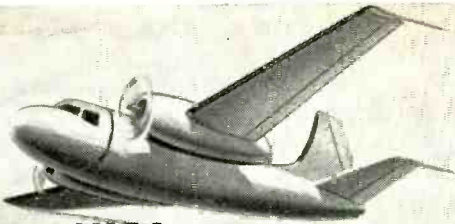

* The ASW use depicted here is typical

FILTERS and DELAY LINES



C.E.C. specializes in the design and production of Custom and Standard Delay Lines and Filters in varied configurations to meet MIL or Commercial Specs.

Electromagnetic Delay Lines: Lumped & Distributed Constant • Fixed • Multi-tapped • Mechanically Variable • Electrically Variable • System Delays

Magnetostrictive Delay Lines: Fixed • Multi-tapped • Variable
Standard Filters: High, Low and Band Pass, Inter-Stage
Special Filters: 90° Phase Shift, Null "T", Ultra-Stable, Band Suppression, Constant Delay

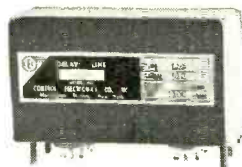

CONTROL ELECTRONICS Co., INC.
Ten Stear Place, Huntington Station, New York

NOTE:
Data Sheets on request

tinuous, even with one or several information gates removed. Active readout capability is from 1 to 88 channels, operating on all standard IRIG sampling rates of 30, 45, 60, or 90 channels at from 75 to 900 pps.

CIRCLE 314 ON READER SERVICE CARD

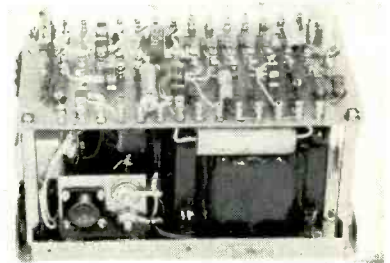

Power Supply ultra-stable

THE DAVEN Co., Livingston, N. J. Model 62AR a-c to d-c transistorized power supply has a stability of ± 0.1 percent regulation for six months. Unit also features reliability of better than 0.95 for a period of one year at 8 hr per day, life expectancy 10 yr, and an output impedance of less than 200 μ ohms at d-c. Applications include use as a voltage reference in computers and complex networks, as a laboratory voltage standard, and as an ultra-stable power source for precision equipment. Units can be cascaded to provide higher voltage without degradation of performance. It can also be supplied as a d-c to d-c unit.

CIRCLE 315 ON READER SERVICE CARD



Vibration Meter versatile unit

SOUTHWESTERN INDUSTRIAL ELECTRONICS Co., 10201 Westheimer Road, Houston 19, Texas. The T-1A battery powered, transistorized vibration meter can accept up to six transducer outputs—three for ve-

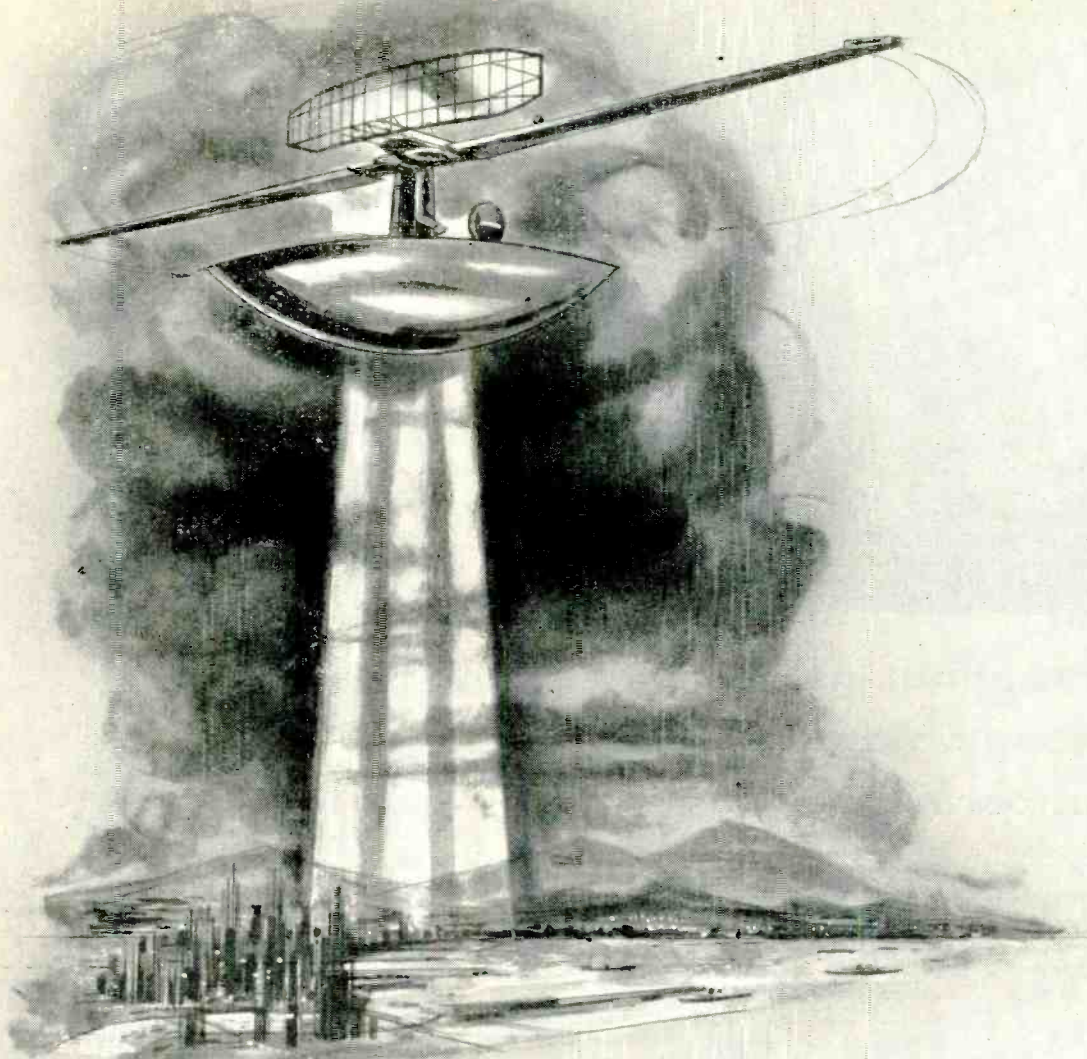

We Were Created to Create . . .
SYSTEMS. Not just electronics.

The systems we foresee will establish new dimensions: In "gaming" and logistical data processing; Undersea; Communications; Continental air defense, ground support; IPV (interplanetary vehicle) control; Missile, Satellite Check-out; Our RAMP microwave platform. And, a variety of non-military systems.

We seek men to generate these systems.

Most are outstanding systems or project engineers. Some are physicists. A few are geo-political analysts.

Each is a broad thinker, experienced at systems planning, hardware, analytical approaches. Aware of the increasing electronic content of systems, each knows that the minds which comprehend this content determine the future influence of systems upon civilization.

To these men, Raytheon's new **SYSTEMS MANAGEMENT** offers unparalleled professional satisfaction. They are invited to inquire of: Mr. Donald Sweet, Engineering & Executive Placement, Raytheon Company, 624N Worcester Road, Framingham, Mass. (suburban Boston).

SYSTEMS MANAGEMENT
 GOVERNMENT EQUIPMENT DIVISION



EXCELLENCE
 IN ELECTRONICS

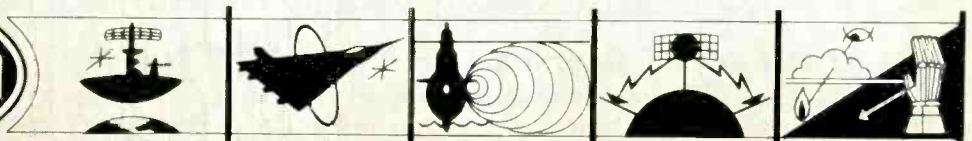

SYSTEMS
 MANAGEMENT

AIRBORNE
 ELECTRONIC

SUBMARINE
 SIGNAL

HEAVY
 ELECTRONIC

SANTA
 BARBARA

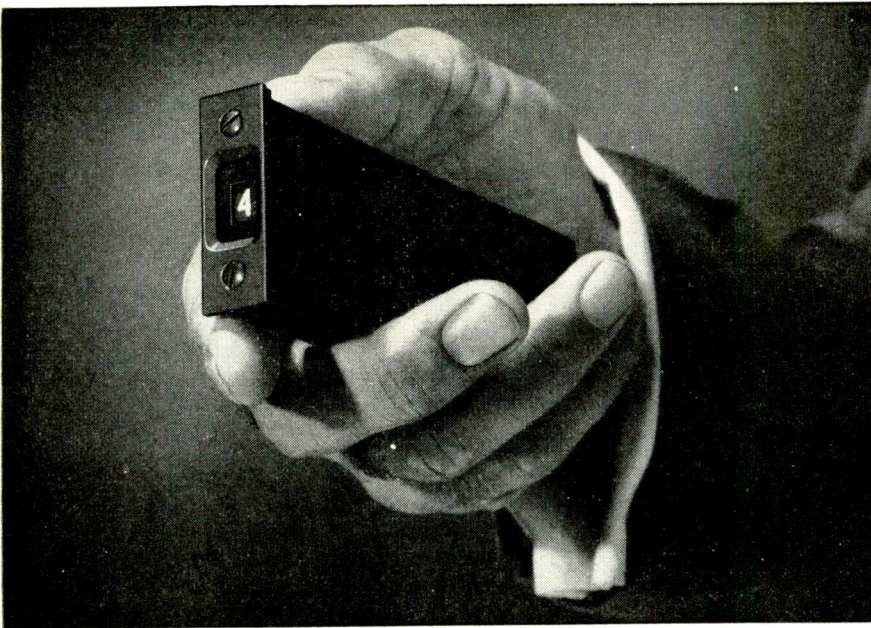

New UNION readout instruments withstand shock, vibration and extreme temperature changes

Union Switch & Signal's new READALL* readout instrument replaces complicated systems of lights and relays for reading, storing or transferring all types of information for industrial and military applications. It is not to be confused with conventional indicating devices.

Designed to meet requirements of MIL-E-5422D. The new READALL readout instrument is precision-built and provides instantaneous and continuous operation under conditions of shock, vibration and extreme ranges in temperature. The digital display includes characters in numerical sequence from 0 to 9 plus two blank spaces. $\frac{7}{32}$ -inch characters can be illuminated red or white as desired; when not illuminated, they appear white against a black background.

Reliability. Performance through one million random operations is an inherent feature of the new READALL instrument. Each module is gasket-sealed in its case to exclude moisture and seal out foreign particles. An especially thin enclosed DC motor, containing ball bearings, permits more efficient operation.

Modular Construction. A unique feature of the readout instrument is its modular construction. It can be used individually or in groups to display multiple characters in a single case.

Direct Code Translation. The operation of the READALL readout instrument is based on a positioning system using a four-bit code. The visual display is the result of a direct electro-mechanical conversion of a binary signal to a decimal read-out. There is no need for additional conversion equipment. Separate code and motor circuits permit the use of the readout instrument in low-level circuitry.

Electrical and Visual Data Storage. Once positioned, the information is displayed until a new code is transmitted to the instrument. No power is consumed while the information is retained. This data may be stored or read-out electrically for further transmission or recording.

Operate Time. The operate time varies from 0.1 second to 1.0 second depending on character position.

Weight and Size. Maximum weight including case is seven ounces; without case, four and one-half ounces. Size encased is $5\frac{1}{4}$ inches long, $1\frac{7}{8}$ inches high and $\frac{3}{4}$ inch wide. The new READALL instrument is designed for operation over a temperature range of -54°C to $+71^{\circ}\text{C}$ in humidities up to 100% and altitudes up to 70,000 feet. For more information, write for Bulletin 1019. *Trademark

"Pioneers in Push-Button Science"



UNION SWITCH & SIGNAL
DIVISION OF WESTINGHOUSE AIR BRAKE COMPANY —
PITTSBURGH 18, PENNSYLVANIA

locity-type pickups, three for crystal accelerometers—one output at a time being selected as desired. From the "Function" switch, it provides readings of up to 1,000 g acceleration, 0.1 to 100 in./sec velocity and 0.001 to 10 in. displacement at better than 5 percent overall accuracy. Plug-in, high-pass filters may be switched in to remove frequencies below 10, 15, 30, 70, 110, 150 and 200 cps. Output jacks on the unit permit it to be used with an oscilloscope or recorder for recording and monitoring vibration waveforms.

CIRCLE 316 ON READER SERVICE CARD

Oscilloscope high-frequency

HEWLETT-PACKARD Co., 275 Page Mill Road, Palo Alto, Calif. Model 160A oscilloscope is built to military standards. It is specifically designed for checkout consoles, field tests and other applications requiring extreme ruggedness and reliability. Instrument features a broad 15 mc bandwidth and high 20 mv/cm sensitivity. It provides dual trace operation on alternate sweep or at a 1 mc chopping rate.

CIRCLE 317 ON READER SERVICE CARD

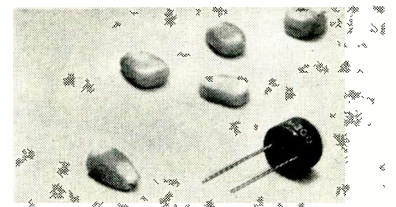

Toroidal Inductors microminiaturized

BURNELL & Co., 10 Pelham Parkway, Pelham, N. Y. The MT series of Kernel toroidal inductors are said to provide lightest weight, maximum reliability and considerable economy in p-c use. MT34 is recommended for frequencies to 30 kc and can be supplied with inductances up to 500 mhys. With inductances up to 200 mhys, MT35 Kernels are applicable to frequencies ranging to 200 kc. Q for the MT34 is greater than 55 at 25

kc, and for the MT35 more than 60 at 100 kc. Units are completely encapsulated.

CIRCLE 318 ON READER SERVICE CARD

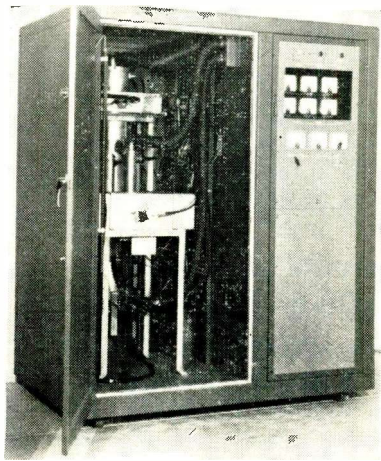

Power Amplifier 200 mc

LEVINTHAL ELECTRONIC PRODUCTS, Stanford Industrial Park, Palo Alto, Calif. Model 224T, a 200 mc power amplifier, meets the particular requirements of particle-accelerator drive applications. Tunable from 195 to 205 mc, the unit produces 1 to 20 kw adjustable peak pulse output power with an input pulse power of 50 w. Pulse repetition rate is 5 to 60 pps. Pulse length is variable from 150 to 400 μ sec, with a pulse rise time of 5 μ sec from 10 to 90 percent of amplitude and a pulse droop less than 5 percent.

CIRCLE 319 ON READER SERVICE CARD

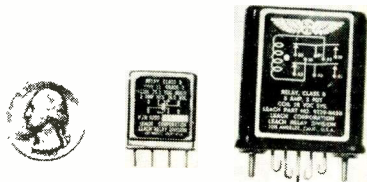

Subminiature Relays crystal can type

LEACH CORP., Compton, Calif. Four subminiature crystal can relays (pictured next to the nearest comparable company relay) are offered for control systems, computers, aircraft and missiles. They have a continuous rated duty and a normal life of 100,000 cycles; weigh approximately 0.6 oz; withstand minimum

Up-to-date information and new working aids
in these recent McGraw-Hill books

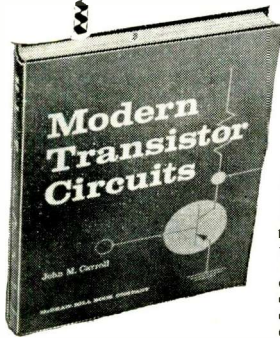

MODERN TRANSISTOR CIRCUITS

JUST PUBLISHED—Quick help when designing equipment and devices in which transistors play a part. This book presents almost 200 modern transistor circuits in 101 separate articles—with all the necessary design information and electronic component values required to utilize them in your own circuit designs. Circuits and data are given for such applications as amplifiers, oscillators, power supplies, and pulse circuits; home-entertainment and broadcast equipment; audio and r-f communications circuits; missile, aircraft, and satellite telemetering equipment; test instruments; and industrial, scientific, and medical devices. Emphasis is upon new circuits combining transistors and electron tubes and transistors and magnetic amplifiers. All the material is arranged so that you can put it to work almost immediately to design similar equipment. By JOHN M. CARROLL, *Managing Editor, Electronics*. 296 pp., illus., \$8.50

DIGITAL COMPUTING SYSTEMS

JUST PUBLISHED—Full coverage of digital computing systems: principles, design, operation, and applications. Describes the various elements contained in modern computers, explaining the underlying principles of the devices used and illustrating the devices themselves. The circuitry by which the elements are made to perform desired functions is clearly covered, with many examples of typical circuits. Logical design and programming are discussed, and how computers are used to solve scientific, business, and data handling problems is shown. By SAMUEL B. WILLIAMS, *Consultant, Dept. of Defense*. 213 pp., 168 illus., \$7.75

PRINCIPLES OF ANALOG COMPUTATION

JUST PUBLISHED—An advanced, practical treatment on how to use the analog computer. You see how to plan and program your problems; simulate linear systems; make use of diodes and function relays in computation circuits; and apply implicit-function techniques and arbitrary-function generators. Main emphasis is upon the type of problem which can be solved and the techniques which will help you produce the solution. By GEORGE W. SMITH, *Research Group Engr.*, and ROGER C. WOOD, *Senior Dynamics Engr., Ryan Aeronautical Co.* 240 pp., 192 illus., \$7.50

SERVOMECHANISM FUNDAMENTALS

JUST PUBLISHED—Practical guide to help you efficiently operate and maintain servo systems. You get a sound working knowledge of servomechanisms needed for effectively working with many of today's industrial devices. Explains engineering principles—using a minimum of mathematics. Shows the various forms of control systems and their components—electronic and magnetic amplifiers—ac and dc servomotors—and other important aspects. Treats hydro-amplifier systems, mechanical gearing and pumping systems, and measurement methods. By BEN ZEINES, *RCA Institutes, Inc.*, 254 pp., 230 illus., \$5.50

TRANSISTORS IN RADIO, TELEVISION, AND ELECTRONICS

JUST PUBLISHED—SECOND EDITION: To give you practical know-how for modern manufacturing and application jobs, and servicing work, this book gives a simplified summing up of facts about transistors and transistor circuits—how they are designed and work, and their use and maintenance. Ranges from a complete explanation of the basic theory upon which the transistor works to valuable information on transistor servicing. By MILTON S. KIVER, *author of FM Simplified, Television Simplified, and other standard books. Second Edition.* 423 pp., 337 illus., \$7.95

SEMICONDUCTORS AND TRANSISTORS

JUST PUBLISHED—Broad, practical, and essential non-mathematical explanation of the physical principles underlying the behavior of semiconductors, transistors, and other solid-state devices. Describes the physics of semiconductors, discusses their characteristics, and shows the way transistors and diodes operate—by means of the working p-n junction. Applications to a variety of useful circuits are given. By DOUGLAS M. WARSCHAUER, *Research Physicist, Aeronautical Research Laboratory, Wright Air Development Center*. 276 pp., 201 illus., \$6.50

CONTROL ENGINEERS' HANDBOOK

With 36 contributing experts represented, this handbook gives engineers, designers, and development engineers basic information on components and techniques for use in the design of feedback control systems. Emphasis is on components, including electro-mechanical, mechanical, hydraulic, and pneumatic as well as electronic and magnetic components. Gives physical explanations of how these components work, mathematical descriptions of their use in typical control systems, etc. Edited by JOHN G. TRUXAL, *Elec. Engr. Dept., Polytechnic Inst. of Brooklyn*. 1048 pp., 1114 illus., \$18.50

MAIL COUPON FOR 10-DAY FREE EXAMINATION

McGraw-Hill Book Co., Dept. F-8-28
327 W. 41st St., N.Y.C. 36

Send me book(s) checked below for 10 days' examination on approval. In 10 days I will remit for book(s) I keep plus few cents for delivery cost and return unwanted book(s) postpaid. (We pay delivery costs if you remit with this coupon—same return privilege.)

Carroll—Modern Transistor Circuits, \$8.50

(PRINT)

Williams—Digital Computing Systems, \$7.75

Name

Zeines—Servomechanism Fundamentals, \$5.50

Address

Warschauer—Semiconductors & Trans., \$6.50

City Zone State

Smith—Principles of Analog Comput., \$7.50

Company

Kiver—Transistors in Radio, Television and Electronics, \$7.95

Position

Truxal—Control Engineers' Handbook, \$18.50

For price and terms outside U. S., write McGraw-Hill Int'l., N.Y.C.

F-10-9



they even work toasted!

At 25°, almost any pot can be a hero! But push them right on up to their ambient limits — and design begins to tell. The test-bench engineers will tell you that ACEPOTS have an endearing habit of running with 25°C-reliability at 165°C! That's why they're specified when high temperature operation is important.

Here are ACEPOTS' special design features: a molded insulating bond between contact and shaft to eliminate any play or change in wiper pressure; an improved higher temperature-resistant winding card, which never changes shape with heat; superior insulation between case and resistance element; and chemical and thermal stabilizing procedures at high temperature prior to final sealing which cure all elements. Which is why, simply, at high temperature — ACEPOTS work. See your ACErep and try them for yourself!

This 3/4" ACEPOT®, designed for conservative operation to 165°C, typifies ACEPOTS' utmost reliability throughout full temperature cycling.



ACE ELECTRONICS ASSOCIATES, INC.
99 Dover Street, Somerville 44, Mass.
SOMerset 6-5130 TMX SMVL 181 West. Union WUX

Acepot® Acetrim® Acetel® Aceohm® *Reg. Appl. for

shock of 50 g's, temperatures from —65 to 125 C and vibration of 20 g's, 2,000 cps.

CIRCLE 320 ON READER SERVICE CARD

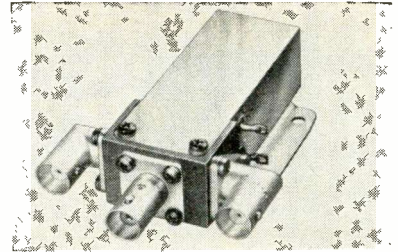

Coaxial Choppers 2,000-hr life

JAMES VIBRAPOWR Co., 4050 N. Rockwell St., Chicago 18, Ill. A line of coaxial choppers incorporate a new center pivot reed construction for dynamic cancellation of external effects of shock and vibration. Units may be used for continuous or asynchronous switching of coaxial signals. The driving frequency can be d-c to 175 cps, switching frequency can be d-c to 500 mc. Design is available in various configurations and types.

CIRCLE 321 ON READER SERVICE CARD

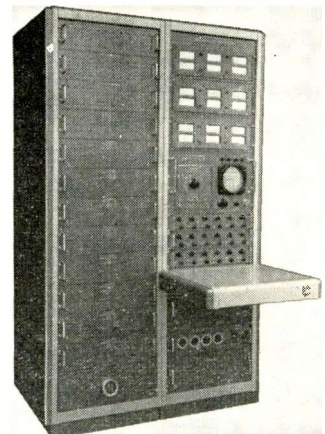

Analyzer high resolution

PROBESCOPE Co., INC., 8 Sagamore Hill Drive, Port Washington, N. Y. Model TA-18 is a telemetering subcarrier, automatic optimum, high resolution analyzer. Subcarrier channel signals from a receiver or ground station will appear as individual vertical pips on a separate subcarrier crt display. Features include: a 3-point marker to show center frequency and end frequency

on each channel; a separate camera mount displays crt which can be slaved to any of the 18 channels for a permanent record; automatic optimum resolution on each channel and a 40-db dynamic range.

CIRCLE 322 ON READER SERVICE CARD



Vane Axial Blower meets MIL-E-5272A

THE TORRINGTON MFG. Co., Torrington, Conn. The SK-2367 blower delivers very high air flow rates against high pressures in cooling airborne electronic equipment. Unit delivers 1,200 cfm output at 7-in. static pressure (sea level) while operating at 11,500 rpm. Other speeds obtainable with the 400-cps, 3-phase motor normally provided are 5,400 and 7,500 rpm. D-C motor speeds of 6,500 and 9,000 rpm may also be obtained. Unit weighs 11 lb and is 7.44 in. long and 8.50 in. in diameter.

CIRCLE 323 ON READER SERVICE CARD

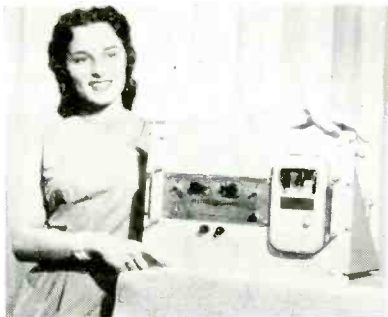

Voltage Regulator rack mounted

GENERAL ELECTRIC Co., Pittsfield, Mass. Single-phase loads up to 8.5 kva and 100 amperes can be handled by this Inductrol voltage regulator. Available either automatic or motor

(Continued on p 104)

from Instrument Calibration HEADQUARTERS



Measures
Precise
AC-DC
Voltage &
Current

Model
1605
\$2450.

A Self-Contained Laboratory Standard Facility

The Model 1605 AC-DC Calibration/Transfer Standard is a multi-function instrument capable of measuring AC and DC voltage and current up to 1500 volts and 15 amperes. It includes a precision four-digit readout potentiometer, laboratory standard cell, precision voltage multipliers, precision shunts hermetically sealed in oil, light beam galvanometer, AC monitoring meter, thermal converter and all necessary batteries and controls. DC measurements utilize the potentiometer or the potentiometer in conjunction with the voltage multipliers or shunts. For AC measurements the potentiometer and/or multiplier-shunt arrangement is used with the compensated AC-DC transfer element.

LIMIT OF ERROR

DC: 0.05% with correction factors;
0.1% direct reading.
AC: 0.065% with correction factors;
0.13% direct reading.
(AC accuracies are to 50 kc
on most ranges.)

For Owners of the RFL Model 829 AC-DC Instrument Calibration Standard

The Model 1605 may be used in conjunction with the Model 829 to calibrate instruments having greater accuracy requirements than that supplied by the Model 829 alone. The Model 1605 may also be used to calibrate the Model 829. The 829/1605 combination provides a calibration system which will handle your requirements, for current and voltage measurements to an accuracy of better than 0.1%, from DC to 400 cps.

Performance is rigidly guaranteed.
Price is net, f.o.b. Boonton, N.J.
and subject to change without notice.

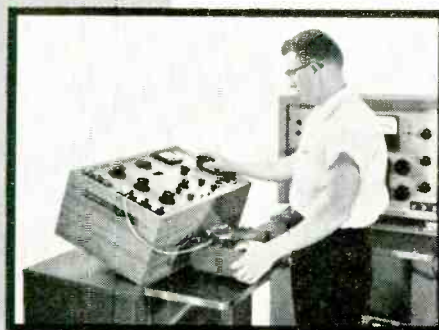

SEND
FOR
TECH.
DATA

For additional information, including application data, write or phone DE 4-3100. Demonstrations available by local representatives.



**Radio Frequency
LABORATORIES, INC.**
Boonton, New Jersey, U.S.A.

Waters has a watertight case!



APW $\frac{1}{2}$
 $\frac{1}{2}$ " dia.

Waters APW $\frac{1}{2}$ Sealed Potentiometer is so watertight and so heat resistant that it operates reliably even in boiling water! The APW $\frac{1}{2}$ is completely unaffected by humidity and water vapor, the two common causes of potentiometer failures in aircraft and missiles, where pressure and altitude changes allow equipment "to breathe". Naturally, the watertight construction of the APW $\frac{1}{2}$ also seals out dust and other minute particles which might cause failure. Meets MIL-E-5272A immersion specifications by means of a double "O" ring shaft seal. The glass-to-metal terminal board is solder-sealed to the case. Available with 125°C or 150°C construction, mechanical rotation stops, special winding angles, values to 100K and tighter linearity tolerances. Can be supplied with optional split bushings and various shaft lengths. (Waters WPW $\frac{1}{2}$ Sealed Potentiometer features the same construction as the APW $\frac{1}{2}$, but with a servo face.) Write for Bulletin APW-359.

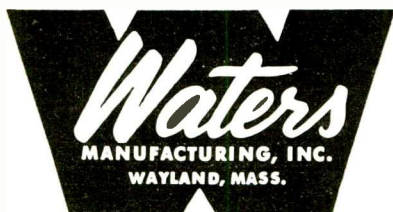

POTENTIOMETERS
SLUG TUNED COIL FORMS
RF COILS
CHOKES
POT HOOK® PANEL MOUNTS
TORQUE WATCH® GAUGES
CONTROL METER/CONTROLLER
INSTRUMENTS

INVESTIGATE the Genalex Two-Way Stepping Switch

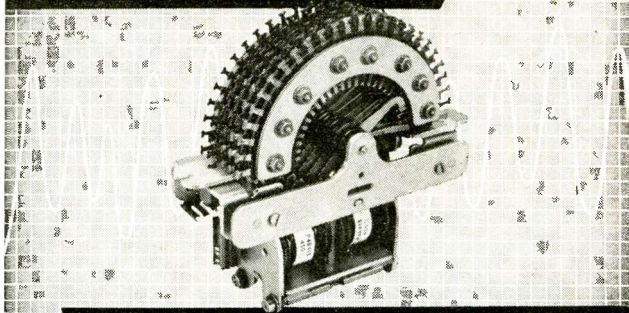

**THE ONLY ONE OF ITS KIND!
10 MILLION STEPS IN BOTH DIRECTIONS**

For: Selection Sequence Control — Counting (including Subtraction) — Totalizing — Pulsing — Step-by-Step Servo Drive.

Self-Cycling or Remote Control Operation. Bridging or Non-Bridging Wipers, or any Combination. Sturdy, compact construction.

Get complete data and price information now on the unique GENALEX Two-Way Stepping Switch — AND the companion 100 Million Step GENALEX One-Way Stepping Switch! Write today, to:

GENERAL ELECTRIC COMPANY, LTD., OF ENGLAND

CARE OF



11 University Rd., Cambridge 38, Mass.

CIRCLE 201 ON READER SERVICE CARD

MEET ROLLY CHAREST

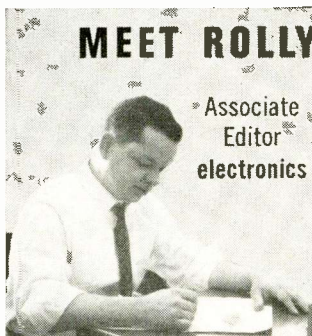

RESUME:

Charest, Roland J., Boston University, BS in Journalism. Formerly New England editor for **electronics**. Navy sonarman. Writer, reporter, editor for Lynn Item, Boston Globe, Boston Traveler. Won a New England Associated

Press (AP) award in 1955 for writing feature articles in the major city newspaper class.

PRESENT OCCUPATION:

Rolly Charest supports Managing Editor Jack Carroll for editorial content accuracy and expediting putting each weekly issue to bed. Rolly reworks headlines for greater readability, is involved in makeup, and helps polish editorial content. Rolly's across-the-board background assures you accuracy in the face of journalistic pressures; articles in this week's issue that could be held over to the next deadline, but are not. The readers' interests come first!

REFERENCES:

If you're not a subscriber, if your subscription is expiring, if you will miss exciting features "in-the-works" by **electronics** 26-man staff, fill in box on Reader Service Card. Easy to use. Postage is free.

electronics

A McGraw-Hill Publication • 330 W. 42nd St., New York 36

ANTENNAS REFLECTORS

& ASSOCIATED EQUIPMENT

FROM DESIGN TO PRODUCTION

Stock Reflectors — solid spun, 4 in. to 10 ft. in diameter • mesh, 4 ft. to 18 ft. in diameter • larger sizes or special shapes on request.

Antennas — up to 10,000 mc

Large Waveguide Components

*Prompt Delivery of any type antenna or reflector
— precision built to your specifications.
Write for technical data.*

Ainslie

CORPORATION

312 Quincy Ave., Quincy, Massachusetts
CIRCLE 202 ON READER SERVICE CARD

specify... G-E SOLID TANTALYTIC* CAPACITORS

for transistor circuitry, both in military and industrial electronic applications.

- Offer small size, stable operating characteristics, long shelf life, and operating temperatures from -55°C to $+85^{\circ}\text{C}$.

- Selected ratings to 50 volts d-c and capacities to 22 mfd in units as small as .003 cu. in.

- Have mechanically rugged, hermetically sealed, dry construction to eliminate leakage and corrosion.

SPECIFYING INFORMATION on G.E.'s Tantalytic line is available from your nearest Apparatus Sales Office, or write for GEZ-2796A, to General Electric, Section 449-13, Schenectady 5, N. Y.

*Registered Trademark of General Electric Co.

GENERAL  ELECTRIC

CIRCLE 203 ON READER SERVICE CARD

Waters has an airtight case!



APH $\frac{1}{2}$
 $\frac{1}{2}$ " dia.

Waters APH $\frac{1}{2}$ hermetically sealed precision potentiometer, in addition to maintaining the hermetic seal behind the panel, is itself tightly sealed against outside atmosphere and salt spray by means of a double "O" ring shaft seal. The entire potentiometer passes Liquid Immersion Tests per MIL-E-5272A, par. 4.12.1, and, excluding the shaft, passes the Mass Spectrometer Test with leak rate less than 10^{-7} CC/sec. N.T.P. Pre-tinned, it can be easily soldered into the panel. Its terminal lugs are installed with a glass to metal seal, and are positioned for easy wiring. The brass case is plated in conformance with military requirements. Waters APH $\frac{1}{2}$ HT Potentiometer also has high temperature operating characteristics. It derates to zero watts at 150°C ; $\frac{3}{4}$ watts may be safely dissipated at 125°C . Available with mechanical rotation stops, special winding angles, resistance values to 100K ohms and tighter linearity tolerances. Write for Bulletin APH.

POTENTIOMETERS
SLUG TUNED COIL FORMS
RF COILS
CHOKES
POT HOOK® PANEL MOUNTS
TORQUE WATCH® GAUGES
C'TROL METER/CONTROLLER
INSTRUMENTS

Waters
MANUFACTURING, INC.
WAYLAND, MASS.

CIRCLE 103 ON READER SERVICE CARD 103

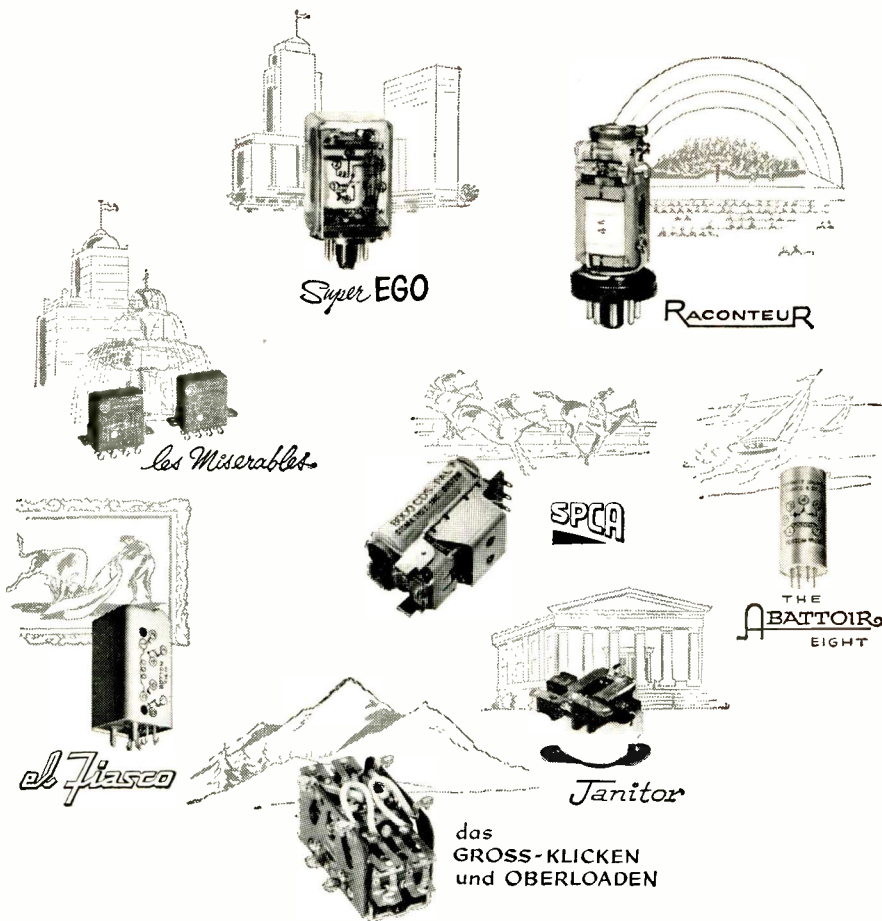

INTRODUCING THE SIGMA MODELS FOR 1960

Total newness is only one of the exciting features of these 1960 Sigma relays. Eager in performance, nimbly darting around the worst circuit parameters, they bring back that forgotten thrill of the first time you got a relay to work in a circuit — and they win the respectful admiration of all your electronic colleagues. No matter what your reason for owning a relay, there's a new Sigma model — standard luxury or fully equipped — to make every magnetic excursion fun again!

All 1960 models come with coils wound with genuine wire, potentially movable armatures, and 100% fresh magnetic fields created by Sigma master craftsmen, at no additional cost. (Models illustrated include optional extras available at added

cost — ohm grown resistance values, dry circuit quencher and Braintree Beige enclosures.)

Decide now to be unhappy with anything less than a 1960 Sigma relay. Make your status clear — fulfill your desire to be known as one who dares to be different ... one who uses Sigma relays. And always remember: when better relays are built, Buick will build them.

SIGMA

SIGMA INSTRUMENTS, INC.
62 Pearl St., So. Braintree 85, Mass.
An Affiliate of The Fisher-Pierce Co. (since 1939)

driven, it features no brushes, introduces no harmful wave form distortion, and is unaffected by power factor, frequency or load. Controls are drift-free, maintain ± 1 percent bandwidth accuracy over a temperature range of -60 C to $+60$ C. Regulators are built to MIL-E-16400 and MIL-E-4158.

CIRCLE 324 ON READER SERVICE CARD



Rectilinear Pot cylindrical

MARKITE PRODUCTS CORP., 155 Waverly Place, New York 14, N. Y. A $\frac{3}{4}$ -in. diameter cylindrical rectilinear potentiometer series are available with single or dual elements and stroke ranging from $2\frac{1}{2}$ in. to 10 in. They have shock, acceleration, and vibration resistance in excess of 50 g's without opening or discontinuity. Other characteristics are virtually infinite resolution and independent linearity in the order of ± 0.2 percent.

CIRCLE 325 ON READER SERVICE CARD

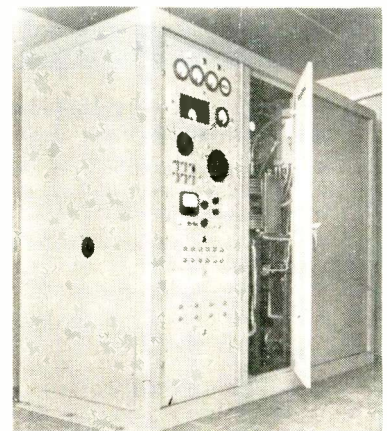

Transmitter System C-band

LEVINTHAL ELECTRONIC PRODUCTS, Stanford Industrial Park, Palo Alto, Calif. Essentially a self-contained power amplifier of compact

design, model 208T can be utilized with various klystrons to cover an extensive frequency range. For example, with the Varian VA804 klystron, it covers a band 4,400 to 5,875 mc; with the VA805, 5,875 to 6,425 mc; and with the VA806, 7,125 to 8,500 mc. R-F power output is 2,000 w e-w minimum in the standard unit. Modifications can be produced to give higher output powers with similar tubes requiring additional power supply capacity. R-F power input is 10 to 100 mw.

CIRCLE 326 ON READER SERVICE CARD



Oscillator uhf and microwave

WATKINS-JOHNSON Co., Palo Alto, Calif. The W-J208 Helitron uhf and microwave oscillator is continuously voltage-tuned and is electrostatically focused. No magnet is employed. Unit covers the frequency range 480-1,020 mc with a power output greater than 1 mw. A tuning voltage from 700 to 1,700 v is required to cover the range. The device features small size and low weight with a length of 16½ in. and weight of 3½ lb. The output signal has a high degree of spectral purity.

CIRCLE 327 ON READER SERVICE CARD

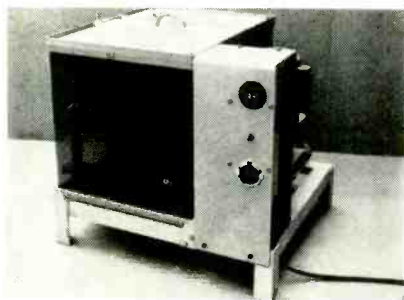

P-C Etcher table model

CENTRE CIRCUITS, INC., P. O. Box 165, State College, Pa. Oscillating spray nozzle etcher for prototype



FOR:
Guide Bushings,
Vanes
and
Wear Rings

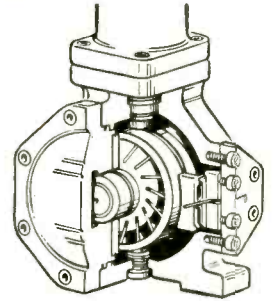

**HAVE YOU
CONSIDERED
THE IMPORTANT
ADVANTAGES OF
FILLED TEFLON*?**



Formed
Gaskets

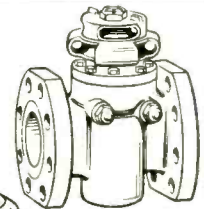

Valve
Seats
and
Packings

It has been definitely established that the value of Teflon can be considerably enhanced by the use of fillers in certain applications. Laboratory and field experience has demonstrated that the use of fillers permit Teflon to be more readily tailored to a wide variety of chemical, electrical and mechanical applications. Also, some mechanical properties can be improved. These include:

- 1) resistance to deformation under load
- 2) resistance to wear
- 3) thermal conductivity
- 4) compressive strength
- 5) hardness

By thus improving its properties, Teflon now offers even greater industrial potential. This is the reason filled Teflon has become an important item in the "John Crane" Chemlon® line of better Teflon products.

Chemlon is available with such fillers as glass fiber, carbon, graphite, copper and bronze, talc, calcium fluoride and other inorganic materials.

Tell us about your requirements. We'll tell you the advantages you can get from filled Chemlon. Request Bulletin T-104.

Crane Packing Company, 6402 Oakton Street, Morton Grove, Illinois, (Chicago Suburb). In Canada: Crane Packing Co., Ltd., Hamilton, Ont

†DuPont Trademark



What's
under
the
Dime?

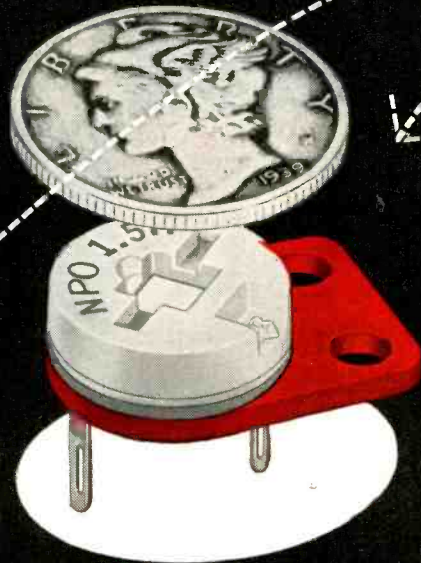

THIS **ERIE** 557 CERAMICON® TRIMMER with excellent stability and high max/min ratio

Within a dime's diameter, ERIE 557 Ceramicon® Trimmers exceed MIL-C-81 specifications for stability. The 1/2"-diameter ceramic rotor is lapped and silvered to mate with a lapped and silvered stator for dependable capacitance control throughout thousands of hours service. Easy to adjust, yet will not drift off setting.

ERIE 557 Trimmers are designed for compact assembly to chassis or multiple-mountings to a base strip.

Made in a wide range of capacities to cover temperature coefficients from NPO through N5200. Tested for 250 hours at twice rated voltage in 85°C ambient.

Let us send specification literature describing ERIE 557 Ceramicon Trimmers, in standard and special types and capacities.
Address:

ERIE ELECTRONICS DIVISION
ERIE RESISTOR CORPORATION
Dept. A — Erie, Pennsylvania

printed circuit work. Polyvinyl chloride and titanium construction throughout; variable spray nozzle pattern. Quartz-cased immersion heater is optional equipment. Unit uses ferric chloride or chromic acid to etch both sides simultaneously on boards up to 10 1/2 in. by 13 1/2 in. Line widths are obtainable to 0.003 in. Sump capacity is 7 to 12 gallons of etchant. Size is 29 in. by 25 in. by 26 in.

CIRCLE 328 ON READER SERVICE CARD



Longitude Counter miniaturized

BOWMAR INSTRUMENT CORP., 8000 Bluffton Road, Ft. Wayne, Ind. Model 10468 longitude counter is designed to aid in miniaturizing airborne navigational computers, dead reckoning systems and missile tracking devices. It provides longitudinal indications adding from 000 deg 00 min. to 180 deg 00 min. in west presentation. It then transfers to east presentation and subtracts to 000 deg 00 min. At this point, shade transfers and the previous cycle is repeated for same shaft rotation. Longitudinal indications are as follows: 000 deg 00 min. E represents 000 deg 00 min., and 000 deg 00 min. W represents 180 deg 00 min. Unit is designed for continuous operation at 500 rpm.

CIRCLE 329 ON READER SERVICE CARD

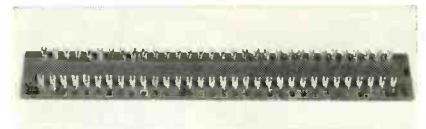

Terminal Board all-purpose

NATIONAL TEL-TRONICS CORP., 52 St. Casimir Ave., Yonkers, N. Y. Type 3101 terminal board assemblies, made to meet MIL-P-3115B type PBE-P, are available in various lengths from 2 in. to 12 in. They can be furnished with any number of terminals as required for the

specific application. Its paper-base phenolic insulation plate is supplied in three thicknesses: $\frac{1}{8}$ in., $\frac{3}{16}$ in., and $\frac{1}{4}$ in. Spacing between terminals is $\frac{3}{16}$ in. with 1 in. distance between terminal rows. Boards are marked to meet customers' specifications.

CIRCLE 330 ON READER SERVICE CARD

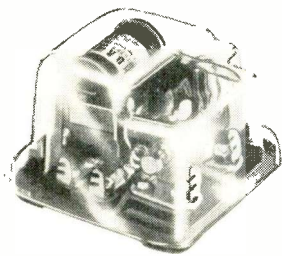

Relay high sensitivity

KURMAN ELECTRIC Co., 191 Newel St., Brooklyn 22, N. Y. Series 300 Microamp is a 2 mw high sensitivity relay for all low power input circuits where available current is at a premium. Applications include high speed keying, remote control or battery operated devices. Relays are field adjustable to handle currents of up to 3 amperes at reduced sensitivity. Mounting: Two 0.196 in. clearance holes on $2\frac{1}{2}$ by $2\frac{1}{2}$ centers.

CIRCLE 331 ON READER SERVICE CARD

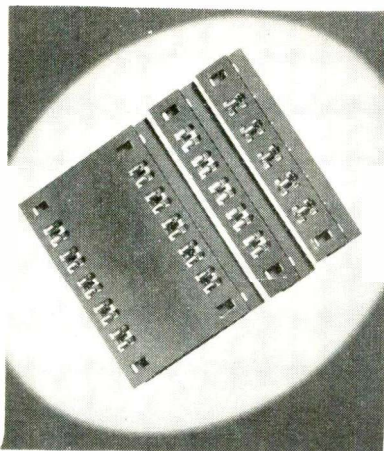

Terminal Board shock absorbing

BEAMTRONICS, INC., P.O. Box 2335, Anaheim, Calif. A new terminal board engineered for high density packaging exceeds military vibration specifications. In addition to

FREE ANALYSIS OF YOUR SMALL METAL PARTS JOINING PROBLEMS

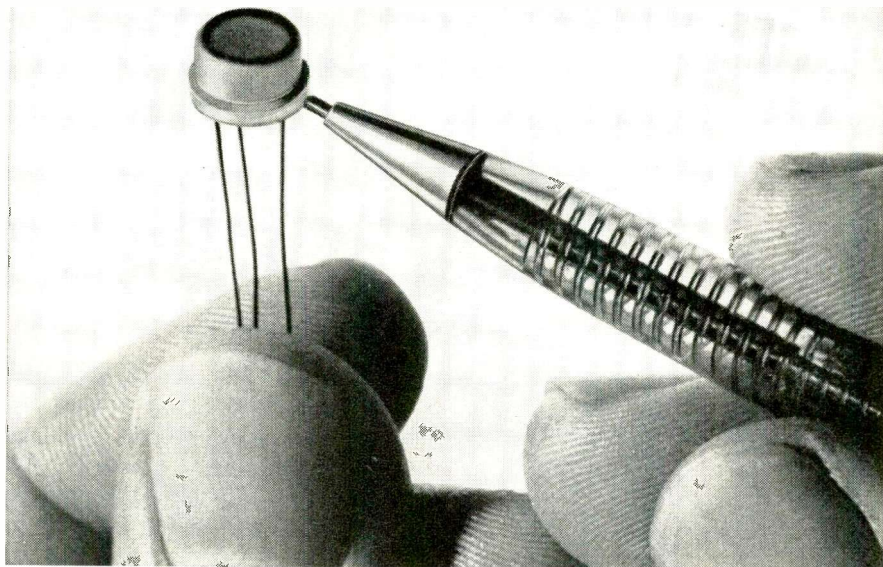

HERMETIC SEAL WELDED WITHOUT HEATING COMPONENT!

PROBLEM: weld transistor cap to base, make a hermetic seal without heating temperature-critical internal parts. **SOLUTION:** A Raytheon Welding Analyst recommended a DC "stored energy" welding system, using only 6.6 kva compared to the 75-100 kva required for an AC welder to do the same job. **RESULT:** 1500 perfectly uniform welds per hour; no damage from heat.

HOW YOU CAN BENEFIT—

If you have a small metal parts joining problem, see your Raytheon Welding Analyst. He will be happy to help you find a solution—without cost or obligation. Mail the coupon below for full details.



Excellence in Electronics

**MAIL THIS
COUPON
FOR FREE
ANALYSIS**
—without
cost or
obligation.

TO RAYTHEON COMPANY
INDUSTRIAL APPARATUS DIVISION
INDUSTRIAL PRODUCTS DEPT. ET-11
WALTHAM 54, MASS.

Please send me literature on Raytheon Welding Systems.

Please have a Raytheon Welding Analyst contact me.

My problem is: (describe metals, thicknesses, type of part, etc.)

NAME _____

COMPANY _____

ADDRESS _____

CITY _____ STATE _____

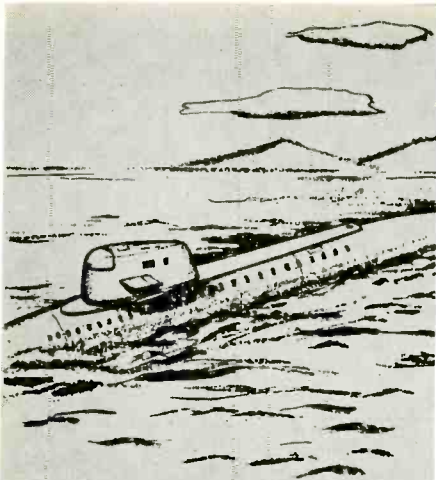

2N416
2N417
2N425
2N426
2N427
2N428



Specify with assurance
when you specify

INDUSTRO

alloy junction germanium

PNP TRANSISTORS

Absolute reliability has been imperative in the Polaris. The extreme reliability designed into the Polaris Missile Program requires transistors which far exceed the operating and environmental conditions of MIL-T-19500A.

Industro is proud of its contribution to the success of this vital military project.

Whether your transistor requirements are military or commercial you can depend on Industro. We invite your inquiries.

INDUSTRO

TRANSISTOR CORPORATION
35-10 36th Avenue • L. I. C. 6, N. Y.
IN CANADA:
CANADIAN GENERAL ELECTRIC COMPANY LIMITED

being ideal for compact component assemblies the terminal is also engineered for mass production of electronic devices of any type. Components may be soldered or crimped.

CIRCLE 332 ON READER SERVICE CARD

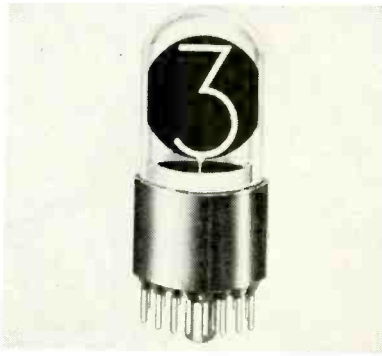

Indicator Tube
ultra long life

BURROUGHS CORP., P. O. Box 1226, Plainfield, N. J. Type B7031 is a 30,000 hr jumbo Nixie indicator tube. It provides a numerical display of the digits zero through nine in a common viewing area. The characters are 2 in. high and are visible at distances of over 150 ft. The tube features a side viewing design which makes possible close stacking of tubes. Thus a large amount of information can be displayed in a minimum of space.

CIRCLE 333 ON READER SERVICE CARD

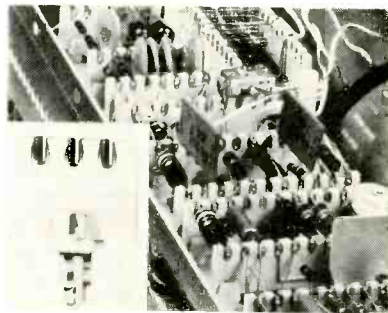

Terminal Strips
reduce chassis bulk

TEKTRONIX, INC., P. O. Box 831, Portland 7, Oregon, announces ceramic terminal strips with nylon-yoke chassis fittings. A quick snap-fit of the nylon yoke-pin into polypropylene spacer sleeve provided is all that is required to attach strip firmly to chassis. Strips come with one or two nylon yokes assembled, depending on size. Three sleeve



N

Solid

State

Discriminator

E

W

First... truly operational solid state subcarrier discriminator... completely transistorized... phase lock circuitry... plug-board replaceable assemblies... frequency capabilities to 300 KC... calibrated output voltage controls... individualized meter design... self-contained power supply... approx. 27 watts input... weighs only 12 pounds.

First of an all new and complete line of DCS solid state telemetry equipments. We invite your inquiries about our Model GFD-3.

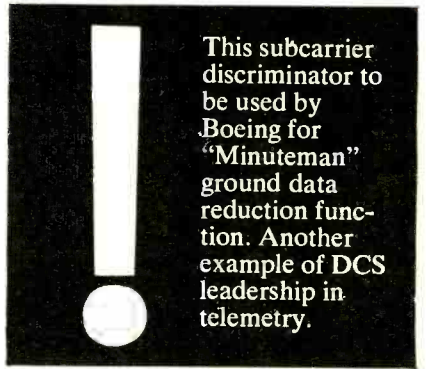

This subcarrier discriminator to be used by Boeing for "Minuteman" ground data reduction function. Another example of DCS leadership in telemetry.

DATA-CONTROL SYSTEMS, Inc.



39 Rose St.,
Danbury, Conn.

CIRCLE 204 ON READER SERVICE CARD
NOVEMBER 6, 1959 • ELECTRONICS

heights are available to vary clearance of strips over chassis. Connection will not break or let go when subjected to shock or vibration. Available in seven standard sizes with from one to eleven silvered notches, pretinned for instant soldering, the strips may be mounted even over tube sockets to conserve space.

CIRCLE 334 ON READER SERVICE CARD



Solid State Relay operates instantly

TREPAC CORP. OF AMERICA, 30 W. Hamilton Ave., Englewood, N. J. Model 550 start stop relay is designed for installation in any commercial teletypewriter, to provide completely automatic control of the printer drive motor—no special starting or stopping signals needed. The electronic relay energizes the motor at the first signal pulse, sustains operation throughout the transmission, and shuts down the motor after completion of the message. The delay period between the last received pulse and automatic shut-down is factory adjusted from 0-180 sec according to customer requirements. Unit is a self-contained, plug-in module, in a case 3½ in. wide, 2¾ in. deep and 4½ in. high (seated). It meets military specs.

CIRCLE 335 ON READER SERVICE CARD

Ceramic Composition improved type

SOLAR MFG. CORP., 4553 Seville Ave., Los Angeles 58, Calif. SS10 piezoelectric ceramic has a higher coupling coefficient and lower dissipation factor than SS9. Dielectric constant is increased from 500 to

Send for this **FREE SAMPLE FOLDER**

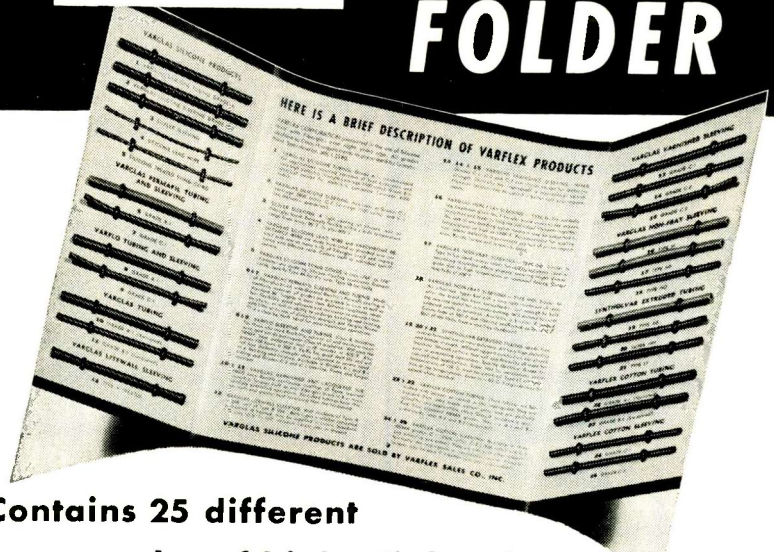

Contains 25 different test samples of high-dielectric **INSULATING TUBING and SLEEVING**

Includes samples and descriptions of...

VARGLAS SILICONE—Class H tubing, sleeving, lead wire, tying cord. Withstands temperature from -85°F to 500°F .

PERMAFIL-IMPREGNATED VARGLAS TUBING—Fiberglas impregnated with General Electric Permafil.

VARGLAS SLEEVING AND TUBING—synthetic-treated, varnished, lacquered, saturated and others.

VARGLAS NON-FRAY SLEEVING—three types available. Withstands temperatures up to 1200°F .

VARFLO TUBING AND SLEEVING—full range of colors, sizes and grades. Vinyl coated Fiberglas.

VARFLEX COTTON TUBING AND SLEEVING—varnish or lacquer impregnated—all NEMA grades.

SYNTHOLVAR EXTRUDED TUBING—listed by UL for use at 105°C . Various formulations to meet unusual requirements.



MAIL COUPON TODAY FOR SAMPLE FOLDER

VARFLEX CORPORATION
506 W. Court St., Rome, N. Y.

Please send me free folder containing samples of your electrical tubing and sleeving.

I am particularly interested in insulation for.....

Name

Company

Street

City Zone State

IN LESS THAN 4 SECONDS

FROM THIS

TO THIS

OR THIS

WITH THE REVOLUTIONARY
PRODUCTION AID TOOL!

"PIG-TAILOR"[®]

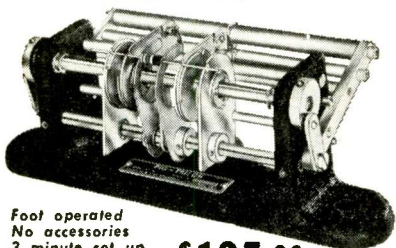

Foot operated
No accessories
3 minute set up

\$125.00

'PIG-TAILORING'

a revolutionary new mechanical process for higher production at lower costs. Fastest PREPARATION and ASSEMBLY of Resistors, Capacitors, Diodes and all other axial lead components for TERMINAL BOARDS, PRINTED CIRCUITS and MINIATURIZED ASSEMBLIES.

PIG-TAILORING eliminates: • Diagonal cutters • Long nose pliers • Operator judgment • 90% operator training time • Broken components • Broken leads • Short circuits from clippings • 65% chassis handling • Excessive lead tautness • Haphazard assembly methods.

PIG-TAILORING provides: • Uniform component position • Uniform marking exposure • Miniaturization spacing control • "S" leads for terminals • "U" leads for printed circuits • Individual cut and bend lengths • Better time/rate analysis • Closer cost control • Invaluable labor saving • Immediate cost recovery.

Pays for itself in 2 weeks

"SPIN-PIN"[®]

Close-up views of "SPIN-PIN" illustrate fast assembly of tailored-lead wire to terminal.

- No Training
- No Pliers
- No Clippings
- Uniform Crimps
- 22 Sizes

**PAYS FOR ITSELF
THE FIRST DAY!**

\$500

EACH



Write for illustrated book to Dept. E-11



BRUNO-NEW YORK INDUSTRIES CORP.

DESIGNERS & MANUFACTURERS OF ELECTRONIC EQUIPMENT
460 WEST 34th STREET • NEW YORK 1, N. Y.

600, and the Curie temperature remains the same (+145 C). SS10 body also shows less variation of dielectric constant and piezoelectric constants with temperature. Frequency constant is a maximum at 25 C and over the temperature range from 13 C to 45 C the frequency changes by less than 0.1 percent.

CIRCLE 336 ON READER SERVICE CARD

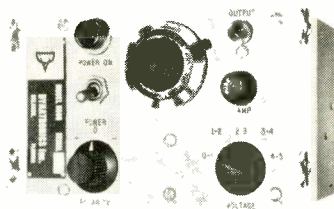

Oscillator Test Set telemetry type

DYNATRONICS, INC., Box 2566, Orlando, Fla. New telemetry voltage calibrator is a practical approach to an accurate, lightweight, low cost test set for calibration of telemetry subcarrier oscillators. It will operate under extreme variations of altitude, temperature and shock, and is equally suited to laboratory, field or airborne application.

CIRCLE 337 ON READER SERVICE CARD



Voltage Calibrator direct reading

SENSITIVE RESEARCH INSTRUMENT CORP., 310 Main St., New Rochelle, N. Y. Model RFVC provides 4 true rms voltage output ranges for vtvm calibrations between 2 mv and 3 v. It has an accuracy of 0.3 of 1 percent of full scale and a maximum frequency influence of ± 0.2 of 1 percent from d-c to 10 mc. A built-in d-c reference supply provides a convenient means for certifying its

SENIOR ENGINEERS

AND PHYSICISTS

FOR SEMICONDUCTOR R & D

Expansion of advanced research and development activity at the Semiconductor Division of Hughes Products (Hughes Aircraft Co.) has created several openings for senior men capable of assuming the direction of important new programs. Openings include:

DEVICE DEVELOPMENT PHYSICIST—to work on new device programs with responsibility for fabrication processes, device theory and analysis or device testing and evaluation. He must have an M.S. or Ph.D. in Physics and several years experience in the development of semiconductor devices.

EXPERIMENTAL DEVICE STUDY PHYSICIST—to do theoretical and/or experimental research on advanced exploratory solids for the devices on a long range study basis. He will work on his own project or in conjunction with other physicists on basic device study, leading to the first model of a new device. Position requires an M.S. or Ph.D. in Physics and several years experience in the experimental research on advanced semiconductor devices.

Recently completed ultramodern facilities of the Semiconductor Division are located in Newport Beach, California—just south of Los Angeles. Here you will find choice suburban living in the heart of Western electronics.

If you meet the requirements for the above positions, or if you are a senior engineer or physicist with experience in the field of semiconductors, we invite your inquiry. Please contact:

Mr. C. L. M. Blocher
Scientific Staff Representative
HUGHES SEMICONDUCTOR DIV.
500 Superior Avenue
Newport Beach 11, California

HUGHES PRODUCTS

SEMICONDUCTOR DIVISION
HUGHES AIRCRAFT COMPANY

full scale deflection without reference to external standards.

CIRCLE 338 ON READER SERVICE CARD

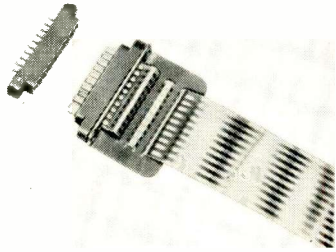

Connector in-line construction

METHODS MFG. CORP., 7447 W. Wilson Ave., Chicago 31, Ill., announces the Plo-Duct connector for use with film insulated flat conductor wiring. The plug-in units incorporate an insulated strain relief handle which is mountable to either male or female connector. Both rack and panel and cable to cable connections are accommodated by the in-line construction.

CIRCLE 339 ON READER SERVICE CARD

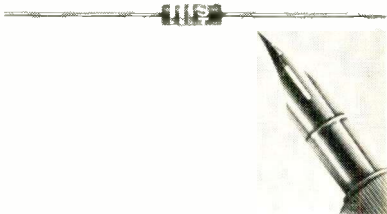

Silicon Glass Diode for the military

SILICON TRANSISTOR CORP., Carle Place, N. Y. Miniature silicon glass diodes meet military high reliability programs, are hermetically sealed, fast switching, operate to 200 C, have extremely low leakage at 150 C; maximum working voltage to 300 v and forward conductance to 200 ma at ± 1 v.

CIRCLE 340 ON READER SERVICE CARD

Comparison Bridge highly versatile

SOUTHWESTERN INDUSTRIAL ELECTRONICS Co., 10201 Westheimer Road, Houston 19, Texas. New series model E-2 comparison bridge

WHEN YOU HAVE
extraneous common mode signals

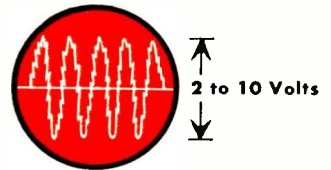

AND WANT TO MEASURE
0.1 to 100 millivolts full scale

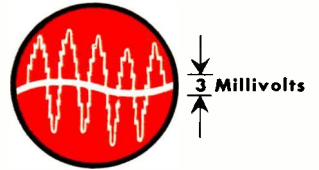

AND THEN AMPLIFY

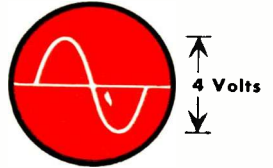

CHOOSE THE NEW HONEYWELL D-C AMPLIFIER



AccuData II

wide-band differential all-transistor D-C Amplifier for strain gages and thermocouples

- Full Scale Input: Unbalanced: $\pm 100 \mu\text{v}$ to $\pm 100 \text{ mv}$
Differential: $\pm 3 \text{ mv}$ to $\pm 100 \text{ mv}$
Open Loop: Below drift level
- Full Scale Output: $\pm 2\text{v}$ at 50 ma, dc to 10 kc
- Frequency Response: to 20 kc
- Output Impedance: Less than 0.5 ohm at dc on all ranges
- Input Impedance: Unbalanced 3 to 100 mv ranges; greater than 20 megohms in parallel with 350 micromicrofarads.
Differential: Greater than ± 2 megohms
- Equivalent D-C Input Drift: Less than $2 \mu\text{v}/10^\circ\text{F}$ ambient temp. change on 0.1 to 30 mv input ranges
- Equivalent Input Noise: $4 \mu\text{v}$ peak-to-peak on 100 μv to 300 μv range (0-10 cps). $8 \mu\text{v}$ rms on 10 to 30 mv ranges (0 to 100 kc)
- Common Mode Rejection: 200,000 at 60 cps on 3 to 30mv ranges

The new Honeywell AccuData II is a completely transistorized D-C Amplifier designed for use in high accuracy data handling systems as a wide-band pre-amplifier for strain gages and thermocouples. Its output can be fed to electronic or electromechanical analog-to-digital converters and simultaneously recorded on galvanometer oscillographs or magnetic tape. Either differential or single-ended input modes can be selected by an eleven position range switch. This switch changes the gain in three-to-one steps. Intermediate gains with high resolution are provided by a ten-turn potentiometer. Write for AccuData II Bulletin to Minneapolis-Honeywell, Dept. 7, Boston Division, 40 Life Street, Boston 35, Mass.

Honeywell



First in Control

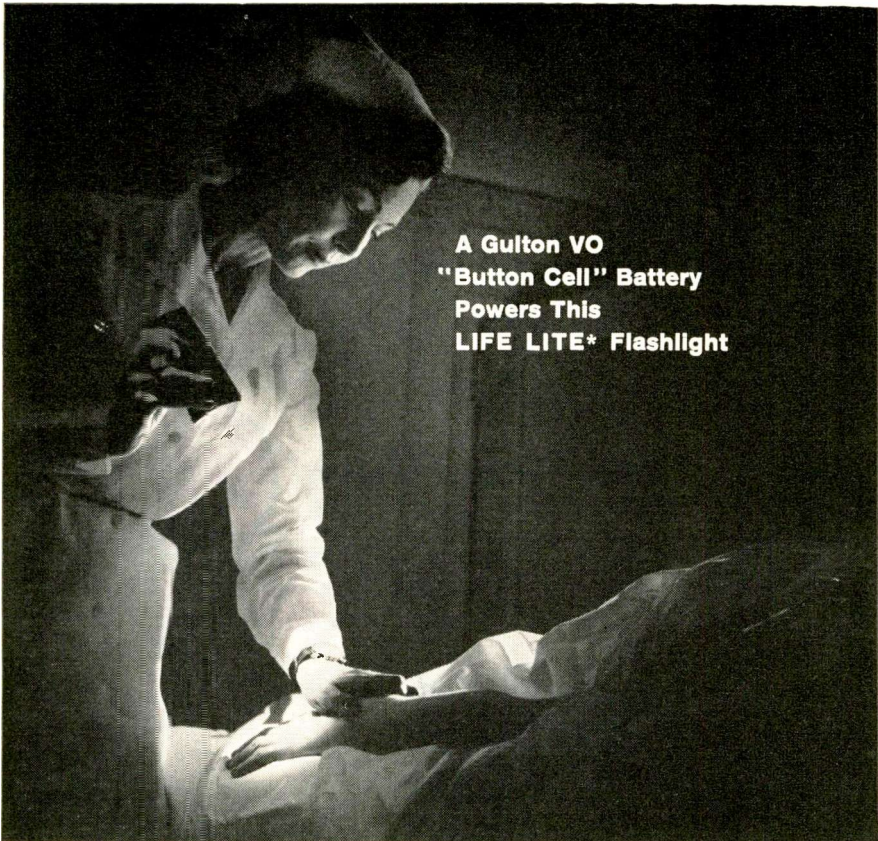

**A Gulton VO
"Button Cell" Battery
Powers This
LIFE LITE* Flashlight**

*Trademark

reliable . . . long-lived . . . rechargeable!



You can read a watch in the dark with any flashlight. The difference in the one the night nurse is using is that it will probably last a lifetime.



That's because it's powered by a *sealed* nickel cadmium button cell battery that's recharged simply by plugging it into an ordinary wall socket for a few hours.

Result: A dependable flashlight that can't corrode and never needs battery replacement.

How Can You Use These Versatile Batteries?

The rechargeable *Life Lite* is only one of many interesting ways in which imaginative engineers are employing these Gulton VO batteries.

Other applications: transistorized radios, guidance canes, missiles, photoflash power packs—*wherever small size, large capacity, light weight, long life, no maintenance, complete reliability, and easy recharging are desired.*

Most Complete Line Available

"VO" cells are available in capacities of 100, 180, 250, 500 and 1750 mah; have a nominal 1.2 voltage; can be packaged in any combination to meet your voltage specs. Patented sintered plate construction provides exceptional cycling characteristics; highest capacity per unit size. Like more information? Write us for Bulletin No. VO-110.



Available from stock—
GLENNITE BATTERY DISTRIBUTORS
92-15 172nd Street, Jamaica, New York
Gulton Industries, Inc.
Alkaline Battery Division, Metuchen, New Jersey

is designed for fast, accurate measuring and matching of resistors, capacitors and inductors for laboratory or assembly-line operations. Ranges encompassed are: 1 ohm to 5 megohms resistance, 500 $\mu\mu\text{f}$ to 2,000 μf capacitance and 3 millihenries to 10,000 henries inductance at accuracies from 2.5 percent down to 0.1 percent.

CIRCLE 341 ON READER SERVICE CARD

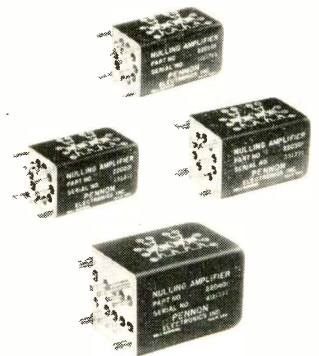

Nulling Amplifiers tiny, rugged

PENNON ELECTRONICS, INC., 7500 So. Garfield Ave., Bell Gardens, Calif. Series 2200 miniature magnetic servo nulling amplifiers. Weight is 5 to 10 oz; output power, 3 to 16 w; 400-cps; response, 12 millisecond; meet all appropriate military specifications, are compatible with silicon or germanium transistor drive circuits, withstand high line transients without damage.

CIRCLE 342 ON READER SERVICE CARD

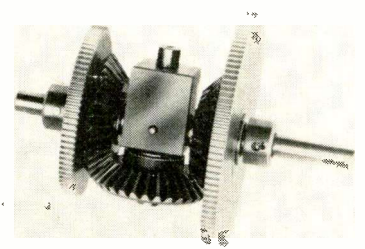

Differential three-gear

DYNAMIC GEAR CO., INC., 20 Merrick Road, Amityville, L. I., N. Y., has introduced a miniature, precision three-gear differential for application in the fields of electronic computers and fire control systems. It has a backlash of only

8 min. of arc and breakaway torque of 0.3 oz in. Tumbling circle is 1.380 in. Maximum recommended load at 2,500 rpm is 75 oz in. Overall length of the differential proper is 1.888 and shaft diameter is 0.1847. Shaft lengths are available up to 4 in.

CIRCLE 343 ON READER SERVICE CARD

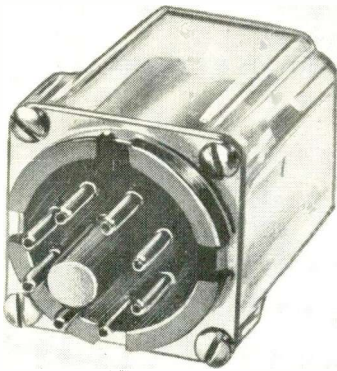

D-C Relay 8-pin octal plug-in

KURMAN ELECTRIC CO., 191 Newel St., Brooklyn 22, N. Y. Series 5D1C relay is a polystyrene enclosed plug-in unit. An easily removable case permits field adjustment without special equipment. Coil resistances of 500-13,000 ohms are available.

CIRCLE 344 ON READER SERVICE CARD

Hall Modulators and multipliers

GRH HALLTEST CO., 157 S. Morgan Blvd., Valparaiso, Ind. Modulators and multipliers as well as small d-c measuring yokes incorporating ferrite embedded Siemens Hall generators can be used up to the megacycle range. Complete units as well as special Hall probes for this purpose are now available. Active air-gaps in these units can be reduced to 0.05 mm.

CIRCLE 345 ON READER SERVICE CARD

D-C Power Supplies high-voltage

GENERAL ELECTRIC Co., Schenectady 5, N. Y., has a new line of tube-type and semiconductor h-v d-c power supplies. Particularly

REGATRAN SEMICONDUCTOR POWER SUPPLIES

Transistorized
for Reliability
Short Circuit Proof
for Dependability

The exceptional reliability of transistorized power supplies is only available when the transistors are fully protected. That's why Regatran Power Supplies employ an exclusive all-electronic circuit breaker. In the event of a short circuit, transistor current is instantaneously cut off, output voltage drops to near zero. Power is restored by simply operating a reset switch located on the front panel.

There are many other features too: 0.1% regulation, less than one millivolt ripple, low output impedance, remote sensing, three-way circuit protection.

Wide range models cover a complete range starting at zero with maximum outputs up to 60 V dc. Narrow range models are available in every popular voltage rating up to 36 V dc. Request complete data from factory.

WIDE RANGE MODELS

D-C OUTPUT		MODEL NO.	DIMENSIONS IN INCHES			APPROX. WEIGHT IN LBS.
VOLTS	AMPS		H	W	D	
0-7	0-15	TO7-15	8¾	19	15	40
0-7	0-5	TO7-5	5½	19	15	30
0-14	0-10	TO14-10	8¾	19	15	40
0-14	0-5	TO14-5	5½	19	15	30
0-32	0-15	TO32-15	8¾	19	15	70
0-32	0-5	TO32-5	5½	19	15	40
0-36	0-15	TO36-15	8¾	19	15	70
0-36	0-5	TO36-5	5½	19	15	40
0-60	0-7.5	TO60-7.5	8¾	19	15	70
0-60	0-2.5	TO60-2.5	5½	19	15	40

BRIEF SPECIFICATIONS

REGULATION: 0.1% or 0.01 volt, no load to full load, 105- to 125-volt line.
 RIPPLE: Less than 1 millivolt rms.

CIRCUIT PROTECTION: Short circuit proof.

OUTPUT POLARITY: Positive, negative, or floating ground.

REMOTE SENSING: Eliminates effect of voltage drop in power leads.

© Registered U. S. Patent Office. Patents pending.

ELECTRONIC MEASUREMENTS

COMPANY OF RED BANK
EATONTOWN • NEW JERSEY

1. HANDBOOK OF AUTOMATION, COMPUTATION AND CONTROL, Vol. 2: Computers and Data Processing

Edited by E. M. GRABBE, SIMON RAMO, and DEAN E. WOOLDRIDGE. *Thompson Ramo Wooldridge Inc.* Presents full details on design of analog and digital computers and gives their applications in science, engineering, and business. This is the latest volume in a complete treatment of all aspects of automation and control, covering practical design data for research, design, and development. Vol. 2, 1959, 1093 pages. \$17.50. Vol 1, *Control Fundamentals*, 1958, 1020 pages, \$17.00. Vol. 3, *Systems and Components*, In Press.

2. MASERS: Molecular Amplifiers

By J. R. SINGER. *Univ. of California*. The first book on quantum mechanical amplifiers, with applications to radar and other forms. Summarizes years of research and unifies material on induced emission amplifiers. 1959. 148 pages. \$6.50

3. PROGRAMMING BUSINESS COMPUTERS

By D. D. MCCrackEN, *Consultant*: HAROLD WEISS and TSAI-HWA LEE of *General Electric*. Principles, processing, programming, and application for all areas of commercial work. DATAC, a composite computer, gives examples. 1959. 510 pages. \$10.25

4. ANALYTICAL TRANSIENTS

By T. C. G. WAGNER. *Univ. of Maryland*. Intensive coverage of the mathematics, broadening the Laplace transform into a more general discussion based upon the Fourier transform. Gives a sense of both limitations and applications of this calculus. 1959. 212 pages. \$8.75

5. SERVOMECHANISMS AND REGULATING SYSTEM DESIGN, Vol. I

Second Edition. by HAROLD CHESTNUT and ROBERT W. MAYER. *General Electric Co.* Revised to include latest developments. Starts with basic mathematics, describes the nature of physical problems involved, then proceeds to solutions of advanced designs. Several new chapters. 1959. 680 pages. \$11.75

6. CIRCUIT THEORY OF LINEAR NOISY NETWORKS

By HERMANN A. HAUS and RICHARD B. ADLER, *both of M.I.T.* Explores a rational approach to the characterization of amplifier spot-noise performance. Coverage is unified around a single hypothesis. A Technology Press Research Monograph, M.I.T. 1959. 79 pages. \$4.50

7. LINEAR NETWORK ANALYSIS

By SUNDARAM SESHU and NORMAN BALABANIAN. *Syracuse Univ.* A mathematically precise treatment, *unifying* steady state and linear transient analysis. Thoroughly modern methods are used, with up-to-date philosophy and point of view. 1959. 571 pages. \$11.75

8. SPACE TECHNOLOGY

Edited by HOWARD S. SEIFERT. *Space Technology Laboratories, Inc.* 38 contributors. A monumental treatment, giving all phases serious analytical attention: ballistics, flight dynamics; propulsion; communications; man in space; scientific uses of space. 1959. 1188 pages. \$22.50

9. MATHEMATICAL PROGRAMMING AND ELECTRICAL NETWORKS

By JACK B. DENNIS. *M.I.T.* A new approach to mathematical programming, based on an analogy with electrical networks. Shows how any d-c network—made up of current sources, voltage sources, ideal diodes, and ideal transformers—is equivalent to a pair of dual linear programs. A Technology Press Research Monograph, M.I.T. 1959. 186 pages. \$4.50

10. FLUID POWER CONTROL

Edited by JOHN F. BLACKBURN. *Raytheon Co.*, GERHARD REETHOF. *Vickers, Inc.*, and J. L. SHEARER, *M.I.T.* Fundamentals, devices, dynamic analysis of fluid systems, electronic analogues, pneumatic servomechanisms. 758 pages. Prob. \$14.50

11. NOMOGRAPHY, Second Edition

By A. S. LEVENS. *Univ. of California*. A logical and lightly mathematical treatment, including short-cuts that simplify design, and much new material. 1959. 296 pages. \$8.50

12. SCIENTIFIC RUSSIAN

By GEORGE E. CONDOYANNIS. 1959. 225 pages. \$3.50

— TRIAL ORDER —

JOHN WILEY & SONS, Inc., 440 Fourth Ave., New York 16, N. Y.

Send on 10 days' approval the books circled. Within 10 days of receipt I'll remit full price plus postage or return books postpaid.

1 2 3 4 5 6 7 8 9 10 11 12

Name

Street..... City..... Zone..... State.....

Check here to save postage. Send full amount with order and we pay postage. Same return privilege. E-119

suitable where self-protected, highly-integrated systems are required, the full line of complete power supply packages is designed for such applications as hard-tube radar modulators, tube and h-f structural testing installations, wind tunnel charging supplies, and linear accelerators for atomic research. A wide range of ratings—from approximately 10 kv to 1,000 kv, d-c, and in current ratings from milliampere to 250 amperes—is available.

CIRCLE 346 ON READER SERVICE CARD

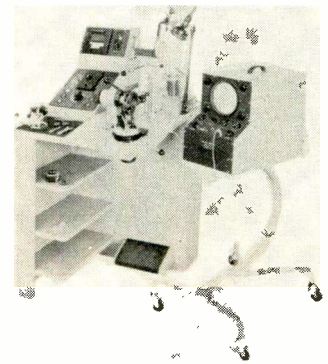

Coil Winder & inductance comparator

UNIVERSAL MFG. CO., INC., 1168 Grove St., Irvington, N. J., announces the S-series winding machine and the IC-601 inductance comparator. The machine handles No. 44 to No. 20 wire. Minimum i-d of a completed toroid is 0.170 to 0.330 in. The inductance comparator is intended primarily as a means of winding toroidal coils to preset inductances for high production rates on permalloy powdered or ferrite cores. A 5-in. scope screen exhibits an ellipse closing to form a straight line while a coil is being wound. When the line is formed, the coil has reached the required inductance.

CIRCLE 347 ON READER SERVICE CARD

Recorder/Reproducer high-speed

CONSOLIDATED ELECTRODYNAMICS CORP., 300 N. Sierra Madre Villa, Pasadena, Calif., has added a 16-track recorder/reproducer to its line of digital magnetic tape equipment. It operates at speeds up to 150 ips. Start time is reduced to

CIRCUIT DESIGN ENGINEERS NEEDED

IN SOUTHERN CALIFORNIA

Bendix-Pacific

the major source for instrumentation systems and components, offers you a unique opportunity to fully use your ability with a rewarding future as a qualified engineer.

Have you had two or more years experience in the design of VHF or UHF transmitters?

... in airborne packaging?

... in transistor circuitry?

If you have, we want to talk to you.

Please send resume to W. C. WALKER
ENGINEERING EMPLOYMENT MANAGER



11604 SHERMAN WAY
NORTH HOLLYWOOD, CALIFORNIA
Other High-Level Electronic Engineering Positions Available

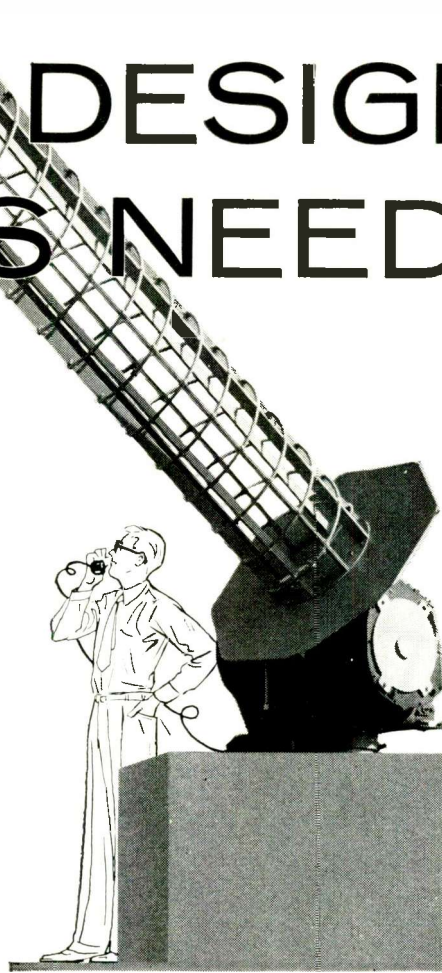

VALUABLE 64 PAGE REFERENCE SECTION

in electronics BUYERS' GUIDE

Prepared especially by the 25-man editorial staff of *electronics*, this 64-page section is designed to assist the buyer by providing him with market data, electronics applications, market distribution, market reports and books, industry organizations and services.

electronics BUYERS' GUIDE
and Reference Issue

A McGraw-Hill Publication

330 West 42nd Street

New York 36, New York



Outstanding Design in UHF, VHF, 2-Way and Microwave Antennas

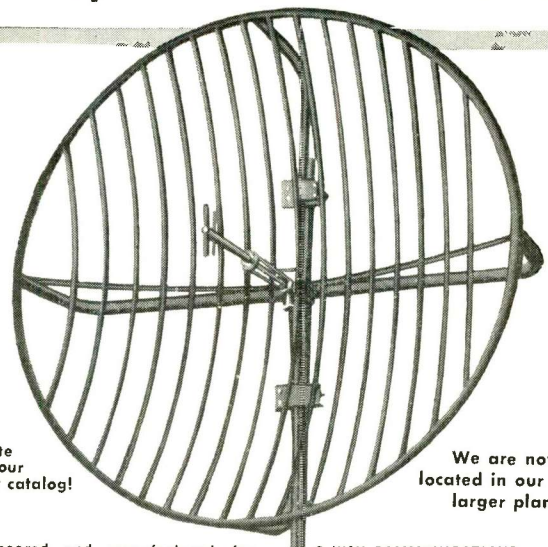

Write for our new catalog!

We are now located in our new, larger plant

Engineered and manufactured for peak efficiency, maximum mechanical stability, simple installation and long trouble-free life.

PARABOLAS and Point to Point
For 450, 900, 2000 and 6000 MC. Up to 15' diameter. Rugged HELLIARC welded aluminum construction.

RAILWAY and VEHICULAR
New low profile R R antenna a brand new Mark development!

2 WAY COMMUNICATIONS

Mark High Gain patented Fiberglass Construction omnidirectional base station antennas provide gains up to 10 db.

SPECIAL DESIGN

Mark offers a complete engineering and research service in antenna design and manufacture . . . now supplemented with greatly increased plant facilities.

MARK PRODUCTS
5439 Fargo Avenue ORchard 5-1500, Skokie, Illinois



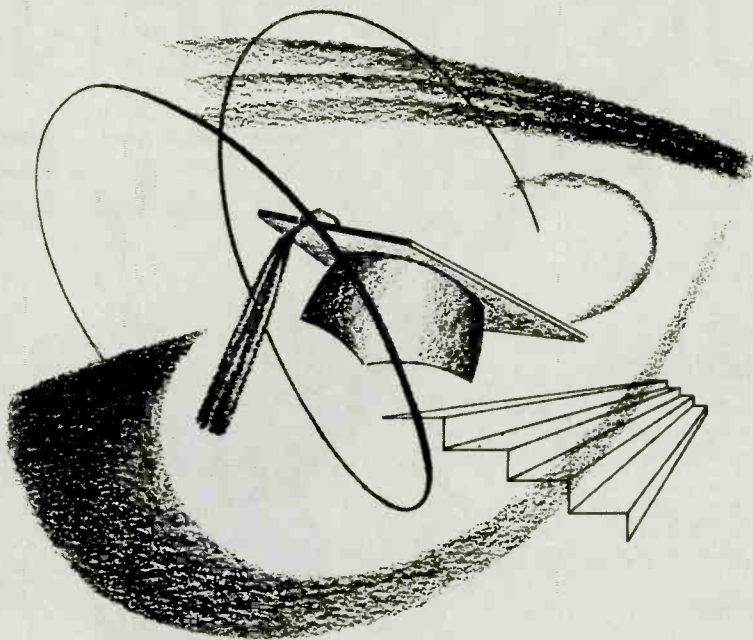

ADVANCED DEGREES

... another plus benefit at the Los Alamos Scientific Laboratory.

Graduate programs for advanced degrees in nuclear, mechanical and electrical engineering, chemistry, physics and mathematics are available to qualified employees of the Laboratory at the Los Alamos Graduate Center of the University of New Mexico. With tuition support from the Laboratory, employees may meet requirements for masters' degrees entirely in Los Alamos evening classes, and for Ph.D. degrees with courses at Los Alamos and a minimum of one academic year at the University of New Mexico campus. Frequently, research for dissertation may be done in the Laboratory with some of the world's finest facilities and equipment.

College graduates in engineering and science who want fascinating research assignments while continuing their advanced education may write to:

Director of
Personnel
Division 59-103

los alamos
scientific laboratory
OF THE UNIVERSITY OF CALIFORNIA
LOS ALAMOS, NEW MEXICO

a maximum of three millisecc by a vacuum buffer added to the mechanical storage arms of the unit. This creates a low inertia point from which the servoamplifier can move the tape. The vacuum also helps maintain contact between the tape and the all-metal magnetic heads.

CIRCLE 348 ON READER SERVICE CARD

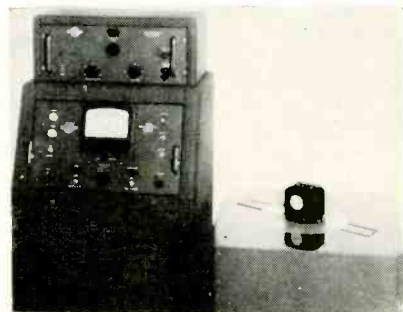

Oscillating Table covers 0.1 to 150 cps

MICRO GEE PRODUCTS, INC., 6319 W. Slauson Ave., Culver City, Calif. Model 60A is an angular oscillating table for rapid frequency response testing of rate gyros and angular accelerometers. It holds constant sinusoidal rate as frequency is changed. With associated d-c servo power amplifier, natural frequency exceeds 150 cps. Unit takes loads in excess of 100 lb (with decreased performance). An auxiliary recorder console is available for automatically recording frequency response on an X-Y recorder.

CIRCLE 349 ON READER SERVICE CARD



Fastening Device reduces wiring time

ELECTROVERT INC., 124 E. 40th St., New York 17, N. Y., announces a miniature version of the Insuloid Cradleclip system for securing or separating wire groups such as are found in electrical harnesses or other wire and cable installations. Pressure tubing for missiles, air-

craft or control assemblies and electrical components such as capacitors, resistors, transistors, etc., may be fastened with the unit. Cradle and permanently-hinged clip weigh only 0.012 oz. Made of DuPont Nylon and Neoprene, both regular and miniature units are in compliance with military specifications.

CIRCLE 350 ON READER SERVICE CARD

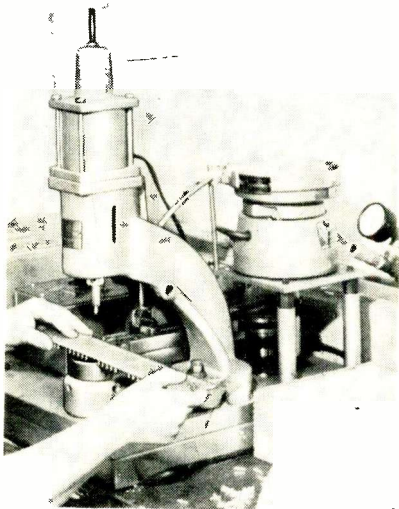

Staking Machine high-speed

CAMBRIDGE THERMIONIC CORP., 445 Concord Ave., Cambridge 38, Mass. The Cambion vibratory-feed staking machine positions and stakes up to 115 solder terminals per minute in perforated panels—approximately 15 times faster than single-stage, hand operated equipment. It permits accurate, efficient lugging of flat panels with throat lengths of 3 in. or under at high production rates. A variable speed feeder bowl assures smooth, rapid feeding without damage to lugs or terminals. A non-jamming feed mechanism delivers parts to exact predetermined location cycle after cycle.

CIRCLE 351 ON READER SERVICE CARD

Voltage Regulators silicon Zener

INTERNATIONAL TELEPHONE AND TELEGRAPH CORP., Clifton, N. J. A line of Gold Crown silicon Zener voltage regulators extend the control range to 100 v. They are available in power ratings up to 3 w,

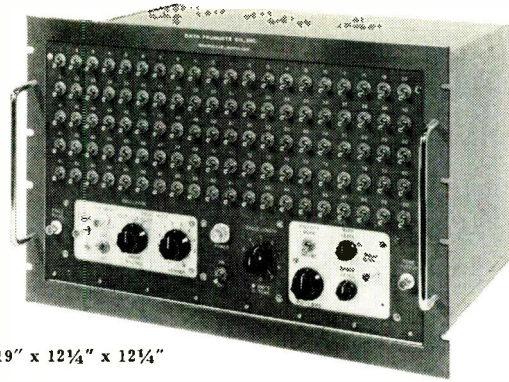

Actual size: 19" x 12 1/4" x 12 1/4"

NEW TRANSISTORIZED PULSE PATTERN GENERATOR

Provides remarkable versatility for military and industrial electronic testing applications

This is Data Products' *new, remarkably versatile* General-Purpose Pulse Pattern Generator. It provides a simulated and flexible time division pulse pattern for a broad range of military and industrial electronic testing applications.

If you manufacture or use electronic equipment that employs a time division multiplex principle, you'll be interested in the new test set's specifications:

- Generates a pulse pattern of any length from one to 100 pulses.
- Pulse rate is continuously variable from 10 to 100,000 pulses per second.
- Can be driven by either internal or external oscillator.
- Can be driven by an external oscillator at a pulse rate as low as desired to 100,000 per second.
- State of each pulse in a pulse sequence can be independently controlled from the front panel. Each pulse assumes a mark or a space condition depending on the position of the switch which represents that particular pulse. There are 100 switches—representing 100 possible pulse positions.
- Output level for the mark (ONE) position is continuously variable from zero to plus 10 volts. Output level for the space (ZERO) position is continuously variable from zero to minus 10 volts. Output impedance is 1,000 ohms nominal.
- Eight microsecond cycle pulse output (occurring at beginning of each pulse sequence) is provided.
- Two microsecond clock pulse output (occurring every pulse time) is provided.
- Can provide up to plus or minus 30 percent pulse width bias. Provided primarily to simulate baud bias conditions in teletype systems.
- Operates from a nominal 117 volts, 50-400-cycle power system.
- One microsecond rise and fall time.
- Tone keyer optionally available.

YOU CAN GET detailed information on Data Products' new Pulse Pattern Generator. Write or call Data Products if you would like to see a demonstration of the instrument's versatility. Or you can write or call for detailed specifications or descriptive literature. Ask if you would like to discuss your specific application requirements with a Data Products application engineer.



DATA PRODUCTS CO., Inc.

7320 WESTMORE ROAD ROCKVILLE, MD.
Garden 4-6750, TWX ROCKVILLE, MD. 999

A NEW FASTENER...A NEW TYPE OF FASTENER

DIE CAST ROUND-HEAD THUMB NUTS & SCREWS

with GRC's exclusive **WIDE GRIP** feature

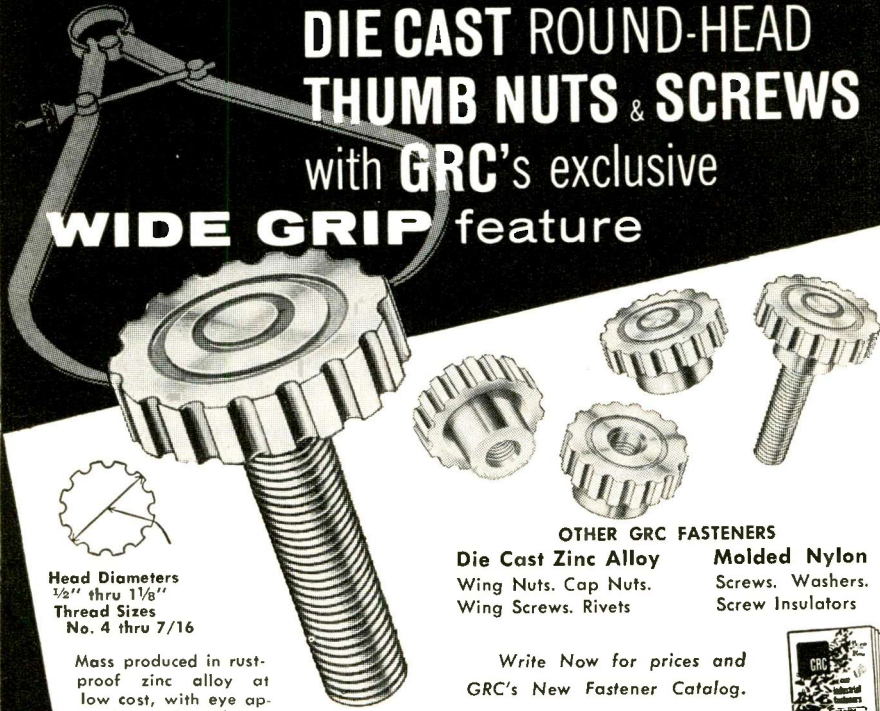

Head Diameters
1/2" thru 1 1/8"
Thread Sizes
No. 4 thru 7/16

Mass produced in rust-proof zinc alloy at low cost, with eye appeal to help sell your product... generous width tops have deep fluted edges for firm, comfortable grip. Closed or open end nuts. 1-pc. die cast or 2-pc. assembled screws with and without shoulders.

OTHER GRC FASTENERS
Die Cast Zinc Alloy Wing Nuts. Cap Nuts. Wing Screws. Rivets
Molded Nylon Screws. Washers. Screw Insulators

Write Now for prices and GRC's New Fastener Catalog.



GRIES
World's Foremost Producer of Small Die Castings

GRIES REPRODUCER CORP.
151 Beechwood Ave., New Rochelle, N. Y. • New Rochelle 3-8600
CIRCLE 205 ON READER SERVICE CARD

Package System Teamwork

Micro-Matic

PRECISION WAFERING MACHINES

Models for all jobs requiring very thin slicing of semi-conductor and other difficult-to-cut materials.

Model WMA

Fully automatic, produces wafers consistent in thickness and parallelism to within .0005" total variation.

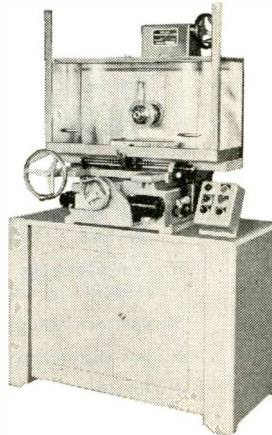

for laboratory or production use

Micromech's experienced Engineering Department is at your service in developing an optical orientation system to meet your particular requirement.

Write for illustrated brochures

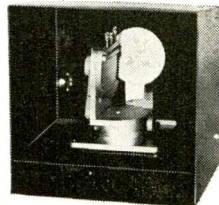

Optical ORIENTATION SYSTEM

EFFICIENT. Visual undistorted pattern allows immediate adjustment. Requires no interpretation or correlation with charts and data.

PRACTICAL. Safe and simple to handle. Always ready for immediate use. Compact—takes up only two square feet of table surface.

ECONOMICAL. Low cost, self contained unit. Uses no film or expendable accessories. No maintenance required.

MICROMECH MANUFACTURING CORP.

A Division of Sanford Manufacturing Corp.

1020 COMMERCE AVE., UNION, N. J.

118 CIRCLE 118 ON READER SERVICE CARD

1 w, 3.5 w and 10 w. Hermetically sealed diffused junction devices which insure the highest reliability, the units have many applications in instruments, computers and industrial equipment, including use as power supply voltage regulators, filament voltage regulators, voltage surge suppressors and clippers.

CIRCLE 352 ON READER SERVICE CARD



Auxiliary Unit for sonic analyzer

PANORAMIC RADIO PRODUCTS, INC., 514 S. Fulton Ave., Mt. Vernon, N. Y. Important extensions in the utility of the LP-1a sonic frequency analyzer are now available through a special auxiliary unit. The auxiliary "C" unit equips the analyzer with these added factors: continuously adjustable i-f bandwidth from 10 cps to 1 kc—10-sec scan interval—adjustable i-f bandwidths in steps of 10, 30, 100, 300 and 1,000 cps—continuously adjustable linear sweep width—adjustable smoothing filter (low pass output)—voltage calibration reset.

CIRCLE 353 ON READER SERVICE CARD

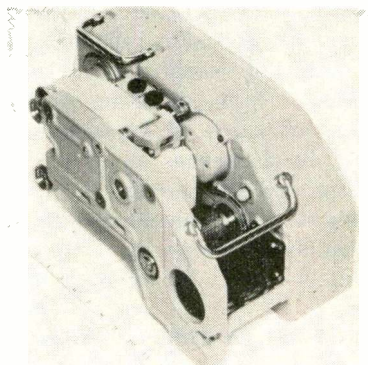

Digital Printer high speed

POTTER INSTRUMENT CO., INC., Sunnyside Blvd., Plainview, L. I., New York. Model 3303 high speed digital printer is completely transistorized and designed to be integrated into preflight checkout

NOVEMBER 6, 1959 • ELECTRONICS

RICHLY DIVERSIFIED



CLOSE TO MILLIONS

Mississippi is located in the heart of the new, growing South. Within a 200-mile radius is a multi-billion dollar market... yet

MISSISSIPPI

is years away from the frustrating congestion and other complex problems that plague many areas.

For Further Information Contact
MISSISSIPPI AGRICULTURAL AND INDUSTRIAL BOARD
Jackson, Mississippi

CIRCLE 206 ON READER SERVICE CARD

send for this

FREE

EICO Electronics Catalog



you save 50% on Top-Quality
Test Instruments
Hi-Fi • Ham Gear
KITS AND WIRED
for professional and home use

TEST INSTRUMENTS
battery eliminators
battery testers
bridges
decade boxes
electronic switch
flyback tester
oscilloscopes
probes
signal and sweep generators
tube testers
transistor tester
vacuum tube voltmeters
volt-ohm-milliammeters

HI-FI
stereo and monaural tuners
preamplifiers
power amplifiers
integrated amplifiers
speaker systems

HAM GEAR
cw transmitter
modulator-driver
grid dip meter

OVER 1½ MILLION
EICO instruments in use throughout the world.

LIFETIME service and calibration guarantee.
IN STOCK at your neighborhood EICO dealer.
Send now for FREE catalog E-11

EICO 33-00 N. Blvd., L. I. C. 1, N. Y.
... praised by the experts
as BEST BUYS IN ELECTRONICS
© 1958 ELECTRONIC INSTR. CO., INC.

CIRCLE 207 ON READER SERVICE CARD
ELECTRONICS • NOVEMBER 6, 1959

systems. Built to conform to MIL-E-16400, it features print-out rates in excess of 10 lines per sec and custom designed format with choice of number of columns up to 20 and type of characters or symbols. Storage and programming electronics are offered in a separate housing that may be integrated with the printer onto a RETMA standard structure for rack mounting. Any character coding or single line control can be employed to control the printer.

CIRCLE 354 ON READER SERVICE CARD

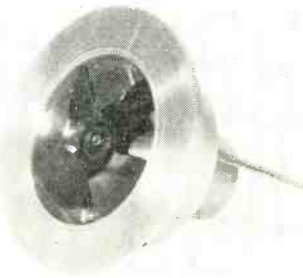

Miniaturized Fan less than 2 in. diameter

ELECTRO PRODUCTS DIVISION of Western Gear Corp., 132 W. Colorado Blvd., Pasadena, Calif. Model F2-17 miniaturized fan is designed for electronic applications. Powered by a 28 v d-c motor, it produces 45 cfm of air at 17,000 rpm. Unit measures less than 2 in. in diameter and 2 in. in length.

CIRCLE 355 ON READER SERVICE CARD

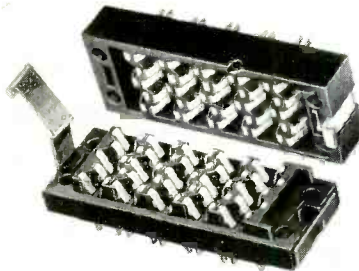

Compact Connectors multiple contact

CINCH MFG. Co., 1026 S. Homan Ave., Chicago 24, Ill. These plugs and sockets offer a maximum number of contacts in a minimum amount of space. Only normal pressure is required to engage the plug and socket units. A simple, yet positive, lock holds them securely

marion

advancement
in instrument
design



SEALED ELAPSED TIME INDICATORS

SCHEDULE MAINTENANCE — STUDY PRODUCTIVITY

Glass-to-metal sealed ELAPSED TIME indicators. Compact, low cost, tamper-proof. Standard ASA/MIL dimensions, 2½" and 3½" sizes. Easy to read standard size counter registers 1/10 hour steps to 9999.9 or hour steps to 99999. Hermetically sealed. Shielded. Starts, operates continuously from -55°C to +85°C. For 110-125 or 220-250 volts 60 cycle A.C. Bulletin on request. Marion Instrument Division, Minneapolis-Honeywell Regulator Company, Manchester, N. H., U. S. A.

Copyright © 1958, Marion

marion meters

"WHERE ELECTRONICS MEETS THE EYE"



CIRCLE 208 ON READER SERVICE CARD

for 34 years



SYMBOL

of

EXCELLENCE

EDO CORPORATION
College Point, L.I., N.Y.
Since 1925

CIRCLE 119 ON READER SERVICE CARD 119

JOHNSON MINIATURE CAPACITORS

*Compact Design!
Rugged Construction!*

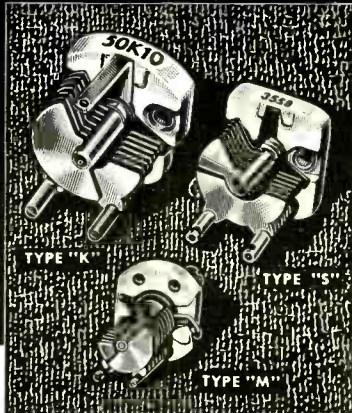

Save valuable space in RF equipment...

Johnson miniature and sub-miniature air variable capacitors are available in a wide range of sizes, types, and capacities—perfect for use in compact RF applications. The 3 types described below have soldered plate construction, oversize bearing, and heavily anchored stator supports to provide extreme rigidity. Inductance path to both stator supports is extremely low with bridge-type stator terminal. Large compression rotor contact provides steady torque—rotor stays "put" where set. Rotor contact and all other metal parts are nickel-plated—steatite insulator is DC-200 treated.

SUB-MINIATURES—In addition to the miniature air variables described below, the new Johnson Type "T" and "U" sub-miniature capacitors are also available in production quantities. Write for our new components catalog 978 listing complete specifications.

TYPE "M"—Peak voltage 1250 volts on .017" plate spacing; 850 volts on .013" spaced units. Shaft slotted for fast screwdriver adjustment—mounting bushing threaded with flats to prevent turning—mounting nut furnished. Available in production quantities with the following features: locking bearings; 180° stop; various shaft extensions; high torque; silver or other platings. Single section, butterfly, and differential types available.

TYPE "S"—Midway in physical size between the Type "M" and "K" capacitors, the Type "S" has a plate spacing of .013" with a peak voltage rating of 850 volts. Other spacings, single hole mounting types, straight shaft, screwdriver shaft, or locking type screwdriver shaft available on special order in production quantities.

TYPE "K"—Widely used for many military and commercial applications, the Type "K" has a peak voltage rating of 1000 volts with a plate spacing of .015". Unit is available in production quantities to meet MIL-C-92A specifications—other capacities and variations for specialized military and commercial applications are also available in production quantities.

New Catalog



For detailed specifications, including engineering drawings, on Johnson miniature and sub-miniature capacitors, as well as other Johnson electronic components, write for your free copy of our new components catalog No. 978.



E. F. JOHNSON CO.

1820 Second Avenue S.W. • Waseca, Minn.

together. Releasing the lock, the units separate by the spring action of the contacts. This wiping action of the contacts keeps them clean at all times. The hinge connectors are made with 20 to 100 contacts in multiples of 10 contacts. They can also be supplied with caps and cable clamps and are rated at 4½ amperes.

CIRCLE 356 ON READER SERVICE CARD



Secondary Standard portable unit

WIANCKO ENGINEERING Co., 255 N. Halstead, Pasadena, Calif. Type Q3403 is a precision standard for direct parameter measurements and calibration of pressure transducers, force pickups and accelerometers in the field, plant or lab. A $\times 2$ and $\times 4$ plug-in multiplier, coupled with bandwidth adjust, provides high resolution and accurate real data capability. It features easily interchangeable plug-in pressure heads—absolute, differential and gage. Accuracy is ± 0.05 percent full scale.

CIRCLE 357 ON READER SERVICE CARD

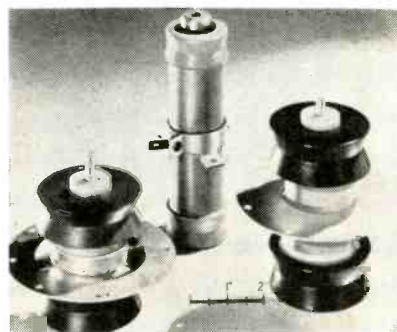

Ceramic Capacitors high voltage

CENTRALAB, A Division of Globe-Union, Inc., 900 E. Keefe Ave., Milwaukee 1, Wis. A group of high current ceramic feed-through ca-



INTERMETALL SEMICONDUCTORS

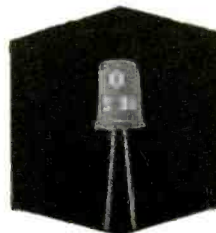
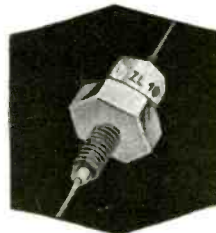
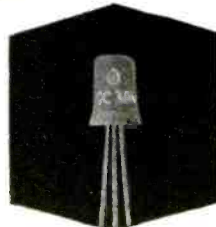

INTERMETALL

semiconductors let you reach the highs in equipment performance and reliability that you expect from first-class silicon and germanium devices.

Here are typical components rated to fit a wide range of your applications:

- PNP Silicon transistors with 660 mW dissipation at 45°C
- Silicon Zener and Zener power diodes with a range of 5 to 11 and 5 to 36 volts, respectively
- Silicon junction diodes with PIV of up to 350 volts
- Silicon rectifiers with max. ratings of: PIV 700 volts, rectified current 1, 2 A
- PNP Germanium AF and RF junction transistors
- Hearing aid transistors for standard and miniature aids

Most types are in stock for quick delivery.

INTERMETALL

Flingerstr. 1-3

Düsseldorf, West Germany

G. m. b. H.

DIVISION OF

CLEVITE CORPORATION



CIRCLE 209 ON READER SERVICE CARD
NOVEMBER 6, 1959 • ELECTRONICS

capitors, with voltage up to 100 v, can be constructed in a wide range of values of capacity, voltage and r-f current. They are extremely flexible in physical dimensions and can be made in a multitude of compact sizes and shapes. Units can be used to replace oil, mica or vacuum capacitors in radar, transmitters, r-f heaters and many other uses.

CIRCLE 358 ON READER SERVICE CARD



Delay Line with 40 turns

AD-YU ELECTRONICS LAB., INC., 249 Terhune Ave., Passaic, N. J. A 40-turn continuously variable delay line has less than 1 mill μ sec resolution time and more than 10 μ sec total delay. The amount of equalization is exactly equal to its optimum value. Features include fast rise time, excellent stability, hairline accuracy, and freedom of time jitter. Characteristic impedance is from 50 ohms up to 300 ohms.

CIRCLE 359 ON READER SERVICE CARD



D-C Power Supply precision instrument

LAWN ELECTRONICS CO., INC., Woodward Road, Englishtown, N. J. Model 630B provides 300 ma at any voltage from 0-600 v with regulation better than 0.1 percent for both line and load, and ripple below 1 mv. A variable bias of 0.250 v and a 6.3 v, 6 ampere filament supply are also available. Unit features an

CURTISS WRIGHT



HIGH-RELIABILITY COMPONENTS

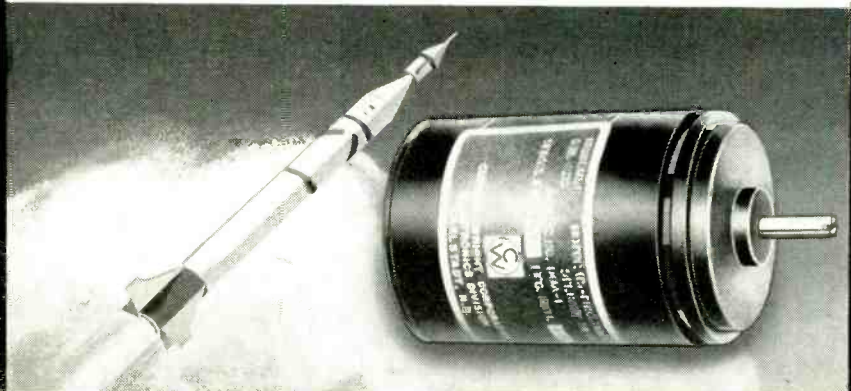

New DIGITAL MOTORS

Positive lock — bi-directional stepping motors

These bi-directional digital motors are designed to withstand severe environmental requirements and are operable under high shock and vibration. In its function the digital motor indexes and locks positively.

The motors are available for angular rotation of 30° or 36° at a rate of up to 40 pulses per second.

ULTRASONIC DELAY LINES

Custom-designed

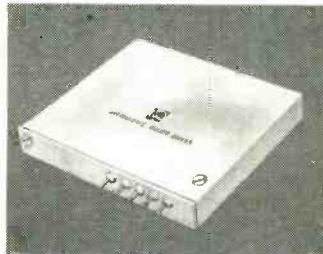

Development engineers can now employ new concepts in existing and projected applications. These delay lines are small in size, hermetically sealed and vibration proof.

SPECIFICATIONS

Delay range... 5 to 6000 microseconds
Meets tolerances of... ± 0.1 microsecond
Signal to noise ratio... Greater than 10 to 1
Input and output impedance... 50-2000 ohms
Carrier frequency... 100 kc — 1 mc
Delay to pulse rise time... Up to 800:1

TIME DELAY RELAYS

Instant reset — voltage compensated



Curtiss-Wright "IR" thermal time delay relays reset the instant that they are de-energized. Variations from 22 to 32 volts will not affect the time delay specified.

SPECIFICATIONS

Time delay... Preset 20 to 180 seconds
Contact arrangement SPST, SPDT, DPDT
Temperature comp... -65°C to +125°C
Weight... 4½ ounces
Terminals... Hooked solder type
Mounting... Bracket or stud

WRITE FOR COMPLETE COMPONENTS CATALOG 159

ELECTRONICS DIVISION

CURTISS-WRIGHT

CORPORATION • WEST CALDWELL, N. J.

CATHODE RAY GUN MOUNTS

BY **Superior**

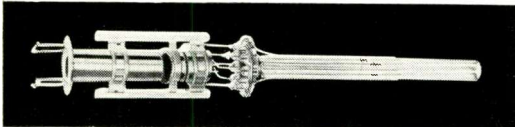
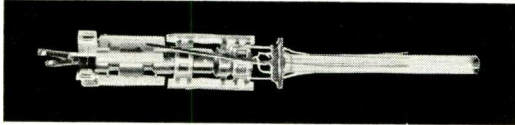
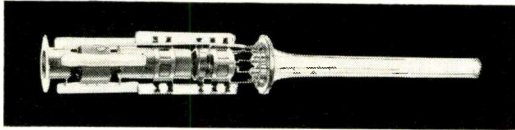

Adherence to tightest specifications by skilled assemblers—100% inspection for perfect construction—precision parts—closely controlled spacing guarantees **RELIABLE PERFORMANCE** in every SUPERIOR electron gun mount.

At your service for any type of electron gun mount. Samples, catalogs, prices available on request.

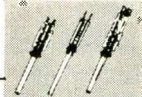

A COMPLETE LINE OF CATHODE RAY GUN MOUNTS

Superior Electronics Corporation

208 Piaget Avenue, Clifton, New Jersey • GREGory 2-2500
CIRCLE 210 ON READER SERVICE CARD

Free send for the most widely used
ELECTRONIC SUPPLY GUIDE

ALLIED'S 1960 CATALOG

BUY AT FACTORY PRICES
WORLD'S LARGEST STOCKS AT YOUR COMMAND

specialists in the complete supply of:

- Semi-Conductors
- Special-Purpose Tubes
- Controls, Resistors
- Connectors
- Test Equipment & Meters
- Switches & Timers
- Relays
- Knight-Kit[®] Instruments
- Knight[®] P.A. Equipmt.
- Transformers
- Electronic Parts for Every Industrial Need

ONE ORDER TO ALLIED FILLS THE WHOLE BILL: Your ALLIED Catalog is the best single source for electronic supply. It puts the world's largest stocks at your command—there's no need to deal with hundreds of separate factories—*one order to us fills the whole bill.* You get same-day shipment (fastest service in electronic supply) and you buy at factory prices. Send today for your FREE 1960 ALLIED Catalog—your one-source electronic supply guide.

your dependable direct factory source for everything in electronic supply

ALLIED RADIO

100 N. Western Ave., Dept. 11-K9
Chicago 80, Ill.



send for **FREE** catalog

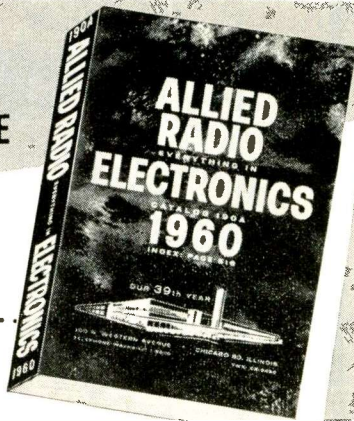

output switch that allows the setting of output voltages before applying power to a circuit.

CIRCLE 360 ON READER SERVICE CARD

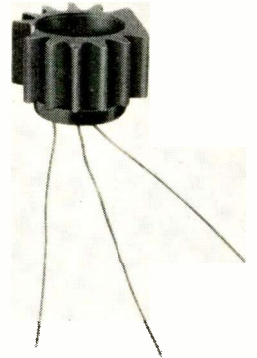

Transistor Radiator and retainer

THE BIRTCHEr CORP., 4371 Valley Blvd., Los Angeles 32, Calif. The 3AL-675 series of radiators for cooling transistors mount directly on the chassis or p-c board, thereby serving also as retainers. Mounting is accomplished by a tapped hole in the mounting base of the radiator. Sizes and modifications are available to cover the full range of TO-6, TO-7 and TO-9 packages. Material is aluminum with anodized finish.

CIRCLE 361 ON READER SERVICE CARD



Teflon Capacitors ultrastable

COMPONENT RESEARCH Co., INC., 2639 S. LaCienega Blvd., Los Angeles 34, Calif. New capacitor design reduces drift due to temperature cycling to nearly zero. Retrace is within 0.02 percent for temperature range of -10 C to 85 C. A temperature coefficient of 10 ppm/deg C with less than 0.06 percent total capacitance change from 25 C to 85 C has resulted in these capacitors being used in guidance computer integrator circuits for outer space missiles. Insulation resistance is 10¹³ ohms

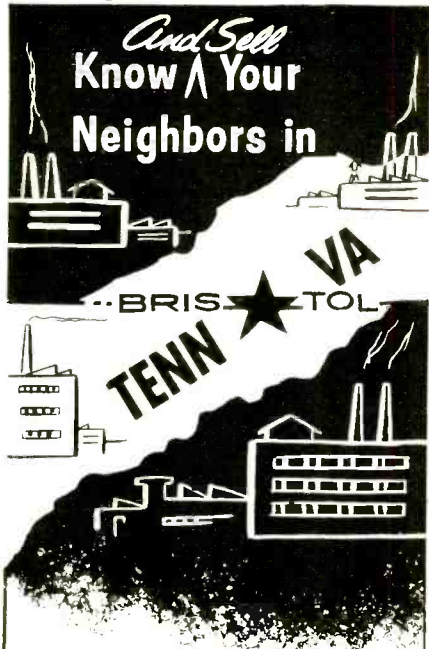

In OLD Industrial Country

Bristol, Tenn.-Va. is a vital part of the industrialized Tennessee Valley development which is one of the most diversified manufacturing areas in our country.

You'll have plenty of friendly industrial neighbors to share their experience with you and, better yet, you'll find major customers for your OEM products right among these neighbors on your own doorstep!

You see, this is OLD industrial country and it's expanding by leaps and bounds as new industry moves in to serve the old. There are important contracts for your production right here in the heart of Bristol, Tenn.-Va. Come and we'll help you investigate them.

Let Ford, Bacon & Davis
Tell You the Whole Story



This nationally famous engineering firm has prepared an exhaustive analysis of Bristol's industrial potential. Write for your copy today—Dept. E1159.

Bristol
INDUSTRIAL DEVELOPMENT BOARD
of the Twin Cities of
BRISTOL • TENN. - VA.

minimum from 25 C to 85 C. Units withstand vibration of 20 g rms noise (5-1500 cps) for 15 minutes.

CIRCLE 362 ON READER SERVICE CARD

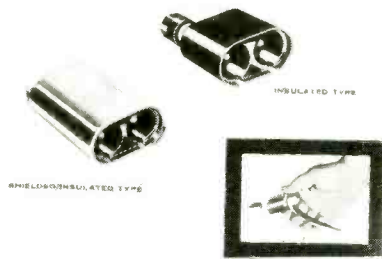

Dual Connectors multipurpose

THE SUPERIOR ELECTRIC Co., 83 Laurel St., Bristol, Conn. Dub-L-Plug dual connectors provide quick, safe electrical connections to binding posts mounted on 1 in. centers. Available shielded or unshielded, they feature gold-plated conducting metal parts, color-coded captive thumbnuts and protectively recessed twin banana plugs.

CIRCLE 363 ON READER SERVICE CARD

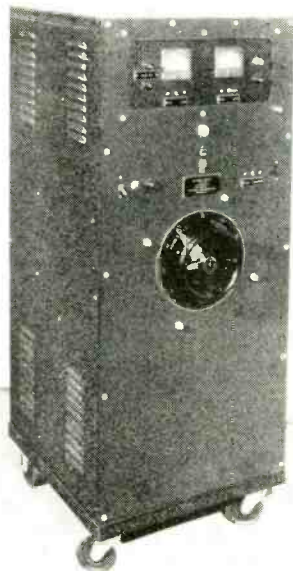

Power Supplies capacitor charging

PESCHEL ELECTRONICS, INC., Towners, Patterson, N. Y. A series of high voltage d-c supplies for wind tunnel charging, for linear accelerators in atomic research, hard tube radar modulators, and similar applications is available from 10 to 250 kv output and in power capacities up to 250 kw. Features include fast charging for capacitor banks

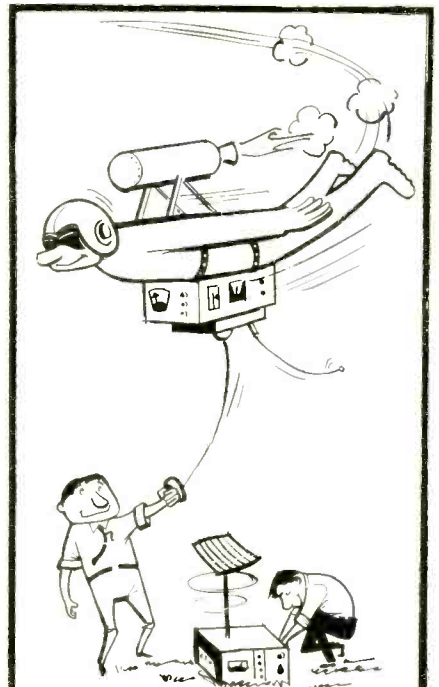

It's a new automatic flight control system.

This one isn't operational yet, but maybe you could lend us a hand in exchange for things like salary and

LRCP*

General Electric's **ARMAMENT AND CONTROL SECTION** in Johnson City (Binghamton) New York, has 14 openings for men with degrees and/or experience in mechanical engineering, electrical (electronics) engineering—also in mathematics and physics.

Some of the product areas include airborne defense systems, automatic flight control systems (not in any way similar to the cartoon), inertial navigation systems, analog and digital computers, gyros, fluid controls, servo controls and many more.

General Electric has the right combination for developing your career potential. ***Long Range Career Potential.**

Let's trade facts. Tell us about your education, experience and interests. We'll send you details about where you'll fit into the Armament and Control Section.

Write in confidence to:
Mr. R. C. McConnell, Div. J-221-2
Armament and Control Section
General Electric Company
600 Main Street
Johnson City, New York

ARMAMENT AND CONTROL SECTION
GENERAL ELECTRIC
JOHNSON CITY, NEW YORK

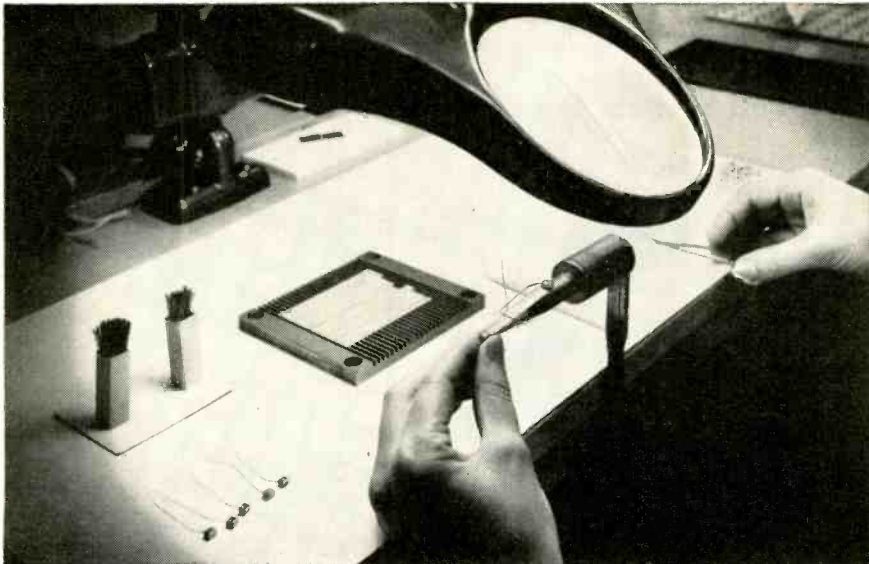

Attach Leads to Ultra-Fine Magnet Wire? Sure!! ...and Economically

Send for samples illustrating how Deluxe Coils' advanced engineering and manufacturing know-how can supply miniaturized coils (48-56 gauge wire) with leads. Cut your scrap and termination problems.

DELUXE COILS, INC.
POST OFFICE BOX 318 • WABASH, INDIANA

CIRCLE 212 ON READER SERVICE CARD

DOLLAR FOR DOLLAR THE BEST PANTOGRAPH ON THE MARKET...NEW ENGRAVOGRAPH ITX

\$575 other models
from \$298

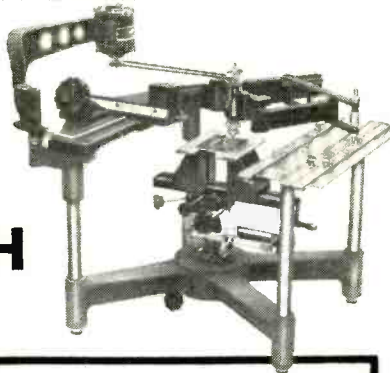

- ★ **PRECISION CONSTRUCTION**
Dovetailed, rigid for continuous, accurate production.
- ★ **LARGE ENGRAVING AREA**
Covers 12" x 3½" in one setup.
- ★ **HEAVY DUTY SPINDLE**
Cuts ⅛" deep in brass, ⅙" in cold rolled steel, in one pass.
- ★ **2 DEPTH REGULATORS**
Uniform depth of cut guaranteed, even on uneven surfaces.
- ★ **UNIVERSAL HOLDING VISE**
Cuts setup time in half.

MACHINE TOOL OF 1001 USES:

marking parts, tools, bins, engraving nameplates, stencils, instrument panels, dials, etc. Profiling, slotting, milling and other jobs, eliminating several setups, costly equipment, and skilled labor.

**all with unskilled
labor because it's
tracer-guided**

Write for catalogue ZT-1.

new hermes ENGRAVING MACHINE CORP. 154 West 14th Street,
New York 11, N. Y.

up to 10 megajoules, and complete convenience and safety controls in a packaged unit.

CIRCLE 364 ON READER SERVICE CARD



Silicon Transistors high power

WESTINGHOUSE ELECTRIC CORP., Box 2278, Pittsburgh 30, Pa. New silicon transistors, when operated as a switch, are capable of controlling over 5 kw of power. They are suited for high power switching and linear power applications since they have the following characteristics: collector-to-emitter voltage ratings from 30 to 200 v; maximum operating junction temperature of 150 C; and saturation resistance less than 0.1 ohm. With a minimum current gain of 10 to 15 amperes collector current, these devices have a maximum collector current rating of 30 amperes.

CIRCLE 365 ON READER SERVICE CARD

Capacitors metallized paper

ASTRON CORP., 255 Grant Ave., East Newark, N. J. Type MQZF tubular axial-lead capacitors are hermetically sealed in metallized paper for 1-v transistorized applications. The 50-v units have a temperature range from -50 C to +85 C. Ratings are from 0.047 to 8.0 µf. Smallest size is 0.195 in. diameter and ⅜ in. long.

CIRCLE 366 ON READER SERVICE CARD

Digital Bridge measures capacitance

ELECTRO INSTRUMENTS INC., 3540 Aero Court, San Diego 11, Calif., announces a fully automatic capacitance measuring system. Basically it is a digital bridge used in conjunction with input scanners and

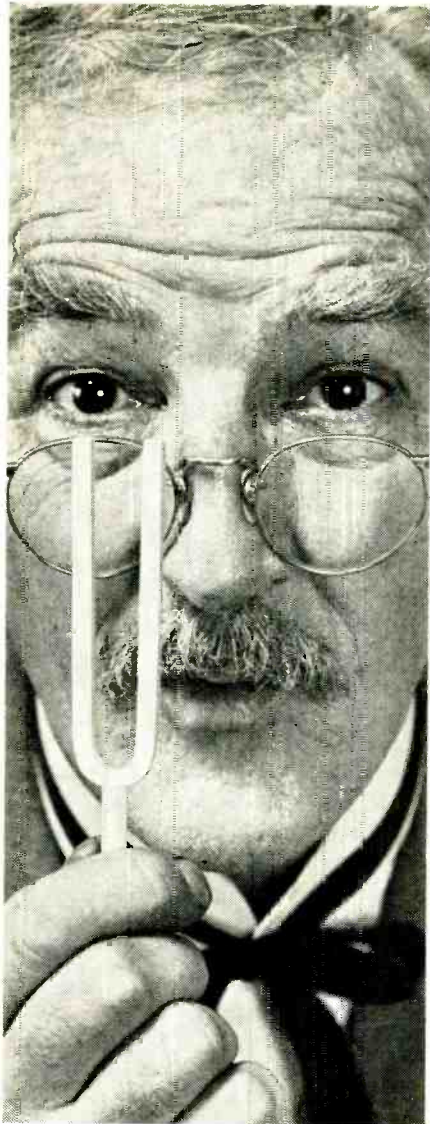

a stable,
accurate **SOURCE OF FREQUENCY**
—but now in miniaturized form...

HAMILTON *Tuning Fork* FREQUENCY STANDARDS

Hamilton provides complete circuit development and packaging of a wide range of miniaturized, transistorized tuning fork frequency standards. Hamilton engineers will be glad to assist you with your frequency control applications. Write today for product catalogs and complete information.

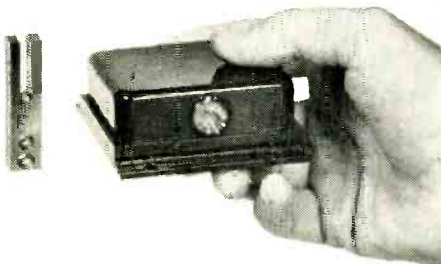

HAMILTON WATCH COMPANY
HATHAWAY INSTRUMENT DIVISION
5800 East Jewell • Denver, Colorado

output recording devices. The system will select inputs, measure capacitance from 10 μf to 1,000 μf , dissipation factor from 0.1 to 99.9 percent and leakage resistance from 0.1 megohm to 9.9 kilomegohms, and record the digital equivalents of the analog values. Both 120 cps and 1 kc frequency bridges are available.

CIRCLE 367 ON READER SERVICE CARD

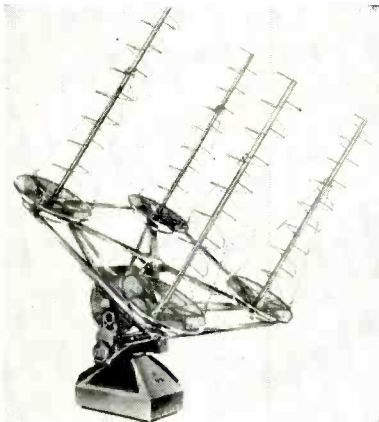

Antenna ground-to-air

ANDREW CORP., 363 E. 75th St., Chicago 19, Ill. A quad-helix antenna for the 215-265 mc range will provide reliable telemetry communication between ground station and in-flight missile or satellite. Gain is 17.5 db at 265 mc; vswr, less than 2 to 1. An easy to control rotator provides for 720 deg azimuth and 180 deg elevation tracking at speeds up to 30 deg per sec.

CIRCLE 368 ON READER SERVICE CARD

Voltage Comparator transistorized

NON-LINEAR SYSTEMS, INC., Del Mar, Calif. The NLS 50 go/no-go voltage comparator quickly and accurately determines whether or not an input voltage is within prescribed limits. Instrument will check any voltage from ± 0.001 to ± 999.9 v. It has a detection threshold of 500 μv , a sensitivity of 0.005 percent and its limit settings are precise to ± 0.01 percent. The transistorized comparison amplifier, limit setters, solid-state reference supplies and range multiplier are all included in the one instrument.

CIRCLE 369 ON READER SERVICE CARD

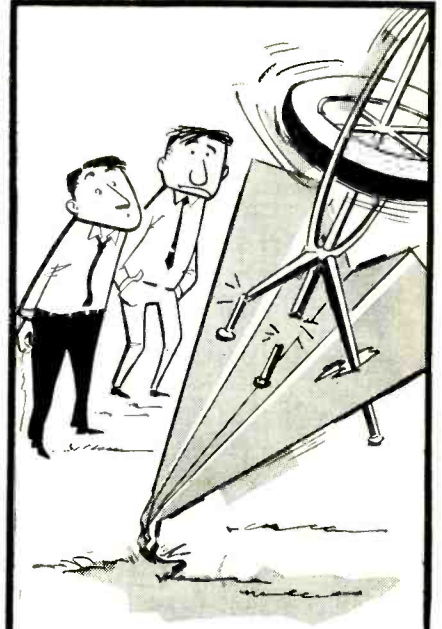

It's a new inertial navigation system.

This one isn't operational, but maybe you could lend us a hand in exchange for things like long range career potential and **IBOM***

General Electric's **ARMAMENT AND CONTROL SECTION** in Johnson City (Binghamton) New York has 14 openings for men with degrees and/or experience in mechanical engineering, electrical (electronics) engineering—also in mathematics and physics.

Some of the product areas include engine control systems, inertial navigation systems (none like the cartoon), transistors and magnetic controls, microwave, ground support equipment, inertial equipment and many more.

General Electric has the right combination for developing your career potential. *Increases Based On Merit.

A complete brochure about our section is available in exchange for your resume information. Write in confidence to:

Mr. R.C. McConnell, Div. J221-3
Armament and Control Section
General Electric Company
600 Main Street
Johnson City, New York

ARMAMENT AND CONTROL SECTION
GENERAL ELECTRIC
JOHNSON CITY, NEW YORK



NULLS - PHASE - VOLTS - COUNT ...

specify NORTH ATLANTIC'S
PHASE ANGLE VOLTMETER—

"A standard of industry"

FEATURES

- Direct reading 0-360°, no ambiguity.
- 1mv to 300v full scale.
- VTVM operation to 50kc.
- 10 microvolt null sensitivity.
- 10 meg input impedance.
- Available in any frequency.
- Unaffected by harmonics with optional filters.
- Low noise.
- Signal and/or Reference Isolation.

PLUG-IN ACCESSORIES

- Reference Isolation Module
- Bridging Transformer Module
- Summing Module

READS DIRECTLY
VOLTAGE QUADRATURE IN-PHASE DEGREES



NORTH ATLANTIC industries, inc.
603 main street, westbury, n.y. EDgewood 4-1122

MODEL 202BR

NEW BOOKS

Topics in Electromagnetic Theory

By DEAN A. WATKINS.

John Wiley & Sons, Inc., New York, 1958, 118 p, \$6.50.

As the title indicates, Prof. Watkins has brought together a number of usually separate topics of advanced electromagnetic theory into a single volume. The material presented here has been used by the author as a one-semester graduate course at Stanford University.

Once the groundwork has been laid in electromagnetic theory, there are a limitless number of topics which might be chosen for further treatment. Thus it is difficult to quarrel with any author's particular choice of topics. This particular selection has a heavy bias toward microwave tubes. However, Prof. Watkins treats the microwave tube structures and stops short of the consideration of the tubes as a whole. This is justifiable in view of the emphasis on electromagnetic theory, but it does seem to drop rather abruptly just as things are about to become practical.

The general methods of treating periodic transmission lines are presented in the first chapter. The second chapter treats the helix in detail. The third chapter is devoted to coupled-mode theory. This most interesting approach, largely developed by J. R. Pierce, is introduced well. Again the applications are only hinted at.

The final chapter, entitled Anisotropic Media, considers microwave transmission lines using ferrites.

For the convenience of those who wish to use this book as a text, the author has included a set of problems. — MORRIS ETTENBERG, *Polytechnic Institute of Brooklyn, Brooklyn, N. Y.*

Junction Transistor Electronics

By R. B. HURLEY.

John Wiley & Sons, Inc., New York, 1958, 473 p, \$12.50.

SINCE this book was designed to give the practicing electronic engineer a thorough background in tran-

IMMEDIATE DELIVERY OF ALL TYPES

BY THE LEADER FOR OVER 10 YEARS

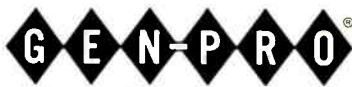

NAVY TERMINAL BOARDS

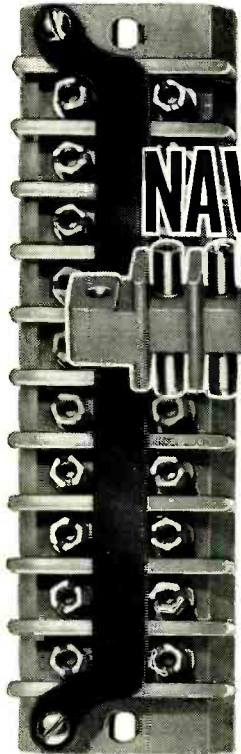

Solid Block 17TB10

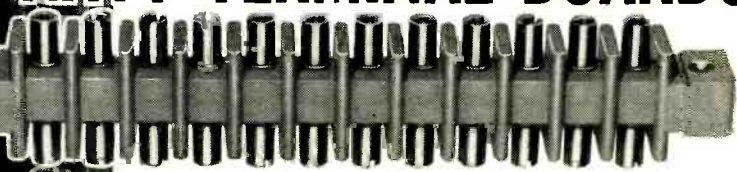

Feed-Thru Terminal Block 7TB12

Gen-Pro military terminal boards are manufactured and inspected in accordance with latest revision of MIL-T-16784, BuShips Dwg. 9000-S6505-B-73214 and BuOrd Dwg. 564101. Molding compound, per MIL-M-14E assures low dielectric loss, high insulation resistance, high impact strength.

NEW MINIATURE TYPES NOW AVAILABLE

Gen-Pro miniature type military terminal boards conform with Bureau of Ships Drawing RE10-D-764, as referenced in MIL Standard #242.

WRITE today for new catalog with illustrations & specifications

Miniature 26TB10



GENERAL PRODUCTS CORPORATION
Over 25 Years of Quality Molding
UNION SPRINGS, NEW YORK TWX No. 169

THE STANDARD 2" BLOWER you've been waiting for!

Dean & Bensons

POW

AIR

New HP & HF Series

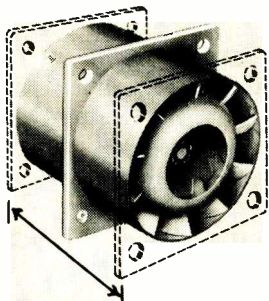

Flange location anywhere

- 1 Lightweight Aluminum alloy construction for clean aerodynamic surfaces and rigid construction.
- 2 Square or round flange located at your option, anywhere along the blower housing.
- 3 Slip out AC or DC motor allows for easy and inexpensive maintenance without replacing entire unit.

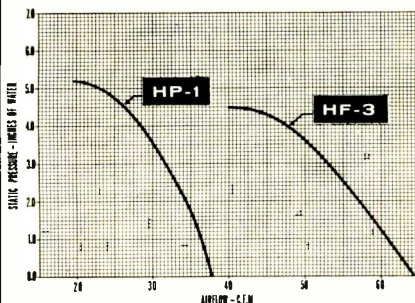

POWAIR performance opens the door to a lighter system design for weight and size reduction.

DEAN & BENSON RESEARCH

Division of Benson Manufacturing Co.
Kansas City 1, Mo.

sistor characteristics and applications, only basic electrical circuit theory and mathematics equivalent to college algebra is required to understand the text. This reviewer disagrees with the author in considering vacuum-tube electronics a prerequisite. It is not needed.

Value—For someone wishing an introduction to the application of junction transistors to electronic equipment with many practical illustrations and considerations (that is, bias stabilization, thermal runaway and switching applications) this is a good book. It is also valuable in that it devotes a greater portion of its material to switching circuits and theory (digital and pulse applications) than previous books in this field. Here the need for gathering many of the published articles and papers under one cover is partially satisfied.

The book is intentionally brief on semiconductor physics and the fabrication of transistors.—F. BRONSTEIN, *Design Engineering Dept., Ford Instrument Co., Long Island City, N. Y.*

Television Engineering, Principles and Practice Vol. IV—General Circuit Techniques

By S. W. AMOS and D. C. BIRKINSHAW.

Hiffe and Sons, Ltd, London, England, 1958, 268 p, 35s.

THIS text is the fourth volume of a series on the fundamentals of television theory and practice. It describes in basic form the general circuit techniques that the encountered in television broadcasting equipment. The information is presented in such a way that mathematical derivations are held to a bare minimum so that the average engineer is not likely to be confused by lengthy equations nor left in the dark about specific functioning or practical aspects.

While the text was intended primarily as a BBC engineering training manual and as such makes reference to the British 405-line, 10-kc horizontal sweep frequency and 50-cps vertical field frequency, it is sufficiently well written to give engi-

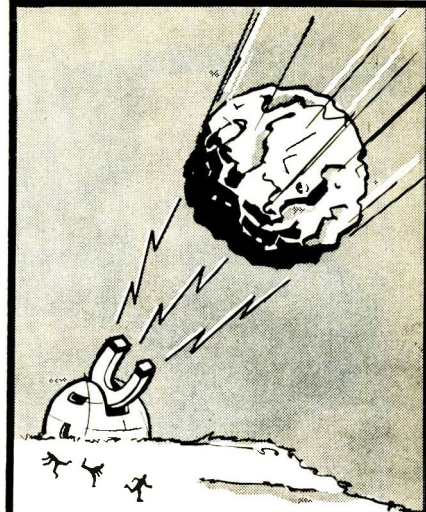

It's a new transistorized magnetic control.

This one works . . . but not the right way. Maybe you could lend us a hand in exchange for things like employee benefits and

GPTL*

General Electric's **ARMAMENT AND CONTROL SECTION** in Johnson City (Binghamton) New York, has 14 openings for men with degrees and/or experience in mechanical engineering, electrical (electronics) engineering, mathematics and physics.

Some of the product areas include transistor and magnetic controls (none like the asteroid-pulling device illustrated), analog and digital computers. Career position openings include project leaders, technical writers, engineers in development, circuitry design, packaging, stress and vibration, systems, quality control and others.

*General Electric has the right combination for developing your career potential. *Good Place To Live (ask the Chamber of Commerce).*

MAIL COUPON TO:

Mr. R. C. McConnell, Div. J-221-4
Armament and Control Section
General Electric Company
600 Main Street
Johnson City, New York

Send me more information. My job interest is _____

Name _____

Degree (year) _____

Address _____

(Street or Route)

(City) (Zone) (State)

My resume is enclosed.

ARMAMENT AND CONTROL SECTION

GENERAL ELECTRIC

JOHNSON CITY, NEW YORK

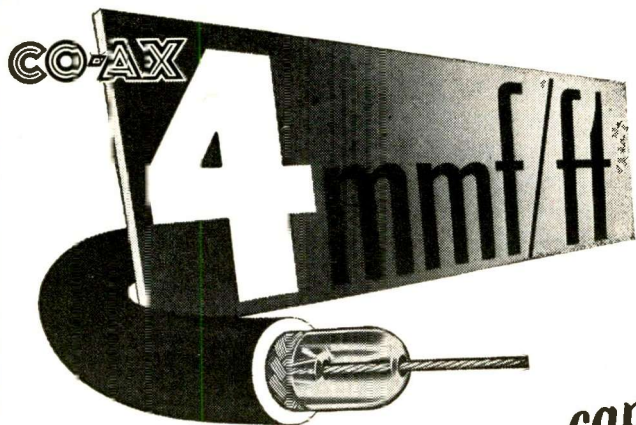

★ ULTRA LOW capacitance & attenuation

WE ARE SPECIALLY ORGANIZED TO HANDLE DIRECT ORDERS OR ENQUIRIES FROM OVERSEAS SPOT DELIVERIES FOR U.S. BILLED IN DOLLARS—SETTLEMENT BY YOUR CHECK CABLE OR AIRMAIL TODAY

TYPE	$\mu\text{F}/\text{ft}$	IMPED. Ω	O.D.
C1	7.3	150	.36'
C11	6.3	173	.36'
C2	6.3	171	.44'
C22	5.5	184	.44'
C3	5.4	197	.64'
C33	4.8	220	.64'
C4	4.6	229	1.03'
C44	4.1	252	1.03'



NEW 'MX and SM' SUBMINIATURE CONNECTORS
Constant 50 Ω - 63 Ω - 70 Ω impedances

TRANSRADIO LTD. 138A Cromwell Rd. London SW7 ENGLAND CABLES: TRANSRAD, LONDON

CIRCLE 216 ON READER SERVICE CARD

neers with a minimum background in television electronics an insight into the circuitry employed in monochrome television systems, without the necessity of guidance by an experienced teacher. The lack of an extensive bibliography, however, might tend to discourage further research and detailed study of the basic fundamentals.

While the text was written primarily as a training manual, its appendices abound in useful design formulas. It is highly recommended as an invaluable reference work for the television engineer.—R. A. CASTRIGNANO, *Engineer in Charge, Closed Circuit TV Systems, CBS Laboratories, Stamford, Conn.*

Industrial Electronics Handbook

Edited by WM. D. COCKRELL.

McGraw-Hill Book Co., Inc., New York, 1958, 1,408 p, \$22.50.

INDUSTRIAL electronics can run the gamut from pure electronics through human engineering to various combinations of electromechanics. Thus, 100 contributing authors, each an expert in his field, have been gathered together to assemble a first-class reference book.

Although any one phase of industrial electronics is not covered in great detail, bibliographical references at the end of each of the design sections, coupled with a listing of technical information sources at the end of the book, point the way to further information.—L.S.

THUMBNAIL REVIEW

Mathematics of Physics and Modern Engineering. By I. S. Sokolnikoff and R. M. Redheffer, McGraw-Hill Book Co., Inc., New York, 1958, 810 p, \$9.50. This successor to Sokolnikoff's "Higher Mathematics for Engineers and Physicists" provides a balanced introduction to applied mathematics, fostering a critical attitude toward analytical processes and stressing those aspects which make mathematics a living discipline in creative scientific developments.

Impedance Matching. By A. Schure, John F. Rider Pub., Inc., New York, 1958, 128 p, \$2.90. Detailed information on how to obtain maximum power transfer between most types of generators and loads.

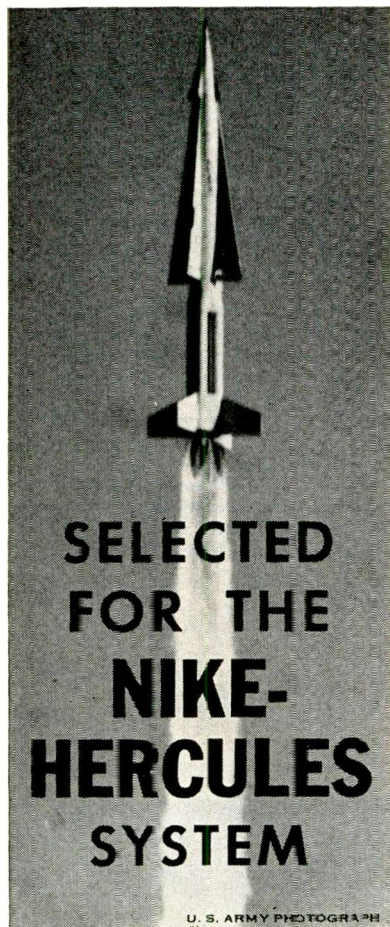

SELECTED FOR THE NIKE-HERCULES SYSTEM

U. S. ARMY PHOTOGRAPH

MINIATURIZED COOLING UNITS

from American-Standard Industrial Division

Now part of eight missile systems, packaged American Blower Air-Moving Units help prevent breakdowns from self-generated heat in sensitive electronic equipment. Your choice of numerous sizes and designs. All can be modified to solve your particular problems. Or we can design and build units to fit the requirements of your electronic equipment. For individual specification sheets write, detailing your requirements, or send for Bulletin No. 5412. American-Standard* Industrial Division, Detroit 32, Mich. In Canada: American-Standard Products (Canada) Limited, Toronto, Ontario.

* AMERICAN-Standard and Standard® are trademarks of American Radiator & Standard Sanitary Corp.



AMERICAN-Standard
INDUSTRIAL DIVISION

AMERICAN BLOWER PRODUCTS • ROSS PRODUCTS • KEWANEЕ PRODUCTS

New! REAR-PROJECTION-TYPE
**IN-LINE
DIGITAL DISPLAY**

WITH ONE-PLANE
PRESENTATION

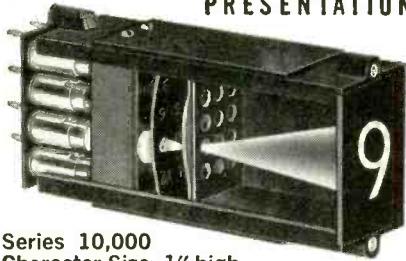

Series 10,000
Character Size—1" high

IDEAL FOR Electronic or Electrical Test Equipment and Instruments, Control Equipment, Production and Inventory Controls, etc.

Specifications include no moving parts, fast easy installation, minimum of maintenance, low unit cost, and long operating life.

Price Per Unit
\$18⁰⁰

Quantity Prices
On Request

Write Today for Complete Specifications

Representatives in Principal Cities



INDUSTRIAL ELECTRONIC ENGINEERS, INC.
3973 Lankershim Boulevard
North Hollywood, California

CIRCLE 217 ON READER SERVICE CARD

MICO Precision Apparatus

NEW HEAVY
DUTY 2 & 3
DIMENSIONAL
ENGRAVER



FOR
Engraving
Nameplates
Fine Routing Work
Profiling Small
Objects
Making Small Dies
and Molds

**UHF COAXIAL
WAVEMENTERS**

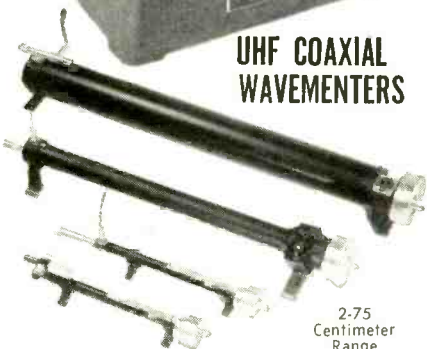

2-75
Centimeter
Range

Send for Illustrated Catalogs
MICO INSTRUMENT CO.

77 Trowbridge St. Cambridge 38, Mass.
CIRCLE 218 ON READER SERVICE CARD
ELECTRONICS • NOVEMBER 6, 1959

Electrical Discharges in Gases. By F. M. Penning, Macmillan Co., New York, 1958, 75 p, \$3.00. This translation of "Electrische Gasontladungen", which was published in 1955, covers conduction of electricity in metals and gases, nonself-sustaining and self-sustaining arc discharges, Townsend discharge and breakdown, glow discharge and the like.

Dynamical Analogies. By H. Olson, Van Nostrand Co., Inc., Princeton, N. J., 1958, 278 p, \$6.75. This second edition deals with analogies between electrical, mechanical, acoustical and magnetic systems. Classical analogies are retained and new chapters are included on magnetic and mobility analogies, noise, distortion and feedback.

The Presentation of Technical Information. By R. O. Kapp, The Macmillan Co., New York, 1958, p 147, \$2.95. This guide to accurate, clear and economical writing of technical material is based on lectures presented at University College, London and to the Institution of Electrical Engineers.

Electrical Measurement Analysis. By E. Frank, McGraw-Hill Book Co., Inc., New York, 1959, 443 p, \$8.75. This clearly-written text covers in detail d-c and low-frequency instruments, basic measuring methods, errors and the application of statistics to analyze errors.

Metal Rectifier Engineering. By E. A. Richards, Pitman Pub. Corp., New York, 1959, 209 p, \$5.95. This volume is a guide to selecting rectifiers for particular applications and includes basic calculations, losses and efficiencies, transformers, voltage control and harmonics, and filtering.

Introduction to Symbolic Logic and Its Applications. By R. Carnap, Dover Pub., Inc., New York, 1959, 241 p, \$1.85. This revised version of "Einführung in die Symbolische Logik", which was first published in 1954, also includes many problems and examples that have been added to enhance its value as a text.

General Circuit Theory. By G. Newstead, John Wiley & Sons, Inc., New York, 1959, 144 p, \$3.00. This latest addition to the Methuen Monograph Series gives an integrated, self-contained development of circuit theory. Emphasis is on development of general relationships rather than detailed analysis of particular circuits.

Video Amplifiers. By A. A. Schure, John F. Rider Pub., Inc., New York, 1959, 88 p, \$1.80. Introduction to design and application of video amplifiers for students and technicians.

**YOKE
DISTORTION**
your problem?



Uniform magnetic fields
Produced in Celco
Precision
Deflection
Yokes
Minimize
**SPOT
DISTORTION**



Exclusive Celco core materials make it possible to achieve faster recovery times, minimum hysteresis, high linearities and maximum sensitivities.

Contact Celco Engineering Department for a fast solution to all your yoke problems.

Celco produces a complete line of standard or special commercial and military precision deflection yokes.

Celco
*Constantine Engineering
Laboratories Co.*

Main Plant: MAHWAH, N. J. DAVIS 7-1123

- Pacific Division - Cucamonga, Calif. - YUKON 2-2688
- Central Division, Lanesboro, Pa. - ULYSSES 3-3500
- Southern Division, Miami, Fla. - WILSON 5-2164

CIRCLE 129 ON READER SERVICE CARD 129



New Working Aids from McGraw-Hill

ELECTRONIC COMPONENTS HANDBOOK, Vol. III

Just Published—Gives designers of military and commercial electronic equipment information they need to select and use components which perform with maximum reliability. Provides data on transformers and inductors, connectors, wire and cable, terminals, tube shields, hardware, and other components. While emphasis is on types for which military specifications are available, other types also are included. Military specifications are clearly summarized. Edited by Keith Henney, Harry Mileaf, and Craig Walsh, Technical Writing Service, McGraw-Hill Book Co. Electronic Components Laboratory, Wright Air Development Center. 180 pp., 8½ x 11, 156 illus., \$10.00

TWO-WAY RADIO

Just Published—Complete guide to two-way radio—from its practical uses to technical information on both AM and FM transmitters and receivers, circuits, selective calling methods, antennas, power supplies, installation, and servicing. Covers digital pulse codes, power sources, transmitter tuning, phase-shift modulators, split-channel operation, and other topics. Describes such recent developments as synchronous AM and single sideband. By A. Lytel, Avco Mfg. Co., Crosley Div. 304 pp., 283 illus., \$9.50

DIGITAL AND SAMPLED DATA CONTROL SYSTEMS

Just Published—Guide to analysis and design of digital and sampled-data control systems—for solving problems in such fields as process control and electronic computers. Covers theory of sampling and quantizing, z-transform analysis, analog digital conversion, and related topics. Latest developments are clearly discussed, including systems with finite sampling duration and those with non-synchronized samplers. By J. T. Tou, Purdue Univ. 631 pp., 406 illus., \$15.00

DIGITAL COMPUTING SYSTEMS

Just Published—Full coverage of digital computing systems: principles, design, operation, and applications. Describes the elements in modern computers, explaining underlying principles of the devices used and illustrating the devices themselves. The circuitry by which the elements perform desired functions is clearly covered, with examples of typical circuits. Logical design and programming are discussed, and how computers solve scientific, business, and data handling problems is shown. By S. B. Williams, Consultant Dept. of Defense. 231 pp., 168 illus., \$7.75

MAIL COUPON FOR 10-DAY FREE EXAMINATION

McGraw-Hill Book Co., Dept. L-9-11, 327 W. 41st St., N.Y.C. 36

Send me book(s) checked below for 10 days' examination on approval. In 10 days I will remit for book(s) I keep plus few cents for delivery costs, and return unwanted book(s) postpaid. (We pay delivery costs if you remit with this coupon—same return privilege.)

- Henney, et al—Electronic Components Handbook, Vol. III, \$10.00
- Henney, et al—Electronic Components Handbook Library, \$31.50
- Lytel—Two-way Radio, \$9.50
- Reza & Seely—Modern Network Analysis, \$10.00
- Tou—Digital and Sampled-data Cont. Sys., \$15.00
- Lion—Instrumentation in Scien. Res., \$9.50
- Williams—Digital Computing Systems, \$7.75
- Hicks—Success. Tech. Writing, \$5.50

(PRINT)
Name

Address

City Zone.... State.....

Company

Position

For price and terms outside U. S., write McGraw-Hill Int'l., N.Y.C.

L-11-6

Literature of

MATERIALS

Adhesive. Bee Chemical Co., Logo Division 12933 South Stony Island Ave., Chicago 33, Ill., has published a bulletin describing R-703, a fast acting solvent type adhesive for joining polystyrene to polystyrene.

CIRCLE 375 ON READER SERVICE CARD

COMPONENTS

Servo Amplifier. Texas Instruments Inc., 13500 N. Central Expressway, Dallas, Texas, has available a 4-page issue of "Application Notes" describing a push-pull transistorized servo amplifier.

CIRCLE 376 ON READER SERVICE CARD

Selenium Rectifiers. General Electric Co., Syracuse, N. Y. Publication ECG-402 is a 27-page booklet of application notes on the use of Vac-U-Sel selenium rectifiers.

CIRCLE 377 ON READER SERVICE CARD

Electrolytic Capacitors. Ohmite Mfg. Co., 3634 Howard St., Skokie, Ill. Complete details of series TF tantalum foil electrolytic capacitors are given in bulletin 152D.

CIRCLE 378 ON READER SERVICE CARD

EQUIPMENT

Computers. E.M.I. Electronics Ltd., Hayes, Middlesex, England, has available a folder providing background information on both the Emidec 1100 and Emidec 2400 computers.

CIRCLE 379 ON READER SERVICE CARD

Electronic Gaging. Radio Corp. of America, 12605 Arnold Ave., Detroit 39, Mich. A complete description of the company's electronic gaging systems and of each of the modules comprising them is given and typical applications are shown in a recent brochure.

CIRCLE 380 ON READER SERVICE CARD

Electronic Overload Detector. Wintriss, Inc., 20 Vandam St., New York 13, N. Y., has issued a bulletin describing the Circuit Master Mark III overload detector that

the Week

eliminates costly die damage due to overload misfeed, buckling, pile-up, end-of-material or other malfunction.

CIRCLE 381 ON READER SERVICE CARD

Radiation Pyrometer System. Bristol Co., Waterbury, Conn. Product Data No. P1220.3-2 illustrates and describes a low-range temperature measuring system that does not require physical contact with the object whose temperature is being measured.

CIRCLE 382 ON READER SERVICE CARD

Digital Clocks. Datex Corp., 1307 S. Myrtle Ave., Monrovia, Calif. Bulletin No. 106 illustrates and describes the DC-100 series digital clocks.

CIRCLE 383 ON READER SERVICE CARD

Spectrum Analyzers. Panoramic Radio Products, Inc., 514 So. Fulton Ave., Mt. Vernon, N. Y. A complete line of automatic spectrum analyzers with 0.5 cps-44 kmc range, response curve tracers, and instrumentation systems are described in the new *Catalog Digest*.

CIRCLE 384 ON READER SERVICE CARD

Phase Sensitive Detector. Boonshaft and Fuchs, Inc., Hatboro Industrial Park, Hatboro, Pa. Technical bulletin No. 91411 describes the theory and operation of a new visual phase sensitive detector.

CIRCLE 385 ON READER SERVICE CARD

High-Vacuum Pumps. Varian Associates, Palo Alto, Calif. An 8-page brochure describes VacIon pumps and high vacuum accessories for cleaning vacuum beyond 10^{-9} mm Hg.

CIRCLE 386 ON READER SERVICE CARD

FACILITIES

Printing Techniques. The Film-sort Co., Pearl River, N. Y. Techniques used by the U.S. Navy to produce printed matter from tabulating (punch cards) and to store whole pages or forms on microfilm inserted in aperture cards are discussed in a 12-page reprint.

CIRCLE 387 ON READER SERVICE CARD

AIRPAX

Transistor Chopper



ACTUAL
SIZE

...requires no
external drive
transformer

The AIRPAX type 6025 transistor chopper has a SPDT switching action capable of handling signal voltages up to 100 volts. Inclusion of drive transformer in the assembly provides signal and drive isolation.

Switching action can be any frequency from 50 to 5000 CPS, using sine or square wave drive. Ideal for use in operational amplifiers, DC measuring instruments, servo systems, and similar applications where fast response and wide-band operation is a necessity.

- High Signal Handling Capacity
- Wide Frequency Range
- Minimum Drive Power Requirement
- Impervious to Shock and Vibration
- Phase and Dwell Time Unaffected by Temperature Changes



CM31

CAMBRIDGE DIVISION, CAMBRIDGE, MARYLAND

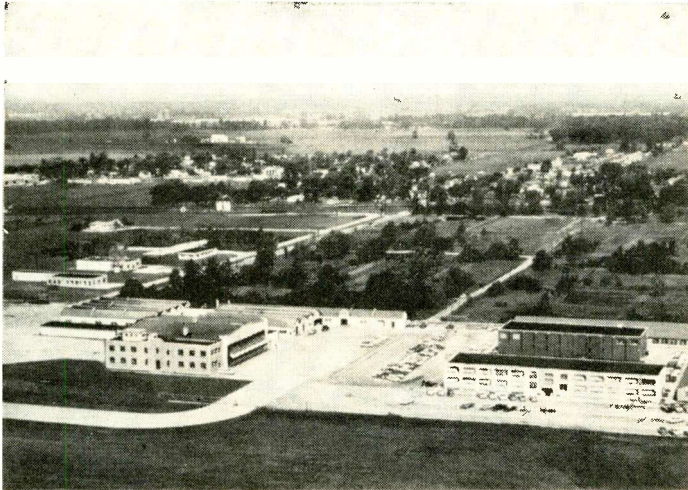

Hazeltine Opens Test Center

OPERATIONS are underway at a new electronics test and engineering facility established by Hazeltine Technical Development Center, Inc., at the Weir-Cook Municipal Airport in Indianapolis. This is a new division of Hazeltine Corp., Little Neck, N. Y., electronics defense contractor.

The technical center's facilities, recently leased from the city of Indianapolis, include a hangar, staging area and approximately 150,000 sq ft of engineering laboratory space on a 23-acre tract with access to the airport.

According to W. M. McFarland, president of the newly-formed division and executive vice president of Hazeltine Corp., work is underway at the test center on portions of an IFF (Identification Friend or Foe) joint service identification which Hazeltine is developing.

"Before the end of the year, we expect to have an engineering department of approximately 300 at the technical development center. Eventually, we hope to have a staff of 1,000 in Indianapolis. The hangar and accessibility to the airport will greatly enhance services we can perform for the government on airborne electronic equipment and systems," McFarland says.

By establishing the new test center and now erecting a new 50,000 sq ft engineering laboratory in Greenlawn, N. Y., Hazeltine is increasing its floor space 40 percent.

The Greenlawn Laboratory, which will be a part of Hazeltine Electronics Division, will adjoin the company's 50,000 sq ft Greenlawn manufacturing plant on an 18-acre site. It will supplement the engineering facilities Hazeltine now has on Long Island in Floral Park, Garden City, Port Washington, and at its Little Neck headquarters. Hazeltine has additional research laboratories in Burbank, Calif., and Chicago, Ill.



Lerco Acquires Subsidiary

LERCO ELECTRONICS INC., Burbank, Calif., recently announced its acquisition of control of Micro Gee Products Inc., Culver City, Calif., designers and manufacturers of flight simulation equipment like that being demonstrated at left by Bela Losmandy, electronic design engineer. Looking on are other members of the Micro Gee technical

staff and corporation officers, including (l to r) B. W. McFadden and David S. York, vice presidents, Hugh P. Moore, chairman of Lerco, and Walter E. Peterson (formerly with Northrop Corp.), newly appointed president of Micro Gee.

Although Micro Gee becomes a Lerco subsidiary, the two companies will continue to operate separately within their different electronics fields of interest. No cooperative design or production projects are anticipated.



Potter Heads DCA Division

ELECTION of Horace R. Potter as vice president of the Reeves Hoffman Division of Dynamics Corp. of America is announced.

Potter, who is general manager of the DCA division, is charged with responsibility for all activities of this producer of quartz crystals, crystal filters and oscillators, and fractional h-p motors. He makes his headquarters at the Reeves Hoffman Division plant in Carlisle, Pa.

Johnson Takes New Position

ROBERT R. JOHNSON has joined Applied Technology, Inc., Palo Alto, Calif., electronic systems firm, as project engineer.

A designer of electronic systems for aircraft and missile applica-

FOR ELECTRONICS PLANTS...
FOR AIRCRAFT AND MISSILE BASES...

NEW 400-CYCLE BUS DUCT

WITH ONLY 1.28 VOLTAGE DROP PER 100 FT!

High-frequency power distribution runs are, for the first time, really practical and economical. Now, a single, central high-frequency generator can completely power tens of thousands of square feet.

At 400 cycles and up, new Westinghouse high-frequency bus duct will deliver power with a maximum voltage drop of only 1.28 volts each 100 feet under full load of 800 amps. Here is performance that cannot economically be begged, borrowed or coaxed out of cable-conduit or other bus duct. Compare this efficiency with conventional systems in which drops of from 7 to 15 volts can normally be expected. Housing of duct is nonmagnetic aluminum

... shields test equipment from radio frequencies originating in duct.

Here is an opportunity, too, to take advantage of all the inherent advantages of bus duct. Power taps every 60 inches over the entire length of duct... no splicing. No complex wire mazes. Infinitely more flexible and convenient to use. Duct is more quickly and easily installed than cable and conduit.

High-frequency bus duct is immediately available... and only from Westinghouse. Get in touch with your local Westinghouse sales representative. Or write or wire Standard Control Division, Westinghouse Electric Corporation, Beaver, Pa. J-30285

YOU CAN BE SURE...IF IT'S **Westinghouse**
WATCH "WESTINGHOUSE LUCILLE BALL-DESI ARNAZ SHOWS" CBS TV FRIDAYS

Multi-tone analysis on SB-7bz Level of tones describes transmission line equalization.

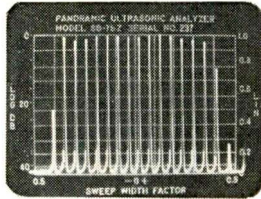

now!
improved

**Panoramic's
ULTRASONIC
SPECTRUM
ANALYZER
SB-7bz
1kc to 300kc**

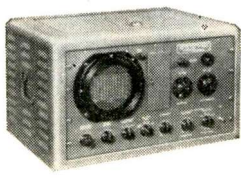

254 v sensitivity, up to 60 db dynamic range and low residual distortion with convenient operation are combined in one, compact, low-priced instrument in the latest version of this Panoramic Ultrasonic Spectrum Analyzer. Standard equipment at military installations and in industry, the SB-7bz is ideally suited for:

- Ultrasonic noise and vibration analysis
- Communication system analysis—wire carrier and VLF radio
- FM Telemetry subcarrier channel analysis
- General Fourier analysis.

Proven reliable under the most extreme field conditions, the SB-7bz features:

- Variable sweep width from 0 to 200kc.
- Linear 40db log 20 db linear and 2.5 db expanded amplitude scales.
- Resolution variable from 100cps to 2kc.
- A 6.7 sweep rate, synchronized to power line, plus provisions for variable sweep rates when used with accessory equipment.
- Auxiliary horizontal and vertical output racks.

Write, wire, phone now for detailed specifications bulletin; and ask to be put on our regular mailing list for the PANORAMIC ANALYZER featuring application data.



Panoramic
RADIO PRODUCTS, INC.

530 S. Fulton Ave., Mt. Vernon, N. Y.
Phone: OWens 9-4600
Cables: Panoramic, Mount Vernon, N. Y. State



tions for the past 10 years, Johnson has been associated with Dalmo Victor Co., Northrop Aircraft Co. and Boeing Airplane Co. Recently he was with Granger Associates in Palo Alto.

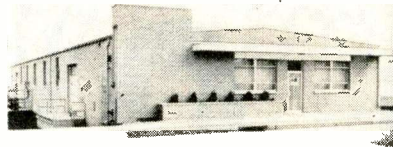

**Uni-Seal Settles
In New Plant**

UNI-SEAL, Inc.'s new Garwood, N. J., plant is complete and running at full production capacity. The newly-formed company is now able to make delivery on its wide line of transistor mounts, multi-headers, complete header and cover assemblies, individual terminals, crystal bases, diode housings, capacitor end seals, and terminal strips.

Plant Briefs

AS PART of its overall growth and diversification program, the corporate name of Waldorf Controls Corp. has been changed to **Instrument Systems Corp.** Also announced was the acquisition of all facilities and assets of the G.B.W. Mfg. Co. Combined facilities and personnel have been consolidated in a 22,000 sq ft plant at College Point, N. Y.

Applied Electronic Co., Inc., manufacturer of marine radiotelephones, depth sounders and direction finders, is building a 22,000 sq ft addition to its South San Francisco plant. Company also purchased 50,000 sq ft of adjacent land for future expansion needs.

U.S. Semiconductor Products, Inc., Phoenix, Ariz., has purchased a manufacturing facility adjacent to its present location. New structure has been obtained, together with 10 additional acres of undeveloped land suitable for further building expansion, at a cost of \$270,000, and will offer the

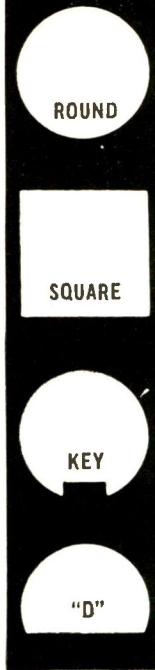

**Cut Holes
In Less Than
90 Seconds!**

with **Walseco**
CHASSIS PUNCHES

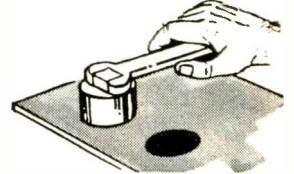

Make any size hole you want for sockets, plugs, meters, others... do it faster with less effort with famous Walseco L.T. Chassis Punches. Easy to use... last a lifetime. Send postcard for free literature.

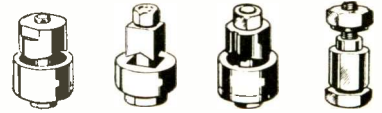

(*L.T. is Walseco's exclusive "Low-Torque" design)

WALSCO ELECTRONICS MFG. CO.

Division of Textron Inc.

Western Plant: Los Angeles 18, California
Main Plant: ROCKFORD, ILLINOIS, U.S.A.

CIRCLE 219 ON READER SERVICE CARD

Booth
3516
Wescon
Show

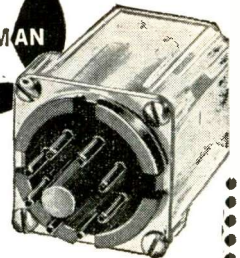

**SERIES
26D
10 AMP.**

**KURMAN
MINIATURE
POWER RELAY**

FEATURES

- Clear polystyrene dust-proof enclosure
 - Up to 3 P D T, 10 amp. contacts
 - AC or DC coil, up to 15,000 ohms
 - Life—100,000 operations minimum
 - Dimensions 1-3/8" sq. x 2-1/16" high
 - Octal or 11 pin plug-in
- STOCKED BY LEADING SALES AGENCIES FROM COAST TO COAST
For Immediate Delivery at Factory Prices

KURMAN ELECTRIC CO.

Subsidiary of Crescent Petroleum Corp.
Quality Relays Since 1928
191 NEWEL ST.
BROOKLYN 22, N. Y.

Export: 135 Liberty St., N. Y.
Cable: TRILRUSH

SEND FOR CATALOG



CIRCLE 220 ON READER SERVICE CARD
NOVEMBER 6, 1959 • ELECTRONICS

manufacturing, sales and administrative units of the company an additional 35,000 sq ft of floor space over the 20,000 sq ft they now occupy.

Solid State Electronics Co. announces a move to its new plant in Sepulveda, Calif. Company manufactures miniature transistorized devices. Development work is being conducted on solid state commutators and radar beacon systems for missile and space vehicle programs.

News of Reps

George F. Bohman, manufacturer's rep of Orlando, Fla., has been appointed southeastern sales rep for Microtech, Inc., manufacturer of flexible and rigid microwave components and transmission lines. Rep will cover Florida, Alabama, and Georgia.

M. F. Electronics Co., New York, N. Y., names J. S. Kempf Co. of Inglewood, Calif., as its western rep. Principal manufactures micro-miniature, transistorized assemblies.

A new IBM system of recording sales has been inaugurated by Murphy and Cota, Winston-Salem, N. C., with an eye to taking the guesswork out of sales analysis. According to J. F. Zammit, technical products division manager, the system can provide any manufacturer Murphy and Cota represents with a complete breakdown of sales by product and customer.

Ray Ripley and Associates of Minneapolis, Minn., will represent the Electronic Applications Division of Sonotone Corp., Elmsford, N. Y., in the states of Minnesota, North Dakota and South Dakota.

Fred F. Bartlett & Co., Wayne, Pa., was recently named field rep in the mid-Atlantic area for the commercial sales of Eimac electron-power tubes manufactured by Eitel-McCullough, Inc., San Carlos, Calif. Rep firm will cover eastern Pennsylvania, southern New Jersey and Delaware.

ATTRACT AND HOLD TECHNICAL PERSONNEL

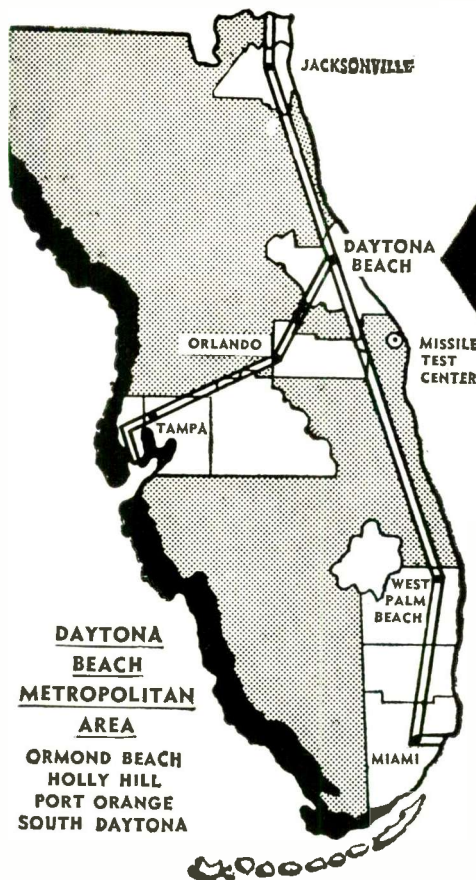

**STRATEGIC
LOCATION FOR
GROWTH INDUSTRIES**
DAYTONA BEACH
FLORIDA
**Metropolitan Area
Industrial Sites**

Daytona Beach, the east-to-west terminal on the north-to-south route of the projected Federal Limited Access Freeway System, gives industry a plus for the future.

Write for new 101 page
Industrial Brochure

R. H. MILES, MGR.
INDUSTRIAL DEPARTMENT
CHAMBER OF COMMERCE
DAYTONA BEACH, FLORIDA

CIRCLE 221 ON READER SERVICE CARD

Technical Staff Opportunities in SEMICONDUCTORS

PSI

Pacific Semiconductors, Inc.—a subsidiary of Thompson Ramo Wooldridge Inc.—announces several challenging Technical Staff positions created by its rapidly expanding development programs for Very High Frequency and Very High Power Silicon Transistors.

We invite inquiries from *Research Physicists* for work in semiconductor materials and solid state diffusion techniques; *Organic Chemists* for surface study research; *Solid State Physicists and Engineers* with experience in transistor development; *Mechanical Engineers* engaged in transistor package and manufacturing equipment development; *Electrical Engineers* experienced in semiconductor device applications and test equipment development.

This organization encourages and rewards resourcefulness and original thinking. Candidates with B.S., M.S. or Ph.D. degrees in physics or engineering should write to:

Technical Staff Placement

Pacific Semiconductors, Inc.

10451 WEST JEFFERSON BOULEVARD, CULVER CITY, CALIFORNIA





Time Tested
Quality

ILLINOIS UP-RIGHT Miniature Electrolytic Capacitors . . . Type SMTU finest for TRANSISTORIZED CIRCUITRY

Aluminum cased, with exclusive patented hermetic sealing. Stable under temperature extremes — stable to shock and vibration. Guaranteed long life. Fully tested and approved. Millions now in use.

Type SMTUCN
Dual Common Negative
Separate Anodes

Compact construction permits exceptional space savings and economy which is highly desirable in modern transistor circuitry. One capacitor saves space where normally two individual capacitors were previously needed. These dual units are ideal for bypass, filtering or coupling where a common ground exists.

Temperature Range: -40 to +65°C; also available -30 to +85°C
Voltage Range: 3 to 250 volts

Type SMTUCP
Dual Common Positive
Separate Cathodes

These dual section common anode constructed capacitors have cathodes which are electrically separated and isolated. Unique construction with "floating" cathodes makes these ideal for coupling, filter and bypass circuits for "above ground" applications.

ILLINOIS

CONDENSER COMPANY
1616 NORTH THROOP STREET
CHICAGO 22, ILL. EV 4-1300

Export Department: 15 Moore Street, New York 4, New York

Write for
complete
technical
literature

CIRCLE 222 ON READER SERVICE CARD

COMMENT

Space-Age Batteries

With reference to the article by Linden and Daniel ("New Batteries for the Space Age," p 59, July 18, 1958), a question comes up.

In Table I, which is a selection chart, capacities have been given for various types of batteries. These capacities have been expressed in terms of watt-hr/lb and watt-hr/cu in., respectively.

We have tried to compare these figures with some others obtained from manufacturers' data, and find rather large discrepancies. Therefore we should like an explanation as to how these "capacities" were obtained.

Wiley has published a book by Vinal on primary batteries which gives, in table 84 on p 315, nominal outputs of mercury cells which do not seem to agree with Linden and Daniel's figures by a wide margin. Conceivably the explanation lies in the interpretation of the term "capacity."

We would welcome your authors' comments . . .

M. WULFINGHOFF

AVCO CORP.
CINCINNATI, O.

Author Linden, who is deputy director of the power sources division at U. S. Army Signal Research & Development Laboratories, sent this reply:

The data published by Vinal or by the manufacturer are not in disagreement with those published in the ELECTRONICS article. The capacities listed in the latter are those obtained under the extremely high discharge rates (10-minute rate) required for missiles. The manufacturer's data and Vinal's data are those obtained under more moderate discharge rates, accounting for the difference in the values presented.

DAVID LINDEN

U. S. ARMY SIGNAL R&D LABS
FORT MONMOUTH, N. J.

The Communication Special

I am not a communications engineer, and this may be the reason why your Associate Editor Weber's special report on Modern Com-

NORTH HILLS'

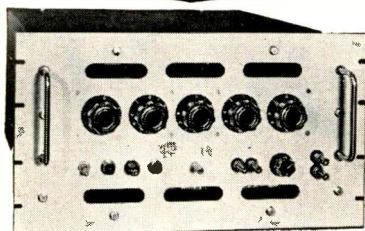

CURRENT GOVERNOR Model CS-11

for **Constant Current**

- Precision Current Source
- Gyro Torquer Supply
- Transistor and Diode Tester

▶ High Accuracy
▶ Excellent Stability
▶ Programmable

For testing and measurement of gyros, transistors, diodes, clutches, solenoids, meters, other current sensitive devices.

- Current Range is 1 μ a to 100 ma with 5 decades — digital in-line readout —
- Regulation and stability 0.002% —
- Accuracy 0.02%

In use by leading companies for gyro torquer supply, transistor avalanche test, diode PIV test, clutch testing, calibration.

Literature describing this and other constant current sources from 0.1 μ a to 30 amp. may be obtained from



NORTH HILLS
ELECTRIC COMPANY, INC
402 SAGAMORE AVE., MINENOLA, N.Y. Pioneer 7-0555

MEET TOM EMMA

Associate Editor, electronics
FINANCE EXPERT



Thomas Emma, BA, Columbia, is a U.S. Naval Reserve officer who was formerly a technical writer with IT&T. Tom prepares "Financial Roundup"—a regular weekly business feature. In the coming months Tom will be concerned with radio communications, but he will be specifically involved with spectrum usage problems. To keep abreast of finance in electronics, turn to Tom's weekly coverage of latest developments. To subscribe or renew your subscription, fill in box on Reader Service Card. Easy to use. Postage free.



A McGraw-Hill Publication
West 42nd Street, New York 36, N. Y.

PRECISION DEFLECTION WITH COSSOR YOKES

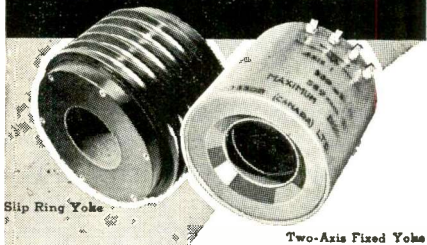

Slip Ring Yoke

Two-Axis Fixed Yoke

Component Development Engineering at its BEST!

- ADVANCED ELECTRICAL DESIGN
- PRECISION MECHANICAL DESIGN
- ACCURATE PRODUCTION METHODS

Custom Built to the most Exacting Specifications by Cossor Engineers

In Mumetal Cores for Optimum Geometry
In Ferrite Cores for Speed and Sensitivity
In Non-magnetic Cores for Perfection of Response

Any of Cossor's Three Core Types can be made in single or double axis with single or push-pull windings, and encapsulated for fixed or slip ring (rotating) use.

Normal characteristics of yokes for 1-1/2 in. neck tubes are:

Positional accuracy - the spot position will conform to the yoke current co-ordinates within 0.25% of tube diameter. For deflection angles less than $\pm 25^\circ$ better accuracy can easily be achieved.

Memory 0.5% max. without over-swing;
0.1% or less with controlled over-swing.

Complete encapsulation in epoxy (stycast) or silicone resins is standard for all Cossor deflection yokes, and is done with special moulding tools ensuring accurate alignment of the yoke axis. When slip rings are added, solid silver rings are mounted in encapsulating resin. The finished slip ring yoke is precision turned to centre bore, and can include bearing mounting surfaces with dimensional tolerances approaching those associated with high quality metal parts.

Settling Time (Micro sec.) = $120 \sqrt{\text{Inductance in Henries}}$

Sensitivity degrees / milliamperes =

$0.095 \sqrt{\frac{\text{Inductance - millihenries}}{\text{Accelerator Voltage - kV}}}$



Complete Rotational Systems

COMPONENTS DIVISION

COSSOR

CANADA LIMITED

301 Windsor St., Halifax, N. S.
8230 Mayrand St., Montreal, Que.
648A Yonge St., Toronto, Ont.
Corporation House, 160 Laurier West, Ottawa, Ont.

CIRCLE 224 ON READER SERVICE CARD
ELECTRONICS • NOVEMBER 6, 1959

munications Methods (p 93, Oct. 23) kept me reading right straight through. On the other hand, I suspect it takes considerable ability to be able to catch and hold the interest of only indirectly interested people for 16 straight pages. Anyway, I think the report is a peach, and Mr. Weber is to be congratulated on presenting it so succinctly and clearly.

H. N. STOVER

CHICAGO, ILL.

Ionizing Radiation

Thank you for your article on Westchester's experience in implementing the New York State ionizing radiation regulations ("Regulating Ionizing Radiation," p 22, Oct. 30).

The article is very interesting and worthy of praise. Dr. W. A. Brumfield Jr., Commissioner of Health, and R. M. McLaughlin, director of the Division of Environmental Sanitation, have read the article and were quite pleased with its content . . .

I wish to express our appreciation for your interest in our work.

CALVIN E. WEBER

WESTCHESTER COUNTY DEPT. OF HEALTH
WHITE PLAINS, N. Y.

Instruments and Calibration

(Re: your article "Calibration Lags Defense Needs," p 16, Aug. 21, and the special report "Instruments for Design and Production," p 59, Sept. 11.)

We are pleased to note the interest you have shown in the subject of calibration, and sincerely feel that you are doing a great service to the country each time you help make people aware of the shortcomings in our nation's capabilities in the field of measurements.

Every effort made toward furthering the state of the art in measurements is appreciated by those of us who know how important this is to the success of advanced defense projects and space-age equipment . . .

FRANK MCGINNIS

SPERRY GYROSCOPE
GREAT NECK, N. Y.

IMMEDIATE DELIVERY!



ON $\frac{3}{8}$ " AND $\frac{1}{2}$ " O. D.

Non-Magnetic

18-8 TYPE 303 STAINLESS

UNIVERSAL JOINTS

Manufacturers of electronic equipment have come to depend on Curtis for precision-made non-magnetic universal joints of 18-8 Type 303 stainless steel, in the sizes most frequently used in the industry. Other sizes are also readily available; also bronze joints.

Curtis joints benefit by a rigid insistence on uncompromising inspection and quality control at every stage of manufacture, insuring minimum backlash.

Curtis torque and load ratings are entirely dependable, since they are based on continuous testing under actual operating conditions.

Not sold through distributors. It will be to your advantage to write or phone. (REpublic 7-0281) for free engineering data and price list.

TRADE
CURTIS ©
MARK

UNIVERSAL JOINT CO., INC.
19 Birnie Avenue, Springfield, Mass.

As near to you as your telephone

A MANUFACTURER OF
UNIVERSAL JOINTS SINCE 1919

CIRCLE 137 ON READER SERVICE CARD 137

ENGINEERS...PHYSICISTS

NEW opportunities at Motorola in Chicago

give yourself and your family
all the big city advantages at a
relaxed midwest pace, while you
ADVANCE YOUR CAREER

Outstanding career opportunities are waiting at the many Motorola research and development laboratories in the Chicago area. This is your opportunity to advance your career with a swiftly expanding company, working in the most modern and well instrumented laboratories . . . with liberal employee benefits, including an attractive profit sharing plan and association with men of the highest technical competence.

You'll like living in one of the beautiful suburbs of the playground of the midwest, where there are endless social, cultural, and educational activities to choose from the year-round. Exciting life or quiet life—Chicago offers either.

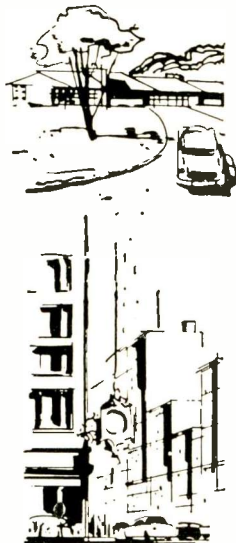

MILITARY POSITIONS OPEN

- Radar transmitters and receivers
- Radar circuit design
- Antenna design
- Electronic countermeasure systems
- Military communications equipment design
- Pulse circuit design
- IF strip design
- Device using klystron, traveling wave tube and backward wave oscillator
- Display and storage devices

CIVILIAN POSITIONS OPEN

- 2-WAY RADIO COMMUNICATIONS**
- VHF & UHF Receiver • Transmitter design & development • Power supply
 - Systems Engineering • Selective Signaling • Transistor Applications • Crystal Engineering • Sales Engineers
- PORTABLE COMMUNICATIONS**
- Design of VHF & UHF FM Communications in portable or subminiature development.
- MICROWAVE FIELD ENGINEERS**

Write to:
Mr. L. B. Wrenn Dept. D
MOTOROLA, INC.
4501 Augusta Blvd., Chicago 51, Ill.



ALSO . . . there are excellent opportunities in
PHOENIX, ARIZONA • RIVERSIDE, CALIFORNIA



MOTOROLA

ELECTRICAL ENGINEERS

Challenging positions open for high caliber Electrical Engineers with some experience to work in interesting research and development programs in instrumentation and circuitry.

We offer you an opportunity to do non-routine research and use your initiative and creative ability.

Excellent employee benefits, including liberal vacation policy and tuition-free graduate study. Please send resume to:

E. P. Bloch
ARMOUR RESEARCH FOUNDATION
of Illinois Institute of Technology
10 West 35th Street
Chicago 16, Illinois

ELECTRONIC SYSTEMS ENGINEER

To be responsible for preliminary design and systems aspects of new secure navigation systems programs. Involves theoretical work in fields of digital data processing, navigational error analysis and computer selection. Experience desired in the design of advanced digital and data handling systems and/or experience in navigation systems design. To arrange interview call collect, Niagara Falls BUtler 5-7851 or send resume to:

**SUPERVISOR ENGINEERING
EMPLOYMENT**

BELL AIRCRAFT CORPORATION

BUFFALO 5, NEW YORK

engineers

Developing UNDERWATER Ordnance Systems to Meet the NEW Threats of Submarine Warfare

EEs MEs AEs Physicists — Immediate openings at various levels:

Systems Development

EEs, MEs or AEs with 5 yrs development of automatic controls for weapons.

Systems Evaluation

EEs with 5 to 8 yrs electronics experience in weapons systems; supervisory experience.

Fire Control Engineering

EEs with 2 to 8 yrs fire control systems, circuits or component design.

Inertial Equipment Design

EE, ME or Physicist with 8 to 10 yrs in design and development of inertial components.

Underwater Equipment Design

EEs or Physicists with 2 to 4 yrs in electronics, design or testing underwater equipment (torpedoes).

Electronic Circuit Development

EEs with 2 to 10 yrs in circuit design preferably solid state.

Contract Administration

EEs, MEs or BBAs with 2 to 5 yrs in military contracts.

Computer Development

EEs with 2 to 7 yrs in digital or analog circuit development, test and evaluation.

Quality Control Engineering

EEs, MEs or Physicists with 2 to 7 yrs in fire control or radar, strong QC interest.

Product Design

EEs, MEs with 6 to 10 yrs in electronic package design, printed wiring boards and heat transfer.

Computer Programming

Physicist or Mathematician with 3 yrs in digital computers.

Sales Engineering

EEs, MEs with 3 to 7 yrs in defense electronic products preferably underwater ordnance or inertial equipment.

Technical Publications

EEs or Physicists with 1 to 6 yrs in engineering writing, military electronics.

*... one stimulus to creative engineering at
General Electric's Ordnance Department*

One of the fastest growing threats to our nation's safety is the mounting offensive power of the submarine, in terms of missile launching capabilities, increased speed, greater cruising depths.

To meet this Under Sea Warfare threat with Anti-Submarine Warfare capabilities, General Electric's Ordnance Department is active in a number of areas.

An example of Ordnance's ASW work is the new submarine killer, the Torpedo MK44, which is capable of *attaining the speeds and depths associated with nuclear powered submarines.*

Designed, developed, and manufactured by the General Electric Ordnance Department, this versatile acoustic homing torpedo can be surface launched or air-dropped in the vicinity of its submerged target. Once in the water, the electric-powered torpedo begins a search for the target in a programmed pattern, its acoustic system listening for the tell-tale sound of the submarine. The target detected, the MK44 homes in for the kill.

Other unclassified ASW projects include mines, their mobile countermeasures, etc.

GE-Ordnance Dept. also deeply engaged in missile programs — They include:

- Missile Inertial Guidance Systems and Components
- Missile Fire Control Systems and Components
- Missile Handling and Launching Equipment
- Missile Guidance Trackers • Missile Directors

Please write to Mr. R. G. O'Brien Professional Relations Div. 69-WR

ORDNANCE DEPARTMENT
OF THE DEFENSE ELECTRONICS DIVISION

GENERAL  ELECTRIC

100 PLASTICS AVENUE, PITTSFIELD, MASSACHUSETTS



ENGINEERS — Electrical, Mechanical, Industrial

WESTERN ELECTRIC Is Augmenting Its Professional Staff

Western Electric has openings for men of superior professional ability. Present areas of activity that afford opportunity to utilize your full technological skills are:

■ NIKE ZEUS ANTI-MISSILE MISSILE SYSTEM ■ MISSILE GUIDANCE SYSTEMS ■ ASSOCIATED GROUND CONTROL RADAR SYSTEMS ■ FIRE CONTROL RADAR ■ UNDERWATER DEFENSE SYSTEMS ■ DIGITAL COMPUTERS ■ WAVEGUIDES AND GYROS ■ HIGH PRECISION ELECTRONIC COMPONENTS AND SOLID STATE DEVICES

You are invited to discuss with us how your previous training and experience can fit you for an important career position in one of these engineering areas:

- Development
- Project
- Test Planning
- Test Set Design
- Pilot Line Manufacture
- Tool Design
- Product Design
- Standards
- Technical Publications
- Field Engineering

Also Openings For:

- Technical Writers
- Engineering Associates

Positions are available at these Western Electric Locations: Winston-Salem, Greensboro and Burlington, North Carolina Laureldale, Pennsylvania and Whippany, New Jersey

For a personal interview in your area or at one of the above locations, address your resume to: Mr. T. R. Lannon Engineering Employment Manager, Dept. 924G.



MANUFACTURING AND SUPPLY UNIT OF THE BELL SYSTEM

Lexington Road, Winston-Salem, North Carolina

FOR ADDITIONAL INFORMATION

About Classified
Advertising,

Contact

*The McGraw-Hill
Office Nearest You.*

ATLANTA, 3
1301 Rhodes-Haverty Bldg.
JACKSON 3-6951
M. MILLER

BOSTON, 16—350 Park Square
HUBBARD 2-7160
D. J. CASSIDY

CHICAGO, 11
520 No. Michigan Ave.
MOHAWK 4-5800
W. HIGGENS—E. S. MOORE

CLEVELAND, 13
1164 Illuminating Bldg.
SUPERIOR 1-7000
W. B. SULLIVAN—T. H. HUNTER

DALLAS, 2—1712 Commerce St.
VAUGHAN BLDG.
RIVERSIDE 7-5117
GORDON JONES—F. E. HOLLAND

DETROIT, 26—856 Penobscot Bldg.
WOODWARD 2-1793
J. R. PIERCE

LOS ANGELES, 17—1125 W. 6th St.
HUNTLEY 2-5450
C. YOCOM

NEW YORK, 36—500 Fifth Ave.
OXFORD 5-5959
H. T. BUCHANAN—R. P. LAWLESS
T. W. BENDER

PHILADELPHIA, 3
Six Penn Center Plaza
LOCUST 8-4330
H. W. BOZARTH

ST. LOUIS, 8—3615 Olive St.
JEFFERSON 5-4867

SAN FRANCISCO, 4—68 Post St.
DOUGLAS 2-4600
S. HUBBARD

SENIOR ENGINEERS

We have immediate openings for qualified applicants in the following fields of engineering. Applicants must have B.S. degree or higher with a minimum of three (3) years experience.

DESIGN:

1. Design and develop remote controlled disconnect (umbilical or explosive breakaway), bellows actuator, or printed circuit connectors. ME degree desired.
2. Design and package electrical ignition systems equipment. Interest in development of igniters for liquid and solid fuel. EE degree desired.

RESEARCH:

1. Analysis and coordination of electro-mechanical ignition systems, involving utilization of semi-conductors, tubes, gaps. Analyze phenomena of ignition of solid fuel.

Please send resume giving full particulars to:

Scintilla Division
BENDIX AVIATION CORPORATION
Sidney, New York

DISENCHANTED ENGINEERS

If your present employer has failed to utilize your full potential, why not permit us to explore the parameters for your personal qualifications with the many dynamic young companies in aviation, electronics, missiles and rockets. We now have in excess of 4,000 openings in the \$8,000 to \$40,000 bracket, all of which are fee paid. Why wait? Send resume in duplicate at once indicating geographical preferences and salary requirements.

FIDELITY PERSONNEL
1530 Chestnut Street, Philadelphia 2, Pa.
Established 1943

ENGINEERS — SCIENTISTS

MORE AND MORE COMPANIES

are continually coming to us for help!
WHY DON'T YOU?

S.E.E. client companies are wide in variety—large and small—with opportunities at all levels, as diverse as "the state of the art". Employers pay placement fee and relocation costs. If you are interested in advancement—

Send Resume to:

SCIENTISTS, ENGINEERS &
EXECUTIVES, Inc.

1026-17th St. N.W., Washington 6, D. C.

RATES "Employment Opportunities"

Displayed—The advertising inch is \$28.67 per inch for all advertising appearing on other than a contract basis. Contract rates quoted on request.

An advertising inch is measured 7/8" vertically on a column—3 columns—30 inches to a page. Subject to Agency Commission.

Undisplayed—\$2.40 per line, minimum 3 lines. To figure advance payment count 5 average words as a line.

Discount of 10% if full payment is made in advance for 4 consecutive insertions. Not subject to Agency Commission.

Send NEW ADS to ELECTRONICS, Class. Adv. Div., P. O. Box 12, New York 36, N. Y.

ENGINEERS

Join Sanders Associates and combine PLEASANT COUNTRY LIVING with a TOP FLIGHT ENGINEERING CAREER

At Sanders Associates—located in the friendly New England community of Nashua, N. H.—you will find a variety of engineering programs that probe deeply into advanced areas of electronic and electromechanical systems and components for industry and defense.

Here in the fresh clean world of the country, away from the soot and strain of heavily populated areas, you will discover that Sanders can offer you a wide range of opportunities—at fully competitive salaries.

You will enjoy diversified assignments on such technically advanced projects as the terminal guidance, or seeker system for the Eagle Missile, working with the engineers who originated such products as Panar® radar, Dare target-seeker system, Flexprint® flexible printed circuits, Tri-Plate® microwave products and other Sanders "firsts."

The cost of living is low in Nashua; schools are excellent and attractive homes are available. Downtown Boston is less than an hour away, as are the recreations of mountains, oceans, lakes.

Openings available for:

SYSTEMS ENGINEERING

All levels of engineers. To conduct studies, design and analyses of missile and other weapons systems. Applicable areas of interest include: systems integration, coherent radar and missile systems, steerable antenna array techniques, acquisition and surveillance radars, countermeasures, CW pulse transmitters, data processing and guidance. R&D and Field.

MICROWAVE ENGINEERING

All levels of engineers. To perform design and development of antennas and components from 30 mgs to K band. Particular area of interest involves crossed-field microwave amplifier tubes. Other areas include directional filters, harmonic generators, low-noise mixers and spiral antennas.

RELIABILITY ENGINEERING

All levels of engineers. To assume responsibility for reliability prediction, design reviews, components evaluation, failure effect analysis, redundancy in design and environmental testing.

SPECIFICATION ENGINEERING

All levels of engineers. To assure conformance of system, environmental, component and process specifications with applicable military formats. Also to establish and revise company standards.

CIRCUIT DESIGN

Engineer & Senior Engineer levels. To perform design of basic circuits relating to missile and other weapons systems. Areas of interest include tube and transistor application to receivers, modulators, transmitters, range tracking, logic, power supplies, parametric amplifiers and other allied circuits. Knowledge of MIL specs desired.

MECHANICAL ENGINEERING

All levels of engineers. To perform broad phases of mechanical engineering activities as pertaining to electronic, missile, airborne and ground equipments. Responsibilities relate to such specialized areas as vibration, stress analysis, heat transfer, plastics and metals, airborne and missile packaging, RF shielding, chassis and structures design, and machine shop techniques.

To learn more about opportunity for YOU at Sanders, send a resume to Lloyd Ware, Staff Engineer, Dept. 906



SANDERS ASSOCIATES, INC.

NASHUA, NEW HAMPSHIRE

®Registered trademark

Scheduled to open about the first of the year, Republic's new Research & Development Center at Farmingdale, Long Island, New York, will comprise seven different laboratory facilities. Included are an Electronic Development Laboratory and a Guidance and Control Systems Laboratory. These modern facilities will contain the most up-to-date equipment obtainable for the research, development and test of advanced astrionic and avionic systems, equipments and components.

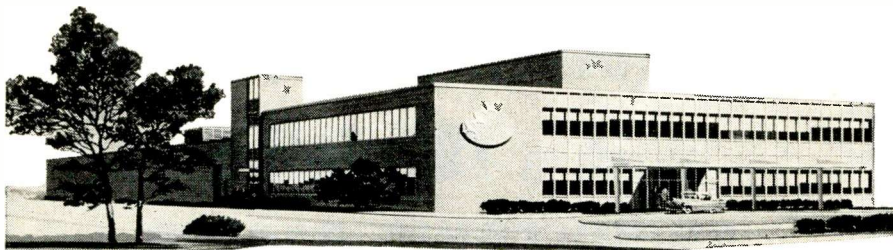

ELECTRONIC ENGINEERS ...

■ You can be one of the R&D men who'll help guide exotic projects at Republic Aviation's new \$14,000,000 Research and Development Center

IN-AT-THE-BEGINNING OPPORTUNITIES at Republic's new Research Center encompass the electronic aspects of a wide diversity of projects and investigations, from space probes to ballistic missiles, from high Mach aircraft to helicopters, from automatic ground control equipment to exotic detection systems. Today Republic's dynamic expansion in research and development activities offers you assignments where you can win technical renown — and rapid personal advancement — in any of these areas:

- INERTIAL GUIDANCE & NAVIGATION
- SYSTEMS ENGINEERING
- DIGITAL COMPUTER DEVELOPMENT
- INFORMATION THEORY
- TELEMETRY-SSB TECHNIQUE
- RECEIVER & TRANSMITTER DESIGN
- JAMMING & ANTI-JAMMING
- RANGING SYSTEMS
- GROUND SUPPORT EQUIPMENT
- DOPPLER RADAR
- COUNTERMEASURES
- RADOME & ANTENNA DESIGN
- MICROWAVE CIRCUITRY & COMPONENTS
- AIRBORNE NAVIGATIONAL SYSTEMS
- MINIATURIZATION-TRANSISTORIZATION
- PROPAGATION STUDIES
- INFRARED & ULTRA-VIOLET TECHNIQUES

Address your resume in confidence to:
Mr. George R. Hickman
Engineering Employment Manager, Dept. 11L-1



REPUBLIC AVIATION

Farmingdale, Long Island, New York

ADDRESS BOX NO REPLIES TO: Box No.
Classified Ad. Div. of this publication.
Send to office nearest you.
NEW YORK 36: P. O. BOX 12
CHICAGO 11: 520 N. Michigan Ave.
SAN FRANCISCO 4: 68 Post St.

POSITIONS WANTED

Field or Liaison Engineer Dr. of Engineering
European Universities. Age 50. Wide experience R & D Power Electronics, manufacturing licensee agreements with foreign companies. Speaks fluently French, Italian. Interested in overseas assignments. Best references. Present salary \$14,000. PW-2939, Electronics.

Electrical Engineer. Development and design
of differential transformers and electro-mechanical transducers. Wish to change position. PW-2913, Electronics.

*"Put Yourself
in the Other
Fellow's Place"*

**TO EMPLOYERS
TO EMPLOYEES**

Letters written offering Employment or applying for same are written with the hope of satisfying a current need. An answer, regardless of whether it is favorable or not, is usually expected.

MR. EMPLOYER, won't you remove the mystery about the status of an employee's application by acknowledging all applicants and not just the promising candidates.

MR. EMPLOYEE you, too, can help by acknowledging applications and job offers. This would encourage more companies to answer position wanted ads in this section.

We make this suggestion in a spirit of helpful cooperation between employers and employees. This section will be the more useful to all as a result of this consideration.

Classified Advertising Division

McGRAW-HILL PUBLISHING CO., INC.
330 West 42nd St., New York 36, N. Y.

SCIENTISTS / ENGINEERS

Which area of progress
at Electronics Park
interests you most?

With the outlook for the electronics industry in 1960 brighter than ever, a significant fact for career-conscious engineers is the breadth of opportunities at Electronics Park. Here General Electric research, development, design and manufacturing groups are actively engaged in almost every area of electronics—whether in the industrial, military, or entertainment fields.

A cross fertilization of products and talents characteristic of Electronics Park will help you advance along with the major advances in the electronics art.

Some of the many areas of research, development, and production at Electronics Park are listed to the right. Check your particular interest and mail the coupon to us today. Requirements for our current openings include a Bachelor's or Advanced Degree in Electronics, Physics, Mathematics, or Mechanical Engineering, and/or experience in electronics. All communications will be held in strict confidence.



To: GENERAL ELECTRIC COMPANY
Electronics Park Div. 69-WR
Syracuse, New York
Att.: Technical Personnel Dept.

I am interested in

- Advanced Development
- Design
- Field Service
- Technical Writing
- Research

in the field of

- Military Radio & Radar
- Multiplex Microwave
- Semiconductors
- Electronic Components
- Computers
- Missile Guidance
- Television Receivers
- Industrial Television
- Antennae
- Defense Systems
- Underwater Warfare

NAME _____

ADDRESS _____

DEGREE _____

**Manager
of
Manufacturing**

Small commercial manufacturer of electronic test instruments requires Manager of Manufacturing to direct machine shop, assembly, inspection and manufacturing services. Should be capable of installing effective manufacturing methods and cooperating with engineering in the product design stages. Must be strong in evaluating and supervising personnel. Engineering degree desirable but not mandatory. Excellent salary and accessory benefits.

Forward complete resume to

BOONTON RADIO CORP.
Intervale Rd., Boonton, N. J.
DEerfield 4-3200

Need Engineers?

Contact them through this

EMPLOYMENT OPPORTUNITIES section

ELECTRONIC ENGINEERS

... with 4 to 10 years' experience in analog or digital computers, test and industrial instrumentation, measurement, circuitry and techniques are required immediately to fill responsible engineering positions in our expanding systems engineering section. These openings will provide career opportunities for the engineer who at present is not fully utilizing his capabilities. Direct your resume including your salary requirements to the—

DIRECTOR OF PROFESSIONAL PLACEMENT

If your experience meets our requirements, a confidential personal interview will be arranged.

Honeywell

Missile Equipment Division
POTTSTOWN, PA.

**New Problems in Advanced
RESEARCH & DEVELOPMENT**
Challenge Engineers at
GENERAL DYNAMICS
Electric Boat Division

Pioneer in design and development of nuclear powered submarines. Electric Boat Division is embarked upon a broad program of expansion and diversification in advanced technological areas.

One project now underway is a complex simulator for training Polaris weapon system crews in submarine control, navigation and missile firing. This trainer, housed in its own building, uses a DC analog computer to provide realistic response to trainee actions and will permit practice of normal operations as well as emergency drills which may be too dangerous to perform in operating submarines.

Other stimulating work areas include large control systems (140-foot precise radio telescope, world's largest wind tunnel, submarine systems); training equipment (simulators and trainers for missiles, submarines and other weapons systems); advanced submarine development (integrated control systems for sonar, navigation, missile launching and weapons guidance).

Immediate Opportunities in:

SYSTEMS

EE, ME or Physics degree required. Responsible for conceptual engineering and systems analysis of large complex devices employing a combination of electrical, electronic, electromechanical, hydraulic and pneumatic systems. Should be familiar with servomechanisms theory, experienced in use of analog or digital computers as a design tool, and have a good grasp of mathematics. Will work on proposal preparations, feasibility studies and execution of hardware contracts.

COMPUTERS

Responsible for conceptual engineering and programming of special purpose digital and analog computers. Should be familiar with system engineering, experienced in programming and check systems for both analog and digital computers, with good grasp of simulation techniques. Requires EE, Physics or Mathematics degree.

Electric Boat Division is located on the beautiful Connecticut shore near New London. Situated half way between Boston and New York City, it affords gracious New England living and year round recreation for you and your family.

To arrange convenient appointment, write in confidence to James P. O'Brien, Technical Employment Supervisor.

GENERAL DYNAMICS
Electric Boat Division

GROTON

CONNECTICUT

**DO YOU NEED
EXPERIENCED
ENGINEERS
ENGAGED IN:**

- Research
- Development
- Design
- Instrumentation
- Servomechanisms
- Missiles
- Audio Systems
- Control Systems
- Radar
- Computers
- Transistors
- Other Fields

Place an "ENGINEERS WANTED" advertisement in this EMPLOYMENT OPPORTUNITIES SECTION of ELECTRONICS. It's an inexpensive, time saving method of selecting competent personnel for every engineering job in the electronics industry. The selective circulation of ELECTRONICS offers you an opportunity to choose the best qualified men available throughout the industry.

For Rates and Information

Write:

CLASSIFIED ADVERTISING DIVISION

Box 12

McGraw-Hill Publications

New York 36, N. Y.



Job lost its challenge?

Professional progress being delayed by a position demanding only a fraction of your ability? At GILFILLAN, ability determines responsibility. Diversified technical challenge is being offered to Electronic Engineers with a minimum of 3 years' experience in Missile Systems, Microwave, Radar Receivers, Pulse Circuitry, and Digital Computers.



DIR. SCIENTIFIC PERSONNEL, DEPT. 62
1815 VENICE BLVD. LOS ANGELES 6, CALIF.

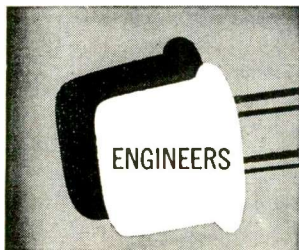

**SYLVANIA penetrates important
new areas which will keep
you ahead of the field**

Fast-moving, new developments in semiconductor devices—many of them the work of Sylvania Semiconductor Division scientists and engineers—have created a stimulating climate which will keep you substantially ahead of the field. Vital new areas are now being probed where your abilities and talents can play an important part—with commensurate rewards and recognition for you.

SEMICONDUCTOR DEVICE ENGINEERS

Experienced in design, development or production engineering, transistors, silicon devices, crystal diodes or rectifiers.

MICROWAVE DIODE ENGINEERS

BS in Electrical Engineering or Physics, 4 years experience in semiconductor work and/or microwave components desirable, but not essential.

FIELD ENGINEERS

To provide technical liaison between development and production engineers and customers who are electronic equipment manufacturers. Must have background in semiconductors and communication circuitry.

Please send your resume in confidence to: Mr. Arthur Sloane

SEMICONDUCTOR DIVISION
SYLVANIA
Subsidiary of
GENERAL TELEPHONE & ELECTRONICS
100 Sylvan Road - Woburn, Mass.

SEARCHLIGHT SECTION

(Classified Advertising)

BUSINESS OPPORTUNITIES
EQUIPMENT - USED or RESALE

DISPLAYED RATE

The advertising rate is \$24.75 per inch for all advertising appearing on other than a contract basis. Contract rates quoted on request. An ADVERTISING INCH is measured 7/8 inch vertically on one column, 3 columns—30 inches—to a page. EQUIPMENT WANTED or FOR SALE ADVERTISEMENTS acceptable only in Displayed Style.

UNDISPLAYED RATE

\$2.40 a line, minimum 3 lines. To figure advance payment count 3 average words as a line. BOX NUMBERS count as one line additional in undisplayed ads.

GENERATORS

High frequency, 400 cycles, also available in variable voltage and variable frequency at any voltage and phase desired. Driven by constant speed motors or variable speed motors, A.C. or D.C. Control panels also available. Large stock on hand. Write for catalogue and prices.

Reliable Electric Motor Repair Co.
19 California Avenue, Paterson, N. J.

CIRCLE 460 ON READER SERVICE CARD

LOOKING FOR USED/SURPLUS ELECTRONIC EQUIPMENT/COMPONENTS?

For an up-to-date listing of such equipment see Searchlight Section of November 13th

CONTACTS

"HOW TO MAKE MONEY IN Mobile Radio Maintenance"

AUTHORITATIVE GUIDEBOOK
ABOUT THE BOOM IN TWO-WAY MOBILE-RADIO:
GIVES FACTS, FIGURES, PAY RATES,
WRITE TODAY!

FREE

LAMPKIN LABORATORIES, INC. Instruments Div. BRADENTON, FLA.

CIRCLE 461 ON READER SERVICE CARD

Toroidal Inductors
Transformers
Converters
MAG-AMPS

Andrew 1-4502

MAGNETICO

INC.

6 Richter Ct.
East Northport
L. I., New York

Our Specialty:
TOROIDAL WINDING

CIRCLE 462 ON READER SERVICE CARD

PROFESSIONAL SERVICES

ALBERT PREISMAN

Consulting Engineer

Television, Pulse Techniques, Video
Amplifiers, Patent technical consultation.

616 St. Andrews Lane, Silver Spring, Maryland

YARDNEY ELECTRIC CORP.

"Pioneers in Compact Power"®

Electro-Chemical Generators of Energy

"from milliwatts to megawatts" *

40-50 Leonard Street
New York 13, N. Y.

Worth 6-3100
* T.M.

SEELSKREWS®

SEELBOLTS®

SEELRIVITS®

High Pressure
Self-Sealing
HARDWARE

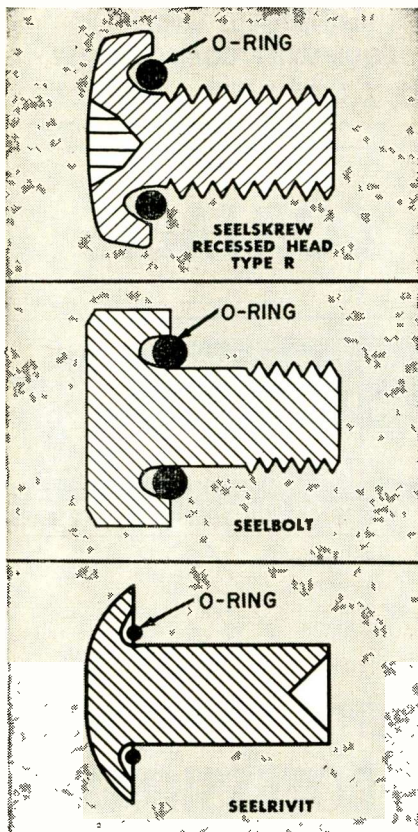

- Removable and static self-sealing screws, bolts and rivets.
- These industrial fasteners meet all applicable military specifications.

Send for Catalog 359



A. P. M. Corporation

(AUTOMATIC and PRECISION MFG.)

252 Hawthorne Ave., Yonkers, N.Y.
Yonkers 8-2010

Designers and Manufacturers of
HIGH PRESSURE STATIC AND MOVABLE SEALS
HEXSEALS® • SEELSKREWS® • SEELBOLTS® • SEELRIVITS®

INDEX TO ADVERTISERS

• AMP Incorporated	20	• Erie Resistor Corporation	106
• Ace Electronics Associates, Inc.	98	Esterline-Angus Company, The	7
Aeronautical Communications Equip- ment Co.	36		
• Ainslee Corporation	103	• Fairchild Controls Corporation	30
• Airpax Electronics, Inc.	131		
Allied Radio	122		
All Metal Screw Products Company, Inc.	148	• G-M Laboratories, Inc.	90
• American Lava Corporation	77	• General Electric Company Apparatus Dept. 103, 123, 125, 127 Lamp Div.	81
• American-Standard Products	128	• General Instrument Corporation	42, 43
• Amperex Electronic Corp.	71	General Mills Mechanical Division	40, 41
Automatic Precision Machine Co.	146	General Products Corporation	126
		General Public Utilities Corp.	86
• Ballantine Laboratories, Inc.	33	• General Transistor Corporation	87
• Bendix-Pacific	115	Gries Reproducer Corp.	118
• Bird Electronics Corp.	44	Gulton Industries, Inc.	112
Bristol Industrial Development Board	123		
Bruno-New York Industries Corp.	110	• Hamilton Watch Co., Hathaway Instrument Div.	125
• Burnell & Company, Inc.	3	• Helipot Division of Beckman Instruments, Inc.	78
		• Hewlett-Packard Company	8, 9
C B S Electronics	25	• Heyman Manufacturing Co.	148
• Cambridge Thermionic Corporation ..	19	• Hughes Aircraft Corp.	110
• Celco Constantine Engineering Laboratories Co.	129		
Consolidated Electroynamics	27	I B M Research	69
• Constantine Engineering Laboratories Co.	129	• Illinois Condenser Co.	136
• Continental Connector Corporation ..	89	Illinois Water Treatment Co.	147
• Control Electronics Co., Inc.	94	Imtra Corporation	102
• Coors Porcelain Company	31	• Industrial Electronics Engineers, Inc. ..	129
• Cornell-Dubilier Electric Corp.	45	Industro Transistor Co.	108
• Cossor Canada (Ltd.)	137	Institute of Radio Engineers, The	93
• Couch Ordnance Inc.	88	Intermetall	120
• Crane Packing Company	105		
• Curtis-Universal Joint Corp.	137	Johnson Co., E. F.	120
• Curtiss-Wright Corp.	121		
		Keithley Instruments, Inc.	24
Data-Control Systems, Inc.	108	Kip Electronics Corporation	38
Data Products	117	• Kleinschmidt Division of Smith-Corona Marchant Inc.	12
• Daven Company, The	3rd Cover	• Kurman Electric Co.	134
Daytona Beach Chamber of Commerce ..	135		
Dean & Benson Research	127	Lampkin Laboratories	145
• DeJur-Amsco Corporation	89	Los Alamos Scientific Laboratory	116
• DeLuxe Coils, Inc.	124		
• Detroit Edison	85	Edo Corporation	119
• Douglas Aircraft	22, 23	• Eitel-McCullough Inc.	10
• DuPont de Nemours & Co. (Inc.) E. I. Pigments Dept.	16	• Electronic Instrument Company, Inc. (EICO)	119
		Electronic Measurements Company	113
Etel Corporation	119	Electronics Capital Corporation	21
• Eitel-McCullough Inc.	10	• Epsco, Inc.	37
• Electronic Instrument Company, Inc. (EICO)	119		
Electronic Measurements Company	113	• See advertisement in the June, 1959 Mid-Month ELECTRONICS BUYERS' GUIDE for complete line of products or services.	
Electronics Capital Corporation	21		
• Epsco, Inc.	37		

Get Water "AS PURE
AS POSSIBLE" with



ILLUSTRATED:
PART OF AN AUTOMATIC
DUPLEX MIXED-BED
DE-IONIZER

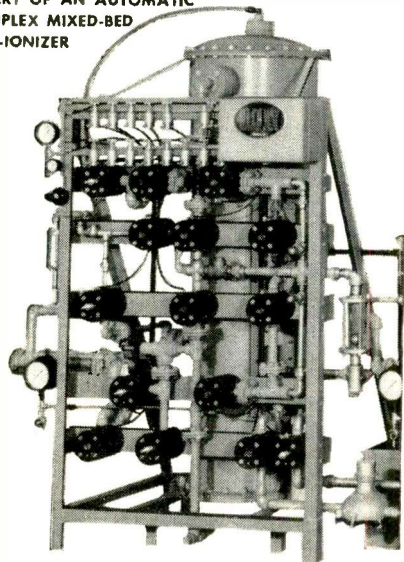

PROVED IN SERVICE

FOR TUBES AND TRANSISTORS

Manufacturers of tubes and transistors using ILLCO-WAY ionXchange Equipment are now getting up to 20-megohm water consistently and at low cost — and you can't hardly do that any other way. We have supplied various types and sizes of Automatic Mixed-Bed and "Package" Units, as required by individual conditions. Several have proved so successful as to call for multiple and repeat installations.

TAKE ADVANTAGE OF OUR PIONEERING KNOWLEDGE

We originated the Mixed-Bed De-Ionizer in 1949 and have led the way in introducing it to the electronics industry. In each case, the particular units furnished have been determined from a careful analysis of raw water conditions. *Where you need the purest possible water*, let your ILLCO-WAY representative advise you.

Write for Bulletin MB



ILLINOIS WATER
TREATMENT CO.
840 Cedar St.
Rockford, Ill.

NEW YORK OFFICE: 141 E. 44th St., New York 17, N.Y.
CANADIAN DIST.: Pumps & Softeners, Ltd., London, Can.

CIRCLE 225 ON READER SERVICE CARD
ELECTRONICS • NOVEMBER 6, 1959

Mallory & Co., Inc., P. R.	46, 47
• Marconi Instruments	92
Marion Instrument Division Minneapolis-Honeywell Regulator Company	119
• Mark Products	115
Magnetics Inc.	145
• Mico Instrument Co.	129
Micromech Manufacturing Corp.	118
• Microswitch, Division of Minneapolis- Honeywell	17, 18
• Minneapolis-Honeywell	111, 147
Mississippi Agricultural and Industrial Board	119

• New Hermes Electric Machine Corp.	124
• North Atlantic Industries Inc.	136
• North Hills Electric Company	136

P C A Electronics, Inc.	6
Pacific Semiconductors, Inc.	135
• Panoramic Radio Products Co.	134
• Phileo Corporation	48, 82
Philips-Gloeilampenfabrieken N. V.	26
Potter-Brumfield	73
Precision Instrument Company	83

• Radio Corporation of America	34
4th Cover	
• Radio Frequency Laboratories, Inc.	101
• Raytheon Company	95, 107

• Shalleross Manufacturing Co.	79
• Sigma Instruments, Inc.	104
Sprague Electric Company	5
Superior Cable Corporation	74
• Superior Electronics Corporation	122
• Superior Tube Company	91

Tektronix, Inc.	2
• Texas Instruments Incorporated	13, 75
Transradio, Ltd.	128
• Trio Laboratories, Inc.	39

• Union Switch & Signal Division of Westinghouse Air Brake Company	96
• United Transformer Corporation	2nd Cover

• See advertisement in the June, 1959 Mid-Month
ELECTRONICS BUYERS' GUIDE for complete line
of products or services.

Reduce rejects and
operational failures
caused by airborne dirt,
dust, lint, abrasives
with the

HONEYWELL ELECTRONIC AIR CLEANER

When microscopic airborne dirt, dust, lint and abrasives get into precision electric and electronic devices, the results are unusually high reject rates, poor product quality, operational failures. The Honeywell Electronic Air Cleaner will protect your precision components from the damaging action of these airborne spoilers by trapping particles 100 times as small as those stopped by mechanical filters.

Pays for itself! Send coupon today to learn how the Honeywell Electronic Air Cleaner soon pays for itself in:

- Electronic Manufacturing
- Controlled environment rooms for precision manufacturing, processing and assembly
- Switch & relay rooms
- Computer rooms
- Transmitter rooms
- Precision component manufacturing

MINNEAPOLIS-HONEYWELL
Dept. EL-11-45 Minneapolis 8, Minn.
Please send free copy of Electronic Air
Cleaner booklet, "A Close Look at Air-
Borne Dirt." We have the following

problems: _____

Name _____

Company _____

Address _____

City _____ Zone _____ State _____

Precision to:
 + .0002
 - .0000



Stainless Steel

PINS in STOCK

**DOWEL & TAPER
 IMMEDIATE SHIPMENT**

DOWEL PINS

(precision tolerance)

- Stainless steel 18-8, type 303
- Diams: .0312 through .500
- Lengths: 3/32" through 2 1/2"
- Chamfered ends
- "Specials" manufactured promptly
- Full range raw material on hand

TAPER PINS

(commercial, precision, AN)

- Stainless 18-8, type 303. Also many in type 316 (Commercial tolerance)
- Size: 9/0 through 10 in stock
- Lengths: 3/16" through 8" (not all lengths in all sizes.)
- "Specials" manufactured promptly, any material

PLUS all types and sizes of screws (slotted, Phillips—both magnetic and non-magnetic—hex, socket), bolts, nuts, washers, rivets, nails, keys, etc.

PHONE OR WRITE for prompt quotation or shipment. Ask for catalog.



ALLMETAL®

SCREW PRODUCTS COMPANY, INC.
 Manufacturers of Stainless Fasteners Since 1929

821 Stewart Avenue, Garden City, L.I., N.Y.
 Phone: Pioneer 1-1200 TWX GCY 603

Midwest Division
 6424 W. Belmont Avenue, Chicago 34, Illinois
 Phone: AVenue 2-3232 TWX CG 3185

West Coast Division—Office and Warehouse
 5822 West Washington Blvd., Culver City, Calif.
 Phone: WEBster 3-9595 TWX LA 1472

- Varflex Corporation 109
- Varian Associates 15
- Walsco Electronics Mfg. Co. 134
- Waters Mfg., Inc. 102, 103
- Westinghouse Electric Corporation 14, 133
- Wiley Company, John 114

PROFESSIONAL SERVICES 145

CLASSIFIED ADVERTISING
 F. J. Eberle, Business Mgr.

EMPLOYMENT OPPORTUNITIES 138-145

EQUIPMENT
 (Used or Surplus New)
 For Sale 145

ADVERTISERS INDEX

- Armour Research Foundation of Ill. Institute of Technology 138
- Bell Aircraft Corporation 138
- Bendix Aviation Corp., Scintilla Div. 141
- Boonton Radio Corporation 143
- Fidelity Personnel 141
- General Dynamics Electric Boat Div. 144
- General Electric Company 139-143
- Gilfillan Brothers, Inc. 145
- Minneapolis-Honeywell, Missile Eqpt. Div. 143
- Motorola, Inc. 138
- Reliable Electric Motor Repair Co. 145
- Republic Aviation 142
- Sanders Associates, Inc. 141
- Scientists, Engineers, & Executives 141
- Sylvania, sub. of General Telephone & Electronics 145
- Western Electric 140

• See advertisement in the June, 1959 Mid-Month ELECTRONICS BUYERS' GUIDE for complete line of products or services.

This index is published as a service. Every care is taken to make it accurate, but ELECTRONICS assumes no responsibilities for errors or omissions.

The Approved
 Standard for
 Insulating and
 Anchoring
**ELECTRICAL
 CORDS & CABLES**

FREE TEST SAMPLES will be sent on the receipt of the sizes of the wires you are using.

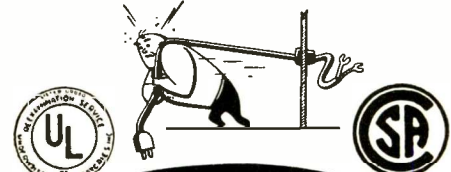

**HEYMAN
 MANUFACTURING CO.**
 KENILWORTH 2, NEW JERSEY
 HEY MAN!—SAY HEYMAN

CIRCLE 226 ON READER SERVICE CARD
 NOVEMBER 6, 1959 • ELECTRONICS



**Reduce costs,
increase reliability**

...with

PRE-WIRED Daven switch assemblies

Daven has established a completely new Packaged Assembly Department. This group assembles various components on Daven rotary switches, does all internal wiring, any external cabling necessary, and pre-tests the entire package. In switch wiring, it is very often easier and less time consuming to wire and make connections to switch decks before they are stacked as a complete unit.

Thus, you can now have a completely tested sub-

assembly, instead of a mixed group of components and switches which ordinarily would have to be individually checked, assembled, soldered, and tested. Daven takes complete responsibility for the design, fabrication, testing and overall reliability of this assembly package.

For more information about Daven's new Packaged Assembly Service, write today.

THE **DAVEN** CO.



LIVINGSTON, NEW JERSEY

TODAY, MORE THAN EVER, THE DAVEN © STANDS FOR DEPENDABILITY

10 Mc "flip-flop" circuit
utilizing either a pair of RCA-2N1300
or RCA-2N1301 Mesa Transistors.

RCA-2N1300 and 2N1301

LOW-COST MESA COMPUTER TRANSISTORS

Now in quantity production... and available!

RCA-2N1300 and 2N1301 Germanium P-N-P Mesa Transistors offer these 10 major benefits to designers of switching circuits. And they're ready for you now!

- rugged Mesa structure—permits extremely small base width to insure top performance at high frequencies
- fast switching times with low values of base input current—made possible by high frequency response and low total stored charge
- high current gain—permits high fan-out ratios (number of paralleled similar circuits per driver-stage output)
- high breakdown voltage and punch-through voltage ratings—the result of the diffusion process
- high power dissipation—150 milliwatts at 25°C— aids in the design of reliable circuits
- high current ratings—improve overall system speed
- rugged overall design—units have unusual capabilities to withstand severe drop tests and electrical overloads
- electrical uniformity—a result of the diffused-junction process used by RCA in the manufacture of Mesa Transistors
- especially well suited for use at pulse repetition rates up to 20 Mc
- exceptionally well suited to applications in saturation-type switching circuits

Information on RCA-2N1300 and 2N1301 Low-Cost Mesa Transistors is available from your RCA Field Representative. For technical data, write RCA Commercial Engineering,

Section K-19-NN-1, Somerville, N. J.

RCA TYPE	Maximum Ratings* Absolute-Maximum Values						Characteristics: Common-Emitter Circuit, Base Input Ambient Temperature of 25°C		
	Collector- to-Base Volts	Emitter- to-Base Volts	Collector Milli- amperes	Transistor Dissipation—mw			Minimum DC Current Gain		Gain Bandwidth Product* Mc
				at 25°C	at 55°C	at 71°C	at collector ma = -10	at collector ma = -40	
2N1300	-13	-1	-100	150	75	35	30	—	40
2N1301	-13	-4	-100	150	75	35	30	40	60

*Maximum collector-to-emitter
voltage rating = -12 volts

• For collector ma = -10 and
collector-to-emitter volts = -3.

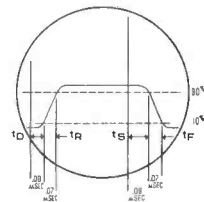

Oscilloscope wave form shows typical delay, rise, storage, and fall times achieved with 10-ma inverter circuit utilizing the RCA-2N1301 MESA TRANSISTOR.

RCA Field Offices

EAST: 744 Broad St., Newark 2, N. J.
HUmboldt 5-3900

NORTHEAST: 64 "A" Street
Needham Heights 94, Mass.
HILlcrest 4-7200

EAST CENTRAL: 714 New Center Bldg.
Detroit 2, Mich.
TRinity 5-5600

CENTRAL: Suite 1154
Merchandise Mart Plaza
Chicago 54, Ill.
WHitehall 4-2900

WEST: 6355 E. Washington Blvd.
Los Angeles 22, Calif.
RAYmond 3-8361

GOV'T: 224 N. Wilkinson Street
Dayton, Ohio
BALdwin 6-2366
1625 "K" Street, N.W.
Washington, D. C.
DIstrict 7-1260



RADIO CORPORATION OF AMERICA

SEMICONDUCTOR AND MATERIALS DIVISION • SOMERVILLE, N. J.

ALSO AVAILABLE THROUGH YOUR LOCAL
RCA SEMICONDUCTOR DISTRIBUTOR.