

electronics

engineering edition

How

TRANSDUCERS

Measure and Control

...page 59

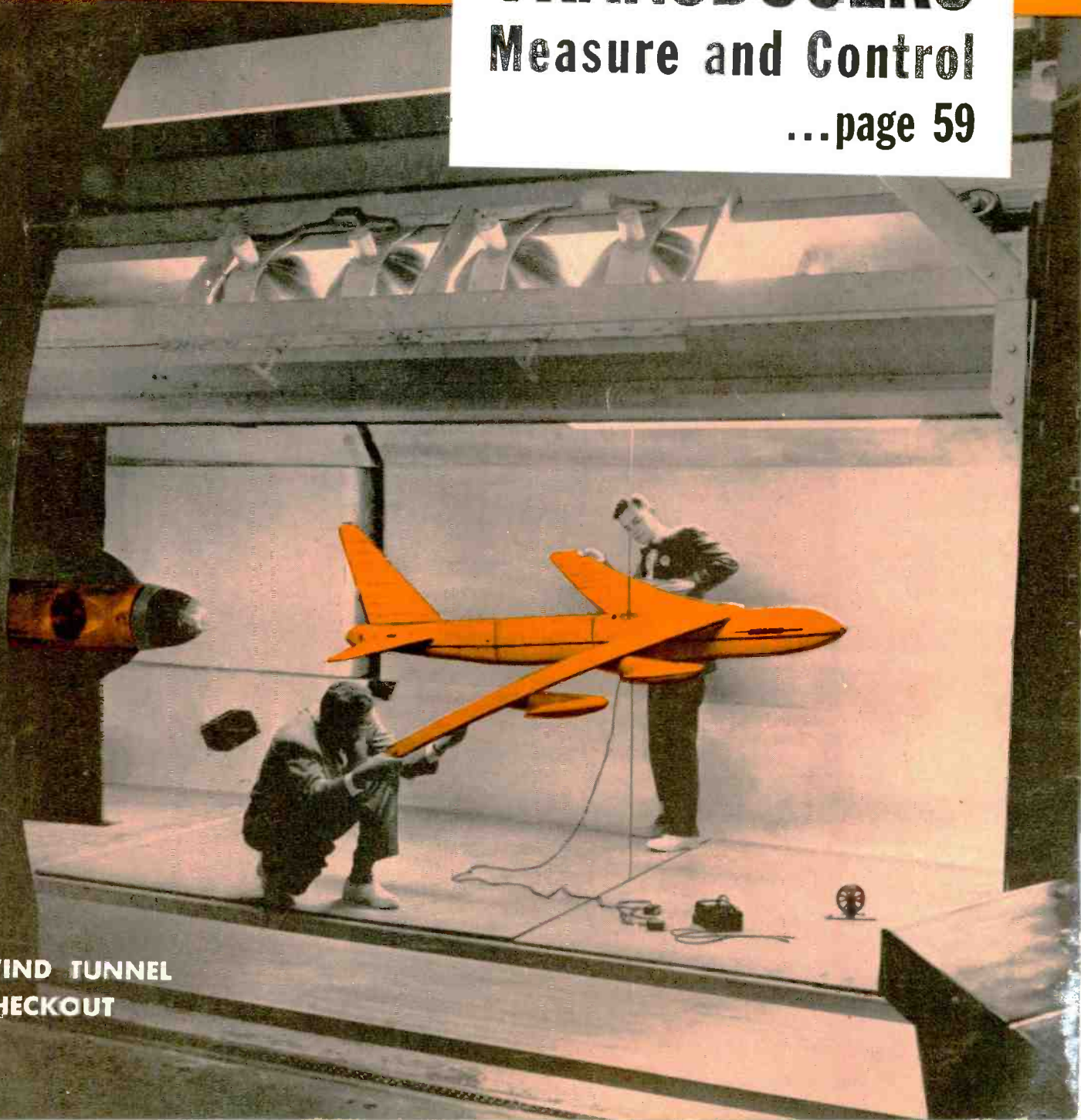

WIND TUNNEL
CHECKOUT



TAKE A CLOSER LOOK

at your sources for R-F Chokes
and Insulated Wire Wound Resistors

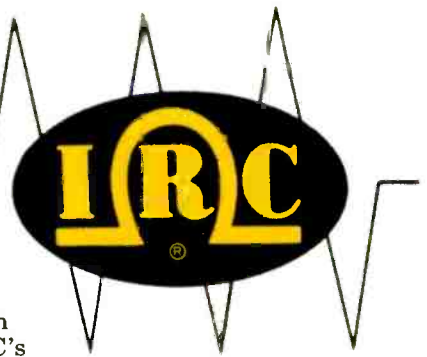

Have you rechecked your sources of supply for these two products recently? Take a look at R-F Chokes. Are you satisfied with quality? Are you getting all the product and assembly advantages your money can buy?

Take a look at Insulated Wire Wound Resistors. Are you happy with their reliability for your applications? Are you saddled with "yesterday" components or are you taking advantage of IRC's specialized wire winds for printed and transistorized circuits?

Finally, take a *closer* look at costs . . . and you'll look no further than IRC. Write for Catalog Data Bulletins.

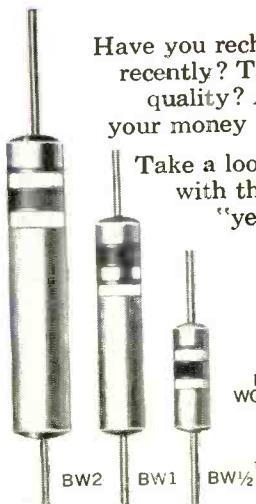

3 SIZES OF
INSULATED WIRE
WOUND RESISTORS
Small, low range,
low resistance—
excellent for
transistor circuits.

4 SIZES OF
R-F CHOKES
Wide range of
inductances. Low
cost, due to exclusive
manufacturing
methods.

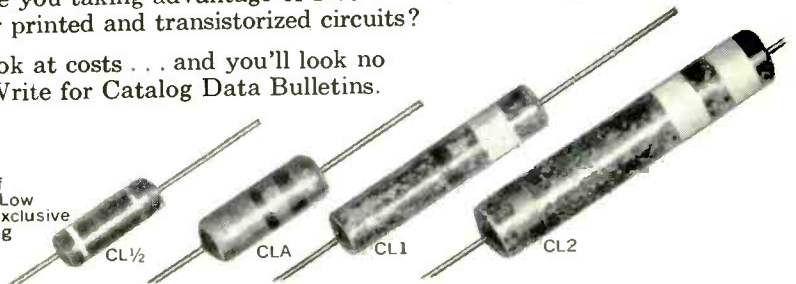

H. W. MATEER, *Publisher*

W. W. MacDONALD, *Editor*

Managing Editor, John M. Carroll.

Feature Editor, John Markus.

Associate Editors: John M. Kinn, Jr., Frank Leary, Michael F. Tomaino, Howard K. Janis, Sylvester P. Carter, Haig A. Manoogian, Roland J. Charest, William P. O'Brien, George Sideris, Edward DeJongh, John F. Mason, Barry Miller, William E. Bushor, Ronald K. Jurgen, Thomas Emma, Patrick J. Lahey, Samuel Weber.

Pacific Coast Editor (Los Angeles) Harold C. Haad; *Midwestern Editor* (Chicago) Harold Harris; *New England Editor* (Boston) Thomas Maguire.

Art Director, Harry Phillips, Roy Thompson.

Production Editor, John C. Wright, Jr., Bernice Duffy, Jean L. Matin.

Editorial Assistants: Gloria J. Filippone, Arlene Schilp, Noreen Hennessy, Patricia Landers, Catherine McDermott.

JAMES GIRDWOOD, *Advertising Sales Manager*, R. S. Quint, *Assistant Advertising Sales Manager and Buyer's Guide Manager*, Fred Stewart, *Promotion Manager*, Frank H. Ward, *Business Manager*, George E. Pomeroy, *Classified Manager*, Jean Heiges, *Research*.

New York: Donald H. Miller, Henry M. Shaw, Martin J. Gallay. *Boston*: Wm. S. Hadgkinson. *Philadelphia*: James T. Hauptli. *Chicago*: Bruce Winner. *Cleveland*: Warren H. Gardner. *San Francisco*: T. H. Carmody, R. C. Alcorn. *Los Angeles*: Carl D. Dysinger, D. A. McMillan. *Denver*: J. Patten. *Atlanta*: M. Miller. *Dallas*: Gordon L. Jones. *London*: Herbert Lagler. *Frankfurt*: Michael R. Zeynel.

Issue at a Glance

How Transducers Measure and Control. Early Boeing B-52 model being set up in wind tunnel for measurement of roll, pitch, yaw, lift, and drag with strain-gage transducers. Leeds and Northrup instrumentation completes the system. Aircraft is shown in orange for emphasis only. See p 59. **COVER**

Business Briefs p 7

Electronics Newsletter	7	Loudspeaker Checks Jets.....	14
Figures of the Week.....	7	U.S. Relaxes Nickel Rules.....	14
Army Testing and Talos.....	8	Military Electronics	14
Reliability Seen Key to Space.....	8	Needles Wind Russian Cores.....	14
Latest Monthly Figures.....	8	Transistors: Next 10 Years.....	16
Transistorized Ignition	12	Financial Roundup	16
Washington Outlook	12	Airport Tv Ends Blind Spot.....	18
Meetings Ahead	18		

Go, No-Go Gage Checks Out Bomarc Automatically. Automatic go, no-go decision is made for each of 140 test steps with over 350 separate measurements p 43
By G. A. Harter and F. A. Buuck

Telemetry Transmitter for Vanguard Rocket. Transmitter sequentially samples rocket monitoring channels and converts data received into pwm/f-m telemetry signal. p 46
By N. Raskhodoff

New Intermetallics Offer Wide Infrared Response. Reproducible indium-antimonide detector cells made with photovoltaic, photoconductive and photoelectromagnetic effects are sensitive into intermediate infrared region p 48
By S. J. Nicolosi, L. H. DeVaux and A. J. Strauss

Compressed Time Boosts Single-Sideband Capacity. System combines features of time-sharing multiplexing and ssb emission p 52
By M. I. Jacob and J. Mattem

X-Band Phase Shifter Without Moving Parts. Ferrite slabs in waveguide walls permit 0 to 360 deg phase variation at powers up to 15 kw. p 56
By W. H. Hewitt, Jr. and W. H. von Aulock

How Transducers Measure and Control. Basic input transducers make possible electronic measurement of most any nonelectrical parameter. This 12-page special report reviews the many different types and shows how they fit into our modern concept of reliable measurement techniques p 59
By Ronald K. Jurgen

DIGEST continued

Radar Power Nomograph. Nomograph predicts whether radiation density from radar antennas is above dangerous limits for nearby personnel.	p 72
By J. E. Allen	
Electrons At Work.	p 74
Radar Developments Aid Defense.	p 74
Digital Amplifiers.	p 74
Tilt Chart for Antenna Feed.	p 80
Transistor Varies Reactance.	p 76
By R. B. Macaskill	
By F. F. Radcliffe	
Component Design.	p 84
Taut-Band Panel Meters.	p 84
Induction-Heater Coil.	p 84
Temperature Controlled Cabinets.	p 88
Adjustable Function Generator.	p 84
By Larkin Scott	
Production Techniques.	p 90
Anvil and Die Fasten Contacts.	p 90
Design Trends.	p 90
Plastic Tube Extends Shaft.	p 94
Vise Tool Seats Grommets.	p 95
Connecting Superconducting Film.	p 92
By J. A. Kurtz	
New Products.	p 96
Literature of the Week.	p 112
Plants and People.	p 114
News of Reps.	p 118
New Books.	p 120
Comment.	p 123
Index to Advertisers.	p 135

electronics

July 4, 1958 Vol. 31, No. 27

Published weekly, with alternating engineering and business editions, and with a BUYERS' GUIDE issue in mid-June, by McGraw-Hill Publishing Company, Inc., James H. McGraw (1860-1948) Founder.

Executive, Editorial, Circulation and Advertising Offices: McGraw-Hill Building, 330 W. 42 St., New York 36, N. Y. Longacre 4-3000.

Publication Office 99-129 North Broadway, Albany 1, N. Y. See panel below for directions regarding subscription or change of address. Donald C. McGraw, President; Joseph A. Gerardi, Executive Vice President; L. Keith Goodrich, Vice President and Treasurer; John J. Cooke, Secretary; Nelson Bond, Executive Vice President, Publications Division; Ralph B. Smith, Vice President and Editorial Director; Joseph H. Allen, Vice President and Director of Advertising Sales; A. R. Venezian, Vice President and Circulation Coordinator.

Single copies \$1.00 for Engineering Edition and 50¢ for Business Edition in United States and possessions, and Canada; \$2.00 and \$1.00 for all other foreign countries. Buyers' Guide \$3.00. Subscription rates—United States and possessions, \$6.00 a year; \$9.00 for two years; \$12.00 for three years. Canada, \$10.00 a year; \$16 for two years; \$20.00 for three years. All other countries \$20.00 a year; \$30.00 for two years; \$40.00 for three years. Second class mail privileges authorized at Albany, N. Y. Printed in U.S.A. Copyright 1958 by McGraw-Hill Publishing Co., Inc.—All Rights Reserved. Title registered in U. S. Patent Office. BRANCH OFFICES: 520 North Michigan Avenue, Chicago 11; 68 Post Street, San Francisco 4; McGraw-Hill House, London E. C. 4; 15, Landgrat-Wilhelm, Frankfurt Main; National Press Bldg., Washington 4, D. C.; Six Penn Center Plaza, Philadelphia 3; 1111 Henry W. Oliver Bldg., Pittsburgh 22; 55 Public Square, Cleveland 33; 856 Penobscot Bldg., Detroit 26; 3615 Olive St., St. Louis 8; 350 Park Square Bldg., Boston 16; 1321 Rhodes Haverly Bldg., Atlanta 3; 1125 West Sixth St., Los Angeles 17; 1740 Broadway, Denver 2. ELECTRONICS is indexed regularly in The Engineering Index.

Subscriptions: Address correspondence to: Fulfillment Manager, Electronics, 330 W. 42nd St., New York 36, N. Y. Allow one month for changes of address, stating old as well as new address. Subscriptions are solicited only from persons engaged in theory, research, design, production, management, maintenance and use of electronics and industrial control components, parts and products. Position and company connection must be indicated on subscription orders.

Postmaster: please send form 3579 to Electronics, 330 W. 42nd St., New York 36, N. Y.



Member ABP and ABC

New



METHOD FOR DIELECTRIC MEASUREMENTS

from 200 to 5000 Mc.

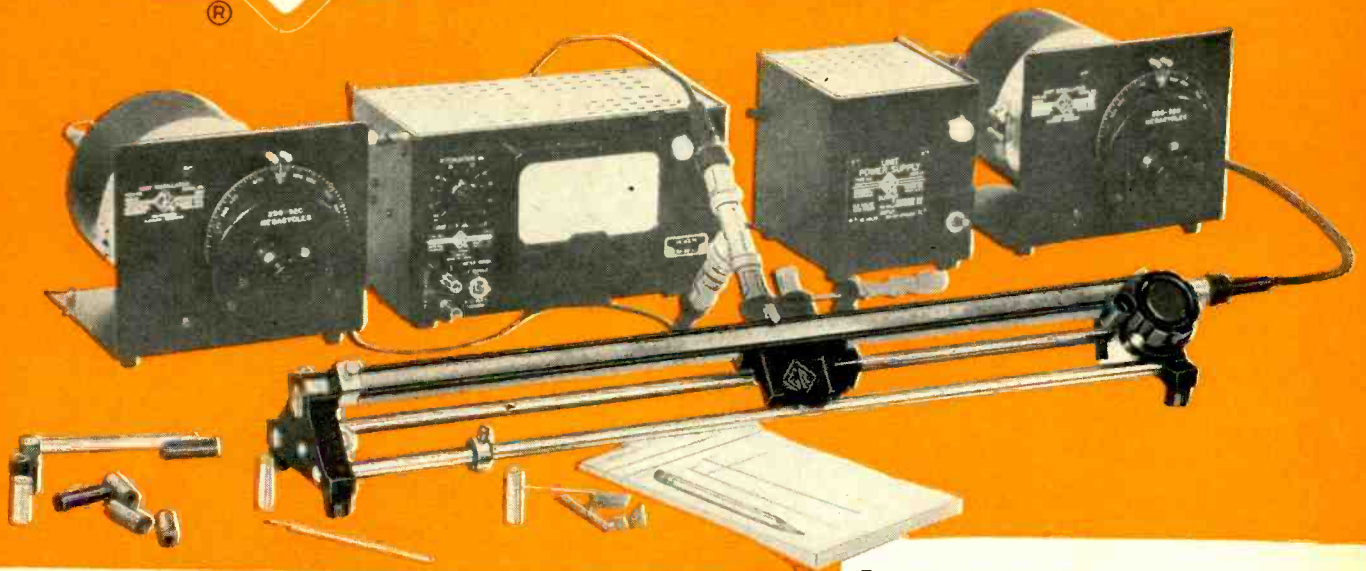

The new Type 874-LM Dielectric-Measuring Line now makes possible rapid and straightforward measurements of solid materials having dielectric constants between 1 and 10, and dissipation factors between 0.0001 and 0.05. Measurement accuracy is $\pm 2\%$ for dielectric constant, and $\pm (5\% + 0.0001)$ for dissipation factor.

The Dielectric-Measuring Line is an air-dielectric, coaxial transmission line whose field is sampled by an electrostatic pick-up probe mounted on a precision probe carriage. Basic construction of this new instrument is similar to that of the time-proven G-R Type 874-LBA Slotted Line with these exceptions: the line is open at one end to accept cylindrical dielectric specimens; and the inner and outer conductors of the coaxial line have silver overlays to minimize losses.

Operation is simple: A cylindrical specimen is fitted into the end of the air-dielectric line. The frequency of a signal source driving the line at the other end is adjusted until a voltage minimum is obtained close to the face of the sample (usually within about 1 cm). Dielectric constant (K) and dissipation factor (D) can then be calculated from these two simple expressions.

$$K = \left[\frac{N\lambda}{4(\ell + x)} \right]^2 \quad D = \left[\frac{\Delta_{10}}{3(\ell + x)} \right] - A$$

With this method there are no complex transcendental equations to solve. The use of the DNT Detector eliminates the need for modulation of source and consequent f-m difficulties and provides an accurate, linear response over a wide range of signal levels.

- λ = wavelength of supplied frequency.
- ℓ = physical length of sample (cm).
- N = odd integer representing number of quarter wavelengths in sample.
- x = distance from voltage minimum to front face of dielectric sample.
- Δ_{10} = width of voltage minimum between 10 db points (measured by micrometer on dielectric line).
- A = constant obtained from chart which corrects for resistive losses in the line.

Type 874-LM Dielectric Measuring Line... \$400

Frequency Range:

Minimum: $\frac{200}{\sqrt{K}}$ Mc

Maximum: 5000 Mc or $\frac{9000}{\sqrt{K}}$ Mc, whichever is smaller

K and D Ranges and Accuracy:

K (dielectric constant): $\pm 2\%$ between 1 and 10

D (dissipation factor): $\pm (5\% + 0.0001)$ between 0 and 0.05

Sample Dimensions:

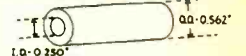

Length depends on dielectric constant and frequency. Long samples can be made up of a number of short sections.

Scale:

Calibrated in centimeters, can be shifted to simplify calculations. Micrometer can be read to 0.0002 cm.

Dimensions: 26 x 4 1/2 x 3 1/2 inches. Net Weight: 8 1/2 pounds.

ACCESSORIES RECOMMENDED:



Any one of a wide variety of G-R Unit Oscillators that cover the v-h-f and u-h-f ranges with Type 1201-A Regulated Unit Power Supply.

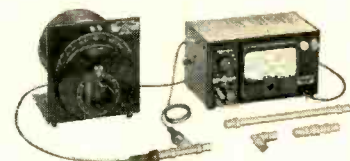

G-R Type DNT Detector Assemblies made up of a Type 874-MR Mixer Rectifier, Type 1216-A Unit I-F Amplifier, and appropriate Unit Oscillator.

Four combinations available for following ranges: 40 to 530 Mc; 40 to 280 Mc; 220 to 950 Mc and 870 to 2030 Mc.

below 500 Mc, 500-1000 Mc, 1000-2000 Mc, and 2000-4000 Mc.



Type 874-F Low-Pass Filters. Four models cover ranges of interest:



Type 874-G6, 6-db Pad.

GENERAL RADIO Company

275 Massachusetts Avenue, Cambridge 39, Mass., U. S. A.

NEW YORK AREA: Tel. N. Y. WOrth 4-2722, N. J. WHitney 3-3140 CHICAGO: Tel. VIlage 8-9400
 PHILADELPHIA: Tel. HANcock 4-7419 WASHINGTON, D. C.: Tel. JUNiper 5-1088
 SAN FRANCISCO: Tel. WHitecliff 8-8233 LOS ANGELES 38: Tel. HOLlywood 9-6201
 In CANADA, TORONTO: Tel. CHerry 6-2171

CIRCLE 1 READERS SERVICE CARD



WE SELL DIRECT. Our District Sales Offices are staffed by engineers especially trained to help you in the selection of instruments and measuring systems best suited to your needs. We welcome your inquiries — will help solve your problems.

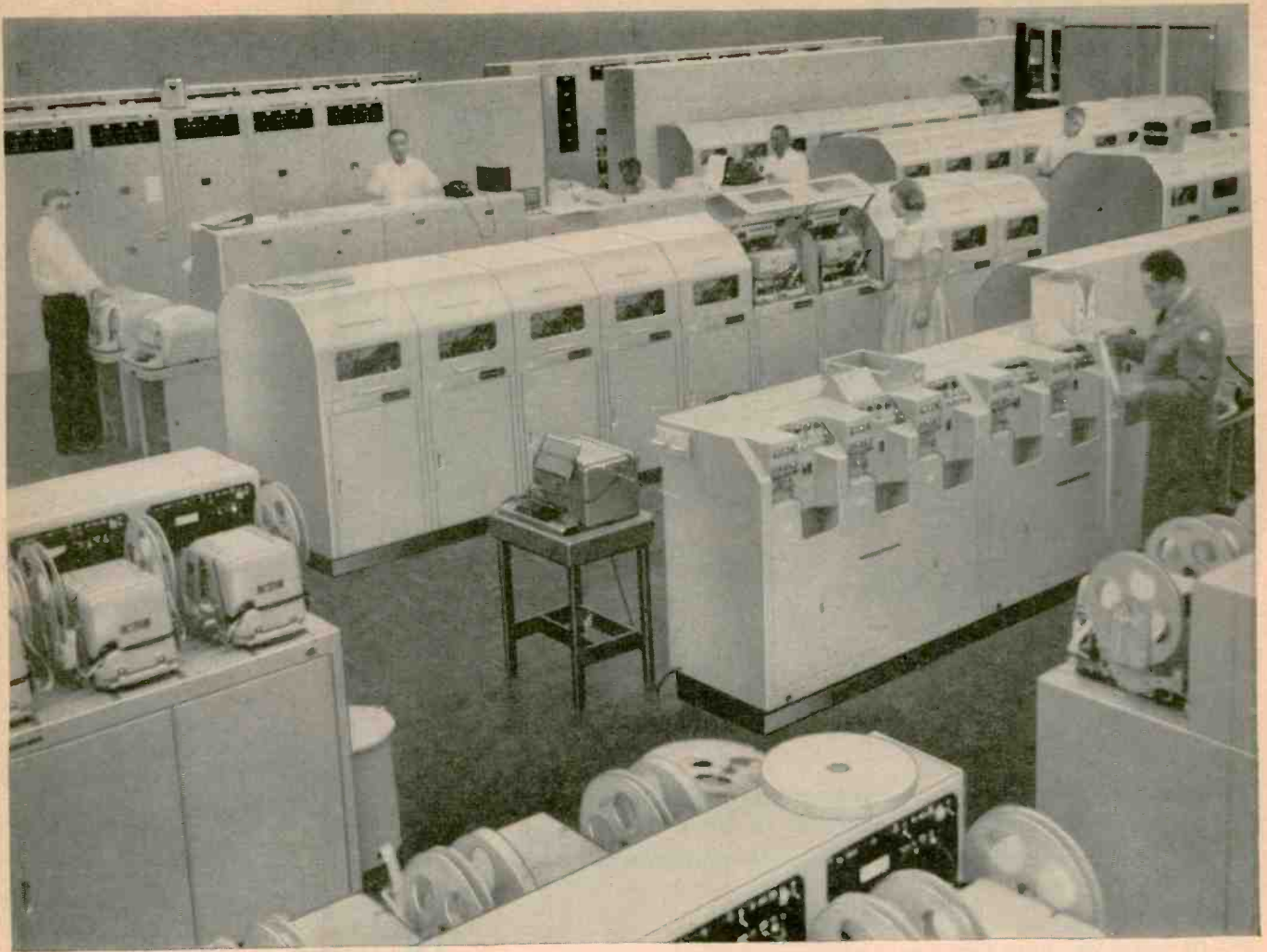

Non-stop relay station for military messages!

Kleinschmidt equipment receives and instantly re-transmits thousands of printed communications daily at the Army's Switching Center, Davis, California.

At one of the largest installations in the U. S. Army's teletypewriter network, Kleinschmidt reperforator-transmitters, teletypewriters and related equipment, developed in cooperation with the U. S. Army Signal Corps, receive and automatically relay the vast load of military communications for the Pacific overseas area and western United States. With related switching equipment, incoming messages are scanned and re-transmitted without manual handling . . . so rapidly that the first portion of a relayed message is received at its destination before the latter part has been transmitted from point of origin!

Research and development of equipment for transmitting and receiving printed communications has been a continuing project at Kleinschmidt for almost 60 years. This unparalleled store of experience, now joined with that of Smith-Corona Inc, holds promise of immeasurable new advances in electronic communications.

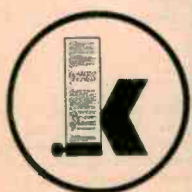

KLEINSCHMIDT

KLEINSCHMIDT LABORATORIES, INC., DEERFIELD, ILLINOIS

Pioneer in teleprinted communications equipment • A subsidiary of Smith-Corona Inc

now

A Complete Line of Magnetic Voltage Regulators



Model MVR60-6

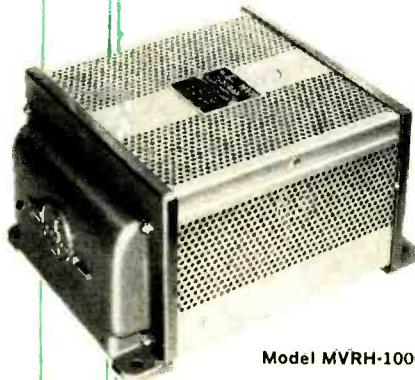

Model MVRH-1000



Model MVR30

SORENSEN MAGNETIC VOLTAGE REGULATORS

Cover the Full Range—30 to 2000 Volt-Amps...

Better Regulation and Fast Response...Smaller and Lighter

Excellent voltage regulation that's constant within $\pm 0.5\%$ against any line change from 95 to 130 VAC—with operation that is instantaneous, automatic, continuous, and protected against overload damage—Sorensen MVR's blanket the low and medium power levels.

Supplied in fifteen standard models that range from 30 to 2000 VA rating, these Sorensen regulators can be mounted in any position. Ideal for bench or shop use, or for inclusion as a component in your product lines to improve performance and life.

These MVR's are available in three basic designs.

1. Basic Line Regulators, providing minimum-cost, general-purpose, highly reliable regulation of RMS voltage, from 30 to 2000 VA.
2. MVR Filament Regulators, providing regulated and isolated 6.3 volt filament supply for vacuum tubes; outputs from 30 to 500 volt-amps. Also a model with 12.6 filament supply and 60 VA rating.
3. Harmonic Filtered Regulators (MVRH). Lowest distortion of any regulator of similar design. Recommended for critical applications requiring precise waveform.



CONTROLLED POWER
FOR RESEARCH AND INDUSTRY

"MVR"

AC REGULATORS

	VA RANGE	MODEL	% REGULATION		OUTPUT			RESPONSE TIME CYCLES	% DISTORTION* FULL LOAD	INPUT VOLTS 60 CPS-1 Ø
			LINE	LOAD	VOLTS	FREQ.	PHASE			
MAGNETIC VOLTAGE REGULATORS "MVR"	30	MVR30	± 0.5	± 0.87	115	60	1	2	18	95-130
	60	MVR60	"	± 0.75	"	"	"	"	20	"
	120	MVR120	"	± 0.75	"	"	"	"	18	"
	250	MVR250	"	± 0.5	"	"	"	"	20	"
	500	MVR500	"	± 0.5	"	"	"	"	20	"
	1000 2000	MVR1000 MVR2000	"	± 0.5 ± 0.5	"	"	"	"	20	"
HARMONIC FILTERED "MVRH"	120	MVRH120	"	0.5	"	"	"	"	3	"
	250	MVRH250	"	0.7	"	"	"	"	3	"
	500	MVRH500	"	0.9	"	"	"	"	3	"
	1000	MVRH1000	"	0.9	"	"	"	"	3	"
FILAMENT REGULATORS "MVR"	30VA 6.3V	5amps. MVR30-6	"	2.5	6.3	"	"	"	20	"
	60 " 6.3"	10 " MVR60-6	"	3	6.3	"	"	"	20	"
	60 " 12.6"	5 " MVR60-12	"	3	12.6	"	"	"	20	"
	500 " 6.3"	80 " MVR500-6	"	2.5	6.3	"	"	"	20	"

Complete information on the full line of MVR's is waiting at your Sorensen representative, or will gladly be mailed on your request to:

SORENSEN & COMPANY, Inc.
Richards Avenue, South Norwalk, Connecticut

In Europe, contact Sorensen-Ardag, •Eichstrasse 29, Zurich, Switzerland, for all products including 50 cycle, 220 volt equipment

Your Design is better Your Product performs better

*with this
full line of*



**DEPENDABLE DIODES
RELIABLE RECTIFIERS**

Germanium GLASS DIODES

TYPE	Working Voltage (max.) v	Forward Current at +1 volt mA	Reverse Current μ A at v	Type	Working Voltage (max.) v	Forward Current at +1 volt mA	Reverse Current μ A at v
1N55B	150	5	500 at -150	1N128	40	3	10 at -10
1N66A	60	5	50 at -10	1N191	90	5	25 at -10
1N67A	80	4	50 at -50	1N198	80	5†	75† at -10
1N68A	100	3	625 at -100	1N294A	60	5	10 at -10
1N95	60	10	800 at -50	1N297A	80	3.5	100 at -50
1N126	60	5	50 at -10	1N298A	70	30*	250 at -40
1N127	100	3	25 at -10				

*at +2 v †at 75°C

Germanium VIDEO DETECTOR Diodes

for TV video and portable radio application;
low capacity video detection; efficiency controlled at 50 Mc

Silicon DIFFUSED JUNCTION GLASS RECTIFIERS

TYPE	Peak Operating Voltage -65°C to +150°C Volts	Ave. Rectified Current		Reverse Current (Max.) in μ A at Specified Voltage		
		25°C mA	150°C mA	Volts	25°C	100°C
1N645	225	400	150	225	0.2	15
1N646	300	400	150	300	0.2	15
1N647	400	400	150	400	0.2	20
1N648	500	400	150	500	0.2	20

Silicon DIFFUSED JUNCTION RECTIFIERS

WIRE IN TYPES

STUD TYPES

TYPE	Peak Operating Voltage -65°C to +165°C Volts	Ave. Rectified Current		Reverse Current (Max.) at Specified PIV, 150°C mA	TYPE	Peak Operating Voltage -65°C to +165°C Volts	Ave. Rectified Current		Reverse Current (Max.) at Specified PIV, 25°C μ A
		25°C mA	150°C mA				25°C Amps.	150°C Amps.	
1N536	50	750	250	0.40	1N253	95*	3.0	1.0*	10
1N537	100	750	250	0.40	1N254	190*	1.5	0.4*	10
1N538	200	750	250	0.30	1N255	380*	1.5	0.4*	10
1N539	300	750	250	0.30	1N256	570*	0.95	0.2*	20
1N540	400	750	250	0.30	CK846	100	3.5	1.0	2
1N1095	500	750	250	0.30	CK847	200	3.5	1.0	2
1N547†	600	750	250	0.35	CK848	300	3.5	1.0	2
					CK849	400	3.5	1.0	2
					CK850	500	3.5	1.0	2
					CK851	600	3.5	1.0	2

† Same as 1N1096 *to +135°C

Ratings at 25°C unless otherwise indicated. All illustrations actual size.

RAYTHEON SEMICONDUCTOR DIVISION
Silicon and Germanium Diodes and Transistors • Silicon Rectifiers

Newton, Mass.....55 Chapel St., Bldg 4-7500
New York:.....589 Fifth Ave., Plaza 9-3900
Chicago: 9501 Grand Ave., Franklin Park, NATIONAL 5-6130
Los Angeles: 5236 Santa Monica Blvd., NORMANDY 5-4221

ELECTRONICS NEWSLETTER

NEW THERMIONIC CONVERTER, a combination of metal and ceramic disks surrounding a high vacuum, has just been disclosed by the GE Research Laboratory. Possible applications might be found wherever a high temperature source of nuclear or conventional heat is available and electricity is needed, says Virgil L. Stout, manager of the lab's physical electronics section. It's estimated that converters the size of a quarter will be made capable of operating in the 1 to 10-watt range. Efficiencies now are low but might eventually reach 30 percent or better. New design halves the operating temperature of 3,000 F for a gas-filled converter, making material requirements easier to meet. The new device has two electrodes held at high but different temperatures; electrons "boiled out" of the hotter cathode are collected by the relatively cool anode and then flow through an external circuit to do their work.

TRANSISTORIZED FAIL-SAFE CIRCUIT is revealed to be in use in the Nike Hercules guided missile which carries a nuclear warhead. Use of transistors in such a circuit increases reliability and makes a premature explosion less likely. J. A. Baird of Bell Telephone Laboratories states the Nike Hercules is provided with circuits that "prevent complete arming of the warhead until it is safely on its way." One problem: possible

failures in the fail-safe circuit must not cause an explosion. "With the small size and low power required by transistors," he explains, "a multi-path or redundant circuit has been developed which prevents individual component failures from making the missile unsafe but still allows it to complete its mission in the normal way." Baird, assistant director of military systems development at Bell Labs., says transistors have also improved the reliability of Nike's guidance, adds that for military applications practically all digital operations to be performed in the foreseeable future will use transistors and/or other solid state devices.

THREE-DIMENSIONAL \$600,000 flight simulator just shipped to Redstone Arsenal subjects components, control and guidance systems, and radar systems to yaw, pitch and roll encountered in actual flight. The manufacturer, Bendix Aviation, says units tested may weigh up to 150 lb; effects on parts are analyzed and recorded, and reaction of systems to near-miss bomb bursts, high-speed wind pockets and other conditions can be studied on the ground. Previous units went to the Navy, USAF and North American Aviation. Analog computer has close to 5,000 tubes; 78 d-c amplifiers have a passband of 300 kc; at 90-degree phase shift, frequency response is 100 cps in roll, 45 cps in pitch and yaw.

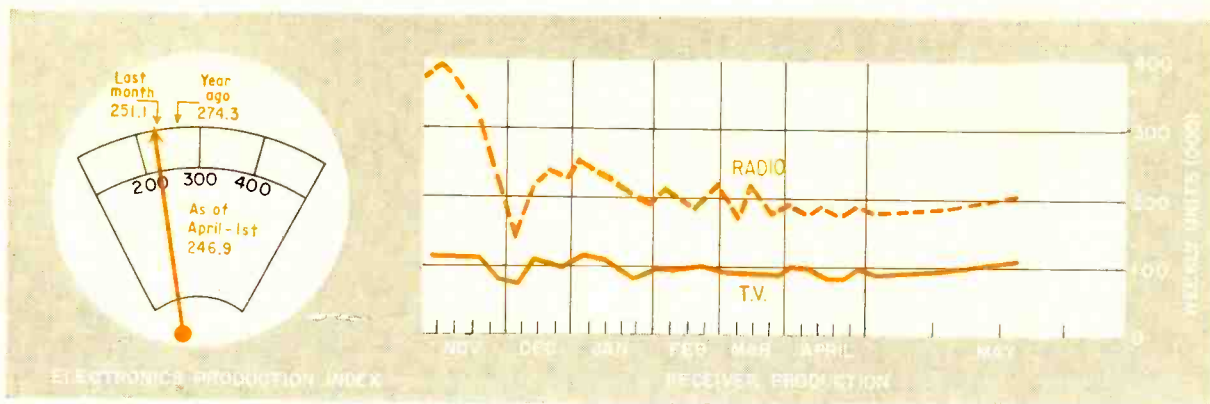

FIGURES OF THE WEEK

RECEIVER PRODUCTION

(Source: EIA)	June 13, '58	June 6, '58	June 14, '57
Television sets, total	76,029	69,290	116,302
Radio sets, total	162,575	156,899	229,967
Auto sets	51,698	48,892	86,270

STOCK PRICE AVERAGES

(Source: Standard & Poor's)	June 18, '58	June 11, '58	June 19, '57
Radio-tv & electronics	49.05	47.54	51.22
Radio broadcasters	63.36	62.08	66.12

FIGURES OF THE YEAR

Totals for first four months

	1958	1957	Percent Change
Receiving tube sales	117,596,000	153,011,000	-23.1
Transistor production	11,895,032	6,899,000	+72.4
Cathode-ray tube sales	2,403,182	2,952,318	-18.6
Television set production	1,523,858	1,835,975	-17.0
Radio set production	3,532,066	5,075,180	-30.4
TV set sales	1,690,101	2,020,876	-16.4
Radio set sales (excl. auto)	1,895,951	2,362,068	-19.7

MORE FIGURES NEXT PAGE



Army Testing Talos

Three services cooperate to produce tactical unit for continental air defense

TACTICAL Talos defense units for land-based anti-aircraft operation are now undergoing evaluation tests at White Sands Missile Range.

RCA is prime contractor for the unit, which is destined to be part of continental air defense. The design of the ground control system was started in January 1955, completed on October 15 of last year when the firm turned it over to the services. The system uses Bendix's Talos missile, is a triservice development: Air Force supplied the funds, Navy's BuOrd supervised the program and Army is now evaluating the system.

Fire-control center for the unit (photo) gives complete picture of the tactical situation. Ppi console (at left) shows the targets under radar surveillance and other targets in the area. Targets under control are numbered and presented in turn to the main surveillance console, whose screen is a modified color tv tube. This provides continuous data on position of targets under control and point of probable impact with missile, also permits color separation of targets controlled, tracked or being fired

upon. Bore-sight tv cameras, mounted on antennas of the guidance and track radars, present pictorial view of targets on the other consoles. The fire-control officer can locate, select, track and destroy targets from this one room.

Missiles are loaded and launched automatically under remote control of this center. The system can simultaneously track eight targets, control as many as four missiles.

Modified AN/FPS-16 instrumentation radar is used to track aircraft or to searchlight targets so Talos can home on reflected energy.

The FPS-16 is a monopulse C-band radar producing angular data precise to 1/200 degree and range data accurate to within a few feet. Present tracking range is about 290 miles; modification now in the works will extend this range to 500 miles. Data is produced in digital form, can be supplied directly to data-processing equipment.

This radar was originally developed for use on the firing range at Cape Canaveral, has been accepted as standard instrumentation on missile ranges of all three services.

Talos can operate in either of two modes. It can home on energy reflected from target in the radar beam. In this mode, it is aided rather than hindered by jamming signals from the craft, since these merely give it more energy to feed on. In its other mode, it rides home on a beam from a guidance radar which is also part of the Talos land installation. A null-seeking proximity fuze is usually used to detonate the missile at its point of nearest passage to the target.

Reliability Seen Key to Space

WASHINGTON—More emphasis must be placed on reliability in designing electronic equipment for space vehicles, says S. W. Herwald, Manager of Westinghouse's Air Arm Division. He spoke at IRE's Second National Convention on Military Electronics late last month.

Much of the reliability, he believes, can be gained by use of solid-state physics and molecular engineering. These techniques can save volume, power, weight and complexity.

For successful space travel, the electronics engineer must provide automatic sensors, computers and controls. To orbit the moon or make a precision landing, mid-course and terminal guidance and control must be developed. Launching two satellites into the same orbit is an electronics problem requiring precision controls, he said.

The call for reliability in electronics equipment was echoed by Wm. H. Holaday, Director of Guided Missiles. "Reliability is the key to successful missilery," he said. "Without it we have nothing."

(Continued on p 12)

TRANSISTOR AND TUBE SALES, MONTHLY

(Source: EIA)	Apr. '58	Mar. '58	Apr. '57
Transistors, units	2,856,234	2,976,843	1,774,000
Transistors, value	\$7,025,547	\$6,795,427	\$4,880,000
Receiving tubes, units	32,582,000	28,524,000	27,970,000
Receiving tubes, value	\$28,788,000	\$25,716,000	\$25,384,000
Picture tubes, units	590,357	634,779	629,838
Picture tubes, value	\$11,591,733	\$12,643,404	\$11,394,043

EMPLOYMENT AND EARNINGS, MONTHLY

(Source: Bur. Labor Statistics)	Apr. '58	Mar. '58	Apr. '57
Prod. workers, comm. equip. . . .	338,500	343,800	380,600
Av. wkly. earnings, comm.	\$79.95	\$80.16	\$79.19
Av. wkly. earnings, radio	\$78.78	\$79.39	\$76.61
Av. wkly. hours, comm.	38.9	39.1	40.2
Av. wkly. hours, radio	39.0	39.3	39.9



GUARANTEED FOR FIVE YEARS



New LAMBDA L-T TRANSISTORIZED POWER SUPPLIES

CONVECTION COOLED

No internal blowers • No moving parts

0-32 VDC 0-2 AMP

Introduced at the 1958 I.R.E. Show

Model LT 2095	\$365
Model LT 2095M (metered)	\$395

- Ambient 50° C at full rating.
- High efficiency radiator heat sinks.
- Silicon rectifier.
- 50-400 cycles input.
- Special, high-purity foil, long-life electrolytics.
- Compact. Only 3½" panel height.
- Short-circuit proof.
- Protected by magnetic circuit breakers.
- Hermetically-sealed transformer. Designed to MIL-E27A.
- All transistor. No tubes.
- Fast transient response.
- Excess ambient thermal protection.
- Excellent regulation. Low output impedance. Low ripple.
- Remote sensing and DC vernier.

CONDENSED DATA*

Voltage Bands . . . 0-8, 8-16, 16-24, 24-32 VDC
Line Regulation . . . Better than 0.15 per cent or 20 millivolts (whichever is greater). For input variations from 105-125 VAC.
Load Regulation . . . Better than 0.15 per cent or 20 millivolts (whichever is greater). For load variations from 0 to full load.
AC Input 105-125 VAC, 50-400 CPS

Electrical Overload Protection . . . Magnetic circuit breaker, front panel mounted. Unit cannot be injured by short circuit or overload.
Thermal Overload Protection . . . Thermostat, manual reset, rear of chassis. Thermal overload indicator light, front panel.
Size 3½" H x 19" W x 14¾" D.

* Preliminary and tentative specifications

Send for complete LAMBDA L-T data.



LAMBDA Electronics Corp.

11-11 131 STREET • COLLEGE POINT 56, NEW YORK
 INDEPENDENCE 1-8500 Cable Address: Lambdatron, New York

Component Specification: ARNOLD

- ✓ SILECTRON CORES
Types C, E and O
- ✓ TOROIDAL CORES
Nylon and Aluminum cased
- ✓ BOBBIN CORES

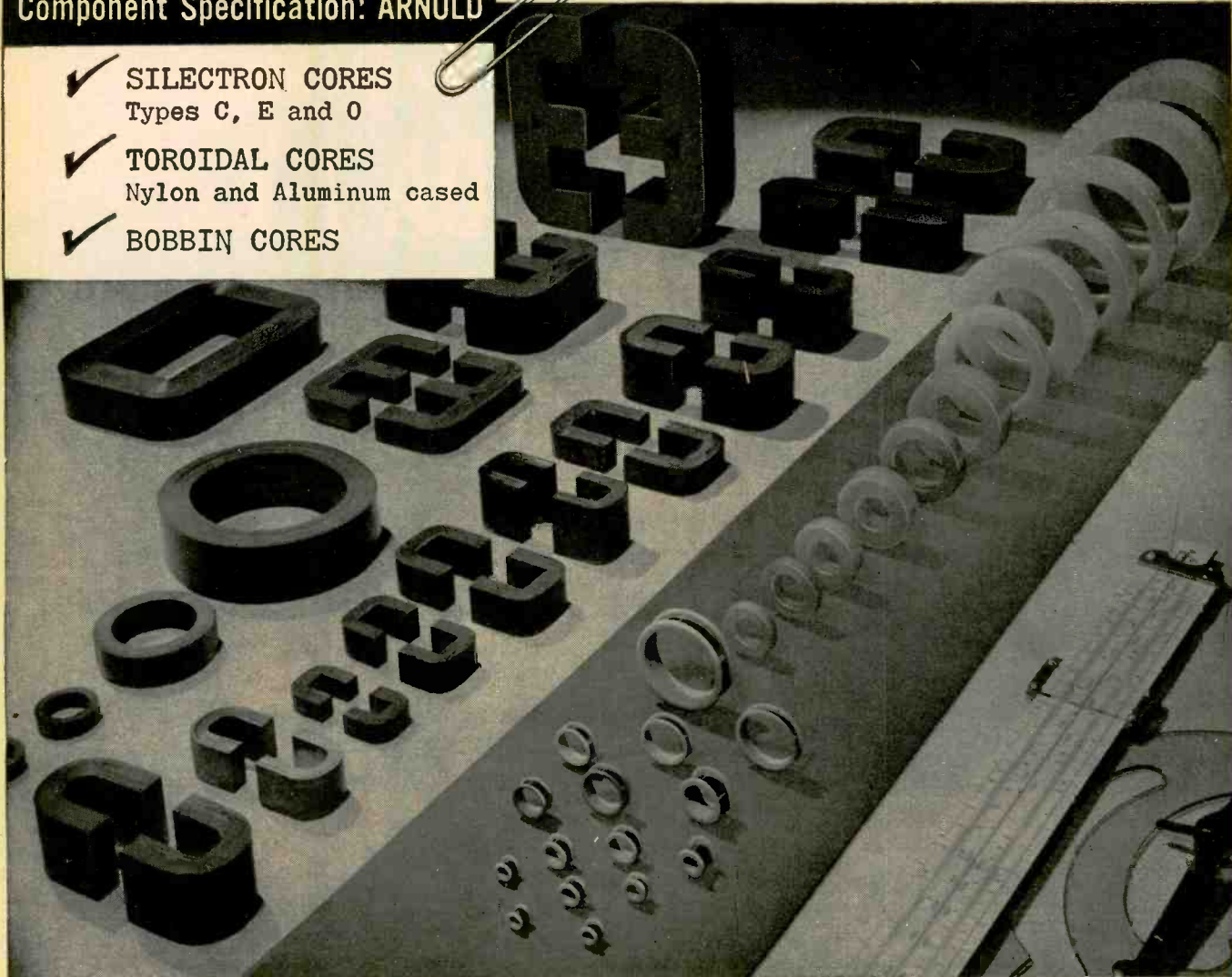

The ARNOLD LINE-UP includes the TAPE CORES you need

APPLICATIONS

We'll welcome your inquiries on your Tape Wound Core requirements for Pulse and Power Transformers, 3-Phase Transformers, Magnetic Amplifiers, Current Transformers, Wide-Band Transformers, Non-Linear Retard Coils, Reactors, Coincident Current Matrix Systems, Static Magnetic Memory Elements, Harmonic Generators, etc.

ENGINEERING DATA

For data on the various types of Arnold Tape Cores, write for these Bulletins:

SC-107—Silectron Cores, Types C, E and O

TC-101A—Toroidal Cores, nylon and aluminum cased

TC-108—Bobbin Cores

ADDRESS DEPT. E-87

How to be sure of tape core performance and uniformity? Just specify and use Arnold Cores in your transformer, magnetic amplifier, reactor and computer assemblies, etc.

Here's why!

To begin with, Arnold is a fully integrated company, controlling every manufacturing step from the raw material to the finished core. Then, modern testing equipment permits 100% inspection of cores before shipment. Finally, you're matching your requirements against the most experienced and complete line of tape cores in the industry. Arnold produces Types C, E and O Silectron cores,

nylon and aluminum cased toroidal cores, and bobbin cores to meet whatever your designs may require in tape thickness, material, core size or weight. Wide selections of cores are carried in stock as standard items for quick delivery; both for engineering prototypes to reduce the need for special designs, and for production-quantity shipments to meet your immediate requirements.

Let us help you solve your tape core problems. Check Arnold, too, for your needs in Mo-Permalloy or iron powder cores, and for cast or sintered permanent magnets made from Alnico or other materials.

WSW6447

THE ARNOLD ENGINEERING COMPANY



Main Office & Plant: Marengo, Illinois

Repath Pacific Division Plant: 641 East 61st Street, Los Angeles, Calif.

District Sales Offices:

Boston: 200 Berkeley St.

Los Angeles: 3450 Wilshire Blvd.

New York: 350 Fifth Ave. Washington, D.C.: 1001-15th St., N.W.

THOMAS A.

EDISON'S

model 250 miniature
time delay relays
are shock and
vibration resistant

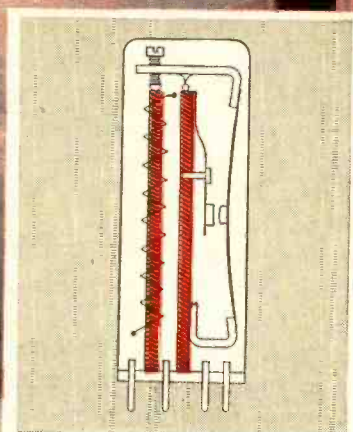
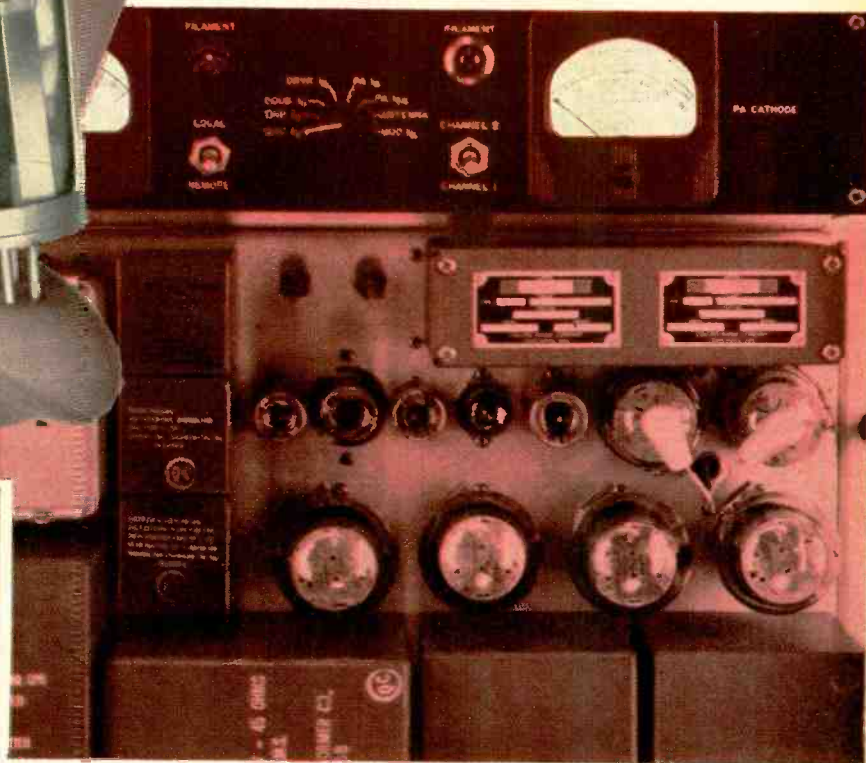
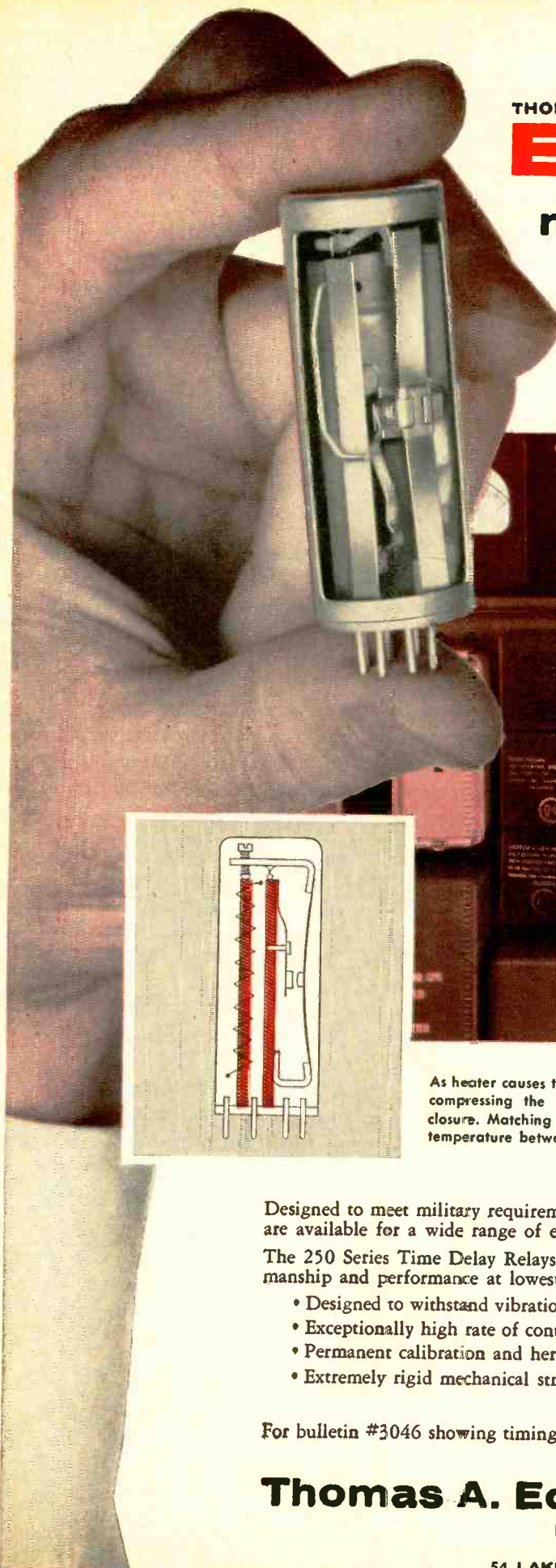

As heater causes the expansion member to stretch, lever pivots on its hinge, compressing the bow spring at a high rate in the direction of contact closure. Matching expansion member compensates for external changes in temperature between -65 and $+100^{\circ}\text{C}$.

Designed to meet military requirements, Edison's line of miniature time delay relays are available for a wide range of electronic applications.

The 250 Series Time Delay Relays combine in one unit superior design, top workmanship and performance at lowest cost. Check these advantages:

- Designed to withstand vibration frequencies to 500 CPS.
- Exceptionally high rate of contact closure.
- Permanent calibration and hermetic seal.
- Extremely rigid mechanical structure using high-strength, high-expansion alloys.

For bulletin #3046 showing timing ranges and operating performance write to:

Thomas A. Edison Industries
INSTRUMENT DIVISION

54 LAKESIDE AVENUE, WEST ORANGE, N. J.



Some 3,000 engineers and scientists assembled at the Sheraton Park Hotel for the three-day sessions on missiles and electronics. There were 106 papers and over 100 exhibits. Among the topics were: guidance radar for satellites and space vehicles; design of equipment to communicate with space vehicles and a tv system capable of seeing on a moonless night.

The exhibits were of special interest to the electronics engineer. The Navy's Grasshopper, automatic weather transmitter weighing 250 lbs, was shown. It has six long legs which jack up the five-ft cylindrical body after hitting the ground. This device may someday be shot to the moon and automatically transmit back weather data.

Other equipment shown ranged from printed circuits so small that they must be read with a magnifying glass to a radio transmitter weighing nearly a half ton.

Bomarc II, an area defense weapon with a range of 400 miles and unique terminal guidance, was mentioned at the exhibit. Westinghouse reportedly is making the ground control system for the missile under a \$10-million subcontract with Boeing.

A 1,000-watt radio transmitter designed for shipboard and submarine service over the 2 to 30-mc range was also shown.

Transistorized Ignition System

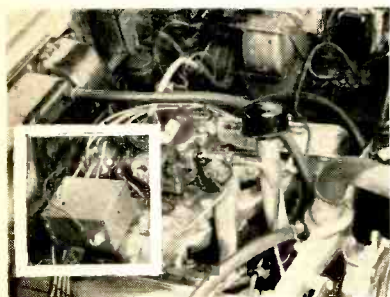

One type of transistorized low-voltage ignition system (ELECTRONICS, p 20, June 27) which Auto-Lite tested on late model car engine. Box (insert) is power supply. Shielded distributor protects against high frequencies generated. Lead wires are also shielded

WASHINGTON OUTLOOK

WASHINGTON looks for a strong pickup in the electronics industry during the second half of 1958. Economists predict electronics will be one of the pace setters of the general business revival now shaping up.

Our industry will benefit from the generally improved business situation. Also, the largest share of new and bigger defense outlays is expected to go to electronics. Finally, the consumer side of the business recently has begun to show new signs of life.

Electronics industry generally begins to pickup activity in April, but this was a little delayed this year. Commerce Department officials now place the turn-around in June. The Department's Division of Electronics is preparing a six-month outlook for the industry to be released in about two weeks. The report is generally optimistic in tone. Officials say there is a good chance the last half of the year may match—or possibly exceed—production in the last half of 1957.

- A \$60-million radio telescope will enter construction stage in August near Sugar Grove, West Virginia—culminating 11 years of research in radio astronomy by the Naval Research Laboratory. Besides serving as a space explorer, it will also be a jam-proof military transmitter for bouncing signals off the planets back to points on earth.

Size of the antenna hasn't been determined but a 60-ft dish—to be built by Kennedy of Cohasset, Mass.—will be installed as a first step in determining the ultimate size of the telescope.

Design of electronic gear, instrumentation will be handled by NRL, with some components bought from outside firms.

- One of NATO's top-priority projects, now under way, is to augment early-warning radar in Norway and Denmark. There are three early-warning radar stations in northern Norway, with limited communication facilities; three stations in southern Norway; and five in Denmark. There are serious holes in the network and the equipment has limited ranges.

For the most part, the present equipment is FPS-8 radars with a range of 160 miles. The new high-powered units, which will be in place over the next few years, will double the early-warning range and fill in most gaps in coverage. Radar coverage eastward to Russia will be extended. Communication facilities serving early-warning radar network will be beefed up.

Electronic communications, particularly in southern Europe, are barely sufficient to carry the load. This is in terms of both physical equipment and specialized personnel.

- NATO's air defense system—providing early-warning radar for U.S. bomber bases in North Africa and in Great Britain and U.S. and allied tactical fighter bases in almost all of the NATO countries—is beset by glaring gaps in physical coverage and lack of coordination between some national radar nets.

Officers at Headquarters, Allied Forces, Southern Europe—in Naples—complain that Greece, Turkey and Italy each want to control their own air defense radar systems. NATO headquarters has a sticky diplomatic problem in trying to coordinate the three early-warning networks without injuring the national pride of the individual nations concerned.

**ONLY KIN TEL
DIGITAL VOLTMETERS
GIVE YOU ALL
THESE ADVANTAGES...
AND FOR ONLY
\$2100**

1. SINGLE-PLANE READOUT: KIN TEL digital voltmeters employ a simple projection system to present numbers on a readable single plane...no superimposed outlines of "off" digits...reduced possibility of error. Standard lamps give 7000 to 8000 hours of life, compared with 100 to 200 hours for ordinary readouts.

2. COMPLETE LINE OF ACCESSORIES—SPECIAL SYSTEMS: Versatile "digital building blocks" permit measurement of AC, ohms, ratios of AC and DC, automatic scanning of multiple inputs. Preamplifiers increase digital voltmeter sensitivity to 1 microvolt DC, 10 microvolts AC. Buffers permit driving typewriters, tape punches and printers. KIN TEL's Special Products Department can design and manufacture digital instruments to meet your special requirements... complete digital systems for data logging, missile checkout and automatic production line testing.

3. ADVANCED CIRCUIT DESIGN: Transistors employed where they contribute to performance and reliability...relay drive coils energized with DC as in telephone type service to provide long, trouble-free operation...automatic, continuous standard cell calibration. No electronic circuitry in readout allows easy remote mounting. Sensitivity control permits stable reading of noisy signals.

4. MANUFACTURING EXPERIENCE: KIN TEL has manufactured over 10,000 "standard cell accuracy" DC instruments on a true production line basis. Only by this method, by years of repeated manufacturing experience, by an over-all awareness of the accuracies and tolerances involved, is it possible to guarantee consistent accuracy and reliability...to assure real value for every dollar you invest.

5. NATIONWIDE APPLICATION ENGINEERING FACILITIES: KIN TEL has engineering representatives in every major city. An experienced staff of over 200 field engineers is always immediately available to help solve your application problems, provide technical data, or prepare a detailed proposal. Factory level service is available in all areas.

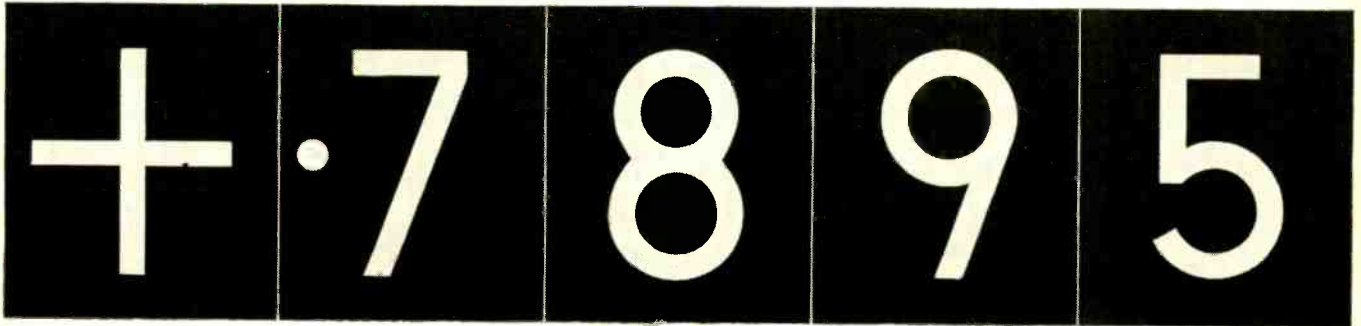

6. DESIDERATE SPECIFICATIONS (MODEL 401 DC DIGITAL VOLTMETER):

Display...Four (4) digit with automatic polarity indication and decimal placement. Total display area 2" high x 7½" long, internally illuminated. Individual digits 1½" high.

Automatic Ranges...0.0001 to 999.9 volts covered in four ranges. Sensitivity control provides least digit sensitivities of .1, 1, and 10 mv.

Accuracy...0.01% ±1 digit.

Counting Rate...30 counts per second, providing average balance (reading) time of 1 second, maximum balance time of 3 seconds.

Reference Voltage...Chopper-stabilized supply, referenced to an unsaturated mercury-cadmium standard cell.

Input Impedance...10 megohms, all ranges.

Output...Visual display, plus print control. Automatic print impulse when the meter



assumes balance. No accessories required to drive parallel input printers.

Input...115 volt, 60 cycle, single phase, approximately 75VA.

Dimensions...Control unit, 5¼" high x 19" wide x 16" deep. Readout display, 3½" high x 19" wide x 9" deep.

Weight...Approximately 40 lb.

Price...\$2,100

Write today for descriptive literature or demonstration. 5725 Kearney Villa Road San Diego 11, California



A Division of Cohu Electronics Inc.

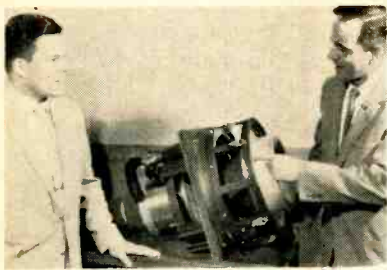

Engineers discuss 1,000-watt loudspeaker designed to check effects of high intensity sound on missiles and jet aircraft

Loudspeaker Checks Jets

A 1,000-WATT loudspeaker for research into effects of high-intensity sound on jet planes and missiles was shipped to Convair's San Diego, Calif., plant this week.

The loudspeaker, made by Stromberg-Carlson, weighs about 150 pounds. It consists of a woofer and midrange units with provisions for adding high-range tweeters.

The loudspeaker's woofer portion is driven by a 2½ pound ring magnet having a total flux in the air-gap of 696,000 maxwells. The mounting allows it to vibrate as much as two inches. Its response extends from the lower limit of audibility to 300 cps. To handle power dissipation, woofer voice coil is designed for continuous operation at 500 F. Coil is air cooled.

For midrange sounds, (300 to 2,400 cps) loudspeaker also includes a high-powered acoustical compression driver, coaxial horn.

For further possible use, special tweeters have been designed. These will extend the loudspeaker range to 15,000 cps.

U.S. Relaxes Nickel Rules

NOW THAT nickel supplies appear adequate for both defense and civilian uses, Business and Defense Services Administration is relaxing its regulations concerning disposal of priority-acquired nickel.

HOLDERS no longer need report excess supplies. Nor do they need permission to use excess for non-defense purposes. However, unfilled defense orders must be given first call on unused nickel.

MILITARY ELECTRONICS

• **SUBROC**, Navy's submarine-launched missile that emerges from the water, flies through the air, and then dives back down into the sea again for its kill (ELECTRONICS, p 30, Apr. 4), has been assigned to Goodyear Aircraft for development under a \$65-million contract. Principle subcontractors are Librascope and Kearfott.

• **Helicopter flight control system** which holds attitude and heading accuracies within a fraction of a degree—even in turbulent air—has been developed by Sperry.

Designed for use with all types of rotary-wing aircraft, the system includes the same automatic and continuous control capabilities now provided for advanced bombers and fighters.

Complete four-axis control allows straight and level flying without assistance and provides stabilization through all maneuvering.

Automatic features of the 40-lb system include electronic trimming to compensate for loading changes, automatic turn coordination and pushbutton controls for precise attitude adjustment.

• **First Dynasoar vehicle**—manned rocket that will orbit the earth and land again (ELECTRONICS, p 21, June 27)—will cost an estimated \$150 million.

• **Navy will open bids**, possibly this month, for its \$60 million Naval Radio Research Observatory, scheduled to get underway before September near Sugar Grove, West Virginia.

Navy spokesmen say it will be operated under Navy management as a common service for the nation's scientific community and defense agencies (see Washington Outlook, p 12).

• **USAF is studying** the feasibility of using Holloman AFB, New Mex., for launching satellites into polar orbits, according to Gen. Leighton Davis, Commander of the Missile Development Center at Holloman.

Also, the base may be used for launching long range ballistic missiles on a high altitude course to Cape Canaveral, Fla., and on down the missile range into the South Atlantic.

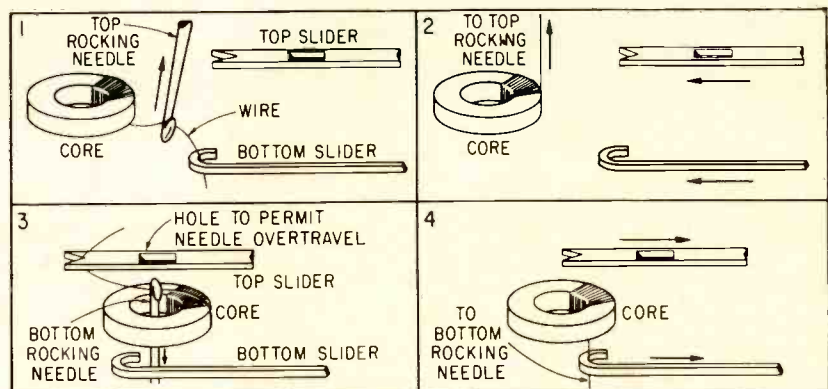

Sliders working in unison with "crocheting needles" pull free end of fine magnet wire around and through miniature cores at 120 to 200 turns a minute

Needles Wind Russian Cores

Size of demonstration toroids (⅛ in. o-d) indicates USSR's miniaturization progress

MINIATURE TOROIDAL CORE winder shown at the International Automation Exhibition in New York recently did not require the wire

to be prewound on ring bobbins.

The machine was part of the USSR Chamber of Commerce exhibit. Several electronics firm em-

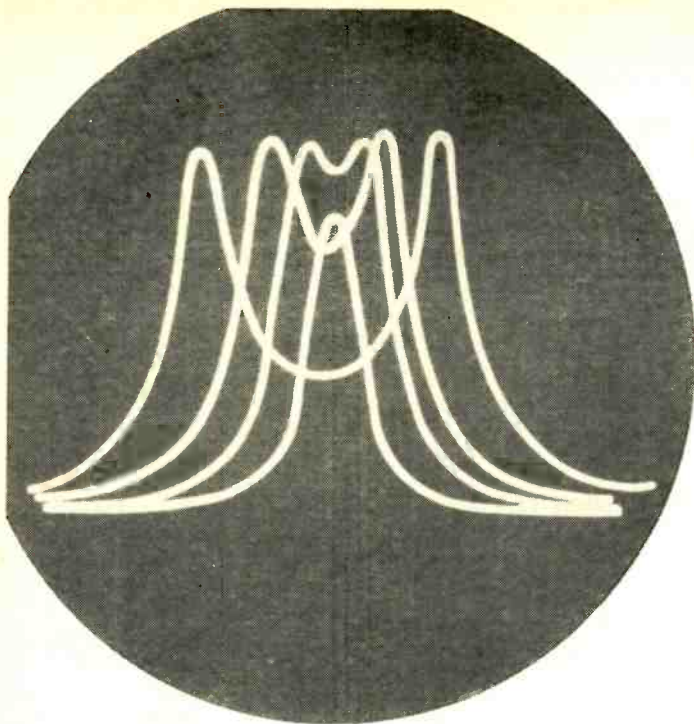

HUGHES... pioneer and largest producer of storage tubes



The MEMOTRON®

Type 6498 tube displays successive transient writings until intentionally erased. Careful analysis and comparison of wave forms now becomes possible without photography.



The TYPOTRON®

Type 6577 tube is the first commercially available storage tube which displays until intentionally erased, any combination of 63 symbols or characters at speeds of 25,000 characters per second.

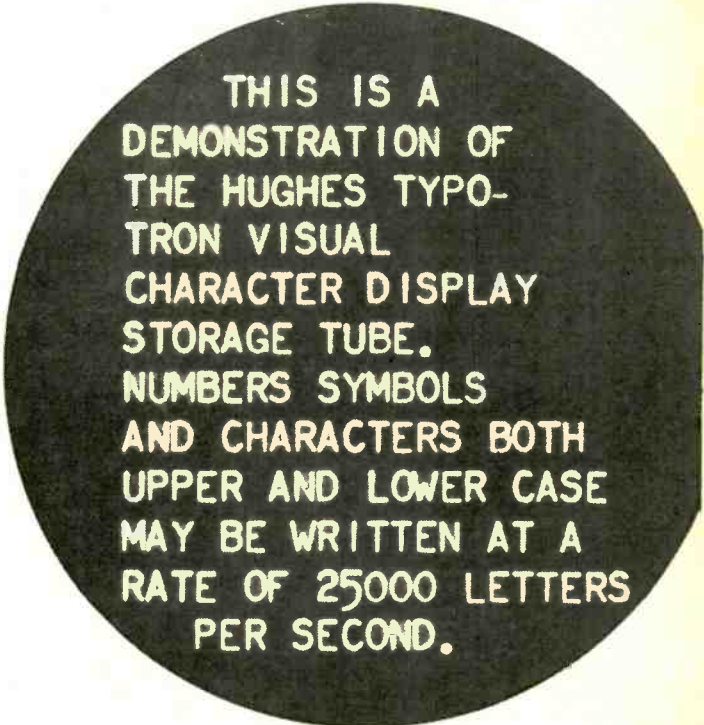

THIS IS A
DEMONSTRATION OF
THE HUGHES TYPO-
TRON VISUAL
CHARACTER DISPLAY
STORAGE TUBE.
NUMBERS SYMBOLS
AND CHARACTERS BOTH
UPPER AND LOWER CASE
MAY BE WRITTEN AT A
RATE OF 25000 LETTERS
PER SECOND.



The TONOTRON*

Type 7033 Magnetic Deflection tube at left presents a complete spectrum of gray shades for use in weather radar and PPI information. Tonotron tubes also available in 3 and 5-inch Electrostatic versions, ideally suited for "B" scan projections and complex radar systems.



Currently being widely used in both military and commercial systems, these cathode-ray tubes have established outstanding records of reliability. New storage tubes are under development for an ever-increasing range of applications. Across the country, Hughes engineers are available to discuss the applicability of these tubes to your problems. For further information please write: HUGHES PRODUCTS, Electron Tubes, International Airport Station, Los Angeles 45, California, or contact our local offices in Newark, Chicago or Los Angeles.

Creating a new world with ELECTRONICS

HUGHES PRODUCTS

© 1958. H. A. C.

*Trademark, H. A. C.

ployees who saw it remarked that the size of the demonstration cores ($\frac{1}{8}$ -inch o-d) and the machine's existence testified to Russian miniaturization progress.

The machine winds insulated wires of 0.05 to 0.11 mm diameter on cores with inside diameters of 2 to 3 mm (0.08 to 0.12 inch). It occupies little more than a square foot of bench space, winds at 120 to 200 turns a minute and will turn out 40 cores with two 50-turn windings in an hour.

Winding is done by two rocking needles, similar to crocheting needles, and two sliders. The top slider has a notch to push the wire over the top of the core. The bottom slider has a semicircular end to pull the wire under the bottom of the core.

The basic motion of the machine is shown in the diagrams. The free end of the wire is drawn around the core in discrete steps during each cycle of the machine.

The rocking needles ride almost a full circle in a drum in the machine case. The drum is 6 or 7 inches in diameter in the model (Type HC-E) shown. Full circle, rather than reciprocating, action apparently gives enough travel to the free end of the wire. Maximum length of wire is 350 mm (14 inches).

The toroids lay on a roller bed consisting of 3 rotating pins with formed rubber heads. The rollers rotate the cores during winding. A lever system will spread the pins to accept several sizes of cores.

Cores are fed to the roller bed by a tube in which 50 to 70 cores are loaded on a center post. Finger pressure on top of the tube extends the post to the roller bed. The rollers grasp the bottom core and it slips over springs on the post as the post retracts.

After loading a core, the operator strips sufficient wire off a supply spool in the machine. He turns the winding mechanism with a hand wheel until the rocking needles engage the wire, then turns on the 10 w, 2,000 rpm drive motor. A counter switches off the machine on completion of a preset number of turns. By doubling up the mechanism, 2 cores may be wound with one end of wire.

FINANCIAL ROUNDUP

- **Litton Industries**, Beverly Hills, Calif., plans to add another string to its bow through acquisition of **Airtron**, Inc., of Linden, N. J. Proposed agreement calls for exchange of all Airtron stock for undisclosed amount of Litton common and preferred stock. If consummated, the merger, planned for August 1, will be number 18 for Litton. Airtron produces a line of specialized microwave products used in advanced missile, aircraft and ground installations. The firm's annual sales rate is about \$10 million. Litton's sales for the first nine months of its fiscal year ending July 31 were \$61.5 million. It looks for sales in excess of \$100 million in the coming fiscal year.

- **Consolidated Electrodynamics** president Philip S. Fogg told members of the New York Security Analysts recently that excess manufacturing capacity is eating into

firm's earnings. Consolidated anticipates total sales of \$30 to \$35 million in 1958 but has capacity to produce enough products for sales of \$40 to \$45 million. The Pasadena, Calif., firm lost \$56,000 in year's first quarter and will be lucky to break even in the second quarter, Fogg said.

- **National Credit Office** analysis of radio-television-electronic manufacturers' earnings shows total sales of 14 large companies in the first quarter of 1958 were off six percent from last year, \$669.4 million against \$746.6 million, while earnings were off 42 percent, \$14.4 million compared with \$24.7 million. Comparison by NCO of total sales and earnings of 50 electronic companies for years 1957 and 1956 showed sales were up seven percent, \$3.6 billion vs. \$3.4 billion, while earnings were up 9.2 percent, \$97.0 million against \$88.7 million.

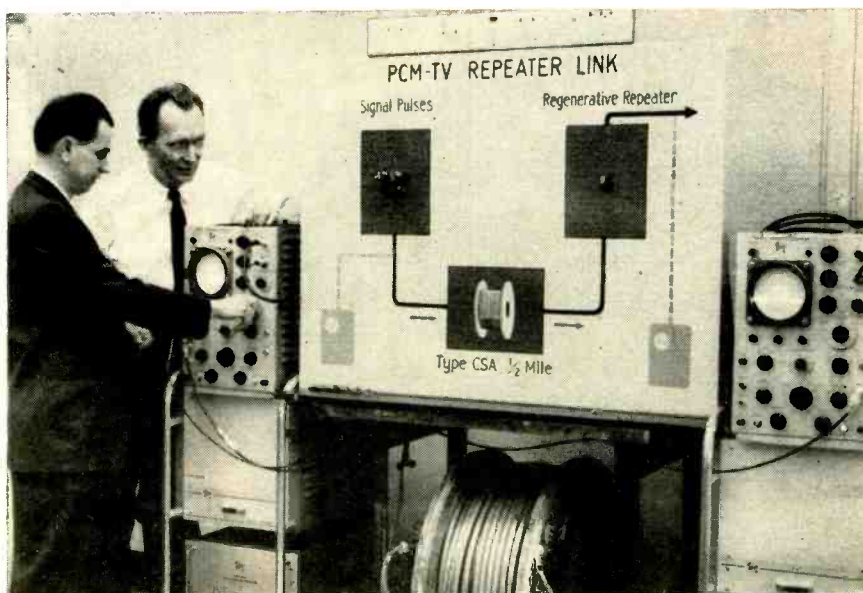

Sending pulse-code-modulated tv signals (left) through telephone cables and reproducing signals exactly (right) may be a highlight in . . .

Transistors: Next 10 Years

TRANSISTORS, despite rapid acceptance since 1948, still have unrealized potentials. Their second decade, starting now, promises, among other things, reduction in

unit cost and increased reliability.

During Bell Lab's recent 10th anniversary celebration of its invention of the transistor, the firm's spokesmen emphasized that the

CERAMIC-JACKETED FOR POSITIVE MOISTURE PROTECTION
MADE TO MEET ALL MIL-R-10509B REQUIREMENTS

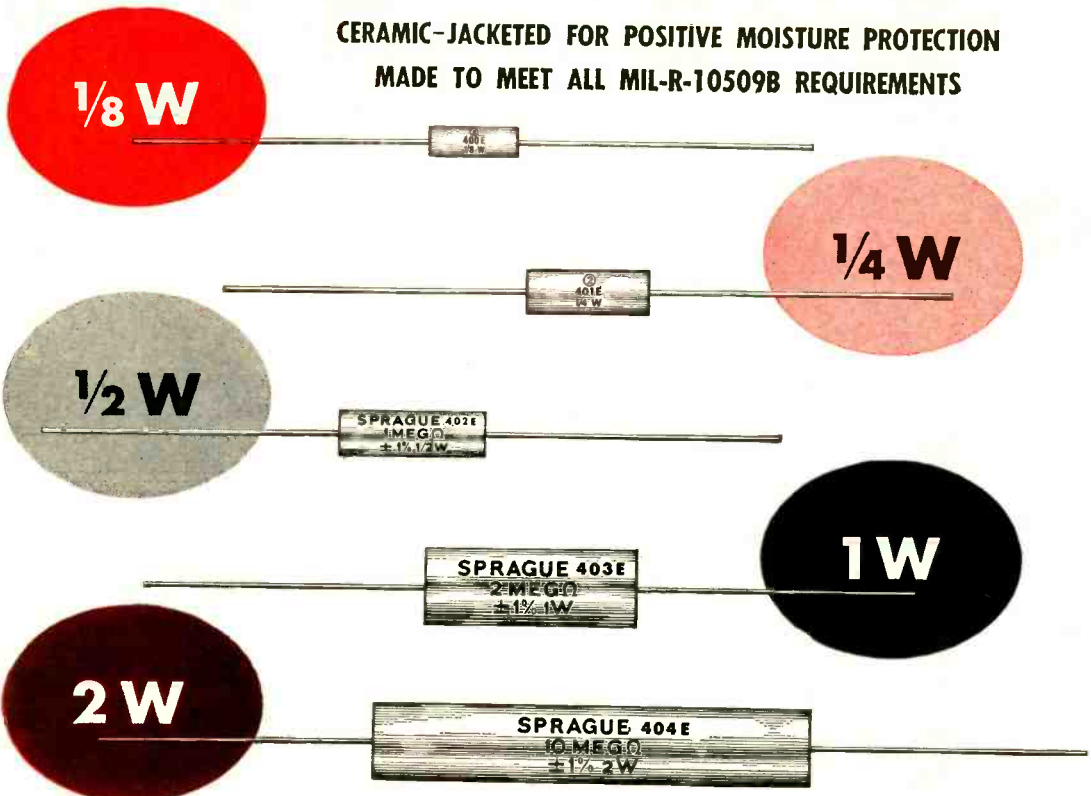

FILMISTOR[☆]
CARBON FILM RESISTORS
 IN RATINGS FROM
1/8 TO 2 WATTS PROVIDE THE STABILITY YOU WANT UNDER THE TOUGHEST LOAD AND HUMIDITY CONDITIONS

WRITE FOR BULLETIN NO. 7010A • SPRAGUE ELECTRIC COMPANY
35 MARSHALL STREET • NORTH ADAMS, MASSACHUSETTS



☆ TRADEMARK REG.

- SPRAGUE COMPONENTS:** RESISTORS • CAPACITORS • MAGNETIC COMPONENTS • TRANSISTORS
 INTERFERENCE FILTERS • PULSE NETWORKS • HIGH TEMPERATURE MAGNET WIRE • PRINTED CIRCUITS

semiconductor industry is just on the threshold of maturity. Even without further new discoveries or developments, they say, the dollar volume of transistor sales should exceed \$500 million by 1968. It is expected the associated diode market will at least equal and perhaps exceed that of transistors.

Unit cost of transistors will also come down. Average price in 1958 is estimated at about \$2.30. By 1968 this should shrink to \$0.70. Transistors used in the entertainment area—radio, television and the like—may drop in cost from present \$1 to \$0.35 per unit.

Top challenge facing researchers: development of cheap, adequate surface protection techniques.

New materials which will come to the fore in the next decade are indium phosphide and gallium arsenide. These intermetallic compounds permit operation at tem-

peratures of between 300 to 400 C while providing wide frequency range and broad bandwidth.

Devices will be developed which capitalize on avalanche multiplication and electronic voltage breakdown phenomena exhibited by *p-n* junctions. This achievement will produce transistors having time constants between 10^{-11} and 10^{-12} sec. Voltage regulators already developed operate through use of these breakdown effects. It is also possible, by confining this effect to a single microscopic region of the crystal, to generate microwave energy. Such a device could then be adapted to amplification applications in the millimeter wavelength range. Also, light emission properties of *p-n* junctions when operated in the avalanching reverse biased condition may be used to interrogate million-bit photographic plates.



Control tower operator (left)—his vision blocked by hangar—uses remote camera to check runway activity

Airport Tv Ends Blind Spot

THIS WEEK control tower personnel at New York's LaGuardia Airport began using closed circuit tv to observe one of the field's major runways. View of this portion of the field is blocked by hangars.

At end of 5,000-ft instrument runway, a tv camera now picks up all traffic activity. The camera uses a telephoto lens fixed at infinity.

A housing 200 feet away from camera enclosure contains control equipment operated from tower.

Coaxial cable designed to provide

shielding against great amount of radio transmission activity on the field connects the three points in the system.

A light compensation unit in control section provides automatic iris control for 24-hr operation.

Equipment for the system was designed by Allen B. DuMont Laboratories. Installation was by Sound Systems, Inc., New York, N. Y. Materiel costs for similar systems at other airports would be about \$12,000.

MEETINGS AHEAD

July 16-18: Forestry Conservation Communications Assoc. (FCCA), Ninth Annual Conf., Parker House, Boston, Mass.

Aug. 1-3: Texas Electronic Clinic and Fair, Statler-Hilton Hotel, Dallas, Texas.

Aug. 6-8: Special Tech. Conf. on Non-linear Magnetics and Magnetic Amplifiers, AIEE, Hotel Statler, Los Angeles.

Aug. 13-15: Conf. on Electronics Standards and Measurements, AIEE, IEE, NBC, National Bureau of Standards Labs., Boulder, Colo.

Aug. 13-15: Seventh Annual Conf. on Industrial Applications of X-ray Analysis, Denver, Colo.

Aug. 18-23: International Conf. on Semi-Conductors, International Union of Pure and Applied Physics, Rochester, N. Y., Contact: M. H. Hebb, GE, P.O. Box 1088, Schenectady, N. Y.

Aug. 19-22: Western Electronic Show and Convention, Los Angeles, Calif., WESCON, IRE, WCEMA, Pan Pacific Auditorium, Ambassador Hotel, L. A.

Aug. 25-29: Electronic Properties of Metals at Low Temperatures, International Union of Pure and Applied Physics, Geneva, N. Y., Contact M. D. Fiske, GE, P.O. Box 1088, Schenectady, N. Y.

Aug. 26-Sept. 6: British National Radio Show, Radio Industry Council, Earls Court, London.

Sept. 3-5: Application of Electrical Insulation, First National Conf., AIEE, NEMA, Cleveland, Ohio.

Sept. 12-13: Communications Conf., IRE, Sheraton Monroe Hotel, Cedar Rapids, Iowa.

Sept. 15-19: Thirteenth Annual Instrument-Automation Conf. and Exhibit, ISA, Philadelphia Convention Hall, Pa.

Sept. 22-24: National Symposium on Telemetering, Americana Hotel, Miami Beach, and Patrick Air Force Base (Sept. 25).

Sept. 24-25: Seventh Annual Symposium on Industrial Electronics, Rackham Memorial Auditorium, Detroit, Michigan.

Oct. 1-2: Radio-Interference Reduction, U. S. Army Signal Research & Devel. Labs., IRE, Armour Research Foundation, Chicago, Ill.

Oct. 6-7: Symposium on Extended Range and Space Communications, IRE and George Washington Univ. Lisner Auditorium, Wash., D. C.

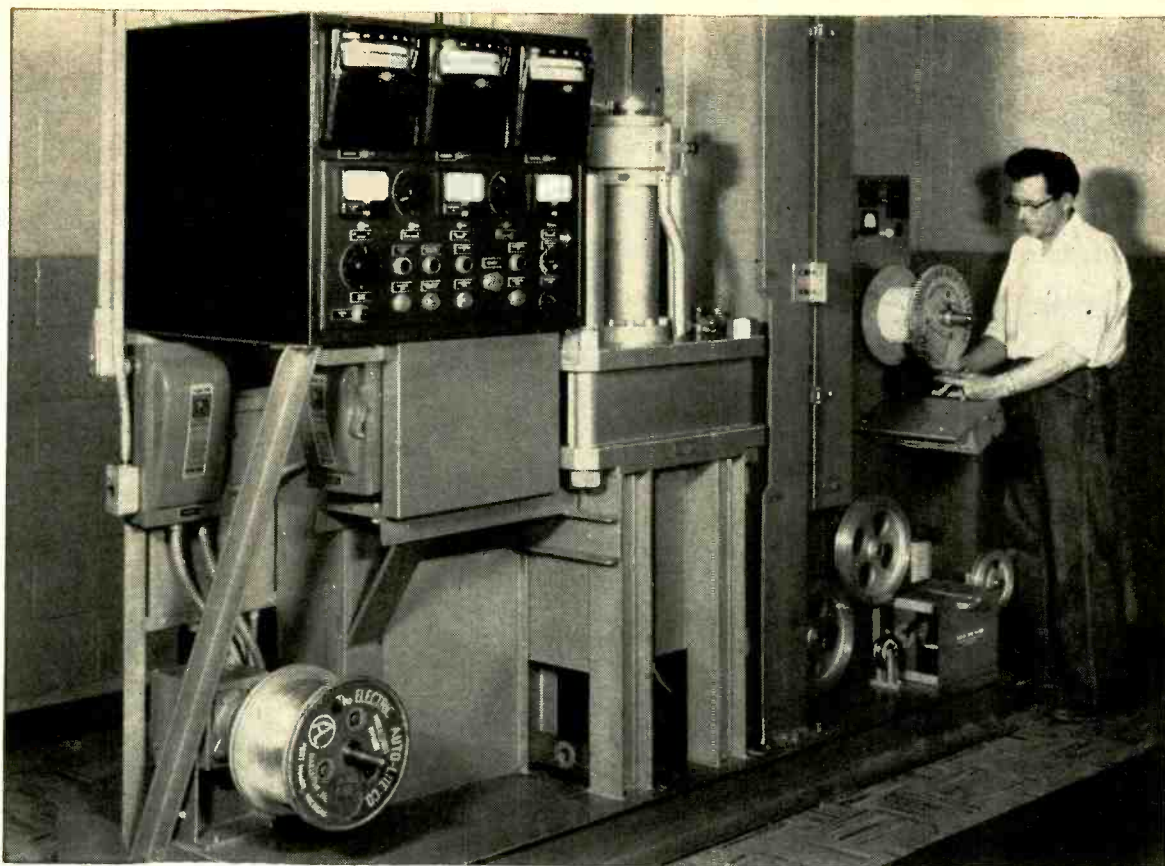

NOW! AN ENGINEERED AND CONTROLLED TEFLON* WIRE

Auto-Lite engineering, plus constant laboratory checking and rigid quality controls assure you of the finest quality Teflon insulations.

Teflon tetrafluoroethylene resins, as applied by Auto-Lite, meet the standards of MIL-W-16878B, Types E and EE, and Class H as designated by AIEE. Teflon wire insulation by Auto-Lite can operate continuously at temperatures higher than 400°F and lower than -80°F and still maintain excellent dielectric properties.

Because of Teflon's high dielectric characteristics, thin wall insulation is effective in simplifying miniaturized component part assemblies. Teflon insulation will not burn, melt or decompose at soldering temperatures; soldering is easier and the danger of accidental grounding minimized.

Auto-Lite applications of Teflon insure a non-inflammable insulation, completely unaffected by sunlight or outdoor weathering. Teflon resins resist corrosion, the growth of fungus, and are free from water absorption by A.S.T.M. test D570-42.

Auto-Lite is equipped to supply extruded or taped types of Teflon insulations in a choice of colors. When you buy Auto-Lite, you buy precision engineering, laboratory and production controls that Auto-Lite uses to manufacture all of its wire and cable products.

*Teflon—Registered trademark of E. I. du Pont de Nemours & Co. (Inc.)

QUICK DELIVERY FROM THESE PLANTS AND WAREHOUSES:

- Port Huron, YUkon 5-6131
- Yonkers, New York, OXford 7-7440
- Chicago, Illinois, WEbster 9-3144
- Hazleton, Pa., GLadstone 5-4781
- Los Angeles, Calif., FAculity 1-2184
- Cincinnati, Ohio, PRinceton 1-8100

AUTO-LITE®

For further information on any of these products write...

THE ELECTRIC AUTO-LITE COMPANY
TOLEDO 1, OHIO

WIRE & CABLE ▶ SPECIAL FABRICATIONS ▶ INSTRUMENTS
PLASTICS & NON-METALLICS ▶ FOUNDRY GROUP

now, with basic modules build...

DIGITAL VOLTMETERS



DIGITAL OHMMETERS



DIGITAL RATIO METERS

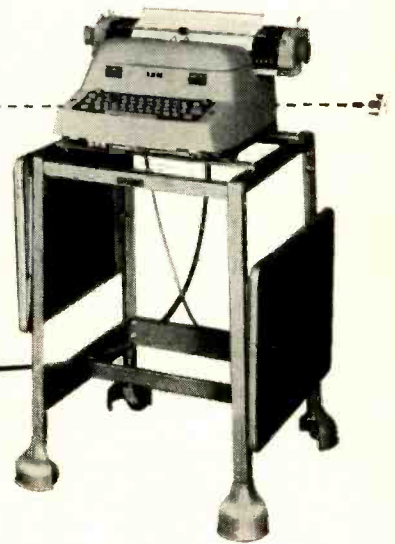

or a COMPLETE DIGITAL, MISSILE ELECTRICAL CHECKOUT SYSTEM

for measuring DC to 0.01%, AC to 0.1%, Ohms to 0.01%, DC ratios to 0.01% and AC ratios to 0.02%

Standard, off-the-shelf modules never become obsolete—provide maximum versatility. As needs change, simply regroup old modules or add new ones. Your system is always current at minimum cost and engineering. Internal construction is also modularized for ease of maintenance.

Fully transistorized circuits result in increased reliability, reduced power consumption, low heat dissipation, miniaturized packages, and eliminate radio noise and line transients.

Important new specifications—Wider, dynamic ranges cover all voltages from 100 microvolts to 1,000 volts; resistance from 10 milliohms to 10 megohms. Input power frequencies from 50 to 400 cycles. New balance logic speeds down ranging. Automatic AC ranging from 30 to 10,000 cycles. Use of transistors increases switch life by a factor of three.

Wide selection of input and output modules for operating printers, IBM punches, etc., can be accommodated without modifications. All contacts are accessible at rear panels with connectors. With plug-in modules, digitized data is provided in printed form, punched cards or tape without modification to basic measuring instruments.



This Short Form Catalog gives complete specifications on both basic and auxiliary modules. Send for it... today.

ELECTRO INSTRUMENTS
INC.

3794 Rosecrans Street
San Diego, California

A
F
V
H
F



EIMAC FIRST

Covering the Spectrum with Reliable Ceramic Tubes

U
H
F

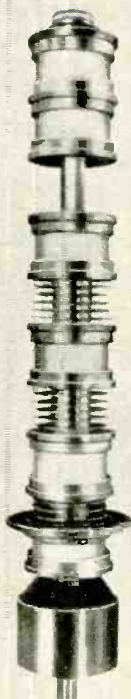

From audio into super high frequencies, Eimac covers the RF spectrum with modern ceramic tubes. This incomparable ceramic electron tube family — more than one-third of the Eimac line — includes reflex and amplifier klystrons, negative grid tubes, rectifiers, pulse modulators, and receiving tubes. The tubes illustrated are typical of more than 40 Eimac ceramic tube types that are being selected by leading equipment manufacturers for use in all types of applications — from tropo-scatter to industrial heating, from single sideband to pulse. The advantages of reliable Eimac ceramic tubes include: resistance to damage by impact, vibration, and heat; smaller size; and better processing techniques.

S
H
F

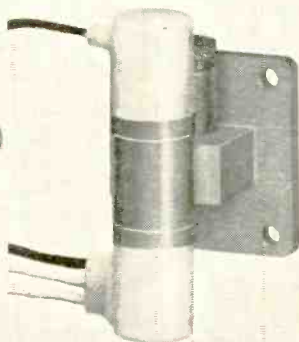
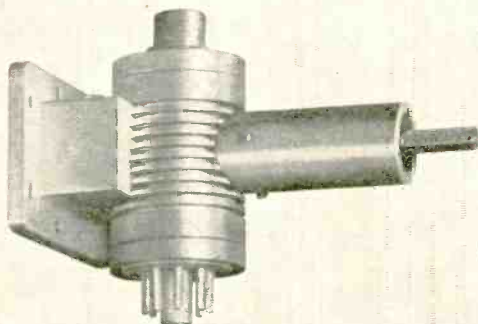

EITEL-McCULLOUGH, INC.
SAN BRUNO, CALIFORNIA

Eimac First with ceramic tubes that can take it

- PRODUCTS DESIGNED AND MANUFACTURED BY EIMAC
- Negative Grid Tubes
 - Reflex and Amplifier Klystrons
 - Ceramic Receiving Tubes
 - Vacuum Tube Accessories
 - Vacuum Switches
 - Vacuum Pumps
- Includes the most extensive line of ceramic electron tubes

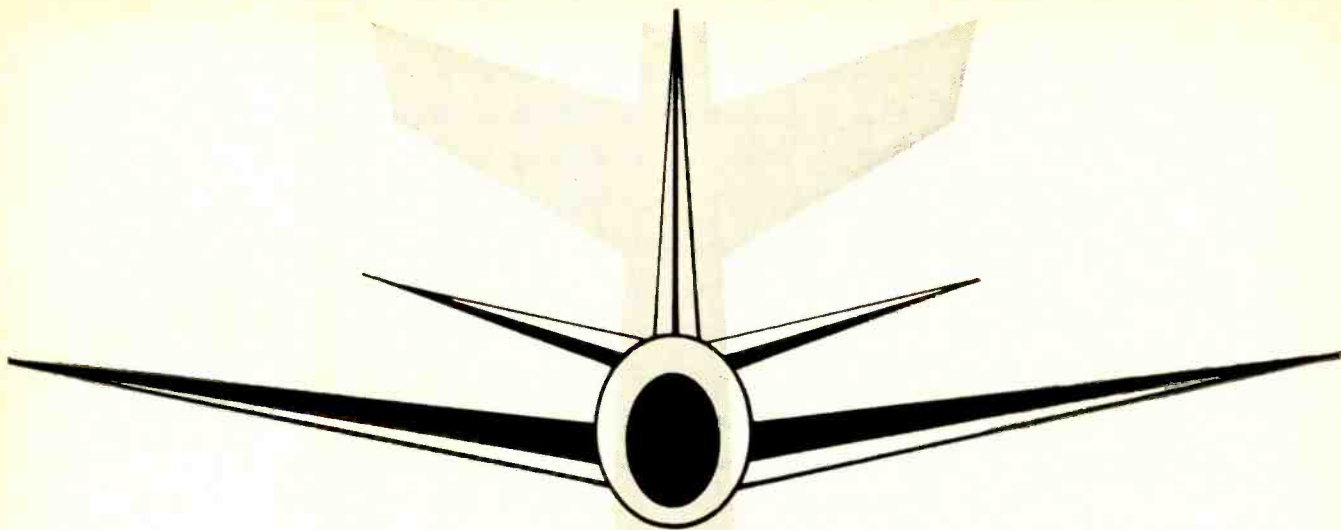

DESIGNED TO FLY

Especially designed to meet the rigid size and weight requirements of airborne instrumentation, Statham's new strain gage carrier amplifiers are transistorized throughout. Operating from normally available 28-volt DC excitation, these units supply excitation to any strain gage transducer of desired range, amplifying and demodulating the transducer's low-level signals to provide an output of from 0 to 5 volts DC. When you require unprecedented accuracy and reliability in the amplification of signals from your strain gage instrumentation, specify a Statham strain gage amplifier.



Model CA3 Strain Gage Amplifier



Model CA5 Strain Gage Amplifier

EXCITATION: 28 volts DC, $\pm 5\%$
OUTPUT: 0-5 volts DC
FREQUENCY RESPONSE: Flat from 0 up to 2000 cps
NON-LINEARITY AND HYSTERESIS: $\pm 1/2\%$
OPERATING TEMPERATURE: -65° to $+165^{\circ}$ F.
OUTPUT IMPEDANCE: 10K ohms (100K recommended load)
WEIGHT: 14.5 ounces, approximately

For complete technical data, write to:

Statham

INSTRUMENTS, INC.

12401 W. Olympic Blvd., Los Angeles 64, California

**AND NOW
FULLY
ENCAPSULATED!**

**NEW
SUBMINIATURE
BURNELL
ADJUSTOROID^{*}
HANDLE BIG JOBS**

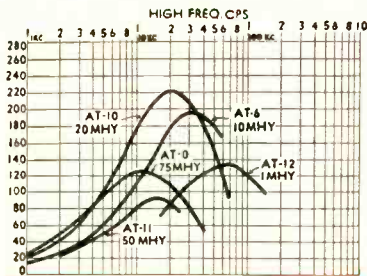

typical Q vs. frequency characteristics

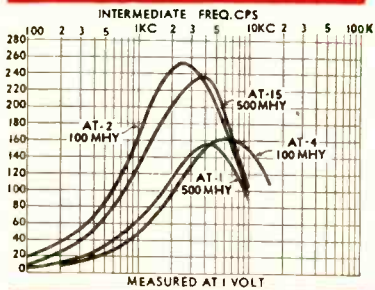

typical Q vs. frequency characteristics

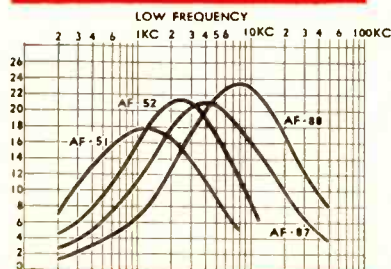

typical Q vs. frequency characteristics

*PAT. 2,782,020

The new subminiature Burnell Adjustoroids utilizing an ingenious patented method of magnetic biasing cover a wide range of frequencies, occupy less space and are available at low cost.

New Burnell Adjustoroids possess all the outstanding characteristics of non-adjustable toroids including:

Precise continuous adjustment of inductance over a 10% range.

No need for external control current.

Hermetic sealing to meet Government MIL E # 15305-A specifications.

If your Adjustoroid needs can't be met from our stock catalogue, we'll be glad to manufacture to your specifications.

	Length/ Dia.	Width	Hgt.	Wt.	Useful Freq. Range	Max Q	Max L in hys
AT-0	1 1/16		1"	2 oz	1 kc to 20 kc	10 kc	3 hys
AT-1	1 3/4	1 3/4	1 1/4"	7.25 oz	2 kc to 10 kc	4 kc	15 hys
AT-2	2 3/4	2 3/4	2 1/4"	24 oz	Below 2.5 kc	2.5 kc	125 hys
AT-4	1 1/8		1 1/4"	4 oz	1 kc to 16 kc	6 kc	15 hys
AT-6	1 1/8		1"	2 oz	10 kc to 100 kc	30 kc	.75 hys
AT-10	1 1/8		1 1/4"	4 oz	3 kc to 50 kc	20 kc	.75 hys
AT-11	4 5/16	4 5/16	3/4"	.83 oz	2 kc to 25 kc	15 kc	5 hys
AT-12	4 5/16	4 5/16	3/4"	.83 oz	15 kc to 150 kc	60 kc	.5 hys
AT-15	1 3/32		1 7/8"	14 oz	Below 5 kc	4 kc	125 hys
AF-51	1 1/8		2"	5 oz	30 cps to 500 cps	120 cps	1000 hys
AF-52	1 1/8		2"	5 oz	50 cps to 1 kc	250 cps	1000 hys
AF-87	4 5/16	4 5/16	1 1/4"	1.7 oz	90 cps to 2 kc	400 cps	80 hys
AF-88	4 5/16	4 5/16	1 1/4"	1.7 oz	16 kc to 4 kc	800 cps	42 hys

Burnell & Co., Inc.

PIONEERS IN TOROIDS, FILTERS AND RELATED NETWORKS

Dept. E-7

EASTERN DIVISION
10 PELHAM PARKWAY
PELHAM, N. Y.

PELHAM 8-5000

TELETYPE: PELHAM 3633



PACIFIC DIVISION

720 MISSION STREET

SOUTH PASADENA, CALIFORNIA

RYAN 1-2841

TELETYPE: PASACAL 7578

CLEVITE 'BRUSH' Multi-Channel Magnetic Heads

A BASIC DESIGN FOR STANDARD REQUIREMENTS
... CUSTOM CONFIGURATIONS FOR SPECIAL APPLICATIONS

Clevite "Brush" Multi-Channel Heads offer distinct advantages for system manufacturer and user alike . . . providing comparative ease and speed of installation, alignment and replacement . . . precise dimensional uniformity . . . extremely rigid mounting.

Clevite's basic design, in 1 to 32 channel form, meets most standard customer requirements on commercial, industrial, scientific and military equipment. Slight modifications adapt them to many special applications. In addition, Clevite supplies custom designs; several are shown below.

As an independent magnetic head specialist, Clevite provides unmatched design experience and production economy. One of our specialists will be pleased to discuss your application by detailed correspondence or personal visit. Write: Product Manager, Magnetic Heads, Clevite Electronic Components, 3311 Perkins Ave., Cleveland 14, O.

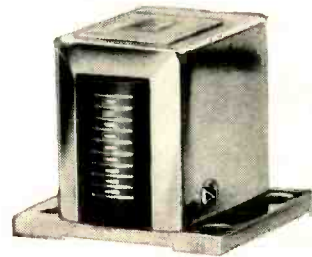

STANDARD—In 1 to 32 channels, for tape widths from ½" to 2". All-metal or epoxy faces.



REDUNDANT—Close-spaced record-reproduce head speeds data processing by reading and checking tape immediately after recording. Reduces necessary equipment and power for checking register.

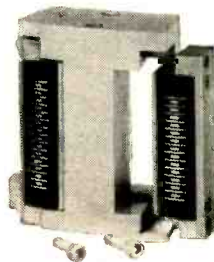

GAP-MOUNTED—Multi-channel head cartridges, easily removed and replaced with no close adjustment necessary. Bracket and cartridges have lapped surfaces providing reference positions to gap perpendicularity, azimuth and contact adjustment.



INTEGRAL BLOCK INTERLACE—Provides twice the number of channels possible with a single head of the same width. Minimum cross-talk and maximum output at no sacrifice in number of tracks. Clevite builds heads of this design to telemetering standards of spacing and performance.

Conventional, high resolution or flux-responsive performance is available in any standard or special multi-channel configuration.

**CLEVITE
ELECTRONIC
COMPONENTS**

DIVISION OF



MAGNETIC HEADS
TRANSDUCERS
PIEZOELECTRIC CRYSTALS,
CERAMICS AND ELEMENTS

For **HIGH** Insulation Resistance
and **Low Power Factor**

AEROVOX Polystyrene Capacitors
are wound with

NATVAR
Styroflex®

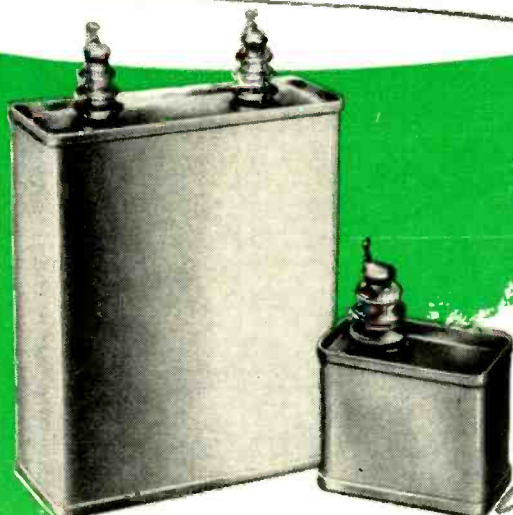

Aerovox Polystyrene Capacitors are designed for applications where stability and low dielectric absorption are essential—such as computing devices, tuned circuits demanding highest Q standards, capacitance bridges, and laboratory standards. They are available in many case styles and in capacities from 0.001 mfd to 25. mfd. and in voltage ratings from 100 VDC to 1600 VDC.

AEROVOX Corporation, with ten plants from coast to coast, have been manufacturing capacitors since 1922. As leaders in the field, they have been quick to take advantage of new and better materials, and to anticipate the demands of the fastest growing industry—electronics.

They use Natvar Styroflex because it has all of the outstanding properties of polystyrene, plus complete flexibility, toughness and uniformity.

Natvar Styroflex is available in standard thicknesses from .0004" to .006" in rolls from 1/2" to approximately 10" in width. Ask for data sheet St-1.



Natvar Products

- Varnished cambric—cloth and tape
- Varnished canvas and duck
- Varnished silk and special royon
- Varnished—Silicone coated Fiberglas
- Varnished papers—rope and kraft
- Slot cell combinations, Aboglas®
- Isoglas® sheet and tape
- Isolastane® sheet, tape, tubing and sleeving
- Vinyl coated—varnished tubing and sleeving
- Extruded vinyl tubing and tape
- Styroflex® flexible polystyrene tape
- Extruded identification markers

Ask for Catalog No. 24

NATVAR CORPORATION

FORMERLY THE NATIONAL VARNISHED PRODUCTS CORPORATION
TELEPHONE
FULTON 8-8800
CABLE ADDRESS
NATVAR: RAHWAY, N. J.
201 RANDOLPH AVENUE • WOODBRIDGE, NEW JERSEY

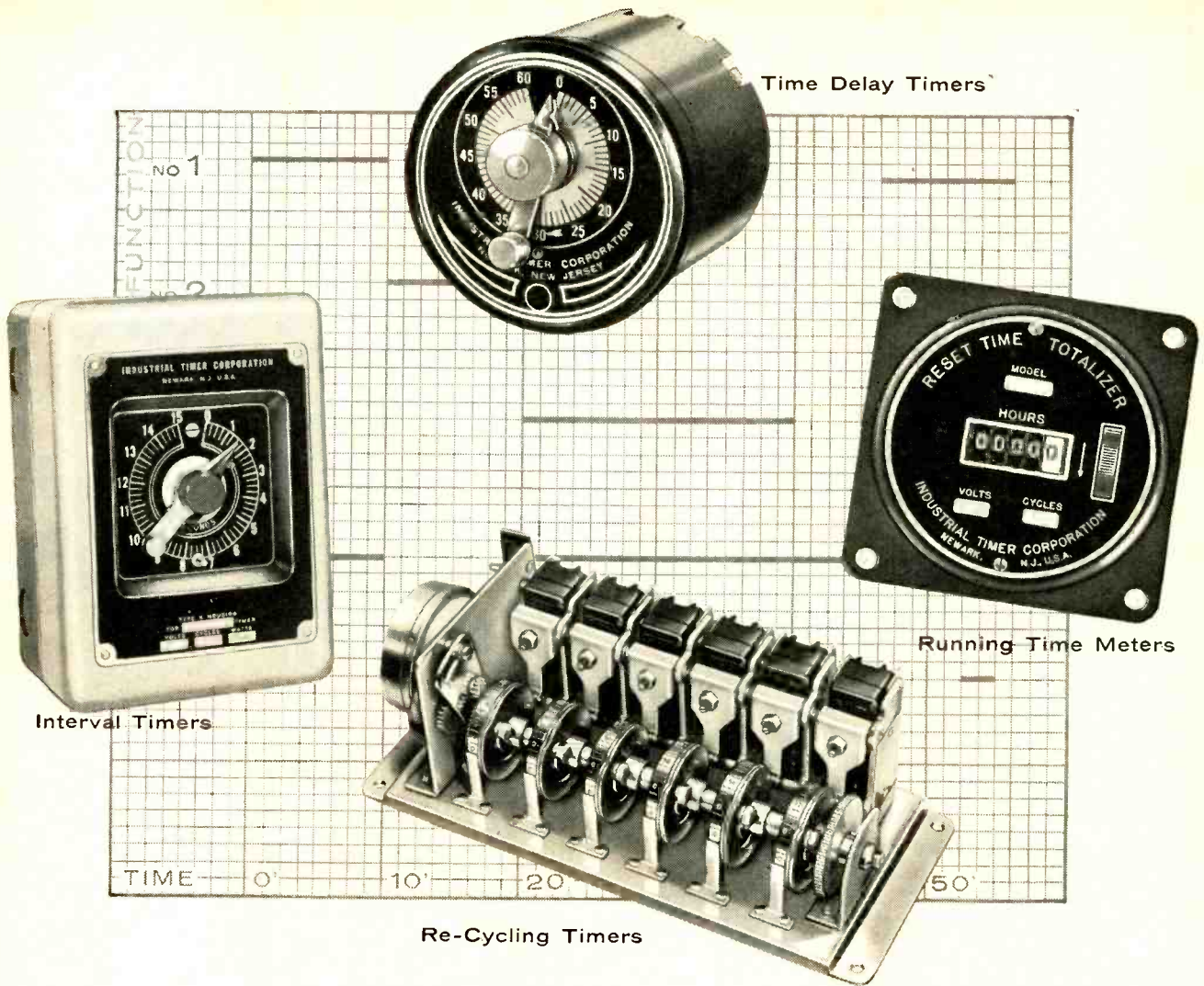

Time Delay Timers

Interval Timers

Running Time Meters

Re-Cycling Timers

Timers for Automatic Control ...Standard or Special?

You'll get quick deliveries from Industrial Timer

If slow deliveries of timers have been delaying you in your automatic control projects, try us! True, your problem may be different and difficult indeed, for no two automatic control jobs are exactly alike. But our record in helping out in situations like these is excellent. For in this field we have a valuable background, twenty years of timer experience to be exact, that has provided us with the special knowledge required to supply our customers with the right answers.

How do we do it? The answer is in what we believe to be

the largest variety of standard and combination timer units anywhere in the industry. To fill the widely varying needs of our customers, we manufacture a complete line of timers in the four broad classifications illustrated above: Time Delay Timers, Re-Cycling Timers, Interval Timers, and Running Time Meters. From these our timer engineers have developed 20 basic types which they have so far combined in over 1000 different ways. Therefore—many jobs that would seem to require a special timer, are in fact, a standard timer with us.

And our large stock assures you of rapid deliveries—even when we have to create a brand new timer for your special needs. So why not send us your specifications. You'll get a prompt reply and you may save yourself much lost motion.

AFFILIATE—LINE ELECTRIC COMPANY

*Timers that Control
the Pulse Beat of Industry*



INDUSTRIAL TIMER CORPORATION

1409 McCARTER HIGHWAY, NEWARK 4, N. J.

ALLIED'S CH RELAY

Miniature 10 Amp 4 PDT

Designed for Resistance to:

Shock—100 gravity units

Vibration—5 to 55 cps at 0.5 inch double amplitude
55 to 2000 cps at 30 gravity units

Temperature—from -85°C
to $+125^{\circ}\text{C}$

Other Specifications:

Contact Rating: 10 amperes resistive, 8 amperes inductive, at 29 volts d-c or 115 volts a-c 400 cps

Weight: 5.3 ounces

Dielectric: 1500 volts rms at sea level

Contact Resistance: .01 ohm max. initial

Contact Arrangement: Four Pole Double Throw

Now with Stabilized Construction*

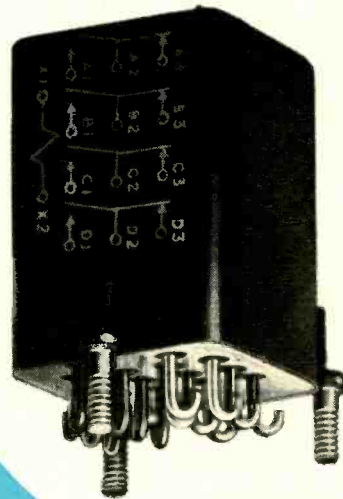

TYPE CH-12D
ACTUAL SIZE

*

Includes materials and processing necessary to minimize contact resistance variations and dielectric deterioration during life due to contact contamination, mechanical wear and shift of adjustments with temperature.

STANDARD 3 STUD MOUNTING

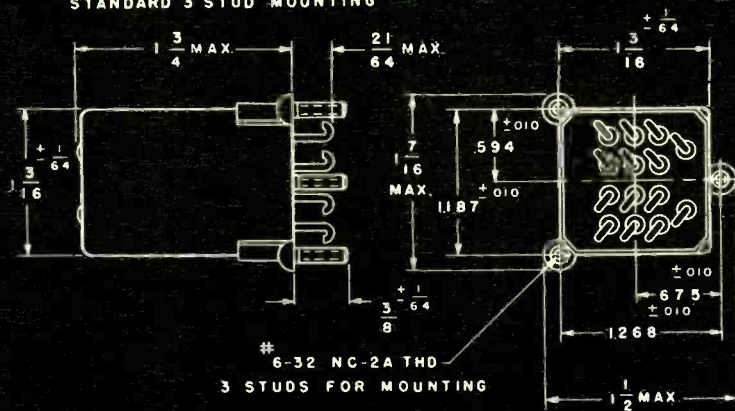

DIMENSIONAL TOLERANCES: ON FRACTIONS $\pm \frac{1}{64}$ ON DECIMALS ± 0.01

The Allied CH-12D Relay was developed to meet the more rigid requirements of vibration, shock, temperature, rupture and overload conditions of the latest MIL spec. This relay is constructed with the latest improved materials and processes available. This relay is available with other mounting arrangements, such as 4 mounting studs, 2 mounting studs or holes with Allied MHY-12D mounting dimensions. For additional information write for Bulletin CH.



ALLIED CONTROL



ALLIED CONTROL COMPANY, INC., 2 EAST END AVENUE, NEW YORK 21, N. Y.

FOR SALE

This is the Magnet Wire with the extras.....



21 different basic insulations

84 different insulation constructions

100,000+ different types and sizes

(in round, square and rectangular fabric and film coated magnet wires)

Add them up! EXTRA care in drawing and annealing—EXTRA care in insulating techniques! EXTRA rigorous "in-process" testing of wire from every machine each day plus 100% final inspection! EXTRA quick identification of size and type on easy-to-read, color coded labels... and EXTRA attention to packaging (spool, reel, and Magna-Pak®) at each of the four plants.

MAGNET WIRE DIVISION, Essex Wire Corp., Fort Wayne 6, Indiana

Manufacturing Plants: Birmingham, Alabama; Anaheim, California; Fort Wayne, Indiana; Hillsdale, Michigan

BUY ESSEX

NATIONAL NETWORK OF WAREHOUSES AND SALES OFFICES... CALL YOUR LOCAL "ESSEX MAN"

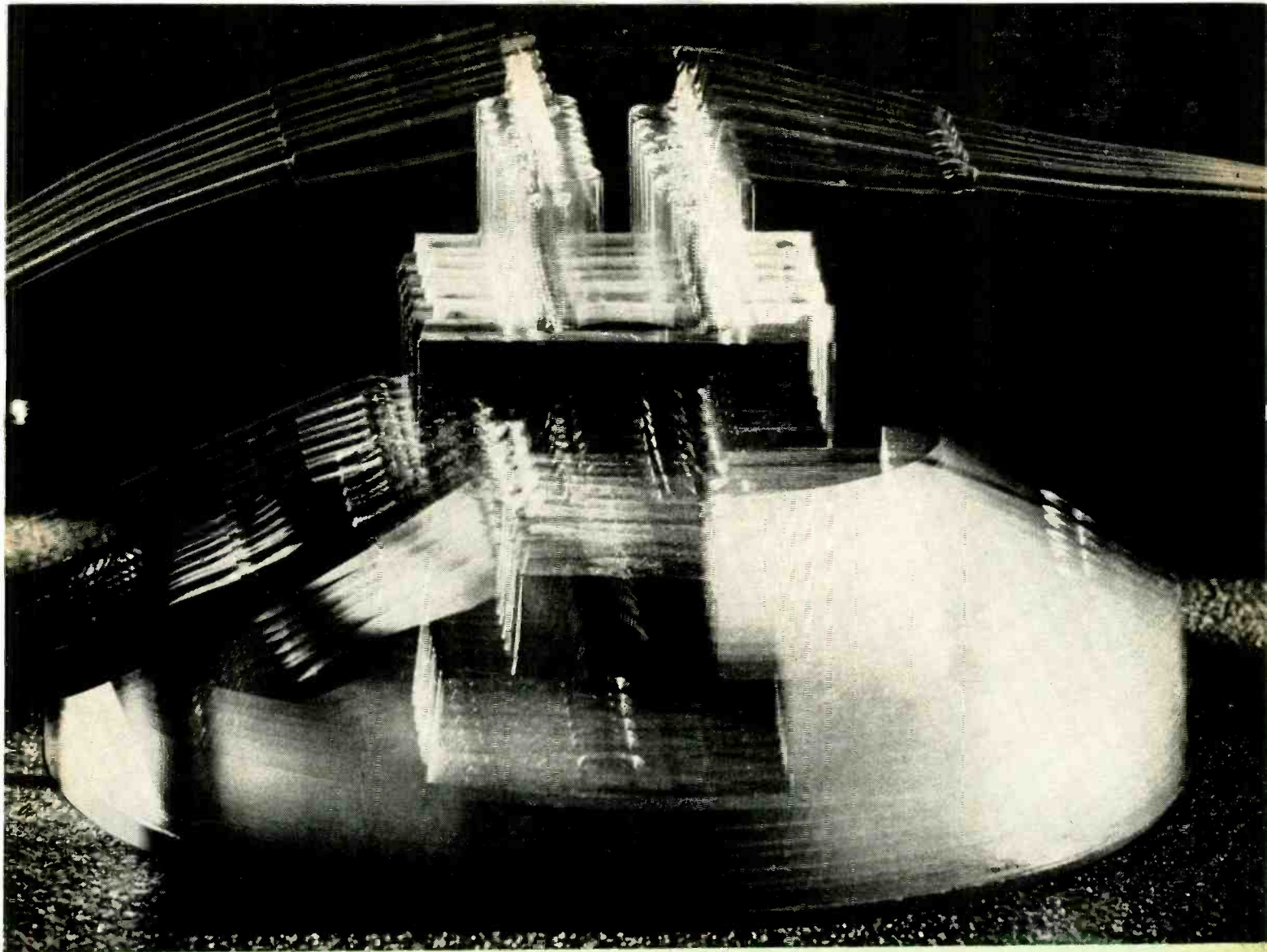

Two Type 7191's receive special "D.C. hold-off" vibration test. All Tung-Sol/Chatham miniature hydrogen thyristors — 7190, 7191, 7192 — must "hold off" while subject to 15G

vibration, swept from 50 to 2,000 cps in 4 minutes. Tubes also are shocked at 48° hammer angle in Navy high-impact flyweight shock machine, equal to 720G/1 millisecond shock.

Tung-Sol/Chatham miniature hydrogen thyristors supply test-proved ruggedness for missile use!

Extensive in-factory tests assure designers Tung-Sol/Chatham miniature hydrogen thyristors — 7190, 7191, 7192 — can withstand the severe shock and vibration met in missile flight. Performance of these tubes in several operational missiles gives in-use proof of their ruggedness.

In radar modulators and tracking beacons, these compact tough tubes supply 10 KW, replace bulkier types. Broad range of pulse repetition rates widens design choice . . . zero bias simplifies circuitry and

triggering requirements. Tubes hold off high voltage, pass high peak current with low tube voltage drop. Three types available: 7190 — pin base, 7191 — top anode connector, 7192 — flexible leads.

Tung-Sol, only producer of miniature hydrogen thyristors for missiles, can supply you immediately. For complete data on these types . . . on special-purpose tubes of all types, phone or write. Tung-Sol Electric Inc., Newark 4, New Jersey. Commercial Engineering Offices: Bloomfield and Livingston, New Jersey; Culver City, California; Melrose Park, Illinois.

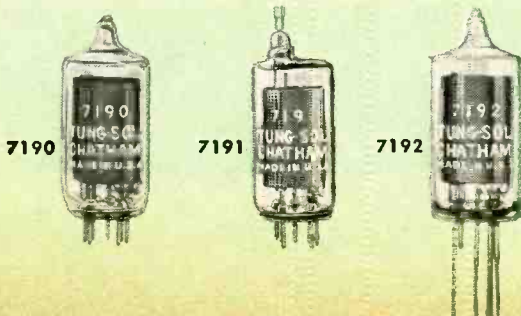

 **TUNG-SOL®**

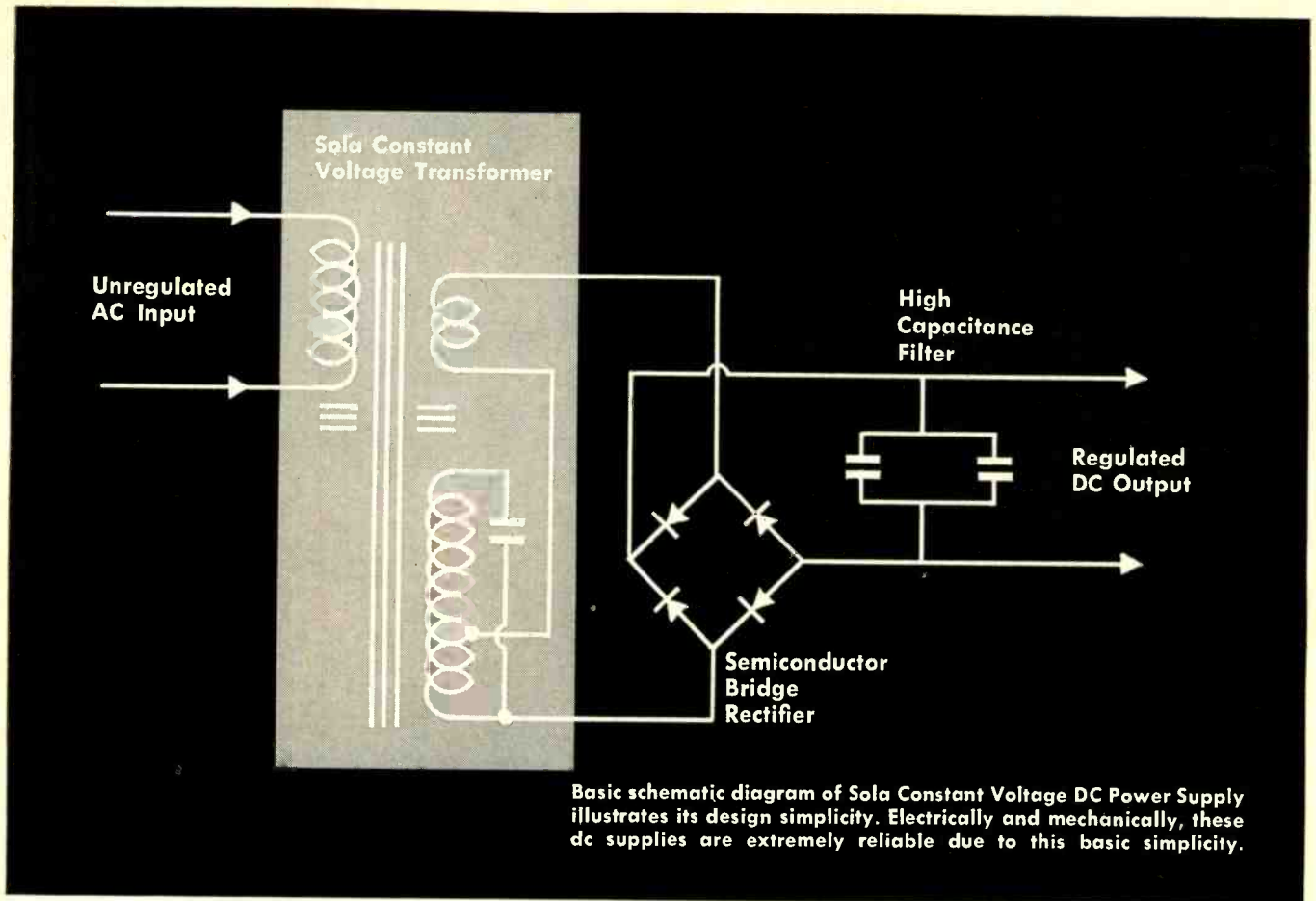

SIMPLE, regulated DC power supply

Emerson said, "To be simple is to be great," and that perfectly describes the Sola Constant Voltage DC Power Supply. If you want to keep your apparatus as simple as you can (especially if it's basically complicated) this dc supply will do it.

You needn't worry about manual adjustments or maintenance in the field. There are no moving or expendable parts . . . no tubes. The entire supply is a unique combination of three components: 1) A special Sola Constant Voltage Transformer, 2) a

semiconductor rectifier, and 3) a high-capacitance filter. It's that simple. It's extremely dependable.

Regulation is $\pm 1\%$ against line voltage variations up to $\pm 10\%$. Ripple is within 1% rms. Outputs are in the "ampere range." It's particularly well-suited for use on apparatus with pulse, intermittent, or variable loads. Efficiency is high.

The Sola Constant Voltage DC Power Supply is simple, compact, very reliable, and moderately priced.



Fixed output — six ratings available from stock



Adjustable output — six ratings from stock



Custom-designed units produced to your specs

Write for Bulletin 7G-DC-235

Sola Electric Co., 4633 W. 16th St., Chicago 50, Ill., Bishop 2-1414 • Offices in Principal cities • In Canada, Sola Electric (Canada) Ltd., 24 Canmotor Ave., Toronto 14, Ont.



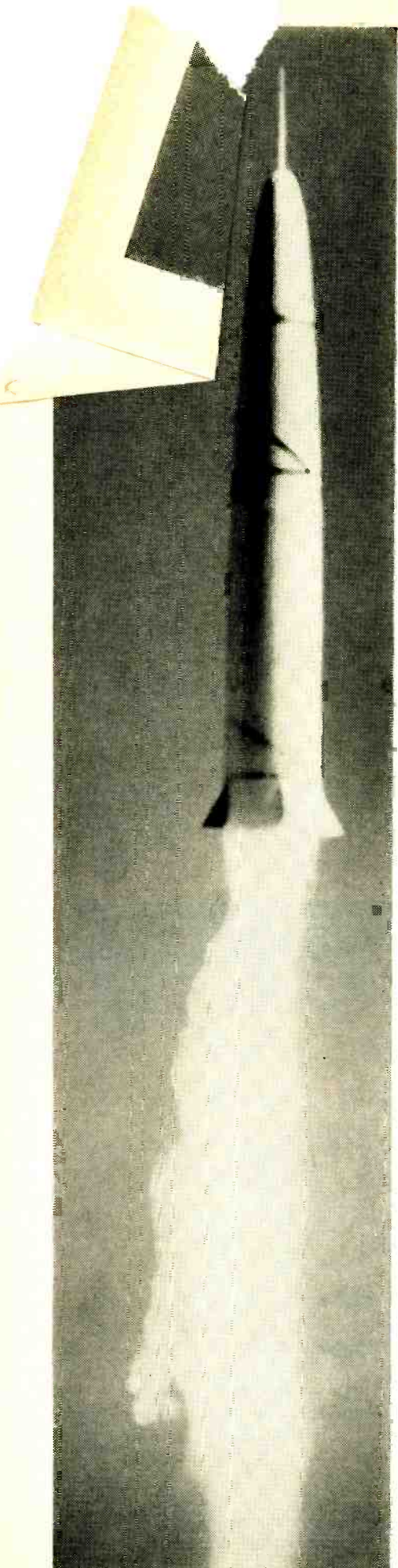

ENGINEERS—ELECTRONIC:
ELECTRICAL:

*Air Force space and operational
programs offer you
unique professional challenge
and opportunity
as a civilian*

Among the myriad current and projected programs of the U. S. Air Force lies a challenge and opportunity for civilian electronic and electrical engineers with varying degrees of specialty and experience. These areas include: the research, development and maintenance essential to sustaining qualitative superiority for the operational Air Force; research and development in IRBM and ICBM fields; the projection into outer space and return of manned, piloted vehicles. Stimulating assignments now exist for qualified men in these categories.

As an Air Force Civilian Electronic or Electrical Engineer you:

WORK... in a fine creative atmosphere... with foremost men in the field... with most modern equipment and facilities... in more than one specific program... in geographic location of your choice.

RECEIVE... assured income... low-cost life insurance... promotions from within... excellent retirement and compensation plans... protection from arbitrary separation... liberal sick and vacation leave plans.

ENJOY... expanded scope of assignment... professional prestige and recognition... job satisfaction... participation in opening new frontiers and conquering space.

For full details mail the coupon below.

Paste on Postcard and Mail or Write to:

Air Force Civilian Personnel, Dept. EL2
Box 7608, Washington 4, D. C.

Please send me further information on U. S.
Air Force Civilian Personnel opportunities.

Name _____

Degree(s) _____ Specialty _____

Address _____

City _____ Zone _____ State _____

**CHALLENGE
SCOPE
CREATIVITY**

*U.S. Air
Force*

you can
only
go ...

UP

with **missiles!**

Missiles are still in their infancy. And that precocious young child of the electronics industry—AC's Inertial Guidance System—offers one of the greatest opportunities in the entire field. Why not go up and grow up . . . with AC and with missiles? You can work* with a team of engineering experts on AC's vital and far-reaching guidance systems. Or, you can exercise your talents on the development and production of many other electronic projects that make AC a new leader in the industry. What's more, you'll enjoy the stability and security and benefits that General Motors offers all their personnel.

* If this kind of opportunity intrigues you . . . and if you are a graduate engineer in the electronic, electrical or mechanical fields—or in gyroscope design . . . AC would like to hear from you. Your inquiry will receive an interesting response from

Mr. Cecil E. Sundeen, Supervisor of Technical Employment, Dept. A,
1925 E. Kenilworth, Milwaukee 1, Wisconsin.



AC SPARK PLUG  THE ELECTRONICS
DIVISION OF GENERAL MOTORS

Producers of: AChiever Inertial Guidance Systems • Afterburner Fuel Controls • Bombing Navigational Computers
Gun-Bomb-Rocket Sights • Gyro-Accelerometers • Gyroscopes • Speed Sensitive Switches • Speed Sensors • Torquemeters

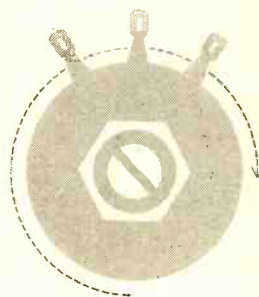
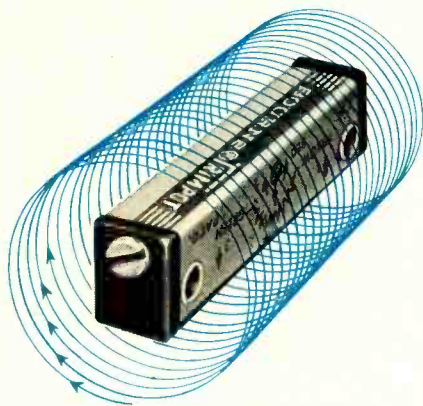

YOU GET **33 TIMES** THE ADJUSTABILITY
WITH BOURNS POTENTIOMETERS!

Compared with the conventional single-turn rotary potentiometer,¹ the adjustability of Bourns potentiometers is a 33:1 improvement.

Providing 9000° of rotation instead of 270°, Bourns potentiometers *simplify* and speed up the adjustment or balancing of circuits.

You can repeat any setting quickly and easily.

Settings are virtually immune to shock, vibration and acceleration. Translatory action of wiper provides inherent stability. The rigidly mounted wiper is driven by a threaded stainless steel shaft, which is actuated by your screwdriver. No need to recheck settings after a lock-nut is tightened. There *isn't* any lock-nut.

Available with printed circuit pins, solder lugs, or stranded insulated leads.



write for TRIMPOT
Model Summary Brochure

BOURNS

Laboratories, Inc.

P. O. Box 2112-B • Riverside, California

ORIGINATORS OF TRIMPOT® AND TRIMIT®
PIONEERS IN POTENTIOMETER TRANSDUCERS FOR POSITION, PRESSURE AND ACCELERATION

Protected by U. S. Patents 2,706,230; 2,777,926. Other Patents Pending.

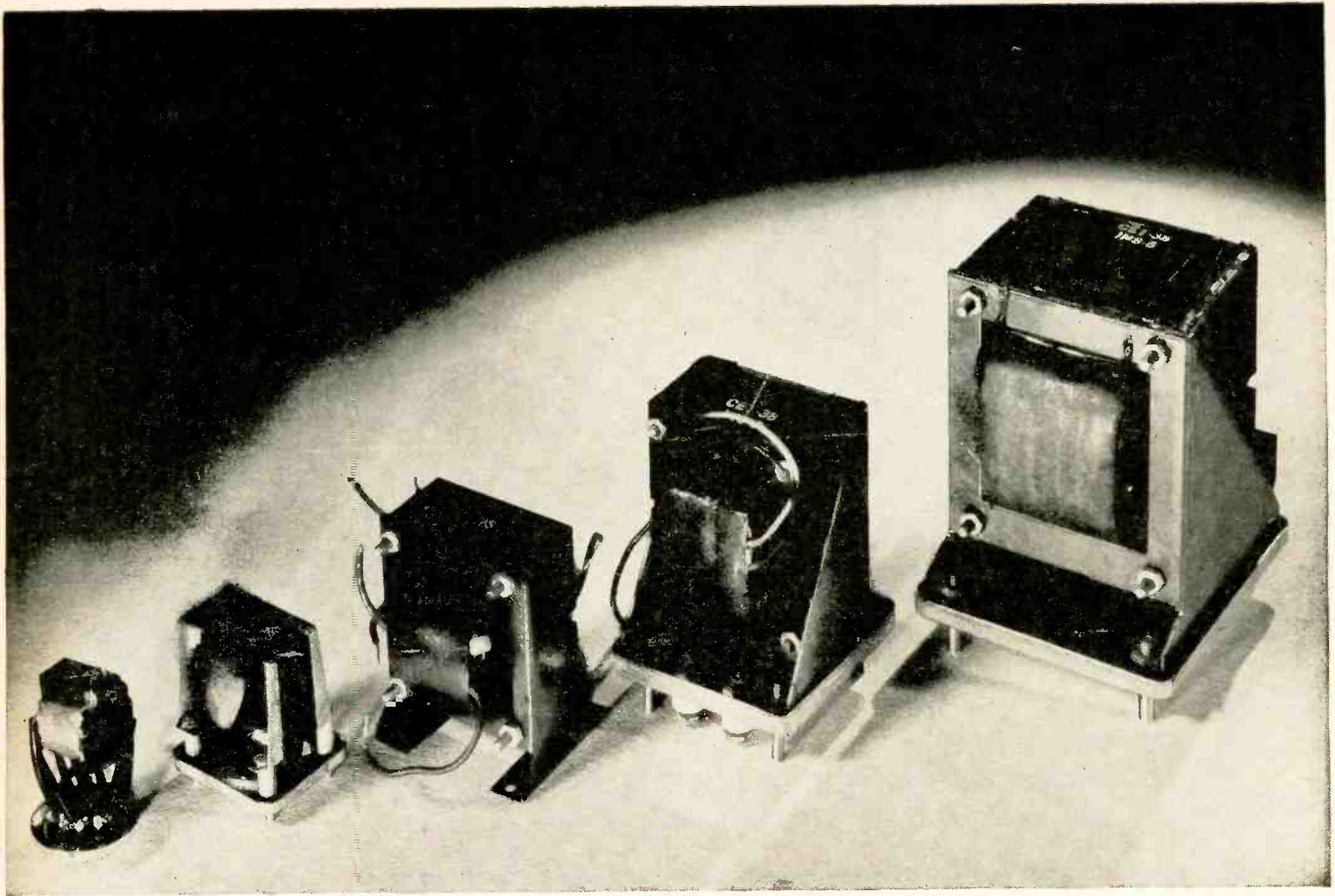

A Transformer becomes a precision device with Allegheny Magnetic Materials in the core



Write for your Copy
"TRANSFORMER LAMINATIONS"

84 pages of valuable technical data on standard and custom-made laminations from all grades of Allegheny Ludlum magnetic core materials. Prepared from carefully checked and certified laboratory and service tests — includes standard dimensions, specifications, weights, etc. Sent free on request . . . ask for your copy.

ADDRESS DEPT. E-7

- ★ ALLEGHENY SILICON STEEL
- ★ ALLEGHENY 4750
- ★ ALLEGHENY MUMETAL

The operation of a transformer is no better than the magnetic core around which it is built. With Allegheny magnetic materials in the core, you get the *best*—uniformly and consistently.

Sure there are reasons why! For one thing, there's the long experience of a pioneer in development and quality control of electrical alloys. But most important, the A-L line offers complete coverage of any requirement you may have, any service specification. It includes all grades of silicon steel sheets or coil strip, as well as Allegheny Silectron (grain-

oriented silicon steel), and a wide selection of special high-permeability alloys such as Allegheny 4750, Mumetal, etc.

In addition, our service on magnetic materials includes complete lamination fabrication and heat treatment facilities. What's more, this extensive experience in our own lamination stamping department is a bonus value for all users of A-L electrical sheets or strip. ● Let us supply *your* needs. *Allegheny Ludlum Steel Corporation, Oliver Bldg., Pittsburgh 22, Pa.*

STEELMAKERS to the Electrical Industry

Allegheny Ludlum

W&D 5333



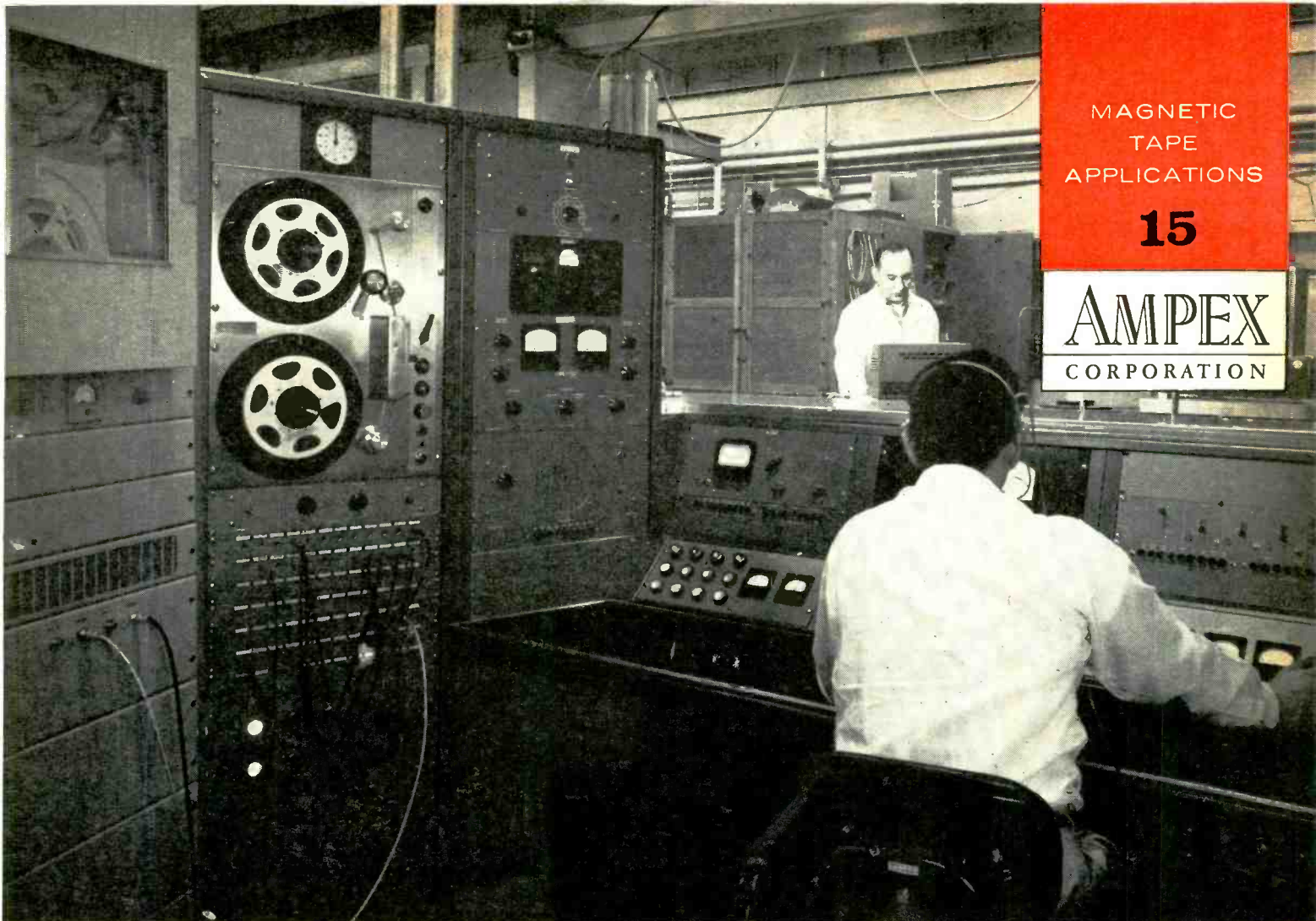

How to improve component reliability by better shake tests

Magnetic tape simplifies complex-wave testing and lessens human error



Many of the components that got their first ride on this tape-driven shaker are now circling the sky in Explorer I, our first successful earth satellite. It is highly significant that the California Institute of Technology Jet Propulsion Laboratory which led the development work on this satellite also pioneered complex-wave vibration testing. In this technique, magnetic recording plays many vital roles.

THE WAY TO OUTGUESS THE UNKNOWNNS

Is simple sine-wave vibration testing sufficient? Or is a closer simulation of the missile's actual vibration environment a necessity? Results are not the same. Sinusoidal simplification often demands knowledge more complex than the complexities of a realistic test itself. Rocket components can bear neither the weight of excess safety factors nor the risks of conjecture — reasons why JPL chose random noise and complex waves.

Telemetered vibration tapes from actual missile flights are often used on shakers to assist development of test procedures. But this is not a complete answer. Different flights yield different vibration environments. A more ideal test-programming tape is a synthesized composite or envelope of the more severe conditions from many flights. This tape often combines random noise of engine vibration and complex waves from aerodynamic properties and structural resonances. And just as the missile's mass, velocity and surrounding atmosphere will change rapidly with time — so the taped program must change too.

Once on magnetic tape, any test program stays intact. It is repeatable without tedious setup and time-varying control of separate signal sources. With a properly calibrated tape, there is little chance that an operator will accidentally create destructive forces by errors in frequency or gain settings. Tape eliminates many possible sources of human error. It also leaves personnel free to concentrate on other requirements of shaker operation and test observation.

TAPE PASSES ALONG THE "IDEAL" TEST

So that co-contractors and subcontractors will run desired shake tests correctly on the components they furnish, Caltech's JPL frequently sends them program tapes. These contain calibration data in addition to the program itself. Thus a similar shake-table setup on the other side of the country can exactly duplicate the tests run in JPL's own laboratory. The tape lessens chance of misinterpretations and additive safety factors.

As quantity production of missile components gets under way, magnetic tape offers a means to run optimum shake tests on large numbers of components at widely separated manufacturers. From copy tapes, test programs of complex waves can be run almost as easily as a simple sinusoidal scan. Individual users need not have equipment to generate their own shaker-control programs. Prime contractor or research co-contractor can furnish the tapes. And since any number of duplicates can be made, a well-conceived test program can have unlimited circulation.

May we send you our 16-page brochure on magnetic-tape instrumentation plus further information on the use of tape for vibration testing? Write Dept. E-11.

FOR WIDER USEFULNESS . . . IMPROVED PERFORMANCE
 . . . GREATER RELIABILITY IN OSCILLOGRAPHIC RECORDING

THE
NEW SANBORN "350" SERIES
 6- AND 8-CHANNEL

DIRECT WRITING SYSTEMS

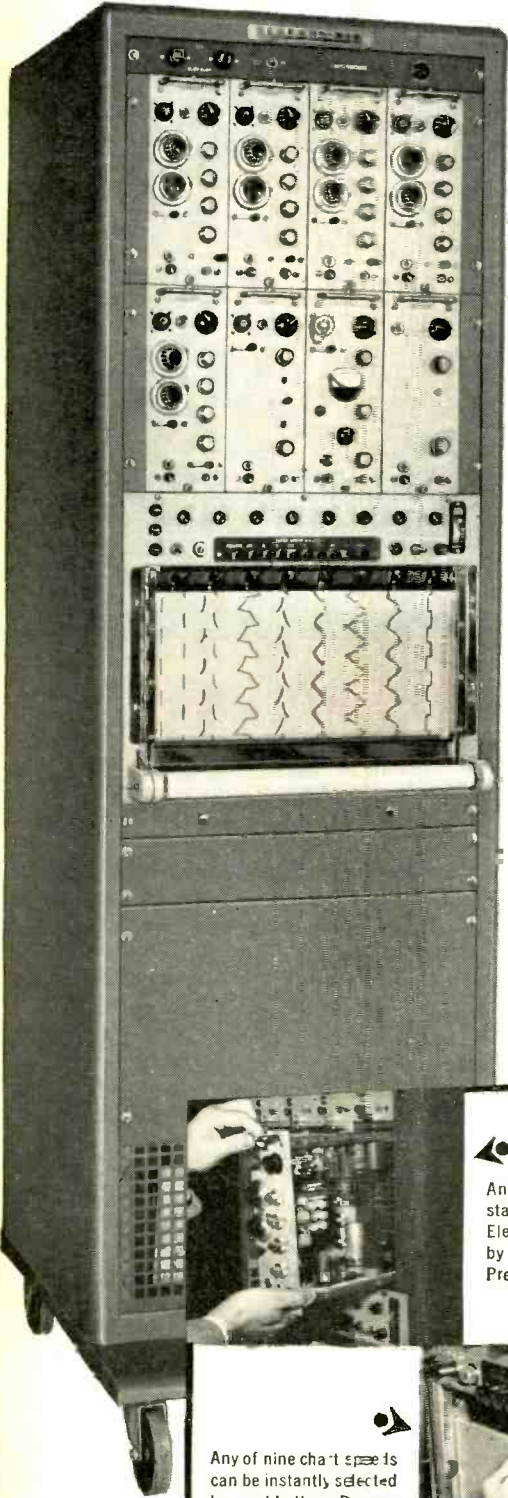

Here are the completely new, instantaneous direct writing 6- and 8-channel Sanborn "350" oscillographic recording systems designed to give you the most useful possible combination of *performance accuracy* - *flexibility* - *reliability* - and *operating convenience*.

Consider first some characteristic *performance* figures and features: essentially flat response to 100 cps at 10-div. peak-to-peak amplitude, down 3db at 120 cps; limiter circuit *ahead* of Amplifier assures damping at all times; current feedback Power Amplifier design to prevent thermal drift; true damping by velocity feedback; galvanometer natural frequency 55 cps; hysteresis level less than 0.2 div.; linearity 0.20 div. over entire 50 divisions; permanent, inkless, direct writing in true rectangular coordinates on plastic coated Permapaper.

Now notice the *packaging*: an entire 6- or 8-channel "350" system - Preamplifiers and their own Power Supplies, Recorder assembly with built-in Power Amplifiers and Power Supplies, and other components - is housed in one mobile cabinet. Preamplifier modules are separated from Recorder-Power Amplifier unit, so that either can be used separately. Self-contained Recorder package uses transistorized, plug-in Power Amplifiers, Power Supplies with solid state rectifiers, low impedance, low voltage enclosed galvanometers; when used as a separate unit, sensitivity is 0.1 volt/chart division.

Add to these "350" performance and packaging features the value and convenience of extremely easy chart loading from the front; nine electrically controlled chart speeds, selected by pushbuttons, with contacts for remote control; built-in paper take-up, paper footage indicator and timer-marker stylus; four presently available interchangeable Preamplifiers (Carrier, DC Coupling, Servo Monitor-demodulator, True Differential DC), with several more to follow.

These are highlights of the new "350's" - duplicated by no other equipment in existence today. Ask your local Sanborn Engineering Representative for more information, or write Sanborn directly.

(All data subject to change without notice)

INDUSTRIAL DIVISION

SANBORN COMPANY

175 Wyman Street, Waltham 54, Mass.

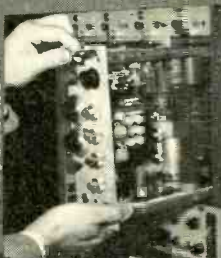

Any "350" Preamplifier installs easily in any channel. Electrical connections made by mating connectors on Preamp and Power Supply.



Quick, simple paper loading is done from front; hinged viewing window is removable. About 8" of record visible. All controls on front panel.



Any of nine chart speeds can be instantly selected by pushbutton. Remote control of all functions provided by connectors at rear.

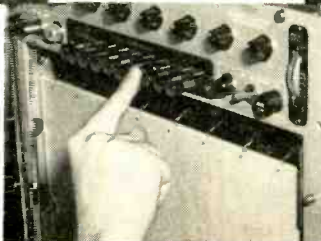

Recorder back plate holds eight plug-in Power Amplifier modules (one shown unplugged), four on either side of Power Supply section. Entire back plate removable for servicing.



COMPUTER DIODE REPORT ET-757

Diode survival during vibration portion of life tests of XA-25-725-A computer. Test conditions: free vibration at 3600 impulses p.m. at amplitude of 0.080 inch.

TEST CIRCUIT 17

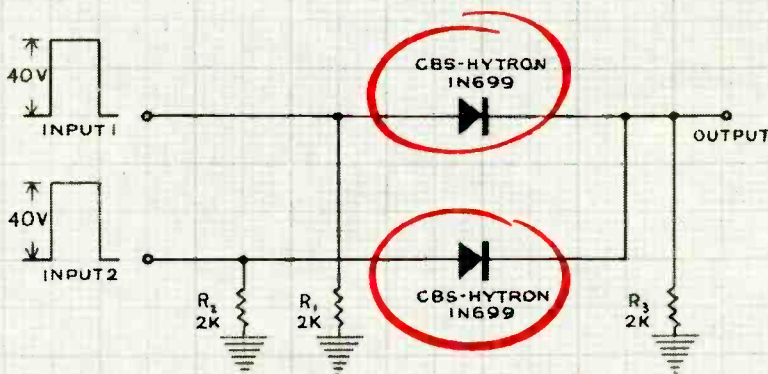

COMPARATIVE LIFE TESTS

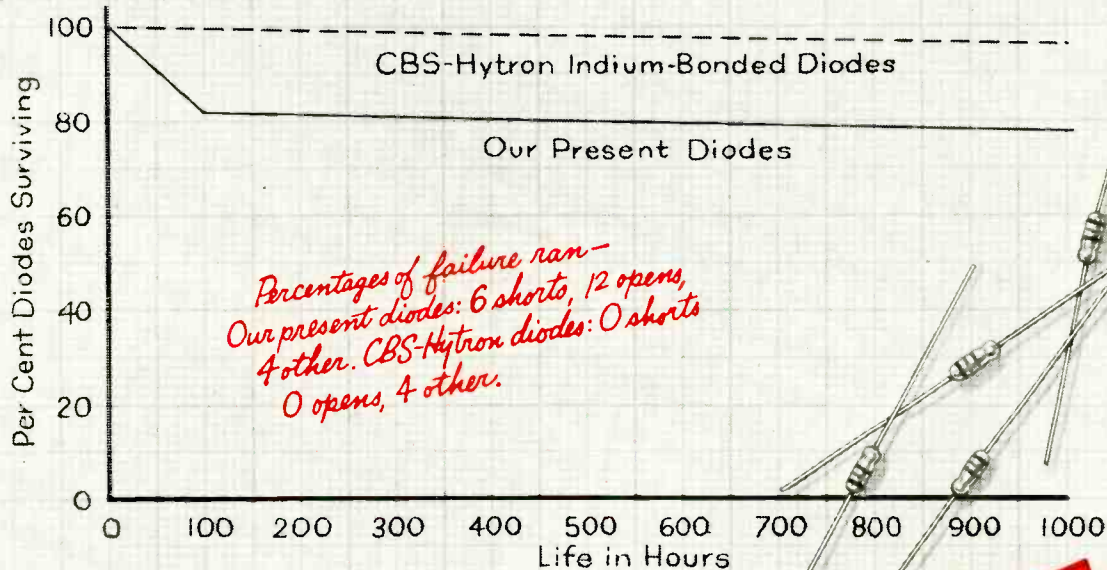

*Percentages of failure ran—
Our present diodes: 6 shorts, 12 opens,
4 other. CBS-Hytron diodes: 0 shorts
0 opens, 4 other.*

*J.D.H.:
New CBS-Hytron indium-bonded
diodes avoid catastrophic failures
on production line. Recommend we
use them. For data, see CBS-Hytron
Bulletin E-286.*

F.G.



CBS-HYTRON Semiconductor Operations, Lowell, Massachusetts. A Division of Columbia Broadcasting System, Inc.
Sales Offices: Newark, N.J.; Melrose Park, Ill.; Los Angeles, Calif.

PIONEERS OF THE THERMAL FRONTIER

Eastern
COOLING ELECTRONIC
SYSTEMS FOR MISSILES

M
Monsanto

NEW FLUIDS FOR THE MISSILE AGE



R. SWANSON

advanced
system of **COOLING**
ELECTRONICS
extends missile performance

**EASTERN AVIONIC COOLING SYSTEM IS LIGHTER . . .
SMALLER . . . MORE RELIABLE**

Electronic equipment is vulnerable to the fantastic heat encountered by missiles. Eastern liquid cooling and refrigeration systems maintain safe avionic operating temperature limits even in the 800°F. environment present at *five times the speed of sound.*

MINIATURIZING ALL COMPONENTS

In addition to efficient, reliable operation, Eastern cooling systems are miniaturized to meet the most rugged missile requirements for space and weight. By using Monsanto Coolanol 45* fluid, a 24,000RPM hydraulic pump no bigger than a fist can be used. Coolanol 45 keeps the high-speed

pump lubricated, as well as providing a coolant with outstanding qualities. The high boiling point of Coolanol 45 permits a smaller system since temperature maintained can be higher. Coolanol 45 is an excellent heat-transfer medium with good dielectric properties. Adequate viscosity assures long life of precision hydraulic pumps. Systems are easily sealed to prevent contaminating air leakage, and the low foam tendency of Coolanol 45 minimizes circulation troubles.

DESIGNS TO MATCH MISSILE PERFORMANCE

Using a basic liquid cooling system, or by adding refrigeration cycle, cold plates, or evaporative cooling as needed, Eastern can protect electronic equipment under the severest temperature conditions. Come to the leader in the field for *complete and creative help.*

LIQUID COOLING SYSTEM

(model shown weighs 10 lbs. --
measures 10-1/2" x 6" x 7-3/4")

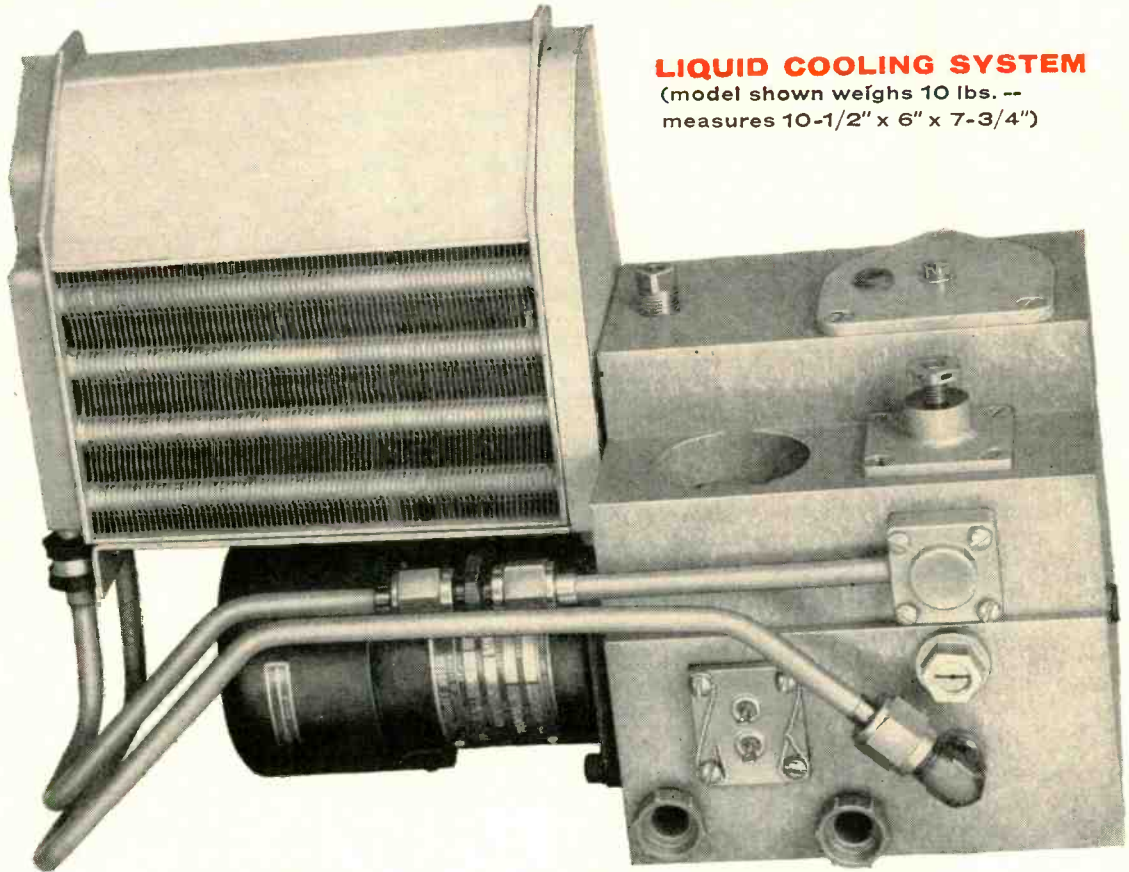

Eastern subsystems and systems for missiles and aircraft

AVIONIC COOLING • REFRIGERATION • HYDRAULIC POWER PACKS • PRESSURIZATION-DEHYDRATION

For bulletin 0-123 on Coolanol 45, write

For aviation bulletin 350, write



MONSANTO CHEMICAL COMPANY
Aviation Fluids Dept. AV-1
Lindbergh and Olive Street Road,
St. Louis 24, Mo.



EASTERN INDUSTRIES, INC.
100 Skiff Street
Hamden 14, Conn.

*Coolanol 45: Monsanto trademark (formerly OS-45)

Over HALF a Missile's Cost is

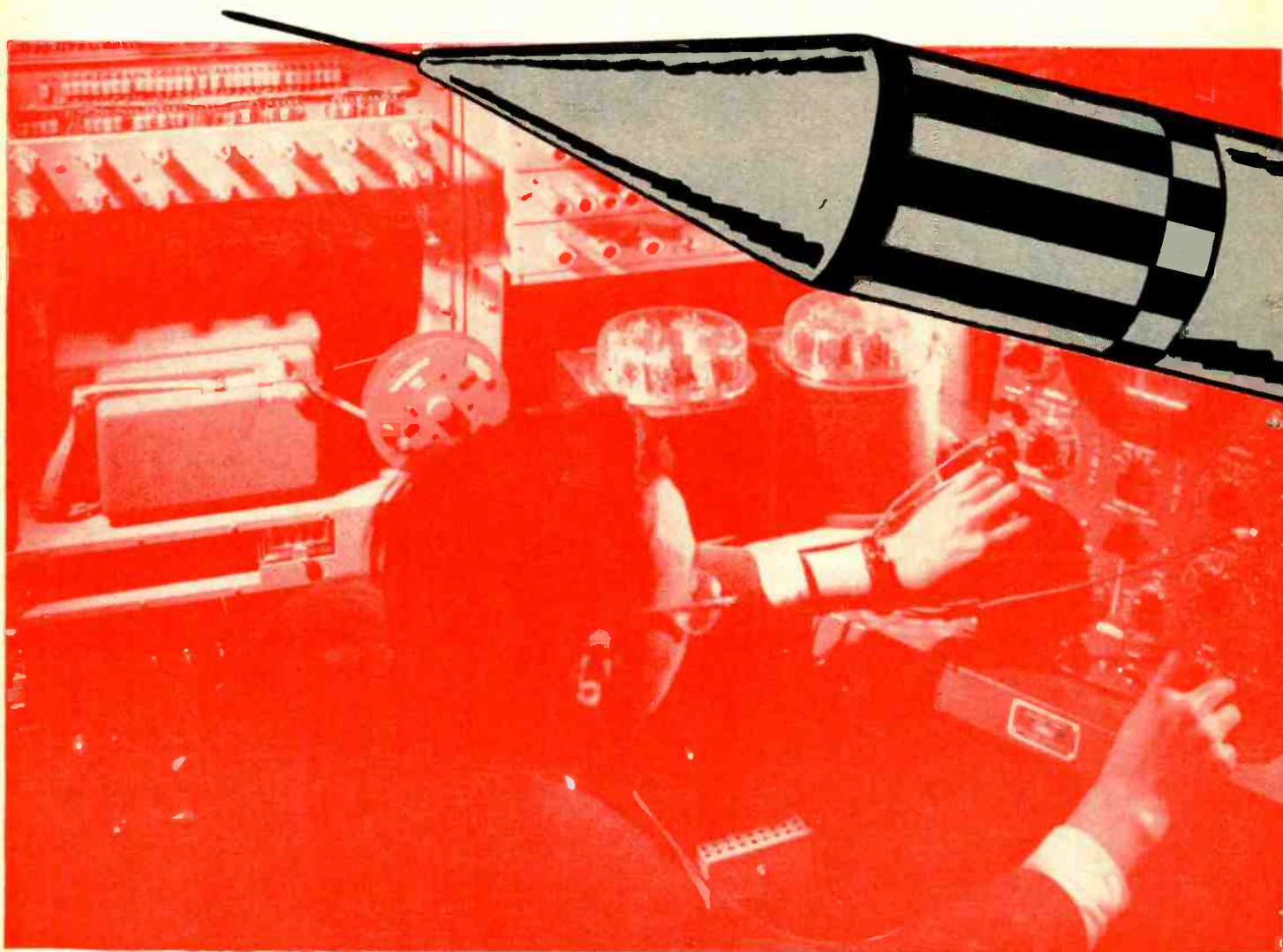

Photo used with permission of Federal Telecommunications

... and electronics sells this \$1-\$2 billion MISSILES market

Guided missiles have clearly moved forward as a mainstay of our defense with increased emphasis on ICBM's which require long range radar, high-speed computers and infra-red detection systems ... *all* dependent on complex electronics circuits!

How big is the market?

Total military expenditures for electronics, currently \$3.6 billion, are slated to hit \$4 billion next year ... with the **largest single item being missiles**. In fact, more than half of the total cost of a missile *today* is for electronics equipment (and this does not include the monitoring and tracking equipment on the ground) with the balance going for the airframe, the propulsion unit, plus associated items ... the trend is toward *greater* use of electronics!

electronics sells the missiles segment of the electronics industry in depth ... *with over 10,000 paid subscribers in prime missile contractors* plus many more thousands among missile subcontractors ...

the men you must reach and impress. (For details see the breakdown shown at the right.)

electronics editorial content gives important working information to missile designers ... more than 50% of all the technical material published in 1957 was applicable to ground or airborne missile guidance systems. And talk about leadership, **electronics** published its first article on guidance systems in August 1930 ... about 28 years ago!

Leading advertisers have already recognized this sales opportunity ... they're *now* using **electronics'** unparalleled coverage of the Design/Production/Management team to sell the entire \$7 billion electronics industry and its growing missile segment. Start now to establish your identity in this industry through the powerful pages of **electronics** magazine.

Send for new 12-page Market and Media Folder giving complete details about **electronics '58**.

ELECTRONIC!

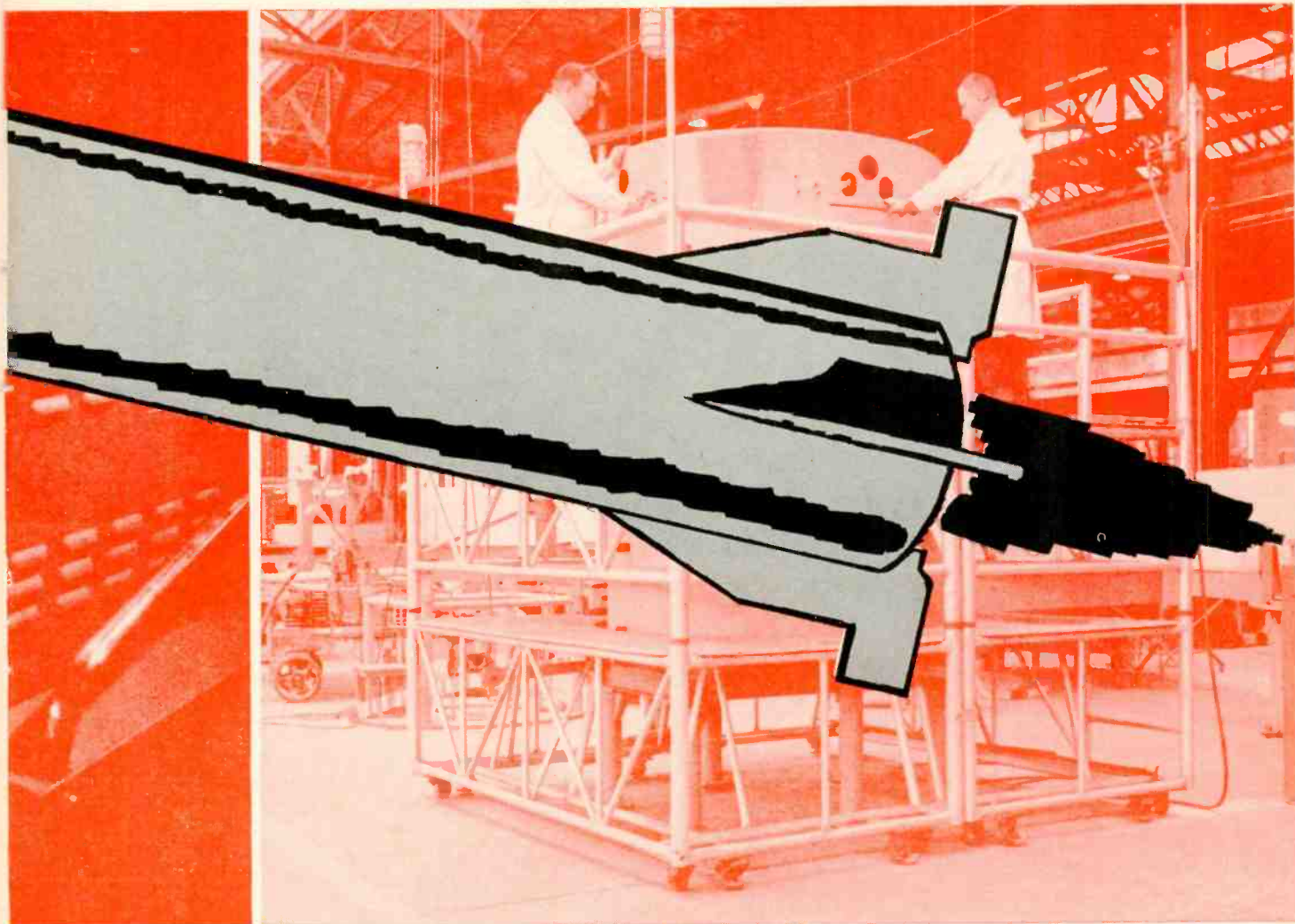

Laboratories

Photo taken in Reynolds Metals Company's missile ballistic shell plant, Sheffield, Alabama

How electronics penetrates 30 giant "Missile Makers"

Company	electronics subscriptions	Company	electronics subscriptions
Avco	133	Lockheed Aircraft Corp.	212
Bell Telephone Labs	282	Glenn L. Martin Co.	170
Bendix Aviation Corp.	544	MIT	193
Boeing Airplane Co.	342	Minneapolis-Honeywell	313
Burroughs	219	Motorola	345
Convair	440	North American Aviation	355
Collins Radio Co.	141	Northrup Aircraft	190
Douglas Aircraft Co.	159	Philco	356
DuMont	113	RCA	703
Federal Tel. & Radio	183	Raytheon	352
General Electric	951	Sperry Rand	465
General Motors Corp.	208	Sylvania-Corning	339
Gifillan Bros.	282	U. S. Rubber Co.	366
Hughes Aircraft	529	Western Electric Co.	295
IBM	403	Westinghouse	367

Remember: During 1958 electronics circulation will reach 52,000 paid subscribers!

electronics  

A MCGRAW-HILL PUBLICATION • 330 W. 42nd ST. • NEW YORK 36, N. Y.

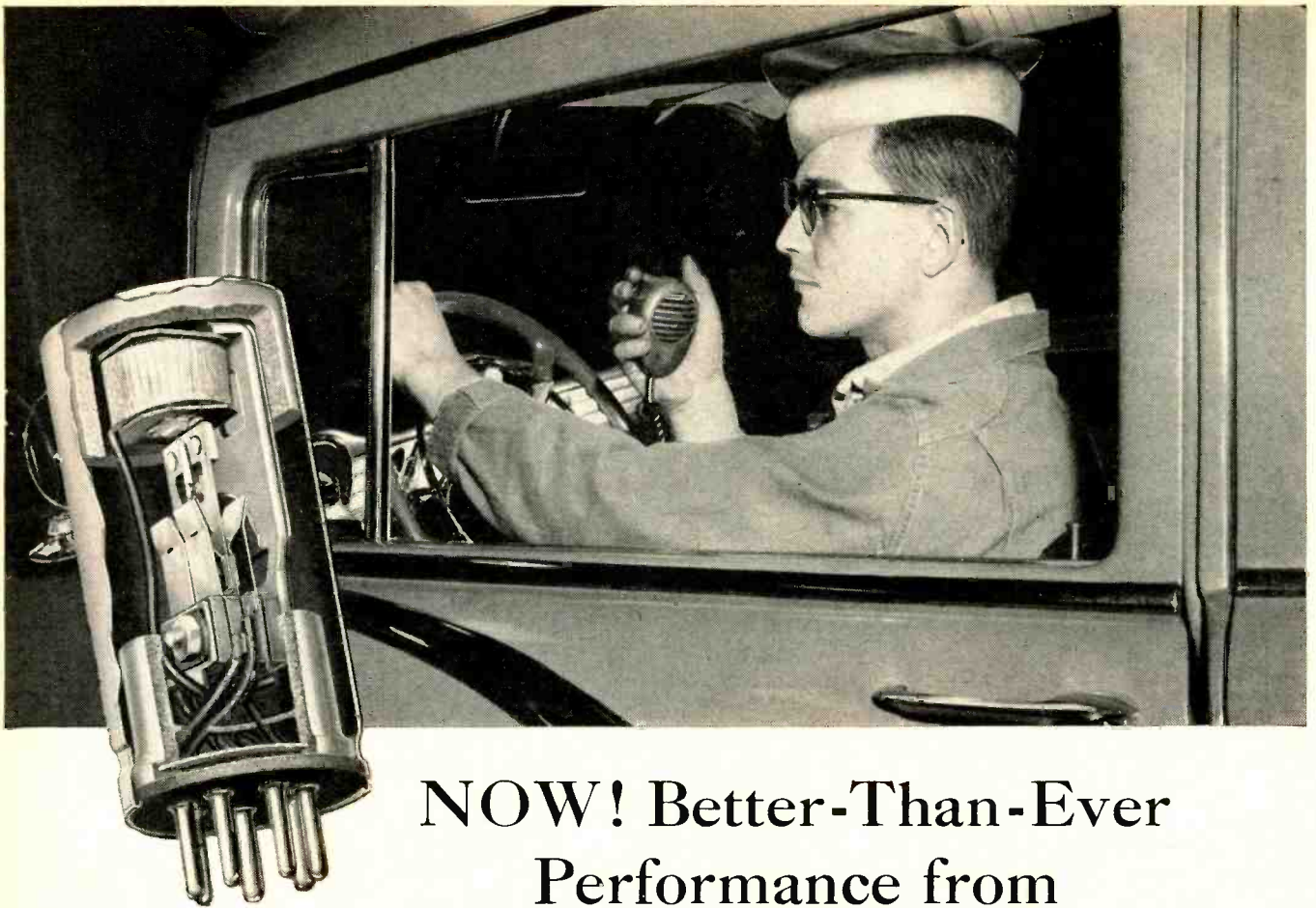

NOW! Better-Than-Ever Performance from Mallory Heavy-Duty Vibrators

Take a vibrator design . . . the Mallory Series 1700 . . . that gives longer service, more constant voltage, faster starts, less noise. Make it even better by using new, higher-conductivity materials and refining mechanical design. That's what we've done in the *improved* Mallory Series 1700 Vibrators that outperform even their famous predecessors.

Series 1700 Vibrators now give you longer contact life, increased current capacity, higher output, less internal heating. They incorporate the unique leaf contact design that enabled the original Series 1700 to set the standard for heavy-duty operation. And like it, they are designed from the ground up for rugged service . . . not just modifications of automotive vibrators.

More than ever, they're your best choice for long life and dependability in two-way communications systems and other mobile electronic equipment. They're available in both split reed and duplex separate drive models.

New design ideas and materials are constantly being applied to the complete line of Mallory vibrators to meet continuing requirements of mobile equipment:

Series 1500—Medium to heavy duty, separate drive interrupter type.

Series 1600—Light to medium duty, shunt drive interrupter type.

Series 1800—Nominal duty, shunt drive self-rectifying type.

Series 1850—Nominal duty, separate drive self-rectifying type.

A Mallory power supply specialist will be glad to help you with circuit design and selection of *all* components. Call or write our Vibrator Division, Du Quoin, Ill., today for a consultation.

Serving Industry with These Products:

Electromechanical — Resistors • Switches • Tuning Devices • Vibrators
Electrochemical — Capacitors • Mercury and Zinc-Carbon Batteries
Metallurgical — Contacts • Special Metals • Welding Materials

Expect more . . . get more from

P. R. MALLORY & CO. Inc.
MALLORY

P. R. MALLORY & CO. Inc., INDIANAPOLIS 6, INDIANA

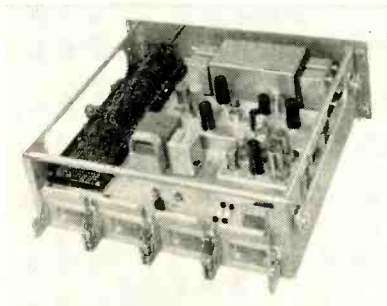

Evaluator chassis has patchboard for flexibility in test point connections and selection of the proper test functions

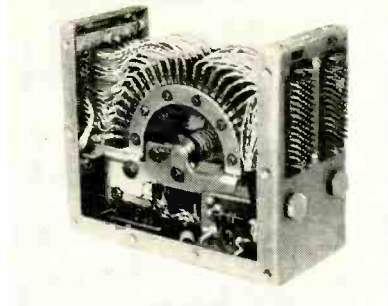

Packaged as a module for plug-in installation, this switch has 25-positions and 12 levels. Seven switches are used

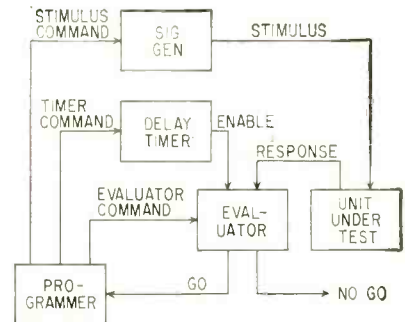

FIG. 1—Essential components of the automatic evaluation system that gives go, no-go indication of missile operation

Go, No-Go Gage Checks Out Bomarc Automatically

How to test advanced weapons systems quickly and efficiently is shown by automatic evaluator for now-operational Air Force missile. Circuits program 140 steps, 350 measurements, in 20 minutes. The evaluator even checks itself. Go, no-go decision is made for each step

By **GEORGE A. HARTER*** and **FREDERICK A. BUUCK**

Farnsworth Electronics Co., A Div. of International Telephone and Telegraph Corp., Fort Wayne, Ind.

ADVANCED WEAPONS SYSTEMS require operational test equipment to provide quick, efficient checkout. Unique characteristics of the equipment to be described include flexibility, automatic operation, and GO, NO-GO evaluation.

Essential components of the automatic evaluation system are shown in Fig. 1. The programmer controls the sequential operation of the system. At the beginning of each test step, a signal generator provides the necessary steady-state stimuli to the unit under test and the timer is commanded

to count off a prescribed delay or preevaluation time. Delay length depends on the time required for the response to reach a steady-state condition. At the end of the delay period, the timer generates an output that enables the evaluator to make a GO, NO-GO decision about the response.

If the result of the test is a GO, an enable potential from the timer passes through the GO channel in the evaluator and back to the programmer. The programmer is then advanced automatically to the next test step. A NO-GO result

stops the test operation automatically and routes the enable potential to a NO-GO channel used for actuating any desired type of readout indicator. The indicator pinpoints the faulty circuit or assembly.

Programmer

Major components in the programmer are a patchboard and seven, 25-position, 12-level stepping switches (maximum capacity of 175 test steps and 12 commands per

*Now with Ramo-Wooldridge Company, Los Angeles, Calif.

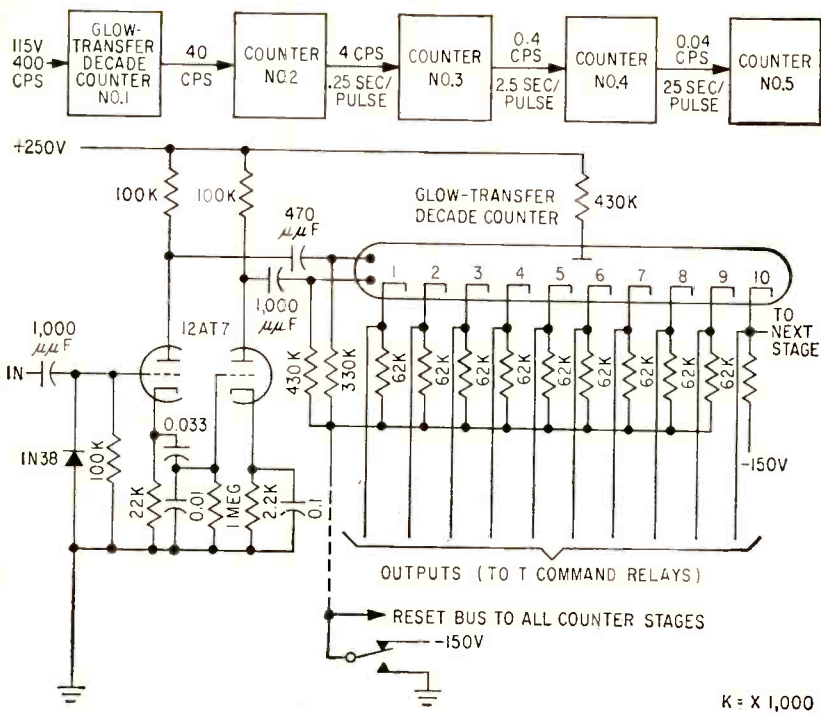

FIG. 2—Each of five decade counters has the circuitry shown

step). The wiper arm on each switch level is tied to a 28-v d-c supply. Each switch contact is wired to a pin on the patchboard so that it may provide any desired output command on any particular step. For example, the stepper output of level 1, position 1, is patched to the timer command which provides a delay time, τ , of 1 sec. It could be patched to provide any other delay time. Other levels on the stepping switches provide signal-generator, evaluator or other desired commands for a given test step. The patchboard accommodates readily any changes in test sequence, delay time and other test parameters.

Delay Timer

Basic timing reference is provided by a tuning-fork-controlled, 400-cps supply. The 400-cps frequency is counted down by a series of five decade counters to provide a maximum delay time of 250 sec in increments of 2.5 millisecc. Each decade counter consists of a twin-triode driver stage and a glow-transfer counter tube as shown in Fig. 2.

Each input pulse to the driver stage causes the beam in the glow-transfer tube to transfer from one cathode to the next. This provides one output pulse from cathode number 10 for each cycle of the beam

or for each 10 input pulses to the driver. The input stages are designed to allow cascading of the counter units and to provide a 10:1 reduction in counting rate for each counter in the string. The counter may be reset and held at the initial position by grounding the first nine cathodes with the relay contacts shown in the circuit. This action returns the beam to cathode number 10 until the ground is removed.

Coincidence Output

Outputs from the digital counter are routed through appropriate command relay contacts to a three-diode coincidence circuit as shown in Fig. 3. A coincidence output is obtained at the end of the commanded delay time and is used to fire the thyatron. A relay in the plate circuit of the thyatron provides a 28-v d-c TEST-ENABLE output to the evaluator. Although not shown in Fig. 3, another set of contacts on the TEST-ENABLE relay is used to reset the digital counter in anticipation of the next test step.

Six evaluators in the test set are available for use during a single test step. Output relay contacts of the evaluators to be used are placed in a series by a command from the programmer. If an evaluator is not to be used during a test step, the output relay is bypassed and the

enable voltage is routed past the evaluator. This makes it possible to evaluate six responses during a single test step.

Each evaluator consists of a comparator, signal converter and associated switching circuits.

Comparators

Two identical signal channels are used in each comparator as shown in Fig. 4. Each channel consists of an a-c amplifier, phase detector and carrier-gate circuit. A dpdt chopper provides each chopper amplifier with square-wave inputs. Phase of these inputs depends upon the relative magnitude of the input signal with respect to each d-c reference potential. When the input signal is above the low reference and below the high reference, the chopper provides signals with identical phase relationship. This situation represents a GO condition.

A phase detector in each channel compares the amplified chopper signal with the 400-cps carrier potential which was also used to drive the chopper. Carrier phases to the detector are such as to cause relays K_1 and K_2 to be energized only if the

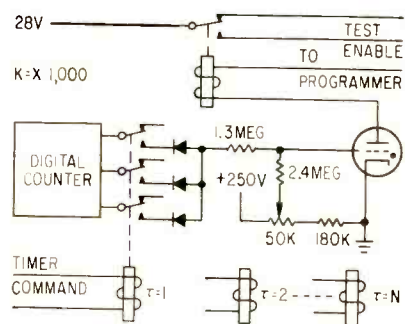

FIG. 3—Three-diode coincidence circuit fires thyatron to provide a 28-v d-c test enable output to the evaluator

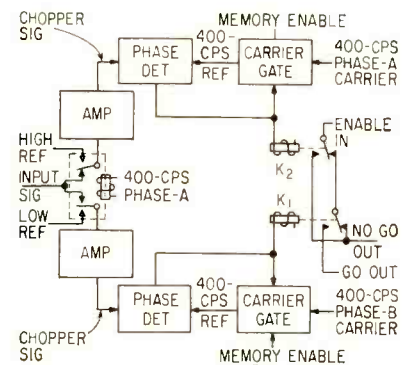

FIG. 4—Each of six evaluators is a two-channel unit as shown

Telemeter Transmitter for

Engine performance data of Vanguard rocket are relayed to earth using this telemetering transmitter. Voltage variations representing performance are picked up with a commutator and converted to pulse width modulated signals by a keyer. Duration of pulse width shifts frequency of crystal-controlled oscillator producing pwm/f-m signal which is frequency multiplied, amplified and fed to telemetering antenna. Power supply is transistorized

By **N. RASKHODOFF**, U. S. Naval Research Laboratory, Washington, D. C.

IN-FLIGHT performance data from the Vanguard rocket are made available to ground control stations using the telemetering transmitter discussed here.

The telemetering transmitter consists of a commutator, a keyer, a

transmitter, an r-f power amplifier, a transistorized power supply and a small coaxial blower. All components are packaged in a cylindrical pressurized container.

Entire unit, including support structure and container, weighs 14

pounds and is 8 $\frac{3}{8}$ in. high by 9 $\frac{1}{8}$ in. in diameter. Before installation, the assembly must withstand a 10-g vibration for two minutes in each of three planes and a random vibration through a bandwidth of 2,000 cycles.

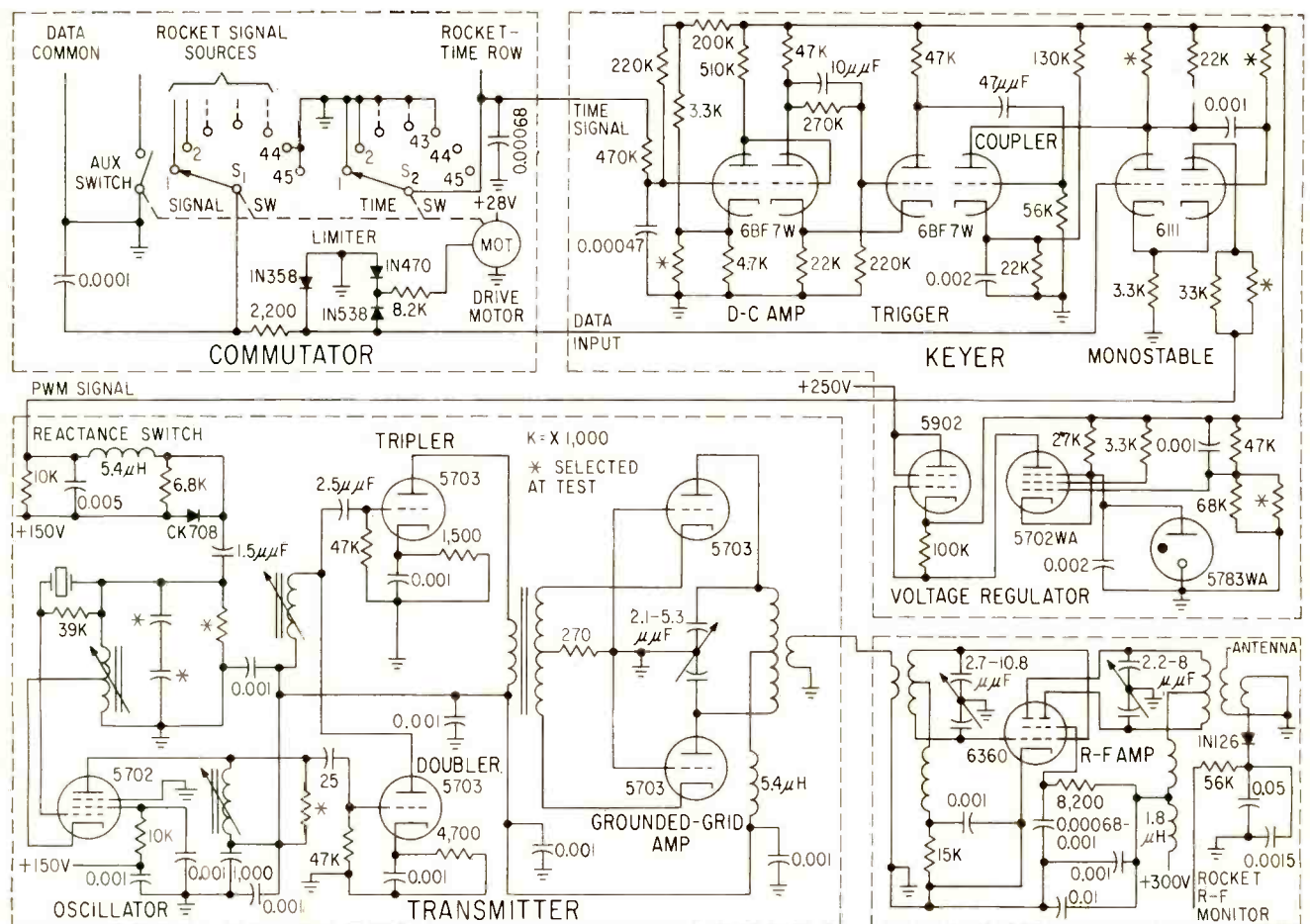
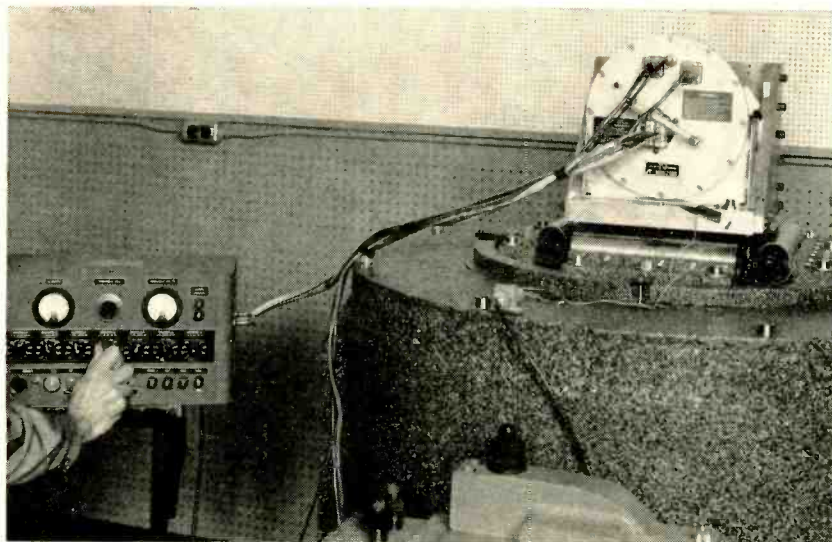

FIG. 1—Data and voltage regulator circuits. Commutator contacts are shown arced for simplicity. Wiper arms run at 1,200 rpm through motor-driven gear reduction assembly. Transmitter operates in the 215 to 235-mc telemetering band and delivers 4 watts of r-f power into a 52-ohm resistive load. Limiter in commutator signal line prevents overloading of keyer

Vanguard Rocket



Telemetering transmitter undergoing vibration testing on shaker table. After testing, unit is installed in second stage of Vanguard rocket and used to supply performance data to engineers during static and preflight checks, as well as after launching

A schematic diagram of the data and voltage regulator circuits is shown in Fig. 1. Rocket signal sources brought out to contacts on the commutator are scanned by

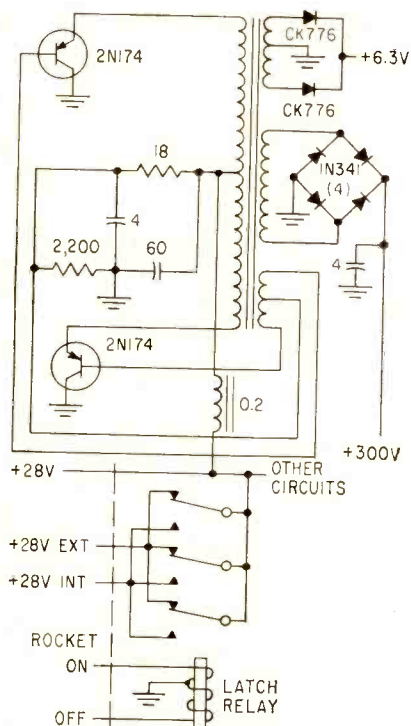

FIG. 2—Power supply circuit. Input choke prevents power supply transients from entering 28-volt source in rocket. Magnetic latch relay eliminates need for holding current and provides positive off-on action

motor-driven wiper arms. As the arms move across the first 43 contacts, information from 41 data and 2 calibration channels on signal switch S_1 and trigger pulses generated by successive making and breaking of grounded contacts on time switch S_2 are sent to the keyer.

Since signal and time data are picked up on separate switches, each channel can be monitored at the exact moment of no brush bounce. This technique eliminates noisy make intervals.

Keyer Signals

When the wiper passes over contacts 44 and 45, switch S_1 is grounded and switch S_2 is open circuited. During this period, time signals from the rocket-time row are fed to the keyer. These signals synchronize the transmitter with the ground station equipment.

The keyer triggering circuit converts the time signals into a series of delayed, sharp pulses which trigger the monostable multivibrator for each succeeding data channel. Result is an output signal made up of a series of synchronized square wave pulses proportional in width to the voltage from 43 data channels.

Pulse-width-modulated signals from the keyer are applied to a reactance switch in the transmitter.

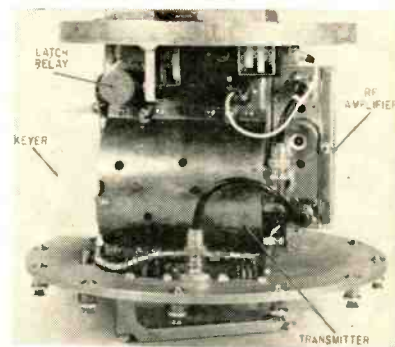

Keyer, transmitter and r-f power amplifier plug into receptacles on sides of U-shaped aluminum support structure. All tuning controls are accessible

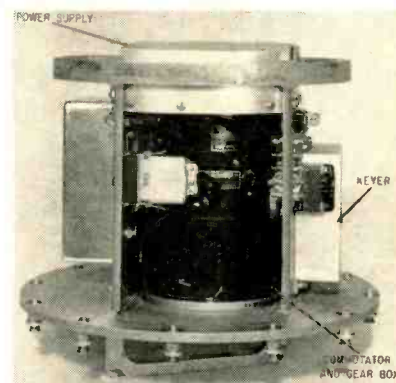

Commutator and power supply are mounted within U-shaped support structure. External connectors are located on bottom plate of unit

This switch modulates the crystal controlled oscillator, causing a shift in the quiescent frequency between 30 kc upper and lower limits for the duration of each pulse. The frequency shift is proportional in time to the voltage applied to each data channel. Output frequency of the crystal-controlled oscillator is then doubled and tripled.

An r-f power amplifier amplifies the signal and f-m carrier. A pickup loop for monitoring purposes is included. The amplifier is capable of delivering an average power output of fifteen watts. Plate and heater voltages are provided by the power supply shown in Fig. 2.

The author expresses his appreciation to M. Kaufman and V. Goblirsch for their assistance and Applied Science Corporation of Princeton, Pa., for permission to publish some of the circuit data.

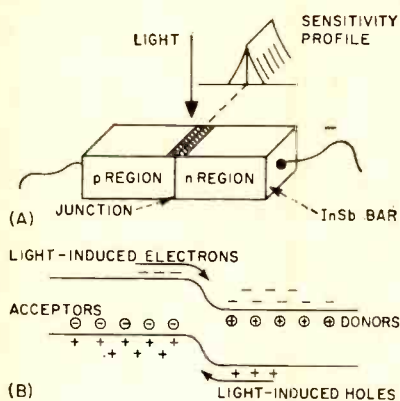

FIG. 1—Operation of grown-junction detector is illustrated by sensitivity profile and bar (A) and energy band (B)

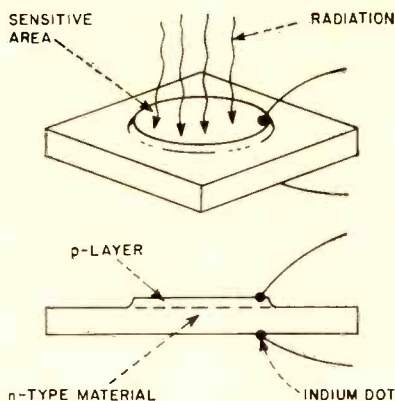

FIG. 2—In InSb diffusion junction, a p layer forms on an n sample by heating. Ohmic contacts are soldered

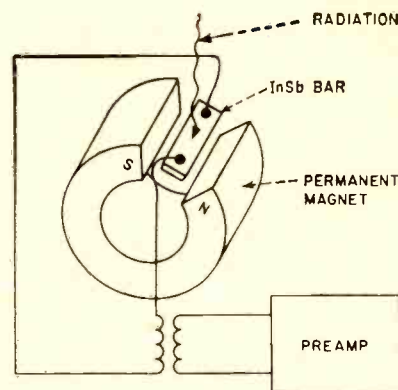

FIG. 3—Strip of InSb is moved into air gap of permanent magnet in forming a pem detector unit

Reproducible indium-antimonide detector cells made with photovoltaic, photoconductive or photoelectromagnetic effects are sensitive into intermediate infrared region. Photovoltaic cells cooled to 77 K require *p-n* junctions obtained by doping during growth, by diffusion of impurities into crystal or by alloying. Detectors are made with small sensitive areas and are well-suited for fast, high-resolution infrared detecting systems

New Intermetallics Offer

By S. J. NICOLosi, L. H. DEVAUX, and A. J. STRAUSS,

Associate Director, Associate Physicist, Associate Scientist
Chicago Midway Laboratories, University of Chicago, Chicago, Illinois

INFRARED DETECTION, following World War II, promised great potentialities for both military and industrial application. Stimulated by Germany's wartime use of lead sulfide, research probed beyond the previously all-important elements, germanium and silicon, for new semiconducting materials with better infrared response. By 1952, however, practical photoconductive cells were still largely limited to those sensitive only in the near infrared regions where radiation wavelength extend from 0.8 to 3 microns.

Two cells sensitive to radiation beyond 3.5 microns existed—one employing a thin film of lead selenide and the other a thin film of lead telluride—but both were difficult to manufacture and both had

shortcomings in their performance. The characteristics of infrared sources, background and atmospheric transmission indicated that detectors sensitive in the intermediate 3-7-micron infrared region are much more valuable than those sensitive only in the near infrared.

A single-crystal detector with extended infrared response affords many advantages, but such a development required either a new principle or a new material. Research in infrared detectors then led to the development of the indium-antimonide cell.

General Properties

Indium antimonide belongs to the III-V class of intermetallic compounds, whose semiconducting properties were only recently dis-

covered. It has a zinc-blende crystal structure, and its low melting point of 523 C compared to other III-V compounds makes metallurgical processing much easier than with sister compounds. The low energy gap and high electron mobility of InSb make it useful for infrared detectors sensitive up to the long-wavelength end of the intermediate infrared region. A comparison between germanium and InSb at low temperature and room temperature is given in Table I.

Indium Antimonide Detectors

Indium antimonide detectors can be made with photovoltaic, photoconductive or photoelectromagnetic effects. Photoconductive and photoelectromagnetic detectors operate at room temperature; however, im-

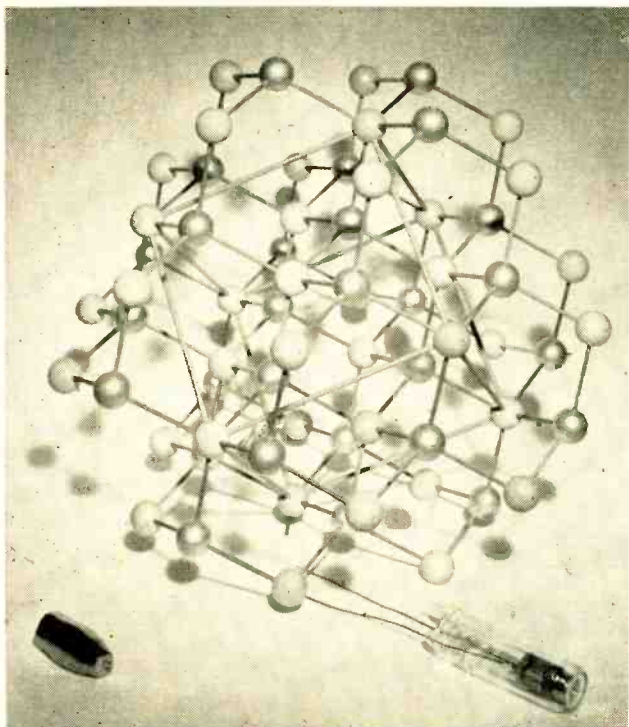

Model of the crystal structure of InSb shown with an actual crystal of the material (lower left) and an InSb detector (lower right)



Technician seals off an InSb detector from the vacuum pumping equipment prior to testing characteristics

Wide Infrared Response

proved sensitivities are realized by reducing the cell temperature. Photovoltaic InSb detectors are operative only at low temperatures. Detectors of indium antimonide have extended and fast response. They can be made with small sensitive areas which make them uniquely suited for fast, high-resolution infrared systems.

In InSb the *p-n* junction required by the photovoltaic detector is obtained by doping during single crystal growth, by diffusing of impurity atoms into the crystal or by alloying. The principle of operation of the grown-junction detector is shown in Fig. 1. A single crystal bar of InSb with a *p-n* junction

near its center is used. The junction plane is perpendicular to the major axis of the bar. Under equilibrium conditions, the junction produces a potential gradient in its neighborhood so that no net charge is transferred across the junction as shown in the energy band pictured in Fig. 1B.

Light of proper wavelength incident on the crystal in a direction perpendicular to the major axis of the bar generates hole-electron pairs. If the excess carriers diffuse to the junction region, they are influenced by the electrostatic field at the junction. The field sweeps electrons in the *p*-type material and holes in the *n*-type material across

the junction. A photovoltage then exists between the ends of the bar.

Only carriers produced within a distance comparable to a diffusion length flow across the junction; therefore the sensitive area of the *p-n* junction detector is concentrated in a narrow region near the junction plane. The form of the sensitivity profile is shown in Fig. 1A.

When the junction is illuminated from the edge, as shown in Fig. 1A the sensitive area is defined by the diffusion lengths along the bar axis and by the width of the bar. For these InSb detectors, sensitive areas as small as 2×10^{-4} are obtained.

Diffused *p-n* Junctions

The *p-n* junctions created by diffusion techniques in indium antimonide lead to another type of detector geometry as shown in Fig. 2. A thin *p*-type layer is formed on an *n*-type sample of InSb by heat

TABLE I—Comparison of Germanium and Indium Antimonide

	Germanium	Indium Antimonide	
Temperature in K.....	300	300	77
Energy Gap in ev.....	0.7	0.17	0.22
Cutoff Wavelength in microns.....	1.8	7.1	5.7
Electron Mobility in cm ² /volt-sec.....	3,800	75,000	500,000
Hole Mobility in cm ² /volt-sec.....	1,800	1,000	10,000
Carrier Lifetime in sec.....	10 ⁻⁸	10 ⁻⁸	10 ⁻⁶

treating. Ohmic contacts are made by soldering. Light perpendicularly incident on the junction plane produces a photovoltage in the same manner as for the grown junction. The size of the sensitive area is governed by the *p* layer left on the sample during processing. It is therefore possible to control the shape of the area and to make these detectors larger in area than the grown-junction type.

Detector Characteristics

Indium antimonide photovoltaic detectors are operated at liquid-

current downward into the material. The magnetic field deflects the holes and electrons in opposite directions, and thereby causes a photocurrent. Open-circuit voltage of the pem cell is directly proportional to the magnetic field intensity for low fields. It is inversely proportional to the thickness of the InSb strip, where the thickness is large compared to both the diffusion length and the optical absorption length.

The noise of the cell results from Johnson noise alone, because no bias is required. Because the re-

sponse of the detector as a function of radiation wavelength;

(f) Time constant; the time required for the detector output to reach 63 percent of its peak.

Grown-Junction Detector

The *p-n* junctions cooled to 77 K, are highly photosensitive².

Indium antimonide at 77 K has an energy gap of about 0.22 eV. Therefore, optically excited transitions between the valence and conduction bands occur for radiation out to 5.5 microns wavelength.

The response of the grown-junction detector peaks at 5.4 to 5.5 microns. The long-wavelength cutoff is in the neighborhood of 5.7 microns.

At peak frequency response, the noise-equivalent input varies from 1×10^{-9} to 8×10^{-8} watt/cm². In most detectors, the response is sharply attenuated in the wavelength region from 2 to 5 microns. The carriers produced by shorter-wavelength radiation are apparently not as effective as those produced by radiation at 5.5 microns. Because the optical-absorption constant is inversely related to wavelength, carriers are produced close to the surface by short-wavelength radiation. If surface conditions are conducive to fast surface recombination, this qualitatively explains the peaked response of the detectors.

The noise power of the detectors is an inverse function of frequency up to high frequencies. Most detectors have exhibited a flat response out to the highest frequency at which they were tested.

The average time constant of the cells is less than 1 μ sec and the largest time constant that has been observed is 2.4 μ sec. The sensitive area of the detectors is of the order of 10^{-4} cm².

Design of the cell is conditioned by its spectral response and cooling requirements. The cell is in the form of a permanently evacuated Dewar flask to allow cooling the sensitive element. In a typical design shown in Fig. 4, two concentric tubes are joined at one end by a seal ring. The outside glass tube is capped by a sapphire window. For the inside tube, the glass is sealed to a short tube of Kovar

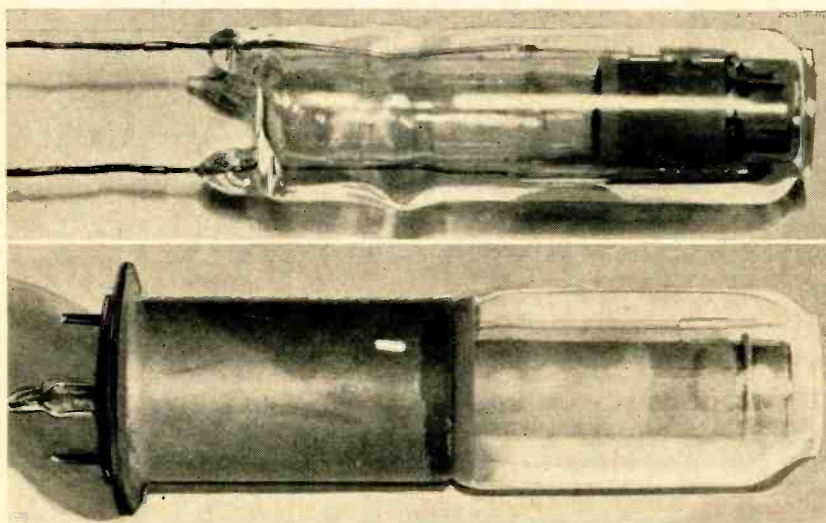

An InSb cell has an all-glass envelope (top). A ruggedized version of the cell (bottom) uses metal cylinder

nitrogen temperature of 77 K. At higher temperatures the sensitivity falls off rapidly.

A photoconductive detector is a device whose operation depends on the change in resistance that occurs in a homogeneous semiconductor when it is illuminated. The cell always requires a bias current to generate a signal voltage.

The principle of the photoelectromagnetic (pem) detector is illustrated in Fig. 3. A thin strip of indium antimonide is placed in the air gap of a small permanent magnet as shown in Fig. 3A. Light is incident on the sample in a direction perpendicular to both the magnetic field and the major axis of the InSb strip.

Light incident on the top of the strip produces hole-electron pairs near the surface. Then the hole-electron pairs produce a diffusion

distance of the cell is approximately 100 ohms, it is necessary to use a transformer to realize the full signal-to-noise ratio of the detector.

Evaluation of Infrared Detectors

Among the most important guides for judging detector performance are:

- (a) Response; the rms voltage output of the detector per unit radiation flux density;
- (b) Noise voltage; the rms noise voltage produced by the detector for a unit cycle bandwidth at an arbitrarily chosen frequency;
- (c) Noise equivalent input (nei); the radiation flux density which produces an rms signal-to-noise ratio of 1;
- (d) Noise equivalent power (nep); the radiant flux which produces a signal equal to the noise voltage;
- (e) Spectral response; the re-

metal. The Kovar tube is capped with a metal block, which serves as a base for the cantilever-mounted InSb bar, provides good thermal contact between the crystal and the liquid nitrogen reservoir and provides one electrical contact for the crystal. The other electrical contact is made with a fine wire soldered to the end of the bar.

Diffusion-Junction Detector

Indium antimonide diffusion junctions are produced by baking *n*-type in InSb in vacuum at about 450 C for 15 minutes. Although the exact mechanism for surface conversion from *n*-type to *p*-type has not been determined, it is believed to be the evaporation of an *n*-type impurity from the surface of the crystal.

Diffusion-junction detectors have properties similar to the grown-junction type. With the cell at 77 K, the shape of the spectral response curve is essentially that of a quantum detector.

The peak spectra response is at 5 microns wavelength compared to a 5.5-micron value for a grown-junction cell. The response shift is caused by the recombination of the carriers before they diffuse back to the junction region during the deep absorption of long-wavelength radiation in the crystal. A typical value for the noise-equivalent input at the peak of the spectral response is 3×10^{-9} watt/cm² for a cell area of 4×10^{-3} cm². Both the response and noise voltage are lower for a diffusion-junction detector than for a grown-junction detector. Either a transformer or a transistor preamplifier is necessary with the cell to realize full-cell signal-to-noise ratio. An important advantage of the diffusion-junction detector is that it allows much flexibility in the size and shape of the sensitive area.

The cell design for the diffusion-junction detector is essentially the same as that for the grown-junction detector except for details in mounting the sensitive element.

Pem Detector

At room temperature, indium antimonide exhibits intrinsic conductivity, and therefore *p-n* junctions cannot be used in photodetection. Furthermore, photoconductive

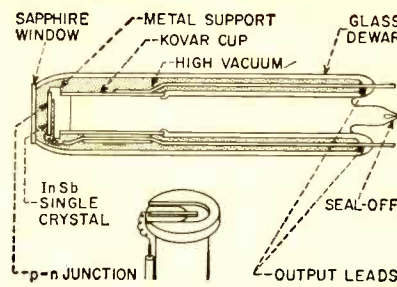

FIG. 4—Cutaway view of photovoltaic grown-junction detector shows Dewar and crystal construction

effects are small because of the short lifetimes and low resistivity of the carriers.

The most promising room-temperature operation is based on the photoelectromagnetic effect. Practical detectors utilizing the pem effect in InSb at room temperature have been produced^{3, 4}.

The spectral response of the room-temperature pem cell peaks at about 6 microns and the cutoff is at 7 microns. The response is essentially that of a quantum detector, and the measured responses agree with theoretical calculations. The pem cell has both a low response and low noise voltage, and therefore requires a transformer. A typical cell of area 2×10^{-2} cm² has a peak noise-equivalent input of 4×10^{-8} watt/cm². Only Johnson noise exists because no bias is required.

Although the time constant of pem cells was not measured directly, from lifetime measurements it is expected to be less than one μ sec. The pem detector is not as sensitive as the junction detector; however, the convenience of room-temperature operation recommends it for applications which require sensitivity to relatively long wavelengths but do not demand extremely high sensitivity.

In a typical laboratory design, a *p*-type InSb in the form of a single-crystal slab is used in the preparation of strips for the pem cell. The slab is cemented to a glass plate and ground down to a thickness of about 1 mil. Sections are made by slicing through the semiconductor and the glass backing and leads are soldered on the ends of the InSb strip. The exposed surface is then electropolished.

A small permanent magnet and

soft iron pole pieces comprise the magnetic circuit. Across a one-mm gap, a field intensity of about 10,000 gauss appears. The InSb strip on its glass backing is cemented into position in the air gap of the magnet.

Photoconductive Detector

A small number of sensitive InSb detectors have been made and evaluated⁵ by reducing the cell temperature. With highly compensated *p*-type material at 77 K, sensitivities comparable to the cooled-junction detector were obtained. For example, a typical cell of area 5×10^{-3} cm² has a noise equivalent input at the spectral peak of 9×10^{-10} watt/cm².

Other independent work⁶ also demonstrates the feasibility of producing sensitive InSb photoconductive detectors. The advantage of the photoconductive detector over other types of InSb detectors is that large-area detectors can be made. Moreover, the metallurgical techniques are not so involved because junctions do not have to be formed.

The research and experimental development work on indium antimonide detectors has yielded fast, reproducible cells that are sensitive well into the intermediate infrared region and that can be manufactured on a large scale.

The types of cells already developed promise to be useful in a wide range of applications of infrared equipment. The small sensitive area of the grown detector makes it valuable in high-resolution systems. For applications calling for a larger area, the diffusion-junction type may be used; in addition to its use as a large-area single-element detector, this type has potentialities for the construction of multielement arrays.

REFERENCES

- (1) F. A. Cunnell and E. W. Saker, Properties of the III-V Compound Semiconductors, "Progress in Semiconductors", 2, John Wiley and Sons, 1957.
- (2) G. R. Mitchell, A. E. Goldberg, and S. W. Kurnick, *Phys Rev*, 97, p 239, 1955.
- (3) S. W. Kurnick and R. N. Zitter, *Jour of App Phys*, 27, p 278, 1956.
- (4) C. Hilsum and I. M. Ross, *Nat*, 179, p 146, 1957.
- (5) L. H. DeVaux and A. J. Strauss, Indium Antimonide Photoconductive Infrared Detector, The Electrochemical Society Meeting, Buffalo, N. Y. Oct. 1957.
- (6) D. W. Goodwin, *Jour Sci Inst*, 34, p 367, 1957.

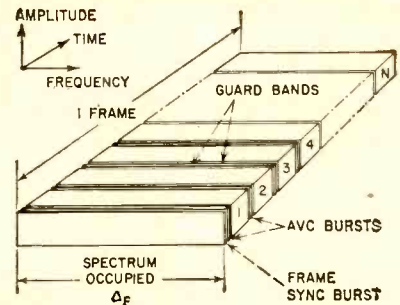
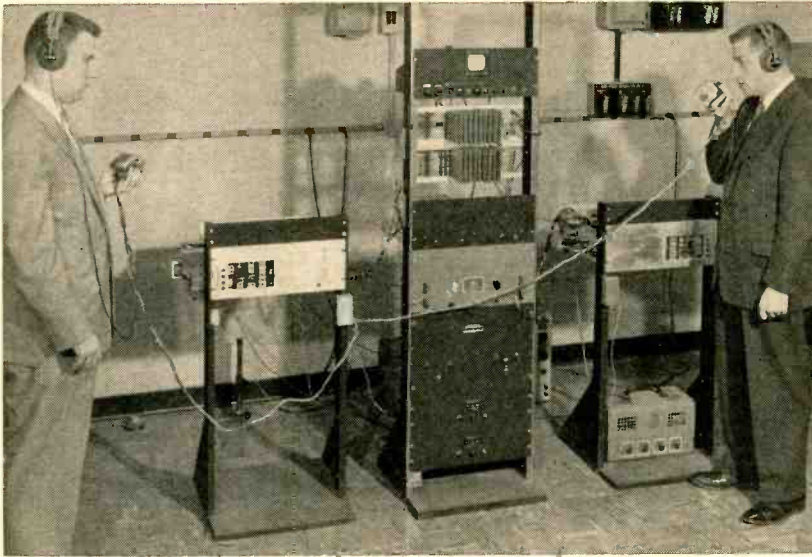

FIG. 1—Time of a single frame is divided into channels, guard bands, avc bursts and sync bursts

Engineers check out laboratory model of synchronizer and unplexers

By M. I. JACOB & JOHN MATTERN

Westinghouse Electric Corporation, Electronics Division, Baltimore, Maryland

Compressed Time Boosts

Time sharing multiplex system needs only one r-f channel with single transmitter and receiver at each station. Subchannels are arranged in sequential time slots to form frame. Transmitters and receivers of stations assigned to a given subchannel are on during assigned time slots. Intelligence is transmitted during subchannel slot, stored at the receiver during channel slot time and then expanded and read out during off-air time

TIME-COMPRESSED, single-side-band, systems (Ticoss) provide the performance required by mobile, multichannel communications systems in the short-to-medium-range. The desired performance is obtained with the advantages of time sharing multiplexing and ssb emission.

Multichannel duplex operation is handled by a single r-f channel. The system handles all transmission on one transmitter, one receiver and one antenna at each station. The subchannels to be multiplexed are arranged in time slots in sequence to form a frame. The transmitters

and receivers of the stations assigned to a given subchannel are off except during their assigned operating slots. Transmitted intelligence is stored during the entire frame interval.

Information is read out and transmitted during the assigned subchannel slot, thereby compressing the message time. At the receiving end the compressed message is stored during the channel-slot time and then expanded and read-out in its original form.

Voice, pulse and data channels can be compressed and transmitted in various time slots of a given time

frame. The product of the upper frequency of the channel's modulation signal and the compression rate determine the band widths. The compression rate is the ratio of

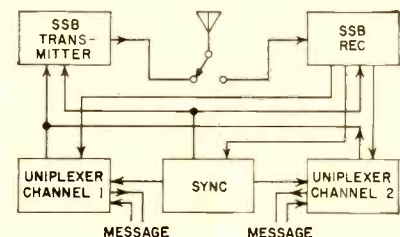

FIG. 2—Two-channel system has two uniplexers and synchronizer

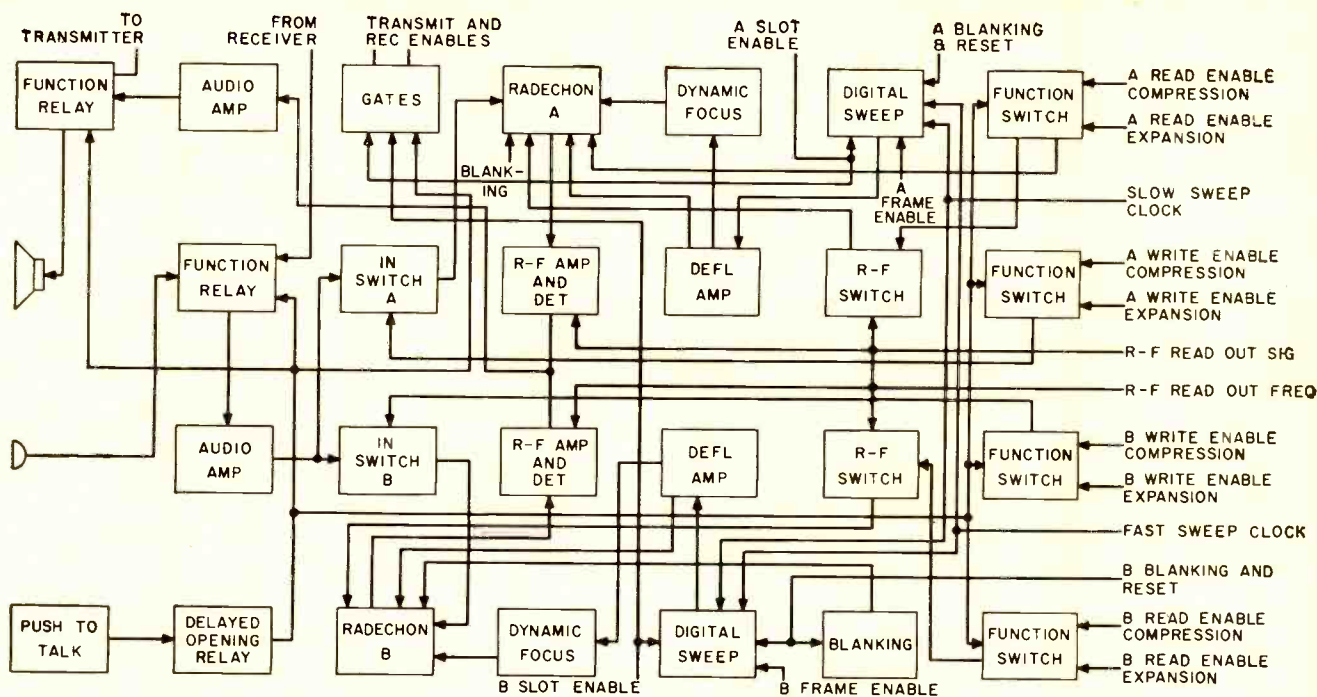

FIG. 3—Uniplexer accepts and stores information. Then reads it out at a different rate

Single-Sideband Capacity

total frame time to the actual message time in a given channel slot.

One frame, shown in Fig. 1, is divided into a number of channels with time for necessary avc and sync bursts. The avc burst controls the receiver level and the other burst synchronizes the frame starting time for all stations in the network. The time-amplitude axis of the chart shows the frame beginning with sync burst followed by transmission time for each channel.

Message space within the total frame time is maximized to minimize required bandwidth. Because avc, sync-burst and guard-band time is fixed by system needs, a longer frame provides a proportionally larger time for message space. But the portion of the message stored during one frame is not transmitted before compression and readout during the following frame.

A storage delay occurs at the receiver because the compressed message stored during one frame is read out at the expanded rate during the following frame. A shorter frame length compromises demands

for a short storage delay time and a maximum frame message space.

Synchronization

Because time is shared, each station must recognize absolute time to insure proper relations between channels. Therefore, a synchronization burst is provided during the time before transmission of slots. While sync signals may be transmitted by all stations during transmission, regular transmission by only the master control station is the better solution. Otherwise, sync signals would reach a receiver at different instants.

Signals from several stations employing different channels may arrive at a receiver during any frame, and the signal levels may vary greatly. To accommodate the different signal levels without loss, an avc burst precedes the message portion of each channel slot.

Each station assigned to a channel transmits the avc signal when it transmits on the channel. Channel receivers adjust to the proper reception level on the avc burst and are then ready to receive the mes-

sage. In present communication receivers avc recovery time may be as long as 2 millisecc, but advances should reduce the time.

Transmission-time delays require a guard band of 2 millisecc for each 186-mile separation of stations. Without the 2-millisecc allowance, signals overlap when widely separated stations attempt to communicate.

In addition, the crystal-oscillator clocks, which are the system timers, vary, and unless continuous correction is made to some master reference, guard bands must be provided. With clocks whose stability is ± 1 part in 10^6 over a 24-hour period the system can operate with each 0.2-millisecc guard band for 160 minutes between clock corrections and not run into synchronization errors.

The counter synchronizer, shown in Fig. 2 is tuned by a crystal-controlled clock and permits several modes of operation. It may run free for short periods of time or may initiate the master sync pulse. Or it may be synchronized by a received sync pulse from a master station,

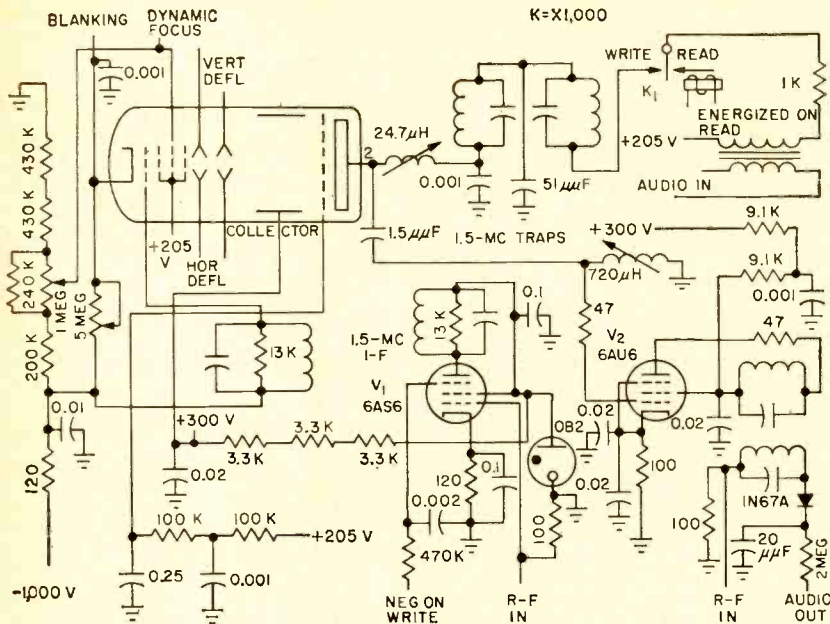

FIG. 4—Storage-tube, is directly coupled to a sweep amplifier and operates with constant current during writing phase of operation

and then corrections to the counter are made from time to time.

The synchronizer generates frame voltages, slot voltages and enable voltages for controlling each of the unplexers. In addition, it develops a slow and fast sweep clock voltage and an r-f read-out voltage.

The Uniplexer

The uniplexer shown in Fig. 3 accepts information at a given rate, stores the information until read-out time and then reads the information out at a new rate.

Two Radechon charge-storage tubes in each uniplexer store and write information. One tube writes while the other tube reads. After readout from one tube, the tubes exchange roles. Thus, the first tube stores odd frames and the second tube stores even frames.

The uniplexer may either com-

press or expand and can change modes of operation in a fraction of a second. A PUSH-TO-TALK switch on the microphone controls the mode. When the switch is pressed, the uniplexer compresses the message for transmission, and when the switch is released, the uniplexer expands the message for reception.

The PUSH-TO-TALK switch also controls the activity of the transmitter and receiver.

Storage-Tube Circuit

The storage-tube circuitry shown in Fig. 4 is backplate modulated with r-f readout. The tube is directly coupled to a sweep amplifier and operates at a constant beam current of $3.5 \mu\text{A}$ during writing. It is r-f pulsed during reading and is blanked during dead time.

During write-in, the relay K_1 is deenergized and the audio signal is applied to backplate 2 of the storage tube. Also, the r-f switch tube V_1 is held at cutoff by the read enable gate causing the tube to be scanned by a constant current. Because the beam is unmodulated, the band-pass amplifier V_2 does not respond to the signal being stored.

During read out the audio signal is disconnected from the storage tube backplate by relay K_1 , which is now energized. Tube V_1 turns on and is r-f coupled to the storage-tube grid by a tuned transformer.

The tuned transformer blocks the approximately +1,200-v d-c grid voltage. As the tube scans, the r-f beam current is modulated by the stored signal.

A suppressed-carrier a-m signal flows in the backplate circuit and is amplified in tube V_2 . It is then synchronously detected. The absence of a carrier pedestal with suppressed carrier simplifies interconnection of the pair of storage tube circuits.

A number of minor features of the storage tube circuitry contribute to successful operation. A dynamic focus circuit partially corrects for the effects of changing spot position. The 1.5-mc traps in the audio circuit effectively block troublesome relay switching transients. Also, blanking of the undeflected spot prevents partial erasure of adjacent areas by redistribution currents.

Waveforms

Waveforms, which time a compressing storage tube, are shown in Fig. 5. The blanking and reset waves in Fig. 5A blank the undeflected or stationary spot and also reset the sweep-generator counters.

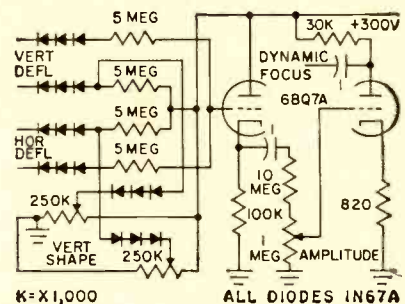

FIG. 6—Dynamic focus circuit generates and sums three-line approximations to parabolas. Resulting waves are simplified and inverted and then applied to the storage tube

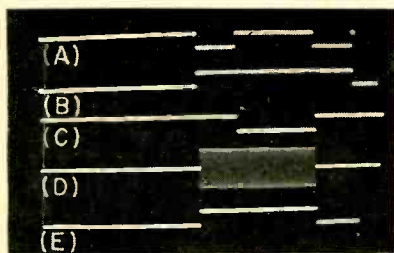

FIG. 5—Waveforms that time compressing storage tube are blanking and reset (A), frame (B), slot (C), read enable (D) and write enable (E)

Resetting of the counters brings the sweep counters initially into step. The frame and slot voltages in Fig. 5B and 5C start and stop the hybrid sweep generator. The r-f read enable pulse in Fig. 5D, is generated by tube V_1 for pulsing the storage-tube beam current. The write enable pulse of Fig. 5E, controls the relay K_1 . Both the enable voltages include a switching inter-

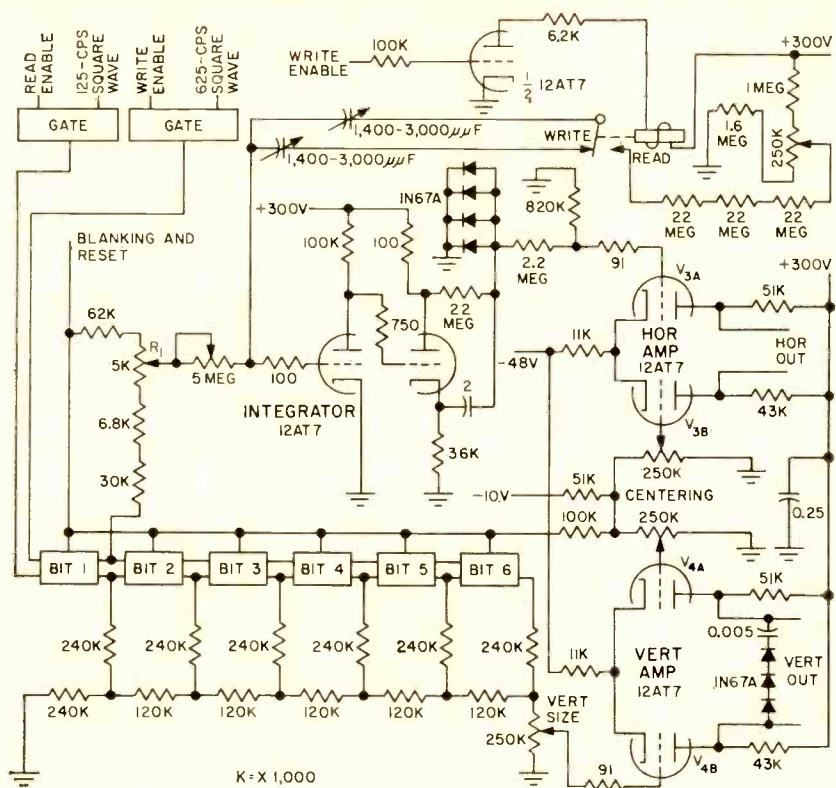

FIG. 7—Hybrid sweep circuit has long-tail-pair amplifier that converts single-ended output of 6-bit counter into push-pull

val and thus begin before the operation to be enabled.

The dynamic focus circuit, shown in Fig. 6, corrects the causes of variation in the output of the storage tube with spot position. The circuit generates a three-line approximation to a parabola for both axes, and the parabolas are summed in equal proportions. The resulting waveforms are inverted and amplified before application to the storage-tube focus element.

The circuit generates the waveform directly from the deflection voltages by a non-rate-sensitive method as required by the changing sweep speed. A negative OR gate connected to the push-pull deflection amplifiers allows the more negative sweep voltage to establish the output. Therefore, voltage increases during the first half sweep and decreases during the second half sweep. A threshold adjustment or shape control flattens the peak of the triangle, thus improving the approximation to a parabola. Both horizontal and vertical corrections are obtained in an identical manner.

The hybrid circuit of Fig. 7 generates the 64-line rectangular sweep shown in Fig. 8 by a semidigital

method. The sweep frame interval of 0.5 sec and slot interval of 0.25 sec correspond to a compression ratio of 2. An operational two-channel system requires a ratio exceeding 2 to allow time for synchronization and avc.

The vertical component of the sweep is generated by digital techniques and gives excellent register of slow and fast sweeps. The 64-step vertical staircase voltage is developed by a 6-bit counter and resistor matrix as shown in Fig. 7.

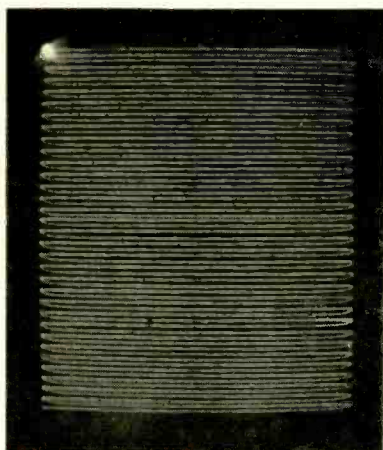

FIG. 8—The 64-line rectangular sweep output of sweep generator circuit

The single-ended voltage is converted to push pull in the long-tail-pair stage V_{3A} and V_{3B} that also drives the storage-tube deflection plates. The circuit has an inherent unbalance that is overcome with unequal plate-load resistances.

Counter Circuit

Operation of the counter is controlled by a pair of AND gates which connect either the slow or fast clock to the counter. The first bit of the counter is a special dual-input flip flop.

Because horizontal sweep-register requirements are not severe, the horizontal sweep voltage is generated by an integrator. The two waveforms are integrated simultaneously to achieve the desired result. One waveform, the output voltage from the first bit of the 6-bit counter, consists of a train of pulses which provide the necessary horizontal deflection when integrated. A second waveform, the blanking and reset-voltage, compensates the d-c component in the pulse train from the counter. The 5,000-ohm potentiometer R_1 adjusts the compensation to produce a square-sided raster.

To make the sweep amplitude independent of sweep rate, the integrator time constant changes with the sweep speed. An auxiliary integrating capacitor is switched into the circuit during the slow sweep and is adjusted for a slow sweep amplitude equal to the fast sweep amplitude. A loss of charge on the capacitor when disconnected from the integrator is compensated by a bleeder circuit connected to a variable voltage source. The horizontal adjustment improves coincidence at the beginning of the sweep.

The output of the integrator contains a d-c restorer which further improves the horizontal coincidence. Deflection amplifier V_{3A} and V_{3B} similar to the vertical amplifier follows.

Systems able to handle 10 channels are entirely feasible with only minor modifications. With further development 30 to 50 channel systems could be produced.

The uniplexer can be applied to any system in which an analog compressor-expander with up to a 50:1 ratio is required.

Electrically controlled reciprocal ferrite phase shifter provides continuous phase variation from 0 to 360 deg with up to 15 kw peak power at X band. Unit comprises two transversely magnetized ferrite slabs in the narrow walls of a rectangular waveguide. Nearly identical characteristics of phase shift against magnetic biasing are possible over a 10-percent frequency band

By WILLIAM H. HEWITT, JR. and WILHELM H. VON AULOCK

Bell Telephone Laboratories, Inc., Whippany, New Jersey

X-Band Phase Shifter

PHASE SHIFTERS for microwave circuits have previously employed mechanical motion of some part of the structure, such as a shorting plug, dielectric fin or rotating half-wave plate^{1, 2, 3, 4}. Remote control operation of these shifters is subject to limitations of motor-driven or hydraulic servo units. An all-electric phase shifter

has been developed to overcome these objections. It is readily adjustable to a desired phase shift without mechanical motion of any part.

Such a device should produce an accurate and reproducible phase shift between 0 and 360 deg over an adequate frequency band. It should have low insertion loss, low

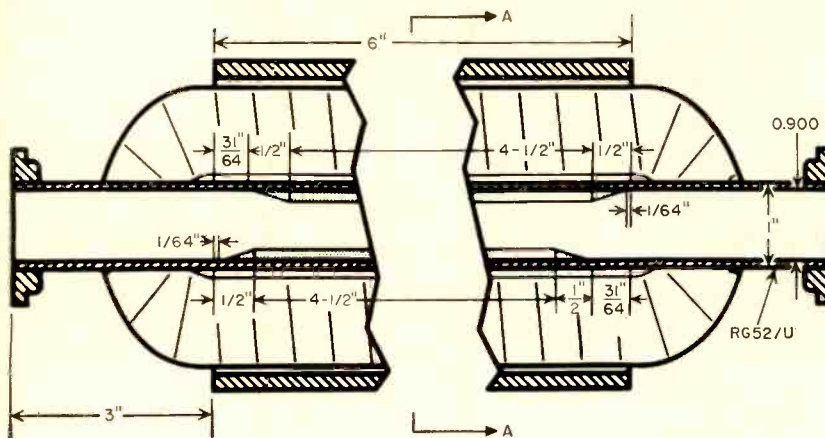
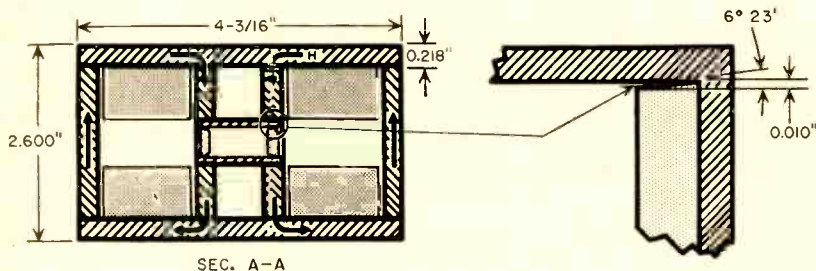

FIG. 1—Physical arrangement of ferrite slabs shows their keystone cross-sections and grooves broached in waveguide

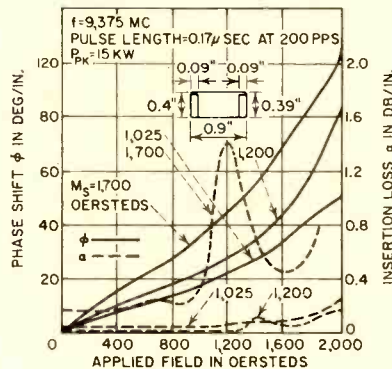
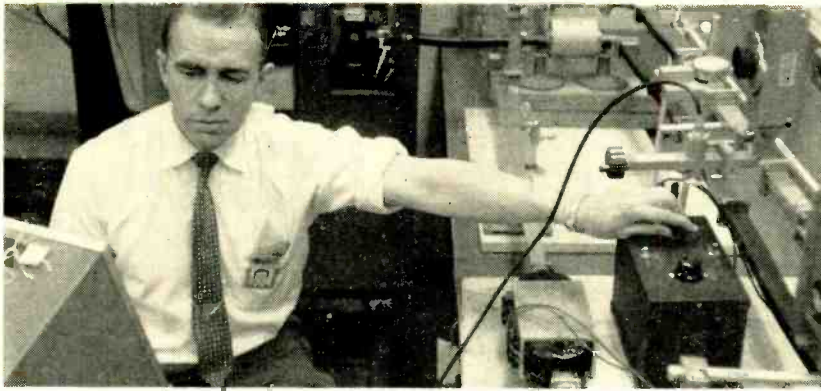

FIG. 2—Phase shift and loss characteristics of magnesium-copper-aluminum-manganese ferrites. Frequency is 9,375 mc, pulse length 0.17 μ sec at 200 pps and peak power is 15 kw

vswr and a phase shift independent of direction of propagation. Its peak power handling capability should be high and it should shift rapidly to any preset value. Power requirements for remote-control operation should be low and operation should be independent of environmental conditions such as temperature, shock and vibration. Finally it should have low weight and small volume. Most of these requirements have been met in a ferrite-loaded waveguide with a variable magnetic biasing field as the phase-shifting element.

System Development

Extensive measurements have shown that a phase shift of 80 to 90 deg/in. can be obtained at an insertion loss of about 0.15 db/in.



Oscillographic check of phase shifter performance being made in laboratory

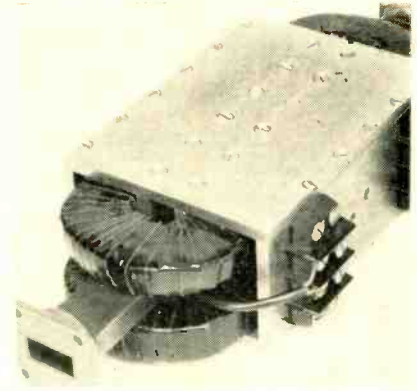

Complete package measures only 1 ft

Without Moving Parts

with a ferrite-loaded rectangular waveguide. Low vswr and a reasonable amount of power handling capability can be attained with available ferrite materials located at the narrow walls of the guide. Wall loading of the waveguide also provides good heat transfer from the ferrite slabs to the guide walls and accurate positioning of the slabs in the guide.

The mechanical design of the phase shifter is essentially determined by the need for a low reluctance magnetic circuit for the transverse magnetization of the two ferrite slabs. The box type yoke of Fig. 1 combines compact-

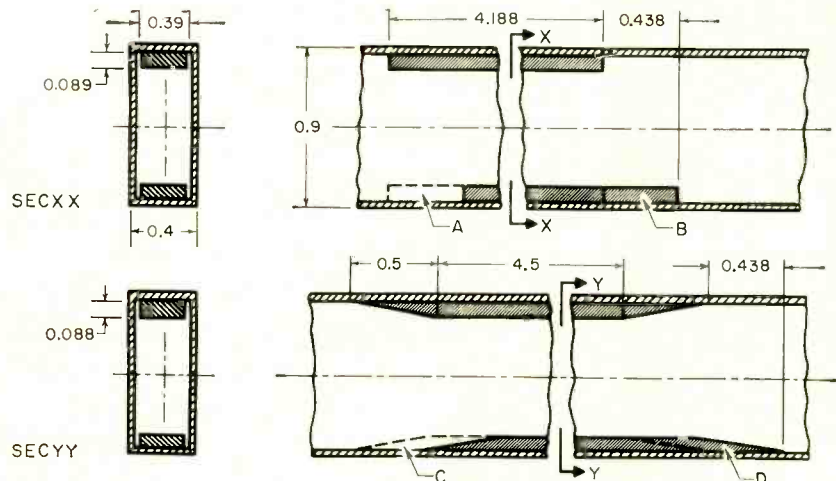

FIG. 4—Physical arrangement of ferrite slabs for minimization of vswr

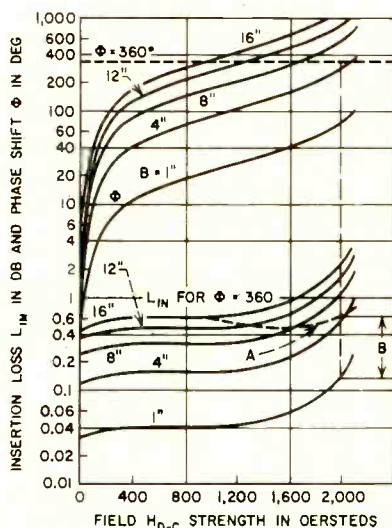

FIG. 3—Phase shift and insertion loss of wall-loaded waveguide with ferrite slabs of various lengths B

ness and rigidity with desirable magnetic properties.

Magnesium-copper-aluminum-manganese ferrites have good phase-shifting properties and low loss. With applied magnetic field and temperature held constant, phase shift increases with the saturation magnetization of the material but the power-handling capability decreases. As shown in Fig. 2, a saturation magnetization of 1,200 oersteds offers the best compromise.

The next design step is to determine the length and thickness of the ferrite slab which permits a phase shift of 360 deg with a structure of minimum weight and at an acceptable insertion loss. Measurements and analysis show that the

maximum permissible slab thickness for operation up to 9,400 mc is 0.088 in. Thicker slabs would permit the occurrence of higher order modes in the waveguide, as evidenced by loss peaks and erratic phase-shift behavior.

Insertion Loss

A practical limitation for the highest required magnetic field H_{d-c} is the maximum insertion loss of the device, which has a broad minimum for a range of slab lengths but increases rapidly for short and long ferrite slabs. This can be seen readily by plotting phase shift ϕ and insertion loss L_{in} for various slab lengths against magnetic field as in Fig. 3. Both ϕ and L_{in} are proportional to the

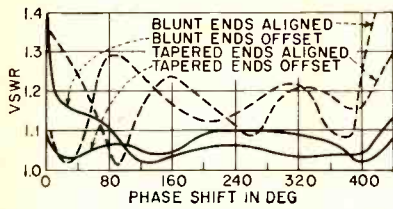

FIG. 5—Effect of tapering and offsetting ferrite slabs in reduction of vswr

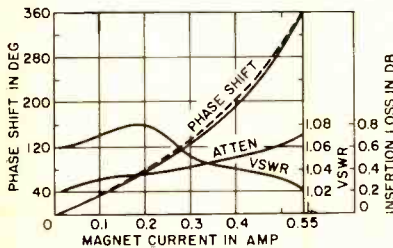

FIG. 6—Basic characteristics of phase shifter at 9,375 mc and 85 F

slab length. Hence the curves are parallel to each other and displaced from the curve for $B = 1$ in. by a separation equal to the slab length in inches.

If a maximum value is chosen for H_{a-c} , the required slab length for a phase shift of 360 deg can be determined, and the insertion loss and H_{a-c} for this length can be read from the chart. When this procedure is repeated for a number of values of H_{a-c} a curve is developed for the maximum insertion loss of the device as a function of slab length and magnetic field. Curve A of Fig. 3 is an example. With a maximum insertion loss of 0.65 db, the highest required magnetic field of 1,960 oersteds and the slab length of 4.5 in. are obtained.

A further advantage of this plot is the direct reading of a figure of merit $F = \theta/L_{in}$. This figure is the distance between two associated graphs of θ and L_{in} . Quantity F is small for low phase shifts, reaches a maximum and then decreases because the loss increases faster than the phase shift as ferromagnetic resonance is approached. The insertion loss of the phase shifter may be reduced to the minimum value shown in Fig. 3 if longer ferrite slabs are used and if the maximum value of H_{a-c} is reduced accordingly. Thus 8-in. slabs and a maximum field of 1,600 oersted reduces the insertion loss to 0.48.

The last step in the design of

the phase shifter is the reduction of reflections from the ferrite slabs to the lowest attainable value over a 10-percent frequency band and at all phase angles between 0 and 360 deg. This is complicated by the fact that the impedance of the phase-shifter undergoes considerable change during a phase-shifting cycle.

It has been determined experimentally that tapering the ferrite thickness and offsetting the slabs produce the lowest vswr over the operating range. The optimum physical arrangement for the slabs is shown in Fig. 4 and the effect of these two measures is shown in Fig. 5 by comparing the vswr of two untapered ferrite slabs with those of two tapered slabs with and without offset.

Physical Form

The final arrangement of the ferrite slabs in the waveguide is as shown in Fig. 1. Each of the two coils has 4,000 turns of No. 29 wire, which at a maximum current of 275 ma will provide a magnetic field of 2,000 oersteds in the ferrite slabs. A second winding of 1,000 turns of No. 31 wire is added to each coil for adjustment of the current phase shift characteristic and compensation for tempera-

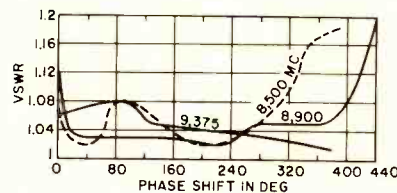

FIG. 7—Effect of frequency on vswr

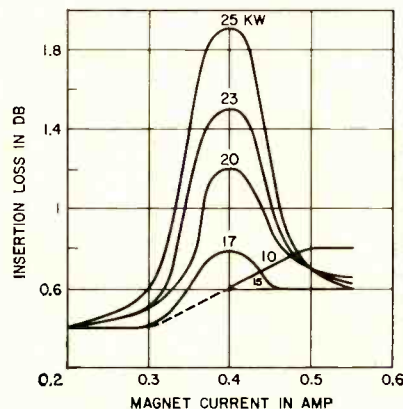

FIG. 8—Insertion loss of phase shifter at magnetron power levels

ture effects and minor frequency changes.

The phase shift, insertion loss and vswr at 9,375 mc are shown in Fig. 6. The phase shift goes through a distinct hysteresis loop because of the properties of the core material. Maximum insertion loss is 0.75 db and the vswr is 1.08 respectively. The current in the compensating coil produces a field of 20 oersteds. Both the phase shift and differential phase shift increase slightly with decreasing temperature. Phase shift at a given value of coil current also increases as the frequency decreases because the waveguide approaches cutoff.

Load Characteristics

As the frequency is lowered the insertion loss stays below 1 db, and as Fig. 7 shows, the vswr remains below 1.2 in the band 8,500 to 9,400 mc. One of the most important tests of the phase shifter is its performance under pulse-power load. From preliminary measurements, it was expected that the threshold for high-power instability of the ferrite would be in the vicinity of 15 kw for the geometry under consideration and a pulse length of 0.17 μ sec. Tests prove the validity of this assumption. An absorption line is evident in Fig. 8 at 17 kw and the insertion loss reaches 1.9 db as the peak power is increased to 25 kw.

The advantage of the ferrite phase shifter is its ability to reproduce any preset program of phase shifts, with switching times of a few millisecc if a feedback-controlled d-c power supply is used. Maximum dissipation in the magnet coils occurs at a phase shift of 360 deg and totals 85 w. Average power dissipation with variable phase shift is estimated at 40 w.

REFERENCES

- (1) H. Scharfman, Three New Ferrite Phase Shifters, *Proc IRE*, p 1456, Oct. 1956.
- (2) A. G. Fox, S. E. Miller and M. T. Weiss, Behavior and Applications of Ferrites in the Microwave Region, *BSTJ*, p 5, Jan. 1955.
- (3) J. Cacheris, Microwave Single-Sideband Modulator Using Ferrites, *Proc IRE*, p 1242, Aug. 1954.
- (4) J. Cacheris and H. Dropkin, Compact Microwave Single-Sideband Modulator Using Ferrites, *IRE Trans PGMTT*, p 152, July 1956.
- (5) H. Suhl, The Nonlinear Behavior of Ferrites at High Microwave Signal Levels, *Proc IRE*, p 1270, Oct. 1956.

How TRANSDUCERS Measure and Control

By **RONALD K. JURGEN**
Associate Editor, **ELECTRONICS**

- 1-Transducers in Measurement
- 2-Voltage and Current
Generating Transducers
- 3-Variable Parameter
Transducers
- 4-Transducer Applications

Typical missile, showing transducer applications. Crescent Engineering and Research Co. Background photo, Convair Div. of General Dynamics.

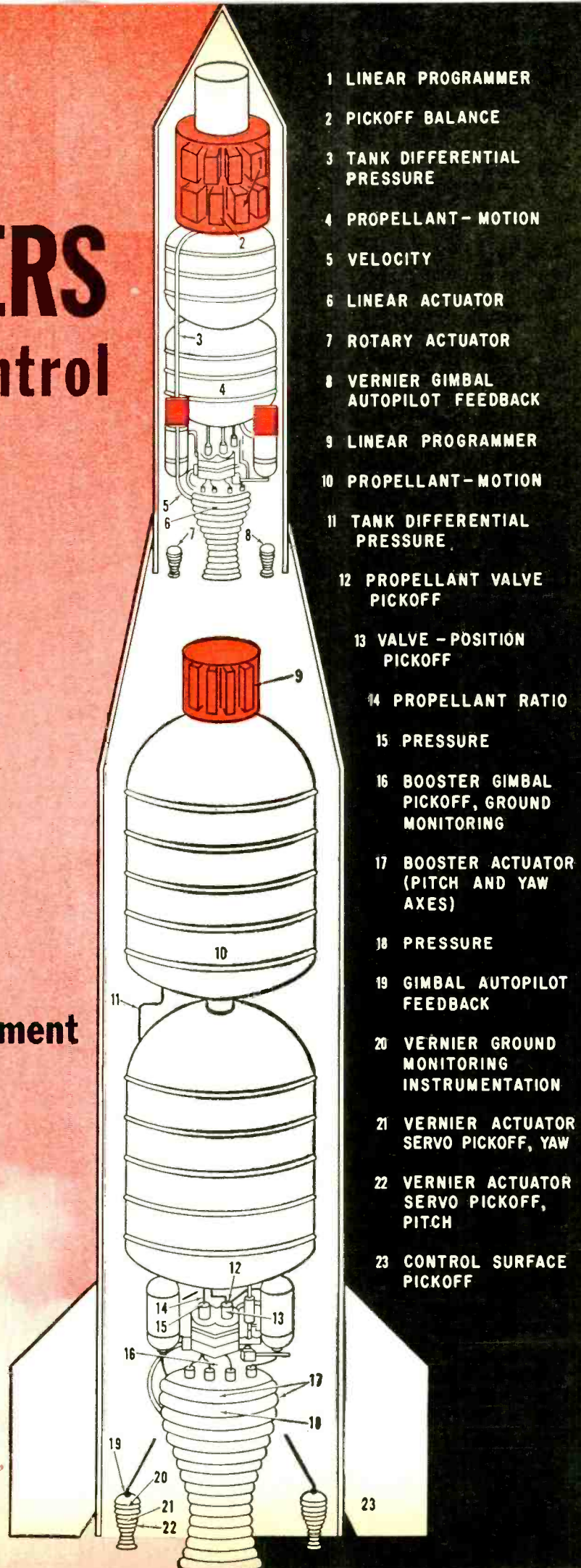

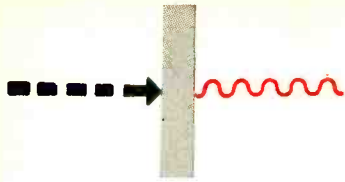

Transducers in Measurement

In any electronic measurement system, a key component is the device that changes its characteristics proportionally to the quantity being measured. This device is the transducer. With it, precise measurement of nearly any parameter is possible

"WHEN YOU can measure what you are speaking about and express it in numbers, you know something about it."—Lord Kelvin.

TODAY, MEASUREMENT with accuracy and reliability is of utmost importance. Inertial and infrared-guidance systems, data-collecting earth satellites and high-speed jet aircraft call for rugged, accurate and compact instrumentation.

Refinements in measuring techniques in recent

years have made possible easy and accurate measurement of extremely small physical displacements. Electronics has been responsible for advances in at least two ways—amplification of weak detected information to a useful level and application of special circuits for wholly new measurement concepts.

Electronic measurement and control depends upon some device that undergoes a change proportional to the quantity being measured. Such a detector is called an input signal transducer. It converts a change in some form of energy such as motion, heat, light or sound into a measurable electrical parameter.

TABLE I—Typical Measurements & Basic Transducers

TYPE OF TRANSDUCER → QUANTITY TO BE MEASURED ↓	Capacitive	Electron Tube	Inductive	Magnetolectric	Magnetostrictive	Photoelectric	Piezoelectric	Radioactive	Resistive	Thermoelectric
Acceleration	X	X	X	X	X		X		X	
Displacement	X	X	X	X		X	X	X	X	
Flow	X		X	X			X	X	X	
Force			X				X	X	X	
Humidity and Moisture	X								X	
Level	X					X	X	X	X	
Light						X			X	X
Mass			X	X			X	X		
Pressure	X	X	X	X	X		X	X	X	X
Temperature						X		X	X	X
Thickness	X		X			X	X	X		
Velocity	X	X	X	X		X	X	X	X	
Viscosity	X				X		X		X	

APPLICATIONS—Project Vanguard's Lyman-alpha earth satellite, for example, has 17 transducers located on its shell and in its internal package. They are used for detecting temperature, collision with micrometeorites and solar Lyman-alpha radiation.

A modern high-speed jet aircraft requires an impressive amount of instrumentation for measurement of nonelectrical quantities. Some of these are: acceleration, air speed, altitude, air temperature, angle of attack, heading, drift, flow, fuel consumption, ice accumulation, inclination, Mach number, pressure, rate of climb, rate of turn, temperature, time and thrust. Each measurement depends upon a transducer. Figures 1 and 2 show typical rocket and jet aircraft applications.

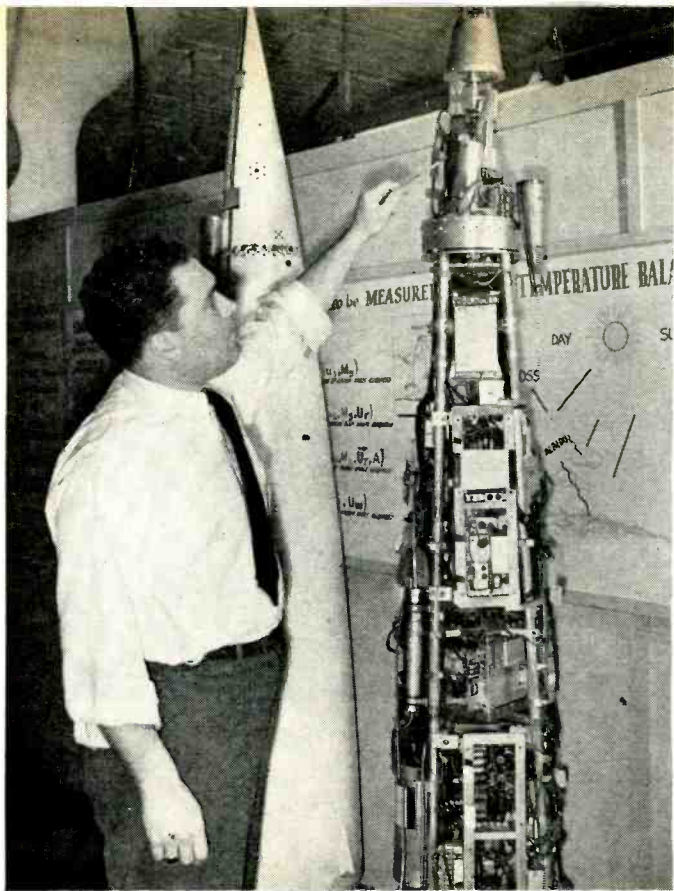

FIG. 1—Ionization gage for Aerobee rocket. Gage manufactured by NRC Equipment Corp. is basically a pressure-sensing device capable of giving accurate readings from atmospheric pressure to below one micron

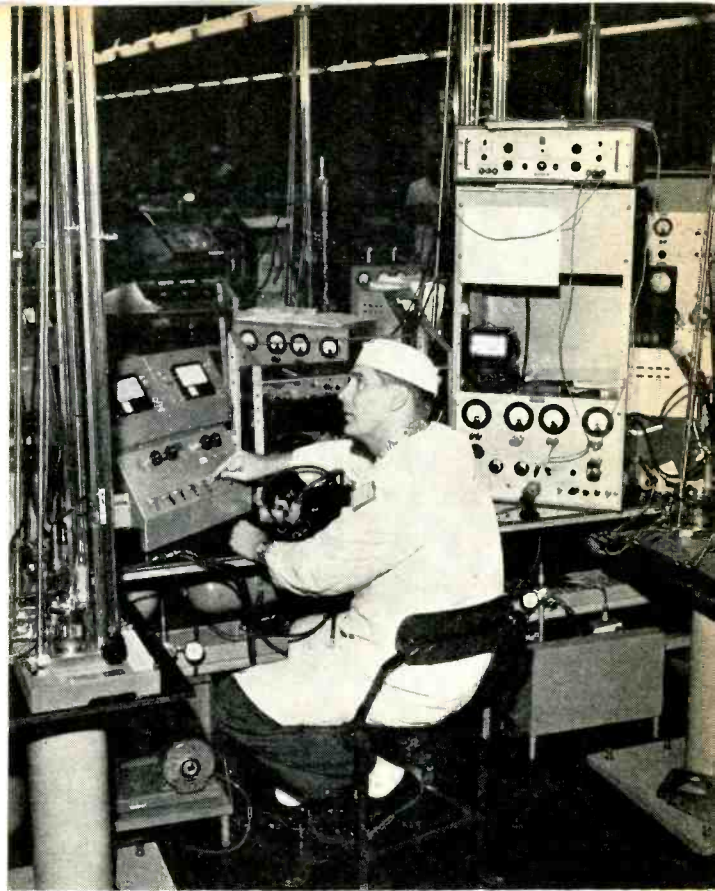

FIG. 2—Potentiometer-type Mach controller for F-100 and F-101 fighters is tested with mercury manometers. Minneapolis-Honeywell equipment holds ratio of dynamic and static pressures constant

TYPES OF TRANSDUCERS—In recent years, types and quantities of commercial transducers have increased rapidly, as have the instruments incorporating them. With this growth has come an increase in applications.

Table I gives an idea of the variety of transducer types applicable to typical measurements.

The ability to control the amount of change in the quantity being measured has been responsible for development of present-day automation techniques. Closed-loop servo systems detect a change and act upon it to bring the quantity back to its original level or to initiate other operations.

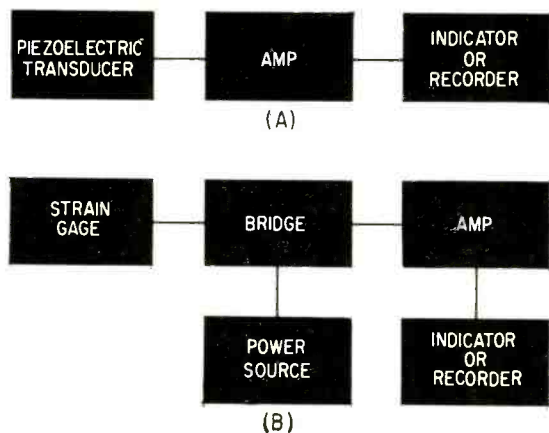
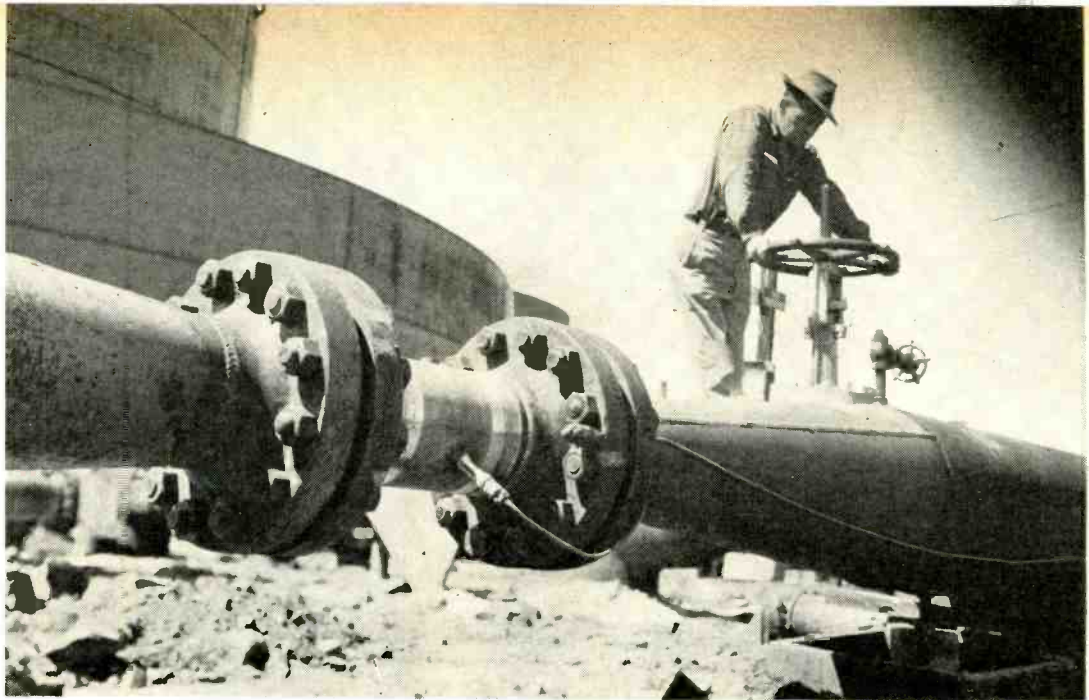

FIG. 3—Comparison of components required for typical voltage-generating transducer (A) and variable parameter transducer (B)

Transducers include two basic types. The first type produces an output voltage or current. In this category, transducers requiring no power supply (such as piezoelectric crystals) as well as those requiring a power source to make the transducer action possible (such as a phototube) are included. Figure 3A shows a simple system incorporating a generating-type transducer requiring no power source, such as might be used for measuring pressure.

The second type of transducer gives a measurable change in resistance (thermistor); capacitance (microphone); or inductance, permeability, or reluctance (linear differential transformer). This second group also includes devices requiring no power source as well as those that do. Figure 3B illustrates a system comparable to that in Fig. 3A for measuring pressure with a transducer requiring no power source for basic transducing action. But, in this case, a varying-resistance-type transducer is used, requiring a bridge circuit and a power source to convert the change in resistance to an electrical signal.

Transducers operating on the basis of a particular phenomenon such as photoelectricity may appear under both categories. Photovoltaic cells, phototubes and phototransistors (all photoelectric devices) appear under the first grouping of voltage-or-current-producing devices. Photoconductive cells (also photoelectric) are discussed with resistance-varying elements since they do not generate a voltage or current.



Flow of petroleum products in pipeline is metered by Potter Aeronautical's voltage-generating flowmeter

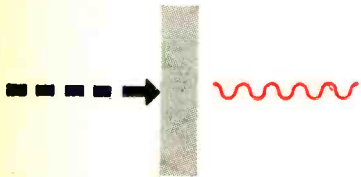

Voltage and Current Generating Transducers

Transducers which generate an output voltage or current usually need only simple measuring circuitry. This output may be of sufficient amplitude to operate an indicating device directly; or low-level amplification may be enough

VOLTAGE OR CURRENT transducers can be subdivided into: piezoelectric, photoelectric, thermoelectric, magnetoelectric, electrochemical, electronic and radio active. Table II gives characteristics of typical units for commonly measured quantities.

PIEZOELECTRIC TRANSDUCERS — Piezoelectric transducers depend upon the fact that voltage is generated in a piezoelectric crystal when its dimensions are changed by mechanical force or stress. Piezoelectric crystals are available both in nature (quartz and tourmaline) and as synthetics (Rochelle salts, barium titanate ammonium dihydrogen phosphate and ethylene diamine tartrate).

Natural crystals exhibit low leakage, withstand temperatures up to about 300 C and are rugged. They give an output of about 0.03 volt per thousand pounds of force applied.

Synthetic crystals, in general, are about 1,000 times more sensitive than natural materials. Rochelle salts have high sensitivity but are temperature-and-humidity-restrictive. Ammonium dihydrogen phosphate withstands temperatures to about 100 C and is less sensitive to humidity than Rochelle salts. Barium titanate is often used with a binder to form a ceramic. Lead titanate may be added to improve temperature stability. Crystals are useful from about -50 to +100 C.

Piezoelectric transducers are used for detecting tensile strength, load, pressure, vibration, surface roughness, pulse beats, time and flow rate.

PHOTOELECTRIC TRANSDUCERS — Transducers depending upon changes in light energy for their operation seldom load or interfere with the phenomenon to be measured. Sensitivity and speed of response are high.

One type of photoelectric transducer is the photovoltaic cell. A commonly used type is the selenium cell—a steel baseplate with a coating of selenium, upon which a coating of cadmium is applied. Platinum, gold, or some other noble metal is then often added in a thin layer. Between the selenium and cadmium, cadmium selenide is formed. Photons hitting the cell cause it to generate a voltage. No power supply is needed.

Some of the other materials used are silicon, germanium, copper oxide and thallus sulfide. With all types, recalibration is necessary on a continuous basis to maintain accuracy.

Another type of photoelectric transducer is the phototube. Amount of current flowing in the tube is a function of wavelength and intensity of light hitting the cathode. Gas phototubes, as opposed to high-vacuum types, experience ionization from the photoelectrons. This so-called gas amplification adds to the total current flow.

Multiplier phototubes have outputs large enough to operate many indicating devices directly. Figure 4 illustrates one interesting application.

Another type of voltage-producing photoelectric transducer is the phototransistor. This semiconductor device operates on the principle that light gives enough energy to the valence-band electrons to raise them to the conduction band. This action increases the supply of electrons and holes which act as current carriers and decrease resistivity. When light shines on a phototransistor having a constant impressed voltage, a marked increase in current takes place. Efficiency decreases rapidly in the infrared region beyond two microns and beyond blue or ultraviolet.

Photoelectric devices may be used to measure indirectly absorption of a gas, reflectivity, color, liquid level, solidification and turbidity.

THERMOELECTRIC TRANSDUCERS — Thermocouples operate on the principle that dissimilar metals having different work functions exhibit an electromotive force or voltage between them when connected together at two ends, and when each end is at a different temperature. Output is proportional to the temperature differential, work-function of the wires and circuit resistance.

Typical combinations of wires used are: iron and constantan, copper and constantan, chromel and alumel and platinum and platinum-rhodium. Operating temperature range varies considerably depending upon wire types used. In general the range is from about -200 to $+1,600$ C.

Thermocouples can be used to operate indicating instruments directly. A number of thermal junctions can be connected in series to form what is known as a thermopile.

MAGNETOELECTRIC TRANSDUCERS—Basic to operation of a magnetoelectric transducer is the fact that a wire moving in a magnetic field generates an emf. Figures 5 and 6 show examples.

Advantages are: usually no physical contact with quantity being measured, small loading effect

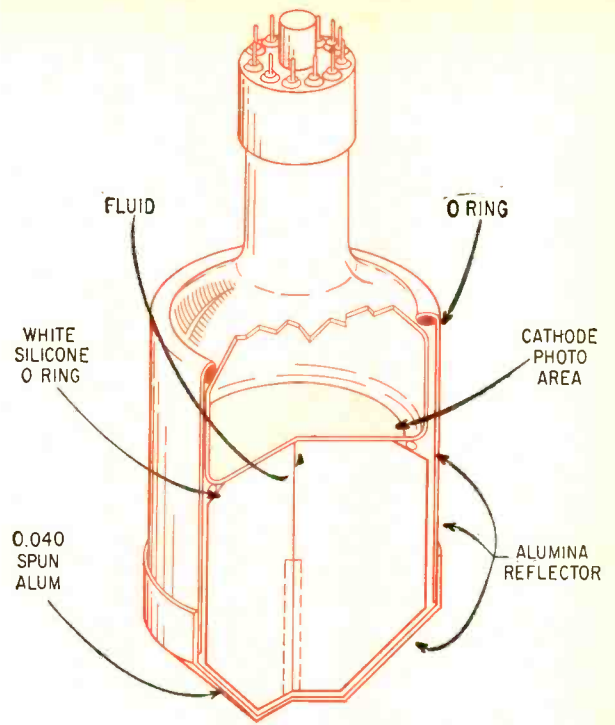
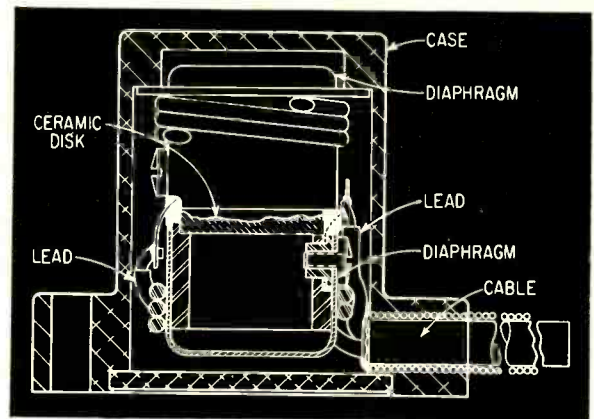

FIG. 4—Sodium-iodide crystal and multiplier phototube are integrally combined in Levinthal Electronic Products' scintillation transducer



Accelerometer by Consolidated ElectroDynamics. Vibration of shock forces polar fluid through the ceramic partition, creating an electrical output

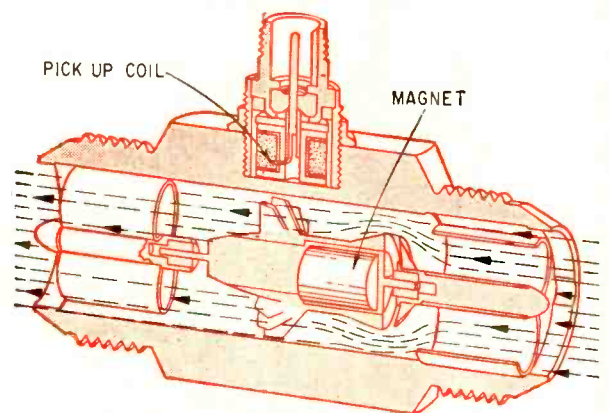

FIG 5—Potter Aeronautical's flow transducer operates on the emf-generating principle. Frequency of induced signal is proportional to flow rate. Total pulses are proportional to total flow

TABLE II — Characteristics of Typical Voltage and Current Generating Transducers

Basic Transducer	Measurement	Input Range	Sensitivity	Operating Frequency Range	Output Characteristics
Piezoelectric Crystal	Vibration acceleration	0.01 to 5,000 g	1 to 100 mv/g	3 to 20,000 cps	700 to 5,000 $\mu\mu\text{f}$
	Sound pressure	1 to 1,000,000 dynes cm^2	10 to 100 $\mu\text{v}/\text{dyne}/\text{cm}^2$	10 to 200,000 cps	300 to 5,000 ohms
Photovoltaic Cell	Light	2,500 to 7,000 A	570 to 615 $\mu\text{a}/\text{lumen}$	Up to 2,000 cps	100 to 20,000 ohms
Phototube	Light	3,000 to 11,000 A	5 to 200 $\mu\text{a}/\text{lumen}$	Gas type to about 10 kc	Changes with operating conditions
Multiplier phototube	Light	2,000 to 7,500 A	6×10^5 to 8×10^7 $\mu\text{a}/\text{lumen}$		
Thermocouple	Temperature	-200 to +1,600 C			-10 to +60 mv
Magnetoelectric Device	Vibration velocity	0.001 to 40 in./sec			
	Speed	100 to 11,000 rpm			
Electrochemical Electrode	pH				1,000 megohms
Electron Tube	Acceleration	0 to 10 g			
Radioactive Gage	Thickness	2 to 20,000 mg/cm^2			

and good accuracy. High-frequency applications are often limited because of hysteresis losses.

ELECTROCHEMICAL TRANSDUCERS—One of the most common applications for an electrochemical transducer is in the measurement of hydrogen-ion concentration or pH.

Two electrodes are immersed in the liquid under test. One electrode has a constant potential with respect to hydrogen regardless of the pH of the liquid. A saturated solution of calomel (mercurous chloride) is often used. The other electrode must have a potential output with respect to hydrogen which varies with pH. For this second electrode, a so-called glass electrode is often used.

ELECTRON-TUBE TRANSDUCERS — Electron-tube transducer refers to any transducer employing an electron tube with an element, or elements, free to move. By change in element position, output of the tube varies in proportion to the quantity being measured such as acceleration, vibration or pressure.

Large output is available because of the gain of the tube. Fine control of electron flow gives

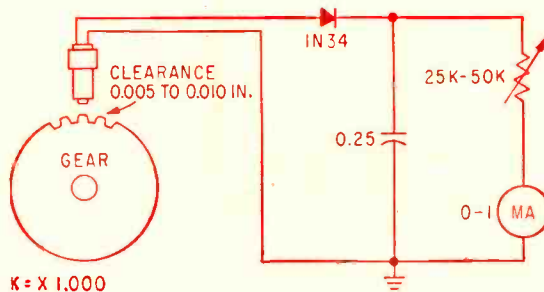

FIG. 6—Angular velocity can be measured with an emf-generating-type transducer and circuitry suggested by Electro Products Laboratories

high sensitivity. Frequency response is almost unlimited. Construction and calibration are frequently complex. A power source is needed.

RADIOACTIVITY TRANSDUCERS—Radioactive materials can be detected either by the ionization or excitation they produce in passing through matter or by secondary charged particles they produce by interaction with matter.

A common detection device is a chamber containing two electrodes. If there is no potential difference between the electrodes, ions produced are subject only to thermal agitations and recombine. Only a small number are collected.

If a potential difference is established between the electrodes and is gradually increased, ions will be more and more completely collected before recombination. When a certain field strength is reached, all ions reach the electrodes.

Increasing the potential still further causes a secondary effect of ionization by collision which results in a multiplication of the ionization. Multiplication continues until a voltage is reached at which point all pulses of ionization, regardless of initial strength, are multiplied to a final constant size. This point is the Geiger-Mueller region.

Below the Geiger-Mueller region, multiplication is constant and ionization collected is directly proportional to that produced by the initial ionizing event. This region is called the proportional region. Chambers operate in three modes—as ionization chambers with no gas multiplication, proportional counters and Geiger-Mueller counters.

Since beta particles have 100 times more penetrating power than alpha particles, they are often used. Gamma and X-rays are used for thick materials. Typical radioactive isotopes used in beta-ray gages include: carbon, calcium, promethium, strontium, yttrium, sulphur and thallium.

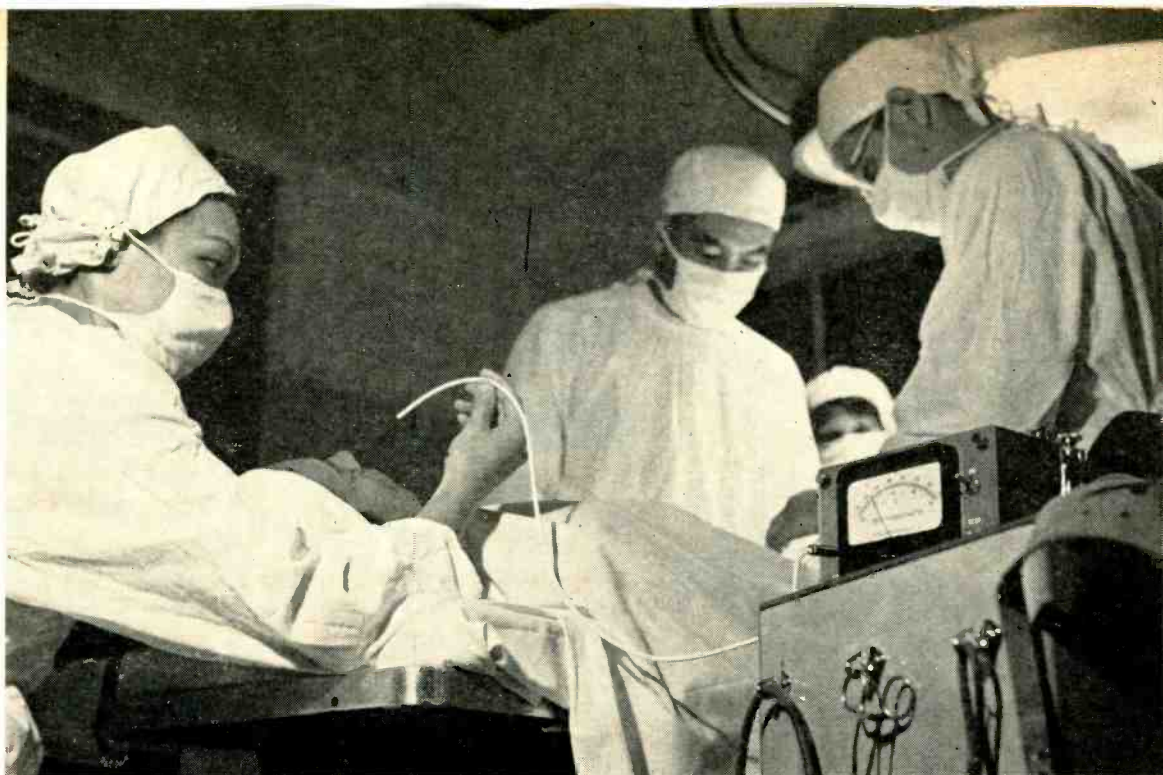

Medical electronics benefits from use of Yellow Spring Instrument's thermistorized Tele-Thermometer

Variable Parameter Transducers

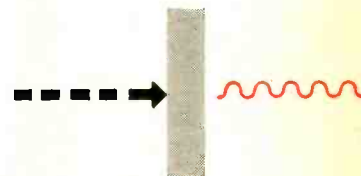

Changes in resistance, capacitance or inductance basic to variable parameter transducers are observed either by the null method using a potentiometer or bridge circuit. Or the varying parameter may produce a voltage for amplification

MAJOR TYPES of voltage-producing transducers have been discussed. Remaining basic transducers are all of the varying-circuit-parameter variety. Table III gives representative characteristics of these units in typical measurements.

VARYING-RESISTANCE TRANSDUCERS — Transducers dependent upon change in resistance or conductance as an indication of physical quantity measured may be subdivided into: (1) transducers which undergo a nonmechanical resistance change, such as a thermistor; (2) transducers experiencing a change in resistivity or internal structure, such as a resistance strain gage; and (3) transducers capable of giving a mechanically variable resistance output, such as the potentiometer.

Photoconductive cells use such semiconductive materials as selenium, germanium, lead sulfide,

copper oxide, zinc oxide, cadmium sulfide and thallium oxysulfide. As the amount of light increases, resistance of these materials decreases (maximum sensitivity for lead sulfide is about 80:1; selenium about 5:1).

Photoconductive devices assume many forms—a semitransparent coating on the inner surface of an evacuated glass container; a blank of glass on which the semiconductor coating is applied; or a pair of wires wound into a closely pitched double helix on an insulated strip.

Applications for photoconductive devices are the same as for other photoelectric devices.

THERMOSENSITIVE RESISTORS—Another non-mechanical resistance varying device is the thermosensitive resistor, or thermistor. Both negative and positive-temperature-coefficient resistors

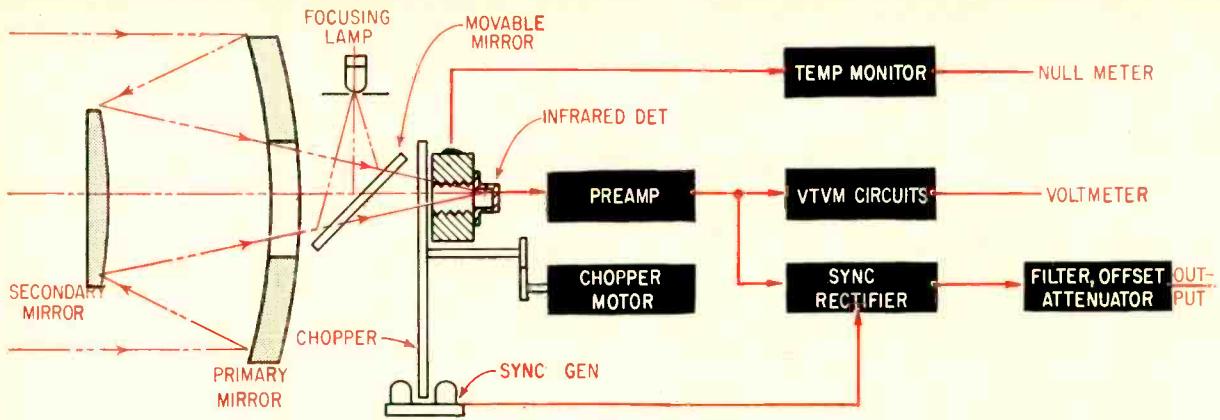

FIG 7—Radiometer by Barnes Engineering uses a thermistor bolometer. Two matched thermistor elements are connected in a bridge circuit across a constant voltage. One compensates for ambient effects on the other

(barretters) are commercially available.

A negative-temperature-coefficient resistor exhibits a decrease in resistance as temperature goes up. Some of the materials used are: oxides of cobalt, copper, iron, magnesium, manganese, nickel, tin, titanium, uranium and zinc. Physical forms may be beads, disks, flakes, washers or rods. A typical thermistor will exhibit a decrease in resistivity by a factor of about 50 as temperature rises from 0 to 100 C. Time constants vary from a few tenths of a second to several minutes.

Figure 7 shows a typical application in a bolometer. Figure 8 illustrates use of two thermistors in a thermal conductivity cell.

STRAIN GAGES—Resistance strain gages depend upon the fact that when wire is stretched elastically, its length and diameter are altered. This results in a change in resistivity or resistance. Some of the advantages of strain gages are: small size, sensitivity and ease of application. Output signals are generally too small to be useful without amplification. The gages are used with either a-c or d-c bridges. They are commonly used for measuring pressure, Fig. 8, weight and acceleration.

There are two main forms of strain gage—bonded and unbonded. The bonded unit usually consists of a flat grid cemented to a ceramic-paper or plastic impregnated-paper carrier sheet. Wire size ranges from 0.001 to 0.0015 in. in diameter. The basic gage has a resistance of about 120 ohms and passes about 25 ma of current in a 6-volt bridge circuit. Available gage resistance ranges from about 60 to 5,000 ohms with effective gage lengths of $\frac{1}{8}$ to six in.

The unbonded strain gage consists of a stationary frame which supports a movable armature through thin cantilever plates.

Four filaments are generally used in an unbonded strain gage. They are connected in a conventional Wheatstone bridge. As the armature moves, strain increases in one pair of filaments and decreases in the other. Maximum armature displacement is about 0.0015 in. Bridge resistance is 60 to 5,000 ohms. Accuracy is about one per-

cent; linearity is about one percent; and resolution is about 0.1 percent—all of full scale.

POTENTIOMETERS—The third type of resistance-changing device relies upon mechanical means to select a variable resistance output. Widely used are potentiometers or slide-wire resistors. The movable slider of the potentiometer is varied by the quantity measured.

In commonly used potentiometer transducers, the resistive element consists either of wound wire, carbon ribbon or deposited-carbon film. In the precision wirewound type, the resistance wire is wound on a mandrel. Linear or nonlinear outputs are available depending upon the shape of the mandrel. Typical nonlinear mandrels produce outputs that are sine, cosine, logarithmic, hyperbolic and exponential functions.

VARYING-CAPACITANCE TRANSDUCERS—Transducers depending upon a change in capacitance proportional to the change in quantity measured make use of fact that capacitance is proportional to the dielectric constant of the dielectric, effective area of the capacitor plates, and the separation of the plates. Any one of these three can be the varying factor causing a change in capacitance.

Capacitive transducers may be accurately calibrated and easily applied, but long lead lengths and moving leads permit stray pickup; the transducers need sensitive amplifiers; and then dielectrics may be temperature-sensitive.

VARIABLE-INDUCTANCE TRANSDUCERS — In the inductance-varying group, are found inductors with powdered-iron or magnetic cores that are movable and result in a change in inductive reactance. Also available are devices in which the length of the flux path or air gap in the armature may be changed by the quantity measured, resulting in a change in inductance or inductive reactance.

Many variable-transformer-type transducers fall under this first category. With most, primary

excitation is alternating current. Output voltage is induced owing to flux changes caused by this primary current. The amount of flux linking the secondary is varied by motion of the primary winding.

Two variable-transformer devices are the synchro and resolver. If the rotor of a synchro is made to turn by the quantity being measured, the relative coupling to the stator is changed. Since the primary or rotor is being supplied with an alternating current, voltage output of the synchro will vary in proportion to the change in position of the rotor.

In the variable-reluctance-type transducers, some element of the magnetic circuit is moved by the mechanical input. This action causes a change in the flux linkages, resulting in varying reluctance and inductance.

DIFFERENTIAL TRANSFORMER—The linear differential transformer is available in many variations but basically it is a core and three coils—primary and two secondaries. Flux linkage between the primary and the secondaries is changed by varying the position of the core. Ordinarily, the two secondaries are connected series-opposed. With the core centered between the two secondaries, minimum output results. As it is moved closer to one secondary coil, induced voltage is increased in the closer coil and decreased in the further one. Consequently, an output voltage is produced proportional to the displacement of the core. The linear differential transformer has high sensitivity, large dynamic range, high resolution and good signal-to-noise ratio. It requires no electrical connection to the moving element eliminating the need for slip rings.

MAGNETOSTRICTION—Magnetostriction, or the Joule effect, is the phenomenon of a change in dimensions of certain materials as a result of a changing magnetic field. But this is a reversible

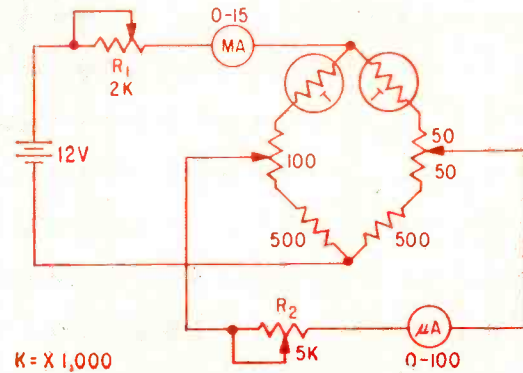
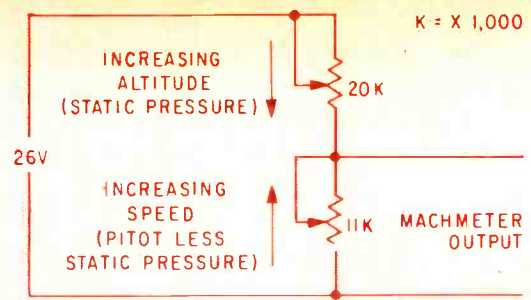

FIG. 8—Two strain-gage pressure transducers give Mach number information in the G. M. Giannini setup (above). Two thermistors are used by Gow-Mac Instrument for its thermal conductivity cell (below). Resistor R_1 is adjusted until current to bridge is between four and six ma. Resistor R_2 is adjusted for full-scale deflection

process and, conversely, change in dimension of a magnetostrictive material will produce a varying magnetic field. This latter property makes magnetostrictive devices useful as nonelectrical-to-electrical input transducers. The magnetostrictive transducer is a varying-permeability device since the change in length causes a change in permeability. This change varies the inductance of associated windings.

Typical magnetostrictive materials are permalloys, cobalt and nickel. Magnetostrictive transducers have found use in sonar equipment and in measurement of force and displacement.

TABLE III — Characteristics of Typical Varying Circuit Parameter Transducers

Basic Transducer	Measurement	Input Range	Sensitivity	Operating Frequency Range	Output Impedance
Photoconductive Cell	Light	2,500 to 30,000 A 0 to 10,000 ft-candle	0.001 to 0.20 ohm/ohm/ft-c		20 kilohms to 4 megohms
Thermosensitive Resistors	Temperature	-240 to +1,100 C	0.3 to 0.6 percent/deg C -3 to -5 percent/deg C		
Strain Gage	Force		1.7 to 3.3 gage factor		60 to 5,000 ohms
Potentiometer	Angular displacement	15 to 14,400 deg			
Capacitive Devices	Level	Length of sensing element	3 $\mu\mu\text{f}$ change full scale		500 ohms
Synchros	Angular displacement	0 to 360 deg	6 to 18 min		
Linear Differential Transformers	Linear displacement	0 to 2.5 in.	0.01 to 0.25 v/v/in.	Depends on power frequency	22 ohms
Magnetostrictive Devices	Linear acceleration	0 to 1,000 g	10 mv/g	Up to 20 kc	270 ohms

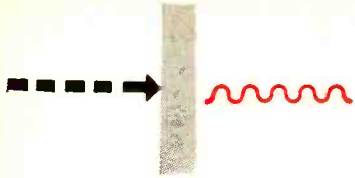

Transducer Applications

Industrial applications of electronic measurement have increased greatly in recent years. Contributing to this increase has been development of new transducers and refinements in existing ones

ALL THE TRANSDUCERS discussed in this report have been basic types. Basic elements are the mainstay of devices such as accelerometers, load cells, bolometers, pyrometers, and temperature probes. Accelerometers, for example, are available incorporating differential transformers, piezoelectric crystals, variable capacitors, resistance strain gages, emf generating mechanisms, variable reluctance units, and potentiometers.

Load cells most often use one or more resistance strain gages. Bolometers usually use a thermoresistive element. Pyrometers can consist of a bolometer or a multiplier phototube.

When a differential transformer or potentiometer is tied in with a gyro to convert displacement to an electrical parameter, the combination is

often called a gyro transducer.

CIRCUITS—Bridge circuits are often used between the transducer and the indicating device. Differentiating and integrating circuits also play important roles. For example, an electrical signal proportional to acceleration may be integrated to give a measure of velocity. A second integrating operation gives a measure of displacement. Differentiating circuits may be applied to go from displacement to velocity to acceleration.

Although the transducer is vital, the circuits between the transducer and the indicator or recorder are areas of electronic ingenuity.

LIQUID BLENDING—Figure 9 shows a system for

FIG. 9—Blending ratio between two liquids is achieved with this Waugh Engineering system

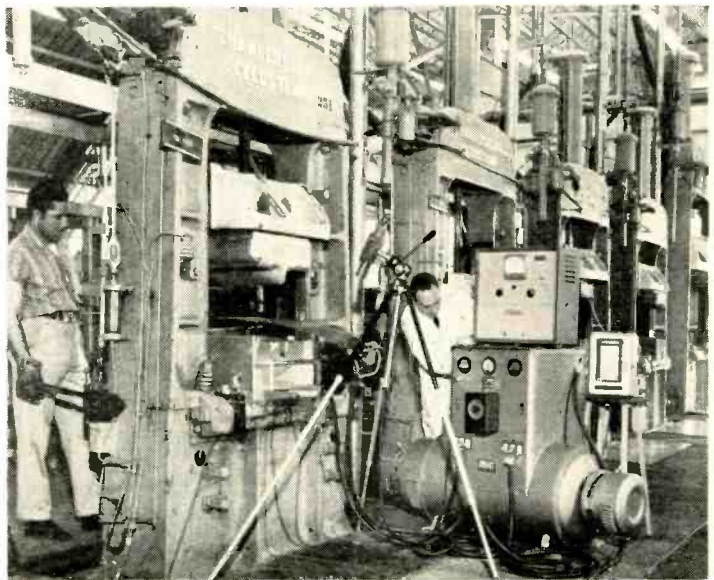
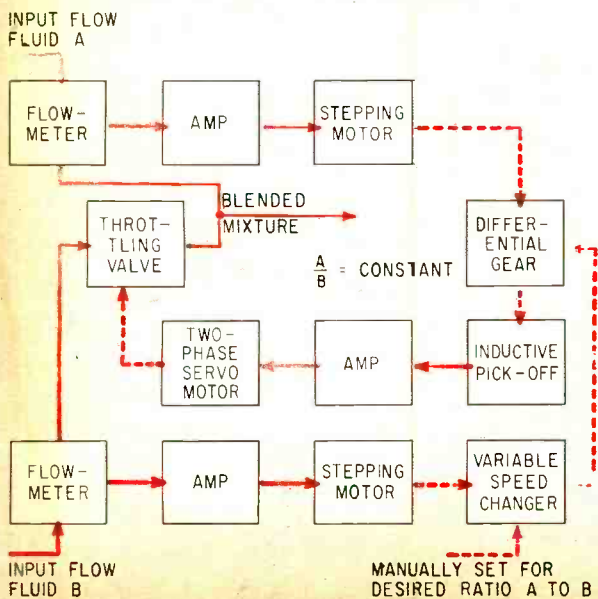

Permanent record of forming temperatures of titanium-metal sheet is kept by infrared pyrometer of Servo Corp. of America and chart recorder

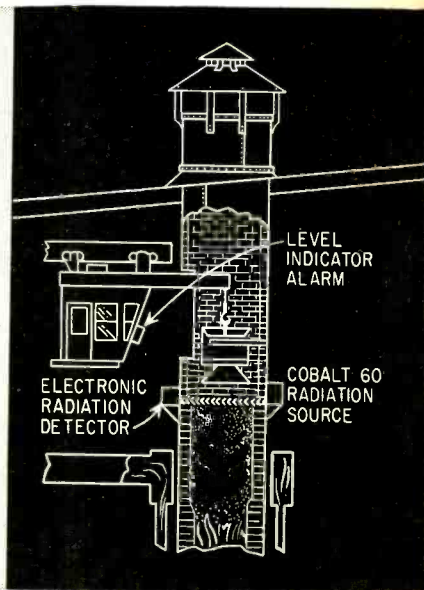
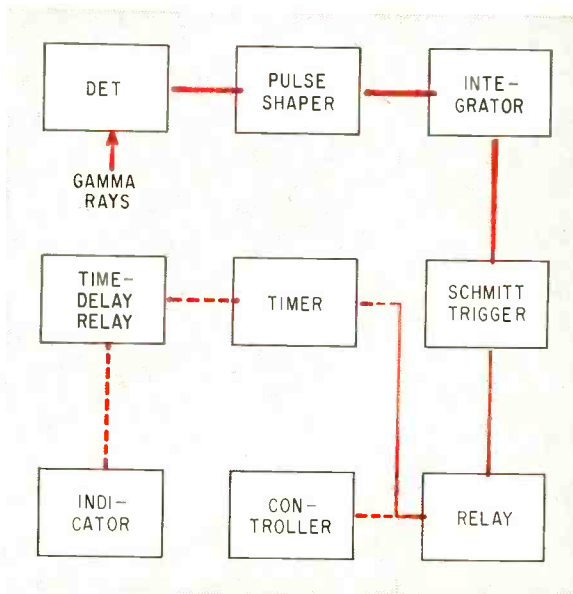
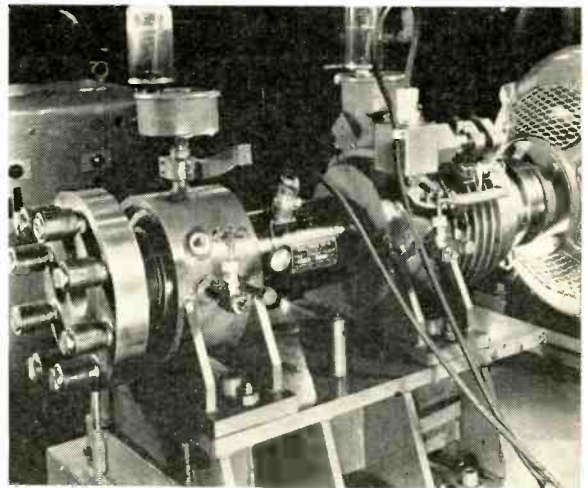

FIG 10—Whether or not a foundry cupola charge is above or below a specified level is determined by this Stromberg-Carlson system

blending two liquids. The flow meter uses a permanent-magnet rotor to induce an a-c signal in a coil. A flow meter is installed in each pipeline and pulse signals from each drive a stepping motor. Meters are calibrated in pulses-per-gallon so that total shaft displacement of the stepping motor is proportional to total quantity of fluid which has passed through the flow meter. Difference between these quantities is converted to a shaft displacement by a differential gear indicating an error in fluid quantities, and is detected by an inductive pickoff. The pickoff controls a servo motor to regulate the throttling valve and reduce the error to zero. A variable speed changer, manually adjusted, sets the desired blending ratio.



Resistance strain gages are incorporated in this Baldwin-Lima-Hamilton torque pickup

FOUNDRY CHARGING—The system shown in Fig. 10 indicates whether or not the level of a foundry cupola charge is above or below a specified level. Gamma rays from a cobalt 60 source are detected

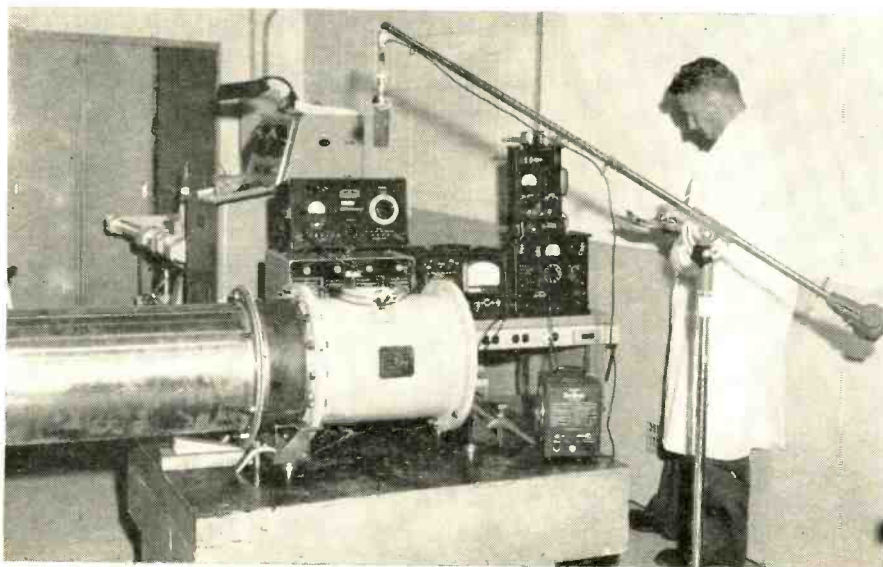

Balancing test of a blower makes use of piezoelectric vibration transducers in this Electric Boat Div. of General Dynamics setup

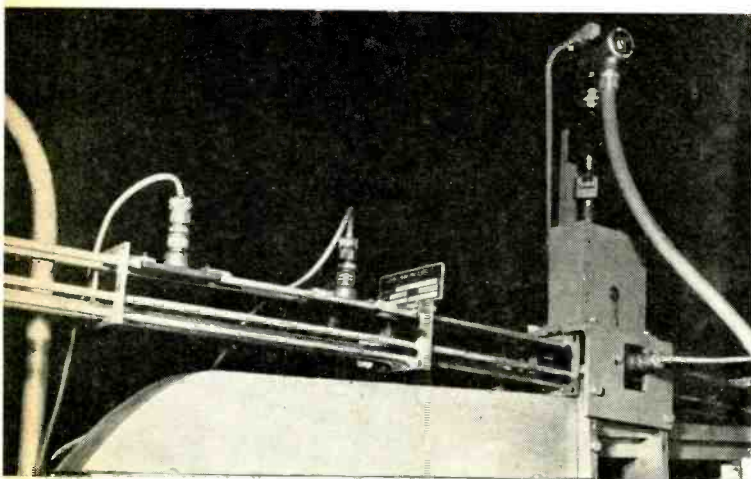

Three proximity pickups of Electro Products Laboratories operating on the eddy-current-loss principle are installed on pinion-gear hobbing line at Ford motor

by a G-M tube. The tube produces one-volt pulses which drive a pulse-shaping circuit to produce pulses of known width and amplitude. The integrating circuit accepts these pulses and produces a d-c output proportional to the counting rate or intensity of radiation transmitted. The d-c output controls a Schmitt trigger which, in turn, starts a timer. The timer actuates a relay after any preset time from one to 30 min.

TELEMETERING—Transducers are often used in a variety of ways to control oscillator circuits. For example, in a telemetering system, the output of a voltage-generating-type transducer may be used to modulate a voltage-controlled oscillator. In some cases, a variable-parameter transducer's output is used to change the frequency of an oscillator by virtue of a change in capacitance or inductance.

Often, the output from a generating transducer is a d-c signal too small to operate an indicator directly. In these cases, it is common practice to use chopper-amplifiers with the transducers to convert the d-c signal to a-c for easy amplification by conventional means.

Auxiliary mechanisms play an important part in electronic measurement systems. When resistance strain gages are used for measuring pressure, a pressure-sensitive tube with the gages bonded to its outside surface is often used. Pressure causes the tube to expand and stretch the wire, increasing resistance. With the unbonded strain gage, the armature is connected by a pin to a metallic bellows or diaphragm. Pressure is applied to one side of the bellows. Venting the other side of the bellows to the atmosphere permits measurement of gage pressure. Evacuating the bellows allows absolute pressure to be measured. For measuring weight, a rectangular steel column may be used with gages bonded to its side. Under load, dimensions of the column change, stretching the wire. In acceleration measurements, gages are



In this Barry Controls setup, ratio of signals from two a-c transducers at left is plotted on recorder at right for a permanent record of vibration transmissibility

often placed at the top and bottom of a cantilever beam or unweighted beam to measure large or small displacements or deflections.

PRESENTATION—Once the quantity of interest has been sensed by a transducer and circuits have acted upon the signal, the remaining requirement is for presentation of the information.

There are countless numbers and varieties of indicators. Meters, cathode-ray oscilloscopes, digital indicators, recorders and printers are all used to present information. In some instances, a simple alarm such as a flashing light or ringing bell suffices. In others, a complex series of operations is initiated for automatic process control. But in all cases, the basic transducer makes the entire procedure possible.

BIBLIOGRAPHY

- J. G. Truxal, "Control Engineers' Handbook", Section 17, McGraw-Hill Book Co., Inc., New York, N. Y., 1958.
- D. M. Considine, "Process Instruments and Control Handbook", McGraw-Hill Book Co., Inc., New York, N. Y., 1957.
- I. F. Kinnard, "Applied Electrical Measurements", Part 2, John Wiley and Sons, Inc., New York, N. Y., 1956.
- M. H. Aronson, "Electronic Circuitry for Instruments and Equipment", Instruments Publishing Co., Pittsburgh, Pa., 1953.
- H. C. Roberts, "Mechanical Measurements by Electrical Methods", Instruments Publishing Co., Pittsburgh, Pa., 1951.
- W. R. Hill, "Electronics in Engineering", McGraw-Hill Book Co., Inc., New York, N. Y., 1949.
- E. H. W. Banner, "Electronic Measuring Instruments", The MacMillan Co., New York, N. Y., 1955.
- W. J. Price, "Nuclear Radiation Detection", McGraw-Hill Book Co., Inc., New York, N. Y., 1958.
- D. B. Kret, "Transducers", Allen B. DuMont Laboratories, Inc., Clifton, N. J., 1953.

35G

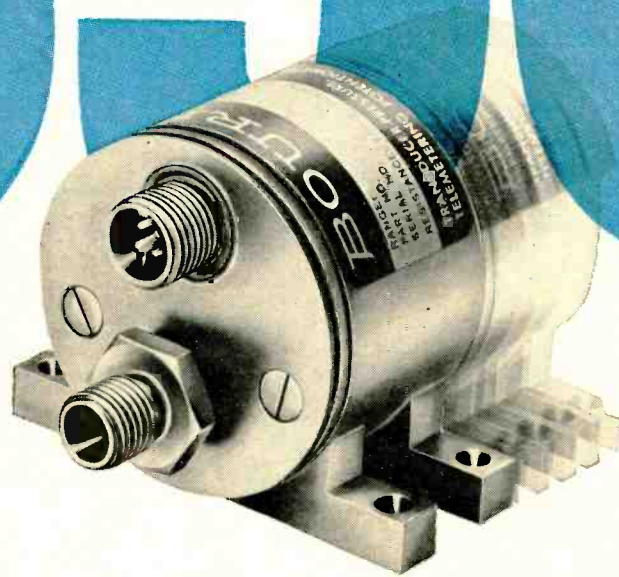

NEW PRESSURE TRANSDUCER: LOW VIBRATION ERROR AT 2000 CPS, 35G

Combine this with 0.17% resolution and you have truly remarkable performance. What's more, this new Model 717 Absolute Pressure Transducer is *in volume production* in ranges up to 4,000 psia.

Simplicity is the keynote—an entirely new type of Bourdon tube instrument eliminates linkage systems. There is only one moving part in the unit, and static friction is less than resolution. Over-all result: excellent performance during high vibration—static error band of $\pm 0.8\%$ (linearity, hysteresis and repeatability).

New concepts in basic design are being combined with high performance in new Bourns accelerometers, pressure transducers, linear motion potentiometers, and other electro-mechanical devices. When your requirements need the experience of a leader—look to BOURNS.

Write for detailed
technical information on
Model 717

BOURNS

Laboratories, Inc.

P.O. Box 2112 • Riverside, California

ORIGINATORS OF TRIMPOT® AND TRIMIT®
PIONEERS IN POTENTIOMETER TRANSDUCERS FOR POSITION, PRESSURE AND ACCELERATION

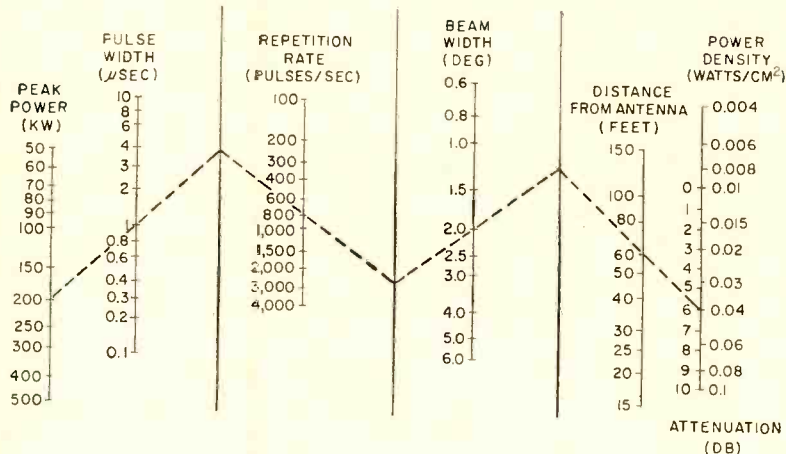

FIG. 1—Radiation power density nomograph for pencil beam. Method yields usable answer for other patterns, using smallest beam width in any plane

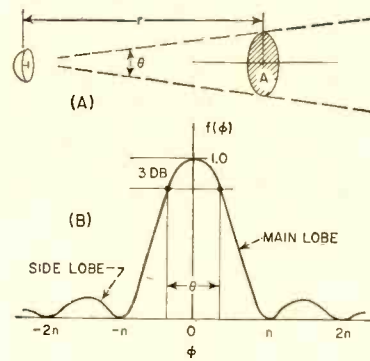

FIG. 2—Antenna geometry (A) produces typical pattern shown in (B)

Radar Power Nomograph

Radiation from high-power radar antennas can seriously injure industrial personnel in the vicinity. Nomograph finds radiation levels rapidly if the radar beam width, peak power, pulse width and repetition rate are known

By J. E. ALLEN *Ab-Arm Division, Westinghouse Electric Corporation, Baltimore, Maryland*

A COMMON SOURCE of high-intensity radiation, capable of inflicting serious injury on nearby personnel, is the high-power microwave radar antenna. A quick method of determining power densities due to radiation from pulsed radar sets is given in Fig. 1. Given the transmitter parameters of a radar set, one can quickly determine the density of radiation at any distance from the antenna.

The nomograph solves the equation

$$\delta_{av} = 3.6 \times 10^{-3} \frac{P_{max} \tau f_r}{r^2 \theta^2} \quad (1)$$

where δ_{av} is average power density in watts/cm², P_{max} is the peak radiated power in kw, τ is the pulse width in μ sec, f_r is the pulse repetition frequency in pulses per second, r is the distance from the radar antenna in feet and θ is the half-power

beam width of the radiation pattern.

A pencil beam of radiation, as produced by a paraboloidal antenna, is chosen because of its prevalence and because, for a given maximum dish dimension, it generally produces the most concentrated beam. The geometry is shown in Fig. 2A. The average power density at a distance r from the antenna is

$$\delta_{av} = \frac{P_{av} \theta}{\Delta} \quad (2)$$

where P_{av} is the average transmitted power within the solid angle of the half-power beam width and Δ is the cross-sectional area of the beam at distance r . To determine P_{av} it is assumed that the beam shape is as described by Fig. 2B and can be expressed as

$$P = f(\phi) = K \left(\frac{\sin \phi}{\phi} \right)^2 \quad (3)$$

Analysis shows that 80 percent of the power is radiated through the solid angle defined by the half-power points. Thus,

$$P_{av, \theta} \cong 0.8 P_{av} \quad (4)$$

The area from Fig. 1A is,

$$A = \frac{\pi}{4} (r \theta)^2 \quad (5)$$

The average power of the radar is,

$$P_{av} = P_{max} \tau f_r \quad (6)$$

Substitution of (4), (5), and (6) into (2) leads immediately to Eq. 1.

Example

Assume that it is desired to know the power density at a location 60 ft from a radar that has a half-power beam width of 2 deg and transmits 200 kw peak power with a one μ sec pulse, 800 times per sec. Referring to the dotted lines in Fig. 2 it is seen that the density is 0.04 watt/cm².

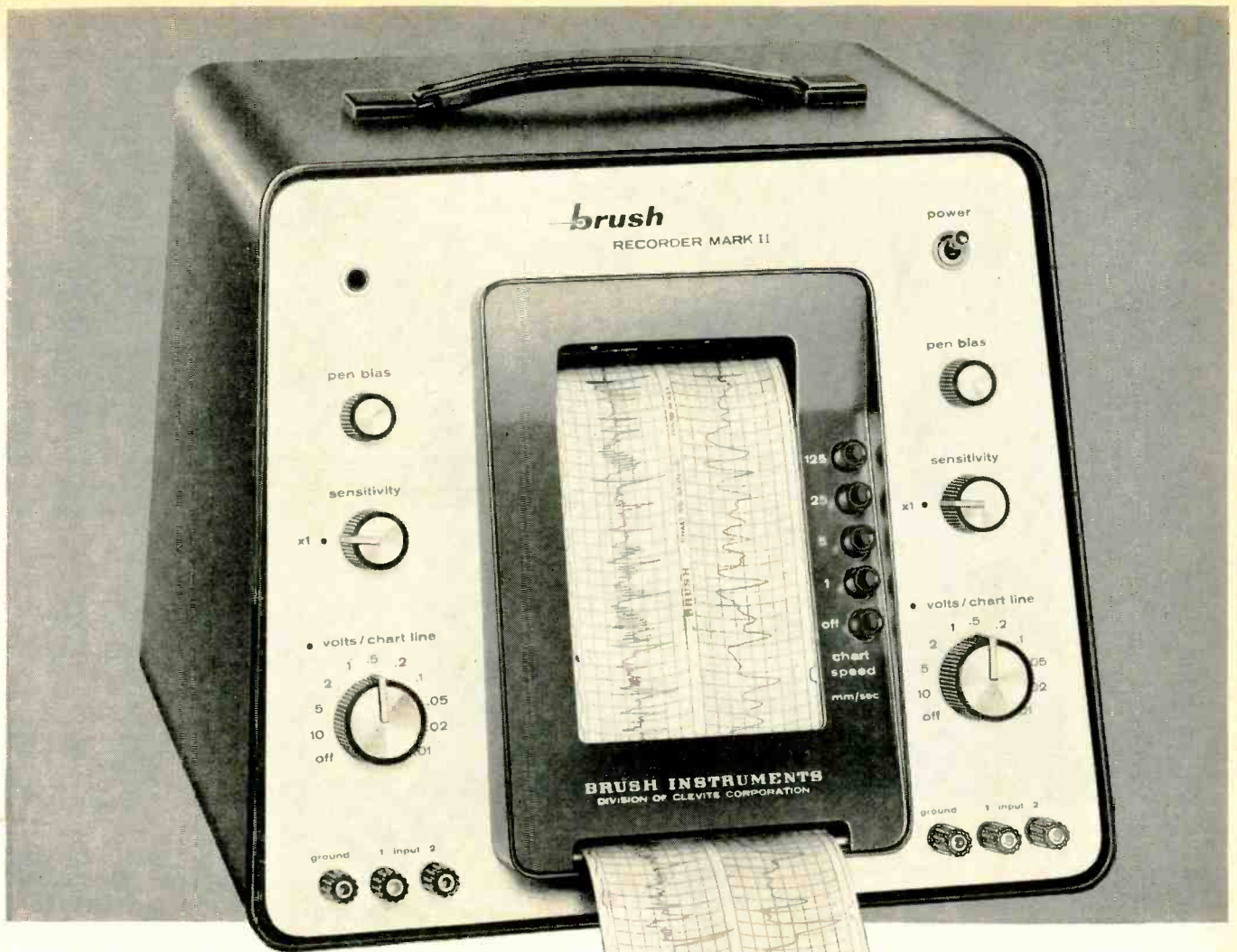

BRUSH
RECORDER MARK II

At last!

New Oscillograph Package

AS "IDIOT-PROOF" AS YOU'VE HOPED FOR

- Built-in amplifiers
- Permanently calibrated
- Instant paper loading
- "White glove" writing system

brush INSTRUMENTS

DIVISION OF
3405 PERKINS AVENUE **CLEVITE** CLEVELAND 14, OHIO
CORPORATION

IMMEDIATELY
AVAILABLE
FROM STOCK
\$1350

Factory branches, service and warehousing at Arlington, Va., Boston, Cleveland, Los Angeles and Seattle; engineering representatives in all key locations.

Radar Developments Aid Defense

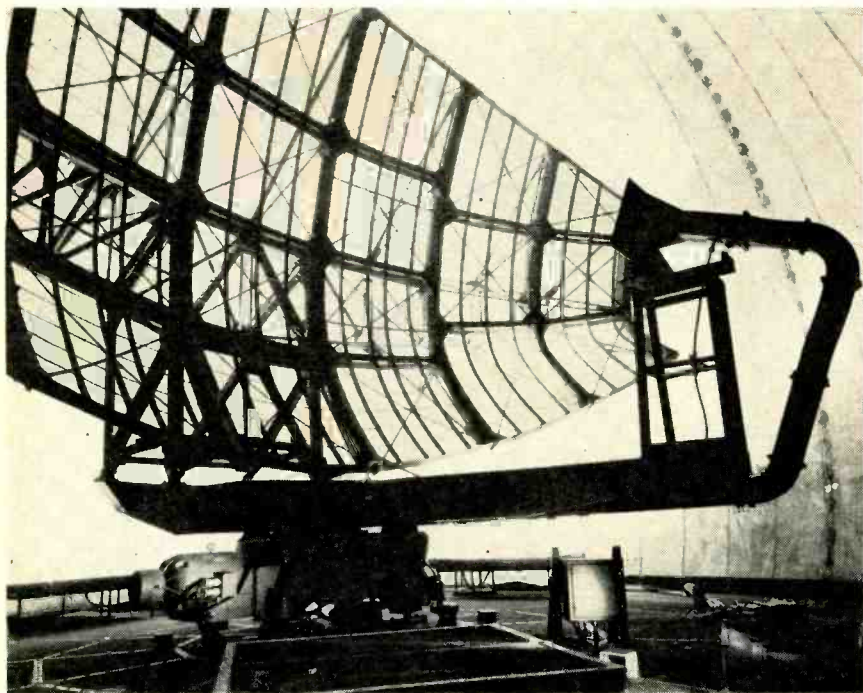

High-gain antenna shown inside radome increases range of search radar 52 percent. Used in Army's Missile Master defense setup, the longer radar range gives more warning time to ready antiaircraft weapons

ADVANCED, long-range search and height-finding surveillance radar has been installed as the principal source of data input for the Army's new Missile Master System at Fort George G. Meade, Md. The Defense Department has authorized the release of some details of the new radar developments.

The Missile Master is a complete electronic system designed to coordinate the fire of Nike and other Army guided missiles used in defense of critical areas. It was developed by the U. S. Army Research and Development Laboratory in Fort Monmouth, N. J., in conjunction with The Martin Co. It is guarding the Baltimore-Washington area.

Major modifications were incorporated in the General Electric FPS-8 search radar for the system. The new search radar is called the FPS-33. GE's FPS-6 height-finding radar has also been improved for the installation.

Significant improvements in the search radar's performance are attributed to a new high-gain antenna. Range is increased 52 percent. Bogies are said to be detected

at sufficient range for defensive solution and weapon alerting by the time the target is within range.

The antenna also increases elevation angular coverage, reducing the overhead cone-of-invisibility. High altitude coverage is said to have been increased appreciably also.

A new double cancellation moving-target indicator (MTI) system has been designed into the radar. The MTI system incorporates video integration, increasing target brilliance and decreasing background noise on the indicator. As a result, targets are more easily detected and operator fatigue is reduced.

Provisions for dual-channel operation in the FPS-33 are said to greatly increase reliability of the system. Addition of the second channel to the basic system makes available a complete standby unit should the operating system go off the air. Routine maintenance is also simplified and can be accomplished without shutting down the system.

Both radars can transmit video and trigger information from a remote site to the Anti-Aircraft Op-

eration Center (AAOC). This permits their location at an optimum site based on terrain and tactical considerations.

A new range height indicator incorporated into the FPS-6 radar features greatly improved calibration stability for better height accuracy, increased elevation coverage and the latest atmospheric refraction correction for more accurate height data. A raid size indicator and remote data unit provide an aid for determining the number of targets in a group of aircraft.

Digital Amplifiers Use Saturable Transformers

DIGITAL AMPLIFIERS of noncritical design based on saturable voltage transformers are being investigated by the National Bureau of Standards. Results indicate that the amplifiers are particularly suited for use with diode gating to provide AND, OR and NOT logical functions. The investigation is part of a program sponsored by the U. S. Air Force Cambridge Research Center.

With semiconductor diode gating, it is necessary to insert amplifiers at intervals within the gating structure to regenerate the signal because signal power is lost in transmission through the gates.

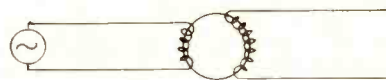

FIG. 1—Basic circuit for producing ones and zeros

The power source (clock signal) in the circuit shown in Fig. 1 produces a square or sine wave. The convention is adopted that the positive half cycle from the source puts the core in the binary ONE state. At this time, the core is said to receive information. The negative half cycle returns the core to its binary ZERO state, and it transmits the signal it has previously received.

The resistance-diode network in Fig. 2 provides for introduction of ONES and ZEROS. The B+ voltage

first in
Performance
Reliability
and Quality

KEPCO

for the most complete line of POWER SUPPLIES

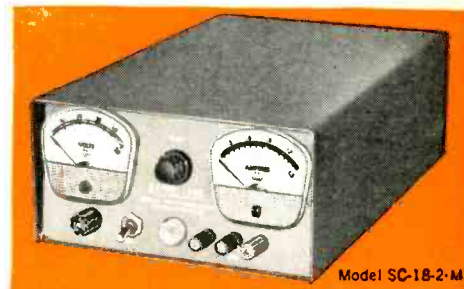

Model SC-18-2-M



0.1%
REGULATION
and
STABILITY



*Two units mounted in
Rack Adapter RA-2

(TUBELESS)
TRANSISTORIZED
SHORT CIRCUIT PROTECTED



Model SC-18-4-M

*** VOLTAGE REGULATED
POWER SUPPLIES**

MODEL	OUTPUT VOLTS DC	OUTPUT AMPERES DC	OUTPUT IMPEDANCE		SIZE			PRICE
			DC- 1KC	1KC- 100KC	W	H	D	
SC-18-0.5	0-18	0-0.5	.04	.4	8 1/8"	4 1/8"	13 5/8"	\$195.00
SC-18-1	0-18	0-1	.02	.2	8 1/8"	4 1/8"	13 5/8"	250.00
SC-18-2	0-18	0-2	.01	.1	8 1/8"	4 1/8"	13 5/8"	295.00
SC-18-4	0-18	0-4	.005	.05	19"	3 1/2"	13"	395.00
SC-36-0.2	0-36	0-0.2	.1	1.0	8 1/8"	4 1/8"	13 5/8"	275.00
SC-1836-0.5	18-36	0-0.5	.08	.8	8 1/8"	4 1/8"	13 5/8"	250.00
SC-1836-1	18-36	0-1	.04	.4	8 1/8"	4 1/8"	13 5/8"	295.00
SC-1836-2	18-36	0-2	.02	.2	19"	3 1/2"	13"	395.00
SC-3672-0.5	36-72	0-0.5	.15	1.0	8 1/8"	4 1/8"	13 5/8"	295.00
SC-3672-1	36-72	0-1	.08	.8	19"	3 1/2"	13"	395.00

Patent Pending

A 0.01% SERIES IS AVAILABLE IN 13 NEW MODELS
KEPCO OFFERS MORE THAN 120 STANDARD VOLTAGE REGULATED
POWER SUPPLIES COVERING A WIDE RANGE OF MAGNETIC, TUBE
AND TRANSISTOR TYPES. MOST MODELS AVAILABLE FROM STOCK.
SEND FOR BROCHURE B-585



KEPCO
LABORATORIES, INC.

131-38 SANFORD AVENUE • FLUSHING 55, N.Y.
INDEPENDENCE 1-7000

- REGULATION (for line or load) 0.1% or 0.003 Volts (whichever is greater)
- RIPPLE: 1 mv. rms.
- RECOVERY TIME 50 microseconds
- STABILITY (for 8 hours) 0.1% or 0.003 Volts (whichever is greater)
- TEMPERATURE COEFFICIENT 0.05% per °C. Ambient operating temperature 50°C maximum. Over-temperature protection included. Unit turns off when over-temperature occurs.
- SHORT CIRCUIT PROTECTION: NO FUSES CIRCUIT BREAKERS OR RELAYS! Designed to operate continuously into a short circuit. Returns instantly to operating voltage when overload is removed. Ideal for lighting lamps and charging capacitive loads.
- OVER CURRENT CONTROL can be set from 0 to 120% of full load.
- REMOTE PROGRAMMING at 1000 ohms per volt.
- REMOTE ERROR SIGNAL SENSING to maintain stated regulation directly at load.
- Suitable for square wave pulsed loading.
- Continuously variable output voltage without switching.
- Either positive or negative can be grounded.
- Units can be series connected.
- Power requirements: 105-125 volts, 50-65 cycles. 400 cycle units available.
- Terminations on front and rear of unit.
- High efficiency. Low heat dissipation.
- Compact, light weight for bench or rack use.
- Color: grey hammertone.

ORDERING INFORMATION:

Units without meters use model numbers indicated in table. To include meters add M to the Model No. (e.g. SC-18-1-M) and add \$30.00 to price.

*Rack adapter for mounting any two 8 1/8" x 4 1/8" units is available. Model No. RA2 is 5 1/4" h x 19" w, is \$15.00

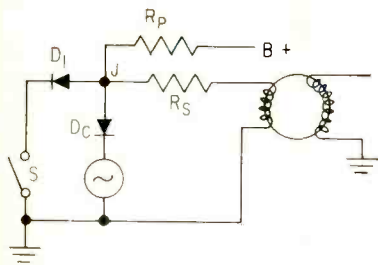

FIG. 2—During transmit half cycle, circuit produces ones when switch is open and zeros when switch is closed

applied to pull-up resistor R_p , causes clock diode D_c to conduct even on the most positive swing of the clock signal. Resistor R_p is large compared with impedance to ground from point J .

When switch S is open, the stage transmits ONES. To do this, the impedance to ground looking to the left from joint J must be high during the receiving half cycle. With S closed, it transmits ZEROS. To do this, the impedance must be low during the receiving half cycle. This impedance must always be high during the transmit half cycle, which is ensured by input diode D_i .

Two such magnetic binary repeater stages can be connected in cascade, as shown in Fig. 3. The two clock voltages are 180 degrees out of phase. Binary signals are introduced into the first stage and transmitted to the second via the transformer. A small positive bias is applied to the lower end of the secondaries. Its amplitude is about $\frac{1}{10}$ the peak clock voltage.

Further improvement is achieved by adding a choke with high reactance at clock frequency in the constant-current pull-up branch. It permits lower values of $B+$ and R_p , greatly reducing the waste of d-c power in R_p .

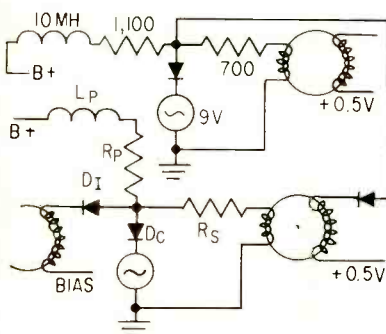

FIG. 3—Addition of chokes in pull-up circuit reduces d-c power requirements in binary repeater stages

The two-stage complementer shown in Fig. 4 was developed to provide a logic NOT function. Stage B is continually provided with a transmit pulse by clock Y through R'_s , but its receive or reset pulse must come from point P . When stage A transmits zeros, its output winding is very nearly a short circuit. Therefore, on its positive excursion, clock X carries P with it. Diode M is conducting, while diode N is open. Current from X resets core B through series resistor R_s . Negligible current passes through R'_s because of the positive excursion of clock Y , which is in phase with X .

On the negative or transmit excursion for core B , diode N clamps P at the bias level and M opens. In this way, a reset pulse is provided for B when A transmits ZEROS, and consequently B transmits ONES. Conversely, when A transmits ONES, it generates a voltage which opposes that of clock X .

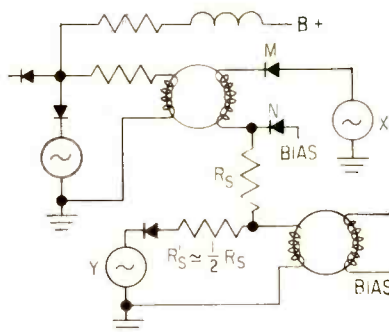

FIG. 4—Two-stage complementer provides logical not function

During this time, as a result of the positive bias on the winding, diode M remains open and P remains clamped at the bias level. Because no reset pulse is available to core B , it transmits ZEROS.

The proposed magnetic repeater shown in Fig. 5 makes use of cascading for increased amplifying power and incorporates a complementer for inhibiting. The package consists of portions of AND gates followed by an OR gate. An input repeater stage is followed by two output stages in cascade, the upper providing an amplified output signal; the lower, an inhibit output.

The AND gate diodes are directly associated with the outputs of the

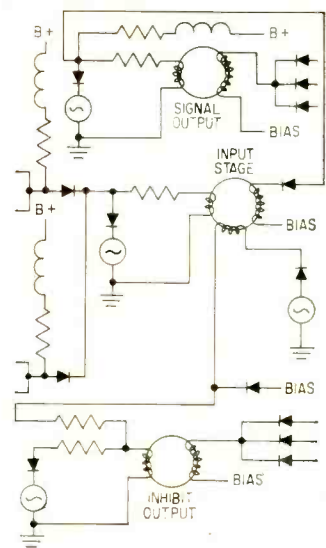

FIG. 5—Logical package consists of portions of and gates followed by an or gate and an input repeater stage followed by two stages for signal and inhibit outputs

package rather than with the inputs. This places the capacitive load of the leads between packages on the anode side of the input diodes rather than on the cathode side. During the transmission of ONES, the impedance from the cathode side to ground is considerably higher than from the anode. This arrangement also ensures that the pull-up currents of the driven stages will not be combined in a single long lead. The inductance of such a lead could well exceed the saturation inductance of the stage output winding.

There is a delay of one full clock cycle through the package.

Transistor Circuit Varies Reactance

By F. F. RADCLIFFE
Bell Telephone Labs, New York, N. Y.

HOLDING the frequency of a 2,500-cycle oscillator constant to within 0.1 cycle was a problem in a development project at Bell Labs. To accomplish this degree of control, a variable-reactance device was chosen in which the reactance could be varied as needed by applying an adjustable d-c current to its input terminals.

Preliminary work indicated that a suitable variable reactance circuit could be built based on a character-

SHIFT REGISTERS

for aircraft
for missiles
for computers
for controls

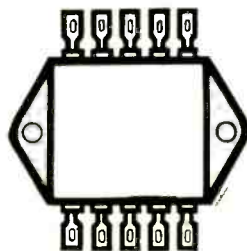

SPRAGUE MAGNETIC SHIFT REGISTER ASSEMBLIES get the full treatment! Every component that is used in their construction is carefully checked for performance and reliability. Only the very best get by. All complete assemblies are 100 % pulse performance tested before they leave the plant . . . assuring on-the-job reliability and long register life . . . at the least possible cost.

Sprague register assemblies matched to your specific application requirements are your best buy! You get just the right case styles, type of sealing, number of stages, read and write provisions you need. Standard designs are easily modified to meet most system requirements. For Data Sheets on core-diode type magnetic shift register assemblies, write the Technical Literature Section, Sprague Electric Company, 35 Marshall St., North Adams, Massachusetts.

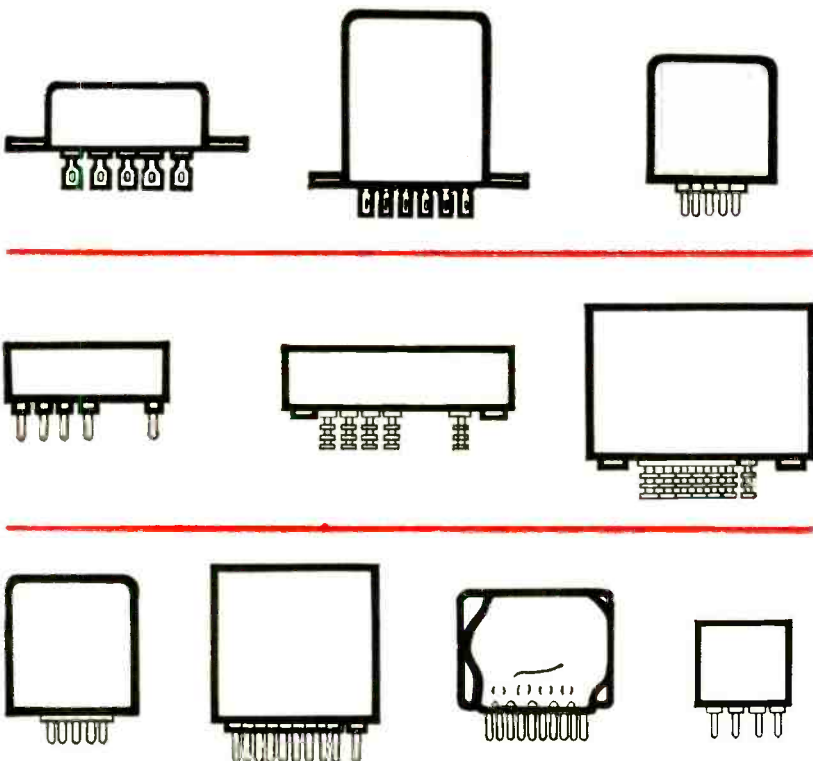

SPRAGUE COMPONENTS:

MAGNETIC COMPONENTS • TRANSISTORS • RESISTORS • CAPACITORS • INTERFERENCE FILTERS • PULSE NETWORKS • HIGH TEMPERATURE MAGNET WIRE • PRINTED CIRCUITS

SPRAGUE®
the mark of reliability

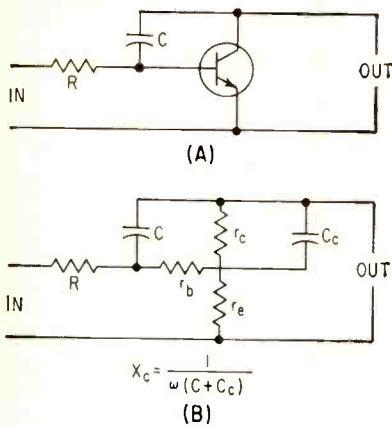

FIG. 1—Equivalent circuit for variable reactor shows dependence of capacitive reactance on emitter current

istic of the transistor. (See ELECTRONICS, Feb 28, 1958, p 97.)

The basic circuit is shown in Fig. 1A, and the equivalent circuit in Fig. 1B. Capacitor C may be assumed to be in parallel with the collector capacitance, C_c , since r_b is small compared to the reactance of C . Also r_c may be omitted in any analysis, since it is large compared to the reactance of C .

A high value of resistance also appears in parallel with the variable reactance and is simply the output resistance of a grounded-emitter stage. With large values of emitter current, this resistance may be low enough to stop the oscillator. But sufficient reactance is usually obtained before this occurs.

The variable reactance occurs because $(c + c_c)$ varies with emitter current. As a first assumption, the variable reactance can be said to be dependent on the variable α vs emitter-current characteristic. An equation for the reactance may be derived by setting up equations for the output impedance of a three-terminal network terminated on the input by R , and the equations for a

grounded-emitter amplifier. When solved for reactance Z , this becomes:

$$Z = X_c \left[1 - \alpha \left(\frac{R + r_b}{R + r_e + r_b} \right) \right]$$

$$Z \cong X_c (1 - \alpha)$$

To test this equation, a 2,500-cycle oscillator was set up similar to that in the developmental unit mentioned.

A variable-reactance circuit was

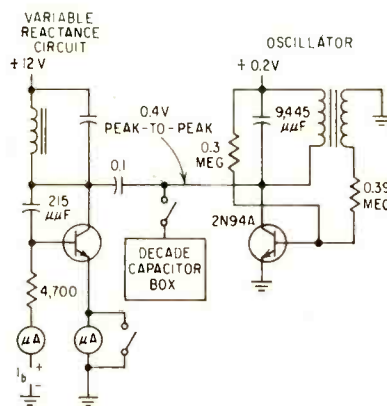

FIG. 2—Experimental silicon transistor varies reactance as d-c current is changed

connected across the oscillator as shown in Fig. 2. The setup was used to measure the frequency shift produced by the circuit. The variable d-c current to control the variable-reactance circuit was fed through resistor R . A similar frequency shift was then obtained by biasing the variable reactance circuit to cutoff and connecting the calibrated decade capacitor to the tank circuit of the oscillator.

The characteristics of the silicon transistor were measured at the same operating currents employed above. From this data, the value

Table I—Comparison of actual and calculated reactances

Freq (cps)	I_c (μA)	I_b (μA)	α	r_b	r_e	Decade Box C ($\mu\mu f$)	X_c	Calculated X_c
2,500	0	0	150 ↓	0	∞
2,450	51	18	0.6		680	500	130,000	106,000
2,400	120	30	0.791		275	1,050	63,200	61,000
2,350	220	40	0.863		148	1,525	44,400	40,400
2,300	350	50	0.900		96	2,220	31,200	31,700
2,250	500	60	0.920		68	2,870	24,700	26,000
2,200	700	68	0.935		50	3,585	20,200	21,600

ENGINEERS

... cross new frontiers in system electronics at THE GARRETT CORPORATION

Increased activity in the design and production of system electronics has created openings for engineers in the following areas:

ELECTRONIC AND AIR DATA

SYSTEMS Required are men of project engineering capabilities. Also required are development and design engineers with specialized experience in servo-mechanisms, circuit and analog computer design utilizing vacuum tubes, transistors, and magnetic amplifiers.

SERVO-MECHANISMS

AND ELECTRO-MAGNETICS Complete working knowledge of electro-magnetic theory and familiarity with materials and methods employed in the design of magnetic amplifiers is required.

FLIGHT INSTRUMENTS AND TRANSDUCER DEVELOPMENT

Requires engineers capable of analyzing performance during preliminary design and able to prepare proposals and reports.

FLIGHT INSTRUMENTS

DESIGN Requires engineers skilled with the drafting and design of light mechanisms for production in which low friction, freedom from vibration effects and compensation of thermo expansion are important.

HIGH FREQUENCY MOTORS,

GENERATORS, CONTROLS Requires electrical design engineers with BSEE or equivalent interested in high frequency motors, generators and associated controls.

Send resume of education and experience today to:

Mr. G. D. Bradley

THE GARRETT CORPORATION

9851 S. Sepulveda Blvd.
Los Angeles 45, Calif.

DIVISIONS:

AiResearch Manufacturing
Los Angeles

AiResearch Manufacturing
Phoenix

AiResearch Industrial

Rex - Aero Engineering

AirSupply - Air Cruisers

AiResearch Aviation

Service

AUXILIARY POWER for the U.S. Army's deadly NIKE HERCULES

*AiResearch units power the controls of
America's most potent defense weapons*

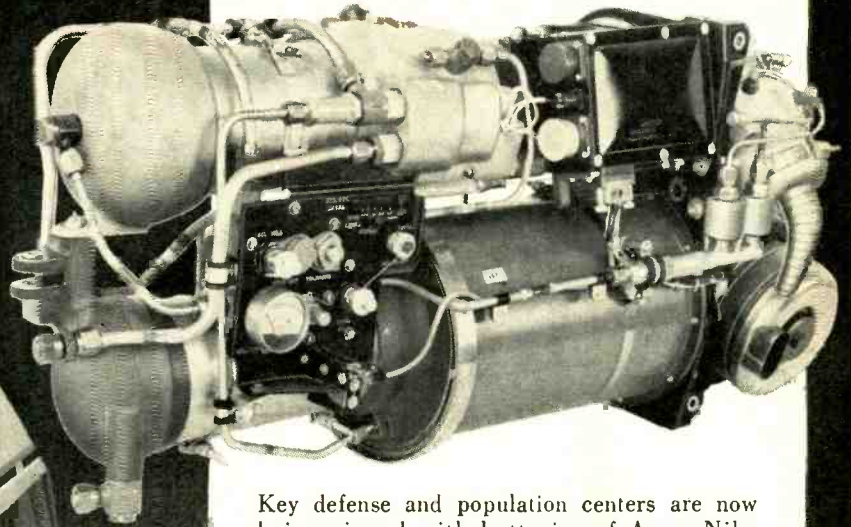

Key defense and population centers are now being ringed with batteries of Army Nike Hercules missiles to deter or destroy aggressors. *Supplying power for flight controls* is the AiResearch auxiliary power unit pictured above, now in production.

As a member of the Army-industry team producing the Nike Hercules (Army Ordnance, Western Electric-Bell Telephone Laboratories and Douglas Aircraft), AiResearch was chosen to design, develop and manufacture this vital accessory power source for the missile because of nearly two decades of experience in light-weight turbomachinery.

This experience includes applications utilizing solid propellants, liquid mono-propellants, bi-propellants, atomic power, cryogenic gases as well as gasoline and air. AiResearch's ability for high capacity production as well as in research and development, made it the logical choice.

Garrett's AiResearch divisions have also designed systems and components for 18 other missiles and rockets in the U.S. defense arsenal.

We invite your inquiries.

THE GARRETT CORPORATION

ENGINEERING REPRESENTATIVES: AIRSUPPLY AND AERO ENGINEERING, OFFICES IN MAJOR CITIES

AiResearch Manufacturing Divisions

Los Angeles 45, California • Phoenix, Arizona

Systems, Packages and Components for: AIRCRAFT, MISSILE, ELECTRONIC, NUCLEAR AND INDUSTRIAL APPLICATIONS

JERROLD

PRECISION EQUIPMENT

SWEEP GENERATORS



Model 95



Model 220



Model 90p



Model 601



Model 662

ACCESSORIES



Matched Delay Line
Model FD-30



Dec. P. Comp.
Model 575-100

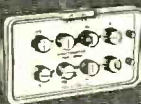

Attenuator
Model 37-50

Sweep Generators
and Accessories
available from
15 KC to 1000 MC

**PERMITS ACCURATE
R.F. Measurements
By Comparison**

Gain - VSWR - Loss

From 200 KC to 1000 MC

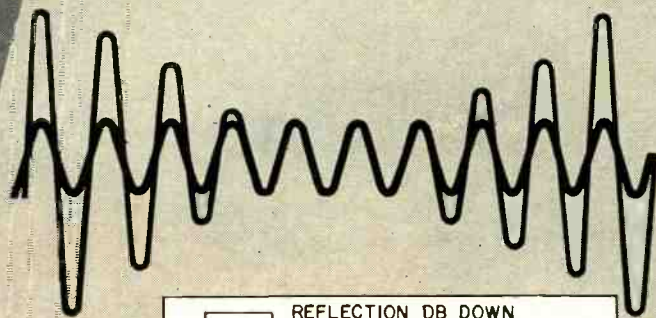

Measurement
Of Voltage
Standing
Wave Ratio

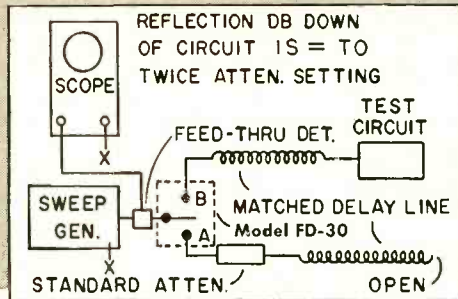

Measurements Unaffected By:

- Oscilloscope Gain or Linearity Changes
- Sweep Generator Power Output Changes
- Square Law Characteristics of Detector
- Delay Line Losses

Comparison Measurement Techniques can achieve accuracies in the order of ± 0.2 —Without Refinement Efforts.

SEND FOR TECHNICAL NEWSLETTER

Informative, fully illustrated technical newsletter describes RF Measurements of Gain, Loss, or VSWR by the Comparison Technique.

JERROLD ELECTRONICS CORP.

15th & Lehigh • Philadelphia 32, Pa.
Export—Rocke International, N.Y., N.Y.

Dept. TED 20

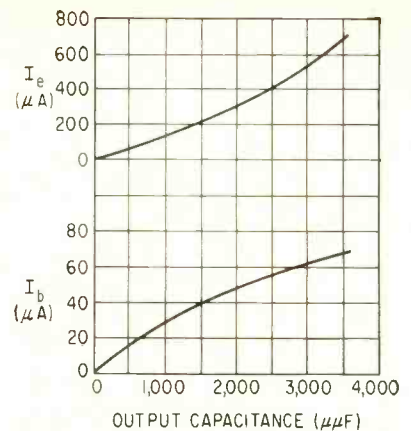

FIG.3—Plot shows variations in capacitance with variations in I_e and I_b .

of the reactance was calculated using the equation. A tabulation of these values is shown in Table I, including the actual measured reactance. The measured and calculated values are in fair agreement except at very low current values.

The table and the curves of Fig. 3 show that effective capacitance variations of up to 3,500 μf and more can be obtained by varying emitter current from zero to 700 microamperes. Such wide variation can be useful in many applications.

Tilt Chart for Displaced Antenna Feed

By R. B. MACASKILL

Senior Electrical Engineer,
Cook Electric Co. Morton Grove, Ill.

REFLECTOR or lens-type antenna design often requires that the effects of a laterally displaced feed upon the tilt of the antenna beam be known. This is especially true in the design or analysis of conical-scan antennas or multiple-feed systems such as monopulse antennas.

When the feed of a focusing-type antenna is displaced from the optical axis, the secondary beam tilts off axis on the side opposite the feed. The amount of beam tilt is proportional to feed displacement, size of antenna aperture and focal length of the antenna.

Assume that the feed point is displaced a distance X from the optical axis of the antenna. The beam tilt can be computed from the following equation, which is normalized for use with any size

OBTAIN IDEAL ELECTRICAL PROPERTIES PLUS UNMATCHED TEMPERATURE RATINGS WITH

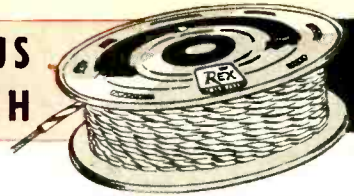

REX TEFLON* INSULATED WIRES & CABLES

(To Mil-W-16878 specifications)

Manufactured to the highest standards of the industry, Rex Teflon Wires and Cables are recommended for high temperature applications to 200°C; and low temperatures to -65°C. In addition, Rex Teflon Wires have low surface friction to resist chafing, abrasion and fraying. High chemical stability prevents corrosion due to atmospheric conditions, chemicals, lubricants and weather. The dielectric constant and dissipation factors are excellent and change far less than any other insulation over wide ranges of temperature and frequency. Use of Rex Teflon Insulated Wire and Cable assures you of unequalled performance — a new standard of excellence.

CABLING IS A REX SPECIALTY
 Complete design and cabling facilities are available to handle all cabling problems — efficiently, perfectly. The Rex reputation as the foremost specialist in designing and manufacturing cable justifies your complete confidence.

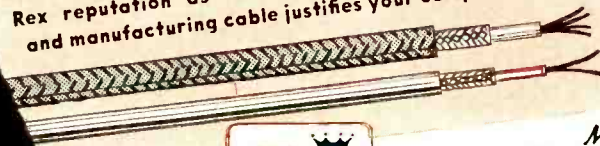

Manufactured by
THE REX CORPORATION

250 HAYWARD ROAD, WEST ACTON, MASS.
 CIRCLE 42 READERS SERVICE CARD



REX also manufactures a complete line of wire and cable for every requirement with wire warehouses centrally located for prompt service.

Write for technical literature on all Rex Wires and Cables, and other products, including Rexolite UHF insulating materials.

*Teflon registered t.m. E. I. duPont de Nemours

theory * design * performance
 of electronic circuits

ELECTRONIC SEMICONDUCTORS

Just Published. A rigorous and systematic introduction to semiconductor physics, developing the subject logically from simple concepts and giving clear pictures of the conduction mechanism of electronic semiconductors within the framework of the *band model*. Among the book's outstanding features are the treatment of acceleration of electrons, the Zener effect, etc. Book is a translation of the 2nd German edition of *Elektronische Halbleiter* by Eberhard Spenke. Translated by D. Jenny, H. Kroemer, E. G. Ramberg, and A. H. Sommer, RCA Laboratories, 430 pp., 163 illus., \$11.00

RANDOM SIGNALS AND NOISE

Just Published. An introduction to the statistical theory underlying the study of signals and noises in communications systems. Contains an introduction to probability theory and statistics, a discussion of the statistical properties of the Gaussian random process, a study of the results of passing random signals and noises through linear and nonlinear systems, and an introduction to the statistical theory of the detection of signals in presence of noise. By William B. Davenport, Jr., and William L. Root, Lincoln Laboratory, M.I.T. 393 pp., illus., \$10.00

NUMERICAL ANALYSIS

Just Published. Covers the topics most directly needed for a clear understanding of methods used in numerical solution of differential equations, both ordinary and partial, and in the solution of integral equations. Clearly explains the use of finite-difference methods in obtaining numerical solutions to problems—emphasizing procedures which can be most readily programmed for an electronic digital computer. Many helpful techniques such as the use of lozenge diagrams for numerical differentiation and integration are supplied. By Kaiser S. Kunz, Ridgefield Research Lab. 381 pp., 40 illus., \$8.00

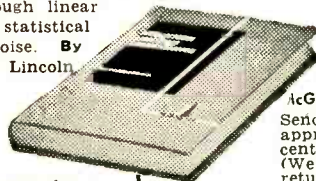

ELECTRON TUBE CIRCUITS

New 2nd Edition Just Published. Discusses and evaluates the fundamental properties of electron tubes and their circuit operations—analyzes tuned and untuned amplifiers—and takes up in detail circuits essential to modern electronic systems such as voltage, video, and power amplifiers; waveform generators; oscillators; modulators, etc. Scores of practical examples show you best applications of theory. By Samuel Seely, Case Inst. of Technology. 2nd Ed. 695 pp., 739 illus., \$10.50

BASIC FEEDBACK CONTROL SYSTEM DESIGN

Just Published. Bases the study of feedback control system design on complex frequency plane analysis—the root-locus. A wide range of servo transducers and components are covered. Recent advances covered include a section of gyroscopes and force-balance transducers, inertial navigation; analysis of nonlinear systems such as the describing function technique and phase plane analysis. Frequency methods, such as Nyquist and Bode, are included. By C. C. Savant, U. of Southern Cal. 418 pp., illus., \$9.50

SEE ANY BOOK 10 DAYS FREE

McGraw-Hill Book Co., Dept. FL-7-4 327 W. 41st St., New York 36
 Send me book(s) checked below for 10 days' examination on approval. In 10 days I will remit for book(s) I keep plus few cents for delivery costs, and return unwanted book(s) postpaid. (We pay delivery costs if you remit with this coupon—same return privilege.)

- Spenke—Elect. Semiconductors, \$11.00 Kunz—Numerical Analysis, \$8.00
 Davenport & Root—Random Signals, \$10.00 Seely—Elect. Tube Circ., \$10.50
 Savant—Feedback Cont. System Design, \$9.50

Name Address
 City Zone State
 Position Company

For price and terms outside U.S., write McGraw-Hill Int'l., N. Y. C. FL-7-4

5 Exclusive Features in the Centralab[®]

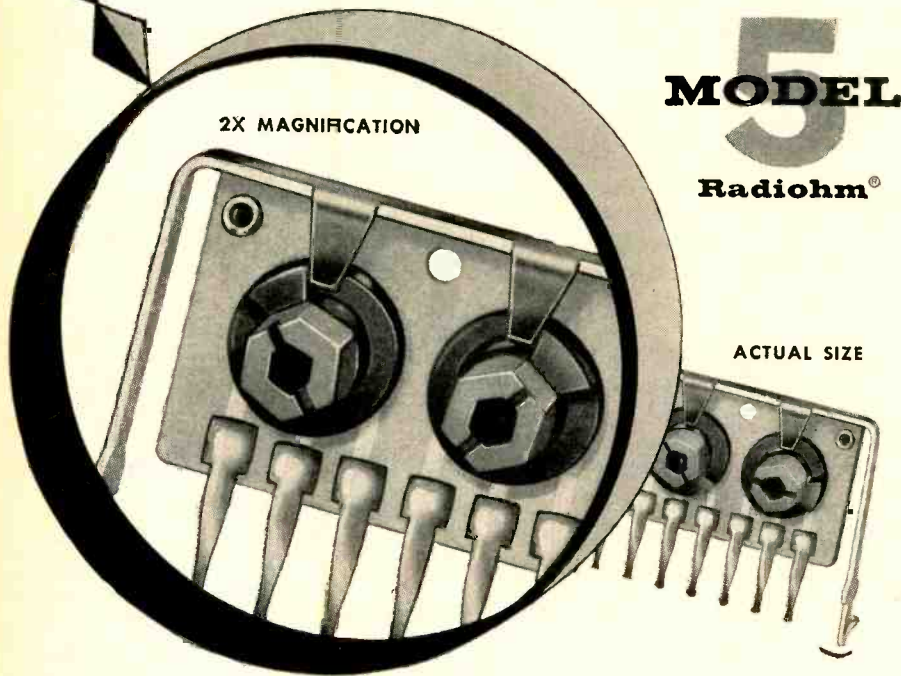

The only 1/4 watt multiple miniature variable resistor*

that gives you these 5 exclusive and important advantages

- LOWER COST:** These compact units with superior electrical characteristics actually cost less than larger units of equivalent rating now on the market.
- REDUCED SIZE:** 1 to 4 variable resistors on a single steatite base plate. The 4-resistor unit measures only 2 1/4" x 3/4". Units with fewer resistors are proportionately smaller.
- VERSATILITY:** Available with horizontal or vertical mounting brackets, plug-in terminals for printed circuit boards or wire leads for metal chassis.
- SUPERIOR KNOB CONSTRUCTION:** Unusual knob design permits adjustment with an internal or external hexagon wrench, screwdriver or by fingertip.
- FLEXIBILITY:** Fixed resistors and capacitors can be incorporated in the Model 5 to make a complete operating circuit.

SPECIFICATIONS:

Resistance Range: 1000 ohms to 5 megohms, $\pm 35\%$, linear taper
 Wattage Rating: 1/4 watt at 70° C. ambient
 Breakdown Voltage: 1250 Volts RMS, between adjacent sections and to bracket
 Minimum End Resistance: Less than 1%
 Rotational Life: 5% change after 250 rotations
 Initial Torque: 2 inch ounces average; 50% change after 250 rotations

Write for Centralab Bulletin EP-539 giving full specifications on the Model 5 Radiohm[®] series.

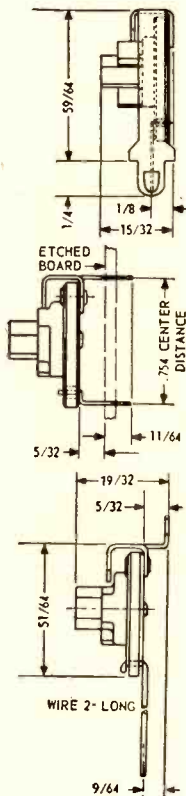

antenna aperture possessing any practical focal length.

$$\phi = \frac{\sin^{-1}}{2} \left\{ \frac{(1+K)}{\sin \left[\tan^{-1} \frac{8R(1+K)}{16R^2-1} \right]} \frac{(1-K)}{\sin \left[\tan^{-1} \frac{8R(1-K)}{16R^2-1} \right]} \right\}$$

Where ϕ is beam tilt in degrees, $R = F/D$ and $K = X/D$. F is focal length and D is antenna aperture in the same units.

The equation holds only for a curved reflector or lens antenna that has an aperture greater than $\lambda/2$. The resulting tilt, however, is independent of wavelength.

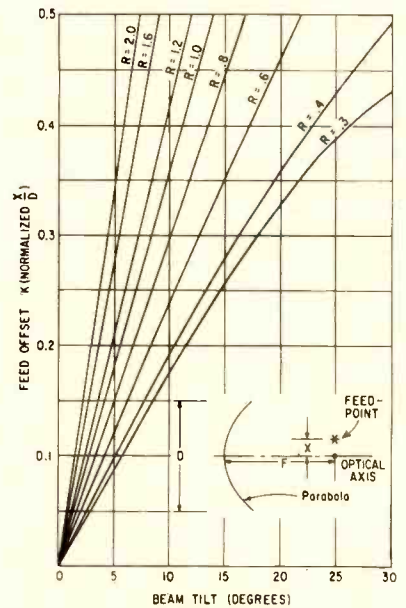

FIG. 1—Plot shows beam tilt in degrees vs antenna feed offset

To find beam tilt of any focusing-type antenna find ratios X/D and F/D . Enter vertical scale in Fig. 1 at value computed for K . Proceed across the chart until lines representing values for K and R intersect. Beam tilt can be determined at this point from the horizontal scale.

For example, to find tilt of a 30-inch parabolic dish with a focal length of 18 inches and a feed displacement of 4 1/2 inches, enter the vertical scale at the value $X/D = 4 1/2 / 30 = 0.15$. Proceed to the $F/D = 18 / 30 = 0.6$ curve, and read the beam tilt value on the horizontal scale. Beam tilt is 6.2 degrees.



A DIVISION OF GLOBE-UNION, INC.
 914G E. KEEFE AVE. • MILWAUKEE 1, WIS.
 In Canada: 804 Mt. Pleasant Rd. • Toronto, Ontario

VARIABLE RESISTORS • PACKAGED ELECTRONIC CIRCUITS • ELECTRONIC SWITCHES
 CERAMIC CAPACITORS • ENGINEERED CERAMICS • SEMI-CONDUCTOR PRODUCTS

IT'S A MUST!

If you sell to the \$7 billion electronics industry, you'll want a *free* copy of *electronics* MARKET MEDIA FILE.

What are the prospects for:
 MILITARY ELECTRONICS?
 REPLACEMENT
 ELECTRONICS?
 HOME ELECTRONICS?
 INDUSTRIAL
 ELECTRONICS?

Who are the
 BUYING INFLUENCES?

Why are more than 9,000 men who make the buying decisions for 30 giant companies subscribers to *electronics*? . . . and what does that mean to your advertising dollar?

The 1958 *electronics* MARKET MEDIA FILE gives the answers in 12 fact-packed pages that you will refer to time and again throughout the year.

Send for your *free* copy today.

ABC electronics ABP
A McGRAW-HILL PUBLICATION
330 W. 42nd St., New York 36, N. Y.



In this brochure—complete facts on DIALCO's **DATALITES®** For the Computer-Automation Industries

DATALITES by DIALCO are ultra-miniature Indicator Lights specially designed to meet the critical requirements of the computer-automation fields. Made in 2 basic styles: *Lamp Holders with DIALCO's own replaceable Lamp Cartridges* (see above); or integrated DATALITES with *Built-in Neon Lamps* which are *not replaceable* (see below). Ultra-compact, single units mount in $\frac{3}{8}$ " clearance hole; the twin-lamp assembly mounts in $\frac{3}{4}$ " clearance hole.

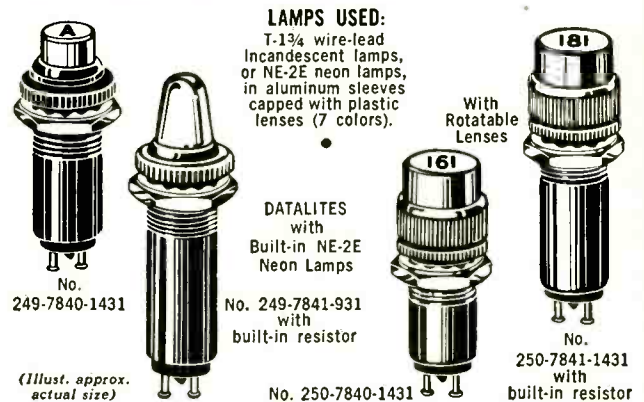

LAMPS USED:
 T-1 $\frac{3}{4}$ wire-lead
 Incandescent lamps,
 or NE-2E neon lamps,
 in aluminum sleeves
 capped with plastic
 lenses (7 colors).

(*Illust. approx.
 actual size*)

DATALITES have fully insulated terminals and conform to all applicable military specifications. Integrated units are available *with or without built-in resistors*. The cylindrical lenses can be hot-stamped with digits, letters, etc. Complete details in *Brochure L-160*. Send for it now.

SAMPLES ON REQUEST—AT ONCE—NO CHARGE



Foremost Manufacturer of Pilot Lights
DIALIGHT
 CORPORATION

58 STEWART AVE., BROOKLYN 37, N. Y. • HYacinth 7-7600

Taut Band Panel Meters

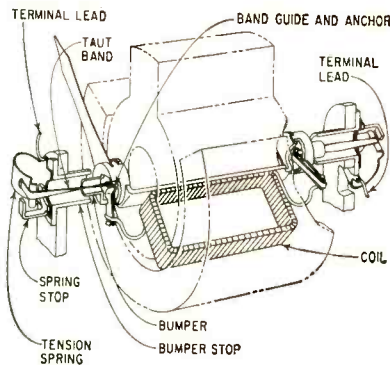
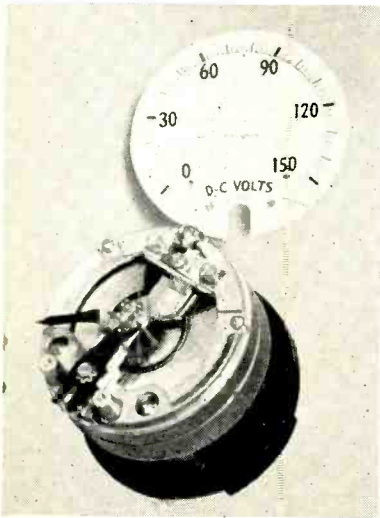

Schematic view of taut-band suspension

Taut-band suspension meter (left) can withstand severe vibration and shock without effect on accuracy

EXTREMELY ACCURATE laboratory galvanometers may be achieved by use of the taut band suspension system. Taut band suspension is used to support the moving element because it reduces frictional losses.

Westinghouse Electric Corp. has adapted the principle to 250 deg industrial panel instrument. Because of the metal used to make the band and safety stops placed in the suspension system, the meters will withstand severe vibration and shock without effect on accuracy. The only frictional loss is molecular friction within the taut metal bands.

Suspension Structure

The moving element is supported at each end by a short hair-like band of high-strength alloy. It is drawn to a rectangular cross section, 0.005000 inch wide and 0.000500 inch thick and dimensionally controlled to five millionths of an inch.

The bands are permanently anchored to the moving element of the instrument and to U-shaped springs which maintain band tension and contribute to shock and vibration immunity. Small stops prevent excessive axial and radial movement. In addition to serving as the "axle" for an instrument, the taut bands also carry current to the moving coil and, by providing restoring torque, eliminate the need for spiral springs. Full-scale 250-degree deflection can be obtained with currents as low as 50 micro-

amperes.

A test bank of instruments which have been operating for over 20,000 hours without adjustment is still within the original 1 percent accuracy. All of the meters are shock driven to full scale current and allowed to come to rest about 8 times per minute.

Induction-Heater Coil Does Not Arc-Over

BY KEEPING the pressure-distance product small an induction-heater coil was devised which will zone-heat carbon rods to a high temperature without causing glow discharges. Carbon with large amounts of occluded gas can be heated by the coil without high vacuum pumping speeds.

One of the main problems associated with this type of heater is the glow discharge obtained in a vacuum tank when using high a-c voltages. This can be eliminated either by the use of a coupling transformer to keep the voltage low or by keeping the pressure-distance product small (in effect maintaining a high pumping speed).

It is difficult to mount a transformer close to the heater or to bring heavy secondary leads through a vacuum seal into the tank. The use of a disproportionately large diffusion pump is also inconvenient. The Radiation Labo-

ratory of the University of California solved the problem by concentrating on distance. If the distance could be made short enough to keep the pressure-distance product small, the pressure could be allowed to make wide excursions without entering the breakdown region.

Number 12 solid copper wire fingers were welded to the copper tubing on the grounded side and extended to shield the high-potential side, thus effectively reducing the pressure-distance product. These fingers were spaced on half-inch centers. With this coil, a 10 kw induction heater delivered full rated output over pressure excursions from 10^{-6} mm Hg to 10^{-2} mm of Hg without breaking into a glow discharge. Before the development of shielding fingers it was not possible to heat the work, for a glow discharge began as soon as outgassing of the carbon raised the pressure. The induction heater had to be quickly disabled to prevent the discharge from puncturing the copper tubing.

Adjustable Nonlinear Function Generator

By LARKIN SCOTT

Perkin-Elmer Corporation, Norwalk, Conn.

FREQUENTLY PARAMETERS affecting servo operation must be continuously and automatically adjusted according to various functions of other variables in the system. Each new function design presents a separate and time-consuming problem. The amount of time involved in acquiring a new fixed function unit prods a system designer to be correct on his first specification.

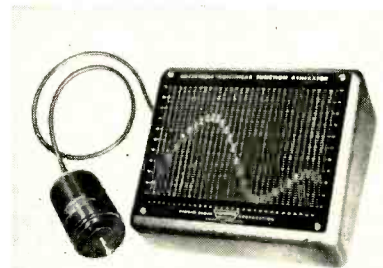
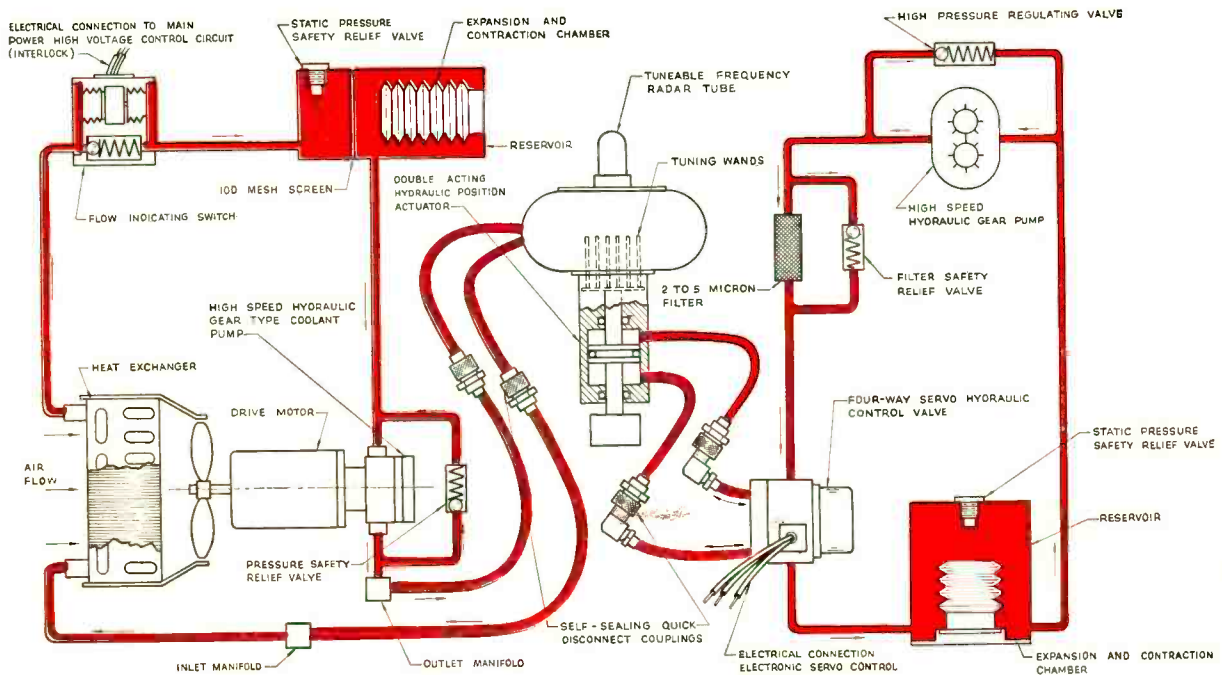

Fig. 1 Curves of any arbitrary shape can be set-up on the adjustable function panel

Organic Fluids in New Electronics

One Monsanto fluid, Coolanol 45, has enabled engineers to design smaller, more reliable electronic packages for missiles and aircraft. Compact, lightweight cooling and hydraulic tuning units make possible longer ranges for missile guidance systems, higher altitudes for aircraft electronics.



Equipment diagram: courtesy Eastern Industries, Inc., Homden, Conn.

This new multipurpose fluid system developed by Eastern Industries, Inc., may be used for missile guidance or fire control systems and electronic countermeasures equipment. It is composed of a liquid heat-

dissipating unit on the left (Model E/HT 200) and a hydraulic tuning unit on the right (Model E/HS 100). Sealed in both units, Coolanol 45 cools the magnetron tube, actuates the mechanical tuning mechanism.

LIQUID cooling with Coolanol 45 brings new performance concepts to electronic equipment by allowing engineers to build more and more power into less and less space. The liquid flows around tube units to dissipate the great heat created by miniaturization. As a result, aircraft electronic systems can operate at altitudes where air cooling is impractical . . . missiles have increased accuracy over their effective striking ranges.

Cooling and hydraulic units can be designed into packages smaller than a portable typewriter. Every pound saved, every watt of increased power contributes to a greater effective range.

Coolanol 45 operates efficiently from -65° F. to 400° F.—a remarkable temperature variation for a liquid. No longer held to the maximum temperature water imposes, engineers can design even "hotter" equipment. Coolanol 45 is one of many Monsanto fluids you

see establishing new performance concepts for guidance and control systems, radar and countermeasures units and nuclear reactors.

Fifty years of fluid research places Monsanto first in the synthetic fluid field. Aside from the 25 commercial fluids now available, Monsanto has a number of base stocks that allow modification. Whatever your requirements, consult Monsanto first if you have a fluid problem.

WHEN YOU NEED A SYNTHETIC FLUID, COME TO MONSANTO—
Creator of Fluids for the Future

Send for more information

MONSANTO FLUIDS

- Coolant/dielectrics for electronic equipment
- Hydraulic fluids in electromechanical systems
- Lubricants for high-temperature operations
- Dielectrics for transformers and capacitors
- Coolant/moderators for nuclear power reactors
- Modifiers for special fluid properties
- Heat-transfer fluids for temperature control
- Coolanol 45: Monsanto T. M. (formerly OS-45)



MONSANTO CHEMICAL COMPANY
Organic Chemicals Division
Dept. F-1, St. Louis 24, Missouri

Please send literature:

- Coolanol 45 Technical Bulletin
- "Fluids . . . For Specialized Engineering"
(Technical Data)

Name Title
Company
Address
City Zone State

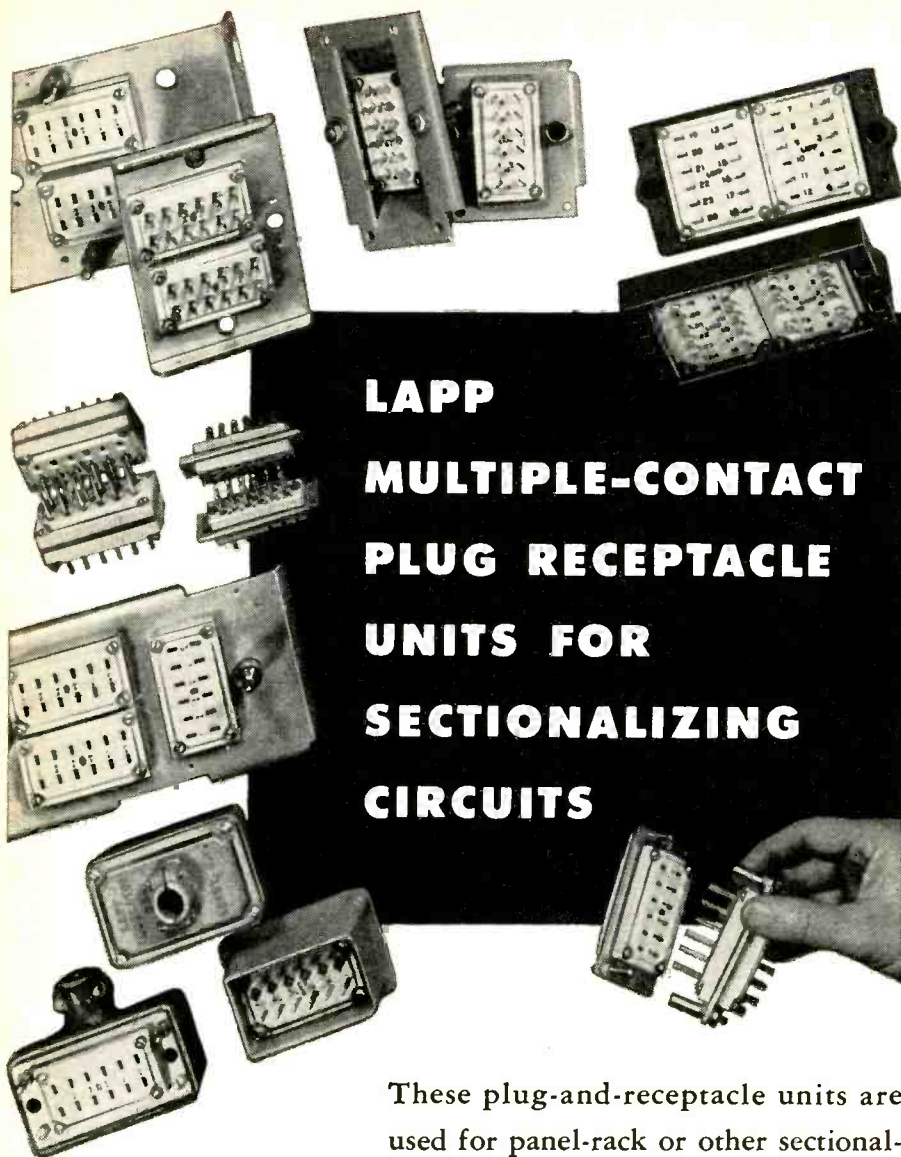

**LAPP
MULTIPLE-CONTACT
PLUG RECEPTACLE
UNITS FOR
SECTIONALIZING
CIRCUITS**

These plug-and-receptacle units are used for panel-rack or other sectionalized circuits where a number of connections must be made or broken. Any number of contacts can be provided (in multiples of twelve). Male and female contacts are full-floating for easy alignment and positive contact. Contacts are silver-plated brass and phosphor bronze with terminals tinned for easy soldering. Ceramic blocks are steatite, white glazed . . . non-carbonizing even under leakage flash-over caused by contamination, moisture or humidity. Write for specifications of available units or engineering recommendations for your requirement. Lapp Insulator Co., Inc., Radio Specialties Division, 143 Sumner Street, LeRoy, New York.



problem. The amount of time involved in acquiring a new fixed function unit prods a system designer to be correct on his first specification.



Panel contains 31 sliders each of which may be adjusted to 101 positions

The nonlinear function generator shown in Fig. 1 has three major advantages; (1) A shaft angle to voltage transducer, suitable for use in operating systems, whose linearity can be externally and quickly adjusted during the experimental stage of operation; (2) An adjustment of linearity which will include curves of any arbitrary shape, yet be such that the setting in one portion of the curve remains independent of adjustments elsewhere and; (3) A similar transducer without external adjustment, whose response curve can be fixed to match any experimentally determined curve by routine production methods and done so without further design study or computation.

The transducer portion at the left of Fig. 1 is constructed in a size 18 synchro housing, convenient for use with associated servo drive equipment. The output-voltage versus shaft rotation is externally adjusted by the function adjusting assembly shown to the right. The cable joining these two units has no major length restriction. Input and output connections are made through terminals at the rear of the transducer.

Function Adjustment

The function adjustment panel is arranged to display the coordinates of the transducer function. Values

along the lower edge of the panel are proportional to equal increments of shaft rotation, and values along the left-hand edge of the panel are proportional to output or the voltage division ratio.

The panel contains a group of 31 sliders, each of which may be separately adjusted to 101 positions in the vertical direction. The vertical position of each slider determines the voltage level produced at the corresponding position of shaft rotation.

Output Voltage

Voltage output varies linearly with shaft rotation between any two adjacent slider positions making the output function a composition of 30 straight-line segments. A visual presentation of the output function makes it possible to change functions quickly.

Construction

In standard form the adjustable function assembly consists of an auto transformer divided into 100 equal sections. By selecting the appropriate tap point, it is possible to use the auto transformer as a voltage divider to give any integral ratio between 0 and 100 percent. The function adjusting panel is thus a 31 pole/101 position switch.

The transducer is an interpolating device which consists principally of a single turn resistance element, tapped at three equally spaced points. Through the action of a commutator and switching mechanism, the potentiometer tap points are connected sequentially to the 31 voltage levels established by the function adjusting assembly. The shaft of the interpolating potentiometer rotates approximately 10 revolutions to cover the full range of travel. The switch wipers on the function adjusting panel make it possible to select any voltage level produced by the auto-transformer for each commutator bar. And the interpolating potentiometer causes the output to be changed linearly from the voltage on one commutator bar to that of the next.

It is possible to reproduce any of the desired nonlinear functions in the shaft angle to voltage trans-

Giannini

PRESSURE TRANSDUCERS

for any airborne application

These instruments are typical of the extensive Giannini line of pressure transducers:

**COMPACT-
LIGHTWEIGHT**



451218 "CUBIC INCH"

SIZE: One inch cube
WEIGHT: 2 ounces
RESOLUTION: to 300 wires (0.33%)
RANGE: 0-15 to 0-50 psi (a, d or g)

**HIGH ACCURACY-
RESOLUTION**



451212 HIGH LEVEL OUTPUT

ACCURACY: 1% of reading for most applications (considering linearity, hysteresis and repeatability)
RESOLUTION: 2000 wires (0.05%)
RANGE: 0-10 to 0-50 psi (a, d or g)

**LOW
PRESSURE**



45154 HIGH VIBRATION

VIBRATION: 25g to 2000 cps
REPEATABILITY: 0.8%
RESOLUTION: to 250 wires (0.4%)
RANGE: 0-10, 0-15, 0-20 psi (a, d or g)

**HIGH
PRESSURE**



461227 BOURDON TUBE

VIBRATION: 36 g to 2000 cps for special applications
RESOLUTION: to 400 wires (0.25%)
RANGE: 200-10,000 psi (a, d or g).

Detailed Bulletins are available on these transducers...write for them today.

Giannini measures & controls:

ω β θ ψ τ v ϕ
 δ Ω α h P ΔP T
 T_s P_s Q_c M T_o P_r TAS

PRECISION
INSTRUMENTS
AND CONTROLS

Giannini

G. M. GIANNINI & CO., INC., 918 EAST GREEN STREET, PASADENA, CALIF.

Engineers & Scientists
OPPORTUNITIES IN

ecm

at melpar

For every new weapon devised a countermeasure has followed to balance the scale.

At Melpar a major segment of our effort is directed toward developing electronic countermeasures to offset the anticipated weapons of tomorrow.

The experienced engineer with an interest in ECM will find Melpar can offer not only the technical challenge he is seeking but also advancement opportunities necessary to further his career.

Our modern and well-equipped laboratories are located in choice suburban areas near Washington, D. C. and Boston, Massachusetts. These locales were selected because of their proximity to superior educational, cultural and recreational facilities. Fine housing in all price ranges is readily available.

For detailed information about openings, write to:
Technical Personnel Representative



MELPAR Incorporated

A Subsidiary of Westinghouse Air Brake Company

3101 Arlington Boulevard, Falls Church, Virginia
10 miles from Washington, D. C.

ducer alone. Space is provided in the transducer for either an auto-transformer or resistive voltage divider whose tap connections can be fixed in any desired arrangement. Since the basic electrical operation is identical to that performed by the function adjusting assembly, no further computation is necessary to specify the design for fixed function transducers which will behave in accordance with an operating curve determined empirically through the use of the variable function device. This permits the circuit designer to work out desired curves during an experimental stage, with the assurance of being able to obtain easily manufactured transducers suitable for use in final equipment.

A typical need for variable performance in a servo system is found in the requirements for automatic flight control of aircraft.

A temporary function generator installation provides manual gain adjustment of the affected servo loop. Best values, as a function of flight conditions, may then be determined empirically by the test crew.

Temperature-Stable Equipment Cabinets

LIGHTWEIGHT, temperature controlled, 19-inch general purpose electrical equipment cabinets have been designed for the U. S. Army Signal Research and Development Laboratory, Fort Monmouth, N. J. by Craig Systems, Inc., Danvers, Mass. The cabinets will provide proper operational temperatures for all types of electronic equipment, improve reliability, and permit more efficient utilization of the limited space available in mobile enclosures.

Design Features

Design features include: all aluminum construction; built-in air ducts; temperature control with either ambient, cooled, or heated air; vertical or horizontal air flow; removable side panels and duct frame assemblies for individual or multiple grouping installation; ad-

justable mounting facilities for equipments of varying heights; and removable insulated top, bottom and back panels. The cabinets are

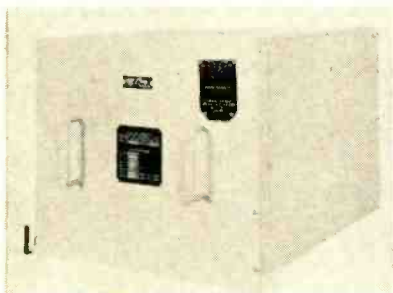

Combination heater and air conditioner unit for electronic equipment

available in 36 $\frac{1}{2}$ and 58 $\frac{1}{2}$ inch heights and weigh 55 and 80 pounds respectively.

Temperature Control

Temperature control for the cabinets is obtained from a combination heater and air conditioner unit designed by Harvey W. Hottel, Inc., Silver Spring, Md. It can be mounted directly in the cabinets and used in multiples where required. The heater has an output of 5100 BTU/hr at -65 F and is automatically shut off when the cabinet temperature reaches +50 F. The air conditioner has an output of 4700 BTU/hr at +125 F. The unit has overall dimensions of 19-inches wide, 15 $\frac{1}{2}$ inches high, and 26 $\frac{3}{8}$ inches long; weighs 83 pounds; and operates on 120 v, 60-cycle, single phase power.

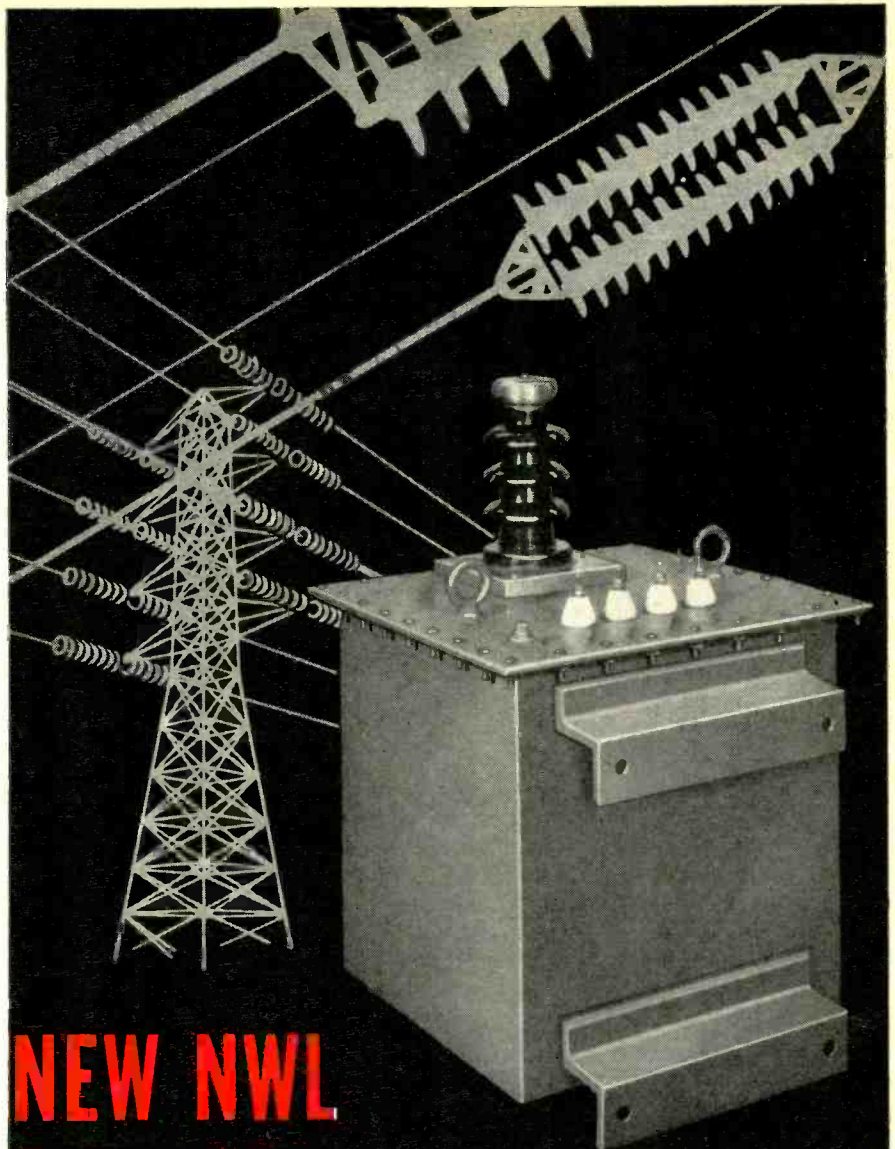

NEW NWL OUTDOOR POTENTIAL TRANSFORMER

- Output: 35KV • 25KVA continuous duty
- Corona-free • Vacuum-oil filled
- Equipped with special brackets for pole mounting

The outdoor potential transformer, a new member of the well-known family of NWL custom-built Transformers, is made to fit the particular needs of the user. Each Nothelfer transformer is individually tested for core loss, polarity, voltage, corona, insulation breakdown and aging characteristics and must meet all customer's requirements before shipment. We shall be glad to receive your specifications and quote you accordingly.



ESTABLISHED 1920



Nothelfer

SAY: NO-TEL-FER

NOTHELPER WINDING LABORATORIES, INC., P. O. Box 455, Dept. E-7, Trenton, N. J.
(Specialists in custom-building)

Anvil and Die Fasten Contact Barrel to Panel



When hydraulic press is used (left) anvil is fixed on moving ram and die is on press base. Positions are reversed in hand method as hammer is used to strike die

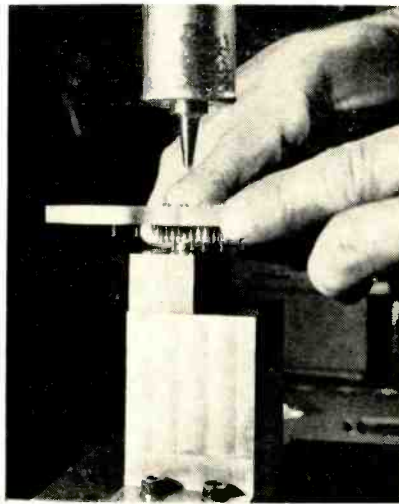

SPRING-LOADED, barrel-type contacts are secured firmly to insulating panels with a ring bulge forced into the barrel at the panel surface. The bulge can be made with anvil and die on a hydraulic press or with hand tools.

The technique described was devised by Kenneth Steward, an electronics shop leadman at Friden Calculating Machine Co., San Leandro, Calif. It is considered faster than cementing, which formerly was used. The mechanical bond also

avoids the possibility of cement softening during soldering or fouling the contact.

The panel is drilled, counterbored and reamed to the dimensions of the contact. The contact is placed in the panel with the contact's shoulder up and lug end down. The lug end is placed in the die located on the base plate of a hydraulic press, as shown in the diagram.

The anvil is located on the moving ram of the press. It presses on the shoulder of the contact. As

pressure is applied to the anvil, it forces the contact and the panel down.

Fit of the contact, anvil and die is held to close tolerance everywhere except at the small opening left by the travel of the die stripper. Pressure of the anvil forces a mushroom at that point around the barrel.

When the press anvil returns to its rest position, the spring in the die housing pushes the stripper up. The stripper releases the contact and panel. The die and anvil may be made as a multiple unit when it is desirable to handle more than one contact at a time.

Contacts can also be inserted in about one minute when the anvil and die are used as hand tools.

For contact replacement, the lug end of the contact is first broken off the panel with a pair of long-nosed pliers. A flat-nosed hand punch slightly smaller in diameter than the barrel is used to punch the remainder of the contact out of the panel. This does not distort the panel holes.

A new contact is fitted in the holes. The anvil is placed on a bench or other firm support. The contact's shoulder, now on the un-

DESIGN TRENDS: Precision AC Potentiometer

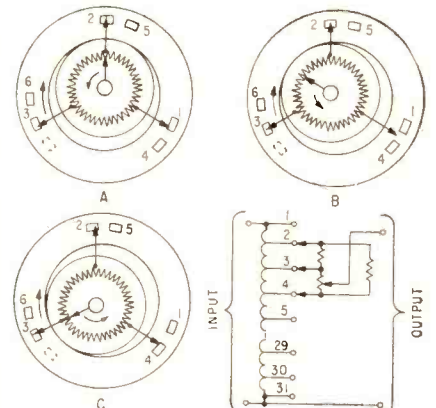
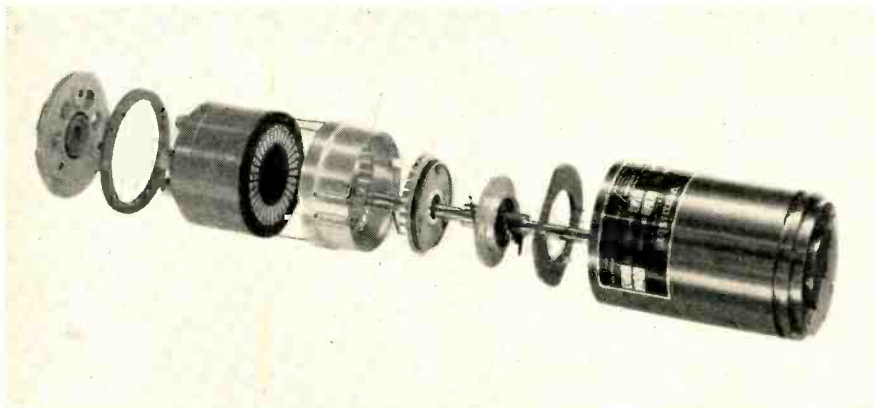

Autotransformer and potentiometer combination yields linear voltage division over transformer range while maintaining high resolution and low output impedance. Transformer handles basic voltage division while pot interpolates in Vernistats designed by Perkin-Elmer Corp., Norwalk, Conn. Potted autotransformer has rhodium-plated, flush printed commutator. Potentiometer action is illustrated at right. Resistance element mounted on planet gear is a 360 degree winding with 3 taps to commutator contacts. Internal tooth gear has 1 gear tooth for each commutator bar; planet gear has 1 less tooth and is mounted on eccentric hub. Planet gear precesses by 1 tooth for each turn of shaft, so that resistance unit switches sequentially along commutator. To right of planet gear is potentiometer wiper, slip ring and stop assembly. Wiper and slip ring are mounted on contact disk. Stops are pile of washers; turning is stopped by pins in housing and on eccentric. Modifications allow device to become a non-linear function generator. Applications include servo systems, computers, guidance and control, flight simulators

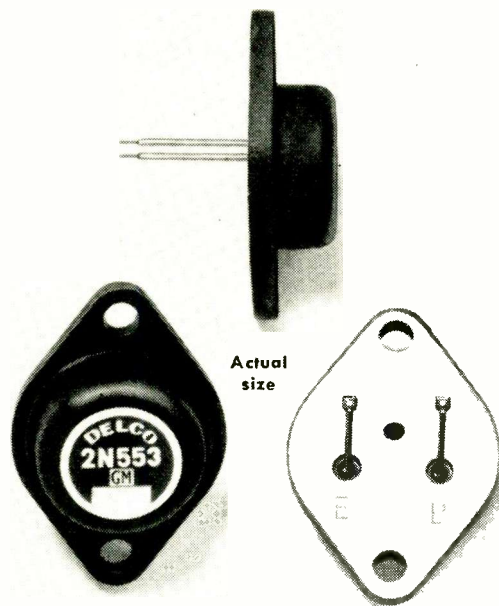

ANNOUNCING...

the newest addition to the Delco family of PNP germanium transistors! It's ideally suited for high-speed switching circuits and should find wide use in regulated power supplies, square wave oscillators, servo amplifiers, and core-driver circuits of high-speed computers. It's the 2N553!

NEW HIGH-FREQUENCY POWER TRANSISTOR BY DELCO

No other transistor offers so desirable a combination of characteristics for applications requiring reliability and consistency of parameters.

TYPICAL CHARACTERISTICS $T = 25^{\circ}\text{C}$ unless otherwise specified

Collector diode voltage V_{CB} ($V_{EB} = -1.5$ volts)	80 volts maximum
Emitter diode voltage V_{EB} ($V_{CB} = -1.5$ volts)	40 volts maximum
Collector current	4 amps. maximum
Base Current	1 amp. maximum
Maximum junction temperature	95°C
Minimum junction temperature	-65°C

Collector diode current I_{CO} ($V_{CB} = 2$ volts)	$12 \mu\text{a}$
Collector diode current I_{CO} ($V_{CB} = -60$ volts)	0.5 ma
Collector diode current I_{CO} ($V_{CB} = -30$ volts, 75°C)	0.5 ma
Current gain ($V_{CE} = -2$ volts, $I_C = 0.5$ amp.)	55
Current gain ($V_{CE} = 2$ volts, $I_C = 2$ amps.)	25
Saturation voltage V_{EC} ($I_B = 220$ ma, $I_C = 3$ amps.)	0.3
Common emitter current amplification cutoff frequency ($I_C = 2$ amps, $V_{EC} = 12$ volts)	25 kc
Thermal resistance (junction to mounting base)	1°C/watt

BRANCH OFFICES

Newark, New Jersey
1180 Raymond Boulevard
Tel: Mitchell 2-6165

Santa Monica, California
726 Santa Monica Boulevard
Tel: Exbrook 3-1465

DELCO RADIO

Division of General Motors
Kokomo, Indiana

NOW... from Victoreen

CORONA TYPE HIGH VOLTAGE REGULATORS WITH CURRENT CAPABILITIES AND SLOPES NEVER BEFORE OBTAINABLE

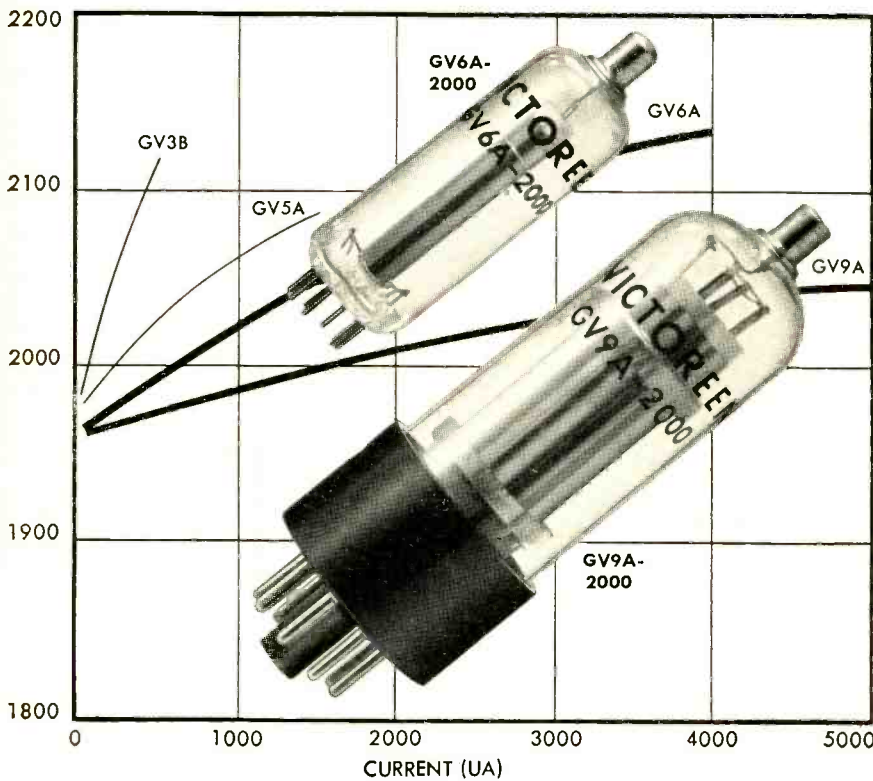

- Maximum currents to 4 ma
- Peak currents to 9 ma
- Regulation to 1.5%/ma
- Voltages from 400 to 3000
- 9 pin and octal base tubes
- In use by the military

Make Victoreen your headquarters for high voltage regulation. Send for Form 2022A and Form 2023A describing the GV6A and GV9A line of corona type voltage regulators.

See us at WESCON, Booth 1542



The Victoreen Instrument Company

Components Division

5806 Hough Avenue • Cleveland 3, Ohio

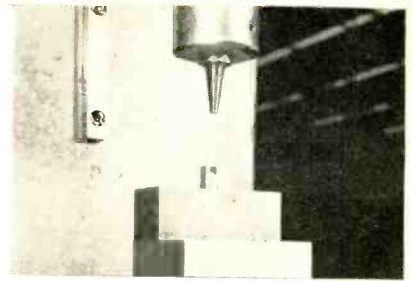

Setup on hydraulic press for securing contacts one at a time

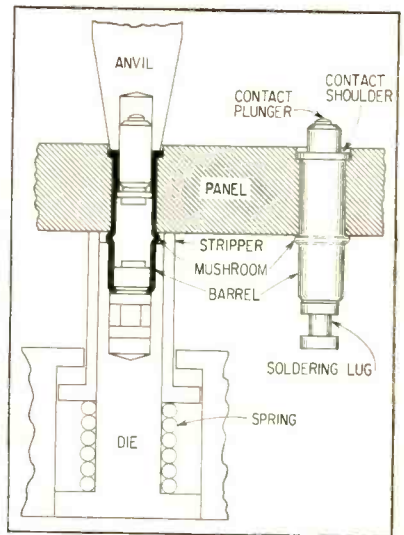

Anvil and die force barrel to bulge at surface of insulating panel

derside of the panel, is placed on the anvil.

The die is placed over the lug end and given a light blow with a machinists' hammer, securing the contact.

Lead Powder Connects Superconducting Film

By J. A. KURTZ,

International Business Machines Corp., Poughkeepsie, N. Y.

SUPERCONDUCTING connections, with zero resistance, are required in cryogenic circuits. A superconductor can be driven into the normal state when the magnetic field of the current passing through it exceeds the critical magnetic field of the metal. A wire will lose its superconducting properties if it is connected to a film at one small point only.

The usual methods of making superconducting electrical connections are not satisfactory when the gate of a cryotron is a film of tin

on insulated wire. Flux, heat, or chemical action destroys the film.

Satisfactory connections may be made with compressed lead powder of the finest commercial size. The lead is compressed in a cavity in which the film, on its wire base, is inserted. External leads are usually solder-coated copper wires.

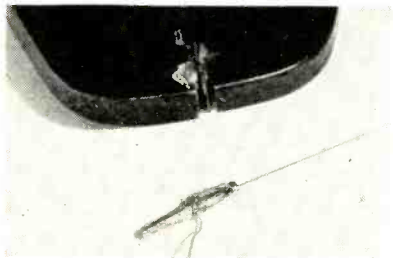

Plug containing cryotron gate, external lead and lead powder. Head of crimping tool is shown above

One such method uses a specially-prepared Aircraft Marine Products plug smoothed out inside and covered with solder. A solder-coated wire is soldered to the tapered end. The wire bearing the film is inserted in a small hole drilled in the other end of the plug.

The cavity is filled heaping with lead powder and compressed with a hand crimper until the lead appears solid, providing a continuous superconducting path between the solder-coated wire and the wire bearing the film.

A second method reduces the strain on the film by supporting the wire on a plastic base which remains permanently attached. Powdered lead is put into cavities at the ends of the base. The wire bearing the film is inserted through slots. External leads are inserted in holes in the front of the base. A punch with 5,000 psi pressure compresses the lead powder.

Flexing the base wire can cause the film to fracture. This is a disadvantage of the first method, not so much of the second.

The critical current of an assembly is the current which causes a voltage to appear across the specimen. To test connections, current and voltage leads are attached to the external leads. A voltmeter of 10 microvolts full scale deflection is used to determine the appearance of voltage across the sample.

The lead powder technique pro-

another Potter First

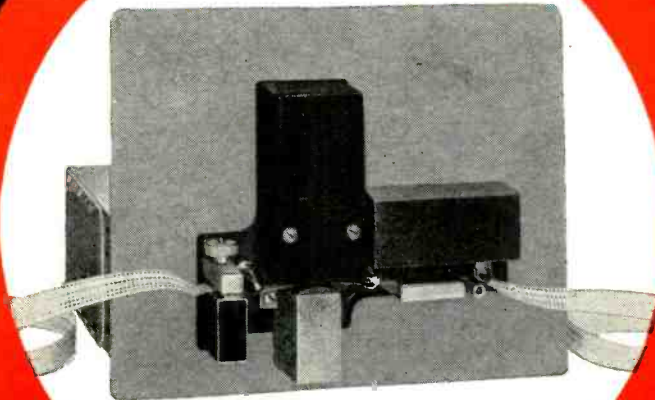

THE NEW POTTER "909"

Now... a device that **READS** and **STOPS** faster, better

The compact '909' Perforated Tape Strip Reader now makes it possible to process information from perforated tape into digital data computer systems at high speed and low cost. Simple to operate by clerical personnel, the '909' is completely transistorized, and will give maximum performance with complete reliability.

The '909' is a compact unit, suitable for console or rack mounting. Here are some of the performance features, available for the first time in equipment of this type:

- Character reading speeds up to 1000 char/sec.
- Simple In-Line threading
- 3 Millisec starting time
- Stops on STOP Character, (0.2 millisec) and will read next character after start
- 100 x 10" operation pinch roll
- Photo Diode Head reads any tape (including oiled yellow teletype tape)
- Reads 5, 6, 7 or 8 level tape with sprocket channel
- Ambient temperature up to 125° F. with 10,000 hour life
- Built to meet requirements of MIL-E-4158A

Specifications

Tape Speed:

10 to 100 ips

Tape Width:

Any Standard Width

Power Requirements:

115V, 60 Cycle, 1 Phase

Control:

Remote/Level Inputs

Contact your Potter representative or call or write direct for further information.



The mark of
Engineering Quality

POTTER INSTRUMENT COMPANY, INC.

Sunnyside Boulevard, Plainview, N. Y.
Overbrook 1-3200

Potter has career opportunities for qualified engineers who like a challenge, and the freedom to meet it.

F.M. Deviation Measurement

Wide Deviation —

High Carrier Frequency



MARCONI DEVIATION METER MODEL 928 CAN BE USED AT CARRIER FREQUENCIES UP TO 500 mc FOR DIRECT MEASUREMENT OF DEVIATIONS UP TO 400 kc.

DEVIATION METER MODEL 928/2

is an alternative narrow-deviation model arranged for use at carrier frequencies between 215 and 265 mc.

Please send for leaflet B132/B

ABRIDGED SPECIFICATIONS 928: — CARRIER FREQUENCY: 20-100 mc (fundamental), up to 500 mc using harmonics. FREQUENCY DEVIATION: 0-100 kc, 0-200 kc; 0-400 kc in the mod. frequency range 50 cps—120 kc. ACCURACY: $\pm 3\%$ R.F. INPUT RANGE: 55 mV—10 V. **928/2:** — As above except for the following: —CARRIER FREQUENCY: 215—265 mc. FREQUENCY DEVIATION: 0-15 kc, 0-50 kc, 0-150 kc.

MARCONI INSTRUMENTS

*Marconi
for f.m.
test gear*

111 CEDAR LANE ENGLEWOOD NEW JERSEY Tel: LOwell 7-0607
CANADA: CANADIAN MARCONI CO · 6035 COTE DE LIESSE · MONTREAL 9
MARCONI INSTRUMENTS LTD · ST. ALBANS · HERTS · ENGLAND

vides critical currents as high as 1 amp with films of soft metals like lead and tin. Critical currents of only 5 milliamps resulted when hard metal wires of tantalum and niobium were used, presumably because the lead particles could not penetrate the harder surface layers.

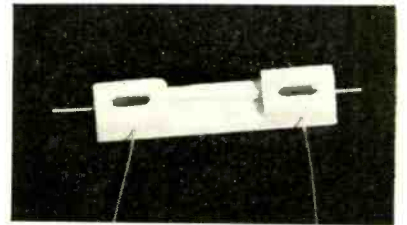
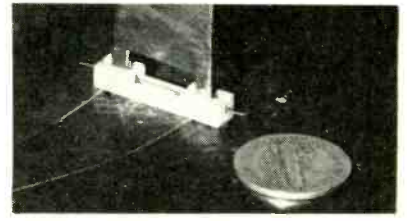

Punch is used when connection is made in plastic support

Plastic Tube Extends Control Parts Shafts

PLASTIC EXTENSION shafts are used by television receiver manufacturers so that variable control parts may be mounted on the main chassis without requiring long-shaft potentiometers.

A crack-resistant polyethylene, Aeroflex-P, is recommended by Anchor Plastics Co., Long Island City, N. Y., as shaft material for automatic gain control and vertical hold potentiometers.

One end is forced over the knurled metal shaft. The outside end flattens after an identifying tag is placed in the pliable tube. Flattening of the shaft end or fluting the outside of the tubing facilitates turning without a knob.

“On-off”, “brightness”, “contrast” and “volume” controls, which require knobs, are made of linear polyethylene which maintains sufficient rigidity after the receiver has heated up. Flutings are mated with the metal shaft knurl. A flare simplifies blind assembly of external knobs.

Nylon shafts are used for width controls. Ferrite core coils require more turning force than other var-

TC 132

iable controls. One end of these shafts are threaded to fit the metal shafts.

Plastic shafts are not recommended for curved extensions. They would tend to set in their bent positions, subsequently causing uneven operation of the control.

Foot-operated Vise Tool Seats Grommets

WISE-LIKE tool is used to seat electrical grommets without damage in the electrical manufacturing department of Convair, Fort Worth, Texas. The tool was designed by John V. Crotty, assistant project engineer.

Previously, humidity, vibration and cable-clamping grommets were forced into their seat by hand. There were many rejections due to insulation and grommet damage.

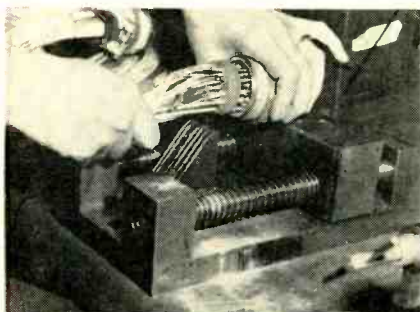

Operator has both hands free to line up connection. Wiring harness fits into parallel metal plates

The new tool looks like a foot-operated vise. The back jaw is a movable flat metal surface padded with a sheet of rubber. The front jaw is a group of parallel metal plates which accommodate AN connector grommet sizes.

Connectors are prepared in the usual manner. The operator threads conductors through the grommet and solders them to their respective solder pots in the connector.

The back connector is placed against the face of the back jaw. The wiring harness is fitted into the plates of the front jaw. The grommet rests against the inside of the front jaw.

While the operator holds the parts in place by hand, the vise is closed with steady foot pressure. The grommet is forced to seat smoothly on the connector.

Now Measure

TRUE RMS

from 100 microvolts to 320 volts
REGARDLESS OF WAVEFORM

with the Ballantine Model 320 Voltmeter

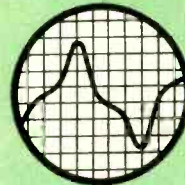
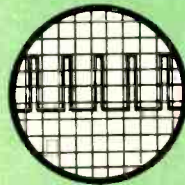
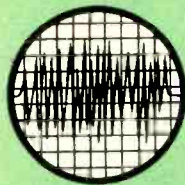
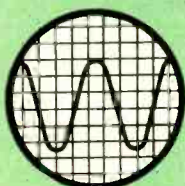

REPRESENTING:

A distinctly new departure in VTVM design.

FEATURING:

A built-in calibrator; — easily read 5-inch log meter; — immunity to severe overload; — useful auxiliary functions.

BRIEF SPECIFICATIONS:

VOLTAGE RANGE: 100 microvolts to 320 volts
DECIBEL RANGE: — 80 dbv to +50 dbv
FREQUENCY RANGE: 5 to 500,000 cycles per second
ACCURACY: 3% from 15 cps to 150KC; 5% elsewhere
Figures apply to all meter readings
MAXIMUM CREST FACTORS: 5 at full scale; 15 at bottom scale
CALIBRATOR STABILITY: .05% for line variation 105-125 volts
INPUT IMPEDANCE: 10 MΩ and 25 μf, below 10 millivolts
10 MΩ and 8 μf, above 10 millivolts
POWER SUPPLY: 105-125 volts; 50-420 cps, 75 watt
Provision for 210-250 volt operation
DIMENSIONS: (Portable Model) 14 3/8" wide, 10 1/8" high,
12 3/8" deep—Relay Rack Model is available
WEIGHT: 21 lbs., approximately

PRICE: \$425

Write for the New Ballantine Catalog describing this and other instruments in greater details.

BALLANTINE LABORATORIES, INC.



100 FANNY ROAD, BOONTON, NEW JERSEY

Market New Transducers

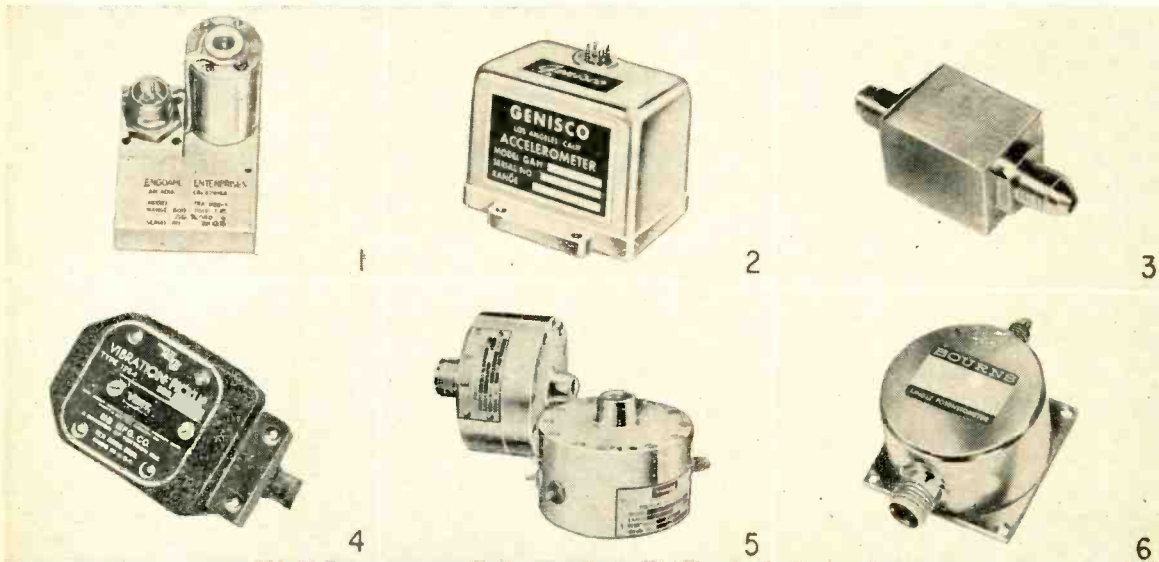

(1) Engdahl Enterprises, triaxial accelerometer. (2) Genisco, Inc., a-c accelerometer. (3) Computer Instruments, pressure transducer. (4) MB Mfg. Co., vibration pickup. (5) G. M. Giannini, oil-filled pressure transducer. (6) Bourns Laboratories, miniature pressure transducer

HIGH ACCELERATIONS, vibrations and pressures are the rule rather than exception in today's space age. Stricter demands continue to be placed upon the input signal transducer—primary detector in telemetering systems. Here are some recently announced transducers.

Engdahl Enterprises, 226 San Antonio Rd., Arcadia, Calif., (200) reports a new triaxial recording accelerometer. It senses and records data for plotting acceleration vs time under extremely rigorous conditions. The self-contained unit will record from 250 to 10,000 g.

Now available from Genisco, Inc., 2233 Federal Ave., Los Angeles, Calif., (201) is the GAH a-c accelerometer, a medium-high natural frequency instrument with a variable transformer pick-off. It is available in ranges from ± 0.1 g to ± 20 g.

Computer Instruments Corp., 92 Madison Ave., Hempstead, L. I., N. Y., (202) announces the series 1,000 precision pressure transducers which provide an electrical voltage output as a function of applied pressure with high accuracy. The unit occupies one cu in. of space.

In production at MB Mfg. Co., P.O. Box 1825, New Haven, Conn., (203) is a new magnetically damped type 128-1 vibration pickup. It is suitable for use in measuring vibratory motions with up to ± 5 g unidirectional steady acceleration superimposed, with little change in sensitivity over -65 to $+250$ F.

G. M. Giannini & Co., Inc., 918 E. Green St., Pasadena 1, Calif., (204) offers transducers designed for noncorrosive gas or liquid pressure measurement within the ranges of 0-100 psi to 0-6,000 psi differential or gage, and 0-100 psi to 0-1,000 psi absolute.

Model 470 miniature absolute pressure transducer may be had from Bourns Laboratories, Inc., P.O. Box 2112, Riverside, Calif. (205). It has extremely low vibration error and noise-free operation at 25 to 35 g. Signal error is less than 0.1 percent at 25 g up to 2,000 cps.



Millivolt Source portable unit

WESTRONICS, INC., 3605 McCart St., Ft. Worth, Texas. A new millivolt source finds application in the calibration of various recording and other millivolt instruments. It features two ranges of 0 to 10 and 0 to 100 mv; the calibrated dial can be read to three places. The instrument remains within 0.25 percent accurate over a reasonable period of time. The unit is extremely portable and may be used in applications where a large potentiometer instrument is unwieldy. Circle 206 on Reader Service Card.

(Continued on page 98)

For more information use READER SERVICE Card

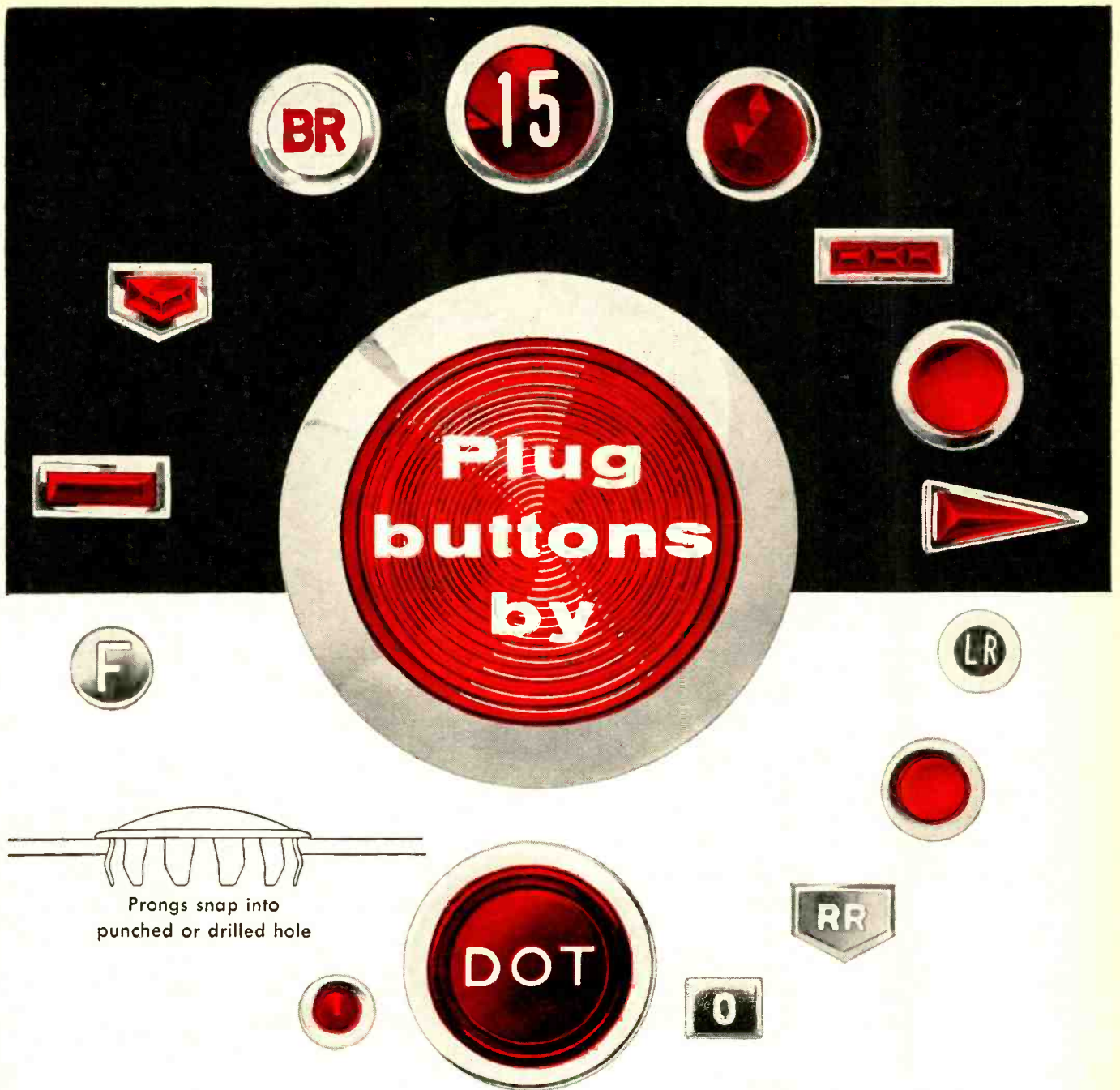

**CUSTOM-DESIGNED AND MASS PRODUCED
TO YOUR PARTICULAR REQUIREMENTS**

Dot plug buttons were originally used in automobiles to fill spaces on standard models which, on de luxe models would be occupied by such extras as cigarette lighters, radio controls and so on. They are now also widely used as lenses for indicator lights and as identification buttons on instrument and control panels of all kinds.

Available in clear or colored plastics... brass or steel in all standard finishes... embossed and enamel-filled or molded to show company insignia or other identification symbols... Dot plug buttons snap into place and stay where they're put even under conditions of extreme vibration. Yet they can be removed and replaced repeatedly without damage.

CARR FASTENER COMPANY

DIVISION OF UNITED-CARR FASTENER CORPORATION 31 Ames Street, Cambridge 42, Massachusetts



To the talented
engineer and scientist

APL OFFERS GREATER FREEDOM OF ACTIVITY

APL has responsibility for the *technical direction* of much of the guided missile program of the Navy Bureau of Ordnance. As a result staff members participate in assignments of challenging scope that range from basic research to prototype testing of weapons and weapons systems.

A high degree of freedom of action enables APL staff members to give free rein to their talents and ideas. Thus, professional advancement and opportunities to accept program responsibility come rapidly. Promotion is rapid, too, because of our policy of placing professional technical men at all levels of supervision.

APL's past accomplishments include: the first ramjet engine, the Aerobee high altitude rocket, the supersonic Terrier, Tartar, and Talos missiles. Presently the Laboratory is engaged in solving complex and advanced problems leading to future weapons and weapons systems vital to the national security. Interested engineers and physicists are invited to address inquiries to:

Professional Staff Appointments

The Johns Hopkins University Applied Physics Laboratory

8609 Georgia Avenue, Silver Spring, Maryland



V-R Tube 7-pin miniature

RADIO CORP. OF AMERICA, Harrison, N. J. The OC2 is a cold-cathode, glow-discharge voltage-regulator tube of the 7-pin miniature type. It was developed for use in applications where a relatively constant d-c output voltage across a load must be maintained despite load current and moderate line-voltage variations. In such applications, the OC2 will supply a regulated voltage of approximately 75 v at d-c cathode currents within the range of 5 to 30 ma. Circle 207 on Reader Service Card.

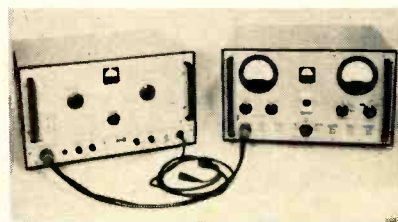

Stability Tester for microwave use

LABORATORY FOR ELECTRONICS, INC., 75 Pitts St., Boston 14, Mass. Model 5009 microwave stability tester is composed of two units: a power supply with a plug-in r-f head and an indicator. It measures drift and f-m in frequency bands between 10 mc and 10,800 mc . . . will measure these same parameters at 30 mc and 30 kc to 70 kc. All information is presented on two large, easy-to-read meters which are calibrated to read peak f-m deviation in cps and drift in kc. Model 5009 is useful in all types of high frequency electronic manufacture as well as other areas where stability must be measured. Outputs may be viewed on an oscilloscope giving it many

applications as a test instrument in research and development. Circle 208 on Reader Service Card.



Precision Pot size 30

GEORGE RATRAY AND CO., 116-08 Myrtle Ave., Richmond Hill 18, N. Y., announces model 300 precision pot. Resistances in excess of 285,000 ohms and resolutions better than 0.2 percent are attainable. Linearities of 0.075 percent can be provided in production quantities. As many as 15 sections can be ganged to a single, rigid shaft. Up to 25 taps can be provided per section. Circle 209 on Reader Service Card.



Panel Instruments high readability

GENERAL ELECTRIC CO., Schenectady 5, N. Y., announces a new line of small panel instruments in 2½ in. and 3½ in. sizes for both a-c and d-c measurements. All types have longer scales yet will fit into the same panel space as conventional equipment. To achieve the units' high degree of readability, GE engineers simplified scale graduations,

immediate delivery... phase-lock discriminators by Hallamore

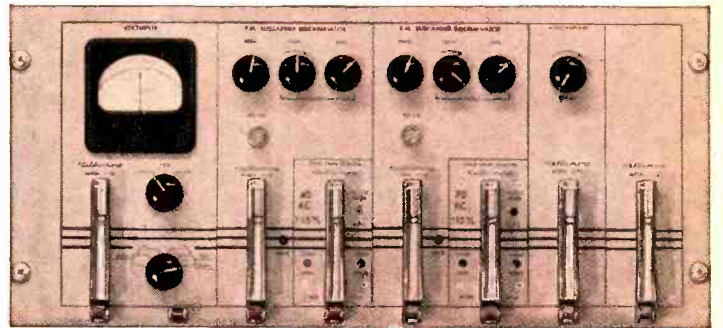
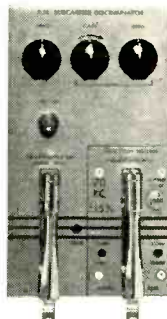
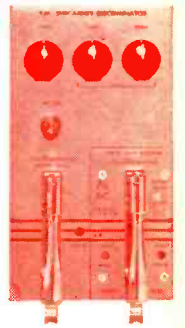

We'll see you at the Wescon Show, Booths 412 & 433.

Ready, as a "building-block" for your system application...Hallamore Model 0162, phase-lock discriminator, a compact plug-in type unit, has been thoroughly proven in telemetering systems of major missile programs. Designed around a concept entirely new to telemetry, it eliminates signal suppression by noise...non-linearity as a result of filtering...thresholding, common at low signal-to-noise levels. For quick action, wire Hallamore Electronics Company, Dept. 24P, 8352 Brookhurst Avenue, Anaheim, California / TWX: AH-9079.



HALLAMORE ELECTRONICS COMPANY

Engineers...for ideal working conditions with a dynamic, creative organization, address resume to Chief Engineer.

a division of The Siegler Corporation



Forerunner in System Development



FREQUENCY DETECTOR

is used for direct frequency indications or for servo frequency control. Because of its stability, the Magmeter detector simplifies telemetering equipment and automatic generator controllers. It is excellent for constant-speed servos. It requires no reference.

Meter Reads Exact Frequency When Using AIRPAX MAGMETER

Output current of Airpax Magmeter detector Type F-5132 is directly proportional to frequency deviation.

Response is rapid. Detector can be used—

- (1) to display frequency directly on a panel meter,
- (2) to record frequency on a chart recorder, or
- (3) to control generator through follow-up loop.

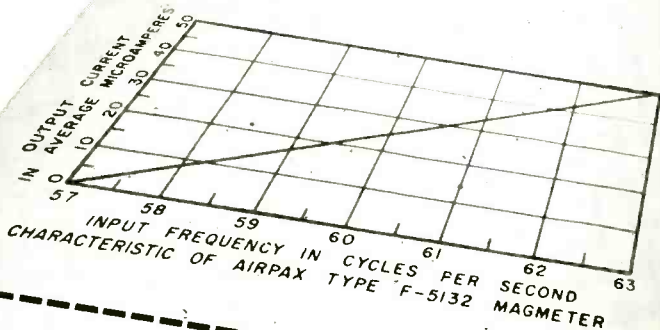

DETECTOR CHARACTERISTICS

Airpax Type F-5132 Magmeter detector operates entirely from the input signal.

RANGE: 60 ± 3 CPS (other ranges on special order)

ACCURACY: Linear within ± 1/4% of mid-scale frequency
Reproducible to ± 1/4% of mid-scale

INPUT: Approx. 1 W of signal power

OUTPUT: 50 μa at 63 CPS (0 at 57 CPS) into load of 2200 ohms maximum

ENCLOSURE: Hermetically sealed rectangular can 1 1/4" x 2 1/4" x 3" with four 6-32 bolt-down studs and 7-pin solder hook header



Airpax Products Company, Seminole Division, Fort Lauderdale, Florida

used a tapered pointer and specified big upper case numerals which are positioned above the graduations. A new moving-magnet design is used in all d-c ratings, except amperes below 5 ma. This eliminates zero set. All instruments are accurate within 2 percent of full scale value. Circle 210 on Reader Service Card.

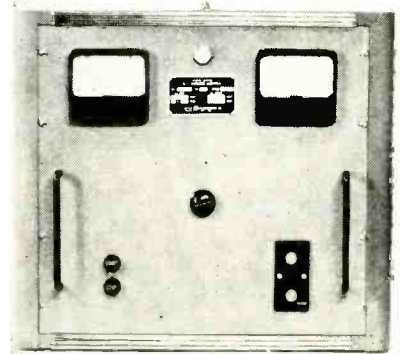

D-C Power Supply silicon unit

GATES ELECTRONIC Co., 2090 Barnes Ave., Bronx 62, N. Y. A new regulated silicon d-c power supply features magnetic amplifier control with ferromagnetic overload protection circuit, completely eliminating one-time fusing normally associated with silicon units. Ratings are: input, 115 v; single phase 60 cycles a-c; output 5-30 v ± 40 amperes d-c. Regulation is ± 1/2 percent, ripple 1 percent. Circle 211 on Reader Service Card.

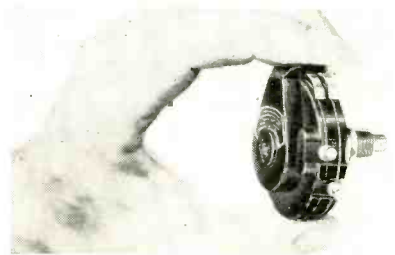

Rheostat fine adjustment

THE SUPERIOR ELECTRIC Co., Bristol, Conn. Mikrohmm rheostats of the 310 series are ideal for applications requiring low resistance controllers having infinitely fine adjustment characteristics. The non-

coil-stepless design is especially well suited wherever exact linear resistance variation is required. Among other uses, a Mikrohm can be used as a dropping rheostat for vacuum tube filaments; as a trimmer for electronic and electrical industrial control apparatus; as an accessory in instrument calibration laboratories for precise controlling of low currents and for setting resistance values. Circle 212 on Reader Service Card.

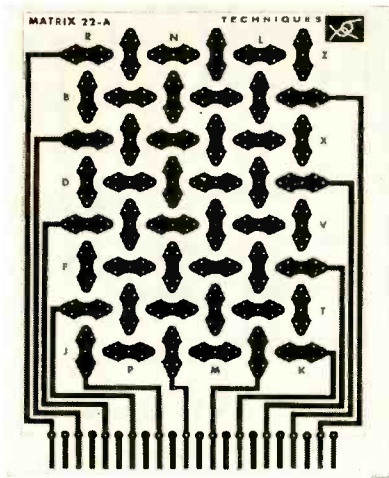

Matrix Board aids computer design

TECHNIQUES, 52 Jackson Ave., Hackensack, N. J. No. M-22A expanded matrix board is announced. Over 100 resistors, capacitors, and other circuit elements can be mounted on this p-c 22 terminal plug-in board. Two sided board provides a total of 944 possible connections to a dual p-c receptacle. Material is XXXP laminate, one ounce copper, two sides. Overall dimensions are 5½ in. by 4 in. by ¼ in. Circle 213 on Reader Service Card.



Linear Motion Pot has floating shaft

Bourns Laboratories, Inc., P.O. Box 2112, Riverside, Calif. Model

You saw it at the New York I.R.E. Show

THE NEW DEKATRAN RATIO TRANSFORMER

model DT-45

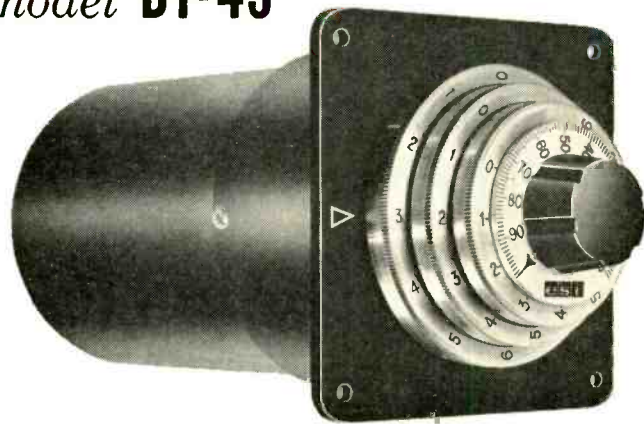

The original concentric dial precision decade ratio transformer voltage divider for panel mounting. A three decade ratio transformer and an interpolating potentiometer provide 5 place readings of voltage ratio in one convenient straight-line.

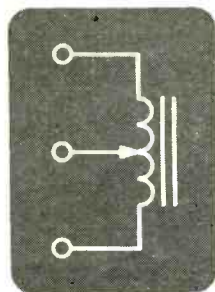

esi

FREQUENCY RANGE: 50 cycles to 10 kilocycles.

ACCURACY: ±(0.001% plus 1 dial division) below 3 kilocycles.

RESOLUTION: Continuous (10 ppm per dial division).

MAX. INPUT VOLTAGE: 0.35 × f in cps (350 v max.).

MAX. OUTPUT IMPEDANCE: Approximately 2 ohms resistance in series with 75 microhenries.

PRICE: \$275.00

ELECTRO-MEASUREMENTS, INC.

7524 S. W. Macadam Avenue • Portland 19, Oregon

Probing Outer Space—Exciting LONG-RANGE PROSPECTS for ENGINEERS and SCIENTISTS

Openings Exist in the Following Areas:

DESIGN AND DEVELOPMENT

One of the most important programs at Cubic includes the design and development of electronic tracking equipment for the major Air Force missile test centers. Equipment includes Range Safety and Long Range Tracking instrumentation. Developmental programs entail Satellite Tracking and Earth Surveying.

NEW PRODUCT DEVELOPMENT

For several years, Cubic Engineers have recognized the importance of the development of Transistorized Digital Voltmeter Systems and Laboratory Test Equipment. Presently, they are pioneering in the development of Power Measuring techniques and Microwave instrumentation. Our Engineers have led the way in the complete transistorization of test equipment.

FIELD ENGINEERING

The Cubic program is long-range, but some of our needs are immediate. At the present time we require additional field personnel for supervisory and project assignments. Current field installations are at Patrick Air Force Base, Camp Cooke, Eleuthra, Ascension and the Grand Bahamas.

Opportunities at Cubic are unlimited . . . our Engineers receive top salaries and generous benefits. We have the finest facilities . . . and our future is expanding. Ability reaches the spotlight quickly under our "growing-company" project system.

If you are a specialist in one of the above areas, contact:

Mr. J. Devlin
5575 Kearny Villa Road
San Diego 11, Calif.
BRowning 7-6780

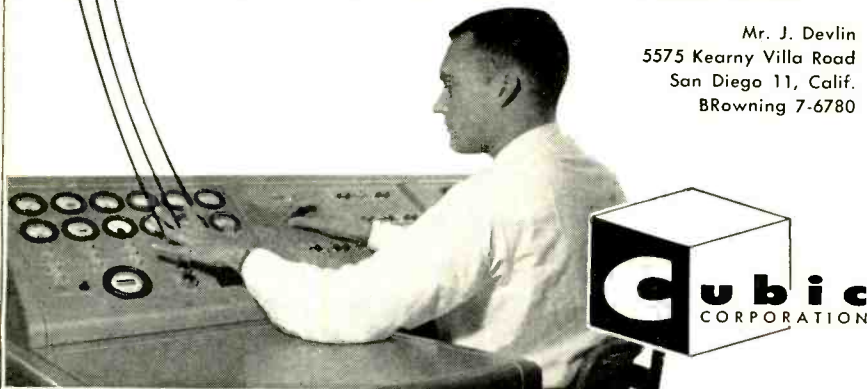

CUBIC CORPORATION

5575 Kearny Villa Road, San Diego 11, Calif., Telephone BRowning 7-6780

156 Align-O-Pot has a floating shaft which permits a wide area of movement for the actuating member. Thus, bending loads and vibratory motion on the shaft are eliminated. Vibration error is less than resolution at 15G for travels of 2½ in. or less and at 25G for travels from 2½ in. to 4 in. Single or dual potentiometer outputs are available, in resistance values of 1, 2, 5, 10, 20 and 50 K. Operating temperatures range from -67 to +221 F, with ranges to 450 F available. Acceleration error is less than resolution at 100 G, without noise. Circle 214 on Reader Service Card.



Gear Head Motor for missile uses

WESTERN GEAR CORP., P.O. Box 182, Lynwood, Calif., has designed a new miniaturized gear head motor for missile application. It is designed to withstand 7,500 G's of shock. It operates on 28.5 to 31.5 v d-c developing 1,000 oz in. of torque at -65 C. Output shaft has a rotation speed of 1.3 rpm. The motor meets MIL-E-5272 specifications. Circle 215 on Reader Service Card.



VHF Multicoupler for ground or air

WESTRONICS, Inc., 3605 McCart St., Ft. Worth, Texas, announces a vhf multicoupler for use in ground or airborne operation to couple as many as five receivers to

one antenna with minimum interaction and loss in sensitivity. Frequency range is from 90 to 200 mc with maximum efficiency and from 50 to 200 mc with reduced efficiency. The unit is available with a plug-in preamplifier so that overall gain from input to each of the outputs can be approximately unity. The multicoupler finds many applications in telemetering and other communication systems. Circle 216 on Reader Service Card.



Erase Head low power

MICHIGAN MAGNETICS, INC., Vermontville, Mich., announces a new low power erase head, the type S, especially suited for use with transistor circuitry. With but 0.5 va current 55 db erasure is obtained. The physical structure is extremely thin and designed to permit ganging to obtain 2-track and 4-track erasure. Alignment of ganged units is obtained through a unique ball and ball seat arrangement. Circle 217 on Reader Service Card.

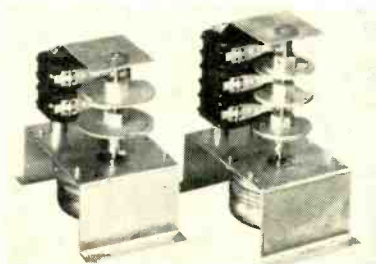

Recycling Timers and timer kits

HERBACH & RADEMAN, INC., 1204 Arch St., Philadelphia 7, Pa., announces a series of recycling timers and timing kits in single, double and three gang assemblies. Speeds varying from 50 cpm to 1 rev/hr are available. Featuring a rugged 115 v, 60 cycle sync motor and spdt 15 amperes at 125 v a-c

From General Electric . . .

PLAIN TALK ON TANTALYTIC* CAPACITOR AVAILABILITY

It's time for plain talk on the facts of tantalum electrolytic capacitor availability. There is no "availability" problem as far as General Electric is concerned.

Here's why:

- No metal shortage—Stocks of capacitor-grade tantalum have doubled within the past year.
- No production capability shortage—General Electric's production facilities have tripled in the past year.
- No delivery bottlenecks—General Electric's improved manufacturing processes and techniques have virtually eliminated production rescheduling.
- Few military directive priorities—Since the supply of Tantalytic capacitors has met demand, the military requirements can be met without directive priorities.

This is why we say—now and in the future, General Electric will continue to provide Tantalytic capacitors in the types and ratings you want—when you want them.

For specific information on Tantalytic capacitor ratings, prices, deliveries, contact your nearest General Electric Apparatus Sales Office or write to General Electric Co., Section 449-4, Schenectady 5, N. Y.

*Registered trade-mark
of General Electric Co.

**Trade-mark of
General Electric Co.



SOLID TANTALYTIC CAPACITORS
—for transistorized circuit applications—rated up to 60 volts, polar units only—sizes down to 0.125 inches by 0.250 inches.

125C TANTALYTIC CAPACITORS—for aircraft electronic systems—ratings 10–180 mfd, 30 to 100 volts. Sizes 1/2 to 1 1/8 inches in height. Also tubular, double-cased units.

KSR TANTALYTIC CAPACITORS**—for missiles, radar, airborne electronic equipment applications—ratings up to 3500 mfd—three case sizes 1.375, 2, 2.5 inches in height.

85C TANTALYTIC CAPACITORS—for applications requiring high quality but where temperatures are less severe.

GENERAL  ELECTRIC

marion
 advancement
 in instrument
 design

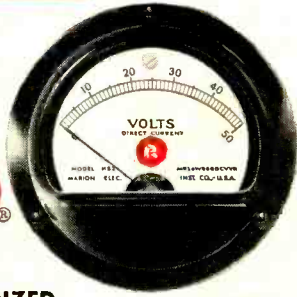

**SEALED
 RUGGEDIZED
 PANEL METERS**

"The 'Original'"
 MIL-M-10304-A
 Instrument

HERMETICALLY SEALED . . . GLASS-TO-METAL

MIL 2½" (MR26) and MIL 3½" (MR36) sizes. Also 1½" Ruggedized and 4½" Sealed Models. ua, ma, amp, mv, volt, KV, AC rectifier types for voltage, decibel and VU measurement. Standard ranges. Bulletin on request. Marion Electrical Instrument Co., Manchester, N. H., U. S. A.

Copyright © 1958, Marion

marion
 "WHERE ELECTRONICS MEETS THE EYE"
meters



CIRCLE 62 READERS SERVICE CARD

FREE BOOKLET
 Will Show You How To
INCREASE YOUR INCOME!

COMMERCIAL 2-WAY RADIO MAINTENANCE IS A BIG BOOMING BUSINESS. LICENSEES PAY GOOD MONEY—USUALLY ON A CONTRACT BASIS—TO PROPERLY QUALIFIED AND EQUIPPED MEN.

IT'S A PERFECT PART-TIME BUSINESS FOR RADIO ENGINEERS AND CAN PAY YOU HUNDREDS OF DOLLARS EXTRA A MONTH!

TO LEARN MORE ABOUT CONTRACTS AND RETAINER FEES SEND FOR FREE BOOKLET

"HOW TO MAKE MONEY IN MOBILE-RADIO MAINTENANCE" USE COUPON TODAY

FIRST CHOICE in TEST EQUIPMENT!



LAMPKIN
 105-B Frequency
 Meter \$220.00



LAMPKIN
 205-A FM Modulation
 Meter \$240.00

At no obligation to me please send "HOW TO MAKE MONEY IN MOBILE-RADIO MAINTENANCE".

Name _____
 Address _____
 City _____ State _____

LAMPKIN LABORATORIES, INC.
 Instruments Div., Bradenton, Fla.

CIRCLE 63 READERS SERVICE CARD

switches, the units are recommended for process control, life testing, pulsing flashing and numerous lab applications. Seventy-five standard types are available from stock. Circle 218 on Reader Service Card.

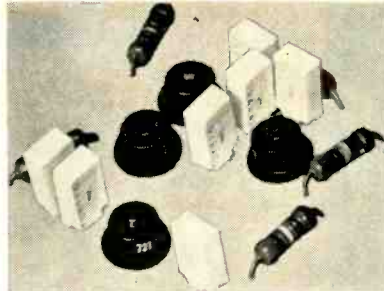

Capacitors for printed boards

VITRAMON, INC., Box 544, Bridgeport 1, Conn. The new parallel series capacitors are ideal for printed board applications. They are designed with both leads from one small face and a lead spacing of 0.2 in., making possible a tiny mounting area of 5/16 in. to 1/4 in. by 1/8 in. and capacitance through 1,000 µf at 100 v d-c. Designed for automatic insertion, the new capacitors are packed for cartridge feeding in production lines. Circle 219 on Reader Service Card.

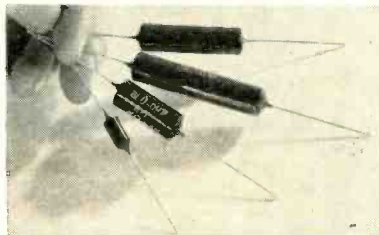

Wirewound Resistor in seven sizes

BRADFORD COMPONENTS, INC., 65 South Ave., Salamanca, N. Y. The Blu-Ohm series are for the more critical needs in the power field for precision resistors which will stand greater temperatures such as required by the missile program, the computer industry and other uses where previously developed types have failed. The resistors are constructed of ceramic materials together with specially developed

AN INVITATION TO JOIN ORO

Pioneer In Operations Research

Operations Research is a young science, earning recognition rapidly as a significant aid to decision-making. It employs the services of mathematicians, physicists, economists, engineers, political scientists, psychologists, and others working on teams to synthesize all phases of a problem.

At ORO, a civilian and non-governmental organization, you will become one of a team assigned to vital military problems in the area of tactics, strategy, logistics, weapons systems analysis and communications.

No other Operations Research organization has the broad experience of ORO. Founded in 1948 by Dr. Ellis A. Johnson, pioneer of U. S. Opsearch, ORO's research findings have influenced decision-making on the highest military levels.

ORO's professional atmosphere encourages those with initiative and imagination to broaden their scientific capabilities. For example, staff members are taught to "program" their own material for the Univac computer so that they can use its services at any time they so desire.

ORO starting salaries are competitive with those of industry and other private research organizations. Promotions are based solely on merit. The "fringe" benefits offered are ahead of those given by many companies.

The cultural and historical features which attract visitors to Washington, D. C. are but a short drive from the pleasant Bethesda suburb in which ORO is located. Attractive homes and apartments are within walking distance and readily available in all price ranges. Schools are excellent.

For further information write:
 Professional Appointments

**OPERATIONS RESEARCH
 OFFICE** **ORO**

The Johns Hopkins University

6935 ARLINGTON ROAD
 BETHESDA 14, MARYLAND

Get out your pencil and . . .

Help yourself to electronics' READER SERVICE it's free—it's easy—it's for your convenience

Each Advertisement and New Product item is numbered.

For more information, simply . . .

- (1) Circle number on postpaid card below that corresponds to number at the bottom of Advertisement, or New Product item.
- (2) Print your name, title, address, and firm name carefully.
It is impossible to process cards that are not readable.

***FOR SPECIFIC ITEMS IN MULTI-PRODUCT ADVERTISEMENTS**

Please indicate in box in post-card marked with asterisk (*) specific item(s) in ad in which you are interested. Please write ad circle number(s) and specific product(s) on which you want more information.

Additional postage MUST be added to cards for all FOREIGN MAILINGS

An occasional Advertisement cannot be numbered for the READER SERVICE CARD due to lack of space and must be indicated by writing the Advertisers' name in the space at the bottom of the card...



An occasional Advertisement cannot be numbered for the READER SERVICE CARD due to lack of space and must be indicated by writing the Advertisers' name in the space at the bottom of the card...



JUL 4 · 58 electronics • ENGINEERING EDITION • READER SERVICE CARD
CARD EXPIRES SEP 4 · 58

(NAME) _____ (POSITION) _____
(COMPANY) _____ (ADDRESS) _____

CIRCLE THESE NUMBERS ONLY WHEN YOU ARE INTERESTED IN ALL ITEMS SHOWN OR DESCRIBED

1	2	3	4	5	6	7	8	9	10	11	12	13	14	15	16	17	18	19
20	21	22	23	24	25	26	27	28	29	30	31	32	33	34	35	36	37	38
39	40	41	42	43	44	45	46	47	48	49	50	51	52	53	54	55	56	57
58	59	60	61	62	63	64	65	66	67	68	69	70	71	72	73	74	75	76
77	78	79	80	81	82	83	84	85	86	87	88	89	90	91	92	93	94	95
96	97	98	99	100	101	102	103	104	105	106	107	108	109	110	111	112	113	114
115	116	117	118	119	120	121	122	123	124	125	126	127	128	129	130	131	132	133
134	135	136	137	138	139	140	141	142	143	144	145	146	147	148	149	150	151	152
153	154	155	156	157	158	159	160	161	162	163	164	165	166	167	168	169	170	171
172	173	174	175	176	177	178	179	180	181	182	183	184	185	186	187	188	189	190
191	192	193	194	195	196	197	198	199	200	201	202	203	204	205	206	207	208	209
210	211	212	213	214	215	216	217	218	219	220	221	222	223	224	225	226	227	228
229	230	231	232	233	234	235	236	237	238	239	240	241	242	243	244	245	246	247
248	249	250	251	252	253	254	255	256	257	258	259	260	261	262	263	264	265	266
267	268	269	270	271	272	273	274	275	276	277	278	279	280	281	282	283	284	285
286	287	288	289	290	291	292	293	294	295	296	297	298	299	300	301	302	303	304
305	306	307	308	309	310	311	312	313	314	315	316	317	318	319	320	321	322	323
324	325	326	327	328	329	330	331	332	333	334	335	336	337	338	339	340	341	342
343	344	345	346	347	348	349	350	351	352	353	354	355	356	357	358	359	360	361
362	363	364	365	366	367	368	369	370	371	372	373	374	375	376	377	378	379	380
381	382	383	384	385	386	387	388	389	390	391	392	393	394	395	396	397	398	399
400	401	402	403	404	405	406	407	408	409	410	411	412	413	414	415	416	417	418
419	420	421	422	423	424	425	426	427	428	429	430	431	432	433	434	435	436	437
438	439	440	441	442	443	444	445	446	447	448	449	450	451	452	453	454	455	456
457	458	459	460	461	462	463	464	465	466	467	468	469	470	471	472	473	474	475
476	477	478	479	480	481	482	483	484	485	486	487	488	489	490	491	492	493	494
495	496	497	498	499	500	501	502	503	504	505	506	507	508	509	510	511	512	513
514	515	516	517	518	519	520	521	522	523	524	525	526	527	528	529	530	531	532
533	534	535	536	537	538	539	540	541	542	543	544	545	546	547	548	549	550	551
552	553	554	555	556	557	558	559	560	561	562	563	564	565	566	567	568	569	570
571	572	573	574	575	576	577	578	579	580	581	582	583	584	585	586	587	588	589
590	591	592	593	594	595	596	597	598	599	600	601	602	603	604	605	606	607	608
609	610	611	612	613	614	615	616	617	618	619	620	621	622	623	624	625	626	627
628	629	630	631	632	633	634	635	636	637	638	639	640	641	642	643	644	645	646
647	648	649	650	651	652	653	654	655	656	657	658	659	660	661	662	663	664	665
666	667	668	669	670	671	672	673	674	675	676	677	678	679	680	681	682	683	684
685	686	687	688	689	690	691	692	693	694	695	696	697	698	699	700	701	702	703
704	705	706	707	708	709	710	711	712	713	714	715	716	717	718	719	720	721	722
723	724	725	726	727	728	729	730	731	732	733	734	735	736	737	738	739	740	741
742	743	744	745	746	747	748	749	750	751	752	753	754	755	756	757	758	759	760
761	762	763	764	765	766	767	768	769	770	771	772	773	774	775	776	777	778	779
780	781	782	783	784	785	786	787	788	789	790	791	792	793	794	795	796	797	798
799	800	801	802	803	804	805	806	807	808	809	810	811	812	813	814	815	816	817
818	819	820	821	822	823	824	825	826	827	828	829	830	831	832	833	834	835	836
837	838	839	840	841	842	843	844	845	846	847	848	849	850	851	852	853	854	855
856	857	858	859	860	861	862	863	864	865	866	867	868	869	870	871	872	873	874
875	876	877	878	879	880	881	882	883	884	885	886	887	888	889	890	891	892	893
894	895	896	897	898	899	900	901	902	903	904	905	906	907	908	909	910	911	912
913	914	915	916	917	918	919	920	921	922	923	924	925	926	927	928	929	930	931
932	933	934	935	936	937	938	939	940	941	942	943	944	945	946	947	948	949	950
951	952	953	954	955	956	957	958	959	960	961	962	963	964	965	966	967	968	969
970	971	972	973	974	975	976	977	978	979	980	981	982	983	984	985	986	987	988
989	990	991	992	993	994	995	996	997	998	999	1000	1001	1002	1003	1004	1005	1006	1007
1008	1009	1010	1011	1012	1013	1014	1015	1016	1017	1018	1019	1020	1021	1022	1023	1024	1025	1026

INSIDE FRONT COVER INSIDE BACK COVER

Circle No.	Product	*

JUL 4 · 58 electronics • ENGINEERING EDITION • READER SERVICE CARD
CARD EXPIRES SEP 4 · 58

(NAME) _____ (POSITION) _____
(COMPANY) _____ (ADDRESS) _____

CIRCLE THESE NUMBERS ONLY WHEN YOU ARE INTERESTED IN ALL ITEMS SHOWN OR DESCRIBED

1	2	3	4	5	6	7	8	9	10	11	12	13	14	15	16	17	18	19
20	21	22	23	24	25	26	27	28	29	30	31	32	33	34	35	36	37	38
39	40	41	42	43	44	45	46	47	48	49	50	51	52	53	54	55	56	57
58	59	60	61	62	63	64	65	66	67	68	69	70	71	72	73	74	75	76
77	78	79	80	81	82	83	84	85	86	87	88	89	90	91	92	93	94	95
96	97	98	99	100	101	102	103	104	105	106	107	108	109	110	111	112	113	114
115	116	117	118	119	120	121	122	123	124	125	126	127	128	129	130	131	132	133
134	135	136	137	138	139	140	141	142	143	144	145	146	147	148	149	150	151	152
153	154	155	156	157	158	159	160	161	162	163	164	165	166	167	168	169	170	171
172	173	174	175	176	177	178	179	180	181	182	183	184	185	186	187	188	189	190
191	192	193	194	195	196	197	198	199	200	201	202	203	204	205	206	207	208	209
210	211	212	213	214	215	216	217	218	219	220	221	222	223	224	225	226	227	228
229	230	231	232	233	234	235	236	237	238	239	240	241	242	243	244	245	246	247
248	249	250	251	252	253	254	255	256	257	258	259	260	261	262	263	264	265	266
267	268	269	270	271	272	273	274	275	276	277	278	279	280	281	282	283	284	285
286	287	288	289	290	291	292	293	294	295	296	297	298	299	300	301	302	303	304
305	306	307	308	309	310	311	312	313	314	315	316	317	318	319	320	321	322	323
324	325	326	327	328	329	330	331	332	333	334	335	336	337	338	339	340	341	342

MEMO:

NEW PRODUCTS RELEASES

TO: ALL MANUFACTURERS

FROM: electronics

electronics publishes all new product items of interest to makers and users of electronic and allied equipment.

The reverse side of this card provides a service to subscribers by facilitating the flow of additional information between manufacturers and our readers.

Take advantage of Reader Service--and the readership of electronics...keep the industry informed about your New Products and New Literature via their mention in the editorial pages of electronics.

FIRST CLASS
PERMIT NO. 64
(SEC. 34.9 P.L.&R.)
NEW YORK, N. Y.

BUSINESS REPLY CARD

NO POSTAGE STAMP NECESSARY IF MAILED IN THE UNITED STATES

4¢ Postage Will Be Paid By

ELECTRONICS
Reader Service Dept.
330 West 42nd Street
New York 36, N. Y.

FIRST CLASS
PERMIT NO. 64
(SEC. 34.9 P.L.&R.)
NEW YORK, N. Y.

BUSINESS REPLY CARD

NO POSTAGE STAMP NECESSARY IF MAILED IN THE UNITED STATES

4¢ Postage Will Be Paid By

ELECTRONICS
Reader Service Dept.
330 West 42nd Street
New York 36, N. Y.

GRC *small nylon coil bobbins*

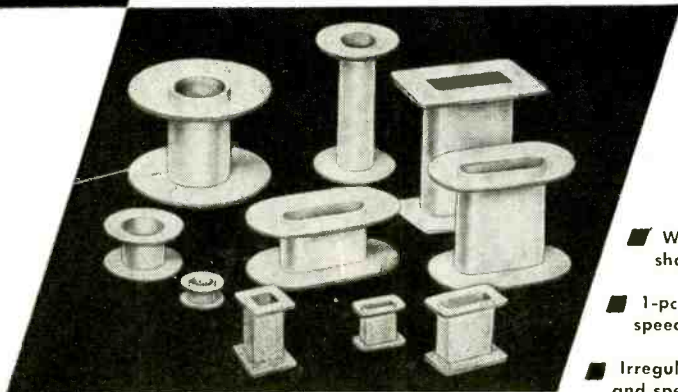

- Wide range of shapes and sizes
- 1-pc. Nylon molding speeds winding
- Irregular shapes and special materials to order
- Accurate, uniform, ready-for use

NOW available from stock

NOW Gries offers a wide variety of nylon coil bobbins from stock. Automatically mass produced at low cost—ready for use. Stock sizes from 1/4" diameter x 1/4" long minimum up to 7/8" diameter x 7/8" long—round, square, rectangular, oval shapes. Check Gries for your bobbin needs—either from stock—or to your size, shape and material specifications on special order.

Write Today for Specification Sheets and Full Information



GRIES REPRODUCER CORP.

151 Beechwood Ave., New Rochelle, N. Y.
New Rochelle 3-8600

World's Foremost Producer
of Small Die Castings
CIRCLE 64 READERS SERVICE CARD

MISSILE ENGINEERING

The "collapsing of time" concept has taken on added significance as a result of the current international situation. In Tucson, Arizona, Hughes has established the Tucson Engineering Laboratory for the purpose of shortening the elapsed time between missile development and its effective tactical use. This activity, established over 2 years ago, has proven that the quasi-simultaneous development and production of missiles can become a feasible reality.

The Tucson Engineering Laboratory is now expanding its scope of operations. Mechanical Engineers, Electrical Engineers, or Physicists who like to work on urgent problems and who have the ability and enthusiasm to constantly improve the product and its reliability, will find this an ideal environment. Specific areas of interest include: missile system analysis, infrared and radar guidance systems, electromechanical and hydraulic control systems, missile and test equipment and electronic circuit design.

An added advantage: Tucson's dry healthful climate. Investigate by sending resume to Mr. W. A. Barnes at:

the West's leader in advanced electronics

HUGHES

TUCSON ENGINEERING LABORATORIES

Hughes Aircraft Company

Tucson, Arizona

ILLINOIS SUB-MINIATURE ELECTROLYTIC CAPACITORS

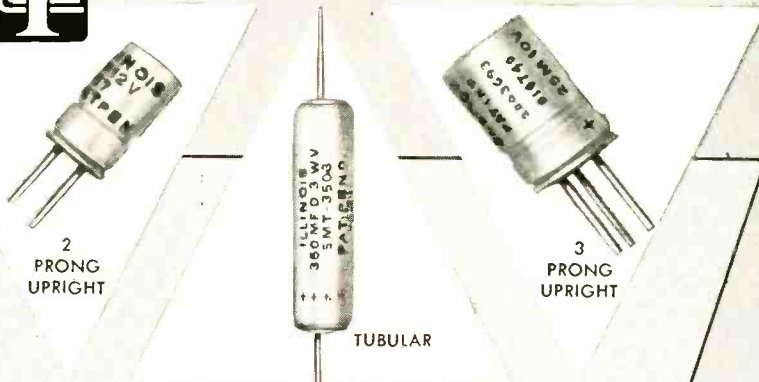

Here is a complete line of sub-miniature electrolytics which are especially desirable for low voltage D.C. circuits.

Advantages include: patented construction; hermetically-sealed; immersion proof; excellent life characteristics; low leakage currents; shock and vibration-resistant; plus many others.

Available in tubular and upright types, as illustrated, ILLINOIS SUB-MINIATURE CONDENSERS are ideal for applications requiring minimum size and weight.

Write for new, illustrated SMT catalog.

ILLINOIS CONDENSER COMPANY
1616 N. Throop Street Chicago 22, Illinois

Telephone: EVerglade 4-1300

CIRCLE 65 READERS SERVICE CARD

NOTABLE ACHIEVEMENTS AT JPL

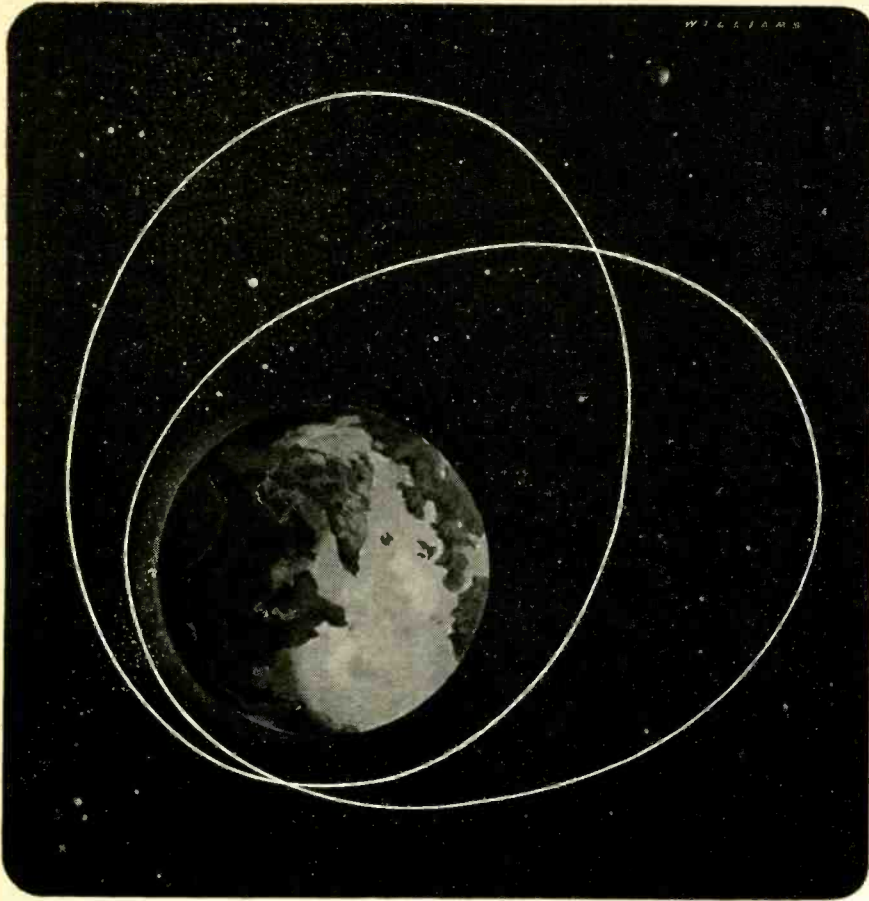

NEWS FROM OUTER SPACE VIA EXPLORER I AND III

Since the successful launchings of the Explorer I and III Satellites under the joint cooperation of the Army Ballistic Missile Agency and JPL, literally, bales of information on conditions outside the earth's atmosphere have been transmitted earthward from both satellites.

This information on cosmic ray activity, micro-meteorite density, and radiative heat flux is providing valuable new and accurate data of immense value to scientific research. Explorer III with its more sophisticated instrumentation is producing more complete data than Explorer I. This is partly due to the wider range of altitudes traversed by the orbit of Explorer III, but principally due to the presence in Explorer III of a tape recorder. Designed by Dr. Van Allen of the State University of Iowa it is no larger than a cigarette package and is capable of transmitting two hours of collected cosmic ray information in a space of five seconds.

The Laboratory is proud to have been chosen by the U. S. Army to spearhead this vital activity and to acknowledge the highly constructive efforts of many individuals and organizations who have cooperated with its own staff.

CAREER
OPPORTUNITIES
NOW OPEN IN
THESE FIELDS

ELECTRONIC, MECHANICAL, CHEMICAL, AERONAUTICAL
ENGINEERING • PHYSICS AND MATHEMATICS
U. S. Citizenship Required



JET PROPULSION LABORATORY

A DIVISION OF CALIFORNIA INSTITUTE OF TECHNOLOGY
PASADENA • CALIFORNIA

alloy wires which will withstand high temperatures. They are made in seven sizes from 2.5 through 15 w. Standard tolerances are 0.5 percent and 1 percent. Circle 220 on Reader Service Card.



Curve Tracer for transistor use

DUNN ENGINEERING ASSOCIATES, Inc., 225 O'Brien Highway, Cambridge 41, Mass. Model 341 power transistor characteristic plotter is a compact, general purpose curve tracer designed for use with both point-contact and junction transistors. Its many uses include supplying design information for transistor circuits, observing transistor anomalies, examining transistors for changes or deterioration, checking tolerance of transistors and matching or comparing transistors. It furnishes collector currents up to 6 amperes in continuous service and up to 15 amperes intermittently and produces the r_{ce} , r_{be} and h_{fe} families of curves on the face of an auxiliary oscilloscope. Circle 221 on Reader Service Card.

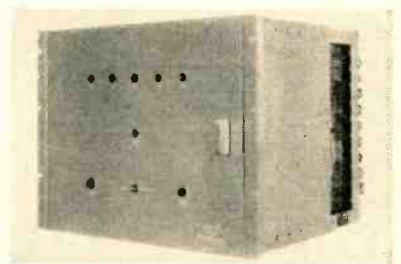

Multiplexer sample-hold type

EPSCO, Inc., 588 Commonwealth Ave., Boston 15, Mass., announces a high-speed electronic sample-hold multiplexer, model EM-51S. A system building block module designed to provide the means to more feasible data control, it time

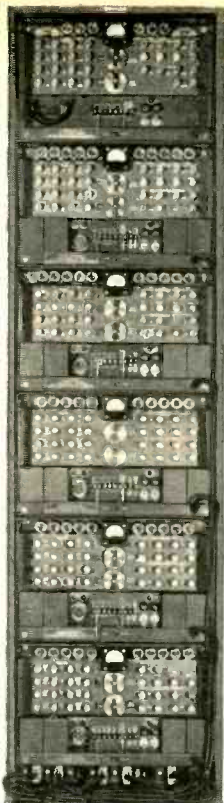

MINIATURIZED CARRIER TELEPHONE SYSTEMS FOR RADIO AND 4-WIRE CABLE

FOUR OR 24 CHANNELS

Two miniaturized voice-multiplex systems providing four or 24 voice channels over radio or 4-wire cable are available. They have many advantages over earlier designs: high performance, small size, light weight, low cost, circuit simplicity, low power requirements, small number of tubes of a single type only, low operating cost, low maintenance and high reliability.

These systems provide a voice-channel flat within 1 db from 300 to 3500 cycles, for each 4 kc of bandwidth occupied. Each channel is equipped with hybrid, signaling, and dialling circuits for all the standard 2-wire and 4-wire loop options.

The basic unit provides an order-wire and 4 carrier-derived channels. These units can be stacked in groups of 2, 3, 4 or 5 by means of a group modem to provide 9, 14, 19 or 24 channels. Full flexibility is provided for dropping and inserting channel groups at repeater and terminal points. Moderate lengths of 4-wire cable or open-wire line may be inserted between the multiplex equipment and the radio terminals.

24-channel carrier-telephone terminal complete with hybrids, ringing and dialling circuits, and test facilities. Dimensions are 58" high, 16" wide and 8" deep. Power input 250 watts. Weight 326 lbs.

RADIO ENGINEERING PRODUCTS
1080 UNIVERSITY ST., MONTREAL 3, CANADA
TELEPHONE CABLES
UNiversity 6-6887 RADENPRO, MONTREAL

CIRCLE 68 READERS SERVICE CARD



DANO

puts
PERFORMANCE
into every coil!



Regardless of type or quantity, every coil is quality manufactured to your exact specifications.

- Encapsulated
- Paper Interleave
- Bobbin
- Cotton Interweave
- Form Wound
- Vacuum Impregnated
- High Temperature Application

Also, Transformers Made To Order

NOW AVAILABLE! New 20-page Dano illustrated catalog including technical coil designing data.



CIRCLE 69 READERS SERVICE CARD

ELECTRONICS engineering edition — July 4, 1958

quality ...
uniformity ...
service ...

GLASS for
HERMETIC SEALING

- EPOXY PREFORMS
- PRESSED CERAMICS

mansol
CERAMICS CO.

138 LITTLE ST. | THORNTON HEATH
BELLEVILLE, NEW JERSEY | SURREY, ENGLAND

CIRCLE 70 READERS SERVICE CARD

Now Available!

Tiny Variable Vacuum Capacitors



Actual Size

VAR-VAC

TYPE A-10/3 WITH
CERAMIC
ENVELOPES

Especially suited for the needs of telemetering and other miniaturized electronic equipment, these new UNITED vacuum variable capacitors represent the latest and most effective solution to many complex problems.

RATINGS

Capacitance range	2 to 10 uuf
Max. peak RF voltage	3000 volts
Maximum RMS current	1 ampere
Maximum temperature	500° C
Shaft revolutions	5 turns
Net weight	4/10 oz.
Nominal overall dimensions less connector lugs	Length: 1 9/16" Diameter: 5/8"

For dielectric stability and maintenance of precise setting of capacitance in high altitude, high temperature environment, *there is no other class of capacitor that can equal these new vacuum variables.* Capacitance variation control is straight line.

Your inquiries are cordially invited.

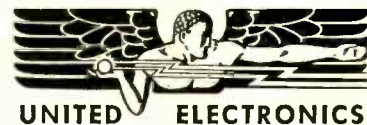

A Subsidiary of Ling Electronics, Inc.
42 Spring Street, Newark 4, N. J.

CIRCLE 71 READERS SERVICE CARD

20
TO
200 D.P.

SEND YOUR
PRINTS FOR
QUOTATION

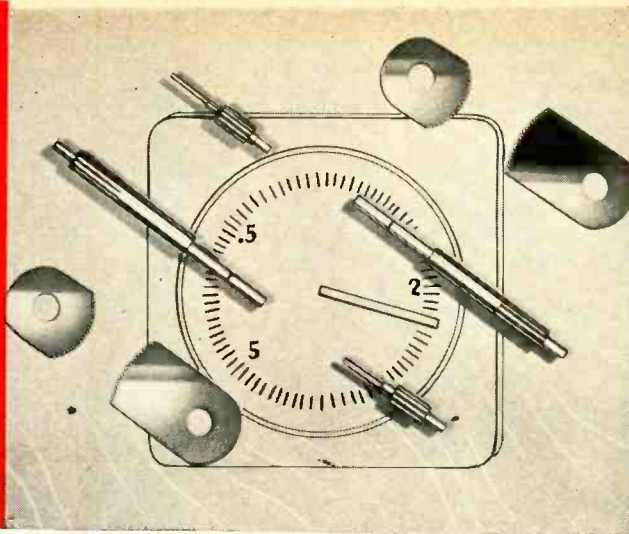

SPURS • HELICALS • WORM AND WORM GEARS • STRAIGHT BEVELS
LEAD SCREWS • RATCHETS • CLUSTER GEARS • RACKS • INTERNALS • ODD SHAPES

THE *Finest* IN GEARS



Beaver Gear Works Inc.

1021 PARMELE STREET, ROCKFORD, ILLINOIS

CIRCLE 72 READERS SERVICE CARD

TOUGH
and tiny

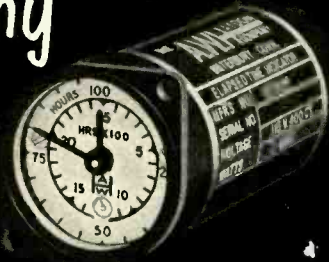

Save SPACE and WEIGHT with the
A. W. HAYDON COMPANY'S
Unique Line of RELIABLE SUB-MINIATURE
ELAPSED TIME INDICATORS

TINY!
1 1/2" Diameter — 2 1/32" long
Weight only 4 ounces
Compact flange or MS-28053 Mounting

TOUGH!
Temperature: — 54° C. to 85° C.
Vibration: 500 CPS, 10g
Shock: 50g
Hermetically Sealed Housings!
Dial Face or Digital Readout!
400 Cycle Models Now in Production!
Custom Designed to Meet Military
Specifications!
Write for Bulletin AWH-ET-602.

A.W. HAYDON
Company

235 NORTH ELM STREET,
WATERBURY 20, CONNECTICUT

Design and Manufacture of
Electro-Mechanical Timing Devices



multiplexes five separate voltage inputs to a single voltage output. The sample-and-hold feature makes possible the simultaneous sampling within 0.2 μ sec of any number of channels of highly dynamic data. Maximum multiplexing rate from channel to channel is 25 kc. Standard input voltage range is ± 10 v. Transfer accuracy from voltage input to voltage output is ± 0.05 percent of full scale. Circle 222 on Reader Service Card.

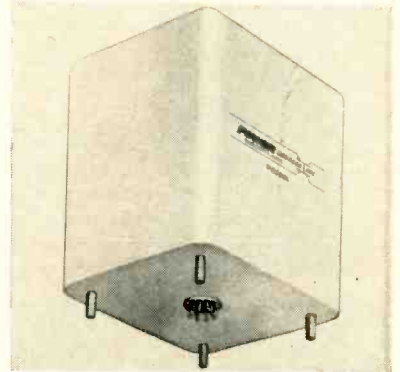

Power Inverter transistorized

POWER SOURCES, INC., Burlington, Mass. Model PS-3001 transistorized power inverter is designed specifically for applications requiring small size and high reliability. Measuring only 4 1/2 by 3 3/4 by 4 1/2 in., these inverters provide 115 v a-c at 400 cps and up to 750 ma load current. Input is 26 v d-c ± 5 percent. Units are capable of operation at temperatures up to 85 C and are hermetically sealed to meet all environmental conditions. Wave shape of the output voltage is square wave. At a slight increase in height a filter is available to provide sine wave output. Circle 223 on Reader Service Card.

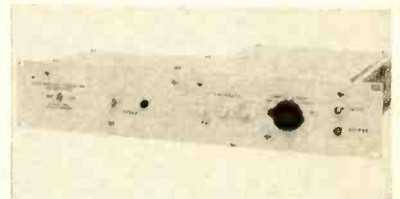

Converter voltage to frequency

DYNAC, INC., 395 Page Mill Road, Palo Alto, Calif. One volt d-c fed



Anywhere...

At sea, in the icy cold of the antarctic! S.S. WHITE Molded Resistors in values up to 50,000 megohms retain their characteristics.



in Any Weather

Airborne, in the steaming heat of the tropics! S.S. WHITE Molded Resistors are made of coated, non-hygroscopic material that resists moisture.



S.S. White

"ALL-WEATHER"

Molded Resistors
Withstand Temperature
and Humidity

FIXED RESISTANCE VALUES RANGE
FROM 1000 OHMS TO 10,000,000
MEGOHMS!

65X Molded Resistor — 1 watt
80X Molded Resistor — 3 watts

While bargain buys in resistors are wearing out and being replaced, durable S.S. WHITE "All-Weather" Molded Resistors are still giving top performance in hundreds of commercial, industrial and scientific applications.

Our resistors are characterized by low noise level... precision... stability... have negative temperature and voltage coefficients. Compact... excellent stability and mechanical strength... values do not deteriorate due to age.

We'll be glad to cooperate with you in applying these high-quality resistors to your product. For our Bulletin 5409, just drop a line to Dept. R.

S.S. White

INDUSTRIAL DIVISION

10 East 40th Street
New York 16, New York
CIRCLE 74 READERS SERVICE CARD

ELECTRONICS engineering edition — July 4, 1958

ENGINEER OPPORTUNITIES AT RAYTHEON

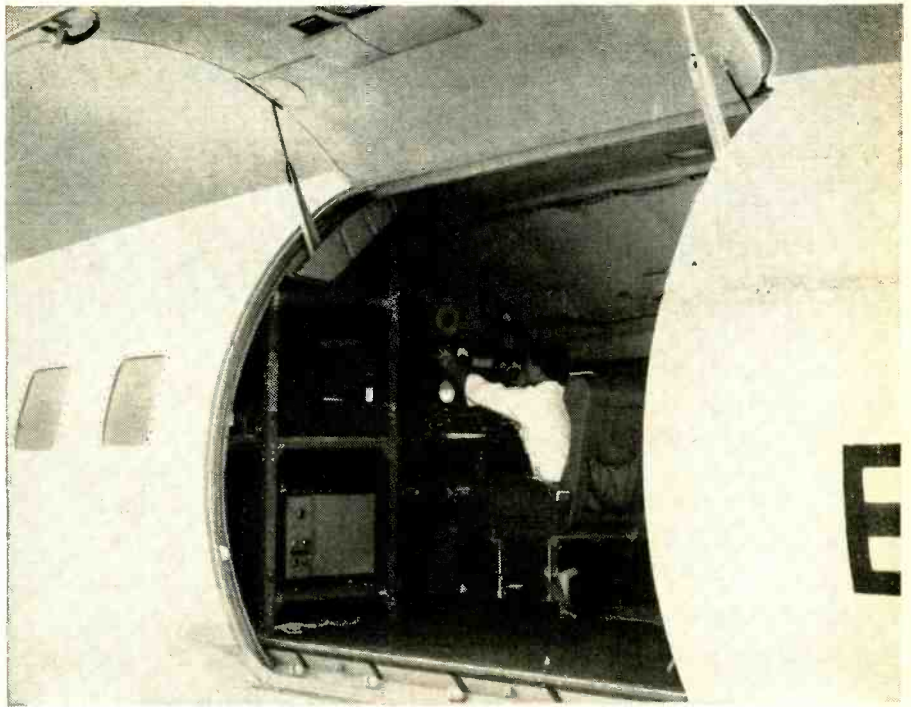

DOPPLER NAVIGATION EQUIPMENT is readied for flight testing under operational conditions. Engineers at the Maynard Laboratory hold responsibility for program from initial study phase through prototype production.

Newly formed project groups solve complex airborne radar problems

Engineers like the project-type organization at Raytheon's Maynard Laboratory. It gives them maximum diversification in their work on the most advanced radar navigational and control problems of the day.

At Maynard, you'll find projects involving many areas of aircraft navigation and guidance systems... doppler navigation, velocity check systems, night-fighter operations systems, flight-control systems, altimeters. There is also interesting new work on counter-measures equipment.

Career opportunities for men at all levels now exist in the following areas:

MICROWAVE COMPONENT
DESIGN

ANTENNA DESIGN
ELECTRONIC PACKAGING

ADVANCED CIRCUIT DESIGN

SYSTEMS ANALYSIS &
ENGINEERING
TECHNICAL WRITING
SPECIFICATIONS WRITING

For complete details on engineering positions in any of Maynard's project groups, please write John J. Oliver, P.O. Box 87E, Raytheon Maynard Laboratory, Maynard, Mass.

RAYTHEON MANUFACTURING COMPANY

Maynard, Massachusetts

Are you the
ONE MAN IN THREE?



MAYNARD LABORATORY



Excellence in Electronics

Bendix-Pacific

MOST COMPLETE SOURCE FOR TRANSMITTING AND RECEIVING TELEMETERING EQUIPMENT

TWO FM/FM RECEIVING STATION SYSTEMS

TGRS-100 Stations are designed for either real time reception and demodulation or demodulation of tape recorded data. Plug-ins, subcarrier band selection, provides complete flexibility in the use of this equipment for in-plant, field installations and related applications.

TGRS-600 Stations are used for extremely precise demodulation of FM/FM subcarrier signals on all standard bands through use of a single band-selector switch.

This equipment is particularly suited for laboratory use in data reduction and handling facilities where a high order of accuracy must be maintained.

Both types of systems may be equipped with wow and flutter compensation and automatic calibration features.

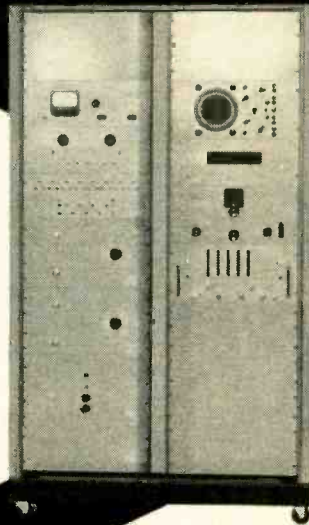

THREE TYPES OF SUBCARRIER OSCILLATORS

Silicon Transistor Strain Gage and Voltage Controlled Oscillators

These oscillators are capable of high temperature performance and provide low power drain, long life and high reliability under extremes of shock and vibration.

Germanium Transistorized Voltage Controlled Oscillators

Low temperature capability, extended life, accuracy under extremes of shock and vibration and low power drain are features of these frequency modulated units.

Vacuum Tube Oscillators — Bridge and Voltage Controlled

Bendix-Pacific offers a complete line of vacuum tube oscillators proven by years of use in the missile and aircraft field. An enviable record of in-flight performance under extreme conditions has been established.



to the model DY-2210 voltage-to-frequency converter produces 10,000 pps output for measurement on electronic counters to an accuracy of 0.1 percent. Range switch gives full-scale output pulse rates for 1, 10, 100 and 1,000 v, at a constant 1-megohm input impedance. The voltage being measured is averaged over the period of the selected counter gate time giving a reading which is insensitive to noise. Positive or negative voltages are measured without lead reversing or switching. The unit is priced at \$650. Circle 224 on Reader Service Card.

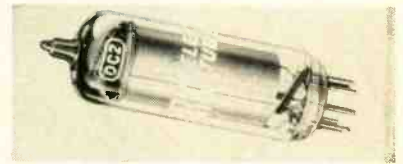

Miniature Tube voltage-regulator

RADIO CORP. OF AMERICA, Harrison, N. J., has introduced a new voltage regulator tube of the cold-cathode, glow-discharge type. It is intended for use in voltage-regulator applications requiring a relatively constant d-c output voltage across a load, independent of load current and moderate line-voltage variations. The tube will supply a regulated voltage of approximately 75 v at cathode currents from 5 to 30 ma. Circle 225 on Reader Service Card.

Memory Cores small size

INTERNATIONAL RESISTANCE Co., 401 N. Broad St., Philadelphia 8, Pa. The IR880 ferrite memory core offers a uniquely square B-H hysteresis loop, making it particularly useful for fast switching memory matrices in digital computers. Its magnetic properties were designed for use with driving currents of approximately 820 ma. The output for a single turn is then above 120 mv. Outside diameter of the core is 0.08 in. ± 0.003 in.; inside diameter, 0.05 in. ± 0.003 in.; and thickness, 0.025 in. ± 0.003 in. Circle 226 on Reader Service Card.

In addition to items shown above we will be glad to send complete data on all Bendix-Pacific Telemetering Equipment.



East Coast: (Eastern Representative) P.O. Box 391, Wilton, Connecticut — Dayton, Ohio: 120 West 2nd — Washington, D. C.: Suite 803, 1701 "K" Street, N.W.
Canadian Distributors: Computing Devices of Canada, Ottawa 4, Ontario
Export Division: Bendix International, 205 E. 42nd Street, New York 17, New York

Here's information you'll want
on

STANDARD
TRADEMARK

**precision
timers**



REQUEST BULLETIN NO. 198

Accurate, reliable, versatile Elapsed Time Indicators. Synchronous motor drive, manual or electric zero reset. Electric clutch controlled by manual or automatic switch or output of electronic tubes. Units available for flush panel mounting or portable use.

Model	Scale Divisions	Totalizes	Accuracy
S-100	1/5 sec.	6000 sec.	±.1 sec.
S-60	1/5 sec.	60 min.	±.1 sec.
SM-60	1/100 min.	60 min.	±.002 min.
S-10	1/10 sec.	1000 sec.	±.02 sec.
S-6	1/1000 min.	10 min.	±.0002 min.
S-1	1/100 sec.	60 sec.	±.01 sec.
MST	1/1000 sec.	.360 sec.	±.001 sec.
MST-500	1/1000 sec.	30 sec.	±.002 sec.

THE STANDARD ELECTRIC TIME COMPANY

89 LOGAN STREET • SPRINGFIELD, MASSACHUSETTS

CIRCLE 77 READERS SERVICE CARD

**ELECTRONICS ENGINEERS
and PHYSICISTS**

Aeronutronic is expanding military and commercial programs involving the most advanced research, development, experimentation and prototype production at plants in Glendale and at modern, new facilities overlooking the Pacific Ocean at Newport Beach, California.

Career opportunities are open for scientists and engineers of high calibre in the fields of space technology, range instrumentation, missiles electronics, automatic controls, and display systems. Advanced degree and three to five years' experience in telemetry, radio propagation, atmospheric physics, servomechanisms, electronic and/or mechanical design, or plasma physics desirable. U. S. citizenship necessary. Qualified applicants are invited to send resume to Mr. L. R. Stapel.

AERONUTRONIC SYSTEMS, INC.

a subsidiary of Ford Motor Company

1234 Air Way • Glendale, California • Telephone CHapman 5-6651

DIGITIZER

[Analog to Digital]

The Coleman DIGITIZER provides a simple, economical, and reliable method of recording, in digital form, the analogs of temperature, pressure, voltage, strain, distance, etc. This record may be produced automatically by printers, punched cards, electric input typewriters, and perforated-tape machines.

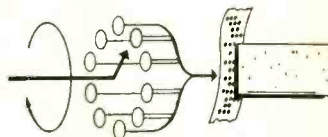

Shaft rotation input.

Unambiguous contact setting.

Digital contact output.



DECIMAL DIGITIZER



BINARY DIGITIZER

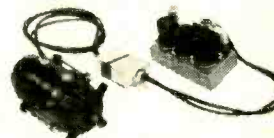

BINARY-CODED DECIMAL DIGITIZER

[Digital to Analog]

Conversion of digital data to analog form is essential in many systems as a positioning device to convert digital data to predetermined analog values.

Your name.....

Company.....

Address.....

Write for Free Data File.
Mention your application.

Coleman

Engineering Company, Inc.
6040 West Jefferson Boulevard
Los Angeles 16, California

CIRCLE 79 READERS SERVICE CARD

DIGITIZERS REPLACE COMPLEX ELECTRONIC EQUIPMENT

DIGITIZERS REPLACE COMPLEX ELECTRONIC EQUIPMENT

49th

LISTEN TO THE ELEMENT

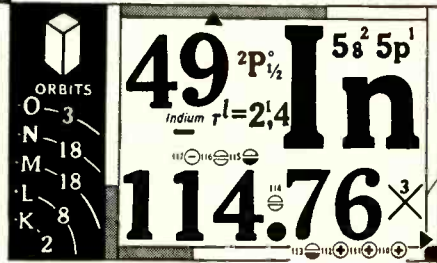

- AIDS LUBRICATION
- UNIQUE STABILIZATION
- ALLOYS READILY

QUALITY

at the Indium Corporation of America means purity of metals, and strict adherence to specifications.

SERVICE

means prompt delivery to customers, and technical help in specific uses of Indium.

RESEARCH

means "forward looking" with respect to new products and new techniques.

INDIUM

Every time you listen to a transistor radio, you are enjoying the benefits of an application of the 49th element, Indium.

The use of Indium with a germanium plate aided electronic engineers to produce transistors commercially — but this is only one of many startling achievements made possible through use of Indium... the metal of unlimited possibilities.

Indium may have significant applications in your own product development.

WRITE TODAY to Dept. E-758 for new Indium bulletin: "INDALLOY" Intermediate Solders.

THE **INDIUM** CORPORATION OF AMERICA
1676 LINCOLN AVENUE UTICA, NEW YORK
Since 1934 . . . Pioneers in the Development and Applications of Indium for Industry.

Literature of

MATERIALS

Insulating Materials. General Electric Co., Schenectady 5, N. Y. Bulletin GER-1467 describes in text, tables and pictures the characteristics and application range of insulating materials which are chemically, physically and electrically compatible. **Circle 227 on Reader Service Card.**

COMPONENTS

Coaxial Tuners. Microlab, Livingston, N. J. Catalog No. 7B announces a new line of constant impedance line stretchers, trombone line stretchers, double slug tuners and double stub tuners. Prices are included. **Circle 228 on Reader Service Card.**

Miniature Capacitors. General Electric Co., Irmo, S. C. A four-page bulletin describes the company's solid Tantalytic capacitors which are expected to have wide application in low voltage circuitry. Pictures, charts, dimensional drawings and rating tables are included. **Circle 229 on Reader Service Card.**

R-F Connectors. Kings Electronics Co., Inc., 40 Marbledale Rd., Tuckahoe, N. Y., has prepared an 84-page looseleaf catalog on r-f connectors. It contains illustrated descriptions, charts and cross indexes, dimensions and assembly instructions. **Circle 230 on Reader Service Card.**

Subminiature Relays. Phillips Control Corp., 59 W. Washington St., Joliet, Ill. Six subminiature relays for critical airborne applications are described in a recent product engineering bulletin. Characteristics and detail specifications are given. **Circle 231 on Reader Service Card.**

Thermistors/Varistors. Victory Engineering Corp., 524 Springfield Road, Union, N. J. An informative catalog contains pertinent engineering data covering over 250 standard

the Week

thermistors and varistors with applications and characteristics. Circle 232 on Reader Service Card.

Transistor Mounting Clips. Vector Electronic Co., 1100 Flower St., Glendale 1, Calif. Bulletin 61 covers a line of transistor mounting clips which clamp transistors of various sizes or transistor sockets to insulated boards or metal chassis. Circle 233 on Reader Service Card.

Ultrasonic Delay Lines. Bliley Electric Co., Union Station Bldg., Erie, Pa. Bulletin 510 is a four-page publication outlining performance characteristics and design considerations for a line of ultrasonic delay lines. Circle 234 on Reader Service Card.

EQUIPMENT

Analog Computer. Mid-Century Instrumatic Corp., 611 Broadway, New York 12, N. Y. An 8-page brochure describes the MC-400 desk-side analog computer, a complete portable computer center with recorder built in. Circle 235 on Reader Service Card.

Pulse Generator. Electro-Pulse, Inc., 11861 Teale St., Culver City, Calif. Model 3450B 2-mc pulse generator is covered in a 3-page booklet. Specifications, instrument photo and typical applications are provided. Circle 236 on Reader Service Card.

FACILITIES

Hermetic Seals. Hermetic Seal Corp., 29 South Sixth St., Newark 7, N. J. Catalog No. 657D is a 16-page folder containing complete physical dimensions and line drawings of over 1,000 different styles and sizes of military and RETMA type hermetic seals and their appropriate part numbers. It also offers specific illustrations and information about the company's custom design engineering service on all types of glass-to-metal seals. Circle 237 on Reader Service Card.

ACEPOT®

SUB-MINIATURE, PRECISION, WIRE-WOUND

LINEAR

POTENTIOMETERS



Small pot size — Big pot performance

Only 1/2" in diameter, the ACEPOT excels in a combination of all around top performance characteristics comparable to larger units. For example, these precision units feature $\pm 2\%$ resistance tolerance and $\pm 0.3\%$ independent linearity. Every potentiometer is completely sealed against sand, dust and foreign matter to avoid abrasive action between moving parts. All materials and metals are treated for maximum resistance to salt spray, corrosion, humidity and conform to shock and vibration tests. ACEPOTS are designed and assembled MIL-A-8625A, QQ-M-1512, JAN-T-152, MIL-E-5272A, MIL-R-19A, NAS-710 and MIL-R-19518 (ships).

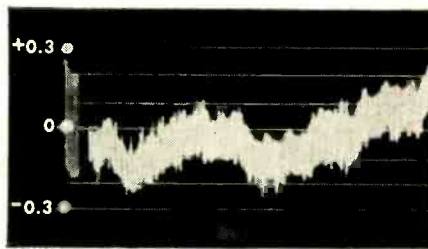

ACEPOT LINEARITY TEST

Plot of voltage ratio error versus rotation illustrates linearity to better than $\pm 0.3\%$.

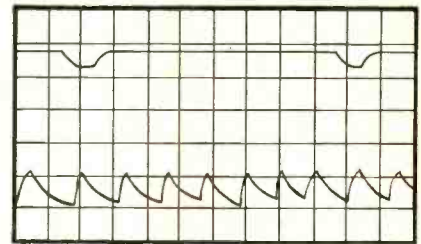

ACEPOT RESOLUTION TEST

Section of oscillograph trace of electrical resolution shows voltage change for each turn of wire.

ACE offers a wide variety of linear and nonlinear precision, wire-wound potentiometers in standard, special and AIA sizes. Custom designs to meet special requirements can be made available on short lead time. Call, write or teletype Dept. F, ACE ELECTRONICS ASSOCIATES, INC., 99 Dover Street, Somerville, Mass., SOMerset 6-5130, TWX SMVL-181.

ACEPOT®
ACETRIM®
ACESET®
ACEOHM®

ACE

 ELECTRONICS ASSOCIATES, INC.



Sylvania: New Defense Lab

AN ESTIMATED record total of \$4½ billion will be spent by the Armed Services on electronic defense this year. So said Don G. Mitchell, Sylvania president-chairman, at the recent formal opening of the company's Amherst Engineering Laboratory in Williamsville, N. Y.

The new 85,000 sq ft laboratory (picture) is part of Sylvania Electronic Systems. The two-story building, adjacent to the Buffalo municipal airport, houses approximately 500 employees, about half of them engineers.

The Amherst facility specializes in research, development, design, and product engineering in communication, countermeasures, radar and navigation. One of the laboratory's major programs is development and production of the "electronic shield," automatic defense system of the USAF's Convair B-58 supersonic bomber.

Other significant projects include:

PLATO—an antimissile system for defense of field armies, under development for the Army Ordnance Corps.

BMEWS (Ballistic Missile Early Warning Systems)—an Air Force program for the detection of intercontinental ballistic missiles.

ECM—an electronic countermeasures subsystem for the B-52 Air Force long-range bomber.

MOBIDIC (Mobile Digital Computer)—van-carried battlefield computer under development for the Army Signal Corps.

UDOFT (Universal Digital Operational Flight Trainer)—a jet plane flight trainer under development for the Navy.

The Amherst Laboratory is the 10th facility of Sylvania Electronic Systems. The division has other facilities in Waltham, Mass.; Buffalo, N. Y.; Mountain View, Calif.; Williamsport, Pa.; and Santa Cruz, Calif. Another new plant just went into operation in Needham, Mass.



GTC Appoints Sinacore to Post

FORMER production manager at Eastern Precision Resistor Corp., Joseph J. Sinacore (picture) is appointed resistor project engineer at General Transistor Corp., Jamaica, New York.

Canada Motorola Creates Dept.

R. M. BROPHY, president of Canadian Motorola Electronics Ltd. announces the formation of a new

department in the company to handle microwave radio, carrier, and control products. Canadian Motorola has a long term sales and manufacturing agreement with Motorola Inc., Chicago, and is exclusive Canadian representative for radio carrier products available from Philips Telecommunication Division, the Netherlands.

John E. Raftis is appointed manager of the microwave and industrial products operation. Garth F. C. Weedon is named sales engineer, and Thomas W. Purdy, systems engineer.

Canadian Motorola Electronics is organized to undertake multi-channel radio projects including completely packaged microwave system installations.

Motorola Ups F. W. Walker

FRANK W. WALKER has been named a vice president and manager, government sales, by Motorola Communications & Electronics, Inc., a wholly owned sales subsidiary at Motorola, Inc. He will work from the company's Washington, D. C. office, where he will assume overall responsibility for sale, contract, lease and service relationships with the federal agencies.

The new v-p has been with Motorola for ten years, the last five as regional manager in the southwestern U. S.



ERA Activates New Subsidiary

FORMATION of a new California subsidiary in Santa Monica known as ERA Pacific, Inc. (picture) is announced by Electronic Research Associates, Inc., Cedar Grove, N. J. The wholly-owned subsidiary will specialize in the design and manu-

TRANSFORMERS INCORPORATED has consistently
designed and manufactured precision transformers
that solved the transformer problems of its
customers. How may we help YOU?

PRECISION

TRANSFORMER

PROBLEMS?

**SIZE AND
WEIGHT**

ACCURACY

RELIABILITY

Because of advances in transformer design calculation methods and technique, Transformers, Incorporated can accurately establish the size and weight of the required transformer from your performance specifications, without the expensive and time consuming construction and testing of prototypes. These same advances in transformer design engineering have enabled Transformers, Incorporated to produce the smallest and lightest precision transformers available. This is particularly important in this era of miniaturization, peculiar space envelopes, and rigid weight requirements.

Transformers, Incorporated designs and manufactures transformers with a measured voltage ratio accuracy of up to five parts per million (0.0005%) at room temperatures and under no-load condition, with comparable accuracies at other temperatures and loads. These accuracies can be maintained in all production quantities from one to one thousand—or any other quantity that you may require. The ability of Transformers, Incorporated to maintain specified accuracies has been consistently proven by samples submitted to the U. S. Bureau of Standards Testing Laboratory.

Each and every transformer is individually inspected and electrically tested, and samples are subjected to the required environmental tests, to ensure the highest degree of reliability. These methods far exceed the usual sampling techniques of most quality control systems, and enable Transformers, Incorporated to guarantee that every precision transformer will meet or exceed customer specifications.

Relieve your engineering department of the arduous task of designing precision transformers. Phone ENDICOTT, NEW YORK 8-3311, collect. Ask for Tres Park. There's no obligation.

Partial List of SATISFIED CUSTOMERS: Ballantine Laboratories • Bell Aircraft • Boeing Airplane Company • Curtiss-Wright • Daystrom Instrument • Dumont Laboratories • General Electric • Hughes Aircraft • IBM • Kollsman Instrument • Link Aviation • Leeds & Northrup Massachusetts Institute of Technology • Melpar, Inc. • Norden-Ketay • Raytheon • Sperry-Gyroscope • Sylvania... and others.

TTRANSFORMERS, INCORPORATED

200 Stage Road, Vestal, N.Y.

TRIAL

BY

Fire!



The heat's on, as withering high temperatures are applied... and once more G-M Servo Motors prove themselves!

This cruel high-temperature exposure in electric ovens at the G-M Laboratories is only one part of a rigorous test series G-M Servo Motors must undergo—prior to use in rocket and missile applications.

At G-M, Servo Motors are proved under all military environmental specifications called for. They are built to withstand the tortures of humidity, salt spray, altitude, vibration and both high and low temperatures. And they pass with honors.

4 GOOD REASONS WHY G-M SERVO MOTORS SERVE YOU BEST!

- 1 G-M Servo Motors are available in standard sizes.
- 2 G-M Servo Motors can be modified to meet specific circuit requirements.
- 3 New "Stock Sample Service" for quick delivery of standard motors for prototype use.
- 4 Fast production—better service.



Write Now

for information, or send for complete G-M charts and specifications. No obligation, of course.

facture of semiconductor and transistorized devices. The company will also offer engineering and related services for both parent company and subsidiary products.



Levinthal Hires Howard Jessup

New department manager of the pulse transformer facility at Levinthal Electronic Products, Inc., Palo Alto, Calif., is Howard L. Jessup (picture). Prior to joining the company in this new post, Jessup was in the Greenville, Pa., plant of Westinghouse Electric Corp., responsible for design, development, and production of high and low power pulse transformers and related reactance devices.

LFE Consolidates Boston Operations

LABORATORY for Electronics, Inc., has begun consolidation of four Boston locations into 210,000 square feet of leased space in building at 1085 Commonwealth Avenue.

When consolidation is completed in the Fall, the 12-year-old Boston firm will have all operations under one roof.

Decision to remain intown counters general trend, exodus of companies to suburban Route 128, "Electronics Row."

Firm employs 892 and expects to add 150 by January of 1959, according to President Henry W. Harding. He said LFE has a back-

G-M Servo Motors

manufactured by the Components Division of
G-M LABORATORIES INC.

4336 N. Knox Avenue • Chicago 41

Protect the life line of
your electrical products
with Nylon **HEYCO**
Strain Relief Bushings

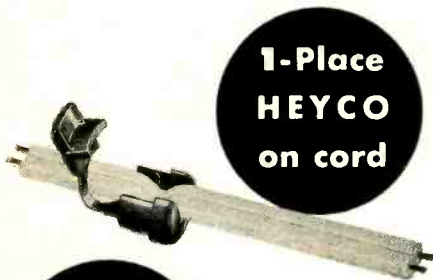

**1-Place
HEYCO
on cord**

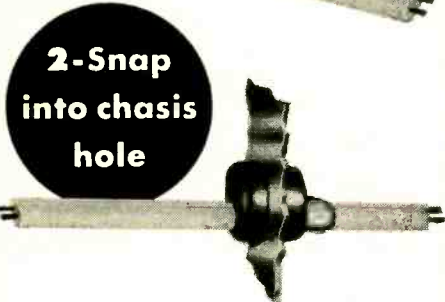

**2-Snap
into chassis
hole**

**Anchor & Insulate
power supply cords**

**SAVE TIME...
...SAVE MONEY**

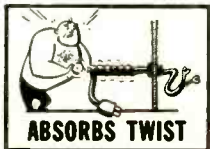

Send for samples to fit your wire, today!

**HEYMAN
MANUFACTURING COMPANY**
KENILWORTH 15, NEW JERSEY



CIRCLE 85 READERS SERVICE CARD
ELECTRONICS engineering edition — July 4, 1958

ENGINEERS: Microwave . . Radar . . Pulse Circuits

Check these

NORDEN LABORATORIES

career advantages:

- High Priority Programs
- Long-Term Stability
- Diversified Systems Engineering
- Reimbursement for Academic Study
- Finest Residential Area

Since the dramatic development of the original Norden Bombsight, Norden Laboratories have pioneered many of the most significant engineering advances. In such a stimulating environment, creativity and imagination are at a premium. Diversified assignments broaden your competence, while individual responsibility assures steady progress. Norden's location is ideal—in the heart of America's most desirable "living room", offering the benefits of suburban Westchester with the proximity of New York City, only 25 miles away. Send the coupon below, or call for details on these and other current assignments.

MICROWAVE

- Senior Microwave Engineers
- Microwave Design Engineers

RADAR AND PULSE CIRCUITRY

- Design Engineers
- Pulse Circuit Design
- Transmitter-Modulator Design
- Radar Test Design

Mail coupon or phone WH 6-4300 for details

Technical Employment Manager

NORDEN LABORATORIES

Norden Division • United Aircraft Corporation

121 Westmoreland Avenue • White Plains, N. Y.

I am interested in MICROWAVE RADAR
 PULSE CIRCUITRY _____

Degree _____ College _____ Year _____

Experience (no. years) _____

NAME _____

ADDRESS _____

CITY _____ STATE _____

(optional) I am enclosing resume for immediate consideration.



Official U. S. Navy Photograph

when all **MANKIND...**

is gazing at the heavens wondering if its bleak and silent spaces will be friend or foe, our Nation's security depends, more than ever before, on the Engineers' and Scientists' determination to make major scientific break-throughs rather than mere improvements in existing hardware.

The professional staff of the Vitro Silver Spring Laboratory is dedicated to this goal.

Our present openings are few but extremely challenging. For detailed information, address your inquiry to:

Manager, Professional Employment
Silver Spring Laboratory, Dept. 103
Vitro Laboratories
14000 Georgia Avenue, Silver Spring, Maryland

***Vitro* LABORATORIES**
Division of the Vitro Corporation of America

log of orders totaling \$18 million, including contract increases being negotiated.

LFE is producing Doppler systems for military, lightweight GCA systems, mobile surveillance radar, computer products, microwave oscillators and stability testers.

Plant Briefs

Bendix Aviation Corp.'s Eclipse-Pioneer division, Teterboro, N. J., has purchased a 117,000 sq ft building adjacent to its present 100-acre installation. This is part of a planned expansion in the field of electronic systems for aircraft and missiles.

Jerrold Electronics Corp. has moved to new and larger quarters at Jerrold Building, 15th St. & Lehigh Ave., Philadelphia 32, Pa.

News of Reps

Barnes Development Co., Lansdowne, Pa., has appointed several reps to handle its line of automatic component test equipment. They are:

(1) **W. K. Geist Co.**, in southern California, Arizona and New Mexico.

(2) **Ellenje Co.**, in northern California and Nevada.

(3) **Peninsula Associates**, in Washington and Oregon.

The company still has territories open in the southeastern and central states.

High-speed counting, timing and frequency measuring equipment of Computer-Measurements Corp., N. Hollywood, Calif., is being handled in Michigan and Ohio by **Dayton Anderson Electronic Co.**; in upstate N. Y., by **Snelling & Bogosian Co.**

Helipot Corp., Newport Beach, Calif., names **S. Sterling Co.** as exclusive engineering sales reps in the lower peninsula of Michigan and northern Ohio for three additional product lines—rotating components, monitoring and control components, and electromechanical breadboard parts.

THE BEST IN STATION RECEIVERS

AeroCom's Model 77 single-channel H.F. crystal-controlled receiver was designed and built to meet your needs.



Power supply 115 Volts or 230 Volts 40/60 Cycles single phase. All controls on front panel, each with switch to permit remote operation.

Removable front cover permits access to all parts for checking without removing receiver from rack.

Miniature tubes extend from rear, providing maximum cooling.

A high-performance, rack-mounted, rugged receiver, designed for reception of A1, F1 or A3 signals. Frequency range is from 2 MCS to 24 MCS, using permanently mounted R.F. coils which are selected by rotary switch. (No plug-in coils). Can be operated continuously in any climate from hot and humid to very cold. Crystal band-pass filter used in I.F. amplifier. 6 KC width normally supplied for A3 and 1.8 KC width normally supplied for FSK.

Two Model 77 receivers can be used in a space-diversity system by using AeroCom's Model DRC diversity combining unit.

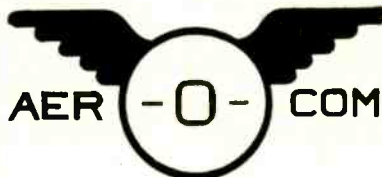

3090 S.W. 37th Avenue
Miami 33, Florida

CIRCLE 87 READERS SERVICE CARD

RIBBONS • STRIPS

★ PURE TUNGSTEN ★ THORIATED TUNGSTEN
★ MOLYBDENUM ★ SPECIAL ALLOYS

of
and OTHER METALS

IN
ULTRA THIN SIZES

to
TOLERANCES CLOSER THAN COMMERCIAL STANDARDS
by

OUR SPECIAL ROLLING TECHNIQUE

Note: for highly engineered applications—strips of TUNGSTEN and some other metals can be supplied

ROLLED DOWN TO .0003 THICKNESS

- Finish: Roll Finish—Black or Cleaned
- Ribbons may be supplied in Mg. weights if required

For HIGHLY ENGINEERED APPLICATIONS

DEVELOPED AND MANUFACTURED BY

H. CROSS CO.

15 BEEKMAN ST., N. Y. 38, N. Y.
TELEPHONE: WOrth 2-2044
COrtlandt 7-0470

CIRCLE 88 READERS SERVICE CARD

ELECTRONICS engineering edition — July 4, 1958

New dual purpose
single coil
latching relay...

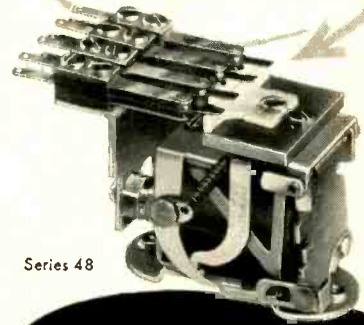

Series 48

TOP RELIABILITY!

2 amp. and 10 amp. Models

Designed for trouble-free operation . . . the Series 48 relays feature AEMCO's patented latching mechanism—for greater dependability than ordinary cam or ratchet relays. Construction is rugged—latch action is positive! Contacts lock open or closed mechanically with a momentary impulse to relay coil. SPST up to DPDT—rated 10 amps. at 115 V. SPST up to 4PDT—rated at 2 amps. at 115 V.

SPECIFICATIONS: CORE: Solid core, heavy copper shading ring. COIL: Vacuum varnish impregnated and baked—tested for 1000 V RMS breakdown. INSULATION: Standard NEMA Grade XXXP Phenolic. CONTACTS: 1/4" dia. for 10 amp. models—fine silver or silver alloy. 1/8" dia. for 2 amp. models—fine silver, gold alloy, or palladium contacts. All metal parts except stainless steel, cadmium plated with cronak finish. Latching members available with case-hardened parts if desired.

For complete information on these Series 48 Relays, write for descriptive data sheet.

Need relays?
ask



AEMCO offers a complete line of relays in a wide choice of spring and coil combinations, operating potentials, and contact ratings. If one of hundreds of standard AEMCO relay types does not exactly meet your requirements, we will be happy to design and manufacture a unit to meet or exceed your requirements.

AEMCO also manufactures a complete line of Sequence and Automatic Re-Set Timers, Time Switches and Sign Flashers.

WRITE TODAY

Your inquiries are invited. Ask for your free copy of Relay Catalog describing all standard relays in the AEMCO line.



INCORPORATED

10 State St. • Mankato, Minn.

CIRCLE 89 READERS SERVICE CARD

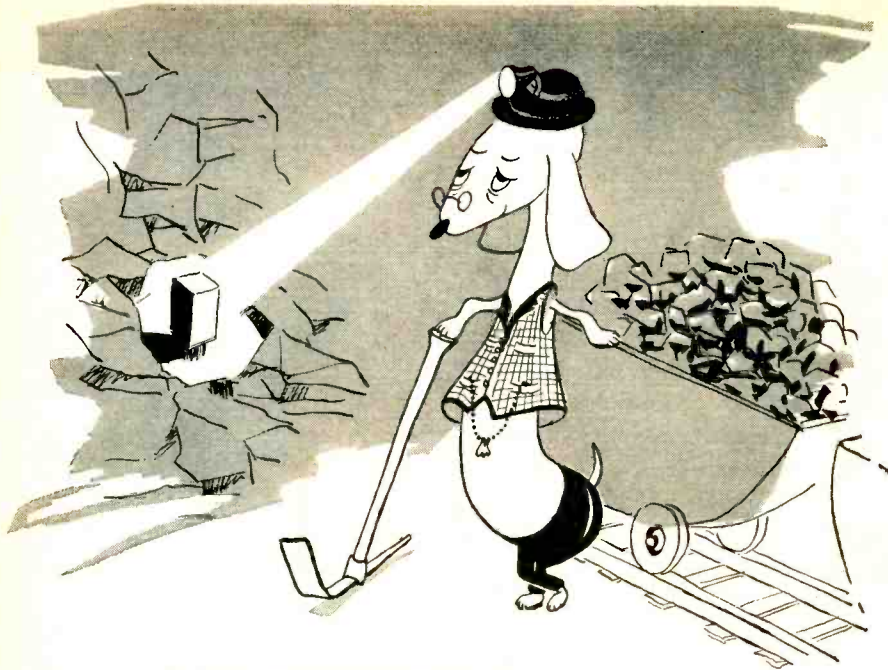

**NEW REFINEMENT
MAKES OLD DOG GOOD
FOR LOW LEVEL WORK**

This particular little friend of man (left, above) has been on the Sigma payroll now for about ten years, which explains why he can be called "old." Over the years he's been sent out on a variety of switching assignments, where neither space nor available power would permit using a St. Bernard. Although he's earned a reputation for being pretty dependable when there's a lot of shaking and tail wagging going on, lately certain people at Sigma have been hard at work to give him more "class." They figure that with his background, he might be able to show up a lot of late-model poodles in cases where loads hover around 0.0000001 watt, or in the native vernacular, "dry circuit" applications.

It looks now as if the Brink of Success has been reached: 98 out of 100 of these refined types consistently pass our special low level tests, switching 10 microamperes at 10 millivolts 5,000 times, with all operations monitored. This is 100% production testing on this type, and the 2% that don't pass are sent to a horrible end (in our plant, not in yours). As a matter of interest, the contacts in these new types for low level work use 24 karat gold.



In case your circuit is considerably more moist, but still calls for long, dependable switching that's immune to high shock and vibration levels, old faithful can also be ordered with silver, palladium or gold alloy contacts. The silver contacts are rated up to 2 amp. (resistive load at 120VAC or 28VDC), the palladium and gold alloy types, 0.5 amp. Latest facts are available in a Sigma bulletin entitled "Series 22 Relay", a straight presentation with no animal pictures.

SIGMA
SIGMA INSTRUMENTS, INC.

62 Pearl Street, So. Braintree 85, Massachusetts

NEW BOOKS

Basic Feedback Control System Design

By C. J. SAVANT, JR.
McGraw-Hill Book Co., Inc., New York, 1958, 418 p, \$9.50.

This is a good elementary textbook on feedback control system design based mainly upon root-locus techniques. However, sufficient coverage of frequency response methods is given to provide a complementary understanding of both. Such a modern approach to servomechanisms is warranted by recent developments in the field, and the author's presentation is lucid and direct.

Contents—Material covered in the text includes a good section on obtaining the differential equations for mechanical and electrical systems, a chapter on steady state errors and servo system specifications. Analysis then proceeds to the root-locus and frequency response methods for closed loop systems and is followed by the synthesis of stabilization networks and the equalization of servomechanisms based on the root-locus approach.

Modern automatic control components are treated in some detail with consideration given to practical engineering limitations on their use. Motors, tachometers, synchros, gyros, accelerometers and pressure transducers are included in the discussion. The two commonly accepted and used techniques, describing function and phase plane analysis, are presented for predicting the performance of systems containing nonlinear elements.

Some aspects of the text which reflect the author's general approach are noteworthy. For one, in the treatment of construction of root-locus diagrams the mechanics of producing the graph are segregated in one paragraph and the theory behind the constructions is given in the following paragraph. This allows an instructor, if he desires, to present the construction techniques for root-locus diagrams without at the same time assigning the theory.

A second point, which appears



—now **WEEKLY** ... added value at same price!

• subscription provides both an **ENGINEERING EDITION** and a **BUSINESS EDITION** . . . alternately each Friday

ELECTRONICS' weekly publishing program helps you keep pace with the dramatic speed of electronic technical and economic developments. Promptly and completely, the service meets the vital need of engineers and executives to be posted on what's new and important.

All subscribers get the **ENGINEERING EDITION** and the **BUSINESS EDITION**, published in turn every Friday . . . providing added benefits in technical data and news . . . delivered faster than ever.

ELECTRONICS' publishing plan *totally informs* subscribers on latest advances in Design, Research, Engineering, Manufacturing . . . New Applications in Industrial, Scientific, and Military Electronics . . . New Products, Components, and Materials. . . .

—and insures speedy profitable contact with all the fast-breaking **NEWS** . . . economic developments, markets, production figures, business conditions, and trends, news of men, companies, and events . . . with authoritative analyses of the economic impact of new technical advances.

SAME RATES AS BEFORE—despite expense of augmented editorial staff and greatly increased production costs. **GET UTMOST VALUE FROM THIS EXPANDED ELECTRONICS SERVICE**—place your personal subscription by means of the card below.

No postage needed on this convenient order card . . .

PRESENT SUBSCRIBERS

— please note!

This subscription card is for **NEW** subscribers. It is not intended as a renewal notice. If you are already personally subscribing, we shall appreciate your passing the form to one of your associates. Thank you.

L 7-4-58

NEW subscription **ORDER FORM**

O.K. — put me down for a personal subscription to "electronics" . . . giving me benefit of your weekly editorial service . . .

Check here for 1 year \$6 for 2 years, \$9 for 3 years, \$12

Name _____ Position _____ Dept. _____

Company Name _____

Street _____ City _____ Zone _____ State _____

Products Mfrd. _____ Number of
Or Service _____ Employees _____

Check here if you want Publication sent to your home

Street _____ City _____ Zone _____ State _____

Please One

Send bill to home address

Send bill to company address

Payment Attached

L -
M -

Please fill out card completely for best service

L 7-4-58

Foreign Rates (1 year) Canada \$10, Other Foreign: \$20

electronics

Established 1930 — Pioneer Publication in the Field

.. NOW ISSUED WEEKLY .. EVERY FRIDAY alternating

**All subscribers get copies of both
the alternately published editions**

**ENGINEERING EDITION
BUSINESS EDITION**

This new expanded service of **ELECTRONICS** provides the most comprehensive and fastest aid for the executive and engineer vitally concerned with every phase of the electronics industry . . .

New Ideas! . . . New Circuits! . . . New Engineering Techniques!
Improved Manufacturing Methods! . . . New Design! . . . Advances in Research!
Prompt word about New Electronic Equipment, Parts and Components!

Latest Word on New Industrial, Scientific and Military Applications!
Sales and Production Figures! . . . Economic Trends! . . . All the Vital News!

SUBSCRIBE PERSONALLY for top-value in NEWS and IDEAS

Postage
Will be Paid
by
McGraw-Hill
Pub. Co.

No
Postage Stamp
Necessary
if Mailed in the
United States

BUSINESS REPLY CARD

First Class Permit No. 64, New York, N. Y.

McGRAW-HILL PUBLISHING CO., Inc.

electronics

330 WEST 42nd STREET

NEW YORK 36, N. Y.

**Use this
handy
order card . . .**

**to profit by
ELECTRONICS
weekly
editorial service**

ELECTRONICS ENGINEERS

with specialized experience

Senior and intermediate positions for experienced engineers are available with Curtiss-Wright, through expansion of divisional activities in these fields:

- Analog Computers and servo-mechanisms
- Missile Guidance
- Digital Computers — General Purpose and Real Time
- Airborne Navigation and Communication
- (a) Logical Design
- Radar System — Pulse Circuits
- (b) Circuits and Systems
- Weapons Systems

Salaries are commensurate with your abilities and experience. In addition, liberal employee benefits are part of the program of this diversified organization where individual accomplishments are quickly recognized. Positions are open, although not all in each category, at the following Curtiss-Wright Divisions: Electronics Division, Carlstadt, N.J.; Research Division, Quehanna, Pennsylvania (40 miles north of State College — Pennsylvania State University); Aerophysics Development Corporation, Santa Barbara, California and Utica Division, Utica, Michigan.

Send detailed resume including salary requirements to:

T. W. COZINE
 Mgr., Engineering Recruitment,
 Dept. G-5,
 Curtiss-Wright Corporation,
 Wood-Ridge, N. J.

All replies confidential

CURTISS-WRIGHT
 CORPORATION • WOOD-RIDGE, N. J.

If you produce
FERRITES
ELECTRONIC CORES
MAGNETIC RECORDING
MEDIA

... then let **WILLIAMS**
 help by supplying you
 with latest, authoritative
 technical data on

PURE FERRIC
OXIDES
MAGNETIC IRON
OXIDES
MAGNETIC IRON
POWDERS

Since final quality of your production of ferrites, electronic cores, and magnetic recording media depends on proper use of 3 specialized groups of magnetic materials ... you'll find it mighty helpful to have all the latest, authoritative technical data describing the physical and chemical characteristics of each. This information is available to you just for the asking. So send today. Meanwhile, here are highlights of each product group.

Pure Ferric Oxides: For the production of ferrite bodies, we manufacture a complete range of high purity ferric oxide powders. These are available in both the spheroidal and acicular shapes, with average particle diameters from 0.2 to 0.8 microns. Impurities such as soluble salts, silica, alumina and calcium are at a minimum.

Magnetic Iron Oxides: For magnetic recording—audio, video, instrumentation etc.—we produce a group of special magnetic oxides with a range of controlled magnetic properties. Both the black ferrosferric and brown gamma ferric oxides are available.

Magnetic Iron Powders: For the fabrication of magnetic cores in high-frequency, tele-communication, and other magnetic applications, we make a series of high purity iron powders.

These materials are products of Williams research facilities. For your convenience, we maintain fully equipped laboratories for the development of new and better inorganic materials. We also investigate new fields of application. Please write, stating your problem. We'll be glad to cooperate. Address Dept. 25, C. K. Williams & Co., 640 N. 13th St., Easton, Pa.

WILLIAMS
 COLORS & PIGMENTS

C. K. WILLIAMS & CO.
 East St. Louis, Ill.

Easton, Penna. • Emeryville, Calif.

CIRCLE 93 READERS SERVICE CARD



CO-AX
4 nmf/ft

★ ULTRA LOW capacitance & attenuation

WE ARE SPECIALLY ORGANIZED
 TO HANDLE DIRECT ORDERS OR
 ENQUIRIES FROM OVERSEAS
SPOT DELIVERIES FOR U.S.
 BILLED IN DOLLARS—
 SETTLEMENT BY YOUR CHECK
CABLE OR AIRMAIL TODAY

TYPE	$\mu\text{mf/ft}$	IMPED. Ω	O.D.
C1	7.3	150	.36'
C11	6.3	173	.36'
C2	6.3	171	.44'
C22	5.5	184	.44'
C3	5.4	197	.64'
C33	4.8	220	.64'
C4	4.6	229	1.03'
C44	4.1	252	1.03'

NEW 'MX and SM' SUBMINIATURE CONNECTORS
 Constant 50 Ω -63 Ω -70 Ω impedances



TRANSRADIO LTD. 138A Cromwell Rd. London SW7 ENGLAND

CABLES: TRANSRAD, LONDON

CIRCLE 92 READERS SERVICE CARD

Now HIGH POWER 60 AND 400 CPS TRANSI-MAGS®

STANDARD LINE OF FAST RESPONSE

TRANSISTOR MAGNETIC AMPLIFIER

FOR SERVO MOTOR CONTROL

For driving AC servo motors in industrial and military servo systems which require hi-power, fast response and (static) high reliability.

- A COMPLETE SERVO AMPLIFIER DRIVE SYSTEM IN A SINGLE PACKAGE
- TEMPERATURE STABILIZED
- FAST RESPONSE
- HIGH GAIN
- INSTANTANEOUS START
- SMALL STANDBY POWER
- RUGGED
- HIGH RELIABILITY
- QUADRATURE REJECTION
- SERVO MOTOR COMPATIBILITY

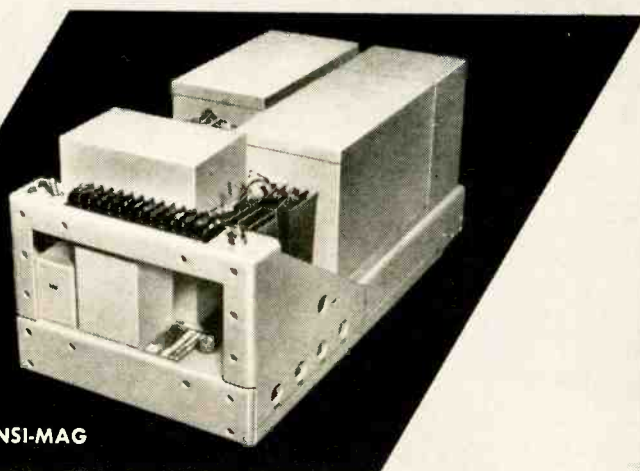

60 CPS TRANSI-MAG

60 CPS PERFORMANCE SPECIFICATIONS

For complete 60 CPS and 400 CPS specs Write for Bulletins S-913 and S-914 Respectively

MODEL	MA-1502	MA-1559	MA-1572	MA-1602	MA-1702	MA-1802	MA-1902
A.C. INPUT	MA-1511	MA-1561	MA-1581	MA-1611	MA-1711	MA-1811	MA-1911
D.C. INPUT							
MAX. POWER OUTPUT WATTS	50	100	120	175	650	1900	2800
TYPICAL SERVO MOTOR LOAD	DIEHL FPF 49-9	DIEHL FPF 49-12-1	DIEHL FPF 66-11-1	DIEHL FPF 85-18-1	ZP 105-2212-1	ZP 143-2247-1	ZP 162-2207-1
SENSITIVITY	A.C. INPUT—0.5V A.C. FOR FULL POWER OUTPUT D.C. INPUT—2.5 MA D.C. FOR FULL POWER OUTPUT						
RESPONSE	0.1 seconds						
AMBIENT TEMPERATURE	-55°C. to +71°C.						



MAGNETIC AMPLIFIERS INC.

632 TINTON AVENUE • NEW YORK 55, N. Y. • CYPRESS 2-6610

West Coast Division

136 WASHINGTON ST. • EL SEGUNDO, CAL. • OREGON 8-2665

to be somewhat of a limitation, is that in the section on nonlinear analysis, major emphasis is on the describing function technique which is essentially a frequency response method of analysis. Unfortunately, the treatment of the Nichol's chart, on which describing functions show up most clearly, was not carried as far as is generally accepted. The author's treatment using Bode plots did not yield the most optimum presentation.

In all, the author is to be congratulated on a concise, thoroughly readable, well organized text which, though more directed to the student than the designer, should have a very useful place in the textbook literature of control systems engineering.—A. E. NASHMAN, Executive Engineer, Federal Telecommunication Lab, Nutley, N. J.

THUMBNAIL REVIEWS

Epoxy Resins—Their Applications and Technology. By Henry Lee and Kris Neville, McGraw-Hill Book Co., Inc., 1957, 305 p, \$8.00. In addition to information on epoxy-resin synthesis, curing mechanisms, curing agents, and filler and modifier materials, the electronics engineer will find of particular interest the chapter on casting, potting, encapsulation, sealing and lightweight foams; this chapter covers formulation and production techniques.

Receiving Aerial Systems. By I. A. Davidson, Philosophical Library, New York, 1957, 152 p. \$4.75. General characteristics of broadcast band and television receiving antennas are covered along with specific types, methods of selection and test methods.

Stereophonic Sound. By Norman H. Crowhurst, John F. Rider Pub., Inc., New York, 1957, 128 p. \$2.25 (paper). Introduction to sound fundamentals and principles and uses of binaural, two and three channel stereophonic, stereosonic and coded stereophonic systems.

Pioneering in Industrial Research—The Story of the General Electric Research Laboratory. By Kendall Birr, Public Affairs Press, Washington, D. C., 1957, 204 p, \$4.50. Policies, problems and accomplishments of GE's Research Lab are discussed with particular attention to research in lighting, X-rays, electronics, chemicals and metallurgy.

work in the fields of the future at NAA



ELECTRO-MECHANICAL ELECTRONIC ENGINEERS

A BS or advanced degrees in EE, ME, or Physics, may qualify you for a rewarding career at North American Aviation, in one of these fields:

Flight Control Analysis, Reliability Analysis, Flight Simulation, Systems Analysis.

Electrical Systems Analysis and Design, Mission and Traffic Control, Fire Control, Bombing Systems, Electronics Systems Integration, Flight Controls, Ground Support Equipment, Airborne and Electronic Test Equipment.

Applied Research in Radar Development, Antenna Development, Infrared, and Acoustics.

Please write to: Mr. F. G. Stevenson, Engineering Personnel, North American Aviation, Los Angeles 45, California.

THE LOS ANGELES DIVISION OF

NORTH AMERICAN AVIATION, INC.



COMMENT

The Saga of Deaf Smith

A long time ago, as these things are measured in the publishing game, we printed a note (Developments Abroad, Apr. 20 '57, p 44) to the effect that some enterprising Australians at British Farm Equipment, Pty. Ltd., were making tractors with radio controls. Time passed; the magazine Industrial Distribution, a McGraw-Hill publication, picked up the news in its April, 1958, edition. A man in Texas saw it and wrote to the editor:

Your announcement of a radio-operated tractor in Australia . . . appears to be issued in the sense of a "first."

I believe if you will check on farming methods in the vicinity of Hereford, Texas, you will find out that radio-controlled tractors have been operating since 1951 and possibly before.

In my utter amazement at seeing a tractor cutting beautiful furrows with absolutely no one in attendance, I forgot I was driving 40 mph and almost wound up in a ditch.

Interrogation on the subject produced the fact that farmers ran their tractors around the clock, which freed them entirely for other duties.

W. J. KOLLER
BRIGGS-WEAVER MACHINERY CO.
DALLAS, TEX.

The editor of Industrial Distribution called on us, and we wrote to Mr. Koller to ask him about the reliability and plowing pattern of these untenanted tractors, not wishing to cast our vote for any device that might chop up the local terrain. We also asked him who made the things. He consulted the Deaf Smith Chamber of Commerce who told him:

... These self-operated tractors are controlled strictly by a mechanical device shop-made here in Hereford. Guides are attached to the front wheel of the tractor which follow the furrow made by the previous round in breaking the land. The tractor cannot make short turns since the guide wheel would jump the furrow and turn

SYNONYMOUS

d & r
LTD.

FLUTTER METERS

For the most complete line of Flutter Meters, there is only one source - d & r LTD. From the meters used in simple maintenance test equipment to the most complex standardization and analysis equipment for missile flight systems and telemetering systems - we make them all.

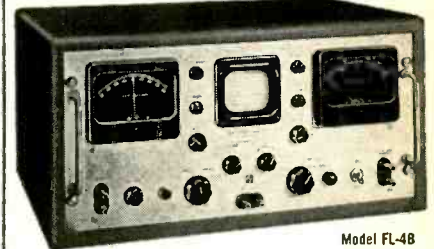

Model FL-48

WIDEBAND FLUTTER METERS

MODEL FL-3D FLUTTER AND WOW METER

Features

A convenient instrument of moderate cost for use in field maintenance of music-system tape recorders and reproducers, and phonograph turntables.

Specifications

Carrier frequency - 3000 cps, stabilized oscillator
Bandwidth - within 3 db to 250 cps modulation
Bandwidth Selection - 0.5 to 6 cps, 6 to 250 cps, 0.5 to 250 cps
Scale Ranges - 2% and 0.5% full scale rms

Price: \$225.00

MODEL FL-4B WIDEBAND FLUTTER METER

Features

A very sensitive broadband instrument for laboratory use in the precise measurement of small amounts of flutter with components up to 5000 cps. Most frequently used in telemetering and data reduction systems.

Specifications

Carrier Frequency - 14,500 cps, crystal controlled
Bandwidth - 0-c to 5000 cps within 6 db
Bandwidth Selection - Full range above, 0.5 to 30 cps, 30 to 300 cps, 300 to 5000 cps
Scale Ranges - 0.2%, 0.6% and 2.0% rms full scale
Drift Meter - $\pm 2.0\%$ frequency change d.c. to 4 cps
Display - 3-inch flat-face oscilloscope for flutter analysis

Price: \$965.00 rack mounted, \$1000.00 in cabinet

MODEL FC-5A LABORATORY STANDARD FLUTTER METER

Features

An extremely stable (temperature controlled discriminator) instrument with great sensitivity and extended bandwidth for laboratory work in connection with precision instrumentation data recorders. Galvanometer outputs provided.

Specifications

Carrier Frequencies - 40 kc. and 70 kc., crystal controlled
Bandwidth - 0-c. to 10 kc. with 70-kc. carrier to 4 kc. with 40 kc. carrier
Indicating Instruments - Level Meter, and $\pm 2\%$ Drift Meter
Output Signals - Scope, two galvanometer outputs
Sensitivity - 0.05%, 0.2% and 2.0% selectable
Drift - On d-c galvo. output, less than 10 parts per million in 1/2 hour

Price: \$3450.00 rack mounted

MODEL FL-6A BROADCAST FLUTTER METER

Features

An instrument designed for accurate measurement and analysis of flutter and wow in high-quality audio tape recorders.

Specifications

Carrier Frequency - 8000 cps, stabilized oscillator
Bandwidth - 0-c. to 1200 cps.
Bandwidth Selection - Full range, 0.5 to 30, 30 to 300, 300 to 1200 cps.
Scale Ranges - 0.2%, 0.6%, and 2.0% rms full scale
Display - 3-inch oscilloscope for waveform observation

Price: \$845.00 rack mounted, \$880.00 in cabinet

WRITE FOR

COMPLETE INFORMATION AND PRICES

d & r
LTD.

dependable & reliable

402 East Gutierrez Street
P O Box 1500
Santa Barbara, California

Telephone: WOODLAND 5-4511

CIRCLE 96 READERS SERVICE CARD

the specs are the proof . . .
the BEST BUYS are **TEICO**[®]
for COLOR & Monochrome TV servicing



COLOR
and Monochrome
dc to 5 mc lab & tv
5" OSCILLOSCOPE
#460
Factory-wired \$129⁵⁰
Kit \$79⁹⁵

• Features DC Amplifiers!

Flat from DC-4.5 mc, usable to 10 mc.
VERT. AMPL.: sens. 25 rms mv/in; input Z3
megs; direct-coupled & push-pull thruout;
K-follower coupling bet. stages; 4-step
freq-compensated attenuator up to 1000:1.
SWEEP: perfectly linear 10 cps-100 kc (ext.
cap. for range to 1 cps); pre-set TV V & H
positions (30 & 7875 cps); auto. sync. ampl.
& lim. PLUS: direct or cap. coupling; bal.
or unbal. inputs; edge-lit engraved lucite
graph screen; dimmer; filter; bezel fits std
photo equip. High intensity trace CRT.
0.06 usec rise time. Push-pull hor. ampl.,
flat to 400 kc, sens. 0.6 rms mv/in. Built-
in volt. calib. Z-axis mod. Sawtooth & 60
cps outputs. Astig. control. Retrace blank-
ing. Phasing control.



TV-FM SWEEP
GENERATOR
& **MARKER** #368
Factory-wired \$119⁹⁵
Kit \$69⁹⁵

Entirely electronic sweep circuit (no
mechanical devices) with accurately-biased
incredulor for excellent linearity.
Extremely flat RF output: new AGC circuit
automatically adjusts osc. for max output
on each band with min. ampl. variations.
Exceptional tuning accuracy: edge-lit hair-
lines, 6:1 vernier. Sweep Osc. Range 3-216
mc in 5 fund. bands. Variable Marker Range
2-75 mc in 3 fund. bands; 60-225 mc on
harmonic band. 4.5 mc Xtal Marker Osc.,
xtal supplied. Ext. Marker provision. Sweep
Width 0-3 mc lowest max. deviation to 0-30
mc highest max. dev. 2-way blanking. Nar-
row range phasing. Attenuators: Marker
Size, RF Fine, RF Coarse (4-step decade).
Cables: output, 'scope horiz., 'scope
vertical.

DYNAMIC CONDUCTANCE



**Tube &
Transistor
Tester**
#666
Factory-wired \$109⁹⁵
Kit \$69⁹⁵

COMPLETE with steel cover and handle.
SPEED, ease, unexcelled accuracy & thor-
oughness. Tests all receiving tubes (&
Color & Monochrome pic tubes with adap-
ter). Composite indication of Gm., Gp &
peak emission. Simultaneous sel of any 1
of 4 combinations of 3 plate voltages, 3
screen voltages, 3 ranges of continuously
variable grid voltage (with 5% accurate
pot). New series-string voltages: for 600,
450, 300 ma types. Sensitive 200 ua
meter. 5 ranges meter sensitivity (1%
shunts & 5% pot). 10 SIX-position lever
switches: free-point connection of each
tube pin. 10 pushbuttons: rapid insert of
any tube element in leakage test circuit
& speedy sel. of individual sections of
multi-section tubes in merit tests. Direct-
reading of inter-element leakage in ohms.
New gear-driven rollchart. Checks n-p-n &
p-n-p transistors: separate meter readings
of collector leakage current & Beta using
internal dc power supply.

See the 50 EICO models
IN STOCK at your neigh-
borhood distributor.
Write for
FREE Catalog E-7
33-00 Northern Boulevard, L. I. C. 1, N. Y.
Prices 5% higher in West.

CIRCLE 97 READERS SERVICE CARD

the tractor wild. Breaking of land
is the only operation adapted to
this driverless tractor operation.

So far as we know, there has not
been a radio-operated tractor in
this area . . . much as we would
like to claim a first in this con-
nection. . . .

W. M. LENDERMAN
DEAF SMITH COUNTY CHAMBER
OF COMMERCE
HEREFORD, TEX.

Mr. Koller left "The Town
Without a Toothache," as Here-
ford calls itself, as despondent as
(we suspect) the C of C was, and
promptly told us:

I goofed!
My humblest apologies, and
three hip-hips for Australia!

W. J. KOLLER
To which we are pleased to add
a dignified "hurrah" and a quiet
"I told you so."

Drone Surveillance

I have just finished reading your
interesting article "Drone Market
Expanding Fast" (May 30, p 13).

The RCA Service Company has
been actively engaged in the drone
program of the Army Electronic
Proving Ground at Fort Huachuca,
Ariz., since July 1955 as a prime
contractor for engineering assist-
ance. During this period our Tuc-
son Systems Engineering Facility
has developed the prototype radar
tracking-plotting system shown in
the picture (page 13); prepared test
plans and assisted in testing and
data-reduction; and developed an
interim telemetry system consist-
ing of airborne components and a
mobile ground station.

J. L. LANGEVIN
RCA SERVICE CO.
TUCSON, ARIZ.

Science and Technology

What ever happened to the Sen-
ate's bill to create a Department of
Science and Technology? It was
scaring the pants off some of my
friends a while back . . .

GEORGE DI GRASSO
BALTIMORE, Md.

Still bottled up in committee.

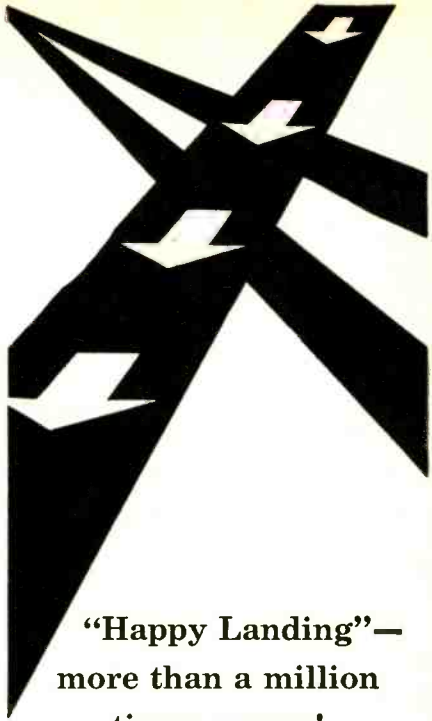

**"Happy Landing"—
more than a million
times a year!**

EVERY 30 seconds, somewhere in
the free world, an aircraft makes a
touchdown with the aid of the ITT-
developed "ILS"—instrument low-
approach system—produced domesti-
cally by Federal Telephone and Radio
Company, ITT's largest U.S. manu-
facturing unit.

This famed landing system is only
one of many vital products made in
Federal's million-square-foot plant.
Federal also produces Tacan, Vortac,
Data Link, missile guidance and
command systems, automatic check-
out and ground test equipment, data
processing computers, countermeas-
ures, direction finders, fire control
and radar simulators, radio transmit-
ters and receivers, ATC transponders,
microwave equipment and other elec-
tronic and telecommunications sys-
tems for air navigation and military
use.

Men of ambition and skill will find
Federal's diversity a fertile field for
challenging and rewarding opportu-
nities . . . in country-like atmosphere
... only minutes away from the heart
of New York City!

For further information on opportunities
at Federal—located in Clifton, New Jer-
sey—write to ITT Technical Placement
Office, 67 Broad Street, New York 4, N. Y.

**FEDERAL TELEPHONE
AND RADIO COMPANY**

A Division of

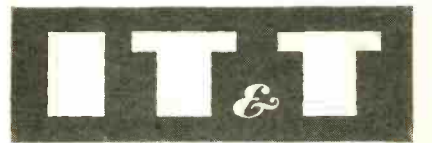

INTERNATIONAL TELEPHONE
AND TELEGRAPH CORPORATION
67 Broad Street • New York

CIRCLE 98 READERS SERVICE CARD

MISSILE DETECTION

SYSTEMS SECTION

OF GENERAL ELECTRIC

AUGMENTING

SYSTEMS MANAGEMENT

GROUP

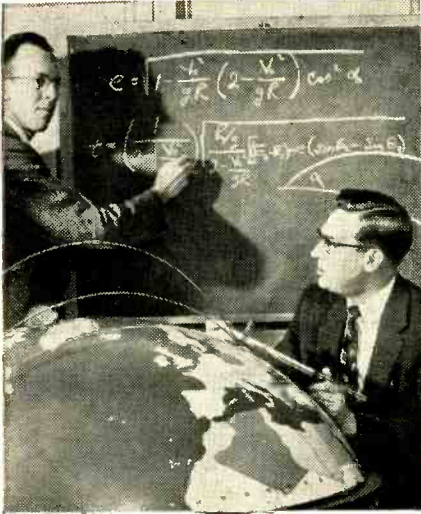

As far back as 1950, G-E engineers and scientists began to investigate ballistic missile detection problems. This study program was part of the long-term investment in electronics research undertaken by General Electric... an investment that is a major factor in the selection of G. E. for such contracts as the \$100,000,000 plus responsibility for high-power, long-range surveillance radar... BMEWS.

Responsible for Development and Design of Long-Range Detection Systems

NEW OPENINGS FOR ELECTRONIC ENGINEERS TO WORK ON RADAR SYSTEMS AND COMPONENTS

- Research and development of new detection techniques.
- Initiation and development of proposals.
- Issuance of design and purchase specifications.
- Liaison between military; engineering and manufacturing sub-contractors.
- Technical and financial scheduling, analysis of radar programs.

SYSTEMS DEVELOPMENT ENGINEERING

(At least 4 years' experience)

RADAR SYSTEMS • SYSTEMS ANALYSIS
DATA ANALYSIS • COMPUTER PROGRAMMING (704)
ELECTRONIC COUNTERMEASURES SYSTEMS

SYSTEMS EQUIPMENT ENGINEERING

(At least 2 years' experience)

ANTENNA DESIGN AND DEVELOPMENT
RF COMPONENTS DEVELOPMENT
UHF AND MICROWAVE RECEIVER DEVELOPMENT
DATA REDUCTION EQUIPMENT D&D
VIDEO DISPLAY DEVELOPMENT
COMPUTER APPLICATIONS

Salaries fully competitive, commensurate with experience

Write in confidence to: MR. JAMES P. KINSELLA, Div. 27-WZ

MISSILE DETECTION SYSTEMS SECTION
HEAVY MILITARY ELECTRONIC EQUIPMENT DEPARTMENT

GENERAL  ELECTRIC

COURT STREET, SYRACUSE, NEW YORK

MISSILES YOUR GOAL?



Get into a key missile program at BENDIX —prime contractor for the Talos missile

Engineering can be a really satisfying career—and within engineering one branch stands out. That's Guided Missiles. If the missile field is the one you want—hear this. We need engineers with exceptional ability who can handle responsibility.

At Bendix you work with men who are outstanding in every phase of engineering. You use facilities second to none. You do work that's challenging and important—work that offers exceptional opportunities to build your professional standing.

You will enjoy Midwestern living at Bendix, too. Fine, four-season climate and excellent recreational facilities are close at hand. In addition, Bendix offers you a liberal personal benefit program.

If this interests you and you want additional information, mail the coupon below for your copy of "Opportunities Abound at Bendix Missiles". You can read it through in half an hour—and it may prove to be the best half hour you've ever spent in your life.



Bendix Products Division—Missiles

403P S. Beiger St., Mishawaka, Ind.

Gentlemen: I would like more information concerning opportunities in guided missiles. Please send me the booklet "Opportunities Abound at Bendix Missiles."

NAME _____

ADDRESS _____

CITY _____ STATE _____

P
H
O
P
H
O
E
N
I
X
N
I
X

At the cross roads of
opportunity for men
in Electronics

GOODYEAR AIRCRAFT CORPORATION

ELECTRONIC LABORATORY

Arizona Division
Litchfield Park, Arizona

A Subsidiary of the
GOODYEAR TIRE & RUBBER CO

**ENGINEERS
IMMEDIATE OPENINGS
ELECTRONIC PACKAGING
RELIABILITY
CIRCUITRY
TEST EQUIPMENT
ELECTRO-MECHANICAL
COOLING SPECIALIST**

*Leisure Living At Its Best
"In the Valley of the Sun"*

Modern Inexpensive Housing

Send resume to: A. E. Manning

Engineering and Scientific Personnel

GOODYEAR AIRCRAFT

LITCHFIELD PARK
PHOENIX, ARIZONA

Similar opportunities available in
our
Akron, Ohio Laboratory

TAKE THE "ELECTRONICS HIGHWAY"SM WHEN VACATIONING IN NEW ENGLAND

...and visit

SYLVANIA'S WALTHAM LABORATORIES

to discuss our newest projects
and your professional opportunities

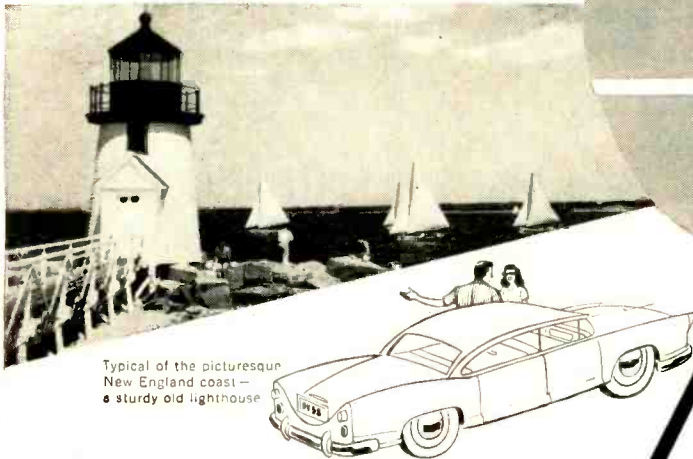

Typical of the picturesque
New England coast —
• sturdy old lighthouse

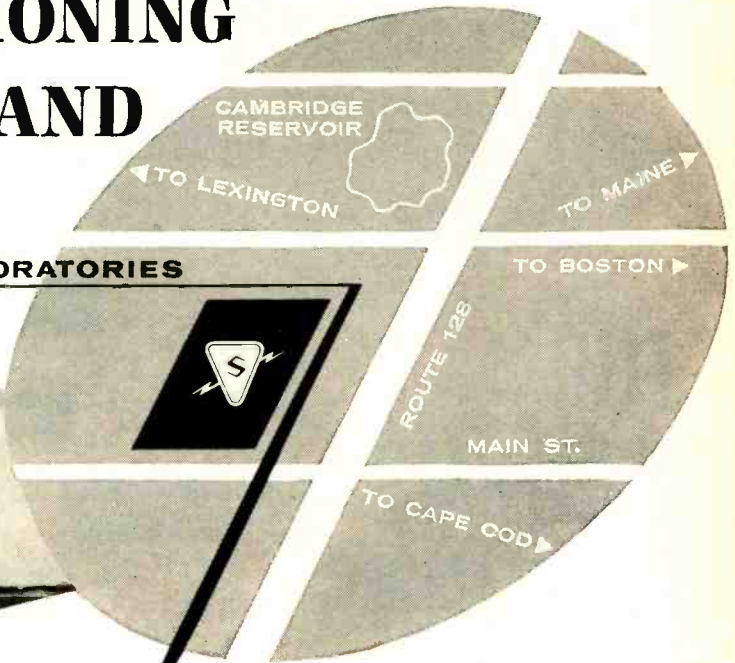

Cruising north along Route 128 through historic Middlesex County, you'll see Sylvania's Waltham Labs high above the highway. Stop off on your way to nearby Lexington for what could be an important interview about a future in advanced electronics with Sylvania.

Big things are happening in your profession at Waltham Laboratories. This is where Sylvania engineers and scientists are developing the Data-Processing nerve-center of BMEWS (giant new program for a Ballistic Missile Early Warning System).

Work on PLATO (AMM system for which Sylvania is Weapons System Manager) is also centered here... plus development programs for other major electronic defense projects.

Express artery around Boston:
Rt. 128. In heart of Pilgrim
Country. Going north, take
Exit 44 for Sylvania (12 miles
from Boston Common). Many
tourist attractions are close
enough for a day's sightseeing.
And 128 connects with main routes
to all New England.

**current
opportunities
at Sylvania are too
good to pass by...**

DATA PROCESSING LABORATORY

- Sr. Development Engineers
- Sr. Packaging Engineers
- Project Engineers
- Sr. Logical Design Engineers
- Engineers with experience in Radar Data Handling and Display

(Previous digital data processing experience is important for most assignments.)

MISSILE SYSTEMS LABORATORY

- Advanced development, VHF & UHF submonitoring complex radar systems
- Systems analysis & synthesis of complex radars, their design and simulation
- Problems in atmospheric physics, ionized gases, astronautics

AVIONICS LAB

- Microwave components design including multi-channel filters incorporating fast-acting microwave switches
- Flush-mounted broad band airborne microwave antennas
- Transistor circuit design & development

APPLIED RESEARCH LAB

- Research & Systems Application in Counter-Countermeasures, Operations Research, Analysis & Applied Physics

Interview and relocation expenses paid by Sylvania. Inquiries will be answered within 2 weeks. Convenient Saturday interviews arranged.

Send your resume to Erling Mostue
WALTHAM LABORATORIES, Electronic Systems Division



SYLVANIA ELECTRIC PRODUCTS INC.

100 First Avenue • Waltham 54, Massachusetts

FOCAL POINT

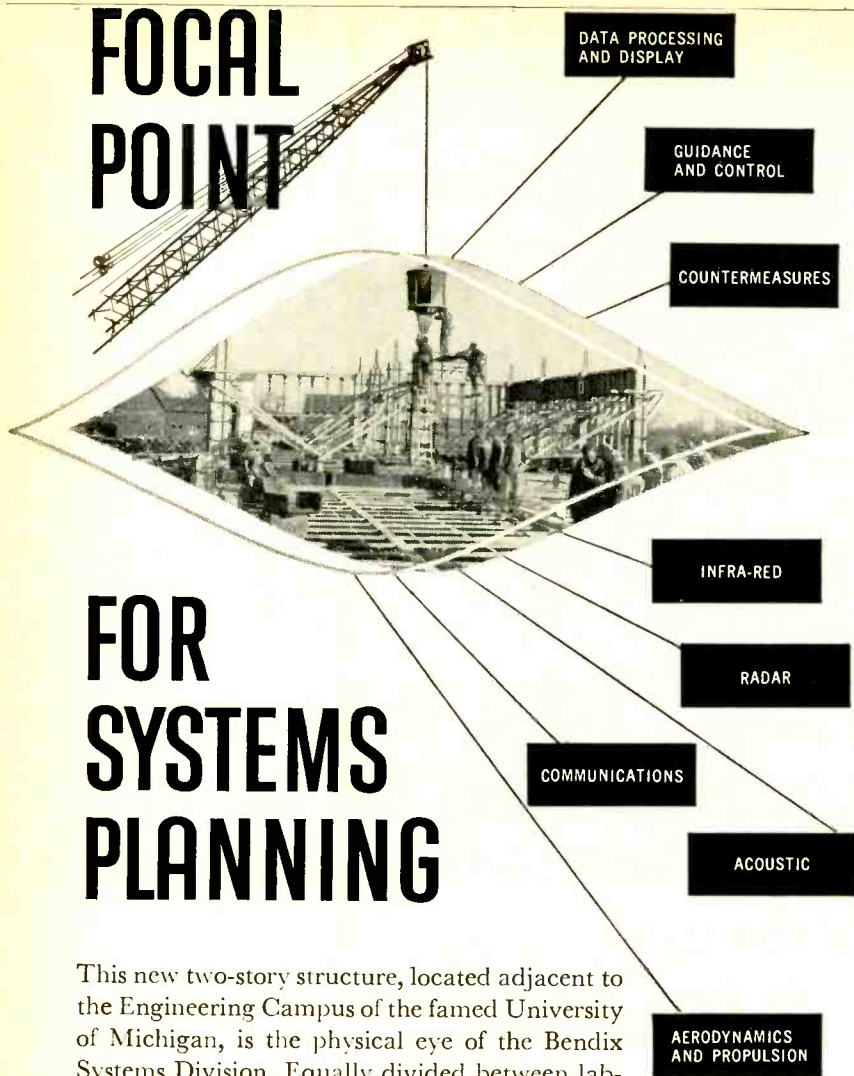

FOR SYSTEMS PLANNING

This new two-story structure, located adjacent to the Engineering Campus of the famed University of Michigan, is the physical eye of the Bendix Systems Division. Equally divided between laboratory and office space, this first among several new units of the Systems Division is being completely equipped for the research and development of advanced weapon systems.

The Systems Division is a creative engineering and scientific group devoted to the exploration of new approaches to the development of weapon systems. Serving as a focal point for the entire Bendix Corporation, it assures harmonious transition from beginning concept to final system production.

If you are a trained engineer or scientist—or are undergoing training—and seek the opportunity to apply imagination and ingenuity to the development of advanced detection, control, or communication systems in a foremost research and development environment, contact the Bendix Systems Division, Dept. B74 in Ann Arbor, Michigan. You cannot pick an organization that offers greater opportunity or a better social and cultural community in which to work and live.

Bendix Systems Division
ANN ARBOR, MICHIGAN



ELECTRONIC ENGINEERS

Interested in creative design responsibilities in the field of

AIRCRAFT ELECTRONIC SYSTEMS



Bell Helicopter Corporation is looking for graduate engineers with experience in design and development of microwave ranging systems, aircraft automatic stabilization systems, analogue computer simulation systems, system analysis, or transistor circuit design.

Send resume to
Engineering Personnel Manager

BELL HELICOPTER CORPORATION
Fort Worth, Texas

ELECTRONIC ENGINEER

For Nuclear Physics Research Laboratory

... for design and development of equipment of varied nature, from D.C. to .001 micro-second pulses. Wide experience useful, but will consider younger man of promise. Salary depends on qualifications; compares favorably with industry. Excellent working conditions and atmosphere. Write, stating age, education, experience and salary desired to—

UNIVERSITY OF PENNA.
Personnel Office
3025 Walnut St., Phila. 4, Pa.
Or Telephone Philadelphia
EVergreen 6-0100, Ext. 8143

ENGINEERS

If you have been looking for an Employment Agency that is skilled in the STATE OF THE ART of Technical Recruitment and RELIABILITY OF INFORMATION concerning positions, why not communicate with us at once!

ALL POSITIONS FEE PAID.
FIDELITY PERSONNEL SERVICE
1218 Chestnut St. Phila. 7, Pa.
Specialist in Aviation, Electronics and Nuclearics

SELLING OPPORTUNITY OFFERED

Sales Representatives Wanted by West Coast Manufacturer for new product. Stock line of high temperature encapsulated R.F. Chokes designed for military applications. NYT Electronics, Inc. 2979 N. Ontario, Burbank, Calif.

EMPLOYMENT PROBLEM?

When you are in need of specialized men for specialized jobs, contact them through an employment ad in this publication.

ELECTRONIC ENGINEERS

needed at

MARTIN

New long-term developments at Martin in the field of electronics have created exceptional opportunities for top electronic engineers. At least 5 years experience required. Salaries from \$9,000 to \$12,000.

**Openings
in these areas:**

- Circuit Design
- Systems
- Inertial Guidance
- Countermeasures
- Digital Computers
- Test Equipment Design

WRITE TO:

William Spangler, Manager
Professional Employment
Department E-7
The Martin Company
Baltimore 3, Md.

MARTIN
BALTIMORE

PROBLEM:

When a quantizing device is included in a servo feed-back loop, how can servo performance be maintained when the quantized signal varies very slowly?

COMPUTER ENGINEERS

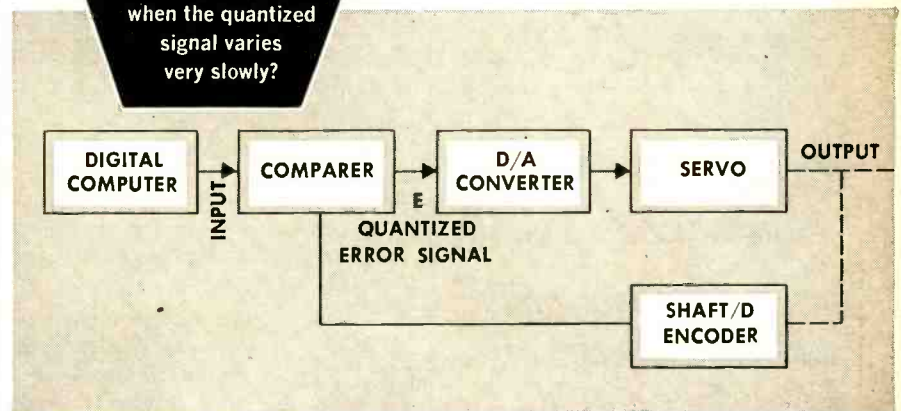

GENERAL ELECTRIC OFFERS EXCEPTIONAL OPPORTUNITY TO THE COMPUTER ENGINEER WHO CAN MEET THESE REQUIREMENTS:

... an engineer qualified by his versatility and experience to act as multi-project advisor in the Ordnance Section of General Electric's Missile & Ordnance Systems Department. A specialist able to determine digital control requirements and specify basic digital systems design for digital computers.

This man will play a key role working with development groups to design computer subsystems for inertial guidance and control elements of TOP PRIORITY WEAPON SYSTEMS. To carry these responsibilities he must have at least 10 years' experience in electronics, plus demonstrated knowledge of military computer applications. Ability to ride herd on development until schematics are translated into functioning hardware is essential to this position.

Specific requirements: BS (EE or Physics) plus design & development experience in pulse and digital circuits, computer logic and memory, transistor circuits, military computer applications, systems philosophy.

Ordnance Section is based in Pittsfield, Mass., heart of the Berkshire summer and winter recreation country.

Send resume in confidence to:

Mr. W. S. Fielding, Ordnance Section, Div. 27-WZ
Missile & Ordnance Systems Dept.

GENERAL ELECTRIC

Pittsfield, Mass.

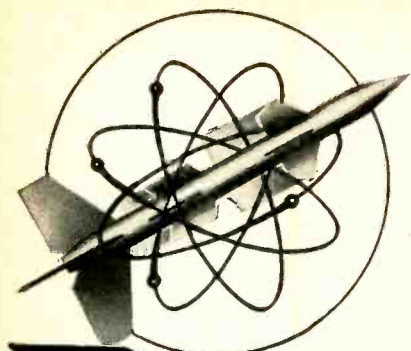

Bendix YORK

offers the opportunity and the challenge of key assignments in...

**GUIDED MISSILE
ELECTRONICS
ELECTRONIC ENG.
MECHANICAL ENG.**

DESIGNERS—DRAFTSMEN

Here is your chance to prove your ability doing *important* work on missile fuzing, guidance, packaging and related test equipment. We have key openings that offer you the opportunity to move ahead rapidly in your profession. At Bendix York, you benefit from the advantages of a small company atmosphere in a growing division of one of the nation's largest engineering and manufacturing corporations. Also, you'll enjoy the "good life" in our beautiful suburban community. Good salaries, all employee benefits.

Drop us a card, briefly stating your education & experience. We'll act immediately to get together with you and talk it over.

ADDRESS:
PROFESSIONAL
PLACEMENT
DEPT. E

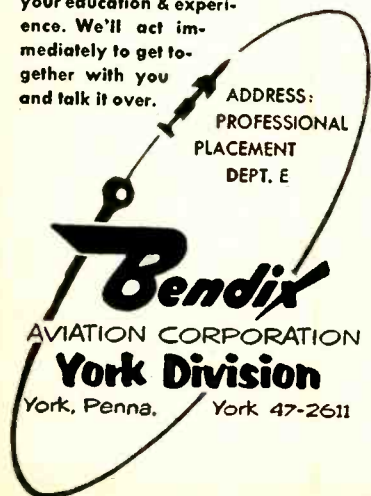

ELECTRONIC ENGINEER

A position tailored to fit the creative man

Is this your idea of a creative assignment?

Solving complex circuit design problems in these fields: electronic missile guidance, memory circuits, digital and analog devices, airborne radar systems—pulse and transistor circuits.

An engineer with the necessary intellectual curiosity and an inventive mind to carry such problems to a successful conclusion can go far at the G-E Light Military Electronic Equipment Department.

Forward your resume in confidence to:

Mr. RICHARD C. KIMM, Room 27-WZ



LIGHT MILITARY ELECTRONIC EQUIPMENT DEPARTMENT

GENERAL ELECTRIC

FRENCH ROAD, UTICA, NEW YORK

RESEARCH PHYSICIST

Ph.D. or equivalent. Man with background in solid state physics for research division of electronics concern.

Excellent salary and working conditions. Submit full details to D. Bellat, Personnel Director.

TUNG-SOL ELECTRIC INC.

200 Bloomfield Avenue, Bloomfield, N. J.

EMPLOYMENT OPPORTUNITY RATES

The Advertisements in this section include all employment opportunities executive, management, technical, selling, office, skilled, manual, etc.

Positions Vacant	Selling Opportunities Wanted	Employment Agencies
Positions Wanted	Selling Opportunities Offered	Employment Services
Part Time Work	Civil Service Opportunities	Labor Bureaus

DISPLAYED

---RATES---

UNDISPLAYED

The advertising rate is \$28.67 per inch for all advertising appearing on other than a contract basis. Contract rates quoted on request.

\$2.40 per line, minimum 3 lines. To figure advance payment count 5 average words as a line. Box Numbers—counts as 1 line.

An advertising inch is measured 7/8" vertically on a column—3 columns—30 inches to a page.

Position Wanted ads are 1/2 of above rate. Discount of 10% if full payment is made in advance for 4 consecutive insertions.

Subject to Agency Commission.

Not subject to Agency Commission.

Send NEW ADS or inquiries to Classified Advertising Division of ELECTRONICS, P. O. Box 12, N. Y. 36, N. Y. for March 14th issue closing Feb. 21st.

ELECTRONIC

WAR TERMINATION INVENTORIES

WRITE OR WIRE FOR INFORMATION ON OUR COMPLETE LINE OF SURPLUS ELECTRONIC COMPONENTS. ALL PRICES NET F.O.B. PASADENA, CALIFORNIA



INVERTERS

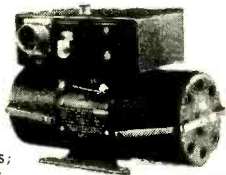

- 10042-1-A Bendix
DC Input 14 volts;
Output: 115 volts;
400 cycles, 1-phase; 50 watt **\$35.00**
- 12116-2-A Bendix
Output: 115 VAC; 400 cyc; single phase; .45 amp. Input: 24 VDC, 5 amps **\$25.00**
- 12117 Bendix
Output: 6 volts; 400 cycles, 6 volt amperes, 1 phase. Input: 24 VDC; 1 amp. **\$15.00**
- 12121 Bendix
Input: 24 volt D.C. 18 amp. 12000 r.p.m.
Output: 115 volts, 400 cycle, 3-phase. 250 volt amp, 7 pf. **\$49.50**
- 12123 Bendix
Output: 115 V; 3 phase; 400 cycle; amps. .5; Input: 24 VDC; 12 amp. **\$49.50**
- 12126-2-A Bendix
Output: 26 volts; 3 phase; 400 cycle; 10 VA; 6 PF. Input: 27.5 volts DC; 1.25 amps. **\$24.50**
- 12142-1-A Bendix
Output: 115 volts, 3 phase, 400 cycle, 250 VA. Input: 27.5 VDC, 22 amps. Voltage and frequency regulated. **\$99.50**
- 12147-1 Pioneer
Output: 115 VAC, 400 cycles; single phase. Input: 24-30 VDC; 8 amps. **\$19.95 each**
- 10285 Leland
Output: 115 volts AC; 750 VA, 3 phase, 400 cycle, .90 pf and 26 volts. 50 VA single phase, 400 cycle, .40 pf. Input: 27.5 VDC, 60 amps. cont. duty, 6000 rpm. Voltage and frequency regulated. **\$59.50**
- 10563 Leland
Output: 115 VAC; 400 cycle; 3-phase; 115 VA; 75 pf. Input: 28.5 VAC; 12 amps. **\$25.00**
- F16 Jack & Heintz
Output: 115 volts, 400 cycle, 1 or 3 phase, 250 VA pf. 9. Input: 27.5 volts, 20 amp. Electronic frequency and voltage regulated. **\$99.50 each**
- PE109 Leland
Output: 115 VAC, 400 cyc.; single phase; 1.53 amp.; 8000 rpm. Input: 13.5 VDC; 29 amp. **\$50.00**
- PE218 Leland
Output: 115 VAC; single phase pf. 90; 380/500 cycle; 1500 VA. Input: 25-28 VDC; 92 amps.; 8000 rpm.; Exc. Volts 27.5 BRAND NEW **\$30.00**
- AN 3499 Eicor, Class "A"
Input: 27.5 volts at 9.2 amps. AC. Output: 115 volts, 400 cycles; 3 phase, 100 voltamp; continuous duty. **Price \$39.50 each**

MG54D BENDIX INVERTER

Output: 200/115 volts; 400 cycle, single or 3 phase; .80 pf, 250 VA. Input: 28 VDC, 22 amps. **\$99.50**

TS148/UP SPECTRUM ANALYZER

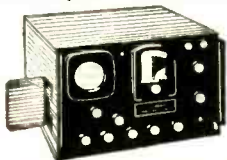

8430-9580 mc. For use with various X-band equipment. New, complete with accessories and carrying case. Limited quantity. **Price \$895.00**

GENERAL ELECTRIC AUTO PILOT DIRECTIONAL gyro INDICATOR and CONTROL UNIT

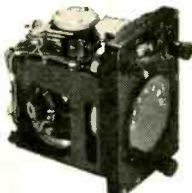

Mod. 8K63AC. 115 volts, 400 cps, 3 phase, 40 watts. Has setback induction pick-off.

Price \$10.00

400 CYCLE, 3 PHASE GENERATOR

BY MASTER ELECTRIC

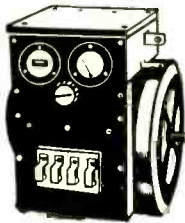

Type AG, frame 364Y, 7.5 kw, 3428 rpm, pf .95. Star connected 120/208 3 phase 22 amps. Delta connected 120 volt single phase 66 amps. Self excited. Complete with control box, voltage regulator, AC voltmeter and frequency meter. Shaft 1" dia., 2" long; overall dim. of unit: 21"x18"x20".

Price \$395.00 each

SELSYNS-SYNCHROS



- 1CT cont. Trans 90/55V 60 cy. **\$34.50**
- 1DG Diff. Gen. 90/90V 60 cy. **34.50**
- 1F Syn. Mtr. 115/90V 60 cy. **34.50**
- 1G Gen. 115V 60 cy. **37.50**
- 1HDG **37.50**
- 1HCT **37.50**
- 1HG **37.50**
- 1SF Syn. Mtr. 115/90V 400 cy. **12.50**
- 2J1F1 Gen. 115/57.5V 400 cy. **7.50**
- 2J1F3 Gen. 115/57.5V 400 cy. **10.00**
- 2J1FA1 Gen. 115/57.5V 400 cy. **7.50**
- 2J1G1 57.5/57.5V 400 cy. **5.00**
- 2J1H1 Diff. Gen. 57.5V 400 cy. **7.50**
- 2J5D1 Cont. Trans. 105/55V 60 cy. **17.50**
- 2J5F1 Cont. Trans. 105/55V 60 cy. **17.50**
- 2J5H1 Gen. 115/105V 60 cy. **17.50**
- 2J15M1 Gen. 115/57.5V 400 cy. **17.50**
- 5CT Cont. Trans. 90/55V 60 cy. **34.50**
- 5D Diff. Mtr. 90/90V 60 cy. **34.50**
- 5ODG Diff. Gen. 90/90V 60 cy. **34.50**
- 5F Syn. Mtr. 115/90VAC 60 cy. **34.50**
- 5G Syn. Gen. 115/90VAC 60 cy. **34.50**
- 5HCT Cont. Trans. 90/55V 60 cy. **37.50**
- 5SDG Diff. Gen. 90/90V 400 cy. **12.50**
- 6G Diff. Gen. 90/90V 60 cy. **25.00**
- 6G Syn. Gen. 115/90VAC 60 cy. **34.50**
- 7G Syn. Gen. 115/90VAC 60 cy. **42.50**
- C56701 Type 11-4 Rep. 115V 60 cy. **20.00**
- C69405-2 Type 1-1 Transm. 115V 60 cy. **20.00**
- C69406 Syn. Transm. 115V 60 cy. **20.00**
- C69406-1 Type 11-2 Rep. 115V 60 cy. **20.00**
- C76166 Volt. Rec. 115V 60 cy. **10.00**
- C78248 Syn. Transm. 115V 60 cy. **12.50**
- C78249 Syn. Diff. 115V 60 cy. **5.00**
- C78863 Repeater 115V 60 cy. **7.50**
- C79331 Transm. Type 1-4 115V 60 cy. **20.00**
- 851 Bendix Autosyn Mtr. 22V 60 cy. **7.50**
- 403 Kollsman Autosyn. Mtr. 32V 60 cy. **7.50**
- FPE-25-11 Diehl Servo Mfr. **19.50**
- 75/115V 60 cy. **19.50**
- FPE-43-1 Resolver 400 cy. **15.00**
- FJE-43-9 Resolver 115V 400 cy. **15.00**

HONEYWELL VERTICAL GYRO MODEL JG7003A-1

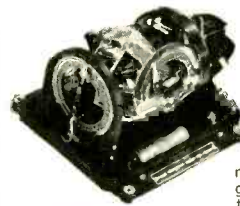

115 volts, 400 cycles, single phase, 35 watts. Pitch and roll potentiometer pick offs 890 ohms, 40 volts max. AC or DC. Speed 20,000 rpm, ang. momentum 12,500,000 gm-cm²/sec. Erection system 27 VAC, 400 cycles, time 5 min. to 1/2°. Weight 5.5 lbs.

Price \$35.00 each

HIGH-QUALITY OPTICAL PARTS

5" Schmidt Ultra Hi-Speed Objective Lens System



Eastman Kodak infra-red receiver, formerly known as U.S. Navy Metascope, Type B, 7" long with 5" SCHMIDT ultra-high speed Objective Lens (approx. f 0.5). Elaborate optical system, many coated lenses. Uses 2 penlight batteries. Govt. cost approx. \$300. Factory-new. Shipping wt. 9 lbs. **Price \$19.95**
Waterproof Carrying Case, extra. Shipping wt. 3 lbs. **Price \$3.00**
Dual purpose U.S.N. floodlight throws strong beam of invisible infra-red rays. With infra-red lens, spare sealed beam lamp, batteries. Shipping wt. 23 lbs. **Price \$14.95**

DIFFERENTIAL



Size 2 1/8" long, 1 1/8" dia. 1-1 reverse ratio. 1/4" shaft on each end; one shaft 25/32" long, one shaft 15/32" long. Input and output gear 1-23.32" dia. 53 teeth. Stock No. 150 **\$3.50 ea.**

SIMPLE DIFFERENTIAL

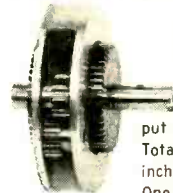

1 to 1 reverse ratio; 48 teeth on input and output gear, 1-1/32 inch diameter. Total outside diameter 1-25/32 inches. Shaft size is 1/4 inch. One shaft is 9/16" long; other

Stock No. 151 shaft is 3/16" long. **\$5.00**

VARIABLE SPEED BALL DISC INTEGRATORS

No. 145

Forward & Reverse 2 1/4-0-2 1/4. Input shaft spline gear 12 teeth 9/32" dia. 3/8" long. Output shaft 15/64" dia. x 15/32" long. Control shaft 11/32" x 3/8" long. Cast aluminum construction. Approx. size 3" x 3" x 2 3/4".

No. 146

Forward & Reverse 4-0-4. Input shaft 5/16" dia. x 3/4" long. Output shaft 15/64" dia. x 9/16" long. Control shaft 11/64" dia. x 11/16" long. Cast aluminum construction. Approx. size 4 1/2" x 4 1/2" x 4". **\$17.50 ea.**

(All Shafts Ball Bearing Supported)

SMALL DC MOTORS



- (approx. size overall 3 3/4" x 1 1/4" dia. :)
- 5067126 Delco PM, 27 VDC, 125 RPM, Governor Controlled **\$15.00 ea.**
- 5069600 Delco PM 27.5 VDC 250 rpm **12.50**
- 5069230 Delco PM 27.5 VDC 145 rpm **15.00**
- 5068750 Delco 27.5 VDC 160 rpm w. brake **6.50**
- 5068571 Delco PM 27.5 VDC 10,000 rpm (1x1x2") **5.00**
- 5069790 Delco PM, 27 VDC, 100 RPM, Governor Controlled **15.00 ea.**
- 5BA10A118 GE 24 VDC 110 rpm **10.00**
- 5BA10AJ37 GE 27 VDC 250 rpm reversible **10.00**
- 5BA10AJ52 27 VDC 145 rpm reversible **12.50**
- 5BA10AJ50, G.E., 12 VDC, 140 rpm **15.00**
- 206-1001 PM Planetary Gear Reduced Motor with Magnetic Brake. Mfgd. by Air Equipment 26 volts 600 ma 145 rpm **17.50**
- 5BA10FJ33, G.E., 12 VDC, 56 rpm reversible **15.00**
- 806069 Oster series reversible 1/50 h.p. 10,000 rpm. 27.5 VDC 1 5/8" x 3/2" **5.00**
- C-28P-1A 27 VDC 1/100 h.p. 7,000 rpm **3.00**
- 7100-B-PM Hansen 24 VDC 160 rpm **7.50**
- SSFD-6-25 Diehl PM 27.5 VDC 10,000 rpm 6-volt PM motor mfgd. by Hansen 5,000 rpm 1 1/4" in dia., 2" long overall **4.00**

Radalab INC.

87-17 124th St., Richmond Hill 18, N. Y.
Phone Virginia 9-8181-2-3

Overseas Customers Call Us Directly By
Telex Overseas Teletype TWX N. Y. 4-4361

ARC-12

This set provides Radio Telephone Communications in the frequency range of 225-350 MC. Provision is made for remote selection of any of the pre-determined main channel frequencies, or a guard channel frequency. Input voltage 24v DC. Receiver and Transmitter crystal controlled. Complete installations available. PDR

EE-94-95

CODE PRACTICE EQUIPMENT

This is 20 and 40 man code practice set. This equipment is a complete setup for a school to teach Morse Code up to 100 WPM. The set consists of a recorder, turntable, switchboard, TG-34 keys, code keys, headsets, clock, timer, wire record set, oscillator, etc. We can supply this set from a current production contract. Write.

SCR-399-499

This is a high power, transportable communications center. This set may be mounted in a shelter type HO-17. Frequency coverage is 1.5 to 18 MC. Power output 300 watts, either phone or CW operation may be used. Receivers are also included with this set. Gasoline power plants are also available to run this set in the field. Sets ready for immediate shipment. PDR.

VHF RADAR LINK

The ART-23 is an air to ground and ground to ground and air to air VHF radar relay link set. The set operates on a freq. range of 78-102 mc. This equipment will accept video, synch pulses from an airborne or ground radar and relay them to the SRR-1 receiving equipment to be displayed on a remote radar indicator such as the VE, VE, VG, etc. The set will transmit a band width of 300 cyc to 2 mc. The power output of the transmitter is 100 watts and has a range of app. 150 miles. This is the type of equipment used in the radar picket planes to relay information to a ground station. The ART-23 operates from 110v 400 cyc. The SRR-1 input is 110v 60 cyc. Write for prices.

COUNTER MEASURES EQUIPMENT

SEARCH DETECTION

AN/APR-4 38-4000 MC RDO 38-4000 MC
AN/APR-2 300 1000 MC SCR-616 145-600 MC
AN/APR-5 1000-3100 MC
AN/APR-6 1,000-10,000 MC

DIRECTION FINDING

AN/APA-17 300-10,000 MC
AN/APA-24 100-750 MC
AN/APA-18 140-300 MC

PANORAMIC AND PULSE ANALYZING

AN/APA-6 Pulse Analyzing
AN/APA-11 Pulse Analyzing
AN/APA-10 Panadapter
AN/APA-38 Panadapter
AN/ARQ-5 18-80 MC Receiver Indicator
AN/ARQ 8 25-105 MC Barfate Rec-Trans Indicator
AN/ARQ-10 1.5 MC-50 MC Receiver-Trans. Jammer Indicator
AN/ARQ-1 Thru 12 also avail.
AN/APA-23 Signal and Time Recorder

NOISE GENERATORS

AN/URA-T1 AN/URA-2T MD-4/URA
Shot-Noise, Bagpipes, Tone, Random Keying, Output.
These units will key any transmitter.

JAMMER TRANSMITTERS

AN/APT-1 thru 10 25-3,000 MC AN/APQ-15
AN/APQ-1 thru 20
AN/SPT-Series
SCR-596 1.5-30 MC Barrage Ground Jammer
TDY, MRQ, SPT, SPQ, TPQ, IAN/UPT-T1, T3, T4
Many other countermeasures equipments avail. both hi and low power. These equipments can be used to test new radar and computer systems for susceptibility to jamming and other countermeasures. We can supply complete setups covering any freq. from 100 KC 10,000 MC, with power supplies for mobile operation.

• RADALAB • RADALAB •

3" Round Elapsed Time Meter

\$12 75



WESTON PHOTRONIC CELL.....\$4.50

PHOTO ELECTRIC Switch
Darkness throws the switch
—turns light on at dusk...
off at dawn. Pools burglars
who watch for signs of an
empty house. \$10 94

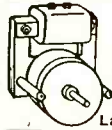

TELECHRON Motors

1 RPM\$3.95 60 RPM ...\$4.85
2 RPM 2.90 3 RPHr ... 2.85
4 RPM 3.90 1 RP2Hr... 2.80
3.6 RPM... 3.15 1 RP12Hr... 3.25

1 RPM—50 Cycles, \$1.85
Laboratory Special 1 of Each Motor \$25

D-E-L-A-Y-E-D A-C-T-I-O-N LIGHT SWITCH
Shuts light off automatically almost a minute later.
Keeps porch or garage light on after you shut it off.
\$3.50

DEALERS WRITE FOR PRICES

GLEASON-AVERY

1800 synchronous motor

115v 18 watt\$4.50
same motor 8 RPM..... 8.50

HAYDON TIMING MOTORS



1 Rev 4 hours 115v.....\$1.70
1 RPM 115v 60cy..... 2.60
1 RPM 230v 60 cy..... 1.00
2 RPM 230v 60 cy..... 1.00
3 RPM 115v 60 cy..... 2.60
30 RPM 115v 60 cy..... 2.60
450 RPM 115v 60 cy..... 1.30
HANSEN 4RPM 115v 60cy. 4.24
CRAMER 4 RPM 115v 60 cy. 4.65
Laboratory special 1 of each motor.....\$16.50

RELAY CONTACT BURNISHERS .59—2 for \$1.00

PM MOTORS

Made by
DELCO or DIEHL \$375
Removed from equipment



INCLUDE
POSTAGE
64 C Dey St.
New York 7,
N. Y.

BLAN
EST. 1923

LEGRI S COMPANY

WANT TO BUY

ALLEN—BRADLEY

RESISTORS & POTENTIOMETERS

all your excess at highest prices

SUBMIT your OFFERING directly to

LEGRI S. COMPANY

391 RIVERDALE AVE.

YONKERS 5, N. Y.

Phone: Yonkers 9-6000

Your inquiry

will have special value . . .

if you mention this magazine, when writing advertisers. Naturally, the publishing will appreciate it . . . but more important, it will identify you as one of the men the advertiser wants to reach with his message & help to make possible enlarged future service.

SCR 584 ANTENNA PEDESTALS

Complete 360° azimuth & full elevation sky sweep (210°). Fully equipped with azimuth & elevation motors, potentiometers, selsyns, and amplidyne. The ideal antenna system for sky sweeping, tracking, telemetering.

In Excellent Condition. Delivery from Stock. An outstanding buy at our special price. Control consoles also in stock. Complete details in McGraw-Hill MIT Radiation Lab Series, Vol 1 Radar System Engineering & Vol 26 Radar Scanners & Radomes.

**RADIO RESEARCH
INSTRUMENT CO.**

550
FIFTH AVE.
NEW YORK
JUDSON
6-4691

PROFESSIONAL SERVICES

AMERICAN GEOPHYSICAL & INSTRUMENT CO.

Oliver W. Osborne
Design & Development Of Electrical
Instruments

Repairing All Types of Electronic Equipment
1723 Market Street Gardena, Calif.
DAVIS 3-7387 DAVIS 4-4858

CROSBY LABORATORIES, INC.

Murray G. Crosby & Staff

Radio - Electronics
Research Development & Manufacturing
Communications, FM & TV
Robbins Lane, Hicksville, N. Y.
WELLS 1-3191

ELECTRONIC RESEARCH ASSOCIATES, INC.

"TRANSISTORIZE" YOUR PRODUCT!
Complete Service in consulting, research, develop-
ment, and production on Transistor circuitry,
products and instrumentation.
67 Factory Place Cedar Groove, N. J.
CEnter 9-3000

ERCO RADIO LABORATORIES, INC.

Radio Communications Equipment
Engineering - Design - Development - Production
Our 27th Year in Air to Ground
Communication and Radio Beacons
Garden City • Long Island • New York

MEASUREMENTS CORPORATION

Research & Manufacturing Engineers

Harry W. Houck
Specialist in the Design and
Development of Electronic Test Instruments
Boonton, New Jersey

ALBERT PREISMAN

Consulting Engineer
Television, Pulse Techniques, Video
Amplifiers, Patent technical consultation.
616 St. Andrews Lane, Silver Spring, Maryland

YARDNEY LABORATORIES, Inc.

Research-Design-Development

Electro-Chemical Generators of Energy
40-48 Leonard Street Worth 6-3100
New York 13, N. Y.

MICROWAVE CAVITY

Receiver front and cavity resonator: Tunes 2700 to 3400 mc with a loaded Q of 3000 50-ohm, type N input. Video output from 1X27 crystal. May be used at quarter wave (1.1 to 1.4 knee). **\$22.50**



SPECIAL VALUES!!

- BC 911, dual coax. switch. With British connectors. Useful up to 400 mc. \$2.50
- 90 deg elbows, "L" Band, with flanges. "H" Plane \$18.55
- Armatures for 1D86 dynamos \$2.50
- Antenna Strain Insulators; Johnson #136-151. . . \$2.00
- Sawtooth potentiometer, W. E. #K5133810-1. 100 ohms, 5.76 Watt. Delivers sawtooth current waveform 360 deg. contin. rotation. Brushes 180 deg. apart \$2.50
- Capacitor, GE Pyranol, #14F103. 0.25 mfd/25,000 vdc \$18.95
- Receiver front end cavity resonator: Tunes 2700 to 3400 mc with a loaded Q of 3000 50-ohm, type N input. Video output from 1X27 crystal. May be used at quarter wave (1.1 to 1.4 knee). \$22.50
- 10 CM ANTENNA ASSY. (Airborne). 30" dish with coax. dipole feed. Focal length is 10 1/2" Horiz. polarization, 350 deg. azimuth. Tilt: plus and minus 20 deg. 28 vdc drive motor, selsyn takeoff. . . \$65.00
- CRYSTAL OVEN. B illey #TVO 215. Local base, with provision for 2 crystals, 6.5V heater 75 deg. Cent. \$2.50
- COAX. SWITCH, 4 pos. 52 ohms imp. Fitted with type N connectors. Useful up to 3,000 mc. \$17.50
- FILTER, Artificial Line; WECO D163169, 650 ohms imp. insertion loss: 5 db. \$17.50
- Bary shock mounts: nos. 2045, C-2060, C-2070, C-2080 \$4.50 ea.
- Trihedral radar reflector, MK-1 aluminum. . . . \$3.50
- SPLICER, for 11/16 perforator tape WECO #X-61859 list 20 SCS #4TW 61859-20. Complete set, with number tape dispenser. \$8.50
- MN 28Y Control box, unit of MN 26 compass. New \$3.75
- Noise filters, Mallory NF-1, 100 amp/55vdc. . . \$1.00
- Power supply unit, navy type #1-2. Input: 115 vac. 60 cy. Output: 135 vdc/10 ma. 90 vdc/5ma; 3 vdc/360 ma. New, complete with spare parts box. To be used with model TBX radio gear. \$9.50
- Hydrophone MODEL M1-2. A lattice of 3 crystals in a disk-like structure; 17-37 Kc. \$27.50
- AN/CRW-2A Remote control receiver, for operating target planes, etc. New, with soundproof mounting box \$34.50
- TEL. REPEATER, EE 89, complete with tubes and tech. manual \$17.50
- TEL. REPEATER, EE 99, with 12 vdc. vibrator power supply (PE 204) \$49.50
- F.T.&R. 101-A. Two-wire applique, contains equalizing devices, and balancing circuit. Used for adapting 2-wire military circuits to 4-wire systems. \$47.50

WAVEGUIDE FLANGES

UG 39/U	\$1.20	UG 51/U	\$1.85
UG 40/U	\$1.65	UG 52/U	\$3.40
UG 40A/U	\$2.00	UG 52A/U	\$3.40

HELMHOLTZ PHASE-SHIFTER

Stator consists of 4 loops oriented at 90 degrees to each other. Total stator inductance is 40MIL. Rotor: 10MIL. Total phase shift: 0-360 deg. Designed for range unit of SCR-268 **\$2.50**

COMMUNICATIONS EQUIPMENT CO.

343 Canal St.
New York 13, N. Y.
CHAS. ROSEN
Phone: CAanal 6-4882

DIRECT ALL INQUIRIES TO DEPT. E7

MICROWAVE ANTENNAS

- AT49/APR—Broadband Conical, 300-3300 MC. \$8.95
- 3 CM ANTENNA ASSEMBLY: Uses 17" paraboloid dish, operating from 24 vdc motor. Beam pattern; 5 deg. in both Azimuth and elevation. Sector Scan; over 100 deg. at 35 scans per minute. Elevation Scan; over 2 deg. Tilt. Over 24 deg. \$35.00
- 3 cm Horn, 17" x 1/2", with twist and 180 deg. bend. With dielectric window \$22.50
- Discone Antenna, AS 125 APR, 1000-3200 mc. Stub supported with type "N" Connector. \$14.50
- AS14A/AP, 10 CM pick up dipole assy, complete w/ length of coax and "N" connectors. \$4.50
- 30" Parabolic Reflector Scan Aluminum dish 10 1/2" Focus \$4.85
- AN/APA-12—Sector Scan adaptor for APS-2 radar—Complete Kit \$37.50
- 10 CM. ANTENNA ASSY. (Airborne). 30" dish with coax. dipole feed. Focal length is 10 1/2" Horiz polarization, 350 deg. azimuth. Tilt: plus and minus 20 deg. 28 vdc drive motor, selsyn takeoff. \$65.00

MICROWAVE MAGNETRONS

2121A	\$3.50	2137	\$9.00	2162	\$3.00
2122	\$7.50	2138	\$12.50	725A	\$5.00
2126	\$5.50	2139	\$12.95	QK60	\$19.50
2127	\$3.50	2149	\$30.00	QK61	\$18.95
2131	\$12.50	2161	\$8.25	QK62	\$18.00

MEDIUM POWER PULSER

The MIT MOD III PULSER is a lightweight, medium power radar modulator using an 829 B in a regenerative blocking oscillator circuit feeding a 715B power amplifier. Peak output is 12 KV at 12 Amps into a 0.5/1.0/2usec. at a 1000 ohm load. Pulse widths are duty ratio of 0.001. Primary power requirements are: 115 vac 400-1200 cps/3.5A. Also 28 vdc at 5 Amp. An external trigger of at least 50 v. peak is required. All units are new, complete with all tubes, pressurized housing, and schematic diagram (Refer to RadLab Series, Vol. 5, Sec. 5.1) **\$97.50**

PULSE TRANSFORMERS

- 352-7150, Primary 50 ohms. Secondary 1000 ohms. 12,000V, 12.0 Amp Pulse; 1 or 2 usec. at .001 duty ratio. Fitted with magnetron well and bifilar winding for filament supply. \$22.50
- K-2745 Primary: 3.1/2.8 KV, 50 ohms Z Secondary: 14/12.6 KV 1025 ohms Z. Pulse length: 0.25/1.0 usec @ 600/600 PPS. Pk Power: 200/150 KW. Bifilar 1.3 Amp. Has "built-in" magnetron well. \$32.50
- K-2461-A Primary: 3.1/2.8 KV—50 ohms (line). Secondary 14/11.5 KV—1000 ohms Z. Pulse length: 1 usec @ 600 PPS. Pk. Power Out: 200/130 KW. Bifilar 1.3 Amp. Fitted with magnetron well. \$29.50
- GE #K-2449A. Primary: 9.33 KV, 50 ohms imp. Secondary: 28 KV, 450 ohms. Pulse length: 1.05/5 usec @ 635,120 PPS. Pk Power Out: 1,740 KW. Bifilar 1.5 amps (as shown) \$52.50
- GE #K-2748-A, 0.5 usec @ 2000 Pps. Pk. 1/2w. out is 32 KW impedance 40:100 ohm output. Trt. volts 2.3 KV Pk. Sec. volts 11.5 KV Pk. Bifilar rated at 1.3 Amp. Fitted with magnetron well. \$24.50



I. F. AMPLIFIER STRIPS

- Model 15; 30 mc center freq. B.W. 2.5mc. Gain: 65db. Uses 3 stages of 6AC7. Has DC restorer and video detector. Input impedance: 50 ohms. Less tubes. **\$15.00**
- 30 Mc. IF strip. Uses 6-6AC7. Bandwidth is 2mc Gain: 120 db. New, complete with all tubes and schematic. \$18.50
- 60 MC. Miniature IF strip, using 6AK5's 60 Mc center Freq. Gain: 95 db at Bandwidth of 2.7 Mc. New. Complete with tubes \$15.00

10 CM ANTENNA

Beacon antenna, AS81/A1N-7. Omni-directional. Radiating surface enclosed in weather proof lucite ball. Type "N" feed **\$12.50**



LARGEST STOCK OF RELAYS

IN THE WORLD

SOLENOIDS • STEPPERS SENSITROLS

PRODUCTION QUANTITIES MOST MAKES IN STOCK

Send for Latest Catalog E

Universal RELAY CORP.
Formerly Universal General Corp.

42 WHITE ST., NEW YORK 13, N. Y. • Walker 5-9257

BEARINGS —

Miniatures; Precision; Stainless Steel; Special Sizes, Tolerance & Construction.

RAWAY BEARING CO.

4-8 Forsythe St. Walker 5-8150 N. Y. C. 2, N. Y.

Money saving prices on tubes. TV, Radio, Transmitting, and Industrial Types. New, list quality, guaranteed. Top name brands only. Government surplus and commercial test, lab, and communications equipment in stock. Sell us your excess tubes and equipment. Unused, clean tubes of all types wanted. Send specific details in first letter. Write for "Green Sheet" catalog 25c.

BARRY ELECTRONICS CORP.

512 Broadway WA 5-7000 New York 12, N. Y.

NEED METERS? STANDARD or SPECIALS

ANY QUANTITY—NEW—MILITARY

FOR ELECTRONIC—MILITARY AIRCRAFT—HAMS

ALL MAKES—MODELS RANGES—SIZES

METERS REPAIRED RESCALED RECALIBRATED

WRITE - PHONE - WIRE

A & M INSTRUMENT SERVICE INC.

76-14 Woodside Ave.

Elmhurst 73, N. Y.

CAA No. 4264 Ltd. HA 9-2925

HARRY KRANTZ CO.

the largest RESISTOR stock in the Country

Tremendous Quantities—1/2, 1 & 2 W. 40 to 70% off mfg. prices

89 Chambers St., N. Y. C. 13 WO 2-5727

V. H. F. U. H. F.

RDO RECEIVER

38 MC to 1000 MC precision Receiver covering complete range using 3 tuning units. The RDO is a high quality Navy search receiver using the same tuning units as the APR-4, but has additional features, such as input and output signal strength DB meters, audio output metering, noise limiter, greater stability, for noise measuring etc. Input 10V60CYC. Panadaptor output avail. Complete W/3 tuning units. **\$159.50**

Brand new, original boxes.

Govt. acq. cost. \$1500.00

HEADPHONES-MIKES-CORDS

Permo Flux \$45.00 HI-FI Headset—Uses annular grooved plastic fibre comes with voice coils as in speakers, and brand new rubber ear pads to obtain spacing for correct acoustical load. GIVES FINEST MUSIC REPRODUCTIONS! Imp: 300 Ohms per unit or 600 Ohms when wire series. **\$9.95**

BRAND NEW \$9.95

Less Head Band. \$6.95

Write for flyer.

R. W. ELECTRONICS

Dept. L.

2430 S. Michigan Ave. Chicago 16, Ill.



HIGH POWER RADAR MODULATOR

27.5-KV AT 46 AMPS

Line type using (2) 5C22 hydrogen thyratron keyers with driver stages and power supply. Primary of high voltage transformer tapped for adjustment of output pulse amplitude. Pulse width of 4.5 microseconds at rep rate of 200 pps. Modulator output voltage is approximately 5 kv. This is stepped up by matching pulse transformer (which is included) to approximately 27.5 kv, pulse transformer has bi-filer windings for 2.2 amp filament (filament transformer not included). This modulator was used with a type 5J26 magnetron with 400 kw output at 1,200 mc. These units are in excellent condition and all components are fully guaranteed. Input requirements: 115/1/400. Matching pulse transformer and schematic diagram. We can also supply 115/1/400 generators! **All for \$450.00**

ANTENNA ROTATING PEDESTAL

U. S. Army type AB-8A/GP. Removed from model MPG-1 radar systems. These pedestals will handle a tremendous rotating load. On the MPG-1 system the rotating antenna weight is over 1,000 pounds, with a cross sectional area of approximately 50 square feet. Rotating motor is 115 volts d.c. reversible. (MPG system used and amplidyne for varying speed and direction) antenna rotating speed is approximately 3.3 r.p.m. 51 contacts are transmitted through the slip ring assembly plus a rotary joint for 4 kv. Pulse line (present wiring utilizes 40 wires, 4-75 ohm CO-AX cables and 48 ohm pulse cable) azimuth information output size "5" Selsyn generators 1:1 36:1 and control transformer 1:1. **(Used-Good) \$450.00**



RADAR OR COMMUNICATIONS VAN

Front wheels removable for conversion to semi-trailer. Overall length: 240", width: 96", height: 130". Two rear wheels open to full width and height. Manufactured by Fruehauf. Internal wiring for 115/1/60 and 24 volts d.c. Extremely heavy duty. Maximum pay load: 14,000 pounds. Excellent for field electronic use. **(Used-extremely serviceable) \$995.00**

LABORATORY X-BAND RECEIVER (8500-9600 MC.)

This receiver is ideally suited as a general purpose laboratory test receiver. It is completely self-contained and requires no external controls. Waveguide input and output is type RG-52 (1/2" x 1"). Duplexing normally used with 40 kw magnetron (2J51) however, TR and ATR boxes are rated to 100 kw. I.F. frequency: 30 megacycles, band width: 10 megacycles, A.F.C., built-in crystal meter and 2" A-scope. Provisions for external S.T.C. This unit has provisions for remote or local control of all functions. Power input: 115/1/60. All units are checked out and in excellent condition. Model #R-115/MPG-1 (including schematic diagram) **\$295.00**



**RADAR DIVISION
RAMAGE & MILLER
ENTERPRISES**

3221 FLORIDA AVE.
RICHMOND, CALIF.
PHONE 8Eacon 4-7061

MERCURY PULSE DELAY LINES

4400 microsecond delay, band width of at least 500 k.c. at 8.2 megacycles. Overall insertion loss of less than 80 db. Utilizing crystal transducers. With input and output via B.N.C. connectors. These units were removed from new equipment. Each unit contains 32 pounds of mercury. **\$195.00**

TERMS: 2% 10 DAYS NET 30 F.O.B. RICHMOND, CALIFORNIA
This is a partial listing. Please write for our flyer.

SEARCHLIGHT EQUIPMENT SPOTTING SERVICE

This service is aimed at helping you, the reader of "SEARCHLIGHT", to locate surplus new and used electronic equipment and components not currently advertised. (This service is for USER-BUYERS only) No charge or obligation.

How to use: Check the dealer ads to see if what you want is not currently advertised. If not, send us the specifications of the equipment wanted on the coupon below, or on your own company letterhead to:

**SEARCHLIGHT EQUIPMENT
SPOTTING SERVICE**

**Electronics
Classified Advertising Division
P.O. Box 12, N.Y. 36, N.Y.**

Your requirements will be brought promptly to the attention of the equipment dealers advertising in this section. You will receive replies directly from them.

Searchlight Equipment Spotting Service
c/o Classified Advertising, ELECTRONICS
P. O. Box 12, N. Y. 36, N. Y.

Please help us locate the following equipment:

.....

 NAME TITLE
 COMPANY
 STREET
 CITY ZONE STATE

T/I diffused silicon

0.3 μ sec recovery time to 400 k

200 VOLT computer diodes

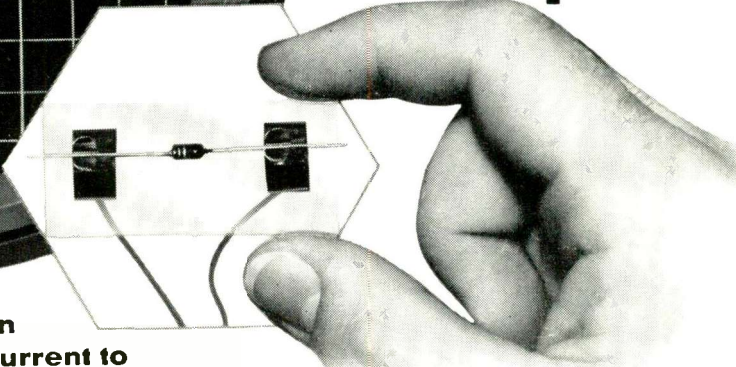
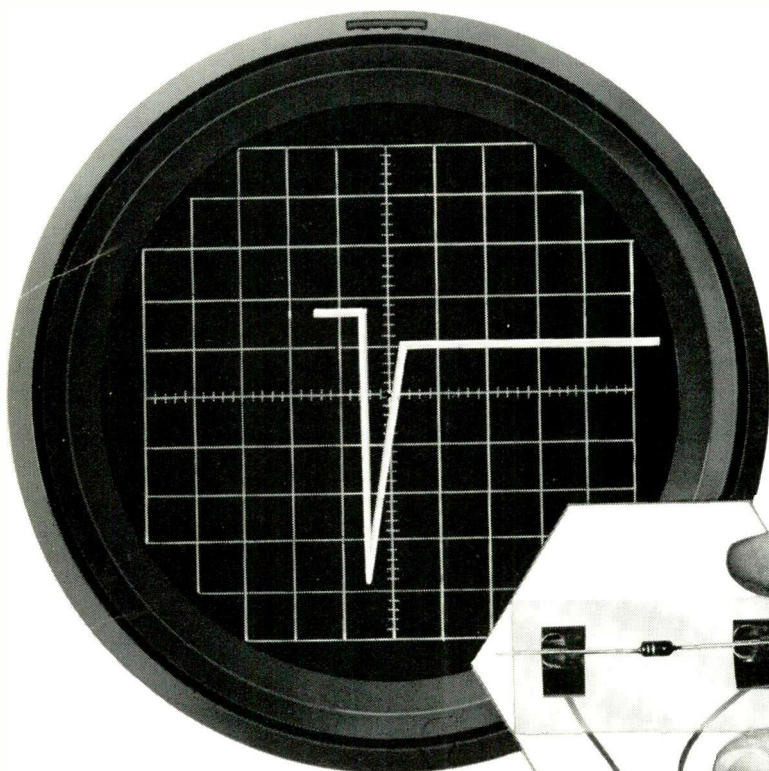

Recovery time to 400 K when switched from 30 mA forward current to -35 V measured in JAN 256 circuit.

(ACTUAL SIZE)

cutaway view of TI glass diode

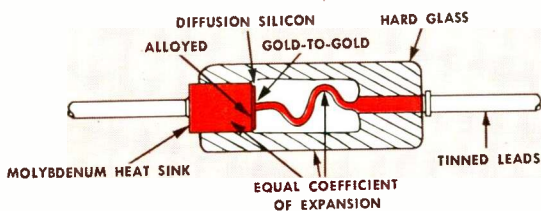

TI diffused silicon computer diodes give you 0.3 μ sec maximum recovery time at 400 K with PIV ratings to 200 volts.

For your computer applications, TI hard glass diodes provide 100 mA average rectified forward current at 25°C. All units are rated to meet military requirements, and provide fast recovery, higher conductance ratings, and shock-proof reliability.

Check the characteristics below and specify TI diodes for all your computer applications.

Also in this same glass package,
TI general purpose diodes

max ratings	1N645	1N646	1N647	1N648	1N649	
PIV.....	225	300	400	500	600	V
I _O	400	400	400	400	400	mA
I ₀	150	150	150	150	150	mA
i _p	1.25	1.25	1.25	1.25	1.25	amp
P.....	600	600	600	600	600	mW
I _{DC}	3	3	3	3	3	Amp
T _A	-65 to +150					°C
specifications						
V _Z	275	360	480	600	720	V
I _{Lb}	0.2	0.2	0.2	0.2	0.2	μ A
I _{Lb}	15	15	20	20	25	μ A
E _b	1.0	1.0	1.0	1.0	1.0	V
C.....	9	9	9	9	9	μ f

maximum ratings

	1N659	1N660	1N661	
Peak Inverse Voltage at -65 to +150°C.....	50	100	200	V
Average Rectified Forward Current at +25°C.....	100	100	100	mA
Average Rectified Forward Current at +150°C.....	30	30	30	mA
Recurrent Peak Forward Current at +25°C.....	320	320	320	mA
Operating Temperature, Ambient.....	-65 to +150			°C
Altitude.....	100,000			ft

specifications

	1N659	1N660	1N661	
Minimum Breakdown Voltage at +100°C.....	60	120	240	V
Maximum Reverse Current at PIV at +25°C.....	5	5	10	μ A
Maximum Reverse Current at PIV at +100°C.....	25	50	100	μ A
Maximum Voltage Drop at I _O = 6mA at 25°C.....	1	1	1	V
Maximum Reverse Recovery Time*.....	0.3	0.3	0.3	μ sec
Typical Capacitance at -10V at 1 mc.....	2.7	2.7	2.7	μ f

Recovery time to 400K when switched from 30 mA forward current to -35V. Measurement made with a Hauman ND-1 standard pulse recovery test set approved by JETEC-14 and described in JAN-256.

TEXAS INSTRUMENTS SALES OFFICES

DALLAS • NEW YORK • CHICAGO • LOS ANGELES
 CAMDEN • DAYTON • DENVER
 DETROIT • OTTAWA • SYRACUSE • SAN DIEGO
 WALTHAM • WASHINGTON D. C.



TEXAS INSTRUMENTS
 INCORPORATED
 SEMICONDUCTOR - COMPONENTS DIVISION
 POST OFFICE BOX 312 • DALLAS, TEXAS

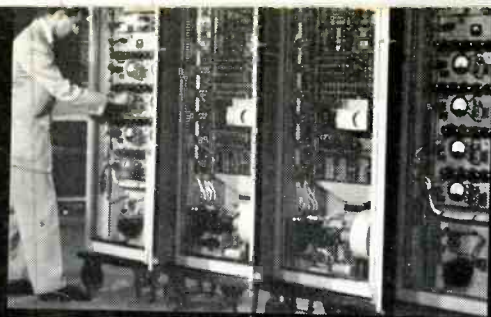

Lewyt Coordinate Data Transmission equipments for SAGE uses RCA Radechons.

RCA-6499 RADECHON: Charge Storage Tube; Single-Beam, Barrier-Grid Type; Non-Equilibrium Writing and Capacitance-Discharge Reading. One of a line of RCA Radechons.



5 ways RCA RADECHONS handle electronic data... *effectively*

Can you name more?

Designed to "take in" electronic data—store it from microseconds to minutes—then release the information at the same rate or at different rates, RCA Radechons can play a key role in electronic data-processing systems for industry and the military.

Read what these remarkable RCA Radechons can do for you—and how they do it:



IN DIGITAL DATA STORAGE SYSTEMS, the Radechon acts as a high-speed, random-access, high-capacity memory element.



IN TIME-BASE CONVERSION APPLICATIONS, the Radechon releases a stored signal at a rate different

from the input rate—as may be required in systems for the transmission of video signals over telephone lines, or in certain systems involving audio-signal multiplexing.



IN SIGNAL DELAY APPLICATIONS, the Radechon stores a signal burst—then releases it after delay periods from microseconds to minutes.



IN RADAR SYSTEMS, the Radechon offers better radar signal "detectability"—through charge integration in the storage element.



IN FIXED-SIGNAL CANCELLATION APPLICATIONS, the Radechon compares successive signals. Originally designed for "line-by-line" Moving Target

Indicators, the Radechon also can be used in "area" MTI systems.

If you are working with these or other Radechon applications, get in touch with the RCA Field Representative at our office nearest you. Remember, RCA is the world leader in Radechon engineering, development, and manufacturing—and welcomes inquiries for Radechon designs to meet specific needs.

Industrial Products Sales

744 Broad Street, Newark 2, N. J.
HUmboldt 5-3900

Suite 1154, Merchandise Mart Plaza
Chicago 54, Illinois • WHitehall 4-2900

6355 E. Washington Blvd.
Los Angeles 22, Calif. • RAymond 3-8361

Government Sales

415 South Fifth Street, Harrison, N. J.
HUmboldt 5-3900

224 N. Wilkinson Street, Dayton 2, Ohio
BAldwin 6-2366

1625 "K" Street, N. W.
Washington 6, D. C. • DIstrict 7-1260



RADIO CORPORATION OF AMERICA

Electron Tube Division

Harrison, N. J.