

# electronics

APRIL 1, 1957

A MCGRAW-HILL PUBLICATION • PRICE 75 CENTS

TRACKING  
TRANSISTOR-TAGGED  
SALMON

<b>MECHANIZED WIRING</b> .....	page 138
<b>Beacon for Missiles</b> .....	144
<b>Tetrajunction Transistor Receiver</b> ...	148



**LEADERS IN  
MINIATURIZATION  
FOR OVER  
TWENTY YEARS . . .**



# MINIATURIZED TRANSFORMER COMPONENTS **FROM STOCK**

Items below and 650 others in our catalog A.

## HERMETIC SUB-MINIATURE AUDIO UNITS

These are the smallest hermetic audios made.

Dimensions . . . 1/2 x 11/16 x 29/32 . . . Weight .8 oz.



### TYPICAL ITEMS

Type No.	Application	MIL Type	Pri. Imp. Ohms	Sec. Imp. Ohms	DC in Pri MA	Response ±2 db (Cyc.)	Max. level dbm
H-30	Input to grid	TF1A10YY	50*	62,500	0	150-10,000	+13
H-31	Single plate to single grid, 3:1	TF1A15YY	10,000	90,000	0	300-10,000	+13
H-32	Single plate to line	TF1A13YY	10,000*	200	3	300-10,000	+13
H-33	Single plate to low impedance	TF1A13YY	30,000	50	1	300-10,000	+15
H-34	Single plate to low impedance	TF1A13YY	100,000	60	.5	300-10,000	+6
H-35	Reactor	TF1A20YY	100 Henries-0 DC, 50 Henries-1 Ma. DC,	4,400 ohms.			
H-36	Transistor interstage	TF1A15YY	25,000	1,000	.5	300-10,000	+10

\*Can be used with higher source impedances, with corresponding reduction in frequency range and current

## COMPACT HERMETIC AUDIO FILTERS

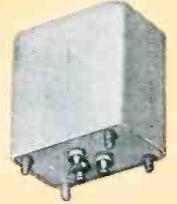

UTC standardized filters are for low pass, high pass, and band pass application in both inter-stage and line impedance designs. Thirty four stock values, others to order. Case 1-3/16 x 1-11/16 x 1-5/8 - 2-1/2 high . . . Weight 6-9 oz.

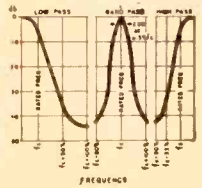

## HERMETIC MINIATURE HI-Q TOROIDS

MQE units provide high Q, excellent stability and minimum hum pickup in a case only. 1/2 x 1-1/16 x 17/32 . . . weight 1.5 oz.

### TYPICAL ITEMS

Type No.	Inductance	DC Max.
MQE-1	7 mhy.	135
MQE-3	20 mhy.	80
MQE-5	50 mhy.	50
MQE-7	100 mhy.	35
MQE-10	.4 hy.	17
MQE-12	.9 hy.	12
MQE-15	2.8 hy.	7.2

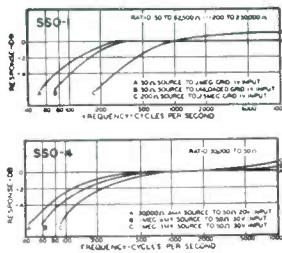
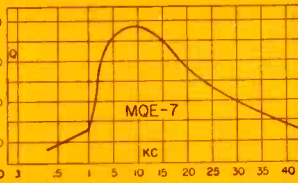

## SUB-SUBOUNCER AUDIO UNITS

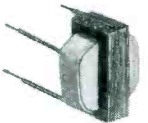

UTC Subouncer and sub-subouncer units provide exceptional efficiency and frequency range in miniature size. Construction details assure maximum reliability. SSO units are 7/16 x 3/4 x 43/64 . . . Weight 1/50 lb.

Type	Application	Level	Pri. Imp.	MA D.C. in Pri.	Sec. Imp.	Pri. Res.	Sec. Res.
*SSO-1	Input	+ 4 V.U.	200 50	0	250,000 62,500	13.5	3700
SSO-2	Interstage /3:1	+ 4 V.U.	10,000	0-.25	90,000	750	3250
*SSO-3	Plate to Line	+20 V.U.	10,000 25,000	3 1.5	200 500	2600	35
SSO-4	Output	+20 V.U.	30,000	1.0	50	2875	4.6
SSO-5	Reactor 50 HY at 1 mil. D.C.						
SSO-6	Output	+20 V.U.	100,000	.5	60	4700	3.3
*SSO-7	Transistor Interstage	+10 V.U.	20,000 30,000	.5 .5	800 1,200	850	125

\* Impedance ratio is fixed, 1250:1 for SSO-1, 1:50 for SSO-3. Any impedance between the values shown may be employed.



## SUB-SUBOUNCER (WIDE RANGE) AUDIO UNITS

Standard for the industry for 15 yrs., these units provide 30-20,000 cycle response in a case 7/8 dia. x 1-3/16 high. Weight 1 oz.

### TYPICAL ITEMS

Type No.	Application	Pri. Imp	Sec. Imp
O-1	Mike, pickup or line to 1 grid	50, 200/250, 500/600	50,000
O-4	Single plate to 1 grid	15,000	60,000
O-7	Single plate to 2 grids, D.C. in Pri.	15,000	95,000
O-9	Single plate to line, D.C. in Pri.	15,000	50, 200/250, 500/600
O-10	Push pull plates to line	30,000 ohms plate to plate	50, 200/250, 500/600
O-12	Mixing and matching	50, 200/250	50, 200/250, 500/600
O-13	Reactor, 300 Hys.—no D.C.; 50 Hys.—3 MA. D.C., 6000 ohms		



## HERMETIC VARIABLE INDUCTORS

These inductors provide high Q from 50-10,000 cycles with exceptional stability. Wide inductance range (10-1) in an extremely compact case 25/32 x 1-1/8 x 1-3/16 . . . Weight 2 oz.

### TYPICAL ITEMS

TYPE No.	Min. Hys.	Mean Hys.	Max. Hys.	DC Ma
HVC-1	.002	.006	.02	100
HVC-3	.011	.040	.11	40
HVC-5	.07	.25	.7	20
HVC-6	.2	.6	2	15
HVC-10	7.0	25	70	3.5
HVC-12	50	150	500	1.5

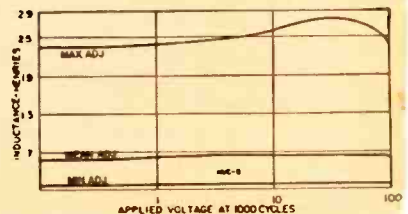
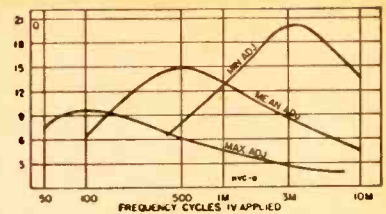

LET US MINIATURIZE YOUR GEAR.

SEND DETAILS OF YOUR NEEDS for SIZES and PRICES

# UNITED TRANSFORMER CO.

150 Varick Street, New York 13, N. Y. • EXPORT DIVISION: 13 E. 40th St., New York 16, N. Y.

CABLES: "ARLAB"

PACIFIC DIVISION: 4008 W. JEFFERSON BLVD., LOS ANGELES 16, CALIF.



**A MCGRAW-HILL PUBLICATION**

**H. W. MATEER**, *Publisher*  
**W. W. MacDONALD**, *Editor*

*Managing Editors*  
 VIN ZELUFF  
 JOHN M. CARROLL

*Feature Editor*  
 JOHN MARKUS

*Associate Editors*  
 ALEXANDER A. MCKENZIE  
 JOHN M. KINN, Jr.  
 FRANK LEARY  
 MICHAEL F. TOMAINO  
 HOWARD K. JANIS  
 SYLVESTER P. CARTER

*Assistant Editors*  
 WILLIAM P. O'BRIEN  
 WILLIAM G. ARNOLD  
 DAVID A. FINDLAY  
 HAIG A. MANOOGIAN  
 GEORGE SIDERIS  
 LAWRENCE KAMARCK  
 EDWARD DeJONGH  
 JOHN F. MASON

*Pacific Coast Editor (Los Angeles)*  
 HAROLD C. HOOD

*Midwestern Editor (Chicago)*  
 HAROLD HARRIS

*New England Editor (Boston)*  
 ROLAND J. CHAREST

*HARRY PHILLIPS*, *Art Director*  
 ROY THOMPSEN  
 BARBARA ELLWOOD  
 JOHN C. WRIGHT, Jr., *Production*  
 JEAN L. MATIN

*Editorial Assistants*  
 GLORIA J. FILIPPONE  
 ARLENE SCHILP  
 BERNICE DUFFY  
 BARBARA HEARST  
 NOREEN HENNESSY  
 PHYLLIS A. CRONIN  
 BARBARA M. SHAW

**JAMES GIRDWOOD**, *Adv. Sales Mgr.*  
 R. S. QUINT, *Assistant Adv. Sales Mgr. and*  
*Buyers' Guide Mgr.*  
 FREDERIC STEWART, *Promotion Mgr.*  
 FRANK H. WARD, *Business Mgr.*  
 G. E. POMEROY, *Classified Mgr.*  
 JEAN W. HEIGES, *Research*  
 WALLACE B. BLOOD, *Market Consultant*

*New York*  
 DONALD H. MILLER  
 HENRY M. SHAW  
 MARTIN J. GALLAY

*Boston*  
 WM. S. HODGKINSON

*Philadelphia*  
 JAMES T. HAUPTLI

*Chicago*  
 BRUCE WINNER  
 WALTER M. LUCE

*Cleveland*  
 WARREN H. GARDNER

*San Francisco*  
 T. H. CARMODY  
 R. C. ALCORN

*Los Angeles*  
 CARL W. DYSINGER  
 R. ANTLES

*Atlanta*  
 M. MILLER

*Dallas*  
 GORDON L. JONES

*London*  
 HERBERT LAGLER

KEITH HENNY, *Consultant*

**TRACKING TRANSISTOR-TAGGED SALMON**—Ultrasonic tracking and ranging equipment homes on 132-kc impulses generated by transistor in tiny capsule attached to adult salmon, for observing behavior near dams. Equipment was developed for Fish and Wildlife Service by Minneapolis-Honeywell Regulator Co. Photo by T. O. Duncan (see p 156)....COVER

SHOPTALK ..... 2

FIGURES OF THE MONTH ..... 6

INDUSTRY REPORT ..... 7

Data Storage Needs Reduced.....	7	Electronics Checks Pitcher.....	20
Improved Missiles Readied.....	7	Radiation Safety Boosts Sales.....	20
Work Force Expands.....	8	Industry's Rank In Patents.....	22
Plant Build Up Moves Ahead.....	8	FCC Actions.....	22
Military Electronics.....	10	Phosphors Find New Markets.....	24
Power Transistors Get Toehold.....	10	Tetrajunction Transistor Appears.....	26
Hot Air Operates Tweeter.....	12	Business Demands Computers.....	26
Experience Boosts Salaries.....	12	New Speeds For Tape.....	26
Steps Taken To Aid UHF TV.....	14	Financial Roundup.....	28
Business Briefs.....	14	Meetings Ahead.....	28
Relay Output Climbs Sharply.....	16	Industry Shorts.....	28
Jet Electronic Needs.....	16		

CROSSTALK ..... 155

**FEATURES**

**Mechanized Production of TV Wiring Boards..... 138**  
 By John Markus

**Subminiature Beacon for Guided Missiles..... 144**  
 By Morton Cohen and Donald Arany

**Tetrajunction Transistor Simplifies Receiver Design..... 148**  
 By R. J. Farber, A. Proudfit, K. M. St. John and C. R. Wilhelmsen

**Chronograph Times Supersonic Models..... 152**  
 By William J. Kerwin

**Ultrasonic Tracer Follows Tagged Fish..... 156**  
 By P. S. Trefethen, J. W. Dudley and M. R. Smith

**Counters Select Magnetic Drum Sectors..... 161**  
 By A. J. Strassman and R. E. King

**Aircraft Radiophone Speeds Communications..... 164**  
 By B. R. Rashkow

**Logarithmic Amplifier Measures Noise..... 169**  
 By J. Douglas Wells

CONTINUED ON NEXT PAGE



<b>CRT Deflection Circuit Has High Efficiency</b> .....	172
By Walter B. Guggi	
<b>Distributed Amplifiers As Antenna Multicouplers</b> .....	176
By Edward T. Pfund, Jr.	
<b>Superregenerative Transistor Transceiver</b> .....	180
By W. F. Chow	
<b>Music Pulse Analyzer Rejects Voice Signals</b> .....	183
By Ronald L. Ives	
<b>Gate Tube Generates Interleaved Pulse Chains</b> .....	186
By David Kushner	
<b>Conversion Formulas for Hybrid Parameters</b> .....	188
By T. P. Sylvan	
<b>ELECTRONS AT WORK</b> .....	192
Ticket Reservations .....	192
Ultrasonic Transducer Tweeter .....	192
Flash Lands Planes .....	194
Aircraft Communications .....	194
Planes Land No-Hands .....	194
Launching Intercommunicator .....	196
Low Temperature Effects .....	196
English Independent TV .....	196
Supply Aids Coupling .....	198
Transmitting Tubes .....	200
Ship Radar .....	200
Automatic Pulse Width Control .....	200
By John H. Porter	
Transistor Inverters .....	203
Transmission Line Filter .....	204
Simulating Computer .....	206
Perfect Metals .....	218
Interelectrode Capacitance .....	220
By R. E. Martin and I. Meth	
Anomalous Propagation .....	224
Chanson Parisien .....	226
.....	226
<b>PRODUCTION TECHNIQUES</b> .....	228
Typist's Guide Aids Cabling .....	228
Plastic Pumps for Etcher .....	228
Design of the Month: Connector .....	230
Connector Holder .....	230
Vibrating-Brush Soldering Iron .....	230
Wood Trays Hold Wiring Boards .....	232
Conveyor Flips Wiring Boards .....	234
Solder Preform is Heat Sink .....	236
Packaging Diodes .....	258
Plastic Trays Hold Parts .....	236
Wire-Twisting Techniques .....	242
Ultrasonic Soldering .....	246
Wire Holder on Nippers .....	248
Etching Klystron Grids .....	248
Cutting Armored Cable .....	252
Drilling Fixture .....	254
Soldering Aluminum Coils .....	256
<b>NEW PRODUCTS</b> .....	262
<b>LITERATURE</b> .....	344
<b>PLANTS AND PEOPLE</b> .....	358
<b>NEW BOOKS</b> .....	374
<b>THUMBNAIL REVIEWS</b> .....	382
<b>BACKTALK</b> .....	384
<b>INDEX TO ADVERTISERS</b> .....	437

# SHOP

► **SPEED vs INFORMATION** . . .  
Every industrial editor knows today's readers are pressed for time and must be fed information in the fastest possible manner. But not all realize that in some instances brevity has been pushed to a point beyond which the publishing service rendered could be more apparent than real.

To meet demand we devote major space in our Technical Edition to indexing, summarize all feature articles, hold text to essentials and include references. Our Business Editions employ nearly every known professional trick to speed understanding, including a technical digest, and some ideas that may be ahead of their time. Still the pressure for more information in less space persists.

The editors of *ELECTRONICS* have harnessed many new ideas that truly convey information faster. On the other hand, they have not pandered to suggestions that sacrifice information to speed. We have an idea the industrial publishing business in general may already have pushed questionable shortcuts too far; brevity breeds demand for more brevity, ad infinitum. Readers can be taught to be superficial.

There will inevitably be a reaction, with readers slowly but surely demanding more information rather than mere speed. When this occurs it will be all right with us; we've streamlined but we haven't emasculated.

## electronics

APRIL 1, 1957

Vol. 30, No. 4



Member ABC and ABP



# TALK

► **FRONT OF LENS . . .** On a recent field trip, associate editor Kinn happened to pick a day when a lot of men were attending a special luncheon. Invited along, he found himself right at home with 79 engineers. Pictures of the group were taken at table.

Later, he received a list of the names of all those who were present and a large group photograph. Ripping off the wrapping paper, he looked for his portrait. We share the view of his brow and eye with the reader. The photoengraver did a mighty good job of blowing up a two-inch slice of the original photo.

Years ago, a staffer hit the jackpot. Attending a convention of police communications officers, he went along on a side trip to a plant that was showing new equipment. Photographers galore shot lots of pictures. Being an editor, Zeluff naturally had his nose stuck in the equipment most of the time. Nevertheless, he, and the equipment, made the cover of one radio magazine and saw himself inside four others soon afterward.

► **LAST WORD . . .** It was with a feeling of relief that we wound up (we thought) the discussion of the proper word for manuscript in the Japanese language (*Shoptalk*, p 3, Nov. 1, 1956). We even showed the envelope that triggered the confusion in the first place.

Par avion, we hear from a Mr. Fujii. He points out that the word



**ATTENDANCE** of an *ELECTRONICS* editor at large luncheon was difficult to verify until enlargement of group photograph was made

“shorui” as a synonym for manuscript is not quite correct. (See *Backtalk*, p 384, this issue). That word is more properly applied to documents or official papers. For manuscript, the word “genko” should be used, he says.

Anyway, we intend to attend the IRE annual New York meeting and sit in on the delivery by engineers of papers, talks, lectures, presentations, descriptions and expositions at the sessions, symposiums, conferences, meetings and discussions.

Some of these will, no doubt, result in manuscripts, papers, abstracts, releases, material and data from which we can prepare articles, features, stories, reports and items for the editorial pages of *ELECTRONICS*.

► **SYNCHRONIZATION . . .** When we heard about an important development recently nearing completion up in Cambridge, Mass., associate editor Tomaino wrote the engineer in charge and suggested that his subject might make a good article for *ELECTRONICS*.

The other day he received two letters from the same engineer. The first letter was written just before the engineer read the letter to him, and he asked us whether we would be interested in publishing a paper about his work.

In the second letter, he thanked us for our interest and informed Mike that his paper would be ready in two weeks.

Couldn't have been timed better electronically.

Published three times a month, with an additional issue in June, by McGraw-Hill Publishing Company, Inc., James H. McGraw (1860-1948), Founder. Executive, Editorial and Advertising Offices: McGraw-Hill Building, 330 W. 42 St., New York 36, N. Y. Longacre 4-3000. Publication Office, 99-129 North Broadway, Albany 1, N. Y. Donald C. McGraw, President; Joseph A. Gerardi, Executive Vice President and Treasurer; John J. Cooke, Secretary; Nelson Bond, Executive Vice President. Publications Division: Ralph B. Smith, Vice President and Editorial Director; Joseph H. Allen, Vice President and Director of Advertising Sales; A. R. Venezian, Vice President and Circulation Coordinator. Subscriptions: Address correspondence to *Electronics*—Subscription Service, 330 W. 42nd St., New York 36, N. Y. Allow one month for change of address. Subscriptions are solicited only from persons engaged in theory, research, design, production, maintenance and use of electronic and industrial control components, parts and products. Position and company connection must be indicated on subscription orders.

Single copies 75¢ for Technical Edition and 50¢ for Business Edition in United States and possessions, and Canada; \$1.50 and \$1 for Latin America; \$2.00 and \$1.50 for all other foreign countries. Buyers' Guide \$3.00. Subscription rates—United States and possessions, \$6.00 a year; \$9.00 for two years; Canada, \$10.00 a year; \$16.00 for two years. Other western hemisphere countries and the Philippines, \$15.00 a year; \$25 for two years. All other countries \$20.00 a year; \$30.00 for two years. Three-year rates accepted on renewals only, are double the one-year rate. Entered as second-class matter August 29, 1936, at the Post Office at Albany, N. Y., under act of Mar. 3, 1879. Printed in U.S.A. Copyright 1957 by McGraw-Hill Publishing Co., Inc.—All Rights Reserved. BRANCH OFFICES: 520 North Michigan Avenue, Chicago 11, Ill.; 65 Post Street, San Francisco 4; McGraw-Hill House, London E. C. 4; National Press Bldg., Washington, D. C. 4; Architects Bldg. 17th & Sanson Sts., Philadelphia 3; 1510 Hanna Bldg., Cleveland 15; 856 Penobscot Bldg., Detroit 26; 3615 Olive St., St. Louis 8; 350 Park Square Bldg., Boston 16; 1321 Rhodes Hagerly Bldg., Atlanta 3, Ga.; 1125 West Sixth St., Los Angeles 17; 919 Oliver Building, Pittsburgh 23. *ELECTRONICS* is indexed regularly in The Engineering Index.



# NOW-PORTABLE 400 cycle power

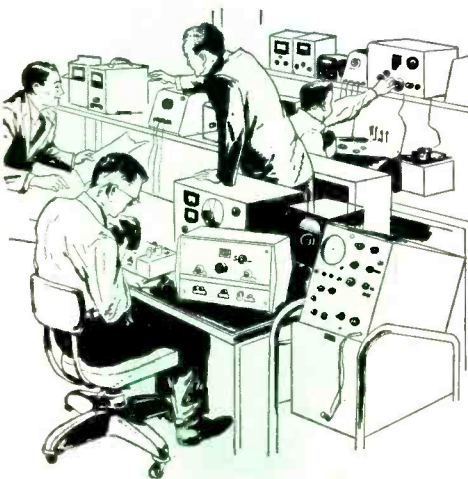

This new frequency changer makes it possible to provide well regulated 400 cycle power conveniently and quickly. This unit, Model FCR 250, is extremely useful in a wide variety of applications including testing, production, airborne frequency control, computers, missile guidance system testing, and in practically any application where the use of 400 cycle power is advantageous.

Model FCR 250 is only one of a complete line of frequency changers available from Sorensen . . . the authority on controlled power for research and industry. Write for complete information.

#### ELECTRICAL CHARACTERISTICS

Input	105-125 VAC, 1 phase, 50-65 cycles
Output voltage	115 VAC, adjustable 105-125V
Output Frequency	320-1000 cps in two ranges
Voltage regulation	±1%
Frequency regulation	±1% (±0.01% with auxiliary frequency standard fixed at 400 cycles)
Load range	0-250 VA



MODEL FCR 250

SORENSEN & COMPANY, INC.



STAMFORD • CONN.

In Europe, contact Sorensen-Ardag, Eichstrasse 29, Zurich, Switzerland, for all products including 50 cycle, 220 volt equipment.



# Buy your Synchro Test Gear

from **THE SYNCHRO MANUFACTURERS**

**MUIRHEAD**



230

**MUIRHEAD**

MUIRHEAD INSTRUMENTS INC. · 677 Fifth Ave · New York 22 · N.Y. · U.S.A.  
MUIRHEAD INSTRUMENTS LIMITED · STRATFORD · ONTARIO · CANADA  
MUIRHEAD & CO. LIMITED · BECKENHAM · KENT · ENGLAND

PRECISION  
ELECTRICAL  
INSTRUMENTS







electronics—April 1 • 1957

## Electronics Dissolves Data Storage Pile-Ups

Storage needs reduced by microfilm and electronic scanning techniques

EFFICIENT storage and processing of large-volume punched-card data is facilitated by a system called Fosdic, for Film-Optical Sensing Device for Input to Computers, that combines microfilm techniques with electronic scanning and selection.

► **How It Works**—Punched-card images are recorded on 16-mm film by a camera using a Cinemascope-type lens that halves the width of the image and squares the hole. A 100-ft roll of film costs \$3.70, holds 13,000 card images—equivalent to 850 characters to the inch, compared to the normal 200 to 250 characters for digital tape.

The film reader uses a flying-spot scanner to search the film at a speed of 72 cardframes a second. Selected frames are punched into new cards.

A bank of 120 thyratrons holds the ten fields during comparison and a section of this bank stores the data temporarily during the punch operation. The film stops while the new card is punched.

► **Market**—The Weather and Standards Bureaus, working with Eastman Kodak, developed the unit and the Weather Bureau may ultimately use 20 or more Fosdics since it regards the machine as ideal for the storage of basic reference data. The space compression ratio is said to be as great as 180 to 1.

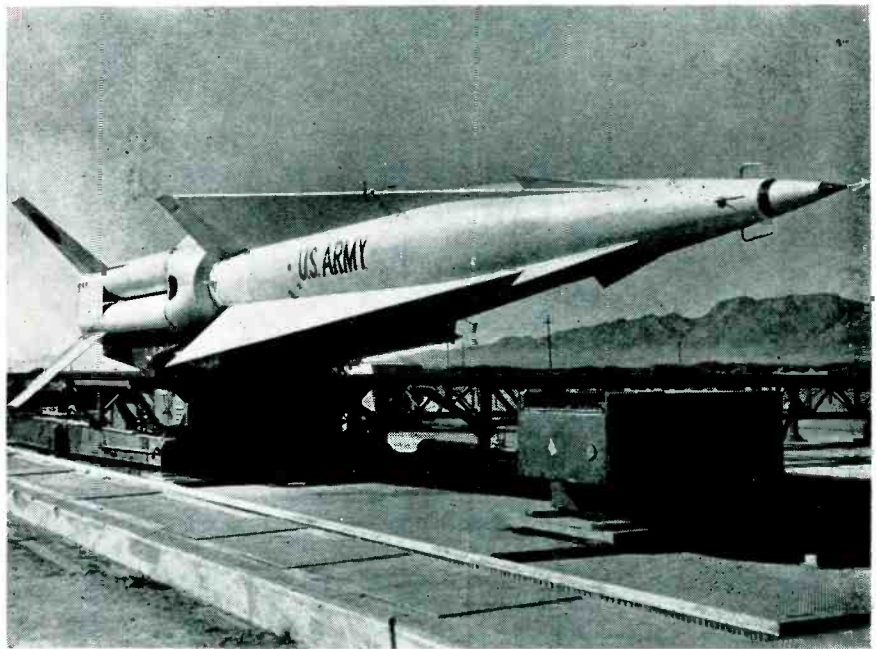

NIKE-HERCULES, more powerful than the original Nike, undergoes tests as . . .

## Improved Missiles Readied For Use

At least three missiles are due for replacement by new versions with better performance and guidance

FAST PACE of missile development, despite interservice squabbles, is emphasized by improvements in existing missiles and guidance systems. An improved version of the Nike, designated Nike Hercules, is now undergoing final tests. Nuclear capability will be incorporated into the missile which is substantially faster and has a much greater range than the original.

The Navy's ship-to-surface Regulus I is to be supplemented by Regulus II, which travels farther at supersonic, rather than subsonic, speeds.

According to the Aircraft Industries Association, the Air Force's RM-61A Matador, designed to support Army troops, has been replaced on the manufacturer's production line by the RM-61B which provides better guidance and thus greater accuracy.

► **Guidance**—The ground guidance and control equipment and missile guidance for the new Nike are being manufactured by Western Electric at its Burlington and Winston-Salem plants in North Carolina. No information on the electronic controls for the new model has been released but it is understood that they have been improved.

► **New**—One aircraft manufac-

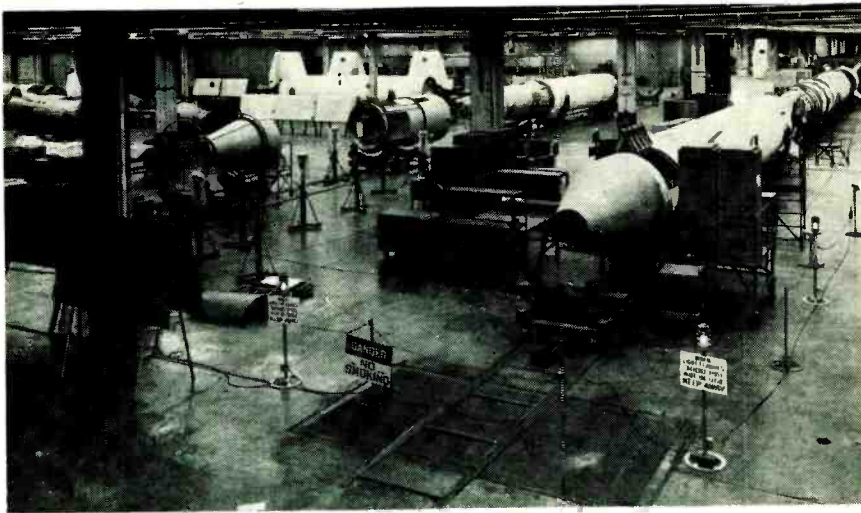

Army's Redstone missiles are assembled at Chrysler plant in Detroit

turer has developed a device for use in advanced missile guidance programs, weighing little more than one ounce, that duplicates the balance mechanism of the human inner ear and resembles its shape.

Made of glass tubing, the device

uses an electrolytic solution to cover tungsten electrodes fused into the glass material. If the missile strays from its course, signal voltages are transmitted through the electrodes to the guidance system which activates controls.

## Electronics Work Force Expands

In face of cuts in some segments of the industry, more workers were employed in 1956

DESPITE lower production of tv receivers and apparently greater use of automatic production, the communications equipment industry work force was of record size in 1956. The total number of workers, both white collar and production workers, employed in the field reached 565,000, the highest number in the last six years.

The number of production workers employed by the industry, 397,800, was the highest since 1953 when 419,900 were employed. This is what Department of Labor preliminary figures show for workers in radio, tv, phonograph, radio tube, telephone and telegraph plants.

► **Productivity**—The increase in the number of workers in the face of some production declines would seem to indicate that the output per man-hour is smaller than it has been in the past, despite progress in production techniques, new

plants and equipment and other aids for higher production.

The seeming paradox has not only hit the electronics industry but seems to hold true for U.S. industry in general. According to government bureaus, output per man-hour of production workers in manufacturing as a whole gained about 2.5 percent or 1 percent in 1956 depending on the production index used, compared with an average of 4.5 percent for previous years.

► **Why?**—Several explanations are

advanced for the what seems to be lower productivity in the industry. It is argued that although the industry's output of consumer goods may have declined last year, the military and commercial-industrial segments of the business more than took up the slack and that is where the increased work force was used. It is also pointed out that Labor Department figures are preliminary and do not show a sharp upturn in output that took place in the final weeks of December.

One leading tv manufacturer has stated that a number of companies have been burned costwise on automatic production and are actually going very slowly in adopting additional mechanized techniques.

► **Future**—Whatever the reasons, the expansion seems to emphasize the need for more efficient production. W. R. G. Baker of GE recently pointed out that in 10 years the U.S. will have a population of almost 200 million people and a gross national product of \$570 billion dollars. Disposable personal income should rise to more than \$400 billion by then.

On this basis, U.S. industry will need to produce about 40 percent more goods and services but with an increase in the total work force of only about 14 percent, because the greatest population growth will be in the age groups that are too old or too young to work.

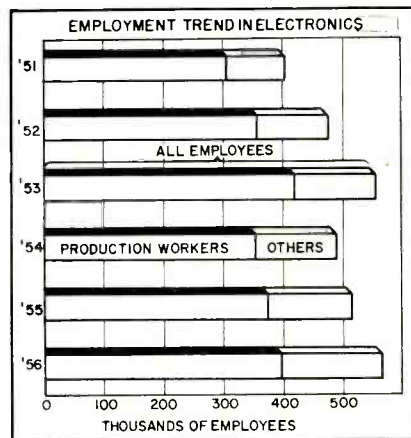

## Industry's Plant Build Up Moves Ahead

Despite an apparent stretch out in expansion plans by some firms, construction is still high

VACILLATION by some manufacturers in the electronics industry on plant and facility expansion plans for 1957 caused some concern in the industry at the beginning of the year. But expansion plans appear to have firmed up and are proceeding at a normal rate. Since the beginning of the year over 2.5 million sq ft of additional

(Continued on page 10)



# Burnell SUBMINIATURE FILTERS

AS SMALL AS 3/4" x 3/4" x 13/8"  
AS LIGHT AS 1 1/4 OUNCES

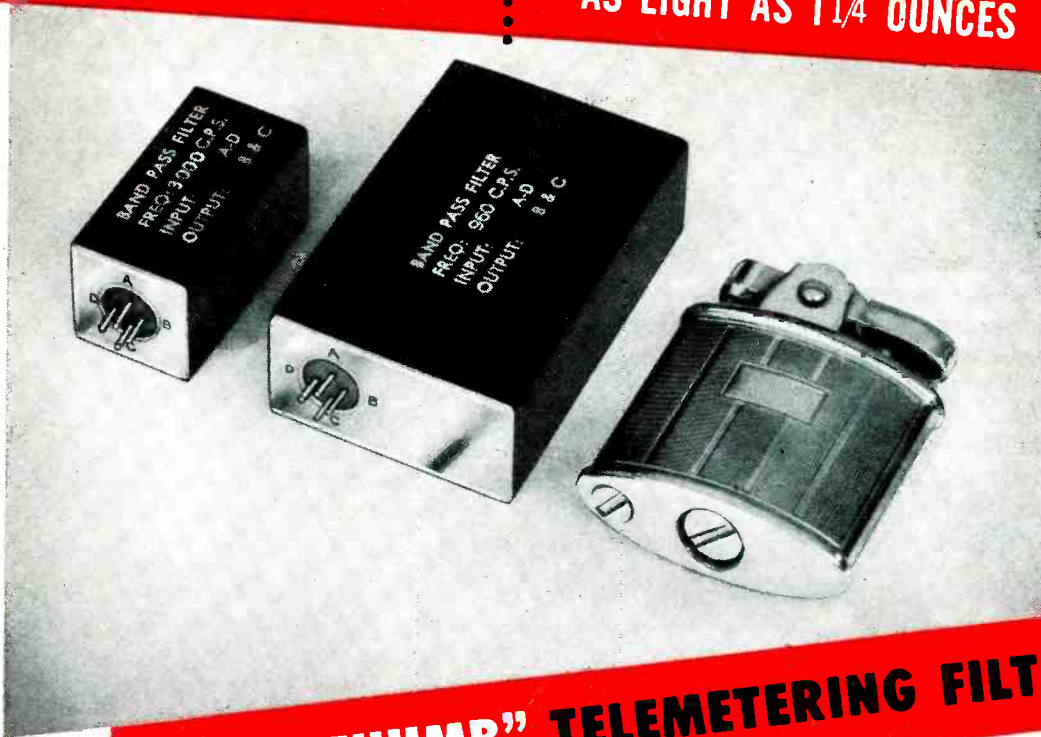

## "TOM THUMB" TELEMETERING FILTERS

Designed and tested to specification #MIL-T 26985

Supplied in two principal case sizes:

1. For RDB channels 1 through 6, case size is 3/4 x 1 1/2 x 2 1/4 inches high; weight: 4 ounces.
2. For channels 7 and up, case size is 3/4 inches square and 1 3/8 inches high; weight: 1 1/4 ounces.

These cases are generally equipped with a 4-pin plug to match the small Winchester socket.

### ATTENUATION CHARACTERISTICS

Impedance: 100 K ohms in and out.

Insertion loss: less than 6 db.

At  $\pm 7.5\%$  band width is less than 3 db.

At  $\pm 25\%$  band width is greater than 15 db.

At 1.75 f attenuation is 40 db or more.

At .57 f attenuation is 40 db or more.

CHAN. #	FREQ.	IMP. 100K P/N	B. W.	SIZE	WT.
1	400 cps.	S-60001	$\pm 7\frac{1}{2}\%$	3/4 x 1 1/2 x 2 1/4 H	4 oz.
2	560 cps.	S-60002	$\pm 7\frac{1}{2}\%$	3/4 x 1 1/2 x 2 1/4 H	4 oz.
3	730 cps.	S-60003	$\pm 7\frac{1}{2}\%$	3/4 x 1 1/2 x 2 1/4 H	4 oz.
4	960 cps.	S-60004	$\pm 7\frac{1}{2}\%$	3/4 x 1 1/2 x 2 1/4 H	4 oz.
5	1300 cps.	S-60005	$\pm 7\frac{1}{2}\%$	3/4 x 1 1/2 x 2 1/4 H	4 oz.
6	1700 cps.	S-60006	$\pm 7\frac{1}{2}\%$	3/4 x 1 1/2 x 2 1/4 H	4 oz.
7	2300 cps.	S-60007	$\pm 7\frac{1}{2}\%$	3/4 x 3/4 x 1 3/8 H	1 1/4 oz.
8	3 KC	S-60008	$\pm 7\frac{1}{2}\%$	3/4 x 3/4 x 1 3/8 H	1 1/4 oz.
9	3.9 KC	S-60009	$\pm 7\frac{1}{2}\%$	3/4 x 3/4 x 1 3/8 H	1 1/4 oz.
10	5.4 KC	S-60010	$\pm 7\frac{1}{2}\%$	3/4 x 3/4 x 1 3/8 H	1 1/4 oz.
11	7.35 KC	S-60011	$\pm 7\frac{1}{2}\%$	3/4 x 3/4 x 1 3/8 H	1 1/4 oz.
12	10.5 KC	S-60012	$\pm 7\frac{1}{2}\%$	3/4 x 3/4 x 1 3/8 H	1 1/4 oz.
13	14.5 KC	S-60013	$\pm 7\frac{1}{2}\%$	3/4 x 3/4 x 1 3/8 H	1 1/4 oz.
14	22 KC	S-60014	$\pm 7\frac{1}{2}\%$	3/4 x 3/4 x 1 3/8 H	1 1/4 oz.
15	30 KC	S-60015	$\pm 7\frac{1}{2}\%$	3/4 x 3/4 x 1 3/8 H	1 1/4 oz.
16	40 KC	S-60016	$\pm 7\frac{1}{2}\%$	3/4 x 3/4 x 1 3/8 H	1 1/4 oz.
17	52.5 KC	S-60017	$\pm 7\frac{1}{2}\%$	3/4 x 3/4 x 1 3/8 H	1 1/4 oz.
18	70 KC	S-60018	$\pm 7\frac{1}{2}\%$	3/4 x 3/4 x 1 3/8 H	1 1/4 oz.
A	22 KC	S-60019	$\pm 15\%$	3/4 x 3/4 x 1 3/8 H	1 1/4 oz.
B	30 KC	S-60020	$\pm 15\%$	3/4 x 3/4 x 1 3/8 H	1 1/4 oz.
C	40 KC	S-60021	$\pm 15\%$	3/4 x 3/4 x 1 3/8 H	1 1/4 oz.
D	52.5 KC	S-60022	$\pm 15\%$	3/4 x 3/4 x 1 3/8 H	1 1/4 oz.
E	70 KC	S-60023	$\pm 15\%$	3/4 x 3/4 x 1 3/8 H	1 1/4 oz.

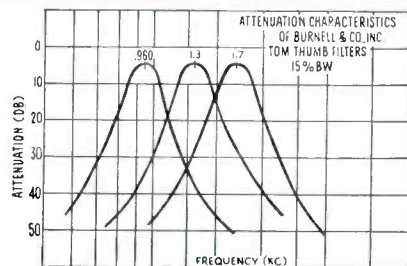

Burnell & Co., Inc.

Dept. E47 45 WARBURTON AVENUE • YONKERS 2, N. Y. • YONKERS 5-6800  
PACIFIC DIVISION • 720 MISSION STREET • SOUTH PASADENA, CALIFORNIA • RYAN 1-2841

plant capacity has been added or planned by manufacturers in the field.

► **Pace**—According to estimates by Sylvania, total factory investment by the industry through 1956 totaled \$9.2 billion and will reach \$11.5 billion in 1960 and \$15.4 billion by 1966. This means that about \$6 billion in new money must be acquired through new financing or retained profits in the next 10 years. The increase would mean a rise in plant investment of approximately \$500 million a year for the industry.

This compares favorably with capital spending of the electrical-electronics industry as surveyed by the McGraw-Hill department of economics. The 1956 annual survey shows that in 1954 and 1955 about 550 million was spent on new plants and equipment. For 1956 an estimated 606 million was spent and expenditures may total \$709 million this year.

► **New Planning**—Some of the larger plant expansion plans of manufacturers in electronics have been announced in the past month.

GE has announced that its capital expenditures this year will not be far off the \$205 million spent in 1956. Its total plant and equipment outlays for the 1956-1958 period, will be well over the \$500 million level. The cutbacks that have been announced by the firm apply to only four of the company's 103 operating departments.

Westinghouse plans \$75 million in capital expenditures this year compared with \$50 million in each of the two preceding years. Of the total, only 20 percent will be used for new plants amounting to about 1 million sq ft of space. The balance will go for new equipment, mostly automatic, and improving existing installations.

Reason for emphasizing automatic production equipment is the need to hold down rising manufacturing costs. Westinghouse now has about 40 million sq ft of manufacturing space. It plans to expand this at the rate of about 2.5 percent a year for the next three years.

## Military Electronics

► **Cutback** to a four-day week at its missile plant producing Falcon guided missiles and other military electronics equipment was made by Hughes Aircraft. The plant was awarded a \$23-million contract last June for production of the missiles. The cutback resulted from realignment of production, parts delivery and company delivery schedules

► **Twenty-million dollar Air Force contract** for radar jammers is in the works for General Electric

► **Contracts worth over \$4 million** for electronic control amplifiers and research and development work on advanced airborne navigation systems have been awarded to General Precision Labs by the Air Material Command

► **Electronics division of Mack Trucks** has received a \$2.6 million contract from the Navy for the manufacture of radar sets for military aircraft

► **Small portable ground control approach radar station, SPAR**, developed and manufactured by Laboratory For Electronics, has been installed at Boeing Field in Seattle

► **Instrumentation radar system** that makes possible direct calibration and immediate evaluation of the performance and behavior pattern of guided missiles has been developed by RCA. The equipment is now in production for use at military test ranges

► **Additional quantities of APN-59 radar sets** beyond those included in a recent \$6 million contract have been ordered by the Air Force under a \$2.7-million contract with Sperry Gyroscope

## Power Transistors Get Toehold

Manufacturers size up the business and see substantial sales gains ahead

POWER transistors accounted for about 15 percent of total 1956 transistor output of some 13 million units and it is expected that the percentage will be maintained in 1957. This could put this year's production of power transistors at 4.5 million units.

► **Outlook**—Minneapolis-Honeywell, which recently expanded its

power transistor facilities in Boston, sees sales of the devices in 1957 as very good and expects that its problems are going to be mainly concerned with making enough to meet demand. The firm also estimates that power transistors, including those for auto radios, will represent 15 percent of total 1957 transistor sales.

► **Types**—According to Honeywell, some customers are requiring special types of power transistors or

(Continued on page 12)



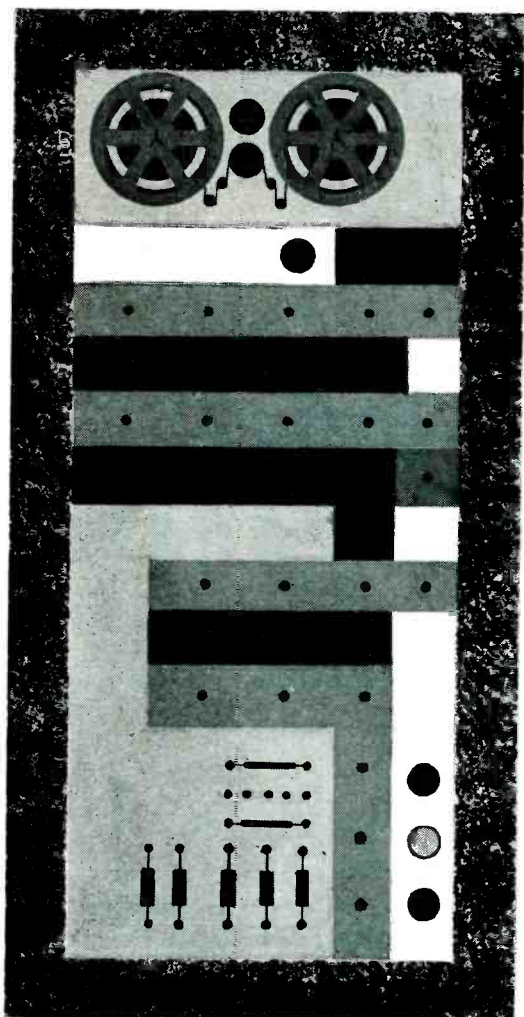

**3 seconds to kill 8 hours**

Eight hours to set up an electronic computer. Three seconds for it to solve the problem. One computer component failure and you start all over.

Sprague high reliability components are used by the leading computing machine manufacturers, because they know the best is the cheapest in the long run.

Write for Bulletins on specialized components for computer applications.  
Sprague Electric Co., 35 Marshall Street  
North Adams, Mass.



**SPRAGUE COMPONENTS:**

CAPACITORS • RESISTORS • MAGNETIC COMPONENTS • TRANSISTORS • INTERFERENCE FILTERS • HIGH TEMPERATURE MAGNET WIRE • PULSE NETWORKS • PRINTED CIRCUITS

units with modified characteristics. However, the firm does not see the need in 1957 of modifying existing types to any great extent. In addition to continuing a line of power transistors, the company plans to begin the manufacture of power tetrodes.

Delco Radio has announced a transistor that can switch 1,000 watts with an input of one watt.

► **Price** — Price trends in power transistors are generally downward, according to Honeywell, but it appears that the problems in transistor manufacture are not being solved as fast as has been expected. The company feels that the true cost of manufacturing transistors is becoming more evident and it does not expect overall prices to take any drastic nosedives during 1957.

► **Output** — Motorola, which recently announced the production of its one-millionth power transistor in a period of eight months, expects that nearly all auto radio production will be using power transistors by the end of this year. It expects that in profits from its transistor manufacturing operations to break even this year and to make a profit in 1958. Its transistor manufacturing operations did not show a profit in 1956.

## Hot Air Operates Hi-Fi Tweeter

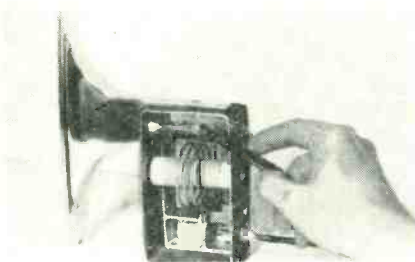

A continuous inaudible spark within the quartz cell (at end of pencil) is moved in and out by voice and music frequencies. The short horn at left amplifies the effect to produce audible sound. Engineers of DuKane Corp. (formerly Operadio) claim a better high-frequency response than that from loudspeakers using conventional diaphragms. Technical details are given in *Electrons at Work*, p 192

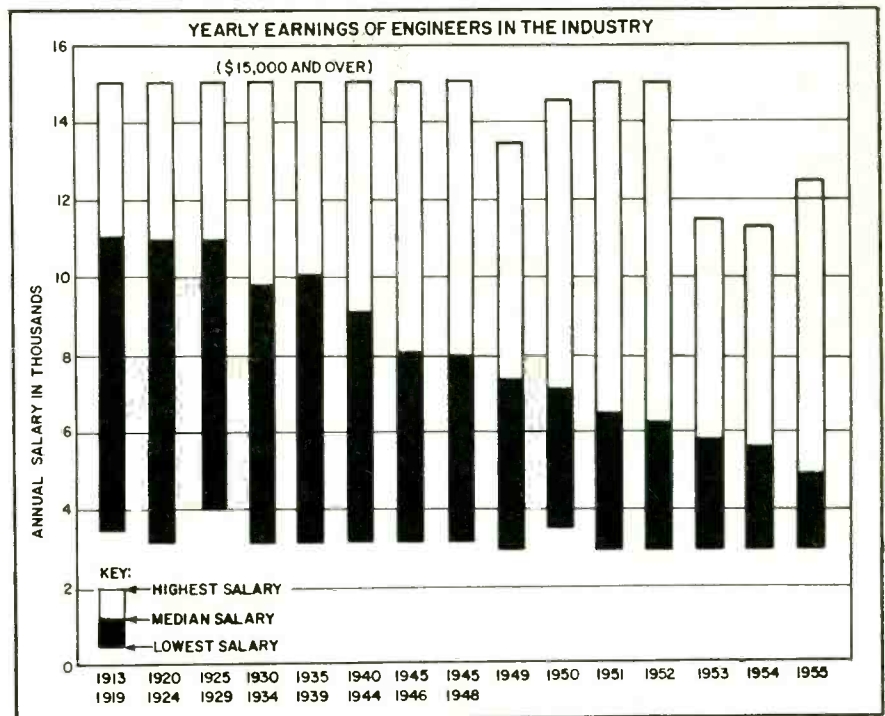

PAY SCALE by year of college graduation shows how . . .

## Experience Boosts Engineer's Salaries

Survey shows engineering salaries in the industry are similar in general to those in other fields

SURVEY covering salaries of 107,000 engineering graduates in industry, government and education, including about 10,000 in the electronics-electrical machinery field, has been completed by Engineers Joint Council.

► **Results**—The report shows that the median salary for engineers in electrical machinery manufacturing range from \$5,000 to \$11,000 depending on years of experience in the industry. It shows that the median starting monthly salary base rate in electrical machinery is \$425 with a high of \$500 a month and low of \$375.

According to the report, the survey was not completely successful in reflecting the earning status of all engineers. It is felt that top administrative and managerial salaries are not fully represented and therefore the salary presentation is lower than the true structure, particularly for classes earlier than 1935. However the data closely approximates the earning position of the engineers employed by the contributing companies.

► **Beginners**—In starting salaries the electrical machinery median of \$425 a month is the same as that for the transportation equipment field and as that for engineers performing miscellaneous services. Only one industry, petroleum, with a median starting salary of \$435 a month exceeded electrical machinery pay.

► **Comparison**—Status of engineer salaries in the electrical-electronics field shows up in comparison of salary medians with those in other industries covered. It shows that the median salary for engineers who entered the electrical machinery field in 1955 is the lowest of any other classification except teaching. But as was indicated previously, this may be due to improper representation of top administrative and managerial salaries in the industry. All of the higher salaries were lumped in the \$15,000 and over classification indicated in the chart.

The industry that registered the highest median salary was the chemical field with a median high of \$13,100. Some of the other industry classifications covered in the survey that had higher medians

(Continued on page 14)



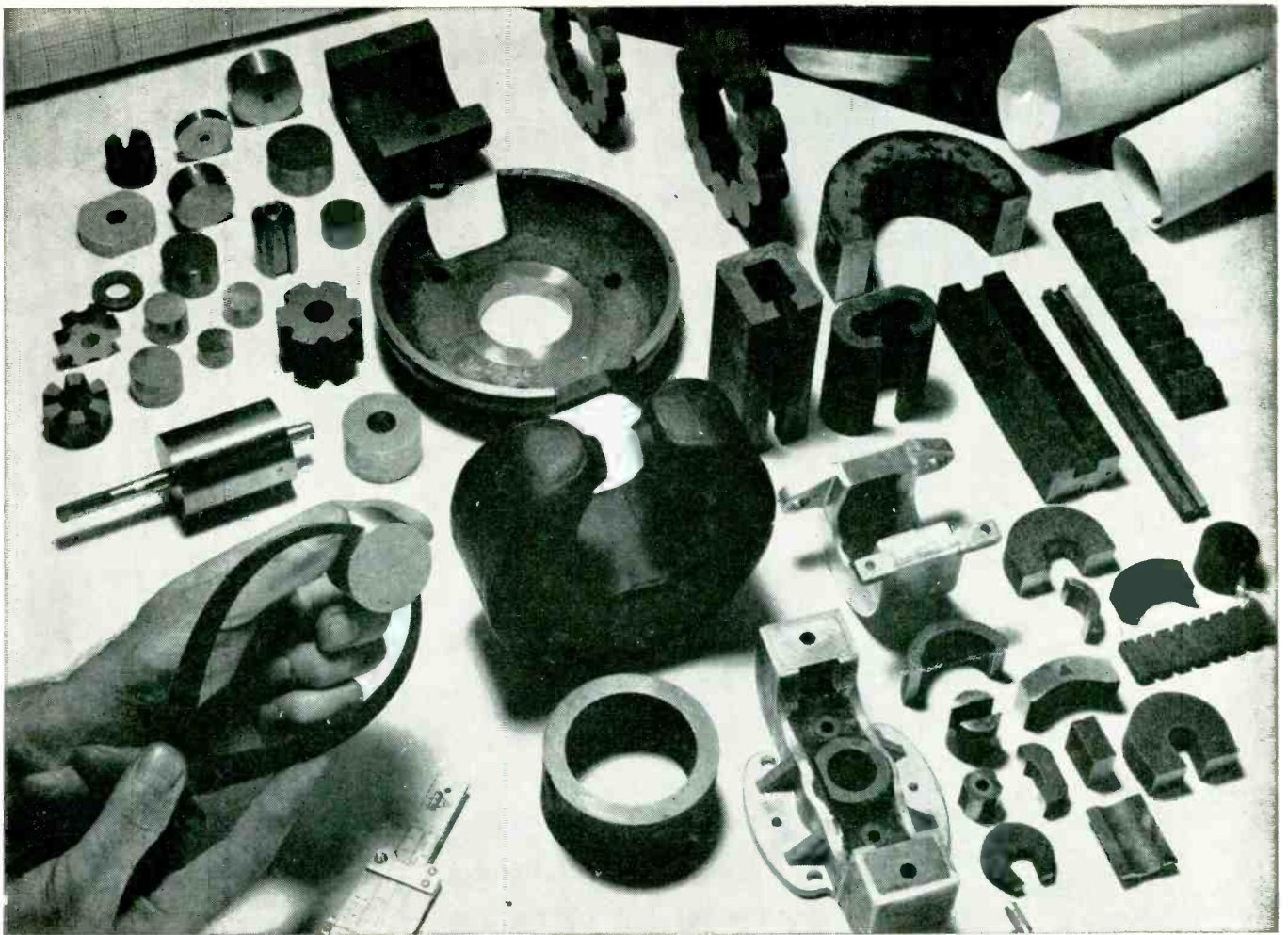

# For A-N-Ything in Alnico Magnets Specify "ARNOLD"

## Materials

Cast Alnico Magnets are most commonly made in Alnico V, VI or III. Sintered Alnico Magnets usually are made in Alnico II, V or VI. Special permanent magnet materials include Vicalloy, Cunico, and Cunife.

## Engineering Data

**Write for your copy  
BULLETIN GC-106 B**

Contains useful data on Alnico Magnets, their physical and magnetic properties. Also lists stock items and standard tolerances for cast and sintered magnets.

**ADDRESS DEPT. E-74**

Your best bet when looking for a source of Alnico magnets and assemblies is Arnold—producer of the most complete line of magnetic materials in the industry. Arnold can supply your need for any size or shape of Alnico magnet, as illustrated by the variety pictured above. Weights range from a few ounces to 75 pounds or more. Die-cast or sand-cast aluminum jackets, Celastic covers, etc., can be supplied as required. Complete assemblies are available with Permendur, steel or aluminum

bases, inserts and keepers as specified—magnetized and stabilized according to the requirements of the application.

A wide range of the more popular shapes and sizes of cast and sintered magnets are carried in stock at Arnold. Unsurpassed plant facilities make possible quick delivery of all special orders. • *Let us handle your magnetron, traveling wave tube and wave guide permanent magnet requirements, or any other magnetic material specification you may have.*

WSW 6445

## THE ARNOLD ENGINEERING COMPANY



**Main Office & Plant: Marengo, Illinois**

**Repath Pacific Division Plant: 641 East 61st Street, Los Angeles, Calif.**

**District Sales Offices:** New York: 350 Fifth Ave. · Boston: 200 Berkeley St.  
Los Angeles: 3450 Wilshire Blvd. · Washington, D. C.: 1001—15th St., N. W.

that the \$11,050 in electrical machinery were: professional and scientific instruments, \$11,375; telecommunication services, \$11,350; research and development, \$12,475; petroleum, \$12,150. About eight industry groups had lower salary medians than \$11,050.

## Steps Taken To Aid UHF TV

More plans are proposed by government and industry to help the declining service

DESPITE concerted efforts by the government and the broadcasting industry to bolster uhf tv, the outlook for the service seems to grow dimmer every month. However, new plans to aid uhf are in the works that may finally solve some of its problems.

► **Status**—There are now 90 uhf stations on the air, a drop of 13 stations in the past year and 33

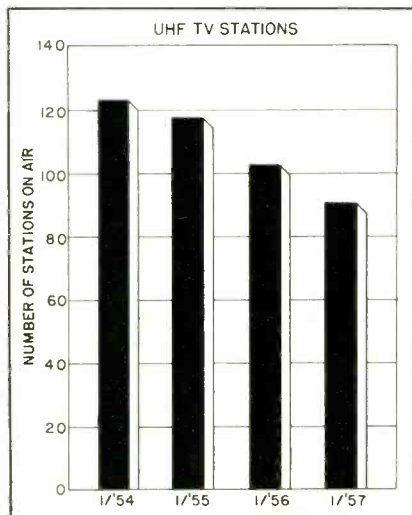

stations since 1954 when 123 stations were on the air. The number of uhf sets produced has also dropped. There were 1,035,237 factory equipped uhf sets produced in 1956 compared to 1,181,788 in 1955. It is estimated that about 10 percent of the 40 million tv sets in the U.S. receive uhf broadcasts.

► **Aid**—Latest proposal to bolster

## Business Briefs

► **Sales for General Electric in 1956** crossed the \$4-billion mark for the first time in the history of the company. Sales of commercial products increased by 24 percent over 1955 while defense product departments showed a 6-percent sales decline

► **Merger of Airborne Instruments Laboratory and Aircraft Radio Corp** is in the works. Aircraft Radio employs about 700 people. AIL employs over 1,100

► **Guided missile maker, Ramo Woolridge**, a Thompson Products affiliate, had sales exceeding \$28 million in 1956 compared to \$9.7 million in 1955. Sales for this year are expected to show substantial increases in both research and development activities and manufacturing business.

► **Volume of RCA sales to the Armed Forces** totaled \$240 million for 1956, representing 21.3 percent of total business compared with 21.7 percent for 1955. The year-end backlog of government orders amounted to \$325 million compared to \$235 million at the end of 1955

► **Liquidation of Ampro Corp.** is to be completed during the first half of 1957 by GPE, parent company. Continued losses of the subsidiary which manufactured tape recorders and movie cameras led to the liquidation

► **Split-up of IBM capital stock** of one additional share for each share held and the offer of additional shares of stock to IBM stockholders to raise approximately \$200 million of capital funds has been scheduled by the company. The funds are needed to keep pace with increased orders for computers and other products, according to the company

uhf-tv was made by FCC chairman McConnaughey who asked Congress to cancel the 10-percent excise tax on all-channel tv sets. He said that the ordinary vhf sets could become all-channel receivers at a cost of \$9 to \$20 or about the amount of the excise tax. Passage of the proposal seems doomed in the face of higher federal budget which may require all available tax revenues.

► **Deadline**—FCC is trying its program of deintermixture under which some areas are to be served by uhf stations only and others by vhf only. Many uhf license holders have been waiting to see how

the plan works before going on the air.

FCC set a deadline in February for 83 uhf cp holders to tell why they were not on the air. Replies were received from all 83, and the Commission is currently studying them. The deadline was set because FCC rules state that cp holders must start construction within two months after the cp award and complete the station in six months. However, time extensions can be and usually are granted.

There are currently about 205 authorizations outstanding for uhf tv stations. Over 140 uhf

(Continued on page 16)



**SEMICONDUCTOR AND ELECTRONIC TUBE MANUFACTURERS . . .**

**INCREASE YOUR ENGINEERING STAFF *without* ADDING A "MAN"**

# LET KAHLE DESIGN AND BUILD

## **YOUR PRODUCTION MACHINERY**

Here's one positive way to relieve your engineering staff. By assigning production equipment and machinery tasks to Kahle you take advantage of over a quarter-of-a-century's craftsmanship and experience . . . adding hours to the "productive" time of your engineers. An example of this know-how in action is the Fusing Furnace illustrated below . . . designed for making alloy junction transistors and similar units at high production speeds. Very close temperature/atmosphere controls and curves are maintained; each of the 12 work platforms remain horizontal throughout the various production stages including the heat zone. Loading and unloading are easily accomplished from the same position.

Kahle's capabilities can fill all of your requirements for production equipment . . . there is no risk involved because machines do not leave Kahle factory until they operate to your complete satisfaction.

Investigate the time and cost-saving possibilities of this design, development and manufacturing service. Write today for information . . . please outline your requirements.

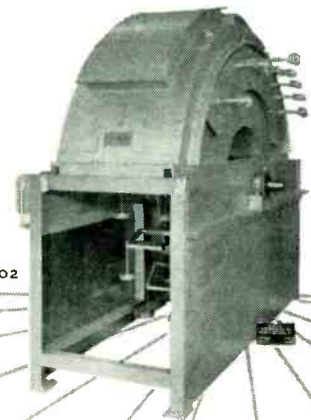

FUSING FURNACE #2902

# **KÄHLE**

**ENGINEERING COMPANY**

1310 SEVENTH STREET • NORTH BERGEN, N. J.

PLANTS: SEVENTH STREET, NORTH BERGEN, N. J.  
HUDSON BOULEVARD, UNION CITY, N. J.

DESIGNERS AND BUILDERS OF SPECIAL AUTOMATIC AND SEMI-AUTOMATIC EQUIPMENT FOR ALL INDUSTRIAL OPERATIONS



construction permits have been deleted since after the end of the tv freeze in 1952.

► **Future**—The special broadcast group, TASO, television allocation study organization, set up in the industry last year to gather

and develop all pertinent information on the subject, has made progress in the long-range effort to expand tv service, according to FCC. The hope is that the group may ultimately be able to find a lasting solution to the uhf tv problem.

least 50 manufacturers of this type which account for an estimated 30 percent of the industry's dollar volume. Average price is about \$6.00 per unit.

► **Growth**—Expansion of the relay business since World War II is reflected in the growth of the National Association of Relay Manufacturers. NARM was founded in 1945 and started out with 10 to 15 members. Today there are about 50. Its objects are to promote standardization of ratings, nomenclature, tests and test equipment and to collect and disseminate information relating to the relay industry.

According to NARM, there are over 100 relay manufacturers in the U.S. today and almost a third of them are new to the field within the last five years.

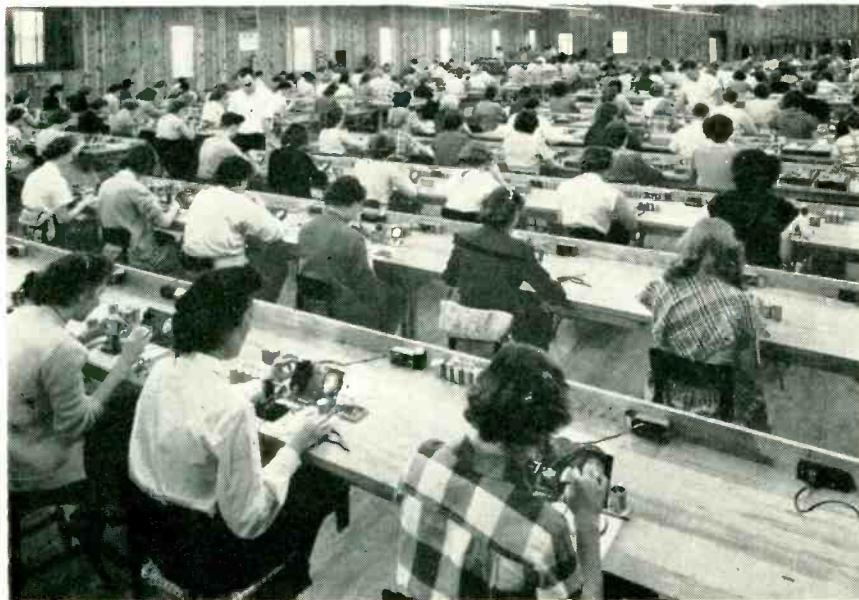

WOMEN workers assemble relays at Price Electric as . . .

## Jet Electronic Needs Add to Design Problems

More equipment and antennas add to weight of high-speed commercial airliners

DEVELOPMENT of jet transport aircraft has pointed up the dependence of aviation on electronics and the shortcomings of present equipment as far as weight and accuracy are concerned.

► **Equipment**—A Douglas DC-8 jet airliner equipped for overwater flights may carry electronic equipment worth \$140,000 and weighing 2,400 pounds with installation and wiring. This includes 26 separate radio systems.

Reducing the weight of this equipment by as little as 10 pounds would be worth \$7,000 per year in operating costs for a transatlantic airliner.

► **Antennas**—At the high speeds of jet airliners, drag produced by external antenna systems adds an additional weight limitation to the aircraft. Since a transatlantic plane can carry as many as 20 antennas, the drag weight loss can be considerable.

For a typical vhf installation

(Continued on page 20)

## Relay Output Climbs Sharply

Both dollar and unit volume increases as military and commercial demands expand

SURVEY of U.S. relay production capacity by the Electronics Production Resources Agency reveals that 17.2 million of the units were manufactured last year for a dollar volume of \$113.7 million. In 1955, 14.3-million units were manufactured worth \$84.8 million. Thus the relay business increased 34 percent in dollar volume and 24 percent in unit volume in the past year.

For 1957 the National Association of Relay Manufacturers sees 20 million units produced worth \$142 million.

► **Why**—One of the main reasons for the whopping increase in relay business dollar volume, according to James V. Roughan, president of NARM and vice-president and general manager of Price Electric division of Con Electron, is increased

unit prices due to heavier military demands for relays that must meet increasingly difficult environmental conditions.

Some military relays must be able to withstand conditions that prevail under 10 g levels. These higher requirements have helped to increase the average selling price of relays from \$5.90 in 1955 to \$6.59 in 1956 to possibly \$7.00 per unit in 1957. Today the prices of some military types run as high as \$15.

► **Subminiature**—Contributing to the increase in unit volume has been the increasing use of the subminiature relay. (ELECTRONICS, p 24, Dec. '55) This type accounts for a substantial percentage of the relay industry's unit volume, as high as 40 percent, according to one company.

So-called telephone-type relays are another important segment of the relay business. There are at



# ELECTRICAL NOISE

FOR the Telephone  
Transmission Engineer



G-R Random Noise Generator and Unit Amplifier in toll-cable crosstalk measurements at General Telephone Company.



In the transmission engineering design of telephone message facilities — wire, carrier, or radio — crosstalk is a factor of major importance. Not only do crosstalk coupling losses impair the quality of transmission, the secrecy of conversation itself is jeopardized should crosstalk magnitudes become

sufficiently high.

Crosstalk effects on existing lines are determined, in common practice, by introducing a disturbing source in one circuit while the induced energies in exposed circuits are measured. Measurements are required at many frequencies, interspaced by small increments over the band under consideration.

At the General Telephone Company of California engineers use the G-R Random Noise Generator, suitably amplified by the G-R Type 1206-B Unit Amplifier, as a wide-band disturbing source. All frequencies in the band are simultaneously applied with constant energy per cycle, while crosstalk energies in the disturbed circuit are measured by the Western Electric 31B Transmission Measuring Set (W.E. 2B Noise Measuring Set for voice frequencies). All carrier channels are excited equally regardless of the channel's position in the carrier band; and, so long as each channel is the same number of cycles wide, the crosstalk noise measured at the output is a valid relative measure of the cross-coupling into the channel. Measurement time is a fraction of that required by single-frequency methods.

In adjusting gain of negative-impedance repeaters used for short-haul regional circuits there is another time-saving use for the Random Noise Generator's extremely broad frequency spectrum. The effective gain representing the complete pass band is obtained in *one measurement*, thereby considerably reducing the time and cost of maintenance and installations testing. Here again, step-by-step measurements are otherwise required.

The telephone transmission engineer is but one of the many to have experienced the advantages of the *controlled* electrical noise supplied by the Random Noise Generator.

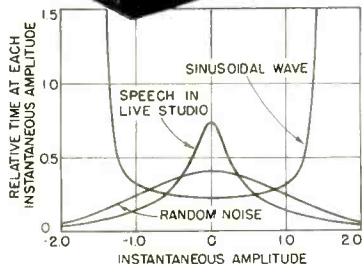

The RANDOM NOISE GENERATOR'S amplitude distribution closely approximates the normal probability distribution of speech, music, and many other sounds and electrical disturbances which occur naturally (note that the distribution of the sine wave is entirely different). For this reason, this signal is especially useful for room acoustics studies, including reverberation and sound-transmission measurements, and for psycho-acoustics work.

The Random Noise Generator is an ideal device for checking performance of recording and audio equipment, communications systems, and detection apparatus for susceptibility to interference. It is also widely used as a wide-band modulating source. Three frequency bands are available with ranges from 30 cycles to 20 kc, 500 kc, and 5 Mc, respectively.

Type 1390-A Random Noise Generator . . . . \$240  
Write for Complete Specifications

## GENERAL RADIO Company

275 Massachusetts Avenue, Cambridge 39, Mass., U.S.A.

Broad Avenue at Linden, Ridgefield, N. J. NEW YORK AREA 920 S. Michigan Ave. CHICAGO 5

1150 York Road, Abington, Pa. PHILADELPHIA

8055 13th St., Silver Spring, Md. WASHINGTON, D. C. 1000 N. Seward St. LOS ANGELES 38



*Now!*  $\frac{7}{16}$ " STUD type as well as WIRE-IN type

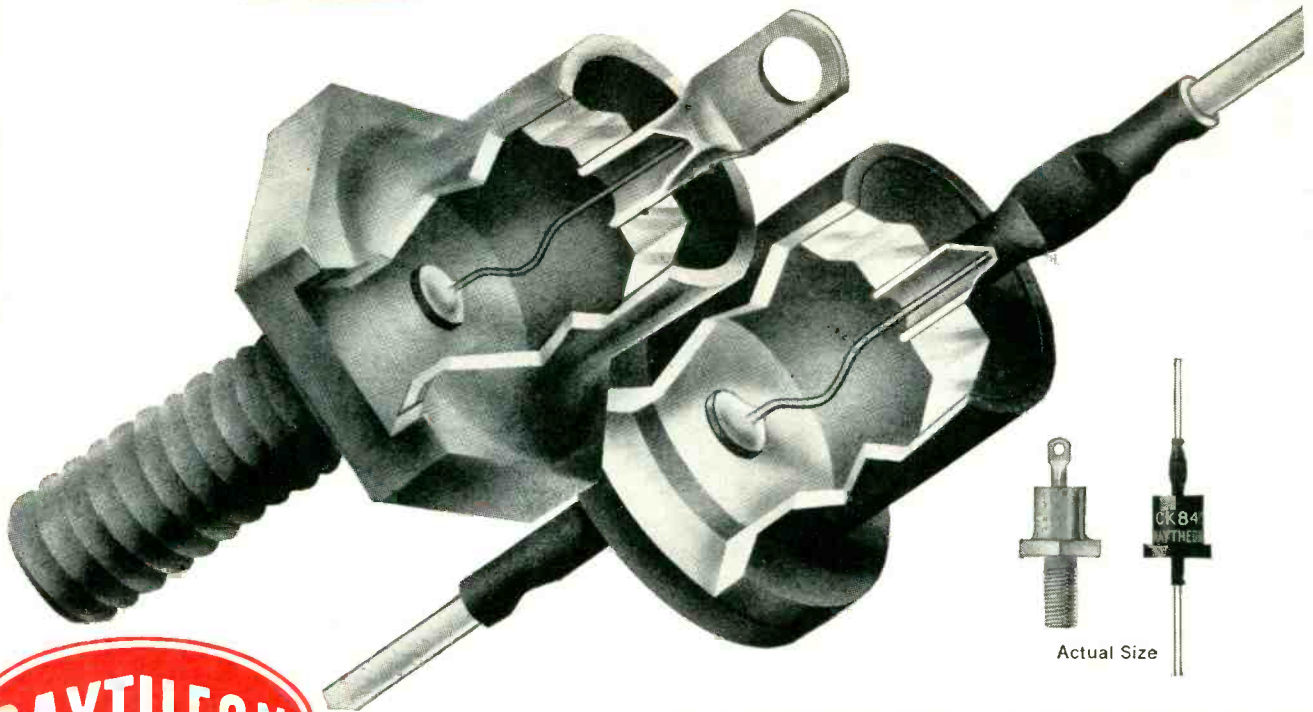

**SOLID STATE DIFFUSED JUNCTION**

# SILICON RECTIFIERS

AVERAGE CHARACTERISTICS				Case Dimensions***	
Type	Peak Inverse Volts*	Forward Current** Amps. 150°C Case Temp.	Reverse Current (max.) at PIV mAdc at 25°C		
<b>CK846</b>	100	1.0	0.002		
<b>CK847</b>	200	1.0	0.002		
<b>CK848</b>	300	1.0	0.002		
<b>CK849</b>	400	1.0	0.002		
<b>CK850</b>	500	1.0	0.002		
<b>CK851</b>	600	1.0	0.002		

Type	Peak Inverse Volts*	Forward Current** Amps.		Reverse Current (max.) at PIV mAdc at 25°C
		150°C Ambient	100°C Ambient	
<b>CK840</b> (1N537)	100	0.25	0.5	0.002
<b>CK841</b> (1N538)	200	0.25	0.5	0.002
<b>CK842</b> (1N539)	300	0.25	0.5	0.002
<b>CK843</b> (1N540)	400	0.25	0.5	0.002
<b>CK844</b>	500	0.25	0.5	0.002
<b>CK845</b>	600	0.25	0.5	0.002

**Operating Temperature—minus 65°C to plus 165°C**

**Storage Temperature — up to 175°C**

**Hermetically Sealed—Welded Precise Junction Gradient for Specific Rectifier Applications**

**Flat Junctions for Uniformity and Control of Characteristics**

Uniform characteristics and uniformly high quality are assured by the Raytheon Solid State Diffusion Process which permits flat junctions and provides exact control of junction penetration.

Now, you can have your choice of ratings in either stud or lead construction, and both are available in production quantities.

\*PIV ratings apply from -65°C to +150°C  
 \*\*Average rectified current into inductive or resistive load  
 \*\*\*All dimensions maximum except where noted



## SEMICONDUCTOR DIVISION

Silicon and Germanium Diodes and Transistors • Silicon Rectifiers

NEWTON, MASS.: 150 California St. • DEcatur 2-7177  
 NEW YORK: 589 Fifth Ave. • PLaza 9-3900  
 CHICAGO: 9501 Grand Ave., Franklin Park • TUxedo 9-5400  
 LOS ANGELES: 5236 Santa Monica Blvd. • NORmandy 5-4221



# NEW PNP

# SILICON TRANSISTORS



in the approved **JETEC 30** package — now available

- designed for automation
- 0.200" pin circle dia. — ideal for printed circuits
- Raytheon-perfected Fusion-Alloy process means extreme reliability — less than one open in 800,000 hours†
- temperature range: minus 65°C to plus 160°C
- low cutoff current
  - welded — hermetically sealed
  - > 2N329 — *new high Beta type*
  - > 2N330 — *lowest noise factor of any make silicon transistor*

†based on 20,000,000 hours of Raytheon fusion-alloy transistor life tests

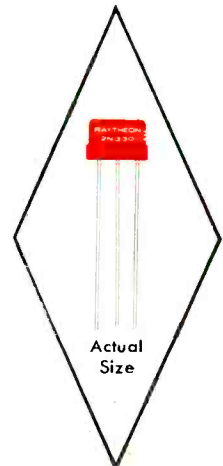

RAYTHEON NEW HIGH TEMPERATURE SILICON TRANSISTORS									
Type	Replaces	Reverse Current at -20V*		Beta	Base Resistance ohms	Collector Resistance kilohms	Noise Factor db(max.)	Collector Capacity $\mu\mu\text{f}$	Alpha Freq. Cutoff KC
		Collector $\mu\text{A}$	Emitter $\mu\text{A}$						
<b>2N327</b>	CK790	0.005	0.005	14	1200	500	30	35	200
<b>2N328</b>	CK791	0.005	0.005	25	1400	500	30	35	350
<b>2N329</b>		0.005	0.005	50	1500	500	30	35	500
<b>2N330</b>	CK793	0.005	0.005	18	1300	500	15	35	250

\*at 25°C

### RAYTHEON SILICON TRANSISTOR TESTS INCLUDE:

- *Life* — conducted at 135°C and 50 mW dissipation
- *Temperature Cycling* — 116°C (Steam at 10 lbs. gauge) and minus 60°C
- *Temperature Aging* — 100 hours at 160°C
- *Acceleration* — 5000 G centrifuge
- *Shock* — 500 G



## SEMICONDUCTOR DIVISION

Silicon and Germanium Diodes and Transistors • Silicon Rectifiers

NEWTON, MASS.: 150 California St. • DEcatur 2-7177  
 NEW YORK: 589 Fifth Ave. • PLaza 9-3900  
 CHICAGO: 9501 Grand Ave., Franklin Park • TUxedo 9-5400  
 LOS ANGELES: 5236 Santa Monica Blvd. • NOrmandy 5-4221

on a jet, a flush antenna can add 45 pounds to the equipment weight. An external antenna may add a weight of only 5 pounds but can produce an additional drag weight in flight of 48 pounds.

In some cases the external antenna has been redesigned to reduce drag weight to as little as 11 pounds.

Douglas reports that more time has been spent on antenna design problems for jets than on the antenna systems of all other commercial aircraft they have produced.

► **Future Needs**—Other electronic equipment needed for jet airliners includes a reliable radio altimeter for above 25,000 ft that does not require a cathode-ray tube indicator.

Another need is a simple reliable proximity or collision warning indicator. The market for such a device includes about 2,000 commercial planes and possibly 140,000 private and military aircraft.

## Electronics Checks Pitcher's Speed

EVEN pitchers in ball parks are not safe from tell-tale electronic devices. At West Palm Beach, Florida, the Kansas City Athletics are using an Admiral traffic radar device to check the speed of a pitcher's delivery.

Ball club manager Lou Boudreau said that previously a pitcher's speed was checked visually—"a not very accurate guide, but with our electronic scout it's now possible to determine the exact speed of the pitched or batted ball. While speeds up to 70 miles per hour already have been recorded it's too early in the season to permit our pitchers to use full steam."

► **Works**—The 26-pound device is operated by a 12-volt storage battery and is set up either behind or beside the catcher. The highest speed of the ball is registered in a fraction of a second on a dial calibrated in miles per hour up to 100. When a ball is batted, the meter also can record its going away speed.

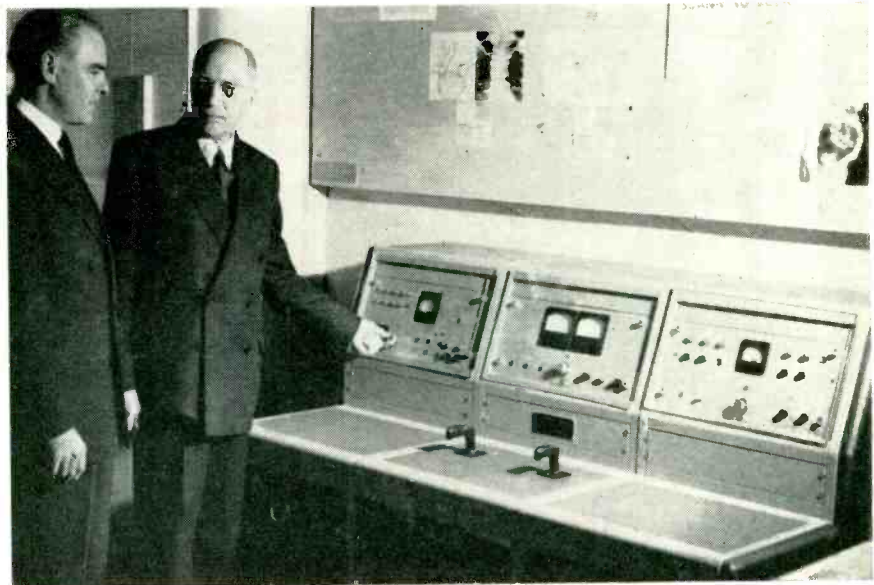

**SCINTILLATION** scanning counter made by Daystrom checks radioactive tracers in organs and tissues as . . .

## Radiation Safety Boosts Sales

Research, development and production of detection and measuring equipment is big business

RECENT discussions on the effects of nuclear radiation and fallout has focused some attention on instruments for radiation safety, most of which are electronic. AEC has a program for the development of new instruments and the improvement of old ones.

It has been estimated that such radiation instrument activities take as much as \$11 million annually. Most of the work is done by electronics firms on their own initiative or under AEC contract or incentive. According to AEC, there are now over 100 firms producing more than 1,000 different instruments or accessories used for detecting radiation.

► **Research**—For the fiscal year ending June 30, 1957, AEC budgeted nearly \$1.3 million for research alone to assist in instrument development. Of \$615,000 for contracts in the field, \$160,000 is allocated to the development of new and improved photomultiplier tubes.

RCA and DuMont Labs have the principle contracts in this development program, according to AEC, and the University of Notre Dame

is conducting a small research project to study the basic phenomena associated with photoelectric emission.

Approximately \$120,000 of the budget is allocated for scintillator material development projects at Levinthal Electronic Products, University of Louisville, Ky., the Engineering R and D Laboratory. The Borden Company and Pilot Chemicals.

► **Medical**—In the field of radiation dosimetry, according to AEC, the utilization of quartz fiber techniques and improved insulator materials are being studied under a research program at St. Procopius College. Additional projects are being conducted at New York University, New England Center Hospital and the National Bureau of Standards.

► **Government** — Instrumentation programs at AEC installations amount to \$664,000 for fiscal 1957. Projects include development of airborne radiological monitoring equipment for the determination of fallout, automatic sample counting equipment, germanium crystal fast neutron detectors and dosimeters.

Of AEC funds devoted to radia-

(Continued on page 22)



# How to Meet Tougher Specifications for Shock and Vibration Protection in Jets and Missiles

You've got to design to tougher specifications for combined shock and vibration isolation if you're going to protect the reliability of electronic controls in today's high-performance jets and missiles. Faster accelerations, zero-length launching, and extreme maneuverability combine to impose shock and vibration loads far beyond current MIL specs. *These severe operating conditions must be reduced to a predictable environment suitable for electronic equipment.*

## Isolator Requirements

Higher shock inputs require more stiffness in the isolator, to store more energy for a given deflection, so there will be less energy to dissipate if the isolator bottoms. Higher vibration amplitudes call for greater clearances and minimum transmissibility at resonance. And vibration protection under high-g sustained acceleration demands a combination of these characteristics.

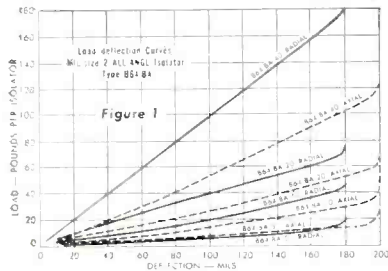

## Use of Performance Curves

The characteristics of an isolator having the stiffness necessary for handling the shock and sustained accelerations of jet and missile take-offs is shown by the curves of Figure 1. These curves can be used in choosing the proper isolator for operation under the expected service conditions, since they show both the deflection of isolators under a wide range of loadings and the maximum allowable deflection due to the combination of static load, sustained acceleration, and vibration amplitude.

A transmissibility at resonance well below three — considered exceptionally low — is shown by the curves of

Figure 2. The measurements for these curves were made with a 27-pound load supported on four 10-pound isolators, with double-amplitude vibration input of 80 mils. These curves, showing performance for both base and bulkhead mounting, also indicate that the isolator satisfies the need for consistent operation in every attitude of flight, launching, and maneuvering.

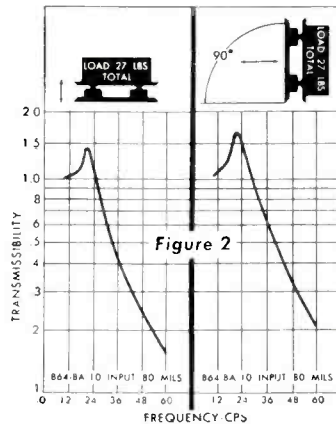

Figure 3 illustrates the construction of the B64 isolator that provides the performance characteristics shown by the curves, yet is dimensionally interchangeable with MIL-size mounts of comparable load ratings.

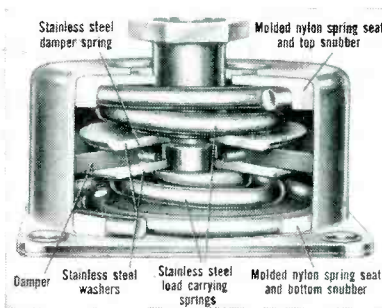
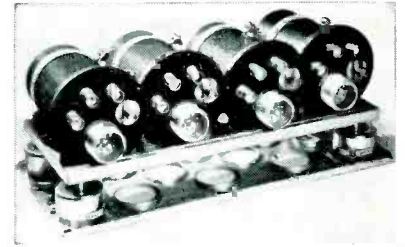

Figure 3

## Sustained Acceleration

The following example shows how Figure 1 aids in the choice of an isolator to give vibration protection under sustained acceleration. The straight part of the curves shows that the working range for each isolator allows about 190 mils maximum deflection (for axial loads). This occurs at about

three times the maximum load rating of the isolator. So a fully loaded isolator will withstand about three g's before bottoming (clearance in the Barry ALL-ANGL isolator is about 200 mils from the no-load position).



ALL-ANGL Barry Mounts protect vital fuel-gaging-system power units under acceleration of 6 g vertical and 5 g horizontal.

For operation under steady-state accelerations, the ratio of actual load to maximum-load rating must be decreased. Thus, for a 6-g acceleration, a five-pound isolator would bottom at an actual load of 2.5 pounds, or a 40-pound isolator would bottom at an actual load of 20 pounds.

## Vibration Protection

Because it is necessary to allow for the deflection due to applied vibration, ALL-ANGL isolators are often used at loads below their maximum ratings. For example: assume a 40-pound isolator loaded at 15 pounds and required to withstand 4 g's. From the curve, the 60-pound force corresponding to 4 g's will produce a 110-mil deflection. Since this is 80 mils below the 190-mil allowable maximum, a double-amplitude vibration input of 80 mils can easily be handled. This is a conservative application which allows for possible resonant conditions.

Because natural frequency increases as the isolator loading decreases, the final choice must take into consideration the relative importance of steady-state loading, vibration isolation, and shock protection. All of these factors are evaluated in engineering data available from Barry Controls Incorporated.

## Additional Design Data

Other curves of isolator characteristics, and data on their use in designing for predictable environment in jets and missiles, are contained in Barry Bulletin 57-2. This bulletin fully describes the complete line of ALL-ANGL Barrymount isolators in standard MIL sizes. Write today for your free copy.

# BARRY

# CONTROLS

INCORPORATED

SALES REPRESENTATIVES  
IN ALL PRINCIPAL CITIES

707 PLEASANT STREET, WATERTOWN 72, MASSACHUSETTS

Barry's new Western Division, in Burbank, California, offers fast, on-the-spot design and prototype service, and production of special systems.

tion instruments activities as an integral part of its program of research and plant operations, about half is allocated to research and development, 25 percent for the procurement of commercial instruments, 5 percent for on-site fabrication of equipment and the remaining 20 percent for repair and maintenance of equipment.

## Industry Ranks High In Patent Ownership

Approximately 12 percent of U.S. patents are owned by firms in field

IMPORTANCE of patents in the electronics industry is indicated in the National Science Foundation's final report on science and engi-

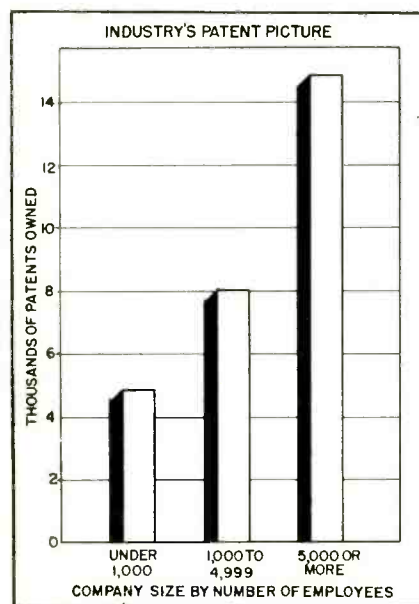

neering in American industry. It shows that companies in the electrical-electronics equipment field owned 28,000 patents and had 8,400 patent applications pending in 1953.

The industry was fourth largest in number of patents owned and third in applications pending. The machinery field ranked first in total number of patents owned with 50,300. Chemicals and allied products ranked next with 33,400, and the professional and scientific field followed with 32,000.

In patent applications pending, chemicals ranked first with 12,200, followed by machinery with 11,000, and electrical equipment with 8,400.

► **Why**—Over 75 percent of 200 large companies supplying information on patents indicated that they patent a substantial proportion of their newly developed products and processes, in general, everything that is patentable or worthwhile. Almost all of these companies cited protection rights rather than a desire for royalties or licensing income as the chief reason for taking out patents.

Of the few companies in the sur-

vey that do not obtain a significant number of patents, the chief reasons were that either they develop few patentable items, or government projects constitute a large percentage of their research effort and on such projects the U.S. agencies involved restrict patent rights.

► **Size**—In the electrical machinery field which covers electronics, companies with 5,000 or more employees accounted for 54 percent of the patents owned or 14,900, and most of the patent applications, 4,000.

Companies in the industry with

(Continued on page 24)

## FCC Actions

► **Decided** to deintermix vhf and uhf tv. Ultrahigh only will be Albany-Schenectady, Springfield-Peoria, Evansville, Ind., Fresno, Calif. and Elmira, N. Y.

► **Tallied** 20 translators on the air, a total of 10 construction permits granted and 57 applications pending

► **Received** GE petition to allocate frequencies in 152-162 mc and 450-460 mc bands for traffic control

► **Filed** proposal for air-ground radiotelephone service by Michigan Bell that would give two-way in-flight communications near Detroit

► **Completed** revision of Part C list showing acceptable equipment other than broadcast

► **Invited** comment on proposals relative to use of frequencies 123.0 and 122.8 mc by certain classes of aircraft

► **Amended** railroad radio rules to provide for land motor vehicles operated in pickup and delivery service

► **Arranged** with Federal Trade Commission to receive copies of FTC complaints of false or misleading radio and tv advertising

► **Granted** special temporary authority to AT&T at Ojus, Fla. for fixed public point-to-point radiotelephone circuit direct to Grand Bahama Island

► **Proposed** to terminate lenient granting of STA (special temporary authority) status to television broadcasters, particularly when issued in lieu of program tests. Existing STA's will be reviewed to speed up formal licensing



# Power where it's Needed!



This new ANDREW 450 MC base station antenna has been designed for the many base stations that are not in the center of their desired coverage area. Such stations, placed to take advantage of mountain tops, or located at operations headquarters, can now concentrate their highest gain in the direction where the need is greatest.

In planning a new radio system or improving an existing system, consider the advantages of an integrated ANDREW antenna system. The following example shows how an ANDREW system, using the Type 201, can give improvement over ordinary equipment in all directions and more than 9 db improvement in the best direction.

Typical Existing System	Relative Gain, db		
	Front	Side	Back
Base Station Antenna (Typical)	5.0	5.0	5.0
Station Cable Loss, 100 feet RG-17/U	(2.5)	(2.5)	(2.5)
Mobile Antenna, $\frac{1}{4} \lambda$ Whip (RG-58)	0*	0*	0*
<b>Combined Antenna System</b>	<b>2.5</b>	<b>2.5</b>	<b>2.5</b>
<b>ANDREW Type 201 System</b>			
Base Station, Type 201	10.8	6.1	3.3
Base Station Cable Loss, 100 feet Type HO HELIAX	(1.0)	(1.0)	(1.0)
Mobile Antenna, Type 233 (RG-8)	1.8*	1.8*	1.8*
<b>Combined Antenna System</b>	<b>11.6</b>	<b>6.9</b>	<b>4.1</b>
<b>IMPROVEMENT, db</b>	<b>9.1</b>	<b>4.4</b>	<b>1.6</b>

\*Gain of Type 233 is relative to assumed 0 db gain of  $\frac{1}{4} \lambda$  whip with RG-58/U, and includes allowance for lower loss of RG-8/U feed cable.

Write for Bulletin 8417 giving complete information on Type 201. Also, be sure your library contains ANDREW Catalog 21, a complete, 100-page guide to antenna and transmission line systems.

**Andrew**  
CORPORATION  
363 EAST 75th STREET - CHICAGO 19

Offices: New York • Boston • Los Angeles • Toronto

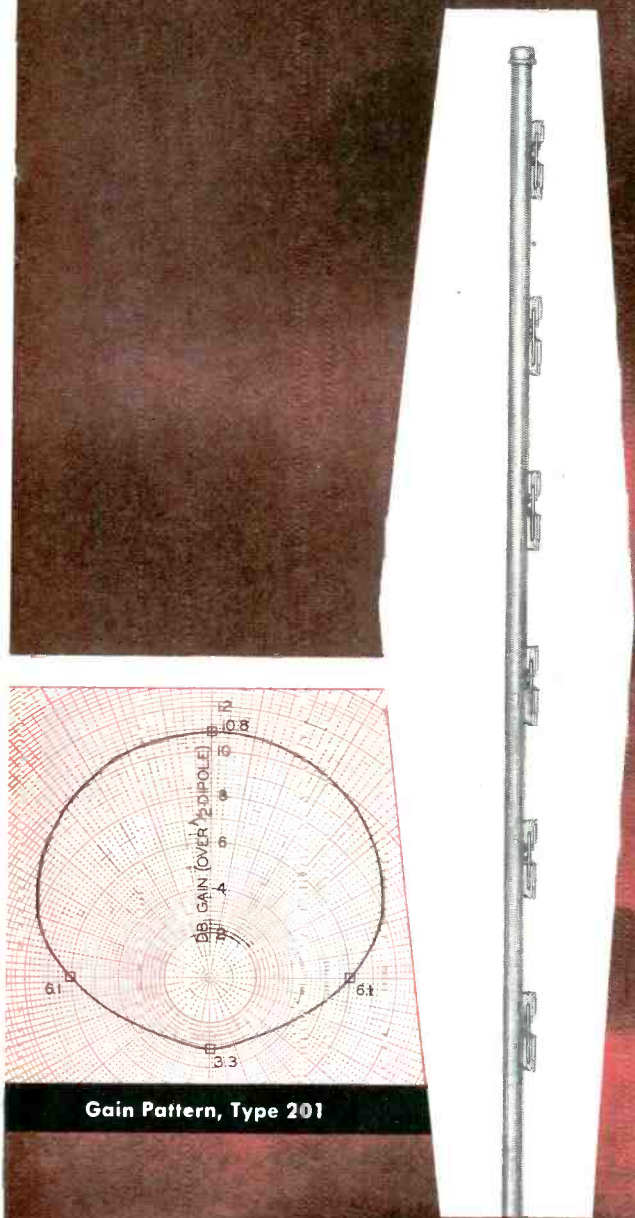

Gain Pattern, Type 201

ANTENNAS • ANTENNA SYSTEMS • TRANSMISSION LINES



1,000 to 4,999 employees accounted for 8,100 of total industry patents owned and 2,700 of the applications. Small firms, less than 1,000 workers, owned 4,900 patents and had 1,700 patents pending.

► **Cost**—In attempting to correlate the number of patents an electronic-electrical company owned and its research and development costs, the study showed that large companies with over 5,000 employees accounted for 63 percent of

the total research and development cost of companies owning patents but only 54 percent of total patent ownership.

Smaller companies, on the other hand, own a proportion of patents substantially larger than their share in the cost of company-financed research and development. The findings suggest that the average cost of r and d work per patent obtained may tend to be lower in small firms than in large ones, according to the study.

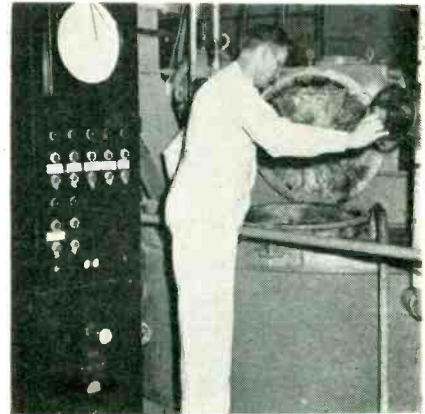

Potassium silicate production at Sylvania

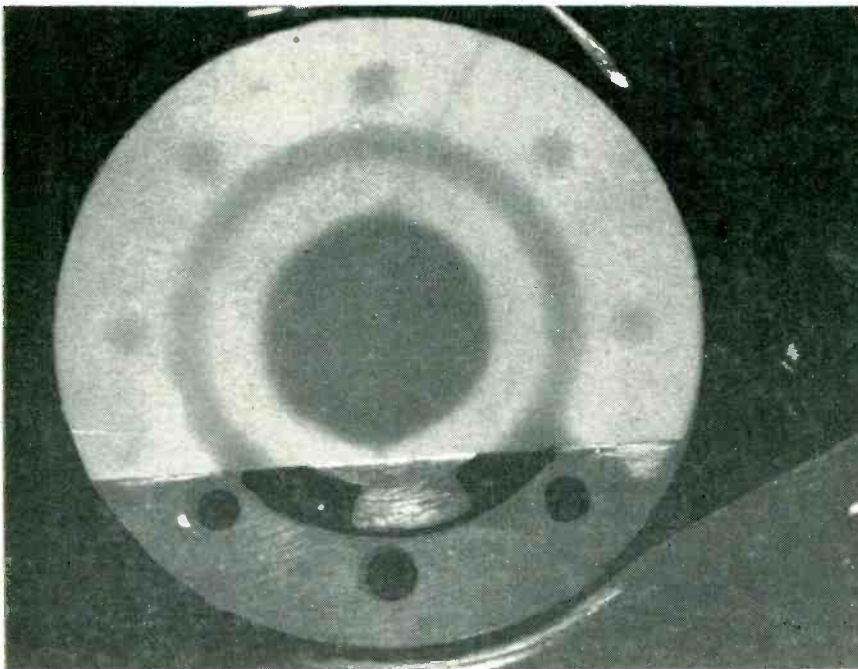

HEAT-sensitive phosphor coating detects breaks in metal bonds as

the material is sprayed on the bonded parts, heat is applied to the joint. Discontinuities in the bond show up as dark spots on the phosphor coating.

► **Volume**—Even though the tv business has dropped off for phosphor manufacturers, it still is one of the main segments of the business. Approximately 375,000 pounds of the material worth \$3.7 million were used in electronics last year. Even with a greater proportion of portables and possible lower set production this year, 1957 volume is expected to total 350,000 to 360,000 pounds and a \$3.6 million dollar volume. Picture tubes account for approximately 95 percent of the volume and other c-r tubes account for the rest.

► **Screens**—Use of the smaller tubes cuts phosphor needs by about 50 percent. The 21-inch tube uses about 7.5 grams of phosphor, not including wastage; the 8.5 inch portable tube uses 1.8 grams; the 10-inch tube, 2.5 grams; the 14-inch, about 3.5 grams and the 17-inch tube about 4.6 grams.

► **Volume**—Amount of phosphor that the electronics industry has used since tv production got underway is indicated by the amount of potassium silicate that the industry consumes. Sylvania recently announced that it had produced and shipped 5-million gallons of the chemical, enough for the manufacture of 50 million tv picture tubes. The chemical is used for bonding the phosphor to the tube face.

(Continued on page 26)

## Phosphors Find New Markets

New applications in missiles and in nondestructive testing may bolster lagging sales

CUT-BACK in tv set production so far this year is having its effects on the volume of the phosphor business. But a new application of the material may boost its volume considerably despite the lag in set production.

► **Development**—United States Radium Corp. recently developed an improved thermographic phosphor specifically designed as a heat-sensitive luminescent material. It exhibits interesting possibilities in

the fields of surface temperature detection and measurement, according to the company.

At present, the maximum sensitivity is greater than 20 percent change in brightness per degree change in temperature. Heretofore, change in brightness has been in the neighborhood of 4 or 5 percent.

► **Applications**—The material, which can be sprayed on any surface and removed easily with a solvent, is being applied in the fields of bonded laminates, bonded sheet materials with substructures and surface air flow patterns. After



# NOW...A MORE COMPACT 28 VOLT, 100 AMPERE tubeless magnetic amplifier regulated DC POWER SUPPLY by **PERKIN!**

24 to 32 Volts Adjustable Range...  
**IMMEDIATE DELIVERY!**

This power supply represents the latest design thinking of the nation's top specialists in the field. Hundreds of these units are now in operation, replacing generators and batteries in electronic laboratories, industrial plants, and military ground radar systems, etc., where utmost reliability and performance are essential. Over 15,000 Perkin power supply units are in operation in industry today.

**No tubes, moving parts or vibrating contacts.**

**Regulation ± 1/2%**

**IMMEDIATE DELIVERY!**

**DIMENSIONS:**  
26 1/2" L x 17" D  
x 17" H.

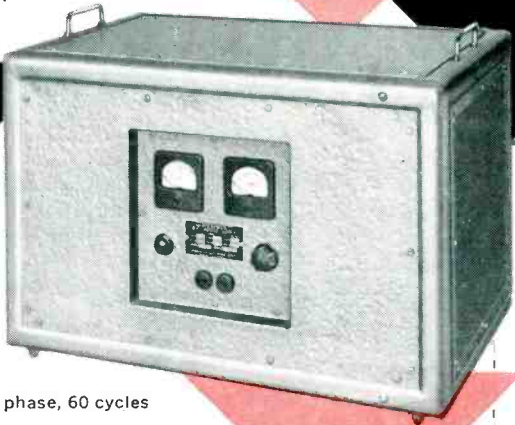

Model MR2432-100XA

**Additional Specifications:**

- Ripple: 1% RMS
- AC Input: 208, 230 or 460V ± 10%, 3 phase, 60 cycles
- Weight: 230 lbs.
- MODEL NO. MR917-100XA—also available: specifications same as above except output of 9—17 volts DC.

When you require a power supply, SPECIFY PERKIN, for a wider range of standard models and immediate delivery from stock.

Wire factory collect for prices. For a prompt reply on your application, write factory on your letterhead or contact local representatives listed below.

# PERKIN

**PERKIN ENGINEERING CORPORATION**  
345 KANSAS STREET, EL SEGUNDO, CALIFORNIA • OREGON 8-7215

*Leader in Tubeless Magnetic Amplifier Regulation*

New York Area: Sales and Warehousing: 1060 Broad St., Newark 2, N.J., MArket 3-1454

**SALES OFFICES:** Chicago: PA 5-6824 • Philadelphia: BR 5-2600 • Boston: MI 8-0756 • Albuquerque: 5-9632  
Atlanta: EL 3020 • Charlotte: ED 2-7356 • Dallas: FO 8-8306 • Denver: MA 3-0343 • Kansas City, Mo.: VA 1-5330 • Miami: MO 5-1563 • Minneapolis: MI 4-7884 • Seattle: MO 4895 • St. Louis: PA 5-7701  
Winston-Salem: 4-9750 • Canada: Agincourt, Ontario: AX 3-7011.

## OTHER PERKIN STANDARD DC POWER SUPPLIES

### 28 Volt Models

Model	Volts	Amps	Reg.	AC Input (60 cps)	Ripple rms
28-5VFM	0-32 V	5	15-20% (24-32V range)	115 V 1 phase	2%
28-10WX	24-32 V	10	± 1/2%	100-125 V 1 phase	1%
MR532-15A	2-36V	15	± 1/2%	105-125V 1 phase	1%
28-15VFM	0-32 V	15	15-20% (24-32V range)	115 V 1 phase	5%
M60V	0-32V	25	± 1%	115V 1 phase	1%
MR1040-30A	5-40V	30	± 1%	100-130V 1 phase	1%
28-30WXM	24-32V	30	± 1/2%	100-125V 1 phase	1%
28-50WX	24-32 V ± 10%	50	± 1/2%	230 V* 3 phase	1%
MR2432-100XA	24-32V	100	± 1/2%	208, 230V* 3 phase	1%
MR2432-200	24-32 V	200	± 1/2%	208 230V* 3 phase	1%
MR2432-300	24-32 V	300	± 1/2%	208, 230V* 3 phase	1%
MR2432-500	24-32 V	500	± 1/2%	208, 230V* 3 phase	1%

\* ± 10%. Also available in 460 V ± 10% AC input. Will be supplied with 230 V input unless otherwise specified.

### 6, 12, 115 Volt Models

Model	Volts	Amps	Reg.	AC Input (60 cps)	Ripple rms
6 Volt	6	5	± 1%	95-130 V 1 phase	1%
	6-5WX ± 10%				
	6-15WX ± 10%				
12 Volt	6	15	± 1%	95-130 V 1 phase	1%
	6-40WX ± 10%				
	12-15WX ± 10%				
115 Volt	12	15	± 1%	95-130 V 1 phase	1%
	115-5WX ± 10%				
	115-125 5				
G125-25**	115-125	25	± 1 1/2-4%	230, 460 V 3 phase	5%

\*\*Germanium Rectifier Unit † Increases to 4% @ 15V. †† Increases to 2% @ 15V.



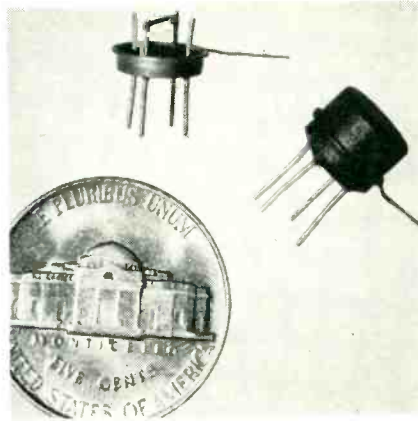

**RELATIVE** size of new solid-state device can be compared to hand (left) and nickel (right) as shown.

## Tetrajunction Transistor Appears

Dual-triode unit designed to reduce components needed in equipment manufacture

**ADVANTAGES** found in the use of dual-triode electron tubes and other multipurpose tubes have spurred the development of transistors with similar attributes. The first result of a development program initiated at General Electric is the tetrajunction transistor.

► **Designed for use**—A superheterodyne receiver has been developed (see p 148, this issue). Four ordinary transistors are replaced with two tetrajunction units with attendant savings in components. The receiver, developed by Hazeltine Research Corp.,

is expected to be marketed in the near future.

► **Economy**—Figures giving the relative price of the new unit compared with the two it replaces are not available at present because of lag between the development of the unit and availability of facilities and techniques that allow economical production. A 20 to 25-percent reduction in cost of transistors for a receiver is expected.

► **Other Uses**—Applications of this device in switching circuits and in computers can easily be found. Construction of units with larger cross section will make their application in high-level audio circuits feasible.

## Business Demands More Computers

Range of customers increases with military supplying impetus for big machines

**WITHIN** the last year, business has tripled its demand for electronic computing equipment. Total volume of computer business ran over \$75 million last year with estimates that 1957 should see this figure doubled and supply remain far behind demand. Predictions are that the next ten years will see 10,000 business computers manufactured and sold in the U.S.

► **Catalyst**—One of the strong reasons behind this excellent growth and outlook is the impetus supplied by the military in the development of large-scale business computers. Examples of this are the recent release of information on the MIT-Lincoln-Laboratory, TX-2 computer and the RCA Bizmac computer.

► **TX-2**—Developed at MIT under Navy sponsorship, this computer is designed to accommodate an internal memory with a capacity of 260,000 words—almost 50 times

greater than the MIT Whirlwind. It uses transistors and by multiple-sequence operations permits a wide variety of input/output devices to be used simultaneously. It will be used for further experimentation and development in the fields of data processing systems and their applications to automatic and real-time control problems.

► **Bizmac**—This \$4.1-million electronic data processing system keeps track of more than 100 million facts about the Army's inventory of tank and automotive spare parts around the world.

To accomplish this, 220 units of nineteen different but fully integrated types of equipment are required. The computer will not only keep an inventory of spare parts but also catalog them and forecast supply requirements.

## New Speeds Shape Up For Tape

Slow tape speeds are sought to reduce cost of recorded magnetic tapes

**BATTLE** OF speeds is emerging in recorded magnetic tape field much as it did in disk recording a few years ago. Slower speeds are coming into the picture but the number of tape recorders with different speeds create problems for the recorded tape business.

► **Status**—Here is the way one tape manufacturer sizes up the tape speed picture: Of an estimated 1.6-million tape recorders in use in the U.S. today, about 1.4 million are home-type machines while 160,000 are professional units. Almost all home types are dual-track units. About 1.1 million of them are two-speed units operating at both 7.5 and 3.75 inches per second.

There are 160,000 home-type units that operate on the single speed of 7.5 inches per second and another 160,000 home units operating at 3.75 ips.

To further complicate the pic-

(Continued on page 28)



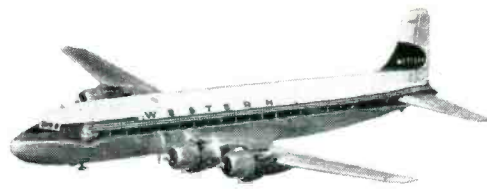

• Using Berkeley's Model 5571 Frequency Meter, a Western Airlines technician checks 360-channel transmitter, part of WAL's new communications system — a model for the airline industry, just like Western's famous "Champagne Flights" in Western America.

How

**WESTERN**  
  
**AIRLINES**

Keeps Its  
 360-Channel  
 VHF System  
 "On The Money"

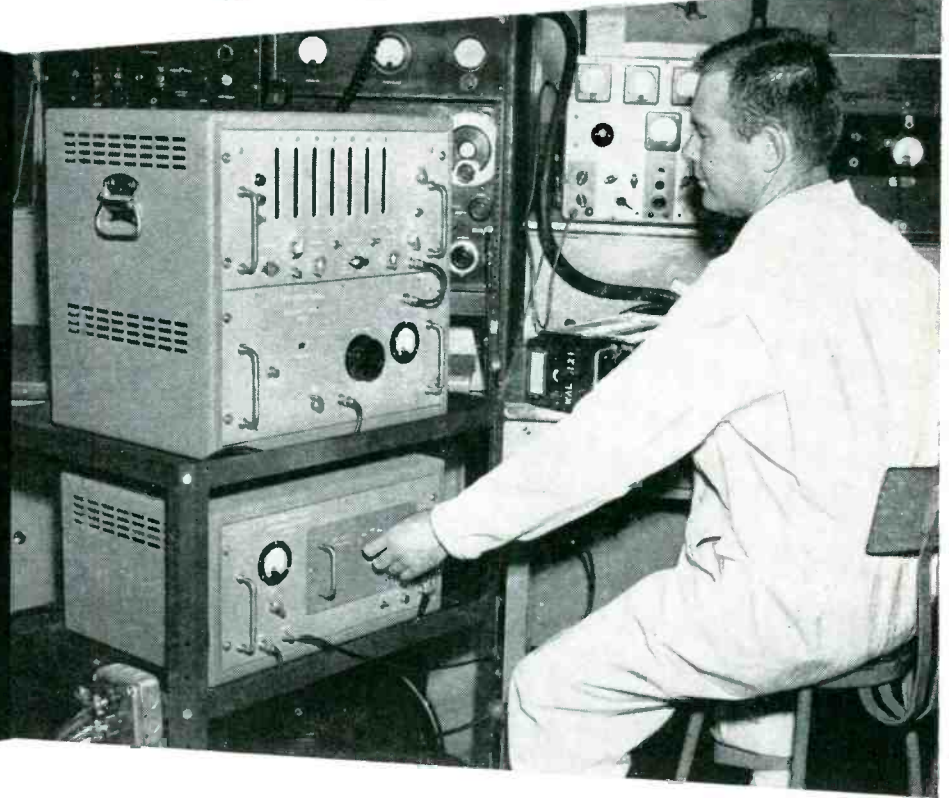

## With a Single Berkeley Frequency Meter

When Western Airlines recently modernized its air-to-ground communications by adding a 360-channel VHF radio system, company engineers needed a truly universal test instrument to make certain their new equipment stayed "on the money."

WAL thoroughly investigated available frequency measuring equipment, then selected a Berkeley Model 5571 combined frequency and time interval meter, with a Model 5580 range extender.

Used Daily in WAL's Radio Maintenance Department in Los Angeles, the Model 5571 rapidly became the most valuable single piece of test equipment there. Western's technicians use it for checking frequency of the 38 crystals in the 360-channel transmitter; IF alignment; transmitter frequency monitoring; periodic checks of frequency standard; evaluation of components and replacement parts, and checking equipment modifications.

### Brief Specifications:

**RANGE:**  
 Frequency—0 cps to 42 mc. Extendable to 1005 mc.  
 Time interval—1  $\mu$ sec to 10<sup>7</sup> seconds.  
 Period—0 to 1 mc.

**INPUT SENSITIVITY:**  
 0.1 volt rms

**INPUT IMPEDANCE**  
 10 megohms to 2 mc, 100 ohms to 42 mc

**ACCURACY:**  
 $\pm 1$  count,  $\pm$  crystal stability  
 $(\pm 3$  parts in 10<sup>7</sup>)

**PRICE: (f.o.b. factory)**  
 \$1825. (0-42 mc Model 5571 only).

PRICE: (F.O.B. FACTORY)

According to Pete Wolf, director of communications for Western Airlines, Berkeley equipment was chosen because:

★ It offers complete frequency coverage, from DC to 1005 megacycles, with the highest degree of accuracy.

★ Digital readout techniques used throughout eliminate the chances of error and time lost in interpreting meter readings.

V. T. Rupp Company, Berkeley's experienced engineering representatives in Los Angeles, greatly aided Western by familiarizing personnel with Model 5571 operating and maintenance techniques. Why not let Berkeley's skilled applications engineers in your area help with your avionics problems?

★ Design permits use of printer.

★ Simplicity of operation.

★ Better input sensitivity and input impedance specifications than competing equipment.

★ No plug-ins required for time interval measurements.

Beckman

**Berkeley Division**

Richmond 3, California

a division of Beckman Instruments, Inc.

130

ture for the recorded tape business, there are a substantial number of professional-type recorders in use in the home market, particularly by the hi-fi addict. There are some single-track units in use and some two-speed units operating at 7.5 inches per second and 15 ips. A few home machines operate at three speeds, going as low as 1½ inches per second.

► **Tapes**—Recorded tape manufacturers face a four-speed market much as the disk makers do. Most recorded tapes today are recorded dual track at 7.5 ips. There is a limited demand for single-track tapes at 7.5 ips to allow for some of the single-track professional machines in use in homes.

Tape record makers expect that tape speeds will settle down in the future to the slower speeds of 3.75 and 1½ ips as technical advances make it possible to obtain higher quality, better frequency response, signal-to-noise ratio and freedom from wow. The big advantages, assuming reasonable fidelity can be maintained, include longer tape playing time in a smaller package at lower cost.

## Financial Roundup

FOURTEEN companies in the electronics industry, who reported in the past month on net profits, split almost evenly between those who increased profits over 1955 and those who did not. Following are the figures for the companies for the fiscal periods indicated.

Company	1956	Net Profit	1955
Borg-Warner 12m	\$35,841,952		\$41,075,084
Cornell-Dubilier 3m	279,693		377,293
Fansteel 12m	3,306,323		2,298,195
Garrett Corp 6m	2,282,000		2,331,000
General Electric 12m	213,756,849		208,908,054
GPE 12m	2,394,729		2,530,753
General Transistor 12m	183,784		*5,720
High Voltage 12m	167,852		106,452
Magnavox 6m	2,276,539		1,774,960
McGraw-Edison 12m	13,965,000		9,501,000
RCA 12m	40,031,000		47,525,000
Siegler Corp 6m	539,953		613,855
Van Norman 12m	1,412,960		
Western Electric 12m	75,054,119		63,339,798
			*(loss)

## Meetings Ahead

Apr. 2-5: International Symposium On The Theory Of Switching, The Computation Laboratory of Harvard University, Cambridge, Mass.

Apr. 4-6: American Rocket Society's Annual Spring Meeting and Rocket and Satellite Exposition, Sheraton-Park Hotel, Washington, D. C.

Apr. 8-11: British Radio and Electronic Component Show, Grosvenor House and Park Lake House, London, England.

Apr. 9-10: Annual Industrial Electronics Educational Conf., IRE, Armour Research, Ill. Institute of Technology, Chicago, Ill.

Apr. 11-13: Southwest IRE Regional Conference & Electronics Show, Shamrock Hilton Hotel, Houston, Texas.

Apr. 14-16: National Symposium On Telemetering, IRE, Sheraton Hotel, Phila., Pa.

Apr. 24-26: Seventh IRE Region Technical Conference & Trade Show, San Diego, Calif.

Apr. 23-25: International Symposium On the Role of Solid State Phenomena In Electric Circuits, IRE, Eng. Soc. Bldg., New York, N. Y.

Apr. 23-25: Fifth National Electromagnetic Relay Conference, Oklahoma A & M College, Stillwater, Okla.

Apr. 25-26: First annual tech-

nical Meeting and Equipment Conference of the Institute Of Environmental Engineers, La Salle Hotel, Chicago, Ill.

Apr. 26-27: Eleventh Annual Spring Technical Conference On TV, IRE, Engineering Society Bldg., Cincinnati, Ohio.

Apr. 29-May 1: Third National Flight Test Instrumentation Symposium, ISA, Statler Hotel, Los Angeles.

May 1-3: 1957 Electronic Components Symposium, Morrison Hotel, Chicago, Ill.

May 9-10: 1957 PGMTT Meeting, Western Union Auditorium, New York, N. Y.

May 12-16: The Electrochemical Society 111th Meeting, Hotel Statler, Washington, D. C.

May 15-16: Age Of Space Symposium sponsored by Southern Research Institute, Birmingham, Ala.

May 16-18: New York State Society of Professional Engineers, 1957 Engineering Industries Exposition and Annual Convention, Statler Hotel, New York, N. Y.

May 13-15: National Aero & Navigational Electronics Conference, IRE, Dayton, Ohio.

May 14-16: Industrial Nuclear Technology Conference, ARF, Ill. Tech, Nucleonics Magazine, Museum of Science and Industry, Chicago, Ill.

## Industry Shorts

► **Dollar volume** of phenolic resin used annually to coat resistors and capacitors is estimated at \$150,000 by Hooker Electrochemical.

► **Exports** of British radio equipment of all kinds in 1956 totaled more than \$110 million, a new record, according to Britain's Radio Industry Council.

► **Number** of semiconductor units produced at Mullard's new plant in England will total 2 million units by 1958.

► **Latest** survey by the Depart-

ment of Commerce of households with tv sets shows that 72 percent of all households had one set, 4 percent had two or more sets and 24 percent had none.

► **Number** of tv stations able to broadcast in color was 257 on Jan. 1, 1957, according to NBC estimates.

► **Ballistic** missile program of Air Force progresses as new data reduction center for conversion of telemetered test data goes into operation at Ramo-Wooldridge Corp., California. All data arrives at center on magnetic tape.



# Announcing A Complementary New Line Of ALL-TRANSISTORIZED INSTRUMENTS

BY

# KAY

DESIGNED FROM THE TRANSISTOR OUT . . .

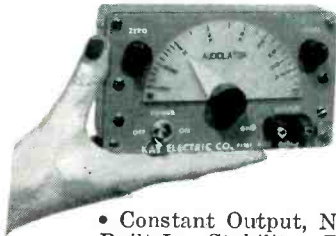

## KAY *Audiolator* All-Transistorized Beat-Frequency Audio Oscillator

### FEATURES

- Constant Output, No Line Voltage Influences
- Built-In Stability By Means of Feedback
- Output Constant with Frequency: 1 db over range
- No Hum • Battery Power Supply—Long Life
- No Grounds Needed—Place Across Any Transmission System • Excellent for Field Service, Military, Commercial and Domestic Hi-Fi, Industrial Applications

### SPECIFICATIONS

**Frequency Range:** 50 cycles to 15 KC  
**Output Voltage:** 1 volt at 600 ohms  
**Output Impedance:** 600 ohms  
**Output Flatness:** 1 db over entire range  
**Attenuator:** Continuously variable from 1 volt to 40 db below 1 volt  
**Δf dial: 0 adjust—**fine frequency control. Constant frequency shift over entire range  
**Power Supply:** Mercury or penlight cells—300 hrs. life  
**Dimensions:** 6" x 2" x 3 3/4"  
**Weight:** 2 lbs. **Price:** \$149.50 f.o.b. Pine Brook, N. J.

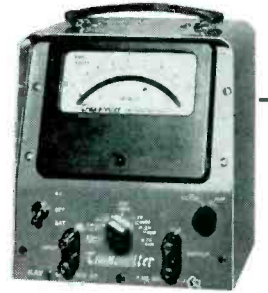

## KAY *Transvolter* MODEL VIDEO All-Transistorized, Broad-Band Audio-Video Voltmeter

### FEATURES

- Inherent stability due to feedback amplifier design
- Broad-Band frequency response 10 cycles to 10 mc
- Inherent advantages with use of transistors instead of vacuum tubes—small size—light weight—long life—rugged use—lower power consumption—high conversion efficiency
- Low Level Measurement over Frequency Range • May be used as a Humless Audio-Video Amplifier

### SPECIFICATIONS

**Frequency Range:** 10 cycles to 10 mc. Direct Reading in Volts and db  
**Amplifier Frequency Response:** Flat  $\pm .5$  db over range  
**Accuracy of Measurement:**  $\pm 5\%$  of full scale reading  
**Voltage Range:** 1 Millivolt to 1 volt full scale—7 ranges  
**Sensitivity:** Will measure down to 250 Microvolts  
**Input Impedance:** Capacity 5 micromicrofarads; Resistance Component 0.5 Megohms at 1 mc  
**Audio-Video Amplifier:** Maximum output .25 Volt at 75 ohms, Gain up to 40 db  
**Price:** \$495.00, f.o.b. Pine Brook, N. J.



## KAY *TransiPLY* Transistorized, Miniature Power Supply

### FEATURES

- Stable Metered Output • Continuously Variable Output • Low Impedance • No Ripple • High Current • Positive or Negative Bias Available

### SPECIFICATIONS

**Input Voltage:** 105-125 V, A.C., 50-60 cps  
**Output Voltage:** 0.5 V—7.0 V, D.C., Continuously variable  
**Output Current:** Maximum 300 Ma  
**Impedance (Internal):** 0.5 ohms  
**Ripple:** Less than 1 millivolt at full load  
**Regulation:** 50 Millivolts output variation over input voltage range  
**Weight:** 3 1/2 lbs.  
**Dimensions:** Width 5", Height 6 1/2", Depth 6 1/2"  
**Price:** \$125.00 f.o.b. Pine Brook, N. J.



## KAY *Transifier* Small, Modular, Plug-in, Wide-Band Transistorized Video Amplifier

### FEATURES

- Broad-Band Response to 15 mc
- Completely Transistorized—Small, Self-Contained, Compact Portable Unit • Signal Gain Controlled by Overall Feedback—Built-In Stabilization • No Hum • Long Stable Life—Powered By Three Penlight or Mercury Cells • Units May Be Cascaded to Provide Additional Gain

### SPECIFICATIONS

**Frequency Response:** 10 db position: 3 db down at 20 cycles and 15 mc—20 db position: 3 db down at 20 cycles and 10 mc  
**Gain:** 10 db and 20 db switchable  
**Input Impedance:** Capacitance 15 micromicrofarads—Resistive Component—20,000 ohms at 1 mc to 15,000 ohms at 10 mc  
**Output Impedance:** 75 ohms, approximately  
**Maximum Output Voltage:** 0.15 Volts 10 db position 0.30 Volts 20 db position  
**Price:** \$85.00 f.o.b. Pine Brook, N. J.



## KAY *Minilator* Multi-Crystal-Controlled Transistor Oscillator

### FEATURES

- Transistorized for Long-Life, Self-Contained Mercury Cells • (For Replacement, Ordinary Penlight Cells May Be Used) • Selection by Switch of 1 mc, 2 mc, 5 mc • External jack for any crystal from 1 mc to 5 mc • Stable; Adjustable to WWV Frequencies • Clean Waveform with Stabilizing Diode • Amplitude Feedback\* • Portable, Light-Weight, Small Cast-Aluminum Case • Low Price—Many Uses

### SPECIFICATIONS

**Output:** 0.25 volt at 1000 ohms impedance level  
**Dimensions:** 2 1/4" x 1 3/4" x 4 1/2"  
**Weight:** 12 oz.  
**\*Pat. Pend. Price:** \$95.00 f.o.b. Pine Brook, N. J.

## KAY *Transiprobe* All-Transistorized, Low-Capacity RF Probe

- ### FEATURES
- First transistorized broad-band probe, 20 cycles to 15 mc
  - Low power dissipation, all transistorized • Built-in stability, amplifier feedback • Open design for easy manipulation • No hum

### SPECIFICATIONS

**Frequency Response:** 20 cycles to 15 mc—1 db down at 50 cycles and 12 mc—3 db down at 20 cycles and 15 mc  
**Output Impedance:** Nominal 50 ohms  
**Input Impedance:** Capacitance, 4 micromicrofarads; resistive component, 100,000 ohms  
**Gain:** 1:1 (Unity gain), held constant by feedback amplifier  
**Maximum Input Voltage:** 0.3 volt peak-to-peak  
**Power Supply:** Mercury cells, 800 hour life; constant supply over life of cells. Separate power supply and connecting cables provided with probe.  
**Price:** \$125.00, f.o.b. Pine Brook, N. J.



# KAY

## ELECTRIC COMPANY

For Literature and Complete Specifications, Write

14 Maple Avenue, Pine Brook, N. J.  
Dept. E-4

# AMP-EDGE

# has the

Design-Engineered with Positive Wiping Contact and Frictional Grippage.

## The new AMP-EDGE connector gives you ...

**... greater flexibility**— your printed circuit area and completed unit are not limited by the size of connection, as found in alternate methods of edge connection.

**... greater design versatility**— they can be applied in any arrangement to any section of the perimeter of the printed circuit.

**... two-way cost reduction**— production time and labor costs are reduced through solderless termination of the connector to the wire (4,000 terminations per hour) and the ease of applying the Edge Connector to the printed circuit.

*For more information on AMP-Edge Connectors, contact:*

## AMP INCORPORATED



*General Office: Harrisburg, Pa.*

*Wholly owned subsidiaries: Aircraft-Marine Products of Canada Ltd., Toronto, Canada • Aircraft-Marine Products (G.B.) Ltd., London, England • Societe AMP de France, Le Pre St. Gervais, Seine, France • AMP-Holland N.V.'s-Hertogenbesch, Holland*

*Japanese Distributors: Oriental Terminal Products Co., Ltd., Tokyo, Japan*



# EDGE ON PRINTED CIRCUITS

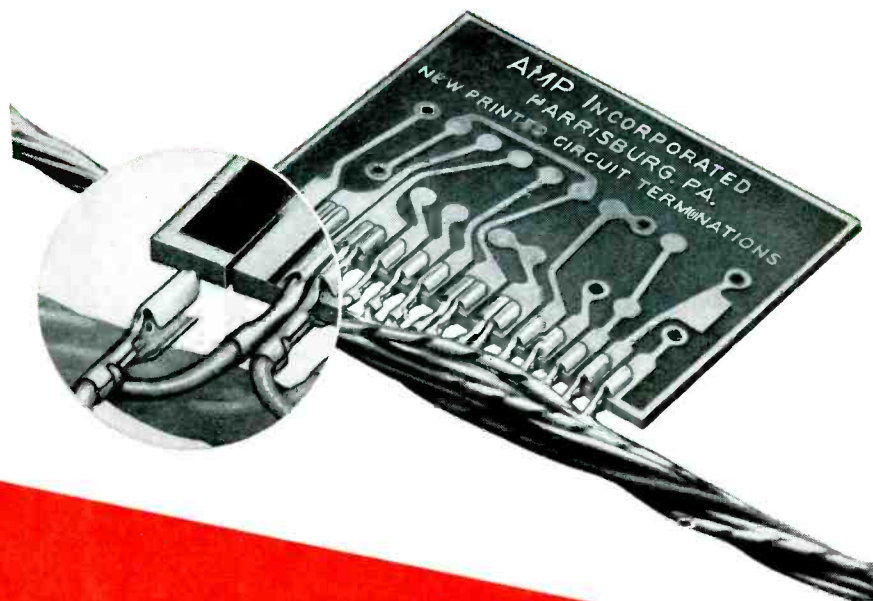

Amp's **C**reative **A**pproach  
TO BETTER WIRING

Another of the many unique designs made available by the AMP-Edge technique is the new, low-cost, compact AMP-Edge Connector Block. It allows freedom of arrangement, with small area displacement.

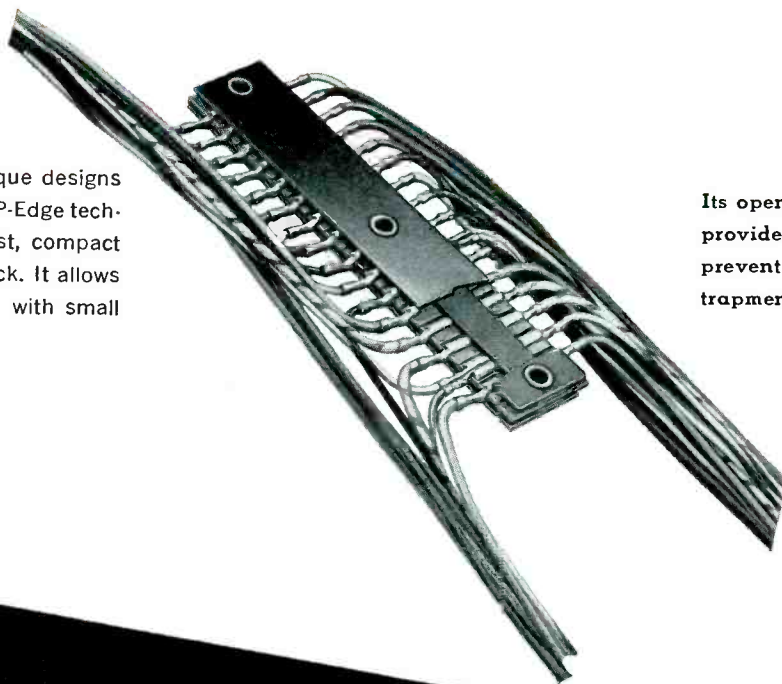

Its open construction provides aeration to prevent moisture entrapment.

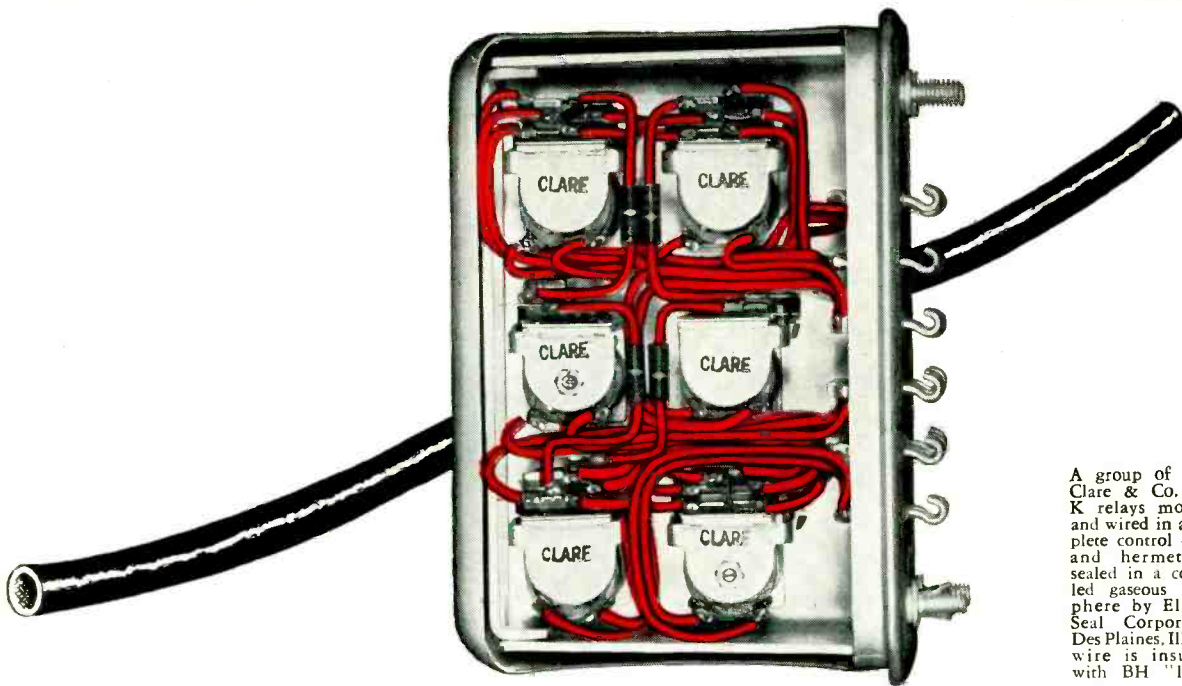

A group of C. P. Clare & Co. Type K relays mounted and wired in a complete control circuit and hermetically sealed in a controlled gaseous atmosphere by Electro-Seal Corporation, Des Plaines, Ill. Each wire is insulated with BH "1151".

*when close-up soldering is a problem*

## Beat the Heat with BH "1151"

When you insulate the wiring in sensitive electronic equipment with BH "1151" Silicone Rubber Fiberglas Tubing you get maximum product protection. BH "1151", with its patented construction of braided continuous filament Fiberglas in combination with Silicone Rubber, does not heat age. It will stay flexible through high temperatures and low, wet or dry.

Even high spot temperatures, as in soldering, have no adverse effect on BH "1151". Protection is assured for continuous operation from  $-90^{\circ}\text{F}$ . up to  $400^{\circ}\text{F}$ . It resists rough handling in assembly work, keeps its dielectric strength even though bent sharply. Capable of expanding to twice its normal size, BH "1151" easily covers bumps, terminals and soldered joints.

Fully meets military specification number MIL-I-18057.

Available in 11 easily distinguishable heat-stable colors, in all standard sizes, BH "1151" is one of the many electrical insulation tubings and sleeveings in the dependable BH line. Each is designed for a specific purpose. Tell us your problem — temperatures and voltages encountered, physical and chemical requirements to be met — we'll be glad to send you free samples for testing.

BENTLEY, HARRIS MANUFACTURING CO. 1304 Barclay Street  
 Conshohocken, Pennsylvania Telephone: Taylor 6-0634

**BENTLEY, HARRIS**

*Fiberglas\**  
**SLEEVINGS**

\*BH Non-Fraying Fiberglas Sleeveings are made by an exclusive Bentley, Harris process (U.S. Patent 2393530). "Fiberglas" is Reg. TM of Owens-Corning Fiberglas Corp.



build reliability  
into your product  
with

**OHMITE<sup>®</sup>**  
**COMPONENTS**

*close-control* **RHEOSTATS**

All-ceramic and metal, close-control rheostats for unsurpassed dependability and smoothness of operation. Ten stock sizes, 25 to 1,000 watts.

*wire-wound* **RESISTORS**

A wide range of dependable, fixed, adjustable, tapped, and noninductive power wire-wound resistors. Also a wide range of precision resistors.

*general-purpose* **RELAYS**

65 Types in four stock models. Good delivery on made-to-order relays. Contact current ratings up to 25 amps, AC or DC. Wide variety of contact arrangements. Hermetically sealed or dust-protective enclosures available.

*high-current* **TAP SWITCHES**

Five compact models, up to 100 amperes, AC, up to 12 taps. All-ceramic and metal construction. Silver-to-silver contacts, with self-cleaning rotor contact.

*radio-frequency* **CHOKES**

Single layer R.F. plate chokes and power line chokes on steatite or plastic cores. Protected by a special moisture-resistant coating.

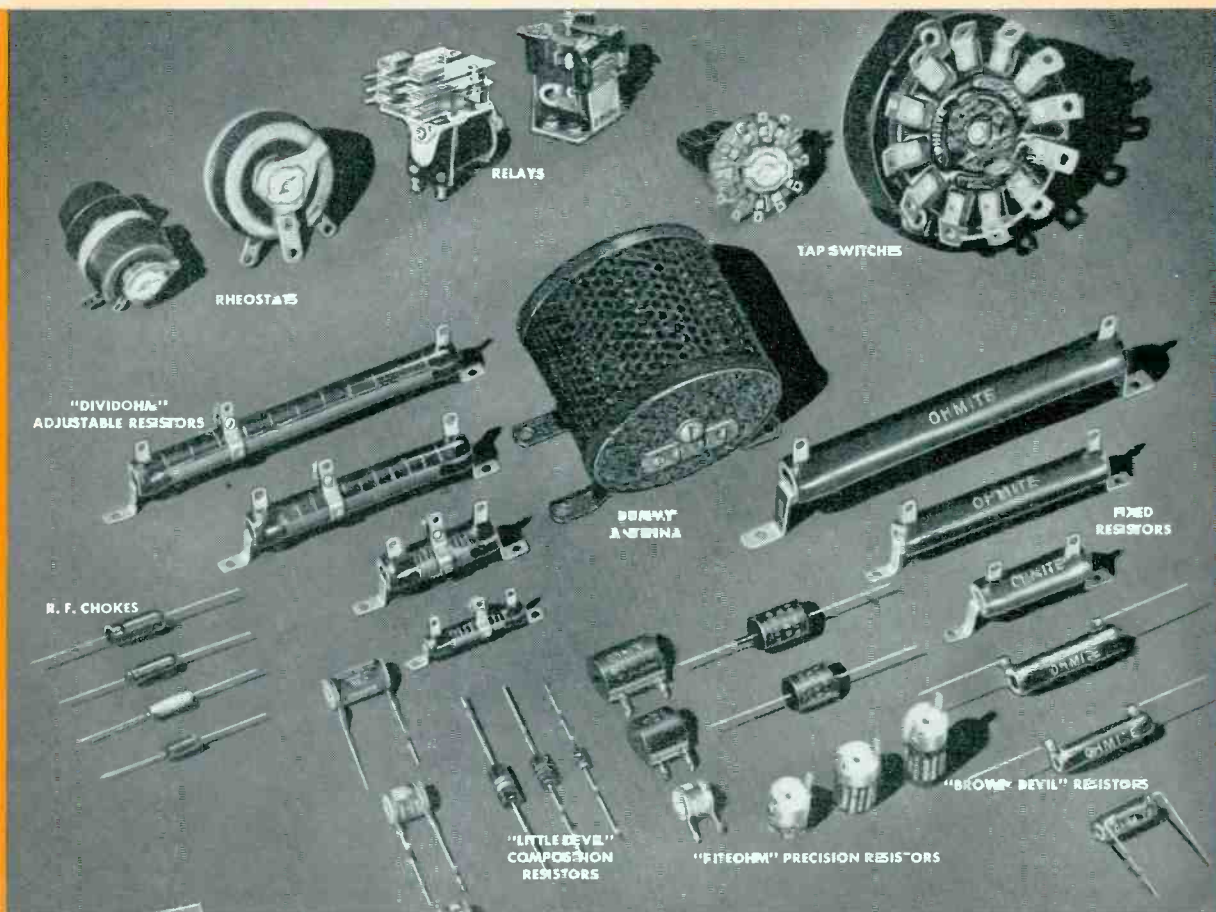

WRITE on  
Company Letterhead  
for Catalog and  
Engineering Manual.

*Be Right with* **OHMITE<sup>®</sup>**

**RHEOSTATS • RESISTORS • RELAYS • TAP SWITCHES • TANTALUM CAPACITORS**

**OHMITE MANUFACTURING COMPANY • 3610 Howard Street, Skokie, Illinois**



# OHMITE<sup>®</sup>

## AMRECON<sup>®</sup>

# Relays

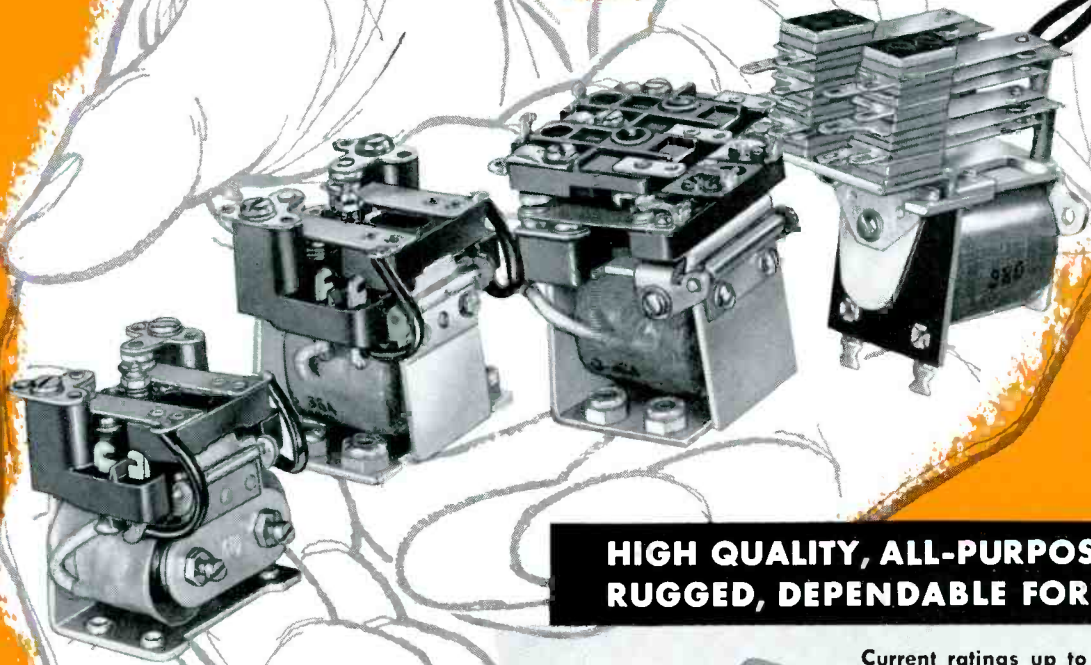

**HIGH QUALITY, ALL-PURPOSE RELAYS ...  
RUGGED, DEPENDABLE FOR LONG LIFE!**

## 65 types in four stock models

Ohmite Amrecon relays have proven their exceptional ruggedness and long life in years of service. Now, four popular stock models—DOS, DOSY, DO, and CRU, in 65 different types—are available from stock.

Models DO and DOS fill many industrial needs for a compact, lightweight relay that handles power loads usually requiring much larger, heavier units. They are particularly adaptable to aircraft and mobile equipment where severe shock and vibration are encountered. The increased operating sensitivity of Model DOSY relay, equipped with twin coils, makes the DOSY adaptable to a wide range of electronic control circuits, such as plate circuit controls. At 115 VAC or 32 VDC, noninductive load, Models DOS and DOSY have contact ratings of 15 amp; Model DO, 10 amp; and Model CRU, 5 amp. Available in a wide range of coil operating voltages and contact combinations.

Current ratings up to 25 amp, AC or DC.  
Also made-to-order models in many contact combinations and coil voltages.



**HERMETICALLY SEALED OR  
DUST-PROTECTIVE ENCLOSURES**

*Be Right with*  
**OHMITE<sup>®</sup>**

**RHEOSTATS • RESISTORS • RELAYS • TAP SWITCHES**



**SEND FOR  
CATALOG R-11**

**OHMITE MANUFACTURING COMPANY**

(Suburb of Chicago)

3610 Howard Street, Skokie, Illinois



**NO TUBES  
to replace . . .**

**NO TRANSISTORS**

**NO MOVING PARTS  
to wear out**

STABILINES type TM (Tubeless Magnetic) are the newest automatic voltage regulators offered by The Superior Electric Company. Without tubes, moving parts or transistors, the TM's provide constant voltage regardless of line or load changes. Where failure at any time under the most adverse operating conditions cannot be tolerated or where maintenance is not a possibility for long periods of time, a STABILINE type TM is a necessity.

# STABILINE\* TYPE TM

(Tubeless Magnetic)

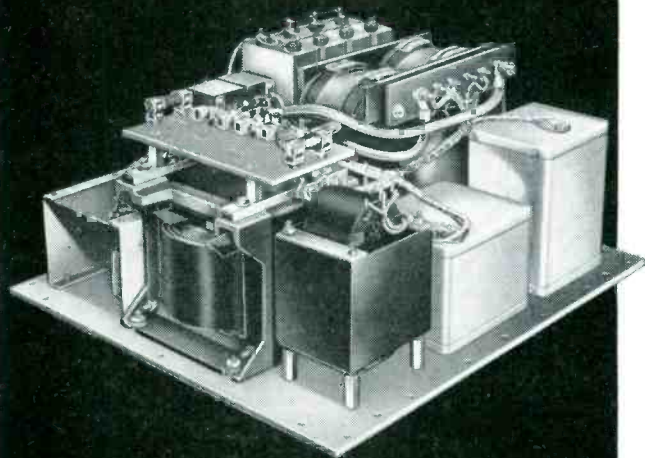

TYPE TM7105 (without cabinet)



TYPE TM7105 (with cabinet as mounted on wall)

#### FOR UNATTENDED LOCATIONS

- Microwave relay stations
- Remote installations

#### FOR CRITICAL APPLICATIONS

- Where sudden need for tube replacement can be costly (at a critical time in a process) or impossible (at an unattended location)
- Where conditions cannot tolerate moving parts.

Be sure to see SUPERIOR ELECTRIC'S  
Mobile Display when it is in your area.

Branch Offices: Los Angeles, California • San Francisco, California • Toronto, Ontario, Canada • Miami, Florida • Chicago, Illinois • Baltimore, Maryland • Detroit, Michigan • New York, New York • Cleveland, Ohio • Dallas, Texas • Seattle, Washington

\*Trademark Reg. U. S. Pat. Off.

#### STABILINE TYPE TM CHARACTERISTICS

**INPUT:** 95-135 volts, single phase on nominal 115 volt types  
195-255 volts, single phase on nominal 230 volt types

**OUTPUT:** Adjustable 110-120 volts on nominal 115 volt types  
Adjustable 220-240 volts on nominal 230 volt types

**ACCURACY:** 1 volt band for line voltage variations and/or load magnitude and power factor changes

**FREQUENCY:** 60 cycles  $\pm$  5%

**WAVEFORM DISTORTION:** 4% maximum

**RESPONSE TIME:** Less than 1/2 second for ordinary line and/or load changes. For extreme conditions of line and load changes, maximum response time is 2.0 seconds. (Response time is measured from the time of initiation of transient to the time when output voltage is within and remains within rated limits)

**LOAD:** Available in 1.0, 3.0 and 5.0 KVA ratings

**POWER FACTOR:** 0.5 lagging to 1.0



**THE SUPERIOR ELECTRIC COMPANY**  
204 BRADLEY AVENUE, BRISTOL, CONN.

Please send STABILINE Bulletin S657   
Have your representative call

Name .....

Company .....

Address .....

City ..... Zone ..... State .....

my job  
is to design  
production tooling  
for your components  
requirements



Testing capacitors along production lines



As chief industrial engineer at National Company, my job is to design tools and fixtures, set up modern, streamlined methods of fabrication and assembly, and to follow through on production runs of the components you depend upon.

Skilled labor on production lines

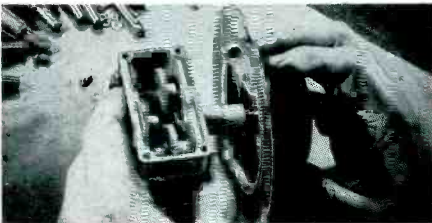

This isn't always easy, because while our catalog lists over 300 different parts, over 60 per cent of our orders are for "other than catalog items." And each of these special orders requires special handling.

National, however, is geared to provide many types of special services. The capabilities and facilities of our components division are as excellent as they are varied. Some of these facilities are illustrated.

Coil winding assembly line



Some of the services our components division offers:

1. Complete model shop.
2. Efficient, low cost production facilities.
3. U.S.A.F. approved environmental test facilities. Reliability test programs.

Assembly line components division



If you have special components requirements or a special design and development problem, write or call NATIONAL (Malden, Mass. 2-7950). Put our 42 years of experience and expanded new facilities to work for you. You'll like our service, the quality, and you will be surprised at the low cost.

Modern tool and die shops



Synching list tank circuit assembly



Complete metalworking facilities for both job shop and high production runs.

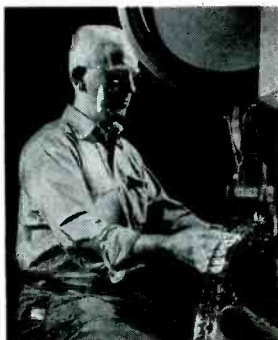

8 OUT OF 10 U.S. NAVY SHIPS USE NATIONAL RECEIVERS

SINCE 1914 **National**  MALDEN 48, MASS.

 *tuned to tomorrow*





Twist-Tab Mountings

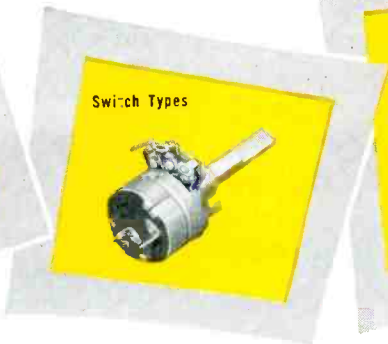

Switch Types

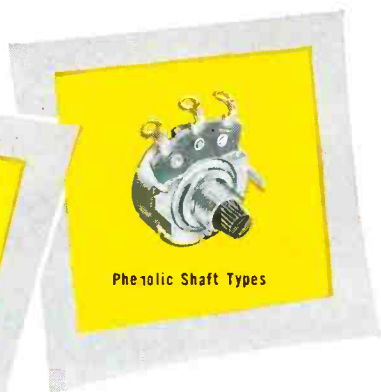

Pheolic Shaft Types

# OVER 300 BASIC TYPES... countless STANDARD modifications

*for TV,  
Radio, Audio, and  
Instrumentation jobs.*



Fold-Tab Mountings

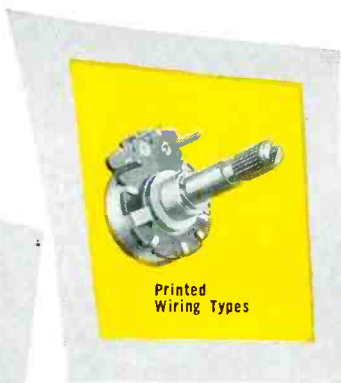

Printed Wiring Types



Plug-in Mountings



Hollow-Shaft Types



Multiple-Unit Types



Midgets—for transistorized equipment

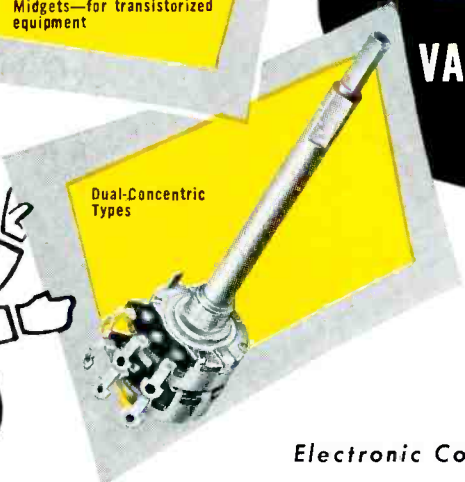

Dual-Concentric Types



# STACKPOLE VARIABLE composition RESISTORS

**NEW!**

TECH DATA ON ALL  
STANDARD TYPES &  
MODIFICATIONS.  
Write for Bulletin  
RC-10B or see your  
local Stackpole  
representative.



*Electronic Components Division*

**STACKPOLE CARBON COMPANY, St. Marys, Pa.**

*In Canada: CANADIAN STACKPOLE LTD., 550 Evans Ave., Etobicoke, Toronto 14, Ont.*

Question 5a:  
What in the last  
analysis made you decide to  
work at Hughes?

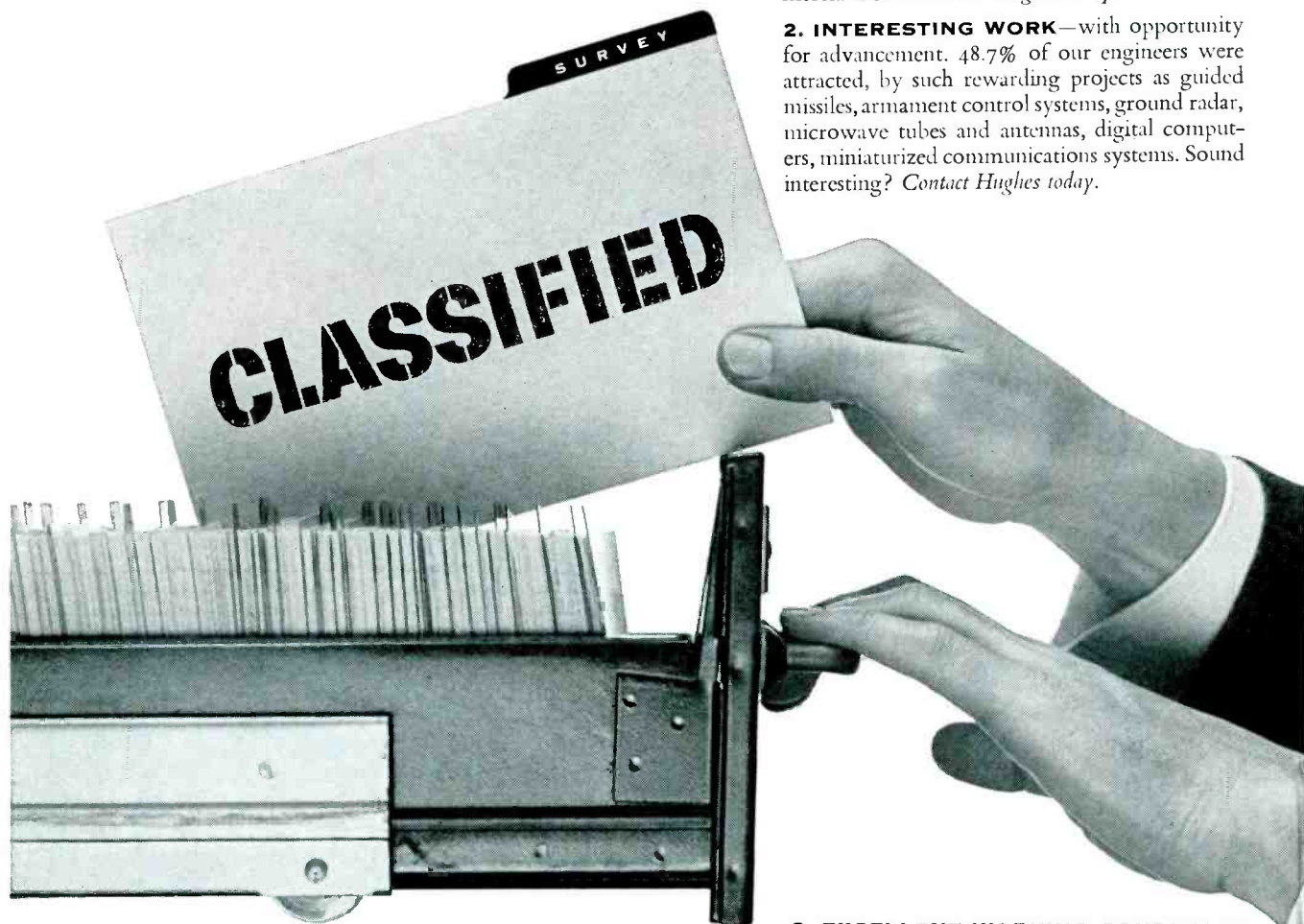

**HUGHES**

RESEARCH AND DEVELOPMENT LABORATORIES

SCIENTIFIC STAFF RELATIONS

*Hughes Aircraft Company, Culver City, California*

We wanted to find out why we have been so successful in attracting such high-calibre engineers to the Hughes Research and Development Laboratories. So we had an independent research organization ask a 15% random sample of our 2,700 engineers and scientists just what attracted them to Hughes.

Of all the things they look for in a job—of all the things they like about Hughes—these four headed the list:

**1. EXCELLENT SALARY.** Talk to the engineers in our Research and Development Laboratories, and 55.8% of them will tell you that one of the reasons they came to Hughes was the favorable salary structure. You can choose your electronics career in either the military or commercial fields. *Contact Hughes today.*

**2. INTERESTING WORK**—with opportunity for advancement. 48.7% of our engineers were attracted, by such rewarding projects as guided missiles, armament control systems, ground radar, microwave tubes and antennas, digital computers, miniaturized communications systems. Sound interesting? *Contact Hughes today.*

**3. EXCELLENT WORKING CONDITIONS**—coupled with scientific atmosphere, high calibre of associates, and prestige of the firm—is one reason why 34% of our engineers came here. They like the exceptional facilities, unusual freedom, the small project groups headed by top scientists. Is this what you seek? *Contact Hughes today.*

**4. PLEASANT CLIMATE.** We're pretty lucky at Hughes to work in the wonderful, sunny climate of Southern California—and that's one of the advantages that attracted 28.2% of our engineers... Here carefree living is the order of the day... and beaches, mountains and deserts are practically next door. Envious? *Contact Hughes today.*

A resume of your education and experience will bring by return mail a *copy of our interesting new booklet*, illustrating and describing the many and varied activities at Hughes.



# NOW! CONTROLLABLE PERSISTENCE FOR TV AND RADAR



## TONOTRON

*Direct-display, cathode-ray storage tube by Hughes with magnetic deflection and electrostatic focusing*

### FOR NARROW BAND, SLOW SCAN CLOSED CIRCUIT TV

Controllable long persistence makes the Tonotron ideally suited for picture transmission over conventional radio channels or telephone lines. Coaxial cables or microwave transmitters and receivers are unnecessary. Pictures up to 80 lines per inch resolution cover the full half-tone scale with controllable persistence—instantaneous or gradual erasure. Light output of 1000 foot-lamberts at 10 kv assures extremely high brightness at the viewing screen for use in high ambient-light levels.



DIMENSIONS  
Over-all length: 11 1/2" nominal  
Bulb diameter: 5 1/4" ± 1/8"  
Neck diameter: 1" ± 1/16"



### FOR RADAR PPI DISPLAY

Because of the Tonotron's compact size, it can be used in many existing radar indicator housings. Brightness of 1000 foot-lamberts at 10 kv makes a viewing hood unnecessary, even in full daylight. Persistence can be adjusted to retain nearly maximum brightness throughout the major portion of a 360° sweep. Ability to cover the complete grey spectrum provides maximum contrast for easy identification of cloud formations, mountains, harbors and waterways, airports, ground clutter and targets.

ELECTRON TUBES

For additional information, write to HUGHES PRODUCTS • ELECTRON TUBES  
International Airport Station, Los Angeles 45, California

© 1957. HUGHES AIRCRAFT COMPANY

**HUGHES PRODUCTS**

# VERSATILE

Multi-channel—telegraph A1 or telephone A3

# STABLE

High stability (.003%) under normal operating conditions

# RUGGED

Components conservatively rated. Completely tropicalized



FROM GROUND TO AIR OR POINT TO POINT

Here's the ideal general-purpose high frequency transmitter! Model 446, suitable for point-to-point or ground-to-air communication. Can be remotely located from operating position. Coaxial fittings to accept frequency shift signals.

This transmitter operates on 4 crystal-controlled frequencies (plus 2 closely spaced frequencies) in the band 2.5-24.0 Mcs (1.6-2.5 Mcs available). Operates on one frequency at a time; channeling time 2 seconds. Carrier power 350 watts, A1 or A3. Stability .003%. Nominal 220 volt, 50/60 cycle supply. Conservatively rated, sturdily constructed. Complete technical data on request.

Now! Complete-package, 192 channel, H.F., 75 lb. airborne communications equipment by Aer-O-Com! Write us today for details!

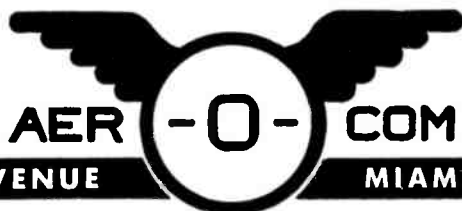

3090 S. W. 37th AVENUE

MIAMI 33, FLORIDA

A-131



**new**  
 a single  
 or multiple  
 disconnect  
 using seamless,  
 crimp-type  
 terminations

**UNILOK — HALF THE SIZE AND WEIGHT  
 OF COMPARABLE AN CONNECTORS**

In one compact unit, conforming to standard AN connector mounting dimensions, UNILOK offers the advantages of a gang connector, or a separable connector for each circuit. Small terminals allow completed harness to be pulled through openings no larger than the cable bundle itself. Circuit checks are simple in either fully or partially assembled UNILOKS.

**Easy Circuit Check**

Probes reach insulation grip of socket terminating each wire. Printed numbers on all faces of plug and receptacle make circuit identification simple.



**Quick Multiple or Individual Connections**

Any wire is easily inserted or removed from plug individually. Each contact clearly identified on all six faces of plugs and receptacle.



**Crimped Terminations**

Each connector is crimped on the insulation as well as on the wire. Provides maximum mechanical and electrical efficiency. Eliminates need for cable grip.

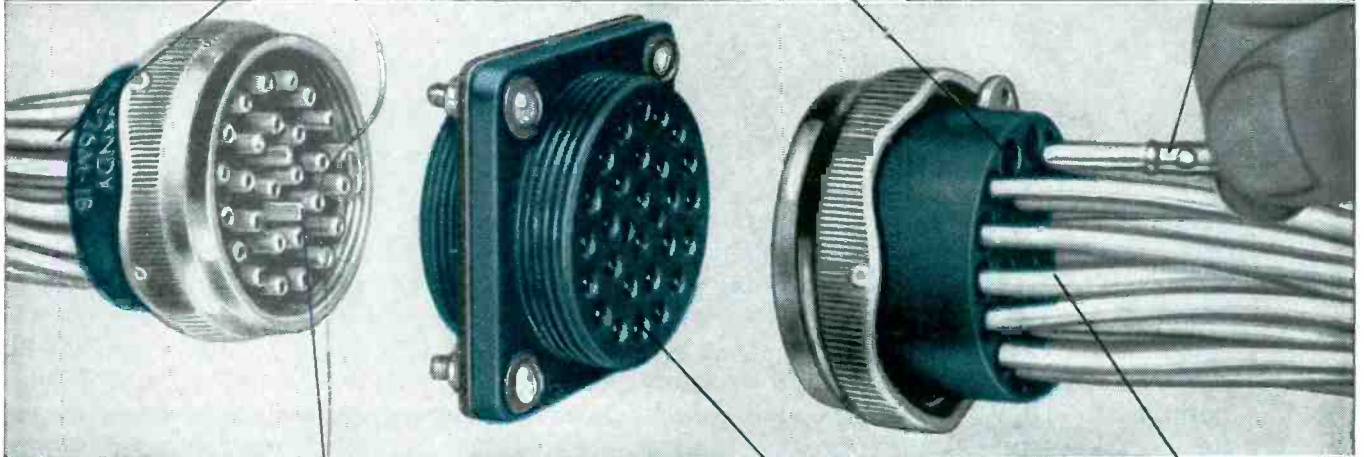

**Rapid, Foolproof Assembly**

Tough nylon polarizing pins engage corresponding holes before the ends or contacts can engage.



**Short Circuit Prevention**

Recessed pins eliminate possibility of shorts from accidental contact of plug and receptacle.

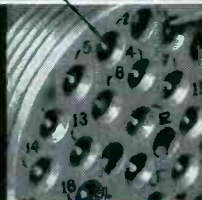

**High Pullout Resistance**

Pull-out from plug (in excess of 50 pounds) is maintained by compression spring locks. Lock is quickly freed for wire removal by small screwdriver or knife blade.

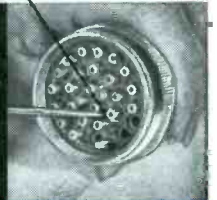

- saves weight
- saves space
- simplifies installation and maintenance on all pressurized bulkheads

New Burndy UNILOK weighs only 1/2 of equivalent AN connectors. Fewer parts — needs no integral cable clamp. No solder, no dissimilar metals near contacts. No metal housing to collect moisture — no corrosion products between pins. Easier to stock — assemble — service. For complete details, write Burndy — Norwalk, Connecticut, Toronto, Canada. Factories: New York, California, Toronto. Export: Philips Export Company.

*It's good business to connect with*

**BURNDY**

...FIRST name in electrical connectors, tools, methods

*Design engineers indicate widespread  
use for*

# **Sylvania Power Transistor Type 2N242**

While the type 2N242 is well known for its original use in the output stage of hybrid auto radio, it is rapidly becoming the standard for general purpose use in a wide range of power applications.

There are good reasons for its growing popularity—10 watts collector dissipation, for instance—welded hermetic seal—and a storage temperature of 85° C to eliminate heat problems under idle conditions.

If you have plans for general purpose transistors you'll be glad to know Sylvania's semiconductor plant in Hillsboro, New Hampshire is just about completely devoted to the production of the Type 2N242. That means Sylvania can meet your volume requirements. And, Sylvania's leadership in the manufacture of semiconductors means you're assured of high product uniformity and dependable performance.

#### **GENERAL FEATURES OF THE 2N242 PNP POWER TRANSISTOR—**

- 10 watts max. collector dissipation
- 2 amps max. collector current
- 45 volts max. collector voltage
- New welded hermetic seal
- 30 db minimum power gain (typically 35 db)
- 85° C storage temperature
- 100° C junction temperature
- Thermal drop—3° C per watt (typically 2° per watt)

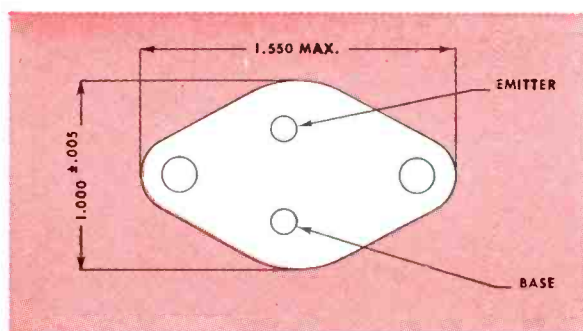

# **SYLVANIA**

SYLVANIA ELECTRIC PRODUCTS INC.  
1740 Broadway, New York 19, N. Y.  
In Canada: Sylvania Electric (Canada) Ltd.  
Shell Tower Building, Montreal

LIGHTING • RADIO • TELEVISION • ELECTRONICS • ATOMIC ENERGY



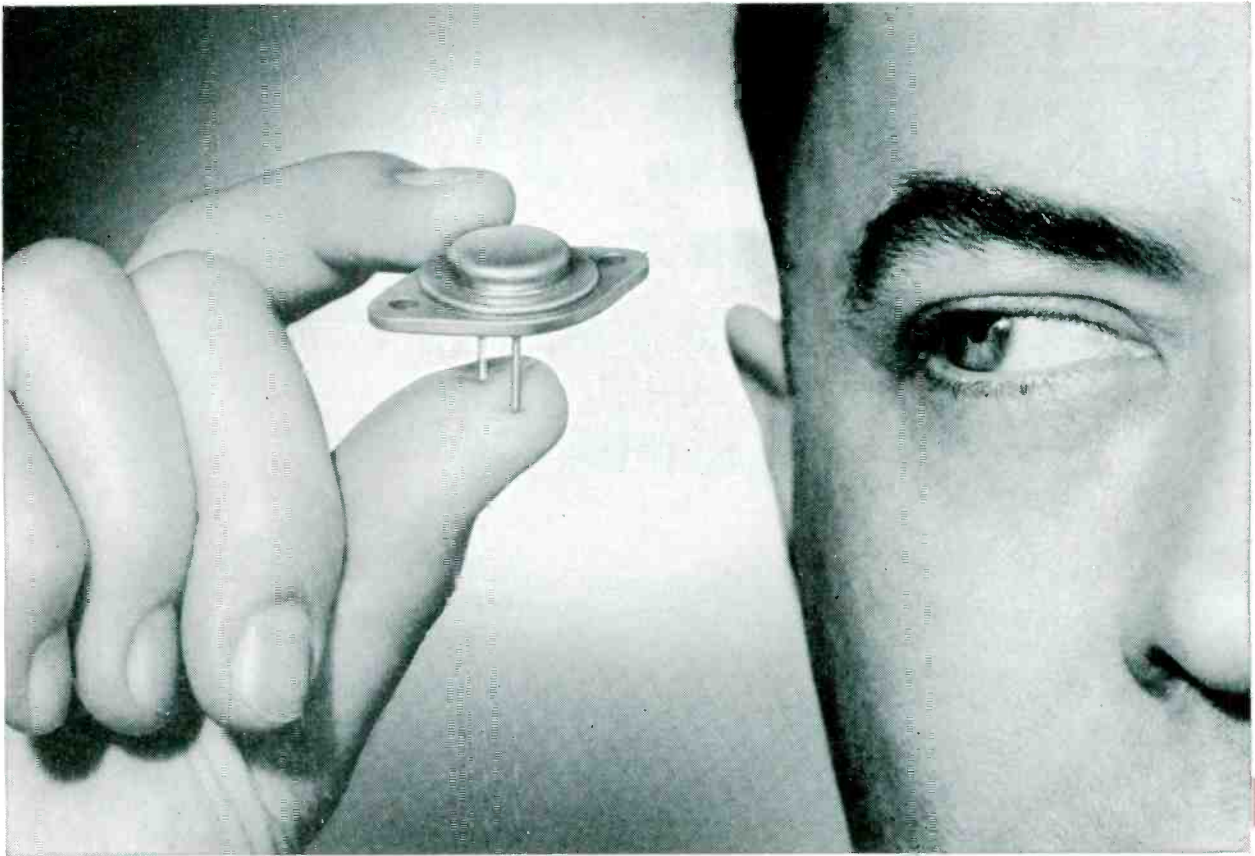

**Here are just some of the applications in which designers are effectively using or planning to use the 2N242**

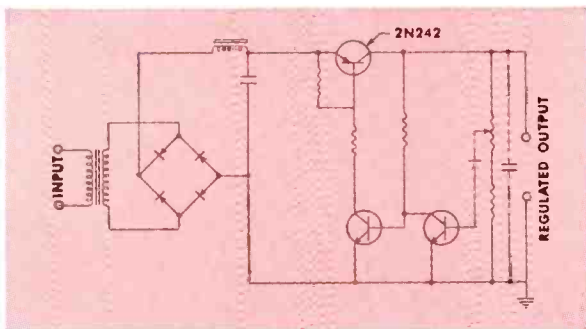

**\* Transistor Voltage Regulation**

Transistorization of voltage regulator circuits is one of the most popular general purpose applications indicated for the 2N242. Here is a typical regulator circuit incorporating the Type 2N242. DC to AC converter rates second in popular usage for this power transistor.

*How about your general purpose plans for the Type 2N242 power transistor? Call your Sylvania representative or write for technical data.*

- \* VOLTAGE REGULATION
- DC CONVERTER
- OSCILLATOR, AMPLIFIER
- TRANSISTOR COMPUTER
- MAGNETIC CORE DRIVER
- SERVO AMPLIFIER
- VERTICAL SWEEP OUTPUT
- PULSE POWER OUTPUT
- HIGH CURRENT SWITCH
- RF MODULATOR

# P & B STRIKE SETTLED!

## AN OPEN LETTER TO RELAY USERS

### Potter & Brumfield, inc.

Dear Friends:

Ruthless violence, culminating on February 13 with the shooting of the four-months-old baby daughter of two of our employees, focused national attention on a recent strike at our Princeton, Indiana plant.

This unjustified strike was called on November 5, 1956 in the face of our "no strike" contract with Local 1459 of the International Association of Machinists. No demands or proposals for settling the strike were made by the Union. Two Company proposals were summarily rejected.

Settlement of the strike was reached on February 28, 1957.

Our plants in Laconia, New Hampshire and Franklin, Kentucky were not affected by the strike.

Production lines were shifted from Princeton to both Laconia and Franklin plants, and employment has been greatly increased at both locations. These plans were made before the work stoppage to increase production.

Production at Princeton was resumed on December 17th, and today a normal work force is manning the remaining lines. Until recently, the training of new workers restricted our productivity, but output now is at satisfactory levels.

With three plants to serve you, we pledge our continued efforts to provide you with relays of the finest quality. Our Engineering Department welcomes the opportunity to work with you on new designs and future projects.

Sincerely,

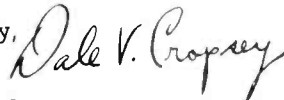

Dale V. Cropsey  
Vice President & Director of Sales



**NOW!**  
**3 PLANTS TO**  
**SERVE YOU**

**POTTER & BRUMFIELD, INC. PRINCETON, INDIANA**  
A Subsidiary of AMERICAN MACHINE & FOUNDRY COMPANY



# Measure Frequency of 400 CPS Power Accurately

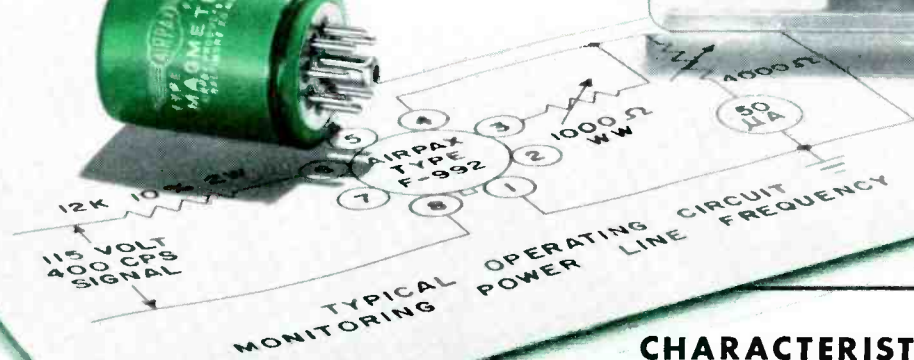
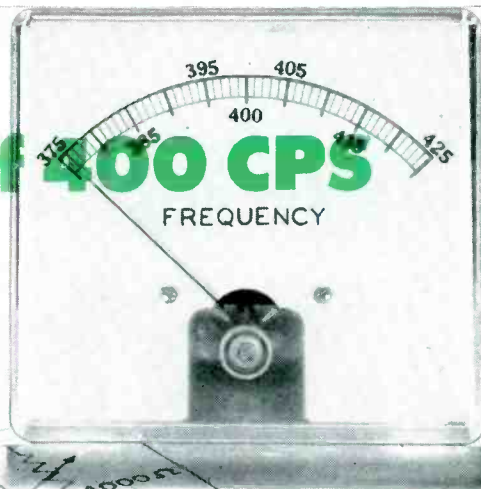

## Expanded Scale Covers 375 to 425 CPS

### Output Operates Recorder or Indicating Instrument

Output current of this novel Magmeter detector is linearly proportional to frequency deviation. The output can be used—

1. to display frequency directly on a d'Arsonval indicating instrument,
2. to record frequency on a servo or d'Arsonval recorder, or
3. to actuate control equipment, such as speed controllers, in accordance with frequency.

Magmeter Type F-992 produces a change in output in response to changes in frequency. It can be used to follow rapid frequency fluctuations. No external reference or supply voltages are needed. It is substantially insensitive to fluctuations in signal amplitude or waveform.

Because of its inherent stability and extreme simplicity, the Magmeter detector is adaptable to telemetering, automatic generator control, and speed regulation. It is fail safe.

In operation, the signal whose frequency is to be measured is applied to the Magmeter detector. About one watt of signal power is required. The signal can be from an aircraft alternator whose frequency is to be measured, a tachometer on a shaft whose speed is to be controlled, or any similar source. The Magmeter detector then delivers a current directly proportional to frequency deviation. At 375 CPS the output current is zero; at 400 CPS it is 25 microamperes, at 425 CPS it is 50  $\mu$ a. A special Magmeter detector can be furnished with zero output at 400 CPS,  $-25 \mu$ a at 375 CPS, and  $+25 \mu$ a at 425 CPS.

You probably have an application in which this one component can replace considerable circuitry. We have engineering data ready for you; just write to

## CHARACTERISTICS

**RANGE:** 400  $\pm$  25 CPS (other ranges available on special order)

**ACCURACY:** Linear within  $\pm 1/4\%$  of mid scale and reproducible to  $\pm 1/4\%$  of mid scale

**INPUT:** Approximately 1 watt of signal power (about 10 ma at 115 RMS volts)

**OUTPUT:** 50 microamperes at 425 CPS (0 output at 375 CPS) linear with frequency throughout rated range. Load resistance 2200 ohms maximum

**TEMPERATURE:** Operates from  $-55$  C to  $+72$  C

**TEMPERATURE EFFECT:**  $\pm 1/2\%$  of mid scale 0 C to 50 C

**VOLTAGE:** Within  $1/5\%$  of mid scale from 100 to 130 RMS volts

**ENCLOSURE:** Hermetically sealed can 2" high, 1.5" diameter, with octal base, weighs 6 ounces

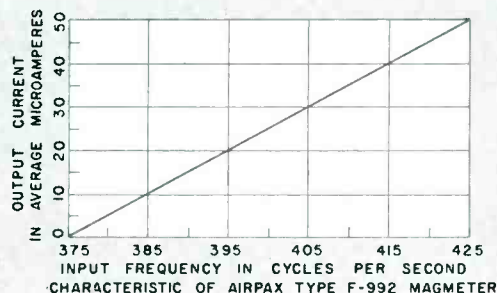

DESIGNERS

ENGINEERS

MIDDLE RIVER • BALTIMORE 20, MD.

and now

# Kineplex<sup>®</sup>

a high-speed digital transmission system

## to double communication capacity

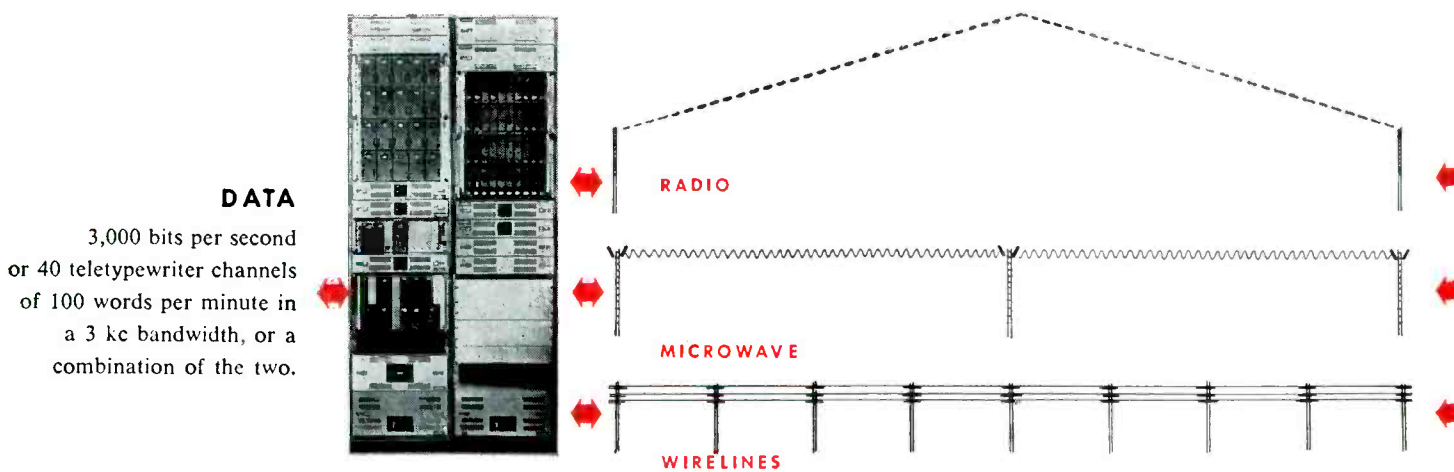

*Collins* **CREATIVE LEADER IN COMMUNICATION**

COLLINS RADIO COMPANY, 315 2nd Ave. S.E., Cedar Rapids, Iowa • 1930 Hi-Line Drive, Dallas 2 • 2700 W. Olive Ave., Burbank  
261 Madison Ave., New York 16 • 1200 18th St. N.W., Washington, D.C. • 4471 N.W. 36th St., Miami 48 • 1318 4th Ave., Seattle  
COLLINS RADIO COMPANY OF CANADA, LTD., 11 Bermondsey Road, Toronto 16, Ontario • COLLINS RADIO COMPANY OF  
ENGLAND, LTD., 242 London Road, Staines, Middlesex



# Collins also leads development in the fields of

Another major stride forward in communication. From the research and development laboratories of Collins Radio Company comes KINEPLEX — a spectrum conserving, high-capacity, synchronous data system which transmits and receives 3,000 bits of information per second on a 3 kc band, with superior signal-to-noise performance.

Adaptable to wireline, cable, radio, or microwave facilities, KINEPLEX provides twice as many channels on a 3 kc band as present day carrier teletypewriter systems. In teletypewriter applications this means 40 channels on a 3 kc band at 60, 75, or 100 words a minute operation.

KINEPLEX will take stored business machine data in serial or parallel form and transmit it at the same 3,000 bit per second rate. Material can be fed from magnetic tape, paper tape, punched cards, or other storage media.

KINEPLEX can also be used for telemetering, supervisory control, and facsimile. The total data transmission capacity of the system can be divided between various services to fit specific applications. Write today for literature on Collins new TE-202 KINEPLEX Data System.

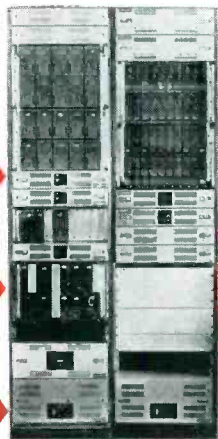

## DATA

3,000 bits per second  
or 40 teletypewriter channels  
of 100 words per minute in  
a 3 kc bandwidth, or a  
combination of the two.



For additional information: call your nearest Collins sales office or write for technical brochure.

## AVIATION

Collins completely outfits airline, military and business aircraft with the most advanced communication, navigation, flight control and instrumentation systems in aviation. Many new lightweight, reduced-size versions are now being delivered. Collins designed the original Integrated Flight System, leads in combining comm/nav/ident units into a single compact "CNI" package for new military aircraft, and continues to pace the industry in developments in airborne radar, ADF, ILS, VOR, HF and VHF communication.

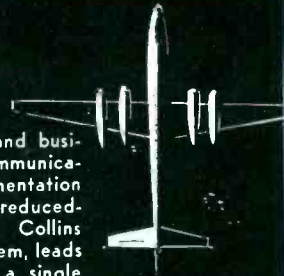

## GROUND COMMUNICATION

Collins engineers, designs and supplies the equipment, installs, and puts into operation integrated point-to-point communication systems of any scope. The Collins system engineering staff is backed by the finest equipment in the world, whether standard MF, HF or VHF, Transhorizon "scatter," microwave relay and multiplex or single sideband HF. Typical of Collins communication progress is "Kineplex" — a high speed data transmission system doubling communication capacity.

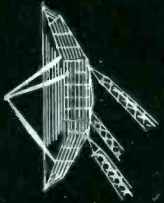

## AMATEUR RADIO

In the early 1930's Collins set the standard in Amateur radio and, through continuous design and development, has raised this standard to its present single sideband station — the most honored and prized in the Amateur fraternity. This station is the top performing rig on the air with its kilowatt KWS-1 transmitter and highly selective 75A-4 receiver. Many of the leaders in the electronics industry became acquainted with Collins through the Company's superior Amateur equipment.

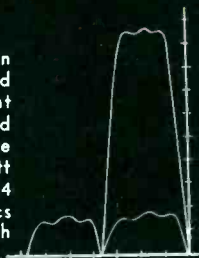

## BROADCAST

Collins supplies a complete new AM station from mike to antenna or modernizes existing facilities. Besides the superior line of transmitters, Collins supplies the broadcaster's needs with such advanced additions as TV-STL microwave relay system, the lightest 4-channel remote amplifier on the market, phasing equipment and audio consoles. Collins field service organization has built an enviable reputation in assisting the broadcaster in installation or in times of emergency.

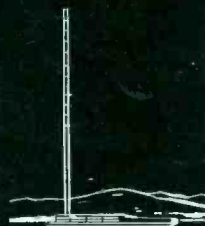

## COMPONENTS AND TEST EQUIPMENT

The degree of precision and reliability of Collins products requires development by Collins engineering of components such as Autotunes and Autopositioners, Mechanical Filters, oscillators, heat reducing tube shields and ferrites. These developments and other high quality components are sold by a Collins subsidiary, Communication Accessories Company of Hickman Mills, Missouri. The same principles of accuracy and reliability apply to Collins test equipment, built especially for Collins but adaptable to testing other equipment types.





# MICRO SWITCH Precision

... FIRST IN PRECISION SWITCHING

If reliability, long life, ruggedness, compactness, sensitivity and accurate repeat point of operation are vital to you, then

## Look to MICRO SWITCH for a solution of your Precision Switch problems

Here is a partial picture of some of the thousands of switch combinations available—news of a new MICRO SWITCH development—how and for what and why one manufacturer is using MICRO SWITCH Precision Switches—and a report on what MICRO SWITCH field application engineering can mean to alert design engineers

This MICRO SWITCH 3-Position Rotary Actuated Switch is compact and rugged

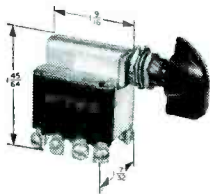

Ideal for airborne and industrial use, this switch is a four-pole double-throw switch with 12 terminals (catalog listing 4TR1). An eight-pole with 24 terminals is also available (catalog listing 8TR1) . . . Eliminates use of relays. Tested for impact, shock, acceleration and vibration.

Careful inspection assures long life operation. Positively detented positions eliminate accidental operation. The solid silver contacts and silver-plated copper moving contact carrier provide maximum conductivity, minimum temperature rise.

(For more details ask for Data Sheet No. 112)

### CHARACTERISTICS

Operating Torque (4TR1) . . . 9 in. lbs. max.  
Pretravel . . . . . 10° each direction  
Operating Torque (8TR1) . . . 4 in. lbs. min. to 6 in. lbs. max.

### ELECTRICAL RATING 4TR1 & 8TR1

Continuous	Resistive Load		Lamp Load		Inductive Load	
	30 v dc	115 v ac	30 v dc	115 v ac	30 v dc	115 v ac
20	20	20	5	4	12	15



This Compact Limit Switch Is Widely Used by Industry

This is a double-pole two-circuit switch, completely sealed. Cover screws are held captive in cover when it is removed. The 1/2 n.p.t. internally tapped opening is in the bottom of the enclosure . . . Actuator can be positively locked in any position through 360° and can be operated in either direction. Actuator head is removable in field, can be rotated to any of four positions. This switch can be mounted either front or back side, .192-inch diameter holes extend through the enclosure, tapped from the back to a depth of 9/16-inch with 1/4-20 nc thread. Mounting holes accept No. 10 screws. No. 8 terminal screws accommodate No. 14 stranded wire. Can be used single-pole double-throw.

(Ask for Catalog 101)

### CHARACTERISTICS

Operating force—3 lbs. max. Pretravel—20° max.  
Full overtravel force—6 lbs. max. Diff. travel—12° max.  
Release force—1/2 lb. min. Overtravel—30° min.  
Rated: 10 amps, 120, 240, 480 v ac; 1/2 H.P. 120 v ac; 1 H.P. 240 v ac; .8 amp. 115 v dc; 4 amp. 230 v dc; 1 amp. 550 v dc. Pilot duty rating 600 v ac. max.

## 15 MICRO SWITCH Precision Limit Switches Assure ABSOLUTE DEPENDABILITY in Particle Board Loader and Unloader Unit\*

Operates 20,000 cycles per day on a 24-hour basis

Prevents shut-down time at estimated cost of \$50.00 to \$100.00 per minute

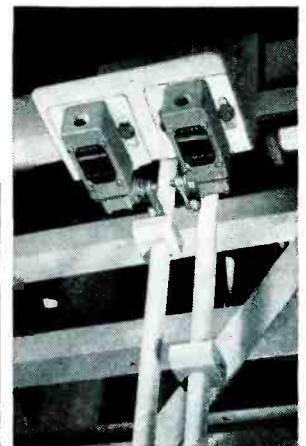
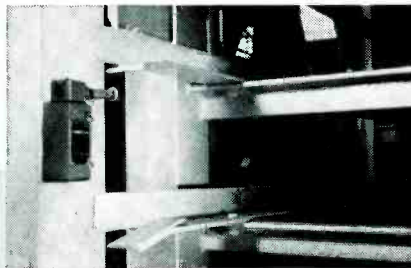

Three of the many MICRO SWITCH Type "ML" 2-circuit switches index the cage stops of the upward and downward travel of the racks of the particle board loader and unloader unit.

Operating 20,000 cycles a day, these rugged MICRO SWITCH "ML" Limit Switches with their long life, accurate repeatability of point of operation, excellent seal, convenient mounting and one-way actuation features, provide dependability for the continuous high speed production of particle board.

Serving as indicators and timers in various automatic operations, these two-circuit switches control the up and down motion of the unit which loads and unloads the particle board to and from the hot plate press.

The manufacturer\* of these custom-built units has standardized on MICRO SWITCH Precision Switches because of their longer life, accurate and dependable operation and excellent environmental seal. As many as 100 switches are used on some of these custom-built units.

(Ask for Catalog No. 83 "Industrial Enclosed Switches")

\*Washington Iron Works, Seattle, Washington



# Switches have uses unlimited



## NEW!

A Subminiature  
Screwdriver  
Operated  
Switch—  
Saves Wiring  
and  
Panel Space

Designed to be used where there is limited access and where accidental operation must be prevented. Switch is operated by a 90° turn of a screwdriver and the slotted head gives visual indication of its position. The switch can be ordered with a number of variations of the subminiature basic switch. Contact arrangement is single-pole double-throw (maintained position).

(To learn full details of this new switch, send for Data Sheet No. 115)

### ELECTRICAL RATING

Listed by Underwriters' Laboratories at 5 amps. 125 or 250 v ac. The 30 v dc is: Inductive—3 amps. at sea level, 2.5 amps. at 50,000 ft., resistive—4 amps. at both sea level and 50,000 ft. Maximum inrush capacity—20 amps. ac and 24 amps. at 30 v dc.

## For Tough Service in Industrial Applications— The "BAF1" High Capacity Series

Especially designed for rough, general service in industrial applications, these MICRO SWITCH Precision Switches are protected from the effects of dirt, dust and occasional liquid splash by an elastomer boot on the plunger and an O-ring gasket under the cover plate . . . This series is really rugged, the three mounting holes in the heavy mounting flange accommodate 1/4 in. bolts. These switches have a capacity to make and break steady state currents of 20 amperes and will handle inrush currents as high as 75 amperes. If your service requirements are rugged, this rugged switch will handle them.

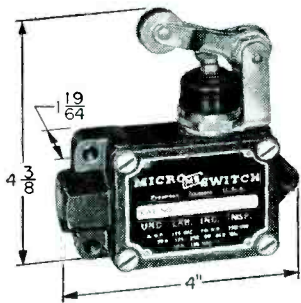

(You can learn all about this series, if you send for Catalog No. 83)

### CHARACTERISTICS

Operating force . . . . .	2 lbs.
Release force . . . . .	1/2 lb. min.
Pretravel . . . . .	7/32 in. max.
Overtravel . . . . .	1/4 in. min.
Differential Travel . . . . .	.015 in. max.

## MICRO SWITCH 3-Light Pushbutton Switch Reduces Panel Space 50%

This compact, double-throw double-pole switch with its pre-wired plug will light in three different colors. It was developed expressly for use in complex console panels. Because push button and switch are combined in one unit, it reduces panel space by 50%. The compact stem carries three separate lamps. The switch incorporates a special connector plug which permits quick and easy installation and replacement—no complicated wiring required. Designed for use where high reliability is a requirement; two SPDT precision subminiature basic switches with fine silver or gold contacts and special treated snap-acting springs are the switching elements. All materials are corrosion resistant.

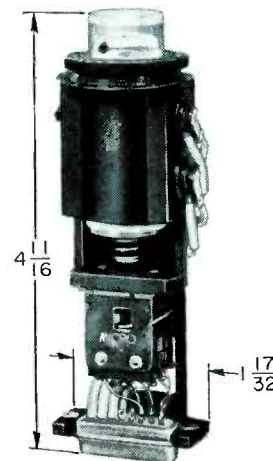

(Data Sheet No. 110 will give you more details. Send for it!)

### ELECTRICAL RATINGS

Rated for .1 amp. inductive at 28 or 48 v dc and 1 amp. inductive at 115 v ac.

## Service Pays Off Again; for Orin McIntyre

"We don't sell switches, we give service. Give them the right switch for the job and the switches sell themselves."



That's the sales approach of Orin Mac McIntyre, MICRO SWITCH salesman. And Mac's approach recently paid off.

Mac offered his talents to a prospective customer's engineers, hoping to assist them with their switching problems.

Mac kept at it and finally found the "in." The prospect needed heavy-duty limit switches with extremely light operating force and soft-roller actuators to prevent breakage of his product. Mac checked the home office, found the perfect solution, and had two samples in the hands of the prospect—pronto.

This prospect's engineers found these switches ideal for their needs, and issued an order.

This fast and efficient service made an impression. Soon Mac was called in on another switching problem which resulted in a second order.

Through Mac's efforts, MICRO SWITCH has gained the added respect of this company.

# MICRO SWITCH

A DIVISION OF MINNEAPOLIS-HONEYWELL REGULATOR COMPANY

In Canada, Leaside, Toronto 17, Ontario • FREEPORT, ILLINOIS



# A Whole Family of Oscilloscopes in ONE BASIC INSTRUMENT

for the DC-to-5MC Range

## The Tektronix Type 532 ...for Industrial and Scientific Applications

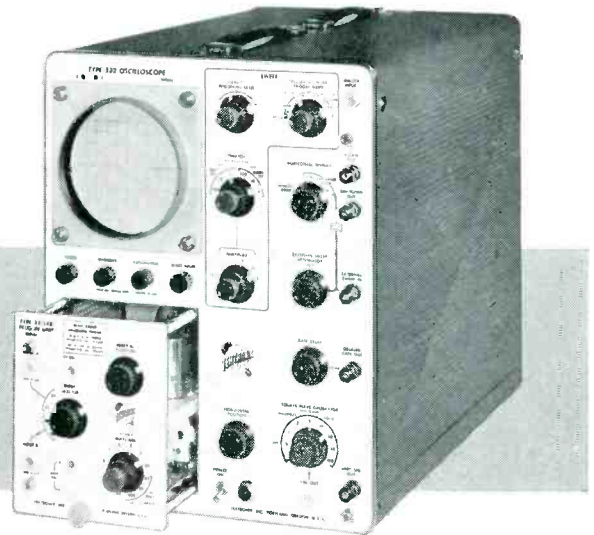

It's the plug-in preamplifiers that make this dependable oscilloscope outstanding in its class. With the Type 53/54B Plug-In Unit

it can effectively cope with laboratory-oscilloscope applications that fall into the five-megacycle range, even when a high-gain vertical-deflection system is required.

The Type 532 becomes another oscilloscope when you plug in the Type 53/54D High-Gain Differential DC Unit, especially useful in industrial and other applications requiring slow sweeps and dc coupling at a deflection factor of one-millivolt per centimeter. It becomes still another oscilloscope when you plug in the Type 53/54E Low-Level Differential AC Unit, providing a vertical deflection factor of fifty-microvolts per centimeter for medical and other low-level applications. The Type 53/54C Dual-Trace DC Unit and the Type 53/54G Differential Wide-Band DC Unit are available to equip the Type 532 for these application areas, too. One oscilloscope . . . plus plug-in preamplifiers . . . adds up to true versatility.

**Type 53/54B**—dc-coupled, 0.05 to 20 v/cm; ac-coupled, 5 mv/cm to 20 v/cm. \$125



**Type 53/54D**—1 mv/cm, dc to 350 kc; 50 mv/cm, dc to 2 mc. \$145

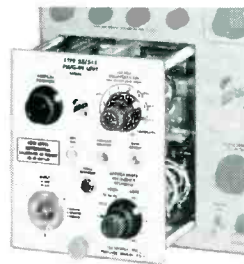

**Type 53/54E**—50 microvolts/cm, 0.06 cycles to 30 kc; 0.5 millivolts/cm, 0.06 cycles to 60 kc. \$165

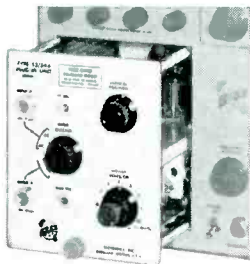

**Type 53/54A**—dc-coupled, 0.05 to 20 v/cm. \$85



**Type 53/54G**—dc-coupled, 0.05 to 20 v/cm; differential input, high rejection ratio. \$175

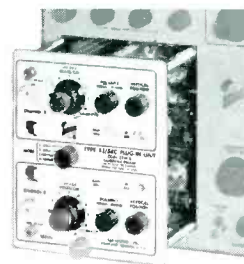

**Type 53/54C**—dc-coupled, 0.05 to 20 v/cm; two identical channels, electronic switching. \$275

## CONDENSED SPECIFICATIONS

### Wide Sweep Range

0.2  $\mu$ sec/cm to 12 sec/cm  
21 calibrated sweep rates  
5x Magnifier

### DC-Coupled Output Amplifier

Less than 3 db down at 5 mc

### 4-KV Accelerating Potential

8-cm linear vertical deflection

### Versatile Triggering

Amplitude level selection and  
Automatic Triggering

### Amplitude Calibrator

Square wave, 0.2 mv to 100 v

### DC-Coupled Unblanking

### Electronic Voltage Regulation

### Type 532

without plug-in units

\$825

Prices f.o.b. Portland, Oregon

Please call your Tektronix Field Engineer or Representative for complete specifications.

**ENGINEERS**—interested in furthering the advancement of the oscilloscope? We have openings for men with creative design ability. Please write Richard Ropiequet, Vice President, Engineering.

# Tektronix, Inc.

P. O. Box 831 • Portland 7, Oregon

Phone CYPRESS 2-2611 • TWX-PD 265 • Cable: TEKTRONIX



# TUBE DESIGN NEWS

GENERAL  ELECTRIC

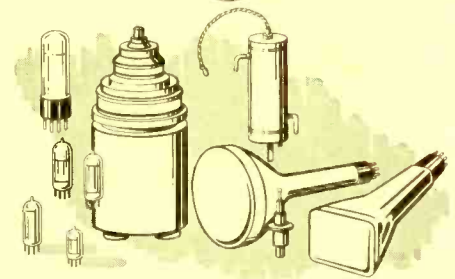

RECEIVING \* POWER \* CATHODE RAY

## New General Electric Camera Tubes "See in the Dark", Are 500% More Sensitive than 5820 at Low Light Levels

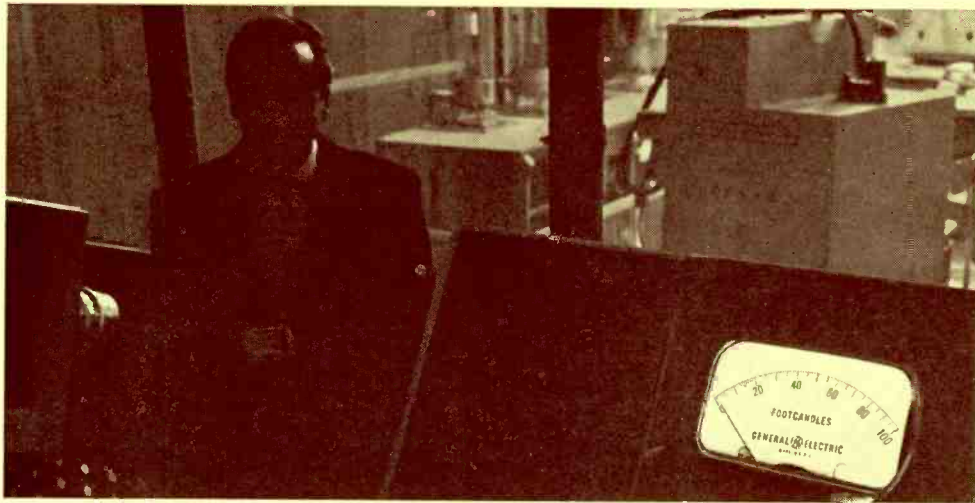

A light meter that reads just above zero, becomes a bright, sharp image on the monitor screen. The camera is using a new General Electric Z-5114 tube to pick up the face of the meter, which is being held before the lens in almost complete darkness.

New boundaries for visual observation—military, industrial, and scientific—are charted by General Electric's Z-5114 and Z-5170 camera tubes. Five times more sensitive than TV image orthicons, the new tubes, with proper amplifying equipment, will bring to life objects so poorly lit, or so faint in outline, that the eye cannot distinguish them.

Air night-reconnaissance is one of many military applications. There also are non-military uses, ranging from X-ray inspection of large-dimension castings, to aid to astronomers searching out stars too dim to be seen through existing telescopes.

Design-wise the new camera tubes have wide spacing between target and mesh, for lower image lag and reduced microphonics. As a result, their threshold of sensitivity is brought down—they pick up more detail at low light levels; also, with anti-microphonic characteristics, the tubes can be used where vibration and impact are severe.

Greater infra-red response marks the Z-5170. Ask any G-E office listed on the next page for further information.

## All G-E Computer Tubes Now Manufactured Under Snow-White Conditions of Cleanliness

Increased reliability is built into all General Electric computer tubes by maintaining Snow-White standards of cleanliness throughout the manufacture, inspection, and handling of the tubes and the tube sub-assemblies.

A particle of lint or a speck of dust can cause a short-circuit; a short, in turn, can impair the "count" of a computer, ruining the calculation. Therefore, extra care is used to make sure that G-E computer tubes are as free from impurities of all kinds as advanced Snow-White factory technique—conditioned air; special lint-free clothing; gloved hands or finger-cots; floors cleaned hourly—can assure.

After manufacture, all General Electric computer tubes—now three 5-star and seven commercial types—receive a series of life tests that triple-check performance under the same conditions as when the tubes are installed and in use.

The first test is Class-A operation for

(Continued on Page 2, Column 1)



Conditioned air, pressurized to keep out dust and dirt; lint-free Dacron garments; gloved hands . . . these accent the surgically clean conditions that apply when cleaning grids of the ten G-E computer tubes shown at lower right.





## Monthly Reports from Broadcast Stations Help Lift GL-6251 Life Over 4000 Hours

An extensive, continuing program of monthly broadcast-station reports has been of marked service to General Electric tube engineers in lengthening the life and improving the performance of the GL-6251 25-kw v-h-f power tetrode. As design advancements for this type are introduced, they are applied, where desirable, to other G-E tubes of the same coaxial, metal-ceramic group, such as the GL-6019 and GL-6942.

Certain early reports of GL-6251 tube trouble, for instance, pointed to weakness in the anode ceramic, which tended to crack at high operating temperatures. Now another ceramic material—alumina—is employed. This is much stronger, and able to withstand thermal changes extending over a wide range.

Another improvement stemming from field performance studies: the tube seal edges now are metallized in hydrogen furnaces at temperatures to 1600 C. With max temperature for tube operation only 200 C, all seals of the GL-6251 have a more-than-ample safety margin.

Still another forward step is the use of platinum-clad tungsten grid wire, which mechanically is far superior to the molybdenum wire employed in the beginning.

Due to these and many other GL-6251 improvements, a gratifying percentage of broadcast-station reports, such as the one above at left, show the tube more than paying for itself in long, dependable service. Average life figure now exceeds 4000 hours, and is still climbing.

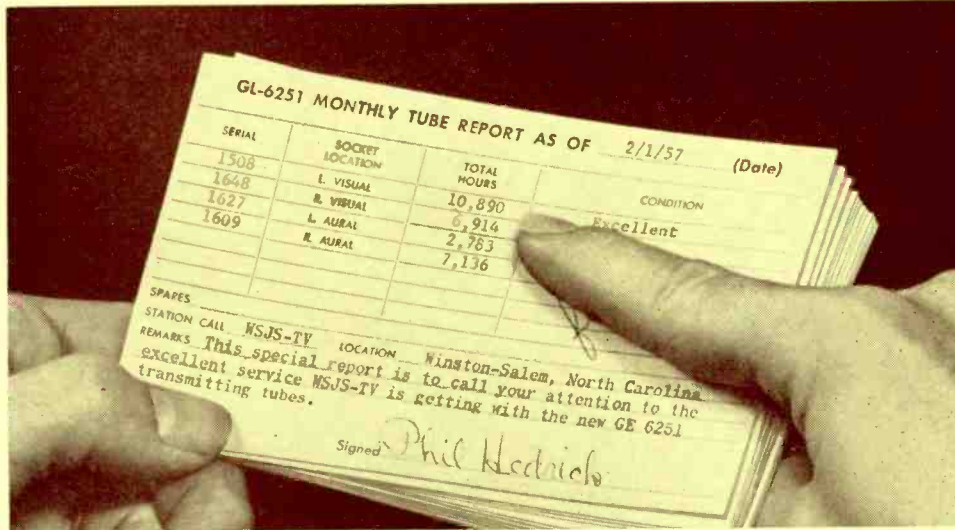

Showing 10,890 hours' life for a GL-6251 still in use, this report card from Phil Hedrick, Operations Manager, WSJS-TV, Winston-Salem, N.C., is one of hundreds that have arrived, enabling G-E tube engineers to check tube performance on a nationwide basis. GL-6251 improvements based on this program of field research have greatly extended the life of the tube.

## All General Electric Computer Tubes

(Continued from Page 1)

500 hours. The second is a zero-bias plate-current test of 1000 hours, that applies directly to dependable performance in computers. The third check also is functional for computer work: a 1000-hour plate-current cutoff test.

First to build special tubes for computers, General Electric continues to upgrade the performance and improve the reliability of these important types.

## New G-E 6840 5-Star Computer Tube Designed for Highest-Speed Counting

Latest addition in General Electric's group of ten computer tubes, is the new 6840 9-pin medium-mu twin triode. This is a 5-Star high-reliability type, for use as pulse amplifier, line driver, and "flip-flop" tube where military or industrial requirements call for extremely high-speed counting. The tube features exceptionally high perveance and sharp cutoff. Ratings, characteristics, and price from any G-E tube office listed below.

### EASTERN REGION

General Electric Company, Tube Sales  
200 Main Avenue, Clifton, N. J.  
Phones: (Clifton) GRegory 3-6387  
(N.Y.C.) Wlconsin 7-4065, 6, 7, 8

### CENTRAL REGION

General Electric Company, Tube Sales  
3800 North Milwaukee Avenue  
Chicago 41, Ill.  
Phone: SPring 7-1600

### WESTERN REGION

General Electric Company, Tube Sales  
11840 West Olympic Boulevard  
Los Angeles 64, Calif.  
Phones: GRanite 9-7765; BRadshaw 2-8566

## TV White Compression Minimized by Pentode Improvement in G-E 6AU8-A

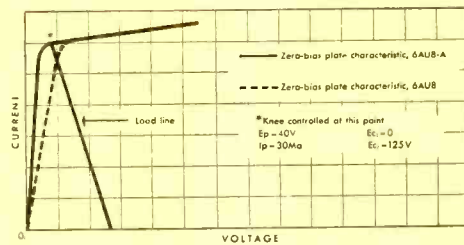

Note that plate characteristic curve of the new high-perveance G-E 6AU8-A meets circuit load line well above "knee", where white compression is absent.

TV line rejects and customer dissatisfaction from white compression—where whites in the picture wash out grays—are virtually eliminated in smaller sets and portables by General Electric's new high-perveance 6AU8-A, the pentode section of which is used as a video amplifier.

The load line now intersects the plate-characteristic curve well beyond the point where white compression occurred with former Type 6AU8. Manufacturers of TV sets employing 135-v B-supply voltage, now can use a higher load resistance in the plate circuit for more video-output voltage, without risking white compression or having to add circuitry in order to avoid this picture hazard.

## UP-TO-THE-MINUTE!



### G-E Industrial and Military Cathode-Ray Tubes

New, revised catalog for equipment designers, with all facts on basic bulb designs, gun designs, bases, and phosphors. Ask for ETD-985-B!

Progress Is Our Most Important Product

**GENERAL ELECTRIC**

182-1C4

ELECTRONIC COMPONENTS DIVISION, GENERAL ELECTRIC COMPANY, SCHENECTADY, N. Y.





US-KON CONDUCTIVE CARDS

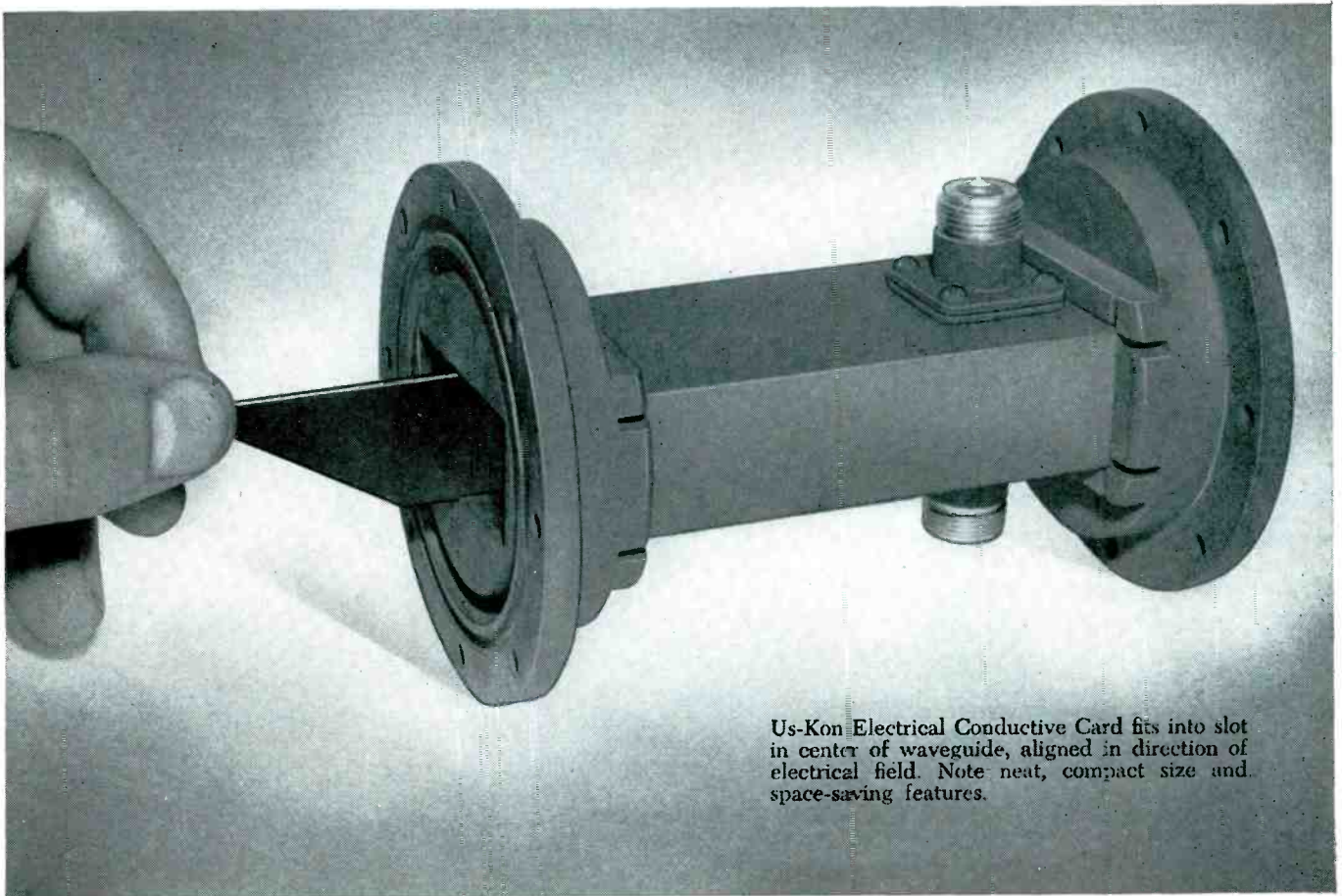

Us-Kon Electrical Conductive Card fits into slot in center of waveguide, aligned in direction of electrical field. Note neat, compact size and space-saving features.

# NEW SENSITIVITY IN ELECTRICAL CONDUCTIVITY

The Convair Division of General Dynamics, Inc., relies on Us-Kon® Electrically Conductive Cards for more precise control of the attenuation of electromagnetic energy in waveguide terminators and attenuators. These remarkable cards provide greater sensitivity of electrical conductivity, more accurate perception.

To fit the job requirements, they can be readily sheared, punched, stamped or machined to a desired shape. The cards are conductive on one face, black in color. Electrical resistances of 50 to 700 ohms per square inch are obtainable.

New uses are constantly being found for Us-Kon

Conductive Cards. These versatile components save weight, space, and require no up-keep. The superior conductivity and versatility of Us-Kon Conductive Cards may suggest ways you can use them profitably. Tell us the type of your product or application.

Write United States Rubber E L  
 Us-Kon Sales Dept.,  
 Mechanical Goods Div., Rockefeller Center  
 New York 20, N. Y.

Name \_\_\_\_\_  
 Address \_\_\_\_\_  
 City \_\_\_\_\_ Zone \_\_\_\_\_ State \_\_\_\_\_



Mechanical Goods Division

# United States Rubber

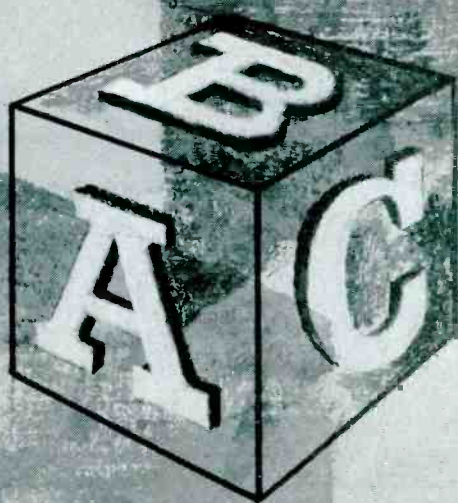

## THE A B C's OF CONNECTORS



**AVNET/Avnet** stocks many connectors. Not only Bendix and Cannon, but connectors made by 15 other manufacturers also. Avnet's two 7 story warehouses hold more than 4,250,000 connectors in constant turnover, with the latest AN and/or JAN specs. Avnet delivers immediately any quantity of connectors. Wide awake buyers buy Avnet.



**BENDIX/Avnet** is already the established Factory Jobber for Bendix Connectors and Bendix Special Purpose Tubes. The new Bendix Pygmy Connectors are a dramatic improvement in Aviation and Electronics. They drastically reduce connector weight, take up much less space! Think of the advantages! Write Avnet for details.



**CANNON/Cannon Connectors.** Cannon appointed Avnet an Authorized Distributor. Cannon's Rack and Panel Connectors, both Standard and Miniature (plus many other types) constitute some of the finest contributions ever made by connector engineering to the field of Avionics. Write Avnet for details. Cannon/Avnet. What a partnership.

**Avnet/** AVNET EASTERN SALES, 36 N. MOORE ST., NEW YORK 13, N. Y. BEEKMAN 3-5780 (AVNET ELECTRONIC SUPPLY CO., INC.)  
AVNET WESTERN SALES, 8966 NATIONAL BLVD., LOS ANGELES 34, CAL. TEXAS 0-7950, VERMONT 7-1461 (AVNET CORP.)

Bendix Connectors, Cannon Connectors, Winchester Connectors, IFC, Bendix Special Purpose Tubes, Sprague Capacitors and Condensers, Westinghouse Bulbs and Tubes, Thordarson Transformers, UG Connectors, JAN Switches and Circuit Breakers, Coaxial Cable, Fuses, JAN Resistors and Potentiometers, Amphenol Connectors, Cinch-Jones Plugs, Sockets, Strips. What a source of supply!

AVNET'S TOTAL CONNECTOR STOCK IS NOW THE MOST COMPLETE TO BE FOUND! —ANYWHERE!



**IMMEDIATE DELIVERY!!**  
 ALL MODELS FROM STOCK

**Computer-  
 Measurements**

electronic counting,  
 timing and controlling  
 instruments

- universal counter-timers
- frequency and period counters
- time-function translators
- preset controllers
- totalizing counters
- time interval meters
- decade counting units
- preset decade counting units

Write for all-new 1957  
 Short Form Catalog TODAY!!



**Computer Measurements Corporation**

Subsidiary of Hancock Manufacturing Co.  
 5528 Vineland Ave. Dept. 78D  
 North Hollywood, Calif.



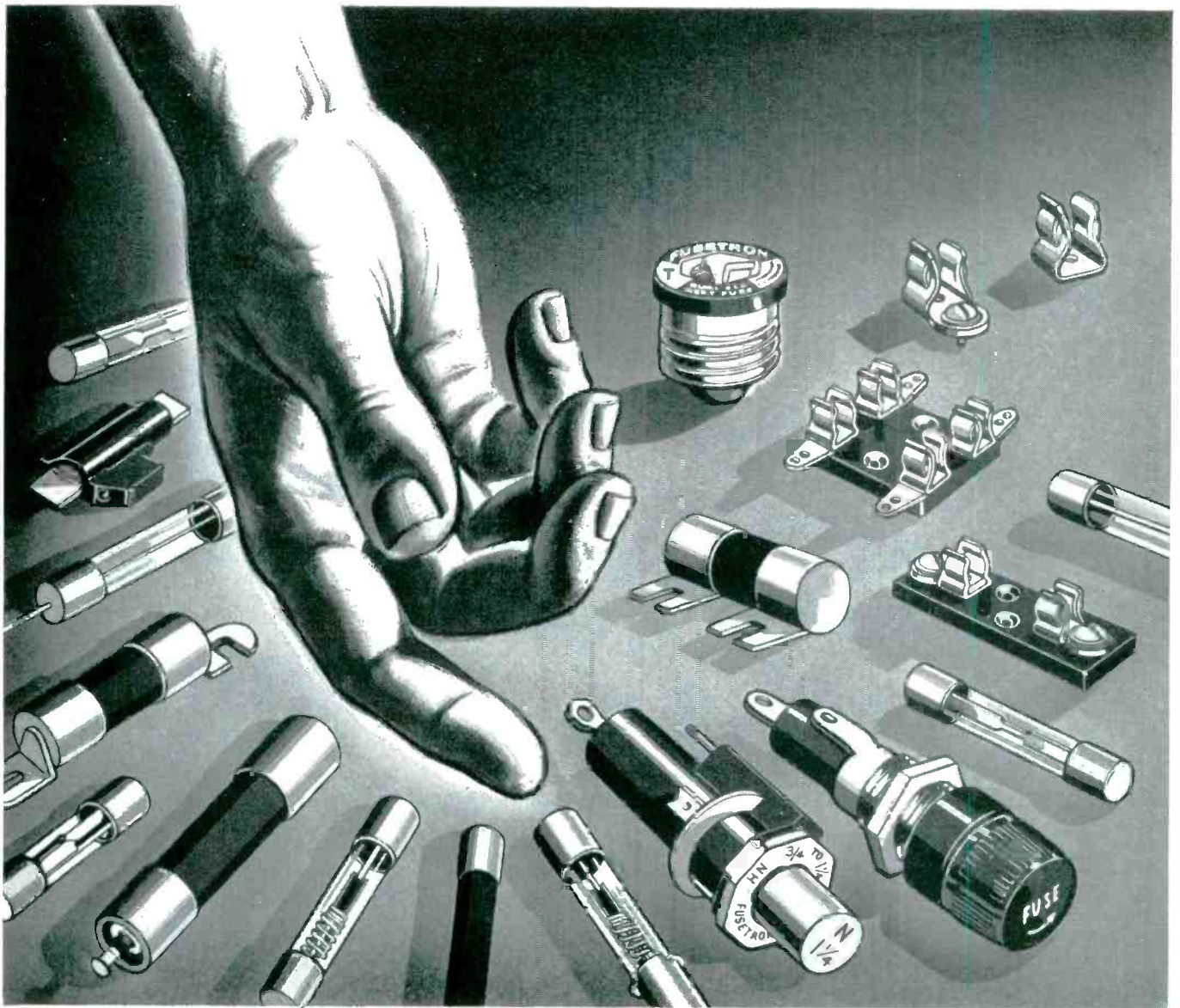

## BUSS FUSES provide maximum protection against damage due to electrical faults

Protection against damage due to electrical faults can be no better than the device used to protect the equipment. The safest, most dependable protection you can get is with BUSS fuses.

To make sure BUSS fuses will clear the circuit should an electrical fault occur,—BUSS fuses are electronically

tested. A sensitive testing device automatically rejects any fuse not correctly calibrated, properly constructed and right in all physical dimensions.

This careful testing is also your assurance BUSS fuses won't give a false alarm by blowing needlessly. Shut-downs due to faulty fuses blowing without cause are eliminated.

With a complete line of "trouble-free" BUSS fuses available in all sizes and types,—it is just good business to standardize on BUSS fuses.

If your protection problem is unusual, you can save engineering time by letting the BUSS fuse engineers help you select the fuse or fuseholder best suited to your needs.

For more information on BUSS and FUSETRON Small Dimension fuses and fuseholders . . . Write for bulletin SFB. Bussmann Mfg. Co. (Div. of McGraw-Edison Co.) University at Jefferson, St. Louis 7, Mo.

*BUSS fuses are made to protect—not to blow, needlessly*



Makers of a complete line of fuses for home, farm, commercial, electronic, automotive and industrial use.



# ALL VIDEO TRANSMISSION TEST

## STANDARDS in a suitcase



The Original Full-Rack and the Portable Unit Produce the same Precise Test Signals.



**TELECHROME**  
INCORPORATED

### Model 1003-B

Video Transmission Test Signal Generator

- ★ Completely self contained ★ Portable
- ★ Multi-frequency burst ★ Stairstep ★ Modulated stairstep
- ★ White window ★ Composite sync ★ Regulated power supply.

Now, Telechrome Video Transmission Test Equipment is available as a completely portable 12 1/4" standard-rack mounting unit.

Everyday these Test Signals generated by Telechrome equipment, are transmitted Coast-to-Coast by NBC, CBS, ABC, the Bell System, Canadian BeB and leading independent TV stations throughout the U.S. and Canada. Hundreds of network affiliated TV stations and telephone TV centers thus check incoming video signals.

The compact, inexpensive, portable Model 1003-B is all that is required to generate signals for local and remote performance checking of your entire video, cable, or micro-wave facilities.

DELIVERY 30 DAYS

Literature on the Above and more than 100 additional instruments for monochrome and color TV by TELECHROME are available on request.

The Nation's Leading Supplier of Color TV Equipment  
28 Ranick Drive Amityville, N. Y.  
Lincoln 1-3160

**TELECHROME**  
INCORPORATED

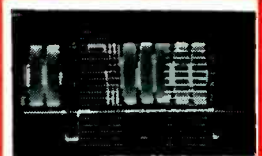

**MULTI-FREQUENCY BURST AMPLITUDE vs FREQUENCY.** Check wide band coaxial cables, microwave links, individual units and complete TV systems for frequency response characteristics without point to point checking or sweep generator.



**WHITE WINDOW LOW & HIGH FREQUENCY CHARACTERISTICS.** Determine ringing, smears, steps, low frequency tilt, phase shift, mismatched terminations, etc. in TV signals or systems.

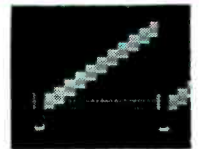

**STAIRSTEP SIGNAL** modulated by crystal controlled 3.579 mc for differential amplitude and differential phase measurement. Checks amplitude linearity, differential amplitude linearity and differential phase of any unit or system. Model 1003-C includes variable duty cycle stairstep (10-90% average picture level).

Model 608-A HI-LO CROSS FILTER for Signal analysis.



**MODULATED STAIRSTEP** signal thru high pass filter. Checks differential amplitude.

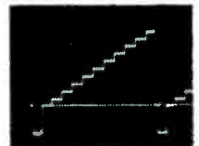

**MODULATED STAIRSTEP** signal thru low pass filter. Checks linearity.

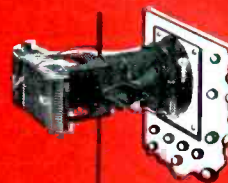

1521-A OSCILLOSCOPE CAMERA—Polaroid type for instantaneous 1 to 1 ratio photo-recording from any 5" oscilloscope.



1004-A VIDEO TRANSMISSION TEST SIGNAL RECEIVER for precise differential phase and gain measurements. Companion for use with 1003-B.

Truflex® Thermostat Metal Parts by

**GENERAL PLATE**

**Give you  
Consistent**

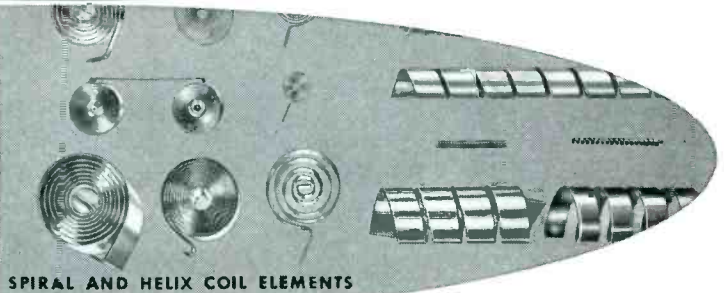

**Performance**

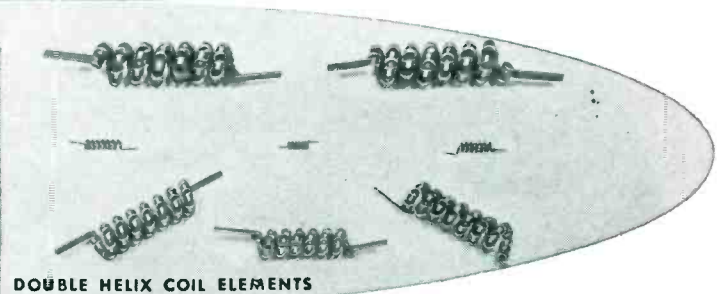

**with Economy**

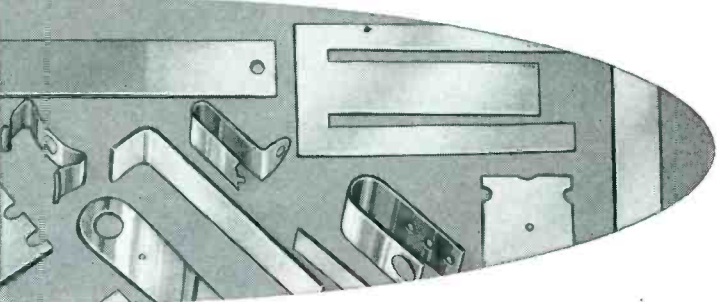

*For better control, indication,  
or compensation of  
temperature in your  
products, look to Truflex  
Thermostat Metal parts.  
Here's why:*

- Every piece, whether in lots of 10 or 10,000, is a duplicate of the original — eliminating rejects and costly adjustments in assembly.
- Truflex Thermostat Metal Parts and Sub-Assemblies are engineered to your specifications, ready for installation.
- Production problems, special equipment, prolonged experimental work, expensive calibrating operations are all eliminated when you use Truflex parts.
- If you prefer to make your own parts, Truflex Thermostat Metals are available in extra long coils or flat strips manufactured to exacting specifications.

You can profit by using General Plate clad metals.

*Why not send us a drawing of  
one of your thermostat metal  
parts, and let us show you what  
we can do? No obligation.*

**METALS & CONTROLS CORPORATION**

General Plate Division  1304 Forest Street, Attleboro, Mass.

FIELD OFFICES: NEW YORK, CHICAGO, DETROIT, MILWAUKEE, LOS ANGELES



# THE STORY BEHIND THE STORY

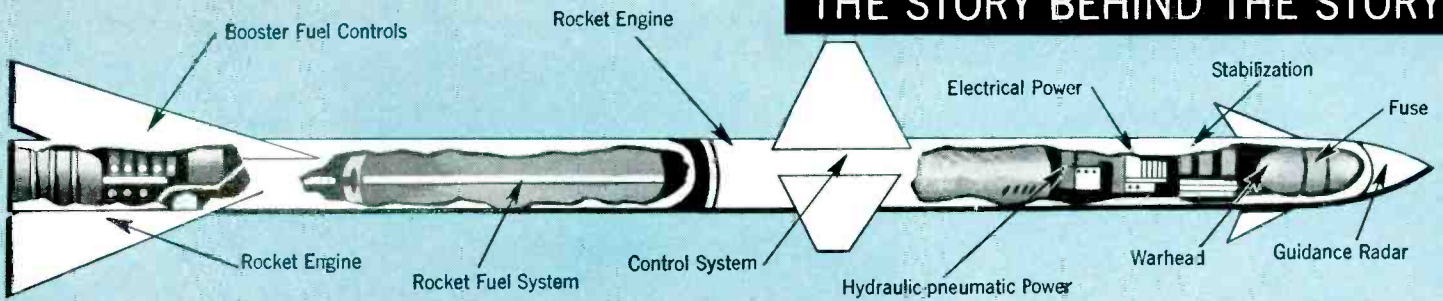

**THOUSANDS OF "FAULTS"** can develop in a guided missile, each capable of causing it to misfire or swerve off-course. Pre-launching

check-out takes specialized technicians many hours. Under stress of enemy attack, a small but fatal defect might be missed.

**IN MINUTES, NOT HOURS,** all critical parts can now be checked by combat personnel—not specialists—simply by pressing buttons on truck-mounted RACE system. Connected to missile, RACE flashes discovered faults on television-like screen and automatically ejects punch card indicating repair instructions.

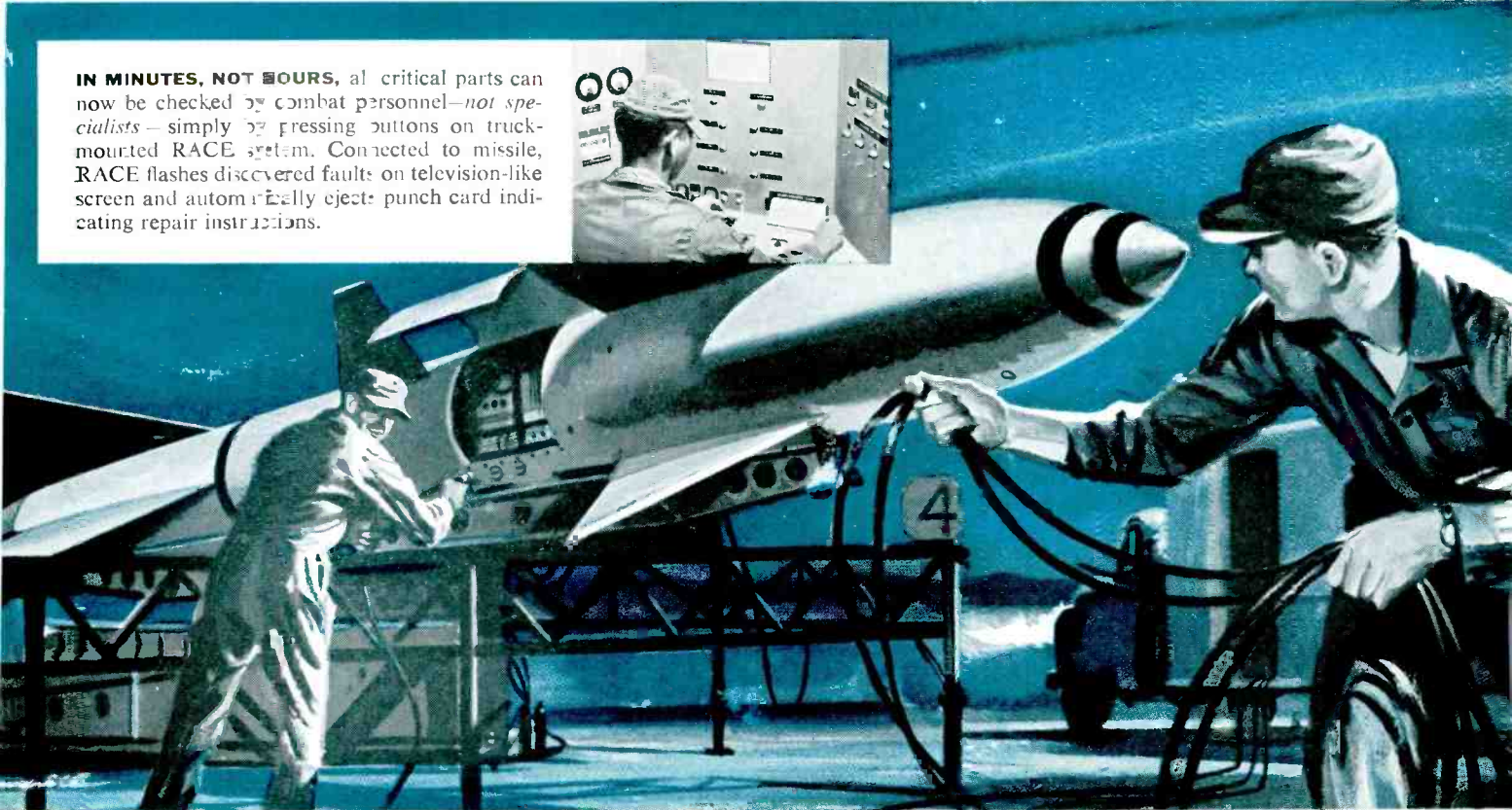

**IN FLIGHT,** RACE-checked guided missile flashes toward target, performing at the peak capacity engineered into it, with all components functioning to give missile best possible opportunity to reach and destroy objective.



## "RACE" TO BOOST MISSILE STRIKING POWER

Electronic System Cuts Launching Time, Ups Dependability

When a rifle bullet misfires you simply fire another. Guided missiles, however, are costly and complex, packed with precision parts in hair-line adjustment. When these "birds" take off, they've got to fly right the first time!

At present, making sure missiles perform properly takes hours, even days, of careful testing by highly trained crews. And under the stress of actual combat, the best-trained crew might neglect an important check-point—and there are thousands of potential trouble-spots in a typical missile.

Sperry's new missile testing system called RACE does the job in only minutes—with little chance for error. RACE (for Rapid Automatic Check-out Equipment)

tests all missile components at the launching platform, warns of the tiniest fault, even tells the operator how to fix it. And RACE doesn't make a mistake because it checks itself while it checks the missile. Result is, missiles are ready to launch far quicker and are more likely to perform with full effectiveness.

Designed to test supersonic aircraft as well as missiles, RACE will strengthen our national defense by keeping key weapons fit to fight.

**SPERRY** GYROSCOPE COMPANY  
Great Neck, New York  
DIVISION OF SPERRY RAND CORPORATION

# How to make a Magnetic Core that's really SMALL?

use **AL**

**PERMENDUR**



Write for  
your copy

"MAGNETIC MATERIALS"

This 32-page book contains valuable data on all Allegheny Ludlum magnetic materials, silicon steels and special electrical alloys. Illustrated in full color, includes essential information on properties, characteristics, applications, etc. Your copy gladly sent free on request.

ADDRESS DEPT. E-88

When the conditions of service make it imperative for you to hold the size and weight of magnetic cores at an absolute minimum, that's the place to use Permendur. With it you can push the flux density up to 20 kilogausses, and practically eliminate weight as a consideration.

Along with its suitability for cores wherever the premium is laid on compactness, Permendur is just the thing for sonar magnetostriction applications, too. We maintain proper annealing facilities for this

alloy. Write for technical data on it, and let our engineers help you to cash in on its possibilities.

In addition to Permendur, we offer a range of high-permeability alloys, oriented silicon steels and other electrical alloys that is unmatched in its completeness. Our services also include the most modern facilities for lamination fabrication and heat treatment.

Let us supply your requirements. *Allegheny Ludlum Steel Corporation, Oliver Building, Pittsburgh 22, Pa.*

**STEELMAKERS** to the Electrical Industry

**Allegheny Ludlum**

WSW 6118





# You can't match **TRIPLET** model 630 VOM

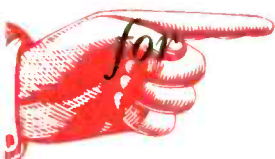

**SPEED  
ACCURACY  
DURABILITY  
CONVENIENCE!**

*heavy molded case*

— $\frac{1}{4}$ " thick for high impact.  
Fully insulated.

*sure grip battery contacts*

Balanced double-spring tension grip assures permanent contact.

*"this wide-range model*

tests AC-DC Volts (DC at 20,000 O/V); DC Microamperes, Milliampers, and Amperes; Ohms (to 100 Megohms); Decibel and Output. Its easy-to-read scales are the longest in this type tester."



*streamlined design*

No protruding knobs on switch or ohms control—both are flush with the panel.



*king size recessed knob*

—Only one switch; (fully enclosed) selects both circuit and range. Just turn the switch and make your reading.

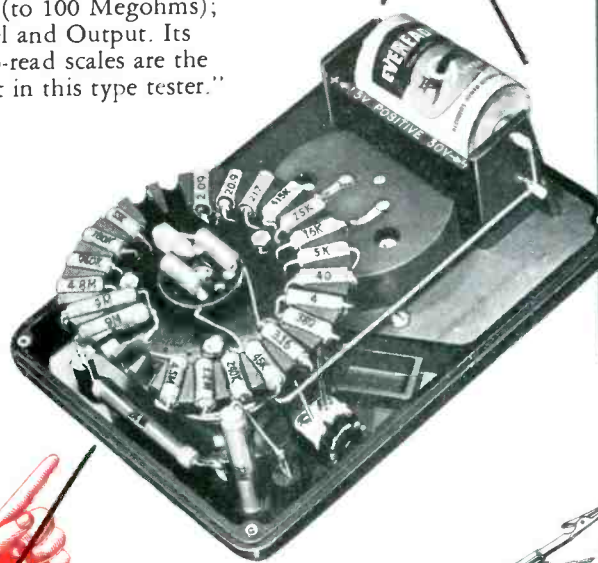

*advanced engineering*

—Molded mounting for resistors and shunts allow direct connections without cabling. No chance for shorts. Longer life and easy-to-replace resistors in their marked positions.

*for quick positive connections*

—Banana jacks and plugs on test leads are best. Alligator clips are provided to slip on test prods for extra convenience.

*for most efficient meter use*

—With every Model 630 you receive complete, simplified instructions on how to use and maintain most efficiently.

*for convenience to reading*

—Available as an extra (only 50c), this special stand tilts meter at best angle for easy reading

*no slip feature*

Four rubber feet furnished as standard equipment fit in back of the case to prevent slipping on smooth surfaces.

**MODEL 630 | \$44<sup>50</sup>**

**TRIPLET ELECTRICAL INSTRUMENT CO.**  
Bluffton, Ohio



**THE MIGHTY NINE VOM LINE**

- 631**  
Combination V.O.M.—VTVM
- 630-NA**  
For Best Testing Around The Lab. Production Line or Bench
- 630**  
The Popular All-Purpose V.O.M.
- 630-A**  
A Good Lab. and Production Line V.O.M.
- 310**  
The Smallest Complete V.O.M. With Switch
- 630-T**  
For Telephone Service
- 666-HM**  
Medium Size For Field Testing
- 625-NA**  
The First V.O.M. With 10,000 Ohms, Volt AC
- 666-R**  
Medium Size With 630 Features



In our humble opinion, the building of reliability into a product requires an alert awareness of the many, many facets of the problem. We'd like to submit these . . .

# Why reliability engineering is not enough

- \* "Integrity of intent" on the part of the manufacturer to meet the problems . . . coupled with provision of a proper climate for the carrying out of reliability objectives
- \* Financial ability to take the necessary steps
- \* Modern manufacturing equipment and methods
- \* Plant capacity and flexibility
- \* Design and engineering know-how that recognizes end-use requirements and environmental conditions
- \* Careful employee selection and training
- \* Long-range master planning
- \* In-plant industrial and production engineering
- \* Research, testing, development laboratory activities, including complete testing of prototype to end-use requirements
- \* Continuous reliability assurance testing during the manufacturing operation, and institution of required corrective action
- \* Collection, in the field, of failure data, analysis, and corrective action
- \* All of these facets in depth

*There's more to reliability than meets the eye . . . a thousand inspectors cannot put reliability into an item that is inherently weak in engineering or production design . . . highest reliability in a component is obtained only when the manufacturer is aware of the problems in obtaining reliability . . . plus providing a proper climate in which employees are motivated by pride in product to surpass specifications.*

Important as all of these are, the most important is the provision of proper climate, in the form of spirit and attitude of all personnel in pride of product, to carry out reliability objectives. In preceding articles in this series we've touched on some of the more technical aspects of reliability engineering. The manufacturer must naturally have an awareness of the problem, the integrity of intent to turn out the best product it can for a particular market or application, the financial ability to establish a Reliability program, the management ability to install it, the necessary manufacturing equipment and engineering organization to carry it out. But *all of these are not enough, if they are not instituted in a climate where an attitude will prevail that makes such things effective.*

The manufacturer's integrity must necessarily be carried out, also, in the design, in manufacturing, and in finally warranting the product created . . . but, again, with every man and woman in the organization trying to meet or exceed the standards that have been created. This latter aspect we call "pride of product" on the part of the people who are producing it. And such pride must exist not only for the final product but for each part of that product, and in each step in the process. There is also an added dividend to reliability; the reputation of the product will cause the user to handle it with the same pride and care as was put into its manufacture.

It is interesting that people who are proud of a product, and enjoy what they are doing, can keep closer tolerances on the parts they work with and produce than those who are merely working for their pay. An assembler, who's proud of the product turned out, sees questionable components and avoids putting them into the assembly, while a disinterested person leaves them for "inspection" to catch. It is interesting in this connection, too, that some of the finest watch

The collage includes several forms:
 

- YOUR OWN MANUFACTURING CO. REPORT**: A report form with fields for date, report number, and various technical details.
- engineering specification**: A document with a title and technical specifications.
- ROUTE CARD**: A card with a grid for tracking parts through different stages.
- PACKING SLIP**: A form for shipping, including a 'TEST REPORT' section.
- INSPECTION REPORT (MISC.)**: A form with fields for 'DATE', 'PART NUMBER AND NAME', 'LOT SIZE', 'DEPARTMENT', and 'REJECTED CAUSE'.
- ORGANIZATION CHART (Partial)**: A hierarchical chart showing departments like 'Production & General Mfg.', 'Manufacturing Division', 'Engineering & Development', and 'Sales Division', with sub-departments and their respective functions.





parts made in Switzerland are produced in little shops where modern quality control techniques are unheard of . . . produced by a craftsman whose major technique is pride in his work . . . and thereby builds everything to the exacting tolerances required.

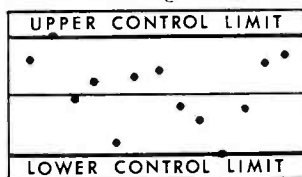

Quality control graph . . . without pride in product.

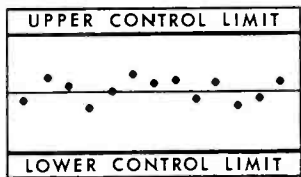

Quality control graph . . . with pride in product.

The atmosphere here at Cannon, since our inception in 1915, has included a design and manufacturing philosophy embracing the highest quality and reliability in each Cannon Plug for the specific application for which it is to be used. *To these principles all Cannon Plugs are built!* Even on connectors designed to customer or MIL-spec we constantly strive to give even more . . . to increase the safety factor . . . to give that "something extra" according to our own high "Cannon Standards", as exemplified in our Cannon Credo.

### THE CANNON "CREDO"

**TO DEVELOP** an organization of exceptional people possessed of respect for the dignity of the individual and imbued with the spirit of the team.

**TO PROVIDE** a facility with which we can produce to our utmost in an efficient and pleasant environment.

**TO DEVELOP** and produce products of such quality, and render such service, that we may always be proud of our efforts.

**TO MARKET** the product of our endeavor at a reasonable profit for continuing growth, reward for effort and a return on investment.

**TO ACCEPT** our responsibility to our community, our country, and our fellow man.

The Cannon "Credo" is posted through all departments of all Cannon plants . . . Copy available to you on request.

On the more technical side . . . we at Cannon have attempted not only to provide the proper climate for a complete reliability program from the viewpoint of mental attitude, but to provide the necessary facilities in which that attitude may work effectively. One of the most important of such fields is that of engineering organization and proper utilization of specialized engineering personnel. As a purchaser of Cannon Plugs, with a personal stake in their reliability, you will be interested to know that our engineering divisions are grouped as follows:

**Master Planning Group** . . . men who look to the future . . . investigating the newest in technological improvements, providing interplant project coordination for maximum flexibility to meet the challenges of our ever-changing future.

**Industrial Engineering Group** . . . experts who call out the materials, methods, and processes to be used in

the manufacturing cycle . . . experts who collect, analyze, and institute corrective action in accordance with field failure data.

**Sales Engineers** . . . fully qualified technical men who contact our customers.

**Design Engineers** . . . specialists in past and present design methods who analyze failure data caused by design inadequacies and initiate corrective action.

**Development Engineering and Model Shop Group** . . . specializing in the development of prototypes. In these Laboratories, your prototype is tested to see that all specifications are met . . . physical, operating, environmental. Test reports are made up, and presented to you for review and approval. Not until all these steps have been taken is your order placed in production.

**Product Engineers** . . . specialists in particular types of connectors.

**Quality Control Group** . . . well qualified to administer the high requirements of "Cannon Standards" . . . staffed by well trained inspectors and analysts equipped with the most modern equipment.

**Quality Engineering Group** . . . handling the technical aspects of sampling plans . . . preparing inspection and test procedures to realize the customer's desired quality level and the over-all quality level of the entire Cannon manufacturing operation. Materials are processed through receiving inspection. Process, re-work and final inspection barriers are set up. In addition to standard Military and Cannon manuals of quality control procedures, specific jobs . . . such as yours . . . may require additional special inspection or testing. If so, these requirements are established throughout the process, and where necessary, coordinated with you. Our failure data collection and analysis in this field has given us intimate knowledge of the critical points at which such control should be used. Recognized statistical control procedures are used both in process and at the inspection points.

**Materials and Processes Laboratory Group** . . . working in both the research and production phases. This is the group that checks performance of new designs, constantly investigates new materials and processes, and (over and above normal manufacturing supervision and quality control operation) runs continuous reliability and assurance tests on the manufacturing cycle.

\* \* \*

Each of our 20,000 Standard Cannon Plugs are of highest quality and were designed to meet exacting reliability requirements. We also produce special designs to meet the most exceptional AQL end-use requirements.

If you have a problem requiring high-reliability Cannon Plugs, we would appreciate the opportunity working with you.

Cordially,

*Robert J. Cannon* President

CANNON ELECTRIC COMPANY  
3208 Humboldt Street, Los Angeles 31, California



Please Refer to Dept. 120



**CANNON PLUGS**

*Eight plants around the seven seas!*

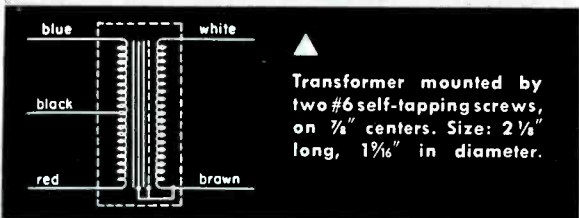
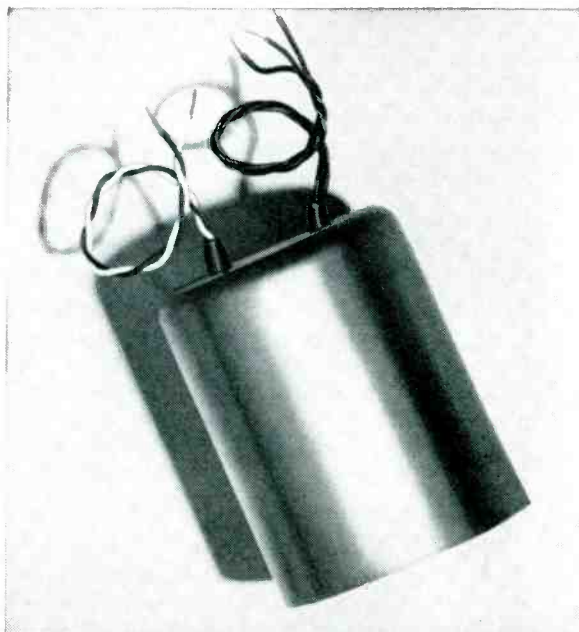

# Shielded low-level transformers

for low-frequency a-c  
or chopper-modulated  
signals from 0.0005 to 200 mv.

Now available for your servo, measuring, and coupling circuits. They're proved by years of industrial service as input transformers in *ElectroniK* instruments. They can faithfully handle low-frequency a-c, or chopper-modulated signals from 0.0005 to 200 millivolts. Used with thermocouples or other transducers.

Hum-bucking winding of both primary and secondary gives maximum cancellation of strays. Highly efficient shielding is designed into the transformers. A grounded copper shield provides electrostatic isolation between primary and sec-

ondary. In addition, the shield and one end of the secondary are internally grounded to the core. Magnetic shielding of -40 db is provided by a high permeability outer can.

Choose from the three models below. Order in single units, or by the hundreds. Write today for immediate quotation and prompt delivery.

MINNEAPOLIS-HONEYWELL REGULATOR Co.,  
*Industrial Division*, Wayne and Windrim  
Avenues, Philadelphia 44, Pa.—in Canada, Tor-  
onto 17, Ontario.

● REFERENCE DATA: Write for Specification S900-1.

Choose from three models		355567-1	356326	355567-2
Primary (center-tapped)	turns (1/2 primary) Resistance (approx.) 60 cps impedance Impedance, full pri.	600 30 ohms 1,300 ohms 5,200 ohms	1,094 450 ohms 7,500 ohms 30,000 ohms	3,400 750 ohms 50,000 ohms 200,000 ohms
Secondary	turns Resistance (approx.) Capacity to tune to 60 cycles	9,600 2,500 ohms	17,000 5,800 ohms	12,000 3,400 ohms
Weight		.015 mfd. 5.7 oz.	.001 mfd. 7.1 oz.	.003 mfd. 6 oz.

**ORDER NOW!**  
Prices from \$21.00  
(even more favorable  
on quantity purchases)



MINNEAPOLIS  
**Honeywell**  
BROWN INSTRUMENTS

*First in Controls*



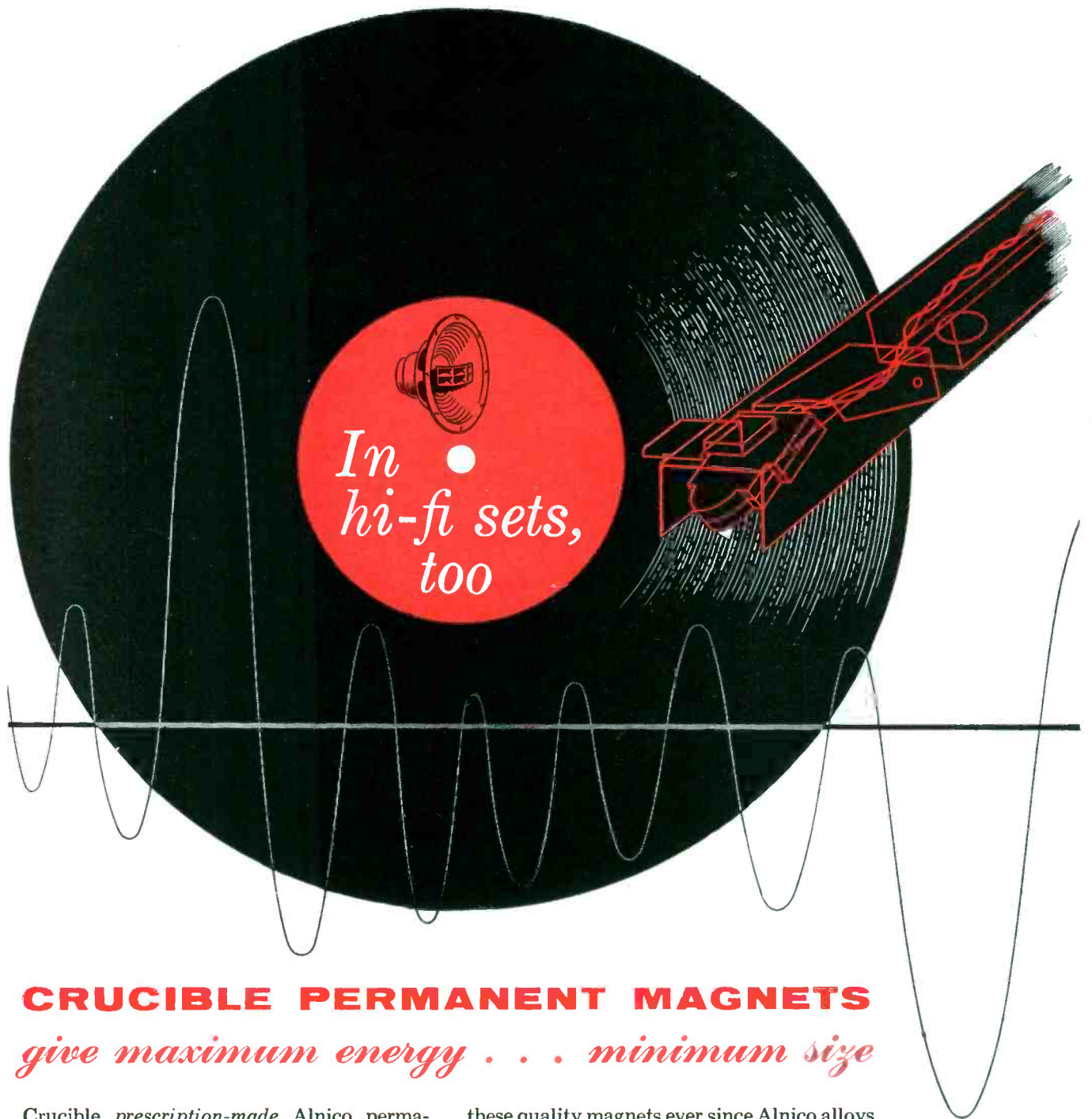

**CRUCIBLE PERMANENT MAGNETS**  
*give maximum energy . . . minimum size*

Crucible *prescription-made* Alnico permanent magnets provide *consistently higher* energy products.

This means greater design freedom . . . more compact products for manufacturers of high-fidelity sound equipment, instruments, controls, motors, and other magnet equipped devices.

Crucible has been a leading producer of

these quality magnets ever since Alnico alloys were first developed. You can get them sand cast, shell molded, or investment cast to meet every size, tolerance, shape and finish need.

Next time you need top quality magnets, or help with magnet applications, call Crucible. *Crucible Steel Company of America, Henry W. Oliver Building, Pittsburgh 30, Pa.*

**CRUCIBLE**

first name in special purpose steels

**Crucible Steel Company of America**

G-M Servo Motors 

GUARANTEED

TO MEET ALL MIL.  
ENVIRONMENTAL  
SPECIFICATIONS

By specializing in servo motors only—not systems—G-M gives you these advantages...

- A broader line of servo motors in sizes and types to meet a wide range of applications.
- Servo motors available in all the standard sizes.
- Standard sizes specially modified to meet specific circuit requirements—available on a quick-service basis.
- Creative engineering in designing special motors with special characteristics.
- Faster production—better service.

When reliability under extreme conditions is essential—specify G-M Servo Motors! G-M has long specialized in supplying precision servo motors to the Military Avionic Industry, especially designed to meet

military specifications for humidity, salt spray, temperature, vibration and altitude. Whatever your needs, let G-M build a servo motor with the *right* characteristics to perform to your specifications.

Write today for G-M charts, specifications, or consultation.



Servo Motors



Motor Generators



Synchronous-Hysteresis Motors



**G-M Servo Motors**

manufactured by the Components Division of

**G-M LABORATORIES INC.**

4336 N. Knox Avenue • Chicago 41



## TECHNIQUES and DEVELOPMENTS in oscillographic recording

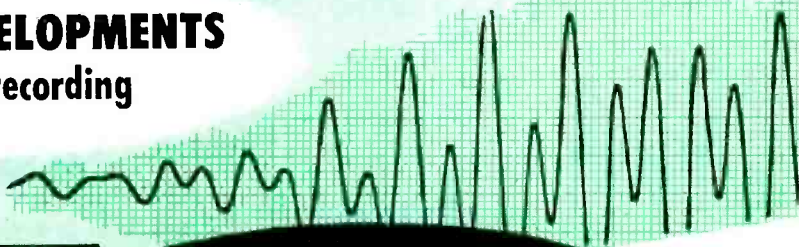

### FROM SANBORN

**PHASE SENSITIVE DEMODULATOR PRE-AMPLIFIER PROVIDES A DC VOLTAGE PROPORTIONAL TO AN INPHASE COMPONENT OF AN AC VOLTAGE WITH RESPECT TO A REFERENCE.**

**T**HE measurement of the amplitude of an AC voltage component is often necessary in performance studies of servo systems or of suppressed carrier signals over the carrier frequency range from 60 to 10,000 cps. In such cases the demodulator responds to inphase signals and rejects quadrature signals.

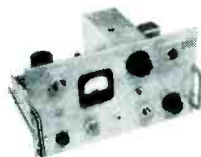

A circuit with these characteristics for use in an oscillographic recording system can be seen in the Model 150-1200 Servo Monitor (Demodulator) Preamplifier. It was developed by Sanborn as one of twelve interchangeable, plug-in front ends for "150" Series equipment,

to be used with the appropriate Driver Amplifier-Power unit in any channel of a "150" system. Elements comprising the circuit from input to output, include: compensated stepped attenuator and cathode follower input circuit, phase inverter, push-pull mixer and demodulator stages, differential DC output amplifier and low pass filter. In addition, the chassis contains a VTVM to facilitate accurate adjustment of the reference voltage, and an overload indicator which lights a warning lamp when excessive quadrature voltages exist.

Adaptability to a fairly wide variety of applications is accomplished through broad input voltage, reference voltage and frequency ranges. In order, these are 50 mv to 50 v (for full scale 5 cm deflection), 10 v to 125 v; 60 cps to 10kc. Rise time with low frequency plug-in demodulation filter is 0.1 seconds; with high frequency filter, 0.01 seconds. Quadrature rejection is better than 100:1; for carrier frequencies up to 5000 cycles.

Two representative uses of the Servo Monitor Preamplifier are in the design and adjustment of servo systems, and with instruments used in the design, development or adjustment of other apparatus. The first is illustrated by use of the Preamplifier and associated equipment in the recording of the output shaft amplitude and driving frequency of an AC positional servo; the second by recordings made with a similar setup of the difference between output signals from a gyroscopically-controlled stabilizing device and the "pitch" and "roll" signals generated by a "Scorsby Table" used for testing the device under dynamic conditions.

For a detailed discussion of the principles and design considerations involved in the Servo Monitor Preamplifier, refer to the February, 1955 issue of the Sanborn RIGHT ANGLE, for Dr. Arthur Miller's article on "Measurements with the Servo Monitor Preamplifier."

Technical literature and engineering assistance on specific problems are always available from our engineering department.

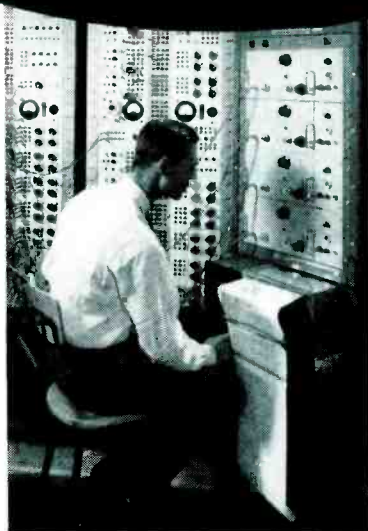

### BASIC FACTORS IN SELECTING OSCILLOGRAPHIC RECORDING EQUIPMENT

**W**HEN considering any oscillographic system or equipment for your application, three useful "yardsticks" to apply are (1) the recording method, (2) equipment adaptability, and (3) variety of equipment available. Here are the answers to the three, as they apply to Sanborn systems. In the record, rectangular coordinates accurately correlate multiple traces, simplify interpretation and eliminate errors. Permanent traces, produced by a hot ribbon stylus without ink, provide sharp peaks and notches, and clearly reveal all signal changes. One percent linearity results from current feedback driver amplifiers and high torque galvanometers of new design; maximum error is 1/4 mm in middle 4 cm of chart, 1/2 mm across entire chart. From the standpoints of "adaptability" and "variety", Sanborn "150" equipment offers the versatility of 13 different plug-in front ends for any basic system . . . the choice of one- to eight-channel systems . . . the variety of nine chart speeds, timing and coding controls, console or individual unit packaging . . . availability of equipment as either complete systems or individual amplifier or recorder units.



The purpose of the foregoing information is to better acquaint industry with typical oscillographic recording problems and their answers, design considerations in Sanborn equipment, and basic data on what Sanborn makes and how it is being used.

## SANBORN COMPANY

INDUSTRIAL DIVISION  
175 WYMAN STREET, WALTHAM 54, MASS.

*from...*  
**SYSTEMS DEVELOPMENT**

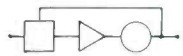

$$J_1 = K_1 = Q_1 \bar{Q}_2 Q_3$$

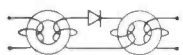

$$V = \mathcal{L}^{-1} E_0 e^{-sT}$$

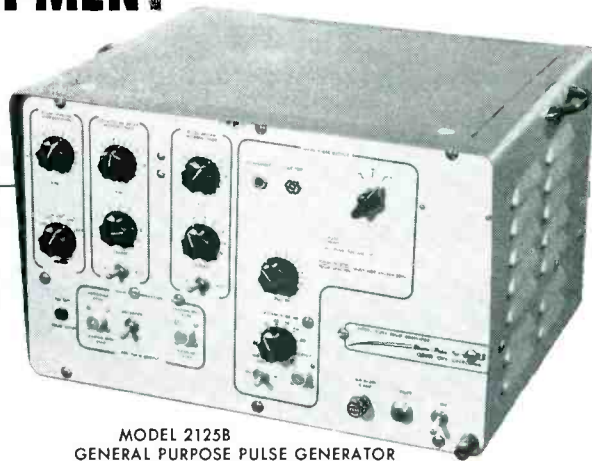
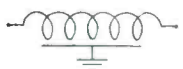

MODEL 2125B  
 GENERAL PURPOSE PULSE GENERATOR

*to...*

**COMPONENT TEST**

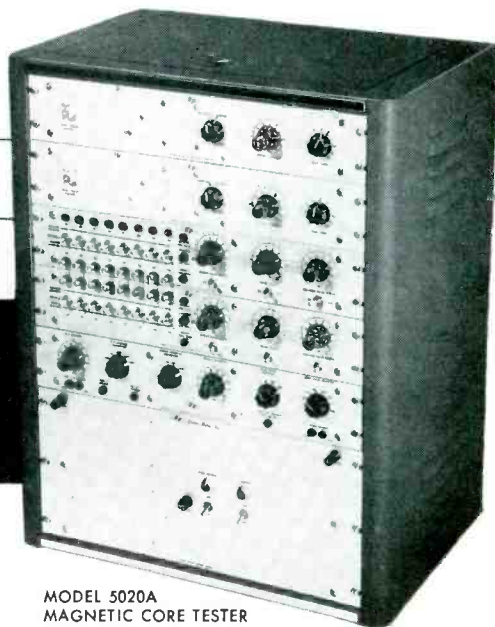
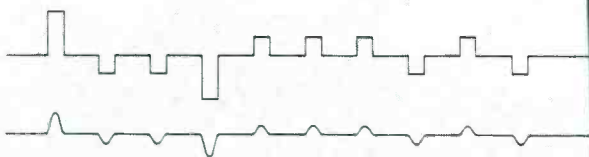

MODEL 5020A  
 MAGNETIC CORE TESTER

**33 STANDARD ELECTRO-PULSE INSTRUMENTS to SIMPLIFY YOUR PULSE INSTRUMENTATION PROBLEM**



$$\Phi = -\frac{1}{N} \int e \cdot dt$$

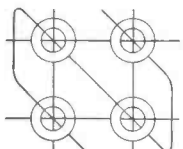
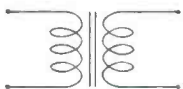

For digital or analog systems, from sub-sonic rep rates to megacycles, pulse widths from milli-microseconds to seconds, in general or special purpose equipment—Electro-Pulse offers a complete and integrated line, designed for your applications by pulse instrumentation specialists.

In addition to the wide range of complete instruments, combinations of standard "block-units" quickly and economically provide ready-made special instrumentation.

Advanced engineering, low-maintenance hard tube circuitry, and flexible wide-range operation typical in Electro-Pulse equipment offers unmatched instrument value for the protection of your project budget and time schedule.

Factory representatives will be pleased to discuss your requirements and recommend applicable equipment.

WRITE FOR COMPLETE CATALOG No. 1-57/E

Representatives in Major Cities

- ✓ Pulse Generators
  - Precision
  - General Purpose
  - Low Speed
  - Megacycle
- ✓ Multi-pulse Generators
- ✓ Pulse Code Generators
- ✓ Beacon Simulators
- ✓ Clock Generators
- ✓ Time Delay Generators
- ✓ Core Testing Equipment
- ✓ Pulse Voltage Calibrators
- ✓ Gate Generators
- ✓ Electronic Counters

**EP** Electro-Pulse, Inc.

11861 TEALE STREET, CULVER CITY, CALIFORNIA • Telephones: EXmont 8-6764 and TEXas 0-8006



# NEW..

for **HIGH TEMPERATURE**  
applications...

## Allen-Bradley TYPE K hot-molded composition VARIABLE RESISTORS

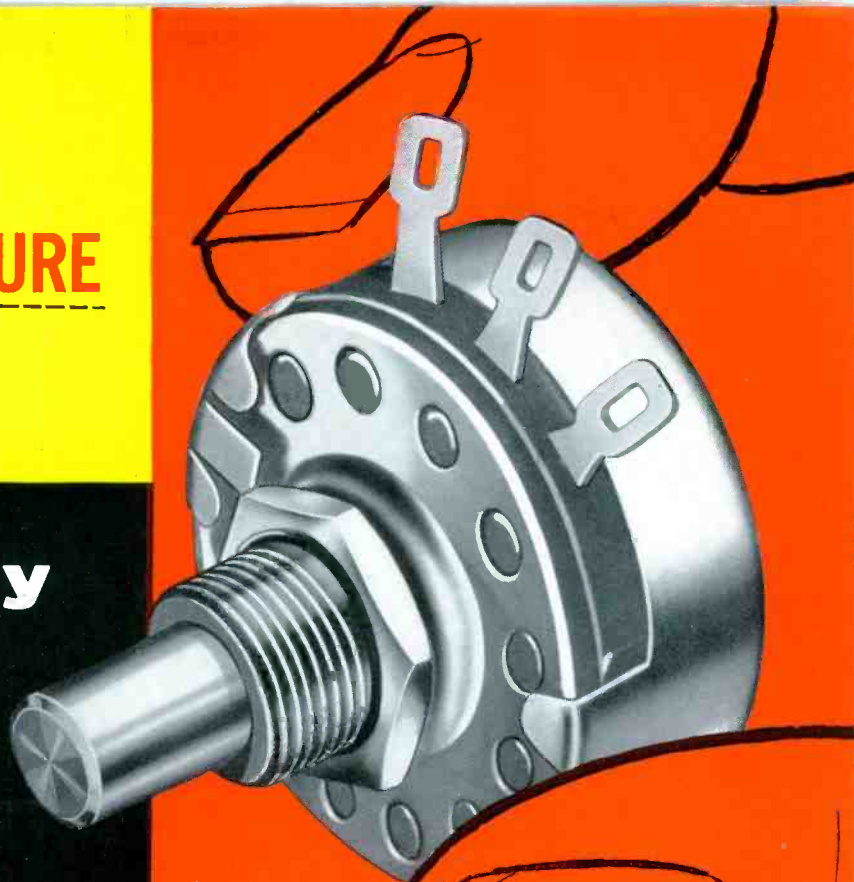

The new Type K Allen-Bradley variable resistor was developed primarily for the high temperatures that are common in so many military applications. In terms of the graph shown to the right, the Type K control has an *ultraconservative* rating of 3 watts when operating in an ambient temperature of 70° C. Also, according to the graph, the Type K potentiometer provides reliable performance when operating at a temperature of 150° C—under “no load” conditions. However, for the first time, a variable resistor is being offered with a conservative rating of 2 watts under 100° C ambient temperature operating conditions. With its reliability remaining constant, the graph suggests that the new Type K potentiometer should find many applications in military electronic equipment.

A remarkable fact is that the new Type K control incorporates *all* the features that have made the Type J Bradley-ometer the Quality standard of the industry. With the *hot-molded* resistance type element, control is smooth and without abrupt resistance changes. The “noise” characteristics are extremely low, even after the control has been in long use.

Where the combination of reliability and operation at high temperature is a *must*, it will pay you to investigate the new Type K Allen-Bradley Quality control. Please write for Bulletin 5200A.

Allen-Bradley Co., 222 W. Greenfield Ave., Milwaukee 4, Wis.  
In Canada—  
Allen-Bradley Canada Ltd., Galt, Ont.

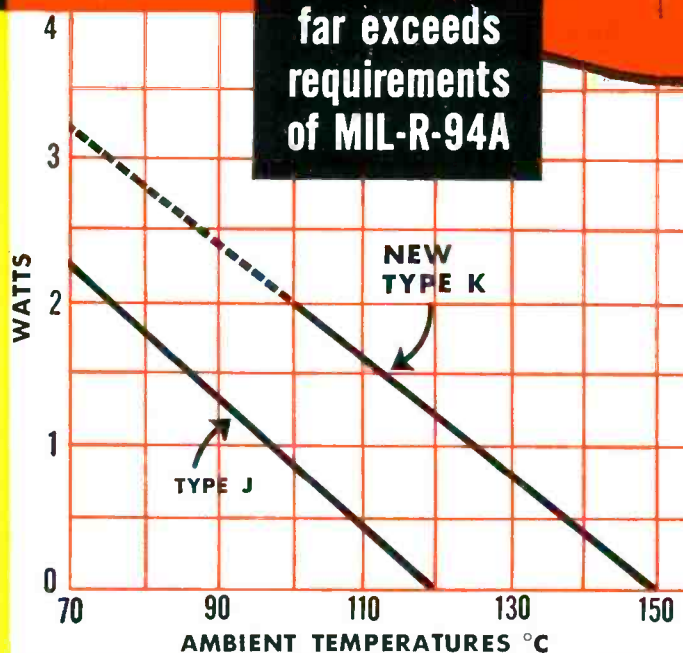

COMPARISON BETWEEN TYPE K AND TYPE J  
VARIABLE RESISTOR  
POWER RATINGS VS. AMBIENT TEMPERATURE



# ALLEN-BRADLEY

RADIO, ELECTRONIC, AND TELEVISION COMPONENTS

QUALITY

# ALLEN-BRADLEY

## QUALITY

# variable resistors

When successful circuit operation depends upon a variable resistor that is not affected by moisture, heat, cold, or age . . . the Allen-Bradley units are the answer. The solid "one piece" hot-molded structure has insulation, terminals, faceplate, and threaded bushing imbedded in the plastic body. With the resistance element as an integral part of the mold—not an added film or paint—it can be made to satisfy any resistance-rotation curve. Write for full details, today.

Sectional view showing how elements are molded in one integral unit

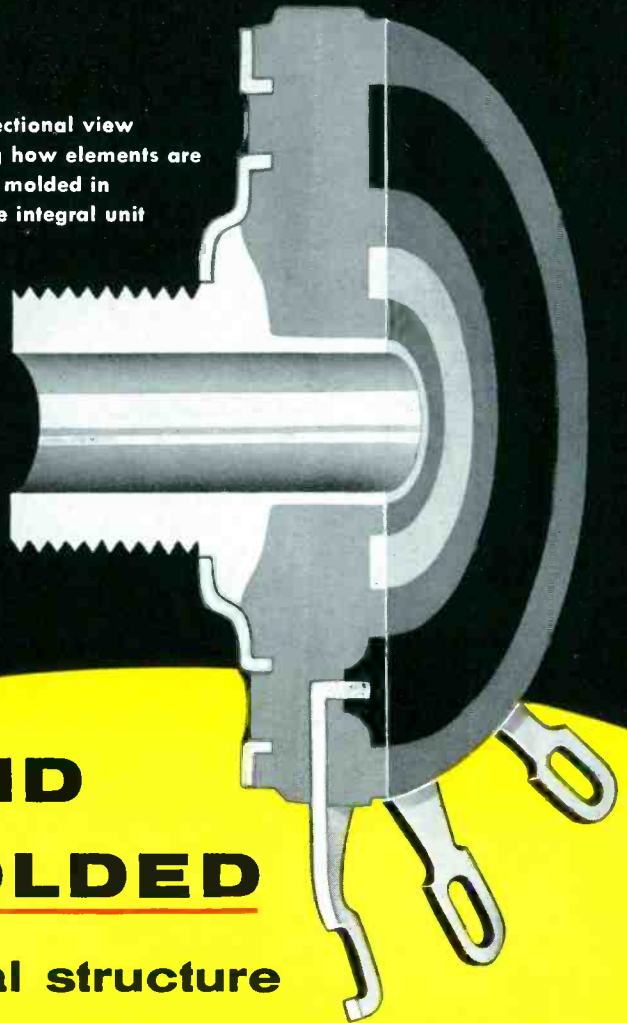

**SOLID**  
**HOT-MOLDED**  
in one integral structure  
for long life and low noise level



**TYPE J**—rated 2 watts at 70C ambient. Total resistance values from 50 ohms to 5 megohms. Available in single, dual, and triple units with various types of adjusting shafts, and with built-in line switch.



**TYPE H**—rated 5 watts at 40C ambient. Total resistance values from 50 ohms to 2.5 megohms. Good for over 100,000 cycles with no appreciable resistance change. Max. voltage 750 v, d-c.



**TYPE T**—rated 1/2 watt at 70C ambient. Plastic cover serves as actuator, making unit extremely flat. Total resistances from 100 ohms to 5 megohms.



**TYPE F**—rated 1/4 watt at 70C ambient. Diameter 1/2". Standard tapers. Slotted shaft. Designed for printed circuits.



**TYPE G**—rated 1/2 watt at 70C ambient. Diameter 1/2". Plain or lock-type bushings; plain or slotted shaft. Available with line switch (right).



Allen-Bradley Co., 222 W. Greenfield Ave.  
Milwaukee 4, Wis.  
In Canada:  
Allen-Bradley Canada Ltd., Galt, Ont.

# ALLEN-BRADLEY

RADIO, ELECTRONIC, AND TELEVISION COMPONENTS

QUALITY

2-57-E



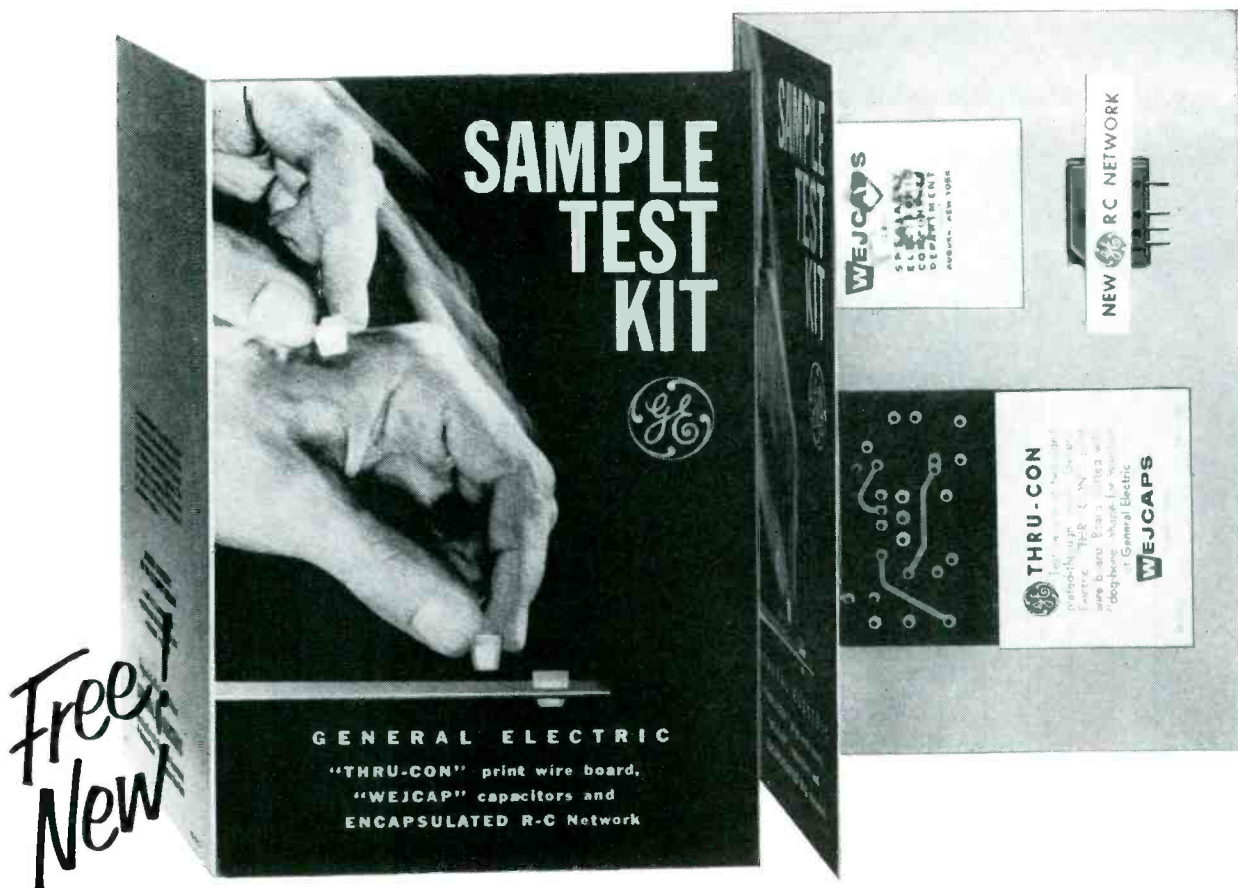

Free  
New

## three-part pack brings you you three-way gains!

Output increases, costs drop, quality climbs—with these General Electric fast-assembly components!

WHETHER your domain is automobile dashboards, radio and TV receivers, temperature controls, or what-have-you, the three units in this free new Sample Test Kit can point the way to big advantages in product improvement and manufacturing economy!

Here's what you'll get...

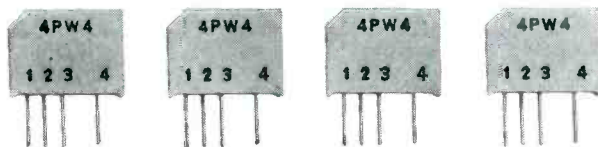

### 1. ENCAPSULATED R-C Network...

This new G-E development is actually several components in one unit, with performance comparable to individual components. Its thin ceramic plate, with a variety of resistor and capacitor patterns and their leads applied to customer requirements, is encapsulated in a compact, uniform phenolic case. This unit thus cuts space and solder requirements under those for individual components, in such applications as coupling, pulse-forming, and R-C filter networks. The encapsulation feature provides excellent resistance to humidity and corrosive agents, and the uniform size and surface of the case is especially suited for mechanized placement.

### 2. "THRU-CON" Print Wire Board...

With this advanced print wire, you can design a compact wiring pattern on *both* sides of the board *without* the cost of further processing to connect them. You gain from the "Thru-Con" additive production technique, which plates *through* the holes at the same time it plates the wiring pattern on the board.

### 3. "WEJCAPS" Leadless Capacitors...

Besides eliminating bothersome lead problems, "Wejcaps" offer low cost, small size, high durability, and high moisture resistance for such applications as antenna coupling networks, AVC and AGC networks, screen by-pass, and other medium tolerance circuits. The "Wejcaps" are simply inserted in a slot in a print wire board and soldered directly to the connection point.

Try these components yourself! If you're after faster production, higher quality assemblies, and lower cost—for present or prospective equipment—send *today* for this free Sample Test Kit. Address, on your letterhead please, *General Electric Company, Specialty Electronic Components Department, Section 2547, Auburn, N. Y.*

*Progress Is Our Most Important Product*

**GENERAL  ELECTRIC**

# Industry's Highest Power Transistors

Combine stability with long life

1957

1958

1959

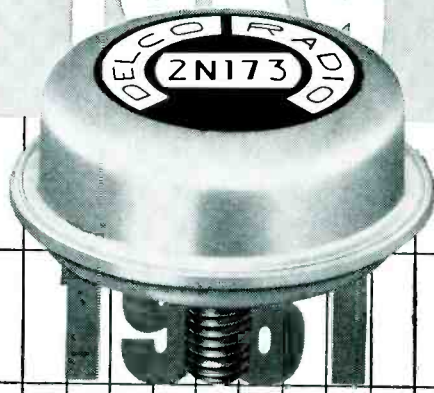

1960

1962

1963

1964

1965

1966

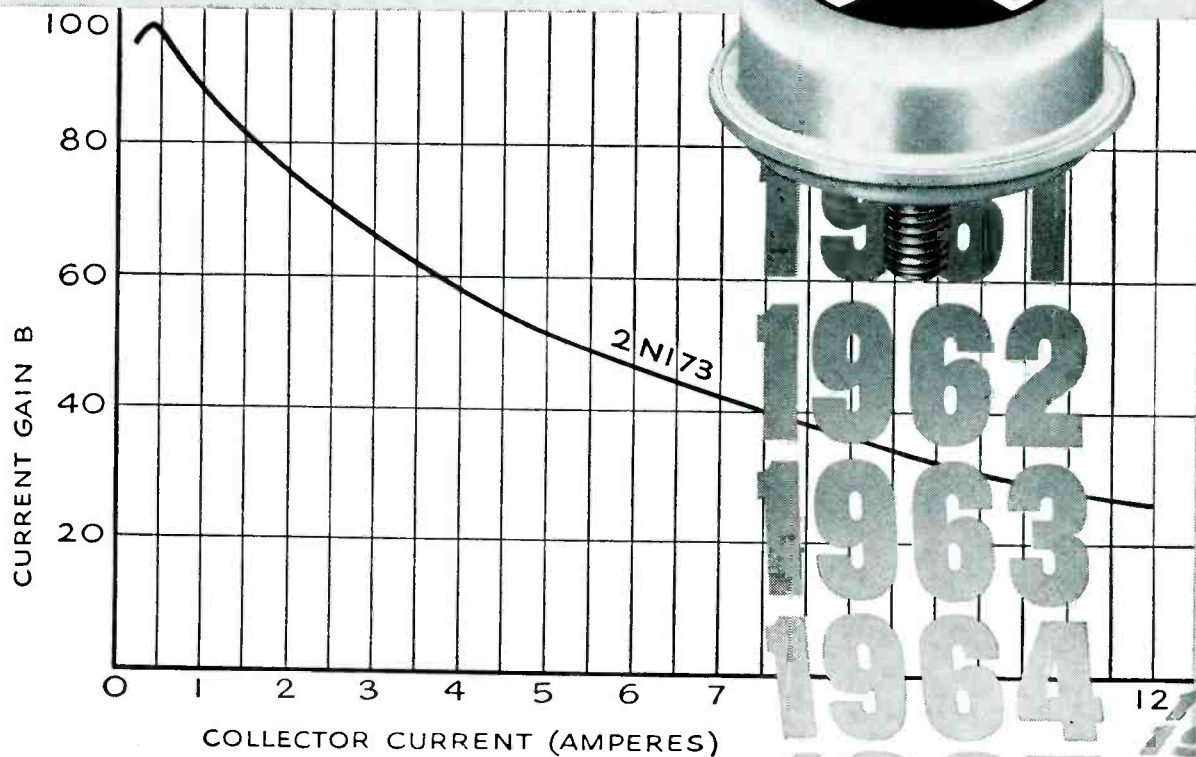

Delco Radio's 2N173 and 2N174 alloy junction germanium PNP transistors have unusual stability and reliability. These superior characteristics are retained by hermetic seal and proper internal atmosphere.

*In addition*, normalizing processes contribute to the high output power, high gain and low distortion characteristics that were designed into them. Delco Radio High Power transistors, ideal for your audio as well as general power applications, are produced by the thousands every day. Write for information and engineering data.

### TYPICAL CHARACTERISTICS

	2N173	2N174	2N277
Properties (25°C)	12 Volts	28 Volts	12 Volts
Maximum current	12	12	12 amps
Maximum collector voltage	60	80	40 volts
Saturation voltage (12 amp.)	0.7	0.7	0.7 volts
Power gain (Class A, 10 watts)	38	38	38 db
Alpha cutoff frequency	0.4	0.4	0.4 mc
Power dissipation	55	55	55 watts
Thermal gradient from junction to mounting base	1.2°	1.2°	1.2° C/watt
Distortion (Class A, 10 watts)	5%	5%	5%

**DELCO RADIO**

**DIVISION OF GENERAL MOTORS  
KOKOMO, INDIANA**



# New Waldes Truarc locking-prong ring functions as spring, shoulder, fastener... and **STAYS PUT!**

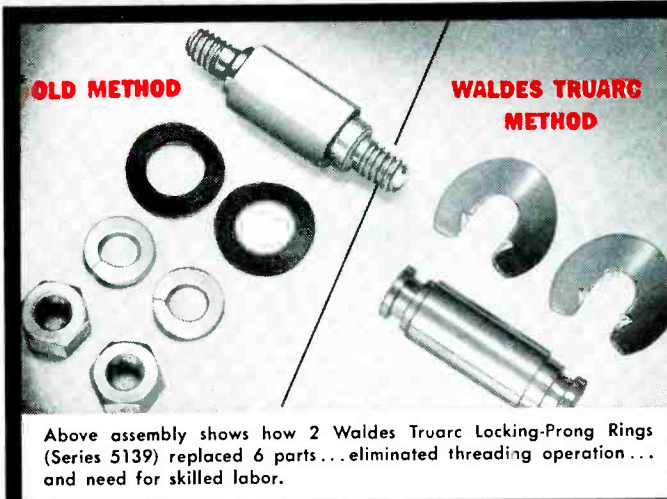

Above assembly shows how 2 Waldes Truarc Locking-Prong Rings (Series 5139) replaced 6 parts... eliminated threading operation... and need for skilled labor.

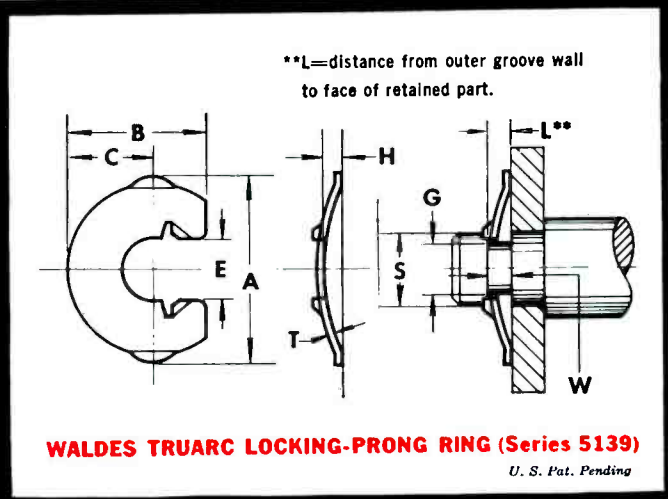

Ring No. 5139-	SHAFT		RING DIMENSIONS											average ultimate shear strength lbs.*	GROOVE DIMENSIONS					resilient end play take up L max-L min		
	Dia. S	tol.	A	tol.	B	tol.	C	tol.	E	tol.	H	tol.	T†		tol.†	Dia. G	tol.	Width W	tol. -.000		L min.	L max.
12	.125	±.002	.340	±.010	.307	±.010	.166	±.005	.086	±.004	.050	±.010	.010	±.0013	400	.082	±.0015	.045	+ .005	.035	.045	.010
★ 15	.156	±.003	.380	±.010	.330	±.010	.184	±.005	.108	±.004	.055	±.010	.010	±.0013	600	.104	±.002	.050	+ .005	.035	.045	.010
18	.188	±.003	.445	±.010	.390	±.010	.213	±.005	.130	±.005	.060	±.010	.015	±.0015	900	.124	±.002	.065	+ .005	.045	.055	.010
25	.250	±.003	.581	±.010	.500	±.010	.280	±.005	.172	±.005	.070	±.010	.015	±.0015	1000	.165	±.002	.070	+ .005	.050	.065	.015
31	.312	±.003	.744	±.010	.620	±.010	.360	±.005	.234	±.005	.095	±.010	.018	±.0015	1300	.228	±.003	.080	+ .005	.080	.095	.015
★ 37	.375	±.003	.853	±.015	.740	±.010	.427	±.005	.280	±.005	.130	±.010	.020	±.002	1900	.270	±.003	.105	+ .005	.090	.115	.025
★ 43	.438	±.003	.960	±.020	.820	±.020	.475	±.010	.337	±.010	.130	±.010	.020	±.002	2200	.327	±.003	.105	+ .005	.095	.120	.025

Additional Sizes Under Development

★ Production dies not available as of date of printing

† Applies to unplated rings only

\* Recommended safety factor = 3 to 4.

The Waldes Truarc Locking-Prong Retaining Ring is a new, low cost, radially applied fastener which can be locked positively in its groove and used as a shoulder against rotating parts. It is primarily intended for use in the automotive, electronic and aeronautical industries.

This radially applied ring locks positively in its grooves by means of two prongs at the open end. Because of its high thrust-load capacity the Waldes Truarc Locking-Prong Ring may be used as a shoulder against rotating parts. Its bowed construction provides for end-play take-up in the assembly and makes less critical the tolerances required for the parts being fastened. Since it serves as a spring as well as a shoulder, this ring eliminates the need for springs, washers, and other accessory fastening devices.

Whatever you make, there's a Waldes Truarc Retaining Ring

designed to improve your product... to save you material, machining and labor costs. They're quick and easy to assemble and disassemble, and they do a better job of holding parts together. Truarc rings are precision engineered and precision made, quality controlled from raw material to finished ring.

36 functionally different types... as many as 97 different sizes within a type... 5 metal specifications and 14 different finishes. Truarc rings are available from 90 stocking points throughout the U. S. A. and Canada.

More than 30 engineering-minded factory representatives and 700 field men are available to you on call. Send us your blueprints today... let our Truarc engineers help you solve design, assembly and production problems... without obligation.



Waldes Kohinoor, Inc., 47-16 Austel Place, L.I.C. 1, N.Y.

- Please send me sample Locking-Prong Rings. (please specify shaft size \_\_\_\_\_)
- Please send me supplement No. 1 which brings Truarc Catalog RR 9-52 up to date. (Please print)

Name.....  
 Title.....  
 Company.....  
 Business Address.....  
 City..... Zone..... State.....

E049

WALDES TRUARC Retaining Rings, Grooving Tools, Pliers, Applicators and Dispensers are protected by one or more of the following U. S. Patents: 2,382,948; 2,411,426; 2,411,761; 2,416,852; 2,420,921; 2,428,341; 2,439,785; 2,441,846; 2,455,165; 2,483,379; 2,483,380; 2,483,383; 2,487,802; 2,487,803; 2,491,306; 2,491,310; 2,509,081; 2,544,631; 2,546,616; 2,547,263; 2,558,704; 2,574,034; 2,577,319; 2,595,787. and other U. S. Patents pending. Equal patent protection established in foreign countries.

# Immediate Delivery...

## **on Mallory Silver Rivet Contacts**



Mallory Silver Rivet Contacts are standardized in 70 stock types and sizes—which means you can count on immediate delivery for pilot run or production.

Mallory's standardization program was built on the results of an intensive study of thousands of silver rivet contact orders. From this survey, 70 basic types were evolved to fit the great majority of applications specified in these orders.

Availability from stock means time saved on orders. Standardization means a wide selection of catalog items, often providing an in-stock item for what might otherwise have been a specially tooled job with its associated higher cost and longer wait.

Dimensions, part numbers, ordering information and pricing data are included in the Mallory folder on silver rivet contacts. Before you place a specially tooled rivet order, why not check the Mallory list for a stock item—and tally up added cost savings on your next production run? Write—or ask the Mallory representative for your copy of Bulletin 3-15A.

**IF** . . . your requirements are unusual, and do call for special contacts—Mallory engineers will be glad to assist in designing and specifying—Mallory production facilities are available for contacts or complete contact assemblies.

**Serving Industry with These Products:**

**Electromechanical** — Resistors • Switches • Tuning Devices • Vibrators  
**Electrochemical** — Capacitors • Mercury and Zinc-Carbon Batteries  
**Metallurgical** — Contacts • Special Metals • Welding Materials

**Expect more...get more from**

**P. R. MALLORY & CO. Inc.**  
**MALLORY**

P. R. MALLORY & CO. Inc., INDIANAPOLIS 6, INDIANA





**Do you have an unsolved "X" spot in your design?  
 ...A place where you would put the "ideal" relay—if you had it?**

**TYPE J DESIGNS TO MEET  
 WIDE DESIGN REQUIREMENTS**

**Standard Type J Relays**

Twin contacts (Palladium standard). Rated current-carrying capacity: 4 amperes, 150 watts.

**Power Type J Relays**

Heavy-duty contacts riveted to springs. Code 18 (Silver). Rated current-carrying capacity; 10 amperes, 27½ volts d-c.

**Type J Video Relays**

For switching video and other high-frequency currents.

CLARE Type J Relays have been filling difficult "X" spots in industrial designs for more than a decade.

Processed of the most positive of all twin-contact designs, the CLARE Type J Relay has all the desirable features of a telephone type relay—yet greatly reduced in bulk.

Many basic design ideas have been improved by this relay—a CLARE original—whose wide acclaim has provoked a lot of imitators but never

an equal—whose many distinctive features have provided an eminently satisfactory solution to many perplexing problems involving efficient, long-life relay operation.

Let us work with you to pick the best relay for YOUR important relay requirement. Address: C. P. Clare & Co., 3101 Pratt Blvd., Chicago 45, Illinois. In Canada: C. P. Clare & Co., 659 Bayview Avenue, Toronto 17. Cable address: CLARELAY.

Write for Engineering Data Book and Bulletin 119

**CLARE RELAYS**

**FIRST in the industrial field**

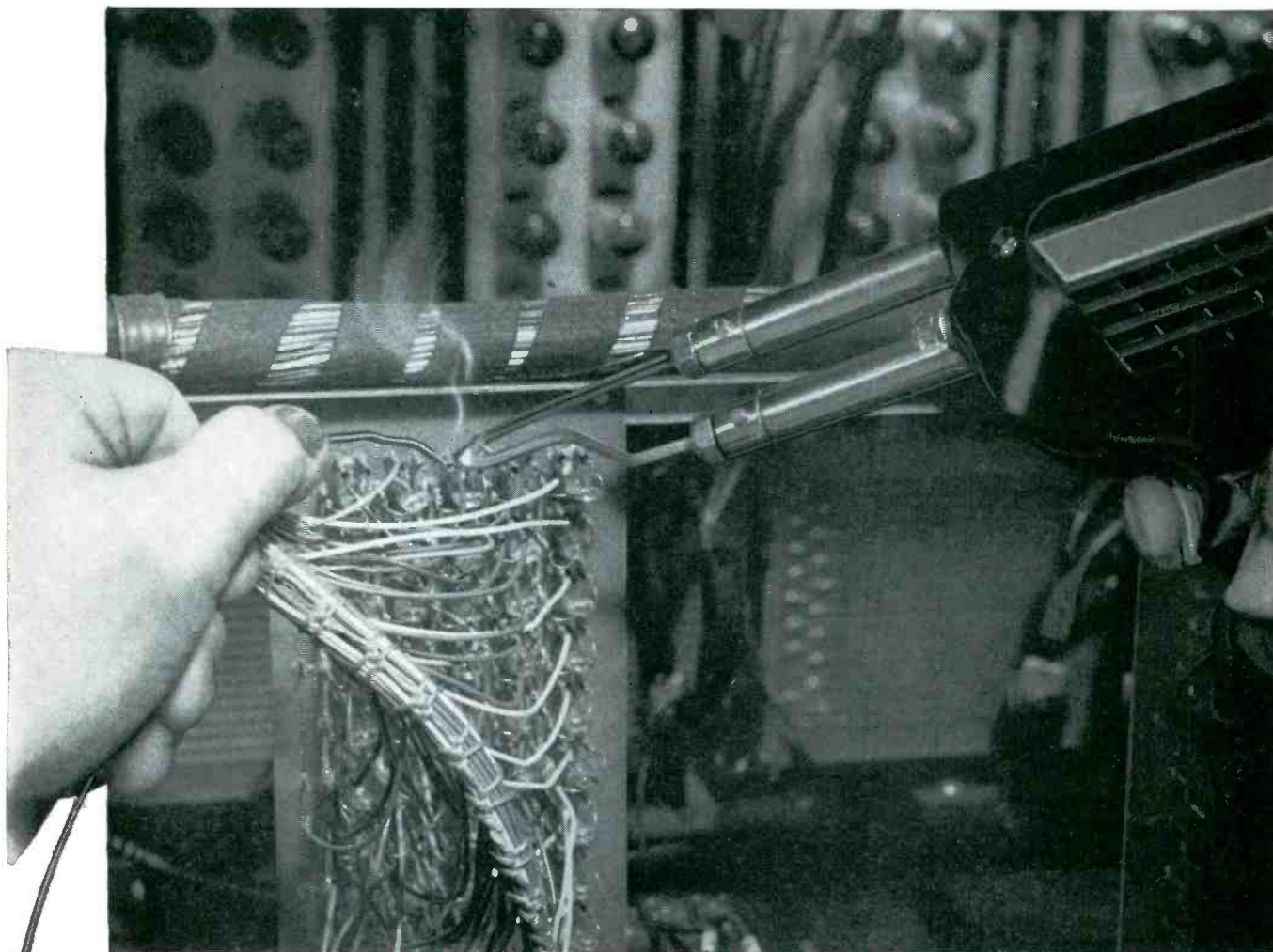

## **“Dutch Boy” Solder specialists help keep electronic brains sane**

*...develop solder-flux  
combinations that  
give practically  
perfect performance*

Who wants a psychopathic computer?

Not the electronic-brain makers... or their customers. That's why they demand... and get... practically never-miss reliability in soldering the thousands of joints and connections in even a small computer. A single open could put the circuitry out of commission.

“Dutch Boy” Solder specialists have done much to improve reliability of metal joining... helping to improve soldering methods, advising on (and sometimes devising) new equipment, and, most of all, developing improved solders and fluxes.

As new electronic devices are developed, as new service requirements unfold, National Lead solder specialists meet the challenge — a new test to insure flux continuity and integrity in cored solders... new formulations for ultra-cold service... fluxes that are truly non-conductive and non-corrosive — these are a few of the things National Lead people have done to solve customers' solder problems... produce solders worthy of the “Dutch Boy” name.

Maybe your “Dutch Boy” Solder specialist can help *you* improve your production soldering. It's easy to find out. Just write National Lead Company, 111 Broadway, New York 6, N. Y. Offices in Principal Cities.

**Dutch Boy® Solders and Fluxes**





# A DEPENDABLE SUPPLIER FOR 61 YEARS

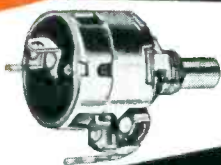
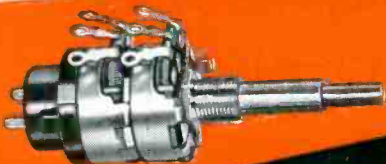
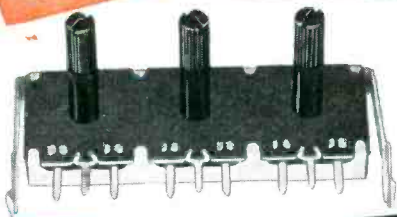

A CTS control can be tailored to your specific requirement. Consult CTS SPECIALISTS on your current variable resistor problems. Ask for 62 page catalog.

## WEST COAST MANUFACTURERS:

Many types of variable resistors now in production at our South Pasadena plant. Your coil, transformer and compression molding business also invited. Prompt delivery. Modern versatile equipment. L. A. phone Clinton 5-7186.

**Specialized Technical Skills—**  
1500 job-trained, class-trained specialists . . . with a world-wide reputation for delivering variable resistors exactly as specified.

**Tremendous Production Facilities—**  
323,000 sq. ft. plant devoted to variable resistors.

**Your changing Requirements Anticipated—**continuous research develops new materials, designs and methods to meet your new requirements.

**Economical Uniform Assembly—**on a precision mass production basis.

**Dependable Delivery—**exceptionally good delivery cycle.

**Complete Line—**variable resistors for military, color and black and white TV, radio, and other commercial applications.

*Variable resistors shown 2/3 actual size*

**WEST COAST SUBSIDIARY**  
Chicago Telephone of California, Inc.  
105 Pasadena Avenue  
South Pasadena, California  
L. A. Phone: Clinton 5-7186  
TWX LA 1105

**CANADIAN SUBSIDIARY**  
C. C. Meredith & Co., Ltd.  
Streetsville, Ontario  
Phone: 310

**EAST COAST OFFICE**  
130 N. Broadway  
Camden 2, New Jersey  
Phone: Woodlawn 6-1668  
TWX No. Camden NJ 380  
Phila. Phone: Market 7-3129

**SOUTHWESTERN U.S.A.**  
John A. Green Company  
137 Parkhouse  
Dallas 7, Texas  
Phone: Riverside 3266

**SOUTH AMERICA**  
Jose Luis Pontet  
Buenos Aires, Argentina  
Montevideo, Uruguay  
Rio de Janeiro, Brazil  
Sao Paulo, Brazil

**OTHER EXPORT**  
Sylvan Ginsbury  
8 West 40th Street  
New York 18, New York  
Phone: Pennsylvania 6-8239

FOUNDED



1896

**CHICAGO TELEPHONE SUPPLY**  
*Corporation*

ELKHART, INDIANA

**The Exclusive Specialists in Precision Mass Production of Variable Resistors**

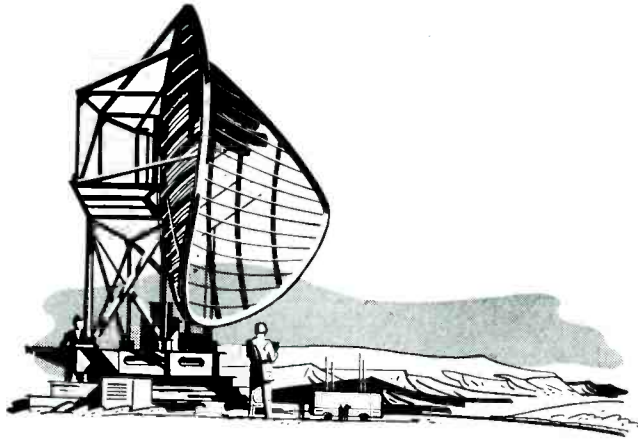

JOIN WITH HANDY & HARMAN SILVER BRAZING FOR PERMANENT PROFIT

## EASY-FLO Brazing Simplifies Multiple Joint Design and Production

Silver brazing with EASY-FLO makes possible simplicity of design and assembly, often abolishing machining operations like stamping, riveting, staking and threading. You see here some of a large variety of brass connectors for radar equipment, manufactured by the King Electronics Company, Incorporated, Tuckahoe, New York. All must meet rigid performance requirements which in turn, establish equally exacting production specifications.

Many different types of joints are involved. Prime performance requirement of these connectors is unimpaired electrical conductivity, for they must in no way impede the current flow of the wires they house. All must be 100% moistureproof and gasproof, have high mechanical strength and take uniform plating without prior finishing. Joined connectors must be perfectly aligned and undistorted.

Each of these requirements is fully met by Handy & Harman silver alloy brazing with EASY-FLO 45 and HANDY FLUX at considerable savings in money and time. Savings that warrant your attention, whatever your product or production methods. Our experience proves that savings through silver alloy brazing can be enjoyed by many manufacturers of many different products in a host of industries. This "King Connector" story is but one example of how silver alloy brazing meets the needs of one product from *start to finish*.

It is worth thinking about—worth getting in touch with Handy & Harman to find out. We will work with you all the way.

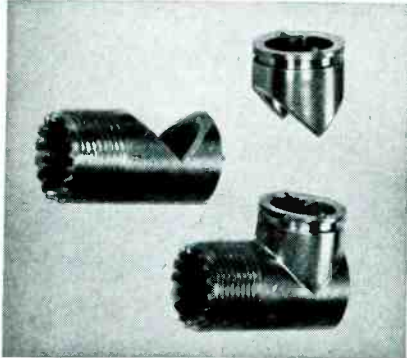

### TAKE TWENTY

BULLETIN 20 tells you why high strength, speed and economy are inherent in EASY-FLO brazing. Also gives Handy information about joint design and fast brazing methods. We'll be pleased to send you a copy.



Your NO. **1** Source of Supply and Authority on Silver Brazing Alloys



**HANDY & HARMAN**  
General Offices: 82 Fulton St., New York 38, N. Y.  
DISTRIBUTORS IN PRINCIPAL CITIES

OFFICES and PLANTS  
BRIDGEPORT, CONN.  
PROVIDENCE, R. I.  
CHICAGO, ILL.  
CLEVELAND, OHIO  
DETROIT, MICH.  
LOS ANGELES, CALIF.  
TORONTO, CANADA  
MONTREAL, CANADA



# Librascope

positive mechanical drive

# XY Plotters

for greater accuracy  
in graphic data  
recording



MODEL 200-A for resistance inputs

Control panel configuration of MODEL 200-B for DC signal input

**LIBRASCOPE'S UNIQUE "FLOATING GEAR TRAIN,"**  
*and conservatively rated conventional vacuum tube and harness circuitry result in static accuracy of 0.1% and dynamic accuracy within 0.5% of full scale, at a tracking rate of 5 inches per second.*

The Librascope Models 200-A and 200-B XY Plotters are engineered for accuracy, rapid response, and ease of operation. The positive mechanical drive of the Floating Gear Train eliminates lost motion, cable stretching or alignment adjustments, normally found in the cable tape or lead screw type of drive. The new, simplified plotting pen of one-piece design—used for point or continuous plotting—eliminates bottles and tubes—permits rapid changing of ink colors. Easy to load and always visible, the plotting table accepts paper up to 11" x 17". Point plotting or curved tracing is accomplished with equal ease with one-second full scale response. A variety of input accessories are listed below.

**MODEL 200-A** can utilize any external resistance potentiometer as an input transducer associated with each axis. Independent 10 to 1 scale expansion and origin positioning controls are provided. Facilities for external control of the pen drop solenoid and for simultaneous control of external equipment through switch closures, are provided.

**MODEL 200-B**, used for DC signal input, has full-scale sensitivities of five millivolts and an input impedance of 1,000 megohms in the millivolt scale ranges. Drift-free operation is assured by chopper-stabilizing the voltage inputs against an Epply standard cell reference.

### READILY ADAPTABLE FOR RACK MOUNTING

Librascope XY desk model plotters are readily adaptable for mounting in standard RCA and RMA racks, for which accessory hardware is available at slight extra cost.



#### LIBRASCOPE PUNCHED CARD CONVERTER

Provides for the conversion of data read from IBM punched cards into analog signals that the MODEL 200-A Plotter can accept as inputs.



#### LIBRASCOPE PUNCHED TAPE CONVERTER

Converts the digital information read from punched paper tape into electrical signals suitable for the control and actuation of a MODEL 200-A Plotter.



#### LIBRASCOPE X-Y DECIMAL KEYBOARD

Consists of three-decimal bank for each axis with associated plus minus keys. Features Librascope designed positive-action self-wiping contacts.



#### LIBRASCOPE BINARY CONVERTER

Translates X and Y coordinate information received in the form of binary signals into analog signals for automatic point plotting by a MODEL 200-A Plotter. Has a capacity of nine binary digits and a resolution of one part in 512.

Career opportunities exist at Librascope for qualified engineers, physicists and mathematicians. Learn about Librascope's new "Creative Project Development Teams." Contact Glenn Seltzer, Employment Manager.



A SUBSIDIARY OF

# LIBRASCOPE

© 1957 LIBRASCOPE, INC.

LIBRASCOPE, INCORPORATED • 808 WESTERN AVENUE • GLENDALE, CALIFORNIA

all  
at  
once...



the HONEYWELL **V**ISICORDER<sup>®</sup>

directly records six phenomena

at frequencies from DC to 2,000 cps

The versatile Visicorder will fit almost unlimited oscillograph applications where instantaneous monitoring and direct recording at high frequencies are needed.

The Visicorder is the only oscillograph that records directly at frequencies up to 2,000 cps, and at sensitivities comparable to photographic-type oscillographs. No peaked amplifiers or other compensation of any kind are needed. The record requires no liquids, vapors, powder magazines or other processing materials.

Deflection is six inches peak to peak, covering the full width of the chart. The D'Arsonval-movement mirror galvanometers, in your choice of natural frequencies will, of course, overlap their traces; they are not limited by adjacent channels.

Let your nearest Honeywell Industrial Sales Engineer tell you more about how the Visicorder fits *your* application. Call him today.

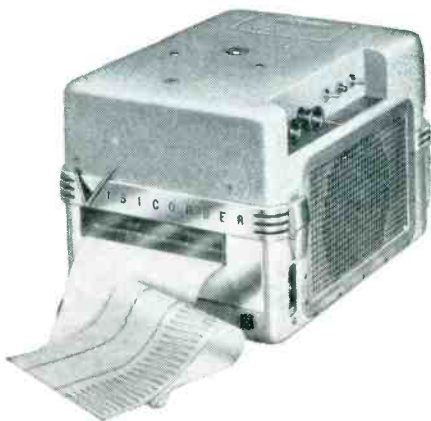

MINNEAPOLIS  
**Honeywell**

HEILAND INSTRUMENTS

5200 EAST EVANS AVENUE • DENVER 22, COLORADO





It's New...!



## A Space Saving capacitor WITH "SKIN-TIGHT" Case

Miniature Size • Tolerances to  $\pm 1\%$

This thin, tough Mylar\* case provides excellent moisture and abrasion resistance — yet adds less than 1/64" to the body diameter.

Miniature size is gained through the use of space-saving mylar dielectric. High insulation resistance and real stability with life are key electrical characteristics.

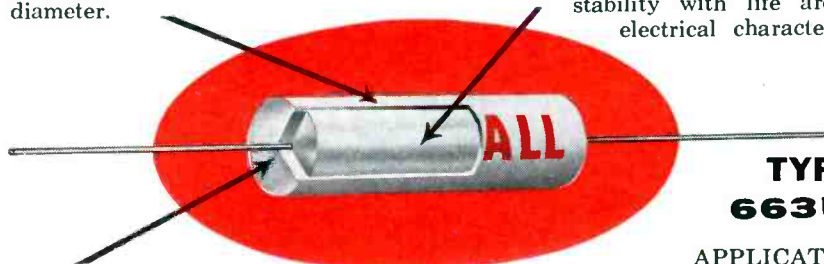

**TYPE  
663UW**

APPLICATIONS:

A dense thermo-setting plastic that bonds securely to the lead and case. The completed assembly is rugged and durable.

- Instrumentation • Filter Networks
- Transistor Circuitry • Amplifiers
- Test Equipment • Computers

### SPECIFICATIONS

\*DuPont's trademark for polyester film.

**INSULATION RESISTANCE:** See curve reproduced below for typical performance

**DIELECTRIC STRENGTH:** 2 times rated voltage

**LEAD PULL TEST:** Steady force of 10 lbs. applied axially for 60 seconds.

**HUMIDITY RESISTANCE:** Far exceeds requirements of RETMA Spec. REC-118-A

**LIFE TEST:** 250 hours at 85°C and 125% of rated voltage

**TEMPERATURE RANGE:** Operation at rated voltage from -60°C to +85°C and to +125°C with 50% derating.

### TYPICAL SIZES—TYPE 663UW

Capacity	100 Volts	200 Volts	400 Volts
.001	.156 x 1/2	.156 x 1/2	.156 x 5/8
.0047	.156 x 1/2	.156 x 1/2	.186 x 5/8
.01	.156 x 1/2	.171 x 5/8	.250 x 5/8
.047	.234 x 3/4	.296 x 3/4	.343 x 7/8
.1	.281 x 7/8	.375 x 7/8	.421 x 1
.47	.468 x 1 1/4	.546 x 1 1/4	.671 x 1 5/8

**Insulation Resistance vs. Temperature**  
Degrees Centigrade

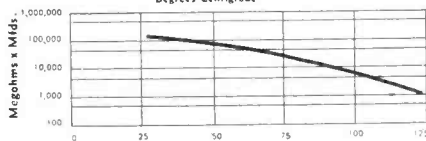

**Capacitance Change vs. Temperature**  
Degrees Centigrade

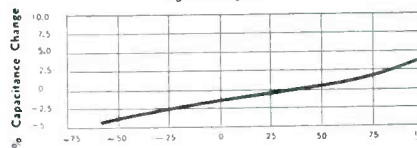

Our engineers are ready to work with you on special applications. Write or wire for specifications and quotations.



**GOOD-ALL ELECTRIC MFG. CO., OGALLALA, NEBRASKA**

A leading manufacturer of Tubular and Ceramic Disc Capacitors



*S.S. White*  
 Flexible Shafts  
 Withstand  
 Temperature  
 Extremes!

A leading aircraft manufacturer has used S.S. WHITE flexible shafts for many years to transmit control between this graduated dial and aircraft thermostat. He finds that under any kind of temperature conditions, there is no measurable variation in torque to turn the shaft, or in torsional deflection required to initiate cam movement over the temperature range!

This ability to withstand temperature extremes is only one of the many remote control and power drive advantages industry has discovered in S.S. WHITE flexible shafts. Perhaps they can help you to simplify control or product design . . . cut your production costs . . . speed assembly. These quality shafts range from small to large sizes, and up to 12 feet in length. The assistance of our engineering staff in helping you work out a flexible shaft application for your product is yours for the asking. Just write to

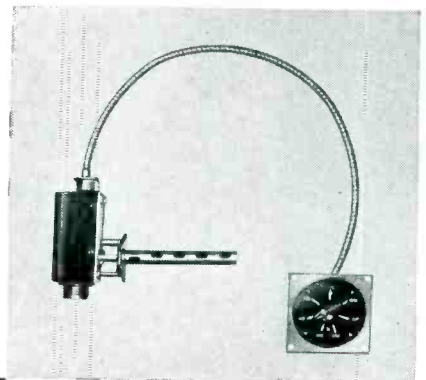

*S.S. White*

FIRST NAME

IN FLEXIBLE SHAFTS



USEFUL DATA on how to select and apply flexible shafts. Write for Bulletin 5601.

S. S. White Industrial Division, Dept. E, 10 East 40th St., New York 16, N. Y. Western Office: 1839 West Pico Blvd., Los Angeles 6, Calif.



# Transitron

## SILICON VOLTAGE REGULATORS

UP TO 50 ma

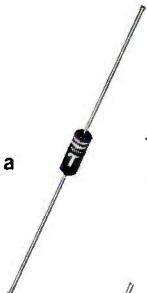

Type	Voltage Range (volts)	Maximum Average Current ma		Maximum Dynamic Resistance (ohms)
		at 25°C	at 125°C	
SV-5	4.3 - 5.4	50	10	55
SV-6	5.2 - 6.4	40	8	20
SV-7	6.2 - 8.0	30	6	10
SV-9	7.5 - 10.0	25	5	20
SV-11	9.0 - 12.0	20	4	70
SV-13	11.0 - 14.5	17	3.4	100
SV-15	13.5 - 18.0	14	2.8	120
SV-18	17.0 - 21.0	12	2.4	200

UP TO 150 ma



SV-804	4.3 - 5.4	150	30	55
SV-805	5.2 - 6.4	120	24	20
SV-806	6.2 - 8.0	90	18	10
SV-808	7.5 - 10.0	75	15	20
SV-810	9.0 - 12.0	60	12	70
SV-812	11.0 - 14.5	50	10	100
SV-815	13.5 - 18.0	40	8	120
SV-818	17.0 - 21.0	35	7	200

UP TO 2 AMPS



Type	Voltage Range (volts)	Maximum Average Current		Maximum Dynamic Resistance (ohms)
		(amps)	(ma)	
SV-904	4.3 - 5.4	2.0	400	2
SV-905	5.2 - 6.4	1.6	320	2
SV-906	6.2 - 8.0	1.2	240	2
SV-908	7.5 - 10.0	1.0	200	2
SV-910	9.0 - 12.0	.8	160	2
SV-912	11.0 - 14.5	.7	140	4
SV-915	13.5 - 18.0	.6	120	6
SV-918	17.0 - 21.0	.5	100	8

Transitron's silicon voltage regulators (sometimes called Zener diodes) are constant voltage elements for control and similar circuitry. They provide excellent regulation and stability over a wide operating range.

Through improved thermal design, each of the three regulator series will give high load currents in the smallest possible size. The subminiature glass types, for example, provide twice the current in less than half the size of conventional regulators. High power types can be used to simplify circuits and eliminate amplification stages.

Inquiries are invited on higher voltage regulators, and precision, temperature compensated voltage reference elements.

SEND FOR  
BULLETIN TE 1352

# Transitron

electronic corporation • wakefield, massachusetts



# What?...a Pulse Transformer..



**Yes . . .**

the world's most powerful and largest (over 49,000 lbs.)! The prototype core-and-coil unit being checked is a 1/10 scale model of the big unit. Circuit parameters of the scale model were checked before fabrication of the giant. Minor adjustments were made to the design so that the unit would operate satisfactorily in its final system. Thus, another Moloney job well done.

Whether you need a giant like this, or production in quantities of our minimum size (500 watts average power, 15 KV output), Moloney will do such an outstanding job that you will say, "What a Pulse Transformer!"

◀ Produced for RCA under contract to Rome Air Development Center

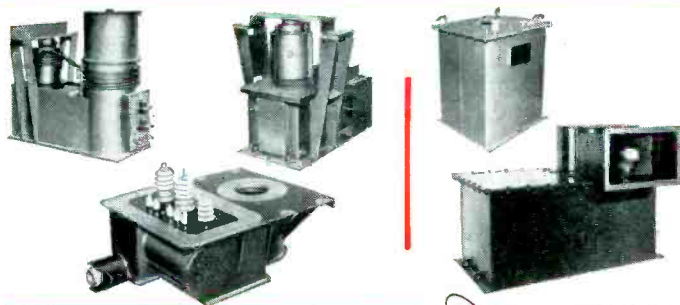

Specify Moloney . . . for pulse transformers and other magnetic components for electronic applications. Only Moloney can offer you unmatched technical know-how and experience . . . the industry's finest manufacturing facilities . . . research and development engineering personnel with the ability to resolve your problems . . . the industry's finest and most extensive test facilities.

ASA, RETMA, MIL-T standards or your own particular requirements can be complied with according to the need.

ME 87-2

Write for Catalog SR 2CE "HyperCores for Magnetic Components" and Catalog ST 3506 "Magnetic Components for Electronic Applications."

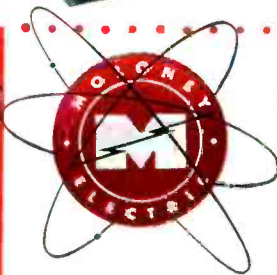

## MOLONEY ELECTRIC COMPANY

Plate and Filament Transformers • Chokes • Unit Rectifiers • Modulation Transformers and Reactors • Pulse Transformers and Charging Chokes • HyperCores for Magnetic Components • Developmental Magnetic Components • Power and Distribution Transformers

FACTORIES AT 5390 BIRCHER BLVD., ST. LOUIS 20, MO., AND TORONTO, ONT., CANADA



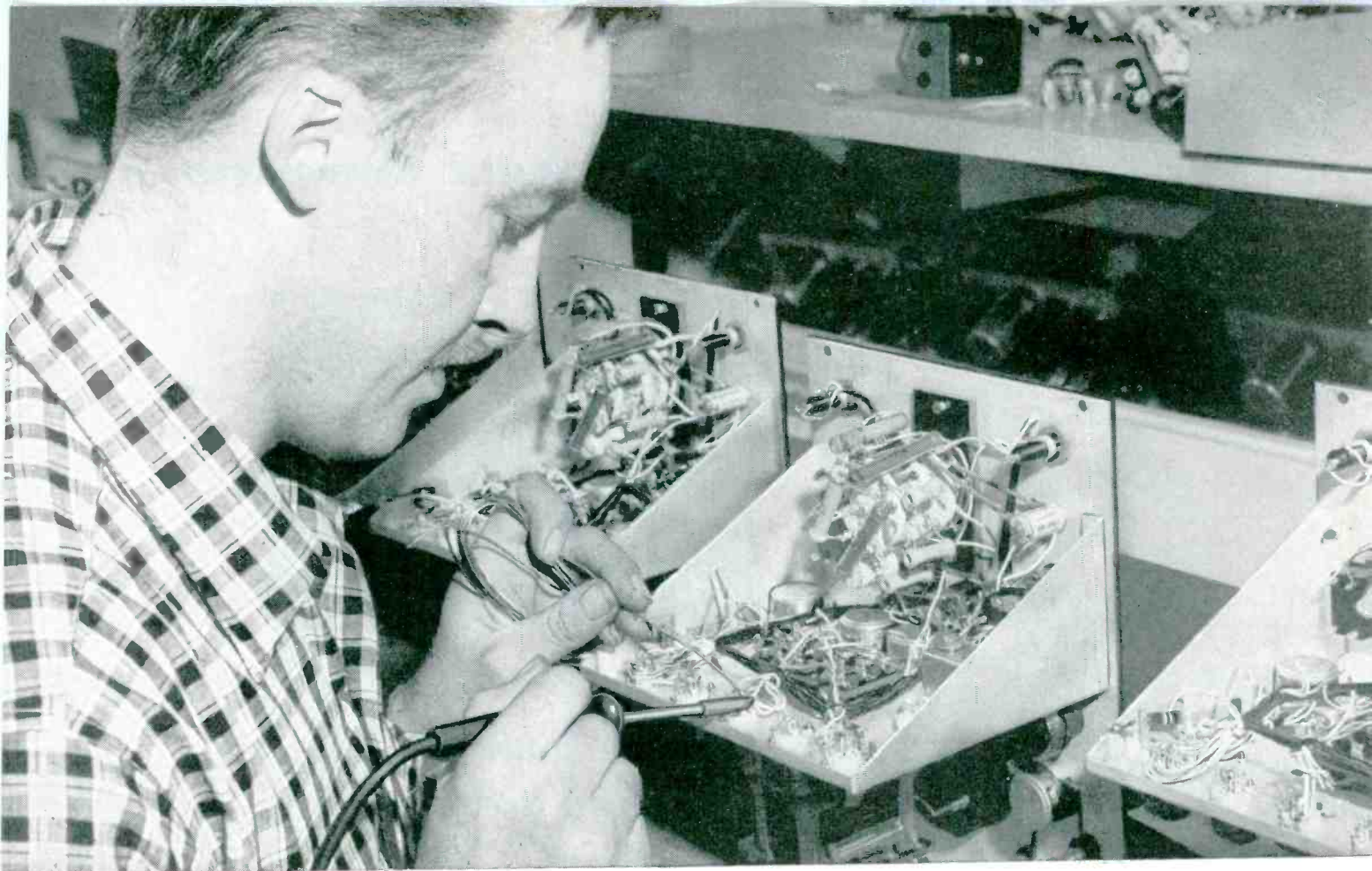

"BEST IRON WE'VE HAD in the plant," says William Fish, a production supervisor of General Radio, Cambridge, Mass. This company has switched to G-E Midget irons for soldering both

delicate and heavy joints in their Type 1862-B Megohmmeters —jobs which formerly required *both* a heavy and a light iron. G-E Midget iron's light weight also helps reduce fatigue.

## 50 G-E Midget irons do work of 100 former irons at General Radio Co., boost production 25%

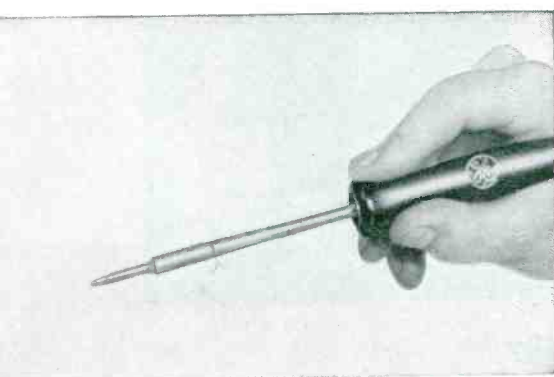

**HANDLES LIKE A PENCIL**—Weighing less than a package of cigarettes, the General Electric Midget soldering iron speeds production by reducing operator fatigue.

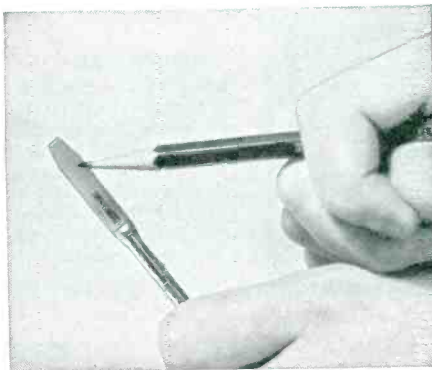

**RAPID HEAT TRANSFER** is achieved by locating the heater directly in the iron-clad-copper tip. Result—the G-E Midget iron's heat efficiency is 90%.

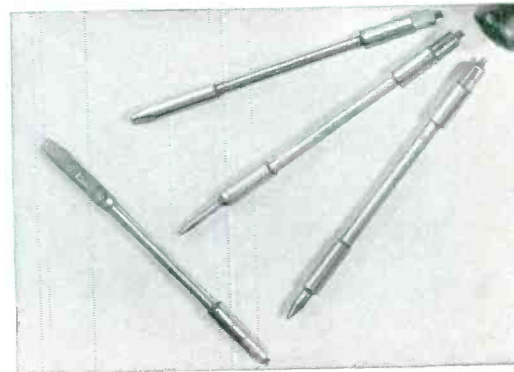

**THREE-IN-ONE IRON** with  $\frac{1}{8}$ ",  $\frac{1}{4}$ ",  $\frac{3}{16}$ " tip sizes gives you greater versatility to meet your soldering requirements. Tips can be changed in only 5 seconds.

For more information write for GED-2263, G-E Midget Soldering Iron, Section 724-3, General Electric Co., Schenectady 5, N. Y.

**GENERAL**  **ELECTRIC**

for applications demanding **DEPENDABLE INSULATIONS**

*Specify...*

**ESSEX**  
EXTRA TEST® **MAGNET**  
**WIRE**

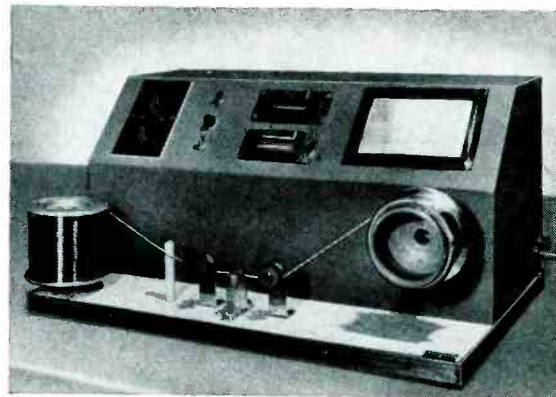

*Quality controlled by tests exceeding accepted standards*

Consistently trouble-free performance characterizes the use of Essex Extra Test Magnet Wire. It stems from close quality control maintained at every step in fabrication. Illustrated above is one example...the continuity test used for measuring breaks in insulation. By this, and similar controls, does Essex produce Magnet Wire to the industry's most severe specifications. Essex only makes one quality... and that's Extra Test. It costs no more to *be sure* by using SX.

**APPLICATION...**

Essex Extra Test Magnet Wire will save downtime... speed operations in your winding department. It has superior windability... maximum dielectric strength... and uniformity of size from spool-to-spool. Winds compactly at high speeds and around sharp radii.

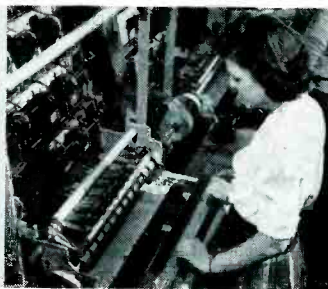

**PACKAGING...**

Essex Extra Test Magnet Wire is available in Metal or Fiber containers (MAGNA-PAK®) or in commercial reel or spool put ups. Distinctive labeling assures fast, accurate identification. MAGNA-PAK containers are palletized for shipment, simplifying storage.



*EXTRA TEST*®  
**ESSEX** **MAGNET WIRE**

DIVISION ESSEX WIRE CORPORATION, Fort Wayne 6, Indiana

MANUFACTURING PLANTS — Birmingham, Alabama; Anaheim, California; Fort Wayne, Indiana; Detroit, Michigan.

SALES OFFICES AND WAREHOUSES\*

\*Birmingham, Ala.  
\*Chicago, Illinois  
Cleveland, Ohio  
Dallas, Texas  
Dayton, Ohio  
Detroit, Michigan  
Fort Wayne, Indiana

Fort Worth, Texas  
Hartford, Conn.  
Indianapolis, Ind.  
Kansas City, Mo.  
\*Los Angeles, Calif.  
Milwaukee, Wisc.  
\*Newark, N. J.

\*Portland, Oregon  
Rochester, New York  
\*Saint Louis, Mo.  
\*San Francisco, Calif.  
Upper Darby  
(Philadelphia), Pa.

Distributed nationally to the repair and maintenance industry through Insulation and Wires, Incorporated



**★ AIRCRAFT PUMPS**

Precision-built to rigid government specifications, a broad selection among Eastern pumps offers flexibility to your choice. Modifications can be made, or custom-made units designed to suit your project. Trim in size, light in weight, Eastern Aircraft Pumps give reliable long-term service.



**★ PRESSURIZATION**

Eastern pressurization units for airborne electronic equipment are available in many capacities to handle a broad range of requirements. Units consist of an air pump and motor assembly, pressure switch, check valve, tank valve, and terminal connectors. They meet government specifications and can be modified to your needs.



**eliminate the "BUGS"**

**with Eastern aviation products**

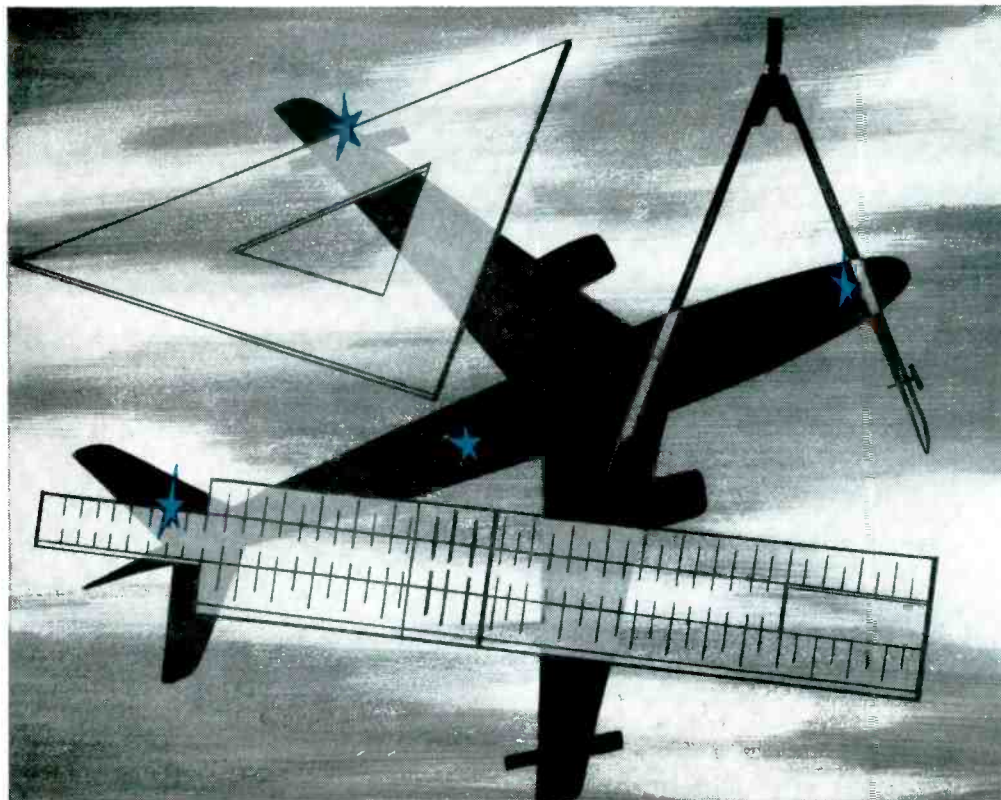
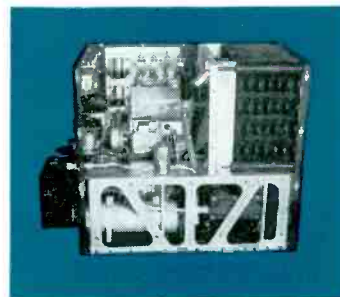

**★ COOLING UNITS**

Hold temperatures to safe operating limits in liquid cooled electronic tubes or similiar devices. By virtue of long experience and using standard component parts, Eastern can suit your specific needs at a minimum cost for equipment.

**★ REFRIGERATION-TYPE**

Enable specified components to be held to fairly constant temperatures by use of various types of refrigeration units. Because of the variation in methods possible, Eastern units fill every requirement where the use of a refrigeration cycle is called for.

**★ SPECIAL UNITS**

Eastern's continual research and development program keeps pace with the growing aviation industry. As new problems occur with progress in aircraft development, Eastern units are constantly developed to fill their function as planes fly higher, or faster, or with greater load capacity.

Eastern welcomes the chance to help engineers "take out the bugs" with equipment that cools, pressurizes, or pumps. From the extensive line of existing units, new adaptations, or custom-made designs, Eastern is ready to meet every challenge for equipment that handles your needs *the best today . . . better tomorrow.*



*Write for Aviation Products Catalog, Bulletin 330.*



## Lightweight! But magnesium can really take punishment

Magnesium is the world's lightest structural metal. It weighs only 23% as much as steel, 20% as much as yellow brass and 65% as much as aluminum. But magnesium is strong, too. How strong? Look at a few of its uses in the aircraft industry, for example:

The magnesium wheel in the picture above has to be light, but it also has to withstand tremendous shock when the plane touches down. In another application, the entire weight of a two-ton helicopter is suspended from a magnesium rotor. In large cargo planes magnesium floor members support heavy weights in flight.

Magnesium was selected because it has the necessary lightness, strength, rigidity, durability and other desirable properties. It's the *combination* of light weight and strength that makes magnesium the choice for countless applications throughout industry.

What do these facts mean in terms of your products, parts or equipment? They mean that magnesium can do an equal or better structural job at a substantial savings in weight. For more information, contact the nearest Dow sales office or write to us. THE DOW CHEMICAL COMPANY, Midland, Michigan, Magnesium Department MA 1401M.

YOU CAN DEPEND ON





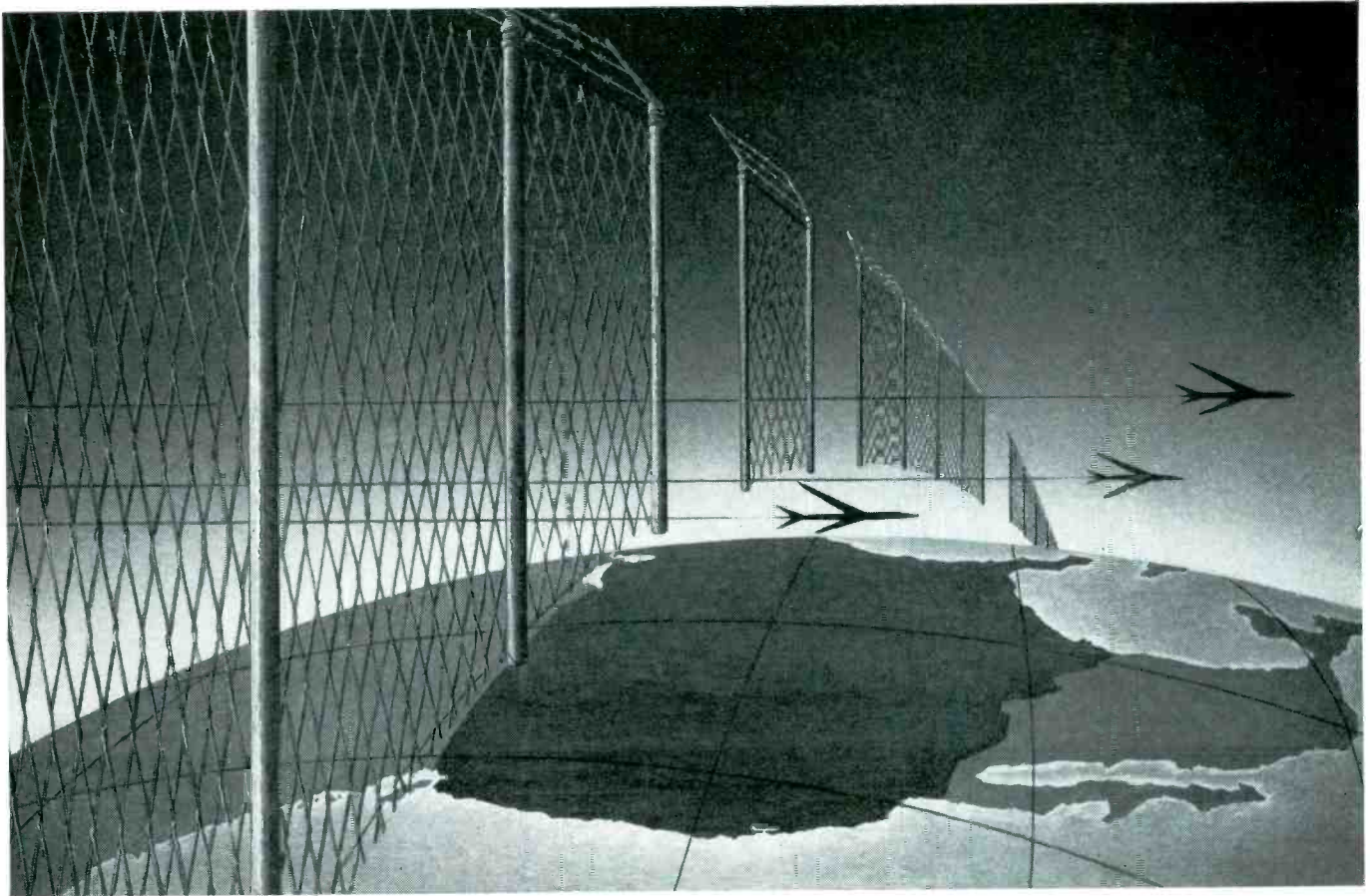

## FILLING THE GAPS IN FREEDOM'S FENCE

The possibility of low-level bombers, slipping through the continental radar fence, has been the cause of much concern in our Air Defense Command. But a new "gap filler" radar eliminates the shadow areas caused by the earth's curvature and irregularities of terrain . . . helps give instant warning of the approach of intruding aircraft.

Vital in the chain of "gap filler" radar sites is a Varian Type VA-87 klystron amplifier, sending out a million-watt pulse of power a thousand times a second on a 24-hour-a-day basis. It provides the absolute dependability necessary to our national security. Result—a radar that will operate fully automatically, for prolonged periods of time, with neither operating nor maintenance personnel at the radar site.

Complete dependability is a characteristic of *all* Varian klystrons, along with extreme ruggedness, frequency stability, and outstandingly long life in service. Write the Varian application engineering department for complete specifications on the Type VA-87, or ask your Varian representative for a copy of the Varian Catalog.

*Varian is now building more than 1,000 VA-87 klystron amplifiers for the United States Air Force, for use in the AN/EPS-18 gap filler radar systems being manufactured by Bendix Aviation Corp.*

See us at the IRE Show  
Booths 2530 and 2532

THE  
MARK OF  
LEADERSHIP



**VARIAN associates**  
PALO ALTO 1, CALIFORNIA

Representatives in all principal cities

KLYSTRONS, TRAVELING WAVE TUBES, BACKWARD WAVE OSCILLATORS, LINEAR ACCELERATORS, MICROWAVE SYSTEM COMPONENTS, R. F. SPECTROMETERS, MAGNETS, MAGNETOMETERS, STALOS, POWER AMPLIFIERS, GRAPHIC RECORDERS, RESEARCH AND DEVELOPMENT SERVICES



**VA-87C**

Frequency range: 2800-2900 Mc  
Peak power output: One megawatt  
Duty cycle: .003  
Power gain: 60db



**CONVENIENT CARRYING HANDLES** are available as an accessory with the new adjustable Sola regulated dc power supply. Here they are in use by an engineer as he lifts the DC Solavolt onto test bench.

## You can "dial" lab test voltages for high-amp loads with this compact, regulated DC power supply

Looking for an *adjustable* source of regulated dc test voltages for design development? Investigate the new Sola Constant Voltage DC Power Supply — the "DC Solavolt". Six models — each with a different output range — span the entire region between 5 volts at 7 amperes, and 400 volts at 0.6 amperes. Each delivers laboratory standards of performance — output voltage regulated within  $\pm 1\%$  though input voltage varies  $\pm 10\%$ ; ripple voltage held within 0.10%, rms.

Design simplicity of the DC Solavolt offers compact

size, low weight, high efficiency, high short-time overload capacity, and moderate price. All stock models occupy only 7" of height and 12 $\frac{1}{4}$ " of depth on a standard 19" relay rack frame. There are no tubes to replace, no "compensating" adjustments are needed, and no maintenance is required. Carrying handles, available as accessory equipment, provide "one-man portability" and self-stacking. Your local electronic distributor, who stocks the DC Solavolt, will be happy to give you further information.

**SOLA** *Constant Voltage*  
DC POWER SUPPLIES

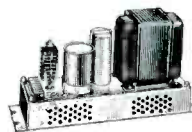

WRITE FOR TECHNICAL BULLETIN 7D-DC-245  
SOLA ELECTRIC CO.  
4633 W. 16th Street  
Chicago 50, Illinois

CONSTANT VOLTAGE TRANSFORMERS • FLUORESCENT LIGHTING BALLASTS • MERCURY VAPOR LIGHTING TRANSFORMERS  
SOLA ELECTRIC CO., 4633 West 16th Street, Chicago 50, Illinois, Bishop 2-1414 • NEW YORK 35: 103 E. 125th St., TRafalgar 6-6464  
PHILADELPHIA: Commercial Trust Bldg., RIttenhouse 6-4988 • BOSTON: 272 Centre Street, Newton 58, Mass., BIgelow 4-3354 • CLEVELAND 15:  
1836 Euclid Ave., PRospect 1-6400 • KANSAS CITY 2, MO.: 406 W. 34th St., JEFFerson 4382 • LOS ANGELES 23: 3138 E. OlymPic Blvd., ANgelus  
9-9431 • SOLA ELECTRIC (CANADA) LTD., TORONTO 17, ONTARIO: 102 Laird Drive, MAFfair 4554 • Representatives in Other Principal Cities



# SPECIAL SERVICES

Scatter communication, which is ordinarily hampered by fading, can be made reliable by diversity reception.

This calls for two or more receivers operating independently and simultaneously from the same signal. Originally, an automatic switching arrangement selected the stronger of the receiver outputs. Even the near-instantaneous act of switching often upsets teletype reception, and an improved method was needed.

REL achieved the solution with the first successful combiner, which continually couples the output of all receivers in a diversity system. In addition, the combined signal is always stronger than that of any one receiver alone. The compact REL combiner (*right*) remains unchallenged in simplicity and reliability.

The same imagination and facilities which so brilliantly served in this case are also available for the solution of your specialized radio problem.

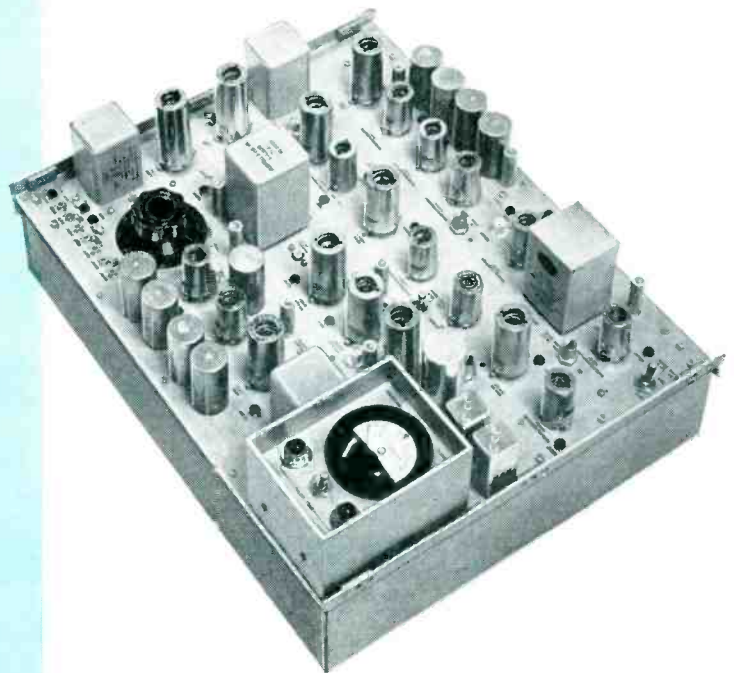

**Radio Engineering Laboratories • Inc.**

36-40 37th St • Long Island City 1, N Y

STillwell 6-2100 • Teletype: NY 4-2816

Canadian representative: AHEARN & SOPER CO • BOX 715 • OTTAWA

*Creative careers at REL await a few exceptional engineers. Address resumes to James W. Kelly, Personnel Director.*

# EE's, ME's can you qualify

**FILL OUT AND MAIL TODAY**

## Collins Radio Company *Confidential Application for Technical Employment*

LAST NAME	FIRST NAME	MIDDLE NAME	BIRTH DATE
STREET ADDRESS			PLACE
CITY		STATE	

EMPLOYMENT RECORD				EMPLOYER'S NAME, BUSINESS, LOCATION	SALARY	POSITION AND NATURE OF DUTIES
FROM		TO				
MO.	YR.	MO.	YR.			
PRESENT OR LAST EMPLOYER						
FORMER EMPLOYER						

STATE NATURE OF YOUR MOST RESPONSIBLE POSITION

EDUCATIONAL RECORD				MAJOR	DEGREE	GRADE PT. AV.
COLLEGE OR UNIVERSITY						

MILITARY SERVICE RECORD			
BRANCH OF SERVICE	RANK OR RATING	ACTIVE SERVICE ENTRY DATE	DISCHARGE DATE

Signature \_\_\_\_\_

### COLLINS in Aviation

Collins completely outfits airline, military and business aircraft with the most advanced communication, navigation, flight control and instrumentation systems in aviation. Many new lightweight, reduced-size versions are now being delivered. Collins designed the original Integrated Flight System, leads in combining comm/nav/ident units into a single compact "CNI" package for new military aircraft, and continues to pace the industry in developments in airborne radar, ADF, ILS, VOR, HF and VHF communication.

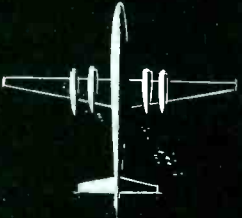

### COLLINS in Ground Communication

Collins engineers, designs and supplies the equipment, installs, and puts into operation integrated point-to-point communication systems of any scope. The Collins system engineering staff is backed by the finest equipment in the world, whether standard MF, HF or VHF, Transhorizon "scatter," microwave relay and multiplex or single sideband HF. Typical of Collins communication progress is "Kineplex" — a high speed data transmission system doubling communication capacity.



*Send your application to:*

*L. R. Nuss  
Collins Radio Co.  
Cedar Rapids,  
Iowa*

*Fred Aiken  
Collins Radio Co.  
2700 W. Olive Ave.  
Burbank, California*

*Harold McDaniel  
Collins Radio Co.  
1930 Hi-Line Drive  
Dallas, Texas*



# as a Collins engineer?

## You've got to be good to

- ✓ *Command highest salary*
- ✓ *Advance rapidly in a strong, growing company*
- ✓ *Work with highest caliber development groups*
- ✓ *Use the world's finest engineering facilities*
- ✓ *Maintain Collins creative reputation*

Collins depends on its engineers. That's why you have to be good to earn a place on a Collins Research and Development team. Collins hard earned reputation was built on a solid foundation of engineering talent. The sales growth of the Company has justified Collins emphasis on engineering. Sales have increased 10 fold in the last 10 years. And employment of research and development personnel has more than kept pace. Collins growth

will continue, and *you* can be a part of this growth.

Send the application form printed on the opposite page as an expression of your interest in knowing more about the opportunities at Collins. Your application will be held in the *strictest* confidence and will be answered immediately by a personal letter. Take only a few minutes now to fill out the application and mail to one of the addresses listed. This can be the turning point in your career.

### COLLINS in Amateur Radio

In the early 1930's Collins set the standard in Amateur radio and, through continuous design and development, has raised this standard to its present single sideband station — the most honored and prized in the Amateur fraternity. This station is the top performing rig on the air with its kilowatt KWS-1 transmitter and highly selective 75A-4 receiver. Many of the leaders in the electronics industry became acquainted with Collins through the Company's superior Amateur equipment.



### COLLINS in Broadcast

Collins supplies a complete new AM station from mike to antenna or modernizes existing facilities. Besides the superior line of transmitters, Collins supplies the broadcaster's needs with such advanced additions as TV-STL microwave relay system, the lightest 4-channel remote amplifier on the market, phasing equipment and audio consoles. Collins field service organization has built an enviable reputation in assisting the broadcaster in installation or in times of emergency.

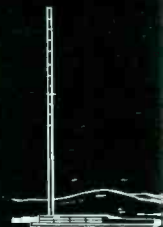

# Collins

CREATIVE LEADER IN ELECTRONICS

Collins Radio Company — Cedar Rapids • Dallas • Burbank



*From the idea...*

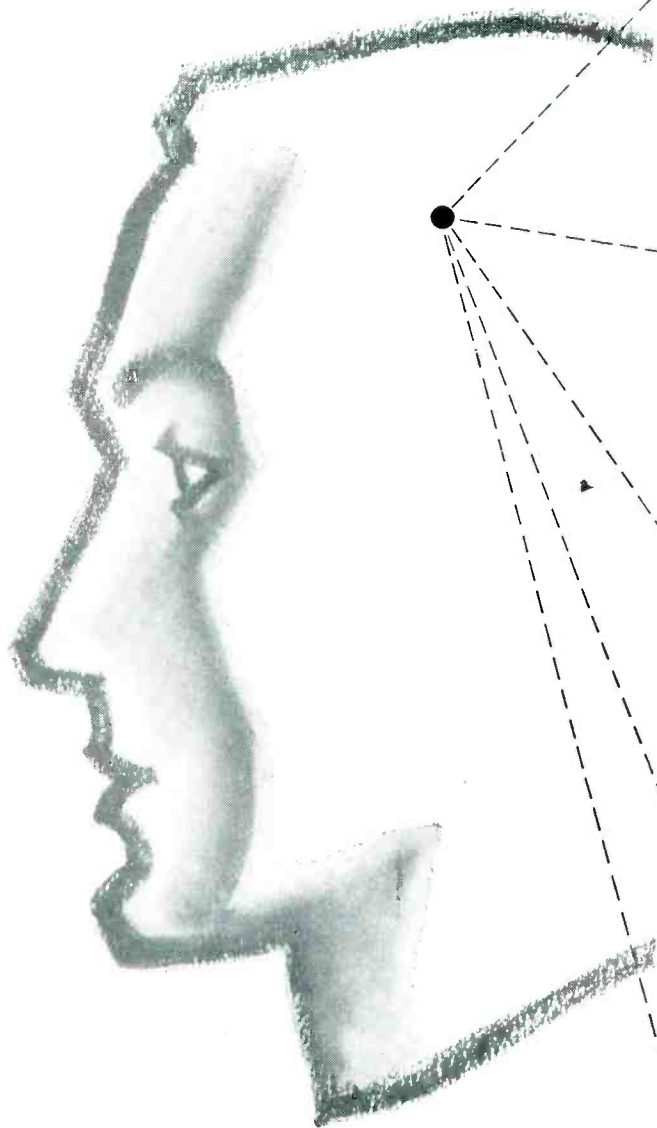

**Headquarters for the Division, the Waltham Laboratories, in Waltham, Massachusetts, specialize in advanced systems related to guided missiles, avionics, radar, data processing and electronic warfare.**



**The Electronic Defense Laboratory, Mountain View, California, is a special development facility devoted to research, technical development and rapid fabrication of ground-based electronic warfare systems.**

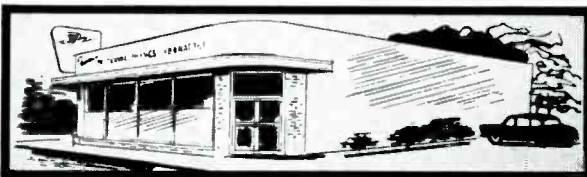

**The Microwave Physics Laboratory, at Mountain View, California, is devoted to the investigation of new magnetic materials and ionized gaseous media for microwave control devices used in radar, communications and electronic countermeasures systems.**

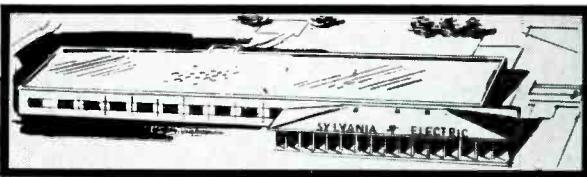

**The Microwave Tube Laboratory, Mountain View, California, is engaged in developing and producing special tubes such as klystrons, traveling wave tubes, backward wave oscillators, and related devices.**

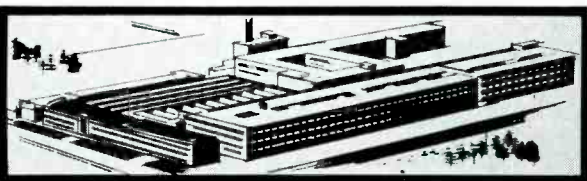

**Buffalo Engineering Laboratory and manufacturing facilities for the Division occupy some 170,000 square feet of floor space in this industrial center. The Laboratory specializes in the development of advanced communications techniques and equipments.**

**...to automated mass production**

**The Sylvania ESD family is equipped to carry out your electronics development programs . . . large or small.**

Backed by the corporation as a whole, Sylvania's Electronic Systems Division has a long record of successful problem solving in both military and industrial electronics. It has made many important contributions in the fields of avionics, guided missiles, countermeasures, communica-

tions, radar, computers and control systems.

Staffed with top-ranking scientists and engineers, backed by extensive research facilities and modern automated mass production capabilities—the Sylvania Electronic Systems Division is a major contributor to our national arsenal for defense. Intensive specialization in the Weapons Systems concept has resulted in

utmost organizational efficiency, as well as the highest order of technical and management competence.

Whether your project requires management or technical experience for complex integrated systems, subsystems, equipments or special components, from initial concept through mass production, Sylvania engineers will be glad to discuss methods of solving your specific problems.



**SYLVANIA**

SYLVANIA ELECTRIC PRODUCTS INC.  
Electronic Systems Division  
100 First Avenue, Waltham, Mass.

LIGHTING • RADIO • TELEVISION • ELECTRONICS • ATOMIC ENERGY



# Switch Ideas

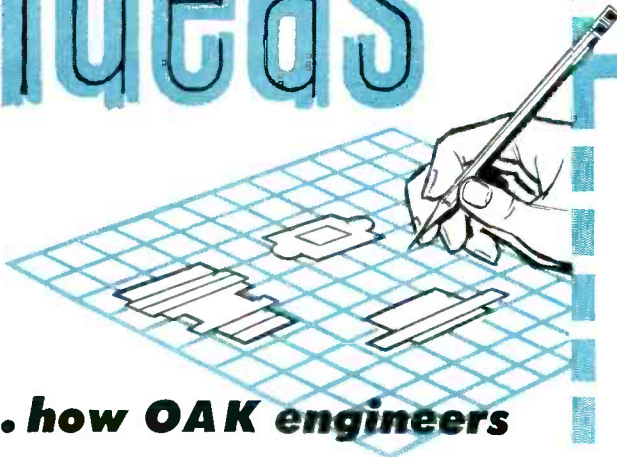

**...how OAK engineers  
are solving  
Special Switch Problems**

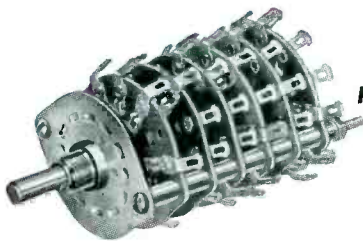

**SPECIAL  
MODIFICATIONS  
INCREASED  
SWITCH LIFE  
TO 200,000  
OPERATIONS**

This switch required a life of 200,000 operations to meet the needs of the completed assembly. Oak's know-how in switches and alloys solved this problem with special variations in clips, dies, and index assembly.

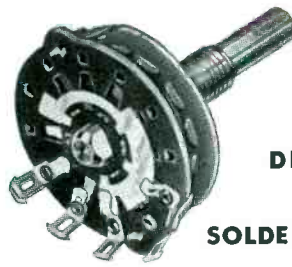

**DECADE SWITCH  
SAVED OVER 100  
SOLDERED CONNECTIONS!**

Space limitations required the redesign of a switch. Oak engineers studied the circuit, reworked it, and recommended a decade switch. In doing so, they saved more than 100 soldered connections, 4 of 10 capacitors, and many dollars in time and material.

**SPECIAL TICKET  
TABULATOR  
SWITCH  
PROVIDES  
MANY  
CIRCUIT COMBINATIONS**

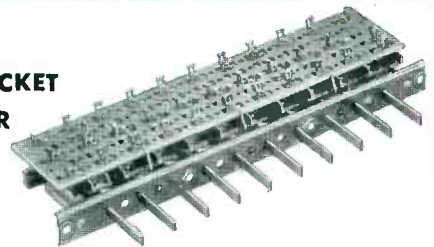

One of the newest applications for Oak switches is in an automatic ticketing machine for air lines, railroads, and bus lines. Required were extra long life, electrical versatility, and circuit complexity. The answer—an Oak pushbutton type switch, with long life modifications engineered into it.

**Switches in infinite variety to  
meet your exact requirements—**

Shown here are but three solutions to low-current switching problems, chosen from the hundreds available in our files. If long life, circuit complexity, special actuating, or space problems face you, let us put our vast experience to work on them. It will pay you to consult Oak engineers early in the design stage. Write or call for Oak's latest switch catalog.



Dept. G, 1260 Clybourn Ave. • Chicago 10, Illinois  
Phone: MOhawk 4-2222

**SWITCHES • ROTARY SOLENOIDS • CHOPPERS • SPECIAL ASSEMBLIES • VIBRATORS • TUNERS**

# Professional development of engineers is basic management policy at Ford Instrument Co.

Engineers accelerate growth of their ability and experience at FICo on really important peace and defense projects.

## DO YOU DARE TACKLE TOUGH PROBLEMS?

The engineer receives the respect and attention he deserves. He *must* be able to follow through a project from start to finish. Jobs are tough and challenging; professional and financial rewards keep pace with your ability.

## OUR PROBLEMS NEED YOUR SOLUTIONS!

The entire project, from breadboard to final design, is the responsibility of the design group which first started work on it. You watch each step of progress in the development of a new idea to practical reality.

## ENVIRONMENT IS CREATIVE!

It brings out the best in you, and you can be sure that your fullest capabilities will be called upon. FICo environment *has* to be creative, because its business is research and development.



**CHEAPER ATOM POWER FOR THE SEA** is a current Ford Instrument Company study in gas-cooled reactors for use in ships. The Atomic Energy Commission contract requires FICo to investigate the feasibility of building, by 1961, a power plant using this type of reactor to power an oil tanker. Ford also works on nuclear instrumentation.

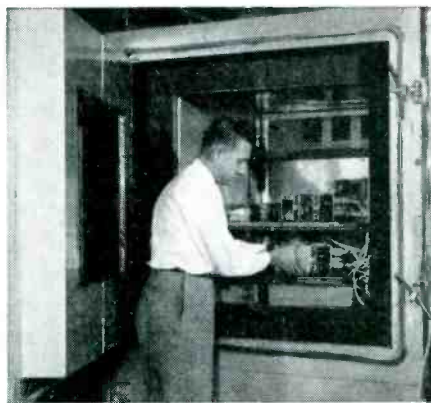

**ENVIRONMENTAL TEST CHAMBERS** like the one above are used by Ford Instrument Company engineers in many projects involving design and development of equipment to be used at extreme altitudes or temperatures. Instruments for jet engines, for polar navigation, and Army and Navy fire control are FICo products.

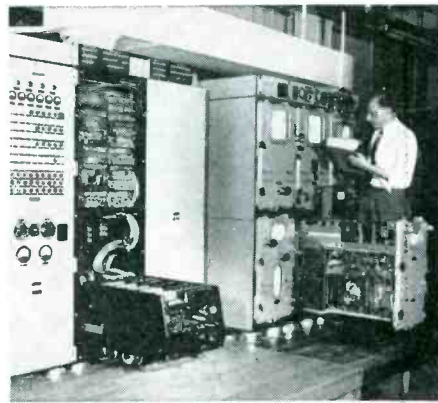

**SPECIAL PURPOSE COMPUTERS**, both analog and digital, comprise a great portion of the work at FICo. In both types, FICo employs a module technology which simplifies not only the problems of design and manufacturing, but servicing as well. This permits stocking fewer spare parts and allows easy training of personnel.

# FORD INSTRUMENT CO.



## NEW FRONTIERS AT FICo!

Ford Instrument Company recognizes no limits to the ingenuity of man. For over forty years the company has been engaged in the research and development of computer and control techniques. Currently, FICo activities include guidance and control for missiles, airborne armament systems, electronic navigation aids, and extensive work in nuclear reactors and controls.

## THIS IS A COMPANY OF ENGINEERS!

The President, and many of our top executives are engineers. It's good to know that the management of your company is able to think along with you, to understand you and to appreciate your performance.

## WE WANT ENGINEERS OF ABILITY!

Our qualifications are high, and we want to be sure you match the high standards of our present engineering staff. Our projects are too important and too complicated to trust to most engineers.

## OPEN DOOR POLICY!

Executives are always accessible at Ford Instrument Company. You'll feel free to discuss your problems with the men who can help you at any time.

## ADVANCEMENT UNLIMITED!

The FICo conference method of tackling a problem enables you to learn from engineers in other scientific fields, thus broadening your knowledge, background and experience. If you've got the capabilities you will get ahead.

## WHAT WILL YOU DO?

That depends on your specific abilities and experience, but whatever your assignment, you will eventually be able to utilize your talents to the fullest. And at the same time, Ford Instrument Company will provide an environment, challenge and opportunity that will let you influence your own rate of advancement and recognition.



**THE ASN-7 AUTOMATIC NAVIGATION COMPUTER** is the latest aid to aerial navigation. The system tells the pilot where he is, and course and distance to destination no matter how he may maneuver. He can also store an alternate destination within the mechanism for insertion in case of emergency.

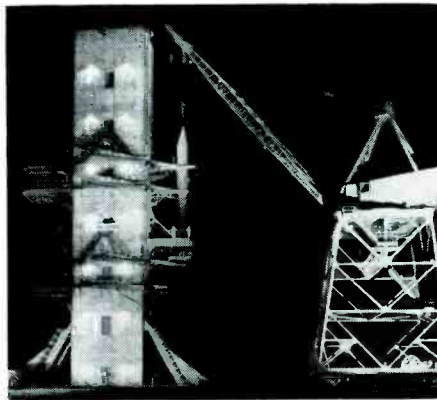

**TYPICAL OF FICo** is its work in conjunction with the Army Ballistic Missile Agency on the guidance system for the Redstone Missile and the more advanced Jupiter Missile. Ford Instrument Company is also working closely with ABMA on research, development and design of more advanced systems.

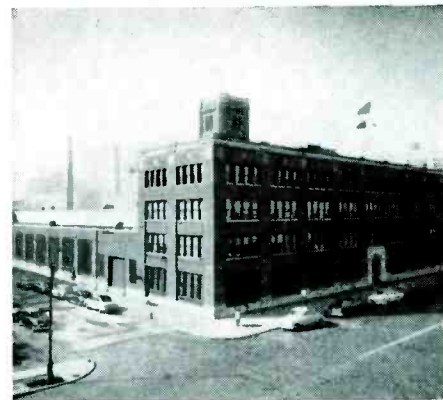

**ONLY 18 MINUTES FROM THE HEART OF BROADWAY**, one of Ford Instrument Company's plants is located in Long Island City, New York, just across the east river from Manhattan. FICo's manufacturing facilities comprise one of the largest high precision shops in the United States.

**DIVISION OF SPERRY RAND CORP. • 31-10 Thomson Ave., Long Island City 1, New York**

# WHICH OF THESE JOBS CAN YOU FILL?

## **ELECTRICAL AND ELECTRONIC ENGINEERS**

with 2 or  
more years  
experience  
in:

### **COMPUTER AND CONTROL ENGINEERING**

- Gyro Development
- Servo-mechanisms and Feedback Systems
- Analog Computers
- Military Specifications
- Electronic Circuitry
- Magnetic and Transistor Amplifiers
- Network Design
- Inverters
- AC and DC Servo Motors
- Electronic Research
- Fire Control Systems
- Microwaves and Radar
  - Antennas
  - Beacons
  - Receivers
  - Transmitters
  - Pulse Circuits
- Digital Computers and Data Processing

### **MISSILE GUIDANCE ENGINEERING**

- Gyro Development
- Servo-mechanisms and Feedback Systems
- Analog Computers
- Military Specifications
- Electronic Circuitry
- Magnetic and Transistor Amplifiers
- Network Design
- Inverters
- AC and DC Servo Motors
- Electronic Research
- Missile Control Systems

## **MECHANICAL ENGINEERS**

with 2 or  
more years  
experience  
in:

- Inertial Guidance Systems
- Gyro Development
- Military Specifications
- Servo-mechanisms
- Product Design and Packaging of Electro-Mechanical Devices
- Fire Control Systems

- Inertial Guidance Systems
- Gyro Development
- Military Specifications
- Servo-mechanisms
- Product Design and Packaging of Electro-Mechanical Devices

## **NUCLEAR ENGINEERS AND PHYSICISTS**

with  
experience  
in:

### **NUCLEAR REACTORS**

- Control
- Metallurgy
- Physics
- Instrumentation

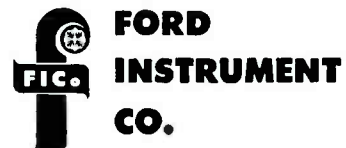



## FICo offers engineers all these extra benefits

Ford Instrument enjoys a unique reputation for offering only positions of permanency to development engineers. Employment is based on a definite need projected years into the future. Today, engineers are needed in ever larger numbers to meet the demands of our increasing research and development business.

Starting salaries are above average currently offered by industry, and quarterly reviews by top executives reward merit by raises or promotions.

A secure financial environment, and a pleasant, stimulating working environment—these are major parts of Ford employment policy, frankly intended to attract men of high calibre, and keep them. Here are a few of the other desirable features of FICo employment:

- Association with engineers with national reputations.
- FICo's 3000 people work together—over

600 in engineering activities—a company small enough for individual attention and large enough for broad opportunities.

- Air conditioned plants and cafeteria.
- Unusually liberal benefits relative to sickness, accident and life insurance, hospitalization, etc.
- Pension plan without cost to the employee.
- Ten paid holidays and two weeks vacation—more for longer service.
- Full tuition for related studies in New York's unexcelled graduate education facilities.

We invite engineers to submit qualifications in person, or by sending resumes to Philip F. McCaffrey. All applications treated confidentially. The brochure titled "—and it's a good place to work!" is yours for the asking.

## Here's what life is like in the engineering center of the country



**AMERICA'S CENTER OF DRAMA, CULTURE AND MUSIC** is eighteen minutes away from Ford Instrument Company. New York is truly the capital of the world with the greatest concentration of entertainment, shopping and sports.



**FICo PAYS FULL TUITION FOR ADVANCED STUDY** at any one of the fourteen colleges and universities in the area. Nowhere is the opportunity greater in choice and excellence of post-graduate studies.



**MOST ENGINEERING AND SCIENTIFIC SOCIETIES** have their headquarters in New York, and FICo engineers can attend their regular meetings for discussion with fellow members, as well as make use of their professional facilities.



# FORD INSTRUMENT CO.

DIVISION OF SPERRY RAND CORPORATION

31-10 Thomson Avenue

• Long Island City 1, N. Y.

for ceramic capacitors  
with greater

# Frequency Stability



## RMC type JF DISCAPS

Type JF DISCAPS are especially designed for applications requiring a ceramic capacitor with superior frequency stability.

These DISCAPS extend the available capacity range of the RETMA Z5F type capacitors between +10° and +85°C and meet Y5S specifications between -30° and +85°C. Now manufactured in capacities between 150 MMF and 10,000 MMF, Type JF DISCAPS exhibit a change of only ±7.5% between +10° and +85° C.

Write today on your company letterhead for information on RMC DISCAPS.

DISCAP  
CERAMIC  
CAPACITORS

# RMC

**RADIO MATERIALS CORPORATION**  
GENERAL OFFICE: 3325 N. California Ave., Chicago 18, Ill.  
Two RMC Plants Devoted Exclusively to Ceramic Capacitors  
FACTORIES AT CHICAGO, ILL. AND ATTICA, IND.



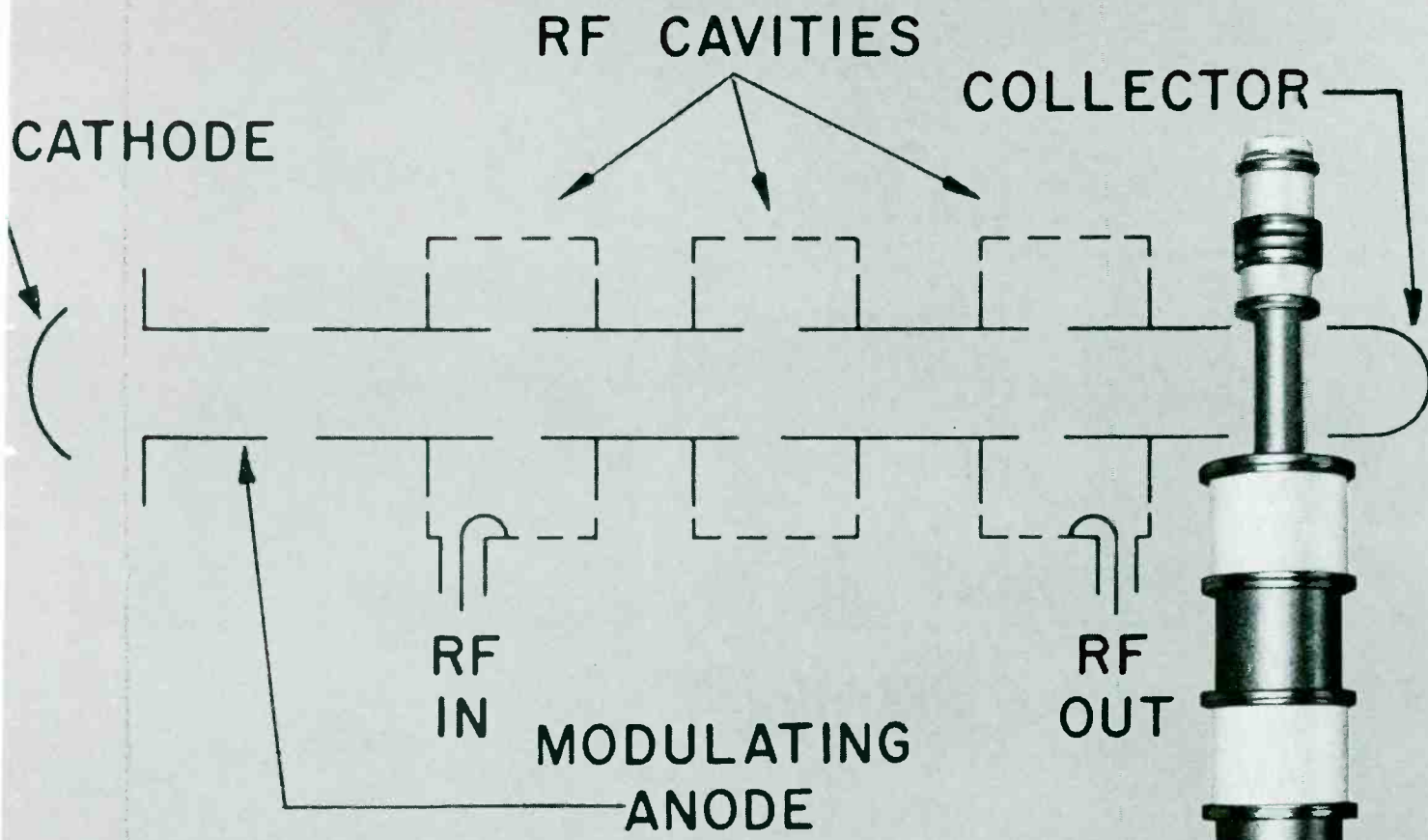

**AVAILABLE NOW!**  
**Eimac high power klystron**  
**for 225-400 mc range**

Eimac has spanned another frequency range... 225-400 mc with its new 3KM50, 000PA ceramic klystron. This tube, designed for the VHF/UHF border junction, will deliver 20KW CW power output with as low as one watt drive and an efficiency of 45%. This high efficiency and power gain of 20,000 times is typical of the incomparable performance of Eimac Klystrons.

Eimac has also incorporated the modulating anode which gives the 3KM50, 000PA 100 percent modulation ability to peak power outputs of 40 KW. It can easily be pulse modulated with low pulsing power.

Wide range tuning and an easy economical approach to high power UHF transmitters is made possible by the Eimac feature of completing RF circuitry outside the vacuum system. These permanent components, available at Eimac, make for ease of tube change plus economy since costly RF circuitry is not repurchased with each tube replacement.

For further information on the 3KM50, 000PA, as well as other Eimac firsts, please consult our Application Engineering Department.

**EITEL-McCULLOUGH, INC.**  
 SAN BRUNO · CALIFORNIA  
*Eimac First in high power amplifier klystrons*



**Typical Operation of the 3KM50, 000PA**

D-C Beam Voltage . . . . .	20kv	Driving power . . . . .	1w
D-C Beam Current . . . . .	2.2 amps	Efficiency . . . . .	45%
Power input . . . . .	44kw	Power Gain . . . . .	43db
Power output . . . . .	20kw		

# The Greatest Names in British Electronics use

# Mullard Tubes

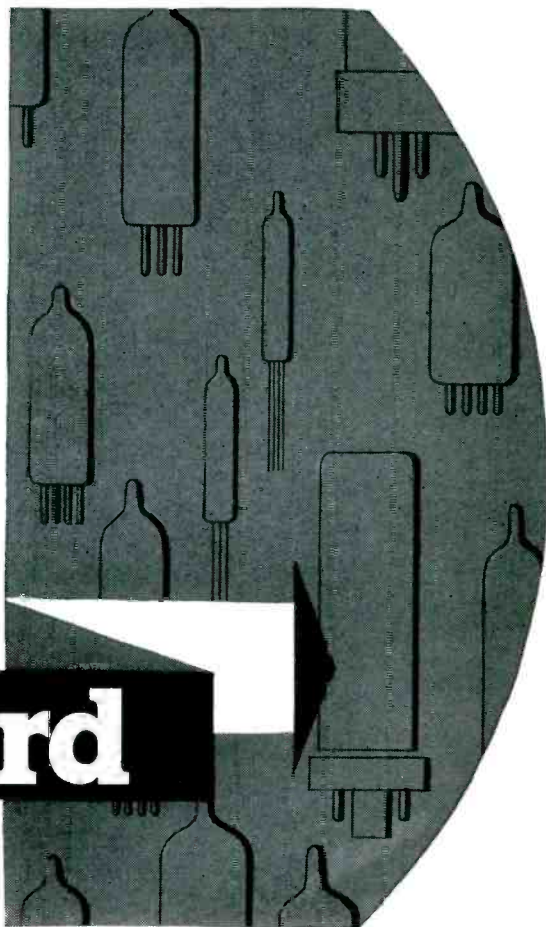

British equipment manufacturers are making a vital contribution to the development of electronics in all fields of application.

Their products are being exported to every corner of the world, earning a universal reputation for advanced techniques and excellent performance.

The majority of these electronic equipment manufacturers consistently use Mullard tubes. This choice is decided upon because they prefer the greater assurance of efficiency and dependability, and because the vast manufacturing resources of the Mullard organisation guarantee ready availability of Mullard tubes wherever they are needed.

Supplies of Mullard tubes for replacement in British equipments are available from the companies mentioned below:—

#### *In the U.S.A.*

International Electronics Corporation,  
Department E-4,  
81, Spring Street, N.Y. 12.  
New York, U.S.A.

#### *In Canada*

Rogers Majestic Electronics Limited,  
Department 1-D,  
11-9 Brentcliffe Road,  
Toronto 17, Ontario, Canada

## Mullard

**Electronic Tubes — used throughout the world**

**MULLARD OVERSEAS LTD., MULLARD HOUSE, TORRINGTON PLACE, LONDON, ENGLAND**

*Mullard is the Trade Mark of*

*Mullard Ltd. and is registered in most of the principal countries of the world*



MEV 45



The '57 DIAL\*—all purpose "desk-top" copy maker

# Copy Anything

with **magic touch dial control**



\* Just turn the dial —get a copy

The dial is the secret of the world's easiest copying method. It automatically makes all adjustments to copy anything.

**APÉCO** *Auto-Stat*®  
DIAL-A-MATIC

Styled by Charles E. Jones & Assoc.

**makes instant photocopies of anything written, printed, typed, drawn, or photographed—right in your own office.**

Now get an exact photocopy of anything—in seconds. With the new all electric 1957 Apeco Dial-A-Matic Auto-Stat, you get clear, bright, sharp, black on white copies—and it's so easy. The magic touch dial control assures a perfect copy every time. Styled in polished, gleaming, stainless steel—the Apeco Auto-Stat is hand-

some, light weight, and compact. It copies any original up to 15" wide, any length or color on opaque or transparent paper—printed on one or both sides. It offers hundreds of money and time saving uses for every business. Priced well within the budget of even the smallest firm. Delivered with lifetime service guarantee.

Sales Offices in All Principal Cities

E 47

**American Photocopy Equipment Co.**  
1920 W. Peterson Ave., Chicago 26, Ill.  
Rush me without obligation your new free book on the Apeco improved all-electric 1957 Dial-A-Matic, Auto-Stat plus the special report on how my business can use this modern copying method.

Company \_\_\_\_\_  
Address \_\_\_\_\_  
City \_\_\_\_\_ Zone \_\_\_\_\_ State \_\_\_\_\_  
Individual \_\_\_\_\_  
Title \_\_\_\_\_  
Type of Business \_\_\_\_\_

In Canada: Apeco of Canada Ltd., 134 Park Lawn Rd., Toronto, Ont.

**TEAR OUT THIS CARD**

Mail this airmail postage-paid card for your

**NEW FREE BOOK**

Plus a special report on how your type of business uses Apeco Auto-Stat copying.

**AMERICAN PHOTOCOPY EQUIPMENT CO.**  
CHICAGO 26, ILLINOIS







New **FREE BOOK** tells how you can use the **APECO Auto-Stat** in your business!

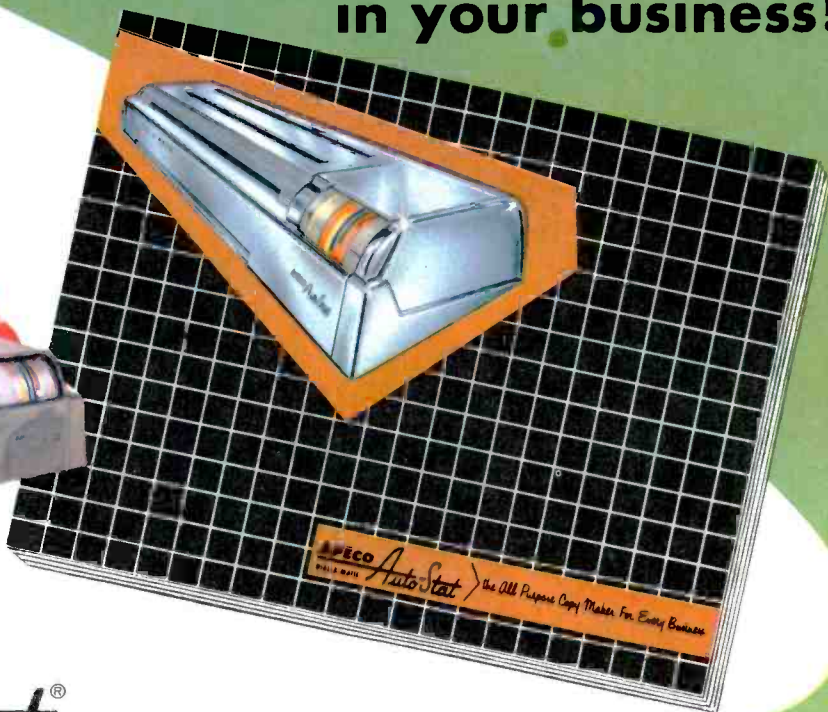

**APĒCO** *Auto-Stat*<sup>®</sup>  
 DIAL-A-MATIC  
**all-purpose**  
 "desk-top"  
**copy maker**  
 that belongs in your office

**FIND OUT HOW** you can save time and money by speeding production . . . by cutting costly office paperwork . . . by expediting shipping and receiving—and hundreds of other ways to increase the efficiency of your business with Apeco Auto-Stat copying. It's all in this new free book and special report. Send for your copy today.

*Plus*

a special report on how companies in your type of business use Apeco Auto-Stat copying!

These industry-by-industry reports are invaluable shortcuts to finding profitable uses for Apeco Auto-Stat copying, no matter what your business. They are the results of a department devoted to application research in every type of business and profession.

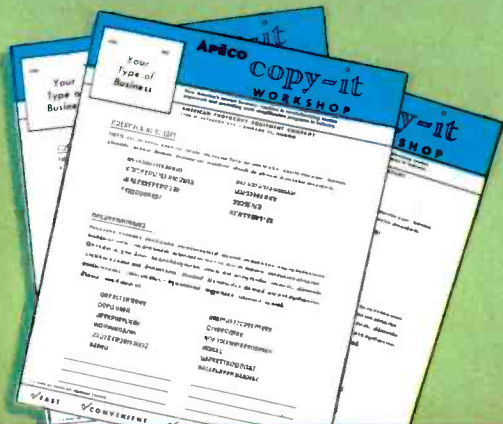

**FIRST CLASS**  
 Permit No. 26670  
 (Sec. 34.9 P.L. & R.)  
 Chicago 26, Ill.

Via Air Mail

**BUSINESS REPLY CARD**

No postage stamp necessary if mailed in the United States

5c postage will be paid by—

**AMERICAN PHOTOCOPY EQUIPMENT CO.**  
 1920 W. Peterson Ave.  
 Chicago 26, Ill.



Get your **FREE BOOK** and **SPECIAL REPORT**

TEAR OUT AND MAIL THIS POSTAGE-PAID AIRMAIL REPLY CARD TODAY



now there are two

complete lines  
of precision  
servo-mechanical  
parts by

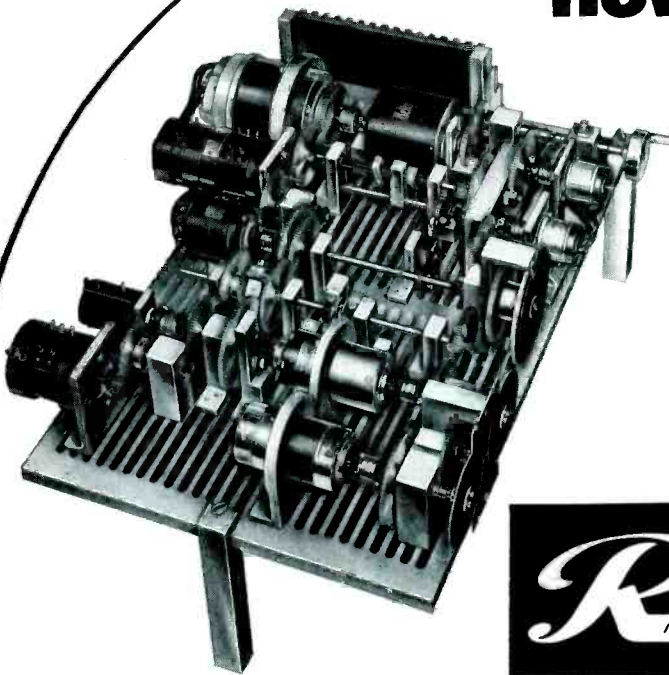

**STANDARD**



**"packaged precision"  
for prototype or  
production assemblies**

Complementing and expanding Reeves' well-known line of STANDARD Servo-Mechanical Parts, a comprehensive new series of MINIATURIZED Components is now available.

This new line will be of special interest to engineers working on 400-cycle servo applications, and offers the following features:

- Low inertia for 400-cycle systems.
- Includes a very complete selection of components, slotted mounting plates, hangers, dial assemblies, couplings, differentials, and mechanical and electrical stop assemblies, produced to high precision standards.
- A wide range of Class II precision gears—20° pressure angle; 64, 96, 120 diametral pitches.
- Unique "T" nut assembly for ease in hanger mounting provides continuous adjustment parallel and perpendicular to mounting plate slots.
- Parts are designed for 1/8" shafting.

**REEVES INSTRUMENT CORPORATION**  
A subsidiary of Dynamics Corporation of America  
201 East 91st Street, New York 28, New York

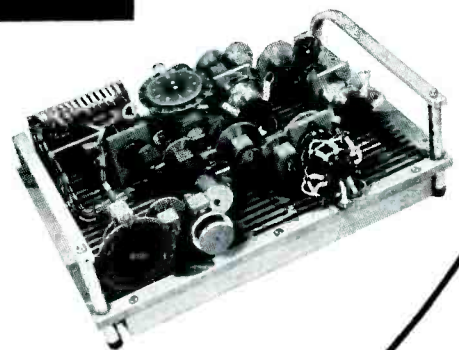

**MINIATURE**

Reeves' new complete Servo-Mechanical Parts Catalog illustrates and lists the new MINIATURE line, as well as the full line of STANDARD parts for use with 1/8" shafting.



**REEVES INSTRUMENT CORPORATION**

A subsidiary of Dynamics Corp. of America  
201 East 91st St., New York 28, N.Y.

Fill in and mail the coupon now to receive your copy of the new catalog.

NAME \_\_\_\_\_

COMPANY \_\_\_\_\_

ADDRESS \_\_\_\_\_

CITY \_\_\_\_\_ STATE \_\_\_\_\_

4RV57

# TAYLOR

Laminated Plastics  
Vulcanized Fibre

# Shop Talk

TAYLOR FIBRE CO.  
Plants in Norristown, Pa. and La Verne, Calif.

PHENOLIC—MELAMINE—SILICONE—EPOXY LAMINATES • COMBINATION LAMINATES • COPPER-CLAD LAMINATES • VULCANIZED FIBRE

## Tips for designers

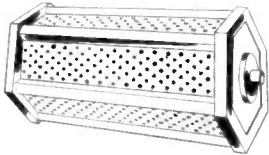

"Metal-plating barrels" of Taylor Grade C-5 melamine withstand corrosion and erosion successfully in alkaline solutions. Downtime and maintenance costs are substantially reduced.



Self-retaining grommets cut from Taylor phenolic tubing shield cables and wires passing through bulkheads . . . offer good electrical insulating properties.

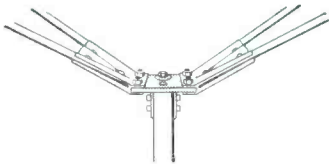

Insulation support of TV antenna rods is made of Taylor laminated phenolic which assures dependable, moisture-resistant insulation . . . is unaffected by weather.



Identification tag, easily fabricated from Taylor super-white vulcanized fibre, is non-abrasive and non-corrosive, can be printed and has safe, non-cutting edges.

### NEW TAYLOR COPPER-CLAD LAMINATES

Taylor GEC (glass epoxy) Copper-Clad and Taylor XXXP-242 cold punching (paper-phenolic) Copper-Clad. Taylor uses high purity rolled copper on base materials with outstanding electrical properties.

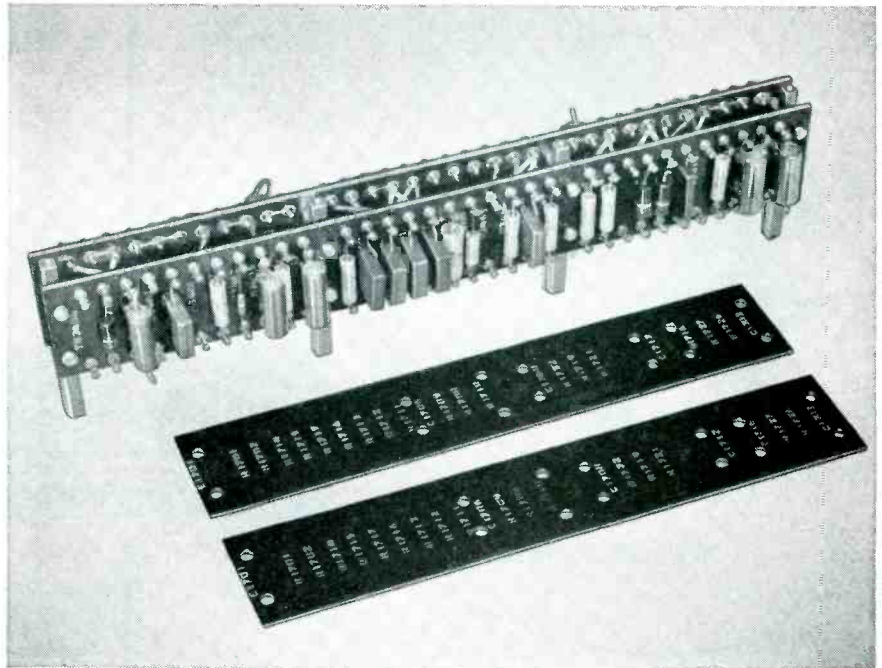

Six resistor board assemblies on the new Martin Matador guided missile are of Taylor Grade GEC (glass epoxy) laminate, chosen for this tough application because of its stable electrical properties and humidity resistance.

## Taylor Glass Epoxy Laminate meets critical insulation needs

Taylor GEC (glass epoxy) meets the Matador's exacting electrical insulation requirements. These requirements consist of . . . high strength to withstand the G's . . . low moisture absorption to withstand the varying humidity and temperature . . . electrical and mechanical stability. Your requirements, which are no doubt different, may be equally exacting. Taylor's wide range of laminates include that combination of electrical, mechanical and chemical properties that you require.

Designed for ease of fabrication . . . Taylor laminates are the result of resin formulations and production techniques developed

to make fabrication of completed parts easier and less costly. They are especially suited to punching, staking, milling, sawing or drilling when accurately sized parts are a must.

When specifications call for stability, specify Taylor laminates. They maintain their original characteristics over long periods of time and under rugged operating conditions.

To help you in your selection of a laminate, Taylor's engineering staff and fabricating facilities are at your service. Contact your nearest Taylor sales engineer for a discussion of your particular requirements.



# Quality

## ALL-IN-ONE ASSEMBLIES

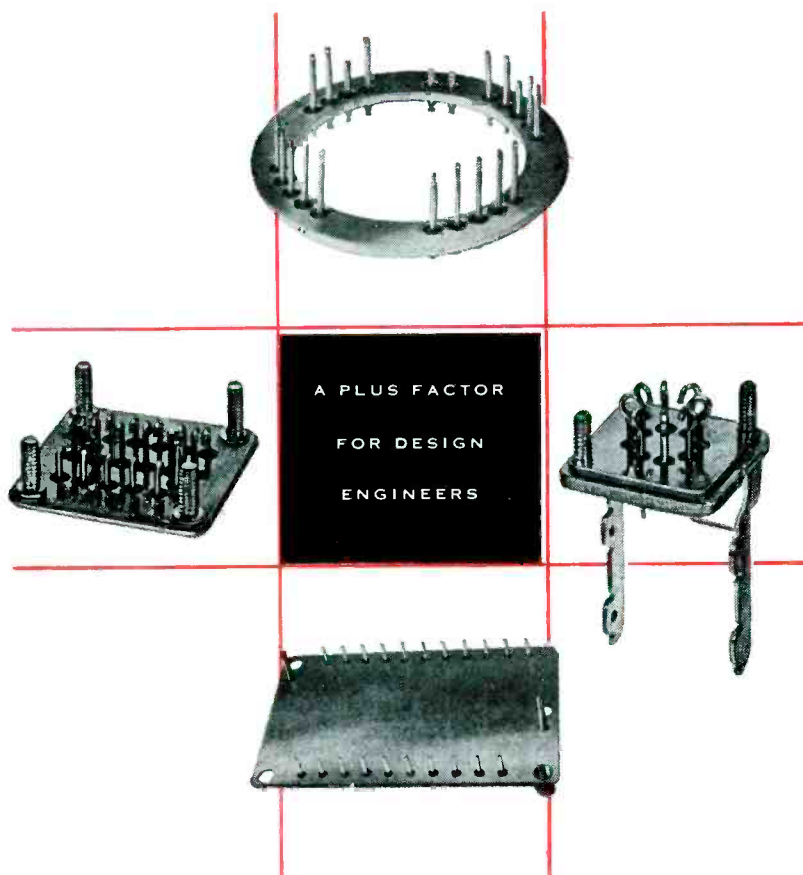

Today's exacting applications have increased the demand for high reliability components. Constantin has met this demand by introducing an entirely new series of all-in-one assemblies that offer the designer new highs in quality construction and design.

Small wonder, too . . . because Constantin's design and manufacturing versatility is the result of decades of glass-to-metal sealing experience . . . experience that is paying giant performance dividends for many of industry's leaders.

Constantin all-in-one assemblies are original pieces designed to individual requirements. Each unit can be supplied with many various types of internal and external mountings, eliminating costly sub-assemblies which entail many parts and processes including stamping, soldering or brazing, seal mounting, etc.

This experience is yours for the asking . . . whether your project calls for all-in-one assemblies, end seals, transistor mounts, crystal covers, connectors, or unit headers, your product's performance will be improved by using a Constantin glass-to-metal seal. Write today for more information.

"QUALITY WITH CONFIDENCE"



# L. L. Constantin & Co.

**MANUFACTURING  
ENGINEERS**

Route 46, Lodi, N. J. • 187 Sargeant Ave., Clifton, N. J.

TRANSISTOR MOUNTS • SINGLE TERMINALS • COMPRESSION HEADERS • END SEALS • CRYSTAL BASES • CONNECTORS • MINIATURIZATION

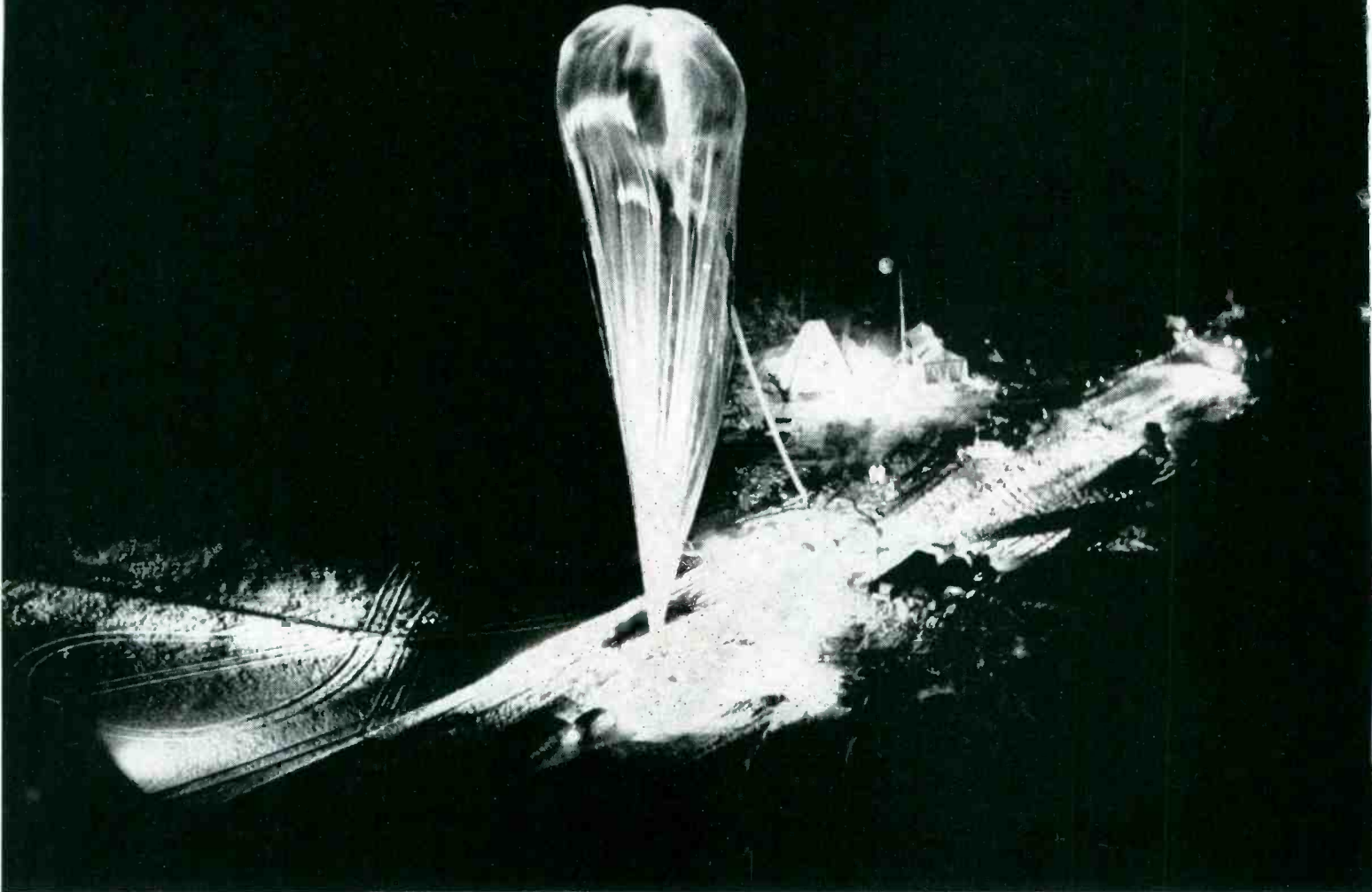

WE START WITH PLASTIC SHEETS, END WITH STRATO DATA ANALYSIS

Building the polyethylene balloon, as shown here, is part of General Mills balloon systems service. The "full package" service, typical of our thoroughness in other areas of activity, includes: design of vehicle and instrumentation, manufacture and flight planning—including meteorological services, flight operations, telemetering, tracking and recovery, and finally, analysis of collected data.

## Manned strato-balloon flights probe the mysteries of space

This is the Navy Project Strato-Lab balloon that set a new altitude record in a recent ascent at Rapid City, S. D. The fact that Commanders M. D. Ross and M. L. Lewis rose to 76,000 feet, the highest man has flown in a balloon, was incidental. Of far more importance was their demonstration that a light, comparatively inexpensive polyethylene balloon, with a gondola carrying its own atmosphere, is a feasible means of carrying human observers above the present ceiling of sustained powered flight. Manned flights to altitudes of 100,000 feet or more are possible today.

Man has flown higher in a rocket plane, but only for seconds at a time. General

Mills strato-balloons can remain at controlled altitudes for days if required. (Thus, "passengers" have time to make detailed observations.) They can also be used as launching stations to give rockets a "head start" into space.

*Upper-air research is one of many areas being pioneered at General Mills. Possibly you can profit from our experience in this field—or from our research, development and production of electro-mechanical sub-systems and major assemblies for weapons defense, guidance and controls, and weapons testing. Send today for booklet with all the facts.*

### MECHANICAL DIVISION

CREATIVE RESEARCH AND DEVELOPMENT + PRECISION ENGINEERING AND PRODUCTION



Minneapolis 13,  
Minnesota



# 50 ohm Coax Terminations dc to 4 KMC!



## 8 new instruments! 1 to 500 watts coverage!

New Sierra 160 series Coaxial Terminations are ideal for use with directional couplers, or in other applications requiring wide frequency range and low VSWR. They provide extremely high stability, and will dissipate full rated power continuously up to an ambient temperature of 40°C. Derating permits operating at still greater ambient temperatures. Terminations are completely shielded, and may be used to adjust transmitters without radiation. They are also useful for converting Sierra Bi-Directional Power Monitors to a termination type wattmeter.

### SPECIFICATIONS

Model	Power*	Connectors	VSWR
160-1F	1 watt	Type N fem.	Less than 1.06, dc to 2 KMC; less than 1.08, dc to 4 KMC.
160-1M	1 watt	Type N male	
160-5F	5 watts	Type N fem.	Less than 1.08, dc to 4 KMC.
160-5M	5 watts	Type N male	
160-20F	20 watts	Type N fem.	Less than 1.08, dc to 1 KMC; less than 1.15, dc to 4 KMC.
160-20M	20 watts	Type N male	
160-100F	100 watts	Type N fem.	Less than 1.2, dc to 3300 MC.
160-500F	500 watts	Type N fem.	

\*Up to 40° C ambient.

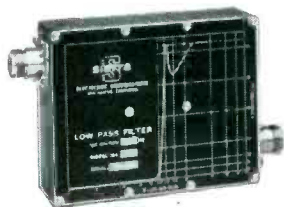

### New LOW PASS FILTERS

Sierra 184 series Low Pass Filters have an insertion loss not more than 0.4 db in pass band, sharp cut-off, 1.5 VSWR or less, and rejection greater than 60 db from 1.25 to 10 times cut-off frequency. Five models: for cut-off frequencies of 44, 76, 135, 230, 400 MC. Power range 250 watts in pass band, 25 watts in rejection band.

*Write for Bulletin!*

## Sierra Electronic Corporation

A Subsidiary of Philco Corporation

3885 Bohannon Dr., Davenport 6-2060, Menlo Park, Cal., U.S.A.

Sales Representatives in major cities

CANADA: Atlas Radio Corp., Ltd., Toronto, Montreal, Vancouver, Winnipeg

EXPORT: Frazer & Hansen, Ltd., San Francisco, New York, Los Angeles



## WIDEBAND DIRECTIONAL COUPLERS

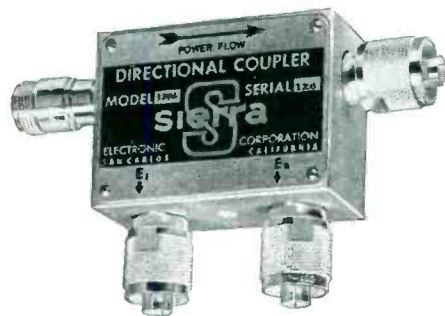

Versatile, accurate Sierra couplers are offered in 6 models for frequencies 10 kc to 2000 mc. Couplers provide transmission line measurements including reflection coefficient, VSWR, power. Also permit matching of loads to lines dynamically by indicating conditions providing minimization of reflected voltages. Request Bulletins 101, 104.

Coupling Factor: (in db  $\pm$  1 db)

Model	10 kc	3 mc	10 mc	30 mc	100 mc	300 mc	1000 mc	2000 mc
137, 137A				73	63	53	43	37
138, 138A				59	49	39	29	
145		52	42	32	22	12		
150				53	43	33	23	
139	50	50						

Directivity: 12 db  $\pm$  3 db greater than coupling factor at each frequency.

Impedance: Models 137 and 138 are 51.5 ohms. Models 137A, 138A, 145 and 150 are 50.0 ohms. Model 139 may be matched to most impedances.

Power: Usable to 1000 watts throughout frequency range.



### SIERRA 148 CRYSTAL DETECTOR

Insures sensitive readout for Sierra Directional Couplers. Low VSWR, high sensitivity to 1200 MC. 50 ohm input impedance, filtered output. Type N input. BNC output connectors.

*Data subject to change without notice*

3663-R



**multiply this**



## **HE NEEDS AND READS ALL**

You can reach him through the Technical Edition  
(published the 1st of each month), or the Business Edi-  
tions (published on the 10th and 20th) – or in *all three!*

**electronics**

A MCGRAW-HILL PUBLICATION



# electronic purchaser by **46,000**

Only certain people are eligible to subscribe to ELECTRONICS magazine.

They must be working engineers . . . production, design or research engineers . . . management personnel . . . or other qualified workers in the field of electronics.

Result of this screening? ELECTRONICS has become the recognized index of the market!

The number of copies going into any territory is proportional to the amount of electronic business in that territory. Also, the number of copies going into any company . . . from 1 to 671 . . . is proportional to the company's participation in the electronic industry.

ELECTRONICS paid 46,000 circulation and estimated readership of 128,000 . . . will give you coverage of the important men in the electronic industry.

Let ELECTRONICS head your list!

3



330 WEST 42ND STREET . . . NEW YORK 36, N. Y.

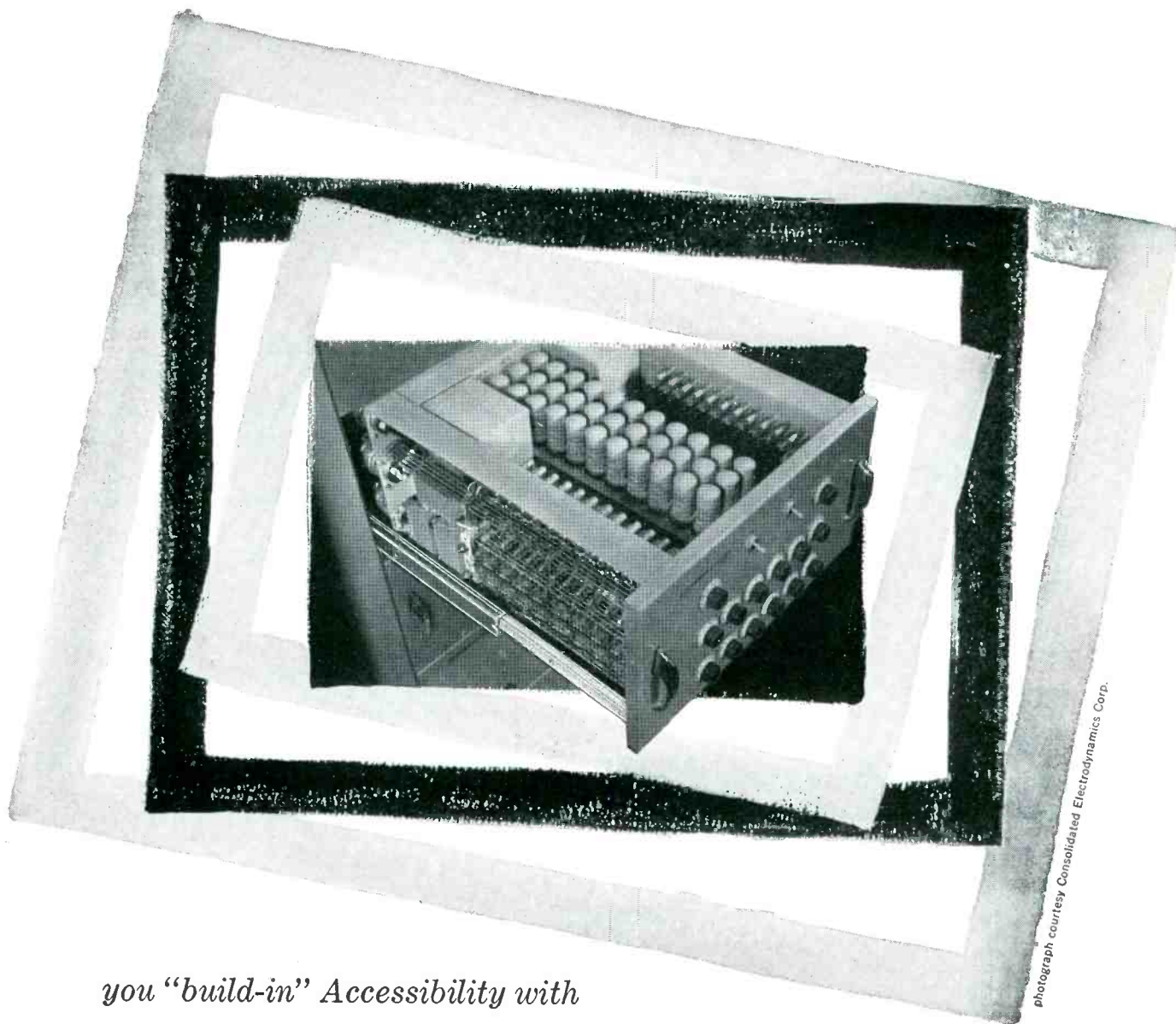

Photograph courtesy Consolidated Electrodynamics Corp.

*you "build-in" Accessibility with*

## **GRANT INDUSTRIAL SLIDES**

**IF** it's important to keep your electronic equipment functioning with as brief interruptions as possible...**IF** even minor testing and replacement takes undue time because of the nuisance of getting at the equipment mechanically...**IF** certain components *must* be accessible for on-the-spot servicing in seconds...**THEN** you should investigate Grant Industrial Slides.

Grant Industrial Slides provide *built-in* accessibility, without effort or costly loss of operating time. Unlimited varieties of standard and custom types are available and Grant offers complete

engineering services including at-your-plant discussions regarding the development of slides that fit your requirements perfectly.

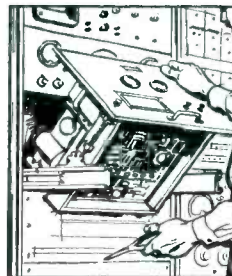

*Five seconds to put chassis in testing position. Slides smoothly out of rack, locks. Pivoting mechanism brings under-chassis parts to easiest working angle. Functioning of unit need not be interrupted!*

*Write for Grant Industrial Slide technical data. Free copy will be mailed on request.*



**Grant Pulley & Hardware Corporation, 31-73 Whitestone Parkway, Flushing 54, N. Y., 944 Long Beach Avenue, Los Angeles 21, Calif.**



# NEW 10 Amp Relay

30g to 2000cps 60 Amp Overload 80 Amp Rupture

Type CH-12D

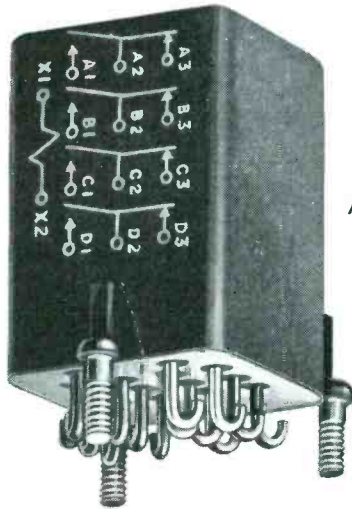

Actual Size

## Here are the facts:

**Contact Rating:** 10 amperes resistive at 30 volts d-c and 115 volts, 400 cps  
Overload—60 amperes  
Rupture test—80 amperes

**Contact Arrangement:** 4 PDT

**Coil:** 26.5 volts d-c, 170 ohms (other resistances are available)

**Temperature:** -65°C to +125°C

**Vibration:** 30 g to 2000 cps

**Operating Shock:** 100 g.

**Weight:** 5 oz.

### Military Specifications:

Meets test conditions of—  
Mil-R-5757B • Mil-R-6106A • Mil-R-25018

For more information, write for Bulletin CH

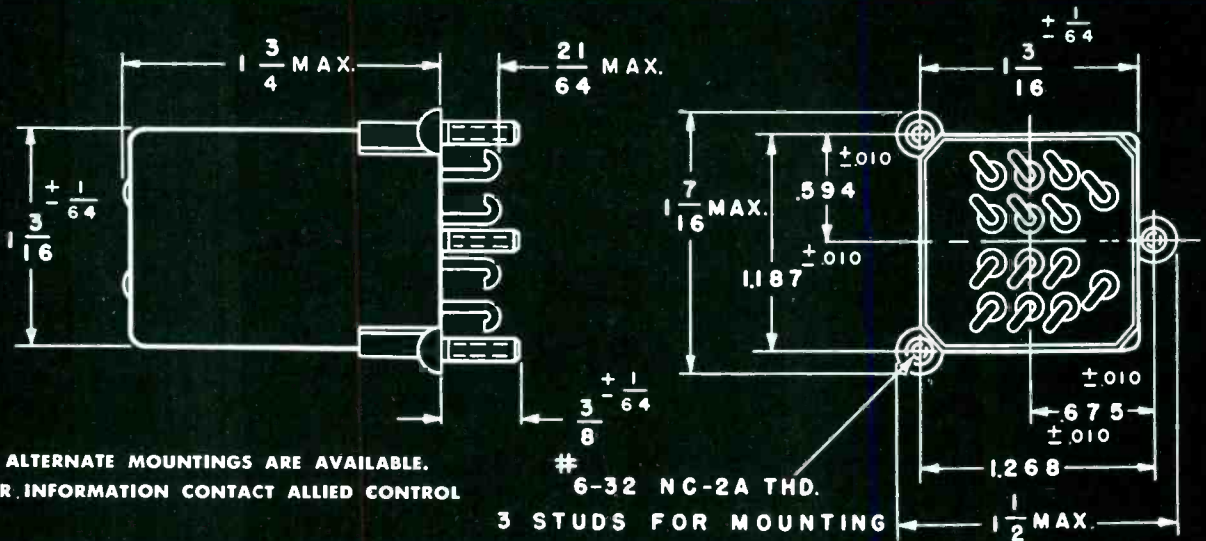

# ALLIED CONTROL



ALLIED CONTROL COMPANY, INC., 2 EAST END AVENUE, NEW YORK 21, N. Y.

Want more information? Use post card on last page.



What!  
they cost  
less too?



The need to compromise on panel instrument quality is now a thing of the past. Model 1301 Weston Cormag instruments cost no more, often less, than the compromise types. Thus you can get the *big increment of dependability* which Weston instruments provide for all your panel and built-in needs; *plus* the other advantages of Weston's core-magnet, self-shielding construction. For example, they can be mounted closer together on a panel without intereffect . . . and used interchangeably on either magnetic or non-magnetic panels. Let us acquaint you with all the advantages of these improved instruments. Consult your nearest Weston representative, or write Weston Electrical Instrument Corp., Newark 12, New Jersey.

# WESTON

## CORMAG<sup>®</sup>

### PANEL INSTRUMENTS





# GENERAL NOW HAS N-P-N

General Transistor now makes available to you a line of N-P-N germanium alloyed junction transistors for your computer applications. The N-P-N, when used in conjunction with P-N-P transistors, simplifies electronic circuitry, offers extraordinary circuit flexibility, and eliminates the need for some additional components.

If you are a computer manufacturer or use N-P-N transistors write us on your company letterhead for "N-P-N Specifications."

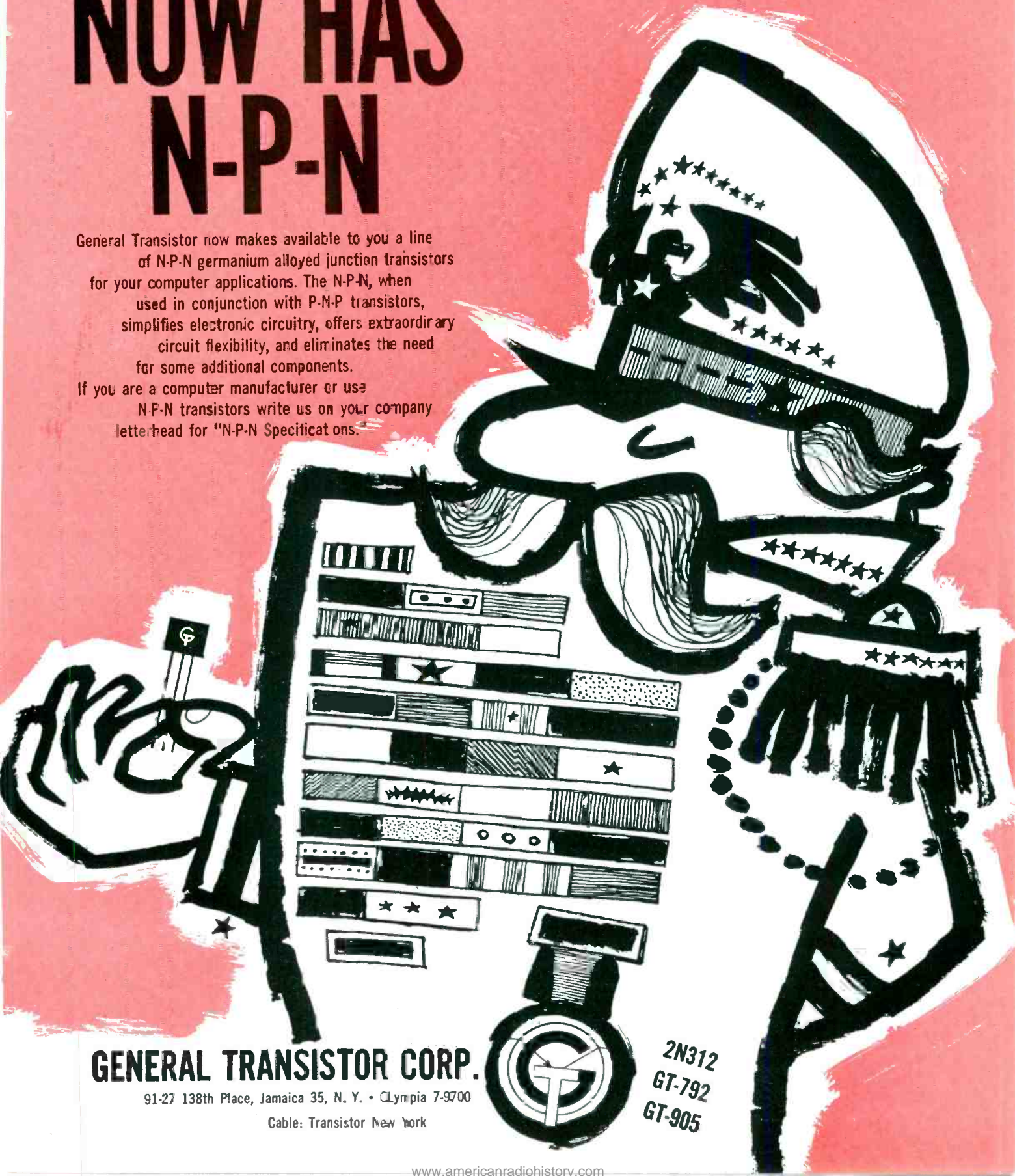

**GENERAL TRANSISTOR CORP.**

91-27 138th Place, Jamaica 35, N. Y. • CLympia 7-9700

Cable: Transistor New York



2N312  
GT-792  
GT-905



**PHELPS DODGE SODEREZE®**

**CUTS**

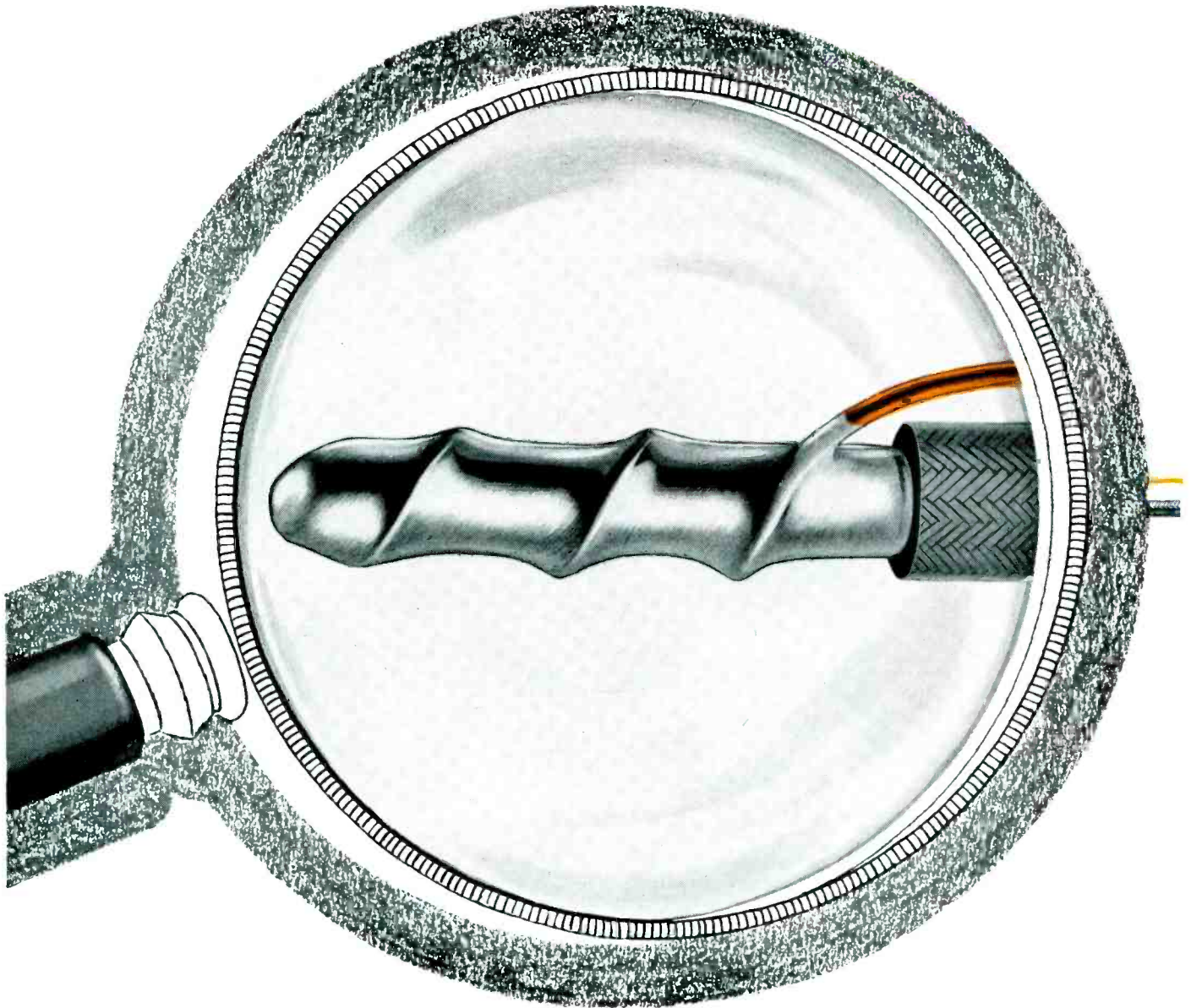

**FIRST FOR LASTING QUALITY—FROM MINE TO MARKET!**

---



# ENDS STRIPPING, CLEANING— SOLDERING COSTS !

Sodereze—Phelps Dodge's isocyanate-type\* magnet wire—provides:

1. *Low temperature* soldering—no damage to copper conductor.
2. A balance of physical, chemical and electrical properties permitting replacement of existing film wires.
3. Resistance to heat and solvent shock for safer wax or varnish treatment.
4. Excellent resistance to alcohol and most solvents.

---

Phelps Dodge Sodereze was designed to keep pace with industry's growing need for magnet wires that handle easily, reduce over-all costs and fit a variety of exacting design requirements.

The versatility of Sodereze not only permits its use wherever solderable wires are required, but allows replacement of conventional film wires.

\* Isocyanates, when combined with other resins, form Polyurethanes that can be balanced in properties to give the maximum in performance as a magnet wire insulation. Several years of research have been spent on Phelps Dodge Sodereze to accomplish this result. A patent application covering Phelps Dodge isocyanate-type magnet wire has been filed.

*Any time magnet wire is your problem,  
consult Phelps Dodge for the quickest, easiest answer!*



***PHELPS DODGE COPPER PRODUCTS***  
**CORPORATION**

**INCA MANUFACTURING DIVISION**  
FORT WAYNE, INDIANA

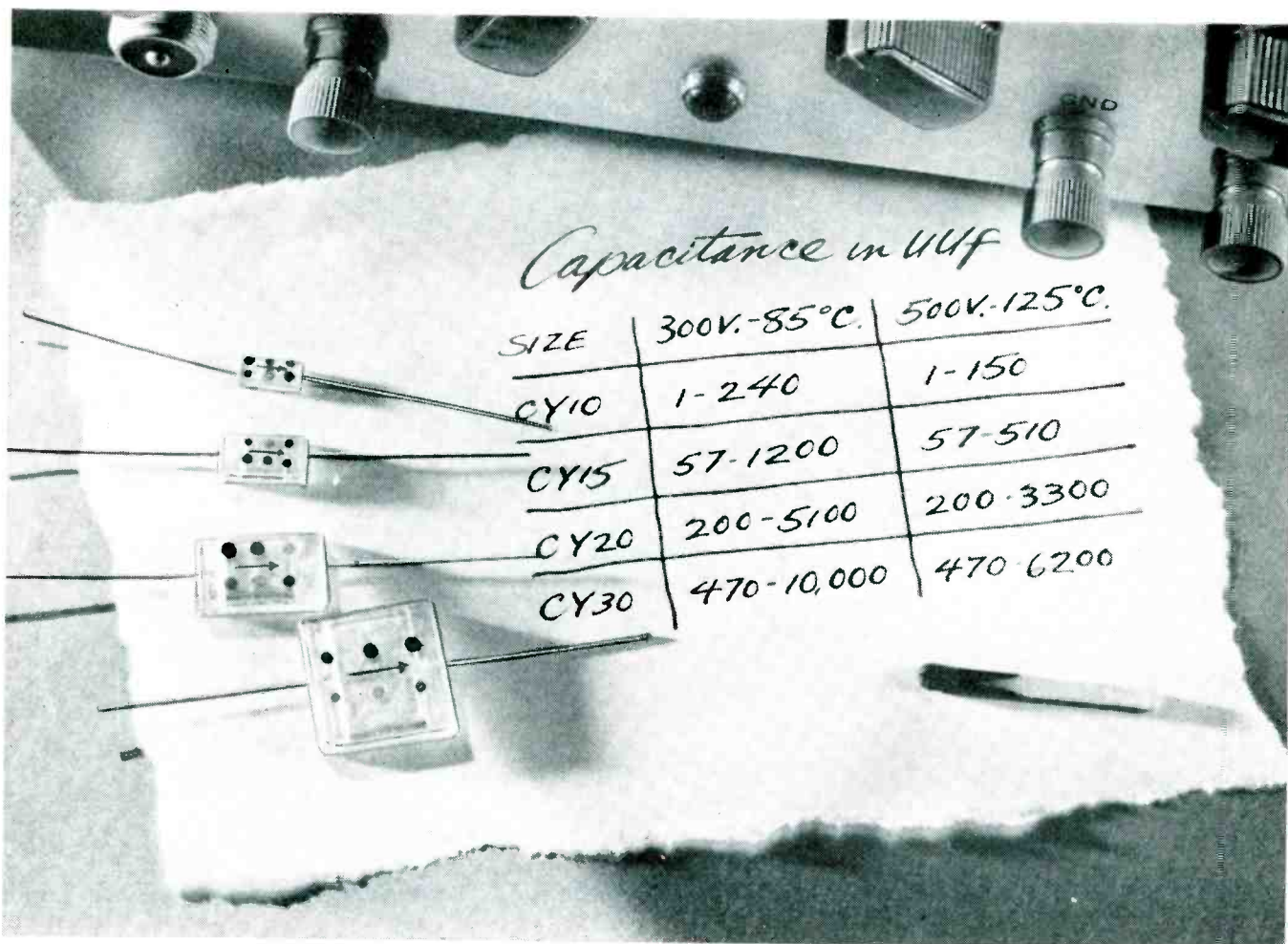

## *uuf* for *uuf*, the smallest, most stable, fixed capacitors you can buy—Here's why...

These are *glass* capacitors—probably as much as one-third smaller than those you're used to; certainly much lighter.

Though made with glass, they are *not* fragile. In fact, the layers of glass dielectric, the metal foil plates and the leads are fused into a surprisingly rugged, inseparable unit.

This unusual construction, developed at Corning offers you these advantages:

**Small size, light weight.** If you're at work on guided missiles, fire controls, computers, and similar devices, you can cut valuable ounces and inches from your assemblies with these capacitors. See table above for some indications.

**Exceptional stability.** After a load life test at 50% more than rated voltage at

85° C., the average change in capacitance of these units is less than 0.4% after 1,000 hours, less than 0.6% after 10,000 hours.

**Very low drift.** This drift is so slight that it's generally within the normal error of measurement. Taking MIL-C-11272A as a standard, capacitance drift is less than 0.1% or 0.1 *uuf* (whichever is greater).

**Predictable, retraceable TC.** The difference in TC between any units at any given temperature is less than 15 ppm/° C. It is well within the limits of  $140 \pm 25$  ppm/° C. from -55° C. to +85° C. and referred to 25° C.

**Low loss.** Even at elevated temperatures, the dielectric loss is relatively low. Dissipation factor at 1 kc. and 25° C. is about 0.055% and independent of capacitance.

Bulletin shows performance charts. Bulletin CD-1.00 contains charts and other data on these capacitors. Circle this magazine's service card for a copy or write us direct at Corning.

### Ask for information on these other Corning Capacitors:

**Medium Power Transmitting**—CY60 and CY70. Ideal for mobile RF transmitters.

**Canned High Capacitance**—Provide the advantages of rugged glass design to your specifications.

**Subminiature Tab-Lead**—Up to 90% less volume compared to pigtail types. To your specifications.

**Special Combinations**—The performance and benefits of glass in infinite shapes, sizes and leads. To custom order.

### Capacitance in uuf

Size	300 V. - 85° C.	500 V. - 125° C.
CY10	1-240	1-150
CY15	57-1200	57-510
CY20	200-5100	200-3300
CY30	470-10,000	470-6200

**Other electronic products by Corning Components Department:** Glass Film Type Resistors\*, LP, LPI, H, R, N, S, HP and Water Cooled Styles. Direct Traverse and Midget Rotary Trimmer Capacitors\*. Metallized Glass Inductances, Delayline Coil Forms, Bushings, Enclosure Tubes, Rectifier Tubes and Attenuator Plates.

\*Distributed by Eric Resistor Corporation

Corning means research in Glass



**CORNING GLASS WORKS, 94-4 Crystal Street, Corning, N. Y.**

Electronic Components Department



*Attention! All Users of Nickel Alloys...*

# **New Driver-Harris Vacuum Melting Service Now in Operation**

**A**fter many years of experience with vacuum melting programs, Driver-Harris now offers a complete vacuum melting service for almost all of the 132 special purpose alloys made by this company.

The specific benefits gained by vacuum melting in the production of nickel-chrome alloys are today clearly established. They are:

**1.** Much closer control of analysis—particularly in alloying with the highly reactive elements, Titanium, Aluminum, Columbium, Calcium, and Zirconium. The normally high affinity for nitrogen and oxygen these elements have is completely eliminated in vacuum melting, thereby opening new avenues in alloy production.

**2.** Great reduction in inclusions, especially oxides and nitrides, results in higher ductility and tensile properties. In fine wires, the improvement in properties is frequently so great that wire sizes may be reduced without sacrifice of strength. An example of the greatly improved microstructure is illustrated in the metallographs shown.

**3.** Complete elimination of gas, not from the surface only but from the entire mass. Alloys so produced are therefore more desirable in the manufacture of electron tubes.

**4.** General improvement in electronic, electrical, and mechanical properties to meet specifications. Because closer control of analysis is a primary advantage of vacuum melting, we can now achieve these specific improvements with remarkable certainty.

Almost all of the Driver-Harris Alloys now vacuum melted and processed under close physi-

cal and analytical control show improvement in one or more of the above ways. If you are seeking further improvements in the D-H Alloys you use, inquire now for information on how Driver-Harris Vacuum Melting Service can help you. Address your inquiry to Dept. VMS.

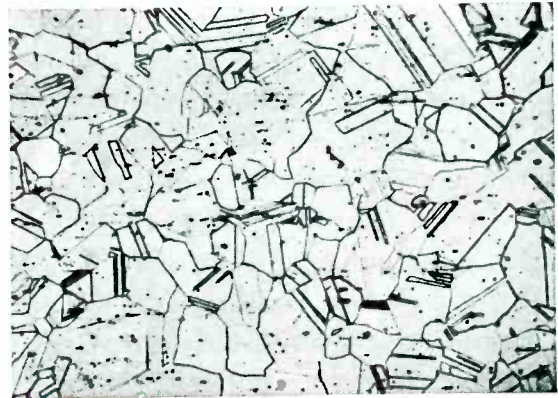

*Polished and etched sample of Air Melted NICHROME\* V in annealed condition.*



*Vacuum melted NICHROME V, annealed. Note that reduced inclusions result in much larger grain size for the same annealing treatment.*

\*T. M. Reg. U. S. Pat. Off.



## *Driver-Harris* COMPANY

HARRISON, NEW JERSEY

BRANCHES: Chicago, Detroit, Cleveland, Louisville, Los Angeles, San Francisco In Canada: The B. GREENING WIRE COMPANY, Ltd., Hamilton, Ontario

**MAKERS OF THE MOST COMPLETE LINE OF ALLOYS FOR THE ELECTRICAL, ELECTRONIC, AND HEAT-TREATING INDUSTRIES**

ELECTRONICS — April 1, 1957

Want more information? Use post card on last page.

111

## A Progress Report on Faculty Salaries:

# UP... But Not Nearly Enough

**T**HE CHART on this page provides a report of the progress being made in solving a problem of crucial importance to every American. The problem is that of seeing that college and university faculty members get decent salaries.

This new chapter, which brings the story forward two years—from 1954, when it was last dealt with in this series of editorials, through 1956—has a decidedly cheering element. For in the last two years faculty salaries have made real headway.

### Two Years of Improvement

In 1954, in terms of what their salaries would buy, faculty members as a whole were actually worse off, by 5%, than they had been fourteen years earlier. As the chart shows, over the same period the real income of the average industrial worker had increased by almost half. And, in what it would buy, the income of the average physician, with professional training comparable to that of the average faculty member, had jumped by 80%.

In 1956, however, the average faculty salary would buy about 12% more of goods and services than it would in 1940. Relative to where they were two years before, faculty salaries showed a larger gain over the two years than those of any of the

other groups whose salary progress is charted.

This movement of faculty salaries in the right direction has many contributing causes. The biggest single boost was given by the great Ford Foundation gift of half a billion dollars to our colleges, universities, and hospitals, almost half of which was ear-marked for faculty salary increases. Gifts from business firms have also

What is Happening to College Faculty Salaries

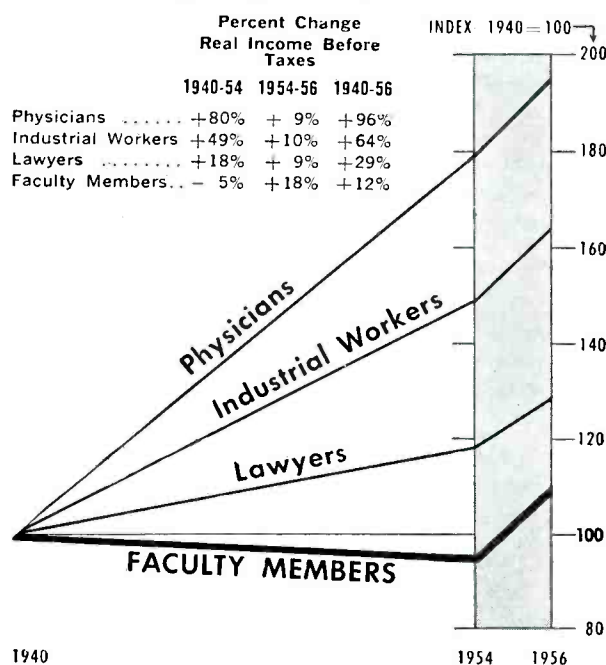

DATA: Council for Financial Aid to Education, U. S. Dept. of Commerce, U. S. Dept. of Labor, National Association of Education Research Dept., McGraw-Hill Dept. of Economics.



helped a lot. And so, in many cases, have stepped-up money-raising campaigns by alumni groups and cooperative regional and state groups of colleges.

## Still a Long Way to Go

However, faculty salaries started their ascent from such a dismal depth that they still have a long, long way to go up before there is room for the comfortable conviction that they are fair, or even safe, from the standpoint of protecting the nation's vital interests. It still remains possible to find many shocking companion pieces for the following incident recently reported to a McGraw-Hill executive group, working on problems of financial aid to higher education, by the president of an illustrious small liberal arts college.

"The recruiting officer of one of our large industrial companies came to our campus a few weeks ago," the college president said, "and offered five of our seniors higher salaries to start working for that company when they are graduated next June than the salary received by any member of our faculty. And the seniors, of course, promptly went to their professors to seek advice on whether or not they should accept. It doesn't take much imagination to see what this sort of thing does to the morale of a faculty."

## Senior Teachers Fare Badly

One of the more devastating things it does, of course, is to make the more experienced college and university faculty members receptive to the idea of going to greener pastures, currency-wise, in business and industry.

For these senior faculty members the financial pounding in the past 16 years has been even worse than the chart indicates. While the average real salary gain reported by the chart has been 12%, the average salary of a full professor still buys less than it did in 1940. This is because most of the salary increases have gone to beginning instruc-

tors, for whose services industry has been providing the sort of competition reported by the liberal arts college president.

And it creates this financial lackluster of posts as senior college faculty members right at the time their services are needed more than ever to handle the oncoming flood of college and university students. Between now and 1970 college and university enrollment is expected to double.

## What is Needed Now

What is clearly needed is a continuation and intensification of the drive to increase their salaries to a point where college and university faculty members will be sharing somewhere near fully in the general prosperity of the nation. It could be counted good progress in this direction if over the next two years faculty salaries on the average were to go up another 12%, with most of the increase concentrated in the senior faculty ranks. And this can be made possible only through more outside contributions.

There is reason to be encouraged by the progress that has been made over the past two years in bailing college and university faculty members out of the terrible financial hole into which they were allowed to slide. But there is the most urgent occasion to keep at it and harder.

*This message is one of a series prepared by the McGraw-Hill Department of Economics to help increase public knowledge and understanding of important nationwide developments that are of particular concern to the business and professional community served by our industrial and technical publications.*

*Permission is freely extended to newspapers, groups or individuals to quote or reprint all or parts of the text.*

*Donald McGraw*

PRESIDENT

McGRAW-HILL PUBLISHING COMPANY, INC.

HERE'S NEW  
**PRECISION in CERAMICS**

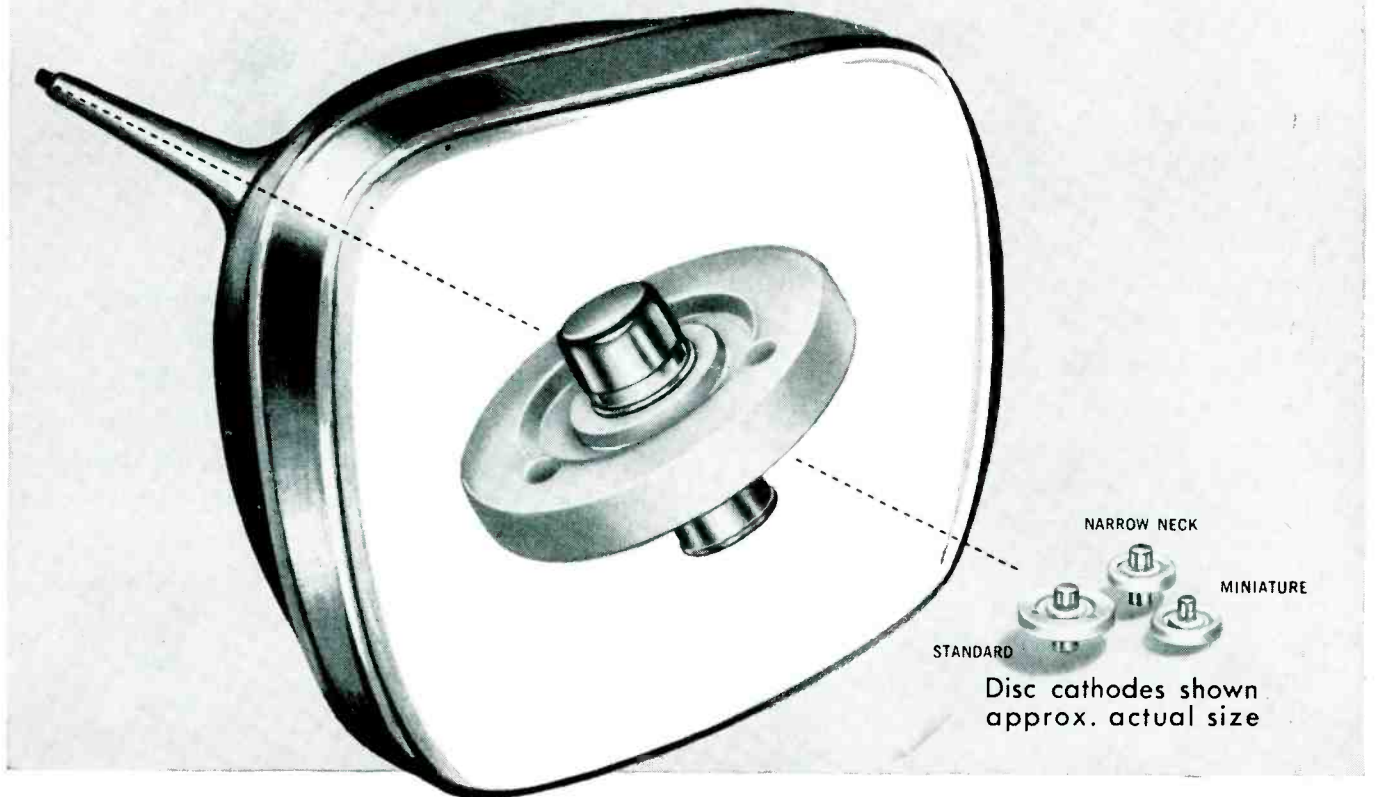

**High quality of SUPERIOR'S disc cathodes made possible with G-C precision steatites**

Superior Tube Company's miniature disc cathodes save space and heater power, reduce cost to users of cathode ray tubes by utilizing slender tube necks. The application required Steatite discs with a heretofore unobtained degree of dimensional accuracy. General Ceramics' progressive manufacturing techniques have made it possible to achieve these critical tolerances and maintain absolute

uniformity in volume production runs. Since the inception of Superior's disc cathodes in 1950, engineers at General Ceramics have helped produce more compact, precision components by refining tolerances over 50% on steatite discs. New design criteria on *precision* steatites for your products is available now — write to General Ceramics Corporation, Kearsbey, New Jersey, Dept. E.

**GENERAL CERAMICS**

*Industrial Ceramics for Industrial Progress... Since 1906*

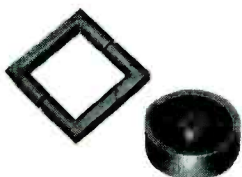

FERRAMIC CORES



FERRAMIC MAGNETIC CORES



MAGNETIC MEMORY PLANES



"ADVAC" HIGH TEMPERATURE SEALS



SOLDERSEAL TERMINALS



THE TRICK IS TO CONTROL THIS

"E" DIMENSION WITHIN .0005"

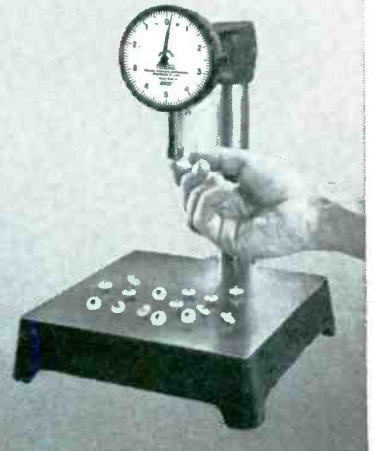

Dial indicator gage measures the critical "E" dimension.

## Precision disc cathodes simplify assembly of TV picture tubes

Because Superior Tube guarantees such close tolerance in disc cathode "E" dimension, makers of TV picture tubes can save the time and cost of compensating for variations.

Cathodes can be used universally in different tubes, and are interchangeable with each other during electron gun assembly. This means both manufacturing efficiency and quality control can be significantly improved.

In addition, Superior Tube precision disc cathodes offer these four important advantages:

1. **Separate cap alloy.** Permits use of best alloys for both cap and shank in varying applications.
2. **Slight flare of shank opening.** Easier insertion of heater. Less abrasion of heater coating during normal expansion and contraction.
3. **Shadow groove in ceramic.** Inhibits electrical leakage between cathode and No. 1 grid.
4. **Chemically clean shank interior.** Minimizes heater-cathode leakage.

Superior Tube disc cathodes are available in three sizes: standard, narrow neck making possible shorter tubes, and miniature for 3-gun color TV picture tubes. Write for complete information to Superior Tube Co., 2500 Germantown Ave., Norristown, Pa.

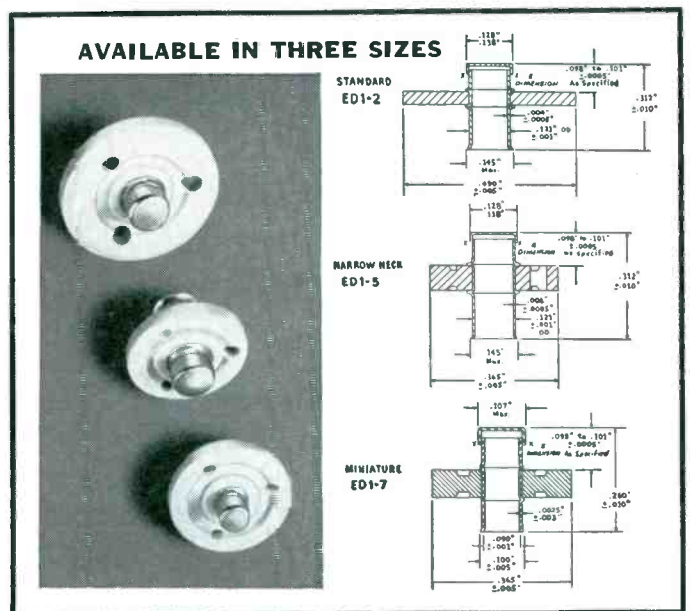

**HOW SUPERIOR DOES IT**—GENERAL CERAMICS CORPORATION, Keasbey, N.J., working for many years with Superior Tube's engineers, has developed mass-production methods resulting in the supply of millions of close-tolerance insulators which have greatly assisted in achieving this uniform "E" dimension. These insulators are produced under rigid quality controls. The cathode shank is double-beaded to the ceramic to insure tight fit. The cap is electrically spot-welded to the shank while held in a precision jig,

*Superior Tube*  
The big name in small tubing

NORRISTOWN, PA.

Johnson & Hoffman Mfg. Corp., Mineola, N.Y.—an affiliated company making precision metal stampings and deep-drawn parts such as those used in the electron guns that go with this new cathode.

# Need a "SPECIAL" TIMER ...need a "STANDARD"?

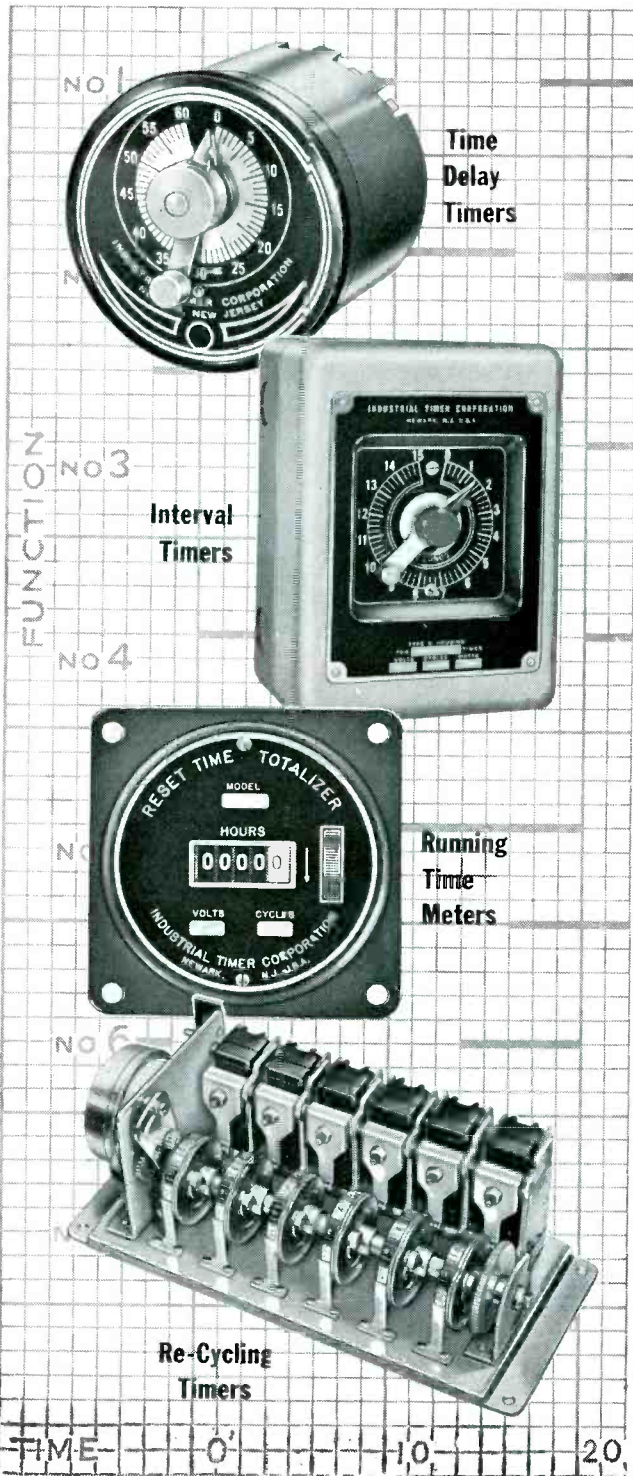

## Here's why WE can give you the fastest service

When you want a timer, you want one that fits your needs 100% — and you want it fast. Get in touch with Industrial and you'll get both. Because:

In our 20 years of experience, we have developed over a thousand combinations from our 17 basic types, to meet the widely varying needs of our customers. Therefore — many jobs that would seem to require a "special" timer are in fact a "standard" timer with us. Here is one tremendous saving of time for you.

When you do need a special timer, this same wealth of experience goes to work for you at once to design it. Our Engineering Department not only originates new designs, but also develops modifications for that purpose. That's why requests for special timers can be filled without delay.

Each method — designing for a standard timer or for a special timer — has its advantages. Designing for an already available timer means lower costs, faster service, simplified replacements.

Designing for a special timer has its advantages too. It means you'll fulfill your needs 100% — no need to limit your designing horizons. Either way — standard or special — you'll get the timer you want most promptly from Industrial.

Or perhaps you need quick service on timers for automatic controls. Here too Industrial Timer is your first source of supply. For in this field Industrial has a big head start. True, each automatic control job is a bit different from the rest. But the record shows that our years of timer experience has given us the special knowledge it takes to give you the right answers in near-record time.

So, for the utmost in all-round timer service, it's Industrial that offers you this outstanding combination: deliveries "Immediate on Standards . . . First on Specials." Plus the experience of one of the foremost group of timer engineers in the nation.

Timers that Control  
the Pulse Beat of Industry



**INDUSTRIAL TIMER CORPORATION**

1409 McCARTER HIGHWAY, NEWARK 4, N. J.



**"WE'VE CUT OUR  
COSTS 50%  
with the WALES  
FABRICATOR-DUPLICATOR"**



Mr. Richard H. Aufderheide, President and Production Manager of Rex Metal-Craft Inc., Indianapolis, Indiana reports: "We have been able to cut our costs 50% by using the Wales Fabricator and Duplicator for the manufacture of the Breathalyzer. This punching equipment has proven highly efficient for fast set-up, close tolerance, short to medium production work."

The WALES Fabricator combined with WALES positive Duplicator is the modern, low cost answer to hole punching. You get holes with sharp definition, clean walls and minimum bell mouth. This equipment is perfect for short to medium runs, from one piece to thousands. Change dies for hole sizes in seconds with a range up to 3½" dia. Accuracy is automatic and positive. Make your own templates, too, on the Fabricator. Eliminate layout, drilling machines or jig-borers. The WALES Fabricator-Duplicator is a complete punching shop in itself.



The Breathalyzer is an instrument for determining immediately the degree of alcoholic intoxication. This instrument is used widely by law enforcement agencies and Laboratories.

**WALES *Strippit* COMPANY**  
**"...the Wales-Way is the PLUS-PROFIT way"**  
**AKRON, NEW YORK**

WALES-STRIPPIT OF CANADA LTD., HAMILTON, ONT.

SEND FOR BULLETIN No. 13C

Time studies, specifications, illustrations etc., are all yours for the asking.



WALES MOBILE FIELD UNITS

We'll bring the Fabricator Duplicator right to your door for a demonstration. Ask for details.





# DATA FOR

## HOW TO BUILD EXTRA DEPENDABILITY INTO YOUR DESIGNS



To meet the ever-growing demand for high-quality tubes that will measure up to critical military specifications and exacting commercial applications—RCA "Premium" Tubes are controlled in process. Process control, rigidly monitored by 100% microscopic inspection of 24 categories of workmanship, constantly improves RCA "Premium" Tubes... maintains RCA leadership in quality and reliability. In addition, RCA "Premium" Tubes are controlled for—shock—stabilization—glass strain—heater-cycling life—fatigue—and low-frequency vibration. For reliable circuitry—under tough conditions of vibration, impact, humidity, and wide temperature variations—back your designs with RCA "Premium" Tubes. Check the chart for the types you need.

### HANDY FACT BOOK ON RCA TUBES FOR DESIGNERS



Fast reference guide (RIT-104) includes technical data, socket diagrams, and descriptions on all RCA "Premium" and Special Red Tubes... plus computer, pencil, glow discharge, small thyristors, low microphonic, and other tube types especially suited for industrial and military applications. For your copy, mail the coupon on next page.

### RCA "PREMIUM" AND "SPECIAL RED" TUBES —to meet Military Specifications and Critical Commercial Applications

RCA "Premium" Tube Type No.	Prototype No.▲	GOVERNMENT INSPECTED PRODUCT			
		Military Type No.	Applicable Military Specification	Qualification Approval Certificate No.	Point of Mfr.**
0A2-WA	0A2	JAN 0A2-WA	Mil-E-1/290A	20255A	W
0B2-WA	0B2	JAN 0B2-WA	Mil-E-1/291	20256A	W
2D21-W	2D21	JAN 2D21-W	Mil-E-1/756	N-4220	W
6AC7-W	6AC7	JAN 6AC7-W	Mil-E-1/354	N-3299	H
6J4-WA	6J4	USN 6J4-WA	Mil-E-1/619C (Navy)	BuShips Ltr 4/26/55	W
12AT7-WA	12AT7	JAN 12AT7-WA	Mil-E-1/3A	21058	H
5636	6AS6	JAN 5636	Mil-E-1/168C	20936	H
5636-A	6AS6	USN 5636-A	Mil-E-1/715A (Navy)	BuShips Ltr 8/24/56	H
5654	6AK5	—	—	—	—
5654/6AK5-W	6AK5	JAN 5654/6AK5-W	{ Mil-E-1/4 Mil-E-1/4A	A-1941	H
5654/6AK5-W/6096	6AK5	JAN 5654/6AK5-W/6096	Mil-E-1/236	20767	H
5690†	—	USN 5690	Mil-E-1/489 (Navy)	BuShips Ltr 4/28/55	H
5691‡	6SL7-6T	JAN 5691	Mil-E-1/133A	N-3623	H
5692‡	6SN7-6T	JAN 5692	Mil-E-1/134A	N-3621	H
5693	6SJ7	JAN 5693	Mil-E-1/81A	N-3624	H
5718	—	JAN 5718	Mil-E-1/172B	20775	H
5718-A	—	USN 5718-A	Mil-E-1/681 (Navy)	BuShips Ltr 8/4/55	H
5719	—	JAN 5719	Mil-E-1/173C	20793	H
5719-A	—	USN 5719-A	Mil-E-1/682 (Navy)	BuShips Ltr 8/4/55	H
5725	6AS6	—	—	—	—
5726	6AL5	—	—	—	—
5726/6AL5-W	6AL5	JAN 5726/6AL5-W	Mil-E-1/7A	A-1929	H
5726/6AL5-W/6097	6AL5	JAN 5726/6AL5-W/6097	Mil-E-1/235A	20055	H
5727/2D21-W	2D21	JAN 5727/2D21-W	Mil-E-1/83	20293	W
5749	6BA6	—	—	—	—
5751	12AX7	JAN 5751	Mil-E-1/107	A-1989	H
5751-WA	12AX7	JAN 5751-WA	Mil-E-1/237	20452	H
5814-A	12AU7	JAN 5814-A	Mil-E-1/12A	A-4131	H
5814-WA	12AU7	JAN 5814-WA	Mil-E-1/238A	20472	H
5840	—	JAN 5840	Mil-E-1/140B	20011A	H
5840-A	—	USN 5840-A	Mil-E-1/720 (Navy)	BuShips Ltr 8/20/54	H
6073	0A2	—	—	—	—
6074	0B2	—	—	—	—
6080-WA	6AS7-G	USN 6080-WA	Mil-E-1/510B (Navy)	BuShips Ltr 8/26/55	H
6099*	6J6	USAF 6099	USAF Exhibit WCL-582	—	H
6101	6J6	—	—	—	—
6101/6J6-WA	6J6	JAN 6101/6J6-WA	Mil-E-1/243A	A-4198	H
6186/6AG5-WA	6AG5	JAN 6186/6AG5-WA	Mil-E-1/244A	20200	H
6189/12AU7-WA	12AU7	JAN 6189/12AU7-WA	Mil-E-1/246A	20297	H
6201	12AT7	—	—	—	—
6205	5840	JAN 6205	Mil-E-1/140B	20954	H

NOTES: † "Special-Red" Tubes. \*\*H=Harrison, N. J. W=Woodbridge, N. J.  
\*This type is intended for special Air Force application only. For other military uses, the 6101/6J6-WA is recommended.

▲Premium versions may differ from their prototypes in electrical characteristics, physical structure, or types of tests to which they are subjected. Tube data should, therefore, be checked before replacing a type in the prototype column with the listed "Premium" type.

### DISTRICT SALES OFFICES

**EAST:** Humboldt 5-3900  
744 Broad Street  
Newark 2, N. J.

**MIDWEST:** Whitehall 4-2900  
Suite 1181  
Merchandise Mart Plaza  
Chicago 54, Ill.

**WEST:** Raymond 3-8361  
6355 East Washington Blvd.  
Los Angeles 22, Calif.



# DESIGNERS

## LONG-TERM POWER DELIVERY —with RCA Power Tubes

The remarkable endurance of RCA Power Tubes in commercial and military applications is related to tube designs that have withstood the tests of practical equipment operation for many years. RCA Power Tubes are available in a complete range of plate-input powers and frequency ratings. Some typical power types are pictured here.



### BEAM POWER TUBES RCA-2E26 RCA-6893

30 watts CW input to 125 Mc and 20 watts at 175 Mc (CCS) — identical CCS and ICAS ratings (except heater) for both types. For 6.3-v. heater circuits, specify RCA-2E26. For 12.6-v. specify RCA-6893.

### BEAM POWER TUBES

#### RCA-6146 RCA-6159 RCA-6883

67.5 watts CW input to 60 Mc and 45 watts at 175 Mc (CCS) — identical CCS and ICAS ratings (except heater) for all three types. For 6.3-v. heater circuits, specify RCA-6146. For 12.6-v. specify RCA-6883. For 26.5-v. specify RCA-6159.



### RCA-6161 POWER TRIODE

400 watts CW input to 900 Mc  
250 watts CW input to 2000 Mc

### POWER TUBE ANSWER BOOK

RCA Transmitting Tube Manual TT-4  
(Types up to 4 Kw Plate Input)

256 fact-filled pages covering 108 power tube types and 13 rectifiers. Includes theory, data, installation, application, and circuits.

See coupon below.



### 1 MEGAWATT INPUT TO 75 MC!

New RCA-6949 Super Power Triode

RCA-6949 is a water-cooled, shielded-grid beam triode capable of generating useful continuous rf power in the order of 500,000 watts — with high efficiency and exceptionally low driving power. It can be used as a class C rf power amplifier (modulated or unmodulated), and as a linear rf power amplifier in single-sideband service. It can provide the rf power needed for nuclear particle accelerators.

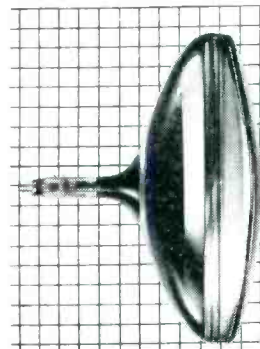

1 square = 1 inch

### DESIGN SLIMMER TV SETS WITH NEW RCA-17BZP4 110° TUBE

- Only 12-9/16" long
- No Ion-Trap Magnet Needed
- Super-Aluminized
- Weighs Only 10 lbs.

Designed specifically for large-screen TV sets in slimmer, lighter-weight cabinets, this 17"-type rectangular glass picture tube is actually 3" shorter than types having the same size faceplate and 90° deflection. "Straight-type" gun has improved focus and eliminates the need for an ion-trap magnet.

### NEW AF TRANSISTOR PROVIDES HIGH POWER GAIN AT LOW DISTORTION AND WITH HIGH EFFICIENCY



RCA-2N270 ... an hermetically sealed, alloy-junction transistor of the germanium p-n-p type ... is designed especially for use in large-signal audio-frequency circuit applications in home-entertainment radio sets, phonographs, and battery-operated communications equipment. In class A service, one RCA-2N270 can deliver a maximum-signal power output of approximately 60 milliwatts with a power gain of 35 db. In push-pull class B service, two 2N270's can deliver a maximum-signal power output of approximately 500 milliwatts with a power gain of 32 db. Low collector saturation current permits design of af amplifiers which can operate under varying ambient temperature conditions and, at the same time, provides both high efficiency and a high degree of operating stability. Current transfer ratio of 2N270 is nearly constant over the full range of the output-signal swing, even when the peak output-signal current reaches the peak collector current rating. This feature minimizes distortion at high power outputs when low supply voltages are used.

Do you want an RCA TT-4 Manual...or more technical data on items listed below? Just check the item in the coupon and mail to:

RCA, Commercial Engineering  
Sect. D19R1, Harrison, N. J.

- TT-4 (please enclose check or money order for \$1.00)
- RIT-104 Booklet on RCA Receiving-Type Tubes for Industry
- RCA-6949\*
- RCA-2N270
- RCA-17BZP4
- RCA-6146, 6159, 6883
- RCA-6161

\*Bulletin in preparation

Name .....

Title .....

Firm .....

Address .....



## RADIO CORPORATION of AMERICA

Tube Division, Harrison, N. J.

Semiconductor Division, Somerville, N. J.

# TOUGH THERMOSTATS SAY "RELAYS FOR SISSIES"

## Snap-Action Thermostat Units Boss Big Loads Without 'Em

### "Relays? Who needs 'em?"

ASHLAND, MASS. — If you want to control good-size electrical loads with a precision thermostat, and you don't want to bother with relays, Fenwal has just the thing.

Fenwal has two series of snap-action Thermostat® units, more than twelve models, all based on the same idea — and they don't need relays.

The idea is this:

A liquid responds to temperature changes by expanding or contracting, and moves a bellows assembly. The bellows assembly works a snap-switch with a push-rod, making or breaking a circuit.

This arrangement will let you control electrical loads up to 20 amps, 115-250 volts A.C., or 10 amps, 125 volts, D.C., without relays, and with a high degree of accuracy.

Fenwal's two series of these remarkable units are called the 20000 and the 22000. The first has only one snap-switch, and the second has two. Two snap-switches and one unit, of course, give you compact control for two-stage heating or cooling.

As for adjusting temperatures — your own men can do it simply in the field. An easy-to-get-at set screw on each switch does the trick. On the double switch models, each switch is set independently.

As for accuracy and speed of response — the units control to within  $\pm 2^\circ$  F.

As for cost — Fenwal has designed both series of snap-action THERMOSWITCH controls along "building block" lines to save you money. That is, Fenwal can assemble specialized units for you from a selection of standardized temperature ranges, head types, "application-rated" snap-switches, and mounting styles.

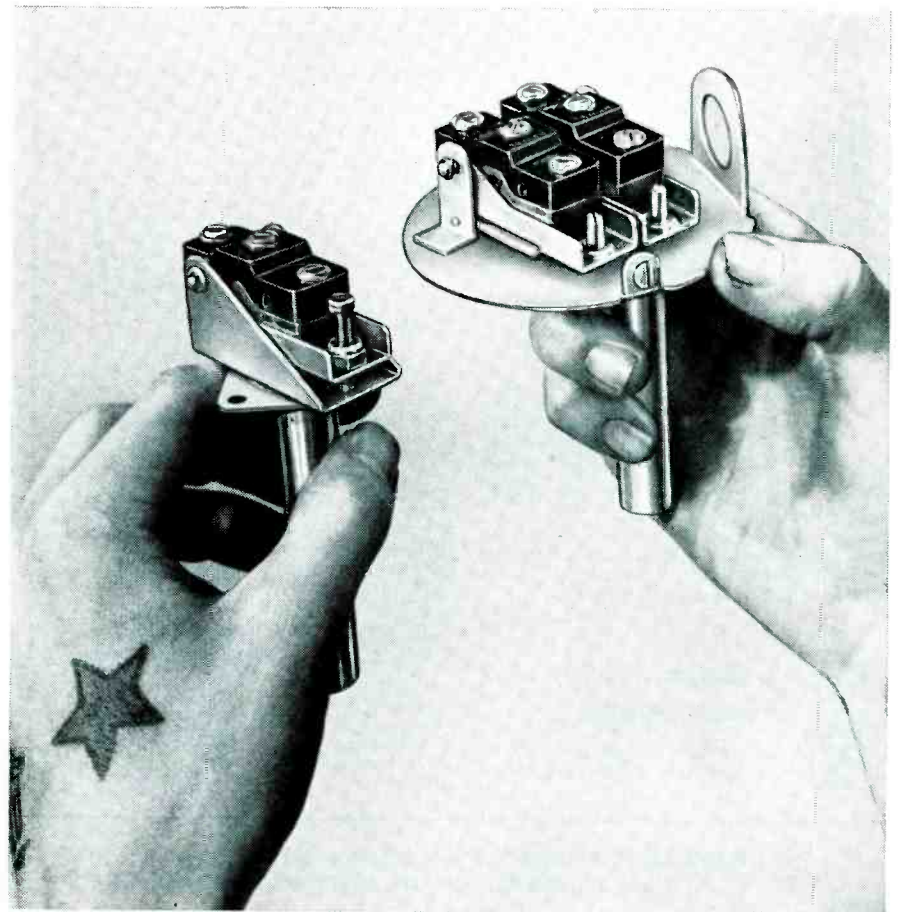

THESE TWO FENWAL SNAP-ACTION THERMOSWITCH UNITS — control loads up to 20 amps, 115-250 volts A.C., or 10 amps, 125 volts D.C. — without relays. These are only two of the twelve models available from Fenwal's Series 20000 (one-switch) and Series 22000 (two-switch) snap-action units.

The temperature ranges you can choose extend from  $-75^\circ\text{F.}$  to  $+300^\circ\text{F.}$

If you choose these controls for your application, you will not be choosing an untried product. You will be joining a large group of satisfied users who have put them to work in such varied equipment as air conditioners, hot-drink vending machines, laundry equipment, and dishwashers.

Designers — write for details on the Fenwal Series 20000 and 22000

snap-action THERMOSWITCH units. You will want those details at your fingertips. Write to **Fenwal Incorporated, 204 Pleasant Street, Ashland, Massachusetts.**



**CONTROLS TEMPERATURE  
...PRECISELY**



# Tuning Fork Controlled

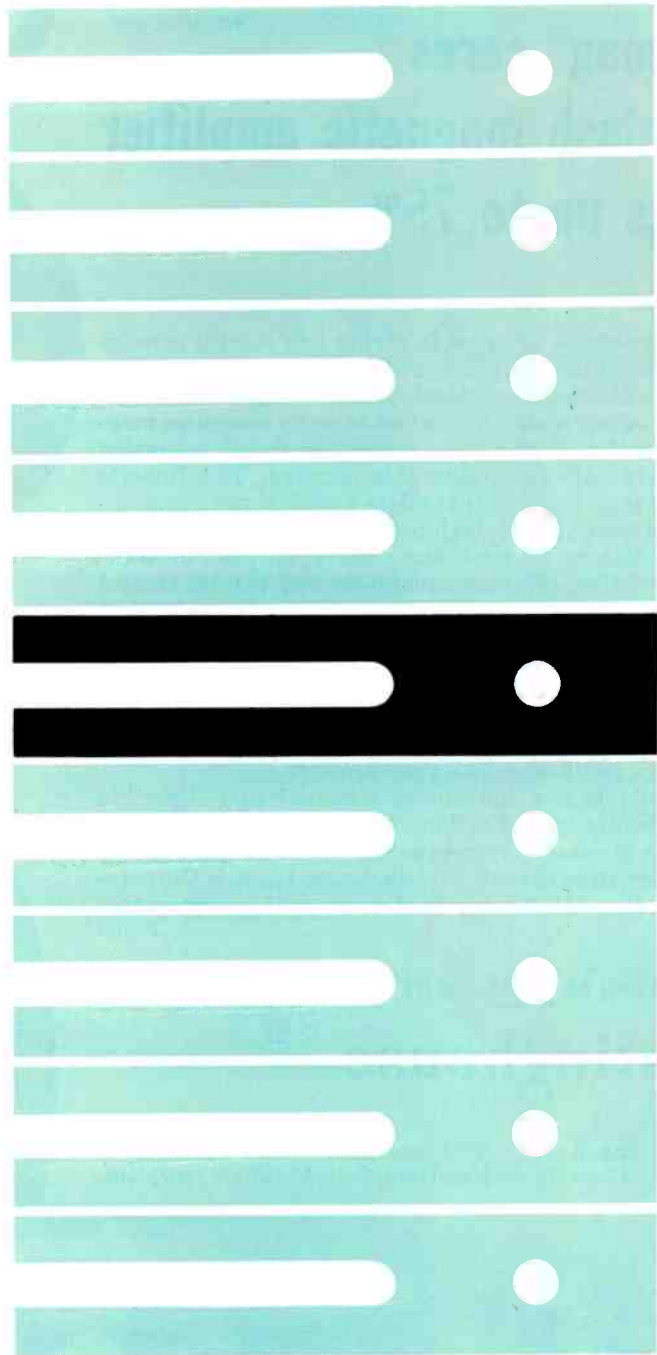

Tuning Fork Resonators, the ultimate in precision audio frequency control.

**PHONE OR WRITE**

for complete information regarding component type Tuning Fork Resonators, and variously packaged Frequency Standards, Oscillators, Drivers, and Frequency Dividers.

**PHILAMON LABORATORIES INC.**

90 Hopper Street, Westbury, Long Island, N. Y. EDgewood 3-1700

*You can now get...*

## **Hipermag\* cores that slash magnetic amplifier rejects up to 75%**

The greatest single advance in giving you reactor cores of such proved reliability is the new Roberts Dynamic Test—an exclusive Westinghouse development. Using the constant-current flux-reset method, this test literally measures magnetic properties of the core under simulated operating conditions in half-wave, saturable reactors. The Roberts Test is the only method that offers practical performance-matched cores required for high-precision magnetic amplifiers.

You get data on (1) peak flux density, (2) peak differential permeability, (3) loop squareness and (4) d-c control magnetizing force at four points on the dynamic B-H curve. Test values can be used directly as constants in amplifier design.

The Roberts Test actually eliminates core testing and matching in your plant—performance is now predictable. Westinghouse cores assure you, as never before, of the performance you design into your product.

Also available is a full line of Hipersil® and Hiperthin cores for electronic applications.

Call your Westinghouse representative or write, Specialty Transformer Department, Westinghouse Electric Corporation, P. O. Box 231, Greenville, Pa.

\*Trade-Mark  
J-70796

**YOU CAN BE SURE...IF IT'S**

# **Westinghouse**



Production line Roberts Test and performance matching at Westinghouse eliminate costly and complicated testing at your plant.

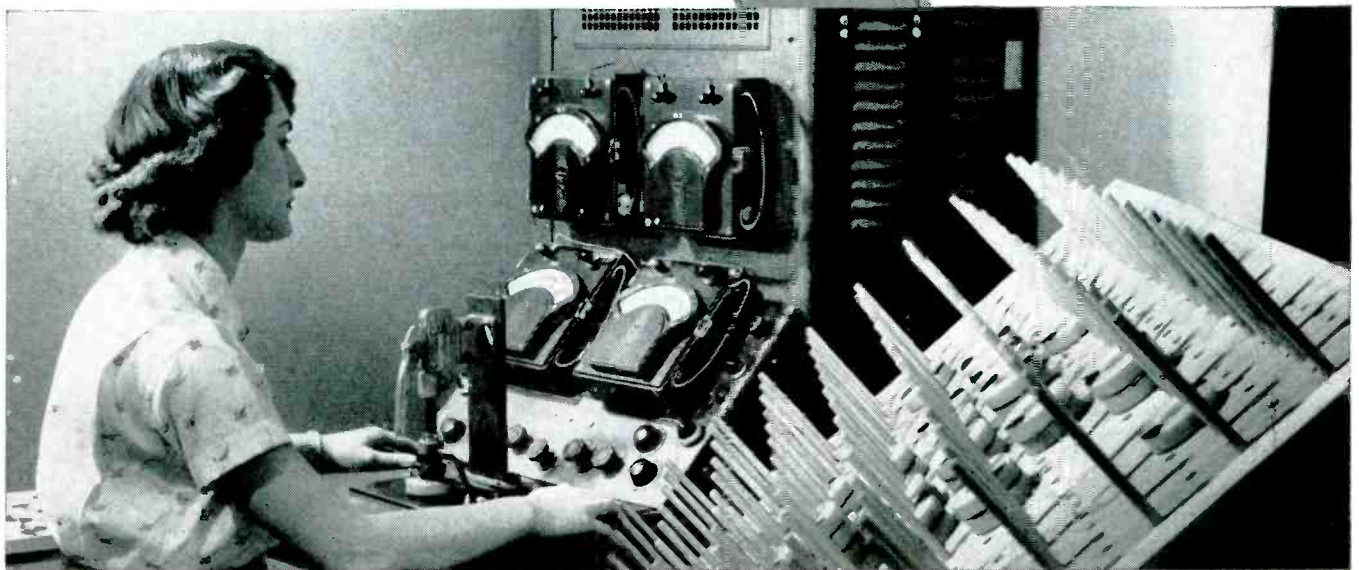



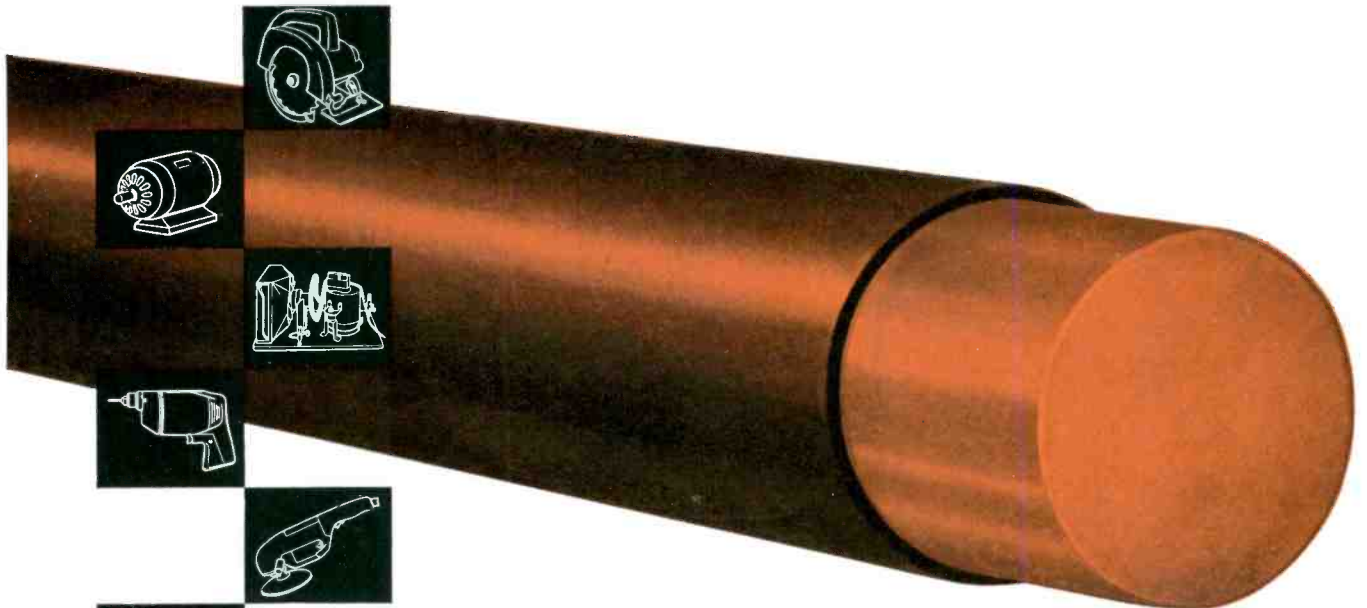

# LECTALITE

## Newest AUTO-LITE Enameled Magnet Wire

LectALite Magnet Wire has been tested in accordance with AIEE 57 and MIL-W-19583 thermal aging test and found to be acceptable for Class B applications. LectALite is available in copper, aluminum, steel or silver. Ideal for small electric motors, transformers, and TV yoke coils. Extreme resistance to Freon 12 and 22 and low extractables make it outstanding for hermetic refrigeration motors.

LectALite opens new magnet wire fields throughout the electrical industry.

LectALite Wire is protected with insulation which offers more heat resistance, higher thermoplastic flow, higher dielectric strength, greater flexibility and lower extractables than vinyl acetal insulation—with no increase in cost! Now available in sizes from 13 AWG through 30 AWG.

Tests indicate LectALite Wire is superior for use in hermetic refrigeration motors due to its outstanding Freon 12 and 22 resistance plus low extractables. LectALite Wire insulation has been found to have 30°C. margin over vinyl acetal insulation by test

performed under AIEE N. 57, Oct., 1955, "Proposed Test Procedure for Evaluation of the Thermal Stability of Enameled Wires" and MIL-W-19583 (NAVY) "Military Specification Wire, Electrical, Magnet, High Temperature, Film Insulated," July 15, 1955. Impregnation of LectALite wound coils can be done by any phenolic-alkyd type or suitable temperature rated impregnation varnishes.

The Auto-Lite Magnet Wire line is complete in classes O, A, B, and H to meet your design requirements. Fill out coupon and mail for further information.

### QUICK DELIVERY FROM THESE PLANTS AND WAREHOUSES

- Port Huron, Michigan, YUkon 5-6131
- Yonkers, New York, Murray Hill 9-1842
- Hazleton, Pennsylvania, GLadstone 5-4781
- Chicago, Illinois, WEBster 9-3144
- Cincinnati, Ohio, POplar 1-3600

The Auto-Lite Engineering Staff is always ready to help you with any wiring problem. Please contact us directly or by mail for assistance.

# AUTO-LITE®

Wire and Cable DIVISION

THE ELECTRIC AUTO-LITE COMPANY  
PORT HURON, MICHIGAN • HAZLETON, PENNSYLVANIA

#### SEND FOR FOLDER

The Electric Auto-Lite Company  
Wire and Cable Division  
Port Huron, Michigan

E

Please send me Auto-Lite folder on complete line of magnet wire products.

NAME \_\_\_\_\_

COMPANY \_\_\_\_\_

ADDRESS \_\_\_\_\_

CITY \_\_\_\_\_ ZONE \_\_\_\_\_ STATE \_\_\_\_\_

# new

**BACK-MOUNTING TEST JACKS**  
permit bench soldering to wiring  
harness before mounting.

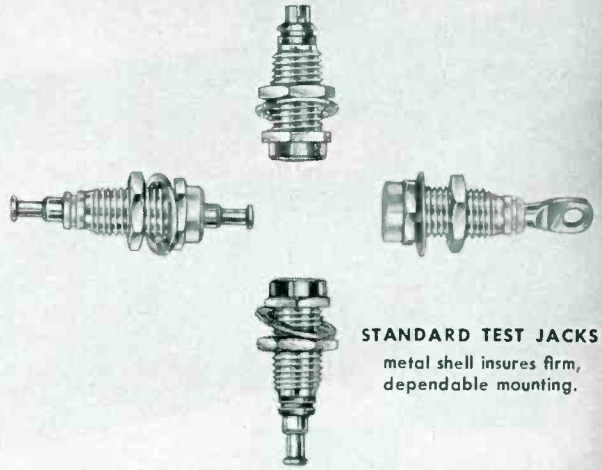
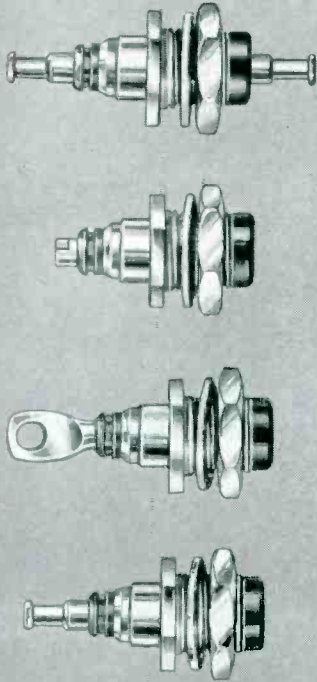

**STANDARD TEST JACKS**  
metal shell insures firm,  
dependable mounting.

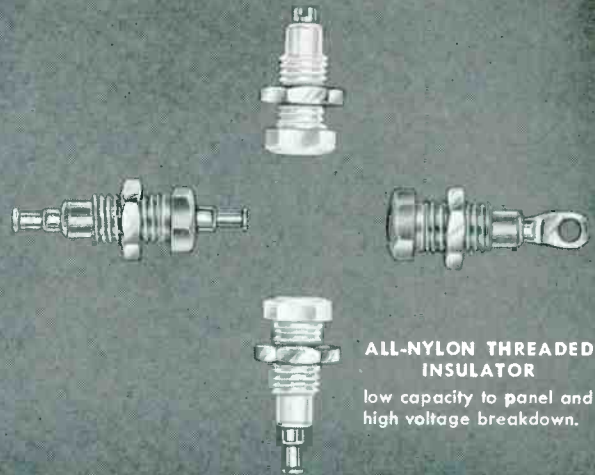

**ALL-NYLON THREADED  
INSULATOR**  
low capacity to panel and  
high voltage breakdown.

## Test Jacks by Ucinite

The introduction of Ucinite's back-mounting jacks makes available for the first time a *complete* line of *high quality* test jacks suitable for use in equipment where long life and dependability are essential.

Ucinite Test Jacks, designed for standard .080 phone tips, are available in a variety of colors ideally suited to coded application. Silver-plated, heat treated beryllium copper contact is made in one piece with large terminal ends for easy solder-

ing. The feed through type is provided with a one-piece brass terminal stud, tin-plated.

The specialized abilities and experience of Ucinite's own staff of design engineers are available for work on new and unusual problems. Volume production facilities ensure fulfillment of the largest requirements.

For full information, call your nearest Ucinite or United-Carr representative or write directly to us.



**The  
UCINITE CO.**

Newtonville 60, Mass.

Division of United-Carr Fastener Corp.

**Specialists in Electrical Assemblies,  
Radio and Automotive**



Improves your product.

Lowers your costs...

**ALSiMAG<sup>®</sup>**  
die pressed  
ceramics

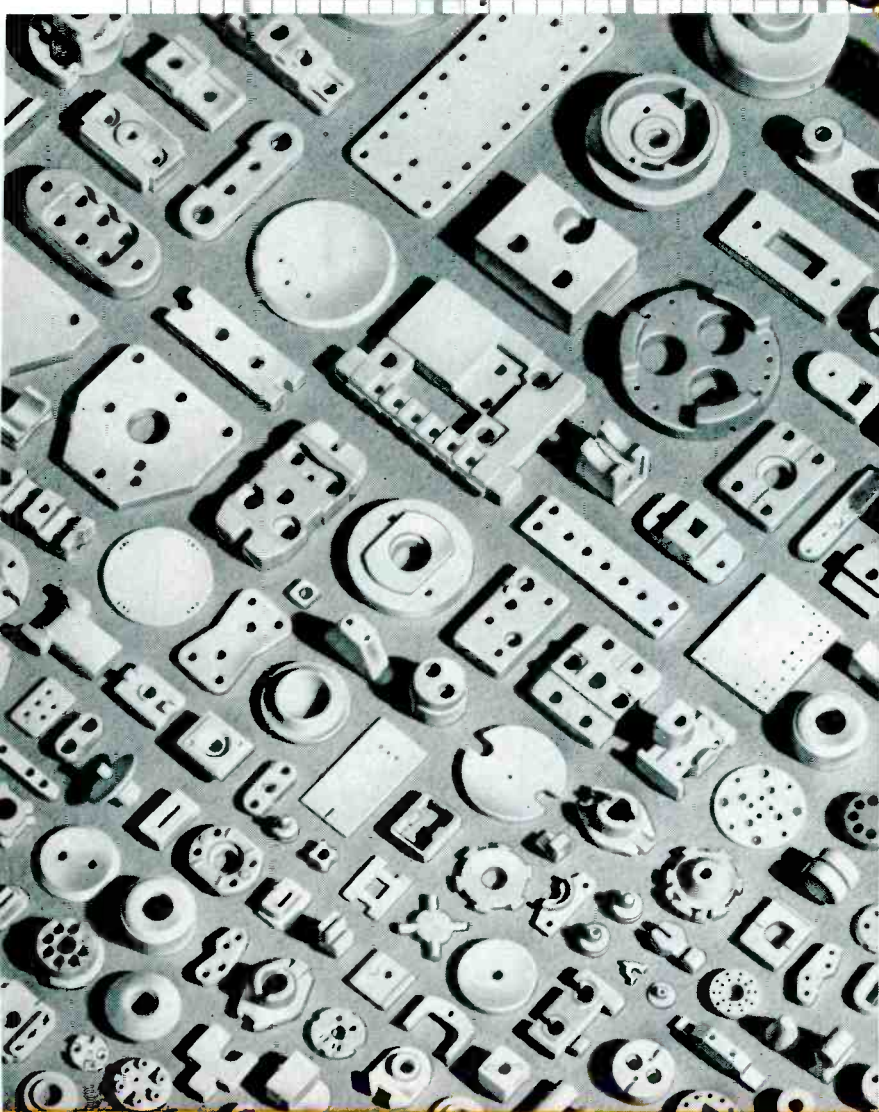

If you need a strong, low cost component . . . custom made for your application . . . with superior electrical characteristics . . . great thermal shock resistance . . . produced to close dimensional tolerances . . . available in volume . . . it will pay you to investigate the "plus" values of ALSiMag pressed ceramics.

Most complete choice of special characteristic materials in the industry, including new and rugged ALSiMag Alumina "super ceramics." Wide latitude in design. Strict Quality Control. Dependable uniformity. Fast deliveries. Batteries of high speed presses. Complete equipment for the most efficient and economical production of parts to specification in any quantity. Ample facilities for volume raw material preparation, firing and machining.

Prototype service available. Check performance under actual operating conditions **before** placing orders for tooling, quantity lots.

Send sketch with detailed specifications for prices and suggestions from our highly specialized Engineering Department on material and design. No obligation.

A Subsidiary of  
Minnesota Mining and  
Manufacturing Company



**AMERICAN LAVA  
CORPORATION**

**CHATTANOOGA 5, TENN.**  
55TH YEAR OF CERAMIC LEADERSHIP

For service, contact Minnesota Mining & Manufacturing Co. Offices in these cities (see your local telephone directory): Atlanta, Ga. • Boston: Newton Center, Mass. • Buffalo, N. Y. • Chicago, Ill. • Cincinnati, O. • Cleveland, O. • Dallas, Texas • Detroit, Mich. • High Point, N. C. • Los Angeles, Calif. • New York: Ridgefield, N. J. • Philadelphia, Pa. • Pittsburgh, Pa. • St. Louis, Mo. • St. Paul, Minn. • So. San Francisco, Calif. • Seattle, Wash. Canada: Minnesota Mining & Manufacturing of Canada, Ltd., P. O. Box 757, London, Ont. All other export: Minnesota Mining & Manufacturing Co., International Division, 99 Park Ave., New York, N. Y.

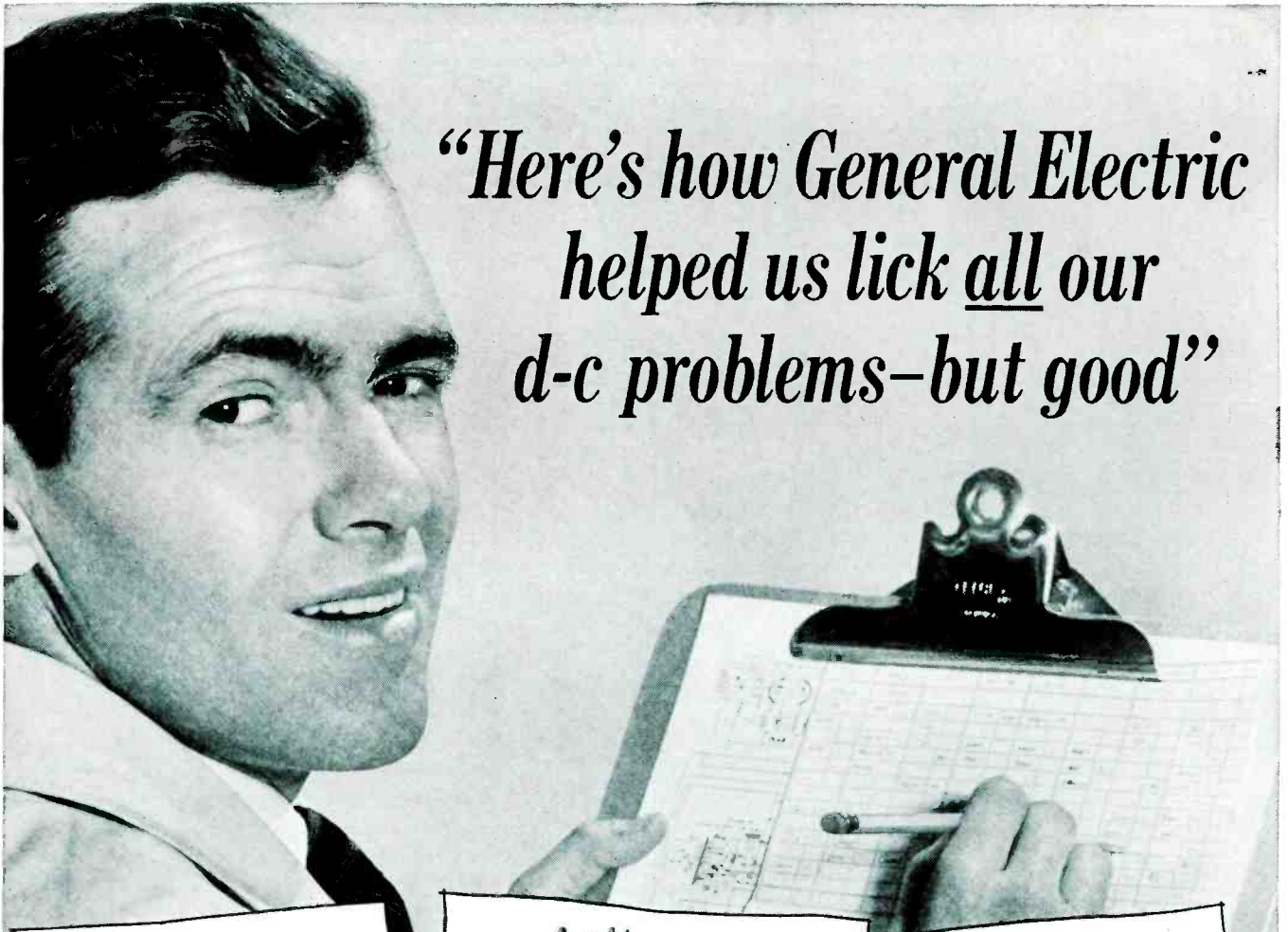

*“Here’s how General Electric helped us lick all our d-c problems—but good”*

**AXIAL LEAD MODELS.** The most adaptable type of Silicon Rectifier. Small, lightweight, taking ambients up to 165°C, they work anywhere, in any position. Their versatile lead mounting facilitates their use in all kinds of installations.

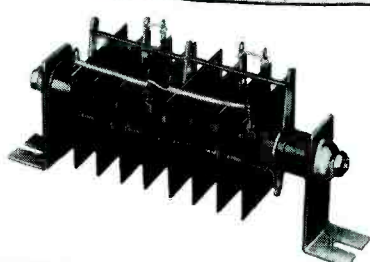

**STACK MODELS.** Assembled from Axial Lead cells mounted in fins, Stacks work singly or in groups to supply almost any power output. Each Stack is mounted with just two screws.



**STUD-MOUNTED MODELS.** Screw into the chassis, using it for heat removal to permit safe performance at higher currents and temperatures. Basically, the same design as Axial Lead models.

**“G-E SILICON Low Current RECTIFIERS cover the field from ¼ amp up to 18 amps† ... really stay on the job ... and the price doesn’t hurt”**

Every engineer who works with d-c power supplies for assemblies or components of moderate current demand finds a valuable source in the General Electric rectifier line. G-E Silicon Rectifiers—whether the Axial Lead or the Stud Mounting models in single cells, or in Stack assemblies with their remarkable range of current and voltage ratings—are part of our extensive range of

rectifier or other semiconductor devices.

The table on output and performance figures only suggests the range of specifications available. For further data, or exact information on rectifiers for your specific needs, call your General Electric Semiconductor representative. Or write *General Electric Company, Semiconductor Products, Section S2547, Electronics Park, Syracuse, N. Y.*



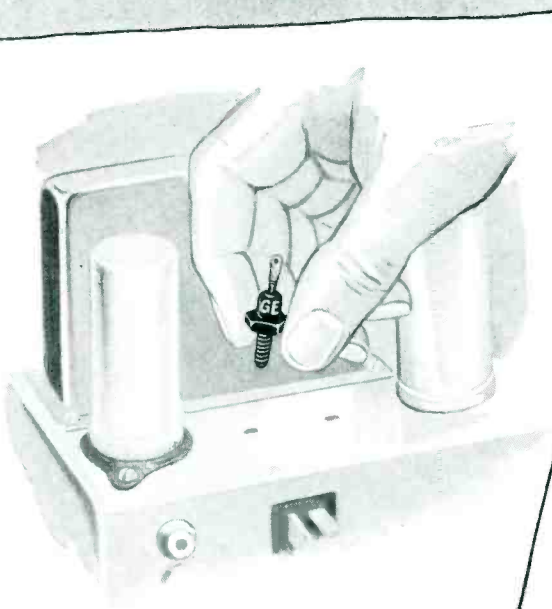

**STUD RECTIFIERS.** Fit them in wherever you need maximum current and temperature in minimum space with rigid chassis mounting.

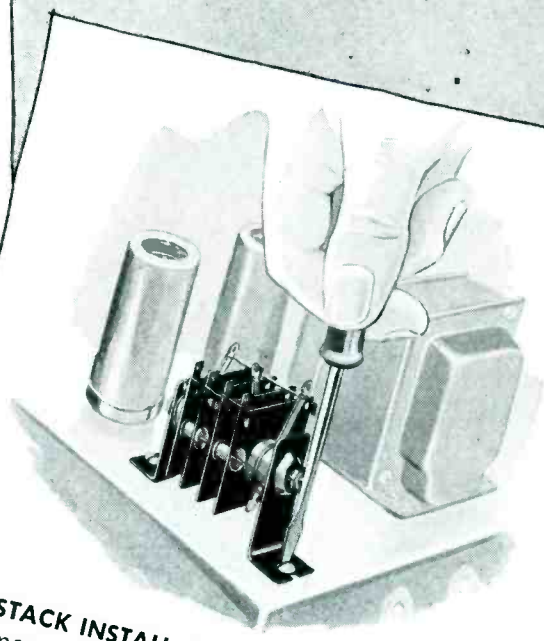

**STACK INSTALLATION.** A typical way of mounting General Electric Silicon Rectifier Stacks. Just two screws fasten the entire assembly in place.

**REPRESENTATIVE  
G-E SILICON RECTIFIER RATINGS**

PIV	STUD*	LEAD**	STACKS***
50		1N536	4JA411F Series
100	1N1115	1N537	4JA411A Series
200	1N1116	1N538	4JA411B Series
300	1N1117	1N539	4JA411C Series
400	1N1118	1N540	4JA411D Series

**NEW ... Following is now in production**

500 1N1095

\*Maximum Current— 600 ma @ 150°C Case Temperature  
1500 ma @ 85°C Case Temperature

\*\*Maximum Current— 250 ma @ 150°C Ambient Temperature  
750 ma @ 50°C Ambient Temperature

\*\*\*Maximum Current— 1/2 amp per fin @ 150°C Ambient Temp.  
1 1/2 amp per fin @ 85°C Ambient Temp.

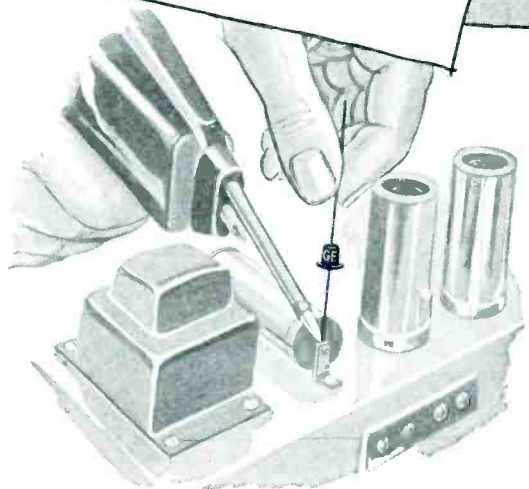

**AXIAL LEAD MOUNTED.** See the versatility of G-E Axial Lead models. They're easy to mount anywhere you need low current silicon rectifiers.

†For higher currents, G-E High Current Rectifiers may be used, or Stacks may be used in parallel.

*Progress Is Our Most Important Product*

**GENERAL  ELECTRIC**



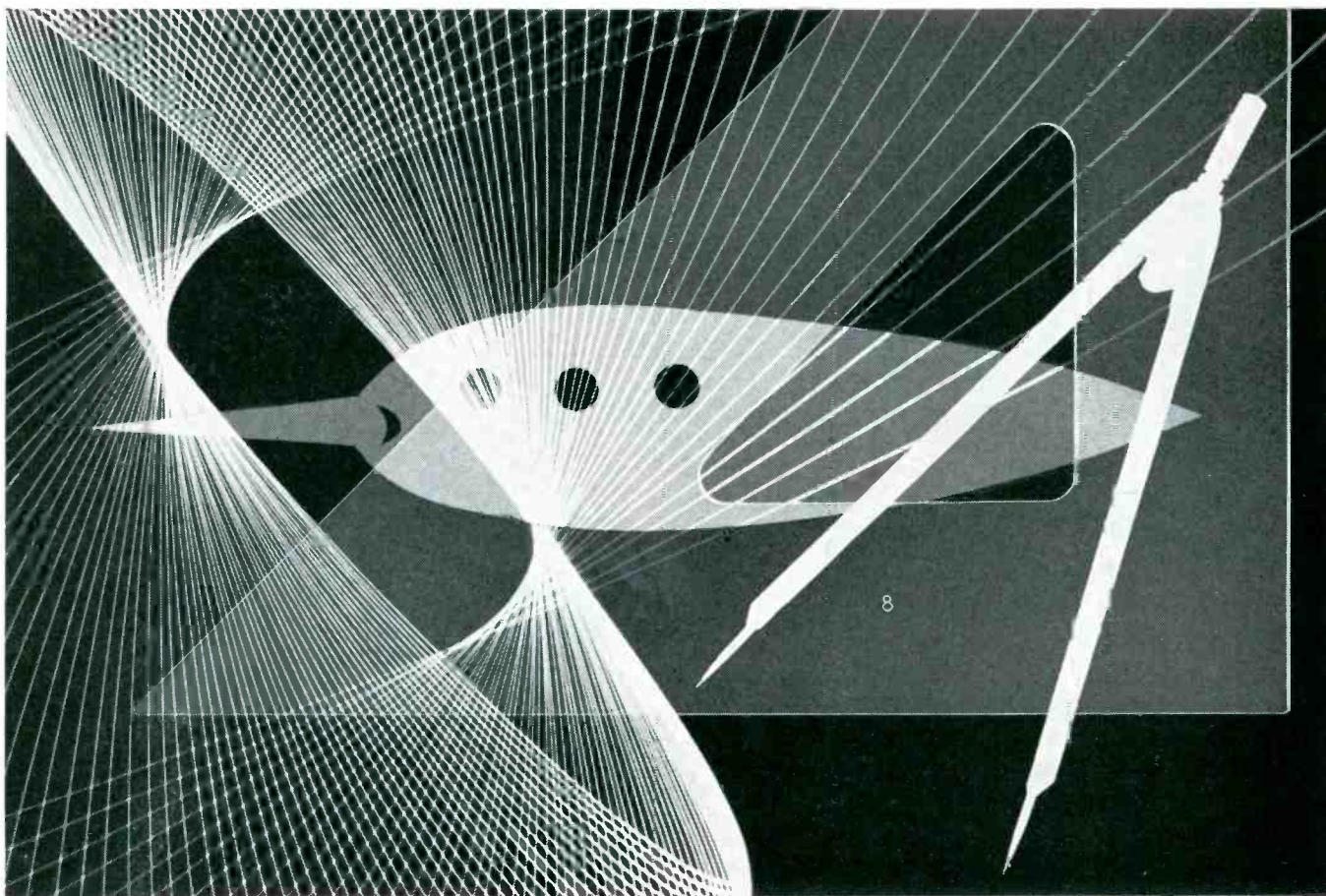

## *Creative Engineers:*

# Work where the breakthroughs are being made in every major field of Electro-Mechanics

As a creative engineer, you belong at the front-line of your field . . . where tomorrow's scientific battles are being won . . . where you can help win them.

For more than a decade, AUTONETICS has been at the forefront of electro-mechanical technology . . . building up the unique stockpile of experience and developing the advanced techniques and tools that can make your professional victories possible at AUTONETICS today.

Just a few specific results of AUTONETICS' pioneering are: the MG-4 Fire Control System for NATO's F-86K Sabre Jet; Flight Control elements for the F-100 Super Sabre; *Numill*, a new magnetic-tape controlled machine-tool system capable of performing complex milling and drilling operations automatically; *Recomp I*, a new portable, high-speed, completely transistorized digital computer; and inertial guidance systems for both airplanes and missiles.

Today, our programs are gathering speed, broadening scope. New engineering methods have been developed to cut lead time. System and component evaluation is being accelerated with automatic checkout equipment. Packaging is being designed and systems micro-minaturized to fit the cramped confines of sleek missiles and jets.

**YOUR OPPORTUNITY EXISTS AT EVERY LEVEL** of creative engineering from Preliminary to Performance Test—because Autonetics is one of the few companies in the world that can design and quantity-produce complete automatic control systems for both the military and industry.

**LET US KNOW** what kind of creative engineering interests you (please include highlights of your education and experience). Write today to: Mr. A. N. Benning, Administrative and Professional Personnel, Dpt. 358-EL-4, AUTONETICS, 9150 E. Imperial Highway, Downey, California.



Assistant Chief Engineer Norman F. Parker joined Autonetics in 1948 after receiving his DSc from the Carnegie Institute of Technology. Dr. Parker has been recognized nationally for his work in Inertial Navigation, and was chosen recently to present a paper on that subject at a NATO conference in Italy.



Jack Wirtkopf was Associate Professor of Electrical Engineering at Oregon State for 6 years before he joined Autonetics in 1951. Now Group Leader in computers and electronics, Jack lives with his wife and four children in Autonetics' home town of Downey, California, where his spare time activities include photography and ham radio.

**Autonetics**   
A Division of North American Aviation, Inc.

AUTOMATIC CONTROLS MAN HAS NEVER BUILT BEFORE



when Manhattan Island  
looks like this...

one relay can be mighty important...

Yes, the higher and faster aircraft and missiles fly, the more you need the kind of dependability LEACH is famous for. One "special" relay, fitting comfortably in the palm of your hand, can mean the difference between a successful mission and a lost plane.

The unique problems brought about by higher and faster flight can only be solved by special devices designed around their solution . . . *system designed*. And that's where Leach Relay has earned its industry-leading reputation; we invite the design challenges that others avoid . . . *build rather than avoid the "difficult" relays*. Here, for example, are three serious aircraft problems and the Leach Relays (each a complete, hermetically sealed control package) that solved them . . .



**ON THE GROUND** . . . incorrectly phased ground power could cause serious equipment damage.

**LEACH'S ANSWER** . . . 9243 Phase-Sequence Relay, which includes a 3-phase stall torque motor and control switches. Unless the predetermined phase sequence is applied at normal voltage, the relay will not allow the main contactor to close.



**IN THE AIR** . . . relays must operate from low-level indicators (thermocouples, subminiature tubes, small slip rings) and shock resistance is vital.

**LEACH'S ANSWER** . . . 9281, a combination of relay and magnetic amplifier, is sensitive to 250 microwatts, is immune to shocks as great as 50 g. In addition it is compact and light.



**ON COURSE** . . . gyro compasses drift if voltage input drops, but the back EMF they generate holds normal relays closed for 15-30 minutes.

**LEACH'S ANSWER** . . . 9267, Close-Differential Relay, a combination of magnetic amplifier, rectifier, and relay which warns the pilot of a drop in voltage. It is not affected by shock or vibration.

**LEACH**

**CORPORATION**

**LEACH RELAY DIVISION**

5915 AVALON BOULEVARD • LOS ANGELES 3, CALIFORNIA

DISTRICT OFFICES AND REPRESENTATIVES IN PRINCIPAL CITIES OF U. S. AND CANADA

with new simplicity and

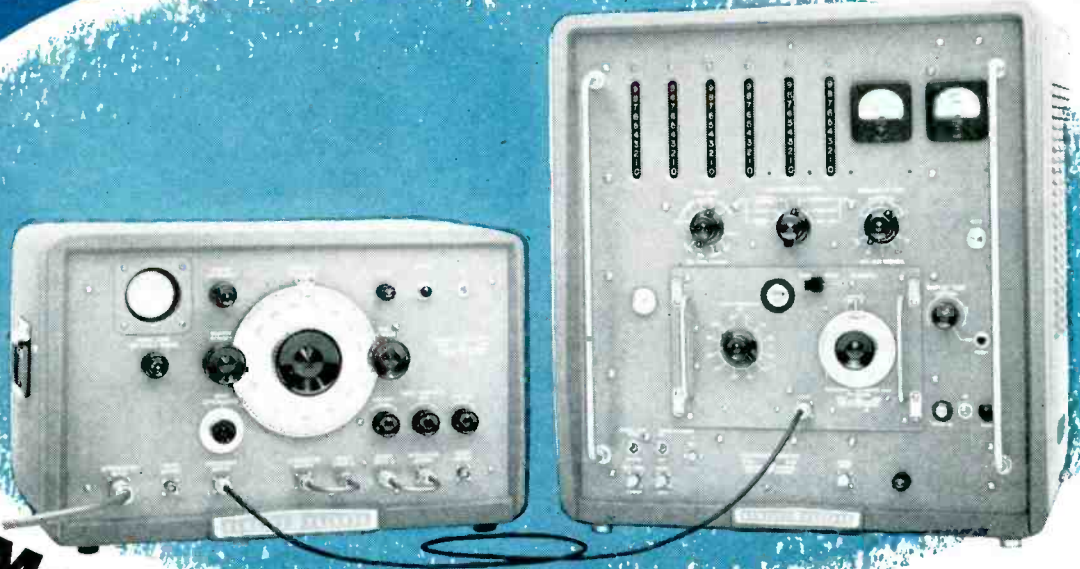

**Measure frequency to 12 KMC on pulsed AM, FM, CW and noisy circuits!**

**Fast, simple, extremely accurate**

**Eliminates guess-work, "trial-and-error"**

**Eliminates expensive, complex setups**

**Includes self-contained oscilloscope**

Two compact, portable *-hp-* instruments permit you to measure unknown frequency from zero to 12 KMC with revolutionary convenience and *electronic counter accuracy!*

Hewlett-Packard 540A Transfer Oscillator and 524B Electronic Counter (524B plus proper plug-ins, oscilloscope or detectors) are the only instruments required. Complex instrument arrangements and tedious trial-and-error "guesstimates" are eliminated.

Model 540A contains a highly stable, 100 to 220 MC oscillator generating harmonics to 12 KMC. These harmonics are provided for comparison with the unknown. The comparison device is a diode mixer, amplifier and built-in oscilloscope. In conjunction with *-hp-* 524B, the 540A extends the 524B's range to 12 KMC with no loss of accuracy or convenience.

#### Simple Measuring Procedure

To measure, with approximate signal frequency known, *-hp-* 540A is tuned until one of its harmonics zero

beats with the unknown. The multiplying factor is noted, and the 540A's frequency measured directly on the 524B. This 524B reading, times the multiplying factor, is the frequency of the unknown.

When the signal frequency is totally unknown, a simple calculation employing two or more harmonics determines the proper multiplying factor. Frequency of the unknown is then determined as before.

#### Pulsed Carrier Frequency

In measuring carrier frequency of pulsed signals, an external oscilloscope is used to display the detected pulse. Zero beat appears as horizontal lines across pulses when the oscillator is tuned to an exact sub-multiple. Video amplifier frequency response controls can be used to simplify this procedure.\*

In working with noisy or AM signals, the *-hp-* 540A response can be narrowed to obtain more accurate indication of zero beat.\*

In signals with appreciable FM, the 540A's oscilloscope presents a characteristic pattern pin-pointing upper and lower frequency deviation limits. If FM deviation is present, center frequency may also be determined.\*

#### 1/1,000,000 Accuracy

The 540A-524B system's accuracy approaches one part per million for stable CW signals. On pulsed signals,



**Precision accuracy, utmost value;**



# electronic counter accuracy

accuracy is governed by carrier frequency and pulse lengths. On noisy or intense AM signals, the transfer oscillator system with -hp- 540A often provides the only means of accurate measurement. Over-all system accuracy is better than 10 times that of the best microwave wavemeters.

## Quality Features

Each of the circuit elements of -hp- 540A may be used separately by shifting front panel patch cords. Controls

are provided for coarse and fine tuning; there is also an electrical vernier with range approximating  $\pm 125$  parts per million. The video amplifier has both gain and bandwidth controls. Horizontal input to the internal oscilloscope is power line frequency with phase control. Input attenuation is variable from approximately 20 to 80 db to adjust signal level for optimum mixing level.

\*For complete details see your -hp- representative and write -hp- for Vol. 6, No. 12, Hewlett-Packard Journal

## SPECIFICATIONS

### -hp- 540A Transfer Oscillator

#### GENERAL:

**Frequency Range:** 10 MC to 5,000 MC. (10 MC to 12,000 MC or higher with external detector such as -hp- 440A)

**Input Signal:** CW, FM, AM or pulse

**Input Signal Level:** Varies with frequency and individual crystals. Minimum input signal approximately 0 dbm to attenuator. Maximum input 0.5 watt average (5 volts into 50 ohms)

#### OSCILLATOR:

**Fundamental Frequency Range:** 100 MC to 220 MC

**Harmonic Frequency Range:** Above 12,000 MC

**Stability:** Less than 0.002% change per minute after 30-minute warmup

**Dial:** Six inch diameter, calibrated in 1 MC increments. Accuracy:  $\pm 0.5\%$

**Output:** Approximately 2 v into 50 ohms

#### ATTENUATOR:

**Range:** Approximately 20 db to 80 db

**Input Impedance:** 50 ohms, SWR: 1.5 max. at 1 KMC; 3 max. at 5 KMC

#### AMPLIFIER:

**Gain:** Variable. Maximum 40 db or more

**Bandwidth:** Variable. High Frequency: 3 db point adjustable approximately 1 KC to 2 MC. Low Frequency: 3 db point switched from 100 cycles to below 10 KC. Adjustable to above 400 KC

**Output:** 1 volt rms maximum into 1,000 ohms

#### OSCILLOSCOPE (Self-Contained):

**Frequency Range:** 100 cps to 200 KC

**Vertical Deflection Sensitivity:** 5 mv rms per inch at mixer output

**Horizontal Sweep:** Internal, power supply frequency with phase control, or external (connection at rear) with 1 v per inch. Sensitivity, 20 cps to 5 KC

#### MISCELLANEOUS:

**Size:** Cabinet Mount: 20½" wide, 12½" high, 15¼" deep

**Power Supply:** 115/230 v  $\pm 10\%$ , 50/1,000 cps, approximately 110 watts

**Price:** -hp- \$615.00

### -hp- 524B Electronic Counter

#### FREQUENCY MEASUREMENT: (without plug-in units)

**Range:** 10 cps to 10 MC

**Gate Time:** 0.001, 0.01, 0.1, 1, 10 seconds or manual control

**Accuracy:**  $\pm 1$  count  $\pm$  stability

**Reads In:** Kilocycles. Automatic decimal.

#### PERIOD MEASUREMENT: (without plug-in units)

**Range:** 0 cps to 10 KC

**Gate Time:** 1 or 10 cycles of unknown

**Accuracy:**  $\pm 0.3\%$  (1 period)  $\pm 0.03\%$  (10 period average)

**Standard Frequency Counted:** 10 cps; 1 or 100 KC, 10 MC, or external

**Reads In:** Seconds, msec,  $\mu$ sec; automatic decimal

#### GENERAL:

**Registration:** 8 places, maximum count 99,999,999

**Stability:** 1/1,000,000 short term; 2/1,000,000 per week. May be standardized against WWV or external 100 KC primary standard

**Display Time:** Variable 0.1 to 10 seconds, or held indefinitely

**Price:** \$2,150.00

#### PLUG-IN UNITS:

-hp- 525A, converts for frequency measurement, 10 cps to 100 MC. Price \$250.00

-hp- 525B, converts for frequency measurement, 100 MC to 220 MC. Price \$250.00

-hp- 526A, converts for high sensitivity frequency measurement, 10 cps to 10 MC. Price \$150.00

-hp- 526B, converts for time interval measurement, 1  $\mu$ sec to 10<sup>7</sup> seconds. Price \$175.00

-hp- 526C, improves period measurement accuracy, 0 to 10 KC. Price \$225.00

*Data subject to change without notice.*

## HEWLETT-PACKARD COMPANY

4226A Page Mill Road • Palo Alto, California, U. S. A.

Cable "HEWPACK" Davenport 5-4451

Field representatives in all principal areas

# as always, time-saving convenience

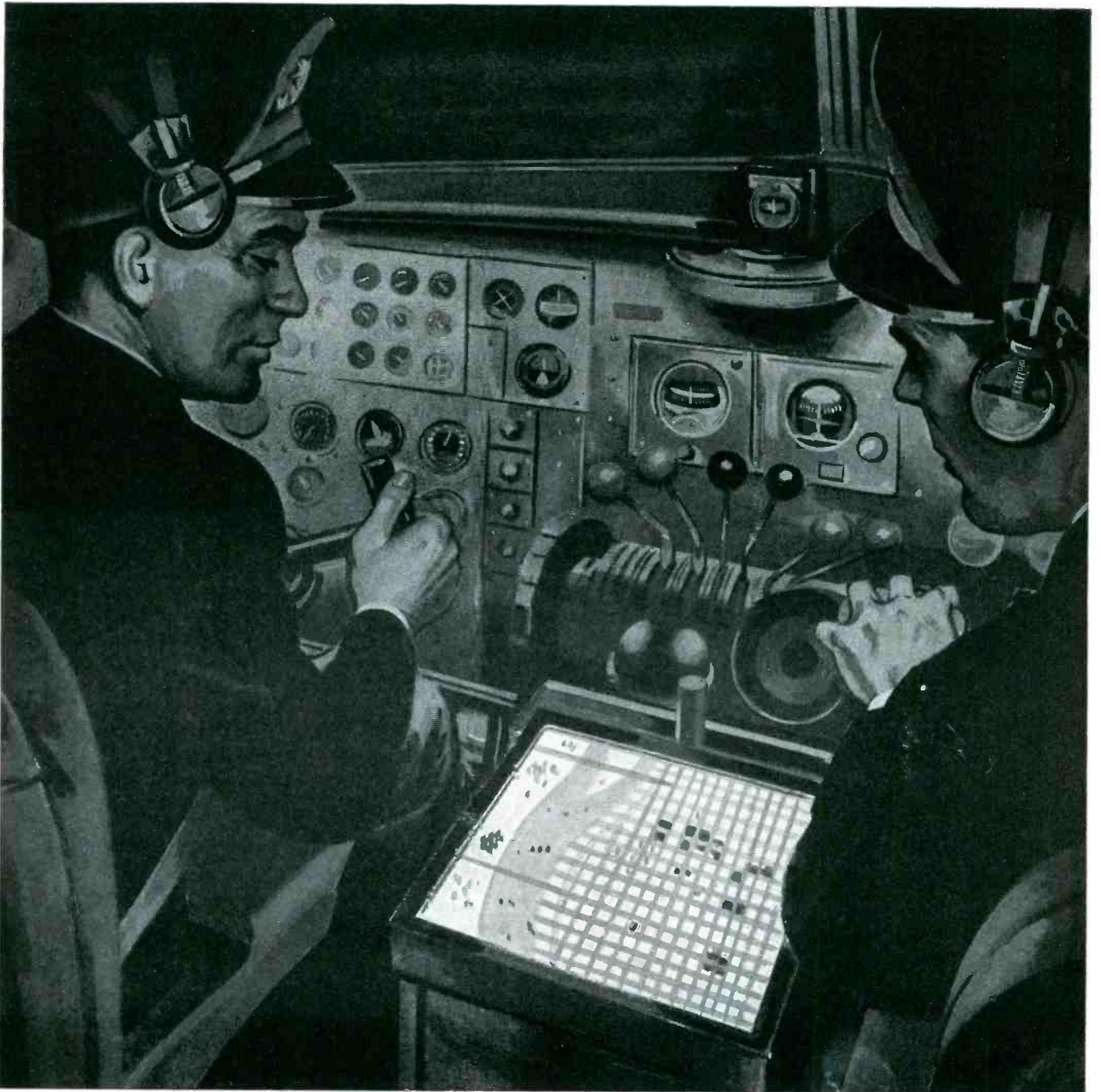

## Next—pilots will watch their own landings on TV!

Up from pitch-dark airfields come light signals invisible to the human eye . . . A new electronic "cat eye" in the cockpit amplifies these signals to produce daylight pictures of the ground on the pilot's television screen.

Thus, in blackout or encased in radiation-proof cockpits, tomorrow's pilots will guide their planes in to safe landings by this latest triumph of electronics.

Like the electronic age itself, the fabulous "cat eye" depends for its operation on the very best of electrical insulations—the kind CDF has been manufacturing for over sixty years.

**FOR SPECIFIC INFORMATION** on CDF products, see Sweet's, Electronics Buyers' Guide, and other direc-

tories. Then send us your print or your problem, and we'll return free samples and technical literature.

**CDF MAKES** Dilecto Laminated Plastics • Celoron Molded Plastics • Micabond Mica Products • Diamond Vulcanized Fibre • Flexible Tapes of Teflon\*, Silicone, and Micabond • Resin-Impregnated Spiral Tubing • *Complete Fabrication Facilities.*

\*duPont trademark for its tetrafluoroethylene resin



**CONTINENTAL-DIAMOND FIBRE**

A SUBSIDIARY OF THE BUDD COMPANY • NEWARK 16, DELAWARE



Industry-wide acceptance of super-durable E-I hermetically sealed terminals has made necessary further expansion of production facilities. The new plant in Murray Hill, New Jersey is one of the most modern in the electronics industry. New equipment, improved processes and larger capacity will make it possible to expand customer service on standard E-I terminals and custom seals.

Other E-I facilities will continue to serve the industry at Irvington-On-Hudson, New York. Complete research laboratory where technicians are constantly at work anticipating future design problems.

*for the Pioneer Producer of*

## COMPRESSION SEALS\*

Specify E-I for performance *plus* in commercial and military service:

Compression Seals	Threaded Seals
Multiple Headers	Transistor Closures
Sealed Terminals	Miniature Closures
Condenser End Seals	Color Coded Terminals

 **ELECTRICAL INDUSTRIES**

MURRAY HILL, NEW JERSEY

*A Division of Philips Electronics, Inc.*

## NOW—a new and expanded plant...



**E-I Single Lead Terminals and Multiple Headers**  
Super rugged, compression terminals available in standard types to meet practically any requirement. Custom designs to specifications.



**E-I Hermetically Sealed Plug-in Connectors**  
Keyed and gaged for use with RETMA octal type sockets. Available for vibrator, chopper, lock-in and noval sockets.



**E-I End Seals for Tubular Closures**  
Completely strain-free. Afford a permanent hermetical seal for condensers, resistors and other tubular-type components.



**E-I Transistor Closures, Custom Terminations**  
For transistors and other components requiring hermetic sealing. Available complete with closures or customer's parts sealed if required.

\*Canadian Pat. 523,390; British Pat. 734,583  
U.S. Patents Pending—All Rights Reserved

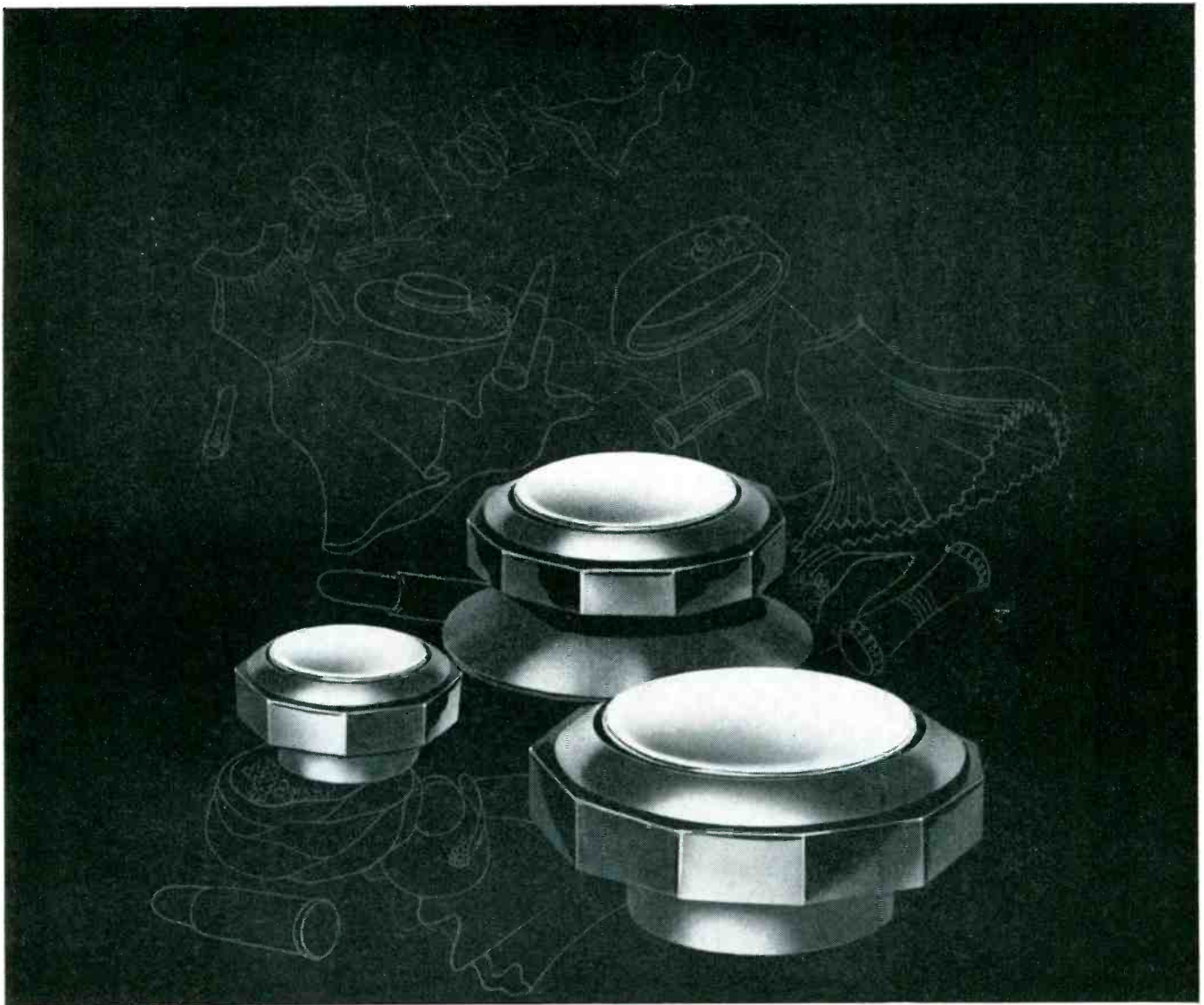

The CTC family of kollet knobs, taking, from left to right, a 1/8" shaft only, a 1/8" to 1/4" shaft, and a 1/4" shaft only.

## Three who'll dress to please you

CTC's family of kollet knobs is carefully made of prime materials, as are all CTC components. And they have this added feature, being in the open as they are: They're good-looking and adaptable.

Made of molded Tenite II in matte finish their metal face plates snap into place, completing the design and covering the kollet locking device. You have a choice of ten color inserts for instrument panel coding, and can have the knobs with or without skirts or indicating lines.

Reliability is the key characteristic of every component CTC makes. Every component is unconditionally guaranteed in quantities from one to millions. Other CTC components include coil forms, coils, terminal boards, terminals, diode clips, insulated terminals and hardware.

For sample specifications and prices, write now to Sales Engineering Dept.,

Cambridge Thermionic Corporation,  
437 Concord Ave., Cambridge 38,  
Mass. West Coast stocks maintained  
by E. V. Roberts Associates, Inc., 5068  
West Washington Blvd., Los Angeles  
16, and 61 Renato Court, Redwood  
City, California.

CTC Panel Hardware meets or betters government specifications. Typical quality hardware shown: oval handle, adjustable handle, folding handle, thumb screw, plug and jack, shaft lock. Other quality hardware includes battery clips, terminal boards, diode clips, dial locks. Variety of finishes available.

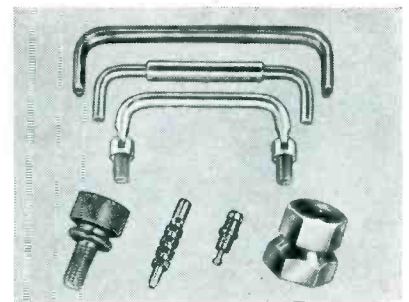

# CTC

CAMBRIDGE THERMIONIC CORPORATION

*makers of guaranteed electronic components  
custom or standard*





# How to record 420 channels of simultaneous data

## Boeing Airplane Company's flight tests demonstrate an easy way

Have you ever seen an oscillograph record that was eight and a half feet wide? At fifty channels per foot this is what it would take . . . which shows the decided advantages in the way the Boeing Airplane Company solves the problem. They put 420 channels of data onto a one-inch magnetic tape. Two hours of flight test can be recorded on one 10½-inch reel.

With FM carrier recording one channel of data occupies one track and provides high instantaneous amplitude accuracy. FM is particularly suitable for shock and vibration records.

When a recording containing a large number of channels of data is reproduced, another of magnetic tape's advantages becomes apparent. The data can be reproduced in electrical form. Consequently it is a relatively simple matter to unscramble the channels by automatic or semi-automatic means. Any combination of channels can be scanned, correlated and fed to computing devices. These fortunate faculties of magnetic tape help reduce the handling of vast amounts of data down to a task of wieldy size. For example in the Boeing flight tests already mentioned, all data is published within two

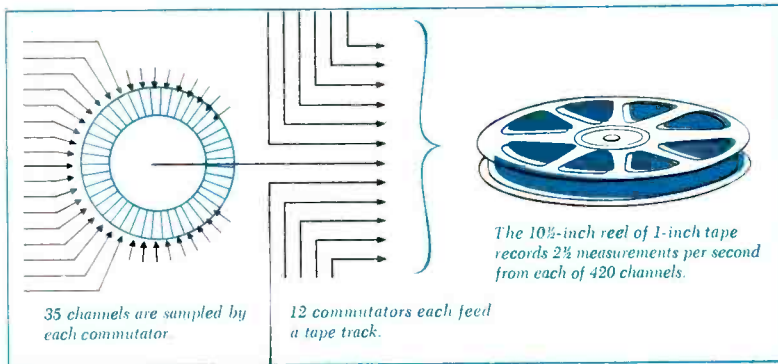

In a published article, Mr. Arthur T. Snyder of Boeing describes their system as a low level, low-speed, pulse-width-modulation technique. It time-multiplexes 35 channels of data onto each of 12 tracks (of 14) on an Ampex 814 Airborne Magnetic Recorder; ( $35 \times 12 = 420$ ). The system inputs are variable resistances, thermocouples, strain-gage bridges and other bridge-type transducers. Each is fed to a segment on one of twelve rotating commutators that sample every channel 2½ times per second. The Ampex 814 recorder running at 3¾ in/sec. records over 8-million measurements in two hours.

or three days after the test instead of from several weeks to several months later as by previous methods.



Boeing KC-135 tanker in flight.

This recording system used by Boeing is limited by choice to data that changes at a slow rate. This is by no means a fixed limitation. Certain Ampex recorders (Series 800, FR-100 and FR-1100) have interchangeable amplifiers. Each track can thus be used with any one of three types of recording according to frequency requirements:

With PWM recording (like the Boeing example) as many as 88 channels of low-frequency data can be put onto one track.

With direct recording up to 18 channels of RDB subcarrier data of varying frequency requirements can go onto one track — or very high-frequency data uses one track per channel.

If you have a specific problem involving large amounts of data or unusual combinations, Ampex's application engineers will be pleased to furnish further information. More of the capabilities of magnetic tape will be discussed in this continuing series of bulletins. Would you like to have copies mailed direct? If so, write Dept. E-3103



Series FR-100



Series 800 Mobile and Airborne



Model FR-200 Digital



Tape Loop Recorder



Series FR-1100

INSTRUMENTATION  
DIVISION

AMPEX  
CORPORATION

FIRST IN MAGNETIC TAPE INSTRUMENTATION

934 CHARTER STREET • REDWOOD CITY, CALIFORNIA

District offices serving all areas of the United States and Canada; Foreign Representatives in countries around the world.

# Volts— Microfarads and Miniaturization

.....for *Transistor Circuitry*



The daily progress of transistor usage is calling for smaller, yet better components. Mallory is proud of their continuous contribution to miniaturization—smaller components without sacrifice of reliability.

In the power supply field, Mallory is a pioneer in the development and production of mercury cells. Their techniques have made possible mass production at highest quality levels. The constant voltage discharge characteristic is ideally suited for transistor operation.

Mallory subminiature Silverlytic® capacitors offer high capacity in a minimum space. Types TAP and TAW are available in a broad range of capacities at several voltage ratings. The newest, a tantalum capacitor designated as type TNT, is only .145 inch in diameter by  $\frac{3}{8}$  inch long. It is available in five basic sizes ranging from 80 mfd at 3 volts to 8 mfd at 50 volts.

Mallory will be glad to consult with you on specific problems of miniaturization and transistor application components, or supply full technical data on battery, capacitor and other Mallory products. Write us, or contact the Mallory representative—today.

Serving Industry with These Products:

**Electromechanical** — Resistors • Switches • Tuning Devices • Vibrators  
**Electrochemical** — Capacitors • Mercury and Zinc-Carbon Batteries  
**Metallurgical** — Contacts • Special Metals • Welding Materials

**Expect more . . . get more from**

**P. R. MALLORY & CO. Inc.**  
**MALLORY**

**P. R. MALLORY & CO., Inc., INDIANAPOLIS 6, INDIANA**

Parts distributors in all major cities stock Mallory standard components for your convenience.



# CROSS TALK

## ► MANAGEMENT MANPOWER

... Shortage of manpower in the expanding electronics industry is not limited to technicians and engineers. Skilled production personnel is hard to come by in some areas. And, although you don't hear it talked about on every street corner, there is a growing need for good management men.

When a company needs engineers today it is not inclined to look too closely at their qualifications. More or less the same attitude applies to production people. But management candidates, particularly those within the organization, are chosen with extreme care and it seems at times that employers are searching for impossibly perfect men.

No man goes to a truly bigger job with all necessary attributes already built in. If he did, the job would not be bigger but just another one on the same level. Who has *most* of the experience needed? If he has also demonstrated the desire and the ability to tack on still more responsibility he is probably a good bet.

## ► MISGUIDED MISSILES . . .

For more than a decade now, military spending has been aimed primarily at developing weapons for pushbutton defense. But if war should come what buttons are

there, really, to push?

In forward areas, there are a few subsonic pilotless bombers whose guidance systems are vulnerable to jamming and reception.

Around our major cities there are batteries of anti-aircraft rockets. But in public tests, even against propeller-driven bombers of World War II vintage, such missiles perform only slightly better than anti-aircraft artillery.

One key to defense against nuclear aggression is reliable electronic missile guidance. This requires coordinated development of circuits and systems. Even more, it requires components resistant to high temperature, vibration and impact shock.

Industry-government teamwork that produced the v-t fuze and the atomic bomb is needed. Missile business is serious business, the most serious this country has yet been called upon to transact in a military sense.

And we are not moving fast enough.

► NAME . . . A new computer being developed up Boston-way is called "Diana," and we've run down the origin of the name.

It seems the computer will go to Chase Manhattan Bank and one of the bank's officials, remembering his Greek mythology, pointed out that Diana was the goddess of *chase*.

### You get **THREE EDITIONS** each month . . .

All **ELECTRONICS'** subscribers have been receiving two **Business Editions** and the **Technical Edition** each month since the first of this year. For those who failed to read page 137 in our December 1956 issue we quote:

"Beginning in January every subscriber on **ELECTRONICS'** circulation list will receive *three* editions each month. Our issue dated January 1, 1957 will be the one you are accustomed to receiving, and will be the same as it has been in recent years; *nothing will be changed*. Then, dated January 10 and again, dated January 20, you will receive a second and a third edition. These two editions will be *Business Editions*."

And, in June, you receive a fourth edition . . . our annual **Buyers' Guide**

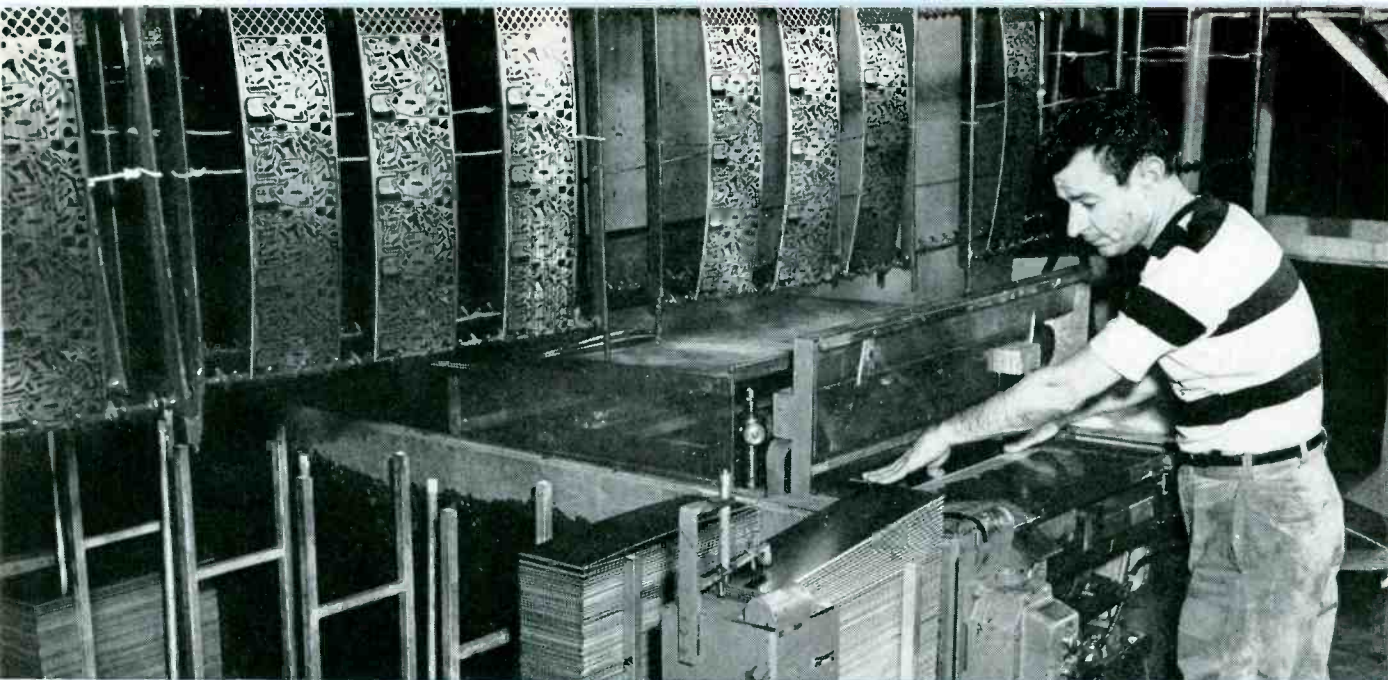

**RESIST PRINTER**—Operator takes copper-clad sheet from automatic sheet feeder at left and positions it against three guides on table. Sheet is held by vacuum as machine moves table back, brings silk screen and squeegee down over sheet, moves sheet and screen forward so stationary squeegee forces resist ink through screen onto sheet, then ejects sheet

# Mechanized Production of TV Wiring Boards

**SUMMARY** — Machines now mechanize each major step in production of etched wiring boards for Philco television receivers. Revealed here are operation details of semi-automatic resist printer, automatic etcher, sheet heater, board processor, component assembly machines, selective dip-soldering machines, board scrubber and error-printing automatic testers

By **JOHN MARKUS**

*Feature Editor*  
ELECTRONICS

**T**HE PHILOSOPHY that reliability in mass production can be achieved through mechanization has now been verified for each step in the production of printed-wiring television receivers. Initial industry-wide steps toward this goal were surveyed in a September 1955 *ELECTRONICS* Special Report, "Mechanized Production of Electronic Equipment". This article brings that report up to date by showing the new machines developed and used by Philco Corp.

**RESIST PRINTER**—First place in the new mechanized production line is occupied by a silk-screen

printer that automatically applies etching resist patterns in multiple with precise register and ejects the printed sheet.

The only manual part of the operation, loading of copper-clad laminate sheets, is expected by an automatic sheet feeder. This uses a motor drive to raise the pile of sheets as the operator removes them to feed the printer. The top sheet of the pile is thus always at the same height, within easy reach. When one stack is depleted, the motor-driven elevator retracts and the next stack rolls into position down an inclined track.

The basic printer is a General Research & Supply Co. model originally designed for printing on cloth or paper. Major modifications are in the loading and unloading facilities at the front of the machine and in the vacuum system that holds the sheet in position.



High-precision locating guides were provided for three points on two adjacent sides of the sheet, because these points must later serve for registering the sheet in the dies that pierce the holes and cut individual boards from the sheet.

Once loaded, the sheet is held in position on the moving table of the resist printer by vacuum. Under cam operation, the machine moves the table back until the sheet is directly under and registered with the silk screen. Sheet and screen then move forward together under a horizontal squeegee that forces the resist ink through the screen onto the sheet.

After the board is printed, the squeegee and screen automatically retract upward and the printed sheet is ejected for loading onto the carrier fingers of the overhead conveyor for the etcher. A doctor blade moves the pool of ink back to the starting position on the surface of the screen, so that screening is always performed in the same direction.

**ETCHER**—A single huge machine enclosing an endless conveyor system more than 100 feet long takes in the freshly printed sheets and delivers etched and cleaned sheets automatically to tote boxes. The machine provides a uniformity of etching action that minimizes rejects from this cause and contributes to the success of other machines on the mechanized line.

If sheets are to be etched on one side only, both sides of the conveyor racks are loaded. The sheets first go through a hot-air drying section to dry the resist. Three spray etching sections come next, to give a complete etch in  $2\frac{1}{2}$  to 3 minutes. Recovery tanks alongside the machine include provisions for continuously treating the acid to adjust its Ph and temperature. Acid recovered from the third section is used for the second spray, recovered acid from that goes to the first spray section and from there the acid is retreated for recirculation. Use of the three spray sections, with individual control of acid volume and pressure, provides a convenient means of adjusting the etching process to accommodate various thicknesses and grades of copper on the sheets being run.

Pressure-spray rinse sections then remove all traces

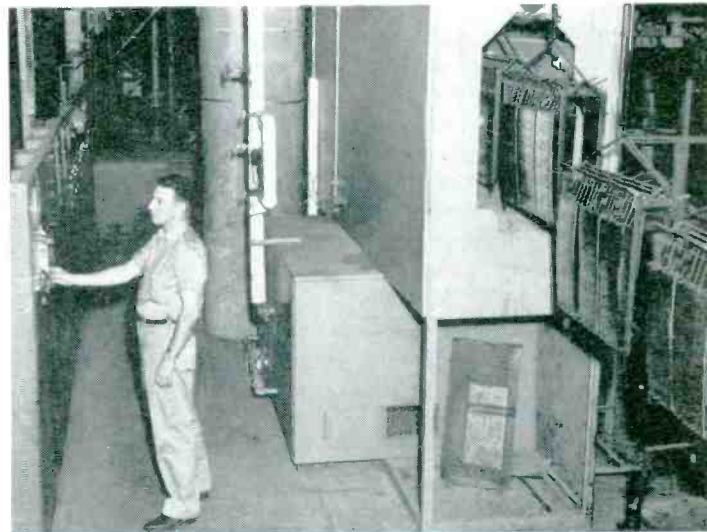

**ETCHER**—Freshly printed sheets are loaded on overhead conveyor for passage through huge combination drying, etching, rinsing, and resist-removing machine controlled by power pcy. Ferric chloride reservoirs shown below

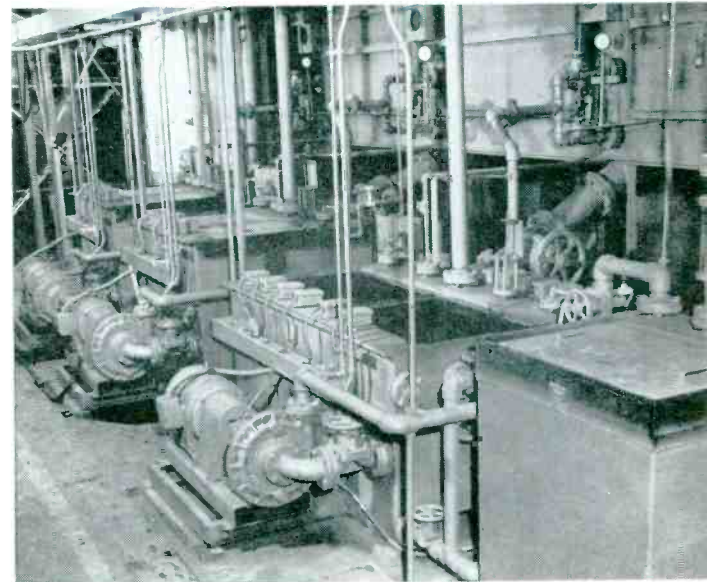

**SHEET HEATER**—Sheets coming from etcher are stacked on automatic feeder at right rear. Timer-controlled air cylinder pushes one sheet at a time into a flat-bed heater, thereby advancing other sheets and pushing out heated sheet within easy grasp of punch press operator. Punched boards drop onto conveyor belt to keep them flat until cool

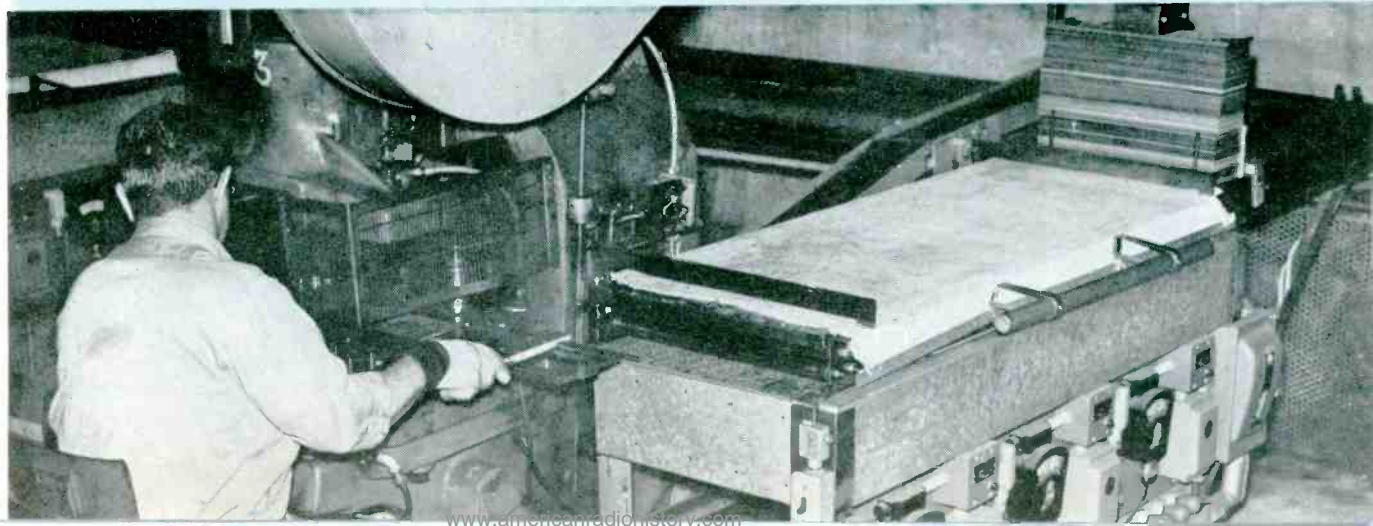



of the ferric chloride etchant, after which high-pressure air jets dry the sheets so there is no water to dilute the solvent that is sprayed on in the next section to remove the resist. After a final rinsing and drying, the sheets emerge.

At an automatic sheet kickoff station, conveyor-controlled pickers release the sheets and low-pressure air jets blow them outward into chutes leading to tote boxes.

**SHEET HEATER**—A combination sheet feeder and heater alongside each punch press eliminates the variables normally encountered with hot plates, to achieve the die life advantages of hot punching without sacrifice of precision. At controlled time intervals an air

cylinder is actuated to push a new sheet into the heater and thereby push out a heated sheet to within easy grasp of the punch press operator.

The punch press is conventional, but a special sliding feed table insures the required accuracy of sheet positioning. Boards are separated by shearing action so there is no waste of material between boards. Edges are removed from the sheet all around by the blanking dies, so no edges remain that were exposed to acid.

The first operation on the heated sheet is shearing off to the leading edge of the first board. To accomplish this the press operator moves a lever to position a temporary stop. This freshly cut edge then serves as guide for the next advance. The sheet is moved up to the fixed stop in the die by sliding the feed table, and

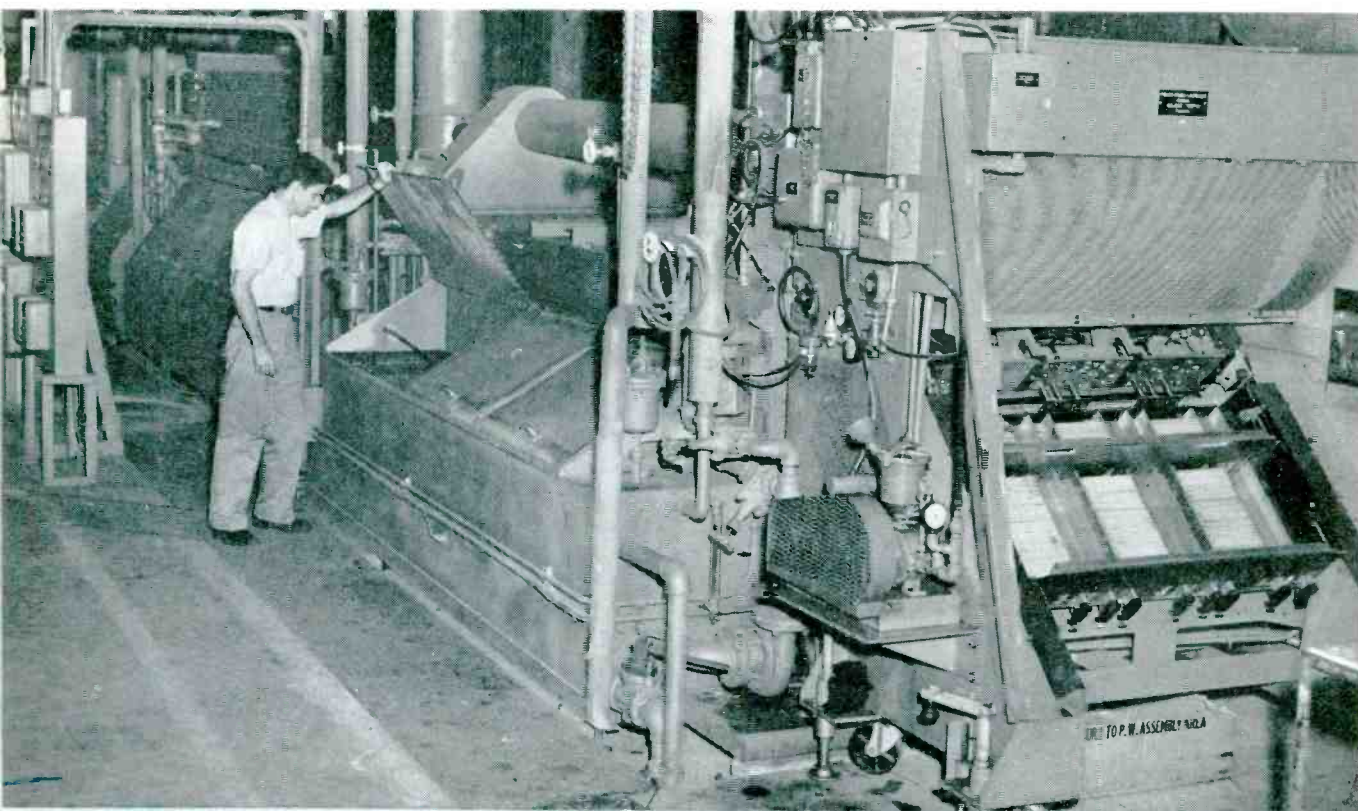

**BOARD PROCESSOR**—Punched boards loaded in racks at input of machine are transferred to open-mesh conveyor by vacuum fingers for spray degreasing, deoxidizing and washing, followed by hot-air drying. Boards are next realigned and spaced by cam disks and roll-coated with flux (lower right), then dried on fingers of vertical oven conveyor and ejected onto conveyor belt for stacking.

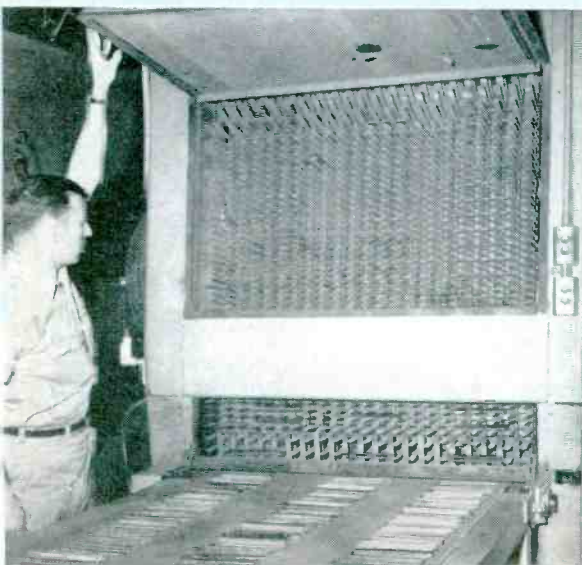



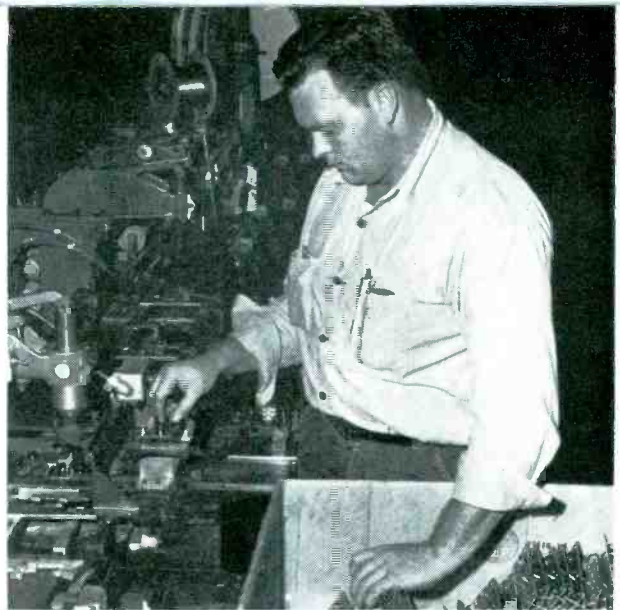
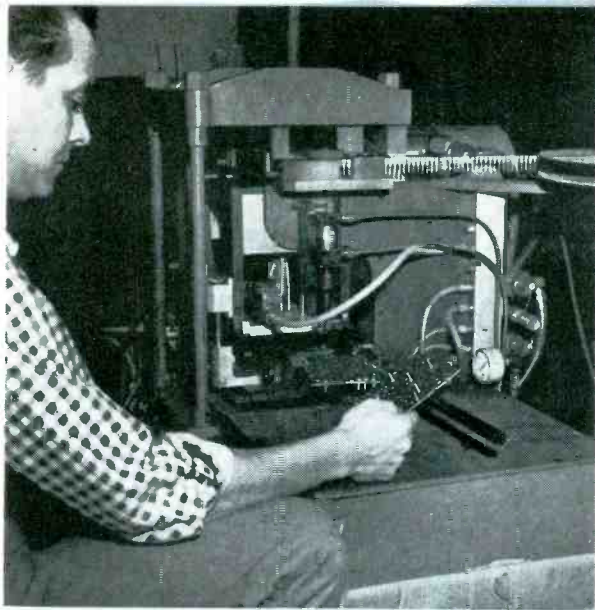

**COMPONENT ASSEMBLY**—Stacks of coated boards feed automatically through modified Malco wire-wrap terminal inserter. After sockets are put in, boards are loaded into United Shae assembly machine. Additional components are inserted manually on conveyor having vertical board holders that simplify clinching of leads with thimble

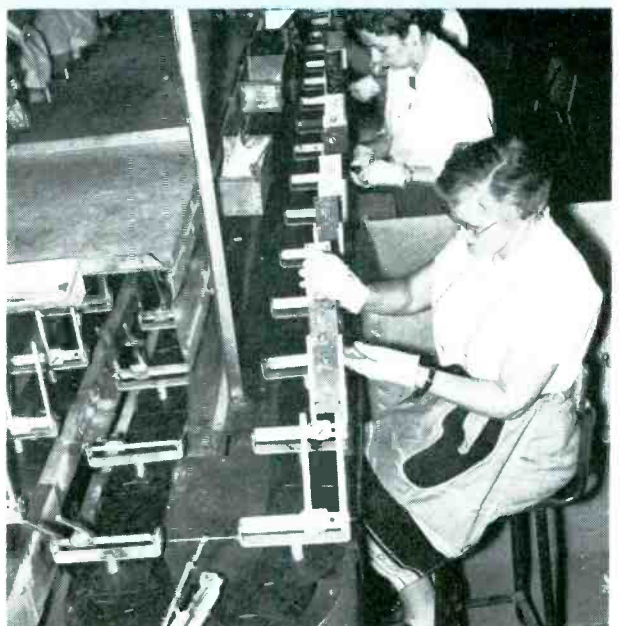

the press is tripped to punch and blank the first board. The following boards in the sheet are then pierced and blanked in sequence. Punched boards drop onto a conveyor belt system that keeps the boards flat until cool, to prevent warping.

**BOARD PROCESSOR**—A completely automatic conveyORIZED machine cleans and coats punched boards so they can be stored and handled without impairing their solderability. At the input a vacuum-operated automatic feed system permits running several different sizes and shapes of boards simultaneously at high rates. The boards are loaded into slanting racks having automatic motorized feed that keeps the top of the stacks at a constant level. Vacuum lifters come down to pick the top board off each stack and place it on the open-screen conveyor inside the machine. This insures that boards are uniformly loaded with no overlap.

A degreasing solution is first sprayed on the boards under pressure from above and below. The boards next pass through sprays of almost chemically neutral oxide-removing solution. In the following section a recirculating water spray followed by a fresh water rinse removes all traces of the solutions. Boards are then stripped of water and dried with blasts of high-pressure hot air.

After drying, the boards are realigned on the conveyor and moved under a roller that applies a thin, uniform coating of a special neutral flux to the wiring side. This coating prevents oxidation of the copper. Coated boards then run onto the fingers of a vertical endless chain conveyor running inside a low-temperature oven followed by a cooling chamber.

The boards are sufficiently dry by the time they reach the top of the oven so there is no damage to the coating when they go over the top and flip over for the descent in the cooling chamber to the unloading posi-



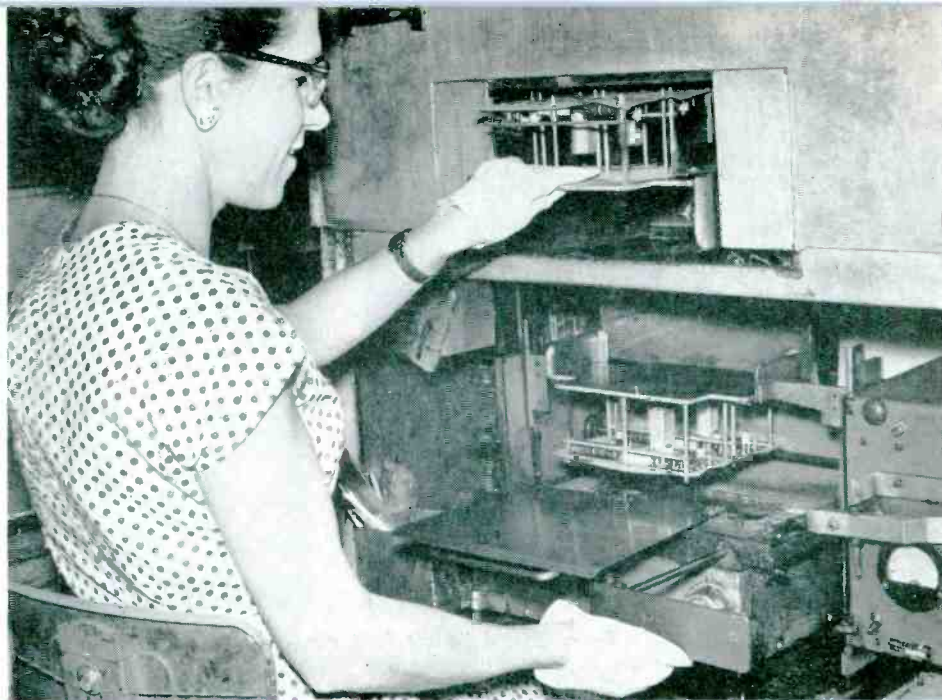
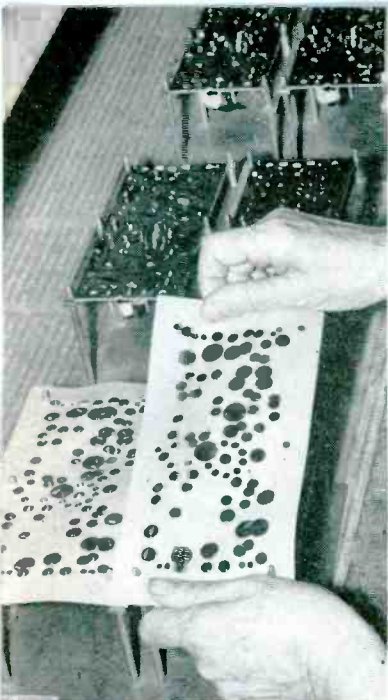

**SELECTIVE DIP SOLDERING**—Assemble boards are loaded upside down onto rotated metal pegs of holders and paper masks are pushed over pegs. At soldering machine alongside conveyor, operator slides one board holder into upper recess for automatic spray fluxing. Another holder, previously inverted over solder pot, is floated on solder by machine

tion. Here synchronized fingers push the boards out onto a slow-moving conveyor belt. The slower belt speed insures that the boards overlap so that they can easily be picked up in quantities and stacked for transfer to the storage boxes.

**COMPONENT ASSEMBLY**—Terminal pins for wire-wrap interconnections go into boards first, using Philco's own modification of a Malco terminal inserter. Tube sockets are next inserted in multiple with an air press, and boards are then loaded manually into one of the modified 36-station United Shoe automatic insertion machines. One new head here inserts tube shield grounding strips through tube sockets. Another installs RC network plates having up to six wire leads or terminals, using gravity feed from magazines, on an automatically indexing turret.

Lead belting is used for most small axial-lead components. Peaking coils and small resistors with body

taping are converted to lead taping by an unwinder that pulls off the body tape and lets the components slide down into a United Shoe taping machine.

Larger body-taped axial-lead components on reels are inserted directly by United Shoe heads, some of which have been modified to pull off the tape automatically.

Components of shapes and sizes not amenable to machine insertion are added on a manual assembly line. This consists of a flexible conveyor carrying adjustable fixtures that support the boards in any desired position. Board position is maintained by friction so that the operators may reposition the boards as necessary. Conveyor flexibility permits making a right-angle turn, for maximum utilization of plant space.

**SELECTIVE DIP SOLDERING**—Partial mechanization of the dip-soldering operation is combined with use of special multi-board holders and punched paper

**BOARD SCRUBBER**—Soldered boards are transferred from belt conveyor to input of scrubber for removal of flux residue prior to testing. Boards are held by spring clips riveted to roller chains while they move over rotating brushes partially submerged in cleaning solution. Brushes revolve in groups of four while rotating. Air blasts dry cleaned boards

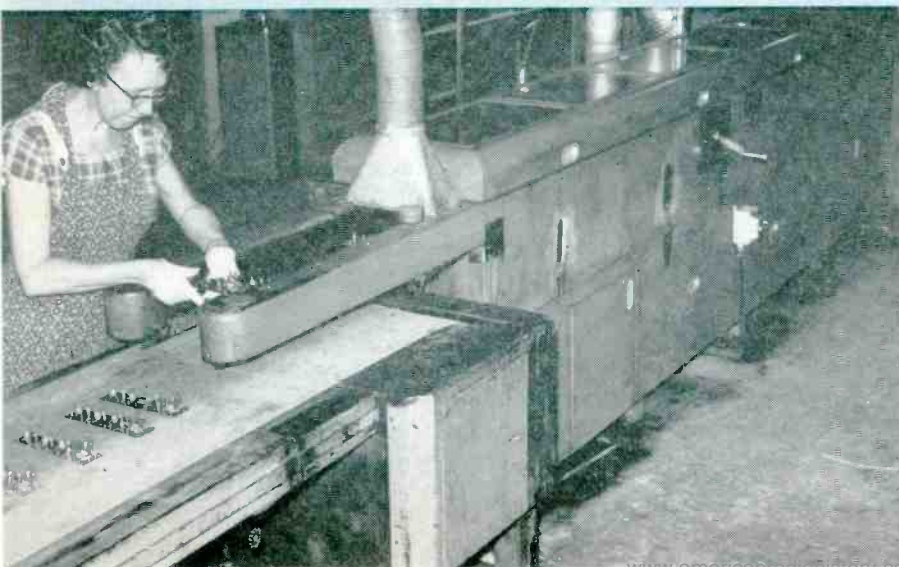



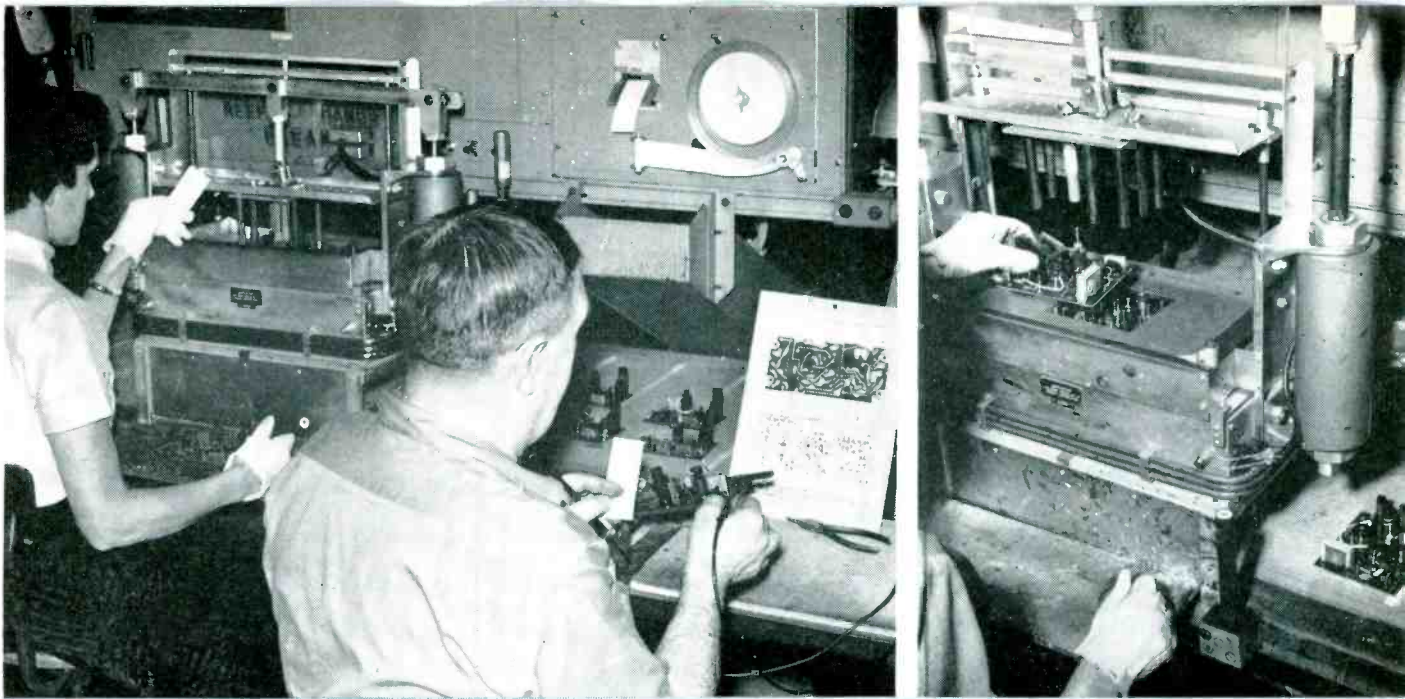

**AUTOMATIC TESTER**—Scrubbed board is placed over spring-loaded contact pins of tester. Air cylinders hold board down while multiple-standard impedance bridge, controlled by stepper switch, checks components and circuits rapidly in sequence. Identifying number is printed on paper tape for any test that is out of tolerance. Troubleshooter makes needed repairs

masks to give dip-soldered joints consistently high in quality. Solder temperature and dip time are accurately controlled to provide uniformity.

At the first position on the soldering conveyor line, assembled boards are loaded upside down onto metal pegs of holders. The long and springy pegs are notched to grip the board securely when the board holder is inverted over the solder pot. At the next position individual masks punched out of special crinkled paper are pushed down over the rounded pegs projecting above the board, to give the required registry so that only the terminals to be soldered are exposed through the holes in the mask. The paper masks fit tightly over the pins so they cannot drop off when the board holder is inverted.

A holder is first slid into the flux spraying position with the mask still upright. Pushing in the holder automatically starts the flux spray guns, which meter the proper amount of flux to be applied.

After fluxing, the holder is inverted and placed in position on shoes over the solder pot. Pressure on a switch then initiates the soldering cycle. First an air cylinder moves the combination metal cover and skimmer off the solder pot, automatically clearing the dross from the surface. Next, a motor-driven cam lowers the boards into the solder pot. This action is rapid at first, and slows up just as the board approaches the solder so there is no splash at impact. The mechanism continues lowering after contact is made with the solder, so that the boards float on the solder. The weight of the holder is chosen and distributed to give the desired and uniform depth of immersion, eliminating need for close level control in the solder pot.

At the end of the solder time interval the boards are withdrawn at a steady rate and the cover is moved back over the solder by the air cylinder. The operator then removes the board holder, inverts it and places it back on the conveyor belt to complete the cycle of the soldering machine.

Following the solder positions are operators who peel the paper masks off the boards and snap the boards out of their holders. Empty holders are placed on a return conveyor at the rear. Soldered boards continue down the main conveyor.

**BOARD SCRUBBER**—An automatic scrubbing machine removes all traces of burned flux and protective coating, to provide clean contact points for subsequent testing. An operator presses each board in turn between spring strips attached to the two synchronized roller chains. The springs are grooved to hold the boards against the upward thrust of the rotating brushes over which the boards are moved.

The nylon brushes are arranged in groups of four forming a cross, with each brush rotating on its horizontal axis while the group of four rotate about a vertical axis. This combination of motions insures that all areas of the boards are brushed.

**AUTOMATIC TESTER**—Soldered and cleaned boards are taken off the line one by one at each appropriate test position and dropped over projecting registering pins on a Philco-designed automatic test machine. Here the board is clamped in place by air cylinders so that contact is made to the required areas of the circuit. Testing starts automatically when the board is in position. Each component, or if desired, a circuit of several components is tested. Any defect in a component or circuit is identified by a code number which the machine prints on a paper tape that is delivered at the completion of the test cycle. Boards which pass the test go back on the conveyor to receive a final protective spray coat of varnish.

Appreciation is expressed to A. V. Nichols, Manager of Value Analysis, Philco Corp. (formerly Manager, Mechanization Planning) for extensive cooperation in connection with preparation of this article.

# Subminiature Beacon

By MORTON COHEN and DONALD ARANY

Senior Engineer  
Senior Project Engineer  
Radio Receptor Co.  
Brooklyn, New York

**SUMMARY** — Transistorized S-band transponder provides echo to missile-tracking radars and signal that could activate a missile fuel-cutoff system. Circuits of preselector, video receiver, modulator, transmitter and power supply are given and their design considerations discussed. Complete unit occupies a 2.5-inch diameter, 6-inch long volume and may replace many older and larger units in existing missiles

**B**EACON TRANSPONDER AN/DPN-43, to be described, normally provides two basic functions. It supplies an amplified echo for missile-tracking radars and an audio-command signal that could be used to activate a missile fuel-cutoff system. It is possible that this unit may replace other beacons of larger size and differing shape.

## System

The beacon contains six main subsections: duplexer, preselector, crystal video receiver, modulator,

transmitting cavity and power supply. The system shown in Fig. 1 receives and transmits over the frequency range from 2,700 to 2,950 mc. The receiver sensitivity is better than  $-35$  dbm and the transmitted power output is greater than 1 watt.

Radio-frequency pulse pairs spaced  $3\text{-}\mu\text{sec}$  apart are used to interrogate the receiver. Coincidence circuitry in the decoder of the video receiver then operates the modulator. The modulator in turn drives the r-f cavity to transmit a single

pulse reply. The power supply operates from a six-volt battery with an estimated operational life of about 30 minutes. Total weight is approximately 2.5 lb and the beacon will operate at ambient temperatures in excess of  $70\text{ C}$  and below  $0\text{ C}$  and at altitudes exceeding 100,000 yards. It will sustain shocks of at least 100 g.

## Duplexer

The duplexer consists of two electrical lines  $W_1$  and  $W_2$ . Their lengths are so chosen that  $W_1$  is

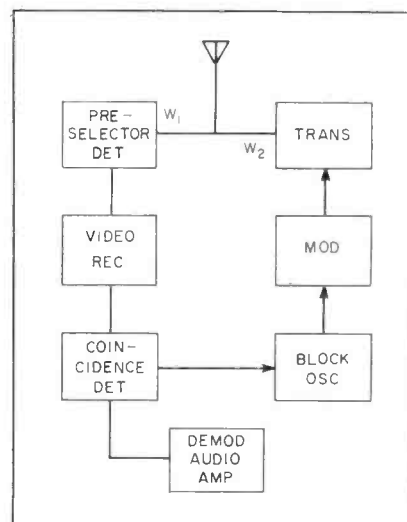
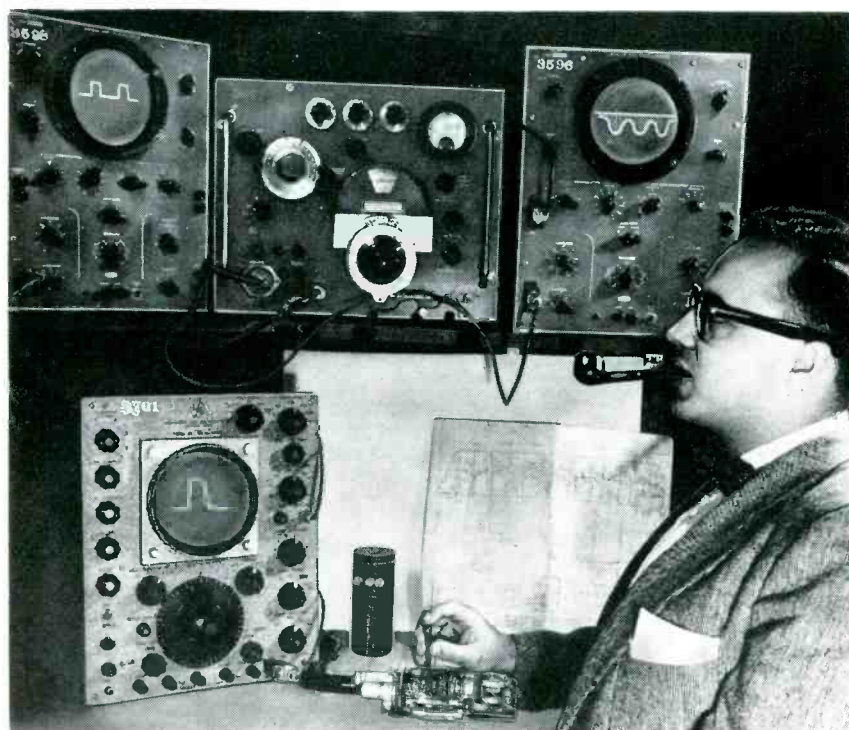
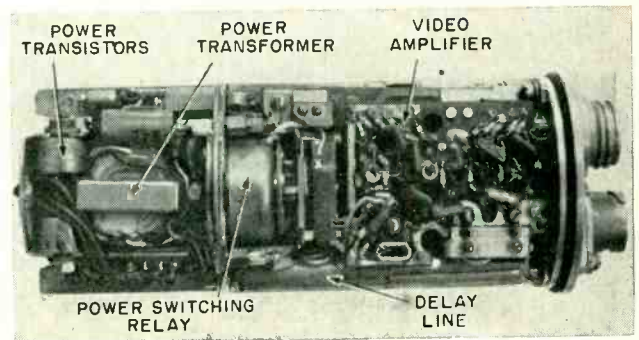
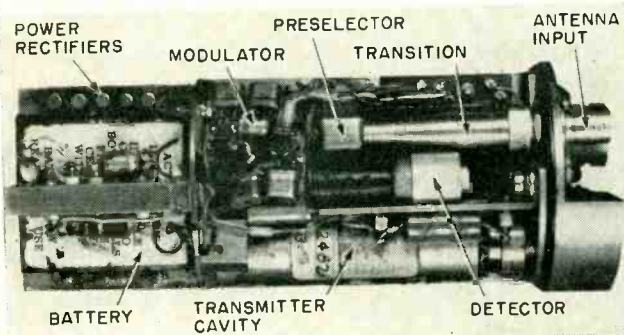

FIG. 1.—Block diagram of compact transponder operating in S band

Beacon video amplifiers are adjusted for proper response characteristic



# For GUIDED MISSILES



Internal views of beacon show compact construction and parts layout required to keep size and weight down

$\lambda/4$  and  $W_2$  is  $n\lambda/2$  at a nominal mid-band frequency of 2,825 mc. Over the  $\pm 5$ -percent nominal frequency swing, the impedance looking into  $W_2$  from the antenna is quite high. Consequently there is little loss of energy from the antenna to the receiver input. Looking into  $W_1$  from the transmitter cavity, the impedance is also quite high. Therefore most of the transmitter's output power is diverted into the antenna where it belongs.

### Preselector and Transmitter

The preselector shown in Fig. 2 consists of two line sections that are coupled together through an iris and are capacitance tuned. Nominal bandwidths obtained with this design are  $> 6$  mc at  $-3$  db,  $< 60$  mc at  $-20$  db and  $< 120$  mc at  $-35$  db down.

Crystal  $CR_1$  is a 1N32 used as the crystal detector. The video crystal is also tuned by a fixed length of line.

The transmitting cavity, also shown in Fig. 2, consists of a ruggedized fixed-tuned ultrahigh frequency oscillator triode intended for grid-pulsed oscillator service between 2,700 and 2,950 mc. The cavity is a tunable plate tank coupled back to a fixed-tuned cathode line section. Power is capacitively coupled to the antenna output. Power output is approximately 1 to 10 watts across 50 ohms.

### Crystal Video Receiver

The crystal video receiver shown in Fig. 3 consists of 6 transistor stages,  $Q_1$  through  $Q_6$ . This receiver

has a 35-db r-f dynamic range which implies a 70-db video dynamic range. This results from the square law operation of the detector.

Three main problems are encountered as a result of this large dynamic range: pulse widening wherein the output pulse width becomes a function of the input signal level, spurious responses that appear at the output because of overshoot at high input levels and the s/n ratio tendency to deteriorate owing to limiting in many of the stages. To insure proper operation of the decoder none of these conditions can be tolerated.

### Storage

One cause of pulse widening is that semiconductors exhibit to a varying extent a storage property that discharge after the input energy has ceased. This storage energy varies with input energy level. Hence this effect causes successive widening of the pulse with each succeeding stage. Silicon junction transistors, while superior for their temperature stability, exhibit this storage effect.

To counteract this problem 2N128 surface-barrier germanium transistors were chosen. This transistor has a negligible storage time constant making it suitable for this application. However, they do not exhibit the good thermal stability of silicon transistors.

A second cause of pulse widening results from the fact that the rise and decay time of the pulse is finite. The  $f_{co}$  of the 2N128 is 30

mc,  $\beta$  is approximately 20 for the common emitter configuration and  $f_{\beta co}$  equals  $1/\beta \times f_{co}$  resulting in an  $f_{\beta co}$  of 1.5 mc. This corresponds to a rise and decay time of 0.24  $\mu$ sec. Hence the 1- $\mu$ sec pulse is more of a trapezoid than a square pulse.

Therefore a low-level signal will be degraded only to the above extent. A high-level signal rise time will be improved because of limiting. However, limiting will cause pulse widening, thus the output pulse width will be a function of the input level.

To eliminate this problem, an overshoot is purposely introduced in  $Q_2$  by introducing a short time constant in the emitter circuit. This forces the pulse to rapidly cross the base line with an extremely small decay time. Hence the squareness of the trailing edge is restored and pulse widening is minimized but an overshoot problem is created.

### Compromise

If each transistor stage were biased full on or full off most of the overshoot would be clipped off. However these two extremes are far from optimum operating points for a pulse amplifier of this nature. In the region near cutoff,  $a$  is low hence the stage gain is low. In the saturation region, the input impedance is low and power consumption is relatively high. Thus to obtain a reasonable gain per stage, a compromise must be employed.

It was necessary to make certain that any overshoot existing in the

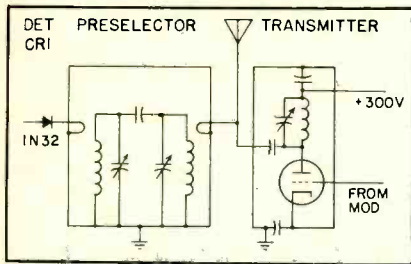
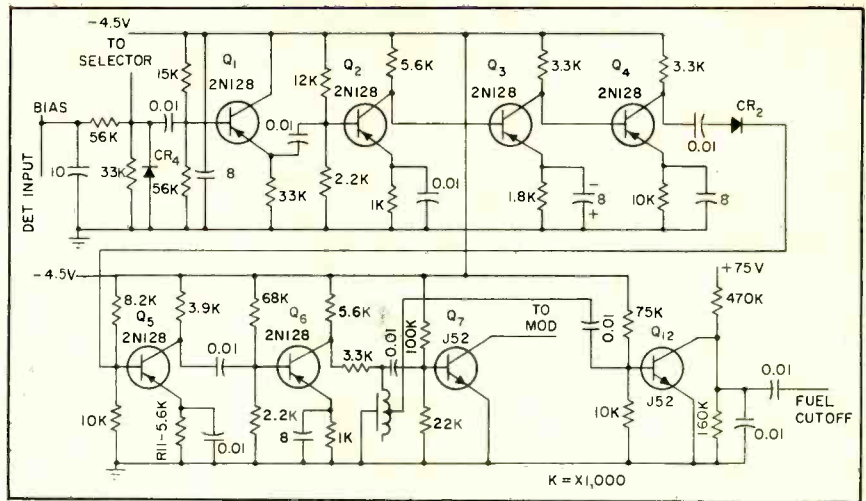

FIG. 2—Preselector and transmitter feed common antenna through duplexer and transition section of coaxial cable

FIG. 3—Video receiver uses direct coupling wherever possible to maintain stability



early stages was not appreciably amplified by the latter stages. Otherwise the overshoot would cross the base line and appear at the output as a spurious response of the same polarity as the desired signal.

To minimize the overshoot, diode  $CR_2$  was placed between  $Q_4$  and  $Q_5$ . Also the quiescent operating points of these stages were carefully chosen to minimize the amplification of the overshoot with only a slight loss in gain.

### Overloading

Another problem occurs when the transmitter cavity and preselector cavity are separated by a small frequency increment. The receiver overloads for all high-level signals. Diode  $CR_1$ , back-biased slightly, limits the incoming video signal to 0.6 volt. As a result the transmitter and preselector may be tuned to the same frequency with only a 2-db loss in receiver sensitivity. The burn-out rating of  $CR_1$  in the detector is just high enough so the transmitter cavity power does not burn out the diode.

Because germanium transistors are employed, each stage had to be temperature stabilized over the operating range of 0 to 70 C. A standard technique in achieving this stabilization is to insert a bypassed resistor in the emitter circuit.

The value of series emitter resistance does not effect the dynamic operation of the stage as it is bypassed but it does control and limit the optimum setting of the quies-

cent operating point.

Direct coupling was used where practical, thus eliminating coupling overshoots and ensuring good temperature stability with minimum loading effects.

### Noise

Since the minimum input signal level is well above the noise level, the design allows biasing the input stages to reduce residual noise. The signal to noise ratio has consequently been improved rather than deteriorated through the receiver.

Limiting occurs over the entire dynamic range. Additional helpful results of limiting cause a better pulse rise time characteristic and supply a constant amplitude output pulse to the coincidence circuitry. Overall video gain is about 100 db.

Coincidence circuitry at the input of  $Q_7$  enables the detection of pulse pairs. An open-circuited delay line, 1.5  $\mu$ sec long, reflects a pulse of the same incident polarity. A succeeding input pulse 3  $\mu$ sec later will therefore occur in coincidence with the reflected pulse al-

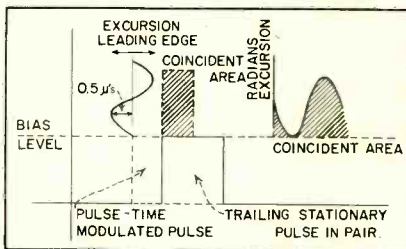

FIG. 4—Pulse-time modulated pulse is compared with stationary second pulse in coincidence circuit to get fuel cutoff signal

lowing  $Q_7$  to conduct and thence initiate the blocking oscillator.

A tap on the delay line drives an audio amplifier that supplies an audio command signal for external use. The leading pulse of the pulse pair is pulse-time-modulated at an audio rate with a nominal excursion of  $\pm 0.5 \mu$ sec. The delay-line tap converts the pulse-time modulation to a pulse-position modulation due to coincidence action as shown in Fig. 4.

Suitable time constants in the demodulator audio amplifier  $Q_{12}$  afford an audio output signal of about 150 millivolts.

### Modulator

The modulator shown in Fig. 5 consists of blocking oscillator stage  $Q_8$  and two grounded collector stages  $Q_9$  and  $Q_{13}$ .

A negative pulse, impressed upon the collector of  $Q_8$  is reflected as a positive pulse at its base. A positive bias is applied to the emitter through network  $R_1$  and  $R_2$  which biases off the base. If the trigger is of sufficient amplitude with respect to the base bias level the transistor will regenerate and blocking oscillator action will ensue. The overshoot of the blocking oscillator pulse will affect the recovery time since the overshoot drives the base more negative and any trigger impressed during this interval will not allow the blocking oscillator to fire.

A junction diode could short out this overshoot decreasing its amplitude but, because of the long storage time effect in such diodes,



recovery time would be excessive.

A point-contact computer diode such as the 1N191 has less of a storage effect, however it is still excessive. By putting two 1N191 in series, the storage effect is greatly reduced and a recovery time of better than 30  $\mu$ sec is obtained.

### Count Down

The beacon is required to operate up to a 4-kc repetition rate without count down and from 4 to 10 kc with a count-down rate that would ensure that the transmitter cavity would operate within its maximum dissipation rating.

One count-down method purposely introduces a large overshoot in the blocking oscillator pulse. However this method results in a recovery time equal to the time constant of the count-down circuit.

The approach assumed incorporates a circuit with a controlled time constant which will not affect the recovery time of the blocking oscillator. The energy is then integrated and fed back as a dc back bias to the base of  $Q_8$ . This energy has to be a function of the output repetition rate of the blocking oscillator.

### Feedback

Operation of the circuit requires that the negative pulse output of the blocking oscillator be reversed in phase. This positive pulse then drives  $Q_8$  which in turn drives  $Q_{13}$ , both grounded-collector stages. These stages are required to obtain power gain to drive the grid of the transmitter cavity. Capacitor  $C_1$  is charged through  $R_3$  to ground when  $CR_5$  conducts.

After the initiating pulse energy has ceased  $C_1$  discharges through  $R_3$ ,  $R_4$  and  $R_5$  in series. The discharge current through  $R_4$  is negative with respect to ground. The d-c level of this voltage is a function of the output repetition rate of the blocking oscillator. This voltage is fed back through isolating resistor  $R_6$  to the base of  $Q_8$ , thereby affording count down.

### Power Supply

Two germanium power transistors operating from a 6-volt battery make up the power supply shown

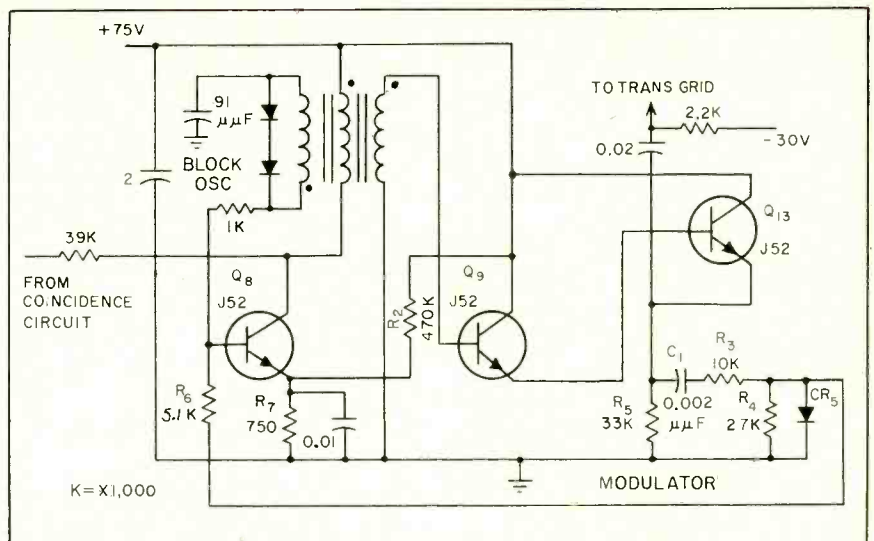

FIG. 5—Modulator provides 4-to-10-kc repetition rate with count down

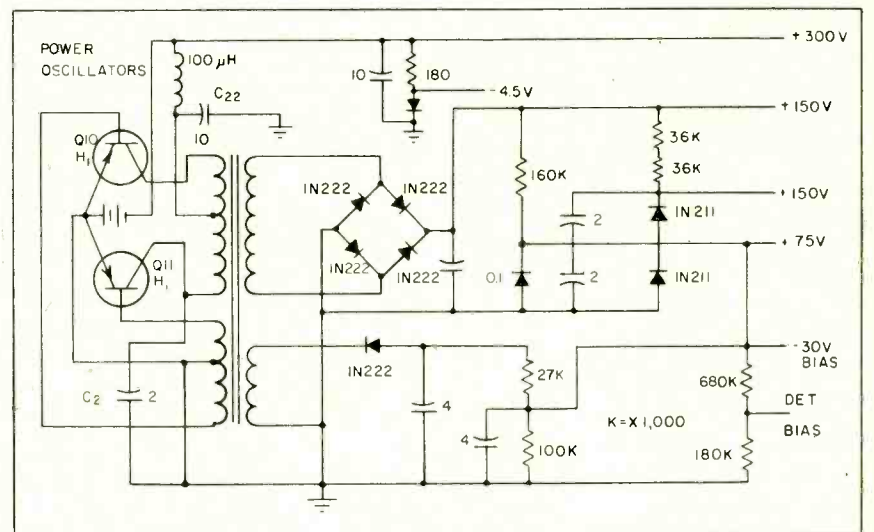

FIG. 6—Oscillator-type power supply converts 6-volt d-c source to circuit potentials

in Fig. 6. Transformer  $T_1$  has a step-up winding and a feedback winding which allows the transistors to oscillate push-pull at a repetition rate of 1 kc.

The transformer input waveform is essentially square wave which is then stepped up to 300-v peak and rectified in a full-wave bridge to furnish the d-c output voltages.

### Regulation

Suitable regulation is accomplished by Zener diode operation. The total power drain including the remote control fuel cutoff device is approximately 2 watts. The video amplifier draws only 2 ma at -4.5 volts.

The major problem in a power oscillator design of this nature is

to obtain a high transformer input impedance. This is necessary so that the transistor can see a load impedance sufficient to cause a loop gain greater than one, thereby ensuring oscillations.

High-frequency oscillation is helpful since it minimizes filter component circuitry. Here the frequency of oscillation is not limited by the transistor or transformer but by the reflected load impedance.

Starting capacitor  $C_2$  has been incorporated to ensure starting of oscillations under all environmental conditions.

Thanks are due B. Karp of our mechanical engineering section.

The beacon was developed under a Signal Corps contract originated at Ft. Monmouth, N. J.

# TETRAJUNCTION Transistor

By R. J. FARBER, A. PROUDFIT, K. M. ST. JOHN and G. R. WILHELMSSEN

Hazeltine Research Corporation  
Little Neck, N. Y.

**SUMMARY** — Dual-triode transistor, with emitter of one unit and collector of the other section of same germanium region, provides performance of two triode units with considerable reduction of circuit components when compared to two individual units. Superheterodyne receiver in which first four stages are replaced with two tetrajunction units is described

**E**XTENSION of techniques used in the construction of grown junction transistors gives rise to an interesting new device that may be applied to a broadcast receiver. Some modifications to normal circuit arrangements are required to obtain optimum performance from these units.

An *npn* transistor, often represented symbolically as a bar with three zones as shown in Fig. 1A, serves as the base for the development of a bar consisting of two transistors formed in a single unit, as shown in Fig. 1B.

When work on this device was initiated, it was based on the thought that the new approach might lead to significant economy in the cost of a broadcast receiver because of reduced transistor cost. Early indications lent support to this expectation. At present, manufacturing techniques have apparently not advanced to the point of immediate production.

In the tetrajunction transistor, the emitter of one unit and the collector of the other are parts of the same germanium region. This limitation on freedom of connection results in applications of the new transistor being somewhat more involved than for a dual-triode tube.

### General

Since use of a transistor in the common-emitter configuration provides the most power gain, it is

generally desirable to operate both sections of the tetrajunction transistor in this fashion. If the input to a transistor is connected between base and emitter and the output is connected between collector and emitter, the emitter is common to input and output, hence the transistor provides maximum power gain. This is irrespective of the ground point in the circuit, as shown in Fig. 2A. All of the circuits in this figure have the same

power gain.

As shown in Fig. 2B, operation of the two triodes can be independent. Ground can be placed at any point. In the receiver to be described the central collector-emitter region was chosen, as shown.

The operation of the two halves of the tetrajunction transistor is then as follows: the upper half is connected in a conventional grounded-emitter common-emitter circuit using a bootstrapping technique. In this way the two halves are operating with complete independence. There has been no evidence to date of any interaction between the two sections because of the common use of the single "N" layer.

### Bias

Generally, there are two methods which can be used to provide bias for the triode sections of the tetrajunction transistor. The first is to connect the center region directly to ground. In this case the two halves have d-c as well as a-c independence, as shown in Fig. 3A.

The second method is to ground the center region for a-c only. In this case the bias current for both halves is substantially set by the biasing elements for the bottom half alone as shown in Fig. 3B. The choice of use of the two methods will depend, to a large extent, on the type of circuit being implemented. The second method, how-

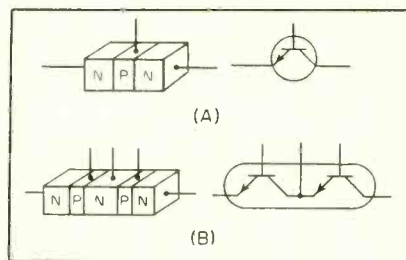

FIG. 1—Normal characterization of triode transistor (A) and that of tetrajunction unit (B)

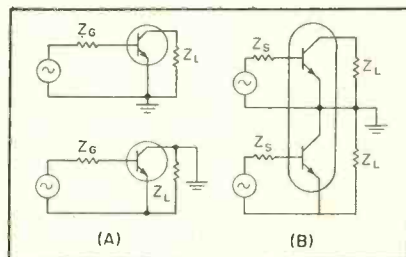

FIG. 2—Configurations shown give maximum power gain regardless of ground point. Central collector-emitter region has not produced interaction between the sections so far



# Simplifies Receiver Design

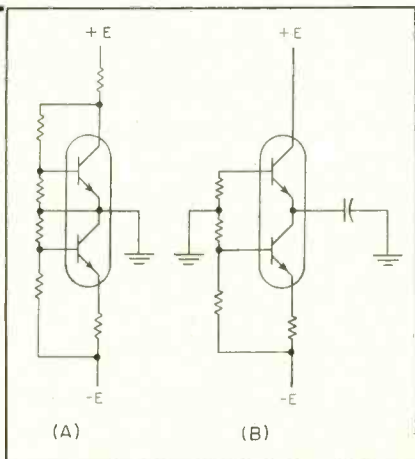
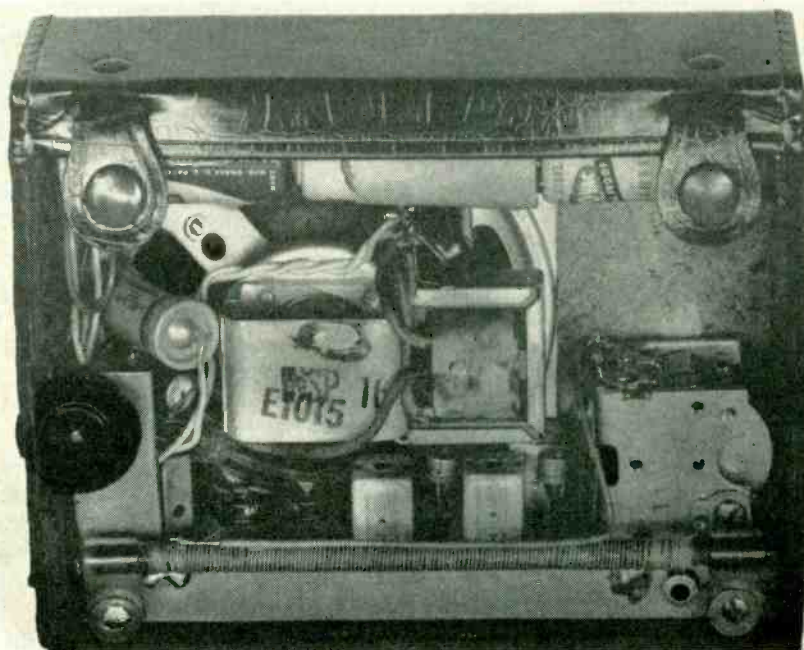

FIG. 3—Tetrajunction unit can be biased by connecting collector-emitter region directly to ground (A) or by grounding center region for a-c only (B)

Component layout of tetrajunction transistor receiver. Two tetrajunction units are visible at right



ever, generally can result in a component saving.

Thus the tetrajunction transistor is a device that potentially can be used to replace the transistors in any existing receiver design, two at a time. The tetrajunction transistors studied to date have been of small crosssection, suitable for low-level r-f and audio applications.

Two of these units plus a diode and normal circuit elements can accomplish all the functions of a receiver up through the audio driver. No restriction is placed on the audio output stage and any of the popular class A or class B arrangements may be employed.

## Problems

When an attempt is made to use the tetrajunction device in the circuit of an existing receiver, several problems arise because of the common connection between the emitter and collector which is generally grounded, at least for signal frequencies.

Since the two halves of the device are in series, to achieve the same collector-to-base voltage as when using two separate triodes in a conventional manner, a battery of

a higher voltage is required. The power requirements, in both cases, however, will be the same. In addition, for some applications, it is desirable that the battery be center-tapped. This is done to advantage in the receiver described. The push-pull *pnp* audio stage can take advantage of the full battery potential regardless of the connections elsewhere in the receiver.

## Stabilization

The stabilization circuits require some review. A typical method of biasing a triode transistor amplifier

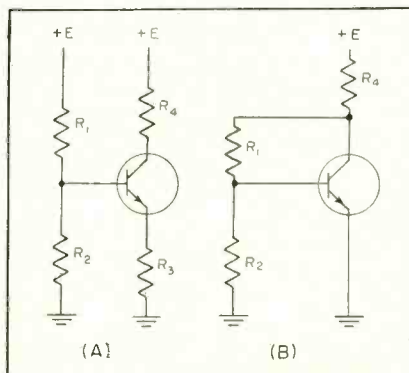

FIG. 4—Typical biasing configuration for temperature stability (A) is modified to provide required degree of stabilization for top triode of tetrajunction unit (B)

is shown in Fig. 4A. Here, d-c degeneration is introduced by  $R_3$  to stabilize the operating point against changes in temperature and/or variation in transistor parameters from unit to unit. In some tetrajunction transistor circuits however, the center region is grounded. Therefore no stabilization resistor can be inserted between the emitter of the top triode and ground. It is possible to get the required degree of stabilization for the top triode by using the circuit of Fig. 4B, in which  $R_4$  introduces the necessary degeneration.

However, for a given degree of stabilization, the resistor in the collector circuit is generally considerably larger than one which would be used in the emitter circuit. Thus with a given size battery and current in the transistor, there will be a larger voltage drop and hence less voltage applied to the transistor.

Using the bootstrap technique for the bottom half of the transistor presents some additional problems. In a transformer-coupled stage, both sides of the winding feeding the base-emitter input are hot with respect to ground as shown in Fig. 2B. This can at times

result in undesirable coupling to other circuits. Direct-current biasing elements for the base generally constitute shunt paths to ground and may result in a compromise between stabilization and stage gain. Furthermore, capacitance between the base and ground, such as stray capacitance or capacitance from the high side of the input coupling network to ground, constitutes feedback between collector and base, since the collector is grounded. This may require neutralization.

### Receiver Description

A block diagram of a typical transistor receiver which also applies to a receiver using tetrajunction transistors is shown in Fig. 5A. The set consists of an autodyne converter, two i-f stages, a diode detector which also supplies the a-gc voltage, and a class A audio amplifier driving the push-pull class B output stage.

Figure 5B shows a modified block diagram of the configuration with each half of the two tetrajunction transistors, as well as two 2N241 audio output transistors. The present arrangement was chosen because it provides an optimum solution to the problems described, as well as offering some chance for additional economy. As pointed out before, the receiver uses only two tetrajunction units, two audio units and a diode, while giving the performance of a six-transistor plus diode set. Figure 6 shows the schematic diagram of the complete receiver.

### Conversion

The autodyne converter utilizes the bottom half of the first tetrajunction transistor in a grounded-collector common-emitter bootstrap circuit. The oscillator uses a common emitter circuit with feedback from collector to base.

A 1000-ohm resistor bypassed by a 0.01- $\mu$ f capacitor is inserted between the emitter and the point common to the input and output circuits. This R-C combination provides low-frequency degeneration in the emitter-base circuit, reduces squegging tendencies and provides some degree of stabilization.

The loop antenna consists of a

ferrite core as large as is consistent with the desired packaging of the receiver. A spaced winding of Litz wire contributes to a high unloaded  $Q$ . The maximum input to the converter is obtained with the resistive component of the input impedance of the converter reflected across the tuned primary equals the equivalent unloaded tuned antenna circuit resistance. This must be consistent with having a loaded  $Q$  sufficiently large to obtain satisfactory image rejection, but not so large as to make tracking a problem, or to narrow excessively the overall bandwidth.

Inasmuch as the quality of the antenna is affected by its proximity to the chassis, the antenna becomes a compromise between the packaging problem, sufficient sensitivity, adequate image rejection, ease of tracking, and a location that reduces undesired coupling.

The distributed primary winding tunes the desired range of 535 kc to 1610 kc with a 220- $\mu$ f variable capacitor. The secondary winding transfers the energy to the base-emitter circuit of the transistor, using the bootstrap technique. This is done by a direct connection to the base and through the oscillator tickler and a 0.01- $\mu$ f capacitor to the point common to the input and output circuits.

The primary of the i-f transformer is connected between the emitter and the tap on the oscillator tank. Since there is little impedance at i-f between this latter point and the grounded collector, the transformer serves as an i-f load between collector and emitter.

The first i-f amplifier uses the

top half of the first tetrajunction transistor in a grounded-emitter common-emitter circuit. The output impedance of the converter is matched to the 500-ohm input impedance of the first i-f amplifier by the input i-f transformer.

Correct stabilization is obtained by returning the 33,000-ohm base bleeder to the collector side of the 2,200-ohm collector resistor. Any change in collector current resulting from variations from unit to unit or of temperature will change the voltage across the bleeder. Thus the current will tend to be maintained at a value of 1 ma.

The base bleeder and associated circuitry is designed to bias the first i-f transistor at 1 ma, place the correct amount of forward bias across the diode (about 0.10 v), provide satisfactory a-gc action and filtering without undue audio attenuation and provide satisfactory stabilization and a satisfactory load for the diode detector. The internal feedback capacitance in the individual triode units is sufficiently small so no neutralization network is required in most cases.

### Interstage

The 15,000-ohm output impedance of the first i-f is matched to the 500-ohm input impedance of the second i-f stage by the interstage i-f transformer. The secondary of this transformer is layer wound rather than bifilar wound, as in the other transformers, to minimize capacitance to ground.

The 150,000 and 33,000-ohm resistors in the base bleeder circuit are a compromise between satisfactory stabilization and shunting of the load for the stage. The bypassed 1,000-ohm emitter resistor provides the necessary d-c degeneration for stabilization.

The second i-f stage is also biased to draw 1 ma. Since it and the audio driver are in series, with no d-c connection between the central collector emitter region and ground, the latter stage is also stabilized at 1 ma d-c.

The load for this i-f stage is connected between emitter and ground, with the emitter connected to the bottom of the primary rather than the tap so that a voltage of the correct phase may be fed back to

Table I—Receiver Characteristics For 50-mw Output

Sensitivity	350 to 500 $\mu$ v/m 66 to 69db below 1 v/m
ENSI	15 to 20 $\mu$ v/m 94 to 97db below 1 v/m
1.0-mc, 6-db bandwidth	6.0kc
AGC figure of merit	32db
Total battery drain	23ma





# CHRONOGRAPH TIMES

By WILLIAM J. KERWIN

Ames Aeronautical Laboratory  
Moffett Field, California

**SUMMARY** — Circular-sweep five-radius oscilloscope display provides vernier readings for four counter circuits used to measure drag on small free-flight models in supersonic wind-tunnel tests. Accuracy of 1.6-mc counter is increased to  $\pm 0.025 \mu\text{sec}$  by determining time lapse between start pulse and first count, and between last count and stop pulse.

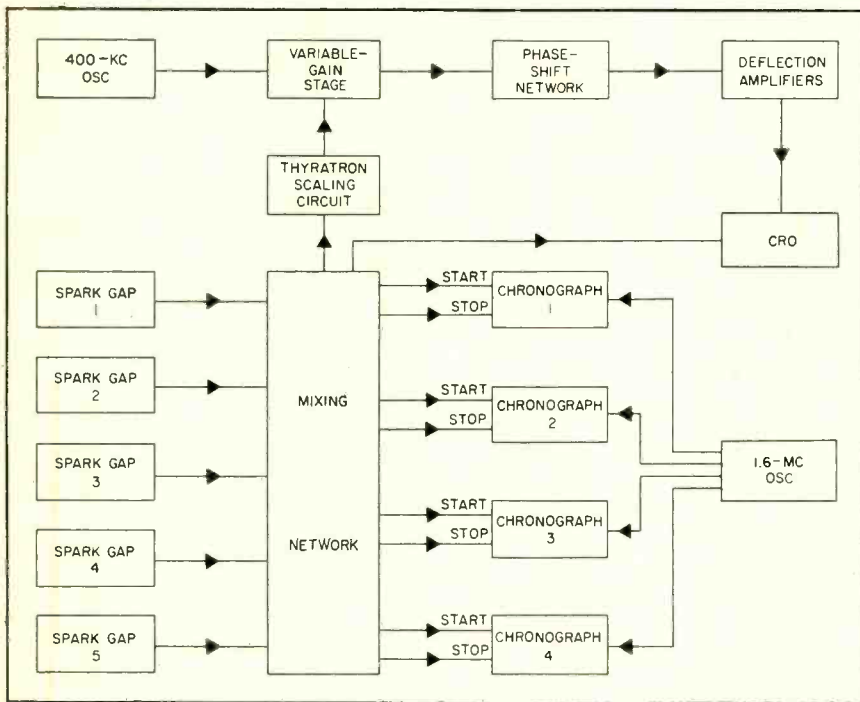

FIG. 1—Spark gaps triggered by passing model in wind tunnel provide start and stop pulses for chronograph timing system

**I**N A SUPERSONIC free-flight wind tunnel small models are fired from a gun at high velocities into a supersonic air stream. These models are not internally instrumented, so that aerodynamic quantities such as drag, position and angle of attack have to be measured by external means. Determination of drag involves the precise measurement of the time of flight of the model between successive reference stations to determine deceleration.

Electronic counters available were capable of measuring time intervals with a maximum accuracy of  $\pm 0.625 \mu\text{sec}$ . This accuracy is insufficient for drag measurement in the short time intervals involved. A time-interval measuring instrument suitable for this purpose has been developed.

## Principle of Operation

Accuracy of an electronic counter can be increased by determining the interval between receipt of the start pulse and the time of the first count, and similarly, the time of receipt of the stop pulse in relation to the last count indicated. This can be done by placing a reference mark from the counter oscillator on a circular oscilloscope trace at the point of the count, and markers at the start and stop pulse times, from which these two time intervals necessary to correct the

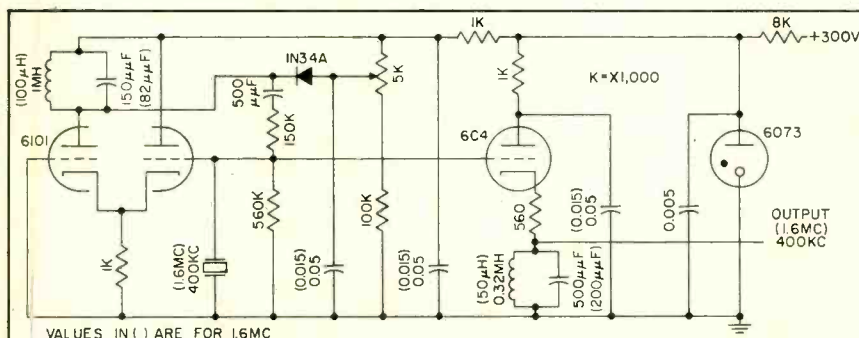
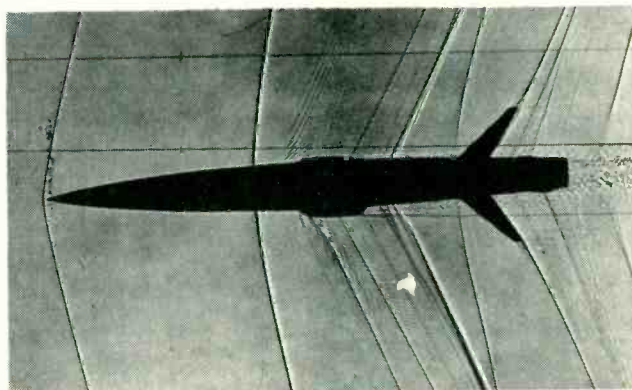
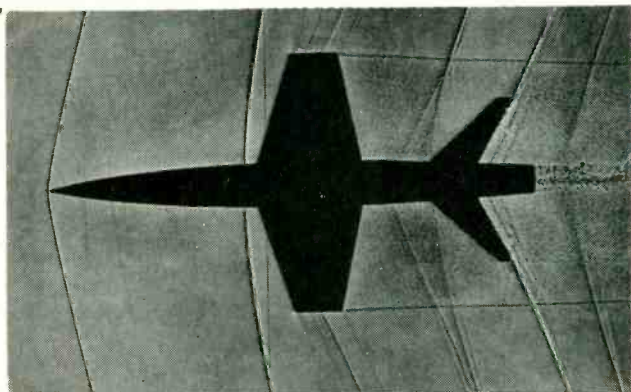

FIG. 2—Oscillators for 400-kc and 1.6-mc. Values for 1.6-mc are in parenthesis



# SUPERSONIC MODELS



Shock-wave patterns generated by free-flight models in supersonic wind tunnel. Accurate timing system is required to measure effect of drag on model. Thin vertical and horizontal lines serve as position indicators

counter reading are determined. A circular time base is preferable, since data could be lost during retrace of a linear sweep. A spiral sweep is unnecessary as an electronic counter is used to indicate the total number of revolutions. The start and stop pulses defining the interval to be measured are fed simultaneously to the oscilloscope and to the counter.

With this arrangement, if the start or stop pulse occurs close to the time in the cycle at which the counter triggers, there is a possible uncertainty as to whether the count was or was not recorded by the counter. Such uncertainty introduces a possible gross error of one or two full counts.

This ambiguity can be eliminated by increasing the circular sweep frequency so that one complete circular sweep instead of corresponding to one count of the counter, corresponds to several counts. In addition a reference mark would no longer be necessary, as only the fractional rotation from start to stop pulse need be measured.

Consequently, a circular sweep frequency of 400 kc is used giving four counts per sweep. With this arrangement, the interpolating scope displays the fraction of four counts between the start and stop pulses. Since the counter reading will always be well within two counts of the true interpolated

time, a single unambiguous value results.

## Circuit Description

Figure 1 is a block diagram of the instrument. Individual spark-gap light sources are flashed as the model passes their respective reference stations providing pulses to operate the counters and to trigger the z-axis grid of the oscilloscope. The mixing network provides the necessary outputs for these functions as well as to trigger the thyratron scaling circuit which, in conjunction with the variable-gain stage, determines the radius of the circular trace and thus serves to identify the station from which each pulse was received. Coaxial cable of 52-ohms impedance is used in all pulse circuits and mixing is done at this impedance and at high levels (100-v peak).

An accurately controlled 400-kc oscillator provides the time base and an *R-C* phase-shift bridge provides the four sine-wave outputs spaced 90 deg apart to drive the deflection amplifiers. The cathode-ray tube is electrostatically deflected and the resulting record is photographed. A 1.6-mc oscillator provides the time base for the four electronic counters.

## Oscillators

Figure 2 is a schematic diagram of the oscillators used. Two sepa-

rate oscillators are used, one to provide the 1.6-mc time base to the counters and the other to provide the 400-kc signal to generate the circular sweep. They are adjusted to a 4-to-1 ratio, but exact control of this ratio is unnecessary since an error as great as one part in ten thousand will not lead to count ambiguity for time intervals up to 6,000  $\mu$ sec.

For the measurement of longer time intervals it would be preferable to obtain the 400-kc sine wave from the 1.6-mc time base by frequency division. The precision of frequency control of the 400-kc oscillator determines the accuracy of time measurement for large time intervals. The oscillators are cathode-coupled multivibrators utilizing crystal frequency control and diode amplitude control. The diode is biased from a regulated d-c voltage, adjustable to control the clipping level and thereby the oscillator output over a range from 0 to 5 volts rms. This clipped wave is filtered by the crystal to give a low-distortion sine wave that is accurately frequency controlled. A cathode-follower output stage having a tuned load is used to provide isolation between the crystal and the load.

To differentiate between the start and stop pulse, a radius-control circuit is used to decrease the radius of the circle after receipt of

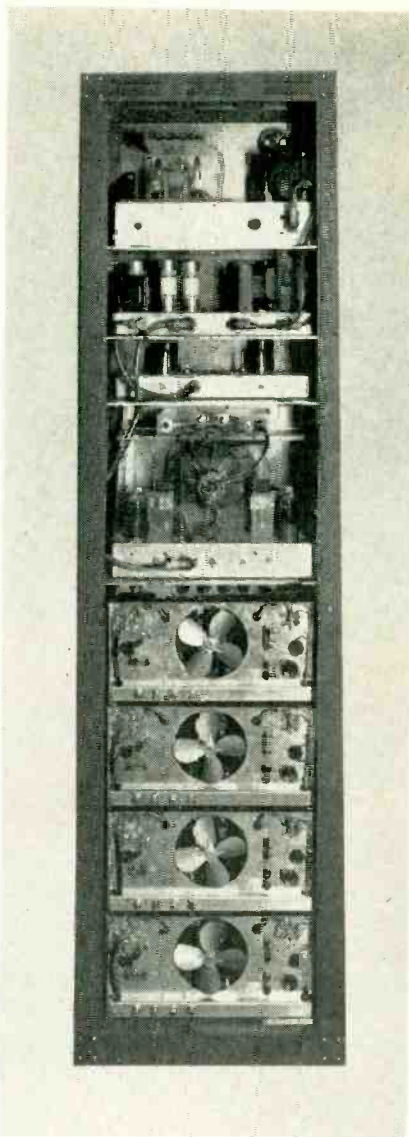
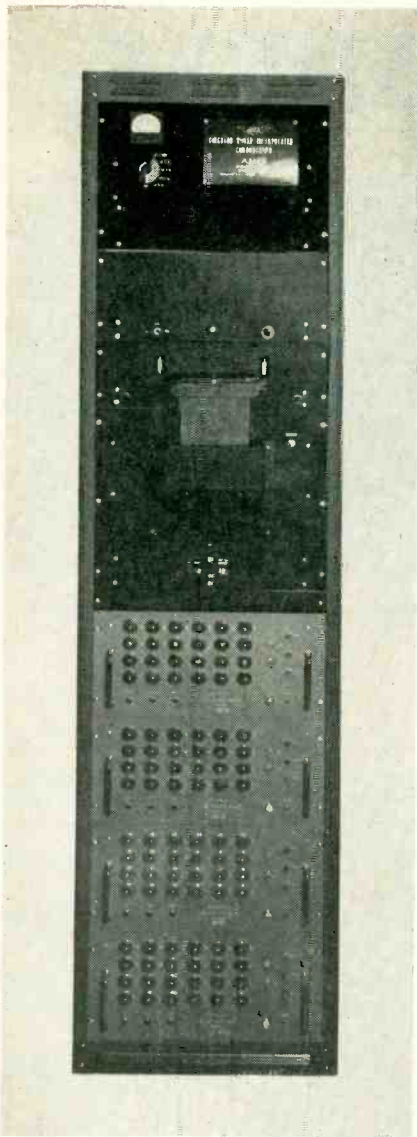

Front and rear views of complete chronograph systems. Four counters are at bottom of rack and mount for camera recorder is at center

the start pulse. Since this instrument is used to present the 4 successive time intervals, 5 radii are used to present the 5 pulses. This circuit, shown in Fig. 3, consists of a 6BA6 remote-cutoff pentode with variable bias applied to the cathode and controlled by a thyatron scaling circuit.

A tuned plate load gives 26-db attenuation to the second harmonic. The screen and cathode are fully bypassed to prevent phase shift and the plate is decoupled from the supply voltage. The thyatron scaling circuit consists of five 5727's interconnected so that the incoming pulse fires the first tube, thus increasing the cathode bias on the 6BA6 and decreasing the bias on the second 5727 so that it will be fired by the next incoming pulse.

A time-delay circuit between successive thyatrons suppresses transients. Plate and cathode load resistors are varied to produce uniform changes in the transconductance of the 6BA6. The input mixing network provides a pulse output whose amplitude is independent of the spark gap providing the input signal. This pulse operates the thyatron scaling circuit whose input capacitance is isolated from the crt grid by a series resistance.

To facilitate measurement of the angular spacing of successive pulses it was found advantageous to add a sixth circle following the last station pulse. This circle is used to locate the center of the concentric circles. The camera shutter remains open for five seconds after the model is fired to

allow time for the film to respond to the low intensity light output of the cathode-ray tube at its normal bias to expose the entire sixth circle. A typical trace is shown in a photograph.

### Phase-Shift Network

The output of the 6BA6 drives a 6AQ5 split-load phase inverter. An R-C phase-shift bridge driven by the 6AQ5 then supplies four outputs spaced 90 deg apart. A signal amplitude of 10 volts rms is required at the grid of the 6AQ5 to produce a circle  $3\frac{1}{2}$  inches in diameter on the oscilloscope. To maintain equal cathode and plate impedance, the operating point is set by positive bias applied to the grid and equal resistors of one-percent tolerance are used at plate and cathode.

Bridge capacitors and resistors are also of one-percent tolerance. For 400-kc operation this R-C bridge was found to give excellent results in terms of outputs spaced accurately 90 deg apart, and in terms of phase stability with time. The driven ends of the bridge have slightly greater output and are used to drive the 807W's coupled to the horizontal deflecting plates. The center sections drive the 807W's coupled to the vertical-deflecting plates as their deflection sensitivity is slightly higher.

### Output Stage

The R-C phase-shift bridge supplies approximately 5-v rms to the grids of the four 807W's used to drive the deflecting plates. This input voltage produces a signal amplitude of 150-v rms at the deflec-

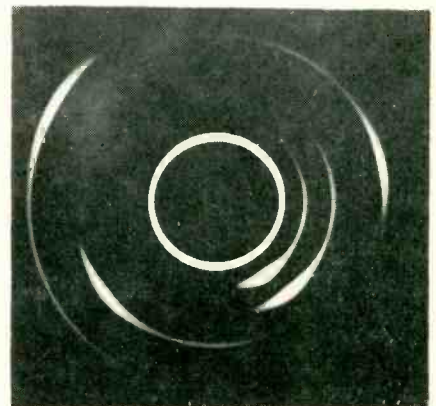

Photographic record of five-trace sweep with intensified centering circle





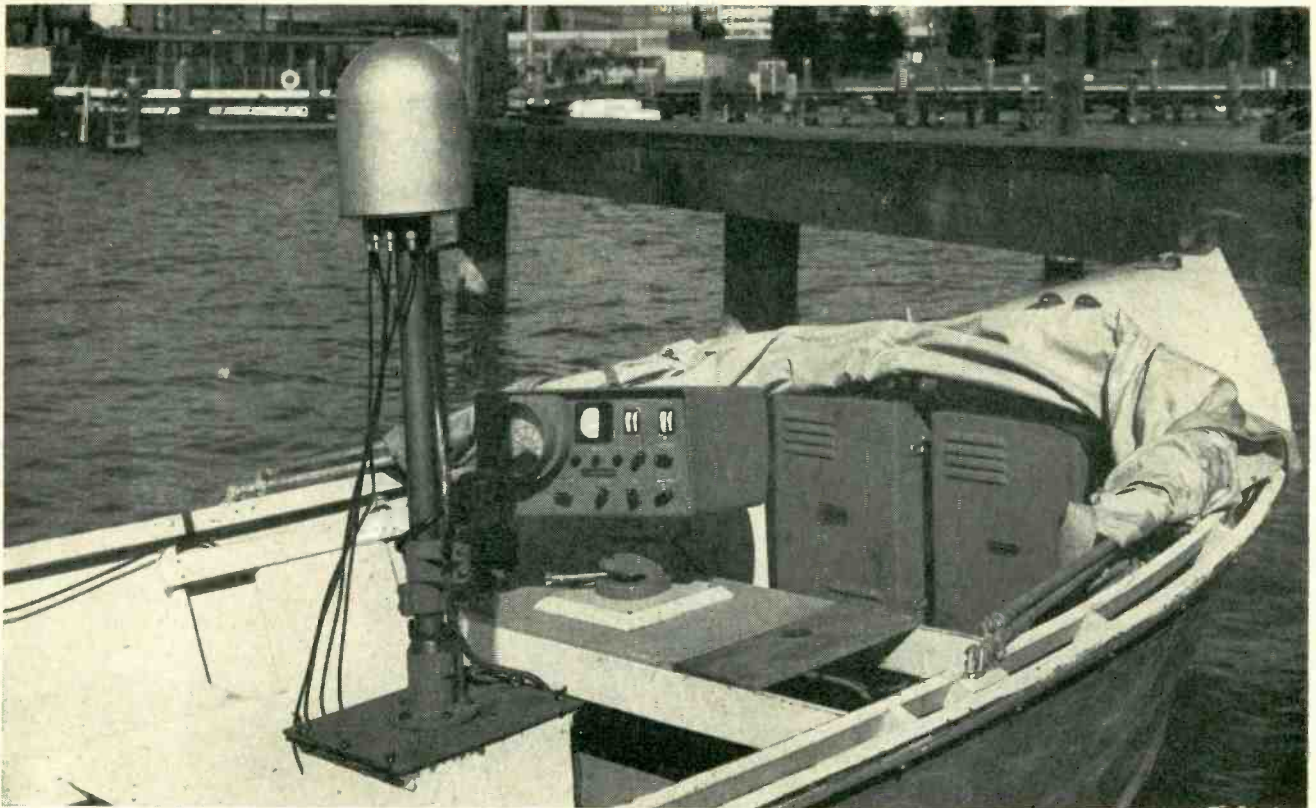

**FRONT COVER:** Field installation of automatic ultrasonic tracking and ranging system on U. S. Fish and Wildlife Service boat Wendy. Five-transducer array is on servo-driven rotating and tilting mount inside dome. Ultrasonic signals (132 kc for tracking and 270 kc for ranging) travel through air to water. Equipment can also be used for studying crabs and lobsters

# ULTRASONIC TRACER

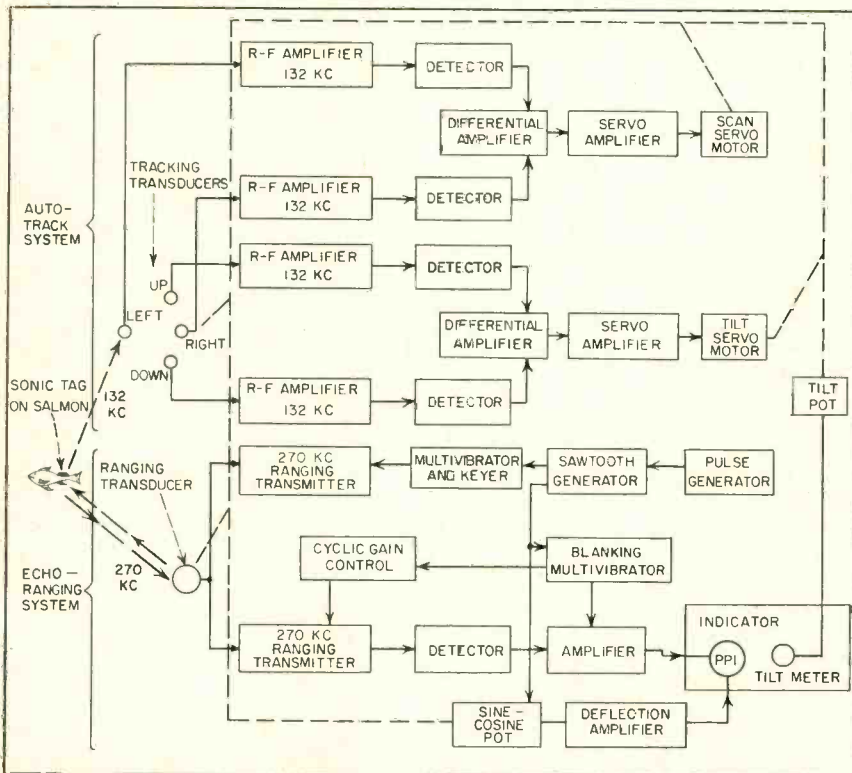

**FIG. 1—**Complete automatic tracking and ranging system for tagged fish

**D**EVELOPMENT of automatic ultrasonic tracking and ranging equipment for the Fish and Wildlife Service provides a method for obtaining information on adult salmon behavior in relation to dams in the Northwest. The design and production of this new research tool was prompted by the need for obtaining a more detailed knowledge of individual salmon behavior than has been possible by conventional methods.

The equipment consists of a miniature ultrasonic source (sonic fish tag), a self-positioning directional transducer array with a receiver-servo system (auto-track) and an echo-ranging system arranged as in Fig. 1.

In operation, the tracking system positions itself or homes on the sonic tag attached to a fish and aims the transducer in that direction. The range and bearing of the fish are displayed on a calibrated cathode-ray tube. The depth of the



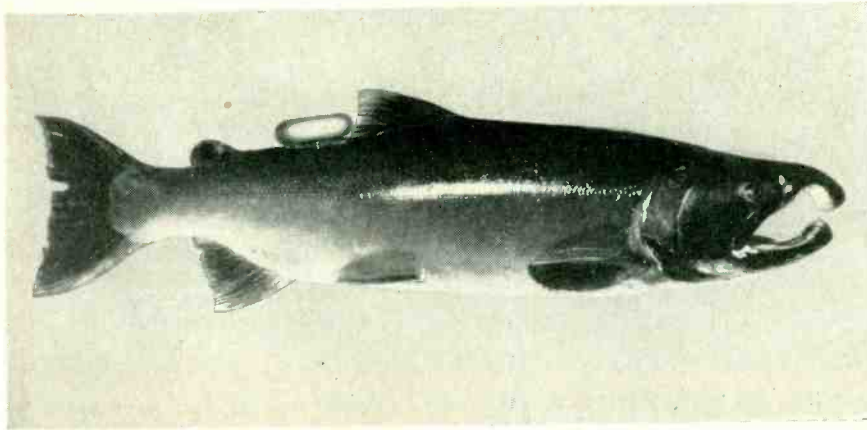

Sonic tag on silver salmon has carefully adjusted buoyancy so as not to affect natural movements of fish. Pulse repetition rate of transistor oscillator in tag is adjustable; with appropriate receiver tuning facilities, up to ten different fish can be tracked simultaneously

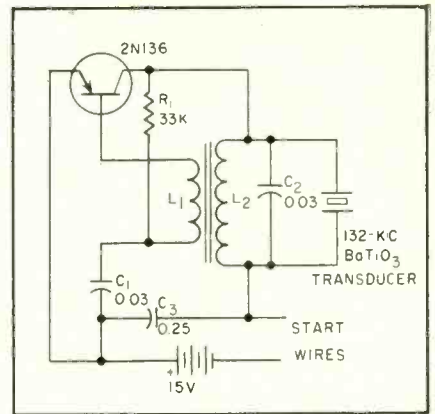

FIG. 2—Pulsed 132-kc ultrasonic oscillator used in sonic fish tag can be detected at distances up to 2,000 feet

**SUMMARY** — Single-transistor pulsed ultrasonic oscillator with 7-hour battery life is clipped to adult salmon on spawning run. After fish is released, movement is tracked with sonar-type equipment on boat to obtain detailed fish behavior patterns in relation to dams. Servo-controlled four-transducer receiving array tracks tagged fish automatically to give elevation and azimuth. Sonar ranging transducer in center of array is thus aimed directly at fish

# Follows Tagged Fish

By **PARKER S. TREFETHEN,**

*Fishery Research Biologist  
U. S. Fish and Wildlife Service  
Seattle, Wash.*

**JOHN W. DUDLEY** and

*Senior Engineer  
Seattle Development Laboratory, Ordnance Division  
Minneapolis-Honeywell Regulator Co., Seattle, Wash.*

**MYRON R. SMITH**

*Senior Staff Engineer*

fish is calculated from the range and the angle at which the ultrasonic impulses from the equipment are projected into the water. By plotting the position of the fish and the position of the boat simultaneously, the operator is able to obtain detailed fish behavior patterns.

## Ultrasonic Fish Tag

To permit attachment to relatively small fish with minimum modification of their behavior, the sonic tag must be of miniature size. Opposed to this requirement is the need for battery life of 8 to 12 hours. Accordingly, circuitry in the sonic tag was chosen to hold current requirements to a minimum.

The additional requirement of approximately neutral buoyancy

modifies the package to some extent. The resultant capsule is 2½ inches long, 0.9 inch in diameter, weighs 29 grams in air and displaces 27 grams of fresh water.

The capsule shell, spun from 7-mil aluminum, is provided with a soldered-on hog ring for attachment to the fish. The tag closes with a slip fit and is sealed with vacuum grease, a wrap of plastic tape and an over-all plastic dip to ensure water tightness to a depth of 30 feet.

Economy of battery life is improved by pulse operation of the sound source. The common-emitter transistor oscillator circuit used in the sonic tag is shown in Fig. 2. Here  $R_1$  and  $C_1$  establish an interruption rate of 2,000 pps and a pulse length of 200 microseconds.

The values of  $L_2$  and  $C_2$  and the clamped capacitance of the transducer determine the 132-kc operating frequency.

The transducer used in the sonic tag is a barium titanate disk 0.040 inch thick and 0.86 inch in diameter. The disk is one-half wavelength in diameter, resonant in the radial mode at 132 kc. It has silver fired on both surfaces and small lead wires soldered to the nodal point or center of each side. The transducer mounts inside one end of the spun aluminum capsule, at the break point of the end radius. Epoxy resin cement secures it in place and gives acoustic coupling to the aluminum shell. This construction, which provides a marked benefit in matching the acoustic impedance of the disk to the water

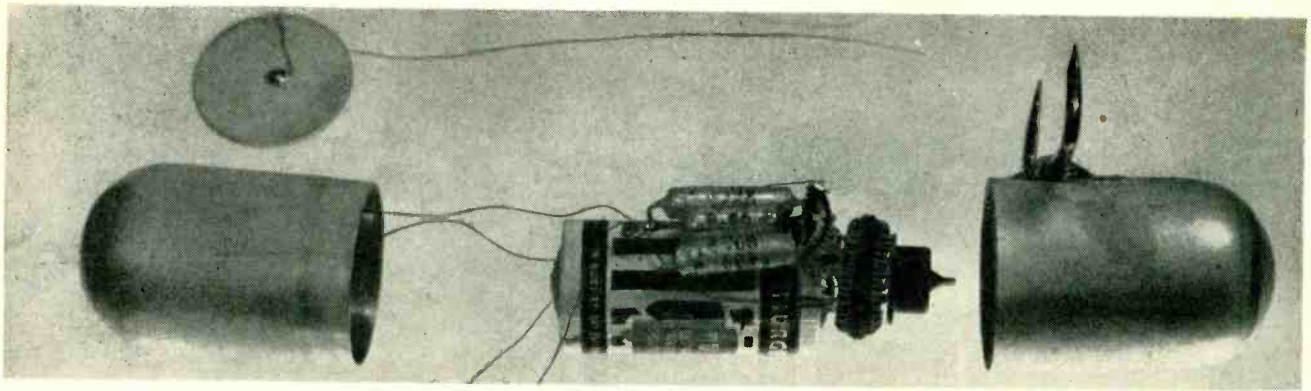

Contents of ultrasonic fish tag. Crystal transducer (top) fits into left half of capsule, which is shaped and dipped in waterproofing plastic solution after assembly. Two leads at lower left come out of capsule through joint, for connecting together to complete circuit just before fish is released. Smaller tag is now being developed for use on small fish

load, gives the desirable nearly circular radiation pattern shown in Fig. 3.

With this circuit arrangement an r-f voltage of 25 volts peak-to-peak is developed across the transducer, providing a signal level of 5 microvolts at the receiver grid at 400 feet. The 15-gram 15-volt battery has a useful life of 7 hours at a current drain of 3 ma.

#### Automatic Tracking System

The servo-powered automatic tracking system uses four receiving transducers, each connected to one of the four receiving channels. Two of these transducers are used for azimuth tracking and two for elevation tracking. Each azimuth transducer has a beam pattern with

a response 10-db down at 20 degrees from its axis. The transducers are mounted with an angle of 40 degrees between their axes. A sound source on the bisecting axis of a pair will produce in each a signal which is 10-db below its maximum response. If this source is moved from the bisecting or common axis toward either transducer axis, the output from that transducer will rapidly increase towards its maximum while the output from the other will decrease. If the two signals are used to balance each other in a difference amplifier, the resultant sharply defined null provides excellent sensitivity to small angular displacements from the common axis.

The receivers use a high-gain

trf circuit with a bandpass of  $\pm 4$  kc to the 3-db-down point. Two of the tracking receiver channels and their common servo amplifier are shown in Fig. 4. Each channel has a biased triode ( $V_{5A}$  and  $V_{10A}$ ) operating as a detector, feeding the 2,000-cps repetition rate frequency of the sonic tag to a zero-bias amplifier. The audio signals from the two channels are rectified by 1N38 diodes which are directly coupled to the grids of the cathode-follower difference amplifier. The output signal from the difference amplifier is a bidirectional d-c voltage which is then modulated by a 60-cps chopper. The chopped signal is amplified by a 60-db amplifier which drives an 8-watt 2-phase servo motor geared to the transducer clus-

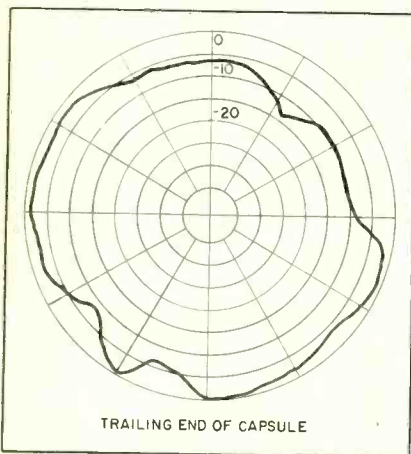
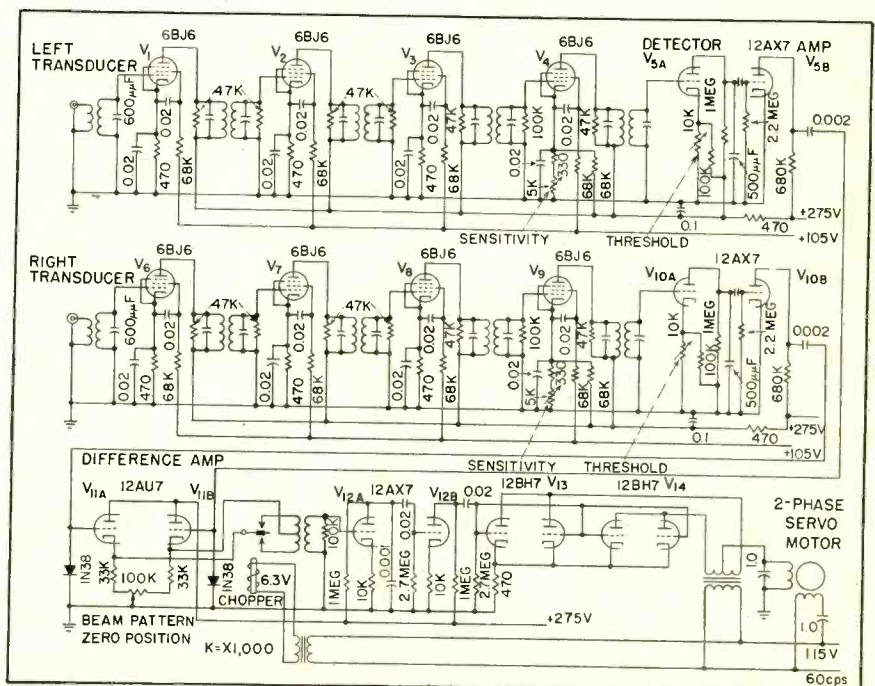

FIG. 3—Ultrasonic energy distribution pattern in horizontal plane for tag attached to fish

FIG. 4—Azimuth tracking receiver channels, servo amplifier and motor circuit for horizontal rotation of transducer array





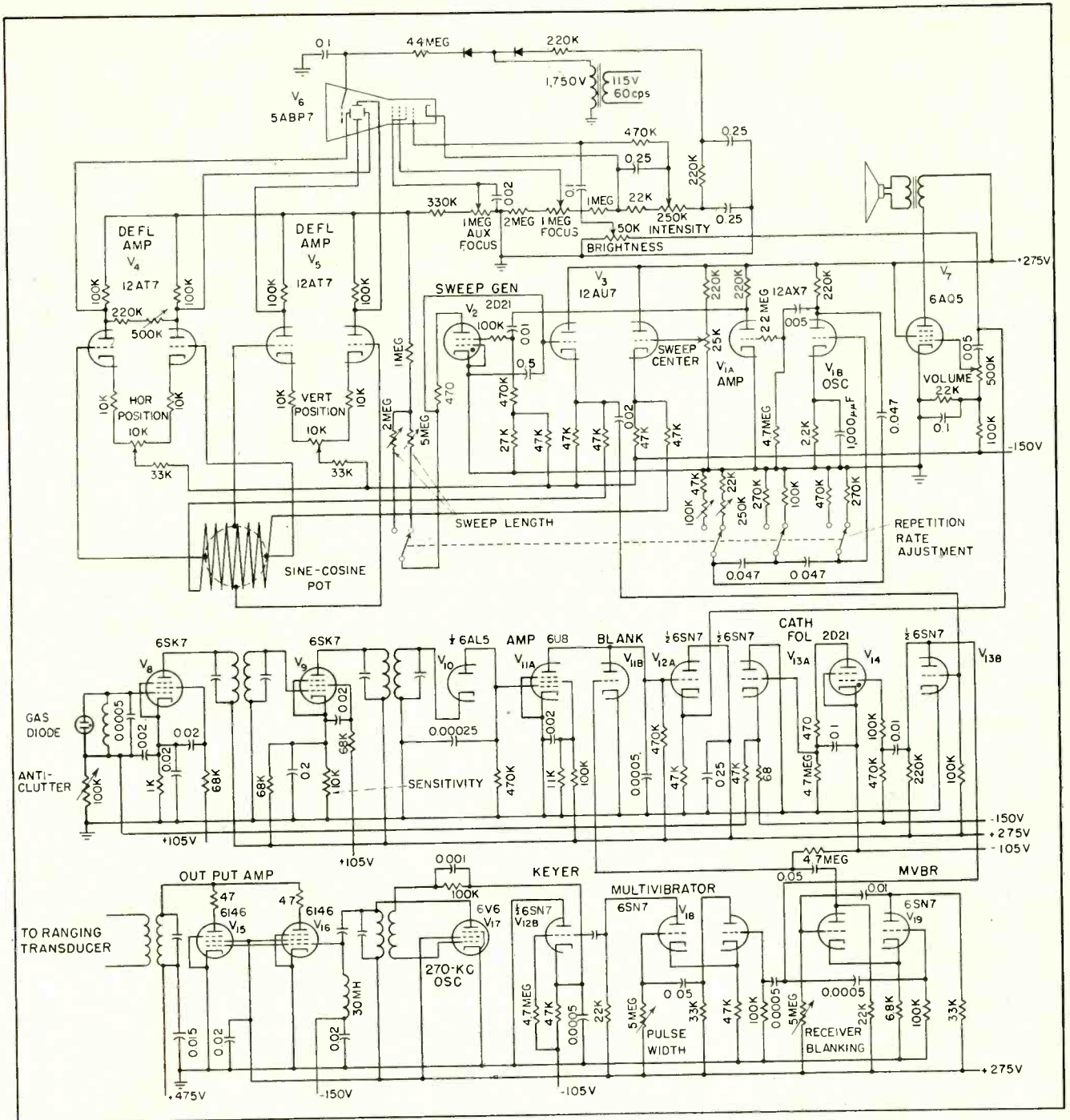

FIG. 5—Transmitter-receiver and indicator display circuits of echo ranging system

ter. Directional sensitivity is inherent in the phase sensitivity of the servo system.

Information on angular position of the sonic tag is presented to the operator as azimuth information and elevation angle (always negative). Azimuth angle is displayed on a ppi scope in conjunction with range information. This is accomplished by using the range sweep sawtooth signal as an input to a sine-cosine potentiometer which is

rotated with the azimuth axis, as indicated in Fig. 5. The sine-cosine potentiometer output is amplified by four triode deflection amplifiers to provide a radial sweep for the cathode-ray tube, in synchronism with the transducer cluster azimuth angle. A conventional potentiometer is coupled to the elevation axis to transmit elevation data to a panel meter.

The ranging system may be described as an echo-ranging search-

light sonar system. A short pulse of ultrasonic energy is emitted by a direction transducer. The transmitted pulse encountering a target results in a small portion of the energy being reflected and returned to the receiving transducer as an echo. The transit time is then a measure of range.

In the ranging circuit of Fig. 5, a pulse repetition rate of 6 cps (400-foot range) or 3 cps (800-foot range) is generated by phase-

shift oscillator  $V_{13}$  and is shaped in saturation amplifier  $V_{14}$ . The differentiated leading edge of this pulse triggers sawtooth sweep generator tube  $V_5$ . The sharp leading edge of the sawtooth is used for timing and synchronizing all time-dependent functions.

In the major signal path this synchronizing signal triggers monostable multivibrator  $V_{18}$  which determines the transmitted pulse width of 500 microseconds. This in turn, acting through keyer tube  $V_{12B}$ , keys on 270-kc oscillator  $V_{17}$  and output amplifier  $V_{15}$  and  $V_{16}$ . The type 6146 transmitter output tube was selected for high pulse output at relatively low voltages. The transmitted acoustic pressure is 120 db above 1 microbar at 1

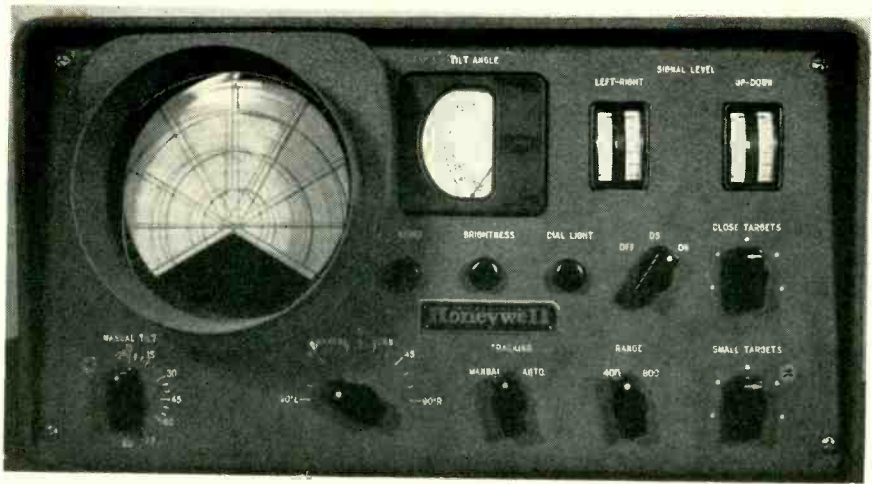

Operator's display panel on boat. Bright spot of light appears on ppi screen, behind calibrated scale on which bearing and range of fish can be read directly. Tilt-angle meter at right of scope gives angle at which beam of ultrasonic impulses enters water when aimed at fish. Depth can be calculated from range and angle

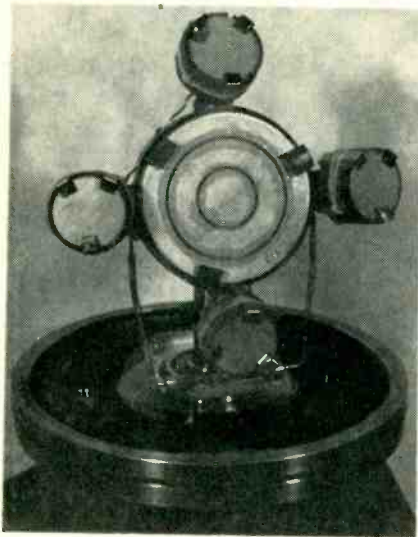

Transducer cluster with protective cover and coupling fluid removed. Ranging transducer is in center of cluster of four tracking units

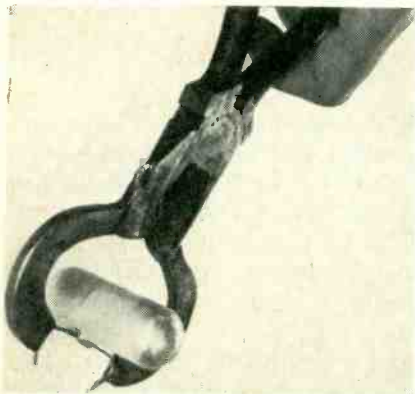

Special pliers permit attaching tag in 30 seconds to back of fish behind dorsal fin, without handling fish in 4-foot-square underwater trap

yard from the ranging transducer.

A single transducer serves for transmitting the outgoing pulse and receiving the returning echo. Coupling is by means of a three-winding transformer with a gas-discharge tube across the receiver winding to decouple the receiver during the transmitted pulse. The transducer in the ranging system is 3.25 inches in diameter with a 5-degree major beam angle at 6-db down. Signal-to-noise ratio and forward sensitivity are greatly enhanced by this directional characteristic. The ranging receiver uses a trf circuit and is conventional through the r-f amplifier and diode detector. The output of the detector is a negative-going pulse and is direct-coupled through amplifier  $V_{11A}$  to cathode follower  $V_{12A}$ , then directly to the c-r tube control grid for the desired Z-axis intensity-modulated display. An audio signal is picked off at this same point to present an audible sound of the echo pulse.

Minor signal paths are used to perform auxiliary functions. The synchronizing leading edge of the sawtooth is also used to actuate blanking monostable multivibrator  $V_{10}$ . The multivibrator produces a pulse slightly longer than the transmitted pulse, applied to receiver blanking tube  $V_{11B}$  to effectively blank out the receiver during the transmitted pulse. This eliminates a high-intensity center spot from the ppi and suppresses the transmitted signal in the audio channel.

Time-varied gain in the receiver is controlled in a cyclic manner by an additional minor signal path. The receiver gain is reduced at the time of the transmitted pulse and is increased at a programmed rate as the echo range increases. The 2D21 thyratron  $V_{14}$  develops the sawtooth signal for this purpose and cathode follower  $V_{13A}$  couples it to the receiver input tube grid. The operator can, to a degree, modify the amplitude of this gain control sawtooth. A panel knob labeled CLOSE TARGETS provides him with controlled discrimination against close-in target response. In addition to this, he has a main receiver sensitivity control labeled SMALL TARGETS.

### Applications

Utilization of the newly developed equipment reveals the behavior patterns of adult salmon at fishway entrances, fishway exits, near spillways and near powerhouse sections of dams.

Although originally designed to study salmon behavior, the equipment is not limited to specific problems in fishery research. When it is employed at sea, detailed information can be added to the present knowledge of tuna, albacore, whale and many other fish.

Thanks are due to the Seattle Development Laboratory, Ordnance Division, Minneapolis-Honeywell Regulator Co., designers and manufacturers of this device, for permission to release this article.



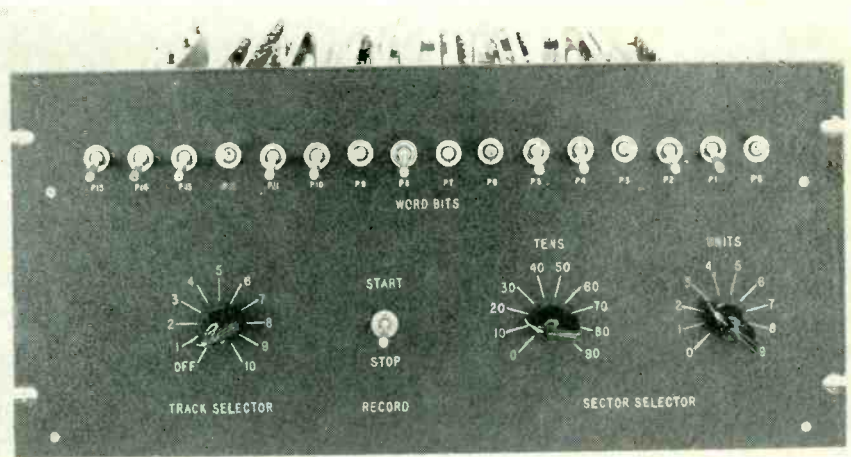

Front view of sector selector shows setup for selecting the word bits, their sequence, the sector and the track to be recorded on

# Counters Select Magnetic Drum Sectors

**SUMMARY** — Large-scale data-processing systems require a means of checking the arithmetic and memory systems employed. A 16-digit and 100-digit counter combined with logic circuits provide an automatic writing unit to produce a predetermined binary pattern in any selected word or sector on a magnetic-drum memory. The equipment can also be integrated with arithmetic units to aid or check computation procedures

By **A. J. STRASSMAN** and **R. E. KING**

*Ground Systems Laboratory  
Hughes Weapon Systems Development Laboratories  
Hughes Aircraft Company  
Culver City, California*

**M**AGNETIC-DRUM MEMORIES in digital data-processing equipment require that the stored information be sometimes entered in specified locations on the periphery of the drum cylinder. To accomplish this, some method of determining location is required as well as system for entering the desired information. The equipment to be described can be used as a piece of testing apparatus to check these magnetic drum operating characteristics and also for computation procedures in a computer arithmetic unit.

The ability to select any particular sector of a magnetic-drum

memory can be achieved if there is a signal written on the drum to indicate the beginning of each word or sector. These signals are then applied to a counter whose output is selected by switching means to display only a selected number. This number is then coincidence gated with the desired action of either writing into or reading from the drum at the particular sector selected. Figure 1 shows the block diagram of a system that accomplishes this task.

### Words

A pulse indicates the beginning of every word written previously

on the drum. This pulse is detected by the read amplifier which triggers the read flip-flop. The flip-flop has the two outputs shown in Fig. 2A; a pulse that is true for only one bit time and its complement which is false for that same bit time and true for the rest of the word.

The true signal  $P_w$  is applied to a modulo- $X$  counter where  $X$  is the total number words on the drum and for this case is equal to 100. The complement is applied to the modulo-16 digit counter and is used for a reset signal.

The selected outputs of the mod-100 word counter and the mod-16

counter are *anded* in logical diode network  $G_1$  and applied to single-input flip-flop 1. Figure 2B shows the output of both the mod-16 and the mod-100 counters.

The output of flip-flop 1 is the selected word time with the selected bits inserted within that word time. Figures 2C and 2D show the output of flip-flop 1 with the coded data in all but one and only one sector respectively. This information is applied to a writing amplifier whose output is fed to a writing head on the magnetic drum. One of several heads can be selected by switch  $S_1$ .

The writing amplifier is gated on and off automatically by the logical circuitry shown in Fig. 1 consisting of the gating applied to the input of flip-flop 2. Schematic of the transistor flip-flop is shown in Fig. 3 and a system time diagram is shown in Fig. 4.

### Automatic Writing

The binary-coded information is recorded on the drum by the writing amplifier illustrated schematically in Fig. 5.

Manually switching the writing amplifier on and off will normally produce transients in the recording waveform which may alter or destroy any information fed through the writing amplifier or recorded on the drum under the recording head at the instant of switching.

The writing amplifier used to record the binary pattern in the selected word or sector is switched on and off by the action of flip-flop 2. When this flip-flop is on or in the true state the writing amplifier is gated on and allows the output of flip-flop 1 to be recorded on the drum.

When flip-flop 2 is off or in the false state no recording is done and the drum carries stored information. To avoid losing information

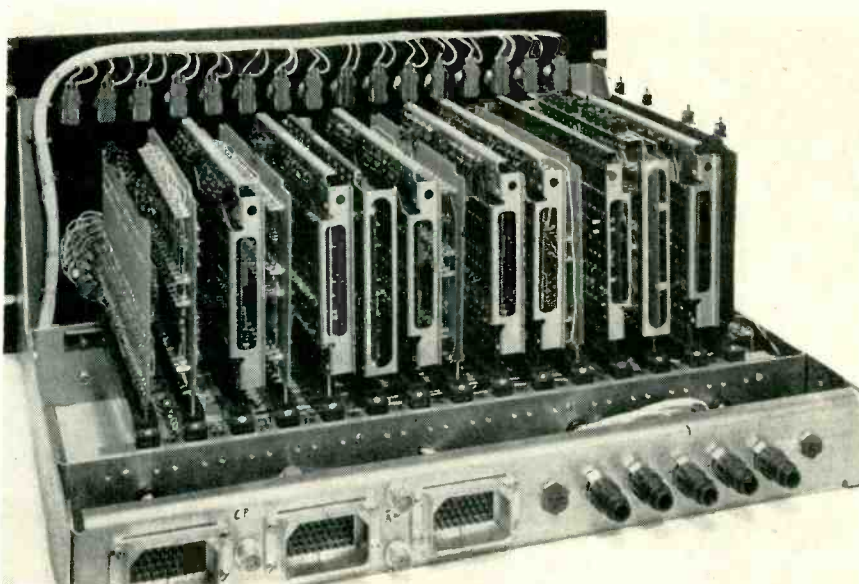

Internal view shows how etched-circuit card containing logic circuits and flip-flops are plugged into standard rack-mounted chassis

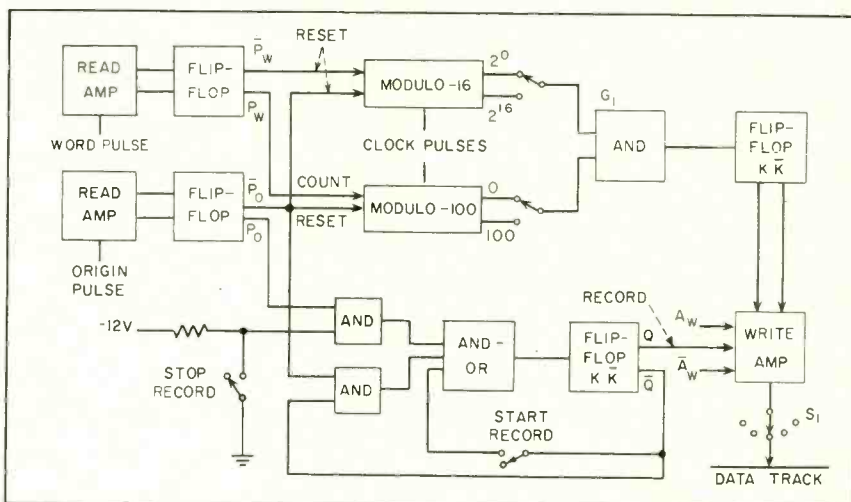

FIG. 1—Sector selector writes preselected word containing up to 16 bits when start-record switch is pressed

the switching time is chosen to coincide with the occurrence of the origin pulse beginning at each drum revolution and precaution is taken never to introduce any information onto the drum in this area.

The circuitry used to avoid this area consists of an *and-or* logical

net whose output triggers a one-input flip-flop and a normally-closed pushbutton, used to start the operation. Stop action is accomplished by a normally-open switch.

The writing amplifier is normally in the off condition, therefore the  $Q$  output of flip-flop 2 is high or on. Flip-flop 2 is held in this

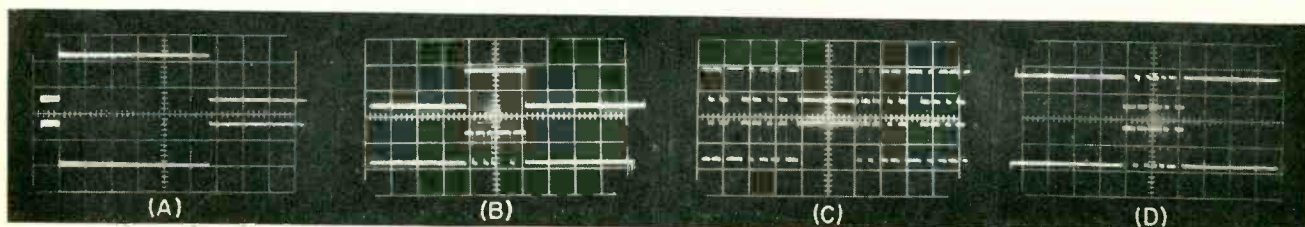

FIG. 2—Waveforms show read amplifier flip-flop output (A) for one bit time, mod-100 (top) and mod-16 (bottom) output as fed to flip-flop 1 (B), output of flip-flop 1 with coded data in all sectors but one (C) and output of flip-flop with data in only one sector (D)



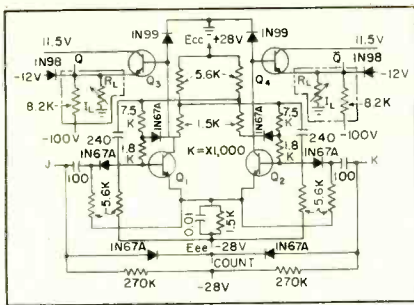

FIG. 3—Output of transistorized flip-flop gates writing amplifier

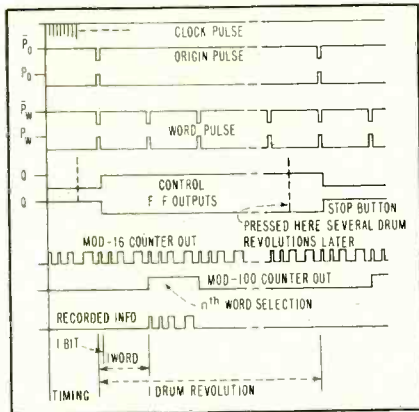

FIG. 4—System time diagram shows operating sequence from time start switch is pressed to time stop switch is pressed

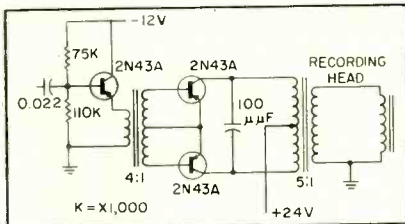

FIG. 5—Transistorized writing amplifier drives recording head over selected drum track in proper sector of rotating drum

condition by feedback through the start switch. When the start switch is pressed this signal is removed, however the gate is still held false by the complement of the origin pulse.

When the origin pulse is received from the drum, all the inputs to flip-flop 2 are removed and the Q output goes high or on. Thus the writing amplifier records when the origin pulse is received.

Recording will continue with the preset pattern injected in the selected word until the stop button is depressed. This triggers flip-flop 2 to its original state when the origin pulse occurs, consequently switching off the writing amplifier.

The writing amplifier is held in

this state until the start button is depressed again.

Thus the writing amplifier has been switched on and off at the beginning of each drum revolution only and any transients that may occur will not affect the rest of the magnetic drum.

### Sector Counter

Two modulo-10 counters in series form a sector counter that produces a count of 100 before recycling. Standard transistor two-input flip-flops are used as the basic element and diode gating is used to accomplish proper timing.

Since the counter is divided into two identical counters, the logical equations for the tens counter are the same as for the units counter with the addition of the final count from the unit counter logic. Circuitry and logic are shown in Fig. 6.

The single selected word output is decided by the position of the unit-sector number switch and the ten-sector number switch. The outputs of all flip-flops are connected to the input of a 10-position 4-pole switch whose outputs are connected to *and* gate  $G_1$ . This produces an on pulse one word long at the selected time only.

An alternate output is the complement of this signal which would cause the output to be on for 99 words and off for the selected word. This allows the same binary pattern to be written in all sectors of the drum except for a guard sector which contains all zeros.

The modulo-16 counter, triggered by logic-circuit output, is used

Table I—Flip-flop Truth Table

J	K	$Q^{n+1}$
0	0	$Q^n$
0	1	0
1	0	1
1	1	$Q^n$

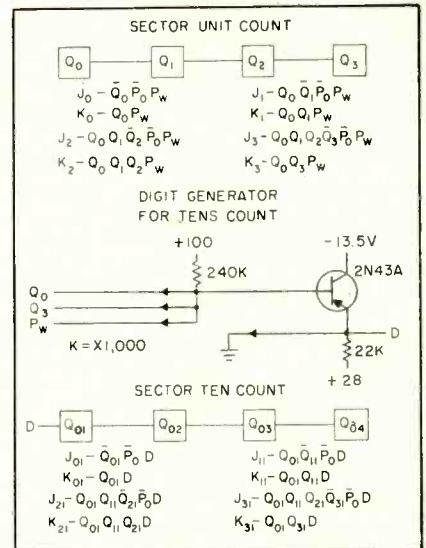

FIG. 6—Logic equations for unit count are shown with circuit of digit generator providing output D, indicating the number 10, to trigger sector ten count that uses lower set of logic equations

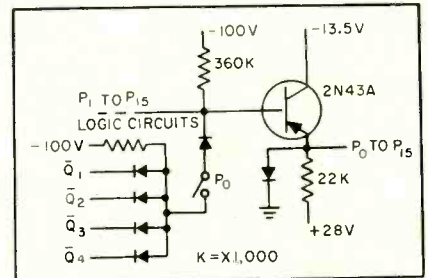

FIG. 7—Modulo-16 digit counter output circuit is driven from  $P_1$  to  $P_{15}$  logic circuits

for the digit counter. Figure 7 shows the logic and diode circuitry necessary to accomplish the generation of a binary pattern. Table I shows the truth table associated with the flip-flops.

The output of this counter is *anded* with the output of the sector counter  $G_1$  whose output is applied to flip-flop 1. The output of this flip-flop is a composite of the sector number and binary count (see Fig. 2C and 2D) that is applied to the input of the writing amplifier.

The writing amplifier output can now be switched to any writing head on the selector switch.

This equipment was designed as a piece of test equipment for evaluating certain functional equipments used and developed in the Ground Systems Laboratory of Hughes Aircraft under a contract with the U. S. Army Signal Corps Engineering Laboratory, Fort Monmouth, New Jersey.

# AIRCRAFT RADIOPHONE

By **B. R. RASHKOW\***

*National Aeronautical Corp.  
Ft. Washington, Pa.*

**SUMMARY** — Direct communication between pilot and ground is accomplished only with radiotelephone. Elimination of long-distance radiotelegraph circuits requires more effective power, reduction of noise and other improved equipment or techniques. Ground-station system must be capable of picking up signal for relay by radio teleprinter, c-w or radiotelephone to ultimate destination in network

**U**NTIL recently, it had generally been considered mandatory that each transoceanic air carrier aircraft include among its flight crew an operator to effect communications with ground stations for purposes of aircraft position re-

porting and meteorological data accumulation.

With the increase in over-ocean air traffic and aircraft speed, it became necessary to re-evaluate the accepted methods of air-ground communications, to increase relia-

bility and speed of intelligence exchange. In appraising possible communications facilities, it became evident that these objectives would be attained by simulation of normal, landline telephone operation.

## System Changeover

Effecting a smooth transition from radiotelegraph (c-w) to radiotelephone required solution of problems in operations, technical equipment and system limitations. Formerly, with a radio operator, any one of several preselected station frequencies between 2 and 18.5 mc could be used to contact one or two specific ground stations.

The present concept of a network system calls for a group of ground stations to be so located as to enable the pilot to make a simple frequency selection by channel number on a remote cockpit control head and thereby contact the station most favored by geographic position and propagation conditions.

Each station may be operative on as many as eight frequencies spread throughout the h-f range to provide maximum flexibility of operation. Point-to-point radioteleprinter, manually operated c-w or radiotelephone circuits can then relay the data to the destination in a matter of minutes. Figure 1 shows a typical deployment of radiotelephone ground stations over the North Atlantic.

Aside from the actual construc-

\* Data collected while author was employed by Pan American World Airways

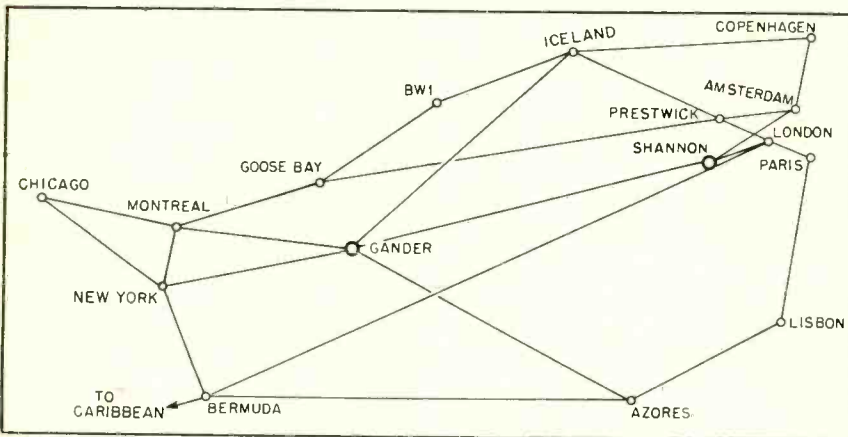

FIG. 1—Air routes and communications network in the North Atlantic area

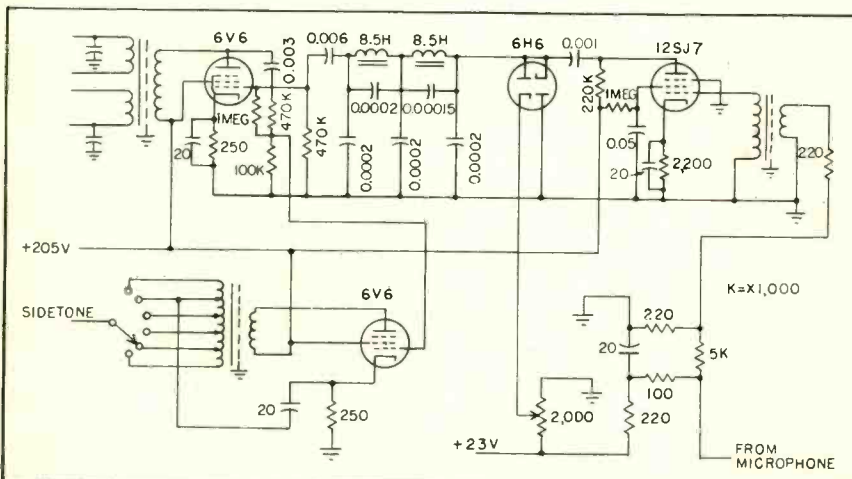

FIG. 2—Speech clipper and filter circuit representative of type used in airborne transmitter



# Speeds Communications

tion of new radiotelephone stations, considerable work was necessary on existing aircraft and ground radio equipments to facilitate this transition. The most serious problem was that of providing the pilot with a multichannel, remotely selectable transmitter to allow operation on the many frequencies that the pilot may find occasion to use in his various international route segments.

Within the transmitter, two basic problems were those of providing a sufficient number of variables in the oscillator, buffer and power amplifier circuits, as well as means to permit antenna impedance transformation at each of the many frequencies to be used. A 144-frequency crystal-controlled transmitter employing automatic tuning and an automatic tuner for transforming antenna impedance to 52 ohms were developed by Aeronautical Communications Equipment Inc.

## Operational Principles

Upon selection of a specific channel, an open-circuit-seeking motor-driven switch wafer effects rotation of the main crystal drum. At the end of this operation, a sequence

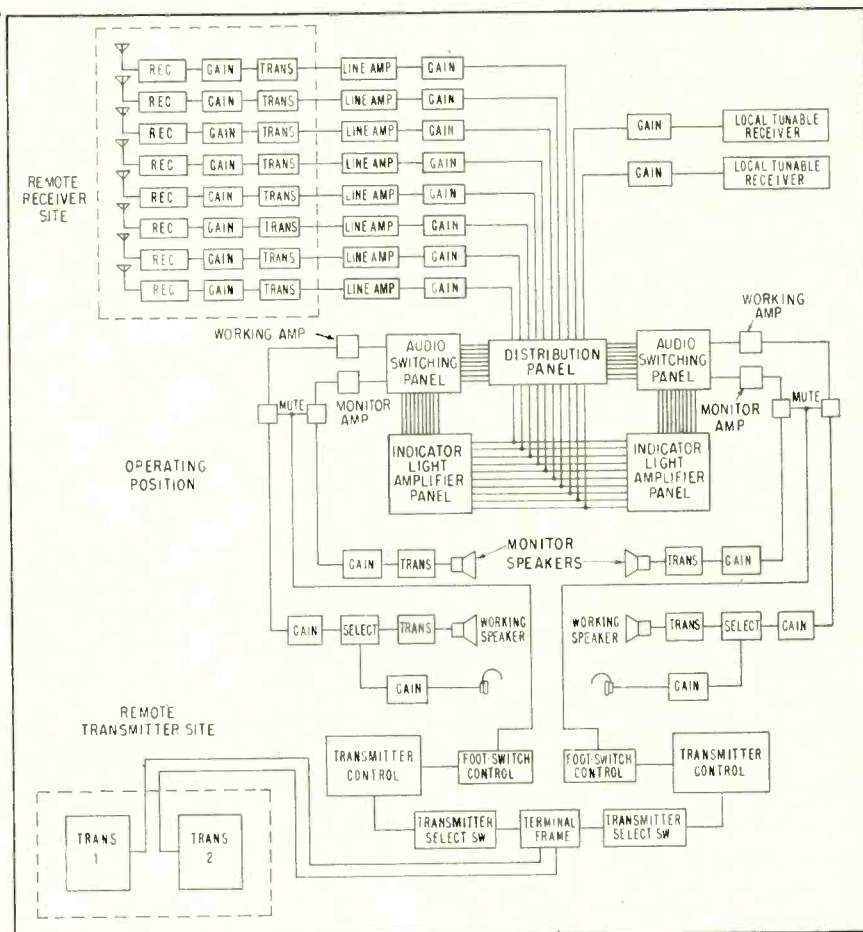

Functional block diagram of equipment used in radiotelephone station at Santa Maria in the Azores

stepping relay initiates a series of circuit-inspecting operations. If there is a crystal in the selected

crystal socket, the modified Pierce oscillator will begin operating immediately to provide a low-level r-f voltage to the input of the buffer.

The plate circuits of the buffer and power-amplifier stages are tuned with motor-driven variometers. Using a differential relay, one of whose coils is in series with the p-a grid, a fixed bias current in the opposing coil establishes a minimum requirement for current through the grid coil to actuate the relay. The relay will close only when sufficient grid current is drawn, indicating proper tuning. Relay actuation results in stopping the tuning process.

Upon completion of the transmitter tuning sequence, the antenna tuner begins essentially the same series of functions with the exception that the servo system, in this

## Pushbutton Airways Communications

Transition from radiotelegraph to radiotelephone for transoceanic aircraft requires engineering at many levels. Important among the concepts and problems involved are those listed below.

- (1) Development of a network that at any point receives radiotelephone messages from aircraft and quickly relays by other means.
- (2) Provision for multichannel, remotely selectable transmitter and receiver for aircraft, including automatic tuning and antenna impedance matching.
- (3) Obtaining optimum modulation characteristics through clipping techniques.
- (4) Quieting receiving equipment by use of noise limiters and codan to overcome fatiguing effects of precipitation static.
- (5) Elimination of aircraft fuselage projections to cut down static discharge resulting in receiver noise.
- (6) Development of new ground station systems in which transmitting and/or receiving equipment may be 40 miles from control point.
- (7) Re-evaluation of radio propagation conditions including effects of aurora and unstable ionospheric layers.
- (8) Improvement in ground-station coverage through exploitation of antenna lobe patterns.
- (9) Optimizing frequency as a function of aircraft antenna configuration.
- (10) Expanding use of selective calling to minimize pilot listening fatigue





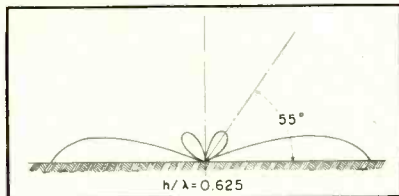

FIG. 4—Optimum ground-wave antenna radiation pattern for  $5/8$ -wave vertical structure. Ground radials are placed 15 deg in azimuth

receiver sensitivity is seriously degraded. Figure 3 shows typical noise limited and codan circuits used in an airborne receiver to achieve more effective receiver operation.

The codan circuit used in the type AR-144 receiver comprises a limiter amplifier  $V_6$ , a carrier rectifier  $CR_1$ , a d-c amplifier  $V_7$ , and the audio amplifier and gate tube  $V_5$ .

Without a signal, current flows through  $R_1$  and  $R_2$  and voltage developed across the first resistor biases off the a-f amplifier grid. When a signal is received, part of the output from  $V_4$  appears at the grid of the limiter amplifier. Output from  $V_6$  is rectified by  $CR_1$  and the negative voltage resulting is applied to the grid of  $V_7$  through an R-C filter. Plate-current flow is cut off, bias is removed from the grid of the audio amplifier and the signal is normally amplified.

A slight delay is provided in the interruption of the audio circuit without increasing activation time by charging capacitor  $C_1$  through germanium diode  $CR_2$  and discharging through the higher resistance of  $R_3$ .

The band-pass filter between detector and grid 3 of  $V_6$  prevents c-w signals from activating the audio gate tube. To improve overall avc characteristics of the receiver a variable degree of negative feedback is used around the audio amplifier.

Dual triode  $V_7$  is connected across the feedback loop as a variable shunt resistance and a control voltage from the detector is fed to the grid of this tube such that plate impedance is proportional to the signal level. Audio gain is thus reduced as signal level as the detector increases.

Reduction in precipitation static effects is controllable to some degree. Rate of change of electric

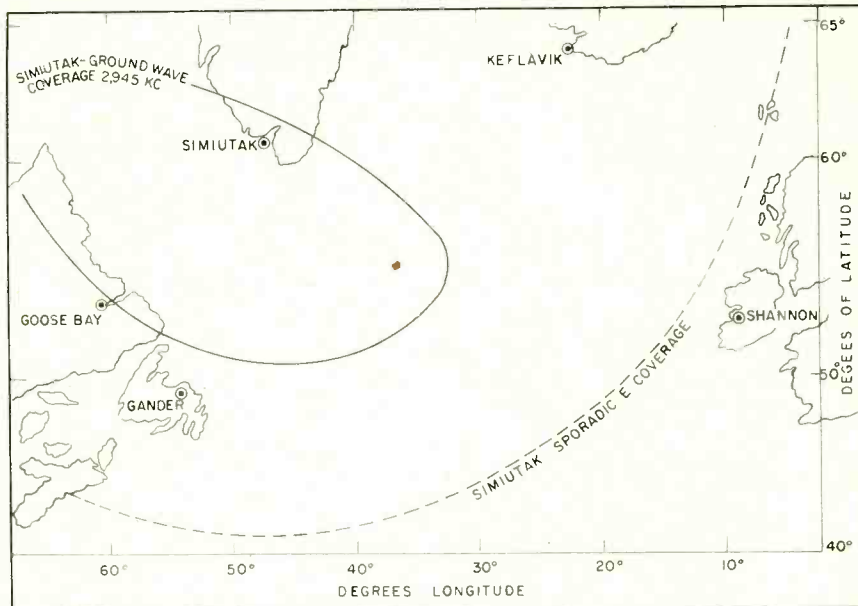
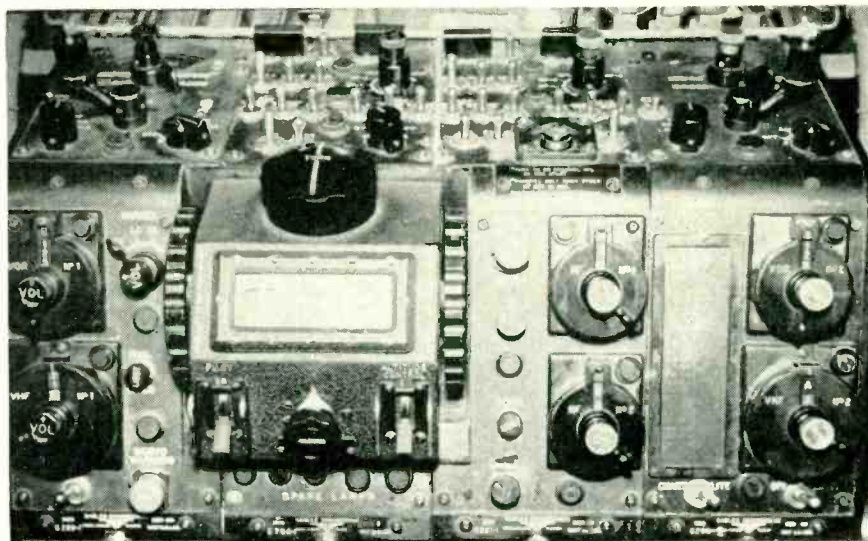

FIG. 5—Position report relays made by Simiutak, Greenland station aided plotting of effective coverage area



Radio receiver control panels mounted in operating position on DC-6B pedestal

charge density is partly a function of aircraft fuselage projections as well as of the antenna system's mechanical fittings. The effects of charge accumulation on the receiver are directly dependent upon the antenna's mechanical characteristics, since electron currents in the aircraft skin as well as in ambient cloud structures will induce sharp-edge current variations in the antenna proper, appearing as noise at the receiver output.

#### Ground Stations

Considerable advancement in ground radio transmitter and receiver circuit technique has been made during past years. Improve-

ments include crystal control, multi-channel transmitters, voice compression and expansion, remote control operation, low-noise, cascade r-f amplifiers and carrier-controlled squelch. There have been no completely packaged h-f communications systems developed by any manufacturer to meet the requirements of airline operational problems. Successful ground station installations have been achieved, however, by adapting the equipment of several manufacturers together with control equipment manufactured by PAA.

Basically, there are two types of radiotelephone ground stations. The more complex are stations of

high traffic density, providing more than five air-ground channels and several point-to-point relay circuits. Such stations as Santa Maria in the Azores; Shannon, Ireland; Roberts Field, Liberia and Frankfurt, Germany are typical. A simpler station is one where relatively low traffic density is experienced and only four or five frequencies are monitored by one operator. Here a simple control position and a transmitter of approximately 1,000 watts output are satisfactory.

### Propagation Problems

It is conventional to establish an h-f communications channel by evaluating the geographic locations of the two points between which it is desired to effect communications and the predicted radio propagation conditions. Use of the Central Radio Propagation Laboratory frequency forecast data simplifies the problem.

However, where heretofore day and night frequencies (3 mc and 5 to 8 mc respectively) were used, the implicit assumption was that of stable ionospheric *E*, *F*<sub>1</sub> and *F*<sub>2</sub> layers.

Presence of aurora borealis over the North Atlantic causes an apparent disappearance of the *F* layers rendering use of the sky wave virtually impossible for effective continual communications.

Considerable improvement in h-f communications is realized with ground waves over a good conducting surface utilizing vertically polarized waves. By employing an optimum antenna configuration, effective power gain along the horizontal path is achieved. For a given amount of radiated power, maximum field strength in a horizontal direction is obtained by utilizing a vertical antenna approximately 5/8-wavelength high—operating above its fundamental frequency.

The energy distribution of this antenna in the vertical plane approximates that shown in Fig. 4. The maximum of the secondary lobe occurs at an angle of approximately 55 degrees. While the aurora is present, the secondary lobe is of little or no significance. In absence of aurora, this high-angle lobe is effectively reflected by the ionosphere back to earth where it interferes with the ground wave and can

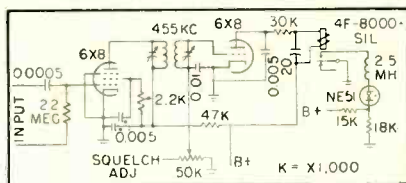

FIG. 6—Simplified squelch control used in remote ground receivers. Light and squelch control can be placed several miles from receiving equipment

cause fading at distances where the magnitudes of the skywave and the ground wave are comparable.

It is thus necessary to reduce the effect of the high-angle secondary lobe. This is accomplished by operating the antenna at slightly below 5/8 wavelength, although some slight compromise is made with respect to the effective radiated power in the horizontal primary lobe in the desired direction.

To maintain a reasonable economic balance, the highest possible frequency was established for ground-wave use, since the ground-station antenna cost is inversely proportional to its frequency of operation. To minimize land attenuation of the ground wave—by starting the radiated wave over as nearly perfect a conducting surface as possible—the transmitting antenna is placed as close as possible to the water's edge.

### Ground System

The antenna tower conventionally used is approximately 200 feet in height. Ground radials 200 feet long of one-inch wide copper strip (0.02 in. thick) are laid about six inches below the surface of the ground every 15 deg in azimuth.

In as many instances as possible, these ground radials actually run into the sea water. A typical ground-wave radiotelephone station antenna constructed in Simitak, Greenland, produces the effective area of coverage experienced for 3 kw of power input to the antenna at 2.9 mc shown in Fig. 5.

Owing to the nature of h-f antenna configurations on conventional, piston-engine, aircraft, the only frequency range where optimum reception and transmission of pure vertically polarized waves can be assured is the region below the first quarter-wave resonance point. The reason is that to achieve maxi-

mum h-f antenna length, wire antennas are usually strung parallel to the fuselage from a feed-through insulator near the cockpit to the vertical stabilizer. In thus establishing the antenna geometry, there is greatest predominance of vertical *E* lines when r-f currents in the antenna proper and throughout any adjacent large airframe segment are completely unidirectional.

For frequencies above the resonance point, a number of current reversals is experienced along the antenna and the airframe; the resulting horizontal *E* lines combine vectorially with the vertical *E* lines, thus changing the polarization of the transmitted wave. For large aircraft, the desirable ground-wave frequency range is that between 2 and 3 mc since aircraft h-f antennas may be as long as 90 feet.

### Further Improvements

Refinements in ground station receivers to reduce operator fatigue and enhance operational performance are still being made. Notable among these is development of a squelch circuit for the type 51N-2 receiver. The circuit diagram is shown in Fig. 6.

To put increasingly less emphasis on the radiotelephone communications aspect of flying, as far as the pilot's tactical burden is concerned, it has been attempted to make radio operation a function secondary to safe navigation and pilotage of the aircraft. Considerable work towards this end has been accomplished by PAA's Pacific-Alaska Division where a selective signaling system is in use.

In the Selcal (Quik-call) selective signaling system<sup>3</sup> a ground station transmits a pair of audio tones followed 0.1 sec later by a second pair of tones. Each tone pair modulates the carrier for approximately one second. Every aircraft has a discrete code assigned to it, and upon reception of the correct tone combination and sequence, an alerting gong and a light are actuated.

### REFERENCES

- (1) C. A. Petry, Frequency Propagation Forecasting for Civil Airline Operations on World Air Routes, Aeronautical Radio, Inc., Washington, D. C.
- (2) Virgil True, Automatic Impedance Matcher, *ELECTRONICS*, p 98, Dec. 1951.
- (3) Alexander A. McKenzie, Getting The Most From Mobile Radio, *ELECTRONICS*, p 156, June 1955.



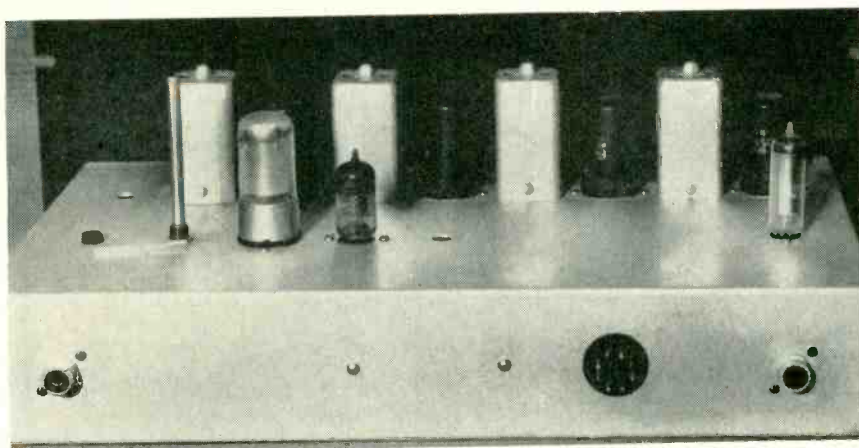

Communications-type i-f amplifier uses d-c amplifier in feedback loop to obtain logarithmic response for noise probability measurements



Adjustment of logarithmic amplifier is made at front panel

# LOGARITHMIC Amplifier MEASURES NOISE

By J. DOUGLAS WELLS\*

*Engineering and Industrial Experiment Station  
University of Florida  
Gainesville, Florida*

**SUMMARY** — Effects of atmosphere radio noise on communications systems may be studied conveniently using logarithmic amplifier in system that determines logarithm of voltage value that noise equals or exceeds 50 percent of the time. System contains a modified communications receiver, probability computers, amplifier, metering and input coupling circuits

**E**FFECTIVENESS of radio communication on frequencies less than 30 mc is often limited by atmospheric noise. Work has been devoted to devising methods of describing atmospheric noise in terms of its statistical properties to aid in the design of systems with improved performance in the presence of noise.

The most commonly encountered measures of noise are quasi-peak, average and rms amplitudes and the first-amplitude probability distribution.

With the exception of the probability distribution method, present noise measuring systems are subject to various errors owing to the

limited dynamic range of practical equipment. A linear dynamic range, that portion of the input-output transfer characteristic that is a straight line, of more than 40 db is rarely obtained for a complete system while the range of noise amplitudes encountered is 80 db or more.

Solution to the problem is possible if equipment with a logarithmic gain characteristic is considered since a logarithmic transformation reduces the range of noise amplitudes to a value within the limits of practical equipment design.

## Amplifier Design

Considering the logarithmic-normal noise distribution, an expres-

sion for its mean  $\log M$  may be written as

$$\log M = \frac{1}{T} \int_0^T \log x(t) dt \quad (1)$$

where  $\log x(t)$  = logarithm of the instantaneous noise envelope.

If a log amplifier is used to obtain  $\log x$  and a simple R-C integrator network used to perform the averaging function, then Eq. (1) can be solved and  $\log M$  obtained.

A more useful method involves:

$$\log x = 2 \left[ \left( \frac{x-1}{x+1} \right) + \frac{1}{3} \left( \frac{x-1}{x+1} \right)^3 + \frac{1}{5} \left( \frac{x-1}{x+1} \right)^5 + \dots \right] \quad (2)$$

where  $x > \text{zero}$ .<sup>1</sup>

The value of  $\log x$  is determined

\*Now with Westinghouse Research Laboratories, Pittsburgh, Pa.

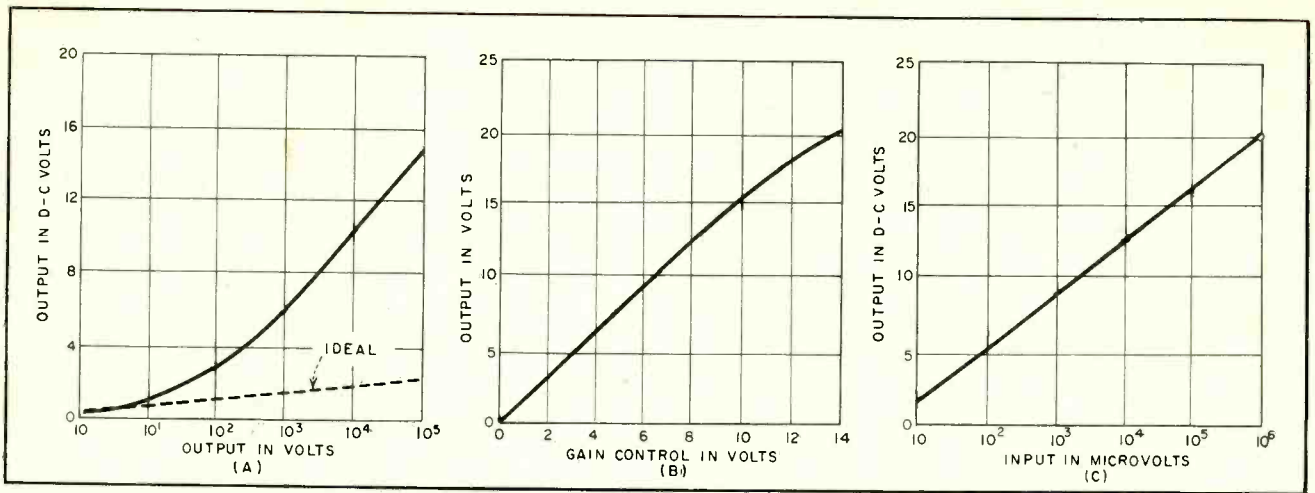

FIG. 1—Curves show amplifier gain characteristic with direct gain-control feedback (A), the required response for the gain control circuit in the amplifier (B) and the final amplifier response (C)

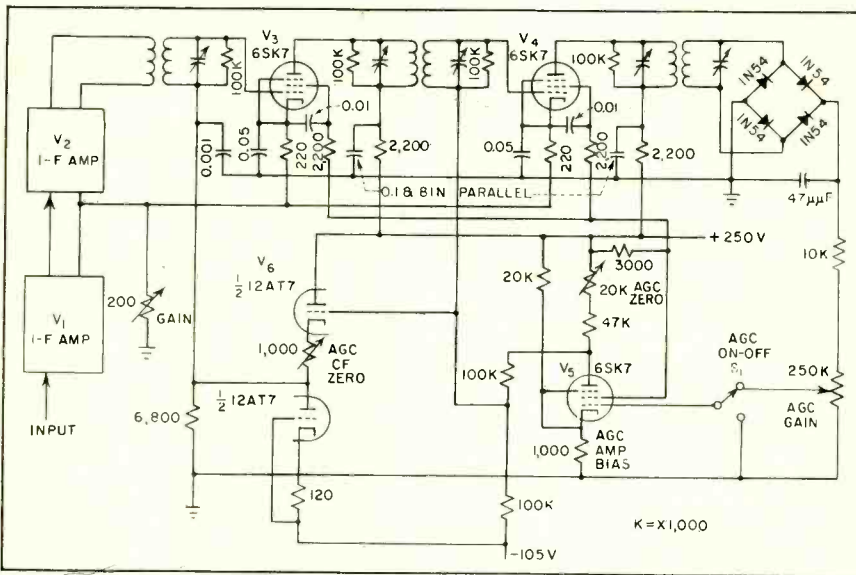

FIG. 2—Characteristics of 6SK7 provide required logarithmic response in i-f amplifier circuit. Balanced cathode followers decouple each amplifier for stability

with approximately five percent accuracy if only the first three terms of the series are considered.

In terms of amplifier specifications, the fifth power term indicates that the fifth harmonic of the input-signal must be within the bandpass of the amplifier. In this case the fifth harmonic of the highest envelope or modulation frequency component is required since the logarithm of the envelope is being considered.

In the final amplifier design the bandpass is made as wide as possible consistent with reasonable gain and the input signal bandwidth is restricted by means of a crystal filter.

Another factor to be considered is the operating dynamic range of

the input signal. A 100-db maximum input dynamic range was selected assuming that the amplitude limits of the noise signal are in that range.

#### Time Delay

Since a finite time delay is required in the amplifier and the control voltage is derived from the output signal, a truly instantaneous log amplifier is impossible using the feedback-amplifier approach. However, total time delay involved in the log action can be reduced to the point where the error because of delayed action is negligible.

A fixed-tuned amplifier operating at common receiver intermediate frequencies was used since the input signal can be derived from any

communications receiver having the proper i-f, thus making measurements possible over a wide range of frequencies. Also the input bandwidth can be controlled by the receiver's crystal filter and the circuit design can be simplified.

A conventional 455-kc i-f amplifier was constructed and direct feedback applied. The time constant of the gain-control-loop filter network was made long at first since the shape of the steady-state gain characteristic was of initial interest. The gain characteristic obtained with this amplifier is shown in Fig. 1A.

#### Gain Control

Insufficient gain-control voltage is present for the desired type of amplifier operation since the gain is too high at all levels. To determine the required gain-control voltage characteristic for accurate logarithmic operation, a d-c voltage is inserted in the loop and adjusted at each point on the gain characteristic for a logarithmic curve over a 100-db input range. The characteristic obtained in this manner is shown in Fig. 1B.

If the required gain-control characteristic is to be obtained with an amplifier stage, that stage must have an increase in gain with increasing input-voltage level. This is obtained over a portion of the d-c grid-to-plate transfer characteristic of a 6SK7 and experimental results show a very close fit of the tube characteristic to the required curve with proper selection of operating point.



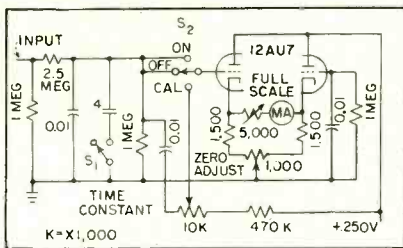

FIG. 3—Meter circuit used for direct observation of noise measurements when graphic recording is not used

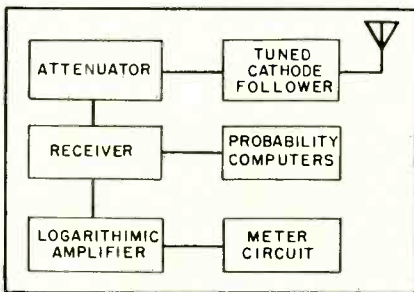

FIG. 4—System used to measure probability distribution of noise

The nonlinear d-c amplifier is inserted in the gain-control loop and the long time constant filter networks removed. With the filter time constants reduced to values required for the necessary response time and a common gain-control line used, instability resulted because of feedback. This is eliminated by using a balanced cathode-follower isolation stage in the loop to decouple each tuned amplifier stage.

### Circuit

Schematic for the final amplifier design is shown in Fig. 2. The bandwidth measured at the 6-db response points is 12 kc which permits a maximum input signal bandwidth of 2,400 cps. This is well within the capabilities of the crystal filter circuit in any communications receiver.

The final gain characteristic achieved is shown in Fig. 1C. This curve matches the required logarithmic response within two percent at all points. An unmodulated sine-wave input signal was used to obtain this characteristic.

To determine the amplifier response time a receiver input circuit is shock-excited by a square wave generator and the resultant pulses coupled through the required bandwidth-limiting circuits to the

log amplifier input.

The total delay time observed before operation of the gain-control loop was 50  $\mu$ sec. Since the shortest output pulse to be expected from the amplifier is approximately 500  $\mu$ sec, because of the input bandwidth restriction, this 50- $\mu$ sec delay was assumed to be negligible.

A graphic recorder with a one-milliampere movement is driven from the amplifier output through the vacuum-tube voltmeter circuit shown in Fig. 3. The R-C integrator circuit which performs the averaging function on the amplifier output is located in this unit and a ten-second time constant is used.

Internal voltmeter calibration is provided for meter circuit adjustment. A standard one-milliampere meter is used for visual observation if a graphic record is not required.

### Results

A block diagram of the noise measuring installation is shown in Fig. 4. The receiver was a modified BC-779 Super Pro. The noise meter consisted of three UF/PC-2B probability computers developed in the course of atmospheric noise research.<sup>3, 4</sup>

Coupling to the log-amplifier input from the receiver crystal filter stage is done through the cathode follower circuit shown in Fig. 5. This isolating stage prevents detuning of the crystal filter circuits by the capacitance of the connecting cable. A capacitive attenuator is included in the grid circuit to

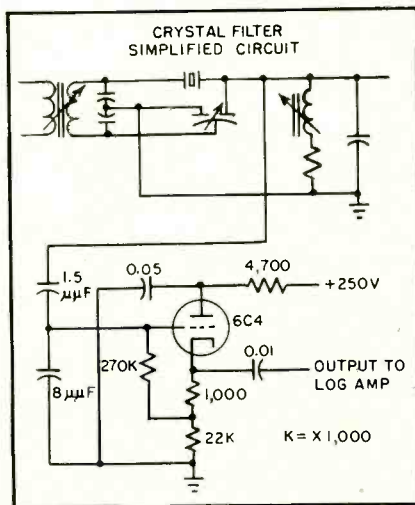

FIG. 5—Crystal filter output coupling circuit for use with communications receiver

reduce the receiver output level to the proper value for the log amplifier input.

Previous work has revealed that there can be considerable generation of intermodulation products in wide-band cathode follower amplifiers.<sup>5</sup> A tuned circuit at the input practically eliminates the intermodulation problem since signals removed from the operating frequency are greatly attenuated.

### Measurements

All measurements were made at 135 kc with a 6-db bandwidth of 2,310 cps. Since the operating bandwidth is determined by the receiver crystal filter, care should be taken to insure that this circuit is the limiting factor in the system bandwidth for both the probability computers and the log amplifier.

The measured probability distribution is taken as the standard in all cases and error calculations are based on the assumption that log  $M$  as determined from the distribution is correct. Each test run consisted of determination of the probability distribution points and simultaneous measurement of log  $M$  by the log amplifier.

A typical noise probability distribution graph shows cumulative probability or percent of time that a given level is exceeded versus the logarithmic microvolt level. The value of log  $M$  measured by the log amplifier is determined directly by noting the output voltage indication and reading the corresponding microvolt level from the calibration curve.

This research was sponsored by the Air Force Cambridge Research Center, Cambridge, Massachusetts, under Contract No. AF 19 (604)-876.

### REFERENCES

- (1) F. E. Terman, "Radio Engineer's Handbook", McGraw-Hill Book Company, Inc., New York, 1943.
- (2) John F. Rider, "Vacuum-Tube Voltmeters", John F. Rider Publisher, Inc., New York, 1951.
- (3) Investigation of Atmospheric Radio Noise, Progress Report No. 5, Contract No. AF 19 (604)-876, Eng. & Ind. Exp. Sta., University of Florida, Gainesville, 1954.
- (4) J. D. Wells, and A. W. Sullivan, A Probability Computer for Noise Measurement, *URSI*, Washington, D. C., 1955.
- (5) Noise Study, Fabrication of Noise Measuring Equipment, Data Collection and Collation Program, Interim Engineering Report No. 17, Contract AF 08 (169)-138, Eng. & Ind. Exp. Sta., University of Florida, Gainesville, 1953.

# CRT Deflection Circuit

By WALTER B. GUGGI

Stanford Research Institute  
Menlo Park, California

**SUMMARY** — Single power transistor operating as switch provides efficient cathode-ray-tube deflection with five-percent linearity for standard television horizontal-sweep applications. Sweep amplitude may be adjusted continuously without affecting linearity or general circuit performance

**P**OWER CONSUMED in conventional television sets in the production of the horizontal deflection has long been a problem since the total useful deflection work output is zero. The entire input of (typically) 45 watts, or even more in the case of color television, is used up in replacing circuit losses.

The completely transistorized deflection system to be described promises to reduce these losses, reducing the power input by a factor of as much as three or four. In addition, most of the transient difficulties that give rise to ringing are eliminated. The simplest embodiment yields a deflection linearity of  $\pm 5$  percent or better. Addition of simple passive el-

ements corrects linearity to  $\pm 2$  percent or better.

The basic principle, shown in Fig. 1 in symbolic form, is one of circulating energy among various reactive elements by low-dissipation on-off switches. While lost energy is replaced during the early part of the sweep cycle, the circulating energy is actually switched into the deflection coil during the retrace period.

## Basic Circuit

Figure 2 shows the circuit conditions together with plots of the important voltages and currents, for three different portions of a complete sweep period. In Fig. 2A, the voltage is shown across the

sweep coil, starting at the instant  $S_1$  is closed, Fig. 2B shows the corresponding sweep current and Fig. 2C shows the current flowing through the switch.

Assuming that retrace capacitor  $C_2$  has reached its final charge with the polarity shown and at this instant ( $t_1$ ) the switch is closed, the full capacitor voltage appears across  $L_1$ . The closed switch completes a tuned circuit,  $L_1C_2$  initiating currents  $i_1$  and  $i_2$ . Within one quarter cycle of the resonant frequency of  $L_1C_2$ , all energy is transferred from  $C_2$  to  $L_1$ . Diode  $D_1$  blocks current flow through branch  $C_1D_1$  during this initial quarter cycle.

At  $t_2$ ,  $C_2$  is completely discharged. However, two independent current components continue to flow within two branches of the circuit. During period  $t_2t_3$ , the sweep current  $i_1$  flows through  $L_1C_1D_1$  and loop current  $i_2$ , which is but a small fraction of the peak sweep current, flows through  $L_2C_2S_1$  and continues

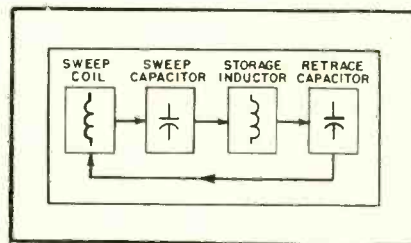
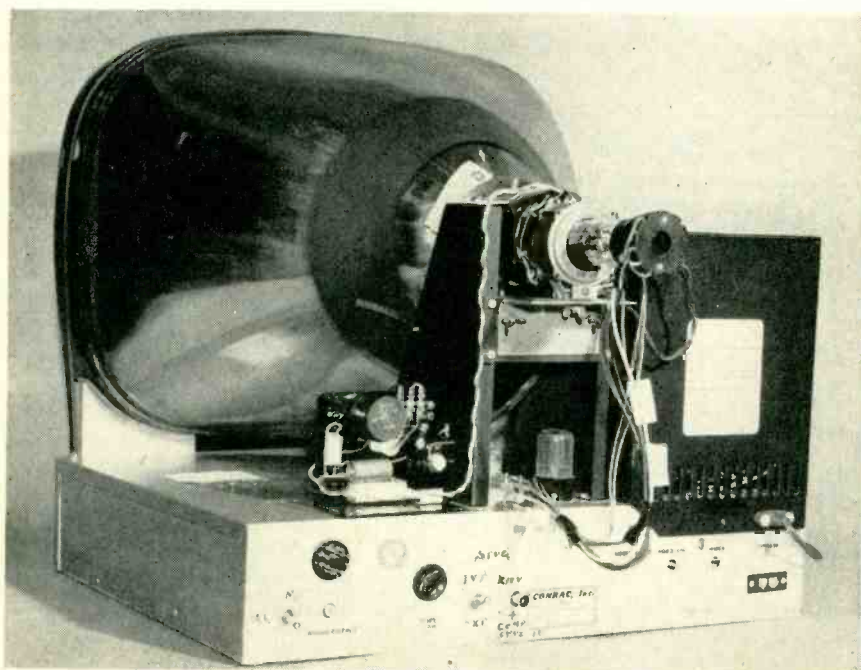

FIG. 1—Pictorial representation of circuit operation

Installation of experimental transistor sweep circuit on picture monitor



# Has High Efficiency

until  $S_1$  is opened at  $t_3$ .

Current  $i_2$  transfers energy from  $C_1$  into  $L_2$ . When  $S_1$  is opened, at  $t_3$ ,  $i_2$  continues to flow in  $L_2$ ; however, it changes its path and flows within loop  $L_2D_1C_2$ , transferring energy from  $L_2$  to  $C_2$ . This is indicated by the voltage buildup which occurs across  $S_1$  as shown in Fig. 2D, and across  $C_2$ , as shown in Fig. 2E.

Capacitor  $C_2$  is chosen to have a relatively small value and, since considerable energy has been stored in  $L_2$ , time period  $t_3t_4$  permits the buildup of sufficient voltage across  $C_2$  to obtain proper retrace performance when  $S_1$  is closed again.

Going back to Fig. 2B, the sweep current actually crosses the zero line and turns negative. This is made possible during the last portion of the sweep cycle ( $t_3t_4$ ) by  $i_2$ , which flows through  $L_2D_1C_2$  and essentially permits  $i_1$  to flow backwards through  $D_1$  by subtraction from  $i_2$ .

Sweep-current flow stops suddenly when its increasing value reaches the value of the decreasing loop current  $i_2$ . At this instant  $S_1$  is closed so  $C_2$  may again be discharged into  $L_1$ . However, a portion of the sweep energy has al-

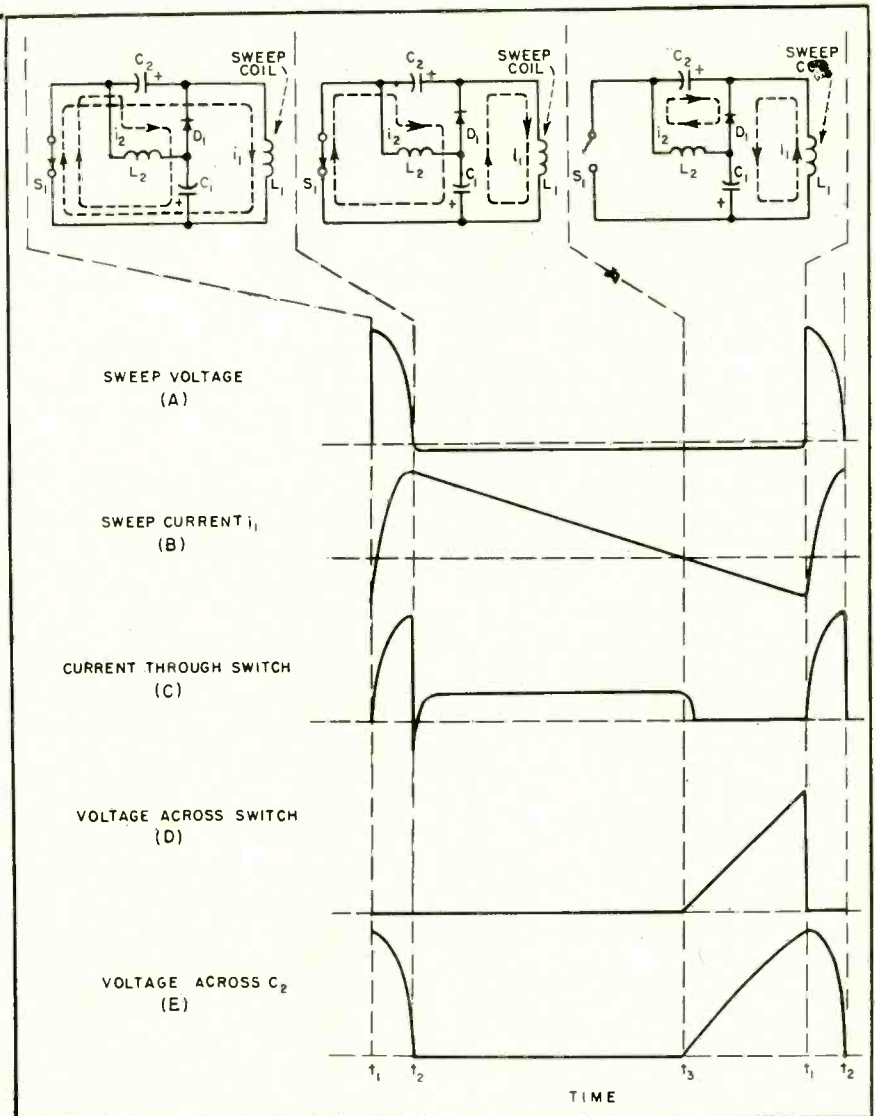

FIG. 2—Current and voltage relationships in equivalent circuit of basic sweep generator

ready been returned from  $C_1$  to  $L_1$  because of sweep current reversal during time  $t_3t_4$ . The retrace voltage across  $L_1$  therefore builds up to a higher value than the peak voltage across  $S_1$ , which shows  $S_1$  does not have to handle all of the

energy circulating within the sweep circuit.

Switch  $S_1$  may be a transistor as in Fig. 3A or it may be an electron tube or other suitable switching element.

## Performance Analysis

Certain desirable performance characteristics become apparent upon further analysis of this circuit. When  $S_1$  is closed the current within the switching element (in this case a transistor) is not a step function, but follows a sinusoidal function, giving the transistor sufficient time to reach its lowest impedance before appreciable current

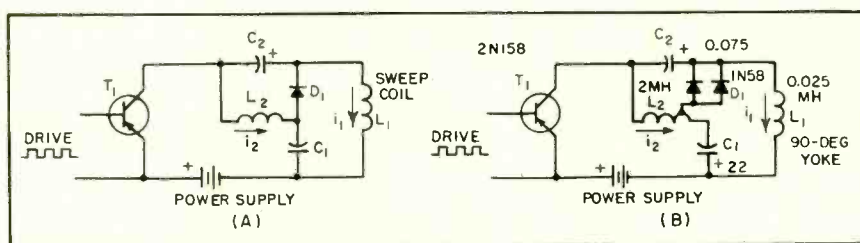

FIG. 3—Basic transistor sweep circuit (A) and circuit (B) compensated for sweep distortion

buildup has occurred. This may be noticed in Fig. 2B, in interval  $t_1$ .

It may be observed in Fig. 2C that at turn-off point  $t_2$  a relatively small current flows through the transistor, followed by a delayed voltage buildup providing at least several microseconds of switching time for the transistor to reach its highest impedance before any appreciable voltage buildup has occurred (Fig. 2D). Therefore, the switching operation in either direction is supported by the circuit itself and takes place with relatively low instantaneous peak transistor power dissipation during either switching transition.

For horizontal-sweep operation, this feature becomes quite important because of appreciable inherent delays in the switching characteristic of power transistors at those frequencies.

### Switching Operation

The switching performance of a commercially available power transistor applied to this circuit is shown in Fig. 4, where it is compared with its performance switching into a purely resistive load. At 15 kc, switching into a resistive load at the same power level would be prohibitive due to the relatively slow transition of the transistor through an area of excessive power dissipation. The operating condition in this sweep circuit, however, is such that maximum peak currents and peak voltages may be reached without reaching the maximum dissipation limit.

The peak deflection current flows through the transistor for only a small portion of the retrace time, at the most a few microseconds, as is shown in Fig. 2C. The high-voltage peak also occurs for only a very short time, as indicated in Fig. 2D. These two factors permit increase

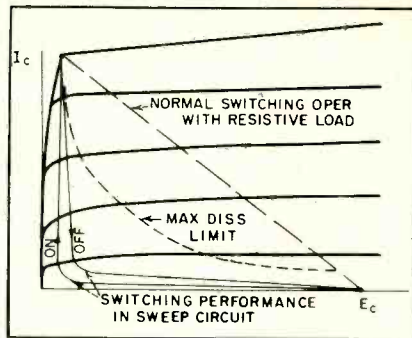

FIG. 4—Switching performance of typical power transistor

of the transistor peak collector current and voltage without exceeding dissipation ratings. No spurious high-voltage transients are present to limit the operation to uneconomically low voltage levels, as they would be in usual sweep circuits. Power transistors may therefore be used quite efficiently in this application.

If a lossless sweep coil and lossless diode were available, the sweep current would follow a perfectly linear function, provided a large sweep capacitor or constant-voltage source were used. In practical circuits, however, a logarithmic decay takes place during each sweep cycle causing deflection distortion, which is further aggravated by the relative increase of diode resistance with decreasing sweep current. The result is a steadily increasing sweep compression which limits the sweep linearity to a value of approximately  $\pm 5$  percent if standard commercial components are used throughout.

### Compensated Circuit

A method has been found to compensate for this sweep compression simply by adding to the sweep voltage a suitable compensating component in the form of a

saw-tooth voltage which is readily available from another portion of this sweep circuit. Figure 3B shows the improved circuit.

During time  $t_1$ , a saw-tooth voltage buildup occurs across  $L_2$  similar to the buildup across  $C_2$ . A low-impedance secondary winding which has the purpose of supplying sufficient compensating signal to the sweep voltage has been added to  $L_2$ .

Figure 5A shows the compensated sweep current, indicating high linearity.

While this circuit was designed to produce linear, transient-free sweep current, certain applications may require additional correction, particularly for sweep distortion caused by the geometrical arrangement of wide-angle deflection systems applied to flat-face cathode-ray tubes.

This circuit can be compensated by introducing electrical sweep compression. The early portion of the sweep current may be compensated by proper selection of the sweep capacitor which permits shifting the sweep current as much as may be desired from the linear portion into the curved portion of a sinusoid. The negative portion of the sweep current may be corrected by reducing, omitting or reversing the compensation obtained by the system shown in Fig. 3B or by adding resistance to the sweep coil.

Figure 5B shows the corrected sweep current for compensating sweep distortion due to flat-face cathode-ray-tube geometry. The bar pattern of Fig. 6 shows the degree of linearity possible with this improved circuit.

### Operating Performance

The deflection angle is 60 degrees at 16-kv accelerating voltage obtained with a 90-degree yoke, which does not give the highest efficiency at this angle. Input power required is six watts.

The transistor used in this circuit dissipates approximately three watts. Peak voltage amounts to 180 v and peak current is five amperes. Driving power of approximately one watt is supplied to the transistor base by transformer coupling from a synchronized pulse generator. Transformer coupling keeps

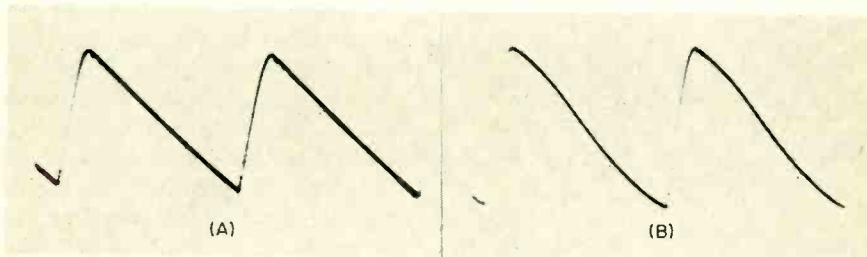

FIG. 5—Sweep current of circuit of Fig. 3B (A) and current for wide-angle deflection (B)



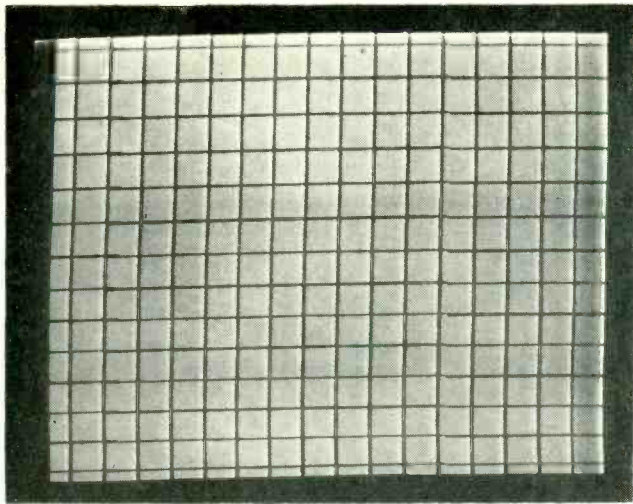
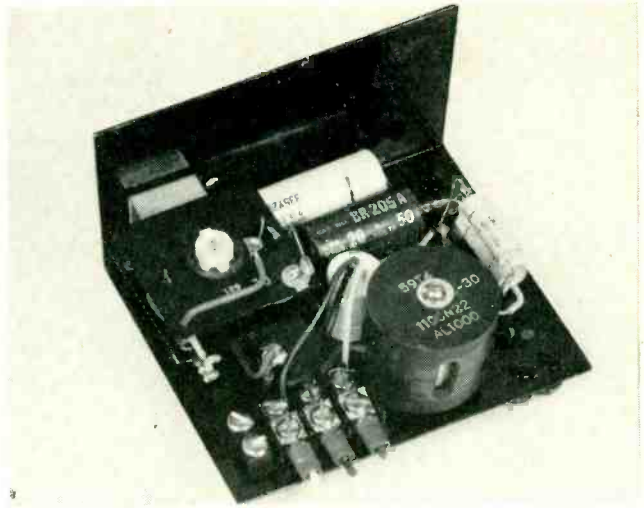

FIG. 6—Bar pattern shows linearity of better than five percent



Closeup of experimental sweep circuit

the base positive during cutoff without an additional bias source. The duty cycle of the pulse is approximately 60-percent on and 40-percent off.

It is estimated by results obtained from this experimental circuit, running at nearly one-half the power required for a 90-degree deflection system, that about 15 w of d-c input power will be required to deflect 90 degrees at 16-kv accelerating voltage, using the highly efficient transistor circuit. The d-c supply voltage will be approximately 20 v, depending on the circuit impedance which again is a function of transistor characteristics. It is necessary to correct for the d-c component in this sweep circuit by using either an output transformer, capacitive bypassing or permanent magnets.

It should be possible to derive high voltage from this circuit by replacing storage inductance  $L_2$  with a step-up autotransformer and a following rectifier. For low-impedance transistor operation, it may be necessary to use voltage-multiplier circuits to avoid difficulties in obtaining the proper step-up ratio. Tests show that a relatively large amount of power may be taken from such a transformer without any sweep interference or increase of peak sweep current.

#### Design Equations

For most practical design purposes, it can be assumed that the

circuit is lossless.

The basic equations are

$$I = \sqrt{2W/L} \quad (1)$$

$$E = \sqrt{2WL/T} \quad (2)$$

where  $W$  is energy stored in inductance, in joules;  $L$  is inductance, in henries;  $I$  is peak sweep current, in amperes;  $E$  is applied constant voltage, in volts (retrace voltage) and  $T$  is time duration of applied voltage, in seconds (retrace time).

These equations give an expression for maximum current and voltage conditions in an inductance having a linear rate of change of current. They are also valid for determining the peak voltage and peak current a switching device a sweep circuit of the type described.

#### Switching Characteristic

The characteristic of the switching device can be determined from

$$IE = 2W/T \quad (3)$$

where  $T$  is retrace time in seconds,  $I$  is peak sweep or retrace current,  $E$  is peak retrace voltage across the sweep coil and  $W$  is the energy required to deflect the beam. This product is equivalent to the peak volt-ampere requirement of the switching device and the diode. After a switching device has been selected, peak current and peak voltage are known; yoke impedance  $L_1$  may be calculated from Eq. 1 or Eq. 2.

The value of  $C_1$  may be deter-

mined as a function of the sweep waveshape desired; the linearity improves with increasing capacitance. Physical size becomes the limiting factor in most cases.

The value of  $C_2$  may be calculated from

$$C_2 = 1/(\omega^2 L) \quad (4)$$

where the value of  $\omega$  is determined by  $\omega = \pi/(2T)$  and retrace time  $T$  is a quarter cycle of resonance frequency.

Storage inductor  $L_2$  should have several times the inductance of  $L_1$ . Diode  $D_1$  is preferably of the semiconductor type because of the low circuit impedance and the relatively large sweep currents. The supply voltage is a function of circuit losses and may be kept relatively low.

The on-to-off ratio of the switching device may be determined experimentally. Its calculation is laborious.

Since the retrace waveform is sinusoidal, the retrace voltage actually increases by a factor of  $\pi/2$  over the value calculated for a constant voltage pulse, for which Eq. 3 is correct. At the same time, however, the peak voltage requirement is reduced by a factor of approximately two-thirds by the amount of energy that returns into the sweep coil during the later part of the sweep cycle. Therefore, Eq. 3 remains quite adequate for practical calculations, without the necessity of any correction factors, since  $(\pi/2) (2/3) \cong 1$ .

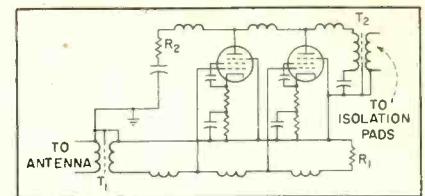
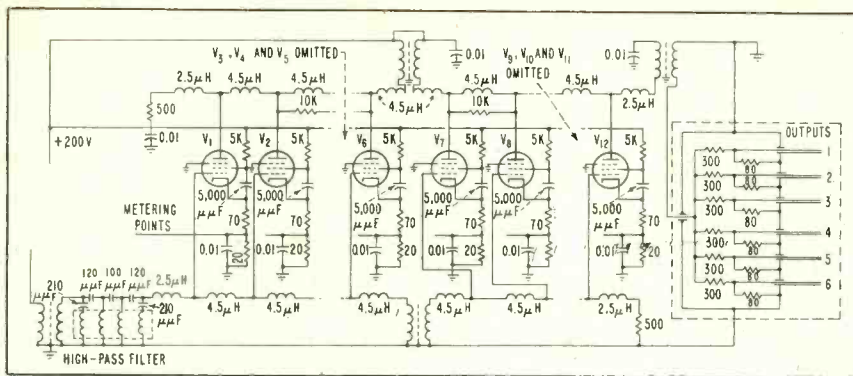

FIG. 1—Fundamental distributed amplifier circuit

Telefunken distributed amplifier. Three identical stages are omitted on each side of coupling transformers

# Distributed Amplifiers

**SUMMARY** — Comparison of three units shows improvement in multiple reception with single antenna when using push-pull distributed amplifier to overcome nonlinear distortion. Factors of insertion loss and isolation are charted. Devices enhance reception and reduce size of antenna farms otherwise required in long-distance broadcasting

By **EDWARD T. PFUND, JR.**  
United Geophysical Corp.  
Pasadena, Calif.

**R**ECEIVING STATIONS are often confronted by a serious problem resulting from the necessity for connecting several receivers to one antenna since prohibitive signal degradation owing to bridging and mismatch losses may occur.

Various schemes have been devised by manufacturers to provide these stations with electronic branching devices that properly terminate the antenna transmission line and feed the voltage introduced in the line to a number of receiver inputs. Generally these devices are based on standard coupled branching circuits.

Such circuits have a virtually flat response versus frequency over the range of interest, introduce negligible noise to the system and serve to isolate the receivers from one another to prevent interference from the various local oscillators. But they introduce intermodula-

tion products into their outputs owing to nonlinear distortion.

## Distortion Reduction

The primary consideration for antenna multicoupler design should be reduction of harmonic distortion. Noise level is often given first priority and it is rare that reports from the field indicate too high a noise level.

An invention by W. S. Percival, patented in England and popularly known as the distributed amplifier, has recently been applied by Telefunken of Germany as a method of overcoming amplitude or nonlinear distortion in antenna multicouplers<sup>1-4</sup>. Additionally, Telefunken has employed what is effectively a push-pull distributed amplifier configuration resulting in a circuit with even more linearity than distributed amplifiers previously reported.<sup>5, 6</sup>

## Utilizing Tube

The fundamental circuit in Fig. 1 shows that the basic elements contributing to amplitude distor-

tion, the grid-cathode and plate-cathode circuits of the tube, are utilized as components of essentially linear circuit elements. That is, the tube capacitances are used as the shunting elements in artificial transmission<sup>7, 8</sup> or delay lines. Intermodulation products are reduced by not completely bypassing the cathode resistances.

In effect, the transmission line from the antenna is terminated in its characteristic impedance by  $T_1$ , and is transformer-coupled to an artificial line utilizing the grid-cathode-ground circuit of the tube as part of the line. This grid-to-cathode line is electron-coupled to the plate-cathode-ground artificial line and gain is obtained through the tubes.

Resistors  $R_1$  and  $R_2$  terminate the electron-coupled lines in their respective characteristic impedances. The remaining end of the plate circuit artificial line, the load, is matched through transformer  $T_2$  to an attenuation pad distribution network feeding several receivers. Isolation depends solely upon re-



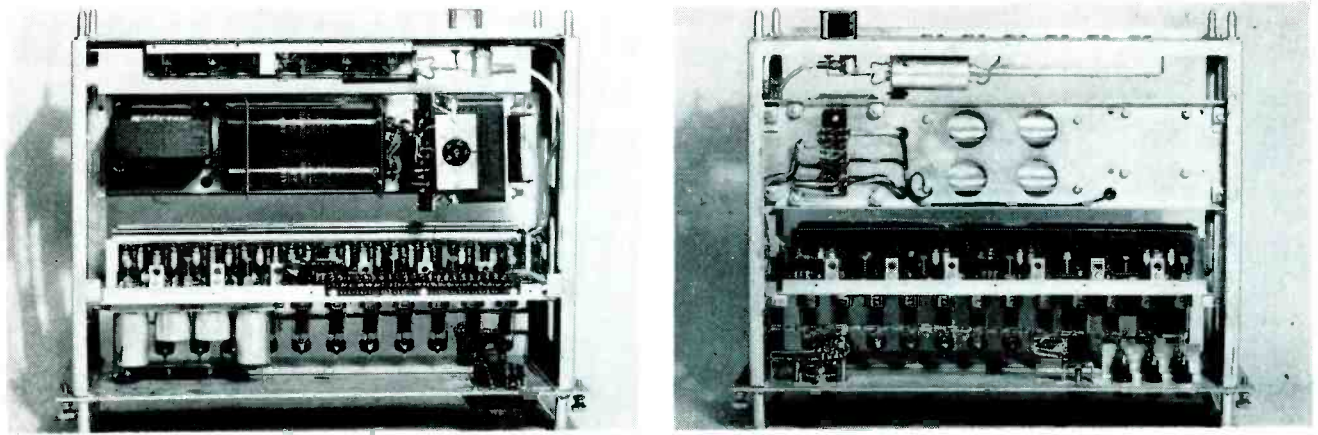

Bottom view, with shields removed, of commercial distributed amplifier (left) and reverse view (right)

# As Antenna Multicouplers

sistive attenuation-matching pad theory. It is therefore easy to predict isolation or to obtain any desired isolation by suitable padding.

When this type of circuit is employed in an effective push-pull configuration, as shown in the Telefunken schematic, a characteristic of high linearity can be realized.

If the output load impedance  $T_2$  loads the plate line in its characteristic impedance the amplification obtained with  $n$  tubes becomes  $A = g_m Z_o n/2$ . These relationships are shown in the literature<sup>9-12</sup>.

Just how well such a system performs in practice is evidenced by curves compiled from laboratory tests of Telefunken unit *A*, multicoupler *B* of Canadian manufacture and multicoupler *C* of German manufacture. Unit *B* represents the typical R-C coupled wide-band amplifier type working from one input tube and branching to individual output amplifiers with

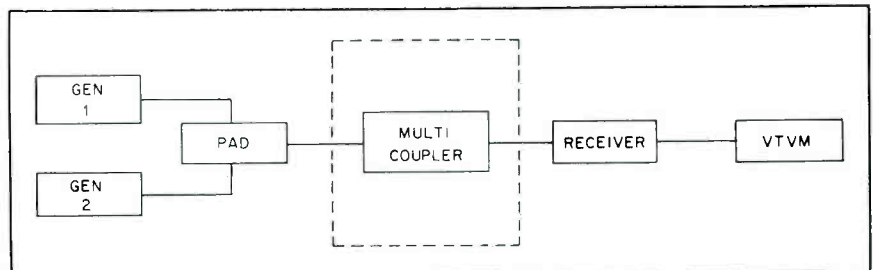

FIG. 2—Circuit used for laboratory tests on multicouplers

autotransformer coupling to each receiver.

Multicoupler *C* employs a grounded-grid input amplifier, high-pass filter, push-pull circuits throughout and has considerable power gain, with transformer coupling to each receiver.

## Frequency Distortion

With the test circuit connected as shown in Fig. 2, the output of one signal generator was first adjusted to 0.3 mv and fed through a resistive network to an SP600 receiver. The other signal generator was connected as shown but with no power connected to it. A frequency response curve was thus obtained using the i-f voltage as output plotted against the frequency of the 0.3-mv generator feeding the system.

Each multicoupler in turn was inserted between the resistive network and the receiver and the new frequency response curves were similarly obtained.

Using results obtained without multicoupler as a standard, the difference between the curves has been plotted in Fig. 3. In this manner the standard curve appears as a zero-axis straight line in all cases and multicoupler frequency response and/or gain can be read directly in db.

Curve *A* is essentially flat, varying up to about +1 db over the range from 3 to 20 mc in a nearly periodic manner. Multicoupler *B* shows an insertion loss averaging -7 db over the same range. Such an insertion loss precludes use of this unit with weak signals in a monitoring or receiving installation and makes comparison measurements with no-loss multicouplers somewhat difficult.

Unit *C* provides more gain than any other multicoupler and would be the most satisfactory if the output were free of intermodulation products and distortion.

With the test circuit connected as shown in Fig. 2, so that the

Table I—Receiver Decoupling

Multicoupler	% voltage change	Freq. in mc
A	3.5	3
	2.6	6
	1.1	9
	1.9	12
	4.34	15
	2.4	20
B	0.0	3 to 20
C	0.0	3 to 12
	0.8	15
	0.0	20

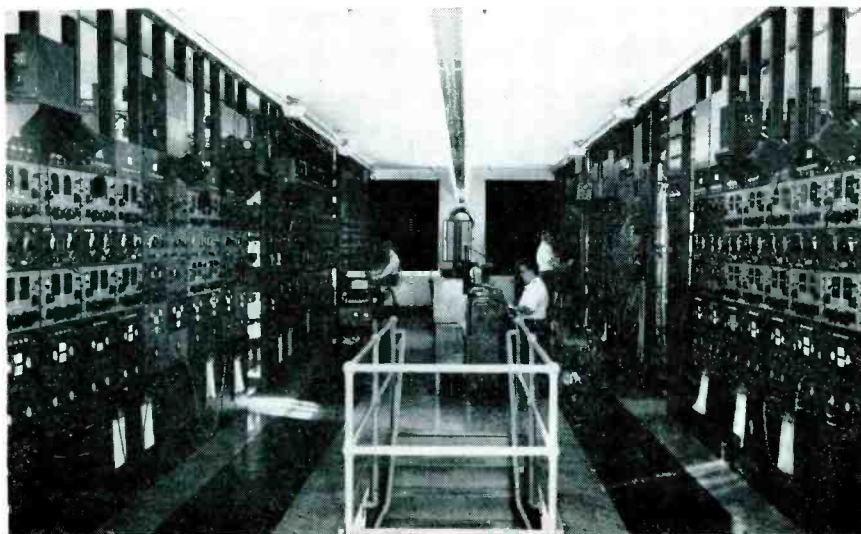

Interior view of Mackay Radio's international receiving station at Southampton, N. Y. shows 50 diversity receiver bays. Antenna and signal patching facilities are at right center

multicoupler and both generators were operating, one signal generator was tuned to 5 mc and the other to 9 mc. The output of each generator was set at 50 mv, the modest nominal value selected for the tests.

A multicoupler should be designed to accommodate such inputs without overloading. The receiver was then tuned to the difference frequency of 4 mc and its sensitivity control, with noise limiter and avc off, adjusted so a reading was obtained on the vacuum-tube voltmeter connected across the receiver i-f output.

The multicoupler under test was then removed from the circuit, and the i-f output measured once again with the two generators feeding the receiver directly through the resistive network only and all controls set as described above.

The foregoing was then repeated with the receiver tuned to the sum frequency—14 mc.

Using the values obtained across the i-f output with the multicoupler not in the circuit as a zero reference axis, the difference in db for all other measurements was plotted for each multicoupler as shown in Fig. 4. In this manner, a clear

pictorial view is obtained of sum and difference frequency response of each multicoupler tested.

The closest to the reference axis is unit A. If the high attenuation of sum and difference frequency products by multicoupler B were not the result of insertion loss, this unit would have the most desirable amplitude distortion characteristic. However, it became necessary to increase the output of one generator to 180 mv to obtain measurable outputs from multicoupler B only, because of its high attenuation.

A more impressive indication of the spurious response of multicoupler A—based on the fact that the same nonlinear distortion that causes intermodulation with resultant difference and sum frequencies also causes the production of harmonics<sup>23</sup> of a pure sine wave—is obtained by reference to Fig. 5.

After removing generator 2 from the test circuit in Fig. 2, a fundamental signal of 4 mc with an amplitude of 0.45 v was fed into multicoupler A and the harmonic outputs measured at the receiver i-f output. The same frequency of equal signal strength was then fed to the receiver directly without the multicoupler and the outputs were

again recorded. The difference in db is plotted and the measurements without multicoupler are referred to a zero axis in all cases so the readings appear as a straight zero reference line in Fig. 5.

#### Isolation Measurements

Table I shows the change reflected at one multicoupler output if another output is shorted. These measurements serve to indicate that the isolation capabilities of each unit are excellent.

These multicouplers were tested operationally for possible use at the Schleissheim, Germany, receiving station of Radio Free Europe. Table II shows sample voltages obtained from various antenna configurations with and without antenna loading. Observations on frequencies from 3 to 30 mc were conducted by laboratory and operating personnel using the test circuit shown in Fig. 6, where two couplers were compared against each other

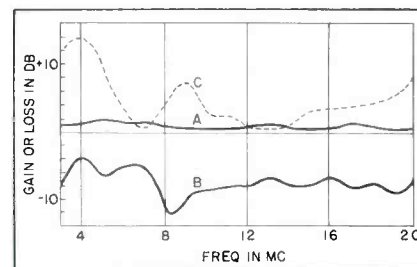

FIG. 3—Frequency distortion characteristics of three units

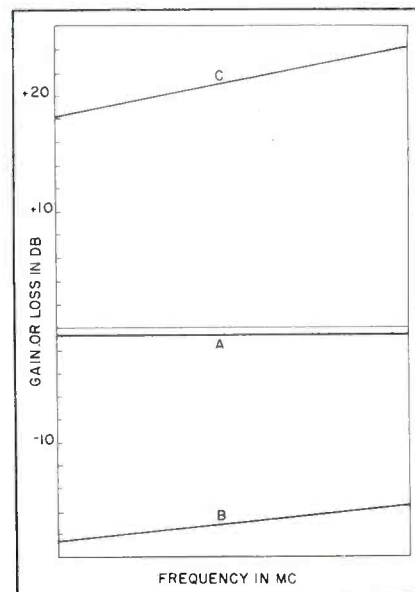

FIG. 4—Sum and difference frequency response of multicouplers

Table II—Sampled Loaded and Unloaded Antenna Terminal Voltages

Antenna Type	Unloaded	51-J load	A coupler load	B coupler load	C coupler load
Vee	0.23	.....	0.078	0.052	0.087
Inverted Vee	1.155	1.15	0.54	0.36	0.71
Beverage	2.00	2.00	0.34	0.2	0.37
Rhombic	Loaded with three Collins 51-J receivers: 1.14 v				



**Table III—Sampled Multicoupler Intermodulation Interference**

Frequency of mixing products in kc	Multicoupler
6,200; 15,222; 21,593; 21,656 and 21,725	C vs B
6,028; 6,090; 6,200; 9,546; 9,573 and 11,769 Interference on 6,200 was more severe than on unit C	
15,284; 15,300; 17,715; 17,772; 17,806; 21,500; 21,656 and 21,687	C vs A
15,284; 17,715 and 21,500 Corresponding interference on C unit was more severe than A, which varied from just audible to very slight	
15,130; 15,270 and 15,330	C with 20 db attenuation vs A
15,130 and 15,270 Corresponding interference on C unit was more severe than A, which varied from just audible to very slight	

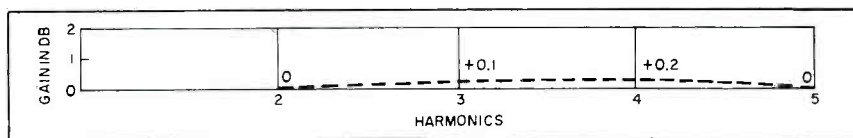

**FIG. 5—Distributed amplifier nonlinear distortion characteristic**

and the antenna direct to the receiver.

At first glance it may appear that the test circuit is not a fair one, since two to three circuits load the antenna at all times. However, those familiar with receiving stations will realize that in practice such a situation is not necessarily rare. That is, the load of simultaneous traffic handled in a receiving station usually exceeds the number of outputs of commercial multicouplers. Consequently, other equipment as required is merely bridged across the line despite the resulting losses.

No receiver oscillator interference was observed and no detuning or resonance effects were noticeable. Multicoupler C had noticeable amplification, as expected from the laboratory measurements, but with an accompanying rise in the interference level. The other two multicouplers had an apparent amplification factor of one. Above 20 mc, however, unit B introduced noticeable attenuation.

Unit C had the highest and A the lowest effective noise level. The manufacturer's specifications over the 3-to-21 mc. range were less than  $8kT$ , and  $6kT$ , respectively.

Intermodulation effects in A were the more satisfactory.

Multicouplers A and C were further operationally compared for intermodulation effects by the author at the Ueberacker, Germany, receiving station of the Voice of America. These tests were conducted utilizing 10 db of input and output attenuation on the type C multicoupler to observe operation with reduced signal input voltages. Unit A was operated normally and the same rhombic antenna and SP-600 receiver were employed for each comparison. Sample specific conditions are included in Table III.

**Other Types**

In fairness to manufacturers of R-C coupled branching amplifier multicouplers with R-C coupling to each receiver, it is noteworthy that multicoupler D of American manufacture was operationally tested by the author at the Voice of America receiving station at Tangier, North Africa, with the following results.

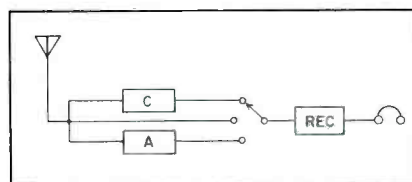

**FIG. 6—Operational test circuit used in the field**

Sampled, measured multicoupler input terminal voltage was 0.5 to 1.5 v for the rhombic antenna configuration utilized.

Radio Canada operating simultaneously in the 9 and 11 mc bands produced interference on 21,500, 21,600, 21,700, 21,800, 23,500 and 24,500 kc. Other interference owing to intermodulation products was noted on 21,640, 21,500, 21,575 and 21,560 kc. No intermodulation interference was noted below 21,500 kc, and in all other respects the multicoupler performed excellently.

The traveling-wave chain amplifier has applications where low non-linear distortion properties are a requisite and should therefore be considered for other than wide-band uses.

The author thanks J. E. De Lisle of the MIT Instrumentation Laboratories for many informative discussions. The co-operation extended by the entire engineering staff of Radio Free Europe in connection with the Schleissheim-Munich measurements was greatly appreciated. The Telefunken multicoupler for test, as well as the equipment photographs, were obtained through the cooperation of K. Fischer of Telefunken Laboratories in Ulm, Germany.

**REFERENCES**

- (1) W. S. Percival, British Patent 460, 562 (July 24, 1935; July 25, 1937).
- (2) E. L. Ginzton, W. R. Hewlett, J. W. Jasberg and J. D. Noe, Distributed Amplification, *Proc IRE*, 36, p 956, Aug. 1948.
- (3) W. W. Horton, J. W. Jasberg and J. D. Noe, Distributed Amplifiers: Practical Considerations and Experimental Results, *Proc IRE*, 38, p 748, July, 1950.
- (4) F. E. Terman, "Electronic and Radio Engineering," McGraw-Hill Book Co., Inc., New York, p 313, 1955.
- (5) U. S. Patent Application Serial No. 438, 807.
- (6) Kurt Enslein, Distributed Amplifier for Nuclear Research, *ELECTRONICS*, p 138, July 1954.
- (7) F. E. Terman, "Radio Engineers' Handbook," McGraw-Hill Book Co., Inc., New York, p 353, 1943.
- (8) H. G. Rudenberg and F. Kennedy, 200-mc Traveling-wave Chain Amplifier, *ELECTRONICS*, p 106, Dec. 1949.
- (9) D. O. Pederson, "Analysis and Synthesis of Distributed Amplifiers with Ladder Networks," Stanford University, Electronic Research Laboratory, Technical Report No. 34, May, 1951.
- (10) H. B. Demuth, "An Investigation of the Iterative Synthesis of Distributed Amplifiers," Stanford University, Electronic Research Laboratory, Technical Report No. 77, Aug. 1954.
- (11) A. Donald Moore, "Synthesis of Distributed Amplifiers for Prescribed Amplitude Response," Stanford University, Electronic Research Laboratory, Technical Report No. 53; Sept. 1952.
- (12) W. H. Kautz, Review of Ref 9, *Trans IRE PGCT*, CT-2, No. 2, June, 1955.
- (13) F. E. Terman, "Radio Engineers' Handbook," McGraw-Hill Book Co., Inc., New York, p 966, 1943.

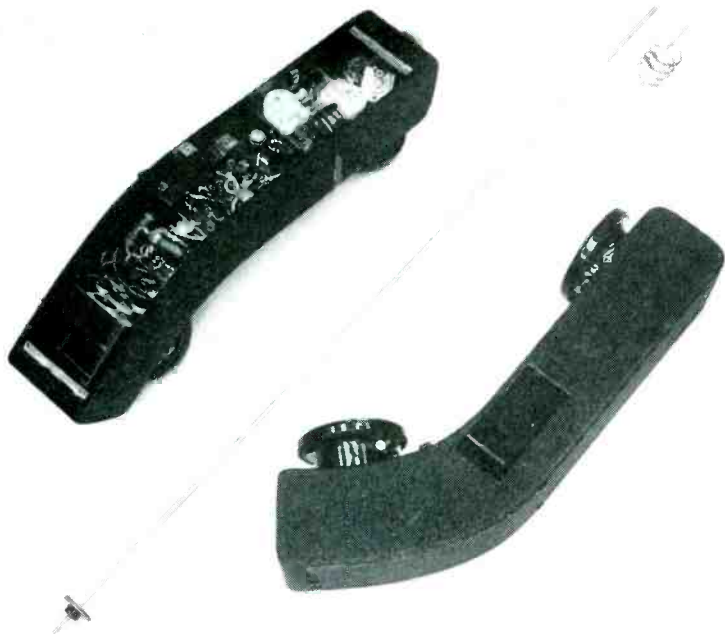

Radio-frequency components of transceiver are mounted on top part of unit, behind headphone. Batteries are mounted at bottom of unit, behind microphone

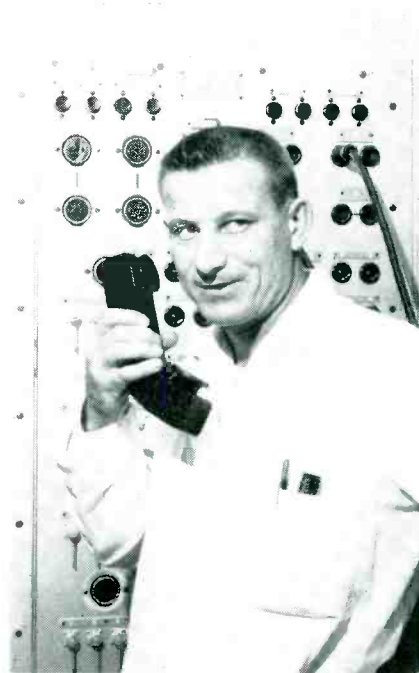

Transceiver in use with 2½-ft inductively coupled antenna attached

# SUPERREGENERATIVE

By **W. F. CHOW**

*General Electric Company  
Syracuse, New York*

**B**ASIC advantages of superregenerative detection, sensitivity and simplicity, are further enchanted by the merits of a transistor.

Because of the dependence of transistor parameters on the operating points, the loop gain of a transistor oscillator can be controlled by changing the emitter current and/or the collector voltage. This property makes possible the control of a transistor by an external quenching signal.

Figure 1 shows the a-c circuit of a junction transistor oscillator. Inductance  $L_1$  and  $C_1$  form a tank circuit and a feedback path is provided by  $C_2$ . Choke  $L_2$  prevents the feedback signal from being shunted to ground.

## Self-Quenched Oscillator

If the oscillator circuit is so designed that the resistance of the circuit between emitter and the base is small, but there is a finite

d-c resistance in the collector circuit as shown in Fig. 2 and if  $C_3$  is large enough, it will function as a self-quenched oscillator.

Initially, the emitter d-c bias current is very small. It is obtained from the d-c voltage drop across the base. Since the collector current is also small, the d-c voltage drop across the  $r$  in Fig. 3 is negligible and collector bias voltage  $V_c$  is practically equal to the battery supply voltage.

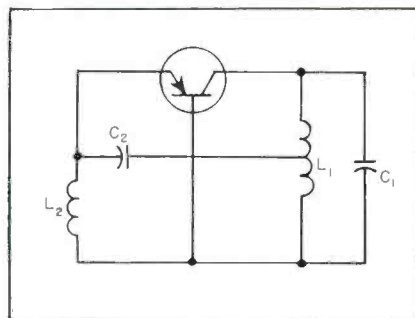

FIG. 1—Basic a-c circuit of junction transistor oscillator

If under this initial d-c bias condition the loop gain of the oscillator circuit is adequate, the oscillation starts and its amplitude builds up. At the same time the instantaneous emitter current increases according to the envelope of oscillation by the rectification action of the emitter diode. At first, the effect of increased emitter current overcomes the effect of slightly increased collector bias. Thus, the loop gain is improved.

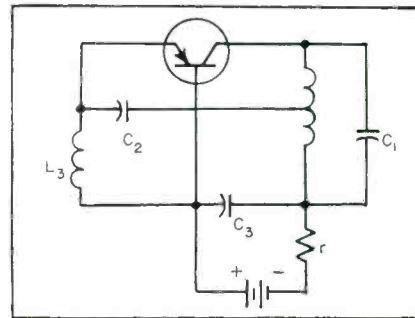

FIG. 2—Self-quenched oscillator for superregenerative detection



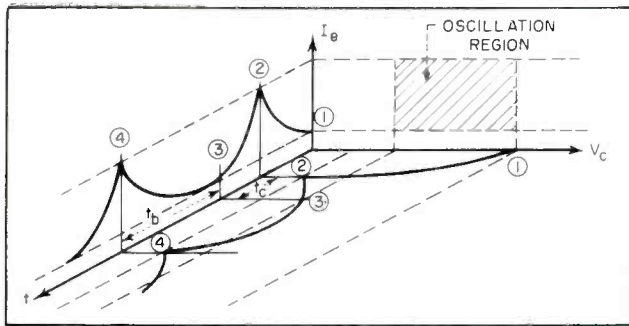

FIG. 3—Bias current and voltage of self-quenched oscillator

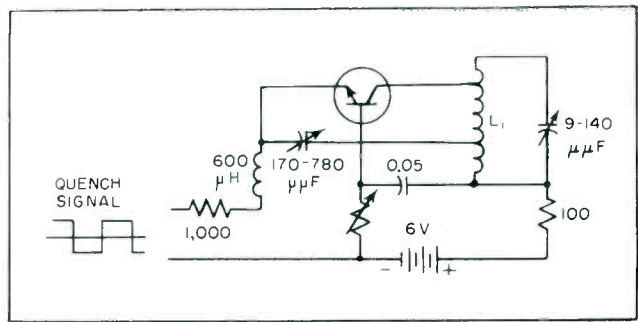

FIG. 4—Experimental circuit of forced-quench transistor oscillator

**SUMMARY** — Three-transistor transceiver uses tetrode as 52-mc oscillator for transmitting and as forced-quench superregenerative detector for receiving. Theory of operation is covered for both self-quenched and forced-quenched modes of regenerative oscillation

# Transistor Transceiver

The oscillation builds up at a high rate and the emitter and collector current increase correspondingly. Due to the presence of  $r$  in the collector circuit, the collector voltage decreases.

The amplitude of oscillation soon reaches a point at which the emitter current is large and the collector bias voltage is small. Then the loop gain drops below unity and the oscillation dies rapidly, the emitter and collector currents decreasing at the same time. Now  $V_c$  recovers, but since  $C_s$  and  $C_c$  are connected across the collector and the base of the transistor as far as the quench frequency is concerned, the instantaneous  $V_c$  will be the same as the voltage across the capacitance.

A finite time is required to build up the voltage across these two capacitances through  $r$ . If the time required to charge these two capacitances is longer than the time required to let the oscillation stop,

or the amplitude of the oscillation decreases to a very small magnitude, the oscillator appears as a self-quench oscillator.

### Bias Variation

Figure 3 shows qualitatively the variation of the bias current and voltage of a self-quenching oscillator with time. The shaded area indicates the oscillation region in which the values of  $I_e$  and  $V_c$  provide a proper bias point for the transistor.

At time  $t = 0$ , the  $I_e$  and  $V_c$  start from the values marked 1. As the amplitude of oscillation builds up,  $I_e$  and  $V_c$  reach the values marked 2. At this bias point, the gain of the transistor is not enough to maintain oscillation. The amplitude of oscillation comes down and  $V_c$  builds up.

When  $V_c$  reaches point 3, the oscillation begins to build up again. The time  $t_c$  required to charge the capacitor plus the time  $t_b$  required

to build up the oscillation to a peak point determines the quench frequency. When there is an r-f or a noise signal,  $t_c$  will be shortened.

The quench frequency is modulated by the envelope of the r-f signal. Since the amplitude of oscillation is the same for all quench frequencies, an increase of frequency indicates an increase of the area under the oscillation envelope. Consequently, a gain of  $I_e$  is obtained, and it follows the envelope of the r-f signal.

### Forced Quenching

When the oscillator oscillates strongly without any self-quenching action, it can be quenched by applying an auxiliary signal. This auxiliary quench signal is used to move the bias point of the transistor to a value such that the loop gain of the oscillator is too small to maintain the oscillation.

If the quench signal is a periodic wave, oscillation will start and stop

for each cycle. The length of the period during which oscillation stops depends entirely upon the properties of the oscillator and the magnitude and frequency of the quenching signal.

If the circuit design of the oscillator is such that the oscillator is not self-starting, an outside quenching signal will be able to start the oscillator and maintain the oscillation for a period of time.

The principle of applying a quench signal to start and stop an oscillation is similar to the externally quenched superregenerative action of a tube circuit.

Figure 4 shows a test circuit of the forced-quench oscillator. Coil  $L_1$  has two taps, one for the feedback circuit and the other for the collector. When the collector is connected across a tap point instead of across the whole inductance, the loading effect of the transistor on the Q of the tank is reduced. The Q of the coil at one mc is 120.

The variable resistance in the base circuit adjusts the bias point for no oscillation when the quench signal is zero or of the wrong polarity. The resistance in the collector circuit is small, so  $V_c$  does not change too much. Consequently, the bias point of the transistor is controlled predominantly by the emitter current.

When a 10-kc square-wave signal is applied, the duration of each half-cycle of the quench signal is long enough to allow the oscillation to build up and to die down

to such a small value that the envelope of the oscillation is controlled by the outside r-f signal. Since the duration of the half-cycle for build up of the oscillation is long enough to let the oscillation reaching the saturation region, the operation is in the logarithmic mode.

If the duration of the building up of oscillation is cut down, the oscillation would be in the linear mode. However, there is a minimum required length for the duration of the quench period. When that period is less than this minimum value, the oscillation is unable to die down to less than the level of noise and outside r-f signals. Consequently, the oscillator oscillates continuously and cannot be controlled.

When a 25-kc quench signal is fed into the emitter, the duration of quenching period is not long enough to quench the oscillation. Using the 25-kc quench signal, a quench oscillation can be obtained by increasing the rate of decay of oscillation. This can be done by increasing the loss in the tank.

#### Self-Quench Test

The circuit of Fig. 2 was used to test self-quenched oscillation. The inductance of the tank circuit was the same as that used in the forced-quench circuit. Capacitance  $C_3$  and resistance  $r$  were varied to study the self-generated quench frequency.

When the transistor was inserted

in the circuit with the feedback path open, the bias point was  $I_e = 90 \mu\text{a}$ ;  $V_c = 6 \text{ v}$ . After the feedback path was closed, oscillation started. The emitter bias current increased by the rectification of the a-c voltage feedback to the emitter.

If the values of  $C_3$  and  $r$  are changed, the self-generated quench frequency is changed.

#### Six-Meter Transceiver

Figure 5 shows the circuit of a completely transistorized six-meter transceiver.

A ZJ7 tetrode is used as the 52-mc oscillator in the transmitting position and as the superregenerative detector in the receiving position. Two 2N44 junction transistors are used, one as the auxiliary quench oscillator and the other as the audio amplifier. Two 2,000-ohm head sets are used, one as the headphone and the other as the dynamic microphone.

In the receiving position, the 20-kc quench signal of the auxiliary quench oscillator is fed into base  $b_1$  of the tetrode through  $T_1$ . Consequently, the oscillation of the tetrode is quenched periodically and superregenerative detection is obtained. The audio output of the detector is fed into the base of the audio amplifier through  $T_2$ .

In the transmitting position, the collector bias supply of the auxiliary quench oscillator is removed. Hence, there is no quench signal and the tetrode oscillates strongly at 52 mc.

When a voice is spoken into the microphone, the induced audio is amplified and fed into the collector circuit of the tetrode through  $T_2$ . Consequently, the oscillator is amplitude modulated by the voice signal.

The modulated r-f is inductively coupled to the antenna.

Field tests of two transceivers indicate a usable distance of one-half mile. Battery drain of each unit is 48-mw for receiving and 60 mw for transmitting.

The author thanks James V. O'Hern and Adam E. Klisz for their part in building and field testing these transistorized transceivers.

#### BIBLIOGRAPHY

R. L. Pritchard, Frequency Variation of Junction Transistor Parameter, p 786, *Proc IRE*, May 1954.

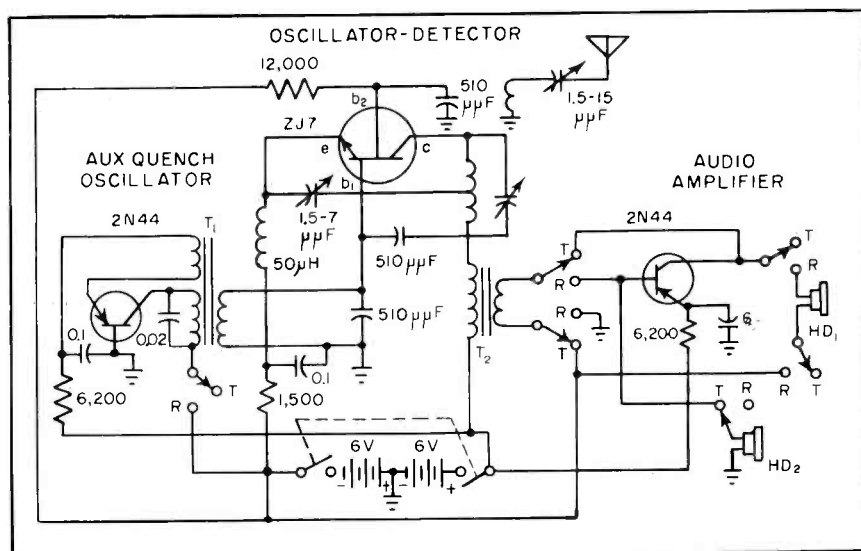

FIG. 5—Six-meter transceiver uses high-impedance headphone as dynamic microphone



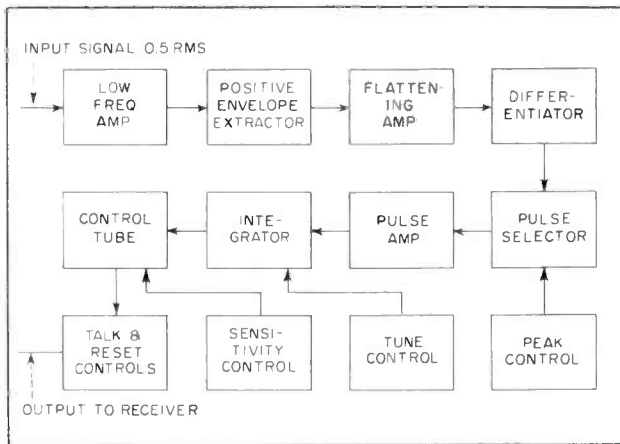
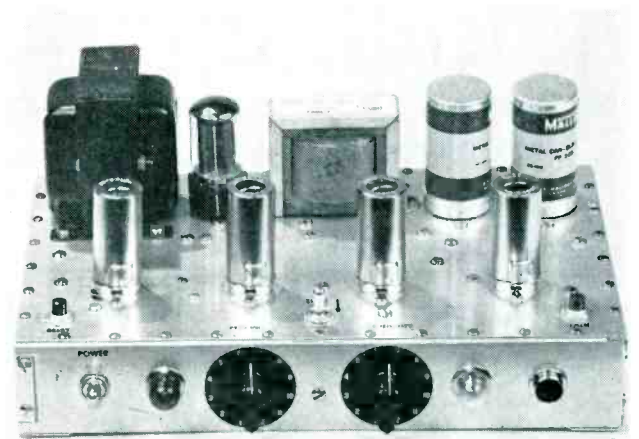

FIG. 1—Block diagram of speech-music discriminator. Differentiator passes all music and suppresses all speech. Control settings take care of language differences



Speech-music discriminator has peaking and sensitivity controls for waveform discrimination and the tuning and talk controls at front of chassis. The 280-v, 50-ma power supply is at rear

# MUSIC PULSE ANALYZER Rejects Voice Signals

By RONALD L. IVES

*Palo Alto, Calif.*

**SUMMARY** — Lightly damped musical tones can be distinguished from heavily damped waves which are characteristic of speech. These waveform differences are used to reject speech in any language, in an a-m radio receiver system that desires nothing but music. Adjustable controls admit or suppress speech signals over a wide range of the acoustical spectrum

**S**PEECH-MUSIC DISCRIMINATION is supplied by the phonemic makeup of almost all languages. Speech, in most linguistic families, is made up of discrete quanta of sound, technically called phonemes, which are usually enunciated with sharp pauses between them. In general, phonemes are heavily damped, whereas musical tones are damped lightly. The spoken word has good decrement, while instrumental music has bad decrement. These decremental differences are most pronounced at low frequencies. Oscilloscopic study of speech in various languages and with a number of speakers, shows that the phoneme occurrence frequency never exceeds 20 per second.

A device has been developed which produces a discrete signal when fed heavily damped repetitive pulses (speech) and which does not produce that signal when fed overlapping poorly damped repetitive pulses (music), thus differentiating between normal speech and normal music.

### Music Only

Steps necessary to convert a received signal into a sound output when the signal is music and to eliminate a sound output when the signal is talk, are shown in the block diagram, Fig. 1. The circuits performing these functions are shown in Fig. 2.

The receiver signal is fed into

a low-frequency amplifier, which has an inherent limiting action to protect the system from overloading. This amplifier does not pass signals at frequencies above about 3,500 cycles and can have a much narrower passband.

Input amplifier  $V_{1A}$ , in Fig. 2 has R-C coupling and band limits of approximately 300 and 1,500 cycles. Miller-effect frequency variations, due to changes in input amplitude, are inconsequential. An L-C band-pass filter does not improve performance enough to justify the added expense.

The output of this amplifier is badly distorted, with bass exaggeration and treble suppression. Music has an echo chamber sound,





such as 50 v, current flows from the cathode through the rectifier, actuates the relay, and returns through the receiver d-c circuit (cathode-bias resistor or receiver power tube and ground.

This current flow increases the bias on the receiver power output stage and reduces the power stage amplification. Current flow takes place only when the speaker shorted and no signal output is wanted.

### Auxiliary Controls

The time constant of the integrating circuit slows tuning considerably, particularly when most of the stations have voice broadcasts. To expedite tuning, a switch shorts the grid of  $V_{4A}$  to ground. When this switch is closed, the speech-music discriminator output is inoperative. The off position restores the discriminator output.

To permit reception of a single interval of talk without suppressing voice signals indefinitely, a one-shot disabler is added. The talk button in Fig. 2, energizes a relay which removes the current from the receiver relay and locks itself in energized position. When the conversation is succeeded by music, the relay releases and the discriminator functions as a speech suppressor. If, after the talk button is depressed, the talk is unwanted, pressing the reset button will eliminate the voice broadcast and music will be received when the talk is over.

### Power Supply

Power required for the speech-music discriminator is about 280 volts, at 50 ma. Filament needs are 6.3 v at about 3.1 amperes. Because several of the cathodes are considerably positive with respect to ground, the filament center tap is biased about 22-v positive to prevent cathode-heater hum modulation.

### Performance

With both resistive controls centered, the discriminator passes all ordinary music of a classical and semiclassical nature and suppresses all ordinary speech. This speech-music discriminator applies for broadcasts in English, French, Spanish, Portuguese, Italian, Ger-

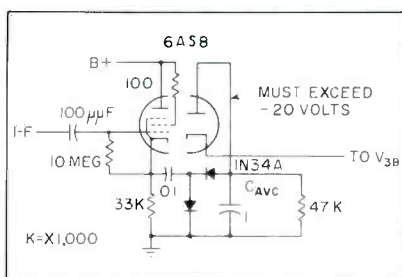

FIG. 3—Automatic discriminator disabler for station tuning

man, Dutch, Danish, Norwegian, Swedish, Polish, Russian, Gaelic, Icelandic, Japanese and Mandarin. However, speech-music discrimination could not be obtained in Cantonese, Burmese, Malayan and several of the southeastern Asian dialects due to the musical intonation of speech.

The music selector does not distinguish between the noises made with the vocal cords and the noises made mechanically by several of the South African native groups. In one test, it could separate speech and music in the Navajo language, but in another test, it failed completely in the Yucateca dialect.

Modern Latin acts as voice when clearly spoken and as music when intoned. Arabic is quite similar and the Muzzein's call to prayer behaves as music. Certain musical forms, having a sharply damped characteristic, are discriminated against by this device, even though they are instrumental. In this group are calliope solos, unaccompanied performances on single trumpets, cornets and some piano solos.

### Control Adjustment

With the peaking control about one-third down from maximum and the sensitivity control about one-third up from minimum, clearly enunciated speech will be rejected and all other radio sounds will be passed. With the peaking control set about one-third up and the sensitivity control about one-third down, practically all voices, most comic operas and most singing commercials are rejected and orchestral music is passed.

### Alternate Circuitry

The need for the tuning switch in Fig. 2 can be eliminated and the

charge on the integrating capacitor dumped automatically whenever the carrier is interrupted, by relatively simple means. Where adequate i-f voltage is available, this is accomplished by use of an auxiliary i-f amplifier and rectifier, with a short-time-constant filter, coupled to the integrating circuit of the discriminator by a diode with high back resistance, as in Fig. 3.

Whenever the voltage on  $C_{AVC}$  falls below that on the integrating capacitor, it is effectively more positive and the diode becomes conducting, effectively dumping the charge on the integrating capacitor. Whenever  $C_{AVC}$  is more negative than the integrating capacitor, the diode cannot conduct and the charge on the integrating capacitor is controlled by the discriminator.

### Codan-Type Disabler

Where the i-f voltage of the receiver is relatively low, this all-thermionic disabler is not effective and is best replaced by a codan-type disabler. Here, when the AVC voltage is from zero to about -3v, the triode conducts and the relay in the plate circuit shorts the integrating capacitor in the discriminator. When the AVC voltage rises to a higher negative value, the triode is cut off, the relay opens and the action of the discriminator depends upon the audio signal fed into it.

A circuit similar to Fig. 3, but fed from the receiver audio system at an appropriate voltage level, can be used to discharge the integrating capacitor whenever the audio signal fails. This is quite effective in accelerating the speech-music transition, taking advantage of the customary short pause (about 0.5 sec) between station announcements and music. The time constant of the filter should be about 0.3 sec, with the circuit resistance not much over 50,000 ohms.

The author is indebted to Dr. C. F. Vogelin, of the Department of Linguistics, Indiana University, for discussions of the nature of speech from the linguist's viewpoint.

### BIBLIOGRAPHY

1. E. Fredmore, Speech-Music Discriminator, *Radio-Electronics*, Vol. 28, p 62, Sept. 1956.

# GATE TUBE Generates

**SUMMARY** — Single-tube circuit provides accurately spaced main-delay pulses and auxiliary pulses for precision time measuring equipment. Adjustable spacing between the two series of pulses is provided over a range from 0 to 10,000 microseconds. Output is 20-volts peak-to-peak

**T**HE INTERLEAVED pulse generator described here was developed for use in the time measuring equipment, shown in the photograph and was employed in early models. In this unit time is measured by generating a fixed and a delayed pulse, the time delay of the latter being accurately known and continuously adjustable over the wide range from 0 to 10,000  $\mu$ sec.

To achieve maximum accuracy and stability the delayed pulse is formed by the addition of the following separate time intervals: The main delay interval, adjustable in steps of 10  $\mu$ sec, formed by the selection of a chosen number of 10  $\mu$ sec increments from a crystal-controlled marker generator and the vernier delay interval formed by a phantastron whose gate duration is continuously adjustable over a range of 10  $\mu$ sec.

The addition of these two delays yields a continuously variable delay of considerable range and accuracy.

## Timing

As the vernier delay control is moved from one extreme of its range to the other, it must cause the delayed output pulse to move from one marker of the 10- $\mu$ sec chain to the next. If the phantastron is triggered from one of these markers, the vernier delay must have a range of 0 to 10  $\mu$ sec or of 10 to 20  $\mu$ sec. The 0 to 10 choice leads to linearity difficulties in the region of zero vernier delay, and the 10 to 20 choice necessitated excessively long delay lines else-

where in the circuits to achieve a minimum fixed pulse-delayed pulse spacing of zero.

The remedy was to employ an auxiliary marker chain, displaced

in time by about 4  $\mu$ sec from the pulses of the main-delay chain. By triggering the vernier-delay circuit from this auxiliary chain, an optimum range of 4 to 14  $\mu$ sec for the phantastron was obtained. To maintain the overall accuracy of the equipment the pulses of this auxiliary chain must be as accurately timed as those of the main delay and the displacement between the two chains must be stable. The interleaved pulse generator was therefore devised to furnish both the main-delay and the auxiliary pulses.

The need therefore was for a simple generator to produce two chains of pulses, the two chains to be interleaved with each other in time and to have an adjustment for determining the relative timing between the two chains. This need was satisfied by an application of the 6BN6 tube which has various features making it suitable for the present purpose.

The 6BN6 tube is a gated-beam pentode. The first and third grids have a large effect on plate current; if either grid is slightly positive, the other will abruptly cut off or fully establish the plate current upon a change of a few volts in the neighborhood of zero potential. This pronounced effect amounts to approximately 4,000  $\mu$ mhos transconductance per milliampere, or 24,000  $\mu$ mhos for a typical 6-milliampere plate current.

Whenever the first or third grid prevents current from reaching the plate, it is diverted to the second grid. The tube therefore

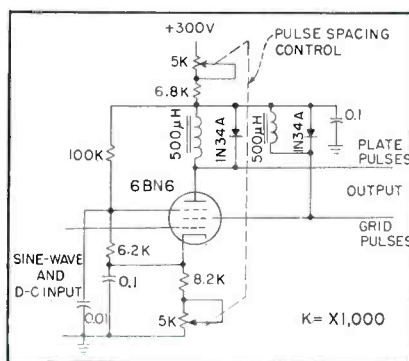

**FIG. 1—Dual pulse-chain generator uses gated beam tube. Ganged potentiometer controls spacing between interleaved sets of pulses from single tube**

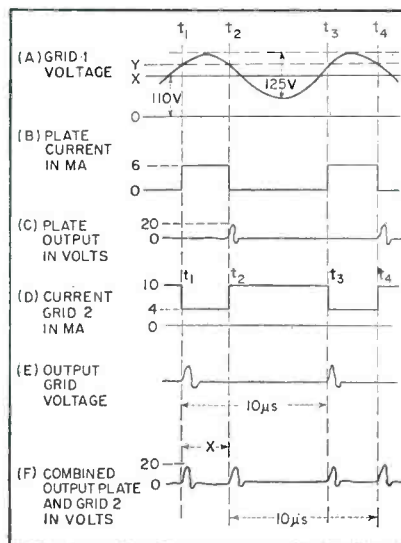

**FIG. 2—Waveforms present at various points in pulse generator circuit**



# Interleaved Pulse Chain

By **DAVID KUSHNER**

Hazeltine Electronics Corp.  
Little Neck, N. Y.

acts as a switch, passing the plate current or diverting it to the second grid.

Impedance looking into either the first or third grids is comparatively high, even with positive potentials on these grids. This permits the application of a large sine-wave input, as in the present circuit design, without objectionable loading of the supply circuit.

## Circuit Design

The circuit of the generator is shown in Fig. 1. The input driving signal consists of a d-c component and a sine wave of 100 kc. Since on positive grid swings the tube draws negligible grid current and has only normal space current, a large driving signal can be used. This has the advantage of producing rapid changes of current at the plate and second grid, with consequent greater amplitude of the inductively produced output pulses. This drive signal is applied to the first grid. The second grid is supplied with direct voltage from the plate source and acts as the output terminal for one of the sets of pulses. The third grid is given a fixed positive potential of 6 volts above the cathode by a 6,200-ohm and 100,000-ohm voltage divider. The plate has a normal direct voltage and acts as the output terminal for the other set of pulses.

The action of the circuit is shown in Fig. 2, where curve *A* shows the applied driving signal. The resulting plate current is of rectangular form as in curve *B*. A 1N34A crystal prevents ringing by short cir-



Time measuring equipment using interleaved pulse technique for accurate timing

cutting all negative portions of the oscillations. Since these include, for each first negative excursion, all the energy required for further oscillations there remain only the initial positive-polarity pulses at times  $t_2$  and  $t_4$ , shown in curve *C*.

In the second-grid circuit, the polarities of the current and voltage excursions are opposite, but the polarity of the crystal is the same, so that pulses are obtained at times  $t_1$  and  $t_3$ , as shown in curves *D* and *E*.

The two sets of pulse chains are delivered separately at individual output terminals, but can easily be added to produce the dual series shown at *F*.

## Adjustment

Adjustment of the relation between the two sets of pulses is obtained by the ganged potentiometers in the plate and cathode circuits. These vary the d-c potentials of the tube with respect to ground and therefore the potential of the cathode with respect to the input driving wave. If the cathode is on the a-c axis of the wave (*X* in curve *A* of Fig. 2), the timing will be in the neighborhood of 5  $\mu$ sec between the sets of pulses. If the arms of the potentiometers are moved upward, the cathode resist-

ance is increased, the cathode is made more positive (*Y* in the diagram) and the timing changes to shorter plate-current pulses and longer second-grid ones. For a 5- $\mu$ sec relation and the input wave of curve *A*, the plate is about 210 volts above ground and the cathode about 110 volts above ground. The tube drop is constant at about 100 volts for various timing adjustments. The 5,000-ohm potentiometers provide a range from about 3.8 to 6.2  $\mu$ sec.

## Output

An output of approximately 20 volts peak-to-peak is obtained. The source impedance of the generator is low enough to permit the load circuit to have a moderately low resistance.

The presence of shunt-load capacitance, however, adds to the shunt capacitance of the coils and lowers their natural resonant frequency; this in turn widens the individual pulses of the two sets, which may be objectionable. An isolating amplifier can be added if needed to prevent this.

The two inductors are universal coils wound on Stackpole G-2 cores. These have a measured *Q* of 80 at 1 mc. The design of these coils is not critical.

# Conversion Formulas For Hybrid Parameters

By T. P. SYLVAN

Transistor Application Engineer  
Advanced Electronics Center  
General Electric Co.  
Ithaca, New York

**SUMMARY** — Charts summarize formulas required to convert transistor  $H$ -parameters to equivalent  $T$ -parameters in common base, emitter and collector configurations. Equivalence between new and old notations is given

**H**YBRID or  $h$ -parameters are coming into increasing favor as a basis for specifying the small-signal characteristics of junction transistors. They are compatible with the inherent characteristics of junction transistors and can be measured conveniently and accurately.<sup>1</sup>

Table I presents equations for the calculation of single-stage transistor amplifier characteristics directly from the corresponding  $h$ -parameters. Table II permits conversion between the familiar equivalent-T circuit and the  $h$ -parameters measured in the common-base, emitter or collector configuration. Typical numerical values for each parameter are given.

Recently adopted IRE standards on semiconductor symbols are used in these tables.<sup>2</sup> The first subscript designates the characteristic, i for input, o for output, f for forward transfer and r for reverse transfer, while the second subscript designates the circuit configuration, b for common base, e for common emitter and c for common collector. The corresponding old symbols are indicated on the left side of Table II.

## REFERENCES

- (1) A.W. Lo, "Transistor Electronics", p 55, Prentice Hall, 1955.
- (2) IRE Standards on Letter Symbols for Semiconductor Devices, *Proc IRE*, p 934, July 1956.

Table I—Single Stage Transistor Amplifier Characteristics in Terms of H-Parameters

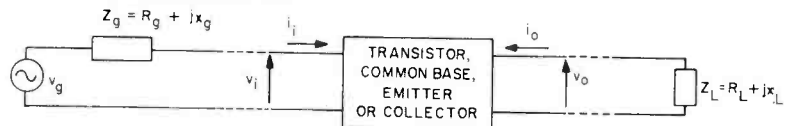

Input impedance	$Z_i = \frac{v_i}{i_i} = h_i - \frac{h_f h_r Z_L}{1 + h_o Z_L}$
Output impedance	$Z_o = \frac{v_o}{i_o} = \frac{1}{h_o - \frac{h_f h_r}{h_i + Z_g}}$
Current gain	$A_i = \frac{i_o}{i_i} = \frac{h_f}{1 + h_o Z_L}$
Voltage gain	$A_v = \frac{v_o}{v_i} = \frac{1}{h_r - \frac{h_i}{Z_L} \left( \frac{1 + h_o Z_L}{h_f} \right)}$

For  $Z_g = R_g$  and  $Z_L = R_L$

Operating power gain $\left( \frac{\text{power into load}}{\text{power into transistor}} \right)$	$G = A_v A_i = \frac{v_o i_o}{v_i i_i} = \frac{\left( \frac{h_f}{1 + h_o R_L} \right)}{h_r - \frac{h_i}{R_L} \left( \frac{1 + h_o R_L}{h_f} \right)}$
Insertion power gain: $\left( \frac{\text{power into load}}{\text{power gen would deliver directly}} \right)$	$G_i = \frac{h_f^2 (R_g + R_L)^2}{[(h_i + R_g)(1 + h_o R_L) - h_f h_r R_L]^2}$
Transducer power gain: $\left( \frac{\text{power into load}}{\text{maximum available generator power}} \right)$	$G_{tr} = \frac{4 h_f^2 R_g R_L}{[(h_i + R_g)(1 + h_o R_L) - h_f h_r R_L]^2}$
Available power gain: $\left( \frac{\text{maximum available output power}}{\text{maximum available generator power}} \right)$	$G_{av} = \frac{h_f^2 R_g}{(h_i + R_g)[h_o(h_i + R_g) - h_f h_r]}$

(continued on page 190)



★ **Visual Alignment Unnecessary...Ribbon Spring Contacts...**

36-4200-8S



36-4100-8P

**Floating Bushings**

# BLUE RIBBON CONNECTORS

# BY CINCH



The ribbon contact principle, with dielectric guide and support eliminates the possibilities of damaged or bent contacts and prevents difficulties of plug-in. No dependence on contact arrangement or visual alignment is necessary.

## BARRIER POLARIZATION TYPE INSURE QUICK POSITIVE CONTACT WITH EASE

The Wedge principle with the strong spring action of the contacts holds the connector in positive contact, and provides ease of insertion and withdrawal. The protective barriers between ribbon contacts insure the spacing. The entire length of the contacts are supported by quality dielectric. Multiple mounting makes it possible to make or break any number of circuits simultaneously. The high tensile strength of blue dielectric provides positive polarization. Molded-in mounting plates are of corrosion resistant passivated stainless steel.

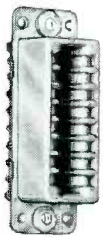

36-4200-16S

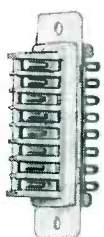

36-4100-16P

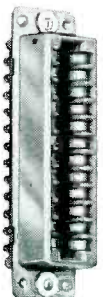

36-4200-24S

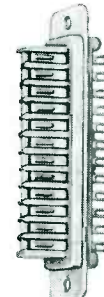

36-4100-24P

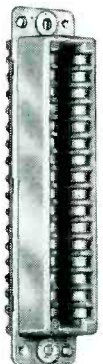

36-4200-32S



36-4100-32P

## BLUE RIBBON CONNECTOR IMPROVED MILITARY TYPE

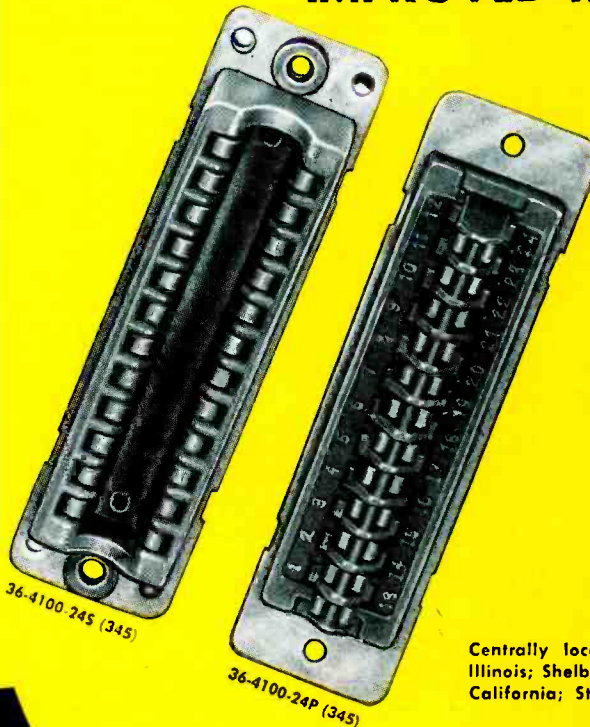

Improved design of plug and socket casting eliminate any possible breakage.

### IMPROVED TYPE:

- 36-4100- 8P (345)
- 36-4100- 8S (345)
- 36-4100-16P (345)
- 36-4100-16S (345)
- 36-4100-24P (345)
- 36-4100-24S (345)
- 36-4100-32P (345)
- 36-4100-32S (345)

### REGULAR TYPE:

- 36-4100- 8P (334)
- 36-4100- 8S (334)
- 36-4100-16P (334)
- 36-4100-16S (334)
- 36-4100-24P (334)
- 36-4100-24S (334)
- 36-4100-32P (334)
- 36-4100-32S (334)

For your connector requirements — you can depend on CINCH.



**Cinch**  
ELECTRONIC  
COMPONENTS

Centrally located plants at Chicago, Illinois; Shelbyville, Indiana; LaPuente, California; St. Louis, Missouri.

## CINCH MANUFACTURING CORPORATION

1026 South Homan Ave., Chicago 24, Illinois

Subsidiary of United-Carr Fastener Corporation, Cambridge, Mass.

# Conversion Formulas For Hybrid Parameters (Continued from page 188)

Table II—Exact Conversion Formulas for H Parameters and Transistor Equivalent Circuits

$$v_i = h_{ij}i_j + h_{rj}v_o$$

$$i_o = h_{fj}i_j + h_{oj}v_o$$

(j = COMMON ELECTRODE, e, b, or c)

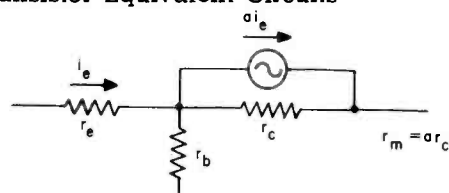
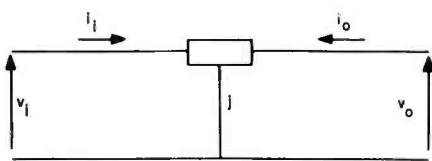

Symbols		Common Emitter	Common Base	Common Collector	Equivalent T Circuit
Old	New				
$h_{11e}$ $1/Y_{11e}$	$h_{ie}$	2,900 ohms	$\frac{h_{ib}}{(1+h_{fb})(1-h_{rb}) + h_{ob}h_{ib}}$	$h_{ic}$	$r_b + \frac{r_e r_c}{r_e + r_c - r_m}$
$h_{12e}$ $\mu_{be}$	$h_{re}$	$9.3 \times 10^{-4}$	$\frac{-h_{rb}(1+h_{fb}) + h_{ib}h_{ob}}{(1+h_{fb})(1-h_{rb}) + h_{ob}h_{ib}}$	$1 - h_{rc}$	$\frac{r_e}{r_e + r_c - r_m}$
$h_{21e}$ $\alpha_{cb}, \beta$	$h_{fe}$	49	$\frac{-h_{fb}(1-h_{rb}) - h_{ob}h_{ib}}{(1+h_{fb})(1-h_{rb}) + h_{ob}h_{ib}}$	$-(1 + h_{fc})$	$\frac{r_m - r_e}{r_e + r_c - r_m}$
$h_{22e}$ $1/Z_{22e}$	$h_{oe}$	$33 \times 10^{-6}$ mhos	$\frac{h_{ob}}{(1+h_{fb})(1-h_{rb}) + h_{ob}h_{ib}}$	$h_{oc}$	$\frac{1}{r_e + r_c - r_m}$
$h_{11}$ $1/Y_{11}$	$h_{ib}$	$\frac{h_{ie}}{(1+h_{fe})(1-h_{re}) + h_{ie}h_{oe}}$	40 ohms	$\frac{h_{ic}}{h_{ic}h_{oc} - h_{fc}h_{rc}}$	$r_e + (1-\alpha)r_b$
$h_{12}$ $\mu_{ec}$	$h_{rb}$	$\frac{-h_{re}(1+h_{fe}) + h_{ie}h_{oe}}{(1+h_{fe})(1-h_{re}) + h_{ie}h_{oe}}$	$4 \times 10^{-4}$	$\frac{h_{fc}(1-h_{rc}) + h_{ic}h_{oc}}{h_{ic}h_{oc} - h_{fc}h_{rc}}$	$\frac{r_b}{r_e + r_b}$
$h_{21}$ $\alpha_{ce}, \alpha$	$h_{fb}$	$\frac{-h_{fe}(1-h_{re}) - h_{ie}h_{oe}}{(1+h_{fe})(1-h_{re}) + h_{ie}h_{oe}}$	-0.98	$\frac{h_{rc}(1+h_{fc}) - h_{ic}h_{oc}}{h_{ic}h_{oc} - h_{fc}h_{rc}}$	$-\alpha$
$h_{22}$ $1/Z_{22}$	$h_{ob}$	$\frac{h_{oe}}{(1+h_{fe})(1-h_{re}) + h_{ie}h_{oe}}$	$0.67 \times 10^{-6}$ mhos	$\frac{h_{oc}}{h_{ic}h_{oc} - h_{fc}h_{rc}}$	$\frac{1}{r_e + r_b}$
$h_{11c}$ $1/Y_{11c}$	$h_{ic}$	$h_{ie}$	$\frac{h_{ib}}{(1+h_{fb})(1-h_{rb}) + h_{ob}h_{ib}}$	2,000 ohms	$r_b + \frac{r_e r_c}{r_e + r_c - r_m}$
$h_{12c}$ $\mu_{bc}$	$h_{rc}$	$1 - h_{re}$	$\frac{1 + h_{fb}}{(1+h_{fb})(1-h_{rb}) + h_{ob}h_{ib}}$	1.0	$\frac{r_e - r_m}{r_e + r_c - r_m}$
$h_{21c}$ $\alpha_{eb}$	$h_{fc}$	$-(1 + h_{fe})$	$\frac{h_{rb} - 1}{(1+h_{fb})(1-h_{rb}) + h_{ob}h_{ib}}$	-50	$-\frac{r_c}{r_e + r_c - r_m}$
$h_{22c}$ $1/Z_{22c}$	$h_{oc}$	$h_{oe}$	$\frac{h_{ob}}{(1+h_{fb})(1-h_{rb}) + h_{ob}h_{ib}}$	$33 \times 10^{-6}$ mhos	$\frac{1}{r_e + r_c - r_m}$
$\alpha = a$		$\frac{h_{fe}(1-h_{re}) + h_{ie}h_{oe}}{(1+h_{fe})(1-h_{re}) + h_{ie}h_{oe}}$	$-h_{fb}$	$\frac{h_{ic}h_{oc} - h_{rc}(1+h_{fc})}{h_{ic}h_{oc} - h_{fc}h_{rc}}$	$(r_m + r_b)/(r_c + r_b)$ 0.98
$r_c = \frac{r_m}{a}$		$\frac{h_{fe} + 1}{h_{oe}}$	$\frac{1 - h_{rb}}{h_{ob}}$	$-\frac{h_{fc}}{h_{oc}}$	1.5 meg
$r_e$		$\frac{h_{re}}{h_{oe}}$	$h_{ib} - (1+h_{fb})\frac{h_{rb}}{h_{ob}}$	$\frac{1 - h_{rc}}{h_{oc}}$	28 ohms
$r_b$		$h_{ie} - \frac{h_{re}(1+h_{fe})}{h_{oe}}$	$\frac{h_{rb}}{h_{ob}}$	$h_{ic} + \frac{h_{fc}(1-h_{rc})}{h_{oc}}$	600 ohms
$a$		$\frac{h_{fe} + h_{re}}{1 + h_{fe}}$	$-\frac{h_{fb} + h_{rb}}{1 - h_{rb}}$	$\frac{h_{fc} + h_{rc}}{h_{fc}}$	0.98



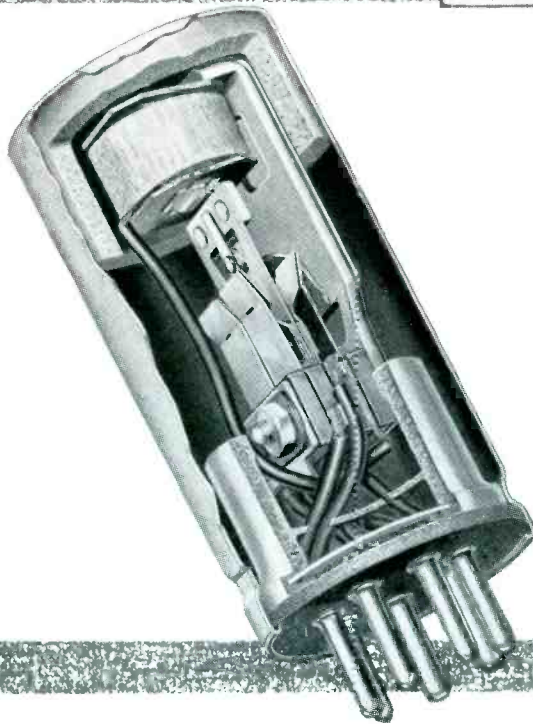

*New 1700 series Mallory split-reed vibrator\* uses special alloy leaves which serve both as contacts and as springs . . . eliminating usual button contacts. Life is greatly increased, constancy of output improved, and driving power reduced.*

*\*Patent Applied For*

## New Heavy Duty Mallory Vibrator

*gives far longer life, constant output*

For the peak in dependability and performance, plan to use this newest Mallory vibrator in your communications equipment. A completely new idea in vibrator design eliminates conventional contact buttons. The spring leaves themselves . . . made of special contact alloy . . . act as contacting members. This design provides greatly increased contact area, with these important advantages:

**Consistently Longer Life.** Tests made on heavy duty cycles prove up to 100% greater service can be expected . . . with a high degree of consistency.

**Steadier Output.** The decreased rate of erosion means less change in contact spacing, less variation in voltage.

**Flare-Proof Starting.** The new low-mass design permits wider contact spacing to prevent start-up flare . . . without need for greater driving power.

**Exceptional Uniformity** of characteristics is made possible by the simplified design.

**Minimum Size** for heavy duty ratings.

The new design is available in the split-reed type shown here, for 6/12 volt service, and in the Duplex heavy duty model without the split reed construction. For full technical data, and for a consultation on your specific power supply requirements, write or call Mallory.

### COMPLETE POWER SUPPLIES

It may be that you can save time and reduce over-all costs by employing a complete Mallory Vibrapack® power supply. Vibrapacks can be engineered around the new heavy-duty 1700 series vibrator to give long, reliable service. Design includes precise balancing of critical components. Normal ratings are conservative. Compact-sized Vibrapacks fit readily into crowded layouts. For further information, advise Mallory of your specific requirements.

#### Serving Industry with These Products:

**Electromechanical**—Resistors • Switches • Television Tuners • Vibrators  
**Electrochemical**—Capacitors • Rectifiers • Mercury Batteries  
**Metallurgical**—Contacts • Special Metals and Ceramics • Welding Materials

Parts distributors in all major cities stock Mallory standard components for your convenience.

**Expect more . . . get more from**

P. R. MALLORY & CO. Inc.  
**MALLORY**

P. R. MALLORY & CO., Inc., INDIANAPOLIS 6, INDIANA

# Electrons At Work

Edited by ALEXANDER A. MCKENZIE

## Data Transmitters Speed Ticket Reservations

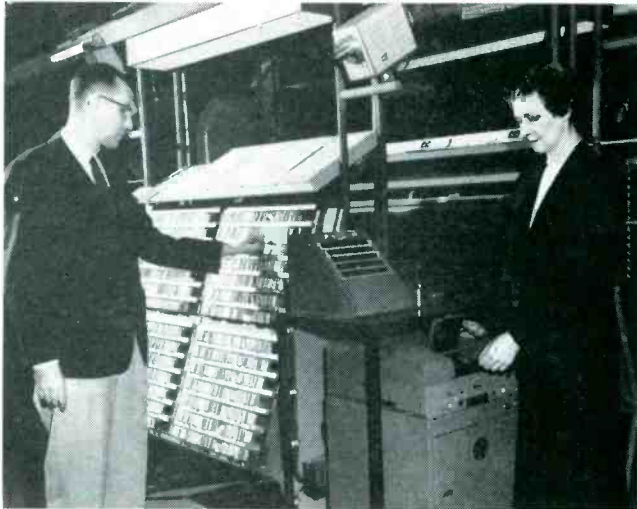

Telephone sales clerks like those at right dial up space-availability charts on Dage tv monitors that show Pullman accommodations on Pennsylvania trains out of New York City. Orders are transmitted in writing by Telautograph to space distributor (left). Seating chart above his left hand is the same as that shown on



sales clerk's screen. Space coupon is being fed into Western Union facsimile machine by woman attendant (left). It will be reproduced in seven seconds at ticket counter in Penn Station where ticket seller will present it to passenger, together with freshly printed ticket from Burroughs Ticketeer machine

## Ultrasonic Transducer Serves As Tweeter

MANUFACTURE has recently begun on the Ionovac, a high-frequency loudspeaker that uses a moving cloud of ions instead of a fabric or metal diaphragm. It is a device similar in basic design to that called the Ionophone, first demonstrated by Siegfried Klein, a French scientist who is now working at DuKane in further development of the new design.

► **Quartz Cell**—Heart of the loudspeaker is a small open-ended quartz cell (shown in the photograph) not unlike a miniature egg cup. Air is cupped in a chamber that narrows down to an aperture the size of a small pencil lead. Within this space air molecules are bombarded at 20 mc with consequent formation of ions.

The resultant cloud, glowing with a violet hue, is varied by audio-fre-

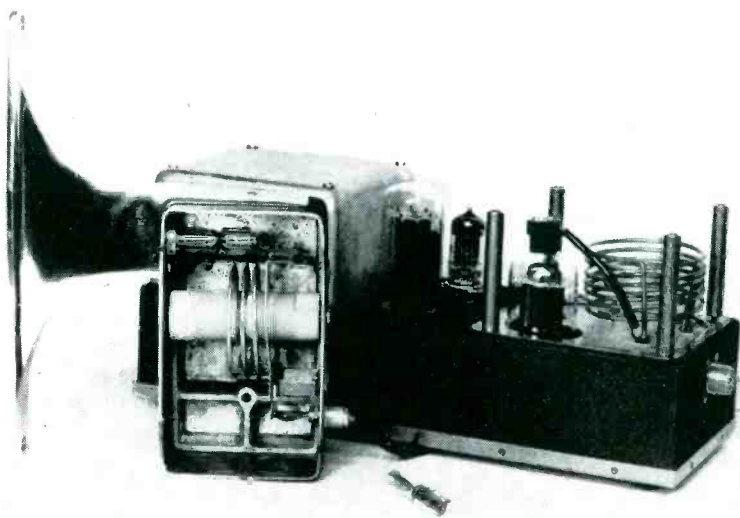

Speaker unit (left) is attached to the 20-mc oscillator-modulator unit (background) through a special coaxial cable. Quartz cup is shown in the foreground

quency modulation producing expansion and rarefaction of the air. An exponential horn effectively amplifies the pressure changes. Thus a nearly inertialess medium replaces the conventional di-



# KEPCO

## VOLTAGE REGULATED POWER SUPPLIES

for powering electronic equipment

### SERIES

with **NEW-IMPROVED FEATURES**

- ★ **FAST RECOVERY TIME**
- ★ **GOOD STABILITY**
- ★ **LOW OUTPUT IMPEDANCE**

**KR** Voltage Regulated Power Supplies are conservatively rated and are designed for continuous duty at 50°C ambient.

**REGULATION:** Less than 0.2 volts for line fluctuation from 105-125 volts and less than 0.2 volts for load variation from 0 to maximum current.

**RIPPLE:** Less than 3 mv. rms.

**STABILITY:** The output voltage variation is less than the regulation specification for a period of 8 hours.

**RECOVERY TIME:** Less than 50 microseconds. The excursion in the output voltage during the recovery period is less than the regulation specification.

**OUTPUT IMPEDANCE:** Less than 0.1 ohms from 20 cycles to 100KC. Less than 0.5 ohms from DC to 20 cycles. Many units have very much lower output impedance.

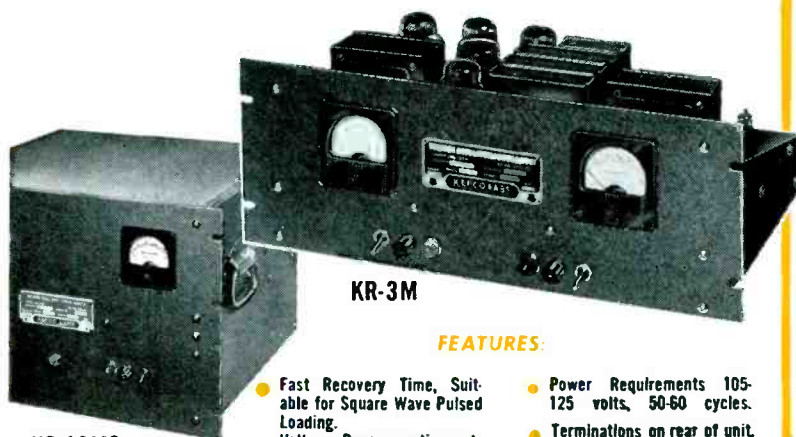

KR-18MC

KR-3M

**FEATURES:**

- Fast Recovery Time, Suitable for Square Wave Pulsed Loading.
- Voltage Range continuously variable without Switching.
- Either Positive or Negative may be Grounded.
- Oil Filled Condensers.
- Wire Harness and Resistor Board Construction.
- Power Requirements 105-125 volts, 50-60 cycles.
- Terminations on rear of unit.
- Locking type voltage control AC, DC Switches, Fuses, and Pilot Lights.
- Color Grey Hammettone.
- Guarantee One Year.

All models available for 400 cycle operation on special order.

### 1.5 Amp. KR SERIES

Model	Volts	6.3V AC	Rack Mount			Price
			W	H	D	
KR16	0-150	Each supply	19"	12¼"	17"	\$625
KR17	100-200	has two	19"	12¼"	17"	\$625
KR18	195-325	15 Amp.	19"	12¼"	17"	\$695
KR19	295-450	outputs	19"	12¼"	17"	\$695

### 600 ma. KR SERIES

Model	Volts	6.3V AC	Rack Mount			Price
			W	H	D	
KR 8	0-150	Each supply	19"	10½"	13"	\$330
KR 5	100-200	has two	19"	10½"	13"	\$240
KR 6	195-325	10 Amp.	19"	10½"	13"	\$240
KR 7	295-450	outputs	19"	10½"	13"	\$250

### 300 ma. KR SERIES

Model	Volts	6.3V AC	Rack Mount			Price
			W	H	D	
KR 12	0-150	Each supply	19"	7"	11"	\$270
KR 3	100-200	has two	19"	7"	11"	\$180
KR 4	195-325	5 Amp.	19"	7"	11"	\$180
KR 10	295-450	outputs	19"	7"	11"	\$190

### 125 ma. KR SERIES

Model	Volts	6.3V AC	Rack Mount			Price
			W	H	D	
KR 11	0-150	Each supply	19"	7"	11"	\$180
KR 1	100-200	has one	19"	7"	7½"	\$ 90
KR 2	195-325	3 Amp.	19"	7"	7½"	\$ 90
KR 9	295-450	output	19"	7"	7½"	\$ 97

To Include 3" Current and Voltage Meters, Add M to Model number (e.g. KR 16-M) and Add \$30.00 to the Price.

To Include Dust Cover and Handles for Table Mounting, Add C to Model number (e.g. KR16-C) and Add \$10.00 to the Price.

To Include Meters, Dust Cover and Handles, Add MC to Model number (e.g. KR-16 MC) and Add \$40.00 to the Price.

PRICES F.O.B. Flushing.

### A LINE OF 50 MODELS

Available from Stock - Catalog on Request



# KEPCO LABORATORIES

131-38 SANFORD AVENUE • FLUSHING 55, N.Y. • INDEPENDENCE 1-7000

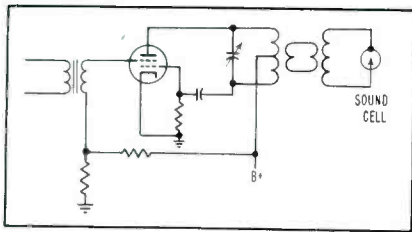

Circuit diagram of the modulated oscillator that drives the DuKane Corp. ion-diaphragm speaker

aphragm. Response is generally uniform from 2 to 20 kc. The method of driving is shown in the diagram.

Primary interest in the new transducer is in the field of ultrasonic techniques where present devices operate at a single frequency. It should now be possible to experiment over a wide range of frequencies using an appropriate driver.

## Controlled Flash Helps Land Planes

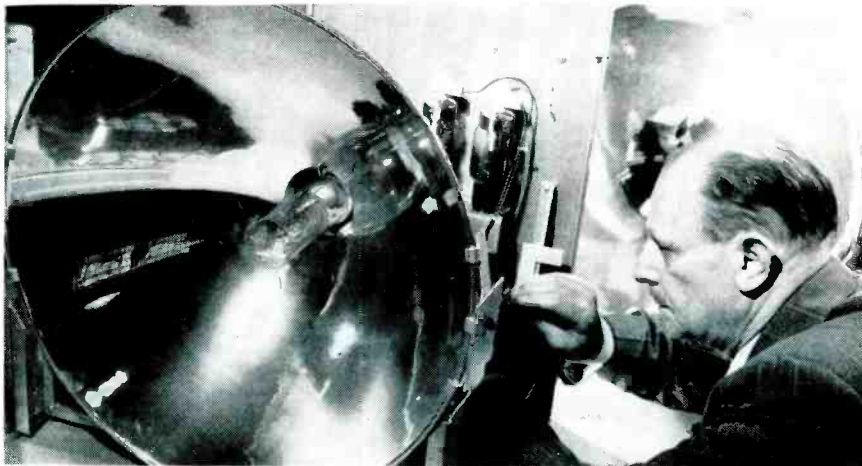

Centerline approach lighting of a type to be installed in major airports by CAA uses electronic control. Each of 20 lights spaced 100 feet apart flashes only 150 microseconds. The entire line flashes twice each second with the light farthest from the airport flashing first. The lightning-like nature of the illumination prevents its being confused with other natural or artificial lighting

## Aircraft Communications Methods Studied

IN THE INTEREST of improved communications and spectrum conservation the airlines, operating through International Air Transport Association (IATA), have evolved a proposal for orderly transition from conventional double-sideband amplitude modulation to single sideband suppressed-carrier transmissions.

Recently, a system of compatible single sideband was introduced by

Kahn (ELECTRONICS, p 188, Dec. 1956) and details of a system employing double sidebands and suppressed carrier (sometimes called synchronous detection) were published by Costas of GE. At a recent symposium held under the aegis of Aeronautical Radio, Inc. (ARINC), engineers discussed the inherent advantages and disadvantages of the various systems. While no official summary has been released

the consensus of engineers attending the meeting is summarized below.

► **Doppler Shift**—Full or pilot carrier ssb would not be troubled by Doppler shift but pilot carrier systems are subject to capture and full carrier systems are subject to beat-note interference. Although the relatively wide-band afc of the GE dsb system accommodates Doppler shift, it is liable to capture and interference to a greater extent than the carrier afc and phase-lock system that might be used with ssb to accommodate Doppler shift.

High-stability suppressed-carrier ssb is probably less subject to capture and jamming than dsb but might require a narrow-band afc where Doppler shift would be appreciable compared to airborne receiver stability, or where phase lock is required to preserve waveform.

Resistance to selective fading is one advantage of ssb. Selective fading with dsb can be ameliorated by listening to one sideband at a time. Speech processing and data transmission will require more complex equipment for ssb than for dsb but the obstacles do not seem

## Planes Land No-Hands On Carrier Deck



Automatic carrier landing system developed by Bell Aircraft uses radar and radio equipment for all-weather flights. Aircraft is located by radar on carrier and information on its location is fed into computer to show relationship to carrier deck. Automatic signals direct the craft down the proper path and land it



Another product *surprise* from Helipot!

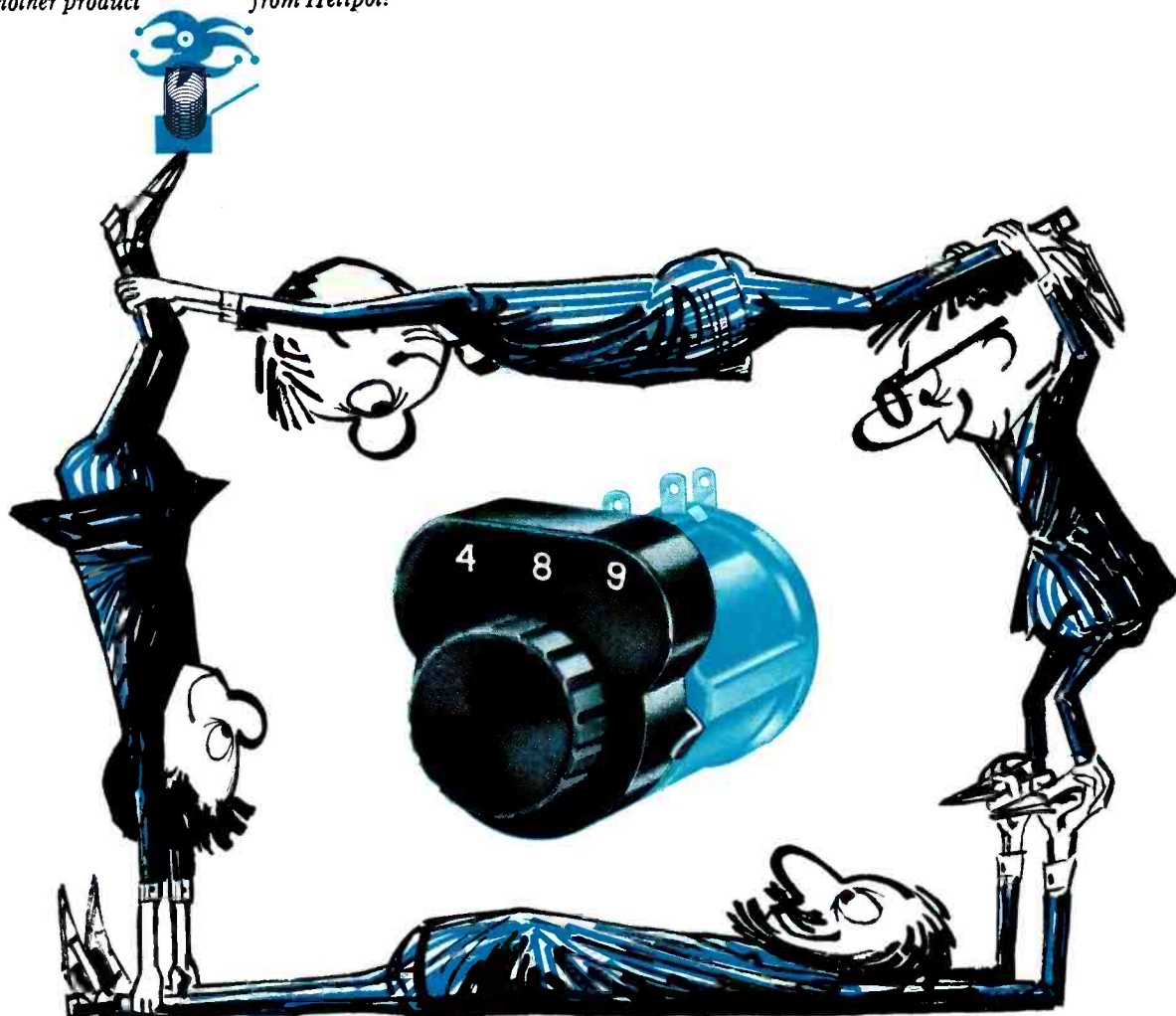

## A Dial to reckon with

When position is everything, you can count on the new DIGIDIAL\* ten-turn decimal-counting dial... for indicating shaft position from  $0^{\circ}$  to  $3,600^{\circ}$ ... with reading resolution of 0.05% of full scale or better.

The DIGIDIAL reads by the numbers. This means farewell to interpolations and operator errors... hail and hello to fast, accurate reading from as far as six feet away... from just about any angle except behind the panel. You'll welcome its compact construction, light weight, simple installation and smooth operation. You'll utter gleeful greetings to the positive, non-distorting locking mechanism.

If position is important to you, you'll want to know more about the DIGIDIAL... to get the whole story, write for data file 421.

Beckman®

**Helipot** Corporation: Newport Beach, California  
a division of Beckman Instruments, Inc.  
Engineering representatives in principal cities

1039 ®Trademark

insuperable with present techniques.

Undesirable aspects of a transmitted carrier can be avoided by using either suppressed-carrier ssb or suppressed-carrier dsb. It is felt that transition to the GE dsb system would be difficult because there is no way to assure worldwide ground station changeover at one time. Serious capture problems would arise unless high-stability ground stations were provided in anticipation of a transition to the GE dsb system.

► **Incompatibility**—Although a dsb synchronous-detection adapter on present airborne receivers will give some increased efficiency, such an approach precludes any transition

to ssb later since the GE dsb system requires both sidebands. The IATA plans would allow conversion to ssb with employment of full carrier during the transition. Operation with suppressed carrier over certain routes would be possible while maintaining compatibility with unequipped ground stations or aircraft on other routes.

The ssb full-carrier portion of the bimode system introduces 23 percent distortion. The Kahn full-carrier cssb system virtually eliminates distortion and increases sideband power by 3.5 db but the circuits do not permit eventual transition to suppressed-carrier ssb.

Single-sideband systems are generally compatible with each other

## Launching Intercommunicator

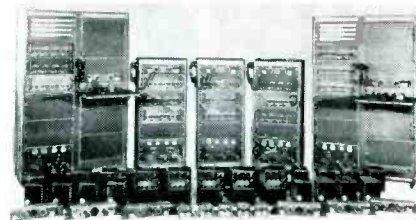

Units shown were produced by Connecticut Telephone & Electric Corp. for intercommunication between stations at a missile launching site of the U. S. Air Force

but dsb is incompatible with any ssb system. There is a relative spectrum advantage in ssb systems over those employing dsb.

## Low Temperature Effects

COLD, or the removal of heat, becomes increasingly important in electronics. Cooling equipment packages is accomplished in several ways, one being the use of transistors in place of electron tubes. However, even the transistorized device must be operated at temperatures below the ambient and the weight of cooling equipment often far exceeds that of the semiconductors.

According to the annual report

of NYU's College of Engineering, use of the Peltier effect is being investigated for cooling transistor packages. This effect employs junctions of dissimilar metals to produce a temperature drop when current is passed in the proper direction.

Among semiconductor alloys whose thermal conductivity, electrical resistivity and thermoelectric power were measured in the last year, the most promising were

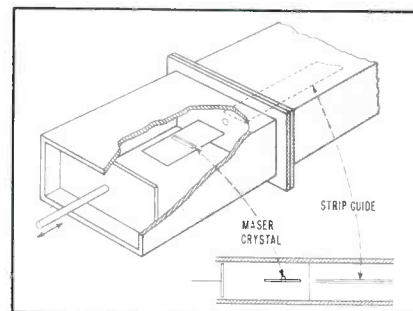

Resonant cavity and Crystal used in Bell Labs solid-state microwave oscillator uses strip guide for output

## English Independent TV Takes Air

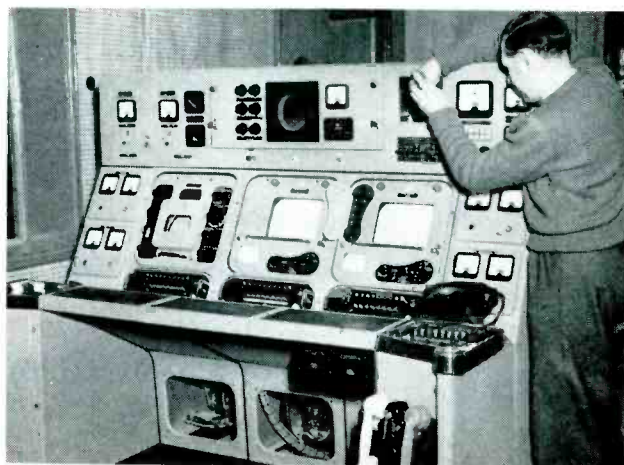
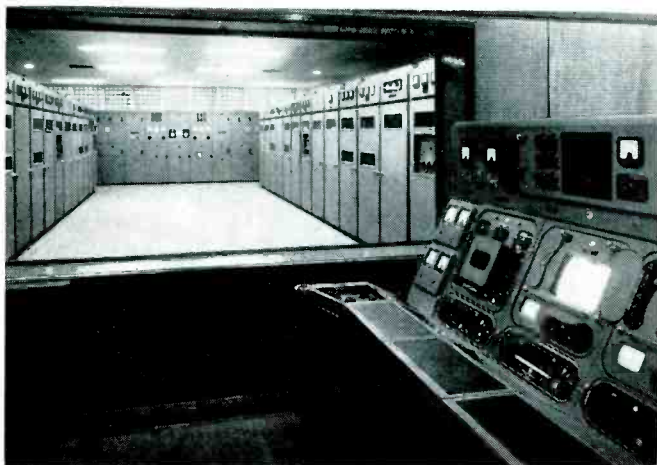

Independent Television Authority's new 200-kw erp station at Emley Moor, near Huddersfield built under a turnkey contract by Marconi is now broadcasting with full program. At left the transmitter hall is seen from the control room. Technician at right is putting finishing touches on transmitter control console



another example of exciting work at los alamos...

## BREAKING PROBLEM BARRIERS

The linearized Boltzmann equation shown at the right describes the transport of neutrons in a slab. Its mathematical structure was first completely worked out at Los Alamos. This is only one of the many fundamental problems in disciplines ranging from pure mathematics through biology that are yielding to newly developed methods of experimental and theoretical analysis.

The Laboratory has entered a new phase of scientific endeavor. Pioneering activities in the unexplored realms of nuclear power, nuclear rocket engines, and controlled thermonuclear power have been added to its weapons program; experiments are being planned and carried out at pressures and temperatures far beyond any previously created by man. These activities exemplify the imaginative approach by which the Laboratory maintains its pre-eminence in scientific achievement.

Los Alamos Scientific Laboratory is a non-civil service operation of the University of California for the U. S. Atomic Energy Commission.

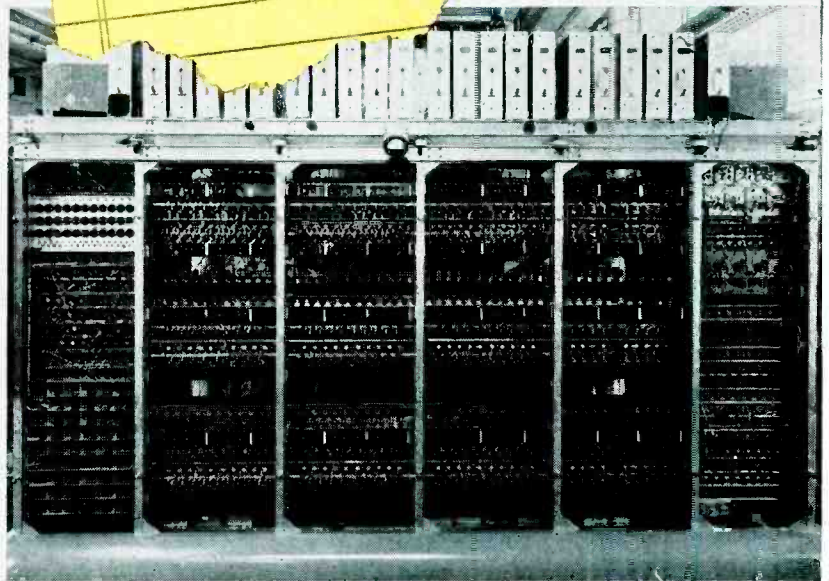
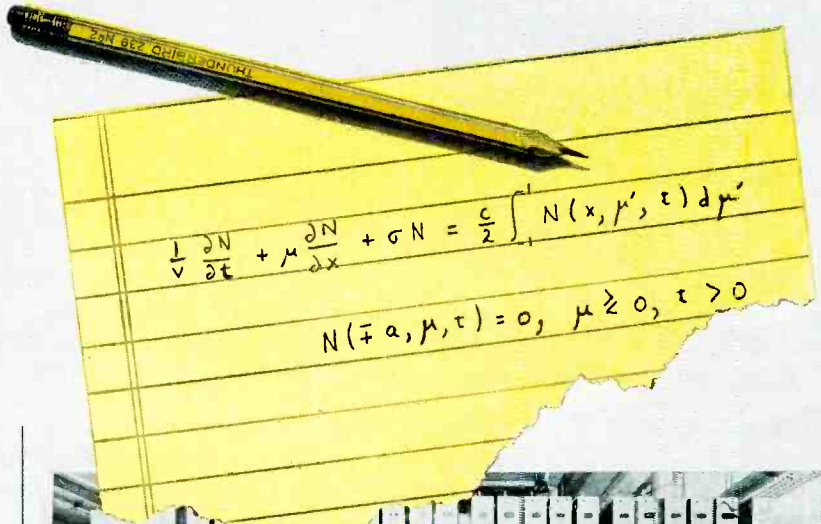

Mathematical support for many of the Laboratory's programs is given by the Theoretical Division, which also pursues its own investigations in hydrodynamics, magnetohydrodynamics, computer theory and design, and other fields. The vast amount of computation involved has brought about the creation at Los Alamos of the largest known computing center devoted exclusively to scientific work.

The "Maniac" (above) is one of the many advanced computers in use at the Laboratory.

los alamos  
scientific laboratory  
OF THE UNIVERSITY OF CALIFORNIA  
LOS ALAMOS, NEW MEXICO

# MORE INCOME IN 1957 FOR INDEPENDENT TV TECHNICIANS!



Receiver . . .  
precision-engineered  
"for those who want the  
finest" . . . is a non-  
competitive line.

**GENEROUS COMMISSIONS  
THRU EXCLUSIVE  
PROFITABLE TV  
TECHNICIAN FRANCHISES  
NOW AVAILABLE**

You can recommend ATR with the pride and assurance of your own know-how and the reputation and craftsmanship of AMERICAN TELEVISION & RADIO

- ✓ . . . as original sets
- ✓ . . . as replacement sets
- ✓ . . . as the No. 1 set in two-set homes
- ✓ . . . and for special chassis installations (without cabinet)

UNEQUALLED  
IN  
PERFORMANCE

UNMATCHED  
IN QUALITY  
CONSTRUCTION

UNSURPASSED  
IN  
BEAUTY



FOR FULL INFORMATION —  
WRITE TODAY FOR COLORFUL  
BROCHURE SHOWING THE  
NEW LINE OF ATR TV SETS

ALSO MANUFACTURERS OF DC-AC INVERTERS,  
"A" BATTERY ELIMINATORS, AUTO RADIO VIBRATORS

**ATR** AMERICAN TELEVISION & RADIO CO.  
Quality Products Since 1931  
SAINT PAUL 1, MINNESOTA—U. S. A.

Want more information? Use post card on last page.

those containing tellurium. The goal is to cut down cooling requirements sufficient to permit power transistor units up to 100 watts to be used in mobile units.

► **Cryogenics** — Low temperature research (ELECTRONICS, p 222, July 1953) has led to development of the cryotron—a nearly perfect electronic switch. It comprises a straight piece of wire 1/10 inch long wound with a single layer of control wire about the size of a human hair.

The device operates in a bath of liquid helium, a few degrees above absolute zero, where many metals offer no electrical resistance. According to the Industrial Bulletin of Arthur D. Little, Inc., a metal cooled to the superconductive state regains normal resistance in the presence of a sufficient magnetic field. Thus the central wire of the cryotron can be made superconductive or resistive at will by raising or lowering the magnetic field created by the control current flowing in the surrounding coil.

► **Feasibility** — An adequate supply of liquid helium can be stored within the cabinet of a computer employing cryotrons, but machinery for the production of liquid helium would require considerable space. Exclusive of refrigeration and terminal equipment, it would be possible to build a large-scale digital

computer in the volume of a cubic foot. One of the first cryotron applications will be a memory to store 2,000 words. About 215,000 cryotrons will be used. A conventional computer for the same purpose might require more than 50,000 tubes.

► **Solid Oscillators**—Scientists at MIT have postulated a solid-state oscillator depending upon electron spins in a paramagnetic crystal and those at Bell Labs have actually produced oscillations and expect that the device can be converted to amplification. The new principle, demonstrated at Columbia University in 1954, has been termed maser (microwave amplification by stimulated emission of radiation).

In the BTL device, a single crystal of gadolinium ethyl sulphate diluted with lanthanum ethyl sulphate was placed in a 2,800-oersted magnetic field and immersed in liquid helium at 1.2 K. A 17,500-mc energizing signal was introduced into the waveguide cavity shown in the drawing through a rectangular waveguide and stimulated radiation at 9,000 mc was taken out through a strip guide mounted inside the rectangular guide. Measured power output was about 20 microwatts. A microwave amplifier based upon this principle is expected to have a very low noise figure and an improvement of several hundredfold in sensitivity.

## Supply Aids Coupling

DIRECT-COUPLING between stages of an amplifier can be accomplished using a circuit similar to that of

Fig. 1A. A negative supply is used and the d-c signal level is changed by the amount of the d-c drop across

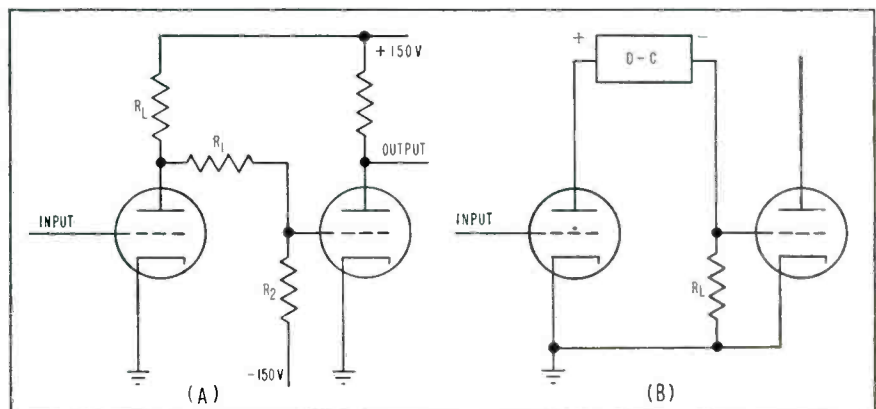
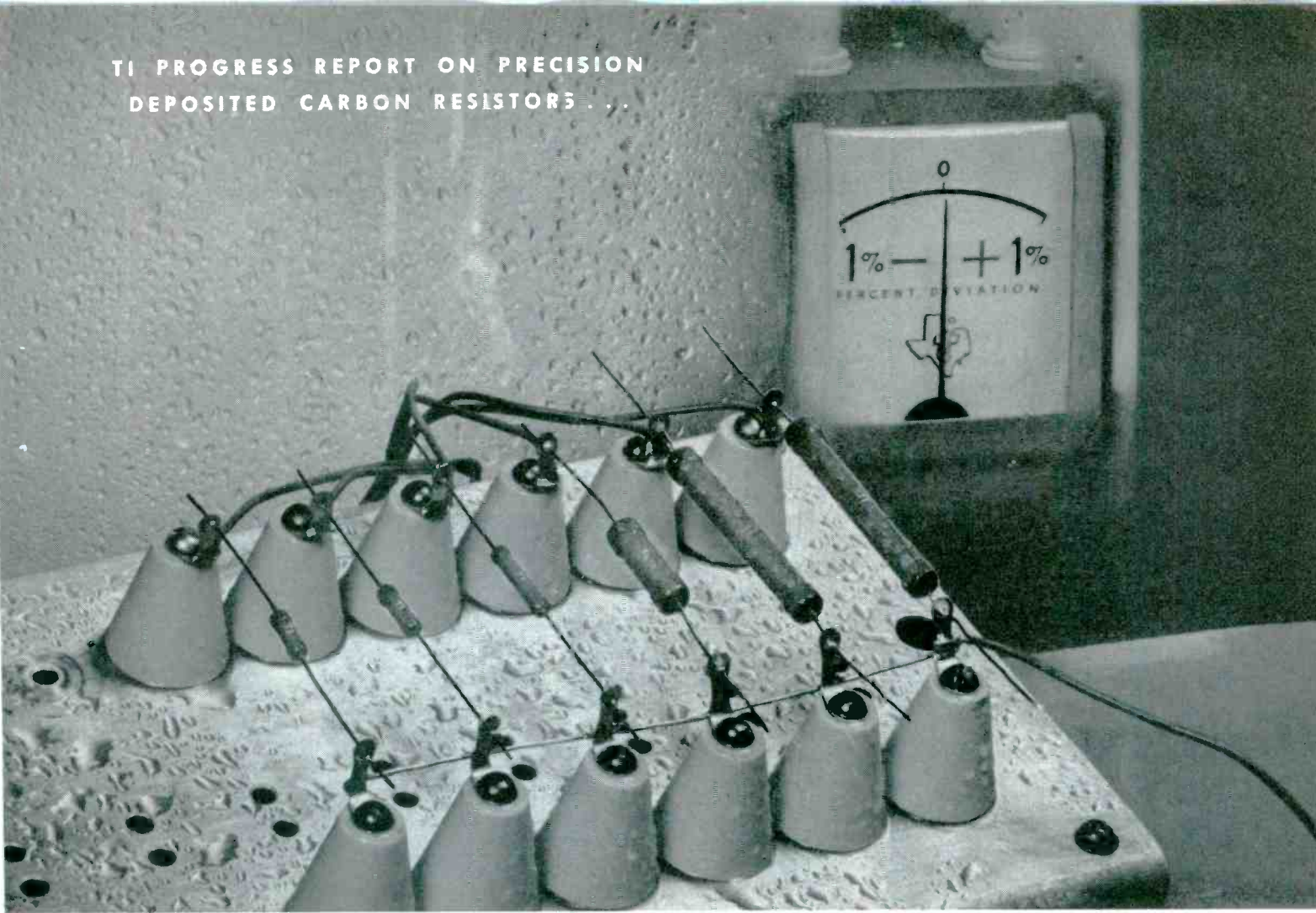

FIG. 1—Conventional direct-coupled connection (A) and that possible with unit power supply (B) use of which is described in the text



TI PROGRESS REPORT ON PRECISION  
DEPOSITED CARBON RESISTORS . . .



### TI MIL-Line Precision Resistors

## HOLD TOLERANCE...EVEN WHEN DRIPPING WET!

Soaking wet, dried out, or 'shook up' — TI MIL-Line deposited carbon resistors still far exceed MIL-R 10509B . . . emerge from one acceptance test after another — by major electronics manufacturers — with performance records that have not been equalled. *It's the seal that makes the difference* . . . an exclusive Texas Instruments process that snugly wraps these precision resistors in tough jackets of a special coating with high dielectric strength.

For ease in design, production, and maintenance

. . . for improving the reliability and saleability of your products, the moisture resistance of TI deposited carbon MIL-Line resistors is just *one* field-proven factor. You also get a choice of 1, 2, or 5% tolerances . . . high stability over wide temperature ranges and under full load . . . low negative temperature coefficients . . . negligible voltage coefficient and noise levels . . . long shelf-life . . . wide selection of sizes and resistance values . . . reasonable prices . . . and, if desired, reel-type packaging for automation.



Here is a typical TI reel pack designed to speed production. TI precision deposited carbon resistors are mass produced and packaged in five sizes from 1/2 watt to 2 watts with resistance values from 25 ohms to 30 megohms.

For complete data, write for  
Bulletin DL-C 539.



TEXAS INSTRUMENTS  
INCORPORATED  
6000 LEMMON AVENUE DALLAS 9, TEXAS

Designed for



Application

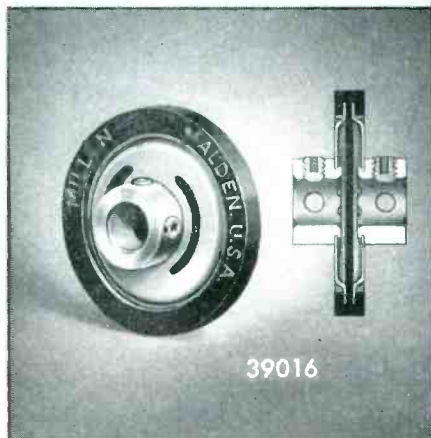

**FLEXIBLE COUPLING**  
No. 39016

Incorporating features which have long been desired in a flexible coupling. No Back Lash—Higher Flexibility—Higher Breakdown Voltage—Smaller Diameter—Shorter Length—Higher Alignment Accuracy—Higher Resistance to Mechanical Shock—Solid Insulating Barrier Diaphragm—Molded as a Single Unit.

**JAMES MILLEN  
MFG. CO., INC.**

MAIN OFFICE AND FACTORY  
**MALDEN  
MASSACHUSETTS**



$R_1$ . Signal amplitude is attenuated and impedance level raised, resulting in poorer high-frequency response. Supply voltages must be held constant to avoid change in bias on the second tube.

► **Unit Supply**—Utilizing a new type of isolated power supply with low shunt capacitance, known as Isoply and manufactured by Elcor, Inc., the circuit shown in Fig. 1B is

possible. Here the power supply is connected between tube and load resistor instead of between load resistor and ground.

Quiescent plate current establishes bias for the following tube. Since  $R_1$  is normally low to obtain good frequency response, the d-c level of the output signal is suitable for direct connection to the following amplifier stage.

## Transmitting Tube Developments



One megawatt c-w at 425 mc can be generated by the tube in the left foreground. On the extreme right is a 1.5 megawatt tube used in atom-smashing particle accelerators. Other RCA tubes shown are designed for delivering up to 15 kw at 500 mc in color television service

## Automatic Pulse Width Control

By JOHN H. PORTER

*Portronics  
Rochester, N. Y.*

WIDTH of the pulse generated by a one-shot multivibrator is largely determined by the time constant of the RC coupling between the two tubes, as indicated in Fig. 1. The output pulses are then of a fixed width, regardless of how often the input triggers occur over wide limits. For most applications this is considered satisfactory.

For certain pulse-position gating purposes it is important to have the pulse width vary with trigger repetition rates and produce a constant duty cycle. The charge on C at any time during the output pulse

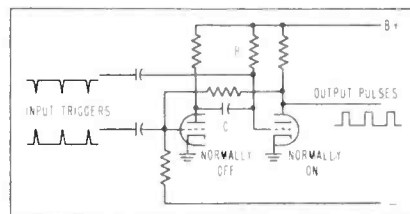

FIG. 1—Pulse width in one-shot multivibrator is determined by RC constant

will be a function of R and also of potential E to which R is returned.

The circuit of Fig. 2 accomplishes pulse-width control by varying the available charging voltage in accord with the repetition rate



# INSTANT AUTOMATIC RELEASE OF EXCESS PRESSURE

Because it is of the utmost importance that a Rupture Disc burst only at the predetermined pressure to afford immediate relief, the metal employed must be selected with specific physical properties that cause the desired burst at the correct pressure. Furthermore, since the bursting pressure is affected by the mechanical working and heat treatment of the disc material, careful control is essential in all phases of manufacture.

BAKER's vast experience in the production, fabrication and applications of precious metal products assures proper selection of disc material as well as skilled technique in manufacturing the discs. Quality is assured by strict supervision of every step in the manufacturing process. Furthermore, the BAKER Physical Research Laboratory tests the final product for bursting pressure to within plus or minus five percent of the specified pressure.

Although the use of precious metals naturally increases the cost of the Rupture Disc, the major metal expenditure is recoverable. The returned precious metal may be credited against the purchase of new discs or paid for in cash. The ultimate cost of a precious metal disc is normally comparable to that of a base metal disc when the scrap value of the precious metal is taken into consideration.

Write for complete catalog material and details.

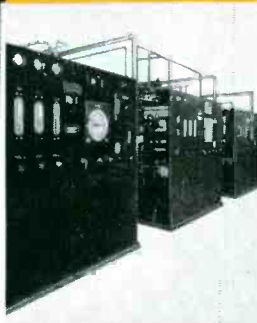
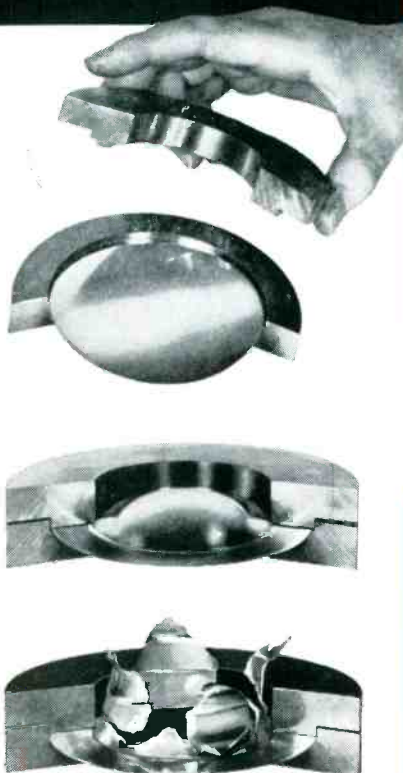

**NITRONEAL® GAS GENERATOR** economically and safely provides fully automatic furnace brazing and bright annealing of stainless steel.



**DEOXO® PURIFIER** provides low-cost purification of hydrogen and other gases to the extent of less than one part oxygen per million.



**DEOXO® PURIDRYER** produces extremely pure, dry hydrogen with a dew-point of better than  $-100^{\circ}\text{F}$ , with no inert gas purging necessary.

**BAKER** PRECIOUS METALS

**BAKER & CO., INC.**

113 ASTOR STREET, NEWARK 2, NEW JERSEY  
NEW YORK • SAN FRANCISCO • LOS ANGELES • CHICAGO

ENGELHARD INDUSTRIES

RESEARCH MAINTAINS BAKER'S LEADERSHIP IN PRECIOUS METALS

# FIRST CHOICE



...for high-quality data recording

Consolidated's 5-119 Recording Oscillograph was developed to fill user-specified requirements for an exceedingly reliable instrument with great data capacity. The most advanced instrument of its type, the versatile 5-119 provides excellent records in mobile and flight testing applications where severe shock, vibration, and temperatures are commonplace. Throughout industry, it serves as the foundation of successful design-engineering-performance programs.

## CEC RECORDING OSCILLOGRAPH

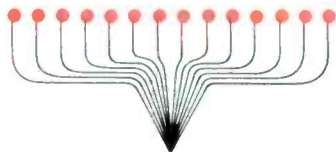

**FLASH TIMING SYSTEM** permits absolute timing with external timing pulses. CEC's new Flash Timing System synchronizes timing lines of from 2 to 100 remotely located oscillographs, permits quicker, more accurate interpretation of recorded data.

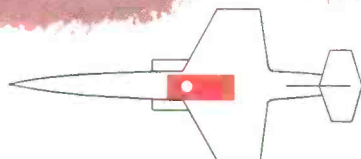

**NEW EXPLOSION-PROOF DESIGN** meets safety requirements of military aircraft specifications for test instruments in hazardous locations. This optional modification (5-119P7-50-MB) is available for 400 cycle, 200 volt, 3-phase operation. See Bulletin mentioned above.



**OPTIONAL RACKMOUNT** is ideal for permanent instrumentation, provides vertical mounting and effective shock isolation for the 5-119 in mobile applications. Even when tilted for adjustments or magazine loading, the 5-119 extends only 13" from front of rack.

### USER-PROVED ADVANTAGES INCLUDE:

- extreme clarity of both timing lines and traces at all recording speeds*
- up to 50 independent channels*
- wide record speed range*
- wide frequency range*
- adjustable scanning speed*
- automatic record numbering*
- automatic record-length control*
- record footage indicator*
- temperature-controlled galvanometer block*
- positive gear drive system*
- built-in shockmount base*
- quick-change magazines*
- two independent recording banks*
- reserve recording lamps*
- centralized, single-surface controls*
- automatic warning and safety systems*
- choice of a-c or d-c models*

*For complete specifications, please contact your nearby CEC field office, or write for Bulletin CEC 1536B-X12.*

# Consolidated Electrodynamics



300 North Sierra Madre Villa, Pasadena, California

NATIONWIDE COMPANY-OWNED SALES & SERVICE OFFICES



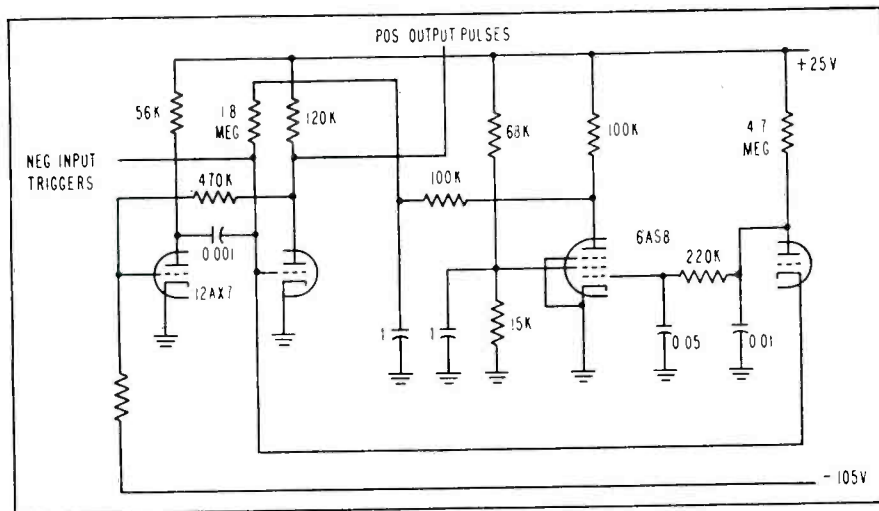
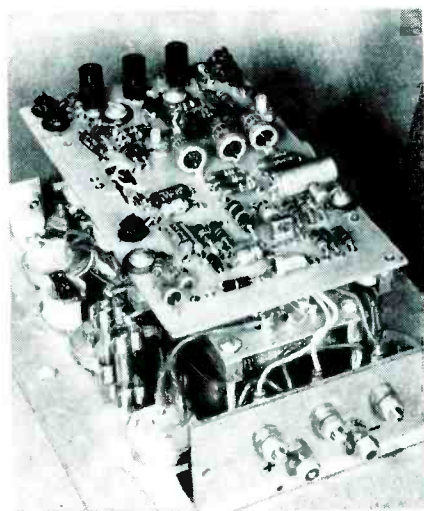

FIG. 2—Available charging voltage dependent upon repetition rate of input triggers determines pulse width

of the input triggers. Negative triggers supplied to the grid of the normally off tube, are simultaneously clamped to a positive voltage through the diode, thence counted up on the diode as a direct voltage. An integrator smooths the negative d-c applied to the pentode section and this bias varies the plate voltage so the higher the trigger repetition rate, the lower is the voltage at the plate.

The pulsating signal at the pentode plate is applied to a long-time-constant filter and becomes the charging voltage for the one-shot multivibrator stage. Since this voltage decreases with increasing frequency, the pulse width decreases. The constants shown produce a 10-percent duty cycle over the range from 30 to 150 cps. There is no reason to believe that the range cannot be considerably extended.

## Transistor Inverters Power Vanguard Rocket



Aircraft power inverter contains no moving parts

INCORPORATION of high-power transistors into power-supply design has made possible a 300-wa light-weight inverter for use with servos in the second stage rocket for the Vanguard Project.

The unit illustrated produces

three-phase, 400-cps power when energized by 28 v d-c and driven by an appropriate tuning-fork oscillator. It weighs 5.5 pounds, has an estimated life in excess of 10,000 hours and operates at 60 to 70 percent efficiency—as contrasted with rotating machinery that has a maximum of about 40-percent efficiency. Its harmonic content does not exceed 5 percent of the fundamental.

The block diagram of a three-phase inverter designed by Electro Solids Corp. of North Hollywood, Calif. is shown in Fig. 1. A typical single-phase inverter amplifier diagram is given in Fig. 2.

► **Oscillator**—The sine wave generated in the tuning fork is controlled to close limits by a silicon reference diode. An amplitude stabilizing circuit in the oscillator compares output voltage to a reference element. The resulting difference voltage is employed to bias



CEC's Recording Oscillographs deliver unexcelled accuracy for exacting users throughout the world. There's a quality oscillograph for your specific requirement.

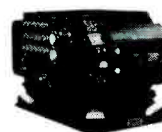

**5-114** is available in either 18- or 26-trace capacity models with preferred quality features. Described in Bulletin CEC 1500C-X15.



**5-116** features 14-trace capacity, a-c or d-c. Economical and highly versatile. Please write for Bulletin CEC 1521A-X11.



**5-117** records 6 separate phenomena on 70-mm paper. Precision throughout, small, low-cost. Bulletin CEC 1533B-X12.



**5-118** is designed for applications demanding extremely small size and light weight. Please write for Bulletin CEC 1531-X5.

## Consolidated Electro Dynamics



300 N. Sierra Madre Villa  
Pasadena, Calif.

NATIONWIDE COMPANY-OWNED  
SALES AND SERVICE OFFICES

Want more information? Use post card on last page.

Now Measure

# TRUE RMS

from 100 microvolts to 320 volts  
REGARDLESS OF WAVEFORM  
with the Ballantine Model 320 Voltmeter

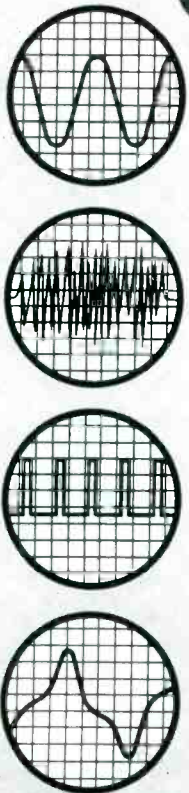
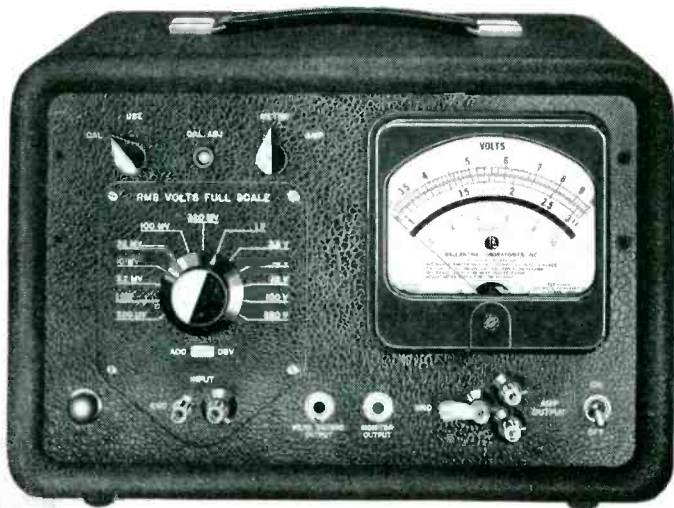

**REPRESENTING:**

A distinctly new departure in VTVM design.

**FEATURING:**

A built-in calibrator; — easily read 5-inch log meter; — immunity to severe overload; — useful auxiliary functions.

**BRIEF SPECIFICATIONS:**

- VOLTAGE RANGE: . . . . . 100 microvolts to 320 volts
- DECIBEL RANGE: . . . . . — 80 dbv to +50 dbv
- FREQUENCY RANGE: . . . . . 5 to 500,000 cycles per second
- ACCURACY: . . . . . 3% from 15 cps to 150KC, 5% elsewhere  
Figures apply to all meter readings
- MAXIMUM CREST FACTORS: 5 at full scale, 15 at bottom scale
- CALIBRATOR STABILITY: .0.5% for line variation 105-125 volts
- INPUT IMPEDANCE: . . . . . 10 M.Ω and 25 μf, below 10 millivolts  
10 M.Ω and 8 μf, above 10 millivolts
- POWER SUPPLY: . . . . . 105-125 volts; 50-420 cps, 75 watt  
Provision for 210-250 volt operation
- DIMENSIONS: (Portable Model) . . . . . 14 3/8" wide, 10 1/8" high,  
12 3/4" deep—Relay Rack Model is available
- WEIGHT: . . . . . 21 lbs., approximately
- PRICE: \$425

1932 1957 25<sup>TH</sup> Anniversary

**BALLANTINE LABORATORIES, INC.** 

100 FANNY ROAD, BOONTON, NEW JERSEY

an amplitude controlling transistor. Output signal from the oscillator passes through phase-shifting networks (for multiphase units) followed by class B high-power amplifiers. Interstage transformers with tertiary winding cancel a-c degeneration in the emitter circuit. This tertiary, wound in parallel with the primary, is used for base return. The greater resistance pos-

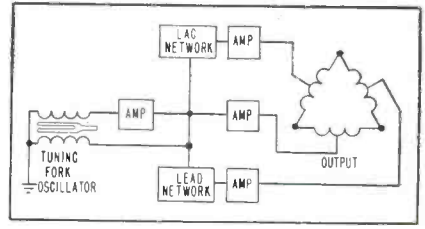

FIG. 1—Three-phase inverter

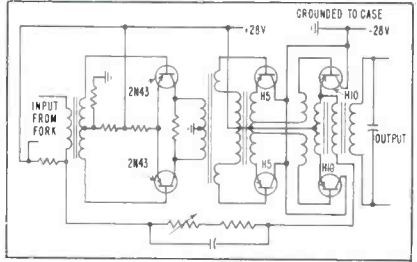

FIG. 2—Typical single-phase inverter amplifier

sible in the primary in this circuit thus increases temperature stability.

The output transformer has a feedback coil connected to cause voltage output to add in opposite phase with that resulting from the current flowing in the resistance of the primary winding. Combined negative voltage and positive current feedback is used in the loop. Output impedance is thus halved as compared with that obtained using voltage feedback alone.

### Lossy Transmission Line Filter Uses Ferrites

By SCOTT L. SHIVE  
Signal Corps Engineering Laboratories  
Ft. Monmouth, N. J.

USUAL PI OR TEE filters for broad-band radio interference filtering are composed of lossless, or nearly lossless, L and C lumped elements. Such filters, therefore, cannot dissipate energy within their rejection range; they merely reflect, reroute



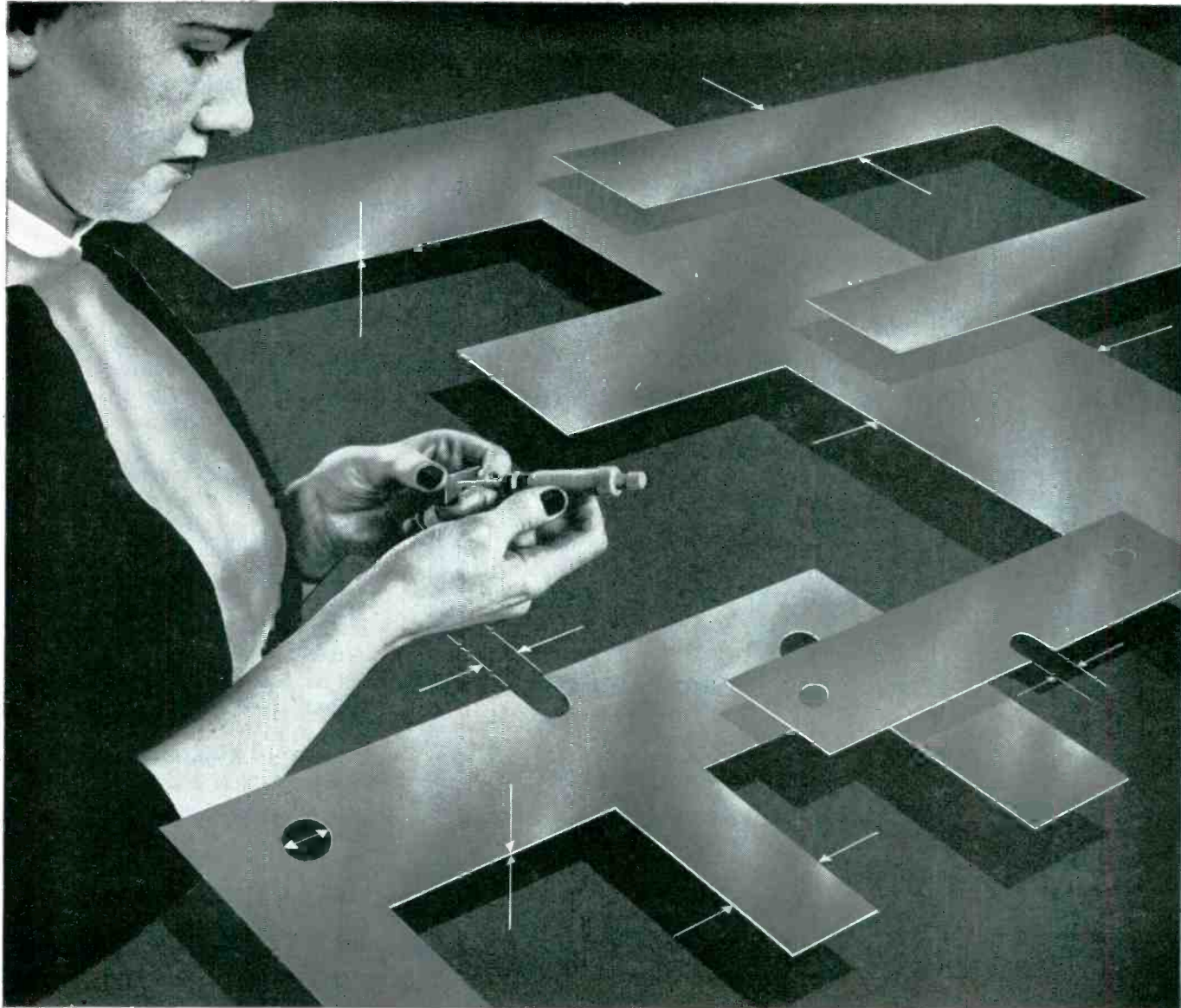

## what are the new Performance-Guaranteed laminations?

Whenever our tungsten-carbide dies have produced enough nickel-iron laminations of a new shape to permit stocking them for immediate delivery, we let you know, because we get so many requests for "what's new in Performance-Guaranteed laminations?"

It's rather sensible, the emphasis our customers put on this "Performance-Guarantee." They know it's a guarantee based upon our *higher* quality hydrogen annealing, vital for high permeability laminations.

You see, small percentages of impurities, particularly carbon, oxygen and sulphur, have a deleterious effect on magnetic properties—and they are present in every alloy at the beginning despite the most rigid control of the metallurgy of the heats. In this as-rolled state, *the steel will develop as little as 5% of its ultimate permeability.*

Now everyone "hydrogen" anneals—but not everyone *dry-hydrogen* anneals. You can't use bottled hydrogen, without leaving a surface oxide injurious to magnetic properties and making soldering virtually impossible. So we dry our hydrogen to a dewpoint of  $-60^{\circ}\text{C}$ , removing

the water vapor which is produced by the reduction of hydrogen. Carbon reduces to methane, sulphur to sulphur dioxide, and both are removed by the continuous flow of dry hydrogen during the 24-hour cycle.

As a result of our superior annealing, *we* develop better magnetic properties and clean lamination surfaces, and *you* get that valued "Performance-Guarantee."

New Performance-Guaranteed shapes, in stock, immediately available: EE 28-29, UI-312, F-21, DU-1, DU-37, rotor, stator and head laminations. Why not write today for Catalog ML-201 and full information on these and all other clean, flat, burr-free laminations we manufacture. *Magnetics, Inc., Dept. E-33, Butler, Pennsylvania.*

**MAGNETICS inc.**

CABLE: MAGNETICS

ANOTHER  
**SPACE-SAVING**  
APPLICATION FOR

**AEROVOX**  
**RIGHT-ANGLE**  
**TUBE**  
**SOCKETS**

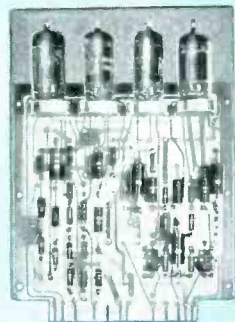
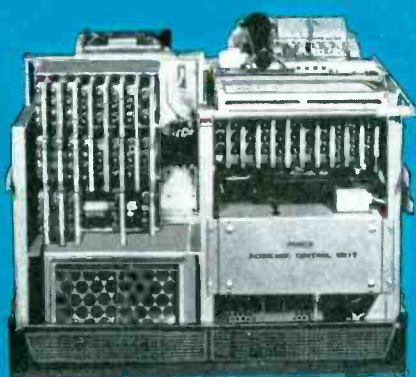

The Royal Precision Corporation LGP-30 Computer fulfills the need for a small size, highly reliable and low-priced scientific computing device. Its large memory capacity is comparable to that of many computers much greater in size while its general physical configuration offers a new approach in computer design philosophy.

AEROVOX RIGHT-ANGLE TUBE SOCKETS are used in the plug-in cards of the LGP-30 contributing to the overall compactness of the computer. The plug-in cards contain all tubes and associated components and are easily removable for quick check-out.

This Space-Saving feature is just one of the many advantages offered by the use of right-angle tube sockets. Other advantages include: Increased shock resistance . . . lower position of tube mass reduces strain on socket caused by acceleration in the plane of the mounting surface; Ease of mounting . . . ideally suited for hand or mechanical insertion into printed-wiring boards using simple, in-line punched round holes; Versatility . . . long terminals allow use of sockets on wide range of board thicknesses.

Available in 7-pin and 9-pin types in four styles these sockets are designed to meet existing MIL specifications. Active contacts are silver-plated and non-fatiguing contact pressure provides proper insertion and withdrawal pressure with a minimum of contact resistance. Send today for complete technical details on these extremely versatile tube sockets.



Aerovox Right-Angle Tube Sockets are stocked and sold nationally by Aerovox Distributors.

**AEROVOX CORPORATION**

PACIFIC COAST DIVISION  
2724 S. Peck Road, Monrovia, California

In Canada: AEROVOX CANADA LTD., Hamilton, Ont.  
Export: Ad Auriema, 89 Broad St., New York, N. Y., Cable: Auriema, N. Y.

or transform it so that under proper conditions it may reappear elsewhere as undesirable signal or interference. For any configuration of lossless circuit elements making up a filter there may be found for any frequency a load impedance for which the filter will transmit to the load the maximum energy available from the source. This means that given the proper source and load impedances, insertion of a lossless filter may actually increase the energy delivered to the load; or the filter, in that circuit at that frequency, would have negative insertion loss. Similarly, the application of a filter composed of lossless lumped elements may also, under proper circuit impedance conditions, increase the voltage or current at the load by virtue of its application. Unlike laboratory circuits used for insertion loss measurements wherein the source and load impedances are fixed at exactly 50-ohms resistive, the impedances which a filter sees in most practical power line applications are extremely variable with frequency.

In a practical application it is not unlikely that at one or several frequencies within the range over which the filter is expected to be effective, the circuit impedances will cause a critical lowering of the filter's insertion loss, if not render it altogether negative.

This deficiency inherent in all filters composed of lossless elements has led to the investigation of a

## Simulating Computer

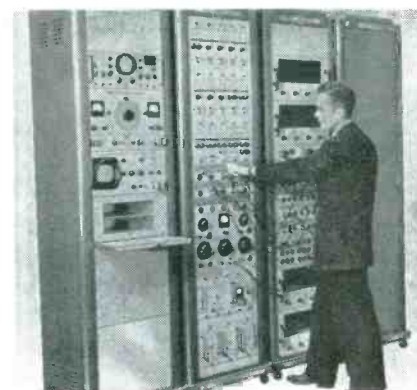

Analog simulating computer built by Servo Corp. of America serves as connecting link between analog computer and production line in the design of control systems for military aircraft



## SILASTIC HELPS MEAT THERMOMETER TAKE GUESSWORK OUT OF ROASTING

Because Silastic\* stays rubbery and retains its dielectric properties at temperatures from -130 to 500 F, its use is expanding in many industries. New applications for Dow Corning's silicone rubber range from jet aircraft to this electric meat thermometer developed by King-Seeley Corporation, Ann Arbor, Michigan.

A highly practical tool for professional and amateur cooks alike, King-Seeley's meat thermometer consists basically of a thermistor sealed inside a probe. When inserted into a roast, the thermistor quickly translates meat temperature into electric current which indicates on a dial the degree to which the meat is "done."

Silastic is used to cover the flexible lead wire running to the probe because it remains resilient and retains good dielectric properties despite frequent and sometimes lengthy exposure to 500 F oven temperatures. In addition, since Silastic transmits neither odor nor taste even at these high temperatures, two spring-compressed



Silastic washers seal the probe and prevent contamination of the thermistor.

Philco was first to offer the King-Seeley thermometers on kitchen ranges, under the trade name "Roastmeter." Hot Point, Magic Chef, and Cribben & Saxton ranges also feature it now. Other manufacturers have either arranged to include the meat thermometer in their line or are considering its early adoption.

**No. 45**

\*T.M. REG. U.S. PAT. OFF.

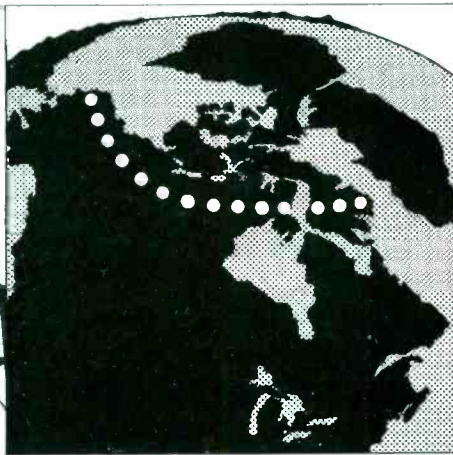

## "DEW LINE" RELIES ON DRY-TYPE TRANSFORMERS INSULATED WITH DOW CORNING SILICONES

New testimony to the extra reliability of Dow Corning silicone electrical insulation is provided by the transformers of the "DEW" defensive radar line now under construction north of the Arctic Circle.

In these remote yet vital installations, dependability and maintenance-free service are essential. That's why Western Electric

Company, prime contractor for "DEW" electrical equipment and installation, specified silicone insulated dry-type transformers right down the Line. Most of the units, supplied by the Pittsburgh works of Allis-Chalmers have been installed.

Designed for maximum dependability, minimum weight and a 302 F (150 C) temperature rise, the transformers range in size from 25 to 75 KVA. They are completely sealed and will withstand ambient temperatures as low as -60 F (-51 C) when idle.

While used primarily for station light and power, the DEW Line silicone insulated transformers will handle power for the radar signal in an emergency. **No. 44**

## REDUCE ELECTRICAL FAILURES WITH DOW CORNING 3 COMPOUND

Want maximum protection against shorts, grounds and arcs caused by moisture, water, dust and corrosive fumes? Then try versatile Dow Corning 3 Compound.

A grease-like, silicone water-repellent, Dow Corning 3 is the ideal dielectric for filling voids and coating insulating parts in electrical and electronic equipment. Also protects cable insulation from oxidation; keeps rubber parts soft and flexible.

You can use Dow Corning 3 to prevent corrosion, too. Many maintenance men keep several tubes handy for use on disconnect switches, cable connectors, battery terminals, fuse cartridge clips and other electrical and electronic fixtures. A thin film of this silicone compound provides long-time protection at temperatures from -40 to 400 F. For free sample and more information, circle ..... **No. 46**

**Send Coupon for More Information**

**DOW CORNING CORPORATION - Dept. 4816**  
Midland, Michigan

Please send me  44  45  46

NAME \_\_\_\_\_

TITLE \_\_\_\_\_

COMPANY \_\_\_\_\_

STREET \_\_\_\_\_

CITY \_\_\_\_\_ ZONE \_\_\_\_\_ STATE \_\_\_\_\_

# WHAT GOES INTO A CHICAGO STANDARD FILTER?

capacitors . . .  
inductors . . . and  
**ENGINEERING!**

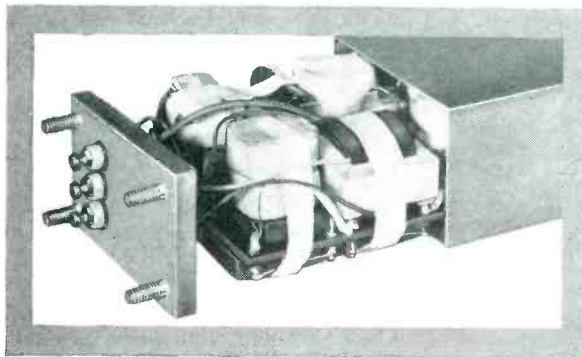

This schematic is typical of the thousands of complex filters regularly designed and built by Chicago Standard engineers . . . engineers who have the highly specialized knowledge and experience, in both mechanical and electrical design, that is essential to good filter production.

Using both toroidal *and* laminated inductors, they design compact, efficient and reliable units, with high Q and low loss. For

**BAND PASS  
BAND REJECT  
LOW PASS  
HIGH PASS**

**FILTERS FOR ANY  
FREQUENCY RANGE  
FROM D.C. TO  
ONE MEGACYCLE**

and for any unusual audio network, designed to your most exacting specifications, your best choice is Chicago Standard.

**CHICAGO STANDARD  
TRANSFORMER CORPORATION**  
3501 ADDISON STREET • CHICAGO 18, ILLINOIS

Export Sales: Roburn Agencies, Inc., 431 Greenwich St., New York 13, N. Y.

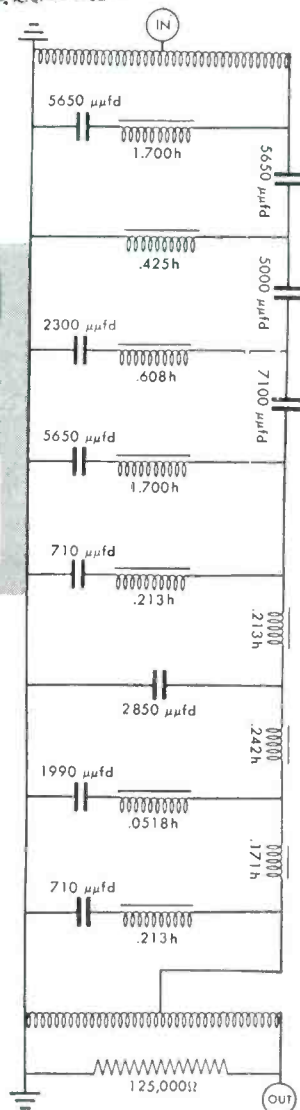

dissipative type of filter which takes advantage of the loss-frequency characteristics of a dielectric material such as ferrite.

The dissipative filter described here is a short length of ferrite tube with conducting silver coatings on inner and outer surfaces to form the conductors of a coaxial transmission line. The line will have high attenuation per unit length in the frequency region where either electric or magnetic losses or both become large and increase rapidly with frequency. This point varies with different materials, but for many ferrites, it occurs in the vicinity of 1 mc.

Figure 1 shows typical curves of measured insertion loss against frequency for two 6-in. samples of lossy transmission line filters made of commercially available ferrite material. The measurements were

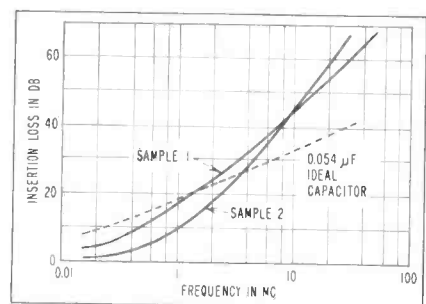

FIG. 1—Insertion loss of two samples of ferrite. Sample 1 was a General Ceramics type H body and sample 2 was a type I body

made in the standard laboratory test jig between resistive source and load impedances of 50 ohms. For comparison, the curve of an ideal capacitor of 0.054  $\mu\text{f}$  is also shown.

Insertion loss of the transmission line at 150 kc is substantially below that of an ideal capacitor of the same total capacitance value. This may be explained by the fact that capacitance measurements on the lines were made at 1,000 cps and the dielectric constant of this material, being a function of frequency, is considerably less at 150 kc than at 1,000 cps. However, in spite of the dropping dielectric constant, the insertion loss at 1 mc is rising at a faster rate than the ideal capacitor and thereafter the slope becomes ever greater.

Significant also is the lack of any



# NOW...IN ROLLS

## CLEARPRINT "FADE-OUT" PAPER

USE CLEARPRINT'S NEW  
"FADE-OUT" GUIDE LINES  
WITH FULL CONFIDENCE

LINES FADE OUT  
COMPLETELY  
IN PRINTING

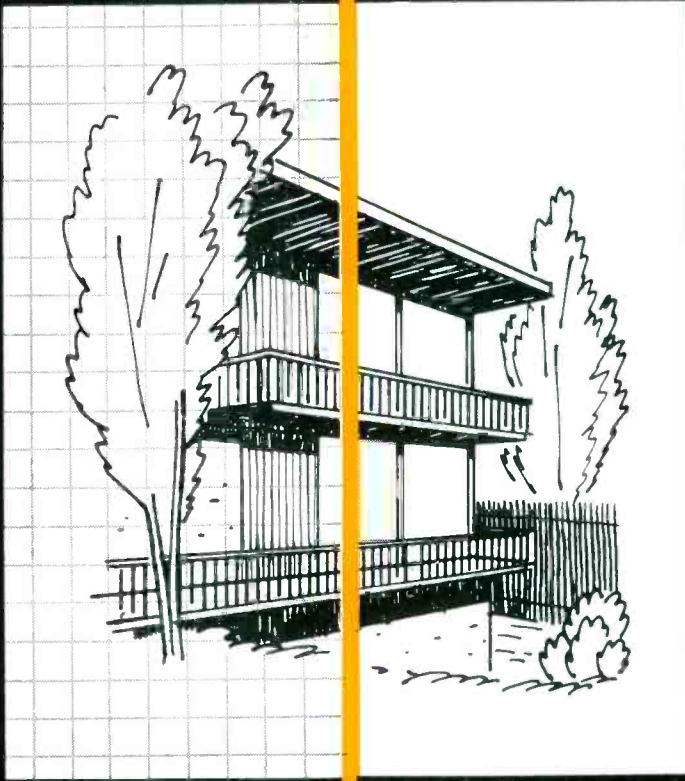

Available in ROLLS up to 42" wide, and in SHEETS of any specified size. Grids ruled 4 x 4, 5 x 5, 8 x 8 and 10 x 10 lines to the inch.

Printed on Clearprint Technical Papers:

No. 1000H—16 lb. weight

No. 1020 —20 lb. weight

### SEEING is BELIEVING!

Ask your dealer for samples, or send coupon

# CLEARPRINT®

## "FADE-OUT" PAPER

THERE IS NO SUBSTITUTE — Demand Watermarked Clearprint

Clearprint "Fade-Out" Paper is especially well adapted for heating, wiring, plumbing and electrical diagrams...for structural and architectural drawings... for plant layouts and tool designs. See how Clearprint can reduce your drafting time and costs. Order a trial roll now, and apply it to your various needs.

### Make This Convincing CLEARPRINT TEST

1. INVITES PENCIL AND PEN — Try Clearprint's perfect working surface with a 2H pencil, then with a ruling pen. Lines are sharp and clean — no feathery edges.
2. ERASES PERFECTLY — Erase some of the lines. Redraw and erase several of them repeatedly. Crease the paper, too. Then hold it to the light and notice the absence of grid lines and ghosts.
3. NO GRID, NO GHOSTS ON PRINTS — Make a quick print of the sheet. The original is faithfully reproduced, clean and easy to read, without erasure ghosts or cross section rulings.

THERE'S A CLEARPRINT PAPER  
FOR EVERY JOB

ASK FOR COMPLETE  
SAMPLE BOOK

IN SHEETS, PADS and ROLLS

**CLEARPRINT PAPER CO.** (EL)

1482 - 67th St., Emeryville, Calif.

Please send me sample Clearprint "Fade-Out" sheets, with prices.

Send me Clearprint samples, with prices, for following uses: \_\_\_\_\_

Have your representative call at my office

Name \_\_\_\_\_

Firm \_\_\_\_\_

Address \_\_\_\_\_

City \_\_\_\_\_

Zone \_\_\_\_\_ State \_\_\_\_\_

# ...know a good place to get EPOXYS?

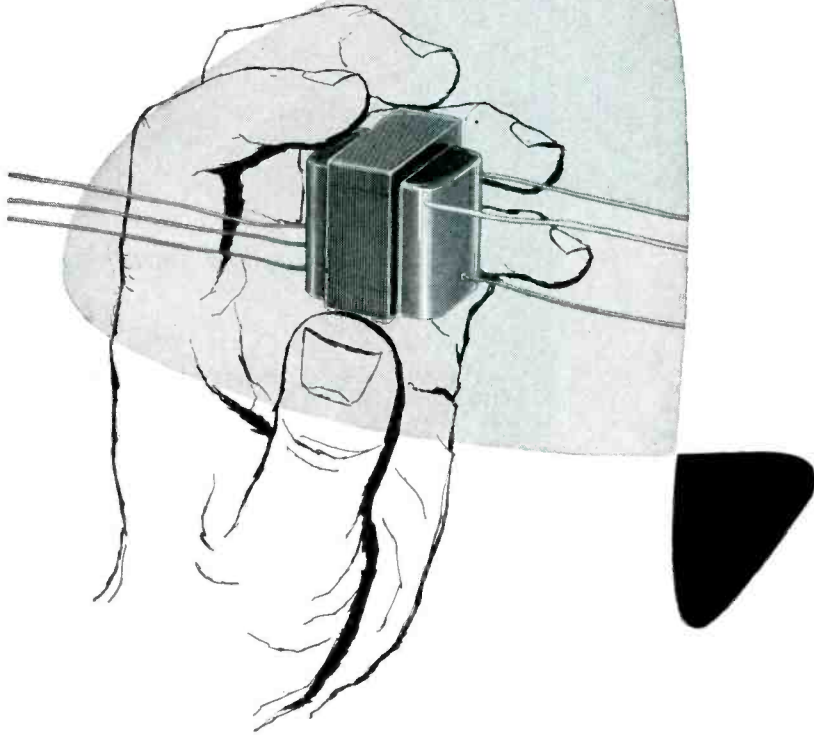

Wheeler's new epoxy resin cast electronic components... including inductors, transformers, and subminiature assemblies of tuned circuit elements... offer the following specific advantages:

- Extremely wide ambient and internal temperature tolerance.
- Exceptional mechanical and physical stability... freedom from cracking, deformation, chemical or physical changes, and deterioration under service conditions.
- Exceptional electrical properties without tendency to deteriorate.
- High resistance to humidity, chemicals and other contaminants.
- Flexible leads and/or terminals.
- Elimination of hermetically sealed cans.
- Elimination, in many cases, of mountings.
- Further steps in miniaturization.

Wheeler's equipment for the casting of epoxys complements already very complete engineering and production facilities in the field of custom transformers, coils, amplifiers and electronic assemblies for military and civilian service. Here is your logical source for both development assistance and experienced production.

**THE WHEELER**   
**INSULATED WIRE COMPANY, INC.**  
 Division of Sperry Rand Corporation  
 1101 EAST AURORA STREET • WATERBURY 20, CONNECTICUT

3WH561R

noticeable dip which is obtained with all reasonably lossless feed-through capacitors. It is assumed that the sharp and increasing rise in insertion loss is due entirely to attenuation within the transmission line, otherwise insertion loss would go through periodic cycles with a maximum or minimum occurring every quarter wavelength, being maximum at the odd and minimum at the even quarter wavelengths. Although, if the charac-

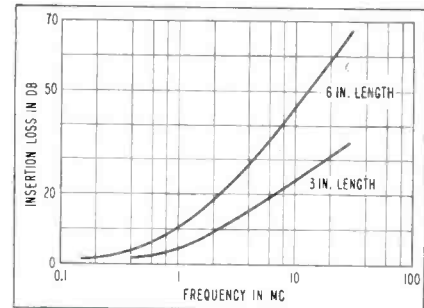

FIG. 2—Variation of insertion loss with length of type I body

teristic impedance of the ferrite tube transmission line were exactly 50 ohms and the line were lossless as well, there would be no insertion loss at any frequency regardless of the capacitance or inductance per unit length.

To determine the effect of physical length on the insertion loss of the ferrite tube transmission line, sample No. 2 was cut in half and each resulting 3-in. section was measured. In Fig. 2, the insertion loss characteristics for the 6-in. and 3-in. lengths are shown for comparison.

Insertion loss for the 3-in. piece is almost exactly half that for the 6-in. length, or that insertion loss is directly proportional to length of line. This means that the insertion loss must be due almost entirely to the high attenuation per unit length along the line and none to reflection or mismatch loss at input or output.

The lack of reflection loss indicates that the characteristic impedance of the lossy line must nearly match the 50-ohm measuring circuit impedances. Since the high and rising insertion loss is due to attenuation within the line because of the lossy nature of the dielectric material, a minimum of at least this insertion loss would always be real-





# how to measure a Sales "Rep"...

A 'Rep' is measured by the quality of the product lines he represents — by the weight of technical knowledge he can apply to an instrumentation problem — by his practical assistance in procurement problems — and by the efficiency of his organization's maintenance facilities.

On all these counts you can rely on your independent FIRST SIX\* sales representative. Keeping pace with every new advance in electronic research and development, technically competent FIRST SIX field engineers have given industry a new concept of field representation that assures not only that you're buying the instrument that best meets your need, but that your investment is being supported by lasting service.

By any yardstick, your independent FIRST SIX sales 'Rep' measures up to the highest standards of technical know-how in engineering ability and service. Rely on him.

The  
**FIRST**

**6**

\* THE FIRST SIX — Six leading, independent manufacturers' representatives functioning cooperatively for the advancement of improved electronic instrumentation in industry.

## A. CROSSLEY ASSOC., INC.

Chicago, Ill.  
Dayton, Ohio  
St. Paul, Minn.

## THE I. E. ROBINSON CO.

Philadelphia, Pa. — (Upper Darby)  
Camp Hill, Pa.  
Asbury Park, N. J.

## S. STERLING CO.

Detroit, Mich.  
Cleveland, Ohio  
Dayton, Ohio

## HORMAN ASSOC., INC.

Washington, D. C.

## J. D. RYERSON ASSOC., INC.

Syracuse, N. Y.

## YEWELL ASSOC., INC.

Burlington, Mass.  
Bridgeport, Conn.

# THE FAMILY OF **Waterman** POCKETSCOPES

**Portable — Dependable — Economical**

Rugged, highly portable "pocket-size" oscilloscopes that can be carried to the job in one hand without sacrifice of the high precision that qualifies them for laboratory use. For field, production line, or laboratory, they save labor, space, money! **POCKETSCOPES** combine high electrical performance, reliability and low cost.



### S-11-A INDUSTRIAL POCKETSCOPE

Features DC amplifier, repetitive sweeps and circuit ground isolation... for DC and low frequency work.  
5" x 7" x 11" ... 8 3/4 lbs. **\$149.50**

### S-14-A HI-GAIN POCKETSCOPE

Identical vertical and horizontal amplifiers, sensitivity to 10 mv; trigger or repetitive sweeps from 1/2 cps. to 50 KC, ± sync; calibrated voltages.  
6" x 7" x 12" ... 12 3/4 lbs. **\$249.00**

### S-14-B WIDE BAND POCKETSCOPE

Similar to S-14-A except lower sensitivity, greater bandwidth. Triggered or repetitive sweeps from 1/2 cps to 50 KC;  
6" x 7" x 12" ... 14 lbs. **\$239.00**

### S-14-C COMPUTER POCKETSCOPE

DC type signal amplifier bandpass more than meets need of most computer service... calibrated trigger sweeps; 5X trace expansion; excellent stability.  
6" x 7" x 12" ... 16 lbs. **\$289.00**

### S-15-A TWIN-TUBE POCKETSCOPE

A unique approach to dual trace oscilloscopy... two rectangular cathode ray tubes, common internal trigger or repetitive sweep generator... DC type signal amplifiers sensitivity to 10 mv.  
6" x 7" x 12" ... 16 1/4 lbs. **\$399.00**

**WATERMAN PRODUCTS CO., INC.**  
PHILADELPHIA 25, PA. CABLE ADDRESS: POKETSCOPE

**MANUFACTURERS OF**

- PANELSCOPE\*
- PANELPACK\*
- PULSESCOPE\*
- RAKSCOPE\*

RAYONIC\* Cathode Ray Tubes and Other Associated Equipment

\*Registered Trademarks

MEMO...  
Write for details today!



**WATERMAN PRODUCTS**

ized in any practical installation regardless of what the source and load impedance might become. The insertion loss would be even greater if there were a substantial mismatch between the characteristic impedance of the filter and the impedance of the line into which it was connected.

Since this type of filter is in effect a lossy transmission line in which the loss and consequently attenuation is dependent upon frequency, it is interesting to isolate the transmission-line parameters and observe individually their variations with frequency.

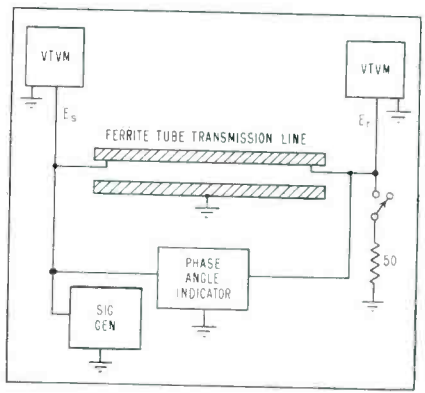

FIG. 3—Block diagram of method used to determine line parameters of lossy ferrite tube transmission line

A procedure was devised in which the line parameters were derived from measurements of the input and output voltage and the phase angle between them at open circuit and with a 50-ohm resistive load across the output. The schematic circuit used for these measurements is shown in Fig. 3. From the general equation for the open circuited transmission line,

$$E_s = E_r \cosh \gamma l, \text{ or } \frac{E_s}{E_r} = \cosh \gamma l$$

and the measured vectorial values of  $E_s$  and  $E_r$  at open circuit, the complex value of  $\gamma$  may be obtained.

The general equation for voltage at the sending end of a transmission line with a finite load at the receiving end is

$$E_s = E_r \cosh \gamma l + Z \frac{E_r}{Z_r} \sinh \gamma l$$

or

$$\frac{E_s}{E_r} = \cosh \gamma l + \frac{Z}{Z_r} \sinh \gamma l$$

By substituting in this equation the measured vectorial values of  $E_s$  and





BURTON BROWNE, New York

MAURICE L. LEVY  
DIRECTOR OF  
COMMERCIAL ENGINEERING

*Emerson* RADIO AND PHONOGRAPH CORP. IS ANOTHER OF THE  
HUNDREDS OF IMPORTANT COMPANIES WHO DEPEND UPON PYRAMID  
FOR A MAJOR SHARE OF THEIR CAPACITOR AND RECTIFIER COMPONENTS.

capacitors—rectifiers  
for original equipment—  
for replacement

**P** PYRAMID ELECTRIC COMPANY

north bergen, new jersey ALUMINIUM WITH FILTER







## I Get Shortest Etching Time with **HUNT** **ETCHANTS**

### HUNT R.C.E. (Rapid Circuit Etch) FOR PRINTED CIRCUIT BOARDS

Hunt R. C. E. is a proprietary etchant, formulated to etch printed circuits fast and to speed up production. It offers these 6 big advantages:

1. 15% increase in etching speed
2. Fast action over entire circuit
3. Uniformly smooth etching
4. Easily removed by washing
5. Substantial increase in capacity
6. Freedom from fumes

### HUNT S.C.E. (Solder Circuit Etch) FOR SOLDER-PLATED CIRCUIT BOARDS

This ready-prepared product is designed to etch solder-plated circuit boards more easily, more effectively than it has ever been done before. You'll find that Hunt S. C. E. . .

1. Etches rapidly at room temperatures
2. Has a high capacity for copper
3. Never attacks the circuit
4. Has guaranteed uniformity, and is of the highest quality because of rigid laboratory control

Hunt S. C. E. is essentially an oxidizing solution with the capacity to keep the oxidized copper permanently in solution. Although many acids will etch copper, S. C. E. solution has the peculiar property of not attacking the solder . . . but giving fast, odorless etching of the copper.

Write to nearest Hunt Branch for:

Technical Bulletin No. 1.—  
"The Etching of Copper by Hunt  
R. C. E. Solution"

Technical Bulletin No. 3—"the  
Etching of Solder Plated Circuit  
Boards by Hunt S. C. E. Solution"

**HUNT R.C.E. SOLUTION**  
145 lb. rubber drums  
600 lb. poly drums

**HUNT S.C.E. SOLUTION**  
125 lb. carboys  
530 lb. poly drums



Manufacturing  
Chemists

Established  
1909

**PHILIP A. HUNT COMPANY**

PALISADES PARK, N. J.

Chicago • Cleveland • Cambridge • Brooklyn • Atlanta • Dallas • Los Angeles • San Francisco

$E_r$ , and the known load resistance  $Z_r$  (50-ohms resistive), and the value of  $\gamma$  found previously, the  $Z_o$  for the line may be calculated. Then from knowledge of the complex  $\gamma$  and the complex  $Z_o$ , the four line parameters  $R$ ,  $L$ ,  $G$ , and  $C$  may be calculated.

The curves of Fig. 4 show the manner in which the line parameters vary with frequency for a typical sample of ferrite transmis-

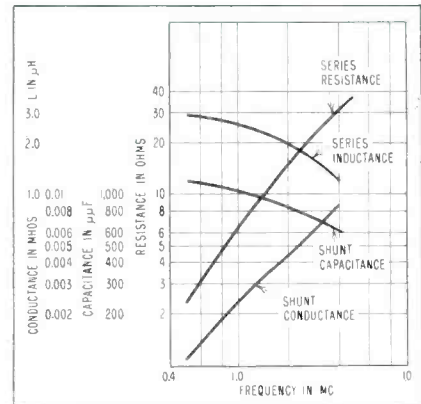

FIG. 4—Characteristics of line parameters over frequency range

sion line. The values shown are for a 1-in. line. Inductance and capacitance decrease slowly with frequency in the region shown, while resistance and shunt conductance, which are primarily indicative of the losses are relatively large and increase with frequency.

Figure 5 shows the variation with frequency for the attenuation constant  $\alpha$  and the phase constant  $\beta$ , the real and the imaginary parts of the propagation constant  $\gamma$ , for the same sample of lossy line. To a first approximation these constants are proportional to the factors  $\sqrt{RG}$  and  $\omega\sqrt{LC}$  respectively. Of particular interest, however, in connection with the use of this line as a dissipative-type low-pass filter is the attenuation constant which, in the frequency region above 1-mc becomes appreciable and rises at an ever increasing rate, in an identical manner to the insertion loss characteristic.

At 4 mc the  $\alpha$  in Fig. 5 has a value of approximately 0.51 nepers per in., or 3.06 for a 6-in. length, or approximately 27 db. This checks within 1 db of the measured insertion loss at 4 mc of the 6-in.



# THE **ONE** UNIVERSAL METER

## MICROVOLTS TO KILOVOLT



The KINTEL Model 203 is a combination DC microvolt-ammeter and amplifier. It provides an exceptionally wide range of measurements. Fifteen voltage ranges cover from 100 microvolts full scale to 1000 volts full scale, with 100 megohms input impedance. Ten current ranges cover from 100 micro-microamperes full scale to 100 milliamperes full scale. As little as 10 microvolts or 10 micro-microamperes may be measured with accuracy. The uncluttered zero-center meter face instantly indicates polarity on a mirrored scale. When used as a DC amplifier, the instrument features exceptionally low drift with high gain, very high input impedance and low output impedance. Gains up to 80 db with less than 10 microvolts drift may be obtained. The Model 203 utilizes KINTEL's unique chopper stabilized circuit to provide high sensitivity with previously unobtainable drift-free stability and high input impedance.

**APPLICATIONS:** Electronic, medical, geophysical, chemical, metallurgical research and development...transistor production and circuit design...thermocouple calibration...null detector...recorder driver amplifier...and as a general purpose laboratory instrument wherever dc voltage and currents are measured or amplified.

### SPECIFICATIONS

Voltage Range (full scale).....	100 $\mu$ v to 1000v	Accuracy on All Ranges.....	$\pm$ 3% of full scale
Current Range (full scale).....	100 $\mu$ ma to 100 ma	Maximum Gain as Amplifier.....	80 db $\pm$ 1.5%
Input Impedance.....	10 megohms below 10 mv, 30 megohms at 30mv, 100 megohms above 30mv	Output Rating.....	1v across 1000 $\Omega$
Impedance Accuracy.....	$\pm$ 1.5%	Output Impedance.....	less than 5 $\Omega$
		Drift (after 15 min. warmup)....	10 $\mu$ v equivalent input
		Price.....	\$550.00

Rack Mounting available as Model 203R



[ KAY LAB ]

**STABILITY**



*Locked in!*

WITH CHOPPER AMPLIFIERS

5725 KEARNY VILLA ROAD • SAN DIEGO 11, CALIFORNIA • BROWNING 7-6700



rocket research . . . remote station connections . . . petroleum electronic cabling . . . computer manufacture

**41,000,000 feet  
of VECTOR Cables  
are now serving  
the electronics industry!**

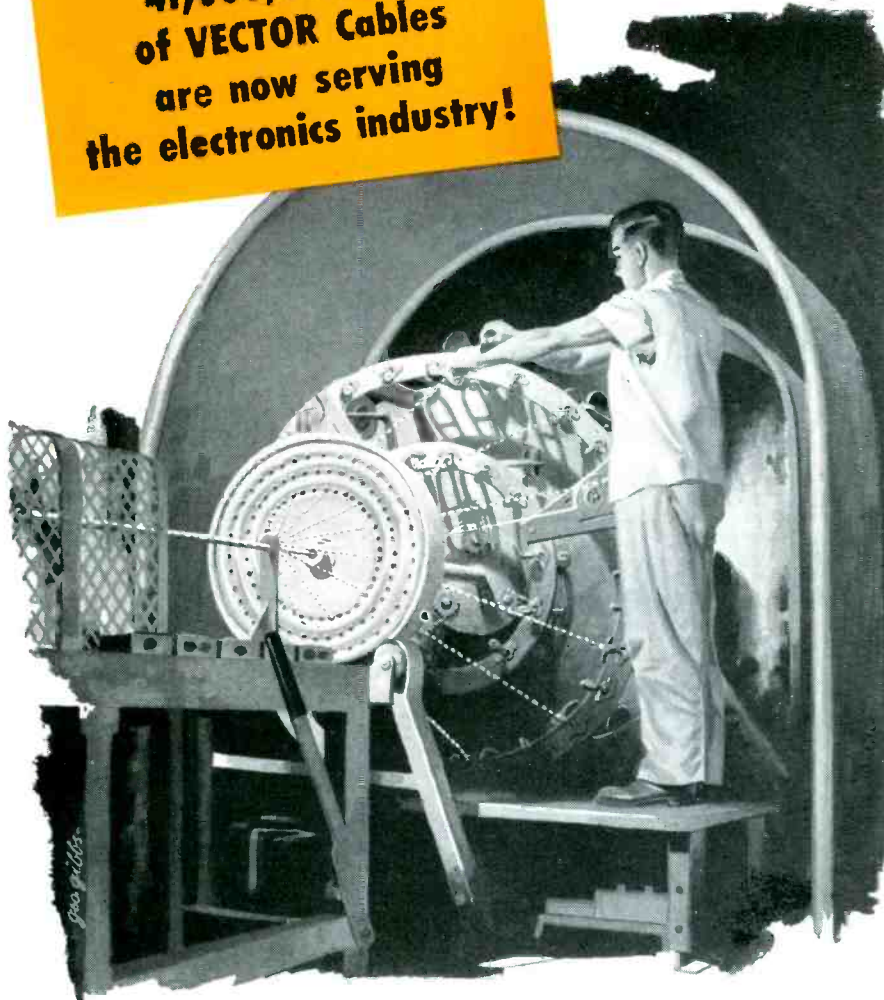

For more than 10 years, Vector has been manufacturing special-purpose multi-conductor cables for industrial applications. These custom products range from only a few feet in length to more than a mile, and have up to 130 concentrically laid conductors.

Sheathed in continuously extruded rubber or vinyl jackets, thousands of these cables are serving industry under the most severe conditions imaginable, from temperatures far below zero to the heat of tropical jungles. In many of these applications, the cables are required to withstand constant flexing and handling and even towing stresses.

Whether you're designing a complex rocket-firing fixture or connecting portable installations, just send Vector's Engineering Department an outline of your project. We'll work out your multi-conductor interconnection problems with a complete cable installation guaranteed to meet your requirements.

**Vector** **MANUFACTURING COMPANY**  
5616 LAWDALE AVE. • HOUSTON 23, TEXAS

Western Representative: C. B. Rush and Associates  
McKinley Building, 3757 Wilshire Blvd.  
Los Angeles 5, California

sample. This confirms the previous conclusion that insertion loss is due almost entirely to attenuation and none to reflection or mismatch loss, and for this to be true, the  $Z_0$  of the line must match closely the impedance of the circuit. Actually, the characteristic impedance of this sample ferrite-tube line was calculated to be  $52.4 + j6.8$  at 4 mc, which is so close to the 50-ohms resistive of the standard insertion loss measuring circuit that reflection losses would be negligible.

Even in its present form using presently available ferrite bodies, this type of filter might have useful but limited application and in certain situations offer advantages over existing suppression components.

Where, for example, extremely high and continually rising attenuation is needed at frequencies above 50 or 100 mc and low line drop and

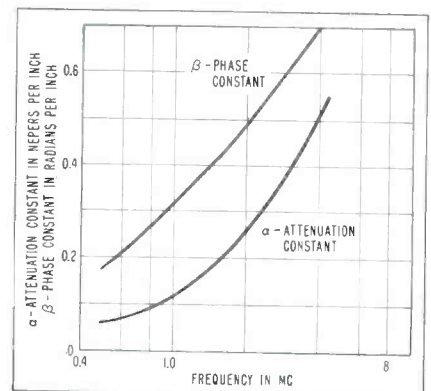

FIG. 5—Phase and attenuation constants for ferrite tube transmission line filter

low capacitance to ground are considerations, and where line current and line voltage requirements are not excessive, a relatively short length of ferrite tube transmission line might be superior to either a feed-through capacitor or an L-C filter from the standpoints of filtering performance, size reduction, and cost.

However, to compete successfully with present power-line L-C filters, or feed-through capacitors in the 150-ke to 50-mc region, the lossy transmission line filter must be improved in many aspects.

The residual losses of present commercial ferrites which, together with reasonably high  $\mu$  and high  $k$ , are responsible for the high attenu-



# Microwave Frequency Meters

by

# FREQUENCY STANDARDS



In offering these frequency meters we have endeavored to bring to the electronics industry instruments for frequency measurement which are fairly priced yet without sacrificing a high degree of accuracy resulting from precision manufacture. The frequency determining element of these instruments is a cylindrical resonator with a tuneable choke plunger that provides a smooth and accurate interpolation of frequency. Four models are offered, each model covering a wide frequency range and employing standard waveguide and flanges. Three types, described below, are offered in each frequency range. All models have been designed to use the standard FS Model M-1000 Micrometer Head which has been widely accepted by the electronics industry. Construction is of Invar and accuracy is .01% under laboratory conditions.

### Three Types Available

**WAVEGUIDE ABSORPTION TYPE I** cavity is mounted on the broad face of waveguide. The transmission indication is secured by a crystal loop monitor located opposite the iris input coupling hole. (Type illustrated)

**WAVEGUIDE FEED TYPE II** cavity is mounted as the termination of a short section of waveguide. The cavity body and output coupling loop are the same as Type I.

**WAVEGUIDE TRANSMISSION TYPE III** cavity is the same as Types I and II but waveguide is used for input and output coupling.

#### DESCRIPTIVE LITERATURE AVAILABLE ON REQUEST

TYPE	FREQUENCY RANGE	WAVEGUIDE
Models 8211-3	8200 to 11500 MC	RG-52/U
Models 7010-3	7000 to 10000 MC	RG-51/U
Models 5882-1, 2, 3	5800 to 8200 MC	RG-50/U
Models 4458-1, 2, 3	4-00 to 5800 MC	RG-49/U

**Frequency Standards**  
General Offices: ASBURY PARK, NEW JERSEY

Address inquiries to  
BOX 504



# HOW TO BOOST A BLIP...

*you could*



make your dish a "spectacular"



... perch it on a peak

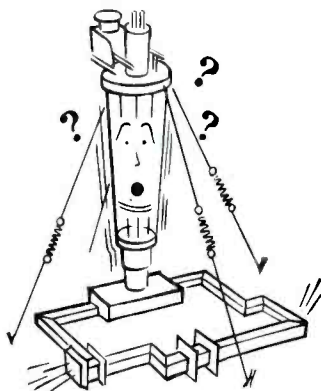

... go "king-size" tube-wise

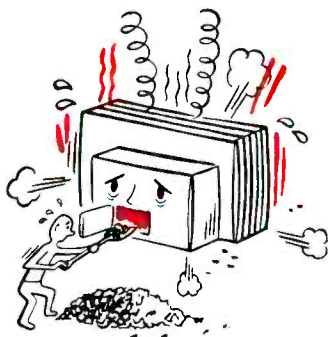

pour on the coal

... and

But... why do it the hard way when

<sup>cool</sup> YOU CAN DO IT WITH "E"s

... and get a signal that really sings... in smaller space... for pennies instead of kilobucks, (\$12.50 in quantity)... without changing your existing system or equipment.

The 1N23E at X and C band and the 1N21E at S and L band provide a typical receiver noise figure of 7.0 db.

Send for technical bulletin and prices

**MICROWAVE ASSOCIATES INC.**



Burlington, Mass.  
BUrlington 7-2711

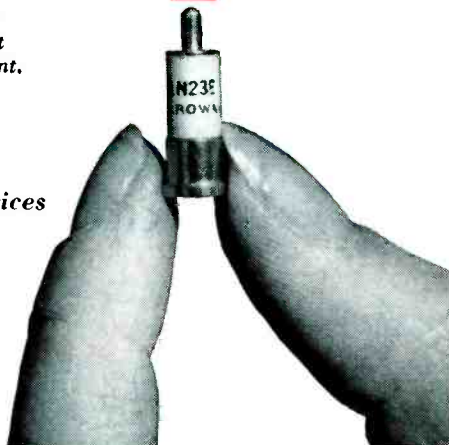

ation per unit length are not sufficiently large at low frequencies. The cut-off frequency for sharply increasing residual losses should be lowered by at least one decade.

Since considerable research in the past has been directed toward reducing losses in ferrites or shifting them to higher frequencies,

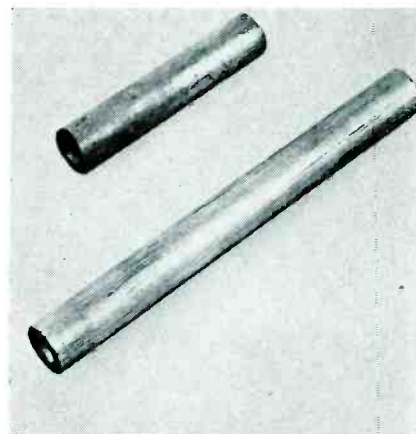

Three and six inch lengths of ferrite transmission line used in experiments. Inner and outer surfaces of tube are coated with conductive silver paint

making bodies more lossy again may be quite feasible.

Attenuation is a function of various ambient variables such as electric-field strength, magnetic-field strength and temperature. The electric and magnetic field strengths existing within the ferrite dielectric material are proportional to the applied line voltage and the line current respectively. Hence the

## Perfect Metals

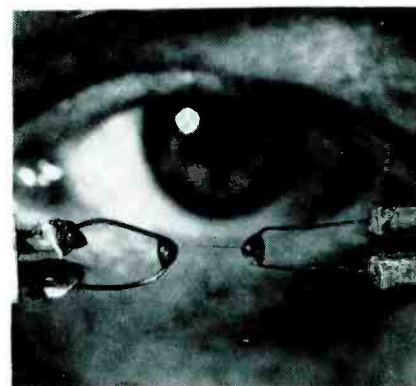

Forces of more than a half million pounds per square inch have been measured on metal whiskers in a device developed at Westinghouse Research Labs. These tests of tensile strength show the magnitude of interatomic forces



CASE history  
number 6



## PISTON CAPACITORS AT WORK

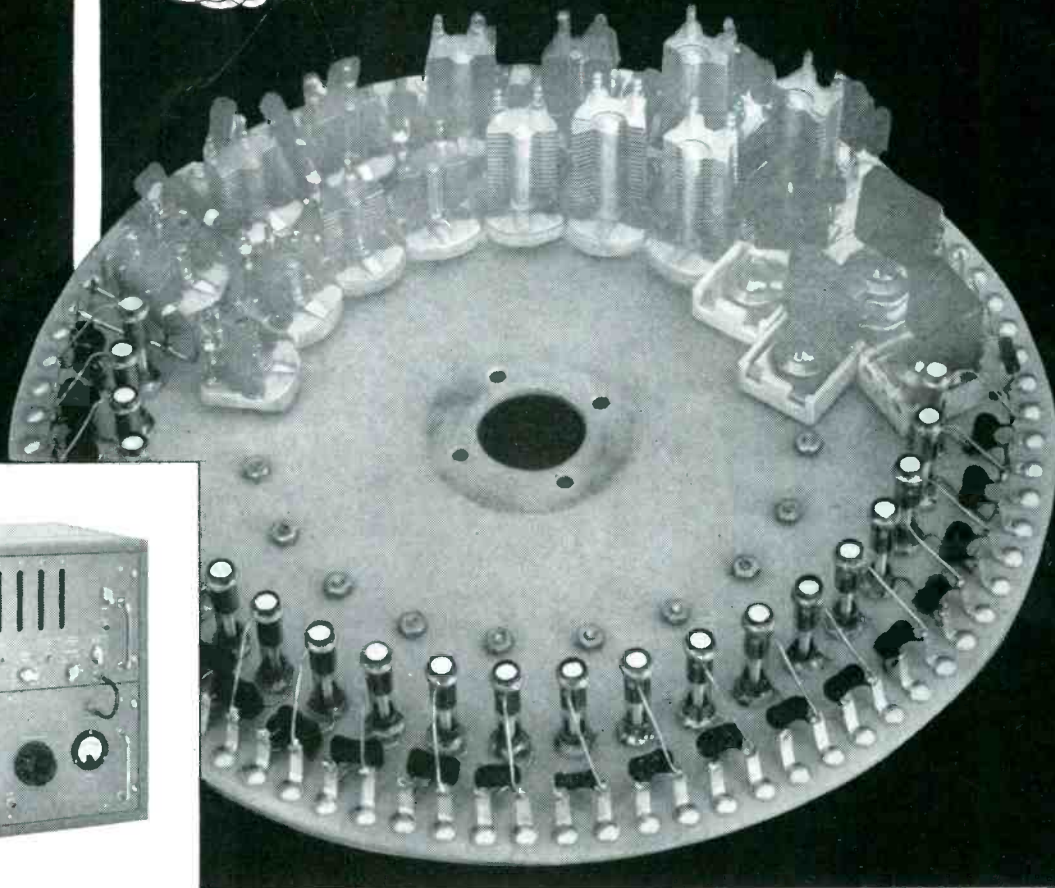

*trimmers achieve maximum measurement, accuracy  
and stability in BERKELEY frequency meters*

**PROBLEM:** To combine functions of precision wide-range frequency meter and universal counter and timer in one compact instrument—to measure frequency from 0 to 42 megacycles with an accuracy of  $\pm 1$  cps or greater and elapsed time from 1 microsecond to 10 million seconds with a maximum accuracy of  $\pm 1$  microsecond.

**SOLUTION:** Berkeley engineers specified 22 model VC11RGA JFD Trimmer Piston Capacitors in the 0-42 mc. harmonic frequency turret to assure precise repeatable selection of reference frequencies. The reasons JFD Variable Trimmer Capacitors were selected? . . . Because an ultra-stable compact, trimmer capacitor was needed to afford rapid and accurate tuning capacity in the reference oscillator circuit.

**RESULT:** Performance so outstanding that Berkeley, division of Beckman Instruments, Inc., has continued to specify JFD Piston Capacitors in their model 5571 Frequency Meters for 3½ years.

**MORAL:** If you are seeking stability, shock-resistance, ultra-linear tuning and wide operating temperature range in a trimmer capacitor, you'll find the best answer at JFD.

actual size

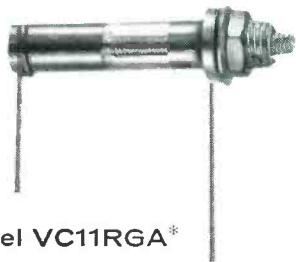

Model VC11RGA\*

(1-10 mmf-glass dielectric-invar rotor)

**Why don't you take advantage of JFD Piston Capacitors in solving your circuit tuning problems?**

*\*One of the miniature and subminiature JFD Piston Capacitors now serving in printed and conventional electronic circuits.  
Write for literature.*



ELECTRONICS CORPORATION, 1462-62 STREET, BROOKLYN 19, N. Y.

*Go Forward with JFD Engineering!*



**ELGIN'S  
NEW**

**MV**

*Big Relay Performance!*

...crystal can size

Elgin's new MV rates superior to other high performance relays, yet is less than an inch long and weighs less than half an ounce. It meets military specifications and is designed for continuous use in the  $-65^{\circ}\text{C}$  to  $125^{\circ}\text{C}$  temperature range. The MV has a life

rating of 100,000 operations minimum at rated load. This new relay is in production now and prompt delivery is assured. For computers, control systems and every installation that requires dependable performance AND miniature size... specify MV.

#### SPECIFICATIONS

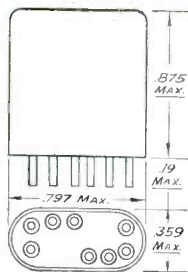

VIBRATION	10 to 80 cycles per second at maximum excursions of .06"—80 to 2000 CPS 20G's acceleration
SHOCK	50G for 11 milliseconds
LIFE	100,000 operations minimum at rated current
AMBIENT TEMPERATURE RANGE	$-65^{\circ}\text{C}$ to $125^{\circ}\text{C}$
DUTY	Continuous
OPERATING POWER	Nominal 1.2 watts at ambient temperature
CONTACT ARRANGEMENT	DPDT (2 Form C)
CONTACT RATING	2 amps resistive at 32VDC or 115VAC
CONTACT MATERIAL	Silver-Magnesium-Nickel Alloy
CONTACT RESISTANCE	.05 ohms
OPERATING TIME	5 milliseconds maximum at nominal power
RELEASE TIME	5 milliseconds maximum
ALTITUDE	Voltage breakdown of relay is 1000 Volt AC to 40,000 ft.—550 Volts AC to 70,000 ft.
DIELECTRIC STRENGTH	1000 volts RMS
INSULATION RESISTANCE	100 megohms minimum at $125^{\circ}\text{C}$
STANDARD COIL RESISTANCES	30, 120, 600, 1000, 2500, 5000, 10000 ohms, others available
SIZE	.875 high x .797 wide x .359 thick max.
WEIGHT	0.45 ounces (max.)
MOUNTING ARRANGEMENT	Bracket, side studs, top studs
TERMINAL ARRANGEMENT	Plug-in, solder-hook, 3-inch Leads



**ELECTRONICS DIVISION**  
ELGIN NATIONAL WATCH COMPANY

107 National Street, Elgin, Illinois  
2435 N. Naomi Street, Burbank, California

small signal attenuation per unit length, or the filtering effectiveness, may be seriously affected by excessive line voltage, which may cause localized heating of the ferrite dielectric, or excessive line current which may cause magnetic saturation.

Further investigations are needed to develop suitable lossy ferrite bodies whose electrical and mechanical properties are not seriously altered by electric or magnetic field strengths or temperature changes over the intended ranges of operation of the filter. The author wishes to acknowledge the extremely helpful assistance of Joseph Allen throughout all phases of this investigation.

### Interelectrode Capacitance Tester

By R. E. MARTIN and I. METH  
Supervisory Electronic Scientists  
Material Laboratory  
New York Naval Shipyard  
Brooklyn, N. Y.

CAPACITANCES as low as  $0.01 \mu\mu\text{f}$  and as high as  $10 \mu\text{f}$  can be measured with good accuracy using the developmental capacitance test set described. The usual methods of connections to the tube being measured may be used.

The theory of this device is based upon a null method originally suggested by Ivan G. Easton of General Radio Co. in connection with design of shielded bridge transformers. It is evident from Fig. 1 that when  $I_0 + I_1 + I_2 = 0$  a null will be obtained in the detector. For a selected value of  $E_0$ , the current in the detector can be minimized by adjusting  $E_1$  and  $E_2$ . When the current in the detector is zero, then

$$I_0 + I_1 + I_2 = 0$$

the following relation will exist

$$Y_0 = \frac{E_1}{E_0} Y_1 + \frac{E_2}{E_0} Y_2$$

from which it follows that

$$C_x = \frac{E_1}{E_0} C_1$$

and

$$G_x = \frac{E_2}{E_0} G_2$$

are the equations of balance.

Electron tubes in general possess



# ARALDITE® EPOXIES

come through  
with the answer to . . .

cyanide-  
resistant

Copper-To-Plastic  
adhesives

for

Printed Circuits!

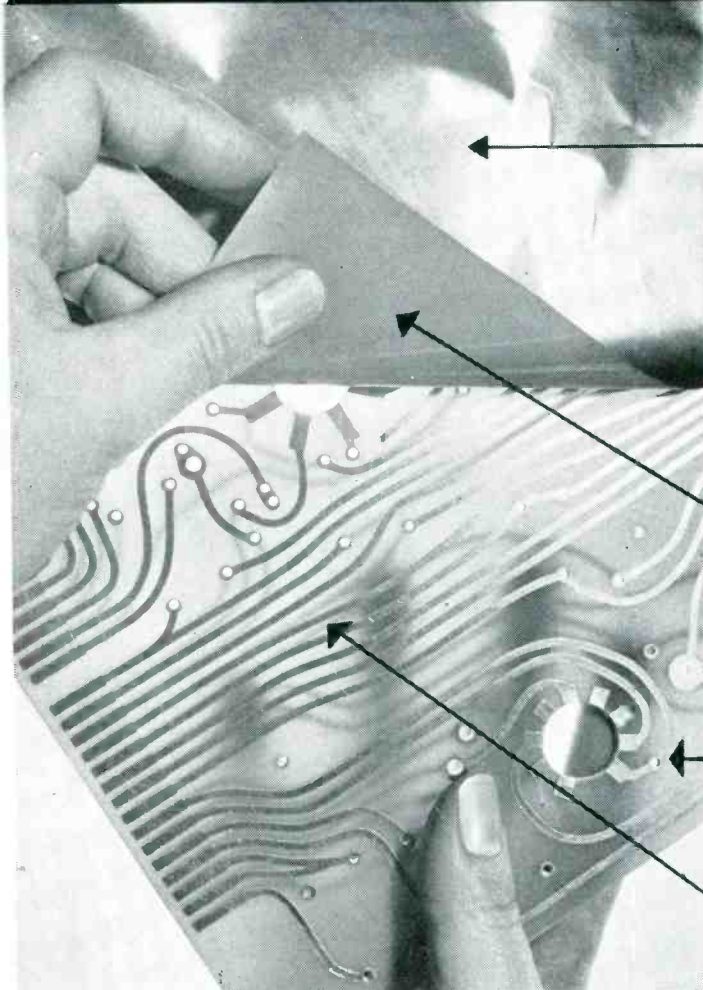

Printed circuits such as this start with a sheet of electrolytically deposited copper of 99.5% purity (generally .00135" or .00270" thick). This is coated on one side with . . .

Plymaster Type "C" a specially formulated Araldite Epoxy-based adhesive which features high resistivity and other electrical insulating characteristics comparable to those of the base-board. This "PLYMASTER" adhesive-coated copper is then bonded to . . .

An epoxy-impregnated fiberglass baseboard which incorporates excellent electrical characteristics . . .

Excess copper is then etched away, leaving a "printed" electrical circuit on one or both sides of the epoxy "board" . . .

Highest grade circuits for use under extreme service conditions, are then plated on top of the copper with a more oxidation-resistant metal (silver or gold). Although these plating baths contain cyanides, new PLYMASTER TYPE "C", utilizing an adhesive based upon Araldite Epoxy Resins, shows no decrease in bond strength even under severest plating conditions.

The Technical Services of CIBA's Plastics Division are the finest in their field. For full information on how CIBA Araldite Epoxies can help you achieve product development and production improvements such as this, write . . .

Drastically reduced costs . . . lighter weight and compactness . . . higher uniformity in production and consistent reliability in service . . . all the "plus" features that favor printed circuit design for electrical and electronic assemblies come through where the bonding agent is Araldite Epoxy-based Plymaster® Type "C", a development of Rubber and Asbestos Corp.

The efficiency of any printed circuit is only as good as the ability of the adhesive to provide not only necessary bond strength but positive resistance to moisture absorption and with insulating characteristics comparable to the baseboard.

How well this newest Araldite Epoxy-based Adhesive tests out under actual production and service conditions is detailed in the picture-captions at the left.

# C I B A

"FIRST IN EPOXIES"

CIBA produces basic resins only,  
to be formulated  
for intermediate and end uses.

CIBA COMPANY INC., Plastics Division  
Kimberton, Pennsylvania

E-4

Please send me full information on CIBA Epoxy Resins for

- Tooling  
 Electrical

- Structural Laminates  
 Hi-Strength Adhesives

- General  
 Surface Coatings  
 Plastic Body Solders

NAME \_\_\_\_\_  
COMPANY \_\_\_\_\_ TITLE \_\_\_\_\_  
ADDRESS \_\_\_\_\_  
CITY \_\_\_\_\_ STATE \_\_\_\_\_



# If it's HOT or DRY

## USE 'DIAMOND H'



## SERIES R RELAYS

Where the temperature hits 200°C. or the dry circuit is downright arid, your best bet for reliability is a "Diamond H" Series R miniature, hermetically sealed, aircraft type relay. Their shock and vibration resistance you may take for granted.

On the other hand, Series R relays (4 PDT) also give excellent reliability at -65°C. and will carry up to 10 amperes in power circuits . . . or even 20 amperes for short life requirements. In other words, they offer an extremely wide range of performance characteristics from which "Diamond H" engineers will be happy to work out a variation to meet your specific requirements. Just ask.

### TYPICAL PERFORMANCE CHARACTERISTICS

<b>Vibration Resistance:</b>	10-55 cycles at 1/16" double amplitude 55-500 cycles at 15 "G" 55-1,000 cycles at 15 "G" 55-2,000 cycles at 20 "G"
<b>Temperature Range:</b>	-55° to +85°C. -65° to +125°C. -65° to +200°C.
<b>Coils:</b>	Resistances—1 ohm to 50,000 ohms Arrangements—single coil; two independent coils, either or both of which will operate unit
<b>Insulation Resistance:</b>	1,000 megohms at room temperature 100 megohms at 200°C.
<b>Dielectric Strength:</b>	450 to 1,000 V., RMS
<b>Operating Time:</b>	24 V. models 10 ms. or less; dropout less than 3 ms.
<b>Contacts:</b>	30 V., D.C.; 115 V., A.C.; 2, 5, 7½ and 10 A., resistive; 2 and 5 A. inductive. Minimum 100,000 cycles life. Low interelectrode capacitance—less than 5 mmf. contacts to case; less than 2½ mmf. between contacts. Special Ratings: to 350 V., D.C., 400 MA., or other combinations including very low voltages and amperages or amperages to 20.
<b>Operational Shock Resistance:</b>	30, 40 and 50 "G" plus
<b>Mechanical Shock Resistance:</b>	up to 1,000 "G"
<b>Mounting:</b>	9 standard arrangements to meet all needs —plus ceramic plug-in socket.
<b>Size:</b>	1.6 cu. in.
<b>Weight:</b>	4 oz. or less

Bulletin R-250 gives more complete data. Send for a copy.

**THE HART MANUFACTURING COMPANY**  
202 Bartholomew Avenue, Hartford, Conn.

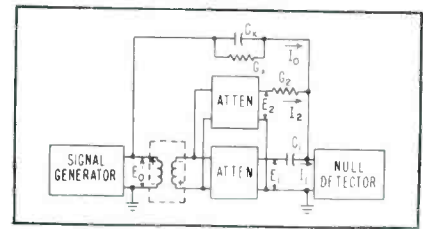

FIG. 1—Basic circuit of the interelectrode capacitance tester

extremely low conductances between electrodes. For this reason, it is possible to neglect  $G_x$  and eliminate  $E_2$ , without affecting the accuracy of  $C_x$  to be measured. A simplified schematic of the circuit employed in the laboratory model test set is shown in Fig. 2. When a null is obtained in the detector, the value of capacitance to be measured  $C_x$  is related to the standard capacitor by the following relation

$$C_x = \frac{E_1}{E_0} C_0$$

where  $E_0$  and  $E_1$  take on the meaning shown in Fig. 2. The following are also evident by reference to the figure

$$E_1' = nE_0 \text{ where } n = \frac{N_1}{N_0} = \text{turns ratio}$$

$$R = R_1 + R_2$$

$$E_1 = \frac{R_2}{R_1 + R_2} E_1' = \frac{R_2}{R} E_1'$$

Substitution of equations yields

$$C_x = \frac{R_2}{R_1} \frac{E_1'}{E_0} C_0$$

$$C_x = n \frac{R_2}{R} C_0$$

The determination of  $C_x$  actually reduces to a measurement of  $R_2$  followed by making the calculation in the final equation. If the values of  $n$ ,  $R_1$  and  $C_0$  are suitably selected, the device can be made direct reading. This merely consists in calibrating the variable voltage divider  $R$  to obtain a relationship between the dial position and the corresponding value of  $R_2$ .

► **Construction** — Good laboratory techniques are the only essential

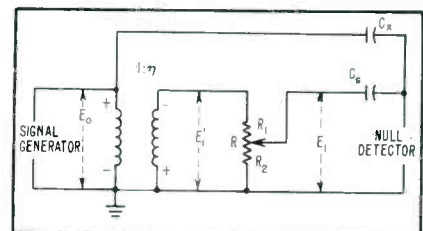
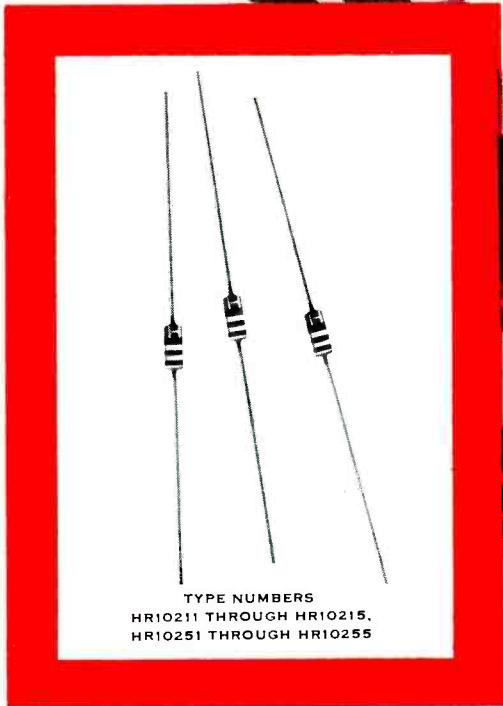
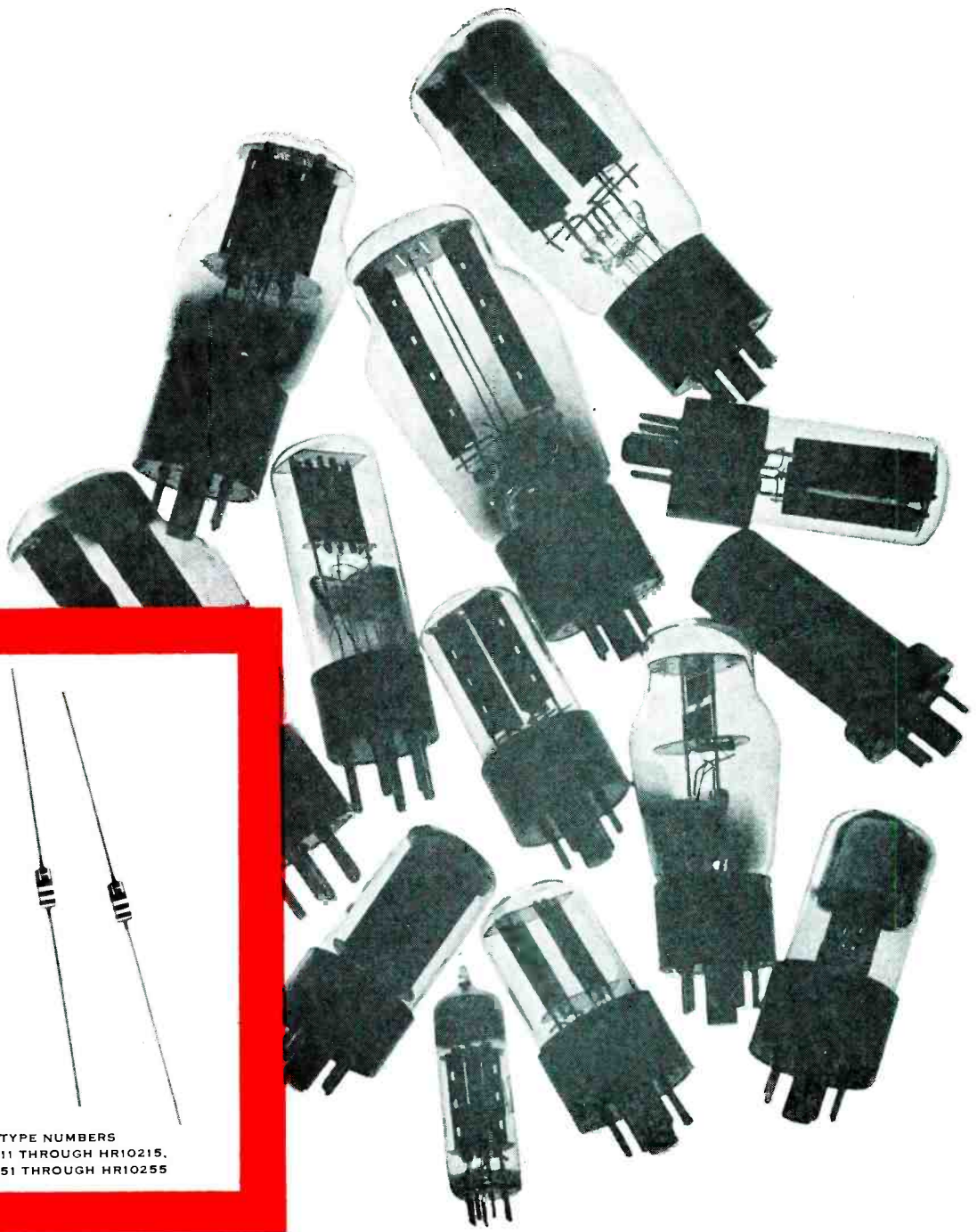

FIG. 2—Simplified schematic circuit



SUBMINIATURE HUGHES SILICON POWER RECTIFIERS PICTURED WITH SOME OF THE STANDARD VACUUM TUBES THEY REPLACE.



*For electronic power supply applications...*

## NEW HUGHES SILICON POWER RECTIFIERS

Hughes now offers silicon power rectifiers (as shown at the I.R.E. convention), designed for use in miniaturized circuitry and particularly effective in electronic power supplies. All types in this new series convert AC to DC with exceptional efficiency. And their power handling capabilities are exceptional, enabling them to deliver considerable power to loads at high voltages. Within PIV ratings in a full-wave rectifier, they can handle as much current per section as standard vacuum-tube rectifier types. In fact, these tiny rectifiers can replace *any* of the standard types when suitable series or parallel combinations are used.

**FEATURES.** The new Hughes rectifiers are characterized by low forward drop, together with low back leakage. They feature: maximum AC input voltages up to 275 volts RMS; maximum reverse

DC working voltages up to 375 volts; maximum average rectified forward current up to 200mA; maximum power dissipation up to 200mW at 25°C. The operating temperature range for all types is from 75°C to 150°C.

**PHYSICAL CHARACTERISTICS.** All types of silicon power rectifiers are packaged in the famous one-piece glass body, developed at Hughes. This construction provides complete protection against contamination and moisture penetration, results in stable operation under severe operating conditions. Maximum dimensions: body diameter, 0.015 inch; body length, 0.265 inch.

*For details, please write:*

SEMICONDUCTOR DIVISION • HUGHES PRODUCTS  
International Airport Station, Los Angeles 45, California

**HUGHES PRODUCTS**

© 1957, HUGHES AIRCRAFT COMPANY

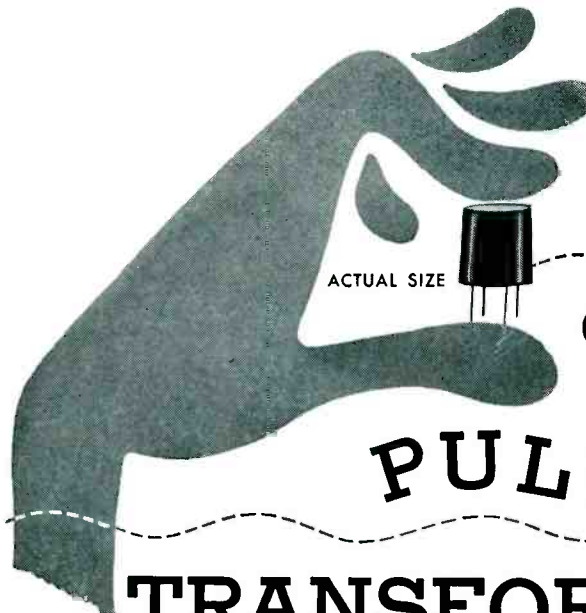

miniature  
encapsulated

# PULSE TRANSFORMERS

by TECHNITROL

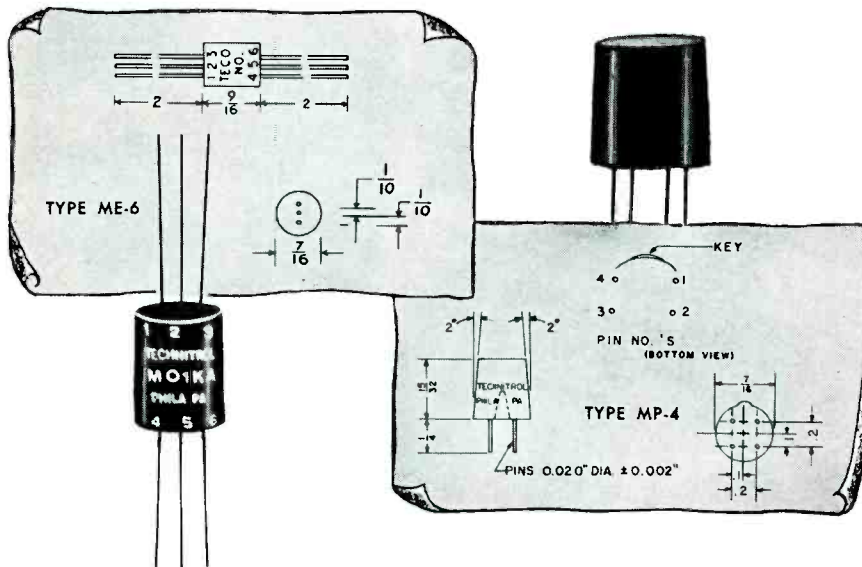

Wound on ferrite cores, the Type M series is available in a variety of windings to cover pulse widths from 2 microseconds down to .05 microsecond, wound inverting or non-inverting.

While the M series is particularly adapted to subminiature and transistor circuits, we design and build pulse transformers to fit specific circuits or to meet definite mechanical or thermal requirements, including MIL-T-27A.

Additionally, Technitrol makes a complete line of lumped and distributed parameter Delay Lines and a variety of electronic test equipment.

For additional  
information,  
write today for  
our bulletin

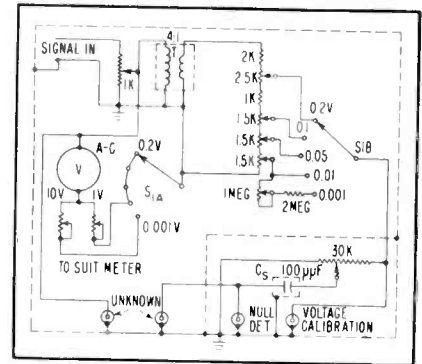
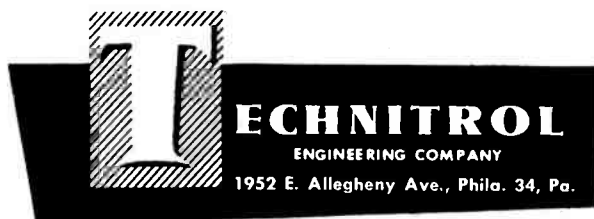
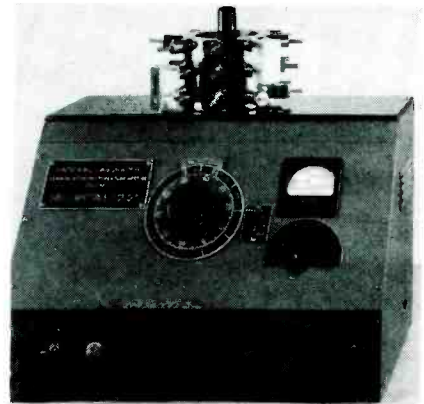

FIG. 3—Interelectrode capacitance test set

precautions required in the construction of the test set. Shielding is not critical. It is advisable to incorporate shielding as shown in the schematic diagram Fig. 3.

Appreciation is acknowledged to E. Rothman of this laboratory for assisting in the construction of the devices and to General Radio for allowing use of a summary.



Packaged version showing tube under test

## Anomalous Propagation

DESPITE gaps in knowledge of radio propagation, the term anomalous is becoming obsolete, reflecting, thereby, the feeling that there may be few unusual propagational conditions that are also unexpected.

► **Official Notice** — In December 1955, FCC gave public notice of the increase in interference to be expected as a result of the rise of the sunspot cycle. Since then there have been a number of news items indicating unusual conditions particularly in the region of 50 mc. During peaks of the 11-year sunspot cycle, the critical frequency that can be turned back by the ionosphere may rise to 70 mc. This



# MIL-AC Custom Air Conditioning



## Condition: Unusual Configuration

Air conditioning today's electronic systems often calls for specialized equipment that saves space, fits into unusual configurations and still meets the most difficult environmental conditions (MIL-E-5272\*).

Custom air-conditioning is our business at Ellis and Watts. For example, our MIL-AC air conditioning units can be square, oblong, L-shaped, T-shaped, curved, pyramid—virtually any shape your conditions require. They can be designed for integral mounting in electronic consoles or computer racks; or for use as adjacent or remote equipment to air condition entire systems.

MIL-AC units are self-contained, compact, lightweight, readily air-transportable. They can be designed to cool, heat, humidify, dehumidify, filter, and can incorporate air-cooled or water-cooled condensers. Units are manually or automatically controlled. We are staffed with specialists who will analyze your requirements, submit a proposal, complete your installation promptly and to your complete satisfaction.

Write for helpful load calculating Nomograph and other technical data for use in making time-saving preliminary calculations.

\*Military specification dealing with the following climatic and environmental conditions: Temperature, humidity, altitude, salt spray, vibration, fungus, sunshine, rain, sand and dust, explosive atmosphere, acceleration and shock



*Typical MIL-AC Unit. MIL-AC configurations, features and functions to suit your specific requirements.*

## ELLIS AND WATTS PRODUCTS, INC.



*P.O. Box 33, Cincinnati 36, Ohio.*

*Ellis and Watts also design and build custom air conditioners, liquid coolers and heaters, dehumidifiers, wave guide dehumidifiers, laboratory temperature and humidity control units.*

# NEW DEVELOPMENT!

tests tubes to *Laboratory* accuracy  
... on a *Production* line basis

## CARDMATIC®

Automatically selects tubes to meet exact requirements of your special circuit applications.



### MODEL 123A

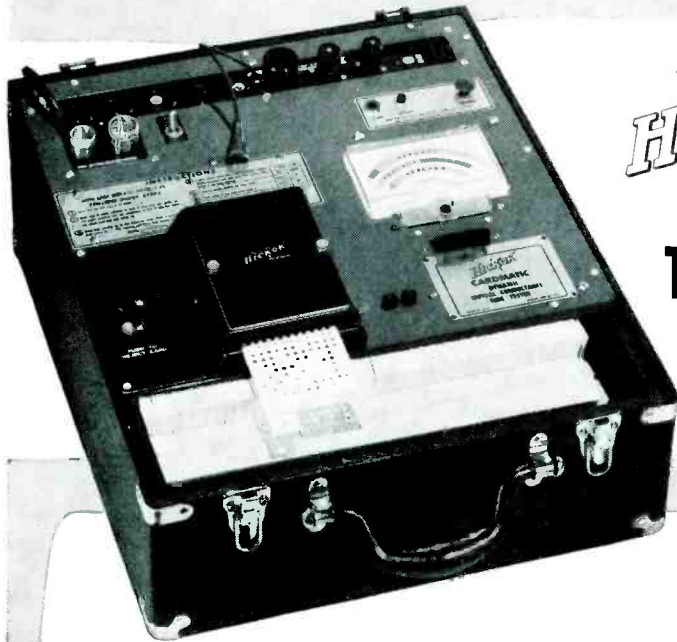

Now... the 123A provides an automatic tube test that is tailored to meet the requirements of your specific circuit application.

With this tester, anyone can accurately and automatically test any tube at any pre-selected voltage on screen, plate, filament or grid.

#### Regulated D. C. Voltages available:

Plate; 12 to 160 volts.

Screen; 12 to 160 volts.

(Combined plate and screen currents up to 100 milliamperes.)

Bias; 0.1 to 100 volts.

#### A. C. Voltages available:

Filament; 0.1 to 119.9 volts.

Signal is 0.22 volts to avoid test distortion in testing even the super sensitive tubes.

In addition, many special evaluations can be made such as cut-off point, zero bias current (up to 200 mils), and other specific controlled emission or gm tests at your designated points. Tubes can be tested for mutual conductance to laboratory accuracy, with provision for readings directly on a meter.

500 tough vinyl cards are furnished with the tester for "typical operating condition checks" to tube manufacturers' specifications. HICKOK will furnish the necessary engineering for automation cards to set-up tests to your exact specification for an unusually nominal charge.

The 123A with Cardmatic system permits an almost unlimited range of tailor-made tube tests for automatic operation by factory production personnel.

Ask for a demonstration of the Model 123A CARDMATIC...  
It's tube-test-automation to laboratory accuracy...for production line use.

**\$470** NET

**THE HICKOK ELECTRICAL INSTRUMENT CO.**

*First in Tube Testing*

10527 DUPONT AVENUE

CLEVELAND 8, OHIO

contrasts with the cycle minimum when the critical frequency may fall as low as 15 mc.

From McGraw-Hill World News in London comes a report that U. S. taxi and police transmitters are causing interference to television programs in the small village of Elvington in Kent, England.

► **Transatlantic TV** — In London, BBC has been monitoring U. S. television channels, which start at 54 mc. For this reason (since maximum usable frequency rarely exceeds 50 mc—despite an occasional higher muf) only intermittent signals have been received and no pictures resolved.

In the other direction, there has been better success. London's Crystal Palace station has an erp of 120 kw and Davis, Northern Ireland, 12 kw. Both stations transmit pictures on 45 mc and sound on 41.5 mc. Pictures recorded on film have been shown to U. S. television network viewers after reception at Riverhead, L. I.

Amateur 50-mc transmissions from the U. S. were heard on 11 days during December 1956.

## Chanson Parisien

SUBSCRIBER services available to users of the State-owned telephone system in Paris now include Telechanson—songs by telephone. By dialing SUF. 84-20 Monday through Friday between 9 and 11 in the morning the songs of Edith Piaf and other popular chanteurs can be heard.

## Ship Radar



High definition radar supplied by RCA for use on liners *INDEPENDENCE* and *CONSTITUTION* uses a new 12-foot slotted antenna with a beam width of 0.65 degree that gives sharp resolution for navigation in congested waters



# Reliable Cable Systems Engineered to Provide Tomorrow's Answers Today

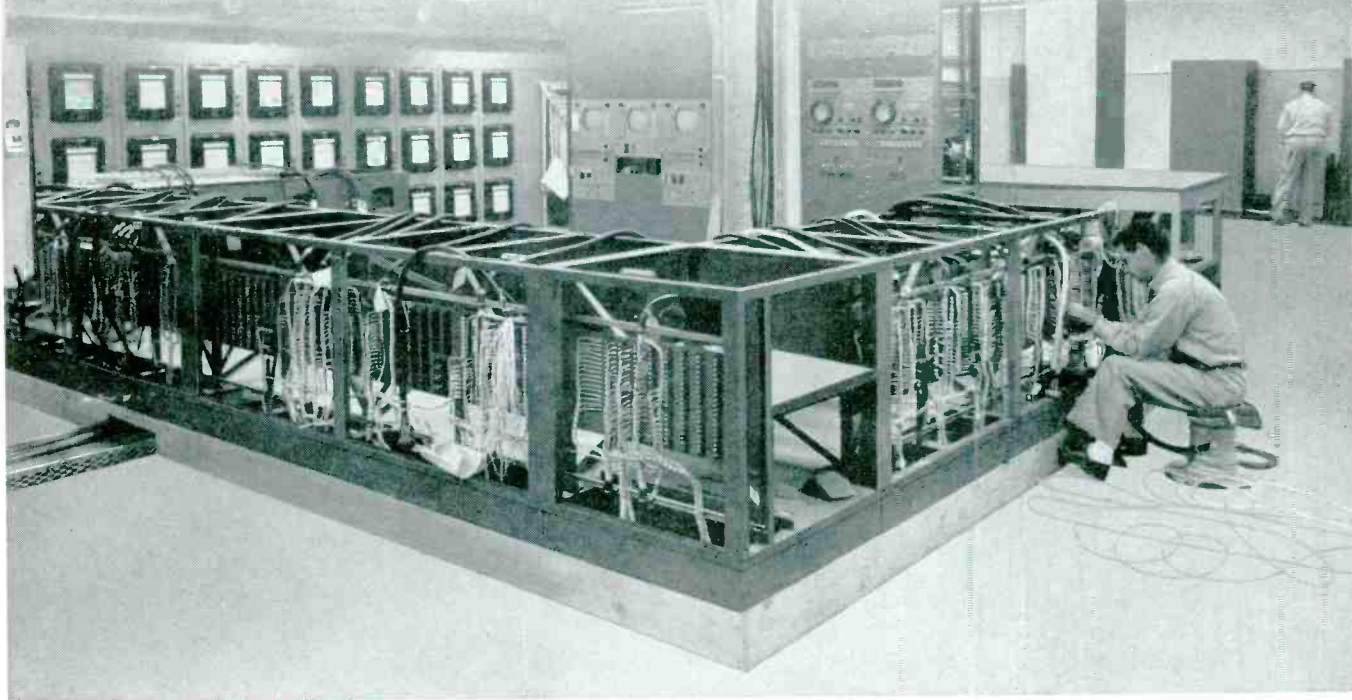

Pacific Automation Products' *systems engineering service*, based on broad missile, aircraft, radiation, communication, computer and allied electronic experience, is available to assist you in your military and commercial projects.

This comprehensive service integrates and coordinates the cabling responsibility for a system in one facility.

## PROGRESSIVE STEPS TO RELIABLE CABLING SYSTEMS

- ANALYZE overall system
- PROPOSE engineering concept of cable requirements conceived by the following criteria: combining circuits; minimizing total number of cables; establishing re-usable standard types
- ENGINEERING liaison team supplied to function with customer's engineering staff, designing cables concurrently with development of the overall system
- MANUFACTURE ready-to-install cables to be available as required
- INSTALL prefabricated cable and connect to terminal hardware in schedule with project activities
- CHECK-OUT the cable system to guarantee compatibility of cable installation with the overall function of the system
- DOCUMENT the complete cable system, including drawings, broken down into components covering consideration to segregation of elements that may be used as building blocks for future addition to the system

*Reliability* is the product of this comprehensive *systems engineering service* . . . achieved only through the thoroughness of the above procedure. For additional information regarding Pacific Automation Products' *systems engineering service*, write for Bulletin 158.



## **Pacific Automation Products, Inc.**

1000 AIR WAY, GLENDALE 1, CALIFORNIA  
CHapman 5-6871 • TWX: GLN 7371  
137 Walnut Hill Village, Dallas, Texas Fletwood 2-5806

Engineers and technicians are invited to investigate career opportunities with us. Submit resume for an interview.





## Typist's Guide Minimizes Errors in Preparing Computer Cables

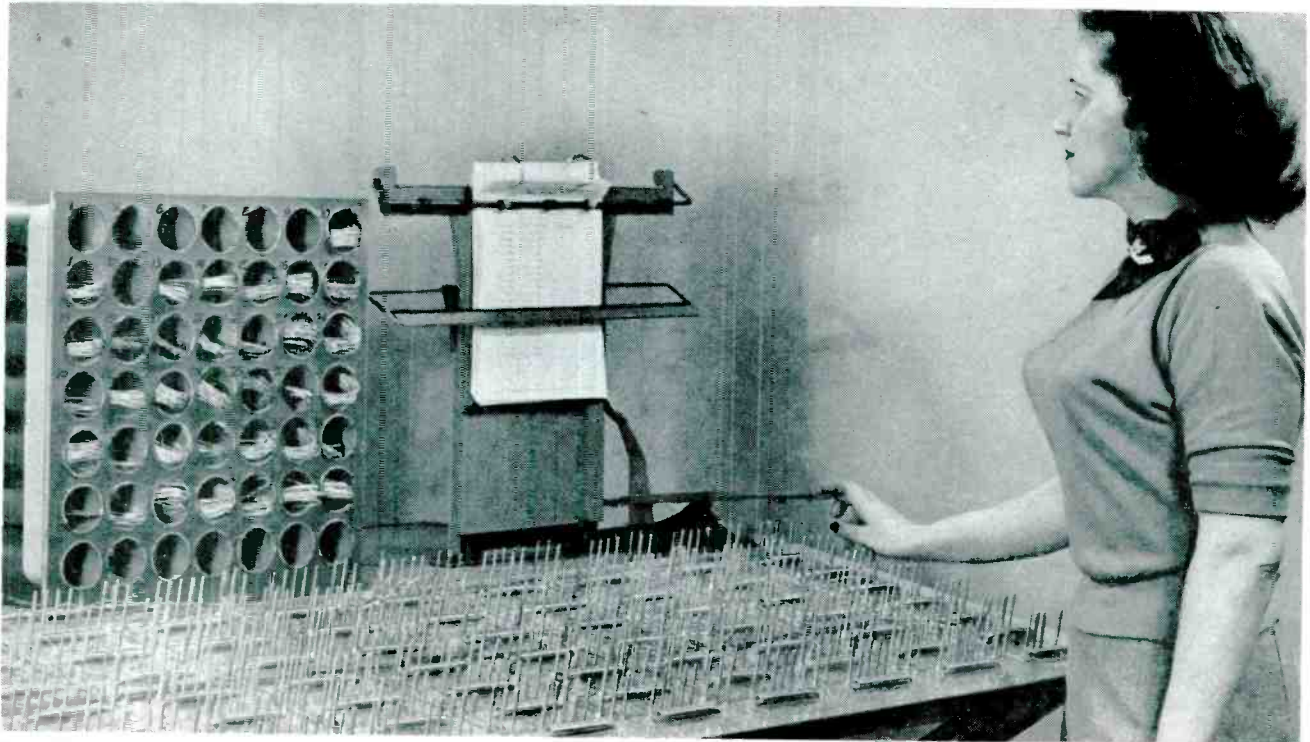

Assembler presses lever of Line-A-Time to move guide bar down to next typewritten line, having installation instructions for next wire to be installed on harness board

TYPEWRITTEN TABULATIONS of wires going into a wiring harness or cable are read easily and accurately with the aid of a Remington Rand Line-A-Time in the St. Paul, Minn. plant of Remington Rand Univac. After installing a wire,

the assembler presses down the operating lever to move the guide down to the next typed line. This then gives her at a glance the number of the next wire to be installed, along with its start, route and termination on the harness board.

Coil springs are bolted to the board at termination points to provide convenient anchors for the leads. The supply of wires is kept in horizontally mounted cardboard tubing within easy reach of the assembler.

## Sealless Plastic Pumps Feed Acid to Wiring-Board Etcher

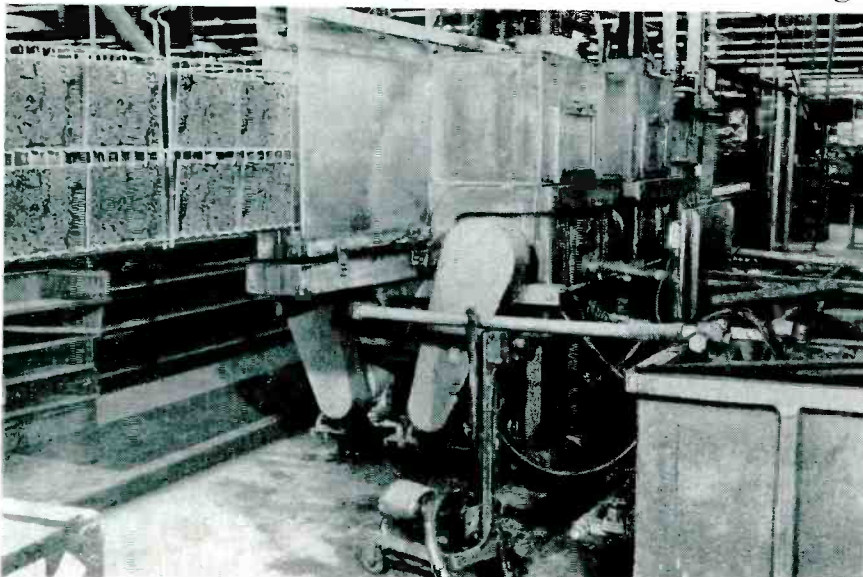

USE OF PLASTIC PUMPS for conveying ferric chloride to an automatic etcher for printed wiring boards solved a costly pump breakdown problem in the Metuchen, N. J. television and radio plant of Westinghouse Electric Corp. Warm concentrated  $FeCl_3$  is highly corrosive to metals and causes leakage through the packing of conventional pumps.

At stuffing boxes or mechanical shaft seals, the leaking solution

Overhead conveyor takes wiring boards through automatic etcher served by portable ferric chloride pump on cart in foreground and two stationary pumps at rear. Reservoirs are at right





**YOU'VE GOT TO HAND IT TO ENGINEERING!**

You've got to hand it to the engineering profession. The "slide-rule" boys know quality when they see it . . . and they won't be satisfied with anything less. Take solder, for example. Engineers depend on KESTER FLUX-CORE SOLDER in their work because they know Kester's reputation

for quality and precision manufacturing . . . a reputation built up over more than 50 years. That's why Kester's the preferred choice of a great majority of electronic manufacturers. *Engineers know that a few pennies saved on a "second-line" solder product can waste dollars!*

**KESTER SOLDER**

*Company*

4204 Wrightwood Avenue, Chicago 39, Illinois  
Newark 5, New Jersey, Brantford, Canada

SEND TODAY for your copy of the 78 page Kester Text-book, "Solder . . . Its Fundamentals and Usage." It's Free.



crystallizes, with resultant abrasion and scoring of pump shafts.

The new pumps, made by Vanton Pump & Eqpt. Corp., Hillside, N. J., each have a capacity of 5 gpm. These have no stuffing box or mechanical seal and are self-priming. The fluid is in contact only with the inner surface of a Bakelite housing and the outer surface of a natural rubber liner. Each of the two etch-chambers has a pump for delivering FeCl<sub>3</sub> from its reservoir. A third pump is used as a movable auxiliary for cleaning out the chambers and reservoirs when the

batch of ferric chloride is exhausted.

► **How It Works**—The dangerous FeCl<sub>3</sub> flows in a channel between the molded plastic body and the rubber liner. No liquid touches metal. Flanges on the liner straddle the pump body block and are pressed to its sides by bolted face plates, thus forming the isolated fluid channel. The pumping mechanism is a rotor mounted on an eccentric shaft which, at each revolution, pushes the liner against the body block and sweeps a slug of

FeCl<sub>3</sub> around a circular track from inlet to outlet. All bearings are permanently lubricated ball bearings completely out of the fluid area and further protected in a stainless steel assembly.

## Connector Holder



Plug-holding fixture, with calibrated dial, can be set anywhere on bench or on wiring harness board, to hold plug at correct angle. Removable inserts are stored in compartment alongside fixture

A SIMPLE HOLDING FIXTURE for electrical plugs brought an award of \$1,625 to Mrs. Vickie Mundell, leadwoman in the F-100 Electrical Assembly Dept. of North American Aviation's Los Angeles Division. Removable metal inserts accommodate different sizes of plugs and have aligning keys at different angular positions with respect to a positioning flat. The fixture is used to assemble cables, insuring that the plug is at the correct angle while wires are being cut and installed.

## Soldering Aluminum with Vibrating Brush on Iron

ADDITION OF A vibrating wire brush to a soldering iron makes possible the soldering of aluminum without flux. The special tool was introduced by Belark Tool and Stamping Co., 9 Carnaby St., London, W. 1, England. With this, the surface of the aluminum is cleaned mechanically by a small steel-wire brush vibrating at twice power-line frequency in the center of the soldering bit. Re-

## Design of the Month: CONNECTOR

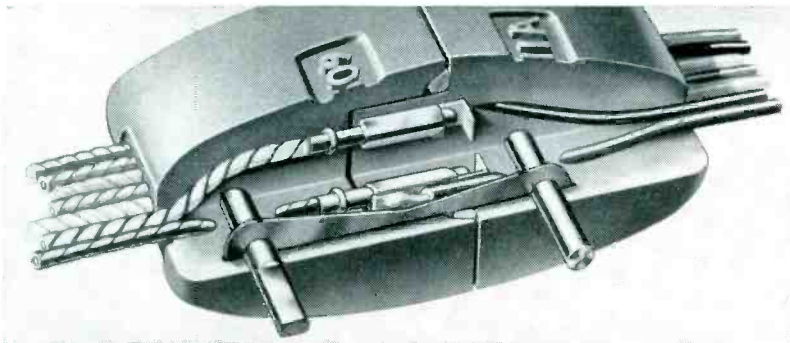
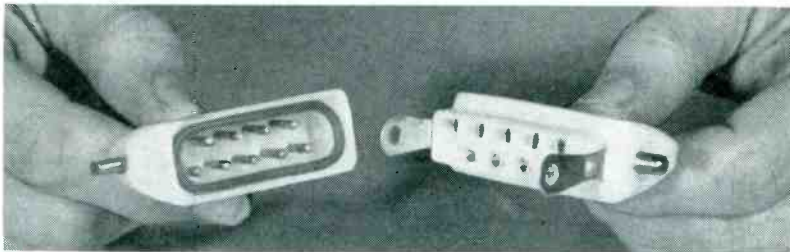
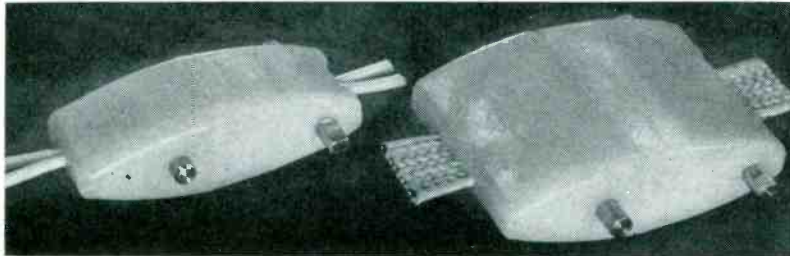

Molding of super-polystyrene body around assembled contacts and leads of umbilical connector for Martin guided missile gives simplified design with higher reliability and improved resistance to environmental conditions at launching sites. New IMI (Integrally Molded Insulation) connectors are currently made by Alden Products Co., Brockton, Mass. in two-lead and nine-lead types. For male half, pins are crimped over leads and plugged into holding clips of molding die, for one-shot molding of body around contacts and leads simultaneously. For female half, leads are looped through punchouts of clips, crimped and soldered, after which clips are pushed over holding pins of female die for molding of body. Mounting shaft projecting out of each connector half anchors frangible separation links, which break at predetermined acceleration as missile leaves launcher. Use of oversize holding pins in female die provides relieving space around each female clip to give floating contact action. Simple resilient O ring provides seal at mating surfaces of connector. Design withstands weather extremes up to 50,000 ft



# Now!

## Vitrohm MIL-R-26C Resistors in all styles!



Famous Ward Leonard Vitrohm® vitreous-enameled resistors are now available in every style to meet all requirements of Military Specification MIL-R-26C including the severe bogeys on moisture resistance, thermal shock, insulation resistance and many other properties.

What's more, this line offers you *all* characteristics—G, V, and the exacting Y—and *all* specification sizes and resistance values—even the highest values using the finest wire (0.00175" dia.) permitted by the spec.

Tab-terminal, axial-lead and stack-mounting types are available in styles and characteristics shown in table.

For complete data on these MIL-R-26C resistors, write us for Bulletin 12. (And incidentally, for Vitrohm resistors to *highest commercial and industrial standards*, get W/L Catalog 15.) Ward Leonard Electric Co., 31 South Street, Mount Vernon, N.Y. In Canada: Ward Leonard of Canada Ltd., Toronto.

### ENGINEERING DATA

TYPE	STYLE	AVAILABLE IN CHARACTERISTICS	RESISTANCE RANGE
Stack Mtg.—Tab	RW20 thru 24	G	All values in Spec.
Tab terminal	RW29 thru 47	V, Y* and G	All values in Spec.
Axial lead	RW55 thru 59	V and G	All values in Spec.†

\*Characteristic Y applies to styles RW30, 33, 37 and 47 only. Characteristic Y is similar to V but requires high insulation resistance at end of moisture-resistance tests.

†Maximum values for single-layer-wound resistors with 0.00175" diameter wire.

LIVE BETTER...*Electrically*



7.7



**WARD LEONARD  
ELECTRIC COMPANY**  
MOUNT VERNON, NEW YORK



RESISTORS



POTENTIOMETERS



RELAYS



CONTROLS



POWER SUPPLIES

**R**eult-**E**ngineered Controls Since 1892

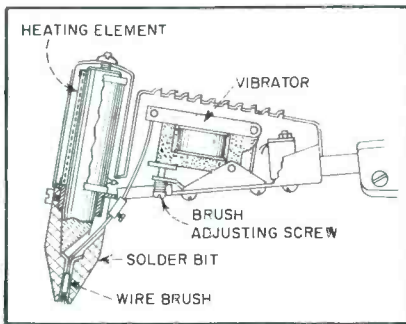

Construction of soldering iron

oxidization is prevented by working with a pool of molten solder round the bit to exclude air while tinning is taking place. Special blowpipe-type solder (80% tin and 20% zinc) with a melting point of 220C is used. The soldering bit is heated to approximately 500C, which is sufficient for heavy sheet metal and small castings. Once tinned, aluminum can be joined by conventional soldering methods.

## Wood Trays Hold Printed Wiring Boards

MANUAL INSERTION of components in etched wiring boards is expedited at Photocircuits Corp., Glen Cove, N. Y. through use of sets of simple wood frames which hold the boards and provide clearance underneath for the projecting leads. Each frame is about 6 ft long and

holds two rows of boards. Several different sizes of frames are kept on hand to accommodate different board widths, and new frames are made up as required for special jobs.

The longitudinal members of the frames are grooved to position the



Wood frames hold wiring boards above surface of work table so that operator can walk along the table inserting the same component in each board in turn. Leads are not crimped because boards have wiring on both sides

## To the ENGINEER of high ability

Through the efforts of engineers The Garrett Corporation has become a leader in many outstanding aircraft component and system fields.

Among them are:

- air-conditioning
- pressurization
- heat transfer
- pneumatic valves and controls
- electronic computers and controls
- turbomachinery

The Garrett Corporation is also applying this engineering skill to the vitally important missile system fields, and has made important advances in prime engine development and in design of turbochargers and other industrial products.

Our engineers work on the very frontiers of present day scientific knowledge. We need your creative talents and offer you the opportunity to progress by making full use of your scientific ability. Positions are now open for aerodynamicists . . . mechanical engineers

. . . mathematicians . . . specialists in engineering mechanics . . . electrical engineers . . . electronics engineers.

For further information regarding opportunities in the Los Angeles, Phoenix and New York areas, write today, including a resume of your education and experience.

Address Mr. G. D. Bradley

### THE GARRETT CORPORATION

9851 So. Sepulveda Blvd.  
Los Angeles 45, Calif.

DIVISIONS  
AiResearch Manufacturing,  
Los Angeles  
AiResearch Manufacturing,  
Phoenix  
AiResearch Industrial  
Rex — Aero Engineering  
Airsupply — Air Cruisers  
AiResearch Aviation  
Service



# AiResearch servo- controller for a pilotless guidance system

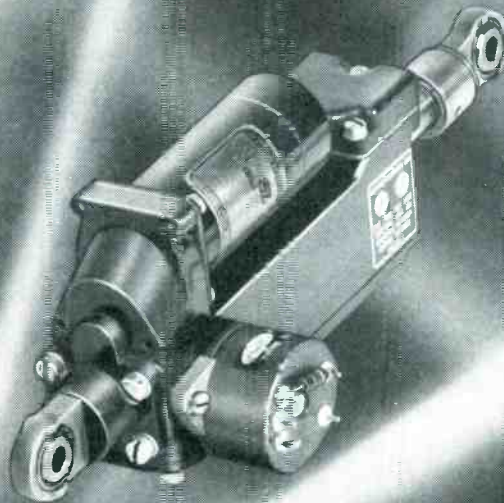
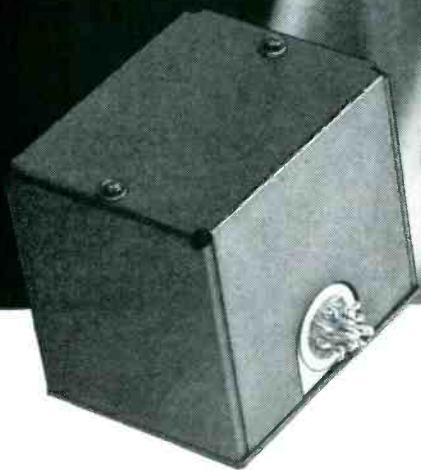

Simple servo-amplifier... actuator system achieves maximum speed of response with high stability

Because most missiles and drones are self-destructive, it is important that the components in their guidance systems be both highly accurate and dependable and be producible in quantity at low cost. The AiResearch servo-controller meets the above requirements.

It operates as follows: an AiResearch servo-amplifier weighing less than .7 of a pound amplifies electric signals from an inertial guidance source and

converts them to command signals. These in turn are transmitted to an AiResearch electrically-powered light weight linear actuator which adjusts control surfaces of missile or drone to maintain a predetermined course.

The servo-controller can operate from either a DC or AC power supply. It can also be designed to take signals from celestial, telemetering or pre-programming sources to maintain or

readjust the course of its pilotless air vehicle. It is another example of the AiResearch Manufacturing Division's capability in the missile field.

Inquiries are invited regarding missile components and sub-systems relating to air data, heat transfer, electro-mechanical, auxiliary power, valves, controls, and instruments.

*Outstanding opportunities for qualified engineers.*



**THE GARRETT CORPORATION**

**AiResearch Manufacturing Divisions**

*Los Angeles 45, California . . . Phoenix, Arizona*

*Designers and manufacturers of aircraft and missile systems and components:* REFRIGERATION SYSTEMS • PNEUMATIC VALVES AND CONTROLS • TEMPERATURE CONTROLS  
CABIN AIR COMPRESSORS • TURBINE MOTORS • GAS TURBINE ENGINES • CABIN PRESSURE CONTROLS • HEAT TRANSFER EQUIPMENT • ELECTRO-MECHANICAL EQUIPMENT • ELECTRONIC COMPUTERS AND CONTROLS

When to specify  
**VULCAN  
ELECTRIC FINNED  
STRIP HEATERS**



**1. When application is for:**

Blower type electric unit heaters, duct heating, unit convection heating, as oven or space heaters in dryers, pump rooms, switch towers, etc.

**2. When specifications call for:**

Steel sheath for sheath temperatures to 750°F; Chromalloy sheath for sheath temperatures to 1200°F; length — 10½" to 42½" (or higher); wattage — 500 to 3250 (or higher); voltage — 115 or 230; rugged non-oxidizing terminal posts.

**3. When you have "hot" problems:**

Vulcan Engineers are ready to provide special heating units — engineered to your needs.

**NEW FINNED  
TUBULAR HEATERS**



Vulcan's new Finned Tubular Heaters provide six times as much radiating surface as standard tubular heaters. Fin is spirally edge wound from continuous strip of steel, then silver brazed to surface of sheath. Heaters can be formed at factory into one or a series of hairpin bends.

Write for free catalog.



**ELECTRIC COMPANY**

DANVERS 10, MASS.

Cartridge • Strip • Tubular • Immersion Electric Heaters • Soldering and Branding Irons • Solder and Glue Pots

boards, so that an operator can apply force to the board where necessary when bending the last lead of a component to make it go into a hole. Leads are cut and formed beforehand, after which each lead is crimped a short distance from the body of the component for standoff purposes, as required when etched wiring is on both sides of the boards.

On boards having etched conductors running out to one side for plugging into connectors, the portions of the leads that are to mate with connectors are masked to prevent damage during assembly.

After assembly is completed, boards are dip-soldered manually one at a time. Plating through holes insures that solder will creep

up and make good contact with the etched wiring on top of the board as well. Since no leads are crimped over when two-sided wiring is used, boards must be handled carefully until all components have been anchored by solder. After soldering, a soft brush is used to clean both sides of each board with isopropyl alcohol, to remove all traces of flux.

This assembly technique has worked out economically for production runs of up to 500 boards in a given design, using boards made by National Vulcanized Fiber Co. from Bakelite phenolic resins. Training time is minimized because the operator inserts the same component in each board in turn, hence needs to remember only one operation at a time.

**Canvas-Belt Conveyor Flips Wiring Boards**

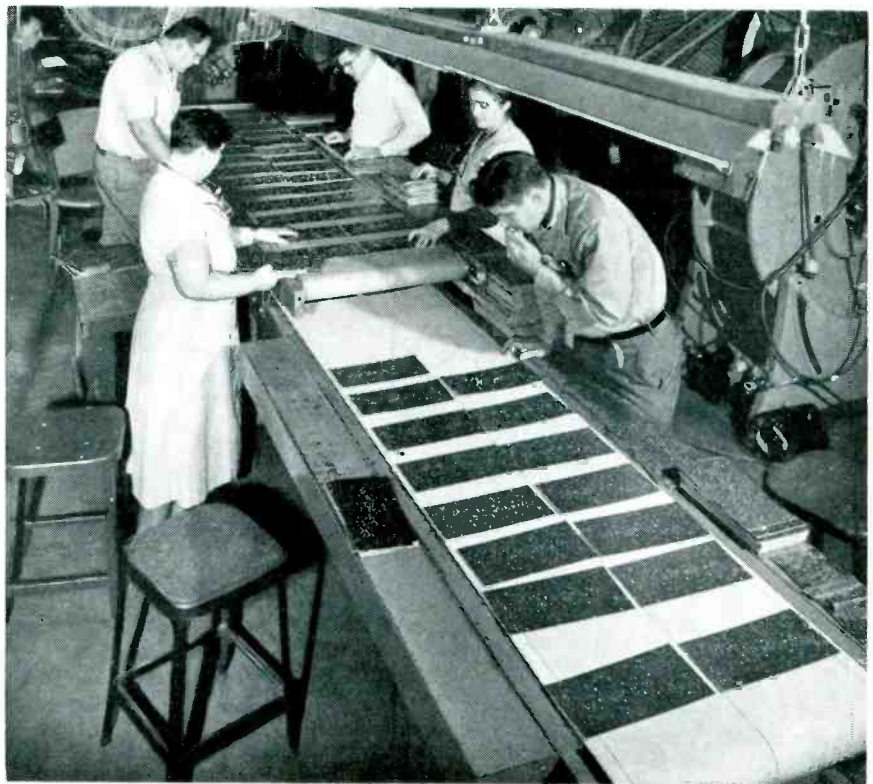

Under close-hung fluorescent lighting, operators inspect etched wiring on conveyORIZED table that turns over boards automatically at far end. Boards travel to rear on upper belt, and to front on lower belt

A CONVEYORIZED inspection table permits inspection of etched wiring on both sides of wiring boards in the plant of Photocircuits Corp., Glen Cove, N. Y. without turning the boards over manually. Two separate endless canvas belts, driven at the same speed by a common

drive, are arranged above each other with the upper one covering half the length of the lower one. Boards are loaded on the upper belt at the center of the inspection table. From here they travel past inspectors to the far end.

As boards drop off the end of



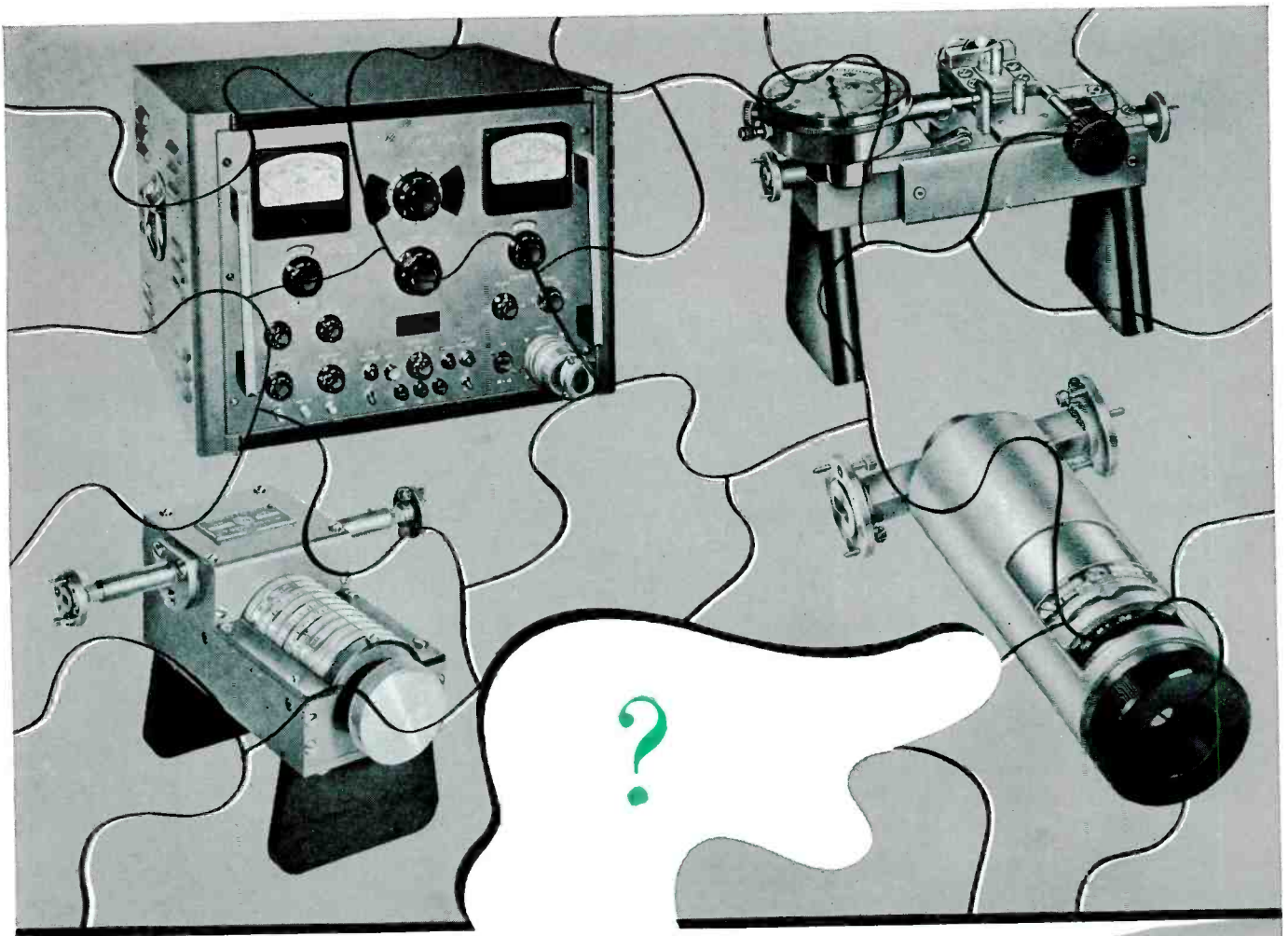

# WHO MAKES THE MOST COMPLETE LINE OF MICROWAVE TEST EQUIPMENT?

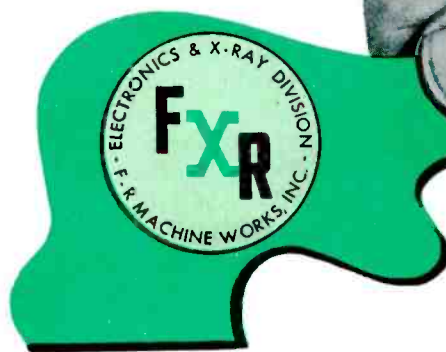

We don't make every type and size  
but we make more types and sizes  
than anyone else.

*Electronics & X-Ray Division*

F-R MACHINE WORKS, Inc.  
Woodside 77, N. Y.

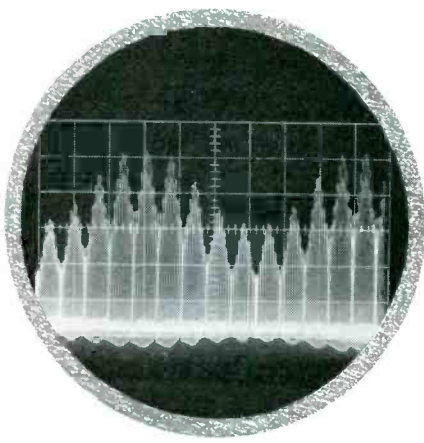

## PHYSICISTS AND ELECTRONICS ENGINEERS

Significant achievements and continuing advances in navigation and communications systems and in other important fields of endeavor at Hoffman have created positions of broad responsibility for physicists, electronics engineers and electro-mechanical engineers. Varied assignments include: TACAN, VORTAC, advanced navigation techniques, VLF, HF, VHF, UHF, forward scatter and tropospheric communications and advanced ECM. Those possessing a high order of ability and initiative are invited to write Vice President of Engineering:



**Hoffman**  
LABORATORIES, INC.  
3761 South Hill Street  
Los Angeles 7, California  
Telephone: RICHmond 9-4831

A SUBSIDIARY OF HOFFMAN ELECTRONICS CORP.

the short belt, they hit a curved guide plate which insures that they turn upside down as they drop onto the lower belt. The boards then travel back between the two belts, emerge upside down at the center of the inspection table, then travel

past another group of inspectors for checking of etching on the reverse side. Boards with defects are removed as soon as spotted, so that only good boards drop off the long canvas belt and stack up automatically in tote boxes.

## Solder Preform Serves also as Heat Sink

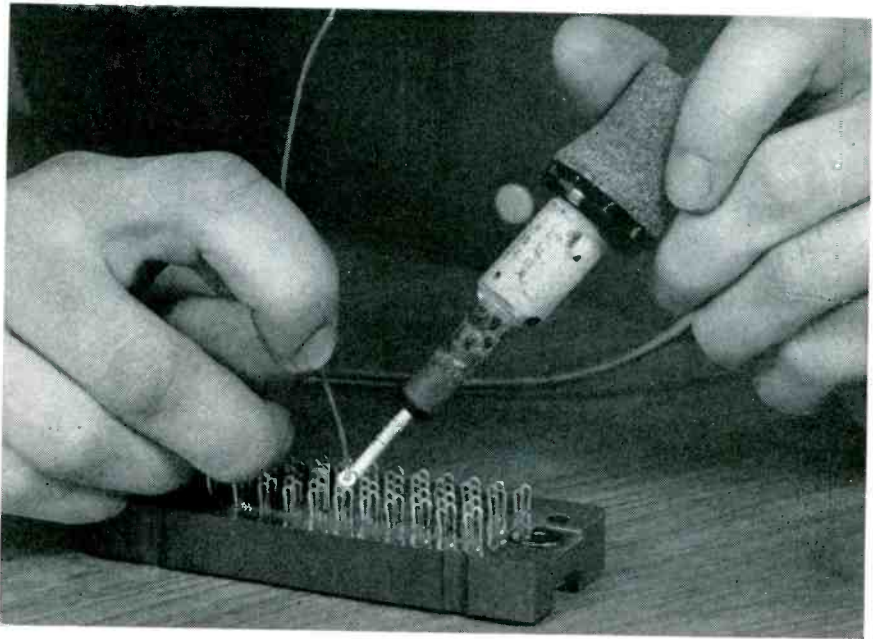

Method of using solder washer preform on lead being soldered to connector

**CREEPING OF SOLDER** up under Teflon insulation on wires was eliminated through use of washer-shaped solder preforms in the St. Paul, Minn. plant of Remington Rand Univac. Sandwiches of solder, flux and solder are punched beforehand to produce the washers. The assembler slips a washer over a stripped lead, inserts the lead in a connector terminal and crimps it conventionally, then applies heat with a pencil-type soldering iron in one hand while holding the wire in the correct position with the other hand.

► **Advantages**—With this technique, the solder serves as a heat sink, leaving the wire cool above the preform and thus inhibiting creeping of the solder up under the insulation, to retain the flexibility of the stripped wire in the critical region adjacent to the connector terminals. The preform also gives precise control of the amount of solder and flux used, giving uniform-size joints despite the closeness of the terminals. This technique also eliminates cold solder joints. The operator is freed from the need for holding wire solder.

## Circular Plastic Trays Hold Components

**MOLDED PLASTIC TRAYS** with removable central dividers hold hardware, small parts and components at assembly positions throughout the Clifton, N. J. plant of Federal Telephone and Radio Co., a Division of IT&T. Each tray has 32 small compartments around its outer edge. The central area of the tray has molded recesses for up to

15 removable plastic dividers, any or all of which can be omitted to give larger compartments when needed.

At the center of each tray is a short length of threaded pipe, held in position by an electrical conduit nut at each end. This serves as a bearing for the tray, so that it can be slipped over the shaft of a bench





**Hoffman Beacon Simulator bench tests TACAN-VORTAC for all-weather flying safety**

The Hoffman-developed HLI-103 Beacon Simulator provides a sure, safe way to ground test airborne TACAN—and the TACAN portion of VORTAC.

It duplicates the functions of a TACAN Land Beacon (AN/URN-3) and tests airborne units (AN/ARN-21) for azimuth from 0 to 360° with a  $\pm 0.2^\circ$  accuracy or better, and range from 0 to 200 nautical miles with a  $\pm 0.1$  mile accuracy or better. The Hoffman Beacon Simulator also tests the AN/ARN-21 at instrument airspeed from 0 to 1500 knots, land beacon identity tone and decoding functions—even simulates adverse weather conditions to assure complete operational reliability.

Hoffman TACAN-VORTAC test instruments, now used by the military services, are also available to aircraft manufacturers, commercial airlines and service operators to provide a vital, extra measure of flying safety for air navigation equipment *from the ground up*. Additional information will be promptly sent upon request.

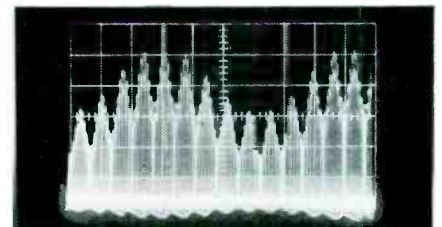

Hoffman HLI-103 simulates the functions of TACAN Land Beacons. Photo shows 135 cps and 15 cps pulse burst detail. Phase relationships indicate surface beacon is due east of aircraft. Comparison of input settings with TACAN dial readings determines operational accuracy.



HOFFMAN HLI-103 BEACON SIMULATOR

**Hoffman**

**LABORATORIES, INC.**

A SUBSIDIARY OF HOFFMAN ELECTRONICS CORP.

3761 South Hill Street • Los Angeles 7, California

**PHYSICISTS • ELECTRONICS AND ELECTRO-MECHANICAL ENGINEERS**

Significant developments at Hoffman in the fields of TACAN, VORTAC, advanced navigation techniques, VLF, HF, VHF, UHF, forward scatter and tropospheric communications and advanced ECM have created important positions for physicists and engineers of high calibre. Please address inquiries to Vice-President of Engineering.



# IRC<sup>®</sup> Hermetic Sealing Terminals

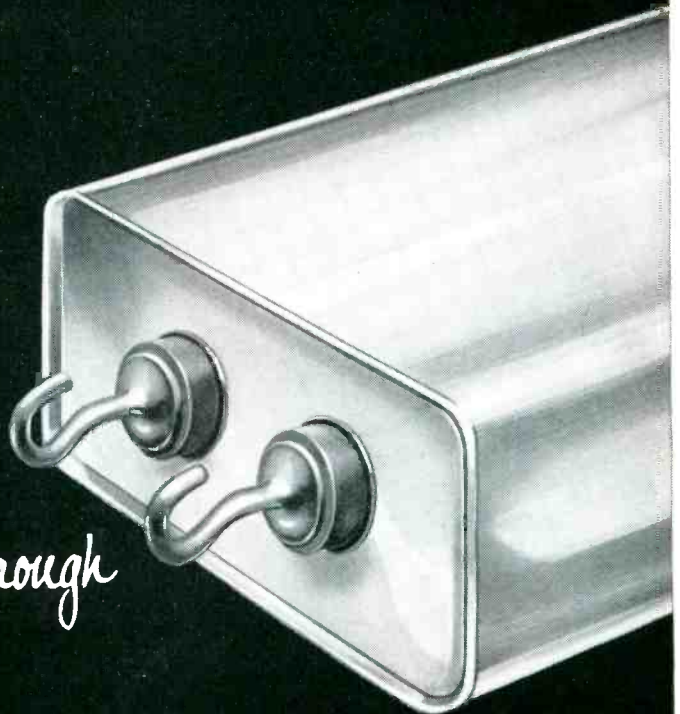

*Only the signal ever gets through*

## THE SEAL STARTS AIR-TIGHT

IRC Type LT Hermetic Terminals more than meet military requirements and commercial standards because of their inherently superior design. First of all, they are a solder seal type. And the terminals are separated from the seal ring by a specially-compounded plastic (polymonochlorotrifluoroethylene) which is bonded to metal surfaces by an exclusive IRC process. Even with rough handling, you're sure of getting the best possible seal from the start.

## THE SEAL STAYS AIR-TIGHT

Not only is the special plastic body a superior insulating material, but it also keeps the seal air-tight under demanding service conditions. Because of its high resistance to thermal shock, it withstands higher operating temperatures ( $-70^{\circ}\text{C}$ . to  $+150^{\circ}\text{C}$ . continuous or  $+190^{\circ}\text{C}$ . intermittent). Furthermore, its zero water absorption eliminates the effects of high humidity. It is also chemically inert to organic solvents, acids, alkalis, oils, fumes, and other atmospheres.

Type LT  
HERMETIC SEALING  
TERMINALS  
1, 2, 3 & 5 KILOVOLT SIZES  
6 LEAD TYPES

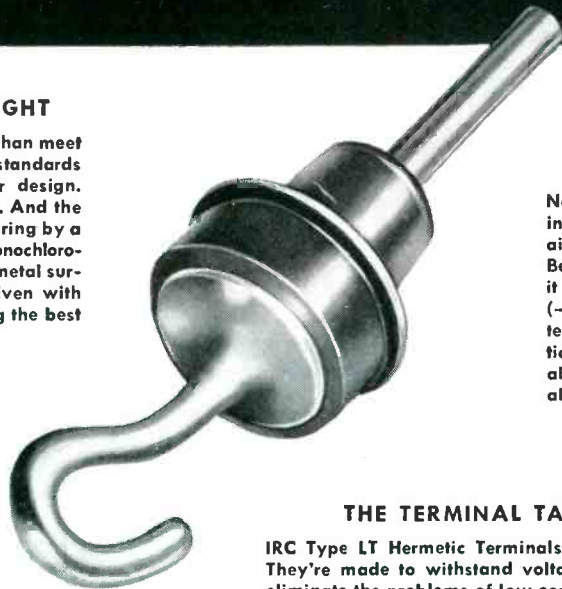

## THE TERMINAL TAKES HEAVY LOADING

IRC Type LT Hermetic Terminals give superior electrical performance. They're made to withstand voltages as high as 5,000 volts and they eliminate the problems of low corona breakdown voltage and excessive electrolysis under high DC voltage. Available in a choice of leads—phosphor bronze, copper, and brass.

### INTERNATIONAL RESISTANCE CO.

Dept. 234, 401 N. Broad St., Phila. 8, Pa.  
In Canada: International Resistance Co., Ltd., Toronto, Licensee  
Send me Hermetic Terminal Bulletin LT-1.

NAME .....

COMPANY .....

ADDRESS .....

CITY ..... STATE .....

Insulated Composition Resistors •  
Deposited and Boron Carbon  
Precistors • Power Resistors •  
Voltmeter Multipliers • Ultra HF  
and Hi-Voltage Resistors.

*Whenever the Circuit Says*

Low Wattage Wire Wounds •  
Resistance Strips and Discs •  
Selenium Rectifiers and Diodes  
• Hermetic Sealing Terminals •  
Insulated Chokes • Precision Wire  
Wounds • Potentiometers.

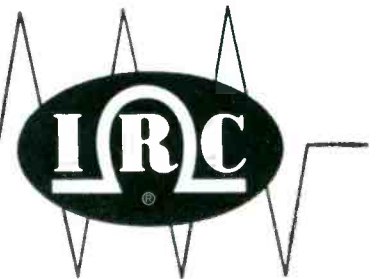





Loading parts into compartments of circular plastic tray. Plastic dividing strips in center section are removable

or floor stand and rotated easily by the assembler. For floor stands, the tray is horizontal. When used on a bench or on a circular turntable, however, the supporting shaft is bent at an angle so that the tray tilts toward the operator.

For heavy-equipment assembly, where units are put together on carts as they are pushed along the floor from one work position to the next along a bench, the tray supports are mounted on ball-bearing rollers of a cart that rides on horizontal rails mounted above the bench. Here the trays can be easily



Placing tray on supporting pipe that comes up through hole in center of caster-mounted rotating assembly turntable. Tray here tilts toward operator

# New Flexibility in Servo Potentiometers from

## CIRCUIT

INSTRUMENTS INC.

Innovation, improvement, and ingenuity are characteristics you find in all CIRCUIT INSTRUMENTS servo and other type potentiometers. They mean greater flexibility in use . . . greater flexibility in specifying. And when you consider that CIRCUIT INSTRUMENTS production facilities feature the same flexibility, you can see why CIRCUIT INSTRUMENTS delivers the goods faster.

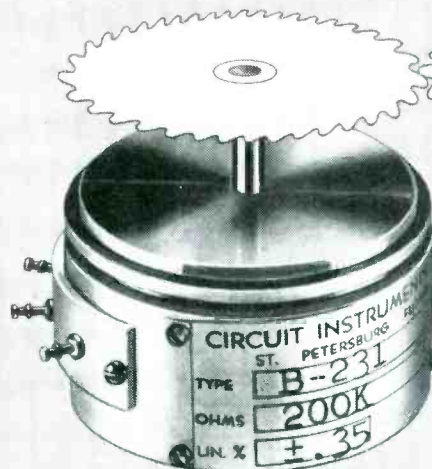

MODEL B  
POTENTIOMETER  
WITH  
SERVO TYPE  
MOUNTING

**GANG UP TO 8 SECTIONS**  
on a common shaft with CIRCUIT INSTRUMENTS servo type potentiometers. Sections can be phased in the field simply by releasing one-piece clamp rings.

**CHOOSE MANY RESISTANCES**  
all the way from 500 up to 600,000 ohms. As a special feature, these servo type potentiometers also can be welded or solder tapped.

**MEET TORQUE REQUIREMENTS**  
with a ball-bearing mounted shaft that assures smooth, low torque operation. Sleeve bearings also available.

**MEET OTHER REQUIREMENTS**  
with linear or non-linear windings, designs for average or high ambient temperatures up to 150° C., and six case diameters from 3/8" to 3"

## CIRCUIT

INSTRUMENTS INC.

**CIRCUIT INSTRUMENTS INC.**  
P.O. Box 1438, St. Petersburg, Florida

Send data sheets on  Servo Type  Hermetically Sealed  Sub-Miniature  Helical  High Temperature  High Precision Potentiometers.

NAME .....  
COMPANY .....  
ADDRESS .....  
CITY ..... STATE .....

Subsidiary of



**INTERNATIONAL RESISTANCE CO.**

they'll produce the special high alumina ceramic parts for developing your projects in a matter of days

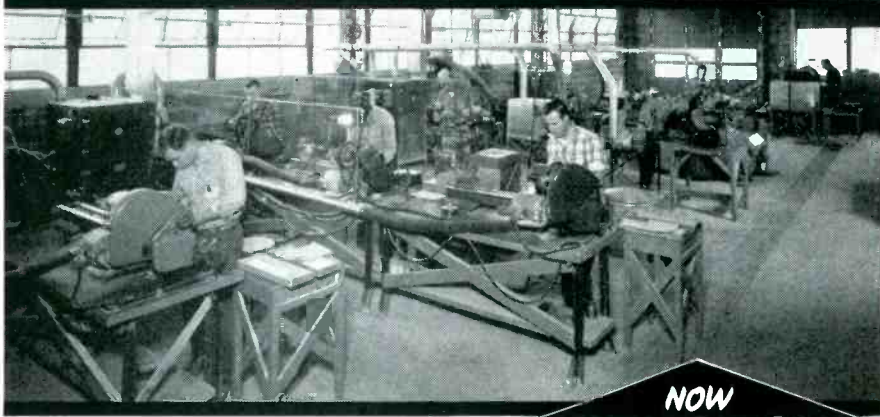

**NOW**  
**OFF-THE-SHELF-SERVICE**  
PROVIDES  
SAME-DAY  
SHIPMENT  
OF

precision  
**DIAMONITE**  
HIGH ALUMINA CERAMIC  
RINGS, TUBES  
RODS

in small quantities for use in pilot and test models. The Diamonite Off-the-Shelf Inventory and Price List will help you with your planning to save time and money and assure highest quality. Write or wire for a copy.

Things must move fast in today's fast-moving electronics world. You can't afford to wait months for a few specialized high alumina ceramic shapes you require for development work.

So Diamonite has added to its large-scale mass production facilities a complete pilot plant that cuts delivery on small quantities of engineered shapes required for testing your ideas from months to a matter of days. Blanks approximating the shape you require are produced with standard dies, then machined and ground on modern precision machines to exactly duplicate your drawings.

In addition to saving months in getting your projects through the preliminary stages, this service enables you to postpone investment in costly dies until you have thoroughly tested your ideas, worked out the "bugs" and are ready for mass production.

*Airmail* your prints and specifications for prompt service.

**DIAMONITE**

products manufacturing company

pioneers in  
the development of high  
alumina ceramics

Canton 3, Ohio



Circular trays mounted at an angle on tiny trolley cars riding on rails above bench can easily be moved to various work positions as heavy units on floor carts are moved along assembly bench



Details of trolley-car mounting for tray riding on rails. Strap handle projecting below angled shaft is used for moving tray along bench

slid along the length of the bench as required.

When production of a particular unit is temporarily discontinued, the trays associated with that product are stored on simple shelves. Production can thus be resumed with minimum setup time.

Although grease crayon could be used to write directly on the outer rim of the smooth plastic tray, such designations tend to smudge quickly as the operator grasps the tray to spin it around each time. For this reason, designations identifying the contents of each compartment are lettered in ink on ordinary masking tape that has been placed around the entire outer rim.

The trays were molded by Prod-



Having your ups  
and downs?



... if they involve WIRE WOUND RESISTORS

# DALOHM has the answer!

All Dalohm components are carefully designed and skillfully made to assure you of supreme quality and dependability, plus the widest versatility of application.

Outstanding examples of the Dalohm line are the following miniature, silicone coated, wire wound resistors.



You can depend on Dalohm

FOR CRITICAL ELECTRONIC DESIGN WHERE SPACE IS A PROBLEM



## TYPE RS



Smallest in size, Dalohm Type RS resistors are silicone sealed, offer high di-electric strength, maximum heat dissipation, and resistance to abrasion, plus every other desirable characteristic:

- 100% impervious to moisture and salt spray
- Complete welded construction from terminal to terminal
- Temperature coefficient 0.00002/Deg. C
- Resistance ranges from 0.05 ohm to 175K ohm, depending on type
- Tolerances 0.05% to 3%, depending on type
- Five wattages—2, 3, 5, 7, and 10; six physical sizes

Write for Bulletin R-23D

## DALE PRODUCTS, Inc.

1300 28th Avenue  
Columbus, Nebraska, U.S.A.

## TYPE RLS

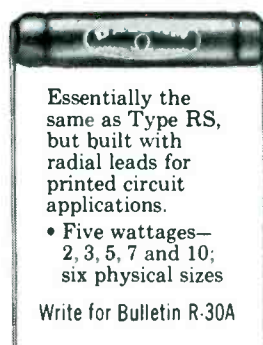

Essentially the same as Type RS, but built with radial leads for printed circuit applications.

- Five wattages—2, 3, 5, 7 and 10; six physical sizes

Write for Bulletin R-30A

## TYPE RSE

"RUGGEDIZED"

A modified RS Type, with tremendous shock resistance obtained by encasing them in a metal housing, yet maintaining miniature size.

- Five wattages—2, 3, 5, 7, and 10; seven physical sizes.

Write for Bulletin R-25B

## JUST ASK US!

You are invited to write for the complete catalog of Dalohm precision resistors, potentiometers and collet-fitting knobs.

If none of our standard line fills your need, our able engineers and skilled craftsmen, equipped with the most modern equipment, are ready to help solve your problem in the realm of development, engineering, design and production. Just outline your specific situation.

• Export Dept:  
Pan-Mar Corp.,  
1270 Broadway, New York 1, N.Y.

• In Canada:  
Charles W. Pointon, Ltd.  
6 Alcina Ave., Toronto, Ont.

# THE **NEW** ARTOS AUTOMATIC wire-stripping and TERMINAL-ATTACHING MACHINE

PRODUCTION TECHNIQUES

(continued)

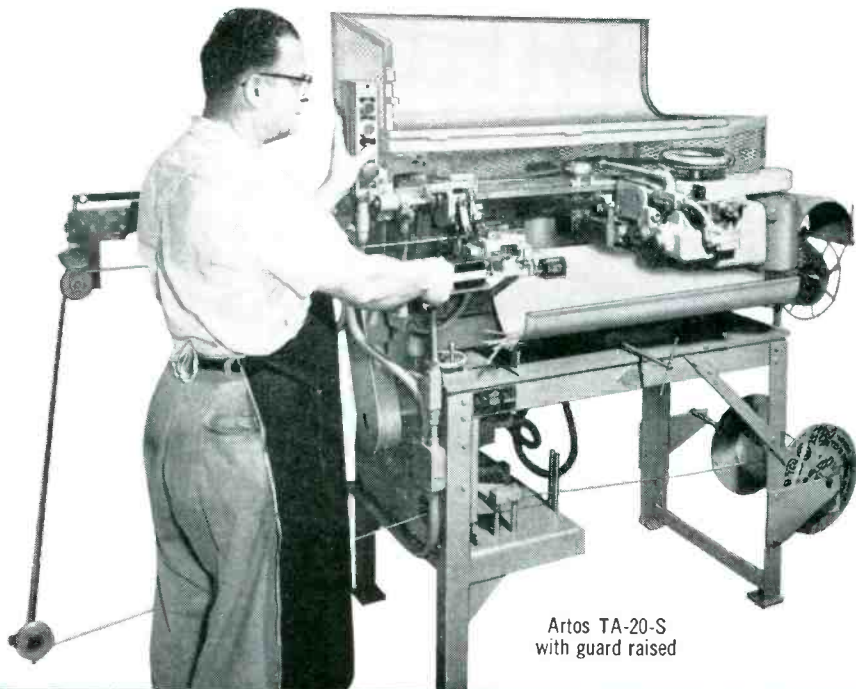

Artos TA-20-S  
with guard raised

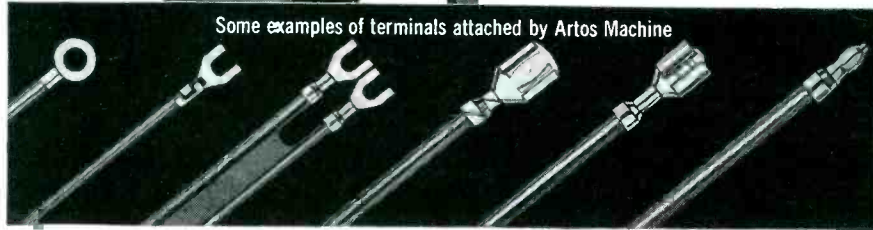

Some examples of terminals attached by Artos Machine

This new Artos TA-20-S brings still greater speed and production economy to large-quantity users of wire leads with terminals attached. It *automatically* performs the following services *all in one operation*:

1. Measures and cuts wire to predetermined lengths.
2. Strips one or both ends of wire.
3. Attaches practically any prefabricated terminal in strip form, to one end of wire.
4. Marks finished wire leads with code numbers and letters. (Optional attachment not standard part of machine.)

**ALL OPERATIONS ARE AUTOMATIC.** Machine can be operated by unskilled labor. It is easily set up and adjusted for different lengths of wire and stripping. Die units for different type terminals simply and quickly changed. Production speeds up to 3,000 finished pieces per hour.

**ARTOS MACHINES ARE USED** by electric appliance, automotive, aircraft, electronics and other industries that want automation in the production of wire leads in quantity. Agents throughout the world.

Engineering consultation and recommendations given without obligation.

**WRITE FOR  
BULLETIN** ▶

No. 655 on the  
Artos TA-20-S



## **ARTOS ENGINEERING CO.**

2743 South 28th Street • Milwaukee 46, Wisconsin

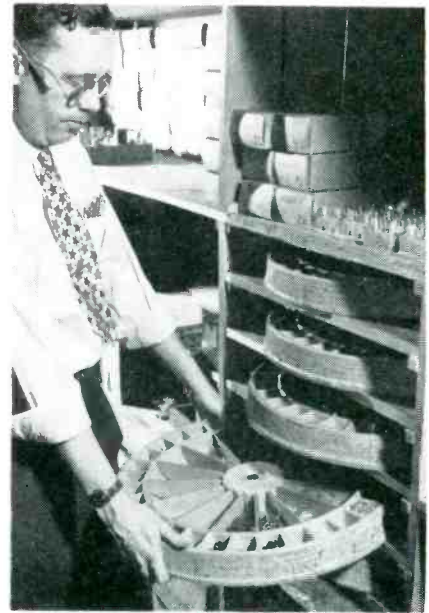

Method of storing trays

uct Engineering Company, Newark, N. J. from a new and tough plastic formulation. In three years of continuous use in the plant, no breakage whatsoever has been encountered.

## Wire-Twisting Methods

LEADS FOR SYNCHROS are quickly and neatly twisted together with a standard Rush wire twister originally intended for commutator leads, in the Long Island City plant of Ford Instrument Co. The operator ties the ends of the leads into a simple knot, inserts the hook of the twisting tool, then pulls the



Method of using commutator wire twister for twisting leads. Hook at each end of twister eliminates need for running reversing-tool handle back each time. Assembly instructions are placed directly on assembly board



# THE NEW AMP CAPITRON<sup>®</sup>

## ARMORED

## WAFER CAPACITOR

... a challenge to your creativeness  
in functional design and application

*When compared with other capacitors, this new A-MP wafer capacitor features these advantages:*

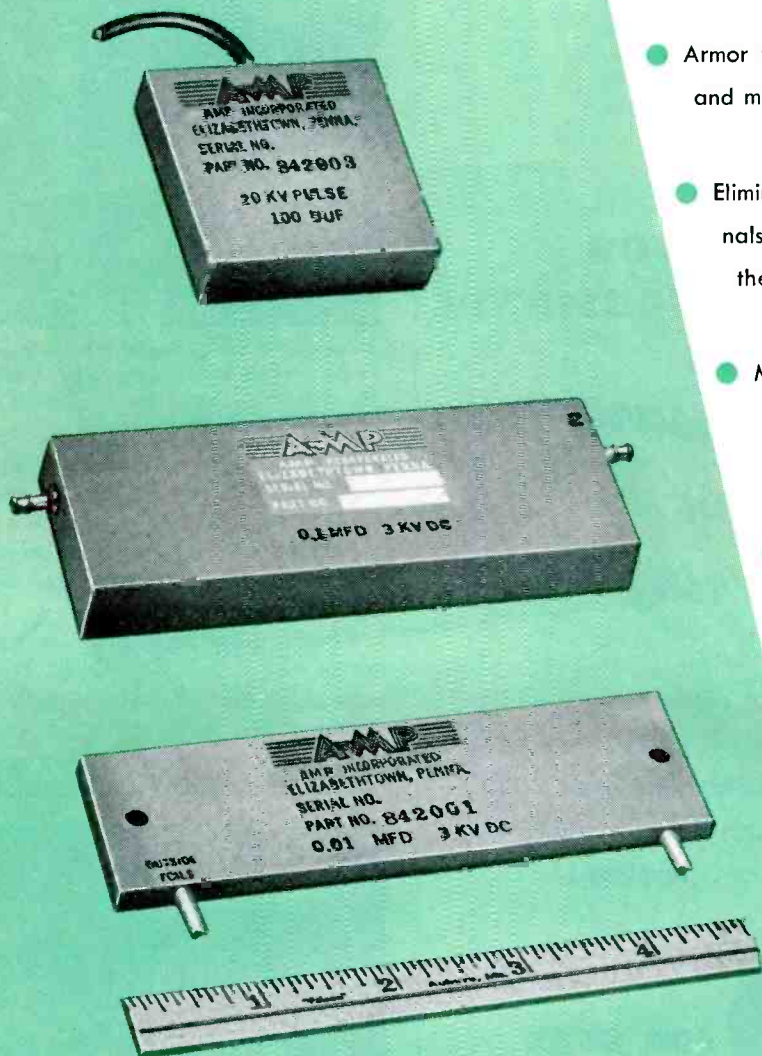

- Armor type encapsulation to resist extreme thermal and mechanical shock;
- Eliminates high altitude flash-over, as metal terminals are not exposed . . . they are enclosed within the armored encasement;
- Multiple connections to capacitor leads can be made with little or no increase in the overall size of the capacitor itself;
- The use of Ampli-FILM<sup>®</sup> dielectric in this new Capatron<sup>®</sup> Armored Wafer Capacitor provides stability, reliability, long life and the adaptability of unusual shapes to your design requirements;
- Versatility of design eliminates the necessity of revamping design of assembly to accommodate the capacitor.

# AMP<sup>®</sup>

**AMP INCORPORATED**  
**CHEMICAL AND DIELECTRIC DIVISION**  
**155 Park Street, Elizabethtown, Pennsylvania**

Wholly Owned Subsidiaries: Aircraft-Marine Products of Canada Ltd., Toronto, Canada • Aircraft-Marine Products (Great Britain) Ltd., London, England • Societe AMP de France, Le Pre St. Gervais, Seine, France • AMP—Holland N.V. 's-Hertogenbosch, Holland.  
Japanese Distributor: Oriental Terminal Products Co., Ltd., Tokyo, Japan.

be "CABLE WISE"...  
put your eggs in ONE basket

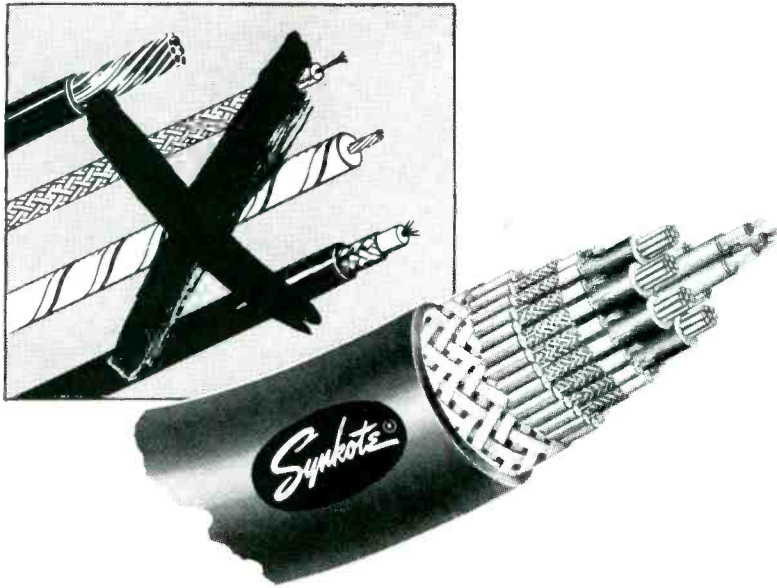

**A SINGLE MULTI-CONDUCTOR  
MAKES ELECTRICAL PERFORMANCE  
FAILURES MORE REMOTE**

*By Eliminating exposure...  
Avoiding friction...  
Simplifying wiring runs!*

Specify SYNKOTE engineered cable of  
"guaranteed-to-specifications" quality and performance.  
Be assured of long-life reliability under many of the  
adverse conditions which may cause breakdowns where  
a multiplicity of separate conductors is employed.

Specify **Synkote®**  
ENGINEERED  
WIRE and CABLE **FOR SURE  
PERFORMANCE**

**PLASTOID**  
Corporation

Plant: HAMBURG, N. J. • Offices: 42-61 24th St., Long Island City 1, N. Y.

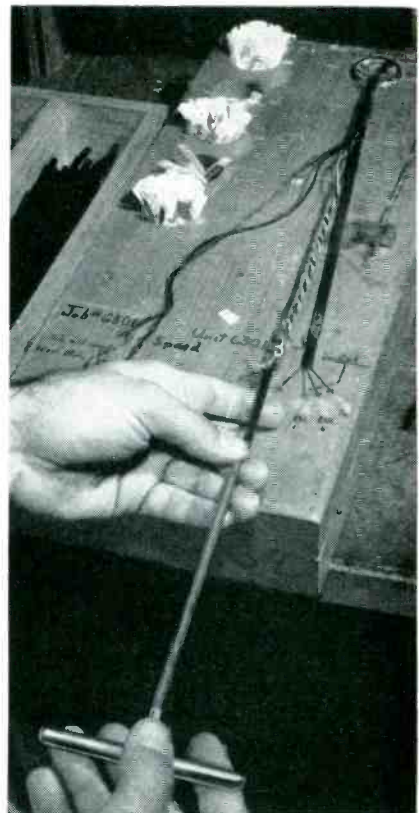

Method of using T-handled needle to pull leads through vinyl tubing. Drilled holes in assembly board hold identifying Speedy Mark labels for leads

handle of the tool the distance required to give the desired number of twists. In addition to electrical benefits, twisting makes it easier to pull the leads through insulating tubing.

Vinyl-Fiberglas tubing is used extensively for synchro leads because it has proved appreciably cheaper in installed cost than taping of leads. The tubing used is one size smaller than actually

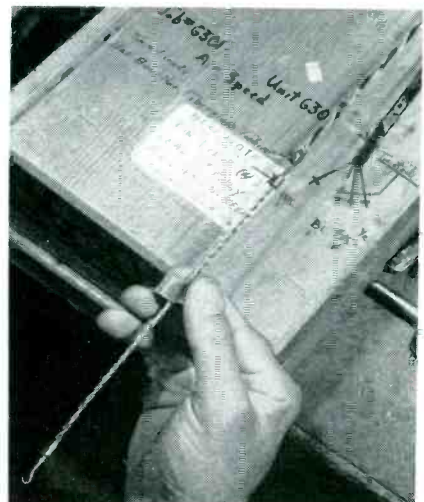

Eye of needle used for pulling leads of control transformer through vinyl tubing



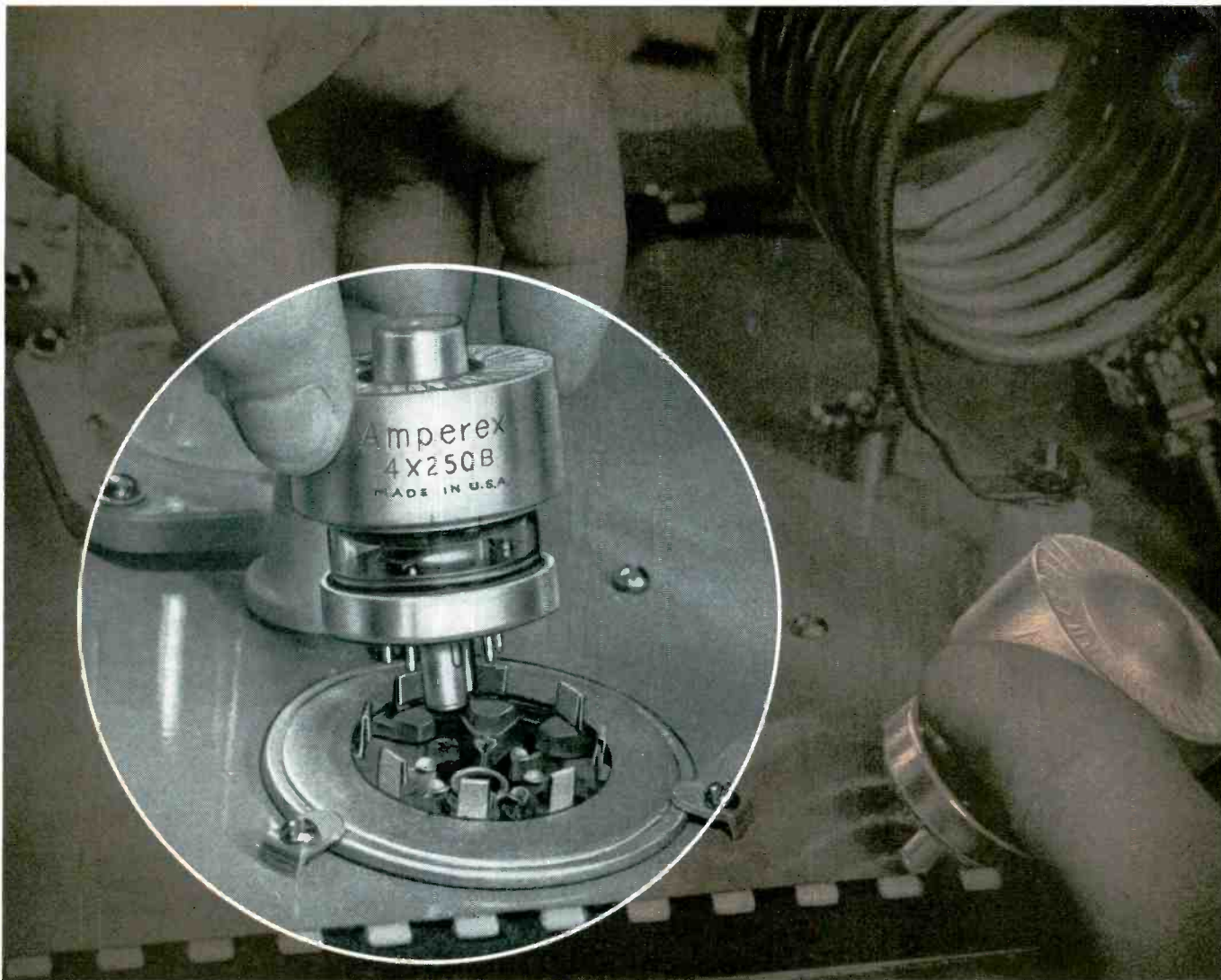

If it's a 4X250B by **Amperex**...you know it's  
**interchangeable**  
 electrically and physically with the 4X150A!

**Amperex TYPE 4X250B AS R-F  
 POWER AMPLIFIER OR OSCILLATOR**

Class C Telephony or FM Telephony  
 (key-down conditions, per tube)

**MAXIMUM RATINGS**

DC Plate Voltage.....	2000 volts
DC Screen Voltage.....	300 volts
DC Grid Voltage.....	-250 volts
DC Plate Current.....	250 ma
Plate Dissipation.....	250 watts
Screen Dissipation.....	12 watts
Grid Dissipation.....	2 watts

**TYPICAL OPERATION**

DC Plate Voltage.....	500	1000	1500	2000 volts
DC Screen Voltage.....	250	250	250	250 volts
DC Grid Voltage.....	-90	-90	-90	-90 volts
DC Plate Current.....	250	250	250	250 ma
DC Screen Current.....	45	35	30	25 ma
DC Grid Current.....	32	28	28	27 ma
Peak RF Grid Voltage (approx.).....	118	116	116	115 volts
Driving Power.....	3.6	3.2	3.2	2.8 watts
Plate Power Input.....	125	250	375	500 watts
Plate Power Output.....	85	195	300	410 watts

The 4X250B has numerous applications as a replacement, in existing circuits, for the 4X150A, where longer life and additional plate dissipation up to 500 Mc are required. It is therefore imperative that the brand of 4X250B you choose be an *exact* plug-in replacement for the 4X150A — meaning the identical base, identical dimensions, identical electrode inductances and identical inter-electrode capacitances. With the AMPEREX 4X250B you can be certain of getting just that — *total* electrical and physical interchangeability!



Write for Detailed Data Sheets

**Amperex ELECTRONIC CORP.**

230 Duffy Avenue, Hicksville, Long Island, N. Y.

In Canada: Rogers Electronic Tubes and Components  
 11-19 Brentcliffe Road, Leaside, Toronto 17, Ont.

# MARS outstanding design SERIES

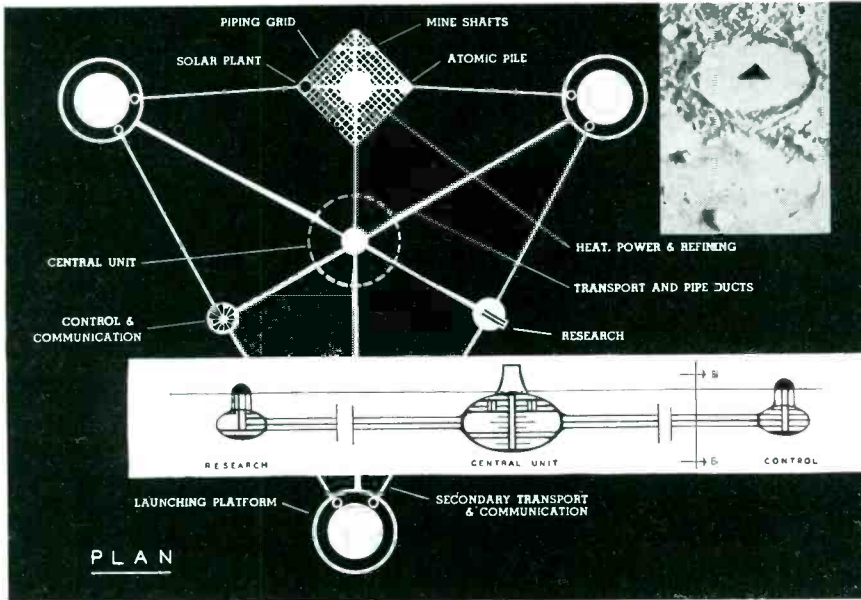

## lunar base

Tomorrow's realities depend on research and imagination today. Both were used extensively in the planning of this lunar base designed by William G. Harvey, Jr. to accommodate space ships and travelers. The suggested location is "Aristotle," one of the craters near the north pole of the moon. Most of the base is beneath ground level to minimize temperature changes. Living quarters are spacious and recreational facilities include a swimming pool and basketball court. Power is supplied by solar plants during the day and atomic pile at night. Research, living and working areas are joined by monorail subway.

No one can be sure which of today's new ideas will become reality tomorrow. But it will be important then, as it is now, to use the best of tools when pencil and paper translate a dream into a project. And then, as now, there will be no finer tool than Mars—from sketch to working drawing.

Mars has long been the standard of professionals. To the famous line of Mars-Technico push-button holders and leads, Mars-Lumograph pencils, and Tradition-Aquarell painting pencils, have recently been added these new products: the Mars Pocket-Technico for field use; the efficient Mars lead sharpener and "Draftsman's" Pencil Sharpener with the adjustable point-length feature; and—last but not least—the Mars-Lumochrom, the new colored drafting pencil which offers revolutionary drafting advantages. The fact that it blueprints perfectly is just one of its many important features.

The 2886 Mars-Lumograph drawing pencil, 19 degrees, EXEXB to 9H. The 1001 Mars-Technico push-button lead holder, 1904 Mars-Lumograph imported leads, 18 degrees, EXB to 9H. Mars-Lumochrom colored drafting pencil, 24 colors.



**J.S. STAEDTLER, INC.**  
HACKENSACK, NEW JERSEY

at all good engineering and drawing material suppliers



Screwdriver-handled version of needle is used here for pulling additional leads through short length of vinyl tubing during modification of completed harness

needed. All leads are pulled through at once, using a long steel needle having a T-shaped handle. The tubing is pushed over the needle, and stripped ends of the wires are inserted in the eye of the needle and bent back. The wires are then pulled through the tubing.

Another advantage of tubing is that changes can be made without untying or untaping. Undesired leads can be readily pulled out of the tubing and additional leads can be added with the needle tool because of the flexibility of the tubing.

## Ultrasonic Soldering of Silicon and Germanium

FLUXLESS ULTRASONIC soldering of silicon and germanium for diodes and transistors provides adherent electrical contacts to these heretofore troublesome metals. When fluxes are used to achieve such contacts, it becomes difficult to achieve the desired low joint resistance due to flux interference.

Contacts as small as 1 millimeter in diameter, having low resistance at temperatures down to  $-196^{\circ}\text{C}$ , have been produced on silicon with a Sonobond 12-watt generator made by Aeroprojects Inc., West Chester,



For **HIGH** Insulation Resistance  
and Low Power Factor

# **AEROVOX** Polystyrene Capacitors are wound with

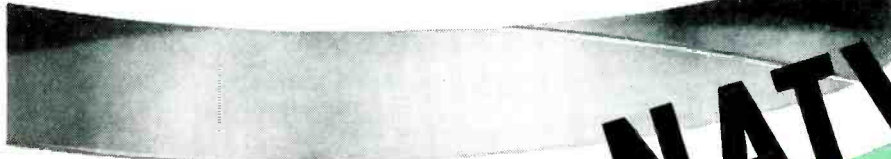

# **NATVAR Styroflex**®

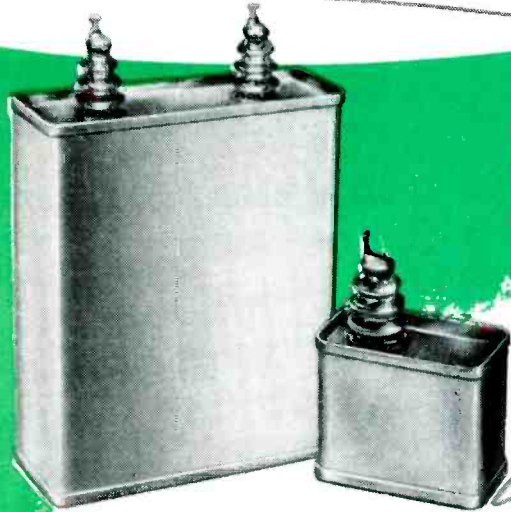

Aerovox Polystyrene Capacitors are designed for applications where stability and low dielectric absorption are essential—such as computing devices, tuned circuits demanding highest Q standards, capacitance bridges, and laboratory standards. They are available in many case styles and in capacities from 0.001 mfd to 25. mfd. and in voltage ratings from 100 VDC to 1600 VDC.

**A**ERVOX Corporation, with ten plants from coast to coast, have been manufacturing capacitors since 1922. As leaders in the field, they have been quick to take advantage of new and better materials, and to anticipate the demands of the fastest growing industry—electronics.

They use Natvar Styroflex because it has all of the outstanding properties of polystyrene, plus complete flexibility, toughness and uniformity.

Natvar Styroflex is available in standard thicknesses from .0004" to .006" in rolls from 1/2" to approximately 10" in width. Ask for data sheet St-1.



### **Natvar Products**

- Varnished cambric—cloth and tape
- Varnished canvas and duck
- Varnished silk and special rayon
- Varnished—Silicone coated Fiberglas
- Varnished papers—rope and kraft
- Slot cell combinations, Aboglas®
- Isoglas® sheet, tape, tubing and sleeving
- Vinyl coated and varnished tubing and sleeving
- Extruded vinyl tubing and tape
- Styroflex® flexible polystyrene tape
- Extruded identification markers

Ask for Catalog No. 23

## **NATVAR CORPORATION**

FORMERLY THE NATIONAL VARNISHED PRODUCTS CORPORATION  
TELEPHONE  
FULTON 8-8800  
CABLE ADDRESS  
NATVAR: RAHWAY, N. J.  
201 RANDOLPH AVENUE • WOODBRIDGE, NEW JERSEY

**ENGINEERS, *Electronic & Mechanical*  
PHYSICISTS:**

**Melpar's Dynamic Growth Creates  
UNCOMMON  
OPPORTUNITIES**

Melpar has doubled in size every 24 months during the past 11 years. This continuous growth, combined with our policy of individual recognition and organization into small project teams, creates opportunities uncommon to the industry.

As a Melpar staff member you will benefit from our policy of *individual recognition*, which means that your rate of advancement is determined solely by your skill and ability.

Our technical staff is organized into *small project teams*, each of which is assigned a specific problem and responsibility to carry through from conception to completion of prototype. Following a problem through research, design, development, and testing will give you the diversified background necessary to occupy high managerial positions.

In addition, the project team system gives more freedom to your creative talents and enables us to quickly recognize your achievements. These factors should be of particular interest to the engineer or physicist stymied by the complexity of a larger company.

Our ultra-modern laboratory is located on a 44-acre wooded tract in Fairfax County, Virginia. Here you can enjoy a relaxed suburban life with a full quota of golf, sailing, riding and other sports. The Nation's Capital with its renowned cultural and educational advantages is 10 miles away. Attractive housing is available traffic-free minutes from the laboratory.

- \* Complete company benefit program including financial assistance for study.
- \* Liberal travel and moving allowances.
- \* Qualified applicants will be invited to inspect the Laboratory at Company expense.

**OPENINGS EXIST IN THESE FIELDS:**

Flight Simulators. Radar and Countermeasures. Network Theory. Systems Evaluation. Microwave Techniques. Analog & Digital Computers. Magnetic Tape Handling. UHF, VHF, or SHF Receivers. Packaging Electronic Equipment. Pulse Circuitry. Microwave Filters. Servo-mechanisms. Subminiaturization. Electro-Mechanical Design. Small Mechanisms. Quality Control & Test Engineering. Field Engineering. Antenna Design.



For Detailed Information, write:  
Technical Personnel Representative

**MELPAR Incorporated**

*A Subsidiary of Westinghouse Air Brake Company*  
3038 Arlington Boulevard, Falls Church, Va.  
10 miles from Washington, D.C.



Soldering silicon disk with 12-watt ultrasonic unit. Heat is provided by electric hot plate

Pa. In addition, small or thin wafers of these metals can be tinned or soldered to tinned copper wire for transistor work without damage from ultrasonic vibration.

**Wire Holder on Nippers**

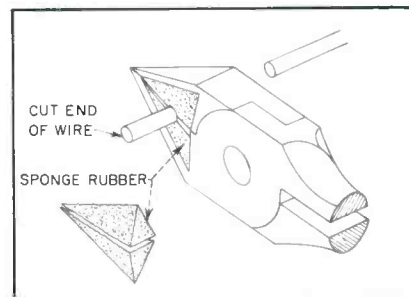

Triangular blocks of sponge rubber cemented inside jaws of cutting pliers hold cut end of wire

TRIANGULAR PIECES of sponge rubber cemented to the jaws of diagonal wire cutters hold cut bits of wire, to prevent the pieces from dropping into a chassis. The sponge rubber pieces can be cut from gasketing or from an ordinary household rubber sponge. Rubber cement or almost any household cement can be used for anchoring the pieces since there is little force exerted on them.







**Etching Klystron Grids**

MICROSCOPIC GRIDS for miniature klystron tubes are manufactured in an ingenious process by Varian Associates, Palo Alto, Calif.

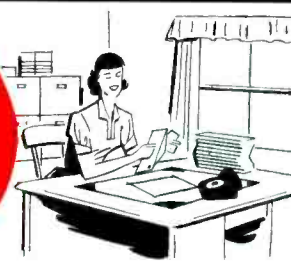
Briefly, the process involves bundling of 23 copper-coated aluminum wires within copper tubing, drawing down the tube until the bundle reaches the desired diameter and the wires assume a

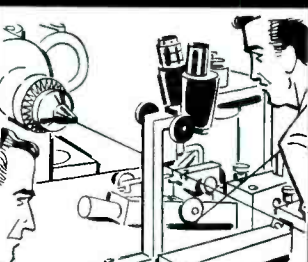
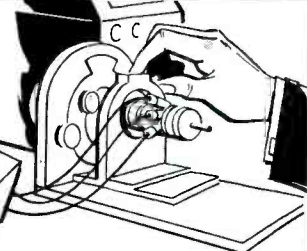

**AVOID  
PROTOTYPE DELAYS!  
SPECTROL  
takes only 10 DAYS!**

 <p><b>MON 1</b> Spectrol's prototype facility goes into high gear the moment your order is received.</p>	 <p><b>TUES 2</b> Design experts analyze the special features of your potentiometer specifications.</p>
 <p><b>WED 3</b> Prototype development engineers determine the best answer to your special problem.</p>	 <p><b>THURS 4</b> There's as much preparation for prototype orders of 1 to 10 as there is for runs of 10,000.</p>
 <p><b>FRI 5</b> Project engineer supervises production in Spectrol's special prototype model shop.</p>	 <p><b>MON 6</b> Coils are specially made on Spectrol's hi-precision winding equipment.</p>
 <p><b>TUES 7</b> Assembly takes place in Spectrol's dust-free conditioned-air laboratory.</p>	 <p><b>WED 8</b> Your finished prototype checks-out on complete test equipment of finest caliber.</p>
 <p><b>THURS 9</b> Proves itself against your special electrical, physical, and environmental specifications.</p>	 <p>Then your potentiometer (from order to reality) is delivered to you — in 10 days! <b>FRI 10</b></p>

**SPECTROL IS FIRST TO MEET  
INDUSTRY'S FAST PROTOTYPE DEMANDS**

Even though Spectrol's regular 30 to 45 day delivery is only half the time you often wait for a prototype potentiometer—we now offer special service to meet urgent needs with 10 day delivery from our new prototype development center. And (just as important) Spectrol backs this unprecedented service with dependable delivery against your follow-up production-run orders in 30 days.

That means, with Spectrol you can actually be in production long before you would receive your first prototype elsewhere. Remember Spectrol—for any of your potentiometer requirements—standard or special!

**A COMPLETE LINE OF PRECISION POTENTIOMETERS**



Single-turn



Multi-turn



Miniature

**SPECTROL**

**SPECTROL ELECTRONICS**

DIVISION OF CARRIER CORPORATION  
1704 South Del Mar, San Gabriel, Calif.

**ALBUQUERQUE**  
BROOKS, FEEGER & MORROW  
**BALTIMORE**  
SAMUEL K. MACDONALD, INC.  
**BELMONT, CALIFORNIA**  
GERALD B. MILLER COMPANY  
**BROOKLINE, MASS.**  
GERBER SALES COMPANY

**CEDAR RAPIDS**  
JERRY VRBIK  
**CHICAGO**  
KNOBLOCK & MALONE  
**DALLAS**  
THOMSON ENGINEERING SERVICE  
**DAYTON**  
THOMCO ELECTRONICS

**DENVER**  
BROOKS, FEEGER & MORROW  
**DETROIT**  
A.B.M. SALES COMPANY  
**MINNEAPOLIS**  
FRED B. HILL COMPANY  
**NEW HAVEN**  
GERBER SALES COMPANY  
**PHILADELPHIA**  
SAMUEL K. MACDONALD, INC.

**PHOENIX**  
BROOKS, FEEGER & MORROW  
**PITTSBURGH**  
SAMUEL K. MACDONALD, INC.  
**SAN DIEGO**  
GERALD B. MILLER COMPANY  
**SEATTLE**  
SEATRONICS, INC.

**SYRACUSE**  
I. A. HOTZE  
**VALLEY STREAM, L. I., NEW YORK**  
D. R. BITTAN COMPANY  
**WASHINGTON, D. C.**  
SAMUEL K. MACDONALD, INC.  
**ROTTERDAM, HOLLAND**  
UNI-OFFICE, LTD.

**ONLY 10 DAYS TO DELIVER**



**SPECTROL POTENTIOMETER PROTOTYPES**

**Save weeks  
when every  
day counts!**

**CALL YOUR NEARBY  
SPECTROL  
REPRESENTATIVE**

... in relay systems  
check what  
**NORTH  
ELECTRIC**  
can do for you

ENGINEERING    CIRCUIT DESIGN  
COMPONENT SELECTION  
PRECISION PRODUCTION  
FABRICATION AND ASSEMBLY  
TESTING

Product developments, commercial and military, that necessitate extensive engineering and production in the areas of complex relay switching and control systems need not become expensive headaches.

Over 70 years' experience in the design, engineering, development, and manufacture of those components and component assemblies embodying relay systems, have given NORTH a wealth of background and know-how that is immediately available to you.

NORTH's specialization in this field puts at your disposal the engineering, design, and production talents of a "specialist team."

Let NORTH assist you — from the very beginning — in the design, engineering, component selection, and production of relay switching and control systems to your specifications.

INDUSTRIAL DIVISION

**NORTH ELECTRIC COMPANY**

774 SOUTH MARKET STREET • GALION, OHIO

Want more information? Use post card on last page.



hexagonal shape, slicing off disks and then etching out the aluminum to form the grid.

The job, much of it done under a microscope, calls for a high degree of skill by the workman, but techniques have been so perfected that the rejection rate is only 10 percent for 0.022-in. grids having 23 holes. Three sizes are made, the smallest with the 23 holes, another with 48 and a third with 65. The largest is the most difficult, with yield dropping to 30 percent here.

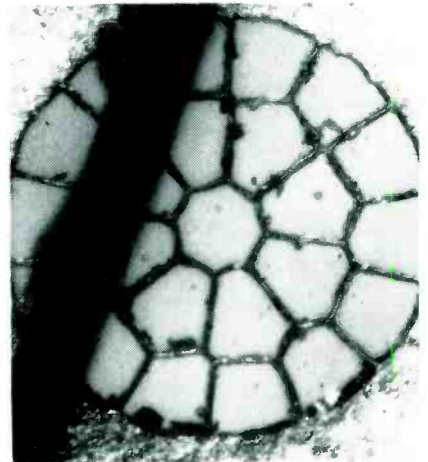

Example of smallest grid, with human hair placed across it for comparison

► **Procedure**—Step by step the operation involves:

1. Coating of 0.005-in. aluminum wire with copper to a thickness of about 0.0002 in. Wire is inspected under a microscope before coating to be sure it is clean and free of pits. The wire is then wound on a special rack to allow coating all around of  $\frac{1}{8}$ -in. lengths. The wire parts touching the rack are cut out. The coated wire is handled with great care so there will be no bumping or scratching to mar the coating.

2. Copper tubing with an inside diameter of 0.029 in. is turned out of solid bar stock and cut into lengths of about  $\frac{1}{8}$  in., then  $\frac{1}{16}$  in. of the inside of one end of the tube is threaded so that it can be screwed onto a piece of bar stock for handling in the drawing operation.

3. In placing the wires in the tube, three sizes of tubes are used. Wires first are put into a relatively large tube one by one, with care taken so they lie parallel to one an-



# New Sperry transponder tubes for missiles and jets offer high signal stability

**High-output SOC-150 and SOU-201 klystron oscillators resist shock, vibration, wide temperature swings**

**NOW AVAILABLE**, these new Sperry klystron oscillators were specially designed to withstand the severe environmental stresses generated in high-speed jet aircraft and guided missiles. Both types feature high signal stability and output power. Yet dimensions are held to the compact size required in radar guidance systems designed for the newest missiles. Each individual tube is tested to the extremes of shock and vibration encountered in these applications. Write for application data on the SOC-150 and SOU-201 as well as similar tubes for other frequency bands.

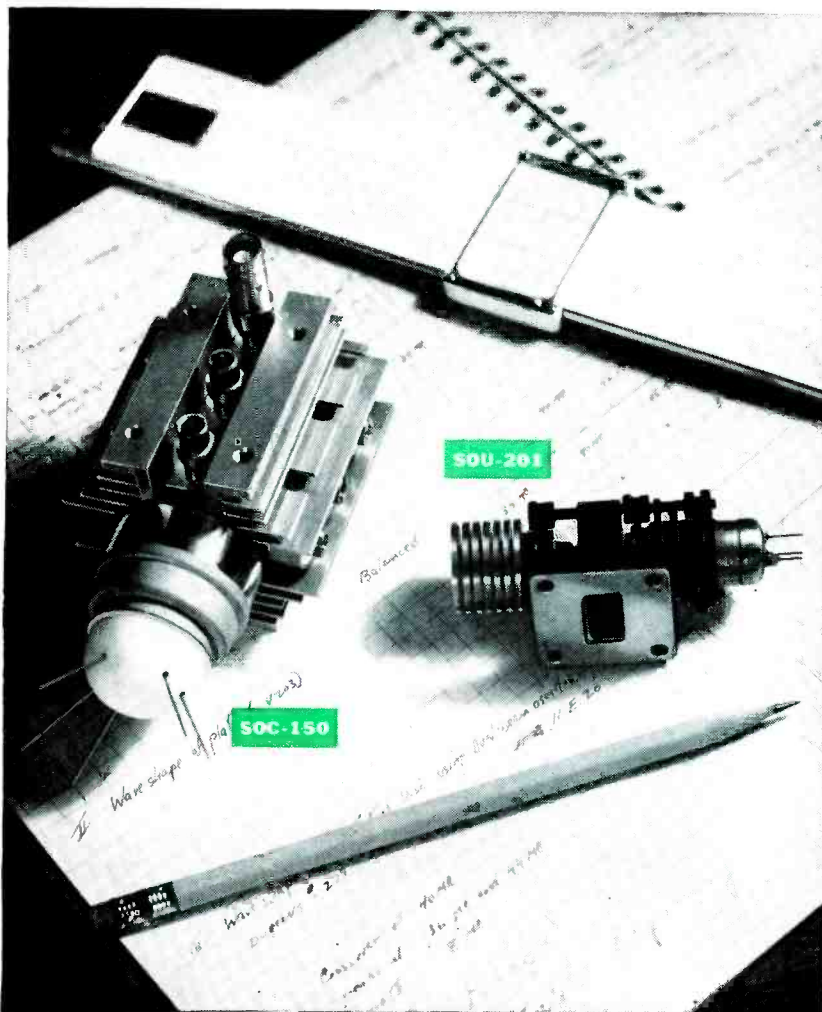

## SOC-150

Two-resonator oscillator easily frequency modulated over a frequency range centered as specified by the customer. Symmetrical mode tuned for operation at high ambient and wide temperature extremes.

Frequency . . . . . C-band  
Beam voltage . . . . . 1000  
Beam current . . . . . 150 ma  
Heater voltage . . . . . 6.3 v  
Heater current . . . . . .8 a  
Power output . . . . . 10 w  
Weight . . . . . 18 oz  
Dimensions . . . . . 4 3/4" x 4 1/16" x 4"

## SOU-201

Two-resonator oscillator of block construction with internal feedback for ruggedness and fast warmup. Short tuning struts. Built to comply with MIL5272A. Tuned by varying resonator gap capacity through semi-flexible diaphragm.

Frequency . . . . . 13.5 ± 0.1 kmc  
Beam voltage . . . . . 1600  
Beam current . . . . . 128 ma  
Heater voltage . . . . . 6.3 v  
Heater current . . . . . 1.5 a  
Power output . . . . . 15 w  
Weight . . . . . 8 oz  
Dimensions . . . . . 3 1/2" x 1 3/8" x 1 3/8"

**ELECTRONIC TUBE DIVISION**  
**SPERRY GYROSCOPE COMPANY**  
Great Neck, New York

DIVISION OF SPERRY RAND CORPORATION  
BROOKLYN • CLEVELAND • NEW ORLEANS • LOS ANGELES  
SEATTLE • SAN FRANCISCO. IN CANADA: SPERRY GYROSCOPE  
COMPANY OF CANADA, LTD., MONTREAL, QUEBEC

**always  
the leader  
— all ways**

**Engineered Economy\* Iron Cores  
originated by  
Radio Cores, Inc.**

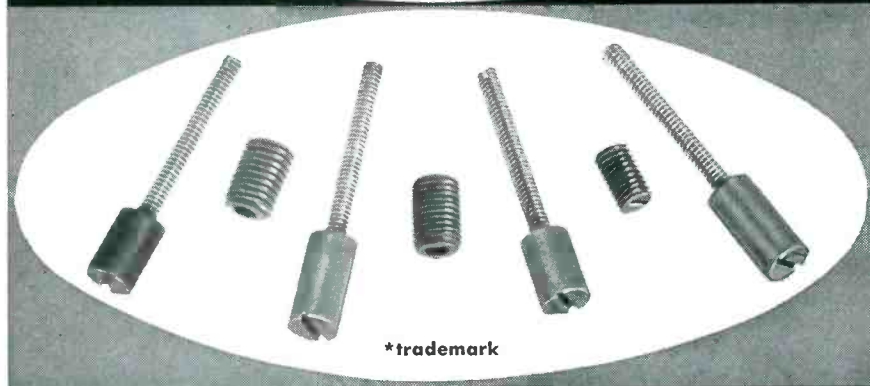

\*trademark

**★ the leader in quality**  
**★ the leader in price    ★ the leader in engineering**  
**★ the leader in volume    ★ the leader in design**

Just a few short years ago, Iron Cores cost over 100% more than at the present time. This has been achieved by the creation of our line of ENGINEERED ECONOMY\* IRON CORES which enables us to reduce the amount of your minimum inventory through guaranteed immediate delivery service . . . this has been achieved by the new use of automation which enables us to cut costs and pass these savings on to you . . . this has been achieved by more efficient production methods, which reduce processing and material costs which again means savings to you.

Now, you can select from over 19 types of ENGINEERED ECONOMY\* IRON CORES which do the job of over 100 types . . . custom-made cores at stock prices. We invite your inquiry.  
**Also, custom iron cores to your specifications.**

**Radio Cores, Inc.**  
 9540 Tully Avenue Oak Lawn, Illinois

Copyright 1956  
Radio Cores, Inc.

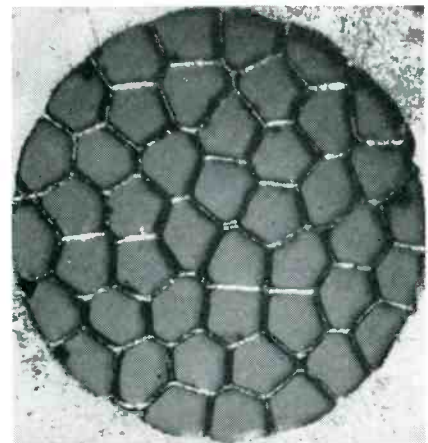

Example of 48-hole grid in finished form, 0.032 in. in diameter and 0.002 in. high

other with no spiraling. They are then put into a slightly smaller tube in preparation for fitting into the final tube.

The tube is then drawn by hydraulic press through 24 dies, with inside diameter decreasing from 0.154 in. to 0.131 in. During this process, space between the wires is eliminated and the wires assume a hexagonal shape.

5. Slices 0.003 in. thick are sawed off the drawn tube with a slitting saw on a milling machine, then placed on a flat plate for hand lapping with fine polishing paper to 0.0015 in. thickness.

6. Aluminum is etched out of the disk with a hydrogen peroxide solution.

7. The grid is placed on a ceramic boat and run through a hydrogen furnace at sintering temperatures to bond the copper webbing.

8. The copper grid is placed under a microscope and etched with an ammonia solution until the grid webbing is from 0.000025 to 0.00005 in. thick, judging by eyesight.

The grids are further processed when they are mounted in the high-frequency klystron tubes; the copper rim is machined down with a diamond tool in a jeweler's lathe under a binocular microscope.

**Cutting Armored Cable**

HEAVY OUTER LAYERS of insulation on multiconductor armored cable are slit lengthwise with a special knife having a curved foot that pre-



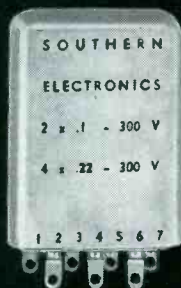

## CONDENSE AND SAVE!



Plastic condenser block capacitors save you space, labor, money!

Multiple capacitors in one block! Now you can install one capacitor case and use 125% less space than before — at a saving in labor costs of up to 300%.

Let us solve your condenser block problems. Send us your requirements. Many case sizes and configurations are available with polystyrene or MYLAR\* dielectric to tolerances as close as 1%.



now after years of intense research and development of military requirements



offers you **RC NETWORKS**

## PITCH FILTERS INTEGRATOR NETWORKS

RC NETWORK as low as ½% capacitors and ½% resistors for reliable RC value of 1%.

- Hermetically sealed and potted
- Meets exacting military specifications
- SAVES SPACE & LABOR

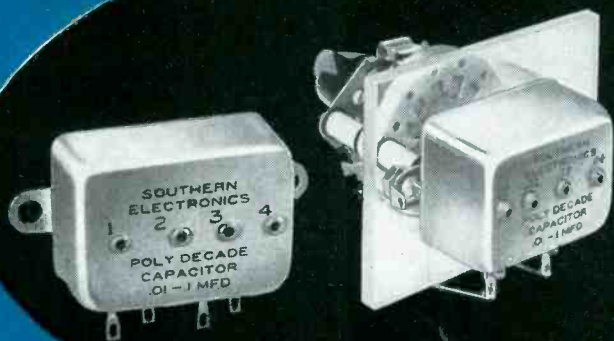

## PRECISION

**DECADE CAPACITORS** with attached rotary switch or completely boxed!

Now on special order! Decade capacitors with higher voltage ratings, closer tolerances and capacitance from .001 to 10 M.F.D. with polystyrene or MYLAR\* dielectric to tolerances as low as 1%.

### CHECK THESE OUTSTANDING FEATURES:

- Standard voltage rating . . . 200 V.D.C.
- Very high insulation resistance
- Low dissipation factor
- Low dielectric absorption
- Small sizes

**SOUTHERN  
ELECTRONICS**  
*Corporation*



For your most exacting requirements—

always specify S.E.C.

Wire, write or phone for a complete catalog today!

239 West Orange Grove Ave., Burbank, California

ENGINEERS & PHYSICISTS *Electronics*

## The Johns Hopkins University Applied Physics Laboratory

# ANNOUNCES

... important openings on our guided missile research and development staff for men who wish to identify themselves with an organization whose prime purpose is scientific advancement.

Because the Applied Physics Laboratory (APL) exists to make rapid strides in science and technology, staff members require and receive freedom to inquire, to experiment, to pursue tangential paths of thought. Such freedoms are responsible for findings that frequently touch off a chain reaction of creativity throughout the organization.

As a staff member of APL you will be encouraged to determine your own goals and to set your own working schedule. You will associate with leaders in many fields, all bent on solving problems of exceptional scope and complexity. The resources of our 350,000 sq. ft. laboratory are complemented by those of the 18 universities and industrial organizations who are working under our technical direction on prime contracts.

Equidistant between Baltimore, Md., and Washington, D. C., our new laboratory allows staff members to enjoy suburban or urban living and the rich cultural, educational and research facilities offered by both cities.

### Openings Exist In These Fields:

**ANALYSIS:** *Dynamic analysis of closed-loop control systems; analysis and synthesis of guidance systems; counter-counter-measures systems; electrical noise and interference.*

**DESIGN:** *Control and guidance circuitry; telemetering and data-processing equipment; microwave components, antennas, and radomes; transistor and magamp applications; external missile systems.*

**TEST:** *Prototype engineering and field test evaluation.*

SEND NOW FOR OUR NEW 30-PAGE PUBLICATION DESCRIBING IN DETAIL THE SCOPE OF THE LABORATORY'S PROGRAMS AND THE UNIQUE ENVIRONMENT IN WHICH STAFF MEMBERS WORK AND LIVE.

WRITE:

*Professional Staff Appointments*

The Johns Hopkins University  
APPLIED PHYSICS LABORATORY

8609 Georgia Avenue • Silver Spring, Maryland



Slitting cable armor with special knife while cable is held in vise. Cushioning material prevents vise jaws from damaging cable

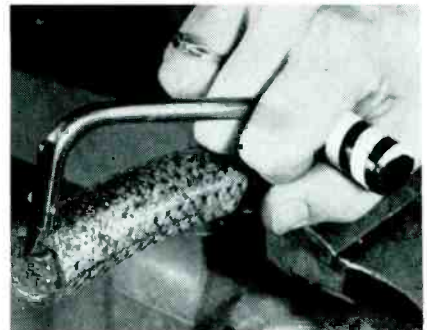

Inserting curved foot of tool under outer armor to start cut. Screw holds removable blade in position on tool

vents cutting or damaging the conductors and their braided metal shield. The blade of the tool is replaceable and is hollow-ground to provide self-cleaning for easy and fast cutting. This tool has greatly simplified preparation of terminations for large cables at Ford Instrument Co.

### Drilling Fixture

A MACHINED STEEL holding fixture for the mechanical counter of an aircraft ground position indicator permits precise drilling of the small hole required for pinning



# THE ELECTRONIC TUBE

*with*

## A "MILLION" APPLICATIONS

### NO OTHER WAY

compares with Beam Switching Tubes in these applications:

1. **COUNTERS** with
  - a. Individual output
  - b. Ability to close relays
  - c. Ability to drive thyratrons
  - d. Ability to drive Numerical Indicator 6844
  - e. Bi-directional at high speeds
2. **DISTRIBUTORS**  
(any number of positions  
random or sequential)
3. **HIGH SPEED ELECTRONIC SWITCH**  
(up to 20 Mc)
4. **CODE AND DECODING GENERATOR**  
(Teletype — Beacon Transponder)
5. **FREQUENCY DIVIDING**  
Variable frequency input Sine Wave or Pulses (Radar timing)
6. **TELEMETERING "TRANSFER-STORAGE"**  
Ability to transfer count from Counter Beam Switching Tubes to Storage Beam Switching Tubes at High Speeds for Direct Readout or Recording Purposes.
7. **INDUSTRIAL CONTROL PROGRAMMING**  
Pulse input, relay, and Nixie output

- Shock 375 g
- Temperature  $-60^{\circ}$  to  $+150^{\circ}\text{C}$
- Vibration 20 g
- Speed up to 20 mc
- Life up to 50,000 hours
- Power minimum input — useful output
- Cost Beam Switching Tube can replace as many as 20 or more tubes or transistors

The Beam Switching Tube is a 10-position high vacuum electronic distributor with high input impedance and ten individual constant current outputs.

Type 6700 75 - 300 v operation  
Type 6701 12 - 25 v operation

LIFE TESTS INDICATE A  
LIFE SPAN OF 50,000 HOURS.

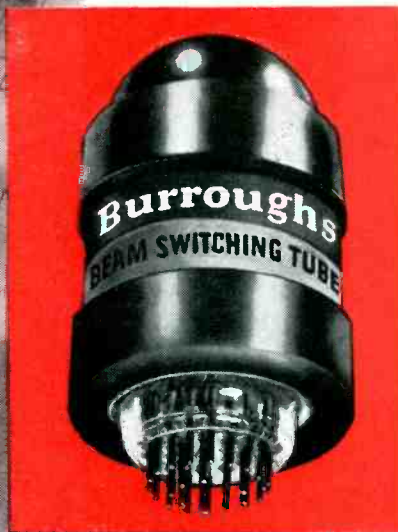

For further information write . . .

## Electronic Tube Division

**B**  
BURROUGHS CORPORATION  
Plainfield, New Jersey

# NEW!

## BRISTOL remote positioning system has inherent fail-safety

The new Bristol Model 702 Remote Positioning System consists basically of a transmitter, amplifier, and receiver available in an extremely large number of variations representing the *biggest selection of components and options* available in any such system. The key features: **High basic reliability** is built into the Bristol Remote Positioning System through:

1. The use of premium quality parts
2. The liberal application of safety factors in electrical and mechanical design
3. The avoidance of critical value requirements (to reduce aging and drift failures)
4. Complete environmental and quality control testing.

**Inherent fail-safety:** While the Bristol Remote Positioning System is as reliable as it is possible to make it, in addition, it is designed for fail-safe operation to give you the surest, safest positioning system available. In the event of breaking, short circuiting, grounding, or any combination of these in the wires connecting the major components, or in the event of any statistically reasonable failure or combination of failures of any parts in the amplifier, the system will either continue to give a satisfactory degree of control, or the output shaft will remain in position. This fail-safety is built-in—not produced by auxiliary devices.

**Accuracy is independent of load.**

**Operates from rotary or linear input;** provides rotary or linear output. Any combination of input and output types can be used.

**Power supply options**—Amplifier and receiver power supplies need not be identical. Amplifier requires a single power supply—400 cps—low power drain—15 va. Receiver may operate on practically any available supply—a-c or d-c.

**Wide variety of options**—includes manual and transducer transmitters in many forms—manual over-ride provisions— inching control—and remote position indication—are only a few of the available options.

Write for complete data. The Bristol Company, 152 Bristol Road, Waterbury 20, Conn. 6.85

# BRISTOL

FINE PRECISION INSTRUMENTS  
FOR OVER 68 YEARS

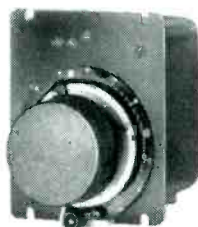

TYPICAL TRANSMITTER



AMPLIFIER AND RACK

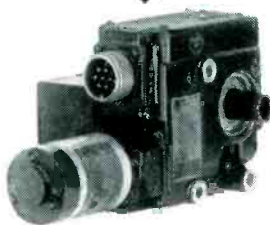

TYPICAL RECEIVER

### IT'S IDEAL

for airborne applications like power plant control, secondary flight-control surfaces, propeller pitch control, valve operation, and nose-wheel steering, and also for ground uses like engine test cell controls and remote manipulation of apparatus in radioactive locations.



Universal holding fixture provides support and correct angles for many drilling operations on counter at Ford Instrument Co.

the counter shaft to its hanger bracket. After drilling one hole the counter is reversed on the fixture to drill the hole on the other shaft.

Drill breakage is minimized by using a small but high-precision

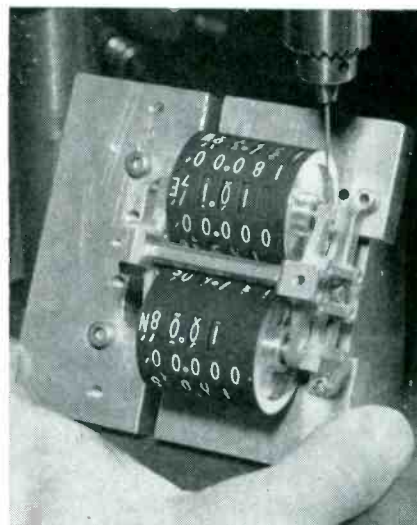

Setup for drilling shaft pin hole

variable-speed bench drill made by Electro-Mechano, Milwaukee. This is easily adjusted from 1,000 to 10,000 rpm by moving a lever over a calibrated spindle speed scale.

## Soldering Aluminum Coils

LEADS of aluminum-wire voice coils are tinned in less than 3 seconds at Wharfedale Wireless Works in England by dipping in a small bath of molten solder agitated by ultrasonic energy. A cavitation effect in the solder removes the oxide film from the aluminum. The tinned



The new  
**DYNASERT**

**#3 Component  
Inserting  
Machine**

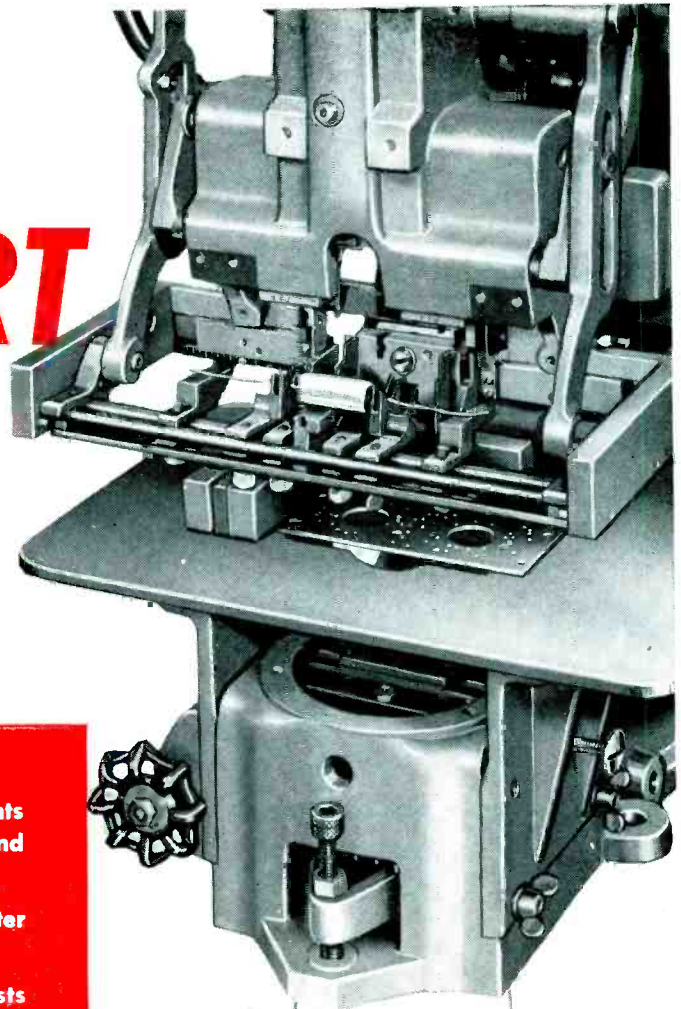

- ☆ Takes axial lead components in broad range of sizes and shapes
- ☆ Handles bent or off-center leads
- ☆ Cuts assembly time and costs — improves reliability

Machine cuts component leads, forms them into a staple shape, inserts them into holes in your wiring boards and clinches in one operation. Up to 700 insertions per hour can be made on average size board.

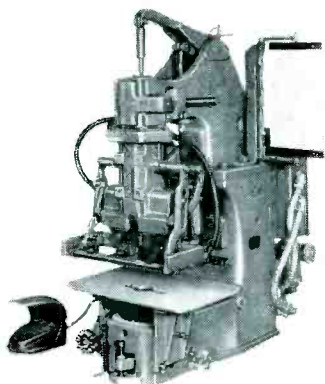
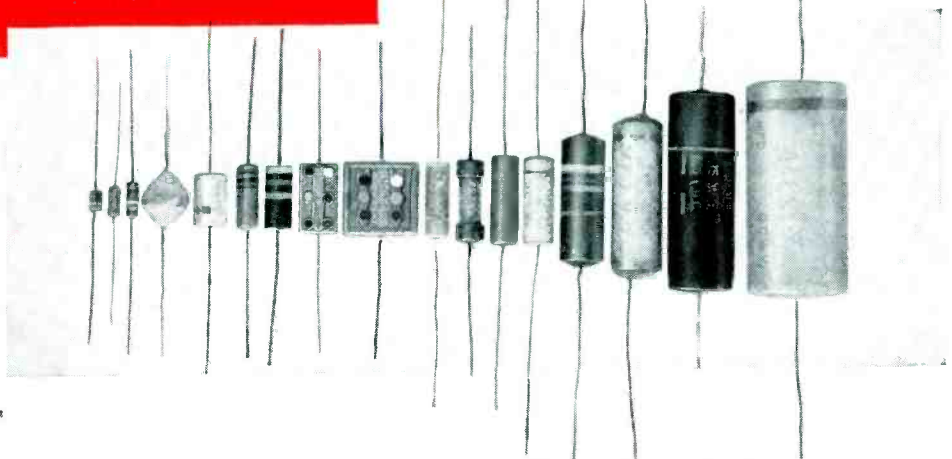

Here's a brand new machine for inserting components in printed wiring boards. It's so advanced in adaptability and performance reliability that it gives new meaning to mechanized assembly.

This machine eliminates normal requirements for straight or centered

leads, special packaging or preparation. It is economical for use on short runs; new set-ups are quickly made by simple adjustments or slip-in tooling.

Available either for individual bench operation or as a unit in fully automated conveyorized assembly lines. For full information write:

INDUSTRIAL SALES DIVISION

**United**

**SHOE MACHINERY CORPORATION**

140 FEDERAL STREET, BOSTON, MASS.

PRODUCTION EQUIPMENT FOR ELECTRONICS

*When speed is measured in  
mach numbers the new*

# WALTHAM VERTICAL GYRO

*operates faster,  
more accurately*

Enables fire control systems  
to "think" more clearly



The high reliability characteristics of the Waltham vertical gyro make it the logical choice of the systems manufacturer. Especially significant is the faster erection rate, for normal operational use or for a super-fast initial or in-flight erection cycle. Equally important is the longer operating life...and lower maintenance costs. Shock-resistant, vibration-resistant, hermetically sealed, this unit meets all military environmental conditions.

## PERFORMANCE

**VERTICAL REPEATABILITY:** To within 10 minutes of arc cone.

**INITIAL-ERECTION (Super-Fast):** From any standing position at any temperature from  $-55^{\circ}\text{C}$  to  $+71^{\circ}\text{C}$  to within  $\pm 30$  minutes of arc of Vertical within 25 seconds after application of power.

**IN-FLIGHT ERECTION (Super-Fast):** Roll  $180^{\circ}$ /minute minimum. Pitch  $200^{\circ}$ /minute minimum.

**NORMAL ERECTION:**  $5^{\circ}$ /minute  $\pm 1^{\circ}$ /minute.

**FREE DRIFT:** Roll,  $0.3^{\circ}$ /minute for any Pitch angle from  $+60^{\circ}$  to  $-60^{\circ}$ . Pitch,  $0.3^{\circ}$ /minute for any roll angle.

**OPERATING LIFE:** 1000 hours minimum.

**SHELF LIFE:** 5 years.

Send today for engineering specifications and drawings. Facilities are also available to manufacture precision mechanical and electro-mechanical assemblies to your specifications.

*Precision has been our business since 1850*

INSTRUMENT AND INDUSTRIAL PRODUCTS DIVISION  
**WALTHAM WATCH COMPANY**  
**WALTHAM 54, MASS.**

wires can then be soldered conventionally. A solder compound of 90 percent tin and 10 percent zinc is used in the bath at a temperature of about  $450^{\circ}\text{F}$  with a dip time of 2 to 3 seconds. The Mullard ultrasonic solder pot and generator used here maintain the ultrasonic energy at the optimum frequency for maximum soldering efficiency.

## Packaging Diodes for Bridge Rectifier

PARALLELING OF DIODES and hermetic sealing in transformer oil permit a ten-times reduction in size for a specified current-carrying capacity in one unit of an electronic camera control system made for the Air Force by Bill Jack Scientific Instrument Co., Solana Beach, Calif. Engineering special-

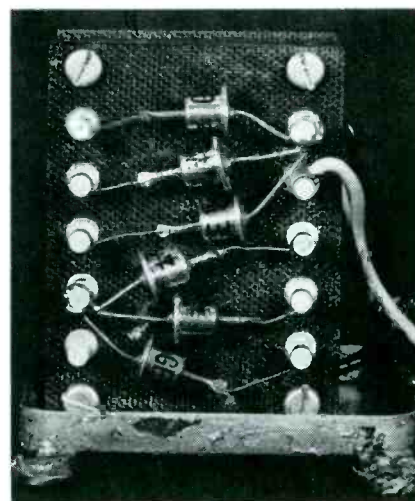

Method of mounting paralleled diodes for hermetic sealing

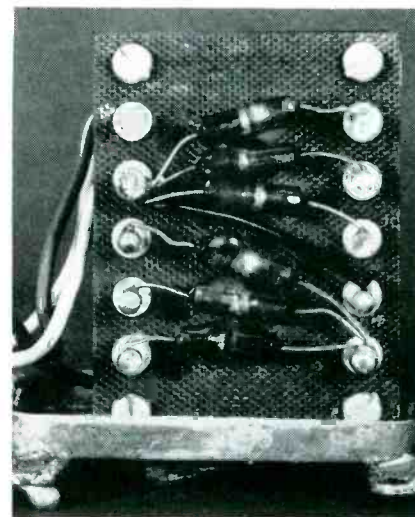

Current-equalizing series resistors at back of board



**Now...an accomplishment so far reaching it will change the sights of all rectifier users**

**RADIO RECEPTOR'S improved new vacuum process**

**\* PETTI-SEL**

*\* High Current Density*  
**Industrial type SELENIUM RECTIFIERS**

*Developed by the famous Siemens Organization of West Germany and now manufactured by Radio Receptor Co. in the U. S. A.*

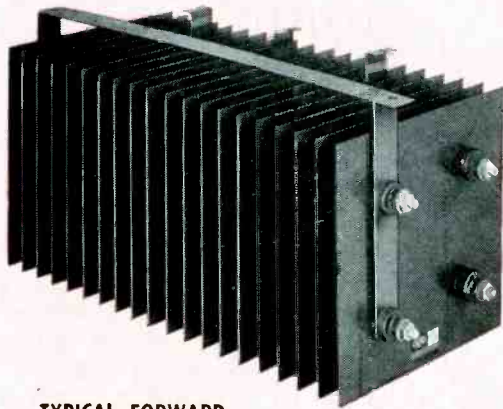

**Estimated life 100,000 hours**

**Much smaller cell sizes than conventional units of the same ratings**

**Lower forward voltage drop**

**Suitable for high temperature applications**

**TYPICAL FORWARD CHARACTERISTICS**

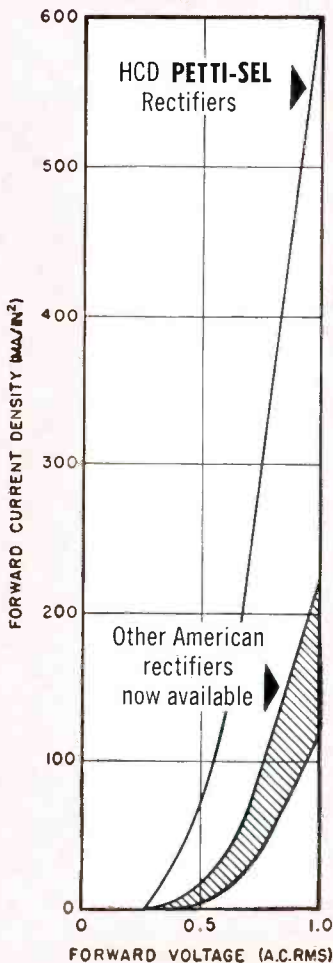

Far smaller in size than other rectifiers of the same current ratings, the new Radio Receptor HCD Petti-Sel units are manufactured under laboratory controlled conditions with fully automatic machinery, assuring new standards of product uniformity.

Field experience extending over several years with these rectifiers indicates an estimated life of 100,000 hours. This is largely attributable to the special process requiring no artificial barrier layer. Low forward voltage drop and low aging rate make the new Petti-Sel Rectifiers applicable to magnetic amplifiers and other control applications.

**TYPICAL AGING CHARACTERISTIC**

Cell size 4" x 4", single phase bridge (4-5-1-B) operated at 130 volts AC input, 8 amperes DC output current, resistive load, 35° C ambient temperature.

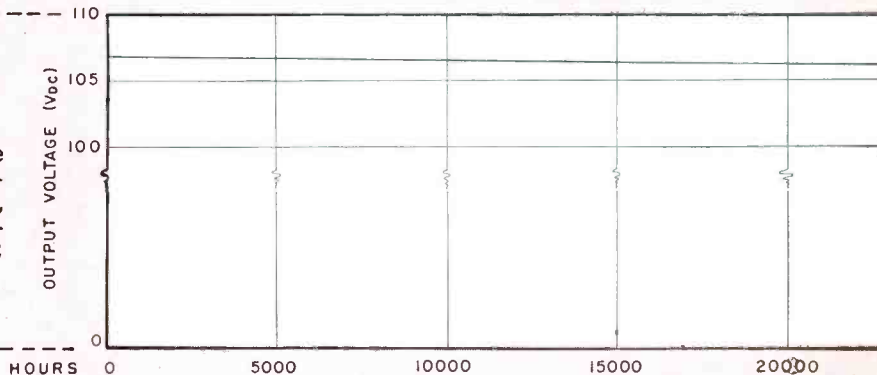

Watch for further announcements of unique developments on these history-making rectifiers. If you would like our new bulletin as soon as it is available, write today to Section E-4R.

*Semiconductor Division*

**RADIO RECEPTOR COMPANY, INC.**

*Radio and Electronic Products Since 1922*

240 Wythe Avenue, Brooklyn 11, N. Y. • EVERgreen 8-6000

Radio Receptor Products for Industry and Government: Selenium Rectifiers • Germanium Diodes  
 Thermanon Dielectric Heating Generators & Presses • Communications, Radar & Navigation Equipment



**1460 series**  
**MOTOR OPERATED**  
Available SP2T thru SP6T—also DPDT and DP transfer. Frequencies thru 11,000 MC. AC or DC operation.



**M1460 series**  
**MANUALLY OPERATED**  
—same contact arrangement and R F head as the 1460 Series. For chassis or panel mounting.

**TRANSCO**

**COAXIAL SWITCHES**

*—they simplify design of R F systems*



**11000 series**  
**SOLENOID OPERATED**  
*Miniature - SPDT*  
HN or Type N connectors. Frequencies thru 11,000 MC. AC or DC operation. Weight 6 oz.



**14000 series**  
**SOLENOID OPERATED**  
*Miniature - SP4T*  
Weight only 12 oz. Frequencies thru 11,000 MC. Designed for wide application flexibility.

With TRANSCO switches, you can cut down the number of components in a system—one switch handles up to 6 circuits. TRANSCO switches are small, and light in weight. Each is supplied in a choice of configurations to simplify installation.

**Adds versatility to a system.** All channels on a TRANSCO can be operated independently, and there's a wide variety of make-and-break arrangements available. TRANSCO switches operate through 11,000 MC—a standardization which cuts your stocking requirements to only one switch for this entire R F band width

**High-efficiency switching** is due to minimum insertion loss, low VSWR, and high isolation between channels. TRANSCO units are qualified to applicable military specifications. Performance has been fully confirmed in the field, where thousands of units are giving dependable service.

Technical data on any unit or the complete line sent on request. Send us your coaxial switching problems.

**PROJECT ENGINEER OPENING FOR R. & D. ELECTRONICS**

*Engineer on Microwave Antenna Systems with Southern California leader in Avionics. Excellent company benefits. Address inquiries to Personnel Director.*

**TRANSCO PRODUCTS, INC.**

*The Finest in R F System Components*  
12210 NEBRASKA AVENUE, LOS ANGELES 25, CALIFORNIA  
REPRESENTATIVES IN MAJOR AREAS

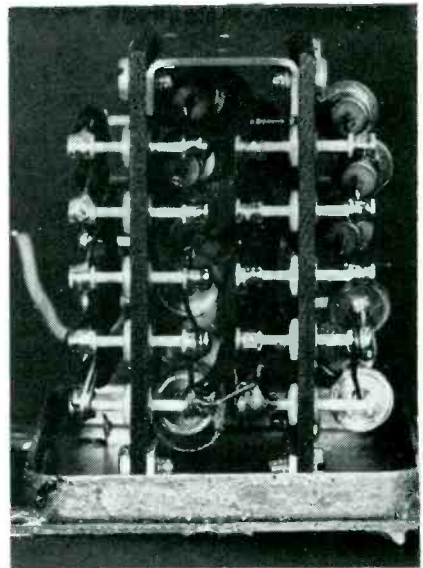

Complete bridge rectifier on two boards, ready for hermetic sealing

ist Helmer Pederson used three GE type IN93 diodes in parallel in each leg of the bridge rectifier for the drive power motor amplifier and sealed them in transformer oil to facilitate dissipation of heat.

While a single diode can carry only 75 ma d-c, three units paralleled in this way with proper current equalization circuits can carry 2,500 ma. So successful is the technique that of 25,000 such diodes now operating in the field, not one report of failure has been received.

Since diodes operated in parallel are sensitive to current distribution, a 2-ohm resistor is used in series with each diode to equalize the current.

Six diodes and their resistors are mounted on a fiber-glass terminal board. Two terminal boards are packaged together in a 2½-inch cube-shaped metal box.

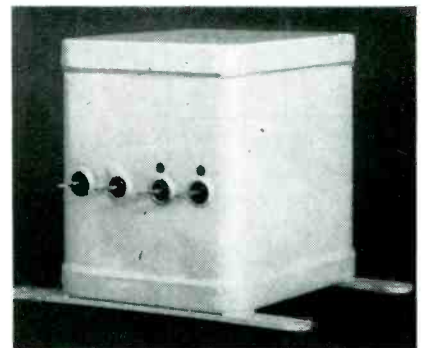

Packaged bridge rectifier



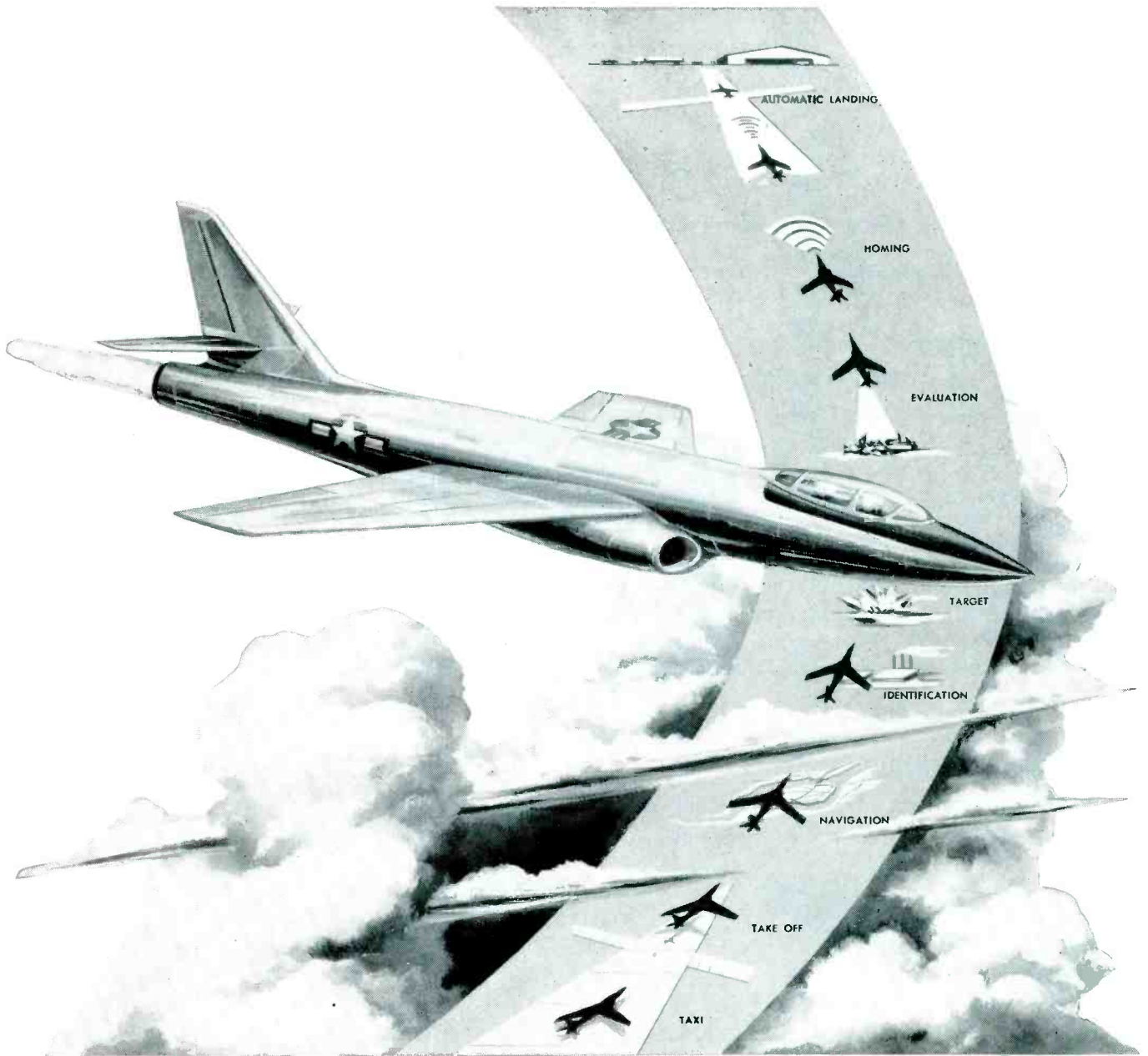

## AVIONICS . . . from A not quite to Z

THE list of products for missiles, aircraft or commercial application with which Bell Aircraft's newly-formed Avionics Division is concerned does not quite span the alphabet. It ends with VHF. But it's all-inclusive and complete—indicating a highly experienced organization capable of dealing successfully with any of the hundreds of electronic, electro-mechanical or mechanical systems and devices which make up the field of Avionics.

It has creative engineering ability for research and development—and efficient manufacturing facilities. It is competent to design and produce

complete systems—or independently operating units for such systems—or components for both.

It's an organization with size and experience to qualify it for any avionic project—with many successes to attest to its capabilities. One of its recent developments is the Navy's Automatic Carrier Landing System which makes precision landings possible with zero-zero conditions.

The services of this organization are available to defense agencies, prime contractors and commercial organizations. If you have problems in Avionics, Bell engineering representatives are at your service to help resolve them.



**Avionics Division**  
BUFFALO, N. Y.

# New Products

Edited by WILLIAM P. O'BRIEN

81 New Products and 62 Manufacturers' Bulletins Are Reviewed  
. . . Control, Testing and Measuring Equipment Described and  
Illustrated . . . Recent Tubes and Components Are Covered

## BINARY COUNTER

with reversible operation

NAVIGATION COMPUTER CORP., 1621 Snyder Ave., Philadelphia 45, Pa. A new series of miniaturized 10-stage indicating binary counters have been announced. The transistorized units feature both serial and parallel read-in and read-out.

Eighteen-volt d-c levels are available from either side of the counter stages and they may be directly loaded by other transis-

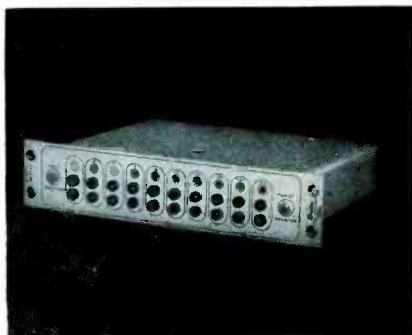

tor stages. Internal amplifier strips may be incorporated to operate relays, low impedance busses and the like.

The reversible counters have completely automatic internal switching. Pulses may be fed into the forward and reverse inputs. The sum of the two inputs is made visible with neon indicators.

The new counters measure 2½ in. by 10 in. by 7 in., and weigh less than 2 lb. **Circle P1 inside back cover.**

## CERAMIC TERMINALS

rugged and miniature

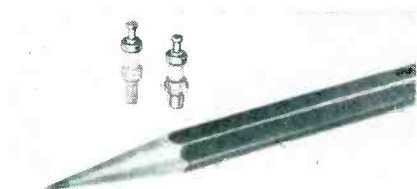

CAMBRIDGE THERMIONIC CORP., 445 Concord Ave., Cambridge 38, Mass., has developed two small, extremely rugged miniature insulated ceramic terminals. The 2255 has a threaded mounting stud; the 2256, a rivet mounting stud.

The units are only ⅛ in. in diameter, only about ⅜ in. high when mounted. They are of grade L5 ceramic, silicone impregnated. All metal fittings are brass.

The mounting studs are cadmium plated and the terminals are gold-flashed over silver for easy soldering. **Circle P2 inside back cover.**

## TUBE SOCKET

microminiature type

JETTRON PRODUCTS, Route 10, Hanover, N. J. Catalog No. 6000 socket features extremely low capacitance between cathode and grid contacts and between grid and anode contacts for uhf amplifier service of the 6BY4 tube. Other characteristics include small size, operation up to 400 F, contacts of silver-plated heat-treated Beryllium copper, easy mounting of socket on chassis and contact lugs notched for easy connection to associated circuitry.

The tube may be inserted in the correct position only and is readily removable from the socket. Con-

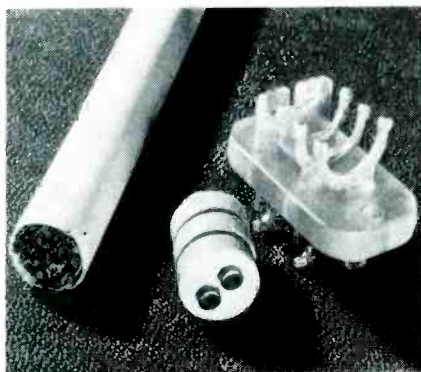

tacts to the cathode, grid and anode have a large area with over 180-deg wrap-around contact. The insulating material for the base

was selected for low dielectric constant, low dissipation factor and high impact strength as well as other desirable characteristics.

Capacitances from cathode to grid and grid to plate, are each 0.42 μμf. **Circle P3 inside back cover.**

## TACAN TEST SET

features portability

FEDERAL TELEPHONE AND RADIO Co., 100 Kingsland Road, Clifton, N. J., has announced a portable TACAN (Tactical Air Navigation) test set, which permits



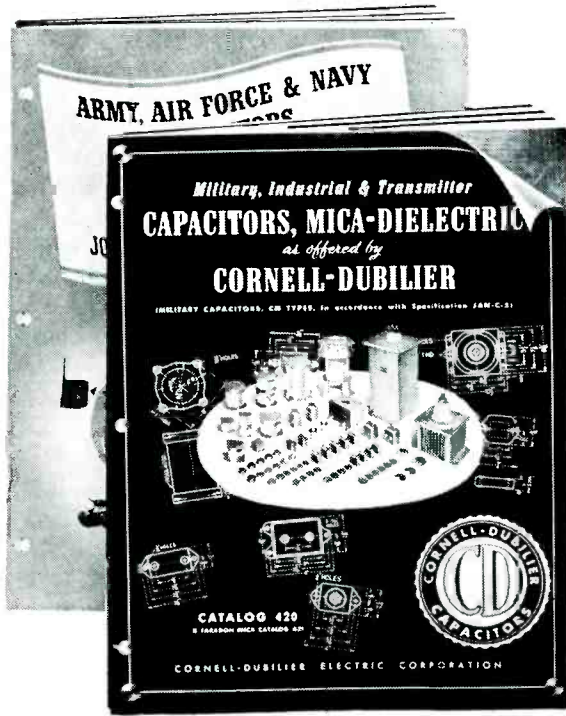

Catalog No. 400. Paper Dielectric Capacitors to Army-Navy specifications.

Catalog No. 420. Mica Capacitors. Industrial, Military, and Transmitter.



Catalog 200D-3  
General: electrolytics, paper, mica, ceramic, filters, printed circuits.



Bulletin 528A  
Tantalum: electrolytic, subminiature, metal-cased, low voltage tubular units.



Bulletin 179  
A.C. Motor Capacitors, oil impregnated and filled rectangular cases.



Catalog 410  
"Powercon inverters" D/C to A/C. A/C to D/C.



Catalog 616  
Ceramic capacitors. Disc, tubular and specials.



Bulletin 147  
Miniaturized tubulars, metal-cased, paper dielectric.



Catalog PRT 225  
Printed Circuitry



Catalog 400  
JAN. Paper Capacitors.



Catalog 166  
R. F. Attenuation Filters.



Bulletin 527  
Low Temperature Electrolytics. Metal-cased tubulars.



Bulletin 162  
Automation: Phenolic cased plug-in tubulars.



Catalog VIB-3  
Vibrators: Automotive, industrial, communications.

# THESE ARE ENGINEER-SAVERS!

**if it's a capacitor we make it**

Any one of these CORNELL-DUBILIER catalogs or engineering bulletins will make it easier to find the right capacitor for practically every problem. A complete file of the C-D Bulletins are available—free of charge, of course. They'll save you precious hours every week. Check off—on convenient coupon below—the catalog, catalogs or engineering bulletins you wish to have us send you.

CONSISTENT HIGH DEPENDABILITY  
CORNELL-DUBILIER CAPACITORS

CORNELL-DUBILIER ELECTRIC CORPORATION  
333 HAMILTON BOULEVARD, SOUTH PLAINFIELD, NEW JERSEY.

Please put me on your mailing list for all engineering bulletins:  
 Please send me—free of charge—the C-D Bulletins circled below:

Name \_\_\_\_\_

Company \_\_\_\_\_

Address \_\_\_\_\_

City \_\_\_\_\_ Zone \_\_\_\_\_ State \_\_\_\_\_

420 200D-3 528A 162 410 616 166 PRT 225 400  
147 527 179 VIB-3

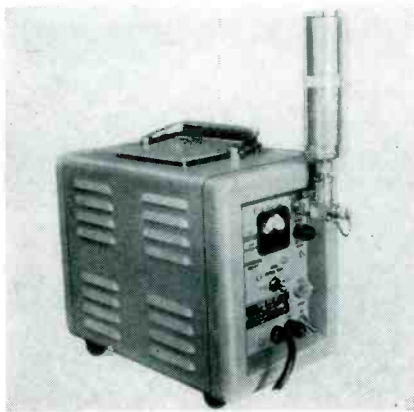

rapid ground testing of airborne TACAN receiver-transmitter equipment while the equipment remains undisturbed in the plane. The test set (type FTR-3156) provides rapid testing of frequency, sensitivity, power output, range, bearing and identity tone.

The unit weighs only 17 lb and measures 9 in. high, 7 in. wide and 11½ in. deep. It operates from any standard aircraft power outlet. No direct connection to the air-

craft is needed and the unit can be operated in all weather conditions.

The test set operates by transmitting simulated bearing and range signals normally transmitted by a TACAN ground beacon station. In actual operation, the test set transmits two crystal-controlled signals on two widely separated channels (964 mc and 1,205 mc). Complete details are available. **Circle P4 inside back cover.**

## ATTENUATORS

used in broadcast equipment

THE DAVEN CO., 530 W. Mt. Pleasant Ave., Livingston, N. J., has available an unbalanced holder network. The LA-130 series are low impedance controls for use in broadcast equipment and p-a systems. Because of the compact design they are well suited for use in portable equipment or in installations where limited mount-

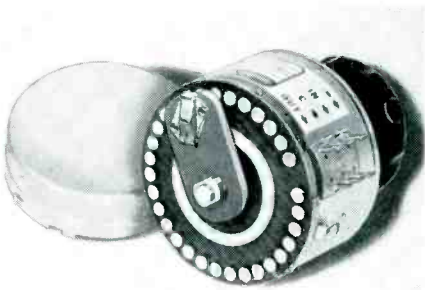

ing space is a factor. They offer a wide range of control (30 steps of attenuation) in a housing only 1¾ in. in diameter by 1¼ in. deep.

Due to the low price of these attenuators, they may readily be adapted as mixer or master gain controls in popular priced equipment. A large selection of various impedance combinations and decibel losses are available in these units from stock. **Circle P5 inside back cover.**

## DIGITAL COMPARATOR

for servo control systems

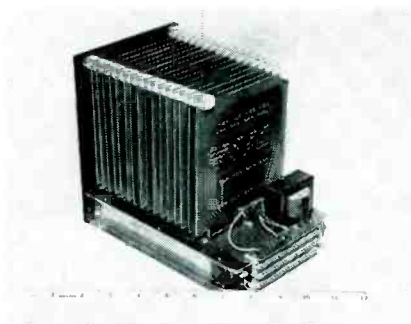

NORDEN-KETAY CORP., Commerce Road, Stamford, Conn., announces a new digital comparator designed for use in digital servo control systems. It makes possible true digital control without recourse to counting techniques.

The digital comparator is particularly useful for airborne applications. Using no relays or tubes, it is readily packaged for rugged

environmental specifications. A built-in preamplifier provides adjustable gain up to 5 v maximum at 1,000-ohms output impedance. The comparator has zero dead time, with a bandwidth limited only by carrier frequency up to several kc.

Voltage requirements are -40, -20 and +20 v d-c and 115 v at carrier frequency. Bulletin 418 contains specifications and application information. **Circle P6 inside back cover.**

## DELAY LINE

is continuously variable

ESC CORP., 534 Bergen Blvd., Palisades Park, N. J., has available a new continuously variable delay line, model 404. It is designed for use as a component or as test equipment in advanced computer and radar systems. The entire delay range, from zero to maximum delay, is covered by a single

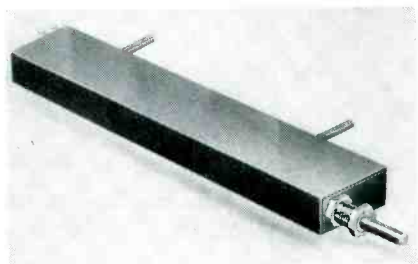

control shaft, in ten turns. A locking device (on model 404B) or hermetically sealed shaft (on model 404C) is available at no extra charge. Thus it can be used as a component in equipment with a fixed delay, or as a continuously variable test unit.

Attenuation is less than 1.0 db. Resolution is better than 0.001 µsec. The unit has a high impedance tap (variable) and it can be



# A DESIGN CONCEPT\*



—that revolutionized an industry!

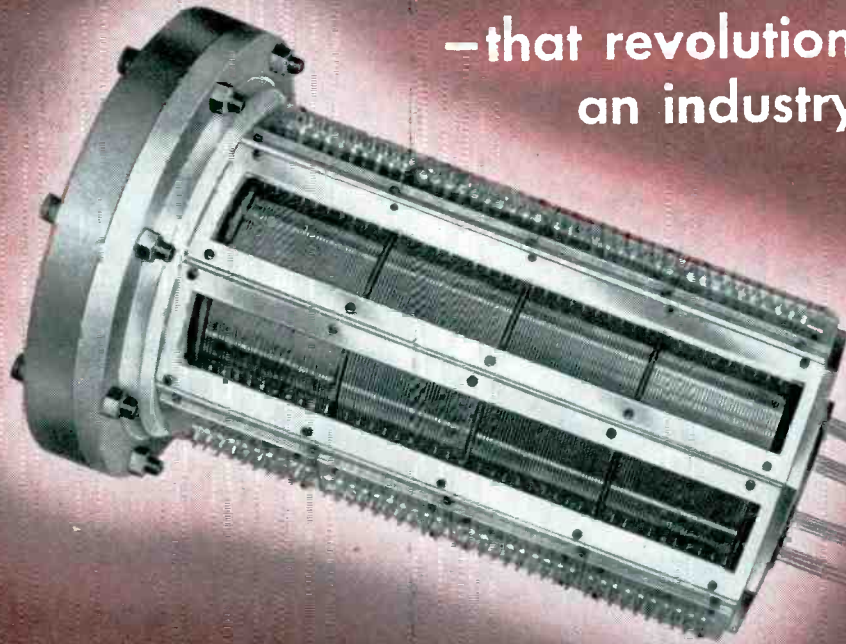

## ELECTRO TEC

PRECISION MACHINED ONE-PIECE CONSTRUCTION

**SLIP RING & COMMUTATOR ASSEMBLIES**

Diameters of multi-ring assemblies from .035" to 36"



Individual components or complete assemblies to precise electrical, mechanical, and environmental specifications.

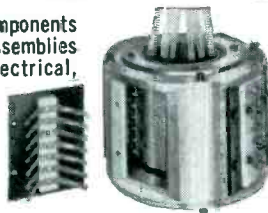

### An Unmatched Record of Performance

Today, Electro Tec Slip Ring and Commutator Assemblies are the choice of leading aircraft, instrument, and component manufacturers throughout the world. Our units are selected for Gyro and Servo applications, for Telemetry and Radar devices, for Guidance systems, and Automation equipment... where sustained and reliable performance is a requisite.

### Facilities Available to Serve You

Plants in South Hackensack, N. J., Blacksburg, Va., and Ormond Beach, Fla., are currently producing a wide variety of Slip Ring, Commutator, and Brush Block Assemblies, Precision Selector Switches, and Miniature Relays. Complete Engineering Facilities and Branch Sales Offices in Los Angeles, Minneapolis, Chicago, and Waltham, Mass. are geared to service your requirements.

Write for fully illustrated literature.

Uniformly hard rings, low noise, minimum friction and dimensional stability.

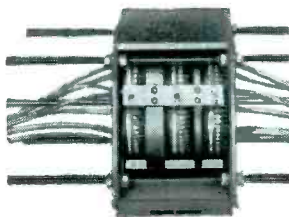

**ELECTRO TEC CORP.**  
SOUTH HACKENSACK, NEW JERSEY



PRODUCTS OF PRECISION CRAFTSMANSHIP

\*PATENT No. 2,696,570

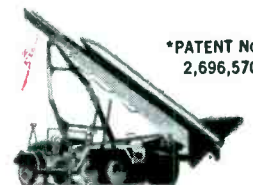

# Ace can meet your requirements in quality and delivery of **NONLINEAR POTENTIOMETERS**

Nonlinear precision wire-wound potentiometers in standard and sub-miniature sizes are now available in prototype or production quantities from Ace Electronics Associates . . . and you can be sure of delivery.

These new Ace nonlinear units incorporate the same advanced engineering, precision craftsmanship, and controlled quality which have made ACEPOT linear potentiometers standards of excellence.

A new Division directed by highly qualified engineers, special prototype section, and mass production facilities are at your service to meet your requirements for quality and delivery of nonlinear precision potentiometers.

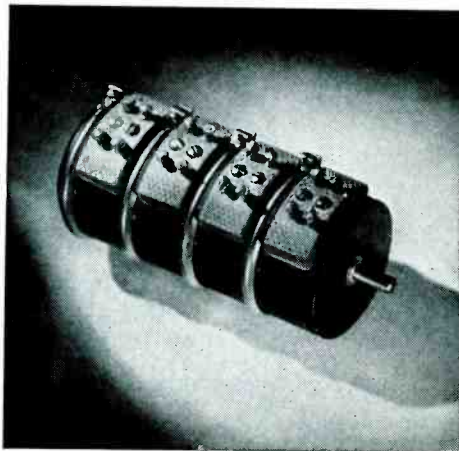

## Featuring!

*Highly developed design techniques achieve high resolution and close conformity for your unique nonlinear requirements.*

**For complete information . . .**

*Call or write William Lyon or Abraham Osborn, Nonlinear Division, outlining your requirements. Your inquiry will receive prompt attention . . . and you will get delivery as specified.*

\* trademarks applied for

**ACEPOT\***  
**ACETRIM\***

**ACE ELECTRONICS ASSOCIATES, INC.**

Dept. E, 101 Dover St. • Somerville 44, Massachusetts

Telephone: MOnument 6-4801

• *Engineering Representatives in Principal Cities*

NEW PRODUCTS

(continued)

operated above ground potential. Maximum delay is 0.50  $\mu$ sec. Maximum rise time is 0.055  $\mu$ sec. Impedance is 750 ohms. Outside dimensions are 6 $\frac{1}{2}$  by  $\frac{5}{8}$  by 1 $\frac{1}{4}$ . Circle P7 inside back cover.



## WIDEBAND AMPLIFIER for pulse applications

INSTRUMENTS FOR INDUSTRY, INC., 150 Glen Cove Rd., Mineola, L. I., N. Y., has introduced a new wideband amplifier, the model M-510. Specifications are as follows: bandpass, 200 kc to 220 mc; rise time, less than  $3 \times 10^{-9}$  sec; voltage gain, 19 db; input impedance, 90 ohms; output impedance, 185 ohms; power output, 0.75w.

This new model has a gain control, a self-contained power supply and has a standard 19-in. rack panel, 3 $\frac{1}{2}$  in. high. Price is \$299. Circle P8 inside back cover.

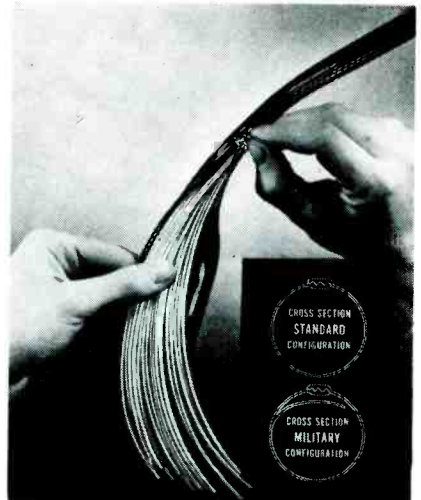

## ZIPPER-STYLE TUBING reduces time, labor costs

W. A. PLUMMER MFG. CO., 752 S. San Pedro St., Los Angeles, Calif. Time and labor costs are greatly reduced in the lacing and tying



**NEW  
CONCEPT**

Unhampered by traditional thinking, TELECHROME engineers have developed an entirely new concept in telemetering equipment. Today's new environmental conditions and distances for missiles require new designs. TELECHROME units are unequalled in compactness, ruggedness\* and dependability. Because of their superior qualities these highly efficient units are replacing equipment of other manufacture.

Direct FM Transmitters Crystal controlled 215-235 megacycles. 125kc deviation.

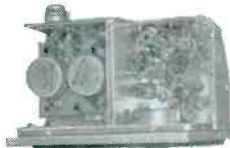

Model 1462—6" x 4 1/4" x 3 3/4"  
50 to 80 Watts



Model 1463—5 1/32" x  
3 1/16" x 4"  
15 to 30 Watts



Model 1472—4" x 1.5"  
x 2.7"  
2 Watts



Model 1460—5" x 4 5/8" x 3 1/16"  
RF Amplifier  
15 to 30 Watts



Model 800—4.5" x 1.3" x 1.4"

SUB-CARRIER OSCILLATOR.  
Deviation stability  $\pm 1\%$   
of band width. Deviation  
linearity less than 1% of  
band width under all con-  
ditions measured from a  
straight line drawn be-  
tween end points.

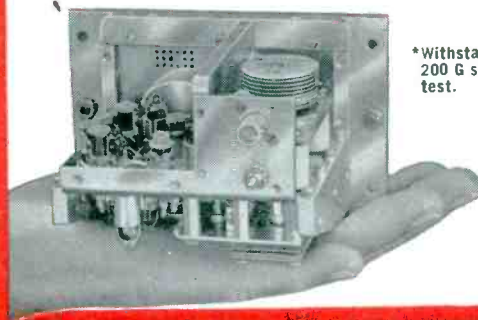

\*Withstands  
200 G shock  
test.

Write for  
Specifications  
& Details

**TELEMETERING TRANSMITTERS  
HIGH POWER  
IN SMALL PACKAGES**



The Nation's Leading  
Supplier of Color  
TV Equipment  
28 RANICK DRIVE  
AMITYVILLE, N. Y.  
Lincoln 1-3600

# Since the choppers must fail, install a **MAGNETIC MODULATOR** for life

A Converter With High Shock and Vibration Resistance and Practically Unlimited Life. Operation in Ambient Temperatures From  $-70^{\circ}\text{C}$  to  $+150^{\circ}\text{C}$

**LOW LEVEL DUAL POLARITY DC SIGNALS**

CONVERTED TO

**PHASE REVERSING SUPPRESSED CARRIER MODULATED ENVELOPE**

## INPUT INFORMATION

- PHOTO CELL
- THERMOCOUPLE
- ANALOG DATA
- STRAIN GAUGE
- MAGNETROMETER
- MICROSEN
- LOW LEVEL DC VOLTAGE

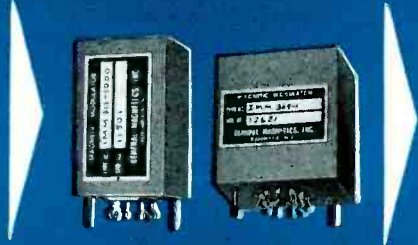

## OUTPUT INFORMATION

- SERVO AMPLIFIERS
- RECORDER
- MOTOR CONTROL
- SPEED CONTROL
- FLIGHT CONTROL
- FIRE CONTROL
- TEMPERATURE CONTROL
- AUTO POSITIONING VOLTAGE, CURRENT, FREQUENCY CONTROL

The magnetic Modulator is designed to convert low level dual polarity DC signals into AC signals of corresponding amplitude and phase sense. We specialize in control systems and MAGNETIC AMPLIFIER components for automatic flight, fire control, analog computers, guided missiles, nuclear applications, antennas and gun turrets, commercial power amplifiers, and control systems.

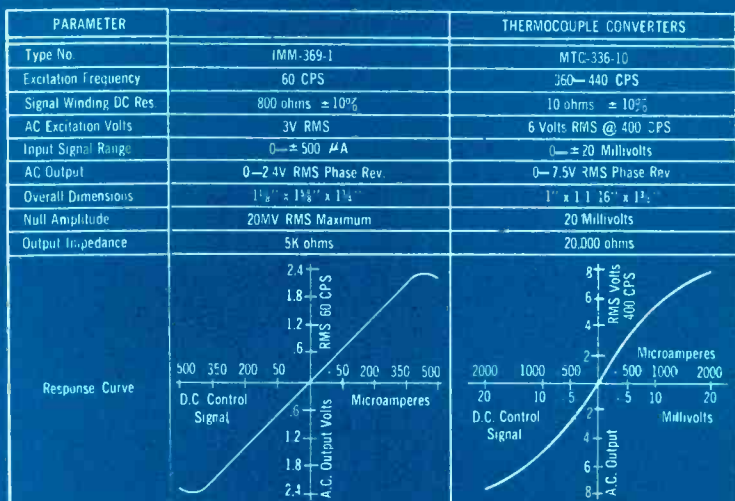
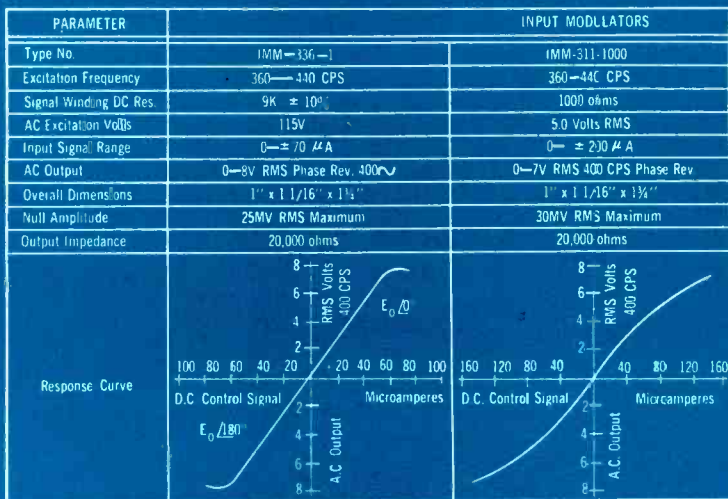

**GENERAL**  **MAGNETICS**  
135 BLOOMFIELD AVE. BLOOMFIELD, N. J.

operation of electrical harness assemblies, through the use of a new zipper-style plastic tubing known as Zippertubing. It is used to enclose, identify and protect multiconductor wiring in the aircraft, electronic or electrical industries.

The zipper pull-tab used to close Zippertubing is detachable. The tubing may be unzipped and reused or permanently sealed with a sealer provided by the manufacturer. When sealed, Zippertubing will withstand a linear strength test of 30 lb per in. Available in nine colors, including black and clear plastic, Zippertubing is made of polyvinylchloride plastics which meet military specifications MIL-I-631B and MIL-I-7444A, for use in aircraft and other types of military wiring. Inside diameters are from 1/8 in. to 4 1/2 in., in increments of 1/8 in.; wall thicknesses are 0.020 in. and 0.040 in. It is available in continuous lengths from 20 to 1,000 ft. **Circle P9 inside back cover.**



## POWER OSCILLATOR has varied applications

INDUSTRIAL TEST EQUIPMENT Co., 55 East 11th St., New York 3, N. Y. Model 1500 power oscillator can be employed as a precision 400-cycle source to energize synchros, resolvers, motors and other electronic or electromechanical equipment. Available in a convenient rack-mounting form it can be readily furnished in various other frequencies. Fifteen watts of undistorted power (less than 1 percent) are supplied through an isolated output transformer. Three impedance taps are provided. A front panel control allows for a continuously variable output from



# Looking around?

Don't overlook the special opportunity  
for engineers at Western Electric

When we say Western Electric offers you something special we're referring to the work we do, the status of the engineer in our company . . . and the unique chance this gives you to grow.

Fifty-five percent of the college graduates in our upper levels of management have engineering degrees. Moreover, we consider all our engineers part of management since they act for and plan in behalf of the company as a whole. They become *more* than engineers since they acquire knowledge of production, handling of people, accounting, merchandising, etc.

Engineers at Western Electric are key figures in our job of manufacturing, distributing and installing equipment needed for the nationwide network of 50 million Bell telephones. To keep pace with the constantly increasing demand for more and better telephone service, there's a constant need here for new products, new processes, new facilities . . . new ideas. Here transistors were first developed for production . . . here repeaters for the first transatlantic telephone cable were tailor-made.

Now — add to our telephone job the continuous flow of defense contracts we've had over the years . . . major projects like producing the Nike guided missile system, the DEW Line of radar stations. You can see why we've got a constant need to advance young engineers and scientists as fast as they measure up.

You owe it to your career to check the specific openings for which you may be qualified (mechanical, electrical, chemical and civil engineers; physicists and mathematicians). To apply, send resume of your education and experience to Engineering Personnel, Room 1066, Western Electric Co., 195 Broadway, New York 7, N. Y.

**Western Electric**

MANUFACTURING AND SUPPLY  UNIT OF THE BELL SYSTEM

Manufacturing plants in Chicago, Ill.; Kearny, N. J.; Baltimore, Md.; Indianapolis, Ind.; Allentown and Laureldale, Pa.; Burlington, Greensboro and Winston-Salem, N. C.; Buffalo, N. Y.; North Andover, Mass.; Lincoln and Omaha, Neb.; St. Paul and Duluth, Minn. Distributing Centers in 30 cities and Installation headquarters in 16 cities. Also, Teletype Corporation, Chicago 14, Illinois.

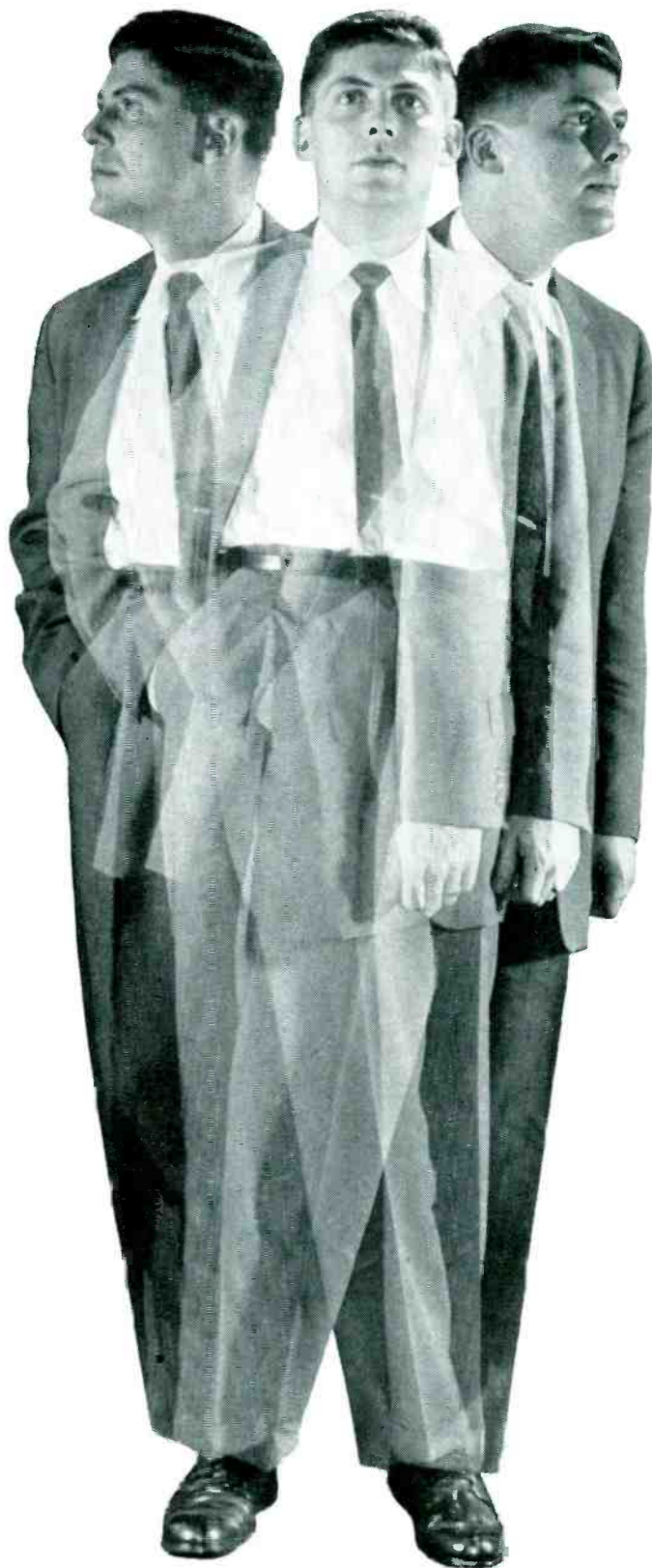

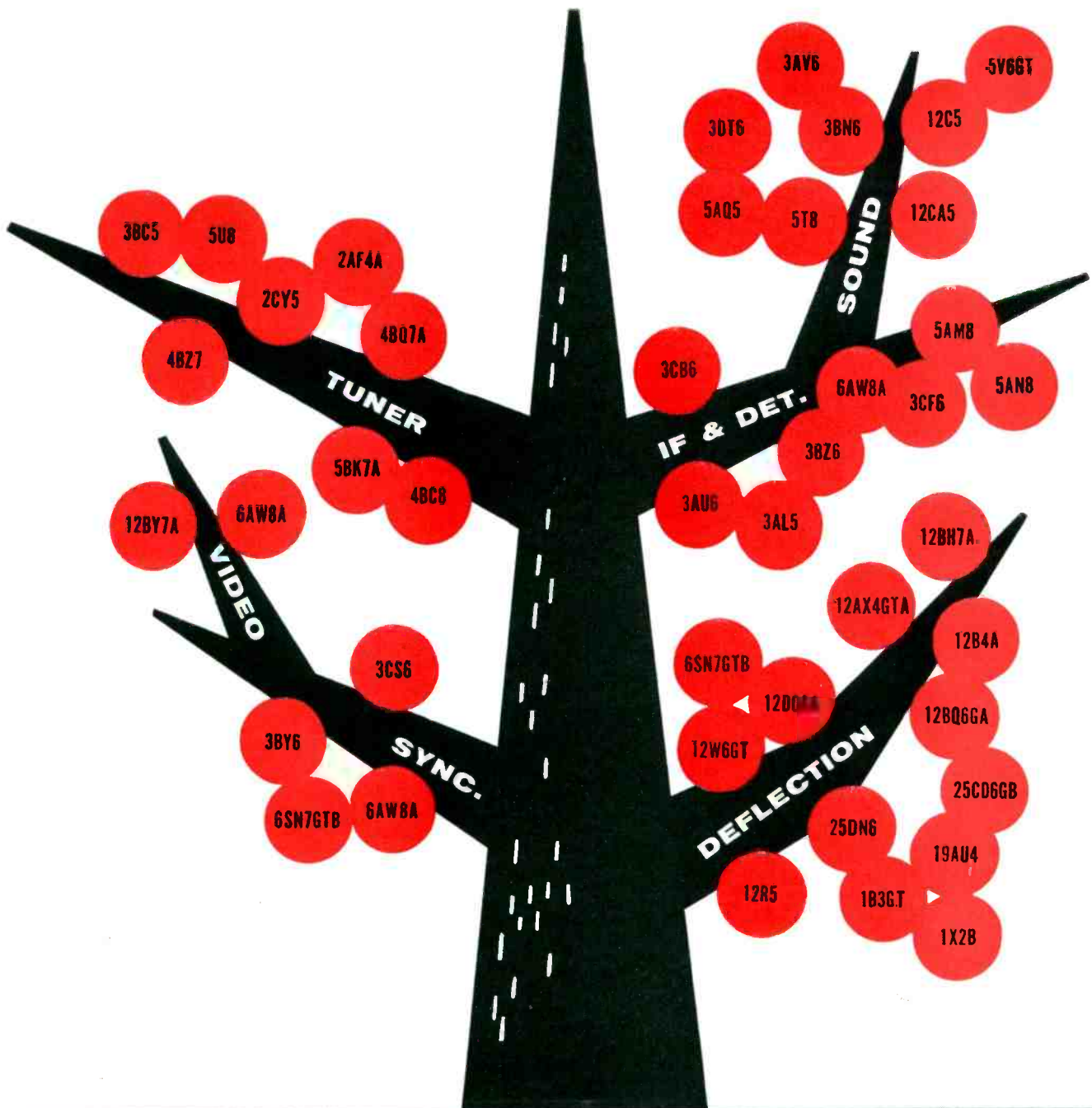

## The first family of 600 ma Series-String TV Tubes

In 1953, Tung-Sol became the leading proponent of 600 ma series heater tubes for TV receivers. This program was made possible through advanced designs in heater and cathode structures that would permit controlled heater warm-up time.

The success of this pioneering led further to the development of series-string tubes for 450 and 300 ma currents. These are designed for sets using smaller numbers of tubes.

In all, nearly one hundred of these types have been introduced, indicating the complete success of the

series-string design principle.

Tung-Sol is currently supplying all of the series-string tube types required for replacement service as well as for initial equipment production.



**TUNG-SOL®**  
ELECTRON TUBES

TUNG-SOL ELECTRIC INC., NEWARK 4, N. J.





## The Complete Roster of Tung-Sol Series String Tubes

300 ma

4CY5	6BY8	6DT6	9X8	12BY7A
6AU6A	6CB6A	8BQ7A	10C8	12CT8
6AX7	6CE5	9CL8	12B4A	12SN7GTB
6BU8	6DK6	9U8A	12BH7A	17H3
				18A5

450 ma

3AF4A	4DK6	6CG8A	8AW8A	17A5
3BN4	4DT6	6CL8	8BA8A	17AU5GA
3CY5	5BQ7A	6CM8	8BH8	17AX4GT
4AU6	5BS8	6CQ8	8BN8	17BQ6GTB
4BA6	5BZ7	6CR8	8CG7	17C5
4BC5	6AM8A	6CS8	8CM7	17CA5
4BC6	6AN8A	6J6A	8CN7	17CU5
4BE6	6AQ5A	6T8A	8CS7	17DQ6
4BN6	6AT8A	6U8A	8SN7GTB	17DQ6A
4BU8	6BE8A	6V6GTA	9AU7	17L6GT
4CB6	6BK7B	6X8A	11C5	17R5
4CE5	6BT8	8AU8	13DE7	35CD6GA

600 ma

2AF4	3DT6	5BT8	6BK7B	12C5
2BN4	4BC8	5CG8	6BN8	12CA5
2CY5	4BQ7A	5CL8	6BV8	12CS5
2T4	4BS8	5CM6	6BY8	12CU5
3AU6	4BX8	5CM8	6CG7	12D4
3AL5	4BZ7	5J6	6CS7	12DB5
3AV6	4BZ8	5T8	6SN7GTB	12DQ6
3BA6	4CX7	5U8	10DA7	12DQ6A
3BC5	5AM8	5V6GT	10DE7	12L6GT
3BE6	5AN8	5X8	12AU5GA	12R5
3BN6	5AQ5	6AU8	12AX4GTA	12W6GT
3BU8	5AS8	6AW8	12B3	15A8
3BY6	5AT8	6AW8A	12B4A	19AU4
3BZ6	5AV8	6AX7	12BH7A	19AU4GTA
3CB6	5B8	6BA8	12BK5	19AU4GT
3CE5	5BE8	6BA8A	12BQ6GA	25CD6GA
3CF6	5BK7A	6BH8	12BQ6GT	25CD6GB
3CS6	5BD8	6BJ8	12BY7A	25DN6

Information about these products and special purpose tubes is available upon request to Tung-Sol Commercial Engineering Division.

**Tung-Sol Electric Inc., Newark 4, N. J.**

Sales Offices: Atlanta, Ga.; Columbus, Ohio; Culver City, Calif.; Dallas, Texas; Denver, Colo.; Detroit, Mich.; Irvington N. J.; Melrose Park, Ill.; Newark, N. J.; Seattle, Wash.

0 to 120 v. The frequency is factory set to 0.25 percent and is maintained with high stability even with line voltage fluctuation.

Power input is 115 v, 60 cps. Dimensions are: height, 8 $\frac{3}{4}$  in.; width, 19 in.; depth, 8 in. Circle P10 inside back cover.



### FREE GYRO solenoid powered

HUMPHREY INC., 2805 Canon St., San Diego 6, Calif., has introduced the series FG01-0203-1 free gyro with a solenoid-powered caging system. It is already in use on new missile systems and is being used in flight test operations where removing caging and uncaging is essential. The caging system has a minimum number of parts and is positive and reliable in operation. Precision potentiometer pick-offs can be furnished with taps if desired.

The instrument is 5 $\frac{1}{2}$  in. long, 3 in. in diameter and weighs only 2 $\frac{1}{2}$  lb. Other features are its cage indicating switches, precision potentiometers on both gimbals and flexibility in choice of motor—400 cycle 115 v (three-phase or single-phase) or 28 v d-c. Circle P11 inside back cover.



### PHASE METER direct indication in degrees

ADVANCE ELECTRONICS LAB., INC., 249-259 Terhune Ave., Passaic, N. J. Type 405 series is a stable



## AT TUNG-SOL... ENGINEERS ENGINEER!

Tung-Sol engineers are individuals given definite responsibilities and the necessary latitude that allows their ability and initiative full opportunity. They handle challenging assignments in design, development, production, research and applications of electron tubes, cathode ray tubes, semiconductors and current intermitters. Quite emphatically, they are not just numbers in an army of engineers.

We know our engineers like this system of individual responsibility (and commensurate rewards) because the Tung-Sol engineer turnover rate is among the lowest in the industry.

The steady growth of Tung-Sol is continually creating openings for additional engineers who are looking for more satisfying activities. If you feel you're still in a college lab after two to five years' experience as an electrical, electronic, mechanical or chemical engineer or as a metallurgist, physicist or scientist, and want to do something about it, contact us. Let's see what we have to offer each other. Write, phone or wire: David Bellat, Tung-Sol Electric Inc., 200 Bloomfield Ave., Bloomfield, N. J.—Pilgrim 8-8700.

# RADIO INTERFERENCE AND FIELD INTENSITY *measuring equipment*

Stoddart equipments are suitable for making interference measurements to one or more of the following specifications:

## AIR FORCE—MIL-I-6181B

150 kc to 1000 mc

## BuAer—MIL-I-6181B

150 kc to 1000 mc

## BuShips—MIL-I-16910A (Ships)

14 kc to 1000 mc

## SIGNAL CORPS—MIL-I-11683A

150 kc to 1000 mc

## SIGNAL CORPS—MIL-S-10379A

150 kc to 1000 mc

The equipments shown cover the frequency range of 14 kilocycles to 1000 megacycles.

Measurements may be made with **PEAK**, **QUASI-PEAK** and **AVERAGE** (Field Intensity) detector functions. **QUASI-PEAK** values meet **ASA** recommendations and can be provided to meet **CISPR** (International) recommendations.

**F.C.C. PART 15**—Now in effect, the revised F.C.C. Part 15 places stringent requirements upon radiation from incidental and restricted radiation devices. Stoddart equipment is suitable for measuring the radiation from any device capable of generating interference or c-w signal within the frequency range of 14 kc to 1000 mc.

*Write Stoddart Aircraft Radio Co., Inc., for your free copy of the new revised F.C.C. Part 15.*

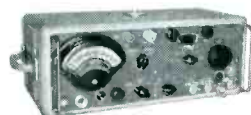

**NM-10A (AN/URM-6B)**  
14 kcs to 250 kcs

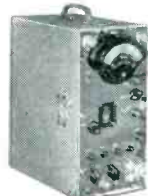

**NM-20B (AN/PRM-1A)**  
150 kcs to 25 mcs



**NM-30A (AN/URM-47)**  
20 mcs to 400 mcs



**NM-50A (AN/URM-17)**  
375 mcs to 1000 mcs

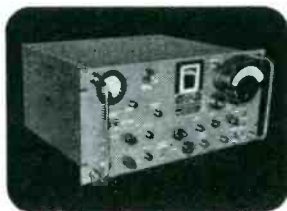

The Stoddart NM-40A is an entirely new radio interference-field intensity measuring equipment. It is the commercial equivalent of the Navy type AN/URM-41 and is tunable over the audio and radio frequency range of 30 CPS to 15 kc. It performs vital functions never before available in a tunable equipment covering this frequency range. Electric and magnetic fields may be measured independently over this range using newly developed pick-up devices. Measurements can be made with a 3 db bandwidth variable from 10 CPS to 60 CPS and with a 15 kc wide broadband characteristic.

and convenient device for measuring a phase angle between two alternating voltages without either amplitude or frequency adjustment. It presents the phase angle directly in degrees on an 8-in. rectangular panel meter with mirror scale and can plot phase-frequency curves on a recorder or oscilloscope. The instrument consists of a coincident slicer and cathode-coupled limiter stages with plate-to-grid degeneration.

Type 405L has a frequency range from 1 cps to 20 kc and type 405H, from 8 cps to 500 kc. Relative accuracy is  $\pm 0.25$  deg and absolute accuracy is  $\pm 1$  deg or 2 percent at any range.

Complete description, features and specifications are available. Circle P12 inside back cover.

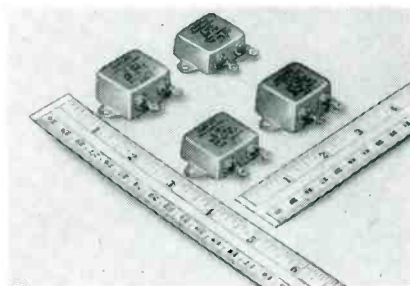

## BATHTUB CAPACITORS metallized-paper type

CORNELL-DUBILIER ELECTRIC CORP., South Plainfield, N. J. Type SBXM series of high-temperature bath-tub-cased metallized-paper capacitors is  $1\frac{1}{8}$  in. by 1 in. with heights of only  $\frac{1}{2}$  in. and  $1\frac{1}{4}$  in. Ratings are 0.1 to 2.0  $\mu$ f at 200, 400 and 600 v d-c working.

These capacitors are designed for operation over the temperature range from  $-55$  C to  $+130$  C and are provided with high-temperature glass-to-metal seals, with solder lug terminals. Hermetically sealed after Polykane impregnation and fill, they conform to MIL-C-25A humidity, inversion, vibration and shock environmental test requirements for paper capacitors.

Type SBXM is ideal for use in communications equipment, power supplies, electronic computers and other equipment where capacitors with short current path and low-r-f impedance characteristics are

# STODDART Aircraft Radio Co., Inc.

6644-A SANTA MONICA BLVD., HOLLYWOOD 38, CALIFORNIA • Hollywood 4-9294





Better Things for Better Living  
... through Chemistry

# ELECTRONIC DESIGN

LATEST PROPERTY AND APPLICATION DATA ON

**TEFLON**<sup>®</sup>

tetrafluoroethylene resin

# NEWS

## Wire insulated with **TEFLON**<sup>®</sup> resin offers unique advantages in Videotape recorder

### Now Du Pont **TEFLON**<sup>®</sup> can be bonded with commercial adhesives

Where a non-slippery surface is required, a special treatment can now be applied to one surface of **TEFLON** resins. Conventional adhesives adhere to this treated surface. As a result, good bonding strength can be achieved between **TEFLON** and wood, glass, steel, aluminum, copper, ceramics, plastics—and, in fact, any material that will bond with an adhesive.

The design possibilities are enormous. For example, cementable **TEFLON** is so slippery on its untreated side that even sticky products will not adhere. It can be cemented to machine rollers and flat surfaces to form low-friction facings. Even pressure-sensitive adhesives may be used. As cementable tape, **TEFLON** is convenient for use in electrical applications, where it offers extraordinary heat resistance and outstanding dielectric properties. The chemical inertness of **TEFLON** makes it a natural for use in corrosive environments. Tubing, cylinders, rods and bars made of **TEFLON** are also obtainable with treated surfaces.

**TEFLON** tetrafluoroethylene resins are inert to nearly all chemicals and solvents in commercial use. The few exceptions to this include attack by the alkali metals under certain conditions. At high temperatures and pressures, halogens and certain halogenated chemicals and solvents may also affect **TEFLON**.

Cementable **TEFLON** offers new scope to imaginative designers in the electronics industry. It may help you find a simple answer to a difficult design problem. You can learn more about this remarkable new material by mailing the coupon.

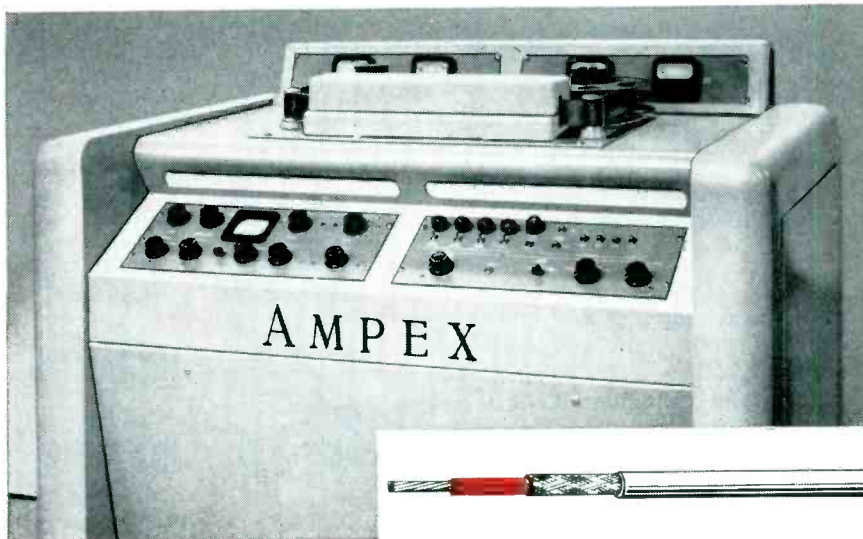

**Du Pont TEFLON** tetrafluoroethylene resins have important uses in this new television tape recorder, which permits immediate playback of TV sound and pictures. Inset shows coaxial cable employed in the recorder. Cable has inner insulation of **TEFLON**. The material

is completely unaffected by cabinet temperatures of electronic equipment. (Recorder by Ampex Corporation—wire supplied by Sequoia Wire, a Division of Sequoia Process Corporation. Both of these companies are located in Redwood City, California.)

Designers of the Ampex Videotape Recorder selected Du Pont **TEFLON** as the superior insulation material for critical points in the new electronic machine which records video and audio on tape. **TEFLON** maintains high mechanical and dielectric strength over a wide range of temperatures, and helps assure dependable operation of electronic equipment.

Wire insulated with **TEFLON** 1, **TEFLON** 5 or **TEFLON** 6 resins has favorable attenuation characteristics, because the power factor of **TEFLON** is less than 0.0003. This applies over the entire spectrum measured to date—60 cycles to 3,000 megacycles. The short-term dielectric strengths of **TEFLON**

are high, ranging from 500 to 4,000 volts per mil, depending on thickness. In assembly operations, its high melting point assures freedom from shrinkage during soldering.

**TEFLON** is tough and durable. It can be used up to 500°F. and displays excellent properties at temperatures far below zero. **TEFLON** is chemically inert. Weathering and aging have shown no effect on **TEFLON**.

When specifications call for extreme temperatures and operating conditions, think first of Du Pont **TEFLON**. This outstanding material has solved the problems of many design engineers. **TEFLON** tetrafluoroethylene resins may well be the answer to your own needs.

### **TEFLON**<sup>®</sup>

is a registered trademark . . .

**TEFLON** is the registered trademark for DuPont tetrafluoroethylene resins, and should not be used as an adjective to describe any other product or any component part; nor may this registered trademark be used in whole, or in part, as a trade name for any product.

### SEND FOR INFORMATION

For additional property and application data on **TEFLON** tetrafluoroethylene resins, mail coupon.

E. I. du Pont de Nemours & Co. (Inc.), Polychemicals Dept.  
Room 1741, DuPont Building, Wilmington 98, Delaware

Please send me more information on Du Pont **TEFLON** tetrafluoroethylene resins. I am interested in evaluating **TEFLON** for \_\_\_\_\_

Name \_\_\_\_\_

Company \_\_\_\_\_ Position \_\_\_\_\_

Street \_\_\_\_\_

City \_\_\_\_\_ State \_\_\_\_\_

Type of Business \_\_\_\_\_

In Canada: Du Pont Company of Canada (1956) Limited, P. O. Box 660, Montreal, Quebec

# The Vacuum Switch Goes to Work IN HIGH VOLTAGE DC CIRCUITS



Years of experimentation and commercial usage have demonstrated that Jennings vacuum switches can interrupt many dc circuits that cannot be easily handled in any other way. They can "make" the high inrush currents that occur when capacitor banks are discharged and they can interrupt the fault currents that occur during the flashover of a power tube in a transmitter.

DC power supplies are now being switched "hot" from low power levels up to 250 kw under either normal or overload conditions. Overcurrent protection is excellent since operate times are only 4 to 10 milliseconds and deionization of the arc is extremely rapid in a high vacuum. Likewise, high voltage isolation, capacitor discharge, or safety grounding is easily accomplished with contact travels of no more than  $\frac{1}{8}$ " regardless of voltage level. This makes possible solenoid actuating mechanisms that are simple in design and lend themselves to completely automatic operation.

*Please send us your circuit conditions. We can suggest vacuum switches that will solve most difficult dc switching problems.*

**TYPE R8G**  
Overload Circuit  
Breaker

**TYPE R1G N/O**  
with 40 kv  
insulation



**TYPE RH7** 85 kv  
N/C Grounding  
Relay

**TYPE RH1G N/O**  
for dc interruption  
up to 200 kw



needed. Power factor does not exceed 1.5 percent at 25 C.

Further information is given in bulletin 152-1. Circle P13 inside back cover.



## D-C VTVM miniature, panel-mounting

TRIO LABORATORIES, INC., 4025 Merrick Road, Seaford, N. Y., announces an improved d-c vtvm that can be mounted in operating or test equipment without exceeding the area required by a standard panel meter. This model F features a higher accuracy of 2 percent; wider range from 0.5 v zero center to 300 v full scale; zero adjustment while connected to the circuit; 10-megohms input impedance and a built-in amplifier and power supply.

The instrument operates from 115 v, 60 or 400-cycle line. It is available in zero center or zero left models and a ruggedized military version. It consists of a standard 4-in. meter with a small housing extending approximately 3 in. from the rear and utilizes the latest miniaturization techniques. Circle P14 inside back cover.

## DELAY CABLE has diameter of 0.28 in.

COLUMBIA TECHNICAL CORP., 61-02 Thirty-First Ave., Woodside 77, N. Y. Type HH-1600 delay cable is built around a unique, flexible, low-loss magnetic core which makes it possible to achieve an extremely high unit delay with low losses and good transmission fidelity. It has a delay of 1.0  $\mu$ sec per ft, an impedance of 1,700 ohms

**JENNINGS RADIO MANUFACTURING CORPORATION • 970 McLAUGHLIN AVE.  
P.O. BOX 1278 • SAN JOSE 8, CALIFORNIA**



# MICROWAVE SIGNAL GENERATORS

950 to 11,500 mc

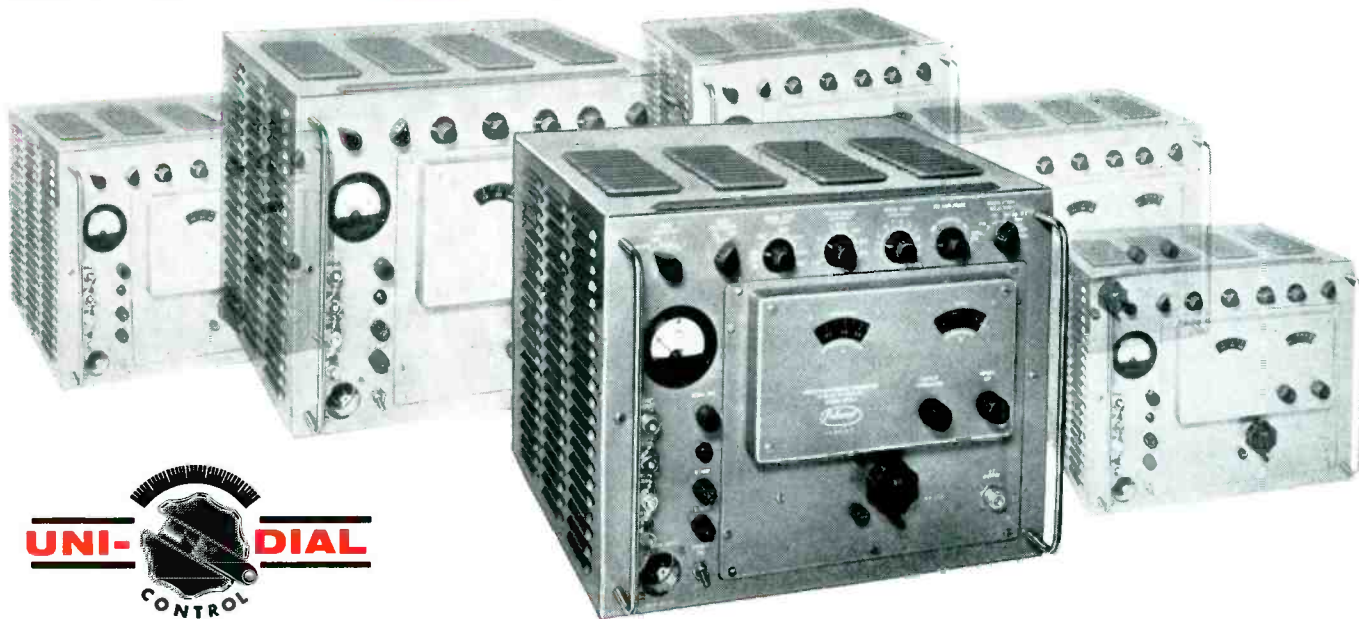

**JUST ONE POLARAD  
MICROWAVE SIGNAL GENERATOR  
CAN MAKE ALL  
THESE MEASUREMENTS**

Each Polarad Microwave Signal Generator (4 models cover 950-11,500 mc) is equipped with the unusually simple UNI-DIAL control that tracks reflector voltages automatically while tuning continuously. Frequency, accurate to  $\pm 1\%$ , is read directly on the single frequency dial. There are no mode charts, no slide rule interpolations necessary.

But, most significant are the built-in features that enable use of these rugged instruments for so many applications: internal modulation, pulse and FM; internal square wave modulation; synchronization outputs, delayed and undelayed; provision for multi-pulse modulation input; provision for external modulation and synchronization; variable attenuator calibrated directly in - dbm; engineered ventilation to insure specification performance over long operating periods.

Contact your local Polarad representative or write directly to the factory for the latest detailed specifications.

**SPECIFICATIONS** (all models unless indicated)

<b>Model #</b>	<b>Frequency Range</b>	<b>Internal pulse modulation:</b>	<b>External pulse modulation:</b>
MSG-1	950 - 2400 mc	Pulse width: 0.5 to 10 micro-seconds	Polarity: Positive or negative
MSG-2	2150 - 4600 mc	Delay: 3 to 300 microseconds	Rate: 40 to 4000 pps
MSG-3	4450 - 8000 mc	Rate: 40 to 4000 pps	Pulse width: 0.5 to 2500 microseconds
MSG-4	6950 - 10,800 mc	Synchronization: internal or external, sine wave or pulse	Pulse separation (for multiple pulses): 1 to 2500 microseconds
MSG-4A	6950 - 11,500 mc		
<b>Frequency accuracy:</b> $\pm 1\%$		<b>Internal FM:</b>	<b>Output synchronizing pulses:</b>
<b>Power output:</b>		Type: Linear sawtooth	Polarity: Positive, delayed & undelayed
MSG-1 & 2: 1 mw		Rate: 40 to 4000 cps	Rate: 40 to 4000 pps
MSG-3, 4 & 4A: 0.2 mw		Synchronization: internal or external, sine wave or pulse	Voltage: Greater than 25 volts
<b>Attenuator range:</b> 120 db		<b>Frequency deviation:</b>	Rise time: Less than 1 micro-second
<b>Attenuator Accuracy:</b> $\pm 2$ db		MSG-1 & 2: $\pm 2.5$ mcs	
<b>Output impedance:</b> 50 ohms nominal		MSG-3, 4 & 4A: $\pm 6$ mcs	
		<b>Internal square wave modulation:</b>	
		40 to 4000 pps	

- Receiver sensitivity
- Noise figure
- Signal to noise ratio
- Image rejection
- Beacon sensitivity
- Bandwidth
- Standing wave ratio
- Antenna gain and pattern
- Conversion gain or loss
- Attenuation
- Filter characteristics
- Multi-pulsed systems, such as Beacons, DME, Tacan, etc.

**AVAILABLE ON EQUIPMENT LEASE PLAN  
FIELD MAINTENANCE SERVICE AVAILABLE  
THROUGHOUT THE COUNTRY**

Prices subject to change without notice.



**ELECTRONICS CORPORATION** 43-20 34th STREET, LONG ISLAND CITY, N. Y.

REPRESENTATIVES: Albany, Albuquerque, Atlanta, Baltimore, Boston, Chicago, Cleveland, Dayton, Denver, Englewood, Fort Worth, Kansas City, Los Angeles, New York, Philadelphia, Portland, Rochester, St. Louis, San Francisco, Schenectady, Stamford, Syracuse, Washington, D. C., Winston-Salem, Canada: Arnprior, Ontario.  
Resident Representatives in Principal Foreign Cities

# SIE

## MODEL E-2

### COMPARISON BRIDGE



FOR FAST, ACCURATE MATCHING OF

**RESISTORS** 1 ohm to 5 megohms

**CAPACITORS** 500 mmfd to 2000 mfd

**INDUCTORS** 3 millihenrys to 10,000 henrys

- Five Meter Ranges: 1%, 2.5%, 5%, 10% and 25% difference readings at full scale
- Accurate within 0.1% on 1% scale
- Component differences of 1 part in 10,000 can be detected
- Foot operated switch available

**\$185.**



**SOUTHWESTERN INDUSTRIAL ELECTRONICS COMPANY**

P. O. BOX 13058      2831 POST OAK ROAD  
HOUSTON 19, TEXAS

NEW PRODUCTS

(continued)

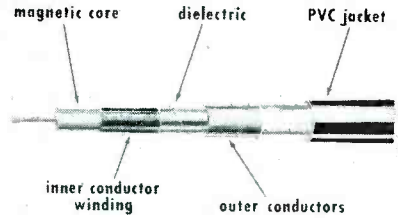

and an insertion loss of 0.3 db for a delay of 1.0  $\mu$ sec. The operating temperature range is from -40 to +85 C.

Compactness of the HH-1600, together with its unusual electrical characteristics, make it particularly useful in complex electronic equipment, such as electronic computers and radar systems, where space is at a premium. It is also widely used in color tv receivers.

It can be furnished in calibrated lengths as calibrated delay lines with molded vinyl endcaps with delays from a fraction of 1 to 100  $\mu$ sec or as bulk cable. Circle P15 inside back cover.

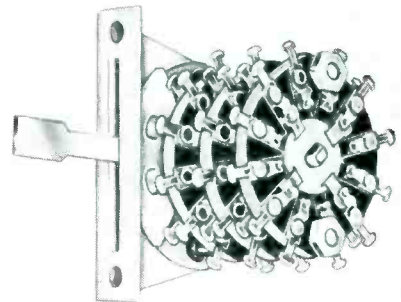

### LEVER SWITCHES

with, without spring return

INTERNATIONAL INSTRUMENT INC., New Haven 15, Conn., announces two new subminiature lever switches — with and without spring return. The series L-7000 (without spring return) and the SRL-7000 (with spring return) are specially designed for use in miniaturized or transistorized test equipment, speech in-put systems, intercoms, remote control panels and other electronic installations where components must combine small size and big-switch performance. Switches with one, two or three decks and up to four poles per deck can be supplied.

Silver alloy contacts are double



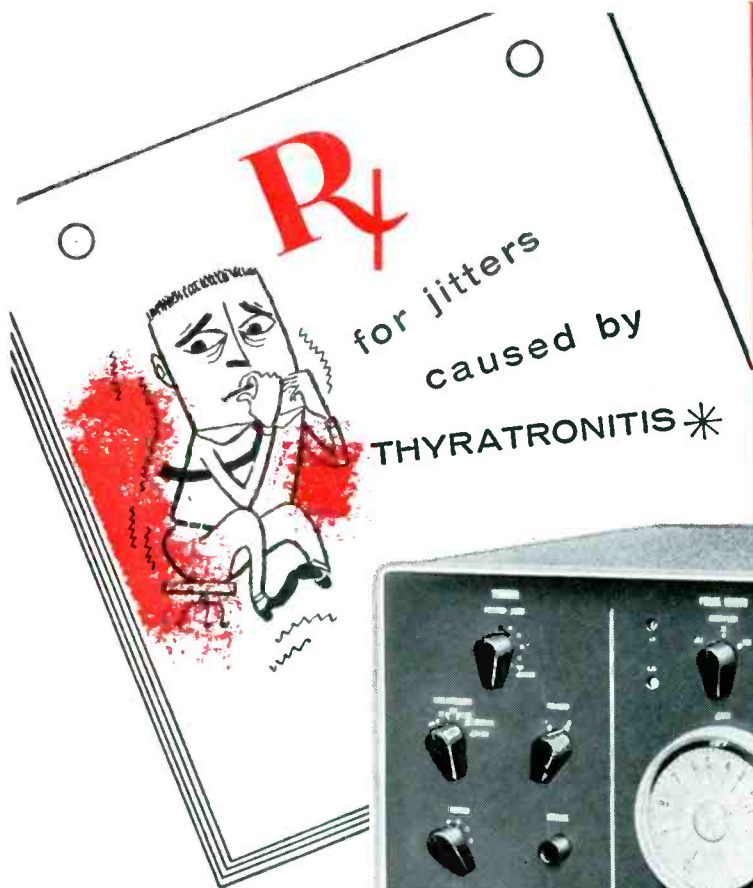

one of the  series

**Hard Tube Circuitry:** Hard tube circuits assure jitter-free relationship between pulse and synchronizing triggers.

**Repetition Rate:** 100,000 PPS to single pulse with either positive or negative polarity.



# DuMONT 404 PULSE GENERATOR

## SPECIFICATIONS

**\*DEFINITION:** A common ailment of an hereditary nature, common to certain species of pulse generators. **Symptoms:** bumps, squiggles, and twitches in pulse. **Cause:** nervous triggering of pulse due to too much hydrogen in thyatron (or something like that).

**PRESCRIPTION:** Hard tube circuitry for pulse generation

Du Mont's done it! Here is a pulse generator that you can depend on for high-speed pulses that are clean and accurate every time. A completely new hard-tube circuit provides pulses with a broad range of widths, amplitudes and repetition rates, resulting in an instrument that can simulate virtually any test condition.

There is no other pulse generator that approaches the 404 in performance, operating ease, or value. Write for complete details...

**Pulse Output:** Nominally 50 volts across 50 ohms; Attenuator provides up to 60 db attenuation in 1/2 db increments; Attenuator accuracy: ±3%; Overshoot less than 3%; positive or negative pulse polarity.

**Pulse Duration:** Width, 0.05 usec to 100 usec continuously variable; Rise or fall time less than 0.018 usec; duty cycle, 10%. Automatic, built-in overload protection.

**Repetition Rate:** Internal, external or manual. Internal 10 pps to 100,000 pps, continuously variable. Facilities for external trigger up to 100 kc. Manual push button for single pulse operation.

**Trigger Output:** 25 volts across 50 ohms, positive or negative. Rise time less than 0.05 usec; width, 0.1 usec.

**Pulse Delay:** -2 to +8 usec with respect to internal or manual trigger; continuously variable.

\$675\* \*Slightly higher for 50 cycle areas.

Cat. No. 4013-K

Description 115-V; 50/60 cps

# DU MONT®

TECHNICAL SALES DEPARTMENT, ALLEN B. DU MONT LABORATORIES, INC., CLIFTON, N. J.

# From Instrument Calibration HEADQUARTERS

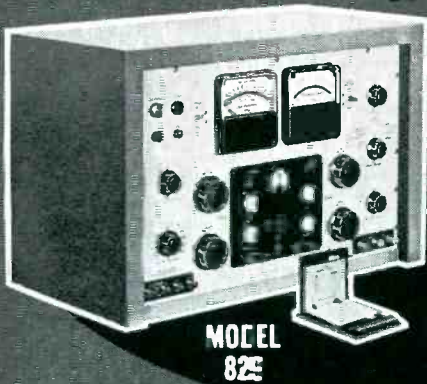

MODEL  
82E

a  
**modern  
method of  
maintaining  
ACCURACY**

*Superior and sustained quality control, through frequent calibration of test instruments, can be achieved by semi-skilled personnel using these self-contained standards.*

Portable Model 829 calibrates both AC and DC meters over ranges from 0.25 millivolt to 2000 volts and 2 microamperes to 20 amperes. Direct reading accuracy of 1% (0.5% using charts supplied). Output frequency from 50 to 400 cps depending on line frequency used.

Net price \$2,650.

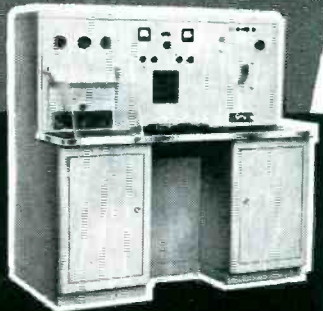

MODEL 261B

Console Model 261B calibrates all types of AC meters to direct reading accuracies of 0.5% (0.25% using calibration charts) over frequency range of 50 to 1600 cps. Current range from 1.5 milliamperes to 200 amperes; voltage range from 75 millivolts to 1500 volts. Output of electronic power oscillator has less than 5% total harmonic content at 60 cycles.

Net price \$9,250.

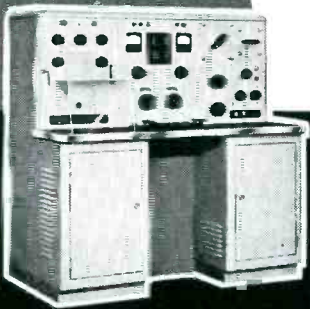

MODEL 262B

Model 262B Dual Potentiometer Standard calibrates DC electrical measuring instruments to direct reading accuracies of 0.1% (0.05% using calibration charts) through voltages ranging from 1 millivolt to 1500 volts and currents ranging from 1 microampere to 150 amperes. Employs Weston instruments and standard cells.

Net price \$15,600.

Prices are f.o.b. Boonton, N.J. & subject to change without notice.



WE CAN  
HELP  
YOU

Technical and application data for our six basic models are fully described in a new 24-page catalog. Send for it today.



**Radio Frequency**  
LABORATORIES, INC.  
Boonton, New Jersey, U. S. A.

wiping and self-cleaning. Connection ends of the wafer contacts are double wiping and self-cleaning. Connection ends of the wafer contacts are solder lug type for easy wiring.

Electrical characteristics are: contact resistance — 0.006 ohm maximum; dielectric strength—1,000 v rms; insulation resistance —100 megohms minimum; current breaking capacity—250 ma at 50 v d-c or noninductive a-c load. Circle P16 inside back cover.

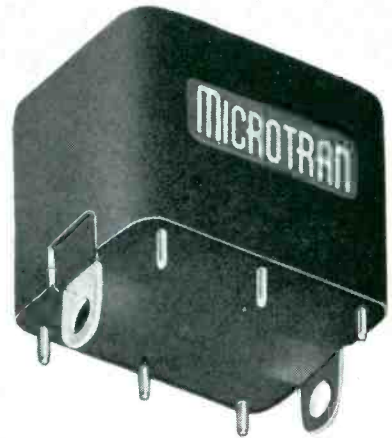

## P-C TRANSFORMERS

epoxy molded plug-in type

MICROTRAN Co., INC., 145 E. Mineola Ave., Valley Stream, N. Y., has available a new line of epoxy molded plug-in, printed-circuit, miniature transformers. The units, available in a wide range of electrical ratings, have been designed to meet the requirements of MIL-T-27A, grades 2 and 5. Further information is available in the 1957 transformer catalog. Circle P17 inside back cover.

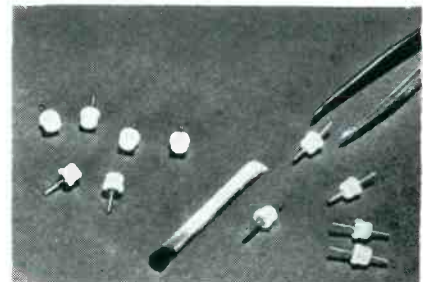

**TEFLON TERMINALS**  
subminiature units

TRI-POINT PLASTICS, INC., 175-177 I.U. Willets Rd., Albertson, L. I.,



# Precision **M**oldite Cores

ENGINEERED and DESIGNED  
with your Equipment  
in Mind

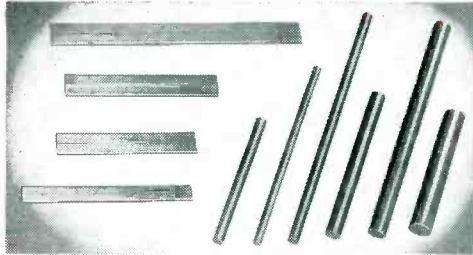

ANTENNA RODS

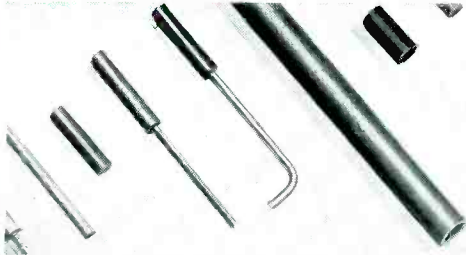

CORES, LOOP STICKS, SLEEVES, CUPS, TOROIDS, RODS



THREADED CORES

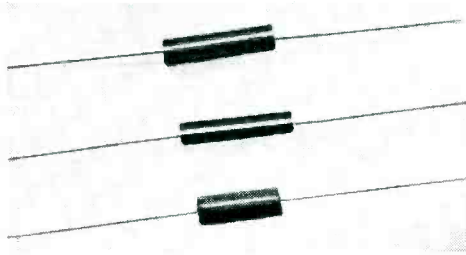

FERRITE COIL FORMS

## Moldite FERRITES

offer these advantages:

- lower losses (eddy current)
- higher efficiency
- lower operating temperatures
- lighter weight
- smaller sizes for more compact construction
- higher permeability
- less corona effect
- lower cost



IRON SLEEVE & CUP CORES

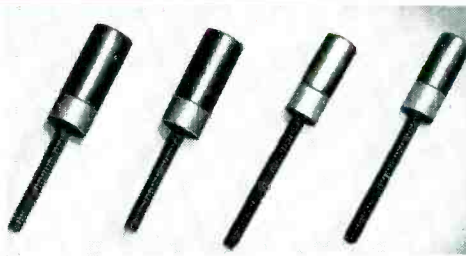

INSULATED IRON CORES

## Moldite IRON CORES

Moldite Iron Cores are made in an infinite variety of powders, shapes, and sizes and include all types of standard cores as well as numerous specially designed cores for new developments, commercial and military applications.

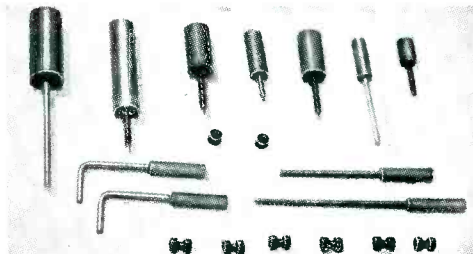

CORES WITH INSERTS (plated or unplated) and PLAIN CORES (Solid or with I.D.)

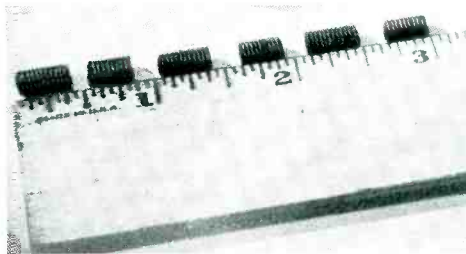

THREADED IRON CORES

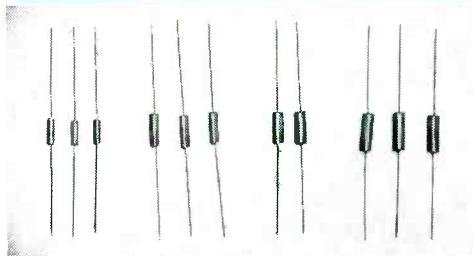

IRON & PHENOLIC COIL FORMS  
(also in ferrite)

## Moldite COIL FORMS

Moldite Coil Forms provide simpler coil assemblies—smaller coils, point-to-point wiring, minimum of solder connections and are inexpensive.

IRON CORES • FERRITES • MOLDED COIL FORMS • E E CORES

The Murray Co.  
604 Central Avenue  
East Orange, N. J.

Jerry Golten Co.  
2750 W. North Ave.  
Chicago 22, Ill.

William A. Franklin  
3 Holly Road  
North Syracuse, N. Y.

Jose Luis Ponte  
Cardoba 1472  
Buenos Aires



WAverly 6-2123

Send for Catalog #150

1410 Chestnut Avenue  
Hillside 5, New Jersey

Perlmuth Electronics Assoc. John S. Plewes Co.  
2419 South Grand Ave. 52 Humbercrest Blvd.  
Los Angeles, Cal. Toronto 9, Ontario

for waveform  
analysis...



there's nothing like  
**LF-2** FOR FLEXIBILITY  
FOR HIGH RESOLUTION

The LF-2 is a heterodyne type analyzer which automatically presents a permanent paper recording of the frequency and amplitude of components between 0.5 cps and 2250 cps.

The LF-2 is used for vibration and sound analysis of large structures or devices in which members rotate or oscillate at approximately the same or multiples of the same rate

- acoustics • noise analysis • servo analysis • geophysical investigations • medical studies • general low frequency waveform investigations.

by analyzing waveform content—obtained through converting any given parameter into electrical energy by means of a sensing device such as a microphone or other transducer—you can detect defects, check variations, make adjustments, test production, improve design

## PANORAMIC'S SUBSONIC Waveform ANALYZER LF-2

No rigid frequency segments here! The LF-2's scan range selector provides 6 different scan widths which may be centered at almost any point of the instrument's frequency range with the variable center frequency control. Check the table below.

A maximum resolution of 1/10 cps! The LF-2's range of scan intervals and sweepwidths make possible exceptional resolution. Check the table below.

Definitive amplitude! The LF-2's dual amplitude scales—20 db linear and 40 db log—permit a broad range of comparative analyses.

Scan Range	Linear Scan Widths (cps)	Cps Resolution at Scan Intervals of		
		10 sec.*	2 min.	16 min.
X 1.0 (0—2250 cps frequency)	500	12	3.5	1.5
	100	6	1.7	0.75
	20	3	0.7	0.5
X 0.1 (0—225 cps frequency)	50	—	1.0	0.5
	10	—	0.5	0.25
	2	0.7	0.18	0.1

\*Useable only with external oscilloscope.

Yes, there's nothing like the LF-2. Complex? Not at all! It's as simple as this:

1. For a quick overall look, set dials for maximum scan width and short scan interval.
2. Select area of interest.
3. Select scan width and scan interval for detail and degree of resolution desired. (The narrower the scan width, the longer the scan interval, the higher the resolution.)
4. Result—a quickly obtained, accurate, detailed, recording of waveform content.

Investigate this VERSATILE TOOL today. There's a Panoramic Spectrum Analyzer (Sub-Sonic through Microwave) to meet every need! A Panoramic Application Engineer is always available to discuss specific problems. Write, wire or phone

PANORAMIC RADIO PRODUCTS, INC.  
10 S. 2nd Av., Mt. Vernon, N. Y.  
MOunt Vernon 4-3970  
Cables: Panoramic, Mount Vernon, N. Y. State

## D-C AMPLIFIER operational broadband type

KINTEL, 5725 Kearny Villa Road, San Diego 12, Calif. By performing very slight modifications to the model 111A broadband d-c amplifier, the zero gain position becomes an open loop position. The user may then employ his own feedback networks to provide up to 100-percent resistive or capacitive feedback around the amplifier. By choosing the proper input and feedback components it is possible to select the desired gain, cause the amplifier to act as an integrator, generate complex linear transfer functions and limit the bandwidth. The open loop d-c gain is practically infinite (greater than 140 db).

When used on other than the open-loop position, the amplifier may be used for normal operation and the following specifications



the pioneer  
is the leader



**PANORAMIC**  
RADIO PRODUCTS, INC.



# AUTOMATIC

# SILICON RECTIFIERS

PIGTAIL



STUD-MOUNT

*Quantity* **PRODUCTION**  
**MEANS**  
*Quantity* **PRICING**  
**FAST DELIVERY**

## TYPICAL VALUES AT 100°C

Type No.	P. I. V. (volts)	Average DC Output Current (MA)	Reverse Leakage At Rated P. I. V. ( $\mu$ A)	Mounting
1N440	100	300	0.03	Pigtail Leads
1N441	200	300	0.075	"
1N442	300	300	0.10	"
1N443	400	300	0.15	"
1N444	500	300	0.18	"
1N445	600	300	0.20	"
1N530	100	300	0.30	"
1N531	200	300	0.75	"
1N532	300	300	1.00	"
1N533	400	300	1.50	"
1N534	500	300	1.80	"

## TYPICAL VALUES AT 100°C

Type No.	P. I. V. (volts)	Average DC Output Current (MA)	Reverse Leakage At Rated P. I. V. ( $\mu$ A)	Mounting
1N535	600	300	2.00	Pigtail Leads
1N560	800	300	1.50	"
1N561	1,000	300	2.00	"
1N550	100	500	.05	Stud-Mount
1N551	200	500	.10	"
1N552	300	500	.15	"
1N553	400	500	.20	"
1N554	500	500	.25	"
1N555	600	500	.30	"
1N562	800	500	1.50	"
1N563	1,000	500	2.00	"

The development of mass production techniques now enables Automatic Manufacturing to offer most types of their quality Silicon Rectifiers **from stock** and at a price consistent with both project and production work.

Now, for the first time, you can utilize all the superior design characteristics of silicon at a cost comparable to other kinds of rectifying devices . . . characteristics which include:

- Smallest Power Rectifiers Available
- Extremely Low Forward Resistance
- Infinitesimal Reverse Leakage
- Rectification Ratio of  $10^9$
- Excellent High Temperature Performance

These all-welded, hermetically sealed units are designed for dependable operation at ambient temperatures in the range of  $-55^{\circ}\text{C}$  to  $+150^{\circ}\text{C}$ . Their small size and light weight make them ideal for use in all types of miniaturized equipment.

Write today for new Automatic spec sheets giving complete technical data.



MASS PRODUCERS OF  
ELECTRONIC COMPONENTS



DIVISION OF GENERAL INSTRUMENT CORPORATION  
65 GOUVERNEUR STREET NEWARK 4, N. J.

# military test equipment

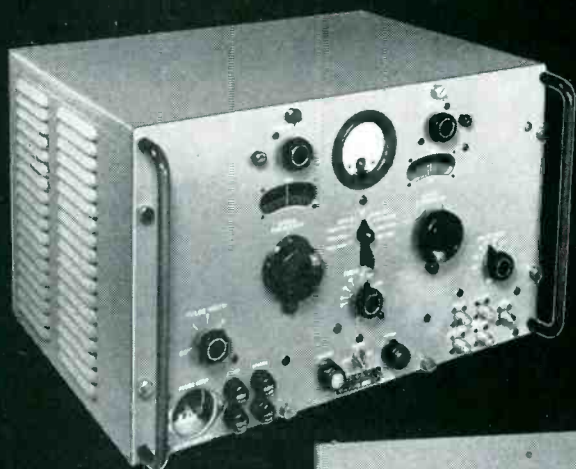

**TS-419  
SIGNAL  
GENERATOR**

900 to 2100 mc

**AN/USM-26  
FREQUENCY  
COUNTER**

10 cps to 220 mc

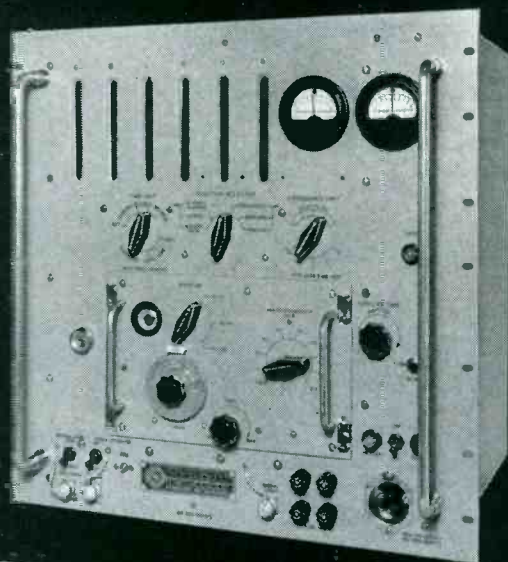

**FREQUENCY  
METER**

TS-186D/UP

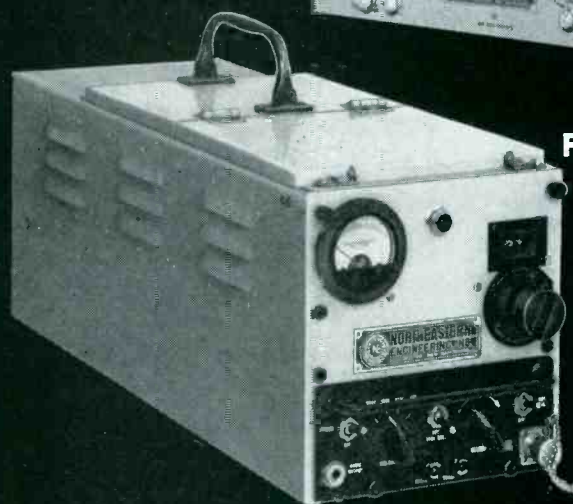

100 to 10,000 mc

**northeastern engineering**

Manchester



New Hampshire

apply: less than 2- $\mu$ v drift;  $\pm 35$ -v or  $\pm 40$ -ma output; 100-megohms input and less than 1-ohm output Z; 1-percent gain accuracy; frequency response of 0.3 db from d-c to 10 kc, less than 3 db down at 40 kc. Circle P19 inside back cover.

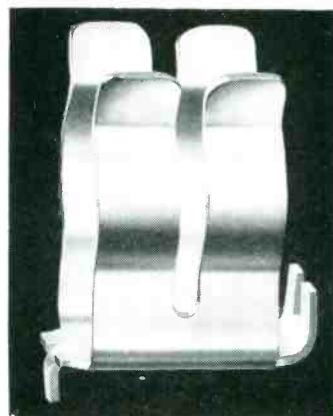

## TRANSISTOR CLIPS

meet heat, shock, vibration

ATLAS E-E CORP., 47 Prospect St., Woburn, Mass., has designed a transistor clip to meet the rugged heat, shock and vibration requirements for aircraft and missiles. This silver-plated Beryllium copper clip will hold all transistors 0.235 in. by 0.375 in.

The clip is split to insure a four point tight grip and has a stop tab to prevent the transistor moving longitudinally. Provided with a single  $\frac{1}{8}$ -in. diameter mounting hole, the clip has an integral tab to be inserted in a second hole to prevent twisting. Bulletin No. 10 is available. Circle P20 inside back cover.

## PLASTIC TUBES

and hollow shapes

ANCHOR PLASTICS CO., INC., 36-36 36th St., Long Island City 6, N. Y., has available extruded plastic tubes and hollow shapes made to exact specifications.

Tubes may be specified from 0.020 in. inside diameter up to 3 in. with heavy or thin wall thicknesses. Hollow shapes are obtainable in cross-sectional designs such as oval, rectangular, flanged or keyed.

Extruded tubes and hollow



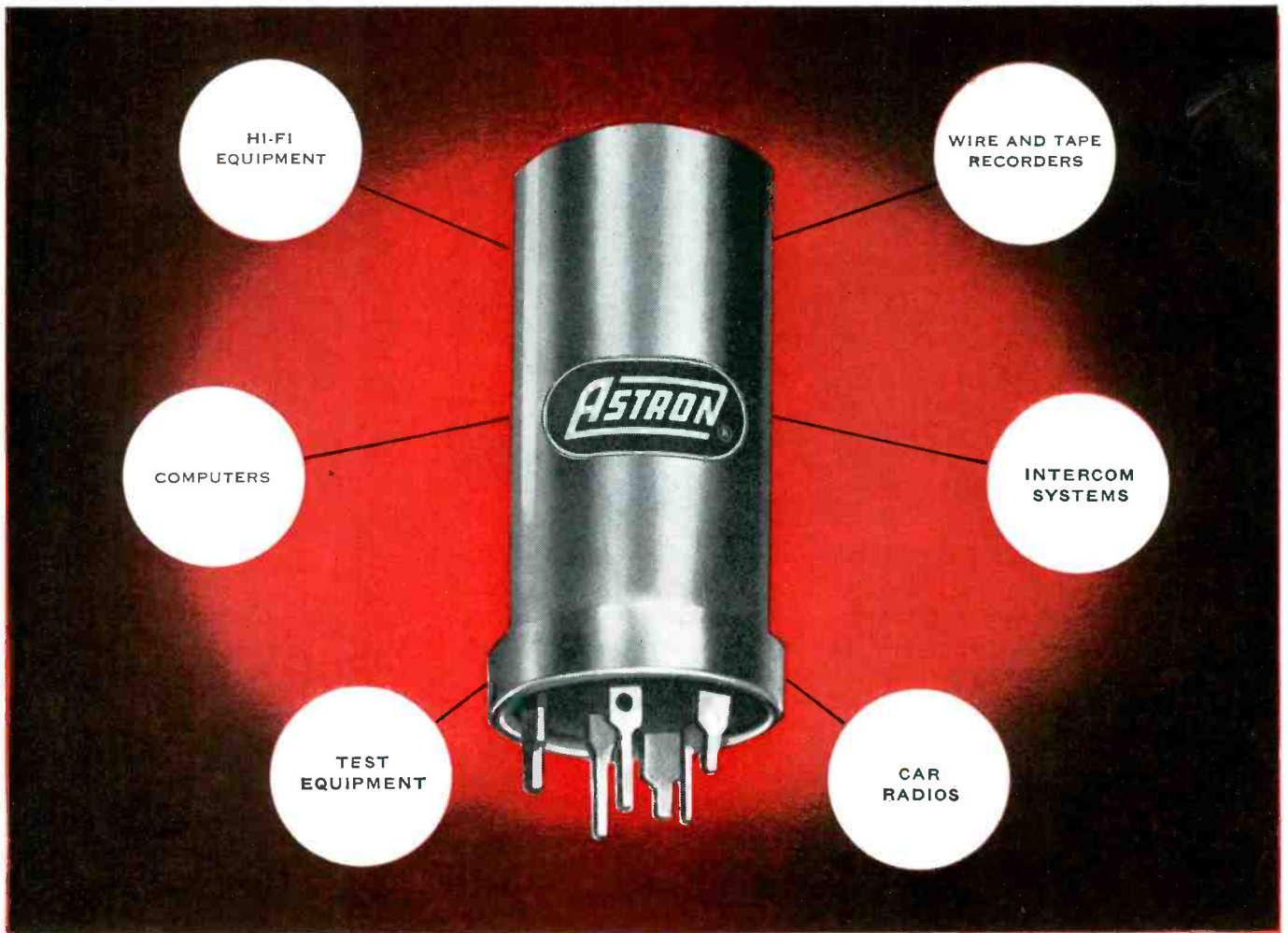

ASTRON 'SAFETY MARGIN' \*

**ELECTROLYTIC CAPACITORS**

**for transistorized and printed circuits**

**IMPORTANT DESIGN ADVANTAGES OF  
ASTRON EZ AND EX ELECTROLYTICS**

- MINIATURIZED SIZE—LIGHT IN WEIGHT
- DESIGNED FOR MINIMUM LOSSES —  
LOW DRAIN
- LONG "SHELF" AND OPERATING LIFE
- HERMETICALLY SEALED
- RUGGEDLY CONSTRUCTED

Today's low-voltage transistorized and printed circuits demand capacitors with absolute minimum leakage and impedance. To meet these exacting needs, Astron Engineers developed new miniaturized EZ and EX Electrolytics for ambient operation up to 85° C.

99.99% pure aluminum foil is specially anodized by an exclusive process . . . power drain is cut to a minimum. They are constructed to withstand extreme temperature changes and give reliable operation after periods of "long idleness."

Each electrolyte formula is scientifically compounded of special chemicals, selected for their high purity. Assembly steps are kept meticulously clean . . . the result: Safety Margin Construction, famous for its ability to withstand ripple currents, vibration, shock and wide temperature fluctuations. These hermetically sealed units are available in a broad selection of capacitance and voltage ratings.

Send today for further technical information . . . **please describe your application; it helps us offer proper assistance to you . . . when special conditions require, we will design a prototype to meet your specifications.**

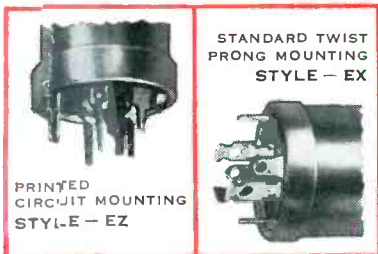

**ASTRON**  
CORPORATION  
255 GRANT AVENUE EAST NEWARK, N. J.



ELECTRONICS CORPORATION • A wholly-owned subsidiary of ASTRON CORPORATION  
PECKVILLE, PENNSYLVANIA

\*Trade-Mark

WEST COAST WAREHOUSE: 9041 WEST PICO BLVD., LOS ANGELES - EXPORT DIVISION: ROCKE INTERNATIONAL CORP., 13 EAST 40TH ST., N. Y., N. Y. - IN CANADA: CHARLES W. POINTON, 6 ALCINA AVE., TORONTO, ONTARIO

# REVERE *Permacode*<sup>®</sup>

## TEFLON-INSULATED WIRE

### *Striped to the core*

PERMACODE is a Teflon-insulated hook-up wire with striping that goes right down to the conductor . . . with colors that won't rub off . . . that heat won't change . . . that are good for the life of the wire. Coding is available in a wide variety of combinations of twin, triple or quadruple stripes selected from fifteen basic solid colors. Insulation quality unaffected by striping process.

Revere PERMACODE — with tough extruded Teflon insulation — offers excellent abrasion resistance and high dielectric characteristics for continuous operation from -90°C to +210°C. Strips clean. Doesn't shrink when soldered. Isn't hurt by the slip of a hot soldering iron.

PERMACODE hook-up wire is available with either solid or stranded silverplated copper conductors. Shielding and jacketing can be furnished. Sizes 28 to 16 gauge in 0.010" wall (600 volt) and 0.015" wall (1,000 volt) thicknesses. Conforms to MIL-W-16878, Types E and EE.

©Revere trade name \*E.I. du Pont trademark

#### TYPICAL SPECIFICATIONS — 22 Gauge Permacode Wire

Spark Test Voltage . . . . .	3000 volts
Insulation Resistance . . . . .	Greater than 10 <sup>4</sup> megohm/1000 ft.
Continuous Operating Range . . . . .	-90°C to +210°C†
Flammability . . . . .	Does not support combustion
Operating Voltage . . . . .	600 or 1000 volts
Tensile Strength . . . . .	2000-3000 PSI
Shrinkage . . . . .	Less than 1/8" in 18" at 250°C
Abrasion (Per MIL-T-5438) . . . . .	Passes 30" of 400 grit, aluminum oxide, 1/2 lb. weight
Water Absorption . . . . .	0.0%
Specific Gravity . . . . .	2.2 average
Chemical and Solvent Resistance . . . . .	Excellent

†Wire passes 96 hour, 250°C heat ageing test as required by MIL-W-16878.

Write today for Engineering Bulletin No. 1901 describing Revere PERMACODE wires.



# Revere CORPORATION OF AMERICA

17

WALLINGFORD, CONNECTICUT A Subsidiary of Neptune Meter Company

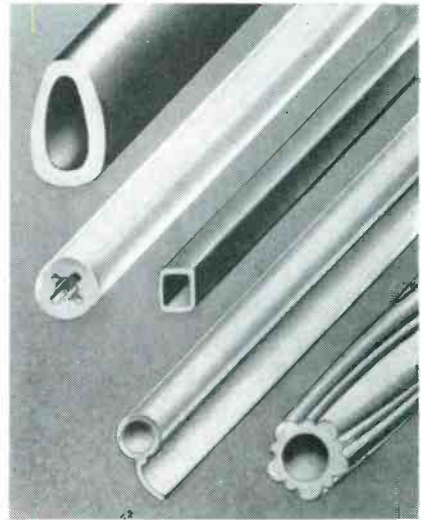

shapes are obtainable in rigid, flexible, hard or soft materials in unlimited color ranges and crystal clear. They come cut to exact lengths or in coils, spools or random lengths. Circle P21 inside back cover.

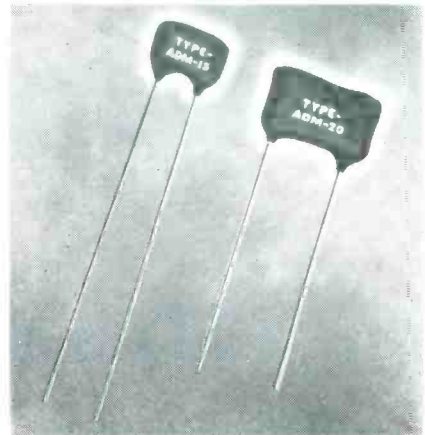

#### MICA CAPACITORS are plastic-coated dipped

AEROVOX CORP., New Bedford, Mass., announces a new line of plastic-coated dipped-mica capacitors that feature greater stability and new versatility. Meeting all the applicable RETMA test standards for molded mica capacitors, these units offer excellent long-life characteristics, improved temperature coefficient range and excellent performance and stability characteristics.

Featuring radial leads for automatic insertion and plug-in assemblies, these units are ideal for printed-wiring applications. They are available in a complete range of standard capacitance values for



# FM-AM

# TELEMETERING

# SIGNAL GENERATOR

## Type 202-F 175-250 MC

DESIGNED FOR BOTH

BENCH USE

AND

RACK MOUNTING

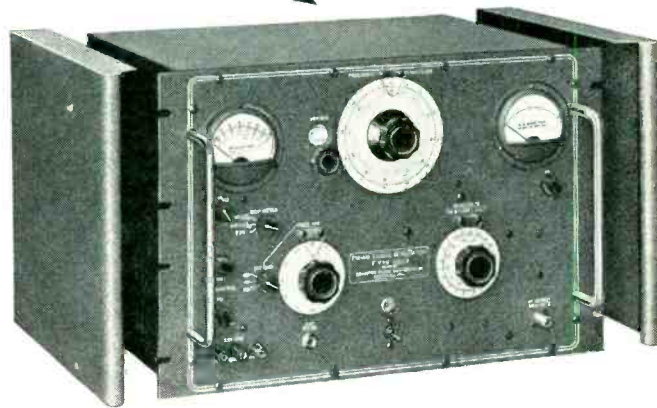
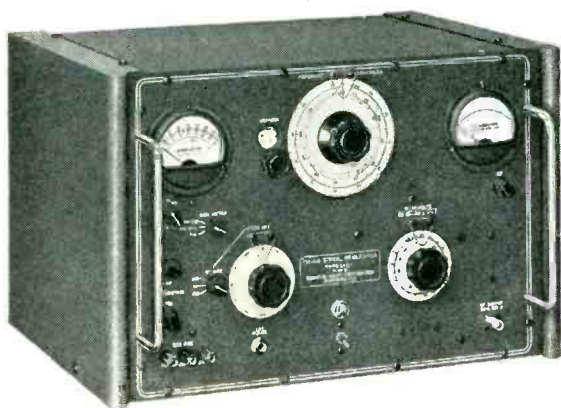

**RF RANGE:** 175-250 Megacycles.

**ACCURACY:**  $\pm 0.5\%$  after warm-up.

**RF OUTPUT:** Max. open circuit output voltage is approx. 0.4 volt. With output cable connected max. calibrated output voltage is 0.2 volt nominal. Min. 0.1 microvolt.

**FREQUENCY MODULATION:** Three frequency deviation ranges, 0-24 KC., 0-80 KC., and 0-240 KC. are provided, each continuously adjustable.

**FM DISTORTION:** The overall FM distortion at 75 KC is less than 2% and at 240 KC less than 10%.

**FIDELITY CHARACTERISTICS:** The deviation sensitivity of the FM modulation system as a function of frequency is flat within  $\pm 1$  db from 30 CPS to 200 KC.

**AMPLITUDE MODULATION:** Internal modulation available from 0-50% with meter calibration points at 30% & 50%. Using an external audio oscillator, the carrier may be amplitude modulated to substantially 100%. For this purpose the modulation meter has a scale calibration point at 100%. A front panel jack is provided which permits direct connection of an external modulation source to the screen of the final stage for pulse and square wave modulation.

**INTERNAL AF OSCILLATOR:** The internal AF oscillator provides either frequency or amplitude modulation; it may also be switched off. The internal AF oscillator provides eight fixed frequencies which may be selected by a rotary type switch—50, 100, 400 cycles and 1, 5, 7.5, 10, 15 kilocycles, accurate to within 5%. Harmonic distortion, in general, is less than 0.5%.

## UNIVERTER TYPE 207-F

The Univerter, Type 207-F, a frequency converter accessory with unity gain, is designed to provide additional frequency coverage from 0.1 MC to 55 MC when used with Signal Generator Type 202-F.



**BOONTON  
RADIO  
CORPORATION**



Boonton, New Jersey

**PRICES:**

FM-AM Signal Generator Type 202-F  
\$1075.00

Univerter, Type 207-F \$380.00

F.O.B. Boonton, New Jersey

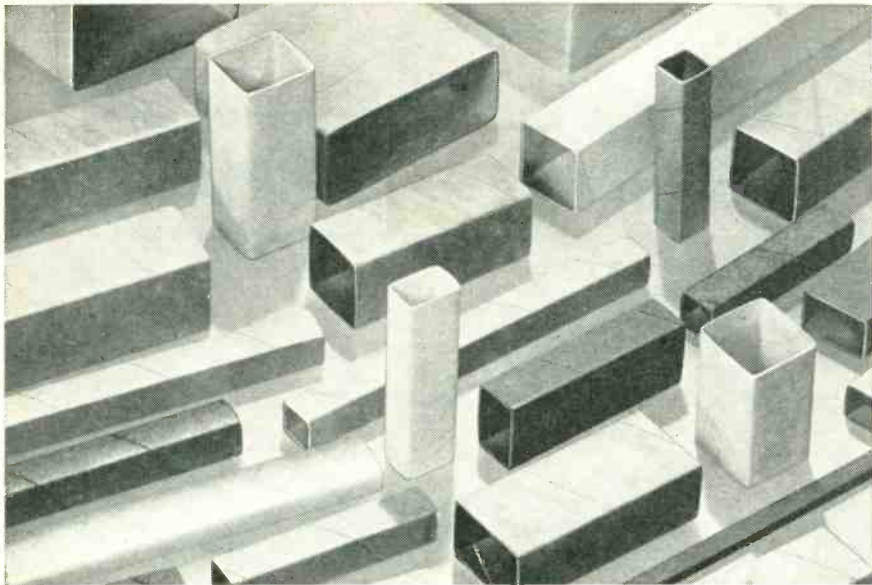

**If Dielectric or Corrosion Problems  
Are Causing Coil Trouble...**

**PRECISION  
CAN HELP  
ELIMINATE  
THEM!**

Precision specializes in the fabrication of square and rectangular, round and special shaped coil forms . . . acetate or mylar covered . . . silicone, phenolic or Resinite impregnated . . . to help you solve any dielectric or corrosion problem. Forms can be made to your exact specifications in all sizes from 1/16" square to 8" square, with wall thicknesses from .010 to .125.

Only the highest quality electrical grade kraft, quinterra, acetate or various combinations of these materials are used. Precision Paper

Tubes are available in standard or exclusive patented DI-FORMED construction for greater crush resistance, high tensile strength and extreme dimensional stability.

Get immediate service. Call a Precision representative or contact our Chicago, Ill., or Hartford, Conn., plant.

**sales offices in:**

California, Oregon, Washington:  
Covina, California, Edgewood 2-4693

Illinois, Indiana, Iowa, Wisconsin,  
Missouri, Minnesota: Chicago, Illinois,  
ARmitage 6-5200

Indiana, Ohio: Logansport, Indiana,  
Logansport 2555

Northern Ohio: Cleveland, Ohio, Atlantic  
1-1060

New England: Framingham, Massa-  
chusetts, Trinity 3-7091

New Jersey, Delaware, Washington,  
D.C., Maryland, Eastern Pennsylvania,

Virginia, Metropolitan New York:  
Jersey City, New Jersey, Swathmore  
5-2480

Upper New York: Syracuse, New York,  
Syracuse 4-2141

CANADA: Montreal, Quebec, Canada,  
Walnut 0337

MEXICO: Mexico 6, D.F., Telephone  
35-06-18

**REQUEST  
CATALOG**

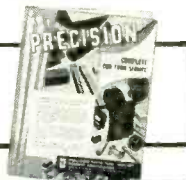

**PRECISION PAPER TUBE CO.**

2041 WEST CHARLESTON STREET • CHICAGO 47, ILLINOIS

Plant No. 2: 1 Flower Street, Hartford, Conn.

operation at temperatures of -55 C to +125 C. Circle P22 inside back cover.

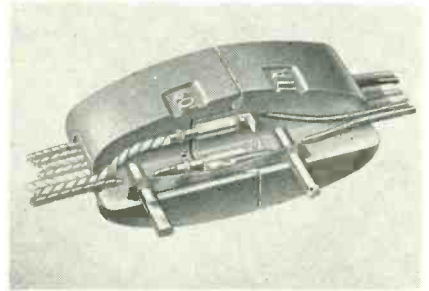

**UMBILICAL CONNECTOR**  
uses new molding technique

ALDEN PRODUCTS Co., 117 N. Main St., Brockton, Mass. The IMI (integral molded insulation) technique makes it possible to supply molded unit cables in which the contacts and leads are molded with one hot shot of connector insulation into connector bodies integral with their cables. The designs eliminate tedious and critical assembly operations, reduce the number of parts in connector designs to a basic minimum, provide positive moisture seal and protect leads and contacts from shock and vibration. Thus connector reliability reaches a new level.

Specifications and literature on IMI connectors are available. Circle P23 inside back cover.



**PRESSURE SWITCHES**  
weigh only 0.75 lb

GULTON INDUSTRIES, INC., Metuchen, N. J. A differential pressure switch designed to make or break electrical circuits when the difference between two pressures is



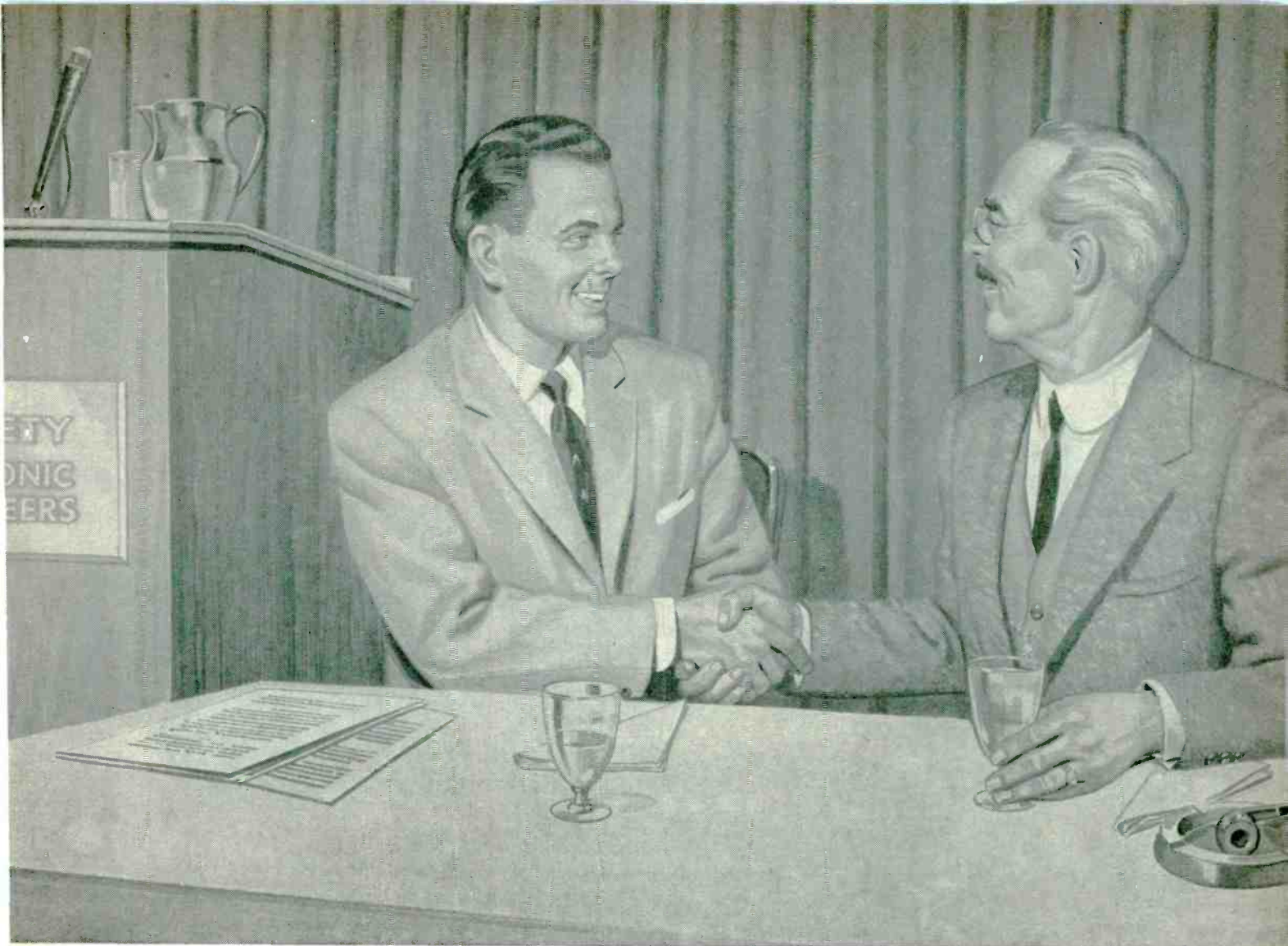

# "I'M WITH UNIVAC"

"I'M WITH UNIVAC"® . . . your password to a new and exciting world of opportunity. A career with Univac takes you behind the scenes of important developments in national defense, scientific research, business and industry. The tremendous advances made by Univac in automatic data processing and automation vitally affect all of these fields.

Become a member of the team that designs and builds the world-famous Univac electronic computers. Build a future for yourself in the most fascinating, fastest-growing industry of our times. Investigate the outstanding opportunities now open to you at Univac — world leader in this industry.

You'll be proud to say: "I'M WITH UNIVAC."

***Remington Rand Univac***

DIVISION OF SPERRY RAND CORPORATION

Check the following openings at any of these three locations

## PHILADELPHIA, PA.

Electronic Engineers, Logical Designers, Physicists, Programmers, Mathematicians. Send complete resumé to Mr. James Drumm, Dept. PA-2, 1900 W. Allegheny Ave., Philadelphia, Pa.

## SO. NORWALK, CONN.

Mechanical Engineers (graduates BS and MS levels), Design Engineers, with or without formal degree, if qualified. Send complete resumé to Mr. Robert Martin, Dept. NA-2, Wilson Ave., South Norwalk, Conn.

## ST. PAUL, MINN.

Electronics Engineers, Mechanical Engineers, Electronic Design Engineers, Engineering Writers, Physicists, Mathematicians. Send complete resumé to Mr. R. K. Patterson, Dept. SA-2, Univac Park, St. Paul 16, Minn.

# Celco TOROIDS

... Offered in a  
wide range of sizes

#50 wire on .062" ID  
#15 wire on 9" OD



Whether it's a complex 10 winding magnetic amplifier or a simple choke . . . at Celco each toroid is precision-made. New core materials are used in Toroidal magnetic amplifiers, reactors and transformers to achieve maximum performance.

At Celco, the proper matching of cores, winding, handling, impregnation, encapsulation and electrical history of the final assembly is carefully controlled to maintain the original design characteristics.

Our years of design, development, and production know-how are available for application to your specific **TOROIDAL** problems.

For immediate attention, call **RAMsey**  
9-1123 — or write today.



## Celco

MAHWAH, N. J.  
DAvis 7-1123

*Constantine*  
*Engineering Laboratories Co.*



Your plant is only hours away by the **Celco Air Fleet!**

equal to or greater than a pre-determined value is one of a new line of Glennite pressure switches announced.

Model 501-A features low and high operating pressures of 250 psig and 500 psig respectively and weighs only 0.75 lb. The pressure differential is sensed by a diaphragm type capsule designed to withstand high overpressure without sacrificing sensitivity. Circle P24 inside back cover.

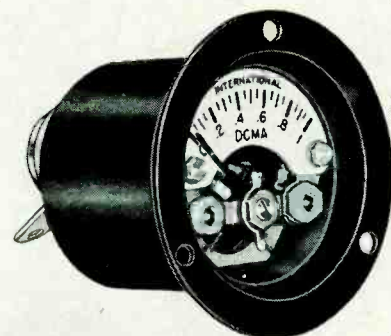

### PANEL METER

is one-in. round

INTERNATIONAL INSTRUMENTS INC., New Haven 15, Conn. Model 104, a 1-in. round meter, provides the longest scale arc in the smallest panel space. It employs a miniaturized D'Arsonval type movement with accuracy held to  $\pm 3$  percent of full scale for d-c instruments and  $\pm 5$  percent for a-c instruments.

Model 104-W meters with watertight seal have been tested successfully in accordance with the environmental requirements of Government Specification MIL-M-17275-A for d-c electrical instruments.

Other models are available. Circle P25 inside back cover.

### FREQUENCY STANDARD with stabilized tuning fork

INDUSTRIAL TEST EQUIPMENT Co., 55 E. 11th St., New York 3, N. Y. Model 1400 frequency standard employs a stabilized tuning fork to generate 400 cps with an accuracy of 0.005 percent. Other frequencies are readily available on request. A front panel control



# HYCON EASTERN introduces

*RAPID ACCESS*

## IN ANALOG DATA REDUCTION SYSTEMS

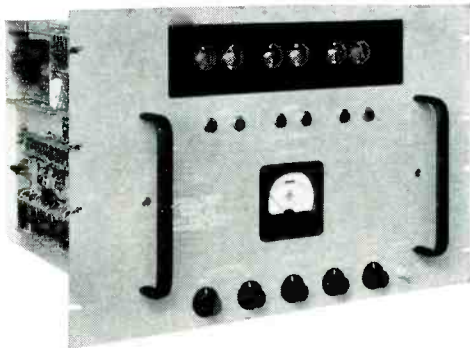
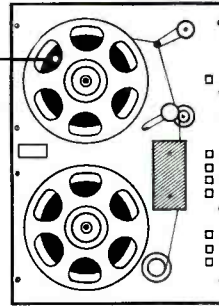

### *For Tape Indexing*

**DIGITAL TIMING GENERATOR**, Model 201, generates numerically coded timing signals which are recorded on the magnetic tape throughout the data recording periods, providing a precise digital index in terms of elapsed time. The Generator also visually displays the exact time in hours, minutes and seconds as illuminated digits.

#### DESIGN FEATURES

**TIMING INFORMATION** occupies only a part of the available bandwidth on a magnetic tape channel . . . remaining bandwidth in timing channel may be used for other purposes; e.g. to record other digital or analog data, or as a voice channel.

**TAPE SPEEDS** of 60, 30, 15,  $7\frac{1}{2}$ ,  $3\frac{3}{4}$  or  $1\frac{7}{8}$  inches per second may be used for recording. For playback, any one of these 6 speeds or a high-speed search rate may be used. Other speeds may be incorporated as required.

**TIMING TRACK** contains a combination of complete time numbers in hours, minutes, and seconds together with interpolation pulses so that time can be measured with a resolution of a few milliseconds.

**ADDITIONAL SIGNALS** for recording, recovery and display may be assigned to arbitrary control functions in the data system.

**FORWARD OR REVERSE** directions may be used for tape search at either the high-speed search rate or any one of the 6 normal record play back speeds.

**MOUNTS** in any RETMA standard 19" relay rack.

Two companion units by Hycon Eastern provide automatic high-speed access to selected data in Ampex Recorders and similar multi-channel magnetic tape instrumentation systems.



### *For Tape Search*

**MAGNETIC TAPE SEARCH UNIT**, Model 202, operates during data reduction periods. On the basis of time indices recorded on the tape by the Digital Timing Generator, this instrument automatically locates and selects for controlled playback the tape data included between a "sequence start time" and a "sequence end time" specified by panel dial settings. The time index is visually displayed as illuminated digits on a small separate panel which may be remotely located for convenience.

Write for Technical Bulletin TSG-O



**HYCON EASTERN, INC.**

75 Cambridge Parkway Dept. A-4 Cambridge 42, Mass.  
Affiliated with HYCON MFG. COMPANY, Pasadena, California

# FM

# TELEMETRY TRANSMITTER

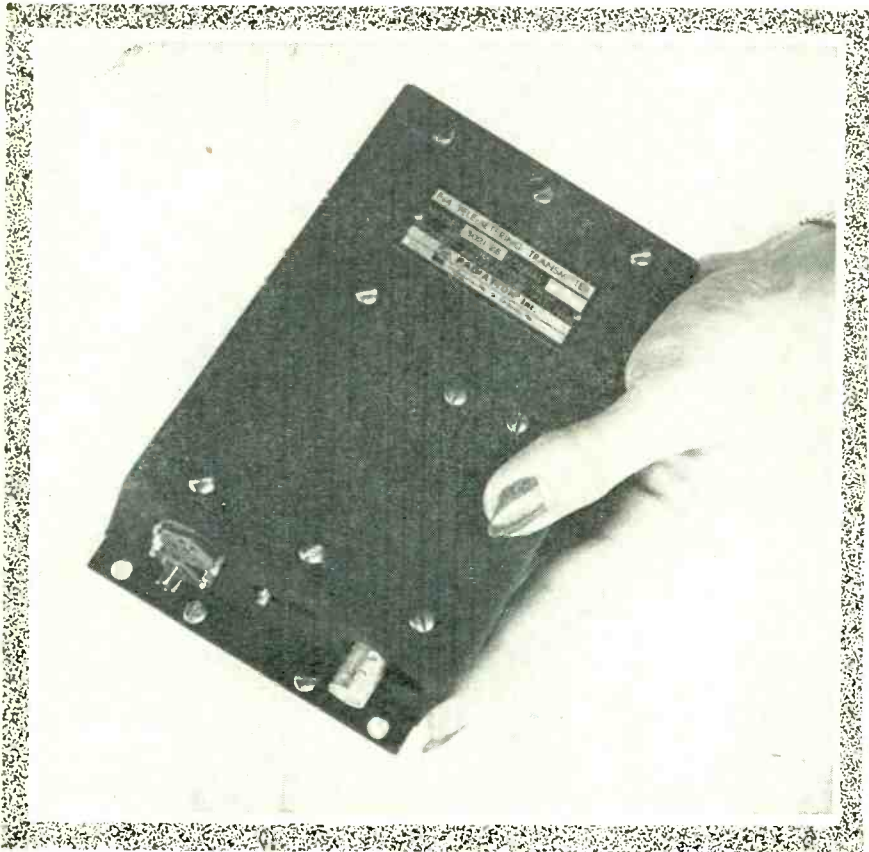

- SMALL SIZE
- LOW DISTORTION
- HIGH RELIABILITY
- HIGH FREQUENCY STABILITY

Frequency Range: 215-235 mc  
 Power Output: 2 watts  
 Weight: 1.7 pounds

An extremely rugged unit designed for high-shock impact and extreme environmental conditions. Subminiaturized and crystal-stabilized.

Write for complete data and prices

Personnel Inquiries Invited



**RADIATION Inc.**

Melbourne, Fla.  
Orlando, Fla.

Electronics • Avionics • Instrumentation

NEW PRODUCTS

(continued)



permits continuous variation of the output voltage. The distortion is less than 1 percent in a compact unit 6 by 9 by 6 in. Completely self-contained it merely requires a power supply of 115 v, 60 cps. Circle P26 inside back cover.

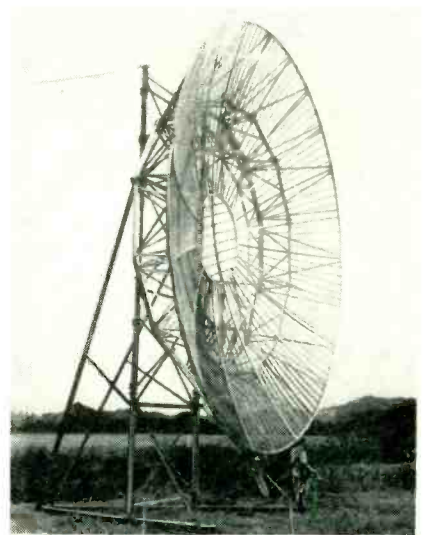

## PARABOLIC REFLECTOR

features new design

TECHNICAL APPLIANCE CORP., Sherburne, N. Y. Model D-322, one of a series of parabolic reflectors, is a 32-ft model featuring greater strength, ease of erection and rigidity in mounting. The dish is built around a 12-sided polygen torsion frame, 3-ft thick and 22 ft in diameter. Dead loads as well as added wind load of the antenna are directly transmitted to this polygon frame.

Model D-322 reflector is made of 12 outer sections and one center section. Each of the outer sections weighs approximately 150 lb. Assembly is simple and fast as the outer sections are bolted one to the other along the periphery. The antenna frame is designed



BURTON BROWNE/New York

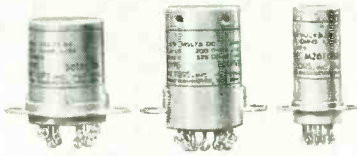

EXCLUSIVE WITH  
**FILTORS, INC.**

## **ONLY PRECISION MACHINED ROTARY RELAY**

NO STAMPED PARTS IN THE MOTOR. MACHINED PARTS—ONLY ONE OF THE ADDITIONAL QUALITY CONTROL STEPS TAKEN BY FILTORS IN THE MANUFACTURE OF HERMETICALLY SEALED SUB-MINIATURE RELAYS . . . YOUR ASSURANCE OF GREATEST RELIABILITY.

WRITE FOR CATALOG, FILTORS, INC., PORT WASHINGTON, LONG ISLAND, NEW YORK, PORT WASHINGTON 7-3850

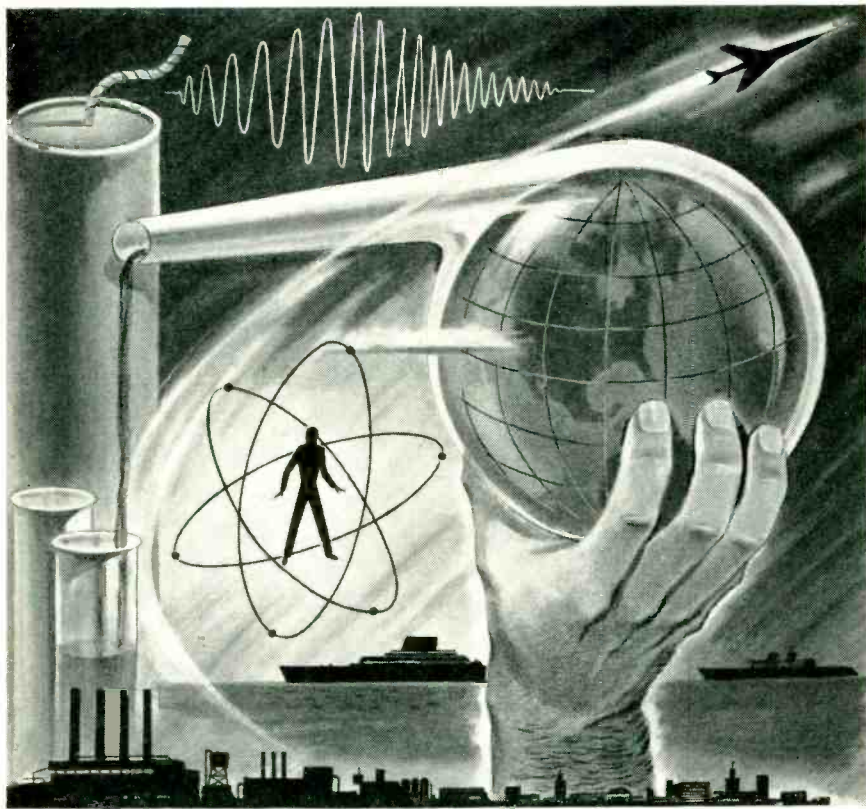

## Conquering Man's Conquest of Man

Today the great scientific brains of the world are engaged in pursuits whose fruits are the miracles of technological advancement. Comfort, safety, health, security—in all areas, great forward strides are being made by industry, by science and by (sigh) engineering.

At Sigma there has not been lack of awareness of the manifest destiny of man to free himself from the shackles of retrogression. The same Sigma thinking (we call it Sigmagineering) that gave Sigma Sensitive Relays to the world has now been directed toward the more serious problems of saving mankind from self-destruction. Our part is small, but perhaps it will be the little ocrn that will prevent the great aches from getting mightier.

Sigma's contribution to this worthy cause is the Aurelius P. Zindbasky Do-it-yourself Kit #1 for Finder Fixing (named for the Sigmagineer who invented it). It is instantly available, cost reasonable, benefits immeasurable. In less than one-half hour you can remove, with an A.P.Z. Kit #1, the unsightly fins on the rear finders of your late model car. Here are actual photographs of the results before (left) and after (right) use of an A.P.Z. #1:

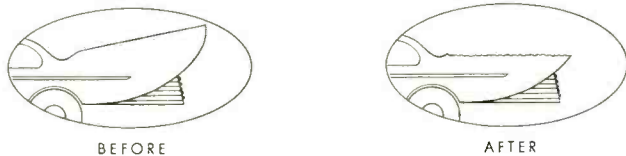

Although not a standard Sigma product, we are prepared to supply A.P.Z. Kit #1's on receipt of 78c (78c) in late model coins. Don't delay—this may be the turning point of your life.

**SIGMA INSTRUMENTS, INC.**  
62 Pearl St., So. Braintree, Boston 85, Massachusetts

ONE OF A SERIES OF ONE ADVERTISEMENTS DEPICTING SIGMA'S PLACE IN THE AMERICAN SCENE AND REPORTING ON ADVANCES IN FIELDS, THOUGH NOT EXACTLY BILATERAL TO SIGMA'S REGULAR FIELD, NEVERTHELESS.

for assembly to the supporting tower at 4 to 6 points along the closed ring, thus providing an extremely rigid mounting.

The D-322 is designed to be driven in a frequency range of 100 mc to 2,400 mc. Focal length is 13½ ft and the gain of the reflector with a focused antenna at 2,400 mc is approximately 44 db per antenna and 88 db per system.

Complete mechanical and electrical details are available. Circle P27 inside back cover.



### DIGITAL DIAL a 10-turn device

HELIPOT CORP., Newport Beach, Calif., announces a new turns-counting digital dial. The 10-turn Digidial gives direct numerical readings in full turns, tenths and hundredths.

The lightweight, ruggedly compact unit is designed for use with many types of multiturn devices, where fast accurate readings are required. It is ideally suited for use with precision potentiometers, variable capacitors and similar components.

The digidial has a reading resolution of 0.05 percent. It is equipped with a friction lock which can be engaged without disturbing the dial setting. Circle P28 inside back cover.

### RELAY in dust-proof enclosure

LINE ELECTRIC Co., 1407 McCarter Highway, Newark 4, N. J., has available the LR series relay in



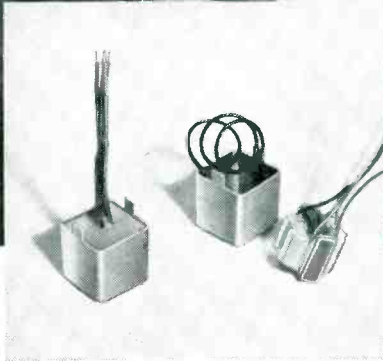

An Installation of Leeson Coil Winders in the Lenkurt Electric Company plant, San Carlos, Calif. Inset shows, left to right: a Lenkurt miniaturized high frequency transformer fully assembled; the transformer casing; and the transformer coil, precision-wound to extremely close tolerances on a fast Leeson No. 108 Hand Feed Coil Winder.

# LENKURT selects Leeson No. 108 Coil Winders for high-precision accuracy

As a leading designer and manufacturer of carrier equipment, the Lenkurt Electric Company of San Carlos, California, supplies the complex electronic apparatus used throughout the world by telephone companies in adding long-distance circuits. For winding the close-tolerance coils that go into this multi-channel communications equipment, Lenkurt depends on Leeson No. 108 Coil Winders. Chester Scarce, Factory

Manager of Lenkurt, reports: *"Our transformers call for coils of the finest quality to meet the high-precision standards of modern carrier equipment. We find that Leeson No. 108 Hand Feed Coil Winders give us not only the high degree of accuracy we must have, but worthwhile economy as well."*

Leeson No. 108 Machines are the easiest to operate, most accurate and flexible hand feed coil winders ever

developed. Winding four to thirty paper-insulated coils in stick form simultaneously, they reduce set-up time and speed production on long or short runs.

### Get the Facts

on how you can improve and economize your own operations. Use the coupon for further facts on Leeson No. 108 Hand Feed Coil Winders, and for other helpful coil winding information.

23B.5.7

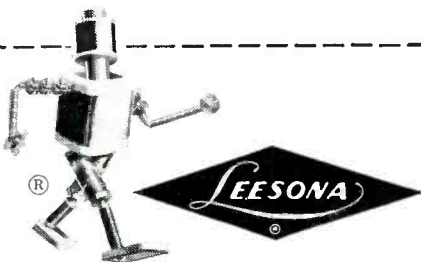

FOR WINDING COILS  
IN QUANTITY...  
ACCURATELY... USE  
LEESONA WINDING MACHINES

## UNIVERSAL WINDING COMPANY

P. O. BOX 1605, PROVIDENCE 1, RHODE ISLAND, Dept. 124

Please send me

- Bulletin on the Leeson No. 108 Hand-Feed Coil Winder.
- Condensed catalog of Leeson Winders.
- Bulletin on the new Leeson Pay-As-You-Profit Plans for purchasing or leasing modern coil winding machinery.

Name.....Title.....

Company.....

City.....Zone....State.....

# WHY SPARK GAP TUBES ARE IMPORTANT—

and how Bendix Red Bank can help  
you with spark gap problems!



Bendix Red Bank "Spark Gap" Tubes are specially designed to do two big jobs in electronic circuits.

First, to act as a "triggering" switch—as on jet ignition systems. Here, Bendix\* Spark Gaps pass high currents with relatively low voltage drop and have the advantage of being able to handle high voltages in small space. Further, these tubes can be made insensitive to ambient temperature variations and are not normally affected by pressure, altitude, or humidity changes.

The second function of Bendix Spark Gaps is as a *protective element*—guarding radar equipment against voltage overload, to name one example. Here, Bendix Spark Gaps keep high voltage surges from getting through to damage circuit components.

Our design and manufacturing experience with spark gap tubes is extremely broad. If our extensive line of these tubes . . . ranging from 750V to 50KV in DC breakdown voltages . . . does not already contain a type to fit your needs, we are in a position to design one to handle the job with the exact degree of efficiency that you require.

To find out more about what we can do to help you with your spark gap problems, get in touch with RED BANK DIVISION, BENDIX AVIATION CORPORATION, EATONTOWN, NEW JERSEY.

\* TRADEMARK

West Coast Sales and Service:  
117 E. Providencia Ave., Burbank, Calif.  
Export Sales and Service:  
Bendix International Division,  
205 East 42nd St., New York 17, N. Y.  
Canadian Affiliate:  
Aviation Electric, Ltd., P. O. Box 6102,  
Montreal, Quebec.

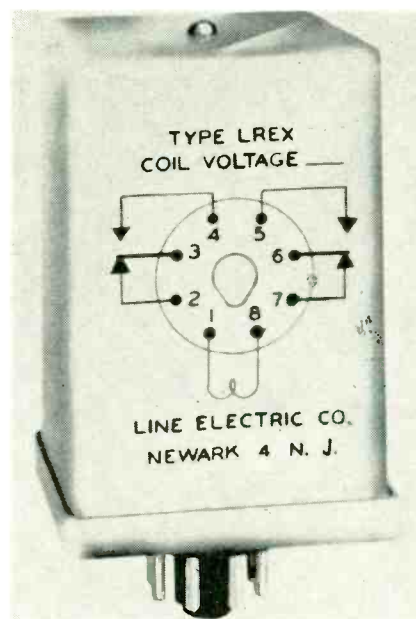

a plug-in dust-proof enclosure. Utilizing a standard octal plug this relay comes in contact arrangements up to dpdt silver contacts rated at 10 amperes 115 v a-c, noninductive. Coils are in all standard a-c and d-c voltages.

Dimensions are 3¼ by 1½ by 2 in. The relay wiring diagram is clearly printed on the enclosure. Circle P29 inside back cover.



## VACUUM PHOTOTUBE low dark current type

CONTINENTAL ELECTRIC Co., 6 N. Michigan Ave., Chicago 2, Ill., has developed a low dark current, high-sensitivity vacuum phototube for instrumentation work. Number CE-75V tube has a maximum dark current rating of  $5.0 \times 10^{-11}$  amperes and the peak sensitivity of the S1 surface is at 8,000 Angstrom units. All internal parts are electropolished to reduce dark





Handwritten notes in the top right corner include:  
20  
12  
25 DB.  
20 DB @ 100  
500 W  
1500

**...pioneers in  
nuclear energy since 1936**

• At the University of California Radiation Laboratory, Berkeley and Livermore, there is an unusual spirit among scientists and engineers—a spirit stimulated by association with pioneers in nuclear research who encourage development of new ideas, techniques, and individual initiative.

Since its founding in 1936, UCRL has contributed an impressive list of achievements to the world's knowledge of the atomic nucleus—from development of the cyclotron and Bevatron, to electromagnetic separation of uranium-235, to the discovery of the antiproton and antineutron.

These accomplishments have, of course, stemmed from an outstanding group of men working with unmatched laboratory facilities. But just as important—and the key, perhaps, to UCRL's successes—has been the spirit with which these men work.

For UCRL is managed and directed by scientists and engineers—men who are liberal with their own knowledge and enthusiastic in the encouragement of their teammates' new ideas and new techniques.

This is the constant and continuing spirit of UCRL. It is to be found in each new and expanded project—whether it involves pure or applied science. It keynotes work on nuclear weapon design, nuclear propulsion, controlled thermonuclear energy (Project Sherwood), and high current accelerators, as well as such problems as the application of radioactive substances to biology and medicine.

The UCRL "spirit" appeals to a particular kind of scientist and engineer—to men of ability and imagination, to men who wish to move forward and challenge the unknown. If you wish additional information, write to the Director of Professional Personnel, University of California Radiation Laboratory, Livermore, California.

when you  
need

# CUSTOM METERS

*Yesterday!*



## CALL WATERS

Of course yesterday is a colloquial term, but we can and will give your order, whether large or small, extra fast attention and quick delivery. Custom meters will be made to your specifications regarding scales, graduations, ranges, colors, and trade names.

All meters have D'Arsonval-type movements with standard accuracy 2% of full scale. All a-c meters include internal rectifier.

*The Waters line includes:*

- A-c and d-c microammeters, milliammeters, voltmeters, d-c millivoltmeters and ammeters.
- 2 1/2" and 3 1/2" round cases.
- 2 1/2" and 3 1/2" square, clear plastic cases.
- 3 1/2" and 4 1/2" rectangular cases.

Hermetically-sealed meters are made to Military Specifications MIL-M-6A and JAN-1-6.

*Write today for further information,  
or see your Waters representative.*

**Waters**  
MANUFACTURING, inc.

APPLICATION ENGINEERING OFFICES  
IN PRINCIPAL CITIES

Wayland, Massachusetts  
P. O. Box 368, So. Sudbury, Mass.



NEW PRODUCTS

(continued)

current to a very low value. The bulb and base have also been silicone treated to reduce external leakage.

Because of extreme low dark current, this tube may prove valuable in many applications besides instruments. Circle P30 inside back cover.

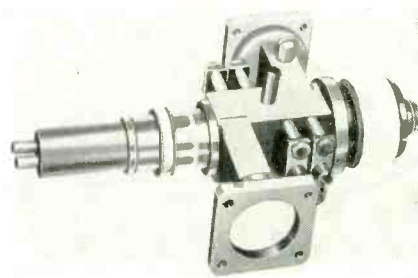

### AMPLIFIER KLYSTRON has long life, high gain

VARIAN ASSOCIATES, Palo Alto, California, has introduced the VA-806 klystron for use as the final amplifier of a high-power microwave transmitter. Performance characteristics permit amplification of frequency, amplitude or phase-modulated signals at power gains on the order of 50 db. It features a unique, all-ceramic and metal construction.

The VA-806 provides 2,000 w of continuous power in the 7,125 to 8,500-mc frequency range. It is a water-cooled, four-cavity cascade amplifier that is tunable +25 mc from the specified center frequency.

Particular advantages include long life, high gain, rugged integral cavities and low microphonics. The VA-806 features matched waveguide input and output and low f-m and a-m noise. Circle P31 inside back cover.

### RADIOTELEPHONE for industrial uses

KAAR ENGINEERING CORP., 2995 Middlefield Road, Palo Alto, Calif., has announced a new version of the IMP (industrial mobile phone), low cost two-way radiotelephone which has many railway applications. It employs a double-conversion superheterodyne receiver and a low-power transmitter



# ACCELERATION TESTING...

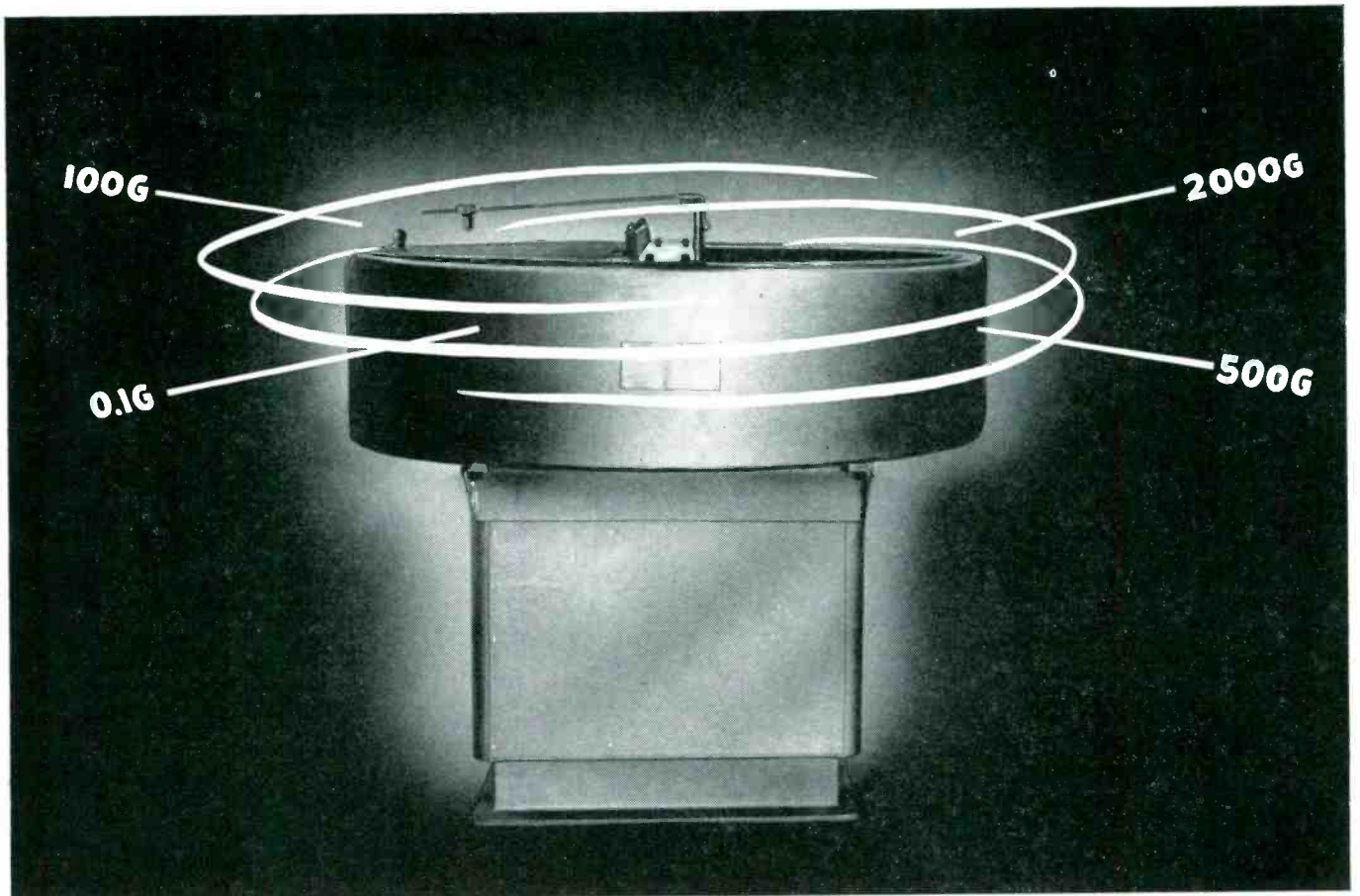

SCHAEVITZ Rotary Accelerators are available for calibration and environmental testing over wide ranges of acceleration. Objects from a tiny accelerometer to a large electro-mechanical assembly can be tested. These accelerators are characterized by: flexible speed control, accurate transmission of signal voltages, convenience and safety in use.

ONLY SCHAEVITZ HAS THE EXACT TYPE OF ROTARY  
ACCELERATOR TO MEET YOUR REQUIREMENTS

**schaevitz**

**machine works**

P. O. BOX 505 CAMDEN 1, NEW JERSEY  
Phone: Merchantville 8-5353 • TWX MERCHANTVILLE NJ 386

# Better solders, fluxes and alloys for better electronic components

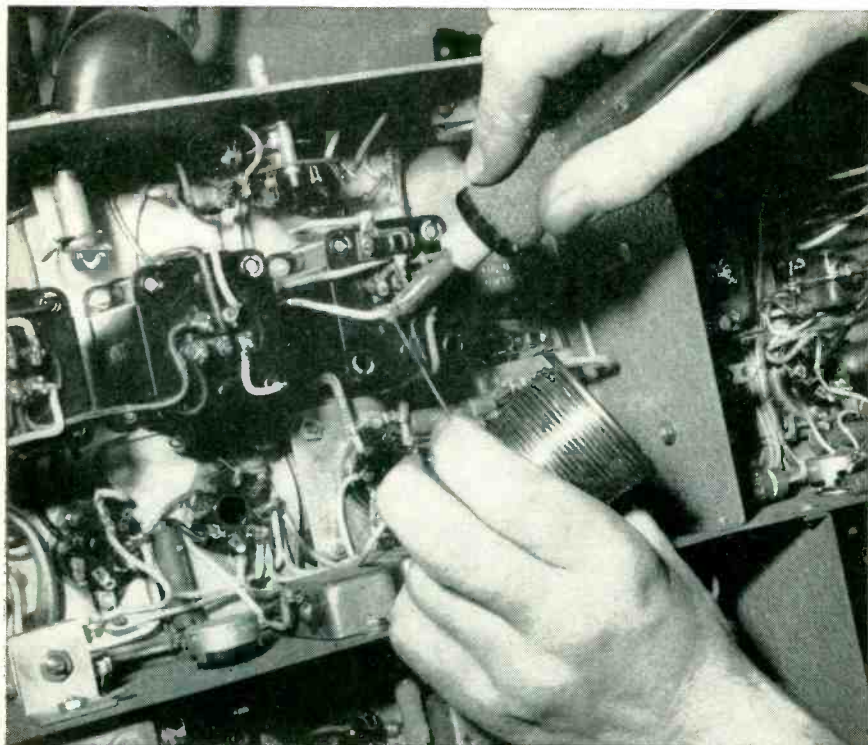

For volume production components, Federated supplies these quality-controlled alloys and non-ferrous supplies:

1. Counter-electrode alloys that are spectrographically or quantometrically tested. Samples from each heat meet exacting specifications to assure proper performance.
2. Rosin Core and Activated Rosin Core Solders of uniform quality for high-speed production, competitively tested to assure maximum efficiency and non-corrosive characteristics.
3. Liquid fluxes that surpass government corrosion-free requirements.
4. High-fluidity Castomatic® Solder for printed circuits, automatically cast under pressure in air-tight machines to minimize dross formation, gives better results in the dipping pans.

All Federated products are produced under the supervision of ASARCO's Central Research Laboratory, where spectrographically pure metals are refined for electronic experimentation.

No other producer of non-ferrous materials gives you such assurance of constant quality. Try Federated products. It will pay you well.



## Federated Metals

Division of



**AMERICAN SMELTING AND REFINING COMPANY**

120 Broadway • New York 5, N. Y.

NEW PRODUCTS

(continued)

which features narrow-band transmission. The transmitted signal requires less than eight kc of band space as compared with 30 kc required by most existing mobile transmitters.

Transmitter, receiver and power supply are contained in a single compact metal enclosure provided with a shock mount for mobile applications. The same unit may be used either as a base station or mobile unit without modification.

The IMP is intended for short-range communications within a radius of two miles. Principal railway applications are in stores and shop operations as well as in first-class freight handling. It may also be used on yard-switching engines and on locomotives and cabooses for end-to-end service or wherever the two-mile range is adequate.

The IMP sells for \$360 complete with plug-in antenna, tubes, crystals, palm microphone and shock-mount. It can be operated on any single frequency in the 152 to 174-mc band. **Circle P32 inside back cover.**

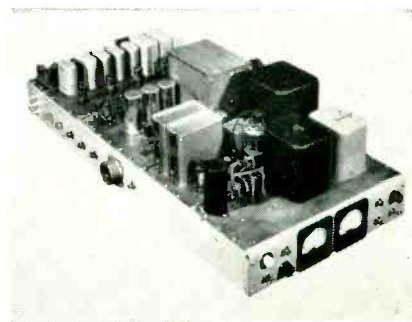

## SIGNAL GENERATOR

simulates radar pulses

ADVANCED ELECTRONICS MFG. CORP., 2025 Pontius Ave., Los Angeles 25, Calif., has developed a radar mark generator which simulates both range timing pulses and 10 deg and 30-deg azimuth pulses. Designed for use in personnel training as well as radar equipment design, the unit is completely self-contained in a portable case or relay rack-mount and has its own power supply. It provides one- $\mu$ sec pulses for 10-mile and 50-mile markers, and a main trigger every 350 miles. Ten-millisecond azimuth pulses are generated from a 36-





**RCA-WV-98A . . . ALL-NEW SENIOR VOLT-OHMYST** . . . incorporates all the important time-proved performance features of earlier VoltOhmysts including direct peak-to-peak readings of complex waveforms. The new Senior VoltOhmyst includes an improved circuit providing greater accuracy, and a BIG full-vision meter face with the easiest-to-read scales ever designed into a VTVM! Complete with WG-299B DC/AC-Ohms probe and cable, instruction booklet . . . . . **79.50\***

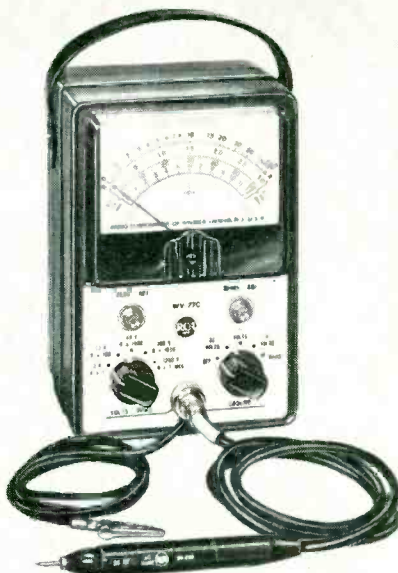

**RCA-WV-77C . . . ALL-NEW JUNIOR VOLT-OHMYST** . . . one of the greatest values in vacuum-tube volt-ohmmeters. Embodies several new design features in addition to operational characteristics which have made earlier versions of the instrument the choice of thousands in radio and TV servicing, industry, electronics, communications, broadcasting, and in the armed forces. Complete with WG-299B DC/AC-Ohms probe and cable, instruction booklet . . . . . **59.50\***

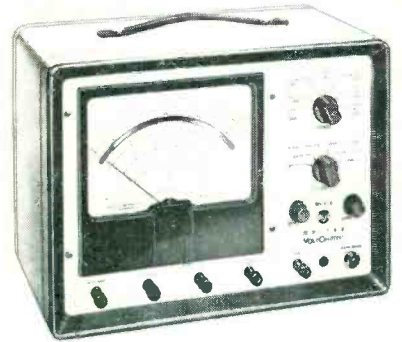

**RCA-WV-87B . . . MASTER VOLT-OHMYST** . . . features a 27 sq. in. meter with mirror scale. Its easy-to-read peak-to-peak scales are particularly useful for TV, radar, and other types of pulse work. Has accuracy and stability necessary for many laboratory applications. Current ranges from 0.01 ma. to 15 amperes. Complete with probes and cables, including: WG-299C DC/AC-Ohms probe and cable, alligator clip, clip insulator and instruction booklet . . . **137.50\***

\*User Price (optional)

Accurate • Stable • Reliable • Portable • Easy-to-set-up • Easy-to-read

# RCA VOLT-OHMISTS®

superior quality test instruments for SERVICING . . .  
LABORATORY . . . PRODUCTION TESTING

Modern engineering, testing, and production techniques demand test instruments with *practical* operating features. RCA VoltOhmysts are "packed" with practical features which make them especially suited for operation over extended periods under rigorous production-line conditions. Features include: electronically protected meters; accuracy unaffected by normal line voltage fluctuations; easy-to-read expanded scales; one zero setting holds for all voltage and resistance ranges; accessory probes extend dc ranges to 50 KV, and extend frequency response to 250 Mc.

Factory-built, factory-tested, and calibrated to laboratory standards, RCA VoltOhmysts are the finest VTVM's for the money. For the VoltOhmyst to fit your needs, see the chart at the right.

CHOOSE THE VOLT-OHMYST THAT SUITS YOUR NEEDS			
Features	Master VoltOhmyst WV-87B	Senior VoltOhmyst WV-98A	Junior VoltOhmyst WV-77C
Measurements:			
DC Voltage	0.02-1500v	0.02-1500v	0.05-1200v
AC (rms) Voltage	0.1-1500v	0.1-1500v	0.1-1200v
AC (peak-to-peak) Voltage	0.2-4200v	0.2-4200v	—
Resistance	0.2-1000 meg.	0.2-1000 meg.	0.2-1000 meg.
Current	10 uamp. -15 amp.	—	—
Accuracy:**			
DC Current	± 3%	—	—
DC Voltage	± 3%	± 3%	± 3%
AC Voltage	± 3%	± 3%	± 5%

\*\*At full-scale points  
+ For positive voltages, ± 5% for negative voltages



**RCA Ultra-Sensitive DC Microammeter, WV-84A, For Reading Extremely "Feeble" Currents.**

WV-84A measures minute currents from 0.002 to 1000 ua—in six ranges! It can be used as a very high-resistance voltmeter—up to 1005 megohms on 100-volt range. And, the WV-84A can be used as a megohmmeter for measuring resistance up to 90,000 megohms. \$110.00\* less batteries

Well-suited for applications in such fields as biology, nuclear physics, chemistry, and electro-mechanics—as well as electronics—the WV-84A is completely portable, with a self-contained battery power supply.



**RADIO CORPORATION of AMERICA**  
COMPONENTS DIVISION  
CAMDEN, N. J.

For technical details on these precision built RCA VoltOhmysts, call your RCA Distributor!

which  
pilot  
light  
to specify?

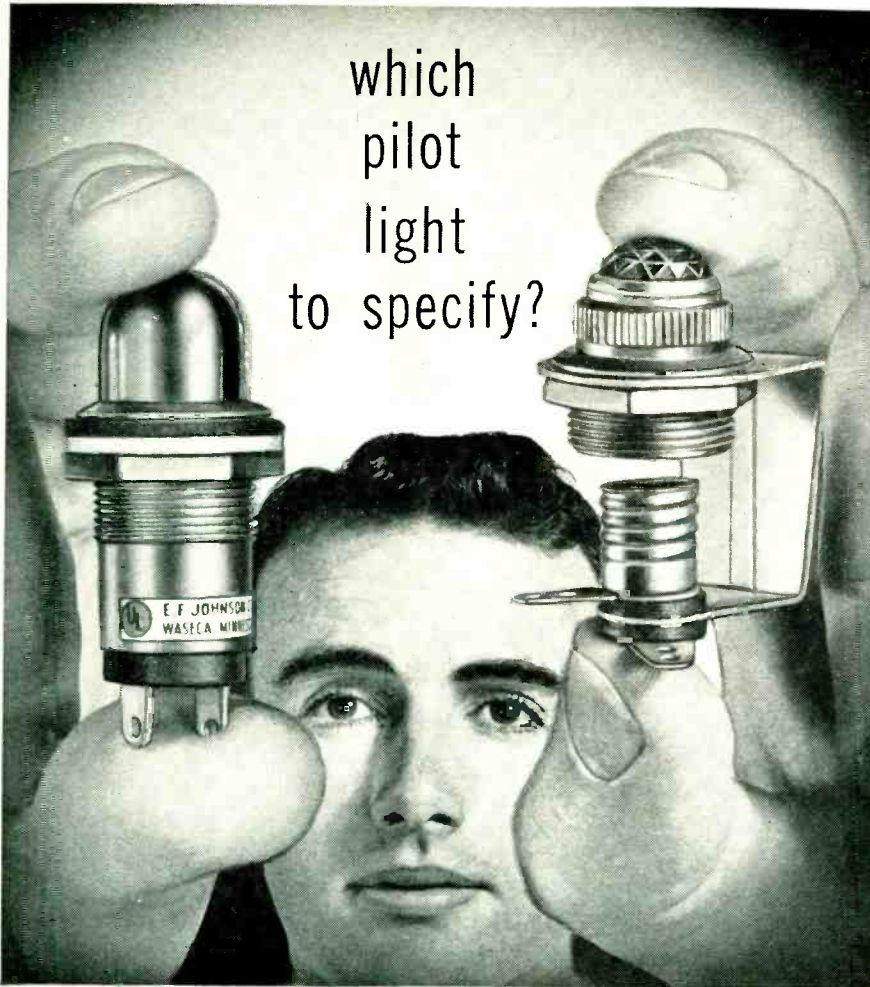

here's a  
quick, easy way  
to find the  
answer!

Save valuable specification time by selecting your panel indicators from Johnson's "preferred" line. This group contains over 47 separate assemblies carefully selected from Johnson's standard line by many of the nation's top design and development personnel. Available in a wide variety of types, these "preferred" units are immediately available at parts distributors throughout the country, for original equipment or in-the-field replacement. Write for your free copy of Johnson's newest pilot light specification catalog — see how easy it is to select the *right* pilot light . . . fast!



free!  
New pilot light catalog  
— contains complete  
specifications, prices  
and technical data . . .  
everything you need to  
select the proper unit  
for original equipment  
or in-the-field replacement.

Available types include: continuous indication neon types; models for high and low voltage incandescent bulbs; standard or wide angle glass and lucite jewels in clear, red, green, amber, blue or opal. Specials, including those meeting military specifications are also available in production quantities.



**E. F. Johnson Company**

2308 SECOND AVENUE S. W. • WASECA, MINNESOTA

for use in a wide range of aircraft. The transmitter, receiver and power supply are all contained in a  $\frac{1}{2}$  ATR case that weighs less than 12 lb.

Named the Mark IV, the new unit uses transistor circuitry that eliminates the less dependable and heavier vibrator or dynamotor. The unit is about three times smaller and 15 lb lighter than the nearest equipment now in production.

Frequency range is from two mc to 10 mc, with six crystal-controlled transmitting and six crystal-controlled receiving channels available for the entire range. Transmitter power output is approximately 35 w into a quarter-wave antenna. Receiver audio output is 10 w. Receiver sensitivity is six db S/N at 5  $\mu$ v. Power consumption is: receiver, 1 $\frac{1}{2}$  amperes; transmitter, seven amperes, at 13.75 v. Circle P35 inside back cover.



### THERMAL RELAYS

are hermetically sealed

NETWORKS ELECTRONIC CORP., 14806 Oxnard St., Van Nuys, Calif. The new thermal relays have metal headers bonded to glass tubing for visibility of interior; quality controlled to provide 99.99-percent plus reliability. They are designed on the "fuse burnout" principle and permit wide latitude in systems design.

Used extensively on current production missiles, other applications of the relays include: rockets, supersonic aircraft, computers, telemetering, printed circuits, dry-circuit switching and specialized electronic devices.

They withstand extreme conditions of temperature (−100 F to +450 F), shock (200 g), vibration





## LIFELINE

... --- ... These are the "call letters" of the U. S. Coast Guard. Watching over more than half a million square miles of our coastal waters, the rescue record of this famous organization is one of the great air-sea sagas of war and peacetime service. Helping to extend the Coast Guard's far-flung lifeline is the Martin P5M and the new P5M-2G, providing long-range sea reconnaissance for any emergency. Also, in active service with both the Atlantic and Pacific fleets of the U. S. Navy, ten squadrons of this famous seaplane—specially armored for anti-submarine warfare—are in operation today, from Norfolk to the Mediterranean and from Washington to the Orient.

---

**MARTIN**  
BALTIMORE · DENVER · ORLANDO

Looking for a "POT"?

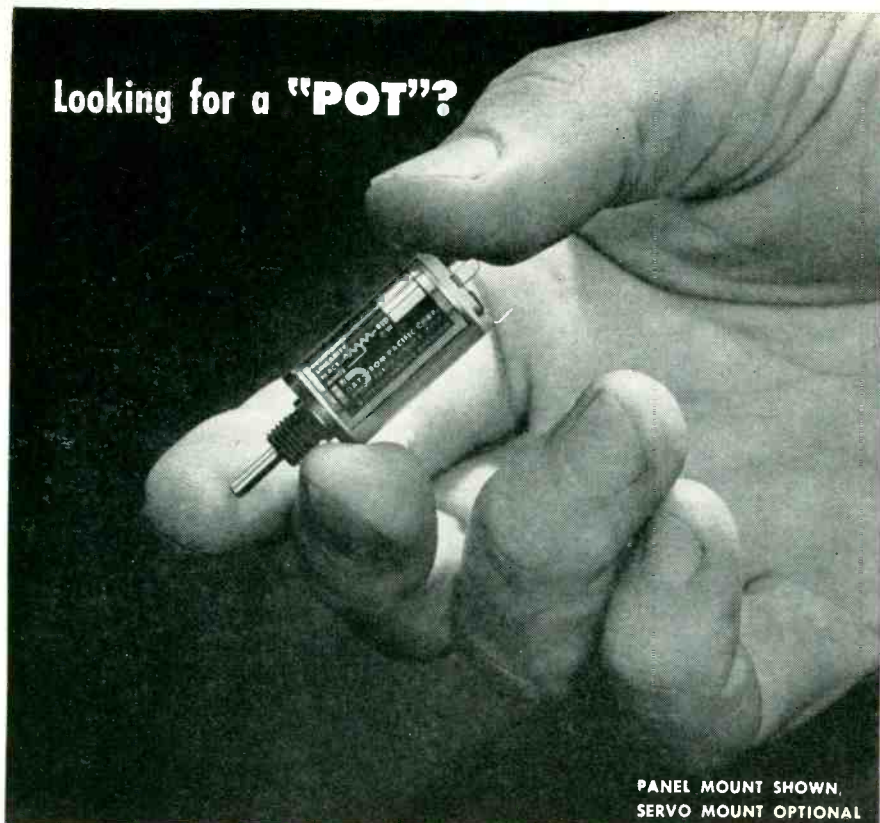

PANEL MOUNT SHOWN,  
SERVO MOUNT OPTIONAL

ACTUAL SIZE

## SERIES 341 TEN-TURN PRECISION POTENTIOMETER

Smaller in diameter than a fountain pen — no longer than a shriveled up Gryllidae Gryllus\*, this tiny "pot" offers ultimate precision in the smallest package on the market.

Check some of the standard specifications of this precision-built, wire-wound, ten-turn potentiometer:

- SIZE:** 17/32" x 1-1/8"
- WEIGHT:** 10 gms. max.
- BACKLASH:** Essentially Zero
- PHASE SHIFT:** Less than 0.1° at 4000 cps.
- VIBRATION:** 10gs to 500 cps (3 attitudes)
- LINEARITY:** Best Practical 0.05%

\* also known as a cricket

STANDARD MODELS AVAILABLE IN PRODUCTION QUANTITIES NOW. SPECIAL REQUIREMENTS CAN USUALLY BE MET. WRITE TODAY FOR COMPLETE INFORMATION CONCERNING THIS AND OTHER MINIATURE WIRE-WOUND, PRECISION POTENTIOMETERS.

Openings exist for highly qualified engineers

WRITE TODAY FOR DETAILS

ACTUAL SIZE



POTENTIOMETER DIVISION

*Daystrom* PACIFIC CORP.

11150 LA GRANGE AVE., WEST LOS ANGELES 25, CALIF.



Series 304

One-turn, Wire-wound, Precision Potentiometer.

LOW COST  
HIGH PERFORMANCE

(20 to 3,000 cps) and have precise electrical characteristics. Samples and complete specifications are available on request. Circle P36 inside back cover.

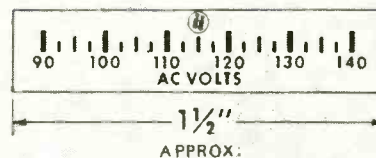

### TINY VOLTMETERS with expanded scales

INTERNATIONAL INSTRUMENTS INC., P. O. Box 2945, New Haven 15, Conn., has produced a line of miniature a-c voltmeter featuring expanded scales. The expanded scale feature permits far more precise voltage readings at the critical point than is possible with normal scales. These instruments will find wide application for accurate monitoring of line voltages to x-ray machines, tv cameras and other electronic equipment where fluctuations would affect operation.

Accuracy on all meters is held to ±5 percent of the expanded portion of the scale—±1.5 v on 90-120 a-c volt scale.

Meters can be manufactured with watertight seals to meet applicable government specifications. Commercial models without watertight seals are also available. Complete information is available on request. Circle P37 inside back cover.

### ANALOG COMPUTER programmed with punched tape

BECKMAN INSTRUMENTS, INC., 2200 Wright Ave., Richmond 3, Calif., has produced a new analog computer series combining a digital output-input translator system (DO/IT) with many other features



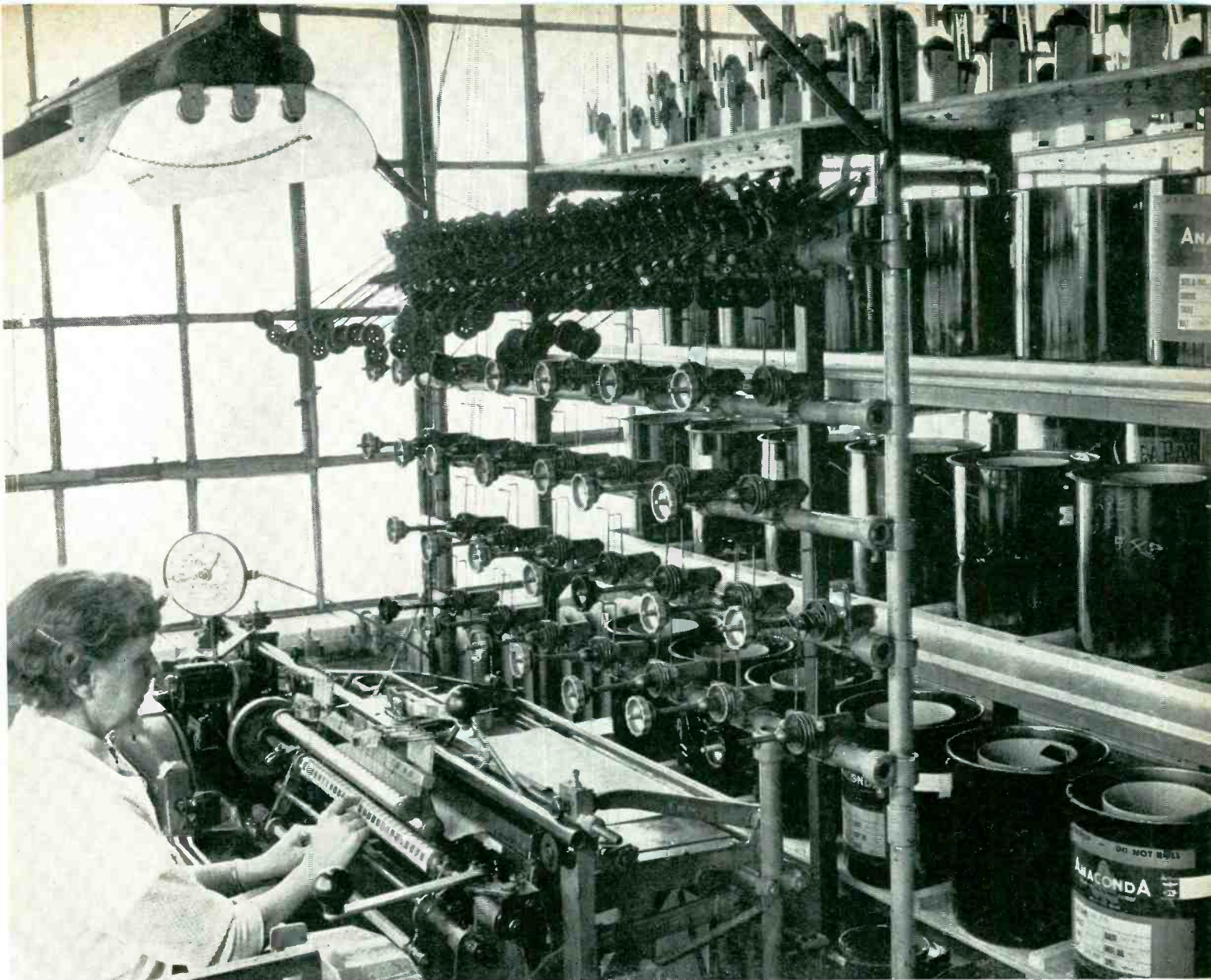

**28 pails** — mounted on racks behind coil-winding machines — are used at a time in fabrication of coils by control manufacturer. Wire passes through tensioning devices and enters the winding machine in the normal manner. Company saves \$2500 a year alone by ending handling and returning of empty spools.

## **\$15,000 a year saved by switching to Anaconda magnet wire in pails!**

**A YEAR AGO**, a well-known control manufacturer's coil-winding department operators used—and replaced—60 to 70 spools on machines a day. Each change meant production time lost . . . and waste of 5 to 50 feet of wire on the end of each spool. Empty spools, too, had to be collected, packed and returned to wire suppliers.

Then the decision was made to switch from magnet wire on spools to

Anaconda quality wire in pails!

**TODAY**, these same operators are saving the hour or hour-and-a-half a day they used to spend changing spools. Coil production has increased from 270 to 320 coils per hour per machine. And wire waste is almost nil. The Company estimates the change will save \$15,000 a year.

**THE MAN FROM ANACONDA** will

be glad to show you how Anaconda leadership in magnet wire packaging can bring greater profit to you, too. Let him explain the advantages of Anaconda drums, pails, reels . . . and how Anaconda's spool rehabilitation program can save you money in the winding room. Write or call today: Anaconda Wire & Cable Company, Magnet Wire Headquarters, Muskegon, Michigan.

57379

SEE THE MAN FROM **ANACONDA**<sup>®</sup>  
FOR **MAGNET WIRE**



# INCOMPARABLE ACCURACY IN THE SMALLEST SPACE

Specify **TIC** linear and non-linear potentiometers

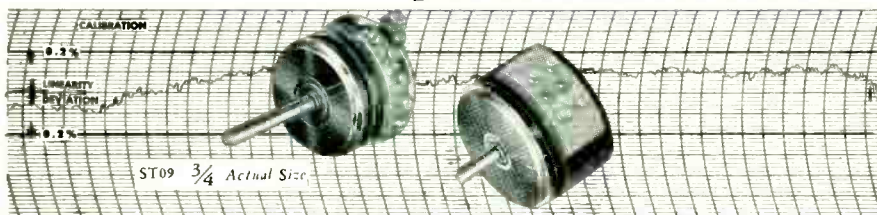

**It's true!**  
TIC's general line of linear and non-linear potentiometers provide more accuracy per unit area than any other potentiometers on the market.

RVP1  $\frac{3}{4}$  Actual Size

ST18  $\frac{3}{4}$  Actual Size

ST20  $\frac{3}{4}$  Actual Size

*Compare*

- ST09  $\frac{7}{8}$ " diam. Linearity of 0.25%
- RVP1 1" diam. Linearity of 0.15%
- ST18  $1\frac{3}{4}$ " diam. Linearity of 0.15%
- ST20 2" diam. Linearity of 0.12%

NEW  
EXPANDED  
PRODUCTION  
FACILITIES  
(doubled)  
ASSURES  
PROMPT  
DELIVERY!

These are not laboratory or model shop curiosities! . . .

They have been *delivered in substantial production quantities* to our customers.

The high accuracy of TIC precision potentiometers are the result of a combination of unique design features . . . high standards of quality control . . . and construction of watchlike precision. Years of experience in supplying precision potentiometers for operational equipment designed to meet military specifications assure high *accuracy* throughout the long life of the unit . . . and under all types of adverse environmental conditions.

An added advantage of specifying TIC potentiometers is the tremendous production facilities and the wide selection of sizes that permits custom-like design in your application. Whether it be high accuracy linear potentiometers, standard function or empirical non-linear potentiometers, you can depend on TIC to provide greater accuracy throughout the long life of the potentiometer. Complete specs on request!

## TECHNOLOGY INSTRUMENT CORP.

569 Main Street, Acton, Mass. COlonial 3-7711  
West Coast Mail Address, Box 3941, No. Hollywood, Calif. POplar 5-8620

designed for automatic operation and highway accuracy.

By using a typewriter and punched-tape system to set up and check problems, EASE 1100 series computers save hours of operating time, take much of the human element out of computing and make practical an installation of any size. The electric typewriter system permits complete computer control—including pot set and electronic function generator set-up. Solutions can be run and rerun automatically with the punched tape.

As a point-by-point check, the typewriter first prints the desired address and value. After the servo-set system nulls, the actual address and value set is printed. Coefficient and amplifier values read out on a printer and can be stored for future use.

Other new features include the patch-bay system, complete push-button monitoring, automatic problem checking, redesigned servo-set potentiometer system and a highly stable temperature-controlled oven. Circle P38 inside back cover.

### NINE-PIN MINIATURES for television receivers

SYLVANIA ELECTRIC PRODUCTS INC., 1740 Broadway 19, N. Y., has announced two versatile nine-pin miniature tubes for use in both color and black-and-white tv receivers. Types 6AW8A and 6BA8A are triode pentodes with 600-ma heaters for series heater string circuitry.

The pentode sections of both are identical. The two tubes permit a wider range of B+ supply voltage (120 v and up) than their prototypes (6AW8 and 6BA8) and have a plate dissipation rating of 3.25 w, reduced sync pulse clipping and minimized white compression. Featuring a high transconductance of 9,000  $\mu$ mhos, they are intended for use as video amplifiers. Both can also serve as video i-f amplifiers, sound i-f amplifiers and age amplifiers.

The triode section of the 6AW8A has a  $\mu$  of 70 and finds usage in sync-separator, sync amplifier, sync-clipper and phase inverter circuits. The 6BA8A tri-



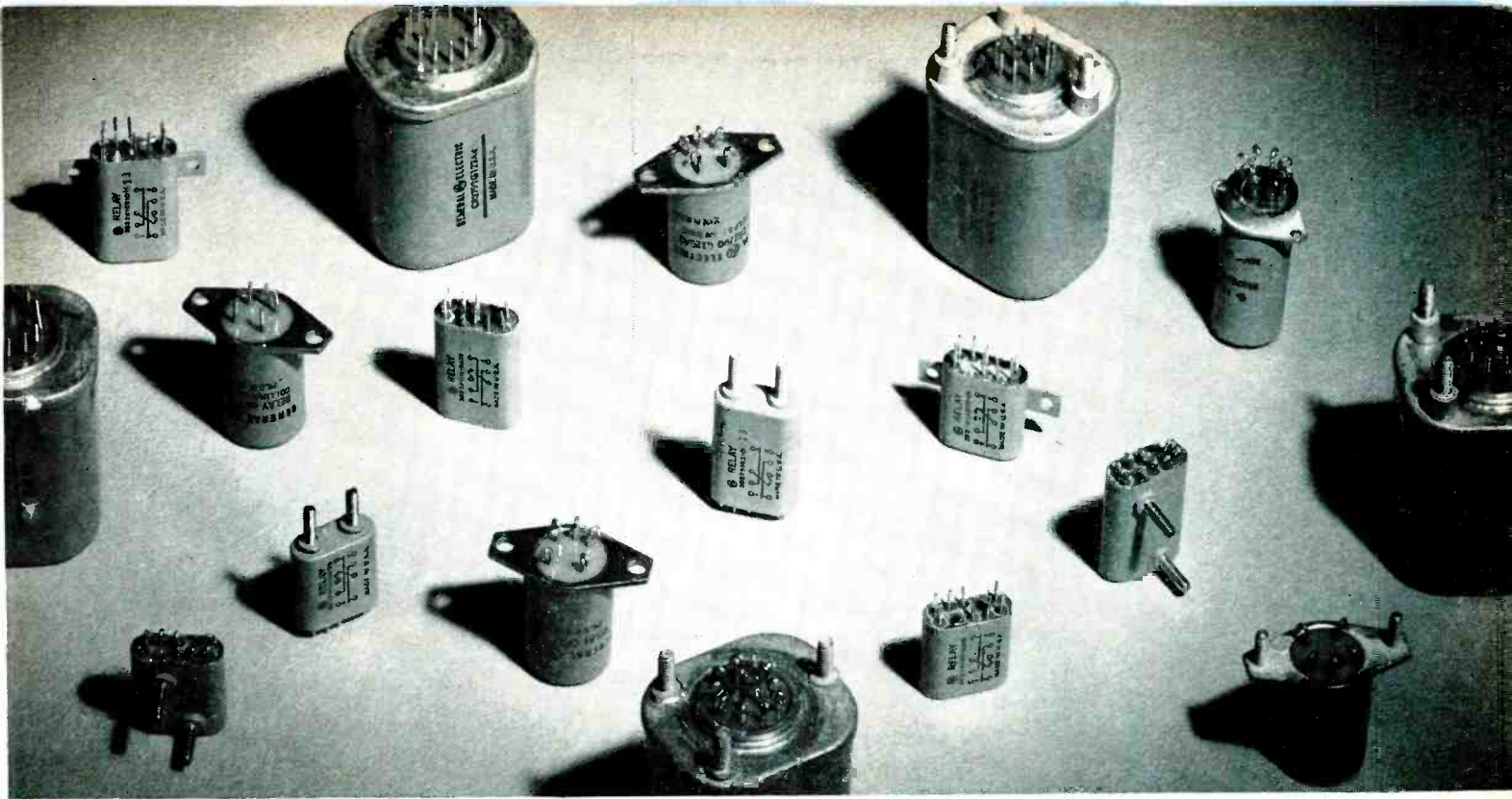

# NOW . . . ONLY 3-WEEK SHIPMENT\* on General Electric's full-line of sealed relays

Improved production techniques now make it possible for General Electric to offer its complete line of standard-listed hermetically sealed relays—including the amazing micro-miniature—on only 3-week shipment from order date!

And, what's more—General Electric is equipped to provide you rapid service on samples and prototypes.

## FOR ALL ELECTRONIC SYSTEMS

G-E miniature, sub-miniature, and micro-miniature relays combine small size with unusual reliability under severe temperature, shock, and vibration conditions—making them ideal for all radio, radar, fire control, navigational equipment, and industrial electronics jobs.

Though initially designed for military applications, more and more G-E sealed relays are being used for industrial jobs. Their extreme reliability and small size now are utilized by industrial designers. Resistance welding and other industrial electronic circuitry is being simplified and miniaturized with G-E sealed relays.

## WIDE RANGE OF COIL RATINGS, HEADER TYPES, AND MOUNTINGS

Whatever your small sealed relay needs—you'll find the answer with one of the many forms of these three models:

**Miniature:** Standard, current-sensitive, and voltage-sensitive models; in 2-, 3-, or 4-pole double-throw and 6-pole normally open forms. Rated 5 amps at 28 volts d-c at 85C. 3-amp make-before-break forms and 125C forms available.

**Sub-miniature:** 2 amps; .651 in. in diameter, 1.6 in. long; weighs one ounce. Unaffected by vibrations of 10 to 55 cps at .12 in. maximum excursion or 55 to 500 cps at 15Gs acceleration. Withstands shock tests in excess of 40Gs. Operates in ambients of 125C.

**Micro-miniature:** Weighs only 0.5 oz., measures .36 in. by .80 in. by .88 in. Rated 2 amp resistive at 28 v d-c or 115 v a-c. Also available in current-sensitive models. Standard relays withstand ambients of 125C, and 20Gs acceleration at 50 to 500 cps. *Contact your G-E Apparatus Sales Office, or mail coupon. Specialty Control Dept., Waynesboro, Va.*

\*Average shipment time for all standard listed relays. Actual time: **MICRO-MINIATURE** (up to 100 units—2 weeks, 100 to 1000 units—4 weeks); **SUB-MINIATURE** (up to 100 units—3 weeks, 100 to 1000 units—5 weeks); **MINI-ATURE** (up to 100 units—1-2 weeks, 100 to 1000 units—3 weeks).

## MAIL TODAY FOR G-E RELAY DATA

General Electric Co., Sect. C 792-6, Schenectady 5, N. Y.

- Miniature—Bulletin GEA-6213
- 2PDT Sub-miniature—Bulletin 6412
- Micro-miniature—Bulletin 6346
- HAVE G-E SALES ENGINEER CALL

NAME.....  
 COMPANY.....  
 ADDRESS.....  
 CITY..... STATE.....

GENERAL  ELECTRIC

**Another  
EECO  
FIRST!**

**TIMING, SEARCH,**

**AND CONTROL SYSTEM FOR**

**TAPE RECORDERS**

- Automatically locates information on tape recording in a matter of seconds.
- Provides second-by-second identification, during recording and playback, re-cycling every 24 hours.
- Incorporates easy-to-read decimal indicators for hours, minutes, and seconds.

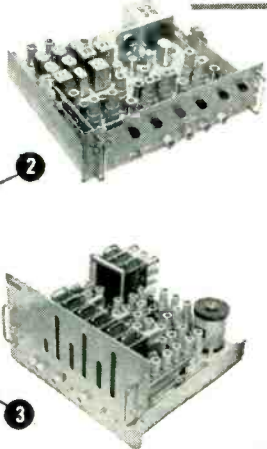
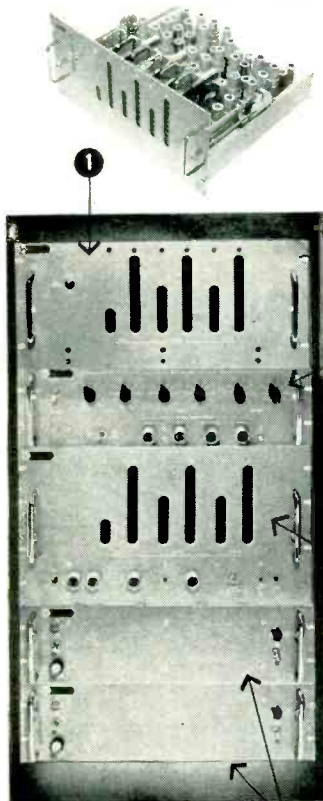

- 1 TIME DISPLAY—accepts timing signal from tape recorder and displays time code during playback.
- 2 TIME SELECTOR—compares playback code with preset code and controls tape recorder during search operation.
- 3 CODE GENERATOR—generates and displays timing code and prepares it in form for recording.
- 4 POWER SUPPLIES—furnish +200 volts and filament voltage. Two power supplies required.
- 5 COMPLETE SYSTEM (less tape recorder) mounted in standard cabinet (panels 19 inches wide, chassis 16 inches deep).

This EECO system provides a means of identifying information as it is recorded on magnetic tape, and of making a rapid search of the recording afterwards for purposes of selective playback, editing, dubbing, erasure, or other treatment. A full two-hour tape recording may be searched from end to end in approximately 57 seconds. Because a one-per-second signal and continuous signal (carrier) on the tape are used to synchronize decoding operation, variations in tape speed during search do not cause errors. During recording operation, time signal can be shifted to nearest 1/100th second to synchronize with standard time transmissions. After initial synchronization, drift is less than one second in 30 days.

The system consists of five basic units: A Code Generator and Power Supply used in the recording operation; a Time Display, Time Selector, and second Power Supply used in the playback operation. The configuration of equipment is entirely flexible, depending upon the desired application. The entire system may be assembled at one location, as illustrated, or the recording and playback functions may be separated for use with different tape machines.

Operates with any tape recorder meeting these primary requirements:

1. Two or more tracks, one for the time code.
2. Provision for remote control.
3. Capability of playback at fast forward and rewind speed.
4. Bandpass adequate to reproduce the time code faithfully at any tape speed encountered during search operation.

For complete description and specifications, ask for Bulletin S-2856-E.

**ELECTRONIC ENGINEERS  
AND PHYSICISTS**

Interesting and challenging work in systems and related projects offers unusual employment opportunity at EECO. Send a resume of your qualifications to the attention of R. F. Lander.



**Electronic Engineering Company of California**

180 SOUTH ALVARADO STREET • • • LOS ANGELES • 57 • CALIFORNIA

ode unit has a  $\mu$  of 18, finding use in l-f oscillator circuits. Circle P39 inside back cover.

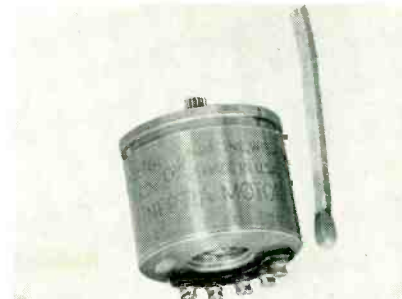

**SERVO**

for amplifier applications

JOHN OSTER MFG. Co., Avionic Division, Racine, Wisc., has available a new size 10 servo which is less prone to single phasing and designed specifically for use with a transistorized amplifier. Type 10-5052-23 will not single phase with fixed phase energized, and with a tuning capacitor 250 percent in excess of value required to tune control phase to unity power factor connected across control phase.

Precision electrical characteristics include 115-v fixed phase, 36-v control phase with 3 w per phase stalled; 6,500 rpm at no load and 0.25 in.-oz. at stall minimum. Operating temperature range is - 65 C to + 85 C. The motor can be modified to cover a wide variety of other amplifier applications where precise control is required. Circle P40 inside back cover.

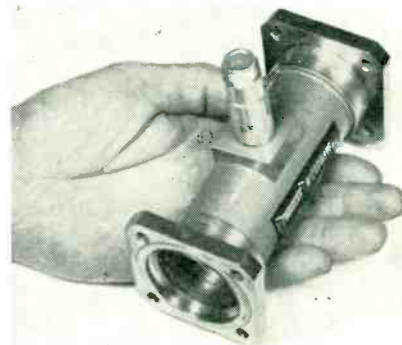

**MICROWAVE COUPLER**

23-db minimum directivity

DOUGLAS MICROWAVE Co., INC., 252 E. Third St., Mt. Vernon, N. Y., is



# Specify COILED CORDS

*...add important convenience  
and safety features to  
your equipment!*

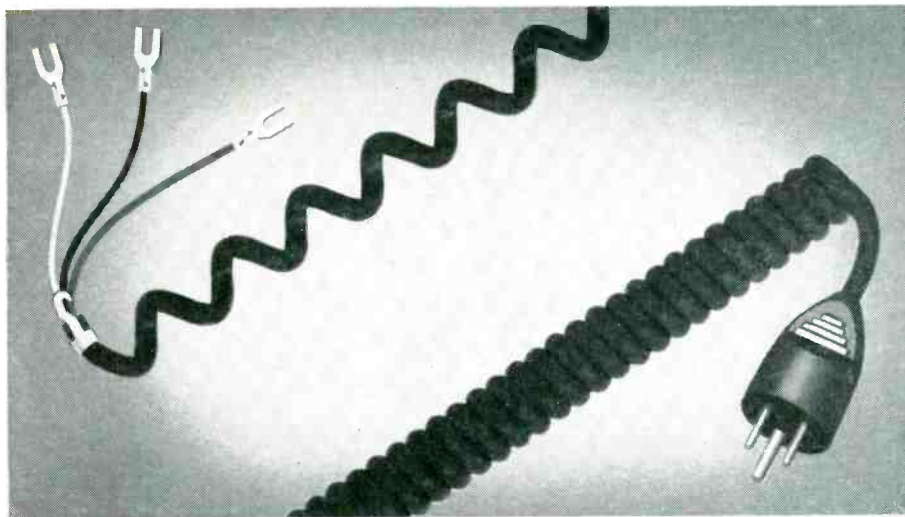

**Cords Limited COILED CORDS are  
engineered for specific application!**

Coiled Cords, first choice in the communications industry, find numerous important applications in other fields! In addition to user convenience, Cords Ltd. Coiled Cords provide a safety factor preventing costly industrial accidents. Maintenance-wise, Coiled Cords give much longer service than straight cords by eliminating common abuses that shorten serviceability.

**Product Data:** A leader in the development of Coiled Cords, Cords Limited is a major supplier of this product to the telephone and communication industries. Coiled Cords are engineered for specific applications. Special oil, acid and moisture resistant properties of the jackets protect the product under unusual conditions. The most modern molding facilities for plug and conductor termination are available at Cords Limited to serve your needs quickly and economically!

**WRITE TODAY** for complete details... your quotation requests will receive immediate attention!



**CORDS LIMITED DIVISION**  
ESSEX WIRE CORPORATION  
DeKalb, Illinois

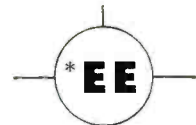

*other outstanding  
\*ESSEX ENGINEERED  
production proven products*

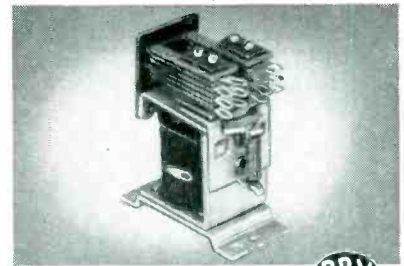

## GENERAL PURPOSE RELAYS

A.C. or D.C. General Purpose Multipole relays. For circuit switching of electrical interlocking remote control devices. Features special cross-bar contacts for low-voltage, low current circuits or button type contacts for power switching circuits. Request Bulletin No. 1060.

R-B-M "Control" Division  
Logansport, Indiana

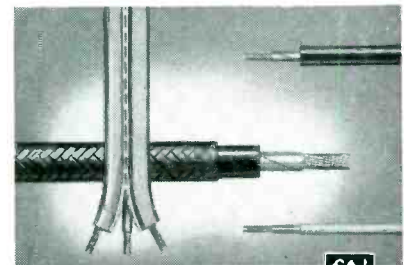

## WIRE AND CABLE

A full "Extra Test" line of lead, appliance, automotive and refrigeration wires, plus submersible pump cable and 200° C. Sil-X insulations are examples of the versatility of "Essex Engineering".

Wire and Cable Division  
Fort Wayne, Indiana

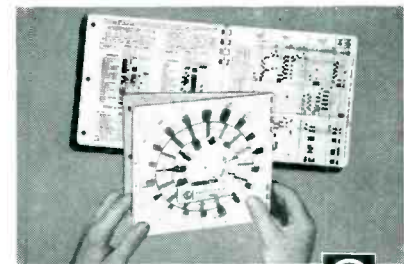

## CORD SET DESIGN AID

The CORDINATOR®, a time-saving engineering tool, features simplified charts showing approved wire by product types. Dial side permits visual fabrication of cord sets and power supply cords. All components standard approved... minimizing cost... assuring scheduled delivery. Write for your free CORDINATOR.

Cords Limited Division  
DeKalb, Illinois



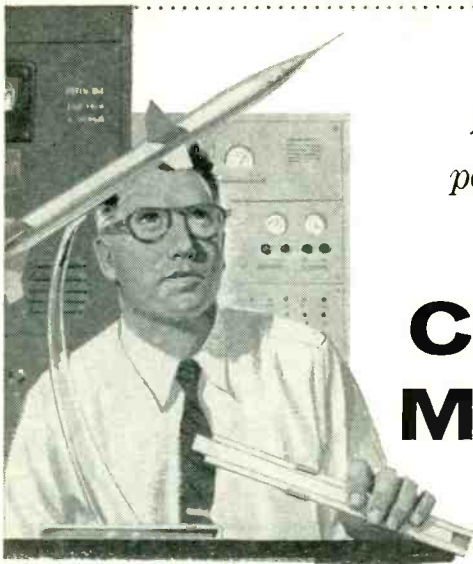

*Have you the growth  
potential to make  
top money as a*

## CONVAIR MISSILES MAN?

Get the facts on **CONVAIR POMONA** in sunny California — *first* fully-integrated missile plant in the U.S.A. — designer and builder of the Navy's **TERRIER** supersonic, surface-to-air missile.

Naturally, you'll work with the most modern electronic equipment known. Better yet, you'll work with the kind of engineering talent that *creates* such equipment... that is pacing the advance of science into outer space.

You'll have the scope and help to show what you can do... and top pay at every step you progress. You and your family will live (California-style) in the lush Pomona Valley at the foot of the snow-capped Sierra Madre. No commuting problems. Ample housing. True country living just 30 minutes from downtown Los Angeles.

*Openings now in:*

Electronics	Operations Research
Aerodynamics	Hydraulics
Dynamics	Mechanical Design
Thermodynamics	Laboratory Test

Generous travel allowance to Engineers accepted.

Write now, enclosing complete resume to:

Engineering Personnel Dept. 3-G

**CV CONVAIR GD**  
POMONA

POMONA • CALIFORNIA

CONVAIR IS A DIVISION OF GENERAL DYNAMICS CORPORATION

introducing a new high directivity broadband microwave coupler. It is a high power coaxial directional coupler with minimum directivity of 23 db for the frequency range 100 through 3,000 mc. Available in line sizes from type N to 3½ in., it will handle full power rating of these line sizes.

Normally supplied for 30-db coupling, this coupling varies three db or a two-to-one frequency range. Directivity is independent of frequency. The vswr is less than 1.15 to 1 for main line. No external d-c return is required for use with crystal detector or bolometer. Accuracy is within 0.25 db at center frequency. **Circle P41 inside back cover.**

### POWER SUPPLY

is transistorized

TRANSVAL ENGINEERING CORP., 10401 W. Jefferson Blvd., Culver City, Calif. Model 5036 power supply has a stability specification of one mv over its entire output range of 0 to four amperes at 10 v during continuous operation for 30 days. The ability of the unit to maintain voltage within 0.01 percent with load variation, combined with its ability to do so for long periods of time, are among its outstanding accomplishments. The unit is chopper stabilized against a standard cell which has a drain of only 1/100 µa. **Circle P42 inside back cover.**

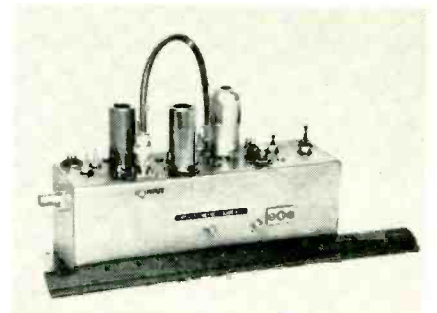

### UHF-VHF CONVERTERS

with 25-db overall gain

APPLIED RESEARCH INC., 163-07 Depot Road, Flushing, N. Y., announces a line of uhf-vhf converters that utilize only four vacuum



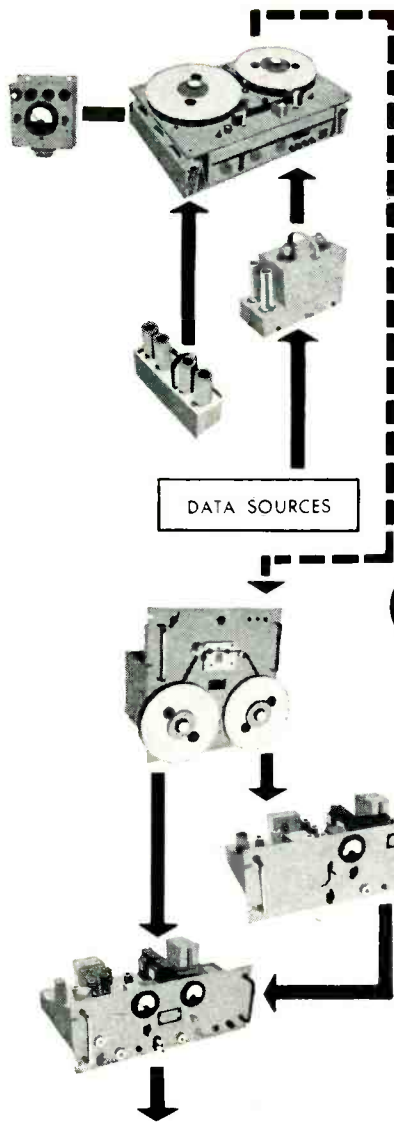

In choosing data recording equipment, it is now feasible to tailor the equipment to present and future data handling needs. It is no longer necessary to tailor your entire program to equipment limitations.

# Choosing A System

for magnetic tape DATA recording

When magnetic recording was in the audio phase of its development, there was just one recording method—direct recording. But today, several methods are available. And while direct recording is still common in audio work, it has taken a back seat to modulated carrier techniques in the more critical field of data recording.

To take advantage of the broad range of equipment and techniques now available, start with a thoroughgoing analysis of your own present and future data handling . . . data processing needs. Then, match the techniques and individual components to those needs.

*Choose the recording method first:* Direct recording is limited in data work by its poor amplitude reproduction and poor low frequency response on playback. Pulse width modulation (PWM) recording is excellent for recording a large number of channels with limited frequency response. Digital recording offers extremely high data accuracy, but relatively low information capacity.

FM recording, electronically compensated for wow and flutter, offers

a combination of high overall system performance, frequency response, and information capacity, suiting it for most analog recording applications. Any or all of these methods can be supplied in the same recording system by inserting the proper plug-in circuitry.

*Consider physical requirements next:* Where you plan to use a system is an extremely important factor. To record data in a missile or jet, you will obviously need different equipment than would be used in a laboratory. But reel size, tape width, tape speeds, must also be selected. And heads, available for recording from 2 to 24 data tracks or even more, should be specified early. Keep in mind also the planned final disposition of the data, whether to a computer, direct writing recorder, or other equipment.

*Finally, select system components and accessories:* In FM carrier recording alone, you can choose from at least three recording oscillators, two reference generators, and several signal and compensation discriminators. Speed control servos, power supplies, and remote controls also require attention.

Needless to say, much of this process of selection requires special experience, and should be placed in the hands of the competent data recording systems manufacturer. But the important thing to remember is that data recording on tape is a field in itself, with special techniques and special equipment that can be matched to virtually any recording need. The day when the problem had to be tailored to the equipment is long past.

More detailed information on recording systems and equipment, and how to select them, is provided in "The Role of Magnetic Tape In Data Recording," available on request to Davies Laboratories, Div.

MINNEAPOLIS  
**Honeywell**

DAVIES LABORATORIES DIV.  
10721 Hanna Street Beltsville Md.  
WEbster 5-2700

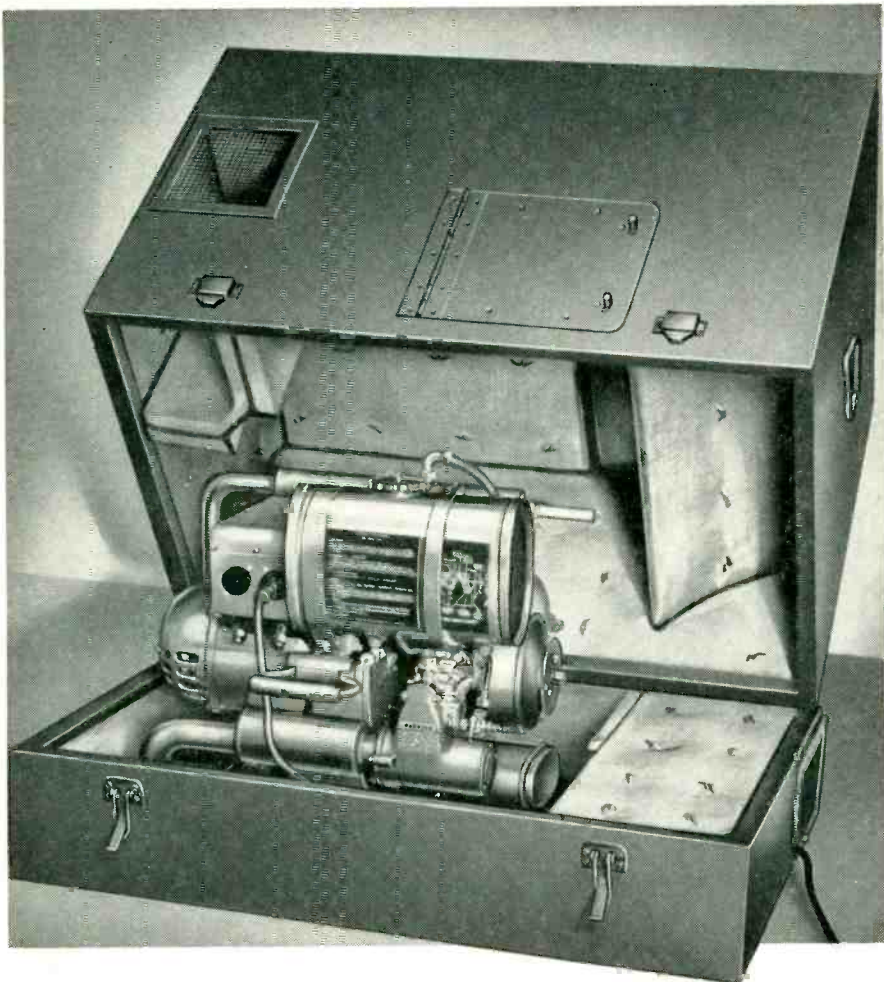

## HOMELITE GENERATORS

### Get the silent treatment

The box shown above is an efficient acoustical housing designed to give an effective silent treatment to Homelite military gasoline-engine generator sets for applications where audio noise must be held to a minimum. At 50 feet, you have to have sharp ears to hear this .5KW generator operating even under full load . . . at 150 feet this unit is virtually inaudible. Specially designed acoustical housings are available to match all of Homelite's military generator-sets.

If you're looking for lightweight, gasoline-engine-driven generators (with or without acoustical housings) which will meet even the toughest MIL specifications, get in touch with Homelite.

With over 35 years' experience in designing and building hundreds of thousands of dependable gasoline-engine and electric-motor driven generators from .15KW to 5KW in all voltages and frequencies, you can be assured that Homelite will find a quick and correct solution to your most exacting electric power requirements.

Manufacturers of  
Carryable Pumps,  
Generators, Chain Saws,  
Blowers

WRITE OR  
CALL TODAY FOR COMPLETE DETAILS

# HOMELITE

A DIVISION OF TEXTRON INC.  
6804 RIVERDALE AVE., PORT CHESTER, N. Y.  
Canadian Distributors: Terry Machinery Co., Ltd.

tubes in advanced circuitry.

Standard units convert any uhf channel to any vhf channel. High sensitivity is achieved through the use of an r-f amplifier. Overall gain of the converter is 25 db. Utilization of multiple-tuned interstage networks provides optimum skirt selectivity with exceptional image rejection and channel separation. Units are designed to operate at any desired input and output impedance. Circle P43 inside back cover.

### FREQUENCY METER

for 15 to 100 cps range

BRITISH THOMSON-HOUSTON CO. LTD., Rugby, England, has developed a new frequency meter which uses transistor crystal and germanium diodes. Designed to use a special long-life battery capable of operating continuously and efficiently up to 2,000 hr, as a reference source, it can also be used for measuring the speeds of rotating shafts by an ancillary photoelectric cell system.

The instrument, which is only 4½ in. high by 10 in. long and 8 in. wide, will give direct readings of frequency from 15 cps to 100 cps over six different frequency ranges. Accuracy of measurement is better than one percent of the full-scale deflection, even on the highest range up to about 70 kc. It can be used to measure frequencies within this accuracy with input voltages ranging from 0.1 v up to 500 v. Circle P44 inside back cover.

### LOAD ISOLATOR

for X-band frequencies

LITTON INDUSTRIES, 5873 Rodeo Road, Los Angeles 16, Calif. Model H500 Ferrite load isolator is especially designed for high-power, broad-band radar systems operating over X-band frequencies.

Up to 500 w and 500 kw can be handled within the air-cooled unit without pressurization. A minimum of 8-db isolation is provided over a bandwidth of 8,600 to 9,600



## IMPORTANT ACHIEVEMENTS AT JPL

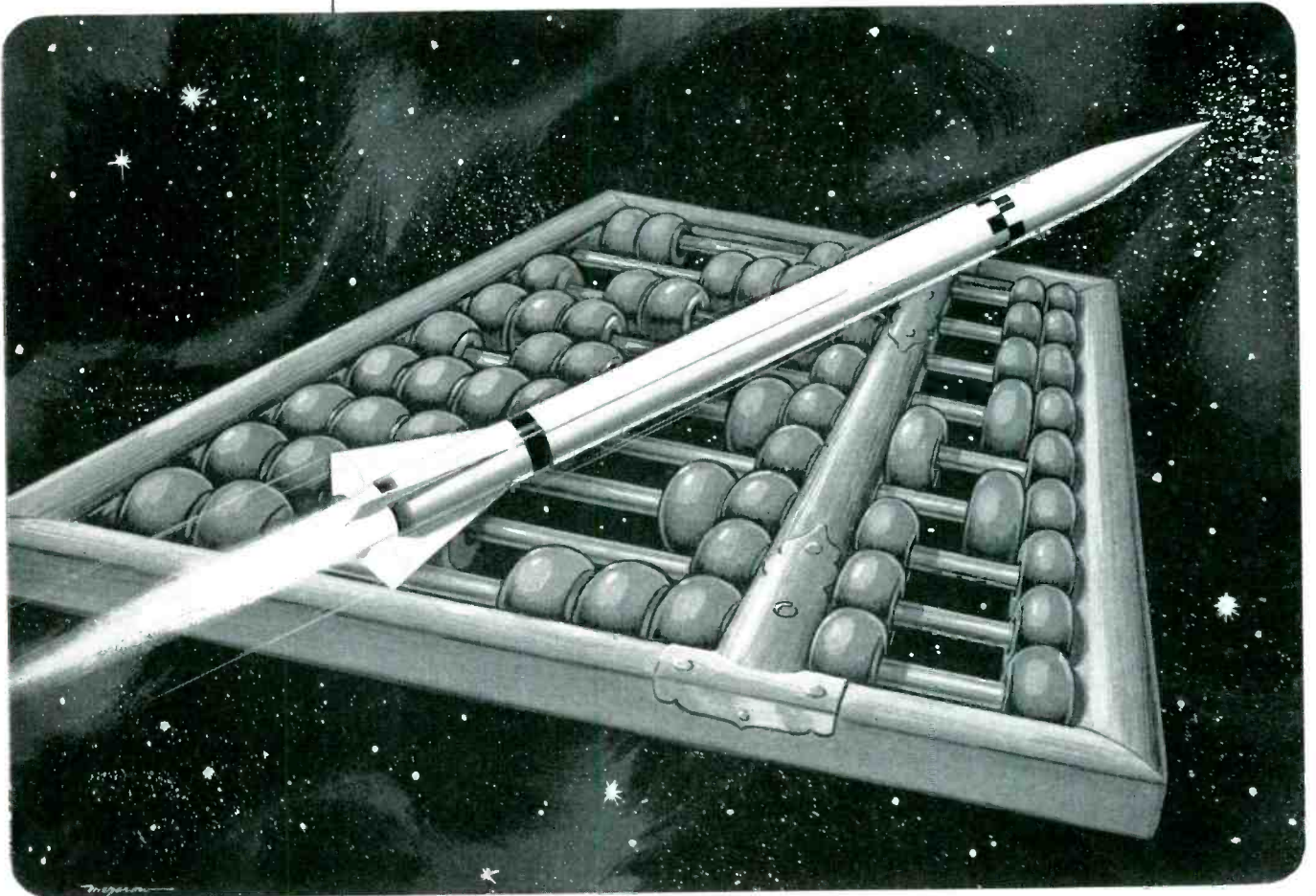

### Computers for Missile Guidance

*The Jet Propulsion Laboratory is a stable research and development center located north of Pasadena in the foothills of the San Gabriel mountains. Covering an 80 acre area and employing 1700 people, it is close to attractive residential areas.*

*The Laboratory is staffed by the California Institute of Technology and develops its many projects in basic research under contract with the U.S. Government.*

*Opportunities open to qualified engineers of U.S. citizenship. Inquiries now invited.*

The abacus is a very ancient and useful computing device in the hands of a person versed in its use. However, the requirements for speed and accuracy in computing the functions necessary for modern missile guidance have obsoleted all man-operated devices, creating a need for computing systems previously considered impossible.

The Jet Propulsion Laboratory pioneered in the application of analog computing techniques to missile guidance systems and, to maintain its leadership in this field, constantly searches for new techniques that will make optimum use of magnetics, transistors and other modern computing components.

The successful application of these techniques to missile systems under development requires designs that will perform properly under the adverse environments

found in today's guided missile. A degree of accuracy and extreme reliability, previously thought possible only under controlled laboratory conditions, is now a reality because of improved instrumentation techniques and development of highly accurate instrumentation equipment. This has been successfully applied to development of special purpose equipment for missile guidance.

The JPL guidance computer group, now engaged in research and development work encompassing electronic, mechanical, electromechanical and servo computing systems and their application to missile guidance and control, now offers attractive opportunities for truly creative engineers interested in advancing the state of computer art.

Send your resume today for immediate consideration.

JOB OPPORTUNITIES  
ARE NOW AVAILABLE



ELECTRONICS • PHYSICS • SYSTEMS ANALYSIS  
COMPUTER DEVELOPMENT • INSTRUMENTATION  
TELEMETERING AND MECHANICAL ENGINEERING

### JET PROPULSION LABORATORY

A DIVISION OF CALIFORNIA INSTITUTE OF TECHNOLOGY  
PASADENA • CALIFORNIA

the wire problem?  
try **CONTINENTAL**  
insulated electronic wire

No door is closed to the company that specifies Continental insulated wire or cable. That extra tough problem requiring seemingly impossible performance of wire may have you asking "What wire?" Why not let Continental's engineering help? There's a wide range of wires developed for special applications at Continental everyday.

Maybe the answer that you've been after is even now a standard in the Continental line. It's worth a letter or call today.

#### ELECTRONIC INSTRUMENT INSULATED WIRE

600-3000 volt service. Sizes: 32 AWG to 6 AWG inclusive. CONSTRUCTION: stranded tinned copper, polyvinyl insulation with or without nylon jacket. Maximum operating temperature: 100°C.

CONFORMS TO: MIL-W-16878B

COLOR CODED: 1, 2, or 3 spiral stripes over polyvinyl insulation.

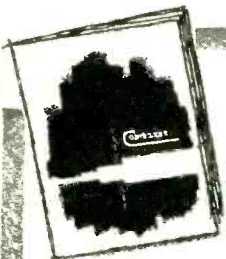

#### FACT-FILLED CATALOG

NEW, COMPLETE CATALOG OF CONTINENTAL INSULATED WIRE AND CABLE AVAILABLE ON REQUEST. WRITE TODAY.

# Continental

WIRE CORPORATION

WALLINGFORD, CONNECTICUT • YORK, PENNSYLVANIA

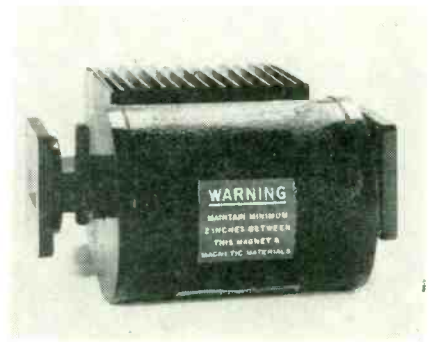

mc. Insertion loss is 0.5 db or less. The vswr is 1.10 maximum. The isolator is designed to operate with RG51/U waveguide, and mates with UG52/U flanges.

Utilizing the resonance absorption characteristics of Ferrites, the H500 isolator provides a simple and compact solution to long-line effects and other magnetron loading problems caused by lengthy transmission lines or excessive vswr's. Circle P45 inside back cover.

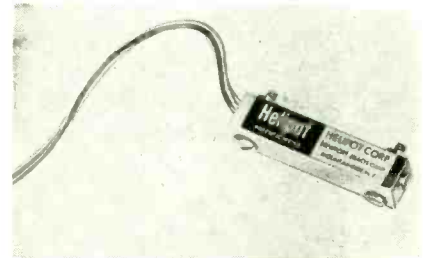

#### TRIMMING-TYPE POTS miniature units

HELIPOT CORP., Newport Beach, Calif., has developed a miniature trimming-type potentiometer. The new product has a total resistance range of 500 to 20,000 ohms in standard models, and can function efficiently at ambient temperatures up to 200 C.

Unique design makes use of a glass-film resistance element fused to a tough ceramic frame. The new pot is highly insensitive to shock and vibration as well as to heat and moisture.

►Types Available — Model 50 weighs approximately 0.25 oz and measures  $\frac{3}{8}$  in. by  $\frac{1}{8}$  in. by  $1\frac{1}{4}$  in. Model 52 is an encapsulated version  $\frac{1}{4}$  in. longer, designed to meet the humidity-resistance requirements of MIL-E-5272A.

Both models have a power rat-



*Here it is ...  
4 to 540 Mc...F.M. Deviation  
measured to within 3%*

## MARCONI F.M. DEVIATION METER TYPE TF 791C

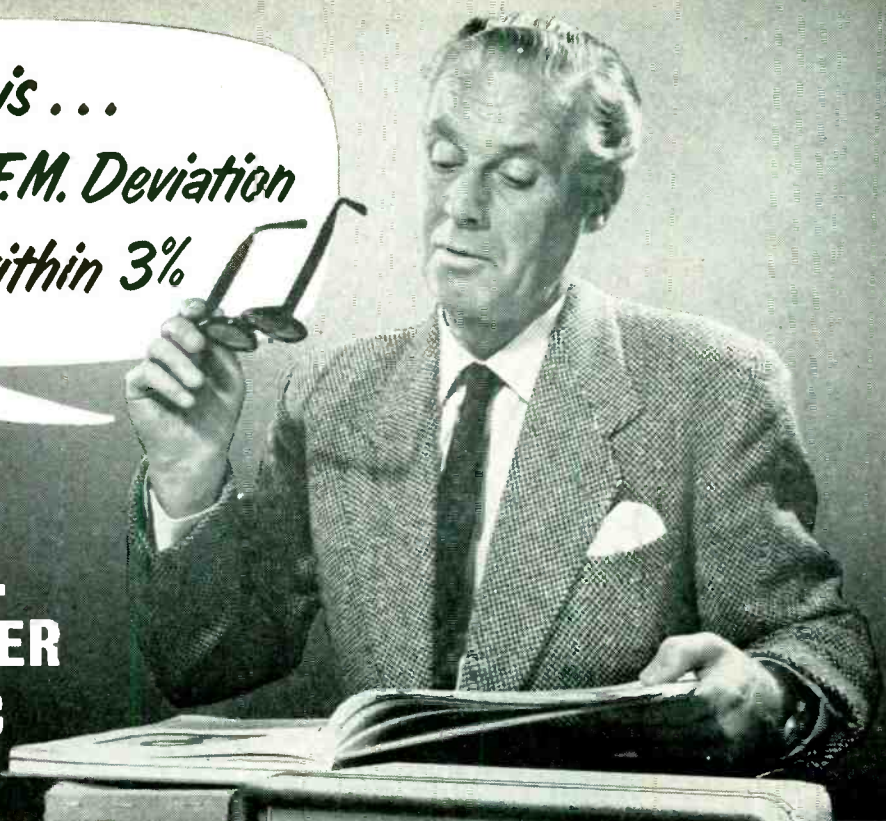

Marconi's new f.m. deviation meter is now in quantity production. Its carrier frequency range extends from 4 to 540 Mc and it has four direct-reading deviation ranges of 5, 25, 75 and 125 kc full scale. It is immediately applicable to all types of system from narrow-band mobile communications to high-fidelity broadcasting. High measurement accuracy is insured by the in-built crystal-controlled deviation standard. There is an independently-buffered i.f. output for aural or visual monitoring.



### ABRIDGED SPECIFICATION

CARRIER FREQUENCY RANGE: 4 to 540 Mc.      DEVIATION MEASUREMENT RANGE: 0 to  $\pm 125$  kc.  
ACCURACY OF DEVIATION MEASUREMENT: For modulation frequencies between 50 cps and 25 kc,  $\pm 3\%$  of full-scale.  
For modulation frequencies between 25 and 35 kc,  $\pm 3\%$  of full-scale  $\pm 3\%$  of the reading.  
TUBES: 6AK5, 6C4, 6CD6G, 5718, 6AL5, OB2, 5Z4G.

**MARCONI  
INSTRUMENTS**

*Marconi-since 1897*

44 NEW STREET · NEW YORK 4

CANADIAN MARCONI COMPANY  
6035, COTE DE LIESSE,  
MONTREAL 9, CANADA

HEAD OFFICE: MARCONI INSTRUMENTS LTD., ST. ALBANS, HERTS., ENGLAND



**TWO-WAY RADIO**  
communications equipment!

VHF-FM FOR: MOBILE AIRCRAFT MARINE MOTORCYCLE PORTABLE BASE

VHF-AM FOR: AIRPORT VEHICLES GROUND STATIONS POINT-TO-POINT

VHF ANTENNAS REMOTE CONTROLS ACCESSORIES

# FLEETCOM Sr.

## MODEL 300-6/12 SERIES

The FLEETCOM Sr. is rugged, compact, universal 6/12, VHF-FM two-way mobile communications equipment for the Public Safety, Industrial, Land Transportation and other radio services.

COMCO'S 17 years experience in design leadership and production "know-how" is engineered and built into every FLEETCOM Sr. unit.

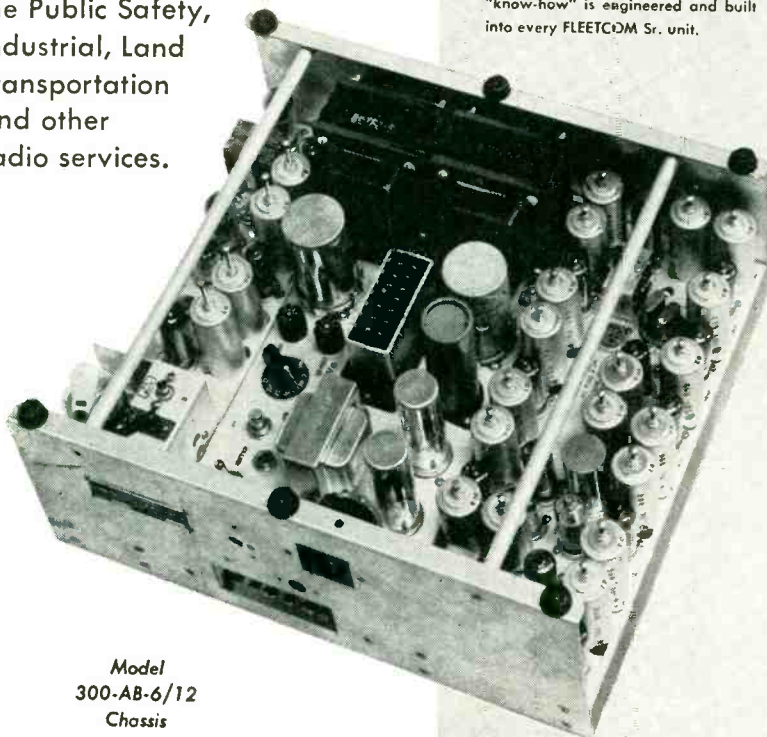

Model 300-AB-6/12 Chassis

**POWERFUL! COMPACT! EFFICIENT!**

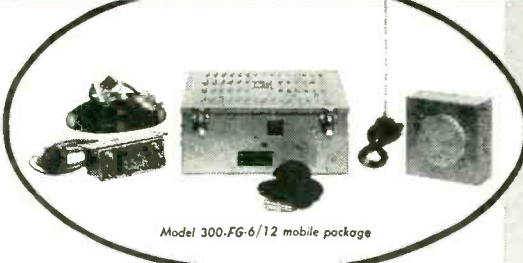

Model 300-FG-6/12 mobile package

### Features:

55 Watts output in low band  
Front or rear mounts  
Case size 14"x13½"x6";  
Maximum output with minimum battery drain.

- UNIVERSAL!** Instantly convertible for 6 or 12 volt operation.
- COMPLETE!** Ready for installation and operation.
- QUALITY!** Exceptional value/price ratio.

ATTENTION DEALERS!  
Write for available territories.



DESIGNERS AND MANUFACTURERS OF RADIO COMMUNICATIONS EQUIPMENT  
**COMMUNICATIONS COMPANY, Inc.**  
FOUNDED 1938 CORAL GABLES, MIAMI 34, FLORIDA

ing of 1.5 w at ambient temperatures up to 120 C, derating to zero at 200 C. Load life is rated at 1,000 hr, and mechanical life expectancy is at least 1,000 cycles or 70,000 shaft revolutions.

Three Teflon-insulated lead wires are spot welded to terminal pins and then clamped securely in place by the stainless steel cover. Model 50 has two holes provided for No. 2-56 mounting screws. It may be mounted either singly or in stacks. Circle P46 inside back cover.

### ANTICORONA SOCKET for 9-pin tubes

SYLVANIA ELECTRIC PRODUCTS INC., 1740 Broadway, New York 19, N. Y., has developed a nine-pin electronic tube socket that protects against h-v corona in miniaturized equipment such as portable tv receivers. The miniature socket contains a deep reinforced skirt or well and can be mounted on the top or bottom of a chassis. The skirt extends far enough beyond the terminals to protect against the presence of h-v corona.

Overall height of the socket is 1½ in. with a body diameter of 1¼ in. Provision has been made in the insulator for ready insertion of a shield ring or center shield. The insulator is of white urea, the contacts of cadmium plated brass. Circle P47 inside back cover.



### WAVEGUIDE PARTS made of oxygen-free copper

AIRTRON, INC., 1103 W. Elizabeth Ave., Linden, N. J. Components such as straight sections, circular bends and adapters are available



# This **NEW** Magnetic Counter is **EASY** to Reset . . .

**Except  
when it's  
Locked!**



Added Evidence  
that —

## Everyone Can Count on **VEEDER-ROOT**

Designed for panel mounting where remote indication is required, this electrically operated counter is a compact package 5.5" long, 2.1" wide, 2.7" high. Capacity: 1,000 counts per minute. Power consumption, 8 watts. Stocked in 110 and 220 AC and DC. Easy to reset, except when locked . . . then the sturdy tumbler-lock\* puts the damper on tampering. Yet one

turn of the key resets all 6 figures to zeros.

This new Magnetic Counter is one of the thousands of Veeder-Root standard and special counters . . . electrically, mechanically and manually operated . . . in daily use throughout the world in industry, business, science and medicine. You, too, can count on Veeder-Root . . . to help you count anything you need.

\*National Lock Co. Lock No. 68-4837; Key D-42B

Stocked at  
Hartford 2, Conn. • New York 19, N. Y.  
Greenville, S. C. • Chicago 6, Ill.  
Montreal 2, Canada  
Offices and Agents in Principal Cities



## **VEEDER-ROOT**

"THE NAME THAT COUNTS"

*u. s. edcor*

## \*MYLAR CAPACITORS

*built to highest  
Quality Control Standards!*

\*DuPont Reg. Trade Mark

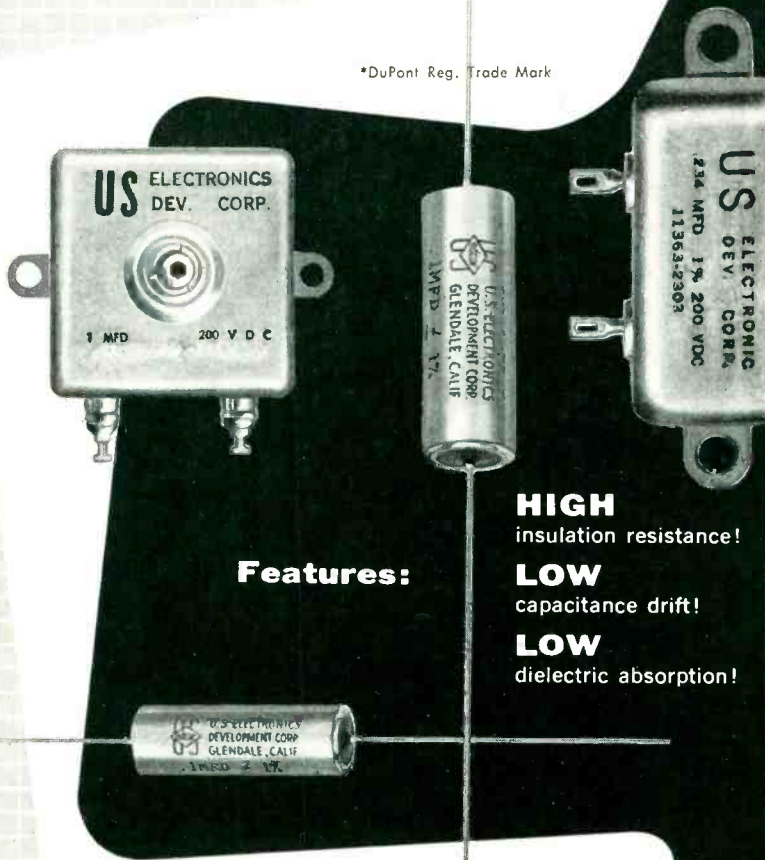

### Features:

**HIGH**  
insulation resistance!

**LOW**  
capacitance drift!

**LOW**  
dielectric absorption!

**Complete variety of standard  
tubular and bathtub types—all  
sizes, ratings and mountings**

**FINEST QUALITY CONTROL—MULTIPLE-LAYER**

**DIELECTRIC CONSTRUCTION assures highest reliability!**

Edecor capacitors are proving their superiority in many missile, computer, navigation, industrial, aviation and military electronic equipment fields. Capacitors built to meet your individual requirements can be supplied—precisely built—delivered promptly!

For complete Edecor literature  
or an Engineering  
Representative to assist you,  
write: Sales-Engineering Dept.,  
U.S. Electronics Development  
Corp., 1323 Airway,  
Glendale 1, California.

**u s edcor**

in the new oxygen-free high conductivity copper used in the WR-137 waveguide size. Used in combination with standard flexible waveguide components and windows, they readily lend themselves to installation for microwave relay systems operating in the 6,000-mc region.

Because of this material's higher conductivity, the oxygen-free copper waveguide components have general application in indoor and outdoor cabinet arrangements of the various microwave relay systems. This copper has a waveguide attenuation between 2.0 and 2.4 db per 100 ft.

Besides a standard line of straight sections, circular bends and pressure adapters made of this material in the WR-137 waveguide size, the company has available standard pressure windows and flexible waveguide components—all with appropriate hardware for use in the many different types of microwave relay system installations. Circle P48 inside back cover.

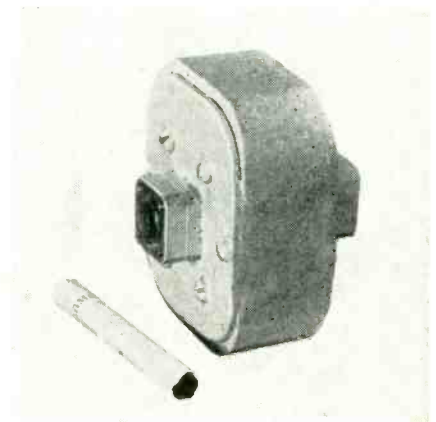

### LOAD ISOLATOR operates within KA band

CASCADE RESEARCH CORP., 53 Victory Lane, Los Gatos, Calif. Model KA-131 Uniline is a small size, lightweight load isolator for operation within the microwave KA band. It is two in. long overall and weighs only 1 lb., 9 oz.

Matched load vswr is less than 1.2 over the operating range from 34 to 36 kmc. Isolation is 20 db at band center, 15 db at band edges. Insertion loss is 0.8 db maximum.

Power rating is 50 w average,



# What kind of men develop microwave highways?

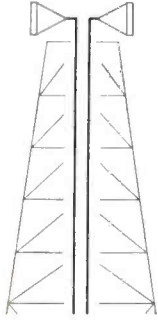

The great microwave systems that relay telephone conversations along with television programs from coast to coast will have to work harder than ever to meet growing demands for service. But at Bell Laboratories scientists have been making important advances in the art of microwave communication. These advances are being applied in the development of a new and more efficient system in which single beams of microwaves will carry simultaneously many more telephone conversations and television programs than is now possible.

The development of the new system demands the varied skills of men in many fields of science and engineering. Just a few of the specialists necessary are . . .

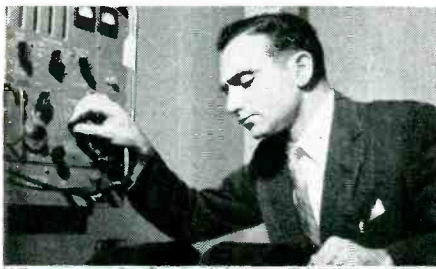

**PHYSICISTS** like J. A. Weiss, Ph.D. in Physics, Ohio State, to harness the properties of ferrites in new ways for better control of the transmission of microwaves.



**MICROWAVE ENGINEERS** like P. R. Wickliffe, M.S. in E.E., M.I.T., to design new circuitry. Microwaves must be conducted, controlled and amplified through waveguides which resemble pipes.



**MECHANICAL ENGINEERS** like W. O. Fullerton, B.S. in E.E., Iowa State, to embody new principles in designing the many structures and devices used in microwave telephony—with all parts feasible to manufacture, practical to install and easy to maintain.

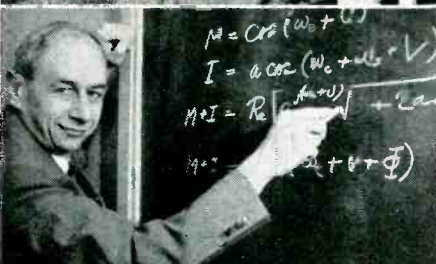

**SYSTEMS ANALYSTS** like J. P. Kinzer, M.E., Stevens Institute, for over-all system planning and prediction. Mr. Kinzer works with numerical quantities and characteristics to predict on paper the performance of an operating system. What will it do? How must it perform to meet the needs?

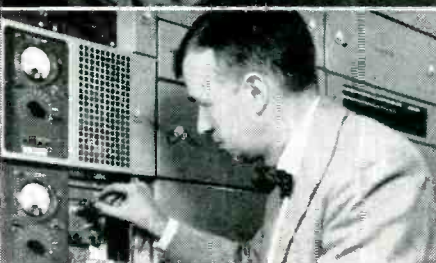

**ELECTRONIC ENGINEERS** like B. C. Bellows, B.S. in Engineering, Cornell, for the development of "watch-dog" equipment to protect against failure. Protective devices must operate automatically in split seconds to maintain uninterrupted service.

**BELL TELEPHONE LABORATORIES**

WORLD CENTER OF COMMUNICATIONS RESEARCH AND DEVELOPMENT



**HIGHEST  
INSULATION RESISTANCE  
and  
CAPACITANCE STABILITY**

**LOWEST  
POWER FACTOR  
and  
SOAKAGE**

**fci  
POLYSTYRENE and TEFLON  
CAPACITORS**

**OPERATING TEMPERATURE**

up to 85°C. for Polystyrene  
up to 200°C. for Teflon

**AVAILABLE IN**

hermetically sealed glass tubes  
with metal end caps

style CP06 metal shells  
with glass-seal buttons

bathtub cases with low-loss  
glass terminals

style CP70 metal cans with  
low-loss glass terminals

**SPECIAL UNITS — INCLUDING MULTI-SECTION BLOCKS —  
AVAILABLE ON SPECIAL ORDER OR MADE TO SPECIFICATIONS**



**ELECTRICAL CHARACTERISTICS**

	POLYSTYRENE	TEFLON
Operating Temp. Range.....	-55°C. to +85°C.	-55°C. to +200°C.
Voltage Range, DC.....	100 to 30,000	100 to 30,000
Capacitance Range.....	.001 to 20 mf	.001 to 20 mf
Power Factor.....	.02% @ 1 kc	.02% @ 1 kc
Dielectric Absorption.....	.01%	.01%
Voltage Derating at 85°C.....	none	none
Voltage Derating at 125°C.....	not operable	none
Voltage Derating at 150°C.....	not operable	none
Voltage Derating at 200°C.....	not operable	33%
Temperature Coefficient.....	-100 ppm/°C.	-50 ppm/°C.
I.R. at Room Temperature.....	10 <sup>7</sup> megohms/mf	10 <sup>7</sup> megohms/mf
Capacitance Stability.....	0.1%	0.1%

**fci film capacitors, inc.**

3400 Park Ave., New York 56, N.Y. • Phone CYpress 2-5180

eight kw peak. Peak power level can be increased up to 100 kw when the system is pressurized. Circle P49 inside back cover.

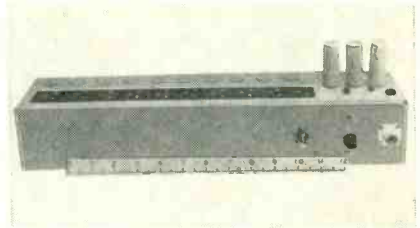

**PULSE GENERATOR  
drives shift registers**

AIRTRONICS, INC., 5522 Dorsey Lane, Washington 16, D. C., has produced the Datarok 200 series of pulse generator circuits to drive its Datarok 100 series of magnetic shift register units. The DK202 employs only solid-state components featuring a combination of novel transistors for switching elements, which provide gain, and magnetic cores with rectangular hysteresis loops to control pulse width, regulate pulse currents, absorb power and discriminate against unwanted signals. This technique makes it possible to replace 10 vacuum tube elements with three cores and four transistors.

Designed to drive 10 Datarok DK101 units at speeds up to 50 kc, the DK202 may be connected into a single register, ten separate single-bit circulating register or any intermediate combination. More technical information is available from the company. Circle P50 inside back cover.

**AIRBORNE COMPUTERS  
with reduced size and weight**

WESTINGHOUSE ELECTRIC CORP., Baltimore, Md. Airborne computers, which predict target position and direct guns from radar information, are now available in reduced size and weight. A typical example is the electronic tubeless analog computer. A major element of this computer, the instrument servo, consists of an amplifier, a servo motor, gear box, and a bank of potentiometers.

Weight of the servo amplifier



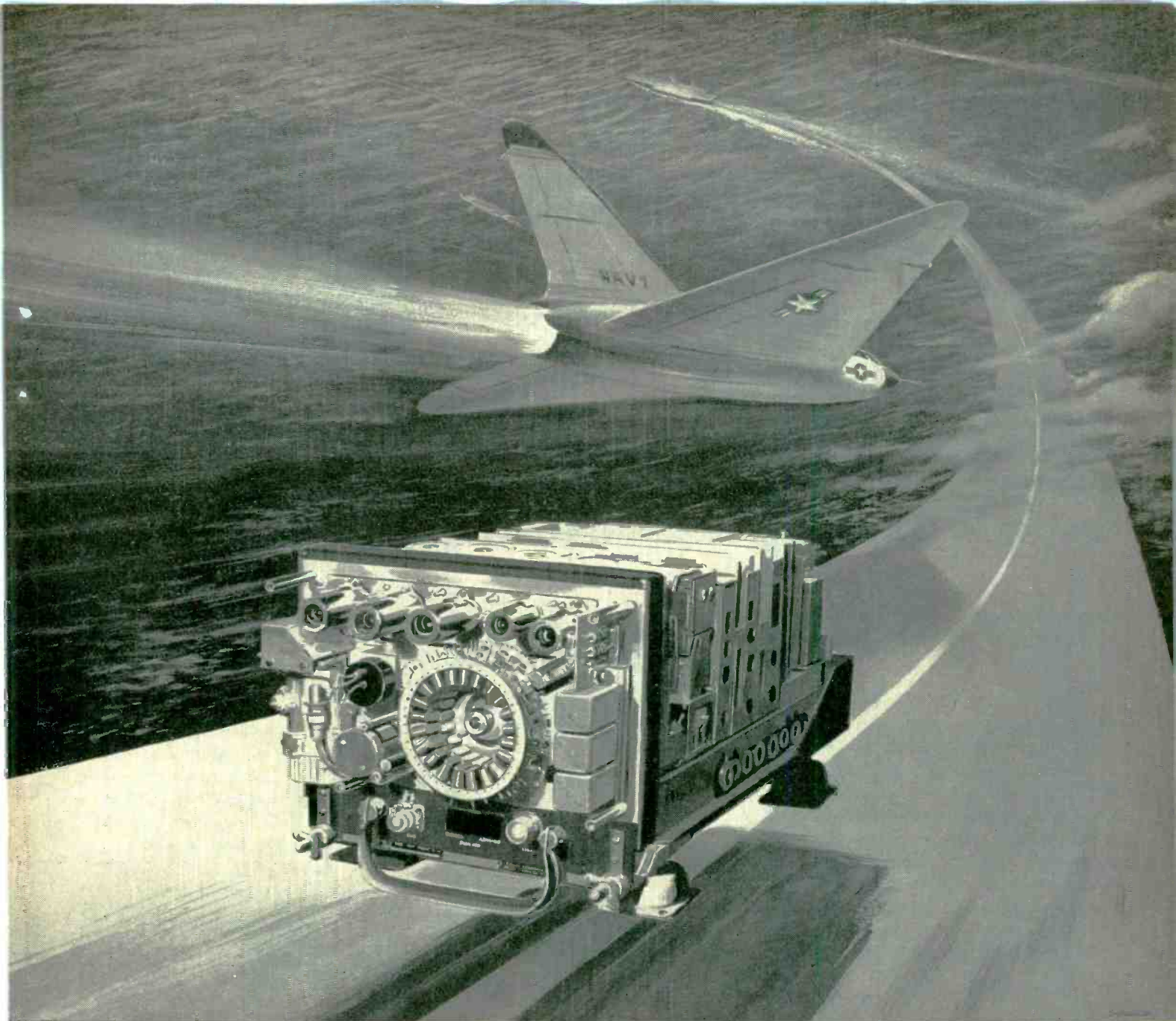

*TACAN unit shown with covers removed; plane is a composite model.*

## *tube* 78-page road map for jets

An 800-foot carrier may be as hard to find as a needle in a haystack, when the plane seeking it is at 20,000 feet and the time is 0200 hours.

To make the homing plane a homing pigeon, we build the "ARN-21" TACAN equipment illustrated above. Its 78 tubes and associated components add up to a self-contained transmitter and

receiver, rugged in its ride-resistance and accurate to pin-point tolerances.

The manufacture of equipment as important and complicated as this demands *perfection*, and nothing less. On the military as well as the home front, Stromberg-Carlson has long displayed the ability to take such problems in stride.



**STROMBERG-CARLSON COMPANY**

A DIVISION OF GENERAL DYNAMICS CORPORATION

General Offices and Factories at Rochester, N. Y.—West Coast plants at San Diego and Los Angeles, Calif.



# WHATEVER YOUR UHF ATTENUATION NEEDS . . .

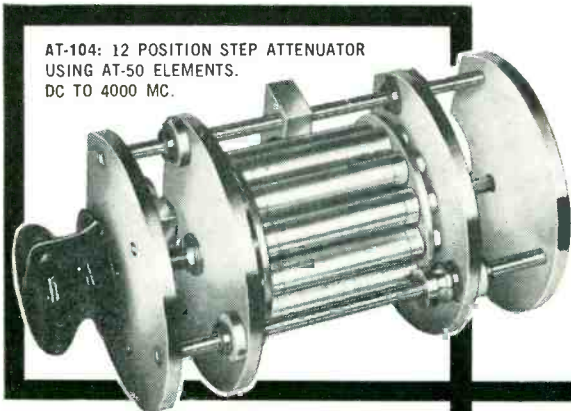

AT-104: 12 POSITION STEP ATTENUATOR USING AT-50 ELEMENTS. DC TO 4000 MC.

**A COAXIAL UNIT FROM  
EMPIRE DEVICES  
WILL MEET  
YOUR REQUIREMENTS**

Empire's UHF attenuators are resistive coaxial networks for the frequency range from DC to 4000 MC.

Accuracy is held to  $\pm 1/2$  DB, VSWR is better than 1.2 to 1. Any attenuation values up to 60 DB are available. Deposited carbon elements are used for stability and operations at higher pulse levels. Standard impedance is 50 ohms, other values upon request. These units have excellent temperature characteristics and are vibration and shock resistant. Standard connectors are type "N", attenuator pads are also available with type "C".

The attenuators may be obtained as individual pads (AT-50, AT-60), or as multi-position step attenuators AT-103 (six positions) and AT-104 (twelve positions). For even greater flexibility, several step attenuators may be series connected.

*For complete technical information about attenuators for your laboratory or production needs, write for free catalog.*

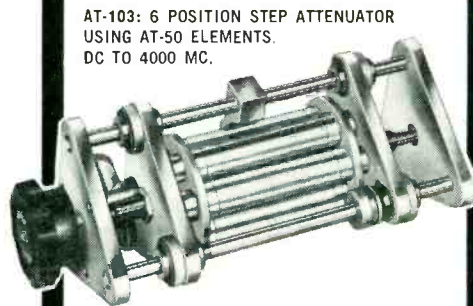

AT-103: 6 POSITION STEP ATTENUATOR USING AT-50 ELEMENTS. DC TO 4000 MC.



AT-50: ATTENUATOR PAD, DC TO 4000 MC. 1 W AVERAGE, 1 KW PEAK.

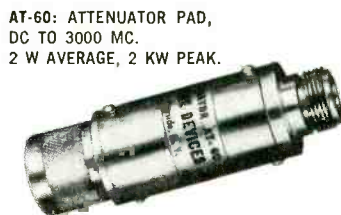

AT-60: ATTENUATOR PAD, DC TO 3000 MC. 2 W AVERAGE, 2 KW PEAK.

NEW YORK—Digby 9-1240 • SYRACUSE—SYracuse 7-47409 • PHILADELPHIA—Sherwood 7-9080 • BOSTON—Twinbrook 4-1955 • WASHINGTON, D. C.—Decatur 2-8000 • ORLANDO, FLA.—Orlando 3-3524 • ATLANTA—Cedar 7-7801 • DETROIT—Broadway 3-2900 • CLEVELAND—Evergreen 2-4114 • DAYTON—Fulton 8794 • CHICAGO—Estebrook 9-2700 • DENVER—Main 3-0343 • FORT WORTH—Walnut 6-4444 • ALBUQUERQUE—Albuquerque 5-9632 • LOS ANGELES—Republic 2-8103 • PALO ALTO—Davenport 3-4455 • CANADA: MONTREAL—Regent 3-6502 • TORONTO—Walnut 4-1226 • HALIFAX—Halifax 4-6487 • EXPORT: NEW YORK—Murray Hill 2-3760

**EMPIRE DEVICES  
PRODUCTS CORPORATION**

38-15 BELL BOULEVARD • BAYSIDE 61 • NEW YORK

manufacturers of

FIELD INTENSITY METERS • DISTORTION ANALYZERS • IMPULSE GENERATORS • COAXIAL ATTENUATORS • CRYSTAL MIXERS

NEW PRODUCTS

(continued)

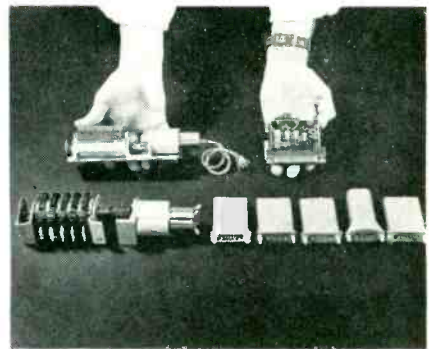

was reduced from 33 to four oz. The new all-transistorized amplifier replaces five molded units using vacuum tubes. The transistors are silicon to operate through a wider temperature range. The amplifier employs a feed-back loop to correct for any temperature deviations in transistor characteristics. Another advantage of the transistorized circuit is the low power consumption. This is especially true during nulls, when the power consumption of the transistorized amplifier is about one w—the previous system required 40w. Size reduction was also aided by fewer total components—39 for the original version to 24 for the transistor servo. Circle P51 inside back cover.

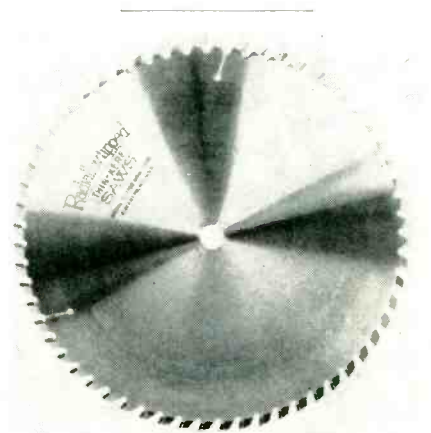

**CIRCULAR SAW BLADE**  
reduces material waste

RADIAL CUTTER MFG. CORP., 831 Bond St., Elizabeth, N. J. The new Thin-Kerf, fine-pitch carbide-tipped circular saw blade reduces material waste by 20 percent or more. The blades have been developed to cut smoothly and precisely without edge chipping or cracking, eliminating sanding and other finishing operations. The blades were designed specifically

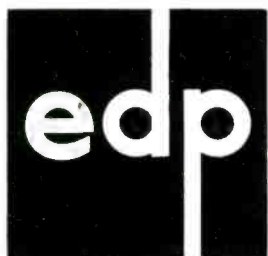





*Get the credit you deserve here,  
where company attitudes, resources,  
and facilities are conducive to prompt  
expedition of workable ideas.*

If you feel your abilities are "lost in the shuffle," contact us at Delco Radio, where ideas become practical realities—and soon!

Delco Radio's new high-power germanium transistors have already set new high standards for the industry—and that's only the beginning. Continued expansion of this program requires additional physicists and

engineers, qualified for work in the research, development and design of semiconductor devices, their applications and production.

Delco Radio offers you big-city salaries, General Motors employee benefits, modern work facilities—and the association of other qualified people under the direction of eminent physicists. You will enjoy the advantages of working for a small organization, plus the stability of a large corporation. Indiana's homey countryside is ideal for peaceful living.

Why not write today and tell us all about yourself? Address: Personnel Director—L, Delco Radio, Division of General Motors, Kokomo, Indiana.

**DELCO RADIO**

**DIVISION OF GENERAL MOTORS  
KOKOMO, INDIANA**

We perfected the highest quality capacitor, for military uses!

**NOW** this renowned engineering quality experience is offered in the

**NEW**

**CO-THERM<sup>®</sup>**  
HIGH TEMPERATURE  
**CAPACITORS**  
FOR INDUSTRIAL USES!

Highest quality paper and foil sub-miniature capacitors, encased in highly dense Steatite tube. Outstanding for TV, radio and other compact circuitry requirements. No voltage derating necessary over temperature range of -55°C to +125°C. Noted for exceptional capacitance stability. Also available in new plastic film dielectrics. Co-Therm capacitors in all standard values and tolerances. Prompt delivery!

ACTUAL SIZE

Special units designed for specific requirements! Write, phone or wire, TODAY!

Send for Literature!



12900 Foothill Blvd.  
San Fernando, Calif. • EMpire 1-8693  
Offices in Washington, D.C. and San Francisco

for applications in thermosetting and thermoplastic materials, printed circuitry and light-gage nonferrous metals. Circle P52 inside back cover.



**VARIABLE AUTOFORMERS**  
designed for aircraft

UNITED TRANSFORMER CORP., Pacific Div., 4008 W. Jefferson Blvd., Los Angeles 16, Calif., has announced its new Vari-Lite aircraft variable autotransformers designed to replace resistive-type light control units with high-efficiency controls of exceptional reliability. Input is 115 v, 400 cycles; output is 0 to 28 v.

A typical Vari-Lite unit is the PA-1028, which has a four-ampere capacity, measures 2 3/8 in. diameter by 2 1/4 in. long and weighs 19 oz. It meets MIL-T-9219 and MIL-E-5272A specifications. Circle P53 inside back cover.

**D-C VOLTMETER**  
compact and dependable

PAMECO, Mill Lane, Waterford, Conn. Model 310 d-c electronic voltmeter has been especially designed for incorporation into equipment where compactness and dependability are important. The instrument is a self-contained, multirange voltmeter possessed of good electrical characteristics which include high input impedance, good accuracy and the ability to effect voltage measurements up to 1,000 v d-c.

Model 310 offers a large scale

Specialists in the Unusual



*Anodized Aluminum Wire*

.0008" TO .030" DIAMETER

HIGH DIELECTRIC COATING

EXCELLENT FLEXIBILITY

To fill a need for high temperature insulation in a high conductivity wire. Precision drawn to close resistance control in the smaller sizes.

Write for List of Products



SINCE 1901

**SIGMUND COHN CORP.**

121 SOUTH COLUMBUS AVE., MOUNT VERNON, N. Y.



# MISSILES to MACHINERY

*Century* MODEL 420

## ELECTROGRAPH

*covers the oscillograph recording field*

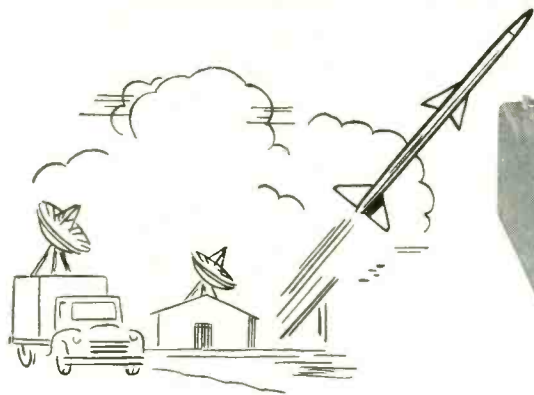

### TELEMETRY APPLICATIONS

- QUICK-LOOK monitoring in the telemetry ground station permits continuous observation of missile in-flight programing results.
- ON-THE-SPOT monitoring permits making in-flight function corrections in controlled missiles or piloted aircraft.
- A NATURAL for mobile telemetry vans . . . compact, rugged, low power consumption, record is PERMANENT, no fading or fogging when exposed to direct sunlight.

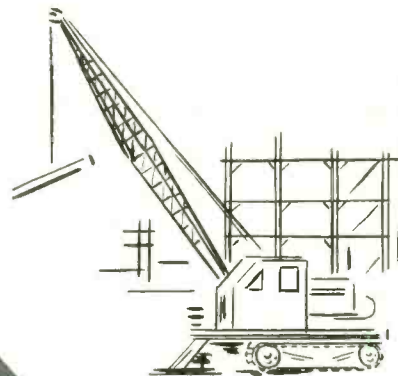

### INDUSTRIAL APPLICATIONS

- STRESS-STRAIN RECORDING with "first-hand" read-out during test.
- PERMANENT record obtained at test site may be stored indefinitely for purpose of future data reduction.
- PORTABLE — extremely useful for field test applications where a "multiplicity" of data must be collected with the least amount of instrumentation.
- No amplifiers required for many applications.

USES a variety of tubular mirror galvanometers pioneered by Century

## ENGINEERS . . .

*Check your requirements against these FEATURES!*

- Permanent continuous record produced within recorder.
- Developed record may be viewed an INSTANT after exposure.
- HIGH CONTRAST photographic qualities . . . black intelligence traces are recorded on light colored background.
- As many as 24 intelligence channels may be recorded on the 8-inch x 200-foot record roll.
- Record is REPRODUCIBLE without loss of contrast by Ozalid, Bruning, etc., processes . . . NO deterioration due to ultra-violet exposure.
- Eliminates need for costly darkroom facilities.

**COSTS NO MORE THAN OLD-FASHIONED METHODS**



## Century Electronics & Instruments, Inc.

1333 NO. UTICA, TULSA, OKLAHOMA

For further information, call on our nearest representative:  
EXPORT OFFICE: 149 BROADWAY, NEW YORK CITY — TEL.: BARCLAY 7-0562

PHILADELPHIA, PA.  
Test Equipment Sales Co.  
4447 N. Bodine St.  
Tel.: Michigan 4-1822

LONG ISLAND CITY, N. Y.  
Test Equipment Sales Co.  
29-46 Northern Blvd.  
Tel.: Stillwell 4-7120

DALLAS, TEXAS  
Arnold Barnes Co.  
5526 Dyer St.  
Tel.: Emerson 6716

TUCSON, ARIZONA  
G. S. Marshall Co.  
3686 Baker Place  
Tel.: East 7-1501

REDWOOD CITY, CALIF.  
G. S. Marshall Co.  
2015 El Camino Real  
Tel.: Emerson 6-8214

SAN MARINO, CALIF.  
G. S. Marshall Co.  
2065 Huntington Drive  
Tel.: Ryan 1-6781

SAN DIEGO, CALIF.  
G. S. Marshall Co.  
3525 5th Avenue  
Tel.: Cyprus 8-8234

DENVER, COLORADO  
Barnhill Associates  
6520 West 62nd Ave.  
Tel.: Harrison 4-7733

ATLANTA, GEORGIA  
E. G. Holmes & Associates  
309 Pharr Road, N. E.  
Tel.: Cedar 7-7801

CLEVELAND, OHIO  
Electro Sales Associates  
281 E. 216th St.  
Tel.: Redwood 2-7444

DAYTON, OHIO  
Electro Sales Associates  
512 Orangewood Drive  
Tel.: Walnut 5426

ORLANDO, FLORIDA  
E. G. Holmes & Associates  
56 W. Columbia St.  
Tel.: 3-3524

# Tough Heyco Nylon STRAIN RELIEF BUSHINGS

Insulate and anchor the  
power supply cord to  
your housing . . .

no need for grommets,  
wire knots or costly  
labor.

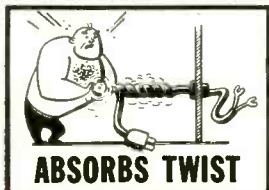
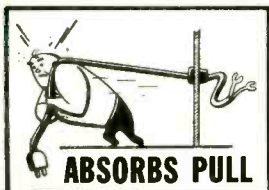

Send for samples to fit your wire, today!

**HEYMAN  
MANUFACTURING COMPANY**  
KENILWORTH 2, NEW JERSEY

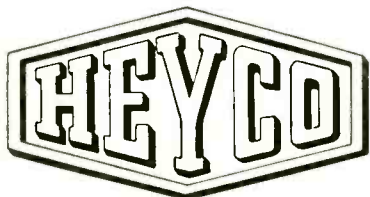

**HEY MAN!  
... SAY HEYMAN**



for convenient readability together with seven discrete voltage ranges, 0-1/3/10/30/100/300/1,000 v. The voltmeter is also characterized by simplicity of operation with the two controls, the zero set and the range switch, immediately accessible at the panel. The input terminals and the calibration adjustment are mounted at the rear.

Single and multiple range versions, both a-c and d-c, are available as standard types, including those with zero-center scales.

Circle P54 inside back cover.



## CYLINDRICAL BOBBINS

custom-formed of plastics

ORANGE PRODUCTS, INC., 554 Mitchell St., Orange, N. J., offers a complete line of custom-formed cylindrical bobbins. They can be made of epoxy resin, Nylon, Teflon and many other plastics and are custom-formed to any cylindrical shape in diameters of  $\frac{1}{8}$  in. to  $\frac{3}{4}$  in. and lengths up to seven in.

Molds are not necessary to the process.

Illustrated are but a small fraction of the countless possible variations of cylindrically shaped bobbins that can be custom-formed of plastic materials. Circle P55 inside back cover.

## TRIODE-TETRODE

for tv receivers

RADIO CORP. OF AMERICA, Harrison, N. J., has developed a nine-pin miniature tube containing a medium-mu triode and a sharp-cutoff tetrode intended for a wide variety of applications in black-and-white and color tv receivers.

The 6CQ8 is especially useful as a combined oscillator and mixer tube in tuners of tv receivers which utilize an intermediate frequency in the order of 40 mc. The triode unit of the tube is not only useful as a vhf oscillator but also as an r-f amplifier, phase splitter, sync clipper and sync separator. The tetrode unit is also useful as a sound or video i-f amplifier tube.

This tube has a 450-ma heater with a controlled warmup time. Design features include a separate cathode for each unit with individual base-pin terminal and an internal shield (to prevent electrical coupling between the triode and the tetrode units). Circle P56 inside back cover.

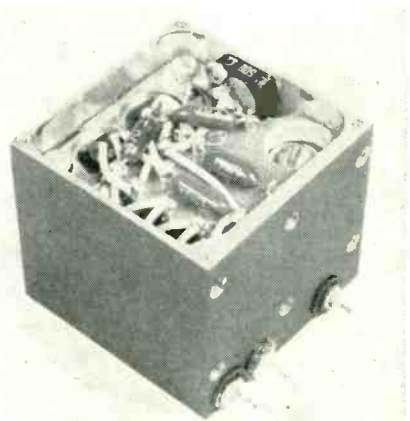

## VOLTAGE REGULATOR

is transistorized

WESTERN GEAR CORP., Electro-Products Div., 132 West Colorado St., Pasadena 1, Calif., announces



# NOW...

## a completely new subminiature paper tubular capacitor

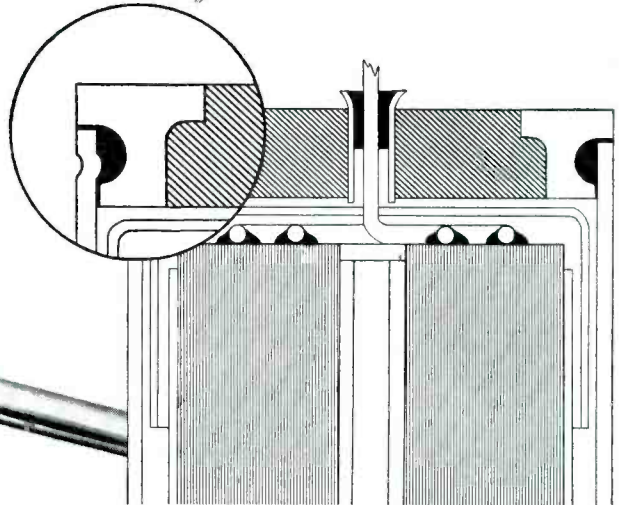
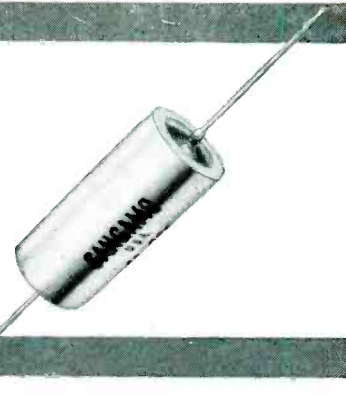
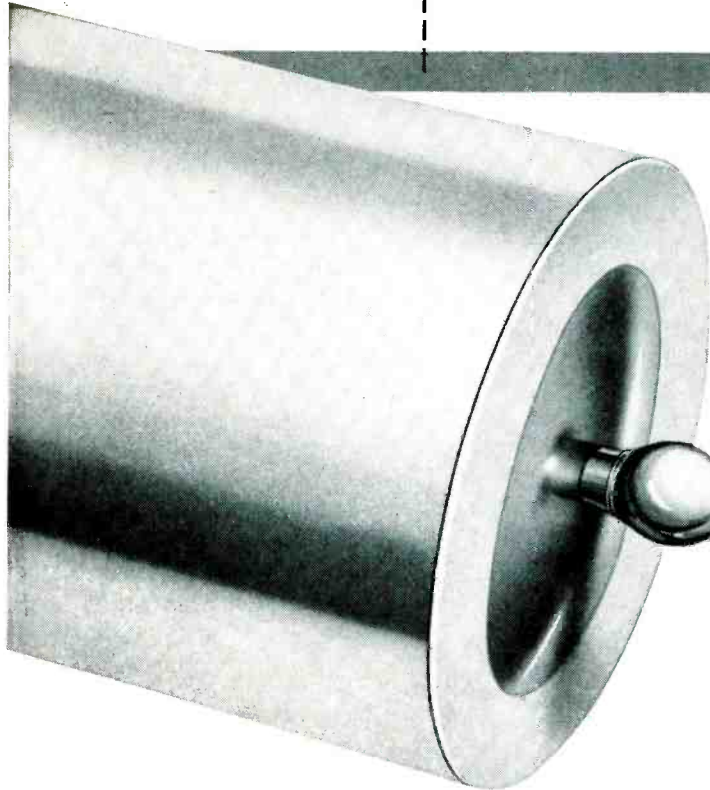

Because the terminal is mechanically retained in the case, independent of the captive solder seal, the new design permits perfect positioning with uniform accuracy.

### Hermetically sealed with Sangamo's new "Innerseal" terminal...for higher reliability...for longer service life

Here is today's latest development in miniaturized military type capacitors—a newly designed terminal for Sangamo subminiatures. This Sangamo engineering development offers many advantages over conventional seals.

The "Innerseal" structure seats and locates itself exactly on the case. Terminals cannot be cocked at angle, extend out of case, or be pushed too deeply into case and cause cupped

ends or section damage. It permits optimum performance and reliability through greater flexibility of internal design.

The solder is confined and automatically sealed. Solder or flux cannot run down inside case to cause life failures due to contamination. There are no cracked terminals due to solder time variation.

Write for Bulletin TSC-117.

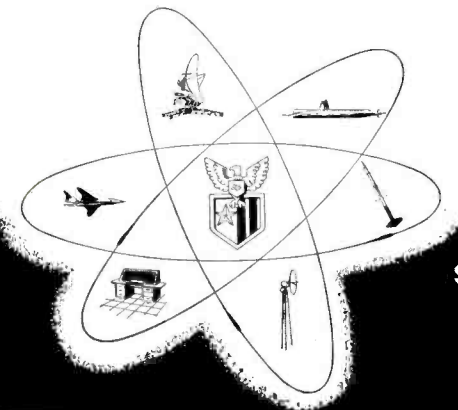

SC57-3

**SANGAMO ELECTRIC COMPANY**  
*Electronic Components Division*  
SPRINGFIELD, ILLINOIS

# BEST ANSWER for Tower Jobs—ROHN

**AMERICA'S FINEST  
COMMUNICATIONS  
TOWER OF ITS KIND  
... WITH EXCLUSIVE  
BUILT-IN ECONOMY**

• **REDUCE COSTS**

by getting the right tower for the right job. When a job calls for a medium weight tower from 200-300 ft. guyed, or self-supporting from 50-66 ft., a Rohn tower can do the job at far less cost. Check your particular tower needs against the "job-rating" a Rohn tower has and you'll save money.

• **HOT DIPPED GALVANIZED**

finishes are available. The erection is quick and easy as all towers are in 10 ft. sections. Rohn towers are designed for economy in erection as no specially trained help is required.

• **PROVEN DESIGN**

that has been tested with thousands of installations. Workmanship is unexcelled. Mass production machinery is used for precision fabrication yet a big reduction in labor cost.

Picture illustrates 300 ft. Rohn No. 40 Tower installation as being used for community television by Caspian Community T. V. Corp., Caspian, Michigan.

Write, wire or phone for data and prices and nearest source of supply. ROHN representatives are coast-to-coast to serve you.

**ROHN Manufacturing Co.**

116 Limestone, Bellevue  
Peoria, Illinois

"Pioneer Manufacturers of TV and Communication Towers of All Kinds."

NEW PRODUCTS

(continued)

a new transistorized d-c voltage regulator offered in two models of varying current capacities. This precision regulator is designed for use under rugged environmental conditions where performance, spacing and weight are at a premium.

The circuitry employs a series power transistor and a temperature compensated Zener-diode reference voltage. Voltage, current, regulation, size and other parameters may be widely varied to suit specific applications.

► **Specifications**—Input voltage is 27.5 v d-c,  $\pm 15$  percent. Output for the model 7VR09 is 20 v d-c at 50 to 250 ma; for model 7VR08, 20 v d-c at 10 to 150 ma. Regulation is less than  $\pm 0.1$  percent for combined variations input voltage, load current, temperature, drift and vibration. Shunt loss is less than 25 ma. Temperature range is from 32 to 150 F. Dimensions are 2 by 2 by 2 in. **Circle P57 inside back cover.**

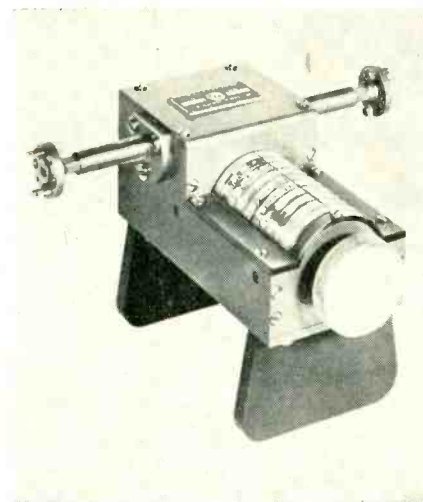

## VARIABLE ATTENUATOR

operates over 50 to 75 kmc

F-R MACHINE WORKS, INC., Electronics & X-Ray Div., 26-12 Borough Place, Woodside 77, N. Y. The FXR type No. M164A precision mm variable attenuator gives direct attenuation readings over the full waveguide bandwidth with high speed and accuracy at millimeter wavelengths.

The compact unit operates over the complete frequency range of

50 to 75 kmc in RG-98/U waveguide. Featuring bilateral matching, the unit is calibrated to 50 db of attenuation. Maximum calibration error is 0.1 db or two percent of reading, whichever is greater, while transmission loss is less than one db and is not included in the calibration. A catalog sheet gives complete specifications. **Circle P58 inside back cover.**

## HEAT SEALING TAPE

has variety of uses

G. T. SCHJELDAHL Co., Medical Arts Bldg., Northfield, Minn., has developed a thermoplastic polyester-resin tape, known as GT tape, for heat sealing Mylar film and a wide range of other materials. Manufacturers of electronic components find this tape ideally suited for chemically cementing together magnetic materials, including Ferrites, while maintaining close tolerances and gap thickness. Insulation resistance and resistance to voltage breakdown has proved excellent in this application.

Further information and complete technical data are available. **Circle P59 inside back cover.**



## SERVO TACH GENERATOR

with  $\pm 0.5$ -percent linearity

EASTERN AIR DEVICES, INC., 397 Central Ave., Dover, N. H., has announced a precise servomotor tachometer generator featuring a  $\pm 0.5$ -percent linearity. Consisting of a high-performance, low-inertia, a-c servo motor directly coupled to an induction generator of the drag cup type, the new size 11 unit is a rugged, one-piece assembly made of nonmagnetic stainless steel and equipped with a precision gearhead for lower backlash. It is designed for operation



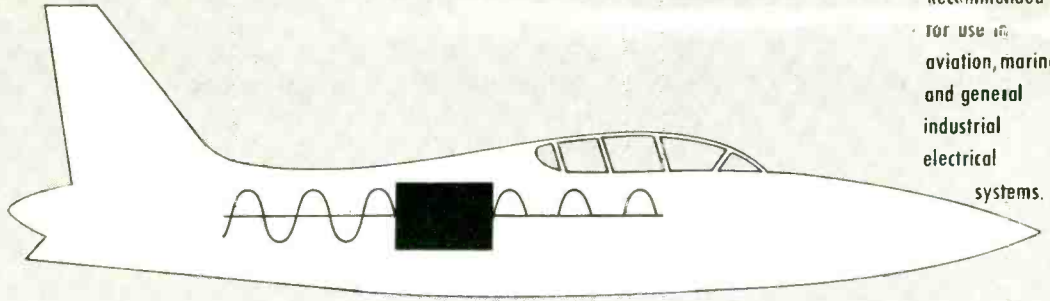
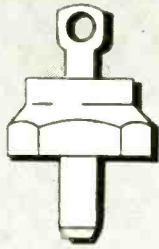

Recommended  
for use in  
aviation, marine  
and general  
industrial  
electrical  
systems.

WN-5051 and WN-5091 with *maximum peak inverse voltage* ratings of 50-350 v. (up to 200 amperes in bridge assemblies).

## TYPICAL RECTIFIER CIRCUITS



Single phase full wave (center tap)

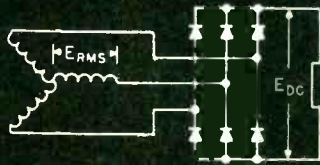

Three phase full wave bridge

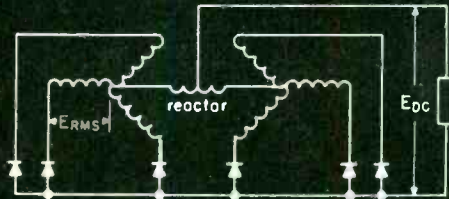

Six phase half wave



WN-5082 with  
*maximum peak*  
*inverse voltage*  
ratings of 50-300v.  
(300 to 5000 amperes  
in bridge assemblies.)

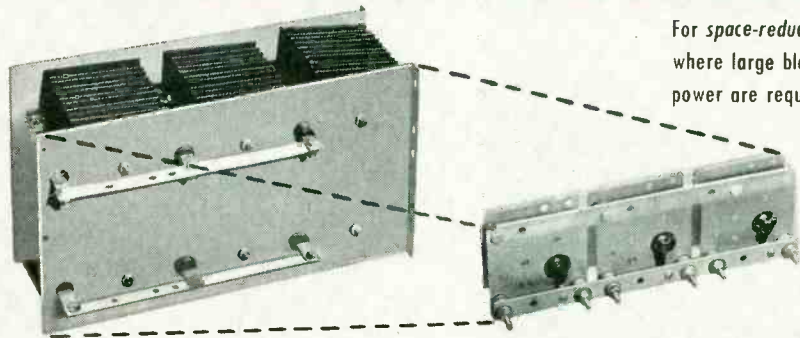

For *space-reducing* design  
where large blocks of D.C.  
power are required.

# Westinghouse SILICON<sup>(SI)</sup> Rectifier cells pack more power in a smaller package!

Recommended for greater reliability, highest efficiency and lowest cost

For the progressive design or application engineer in power, control or electronics . . . for anyone who builds or specifies rectifier assemblies and is constantly seeking equipment design and operational improvement that:

- Provides more power in a smaller space
- Lowers installation cost
- Insures minimum maintenance
- Results in no detectable aging
- Makes possible high ambient temperature operation
- Improves A.C. to D.C. conversion efficiency

Westinghouse Electric Corporation  
Semi-Conductor Division, Dept. E-4  
P. O. Box 868, Pittsburgh, Pa.

**YOU CAN BE SURE...IF IT'S Westinghouse**

7ET-4101

# HIGH POWER at TRANSISTOR VOLTAGES

## Model DV 60-2 Transistor POWER SUPPLY

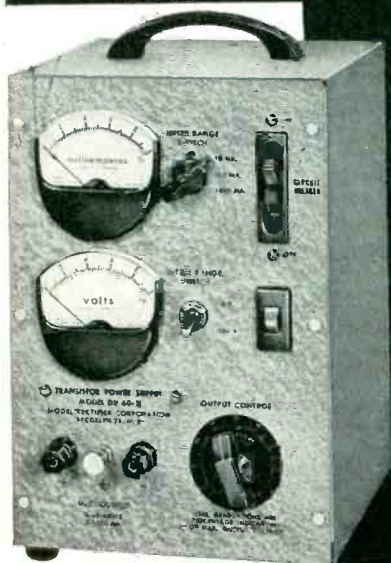

**\$110**



Thorough and versatile! Efficiently powers all transistor circuits. Unparalleled performance and price.

- AC OPERATED, delivers 0-60 volts DC at currents up to 1000 milliamperes.
- SUPERIOR to conventional DC power supplies specified for vacuum tube high voltage range and offering erratic reactions when used at low transistor voltages.
- CONTINUOUSLY VARIABLE, equivalent to a battery. High power.
- RIPPLE SUPPRESSION below 0.2% at rated current, by two section choke input filter.
- COMPLETE CONTROLS, front panel switch-type magnetic circuit breaker, neon pilot light, Powerstat output control, multirange voltmeter and milliammeter and output binding posts. Meters accurate to 2%, readable at distance. Height 10 $\frac{3}{4}$ "", Width 7" , Depth 9 $\frac{1}{4}$ "", 21 lbs.

WRITE FOR CATALOG  
OF ENTIRE LINE  
**MODEL RECTIFIER  
CORPORATION**  
1065 Utica Ave.  
Brooklyn, New York

in ambient temperatures up to 150 C and is suitable for such applications as instrumentation, fire control, autopilots, missiles and computers.

It features lower nulls (0.008 v rms in phase; 0.015 v rms quadrature and 0.019 v rms total null) and linearity of 0.5 percent at 3,600 rpm. The unit meets Bu Ord MK-14 specifications. **Circle P60 inside back cover.**

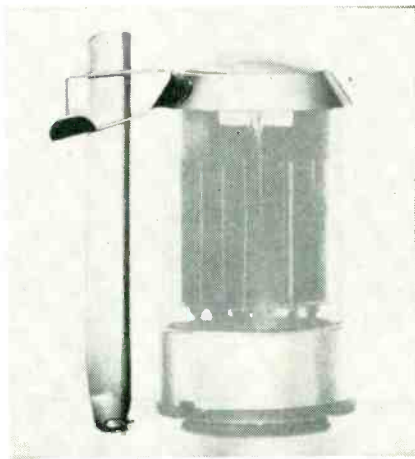

mounting base provided by the dual mounting feet. Catalog and complete specifications are available. **Circle P61 inside back cover.**

## PULSE GENERATOR with variable output

FRANKLIN ELECTRONICS INC., East Fourth St., Bridgeport, Montgomery Co., Pa., has announced a new, low-cost precision pulse generator for checking and calibrating nuclear instruments such as linear amplifiers and radiation spectrometers. It is exceedingly stable with a drift rate of less than 0.005 percent per hour or 0.02 percent per day. Output is variable from  $\mu$ v to 10 v by a 10-turn pot and a step-type attenuator.

Its fast rise time (seven microsecond) and exponential delay pulses (300  $\mu$ sec) approximate those produced by radiation detectors. Repetition rate is 60 pps, fixed.

Offering laboratory precision in a portable case, this instrument weighs only nine lb and measures 6 $\frac{1}{8}$ " by 10 $\frac{1}{8}$ " by 6 $\frac{1}{8}$ " in. Power requirements are 115 to 125 v, 60 cps, at 39 w. **Circle P62 inside back cover.**

## TUBE RETAINERS top-holding type

THE BIRCHER CORP., 4371 Valley Blvd., Los Angeles 32, Calif., has developed and produced a new line of stainless-steel top-holding electronic tube and component retainers. The Top-Tainers are designed to conform with the military approved method of tube retention. Consisting of two parts, a post and a cap, they are available in single and double-post modifications to hold all tubes and cylindrical components ranging from  $\frac{1}{8}$  in. to 2 $\frac{1}{8}$  in. in diameter. Post heights range from  $\frac{1}{8}$  in. to 5 $\frac{1}{2}$  in. in increments of  $\frac{1}{8}$  in.

Top-Tainers hold tubes and components securely in place under severe shock and vibration, yet can be removed for tube maintenance with a slight upward pressure on the locking tab. The cap rides on a double rail which is serrated on the bearing edge, effectively preventing the cap from riding up the post under vibration. Additional lateral support is provided by the "U" shape of the post and by the broad

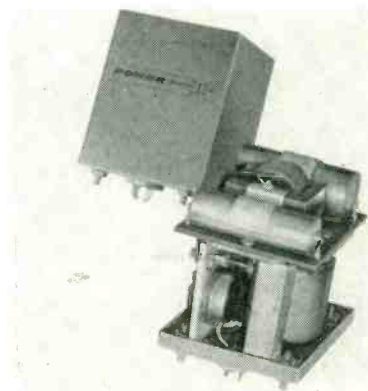

## D-C/D-C CONVERTERS all-semiconductor units

POWER SOURCES, INC., Arlington, Mass., announces four all-semiconductor d-c/d-c converters available with inputs of 12 and 28 v d-c and filtered d-c outputs of 325 v at both 100 and 200 ma. These supplies are hermetically packaged in



# ENGINEERS... LOOK TEN YEARS AHEAD!

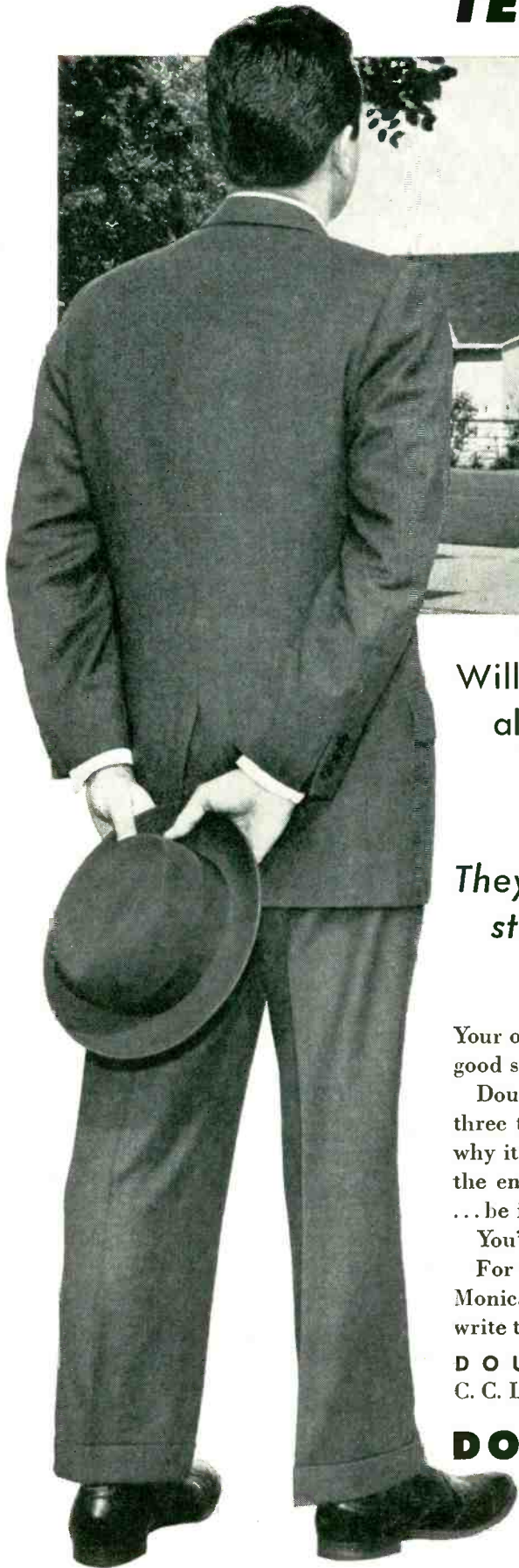

*A Douglas engineer lives here*

Will your income and location allow you to live in a home like this...spend your leisure time like this?

*They can...if you start your Douglas career now!*



Your objectives are probably high professional standing, good income, good security and good living. All four can be achieved at Douglas.

Douglas has the reputation of being an "engineer's outfit," with the three top administrative posts being held by engineers. Maybe that's why it's the biggest, most successful unit in its field. Certainly it offers the engineer unexcelled opportunities in the specialty of *his* choice...be it related to missiles or commercial or military aircraft.

You've looked around. Now look ahead... and contact Douglas.

For further information about opportunities with Douglas in Santa Monica, El Segundo and Long Beach, California and Tulsa, Oklahoma, write today to:

**DOUGLAS AIRCRAFT COMPANY, INC.**  
C. C. LaVene, Box F-620, 3000 Ocean Park Blvd., Santa Monica, Calif.

**DOUGLAS**



**First in Aviation**

## Doing it Yourself?

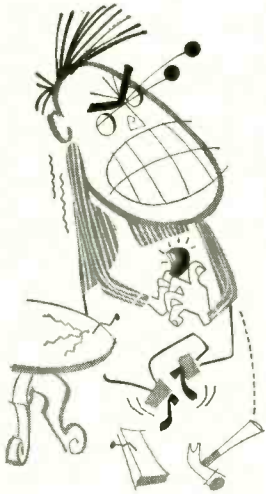

### It's Easier to Standardize on Jeffers R.F. Choke Coils

You can eliminate tedious, expensive hand assembly from miscellaneous forms and wires by using completely assembled standard Jeffers R. F. choke coils. You will save time, labor and money by stocking the broad range of Jeffers coils just as you do resistors, capacitors and other similar electrical components.

Jeffers coils are made of highest quality materials... using insulated copper wire windings encased in husky molded jackets. All windings are soldered to leads... no chance of shorted end turns.

Enjoy the benefits of superior, standardized components in your circuits. Jeffers Electronics offers you a full line of R. F. choke coils with a complete range of inductance values...ready for immediate delivery. Write today for our specification sheets.

Other Jeffers Products  
fixed composition capacitors

Other Speer Products  
for the Electronics Industry  
anodes • contacts • resistors  
discs • brushes • molded notched\* coil forms  
battery carbon • graphite plates and rods

\*Patented



JEFFERS ELECTRONICS  
DIVISION  
SPEER CARBON COMPANY  
Du Bois, Pennsylvania

Other Speer Divisions:  
Speer Resistor, Speer Carbon Products,  
International Graphite & Electrode

cans 3 $\frac{1}{8}$  by 2 $\frac{3}{8}$  by 2 $\frac{3}{8}$  in. and are designed primarily for use where severe operating conditions are prevalent. They can be operated in ambients from -55 to +75 C with efficiencies as high as 90 percent. Elimination of all moving parts makes the units suitable for use under conditions of shock and vibration which cannot now be served by dynamotors and vibrators. Typical applications are missile beacon power supplies and mobile communications equipment.

The supplies use two power transistors in an oscillator to interrupt the d-c inputs. Silicon power diodes and high reliability capacitors serve in the rectifier circuit. High conversion efficiency over widely variable load conditions is maintained by use of a transistor control circuit.

Regulation on the standard units is 20 percent. Circle P63 inside back cover.

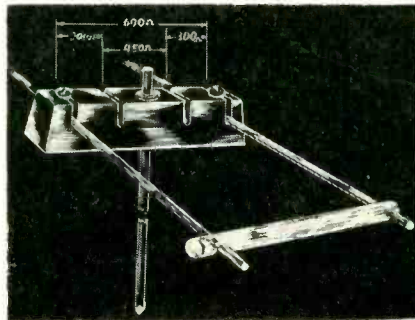

### TRANSMISSION WIRE high-gain, low-loss

SAXTON PRODUCTS, 1661 Boone Ave., New York 60, N. Y., manufacturer of 300 and 450-ohm open-line transmission wire, has added 600-ohm, two-in. spaced open line to its roster of high-gain, low-loss lead-in wires. Made of 12-gage hard-drawn Copperweld and random spaced to avoid tuned trap circuits, it has been supplied for airline transmitters, color-tv installations, ship-to-shore communications and others.

Available in 250 or 500-ft spools, this line transfers the maximum amount of energy from antenna to receiver, thereby improving reception in good signal areas and making reception pos-

sible where none is otherwise possible. Circle P64 inside back cover.



### SENSING RELAY for aircraft component uses

COOK ELECTRIC CO., Diaphlex Division, Chicago 14, Ill., announces a new precision sensing relay for aircraft component applications. This relay uses snap-action switches and was developed as a suitable component for accurate voltage sensing with controlled differential between operate and release voltages. The relays are designed and built to specifications. Applications to aircraft components are described in *Cook Diaphlex Newsletter*, issue No. 31, Volume 1. Circle P65 inside back cover.

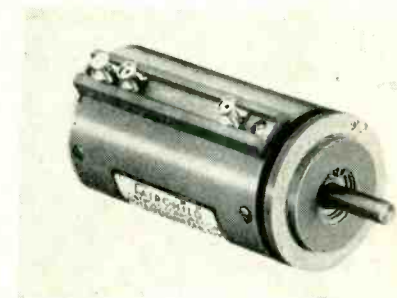

### TEN-TURN POTS feature long life

FAIRCHILD CONTROLS CORP., 225 Park Ave., Hicksville, N. Y. Two new ten-turn precision pots have been announced. Types 907 phenolic and 908 metal case are  $\frac{3}{8}$ -in. diameter units with 3,600-deg electrical rotation. Resistance ranges are from 100 to 100,000 ohms in both models. Type 907 has a line-



# Who put out the "fire" in the tail?

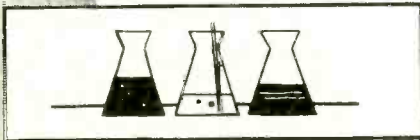
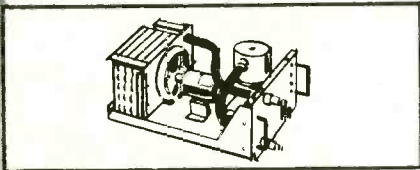

## SPECIAL CONTROL DEVICES

The following special devices are standard equipment for closer control of electronic equipment operating conditions:

1. **Overheat thermostat control.** Provides emergency shut-off of entire electronic system in event of failure of any electronic device.
2. **Self-actuating temperature bypass valve.** Permits predetermination of optimum liquid temperature and control within very close limits  $\pm 2^\circ$  C.
3. **Flow control valve.** Exclusive new Hallicrafters device operates independently of system pressure, supplies emergency shut off of Electronic Equipment in event of pump failure or blockage.

**Hallicrafters . . . with a revolutionary, mass produced cooling unit for airborne electronics. Dissipation up to 7,000 watts . . . 20% less costly . . . 30% lighter.**

Tested, proven, set for mass production — Hallicrafters new Models CR-2, CR-5 and CR-7 airborne cooling units meet environmental conditions of MIL-E-5272 specification. Revolutionary design permits use of standard racks (CR-7 dimensions:  $15\frac{3}{8}''$  x  $19\frac{9}{16}''$  x  $10\frac{5}{8}''$ ) and also accommodates whatever auxiliary gear, such as relays and switches, you may desire.

Vital weight factor is another advantage. For instance: the CR-5 weighs just 30 lbs., is 30% lighter than conventional 5,000 watt units. And your choice of cooling fluids gives great flexibility of application: silicone oil; ethylene-glycol solution; hydraulic fluid.

Only Hallicrafters fits rated dissipation to *your needs*. Three stock units available — 2,000, 5,000, and 7,000 watts. Design adaptable to intermediate ratings with comparable advantages in cost, weight and performance.

**INVESTIGATE NOW!** *If you design, build, purchase, or fly military aircraft . . . if you provide, install or specify airborne electronics . . . write today for complete details.*

*Tested and proven in many airborne installations of Hallicrafters electronic equipment.*

The  
**hallicrafters**  
Company

4401 W. Fifth Avenue, Chicago, Illinois

let Williams  
help you apply

**FERRIC  
OXIDES**

to the manufacture  
of your

**FERRITES**

You'll be well repaid by getting the facts on a special group of Pure Ferric Oxides, developed by Williams especially for use in the manufacture of ferrites.

Williams Ferric Oxides analyze better than 99%  $Fe_2O_3$ . They contain a minimum of impurities. They are available in a broad range of particle sizes and shapes. Among them, we're certain you'll find one that's "just right" for your requirements. The proper application of Ferric Oxides to the manufacture of Ferrites is our specialty.

Tell us your requirements . . . we'll gladly send samples for test. Chances are good that our Ferric Oxide "Know How" can save you considerable time and money. Address Dept. 25, C. K. Williams & Co., Easton, Pa.

**WILLIAMS**  
**COLORS & PIGMENTS**

**C. K. WILLIAMS & CO.**  
Easton, Pa. • East St. Louis, Ill.  
Emeryville, Cal.

**P.S.** We also produce IRN Magnetic Iron powders for the Electronic Core Industry, the Magnetic Tape Recording Industry and others. Write for complete technical information.

NEW PRODUCTS

(continued)

arity range of 0.1 to 0.50 percent, while the 908 has a linearity range of 0.05 to 0.25 percent. They are rated at 2 and  $2\frac{1}{2}$  w respectively, at 40 C.

The mechanical drive in the type 908 is separate from the helical coil of resistance wire thereby eliminating wear on the coil and greatly extending life. In these units the contact wiper is guided on the resistance element by a metal tab that slides in a helical groove parallel to the winding. The liner material has both long wear and low friction characteristics at high temperatures.

Standard units have an ambient temperature operating range of  $-55$  to  $+85$  C. At 85 C both pots are normally derated to 15 percent of rated wattage. Circle P66 inside back cover.



### HOT WIRE STRIPPER removes plastic insulation

WESTERN ELECTRONIC PRODUCTS Co., 655 Colman St., Altadena, Calif. Model B hot wire stripper removes plastic insulation from large coaxial cable down to the finest plastic-insulated stranded wire.

The stripper will remove most types of plastic insulation such as vinyl, nylon and polyethylene (but not Teflon or rubber). Using a heated nichrome filament to sever insulation, it is impossible to cut or nick even the finest wire strands since no sharp blades are used. Adjustment for various types and sizes of wire is not necessary.

An adjustable stop permits stripping a predetermined length of insulation. Power is supplied from the regular 115-v a-c supply through a stepdown transformer housed in

a metal box. Also provided are an on-off switch and handy metal clamps to hold the stripper when not in use. Price is \$22.95. Circle P67 inside back cover.

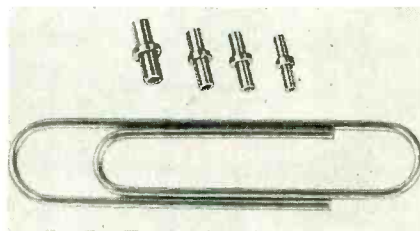

### MINIATURE EYELETS for printed circuits

CAMBRIDGE THERMIONIC CORP., 445 Concord Ave., Cambridge 38, Mass. Series 2352 miniature eyelets are for mounting components on printed circuits. They are machined to close tolerances.

A unique feature permits solderless connections for component leads if desired. Nonsoldered mounting results in a strong mechanical connection. In the case of soldered connections, the eyelets afford excellent capillary action in the soldering process.

The standard eyelets are tin-lead solder-plated brass. Other finishes such as silver and gold are also available. They are designed so that they can be fed and inserted into printed circuits through automatic equipment. Circle P68 inside back cover.



### LOAD INDICATOR completely transistorized

SOUTHERN ENGINEERING, 309 Volunteer Bldg., Chattanooga 2, Tenn. Model LCI is portable, completely transistorized and suitable for all resistance-bridge electronic weighing, pressure meas-



One-quarter turn . . .  
**CLOSED**

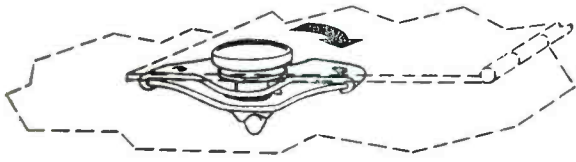

One-quarter turn . . .  
**OPEN**

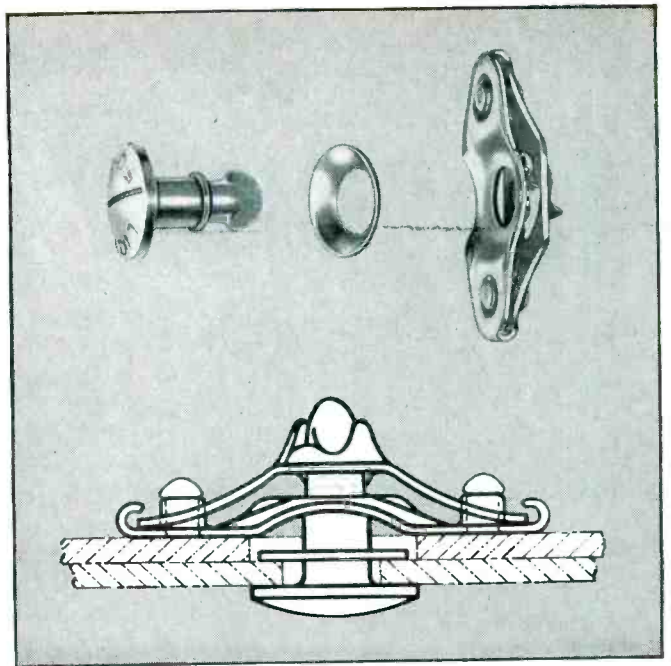
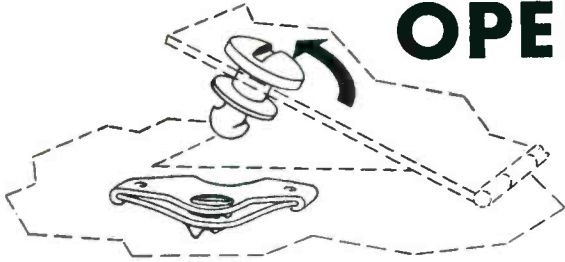

**LION QUARTER-TURN FASTENERS**

**QUICK TO INSTALL**

Lion Fasteners can be installed rapidly. Studs simply slip through drilled hole and are retained by a grommet. Springs are riveted or spot-welded in place.

**RUGGED**

Lion Fasteners stand up under the most rugged conditions of shear, tension, and vibration . . . meet or exceed the exacting requirements of Army-Navy-Air Force Specifications MIL-F-5591A (ASG) and have Civil Aeronautics Administration approval for civilian aircraft use.

**LIGHTWEIGHT**

Made of cadmium-plated steel to provide a high strength-low weight ratio, No. 5 Fasteners weigh only 12 to 14 lbs. per 1000 . . . No. 2 Fasteners 3 3/4 lbs. per 1000 . . . No. H Fasteners approximately 35 lbs. per 1000.

**VIBRATION-PROOF**

This group of fasteners is particularly suited to metal fastening conditions where vibration is an im-

portant factor. Lion Fasteners can't shake loose . . . can't open by themselves.

**FULL RANGE OF HEADS . . .**

The Lion No. 5 Fastener is available with flush, oval, ring, wing, knurled, or notched head and key; No. 2 Fastener is available with flush, oval, or wing type head; the No. H Fastener comes with an oval head.

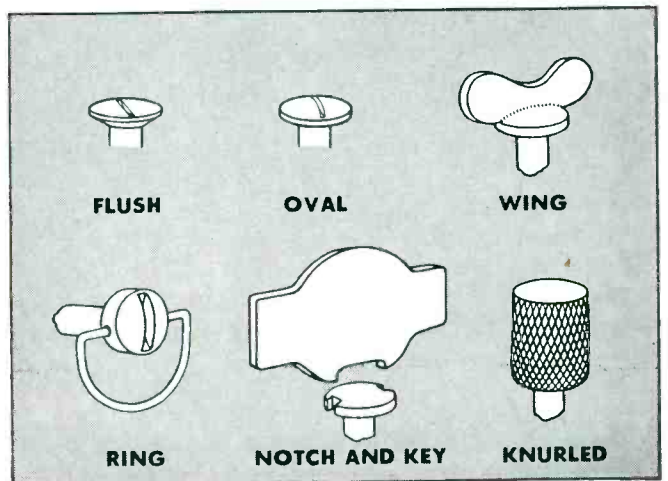

**LION Aviation FASTENERS**

**SOUTHCO FASTENERS**  
SOUTH CHESTER CORPORATION • LESTER, PENNSYLVANIA

For complete information on Lion Quarter-Turn Fasteners, as well as on the complete Southco line, write today to Southco Division, South Chester Corporation, 233 Industrial Highway, Lester, Pa.

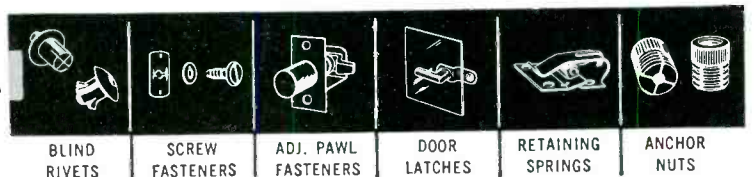

BLIND RIVETS

SCREW FASTENERS

ADJ. PAWL FASTENERS

DOOR LATCHES

RETAINING SPRINGS

ANCHOR NUTS

# Cylindrical BOBBINS UNLIMITED

OF EPOXY RESIN, NYLON,  
TEFLON AND OTHER PLASTICS

CUSTOM-FORMED TO ANY  
CYLINDRICAL SHAPE IN  
DIAMETERS OF 1/8" TO 7/8"  
AND LENGTHS UP TO 7"

NO MOLDS NECESSARY

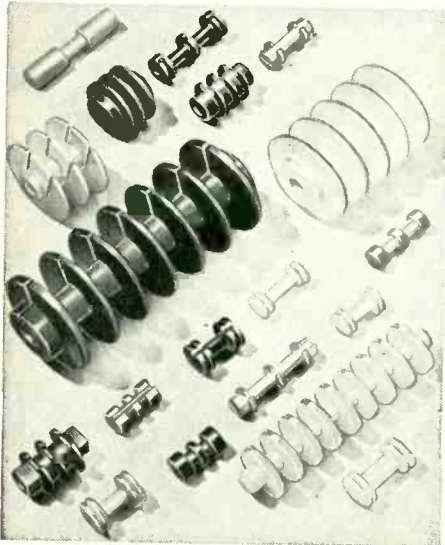

Illustrated are but a small fraction of the countless possible variations of cylindrically shaped bobbins we can custom form of plastic materials.

Whatever your particular individual requirements in cylindrical bobbins in above size ranges, it will be in your best interests to consult with our engineering staff. This service is offered without cost or obligation, of course. Any quantity promptly supplied—and remember . . . no molds necessary.

Send blueprint or samples for prompt quotation.

## ORANGE PRODUCTS INC.

554 Mitchell St., Orange, N. J.

NEW PRODUCTS

(continued)

urements and strain indication. Resolution of the indicating dials is one part in ten-thousand.

A transistor power oscillator furnishes bridge excitation and is tapped to accommodate different bridge resistances. Power can be supplied by mercury cells, storage batteries or an a-c power pack. A self-contained mercury battery operates the instrument for 600 hr. Battery operation provides an unusual degree of immunity to zero drift and loss of sensitivity due to a-c ground loops and power-line harmonics and noise.

The transistor amplifiers provide a tremendous reserve of amplification with a minimum of generated noise and complete immunity to microphonics. Circle P69 inside back cover.

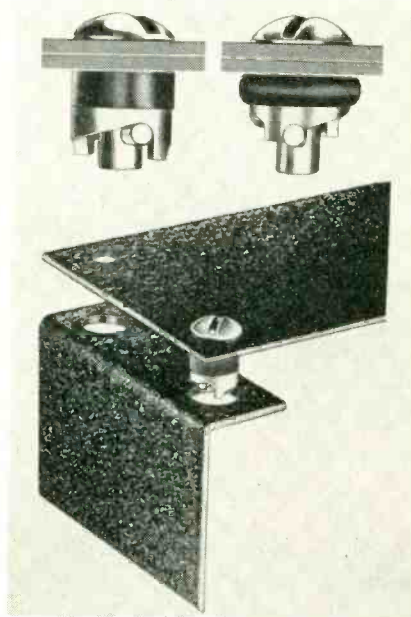

### PANEL FASTENER quick-acting device

THE GENERAL TIRE & RUBBER Co., Akron 9, Ohio. Expanding rubber provides the sturdy, indestructible locking mechanism for the new multifunction Vibrex fastener. The use of rubber results in a unique combination of quick-action fastener and vibration isolator, for panels and assemblies. Floating the assembly in live rubber, the fastener effectively suppresses noise, rattles and vibration.

The Vibrex fastener locks in

metal, plastic and even glass or composition board. It consists of a single unit, requires no separate receiver and locks in a plain hole. The fastener is water, dust and pressure proof. A simple half turn either locks or disengages the unit. It is made in a variety of types including latches for the cabinet doors and drawers. Circle P70 inside back cover.

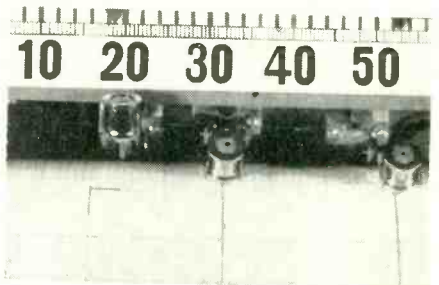

### BALL POINT PEN for strip chart recorders

AMERICAN INDUSTRIAL ELECTRONICS, P. O. Box 14105, Houston 21, Texas. This new ball point pen is available in two models, the No. 1 thinline and the No. 2 wide-line. It is adaptable to the different type strip chart recorders by the brackets which the company makes. The cartridges can be refilled and the ink used is black, no smear, dry writing, free-flowing and does not fade. A good print can be obtained from the chart. Average capacity of each pen is five 50-ft charts. Circle P71 inside back cover.

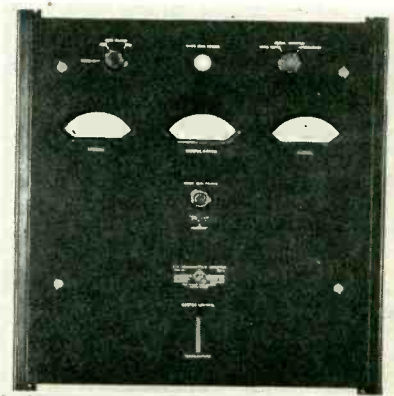

### MONITOR for tv transmitters

GENERAL RADIO Co., 275 Massachusetts Ave., Cambridge 39,



# Streamline

**that  
servo  
work!**

**WITH THE WORLD'S  
FOREMOST SERVO  
TEST RANGE**

Major companies the world over recognise the Solartron range of Servo Test Equipment as essential equipment for the design and testing of all types of servos. Our Technical Engineers can help to solve your servo problems now!

**standardised by:**

BRISTOL AEROPLANE CO., BRITISH ADMIRALTY RESEARCH LABORATORIES, BRITISH ATOMIC ENERGY RESEARCH ESTABLISHMENT, ROYAL AIRCRAFT ESTABLISHMENT, ROYAL NAVY, ENGLISH ELECTRIC CO., FERRANTI LTD., GENERAL ELECTRIC CO., METROPOLITAN VICKERS, ROLLS-ROYCE, SPERRY GYROSCOPE, VICKERS ARMSTRONG, ETC., ETC.

**now adapted by:**

BENDIX, BOEING, DALNO-VICTOR, JOHNS HOPKINS UNIVERSITY, HUGHES AIRCRAFT, NORTH AMERICAN AVIATION, CONVAIR, WESTINGHOUSE, AIRESEARCH MANUFACTURING, KEARFOTT, ETC., ETC.

**THE TRANSFER FUNCTION ANALYSER**

- Tests AC, DC or carrier servos
- Plots high accuracy Nyquist diagrams
- Covers 0.1 c/s to 1,000 c/s
- Independent of harmonics, noise and spurious frequencies
- Answers G.M., fire control, simulator, computer, vibration, magama and all servo problems

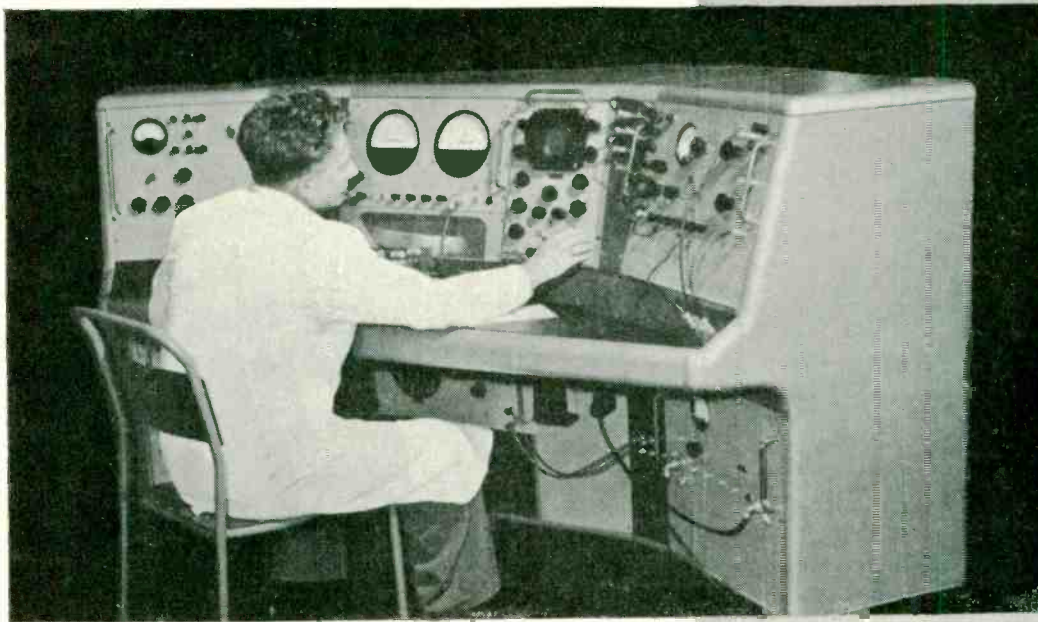

**SERVO TEST CONSOLE**  
comprising  
Mechanical Reference  
Generator  
**JX 603A**  
Sub Sonic  
Power Amplifier  
**JX 612A**  
T.F.A.  
Carrier Converter  
**JX 541A**  
Two Phase  
L.F. Oscillator  
**BO 567A**  
Servo  
Test Set  
**JX 563**  
D.C. Wide-band  
Oscilloscope  
**AD 557A**  
Synchrotest  
**JM 555A**

For further information, or to call a Technical Engineer, write, wire or phone

**SOLARTRON**  
**INCORPORATED**

Canadian Agents: Computing Devices of Canada Ltd.,  
P.O. Box 603, Ottawa, Ont. Tel: PA 8-1761.

West Coast Office:  
3071 Burbank Boulevard,  
N. Hollywood, Calif.  
Tel: ST 7-5081.

East Coast Office:  
228 Long Lane,  
Upper Derby, Pa.  
Tel: GR 6-2541.

another product *surprise* from Helipot!

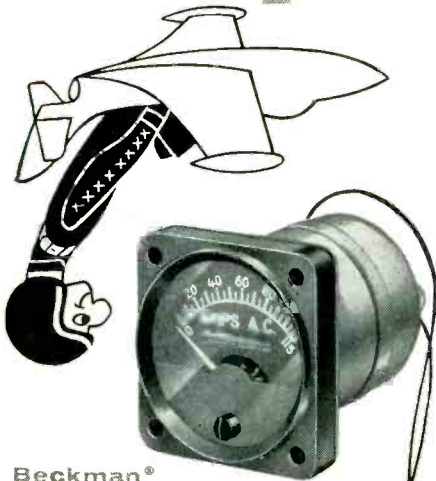

Beckman®  
**Linear Scale AC Ammeter**

There's no peek-a-boo with our new BECKMAN Linear Scale AC Ammeter, designed for rapid, accurate monitoring of generator load. We'll fly upside down to prove you can get quick readings from any angle. And no bunched-up graduations... the needle deflection is always directly proportional to amperage.

It's plain to see that the Helipot engineers responsible for our 22-ounce meter-transformer unit know their onions as well as their ohms. They gave it intestinal fortitude (that's right—guts!)...to withstand extreme vibration, shock, moisture, salt spray and fungus. They gave it airworthy performance...anywhere from sea level to 50,000 feet and from  $-55^{\circ}$  to  $+71^{\circ}\text{C}$ . And they gave it flexibility... the compact meter can be installed on your instrument panel, the potted transformer as far away as 150 feet (with negligible effect on accuracy).

In your next free moment (like right now), write for data file 441, which has complete information on our standard units.

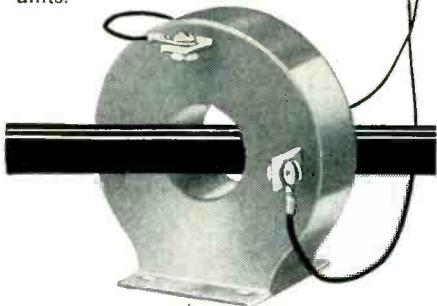

Beckman® **Helipot Corporation**  
Newport Beach, California  
a division of Beckman Instruments, Inc.  
Engineering representatives in principal cities

988

Mass., announces the type 1184-A tv transmitter monitor. The instrument will monitor tv visual transmitter and intercarrier frequencies. In addition, a complete intercarrier sound detection system has been included within the unit. Besides provisions for the measurement of residual a-m noise on the aural transmitter, circuits for the direct measurement of the residual f-m noise on the visual transmitter carrier are also provided.

Every operation in the installation, use and maintenance of the monitor can be handled from the front. Price of the unit is \$2,650, including individually adjusted master quartz crystal. Circle P72 inside back cover.

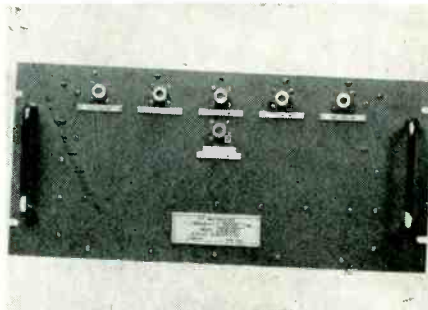

### R-F MULTIPLEXERS in 50 to 4,000-mc range

APPLIED RESEARCH INC., 163-07 Depot Road, Flushing, N. Y., has available r-f multiplexers in the frequency range of 50 to 4,000 mc. They are designed for applications in communication systems, r-f coding and encoding systems, broad-band reception coverage, multiple-channel transmission and reception from a single antenna and wideband nonscanning surveillance systems.

Type RFM multiplexers operate over an octave of frequency with outputs divided into five channels of equal bandwidths. Overlap of each channel eliminates dead spots in the frequency spectrum covered. Cross-frequency interference is minimized and skirt selectivity is greatly sharpened by the use of four resonant circuits in each channel. The insertion loss of each resonant element is carefully limited to avoid deterioration of the

overall system performance.

Depending on frequency and size requirements, either lumped or distributed parameters are used. Circle P73 inside back cover.

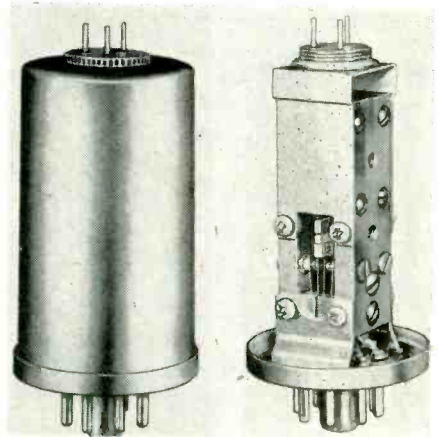

### CHOPPER features frequency doubling

JAMES VIBRAPOWR Co., 4036 N. Rockwell St., Chicago 18, Ill. The 1900 series chopper features unique switching characteristics. It is polarized, nonresonant and capable of frequency doubling, or providing two circuits 90 deg apart in phase. Models are available for both 60 and 400-cps operation. Complete technical data and engineering specifications are available. Circle P74 inside back cover.



### CONVERTER pulse-to-analog type

G. M. GIANNINI & Co., INC., 918 E. Green St., Pasadena 1, Calif. Model 8915 Rotostepper is an electromechanical shaft positioning



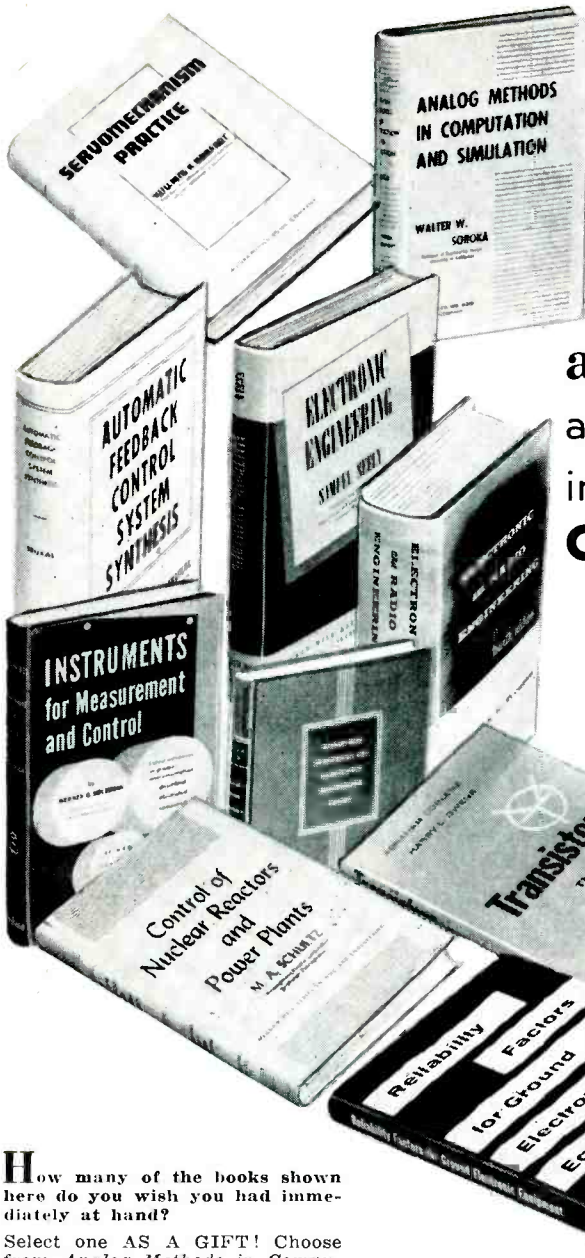

# Take any Two

OF THESE OUTSTANDING BOOKS

## Take one *Free!*

and one as your 1<sup>st</sup> selection and enjoy the benefits of membership in the **McGraw-Hill Electronics and Control Engineers' Book Club**

Mail  
Entire Coupon  
**TODAY**



**H**ow many of the books shown here do you wish you had immediately at hand?

Select one AS A GIFT! Choose from *Analog Methods in Computation and Simulation*, *Random Processes in Automatic Control*, *Automatic Feedback Control System Synthesis*, *Electronic Engineering*, and eight other valuable books . . . your introduction to membership in the *Electronics and Control Engineers' Book Club*.

If you find you're missing out on important technical literature you'd really like to own—if today's high cost of reading curbs the growth of your library—here's the solution to your problem. *The McGraw-Hill Electronics and Control Engineers' Book Club* was organized for you, to provide an economical technical reading program that cannot fail to be of value to you.

All selections will be chosen by the editors of the McGraw-Hill Book Company . . . whose thoroughgoing understanding of the standards and values of the literature in your field guarantees the authoritativeness of the selections.

**How the Club operates.** Every second month you receive free of charge *The Electronics and Control Engineers' Book Bulletin* (issued six times a year). This gives complete advance notice of the next main selection, as well

as a number of alternate selections. If you want the main selection you do nothing; the book will be mailed to you. If you want an alternate selection . . . if you want no book at all for that two-month period, notify the Club by returning the form and postage-paid envelope enclosed with your *Bulletin*.

Certainly out of the large number of books in your field offered you in any twelve months there will be at least three you would buy anyway. Let the Club bring them to you! Save yourself the irritation of shopping. Save yourself, in cost, about 15 per cent from publishers' prices.

Reach for your pen right now; check off any two (or more) books you want. Indicate clearly the book you'd like us to send you FREE. Remember, by taking advantage of this offer now, you get two books for less than the regular price of one.

**No-risk guarantee.** If not completely satisfied, you may return your first shipment within 10 days and your membership will be canceled.

**The McGraw-Hill Electronics and Control Engineers' Book Club,**  
330 West 42nd Street, New York 36, N. Y. P. O. Box 97

Please enroll me as a member of the Electronics and Control Engineers' Book Club. I am to receive **FREE** the book I have indicated along with my first selection checked below. You will bill me for my first selection only at the special club price, plus a few additional cents for postage and handling. (The Club assumes this charge on prepaid orders.) Forthcoming selections will be described to me in advance and I may decline any book. I need take only 3 selections or alternates in 12 months of membership.

**Electronic Engineering** by Samuel Seely. Publisher's Edition, \$8.00. Club Price, \$6.80.

**Instruments for Measurement and Control** by Werner G. Holzbok. Publisher's Edition, \$10.00. Club Price, \$8.50.

**Automatic Feedback Control System Synthesis** by John G. Truxal. Publisher's Edition, \$12.50. Club Price, \$10.60.

**Reliability Factors for Ground Electronic Equipment** edited by Keith Henney. Publisher's Edition, \$7.50. Club Price, \$6.40.

**Random Processes in Automatic Control** by J. H. Laning, Jr. and R. H. Battin. Publisher's Edition, \$10.00. Club Price, \$8.50.

**Control-System Dynamics** by Walter R. Evans. Publisher's Edition, \$7.00. Club Price, \$5.95.

**Electronic and Radio Engineering**, 4th ed., by Frederick E. Terman. Publisher's Edition, \$12.50. Club Price, \$10.60.

**Servomechanism Practice** by W. H. Ahrendt. Publisher's Edition, \$7.50. Club Price, \$6.35.

**Control of Nuclear Reactors and Power Plants** by M. A. Schultz. Publisher's Edition, \$7.50. Club Price, \$6.40.

**Analog Methods in Computation and Simulation** by W. W. Soroka. Publisher's Edition, \$7.50. Club Price, \$6.45.

**Introduction to Electronic Analogue Computers** by C. A. A. Wass. Publisher's Edition, \$6.50. Club Price, \$5.50.

**Transistors** by Abraham Coblenz and H. L. Owens. Publisher's Edition, \$6.00. Club Price, \$5.00.

Name ..... (Please Print)

Address .....

City ..... Zone ..... State .....

This offer is available only in the United States and its possessions. In Canada write McGraw-Hill Canada, 253 Spadina Road, Toronto 4.

No waveform distortion

from G-E Inductrol\*  
Voltage Regulators

Unlike many other types of voltage regulators, General Electric Inductrols introduce no waveform distortion.

Featuring drift-free controls, Inductrols maintain the a-c or d-c voltage powering electronic circuits within  $\pm 1\%$ ; are small and light.

They have long life and require little maintenance because *they use no brushes!*

For more information, write Section 425-6, General Electric Co., Schenectady 5, N. Y., or contact your G-E sales office or agent.

\*General Electric Trade Mark for Induction Voltage Regulators.

Progress Is Our Most Important Product

GENERAL  ELECTRIC

NEW PRODUCTS

(continued)

loose springs. This design permits use of a standard miniature motor and avoids loading of the gimbal with static mass of the motor.

Series RG03-0100 gyros have advance design features that result in light, compact and unusually rugged units. High natural frequency, potentiometer pickoffs, pressure-sealed cases and trouble-free floating piston dry air dampers are outstanding features.

Case height is 2.47 in.; diameter, 2.13 in.; weight, 14 oz. Standard potentiometer pickoff is 5,000 ohms, with power dissipation up to one w. Resolution is 0.35 percent; linearity,  $\pm 1.0$  percent; hysteresis,  $\pm 0.5$  percent; angular momentum, 250,000 cgs units. Further technical data are available. Circle P77 inside back cover.

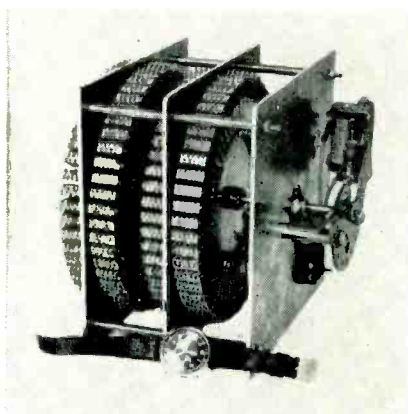

SAMPLING SWITCHES

test many components

TENSOR ELECTRIC DEVELOPMENT Co., 1873 Eastern Parkway, Brooklyn 33, N. Y., announces automatic sampling switches that are designed to sequentially test large numbers of electronic components such as diodes and transistors under actual operating potentials and extreme environmental conditions. The individual switch elements are multiple throw. Aging potentials can be maintained on all the components under test except when performing a readout. Readouts can be taken at rates up to three per sec and automatically recorded.

Model 6000 switch can handle up to 1,252 two-terminal components. By suitable connection this switch will handle 626 three or

four-terminal components.

In the missile, computer and other fields where reliability is vital, the application of this switch facilitates automatic 100-percent component inspection. Circle P78 inside back cover.

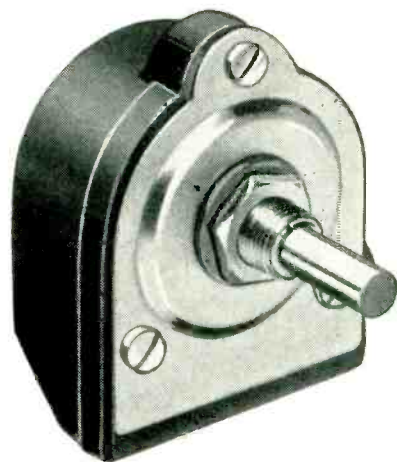

VARIABLE RESISTOR

for industrial applications

ALLEN-BRADLEY Co., 136 W. Greenfield Ave., Milwaukee 4, Wisc. Type H low-noise long-life five-watt molded composition variable resistor is especially suited to industrial electronic applications. It has a maximum d-c working voltage of 750 v; a resistance range from 50 ohms to two megohms and will operate effectively between temperatures of  $-55$  and  $+120$  C. Circle P79 inside back cover.



LIMITER AMPLIFIER

with noise squelch

ELECTRONIC SYSTEMS ENGINEERING Co., 903 Cravens Building, Oklahoma City, Oklahoma. Model 100, Limpander Jr., is a new, high-



speed, nonfeedback, a-f limiting amplifier with an automatic background-noise-squelching system. It has high and low-level outputs and a high impedance input pre-amplifier that has sufficient gain to produce 30 db of audio limiting. Its nonfeedback circuitry allows a limiting attack time constant of 50  $\mu$ sec with complete stability, assuring no overmodulation and high average percentage modulation.

► **Uses**—In addition to transmitter modulation control, this amplifier is designed for use in making conference recordings, where its high-speed squelch system eliminates room background noise while the limiter controls the maximum output levels. These same features make it an ideal addition to most radio receiving systems. Circle P80 inside back cover.

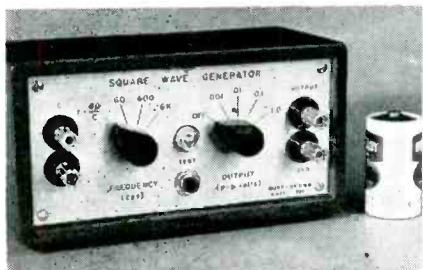

**SQUARE WAVE GENERATOR** uses transistors exclusively

BURR-BROWN RESEARCH CORP., Route 4, Box 139, Tucson, Arizona, has developed a miniature battery operated transistorized square wave generator featuring long battery life and an operating frequency range from five to 30,000 cps. Model 200 is suited for work on audio systems, equalizing networks, oscilloscope attenuators and l-f response problems.

Frequencies of 60, 600 and 6,000 cps may be selected by a front-panel control. Other desired frequencies may be obtained with an external capacitor. The output signal may be attenuated from 1 v to 1 mv peak-to-peak. The output wave is perfectly flat on both top and bottom and has a rise time of 0.25  $\mu$ sec. Operating temperature range for the generator is 0 to 140 F. Circle P81 inside back cover.

# YOKE

SPECIALISTS

**COMPLETE LINE** for every Military and Special purpose.



- Yokes for 7/8", 1-1/8", 1-1/2", 2-1/8" neck diameter CR tubes.
- Rotating and fixed coil designs.
- Core material to suit your requirements.

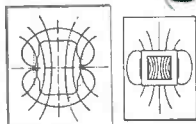

Special test instruments can establish your yoke deflection parameters to an accuracy of  $\pm 0.1\%$ .

Consult Dr. Henry Marcy or Bernard Cahill on your new applications today.

Series aiding field and parallel (bucking) field designs.

Phone: Terrace 4-6103

170 Industrial Road • Addison, Ill.

*syntronic*

**INSTRUMENTS, INC.**

## free engineering guide tells you how

to design-in panel-mounting miniature electronic instruments

HOW TO build-in such miniature instruments as:

- DC VTVMs and AC VTVMs
- Ruggedized Versions
- Phase-sensitive AC devices
- Low-Level DC Millivoltmeters
- Standard and Special designs
- ... with high sensitivity, broad frequency response, high input Z

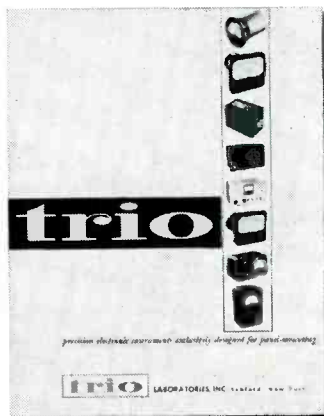

TRIO laboratories inc., SEAFORD, N. Y.

Please send me your FREE engineering guide. E-4

Name ..... Title .....

Firm .....

Address .....

City ..... Zone ..... State .....

... when ordinary instruments are too big or inadequate

# trio

... the leader in panel-mounting electronic instruments.

the specs are the proof . . .  
the BEST BUYS are **EICO**  
for COLOR & Monochrome TV servicing



**NEW COLOR**  
and Monochrome  
DC to 5 MC LAB & TV  
5" OSCILLOSCOPE

460  
Factory-wired  
and tested \$129<sup>50</sup>  
Also available as kit \$79<sup>95</sup>

• Features DC Amplifiers!

Flat from DC-4.5 mc, usable to 10 mc. VERT. AMPL.: sens. 25 rms mv/in; input Z 3 megs; direct-coupled & push-pull thruout; K-follower coupling bet. stages; 4-step freq-compensated attenuator up to 1000:1. SWEEP: perfectly linear 10 cps-100 kc (ext. cap. for range to 1 cps); pre-set TV V & H positions (30 & 7875 cps); auto. sync. ampl. & lim. PLUS: direct or cap. coupling; bal. or unbal. inputs; edge-lit engraved lucite graph screen; dimmer; filter; bezel fits std photo equip. High intensity trace CRT. 0.06 usec rise time. Push-pull hor. ampl., flat to 400 kc, sens. 0.6 rms mv/in. Built-in volt. calib. Z-axis mod. Sawtooth & 60 cps outputs. Astig. control. Retrace blanking. Phasing control.



**NEW TV-FM**  
SWEEP GENERATOR  
& MARKER

368  
Factory-wired  
and tested \$119<sup>95</sup>  
Also available  
as kit \$69<sup>95</sup>

Entirely electronic sweep circuit (no mechanical devices) with accurately-biased inductor for excellent linearity. Extremely flat RF output: new AGC circuit automatically adjusts osc. for max. output on each band with min. ampl. variations. Exceptional tuning accuracy: edge-lit hairlines, 6:1 vernier. Swept Osc. Range 3-216 mc in 5 fund. bands. Variable Marker Range 2-75 mc in 3 fund. bands; 60-225 mc on harmonic band. 4.5 mc Xtal Marker Osc., xtal supplied. Ext. Marker provision. Sweep Width 0-3 mc lowest max. deviation to 0-30 mc highest max. dev. 2-way blanking. Narrow range phasing. Attenuators: Marker Size, RF Fine, RF Coarse (4-step decade). Cables: output, 'scope horiz., 'scope vertical.

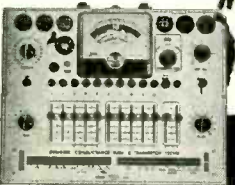

**NEW DYNAMIC**  
CONDUCTANCE  
Tube &  
Transistor Tester

666  
Factory-wired  
and tested \$109<sup>95</sup>  
Also available  
as kit \$69<sup>95</sup>

COMPLETE with steel cover and handle.

SPEED, ease, unexcelled accuracy & thoroughness. Tests all receiving tubes (and picture tubes with adapter). Composite indication of Gm, Gp & peak emission. Simultaneous sel of any 1 of 4 combinations of 3 plate voltages, 3 screen voltages, 3 ranges of continuously variable grid voltage (with 5% accurate pot). New series-string voltages: for 600, 450, 300 ma types. Sensitive 200 ua meter. 5 ranges meter sensitivity (1% shunts & 5% pot). 10 SIX-position lever switches: free-point connection of each tube pin. 10 push-buttons: rapid insert of any tube element in leakage test circuit & speedy sel. of individual sections of multi-section tubes in merit tests. Direct-reading of inter-element leakage in ohms. New gear-driven rollchart. Checks n-p-n & p-n-p transistors: separate meter readings of collector leakage current & Beta using internal dc power supply.

See the 50 EICO models IN STOCK at your neighborhood distributor. Write for FREE Catalog E-4

Prices 5% higher on West Coast

**EICO** BROOKLYN 11, N. Y.

New Literature

Counting, Timing, Controlling Instruments. Computer-Measurements Corp., 5528 Vineland Ave., North Hollywood, Calif. A new short form catalog illustrates the company's line of counting, timing and controlling instruments, with the most important features, applications and specifications highlighted in readily understood non-technical terms. Optional features are clearly indicated together with instrument construction details and prices. Plant facilities for research, engineering, manufacturing and service are described. Circle L1 inside back cover.

Multiplex Equipment. Browning Laboratories, Inc., 750 Main St., Winchester, Mass., has available a new catalog showing a complete line of simplex-multiplex receivers, amplifiers and accessories. Reduced prices are announced. Circle L2 inside back cover.

Power Supplies. Opad Electric Co., 69 Murray St., New York 7, N. Y., has issued a new 16-page catalog describing its standard low voltage rectifier power supply equipment. A power equipment questionnaire form is also included for requesting information and quotations on special and custom-built power supplies. Circle L3 inside back cover.

Tubular-Plastic Wire Markers. E. C. P. Corp., 6808 Wade Park Ave., Cleveland 3, Ohio, has announced a bulletin illustrating and describing a new time-saving, permanent method of coding wire with plastic tubular markers to identify complicated thermoplastic wiring circuits. Circle L4 inside back cover.

Carbon Film Resistors. Continental Carbon, Division of Wirt Co., 5221 Greene St., Philadelphia 44, Pa. Form 307 lists characteristics and specifications of ceramic encased carbon film resistors and coated carbon film resistors. The resistors described meet MIL-R-

10509 specifications and are recommended especially for use in test equipment, meters and high-frequency circuits. Circle L5 inside back cover.

Specialized Electronic Equipments. Manson Laboratories, Inc., 207 Greenwich Ave., Stamford, Conn. A new two-color 36-page catalog describing the special and general-purpose electronic testing equipment and the precision communications products that this company manufacturers, is currently available upon request. Complete descriptions, photos, specifications and performance data are given for over 50 different equipments, including soft and hard-tube pulse modulators, tube testers and checkers, unique types of power supplies, pulse and trigger generators of widely varying characteristics, crystal frequency synthesizers, and ultrastable harmonic generators and frequency measuring devices. Also described are several types of HI-Pot sets, together with wire and cable testers. Requests for the catalog should be made on letterhead stationery.

Magnetic Tape Recorders. Magne-cord, Inc., 1101 S. Kilbourn Ave., Chicago 24, Ill., has available a new catalog of its entire line of professional magnetic tape recorders. It contains 15 pages of complete specifications and pertinent information on all models. Also included are photographs illustrating the tape recorders, accessories and modification kits complete with descriptions and specifications. Circle L6 inside back cover.

Transformer Catalog. Microtran Co., Inc., 145 E. Mineola Ave., Valley Stream, N. Y., has available on request its 1957 transformer catalog. The 20-page booklet lists a new stock line of miniaturized transistor driver and output transformers available for typical servo, missile or airborne applications in MIL-T-27 hermetic,



molded or open constructions. Circle L7 inside back cover.

**Miniature Electronic Tubes.** State Labs Inc., 649 Broadway, New York 12, N. Y., has published a technical handbook covering the complete line of LM Ericsson's ruggedized long-life miniature electronic tubes. All types currently in production are covered with complete ratings and characteristic curves, featuring types 5842/417A and 5847/404A.

A particularly interesting feature of the handbook is a two-page quick reference chart, showing in concise detail all basic technical data on the tubes. The handbook is available on request on company letterhead.

**Input Transformers.** Minneapolis-Honeywell Regulator Co., Wayne and Windrim Aves., Philadelphia 44, Pa. Specification S900-1 describes Brown input transformers, originally designed for ElectroniK potentiometers, but now available for many low-level a-c and d-c servo measuring and coupling circuits. Circle L8 inside back cover.

**Copper-Clad Laminated Plastics.** Taylor Fibre Co., Norristown, Pa., has available a new piece of literature on copper-clad laminated plastics for the production of printed circuits.

This bulletin contains information about rolled copper and its use on laminated plastics, as well as technical data on the properties of the base laminates. Circle L9 inside back cover.

**Components Catalog.** Schweber Electronics, 122 Herricks Road, Mineola, L. I., N. Y. The 1957 four-color, beautifully illustrated catalog No. IEC-2 features detailed information on Amphenol connectors and other electronic components. Circle L10 inside back cover.

**Electronic Metal Detectors.** E. W. Brilmayer Laboratories, Inc., 86 Fulton St., New York 38, N. Y., has available a four-page brochure on its electronic metal de-

# Why are some Engineers more successful than others?

Some are smarter. But that's not the main reason. The most successful engineers are those who work within a climate of true technical and managerial competence which fosters imagination, stimulates growth and provides opportunity for achievement. Of course the popular measure of success is material reward. At the Mechanical Division of General Mills, we champion the idea.

We help our men realize their fullest capabilities, pay them accordingly. All of us benefit.

Right now we have openings at all levels in interesting, challenging fields. Maybe one of them is an opportunity for you to become the successful engineer you really are. No need to write, just send coupon. We'd like to tell you more.

**INCIDENTALLY, IF YOU'RE MARRIED,** you'll find working at Mechanical Division of General Mills even more rewarding . . .

**THERE'S TIME AND OPPORTUNITY** for all kinds of fun for you and your family, here in the land of 10,000 lakes . . .

**YOU HAVE FINANCIAL SECURITY,** knowing you work for one of the nation's largest, most diversified companies . . .

**HOMES ARE BEAUTIFUL,** relatively inexpensive. Many General Mills families own "dream" homes in resort-like settings only minutes from work . . .

**PEOPLE ARE FRIENDLY,** anxious to make you feel at home. And you'll never find nicer people than those working at General Mills right now . . .

**SCHOOLS ARE EXCELLENT WITH LOW PUPIL-TO-TEACHER RATIO.** Even you might want to share in our tuition reimbursement plan at the university of Minnesota.

**Grow bigger, faster — join the excitement at General Mills in any of these fields:**

- Missiles
- Applied Mechanics
- Geophysics
- Underwater Ordnance
- Electronic Counter-measures
- Digital & Analog Computers
- Instruments & Controls
- Solid State Physics
- Microwaves & Antenna
- Infrared Systems
- Inertial Systems
- Systems Analysis & Design
- Servomechanisms
- Balloon Systems
- Upper Atmosphere Research
- Fine Particle Technology
- Surface Chemistry
- Optics
- Mechanical Design
- Airborne Early Warning
- Radar Systems
- Information Theory
- Production Engineering

## MECHANICAL DIVISION OF



*We'd like to send you more information in complete confidence. Return the coupon for a quick reply.*

Peter D. Burgess, Personnel Director—U  
Mechanical Division General Mills  
1620 Central Avenue Northwest  
Minneapolis 13, Minnesota

Name .....

Address .....

City ..... State .....

College ..... Degree ..... Year .....

*Simplifying HF Power Measurement*  
**Model 67 TERMALINE**  
**DIRECT-READING R-F WATTMETER**

30 mc to 500 mc  
 (to 1000 mc if specified)

50 ohms

Triple Range 0-25 watts

0-100 "

0-500 "

Type N Input Connector  
 (Adaptor for PL-259 supplied)

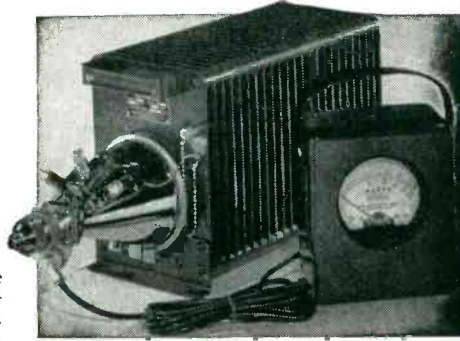

● Model 67 is a larger type Wattmeter than the well-known AN-ME-11/U (our Model 611) R-F Wattmeter. Specifically designed for fixed station transmitters to 500 watts output, it may be used nicely on low range for mobile gear. Provided with an aluminum cased, shock-mounted meter, Model 67 is as simple to use as a DC voltmeter. Now in general use throughout the industry, TERMALINE Wattmeters may be depended upon for fast, accurate and repeatable power readings

**NON-RADIATING**

... Accuracy — 5%

**RUGGED CONSTRUCTION**

... Size — 17" x 9" x 6"

Wght. — 30 pounds



**BIRD**  
**ELECTRONIC CORP.**  
 1800 EAST 38<sup>TH</sup> ST., CLEVELAND 14, OHIO  
**TERMALINE Coaxial Line Instruments**

**VAN GROSS**  
**COMPANY**  
 Sherman Oaks, Cal.



**A RELAY that flies with**  
**NIKE**  
**15 G UP TO 2000 CPS**

Limited quantity of model shop samples available. Submit your specifications and requirements with your inquiry.

Photo Nike installations, courtesy Western Electric Company

**DIMENSIONS**

15/32" dia. x 1-3/4" long

**WEIGHT**

7/8 oz.

**OPERATING POWER**

500 MW Max. (This relay is available for power requirements as low as 100 MW but with slightly less vibration resistance.)

**VIBRATION RESISTANCE**

15G up to 2000 CPS

*Wheelock* **SIGNALS**  
 INC.

RELAYS



LONG BRANCH, N. J.

tectors. One section of the illustrated literature is devoted to the application of the metal detector in the food industry. Chief features are outlined. Circle L11 inside back cover.

**Environmental Test Equipment.** Mantec, Inc., Custom Division, 126 Maryland St., El Segundo, Calif. Various types of environmental simulation equipment made-to-order for military suppliers to meet their special test requirements are presented in a new four-page brochure. Photographs of the custom engineered equipment are identified by name of customer, function of equipment and brief technical data pertaining to it. Circle L12 inside back cover.

**Resistor Specifications.** Shallcross Mfg. Co., Collingdale, Pa. The latest MIL-R-93A, MIL-R-9444 and commercial specifications for 24 types of encapsulated wirewound resistors are compared in a handy new cross-reference chart. The reverse side contains helpful application notes to aid in interpreting the various ratings and characteristics according to the requirements of each job. Circle L13 inside back cover.

**Subcarrier Oscillator.** Hoover Electronics Co., 3640 Woodland Ave., Baltimore 15, Maryland. New literature provides complete engineering specifications and application data of this vital component for the standard f-m/f-m telemetering system. The compact oscillators described are designed to operate in conjunction with transducers having a varying d-c voltage type output. Circle L14 inside back cover.

**Casting With Epoxy Resin Compounds.** Smooth-On Mfg. Co., 572 Communipaw Ave., Jersey City 4, N. J., has published a bulletin containing a complete description of techniques involved in using epoxy resin compounds for casting.

Technical bulletin No. 10 discusses the company's Metalset and Sonite epoxies, but the same information generally applies to the handling of all epoxy resin



casting compounds. It covers the general handling characteristics of epoxies for casting and the special handling required with wood, plaster, plastic, and flexible molds. The important aspects involved in curing of these cast epoxies are discussed in detail regarding both small and large castings and including the times and temperatures involved. Circle L15 inside back cover.

**Magnetic Components.** Magnetics Research Co., 255 Grove St., White Plains, N. Y. A 16-page booklet covers magnetic components for computers, business machines and electronic systems. Complete operating principles and applications are described. Circle L16 inside back cover.

**Magnetic-Core Delay Lines.** Columbia Technical Corp., 61-02 Thirty-First Ave., Woodside 77, N. Y., has published a catalog filled with useful information on performance and applications of the company's magnetic-core delay lines for commercial and military electronic uses. Circle L17 inside back cover.

**Research Facilities.** Armour Research Foundation, 10 W. 35th St., Chicago 16, Ill. Electrical engineering research facilities are described in newly published literature. The information is presented in the form of five 4-page folders that explain the areas of research conducted in the following fields: computer systems; electric machines, components and measurements; electronic instrumentation; communications; r-f applications and control systems. Circle L18 inside back cover.

**Linear Amplifier.** Baird-Atomic, Inc., 33 University Road, Cambridge 38, Mass. A new engineering bulletin covers the model 215 nonoverloading linear amplifier which is designed especially for amplification of pulses from scintillation detectors used in measurement of radioactivity. An important feature of the amplifier described is its recovery time—40  $\mu$ sec after an overload of 1000 times. Engineering specifications

# NOW—increase electron tube life \* 12 TIMES!

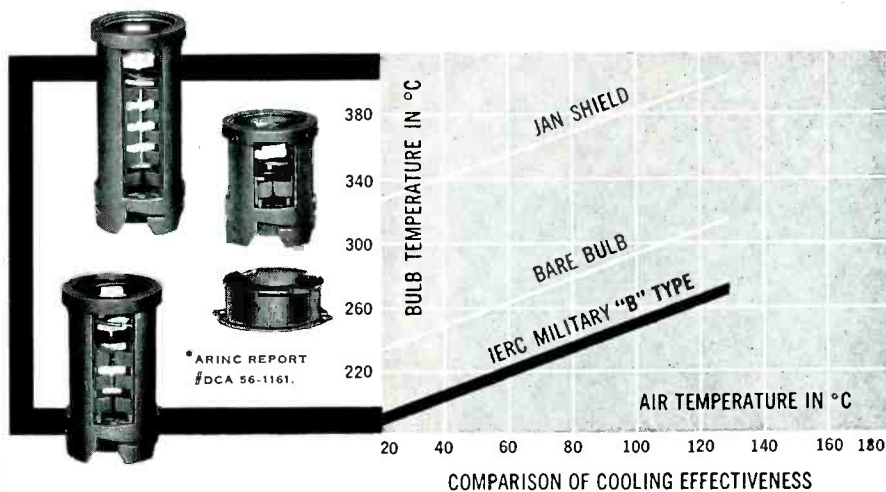

## Exclusive IERC Tube Cooling Effectiveness Provides Greatly Extended Tube Life And Reliability!

Though electronic engineers know that even the *slightest* tube temperature reduction improves tube life, the greatest success enjoyed in obtaining *extended* tube life has been when IERC Heat-dissipating Tube Shields have been specified and used. Results show that extensive gains in tube life and reliability are easily achieved—that tube operating temperatures are reduced as much as 150°C—that IERC's Military Type "B" shield is the *only effective answer* to obtain these benefits in your new equipment. Positive shock and vibration protection plus electrostatic shielding is provided. Graphs show temperature reductions when IERC "B" and "TR" shields are used with 6005 tube operating at full plate dissipation.

PATENTED OR PATS PEND. CROSS-LICENSED WITH NORTH AMERICAN AVIATION, INC.

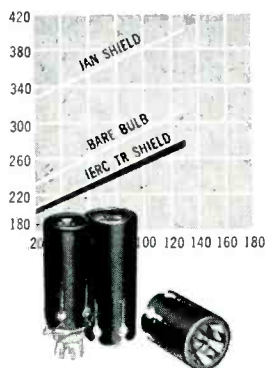

### Retrofit For Maximum Tube Life

No modification is required with IERC "TR" Type Heat-dissipating tube shields! TR's fit easily to existing JAN sockets—greatly extend tube life through excellent cooling and retention against shock and vibration.

Complete IERC literature and Technical Bulletins sent on request. WRITE TODAY!

**International**   
electronic research corporation

145 West Magnolia Boulevard, Burbank, California

# Vitramon<sup>®</sup> CAPACITORS

will help you build

## WIDE TEMPERATURE RANGE

... into your circuit systems

VITRAMON capacitors . . . fine-silver electrodes fused to pure porcelain enamel dielectric . . . operate predictably over a range of more than 300° C and come back from the extremes — unaltered.

WIDE TEMPERATURE RANGE?

**YES!** PLUS . . .

**RUGGED    LOW LOSS    STABLE**

**VAPORPROOF**

**LOW NOISE                    MINIATURE**

The biggest names in electronics use VITRAMON capacitors in guided missiles, jet ignition, proximity fuses and in radar, servo, guidance, fire control, telemetering and carrier telephone systems.

If substitutes are not good enough . . . if you need the best . . . write today!

# Vitramon<sup>®</sup>

Incorporated

BOX 544 E • BRIDGEPORT 1 • CONN.

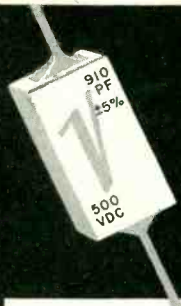

VITRAMON capacitors have low dissipations from -55°C to 250°C.

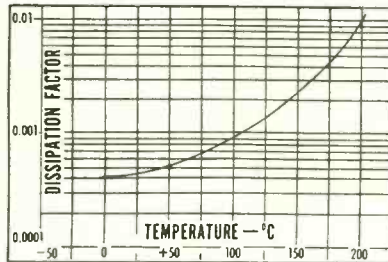

Two materials — a monolithic block of porcelain enamel and fine-silver electrodes — fused into one strong, stable, efficient and effectively homogeneous **RELIABLE** unit.

one reliable source

for all your

## CLIP, BLOCK and HARNESS STRAP needs!

ADEL offers the widest variety of LINE SUPPORTS in the World . . . 19,000 different types and sizes for safe, vibration-free, positive support in all types of aircraft, missiles, rockets, ordnance, automotive and original equipment of all kinds.

**SAFETY . . . FLEXIBILITY . . . DURABILITY . . .  
ECONOMY . . . SERVICE FITTED . . . SERVICE  
TESTED . . . SERVICE APPROVED**

Illustrated are but a few of the World's most complete line of Line Supports that meet or exceed all applicable specifications and/or requirements. Whatever the application — **STANDARDIZE ON ADEL** — the leader in completeness of line, service and reliability.

Reliability

# ADEL PRECISION PRODUCTS

A DIVISION OF GENERAL METALS CORPORATION

SPECIFICATIONS ARE AVAILABLE TO AIRCRAFT, MISSILE AND ORIGINAL EQUIPMENT MANUFACTURERS . . . WHAT ARE YOUR REQUIREMENTS?

Direct inquiries to Huntington Division  
1444 Washington Ave., Huntington 4, W. Virginia  
DISTRICT OFFICES: Burbank • Mineola  
Dayton • Wichita • Dallas • Toronto

and performance curves are included in data sheet AM-5505. Circle L19 inside back cover.

**Aircraft Equipment.** Aircraft Radio Corp., Boonton, N. J., is currently issuing new literature on its aircraft communication and navigation equipment, with some special emphasis on business flying. The type 21 adf is discussed in reprints and is also described and illustrated in new company brochures.

The general company line is described in a new two-color condensed catalog entitled "Communication and Navigation Equipment for All Classes of Aircraft." It shows a typical instrument panel with dual ARC equipment installation. Circle L20 inside back cover.

**Test Instruments.** Shasta Division, Beckman Instruments, Inc., P. O. Box 296, Station A, Richmond, Calif., has available a new four-page, two-color catalog describing its line of electronic test instrumentation. Included are data on expanded scale voltmeters and frequency meters, synchro tester, vtvm's, oscillators, resistance bridges, power supplies, wide-band amplifiers, WWV receiver and decade inductor. Circle L21 inside back cover.

**Servo Motors.** Norden-Ketay Corp., Commerce Road, Stamford, Conn. Bulletin 385 offers engineers complete information on standard and custom servo motors. Data include complete electrical and mechanical specifications, application data on direct plate to plate, transistorized servo amplifier and magnetic servo amplifier uses. Circle L22 inside back cover.

**Tungsten Coil Products.** Sylvania Electric Products Inc., 1740 Broadway, New York 19, N. Y., has published a new booklet discussing its tungsten coil products. The 12-page, two-color booklet describes in text, photographs, charts and graphs, Sylvania coils and heaters manufactured for the principal electronic and lighting applications and includes illustrations of production facilities and proc-





esses. Circle L23 inside back cover.

**Tape Control System for Machine Tools.** Electronic Control Systems, Inc., 2136 Westwood Blvd., Los Angeles 25, Calif. Principles and mode of operation of the Digimatic tape control system for machine tools are described in a new 12-page booklet. The booklet describes and illustrates the techniques for preparing and checking data, entering the data into the planning desk and operating the machine control unit. It also tells how small manufacturers can contract for the preparation of Digimatic control tapes through the service offered by Electronic Control Systems, Inc. Circle L24 inside back cover.

**High-Speed Analog Computers.** GPS Instrument Co., Inc., 811 Boylston St., Boston 16, Mass. A new booklet, "High-Speed Analog Computers, Key to Rapid System Development," answers questions from engineers, executives and educators who are concerned with automation and the development of control systems for industrial and military applications. In question-and-answer style the booklet defines certain types of computers and summarizes the applications of each. The virtues and limitations of high-speed analog computers, as compared with real-time computers, are then discussed, using the GPS computer as an example. Circle L25 inside back cover.

**Electromechanical Devices.** Microvac Corp., 5300 W. 104th St., Los Angeles 45, Calif. A complete line of electromechanical release and ejection mechanisms for aircraft, missile and ordnance applications are described in an illustrated, four-page brochure. Circle L26 inside back cover.

**Solenoids and Relays.** E. V. Naylor Laboratories, Inc., 2 Yennicock Ave., Port Washington, N. Y., has published new literature on its electromagnetic products. The bulletins cover two special solenoids, two five-ampere multipole

# TEFLON

SHEET...ROD...

TUBING...MOLDED OR MACHINED PARTS?

## YOU CAN GET JUST WHAT YOU WANT

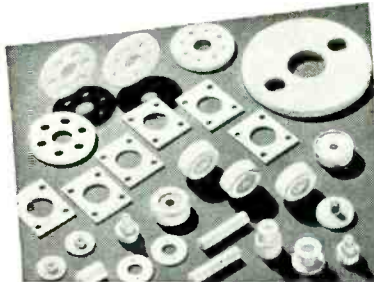
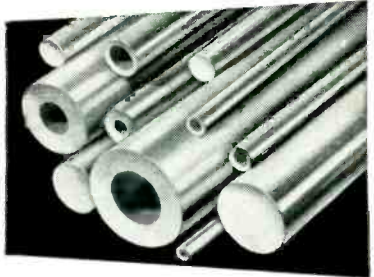

from

**JOHN CRANE**

"Made of Teflon by JOHN CRANE" has become practically a standard specification for parts and components subject to severe electrical, corrosive, thermal, mechanical or atmospheric abuse. Whatever your requirements in Teflon . . . sheet, rod, tubing, packings, gaskets, bellows, insulators, sealing discs or non-stick parts . . . "John Crane" can supply them!

In addition, you get these important *plus* factors: complete uniformity throughout, high density control, freedom from flaws and rigid adherence to your specifications.

"John Crane's" complete fabrication facilities assure you prompt delivery on *exactly* what you want — no compromise. If you have an entirely new requirement, no standard design or procedure — "John Crane's" laboratory facilities, know how, research and engineering experience go to work on *your particular* need.

Now is a good time to put "John Crane" to test. Contact Crane Packing Company today.

Crane Packing Co.,  
6402 Oakton St.,  
Morton Grove, Ill.  
(Chicago Suburb)

In Canada: Crane  
Packing Co., Ltd.,  
Hamilton, Ont.



\* **TEFLON** DuPont trademark

**Advantages:**

- CHEMICAL**—Completely inert
- ELECTRICAL**—Extremely low power factor  
Very high dielectric strength
- THERMAL**—Temperature range  
—300°F. to +500°F.
- MECHANICAL**—Strong, flexible  
Weather resistant
- LOWEST COEFFICIENT OF FRICTION**  
**ABSOLUTELY NON-STICK**

**JOHN CRANE**

**CRANE PACKING COMPANY**

OFFICES IN ALL PRINCIPAL CITIES

38 YEARS  
INDUSTRIAL PROGRESS

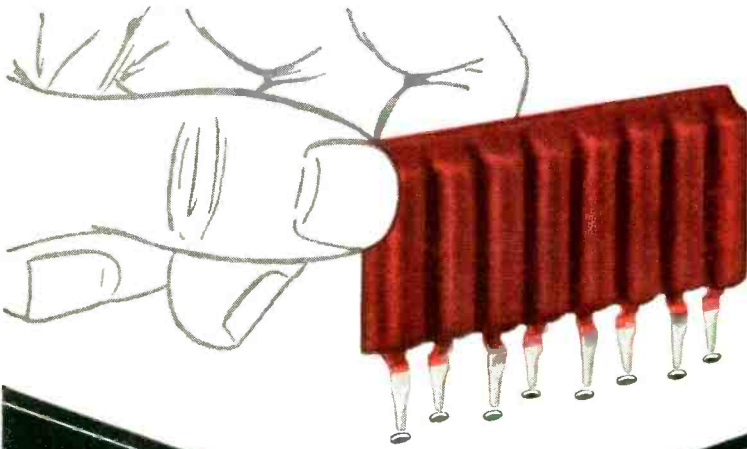

## REDUCE YOUR COSTS WITH ERIE PAC\*

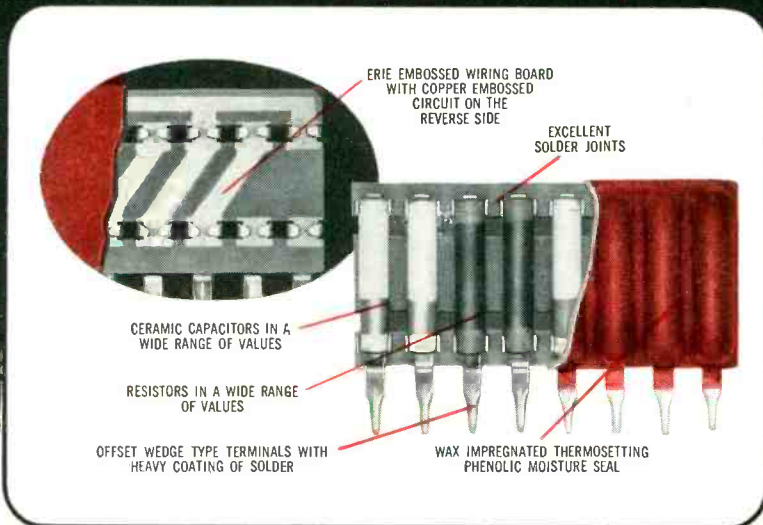

### \* PRE-ASSEMBLED CIRCUITS

The ERIE Pre-Assembled Circuits system presents an entirely new approach to packaging electronic components. This new modular system is now being used by many large radio and TV manufacturers in their 1957 models. PAC has proven itself to be technically sound as well as economical and easy to handle on the assembly line.

Leading producers choose PAC—because PAC reduces labor costs . . . requires fewer component insertions . . . needs less assembly equipment . . . uses a smaller printed wiring board area . . . means fewer punched holes . . . reduces overhead costs . . . keeps inventory down.

*For further information write for Engineering Bulletin 450-1 or contact your ERIE representative.*



time delay relays and a 10-ampere single-pole time-delay relay. Descriptions, special features and specifications are included. Circle L27 inside back cover.

**Electronic Volt-Ohmmeter.** The Hickok Electrical Instrument Co., 10527 Dupont Ave., Cleveland 8, Ohio. Form 415 lists special design features and specifications of the new portable electronic volt-ohmmeter. The unit discussed has a curved plastic face, is designed to lie flat in normal use and has a multifunction range selector color coded to facilitate use and speed selection. It also features all d-c ranges with zero-center design for use with complex circuit arrangements. No batteries are required for the equipment described. Circle L28 inside back cover.

**Linear Amplifier.** Baird-Atomic, Inc., 33 University Road, Cambridge 38, Mass. A new engineering bulletin covers the model 215 nonoverloading linear amplifier. The unit is designed especially for amplification of pulses from scintillation detectors used in measurement of radioactivity.

An important feature of the amplifier described is its recovery time—40  $\mu$ sec after an overload of 1,000 times.

Engineering specifications and performance curves are also included in data sheet AM-5505. Circle L29 inside back cover.

**Color Kinescope Circuit.** Radio Corp. of America, Harrison, N. J. Application Note AN-168 describes a new tubeless convergence circuit for the 21AXP22-A color kinescope. The circuit described utilizes a revised control system and permits complete dynamic-convergence connection. It includes controls for the operation of electromagnetic static-convergence components and permits simpler more rapid convergence setups. Circle L30 inside back cover.

**Motion Transducers.** Minneapolis-Honeywell Regulator Co., Wayne & Windrim Aves., Philadelphia 44, Pa. Instrumentation data sheet 10.18-12 explains how Sostman



motion transducers can be used with any Brown ElectroniK instrument wherever linear or angular motion must be measured with a high degree of reliability and accuracy. Typical applications, performance data, and construction features are illustrated for both linear and angular motion types. **Circle L31 inside back cover.**

**Dead Reckoning Tracer.** Servo Corp. of America, 20-20 Jericho Turnpike, New Hyde Park, N. Y. A new brochure discusses an airborne electromechanical analog computer and plotting board employed for the continuous automatic plotting of an aircraft's own position on a standard Mercator chart. The equipment covered is designated as the model AN/ASA-14.

Application and specifications of this navigation system are given in TDS-5270. **Circle L32 inside back cover.**

**Teflon Thin-Walled Tubing.** Haveg Industries, Inc., 900 Greenbank Rd., Wilmington 8, Del. Two-page bulletin T-200 stresses Teflon's excellent range of electrical properties for thin-walled tubing which finds wide applications in electronics as sheathing for cables, slip-on and sleeving insulation in motors, generators and transformers. The tubing is further used for aviation, communications, electronics, marine equipment and missile instrument wiring. The bulletin charts the diameters, wall thicknesses and tolerances, and weights of standard tubing sizes. **Circle L33 inside back cover.**

**Choppers.** James Vibrapowr Co., 4050 North Rockwell, Chicago 18, Ill. A complete new chopper catalog has been made available. It contains electrical and mechanical specifications of all the 1200 series choppers. Included are new flange mount wire in models for high-frequency operation. **Circle L34 inside back cover.**

**Package Controls.** Sensory Inc., New Vernon, N. J. Bulletin 571 covers the company's electromag-

# REMEMBER!

SPECIFY

# ERIE

# TUBULAR CERAMICONS®

for

# PRINTED WIRING APPLICATIONS

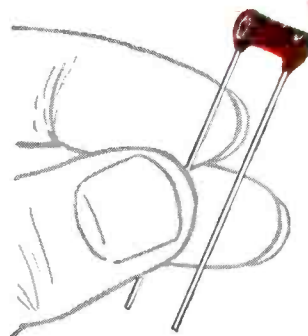

**DIPPED PHENOLIC INSULATED**

These Radial lead units are dipped in low-loss phenolic material which is baked and vacuum wax impregnated.

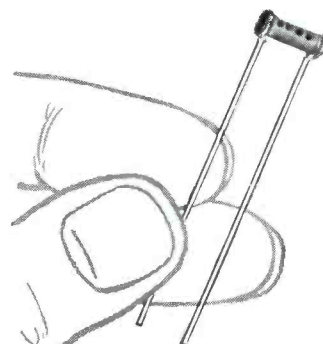

**NON-INSULATED**

Radial leads soldered to silver electrodes and sealed with moisture impervious coating to withstand humidity.

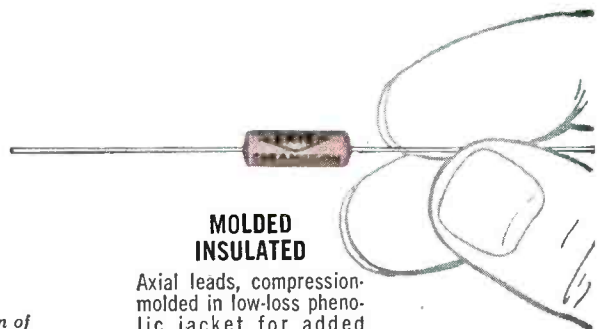

**MOLDED INSULATED**

Axial leads, compression-molded in low-loss phenolic jacket for added strength and protection against humidity.

Write for 16 page Bulletin 313-2 for description of **ERIE TUBULAR CERAMICONS.** Also ask for our new 8 page Feed-Thru Ceramicon Bulletin 323.



**ERIE ELECTRONICS DIVISION**

**ERIE RESISTOR CORPORATION**

Main Offices and Factories: **ERIE, PA.**

Manufacturing Subsidiaries

HOLLY SPRINGS, MISSISSIPPI • LONDON, ENGLAND • TRENTON, ONTARIO

# MEASUREMENTS' MEGACYCLE METER

**Gives You Extended  
Coverage from  
100 Kc to 940,000 Kc  
PRECISION GRID-DIP METERS**



**MODEL  
59  
Power Supply  
\$75.00**

## MODEL 59-LF OSCILLATOR UNIT

Frequency Range:  
100 Kc to 4.5 Mc.  
Price - Oscillator Unit  
(Head) only \$98.50  
with Power Supply  
\$168.00



## MODEL 59 OSCILLATOR UNIT

Frequency Range:  
2.2 Mc to 420 Mc.  
Price - Oscillator Unit  
(Head) only \$98.50  
with Power Supply  
\$168.00



## MODEL 59-UHF OSCILLATOR UNIT

Frequency Range:  
420 Mc to 940 Mc.  
Price - Oscillator Unit  
(Head) only \$128.50  
with Power Supply  
\$198.00



Measurements' Megacycle Meter is now available in a choice of three oscillator heads providing frequency range coverage from 100 Kc to 940,000 Kc. Thus, the utility of this versatile instrument has been extended, making it, more than ever, indispensable to anyone engaged in electronic work; engineer, serviceman, amateur or experimenter.

Laboratory Standards



**MEASUREMENTS CORPORATION**

BOONTON • NEW JERSEY

NEW LITERATURE

(continued)

netic director systems, a line of low cost package controls custom designed to suit the customer's machine or manufacturing process. Illustrations and complete description are included. Circle L35 inside back cover.

**Radar Data Transmission System.** Skiatron Electronics & Television Corp., 180 Varick St., New York 14, N. Y. A four-page folder tells the full story of RADAT, an electronic system over which radar signals can be picked up from outlying radar screens and transmitted with accompanying identification and other pertinent data over existing telephone wires to any desired central control location. An important element of the overall system described is the data inserter, known as DATIN, which makes it possible for planes picked up at remote radar stations to be identified clearly on the control scope at Command Headquarters or at an Air Traffic Control Center. Circle L36 inside back cover.

**Data Reduction.** Coleman Engineering Co., Inc., 6040 W. Jefferson Blvd., Los Angeles 16, Calif. Bulletin CR-187 describes, with the aid of a block diagram, the various combinations of accessories and output equipment which can be combined with the company's oscillogram reader in the building up of a customized data reduction instrument to best suit the individual user's problems. Circle L37 inside back cover.

**Epoxy Resin Encapsulation.** Smooth-On Mfg. Co., 572 Communipaw Ave., Jersey City 4, N. J. Technical bulletin No. 18 describes the physical and electrical properties of the Sonite series of filled epoxy resins for room temperature encapsulation of electronic and electrical components. It also contains pertinent information on successful methods for proper encapsulation work. Circle L38 inside back cover.

**Transducers and Capacitors.** Nilsen Mfg. Co., Addison, Ill. A recent four-page folder discusses the Variogon continuous phase

## D-B broad band gas-filled cavity wavemeters

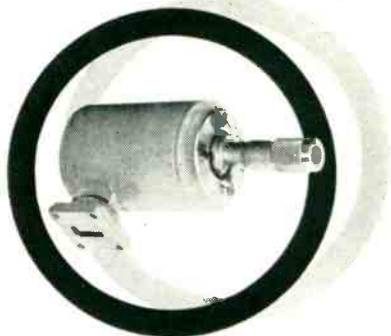

Each instrument covers a wide segment of the total range. Only 11 sizes serve from 2.6 KMC to 90 KMC. Accuracy is so high they may be used as secondary standards. Nitrogen filled and sealed for long life and high Q. Bi-metallic structure provides high degree of thermal compensation. Write for literature.



780 South Arroyo Pkwy. • Pasadena, Calif.

## Product Engineering Electronics

An opportunity for a mechanical or electrical engineer skilled in starting with laboratory breadboard configurations and developing designs suitable for production. Requirements are a minimum of three years experience in the design of airborne electronic units or small electro-mechanical devices to applicable military specifications.

Please address inquiries to:  
Mr. Frank C. Nagel

**The Ramo-Wooldridge  
Corporation**

5730 ARBOR VITAE STREET  
LOS ANGELES 45, CALIFORNIA



shifting transducers which are used at specific frequencies to produce time delays or phase variations directly proportional to shaft rotation. Included are electrical characteristics of standard Vario-gon capacitors, a typical calibration curve, dimensional drawings, specifications and special features. Circle L39 inside back cover.

**Engravers and Accessories.** Mico Instrument Co., 80 Trowbridge St., Cambridge, Mass. Catalog No. 57 devotes 14 pages to a line of engravers and accessories. The Mico engraver described fills the need for a portable, inexpensive, dependable and accurate machine to make small dies and molds for plastics, rubber, glass, die castings, templates or for other similar forming operations. The engravers and accessories are illustrated and chief features are given. Circle L40 inside back cover.

**New Battery Handbook Section.** Ray-O-Vac Co., 212 East Washington Ave., Madison 10, Wis. With the rapid development of transistor radio and other electronic equipment, new types of dry batteries are being designed and developed especially for same. Section 4A of the dry-battery engineering handbook consists of 11 engineering bulletins including the latest data on these applications. The bulletins, in addition to regular supplements, will be sent as new information is available. Circle L41 inside back cover.

**Silicon Rectifiers.** Sarkes Tarzian Inc., Rectifier Division, 415 North College Ave., Bloomington, Ind., was recently given a set of 1N numbers by RETMA for its line of silicon rectifiers. Handbook No. 669 contains the most complete information on silicon rectifiers. It also shows these 1N numbers listed alongside the company's regular part numbers. The booklet may be had for 25¢ to defray the cost of handling. Circle L42 inside back cover.

**Use of Adhesives With Reinforced Plastics.** Rubber & Asbestos Corp., 225 Belleville Ave., Bloomfield,

# ARE THESE PROBLEMS BOTHERING YOU ?

- Productive and idle time ?
- Flow of materials ?
- Position of gates and dampers ?
- Time of failure in life tests ?
- Length of phone calls ?
- Sequence of switching ?
- Timing of events ?

The operation recorder will obtain the answers to these problems, and many more, for you. An instrument with 20 pens writing on a moving chart, the operation recorder shows:

- When events occur
- How long they last
- How frequently they occur
- The relationship of a series of events to each other

Product Representatives in Most Principal Cities

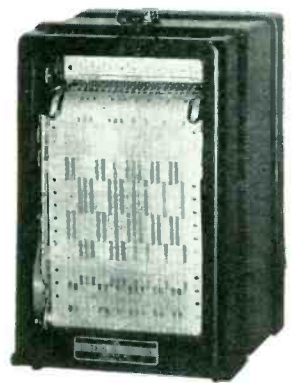

Write for Bulletin 247A, "Operation Recorders—Their Selection and Use."

## The ESTERLINE-ANGUS Company, Inc.

Pioneers in the Manufacture of Graphic Instruments

Dept. E3, P. O. Box 596, INDIANAPOLIS 6, INDIANA

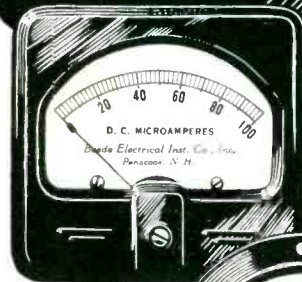
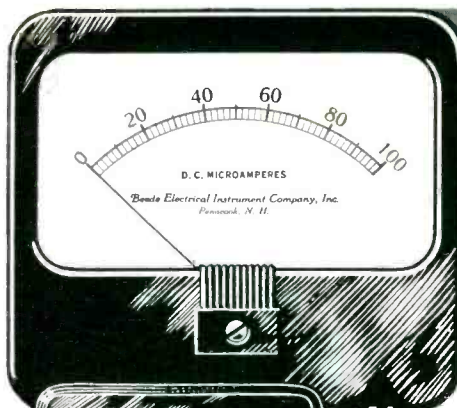

15  
3" x 3"

2 3/4" DIA. 501

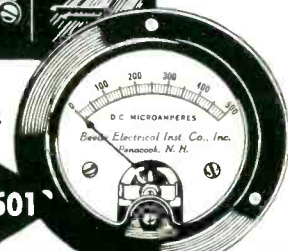

16  
4 21/32" x 4 3/16"

# BEEDE



# ELECTRIC METERS

FOR SMALL POWER-UNIT PANELS  
INDUSTRIAL TEST UNITS  
COMMUNICATION EQUIPMENT  
AND MANY OTHER USES

**ACCURATE TO THE DOT!**

CATALOG ON REQUEST

# BEEDE ELECTRICAL INSTRUMENT CO., INC. PENACOOK, N. H.

# NEWS for design engineers

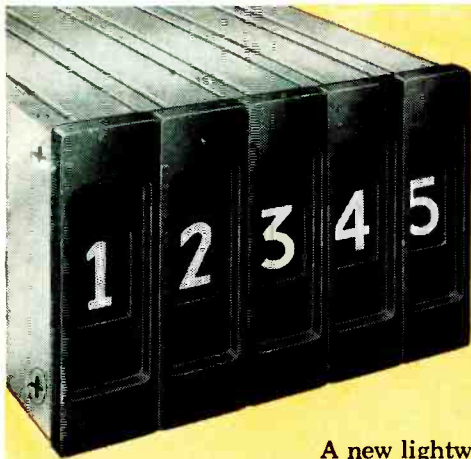

ACTUAL SIZE

## UNION DIGITAL INDICATOR

A new lightweight Digital Indicator for data display has been developed by Union Switch & Signal that has many uses in aviation and other industries. It is designed for either local or remote use, on a direct wire basis, and responds to binary code. The indicator reads out directly and has a non-dissipating storage facility. Data can be printed out if necessary. Write for Bulletin 1011.

## UNION MINIATURE RELAYS AC or DC

A wide variety of UNION AC or DC Miniature Relays, with all standard mountings, is stocked for immediate shipment. Contacts can be gold alloy, palladium or the new HI-LO material which permits the use of one relay for both high-level loads of two amperes and low-level, dry-circuitry loads, eliminating the need for two separate relays.

Coil resistance runs up to 13,500 ohms, vibration resistance up to 2000 cycles at 30 G's, and shock in excess of 50 G's. Write for Bulletin 1010.

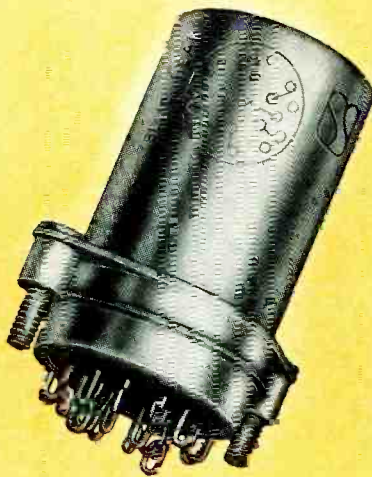

ACTUAL SIZE

GENERAL APPARATUS SALES

# UNION SWITCH & SIGNAL

DIVISION OF WESTINGHOUSE AIR BRAKE COMPANY

PITTSBURGH 18, PENNSYLVANIA

NEW LITERATURE

(continued)

N. J. An eight-page illustrated booklet, amply supported by tables, charts and diagrams, contains data on effect of temperature on tensile shear strengths; physical properties of foamed-in-place plastic sandwiches; peel strength of Kel-F laminate-to-steel bonds with epoxy room temperature curing adhesives and bond properties of printed circuit laminates made with various adhesives.

Also included is a detailed bibliography containing many helpful reference sources for further technical information on adhesive usage and testing. Circle L43 inside back cover.

**Ultrasonic Test Equipment.** Arenberg Ultrasonic Laboratory, Inc., 94 Green St., Jamaica Plain 30, Mass. A four-page folder contains illustrated descriptions of the WA600 wide band amplifier, the model PG-650 high-power pulse oscillator, the PA620 preamplifier and the ATT 693 precision attenuators. Specifications for each are included. Circle L44 inside back cover.

**Panel Wiring Techniques.** Stahlin Brothers, Inc., 350 Maple St., Belding, Mich. An eight-page bulletin outlines new raceway techniques for wiring of electrical and electronic equipment. Bulletin S-301 outlines methods for simplifying wiring operations from the drafting room to the assembly floor by use of raceways and pre-cut wires. It points out ways to improve appearance with one-third the work of bundling and lacing wires.

One section describes, in text and pictures, the procedure for installation and how corners and T's are readily made. A complete guide is also provided to all standard panel channel raceways, giving specifications, part numbers and sizes. Circle L45 inside back cover.

**Building Blocks for Equipment and Systems.** Engineered Electronics Co., 506 E. First St., Santa Ana, Calif. A 74-page catalog, No. 856-A, illustrates and describes a number of products used in high-quality systems for both



industrial and military applications. New products included are standard-series plug-in circuits; a complete new computer series of plug-in units, including diode logics; chopper stabilized d-c amplifiers; power supplies; systems development racks and jack panel assemblies. **Circle L46 inside back cover.**

**Ultralinear Amplifier.** Keroes Enterprises, 369 Shurs Lane, Philadelphia 28, Pa. A 24-page booklet presents a detailed study of the theory and operation of the ultralinear circuit, which has become recognized as one of the most suitable forms of output stage in a quality audio amplifier. Included in the booklet are the mathematical analysis of ultralinear operation and a typical ultralinear amplifier design. Booklets are available at 25 cents per copy. **Circle L47 inside back cover.**

**Servo Motors.** Norden-Ketay Corp., Commerce Road, Stamford, Conn. Bulletin No. 385 offers engineers complete information on standard and custom servo motors. Data include complete electrical and mechanical specifications, application data on direct plate-to-plate, transistorized servo amplifier and magnetic servo amplifier applications. **Circle L48 inside back cover.**

**Microwave Catalog.** Douglas Microwave Co., Inc., 252 E. 3rd St., Mt. Vernon, N. Y., has published a 118-page catalog with more than 700 different standard microwave-radar test equipment and component parts. The catalog, bound with an embossed cover, features easy-to-read type and hundreds of clear illustrations. **Circle L49 inside back cover.**

**Transistor Manual.** General Electric Co., Syracuse, N. Y., has published a transistor manual containing basic information on transistors and their operation in circuits. It includes information on basic semiconductor theory, construction techniques used to make the various types of transistors now on the market, basic principles of transistor circuit design and specifications, with outline

drawings, of all transistors registered with RETMA.

The booklet also contains complete explanations of transistor parameter symbols now in common use. Nineteen circuit diagrams ranging in complexity from a one-transistor simple audio amplifier to a six-transistor super-heterodyne broadcast receiver are included with complete parts list. A cross-reference chart for replacement of transistors in current transistorized radios of all manufacturers is also included. The booklet is priced at fifty cents. **Circle L50 inside back cover.**

**Oscillograph Record Developer.** Hathaway Instrument Division, Hamilton Watch Co., 5800 E. Jewell Ave., Denver 22, Colorado. Of interest to organizations faced with the problem of developing and drying records from recording oscillographs, a new catalog mailer features the SD-10 automatic record developer. An outstanding feature of the unit described is its self-threading feature which eliminates record loss and makes possible development of short records. Other features discussed include stainless-steel solution tanks that are rust and leakproof and a hinged top which swings back for speedy accessibility. Developing can be completed without a water supply for washing the sensitized paper, while loading and processing can safely be done in lighted rooms at the recording area.

Described briefly in one section of the catalog mailer are several of the company's oscillographs. **Circle L51 inside back cover.**

**Industrial TV Camera.** Diamond Power Specialty Corp., Lancaster, Ohio. Bulletin 1175 B covers the series 400 Utilivue closed-circuit tv camera. It shows the uses, advantages and technical specifications. Illustrations of its accessory equipment are also included. **Circle L52 inside back cover.**

**Insulating Films and Tapes.** Minnesota Mining and Mfg. Co., 900 Fauquier St., St. Paul 6, Minn. A new illustrated booklet describes four types of PTF (poly-

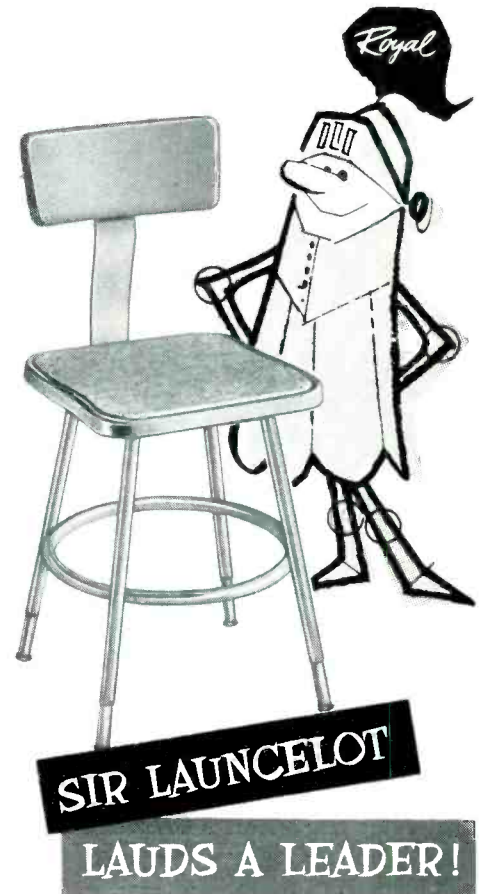

Here's a distinguished member of the *Royal Family* of Fine Factory Seating—the popular Model 515, used in hundreds of laboratories and industrial plants for comfort, convenience, endurance. Rust-resisting, telescopic legs lock at 1" intervals for 17" to 25" or 24" to 32" seat-height adjustment. Back rest adjusts four ways—up, down, forward, backward—to give the 515 many healthful qualities of the finest office posture-type seating. Here's a chair really built to serve the sitter, speed work, save you money.



Mail ye coupon for full information on Royal Seating for Modern Industry.



Model 515    Model 625    Model 624    Model 511

**ROYAL METAL MANUFACTURING COMPANY**  
175 N. Michigan Ave., Chicago 1, Ill., Dept. 30-E  
Please send me free 24-page Catalog No. 7001, "Royal Seating for Modern Industry;" Complete information on Royal Verti-File Vertical Filing.

Individual \_\_\_\_\_  
Company \_\_\_\_\_  
Street \_\_\_\_\_  
City & State \_\_\_\_\_

# 96 STANDARD VARIATIONS

## New Y

### DIGITAL READ-OUT COUNTERS

by **DURANT**

Design engineers can now select one or more standard units from a range of 96 Instrument Counters, having the same type of frame and configuration.

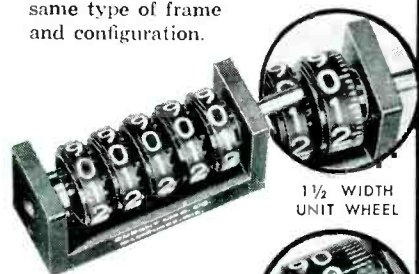

5-Y-8822 WITH SINGLE WIDTH UNIT WHEEL

**SINGLE BANK SERIES**  
(Right or Left Drive)  
2 to 7 Figures



1 1/2 WIDTH UNIT WHEEL



DOUBLE WIDTH UNIT WHEEL

Here is a family group that provides uniformity in digital recording to satisfy nearly all design requirements . . . on radar equipment, navigation instruments, computers, missile tracking devices, and gauging instruments.

They are compact, average weight only 2 ounces, have easy to read figures, white on black . . . speeds to 2500 RPM. Available in single or dual bank style, in 2 to 7 figures capacity . . . three styles of unit wheel configuration.

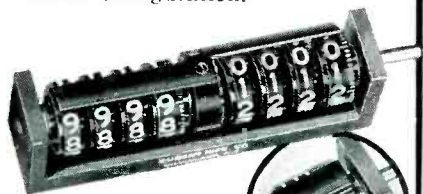

4-4-Y-8831 WITH 1 1/2 WIDTH UNIT WHEEL

**DUAL BANK SERIES**  
(Right or Left Drive)  
2 to 5 Figures EA. BANK



Send for  
FACTUAL  
BULLETIN  
No. 400

**DURANT MFG. CO.**  
1912 N. Buffum St., Milwaukee 1, Wis.  
12 Thurbers Ave., Providence 5, R.I.  
Representatives in Principal Cities

**PRODUCTIMETERS**  
SINCE 1879  
*Count Everything*

Want more information? Use post card on last page.

neer of the RCA Laboratories. In 1951, after six years as executive vice-president in charge of the RCA Laboratories division, he was advanced to his present position of vice-president and technical director.

RCA also established a missile electronics engineering operation at the Army guided missile test range, White Sands Proving Grounds, New Mexico.

Leslie A. Skinner, missile and rocket specialist, has joined the missile and surface radar department as manager of the new operation.

Skinner retired from military service in 1949 with the rank of Colonel. His military career was devoted primarily to air and ground weapons development, planning, and management. Since 1949, he has been engaged in various industrial executive capacities.

The company announced E. V. Space has been appointed to the newly created position of manager, equipment and production development, RCA semiconductor division.



Leslie A. Skinner

He joined the RCA tube division in 1943, as a development engineer. After 30 months in the armed forces he returned to receiving tube development in 1946. Following seven years in that position he was made manager of production engineering in the transistor department.

In 1956, he was appointed manufacturing manager of the newly formed RCA semiconductor division and continued in that post until his current appointment.

## Sylvania Plans Plant, Appoints Engineer

SYLVANIA ELECTRIC plans a plant and laboratory in Arizona.

The firm may announce plans for a test site for electronic devices within the boundaries of Arizona by year's end, depending upon government requirements. Such a site would require 500 to 1,000 acres.

► **Waltham**—Frederick J. Anderson has been appointed assistant manager of the avionics laboratory of Sylvania's Waltham Labs. The Waltham laboratories are part of Sylvania's electronic systems division.

In addition to his new responsibilities, Anderson continues to act as manager of the projects department of the avionics laboratory, a position to which he was appointed early in 1955. The Laboratory is engaged in advanced research and development work in radar, communications, countermeasures and other phases of aviation electronics, as well as in the computer field.

He joined Sylvania in 1947 as a junior engineer, advancing through

the positions of senior engineer, engineer-in-charge, section head and supervisor of the computer development department.

## M.I.T. Gets New Lincoln Lab Heads

CARL F. J. OVERHAGE was appointed director and William H. Radford associate director of Lincoln Laboratory of M.I.T. They succeed, respectively, Dr. Marshall G. Holloway and Dr. George E. Valley, who have resigned.

Dr. Holloway will go to a new position in industry and Dr. Valley, promoted from associate to full professor of physics, is returning to faculty service on the M.I.T. campus in Cambridge. Dr. Overhage has been head of division II, aircraft control and warning, and Professor Radford has been head of division III, communications and components, at Lincoln.

Dr. Holloway came to the directorship at Lincoln Laboratory in 1955 from the Los Alamos Scien-



tific Laboratory in New Mexico. Dr. Valley became associate director in 1953. During World War II he was on the staff of the M.I.T. Radiation Laboratory and served as technical editor of the laboratory's office of publications.

Dr. Overhage was a group leader at the Radiation Laboratory during the war, was on the staff of Eastern Kodak Co. for five years and in 1951 returned to M.I.T. He joined the newly organized Lincoln Laboratory, then returned to Eastman for a time and served the Air Force as a member of the Scientific Advisory Board to the Chief of Staff before becoming a division head at Lincoln.

Professor Radford has been on the staff of the M.I.T. department of electrical engineering since 1932, becoming a full professor in 1951.

In 1941 he assisted in establishing the M.I.T. radar school and he became associate director of it in 1944. He was a section member and consultant to the National Defense Research Committee from 1940 to 1943.

In 1953 Professor Radford went to Lincoln, where he has pioneered in the development of scatter radio communications, the "over-the-horizon" system which is used for all communications between the mainland and the Texas Tower and for other purposes. The division which he has headed also carries on research and development in such scientific fields as solid state physics.

### Convair Adds Five Engineers

FIVE scientists were added to the staff of the department of scientific research at Convair division of General Dynamics Corp. The department, established last year, is devoted to basic research in scientific fields associated with advanced aircraft and missile technology.

Most recent appointees are Dr. John E. Naugle, senior staff scientist in physics; Dr. Harold A. Papazian, staff scientist in physical chemistry, Eugene J. Putzer, staff scientist in mathematics; and

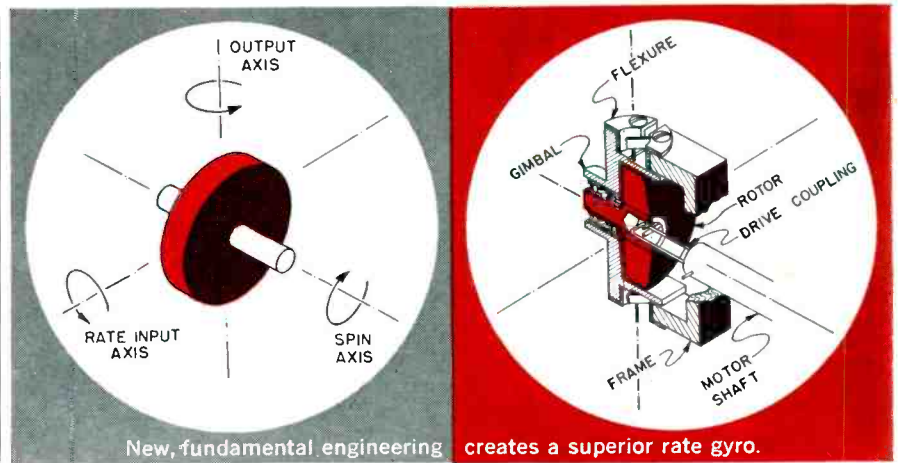

New, fundamental engineering creates a superior rate gyro.

## New 'SW' Rate Gyro

*Simplicity delivers superior performance*

Fundamental engineering and precision manufacturing team up to enable new Humphrey SW Rate Gyros to deliver superior performance. More rugged... more dependable... greater precision for the most demanding applications in advanced missile and aircraft systems.

Simplicity of design eliminates unnecessary parts. Heart of the SW Rate Gyro is the solid rotor inertial element mounted on precision radial thrust bearings in the exclusive bridge-like gimbal. Two unitized steel flexures give pivot and spring-restraint functions attaching gimbal to frame.

Using compatible materials and high-G centrifuge balancing adds to superior performance qualities. No deterioration of the SW's performance even under the most severe environmental conditions. Operates in temperatures from  $-65^{\circ}\text{F}$  to  $\pm 185^{\circ}\text{F}$ ; vibration at 10G from 20 to 2,000 cps; and shock to 100G.

Four basic sizes provide choice of drive motors and pick-offs to avoid any compromise in your system design.

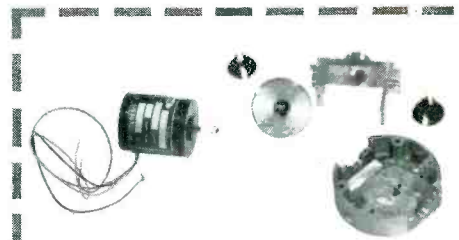

*Minimum number precision parts: solid rotor; exclusive coupling, flexures.*

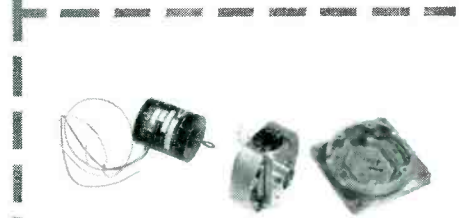

*Simple sub-assembly: one compact unit; motor separate from sensing element.*

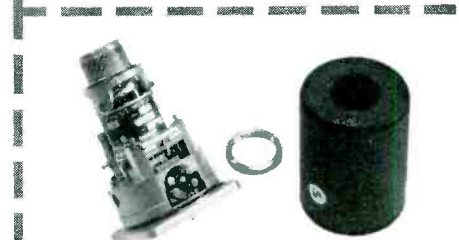

*Floating-piston constant-action dry-air damper; effective pressure-sealed case.*



**Humphrey Inc.**  
ELECTRO-MECHANICAL INSTRUMENTS

Dept. E-4  
2805 CANON ST. • SAN DIEGO 6, CALIF.

*Send new catalog immediately:*

NAME \_\_\_\_\_

COMPANY \_\_\_\_\_

ADDRESS \_\_\_\_\_

CITY \_\_\_\_\_ STATE \_\_\_\_\_

# ENGINEERS!

**ARE YOU  
LOOKING FOR  
DIVERSITY?**

You can work in these fields

at **Bendix**

in Southern California

Telemetering

Servo Valves

Airborne Radar

Miniature Electric Motors

Missile Guidance

Underwater Sonar

Industrial Sonics

Aircraft Hydraulics

**Bendix-Pacific offers you this broad cross section of absorbing tasks.**

Here, in Southern California, you will find excellent positions open for electronic, hydraulic and mechanical engineers at all levels. At Bendix-Pacific the diversity of work never traps you in the monotony of a one-product job.

**Write us today or mail the handy coupon for complete information.**

W. C. Walker, Engineering Employment Mgr.  
Pacific Division, Bendix Aviation Corp.  
11608 Sherman Way, North Hollywood, Calif.

I am interested in this engineering field \_\_\_\_\_  
I am a graduate engineer with \_\_\_\_\_ degree.  
I am not a graduate engineer but have \_\_\_\_\_ years experience.

Name \_\_\_\_\_

Address \_\_\_\_\_

City \_\_\_\_\_

Zone \_\_\_\_\_ State \_\_\_\_\_

Robert J. Good, staff scientist in chemistry.

As a research associate at the University of Minnesota from 1953 until he joined the Convair staff, Dr. Naugle's work included teaching and research with the cosmic ray emulsion group. At Convair he is conducting upper atmosphere research.

Dr. Myers, whose work currently is in electron paramagnetic studies, thermodynamics and high temperature and tracer chemistry, formerly was associated with the Stanford Research Institute.

Harold A. Papazian, who will do research in the chemistry and

physics of free radicals, important in combustion and propulsion, came to Convair from the Research Division of Raytheon Manufacturing Company.

Putzer, formerly an instructor in mathematics at Macalester College at St. Paul, Minn., has specialized particularly in nonlinear differential equations, currently as these are applied to the solution of equations used in servomechanism analysis.

Dr. Good, formerly assistant professor of chemistry at the University of Cincinnati, will do research in surface chemistry and adhesion.

## Page Names Assistant Design Chief

PAUL D. ROCKWELL, since 1954 in charge of design, review and final tests of ionospheric-scatter communications systems installed by Page Communications Engineers, Inc., has been appointed assistant engineering director for design engineering. The firm develops and installs ionospheric- and tropospheric-scatter communications systems.

Prior to joining PCE, Rockwell, as systems engineer for the Bendix Radio division, was responsible for development of a long line of communications and navigational systems including the AN/ARC-22 subminiature equipment for the Air Force and the AN/ARC-44 airborne transmitter-receiver which is now in production for the Signal Corps. Earlier, as communications



Paul D. Rockwell

engineer for the Radio Development Corp., he spent several years in Peru working on h-f ground-to-air radio communications and frequency authorization, following a period there as radio inspector for Pan American-Grace Airways.

## Bendix Selects Six Engineers

WINSTON E. KOCK was named chief scientist in charge of surveillance and detection systems work of the systems division of Bendix Aviation. John D. Trimmer will be responsible for nuclear systems development; Jay E. Browder, electronic countermeasures; and William Hampton will be in charge of several weapons systems projects.

Formerly Dr. Kock was director of audio and video systems research of Bell Telephone Labora-

tories. He is the inventor of the microwave lens antenna. More recently he directed the research and development of picture-phone—which makes possible the transmission of a picture over a telephone.

Dr. Trimmer was professor of physics at the University of Tennessee, and a consultant on control of nuclear reactors at the Oak Ridge National Laboratory.

Before joining the Bendix staff, Browder was chief of the radio



communications engineering section of the Kollsman Instrument Corp.

Hampton was on the staff of the Goodyear Aircraft Corp. as head of weapons systems. He holds patents for several electronic systems and components.

The systems division, located near the University of Michigan's North Campus, is being equipped and staffed to develop and analyze new types of interacting systems from the initial planning stage through research and development to the building of prototypes. The division will occupy leased space pending completion of its first building next year.

► **Product** — R. E. Whiffen has been named plant manager and J. P. Field, quality manager of the missiles section of Bendix Aviation's product division. Whiffen will direct manufacturing activities in the production of the Talos missile at the Mishawaka plant, and Field will be responsible for all phases of missile test and inspection.

Whiffen joined the radio division of the corporation following service with the Navy during World War II. He was assistant chief engineer of test and inspection for the division, working on the design and development of UHF airborne communications equipment, microwave components and radar systems. In 1953, Whiffen transferred to the products division staff as technical staff assistant to the general manager, and shortly afterward was promoted to quality manager.

Field joined Bendix in 1954 as assistant quality manager at the Talos plant. Previously he had served 14 years in the naval service.

**Panellit Opens On the West Coast**

PANELLIT, INC. of Skokie, Ill. opened new West Coast manufacturing facilities. The firm is a fabricator of instrument control centers, and designer and fabricator of control systems, data re-

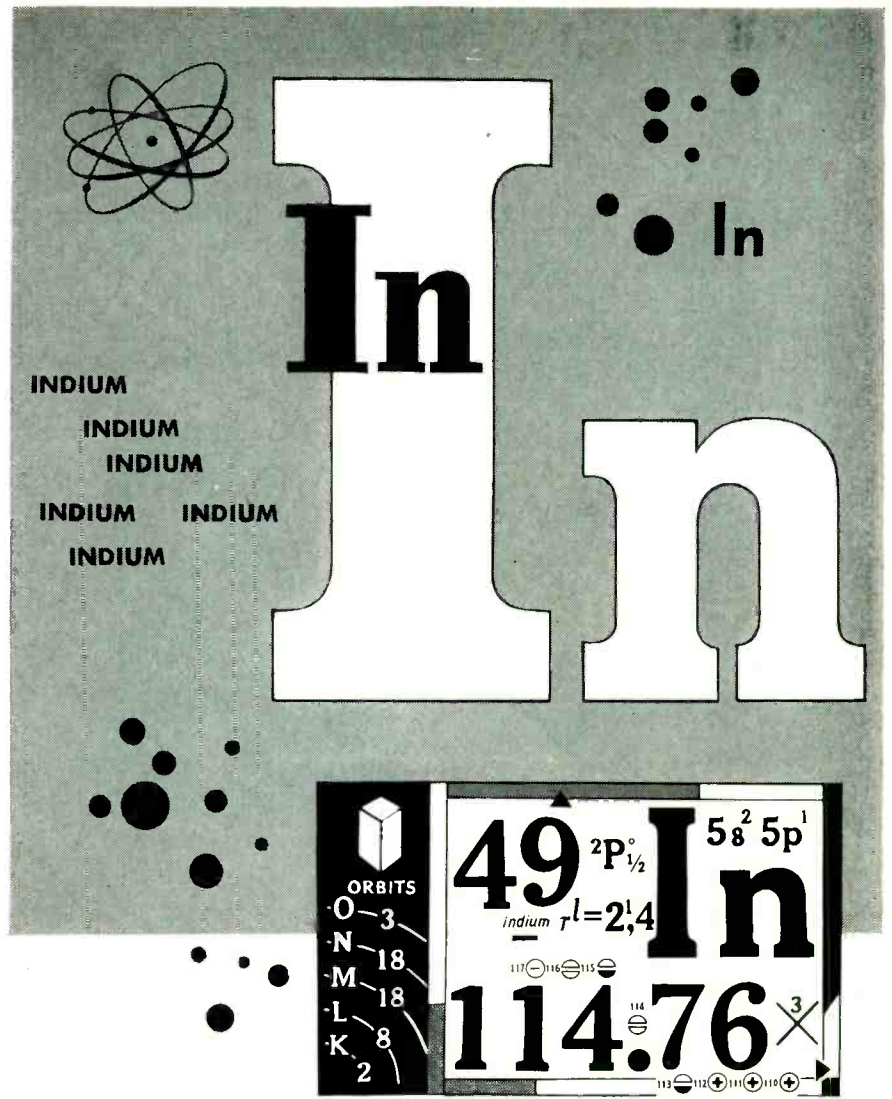

**ELEMENT OF SUCCESS**

**in revolutionary industrial and engineering advances**

**QUALITY**

at the Indium Corp. of America means: purity of metals, and strict adherence to specifications.

**SERVICE**

means prompt delivery to customers, and technical help in specific uses of Indium.

**RESEARCH**

means "forward looking" with respect to new products and new techniques.

Our files contain an imposing list of prominent metallurgists and engineers credited with startling achievements through use of Indium . . . the metal of unlimited possibilities.

INDIUM may have significant applications in your own product development.

**COMMERCIAL QUANTITIES AVAILABLE**

- Indium metal (specially refined 99.999% pure)
- Indium metal (99.97+ % pure)
- Indium wire
- Indium foil and ribbon
- "Indalloy" intermediate solders
- Indium pellets
- Indium spheres
- Indium powders
- Also other high-purity metals

**WRITE TODAY**

for new Indium Bulletin, "Nomographic Charts of Pellets and Spheres — Weights per Thousand in Grams — with Alloy Analysis Equation."

**THE INDIUM CORPORATION OF AMERICA**

1676 LINCOLN AVENUE UTICA, NEW YORK  
 Since 1934 . . . Pioneers in the Development and Applications of Indium for Industry.

# EISLER VERTICAL SPOT WELDERS

MADE IN SIZES 1/2-1-2-3-5 KVA  
WITH OR WITHOUT TRANSFORMER OR TIMER  
Sent to Any Radio Tube Manufacturer  
in U.S.A. on a 30 Day Free Trial Basis.

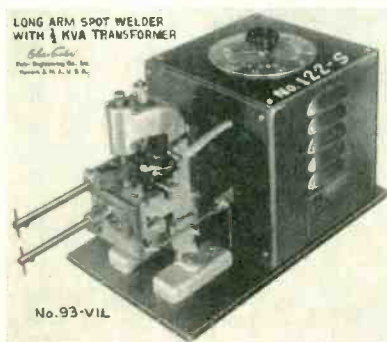
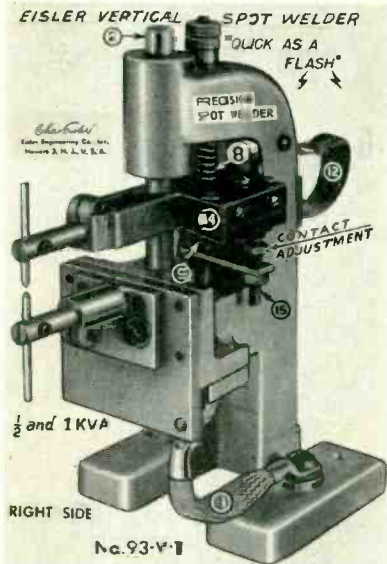

## TRANSISTOR MAKING EQUIPMENT

### DIODE MACHINERY AUTOMATIC OR SEMI-AUTOMATIC

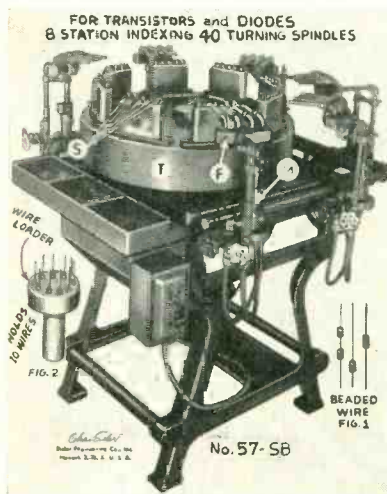

Send for Catalog Dr. Chas. Eisler, M. E. Founder  
CHAS. EISLER, JR., PRES.

**EISLER ENGINEERING CO., INC.**  
751 So. 13th St. NEWARK 3, N. J.

Want more information? Use post card on last page.  
366

duction systems and annunciators. The new plant is located in Alhambra, California. G. A. Walley was appointed chief engineer in charge of newly-opened facilities. Prior to assuming his new post, Walley was senior project engineer

for Panellit on the recently-completed instrumentation for a giant refinery. Before joining Panellit in 1951, he was associated with Jos. E. Seagram and Son, Inc., in the process and plant instrument sections.

## Baird-Atomic Appoints Driscoll



Walter G. Driscoll

WALTER G. DRISCOLL has been named vice-president in charge of research at Baird-Atomic, Inc., Cambridge, Mass.

Dr. Driscoll, formerly director of research for Baird-Atomic, will continue to supervise the company's extensive basic and applied research activity. He has been a member of the Baird-Atomic staff since 1954, after serving many years in the laboratories of the FBI and directing a number of important research and development programs for the Department of Defense.

Baird-Atomic, Inc. is the new corporate name of Baird Associates-Atomic Instrument Company. The firm manufactures spectrochemical and radioactivity instrumentation as well as electronic counting, control and test devices.

## Microwave Associates Forms Group

A NEW research and engineering group has been formed by Microwave Associates in Burlington, Mass. for the study and improvement of high power microwave switching devices.

The group is working on fundamental research and engineering directed toward improved techniques and devices. Emergence of new radar systems incorporating advanced magnetrons of enormous power output has created difficulties in switching microwave power effectively.

Chosen to head the new department which at present consists of 10 engineers and physicists is Dr. Lawrence Gould. "The problem of high power microwave switching," he said, "has unfortunately been handicapped by a lack of basic information concerning the high power behavior of a gaseous discharge. The power requirements of modern systems have actually sur-

passed the gas discharge state of the art." The new group therefore has already outlined a priority program directed toward understanding the mechanism existing in a TR tube at high power levels in the various radar bands.

## Varo Promotes Chief Engineer

VARO MFG. Co. appointed W. Dale Fuller as director of research.

Fuller is well known in Garland from his previous residence here between 1950 and 1954 at which time he was chief electronics engineer for Engineering Laboratories. His first association with Varo was in 1953 when he was employed as a project engineer on airborne power conversion equipment. In 1954 he moved to Tulsa to further his education toward his Doctor-



ates Degree, also to open his own consulting firm of SAER Labs.

He was appointed chief engineer for Varo in June of 1956, and held this post until transferred to his new position.

He started his professional career in 1943 with General Electric in their transmitter engineering department as development engineer



W. Dale Fuller

working on radar components and communication systems.

In 1947, he accepted an instructorship in the electrical engineering department at Iowa State College to gain experience in teaching and to further his education. In 1949, Fuller became associated with Engineering Laboratories, Inc. in Tulsa, Okla., as a research engineer and was promoted to chief engineer in 1950.

### Stupakoff Moves Up At Carborundum

THE CARBORUNDUM Co. announced two important management promotions. Semon H. Stupakoff, vice-president of the Carborundum Co. and formerly general manager of the Stupakoff division, has been appointed advisor to the group vice-president and the director of research & development division of the company. Robert A. Barr, formerly sales manager of Carborundum's refractories division at Perth Amboy, N. J., will succeed Stupakoff as general manager of the Stupakoff division at Latrobe, Pa.

Vice-president Stupakoff will continue to maintain an office in Latrobe. With a rich experience in

# SPECIFY *HOYT* METERS

FOR

## EVERY APPLICATION

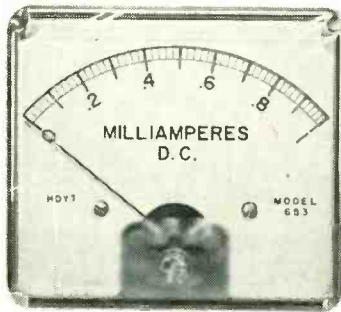

No. 653 (illustrated)

A new 3½", clear polystyrene cased meter, specially designed for modern component applications.

Be sure of highest accuracy, dependability, and readability PLUS economy with HOYT precision AC and DC instruments—the complete line of Panel Meters. Moving coil, rectifier, and repulsion types promptly available in a wide variety of sizes, ranges, cases, and colors. Also, custom designed to comply with your specifications.

Write for NEW literature containing descriptions, engineering data, and prices.



## ELECTRICAL INSTRUMENTS

Sales Div.: BURTON-ROGERS COMPANY

42 Carleton Street, Cambridge 42, Mass., U.S.A.

# RIBBONS · STRIPS

of  
★ PURE TUNGSTEN                      ★ THORIATED TUNGSTEN  
★ MOLYBDENUM                      ★ SPECIAL ALLOYS

and OTHER METALS

IN

## ULTRA THIN SIZES

to

TOLERANCES CLOSER THAN COMMERCIAL STANDARDS

by

## OUR SPECIAL ROLLING TECHNIQUE

Note: for highly engineered applications—strips of TUNGSTEN and some other metals can be supplied

## ROLLED DOWN TO .0003 THICKNESS

- Finish: Roll Finish—Black or Cleaned

- Ribbons may be supplied in Mg. weights if required

## For HIGHLY ENGINEERED APPLICATIONS

DEVELOPED AND MANUFACTURED BY

# H. CROSS CO.

15 BEEKMAN ST., N. Y. 38, N. Y.  
TELEPHONE: WOrth 2-2044  
COrtlandt 7-0470

# Langevin

## 8 Watt Audio Amplifiers



### Featuring 4 Interchangeable Input Panels

Designed for high quality sound systems, Langevin Type 138 Series low noise, low distortion Amplifiers feature self-contained power supply and plug-in type connectors. Taps on the output transformer for the entire 138 Series permit matching at 3.2, 6.4, 16, and 600 ohms. Small and compact, the 138 Series Amplifiers measure only 3 1/8" wide 5" high, and 13" long in a 16 gauge cold rolled steel chassis.

## MAXSON MAKES IT

### Specifications

Harmonic Distortion: All Models < 2.0% 30-15 KC across 6.4 ohm tap at +39 dbm

138-G (includes a preamplifier input for microphones)

Source Impedance: 30, 150, 250, 600 ohms

Gain: 96 db 600 ohms input — 600 ohms output at 1 KC

Output Noise: —63 dbm below full output

Response:  $\pm 1.5$  db 30 to 15,000 cps

138-K (includes a preamplifier equalized for G.E. or Pickering type pickups)

Source Impedance: 6800 ohms

Gain: 75.3 db bridging 600 ohms at 1 KC

Output Noise: —52 dbm below full output

138-L (includes a preamplifier input for high impedance microphones or crystal pickup)

Source Impedance: 1 megohm

Gain: 77 db bridge 600 ohms at 1 VC

Output Noise: —63 dbm below full output

Response:  $\pm 1.5$  db 30 to 15,000 cps

138-M (includes an input panel designed for bridging or cueing)

Source Impedance: 150, 600, 5,000, 20,000 ohms

Gain: 58 db 600 ohm input — 600 ohm output at 1 KC

Output Noise: —76 dbm below full output

Response:  $\pm 1.0$  db 30 to 15,000 cps

Complete specifications for 138 Series available upon request. Write: Audio Dept. 4.



## MAXSON INSTRUMENTS

47-37 Austell Place  
Long Island City 1, New York

Division of the W. L. Maxson Corporation

Want more information? Use post card on last page.

parts manufacture for the electronic industry, he will give full time to advisory assistance to the group vice-president, William H. Wendel, in behalf of the Stupakoff

and Gload divisions of the company. Stupakoff will also be an advisor to General Leslie E. Simon, vice-president of the company and director of research & development.

## Air Associates Chooses Electronics

AIR ASSOCIATES changed its name to Electronic Communications. The change signals a redirection of aims, new emphasis on electronic research as well as physical relocation of all operations.

The name Air Associates, for 30 years prominent in aviation, will be retained for an aviation supplies division of ECI. This division will carry on its original activities as a distributor of its myriad line of aviation products.

The company has established a research center in Baltimore and obtained Dr. Donald D. King, former director of the Johns Hopkins Radiation Laboratory to direct it. A new building to house the ECI laboratory is in the initial construction stage in Baltimore.

Dr. King and a staff of scientists already are concentrating on electronic counter measures research, fire control systems studies, infra-

red work and related military electronics research of an advanced development nature.

Members of ECI top management are, F. W. Godsey, Jr., president; W. R. Yarnall, financial vice-president; Charles A. Sereno, executive vice-president; Lorian W. Willey and Thomas F. Grieser, vice-presidents for material and manufacturing respectively.

Yarnall is also a vice-president of the Donner Corp. Sereno, a veteran of engineering research administration at Air Associates, was recently elevated from a vice-presidency.

Grieser came to the company from an executive position at CBS Columbia and Willey from Westinghouse.

The company plans to move all New Jersey facilities to 75 acres of land under lease in St. Petersburg, Fla.

## Cole Joins Tally Register

ROBERT A. COLE has joined Tally Register Corp. as chief engineer.

He has been supervisor of computation and data processing for Boeing Airplane's Bomarc project since its inception five years ago, and for six years prior to that time, he did similar work in the company's Gapa program.

Stuart D. Barger was named assistant chief engineer and Tedrowe Watkins was appointed to supervise administrative services.

Besides supervising actual data processing at Boeing, Cole developed certain data processing systems and procedures which have reduced the time required between flights to analyze information.

At Tally Register, he will devote much of his time to creative engineering in this special field.



Robert A. Cole

M. Ray Dilling, vice-president, who has served as chief engineer, will now devote more of his time to directing sales engineering.

Tally Register Corporation, which develops special electrical and mechanical machines for business and



## McGraw-Hill TECHNICAL WRITING SERVICE

TWS offers you a single INTEGRATED publishing service prepared to undertake a project from research and planning through finished manuscript and art, typesetting, mechanical preparation, printing and binding. Whatever the situation, whatever the type of literature you need, our editorial and art consultants can help you, bringing to your most specialized job the craft and skill of publishing experts.

## WRITING EDITING ILLUSTRATING PRINTING

TO YOUR OWN OR  
GOVERNMENT SPECIFICATIONS

Whether you need an instruction book or service manual, to accompany your equipment, written to government specifications . . . or product catalogues or training booklets . . . or annual reports . . . or company histories . . . our writing staff can do the job for you, our artists can create and execute the illustrations. And McGraw-Hill printing, binding, and paper resources are among the best in the country.

SAVE MONEY AND TIME  
LET OUR STAFF BE  
YOUR STAFF FOR  
TECHNICAL and BUSINESS  
PUBLICATIONS

ASK  
OUR REPRESENTATIVE  
TO CALL

Write • Phone

Technical Writing Service  
McGraw-Hill Book Co., Inc.  
330 W. 42nd St., N. Y. 36, N. Y.  
LOnacre 4-3000

Want more information? Use post card on last page.

ELECTRONICS — April 1, 1957

PLANTS AND PEOPLE

(continued)

industry on a contract basis, has produced four analog-to-digital data reduction systems for Boeing and is presently developing a \$150,000 all-digital system for Glenn L. Martin Co.

## HRB Expands Plant Facilities

HALLER, RAYMOND AND BROWN, INC. of State College, Pa., has begun construction on a 41,000 sq ft primary office and laboratory unit, which is scheduled for completion later this year.

Located on a 235 acre plot, the 3-story, \$400,000 building will furnish modern office and laboratory space for management and research facilities.

## General Transistor Acquires Subsidiary

GENERAL TRANSISTOR CORP., manufacturer of transistors and other semi-conductor devices, acquired an 80 percent interest in Magne-Head Electronics Co. of Los Angeles, Calif.

Under the name of General Transistor Western Corp. the subsidiary will manufacture recording heads for electronic computers and automation equipment. Recording heads for tape recorders and devices for geophysical studies and air traffic control, plus other industrial and consumer products will also be made.

Malcom Ross was elected president of General Transistor Western Corp.

He has served in various executive capacities in such firm as Emerson Radio, Sylvania Electric, Teletone and Pacific Mercury.

It is the second subsidiary acquired by General. The first, Semi-metals, Inc., became a subsidiary in 1956.

## Hallikainen Promotes Two Engineers

NORMAN S. WANER, chief engineer of Hallikainen Instruments, Berkeley, Calif. manufacturer of indus-



## New "E" Relay interchangeable with many other makes

Stromberg-Carlson's new type "E" relay combines the time-proven characteristics of the type "A" relay with a mounting arrangement common to many other makes.

As the sketch above shows, our new frame mounting holes and coil terminal spacing allow you to specify these relays—of "telephone quality"—interchangeably with brands you have been using. Costs are competitive and expanded production means prompt delivery.

Welcome engineering features of the new "E" relay are—

- ★ Contact spring assembly: maximum of 20 Form A, 18 B, 10 C per relay.
- ★ Coil: single or double wound, with taper tab or solder type terminals at back of relay.
- ★ Operating voltage: 200 volts DC maximum.

You may order individual can covers in a choice of 3 sizes for the new relay, as well as for our type "A" and "C" relays.

For complete details and specifications on the "E" relay and other Stromberg-Carlson relays, send for your free copy of Catalog T-5000R.

## STROMBERG-CARLSON

A DIVISION OF GENERAL DYNAMICS CORPORATION  
TELECOMMUNICATION INDUSTRIAL SALES  
114 CARLSON ROAD, ROCHESTER 3, N. Y.

Want more information? Use post card on last page.

# HIGHER EFFICIENCY H-F POWER TRANSFORMERS

THIS IS A TYPICAL FERROXCUBE  
MAGNETIC CORE DESIGN

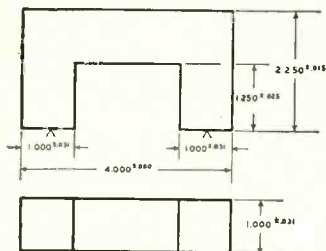

Smaller, lighter and less costly H-F power transformers of outstanding efficiency are being designed around Ferroxcube magnetic cores. The unique advantages of Ferroxcube are particularly marked in transformers required to handle up to 2 kilowatts of power in the frequency range from 2 kilocycles to 2 megacycles.

Ferroxcube-cored transformers are being used successfully in applications as diverse as ultrasonic power generators and rectifier power packs operating from an aircraft's normal a-c supply. In the latter application, the low leakage field of Ferroxcube eliminates the need for external shielding—for further reduction in transformer size and weight.

Ferroxcube cores are designed and produced to specifications. Our engineering department offers a complete, prompt service to assist in the design of Ferroxcube cores for specific applications. Your inquiry will receive immediate attention.



**FERROXCUBE CORPORATION OF AMERICA**

A Joint Affiliate of Sprague Electric Co. and Philips Industries  
Managed by Sprague

55 EAST BRIDGE STREET • SAUGERTIES, NEW YORK

Want more information? Use post card on last page.

PLANTS AND PEOPLE

(continued)

trial and scientific instruments, has been elected to the firm's board of directors. H. A. Hoebel, former president of Electro Analysis, Inc., Oakland, has been named plant superintendent of Hallikainen. Waner was partner in Specialized Laboratory Apparatus Co., Berkeley, when it was merged into Hal-

likainen two years ago. He is an inventor and University of California instructor. Hoebel, inventor of an automotive analyzer, was associated with Land-Air, Inc., and California Eastern Airways of Oakland and Electro Science, Inc., Culver City, Calif., before forming his own firm.

## Graphik Circuits Opens New Plant



Fabrication area at new Graphik Circuits plant in California

GRAPHIK CIRCUITS, West Coast manufacturer of etched circuits, formally opened their new manufacturing facility in La Puente, Calif.

The new 26,000 sq ft plant has been equipped with modern equipment.

Graphik Circuits is a division of Cinch Manufacturing Corp. in Chicago, manufacturer of electronic components. The executives of Graphik Circuits are Harry Gillespie, general manager; Spencer L. Glaspell, sales manager, and James R. Allen, chief engineer.

## Passow Rejoins Zenith Radio

ELWARD B. PASSOW has returned to Zenith Radio Corp. as head of engineering for the company's special products division.

The division is responsible for the development of new hearing aids, products for the government and other radionic and communication products being developed by Zenith.

Passow has almost twenty years experience in executive assignments in radio and television engineering.

For the past eight years, he has been director of television engineering for Motorola. Earlier, he was vice-president in charge of engineering for Majestic Radio and Television of Elgin, Ill.

From 1938 to 1946, he was chief

radio engineer of the household radio division of Zenith. He has also been chief radio engineer for Fairbanks, Morse & Co. in Chicago and later in Indianapolis.

## Litton Promotes Harvard Hull

HARVARD L. HULL, vice-president of Litton Industries, has been appointed general manager of the College Park, Maryland, subsidiary of the company. A change of name for this wholly owned subsidiary from the Ahrendt Instrument Company to Litton Industries of Maryland, has been made.

Dr. Hull was assistant general



manager of the electronic equipments division at Beverly Hills, California, since October 1, 1956. Prior to joining Litton Industries he had been vice-president for research and development, and later president of Farnsworth Electronics Company, a division of IT&T.

Dr. Hull will be the top resident executive at College Park, replacing William R. Ahrendt, founder of the company which bore his name, who requested a leave of absence in order to devote more time to personal interests.

### Datamatic Selects Manufacturing Head

LAWRENCE W. KELBLEY was appointed director of manufacturing for Datamatic Corp.

Kelbley comes to Datamatic from the Calidyne Co. where he has been plant manager since 1951. The firm manufactures large electromechanical devices and a variety of electronic equipment. Prior to association with Calidyne, he was with Curtis-Wright, Wright-Patterson Air Base and Carrier Corp.

### IBM Names Plant Manager

DANA L. KILCREASE was appointed general manager of IBM's new manufacturing plant in Essex Junction, Vermont. He previously was assistant general manager of the IBM Poughkeepsie, N. Y., plant.

The 40,000 sq ft facility, a unit of the company's data processing division, will be used for the manufacture of components for data processing machines and systems. It was obtained by IBM along with a 20-acre tract of land, under a 10-year lease with purchase option. Options to purchase an additional 240 acres of property in the area have also been obtained to provide for possible future expansion.

### Veeder Root Enters Electronics

VEEDER-ROOT of Hartford, Conn. established a laboratory in Dan-



## GOES DIELECTRIC STRENGTH

(Up to 2,500 VRMS\* as required by MIL Specs—even up to 3,000 VRMS\*)

## GOES INTERNAL TEMP. RISE

(25% cooler internal hot spot)



### NEW SAGE Type "M" (Metal-clad) "Silicohm" Resistors Give You BOTH!

If you have been stumped because miniature, chassis-mounted resistors in the past offered only 1,000 VRMS dielectric, then here's good news. Thanks to a superior, new type of filling material and new production techniques, SAGE now offers this new, improved, precision wire-wound resistor with a standard rating of 1,500 VRMS dielectric strength—and up to 3,000 VRMS on special order. And the cooler hot-spot means longer life, improved stability and greater all-around reliability.

Meet all requirements of applicable military specifications in existence or in prospect.

\*GUARANTEED (AT SLIGHT PREMIUMS)

Complete data available on request

SAGE
ELECTRONICS CORPORATION  
302 North Goodman St., Rochester 7, N.Y.

## ELECTRONIC ENGINEERS

Consider Your future with the Aeronautical Division of ROBERTSHAW-FULTON

... in Design and Development of Aircraft and Missile Control Systems and Communications Equipment.

We have immediate requirements for graduate Electrical or Electronic Engineers with 2 to 5 years experience in Servo Techniques, Transistor and/or Mag Amp Circuitry or similar projects.

With this rapidly expanding Aeronautical Division the future is bright. Send today for your copy of our brochure which details our facilities, and your opportunity with us.

Wire or Write today to:

LAWRENCE R. BIGBEE  
 Dir. of Engineering Placement  
 407 N. Manchester, Anaheim, California



Aeronautical Division  
**Robertshaw-Fulton**  
 CONTROLS COMPANY

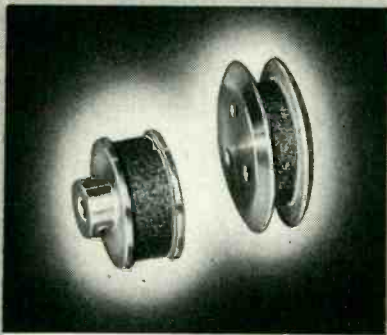

### PRECISION FRICTION DRIVE, GUIDE & TAKE-UP WHEELS FOR RECORDERS

By **UNIWAVE**

- Available in steel, stainless steel, brass, aluminum and all plastics.
- Variety of drive surfaces including bonded or cemented rubber and even abrasive coatings if desired.
- With or without precision ball bearings.
- For all widths of tape, paper and wire.
- Finishes ranging from polished chrome to beautiful anodized colors.
- Will meet government and commercial inspection standards.

May we quote your requirements?

#### UNIWAVE'S SPECIALIZED FACILITIES

UNIWAVE has engineering and manufacturing facilities particularly suited to the production of special components.

For further information contact —

## UNIWAVE, INC.

2 Marine Street  
Farmingdale, N. Y. — Tel. CHAPEL 9-8180

## I Bought My Wife a Sports Car with the EXTRA MONEY



I earned in Mobile-Radio Maintenance!

Sure, an engineer's pay is good—but mine just wouldn't stretch far enough to give my family all the nice things they deserve. So in my spare time I'm servicing commercial mobile-radios in my home town. And I'm mighty proud to think of my wife driving that new Thunderbird!

This can be your story, too. Send coupon for your free copy of "HOW TO MAKE MONEY IN MOBILE-RADIO MAINTENANCE." Published by Lampkin Laboratories, Inc., manufacturers of the 105-B Micrometer Frequency Meter & 205-A FM Modulation meter. Easy monthly payment plan available!



LAMPKIN LABORATORIES, INC.  
Instruments Div., Bradenton, Fla.

At no obligation to me please send "HOW TO MAKE MONEY IN MOBILE-RADIO MAINTENANCE."

Name \_\_\_\_\_  
Address \_\_\_\_\_  
City \_\_\_\_\_ State \_\_\_\_\_

Want more information? Use post card on last page.

vers, Mass. for the design and development of electronic controls, counters and instruments.

The new laboratory is under the direction of James W. Farmer, recently head of the electronics department of the Post Machinery

Company, manufacturers of paper boxmaking machinery. He has also done work in electronics at M.I.T.

This new enterprise is an extension of Veeder-Root's work in the design and manufacture of counters, computers, and control devices.

## Granger Selects Two Engineers

GRANGER ASSOCIATES appointed William E. Ayer as vice-president and director of engineering and Hugh D. Kennedy as production manager.

Dr. Ayer has been a research associate with Stanford University's Electronics Laboratories for the past six years. In 1955 he was made supervisor of the Stanford group's program in systems development.

Immediately following his service career he was an engineer with Mackay Radio & Telegraph Co., Palo Alto, where until 1951 he was responsible for the development

and design of antennas and associated distribution systems for the company's point-to-point and ship-to-shore communications systems.

Kennedy joined Granger Associates from Sierra Electronic Corp., San Carlos, where he was production engineer from 1953 to 1956.

Previously he was a production control engineer for the Hewlett-Packard Co. of Palo Alto and a production foreman for the AC Spark Plug division of General Motors Corp. at Milwaukee, Wis., where he dealt with the manufacture of airborne bombing and navigational computers.

## Consolidated Appoints Chief Engineer

DONALD E. BROWN was appointed chief engineer of Consolidated Electrodynamics Corp.

The division formerly was R. A. Castell & Company, specializing in the development and manufacture of a series of miniature electrical connectors of the type used in missiles. The firm, located in Glendale, Calif. was acquired by Consolidated in December, 1956.

Brown joined CEC a year ago

as an engineering specialist in advanced electronic techniques. Previously, he was an engineer with the Johns Hopkins Applied Physics Laboratory and Vitro Corporation, both of Silver Spring, Maryland.

## Motorola Changes Division Headquarters

MOTOROLA INC., has moved several of its divisional headquarters on the East and West coasts. The eastern Communications and Electronics headquarters has moved from Fort Lee to Ridgefield, N. J. The unit houses credit, administration and accounting offices servicing two-way radio and industrial products customers in a 15 state area.

The company's West coast headquarters was also moved from San Mateo, Calif. to a new and larger building at Burlingame, Calif. Decentralizing certain administrative procedures formerly handled at the



D. E. Brown



Chicago general office is another goal in the move. Ten western states are handled from the new office. Executives located there include the divisional sales and service managers for consumer products, and the regional manager and radio communications engineers.

### Weston Elects Executive V-P

WALTER W. SLOCUM was elected executive vice-president of Weston Electrical Instrument Corp. He was previously vice-president of operations of Daystrom, Inc., of which Weston is a wholly-owned subsidiary.

Slocum has been a member of the Weston board of directors since



Walter W. Slocum

1955 and has also served as president of Daystrom instrument division. Prior to joining Daystrom he was president of W. W. Slocum & Co., industrial engineers, and held general management positions with Day & Zimmerman in Philadelphia and the J. G. White Engineering Corporation, New York.

### San Francisco Firm Names Research Head

DONALD E. BENTLEY has been named director of research for Electrical Communications, Inc. of San Francisco. Formerly project engineer for Donner Scientific Co. One of his first projects will be transistorizing the products produced by the firm.

# GRC small nylon coil bobbins

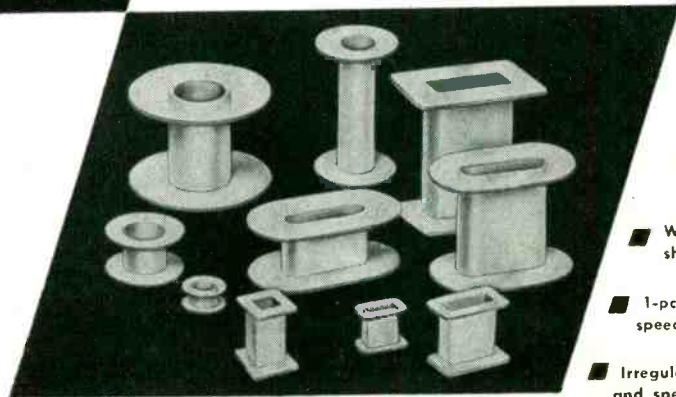

- Wide range of shapes and sizes
- 1-pc. Nylon molding speeds winding
- Irregular shapes and special materials to order

## NOW available from stock

Accurate, uniform, ready-for-use

WRITE FOR FULL INFORMATION

NOW Gries offers a wide variety of nylon coil bobbins from stock. Automatically mass produced at low cost—ready for use. Stock sizes from 1/4" diameter x 1/4" long minimum up to 7/8" diameter x 7/8" long—round, square, rectangular, oval shapes. Check Gries for your bobbin needs—either from stock—or to your size, shape and material specifications on special order.

See us at Booth 421  
Design Engineering Show May 20-23rd, N. Y.

### GRIES REPRODUCER CORP.

151 Beechwood Ave., New Rochelle, N. Y.  
NEW Rochelle 3-8600



World's Foremost Producer of Small Die Castings

## IF IT'S NEW...IF IT'S NEWS...IT'S FROM ELCO



VARICON'S SECRET

*New Idea*

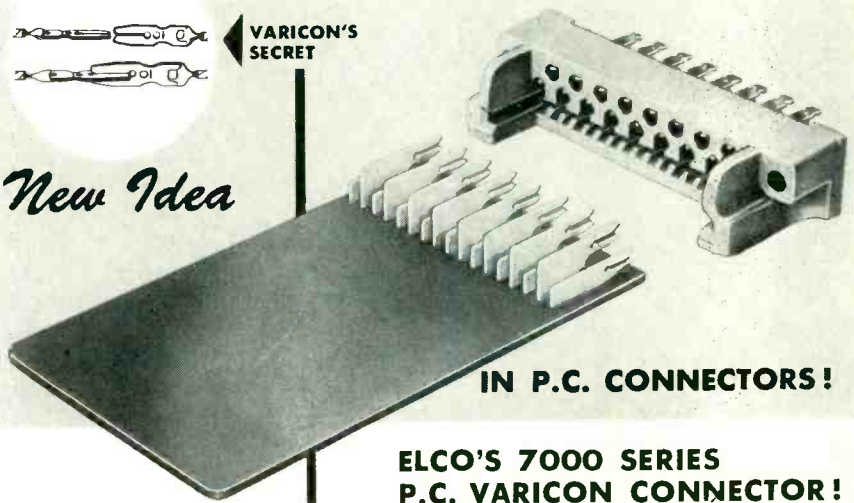

**IN P.C. CONNECTORS!**

**ELCO'S 7000 SERIES P.C. VARICON CONNECTOR!**

Contacts are staked directly into printed circuitry providing independent mechanical bond. Current Rating: 7 amps. Withstanding Voltage (sea level): 2,000 volts R.M.S. Contact Resistance: .002 ohm (unchanged after thousands of matings). Spacing at .100 centers provides maximum number of contacts in minimum space. Available in 17 contacts; other sizes under development.

(See Inset) Varicon's better conductivity results from large contact area and contact pressure at all times from all 4 sides.

For Detailed Bulletins: ELCO CORPORATION, M below Erie, Phila. 24, Pa., CU 9-5500

## New Books

# For PILOT LIGHTS

CONSULT

# DIALCO

Your product benefits  
3 ways from the use  
of a DIALCO Pilot Light:

**Enhanced appearance:**  
The glow of light and  
sparkle of a lens add  
colorful visual attraction.

**Greater safety:** A timely  
warning flashed by a  
pilot light can prevent  
damage to equipment.

**Added service:** Discs  
inserted behind lenses  
can be used to deliver  
specific messages, such  
as "FUEL LOW",  
"ON", "OFF", etc.

Let the Dialco engi-  
neering department as-  
sist you in selecting  
the *right* lamp and  
the *most suitable* pilot  
light for your needs.

Dialco offers the com-  
plete line of pilot  
lights, from sub-mini-  
ature types to giant  
units with 1½" lenses.

Every assembly is avail-  
able complete with lamp.

**SAMPLES ON RE-  
QUEST AT ONCE —  
NO CHARGE**

Illustrations are ap-  
prox. 70% actual size  
... (A) No. 8-1930-  
111 sub-miniature  
pilot light... (B) No.  
521308-991, with mul-  
titude cap... (C) No.  
922210-111, dimmer  
type... (D) No. 47901  
with light shield cap.

Write for latest cata-  
logues and Design Bro-  
chure.



Foremost Manufacturer of Pilot Lights

# DIALIGHT

CORPORATION

60 STEWART AVE. • BROOKLYN 37, N. Y.

HYACINTH 7-7600

PLANT AT  
BROOKLYN, N. Y.

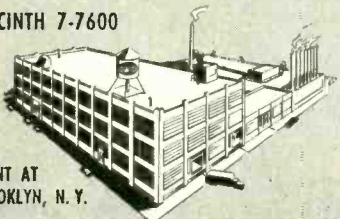

Want more information? Use post card on last page.

## Frequency Modulation Engineering

BY CHRISTOPHER E. TIBBS AND  
G. G. JOHNSTONE.

*Second Edition Revised*  
John Wiley and Sons Inc., 1956, 432 p.,  
\$8.50.

THIS new addition to the literature on frequency modulation represents an expansion and reworking by G. G. Johnstone of the original "Frequency Modulation Engineering" by Christopher E. Tibbs, first published in Great Britain in 1947 by Chapman and Hall Ltd. The need for the revision arose from the extensive additions to the literature in the last ten years and the change in emphasis caused by moving the f-m band from the 40-mc. to the 100-mc region in the post-war period.

► **Format**—The format of the book remains unchanged, containing eleven chapters, with the chapter titles identical to those of the original edition. In size, the revision has been expanded from 304 pages to 432 pages with the sections on f-m theory, propagation, aeri-als and receivers being the chief beneficiaries. The book has profited by the revision and although there are some important deficiencies, the book is a useful tool for engineers and students interested in the field of frequency modulation.

The first four chapters are concerned with a brief historical introduction and the theory of frequency modulation of a carrier wave, interference, noise structure and interference suppression. The subject matter covered in these introductory chapters is well presented and provides in one place a nice package introduction to f-m. For the interested reader, references are provided at the end of each chapter.

The chief deficiency in this theoretical section is the inadequate discussion of distortion in tuned circuits, since the means used relies on the side-band approach. Although the text handles this problem in an empirical way for the broadcast field, if the engineer is to design for other f-m applications, he must look elsewhere.

The chapters on propagation and aeri-als seem adequate both as to content and references considering the scope of the book.

► **FMQ System**—In the chapter on transmitters, an extensive review is made of the various approaches to frequency or phase modulation. Novel to American readers is the description of the fmq (frequency modulated quartz) system used by the Marconi company in their transmitters. The phasitron has a place only in the references and mention of the Serrasoid is omitted entirely.

The chapters on limiters, discriminators and f-m receivers represent the major portion of the expansion of the book and here a good job has been done. Where further information is necessary, the references will suffice.

To complete the book, the authors have included a few pages on f-m measurements and enumerated some practical uses of f-m. The latest references for these sections are dated 1946.

The book is a worthwhile addition to the library of the engineer and students interested in f-m. Future editions would be improved by including a more quantitative discussion of distortion, high-capture receivers of the Arguimbau type, the theory of the Serrasoid phase modulator, f-m multiplexing and the growing use of f-m in scatter circuits. JOHN H. BOSE, *Columbia University, N. Y.*

## Operations Research, Armament, Launching

BY GRAYSON MERRILL, HAROLD GOLDBERG, ROBERT H. HELMHOLZ.  
*D. Van Nostrand Book Company, Inc.,*  
1956, 508 p., \$10.00.

THIS text, the third in a series on the principles of guided missile design, provides a valuable insight into areas of guided missile engineering normally not available to the electrical engineer. While none of the book's technical material is electronics, much of the data presented therein has a definite and direct application to electrical engi-



neering personnel who play a part in preparing proposals or specifications or who are involved in the procurement of missile guidance equipment.

The book is divided into three distinct subsections, treating material on operations research, armament and launching respectively.

► **Operations Research**—This portion of the text, which comprises 40 percent of the page count, appears to be the most generally useful and absorbing section. It provides a keen insight into the determination of an operations research requirement and subsequent performance specifications for a proposed missile weapon system. It takes the engineer away from detailed missile design and makes him think in terms of the overall weapon system operational suitability and the tactical doctrine associated with missile usage. Above all, it provides in a clear, concise and simple way the mathematical background for performance of an operations research analysis on a contemplated or existing weapons system. At all times the emphasis is directed to the weapons system point of view.

A large area of the section on operations research is devoted to the theory of random elements, distribution laws and game theory. The mathematics of the more common statistical distribution laws are presented and subsequently applied in examples of operational analysis. These examples include calculation of vectoring errors involved in aircraft interception problems, the derivation of missile performance envelopes and data on missile kill probabilities. A particularly fascinating discussion of the mathematics of battle and Lancaster's equations on the strength of a military force yields valuable and thought provoking data of great utility in systems planning problems.

► **Armament**—The section of the book devoted to armament provides, to personnel concerned with overall missile system effectiveness, evaluation data on target vulnerability, warheads and warhead fuzing. The relationship and interdependence of armaments and guidance is clearly



# Welwyn

## High Stability Resistors

DEPOSITED CARBON

MINIATURE POTENTIOMETERS

GLASS SEALED HIGH VALUE WELMEGS

VITREOUS ENAMEL COATED WIRE WOUND

ENCAPSULATED DEPOSITED CARBON RESISTORS

Welwyn precision products are manufactured in Canada and England. They are designed and constructed for the most exacting electronic requirements. These standards are uniformly maintained through rigid quality controls.

Please address communications to Dept. ND-7

**Welwyn International, Inc.**

3355 Edgecliff Terrace, Cleveland 11, Ohio

for service and lab. work

### Heathkit

PRINTED CIRCUIT

## OSCILLOSCOPE KIT

FOR COLOR TV!

① Check the outstanding engineering design of this modern *printed circuit* Scope. Designed for color TV work, ideal for critical Laboratory applications. Frequency response essentially flat from 5 cycles to 5 Mc down only 1½ db at 3.58 Mc (TV color burst sync frequency). Down only 5 db at 5 Mc. New sweep generator 20-500,000 cycles, 5 times the range usually offered. Will sync wave form display up to 5 Mc and better. Printed circuit boards stabilize performance specifications and cut assembly time in half. Formerly available only in costly Lab type Scope. Features horizontal trace expansion for observation of pulse detail — retrace blanking amplifier — voltage regulated power supply — 3 step frequency compensated vertical input — low capacity nylon bushings on panel terminals — plus a host of other fine features. Combines peak performance and fine engineering features with low kit cost!

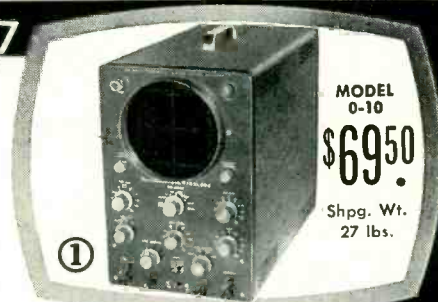

### Heathkit TV

## SWEEP GENERATOR KIT

ELECTRONIC SWEEP SYSTEM

② A new Heathkit sweep generator covering all frequencies encountered in TV service work (color or monochrome). FM frequencies too! 4 Mc — 220 Mc on fundamentals, harmonics up to 880 Mc. Smoothly controllable all-electronic sweep system. Nothing mechanical to vibrate or wear out. Crystal controlled 4.5 Mc fixed marker and separate variable marker 19-60 Mc on fundamentals and 57-180 Mc on calibrated harmonics. Plug-in crystal included. Blanking and phasing controls — automatic constant amplitude output circuit — efficient attenuation — maximum RF output well over .1 volt — vastly improved linearity. Easily your best buy in sweep generators.



# Using Thermistors

Edited by  
FENWAL ELECTRONICS

Thermistors, with their almost incredible sensitivity to temperature change, now get a news column all their own.

The cases in point for the first column: temperature measurement and temperature control.

Three basic circuits for temperature measurement with thermistors:



FIG. 1

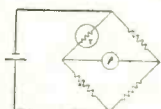

FIG. 2

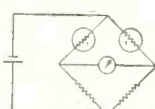

FIG. 3

The first is a battery, a thermistor, and a micro-ammeter. The second, more sensitive, has a thermistor as one leg of a bridge circuit. The third incorporates two thermistors in a bridge, making possible even more precise temperature differential measurements.

Two basic circuits for temperature control with thermistors:



FIG. 4

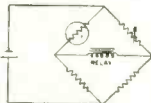

FIG. 5

The first has a thermistor in series with a relay, a battery, and a variable resistor. By adjusting the resistor, it is possible to make the relay operate at any desired temperature of the thermistor.

The second is more sensitive, and has a thermistor as one leg of a bridge circuit, a variable resistor in another leg, and a polarized relay across the output. Even more sensitive control can be had by applying AC to the bridge and placing a high-gain amplifier between the bridge and the relay.

*Designers:* if you are not already familiar with the tremendous possibilities of thermistors, write for details to FENWAL ELECTRONICS, INC., 23 Mellen St., Framingham, Massachusetts.



Makers of Precision Thermistors

Want more information? Use post card on last page.

brought to view. The mathematical tools developed in the first sections are used here in an analysis of target kills and target vulnerability.

A classification of warheads by type and function which includes information on the chronological development of atomic explosions immediately after detonation is of singular significance. Armament system engineering as applied to redundancy and its attendant effects upon fuze accuracy is included in this section. Computations involving probabilities for various series and parallel combinations in fuzing are considered.

► **Launching Systems**—The last 25 percent of the book is devoted to missile launching systems, their characteristics and the basic design principles involved in their selection to meet a specific requirement. The principles involved in design of airborne and ground launchers are considered along with the characteristics of various launching systems as applied to the guidance system employed. Various booster arrangements are considered and sample computations involving impulse, thrust and duration of burning give valuable insight into orders of magnitudes.

In general, the book is clearly written, carefully edited, well illustrated and is recommended for reading by persons involved in the specialties treated, those concerned with overall weapon system synthesis, design, or procurement, and those who must have a general technical understanding of the full scope of guided missile technology.

—A. E. NASHMAN, *Federal Telecommunications Laboratories, Nutley, N. J.*

## Linear Transient Analysis Vol. II

BY ERNST WEBER.

John Wiley & Sons, New York, 1956, 442 p., \$10.50.

PRACTICING engineers, as well as teachers and students of engineering, will welcome the publication of this textbook because the two-volume set "Linear Transient Analy-

sis" by Ernst Weber is now complete. These two books furnish a complete and definitive treatment of the time response of linear systems. The physical and mathematical aspects of the analysis of such systems are presented clearly, completely, logically and with a readability which reveals many years of successful teaching experience on the part of the author.

► **Scope**—In Volume I, lumped parameter two-terminal networks are treated. Volume II deals with two-terminal pairs and transmission lines. Thus the contents of this set suits the usual first year graduate electrical engineering course in linear systems.

The introductory section of this book consists of a chapter in which the Fourier and Laplace transform methods are concisely reviewed; hence Volume II stands as a complete work, independent of its earlier companion.

► **Networks**—The first major section deals with two-terminal pair networks. First a complete exposition of the several methods which are used to describe such networks is given. Examples of response calculations make up the bulk of this section and such items as response to frequency modulated as well as to amplitude modulated signals are treated. Active, as well as passive, systems are included.

Examples are carefully chosen to include vacuum tube and transistor circuits as well as feedback amplifier theory.

A chapter of basic transmission theory is included. The Fourier transform is used in conjunction with idealized transmission characteristics so the frequency domain-time relationship is firmly established.

A discussion of the realizability criteria of network characteristics is given. An intensive treatment of wave filter structures makes the lumped-parameter section complete.

► **Transmission Lines**—The second major section of the book deals with transmission lines. Infinite and finite lossless and distortionless lines are first presented, using both the standing wave and travel-



## You Get Things Done With Boardmaster Visual Control

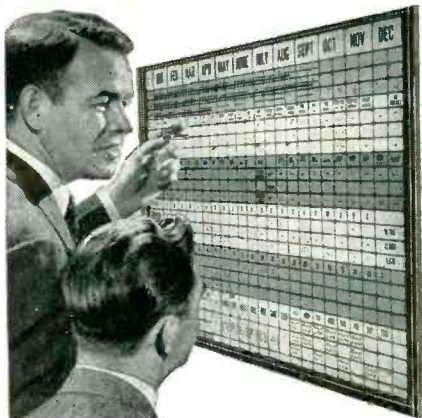

- ☆ Gives Graphic Picture of Your Operations Spotlighted by Color
- ☆ Facts at a glance — Saves Time, Saves Money, Prevents Errors
- ☆ Simple to operate — Type or Write on Cards, Snap in Grooves
- ☆ Ideal for Production, Traffic, Inventory, Scheduling, Sales, Etc.
- ☆ Made of Metal. Compact and Attractive. Over 100,000 in use.

Complete price **\$49.50** including cards

**FREE** 24-PAGE BOOKLET NO. C-40 Without Obligation

Write for Your Copy Today  
**GRAPHIC SYSTEMS**

55 West 42nd Street • New York 36, N. Y.

## Lepel HIGH FREQUENCY Induction HEATING UNITS

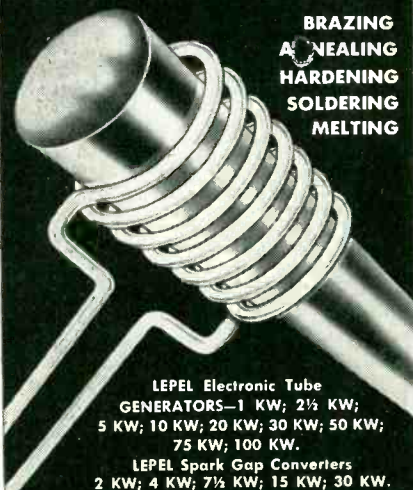

**BRAZING  
ANNEALING  
HARDENING  
SOLDERING  
MELTING**

LEPEL Electronic Tube GENERATORS—1 KW; 2½ KW; 5 KW; 10 KW; 20 KW; 30 KW; 50 KW; 75 KW; 100 KW.

LEPEL Spark Gap Converters 2 KW; 4 KW; 7½ KW; 15 KW; 30 KW.

WRITE FOR THE NEW LEPEL CATALOG . . . 36 illustrated pages packed with valuable information.

All Lepel equipment is certified to comply with the requirements of the Federal Communications Commission.

**LEPEL HIGH FREQUENCY LABORATORIES, INC.**

55th STREET and 37th AVENUE, WOODSIDE 77, NEW YORK CITY, N. Y.

Want more information? Use post card on last page.

ELECTRONICS — April 1, 1957

NEW BOOKS

(continued)

ling wave forms of the solutions. A full treatment of certain non-ideal and low-loss lines completes the book.

A large number of examples are completely worked out in the text to illustrate the technique used in the solution of systems defined by partial differential equations. In addition, the results obtained in the solution of these examples will extend the student's knowledge of such phenomena beyond the standard undergraduate level. This comment, in fact, applies consistently to all the examples in the text.

In the latter sections, the detailed presentation of the inversion process, when the Laplace transform of the time function is irrational, should prove of especial value in the classroom.

The bibliography is particularly useful because comments concerning the strong points of each reference are made. The appendices on notation, functions of a complex variable and other mathematical aids are reproduced from Volume I. Unfortunately the tables of transforms are not collected in one place, such as in an appendix, but are scattered throughout the text. At the end of each chapter, an extensive collection of problems is given.

As was intimated at the outset, this reviewer feels that "Linear Transient Analysis" will serve to strengthen the graduate education of electrical engineers in this country noticeably, particularly through the successful merging of advanced mathematical tools and basic physical concepts which make this such an outstanding book.—EGON BRENNER, *The City College, New York 31, N. Y.*

## Handbook of Industrial Electronic Control Circuits

By JOHN MARKUS and VIN ZELUFF. McGraw-Hill Book Co., Inc., New York, 1956, 352 p., \$8.75.

THIS volume combines the best of the industrial electronic control circuits which have appeared in ELECTRONICS over an eight-year period (1948 to 1955). It is a sequel to "Handbook of Industrial Electronic

# HEAVY DUTY MINIATURE RELAYS

## for Industrial Reliability

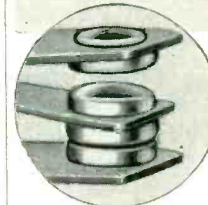
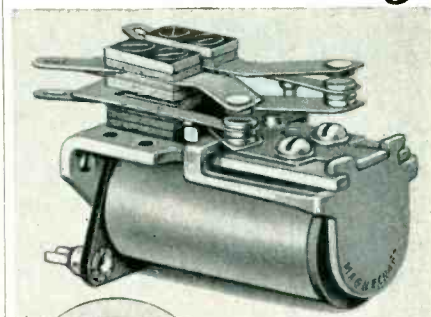

Special heavy duty contact arms and contacts switch 10 amperes (non-inductive) reliably in heavy duty service.

Contact combinations up to 4PDT for DC operation and DPDT for AC. Operating voltages to 230 V, DC and 440 V, 60 C.

Resistance to shock, vibration and temperature change to meet military specifications.

Heavy duty contacts can also be furnished in combinations with normal or low level signal load contacts.

Available with plug-in mounting, also dust tight or hermetically sealed enclosure.

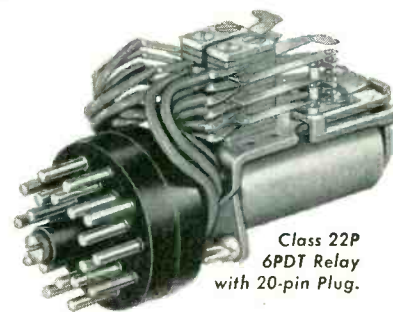

Class 22P  
6PDT Relay  
with 20-pin Plug.

## Magnecraft Plug-in Relays

- Simplify wiring — may be plugged in after equipment is installed.
- Easily removed or replaced — no special skill or equipment required.
- Permit inspection, testing or adjustment with negligible down time.

Available for wide range of requirements. Tell us what you need or send for catalog.

**MAGNECRAFT**  
Electric Company

3350B W. Grand, Chicago 51, Ill.

Want more information? Use post card on last page.

377



Circuits", published in 1948.

Each circuit is appropriately labeled and has sufficient explanatory text for ready comprehension. The book is completely nonmathematical except for a few simple formulas. The diagrams are easy to follow and are well placed with respect to the text. The type is clear and easily read; the paper is of excellent quality.

The book is directed both toward the young engineer just out of college and to the instructor in engineering who might wish to supplement theory with a study of practical circuits. The diversity and recency of the material makes it helpful to the experienced engineer as a time-saver in designing the circuit he must use.

The text is divided into 20 chapters, arranged alphabetically, each concerned with a different subject which is amply illustrated by circuit designs. The number of circuits in each chapter varies with the importance of the subject under discussion. The chapter on transistors has 40 circuit designs. In spite of the great diversity of articles, there is comparatively little duplication in either circuitry or application.

► **Indexing**—There is an extensive cross-reference index, both author and subject, for quickly locating any desired circuit. The subject index is sufficiently thorough to allow one to locate several different modes of application for any circuit element or configuration one may wish to study. A source reference is also given with the text of each diagram so a more thorough study can be made of the subject if desired.

The functions covered in the different chapters are: amplifiers, capacitance control, cathode-ray control, counting, measuring, motor control, multivibrator, oscillator, photoelectric, power supply, radiation, remote control, sorting, timing, transistor, ultrasonic control and welding control. The individual circuits in any one chapter are as varied as the chapter headings themselves.

In the chapter on amplifier circuits, units are described which are best suited for low or high frequen-



## Specialists IN STAMPING AND DRAWING

- KOVAR • RODAR
- THERLO • FERNICO
- Other IRON-NICKEL-COBALT Alloys

### COMPLETE FACILITIES FOR PRECISION PRODUCTION OF ELECTRONIC COMPONENTS

Our facilities are geared to meet your production and engineering needs for components of any description. Unusually Complete Tool Room • Press Shop • Hydrogen Annealing, Machining and Polishing Operations • Glass-to-Metal Hermetic Sealing. Production of completed parts ready for assembly in your own plant.

A complete service in our plant  
means prompt service to your plant.

### CUT TOOLING COSTS!

Over 3,000 high precision tools and dies available to reduce your initial tooling time and costs.

Call on us for free consultation and quotations.

**ZELL PRODUCTS CORP.**  
279 Main Street, Norwalk, Conn.

**RESEARCH**

**Electronic Engineers**

CAREER FULFILLMENT  
IS A MAXSON TRADITION

Too often ability and ambition go unrecognized simply because an engineer is associated with an organization whose scope is too shallow to permit complete expression. We sincerely believe that the currently expanding activities of The W. L. Maxson Corporation offer the creative engineer a limitless range of assignments for career fulfillment.

**DEVELOPMENT**

**MAXSON**

Responsible positions now available in the fields of research and development. Kindly send resume and salary requirements to:

Mr. L. W. Albright  
Technical Placement Manager

**THE W. L. MAXSON CORPORATION**

460 W. 34th St.,  
New York 1, N. Y.



cies and with linear or purposefully nonlinear characteristics. Capacitance control circuits are designed for various process controls and laboratory usage.

► **Counters**—Much space is given to the subject of counting which is becoming so important in manufacturing processes. Various types of counters are given as well as circuits for increasing their accuracy and speed. The direct-current amplifier circuits, both simple and involved, employ a number of stabilization methods to laboratory and production.

In addition to ordinary tube circuitry, control methods of motors with speeds from simple positioning to 50,000,000 rpm include such transducers as magnetic tape and photocell pickups to feed through such power devices as thytrons and magnetic amplifiers.

Different types of multivibrator circuits are used in pulse generator, electronic switches, square wave generators, flash lamp apparatus, etc. Various oscillator circuits are given and uses for them suggested, including telemetering, data recording, frequency measurements, wave shaping. Photoelectric circuits are used in quality control, lighting control, sorting devices and width and thickness gauges.

The section on power supply circuits leans more toward the subject directly with very few applications. Circuits presented in the chapter on radiation control are few in number but important industrially: punch-press safety devices, warning against dangerous radiation, demonstration and test equipment. Remote control circuits perform such important functions as telemetering from hazardous areas, but are also used in model railroads and model boats. Sorting circuits of varying complexity, employing thytrons and ordinary vacuum tubes, are used in dimension-measuring gauges and in the manufacture of electronic parts. Temperature control circuits are given for use in homes, heat treatment of steel, refrigeration, and permanent waves.

► **Timing Circuits** — Production controls, computer servo systems, and ballistics photography are in-

*Zell*

**Compression and Kovar Type  
HERMETIC SEALS**  
"The Seal of Excellence"

Meeting the ever-increasing standards of perfection established by the electronics industry is a challenge admirably met by Zell's highly skilled engineers. They are able to exercise unusually rigid quality controls because all production operations are carried out in Zell's own completely equipped, ultra modern plant.

**ZELL Hermetic Seals Enjoy These Desirable Characteristics:**

- ★ High resistance to mechanical and thermal shock.
- ★ A stable finish that protects seals against corrosive atmospheres. ZELL'S GOLD PLATE WITHSTANDS THE MOST STRINGENT TRANSISTOR ETCH TESTS DEvised.
- ★ Excellent electrical properties. ★ Tight dimensional tolerances.
- ★ Easy weldability and solderability.

**ALL FACILITIES UNDER ONE ROOF**

- Complete tool room facilities.
- 65 Power Presses (to 50 tons).
- Double stage annealing-fusing furnaces.
- Advanced plating facilities for Nickel, Gold, Tin, Cadmium, Copper, Silver, etc.
- Complete glass facilities.
- Mass Spectrometer leak testing.

ZELL engineers control every process every step of the way, assuring uniform quality and performance.

*Specialists IN*  
**STAMPING AND DRAWING**  
KOVAR — RODAR — THERLO —  
FERNICO AND OTHER ALLOYS

Write us for **FREE** Technical Consultation and Information.

**ZELL PRODUCTS CORP.**  
279 Main Street, Norwalk, Conn.

The completeness of our facilities assures the completeness of your satisfaction!

## Make springs yourself . . . fast, exact! WITHOUT USE OF ARBORS

For a replacement or experimental spring, any shape, diameter or pitch from flat or round wire sizes .005" to .125", you can produce it in a matter of seconds with Perkins Precision Spring Coiler. You eliminate arbors, yet turn out precision springs — torsion, compression, extension, tapered, or special springs, coiled either

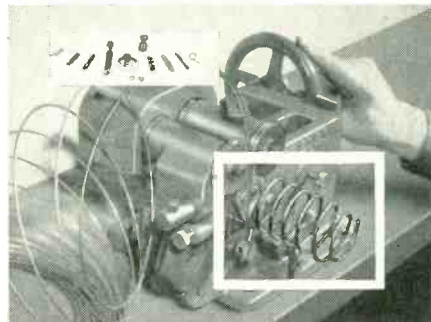

left or right hand, in any desired length, any diameter from 3/32" to 12" and larger, with or without initial tension, and with open or closed ends. Eliminate expensive special orders and costly production delays! Make your own springs to exact specifications as replacements or experimental work. Make them fast, right in your own shop!

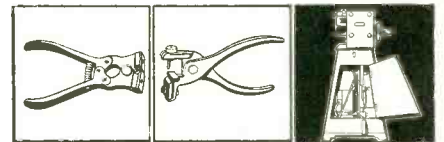

Starret adjustable jaw cut nippers (left) and Gardener Hook-Kon spring looping tool (center) — handy, precision, time-saving accessories for spring coiling. Perkins Spring Coiler available as bench model or power model shown here, (right) for tool shop or continuous runs.



**PERKINS**  
MACHINE AND GEAR CO.

Special Machinery Division,  
West Springfield, Mass.

Perkins Machine and Gear Co.  
Special Machinery Division, Dept. C3  
W. Springfield, Mass.  
Please send information and prices on  
Perkins Spring Coiler.  
Hand Model  Power Model

Name..... Title.....  
Company.....  
Address.....  
City..... State.....



A personal tool for every engineer

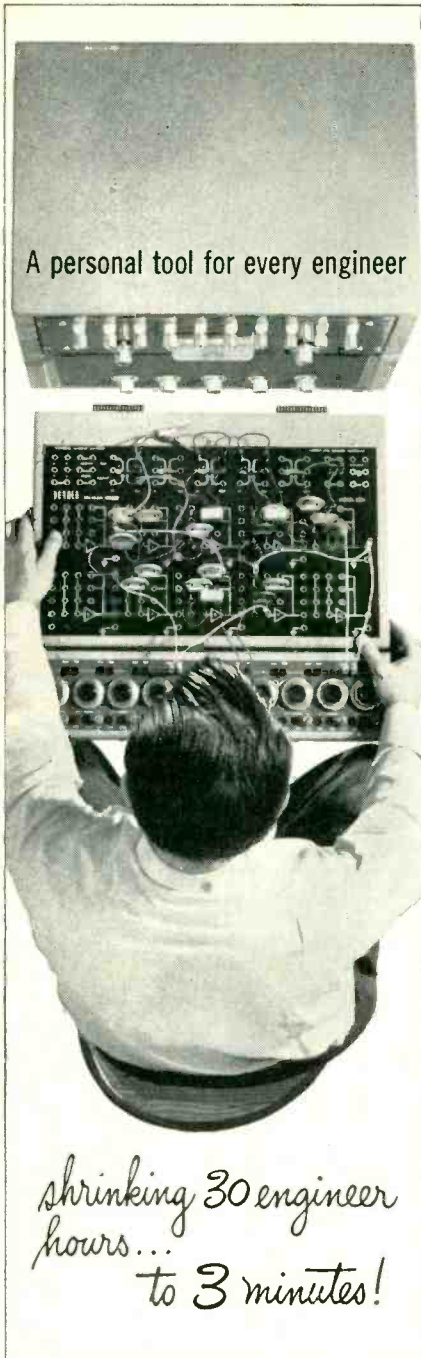

shrinking 30 engineer hours...  
to 3 minutes!

### ANALOG COMPUTER MODEL 3000

Simplified analog computer solves wide variety of engineering problems. Detachable problem boards and plug-in components facilitate rapid problem set-up.

Can be expanded building block fashion to larger computing system. Function generator, multiplier, chopper stabilizer, and other accessories available. Write for complete data. Model 3000, \$1150, FOB Factory. Problem board \$95

**DONNER** SCIENTIFIC COMPANY  
806 Galindo Street  
Concord, California

Want more information? Use post card on last page.  
380

cluded in the chapter on timing circuits. These circuits control flash lamps or operate relays by thyratrons, phantastrons, phototubes, and other circuit elements.

The chapter on transistors is one of the longest in the book. Transistor circuits include amplifiers, modulators, high-voltage power supplies, many types of oscillators, flip-flops, and decade counters. Some of the applications include servo systems, geiger counters, analog and digital computers and telemeters. In the chapter on ultrasonic controls is shown a circuit of an oscillator with a frequency range of one to 120,000 cps and circuits performing tire inspection, acting as burglar alarms and controlling slide projectors.

Some of the errors noted in the diagrams are: omission of decimal points; omission of connecting lines; insertion of unnecessary connections; omission of values of some components and deletion of tube and transistor types. The heading of one article (p 31) was found to be misleading as it states that "A Synchronized Electronic Switch Uses Square-Wave Generator Instead of Multivibrator", but the circuit shows the square-wave generator built around an Eccles-Jordan binary flip-flop, a form of multivibrator.

In the circuit on "Precision Interval Timer for Welder . . ." (p 292) the timing capacitor should not be connected through the relay contacts directly to the + or -200-v supply as it cannot be affected at all by the timing resistors when so connected. The timing resistors are shown in series with the relay coil. Since the value of the resistors can be increased to many megohms, such connections would not give enough current to operate the relay.  
—SAMUEL E. DORSEY, *Research Dept., U.S. Naval Ordnance Test Station, China Lake, Calif.*

### Electrons, Waves and Messages

By JOHN R. PIERCE.

*Hanover House, New York, 1956, 318 p., \$5.00.*

THE author of this book is well known to electronics engineers for

# now...

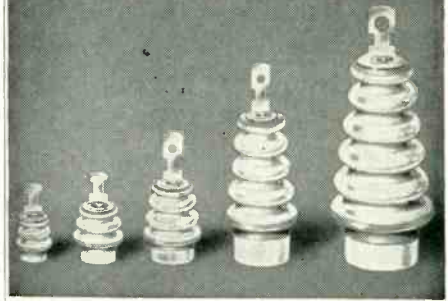

### Frenchtown Metallized Terminals!

Here is Frenchtown's improved line of Annulated Type NICOTE Metallized Hermetic Terminals for use in controls, relays, transformers, capacitors, motors, and heater units. Custom-engineered of HIGH ALUMINA CERAMICS and metallized with our exclusive NICOTE, these terminals are available in six varying sizes with a choice of terminal hardware to fit any exacting application. Write for Engineering Bulletin 1055.

**frenchtown** PORCELAIN COMPANY

86 Muirhead Avenue • Trenton 9, N. J.

National Representatives: Lundey Associates  
694 Main St., Waltham 54, Massachusetts

# COSMIC

ELECTROLYTIC & PAPER  
TUBULAR

## Condensers

35 YEARS OF  
"PROVEN  
DEPENDABILITY"

COSMIC CONDENSER CO.  
853 Whittier St., Bronx, N. Y.  
PHONE  
LUdlow 9-3360

Want more information? Use post card on last page.  
April 1, 1957 — ELECTRONICS



his numerous contributions in the field of microwave tubes. In the book under review, he has combined his scientific talents and his talent for writing to produce an extremely interesting and readable treatment on the art and science of electronics.

Although this volume is intended for the general reader, the author does not talk down to his audience nor does he sacrifice any accuracy to clarify his subject. The book, therefore, is of considerable interest to the engineer as well as to the layman.

► **Contents**—A brief discussion of the relationship between electronics and our present day technology is followed with a group of chapters containing a concise summary of the basic laws of physics which are essential to an understanding of communications. These chapters contain graphic descriptions of the nature of electric fields, magnetic fields, waves and the role of Maxwell's equations in electromagnetic propagation.

The next chapter treats a number of vacuum tube amplifiers and explains the operation of triodes, pentodes and klystrons. This is followed by a chapter discussing the nature of communications signals, the necessity for band width and the general nature of traveling wave tubes.

The author then devotes a chapter to the subject of noise and its inherent limitations on communications systems. This is followed by an entertaining discussion of radiation of heat and light, which is enlivened by using as an example, the temperature of a man cast adrift in a space suit.

Dr. Pierce then discusses microwave systems and some of the parameters which are needed for such diverse examples as the Bell System's TD-2 system and a system for interplanetary communication. This is followed by a discussion of the scanning problems and the light pickup problems in television.

► **Communications Theory** — A chapter about signals and noise leads up to the next two chapters on communications theory and some of its applications. Although



## Chip-proof PLASTIC LEGEND PLATES

*engraved in your own plant*

Tough GRAVOFLEX blanks are laminated in sharp contrast colors. No need to keep large inventory—all sizes, varied colors available on short notice. Low-cost GRAVOFLEX legend plates stand *up* better, stand *out* better!

Use the portable ENGRAVOGRAPH to mark legend plates to your specifications, on the spot, when you need them—with unskilled labor, because it's tracer-guided. Big savings on short runs and "one-shot" jobs. Eliminates costly delays. 17,000 Engravographs in use.

See demonstration at  
BOOTH #1234  
I. R. E. SHOW

Send for Booklet ZL-1 and sample plate.

**new hermes ENGRAVING MACHINE CORP.**  
13-19 UNIVERSITY PLACE, NEW YORK 3, N. Y.

# DEFLECTION YOKES

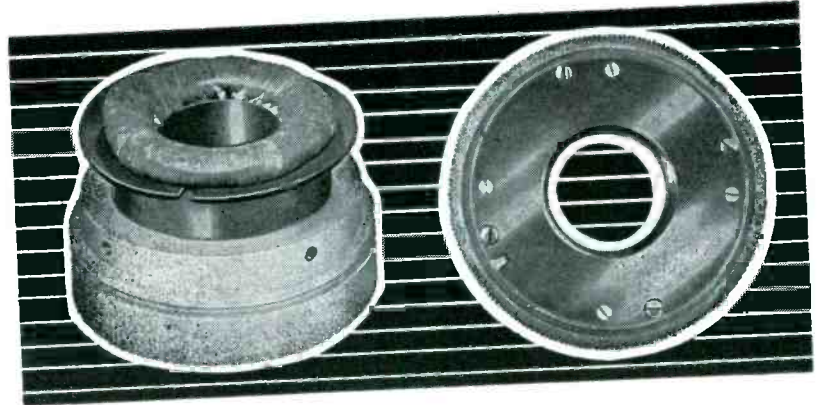

We specialize in the design and manufacture of precision deflection yokes for military and commercial applications. Phone or write for immediate engineering evaluation of your critical display problems.

**Celco**

Phone: DAVis 7-1123

*Constantine Engineering Laboratories Co.*

Island Avenue

Mahwah, N. J.

# Brew Delay Lines meet exacting specifications

Whatever your delay line requirements, from prototype to large scale manufacture of production units, Brew offers you the design-engineering experience and complete facilities to supply your most exacting specifications.

Brew Delay Lines are custom made to your requirements and are available covering an extremely wide range of characteristics. A Laboratory Report accompanies every prototype showing your specifications and the characteristics of the prototype.

Send us specifications on your requirements or send for your copy of catalog 54.

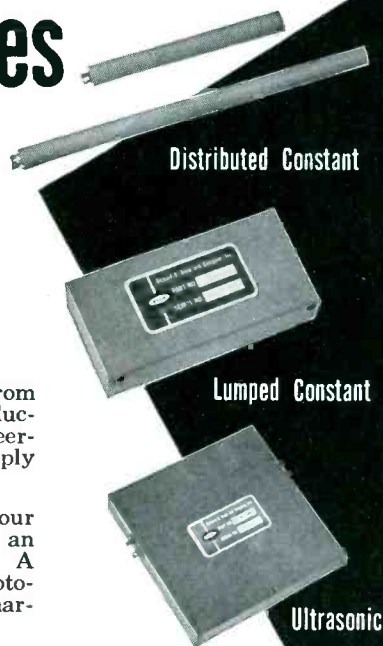

**BREW** Richard D. Brew and Company, Inc.  
Concord, New Hampshire  
design • development • manufacture

Now... Modernize  
high power electrical and electronic  
equipment with

## NEW ELECTROSEAL TRANSFORMERS



Unique sealed construction exclusive with Electro Seal transformers allows new applications for an open-type unit. Whether you want 1 or 100 KVA, Electro Seal gives drastic size reduction along with a neat and clean appearance. Actual weight per KVA as much as two-thirds less, dimensions as much as one-half competitive transformers. New sealing compound protects coils against dirt and moisture, and permits high temperature operation (Class B or C). Electro builds in the reliability you need... plus high overload capacity. Electro Seal transformers are built to your specifications. Write for literature.

**ELECTRO ENGINEERING WORKS, INC.**

401 Preda Street, San Leandro, California / In the Metropolitan Oakland area

the reader who has delved into Shannon's work will not learn anything new in these chapters, the average layman or the engineer who has not previously concerned himself with this subject will come away with some understanding of this important topic and will have been considerably entertained in the process.

The penultimate chapter is on relativity and quantum mechanics and their importance to the subjects of electron motion and to solid state devices. The author closes with a discussion on the possible future trends of the communications field and some of the developments that might be anticipated on the basis of present day knowledge.

The professional engineer will find this book to be entertaining reading regardless of his field of specialization. For the young man who is considering electronics as a profession, the reviewer can think of no book which better presents the field of electronics as a fascinating intellectual adventure.

Perhaps the best way of summarizing this book is to state that the author has written an excellent popular treatise on the electronics field as has been done by Sir James Jeans in the field of astronomy. It is unusual to find a first rate scientist who can also write about his own field in such a clear and interesting manner as to make its fundamentals understandable and readable to any intelligent person. The electronics field is fortunate in having such a spokesman as Dr. Pierce and it is to be hoped that this book will have a wide audience.—Henry Jasik, Consulting Engineer, Mineola, N. Y.

### Thumbnail Reviews

**Rayleigh's Principle and its Applications to Engineering.** By G. Temple and W. G. Bickley, Dover Publications, Inc., 1956, 152 p, \$1.50. Rayleigh's principle, which relates the frequency of oscillation of an elastic system to the distribution of kinetic and potential energies in the system, is the subject of this book. The energy method of analyzing dynamic systems is presented. Rayleigh's principle proved for



**NEW CHRISTIE**  
**SILICON**  
**POWER RECTIFIERS**



**For Top Reliability**

- A standard line from 30 to 1000 amps
- Closely regulated by magnetic control
- Voltages: 8-16-32-36
- Stationary or Mobile Types
- For Missile, Aircraft, Lab & Factory

Write for Latest Bulletins on  
 Silicon & Selenium Power Rectifiers

**CHRISTIE ELECTRIC CORP.**  
 Dept. EL, 3410 W. 67th St., Los Angeles 43  
 Over a Quarter Century of  
 Rectifier Manufacturing

**NEW Programer MPR-13**

Extremely small and rugged...  
 For Missile, Instrumentation  
 and Automation Application

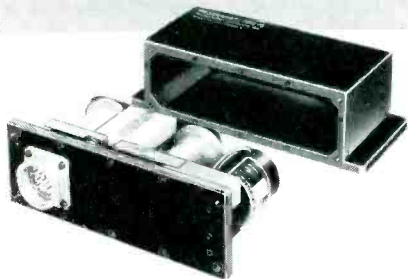

**NEW OSCILLOTRON**

Extremely Compact  
 Camera Recording  
 System—Model K-5

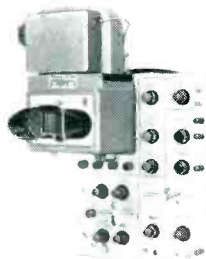

A Complete System for  
 Oscilloscope Recording  
 ...from Single Frame  
 to Continuous Motion,  
 plus Polaroid-Land

Write for complete  
 detailed literature today.



Want more information? Use post card on last page.  
 ELECTRONICS — April 1, 1957

NEW BOOKS

(continued)

systems with a finite number of degrees of freedom and also for continuous systems. Level is suitable for engineers and physicists.

**The  $j\omega$  or Symbolic Method.** By Harry Stockman, SER Co., 543 Lexington Ave., Waltham, Mass., 1956, 312 p., \$3.50. Treatment of  $j\omega$  calculation from operational point of view, using the "spinning-frozen sinor" concept. Appendices describe short-hand methods of D-operator and Laplace transform solving of integrodifferential equations.

**Patent Notes for Engineers (7th Edition).** By C. D. Tuska, McGraw-Hill Publishing Co., Inc., New York, 1956, 192 p., \$7.00. Explains: what patentable inventions are and how to protect them; how to keep records; how to prepare and file applications; and other practical details of concern to the engineer.

**Statistical Analysis of Stationary Time Series.** By Ulf Grenander and Murray Rosenblatt, John Wiley & Sons, Inc., New York, 1957, 300 p., \$11.00. A full-length treatment of the statistical theory of spectral analysis of stochastic processes.

**How to Install & Service Intercommunication Systems.** By Jack Darr, John F. Rider Publisher, Inc., New York, 1957, 152 p., \$3.00. Installation and maintenance of commercial intercom systems for service technicians with system design information for the do-it-yourself reader.

**1955 Supplement to the Bibliography and Abstracts on Electrical Contacts, STP56J.** ASTM, 1916 Race St., Philadelphia, Pa., 1956, 48 p., \$1.00. Author and subject indexes and references on subjects including bridging of high-current contacts in arc discharges, loading noise of carbon film resistors, conductivity of thin metallic films, physical and chemical properties of contact materials, etc.

**Official Registry of Radio Systems in the Industrial Services.** By Milton B. Sleeper. Communication Engineering Book Co., Monterey, Mass., 1957, 152 p., \$5.00 (paper). Listing by companies and by operating frequencies of power utility, petroleum and gas pipeline, low-power industrial, special industrial, forest products, relay press and motion picture as well as vhf maritime transmitters licensed by FCC.

**RCA Receiving Tube Manual (RC-18).** Commercial Engineering, Tube Division, RCA, Harrison, N. J., 1956, 352 p., \$.75 (paper). This latest edition contains data on more than 575 receiving and 75 picture tubes. Expanded applications section now includes tuner tv tuners, video amplifiers, sync circuits, age circuits and deflection systems.



**.000175"**  
**THIN**

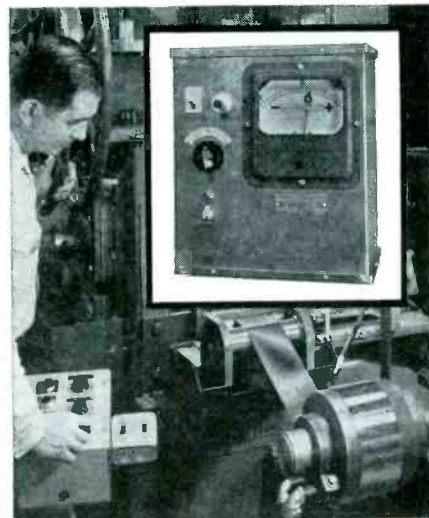

Now available  
 in production  
 quantities

Keeping pace with the advanced design of transistors and other electronic components, Somers Brass Company has installed a unique mill for the production of ultra-thin strip. Brass, copper and nickel are now being rolled down to .000175", up to 4" wide, in footages to satisfy mass production requirements.

You can rely on Somers, specialists for nearly 50 years, for the experience to solve your thin strip problems, whether in design or manufacturing.

Write for Confidential Data Blank and a complete analysis of your present or proposed application at no cost or obligation.



**Somers Brass Company, Inc.**  
 112 BALDWIN AVE, WATERBURY, CONN.

Want more information? Use post card on last page.

# REDUCE Your Rejects

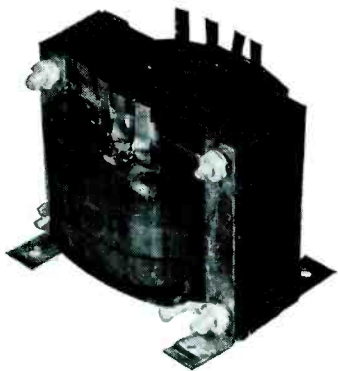

## USE "ACME" UNIFORM COMPONENTS

MAGNET WIRE  
COIL WINDINGS  
VARNISHED INSULATIONS  
INSULATING VARNISHES  
COMPOUNDS

"Acme" stands for a half century of specialization in electrical insulations, with *uniformity* a first consideration.

Standardize on Acme-made components in your product and be 100% sure of a balanced assembly every time.

Submit us your product for a no-obligation analysis. Our engineers may be able to save you many dollars in its production. Our catalog should be in your planning. Let us send you one.



## ACME WIRE CO.

NEW HAVEN, CONN.

MAGNET WIRE • COILS  
VARNISHED INSULATIONS  
INSULATING VARNISHES  
AND COMPOUNDS



## Backtalk

### Flat Picture Tube

DEAR SIRs:  
WITH reference to an article entitled "British Push Simpler Flat Television Tube", which appeared in the January 1, 1957 issue of *ELECTRONICS*, p 14, we direct attention to the statement which reads "Competition with similar U.S. developments is effectively nullified through patent pooling with Kaiser Aircraft & Electronics Corporation."

There has been no nullification of competition—effective or otherwise. Briefly stated, during interference proceedings which were declared by the U.S. Patent Office between W. Ross Aiken of Kaiser Aircraft & Electronics Corp., and Dennis Gabor of Imperial College, London, to determine the first inventor of the flat cathode-ray tube, Gabor conceded priority of invention to Aiken, and the rights to such invention were awarded to Aiken. Kaiser Aircraft & Electronics Corp. has granted a nonexclusive license to NRDC under such rights, and any activities of NRDC in the United States relative to the subject matter concerned are conducted under such license.

ARTHUR J. WAGNER  
*Brown, Jackson, Boettcher & Diener  
Chicago, Illinois*

### Genko, Not Shorui

DEAR SIRs:  
I READ with great interest your article in the *Shoptalk* section of the November (and August) issue of *ELECTRONICS* with regard to Dempa Confusin (this seems to be correctly spelt as Confusion). I am a 100-percent Japanese citizen educated in Tokyo, except for my one-year stay at Stanford University, California, as a graduate student in 1951/52 under the GARIOA scholarship program sponsored by the U.S. Government.

It is true that "dempa gizitsu" does not mean "literature" or "manuscript". As Frank Iwami points out, "dempa" literally means "electric waves", but Japanese people often use the word vaguely to mean "electronics", although it is

incorrect from the strict sense of the word. "Gizitsu" and "gijitsu" mean the same. The only difference depends upon one's opinion, which more closely resembles the original Japanese pronunciation.

By the way, in the Japanese language the English alphabet is not used, except when the use of the alphabet is thought to be more convenient, e.g., to show the pronunciation to foreigners. The meaning of the word is "technique". The name of the Japanese electronics magazine "dempa gizitsu", therefore means "electronic techniques".

Mr. Nishida's statement for the correct word for "manuscript" must be corrected. I understand the word "manuscript" means either a book, document, letter etc written by hand, an author's copy for typesetting or writing as distinguished from print. For practically the same meaning we use the word "genko". Shorui, as against Mr. Nishida's statement, is equivalent to "documents" or "papers".

"Genko" is a kind of shorui, but we usually distinguish the two words. Mr. Morita's statement seems to comprise some misunderstanding.

I am very glad to know that you Americans have so much interest in our language. I am writing this note just to give *ELECTRONICS* readers the correct meaning of the Japanese words.

TADAKUNI FUJII  
*Tokyo, Japan*

### Early Hot Air Power

DEAR SIRs:  
YOUR "Hot Air Powered Thermopile Radio" (Feb. 1, p 14, 1957), its reference to a similar Signal Corps development during World War II, and a recent report in another publication of a Russian reinvention along the same lines, recalls a much earlier and very similar development of my own in 1922. I still have several of these laboratory models and they are still operative.

I used iron-constantan junctions in the form of .010×.25×1 inch



strips, which I joined together, with an improvised storage battery welder, into a zig-zag series. Externally axial slots in porcelain or lava tubes received the pressed-in junctions along one side of the zig-zag series, spiralled along the tube from one end to the other, and held securely mechanically and thermally by high temperature porcelain cement.

Heavy asbestos cord was slipped axially of the tube, through the inside of the aligned, protruding, V-shaped strips, for heat insulation of the hot inner junctions. The outer junctions were cooled by radiation and convection. Artificial cooling by a fan would easily double the output.

I used two types of heat inside the porcelain tube. One was by kerosene or gas flame; the other was a nichrome heater coil inside the tube. In one form of the latter, a screw plug for a 110-v power source socket was fixed in one end.

I used about 300 junctions and, with about 600 watts power input, got a d-c output of 1-2 amperes at 5-10 volts; best efficiency, of course, was obtained when the external load resistance equalled the hot resistance of the junction series.

I operated radio receivers using a few 201-A or 199 or WD-11 type tubes with such a-c/d-c converters.

I designed another form using 4-inch diameter, punched disks with central and radial apertures.

These were assembled in an alternate iron and constantan axial series, with mica and conductive washers so arranged as to connect these disks in a thermo battery series from one end of the compressed stack to the other. The radial apertures left a number of wheel-spoke-like connecting arms between outer and inner ring shaped portions of the disks. Through these air could flow for maintaining a large temperature gradient. This form was never fully tested due to interruption of this work.

During World War II, I submitted these designs to the Signal Corps, via my friend Maj. General Joe Mauborgne, then its head at Little Silver, N. J. In addition to its possibilities for field use, I sug-

**d&r**  
dependable & reliable

# WIDEBAND FLUTTER METER

*in use at Lockheed Missiles*

**FOR MEASURING AND EVALUATING WIDE BAND FLUTTER**

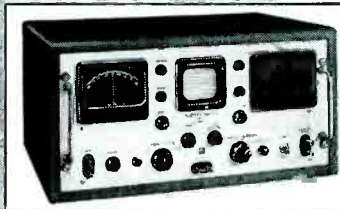
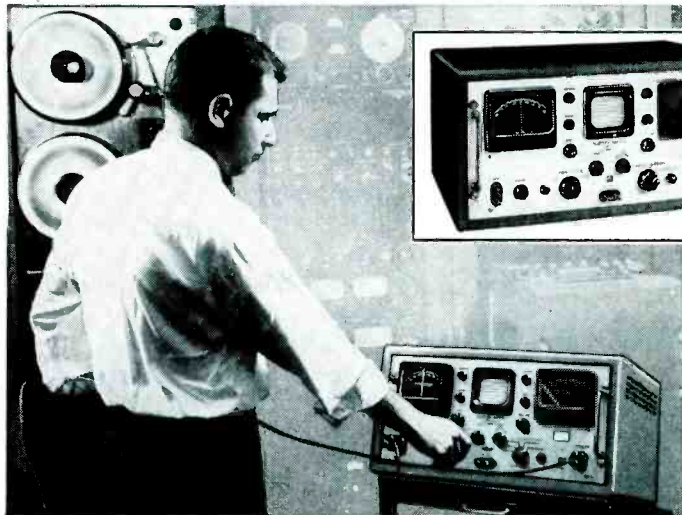

**\$91000**  
COMPLETE  
WITH  
CABINET

Model FL-4A  
... for  
manufacturers  
and users of  
high speed tape  
recorders, who  
are engaged in  
instrumentation,  
telemetry  
and data  
transmission  
systems

Lockheed Photo

**Features:**

- Measures flutter frequencies dc to 5000 cps
- Internal 24 db/octave filters for analysis
- 3" oscilloscope for detailed flutter studies

**Specifications:**

Carrier frequency: 14.5kc from crystal oscillator  
Indicators: ±2% drift and rms flutter meters  
Range: 0.2, 0.6, and 2.0% rms full scale  
Flutter filters: 0.5 to 30 cps; 30 to 300 cps;  
300 to 5000 cps  
Dimensions: 8 3/4" x 19" standard rack

*Order Direct  
or write us for  
name of nearest  
representative*

Manufacturers: Electronic  
and Electro-Mechanical  
Equipment & Components



406 East Gutierrez Street  
P.O. Box 1500, Santa Barbara, California  
Telephone: WOODLAND 5-4511

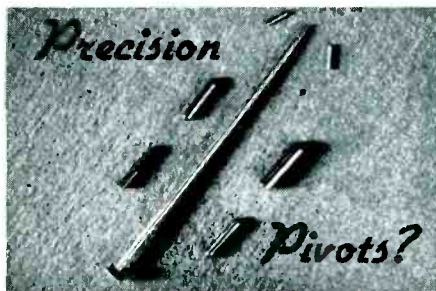

The "spike" in the center is a common pin.  
The others are VK precision pivots.

*Call VK*

Steel, chromium plated, or carbide precision pivots to .013" diameter. 1 RMS or finer surface finish. Diameter tolerance to .000010". Chamfers, radii, lapped ends, etc.

Also volume production lapping of flat or round production parts.

Send us your specifications.

**The VAN KEUREN COMPANY**  
176-D WALTHAM ST. WATERTOWN, MASS.

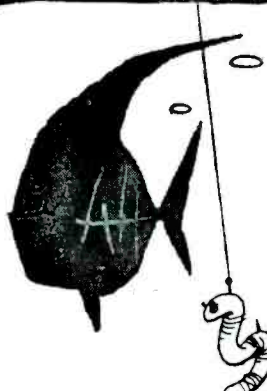

**experience pays**

let TWS\* prepare  
your industrial literature

**\*TECHNICAL WRITING SERVICE**  
McGraw-Hill Book Co.  
330 W. 42nd St., N.Y.C.

*send for information*

# LINE VOLTAGE VARIATIONS?



## SMOOTH 'EM OUT WITH RAYTHEON Voltage Stabilizers

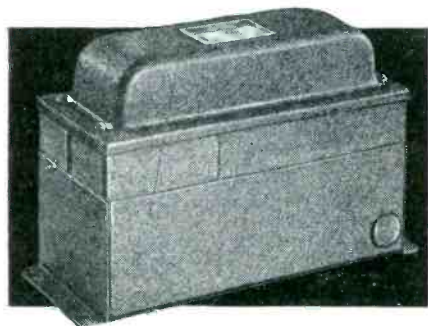

### ± 1/2% Stabilization

If your equipment depends on a well-regulated power supply, Raytheon Voltage Stabilizers assure you top performance under virtually all conditions.

- Guaranteed stabilization to ± 1/2%
- Up to 50% increased tube life
- Regulated to temperature and frequency changes
- Response time within 3 cycles
- Compact, rugged, dependable, low cost.

#### 26 STANDARD MODELS AVAILABLE

Available in a wide variety of input and output voltages from 15 to 2000 watts and where needed, harmonic filtered models for 250, 500 and 1000 watts. Special models can be built on order to your specifications.

For full information see your electronic supply house or write Dept. 6120 - request bulletin 4-260.

"Excellence in Electronics."



**RAYTHEON MANUFACTURING CO.**  
COMMERCIAL EQUIPMENT DIVISION  
Waltham 54, Mass.

Want more information? Use post card on last page.

gested that heavy-duty forms might find use on aircraft, as an extension of the engine exhaust pipes, where so much heat energy is wasted, and where extreme cooling in the air stream is available for developing a high-temperature gradient between hot and cold junctions. While nothing that I was informed of ever came of these suggestions to the Signal Corps, I still have a strong conviction that such designs may be useful, not only on reciprocating engine planes and ground vehicles, but also for jet-engined craft of all types.

The efficiency, of course, is now very low, but with otherwise wasted thermal energy, this is of little consequence. For many electric-powerless locations, coupled with the low d-c power requirements of modern transistor type radio and audio equipment, it could be very useful.

It is also very likely that modern researchers in solid state physics will turn up much higher efficiency thermoelectric materials, or materials with a better ratio of electrical to thermal conductivity, which would develop higher temperature gradients and thus higher voltage and lower internal resistance.

This is an interesting and challenging opportunity, what with some 35 years of accumulated new knowledge available, for a reevaluation of the involved principles and a renewed attack on the problem.

B. F. MIESSNER  
*Miessner Inventions, Inc.*  
Morristown, N. J.

### Has Surprise Output

DEAR SIRS:

IT MIGHT appear to others, as it did to me, that the control of automatic machinery by digital coded tape feed is a recent innovation. However, I ran across just such a control system in a machine which, as near as I can tell, was built in 1910.

The machine utilized a punched tape, feeding at about three inches per second, with readily interchangeable reels for different pro-

EXTRA CURRENT FOR TESTING NEEDS

## KATO VARIABLE FREQUENCY MOTOR GENERATOR SETS

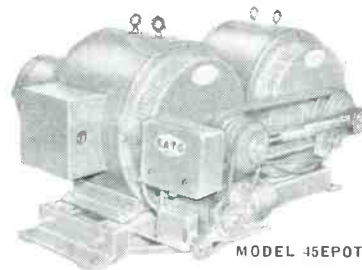

### AUTOMATIC ADJUSTMENT MODEL

Fully automatic variable frequency motor generator set adjusts 360 to 400 CPS. Generator mounted controls include reset buttons, Cutter Hammer Limit Switch. Motor and generator remain stationary. Vari-drive pulley adjustment controlled by small motor. Remote control panels available. Units can be equipped with synchronous motor starter and magnetic amplifier automatic voltage regulator.

### MANUAL ADJUSTMENT MODEL

Easily adjusted by simple hand wheel controlling variable pitch pulley V-belt arrangement. This Motor Generator Set gives 45 to 60 CPS output. Unit holds speed accurately. Frequency meter indicates output. Single phase generator speed varies from 1350 to 1950 rpm.

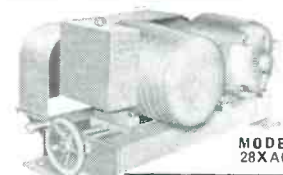

Builders of fine Electrical Machinery Since 1928

**KATO Engineering Company**  
105 MAXFIELD AVENUE, MANKATO, MINN.

## SINCE 1920 QUALITY WENCO PRODUCTS SPADE BOLTS

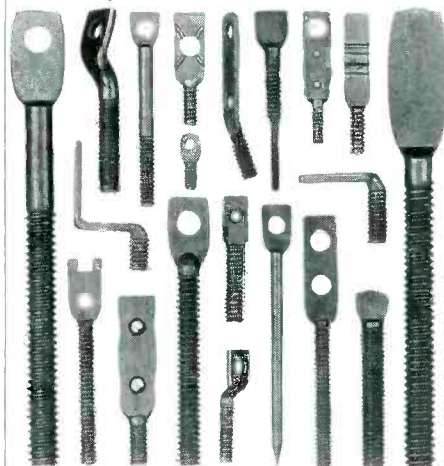

Specialists in designing and manufacturing of all-purpose fasteners and wire forms. Tooled to produce over 1000 styles in any screw size, material, finish, quantity, to your specifications.

Serving Industry for Thirty-Five Years  
— OTHER PRODUCTS —

## Simplex WIRE STRIPPERS & CUTTERS

• TOOLS • DIES • STAMPINGS  
Bulletins on complete line on request

**WENCO MANUFACTURING CO.**  
1133 W. Hubbard St., Chicago 22, Ill., U. S. A.

Want more information? Use post card on last page.



cedures. The tape was read by a vacuum system, operating valves which controlled pneumatic servos. In the absence of modern matrix decoding systems, or even relay trees, the tape was punched for a one-to-one correspondence between perforations and values of output function.

This, of course, required a considerable number of hole positions, and the machine examined has a wide tape with 90 possible perforated positions. Of these, two were used for other than direct output control. One position was for retaining an output previously obtained for a determined number of subsequent steps. The other varied the pressure supplied to the servos. The remaining perforations controlled an exact step function of the output, with the possibility of exact duplication of work to the ultimate precision of the machine.

Tape speed was variable and the value written on the tape to correspond to settings of a speed control on the tape puller. The machine examined was apparently a production model and from the serial number it appears that a great many had been produced. It is difficult to account for their disappearance from the scene, since they were adaptable for use by completely untrained workers.

We tested the model we saw, using one of a series of tapes stored with it, and while there were no rock'n roll rolls, that player piano certainly pounded out the ragtime.

LEO MACKTA  
Belle Harbor, N. Y.

### On the Nature of Gravitation

DEAR SIRs:

THERE has been carried on recently in these pages a very interesting discussion of the possible nature of gravitational attraction.<sup>1-5</sup> The writer would like to comment on some of the ideas proposed, after summarizing them, and to consider another way of looking at the question.

The gravitational attraction un-

new designs on the board?

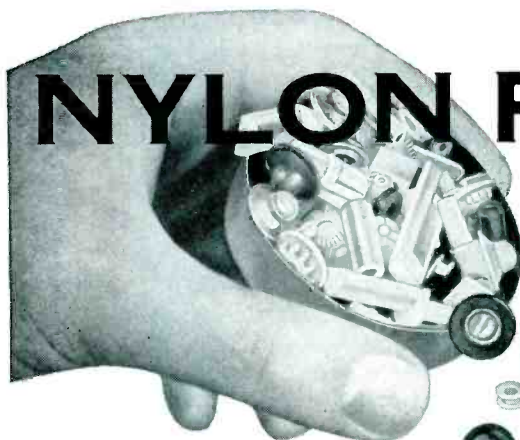

# NYLON PARTS

**GRC**  
TINY MOLDED

may be the difference between "problems" and profits!

Gries' unique single cavity molding facilities are flexible—provide the practical answer to countless problems of product design and improvement. No matter how tiny, or how intricate, GRC molds nylon parts to meet your exact specifications, with precise tolerances and uniform quality. And, because GRC methods are completely automatic, costs are surprisingly low—GRC tiny nylon parts are produced completely trimmed and ready for use, in one high-speed, money-saving operation!

Write today for Bulletin.

Send prints for quotation.

See us at **BOOTH 421**

Design Engineering Show  
May 20-23rd, N. Y.



## GRIES REPRODUCER CORP.

151 Beechwood Ave., New Rochelle, N. Y. Phone: NEw Rochelle 3-8600  
World's Foremost Producer of Small Die Castings



GRC MOLDS ALL THERMOPLASTICS SWIFTLY, DEPENDABLY, ECONOMICALLY!

Automatic Continuous and Individual Inserts! Single Parts!

Quick deliveries on quantities of 25,000 to millions.

MAXIMUM SIZE .03 oz.—(1/4" long

NO MINIMUM SIZE! LOW MOLD COSTS!

## Electrical Coil Windings

For 40 years . . . specializing in all types of coils to customers' specifications. Design or engineering assistance available on request.

# COTO-COIL CO., INC.

SINCE 1917

65 Pavilion Avenue Providence 5, Rhode Island

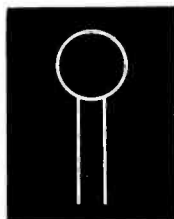

## SILK SCREENS

from your finished art or sketch

- ★ CERAMIC CAPACITORS
- ★ PRINTED CIRCUITS
- ★ SCHEMATICS

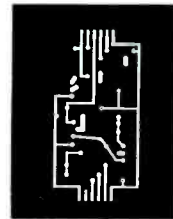

SILK OR WIRE MESH SCREENS TO TOLERANCES OF .001 FOR PRODUCTION RUNS. SHIPPED 48 HOURS ON RECEIPT OF ART. WRITE FOR ESTIMATES.

**bollling Industries**

1117 N. MAIN AVE. INC. SCRANTON 2, PA.

**DC-AC CHOPPERS**

**For 60 Cycle Use**

Built to rigid commercial specifications.

Twenty-two types, both single and double pole.

Long life.

Low noise level.

Extreme reliability.

Write for Catalog 370.

**STEVENS INCORPORATED ARNOLD**

22 ELKINS STREET  
SOUTH BOSTON 27, MASS.

S/A-10

der consideration is just that described by Newton's law of universal gravitation, which states that "every particle of matter in the universe attracts every other particle with a force which varies directly as the product of the masses of the two particles, and inversely as the square of the distance between them."

The constant of proportionality is the gravitational constant  $G$ , which, in Giorgi units, is equal to  $6.67 \times 10^{-11}$  newtons meters<sup>2</sup>/kilogram<sup>2</sup>. This law has been verified experimentally in the laboratory, in the Cavendish experiment, by actually measuring the attraction between masses.<sup>6</sup>

It is true that general relativity offers a quite different description; bodies are described as moving along curves in space-time.<sup>7</sup> However, the differences which this makes are usually so small that it is not yet certain that the general theory of relativity has been verified.<sup>8</sup> Besides, a space-time description can be given for classical motion, which is strictly Newtonian.<sup>9</sup>

It was suggested that gravitation might be the result of forces from outer space pressing upon the earth.<sup>1</sup> While this is a most interesting thought, it would seem to need some extension to explain the Cavendish experiment. The thought that partial shielding of one body by another may be involved<sup>2</sup> could be applied here. However, the efficiency of shielding will have to follow some rather special laws, in order to make the attraction between bodies of a given material depend on their volume, rather than on their cross section. A comet shows both forces of radiation and gravitation; at the same time that the head is being attracted toward the sun, the tail is being repelled by radiation pressure. Radiation attraction may be important in astronomy, however, in starting the coagulation of cosmic dust clouds.<sup>10</sup>

It may be appropriate to remark that the acceleration of gravity, about 9.8 meters/second<sup>2</sup>, does vary somewhat with location, as has been pointed out.<sup>3</sup> It should be possible to calculate it for any location from the universal constant  $G$  if the distribution of mass in the earth were known. In fact, one might reverse

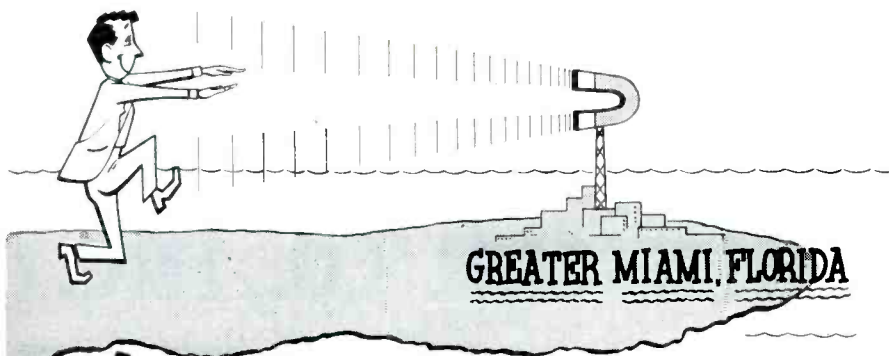

**MAGIC WORDS**

when you need critical personnel

Greater Miami manufacturers—there are over 1700 prospering here now—find they can select just the engineers... skilled technicians...office and plant workers needed from a constant flow of applications from all over the country. Their employees produce better, too... working where they want to live.

That's why we say, "There's a Hard Dollar Reason for Locating Your Plant in Greater Miami."



For the complete story on Greater Miami as a possible location for your plant—send, on your letterhead, for 30-page Fact File—**complete statistical area analysis.**

**GREATER MIAMI INDUSTRIAL DIVISION**  
DADE COUNTY ADVERTISING DEPT. 200 • 141 N. E. 3rd AVE. • MIAMI, FLORIDA • PHONE FR 1-3611



# DANO COILS

BUILD "Customer Confidence"

From making the most precision coils required in electronically operated relays, timers, switches and devices to meeting most exact specifications of coils for high temperature application—*Dano Coils Build Confidence.*

- Encapsulated coils . . . in either polyester or epoxy resins.
- Coils for high temperature applications.
- Bobbins coils.
- Paper section coils.
- Cotton interweave coils.

TRANSFORMERS MADE TO ORDER



For **HEAVY DUTY** Work! Severest Electrical Services!

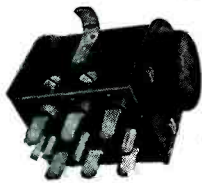

P-506-CE Plug with Cap

**JONES PLUGS & SOCKETS**

500 SERIES

Proven Quality



S-506-DB Socket with deep brackets

For 5,000 Volts  
25 Amperes per Contact  
Alterable by circuit Characteristics.

Socket contacts phosphor bronze knife-switch type, cadmium plated. Plug contacts hard brass cadmium plated. 2, 4, 6, 8, 10, and 12 contacts. Plugs and sockets polarized. Long leakage path from terminal, and terminal to ground. Caps and brackets, steel parkerized (rust-proofed). Plug and socket blocks interchangeable in caps and brackets. Terminal connections most accessible. Cap insulated with canvas bakelite.

Write for Jones BULLETIN 21 for full details on line.



**HOWARD B. JONES DIVISION**  
CINCH MANUFACTURING CORPORATION  
CHICAGO 24, ILLINOIS  
SUBSIDIARY OF UNITED-CARR FASTENER CORP.

Want more information? Use post card on last page.

BACKTALK

(continued)

the process, and from variations in the acceleration of gravity, try to draw some conclusions about the distribution of mass in the earth.

The suggestion that gravitation might be just a manifestation of inertia, because the universe is expanding at a linearly increasing rate,<sup>4</sup> certainly deserves some thought. The most obvious difficulty is to explain the inverse square law; the uniform expansion would seem to make the mutual acceleration of two bodies, and hence the force of attraction, directly proportional to the distance between them.

### Electromagnetic Theory

The writer offers the following thoughts, in the spirit that, as was suggested previously in this discussion, gravitation is a resultant of forces within bodies,<sup>5</sup> and to propose an electromagnetic interpretation.

In the first place, all matter is made up of charged elementary particles. The inertia of such a particle, such as an electron, can be ascribed to the magnetic field which is set up when the particle moves.<sup>11</sup> (The neutron, for the present purpose, could be considered as a proton and an electron in close association.) This inertial mass, moreover, increases as the velocity approaches that of light, as relativity predicts. The moving particle is, in a sense, analogous to a single conductor carrying current, (although here a discussion in terms on the effect of changing electric displacement offers certain advantages<sup>12</sup>), and the inertia of the particle is analogous to the inductance of the conductor.

A neutral atom may be considered as a positive charge shielded by a negative. When in motion, it would be analogous to concentric flows of current in opposite directions, such as current flowing in a coaxial cable. Although there are no fields outside the coaxial cable, (or the atom), it still has an inductance, corresponding to the inertia of the atom. Moreover, the same electric field which is responsible for the inertia of the particle represents energy, and the amount can be made to agree with the Einstein formula  $E = mc^2$ ,  $E$  being the energy,  $m$  the mass of the

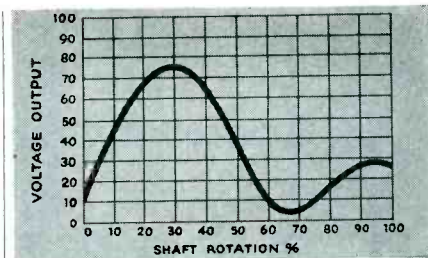

How would you match this curve to shaft rotation?

The **VERNISTAT Adjustable Function Generator** will do it for you! Here it is:



The VERNISTAT Adjustable Function Generator—a variation of the VERNISTAT a.c. potentiometer—permits quick and easy alteration of any nonlinear function. The adjusting mechanism provides a graphic display of the function which may be mathematical or empirical, including those with multiple slope reversals.

### CHARACTERISTICS:

- 100-transformer taps connected to 31-pole, 100-position printed circuit switch.
- any pole can be switched to any tap.
- size: 6 1/4" x 7 7/8" x 2 7/8".
- potential of each pole adjustable to  $\pm 0.5\%$ .
- minimum slope of voltage output curve: zero.
- maximum voltage between adjacent poles: 12.
- frequency rating: 400 or 60 cps @ 130 volts depending on model.
- output impedance: 130 ohms maximum.

**vernistat**®

division

PERKIN-ELMER CORPORATION  
Norwalk, Connecticut

Want more information? Use post card on last page.

To Solve  
Your Problems in  
Conductive Silver Coatings  
try  
**DRAKENFELD**  
SILVER PAINT  
AND SILVER PASTE  
TAILORED TO MEET YOUR NEEDS

★  
Special Compositions for Glass and  
Ceramic Bodies and other Materials

★  
Ask for a Sample Made to Fit Your  
Specific Requirements Write to:

**B. F. DRAKENFELD & COMPANY, INC.**  
Box 519, Washington, Pennsylvania

*Drakenfeld*

YOUR PARTNER IN SOLVING CONDUCTIVE COATING PROBLEMS

for complete  
selection of Basic Requirements  
for your Coil Winding needs it's . . .

*Coil Winding Equipment Co.*

write for complete  
technical literature

COIL WINDING EQUIPMENT CO., Oyster Bay, New York

**PRECISION  
PLASTIC  
CAPACITORS  
AT  
COMPETITIVE  
PRICES!**

**POLYSTYRENE and MYLAR\***

Capacitance From .001 mfd to any value  
Voltage From 50 V.D.C. to 30 KV  
Tolerance Polystyrene From  $\pm 0.1\%$  to  $\pm 5\%$   
Mylar\* From  $\pm 1\%$  to  $\pm 10\%$

**SMALLEST CASE SIZES  
TUBULAR—BATHTUB—RECTANGULAR**

Very Good Deliveries \*DuPont T.M.

**PRECISION CAPACITORS, INC.**  
150 W. Cypress Ave. Burbank, Calif.

particle, (proportional to the inertia), and  $c$  the velocity of light.

Since the gravitational attraction is proportional to the inertial mass, (all bodies fall at the same rate in a vacuum), and also to the "rest mass" mentioned above, it is tempting to ascribe it to some electromagnetic effect. At first, attraction of neutral atoms due to mutual distortion (Van der Waals attraction), seems a candidate, but that leads to forces falling off much more quickly than as the inverse square, typically as the inverse seventh power.<sup>13</sup>

The simplest thing is just to suppose that the force of attraction between unlike charges is a little greater than that of repulsion between like. If the force of attraction were  $(-8.98 \times 10^9 q_1 q_2 + 1.82 \times 10^{-27} |q_1 q_2|) / r^2$ ,  $q_1$  and  $q_2$  being the charges in coulombs and  $r$  the distance between them in meters, and the vertical lines indicating the absolute value, this would give between two neutral hydrogen atoms, say, an attractive force of  $1.86 \times 10^{-44} / r^2$ , which is just the gravitational attraction. At the same time, the second term would affect the force between charges only negligibly.<sup>14</sup> Thus gravitation and electrostatics become one and the same thing.

These thoughts are highly speculative. Still, it seems as if it might be fruitful to try to carry this further, and to apply principles of electricity to the study of gravitation.

REFERENCES

- (1) ELECTRONICS, p 121, Jan. 1956.
- (2) G. F. Forbes, ELECTRONICS, p 463, Oct. 1956.
- (3) J. J. Rivera, ELECTRONICS, p 465, Oct. 1956.
- (4) C. C. Littell, ELECTRONICS, p 500, March 1956.
- (5) C. H. Tewksberry, ELECTRONICS, p 372, July 1956.
- (6) G. Shortley and D. Williams, "Physics" Vol. 1, Prentice-Hall 1950, p 136.
- (7) G. Joos, "Theoretical Physics", English translation by I. M. Freeman, Blackie and Son, London, p 246, 1934.
- (8) G. B. Brown, Science Progress (London) 44, 619, 1956. (see especially p 631).
- (9) H. L. Armstrong, Am J Phys 22, p 615, 1954.
- (10) R. H. Baker, "Astronomy" fifth edition, Van Nostrand section 15, 17, 1950.
- (11) M. Mason and W. Weaver, "The Electromagnetic Field", Dover, p 309, 1929.
- (12) H. L. Armstrong, Elect Eng 75, p 554, 1956.
- (13) J. C. Slater, "Introduction to Chemical Physics", McGraw-Hill, p 366, 1939.
- (14) F. W. Sears, "Electricity and Magnetism", Addison-Wesley, p 15, 1951.

H. L. ARMSTRONG  
Radio and Electrical Engineering Division  
National Research Council  
Ottawa, Canada





## How to keep informed on the “with what” part of your business

AT YOUR FINGER TIPS, issue after issue, is one of your richest veins of job information – advertising. You might call it the “with what” type – which dovetails the “how” of the editorial pages. Easy to read, talking your language, geared specifically to the betterment of your business, this is the kind of practical data which may well help you do a job quicker, better – save your company money.

Each advertiser is obviously doing his level best to give you helpful information. By showing, through the advertising pages, how his product or service can benefit *you* and *your* company, he is taking his most efficient way toward a sale.

Add up all the advertisers and you’ve got a gold mine of current, on-the-job information. Yours for the reading are a wealth of data and facts on the very latest in products, services, tools . . . product developments, materials, processes, methods.

You, too, have a big stake in the advertising pages. Read them regularly, carefully to keep job-informed on the “with what” part of your business.



**McGraw-Hill PUBLICATIONS**



# MANUFACTURERS' REPRESENTATIVES

IN THE ELECTRONIC INDUSTRY

As a service to readers, ELECTRONICS presents the advertisements for some of the leading manufacturers' representatives in the electronic industry. These firms are qualified to help the Manufacturer with his distribution problems; the Buyer with his product needs.

**HORMAN ASSOCIATES, INC.**  
2017 "S" STREET, N.W.  
WASHINGTON 9, D. C.  
DECATUR 2-5705

SERVING  
DELAWARE, MARYLAND,  
DISTRICT OF COLUMBIA,  
ARLINGTON AND FAIRFAX  
COUNTIES IN VIRGINIA

TELETYPE NO. WA-559

REPRESENTING —

HEWETT-PACKARD CO.  
SORENSEN & COMPANY INC.  
VARIAN ASSOCIATES  
BETA ELECTRIC CORP.  
ELECTRO-MEASUREMENTS INC.  
GERTSCH PRODUCTS INC.

SENSITIVE RESEARCH INST. CORP.  
SANBORN COMPANY  
KINTEL (formerly KAY LAB)  
JOHN FLUKE MANUFACTURING CO.  
BUDD STANLEY COMPANY, INC.  
WEINSCHTEL ENGINEERING CO.

Complete Recalibration Laboratory

# CONTACTS



Inductive & Non-Inductive  
Rheostats & Resistors  
Toroidal Coil Winding Mach.



Taping Machines

Winding Machines

**REX RHEOSTAT CO.**  
BALDWIN, SO. L. I. N. Y.

## SCHWEBER ELECTRONICS

The Industry's Only Specialized Manufacturers  
Distributor

122 Herricks Road, Mineola, L. I., N. Y.  
Pioneer 6-6520



**TANTALYTIC®  
CAPACITORS**

In Stock . . .  
over 250 different  
ratings polar and  
non-polar types.

## SAMUEL K. MACDONALD, INC.

manufacturers representatives over 25 years  
1531 SPRUCE STREET, PHILA. 2, PA.

Territory:  
Pennsylvania • New Jersey  
Delaware • Maryland  
Virginia • West Virginia  
District of Columbia

Other Offices:  
Pittsburgh  
Baltimore  
Washington, D.C.

## MANUFACTURERS' REPRESENTATIVES!

Plan to use the "Manufacturers' Representatives" Section of the ensuing 1957 Mid-June Electronics Buyers' Guide to sell your products; attract new lines. For information, write:

Classified Adv. Division  
Post Office Box 12  
New York 36, N. Y.

## PRINTED CIRCUIT BOARD

4x8 1/2 inch Sheets—0014 copper  
1/16 inch XXXP-36 base—NEMA Limits  
Plastic Protective Coating  
\$1 per sheet, 6 for \$5, 24 for \$12.50  
Other sizes on request

**EXPERIMENTERS SUPPLY CO.**  
1245 Overlook Rd. Lakewood, Ohio

## BRIGGS ASSOCIATES, INC.

Engineering Services

ELECTRONICS MECHANICAL  
Development — Manufacturing — Consulting  
Special Machines — Instrumentation — Automation  
Electron Tube Design, Materials, Reliability

10 DeKalb St. Broadway 9-2120 Norristown, Pa.

# PROFESSIONAL SERVICES

## ALBERT PREISMAN

Consulting Engineer

Television, Pulse Techniques, Video  
Amplifiers, Patent technical consultation.

616 St. Andrews Lane, Silver Spring, Maryland.  
JU niper 5-6307

## CROSBY LABORATORIES, INC.

Murray G. Crosby & Staff

Radio - Electronics  
Research Development & Manufacturing  
Communication, FM & TV

Robbins Lane, Hicksville, N. Y.  
WE lts 1-3191

## McCann Engineering Company

Consulting Mechanical Engineers

Design and Development of Test Equipment  
for Synchros, Potentiometers, Gyros, Etc.  
Redesign of Products—Trouble Shooting  
Production—Automatic Machinery.  
Special Machines with Sequence, Form  
Recognition, Dimension Decision and  
Special Environment Features.

9210 So. Vermont Los Angeles 44, Calif.

## TELECHROME MFG. CORP.

Electronic Design Specialists

COLOR TELEVISION EQUIPMENT  
Flying Spot Scanners, Color Synthesizers, Keyers,  
Monitors, Oscilloscopes and Related Apparatus,  
Telemetering for Guided Missiles.

J. R. Popkin-Curman Pres. & Dir. of Eng.  
28 Ranick Dr. Amityville, L. I., N. Y.

## DELAWARE PRODUCTS CO.

Analog Voltage to Digital Conversion  
Digital Voltage Recording Systems

Design-Development-Manufacturing

300 Broadway Camden 3, N. J.

## Measurements Corporation

Research & Manufacturing Engineers

HARRY W. HOUCK MARTIAL A. HONNELL

Specialists in the Design and  
Development of Electronic Test Instruments  
Boonton, New Jersey

## TRANSISTOR CONSULTANTS, INC.

TRANSISTOR ENGINEERING

Consultant; cost analysis; training programs.  
Engineering systems and Design Studies.  
Instrumentation; Prototype Construction.  
New Processes and Component Designs for Transistorized Computers; Servos; Radios.  
Laboratory Investigations; "Life-Test"; "Fringe Area" Evaluations.

P. O. Box 333 Morris Plains, N. J.

## ELECTRONIC RESEARCH ASSOCIATES, INC.

"TRANSISTORIZE" YOUR PRODUCT!  
Complete Service in consulting, research, development, and production on Transistor circuitry, products and instrumentation.  
67 East Centre Street Nutley, N. J.  
NUTley 2-5410

## NIAGARA ELECTRON LABORATORIES

CONSULTATION - DESIGN - CONSTRUCTION  
MFG. THE THERMOCAP RELAY

Specializing in solution of problems of electronic and electro-physical instrumentation for the research or analytical laboratory. Industrial plant problems also invited.

Andover, New York Cable Address: NITRONLAB

## WHEELER LABORATORIES, INC.

Radio and Electronics

Consulting — Research — Development

R-F Circuits — Lines — Antennas  
Microwave Components — Test Equipment  
Harold A. Wheeler and Engineering Staff  
Great Neck, N. Y. HU nter 2-7876

## ERCO RADIO LABORATORIES, INC.

Radio Communications Equipment

Engineering - Design - Development - Production  
Our 27th Year in Air to Ground  
Communications and Radio Beacons  
Garden City • Long Island • New York

## PICARD & BURNS, INC.

Consulting Electronic Engineers

Analysis and Evaluation  
of Radio Systems

Research Development and Production  
of Special Electronic Equipment  
240 Highland Ave. Needham 94, Mass.

## YARDNEY LABORATORIES

Research-Design-Development

Electro-Chemical Generators of Energy

40-48 Leonard Street WOrth 6-3100  
New York 13, N. Y.



# EMPLOYMENT OPPORTUNITIES

The Advertisements in this section include all employment opportunities—executive, management, technical, selling, office, skilled, manual, etc.



**Positions Vacant  
Positions Wanted  
Part Time Work**

**Civil Service Opportunities  
Selling Opportunities Wanted  
Selling Opportunities Offered**

**Employment Agencies  
Employment Services  
Labor Bureaus**

### DISPLAYED

The advertising rate is \$25.25 per inch for all advertising appearing on other than a contract basis. Contract rates quoted on request.

An advertising inch is measured 3/8" vertically on a column—3 columns—30 inches to a page.

Subject to Agency Commission.

### ---RATES---

\$2.40 per line, minimum 3 lines. To figure advance payment count 5 average words as a line.

Box Numbers—counts as 1 line.

Position Wanted ads are 1/2 of above rate.

Discount of 10% if full payment is made in advance for 4 consecutive insertions.

Not subject to Agency Commission.

### UNDISPLAYED

Send NEW ADS or inquiries to Classified Advertising Division of ELECTRONICS, P. O. Box 12, N. Y. 36, N. Y., for May issue closing April 2nd.

REPLIES (How No.): Address to office nearest you c/o This publication Classified Adv. Div.  
NEW YORK: P. O. Box 12 (36)  
CHICAGO: 590 N. Michigan Ave. (11)  
SAN FRANCISCO: 68 Post St. (4)

### POSITION WANTED

**RF Coil Engineer Graduate EE at present Chief Engineer with well known Coil Company, seeks similar position with medium size progressive Company. Reply PW-4428, Electronics.**

### SELLING OPPORTUNITY WANTED

**Lines wanted—Mechanical engineer will give capable New England sales representation. RA-4509, Electronics.**

### ELECTRONICS ENGINEER \$14 to \$18,000 Yr.

Well known company seeks Supervisory Engineers with experience in Computer & Analytical devices. Should have Executive ability, & Technical background.

For Confidential & Prompt Service

Send resume to:

J. COOPER  
202 S. State—Suite 1116 Phone: Harrison 7-6337  
Chicago, Illinois

### ENGINEERS

If you have been looking for an Employment Agency that is skilled in the STATE OF THE ART of Technical Recruitment and RELIABILITY OF INFORMATION concerning positions, why not communicate with us at once! ALL POSITIONS FEE PAID.

FIDELITY PERSONNEL SERVICE  
1218 Chestnut St. Phila. 7, Pa.  
Specialists in Aviation and Electronics

## QUICK SOLUTION TO MANPOWER PROBLEMS

through the EMPLOYMENT OPPORTUNITIES section of this publication. The market place for those wanting the services of men on engineering, technical and executive level.

# ENGINEERING OPPORTUNITIES

Aircraft Radio Corp., the industry's leader in avionics for over 30 years, has openings on its staff for forward thinking engineers in the following fields:

- TRANSISTOR CIRCUIT PROJECT ENGINEER
- SERVO AND INSTRUMENT ENGINEER
- ENVIRONMENT—TEST ENGINEER
- TECHNICAL WRITER
- CHIEF ENGINEER TO HEAD SERVO AND INSTRUMENT DEPT.
- ADVANCED TECHNICIANS

WRITE OR CALL COLLECT: Personnel Manager



## AIRCRAFT RADIO CORPORATION

BOONTON, NEW JERSEY

Deerfield 4-1800 Ext. 238

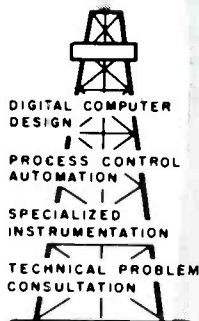

# Electronic Engineers

IF YOUR ABILITIES & AMBITIONS ARE STYMIED, YOUR TIME IS VALUABLE IN RESEARCH AT

**CONTINENTAL OIL COMPANY**  
PONCA CITY, OKLAHOMA

SEND DETAILED RESUMÉ TO PERSONNEL DIVISION

# ENGINEERING and

## *From the Chart...*

### DETAILS DESCRIBING SOME OF THE PROFESSIONALLY SIGNIFICANT POSITIONS

#### MECHANICAL ENGINEER

Salary to \$10,500

Design engineering on silicon and germanium semiconductor devices including diodes for computers, rectifier diodes, and transistors for entertainment, military or computer use. Experience in design engineering of electronic components from the advanced development stage to the point that a practical design for manufacturing is complete. Capable of performing all phases of product design including advanced and product design, factory follow-up and customer application. Position is at RCA's new Semiconductor Headquarters in suburban Somerville, N.J., convenient to New York City, Princeton, and New Jersey Shore Points.

#### MICROWAVE SYSTEMS MANAGER

Salary to \$16,000

Supervise engineers in the design and development of military microwave communications systems. Considerable experience is necessary in the product design of multi-channel radio relay equipment, including military equipment packaging, problems of tactical and fixed plant equipment and in the management of engineering projects and scientific personnel. Degree in EE or Engineering Physics required. Position will include technical liaison with customer representatives. Location at Camden, N.J., adjacent to Philadelphia.

#### DESIGN ENGINEER

##### RADAR TRANSMITTER & MODULATOR

Salary to \$12,000

An Electrical Engineer desiring to do creative work in a professional atmosphere will find this an interesting opportunity. You should be experienced in the design of high power ground based radar transmitter and modulator equipment. Some experience with High Power Klystron transmitters is desirable. RCA will pay relocation expenses to the engineer who can fill this vacancy. Modern benefit program, along with top salary. This position is located adjacent to Philadelphia in pleasant, suburban Moorestown, New Jersey.

#### INFRARED SYSTEMS ENGINEER

Salary to \$15,000

Engage in overall coordination and design of Infrared systems for Airborne Fire Control Defense and Missile Guidance. You should be experienced in general performance specifications, servo design, displays, Infrared heads and optical systems. You also must be capable of giving technical guidance to Junior Engineers. Minimum of 5 years' experience necessary. EE or Physics degree. The location is Camden, New Jersey, in the Greater Philadelphia area.

#### RECEIVING TUBE DESIGN ENGINEER

Salary to \$10,000

Design and development position in entertainment receiving tubes for r.f. and i.f. amplifiers, transistor driver tubes, multiple-purpose triode pentode tubes and others. Major responsibility for establishing tube design specifications. Work with methods and processing engineers, test engineers, application engineers and manufacturing engineers. Must have EE, ME or Physics degree, plus design and development experience in electronic devices or systems. Location at Harrison, N.J., convenient to Manhattan.

#### SYSTEMS INTEGRATION ENGINEER

Salary to \$13,000

Here is a position that requires an Engineer capable of translating customer needs to design requirements. The engineer to fill this position must have experience in missile, fire control or radar systems engineering. He must have the ability to understand technical problems, evaluate systems and guide design groups. This position is located adjacent to Philadelphia in pleasant, suburban Moorestown, New Jersey.

#### RECEIVING TUBE TEST ENGINEER

Salary to \$10,000

Establish electrical test specifications for industrial or entertainment tube types to insure quality control. Set up tube ratings, typical operating conditions and characteristic curves for publication release to customers. Design and develop test equipment for tube testing in laboratory or in production. Coordinate work with design, application, quality control, factory, government sales and other activities on tube testing and test equipment problems. Must have EE plus some industrial experience. At Harrison, N.J., 30 minutes from Manhattan.

#### COMMUNICATION DEVELOPMENT ENGINEER

Salary to \$12,500

An ideal opportunity for a development engineer. Work in Advanced Development Information Handling and Control Group. Develop techniques for application to PCM for voice and data transmission. Work will involve development of both digital and analogue transistor circuits for application to pulse code modulation voice and data transmission systems. One to two years' experience in digital and/or communication techniques is required. EE or Physics degree. Location in Camden, New Jersey, in Greater Philadelphia area.

#### PHYSICIST

Salary to \$10,500

Development of design and fabrication techniques for semiconductor devices of an advanced nature. Experience in electronic component development and processing in the solid state field, including instrumentation and measurement. Some background in theoretical analysis and experimental solid state physics required. Position is at RCA's new Semiconductor Headquarters in suburban Somerville, N.J., convenient to New York City, Princeton, and New Jersey Shore Points.

*Modern benefit program . . . relocation expenses paid . . .*



# SCIENCE at



STARTING SALARIES: NON-MANAGERIAL TO \$15,000... MANAGERIAL OPEN

FIELDS OF ENGINEERING ACTIVITY		MANAGERS	TYPE OF DEGREE AND YEARS OF EXPERIENCE PREFERRED											
			Electrical Engineers			Mechanical Engineers			Physical Science			Ceramics Glass Technology Metallurgy		
			0-2	2-3	4-15	0-2	2-3	4-15	1-2	2-3	4-15	1-2	2-3	4-15
<b>• SYSTEMS</b> <i>(Integration of theory, equipments and environment to create and optimize major electronic concepts.)</i>	<b>AVIATION ELECTRONICS • CONTROLS</b>		W	W	W	W	W	W	W	W	W			
	<b>DIGITAL DATA HANDLING DEVICES</b>	M		M	M		C	C		C	C			
	<b>MISSILE WEAPONS SYSTEMS • RADAR</b>	M	W	W	W	W	W	W	W	W	W			
	<b>INERTIAL NAVIGATION</b>			W	W		W	W		W	W			
	<b>COMMUNICATIONS</b>		C	C	C	C	C				C	N		
<b>• DESIGN • DEVELOPMENT</b> <b>MISSILE WEAPONS SYSTEMS</b> —Planning and Design—Radar—Fire Control—Servomechanisms—Computers		C	W	W	W	W	W	W	W	W	W	W	W	W
		M	C	C	C	C	C	C	C	C	C	C	C	C
<b>AVIATION ELECTRONICS</b> —Radar—Computers—Servomechanism—Shock and Vibration—Circuitry—Remote Control—Heat Transfer—Sub-Miniaturization—Automatic Flight—Automation—Transistorization—Infrared—Airborne TV		W	W	W	W	W	W	W	W	W	W			
		C	C	C	C	C	C	C	C	C	C			
<b>RADAR</b> —Circuitry—Antenna Design—Servo Systems—Gear Trains—Intricate Mechanisms—Fire Control—Information Handling—Display		M	W	W	W	W	W	W	W	W	W			
		C	C	C	C	C	C	C	C	C	C			
<b>COMPUTERS</b> —Systems—Advanced Development—Circuitry—Assembly Design—Mechanisms—Programming—Digital Data Handling Devices		M	C	C	C	C	C	C	C	C	C			
			W	W	W	W	W	W	W	W	W			
<b>KINESCOPIES (B &amp; W and Color), OSCILLOSCOPES</b> —Electron Optics—Instrumental Analysis—Solid States (Phosphors, High Temperature Phenomena, Photosensitive Materials and Glass to Metal Sealing)		L	L	L	L	L	L	L	L	L	L	L	L	
<b>GAS, POWER AND PHOTO TUBES</b> —Photosensitive Devices—Ceramic to Metal Sealing—UHF and VHF—Super Power		L	L	L	L	L	L	L	L	L	L	L		
<b>RECEIVING TUBES</b> —Tube Design—Test and Application Engineering—Chemical and Physical Development—Methods and Process Engineering		H	H	H		H	H		H	H		H	H	
<b>MICROWAVE TUBES</b> —Tube Development and Manufacture (Traveling Wave—Backward Wave—Magnetron)		H	H	H	H	H		H	H		H	H		
<b>SEMICONDUCTORS</b> —Materials research (surface studies—crystallography)—device design—circuitry—process engineering—automation.		V	V	V	V	V	V	V	V	V	V	V	V	
<b>COMMUNICATIONS</b> —Specialized Systems—Microwave—Mobile—Aviation—Audio—Propagation Studies—Acoustics—Transducers		C	C	C	C	C		C	C	C				
<b>BROADCAST AND TV</b> —Monochrome and Color Studio Equipment—Cameras—Voritors—High Power Transmitters		C	C	C	C	C		C	C	C				
<b>• SYSTEMS APPLICATION</b> <i>(Evaluation and Planning—Design and Development—Modification—Specification)</i>														
<b>MISSILE TEST INSTRUMENTATION</b> (Data Acquisition and Processing)—Radar—Telemetry—Timing—Communications—Optics—Computers		F	F	Z	Z	F	F	Z	F	F	Z	F	F	
<b>RADAR</b> —Airborne—Surface—Shipboard—Scnar—Fire Control		F	F	Z	Z	F	F	Z	F	F	Z	F	F	
<b>COMMUNICATIONS</b> —Radio—HF—VHF—UHF—Microwave—Telephone—Teletype—Telegraph Terminal Equipment—Wave Propagation		F	F	F	F	F	F	F	F	F	F	F	F	
<b>• MACHINE DESIGN</b> Mechanical and Electrical—Automatic or Semi-Automatic Machines		L	L		L	L			L	L				

Locations: C—Camden, N. J. F—Cocoa Beach, Fla. H—Harrison, N. J. L—Lancaster, Pa. M—Moorestown, N. J. N—New York, N. Y. S—RCA Service Co. (Cherry Hill, N. J.); Alexandria, Va.; Tucson, Ariz.; Dayton, Ohio; San Francisco, Calif. V—Somerville, N. J. W—Waltham, Mass. X—West Los Angeles, Calif. Y—Marion, Ind. Z—White Sands, N.M.

Please send resume of education and experience, with location preferred, to:

Mr. John R. Weld, Employment Manager  
 Dept. A-16D, Radio Corporation of America  
 30 Rockefeller Plaza, New York 20, N.Y.



**RADIO CORPORATION of AMERICA**

Copyright 1957 Radio Corporation of America

Tmkz. ®

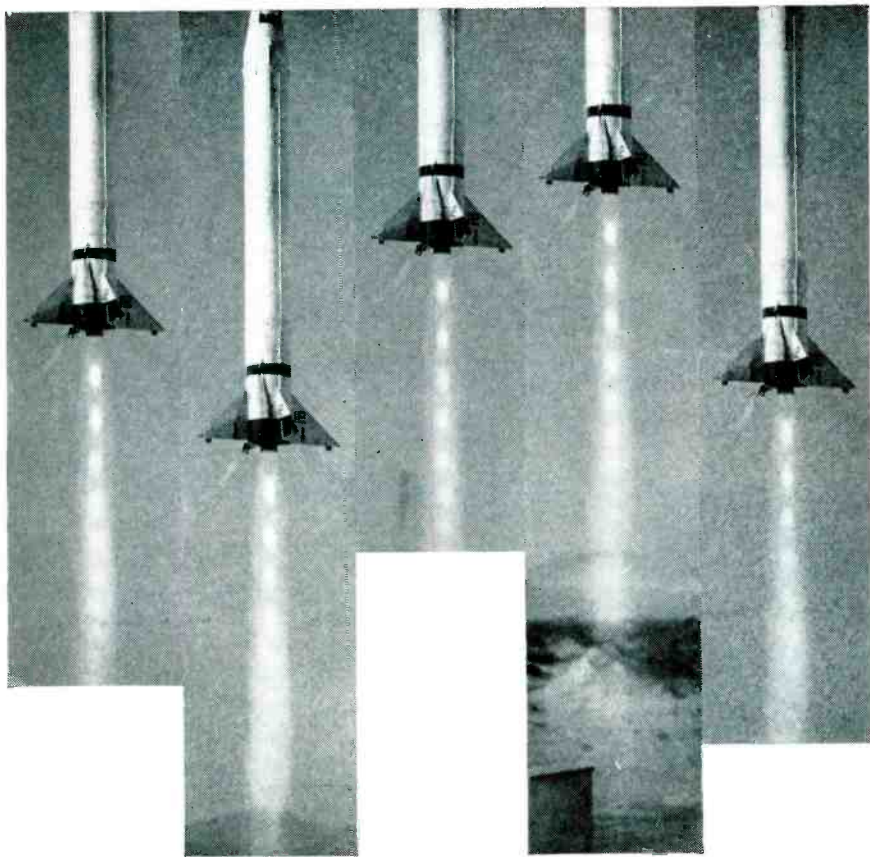

**What 5 top missile projects offer to your future in servo controls and instrumentation**

From the satellite launching vehicle to the No. 1 ICBM missile, Martin's five top rocket and missile projects offer the finest opportunities—and the most advanced engineering environment — available today in the fields of servo and instrumentation engineering.

Because of the pace-setting speed of development at Martin, there are many exceptional opportunities for newcomers as well as for trained specialists in these two big areas of career engineering.

Contact J. J. Holley, Dept. E-04, The Martin Company, Baltimore 3, Maryland.

**MARTIN**  
BALTIMORE

**ORO  
ANNOUNCES  
Challenging  
Openings in  
OPERATIONS  
RESEARCH**

Operations research is a fast growing and practical science attracting some of the best brains in the country. Its future is unlimited. If you want to join a group of pioneers in this exciting field, we invite you to investigate the openings on our staff.

**ON OUR PART WE OFFER:**

1. A record of experience in operations research, out-distanced by perhaps no other organization.
2. A scrupulously maintained professional approach and atmosphere.
3. The team approach to problem solving. On each team are representatives of varied disciplines—sometimes three, occasionally as many as a dozen.
4. Fully equipped digital and analog computing facilities.
5. ORO occupies several buildings in Chevy Chase, Maryland, one of America's most attractive suburbs. Pleasant homes and apartments in all price ranges are available. Schools are excellent. Downtown Washington, D. C., with its many cultural and recreational advantages is but a 20-minute drive.
6. Favorably competitive salaries and benefits, extensive educational programs, unexcelled leave policy.

**FOR DETAILED INFORMATION, WRITE:**

**Dr. L. F. Hanson**

**OPERATIONS RESEARCH  
OFFICE ORO**

**The Johns Hopkins  
University**

7100 Connecticut Avenue  
Chevy Chase, Maryland

April 1, 1957 — ELECTRONICS



# ENGINEERS

**AC** OFFERS YOU SECURITY

G M's long-standing policy of decentralization creates unlimited opportunities for qualified Electrical, Mechanical Engineers and Engineering Technicians.



## DEVOTED TO RESEARCH

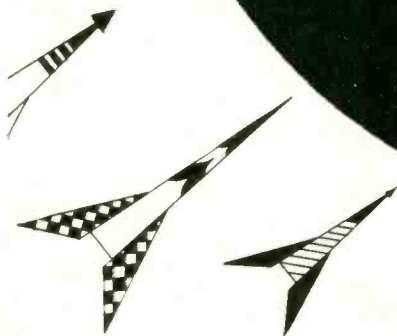

AC'S new, modern 225,000 square feet, glass-masonry, aluminum plant (being built in suburban Milwaukee) is another step in GM's Electronics Division's Permanent, Progressive Program.

For a confidential opinion as to how YOU can fit BEST in our Challenging Program write to us today.

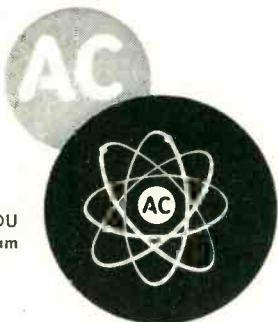

**A**VIONICS - MISSILE GUIDANCE  
 - JET ENGINE FUEL CONTROLS - COMPUTERS  
 - COMMUNICATION EQUIPMENT - CIVIL DEFENSE  
 AVIATION - AUTOMOTIVE ELECTRONIC PRODUCTS

all offer you personally, opportunities that demand investigation. To arrange personal, confidential interview in your territory, write today to

Mr. Cecil E. Sundeen

Supervisor of Technical Employment

**AC THE ELECTRONICS DIVISION**  
**General Motors Corporation**

Milwaukee 2, Wisconsin

Flint 2, Michigan

engineers...physicists

# There's a NEW KIND OF LIFE waiting for you and your family at MOTOROLA in PHOENIX ARIZONA



## WORK IN A VACATIONLAND (your family will love year-round outdoor living) WHILE YOU ADVANCE YOUR CAREER

Here are two of the country's newest and most complete Electronic Laboratories: (1) our expanding Military Research lab. and (2) our new Semiconductor lab. Both offer outstanding career advantages... (see listing at right). This is your opportunity to get in on the ground floor of a swiftly expanding company. You'll enjoy working in air conditioned comfort in the most modern and well instrumented laboratories... with liberal employee benefits, including an attractive profit sharing plan and association with men of the highest technical competence.

Salary levels are open and commensurate with ability. You'll like working with Motorola in Phoenix, where there's room to grow and it's fun to live.

**Electronic Engineers, Mechanical Engineers, Physicists, Metallurgists, and Chemists, in the following categories:**

**RESEARCH LABORATORY**

- Microwave Antennas
- Pulse and Video Circuitry
- Radar Systems Design
- Circuit Design
- Electro-Mechanical Devices
- Systems Test
- Transistor Applications
- Missile Electronics
- Draftsmen (Electrical Design and Layout)

• for above positions write to:  
Mr. R. Coulter, Dept. A  
3102 N. 56th St.  
Phoenix, Arizona

**SEMI-CONDUCTOR DIVISION**

- Transistor Application
- Transistor Devices
- Solid State Physics
- Physical Chemistry
- Metallurgical Engineering
- Production Engineering
- Transistor Sales Engineer
- Draftsmen (Electrical Design and Layout)

• for above positions write to:  
Mr. V. Sorenson, Dept. A  
5005 E. McDowell Road  
Phoenix, Arizona



FOR A  
PERSONAL  
INTERVIEW  
MAIL  
COUPON  
TODAY

**MOTOROLA IN PHOENIX, ARIZONA** (SEE ADDRESS AND LISTING ABOVE)

I WOULD BE INTERESTED IN DISCUSSING THE OPPORTUNITIES YOU CAN OFFER ME IN PHOENIX

NAME \_\_\_\_\_

HOME ADDRESS \_\_\_\_\_ CITY \_\_\_\_\_

STATE \_\_\_\_\_ DEGREE FROM SCHOOL: \_\_\_\_\_

NUMBER OF YEARS OF EXPERIENCE \_\_\_\_\_

MY MAIN JOB INTEREST IN PHOENIX IS: (SEE JOB LIST ABOVE)

\_\_\_\_\_

## RAPID GROWTH OPPORTUNITIES with GENERAL ELECTRIC ... in SEMICONDUCTORS

**Electrical Engineers . . . Physicists**  
... who have a B.S., M.S. or Ph.D. degree, above average ability, and are adventurous enough to tackle unusual problems in:

**ENGINEERING . . .**

Transistor, Rectifier and Diode device definition, evaluation and processing; development and design of automatic controls and automatic test equipment.

and

**RESEARCH . . .**

in semiconductor solid state physics and electrical chemistry, x-ray crystallography, materials and measurements.

Here is a chance to work with the industry's leading engineers and scientists in modern, campus-like Electronic Park. With decentralized management, you will have the equivalent advantages of a small company while being backed by G.E.'s tremendous financial resources and complete research facilities.

Enjoy gracious living in the heart of New York's vacationland.

U. S. Citizenship  
NOT Required.

Write in confidence to:

William E. Wendt  
SEMICONDUCTOR PRODUCTS DEPARTMENT

**GENERAL  ELECTRIC**  
1224 W. Genesee Street Syracuse, New York



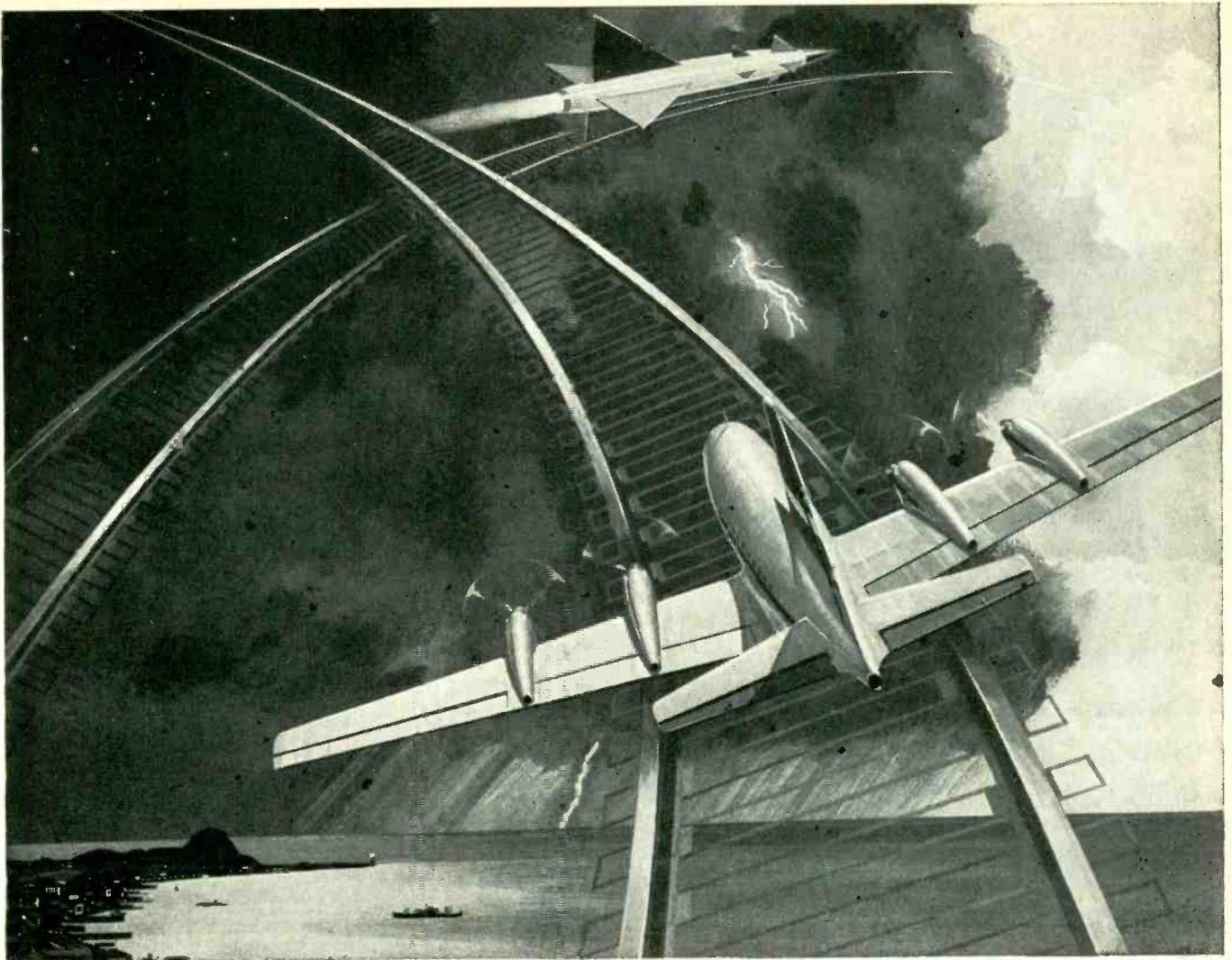

## Pathfinders of the airy blue

**ATRAN is an uncanny navigating device developed by Goodyear Aircraft engineers. It is so vital to our national security, the facts about it are still top-secret.**

**T**O MASTER the mystic forces of the sky — that is the purpose and the plan of all Goodyear Aircraft engineers.

How well they succeed is evidenced by such miracle developments as ATRAN. This is the amazing all-weather navigator which unerringly pilots planes and missiles to targets thousands of miles away.

ATRAN is a good example of the challenge — and the opportunity—available at Goodyear Aircraft. Here are myriad outlets for your skill and imagination in airship design, electronics, radomes, fire control, cockpit canopies, radar structures, metals engineering — to name just a few.

At your disposal are the most modern engineering and research laboratories, including one of the largest computer laboratories in the world.

If you have faith in your ideas and confidence in your ability to make them work, a rewarding career can be yours at Goodyear Aircraft. Our continued growth

and diversification have required expansion of our engineering staffs in all specialties at both Akron, Ohio, and Litchfield Park, Arizona.

Salaries and benefits are, of course, liberal. And if you wish to continue your academic studies, company-paid tuition courses leading to advanced degrees are available at nearby colleges.

For further information on your career opportunities at Goodyear Aircraft, write: Mr. C. G. Jones, Personnel Dept., Goodyear Aircraft Corporation, Akron 15, Ohio.

*They're doing big things at*  
**GOOD YEAR**  
**AIRCRAFT**

ATRAN—T. M. Goodyear Aircraft Corporation, Akron 15, Ohio



## A POSTAGE STAMP CAN CHANGE YOUR WHOLE FUTURE

Sometimes little things can be mighty important. For example, a three-cent stamp can put in your hands a complete account of opportunities in the guided missile field.

The guided missiles business is the business of the future, and your future can be brighter with Bendix—the prime contractor for the important and successful Talos Missile.

Here at Bendix you will be associated with many of the world's foremost missile engineers. The work necessarily covers the broadest possible technical assignments with practically unlimited opportunity for advancement.

The thirty-six-page booklet, "Your Future in Guided Missiles", contains

exactly the type of information every ambitious engineer should have.

It gives a detailed background of the function of the various engineering groups such as systems analysis, guidance, telemetering, steering intelligence, evaluation engineering, missile testing, environmental testing, test equipment design, reliability, ram-jet propulsion and hydraulics, and other important operations.

Mail this coupon today. It can bring you a brighter tomorrow.

**Bendix**—prime contractor  
for the TALOS MISSILE

Bendix Products Division—Missiles  
4031, Bendix Drive, South Bend, Indiana  
Gentlemen: I would like more information concerning opportunities in guided missiles. Please send me the booklet "Your Future In Guided Missiles".

NAME \_\_\_\_\_  
ADDRESS \_\_\_\_\_  
CITY \_\_\_\_\_ STATE \_\_\_\_\_



## ENGINEERS AND SCIENTISTS

with degrees in  
E.E., M.E., Ch.E. or PHYSICS

# Honeywell

BROWN INSTRUMENTS

*First in Controls*

### LEADS THE WAY IN A WORLD OF OPPORTUNITIES

■ **THE COMPANY**—Judging a company on its past performance constitutes sound logical thinking. Looking over BROWN INSTRUMENTS record of accomplishment tells a reassuring story of continuous growth during nearly a century of pioneering in the industrial instruments and control field.

■ **ASSIGNMENTS**—Diversified . . . permanent, non-routine, in the newest scientific field of NUCLEAR INSTRUMENTATION and AUTOMATION. The bulk of our work is for industrial use.

■ **COMPENSATION**—Rewarding . . . salaries are competitive with those offered in other industries. Our benefits include free group health insurance, hospitalization and surgical benefits, as well as an excellent retirement plan. Relocation assistance.

■ **GROWTH**—Unlimited . . . your performance and salary is re-evaluated twice yearly. Our policy to promote from within is responsible for present management.

■ **EDUCATION**—Excellent . . . financial assistance for those desirous of furthering their education at one of several renowned Philadelphia colleges or universities.

Men with the vision to create and the will to act can find an abundant outlet for their creative talent in either RESEARCH, DESIGN and DEVELOPMENT APPLICATION or SYSTEMS ENGINEERING. Whatever the choice, you and only you will be able to control and measure your progress with this company which leads the way in a world of opportunities . . .

Write to D. R. GARVEY  
Manager Employment,  
Dept. E

## Honeywell

BROWN INSTRUMENTS DIV.

Wayne & Windrim Aves.  
Philadelphia 44, Pa.



rejection of spurious frequencies: 80 db

image rejection: 80 db

sensitivity: 0.4 microvolt for 10 db  $\frac{S+N}{N}$

frequency stability:  $\pm 5$  kc

temp. range:  $-40^{\circ}\text{F}$  to  $+160^{\circ}\text{F}$

frequency range: 24-52 mc

## Electronics Engineers— Can you translate these specifications into a transistorized design?

Tough specs—even with conventional vacuum tube circuits. With transistors—even a greater challenge! In this high-performance FM receiver, requirements for reliability and miniaturization are extremely rigid.

Thrive on this kind of challenge? Then you're our kind of man! Stromberg-Carlson's booming Electronics Division offers you: interesting, important assignments; quick

recognition; excellent salary and benefits; *unbeatable growth potential.*

Good living, too, in Rochester. Beautiful homes, fine schools, great facilities for culture and recreation. Combines small-city living convenience with big-city advantages.

To decide what field challenges you most, check assignments at right. Then send your letter or resumé immediately to:

R. W. HOLMES, Electronics Engineering

- Communication Systems
- Components and Specifications
- Countermeasures
- Data Systems
- Digital Techniques
- Field Engineering
- Microwave Circuits
- Missile Guidance Systems
- Radar
- Sonar
- Sales Engineering
- Systems Test Equipment
- Transistor Engineering
- Writers—Technical



**STROMBERG-CARLSON COMPANY**

A DIVISION OF GENERAL DYNAMICS CORPORATION

32 CARLSON ROAD

• ROCHESTER 3, N. Y.



# To Help Meet Tomorrow's Challenges Today

## BURROUGHS

*The Foremost Name in Computation*  
Invites Special Inquiries from Engineers  
Qualified as Follows:

### ELECTRICAL ENGINEERS Senior & Junior Levels

- • • for study and evaluation of reliability program with emphasis on failure analysis of components.
- • • to design circuits and set-up design criteria for advanced solid-state digital computing systems.
- • • to design specific portions of large transistorized digital computer working from logical diagrams.
- • • to determine actual circuit configurations and packaging requirements.
- • • to design and develop coincident core memories.
- • • to define and develop specialized test equipment for large digital computer.
- • • for spec writing relating to materials, components and equipment.
- • • with some experience in Mechanical Engineering, to coordinate in the interconnection area between equipment and mechanical design groups working on large digital computers.

### MECHANICAL ENGINEERS Senior & Junior Levels

- • • for study and evaluation of component reliability, with emphasis on plug-in packages and test results.
- • • to develop packaging techniques for components and assemblies of large digital computers.
- • • to work in the area of Structure and Vibration analysis on components, sub-assemblies and packaging.

### MATHEMATICIANS

- • • for statistical analysis and evaluation of Reliability Data as related to electronic circuits and components.
- • • to prepare and program problems for solution by digital computer.
- • • to develop basic logical requirements and detailed logical design of digital systems.
- • • skilled in mathematical analysis as related to programming, systems and design of large digital computer.
- • • to do analysis and report writing in areas of "operations research", systems analysis and engineering mathematics.
- • • to perform systems engineering "operations research," knowledge of probability required, for work in fields of aerodynamics, radar, computers, fire control, missiles and air defense.

#### In Addition to Pay Commensurate With Your Ability

... you can receive cooperative educational aid, liberal pension plan and all the usual health and hospitalization benefits for you and your family, PLUS delightful suburban surroundings and an ideal community life for your children, only 30 minutes from Philadelphia.

For Details, Write M. E. Jenkins, Placement Manager

## BURROUGHS CORPORATION

Research Center

PAOLI, PA.

PAOLI 4700

### ENGINEERS

## How Long Until You'll Make \$25,000

If you're worth that much now and feel your best contributions can be made elsewhere, we have important openings with blue-chip companies whose expansion has been so rapid that many positions cannot be filled from within. The following openings are available:

**Engineering Executive** — Thoroughly versed in all phases of electronic R&D in missiles and radar.

**Department Head** — Radar, counter-measures, search-track and propagation.

**Senior Electronic Engineer** — Circuit design of synthetic display systems, transistorized digital data processing background.

**Manager, Mechanical Design & Standards** — In servos and gyros.

**Mechanical Engineer** — Packaging and production liaison of racks, cabinets, printed circuits and mechanical components.

**Electro-Mechanical Designer** — Design of precision electro-mechanical devices.

Our business is referring outstanding men to some of the finest, best-known companies in the country. If you are better than average and are looking for a better than average position, Abbott's can help you. Our clients assume all expenses. Your reply held in strictest confidence. Send detailed resume to Mr. George R. Sandel, Director.



EMPLOYMENT SPECIALISTS

333 Washington St. Boston 8, Mass.

## COMMUNICATIONS ENGINEERS and TECHNICIANS

EXCELLENT SALARIES  
MINIMUM PREREQUISITES

**ENGINEER** EE Graduates with 3 years experience  
**TECHNICIAN** 2 years technical school in communications and 3 years experience.

Require installation adjustment and maintenance experience with communication receivers and associated terminal equipment. Also, men with similar experience with high-powered transmitters, antennas, transmission lines.

Must be willing to travel in United States and Overseas

Page Communication Engineers, Inc.  
710 Fourteenth St., N.W., Washington 5, D.C.

## NEED ENGINEERS?

An employment advertisement in this EMPLOYMENT OPPORTUNITIES section will help you find the engineers you need. It's an inexpensive, time saving method of selecting competent personnel for every engineering job in the electronics field. The selective circulation of ELECTRONICS offers you an opportunity to choose the best qualified men available.





Flight Test Facility . . . Bedford, Mass.

## Missiles are TOPS and we're TOPS in Missiles!

Included among the most important efforts in this country's plans for defense are the design and development of missiles. History making events, such as the first interception of an aircraft by a guided missile (Navy's LARK) were made possible by Raytheon's engineering staff. Raytheon is the only electronic company in the country with TWO prime missile contracts (Navy and Army). The Missile Systems Division is composed of a dynamic active organization of over 3400 employees including more than 500 engineers. Our contract commitments are increasing—we need additional engineers to grow with us.

You start at an excellent rate of pay with periodic increases based on ability and performance. Raytheon pays the major cost of graduate study at Harvard, M.I.T., Boston University or Northeastern. Our staff attends meetings and seminars at Company expense.

Raytheon's tradition of achievements in the forefront of electronic research and development—the opportunity to advance rapidly as an individual—the combination of exceptional living conditions (suburban or rural), proximity to Boston (cultural, educational, medical, recreation & research center)—a healthy and varied climate—engineer management—all these have attracted a growing number of able engineers to us.

If you are interested in guided missile systems and have experience in these fields:

Circuit Design  
Microwave  
Antenna Design  
Systems Engineering

Electronic Packaging  
Test Equipment Design  
Specifications  
Tube Applications

Infra-Red

Come in, telephone or send brief resume to:

G. P. O'Neil



MISSILE  
SYSTEMS  
DIVISION

B E D F O R D , M A S S .

# Electronics Engineers

## GROW FASTER IN AN ORGANIZATION THAT TRIPLED IN SIZE LAST YEAR

A variety of opportunities are now open at our Stamford, Connecticut Electronics Laboratory. This is AMF's central organization for electronics development in our General Engineering Laboratories — the organization that tripled its size last year. Let this kind of growth help speed your own career, in such programs as:

- Industrial electronics for application to machines such as: automatic pin spotter, cigarette and cigar-making machines, bakery machines.
- Radio-frequency development for point-to-point communications systems, radar, and special measuring instruments.
- Antenna development including design of narrow beam microwave antennas, antenna phasing devices, and antenna pattern tests and propagation measurements on AMF's antenna range.

*Openings for:*

### ELECTRONICS ENGINEERS

With interest in radio frequency circuits for development and application of communications and special devices.

### ELECTRONICS ENGINEERS (*Advanced*)

Experience in radio frequency circuits for development and application of communications and special devices. Will be responsible for organizing a group carrying out project objectives.

### ANTENNA ENGINEERS

Experience in test and measurement techniques on antennas and associated equipment. Will be trained for advanced work under direct supervision of experienced antenna engineers.

### ANTENNA ENGINEERS (*Advanced*)

To expand our present antenna group for the analysis and design of antennas, rotary joints, baluns, and feed systems. Capable of working with mechanical engineers and designers.

### ELECTRONIC PACKAGING ENGINEERS

With 5-10 years electronic experience in packaging of component units of electronic and electrical systems. Will work closely with circuit and system engineers from breadboard and schematic diagrams to organize the design of the finished product.

### OTHER OPPORTUNITIES ARE AVAILABLE FOR ENGINEERS AT ALL EXPERIENCE LEVELS, IN BOTH COMMERCIAL AND MILITARY FIELDS.

Full responsibility and authority are given to engineers to carry out all aspects of their tasks, including design, material specifications, prototype fabrication, test and reports. AMF supports a tuition reimbursement plan, post-graduate extension courses in Greenwich, and a liberal policy of attendance at symposiums and technical meetings. And you'll enjoy top salaries and regular merit reviews.

Please send complete resume to MR. JOSEPH F. WEIGANDT



GENERAL ENGINEERING LABORATORIES

**American Machine & Foundry Company**

Fawcett Building • Fawcett Place • Greenwich, Connecticut

P  
H  
O  
N  
I  
X  
  
P  
H  
O  
E  
N  
I  
X

At the crossroads of opportunity for men with vision in Electronic Engineering and other related fields:

## GOODYEAR AIRCRAFT CORPORATION

### ELECTRONIC LABORATORY

Arizona Division  
Litchfield Park, Arizona

A Subsidiary of the  
**GOODYEAR TIRE & RUBBER CO**

We have openings in our modern Laboratories at all levels of experience in the branches of Engineering listed below. We urge you to investigate the opportunities here for employment. We think you will like the friendly, informal atmosphere of our laboratory. The stimulation of working with top level engineers and scientists will make your work interesting and challenging.

**Complete Missile and Electronic Systems**  
**Microwaves, Servomechanisms**  
**Radars and Stabilized Antennas**  
**Transistor Application, Electronic Packaging**  
**Electronic Ground Support Equipment**

Long range research and development projects

University of Arizona graduate studies available under the Goodyear Fellowship Program, or company financed evening courses.

*Leisure Living At Its Best*  
*"In the Valley of the Sun"*

Modern Inexpensive Housing

Send resume to: A. E. Manning

Engineering and Scientific Personnel

## GOODYEAR AIRCRAFT

LITCHFIELD PARK  
PHOENIX, ARIZONA

Similar opportunities available in our Akron, Ohio Laboratory



# ELECTRONIC ENGINEERS

***Consider the significance of your profession!***

The shape of things to come is being designed by electronic engineers of professional stature, the exceptional engineers who—by education and experience—are qualified to fulfill an important destiny. Such men are needed at Bendix Radio to do research and development on the most advanced electronic systems in both military and commercial fields.

Nowhere are the professional aspects of the engineer's career held in higher regard than they are at Bendix Radio!

At Bendix you will be given the opportunity for important accomplishment while working on the most advanced electronic systems. These include:

MISSILE GUIDANCE & TRACKING SYSTEMS  
 RADAR WARNING SYSTEMS  
 MILITARY ELECTRONICS  
 RESEARCH & DEVELOPMENT  
 AUTOMOTIVE ELECTRONIC RESEARCH  
 AIRBORNE ELECTRONICS SYSTEMS  
 MOBILE COMMUNICATIONS SYSTEMS

At Bendix Radio, the importance of *your* career is fully recognized. You are given the opportunity for rapid professional growth while working with leading engineers who are pioneers in their fields. You are backed up by skilled sub-professional people and kept well-informed as to the status of company work and project developments. You work in a modern plant with the latest equipment and will receive an excellent salary, periodic merit reviews and complete company benefits, including assistance in graduate education.

The attitude, the way of life and the vision of the future is designed for the man of professional stature at Bendix Radio. We invite you to take up this way of life in our beautiful residential area and look upward toward a bright future.

*Drop us a postal card,  
 briefly stating your education  
 and experience. We'll act fast  
 . . . and confidentially!*

*Address: Employment Supervisor, Dept. J*



***Bendix***

DIVISION OF BENDIX AVIATION CORP., BALTIMORE 4, MD.

***Radio***

# You'll Find OPPORTUNITY TO GROW

at  
**Westinghouse**

Electronic Tube Div.  
ELMIRA, N. Y.

Do you want to rise above the crowd?  
Investigate these outstanding careers in electronics. Your engineering experience and education will receive personal recognition. Salary is open.

You will feel yourself GROW as you tackle challenging assignments that penetrate new frontiers in our rapidly-expanding Electronic Tube Division. In-plant training will enable you to progress into special fields.

Comfortable low-cost suburban living in upstate New York with city conveniences. Scenic country near famous Finger Lakes vacation-land for swimming, boating, fishing, hunting.

Get the FACTS on these specific opportunities: (Previous experience desirable)

- **TUBE DESIGN ENGINEERS**  
For work on microwave, power and cathode ray tubes. Also pickup devices.
- **RESEARCH ENGINEERS**  
On any of the above tubes or related fields.
- **MACHINE DESIGN ENGINEERS**  
Automatic tube manufacturing equipment from specifications to operation, or related experience on special machines and equipment.
- **TOOL DESIGN ENGINEERS**
- **MANUFACTURING ENGINEERS**  
Microwave tube testing and fabrication, magnetron fabrication, power tube manufacturing.
- **MATERIALS & STANDARDS ENGINEER**  
For engineering standardization. 1 or more years' experience
- **ELECTRONICS ENGINEERS**  
Experience in design of magnetron tube equipment, hard and soft modulators for pulsing magnetrons, waveguide mismatches.
- **GLASS ENGINEERS**
- **DRAFTSMEN**  
Detail layout and design.

Write or send resume to Mr. W. Kacala, P. O. Box 284, Dept. M-31, Elmira, N. Y., or phone collect Elmira 9-3611. Evenings or weekends, phone 2-2139.

**Westinghouse**  
ELECTRONIC TUBE DIVISION ELMIRA, NEW YORK



## ENGINEERS

### PARTS APPLICATION

(Reliability)

ME or EE degree with design experience and/or application experience. Job will be to recommend types of parts to be used and how these parts shall be used.

Qualified men will become a vital part of a Reliability Group.

**GM**

### INERTIAL GUIDANCE SYSTEM PROGRAM

#### • ELECTRONICS DIV.,

Milwaukee 2, Wis.  
Flint 2, Mich.

Enjoy Challenging Opportunities in the most versatile Laboratories in the country. Work with the top men in the field and with the finest test, research and development facilities. We are in the process of a Major, Permanent, Expansion Program. New Plant facilities being added in suburban Milwaukee area.

To aid you in your professional advancement AC will provide financial assistance toward your Master's degree. A Graduate Program is available evenings at the University of Wisconsin, Milwaukee.

GM's Electronics Division aggressive position in the field of manufacture and GM's long-standing policy of decentralization creates individual opportunity and recognition for each Engineer hired.

#### Recent EE,ME Graduate Inquiries Also Invited

Milwaukee offers ideal family living in a progressive neighborly community in cool, southern Wisconsin where swimming, boating, big league baseball and every shopping and cultural advantage is yours for the taking.

To arrange personal, confidential interview in your locality send full facts about yourself today to

Mr. Cecil E. Sundeen  
Supervisor of Technical Employment

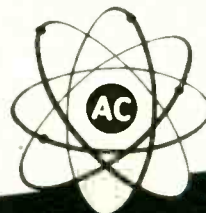

Electronics Div.  
General Motors Corp.  
FLINT 2, MICHIGAN  
MILWAUKEE 2, WISCONSIN

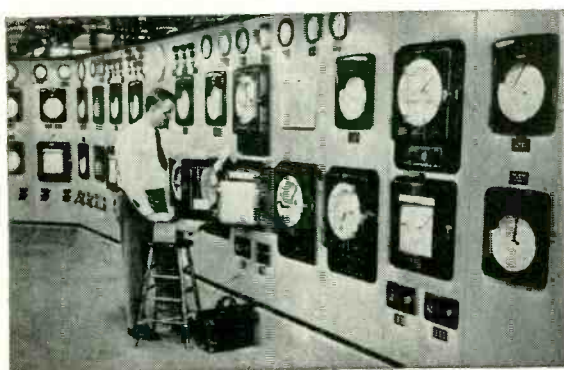

**ENGINEERS . . .**• *Market Development*• *Visit Customer Plants*• *Plant Engineer Contacts*• *Servicing Customers' Instruments*

## Step into the Expanding Field of Instrumentation

### *Ever Think of MARKETING As a Career?*

Marketing, as we practice it, consists largely of analyzing problems and finding the answers. It is far removed from "ringing doorbells", because the doors are already open. And it is far removed from "pushing" anything or anybody, because buying and selling in industry are based on reason, not emotion. Industrial Marketing includes careful engineering, good judgment, and expert knowledge of the equipment you're discussing.

For our open positions in Marketing a college degree in science or engineering is necessary plus a normal liking for people and an ability to get along with them. Our specifications are as follows:

**MARKET DEVELOPMENT:** 3-5 years experience in the following areas of specialization. Instrumentation and control knowledge desirable: Aluminum or Steel, Glass or Cement, Electric power, Combustion Control, Nucleonics, Electrical Measurements, Data Processing, Petroleum or Chemical Process Instrumentation. Location—Philadelphia

**SALES ENGINEERING:** 1-3 years experience in selling instrumentation and controls to basic process industries. Location—District Sales offices listed below

**SERVICE ENGINEERING:** 2-5 years experience in Steam or Electric Power plant instrumentation. Location—Chicago, Philadelphia, Houston, Cincinnati, Atlanta

This can be a career of infinite variety, great usefulness and excellent income. Why not let us set up an interview with some of the managers of our Marketing Departments.

We also have several openings for experienced technical personnel in Research, Development and Engineering.

Address your reply to:

**Wayne L. Besselman, Coordinator of Technical Employment**



4979 Stenton Ave., Philadelphia 44, Pa.

Atlanta	Columbus	Los Angeles	Seattle
Boston	Denver	Milwaukee	St. Louis
Buffalo	Detroit	New York	Tulsa
Chicago	Hartford	Philadelphia	Integra, Leeds
Cincinnati	Houston	Pittsburgh	& Northrup,
Cleveland	Indianapolis	San Francisco	Birmingham, Eng



▲ Plant of Westchester manufacturing subsidiary, Pleasantville Instrument Corporation; additions are under construction.

Latest GPL engineering building, for which ground was broken recently. ▶

## Electronics Engineers



◀ Plant of Bloomfield, N. J., manufacturing subsidiary, Simplex Equipment Corporation; added in 1957.

▼ New GPL environmental test lab, most modern of its kind, now nearing completion.

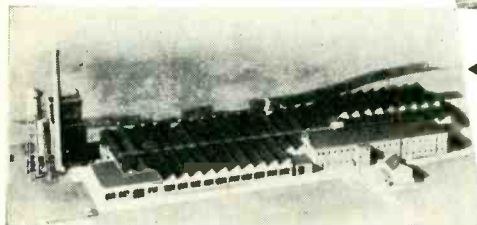

# GPL keeps GROWING

## ... how about YOU?

You can find opportunity in many places, but you can find more of it at GPL. As a result of GPL's brilliant scientific break-through in harnessing Doppler to air navigation, scores of new development and production opportunities have been created. We need electronics engineers who can keep pace with us and, more important, help set the pace for future growth.

You can find security in many places, but here at GPL you get a double measure. You participate in the secure strength of the nationwide GPE Group. Top salaries and ideal working conditions give you the peace of mind to enjoy pleasant living in semi-rural surroundings, less than an hour away from New York City.

Greater opportunity and more security—for yourself and your family—are a part of every job here at GPL.

<p>In connection with <b>DOPPLER &amp; INERTIAL Air Navigation and Guidance Systems</b> we have openings for work on Computers, Magnetic Amplifiers, Servos, Microwave Techniques, Transistorization, IF Amplifiers and Pulse Circuitry.</p>	<p><b>Research &amp; Development:</b> Applications • Systems Analysis • Systems Test • Mechanical Design • Mechanical Packaging • Project Engineering • Component Specification and Test • Proposal Writer • Contract Administrator.</p> <p><b>Manufacturing Engineering:</b> Systems Test • Quality Control • Mechanical Design • Production Follow-up.</p> <p><b>Field Engineering:</b> At Military Installations and Airframe Manufacturers' Plants.</p>
--	---

Send your resumé to: Mr. Richard E. Hoffman, Employment Manager. We will pay the expenses of qualified applicants to come for an interview.



**General Precision Laboratory Incorporated**  
63 Bedford Road, Pleasantville, New York

### ENGINEERS

#### THESE JOBS OFFER THE BEST IN ALL 3:

- Salaries to \$20,000
- Location
- Growth

You're bound to do better in New England, the heart of activity in the electronics industry. In fact, a competitive manpower area is your assurance of highest salaries and best growth opportunities. Present openings include:

- Chief Engineer—*Gyro research & development*
- District Sales Manager—*Semi-conductors & microwave tubes*
- Manager of Math & Simulation Laboratory R&D
- Product Engineer—*Magnetron tubes production & development*
- Semi-Conductor Engineers—*Silicone and germanium transistors and diodes*
- Test Equipment Engineer—*Development of automatic production test equipment*
- Magnetron Engineer—*Advanced development of backward wave magnetrons*
- Tube Applications Engineer—*Microwave & special purpose tubes*
- Microwave Diode Development Engineer
- Transistor Circuit Development Engineer

Our business is referring outstanding men to some of the finest, best-known companies in the country. If you are better than average and are looking for a better than average position, Abbott's can help you. Our clients assume all expenses. Your reply held in strictest confidence. Send detailed resume to Mr. George S. Sandel, Director.



EMPLOYMENT SPECIALISTS  
333 Washington St. Boston 8, Mass.

### RESEARCH AND DEVELOPMENT ENGINEERS

Career opportunities in Central Research Laboratory of stable, growing company. Electronic engineers with B.S. or M.S. for advanced circuit design on audio systems, magnetic recording, transistor control circuits for aircraft instrumentation and high frequency instruments. Positions offer opportunity for creative work in stimulating environment. Send resume to: Frank V. Paley, Professional and Technical Employment Manager,

**THOMAS A. EDISON, Inc.**  
WEST ORANGE, N. J.

#### New Advertisements

received by April 2nd will appear in the May 1st issue subject to space limitations.

Classified Advertising Division  
ELECTRONICS  
P. O. Box 12 New York 36, N. Y.



ENGINEERS · SCIENTISTS  
PROJECT ENGINEERS  
ENGINEERING SPECIALISTS

## Mountain View, California

### MICROWAVE PHYSICS LABORATORY

- Magnetic Ferrites
- Gaseous Electronics
- Paramagnetic Resonance
- Ferroelectrics
- Microwave Propagation
- Guided Microwave Control Devices

### ELECTRONIC DEFENSE LABORATORY

- Systems Analysis & Design
- Operations Research
- Computers
- Equipment Development
- Microwave Circuits & Antenna Design
- Mechanical Design

*For positions in either of these two laboratories at Mountain View, Calif. please send resume to J. C. Richards, Box 205 Mountain View, Calif.*

### MICROWAVE TUBE LABORATORY

For research, development and production on Traveling Wave Tubes, Backward Wave Oscillators and Klystrons

- Internal Microwave Tube Circuits
- Power Handling Circuits
- Interaction Studies on Beams & Fields
- Boundary Conditions Studies in Cavities
- Ceramic-Metal Techniques
- Production Devices Design
- Field Generation Devices

*For positions at this laboratory at Mountain View, Calif. please send your resume to Gordon McClure 500 Evelyn Ave. Mountain View, Calif.*

Sylvania  
Laboratories  
now  
selecting men  
for  
advanced  
electronic research  
& development

CHOOSE EAST COAST OR  
WEST COAST LOCATION

East or West, Sylvania Laboratories are in the forefront of advanced electronics research and development, offering fine positions to men capable of important scientific contributions...and interested in the rewards this growing company offers for creative work. Positions are open in the following fields.

## Waltham, Massachusetts

### MISSILE SYSTEMS LABORATORY

- Atmospheric effects on radio & radar propagation
- Signal & Noise Studies
- Estimation Techniques
- Smoothing & Prediction Theory
- Aerodynamics Heating & Heat Transfer
- Error Analysis
- Electronically Scanned Antennas
- Modulation Theory

### AVIONICS LABORATORY

- Electronic Systems Design & Development
- Microwave & Antenna Research & Development
- Electronic Packaging & Test Design
- Computer Systems Engineering & Logical Design
- Technical Coordination & Liaison

### APPLIED RESEARCH LABORATORY

- Operations Research
- Communications Theory
- Automatic Controls
- Airborne Interceptor Radar
- Infra-Red Systems
- Radar Simulators
- Missile Electronics

*For positions at Waltham, Mass. please send your resume to Erling Mostue Waltham Laboratories, 100 First Avenue Waltham, Massachusetts*

ELECTRONIC SYSTEMS DIVISION

 SYLVANIA 

SYLVANIA ELECTRIC PRODUCTS INC.



Match your interests to this check list of  
**ENGINEERING OPPORTUNITIES**  
 with  
**Admiral®**

Research and development projects, now in progress, have gained for Admiral a commanding lead in certain broad areas of military and civilian electronics. A number of challenging opportunities exist, and one of them may closely match your special interests and past experience. Examine the following check list.

**RADAR**—L band radar, beacon coding and decoding, pulse train generating and processing circuits. Airborne radar in X band range.

**ELECTRONIC COUNTERMEASURES**—Analysis, development and design, employing advance radar techniques.

**MILITARY TV**—Airborne and ground systems, including receivers, transmitters, cameras, antennas, sync generating systems and displays.

**TELEVISION, VHF AND UHF**—Tuner design, deflection circuitry, design of low noise wide band front ends and I.F. circuits.

**NUCLEAR ENGINEERING**—Evaluation of nuclear radiation damage to electronic components. Work involves experimentation with reactors and 20,000 curie cobalt source. Development of radiac techniques and instrumentation.

**PALO ALTO RESEARCH**—Development of new technologies opens door on a program of advanced research in aeronautical electronics. Experienced and intermediate level engineers send resume and salary requirements to *R. M. Jones, Admiral Corporation, 901 California Ave., Palo Alto, Cal.* . . . for California openings only.

Current openings offer excellent income and opportunity for rapid advancement. Complete employee benefit program includes retirement plan, paid group insurance, college tuition refund plan and ideal working conditions. On-the-job training for junior and intermediate engineers. Write, summarizing your education and experience to *W. A. Wecker, Personnel Division.*

**Admiral Corporation**  
 3800 W. CORTLAND ST., CHICAGO 47, ILL.

**ENGINEERS**



**SCIENTISTS**

for new Bendix  
 Systems Division

Opportunities for Research Engineers, Physicists and Mathematicians for Systems Research and Development in the fields of:

- AVIONICS
- NUCLEAR
- AIRCRAFT AND MISSILES
- DIGITAL COMPUTERS
- INFRARED
- UNDERWATER ACOUSTICS
- COMMUNICATIONS
- CIRCUIT DESIGN
- SYSTEMS ANALYSIS
- COUNTERMEASURES
- RADAR

Excellent working conditions. Adjacent to the University of Michigan. Unusual opportunity to carry on, with assistance university graduate studies while working full time. Moving expenses paid. U. S. citizenship required.

Write giving details of education and experience, to:

Personnel Office  
 BENDIX SYSTEMS DIVISION  
 ANN ARBOR, MICHIGAN



SYSTEMS  
 DIVISION

April 1, 1957 — ELECTRONICS



TI  
**ENGINEERS,  
 PHYSICISTS**

**BUILD**



## TRANSISTOR 'STOP-WATCHES' FOR INDUSTRY\*

*accuracies to a 50 millionth | intervals from microseconds to months*

Experienced graduate engineers and physicists are invited to join one of the many expanding programs at engineer-managed Texas Instruments... where recognition of individual achievement has contributed to TI's fifteenfold growth in the last ten years — to a current \$45 million volume. Advanced personnel policies include company-sponsored educational assistance, profit sharing, insurance, and retirement programs.

Texas Instruments plants are within Dallas, yet away from downtown traffic... within 5 minutes of fine residential areas, churches, and public and private schools. Your home will be within 15 minutes of year-around recreational, amusement and cultural activities.

**SEMICONDUCTORS & OTHER COMPONENTS** — Transistors, transistor circuits, diodes, rectifiers, transformers, resistors, panel meters, test equipment. *Write W. C. Spaller.*

**ELECTRONIC & ELECTROMECHANICAL APPARATUS** — Radar, sonar, infrared, navigation, magnetics, telemetering, communications, computers. *Write R. E. Houston.*

**RESEARCH** — PhD level for research: semiconductor materials and devices, ferromagnetics, infrared, high speed data reduction, etc. **ADMINISTRATION** — Engineers for: production, planning, purchasing, cost analysis, etc. *Write W. D. Coursey.*

\* Texas Instruments engineers are building portable electronic timing devices to uncanny accuracies with interval variations to infinity. They allow applications never before practical because of previous size, weight, power drain, and maintenance limitations... particularly in airborne installations. Essentially binary counting and storage devices, these TI timers present an entirely new concept in time measurement... a result of the new design freedom allowed by transistors... of which TI is also the world's largest commercial manufacturer.



# TEXAS INSTRUMENTS

INCORPORATED

6000 LEMMON AVENUE DALLAS 9, TEXAS



ENGINEERS & SCIENTISTS

**JOIN IN DEVELOPING  
1 IN 10<sup>11</sup> ACCURACY  
AT NATIONAL**

4	29 Cu 63.57	30 Zn 65.38	31 Ga 69.72	
	37 Rb 85.48	38 Sr 87.62	39 Y 88.92	4 9
5	47 Ag 107.88	48 Cd 112.41	49 In 114.76	
	55 Cs 132.91	56 Ba 137.36	57-71 Rare earths	
6	79 Au 197.2	80 Hg 200.61	81 Tl 204.39	
	87 —	88 Ra 226.05	89 Ac 227	9 2
7				

Utilizing the resonance frequency of cesium\*, National's electronics engineers & scientists have developed the ultimate in atomic clocks—the Atomichron—which promises to become the primary frequency standard much as the  $\lambda$  of cadmium's red line has become the standard of length.

Problems in the development of precision frequency standards are some of the ones you will meet at National. Others lie in the design and development of tropospheric and ionospheric scatter systems, high information density receivers, classified signal processing equipment, and in applied physics.

At National you can work with the best of associates, with the latest in equipment—on some of the most pressing and intriguing problems in communications, atomic and molecular physics.

If you are the sort of engineer who cares more for the solidity of good work and professional reward, rather than for the frills of mahogany desks and landscaped surroundings, you owe it to yourself to contact National.

Send your resume to John Bigelow. It will be read by engineers and you will get a reply from an engineer.

\* $9192.631830 \pm 0.000010$  mc/sec. The atomic beam technique as used in the Atomichron has already resulted in an accuracy of 1 part in  $10^{10}$ —in terms of time, 1 second in 300 years; and it promises to yield even better results by orders of magnitude.



**NATIONAL COMPANY, INC.**

61 Sherman St., Malden, Mass.

Electronic Engineers  
Mechanical Engineers  
*Advancement... Security*  
*...Responsibility*

Professional personnel needed at all levels to fill responsible openings at this steadily expanding Division of Bendix Aviation Corporation. It's your chance to get specific assignments at the peak of the art in ELECTRONICS and MICRO-WAVE DEVELOPMENT and DESIGN. Good salaries, all employee benefits, ideal suburban living conditions. Whether you be a Department Chief or a Junior Engineer with less than one year's experience, we have the opening and the shoes for you to fill.

Address: Chief Engineer Dept. H



**York**  
DIVISION

York, Penna. York 47-2611

**Electrical Engineers  
Mechanical Engineers  
Physicists**

PRINCETON-PENNSYLVANIA  
SYNCHROTRON

Get  
Research  
Experience  
And  
Training

Our  
Program  
Promises  
Opportunity in  
Research  
That offers  
Unlimited  
New Horizon of  
Interest  
To  
You

Under contract with the AEC, Princeton and the University of Pennsylvania are designing a 3-billion volt, high intensity proton synchrotron to be built at the James Forrestal Research Center in Princeton. Outstanding opportunities for engineers and physicists in unclassified research are now available.

Salaries commensurate with ability. Live and work at Princeton in an academic surrounding with University benefits.

Send resume or inquiry to:

Silas Spengler  
Committee on Project Research and Inventions  
123 Pyne Administration Building  
Princeton University  
Princeton, New Jersey



EH, SPORT?

by dahl

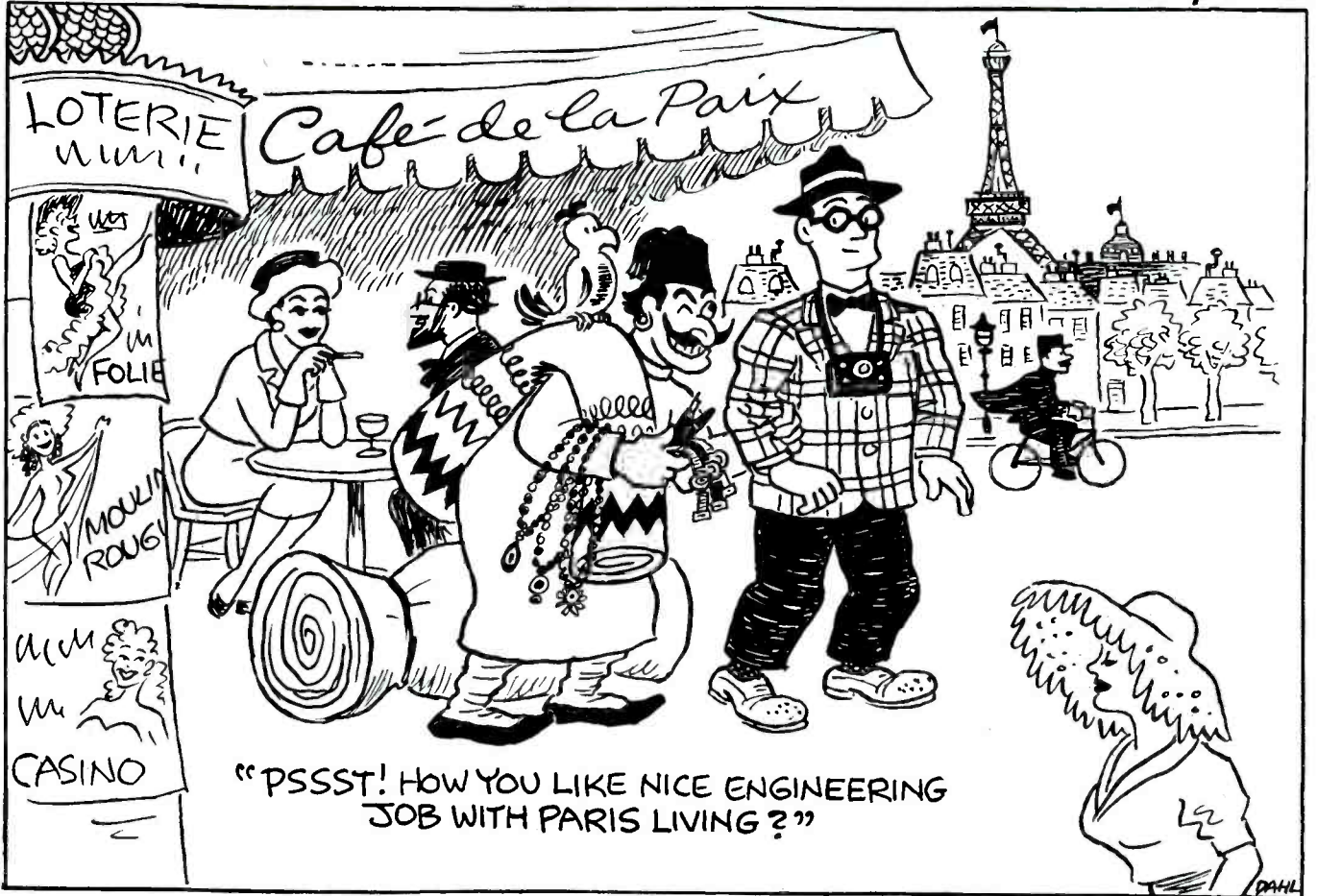

For information regarding  
 Engineering Positions  
 in the  
 Microwave and Power Tube Operations  
 Write D. Hamant

**RAYTHEON MANUFACTURING COMPANY**

Waltham 54, Massachusetts



*Excellence in Electronics*

# HOW DO YOU GROW AT ARMA?

*Through diversification!*

In our recent advertisements, we spoke of the growth opportunities offered by Arma. Almost immediately, perceptive engineers began writing us, asking for more information.

"How does an engineer grow at Arma — precisely?"

Our answer, in a word, is *diversification*. Arma offers one of the broadest programs of work diversification in the electronics field.

At Arma, an engineer follows a project from original design, right through final production. As a result, our engineers and scientists are exposed to many activities not usually found under one roof — areas into which they can grow, as their abilities and interests lead them.

Here are some of the areas — 69 examples — in which Arma concentrates its efforts in:

## MISSILE CONTROLS & GUIDANCE and FIRE CONTROL

### 1.0 SYSTEMS DEVELOPMENT

- 1.1 Digital Computers
- 1.2 Autopilots
- 1.3 Infrared
- 1.4 Electromagnetic Devices
- 1.5 Gyroscopes
- 1.6 Inertial Platforms
- 1.7 Missile Guidance
- 1.8 Fire Control
- 1.9 Servos

### 2.0 PROJECT ENGINEERING

- 2.1 Airborne Fire Control
- 2.2 Airborne Armament
- 2.3 Air-to-Air Missiles
- 2.4 Semi-Automatic Test Equip.
- 2.5 Air Traffic Control
- 2.6 Optical Systems
- 2.7 Stabilizing Devices
- 2.8 Submarine Fire Control
- 2.9 Electronic Test Equipment

### 3.0 SYSTEMS EVALUATION

- 3.1 Instrumentation Evaluation
- 3.2 Telemetry
- 3.3 Data Reduction
- 3.4 Data Analysis
- 3.5 Project Engineering
- 3.6 Data Process Planning
- 3.7 Control Circuitry Design

### 4.0 SYSTEMS ENGINEERING

- 4.1 Trajectory Analysis
- 4.2 Airframe Performance
- 4.3 Weapons Control
- 4.4 Operations Research
- 4.5 Radar
- 4.6 Error Analysis
- 4.7 Reliability

### 5.0 COMPONENTS

- 5.1 Transistors
- 5.2 Magnetic Amplifiers
- 5.3 Synchros
- 5.4 Tachometers
- 5.5 Accelerometers
- 5.6 Resolvers
- 5.7 Integrators

### 6.0 RADAR

- 6.1 CW Doppler Systems
- 6.2 Antenna Design
- 6.3 Components
- 6.4 Pulse Circuitry
- 6.5 Countermeasures
- 6.6 Laboratory Evaluation

### 7.0 PROJECT ADMINISTRATION

- 7.1 Project Planning & Control
- 7.2 Sub-Contracted Liaison
- 7.3 Contracts Evaluation
- 7.4 Project Coordination

### 8.0 DIGITAL COMPUTERS

- 8.1 Logical Design
- 8.2 Dynamic Analysis
- 8.3 Circuit Development
- 8.4 Component Development
- 8.5 Packaging
- 8.6 Field Evaluation

### 9.0 ENVIRONMENTAL

- 9.1 Vibration
- 9.2 Shock
- 9.3 System Test
- 9.4 Component Test
- 9.5 Materials Analysis
- 9.6 Dynamics

### 10.0 MISSILE GROUND EQUIP.

- 10.1 Operations Techniques
- 10.2 Count-down Equipment
- 10.3 Launching Control Instrumentation
- 10.4 Control Circuitry
- 10.5 Automatic Test Equipment
- 10.6 Console Integration
- 10.7 Remote Data Recording
- 10.8 Optical Monitoring

If you want to participate in the growth that *must* come to a man working in so diversified an environment, write and tell us the area in which you're most interested. (Or use the coupon below.) Your confidence will be respected, and you will hear from us promptly. If you prefer, forward confidential resume. No reference contact without your permission.

Technical Personnel Department E-674

# ARMA

Division of American Bosch Arma Corporation  
Roosevelt Field, Garden City, Long Island, N. Y.

Gentlemen:

Please send me additional information concerning the job numbered \_\_\_\_\_

Or, additional information concerning the area of \_\_\_\_\_ (state interest if not in above listing)

NAME \_\_\_\_\_

ADDRESS \_\_\_\_\_

CITY \_\_\_\_\_

ZONE \_\_\_\_\_ STATE \_\_\_\_\_

## ENGINEERS

Advances in Military  
Electronics Today . . .  
Pave the Way for  
Commercial Developments  
Tomorrow  
At Otis' Electronic Division

The full resources of the century-old Otis Elevator Company are available for expansion of its new Electronic Division. And engineers who join this division now will have the satisfaction of working in the forefront of the military electronics field . . . with the realization that its potentialities in commercial development will also be explored by Otis . . . that this is a long-range program in which Otis will spare no effort in broadening the position of its Electronic Division as a leader in this important field of industry.

Current prime contracts are on basic development work in the most advanced areas of bombing navigation systems, radar systems and missile launching test equipment.

Engineering know-how is required in servo-mechanisms, analog computers, pulse and sweep generators and in the field of microwaves.

If you are interested in a high level career in electronics . . . with promotions waiting to be earned . . . send your resume now to William B. Del'Francis. All inquiries in strict confidence.

ELECTRONIC DIVISION  
Otis Elevator Company

35 Ryerson St. Brooklyn 5, N. Y.

# TITANIUM METALS CORPORATION

OF  
America

Openings for RESEARCH ENGINEERS at company's facilities in Henderson, Nevada, (located 11 miles east of Las Vegas, Nevada).

BS or MS in ELECTRICAL ENGINEERING or PHYSICS.

Positions open in Melting Research Division of Technical Department, for fundamental and applied research on melting arc characteristics and CONTROL SYSTEMS APPLICATIONS. Previous experience desirable but not necessary.

Salary commensurate with ability, experience and education.

Send resumes to:

Industrial Relations Department  
TITANIUM METALS CORPORATION  
OF AMERICA  
P. O. Box 2128  
Henderson, Nevada



**electronic systems engineers***Immediate Openings for* **SPECIALISTS****START WORK NOW – SWITCH SOON TO SYLVANIA'S NEW  
MULTI-MILLION DOLLAR ELECTRONIC R&D LABORATORY**

*Not every man will be able to qualify for these positions, but for men who can, here's a triple opportunity with Sylvania:*

- 1. Specialist positions** – High-salaried openings in key positions. All in applied research, all requiring considerable background with solid experience.
- 2. Multi-million dollar R & D lab** – In keeping with Sylvania's phenomenal growth (we invite you to compare our growth curve with that of the entire electronic industry), we are building a new electronics R&D Lab to be completed later this year. The finest, most advanced equipment has been specified for this lab. You'll begin working with these new facilities as soon as they are ready.
- 3. Suburban Buffalo location** – Lets you live in lovely Amherst, only 7 miles from downtown Buffalo. Virtually next door to Niagara Falls, Canada, and the Great Lakes resort area.

*Check these openings now. See which interests you-- and let us hear from you. We'll answer promptly.*

**ADVANCED CIRCUITS SPECIALISTS**

With ingenuity, ability and interest to create operable circuits required to bring to fruition radically new theoretical concepts in the field of communications. Requires 10 years experience and proven ability to supervise work of a group of engineers creating original circuit designs. Techniques include: transistor applications, digital computer design and a variety of novel video-radio frequency circuits as well as modulation in unconventional dimensions.

**COMMUNICATIONS SYSTEMS SPECIALIST**

Opening for an engineer with vision and creative ability to derive and direct applications of new techniques developed in Buffalo Engineering Laboratory to existing and newly developed systems. These techniques now permit solution of many long-standing problems which exist in fields ranging from radio to radar or sonar from radio teletype to DME. Should have 10 years experience in communications field and an interest in systems synthesis and analysis. Advanced degree in E.E. Physics, Mathematics, or equivalent in course-work on a graduate level is desirable.

**ELECTRO-MAGNETIC PROPAGATION SPECIALIST**

Should have 10 years experience and ability to supervise the work of a group of advanced research engineers searching for the solutions to problems in multi-path transmission as a function of frequency, vector scatter propagation, broadband antenna design, etc., which are necessary in the utilization of new communications systems.

**MATHEMATICIAN**

A challenging permanent opening now exists in the field of applied mathematics offering an opportunity for creative and original work of a non-routine nature and supervision of a small group of mathematicians. Should have an active interest in the theory of numbers, theory of groups, Boolean algebra and symbolic logic; PhD in mathematics or equivalent in practical experience and an interest in working with a group of highly skilled engineers in the development of non-conventional communications systems and equipment.

*Please send your resume to:* E. F. CULVERHOUSE



SYLVANIA ELECTRIC PRODUCTS INC.

175 Great Arrow Avenue • Buffalo, New York

For your immediate use  
the 6 most vital assets

to insure your

## EXECUTIVE SUCCESS



**SUCCESSFUL** executives will tell you this simple fact: certain *key abilities* practically allow a man to write his own paycheck. And one doesn't have to be born with these proven executive qualities—they can be self-developed to a degree you may never have thought possible—easily, and *without* long years of study. You can help yourself acquire them with this specially selected Library of practical executive techniques.

The six books comprising this library have been selected by successful executive as the ones most useful in developing the six qualities of executive success.

Helps you develop these 6 success qualities:

- Handling People
- Managing Yourself
- Speaking forcefully
- Writing Clearly
- Working Efficiently
- Thinking Straight

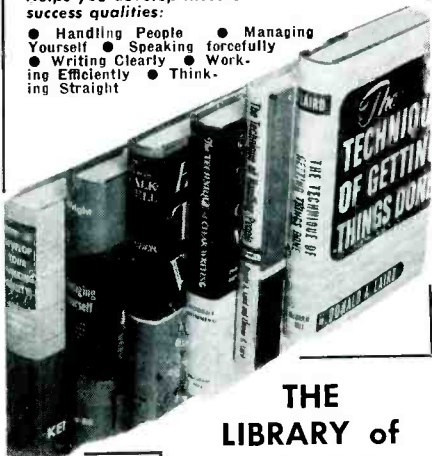

### THE LIBRARY of

## PRACTICAL EXECUTIVE TECHNIQUES

- 6 volumes ● 1633 pages
- \$20.00 — payable \$4.00 in 10 days, then \$4.00 a month

You'll find here the best thinking on a variety of important executive techniques... like getting the best out of your associates, putting your thoughts down clearly and forcefully on paper, speaking with authority in front of people, thinking a job through logically, and getting it done most efficiently. All in all, you have a storehouse of information on doing *best* every job the successful executive must know how to handle.

Library contains these books:

- Managing Yourself by Wright
- The Technique of Getting Things Done by the Lairds
- How to Develop Your Thinking Ability by Keyes
- The Technique of Clear Writing by Gunnings
- How to Talk Well by Bender
- and The Technique of Handling People by the Lairds

**SAVE \$4.00.** Bought one at a time, the total price of these books would be \$24.00. Under this special offer, the complete Library is available for only \$20.00—a cash saving of \$4.00. And you also have the privilege of paying for the books on easy terms, while you use them.



Edited by DON FINK

# TELEVISION ENGINEERING HANDBOOK

- Prepared by a staff of 33 Specialists
- 1483 pages, 6 x 9
- Hundreds of charts, circuits, tables, and illustrations

\$18.00

Full 10 days' examination before you decide to purchase. See coupon.

All your design work is made easier and faster with the help of this comprehensive guidebook. It covers the entire field of television technology, including not only the basic fundamentals, but practical design data for transmitters, receivers, and networks. Monochrome and color television are treated in equal detail, and there is coverage of the related topics of vision, photometry, illumination, optics, and colorimetry.

Look to this handbook for quick help on the countless questions arising in your daily work—on television standards for scanning, modulation, synchronization—on band and channel designations—on camera and picture tubes—on circuit functions and design—on transmission lines and radiators—and many other topics, covered in the 20 big, authoritative sections of this new working tool.

## TRANSISTORS

### HANDBOOK OF SEMICONDUCTOR ELECTRONICS

Edited by LLOYD P. HUNTER

Senior Physicist, International Business Machines Corporation, Poughkeepsie, N. Y.  
604 pages, 6 x 9, 484 illustrations, \$12.00

This book gives you a rounded view of semiconductor devices—all the help you need to prepare for practical circuit design and engineering of applications utilizing transistors, diodes, or photocells. Emphasis is on actual circuit design. The extensive section on this subject covers the use of semiconductor devices in band-pass and video amplifiers, computers, measuring instruments, industrial control equipment, oscillators, etc. In addition, theory of semiconductor devices, important aspects of how they are made, and background of analysis and measurement is given, to provide engineers with an intensive one-volume treatment of this growing new field.

## CONTROL CIRCUITS

### HANDBOOK OF INDUSTRIAL ELECTRONIC CONTROL CIRCUITS

By JOHN MARKUS and VIN ZELUFF

352 pages, 8½ x 11, illustrated, \$8.75

Here are the circuits you need for sorting, timing, measuring, and counting; for sweep control, triggering, temperature and motor control, and hundreds of other industrial uses—each with concise description, performance characteristics, component values, and practical applications. Save hours of search and preliminary work to find basic circuit ideas for particular applications—consult this big, handy collection of tested circuits—selected from recent issues of *Electronics* and classified and indexed for quick use.

### 10 DAYS' FREE EXAMINATION

JUST MAIL THIS COUPON

McGraw-Hill Book Company, Inc.,  
Dept. FL-4  
327 West 41st St., New York 36, N. Y.

Send me book(s) checked below for 10 days' examination on approval. In 10 days I will remit for book(s) I keep, plus few cents for delivery costs, and return unwanted book(s) postpaid. (We pay delivery costs if you remit with this coupon; same return privilege.)

- Fink—Television Engineering Handbook, \$18.00
- Hunter—Handbook of Semiconductor Electronics, \$12.00
- Markus & Zeluff—Handbook of Industrial Electronic Control Circuits, \$8.75

For prices and terms outside U. S., write McGraw-Hill Intl., N. Y. C.

Send me the Library of Practical Executive Techniques for 10 days' examination on approval. In 10 days I will send (check one)  \$20.00 in full payment, or  \$4.00 and \$4.00 monthly until the full price is paid. Otherwise I will return books postpaid.

(Print) Name .....

Address .....

City & Zone..... State .....

Company .....

Position .....

FL-4



# B U D D

Explorers of the Unknown  
in Metals—Wants High Level  
**ENGINEERS**

To Blaze New Trails in the  
Development & Perfection of  
Metals Suited for Use in

- AIRCRAFT STRUCTURES
- MISSILE STRUCTURES
- NUCLEAR PROPULSION & REACTOR ELEMENTS
- NUCLEAR PROPULSION STRUCTURES

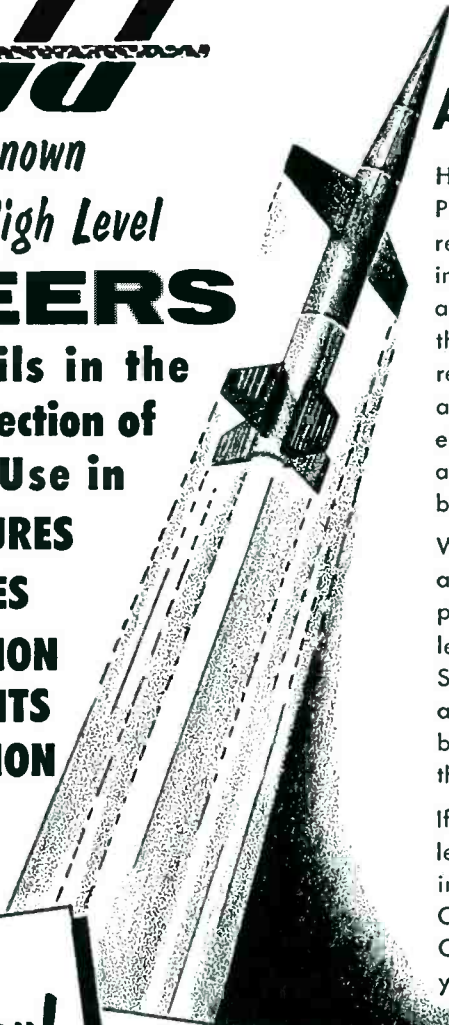

## Another FIRST for Budd!

Here in our Aircraft Research and Nuclear Propulsion Laboratories — an outgrowth of the research activity which produced such great industrial engineering FIRSTS as the all steel automobile body, stainless steel railway cars and the all steel two-engine planes — BUDD has just reached another milestone in its exploratory achievements: a solution to the practical and efficient manufacture of structures for aircraft and missiles subject to aerodynamic heating has been found!

With a manufacturing background of nearly half a century and more than 20,000 people on its payroll, The BUDD Company is the established leader in its field. To competent Technical and Scientific Personnel seeking an association with a company offering established employment stability and salaries commensurate with ability, there truly is no finer place to work.

If you are interested in an association in a high level research environment, in one of our plants in the East, please fill in the Ready-Reference Card below and send to THE PLANT OF YOUR CHOICE, today, along with a complete resume of your educational and work background.



READY-REFERENCE CARD  
**ENGINEERING EMPLOYMENT SERVICE**  
Address Your Inquiry To One Of The Following:  
**THE BUDD COMPANY**

Personnel Manager  
HUNTING PARK PLANT  
Philadelphia 32, Pa.

Personnel Manager  
RED LION PLANT  
Bustleton, Pa.

Personnel Manager  
CHARLEVOIX PLANT  
Detroit 15, Michigan

Personnel Manager  
CHASE PLANT  
Gary, Indiana

NAME \_\_\_\_\_ (Last) \_\_\_\_\_ (First) \_\_\_\_\_ (Middle) \_\_\_\_\_ Date \_\_\_\_\_

PRESENT ADDRESS \_\_\_\_\_

BIRTH DATE \_\_\_\_\_

ARE YOU A CITIZEN OF U.S.? YES \_\_\_\_\_ NO \_\_\_\_\_ DATE AVAILABLE \_\_\_\_\_

List in order of preference positions for which you feel best qualified:

1 \_\_\_\_\_ 2 \_\_\_\_\_ 3 \_\_\_\_\_

EDUCATION	NAMES & LOCATIONS	DATES ATTENDED	COURSE	DEGREE	DATE
High School					
College					
Other					

NAME OF PRESENT OR MOST RECENT EMPLOYER \_\_\_\_\_ CITY AND STATE \_\_\_\_\_

ADDRESS \_\_\_\_\_ EARNINGS \_\_\_\_\_

POSITION HELD \_\_\_\_\_

(THIS INFORMATION WILL BE HELD IN STRICT AND COMPLETE CONFIDENCE)  
Is Your Resume Attached?

Engineers  
who want to

# Be Engineers

... rather than glorified draftsmen,  
paper jockeys or rehash artists

# Come to Sanders and Go to Work...

... ON ACTUAL, PRACTICAL, THOUGH INTRICATE, OFF-BEAT AND INTRIGU-  
ING PROBLEMS IN ADVANCED ELECTRONICS AND ELECTRO-MECHANICS.

Sanders is particularly interested in engineers  
versed in:

- Hydraulic servo systems, gyroscopes, accelerometers, circuit design & development, magnetic amplifiers, receivers & transistors.
- Men with similar experience, interested in sales engineering, have real opportunity here.
- Also openings for Physicists and Applied Mathematicians.

You'll be working on projects to meet specific customer requirements—not making plans to gather dust in filing cabinets—and you'll be doing it in the company of first rate minds, men who have sparked Sanders' many "firsts"—Panar, Dare pulse doppler radar and seekers, counter-measure systems and special fusing.

This is a company owned by engineers, run for engineers, in the interests of better engineering. If engineering is more to you than a name on an imposing organization chart... if the opportunity to make a genuine contribution to the state of the art ranks higher than a fancy location (though we think ours is pretty nice)... then we'd welcome the opportunity to read your resume. A convenient interview will be arranged. Please address D. H. Johnson.



only an hour from downtown Boston

*Servo Engineers*

**ELECTRICAL  
MECHANICAL**  
Inertial  
Guidance  
System  
Program



Recent EE, ME  
Graduate  
Inquiries  
Also Invited

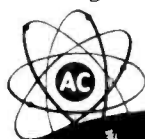

THE ELECTRONICS DIVISION

**GENERAL MOTORS CORPORATION**  
FLINT 2, MICH. • MILWAUKEE 2, WIS.



Enjoy Challenging Opportunities in the further development and systems testing of Inertial Guidance Systems and their Servo Loops in the most versatile laboratories in the country.

Work with the top men in the field and with the finest test, research and development facilities. New plant being added in suburban Milwaukee as a part of Major, Permanent, Expansion Program.

AC will provide financial assistance towards your Master's Degree. A Graduate Program is available evenings at the University of Wisconsin, Milwaukee.

GM's long-standing policy of decentralization creates individual opportunity and recognition for each Engineer hired.

Milwaukee offers ideal family living combining small town hospitality with every metropolitan shopping and cultural advantage.

For personal, confidential interview in your locality send complete resume to

Mr. Cecil E. Sundeen  
Supervisor of Technical Employment

PERSONNEL MANAGERS

Looking for Engineers . . .  
Technicians?



Write  
for free  
copy of

**"RESERVOIR of ENGINEERS  
and TECHNICAL MEN"**

The engineers and technicians you want to reach are gathered in convenient, compact groups—as this 16-page booklet points out.

It keys the job titles these men hold to the McGraw-Hill publications they read for on-the-job information. It explains how you can make contact . . . channel, concentrate your employment advertising to just the men with the job qualifications you want . . . without wasting advertising money for higher-priced space in publications with general circulation, in which you pay for perhaps 999 unqualified readers for every 1 who may meet your job requirements.

Write for your free copy to  
Classified Advertising Division  
**ELECTRONICS**

P. O. Box 12, N. Y. 36, N. Y.





# REAC<sup>®</sup> FIELD SERVICE ENGINEERS

## GRADUATES OR EQUIVALENT EXPERIENCE

Electronic Technicians or Engineers, preferably with some experience in analog computers, military or commercial, who have a real interest in Field Service, including the *Travel* aspects, are needed for Computer Field Service.

Here is an opportunity to join an expanding organization with an exceptional reputation in the Electronic Field.

The REAC (Reeves Electronic Analog Computer) is the foremost general purpose computer widely used by industry and military installations.

Free Hospitalization and Surgical benefits for you and your dependents.

Excellent starting salary—opportunity to advance. No Overseas travel required.

Interviews can be arranged Daily until 6 P. M.  
Telephone or write Mr. Tom Waters

# REEVES INSTRUMENT CORP.

Subsidiary of Dynamics Corp. of America

East Gate Boulevard, Roosevelt Field, Garden City, L. I., N. Y., Pioneer 6-8100

## WHAT "CAREER OPPORTUNITY"

Means to an Electronic Engineer at General Electric

"CAREER OPPORTUNITY"...two words you see used everywhere.

**WE USE THEM** a lot at Electronics Park. But with this difference. To every man who comes to work with us, "career opportunity" has a specific meaning.

And for a very good reason.

**ELECTRONICS PARK** is where many new concepts in electronics are born. The G-E organization here is primarily in the business of designing and developing *new* things—components, systems, equipments. Often a whole new product line results from applied research activities here—and after preliminary

production and sales in this area, a new department is organized to handle it—a new plant built in another area—and a new management staff appointed to direct it.

**AND MANY** of the supervisory and specialist positions in such a new G-E department are drawn from the experienced development staff at Electronics Park.

**JOIN US NOW**... if you have a BS, MS or PhD degree in Electrical or Mechanical Engineering or Physics AND/OR electronic experience. Send the coupon below... or if you prefer, write us personally in complete confidence.

TO: GENERAL ELECTRIC  
Electronics Pk.,  
Syracuse, N. Y.  
ATT: Dept. 4-7-E  
Technical Personnel

I am interested in ...  
... Advanced Development  
... Design  
... Field Service  
... Technical Writing  
... Sales

In the field of ...  
... Military Radio & Radar  
... Multiplex Microwave  
... Mobile  
... Communications  
... Semiconductors  
... Electronic Components  
... Computers  
... Tubes  
... Television Receivers  
... Industrial Television  
... Antennas

FROM:

NAME \_\_\_\_\_

ADDRESS \_\_\_\_\_  
\_\_\_\_\_

DEGREE \_\_\_\_\_

GENERAL  ELECTRIC

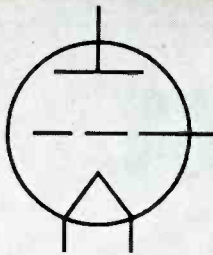

Q. What will he be working on?

A. On the design and development of advanced tubes, including Sylvania's new Backward Wave Magnetron — a tube that's opening new avenues in microwave techniques.

Q. What will his status be?

A. He will be a product engineer — the man to have complete responsibility for his particular work, from original development to quantity production. He'll find it an opportunity to use *all* his talents.

**Q.** Where can a Tube Engineer get ahead on a Backward Wave?

**A.** At SYLVANIA'S New Williamsport Plant.



**SYLVANIA**

SYLVANIA ELECTRIC PRODUCTS INC.  
SEMI-CONDUCTOR DIVISION  
AND SPECIAL TUBE OPERATION

100 Sylvan Road  
Woburn, Mass.

Q. What is his reward?

A. Twofold. First, recognition — the product or group of products is *his*. Second, salary — it's competitive with the best in the industry. And Sylvania's benefits are geared to a man's *future*, as well as his present needs.

Q. Where is the work?

A. At Sylvania's new plant in Williamsport, a city of 50,000 in the green hill country of Pennsylvania — where skiing in the Poconos and fishing in good trout streams aren't just once-a-year happenings.

Q. For recognition and reward — in an atmosphere that's as good for *living* as for working — what should an engineer do?

A. Get in touch with Sylvania now — by writing in confidence to Roland W. Coates.

## electronic engineers

- DESIGN ● DEVELOPMENT
- FIELD ENGINEERING ● TECHNICAL WRITING

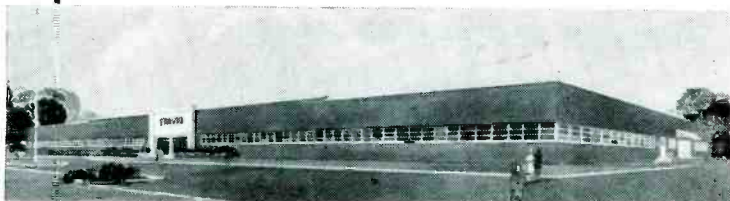

STAVID is engaged in design, development, modification, installation, testing and evaluation of military electronic and electro-mechanical equipment.

STAVID ENGINEERS possess an enviable reputation and are noted for their competence and diversification. You can fulfill your professional ambitions at STAVID.

(New Plant now under construction — 65,000 square feet)

PERMANENT LOCAL AND FIELD ASSIGNMENTS NOW AVAILABLE AT MORE THAN 30 DESIRABLE LOCATIONS THROUGHOUT THE U.S.

Call for interview arrangement or send complete resume to: Personnel Dept.

Opportunities available in the following fields for those persons with EE or ME degree with minimum of 3 years' experience or equivalent:

- Fire Control Radar
- Missile Electronics
- Coils, Transformers
- Filter Networks
- Instrumentation
- Microwave
- Servos
- Antennas
- Computers
- Simulators



**ENGINEERING, INC.**

Route 22, Plainfield, N. J.  
Plainfield 7-1600

## GOODYEAR ATOMIC CORPORATION

ENGINEERS and PHYSICISTS  
M.S. - Ph.D.

Several engineers and physicists with extensive background in the fundamentals of analytical and laboratory research and development are needed for activities involving:

Computers, automatic controls, electromechanical designs.

Electronic circuit design and analysis.

Development and application of transistor circuitry.

Servomechanism and control system analyses.

Instrument design—electronic and pneumatic.

Mass spectrometer development.

Send comprehensive resume indicating qualifications, minimum salary requirement and availability for interview. All replies held in strict confidence.

EMPLOYMENT DEPARTMENT B  
GOODYEAR ATOMIC CORPORATION  
BOX 628, PORTSMOUTH, OHIO



**YOU** HAVE THE ENGINEERING ABILITY ...

**WE** HAVE THE ENGINEERING FUTURE !

Great combination . . . your ability and the opportunities only a pioneer and leader in commercial electronics can offer! Join this team of creative-minded engineers and your ability wins first the recognition and then the responsibility it deserves in a small-group engineering organization.

The future looks practically limitless, speaking from our position today in the vanguard of precedent-shattering electronics developments. Current and appealing openings exist in:

**Data Handling and Computers**  
**Broadcast Equipment**

**Scientific and Industrial Equipment**  
**Sound Products**  
**Communications**

Attractive salaries to start . . . advancement on merit. Liberal company-paid benefits make your future even more secure.

Senior or Junior EE's or ME's . . . men who will accept no measurements for their future except their own achievements . . . you are invited to send a complete resume to

P-4531, Electronics  
Class. Adv. Div., P. O. Box 12, N. Y. 36, N. Y.

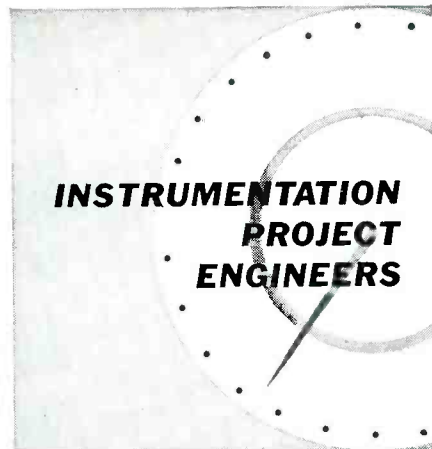

**INSTRUMENTATION  
PROJECT  
ENGINEERS**

The Missile and Ordnance Systems Department of General Electric Company has several challenging openings on its staff for Instrumentation Project Engineers.

**Position Requirements:**

- BSEE with electronics major
- Minimum of four years' experience in the synthesis and/or operation of electrical instrumentation systems and electronic circuitry

**Position Responsibilities:**

- Determine and integrate data requirements for ICBM nose cone development and testing
- Establish and specify instrumentation systems and characteristics, such as, power supply requirements, component size, shape and weight, cabling and connection points, and external interconnections.
- Evaluate ground and airborne instrumentation test results

The environment is completely technical and professional. We are a research and development laboratory affiliated with one of the world's largest, most diversified and progressive industrial organizations. We hold prime contracts of a long-term nature with all the armed services. Salary and benefits are liberal. Philadelphia location. Excellent facilities and equipment.

Please send resume in confidence to:  
**Mr. John E. Watt**  
Technical Recruiting, Room 582-2



**MISSILE & ORDNANCE  
SYSTEMS DEPARTMENT**

**GENERAL ELECTRIC**

3198 Chestnut Street  
Philadelphia 4, Pa.

**TEST  
ENGINEERS**

**WILL YOU REACH  
YOUR MAXIMUM POTENTIAL?**

No matter what your ability, you **MUST HAVE** the job opportunity and the **BEST** of **TOOLS** and **FACILITIES** to develop your talents to the fullest.

Investigate the Environment created at AC for its Advanced Development Programs on Missile Guidance and Aircraft Fire Control Systems.

**OUR ENVIRONMENTAL LABORATORY**

is one of the most versatile laboratories in the country and we are in the process of a Major, Permanent Expansion. 225,000 square feet plant being added in suburban Milwaukee.

Our men enjoy working with the finest of test equipment and lab facilities and with the top men in the field.

We are currently engaged in the following types of Test Activities.

- VIBRATION TESTING
- COMPLEX WAVE ANALYSIS
- LOW TEMPERATURE-ALTITUDE
- HIGH TEMPERATURE
- RELIABILITY EVALUATION
- INSTRUMENTATION

Mr. Cecil E. Sundeen, Supervisor of Technical Employment

**THE ELECTRONICS DIVISION**

**GENERAL MOTORS Corporation**

FLINT 2, MICH.

MILWAUKEE 2, WIS.

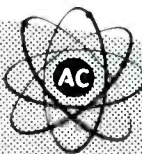

Opportunities in Design & Engineering for

DESIGN ENGINEERS  
 ELECTRICAL ENGINEERS  
 PROJECT OR SYSTEMS ENGINEERS  
 ELECTRONIC ENGINEERS  
 FIELD ENGINEERS

Kollsman's expansion in the airborne equipment field has created openings for additional engineers and electromechanical designers, and offers unusual scope to alert, capable and enthusiastic professional men. For engineers, a degree in Mechanical Engineering, Electronic Engineering or Physics is necessary, plus experience or a strong interest in airborne instrumentation or allied fields.

The congeniality at Kollsman, plus the modern facilities and top professional men provide an atmosphere conducive to creative effort and achievement. Here are designed America's finest aircraft instruments.

Please submit resume to T. A. DeLuca. Confidential interviews will be arranged.



**kollsman** INSTRUMENT CORPORATION

80-08 45th AVENUE, ELMHURST, NEW YORK • SUBSIDIARY OF *Standard* COIL PRODUCTS CO. INC.

# DO YOU NEED ENGINEERS WITH EXPERIENCE IN:

- Research
- Development
- Design
- Instrumentation
- Servomechanisms
- Missiles
- Audio Systems
- Control Systems
- Radar
- Computers
- Transistors
- Other Fields

Place an "ENGINEERS WANTED" advertisement in this EMPLOYMENT OPPORTUNITIES SECTION of ELECTRONICS. It's an inexpensive, time saving method of selecting competent personnel for every engineering job in the electronics industry. The selective circulation of ELECTRONICS offers you an opportunity to choose the best qualified men available throughout the industry.

For Rates and Information

Write:

CLASSIFIED ADVERTISING DIVISION

McGraw-Hill PUBLICATIONS

P. O. Box 12

New York 36, N. Y.



## Why blow your top?

Just shoot us a line if you feel like blasting ahead. We offer real opportunities with individual recognition only possible in a small organization.

Challenging positions open for Physicists, Principal, Senior and Project Engineers in the new field of light intensification, closed circuit TV, X-ray and other related products.

Experience in design of pulse, sweep or video circuitry is preferred.

Newly organized group located in beautiful northern suburb of Baltimore.

Call, wire or write  
 Mr. R. A. Lee

**Bendix - Friez**

DIVISION OF BENDIX AVIATION CORP.  
 TOWSON 4, MARYLAND



# 1957 GOVERNMENT ELECTRONIC SALES!

## *DAYTON AIR FORCE DEPOT*

### INVITATION TO BID ON ALL SALES HELD IN 1957

Dayton Air Force Depot is disposing of \$20,000,000 in electronics and communications equipment, components, and parts. Much of this new and used material, while no longer needed by Government agencies because of technological advances, and revised requirements based on current strategic and technical concepts, is commercially useable *without modification*.

The material to be offered for sale will include small and large quantities of ground and airborne RESISTORS, TRANSMITTERS, TUBES, MAGNETRONS, TRANSFORMERS, POWER GENERATORS, DYNAMOTORS, TEST SETS, LABORATORY EQUIPMENT, INSTRUMENTS, RECORDERS, together with miscellaneous items such as terminal boards, plugs, connectors, relays, switches, timing units, coils, indicators, amplifiers, motors, wire, cable, insulation materials, dials, knobs, and thousands of other types of electronic hardware for your every electronic need.

Hundreds of these excellent buys will appeal to manufacturers, distributors, large and small businesses, research organizations, hobbyists, and other users.

### THESE SALES ARE CONDUCTED ON A COMPETITIVE BID BASIS

**NO RED TAPE INVOLVED.** Simply fill out and mail the coupon below and you will receive an Invitation to Bid on each individual sale. These Invitations to Bid will describe the material to be sold, and provide all necessary information concerning the conditions under which the sale will be conducted.

Material offered for sale will be displayed at Dayton Air Force Depot, Dayton, Ohio. We welcome your participation. Invitations to Bid will be mailed to you. Participation in these sales may be accomplished either in person or by mail.

**You'll Be Interested In Our Next Sale!!**  
**Act Now To Become An Officially Qualified Bidder**  
**FILL THIS OUT AND MAIL NOW!**

Be sure to indicate type of material you are interested in.

ADDRESS ENVELOPE TO:  
 DISPOSAL AGENT  
 (MDPS)  
 BOX 1659  
 DAYTON AIR FORCE  
 DEPOT  
 GENTILE AIR FORCE  
 STATION  
 DAYTON 10, OHIO

Name \_\_\_\_\_ Title \_\_\_\_\_

Address \_\_\_\_\_

City \_\_\_\_\_ Zone \_\_\_\_\_ State \_\_\_\_\_

Company \_\_\_\_\_

I am interested in \_\_\_\_\_

CLASSIFIED

# SEARCHLIGHT SECTION

ADVERTISING

BUSINESS OPPORTUNITIES

EQUIPMENT - USED or RESALE

**UNDISPLAYED RATE**

\$2.40 a line, minimum 3 lines. To figure advance payment count 5 average words as a line.

BOX NUMBERS count as one line additional in undisplayed ads.

DISCOUNT of 10% if full payment is made in advance for four consecutive insertions of undisplayed ads (not including proposals.)

Send NEW ADS or inquiries to Classified Adv. Div. of Electronics, P. O. Box 12, N. Y. 36, N. Y., for May 1st issue closing April 2nd

The publisher cannot accept advertising in the Searchlight Section, which lists the names of the manufacturers of resistors, capacitors, rheostats, and potentiometers or other names designed to describe such products

**DISPLAYED RATE**

The advertising rate is \$21.75 per inch for all advertising appearing or other than a contact basis. Contract rates quoted on request.

AN ADVERTISING INCH is measured 7/8 inch vertically on one column, 3 columns—30 inches—to a page.

EQUIPMENT WANTED or FOR SALE ADVERTISEMENTS acceptable only in Displayed Style.

## NEW YORK TUBE & MICROWAVE TEST EQUIPMENT EXCHANGE

### NEW UNUSED SURPLUS AN/APR 4 LABORATORY

COMPLETE WITH FIVE TUNING UNITS 38 TO 4,000 MC.

### Special! TS45 X BAND GENERATOR—\$99<sup>00</sup>

### SPECIAL! 5,000 V. POWER SUPPLY

For IP25 Infrared Image Converter from 3 V. Battery Source. NEW, Complete with RCA 1654 Tube.....

**\$990**

### NEW MICROWAVE TEST EQUIPMENT TS148/UP SPECTRUM ANALYZER ST147UP SIGNAL GENERATOR

Field Type X-Band Spectrum Analyzer. Band 8430-9580 Megacycles. Will Check Frequency and Operation of various X Band equipment such as Radar Magnetrons, Klystrons, FR Boxes. It will also measure pulse width, c-w spectrum width and Q, or resonant cavities. Will also check frequency of signed generators in the X band. Can also be used as frequency modulated Signal Generator etc. Available now complete with ad accessories, in carrying cases.

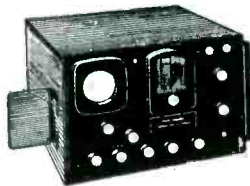

### OTHER TEST EQUIPMENT USED CHECKED OUT SURPLUS

- |         |           |          |               |  |
|---------|-----------|----------|---------------|--|
| TSK1/SE | T35/AP    | TS108    | TS226         | SURPLUS EQUIP.<br>APA10<br>APA38<br>APS3/APS4<br>APR4<br>APR5A<br>APT2-APTS<br>and many others |
| TS3A/AP | TS36/AP   | TS110/AP | TS235A-TS239C |  |
| RF4/AP  | 1-96A     | TS125/AP | TS251         |  |
| TS12/AP | TS-45     | TS126/AP | TS258         |  |
| TA13/AP | TS47/APR  | TS147    | TS270         |  |
| TS14/AP | TS69/AP   | TS174/AP | TS418         |  |
| TS33/AP | TS100     | TS175/AP | TF890/1       |  |
| TS34/AP | TS102A/AP | TS182    | 834           |  |

### SPECIAL

Thousands of tubes available at special prices

#### PARTIAL LIST

2AP1	6M6	307A	5691
4C27	6K8G	274A	5692
4C28	6AR6	274B	5693
5A6	5R4	282B	5639
58P4	5W4GT	328A	5814
4J52	OZ4A	357A	9001
2A4G	6AC7	450TH	9002
6C21	28D7	450TL	9003
6J5GT	89	—ANY OTHER TYPES	

WHOLESALE and EXPORT ONLY  
Minimum tube order \$25



Phone: ORegon 4-7070

### LIBERTY ELECTRONICS, INC.

119 PRINCE ST.  
NEW YORK 12, N. Y.  
Cable: TELESERP

## "S" BAND TEST EQUIPMENT

Bolton Laboratories, manufacturer, has available from stock, both the TS-125 and the TS-117, popular means of measuring power and frequency in the "S" band. In addition we have developed a new instrument identified as BL-121 which combines the functions of the TS-117, TS-125 and the TS-268. The BL-121 is popularly priced. Details on request.

The TS-125 is a small portable hand carried instrument designed to give full scale deflection when 2 milliwatts of RF power is applied to the input connector. Two scales enable the operator to read both milliwatts of power and decibels above and below one milliwatt. Fundamentally a thermistor bridge, this instrument is supplied in a die cast aluminum case measuring 10" x 8" x 6" and weighing, complete with accessories, 9 lbs. It covers the range of 9.0 CM-12.5CM. An instruction book with conversion charts is supplied.

The TS-117 is likewise a small compact self-contained instrument intended for the accurate measuring of frequencies between 2400 mc-3400 mc. The equipment may be used as a tuned to dip, or, tuned to peak meter. Its normal accuracy is within ± 3 mc over the entire range of the unit. Its accuracy at 3250 mc is ± 1/2 mc. Supplied with accessories and pickup antenna in its own transit case, it measures 8" x 7" x 6" and weighs 8 lbs.

## BOLTON Laboratories, INC.

BOLTON, MASSACHUSETTS, U. S. A.

### Technicians Available To MANUFACTURERS and/or USERS of ELECTRONIC EQUIPMENT

Thousands of financially sound, qualified electronic servicemen and service organizations are desirous of affiliating with manufacturers (who can train them if need be) and then designate them as official factory branch service depots or service representatives. If you are interested in utilizing the services of these capable, experienced technicians on a contract, or otherwise mutually advantageous basis, please advise us of your needs and requirements, and we will forward to you the names and addresses of such individuals and service organizations in any area you specify.

This is a free service of ELECTRONIC SERVICING MAGAZINE. Write "Contact Department."

#### ELECTRONIC SERVICING

Cowan Publishing Corp.

300 West 43d St. New York 36, N. Y.

### ENGINEERING DEGREES

(Under and Postgraduate)

E. E. Option Electronics  
Earned Through HOME STUDY  
RESIDENCE CLASSES ALSO AVAILABLE  
PACIFIC INTERNATIONAL UNIVERSITY  
American College of Engineering  
5719-G Santa Monica Blvd. Hollywood 38, Calif.

### FOR SALE

EXCELLENT OPPORTUNITY—WELL ESTABLISHED (EAST) 2-way MOBILE INSTALLATION AND SERVICE BUSINESS—Fully Equipped—7 Vehicles, all Accounts under Contract—Owner Retiring.

BO-4080 Electronics

Class. Adv. Div., P. O. Box 12, NY 36, NY

### FOR SALE

### COIL WINDERS

UNIVERSAL WINDING COMPANY  
3 Model 105 1 Model 102 1 Model 84

WIRE & TEXTILE MACHINERY, INC.  
80 Fountain St., Pawtucket, R. I., PA 2-7750

### Superior Vacuum Tube Patents

Eleven U. S. Patents for sale or license. Cover superior, practical, standard vacuum tubes for UHF, VHF, FM, TV, Radio, Power, Transmitting, Industrial Applications.

BINNEWEG TELEVISION 5330 College Ave. Oakland 18, Calif.



# SPECIAL PURPOSE TUBES

## TEST SETS

Hundreds of different types of test equipment, military as well as commercial types. Please advise your needs

TS-35A/AP-X Band Signal Generator and Power Meter. Input—110/1/50—1200 cps. Can generate and measure RF power. New. \$175.00

MAG—10cm remarkable link radar, portable, operated from 6 volt battery, uses folding antenna and tripod. A pair at. \$1750.00

APS-3—3 cm—Airborne radar for search and homing, 5-in. scope. 10 brand new sets at \$750.00 ea

APQ-13—Very late model airborne radar set, complete and new. One only at. \$2,950.00

SCR-545—Complete radar set, less vehicle, antenna and power plant, pretty fair condition, sold as-is at. \$1,375.00

TS-13/AP-X BAND RADAR TEST SET—Measures power, freq. signal-to-noise ratio, I.F. Bandpass, etc. Input—115/1/60—800

TS-100/AP—TEST SCOPE, type A, R, J & X indications, gated & ungated sweep, Int. or Ext. trigger.

ANTENNA ASSEMBLY—Reflector is a light-weight parabolic cylinder, Ass'y has both manual and motor drive. Ideal unit for lab, classroom demonstration, small craft. etc. \$49.50 ea

## TRANSMITTERS

SCR-284—The famous mobile and ground equipment station for field use, complete with all accessories. Range 3.8—5.8 mcs, 20 watts cw, 5 watts phone.

SCR-510—Mobile, portable FM radio station. Operates from 6, 12, or 24 volt dc supply. Frequency range: 20.0 to 27.9 mcs.

SCR-610—Same as SCR-510, but with built-in speaker and range of 27.0-38.9 mcs.

SCR-528—Mobile FM radio station, operates from 12 or 24 volt dc. Frequency range: 20.0-27.9 mcs.

SCR-628—Same as SCR-528, but with range: 27.0 to 38.9 mcs.

BC-325—400 watts c.w., 100 watts new or voice operates from 110 or 220 volts ac. Freq. range: 1.5-18.0 mcs. Master oscillator or crystal control.

14C—400 watts phone or 800 watts c.w. Operates from 220 volts ac. Freq. range: 2.0-18.1 mcs. Has automatic dial selection of anyone of ten preset channels. Mfr. Western Electric.

TCS—Collins, Navy radiotelephones for shipboard and mobile use, complete with all accessories for operation from 12, 24, 110, 230 volts d.c. and 110 or 220 volts a.c.

TBK—High frequency transmitter, 2-20 mcs; 500 watts output. Supplied complete with m/g and starter for d.c. or a.c. operation.

TBL—All-wave transmitter; 350 watts output; CW and phone. Supplied complete with m/g and starter for d.c. or a.c. operation.

TAJ—Intermediate freq. transmitter, 175-550 kcs; 500 watts output. Supplied complete with m/g and starter for a.c. or d.c. operation.

TBN—200-3,000 kcs, complete with 220/440 volt, 3 ph. 50-60c power supply—conservatively rated at 1 kw. output.

## MOTOR GENERATORS CONVERTERS

50, 60, 400 and 800 cycle and DC Power Supplies

DUAL OUTPUT GENERATOR: 115/1/400 @ 39 Amps and 28 V DC @ 17.9 Amps. NEW, MOUNTED OR UNMOUNTED. Write

28dc to 110/1/800 @ 1kva	\$49.50
(Overall length 12 inches)	
110dc to 110/1/800 @ 350va	150.00
110 ac to 110/1/800 @ 350va	235.00
110/1/60 to 110/1/400 @ 2kva	400.00
110dc to 28dc @ 250va	49.50
110/1/60 to 28dc @ 250va	97.50
220/1, 3/60 to 28dc @ 250va	97.50
110dc to 110/1/60 @ 1.25kva	135.00
220dc to 110/1/60 @ 1.25kva	145.00
110dc to 110/1/60 @ 350va	85.00
110dc to 110/1/60 @ 500va	95.00
110dc to 110/1/60 @ 5kva	285.00

## SYNCHROS & SELSYNS

1F	\$55.00	6DG	\$34.50
1SF	55.00	6G	49.50
1G	55.00	7G	49.50
1DG	42.50	2J1F1	10.00
5F	39.50	2J1G1	10.00
5G	39.50	2J1H1	10.00
5CT	45.00		
5SDG	27.50	AY-43 autosyn	

• DESIGN, MODIFICATION, PRODUCTION, AND TESTING OF COMMUNICATIONS AND RADAR EQUIPMENT

## COMPASS ELECTRONICS SUPPLY

A Division of Compass Communications Corp.

75 Varick Street  
New York 13,  
N. Y.



CANAL 6-7455  
Cable Address:  
Compradio, N. Y.

OA2	.70	3K27	150.00	26Z5W	3.00	464A	1.75	5654	1.35
OA2WA	3.00	3KP1	7.50	FG-27A	15.00	GL-502A	1.25	5656	6.00
OA3/VR-75	.90	3X2500A3	150.00	FG-32	4.00	GL-575A	10.00	5663	.95
OA5	4.00	4-65A	13.50	FG-33	15.00	631-P1	5.00	5667	100.00
OB2	.60	4B31	20.00	VX-33A	5.00	WE-701A	1.50	5670	2.00
OB2WA	3.00	4B32	7.50	35T	2.85	707B	2.00	5672	1.00
OB3/VR-90	.85	4C27	7.25	35TG	2.85	715C	10.00	5675	6.85
OC3/VR-105	.50	4C33	75.00	VX-41	5.00	719A	15.00	5676	1.00
OC3W	2.50	4C35	15.00	FP-54	50.00	721A	.50	5678	.75
OD3/VR-150	.50	4D32	19.50	HK-54	2.00	721B	8.50	5685	12.00
OD3W	2.50	4E27	7.00	VX-55	6.00	723A/B	7.25	5686	2.00
EL-C1A	6.00	4J38	100.00	FG-57	9.00	WE-725A	2.50	5687	2.75
1AD4	.90	4J39	100.00	RK-65/5D23	6.50	726A	4.50	5687WA	4.50
1AE4	1.00	4J46	25.00	FG-67	8.00	726B	12.50	5691	4.50
1AF4	2.50	4J51	7.50	HY-69	7.50	802	3.00	5692	5.00
1AG5	2.00	4J52	50.00	RK-73	7.50	804	7.50	5693	4.50
1B23	1.00	4J61	150.00	FG-81A	3.50	805	3.50	5696	.85
1B24	7.50	4PR60A	35.00	FG-95	15.00	807	1.15	5702	1.50
1B27	12.50	4X150A	18.50	100TH	1.50	807WA	5.00	5703	1.00
1B35	3.50	4X500F	50.00	WE-121A	1.50	809	2.00	5704	1.50
1B35A	7.50	5A6	2.00	WE-122A	1.50	810	10.00	5719	1.50
EL-1C	1.25	5AP1	5.00	WE-123A	2.50	811	3.00	5720	15.00
1P21	30.00	EL-5B	5.00	WE-124A	3.50	812	2.50	5725	2.50
1P22	5.00	5BP1A	7.50	FG-190	15.00	813	10.00	5726	.75
1P28	9.00	5BP2A	5.00	CE-203	2.50	814	1.25	5727	1.25
1Z2	2.25	5C22	22.50	203A	5.00	815	1.25	5728	8.00
2AP1	2.00	5CP1	2.00	VT-227A	2.50	826	.75	5734	12.50
2AP1A	6.00	5CP1A	7.50	CE-235A	2.50	826	8.00	5734	50.00
2B22	2.00	5CP7A	8.00	FG-235A	55.00	828B	8.00	5749	1.25
2C36	35.00	5CP11A	9.50	WE-242C	10.00	832A	8.50	5750	2.50
2C39	5.00	5CP12	10.00	QK-243	40.00	836	4.85	5751	2.50
2C39A	10.00	5FP14	5.00	WE-244A	7.50	837	1.25	5755	7.50
2C39B	29.00	5HP1A	10.00	WE-245A	6.00	838W	3.50	5763	1.15
2C40	7.50	5J29	4.00	WE-249B	3.50	845	2.75	5771	275.00
2C40A	26.00	5J30	4.00	WE-249C	2.50	850	10.00	5783WB	5.50
2C42	8.00	5J31	8.50	525R	5.50	851	6.50	5787WA	6.00
2C43	8.00	5J32	5.00	WE-251A	50.00	866A	1.25	5796	15.00
2C44	.25	5J32A	7.50	WE-252A	7.50	868/PJ-23	1.50	5798	10.00
2C46	5.00	5J34	3.50	WE-253A	2.00	872A	1.00	5801	5.00
2C50	6.00	5J35A	10.00	WE-254A	2.25	874	.75	5803	6.00
2C51	3.50	5J37A	7.50	WE-257A	3.00	884	.95	5814	.75
2C52	2.75	5LP1	9.50	FG-258A	75.00	885	.75	5814A	1.50
2C53	10.00	5LP2A	10.00	WE-259A	15.00	913	17.50	5814WA	3.25
2D21	.70	5R4GY	1.25	WE-262B	5.00	917	1.40	5827	30.00
2D21W	.85	5R4WGY	2.50	FP-265	18.50	918	1.50	5827	5.00
2E22	2.25	5RP1A	17.50	WE-267B	5.00	920	2.00	5829	.85
2E24	2.25	5RP11A	75.00	WE-268A	5.00	922	1.50	5830	85.00
2E26	3.35	5SP1	50.00	WE-271A	5.00	923	1.25	5836	93.00
2J51	200.00	5UP7	12.50	WE-272A	7.50	931A	4.85	5840	3.25
2J52	50.00	5X3	2.00	WE-274B	7.50	958A	3.00	5842	15.00
2J54	25.00	5X31	50.00	WE-275A	3.50	959	1.15	5847	15.00
2J55	35.00	5Z2P7	25.00	WE-276A	7.50	991/NE-16	2.25	5854	6.75
2J56	50.00	5Z4P11	50.00	WE-279A	175.00	CK-1006	2.25	5876	3.00
2J59	50.00	EL-C6J	12.00	WE-282A	2.25	1611	1.00	5881	2.75
2J61	12.50	EL-C6L	6.50	WE-282B	4.00	1613	1.00	5886	2.75
2J62	5.00	6AC7W	.85	WE-283A	3.25	1614	1.75	5902	4.50
2J64	100.00	WE-6AK5	1.25	WE-285A	4.50	1619	.50	5915	3.50
2K25	12.50	6AK5W	1.00	WE-286A	3.50	1620	3.50	5932	1.50
2K26	35.00	6AL5W	.75	WE-287A	2.50	1622	1.50	5933	5.00
2K28	30.00	6AN5	2.25	WE-300B	7.50	1624	1.50	5933WA	5.00
2K29	25.00	6AQ5W	1.70	304TH	12.50	1625	.50	5948/1754	175.00
2K30	50.00	6AR6	1.35	304TL	12.50	1846	50.00	5962	5.00
2K33A	60.00	6AR6WA	2.50	WE-310A	3.85	2050	1.00	5963	1.25
2K34	100.00	6AS6	1.25	WE-311A	4.00	2050W	3.50	5964	1.00
2K35	100.00	6AS6W	2.50	WE-313CD	4.00	ZB-3200	100.00	5977	2.75
2K39	100.00	6AS7G	2.50	WE-316A	.50	5528	6.50	5979	10.00
2K41	85.00	6AU6WA	2.50	WE-323A	8.50	5550	30.00	5980	8.50
2K45	30.00	6BA6W	1.25	WE-323B	5.00	5551	40.00	5981/5650	60.00
2K47	100.00	6BE6W	2.50	WE-328A	3.50	5552	55.00	5998	4.75
2K48	50.00	6BL6	30.00	WE-336A	4.00	5553	75.00	6005	1.70
2K50	125.00	6BM6	30.00	WE-338A	4.00	5556	10.00	6021A	4.50
2K56	50.00	6CA4W	4.00	WE-339A	10.00	5557	3.50	6028	2.00
2V3G	1.25	6C21	14.00	WE-347A	2.50	5558	4.00	6037	50.00
2X2A	.85	6F4	2.25	WE-348A	5.00	5559	9.00	6038	7.50
3ABP1	75.00	6J4	1.25	WE-350A	2.50	5560	15.00	6073	1.50
3AP1	2.00	6J4WA	2.00	WE-350B	2.00	5584	3.00	6087	4.25
3AP11A	5.00	6J6W	1.00	WE-352A	15.00	5591	2.75	6098	2.50
3B24	.85	6K4	2.00	WE-354A	8.50	5610	1.00	6100	2.25
3B24W	4.50	6K4A	2.75	WE-355A	8.50	5632	10.00	6130	5.00
3B24WA	8.00	6L4	3.50	WE-388A	1.25	5633	6.00	6134	4.50
3B25	3.50	6L6WGA	3.50	WE-393A	3.50	5634	6.00	6136	2.50
3B26	2.75	6L6WGB	3.50	394A	2.50	5635	6.00	6137	2.00
3B28	4.50	6Q5G	2.25	WE-396A	3.50	5636	2.75	6146	4.40
3B29	5.50	6S17WGT	2.00	WE-403A	1.35	5636A	3.25	6189	2.50
EL-3C	4.50	6SK7W	.85	WE-403B	2.75	5637	3.75	6201	3.00
EL-C3J	10.00	6SK7WA	2.00	WE-404A	15.00	5638	6.50	6236	185.00
EL-C3JA	12.50	6S17WGT	1.25	WE-407A	3.25	5639	6.00	6263	12.50
3C23	3.50	6SN7WGT	1.00	WE-408A	2.00	5639A	6.50	6264	10.00
3C24	3.00	6SUTGYT	2.25	WE-409A	4.25	5640	6.00	6280	35.00
3C33	6.00	6X45WA	2.00	WE-416B	35.00	5641	5.0		



# TUBES

★ NEW ★ NAME BRANDS ★ IMMEDIATE DELIVERY  
★ LOW PRICES ★ UNCONDITIONAL GUARANTEE

1108 Venice Boulevard • Los Angeles 15, California  
Richmond 9-7644

Cable Address: JASHELEC

Telegraph: FAX

OA2	50.70	2K25	13.50	6AN5	2.25	63107	75.00	722A	.75	1945	65.00	5751	2.00
OA2WA	3.00	2K26	35.00	6AN5WA	5.00	V-262	75.00	723A/B	7.50	2000T	150.00	5755 420A	6.50
OA5	3.50	2K28	30.00	6AR6	1.50	FP265	20.00	725A	3.00	2050	1.00	5763	1.20
OB2	.60	3K33	100.00	6AS6W 5725	2.70	WE-269A	6.00	726A	4.50	2051	.65	5779	70.00
OB2WA	3.00	2K33A	60.00	6AS7G	2.50	FG-271	25.00	726B	15.00	HK3054	100.00	5783WB	6.50
OB3/VR90	.85	2K33B	100.00	6AUGWA	2.50	271A	5.00	726C	15.00	ZB3200	99.50	5784WA	7.00
OC3/VR105	.60	2K34	85.00	6BF7W	2.50	WE-258A	75.00	730A	7.50	4210	Q	5785	1.50
OD3	.60	2K41	100.00	6BL6	30.00	WE-258B	5.00	750TL	32.00	R-4330	9.00	CK-5787	4.75
1AD4	1.00	2K42	110.00	6BM6	30.00	V-260/VA-		803	2.00	R-4340	9.00	5814	.65
ELC1B	1.00	2K44	110.00	6BM6A	35.00	804	75.00	804	7.50	5516	5.50	5814WA	3.00
1B22	1.10	2K45	110.00	6C17GTY	15.00	807	20.00	807W	1.10	5517	1.00	5819	27.50
1B23	2.75	2K46	200.00	6D4	1.75	WE-274B	.90	811	1.75	5531	200.00	5825	6.00
1B24	5.00	2K47	75.00	6F4	2.50	FG-280	15.00	812A	1.00	5544	15.00	5829	1.00
1B24A	12.50	2K48	55.00	6J4	1.75	WE-282A	2.25	813	2.25	808	25.00	5837	50.00
1B25	1.25	2K50	150.00	6J4WA	2.50	WE-282B	4.50	814	4.50	815	1.50	5842 417A	12.50
1B29	2.50	2K54	5.00	6J6W	1.00	WE-283A	15.00	815	3.50	5561	29.50	5844	1.50
1B32	1.00	2K56	50.00	6K4	4.75	QK283A	150.00	828	8.00	5586	110.00	5851	4.00
1B35	3.35	2X2A	.90	6L6SWG	3.50	QK284A	150.00	829	5.00	5588	80.00	5852 TES	6.00
1B36	3.75	VR3B	25.00	6L6WGB	3.00	WE-285A	5.00	829B	8.50	5591/403B	2.75	5853	60.00
1B40	3.00	3AP1	1.25	6L6Y	2.00	WE-286A	3.50	830B	.50	5606	125.00	5876	5.00
1B42	4.50	3B22	1.45	6SK7W	1.00	287-A	2.00	832A	5.00	5611	45.00	5879	1.25
1B44	15.00	3B24	1.00	6SL7W	1.25	WE-305A	3.00	833A	33.00	5634	6.50	5881	2.50
1B45	4.00	3B24WA	8.00	6SUTGTY	2.25	WE-290A	7.00	834	5.00	5636	2.95	5893	9.00
1B47	4.00	3B24WA	8.00	6X4WA	3.00	GB-302	5.00	836	1.25	5639	6.00	5896	3.00
1B51	6.75	3B26	3.00	6X5W	1.00	304TL	15.00	837	1.25	5639A	6.50	5899	4.00
1B58	60.00	3B29	6.00	6X5WGT	1.25	WE-312A	1.50	838	.70	5641	5.00	5902	4.50
1B62	4.00	3C22	65.00	7UP7	20.00	WE-315A	10.00	842	1.50	5643	4.50	5902A	5.50
1B63A	19.50	3C23	3.50	7YP2	75.00	QK-319	100.00					5902A (CL)	2.50
1N21B	2.50	3C24	2.50	SRC-12	150.00	WE-323A	9.00					5904	8.50
1N21C	2.10	3C31	1.00	12A7Y	15.00	WE-326A	4.50					5906	8.50
1N23B	.90	3C33	6.50	12DP7	15.00	WE-336A	4.50					5907	8.50
1N23BM	2.50	3C45	6.00	12GP7	15.00	WE-337A	5.50					5910	.60
1N25	2.20	3DP1-S2	5.00	12SP7B	25.00	WE-338A	4.00					5915	.50
1N26	3.50	3DP11A	6.00	X-13	150.00	WE-348A	5.00					5916	8.50
1N28	3.00	3D11A	3.00	BL-15	Q	WE-349A	5.00					5932	3.50
1N31	6.75	3E29	8.50	BL-16	Q	WE-350A	1.00					5933/807W	3.00
1N32	9.00	3FP7A	2.50	FG17	3.95	350B	2.00					5948/1754	175.00
1N38A	.60	3JP1	7.50	RX-21	3.50	354C	5.00					5956	35.00
1N40	4.75	3J30	25.00	PJ22	3.00	WE-355A	9.95					5962 BS101	4.50
1N42	8.00	3J31	35.00	HK24	3.00	WE-356B	3.50					5964	.80
1N46	.60	3K22	150.00	26A7GT	3.00	WE-359A	2.00					5965	1.00
1N52	.65	3K23	150.00	26E6WG	2.50	36AS	2.50					5977A	3.00
1N63	1.40	3K30	100.00	RK-28A	2.50	385A	Q					5981	70.00
1N69	.40	4-65A	14.50	28D7D	5.00	WE-388A	1.20					5982	149.50
1P21	30.00	4-125A	19.50	RK29D	Q	WE-393A	3.50					5987	9.50
1P22	6.00	4A1	2.00	VR33	30.00	WE-394A	2.50					5993/TE-10	9.00
1P24	1.50	4B23	3.00	WF-35A	3.00	WE-400	20.00					6005 6AQ5W	1.75
1P25	45.00	4B26	7.50	D-42	40.00	FP-400	20.00					6019	300.00
1P28	7.50	4C27	7.50	RK47	3.00	WE-403A	1.50					6021-A	4.50
1P30	1.35	4C28	19.75	V-50	75.00	WE403B/5591	2.75					6028 408A	2.00
1Q22	40.00	4C35	13.50	V-50XR	75.00	WE-407A	4.00					6037/QK243	75.00
1V5	.90	4D21	19.50	HK 54	2.00	WE-408A	2.25					6038	8.50
1W5	.90	4E27	9.00	QK-57	Q	WE-412A	3.75					6044	15.00
1Z2	2.50	4J22	35.00	QK-59	20.00	GL-414	63.00					6046	.75
2AP1	3.00	4J26	50.00	QK-60	20.00	WE-416B	35.00					CK-6050	2.00
2AP1A	6.00	4J27	50.00	RK-60/1641	1.25	417A	2.50					6073	1.75
2AS15	4.75	4J28	50.00	QK61	20.00	WE-417A	12.50					6074	2.50
2B22	1.00	4J29	50.00	RK-61	2.50	WE-418A	16.00					6080	4.00
2B24	.80	4K30	50.00	QK-62	20.00	WE-421A	10.00					6080WA	6.75
2C33	.75	4J32	45.00	HY-65	1.00	WE-422A	10.00					6081 ATR407	22.50
2C35	2.00	4J34	25.00	RK-65/5D23	7.50	WE-423A	5.75					6082	3.00
2C36 846B	25.00	4J42	25.00	FG-67	8.00	WE-429A	40.00					6088	1.50
2C39A sealed	11.00	4J50	95.00	HY-69	2.25	GL-434A	4.00					6095	2.00
2C40	6.75	4I52	50.00	RKR-72	.50	WE-438A	5.00					6096	1.30
2C42	8.00	4K13	45.00	PKR-73	5.00	446B	1.00					6097	1.50
2C43	8.00	4J64	49.50	FG-95	16.50	WL-456	59.50					6099	1.40
2C46	5.00	4PR60A	37.00	ML-100	50.00	QK459	250.00					6100 6C4WA	2.25
2C50	6.00	4X150A	30.00	100TH	6.50	464A	1.95					6101 6J6WA	2.25
2C51	3.95	4X150G	35.00	WE101D	3.00	X-481D	50.00					6110	6.00
2C52	2.50	4X150D	25.00	WE101F	3.00	CK501AX	1.00					6111	4.50
2C53	9.75	4X250B	30.00	FG-105	11.00	RM-507	20.00					6112	4.00
2D21	.75	4X250M	35.00	F-123A	2.50	508/6246	150.00					6116	150.00
2D21W	1.00	5ABP1	20.00	F-128A	10.00	527	25.00					6117	60.00
2D29	.80	5ADP1	20.00	FG-154	10.00	WL-530	17.50					6130	6.00
2E22	2.50	5B	1.00	VT158	9.75	559	8.50					6134	3.50
2E24	2.50	5BP2A	2.95	FG-166	6.75	QJES78	Q					6136	60.00
2E25	3.75	5CP1	1.95	FG-172	15.00	579B	15.00					6161	75.00
3E26	3.25	5CP1A	7.50	QK172	200.00	583	12.50					6184	9.00
3E27	.60	5CP7	6.00	QK-181	10.00	KU-610	7.50					6189 12AU7WA	3.00
3E32	1.00	5CP7A	8.00	HF-200	10.00	KU-627	7.50					6199	27.50
3E41	1.50	5CP11A	9.50	WL-200	50.00	KU-628	7.50					6201 12AT7WA	3.00
2H21	60.00	5C22	20.00	QK202	165.00	WL-652	20.00					6203	2.75
2J22	4.25	5J1	10.00	203A	3.50	HK-654	17.50					6205	4.50
2J31	12.25	5JP1A	30.00	204A	25.00	GL-672	20.00					6211	1.25
2J32	10.00	5JP2	5.00	205F	6.00	WE-701A	2.50					6264	11.50
2J34	10.00	5JP4	5.00	207	75.00	WE-703A	1.25					6339	20.00
2J36	29.50	5JP5	6.50	211 VT4C	.50	WE-704A	.60					6339	20.00
2J39	25.00	5JP11A	7.50	212E	15.00	WE-705A	.75					6406/QK428	200.00
2J48	25.00	5MP1	2.95	WL-218	15.00	706A-Y-GY	10.00					5725 6AS6W	2.75
2J49	35.00	5NP1	2.00	CEP220	4.00	707B	2.50					5725 6AS6W	2.75
2J50	35.00	5R4G	1.25	OK221	150.00	WE-708A	1.50					5726 6AL5W	1.00
2J51	150.00	5R4WG	4.00	RX233A	.75	WE-709A	1.50					5726 6AL5W	1.00
2J54	25.00	5R4WGY	2.50	QK235	150.00	714A	7.50					5727 2D21W	1.50
2J56	40.00	5SP7	45.00	OK-243	50.00	715A	1.75					5749	.85
2J61	15.00	5Y3WGT	1.75	QK-249	150.00	715B	2.50					5749 6BA6W	1.00
2J61A	40.00	5Y3WGT	3.75	WE245A	6.45	715C	10.00					D178461	50.00
2J62	5.00	5ZP16	60.00	249B	2.50	717A	.50						
2J62A	40.00	6AC7A	1.00	249C	3.00	720A-Y-EY	35.00						
2K22	13.50	6AC7W	1.00	250-R	4.50	721A	.75						
2K23	12.50	6AK5W	1.00	250TH	21.00	721B	7						



# ELECTRONIC

WAR TERMINATION INVENTORIES

WRITE OR WIRE FOR INFORMATION ON OUR COMPLETE LINE OF SURPLUS ELECTRONIC COMPONENTS. ALL PRICES NET F.O.B. PASADENA, CALIFORNIA

# C&H

SALES CO.

2176 E. East Colorado St.  
Pasadena 8, California  
RYan 1-7393

## INVERTERS

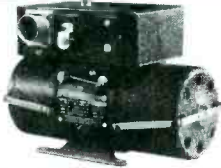

- 10042-1-A Bendix  
DC Input 14 volts; output: 115 volts; 400 cycles. 1-phase; 50 watt **\$35.00**
- 12116-2-A Bendix  
Output: 115 VAC; 400 cyc; single phase; 45 amp. Input: 24 VDC, 5 amps. **\$35.00**
- 12127 Bendix  
Output: 26 volts; 400 cycles, 6 volt amperes, 1 phase. Input: 24 VDC; 1 amp. **\$15.00**
- 12121 Bendix  
Input: 24 volt D.C. 18 amp. 12000 r.p.m. Output: 115 volts, 400 cycle, 3-phase, 250 volt amp, 7 pf. **\$49.50**
- 12123 Bendix  
Output: 115 V; 3 phase; 400 cycle; amps. .5 Input: 24 VDC; 12 amp. **\$49.50**
- 12126-2-A Bendix  
Output: 26 volts; 3 phase; 400 cycle; 10 VA; 6 PF. Input: 27.5 volts DC; 1.25 amps. **\$24.50**
- 12130-3-B Bendix  
Output: 125.5 VAC; 1.5 amps. 400 cycles single phase, 141 Va. Input: 20-30 VDC. 18-12 amps. Voltage and frequency regulated. **\$49.50**
- 12137 Bendix  
Output 250 VA, 115 volts, 3 phase, 400 cycle, 1.25 amp., 0.8 pf. Input 27.5 volt DC, 20 amp. **\$59.50**
- 12142-1-A Bendix  
Output: 115 volts, 3 phase, 400 cycle, 250 VA. Input: 27.5 VDC, 22 amps. Voltage and frequency regulated **\$99.50**
- 12147-1 Pioneer  
Output: 115 VAC 400 cycles; single phase. Input: 24-30 VDC; 8 amps. **Price \$39.50 each**
- 778 Bendix  
Output: 115 volt 400 cycle; 190 VA; single phase and 26 volt, 400 cycle, 60 VA, single phase. Input: 24 VDC. **\$37.50**
- 10285 Leland  
Output: 115 volts AC; 750 VA, 3 phase, 400 cycle, .90 pf and 26 volts. 50 VA single phase, 400 cycle, .40 pf. Input: 27.5 VDC 60 amps. cont. duty, 6000 rpm. Voltage and frequency regulated. **\$59.50**
- 10339 Leland  
Output: 115 volts; 190 VA; single phase; 400 cycle, .90 pf and 26 volts; 60 VA; 400 cycle, .40 pf. Input: 27.5 volts DC, 18 amps. cont. duty, voltage and freq. regulated. **\$49.50**
- 10486 Leland  
Output: 115 VAC; 400 cycles; 3-phase; 175 VA; .80 pf. Input: 27.5 DC; 12.5 amps.; cont. duty. **\$70.00**
- 10563 Leland  
Output: 115 VAC; 400 cycle; 3-phase; 115 VA; 75 pf. Input: 28.5 VAC; 12 amps. **\$35.00**
- PE109 Leland  
Output: 115 VAC, 400 cyc.; single phase, 1.53 amp.; 8000 rpm. Input: 13.5 VDC; 29 amp. **\$50.00**
- PE218 Leland  
Output: 115 VAC; single phase pf. 90; 380/500 cycle; 1500 VA. Input: 25-28 VDC; 92 amps.; 8000 rpms.; Exc. Volts 27.5. **BRAND NEW \$30.00**
- MG149F Holtzer-Cabot  
Output: 26 VAC @ 250 VA; 115 V. @ 500 VA; single phase; 400 cycle. Input: 24 VDC @ 36 amps. **\$40.00**
- MG153 Holtzer-Cabot  
Input: 24 VDC; 52 amps. Output: 115 volts —400 cycles, 3-phase, 750 VA. Voltage and frequency regulated. **\$95.00**
- DMF2506M Continental Electric  
24-30 volts input; 5.5-45 amps.; cont. duty. Output: 115 volts; .44 amps.; 400 cyc.; 1 phase; pf. 1.0; 50 watts **\$39.50**
- AN 3499 Eicor, Class "A"  
Input: 27.5 volts at 9.2 amps. AC. Output: 115 volts 400 cycles; 3 phase 100 voltamp; continuous duty. **Price \$39.50 each**

## VARIABLE SPEED BALL DISC INTEGRATORS

Forward & Reverse 4-0-4. Input shaft 5/16" dia. x 3/4" long. Output shaft 15/64" dia. x 9/16" long. Control shaft 11/64" dia. x 11/16" long. Cast aluminum construction approx. size 4 1/2" x 4 1/2" x 4".



**No. 146**  
**\$17.50 ea.**

Forward & Reverse 2 1/4-0-2 1/4. Input shaft spline gear 12 teeth 9/32" dia. 3/8" long. Output shaft 15/64" dia. x 15/32" long. Control shaft 11/32" x 3/8" long. Cast aluminum construction. Approx. size 3" x 3" x 2 9/4".



**No. 145**  
**\$17.50 ea.**

(All Shafts on Both Ball Bearing Supported)

## SELSYNS-SYNCHROS



- 1CT Cont. Trans. 90/55V 60 cy. **\$37.50**
- 1DG Diff. Gen. 90/90V 60 cy. **37.50**
- 1F Sym. Mtr. 115/90V 60 cy. **37.50**
- 1G Gen. 115V 60 cy. **37.50**
- 1SF Syn. Mtr. 115/90V 400 cy. **12.50**
- 2J1F1 Gen. 115/57.5V 400 cy. **7.50**
- 2J1F3 Gen. 115/57.5V 400 cy. **10.00**
- 2J1F4 Gen. 115/57.5V 400 cy. **7.50**
- 2J1G1 57.5/57.5V 400 cy. **5.00**
- 2J1H1 Diff. Gen. 57.5V 400 cy. **7.50**
- 2J5D1 Cont. Trans. 105/55V 60 cy. **17.50**
- 2J5F1 Cont. Trans. 105/55V 60 cy. **17.50**
- 2J5H1 Gen. 115/105V 60 cy. **17.50**
- 2J15M1 Gen. 115/57.5V 400 cy. **34.50**
- 5CT Cont. Trans. 90/55V 60 cy. **34.50**
- 5D Diff. Mtr. 90/90V 60 cy. **34.50**
- 50DG Diff. Gen. 90/90V 60 cy. **34.50**
- 5F Sym. Mtr. 115/90VAC 60 cy. **34.50**
- 5G Syn. Gen. 115/90VAC 60 cy. **42.50**
- 5HCT Cont. Trans. 90/55V 60 cy. **12.50**
- 5SDG Diff. Gen. 90/90V 60 cy. **25.00**
- 6DG Cliff. Gen. 90/90V 60 cy. **34.50**
- 6G Syn. Gen. 115/90VAC 60 cy. **42.50**
- 7G Syn. Gen. 115/90VAC 60 cy. **42.50**
- R110-2A Kearfott Cont. Mtr. 115V 400 cy. **17.50**
- R200-1-A Kearfott Cont. Trans. 26/71.8V 400 cy. **15.00**
- R210--A Kearfott Trans. 26/71 8V 400 cy. **20.00**
- R220--A Kearfott Receiver 26/71.8V 400 cy. **20.00**
- R235--A Kearfott Resolver 26/71 8V 400 cy. **22.50**
- C56701 Type 11-4 Rep. 115V 60 cy. **20.00**
- C69405-2 Type 1-1 Transm. 115V 60 cy. **20.00**
- C69405 Syn. Transm. 115V 60 cy. **20.00**
- C69405-1 Type 11-2 Rep. 115V 60 cy. **10.00**
- C76165 Volt. Rec. 115V 60 cy. **12.50**
- C78243 Syn. Transm. 115V 60 cy. **5.00**
- C78249 Syn. Diff. 115V 60 cy. **7.50**
- C78863 Repeater 115V 60 cy. **20.00**
- C79331 Transm. Type 1-4 115V 60 cy. **7.50**
- 851 Bendix Autosyn Mtr. 22V 60 cy. **7.50**
- 403 Kollsman Autosyn. Mtr. 32V 60 cy. **7.50**
- FPE-25-11 Diehl Servo Mtr. 75/115V 60 cy. **19.50**
- FPE-43-1 Resolver 400 cy. **25.00**
- FJE-43-9 Resolver 115V 400 cy. **19.50**
- 999-0411 Kollsman 26V 400 cy. **15.00**
- 13770410 Kollsman 26V 400 cy. **10.00**
- 1515B-0410 Kollsman 26V 400 cy. **20.00**
- 10047-2-A Bendix 26V 400 cy. **12.50**
- 2900 Transicoil 115V 400 cy. **15.00**
- 15CX4a Synchro Transmitter MK 22 Mod 1 **15.00 ea.**

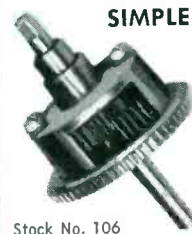

## SIMPLE DIFFERENTIAL

1:1 reverse ratio, 60 teeth on large gear; 1/4" shaft. Size: 3" long with 1-15/16" dia.

**\$3.95 ea.**

Stock No. 106



## DIFFERENTIAL

Size 2-11/16" long 1-11/16" dia. 1-1 reverse ratio. 1/4" shaft on each end; one shaft 25/32" long, one shaft 15/32" long. Input and output gear 15/16" dia. 60 teeth.

**\$3.50 ea.**

Stock No. 148

## Dual Simple Differential



1:1 reverse ratio or both. Size: 3 1/4" long x 1-7/16" dia. Shaft size 1/8" and 5/32".

**\$7.50 ea.**

Stock No. 110

## 3800 CYCLE INVERTER

Mfgd. by Eclipse-Pioneer #12144-1-A Input: 24-30 volts DC, 10 amps AC. Output: 115 volts, .95 amps, 3800 cycle, single phase. Approx. weight 2 1/2 lbs. **Priced at \$39.95**

## UTILITY RECTIFIER

27 volt DC, 40 amps, intermittent duty. Input: 220 volts, 60 cycle, single phase, 9 amps. Mfgd. by Strong Electric Corp. Model #16200-8. Dimensions: 12 x 18 x 20 **Priced at \$75.00**

## SMALL DC MOTORS



- (approx. size overall 3 3/4" x 1 1/4" dia.):
- 5067126 Delco PM, 27 VDC, 125 RPM, Governor Controlled **\$15.00 ea.**
- 5069600 Delco PM 27.5 VDC 250 rpm **12.50**
- 5069230 Delco PM 27.5 VDC 145 rpm **15.00**
- 5068750 Delco 27.5 VDC 160 rpm w. brake **6.50**
- 5068571 Delco PM 27.5 VDC 10,000 rpm (1 1/2 x 2") **5.00**
- 5069625 Delco 27.5 VDC 120 rpm w/governor **15.00**
- 5069790 Delco PM, 27 VDC, 100 RPM, Governor Controlled **15.00 ea.**
- 5BA10A118 GE 24 VDC 110 rpm **10.00**
- 5BA10A137 GE 27 VDC 250 rpm reversible **10.00**
- 5BA10A152 27 VDC 145 rpm reversible **12.50**
- 5BA10A150, G.E., 12 VDC, 140 R.P.M., 206-1001 PM Planetary Gear Reduced Motor with Magnetic Brake. Mfgd. by Air Equipment 26 volts 600 ma 145 rpm **17.50**
- 5BA10F133, G.E., 12 VDC, 56 R.P.M., reversible **15.00**
- 806069 Oster series reversible 1/50 h.p. 10,000 rpm 27.5 VDC 1 5/8" x 3 1/2" **5.00**
- C-28-1A 27 VDC 1/100 h.p. 7,000 rpm **3.00**
- 7100-B-PM Hansen 24 VDC 160 rpm **7.50**
- 55FD-6-1 Diehl PM 27.5 VDC 10,000 rpm **4.00**
- 6-volt PM motor mfgd. by Hansen 5,000 rpm 1 1/4" in dia., 2" long overall **\$4.00**

# Universal YOUR RELAY HEADQUARTERS!



## GUARDIAN SERIES 200M RELAYS

Guardian Series 200M are a versatile group which include coil and contact assemblies for combining your own relays. Locating pins are provided which assure accurate adjustment after assembly. Many possible combinations are possible from a small inventory of units. Also, for spare parts only half the stock is required, since either part may be replaced independently of the other. The coil assembly consists of the coil and the field piece; the contact assembly consists of switch blades, armature, return spring and mounting bracket. Use contact switch parts to add poles.

Listed below are GUARDIAN contact assemblies and coils from our stock. These may be purchased separately. However, a complete relay consists of coil and frame. In ordering complete relays specify which contact assembly, i.e.: F605 with K603. †Note: 6PDT(6C) will not operate on 110VAC with coil K604.

### CONTACT ASSEMBLIES

8 ampere, non-inductive 24VDC or 115VAC rating

Stk#	Contacts	Price Ea*
F601	1A	.85
F602	2A	.95
F604	4A	1.10
F605	1A, 1B	.95
F606	2A, 2B	1.10
F607	1B	.85
F608	2B	.95
F610	4B	1.10
F611	6B	1.40
F612	1C	1.00
F613	2C	1.20
F614	3C	1.40
F615	4C	1.65
F616	6C†	2.10

† Note: 6PDT will not operate on 110VAC with coil K604.

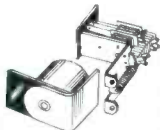

### COIL ASSEMBLIES

Stk#	Volts A-C	Ohms	Price Ea*
K601	24	24	.85
K602	32	48	.85
K603	55	125	1.00
K604	110	725	1.50
K605	230	2000	1.85

Stk#	Volts D-C	Ohms	Price Ea*
K606	6	24	1.20
K607	8	48	1.20
K608	12	125	1.25
K609	110	3400	2.00

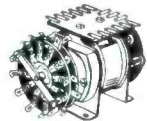

### PRICE TYPE 8507-1 Automatic Stepping Selector

A rotary unit that will automatically select any one of twelve shaft positions, or wafer settings, when actuated from a twelve-point selector switch. The selector switch is manually operated and set to desired circuit. The rotary automatic stepping selector will step automatically to the selected circuit and stop. No holding current is required once the desired circuit is established.

Specifications  
Operating Voltage: 24V DC  
Intermittent Duty  
Torque: 8 Inch-ounces  
Dimensions:  
2" long, 2 1/8" wide,  
(Water 2 1/4" dia)  
2 1/2" high  
Weight: 15 ounces

Unit is composed of a ratchet-drive rotary powered mechanism, complete with position selecting switch wafer repeater switch and terminal deck. The shaft extension provides mounting for additional wafers, up to a total of three, providing available torque is not exceeded. #R1250 7.50\*



### WICO SOLENOID OPERATED STEPPER

44 contact with 180° wiper arm (bridging) which connects diametrically opposite contacts, viz: Arm shorts position 1 and 23, position 2 and 24 etc. However, one side of arm can be removed to provide a single deck 44 position resettable stepper.

Both step and release are solenoid driven. Normal speed of operation should not exceed 5 steps per second. Operates at termination of actuating pulse. Has DPST n. o. (2A) off-normal spring; 4 1/2 x 4 1/4 x 3" D. #R1251 24VAC 8.50\* #R1252 12VDC 8.50\*

Prices listed with asterisk (\*) are subject to QUANTITY DISCOUNTS  
ALL MERCHANDISE IS GUARANTEED AND MAY BE RETURNED FOR FULL CREDIT

1-9	as quoted	50-99	15%
10-49	10%	over 100	20%

**NOTE!**  
New Name  
New Address

# Universal RELAY CORP.

Formerly Universal General Corp.

42 WHITE ST., NEW YORK 13, N. Y. • WALKER 5-9642

## FOR SALE

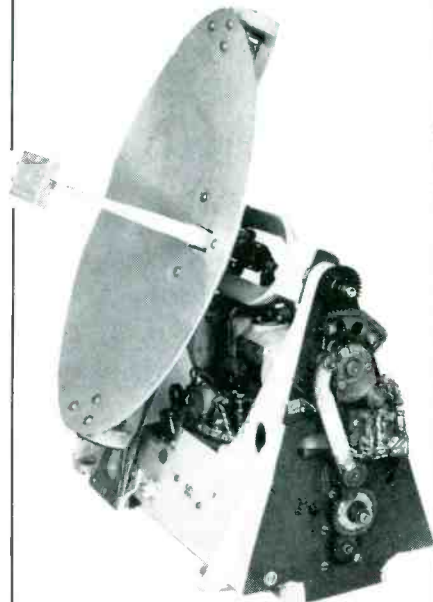

### X BAND SEARCH ANTENNAS

Removed from APS equipment

## NIBUR SALES CORP.

208 RIVER STREET  
RED BANK, N. J.  
SHADYSIDE 1-0404

Just say:  
"Information,  
please"

whenever you need products or services not advertised in a particular issue of this magazine.

Each issue is only part of the complete service we are organized and glad to render to reader and advertiser, alike. We want you to consider this publication your primary source of information in this field.

ELECTRONICS  
Classified Advertising  
P. O. Box 12  
New York 36, N. Y.

WE ARE NOW  
AT OUR  
NEW PLANT  
ADDRESS

## COMMUNICATION EQUIPMENT

for all TYPES of SIGNAL CORPS, MARINE  
and INDUSTRIAL USE . . . IN STOCK

# COMMUNICATION DEVICES CO.

Cable:  
COMMUNIDEV, GREATNECK N. Y.

269 EAST SHORE ROAD, GREATNECK, N. Y.

Telephone:  
HUNTER-2-2320, 1, 2



# FOR RATES OR INFORMATION

About Classified  
Advertising,

Contact  
*The McGraw-Hill*  
Office Nearest You.

ATLANTA, 3  
1301 Rhodes-Haverty Bldg.  
JACKSON 3-6951  
M. MILLER

BOSTON, 16  
350 Park Square  
HUBBARD 2-7160  
H. J. SWEGER

CHICAGO, 11  
520 No. Michigan Ave.  
MOHAWK 4-5800  
W. HIGGINS  
J. BRENNAN

CINCINNATI, 37  
1825 Yorktown Road  
Swifton Village, Apt. 2  
G. MILLER

CLEVELAND, 15  
1510 Hanna Bldg.  
SUPERIOR 1-7000  
W. SULLIVAN

DALLAS, 2  
Adolphus Tower Bldg.,  
Main & Akard Sts.  
RIVERSIDE 7-5117  
G. JONES

DETROIT, 26  
856 Penobscot Bldg.  
WOODWARD 2-1793  
W. STONE

LOS ANGELES, 17  
1125 W. 6 St.  
MADISON 6-9351  
C. DYSINGER  
D. McMILLAN

NEW YORK, 36  
330 West 42 St.  
LONGACRE 4-3000  
S. HENRY  
D. COSTER  
R. LAWLESS

PHILADELPHIA, 3  
17th & Sansom St.  
RITTENHOUSE 6-0670  
H. BOZARTH

ST. LOUIS, 8  
3615 Olive St.  
JEFFERSON 5-4867  
W. HIGGINS

SAN FRANCISCO, 4  
68 Post St.  
DOUGLAS 2-4600  
R. ALCORN

# TUBES

- ★ Brand New! Guaranteed!
- ★ Gigantic savings! Act now!
- ★ Lowest open-market quotes!

BROADCAST TUBES			
2H21	550.00	381A	55.00
3C33	15.00	403B	15.00
3E29	8.25	403B	2.65
3X2500A3	150.00	404A	14.00
4E27	7.00	407A	2.75
4X150A	18.50	408A	2.00
4X150D	20.00	416B	27.50
4X150G	28.50	417AWE	12.00
5D23/RK65	7.00	421A	6.75
6C21	15.00	423A	7.50
15E	1.20	426A	2.10
24G	2.00	429A	8.00
HK24	2.00	440A	P.O.R.
53A	5.00	441A	4.00
HY65	1.40	450TH	40.00
100TH	5.00	471A	4.00
VT127	1.50	508	190.00
VT-127A	2.50	575A	12.00
F-128A	7.25	HK7654	15.00
VT-158	9.50	750TL	30.00
211	4.00	813A	3.25
220B	55.00	803	2.50
250TH	21.00	813	8.50
250TL	12.00	814	2.00
251A	45.00	828	8.00
267B	4.95	829	3.50
272A	7.25	829B	8.00
300B	5.00	830B	4.5
305A	2.75	832A	5.75
310A	3.50	838	.70
311B	3.75	838W	4.00
313C	1.75	843	.35
316A	4.00	845	3.00
327A	3.50	852	4.00
328B	5.00	858	140.00
331A	7.50	864	.25
337A	4.75	880	200.00
348A	4.75	892A	200.00
349A	5.00	1611	.90
354AWE	19.00	1613	1.00
356B	3.25	1619	.30
359A	1.50	1620	3.50
371A	1.00	1625	.30
372A	2.10	5680	130.00
374A	3.25	5736	110.00
		D91143/101F	4.00

5,000 SERIES & UP					
5517	51.00	5718A	54.00	5977A	53.00
5588	75.00	5719	1.50	5995	9.75
5610	1.00	5719A	2.75	5993	9.00
5633	5.75	5722	3.25	5995	4.60
5635	6.00	5725	2.00	6005	1.75
5636	2.85	5726	.70	6021	3.85
5637	3.75	5726/6097		6045	2.95
5639	5.75	6ALS	3.00	6080	4.75
5640	5.85	5744	1.00	6080WA	6.50
5641	4.75	5749	1.20	6087	4.00
5642	1.00	5750	2.25	6096	1.30
5643	4.50	5751	2.00	6098CT	1.90
5644	6.25	5751WA	3.50	6099	1.40
5645	5.75	5763	1.10	6100	2.00
5646	4.50	5783	3.00	6101	2.00
5647	4.50	5784	4.75	6106	8.50
5651	1.40	5784WA	7.00	6110	5.50
5651WA	3.25	5787	4.50	6111	3.95
5654	1.00	5794	5.00	6112	4.50
		5814	.50	6147	3.00
5654/6AKSW		5814A	1.50	6152	6.00
6096	2.95	5814WA	3.00	6159	3.00
5658	6.75	5829	1.00	6161	45.00
5663	1.20	5840	3.50	6201	
5670	1.00	5840A	4.75	12AT7WA	3.50
5670WA	4.25	5844	1.40	6211	1.50
5672	1.25	5845	5.00	6263	11.50
5677	5.00	5851	3.50	6279/5C22	27.00
5678	1.00	5851	1.30	6280/416B	35.00
5686	1.70	5876	7.00	6386	5.00
5687	2.40	5896	3.00	7193	.20
5687WA	4.75	5898	7.50	8012	1.00
5692	5.00	5899	4.00	8025A	1.75
5693	4.25	5899A	5.75	9001	.75
5696	1.00	5931/5U4WG	4.75	9003	1.00
5702	1.50	5932	3.50	9004	.75
5702WA	5.85	5933	1.50	9005	2.25
5703WA	4.00	5967	10.00	9016	.20
5704	1.50	5969	10.00		
5718	1.75	5977	3.00		

RECEIVING TUBES			
RUGGEDIZED			
54RWGY	\$2.75	64JWA	\$2.25
5Y3WGT	1.40	6J6W	.90
6AC7W	1.00	6J6WA	1.50
6AK5W	1.20	6SK7W	.90
6AL5W	.70	6SN7WGT	1.50
6AS6		6X4W	1.35
6BF7W	2.40	6Y4W	3.75
6CAW	3.75	7A7TWA	3.00
		12SX7	1.25
		2625W	4.50

Non-Ruggedized Write for new low prices			
1A3	6BA6	6LG6	6SR7
1D8GT	6BA7	6L6Y	6V6Y
1C6	6C5	6N7	6X5GT
1G4GT/G	6CL6	6S7J	6Y6G
2A3	6F6	6SK7	7A8
6AB7	6J4	6SK7GT	7C7
6AC7	6J5	6S6TY	7F8
6AC7	6K8GT	6SK7Y	12A6
6AK6	6L6	6SL7GT	12AH7GT
6AT6	6L6GA	6SN7GT	12AT7

THYRATRONS			
C1K	57.50	FG172	\$15.00
1C	1.00	FG-21	22.00
2D21	.70	KU-627	7.00
2D21W	.90	677	30.00
3C45	5.75	715C	10.00
4B25	7.50	885	.75
C5B	6.75	VC1258	P.O.R.
E15B	5.00	2050	3.50
5C22	25.00	2050W	3.50
66M/5528	7.00	2051	.65
FG-32	4.00	5559/FG57	9.00
FG105	11.00	5560/FG95	16.00
5G154	9.00	5948/1754	25.00
VT-158	9.00	6130/3C45	5.75

MAGNETRONS			
2J21A	54.75	4J33	\$100.00
2J22	4.50	4J34	35.00
2J26	4.50	4J50	90.00
2J27	4.50	4J51	75.00
2J31	32.50	4J58	90.00
2J32	9.50	4J61	15.00
2J33	28.50	4J64	45.00
2J34	13.00	5J23	75.00
2J37	28.50	QK60	19.50
2J38	28.50	QK62	19.50
2J49	32.50	QK284	95.00
2J50	32.50	702Y-GY	14.00
2J55	45.00	706CY	15.00
2J56	45.00	714A	9.50
2J61	9.95	714AY	50.00
2J62	5.50	725A	2.75
4J21	100.00	5586	105.00
4J31	125.00	5857	105.00
4J42	25.00	5780	175.00
4J26	45.00	6177	85.00

RECTIFIERS & REGULATORS			
OB2	5.60	5R4CY	\$1.25
OC3	.75	5R6WGY	2.75
OD3	.55	5Y3WGT	1.50
SB	2.00	5X3	2.20
SC	1.95	6-4	1.00
1V	.90	6-7	1.00
2C53	12.50	6-11	1.00
2X2	2.25	7H4B	1.00
2X2A	1.00	15R	3.00
3B24	1.35	100R/8020	1.75
3B24W	4.75	249B	3.00
3B28	4.00	249C	3.00
3B29	5.95	250R	4.95
		5931/5U4WG	4.75
		267B	4.95

SCOPE TUBES			
2AP1	\$2.75	3EP1	\$1.25
2BP1	5.95	5BP1A	8.50
3AP1	2.75	5BP4	2.25
3CP1	1.75	5CP1	1.75
3DP1S2	4.75	5CP1A	7.00
3FP7	2.50	5CP11	7.00
3GP1	2.00	5CP11A	8.50
3JP1	7.50	5FP7A	2.50
3W2P1	50.00	5JP1	8.75
		5JP1A	25.00
		5NP1	2.00
		7BP1A	15.00
		7CP1	4.99
		9LP7	10.00
		12D7	12.00
		15CP11	25.00
		902P1	2.25

KLYSTRONS					
1K015XA/X481	3K30	\$95.00	726B	\$14.00	
B.C.D	540.00	6BL6	24.00	726C	13.00
SRX16	100.00	6BM6	29.50	5611	40.00
2K25	12.00	6N6A	32.50	5721	135.00
2K28	24.00	V45	P.O.R.	5981/5650	60.00
2K45	32.50	V50	80.00	6116	30.00
2K48	50.00	V82	P.O.R.	6236	160.00
2K54	14.00	723A/B	7.00		
2K55	14.00	726A	4.75		

LIGHTHOUSE TUBES			
2C39A	\$10.00	3C22	\$60.00
2C40	7.00	4C27	7.00
2C42	8.75	446A	.50
2C43	7.75	446B	1.24
2C46	5.00	8011	1.00
		8014A	60.00

TR. AND AT. TUBES			
1B24	\$5.50	1B40	\$2.00
1B24A	12.50	1B47	7.00
1B35	3.50	1B63A	18.50
1B35A	8.00	5958	45.00
1B37	7.00	1Q22	40.00
		GA4	54.00
		532A	.25
		709A	.50
		744B	.65
		6232	17.00

DIODES			
1N21	5.45	1N25	\$2.15
1N21C	2.75	1N27	8.15
1N23B	.80	1N34A	.45
1N23C	2.25	1N38	.50
		6006	P.O.R.
		1N38A	5.65
		1N47	.90
		CK705	.60

COMPUTER TUBES			
2G21	\$2.00	6ANSWA	\$4.75
6AN5	2.75	5964	1.00
		6211	1.10

All items F.O.B. Los Angeles, subject to prior sale and change of price without notice.  
Write for unlisted items or call REpublic 5-0215. Cable VHRADLECT. Bell Teletype: TWX LA 1460

# V & H RADIO and ELECTRONICS

2029-2047 W. VENICE BLVD. LOS ANGELES 6, CALIF.

Write - Wire or Phone for:

**NEW FREE FLYER!**

Hundreds of excellent buys in air, marine and ground electronics, air frame and electrical parts, components, etc. Get your copy.

**SEE INFRA-RED!**

**IP25A TUBE:** Just released! Infra-red image converter made by Farnsworth. Limited quantity. Do not delay! Brand new. **\$24.95**

**WIDE RANGE RECEIVER: 80-3,000 MC!**  
Far more sensitive than a radar receiver! We quote: "It is designed to detect radar signals beyond the effective range of the radar, to measure carrier frequencies from 80-3,000 mc and pulse repetition rates from 50-8,000 cps. In addition it is a direction finder! A special antenna installation is included for this purpose. Also includes its own power supply (115 V. 60-2400 cy.), a test oscillator for frequency calibration, audio amplifier with cathode follower output, visual indicator for tuning sharply, metered pulse amplifier and counter, and an elaborate antenna and RF detector unit. Brand new and complete with Instruction and Maintenance Manual. A real steal at **\$95.00**

**ASK FOR OUR NEW RELAY CATALOG!**

- Here are examples of buys to be found:
- ELECTROSTATIC RELAYS:** Plug-in, hermetically sealed, one SPST N.O., one SPST N.C., which operate on 1 mv-second of energy! No magnetic fields! No magnetic coils! No magnets - period! Uses electro-strictive ceramic to transfer the silver-palladium contacts when charged to 200 V. Brand new. Either one **\$9.95**
  - WESTON SENSITROL MODEL 705 TYPE B:** SPDT. Polarity 40 ohm coil determines which contact makes, 400 microamps (18 mv) sensitivity. Stationary contacts are permanent magnets which latch the moving contact. Contacts rated ultra-conservatively at .1 A. DC. Resets by monetary application of 115 V., 60 cy. to the reset coil. Brand new and **\$95.50** value for only **\$12.95**
  - Sigma sealed sensitive polarized SPDT octal plug-in #80030.** Snap-action contacts latch on momentary current. Reversing the coil polarity snaps the common to the other contact. Contacts rated 2 A at 28 V DC. The sample we tested snapped at 0.42 ma. 5000 ohm coil sensitivity is rated 0.9 ma. The sample we tested snapped at 0.42 ma. New. Only **\$2.95** (Write for quantity prices.)
  - FREE!** At request, with your polarized relay order, a new brochure on the optimum design of Wheatstone Bridges for control circuitry. Equipment providing vast improvement over symmetrical resistances. ALSO: Steppers, delayers, latches, etc.

**PAY LESS THAN \$18.00 FOR \$800.00 FREQ. METER!**

Brand new Navy, original packing, with instruction book containing schem, and operating instr. Crystal-cmb. with harmonics met 470 mc. Is Het. freq. meter and Sig Gen. Output of 10 mw either CW or 90% AM with 30 kc sine wave or 100% AM with 10 u-sec pulse at 1 kc. The AF pulse also available at 50 & 6,000 ohms. RF either CD or AM. Is at 50 fitting, 50 ohms, or radiated from antenna supplied. Input 80 or 115 v. 50 to 800 cy. This power supply alone is worth more than our GIVE-AWAY PRICE! With headset, cord, & attenuator, plus complete tech manual. LU-1: 470-493.5 mc. Cat. No. 2808T2. Shpg wt 65 lbs. **BRAND NEW! ONLY \$17.95**  
LU-3: 465-498.5 mc. Cat. No. 2008TY1. Shpg wt 85 lbs. **BRAND NEW! ONLY \$19.95**

**VHF CHECKER WITH SCOPE DISPLAY 150-240 MC**

Brand new unit made for Air Forces, so you know that it is made right. Signal generator feeds pulsed RF to your receiver. Output of your receiver is displayed and measured accurately. Built in AC power supply 115 V. any frequency from 50 to 1200 cy. Also use the scope to analyze Hi-FI amplifiers by pulsing its sweep from your square-wave generator. Each sweep will present one complete pulse from your amplifier's output. Shpg. wt. 50 lbs. A \$1200 set. **BRAND NEW**, with all tubes and instruction book. **TS-182. Only \$42.50**

**SIGNAL GENERATOR-WAVEMETER 155-235 MC 460-570 MC**

AN/UPM-1 was designed and built as a complete analyzer of Shoran, beacon, and transponder equipment AN/APX-1, MK-III, -IV, Rebecca, Eureka, etc. Has 115 V. 60. The entire assembly and accessories. Excellent cy power supply condition **\$99.50**

**GO/NO-GO TEST SET X-BAND WAVEMETER ECHO BOX**

**TS-120/UP** test set wave meter assembly. 2 1/4" OD x 2 3/4" OA length. Tuned cylindrical cavity, with 2 standard flange wave guide fittings diametrically opposite each other. Flanges are 1 5/8" square and slot is 1 3/32" x .29/32". The entire assembly mounts by 3 faced-off threaded ears. A standard hairline indicator rides against a 2 3/4" dial calibrated 0 to 18. in 180 steps, over approximately 270 degrees of the dial circumference. Standard bakelite knob and shaft friction drive the calibrated dial, to provide resettable micrometer tuning. Brand new in original waterproof padding. This is symbol number M-102 in the test set and is the heart of it. Shpg. wt. 4 lbs. **\$39.50**

**FRONT END FOR HARMONIC AND NOISE ANALYZER**

AN/APR-1 is broad-band tuner 38-80 mc. output is 30 mc. Requires low currents at 6.3 V AC and 250 V B plus. Individually hand-calibrated curve supplement direct-reading vernier dial when greater accuracy is desired. Brand new in storage container CY-57/APR-1. **\$24.50**

NEW ARRIVALS	
All unused	Excellent condition
TS-3/AP	\$95.00
TS-3A/AP	125.00
TS-92/AP	97.50
TS-667A/AP, for APA-44	72.50
1-203-A RF WATTMETER	
For SCR-720	79.50
And MANY more	What do YOU Need?

**BRAND NEW IMPEDANCE-BRIDGE SPECIAL**

Designed not only to measure reactance and resistance of components, but also to measure antenna and transmission line resistance and reactance of components, but also to measure antenna and transmission line resistance and reactance at frequencies from 25 kc to 5 mc. Complete with accessory box of plug-in standards and a special sectional instruction book with a special section devoted to antenna measurements. No power is required for the bridge. Carry it anywhere you carry your signal generator. This is what you have always needed to load and trim antennas to get all the power of your customer's transmitters into the air. Here is accurate laboratory equipment, made for the U.S. Navy to exactly duplicate a commercial bridge presently being sold for \$500. Shpg. wt. **only \$125.00** All prices F.O.B. subj. to change without notice. Items subj. to prior sale.

**ARROW SALES, Inc.**

OFFICE AND MAIN WAREHOUSE:  
7460 VARNA AVE., NO. HOLLYWOOD, CAL.  
Mail to: BOX 3007-E, NO. HOLLYWOOD, CAL.  
Phones: Stanley 7-0406 POplar 5-1810  
Telegraph: WUX, NO. HOLLYWOOD  
Cable: ARROWSALES, NO. HOLLYWOOD  
CENTRAL WAREHOUSE & SALES SHOWROOM  
2441 S. MICHIGAN AVE., CHICAGO 16, ILL.  
OTHER WAREHOUSES IN:  
Atlanta, Ga., San Antonio, Tex., Pasco, Wash.,  
Sacramento, Cal., Burbank, Cal.,  
Los Angeles, Cal.

Special Prices This Month Only

**TUBES!**

CONSISTENTLY HIGH QUALITY AT SENSIBLE PRICES.

- ★ BRAND NEW! GUARANTEED!
- ★ STANDARD BRANDS
- ★ NO USED, RETESTED "BARGAINS".

0A2	.79	6C21/450TL	808	.....	75
0A3/VR75	.89		811	.....	2.40
0B2	.70	6J6W	75	.....	3.00
0B3/VR90	.51	7H7Jaw	.25	.....	830B
0C3/VR105	.75	12A77Wa		.....	837
0D3/VR150	.75	6201	3.00	.....	838
C1B/3C31	2.80	12AU7W		.....	85
C1C	8.00	6189	2.50	.....	872-A
1B35	3.35	12DP7A	25.00	.....	918
1B36	2.50	15Y4	1.15	.....	1.10
1N21	1.19	RX21A		.....	1625
1Q22	44.50	(Eimac)	9.00	.....	1850A New
1Z21	1.35	KY21A		.....	RCA
2B21	3.00	(Eimac)	13.25	.....	5636
CL2	10.00	24C3C24	1.90	.....	5636-A
2C39A	10.75	28D2	.88	.....	5644
2C45	2.50	F32		.....	6AK5W
2C43	7.00	35TC(Surp)	2.45	.....	WL5736
2C51/396A	1.90	VC50/32		.....	5812
2E24	2.25	408A	8.00	.....	5822/417A
2D21W	.90	RM-65	7.50	.....	5847/404A
2E22	1.90	90NB		.....	12.50
2E24	2.25	(Amperex)	11.50	.....	5894
2E25	2.95	100TH		.....	5915
2E26	2.95	(Surp)	6.35	.....	5933/807W
2E30	1.90	FG105	10.85	.....	5962
2K25	13.50	VT166/371B	.75	.....	6004
2K30/410R	90.00	PL-172	135.00	.....	Hytron
2K34	85.00	215VT4C	.75	.....	6072
2K45	34.40	250TH		.....	6130/3C45
2K54/406A	5.00	(Surp)	19.35	.....	6135
2K55	15.00	251A	10.55	.....	6042
3B24	1.50	HM253	5.00	.....	6161
3B24WA	10.50	GL-299	1.00	.....	6178/CSF1415.00
3C23	3.95	350-B	1.70	.....	6232
3C24/24G	3.70	313C	2.55	.....	Jobber
3C31/C1B	1.00	327A	3.50	.....	Boxed
3C33	6.40	350-B	1.70	.....	6232
3C45	6.95	355-A	10.75	.....	1B63A
3D21A	2.90	368AS	1.00	.....	8002-R
3DP1	2.00	371B/VT166	.75	.....	8008/872A
3E21/2B35	4.75	396A/2G51	1.95	.....	Jobber
3J30	25.00	403A		.....	Boxed
3K20000LK	Write	We6A5	5.55	.....	9002
PL4-400A	45.00	404A/5847	12.50	.....	9005
4-100B-A	Write	407A	2.00	.....	9006
4PR6A	40.00	408A	2.00	.....	
4X150A	19.00	417A	3.50	.....	WE STOCK
4X500A	75.00	502	1.60	.....	CBS
4X500F	43.95	559		.....	EIMAC
5B21	1.45	5L1610	.35	.....	RCA
5C22	26.60	GL-673	12.50	.....	GE
5D21	6.00	703A		.....	PENTA
5F27	.80	Tuna Sol	.99	.....	SYLVANIA
5J25	5.85	715B	2.90	.....	RAYTHEON
5J30/2666	5.00	717A	.24	.....	KUTHE
5L21	18.00	719A	10.00	.....	DUMONT
5Y3WGT	1.50	726C	12.00	.....	ELECTRONS
6AK5W	1.10	750TL		.....	
6A56	1.00	(Surp)	30.00	.....	
6B16	20.00	803	2.00	.....	
6C1/5528	5.00	805	4.00	.....	

AND MANY OTHERS. OVER 1000 TYPES IN STOCK WRITE FOR LATEST CATALOG.

**BARRY ELECTRONICS CORPORATION**

512 Broadway, N. Y. 12, N. Y.  
Phone: Walker 5-7000. Wire: Barry Fax, N.Y.C.  
TWX: NY1-3731-U, Cable: Barry Lect., N. Y.

**Equipment-Components-Test Sets**

Signal Generator I-96A (Used for checking SCR522) near new condition—**\$9.95.**

TS-182-RF Signal Generator & Built in "Scope". Self contained 115V-60 Cycle P.S.—Exec. Cond.—**19.95.**

TS-56 A/P—Slotted Line with Meter & Accessories—New—**59.95.**

Auto Former 220V-15A to 115V-30A—variable output (7 steps) #TF 101/TRC-5 (XC-3). Part of AN-TRC-5. New in metal housing—180 lbs.—**\$9.95.**

L-208 Signal Generator—Exc. Cond.—**59.95.**

Tube Type 5933/807W—Ruggedized version 807 new Sylvania boxed 1.59—dozen **15.00.**

Oil Cond.—2 MFD.-1000 VDC—Porc. Term'l-Rect.—**55¢**

TS-45 A/APN-3—New—W/Tech Manual—**29.95.**

National Longwave Communication Receiver RBL-5 115V. 60 Cy. 6 Band—15-600Kc—New W/Tech Man. **59.95.**

Mike Transformer (Collins) PRI-75 ohms—SEC-125,000 ohms CT Cased, Small—Ea. **1.00.**

Just Arrived Large Quantity Western Electric, Telephone Equip., Teletype, Power Supplies, Etc.—All New—Inquiries answered at once.

RCA Boxed Tubes—In Date—50+10 Off List.

**REX RADIO SUPPLY CO.**  
88 Cortlandt St., New York 7, N. Y.  
Cortlandt 7-1617

FOR MORE QUALITY-PER-DOLLAR, BUY RECONDITIONED

**TEST EQUIPMENT**

WE WILL QUOTE ON NEW AND USED TOP-QUALITY COMMERCIAL BRANDS AND SELECT MILITARY SURPLUS ITEMS IN OUR CHOICE STOCK, TO YOUR NEEDS.

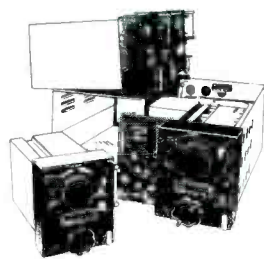

**AN/APR-4 LABORATORY RECEIVERS**

Complete with all five Tuning Units, covering the range 38 to 4,000 Mc; wideband disc and other antennas, wavetraps, mobile accessories, 100 page technical manual, etc. Versatile, accurate, compact—the aristocrat of lab receivers in this range. Write for data sheet and quotations.

We have a large variety of other hard-to-get equipment, including microwave, aircraft, communications, radar; and laboratory electronics of all kinds. Quality standards maintained. New Reduced Prices On: LARGE POWER UNITS, DYNAMOMETERS, SHAKETABLES. SPECIAL: NEW SURPLUS RAYTHEON 5721 WIDE-BAND KLYSTRONS, \$85.00.

**ENGINEERING ASSOCIATES**

434 PATTERSON ROAD

DAYTON 9, OHIO



**RADAR**  
P.P.I. REMOTE REPEATERS

VD 7" Upright  
VE-7" Table Type  
VF-5" "B" Scope "5" P.P.I.  
VG-24" Plotting Table  
VJ-12" Upright  
VK-12" Upright  
VL-12" Upright R.H.I. IND.  
All indicators are 110v 60 eye.

**RADALAB INC.**

37-17 124th St., Richmond Hill 18, New York, N. Y.

Phone Virginia 9-8181-2-3

OVERSEAS CUSTOMERS CALL US DIRECTLY BY TELEX OVERSEAS  
TELETYPE TWX N. Y. \*4-4361

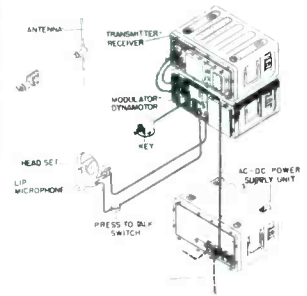

**AN/APR-4**  
38-4000 MC RECEIVER



**RDO**

**NAVY SEARCH RECEIVER**

The RDO is a very elaborate radar search receiver greatly improved over the APR-4. The set uses APR-4 tuning units, but is much more versatile, having input metering, D.B. output meter, automatic noise limiter, and greater selectivity and sensitivity. The RDO is recommended when only the very best will do. Input 110v 60 eye.



**AN/ASQ-1 AIRBORNE MAGNETOMETER**

This is an airborne chart recording magnetometer. The set consists of an amplifier, oscillator, detector head, chart profile recorder, power supply. The equipment has a sensitivity of 2 gamma. The AN/ASQ-1 records on an Esterline angus recorder disturbance in the earth's magnetic field. An indicator is provided that gives a hearing on a magnetic disturbance. Input is 28v DC. Weight about 130 lbs.

**SHORAN**

**AN/APN-3-AN/CPN-2**

The AN/APN-3 and AN-CPN-2 are Precision distance measuring installations. This equipment operates on 225 mc. The range is 250 miles with an accuracy of 25 feet. This equipment is widely used by geological companies for prospecting and mapping. Power input is 110v 400eye and 28v DC.

**AN/GSQ-1 SPEECH SCRAMBLER**

This is a unit designed to be attached to either a radio or telephone circuit to scramble speech or code. This equipment utilizes coded cards in each terminal equipment. Unless the properly numbered card is inserted on the receiving end the speech can not be unscrambled. This provides an excellent privacy system. 24 VDC input. Mfg. Western Electric.

**AN/TPS-1B**

**200 MILE AIR SEARCH RADAR**

The TPS-1B is a very late type L-band mobile or portable air search radar. This set will detect aircraft up to 200 miles and up to 40,000 ft. The set is composed of small portable carrying cases that are bolted together to make up the set. A 7" P.P.I. and a 5" "A" scope are provided. This set is in use by the Air Force and Marine Corps. Complete sets available. P.O.R.

**AN/TPS-3-AN/TPQ-3**

Airsearch or artillery shell tracking radar. The AN/TPS-3 is a 600mc airsearch portable radar. The set has a range of 120 miles on aircraft up to 40,000 ft. This set has a 7" P.P.I. and a 5" "A" scope. The AN/TPQ-3 is a modification of the AN/TPS-3 to provide mortar and artillery shell tracking and plotting. P.O.R.

**AN/TRC-1-3-4**

**100 MC RADIO-RELAY EQUIPMENT**

The AN/TRC series is a mobile portable set for duplex or simplex radio. Telephone point to point communication. This set will operate with the GF series carrier systems to provide multi channel operation. The TRC operates on 100 MC with an output of 10-50 watts. The set is crystal controlled. Complete sets avail. Input 110v 60 eye.

**AN/ARC-12**

**AIRBORNE 225-350 MC TRANSCIEVER**

Noise and field strength measuring equipment

Test sets TS-1 THRU 800

Portable 225-398 mc point to point 10 chan. crystal controlled voice and mcw radio set. This is a very late radio set used for point to point and ground to air communication. The transmitter output is 8 watts on 10 pre-set crystal controlled channels instantly selected by a hand switch. The RFC is also crys. controlled on the trans. freq. The set is inclosed in 3 water proof shock proof cabinets that may be set up in a few minutes on location. This equipment is ideal where a reliable radio link easily transported is needed. Power input is either 24 VDC 115/230V AC or DC. Complete sets avail. Write

**MISC. EQUIP.**

- SCR-193 1.5-18 mc field radio
- SCR-291-A 1.5-20 mc direction finder
- SCR-399 1.5 mc-18 mc mobile radio
- SCR-499 1.5 mc-18 mc field radio
- SCR-508-528 28 mc. FM field radio
- SCR-608-628 30 mc FM field radio
- SCR-505-A field radio
- SCR-694 field radio
- AN/APA-11 pulse analyzer
- AN/APA-17 300-10,000 direction finder
- AN/APR-5 1,000-3, 100 mc receiver
- AN/ART-3 THRU 11 jammer
- AN/ARQ-1 THRU 12 jammers
- AN/APQ-2 THRU 9 jammers
- AN/ARC-1 100-156 radio set
- AN/APN/ARC-12 200-325 mc radio set
- AN/APS-2 THRU 34 airborne radar
- AN/PRC-6 handi-talkie FM
- AN/PRC-8, 9, 10 walkie talkie FM
- AN/GRC-9 field radio
- AN/TXC-1 page printing facsimile
- AN/TRC 7 100-156 mc walkie talkie
- SCS-51 instrument landing systems
- RC-115B 75 mc marker ground set
- SA, SC, SK, SO, SX, other navy radars

**TUBES • ALL FAMOUS ADVERTISED BRANDS ONLY • TUBES**

**RMA GUARANTEE—From 10% to 95% Below Manufacturers Price—Look and Compare**

Special Prices to Quantity Buyers. Most of Our Tubes are Jan.—95% are Original boxed—Brands such as R.C.A., G.E., Ken-Rad., Sylvania, Tung-Sol and Raytheon.

Type	Prices	Type	Prices	Type	Prices	Type	Prices	Type	Prices	Type	Prices	Type	Prices
AB-150	\$1.99	VR-150	.79	2K22	14.50	5B1A	2.49	7B7	6.25	350B	2.99	724A	1.15
C31	6.35	OA2	.74	2K23	16.50	5B1A	8.39	3L7	5.00	350C	14.95	724B	1.45
C5B	.49	OB2	.89	2K25	18.99	5B4	2.99	10Y	.39	388A	1.49	725A	9.90
C6	7.99	1B22	1.69	2K28	29.50	5C22	25.00	12X3	1.59	394A	2.99	726A	3.50
CK-551A/3E41	1.79	1B24	5.99	2K33A	59.95	5C1A	12.49	34T	4.99	446A	5.66	728B	25.00
CRP RK-72	.49	1P30	1.39	2K45	32.50	5C11A	14.50	35T	7.25	446B	1.49	728C	24.50
EC1	1.99	2A/G	1.10	2K54	18.95	5D21	6.99	35TG	7.25	534	2.29	728A/B/Y	9.3
EF-50	.80	2AP1	6.44	2K55	19.50	5FP7	3.99	35T	4.99	534	1.49	728A/B/Y	9.3
E1148	.29	3B22	1.89	2V3/G	1.39	5HP4	2.49	35T	4.99	534	1.49	728A/B/Y	9.3
EM-3GA	39.50	2B11	7.99	2X2	.34	5J1A	16.99	35T	4.99	534	1.49	728A/B/Y	9.3
F123A	5.99	2A/G	1.10	2X2A	.89	5J1A	14.99	35T	4.99	534	1.49	728A/B/Y	9.3
FG17	4.50	2C22	.39	3A5	.69	5J32	65.00	35T	4.99	534	1.49	728A/B/Y	9.3
FG-105	14.99	2C26	.39	3AP1	5.95	5J33	7.99	35T	4.99	534	1.49	728A/B/Y	9.3
FG-154	14.99	2C33	.69	3AP11A	4.95	5L1A	13.99	35T	4.99	534	1.49	728A/B/Y	9.3
FG172	24.95	2C39A	11.50	3B24	3.25	5R4WGY	3.19	35T	4.99	534	1.49	728A/B/Y	9.3
HF-100	7.49	2C40	8.95	3B24W	4.99	5S1A	19.95	35T	4.99	534	1.49	728A/B/Y	9.3
HK-24	3.69	2C42	9.75	3B27	3.49	5S1A	19.95	35T	4.99	534	1.49	728A/B/Y	9.3
HK-54	1.20	2C43	10.99	3B28	4.69	5S1A	19.95	35T	4.99	534	1.49	728A/B/Y	9.3
HY-65	1.20	2C44	1.35	3B29	2.99	5S1A	19.95	35T	4.99	534	1.49	728A/B/Y	9.3
HY-114B	.59	2C45	7.49	3B31A	6.35	5S1A	19.95	35T	4.99	534	1.49	728A/B/Y	9.3
KU-610	3.49	2C46	7.49	3B31A	6.35	5S1A	19.95	35T	4.99	534	1.49	728A/B/Y	9.3

Manufacturers, exporters, and large quantity users—Inquire on your letterhead for our inventory listing of receiving tubes, special purpose tubes, resistors, condensers, and other radio and television parts.

HY-65	1.70	2C51	2.75	3C21	1.29	6A56	1.19	250TH	24.95	706B	14.50	816	1.05	1625	.29	8025A	2.25
REL-21	1.00	2C53	9.90	3C22	64.95	6A57 G	2.49	250TL	13.95	706C	17.50	826	7.75	1626	.29	9001	.79
RK-34	.39	2E24	2.49	3C23	5.99	6B1M6	39.50	250R	4.99	706DY	35.00	829B	9.95	1629	.29	9002	.69
RK-59	1.88	2E27	.99	3C24	1.50	6C4	.49	250S	3.99	707A	3.55	830B	2.99	1630	.79	9004	.19
RK-60	1.99	2D21	.79	3C28	5.95	6D4	2.99	250A	5.99	707B	3.95	830B	2.99	1632	.39	9006	.19
RK-61	3.50	2G22	2.29	3C33	8.99	6F4	2.99	264C	3.90	708A	2.99	833A	31.50	1642	.39		
RK-65/5D23	14.99	2J21	2.99	3C45	6.25	6J4W	3.75	271A	12.99	709A	1.69	836	1.99	1644	.48		
RK-73	.69	2J22A	4.95	3CP1	2.25	6J6W	1.29	274A	5.95	710A	8.37	837	1.99	1606P1	4.99		
RK-233A	.69	2J22	4.95	3CP2	4.29	6K4	3.99	274B	1.79	715A	2.65	841	6.49	2050W	2.40		
VT25/10	.49	2J26	2.50	3DP1	1.88	6L4	1.49	271A	3.99	715B	6.45	843	4.95	2051	.76		
VT25A/10Y	.39	2J27	5.99	3E9	10.25	7B1	9.95	286A	6.49	715C	14.50	845	6.49	2051	.76		
VT67/10Seye	1.70	2J30	14.50	3EP1	1.48	7C22	49.95	282	7.25	717A	.49	851	16.50	5591	2.95		
VT-158	.17	2J31	14.50	3FP7	3.95	12A6	.85	304TH	7.95	717A	.49	850	19.00	5636	2.75		
VU-111	.19	2J32	13.50	3HP7	2.95	12A7	.85	304TL	11.95	719A	14.65	864	.69	5651	1.39		
VB32/532A	.99	2J33	13.50	3HP7	2.95	12A7	.85	304TL	11.95	720A	14.65	865	.49	5654	1.39		
QK-59	29.50	2J34	13.50	3J21	49.94	12DP7A	18.95	307A	1.85	720A	14.65	866A	1.19	5656	3.25		
QK-61	32.00	2J38	14.00	4A11	4.49	12DP7A	18.95	310A	3.99	721A	1.49	866JR	1.40	5670	2.20		
QK-185	99.00	2J49	39.50	4C27	8.95	15E	1.25	310A	3.99	722	1.99	868B	30.00	5686	1.79		
VR-78	.89	2J61	16.40	4C28	35.50	26C6	1.19	329A	4.69	722	1.99	868B	30.00	5687	2.69		
VR-90	.89	2J62	9.60	5A11	3.95	28D7	.89	347A	3.88	723A/B	8.99	869B	30.00	5702	1.49		

**FAY-BILL DISTRIBUTING CO. DEPT. E1**  
418 Broome St., N. Y. 13, N. Y.  
Telephone CAnal 6-8404

All boxed and fully guaranteed. Special quantity discount—10% on 100 or more of same type. Minimum order \$10.00. Thousands of other types in stock. Send us your requirements. F.O.B. New York 25% deposit with order or if paid in advance save C.O.D. charges. Rated firms net 10 days. Prices subject to change without notice. For fast service ask for Sy.

**COAX CONNECTORS**

SO239	M359A
24¢	15¢
831R	831AD

# CALVERT ELECTRONICS, INC.

# TUBES

Over one million tubes in stock

RCA • KEN-RAD • SYLVANIA • CBS  
WESTINGHOUSE • WESTERN ELECTRIC

Type	Price	Type	Price	Type	Price	Type	Price	Type	Price
OA2	.75	3HP14	1.75	VU111S	.75	CK522AX	1.25	5637	5.00
OC3	.50	3J21	50.00	114B	.50	WLS32A	.25	5650	50.00
OD3	.45	3JP7	3.45	RX-120	20.00	705A W.E.	.65	5651	1.25
1B26	1.25	3KP1	7.50	F-123A	6.75	706AY	15.00	5676	.75
1B32	.25	3X2500A3	175.00	F127A	15.00	707B	2.50	5693	4.50
1B35	3.50	4-250A	33.00	F-128A	7.50	713A	.25	5703	1.00
1B38	25.00	4J25	25.00	GL-152	10.00	715A	2.00	5719	1.50
1L24	18.00	4J26	25.00	FG-154	10.00	717A	.35	5726	.75
1L33	22.00	4J27	25.00	203A	2.50	718CY	25.00	5744	1.00
1N21	.25	4J29	.50	204A	25.00	720BY	35.00	5803	4.75
1N22	.50	4J30	.40	AV209	5.00	721A	.75	5814	1.00
1N23	.50	4J31	100.00	212E	15.00	722A	.75	5825	6.25
1N23B	1.00	4J33	75.00	215A W.E.	2.00	724B	.50	5827X	5.00
1N38A	.50	4J51	75.00	217C	1.75	730A	5.00	5838	5.00
1N43	.25	4PR60A	35.00	220B	90.00	801A	.25	5933	1.50
1N70	1.00	4X150A	20.00	221A	100.00	803	2.00	6035	10.00
1P23	1.75	5AP1	2.75	222A W.E.	100.00	805	4.50	6038	5.00
1P41	2.50	5BP4	3.50	249B	3.00	806	7.50	6373	1.75
2C22	.35	5B21	1.25	250TL	12.50	807	1.25	6098CT	2.00
2C26	.25	5C22	17.50	253A W.E.	2.00	810	10.00	6099	1.00
2C26A	.50	5D21	5.00	254 W.E.	2.50	811	3.00	6130	4.75
2C27	5.00	5D23	10.00	259B	5.00	813	9.50	8008	3.00
2C33	.50	5D24	15.00	274A W.E.	2.50	829B	8.45	8012	1.00
2C34	.25	5JP2	6.00	285A W.E.	5.00	832A	6.75	8013A	3.50
2C40	6.50	5MP1	2.75	310A W.E.	3.75	836	1.25	9002	.50
2C46	5.00	5R4WGY	2.50	313C	3.00	841	.29	D17846 W.E.	Q
2E22	2.75	5SP7	45.00	323A	7.50	842	1.00		
2E25	2.50	5SP11	45.00	348A W.E.	4.75	843	.35		
2E36	1.35	5Y3WGT	1.50	350B W.E.	2.00	845	4.00	1A3	.35
2J21	4.00	6AC7W	1.00	356B W.E.	3.00	851	6.50	1LD5	.45
2J22	4.00	6AJ5	1.75	359A W.E.	1.75	861	10.00	2X2	.15
2J29	50.00	6SN7WGT	1.25	368A W.E.	2.00	872A	1.00	68C7	.50
2J31	10.00	7AC, 19		374A W.E.	1.75	876	.75	68J6	.50
2J33	20.00	DUMONT	100.00	375A W.E.	10.00	884	1.00	6D6	.55
2J34	15.00	7BP7	3.75	387A W.E.	5.00	891	75.00	6F8G	.20
2J38	10.00	7C29	65.00	QK389	15.00	893A	375.00	6K7	.45
2J49	25.00	9GP7	10.00	394A	2.50	955	.25	6K8G	.55
2K26	35.00	12DP7	10.00	402A W.E.	12.50	991	.30	6P5GT	.30
2K33	100.00	12DP7A	20.00	404A W.E.	15.00	K-1001		6SD7GT	.25
2K33B	100.00	12SP11	45.00	416A W.E.	Q	Dumont.	50.00	6SG7	.45
2K37	100.00	RX21A	9.00	416B W.E.	Q	K-1051		6SS7	.65
2K56	50.00	28D7	1.00	417A W.E.	15.00	Dumont.	50.00	6V6GT	.50
2X2	.15	FG32	3.50	429A W.E.	6.00	1616	.35	6W7G	.45
EL-3C	3.45	RK34	.50	421A W.E.	3.75	1619	.25	6Y6G	.45
3B27	3.75	L40CT	2.00	422A W.E.	7.50	1625	.25	7A8	.35
3BP1	1.25	UH50	5.00	446B	1.50	1626	.25	7E5	.15
3C37	20.00	HK54	4.00	464A	2.00	1629	.15	7F7	.55
3CP1	2.50	QIC59	100.00	WL468	15.00	1631	1.00	7H7	.20
3CP1S1	2.00	RK59	1.75	H500	35.00	1632	.20	12SK7GT	.45
3DP1S2A	7.50	RK60	1.25	CK502AX	1.00	1680	1.00	12SR7	.40
3D21A	3.25	QK61	20.00	CK503AX	1.00	1846	50.00	34	.15
3E29	8.45	RK72	.25	CK505AX	1.25	2051	.65	37	.10
3FP7A	3.50	CV88	2.00	CK506AX	1.00	5517	1.25	38	.10
3GP1	2.00	101D W.E.	2.50	CK507AX	1.25	5518	275.00	73	.10
		101F W.E.	2.50	CK507AX	1.25	5528 C6L	5.00	89Y	.15

Partial list, many additional types in stock are not listed here. Export Facilities.

## CALVERT ELECTRONICS, INC.

Cable Address: Calvertron, N. Y. Telephone CA 6-7400

Dept. E, 536 Broadway, New York 12, N. Y., U. S. A.

## DUMONT HIGH VOLTAGE POWER SUPPLIES

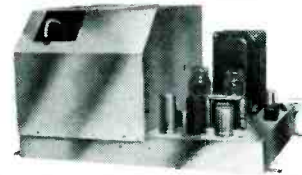

Delivers 23 kv. fully regulated and adjustable  
 • RADAR • SNOOPERSCOPIES  
 • COLOR AND PROJECTION TV  
 • HIGH VOLTAGE TESTING, ETC.  
 Just 150. Made by Dumont for RA119, 30 inch TV. Pulse type H.V. generator and voltage-doubler with 3 tube voltage-regulator. Contains sweep protection circuits to disable the H.V. upon sweep failure. Low voltage also regulated by use of Sola Power Transformer with matching capacitor (cost over \$30). Contains 13 tubes and 3 relays. Input 117 V. AC 60 cycles. Schematic diagram included. Original cost over \$150.

NEW.....\$49.95 ea F.O.B. BROOKLYN

SEG ELECTRONICS CO., INC.

1778 Flatbush Ave. Brooklyn 10, N. Y.  
 Terms: Check with order. Well-rated firms net 10 days

## WANTED

we will pay you

# TOP \$\$\$.

for an AN/ARN-6  
 or any of its components  
**ALSO AS-313 LOOP**

Phone us collect  
**Stanley 7-0406**  
 on above items

SIMILAR FABULOUS PRICES FOR:

APR-9 . . . ARC-1 . . . ARN-7 . . . ART-13  
 PARTS . . . BC-788-C . . . I-152-C . . . LP-21-  
 AM, -LM, or MO-18A or MC-507 from these  
 loops . . . R-65/APN-9 . . . TEST SETS 1-100,  
 TS-117, -125, -147, -148, -488. What else have  
 you?

**ARROW SALES, INC. Dept. E.**  
 7460 VARNA AVE., NO. HOLLYWOOD, CAL.

**CASH PAID!** Sell your surplus elec-  
 tronic tubes. Want  
 unused, clean transmitting, special purpose,  
 receiving, TV types, magnetrons, Klystrons,  
 Broadcast, etc. Also want military & commer-  
 cial lab test and communications gear. We  
 swap too, for tubes or choice equipment.  
 Send specific details in first letter. For a fair deal  
 write, wire or telephone: WAlker 5-7000  
**Barry, 512 Broadway, New York 12, N. Y.**

## FOR EXPORT ONLY

We offer:

RECEIVING, TRANSMITTING & SPECIAL PURPOSE TUBES  
 RADIO & TELEVISION SETS & PARTS - TESTING INSTRUMENTS  
 CATHODE RAY TUBES - TRANSISTORS - DIODES - SEMI CONDUCTORS  
 PROJECTOR, REFLECTOR, GERMICIDAL & OTHER TYPE OF LAMPS  
 FLUORESCENT LAMPS - BALLASTS & STARTERS - ELECTRICAL CLOCKS  
 ELECTRICAL APPLIANCES - HOUSEHOLD & BATHROOM SCALES  
 HEARING AID BATTERIES - WIRE & CABLES

All merchandise direct from outstanding U. S. Manufacturers—Original Packing—  
 No Surplus or distressed lots—We take care of Export Formalities for account of  
 Foreign Customers. WILL QUOTE AGAINST SPECIFIC REQUEST.

# MILANO BROTHERS

250 West 57th Street

Tel. Circle 6-0375

Cable: MILANBROS, NEW YORK.

**WANTED**  
 ART-13/147A Trans- BC-348 Rec'r Unmodi-  
 mitters . . . \$175.00 fied Q and R Models  
 ART-13/147 Transmitt- \$50.00  
 ers . . . \$125.00  
 BC-788C Alt. . . \$175.00 A R C - I Transceiver  
 A R C - 3 Transceiver \$225.00  
 Complete . . . \$325.00 BC-342 Rec'r . . \$ 50.00  
 RS/ARN-7 Radio Com- BC-312 Rec'r . . \$ 40.00  
 pass . . . \$160.00  
 Ship via Express C.O.D. Subject to inspection to  
 H. FINNEGAN, 49 Washington Ave. Little Ferry, N.J.

## WE WANT TO BUY!

BC-224, BC-348 RECEIVERS

ARC-3 BC-788 RS/ARN-7 ART-13

Cash or trade. Immediate action. Top \$\$\$!

**HARJO SALES CO., Dept. B**

503 N. Victory Blvd., Burbank, Calif.



# COMMUNICATIONS EQUIPMENT CO.

## PULSE TRANSFORMER



352-7150. Primary 50 ohms. Secondary 1000 ohms. 12,000V. 12.0 Amp. Pulse: 1 or 2 usec. at .001 duty ratio. Fitted with magnetron well and bifilar winding for filament supply. **\$32.50**

**MAGNETRON PULSE TRANS. #964:**  
Prim. imp. 30 ohms. 1600 v. pulse. Secondary imp. is 1250 ohms. 12 KV pulse. Turns ratio sec:pri. is 7.5:1. Duty ratio is 0.001 at 1.2 usec. Bifilar winding 1.2A. **\$8.50**

**RAYTHEON WX 4298E:** Primary 4KV., 1.0 USEC. SEC. 16K-16 AMP DUTY RATIO: 001 400 CYCLE PLS. TRANS. "BUILT-IN" **\$22.50**

**GE #K-2449A:** Primary: 9.33 KV, 50 ohms imp. Secondary: 28 KV, 450 ohms. Pulse length: 1.05/5 usec @ 635/120 PPS. PK Power Out: 1,740 kW. Bifilar: 1.5 amps. **\$62.50**

**GE #K-2748-A:** 0.5 usec @ 2000 Pps. PK. Pwr. out is 32 KW impedance 10:100 ohm output. Pfr. volts 2.3 KV PK. Sec. volts 11.3 KV. Bifilar rated at 1.3 Amp. Fitted with magnetron well. **\$24.50**

**K-2745:** Primary: 3 1/2 KV, 50 ohms Z Secondary: 14/12.6 KV 1025 ohms Z. Pulse length: 0.25/1.0 usec @ 600/600 PPS. PK. Power: 200/150 KW. Bifilar: 1.3 Amp. Has "built-in" magnetron well. **\$32.50**

**K-2461-A:** Primary: 3 1/2 KV—50 ohms (line). Secondary 14/11.5 KV—4000 ohms Z. Pulse Length: 1 usec @ 600/600 PPS. PK. Power: 200/150 KW. Bifilar: 1.3 Amp. Fitted with magnetron well. **\$29.50**

## MICROWAVE ANTENNAS

**3 CM ANTENNA ASSEMBLY:** Uses 17" paraboloid dish, operating from 24 vdc motor. Beam pattern: 5 deg. in both Azimuth and elevation. Sector Scan: over 180 deg. at 35 scans per minute. Elevation Scan: over 2 deg. Tilt. Over 24 deg. **\$35.00**

**AT49/APR—Broadband Conical, 300-3300 MC, Type N Feed** **\$8.95**

**Discone Antenna, AS 125 APR, 1000-3200 mc.** Stub supported with type "N" Connector. **\$14.50**

**ASHA/AP, 10 CM pick up dipole assy., complete w/ length of coax and "N" connectors** **\$22.50**

**AS46A/APG, 4 Yagi Antenna, 5 element array** **\$22.50**

**30" Parabolic Reflector Spun Aluminum dish 10 1/2" Focus** **\$4.85**

**AN/APA-12—Sector Scan adaptor for AFS-2 radar—Complete Kit** **\$37.50**

**LP-24 Allford loop, for use with glide-path transmitters (AHSN-1), etc. 100-108 mc.** **\$32.50**

**18" PARABOLIC DISHES, spun aluminum. Focus approx. 8 inches** **\$4.95**

**10 CM. ANTENNA ASSY. (Airborne), 30" dish with coax. dipole feed. Focal length is 10 1/2" Horiz. polarization. 350 deg. azimuth. Tilt: plus and minus 20 deg. 28 v dc drive motor, selsyn takeoff.** **\$65.00**

## OVERTONE CRYSTALS

These units are mounted in FT213 holders, and are designed to operate at the 9th overtone. Thus the output of a 16 mc crystal would be 144 mc. Fundamental frequencies are as follows: (in mc/sec)

15.073	15.753	17.173	17.413
15.113	15.793	17.193	17.453
15.153	15.833	17.233	17.493
15.233	15.953	17.113	17.533
15.313	15.293	17.293	17.573
15.353	16.953	17.333	17.773
15.393	16.973	17.373	17.993
15.473	16.993		18.133
15.633	17.013		
15.713	17.053		

Price ---- **\$1.50 ea.**

## 3000 MC WAVEMETER

Mfd. by GE for Armed Services. Calibrated directly in mc/sec. from 2200 to 4800 mc. Comes furnished with variable attenuator, coax. adapter cord, and pickup antenna. Has output jack for external meter or other monitor device. Resonance indicator is 3/2 20 microamp meter. Brand new, in portable wooden carrying case. **\$75.00**

## 10 CM R.F. HEAD

Complete R.F. Head and Modulator delivers 50 KW Peak R.F. at 3000 MC. Pulsed delivers 12KV pulse at 12 Amp. to magnetron of .5, 1, or 2 microsec. duration at duty cycle of .001. Unit requires 115V, 400-2400 Cycles, 1 phase @ 8.5A. Also 24-28 VDC @ 2A. External sync. Pulse of 120 V Req'd. Brand New. Complete with magnetron, magnet, plumbing and all tubes **\$275**

## TEST SET

TS-146/UP, Radar Test Set, 9285-9465 mc. F-M 723A/B osc. attenuators, freq. meter, thermistor bridge, sawtooth generator, etc. in one convenient package. Power supply so well regulated that line may be 109-121 volts, 50-1200 cy. Measures transmitter spectrum width, freq., power, recovery time of T-R and I-T cavities, checks magnetron tuning, tunes radar receivers, tunes T-R and I-T cavities, measures receiver sensitivity and band width, checks AFC circuits. In excellent condition. Price on Request.

## THERMISTORS

D-164699 Bead Type DCR, 1525-2500 Ohms @ 75 Deg. F. Coefficient: % Per. Deg. Fahr. Max. Current 25 MA AC/DC **\$1.00**

D-167332 Bead Type DCR is 2525-2550 Ohms. Rated 25 MA at 825-1175 VDC **\$1.00**

D-167614 Disk Type DCR: 355 Ohms @ 75 Deg. F. P.M. 2.5%, 1 watt. **\$1.00**

## 420-500 MC TRANSCEIVER

BC645 — NAVY ABA-1

Two-way rig for mobile or fixed station covering the VHF band for amateur or CITIZEN'S radio. (See complete conversion details in Dec. issue '56 of CQ magazine) Brand New, in original factory cartons. Complete with 12-volt dynamotor, PE101, shock mounting, and control box. Original government cost was over 1,000 \$. Now you can get this super value **\$32.50** for only

ARC-4 2 METER RIG. Transmitter-receiver unit is xtal controlled for 144-148 mc. phone or C.F. 832 in Final. Makes a beautiful rig for mobile or home station. Used, excellent, but less tubes and dynamotor. With conversion info for use on 110 vac. or **\$14.50** battery

## ARC-5 EQUIPMENT

T-19/ARC-5, 3-4 mc. used, exp., all tubes. **\$4.95**  
T-15/ARC-5, 500-820 KC. New. **\$7.49**

## X BAND — 1" x 1/2" WAVEGUIDE

90 degree elbows. "E" or "H" Plane 2 1/2" radius **\$8.50**

ROTARY JOINT (A1'S-6) Sperry IPT #58275, 180 deg. rotation, choke-to-choke. Has "Built-in" Di-Coupler, 20 DB. with "N" Takeoff **\$22.50**

PARABOLOID DISH, 18" diam. Spun Aluminum, 8" Focus. For AN/A1'S-6. **\$4.95**

3 CM. DIPOLE and Feed Assembly. (May be used with above dish) 8 inches long. **\$5.00**

FLEXIBLE SECTION 9 in. long. Cover. **\$5.50**

ROTARY JOINT (A1'S-6) Sperry IPT #58275, 180 deg. rotation, choke-to-choke. Has "Built-in" Di-Coupler, 20 DB. with "N" Takeoff **\$22.50**

3 CM. DIPOLE FEED, 15" L for A1'S-15. **\$14.50**

MITRED ELBOW, Cast aluminum, 1 1/2" x 3/4" W.G. W.E. Flanges. "E" Plane. **\$3.50**

3 CM. ANTENNA ASSEMBLY: Uses 17" paraboloid dish, operating from 24 vdc motor. Beam pattern: 5 deg. in both Azimuth and elevation. Sector Scan: over 180 deg. at 35 scans per minute. Elevation Scan: over 2 deg. Tilt. Over 24 deg. **\$35.00**

Cross-Guide Directional Coupler, UG-40 output flange. Main Guide is 6" Long, with 90 Deg. "E" Plane bend at one end, and is fitted with Std. UG 39/UG 40 flanges. Coupling figure: 20 db Nominal. **\$22.50**

Rotating Joints supplied either with or without deck mountings. With UG40 flanges. **each \$17.50**

Bulkhead Feed-Thru Assembly. **\$15.00**

Pressure Gauge Section with 15 lb. gauge. **\$10.00**

Directional Coupler, UG-40/U Take off 20db. **\$17.50**

MAGNET AND STABILIZER CAVITY For 2J41 Magnetron **\$24.50**

343 Canal St., New York 13, N.Y. Dept. E-4 Chas. Rosen Phone: Canal 6-4882

## INFRARED SNOOPSCOPE TUBE



TYPE 6032—Infrared Image Converter Tube. Electrostatic focusing. Size 2x1 1/2". Last \$150.00. Requires 20,000 volt, 0.05 milliamper supply. This tube is in current use in all U. S. military infrared equipment & is 2 to 3 times superior to the old IP25 in definition and performance. Diagram for simple power supply included. A \$120.00 saving—NEW SURPLUS. Guaranteed. ONLY \$29.95 postpaid.

## INFRARED LIGHT SOURCE



Snooperscope Part #1364A.—Input 6 volts, 5 amps. Has special 5% dia. #1-1529 glass filter & goldplated reflector. Projects a powerful beam of invisible infrared radiation (free of all visible light) that illuminates objects for infrared viewing (or photography) up to 400 feet of distance. For any infrared system. Complete with bulb. **\$7.95 Ppd.**

## IMAGE TUBE POWER SUPPLY



Snooperscope Part #1450A.—Power Pack for IP25 Tube (will also supply CV-147 Tube). Input 6 V.D.C. output 4,250 V.D.C. and additional focusing voltages. Checked-out, complete, and operating with 1634 Tube. 4 1/2" x 3" x 8". Diagram included. Gov't Used. NEW CONDITION—\$7.95 Ppd. cost \$68.00.

**McNEAL ELECTRIC & EQUIPMENT CO.**  
4736 Olive St. Dept. E-4, St. Louis 8, Mo.  
Terms: Prices Include Postage, Cash With Orders.  
Well Rated Concerns (D & B) Net 10 Days Cash.

## 115 V. 60 CYCLE BLOWERS:



At Left: 115 VAC 60 Cycle SINGLE TYPE — 100 CFM — 2 1/4" intake; 2" outlet. Complete size: 5" x 6" **\$9.95**

15 VAC 60 Cycle DUAL TYPE — 100 CFM—4" intake; 2" Dis. E a o n Side. Complete size: 8" x 8" **\$14.95**

115 VAC 60 cycle COMPACT TYPE—108 CFM: Motor built inside squirrel cage; 4 1/2" intake; 3 1/2" x 3" Dis. Complete size 4 1/2" W x 8 1/2" H x 3" **\$15.95**

115 VAC 60 cycle FLANGE TYPE—140 CFM; 3 1/2" intake; 2 1/2" Dis. Complete size: 7 1/2" W x 7 1/2" H x 6 1/2" D—No. 1C807 **\$14.95**

115 VAC 60 cycle FLANGE TWIN—275 CFM; 4 1/2" intake; 3 1/2" x 3" Dis. Complete size: 11 1/2" W x 2 3/4" H x 8-1/16" D—No. 2C069 **\$22.95**

## DYNAMOTORS

INPUT VOLTS	OUTPUT MA	STOCK NO.	PRICES USED	PRICES NEW
12 VDC	220	80	DM-34	\$2.95 \$4.95
12	625	225	DM-35	9.95
12	230	90	PE-133	4.95 6.95
12 or 24	540	450	DA-12	14.95
12 or 24	230	100	DA-14	8.95
14	220	70DM-24	4.95	7.95

## MINIATURE BLOWERS:



MOTOR and BLOWER—DELCO 5068571—27 VDC Reversible PM Motor, 6000 RPM, with Blower. Overall size, including Blower: 2 3/4" x 3 3/4" x 3". Wt. 9 oz. As pic **\$4.50** tured to left. Price DELCO 5069267 — 27 VDC. 6000 RPM, 1.5 oz. in torque. Reversible S h u n t Motor. Flange Mounted. Size: 2 3/4" x 3 3/4" x 3". Wt. 9 oz. As pic **\$5.95** S82345

115 VAC 400 CY. 10 CFM BLOWER—7200 RPM 1/100 HP. Bakelite blower Housing. Overall size: 3 1/2" x 3 1/2" x 4 1/2". Wt. 1 lb. 7 oz. East- **\$5.95** ern Air Devices No. 431A

10 CFM BLOWER—OSTER MOTOR C2BP-1A—27.5 VDC 1/100 HP. 7000 RPM. Bakelite Blower Housing. Overall size: 3 1/2" x 3 1/2" x 4 1/2". Wt. 1 lb. 4 oz. Price. **\$5.95**

4 1/2" x 1". Blower Fan attached. No. **\$2.95** 10D287

24 VOLT 10 CFM BLOWER—Housed in a cast aluminum case. Shunt Type Motor 24 VDC @ .6 A. 5000 RPM with motor noise Filter. Size: 3 1/4" D x 4 1/4" L **\$5.95**

115 VAC 400 CY. 10 CFM BLOWER—7200 RPM 1/100 HP. Bakelite blower Housing. Overall size: 3 1/2" x 3 1/2" x 4 1/2". Wt. 1 lb. 4 oz. Price. **\$5.95**

New List— Just Out—Including many other Motors, Blowers, Dynamotors, etc. Free—Write for copy today!

# FAIR RADIO SALES • LIMA, OHIO

## CONSISTENTLY HIGH QUALITY

## ELECTRON TUBES

AT SENSIBLE PRICES!

Largest stock in the country.

• ALSO •

Large diversified selection of

## TEST & COMMUNICATIONS EQUIP.

WRITE

For latest comprehensive catalog and tube price sheet

BARRY ELECTRONICS CORP.

512 Broadway, N. Y. 12, Walker 5-7000  
TWX: N. Y. 1-3731

## ELECTRONIC COMPONENTS

### JAN BOXED TUBES

7,000 6SG7GT ..... @ 25c  
2,500 12SF7 ..... @ 30c  
800 395A ..... @ 75c  
1,000 12A6 ..... @ 30c  
1,300 77 ..... @ 20c  
10" long IB3 insulated TV cans @ 3 1/2¢ precision resistors 1 & 2 w 1%, carbon deposited, all sizes 1 w @ 3¢ 2 w @ 5¢ precision resistor kits: 10 two watters, 15 one watters @ \$1.00 insulated resistors kits @ 75¢ ceramic kits @ 75¢ wire #16, 18 & 20 g SRIR plastic 16—\$4.00 M; 18—\$3.50 M; 20—\$3.00 M Special prices to export & wholesale buyers.

## BELVISION

254 Greenwich St. BA 7-6063  
New York, N. Y.

3A5 50¢ 10000 Each  
6F5 35¢ "  
6SH7 35¢ "

2K50 150.00  
5721 135.00  
5820 140.00

EMELTONE ELECTRONICS  
71 West Broadway, N. Y. 7, N. Y. REctor 2-1696

## FOR SALE TEKTRONIX 'SCOPE

Model 517  
Not 2 years old and used less than 200 hours. Perfect condition.

contact: WALTER EELLS  
SHALLCROSS MFG. CO.  
Collingdale, Pa. LUdlow 3-5100

**A BARGAIN FOR YOU in a . . .**

# SOLA *Constant Voltage* TRANSFORMER

**End  
Fluctuating  
Line  
Voltage**

**BIG DISCOUNT OFF . . .**

the factory price of a 1-input 2,000 VA unit! And here's another bonus! This Air Forces 2,000 VA overstock, Sola Cat. No. 30768, has 4 inputs! 90-125 V., 190-250 V., 60 cy. or 50 cy. Isolated secondary is constant 115.0 V.  $\pm$  1% from no-load to full-load of 17.4 amp. So, if you choose, use it as a 220-115 V. step-down. And slash \$97.50 off the factory 1-input price!



**\$147.50**

Brand new in original wood box. 4 cu. ft. Ship. wt. 254 lbs. F.O.B. Pasco, Wash. Only . . . . .

(EXPORTERS: Note choice of 50 cycles.)

**THE M. R. COMPANY**

P. O. Box 1220-B

Beverly Hills, Calif.

**SELLING**

**WILL BUY ALL**

- Receivers
- Transmitters
- Radar
- Special Purpose Tubes
- Relays
- Meters
- Switches
- Connectors
- Rectifiers
- Transformers
- Motors & Generators
- Wiring Cable
- Instruments and
- All Electronic Components

**New or Used**

- Leach Relay  $\approx$  5059-R
- $\approx$  5058
- $\approx$  5055
- $\approx$  5053-SM
- $\approx$  5053

- Price Bros. Relay  $\approx$  10
- Relay  $\approx$  5586
- $\approx$  5587

- Antenna Switching Relay
- Box # CBY 23049
- # BG-AN-198
- # BC -408

- Tubes #53A
- VT-127A VT-227A
- 35T VT-327A
- WL-530 15E

Highest prices paid for most all types of aircraft sparkplugs any condition

Wholesale Only

**RADIO & ELECTRONIC SURPLUS**  
14000 BRUSH STREET  
Detroit 3, Mich. TO 9-3403

Wholesale Only

**NEW LOW PRICE**

Only \$4.95 • 2 for \$9.00

**PULSE TRANSFORMER PT-3**

TUBE BASE PLUG-IN TYPE

Similar characteristics to UX 7350. Precision-made. Two 100-turn and two 50-turn coils wound on high quality hypersil cores. Built into octal bakelite tube bases. Completely impregnated and sealed—humidity-resistant. Diagram on end disc of each unit provides versatility of application.

**THESE PT-3 TRANSFORMERS may be used**

- In Blocking Oscillator, Multivibrator and Scope Circuits.
- For Interstage coupling, impedance matching and isolation.
- Wherever accurate timing and triggering are essential.
- In circuit applications requiring the generation of low power and low voltage pulses.
- In circuits utilizing repetition rates from 0 to well over 1 MC and pulse widths from .03 microsecond.

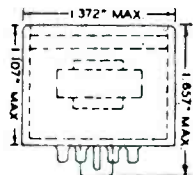
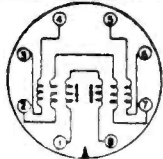
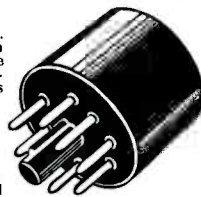

**CHARACTERISTICS**

Impedance, ohms . . . . .	120
Rise time, microseconds .03	
Drop in 1 microsecond	20%
2 microsecond	40%
5 microsecond	55%
10 microsecond	75%

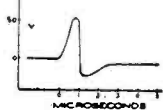

**Cramer Electronics, Inc.**

811 Boylston St., Boston 16, Mass. CO 7-4700

Write for Bulletin of late items.

**COMMUNICATIONS & TEST EQUIPMENT**

Top quality communications and test equipment at low prices.

Here are a few leaders . . . .

- APR-4—Laboratory receiver w/TN-16, 17 & 18
- ARC-1 & ARC-27—Transmitter-receivers
- ARN-6 & 14—Radio compass receivers
- ART-13—100 W Transmitter Airborne or ground w/or W/O LFO
- BC-375—Unused surplus, original packing, transmitters and tuning units
- I-208—FM Signal Generator
- SCR-508 — Vehicular push-button transmitter-receiver
- TS-147D/UP—X band test equipment
- TS-323/UR—Frequency meters w/ crystal calibration book. Frequency coverage 20-450 Mc. Accuracy .01.
- TS-155A/UP—Signal Generators S Band

Prices on request only  
Immediate Delivery

We buy clean communications and test equipment unmodified. Top prices.

**MONTGOMERY EQUIPMENT CO.**

14315 Bessemer St.  
Van Nuys, California  
Telephone: STate 6-4657  
Telegraph Station YHV  
Cable Address MONTEQUIP

**NEED METERS?**

STANDARD or SPECIALS

ANY QUANTITY—NEW—MILITARY

**FOR** ELECTRONIC—MILITARY  
AIRCRAFT—HAMS

**ALL** MAKES—MODELS  
RANGES—SIZES

**METERS** REPAIRED  
RESCALED  
RECALIBRATED

WRITE - PHONE - WIRE

**INSTRUMENT SERVICE**

76-14 Woodside Ave.

Elmhurst 73, N. Y.

CAA No. 4264 Ltd. HA 9-2925

**ANNOUNCING: METRO ELECTRONICS CORP.** now under management of Sy Denby (W2BNW) and Lou Dolin—50 years of combined experience in the electronics industry to help meet your needs.

Specializing in: Industrial Tubes and Components

Write for quotations. We have thousands of tubes and parts in stock.



**METRO ELECTRONICS CORP.** 172 Washington St. N.Y. 7, N.Y.

Telephone Beekman 3-4245



**SAVE UP TO 70% OF WHOLESALE COST**

**PULSE TRANSFORMERS**  
OVER 50 TYPES LOW AND HIGH POWER TYPES IN STOCK FOR IMMEDIATE DELIVERY

MFD. BY UTAH, G.E., RAYTHEON, PHILCO, WESTINGHOUSE, WESTERN ELECTRIC, ETC.

132AW2F	7P1	\$6.95
134BW2F	7P4	6.95
176AW2F	7P10	7.50
139DW2F	7P13	5.95
148DW2F	7P15	7.60
Utah X124T-9262		12.50
Utah X139T1-9278		3.75
G.E. 68G28		14.50
G.E. 68G27		16.50

SEND US YOUR INQUIRIES

**POLYSTYRENE CAPACITORS**

1% Tolerance

Hermetically Sealed-200VDCW-500VDC	T
0.5 MFD.	\$7.50 Ea.
1 MFD.	\$12.10 Ea.
Mdf. by Western Electric.	Brand New

**PRODUCTION QUANTITIES**

**TEFLON and KEL-F INSULATED HOOK-UP WIRE**

In Stock For Immediate Delivery  
VARIOUS COLORS and SIZES  
Inquire For Complete Listing  
At Money Saving Prices

**TYPE "J" POTENTIOMETERS**  
2 Watt Carbon

Full Range of Values Available From Stock for Immediate Delivery

Single Type J Units	\$ .95 Ea.
Dual Type JJ Units	2.95 Ea.
Triple Type JJJ Units	3.95 Ea.

SEND FOR COMPLETE LISTING

**ALL COMPONENTS 1ST QUALITY AND 100% GUARANTEED**

**SYNCHROS**

COMPLETE LINE OF COMMERCIAL ARMY AND NAVY TYPES

1CT	\$37.50	5N	\$22.50
1DG	37.50	5SDG	12.50
1HCT	42.50	5SF	29.50
1F	37.50	5SG	29.50
1G	37.50	6G	34.50
3D	62.50	6DG	27.50
3HCT	62.50	6HG	42.50
5B	22.50	7G	42.50
5CT	34.50	7DG	47.50
5HCT	42.50	23CX6	45.00
5F	34.50	21JF1	4.95
5G	34.50	21JG1	3.95

MANY OTHER TYPES IN STOCK  
QUOTATIONS ON REQUEST

**IMMEDIATE DELIVERY**

**KOLLSMAN SERVO MOTORS WITH TACH GENERATOR**

TYPE 890-0160640-MOTOI-115V-60Cy.-2 Ph. 3350 RPM-5 Watts Output	
GEN. 6.5V/1000 RPM	\$59.50 Ea.
TYPE 1623B-0410120 Motor-26V-400 Cy.-2 Ph.-6500 RPM-0.45 Watts Output	
GEN. 0.34V/1000 RPM	\$42.50 Ea.

**SOUND POWERED PHONES**

**Head and Chest Set**

**U. S. NAVY TYPE "M"**

Heavy Duty Includes Headset, Chest Mike and 20 Ft. Cord.  
\$14.88 Ea.

T.S. 10 Type S.P.Handset. \$9.48 Ea.

Terms: 20% cash with order, bal. C.O.D. unless rated. All prices net F.O.B. our warehouse Phila., Pa., subject to change without notice.

Special Discounts on Quantity Purchases

**WE INVITE YOUR INQUIRIES FOR ALL YOUR ELECTRONIC NEEDS**

**FROM ONE OF THE LARGEST INVENTORIES IN THE U.S.A.**

**TEST EQUIPMENT**

**TEST EQUIPMENT**

A.L.L. 116 Polar Pattern Recorder	
Equip. 6 Units	
AX/UPM-2 Wavemeter 80-1220 Mc	
Accur. 1 MC	97.50
AT-48/UP CM Pickup Horn Antenna	9.95
AT-105/AP K Band Pickup Horn Ant.	12.95
BC-221 Frequency Meter 125 KC-20,000 KC-Accur. .05%	115.00
I-120 Signal Generator 15-25 MC & 195-225 MC-Int. Mod.	115.00
I-138A 10CM Signal Generator 2700-2900 MC	125.00
LAE-1 UHF Signal Generator 510-1800 MC. Accur. 1%	225.00
LAF VHF Signal Generator 90-600 MC. Accur. 1%	\$325.00
LAG Microwave Signal Generator 1200-4000 MC. Accur. 1%	\$375.00
LAJ Audio Oscillator 20-20,000 cy. Mfd. by Hewlett-Packard.	\$85.00
LM Freq. Meter 125 KC-20 MC	115.00
LP Std. Signal Generator 9.5 KC-50 MC. 2V Output	\$375.00
ME-11A/C. R.F. Wattmeter	\$80.00
TS-28/AP 3 Cw Frequency Meter 8700-9500 MC. Accur. .03%	\$145.00
TS-34/AP Oscilloscope 30cps-1Mc Portable	\$195.00
TS-46/AP Freq. Meter 3000 MC. Accur. .05%	49.50
TS-100/AP Oscilloscope-A, J, K & X Indication. Freq. video to 8 MC.	\$89.00
TS-174/V Freq. Meter 20-280 MC. Accur. .05%	385.00
TS-811A/UP Precision Echo Box 8730 to 8910 MC—Measures frequency, power, spectrum analysis. Incl. Crystal mixer tester.	\$225.00
STODDART TS-587/v Noise and Field Intensity Meter 15-400 MC.	1500.00
TS-588A/v Std. Signal Generator 5KC-50MC 2V. output.	390.00

Quote

**GENERAL RADIO**

GR 218M Decade Condenser	\$65.00
GR 419A Wavemeter 20-300 Mc.	75.00

Note—All Items new except where noted \* Excellent Used—Checked out & Guaranteed.

GR 572H IKC Hummer	7.50
GR 583A Output Power Meter	85.00
GR 620A Het. Freq. Meter	345.00
GR 700P1 Voltage Divider	27.50
GR 713B Beat Freq. Osc.	\$225.00
GR 715AE DC Amplifier	275.00
GR 720A Het. Freq. Meter	\$89.50
GR 724B Precision Wavemeter	160.00
GR 727A VTM (Battery Oper.)	\$105.00
GR 1176A Freq. Meter 25-60,000 cy.	170.00

Boonton 202B FM/AM Signal Generator 54-210 MC	485.00
Boonton 207A Univerter	180.00
Boonton 110A Qx Checker	\$170.00
Boonton 152A FM Signal Gen. 20-28 MC & 1-5 MC. w/150R Pwr Supply	185.00
Dumont 208 Oscilloscope	\$95.50
Dumont 248 Oscilloscope	\$375.00
Esterline Angus-20 Pen Operation Recorder Portable type	\$320.00
Hewlett-Packard 325B Distortion Analyzer	\$220.00
Hewlett-Packard 337B FM Monitor 25-75 MC	\$465.00
Kay Megawavep 50 KC-1000 MC.	\$200.00
Lavoie LA-239A Oscilloscope	\$85.00
Measurements 62 VTM	\$375.00
Measurements 78E STD. Signal Gen. 50-75 MC	115.00
Measurements 79H Pulse Gen.	165.00
Rubicon 1168 Resis. Std. .001 ohms	85.00
Rubicon 1171 Resis. Std. .001 ohms	150.00
Victoreon 247A Radiator Survey Meter 0-2.5/25/250 milliroentgens/hr.	179.50
Waterman S-12-B 3" Rakoscope	325.00
Weston Model 1 Direct Reading Ohmmeter 0-2.5/25/50 ohms 1/2"	120.00
Weston 45 DC Voltmeter 0-15V-1/2"	\$35.00
Weston 695 Power Level Meter	30.00
Weston 785 Ind. Circuit Tester	95.00
Weston 795 Ohmmeter 0-20/200 megohms 500V. Battery Operated	42.00
Winlog 5G-100 Megohm-Insul. Res. Test Set-0-1000 Megohm 500VDC	125.50

**WRITE FOR A COMPLETE LIST OF SURPLUS EQUIPMENT**

**LECTRONIC RESEARCH LABORATORIES**

715-19 Arch St., Phila. 6, Pa. • MArket 7-6771-2-3  
Cable Address: LECTRONIC, Philadelphia

**CONSISTENTLY HIGH QUALITY ELECTRON TUBES**

AT SENSIBLE PRICES!

Largest stock in the country.

• ALSO •

Large diversified selection of

**TEST & COMMUNICATIONS EQUIP.**

WRITE

For latest comprehensive catalog and tube price sheet

BARRY ELECTRONICS CORP.

512 Broadway, N. Y. 12, Walker 5-7000  
TWX: N. Y. 1-3731

**AN INVESTMENT**

Productive advertising is an investment rather than an expenditure.  
BE CONVINCED—send us your advertisement TODAY.

**ELECTRONICS**

Classified Advertising  
P. O. Box 12, New York 36, N. Y.



**KOILED KORDS 3 wires \$126**  
22 inches long stretches to 9 ft.

**GONIOMETER**  
TYPE CFT-47372 — 250 to 1500 K.C.

**nightlighter \$1595**

Automatic light switch. Darkness throws the switch — turns lights on at dusk — off at dawn. Fools burglars who watch for signs of an empty house. Same as your city buys for \$45 on top of lamp posts.



**TELECHRON Motors**

2 RPM	\$2.90	1 RPM	\$3.95
3 RPM	3.90	3 R.P. Hr.	2.85
4 RPM	2.90	1 R.P. 2Hr.	2.80
3.6 RPM	3.15	60 RPM	4.85
		1 RPM—50 Cycles	\$1.85

Laboratory Special 1 of Each Motor \$25

PLEASE INCLUDE POSTAGE

**BLAN**  
EST. 1923

64 M Dey St.  
New York 7,  
N. Y.

General Radio **VARIACS** in stock. Special Sale on a few 200-B (1 amp.) removed from equip't. \$8.95

**HAND WOUND 10 Sec. to 24 Min. TIMER SWITCH \$1.35**

**6 Watt Most POWERFUL TELECHRON MOTOR**  
110v 60 Cy  
6 RPM reversible \$10.00  
1 RPM \$6.50



**HAYDON TIMING MOTORS**  
110v 60 cycle 30 RPM \$2.60  
110v 60 cycle 1 RPM 2.60  
230v 1/2 RPM 1.00  
60 cy/1 RPM 1.00  
**HANSEN Synchron 4 rpm \$4.24**  
**CRAMER 4 rpm \$4.65**



**DIEHL-DELCO**

P.M. motors. Made for 24 volts. Will work at lower speed at 12v. or 6v. Battery or Rectifier. Size 1"x1"x2"



**AN CONNECTORS**

**FAST DELIVERY**

**FROM STOCK**

Let us quote on your requirements.

**LOW PRICES**

All comply with government specifications

*Wilgreen Industries*  
99 MURRAY ST., NEW YORK 7, N. Y.  
Worth 4-2490-1-2

Cadmium or olive drab finish.







# INDEX TO ADVERTISERS

Ace Electronics Associates.....	266	Chicago Standard Transformer Corp.....	208
Aeme Wire Co. ....	384	Chicago Telephone Supply Corp. ....	71
Adel Precision Products .....	348	Christie Electric Corp. ....	383
Advance Electronics Lab, Inc.....	438	Ciba Company, Inc. ....	221
Aeronautical Communications Equip- ment, Inc. ....	38	Cinch Mfg. Corp. ....	189
Aerovox Corp. ....	206	Circuit Instruments, Inc. ....	239
Airpax Products Co. ....	43	City of Jacksonville .....	440
Allegheny Ludlum Steel Corp.....	56	Clare & Co., C. P. ....	69
Allen-Bradley Co. ....	64A, 64B	Clearprint Paper Co. ....	209
Allied Control Company, Inc.....	105	Cohn Corp., Sigmund .....	324
American Lava Corporation .....	125	Coil Winding Equipment Co. ....	390
American Photocopy Equipment Co. 96A, 96B		Collins Radio Company .....	44, 45, 86, 87
American Television & Radio Co. ....	198	Communications Company, Inc. ....	316
Ampex Corp. ....	135	Computer-Measurements Corp. ....	51
AMP, Incorporated .....	30, 31, 243	Con-Elco .....	340
Amperex Electronic Corp. ....	245	Consolidated Electrodynamics .....	202, 203
Anaconda Wire & Cable Co. ....	305	Constantin & Co., L. L. ....	99
Andrew Corporation .....	23	Continental-Diamond Fibre Div. of the Budd Company, Inc. ....	132
Arnold Engineering Co. ....	13	Continental Wire Corp. ....	314
Artos Engineering Co. ....	242	Convair, A Div. of General Dynamics Corp. ....	310
Astron Corp. ....	283	Cords Limited, Division Essex Wire Corp.	309
Automatic Mfg., Division of General In- strument Corp. ....	281	Cornell-Dubilier Electric Corp. ....	263
Antonetics, Div. of North American Avia- tion, Inc. ....	128	Corning Glass Works .....	110
Avnet .....	50	Cosmic Condenser Co. ....	380
		Coto-Coil Co., Inc. ....	387
		Crane Packing Co. ....	349
		Cross Co., H. ....	367
		Crucible Steel Company of America.....	61
Baker & Co., Inc. ....	201	D & R Ltd. ....	385
Ballantine Laboratories, Inc. ....	204	Dale Products, Inc. ....	241
Barry Controls, Inc. ....	21	Dano Electric Co. ....	389
Beede Electrical Instrument Co., Inc.....	353	Daven Company .....	3rd Cover
Bekey Electric Co., Inc. ....	438	Daystrom Pacific Corp., A Subsidiary of Daystrom, Inc. ....	304
Bell Aircraft Corp. ....	261	Deleo Radio, Div. of General Motors. 66,	323
Bell Telephone Laboratories .....	319	DeMornay-Bonardi .....	352
Bendix Aviation Corp. Pacific Div. ....	364	Dialight Corporation .....	374
Red Bank Div. ....	294	Diamonite Products Mfg. Co. ....	240
Bentley, Harris Mfg. Co. ....	32	Donner Scientific Co. ....	380
Berkeley Div., Beckman Instruments, Inc.	27	Douglas Aircraft Co., Inc. ....	331
Bird Electronic Corp. ....	316	Dow Chemical Company .....	82
Bolling Industries, Inc. ....	387	Dow Corning Corp. ....	207
Boonton Radio Corp. ....	285	Drakenfeld & Co., Inc., B. F. ....	390
Brew and Company, Richard D. ....	382	Driver-Harris Company .....	111
Bristol Co. ....	256	Dumont Laboratories, Inc., Allen B. ....	277
Burdny Corporation .....	39	duPont de Nemours & Co., (Inc.) E. I. Polychemicals Dept. ....	273
Burnell & Co., Inc. ....	9	Durant Mfg. Co. ....	362
Bussmann Mfg. Co. ....	52		
Cambridge Thermionic Corp. ....	134		
Cannon Electric Co. ....	58, 59	Eastern Industries, Inc. ....	81
Celeca-Constantine Engineering Labora- tories Co. ....	288, 381	Elsler Engineering Co., Inc. ....	366
Century Electronics & Instruments, Inc.	325	Eitel-McCullough, Inc. ....	95
Chicago Condenser Corp. ....	442		

# ESSEX

*Custom-Designs*

**ENCAPSULATED AND  
HERMETICALLY SEALED**

**DELAY LINES**

*to Your  
Specifications*

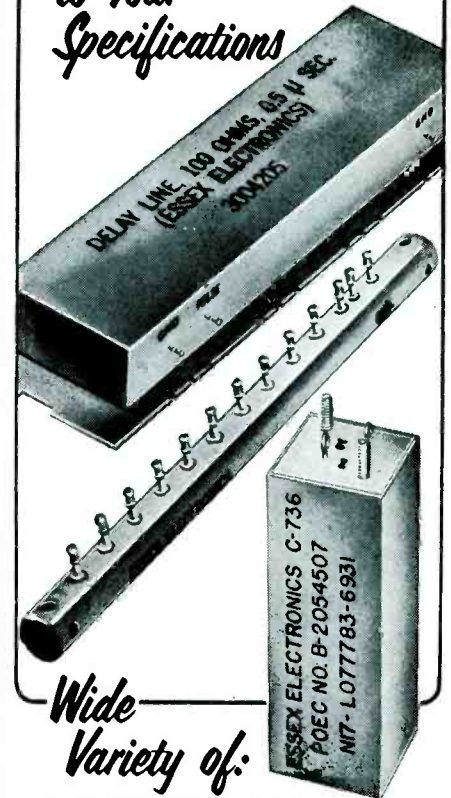

*Wide  
Variety of:*

**DISTRIBUTED CONSTANT  
DELAY LINES** designed for  
fast rise time and low at-  
tenuation made in flexible,  
metal-shielded and stick  
types.

**LUMPED CONSTANT  
DELAY LINES** feature high  
fidelity as well as compact  
size.

The name, Essex Electronics, is  
your reassurance of highest pos-  
sible product quality, efficiency,  
performance and satisfaction.

Send specifications as detailed  
as possible for prompt cost  
quotations.

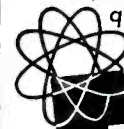

**ESSEX  
ELECTRONICS**

Exec. Off. & Main Plant.  
Berkeley Heights, New Jersey  
CRestview 3-9300

Other Plants at:  
7303 Atoll Ave., No. Hollywood, Calif.  
Trenton, Ontario—Canada

Want more information? Use post card on last page.





Heath Company	375
Heiland, a Div. of Minneapolis-Honeywell	74
Helipot Corp., Div. of Beckman Instruments, Inc.	195, 338
Hewlett-Packard Company	130, 131
Heyman Mfg. Co.	326
Hickok Electrical Instrument Co.	226
Hoffman Laboratories, Inc.	236, 237
Homelite, a Div. of Textron, Inc.	312
Hopkins Engineering Co.	324
Horman Associates, Inc.	392
Hoyt Electrical Instruments	367
Hughes Products, a Div. of Hughes Aircraft Co.	37, 223
Hughes Research & Development Laboratories	36
Humphrey, Inc.	363
Hunt Company, Philip A.	214
Hycon Eastern, Inc.	289

Indium Corp. of America	365
Industrial Timer Corporation	116
International Electronic Research Corp.	347
International Resistance Co.	238

J F D Electronics Corp.	219
Jeffers Electronics Division of Speer Carbon Co.	332
Jennings Radio Mfg. Corp.	274
Jet Propulsion Laboratory	313
Johns Hopkins University, Applied Physics Laboratory	254
Johnson Company, E. F.	302
Jones Div., Howard B. Cinch Mfg.	389

Kable Engineering Co.	15
Kato Engineering Co.	386
Kay Electric Co.	29
Kepeo Laboratories, Inc.	193
Kester Solder Co.	229
Kintel (Kay Lab)	215

Lampkin Laboratories, Inc.	372
Lapp Insulator Co., Inc.	300
Leach Corporation	129
Lepel High Frequency Laboratories, Inc.	377
Librascope, Inc.	73
Lockheed Aircraft Corp., Missile Systems Div.	301
Los Alamos Scientific Laboratory	197

## UNEQUALED PERFORMANCE IN

- TELEMETERING
- GUIDED-MISSILE MONITORING
- RADIOSONDE RECEPTION

This Special Purpose Receiver is an improved version of the NEMS-CLARKE 167-J1 and 167-J2. This new Receiver incorporates the best qualities of both of the former types plus many new features including a BFO. A video bandwidth control is provided to greatly improve signal-to-noise ratio when full bandwidth is not needed. It is especially useful as a high quality general purpose laboratory receiver.



## NEMS-CLARKE

INCORPORATED

919 JESUP-BLAIR DRIVE  
SILVER SPRING, MARYLAND

For further information write  
Dept. H-8

## TYPE 1501 SPECIAL PURPOSE RECEIVER



### SPECIFICATIONS

Type of reception	AM, FM, or CW
Tuning range	55-260 mc
IF bandwidth	300 kc
Sensitivity (measured without band-restricting filters)	8 uv produces at least 23 db S/N ratio with 100-kc deviation, 400-cycle modulation.
Noise figure	11 db, maximum
IF rejection	Not less than 70 db
Image rejection	Not less than 40 db below 130 mc; 30 db minimum at any frequency.
FM output	0.15 volt per kc deviation (Approx.)
AM output	12 volts for 10 uv input modulated 30% at 1000 c.p.s. (Approx.)
Squelch	Operates on monitor circuit

Little Mag says . . .

"DID YOU KNOW THAT  
**MAGNATRON** IS HELPING  
'BUILD A FENCE  
AROUND YOUR BACKYARD?'"

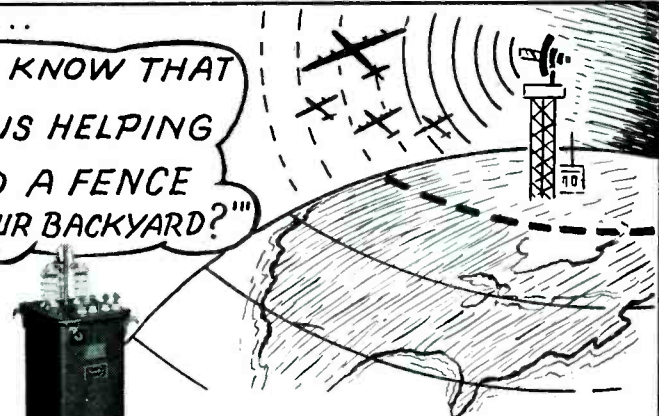

**The Distant Early Warning (DEW) radar picket line is that safety fence.** Its performance must be absolutely dependable.

Magnatran heavy duty components including unitized rectifiers, are the "standard" power supplies in the vital transmitters completing the system.

Whenever you require reliability and dependability you too can use.

Magnatran transformers.

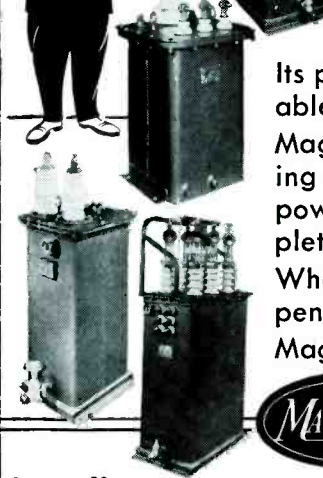

**MAGNATRON** incorporated  
P.O. Box 211 KEARNY, NEW JERSEY, U.S.A.

See page 39  
'56 Electronic Buyers Guide

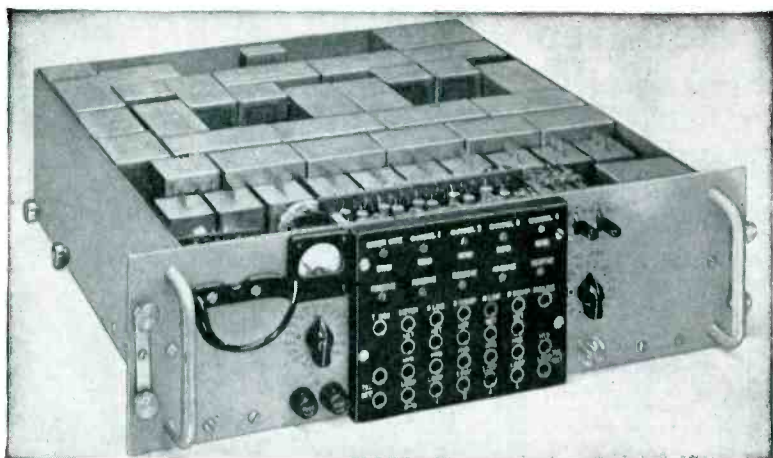

### FOUR-CHANNEL CARRIER-TELEPHONE TERMINAL FOR RADIO LINKS

This is a miniaturized unit of advanced design which provides four voice channels on a frequency-division basis above a voice-frequency order-wire channel. Each of these five channels is provided with a 4-wire 2-wire termination and a voice-frequency ringing circuit for d-c or 20-cycle signals. Adjustable attenuators are provided in the 4-wire side of all channels, and a built-in test oscillator and meter permit complete line-up, maintenance and trouble-shooting checks to be made. Channel levels are from -9 to 0 dbm and line levels from -30 to 0 dbm. Channel width is 300 to 3500 cycles within 1 db.

This unit is only 5 1/4" high by 19" wide by 14" deep. It mounts on a standard rack and operates from 115 volts 50-60 cycles a.c.

## RADIO ENGINEERING PRODUCTS

1080 UNIVERSITY ST., MONTREAL 3, CANADA

TELEPHONE  
UNiversity 6-6887

CABLES  
RADENPRO, MONTREAL

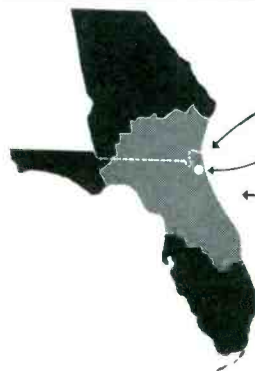

Since 1950 a population equivalent to  
Nebraska's has moved into the market of

## Jacksonville, Florida

Jacksonville's immediate market—Florida-Georgia—to say nothing of other areas within overnight shipping distance, and the Latin-American market, has increased since 1950 by 1,380,112. The entire State of Nebraska in 1950 had a population of only 1,325,510.

Here it is:

FLORIDA-GEORGIA population, 1957.	7,596,000
FLORIDA-GEORGIA population, 1950.	6,215,888
INCREASE	1,380,112
NEBRASKA'S 1950 population.	1,325,110

This great and growing population picture provides markets, yes. But it also supplies a manpower pool of increasing importance because it embodies large numbers of special skills, including men trained in electronics, chemicals, aviation and many other industries.

This is one major reason why more and more national firms are using Jacksonville as headquarters for Florida-Georgia operations . . . why they find their Jacksonville operations leading the field.

Jacksonville has what many industries, branch operations and distributing branches need. It has ample manpower, transportation by air, rail, highway and water, adequate industrial water and electric power. It is the distribution hub of the Southeast, as a glance at the map will show you.

**DON'T DELAY BEYOND TODAY!** Plan now to move to the heart of the market. Get the facts! Write for "THE JACKSONVILLE STORY," which gives you full information. Or ask us to prepare an individualized survey covering your needs. Confidential, of course.

IDEAL EVERY DAY FOR WORK AND PLAY

### The CITY OF JACKSONVILLE, Florida

Electric & Water Utilities

The Committee of One Hundred  
Jacksonville Area Chamber of Commerce  
604-E HOGAN STREET PHONE ELGIN 3-6161

MacDonald, Inc., Samuel K.	392
Magnatran, Inc.	439
Magnecraft Electric Company	377
Magnetics, Inc.	205
Mallory and Co., Inc., P. R.	68, 136, 191
Marconi Instruments, Ltd.	315
Martin Company, Glenn L.	303
Maxson Corp., W. L.	378
Maxson Instruments	368
McGraw-Hill Book Co.	339, 443
Measurements Corp.	352
Melpar, Inc.	248
Metals & Controls Corp., General Plate Div.	54
Micro Switch a Division of Minneapolis-Honeywell Regulator Company	46, 47
Microwave Associates, Inc.	218
Millen Mtg. Co., Inc., James	200
Minneapolis-Honeywell Regulator Co. Davies Laboratories Div. Industrial Division	311, 60
Model Rectifier Corporation	330
Moloney Electric Co.	78
Muirhead & Co., Ltd.	5
Mullard Overseas, Ltd.	96
National Company	34
National Lead Company	70
National Moldite Co.	279
Natvar Corp.	247
Nems-Clarke, Inc.	439
New Hermes Engraving Machine Corp.	381
North Electric Co.	250
Northeastern Engineering	282
Oak Mfg. Co.	89
Ohmite Mfg. Co.	32A, 32B
Orange Products, Inc.	336
Pacific Automation, Inc.	227
Panoramic Radio Products, Inc.	280
Perkin-Elmer Corp.	389
Perkin Engineering Corp.	25
Perkins Machine & Gear Co.	379
Phelps-Dodge Copper Products Corp. Inc. Mfg. Div.	108, 109
Philamon Laboratories, Inc.	121
Philco Corporation	361
Photographic Products, Inc.	383
Plastoid Corporation	244
Polorad Electronics Corporation	275
Potter & Brumfield, Inc.	42
Precision Capacitors, Inc.	390
Precision Paper Tube Co.	286
Pyramid Electric Co.	213



Radiation Inc. ....	290
Radio Cores, Inc. ....	252
Radio Corporation of America.....	118, 119 299, 359, 4th Cover
Radio Engineering Laboratories, Inc....	85
Radio Engineering Products .....	440
Radio Frequency Laboratories, Inc.....	278
Radio Materials Corp. ....	94
Radio Receptor Co., Inc. ....	259
Ramo-Wooldridge Corp. ....	352
Raytheon Mfg. Company.....	18, 19, 386
Reeves Instrument Corp. ....	97
Remington Rand Univac Div. of Sperry Rand Corp. ....	287
Revere Corporation of America .....	284
Rex Rheostat Co. ....	392
Robertshaw-Fulton Controls Company..	371
Rohn Manufacturing Co. ....	328
Royal Metal Mfg. Co. ....	355

Sage Electronics Corporation .....	371
Sanborn Company .....	63
Sangamo Electric Co. ....	327
Schweber Electronics .....	392
Shaevitz Machine Works .....	297
Sierra Electronic Corp. ....	101
Sigma Instruments Inc. ....	292
Sola Electric Co. ....	84
Solartron Electric Group Ltd.....	337
Somers Brass Company, Inc. ....	383
Sorensen & Co., Inc. ....	4
South Chester Corporation .....	335
Southern Electronic Corp. ....	253
Southwestern Industrial Electronics Co..	276
Spectral Electronics, Div. of Carrier Cor- poration .....	249
Sperry Gyroscope Company, Division of Sperry Rand Corp. ....	55, 251
Sprague Electric Co. ....	11
Stackpole Carbon Co. ....	35
Staedtler, Inc., J. S. ....	246
Stevens Arnold, Inc. ....	388
Stoddart Aircraft Radio Co., Inc.....	272
Stromberg-Carlson Company .....	321, 369
Superior Electric Company .....	33
Superior Tube Co. ....	115
Sylvania Electric Products, Inc.....	40, 41, 88
Syntronic Instruments, Inc. ....	343

Taylor Fibre Co. ....	98
Technitrol Engineering Co. ....	224
Technology Instrument Corp. ....	306
Tektronix, Inc. ....	48
Telechrome Incorporated .....	53, 267
Texas Instruments, Incorporated .....	199
Tranco Products, Inc. ....	260
Transitron Electronic Corp. ....	77
Trio Laboratories, Inc. ....	343



## The Career of Tomorrow Can Be Yours... TODAY!

You and Your Family Should Read This Exciting New  
Brochure on Tomorrow's Brightest Engineering Activities!

Add **NEW DIMENSIONS** to your professional life . . .

A position with Westinghouse-Baltimore will add new dimensions to your engineering work in a number of ways. You will be a member of an engineering team pioneering advanced developments in the electronics field far beyond the state of the art. And, as an active participant in these pioneering ventures, you will find your creative and imaginative skills taxed to their utmost. You will grow as an individual through your contacts with some of the outstanding engineers and scientists of our day. And, you will be given every opportunity to continue your education and to take an active part in professional activities designed to further your career.

Add **NEW DIMENSIONS** to your family life . . .

More and more engineers are finding that a satisfying career can only be built around a full, rich family life. That is why Westinghouse-Baltimore stresses the advantages to the young engineer of coming to Baltimore. In the colorful new book, "New Dimensions," your family can get all the facts on this friendly city—its homes, schools, churches, social and cultural activities and its recreational facilities.

### FOR YOUR COPY OF NEW DIMENSIONS:

Write to Dr. J. A. Medwin, Dept. 641  
WESTINGHOUSE ELECTRIC CORPORATION  
P. O. Box 746 • Baltimore 3, Maryland

Please indicate your field of interest, and if you'd  
like a confidential interview, include a resume of  
your education and experience.

# Westinghouse - BALTIMORE

Advanced Electronics Systems, Ordnance,  
X-Ray, Carrier Microwave, and Induction  
Heating Equipment for Military, Indus-  
trial, and Commercial Purposes.



An Engineer's Company

# What's New in Caps \*



**FROM 10 VDC TO 100,000 VDC  
SPECIALIZING IN 1% TOLERANCES**

Highly desirable for critical applications in limited space. Heavy wall pyrex with metal end caps. Designed for computers and control equipment, they have high insulation resistance and stability vs. temperature, low dielectric absorption and power factor.

Call on us for all your film capacitor requirements.  
**POLYETHYLENE, ACETATE,  
POLYSTYRENE, and MYLAR  
capacitors.**

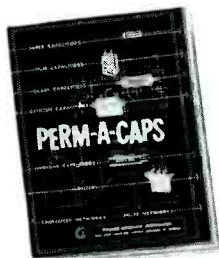

Write Dept. A



**CHICAGO  
CONDENSER  
CORPORATION**

3255 WEST ARMITAGE AVENUE  
CHICAGO 47, ILLINOIS

KING-MOON COMPANY  
15044 VENTURA BLVD.  
SHERMAN OAKS, CALIF.

M. CLIFFORD AGRESS  
891 FULTON STREET  
VALLEY STREAM, N. Y.  
Z. S. MEYERS, 4538 MAIN ST., KANSAS CITY 11, MO.

Triplet Electrical Instrument Co. .... 57  
Tung-Sol Electric, Inc. .... 270, 271

U. S. Electronics Development Corp. .... 318  
Uinite Co. .... 124  
Union Switch & Signal Div. of Westinghouse Air Brake Company .... 354  
United Shoe Machinery Corp. .... 257  
United States Rubber .... 49  
United Transformer Co. .... 2nd Cover  
Universal Winding Co. .... 293  
University of California Radiation Laboratory .... 295  
Uniwave, Inc. .... 372

Van Keuren Co., The .... 385  
Varian Associates .... 83  
Vector Manufacturing Company .... 216  
Veeder-Root, Inc. .... 317  
Vitramon, Inc. .... 348  
Vulcan Electric Co. .... 234

Waldes Kohinoor, Inc. .... 67  
Wales Strippit Company .... 117  
Waltham Watch Co. .... 258  
Ward Leonard Electric Co. .... 231  
Waterman Products Co., Inc. .... 212  
Waters Manufacturing, Inc. .... 296  
Welwyn International, Inc. .... 375  
Wenco Manufacturing Co. .... 386  
Western Electric Co. .... 269  
Westinghouse Electric Corp. .... 122, 329, 441  
Weston Electrical Instrument Corp., a Subsidiary of Daystrom, Inc. .... 106  
Wheeler Insulated Wire Co., Inc. .... 210  
Wheeslock Signals, Inc. .... 346  
White Dental Mfg. Co., S. S. .... 76  
Williams & Co., C. K. .... 334

Zell Products Corp. .... 378, 379

PROFESSIONAL SERVICES ..... 392

## CLASSIFIED ADVERTISING

F. J. Eberle, Business Mgr.

EMPLOYMENT OPPORTUNITIES...393-422

BUSINESS OPPORTUNITIES ..... 424

EDUCATIONAL ..... 424

EQUIPMENT  
(Used or Surplus New)  
For Sale ..... 423-436

WANTED  
Equipment ..... 432

## EMPLOYMENT OPPORTUNITIES ADVERTISER'S INDEX

Abbott's Employment Service.....402, 408  
Admiral Corp..... 410  
Aircraft Radio Corp..... 393  
American Machine & Foundry Co..... 404  
Arma, Div of American Bosch Arma Corp.. 414

Bendix Aviation Corp.  
Bendix-Freiz Division..... 422  
Products Division—Missiles ..... 400  
Radio Division..... 405  
Systems Division ..... 410  
York Division..... 412

Budd Manufacturing Co..... 417  
Burroughs Corp..... 402

Continental Oil Co..... 393  
Cooper, J. J..... 393

Edison Inc., Thomas A..... 408

Emerson Electric Manufacturing Co., Electronics & Avionics Div..... 416

MANUFACTURERS REPRESENTATIVES ..... 392



Fidelity Personnel Service.....	393
General Electric Co Philadelphia, Pa.....	421
Syracuse, N. Y.....	398, 419
General Motors Corp AC Electronics Div.....	397, 406, 418, 421
General Precision Laboratory Inc.....	408
Goodyear Aircraft Corp Akron, Ohio.....	399
Litchfield Park, Arizona.....	404
Goodyear Atomic Corp.....	420
Honeywell-Brown Instruments Division.....	400
Johns Hopkins University, Operations Research Office.....	396
Kollsman Instrument Corp.....	422
Leeds & Northrup Co.....	407
Martin Co., Glenn L. (Baltimore Div).....	396
Motorola Inc.....	398
National Co. Inc.....	412
Otis Elevator Co.....	414
Page Communications Engineers, Inc.....	402
Radio Corp. of America.....	394, 395
Raytheon Manufacturing Corp.....	403, 413
Reeves Instrument Corp.....	419
Sanders Associates, Inc.....	418
Spengler, Silas.....	412
Stavid Engineering Inc.....	420
Stromberg-Carlson Co A Div. of General Dynamics Corp.....	401
Sylvania Electric Products Inc Buffalo, N. Y.....	415
Mountain View, Calif.....	409
Waltham, Mass.....	409
Woburn, Mass.....	420

## Just Published

# American Institute of Physics Handbook

DWIGHT E. GRAY, Coordinating Editor

Compiled by more than 90 Experts. 8 Big Sections. Over 1500 pages, 6 x 9, illustrated, \$15.00

With the help of this Handbook, you can now save yourself hours of searching through scattered references for the fact or formula you need. Here, instantly available, are the basic physical data so frequently needed in scientific, engineering, and research endeavors. Sections cover mechanics, acoustics, heat, electricity and magnetism, optics, atomic and molecular physics, and nuclear physics.



## TELEVISION ENGINEERING HANDBOOK

**Just Published.** Covers the entire subject of television technology, including fundamentals as well as practical design data for transmitters, receivers, and networks. The entire field of color television has been treated right up to date. There is new material on

colorimetry, video waveforms and spectra, the design of wideband amplifiers, and of deflection systems. Prepared by 33 specialists. Edited by Donald G. Fink, Director of Research, Philco Corporation. 1483 pages, 6 x 9, 1159 illustrations, \$18.00

## MATHEMATICS AND COMPUTERS

**Just Published.** Surveys the work of the applied mathematician, the problems he studies, the methods he uses, especially computational methods, and the computing devices that help him in the application of mathematics to problems in science, engineering, and busi-

ness. Computing devices and their components are described, especially the automatic digital computer. By George R. Stibitz, Consultant, and Jules A. Larrivee, Worcester Poly. Inst. 225 pages, 6 x 9, 49 illustrations, \$5.00

## ELECTRONIC ANALOG COMPUTERS

**Just Published, 2nd Edit.** Practical presentation of the facts and data to help you do better work with automatic computing devices—in doing problems with them, and adapting or designing them. Covers every step in operation of d-c analog computers, including repetitive computers used as dif-

ferential analyzers and equation solvers; describes the design of circuits, auxiliary components, and complete computer installations for today's applications in industry and science. By Granino A. Korn and Theresa M. Korn, Industrial Consultants, 2nd Ed., 464 pages, 6 x 9, 223 illustrations, \$7.50.

## MECHANICAL DESIGN FOR ELECTRONICS PRODUCTION

**Just Published.** Describes the nonelectronic aspects of the design of equipment using electron tubes and transistors—including radar and communications equipment manufactured for the armed forces. Show how to translate a workable circuit into a durable, economical unit of equipment. Covers such subjects as mechanical layout of equipment, sheet-metal work, machining operations, shielding, sealing compounds, theory and application of mechanisms and electric motors, etc. Contains many tables of properties. By John M. Carroll, Associate Editor, Electronics. 348 pages, 6 x 9, 172 illustrations, \$6.50.

**Inventors and Inventions**

Helps engineers and technicians make money *inventing*. Shows many ways profitable inventions originated. Pointers on protecting, patenting, marketing inventions. By C. D. Tuska, RCA Patent Expert. 173 pp., illus. \$3.75

---

**Patent Notes for Engineers**

Manual for inventors, especially engineers, technicians in industry. Shows what makes an invention patentable. Covers relations with employer, patent attorney; infringement, etc. By C. D. Tuska. 7th Ed., 198 pp., illus. \$4.00

**MAIL THIS FREE EXAMINATION COUPON**

McGraw-Hill Book Co., Inc., Dept. L-4  
327 W. 41st St., New York 36, N. Y.

Send me book(s) checked below for 10 days' examination on approval. In 10 days I will pay for book(s) I keep, plus few cents for delivery costs, and return unwanted book(s) postpaid. (We pay delivery costs if remittance is sent with this coupon; same examination and return privilege.)

- |   |                              |
|---|------------------------------|
| <input type="checkbox"/> American Institute of Physics Handbook, \$15.00  | (Print) Name .....           |
| <input type="checkbox"/> Fink—Television Engg. Handbook, \$18.00          | Address .....                |
| <input type="checkbox"/> Stibitz & Larrivee—Math. & Computers, \$5.00     | City & Zone ..... State..... |
| <input type="checkbox"/> Korn & Korn—Electronic Anal. Computers, \$7.50   | Company .....                |
| <input type="checkbox"/> Carroll—Mech. Des. for Electronics Prod., \$6.50 | Position .....               |
| <input type="checkbox"/> Tuska—Inventors & Inventions, \$3.75             |                              |
| <input type="checkbox"/> Tuska—Patent Notes for Eng., \$4.00              |                              |

For price & terms outside U. S., write McGraw-Hill Intl., N.Y.C.

L-4

# FREED TELEMETERING COMPONENTS

FOR IMMEDIATE DELIVERY  
FROM STOCK

BAND PASS FILTERS				DISCRIMINATORS			
Catalog No.	Center Frequency $F_0$ (Kc)	3DB Bandwidth (per cent of $F_0$ )	Attenuation	Catalog No.	Center Frequency $F_0$ (Kc)	Per cent Deviation of $F_0$	Per cent Linearity
FBP-10	4	9 3/4	19 1/2	DST-10	8 1/2	15	0.5
FBP-11	5.6			DST-11	15		
FBP-12	7.3			DST-12	0.5		
FBP-13	9.6			DST-13	1.0		
FBP-14	1.3			DST-14			
FBP-15	1.7			DST-15			
FBP-16	2.3			DST-16			
FBP-17	3.0			DST-17			
FBP-18	3.9			DST-18			
FBP-19	5.4			DST-19			
FBP-20	7.35			DST-20			
FBP-21	10.5			DST-21			
FBP-22	12.3			DST-22			
FBP-23	14.5			DST-23			
FBP-24	22.0			DST-24			
FBP-25	22.0			DST-25			
FBP-26	30.0			DST-26			
FBP-27	30.0			DST-27			
FBP-28	40.0			DST-28			
FBP-29	40.0			DST-29			
FBP-30	52.5			DST-30			
FBP-31	52.5			DST-31			
FBP-32	70.0			DST-32			
FBP-33	70.0			DST-33			

DISCRIMINATOR LOW PASS FILTERS			
Catalog No.	Center Frequency $F_0$ (cps)	Catalog No.	Attenuation
LPO-10	6	LPO-19	81
LPO-11	8	LPO-20	110
LPO-12	11	LPO-21	160
LPO-13	14	LPO-22	185
LPO-14	20	LPO-23	220
LPO-15	25	LPO-24	330
LPO-16	35	LPO-25	450
LPO-17	45	LPO-26	600
LPO-18	60	LPO-27	660

OUTPUT			
Catalog No.	Center Frequency $F_0$ (cps)	Catalog No.	Attenuation
LPO-10	6	LPO-19	81
LPO-11	8	LPO-20	110
LPO-12	11	LPO-21	160
LPO-13	14	LPO-22	185
LPO-14	20	LPO-23	220
LPO-15	25	LPO-24	330
LPO-16	35	LPO-25	450
LPO-17	45	LPO-26	600
LPO-18	60	LPO-27	660

INPUT			
Catalog No.	Center Frequency $F_0$ (cps)	Catalog No.	Attenuation
LPI-10	400	LPI-17	3,000
LPI-11	560	LPI-18	3,900
LPI-12	730	LPI-19	5,400
LPI-13	960	LPI-20	7,350
LPI-14	1,300	LPI-21	10,500
LPI-15	1,700	LPI-22	12,300
LPI-16	2,300	LPI-23	14,500
		LPI-24	22,000
		LPI-25	30,000
		LPI-26	40,000
		LPI-27	52,500
		LPI-28	70,000

Write for detailed information on these and other components for military and commercial applications. Send for NEW 48 page TRANSFORMER CATALOG. Also ask for complete LABORATORY TEST INSTRUMENT CATALOG.

**FREED**  
**TRANSFORMER CO., INC.**

1722 WEIRFIELD STREET  
BROOKLYN (RIDGEWOOD) 27, N. Y.

Want more information? Use post card on last page.

Texas Instruments Inc. .... 411	Lectronics Research Laboratories ..... 435
Titanium Metals Corp. of America ..... 414	Liberty Electronics Inc. .... 424
Westinghouse—Electronics Tube Division... 406	Metro Electronics Corp. .... 434
	M. R. Co., The ..... 434
	McNeal Electric & Equipment Co. .... 433
	Milano Brothers ..... 432
	Montgomery Equipment Co. .... 434
	Nibur Sales Corp. .... 428
	Pacific International University ..... 424
Arrow Sales Inc. .... 430, 432	Radalab, Inc. .... 431
	Radio & Electronics Surplus ..... 434
	Rex Radio Supply Co. .... 430
Barry Electronics Corp. .... 430, 432, 433, 435	Seg Electronics Co., Inc. .... 432
Belvision Inc. .... 433	Shallcross Manufacturing Co. .... 433
Binneweg Television ..... 424	
Blan ..... 435	
Bolton Laboratories Inc. .... 424	
	"TAB" ..... 436
Calvert Electronics, Inc. .... 432	
C & H Sales Co. .... 427	
Communication Devices Co. .... 428	V & H Radio & Electronics ..... 429
Communications Equipment Co. .... 433	
Compass Electronics Supply Co. .... 425	
Cowan Publishing Co. .... 424	
Cramer Electronics Inc. .... 434	Western Engineers ..... 425
Dayton Air Force Depot ..... 423	Wilgreen Industries ..... 435
	Universal Relay Corp. .... 428 (Formerly Universal General Corp.)
Emeltone Electronics ..... 433	
Engineering Associates ..... 430	Wire & Textile Machinery ..... 424
Fair Radio Sales ..... 433	
Fay-Bill Distributing Co. .... 431	
Finnegan, H. .... 432	
Harjo Sales Co. .... 432	
Instrument Service Corp. .... 434	
JSH Sales Co. .... 426	

This index is published as a service. Every care is taken to make it accurate, but ELECTRONICS assumes no responsibility for errors or omissions.



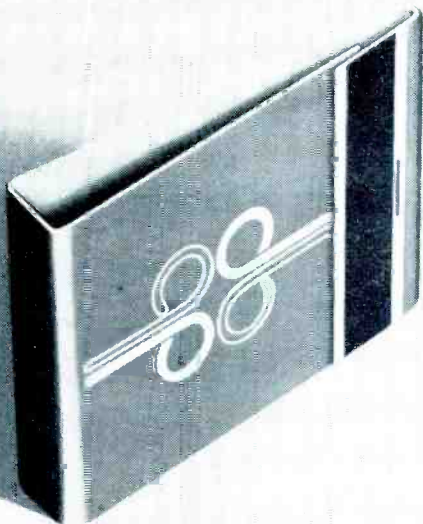
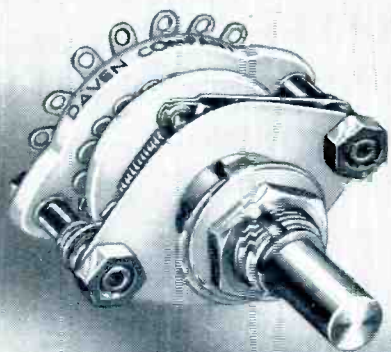

**DID YOU SAY**

**small?**

Occupying less than  $1\frac{1}{2}$  square inches of panel space, this Miniature Ceramic Switch nevertheless contains as many as **18 positions on a single wafer**. And it's rugged! Solid silver alloy contacts, rotors, and slip rings provide low and uniform contact resistance. Ceramic parts are silicone impregnated to function under extreme humidity. Sturdy solder terminals are supplied for wiring. This miniature switch meets and exceeds the electrical and environmental requirements of Mil-Spec S-3786. Flashover voltage at 60 cycles is 1000 volts peak . . . current carrying capacity is 2 amperes. For guided missiles, airborne radar equipment, portable and mobile ground equipment . . . for any application that requires an extremely small and rugged switch, specify Daven's Series M Miniature Ceramic Switches. These units can be "ganged" with up to 8 decks with slight mechanical modifications. 2 or 3 poles per deck may also be obtained as standard. Prototypes can be delivered within 2 weeks.

Write for complete information.



THE **DAVEN** CO.

526 West Mt. Pleasant Ave.  
Route 10, Livingston, N. J.

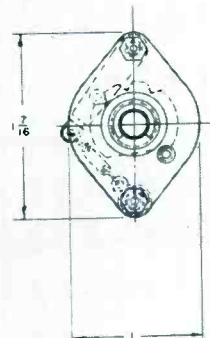
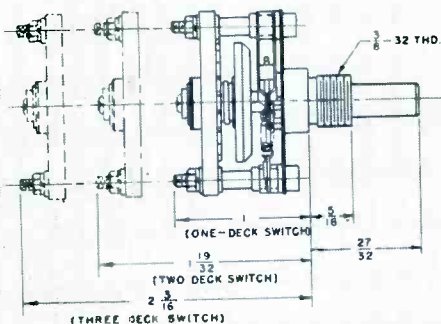

TODAY, MORE THAN EVER, THE DAVEN © STANDS FOR DEPENDABILITY!



Another  
RCA first in  
110° design



## RCA-17BZP4

- Weight—only 10 pounds
- Length—only 12  $\frac{3}{16}$  inches
- No Ion-Trap Magnet Needed

Scale: 1 square = 1 inch

Pioneer in the development of 110°-deflection picture tubes for compact black-and-white TV receivers, RCA presents the 17BZP4—the 17-inch-type, rectangular, glass tube designed specifically to meet popular demand for large-screen TV in smaller, lighter-weight cabinets. Here is a very short picture tube with a large viewing area of 155 square inches—3 inches shorter than types having the same size faceplate and 90° deflection. Super-aluminizing produces bright, high-contrast pictures that have made RCA picture tubes famous. The new RCA electron gun of the “straight-type” design *DOES AWAY ENTIRELY WITH THE NEED FOR AN ION-TRAP MAGNET!*

Available in quantity to meet your production schedule, RCA-17BZP4 is another important addition to RCA's expanding family of 110°-deflection types—including the RCA-21CEP4, the first commercially available 110° tube, a 14-inch developmental type now available for sampling to equipment manufacturers; and a 24-inch type in development.

For sales information and delivery schedule on RCA 110°-deflection types, call your RCA Field Representative. For technical data, write RCA Commercial Engineering, Section D-19-Q-1, Harrison, N. J.

**NOTE:** RCA can supply you with the horizontal and vertical deflection tubes and components needed for 110°-deflection-angle systems.

#### RCA FIELD OFFICES

**East:** Humboldt 5-3900  
744 Broad Street  
Newark 2, N. J.

**Midwest:** Whitehall 4-2900  
Suite 1181,  
Merchandise Mart Plaza  
Chicago 54, Illinois

**West:** Raymond 3-8361  
6355 East Washington Blvd.  
Los Angeles 22, Calif.



**RADIO CORPORATION OF AMERICA**  
Tube Division

Harrison, New Jersey





