

TALK



EDITORIAL office of ELECTRONICS in New York partially shown above includes eleven modular offices for editors at right, men working and not visible, with some overflow into the in-line arrangement at center. Through these doors pass the editors pictured last month

special Sears, Roebuck-size ones that have to be delivered by truck, yet.

"But now you blithely announce that you're going to begin publishing not one, but THREE of these sacred tomes monthly, and Sirs, that puts you 'way at the top of my hate list. Gee, there's a limit to what any woman should have to put up with. A few months of this and the kids and I will have to move out to the garage.

"Housewives, unite!"

► **SAVES FACE . . .** Mailing of the first issue of the ELECTRONICS Business Edition solved a problem for some of the editorial staff.

In planning the layout of the new edition, dummy copies were prepared consisting of headlines set in

type, black boxes for photographs, and wiggly lines to represent text.

Quite often on the way home one of the editors would look up from studying his dummy copy to find his fellow commuters trying to figure out what a sane man could possibly find to study in articles with interesting headlines but with no printed text and black gobs instead of photographs.

With editions now out, an editor can face his friends once more without having them suspect mental degeneration.

► **STRANGE PLACES . . .** Twice in the past year we have seen a copy of ELECTRONICS play a minor role in television dramas presented over New York stations.

The first time, one of the leading characters seemed to be reading an issue, as part of the plot, but we didn't learn what his special interest was.

In the second instance, the issue was lying on top of a table in a harrassed businessman's home. The cover was upside down and caused us to engage in some physical and optical gymnastics in front of the set and family to identify the issue.

We assume that the prop men didn't bother to buy a newsstand magazine, just borrowed a copy of ELECTRONICS from a studio engineer.

Which reminds us that for the past two and a half years the NBC "Home" show has been subtitled "the electronic magazine for women."

Published three times a month, with an additional issue in June, by McGraw-Hill Publishing Company, Inc., James H. McGraw (1860-1948), Founder, Executive, Editorial and Advertising Offices: McGraw-Hill Building, 330 W. 42 St., New York 36, N. Y. Longacre 4-3000. Publication Office, 99-129 North Broadway, Albany 1, N. Y. Donald C. McGraw, President; Joseph A. Gerardi, Executive Vice President and Treasurer; John J. Cooke, Secretary; Nelson Bond, Executive Vice President, Publications Division; Ralph B. Smith, Vice President and Editorial Director; Joseph H. Allen, Vice President and Director of Advertising Sales; A. R. Venezian, Vice President and Circulation Coordinator. Subscriptions: Address correspondence to Electronics—Subscription Service, 330 W. 42nd St., New York 36, N. Y. Allow one month for change of address. Subscriptions are solicited only from persons engaged in theory, research, design, production, maintenance and use of electronic and industrial control components, parts and products. Position and company connection must be indicated on subscription orders.

Single copies 75¢ for Technical Edition and 50¢ for Business Edition in United States and possessions, and Canada; \$1.50 and \$1 for Latin America; \$2.00 and \$1.50 for all other foreign countries. Buyers' Guide \$3.00. Subscription rates—United States and possessions, \$6.00 a year; \$9.00 for two years. Canada, \$10.00 a year; \$16.00 for two years. Other western hemisphere countries and the Philippines, \$15.00 a year; \$25 for two years. All other countries \$20.00 a year; \$30.00 for two years. Three-year rates accepted on renewals only, are double the one-year rate. Entered as second-class matter August 29, 1936, at the Post Office at Albany, N. Y., under act of Mar. 3, 1879. Printed in U.S.A. Copyright 1957 by McGraw-Hill Publishing Co., Inc.—All Rights Reserved. BRANCH OFFICES: 520 North Michigan Avenue, Chicago 11, Ill.; 68 Post Street, San Francisco 4; McGraw-Hill House, London E. C. 4; National Press Bldg., Washington, D. C. 4; Architects Bldg., 17th & Sansom Sts., Philadelphia 3; 1510 Hanna Bldg., Cleveland 15; 856 Penobscot Bldg., Detroit 26; 3615 Olive St., St. Louis 8; 350 Park Square Bldg., Boston 16; 1321 Rhodes Hagerly Bldg., Atlanta 3, Ga.; 1125 West Sixth St., Los Angeles 17; 919 Oliver Building, Pittsburgh 23. ELECTRONICS is indexed regularly in The Engineering Index.

WHY SETTLE FOR LESS?

WHEN YOU SPECIFY POWER SUPPLIES

... you are entitled to all of the benefits of complete facilities, thoroughly experienced engineers, wide product range, prompt delivery and competitive prices.

WHY SETTLE FOR LESS?

Take a standard DC requirement, anywhere between 6 and 1000 volts. You need a good, reliable standard DC source — you want to be able to install it and forget it. You want it promptly and, since it's a standard item, you want it for a reasonable price.

If you investigate Sorensen's "Nobatron" group — more than 70 models available "off the shelf" — and look a bit deeper than the electrical and mechanical specs, here's what you'll find:

*Reg. U.S. Pat. Off. (NO BATTERIES — ELECTRONIC CONTROL)

THE OUTSIDE APPEARANCE —



clean, functional, careful attention to small details. Not always vital, but indicators of quality design, workmanship, and materials.

IF WE CAN MAKE A COMPONENT BETTER, WE DO.



If somebody else can do it better, more economically and faster — like we make power supplies — we buy it. Either way, it means better quality for you.

INSIDE, TOP QUALITY COMPONENTS —



rugged construction — sound engineering proved by tens of thousands of successful units.

THE ACCUMULATED EXPERIENCE OF SORENSEN'S ENGINEERING STAFF —



specializing in power control — is more than 215 man-years. That means less "second guessing," less engineering time, faster delivery, lower cost. And better units.

NEAT, UNCLUTTERED WIRING —



firm, long lasting connections — hallmarks of skilled people. You don't learn this workmanship overnight, but it's the key to a reputation for precision.

OUR SALES ENGINEERING STAFF AND MANUFACTURERS REPRESENTATIVES



work together to put all of these facilities, all of this experience, at your immediate disposal. All it takes is a phone call.

In short, don't just buy "a power supply." Whether it's a precision regulated source for a special job, or a standard low cost unit, start with Sorensen ...



SORENSEN & COMPANY, INC.

375 FAIRFIELD AVE. • STAMFORD, CONN.

Europe, contact Sorensen-Ardag, Eichstrasse 29, Zurich, Switzerland, for all products including 50 cycle, 220 volt equipment.

Want more information? Use post card on last page.

February 1, 1957 — ELECTRONICS

See The Muirhead Synchro Test Equipment at Booth 3230

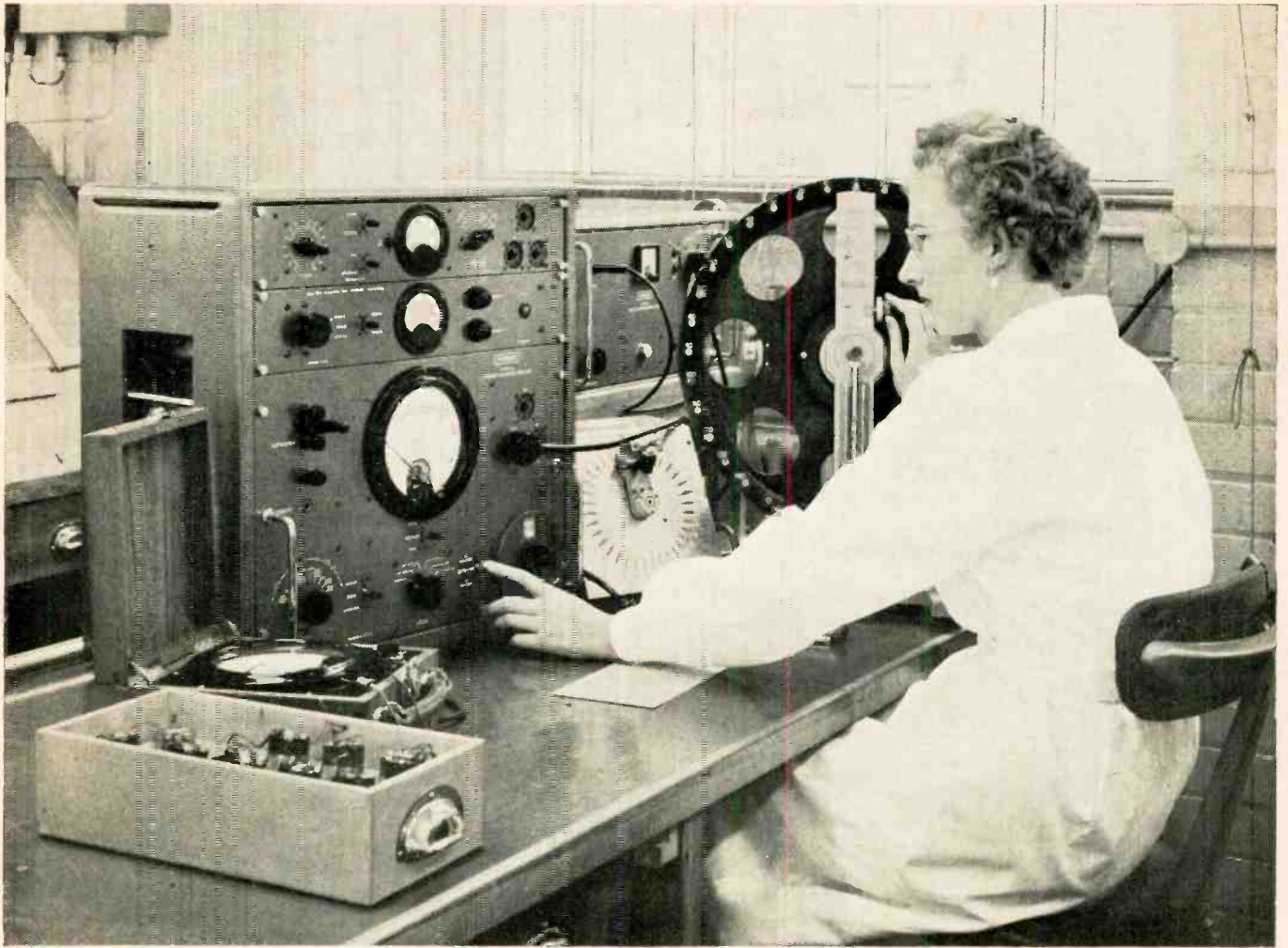

Bring a MIL Synchro to the I.R.E. Show New York
(March 18-21)

and have it tested on the Muirhead Test Equipment,
for 115V 400 c/s Control Synchros MIL Types 11, 15, 18 and 23.
Muirhead Synchro Test Equipment can be supplied with special adaptors
for near MIL Synchros.
The equipment is fully described in Publication 7741,
available on request.

MUIRHEAD PRECISION ELECTRICAL INSTRUMENTS

MUIRHEAD INSTRUMENTS INC., 677 Fifth Avenue, New York 22, N.Y., U.S.A.
MUIRHEAD INSTRUMENTS LIMITED, STRATFORD, ONTARIO, CANADA.
MUIRHEAD & CO. LIMITED, BECKENHAM, KENT, ENGLAND.

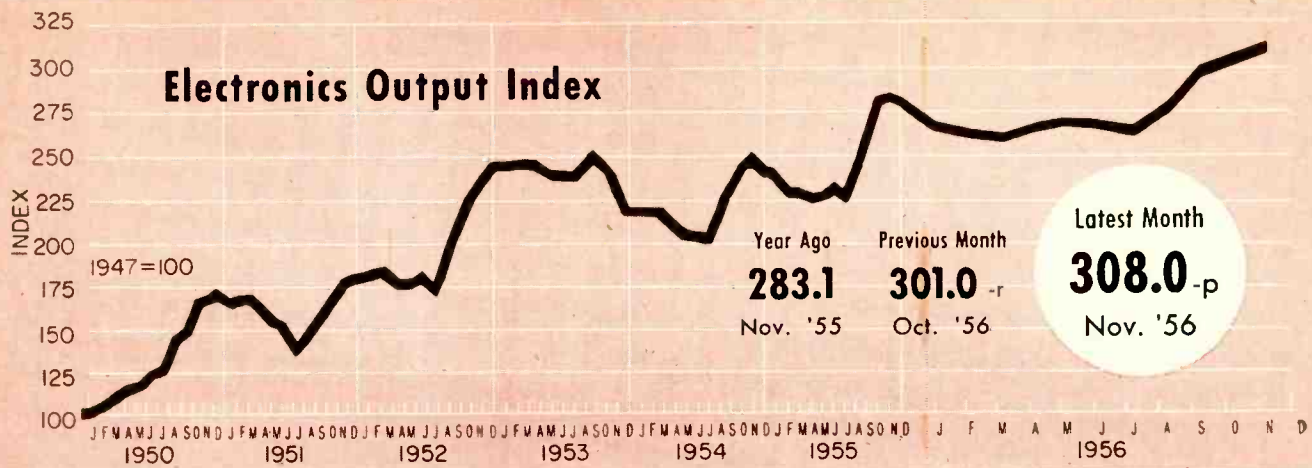

FIGURES OF THE MONTH

	Latest Month	Previous Month	Year Ago
RECEIVER PRODUCTION			
(Source: RETMA)	Nov. '56	Oct. '56	Nov. '55
Television sets, total	679,993	820,781	631,654
With UHF	116,183	131,243	114,645
Color sets	nr	nr	nr
Radio sets, total	1,381,831	1,348,864	1,580,797
With F-M	2,326	nr	44,357
Auto sets	609,139	547,818	733,859

	Latest Month	Previous Month	Year Ago
RECEIVER SALES			
(Source: RETMA)	Nov. '56	Oct. '56	Nov. '55
Television sets, units	560,391	683,573	591,366
Radio sets (except auto)	689,409	585,666	865,602

	Latest Month	Previous Month	Year Ago
RECEIVING TUBE SALES			
(Source: RETMA)	Nov. '56	Oct. '56	Nov. '55
Receiv. tubes, total units	39,489,000	42,921,000	45,965,000
Receiv. tubes, value	\$31,476,000	\$34,362,000	\$34,788,000
Picture tubes, total units	957,765	1,146,428	1,086,998
Picture tubes, value	\$16,014,839	\$19,786,764	\$20,894,647

	Quarterly Figures		
	Latest Quarter	Previous Quarter	Year Ago
INDUSTRIAL TUBE SALES			
(Source: NEMA)	2nd '56	1st '56	2nd '55
Vacuum	\$7,680,250	\$8,754,054	\$9,832,751
Gas or vapor	\$2,983,488	\$3,394,059	\$3,365,008
Magnetrons and velocity modulation tubes	\$16,254,025	\$15,136,522	\$13,193,395
Gaps and T/R boxes	\$1,238,469	\$1,455,558	\$1,677,574

	3rd '56	2nd '56	3rd '55
MILITARY PROCUREMENT			
(Source: Defense Dept.)	3rd '56	2nd '56	3rd '55
Army	\$23,107,000	\$44,882,000	\$19,477,000
Navy	\$22,273,000	\$34,132,000	\$20,054,000
Air Force	\$84,952,000	\$128,781,000	\$128,023,000
Total—Electronics	\$130,332,000	\$207,795,000	\$167,554,000

	Latest Month	Previous Month	Year Ago
BROADCAST STATIONS			
(Source: FCC)	Dec. '56	Nov. '56	Dec. '55
TV stations on air	511	511	482
TV stations CPs—not on air	120	117	108
TV stations—new requests	59	55	29
A-M stations on air	3,008	2,987	2,824
A-M stations CPs—not on air	117	121	111
A-M stations—new requests	291	288	229
F-M stations on air	530	528	540
F-M stations CPs—not on air	24	22	17
F-M stations—new requests	5	7	3

	Latest Month	Previous Month	Year Ago
COMMUNICATION AUTHORIZATIONS			
(Source: FCC)	Nov. '56	Oct. '56	Nov. '55
Aeronautical	53,192	51,826	43,939
Marine	60,153	59,073	53,622
Police, fire, etc.	21,829	21,539	19,637
Industrial	32,788	32,434	27,427
Land transportation	9,287	9,227	8,381
Amateur	154,839	154,311	142,408
Citizens radio	22,036	21,356	14,147
Disaster	330	330	319
Experimental	775	744	666
Common carrier	2,559	2,358	2,056

	Latest Month	Previous Month	Year Ago
EMPLOYMENT AND PAYROLLS			
(Source: Bur. Labor Statistics)	Oct. '56	Sept. '56	Oct. '55
Prod. workers, comm. equip.	419,500-p	403,100	408,600
Av. wkly. earnings, comm.	\$78.12-p	\$77.33-r	\$75.12
Av. wkly. earnings, radio	\$76.07-p	\$74.74-r	\$71.40
Av. wkly. hours, comm.	40.9 -p	40.7	41.5
Av. wkly. hours, radio	40.9 -p	40.4-r	40.8

	Latest Month	Previous Month	Year Ago
SEMICONDUCTOR SALES ESTIMATES			
	Oct. '56	Sept. '56	Aug. '56*
Transistors, Units	1,290,000	1,155,000	1,315,000

	Latest Month	Previous Month	Year Ago
STOCK PRICE AVERAGES			
(Source: Standard and Poor's)	Dec. '56	Nov. '56	Dec. '55
Radio-tv & electronics	345.2	353.9	451.5
Radio broadcasters	454.1	446.9	519.1
p—provisional r—revised nr—not reported			
*1955 not available			

FIGURES OF THE YEAR

Television set production	6,730,045	7,151,895	— 5.8	7,756,521
Radio set production	12,266,591	13,108,365	— 6.4	14,894,695
Television set sales	5,847,563	6,487,617	— 9.9	7,421,084
Radio set sales (except auto)	6,680,127	5,532,583	+ 20.7	6,921,384
Receiving tube sales	429,846,000	441,753,000	— 2.7	479,802,000
Cathode-ray tube sales	10,191,545	9,992,769	+ 2.0	10,874,234

TOTALS FOR FIRST ELEVEN MONTHS

	1956	1955	Percent Change	1955 Total
Television set production	6,730,045	7,151,895	— 5.8	7,756,521
Radio set production	12,266,591	13,108,365	— 6.4	14,894,695
Television set sales	5,847,563	6,487,617	— 9.9	7,421,084
Radio set sales (except auto)	6,680,127	5,532,583	+ 20.7	6,921,384
Receiving tube sales	429,846,000	441,753,000	— 2.7	479,802,000
Cathode-ray tube sales	10,191,545	9,992,769	+ 2.0	10,874,234

INDUSTRY REPORT

electronics—February 1 • 1957

Sonar Sales Register Five-Fold Growth

Increasing military and commercial sales lift volume beyond \$35 million

UNDERWATER electronics in the form of all types of sonar equipment has grown into a sizable business for marine equipment manufacturers. Sales hit a volume of nearly \$35 million in 1954, according to the Census Bureau, and probably exceed \$40 million now if the past growth trend has held its course. Since 1947, when volume was estimated at less than \$7.5 million, sonar sales have increased five-fold.

► **Market**—It has been estimated that the military market for sonar accounts for 90 percent of the total business with the commercial and pleasure boat field taking the remaining 10 percent. Today, many of the nation's 450,000 commercial fishing boats have the equipment. Not only has it helped to spot obstructions but has also saved expensive nets from being ripped and ruined. Sonar has also helped to improve the catch. It enables the fisherman to know at what depth to keep his nets. For the commercial fishing and pleasure boat field, an annual sonar business volume of \$2.5 million has been estimated. The remainder of the business goes to the larger commercial ships with 30 to 40 sales a year and to the military.

► **Makers**—According to the Census Bureau there are between 20 and 30 manufacturers of sonar.

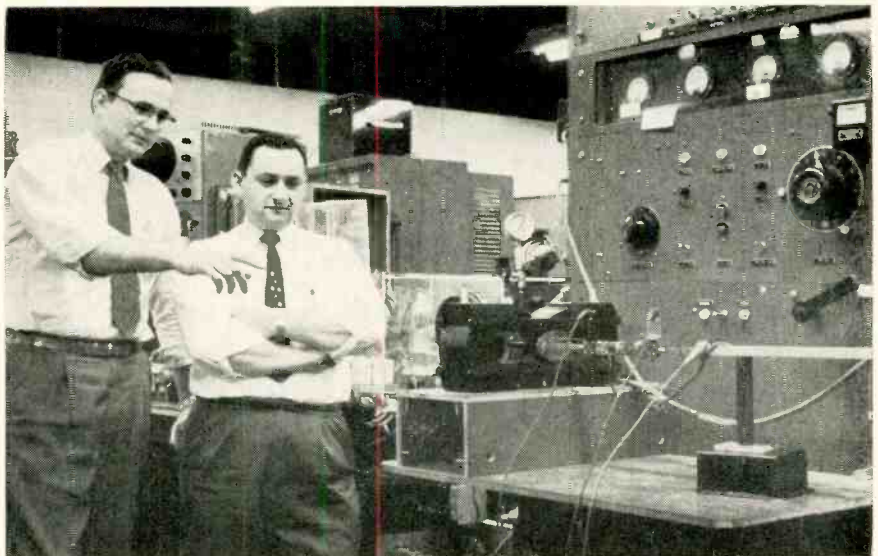

ENGINEERS at Sylvania test out a magnetron as new contracts . . .

Spur Microwave Tube Output

Contracts for magnetrons and klystrons boost plant expansion and sales volume

INCREASING activity in the \$ multi-million microwave tube field has been marked by new business and defense contracts and sizable plant expansion plans by firms in the field.

► **Business**—Sylvania will start development and production operations under a \$1.4-million defense contract for four types of magnetrons in the next few months. Raytheon was awarded a \$1.4-million magnetron contract and Westinghouse also began production on the tubes. GE announced that its line of voltage-tunable magnetrons will be in volume production this year.

In the klystron field, Sperry an-

nounced plans to double production at its Florida plant. Varian Associates has built and installed \$500,000 worth of tube processing equipment to go into production on a \$4-million order for their V-87 million-watt pulsed klystron.

► **Expansion**—Increasing business, both military and civilian, has forced the microwave tube maker to expand plant and facilities. Sylvania's microwave tube lab in Mountain View, Calif., plans to add 18,000 sq ft of space for its engineering research and development work. Varian, which began operations in a 1,200 sq ft plant, is completing a 126,000 sq ft vacuum-tube factory in Stanford Industrial Park. The new tube plant is designed to be enlarged to 252,000 sq ft if necessary.

GE announced that facilities at

the firm's microwave lab at Stanford University are being increased to provide more efficient and higher power microwave developments particularly for defense systems.

► **Klystrons**—Sperry, in planning to double production, will expand its 18-month old Gainesville, Florida plant. The addition to be completed by next summer will produce multi-million watt klystrons for high-power missile guidance systems.

The expanded plant is expected to employ 600 and will contain over \$3.5 million of scientific instruments, automated devices and special machine equipment. Production lines of the division are currently producing 17 types of microwave tubes for industry and the military.

► **Future**—Varian expects that microwave tube sales, which account for about 55 percent of its total dollar volume, will increase by as much as 100 percent over the next five years. GE, which lumps magnetrons and klystrons in with other power tubes, sees a 10 percent increase in the power tube market in 1957 and a 100 percent increase during the next ten years.

Census figures show that the magnetron field alone has had a ten-fold sales increase since 1947.

One Radar Coupler—Well Done



Chassis that connects a firecontrol system to the automatic pilot control system, to automatically zero an airplane in on its target, goes into an oven for tests at Westinghouse. It's designed for operation at 400 F

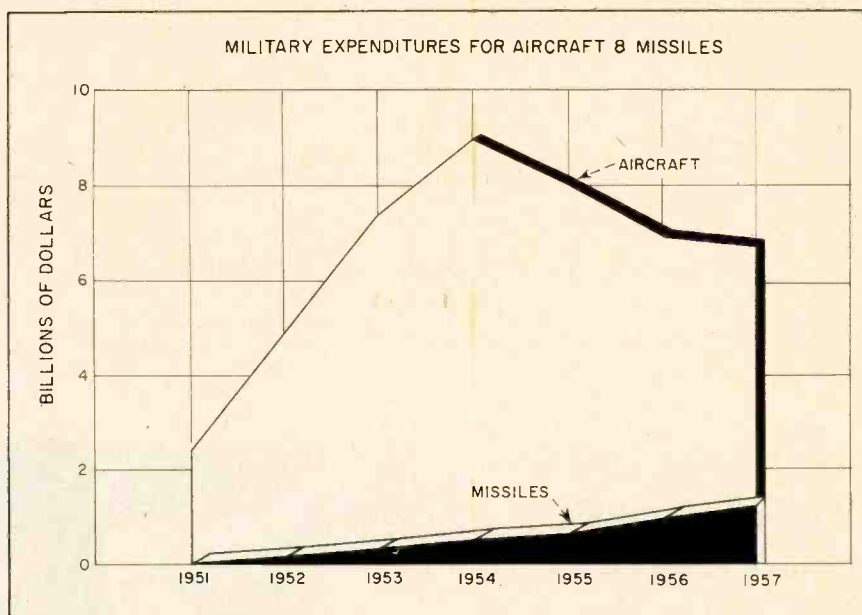

Aircraft Electronics Levels Off

Planes still account for the king-sized share of airborne business despite missile growth

ALTHOUGH military expenditures for guided missiles have risen at a rapid rate, the missile electronics business has a long way to go before it becomes the market that aircraft represents.

► **Comparison**—Right now defense expenditures for manned aircraft are about six times greater than those for missiles, as shown in the chart. Although production of military airplanes has been tapering off since 1953, according to Aircraft Industries Association of America, funds for procurement have held relatively steady due to the heavier and more expensive craft. Some 7,000 military planes were produced in 1956. In 1955 the total was about 8,000 units. A further tapering off is expected this year.

Despite the decline in plane unit production, military aircraft takes about 85 percent of Defense department procurement expenditures for aircraft and guided missiles. The AIA predicts that beginning in fiscal 1958 military orders will probably be in a ratio of 65 percent to 35 percent in favor of manned aircraft and that it will be 1961 before the ratio evens out at 50-50.

► **Electronics**—The modern jet bomber uses more than 1,000 vacuum tubes that range in cost from 56 cents to \$681 each while a missile may require no more than eight tubes.

Some modern fighter planes use more electron tubes or transistors than 80 home radios. The Sidewinder missile, on the other hand, uses no more tubes than one average home radio and is said to be no more complex.

Paper Types Lead Capacitor Sales

Shipments have tripled in ten years and now account for 43 percent of sales

CAPACITOR manufacturing has grown into a kingsize business in the past ten years. This is revealed in the latest census report that shows volume grew from \$50 million in 1947 to \$158 million in 1954.

► **Breakdown**—Paper capacitors account for 43 percent of the industry's dollar volume. They rank next to ceramic capacitors in unit volume with some 443 million produced in 1954 compared to 227 mil-

(Continued on page 14)

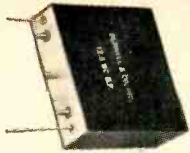

SUBMINIATURE FILTERS

- for I.F. amplifiers, printed circuit use
- temperature compensated to .15% from -55°C to $+85^{\circ}\text{C}$
- for operations above 1 mc
- dimensions: $13/16'' \times 2-1/2'' \times 2''$ high



ENCAPSULATED TOROIDS

- hermetically sealed
- high Q
- center-mounting permits stacking
- complete range of sizes and types
- dimensions: $21/32'' \times 3/8''$



TOM THUMB TELEMETERING FILTERS

- miniaturized for guided missiles
- high temperature stability
- designed to withstand shock and vibration
- hermetically sealed—wt. 1.5 oz.
- dimensions: $45/64'' \times 45/64'' \times 2''$ high



SUBMINIATURE ADJUSTOROIDS

- precise continuous adjustment of inductance over a 10% range
- no external control current needed
- hermetically sealed
- low cost—wt. .83 oz.
- dimensions: $45/64'' \times 45/64'' \times 3/4''$ high



you're all set to roll...

...with a toroid, filter or related network by Burnell.

For Burnell *specializes* in these components; in manufacturing them *and* in delivering them on schedule — at competitive prices.

Today Burnell makes toroids, and the filters of which they are the basic components, small enough to meet a multitude of new purposes . . . in aircraft and guided missiles . . . in receivers, carrier and telemetering systems.

Very likely we already have the answer to your network needs among our extensive files. If not, we can swiftly find that answer for you. Try us and see.

Burnell & Co., Inc.



first in toroids, filters and related networks

45 WARBURTON AVENUE, YONKERS 2, N. Y. TELEPHONE: YOnkers 5-6800 DEPT. E-27

PACIFIC DIVISION: 720 MISSION STREET, SOUTH PASADENA, CALIFORNIA TELETYPE: PASADENA 7578

You are warmly invited to visit our Booth, #2131 on the second floor of the IRE show

lion in 1947. Electrolytics, with 75 million produced in 1954, ranked second in sales and accounted for 24 percent of total dollar volume. Ceramic capacitors led in units with 560 million but accounted for only 17 percent of total dollar shipments volume. Mica capacitors with shipments of 105 million units and other types with unit shipments of 79 million followed. In 1947 mica capacitors led ceramic types in dollar shipments but even then were behind in unit volume.

► **Companies** — Today there are probably over 90 companies producing capacitors for the electronics industry, according to figures from the Electronic Production Resources Agency. EPRA estimates that about 25 of the companies produce the bulk of U.S. output. The number of companies in the field has grown with its volume. In 1952 there were about 60 companies manufacturing the components.

► **Need** — The electronics division of the Business and Defense Services Administration with the EPRA recently reviewed with 14 capacitor makers the ability of the capacitor industry to meet mobilization requirements. Deficiencies due to shortages of tantalum and other materials were found. As a result the government is to be asked to look into the tantalum situation. Capacitor manufacturers also ex-

pressed concern over their supplier's capacity to come up with needed quantities of sub-components in case of emergency, such as pressure seals, small metal cases, capacitor grade paper and very thin aluminum foil. More than 60 cate-

gories of capacitors were studied in the review.

On the whole, however, the meetings indicated that U.S. capacitor manufacturers have sufficient capacity to produce most types in the

quantities needed to meet an emergency. Manufacturers indicated, however, that the exacting specifications for missile capacitors will substantially reduce the industry's ability to meet emergency needs.

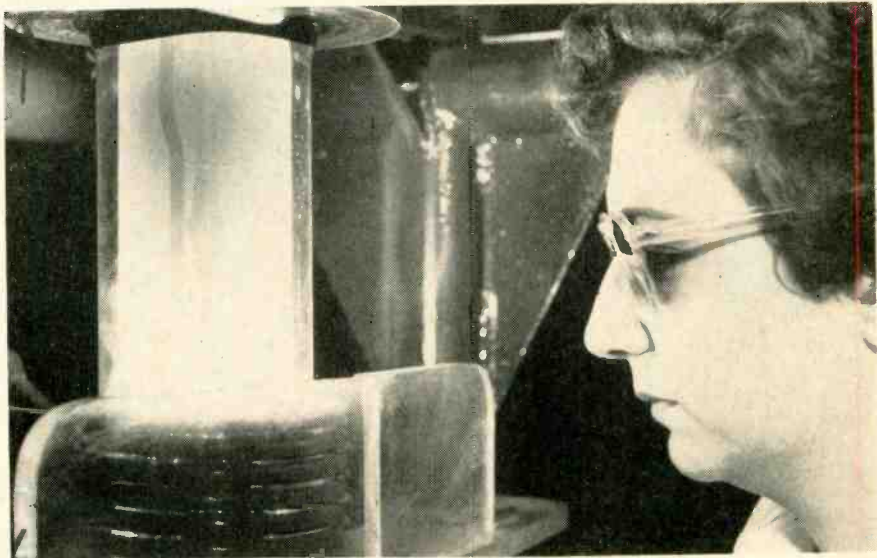

FURNACE at Hughes Aircraft converts coarse nuggets into silicon ingots as . . .

Silicon Output Increases

New company enters field. Consumption grows and production increases as prices drop

WITH demand for pure silicon growing fast, there are only a handful of commercial sources for the material in the United States, although a score of companies produce it experimentally or for their own use.

Latest company to enter the supply field is Flight Research of Richmond, Va. which recently established a division for the manufacture of single-crystal silicon. The firm's plans include growing silicon crystals to specification for rectifier and transistor manufacturers. The company is now in production and has 50 gram boules available. They measure 2.5 inches high and 1.5 inches in diameter.

► **Source**—Sylvania has stepped up its silicon production. It has been operating a production unit since last year that is yielding commercial quantities of pure silicon on a regular basis. Through plant expansion, production quantities are being increased. The firm's tung-

sten and chemical division is being expanded by 48,000 sq. ft.

► **Price**—As silicon production has increased, prices have dropped. DuPont recently dropped prices on pure silicon for a third time, reducing them from \$350 to \$320 a pound. Solar-cell-grade silicon was cut from \$180 to \$150 a pound. Sylvania presently offers transistor grade silicon at \$704 a kilogram and solar grade at \$330.

► **Market**—Texas Instruments has announced quantity price reductions up to 10 percent on production-type silicon transistors and rectifiers.

There are some 19 types of silicon transistors available from the company.

Hughes Aircraft, which estimates that it does 20 percent of the total semiconductor business, says that its silicon sales are to a point where they now approach in dollar volume the sales of its germanium products. This could place its present silicon sales at \$4 to \$6 million. The company has indicated that technical problems in developing

(Continued on page 12)

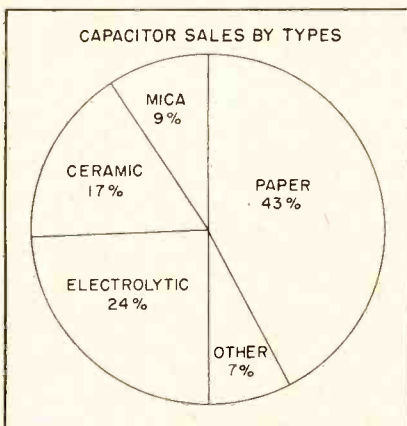

pressed concern over their supplier's capacity to come up with needed quantities of sub-components in case of emergency, such as pressure seals, small metal cases, capacitor grade paper and very thin aluminum foil. More than 60 cate-



new method solves **DIFFICULT R-F NOISE** *problem*

Of course he's relaxed!

Faced with a new version of the same old r-f interference vs. space-weight problem, he came upon a solution that sidestepped the usual time, trouble, and expense . . . by calling on Sprague.

The perfect solution was found almost immediately among the more than four thousand filter designs already available from Sprague.

Even if his problem *had* required the weeks of research—special measurements and tests—Sprague field consulting service—he would be no less at ease.

With mass production facilities on both the East and West Coasts, deliveries are no problem either.

If you, too, have an interference problem, pick up your phone and call your nearest Sprague Electric Field Engineering Laboratory.

They are located at 12870 Panama Street, Los Angeles 66, California (TEXas 0-7531 or EXmont 8-2791); 224 Leo Street, Dayton 4, Ohio (ADams 9188); 35 Marshall Street, North Adams, Massachusetts (MOhawk 3-5311).

see

SPRAGUE®

for filters



Top engineers of Hoffman Electronics look over firm's new silicon solar cell portable radio

advanced silicon diodes and transistors are rapidly being overcome.

► **Solar Cell**—Use of solar-cell-grade silicon is also increasing. At least two companies now have solar portable radios on the market. Hoffman Electronics introduced a transistorized model last month that has the silicon solar battery pack encased in the carrying handle. The cells are produced by the company's semiconductor division in Evanston, Ill.

Manufacturers Forecast Business For 1957

Firms see overall good year ahead but with specialized problems for some segments

YEAR-END reviews by associations and major manufacturers in the electronics field also contain some crystal gazing on what 1957 may hold in store for the industry. Here is a rundown of some of the forecasts:

► **RETMA** — President W. R. G. Baker predicts that 1957 will bring an added 10-percent growth to the electronics industry. He sees sales of closed-circuit tv exceeding \$6 million in 1957 and the percentage of defense spending for electronics increasing by 100 percent in the next 10 years. Hi-fi is expected to remain in good demand and transistor output for 1957 is estimated at 22 million units.

► **NICB** — Economists at a forum held by the National Industrial Conference Board gave an overall view of what businessmen, electronic and otherwise, might expect this year. Consensus of the forum is that 1957 will be a record year for total business but only moderately above the record set in 1956. Rising national output and rising prices during the first-half of 1957, and a tapering off or plateau in business growth during the following six months was foreseen by 14 economists at the forum.

► **Admiral** — President Ross D. Siragusa made the forecast that

tv output for the industry this year might reach 9-million units with nearly half in 10, 14 and 17-inch portable models. Color sales are estimated at nearly 500,000 units for the year and radio may increase 5 percent.

► **GE**—President Ralph J. Cordiner predicted that shipments of the electrical manufacturing industry, which includes electronics, will rise 4 to 5 percent to a record \$21 billion. The company is sticking to its plans for a \$500-million capital expenditure in the 1956-58 period despite a cutback in three planned

(Continued on page 14)

Business Briefs

► Sale of \$8 million in debentures this year is planned by Daystrom. Proceeds will be added to general funds and used, among other things, for plant additions and working capital

► Sharp rise in tv and hi-fi sales will boost Magnavox sales to nearly \$50 million for the first six months of its fiscal year compared to \$34 million during the period last year. Annual sales will approach \$95 million this year compared to \$70 million in fiscal 1955. A \$6-million loan from two insurance companies will be used to retire a \$2.8-million loan and bring working capital to approximately \$19 million

► Parent company to 13 major divisions including several in electronics, Thompson Products, anticipates total sales for 1956 in the range of \$300 million. It sees sales in 1957 exceeding by a substantial margin the previous record of \$326 million set in 1953. Its sales currently run at annual rate in excess of \$350 million

► Business developed more favorably than expected during 1956, according to Philips. Sales for the Netherlands electronics manufacturer totaled \$466.5 million in the first 9 months of 1956 compared to \$399.8 million for the period in 1955, a 16.7-percent increase. The company now employs 150,000 workers compared to 137,000 a year ago

► Year-old Pacific Automation Products had gross sales of \$1.1 million for the first 11 months of 1956. It currently serves 150 accounts

► Producer of patented cable and panel equipment and triaxial connectors, Mutual Electronic Industries, was acquired by Sightmaster Corp., manufacturer of fuses and hi-fi equipment

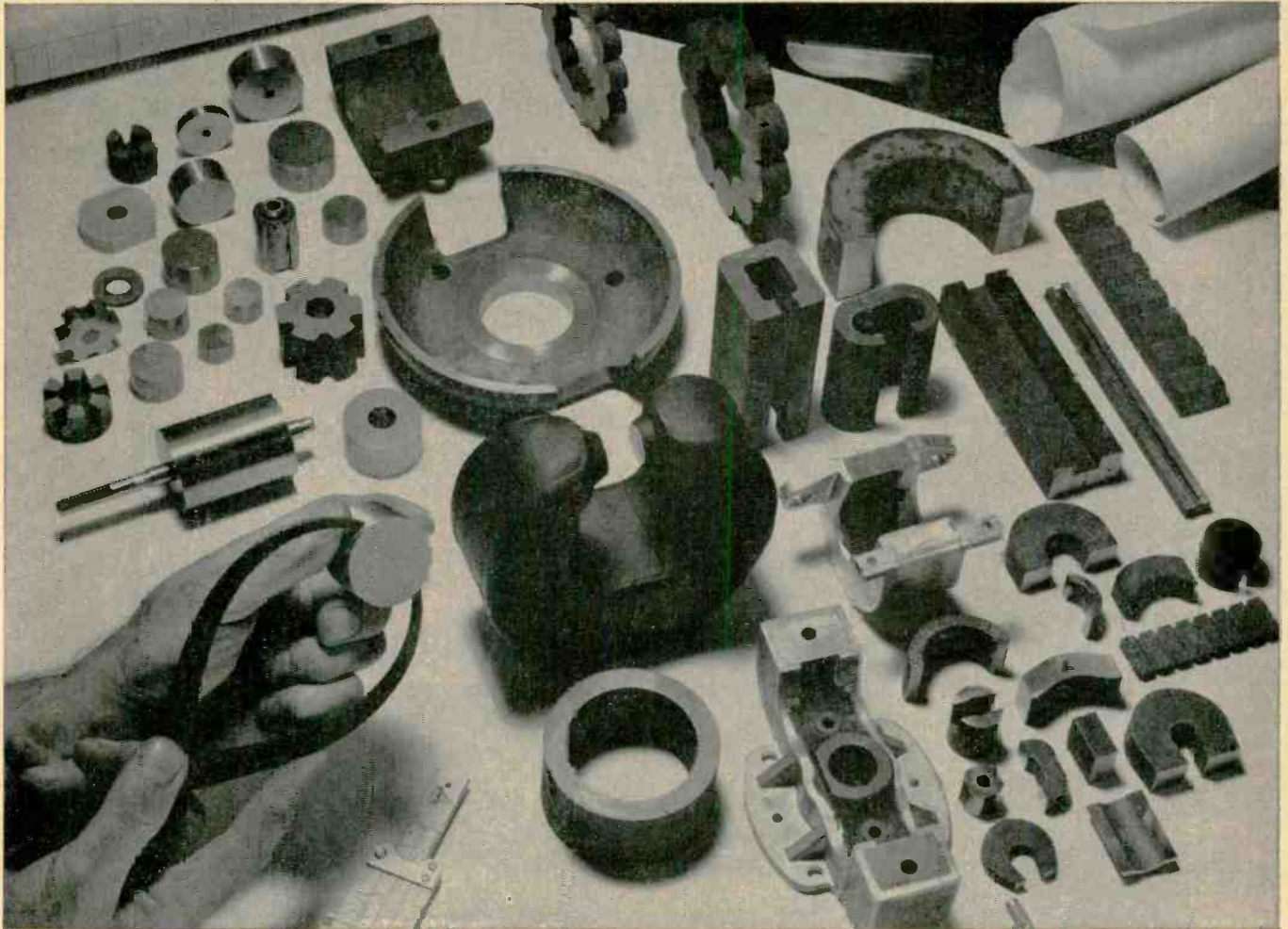

For A-N-Ything in Alnico Magnets Specify "ARNOLD"

Materials

Cast Alnico Magnets are most commonly made in Alnico V, VI or III. Sintered Alnico Magnets usually are made in Alnico II, V or VI. Special permanent magnet materials include Vicalloy, Cunico, and Cunife.

Engineering Data

Write for your copy
BULLETIN GC-106 B

Contains useful data on Alnico Magnets, their physical and magnetic properties. Also lists stock items and standard tolerances for cast and sintered magnets.

ADDRESS DEPT. E-72

Your best bet when looking for a source of Alnico magnets and assemblies is Arnold—producer of the most complete line of magnetic materials in the industry. Arnold can supply your need for any size or shape of Alnico magnet, as illustrated by the variety pictured above. Weights range from a few ounces to 75 pounds or more. Die-cast or sand-cast aluminum jackets, Celastic covers, etc., can be supplied as required. Complete assemblies are available with Permendur, steel or aluminum

bases, inserts and keepers as specified—magnetized and stabilized according to the requirements of the application.

A wide range of the more popular shapes and sizes of cast and sintered magnets are carried in stock at Arnold. Unsurpassed plant facilities make possible quick delivery of all special orders. • *Let us handle your magnetron, traveling wave tube and wave guide permanent magnet requirements, or any other magnetic material specification you may have.*

WSW 6445

THE ARNOLD ENGINEERING COMPANY



Main Office & Plant: Marengo, Illinois

Repath Pacific Division Plant: 641 East 61st Street, Los Angeles, Calif.

District Sales Offices:

New York: 350 Fifth Ave. Los Angeles: 3450 Wilshire Blvd. Boston: 200 Berkeley St.

plant expansions. It was predicted that within the next ten years GE will go substantially all the way electronically with many of the jobs now done electrically taken over by electronics.

► **Motorola**—President Robert W. Galvin saw industry tv sales possibly reduced to the area of 6.8 million in 1957 with portables accounting for 2.5 million of the total. Color tv sales were expected to exceed 300,000 and consumer radio were seen rising by five to ten percent in the first half of the year. For the first half of 1957, Galvin predicted an industry increase of 20 percent in hi-fi record player sales. In the first half of 1956, over 920,000 units were sold, according to the company.

► **Philco** — President James M. Skinner sees production and sales of tv sets leveling off at about 7 million in 1957. He said that the largest gains in 1957 will be made in the fields of military and industrial electronics with a gain of 10 percent over a 1956 volume of almost \$3 billion.

Hot Air Powers Thermopile Radio



Metal tube and thermopile, mounted on glass chimney of paraffin lamp, utilizes wasted heat to operate transistorized radio. (ELECTRONICS, p 196, May, 1946) Receiver, developed by The Philips Industries, uses 7 transistors

Color Television Shows Progress

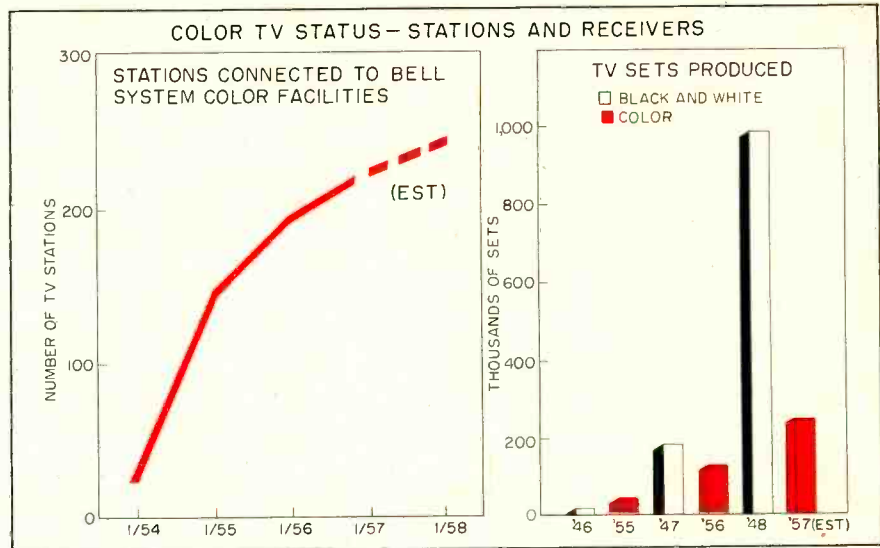

Although its growth did not meet expectations in 1956, it moved ahead significantly

DESPITE the fact that color television did not turn out to be the whiz kid of the electronics industry during 1956, it nevertheless made substantial progress both in number of color tv stations and in color set production.

► **Service**—Number of tv stations that have color tv service available over Bell System routes increased from 190 at the beginning of 1956 to 219 at the beginning of 1957, an increase of 29 stations. This is a smaller increase than took place during 1955 when 51 stations were added for color network service and 1954 when 118 stations had network color service available. However, over half of the 428 tv stations in the U.S. are now on color network routes.

► **Networks**—American Broadcasting does not as yet have any of its stations or studios equipped for color but has funds set aside so that it can convert to color at any time. It's new facilities being built in Chicago, New York and Hollywood will be able to handle color equipment. AB-PT has obtained a \$60-million loan to finance further growth of the network.

Total of 146 of CBS's 216 tv affiliates are equipped for network color. Of these 22 have color slide and film equipment and another 11 have color studio equipment including color cameras as well as slide and film equipment.

This represents a substantial increase for the network. A year ago 110 of its affiliates were equipped for network color including six with color studio, film and slide gear.

At the end of 1956, 132 of NBC's 201 affiliated tv stations were able to rebroadcast network color shows. Forty-nine of the stations were equipped for some form of local color broadcasting and 21 had color cameras for live programs. A year ago 106 of the network's stations were set for network color, 32 had slide and film equipment and 11 could originate live color shows.

► **Sets**—The chart shows the relative rate of growth of color tv set production compared to black-and-white during its beginning years. It shows that although color is not growing as fast as black and white, production of the sets has more than tripled in the past three years. This year with production of some 300,000 color sets forecast, color tv will fall further behind the growth rate of black and white sets but will still represent plus business.

(Continued on page 16)

KÄHLE

automatic machines

... PERFORM ALL
OPERATIONS FOR THE
PRODUCTION OF YOUR

GLASS DIODES

INCLUDING:

- GLASS CUTTING
- ENCAPSULATING
- CRYSTAL GROWING (GERMANIUM OR SILICON)
- CRYSTAL SLICING AND DICING
- MOUNTING AND ETCHING
- CAT WISKER PRODUCTION
- FINAL SEALING
- TESTING

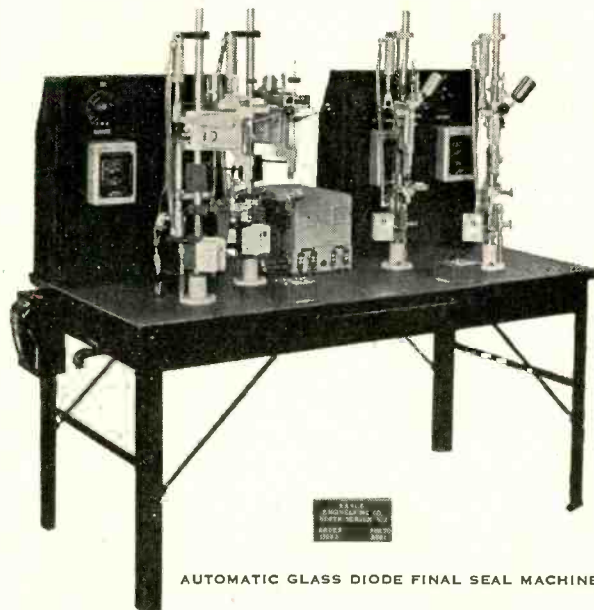

Automatic Glass Diode Final Seal Machine #2881

SEND FOR INFORMATION ON INDIVIDUAL PRODUCTION MACHINES
OR COMPLETELY AUTOMATED LINES — PLEASE SPECIFY YOUR
PROBLEMS OR APPLICATIONS.

KÄHLE ENGINEERING COMPANY

GENERAL OFFICES:
1310 SEVENTH STREET, NORTH BERGEN, N. J.

PLANTS:
SEVENTH STREET, NORTH BERGEN, N. J.
HUDSON AVE., UNION CITY, N. J.

DESIGNERS AND BUILDERS OF SPECIAL AUTOMATIC AND
SEMI-AUTOMATIC EQUIPMENT FOR ALL INDUSTRIAL OPERATIONS



SUBMICROSCOPIC iron particles are collected from a pool of liquid metal with a conventional magnet (left). These are later pressed to form a superpower magnet that can be drilled and tapped as . . .

Magnets Make New Advances

Continuing magnet research brings new developments that will open broad markets

SIGNIFICANT advances in magnets were made by government and industry researchers last year. Purified manganese-bismuth was developed by Westinghouse for the Air Research and Development Command to yield permanent magnets with high resistance to demagnetization. At Naval Ordnance Laboratory, flakenol was developed as a magnetic core material for electronic filter and communications systems.

As 1957 gets underway, further advances show promise. General Electric has announced an experimental magnet made from invisible iron "dust" that is equal to the strongest commercial magnets now available and which the company believes can be made ten times stronger.

► **How**—Fine single-domain iron particles several times longer than their cross-section are being successfully produced at the Lynn labs. The long particles resist demagnetization as well as such high-coercivity materials as the ferrites and Alnicos.

The elongated particles are dispersed in a binder, which can be glass, plastic, rubber or another metal. The dispersion is aligned in the binder by a strong magnetic field. Once made, such a magnet

must be placed in an opposite field strong enough to reverse its polarity before it can be demagnetized.

The magnets can be machined drilled, tapped and molded into any desired shape.

► **Uses**—The new magnet will allow smaller, lighter more accurate and more rugged instruments to be made. They are expected to make possible the application of magnets in nuclear reactors, something now limited because of the potential radioactivity of the cobalt in alnico.

The already important permanent magnet market today consumes about 150-million magnets annually. The electronics industry alone accounts for more than 50 percent of this amount.

► **Future**—Research will continue at a high rate. GE, for example, is keeping more than 20 scientists at its research laboratory working on the basic physics of magnets and metallurgical development of magnetic material.

Westinghouse has developed a technique for taking pictures of the atomic insides of magnetic materials. Using it, neutron diffraction is made visible to photographic film. Heretofore neutrons were invisible to film. The new technique will expedite the analysis of crystals of magnetic materials which cannot be done with x-rays.

College Recruiters Get Set For 1957 Market

More colleges will be contacted and company representatives will offer engineers more money

ELECTRONIC manufacturers are once again getting set for annual engineer recruitment drives at the nation's colleges. A recent survey of the policy and practice of 200 companies in the employment of college and university graduates, by Northwestern University, gives some indication of what's ahead in recruiting.

Trends in almost all aspects of engineer recruiting are up. In 1957, more companies will visit more campuses to hire more engineers at more money than last year.

► **Contacts**—Companies reporting in the survey almost without exception send representatives to various campuses. The firms include 145 with recruiters who visit 10 or more campuses. These companies used a total of 923 recruiters. In all, 8,989 campus contacts were made last year, an average of 45 schools per company.

This year, plans are to contact an average of 52 schools per company. Only 25 firms will contact less than 10 schools while 34 will contact more than 100 colleges and universities. One company will contact over 300 colleges and universities in 1957.

► **Number**—According to the survey, in 1957 some 63 companies will hire approximately 1,627 electrical engineers or an average of 26 men per company. Last year 51 companies hired 862 men for an average of 17 men per company.

In physics, 27 firms hired 186 men last year while this year 33 firms expect to recruit 269 men. For total engineering, chemistry and physics graduates, employment demand from the companies surveyed will be up 35 percent this year over last.

► **Salaries**—Starting salaries in 1957 for college engineering grad-

(Continued on page 20)

How to Make Manual Instruments Automatic

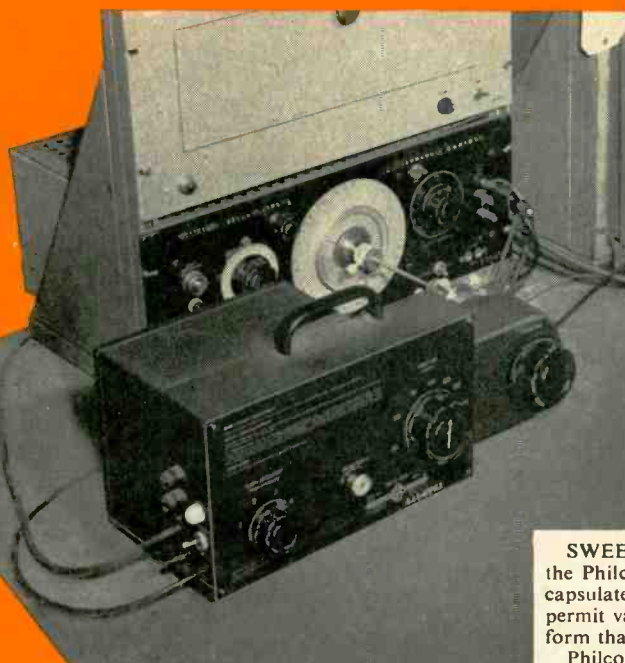

PHOTO COURTESY PHILCO CORPORATION



SWEEP DRIVE operates the G-R Type 1304-B Beat-Frequency Oscillator at the Philco Corporation. This setup is designed to check frequency response of encapsulated R.C. printed networks. The limit curves penciled on the scope faces permit various characteristics of each printed circuit to be checked rapidly and in a form that is easily interpreted by unskilled personnel.

Philco engineers specified this mechanical sweeping technique because the response at the low end of the audio spectrum of certain networks under test was of prime importance. The poor frequency distribution of electronic audio sweeps ruled this type of equipment out for this application.

G-R Type 1750-A Sweep Drive . . . \$460

The G-R Sweep Drive attaches to knobs, dials and shafts for the automatic sweeping of a wide variety of equipment. This Drive can be used to turn shafts automatically for many purposes . . . to sweep a receiver or analyzer to obtain panoramic response . . . to open or close a switch or shutter . . . to modulate light, heat, or sound . . . and, most important, to convert manually-operated signal sources to sweep devices.

Many mechanical or electronic integral sweep oscillators are available, but here is a new concept — a drive that can be attached to any oscillator or signal generator to fit it for a specific measuring job. Oscillators can be taken off the shelf for conversion to sweep devices as the need arises. There is a choice of as many sweep generators as there are hand-operated oscillators available.

WE SELL DIRECT
Prices are net, FOB Cambridge
or West Concord, Mass.

GENERAL RADIO Company

275 Massachusetts Avenue, Cambridge 39, Mass., U.S.A.

Broad Avenue at Linden, Ridgefield, N. J. **NEW YORK AREA** 920 S. Michigan Ave. **CHICAGO 5**

1150 York Road, Abington, Pa. **PHILADELPHIA**

8055 13th St., Silver Spring, Md. **WASHINGTON, D. C.** 1000 N. Seward St. **LOS ANGELES 38**



Speed Range: adjustable 0.5 — 5 cps, reciprocating motion

Sweep Arc: adjustable 30° — 300°

Sweep Arc Center-Position: on reduction drives, may be set to any point within eight full turns.

Coupling System: four spider-like arms attach to knobs and dials 1" to 4" in diameter and to ¼" and ⅜" shafts.

Limit Switch Circuit: disconnects and brakes the motor if preset limits of shaft travel are accidentally exceeded.

CRO Deflection Circuit: voltage proportional to shaft angle is provided for application to oscilloscope horizontal deflection plates.

Blanking Circuit: eliminates the return CRO trace and produces a reference base line.
Rated Maximum Torque: 24 oz.-in.

Used in combination with G-R's popular line of Unit Oscillators, the Sweep Drive makes available sweep generators for the frequency ranges: 500 kc-to-50 Mc, 50 Mc-to-250 Mc, 65 Mc-to-500 Mc, 250 Mc-to-920 Mc, and 900 Mc-to-2000 Mc. The Drive can be coupled to either the oscillator's slow-motion drive for sweeping over small ranges or coupled directly to the main shaft to take advantage of the extremely wide frequency ranges offered by G-R Unit Oscillators.

The Type 1263-A Regulating Power Supply has been especially designed to hold oscillator output constant for sweep-type presentation. Regulation is held to within ±2% of the preset output level, independent of frequency.



GOOD AS NEW!

after 96 hours at 320 cps, 35G VIBRATION

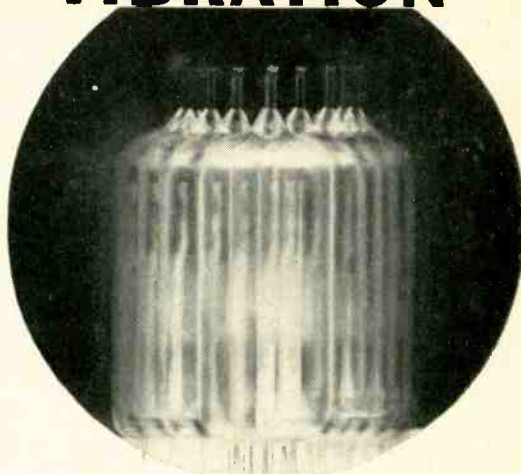

Conventional rectifiers are destroyed by this same vibration test in less than five hours.

The NEW



CK6763 Cold Cathode Medium Voltage Rectifier

(a ruggedized version of the popular CK5517)

The improved structure of this Raytheon CK6763 makes it almost impervious to fatigue from high level vibration.

What's more it requires *no heater power* • *no warm-up time* • and it permits a wider ambient temperature range.

Some of the characteristics of this and other Raytheon Cold Cathode Rectifiers are shown in the chart.

ENGINEERING • DEVELOPMENT PRODUCTION

When you have an application calling for gas filled tubes, whether it involves modification of an existing type or a completely new design, Raytheon, with over thirty years of experience in this field, can provide the engineering, development and production resources to meet your needs.

EXPANDED FACILITIES FASTER SERVICE

For fast, dependable delivery as well as performance, specify Raytheon.

RAYTHEON COLD CATHODE, HALF WAVE, GAS RECTIFIER TUBES

Type	Max. Dimensions Inches		Max. Peak Inverse Voltage	Max. Peak Plate Current Per Plate	Max. DC Output Current
	Height	Diam.			
CK5517	2.25	0.75	2800	100 ma.	12 ma.
CK6174	2.25	0.75	2800	30 ma.	3 ma.
CK6436	1.82	0.40	1500	10 ma.	100 μ a.
CK6659	2.13	0.40	2800	40 ma.	8 ma.
CK6763	2.25	0.75	2800	100 ma.	12 ma.

*MIL Specification



SPECIAL TUBE DIVISION

RELIABLE MINIATURE AND SUBMINIATURE TUBES • VOLTAGE REFERENCE TUBES
VOLTAGE REGULATOR TUBES • PENCIL TUBES • NUCLEONIC TUBES

NEWTON, MASS.: 55 Chapel St. • Bigelow 4-7500
NEW YORK: 589 Fifth Ave. • PLaza 9-3900
CHICAGO: 9501 Grand Ave., Franklin Park • T Uxedo 9-5400
LOS ANGELES: 5236 Santa Monica Blvd. • NOrmandy 5-4221

another **RAYTHEON** first!

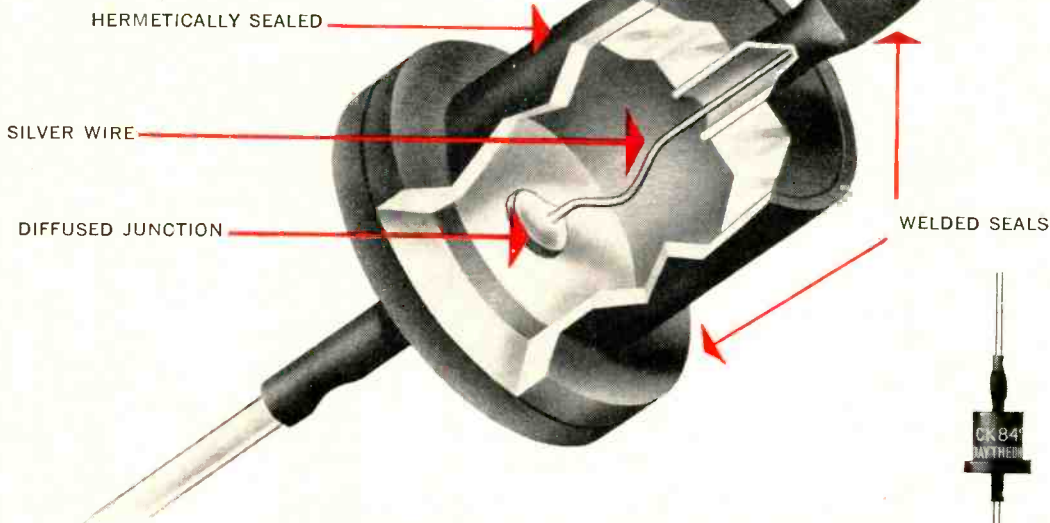

SOLID STATE **DIFFUSED JUNCTION**
SILICON RECTIFIERS
 now in **QUANTITY PRODUCTION**

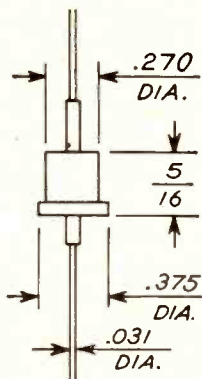

Uniform Characteristics — Uniformly High Quality

The Solid State Diffusion Process involves the formation of a junction by diffusing suitable gaseous materials into silicon at high temperatures. This process offers many advantages including:

1. Exact control of junction penetration.
2. Precise junction gradient for specific rectifier applications.
3. Flat junctions for uniformity and control of characteristics.

Operating Temperatures — minus 65°C to plus 165°C

Storage Temperature — up to 175°C

Hermetically Sealed — Welded

AVERAGE CHARACTERISTICS — NEW, IMPROVED RATINGS

Type	Peak Inverse Volts*	Forward Current** milliamperes		Forward Volts at 300 mAdc 25°C	Reverse Current (mAdc) (max) at PIV 25°C
		100°C	150°C		
CK840 (1N537)	100	500	250	1.0	0.002
CK841 (1N538)	200	500	250	1.0	0.002
CK842 (1N539)	300	500	250	1.0	0.002
CK843 (1N540)	400	500	250	1.0	0.002
CK844	500	500	250	1.0	0.002
CK845	600	500	250	1.0	0.002

*PIV ratings apply from -65°C to +165°C

**Into inductive or resistive load



SEMICONDUCTOR DIVISION

Silicon and Germanium Diodes and Transistors • Silicon Power Rectifiers

NEWTON, MASS.: 150 California St. • DEcatur 2-7177
 NEW YORK: 589 Fifth Ave. • PLaza 9-3900
 CHICAGO: 9501 Grand Ave., Franklin Park • TUxedo 9-5400
 LOS ANGELES: 5236 Santa Monica Blvd. • NOrmandy 5-4221

uates, as reported by 144 of the companies, indicate that they will average \$433 per month compared to \$415 last year. Seventy-seven of the firms, the largest single group, will pay between \$426 and \$450.

Total of 139 of the companies hiring engineers reported a salary spread of \$56, the gap between \$405 and \$461, the bottom and top average starting salaries.

► **Raise**—Of the companies hiring engineers last year, 81 raised rates after the interviewing season began and 62 did not raise rates. Of those who raised rates, 10 met their needs and 71 did not. For the 62 firms that did not raise rates, 20 met their needs and 42 did not. It is considered likely that companies will again raise rates after recruiting has started this year.

► **Time**—The survey also shows earnings of engineers from previous graduating classes. Engineers with 3 years of experience earn an average of \$527 per month; 5 years, \$592 per month; 7 years, \$650 per month and 10 years, \$740 per month.

► **Factors**—Recruiters listed what they considered to be the most important factors limiting a company's effectiveness in recruiting. The five most important factors, according to the survey were: The number of college graduates available is too small; College professors need a better understanding of our type of business; The quality of many applicants is below our standard; Company not well known on college campuses; Too many graduates have not decided what to do.

R & D Take Half of Industry's Engineers

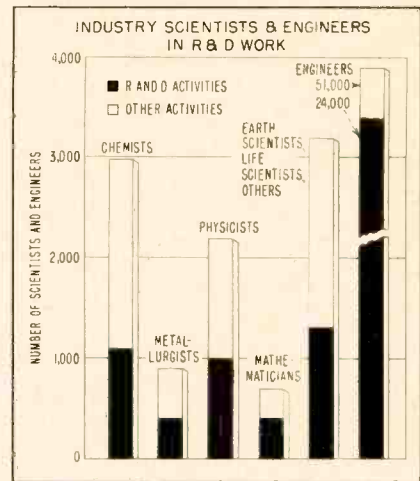

Increasing importance of research and development boosts costs and manpower needs

RESEARCH and development in the electronics industry is big in both dollars and manpower. Today, annual research costs approach \$1 billion and nearly 50 percent of the scientists and engineers in the industry are engaged in research and development work. Figures are from the final report of the National Science Foundation study of science and engineering in American industry.

► **Cost**—Estimated cost of research and development in the electronics, electrical industry in 1953 was \$743.3 million and rose to \$823.0 million in 1954, a 10.7 percent increase. The industry accounts for 20.3 percent of total r&d costs for U.S. industry. Only the aircraft industry accounts for more, 20.7 percent.

► **Personnel**—Of the 61,000 engineers and scientists working in the electronics-electrical field, 28,800 are in research and development work. Here is r&d's take in manpower from the industry's various individual occupational groups: engineers, 24,600 out of 51,000; chemists, 1,100 out of 3,000; metallurgists, 400 out of 900; physicists, 1,000 out of the 2,200; mathematicians, 400 out of the 700; and 1,300

(Continued on page 22)

Video Tape Goes To Work



Every weekday evening since Nov. 10, 1956, CBS has been recording in Hollywood, Calif. a 15-minute news program which originates in New York, and playing it back later the same evening to west coast affiliates. In addition, one half-hour show and a one-hour program have been regularly taped since the beginning of the year for the same purpose. The video tape recorder shown is one of two units delivered last spring to CBS by Ampex Corp. Since mid-January, NBC has been recording a half-hour daily program on video tape for West Coast playback

HOW to CHOOSE VIBRATION MOUNTS

For Jet and Missile Applications

Use our free engineering data sheets on ALL-ANGL Barrymount® Isolators. They describe and illustrate the operating principle of the ALL-ANGL Barry Mount, telling how it works to control shock and high-frequency vibration. They give

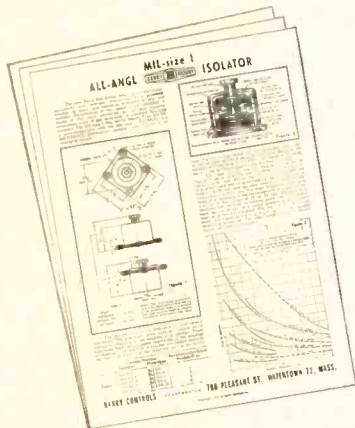

you load-deflection curves, transmissibility curves, and load-versus-natural-frequency curves that show how these isolators perform under various loads and vibration inputs and for different directions of applied acceleration. They explain how these curves can be used to evaluate isolator performance. And they contain detailed drawings that show all necessary dimensions and clearances.

Because of their proved efficacy in protecting delicate electronic apparatus through every flight attitude, ALL-ANGL Barry Mounts give the designer valuable aid in cramming the most instrumentation into the least space. They make it practicable to mount equipment on any available surface — upright on a deck or shelf, hung from above, attached to a bulkhead, or at any angle necessary to fit a unit into limited space. Regardless of mounting position, ALL-ANGL Barry Mounts give protection against high-frequency vibration through every operational maneuver of the most modern aircraft.

Barry engineering data sheets are free on request. Write for your copies today.

NEW

ALL-ANGL BARRY MOUNT

for Jets and Missiles

MIL SIZE 0

MIL SIZE 1

MIL SIZE 2
loads up to 40 lbs.
per mount

molded nylon spring seat and top snubber 1

stainless steel core 2

stainless steel cup 3

damper spring 4

phenolic damper 5

stainless steel load carrying springs 6

molded nylon spring seat and bottom snubber 7

NOW AVAILABLE in PRODUCTION QUANTITIES

Gives shock and vibration isolation where MIL-spec mounts won't work

- in every attitude of flight or launching
- under sustained high-g acceleration
- at high amplitudes of vibration input
- during severe shock conditions
- at high vibration frequencies

* These curves show why ALL-ANGL Barry Mounts really work through all attitudes. Data Sheet 57-02 gives detailed specifications. Write now for your copy.

ALL-ANGL BARRY MOUNTS are meeting the tougher requirements for shock and vibration isolation in such high-performance aircraft and missiles as North American Aviation's F-100 Super Sabre, Convair's supersonic F-102A, Martin's MATADOR, and in others still classified *top secret* — giving reliability protection where failure cannot be tolerated. "Only ALL-ANGL Barry Mounts gave effective isolation . . ." is the way their performance in one of today's hottest fighters is described.

When your problem is protection under the tough, complex requirements of jet and missile flight, your answer is ALL-ANGL Barry Mounts. For recommendations, call your nearest Barry Sales Representative.

Barry's new Western Division, in Burbank, California, offers fast, on-the-spot design and prototype service, and production of special systems.

BARRY

CONTROLS

INCORPORATED

BARRY B MOUNT

SALES REPRESENTATIVES
IN ALL PRINCIPAL CITIES

707 PLEASANT STREET, WATERTOWN 72, MASSACHUSETTS

of the 3,200 remaining scientists and engineers in other occupations.

► **Assistants**—The survey also shows that for each 100 of the 28,800 r&d scientists and engineers in the industry, there were 150 supporting personnel, or statistically, 1.5 men per engineer or scientist. Of the 150, 90 are technicians, 10 are craftsmen and the remaining 50 are in various other classifications.

At least three other industries use more supporting personnel per man than the electronics, electrical field. Tops is aircraft where there are 270 supporting personnel per 100 r&d engineers and scientists. Next is machinery with 170 per 100, followed by fabricated metal products with 160 per 100.

► **Definition**—Research and de-

velopment as defined in the study includes activities carried on by persons trained in the physical sciences including related engineering if the purpose of such activity is to pursue a planned search for new knowledge; apply existing knowledge to problems of creating a new product or process or apply existing knowledge to problems involved in the improvement of a present product or process.

If the primary objective is to make further improvements on the product or process, then the work comes within the definition of research-development. If the product or process is substantially "set" and the primary objective is to develop markets or to do preproduction planning, or to get the production process going smoothly, then the work is not research-development.



BOMARC-NOSED B-57 Canberra jet bomber, modified by Temco Aircraft, tests guidance system as . . .

Missile Gets Ready For Production

ELECTRONIC guidance system for the Bomarc long-range supersonic missile will soon be in use as the Air Force gets ready to go into quantity production of the missile. Produced by Boeing Airplane Co. in Seattle, Wash., the missile is believed to be in the 200-mile range class.

► **Navigation**—Its guidance system has been under test at Temco Aircraft using the modified B-57 shown. The modification included

attaching the 17-foot nose which involved weight and stress and design changes in the bomber itself. Temco's work was done under contract to Boeing.

► **TV**—Industrial tv applied to guided missiles allows tv in a missile's nose to transmit back to the pilot in a control plane a picture of what's ahead. Pilot could select target and aim missile via remote control while a video tape recorder "cans" the operation.

Computers Solve Aircraft Problems

Flight test data reduction requires more special large-scale computers

MULTIMILLION-DOLLAR airplanes must be tested thoroughly and quickly to keep up with the ever-increasing race for air superiority. Data-processing time and costs are important factors here.

► **Latest**—A system that automatically takes care of data reduction of flight test information obtained from airborne magnetic tape recorders is now in use at Boeing Aircraft. The system, engineered by Boeing and other firms, simultaneously records 14 tracks of data on a single inch-wide magnetic tape using pulse-width modulation techniques.

► **How It Works**—In processing, the first step is to scan the data at high-speed using a tv display. The equipment operator can tag important data for immediate attention. This tagged tape is fed to the digitor for conversion from pulses to numbers which are recorded on a second tape. This second tape is run through the computer which scales and calibrates the data and presents it in the desired form.

► **Other**—Research and development work in the fields of supersonic aircraft, missiles and rocket engine design at North American Aviation, is being accelerated through the use of three IBM 704's now in operation.

Ammunition Pack May Replace Parts Reels

Boxes for belted components require less space and give smoother feed to machines

ADVANTAGES OF boxes for storing, handling and feeding machine-gun bullets may bring about an industry-wide transition to this type of

(Continued on page 24)

Accelerated testing

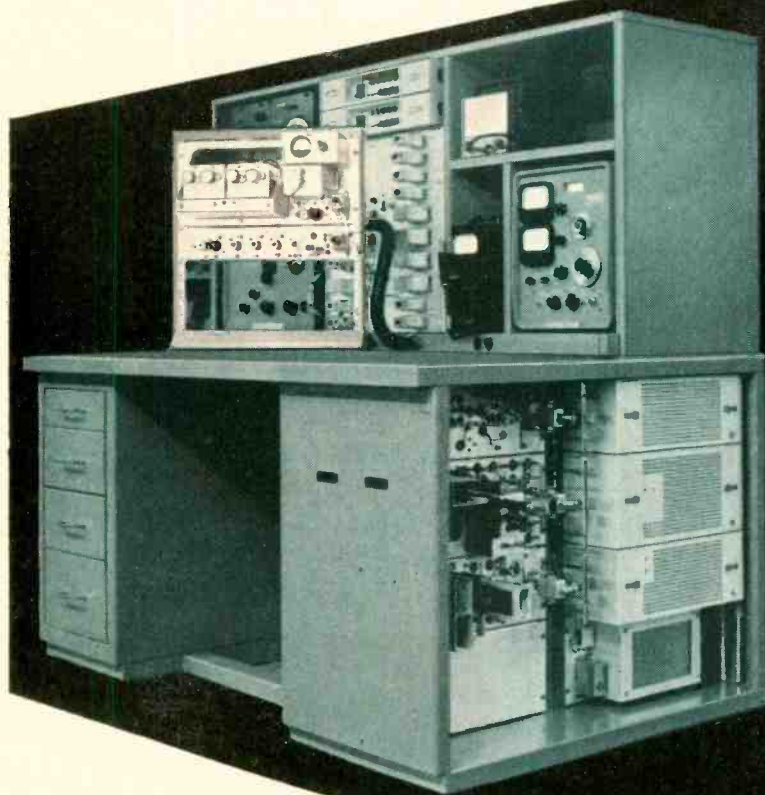

A vital link in our national defense is White Alice—largest Tropospheric Scatter system yet conceived—which is to provide military communications and civilian telephone service throughout Alaska.

With the system now in partial operation, reliability of the equipment becomes essential. This is assured both by the choice of REL for the development and manufacture of the Tropo Scatter radio equipment, and by the remarkable test bench pictured, also designed and built by REL.

Any panel of the White Alice driver exciters or dual diversity receivers can be slipped into the test rack (left) and instantly plugged into the bench for immediate testing. This eliminates the bother and delay of cumbersome conventional test procedures, and is an important addition to the overall operating reliability of White Alice.

REL's unique facilities and thirty-five-year experience are available for the solution of your specialized radio problem.

REL Radio Engineering Laboratories·Inc.

36-40 37th St · Long Island City 1, N Y

Stillwell 6-2100 · Teletype: NY 4-2816

Canadian representative: AHEARN & SOPER CO · BOX 715 · OTTAWA

*Creative careers at REL await a few exceptional engineers.
Address resumes to James W. Kelly, Personnel Director.*



Experimental ammunition pack for video peaking coils having lead belting. Components stack automatically as belt is lowered

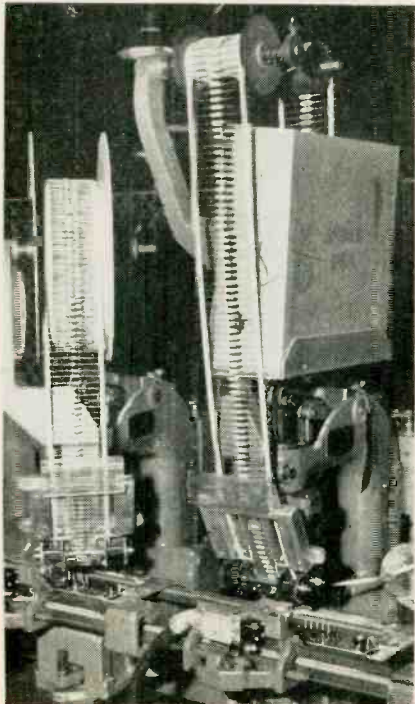

New box pack on coil insertion head of United Shoe machine in Philco plant, with reel pack on adjacent head for comparison

pack for belted electronic components as well.

Tests by Philco Corp. and others have shown that up to about 60 percent more components can be

Military Electronics

► Navy awarded Convair division of General Dynamics a \$29-million contract for production at Pomona, Calif. of guidance and control units for the Terrier guided missile. Convair operates the 1.2-million sq ft government-owned Naval Industrial Reserve Ordnance plant at Pomona for the Bureau of Ordnance

► Government backlog totaling \$245 million at the end of 1956 for Raytheon is the largest in the firm's history and almost two and a half times the backlog of a year ago

► Test and launching equipment for the Thor intermediate range ballistic missile will be built by Packard-Bell for Douglas Aircraft under a \$3-million contract. Production test equipment, check-out equipment and launching equipment, including closed-circuit tv gear to monitor the projectile before and during flight and observation of the firing site, will be designed and developed

► More Doppler navigation systems for the Air Force will be built under a \$17-million contract awarded to GPL by the Air Material Command. The systems provide direct and continuous readings of a plane's ground speed and drift angle independent of ground or celestial guidance

► Volume of military electronics for the industry will run about \$3 billion in 1957, an increase of 10 percent over last year, according to G. L. Haller of GE

► Electronic controls and instrument sales for U.S. planes and guided missiles will total \$1.5 billion in 1957, up \$100 million over 1956, according to Minneapolis-Honeywell estimates

put into a box than on a reel requiring the same shipping space. With boxes, loading onto the insertion head of an automatic assembly machine is much easier; the box is simply placed on a shelf, whereas a reel must be placed on a shaft and locked in position. From boxes the feed tension is essentially constant; with reels the tension increases as the reel runs down, causing occasional jams. Finally, boxes are considerably cheaper than reels.

► **Size**—Component vendors, manufacturers of automatic assembly machines and users of the machines now seek agreement on standard

sizes for the boxes. This standardization can mean added cost savings in making the throw-away boxes, particularly if component manufacturers use the same type of pack for all. The box pack works for both body taping and lead taping, and insertion heads of United Shoe and other machines are easily modified to take the boxes. Small axial-lead coils such as television peaking coils can be handled equally as well as axial-lead resistors and capacitors in the boxes.

► **Trend** — Practically all component manufacturers are now pro-

(Continued on page 26)

There's a
standard
PERKIN
model for
your every
need!

In addition to the 28 volt models featured at the right, the following units are also available:

OTHER 28 VOLT MODELS

Model	Volts	Amps	Reg.	AC Input (60 cps)	Ripple rms
28-5VFM	0-32 V	5	20% (24-32 V range)	115 V 1 phase	2%
28-10WX	24-32 V	10	$\pm 1/2\%$	100-125 V 1 phase	1%
28-15VFM	0-32 V	15	20% (24-32 V range)	115 V 1 phase	5%
28-50WX	24-32 V	50	$\pm 1/2\%$	230 V* 3 phase	1%
MR2432-200	24-32 V	200	$\pm 1/2\%$	230 V* 3 phase	1%
MR2432-300	24-32 V	300	$\pm 1/2\%$	230 V* 3 phase	1%
MR2432-500	24-32 V	500	$\pm 1/2\%$	230 V* 3 phase	1%

* $\pm 10\%$. Also available in 460 V $\pm 10\%$ AC Input. Will be supplied with 230 V input unless otherwise specified.

6, 12, 115 VOLT (NOMINAL) MODELS

Model	Volts	Amps	Reg.	AC Input (60 cps)	Ripple rms
6 Volt	6-5WX	5	$\pm 1\%$	95-130 V 1 phase	1%
	6-15WX	15	$\pm 1\%$	95-130 V 1 phase	1%
	6-40WX	40	$\pm 1\%$	95-130 V 1 phase	4%
12 Volt	12-15WX	15	$\pm 1\%$	95-130 V 1 phase	1%
	115-5WX	5	$\pm 1/2\%$	95-130 V 1 phase	1%
115 Volt	MR15125-5	5	$\pm 1\%$ †	95-130 V 1 phase	1% †
	G125-25**	25	1 1/2-4%	230/460 V 3 phase	5%

**Germanium Rectifier Unit †Increases to 2% @ 15 V.

PERKIN SALES OFFICES:

New York area N.J.
Newark - MAkt 3-1454
Philadelphia
BR 5-2600
Chicago
PA 5-6824
St. Louis
PA 5-7701
Kansas City, Mo.
VA 1-5330
Dallas
FD 8-8306
Denver
MA 3-0343
San Francisco area
(Palo Alto)
DAvopt 5-6136
Los Angeles
RY 1-8810
Pittsburgh
WA 1-2959

Minneapolis
MI 4-7884
Seattle
MO 4895
Albuquerque
5-9632
Atlanta
EL 3020
Miami
MO 5-1563
Charlotte
ED 2-7356
Winston-Salem
4-0750
Boston
MI 8-0756
Canada
Agincourt,
Ontario
AX 3-7011

PERKIN...THE LEADER

in tubeless magnetic
amplifier regulated

DC POWER SUPPLIES

No Moving Parts • No Vibrating Contacts



Model MR532-15A

2-36 VOLTS @ 15 AMPS SPECIFICATIONS

Regulation: 5-32 Volt Range: $\pm 1/2\%$
2-5 Volt and 32-36 Volt Range: $\pm 2\%$

AC Input: 105-125 Volts, for 2-32 V.DC, 110-125 V, (for 32-36 V.DC), 1 phase, 60 cps (8 amps)

Ripple: 1% rms max. (@ 36 volts and full load. Increases to 2% @ 2 volts and full load).

Remote Sensing • Vernier Control



Model M60V

0-32 VOLTS @ 25 AMPS SPECIFICATIONS

Regulation: $\pm 1\%$ @ 28 Volts (Regulation increases to 2% over range of 24-32 volts; does not exceed 2 volts over 4-24 volt range. Not stabilized for AC line changes.)

AC Input: 115 Volts, 1 phase, 60 cps (12 amps).

Ripple: 1% rms (@ 32 volts and full load - 2% rms max. @ any voltage above 4 volts).



Model MR1040-30A

5-40 VOLTS @ 30 AMPS SPECIFICATIONS

Regulation: $\pm 1\%$ (over entire 5-40 volt range)

AC Input: 100-130 Volts 1 phase, 60 cps

Ripple: 1% rms



Model 28-30 WXM

24-32 VOLTS @ 30 AMPS SPECIFICATIONS

Regulation: $\pm 1/2\%$

AC Input: 100-125 Volts, 1 phase, 60 cps (20 amps). (Unit rated for DC output of 28 volts $\pm 10\%$ for 95-130 volt input.)

Ripple: 1% rms



Model MR2432-100XA

24-32 VOLTS @ 100 AMPS SPECIFICATIONS

Regulation: $\pm 1/2\%$

AC Input: 208, 230 or 460 Volts, $\pm 10\%$, 3 phase, 60 cps (14, 12 and 6 amps respectively). 230 volt input will be supplied unless otherwise specified.

Ripple: 1% rms

Wire factory collect for prices... Write for catalog.



PERKIN

LEADER IN TUBELESS MAGNETIC AMPLIFIER REGULATION

Representatives in Principal Cities

PERKIN ENGINEERING CORPORATION

345 KANSAS ST. • EL SEGUNDO, CALIFORNIA • PHONE: ORIGIN 8-7215

viding belted components to meet the demands of their high-volume customers, despite early reluctance to give up bulk packaging.

The change in packaging is hinged to the success of these assembly machines in most of the large assembly plants; here it is not at all unusual to run every

single printed wiring board through an assembly machine, even though additional parts are inserted by hand later to complete the assembly.

Natural evolution is thus bringing about now a packaging standardization for mechanization that was impossible to achieve during the first year of transition.

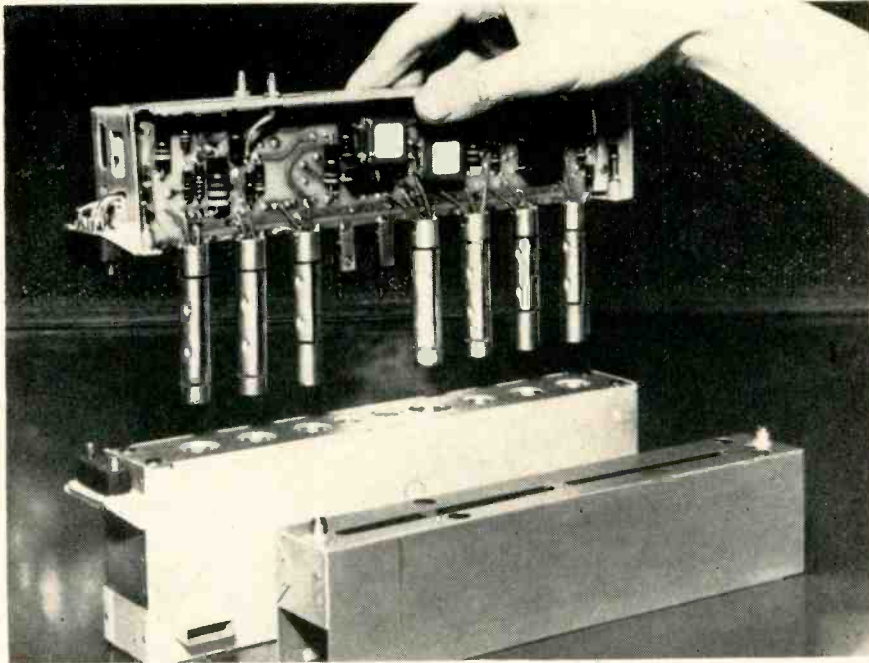

NEW packaging for airborne assemblies insulates and cools vacuum tubes as . . .

Electronics Adds Air Conditioning

More tubes, higher speeds, boost cooling requirements for electronic equipment

ALTHOUGH only a drop in the bucket to the billion-dollar air-conditioning market, the growing amount of cooling equipment required by increasingly complex electronic equipment is adding up to sizable business.

In terms of household unit ratings, some computers require 25-ton equipment. In military aircraft, the modern jet bomber has sufficient air conditioning capacity to air condition five five-room houses.

► **Market**—It has been estimated that by 1960 there will be some 5,000 computers in use in the U.S. This could mean a total air-cooling requirement of about 5,000 20-ton units. This estimate could be re-

vised sharply downward depending on the speed with which semiconductors come into the computer picture. Up to now, air conditioning requirements of computers have almost doubled in the past two or three years as each model becomes more complex.

► **Military**—Cooling of military electronic equipment has become highly important especially with the advent of supersonic flight. Not only does it have important effects on the performance and reliability of the electronic equipment but also upon the operation of the aircraft itself. The advantage of the equipment must be balanced against the penalties that the added weight will have on flying performance.

Above the speed of sound, the metal skin of jet aircraft heats up to several hundred degrees. Gar-

rett Corp.'s AiResearch division has developed a aircraft refrigeration system with a two-pound turbine that cools the air entering the cabin to 40 degrees in 2/10 of a second.

► **Packaging**—One method of reducing the amount of aircraft air cooling equipment is with special packing. Sylvania has a method in which vacuum tubes are mounted in carefully sized holes in light foam plastic material of the desired thermal properties. Controlled air flow gives optimum cooling while exhausting the air at high temperature. The method gives cooling efficiencies of about 90 percent and reduces the amount of air cooling equipment required.

► **Coolers**—Production of weather simulators, which are devices that prevent electronic equipment in jet aircraft from being damaged by heat when operated on the ground during run up and maintenance operations, is also becoming kingsize business, according to American Electronics of Los Angeles. The company, in the past year, has received almost \$10 million in orders for the equipment. Output of the units has climbed from 25 units a month to 82 units. Average cost of a weather simulator is about \$11,000.

Manufacturers Cash-In On Hustler

About 35 companies in electronics contribute to the new jet's complex subsystems

AIR FORCE'S new delta-winged supersonic bomber is loaded with electronics equipment and some 35 companies in the industry are supplying equipment for the Hustler.

► **Makers**—To indicate the importance of electronics in modern aircraft and the types of firms sharing in the business here are the 16 major system vendors for the B-58: Bell Aircraft, Fairchild, Sperry, Melpar, Bendix Eclipse-Pioneer,

(Continued on page 28)

glass-base laminates?

C-D-F DILECTO® is the answer!

Teflon*, silicone, epoxy, melamine, phenolic, polyester resins laminated with glass-fiber cloth

You can improve design, speed production, and save money by specifying one of the many C-D-F Dilecto grades. Whatever your application for these laminates — with fine- or medium-weave glass-cloth base — you'll find a better answer to your problem at C-D-F. (Melamine and polyester can also be made with glass-mat base.) And C-D-F offers modern machining and fabrication facilities to deliver production quantities of finished Dilecto parts to your specifications.

See our catalog in Sweet's Product Design File, where the phone number of your nearby C-D-F sales engineer is listed. For free trial samples of glass-base Dilecto, or of any other C-D-F plastics, mica, or fibre product, send us your print or your problem! Write for your free copy of C-D-F Technical Bulletin 64.

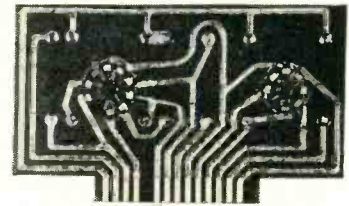

SPEED AUTOMATIC PRODUCTION of printed circuits with warp-resistant C-D-F metal-clad Teflon* and epoxy laminates. Other advantages: high bond strength of copper to laminate, superior blister-resistance in solder immersion.

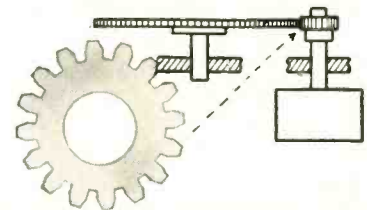

HIGH-VOLTAGE (1800v.) RF ISOLATION is achieved by miniature C-D-F Dilecto gears in an aircraft receiver-transmitter switch. They also had to exhibit dimensional stability through a wide temperature range, resistance to fungus growth and thermal shock.

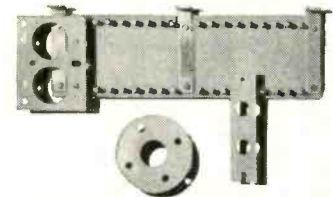

PRECISE MACHINING AND FABRICATION are standard benefits of Dilecto laminated plastics. These silicone glass-base parts (coil mountings, aircraft terminal board) were sawed, drilled, punched, and milled in production quantities by C-D-F and customer.

PROPERTIES OF SOME TYPICAL C-D-F DILECTO GLASS-BASE GRADES

Grade	Equivalent NEMA or ASTM grade	Flexural Strength Lengthwise (PSI)	Dissipation Factor at 10 ⁶ Hz Cond. D24/23	Dielectric Strength Parallel Step x step	Insulation Resistance Cond. C96/35/90	Arc Resistance (seconds)	Maximum Operating Temp. (°C.)
GB-116T (Teflon*)	None	14,000	0.001	65	100,000	180 +	250
GB-12S (Silicone)	G-7	30,000	0.008	60	100,000	245	200
GB-181E (Epoxy)	G-10	75,000	0.020	75	20,000	120	165
GB-28M (Melamine)	G-5	48,000	0.025	50	100	185	150
GB-261D (Phenolic)	G-1 and G-2	22,000	0.060	55	10,000	5	150
GM-PE (Polyester)	GPO-1	35,000	0.060	60	5,000	145	150

These are typical grades for typical applications. To meet special requirements, C-D-F makes many other Dilecto grades, one of which may serve your purpose better than any of these listed here. Consult the C-D-F Technical Department for expert assistance with your design problem involving laminated plastics products.

*DUPONT TRADEMARK FOR TETRAFLUOROETHYLENE RESIN



CONTINENTAL DIAMOND FIBRE

CONTINENTAL-DIAMOND FIBRE DIVISION OF THE BUDD COMPANY, INC.

NEWARK 16, DELAWARE

Emerson Electric, Sylvania, Magnavox, Motorola, Westinghouse, Hamilton Standard, Ultrasonic Corp., Minneapolis-Honeywell, Airojet, Federal Electric and Bendix Radio. Total of about 55 companies, electronic and otherwise, are involved in the production of the newest jet bomber.

Some of the types of equipment that electronics manufacturers are making for the bomber include transistorized fuel gauges and autopilots, passive defense systems, armament systems, bombing and navigation systems, photo-reconnaissance systems and closed-circuit tv systems.

► **Operation**—The new plane is designed to operate at altitudes above 50,000 feet. It measures 95 feet in length and has a wingspan of 55 feet. Its crew consists of a pilot, navigator-bombardier, and electronics defense systems operator.

Solid State Gains New Transistor

Symmetrical units acts as switch in prototype board produced for Navy

A NEW addition to the family of transistors apparently has been at work for some time. Known as a symmetrical transistor, the device passes signals in either direction under proper base-biasing conditions. Its most recent application is in a 100-line electronic switchboard built for the Navy by Stromberg-Carlson and now undergoing evaluation. Approximately 4,500 transistors and 5,000 diodes are used in the switchboard which is purported to save a third the power and weight of its predecessors.

► **Device**—The new transistor can provide gain in either direction by changing bias conditions or may be used as a fast relay by accepting a loss. The latter operating condition is employed in the 100-line switchboard. A voltage of one polarity applied to the base allows signals to pass whereas an opposite polarity voltage switches the unit off.

Meetings Ahead

Feb. 7: Annual Mid-Winter Symposium Aircraft Instrumentation, New York ISA, Garden City Hotel, New York.

Feb. 7: IRE Operations Research Symposium, University of Penn. Museum Lecture Hall, Philadelphia, Pa.

Feb. 7-8: 1957 West Coast Convention of the Audio Engineering Society, Ambassador Hotel, Los Angeles, Calif.

Feb. 14: Symposium On Recording Of Heart Sounds. IRE, University Of Buffalo Medical School, Buffalo, N. Y.

Feb. 14-15: 1957 Transistor & Solid State Circuits Conference, IRE, AIEE, U. of Pa., Philadelphia, Pa.

Feb. 15-16: Cleveland Electronics Conference, IRE, Masonic Auditorium, Cleveland, Ohio.

Feb. 26-27: Third Conference on Radio-Interference Reduction, Armour Research Foundation, Chicago, Ill.

Feb. 26-28: Western Joint Computer Conference, IRE, AIEE, ACM, Statler Hotel, Los Angeles, Calif.

Feb. 26-28: Joint Military-Industrial Guided Missile Electronic Test Instrument Symposium, Redstone Arsenal, Huntsville, Ala.

March 11-15: 1957 Nuclear Congress, EJC, Convention Hall, Phila., Pa.

March 18-21: IRE National Con-

vention, Waldorf-Astoria Hotel, New York Coliseum, New York, N. Y.

March 18-21: Military Automation Show, New York Trade Show Bldg., New York, N. Y.

Apr. 8-11: British Radio And Electronic Component Show, Grosvenor House and Park Lake House, London, England.

Apr. 9-10: Annual Industrial Electronics Educational Conf., IRE, Armour Research, Ill. Institute of Technology, Chicago, Ill.

Apr. 11-13: Southwest IRE Regional Conference & Electronics Show, Shamrock Hilton Hotel, Houston, Texas.

Apr. 14-16: National Symposium On Telemetering, IRE, Sheraton Hotel, Phila., Pa.

May 13-15: National Aero & Navigational Electronics Conference, IRE, Dayton, Ohio.

May 14-16: Industrial Nuclear Technology Conference, ARF, Ill. Tech, Nucleonics Magazine, Museum of Science and Industry, Chicago, Ill.

May 20-23: 1957 Electronic Parts Distributors Show, Conrad Hilton Hotel, Chicago, Ill.

May 27-29: 1957 National Telemetering Conference, AIEE, ISA, IAS, Hotel Cortez, El Paso, Texas.

Aug. 20-23: 1957 WESCON, IRE, WCEMA, Cow Palace, San Francisco, Calif.

Industry Shorts

► All 12-volt models in Motorola's new car radio line are transistor powered. Printed circuits and a form of the module concept of condensed circuitry has been added to some models.

► Public information office has been established by the Army Ballistic Missile Agency in Huntsville, Ala.

► West German radio and tv industry sold about 3.3 million radios in 1956, about the same as in 1955, and produced 600,000 tv sets compared to 350,000 in 1955.

► Chicago area (50 mile radius) bought 292,389 tv sets during the past year, according to the city's electric association.

► Attendance of at least 50,000 is expected for the IRE National Convention and Radio Engineering Show, to be held at the Waldorf-Astoria Hotel and the New York Coliseum, March 18-21, 1957.

► Third in a series of ARDC-sponsored symposia on the Use of Computers in Medicine, designed to bring together leaders in the computer and medical research fields, was held in Chicago.

HIGH Output (1.0 v. RMS into 70 ohms)
WIDE Range (2-220 Megacycles. All At Fundamental)
 and
CONSTANT OUTPUT
 (Fast Acting AGC)

NEW
KAY

Vari-Sweep



ALL-ELECTRONIC HIGH LEVEL SWEEPING OSCILLATOR OR, (with sweep off) CONTINUOUSLY TUNED CW SIGNAL SOURCE

SPECIFICATIONS

- Range:** Fundamental frequency 2 to 220 mc., continuously variable in 10 switched overlapping bands. Direct reading frequency dial calibrated to $\pm 2.0\%$.
- RF Output:** 1.0 v. RMS into 70 ohms, metered. Flat within ± 0.5 db over widest sweep and frequency band.
- Sweep Width:** Continuously variable to $\pm 30\%$ of center frequency to maximum of at least 30mc.
- Sweep Rate:** Continuously variable 10 to 40 cps.; also locks at line frequency.
- Attenuator:** Switched 20, 20, 10, 6, and 3 db plus continuously variable 6 db.
- Power Supply:** Electronically regulated 105 to 125 v. A. C. 50 - 60 cycles

- Operates On Fundamental Frequency, Therefore Stable Narrow-Band Sweeps
- 1.0 v. RMS (into 70 ohms) Output Flat to ± 0.5 db Over Widest Sweep
- Output Automatically Held Constant (AGC) Over Complete Range
- Variable Sweep Width (to 30 mc. PLUS) — Variable Center Frequency
- Direct Reading Frequency Dial Accurate To $\pm 2.0\%$
- Sweep Repetition Rates Down to 10 cps

Price: **\$695.** FOB Plant

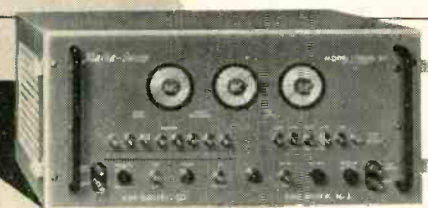

NEW KAY *Marka-Sweep* MODEL VIDEO 50

Combined Video and IF Sweeping Oscillator with Marks
SPECIFICATIONS

- Frequency Range:** Continuously variable, 50 kc to 50 mc.
- Sweep Width:** Linear, continuously variable, 4.0 mc to 50 mc.
- Sweep Rate:** Variable around 60 cps; locks to line frequency.
- Amplitude:** 1.0 v, peak-to-peak, into nom. 70 ohms. Flat within ± 0.5 db over widest sweep.
- Attenuators:** Switched 20, 20, 10, 6 and 3 db, plus continuously variable 3 db.
- Markers:** Eight sharp, pulse-type, crystal-positioned, internal and external markers.
- Price:** \$695.00 F.O.B. Factory. Substitute markers, \$10.00. Additional markers, \$20.00 each.

KAY ELECTRIC COMPANY
 14 MAPLE AVENUE PINE BROOK, N. J. CAldwell 6-4000

See us at the IRE Show
 Booths 2608-09-10

Dept. E-2



Kennard and V. C. McIntosh of WRIGHT AIR DEVELOPMENT CENTER
Install Magnetic Tape Recorder in F-101 Aircraft.

Dynamics Section, Engineering Support Branch at Wright Air Development Center's Equipment Laboratory is primarily responsible for evaluating aircraft equipment under conditions of actual use . . . particularly vibration, shock, and acceleration. Under Section Chief D. C. Kennard, it records these phenomena as they actually exist in aircraft and missiles under all conceivable service conditions.

Prior to 1952, 12-channel recording oscillographs were used. But weight and size limited their use, as did the need for an operator to set attenuators for optimum sensitivity on each channel. Furthermore, the Dynamics Section is particularly interested in the frequency content of vibration, and the relative amplitude of

each component frequency. But getting this information from oscillograph traces proved something of a problem. Visual examination was neither accurate nor complete. The Section resigned itself to using the 24-point method of Fourier Analysis in conjunction with punched card equipment, but was far from satisfied.

Searching for an entirely new approach, the Dynamics Section settled on magnetic tape recording, despite the fact that no suitable equipment was in existence. On November 2, 1949, in Exhibit MCREXE84-2, The Air Force called for the development of airborne magnetic tape data recording, reproduction and analysis equipment.

Among the responses to the exhibit was a proposal from

the Davies Laboratories, Inc. Though the company had no previous experience with tape or recording, the ideas which Gomer L. Davies set forth in that proposal were interesting enough to gain his company the contract. Let on April 7, 1950, it called for three 14-channel airborne recorders, a 14-channel ground playback unit, and a dual channel automatic wave analyzer.

The combined efforts of Davies and his staff, and the Dynamics Section overcame obstacles that for years had chained magnetic tape to the broadcasting studio. The first system delivered to the Dynamics Section included such refinements as servo speed control for correcting low-frequency tape speed variations and a unique, completely elec-

MAGNETIC TAPE data recording

Born: April 7, 1950

Today, magnetic tape is an accepted tool for data acquisition, processing, and storage. It has proved its worth in laboratories, industrial plants, even missile test centers. But a decade ago magnetic tape data recording did not exist. And without the inspired cooperation of a government agency and a private enterprise, it might not exist yet.

tronic compensation system for eliminating the effects of wow and flutter.

By 1952 magnetic tape data recording was a reality, with the delivery and acceptance of the first complete system for airborne use in November.

Substantially all the requirements set forth in the 1949 exhibit had been met. And several had been exceeded. The completely self-contained recorders were even smaller than specified. The three recorders so speeded up data acquisition that The Air Force immediately placed an order with Davies for four additional channels of analysis equipment.

With the introduction of magnetic tape data recording in November, 1952 as a full grown art, the technique was quickly adopted in laboratories, manufacturing plants, and

government installations across the country . . . an amazing growth. But the record set by Davies equipment at Wright Air Development Center is impressive enough in itself. Davies recorders have been used there in testing every conceivable kind of aircraft, including:

F-86A F-86D B-36 B-45 B-47
B-50 B-52 B-57 B-66 C-47
C-54 C-123 C-124 C-130
H-19 KC-97 Q-2A RB-50

They have been used for ground testing at least ten different power plants. They have been taken to other military installations so that data recorded there could be analyzed on Davies equipment at the Dynamics Section. Most important, data made available by Davies equipment assisted in causing revisions in basic Air Force Specifications. It has

been possible to prove, for example, the importance of high frequency vibration as a vital design consideration, and thereby eliminate an arbitrary upper limit of 55 cps on vibration testing.

Surely, magnetic tape data recording has been proved a development of vital importance. But it has even greater significance as an outstanding example of the benefits of a country in which government and industry can work hand-in-hand . . . cooperating on every level for the eventual betterment of all mankind.



LABORATORIES, DIVISION
10721 HANNA STREET • BELTSVILLE, MARYLAND
WEBSTER 5-2700

 **Honeywell**

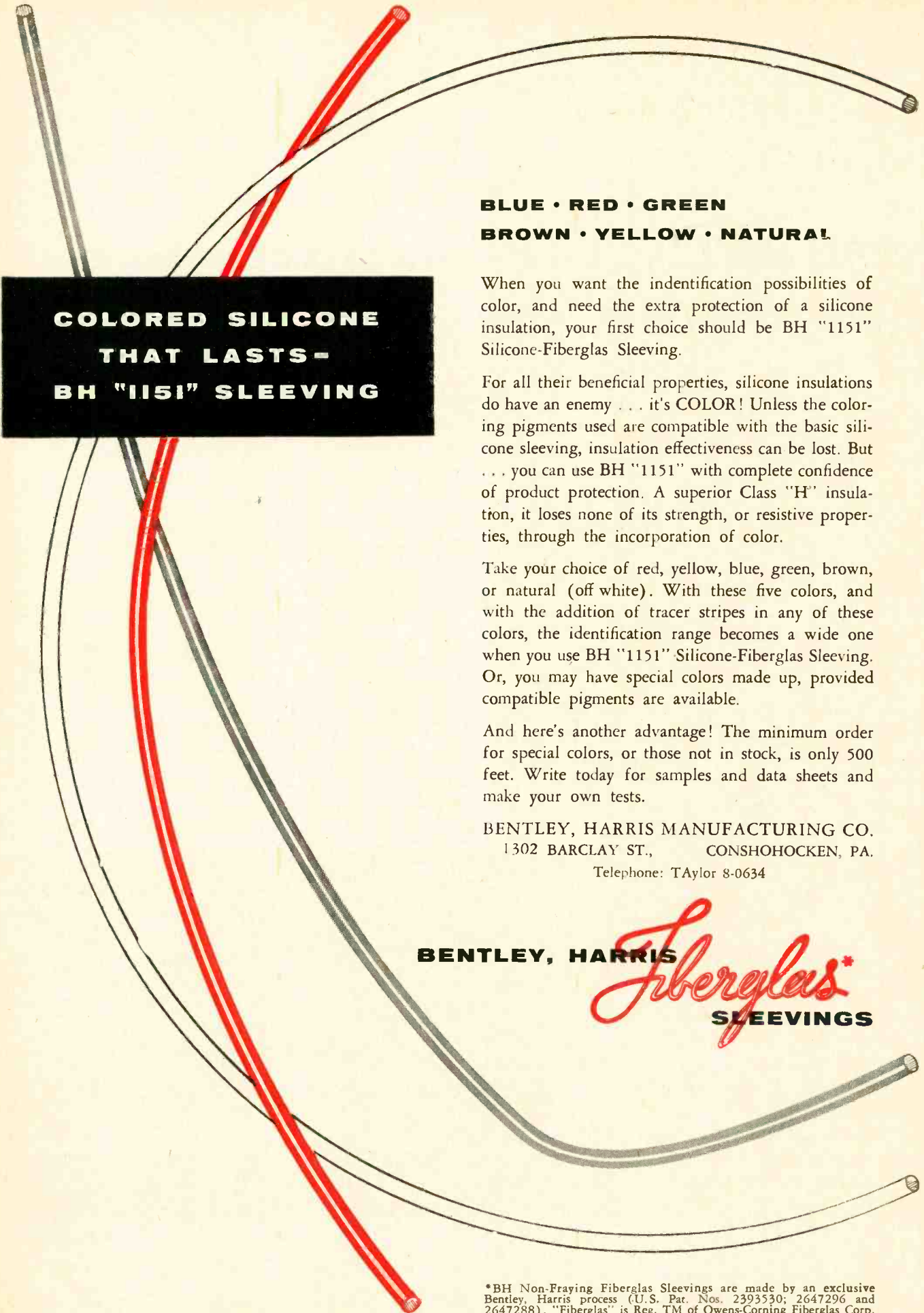

**COLORED SILICONE
THAT LASTS -
BH "1151" SLEEVING**

**BLUE • RED • GREEN
BROWN • YELLOW • NATURAL!**

When you want the identification possibilities of color, and need the extra protection of a silicone insulation, your first choice should be BH "1151" Silicone-Fiberglas Sleevings.

For all their beneficial properties, silicone insulations do have an enemy . . . it's COLOR! Unless the coloring pigments used are compatible with the basic silicone sleevings, insulation effectiveness can be lost. But . . . you can use BH "1151" with complete confidence of product protection. A superior Class "H" insulation, it loses none of its strength, or resistive properties, through the incorporation of color.

Take your choice of red, yellow, blue, green, brown, or natural (off white). With these five colors, and with the addition of tracer stripes in any of these colors, the identification range becomes a wide one when you use BH "1151" Silicone-Fiberglas Sleevings. Or, you may have special colors made up, provided compatible pigments are available.

And here's another advantage! The minimum order for special colors, or those not in stock, is only 500 feet. Write today for samples and data sheets and make your own tests.

BENTLEY, HARRIS MANUFACTURING CO.
1302 BARCLAY ST., CONSHOHOCKEN, PA.
Telephone: TAYlor 8-0634

BENTLEY, HARRIS

*Fiberglas**
SLEEVINGS

*BH Non-Fraying Fiberglas Sleevings are made by an exclusive Bentley, Harris process (U.S. Pat. Nos. 2393530; 2647296 and 2647288). "Fiberglas" is Reg. TM of Owens-Corning Fiberglas Corp.

solve many difficult control problems...use

OHMITE®

RHEOSTATS

with special features

Ohmite offers not only a line of *standard* rheostats but also rheostats with a wide variety of *special features*. Illustrated are only a few. All have the distinctive Ohmite design features: smoothly gliding metal-graphite brush; all-ceramic construction; insulated shaft and mounting; windings permanently locked in place by vitreous enamel. You will find the special rheostat feature you need in the dependable Ohmite line.

SPECIAL TANDEM ASSEMBLIES

Ohmite Rheostats can be mounted with two, three, or more in tandem for simultaneous operation of several circuits by one knob.

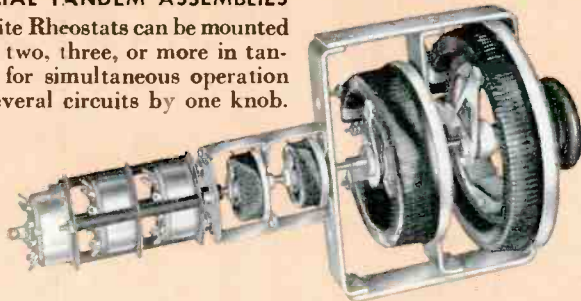

BUSHINGS FOR SPECIAL THICKNESS

Extra-long bushings and shafts for panels up to 2" in thickness. Seven bushing lengths.



SCREW DRIVER SLOT SHAFT

Shaft ends slotted for operation with a screw driver where few adjustments are needed.



VENTILATED CAGES

Prevents mechanical injury to rheostat or human contact with electrically "live" parts.



SENSITIVE SWITCH

Opens or closes circuit with minimum movement of control knob shaft. Extremely dependable long life switches.



TOGGLE SWITCH

Is operated with a positive snap by the rheostat arm at either end position. Used for heavy-duty applications.



WITH OFF POSITION FEATURES

Opens circuit at high or low resistance position with *snap-action* (illus.); opens circuit at high resistance position with *dead lug* off position; or has *dead section* off position.

INDUSTRY'S MOST COMPLETE LINE OF RHEOSTATS

from 25 to 1000 watts. Also available to meet MIL-R-22A requirements in each of the 26 type designations.

WRITE on Company Letterhead for Catalog and Engineering Manual.

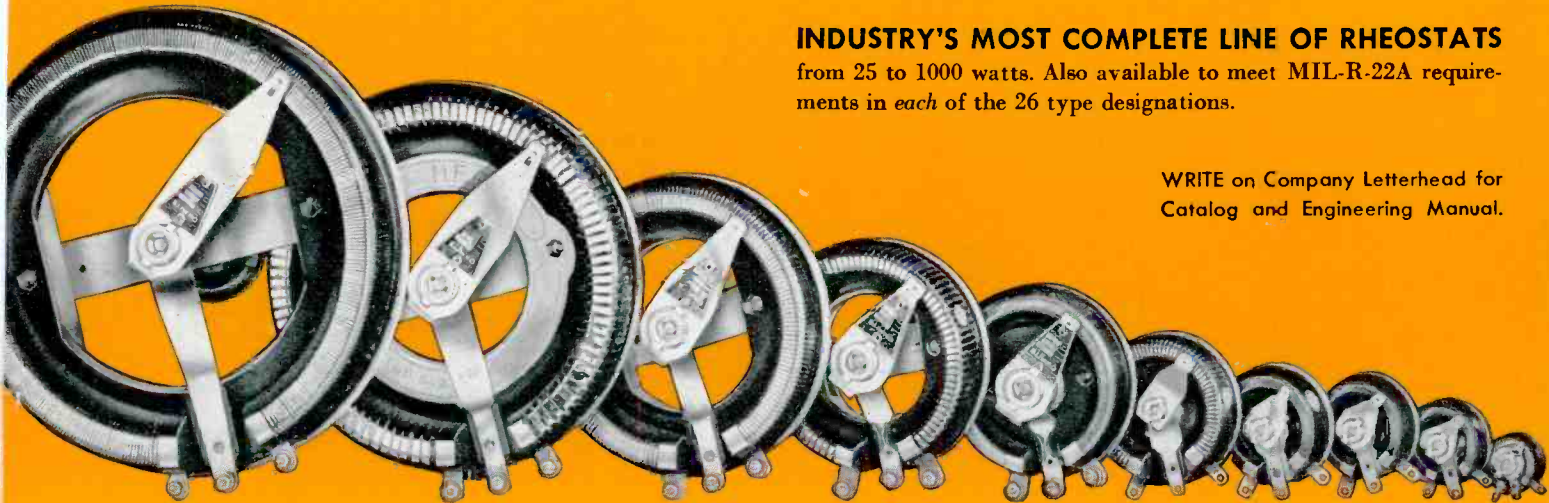

BE RIGHT WITH

OHMITE®

OHMITE MANUFACTURING COMPANY, 3610 Howard Street, Skokie, Illinois

RHEOSTATS • RESISTORS • RELAYS
TAP SWITCHES • TANTALUM CAPACITORS

specify

OHMITE®

Power Type

RESISTORS

for high current
low resistance
applications —

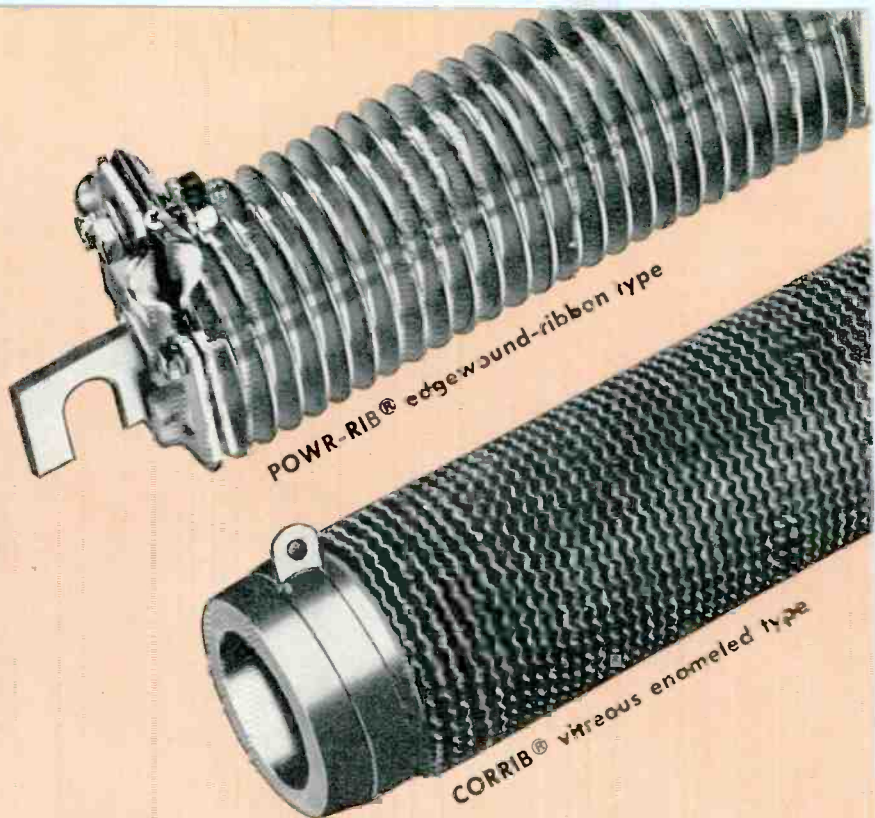

The Ohmite line of specialized CORRIB and POWER-RIB resistors solves your high-current, low-resistance problems. The four basic types of Ohmite units (shown below) handle a wide range of special power resistor needs. They are designed for continuous or intermittent duty and provide dependability for heavy-duty applications. Available in Fixed or Adjustable "DIVIDOHM®" Types.

IN STOCK—22 Corrib Resistance Values in 300 Watt Size (Core 8 1/2" x 1 1/8").

IN STOCK—26 Powr-Rib Resistance Values in 5 Section Size (17 7/8" long).

Write for Bulletin 144

- 1 CORRIB®**
vitreous-enameled
corrugated-ribbon type
Fixed, tapped, and adjustable types in 25 sizes, 90 to 1500 watts. Resistances from .04 to 11C ohms.
- 2 CORRIB®**
bare threaded tube type
For continuous or intermittent operation at higher than normal 375°C temperature rise. In two sizes, from 0.36 to 4.25 ohms.
- 3 PCWR-RIB®**
edgewound-ribbon type
Has ceramic core, sectionalized to resist shock. Four sizes. Values .043 to 1.6 ohms; 24 to 95 amps.
- 4 PCWR-RIB®**
round-wire type
Has sectionalized core similar to ribbon type. Four sizes. Values from .69 to 25 ohms; 5.1 to 18.4 amps.

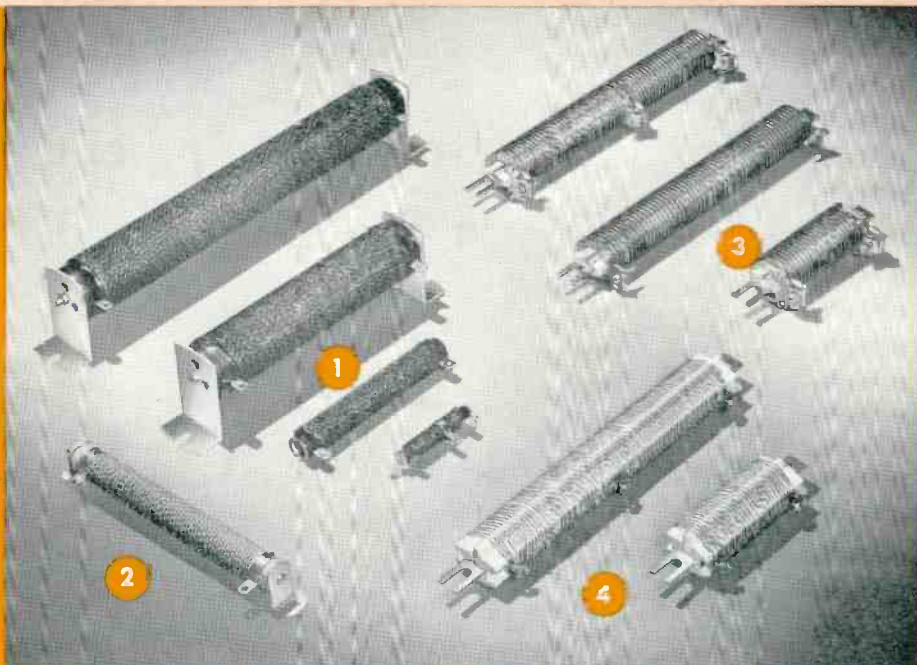

Be Right with

OHMITE®

OHMITE MANUFACTURING COMPANY, 3610 Howard Street, Skokie, Illinois (Suburb of Chicago)

**RHEOSTATS
RESISTORS
RELAYS
TAP SWITCHES
TANTALUM CAPACITORS**



Here's why Electronic Equipment is Safeguarded Best — when Protected by BUSS Fuses

To make sure BUSS fuses will give dependable electrical protection under all service conditions . . . BUSS fuses are tested in a sensitive electronic device. Any fuse not correctly calibrated, properly constructed and right in all physical dimensions is automatically rejected.

That's why BUSS fuses blow only to protect—and not needlessly. Equipment receives maximum protection

against damage due to electrical faults—yet, it is not put out of operation by needless fuse blows.

Most important, the reputation of your equipment for service and quality is not harmed by the faulty operation of poor quality fuses.

Why settle for anything less than BUSS quality fuses? To meet your

needs, a complete line of BUSS fuses is available, plus a companion line of fuse clips, blocks and holders.

For more information on BUSS and FUSETRON Small Dimension fuses and fuseholders . . . Write for bulletin SFB. Bussmann Mfg. Co. (Div. of McGraw Electric Co.), University at Jefferson, St. Louis 7, Mo.

***BUSS fuses are made to protect
—not to blow, needlessly***



Makers of a complete line of fuses for home, farm, commercial, electronic, automotive and industrial use.

NEW



Model R

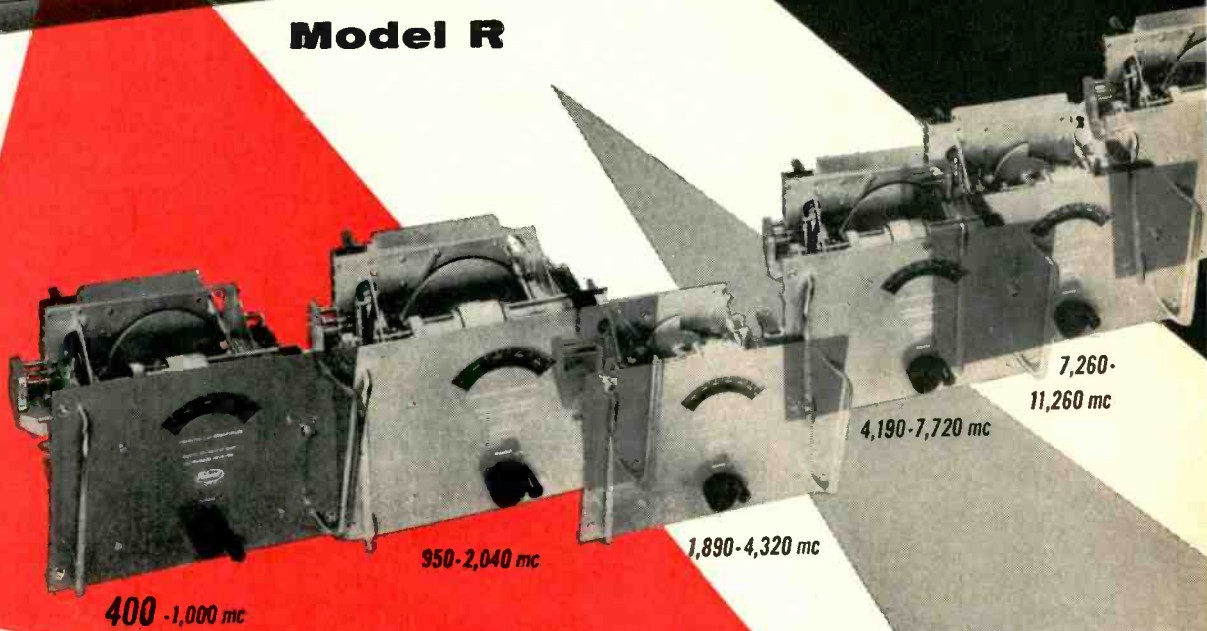

Note these special features:

- AM, FM, CW, MCW, and PULSE reception.
- Uni-dial control.
- Direct reading.
- Broadband coverage.
- Output level reading directly in db.
- High sensitivity.
- Seven interchangeable plug-in r-f tuning units cover the entire frequency range.
- Low noise figure; excellent gain stability.
- Microwave preselection, tracked and double-tuned, used in the plug-in tuning units covering the range 400 to 11,260 mc.
- Audio, video, and trigger outputs.
- Special recorder output.
- High video output—low impedance.
- AGC and AFC circuits.

For these applications:

- General communications.
- Field intensity meter.
- Frequency meter.
- Measurement of radiation and leakage of microwave devices.
- Measurement of bandwidth of microwave cavities.
- Measurement of relative power of fundamental and harmonic signal frequencies.
- Measurement of noise figure.
- Antenna field patterns.

EXTENDED RANGE MICROWAVE RECEIVER!

400 to 22,000 mc



14,700-22,000 mc

9,500-15,600 mc

SPECIFICATIONS:

Basic Receiver: Model R-B

Tuning Unit Frequency Ranges:

* Model RR-T	400 — 1,000 mc
* Model RL-T	950 — 2,040 mc
* Model RS-T	1,890 — 4,320 mc
* Model RM-T	4,190 — 7,720 mc
* Model RX-T	7,260 — 11,260 mc
* Model RKS-T	9,500 — 15,600 mc
* Model RKU-T	14,700 — 22,000 mc

Signal Capabilities:

AM, FM, CW, MCW, pulse

Sensitivity:

- (a) For Model RR-T: Minus 85 dbm
- (b) For Models RL-T, RS-T, RM-T, and RX-T: Minus 80 dbm
- (c) For Models RKS-T and RKU-T: Minus 65 dbm

Frequency Accuracy: $\pm 1\%$

IF Bandwidth: 3 mc

Video Bandwidth: 2 mc

Image Rejection:

- (a) For Models RR-T thru RX-T: Greater than 60 db

- (b) For Models RKS-T and RKU-T: Spurious response rejection obtained through the use of a bandpass filter

Gain Stability with AFC: ± 2 db

Automatic Frequency Control:

Pull-out range 10 mc off center

Recorder Output: 1 ma. full scale (1,500 ohms)

Trigger Output:

Positive 10-volt pulse across 100 ohms

Audio Output:

5 volts undistorted, across 500 ohms

FM Discriminator:

Deviation Sensitivity: .7 v./mc

Skirt Selectivity:

60 db — 6 db bandpass ratio less than 5:1

IF Rejection: 60 db

Input AC Power:

115, 230 V ac, 60 cps, 440 watts

Input Impedance:

Models RR-T through RX-T: 50 ohms
Models RKS-T & RKU-T: waveguide

VSWR: Less than 4:1 over the band

Range of Linearity: 60 db

Receiver Type: Superheterodyne

Maximum Acceptable Input

Signal Amplitude: 0.1 volt rms, without external attenuation

Video Response: 30 cps to 2 mc

Size: 17" w x 23" d x 19" h

Weight: 180 lbs. for basic unit with one tuning unit.

AVAILABLE ON EQUIPMENT LEASE PLAN

U. S. PATENT NO. 2,774,243



ELECTRONICS CORPORATION

43-20 34th Street · Long Island City 1, New York



For private demonstration
without obligation
ask for the

to stop
at your plant

**maintenance
available by field
service specialists**

REPRESENTATIVES: Albuquerque, Atlanta, Baltimore, Boston, Buffalo, Chicago, Cleveland, Dayton, Denver, Fort Worth, Kansas City, Los Angeles, New York, Philadelphia, Portland, St. Louis, San Francisco, Schenectady, Syracuse, Washington, D. C., Winston-Salem, Canada; Arnprior, Ontario. Resident Representatives in Principal Foreign Cities

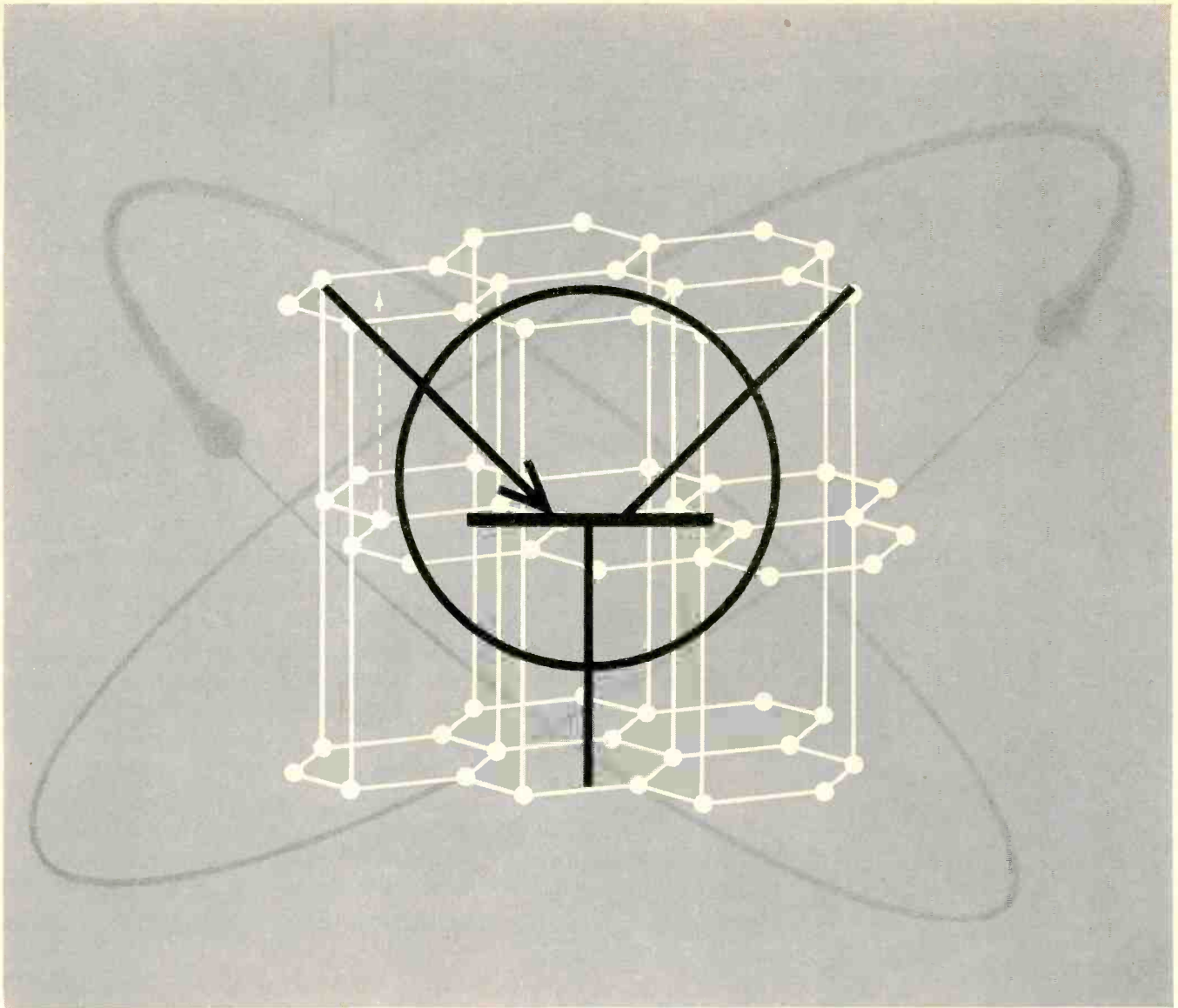

GRAPHITE

... ultra pure for the electronic industry

If you wish competent technical help concerning the use of graphites in the electronics field ... combined with graphite products of the maximum density and purity ... we invite you to UNITED CARBON PRODUCTS CO., INC.

Your electronic graphite problem—whether it be on production material or parts—can probably find fast solution in the technical service division at UNITED.

We have been privileged, over the years, to have worked out successful solutions to innumerable graphite problems for many world-famous organizations.

A simple, brief letter concerning your problem will put our technical service division at your confidential service—immediately. Or, if you wish, telephone or wire.

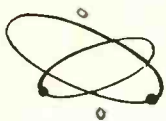

UNITED

CARBON PRODUCTS CO. INC.

P. O. BOX 269, BAY CITY, MICH.

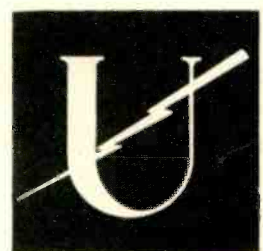

0 cps
to 1 MC

frequency
period
time interval
INSTANTLY!



**CMC model 226A
UNIVERSAL COUNTER-TIMER**

Complete specifications
available from representative in your area
or direct from factory . . .



FEATURES:

- ★ Three independent, adjustable trigger-level controls permitting full rated sensitivity at an average voltage level between -300 and +300 volts.
- ★ Simplified color-coded controls and direct read-out in kc, mc, sec or millisecc with automatic decimal point indication.
- ★ Small voltage increments ordinarily masked by attenuators are easily selected.
- ★ Oscilloscope marker signals facilitate start and stop trigger-level adjustment for time interval measurement of complex waveforms.

APPLICATIONS:

Multi-purpose instrument designed for precise measurement of Frequency, Frequency Ratio, Period (1/frequency) and Time Interval. Pressure, Velocity, Acceleration, Displacement, Flow, RPS, RPM, etc., may also be measured with suitable transducers. May be used as a secondary frequency standard.

BRIEF SPECIFICATIONS

Frequency Range	0-1,000,000 cycles per second
Period Range	0.000001 cps to 100 kc
Time Interval Range	3 microseconds to 1,000,000 seconds
Time Bases	0.00001, 0.0001, 0.001, 0.01, 0.1, 1 and 10 seconds; external 1 and 10 cycles of unknown (period)
Secondary Frequency Standard	1 mc; 100, 10, 1 kc; 100, 10, 1 cps
External Standard Input	0 to 1 mc

Price \$1,100.00

Model 225A - 0 cps to 100 kc also available. Price \$840.

Computer Measurements Corporation

5528 Vineland Ave. • No. Hollywood, Calif.

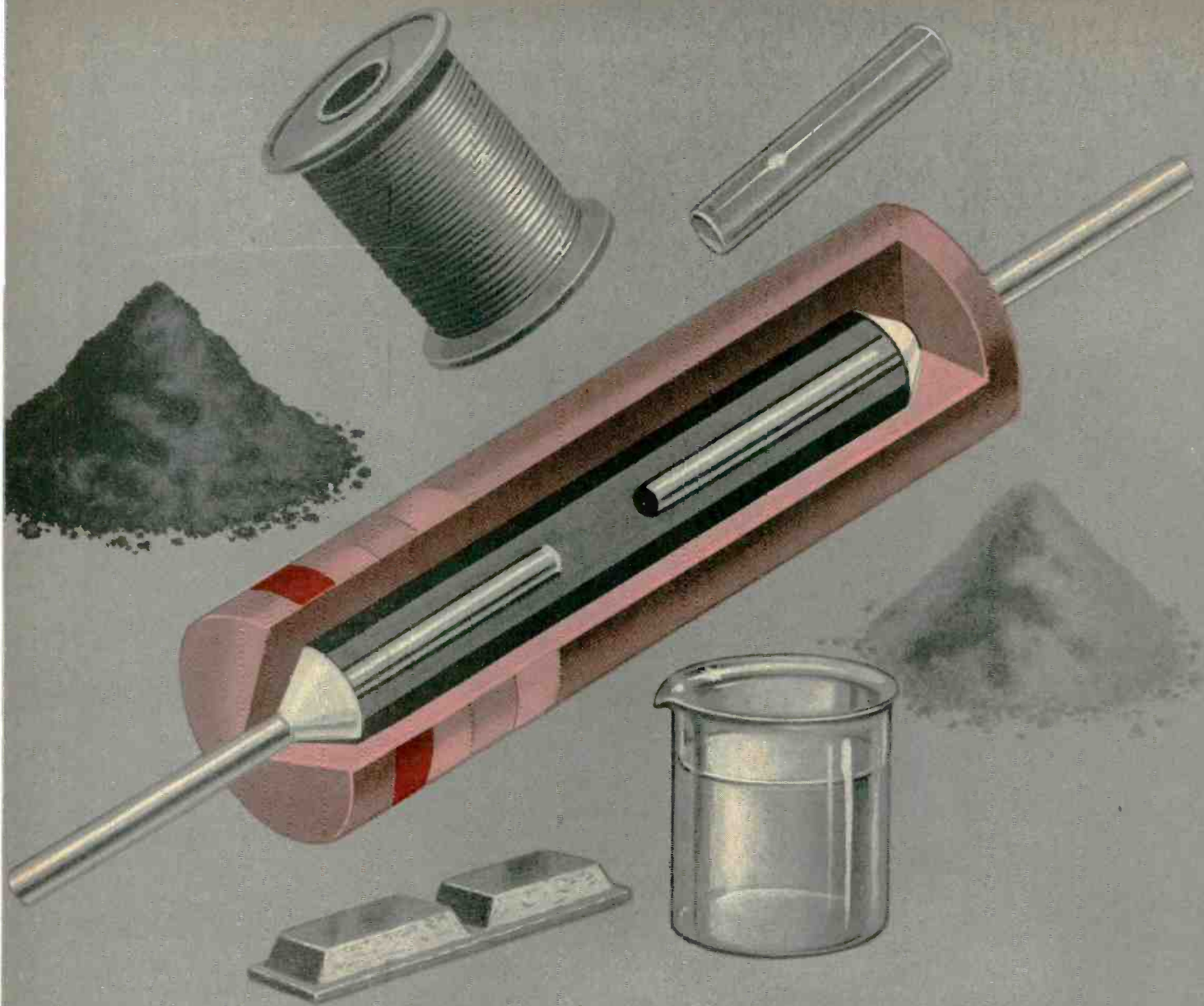

They're made from standard materials—

WHY DO IRC[®] RESISTORS OFFER HIGHEST REPRODUCIBILITY ?

Carbon, glass, coating resins, molding powder, copper wire, and a metal alloy—they're the only materials you'd need to make a resistor such as IRC's famous Type BT fixed composition resistor. But the real problem, you'd soon discover, is to make every resistor just like the ones before it and just like those following it. That's where IRC's exclusive processes pay off. They give you resistors that "test out" more alike in mechanical and electrical characteristics than any other resistors of their type. That's why only IRC

resistors make possible unvarying performance of your own equipment.

The outstanding thing about IRC production processes is that they provide this uniformity at economical mass-production rates. For example, over 5 miles of carbon filament are drawn every day for film type resistors. And for maximum efficiency and uniformity, this filament is measured and cut while it's being produced. It's this kind of know-how that makes every type of IRC resistor your best buy. Send the coupon today for more facts.

How **IRC** provides unique reproducibility

FILM RESISTORS



Type BT Fixed Composition Resistors



Type DC Deposited and Type BO Boron Carbon Resistors



Molded Type MD Deposited and Type MB Boron Carbon Resistors



Type HFR High Frequency Resistors



Type MV High Voltage Resistors



Resistance Strips and Discs

IRC film resistors exceed military specifications but the really outstanding thing is that they do it with unusual lot-to-lot uniformity in characteristics. What's the reason for this reproducibility? IRC's secret production processes!

You'll find this kind of production know-how in the making of Type DC Deposited Carbon Resistors, for example. The carbon used and the way the carbon film is formed both assure complete dispersion for better resistor performance. In IRC Boron Carbon Resistors, too, the unique method used to combine gases results in greater uniformity at low cost.

WIRE WOUND RESISTORS

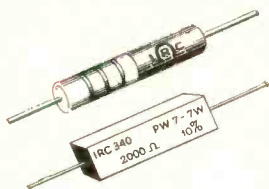

Types BW and PW Low Power Wire Wound Resistors

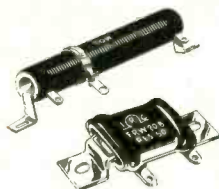

Types PWW and FRW Power Wire Wound Resistors



Type WWJ Precision Wire Wound Resistors



"PH" Series Encapsulated Precision Resistors



Type CL Insulated Wire Wound Chokes

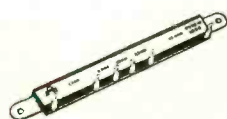

Type MW Bracket Mounted Resistors

IRC wire wound resistors are exceptionally uniform in their accuracy of adjustment and in characteristics making for long-term stability. The main reason is that they are all automatically machine wound under uniform tension and constant temperature and humidity conditions.

You can see the result of this superior winding skill in the element of the Type CL Insulated Choke, for example. Extremely fine wire is wound so expertly that the element appears to be one smooth, uninterrupted surface! This same winding skill also makes the element of all other IRC wire wound resistors a study in perfection—free from shorted turns or winding strains.

Insulated Composition Resistors • Deposited and Boron Carbon Resistors • Power Resistors • Voltmeter Multipliers • Ultra HF and Hi-Voltage Resistors.

Whenever the Circuit Says

Low Wattage Wire Wounds • Resistance Strips and Discs • Selenium Rectifiers and Diodes • Hermetic Sealing Terminals • Insulated Chokes • Precision Wire Wounds.



HYCOR, Division of International Resistance Co., Sylmar, Los Angeles County, California

Subsidiaries:

Circuit Instruments Inc., St. Petersburg, Florida
Hycor Company, Inc., Vega Baja, Puerto Rico

INTERNATIONAL RESISTANCE COMPANY

Dept. 234, 401 N. Broad St., Philadelphia 8, Pa.

In Canada: International Resistance Co., Ltd., Toronto, Licensee

Please send technical bulletins describing Fixed Compositions Deposited and Boron Carbons High Frequency Types High Voltage Types Low Power Wire Wounds Power Wire Wounds Precision Wire Wounds Insulated Chokes Resistance Strips and Discs.

NAME _____

COMPANY _____

ADDRESS _____

CITY _____ STATE _____

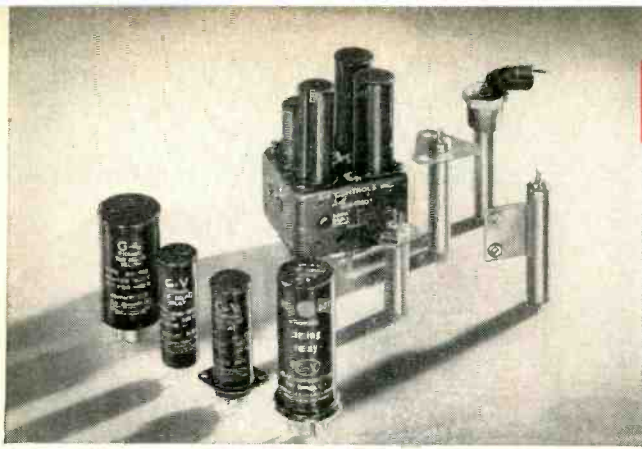

THE G-V LINE—(l. to r.) Thermal Relays, a Thermal Relay Assembly, Sealed Thermostats. The complete G-V line, incorporating over 1,000 variations, covers more than 98% of all application requirements.



No. 1 of a series

Research and Engineering



What Makes G-V Controls

G-V TOPS IN THERMAL RELAY FIELD

In business as a producer of thermal relays and thermostats for less than 6 years, G-V Controls has already achieved the enviable position of undisputed leader in the design, development and manufacture of thermal relays. In the vast, competitive electronic industry, this can be considered an outstanding accomplishment.

G-V OFFERS UNIQUE FACILITIES

G-V Controls' rapid progress has been due in large measure to the highly competent personnel and modern equipment which it has devoted to the field of thermal relays. Its Engi-

neering Staff has produced most of the recent technical advances in this field. Its Manufacturing Department has built a reputation for high quality and dependable deliveries. Its Field and Sales Engineering Organization is known throughout the country for helpful and intelligent cooperation. All of these facilities are freely available to our present and prospective customers. They can help you to make your products better.

We give you on these pages a view of some of our Research and Engineering activities. Later in this series, we will feature Production and Sales and Field Engineering.

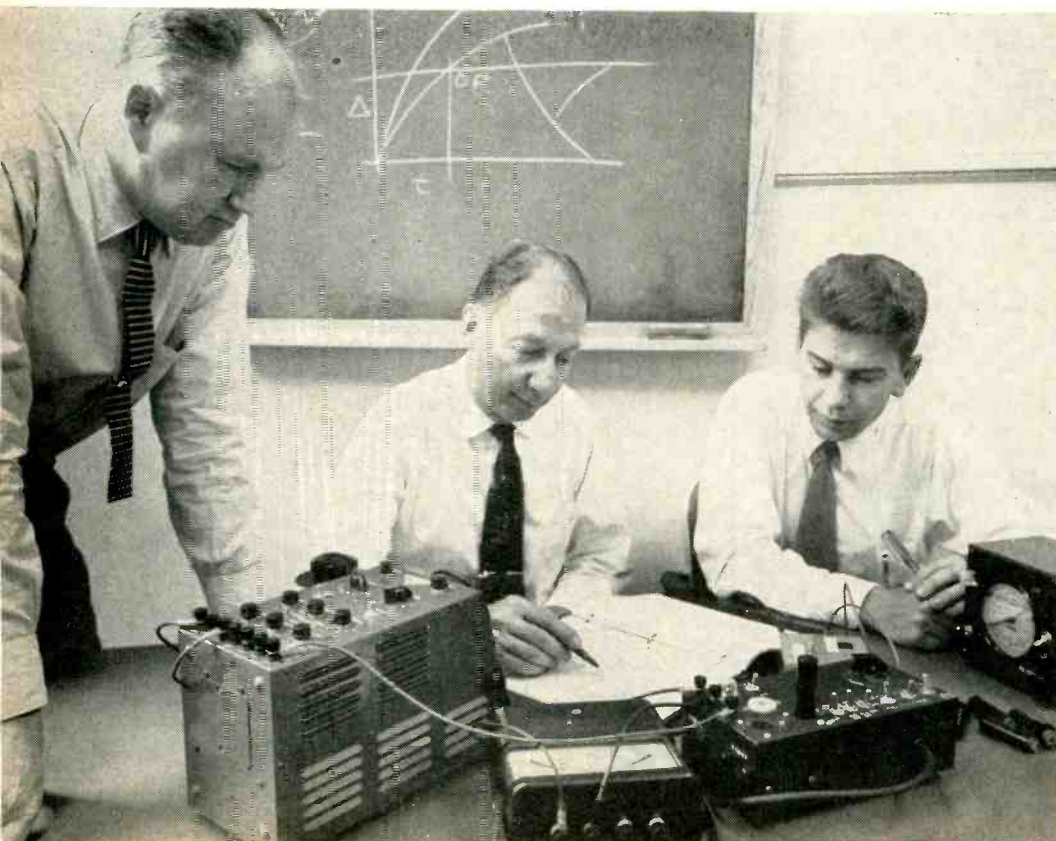

APPLICATION ENGINEERING

Every new relay application is studied by the Application Engineering Group. Complete operating data on over 1000 types and variations of thermal relays permits these men to recommend the best type and to predict its behavior.

Key spots open for engineers interested in going places with a young progressive organization.



RESEARCH and DEVELOPMENT—G-V Controls developed the first 7-pin miniature thermal relay, the first adjustable hermetically sealed thermal relay, the first her-



metically sealed hot-wire relay. The precision and uniform characteristics of G-V's relays have qualified them for many uses new to relays of this type.

The Leader In Thermal Relays ?



Complete catalog data is available.

G-V CONTROLS INC.

24 Hollywood Plaza, East Orange, N. J.

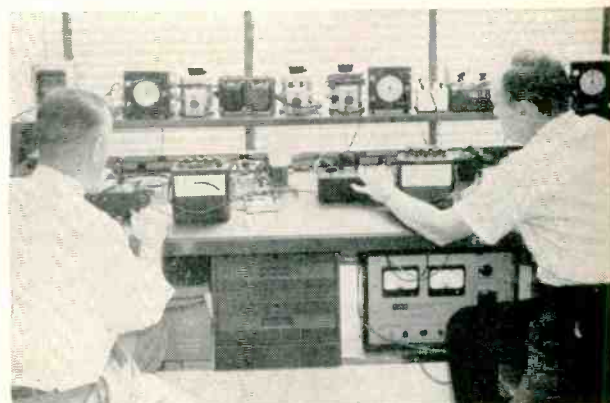

UNUSUAL APPLICATIONS are "bread-boarded" to duplicate conditions in users' equipment.

G-V ENVIRONMENTAL TEST LABORATORY—This modern laboratory, with all the newest testing equipment, assures the user of maximum reliability. Qualification

tests to military requirements, followed by periodic quality control testing, guarantees continued reliability under extreme environmental conditions.

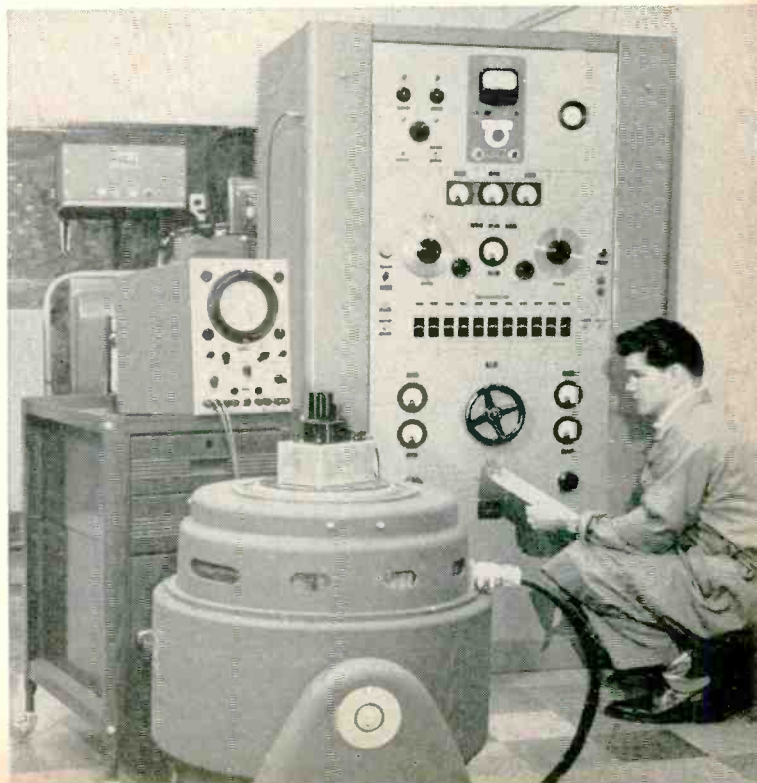
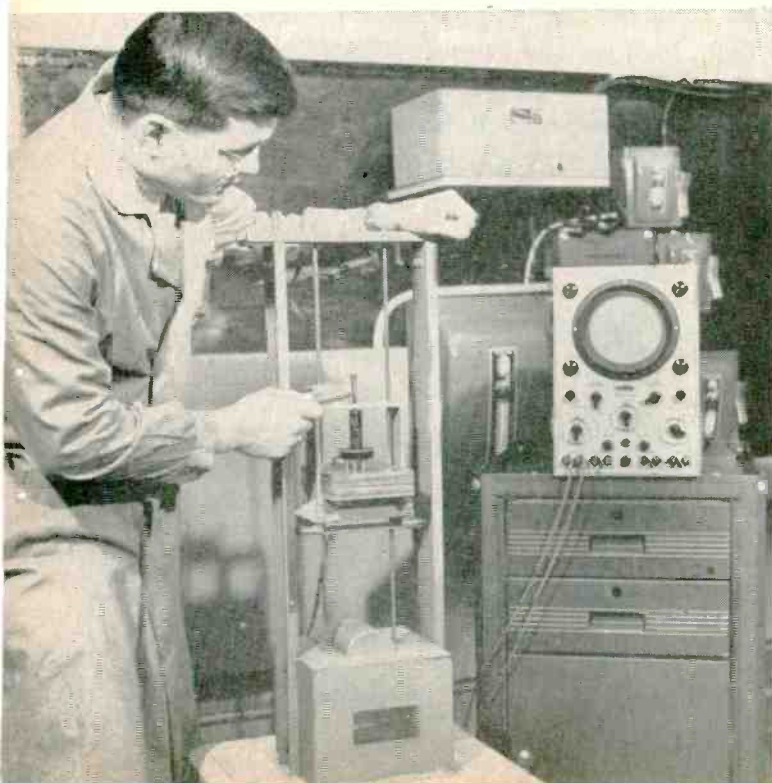

**when good enough
is not enough...**

specify RMC DISCAPS
for the **ultimate**

If you want to improve the quality of your electrical or electronic product you will do well to investigate the advantages of RMC DISCAPS.

Modern research methods and strict quality controls have made DISCAPS the outstanding ceramic capacitors for a wide range of applications.

RMC offers standard temperature compensating, heavy duty, high voltage frequency stable, and temperature stable as well as special types. If you use ceramic capacitors look to RMC, DISCAPS are our only business.

Write for complete information on your company letterhead.

DISCAP
CERAMIC
CAPACITORS

RMC

RADIO MATERIALS CORPORATION
GENERAL OFFICE: 3325 N. California Ave., Chicago 18, Ill.
Two RMC Plants Devoted Exclusively to Ceramic Capacitors
FACTORIES AT CHICAGO, ILL. AND ATTICA, IND.

Generation of Functions of *Two or More* Variables

with the

400 series REAC®

DIODE FUNCTION GENERATOR

- Allows direct generation of slopes up to 12 volts/volt without paralleling diode segments.
- 10-turn potentiometers for both "slope" and "break point" give excellent resolution. Still further improvement in resolution is obtained by splitting slope adjustment into two ranges.
- 1000-division direct read-out 10-turn dials permit logging of function for fast reproduction later.
- Flexible switching system allows number of segments per channel to be varied from 2 to 30.
- Built-in calibration circuit permits functions to be set up quickly and easily without use of external plotting board.

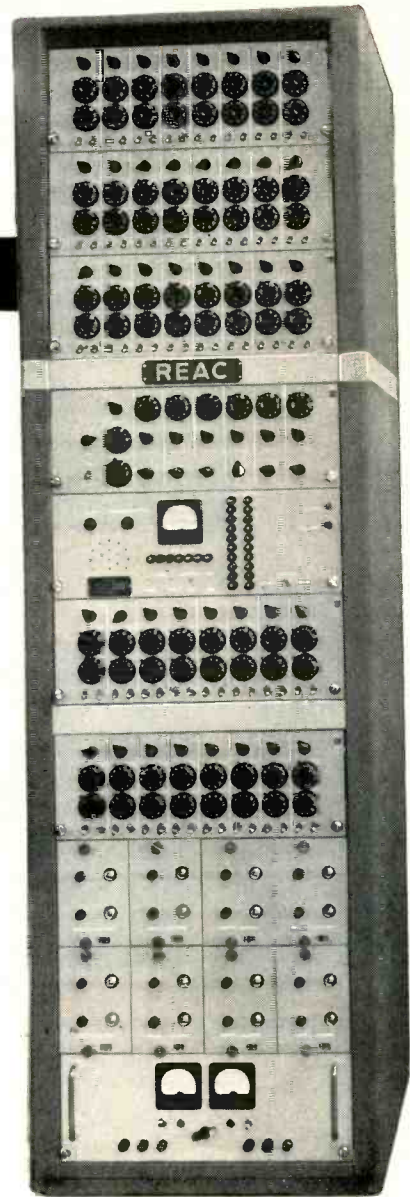
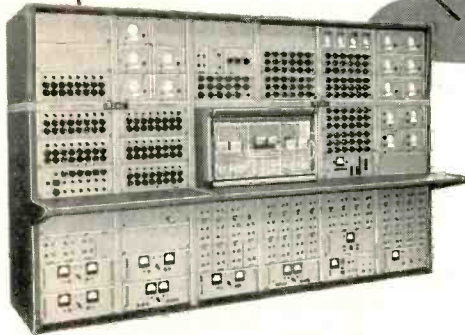

... a complete self-contained unit

The DFG-401 is a completely self-contained unit consisting of 5 channels of function generation, 15 DC amplifiers (with VTVM and all control circuits for monitoring and balancing), and all necessary power supplies (except relay and reference voltages). In the event that any amplifiers supplied are not needed in the problem, they can be made available in groups at the patchbay as inverters with one gain of one.

This unit is ideal for the addition of up-to-date diode function generation equipment to an existing analog computer installation.

Electronic generation of functions of two or more variables is another outstanding Reeves contribution to the flexibility and efficiency of the electronic analog computer. Before installing new equipment, it will pay you to consult us. A comprehensive new REAC "400" series computer technical brochure will be sent upon request.

REEVES INSTRUMENT CORPORATION

A Subsidiary of Dynamics Corp. of America, 201 East 91st St., New York 28, New York

2RV57



REAC Analog Computers



Precision Floated Gyros



Precision Resolvers and Phase Shifters



Servo Mechanical Parts



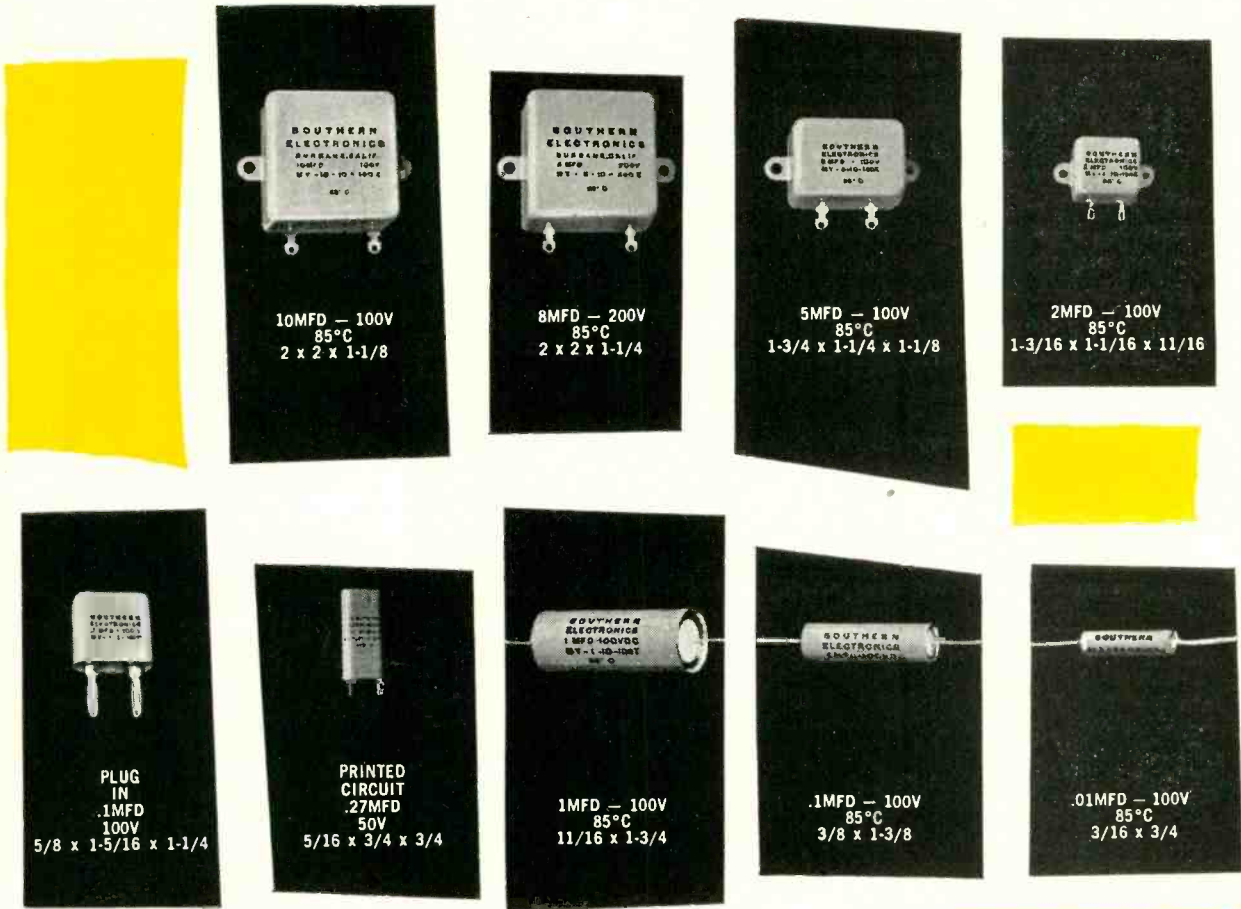

At last!
Mycon Plastic
Capacitors
up to 150° C!

- *Reliability proved*
 - *Rated for infinite long life*
- *Insulation resistance 1×10^{11} OHMS*

Wire, write or phone for complete catalog today!

SOUTHERN ELECTRONICS
Corporation

239 West Orange Grove Ave., Burbank, California
 PIONEERS IN CUSTOM CAPACITOR ENGINEERING

Derated at 125°C as follows:

- 100 volts — 50%
- 200 volts — 50%
- 300 volts — 33½%
- 400 volts — 33½%
- 500 volts — 20%
- 600 volts — 16%

Tested and proved! Only Southern Electronics Corporation has developed a test procedure which insures built-in reliability! For your most exacting requirements—be sure—always specify S.E.C.

SUPER MYCON CAPACITORS

Tolerance to 1%—lowest temperature coefficient. Superior insulation resistance at high ambient temp. Good stability compatible with material.



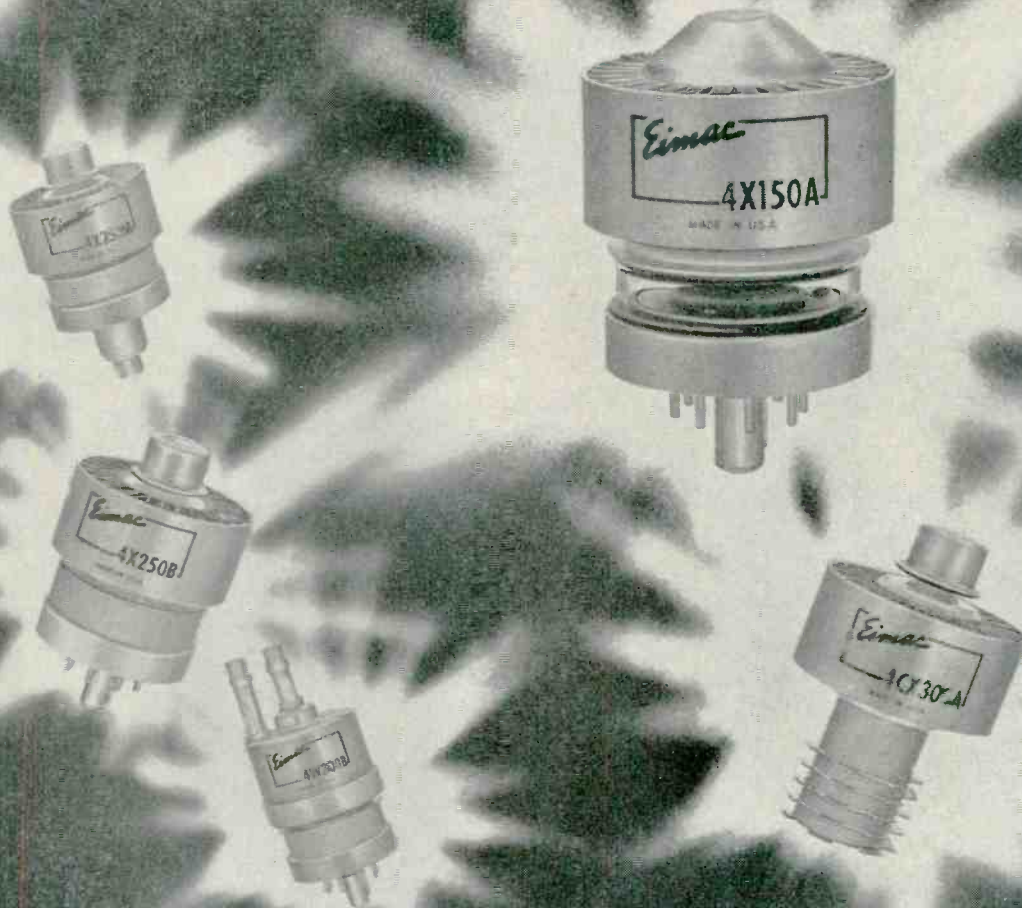

Evolution at Eimac

Back in 1946 Eimac developed and produced the 4X150A—a new concept in power tetrodes. Its immediate acceptance by the industry then, has led to even more popularity now.

But today at Eimac the glass 4X150A is virtually obsolete.

Since 1946 Eimac has constantly improved the 4X150A to the point where it has evolved into a family of superior quality 250w and 300w tubes for operation to 500Mc. Small, compact structure has been retained. In fact, the 4X250 series is interchangeable with 4X150

tubes. Ceramic envelopes make possible greater mechanical strength, better production techniques, and higher temperature processing.

Because "good enough" has never been accepted at Eimac, however, this family of air cooled or water cooled, co-axial or conventional socketed tubes (2.5v, 6v, and 26.5v) is again accelerating the pace in quality, design, and performance, exactly as the 4X150A did a decade ago.

EITEL-McCULLOUGH, INC.
 SAN BRUNO · CALIFORNIA
 The World's Largest Manufacturer of Transmitting Tubes



4X150A

4X150 Series
 4X150A-1946
 4X150G-1949
 4X150D-1952

4W300 Series
 4W300B-1953

4X250 Series
 4X250B-1955
 4X250F-1955
 4X250M-1955
 4CX250K-1956

4CX300 Series
 4CX300A-1956



ELECTRON TUBES FOR SURVIVAL

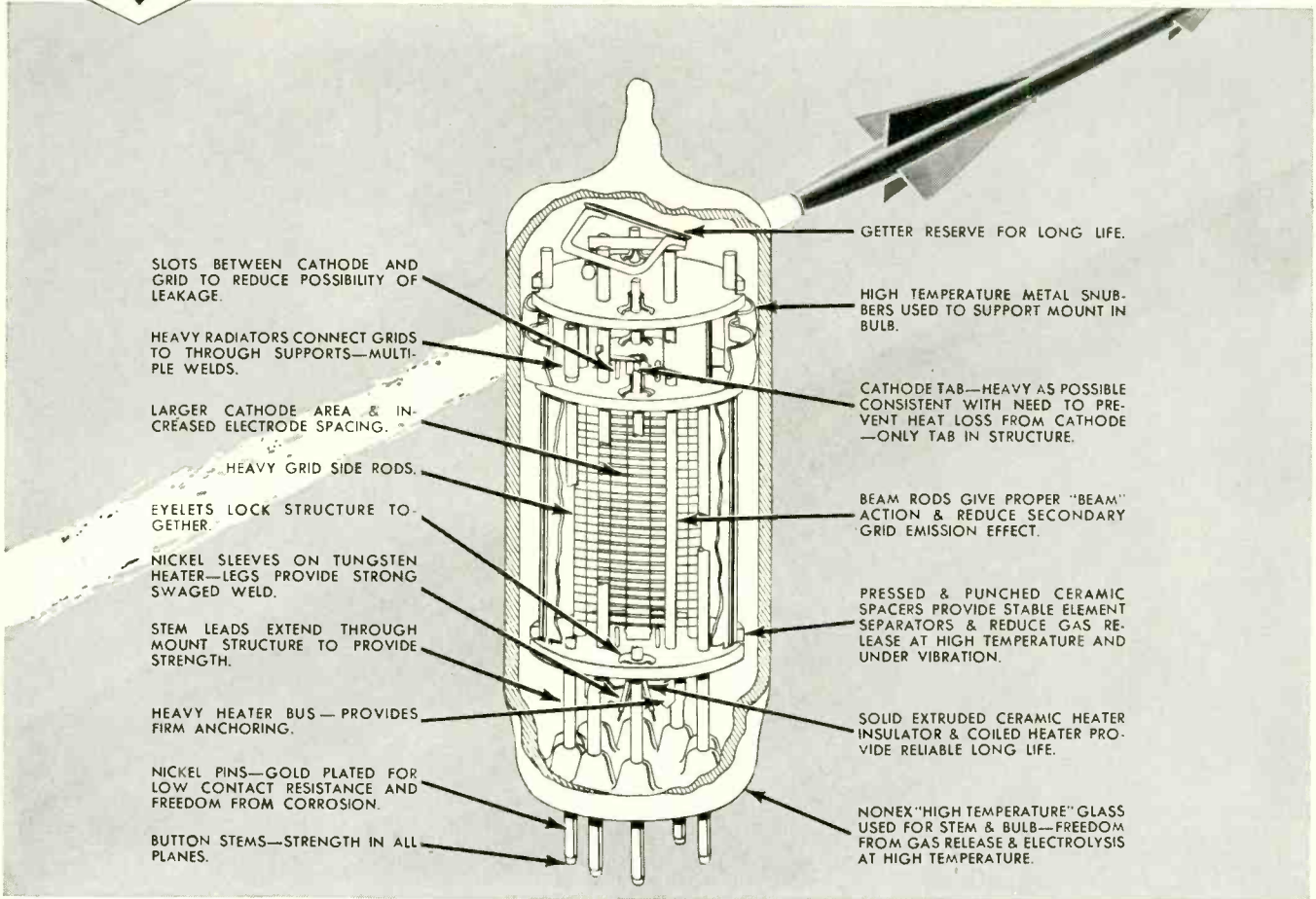

WHY BENDIX* HY-G-300 ELECTRON TUBES ARE BEST FOR EXTREME SHOCK, VIBRATION AND TEMPERATURES!

From the standpoint of design features (see above), these reliable hard glass tubes offer the superior quality needed to survive today's severe environmental demands.

Specifically, Bendix HY-G-300's are designed to withstand the following environmental conditions—bulb temperatures up to 300° C; vibration up to 20G's over the range of 5-2000 cycles; and shock of 200G's having 20-millisecond duration.

For full information about the HY-G-300 line . . . the surest answer to electron tube applications in jet aircraft, missiles and rockets . . . write RED BANK DIVISION, BENDIX AVIATION CORPORATION, EATONTOWN, NEW JERSEY.

*TRADEMARK

West Coast Sales and Service: 117 E. Providencia, Burbank, Calif. • Export Sales and Service: Bendix International Division, 205 E. 42nd St., New York 17, N. Y. • Canadian Affiliate: Aviation Electric, Ltd., P. O. Box 6102, Montreal, Que.



TUBES ARE AVAILABLE FROM STOCK

Bulb Size	Dbl. Triodes Volt Amp.	R. F. Pentodes	Gate Pentodes	Rectifiers FullWave	Beam Power	Power Triodes Passing
T-12	—	—	—	—	—	6080WB 6082A
T-11	—	—	—	—	6384 6889	—
T-9	—	—	—	6853	—	—
T-6½	6851 6854 6900	6582A	6486A	6754	6094	6877 6900

Retma Type No.	Retrofit For	Generic Type	E _f	I _f	Bulb	Bendix Type No.
6080WB	6080 6080WA	6080	6.3	2.5	T-12	TE-46
6094	—	6A05-6095	6.3	0.6	T-6½	TE-18
6853	6106 5Y3	5Y3	5.0	1.7	T-9	TE-45
6384	6AR6 6098	6AR6	6.3	0.9	T-11	TE-27
6854	6385	2C51 5670	6.3	0.5	T-6½	TE-47
6486A	6486	6AS6	6.3	0.25	T-6½	TE-43
6582A	6582	6AK5	6.3	0.25	T-6½	TE-44
6754	412A	—	6.3	1.0	T-6½	TE-36
6851	5751	—	6.3	0.5	T-6½	TE-42
6877	—	Half of 6080	6.3	0.8	T-6½	TE-48
6900	5687	5687	6.3	0.9	T-6½	TE-54
6889	—	—	6.3	0.9	T-11	TE-52
6082A	6082	6082	26.5	0.6	T-12	TE-55

Red Bank Division



Waldes Truarc grip rings used on die-cast studs eliminate threading, tapping, other costly machining



Mark Simpson Manufacturing Co., Long Island City, N. Y., uses Waldes Truarc series 5555 Grip Rings to secure parts to studs of the zinc die-cast base of its "Masco 500" portable tape recorder. The rings—which need no grooves—replace nuts, screws, cotter pins and other types of fastening devices which require threading, tapping, drilling and other expensive machining operations. Because a single cracked or broken stud would render the entire cast base useless—and with it, all assembly completed to that point—the rings also eliminate extremely costly rejects.

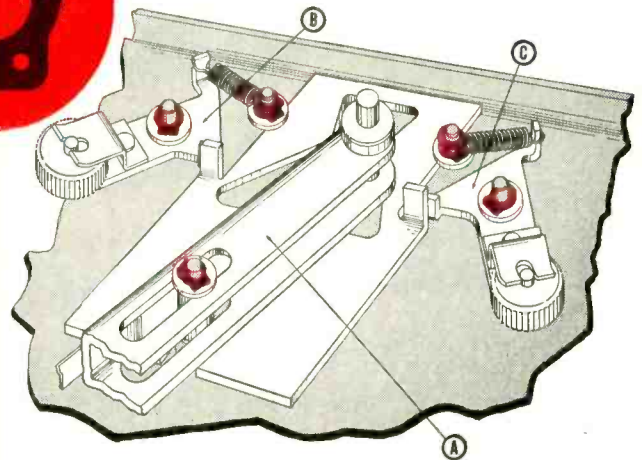

Pivot Assembly of shift lever (A) is secured by a single Waldes Truarc Grip Ring and washer. Because the washer must be installed over the shift level in a sliding fit, critical tolerances would have to be maintained if a screw or cotter pin were used. The Truarc Grip Ring eliminates that problem: it requires no groove and may be seated over the washer at any point on the stud, automatically compensating for accumulated tolerances in the parts. **BRAKE ASSEMBLIES** (B and C) use Grip Rings to secure the brake wheel and spring sub-assemblies. Here again problems of critical tolerances are avoided and expensive rejects eliminated.

Whatever you make, there's a Waldes Truarc Retaining Ring designed to improve your product... to save you material, machining and labor costs. They're quick and easy to assemble and disassemble, and they do a better job of holding parts together. Truarc rings are precision engineered and precision made, quality controlled from raw material to finished ring.

36 functionally different types... as many as 97

different sizes within a type... 5 metal specifications and 14 different finishes. Truarc rings are available from 90 stocking points throughout the U. S. A. and Canada.

More than 30 engineering-minded factory representatives and 700 field men are available to you on call. Send us your blueprints today... let our Truarc engineers help you solve design, assembly and production problems... without obligation.

For precision internal grooving and undercutting... Waldes Truarc Grooving Tool!

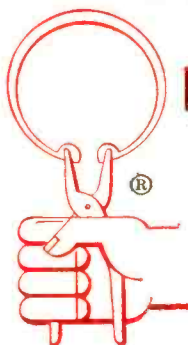

WALDES
TRUARC®
RETAINING RINGS

WALDES KOHINOOR, INC.
47-16 AUSTEL PLACE, L. I. C. 1, N. Y.

Waldes Kohinoor, Inc., 47-16 Austel Place, L. I. C. 1, N. Y.
Please send the new supplement No. 1 which brings Truarc Catalog RR 9-52 up to date.
(Please print)

Name.....
Title.....
Company.....
Business Address.....
City..... Zone..... State.....

E029

WALDES TRUARC Retaining Rings, Grooving Tools, Pliers, Applicators and Dispensers are protected by one or more of the following U. S. Patents: 2,382,948; 2,411,426; 2,411,761; 2,416,852; 2,420,921; 2,428,341; 2,439,785; 2,441,846; 2,455,165; 2,483,379; 2,483,380; 2,483,383; 2,487,802; 2,487,803; 2,491,306; 2,491,310; 2,509,081; 2,544,631; 2,546,616; 2,547,263; 2,558,704; 2,574,034; 2,577,319; 2,595,787, and other U. S. Patents pending. Equal patent protection established in foreign countries.

need quick service on **TIMERS** for automatic control?

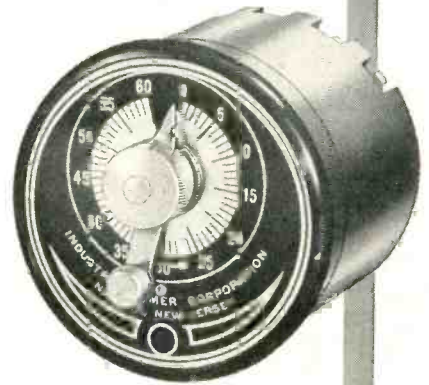

Time Delay Timers

The more automatic control problems we get, the better we like it. For while it's true each automatic control job is a bit different from the rest, the record shows that our 19 years of timer experience has given us the special knowledge it takes to give you the right answers, and in near-record time.

If one of our standard timers won't do your job — or one of the 721 combinations we have thus far developed from our 17 basic units — our engineers will go right to work to develop a new combination that's the one for you. That's the way we grow — and we like it.

We manufacture a complete line of timers in these 4 broad classifications:

**TIME DELAY TIMERS • INTERVAL TIMERS
RE-CYCLING TIMERS • RUNNING TIME METERS**

And since we maintain large stocks of our 17 basic units, we can assure you of rapid deliveries — of excellent deliveries even on special orders. So whatever your automatic control problem, you have everything to gain by submitting it to our timer specialists. They'll give you a profitable answer — almost with the speed of automatic control itself.



Interval Timers

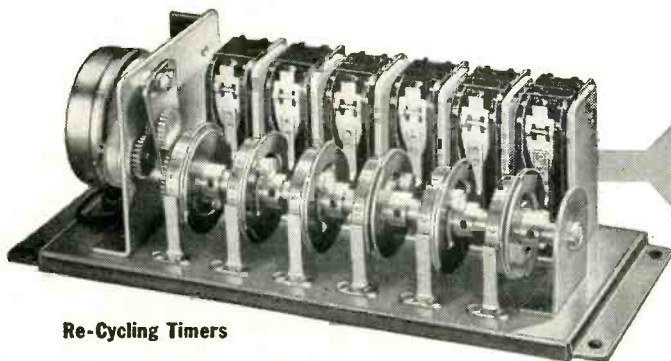

Re-Cycling Timers

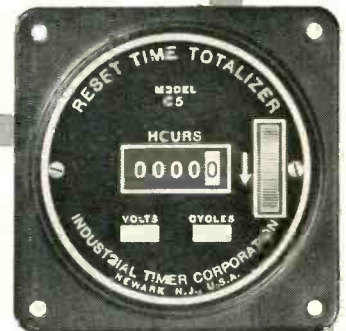

Running Time Meters

*Timers that Control
the Pulse Beat of Industry*



INDUSTRIAL TIMER CORPORATION

1409 McCARTER HIGHWAY, NEWARK 4, N. J.

*The most important announcement
in modern oscillograph history...*

the dramatic new **Honeywell** direct-recording

VISICORDER[®]

All at once you can record and read the record of the Visicorder. Using a completely new direct-recording principle, the Visicorder puts six channels on a direct-reading record at sensitivities comparable to photographic oscillographs, and at frequencies from DC to 2000 cps!

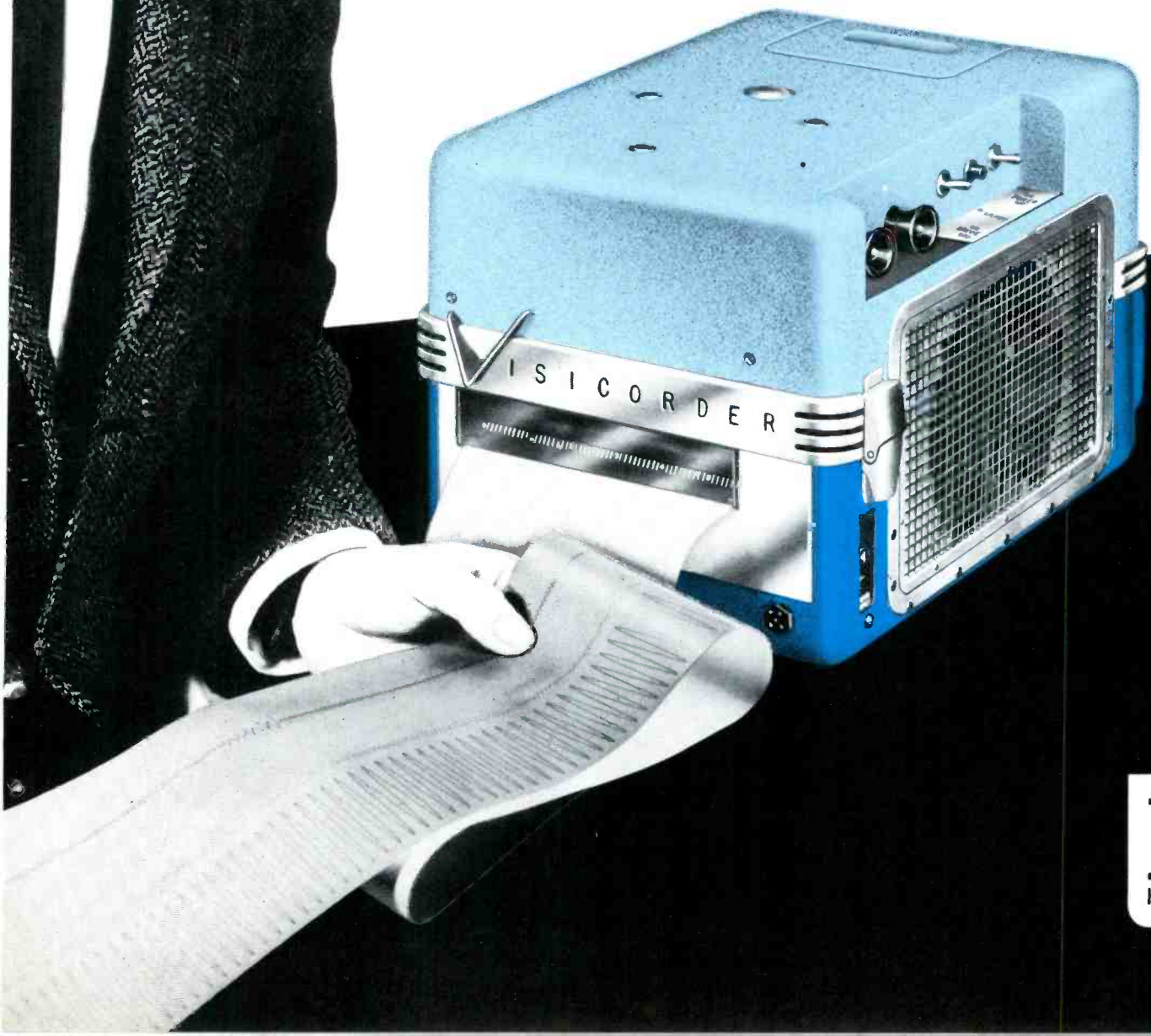



THE NEW VISICORDER, perfected after years of research by the Heiland Division of Honeywell, combines the high frequency and high sensitivity characteristics of photographic oscillographs with the convenience of a direct-recording instrument.

By means of a completely new type of recording paper, light source, and optical system, the Visicorder makes use of mirror-type galvanometers to record phenomena from DC through 2000 cps *without* peaked amplifiers or other external compensation.

The record requires no liquids, vapors, powder magazines, or other processing materials. Development is accomplished by external light only as the record emerges from the oscillograph.

The Visicorder records are stable and require no further processing under normal conditions. They may be subjected to room light for extended periods without fading, and are permanent indefinitely when protected from light. Should it be necessary to subject the records to direct sunlight, they may be chemically "fixed" (in room light) using conventional photographic practices.

Visicorder records are reproducible by several methods using commercially available equipment.

Since the Visicorder operates on light-beam galvanometers, traces may deflect the full 6" width of the chart, peak to peak, and their deflection is not limited by adjacent channels.

The remarkable exclusive features of the Visicorder make it the ideal recording oscillograph for applications where readable, permanent analog records are required and for additional uses where the measured phenomena need to be monitored or where immediate recorded results are desirable.

GENERAL FEATURES

FREQUENCIES	From DC to 2000 cps <i>without</i> peaked amplifiers or other compensation of any kind.
SENSITIVITIES	Comparable to photographic-type oscillographs.
RECORDING METHODS	Records directly on paper which requires no powder magazines, liquids, vapors, or other processing. Records are immediately visible and usable. Daylight loading. Accommodates recording paper 100 feet in length. Indicator shows unused recording paper available.
NO. OF CHANNELS	6 channels on 6" wide paper plus provisions for two timing traces.
DEFLECTION	Full 6" peak to peak. Traces may overlap; not limited by adjacent channels.
RECORD SPEEDS	0.2, 1, 5, and 25 inches per second, minute, or hour.
GALVANOMETERS	D'Arsonval-movement mirror galvanometers with choice of natural frequencies to suit individual requirements.
AMPLIFICATION	None required for most applications.
POWER	115 volt 60 cycle AC operation. 4 amperes.
DIMENSIONS	10" height; 15" depth; 10" width.
WEIGHT	37 pounds, complete and ready to operate.
PRICE	\$2,500.00, less galvanometers. Galvanometers \$150.00 each.

Deliveries starting January, 1957

1 THE VISICORDER is the first and only photographic-type oscillograph that can be loaded with recording paper in daylight. The paper speeds can be selected while the instrument is in operation. The light spots from the galvanometers are *visible from the exterior* at their point of contact with the paper; thus phenomena can be monitored simultaneously with their recording.

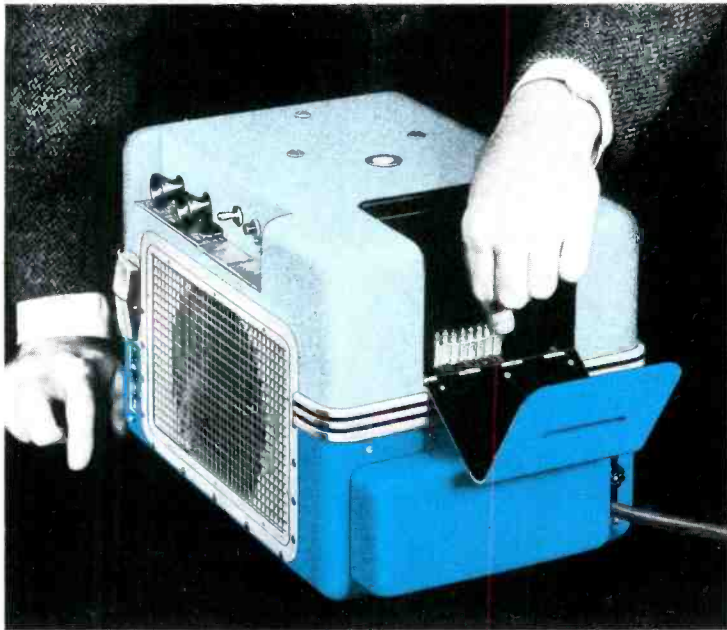

2 GALVANOMETER ADJUSTMENTS

may be made through a panel-covered opening in the back of the instrument. Other operating controls—power on-off, lamp switch, paper drive and paper speed—are located on one convenient panel. Galvanometers are of the familiar Heiland solid-frame type: high sensitivity, accurate balance, high stability, low drift, in a versatile range of frequencies and sensitivities.

3 SERVICE on the Visicorder is extremely easy, since the instrument opens completely as shown. All components—galvanometers, recording lamp, transmission—are completely accessible.

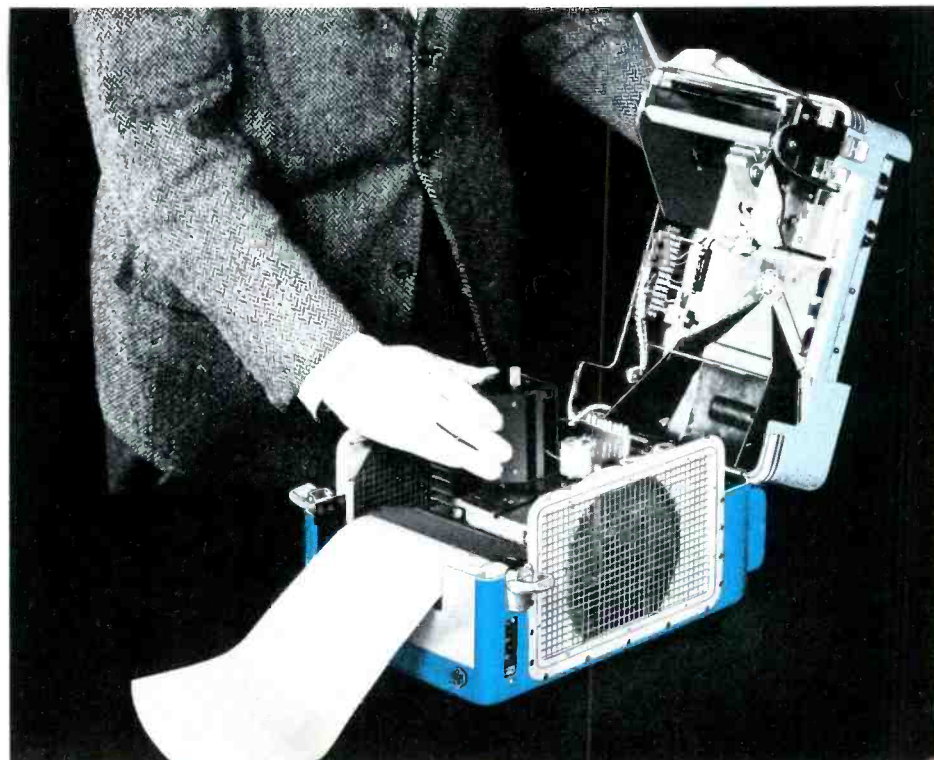

ISICORDER[®] APPLICATIONS

The versatile Visicorder will fit almost unlimited applications because of its high frequency and sensitivity characteristics, and because of its ease of operation.

In any application where instantaneous monitoring is needed, whether or not a record is desired, the Visicorder is ideal.

- ★ In **CONTROL** applications the Visicorder will continually monitor and record reference and error signals, and present an immediately available recording of information.
- ★ In **NUCLEAR** applications, the Visicorder will monitor and record temperatures, pressures, and all other phenomena needed.
- ★ In **PRODUCTION TEST** applications, the Visicorder will provide a final dynamic inspection of electrical and mechanical devices such as motors, relays, generators, governors, solenoid valves, etc., where high frequency response has been required, but unavailable in the past.
- ★ In **COMPUTING** applications, the Visicorder will provide immediately-readable analog recordings representing dynamic solutions at much higher frequencies than have ever been available via pen—and-ink-type recorders previously used for this work.
- ★ In **PILOT and COMPONENT TESTING**, the Visicorder will accomplish more rapid evaluation of design and prototypes than any other direct-writing oscillograph available.
- ★ In **MEDICAL** applications the Visicorder is useful for dynamic blood pressures, electrocardiograms, EEG, and other physiological measurements.
- ★ In **all TEST** applications the direct-recording features of the Visicorder are invaluable. Where complex tests involve the assembly of considerable equipment and the gathering of personnel, the immediate Visicorder record will prove the success of the test at once before the test equipment is dispersed.

For further information about the Visicorder, contact the Minneapolis-Honeywell Industrial Division Sales Office nearest you. Sales-service facilities in over 130 principal cities throughout the world.

700-C Series Recording Oscillographs
Galvanometers
Bridge Balance Units
Amplifier Systems
HEILAND Photo-Flash Equipment

MINNEAPOLIS
Honeywell
HEILAND INSTRUMENTS
5200 E. EVANS AVENUE • DENVER 22, COLORADO

In color tv, too

CRUCIBLE PERMANENT **MAGNETS**

*for beam correctors, color purifiers and color equalizers
give maximum energy . . . minimum size*

Designers of electronic and control equipment can count on a *consistently higher* energy product with Crucible alnico magnets. *It means greater power from a minimum size magnet!*

And they're available in practically any size you want—from a fraction of an ounce to several hundred pounds. What's more, Crucible alnico permanent magnets can be sand cast, shell molded, or investment cast to your exact size, shape, or tolerance requirements.

Crucible has been a leading producer of these permanent magnets ever since alnico alloys were developed. And their manufacture is backed by over a half century of fine steelmaking experience. That's why so many magnet applications begin at Crucible.

*Crucible Steel Company of America,
The Oliver Building, Mellon Square,
Pittsburgh 22, Pa.*

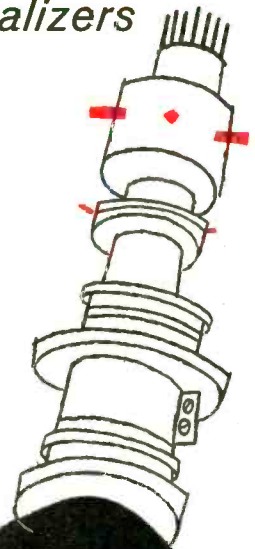

CRUCIBLE first name in special purpose steels

Crucible Steel Company of America

FOR HIGHEST STABILITY...

WESTON precision in a metal film resistor...

PRACTICALLY FULL 1/2 WATT ZERO T.C. AT 125 C

WESTON
VAMISTOR

Actual Size

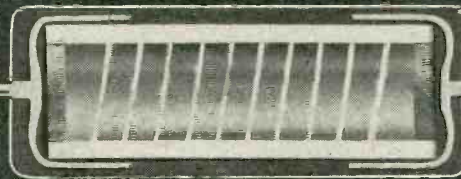

Enlarged Cutaway view

The Weston VAMISTOR offers you many advantages over wire wound or conventional film resistors, in critical applications. It is a sealed, metal-film resistor that provides greater stability than all previous types. Following are a few of its outstanding characteristics:

- Stable under temperature, moisture and load life
- Stable under vibration, acceleration
- Non-inductive
- Noise free
- Excellent HF performance

As shown on table at right, VAMISTORS meet or surpass MIL specifications. They are now available in the following types:

	INITIAL TOLERANCE	TEMP. COEFF.
Model 9851 — 1/2 watt at 85C	1% or .5% ± 50 or ± 25 ppm	
Model 9852 — 1/2 watt at 125C	1% or .5% ± 50 or ± 25 ppm	
Model 9853 — 1 watt at 70C	1% or .5% ± 50 or ± 25 ppm	

all models available in resistance values from 100Ω to 100,000 ohms

For complete information on VAMISTORS, return the coupon today.

WESTON VAMISTOR PERFORMANCE DATA
COMPARED WITH SPECIFICATIONS FOR OTHER PRECISION TYPE RESISTORS

Characteristic	Vamistor production units	MIL-R-19074A (ships) Style RI-94	Wirewound MIL-R-28A Style RB-52 Char. A	Film MIL-R-10508B Style RN-70 Char. A
Short Time Overload 2.5 Times—10 min	Average + .01% Low — .00% High — .06%	.5% max.	.5% max.	.75% max.**
Load Life 1000 hrs—85 C	Average + .15% Low + .10% High + .20%	.5% max.	.5% max.	1.0% max.**
Low Temperature —65 C—24 hours	Average — .03% Low — .00% High + .02%	.5% max.	(no test)	1.0% max.
Moisture Resistance MIL-STD-202, Method 106	Average ± .23% Low — .15% High + .36%	.5% max.	1.0% max.	3.0% max.
Salt Water Immersion 0 to 85 C—5 cycles	Average — .04% Low + .02% High — .10%	.5% max.	.5% max.***	(no test)
Temperature Cycle —55 to 85 C—5 cycles	Average + .04% Low + .02% High + .07%	1% max.	.2% max.	1.0% max.
Insulation Resistance 100 v d-c	Greater than 10,000 megohms	100 megohms min.	50 megohms min.	10,000 megohms min.
Dielectric Strength 900 v rms—1 minute		.05% max.	.05% max.	.5% max.
Terminal Strength	Below measurable value—all samples	.5% max.	(no limit)	.5% max.
Effect of Solder		.5% max.	(no test)	.5% max.

*MIL-R-10509B test 2.5 times—5 seconds

**MIL-R-10509B test at 70 C ambient

***MIL-R-93A test not cycled, 25 C—24 hours

Weston Electrical Instrument Corp.
617 Frelinghuysen Ave., Newark 2, N.J.

Rush me full particulars on WESTON precision metal film resistors.

Name _____

Company _____

Address _____

WESTON

VAMISTORS

precision metal film resistors



New Stromberg-Carlson equipment speeds up telephone service... cuts cost!

Heart of system is automatic recorder using tape made of Du Pont "Mylar"

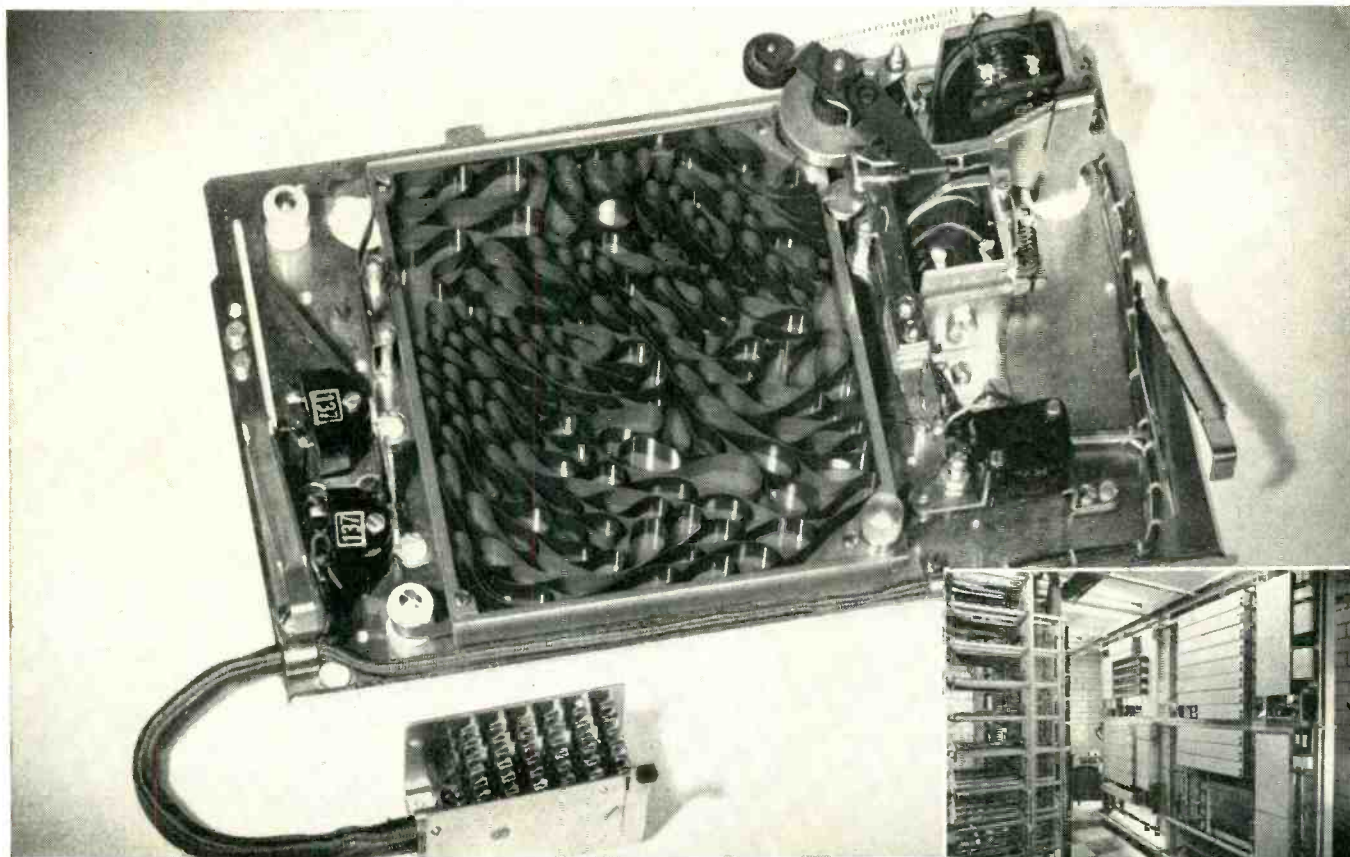

ABOVE—Stromberg-Carlson's "XY" Toll Ticketing Recorder using magnetic tapes made with "Mylar".

INSET—Central office equipment holding "XY" records.

Thanks to Stromberg-Carlson's new "XY" Toll Ticketing system, independent telephone companies are now able to speed up service while cutting equipment and operational costs.

The system works like this: When a customer dials, all pertinent data—such as numbers involved, rate and duration of call—is recorded on magnetic tape formed into an endless loop in its own magazine. The tape, 35 feet long, holds up to 50 completed calls. When the "read-out" equipment is ready, the recorded information is translated into impulses that actuate billing equipment.

Why tape made with "Mylar"?

"We selected magnetic recording tape made with 'Mylar'* polyester film after a long period of testing," reports Mr. J. D. McKay, design engineer of Stromberg-Carlson, division of General Dynamics Corporation. "We had to be sure the tape was tough enough to withstand the grueling stops and starts of the recorder. We had to be sure the tape was dimensionally stable—not be affected by humidity. But, most important, the tape had to be economical—it had to provide long-lasting service with a min-

imum number of magazine changes."

This is but one of the hundreds of new uses industry has found for magnetic recording tape made with "Mylar". Computer manufacturers, geologists, audio and video engineers for TV broadcasting, archivists, and guided missile manufacturers are switching to recording tapes made with "Mylar" because of thinner tape, better performance and longer life. If you're interested in more information on "Mylar"—or how tapes made with "Mylar" can help you speed up service while cutting costs—send in coupon below.

*Du Pont manufactures the base material "Mylar"—not finished magnetic recording tape. "Mylar" is a registered trademark for Du Pont's brand of polyester film.



REG. U. S. PAT. OFF.

BETTER THINGS FOR BETTER LIVING
... THROUGH CHEMISTRY

DUPONT

MYLAR[®]
POLYESTER FILM

E. I. du Pont de Nemours & Co. (Inc.), Film Dept.
Room E-2, Nemours Bldg., Wilmington 98, Delaware

Please send your booklet outlining advantages of magnetic recording tape made with "Mylar".

Please send your booklet listing properties, applications and types of "Mylar" available.

Name _____

Firm _____

Address _____

City _____ State _____

application time cut to a **SHIELDED WIRE SPLICES** and for the aircraft and

This newest team of A-MP connectors is crimped onto shielded wires making permanent mechanical and electrical connections. More than three and one-half years of engineering and development have gone into these new A-MP shielded wire parts, with advantages that minimize application time and costs. There are no loose pieces required to make connections. A splice between two shielded wires is completed by crimping the connector on each end with a recommended A-MP hand crimping tool or appropriate power tooling. Grounding connections are made with the Shielded Wire Ferrule and similar tooling.

The new A-MP Shielded Wire Connectors and Shielded Wire Ferrules incorporate several new features which facilitate inspection and selection of the proper connector and ferrule. These are: color coding to identify wire sizes and inspection ports to establish definitely and positively the depth of the braid which is enclosed after crimping.

A rectangular window in the center of the Shielded Wire Splice enables the operator or inspector to see at a glance if the ends of the inner conductors are properly placed.

The new A-MP Shielded Wire team proves to be the answer to faster, more compact splicing with resultant superior performance.

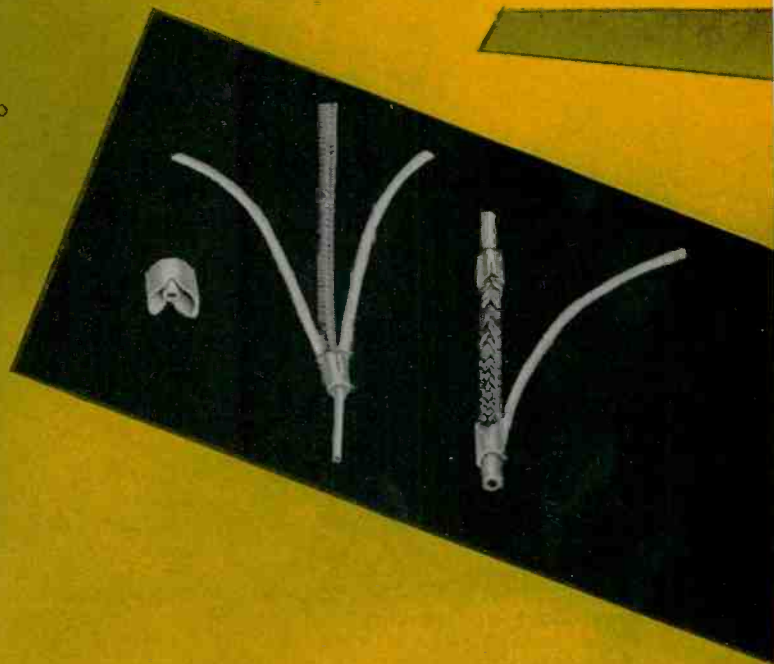

minimum with **A-MP**
SHIELDED WIRE FERRULES
electronic industries

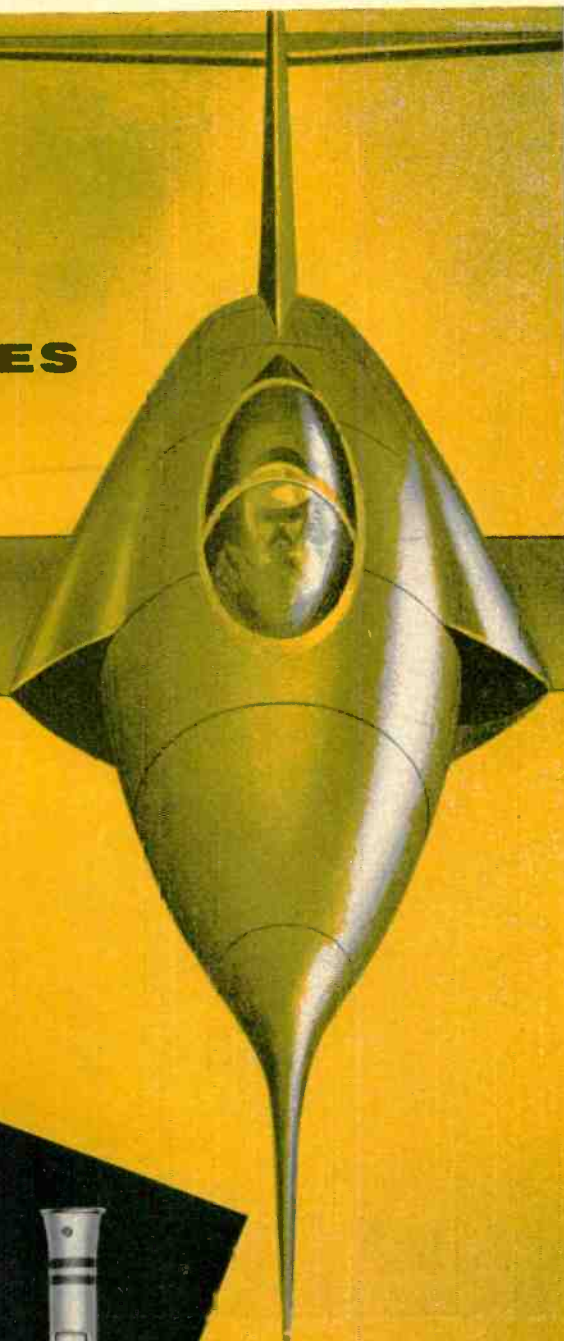

AMP INCORPORATED



GENERAL OFFICE: HARRISBURG, PA.

*A-MP of Canada, Ltd., Toronto, Canada • A-MP—Hollanc N.V., 't Hertogenbosch, Holland
Aircraft-Marine Products (G.B.) Ltd., London, England • Soci t  A-MP de France, Courbevoie, Seine, France*

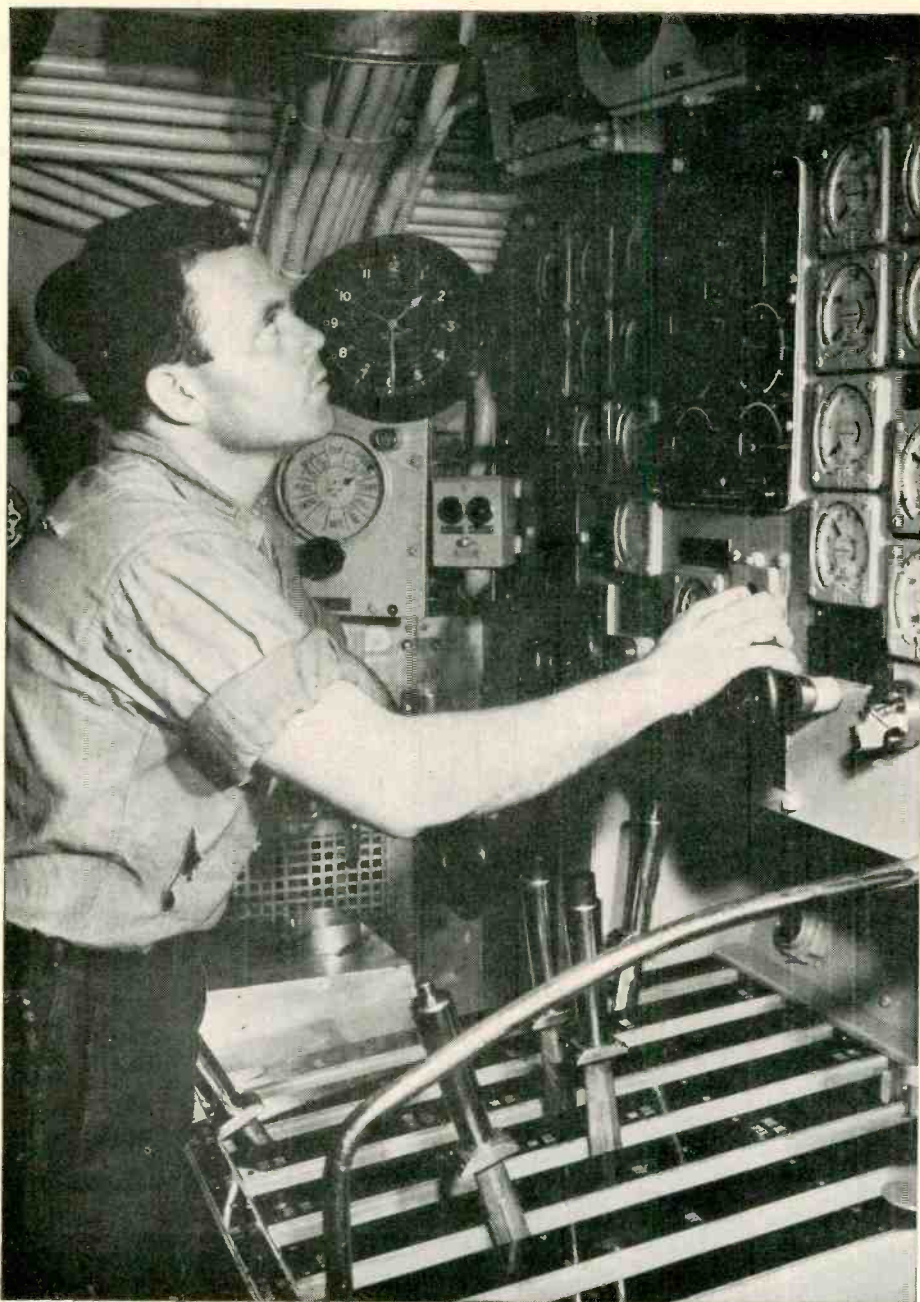

Meters
tell the tale
but
**SPECIAL
ELECTRICAL
ALLOYS**
do the
work

"Steelmaker to the Electrical Industry" is a title we have earned the hard way . . . by the sweat of research and pioneering development. In this modern world of gauges and instruments, of automation, electronics and atomics, the heart of the design is so often some silicon steel, high-permeability alloy, or other special electrical material that we produce. • When *you* need a steel to do what ordinary steels cannot do—whether electrically or in resisting corrosion, heat, wear or great stress, call on us. *Allegheny Ludlum Steel Corporation, Oliver Bldg., Pittsburgh 22, Pa.*

STEELMAKERS to the Electrical Industry

Allegheny Ludlum

Warehouse stocks of AL Stainless Steels carried by all Ryerson plants



Write for "MAGNETIC MATERIALS"

This 32-page book contains valuable data on all Allegheny Ludlum magnetic materials, silicon steels and special electrical alloys. Illustrated in full color, includes essential information on properties, characteristics, applications, etc. Your copy gladly sent free.

ADDRESS DEPT. E-86

available
now...

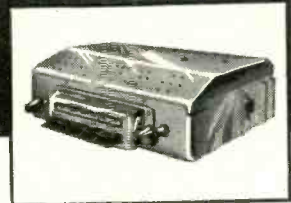

POWER TRANSISTORS

Clevite Power Transistors are used in leading auto radios.

- High power ratings
- High power gain
- Rugged, compact mechanical design
- Welded, hermetically sealed package for stability and long life
- Excellent heat dissipation characteristics

Now Clevite can supply you with power transistors that fit your needs for audio applications, portable power supplies, etc., from a full line of six types. All are available in production quantities. All are rated at 25 watts continuous operation with infinite heat sink — 15 watts with 36 sq. in. heat sink.

Clevite Power Transistor packaging is compact. Vacuum baking and hermetic sealing of the package insure stability and long life. Low thermal resistance between collector junction and large copper flange insures excellent heat conduction from the package to the heat sink.

OUTLINE SPECIFICATIONS

TYPE	2N268	CTP 1111	2N257	CTP 1104	CTP 1109	CTP 1108	Units
Instantaneous Collector-to-Base Voltage (absolute maximum)	-80	-80	-40	-40	-20	-20	Volts
Junction Temperature (absolute maximum)	85	85	85	85	85	85	°C
Average Total Power Dissipation (with inf. heat sink @ 25°C)	25	25	25	25	25	25	Watts
Average Total Power Dissipation (with 36 sq. in. heat sink @ 25°C)	15	15	15	15	15	15	Watts
Power Gain	28 ^a	23 ^a	30 ^a	23 ^a	27 ^b	20 ^b	db
Frequency Cutoff	6	4	7	4	6	4	kc/s

^a $V_{cc} = -14V$; $I_c = 500$ ma; $R_L = 30 \Omega$ (choke coupled); $R_E = 10 \Omega$

^b $V_{cc} = -7V$; $I_c = 500$ ma; $R_L = 15 \Omega$ (choke coupled); $R_E = 10 \Omega$

Write for Data Sheet B-211



CLEVITE

TRANSISTOR PRODUCTS

241 Crescent St., Waltham 54, Mass. TWinbrook 4-9330

Clevite Divisions: Brush Electronics Co. • Cleveland Graphite Bronze Co. • Clevite Harris Products Inc. • Clevite Research Center • Clevite Ltd.

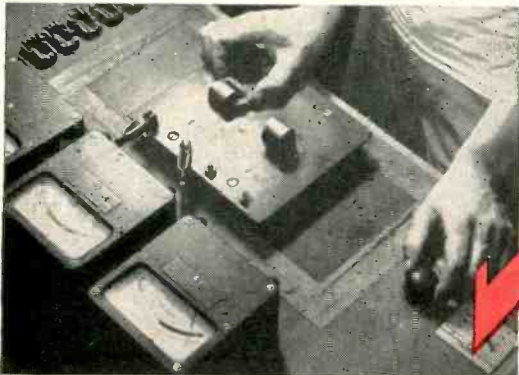

MOLONEY HyperCore ELECTRONIC CORES

Check and double Check

HyperCore Electronic Cores measure up to the highest standards of quality and performance. One check is not enough . . . each core undergoes at least two rigid inspections. The first makes certain that it is of the specified size . . . and the second determines that finished cores have the desired electrical qualities. All HyperCore electronic cores *must* test well within industry tolerances. Special tests for specific operating conditions can be made also if desired.

These tests are the real proof of the superior fabrication which combines the finest materials with superior "know how". Result; electronic cores that give better performance . . . have greater flux carrying capacity and lower losses. And since Moloney HyperCore Electronic Cores are wound cores of cold-rolled oriented silicon steel, they are smaller and lighter.

ME86-17



Specify HyperCore Cores for smaller, low loss transformers



Write for Catalog SR 206 "HyperCores for Magnetic Components" and Catalog ST 3506 "Magnetic Components for Electronic Applications."

M O L O N E Y E L E C T R I C C O M P A N Y

Plate and Filament Transformers • Chokes • Unit Rectifiers • Modulation Transformers and Reactors • Pulse Transformers and Charging Chokes • HyperCores for Magnetic Components Developmental Magnetic Components • Power and Distribution Transformers



SALES OFFICES IN ALL PRINCIPAL CITIES • FACTORIES AT ST. LOUIS 20, MO. AND TORONTO, ONT., CANADA

DESIGN PROBLEM:

MORE RECTIFIER POWER PER INCH OF SPACE...

SOLVED AT LOWER COST— with greater reliability—by this new General Electric High Current Silicon Rectifier

Packing *greater* rectifying capacity into *less* space—with maximum reliability and efficiency—is becoming standard practice with General Electric Silicon Rectifiers. And the cost of these G-E High Current Silicon Rectifiers, with their unmatched performance, is now actually less than that of comparable rectifying devices.

REQUIRE MINIMUM SPACE

The Silicon Rectifier pictured here in full size has ratings up to 85 amps...yet measures less than 1 $\frac{1}{8}$ inches in diameter. It operates, or can be stored, safely at temperatures from 200° to -65° centigrade and checks out above 99% in efficiency. Maximum peak inverse voltage is 300. Silicon rectifiers of higher ratings are on the way.

Produced by the alloy technique developed in General Electric laboratories, these high-capacity rectifiers show no deterioration in rectifier characteristics during

extended life tests at full rated condition. The silicon element is hermetically sealed in a steel housing for protection against moisture, fumes, dust, vibration, and corrosion. Effective cooling is assured by the tapered thread "plumbing type" stud that screws tight into heat sink or cooling fin.

WORK ANYWHERE... ON ANY APPLICATION

General Electric Silicon Rectifiers are installed in any position or location, and work in any rectifier operation. They are now serving in many applications such as arc furnaces, welding, and protection against cathodic erosion.

They are available now in different voltage ranges, and meet rigid military specifications. For detailed information, consult your local General Electric representative, or write to *General Electric Company, Semiconductor Products, Section S2527, Electronics Park, Syracuse, New York.*

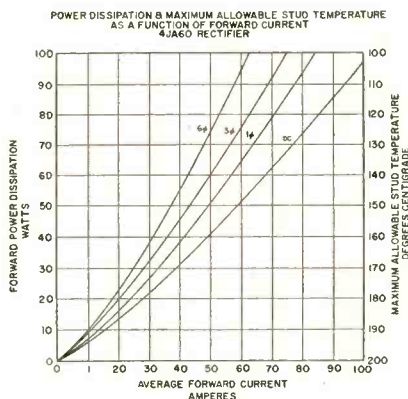

TYPICAL APPLICATION GENERAL ELECTRIC HIGH CURRENT SILICON RECTIFIER

CIRCUIT	Three Phase Bridge Rectifier, Resistive Load.
DC OUTPUT	280 Volts, 215 amperes, 60 kilowatts.
RECTIFIER LOSSES	Approximately one percent ($\frac{1}{2}$ kilowatt).
COOLING REQUIRED	One 6 $\frac{1}{2}$ -inch square, $\frac{1}{8}$ " thick copper fin for each of six rectifying units when used with 2000 fpm 30°C forced air. Free convection cooling may be utilized by increasing the fin area.
VOLUME	Total volume of rectifiers and fins—less than $\frac{1}{3}$ of a cubic foot.



Progress Is Our Most Important Product

GENERAL  ELECTRIC



FROM DATA TO DIGITS...

Today Hughes is developing systems which convert radar data and other information to digital form and process it for use in performing control functions.

These systems will be able to receive and store vast quantities of data from many different sources and distribute it, after processing, over large and complex ground nets.

Special-purpose digital computers are employed, utilizing magnetic drum memory and novel programming techniques. The systems will also include visual displays and employ the latest concepts of human engineering to simplify equipment operation and minimize the possibility of human error. Vacuum tubes are being replaced by transistors or ferrite cores in flip-flops, registers, and amplifiers; and diode matrices are being replaced by ferro-magnetic circuitry.

These and other features of the new systems promise to maintain and extend Hughes leadership in the fields of digital computers and processing systems. In order to design and build these and future systems, Hughes requires engineers with experience in electronic circuit design, logical design, electronic packaging, radar systems, and many others.

For further information write us at the address below.

HUGHES

RESEARCH AND DEVELOPMENT LABORATORIES
SCIENTIFIC STAFF RELATIONS

Hughes Aircraft Company, Culver City, Calif.



Make your selection from

HUGHES SILICON JUNCTION DIODES

STANDARD—HIGH TEMPERATURE • EXTREMELY HIGH BACK RESISTANCE • SHARP BACK VOLTAGE BREAKDOWN.

This famous series of diodes comprises standard RETMA and JAN types, as well as many specials—all noted for their exceptionally stable characteristics. Performance reports without exception indicate that, in military and commercial installations alike, the Hughes diodes have maintained a phenomenal record of failure-free service. Registered types: 1N456, 1N457, 1N458, 1N459, 1N461, 1N462, 1N463 and 1N464.

QUICK RECOVERY—HIGH SPEED • HIGH TEMPERATURE • HIGH VOLTAGE. Hughes Quick Recovery Diodes have significantly faster recovery than even germanium computer diodes. The excellent high-frequency characteristics of this new series enables you to use them instead of vacuum or germanium diodes in flip-flop circuits, modulators and demodulators, discriminator circuits, clamping and gating circuits, and detectors. Types now available: 1N625, 1N626, 1N627, 1N628 and 1N629.

HIGH-CONDUCTANCE—HIGHER VOLTAGE • HIGHER CURRENT • EXTREMELY HIGH BACK RESISTANCE • HIGH TEMPERATURE. The first five types in this new series have been especially established to fill specific applications requiring relatively moderate speed, with high voltage and high current characteristics. Examples: high-current clamping, magnetic amplifiers. Available at this time: HD6751, HD6752, HD6753, HD6754 and HD6755.

All Hughes Silicon Junction Diodes are packaged in a one-piece, fusion-sealed glass body, impervious to moisture. Maximum dimensions, diode glass body: 0.105-inch diameter, by 0.265-inch length.

Whenever your circuit applications require diodes with combinations of special characteristics, such as High Temperature, High Conductance, Quick Recovery, or High Back Resistance, be sure to make your selection from the wide variety of Hughes Silicon Junction Diodes. And remember—in germanium or silicon diodes, HUGHES QUALITY means HIGHEST QUALITY!
For information, please write:

SEMICONDUCTOR DIVISION • HUGHES PRODUCTS
International Airport Station, Los Angeles 45, California

HUGHES PRODUCTS

© 1957. HUGHES AIRCRAFT COMPANY

LIQUID COOLING

of
Electronic
Tubes

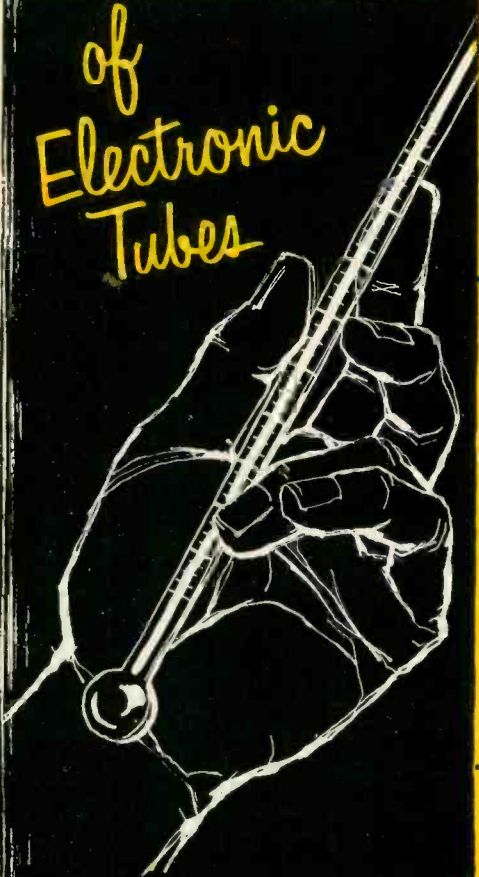

WITH **Eastern** COOLING UNITS

By a sustained program of research, Eastern continuously extends the uses of the latest units in electronic tube cooling, pressurizing electronic equipment, and pumping fuels and hydraulic fluids. Research and testing laboratories, a model shop, and three manufacturing plants provide the specialized equipment and manpower to turn out fully qualified units to meet appropriate government specifications.

From our extensive line of existing units, adaptations of these units, or completely new designs, Eastern can provide equipment to handle your project well. Your inquiry is welcomed.



EASTERN INDUSTRIES, INC.
100 SKIFF STREET
HAMDEN 14, CONNECTICUT

Eastern Cooling Units provide coolant liquid for maintaining within safe operating temperature limits liquid cooled electronic tubes or similar devices. The units are completely self-contained and usually comprise such components as heat exchangers, fans or blowers, liquid pumps, reservoirs, flow switch, thermostat, etc. Cooling units can be modified as required for varying conditions encountered in land or sea as well as aircraft service. Almost all units are designed to meet such specification as MIL-E-5400 and MIL-E-5272.

The units shown below are intended only to illustrate the varying requirements which can be satisfied. By utilizing fairly standard components and designs based on broad experience in this field, Eastern is able to provide at minimum cost equipment exactly suiting a specific requirement.

Eastern welcomes your consultation on liquid cooling problems ranging from 200 to 20,000 watts dissipation.

Write for Aviation Products Bulletin 330.

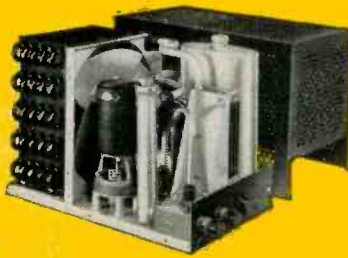

MODEL MB-175, TYPE 200 DISSIPATION: 2,000 watts. **ALTITUDE RANGE:** sea level to 50,000 feet. **POWER REQUIRED:** 28 volts D.C. **WEIGHT:** 25 pounds. **SIZE:** 10" x 15-15/16" x 10 3/4" high.

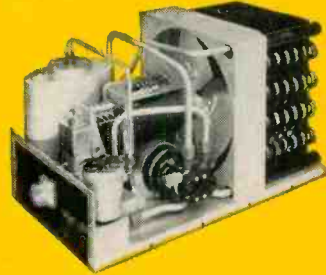

MODEL E/HT-205, TYPE 200A DISSIPATION: 1600 watts. **ALTITUDE RANGE:** sea level to 5,000 feet. **POWER REQUIRED:** 28 volts D.C. **WEIGHT:** 25 pounds. **SIZE:** 10" x 21" x 10" high.



MODEL MB-177, TYPE 202 DISSIPATION: 1700 watts. **ALTITUDE RANGE:** sea level to 50,000 feet. **POWER REQUIRED:** 110 volt, 400 cycle, 3 phase. **WEIGHT:** 27 pounds. **SIZE:** 10" x 19 15/32" x 7 3/8" high, per JAN-C-1720A, size B1-D1.



MODEL E/HT-210, TYPE 200 DISSIPATION: 1500 watts. **ALTITUDE RANGE:** sea level to 10,000 feet. **POWER REQUIRED:** 208 volts, 400 cycle, 3 phase. **WEIGHT:** 35 pounds. **SIZE:** 11 1/4" x 19 1/2" x 12 1/2" high.

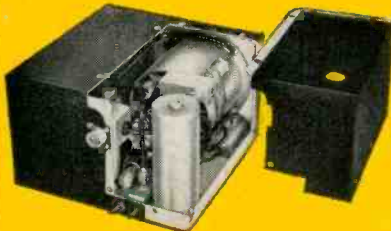

MODEL E/HT-200, TYPE 201 DISSIPATION: 1,000 watts. **ALTITUDE RANGE:** sea level to 50,000 feet. **POWER REQUIRED:** 28 volts D.C. **WEIGHT:** 14 1/2 pounds. **SIZE:** 10" x 10" x 6" high.

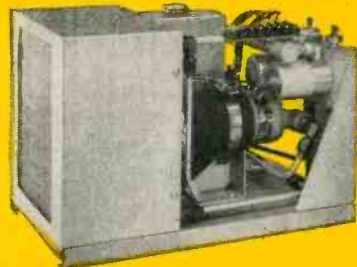

MODEL NO. 5-A DISSIPATION: 1,000 watts. **ALTITUDE RANGE:** sea level to 5,000 feet. **POWER REQUIRED:** 100 to 110 volts D.C. **WEIGHT:** 10 pounds. **SIZE:** 7 7/8" x 13 1/2" x 9-1/16" high.

ANDREW HIGH GAIN ANTENNA IS RUGGED, DEPENDABLE

Says William E. Whiting,
Director of Communications,
Kern County, California

RADIO COMMUNICATIONS DEPARTMENT

Telephone 3-1788 or
3-7671 — Ext. 2300

William E. Whiting
Director of Communications
Mailing Address
P. O. Box 643
Bakersfield



BAKERSFIELD, CALIFORNIA

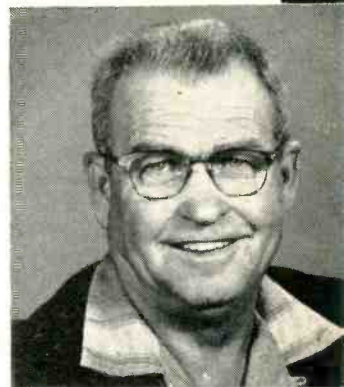

Andrew Corporation
363 East 75th Street
Chicago 19, Ill.

Gentlemen:

The County of Kern has, for the past 27 months, had two of your type 3000 Antennas installed on a mountain top at an elevation of 4,853 feet. At this location, during the winter months, there is a great amount of ice and sleet and, at times, the wind reaches velocities approaching 100 m.p.h.

There have been times when there was a build-up of ice on these antennas to such a degree that the elements were entirely enclosed in the ice formation and the total thickness of the antenna was approximately 30". Even under these conditions there was little noticeable signal attenuation. In periodic physical checks of these antennas, we have been unable to find any broken or damaged elements, loose connections or clamps—something that might be expected from the strain of expansion and contraction together with action of high wind velocities at this location.

These antennas have given such complete satisfaction that we are ordering two additional for our new installation which will be at 7,500 feet elevation on Breckenridge Mountain, where snow, ice and wind conditions will be as severe as any encountered in California. We are confident that they will give as good service as they have at the lower elevation.

Yours very truly,

William E. Whiting

William E. Whiting, Director of Communications
County of Kern

Type 3000A antenna for 148-174 mc range has 6.3 db gain. Omnidirectional with vertical polarization — eliminates high angle (wasted) radiation . . . Multiplies the effective power of base and mobile transmitters.

Other high gain antennas with db gains up to 7.6 are available for 400-420 and 450-470 mc ranges.

For complete information on Andrew Antenna systems, write for Communication Antenna Folder — No. 15C.

Andrew
CORPORATION
363 EAST 75th STREET • CHICAGO 19

Offices: New York • Boston • Los Angeles • Toronto



MICRO SWITCH Precision

... FIRST IN PRECISION SWITCHING

small ... accurate ... reliable ... precise
MICRO SWITCH Precision Switches
meet wide range of modern
electronic control requirements

Design engineers find MICRO SWITCH precision switches to be ideal components for computers, high speed switching devices and other industrial devices.

Whether the requirement is for an individual switch—or a complete switch assembly—MICRO SWITCH Engineering is at your service. Development of precise, reliable switching components is our sole business. Our switching

specialists have met successfully many knotty problems of switch design and application. This long, practical experience will save you time and money.

A call to the nearest MICRO SWITCH branch office will put MICRO SWITCH Field and Factory Engineering to work on your specific problem. This cooperation can be your short cut to improved design.

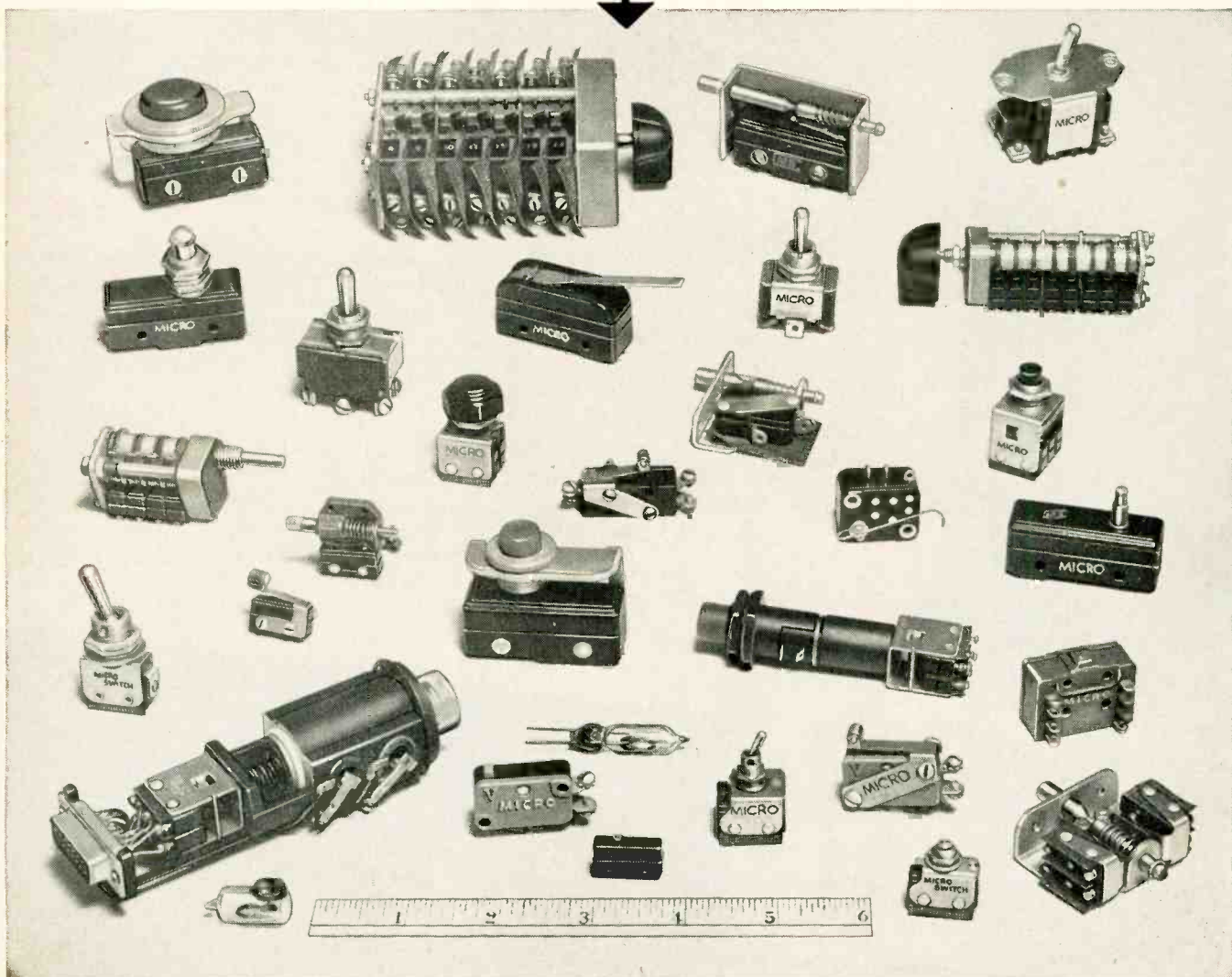

Switches have uses unlimited



3-LIGHT PUSH BUTTON SWITCH FOR COMPLEX CONTROL PANELS

Here is a new, unique indicating push button switch which lights in three different colors. It is the latest MICRO SWITCH development for use in complex console panels. This compact assembly is ideal for applications where absolute dependability is required. It has a reliable operating life through hundreds of thousands of operations. Use is simplified by a pre-wired connector plug.

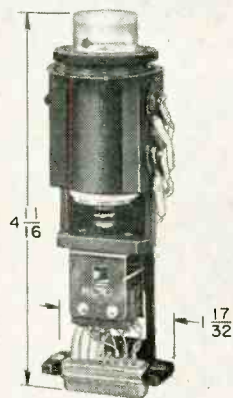

(Send for Data Sheet 110)

SUBMINIATURE SAFETY SWITCH DEVICE FOR HAZARDOUS EQUIPMENT

This MICRO SWITCH Subminiature door interlock switch assembly is designed for use as a safety device on such hazardous equipment as radio, radar, and X-ray cabinets. Installed on the cabinet door the switch automatically cuts off the power circuit when the service door is opened. Assembly shown uses a MICRO SWITCH Subminiature basic switch with single-pole, double-throw contact arrangement.

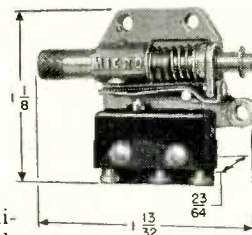

(Write for Data Sheet 108)

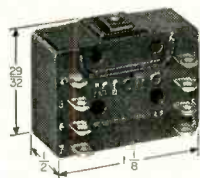

FOUR-CIRCUIT SWITCH FOR CONTROL OF COMPLEX CIRCUIT

Here is a four-circuit double-break switch for simultaneous control of four isolated circuits. This small switch is ideal in complex circuit applications where space and weight are prime factors in switch selection. Two snap-action springs are operated with each actuation of the plunger. This provides quick make and break of the contacts in each of the four double-break circuits. Electrical rating is 10 amperes 115-230 volts a-c; 10 amperes 30 volts d-c.

(Write for Catalog 78)

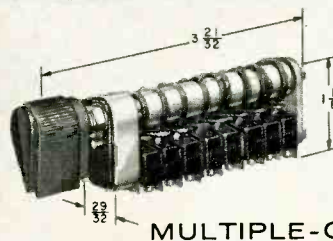

SUBMINIATURE ROTARY SELECTOR SWITCH FOR MULTIPLE-CIRCUIT CONTROL

This assembly is an 8-gang, 8-position rotary selector switch. It consists of 8 single-pole, double-throw Subminiature basic switching units operated by cams on a common shaft. Any combination of the 8 basic switching units may be actuated in any of the 8 positions if cams are set to specifications at the factory. Variations with from 2 to 8 single-pole, double-throw basic switches are available.

(Write for Catalog 75 "Subminiature Switches")

SEALED PUSH BUTTON SWITCH FOR PANEL MOUNTING APPLICATIONS

This MICRO SWITCH push button switch for panel mounting is outstanding because of its very small size and ease of installation. After the push button is mounted on a panel, the switching unit can be wired and then easily snapped into place on the end of the button assembly behind the panel. In addition, the push button is sealed to keep dirt and moisture from penetrating to the back of the panel. Switch has operating force of 3 lbs., weighs but .05 lbs.

(Write for Catalog 75 "Subminiature Switches")

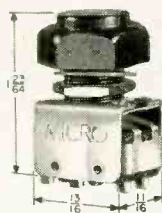

SMALL HONEYWELL MERCURY SWITCH MEETS SMALL LOAD CIRCUIT DEMANDS

The small Honeywell Mercury Switch shown here is especially designed for reliable service in low-energy circuits. This switch meets the requirements of applications where space and economy are critical factors. Mercury switches are widely used in animated displays, control and indicating devices, home freezer units, alarms and hundreds of other tilt-motion, low-force applications. Ratings available down to micro-volt, milli-ampere ranges.

(Write for Catalog 90 on "Mercury Switches")

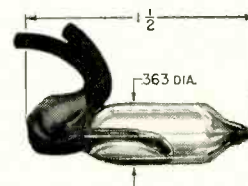

MICRO SWITCH, a division of Honeywell, is the pioneer in the manufacture of precision snap-action switches.

MICRO SWITCH

A DIVISION OF MINNEAPOLIS-HONEYWELL REGULATOR COMPANY

In Canada, Leaside, Toronto 17, Ontario • FREEPORT, ILLINOIS



ABOVE THE SEA

LORAN

ON THE SEA

RADAR

BELOW THE SEA

SONAR

HIGH-PERFORMANCE EQUIPMENT BY



SONAR, RADAR, LORAN and other related equipment designed and built by Edo serves commerce and national defense below the sea, on the sea, above the sea.

- Newly introduced Edo airborne LORAN puts this over-ocean navigation aid in the pilot's cockpit, so compact is its design, so simple its direct-reading capability.
- Edo RADAR, with close-in definition heretofore unheard of, provides safe, accurate navigation in the thickest weather for vessels, large and small, in open sea or the narrow confines of river, harbor or channel.
- Edo SONAR—active or passive—is in production for a wide range of commercial and naval applications from fish finding to long range submarine detection.

Whether it involves equipment for use below the sea, on the sea or above the sea, Edo's unique 33 years of work in aerodynamics, hydrodynamics and electronics gives the company a unique background of experience that is reflected in the superior performance of equipment bearing Edo's famed flying fish emblem.



CORPORATION College Point, L. I., N. Y.

SINCE
1925

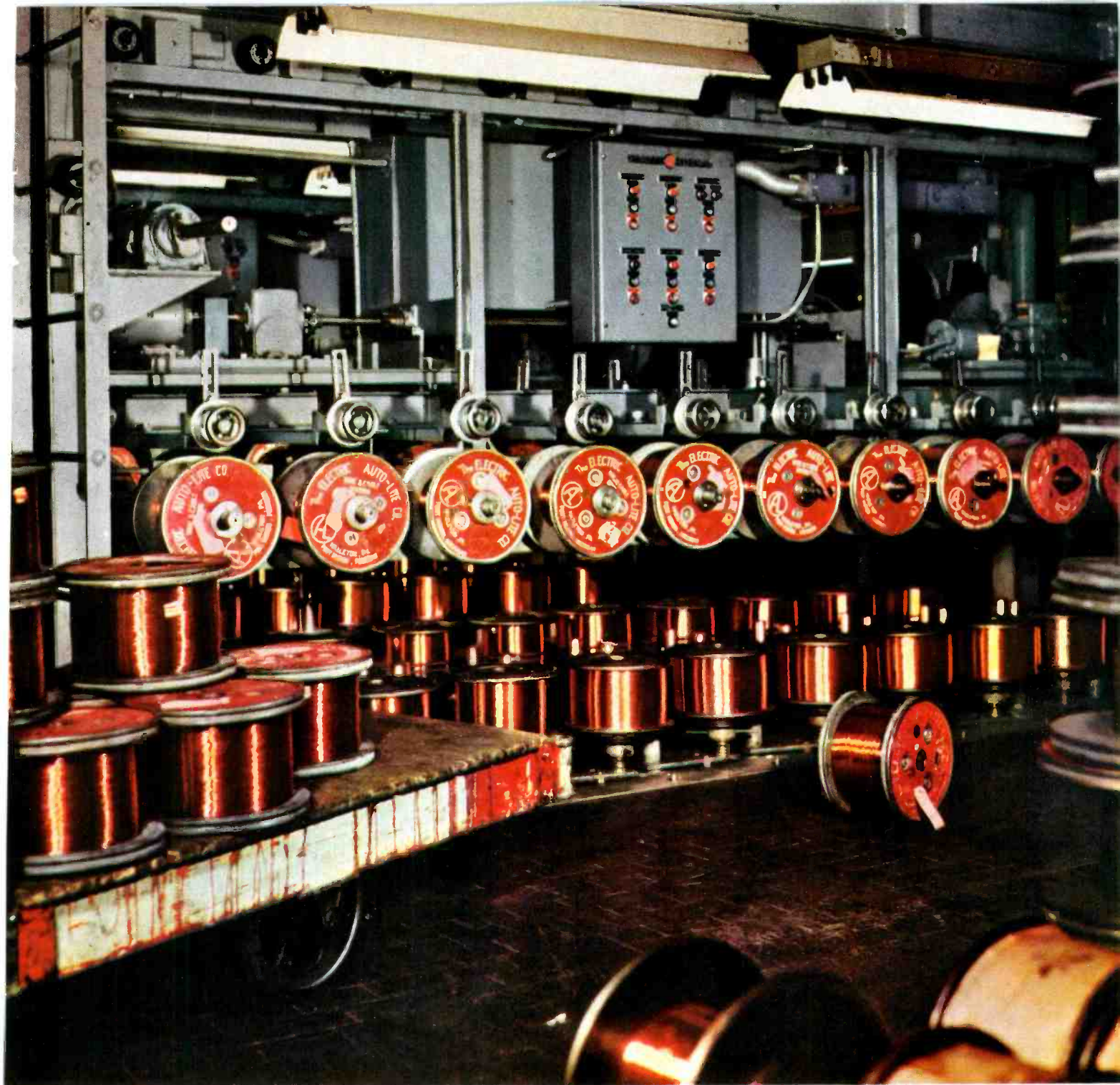

Modern specialized plants assure prompt delivery of Magnet Wire.

Auto-Lite Expands Productive Capacity to Assure Quick Delivery of Finest Quality Magnet Wire

New facilities including filtered air conditioning, latest equipment, and rigid production controls have been installed in Auto-Lite Wire Plants to give customers a new high in production, quality, and service.

PLANTS and WAREHOUSES . . .

Port Huron, Mich.
YUkon 5-6131

Hazleton, Pa.
GLadstone 5-4781

Yonkers, N. Y.
Murray Hill 9-1842

Chicago, Ill.
WEBster 9-3144

Cincinnati, O.
POplar 1-3600

MAGNET WIRE

LECTALITE

Newest Enameled Magnet Wire by Auto-Lite!

LectALite magnet wire has been tested in accordance with AIEE 57 and MIL-W-19583 thermal aging test and found to be acceptable for Class B applications. LectALite can be applied to copper, aluminum, steel or silver magnet wires. Ideal for small electric motors, transformers, and TV yoke coils. Extreme resistance to Freon 12 and 22 and low extractables make it an outstanding wire insulation for hermetic refrigeration motors.



LectALite opens new magnet wire fields throughout the electrical industry.

This new insulation offers more heat resistance, higher thermoplastic flow, higher dielectric strength, greater flexibility and lower extractables than vinyl acetal insulation—with no increase in cost! Now available in sizes from 13 AWG through 30 AWG.

Tests indicate LectALite is the superior insulation for use in hermetic refrigeration motors due to its outstanding Freon 12 and 22 resistance plus low extractables. LectALite insulation has been found to have 30°C margin over vinyl acetal insulation by test performed under AIEE No. 57, Oct. 1955, "Proposed Test Procedure for Evaluation of the Thermal Stability of Enameled Wires" and MIL-W-19583 (NAVY) "Military Specification Wire, Electrical, Magnet, High Temperature, Film Insulated", July 15, 1955. Impregnation of LectALite wound coils can be done by any phenolic-alkyd type or suitable temperature rated impregnation varnishes.

The Auto-Lite magnet wire line is complete in classes O, A, B, and H to meet your design requirements.

ELECTRICAL, PHYSICAL AND CHEMICAL PROPERTIES

Description of Test	LectALite Insulation	Vinyl Acetal Insulation
Build	.0021	.0023
Heat Aging—hrs. 125°C	1500 hrs.	288 hrs.
Heat Aging Twist AIEE 200°C	506 hrs.	165 hrs.
Heat Aging Twist AIEE 225°C	110 hrs.	59 hrs.
Heat Aging Twist AIEE 250°C	20 hrs.	17 hrs.
Dry Dielectric Break-down—KV/mil	2.5 to 3.5 KV/mil	1.5-2.0 KV/mil
Wet Dielectric Break-down—KV/mil	1.1 KV/mil	1.1 KV/mil
Wet Insulation Resistance	1-2 months	1-3 weeks
G.E. Scrape Abrasion	45	41
Cut-Through Temperature—°C	300-320°	170-180°C
Heat Shock	(IX at 175°C 1 hr. O.K.)	(IX at 125°C 1 hr. O.K.)
Solderability	Good—900°F	Very Poor
Extractables—%	0.5-2.5%	3.0-6.0%
Solvent Resistance	Good	Good
Freon 22 Resistance	Excellent	Fails
Freon 12 Resistance	Excellent	Fair
Chemical Resistance		
5% Sulfuric Acid	Very Good	Very Good
5% Hydrochloric Acid	Very Good	Very Good
1% Potassium Hydroxide	Very Good	Very Good
Xylene	Very Good	Very Good
Cresylic Acid	Good	Poor
Carbon Tetrachloride	Very Good	Very Good
Naphtha	Very Good	Very Good
Acetone	Poor	Poor
Alcohol	Very Good	Fair
Pyridine	Failed (Softens)	Failed (Softens)
Solvent Crazing (Stretched 5%— Dipped in Toluene)	Very Slight Crazing	Crazes
Annealed 15 Min. at 105°C Dipped in Toluene	No Crazing	Borderline Failure
Crazed Sample Heated 10 Min. at 150°C	Heals Completely	Heals Completely
Adherence Twist Test—4 in sample twisted on its own axis until coating twist cracks	120 to wire break	57

Auto-Lite Magnet Wire Line Is Complete In All Classes

CLASS O (90°C)

COTTON—Unbleached, long-staple white cotton protects primary insulation from damage caused by sharp bends and mechanical handling. Even wrapping forms a close, firm, continuous covering for increased dielectric. Additional layers, when required, are wound in opposite directions. When impregnated or immersed in a liquid dielectric, cotton is Class A insulation; when used alone, it is Class O. Available with colored tracers for coding. Manufactured to latest NEMA specifications. Available in a variety of combinations with other insulations. Double or triple conductors, individually cotton or paper covered, formed into a unit by an over-all cotton or paper covering supplied to meet requirements.

PAPER—A thin paper ribbon, wrapped spirally with overlap, is bonded to wire with adhesive. When impregnated or immersed in a liquid dielectric, paper is Class A insulation; when used alone, it is Class O. Similar to cotton in protective qualities, occupies less space because of uniformity of size, and increases dielectric. Paper insulation is available with one cotton wrap applied over two wraps of paper wound in opposite directions. Available with wax coating. Manufactured with multiple or single paper with a $\frac{3}{4}$ " lap, on round, square, or rectangular wire to the latest NEMA specifications.

Availability: **Round**, AWG #4 through #26;
Square, AWG #4 through #12;
Rectangular, width plus thickness not to exceed 0.650".

CLASS A (105°C)

COTTON—When impregnated or immersed in a liquid dielectric, cotton is Class A insulation.

PAPER—When impregnated or immersed in a liquid dielectric, paper is Class A insulation.

CONVENTIONAL ENAMEL—A smooth uniform insulation with the basic electrical, physical and chemical properties for limited use as Class A insulation. Manufactured in single and heavy grades to latest NEMA specifications.

Availability: **Round**, AWG #9 through #40.

FORMVAR—A synthetic insulation of vinyl acetal, Formvar has better dielectric qualities, higher heat resistance, better flexibility and adherence, lower power factor and better solvent resistance than conventional enamel. Formvar is manufactured in single and heavy grades to the latest NEMA specifications.

Availability: **Round**, AWG #4 through #40;
Square, AWG #4 through #12;
Rectangular, width plus thickness not to exceed 0.650".

NyALite—Moisture resisting quality of a Formvar base coat is coupled with an overcoating of nylon, for its excellent craze resistance, to produce NyALite. The high dielectric qualities of each insulation combine to provide an excellent magnet wire both in single and heavy grades for winding difficult coils.

Availability: **Round**, AWG #8 through #40.

BondALite—A combination of a Formvar insulation plus a thermoplastic overcoat. BondALite can be quickly and easily bonded wire-to-wire without damaging basic insulation. BondALite can be bonded in three ways: oven heat, electrical resistance, and solvents. Ease of bonding simplifies manufacturing of coils of the most complex forms.

BondALite No. 1 consists of Single Formvar with the addition of a bond coating to bring it up to the approximate dimension of Heavy Formvar.

BondALite No. 2 consists of Heavy Formvar with a bond coating to bring it up to the approximate dimensions of Triple Formvar.

BondALite No. 3 consists of Triple Formvar with a bond coating to bring it up to the approximate dimensions of Quadruple Formvar.

Availability: AWG #20 to #30.

SodALite—A new polyurethane insulation designed for ease of solderability at low temperatures (650-700°F) without scratch brushing or chemical stripping. SodALite has excellent over-all electrical and physical properties, approaching vinyl acetal insulation. It is manufactured under exacting conditions for ease of solderability.

Availability: AWG #8 through #40.

CLASS B (125° C)

LectALite—(See page 2)

IsALite—A new high temperature magnet wire for use up to 150° C as tested by Underwriter's Laboratories and Auto-Lite tests performed under AIEE No. 57. This magnet wire is manufactured with a polyester type enamel (Isonel) and found to have outstanding physical, electrical and chemical properties.

Availability: Round, AWG #8 through #40.

Latest equipment and controls assure consistent quality.

CLASS H (180°C)

GLASS-DACRON—An inorganic insulation bonded with suitable organic-inorganic binders for use at Class H ratings. Good electrical and mechanical properties are incorporated in this product to give improved flexibility and abrasion. It is wrapped in an even spiral, forming close, firm, continuous covering with single or double glass-dacron for increased dielectric strength.

Availability: Round, AWG #4 through #26;

Square, AWG #4 through #12;

Rectangular, width plus thickness not to exceed 0.650".



SEND FOR THESE FREE WIRE AIDS . . .

MAIL TODAY

THE ELECTRIC AUTO-LITE COMPANY
WIRE AND CABLE DIVISION
PORT HURON, MICHIGAN

- MAGNET WIRE CATALOG WIRE-O-METER
 AIRCRAFT WIRE AND CABLE KIT
 WIRE GUIDE OF ELECTRICAL & CHEMICAL PROPERTIES

NAME _____

FIRM _____

ADDRESS _____

CITY _____

ZONE _____ STATE _____

WIRE-O-METER—This convenient slide-rule type of pocket reference gives you complete specifications on all common sizes of wire. At a glance it tells you area in circumference, feet to a pound and pounds per thousand feet, turns per lineal inch and per square inch, and ohms per foot and ohms per pound.

MAGNET WIRE CATALOG—This quick reference is full of facts covering many different types of wire. It's complete with physical, chemical, electrical and military specifications.

AIRCRAFT WIRE AND CABLE KIT—This handy kit gives you complete military specifications for Auto-Lite Aircraft Wire including samples of famous Auto-Lite 350 General Purpose High Temperature Aircraft Wire.

WIRE GUIDE OF ELECTRICAL AND CHEMICAL PROPERTIES—Here's a handy reference that gives you a complete run-down on 9 basic kinds of insulation.

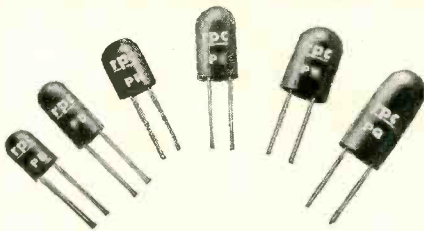

Precision Resistors Printed Circuit

To meet the requirements for printed circuitry, RPC has developed Type P Encapsulated Wire Wound Precision Resistors. Miniature, single ended units designed for easy rapid mounting on printed circuit panels with no support other than the wire leads. Many newly developed techniques are employed in the manufacture of Type P Resistors. These units can be operated in ambient temperatures up to 125°C. and will withstand all applicable tests of MIL-R-93A, Amdt. 3. Available in 6 sizes, rated from 1/10 watt to .4 watt. $\frac{1}{4}$ " diameter by $\frac{3}{16}$ " long to $\frac{3}{8}$ " diameter by $\frac{3}{4}$ " long. Resistance values to 3 megohms. Tolerances from 1% to 0.05%.

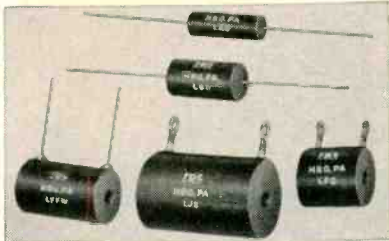

Encapsulated Precision Wire Wound Resistors

RPC Type L Encapsulated Resistors will withstand temperature and humidity cycling, salt water immersion and extremes of altitude, humidity, corrosion and shock without electrical or mechanical deterioration. Type L resistors are available in many sizes and styles ranging from sub-miniature to standard with lug terminals, axial or radial wire leads. Available for operation at 105° C. or 125° C. ambient temperatures. These resistors will meet all applicable requirements of MIL-R-93A, Amdt. 3. Type L can be furnished with all resistance alloys and resistance tolerances from 1% to .02%.

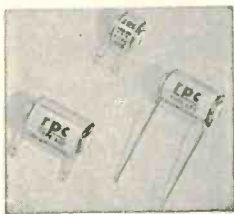

Wire Wound Precision Resistors

Type A Precision Resistors are widely used for all general requirements. They are available in a wide variety of sizes, styles and terminal types. They can be furnished with all resistance alloys in tolerances from 1% to .02%. Type A will meet the requirements of MIL-R-93A, Amdt. 2, Characteristic B. Special winding techniques, impregnation and thermal aging result in resistors of exceptional stability. Matched resistors, networks and special assemblies can be supplied.

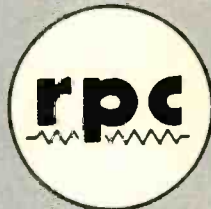

HIGH QUALITY RESISTORS FOR ELECTRONICS

RPC is a widely recognized supplier of high quality resistors to industry, Government Agencies and the Armed Forces. Advanced production methods, modern equipment and scientific skill enables RPC to manufacture resistors of highest quality in large quantities at reasonable cost. Modern manufacturing plant is completely air conditioned and equipped with electronic dust precipitators to insure highest production accuracy. RPC resistors are specified for use in instruments, electronic computers, radiation equipment, aircraft equipment and scientific instruments.

Test equipment and standards for checking and calibrating are equalled by only a few of this country's outstanding laboratories. Our ability to produce resistors of highest quality coupled with prompt delivery have established RPC as a leading manufacturer of resistors. Small or large orders are promptly filled.

Representatives in principal cities. For full information send for latest catalog.



High Frequency Resistors

Used where requirements call for very low inductance, capacitance and skin effect in circuits involving pulses and steep wave fronts. Depending on size and resistance value, these resistors are usable at frequencies to over 400 mc. Resistance values range from 20 ohms to 100 megohms with tolerance of 20% to 5%. 2 types available.

TYPE G resistors (shown) are tubular, in 6 sizes from $4\frac{1}{2}$ " long x $\frac{3}{4}$ " diameter to $18\frac{1}{2}$ " long x 2" diameter. With band terminals or ferrules. Power rating 10 to 100 watts.

TYPE F resistors (not shown) in 8 sizes from $9\frac{1}{16}$ " long x 0.10" diameter to $6\frac{1}{2}$ " long x $9\frac{1}{16}$ " diameter. Lugs or wire leads. Power rating $\frac{1}{4}$ to 10 watts.



High Voltage Resistors

Type B Resistors are stable compact units for use up to 40 KV. These resistors are used for VT voltmeter multipliers, high resistance voltage dividers, bleeders, high resistance standards and in radiation equipment. They can be furnished in resistance to 100,000 megohms. Available as tapped resistors and matched pairs. Sizes range from a 1 watt resistor 1 inch long x $\frac{3}{16}$ inch diameter rated at 3500 volts, to a 10 watt resistor $6\frac{1}{2}$ inches long x $\frac{3}{16}$ inch diameter rated at 40 KV. Low temperature and voltage coefficients. Standard resistance tolerance 15%. Tolerances of 10%, 5% and 3% available. Tolerance of 2% available in matched pairs.



High Megohm Resistors

Type H Resistors are used in electrometer circuits, radiation equipment and as high resistance standards. Resistance available to 100 million megohms. (10^{14} ohms). For utmost stability under adverse conditions Type HSD and HSK Hermetically Sealed are recommended. Eight sizes from $\frac{1}{8}$ inch to 3 inches long are available. Voltage rating to 15,000 volts. Low temperature and voltage coefficients. Standard resistance tolerance 10%. Tolerance of 5% and 3% available. Also matched pairs 2% tolerance.

RESISTANCE PRODUCTS CO. 914 S. 13th Street HARRISBURG, PA.

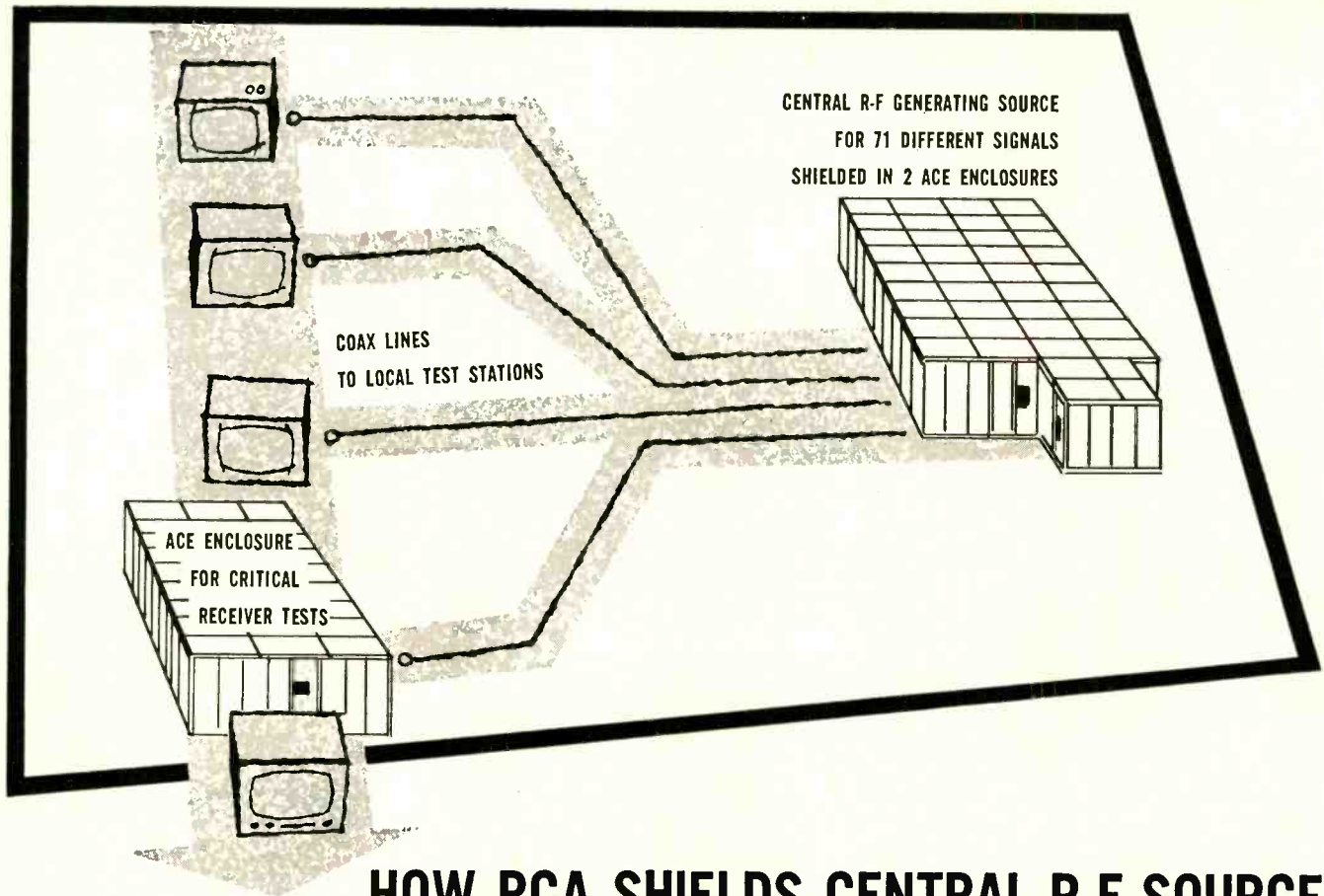

HOW RCA SHIELDS CENTRAL R-F SOURCE FOR INTERFERENCE-FREE LOCAL TESTING

Almost all of the 70-odd r-f signals needed to test receivers in RCA's modern plant at Indianapolis, Indiana, are generated at a central location. These signals are then piped via coaxial cables to testing sites throughout the plant. This novel approach to production line testing and aligning decreases r-f interference . . . allows more precise adjustment of the receivers.

For this system to work, however, the central r-f generators must be shielded properly. Otherwise, direct radiation of the oscillators would interfere with the receiver tests. In addition, certain critical tests require that the receivers themselves be shielded from all sorts of miscellaneous electrical interference associated with a large manufacturing plant.

To achieve its testing needs, RCA installed three Ace solid sheet metal enclosures (RFI Design)*. Two measure over 30 feet by 16 feet, stand ten feet high, and house the powerful signal generators. The third is used for analyzing the television receivers.

All of the rooms are equipped with air-conditioning, and two personnel access doors. Coaxial and electrical cables enter the enclosures through special filter traps designed to eliminate any possible stray radiations.

In addition to supplying a guaranteed 100 db attenuation from 14 kc to 1000 mc. (they have been known to hit 128 db), these rooms offer RCA several distinct advantages:

*Lindsay Structure

1. They may be easily moved in the assembled state if the plant should be rearranged.
2. Their dimensions may be altered, if necessary, by adding or removing interchangeable panels.
3. They are designed for exceptionally long life with no decrease in attenuation due to aging.

The Indianapolis installation shows just one of the ways in which Ace enclosures are being used today in industrial, military, and medical applications. An Ace Sales Engineer would be glad to show you how you can solve your interference problems with comparable success. Write for further information—a free catalog on standard enclosures is yours for the asking.



First and Finest in Shielded Enclosures

ACE ENGINEERING & MACHINE CO., INC. 3644 N. Lawrence St. • Phila. 40, Pa.

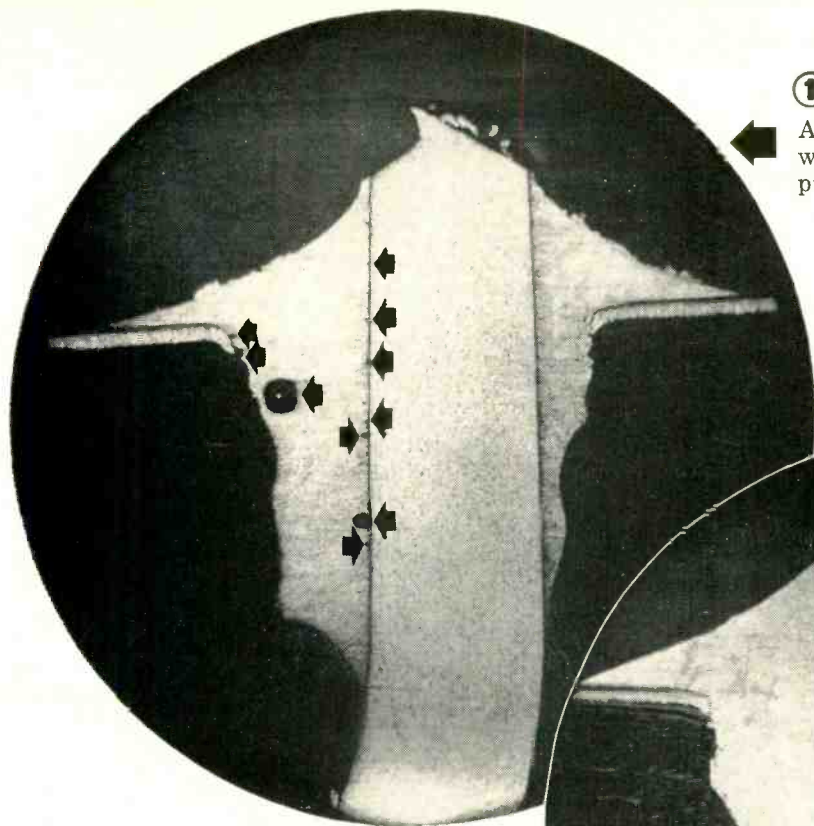

①

Arrows point out porosity that weakens the joint in this typical printed circuit soldered lead.

②

In this "Dutch Boy" joint porosity has been done away with. Joint is stronger.

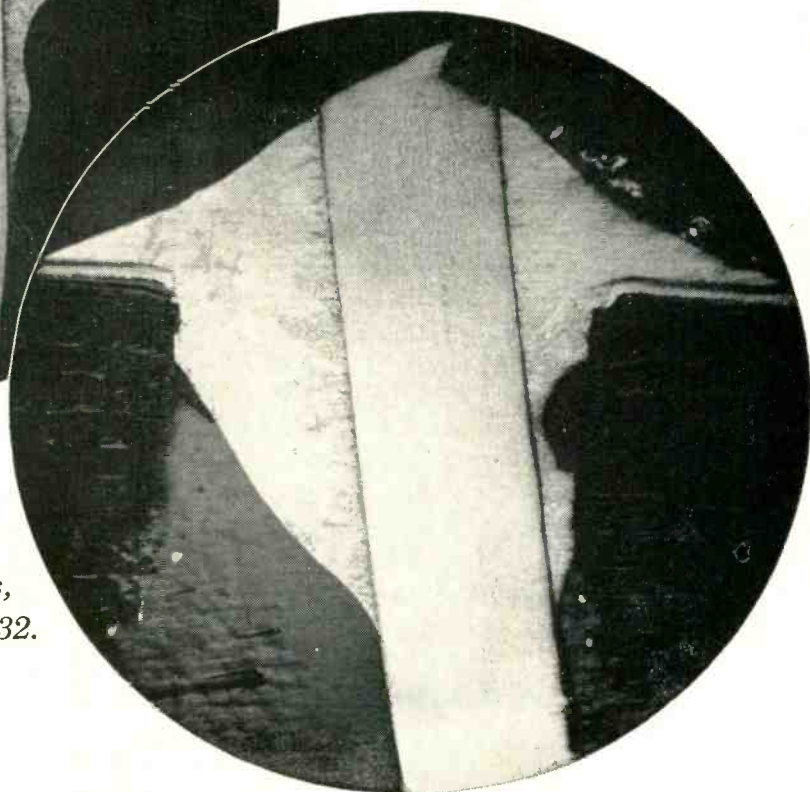

Photomicrographs of printed circuit soldered leads, polished, etched, and magnified by 32.

"Dutch Boy" gets inside story on printed circuit soldering

...develops solders and fluxes that give stronger joints, coat more uniformly, show higher conductivity

"Dutch Boy" researchers keep a close eye on printed circuit soldering.

For example, they cross-section soldered leads, polish, and examine the polished sections under the microscope.

Most such joints prove too weak

The photomicrograph above left shows why. Notice this typical joint is honeycombed with porosity. Arrows point to holes.

Now look at the photomicrograph on the right. This joint is strong. Non-porous.

How was joint on the right made stronger?

No great trick. A "Dutch Boy" Solder Specialist simply worked out slight improvements in flux and solder formulae and operating conditions.

Maybe this would help improve *your* printed circuits.

"Dutch Boy" solders develop maximum surface tension. They don't form "tear drops" when coated boards are lifted from the bath...they improve coating uniformity. The residual flux is both non-corrosive and non-conductive, and can be left on the soldered board.

So, if you feel there is room for improvement in your printed circuit soldering, look first to "Dutch Boy". Write, giving details if possible, to National Lead Company, 111 Broadway, New York 6, N. Y.

Dutch Boy®
SOLDER AND FLUXES



HOW TO TEST CORES

With the growing realization that cores are here to stay, more companies every day are expressing an interest in their application. But as Burroughs discovered some six years ago, a core investigation program must be a core *testing* program as well. And since the special equipment and procedures needed for core testing were not available at the time, Burroughs had to develop them.

These tools and techniques, born of a practical need are available now for your core testing needs. The tool is the Burroughs BCT-301, a complete and flexible system for accurately measuring the operating characteristics of tape wound cores. Allowing precise control over frequency, pattern, amplitude, and rise time of the core driving signal, the BCT-301 gives you extremely accurate measurements of the switching time of the core as well as the amplitude of the output pulse. And since it is constructed of unitized sections, the BCT-301 can be expanded and modified to meet new testing requirements as they arise.

But the BCT-301 is more than just a tool. With it you get the benefit of techniques and procedures which are now in everyday use at Burroughs, and are accepted practice among major core manufacturers. If you're interested in designing tape wound cores into your products, we'll be glad to send you additional detailed information on the BCT-301. Or, if you wish, have a Burroughs Sales Engineer demonstrate how the BCT-301 can get your core testing program off the ground . . . NOW.

tools for engineers

BCT 301

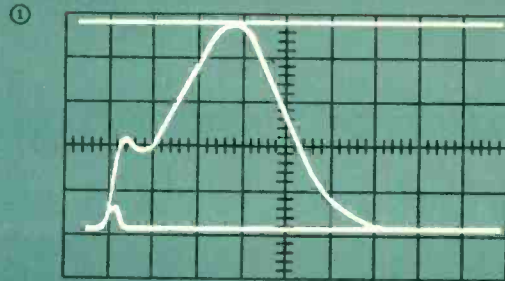

Figure ① shows the peak voltage amplitude of the output pulse being measured with the calibrating voltage. For amplitudes less than one volt, measurements can be made in millivolts.

Figure ② shows the calibrating voltage being used to measure pulse width at 10% of the amplitude.



Burroughs Corporation • ELECTRONIC INSTRUMENTS DIVISION
DEPARTMENT C • 1209 VINE STREET • PHILADELPHIA 7, PENNSYLVANIA

... with the BCT-301

A Complete and Flexible Core Testing System

The BCT-301 has been designed expressly for the individual testing of square loop cores. It provides precise control over the frequency, pattern, amplitude and rise time of the core driving signal, and allows extremely accurate measurements of the switching time of the core, as well as the amplitude of the output pulse. The unit is composed of five basic sections, each of which can be replaced or expanded for other types of core testing.

Core Mounting Jig This low-noise test mounting jig applies tight single turn loops around the core for input and output windings. It has been designed to minimize not only pickup by the secondary, but also other disturbances caused by air flux. Adjustable pins accommodate a wide range of bobbin sizes with equal precision.

Pattern Generator The Pattern Generator provides extreme flexibility in generating the pulse patterns which are applied to the core. This section of the system controls the pulse spacing, repetition rate of the cycle, and the number of pulses in the pattern.

Current Drivers Two Current drivers convert the voltages from the pattern generator into the positive and negative constant current pulses used for driving the core.

Front panel controls provide:

- Variable current amplitude from 0 to 1.0 ampere
- Variable rise time from 0.2 μ sec. to 1.0 μ sec.
- Variable pulse duration from 1.0 μ sec. to 10.0 μ sec.

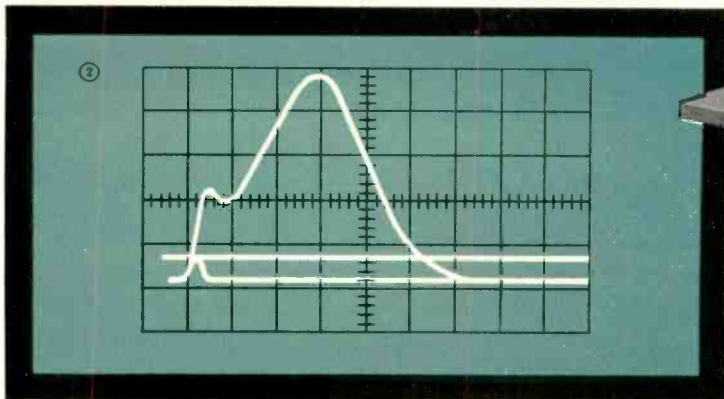

Calibrator The calibrator is designed to accurately measure currents and voltages. It permits the measurement of both the driving current and the amplitude of the output voltage with an error of less than 1%. When used with a calibrated oscilloscope, it makes possible highly accurate readings of switching time.

Power Supply The power supply provides seven regulated d-c voltages.

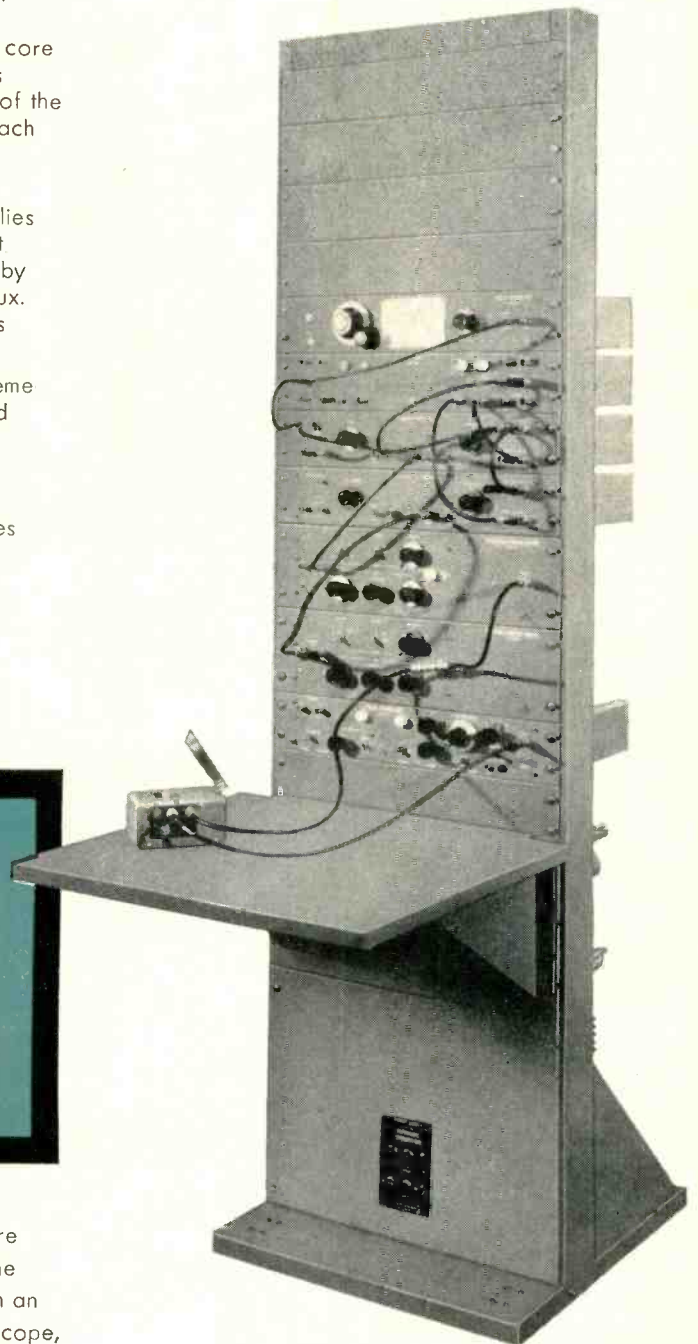

over **100** designs of **Grant** INDUSTRIAL SLIDES
to meet every operating situation!

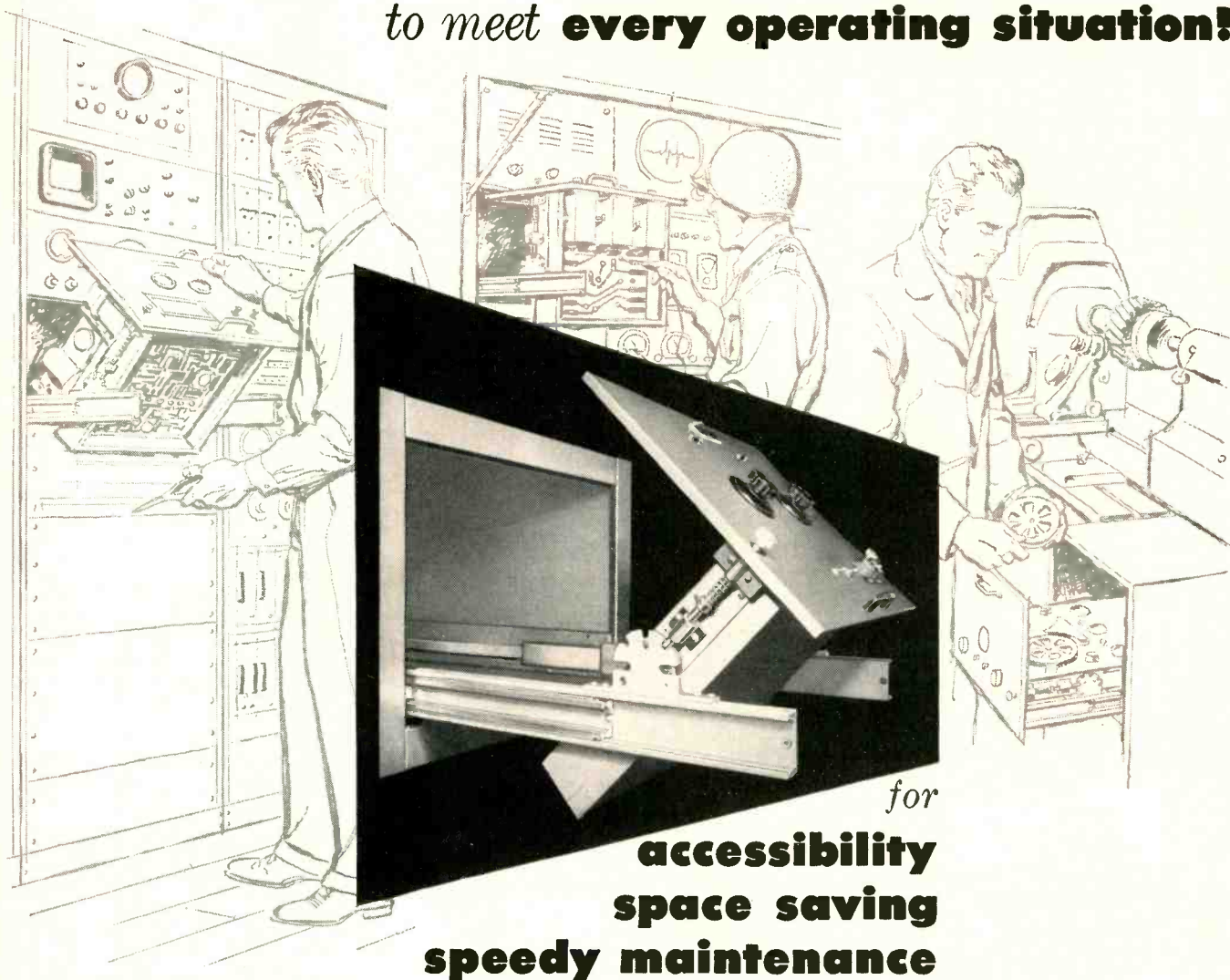

for
accessibility
space saving
speedy maintenance

Grant Industrial Slides afford substantial, practical mountings for nearly all types of assemblies—electronic, hydraulic, pneumatic, mechanical. They allow quick access... the pivoting types permit testing or work on underside as well as top of chassis... also provide for quick release of chassis for bench servicing. Slide mounting usually eliminates need for rear access doors and rear aisles—a very important saving of space. Grant slides are soundly engineered, durable and dependable. Load capacities range up to 500 lbs. and more.

Grant engineers and representatives in all important industrial areas offer specialized experience—will aid in working out custom variations to adapt standard slides to especially exacting requirements.

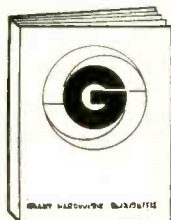

**Ask For
This Important
Working Data**

The Grant Industrial Slide Catalogue is a working manual on built-in accessibility. Ask us to mail your free copy.



Grant INDUSTRIAL SLIDES

Grant Pulley and Hardware Corporation
31-73 Whitestone Parkway, Flushing 54, N. Y.
944 Long Beach Avenue, Los Angeles 21, Calif.

NEW GRID-CONTROLLED KLYSTRON NOW IN QUANTITY PRODUCTION



SAL-89

HIGH-POWER PULSE AMPLIFIER FOR AIR NAVIGATION SYSTEMS

In introducing the SAL-89, Sperry is offering the first production tube featuring grid-controlled pulse operation for ease of modulation. This tube, with its unique technological advances, was designed specifically for air navigation and traffic control service.

With grid control, Sperry has greatly eased the problem of modulating high-power klystrons. For example, only 575-volt pulses are now required to modulate the tube where previously 10,000-volt pulses were necessary. Specially shaped pulses are also easily applied to the tube.

SAL-89 incorporates space-charge focusing, another Sperry development, which eliminates large, heavy magnetic structures and simplifies cooling. Integral resonant cavities make external microwave circuits with their associated sliding contacts unnecessary.

For further information on this new tube, write our Electronic Tube Division.

GENERAL CHARACTERISTICS

Frequency Range	960 to 1215 mc
Peak Output Power	30 kw
Grid Bias (Negative)	1% of Beam Voltage
Grid Drive (Positive)	2.2% of Beam Voltage

TYPICAL PULSE OPERATION

Frequency	1100 mc
Grid Bias	-170 v
Grid Drive	575 v
R-f Input Peak Power	30 w
R-f Output Peak Power	25 kw
Duty Cycle	2.5%
Beam Voltage	17 kv

SPERRY

ELECTRONIC TUBE DIVISION

GYROSCOPE COMPANY

Great Neck, New York

DIVISION OF SPERRY RAND CORPORATION

CLEVELAND • NEW ORLEANS • BROOKLYN
LOS ANGELES • SAN FRANCISCO • SEATTLE
IN CANADA: SPERRY GYROSCOPE COMPANY
OF CANADA, LIMITED, MONTREAL, QUEBEC

all new



precision

**18
KMC**

The revolutionary new waveguide equipment shown here represents a practical, efficient adaptation of an ultra-modern concept of waveguide instrumentation. Emphasis throughout is on functional simplicity, rugged dependability, highest accuracy, and low cost. The instruments are offered as individual basic test components, yet all are integrated electronically and mechanically with the *-hp-* waveguide line.

**each covers full waveguide band
accurate, stable, versatile
-hp- quality at low cost
easy set-up, simple operation**

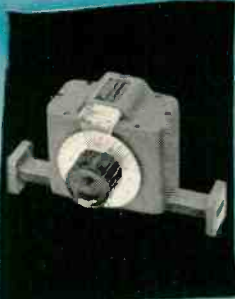

◀ **-hp- 375A Variable Flap Attenuators.** For introducing variable power levels, or isolating power sources and loads. Consists of a single slotted section with movable matched resistive strip. SWR less than 1.15. *-hp- K375A*, \$60.00. *-hp- R375A*, \$70.00.



◀ **-hp- 752 Directional Couplers.** Available with coupling factors of 3, 10 and 20 db \pm 0.7 db full range. SWR better than 1.05. Directivity 40 db or better over entire range. *-hp- K752*, \$100.00. *-hp- R752*, \$120.00.



◀ **-hp- 910A Waveguide Terminations.** Matched load for use where waveguide must be terminated in its characteristic impedance. Residual reflection approx. 1.0%. Average power 0.5 watts. *-hp- K910A*, \$30.00. *-hp- R910A*, \$35.00.



There has been no compromise with traditional *-hp-* quality in extending *-hp-* waveguide instrument coverage to the 40 KMC region. Yet there is present the same ingenious design simplicity which make possible mass-production economy—low cost to you.

Today, more than ever, *-hp-* offers you the best value in waveguide instrumentation ever available.

HEWLETT-PACKARD COMPANY

3809A Page Mill Road • Palo Alto, Calif., U.S.A.
Cable "HEWPACK" • Davenport 5-4451
Field engineers in all principal areas

See your  representative for quality

to
40
KMC

**complete
coverage**

K-band
18 to 26.5 KMC
.500" to .250"

R-band
26.5 to 40.0 KMC
.360" to .220"

◀ -hp- 814A UNIVERSAL PROBE CARRIAGE

Covering frequencies 12.4 to 40.0 KMC, the new, convenient -hp- 814A mounts -hp- 815A Waveguide Slotted Sections in P, K and R bands. Waveguides may be interchanged instantly with positive-accuracy alignment. For use with the new -hp- 446A Broadband Probe (\$145.00), the 814A Carriage provides direct readings to 0.1 mm and interpolation to 0.01 mm (approximately 0.001 wavelength). Dial adjusts quickly for differential readings; accuracy is assured by a precision-threaded drive free of backlash. SWR to 1.02 is easily read, and slope error can be eliminated. \$225.00.



◀ -hp- 815A Slot Section. Extremely careful machining insures time-saving accuracy for measuring SWR to determine reflector, match and impedance. Machine from tellurium copper exterior or rhodium plated to prevent corrosion. -hp- P815A, K815A, or R815A, \$200.00.

◀ -hp- 487A Thermistor Mounts. Broadband mounts for fast accurate power measurements. Negative-temperature coefficient thermistors provide burnout protection. SWR approx. 2.0. -hp- K487A, \$85.00.



◀ -hp- 870A Slide Screw Tuners. For flattening waveguide systems. Probe sets up SWR which cancels existing SWR. No back lash in adjustments. Accuracy SWR 1.02. -hp- K870A, \$140.00. -hp- R870A, \$140.00.



◀ -hp- E80A E-H Tuners. For tuning high power systems or setups where low leakage is essential. Consists of hybrid tee, with movable choke shorts in shunt and series arm. -hp- K880A, \$155.00. -hp- R880A, \$170.00.

Remember
-hp- also offers
complete
waveguide
instrumentation

◀ -hp- 914A Moving Loads. Low reflectance load (1.0%). Load position variable at least $\frac{3}{4}$ wavelength, permitting reversing phase of residual reflection. -hp- K914A, \$65.00. -hp- R914A, \$75.00.



◀ -hp- 920A Adjustable Shorts. Choke type adjustable shorts for introducing reactance in combination with detecting sections, series, shunt or hybrid tees. -hp- K920A, \$75.00. -hp- R920A, \$85.00.

3 through 18
KMC for S, G,
J, H, X and
P bands!

waveguide instrumentation 3 through 40 KMC!

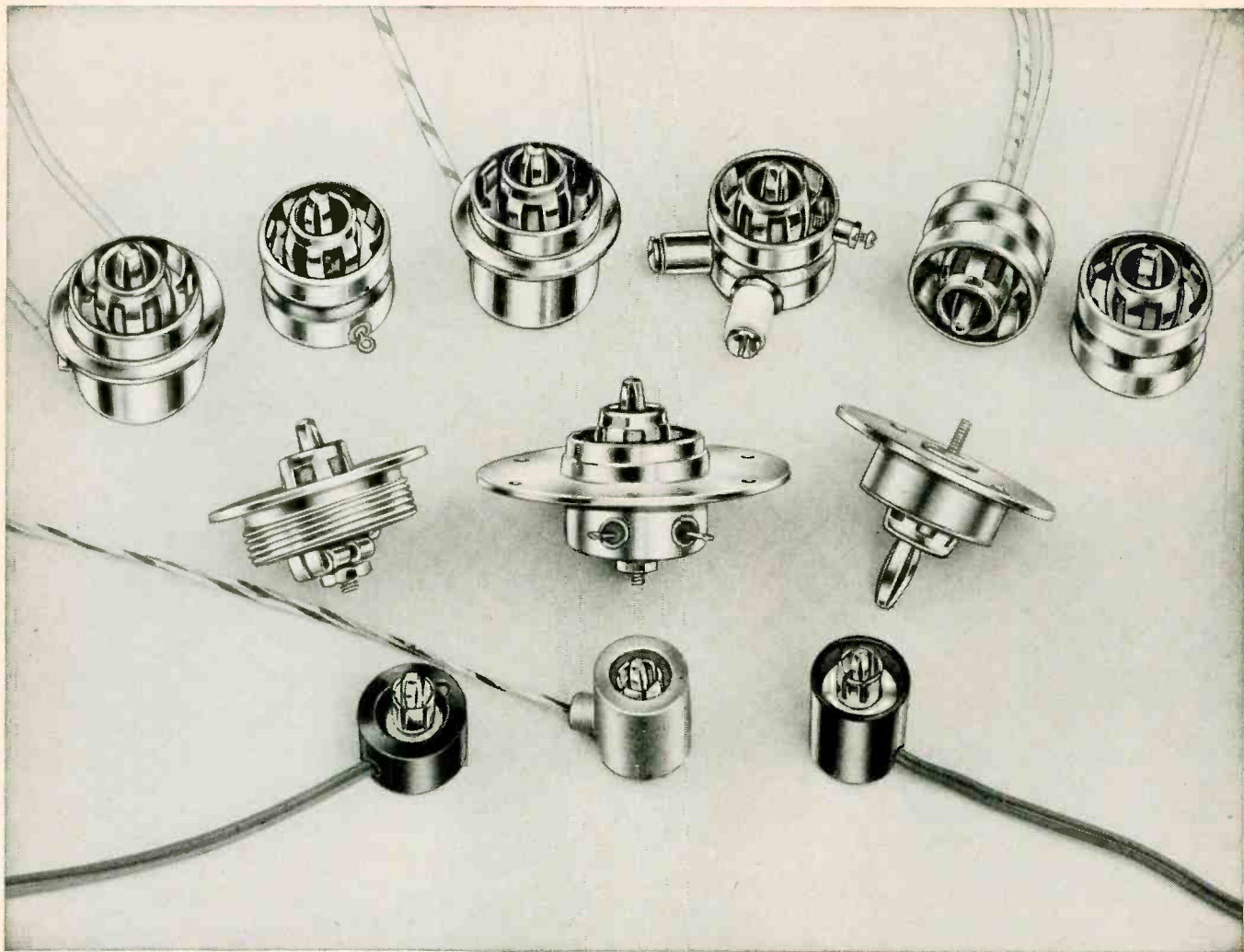

Ucinite Magnetron Connectors

Ucinite manufactures a variety of special connectors for the heater and heater-cathode terminals of magnetrons. Many of these have been adapted for special applications as to size and function to meet the sealing and mounting requirements of high temperature and high altitude operation and other special conditions.

Connectors are coaxial in construction and can be supplied with built-in capaci-

tors for added protection. Connecting leads of any length can be furnished to customer's specifications.

With an experienced staff of design engineers, plus complete facilities for volume production, Ucinite is capable of supplying practically any need for metal or metal-and-plastics assemblies. Call your nearest Ucinite or United-Carr representative for full information or write directly to us.



The
UCINITE CO.
Newtonville 60, Mass.
Division of United-Carr Fastener Corp.

Specialists in
ELECTRICAL ASSEMBLIES,
RADIO AND AUTOMOTIVE



**ULTIMATE IN
TOROIDS
FILTER NETWORKS
MAGNETIC
AMPLIFIERS**

When you "team up" with C-A-C, you have at your disposal an outstanding engineering staff... backed by facilities of the world's largest exclusive producer of toroidal components.

**COMMUNICATION
ACCESSORIES COMPANY**

Hickman Mills, Missouri • Phone Kansas City, South 1-6111

*A Subsidiary of the
Cohins Radio Company*

C-117



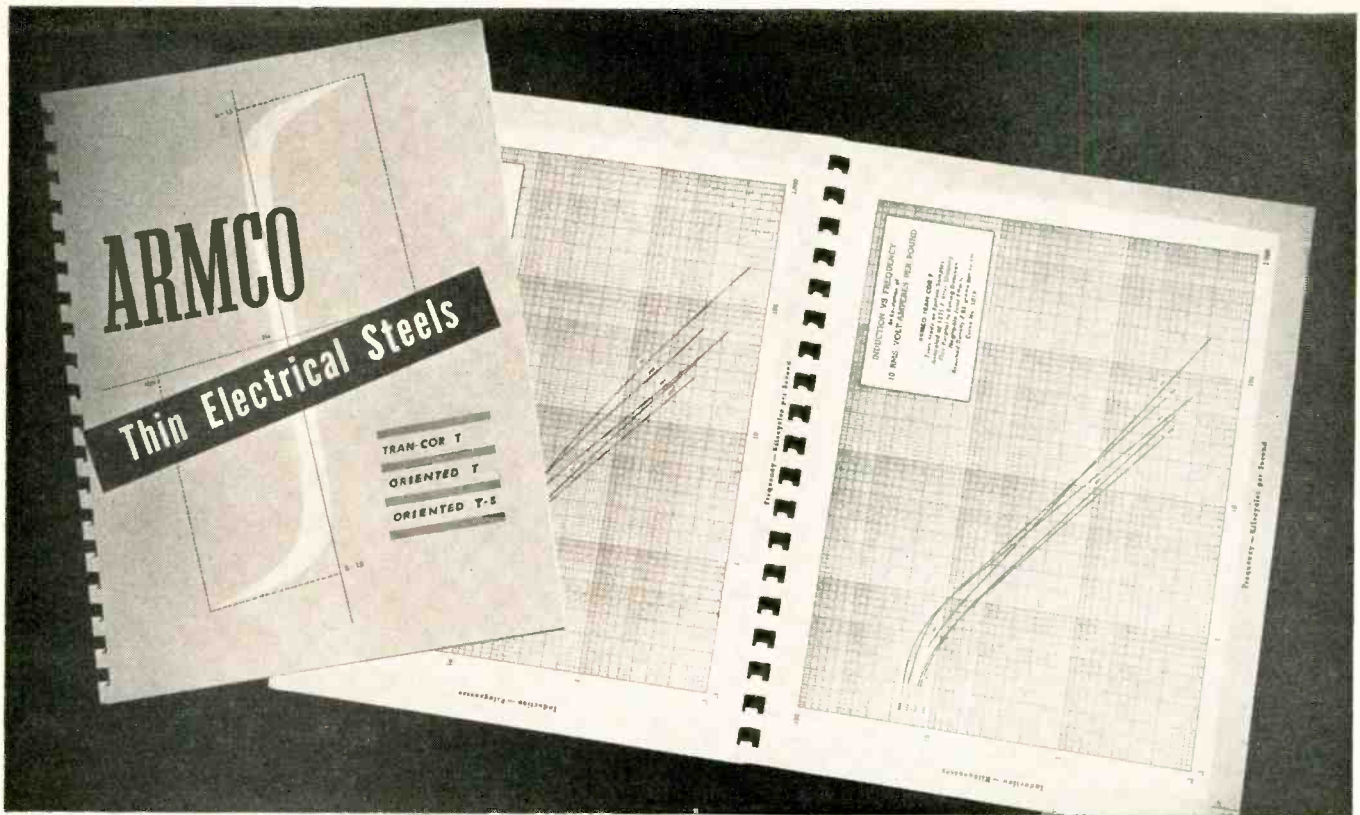

NEW DESIGN DATA on Armco Thin Electrical Steels NOW AVAILABLE

Booklet gives designers of high frequency equipment, 400 to 200,000 cycles, basic data on Armco's 1 to 7 mil iron-silicon materials, plus 39 pages of design curves on pertinent magnetic properties.

Design information in the new catalog "Armco Thin Electrical Steels" enables you to make more effective use of the multiple advantages of Armco TRAN-COR T (7 and 5 mils), Oriented T (4, 2 and 1 mil) and Oriented T-S (4 mil).

New Data Included

Added to the extensive information in the original edition are 18 new sets of curves which expand the data on 4 mil material, offer a widened range of DC properties, and include data on operation at elevated

temperatures. A detailed discussion of testing methods is also included.

Selection of the grade and gage for most efficient balance of performance and cost is simplified with this helpful, easy-to-use new Armco booklet. The facts you need for designing maximum-performance aircraft, television, radio and higher frequency equipment are at your finger tips.

Write us today for your copy of the 1956 edition of "Armco Thin Electrical Steels."

ARMCO STEEL CORPORATION

2616 Curtis Street, Middletown, Ohio

SHEFFIELD STEEL DIVISION • ARMCO DRAINAGE & METAL PRODUCTS, INC. • THE ARMCO INTERNATIONAL CORPORATION



LEACH MAGNIVOLT

regulated D-C power supplies



Here's a closely regulated D-C Power Supply accurate enough for the most exacting laboratory use, yet sufficiently rugged to use out in the plant for production testing and quality-control work. Back of this unusual combination is the Leach MAGNIVOLT's construction . . . it uses only static components, contains no vacuum tubes or other fragile parts. Heart of the unit is a design based on magnetic amplifiers and selenium rectifiers, assurance of stability today and long, maintenance-free dependability for years to come.

Use the MAGNIVOLT, either portable or easily rack mounted, as a dependable D-C voltage source in such demanding applications as these . . .

*strain-gage excitation
d-c amplifier filament supply
computer filament supply
incoming parts inspection
production-line testing
calibration reference
standard light-source power
radio and radar research*

PERFORMANCE SPECIFICATIONS

A-C Input 120 volts, 60-cycle, single phase
D-C Output 3-32 volts (continuously adjustable)
 at 0 to full-rated amperage
Ratings Available 5 to 30 amperes (max.)
Voltage Regulation . . . $\pm 1/2\%$ from 24 to 32 volts for load
 change of no-load to full-load and for supply-voltage
 change from 105 to 125 volts
Ripple less than 1% r.m.s.
Recovery Time . . . less than 0.2 seconds to reach 1% of
 regulated voltage
 (no-load to full-load or full-load to no-load)
 MAGNIVOLT models are available for immediate delivery

LEACH

CORPORATION

INET-PALMER DIVISION

4441 SOUTH SANTA FE AVENUE • LOS ANGELES 58, CALIFORNIA

DISTRICT OFFICES AND REPRESENTATIVES IN PRINCIPAL CITIES OF U. S. AND CANADA

FROM A "CAT'S WHISKER" TO A COLISEUM!

Crystal sets to satellites . . . only decades away from the first primitive experiments looms today's giant 12 billion dollar radio-electronics industry. Now, all 4 floors of New York City's Coliseum are needed to display one year's growth!

The purpose of *The Radio Engineering Show* is to bring new and stimulating ideas in radio-electronics to engineers. To achieve this, more than 200 papers will be presented by 22 professional groups at the Convention's 55 technical sessions. Over 800 new ideas in radio-electronics engineering will also be presented by 834 exhibitors representing more than 80% of the productive capacity of the industry.

Yes, it's big in size, big in scope. Whatever your special interests, attending this Convention can cut weeks off your "keeping informed" time. Plan now to be there.

ATTEND THIS CONVENTION: ♦ *Save time; a whole year's productive effort seen in days!* ♦ *See all that's new in radio-electronics products, developments, and engineering—meet the men responsible!* ♦ *Hear the best technical papers about your specialty!* ♦ *Meet old friends, make new ones, enjoy association and social events!*

REGISTRATION: IRE Members \$1.00
Non-members \$3.00

**MARCH
18-21**

**The IRE National
Convention
Waldorf-Astoria Hotel
and The Radio Engineering Show
Coliseum**

New York City

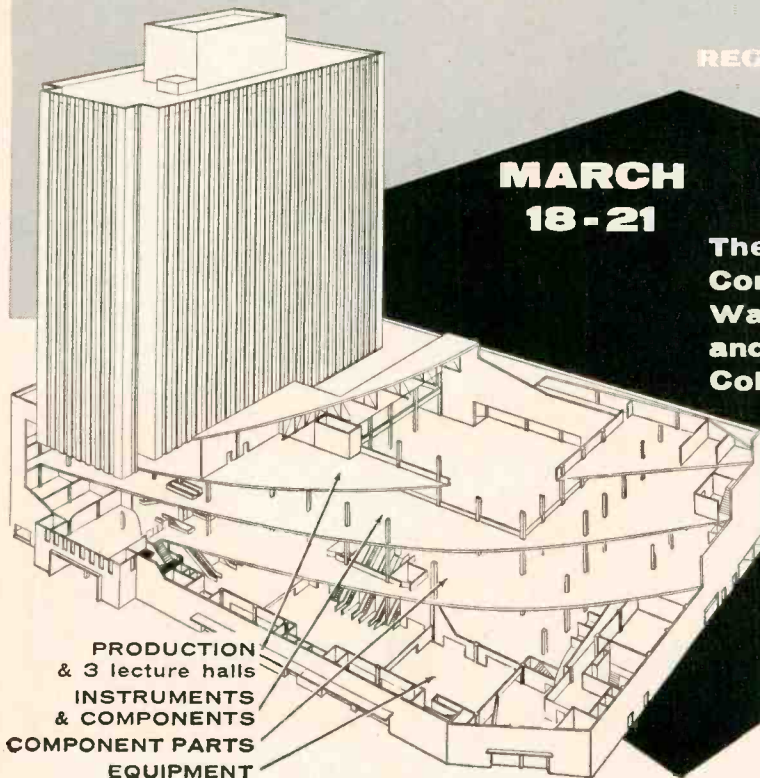

The
Institute of
Radio
Engineers

1 East 79th Street, New York 21, N.Y.

**PRECIOUS
METAL
CONTACTS
PROVIDE LONG
OPERATING
LIFE AND
UNVARYING
PERFORMANCE**

Progressive research development policies, coupled with vast experience in related fields, enable BAKER to apply its know-how in precious metals to meet the diverse problems accompanying the selection of precious metal contacts to suit individual requirements. The following BAKER precious metal materials serve to illustrate what BAKER's research departments make available in SILVER, PLATINUM, PALLADIUM and GOLD, in pure or alloy form, for supply as wire, rod, sheet, and as fabricated forms, such as rivets, discs, solderbacks, welding types, overlay, edgelay, inlay and irregular shapes.

SILVER AND SILVER ALLOYS

One of the most widely used materials for electrical contacts, SILVER provides high resistance to atmospheric corrosion. Silver Alloys—which contain base metals to achieve specific properties—provide other modified characteristics, such as increased resistance to arc erosion, sticking and metal transfer.

PLATINUM AND PLATINUM ALLOYS

Offering a higher resistance to tarnish and corrosion than any other contact material, the contact resistance of platinum can be maintained at a low value throughout its operating life. Platinum alloys provide higher melting points and hardness, greater resistance to deformation, longer life and increased resistance to sticking and metal transfer.

Write for complete catalog material and details.

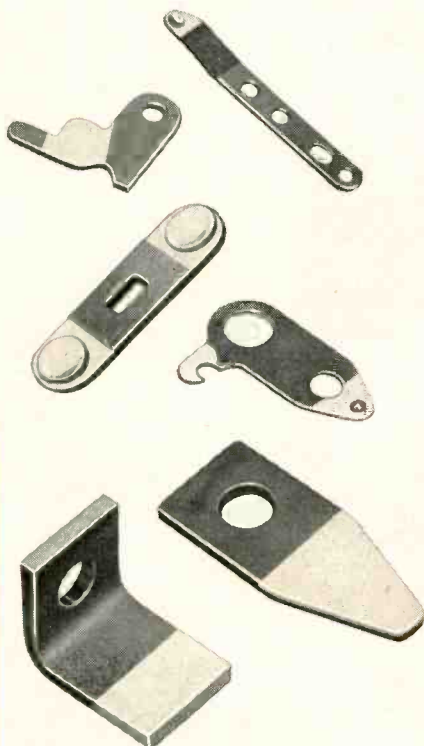

NITRONEAL® GAS GENERATOR economically and safely provides fully automatic furnace brazing and bright annealing of stainless steel.



FINE WIRE of ductile and non-ductile material meets the expanding requirements of industry with highest quality.

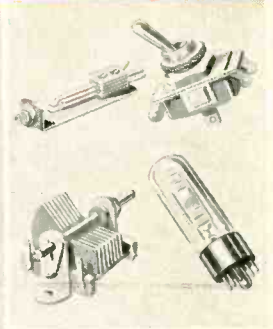

RHODIUM PLATING provides a hard, brilliant white, non-tarnishable surface extremely resistant to corrosive conditions.

BAKER PRECIOUS METALS

BAKER & CO., INC.

113 ASTOR STREET, NEWARK 2, NEW JERSEY
NEW YORK • SAN FRANCISCO • LOS ANGELES • CHICAGO

ENGELHARD INDUSTRIES

RESEARCH MAINTAINS BAKER'S LEADERSHIP IN PRECIOUS METALS



Belden 8411

If it's worth Engineers' time . . .



Belden 8422

. . . It's worth Engineered Cable



Belden 8412



**Belden
microphone
cables**

Whatever the installation,
whatever the requirements,
there is an accurately
rated Belden Microphone
Cable built for the job.



Belden

WIREMAKER FOR INDUSTRY
SINCE 1902
CHICAGO

4-8

1001 WIRES FOR EVERY ELECTRONIC NEED

Electron Tube News

-from Sylvania

- contributing to equipment performance
everywhere in electronics

Sylvania adds its newest reliability factor to premium subminiature tubes

- "White noise" vibration test is worthy measure of the superior construction of the button-header subminiature.

A full line of Sylvania "gold brand" subminiature tubes is now being "white noise" tested on a pro-

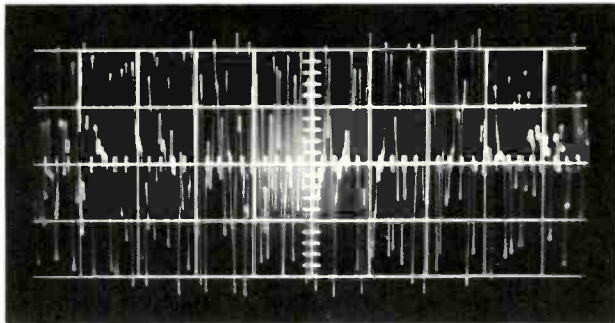

This unretouched oscillogram demonstrates the wide spectrum of frequencies inherent in the "white noise" vibration test, which is applied to the tube.

duction basis. Thus a new measure of reliability has been added to the tubes already acknowledged as the world's most reliable.

The "white noise" test presents a full range of frequencies over a broad spectrum at peak g-levels of 15 and provides a closer approximation of vibrational environment encountered in guided missile and other vehicular applications.

The ability of Sylvania subminiatures to submit to this more exacting test is dramatic proof of the superior construction of the button-header design. Stronger leads, vertical support in three rather than a single vertical plane, wider spacings - these and other features of the button-header have added considerable impetus to the accepted use of Sylvania "Gold Brand" subminiatures in guided missiles.

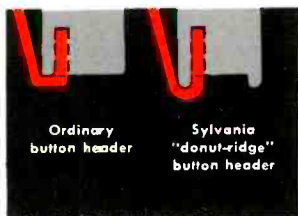

Here's a simple comparison of the advantage of Sylvania's "donut ridge" button-header over ordinary types. When the leads are bent sharply as shown, ordinary headers will flake, chip, or crack; but leads bend cleanly around the "donut ridge" in Sylvania "Gold Brand" subminiatures.

- in
military
equipment

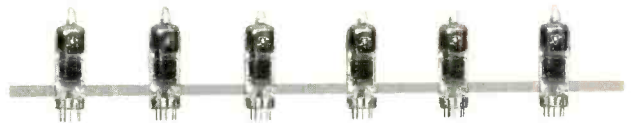

For the first time by any manufacturer, subminiature tubes are being given the "white noise" vibration test in addition to the currently used static-vibration tests at 40 cps and 15 g. Types listed are now being tested for "white noise."

Type 5636.....	UHF pentode
Type 5639.....	Video pentode
Type 5718.....	UHF medium Mu triode
Type 5719.....	High Mu triode
Type 5840.....	UHF sharp cutoff pentode
Type 5899..	UHF semi-remote cutoff pentode
Type 5902.....	Audio Beam Power Pentode
Type 5977.....	Medium Mu Triode
Type 6021.....	Medium Mu Double Triode
Type 6111.....	Medium Mu Double Triode
Type 6112.....	High Mu Double Triode
Type 6205.....	UHF sharp cutoff pentode
Type 6206..	UHF semi-remote cutoff pentode
Type 6788.....	RF Pentode



New Subminiature RF Pentode is Tailor-made for Guided Missiles

The new Sylvania Type 6788 features high gain in the audio region and has exceptionally low vibrational noise, making it ideally suited for guided-missile application.

It is the first subminiature tube released from Sylvania's guided-missile development program and is the only tube specifically designed for use as an amplifier where conditions of severe mechanical vibration are encountered.

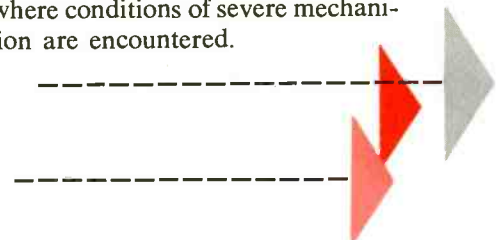

-contributing to equipment performance,

-in
television

New Dual Triode developed for Vertical Deflection in 110° Systems

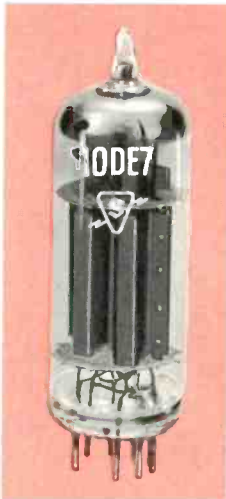

Anticipating the need for a new vertical deflection tube to complete the designer's needs in 110° deflection circuits, Sylvania developed the type 10DE7. The 10DE7 is a T6½ double triode with dissimilar sections — one triode for vertical deflection and the other suitable for vertical oscillator use. The type utilizes a 600 ma heater with warm-up time control for series string operation.

The high perveance type 10DE7 will deliver 80 ma peak plate current at lower supply voltages and at a plate

dissipation up to 7 watts in the vertical deflection amplifier section.

The grid of the output section is connected to two external pins providing for additional cooling and greater circuit flexibility. The miniature construction of the type 10DE7 also makes it particularly adaptable to printed circuits and automation techniques.

The types 6DE7 and 13DE7 are also available for use in transformer circuits and 450 ma series string operations respectively.

Average characteristics of the 10DE7 in a typical 110° deflection circuit

Amplifier Section

Cathode Current	29 ma
Peak Cathode Current	80 ma
Peak-to-Peak Grid Drive	103 V
Grid Bias	-11.5 V
Cathode Bias D.C.	21 V
Plate Voltage—Peak-to-Peak	577 V
Filament Voltage	10 V
High Voltage	16 KV @ 100 ma
B+ Voltage	250 V

Oscillator Section

Plate Voltage	65 V
Cathode Current—Peak	47 ma
Grid Voltage	-55 V
Grid Voltage—Peak-to-Peak	235 V

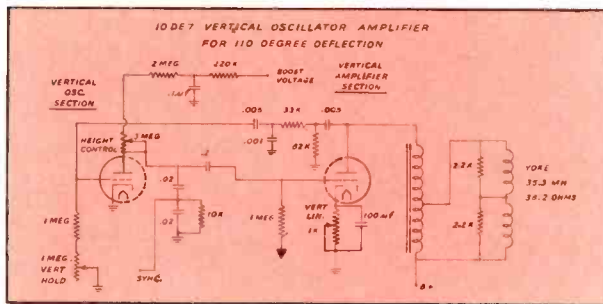

Design and performance capabilities of the 10DE7 have been checked out thoroughly in the typical 110° circuit shown. Characteristics reflect average characteristics measured.

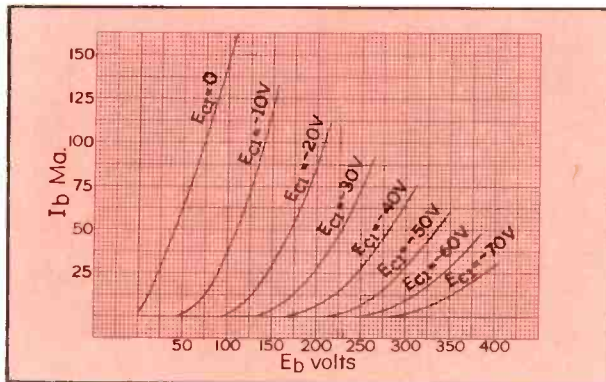

Plate family characteristic curves for the Type 10DE7

Beam Power Pentodes for 110° vertical deflection

For systems using pentodes for vertical deflection amplifier use Sylvania provides two basic important types, the type 6CM6 and type 6CZ5. Both are suited for 110° deflection—the 6CM6 for up to 17" picture sizes and the 6CZ5 for larger.

Characteristics — pentode connections

Type 6CM6pentode conn.
Plate V315 V Max.
Peak Pos. Plate Volt2000 V Max.
Plate Diss.8 Watts Max.
Grid 2 V285 Volts Max.
Grid 2 Diss.1.75 Watts Max.
Type 6CZ5 —	
Plate V315 V Max.
P.P.P. V.2200 V absolute Max.
Plate Diss.10 Watts Max.
Grid 2285 volts Max.
Grid 2 Diss.2 watts Max.

The types 6DQ6A and 6DN6 will meet horizontal deflection needs in 110° circuits and the proved type 6AU4GTA or 6AX4GTA will provide adequate damper service.

Completing the tube needs in 110° deflection systems, Sylvania offers the types 1B3GT and 1X2B for high voltage rectifier use.

everywhere in electronics

New 110-Degree Picture Tube offers more picture per cubic inch of TV set

— other new tubes offered include 90° short-neck, non-ion trap types and a dramatic new development scheduled for early production.

New, shorter, lightweight, 110° deflection picture tubes will save as much as 20% in picture tube weight and will make it possible to design more compact, lighter TV consoles, as well as more portable TV sets.

Light weight and structural strength of the picture tube have been achieved in a new face-plate design. New trim set styling made possible by shorter lengths should provide new stimulus for the sale of black-and-white TV sets.

As a leading picture tube manufacturer, Sylvania is working closely with TV set makers to supply the industry's requirements for both 110° deflection types and 90° short-neck non-ion trap types. New developments will be made available early this year.

Compare a 21" bulb in 90° and the new 110° versions. New 110° offers considerable savings in depth per square inch of picture.

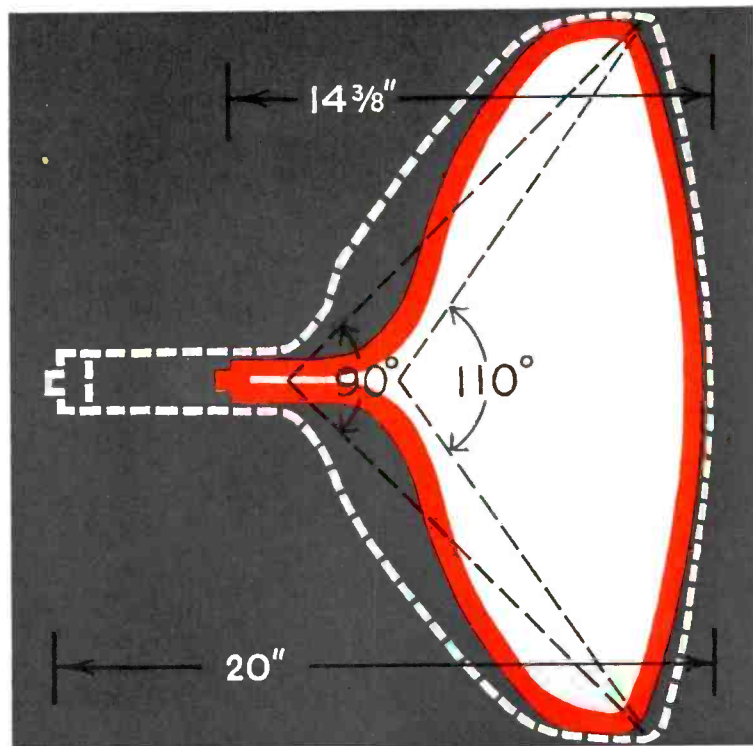

Sylvania offers new types in a complete line of 12-volt tubes for hybrid auto radio

—in
Radio

Sylvania's line of 12-volt tubes for hybrid auto radio features an RF pentode with high transconductance, an IF pentode with high gain and a transistor driver designed to match the input characteristics of single-ended or push-pull transistor output stages.

These developments reflect the specific design requirements which have been brought about by the hybrid radio design, particularly the need for high performance with fluctuations in voltage-supply conditions.

All auto-radio types are produced under Sylvania's well-known "noise-free" tube program which exerts tighter limits and more rigid controls on all factors influencing microphonism.



Type 12CY6 —
New T5½ IF Pentode

Heater Voltage — 12.6 volts
Heater Current — 200 ma.
Transconductance — 3250 umhos
Plate Resistance — 140K ohms
Plate Current — 1.6 ma.
Grid to Plate Capacitance — .18 uuf max.



Type 12CX6 —
New T5½ RF-IF Pentode

Heater Voltage — 12.6 volts
Heater Current — 150 ma.
Transconductance — 3100 uhms
Plate Resistance — 40K ohms
Plate Current — 3.0 ma.
Grid to Plate Capacitance — .05 uuf max.



Type 12J8 —
New T6½ Transistor Driver

Heater Voltage — 12.6 volts
Heater Current — 350 ma.
Transconductance — 5400 ohms
Plate Resistance — 4000 ohms
Power Output — 20 mw.
Total Harmonic Distortion — 5%

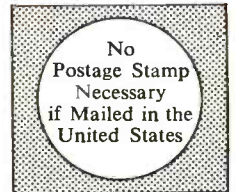
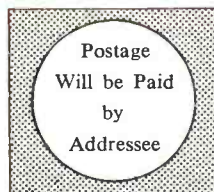

BUSINESS REPLY CARD

(First Class Permit No. 46687, New York 19, N.Y.)

SYLVANIA ELECTRIC PRODUCTS INC.
1740 Broadway
New York 19, N. Y.



-contributing to product performance,
everywhere in electronics

-in
computers



The Type 6888 is a dual control computer pentode designed for long life and low failure rate. It is especially designed for pulse amplifier use, core driver and coincidence circuits.

It is built to the highest standards of reliability established for commercially available tubes and is dynamically tested for pulse characteristics under pulse test conditions.

The type 6888 is just one of a full line of Sylvania tubes especially designed for computer applications.

**Write for this complete brochure of Sylvania's
 line of computer products**

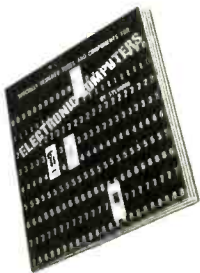

What every computer designer should know about Sylvania components is completely outlined in this 64-page book. Between these two covers is the complete story of Sylvania's stake in the computer field: its philosophy of reliability, its testing procedures, and its ability to develop the tube parameters required for computer applications.

-in test
equipment



Type 6D4 is specified for noise output

The type 6D4 has been redesigned to meet the requirements of test-equipment manufacturers and is specified to produce, in its output, a wide range of random noise frequencies.

It's the first commercial tube ever to be so specified and typifies the co-operation between Sylvania and equipment manufacturers to produce tubes for special applications.

-Advanced
**Engineering
 Series**

**Series on Electron
 Tube Life and
 Reliability is
 published by Sylvania**

As a service to the industry and in an attempt to explore the factors of design and application of reliable tubes, Sylvania is currently publishing a high-level technical discussion on tube reliability in chapter form.

This series is available to electronic engineering staffs through their chief engineer who may request it directly on company letterhead.

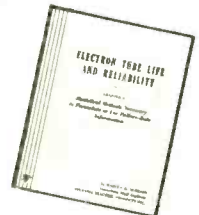

SYLVANIA ELECTRIC PRODUCTS INC.
 1740 Broadway, New York 19, N. Y.
 In Canada: Sylvania Electric (Canada) Ltd.
 Shell Tower Bldg., Montreal



SYLVANIA

LIGHTING • RADIO • TELEVISION • ELECTRONICS • ATOMIC ENERGY

Please send additional information on the items checked below.

- | | |
|--|---|
| <input type="checkbox"/> "white noise" test | <input type="checkbox"/> premium subminiature tubes |
| <input type="checkbox"/> type 6788 | <input type="checkbox"/> miniature deflection package |
| <input type="checkbox"/> 110° deflection tubes | <input type="checkbox"/> hybrid auto-radio tubes |
| <input type="checkbox"/> type 6888 | <input type="checkbox"/> computer book |
| | <input type="checkbox"/> 6D4 |

Name _____

Address _____

Company _____

**Use this handy
 business reply card
 to request
 additional information
 on these new Sylvania
 tube developments**



When you need Reliable Control of Movement

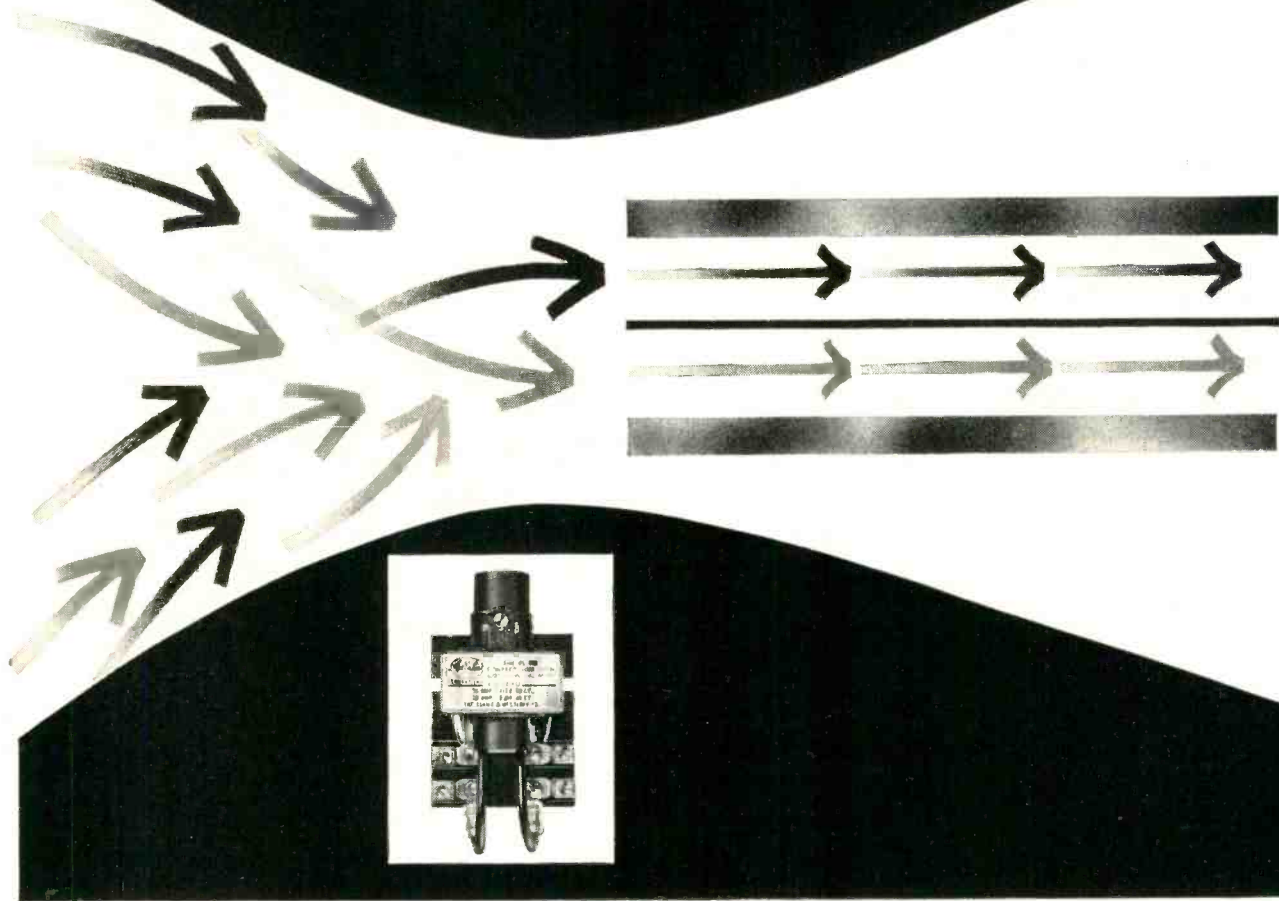

you need **Adlake**
mercury-to-mercury
relays

- Mercury-to-Mercury contact of Adlake Relays gives ideal snap-action with no pitting, sticking or burning.
- Hermetically sealed at the factory so dust, dirt, moisture cannot affect them.
- Time delay characteristics are fixed and non-adjustable.
- Adlake Relays are quiet, chatterless and require no maintenance whatever.

If you have a control problem, our engineers will be happy to help you solve it. There's no obligation. Write The Adams & Westlake Company, 1171 N. Michigan, Elkhart, Indiana.

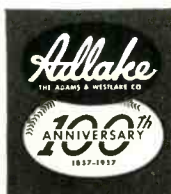

The Adams & Westlake Company
NEW YORK ELKHART, INDIANA CHICAGO
original and largest manufacturers of plunger-type relays



**Oil Circuit Breaker Leads
are Insulated
and Protected**

with
NATVAR
Varnished
Seamless
Bias



This Federal Pacific Electric Type AJ-54 heavy duty oil circuit breaker, 69 kv, 2000 amp, has a 5000 mva interrupting rating. Interrupting time is 5 cycles with 20 cycle reclosing. Natvar seamless bias cut varnished cambric is used to insulate the current transformers located around each bushing, and the leads from the transformers to the operating control mechanism. Natvar 400 extruded vinyl tubing is also used to protect the conductor between the expulsion chamber and the resistors.

The Pacific Switchgear Division of the Federal Pacific Electric Co., San Francisco, now celebrating its 50th anniversary, manufactures oil circuit breakers to provide protection for large high voltage systems so they may keep pace with rapid load growth, and yet retain the advantages of simplified bus schemes and minimum use of current limiting devices.

Both design and materials play an important part in reliability of performance. Natvar flexible insulating materials are used because of their excellent physical and electrical properties—particularly their resistance to oil—and their exceptional uniformity.

Where performance of electrical apparatus and equipment is important, it pays to specify Natvar flexible insulations. They are always of uniformly high quality, whether supplied from your wholesaler's stock or direct from our own.



Natvar Products

- Varnished cambric—cloth and tape
- Varnished canvas and duck
- Varnished silk and special rayon
- Varnished—Silicone coated Fiberglas
- Varnished papers—rope and kraft
- Slot cell combinations, Aboglas®
- Isoglas® sheet, tape, tubing and sleeving
- Vinyl coated—varnished—lacquered tubing and sleeving
- Extruded vinyl tubing and tape
- Styroflex® flexible polystyrene tape
- Extruded identification markers

Ask for Catalog No. 23

NATVAR CORPORATION

FORMERLY THE NATIONAL VARNISHED PRODUCTS CORPORATION
TELEPHONE
FULTON 8-8800
CABLE ADDRESS
NATVAR: RAHWAY, N. J.
201 RANDOLPH AVENUE • WOODBRIDGE, NEW JERSEY

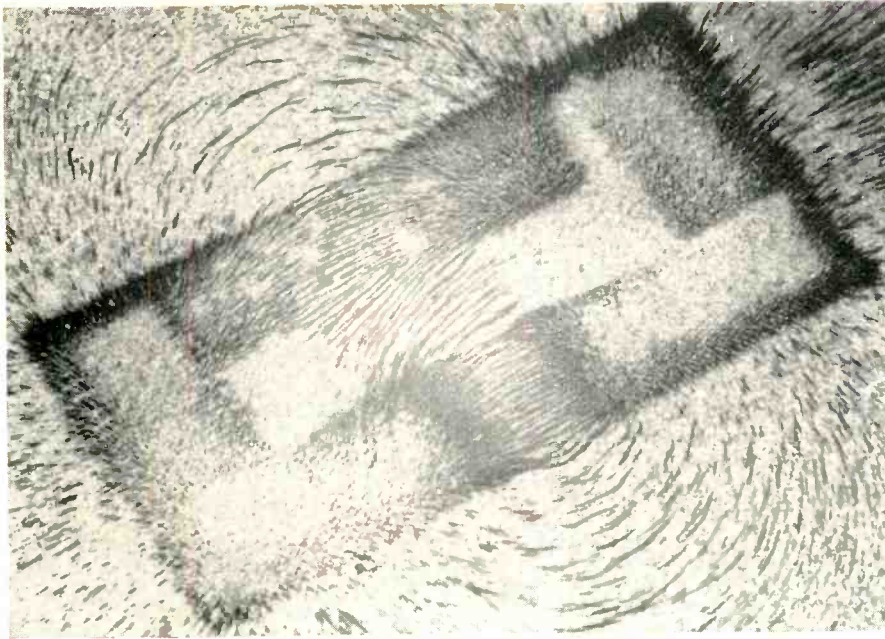

Flux pattern of experimental magnetic circuits

How location of magnets affects magnetic circuits

Adapted from an article by Charles A. Maynard, vice president, Research and Engineering, The Indiana Steel Products Company

The LOCATION of permanent magnets in a magnetic circuit is a definite factor in design. To determine the extent to which this is true, involved calculations are necessary.

A comparatively simple experiment, however, which shows the nature of the changes that take place when permanent magnets are placed in different positions in a magnetic circuit, was devised by Mr. Maynard. The material on which the following questions and answers are based was taken from a report, "An Experiment in Magnet Location," published in Vol. 3, No. 5, of *Applied Magnetism*. A copy of this issue is available on request to The Indiana Steel Products Co., Dept. A-2, Valparaiso, Ind.

Question: What effect does the location of permanent magnets have on a magnetic circuit?

Answer: It has a marked influence on the flux density in the various portions of the magnetic circuit.

Question: Is there a preferred location for magnets?

Answer: Yes, it is important to place the magnets as close to the air gap as possible.

Question: What is the benefit of their location?

Answer: The leakage flux is reduced, and the useful flux in the air gap is increased.

Question: How is this an important factor in design?

Answer: It minimizes the amount of magnet material required to produce a given flux in the air gap.

Question: Does this mean lower magnet costs?

Answer: Generally, this is true. However, structural considerations may prevent the placement of permanent magnets at preferred positions.

Question: Are there available quantitative data which indicate the degree to which magnet position influences the efficiency of a circuit?

Answer: A brief experiment was conducted on the nature and magnitude of the changes that occur when magnets are placed in various positions in a simple magnetic circuit. The results are discussed in *Applied Magnetism*, Vol. 3, No. 5.

World's largest permanent magnet separates electron particles

The largest and most powerful permanent magnet ever designed is an important part of a new Mass Spectrometer to be used for high molecular weight hydrocarbon



Indiana's C. A. Maynard inspects air gap of giant Alnico V magnet assembly

analysis at the Whiting, Indiana, research and development laboratories of a large Midwestern oil company. Function of the spectrometer is to establish a strong magnetic field that separates electron particles.

The Alnico V permanent magnet used in the assembly has a maximum field strength of 6,000 gauss . . . equal to 10 tons of magnetic holding force . . . and weighs 1,300 pounds. The complete assembly, which weighs approximately 4,700 pounds, was designed and fabricated by The Indiana Steel Products Company, Valparaiso, Indiana.

THE INDIANA STEEL PRODUCTS COMPANY
VALPARAISO, INDIANA

THE WORLD'S LARGEST MANUFACTURER
OF PERMANENT MAGNETS

INDIANA
PERMANENT
MAGNETS

In Canada . . . The Indiana Steel Products Company of Canada, Limited, Kitchener, Ontario

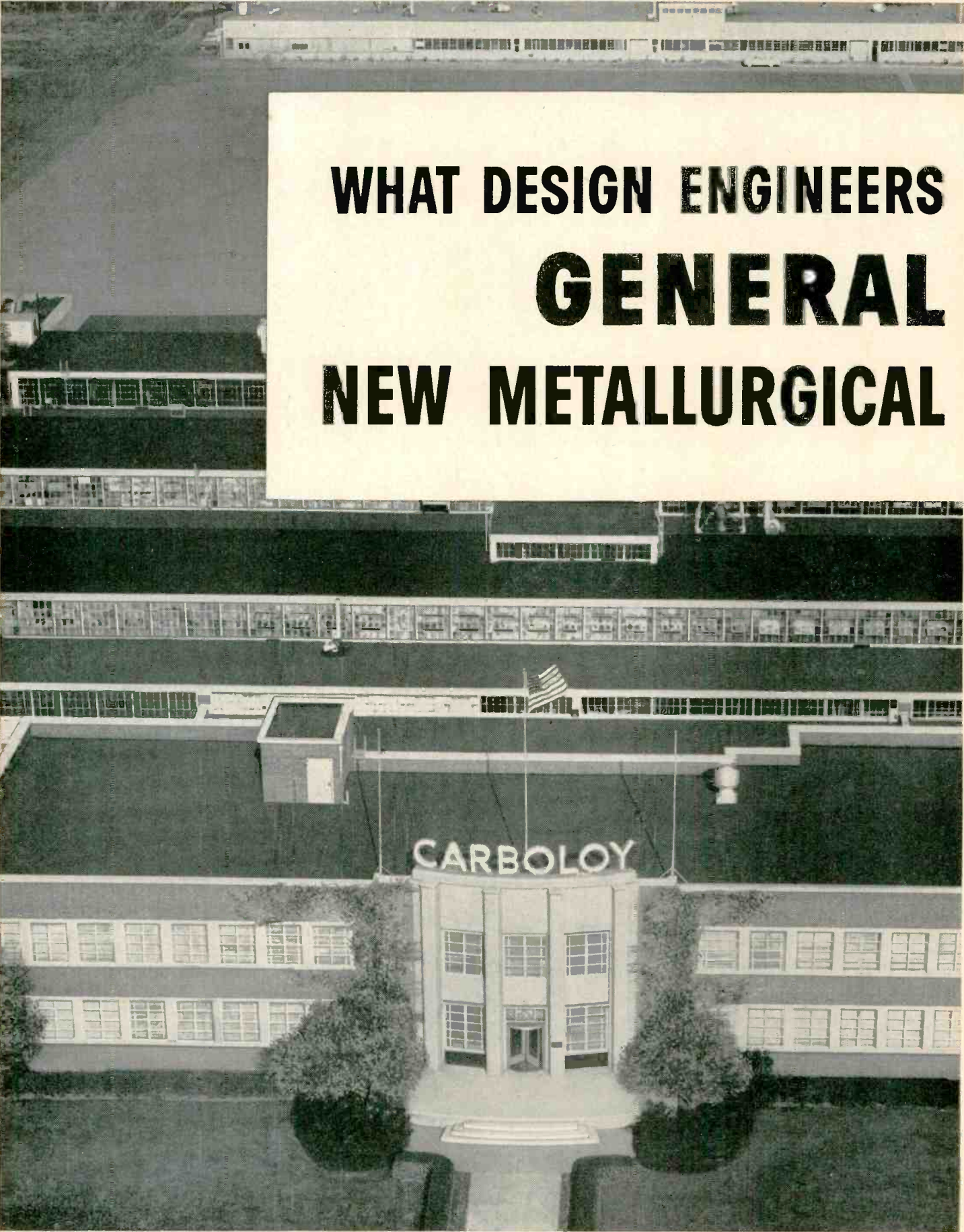

WHAT DESIGN ENGINEERS GENERAL NEW METALLURGICAL

Headquarters of the Metallurgical Products Department of General Electric Company, 11137 E. 8 Mile. Ave., Detroit 32, Michigan. Carbides, vacuum-melted alloys, and hevimet are made here. G-E permanent magnets and specialty resistors are manufactured in the Edmore, Mich., plant.



CAN LOOK FORWARD TO FROM ELECTRIC'S PRODUCTS DEPARTMENT



The new G-E Metallurgical Products Department is the successor to the Carboloy Department. Here's what this change will mean to you.

Since 1928, the General Electric trademark "Carboloy" has been identified with a brand of cemented carbide. First used solely as a cutting tool material because of their strength and toughness, carbides have more recently become one of the designer's most effective wear-proofing materials.

Carboloy® cemented carbides are manufactured by the new Metallurgical Products Department—successor to the Carboloy Department, which G-E organized to produce this metal for industry. But today carbides are just one of a broad range of products and materials this Department manufactures—many of which do not carry the famous Carboloy trademark.

These include G-E Alnico permanent magnets, thermistors, and Thyrite® varistors which have helped solve many basic design problems in the electrical and electronics industries. And G-E vacuum-melted alloys, and hevimet, which are now making important contributions to advanced aircraft, automotive, and atomic energy programs.

Thus, the new departmental name symbolizes the broadened scope of this Department's activities . . . a scope which will have far-reaching effects for design engineers in every phase of industry.

For General Electric—through its Metallurgical Products Department and the G-E Research Laboratory—is carrying on fundamental investigations which are extending the frontiers of metallurgy.

For example, the process which created G-E man-made diamonds may yield new structural and design materials which do not even exist in nature. And General Electric's work in powder metallurgy, metallic oxides, and semiconductors—which produced many of the products mentioned above—has a fascinating future all its own.

New products, and new methods of utilizing these products, are on their way. And when they are developed, they, too, will come to you from the new G-E Metallurgical Products Department.

Progress Is Our Most Important Product

GENERAL  ELECTRIC

SOLA CONSTANT VOLTAGE DC POWER SUPPLY is shown here with its three major components indicated. This assembly is a typical standard design rated at 125 volts, 2 amperes, and is mounted on a standard, 19" relay rack chassis only 5 1/4" high.

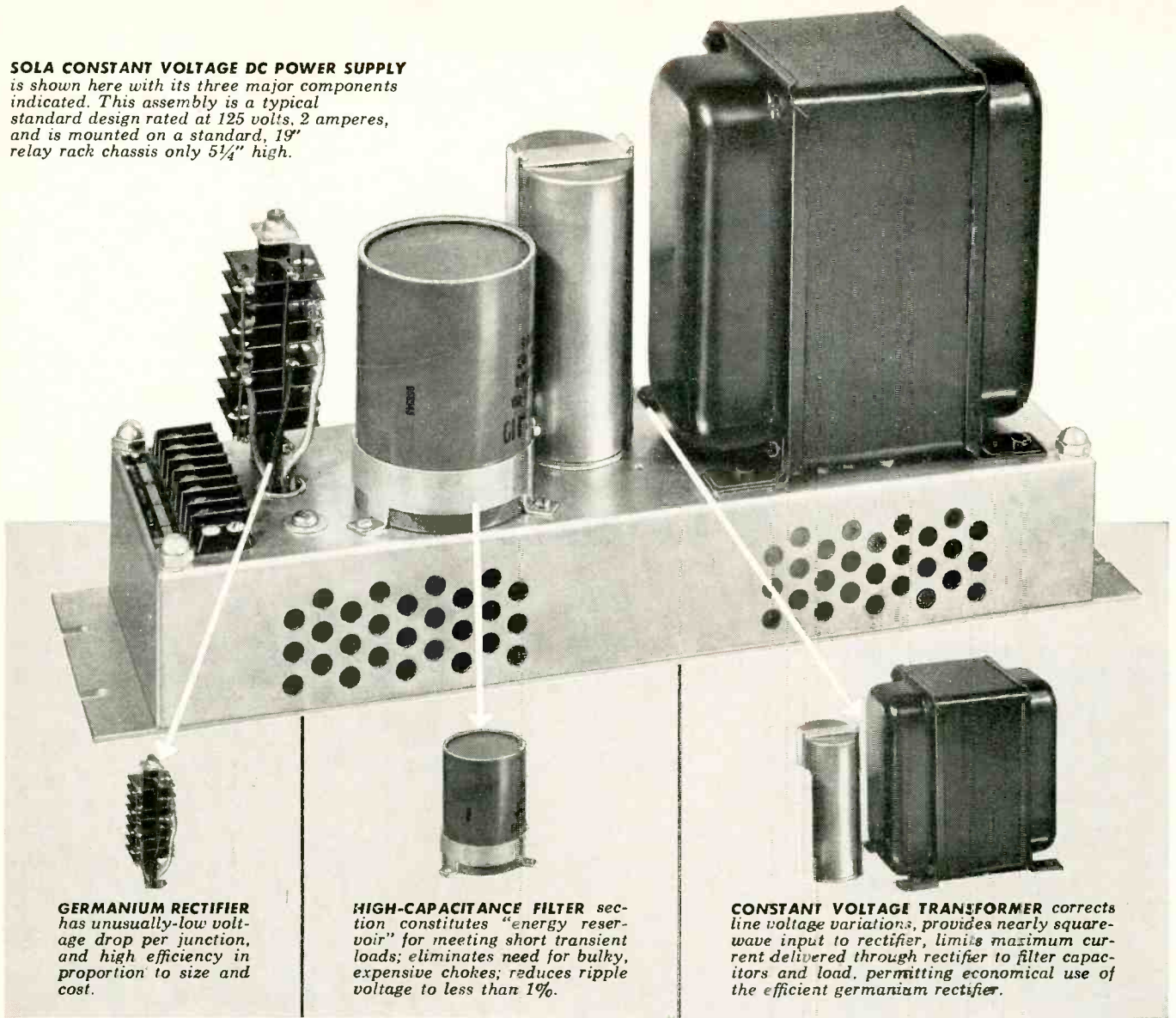

GERMANIUM RECTIFIER has unusually-low voltage drop per junction, and high efficiency in proportion to size and cost.

HIGH-CAPACITANCE FILTER section constitutes "energy reservoir" for meeting short transient loads; eliminates need for bulky, expensive chokes; reduces ripple voltage to less than 1%.

CONSTANT VOLTAGE TRANSFORMER corrects line voltage variations, provides nearly square-wave input to rectifier, limits maximum current delivered through rectifier to filter capacitors and load, permitting economical use of the efficient germanium rectifier.

2 amps of 125v regulated dc power in only 5 1/4" of relay-rack height

Exceptional performance under intermittent, variable, pulse, or high-amperage loads is a prime advantage of the new static-magnetic, Sola Constant Voltage DC Power Supply. Its design simplicity — possible because of the mutual support and protection provided by the combination of its three basic components — provides compact size, low weight, and moderate price in proportion to power output and performance.

Output of these power supplies is regulated within $\pm 1\%$ for line voltage variations of up to $\pm 10\%$. They

are available in six stock models, in ratings ranging from 24 volts at six amperes to 250 volts at one ampere. Also, design-and-assembly service for special ratings is offered to meet the specific requirements of equipment manufacturers.

Your area representative, listed below, is part of a nationwide organization maintained to provide you with prompt service. He'll be happy to supply further information on stock or special Sola Constant Voltage DC Power Supplies.

SOLA *Constant Voltage*
DC POWER SUPPLIES

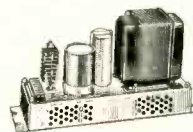

Write for Bulletin 7B-CV-235
SOLA ELECTRIC CO.
4633 W. 16th Street
Chicago 50, Illinois

CONSTANT VOLTAGE TRANSFORMERS • FLUORESCENT LIGHTING BALLASTS • MERCURY VAPOR LIGHTING TRANSFORMERS
SOLA ELECTRIC CO., 4633 West 16th Street, Chicago 50, Illinois, Blshop 2-1414 • NEW YORK 35: 103 E. 125th St., Trafalgar 6-6464
PHILADELPHIA: Commercial Trust Bldg., Rittenhouse 6-4988 • BOSTON: 272 Centre Street, Newton 58, Mass., Blgelow 4-3354 • CLEVELAND 15:
1836 Euclid Ave., Prospect 1-6400 • KANSAS CITY 2, MO.: 406 W. 34th St., Jefferson 4382 • LOS ANGELES 23: 3138 E. Olympic Blvd., Angelus
9-9431 • SOLA ELECTRIC (CANADA) LTD., TORONTO 17, ONTARIO: 102 Laird Drive, Mayfair 4554 • Representatives in Other Principal Cities

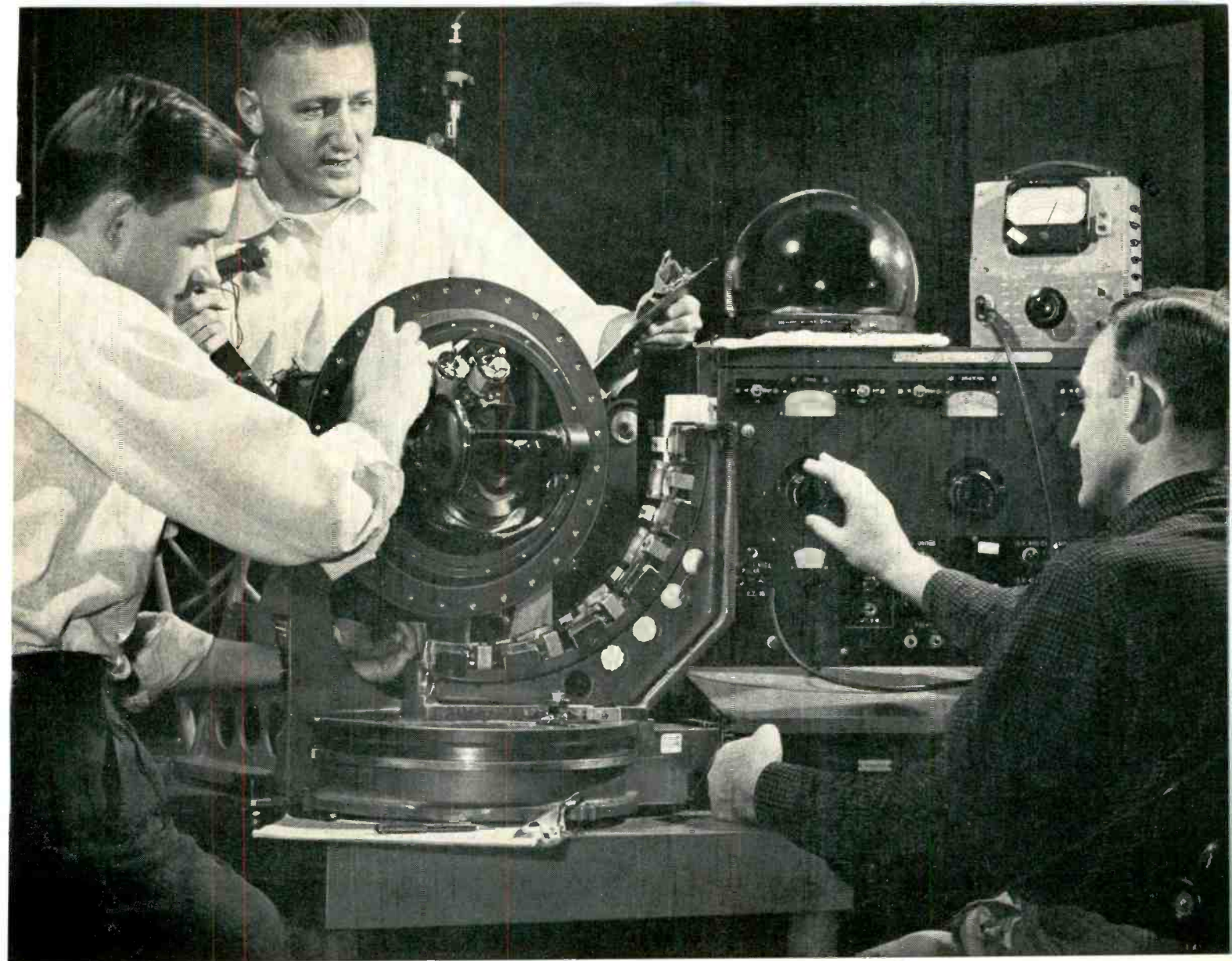

Can you use the talent that built 1,500 Y-4 bombsights on schedule?

These General Mills technicians are representative of the production talent that built more than 1,500 Y-4 bombsights, 1,500 coordinate converters, 1,400 azimuth and sighting angle indicators and 1,400 amplifier and power supply units—and, delivered them to the Air Force on time. Here the men inspect a bombsight before it progresses to the next stage of production.

Because we have the highly skilled men—and the men have the specialized tools and machines—we produce precision piece parts or complete, complex assemblies to meet the most exacting requirements.

While building the Y-4 bombsight, we improved original design, exceeded USAF specifications. In addition, our thorough testing facilities assured delivery of only perfect instruments.

Such performance has come to be expected of us and has benefited many other customers. We'd like to help with your production problems too.



Booklet Tells More, explains mechanical and electro-mechanical production facilities. Send to Dept. EL-1, Mechanical Division, General Mills, 1620 Central Ave. N.E., Minneapolis, Minn.



No slow-downs for the B-47—Bombsights ready in advance! During production of the B-47 Stratojet, not a one was kept from the ready-line for lack of a bombsight. The same developmental, engineering and production skills that gave the Air Force on-time delivery are available to speed production of your products.

MECHANICAL DIVISION

CREATIVE RESEARCH AND DEVELOPMENT + PRECISION ENGINEERING AND PRODUCTION

**General
Mills**

another example of exciting work at los alamos...

PREPARATION OF RaLa SOURCES

Since 1944 the Los Alamos Scientific Laboratory has pioneered in the study of the effects of intense radiation on chemical, biological and radiographic systems. Among energy sources for such experimentation are extremely small, high-intensity gamma ray emitters containing radioactive lanthanum-140. Known as RaLa, these sources range up to 10,000 curies (370 million million disintegrations per second, equivalent to several times the known amount of the world's extracted radium).

Obviously, preparation of RaLa sources is done entirely with remote-handling equipment largely controlled with pushbuttons and actuated through servo-mechanisms. Design and much of the fabrication of the handling apparatus are also Los Alamos accomplishments and the Laboratory facility is one of the most highly developed in the United States.

Scientists and engineers interested in these or other projects at Los Alamos Scientific Laboratory are invited to write to:

Director of Scientific Personnel
Division 1703

los alamos
scientific laboratory
OF THE UNIVERSITY OF CALIFORNIA
LOS ALAMOS, NEW MEXICO



Operator at the control console of the RaLa processing laboratory. The apparatus shown at the right is seen through the periscope.

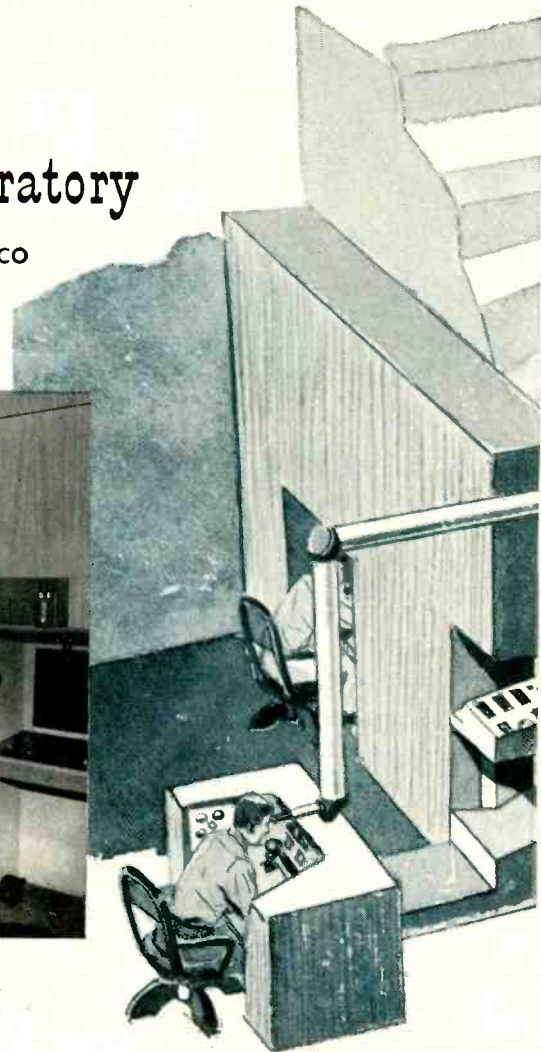

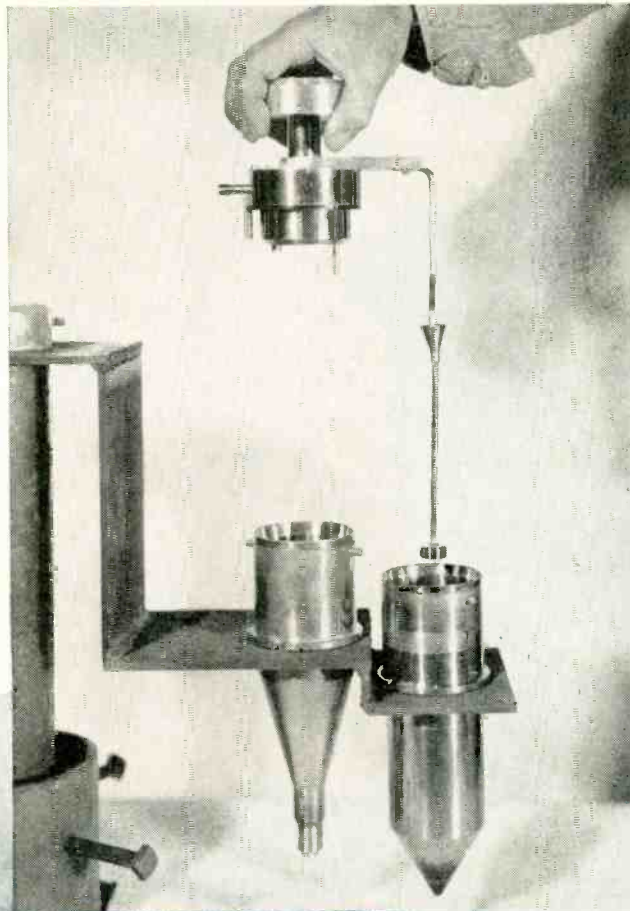

The apparatus to the left is used for precise alignment of the filtering assembly used in hot cells for RaLa processing. When in actual use it is operated by remote control.

Los Alamos Scientific Laboratory is a non-civil service operation of the University of California for the U. S. Atomic Energy Commission.

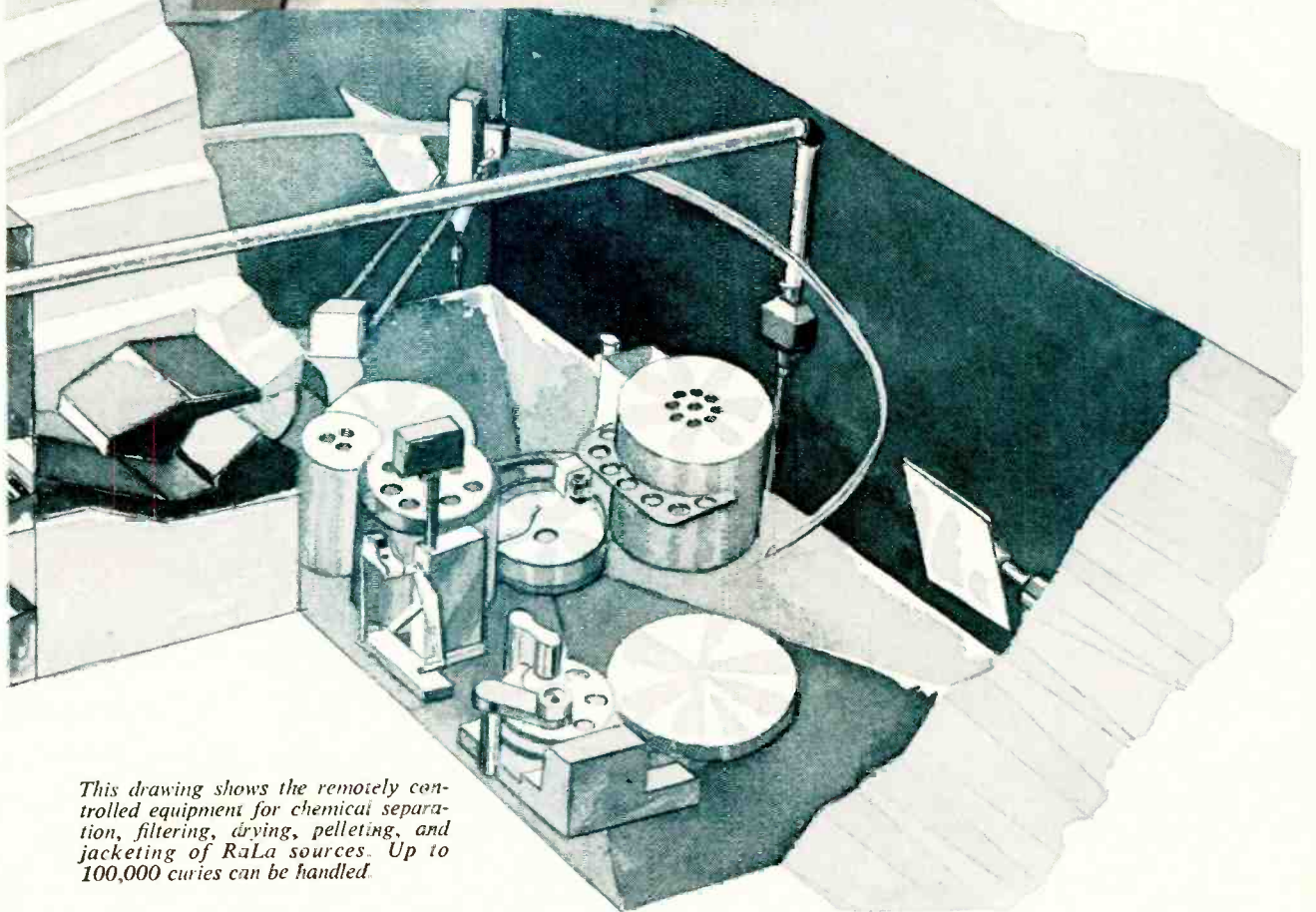

This drawing shows the remotely controlled equipment for chemical separation, filtering, drying, pelleting, and jacketing of RaLa sources. Up to 100,000 curies can be handled.

Phelps Dodge modern fits new



First for Lasting Quality—from Mine to Market!

enamel wire

exacting coil designs!

*New processes and controls
assure uniform quality:*

- 1** Uniform over-all size — for uniform windings.
- 2** Uniform softness with high tensile strength for tighter windings, reduced breakage.
- 3** Uniform spooling, larger packages for lower-cost windings.
- 4** Uniform property balance for good flexibility, solvent resistance and dielectric strength.

*Any time magnet wire is your problem,
consult Phelps Dodge for the quickest, easiest answer!*

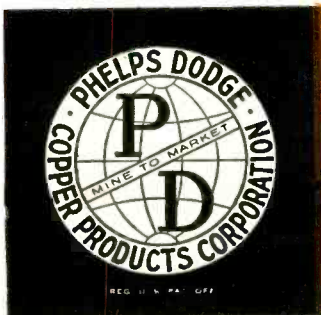

PHELPS DODGE COPPER PRODUCTS
CORPORATION

INCA MANUFACTURING DIVISION
FORT WAYNE, INDIANA

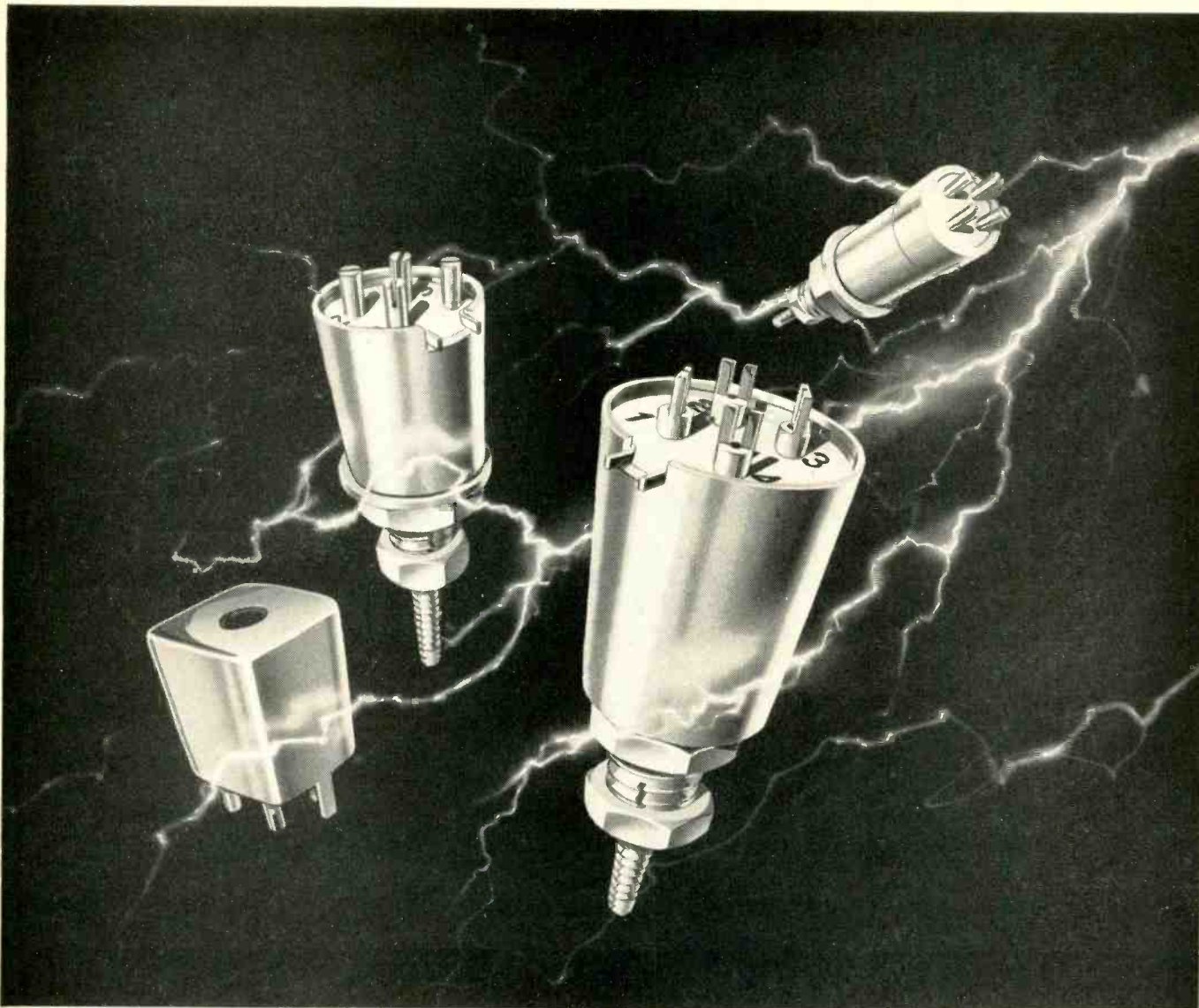

These shielded coil forms offer the utmost in reliability due to their unique design and construction. Dimensions when mounted, including terminals, are: LS-9, $\frac{1}{16}$ " diameter x $\frac{1}{2}$ " high; LS-10, $\frac{5}{8}$ " x $\frac{1}{16}$ "; LS-11, $\frac{1}{16}$ " x $\frac{1}{32}$ ". Each form mounts by a single stud. The LS-12 is a square type for printed circuits and measures $\frac{1}{2}$ " x $\frac{1}{2}$ " x $\frac{1}{2}$ ". Single layer or pie-type windings to your specifications.

Reliability — under any condition!

CTC miniaturized shielded coil forms are highly shock resistant. With mechanically enclosed, completely shielded coil windings, they bring all the ruggedness and dependable performance you require for your "tight spot" applications — IF strips, RF coils, oscillator coils, etc.

CTC combines *quality control* with *quantity production* to supply exactly the components you need, in any amount. CTC *quality control* includes material certification, checking each step of production, and each finished product. And CTC *quantity production* means CTC can fill your orders for any volume, from smallest to largest.

For samples, specifications and prices, write to Sales Engineering Dept., Cambridge Thermionic Corporation, 437 Concord Ave., Cambridge 38, Mass. On the West Coast contact E. V.

Roberts and Associates, Inc., 5068 West Washington Blvd., Los Angeles 16, and 61 Renato Court, Redwood City, Cal.

TYPE SPC phenolic and ceramic printed circuit coil forms can be soldered after mounting. Phenolic forms: $\frac{3}{4}$ " high when mounted, in diameters of .219" and .285". Ceramic forms: $\frac{3}{4}$ " diameter, in mounted heights of $\frac{5}{16}$ " and $\frac{13}{16}$ ", with $\frac{19}{32}$ " powdered iron core, and collars of silicone fibreglas. Forms come with threaded slug and terminal collar. Units mount through two to four holes, as required. Available as forms alone or wound as specified.

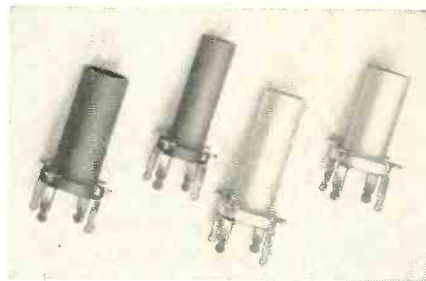

CTC

CAMBRIDGE THERMIONIC CORPORATION

*makers of guaranteed electronic components
custom or standard*

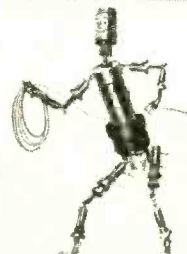

MAGNETIC AMPLIFIER SIMPLIFIES GYRO PICK-OFF

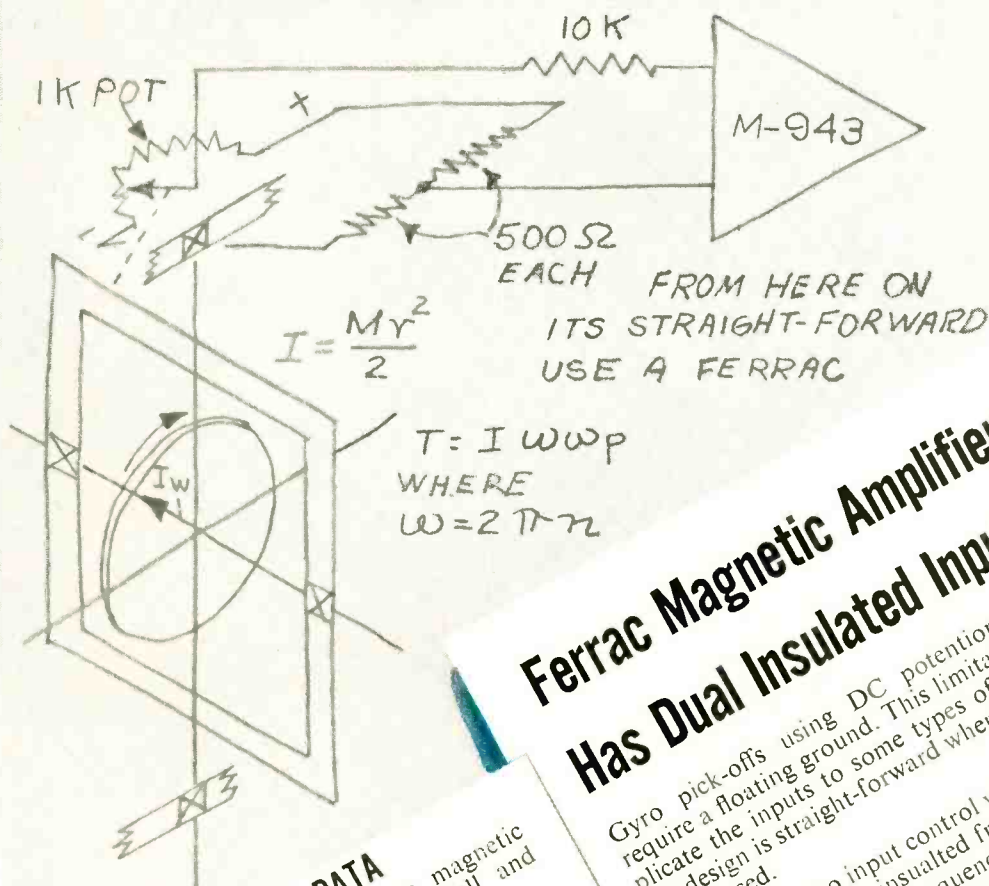

Ferrac Magnetic Amplifier Has Dual Insulated Inputs

Gyro pick-offs using DC potentiometers often require a floating ground. This limitation can complicate the inputs to some types of amplifiers but the design is straight-forward when a Ferrac amplifier is used.

Each of the two input control windings of a Ferrac unit is completely insulated from ground and from each other. As a consequence, the ground connection can be at any convenient point of the input circuit. If another signal, such as a course command, is to be mixed with the gyro signal, it can be fed to the other Ferrac input, again with the ground wherever most convenient.

This flexibility of Ferrac type magnetic amplifiers makes them useful in a variety of guidance equipments. They are sufficiently stable to be used in analog computing portions of such equipments, and are so rugged as to withstand most environmental conditions.

TECHNICAL DATA

Ferrac units are instrument-type magnetic amplifiers having unusually low null and standoff errors.

Input: Two independent control windings for reversible DC.

Output: Unfiltered DC linear over the range ± 7.5 volts into 1000-ohm load.

Power Requirements: Less than 3 W at 115 ± 10 RMS volts and 400 ± 40 CPS; no bias supply is needed.

Gain: Gains of typical standard Ferrac amplifiers for each of their two control windings are:

Type	Control B	Control A
M-943	2.5v/100ua	2.5v/100ua
M-1039	0.5v/100ua	10.0v/100ua
M-1057	5.0v/100ua	5.0v/100ua

These gains are expressed as output volts per 100 microamperes of input. Gains are stable within ± 1 db.

Environment: Units are rated for operation -55 C to $+85$ C, withstand vibrations of 10 G at 10 to 2000 CPS, shocks of 100 G for 11 ± 1 milliseconds along each principal axis, and are hermetically sealed.



BALTIMORE 20, MD.
MIDDLE RIVER

**EFFICIENT
HEAT
TRANSFER
WITH**



*... an internal thermal gradient
of 1.2° C/watt or less!*

Industry's Highest Power Transistors

Large area, thinness and intimacy of collector contact with large copper base provide the efficient thermal transfer.

Result—an unusually cool collector junction in the Delco Radio alloy-type germanium PNP power transistor. The Delco Radio 2N173 and 2N174 transistors not only have high power handling ability but also low distortion characteristics. Thus, they are ideal for audio as well as your general power applications.

Furthermore, these transistors are normalized to retain their performance characteristics regardless of age. Write for engineering data. Delco Radio transistors are produced by the thousands every day.

TYPICAL CHARACTERISTICS

	2N173	2N174
Properties (25°C)	12 Volts	28 Volts
Maximum current	12	12 amps
Maximum collector voltage	60	80 volts
Saturation voltage (12 amp.)	0.7	0.7 volts
Power gain (Class A, 10 watts)	38	38 db
Alpha cutoff frequency	0.4	0.4 Mc
Power dissipation	55	55 watts
Thermal gradient from junction to mounting base	1.2°	1.2° °C/watt
Distortion (Class A, 10 watts)	5%	5%

DELCO RADIO

**DIVISION OF GENERAL MOTORS
KOKOMO, INDIANA**

It costs you nothing to prove

CLEARPRINT IS AMERICA'S FINEST TECHNICAL PAPER

YOU BE THE JUDGE . . .

Ask for sample sheets to make the famous Clearprint test. With this convincing two-minute trial you will see for yourself why leading engineers, architects and designers from coast-to-coast insist upon Clearprint for their original drawings and permanent records.

Make this famous CLEARPRINT TEST

- 1. INVITES PENCIL AND PEN** — Try Clearprint's perfect working surface with a 2H pencil, then with a ruling pen. Lines are sharp and clean — no feathery edges.
- 2. NO GHOSTING** — Erase some of the lines. Redraw and erase several of them repeatedly. Crease the paper, too. Then hold it to the light, or make a reproduction. Seeing is believing!
- 3. NEVER CHANGES** — Sheets in use since 1932 prove Clearprint's remarkable stability. Its strength, transparency and printing qualities remain unchanged after extended exposure to age, atmosphere, heat and light.

Make this test, too, on the paper you are now using. The difference will convince you!

SEEING is BELIEVING!

Ask your dealer for samples, or send coupon

Clearprint Paper is **WATERMARKED** for your protection.

THERE'S A CLEARPRINT PAPER FOR EVERY JOB

Tracing Paper • "Papercloth"

Clearprint Charts

Federal Aid Sheets • "Fade-Out" Grid Paper

IN SHEETS, PADS and ROLLS

CLEARPRINT[®]

TECHNICAL PAPER

THERE IS NO SUBSTITUTE — Demand Watermarked Clearprint

2

CLEARPRINT PAPER CO.

(EL)

1482 - 67th St., Emeryville, Calif.

Please send me Clearprint Paper samples, with prices, for the following uses: _____

Have your representative call at my office

Name _____

Firm _____

Address _____

City _____ Zone _____ State _____

Special 111-conductor Rome cable tough guided missile pro

When project engineers at North American Aviation, Inc., needed a special telemetering cable for their advanced guided missile work at various missile test centers, Rome Cable Corporation was asked to make it.

The cable was a tough one to manufacture. The specifications called for exacting dielectric requirements, low-loss characteristics, adequate service life—and a total of 111 conductors—all contained by one heavy-duty jacket.

Because Rome Cable engineers are accustomed to solving tough cable problems like this, they readily produced the cable which met North American's rigid specifications. Rome RoLene—a polyethylene compound—proved perfect for insulating the 37 triplets inside the jacket, and it easily met the specification requirements calling for controlled capacitance and uniform wall thickness. Rome Synthinol, a tough polyvinyl chloride compound, proved to be an excellent jacket material.

Rome Cable can also help you
You can turn to Rome Cable with

confidence for the right solution to *your* special cabling problems. Rome's competence in its field is, in part, a function of the following factors:

1. Engineering experience. Rome engineers regularly handle complicated specification problems. They've had years of experience dealing with electronic circuit problems.

2. Complete production facilities. The completeness of Rome Cable's manufacturing facilities is unique.

3. Uncompromising quality control. Latest devices, like the photoelectric gauge, are regularly used to assure highest quality. This particular gauge enabled Rome to maintain an exacting control on the diameter limits of insulations and jacket for this special cable.

Rome Cable's engineers can probably be of real help to you on your next cable problem, especially if it is a really tough one. For more information as to what we can do to help you, simply contact your nearest Rome Cable representative—or write to Department 850, Rome Cable Corporation, Rome, N. Y.

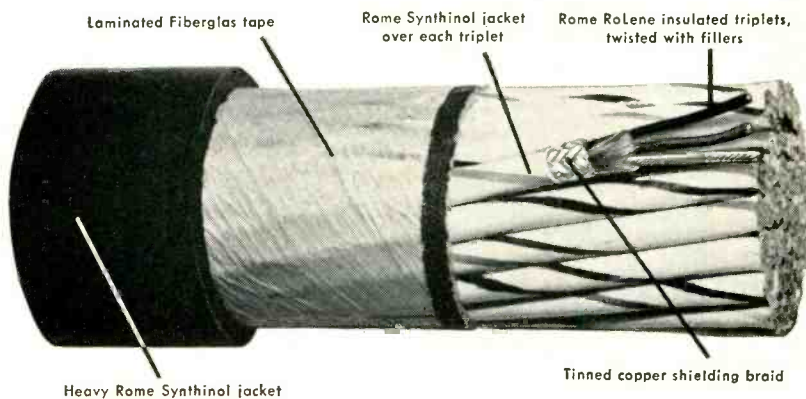
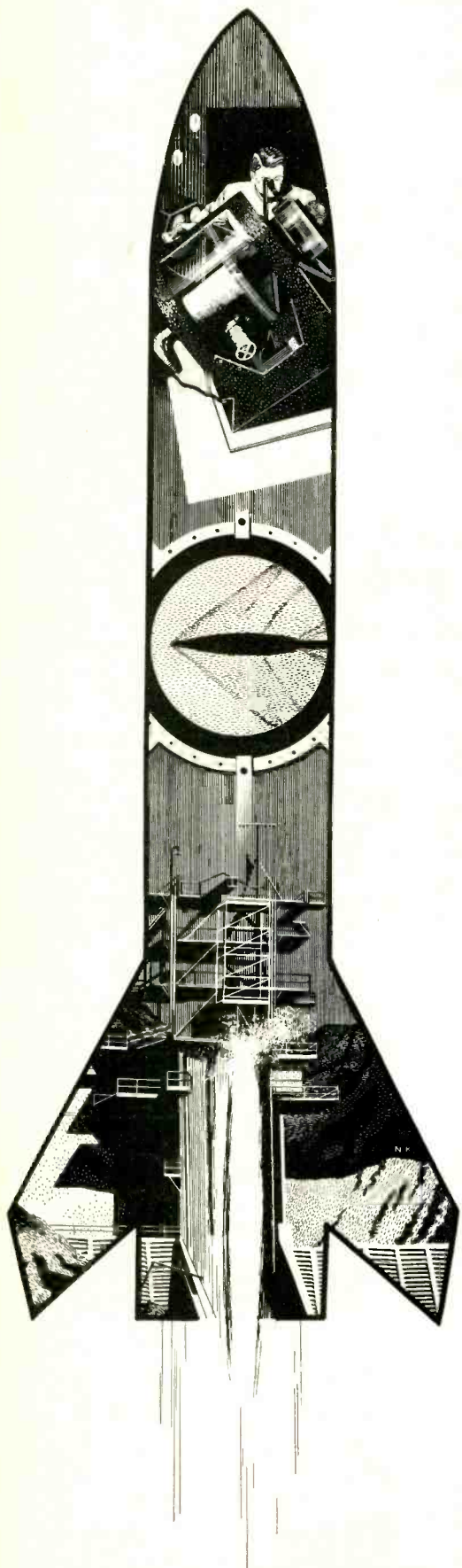

ROME CABLE

C O R P O R A T I O N

WITH THIS GREAT NEW AUTOMATED PLANT

PHILCO

revolutionizes production methods and sets new quality standards in the transistor field

It's the greatest development in transistor history. A complete plant, housing the most advanced transistor manufacturing equipment and utilizing entirely new production methods, is now in mass production at Spring City, Pa. We call it Philco Transistor Center, U.S.A.—and, that's exactly what it is. From this plant come the world's finest transistors—unmatched in quality and reliability.

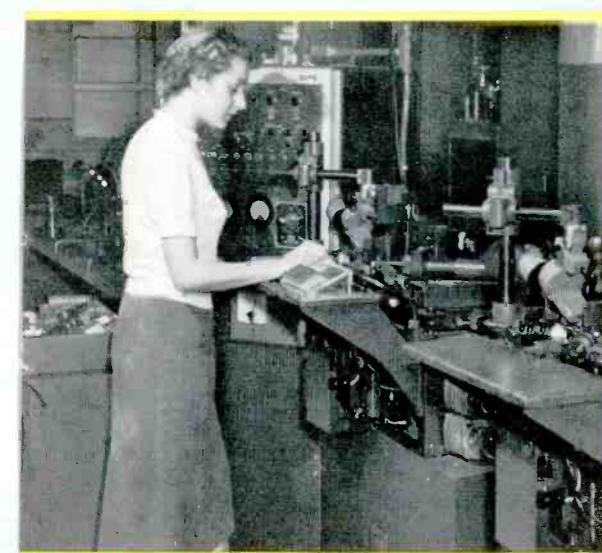

An exclusive machine, designed by Philco engineers. It's a Surface Barrier Transistor Lead Attacher which feeds, cuts, plates, precisely positions and automatically solders the whisker wire to the transistor emitter and collector.

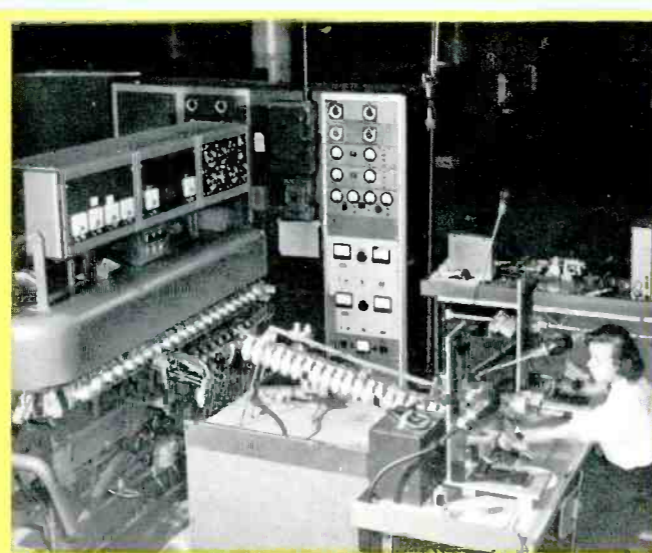

New Philco automatic "Carousel" assembles and processes alloy junction type transistors. It prepares stems by localized plating, solders stems to transistors, solders leads to emitters and collectors, and follows with electrolytic clean-up etching, dip rinsing and ultra sonic rinsing to remove contaminants.

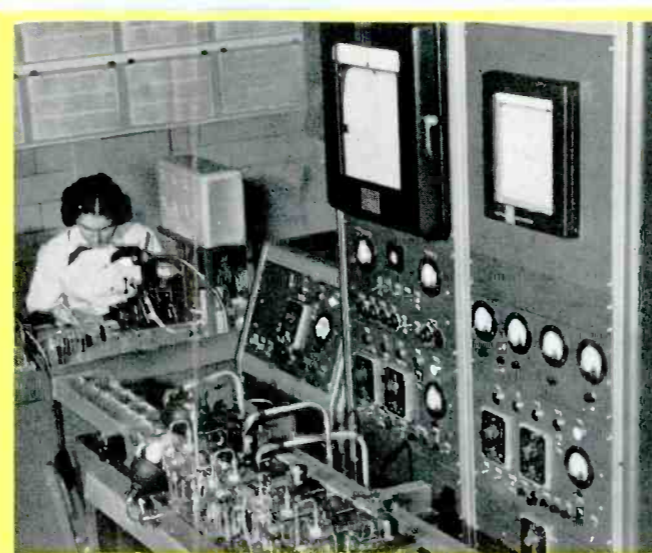

This exclusive Philco Automatic Transfer Machine performs nine operations in the manufacture of surface barrier transistors. Following each step is a rinsing operation, and finally—hot nitrogen drying. Critical operations are automatically monitored and recorded for quality control.



100,000 square feet of area devoted exclusively to semi conductor production. This plant is equipped with centralized supplies of de-ionized water, vacuum, disassociated ammonia, hydrogen, nitrogen and high purity compressed air, plus complete air conditioning with dust and humidity control.

Shown below is a portion of the Life Test Section where all types of Philco transistors are tested under a variety of storage and operational conditions. Individual test positions are provided for over 10,000 units.

The new Spring City Transistor Plant is unmatched for advanced testing methods. Below is a Philco designed high speed Automatic Test Facility for testing seven parameters of power transistors.

Unsealed power transistors in large batches go into vacuum oven (shown below at left) for baking, while simultaneously caps go into vacuum oven (shown at right). After baking cycle the transistors roll on carriers into dry box for cold weld sealing.

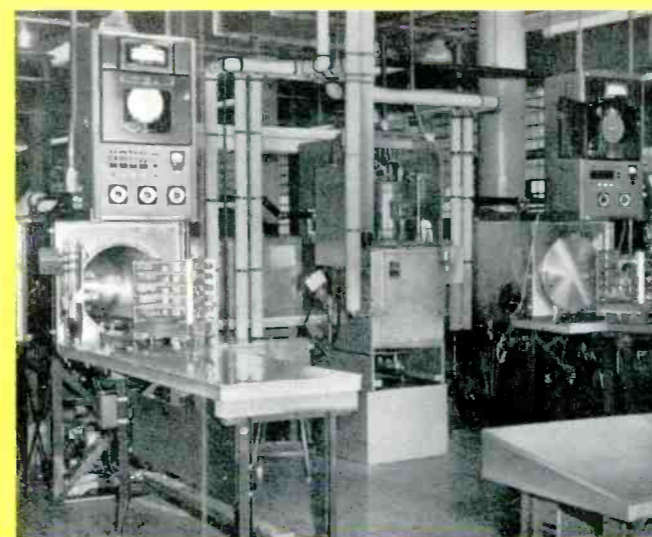
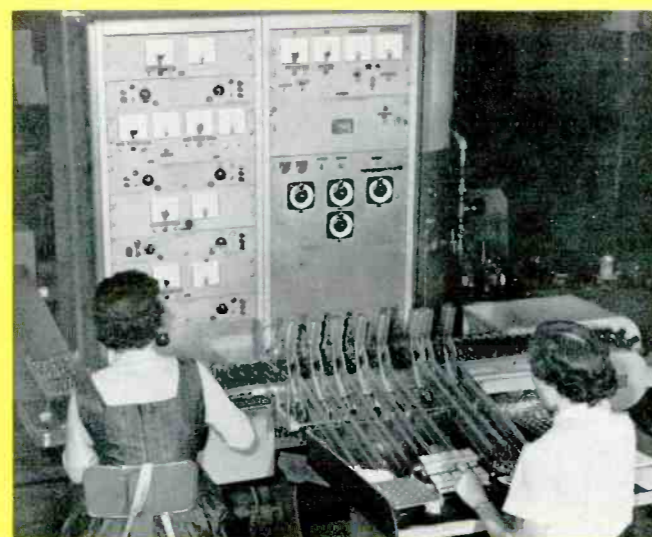
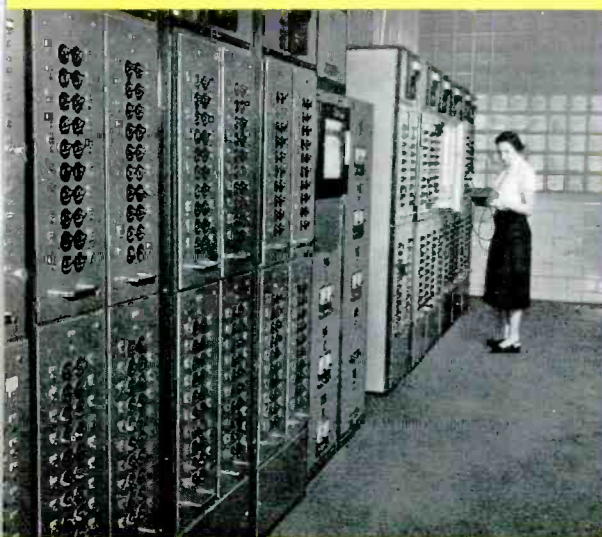

NEW METHODS Extensive research, design and planning by Philco engineers has resulted in completely new and far superior transistor production methods. Mass production is now a reality, and special equipment results in closer device tolerances.

NEW MACHINES Designed specifically for the new mass production methods at Spring City, Pa., machinery completely new in concept is now in operation, with the finest precision control in the industry. These new machines have been designed with the flexibility to accommodate future advances in the transistor field.

NEW AUTOMATION The result of this new production machinery is automation—more automation than ever before in the transistor field. This automatic equipment eliminates human error, increases production capacity and minimizes contamination.

NEW TEST CONTROLS Automatic test equipment, designed by Philco engineers, tests each transistor at every stage of fabrication. Each vital performance parameter is accurately tested. Environmental and life tests assure utmost reliability.

See Back Page FOR DETAILS ON PHILCO TRANSISTORS

NOW IN MASS PRODUCTION AT SPRING CITY, PA.

PHILCO Transistor Center, U.S.A.







For the first time, the dream of the electronic industry comes true ... made possible by many years of Philco pioneering, research and production of semi conductors. Philco's great new transistor plant at Spring City, Pa. is designed for and dedicated to the mass production of reliable transistors.

← Lift the Page and read this important news!

FOR RELIABLE PERFORMANCE,
STABILITY OF OPERATION AND LONG LIFE
...base your designs on

PHILCO *Transistors*

Proven performance of Philco Hermetically Sealed Transistors has made them the basis for design in commercial and military applications where reliability is the major consideration. Philco transistors range from the world's smallest germanium transistors now in production to silicon transistors with excellent performance at temperatures from -60°C to $+150^{\circ}\text{C}$. The following are some of the available Philco transistor types:

 ACTUAL SIZE	<p>Low Level Transistors 2N207, 2N207A and 2N207B—Germanium PNP Alloy Junction Transistor ... world's smallest transistor in production. Useful in any low level audio application such as hearing aids where size is an important consideration.</p>	 ACTUAL SIZE	<p>Medium Power Transistors 2N223, 2N224, 2N225, 2N226, 2N227—Germanium PNP Alloy Junction Transistor for portable radio output stages, medium power switching, servo-amplifiers and other applications where medium power must be handled at low frequencies.</p>	 <p>Power Transistors T1040, T1041—Germanium PNP Alloy Junction Power Transistor with low thermal drop designed for audio output stages, power switching, servo-amplifier output stages and other applications where high power must be handled.</p>	
 ACTUAL SIZE	<p>High Frequency Transistors Surface Barrier Types 2N128 and 2N129—Surface Barrier Transistors for critical military applications, produced to meet MIL-T-12679A (SigC) military requirements.</p>	 ACTUAL SIZE	<p>High Speed Switching Transistors 2N240—Germanium Surface Barrier. High Speed switching transistor with response time in the low millimicrosecond range. Made the basis for design of both military and commercial computers where speed and reliability are essential.</p>	 ACTUAL SIZE	<p>Silicon Transistors T1025, T1159—PNP High Speed Silicon Transistors for computers and amplifiers operating at high ambient temperatures. These transistors feature low saturation voltage.</p>

All Philco transistors are hermetically sealed to insure long life. In addition to the above types, Philco produces a wide range of transistors designed for special applications in accordance with customer requirements. The Philco Micro Alloy Transistor is already in pilot production and tentative specifications and design quantities are available. New and exciting transistor types, such as the Philco Micro-Alloy Diffused Base Transistor, are now in development. In keeping with our policy, specifications will be made available as soon as these units reach pilot production and are available in design quantities.

Make Philco your prime source for complete transistor application information ... write to Lansdale Tube Company, Dept. 1-2, Lansdale, Penna.

Regional offices—Merchandise Mart Plaza, Chicago 54, Ill.—10589 Santa Monica Blvd., Los Angeles 25, Calif.

PHILCO CORPORATION
LANSDALE TUBE COMPANY DIVISION
LANSDALE, PENNSYLVANIA

IMPORTANT ACHIEVEMENTS AT JPL

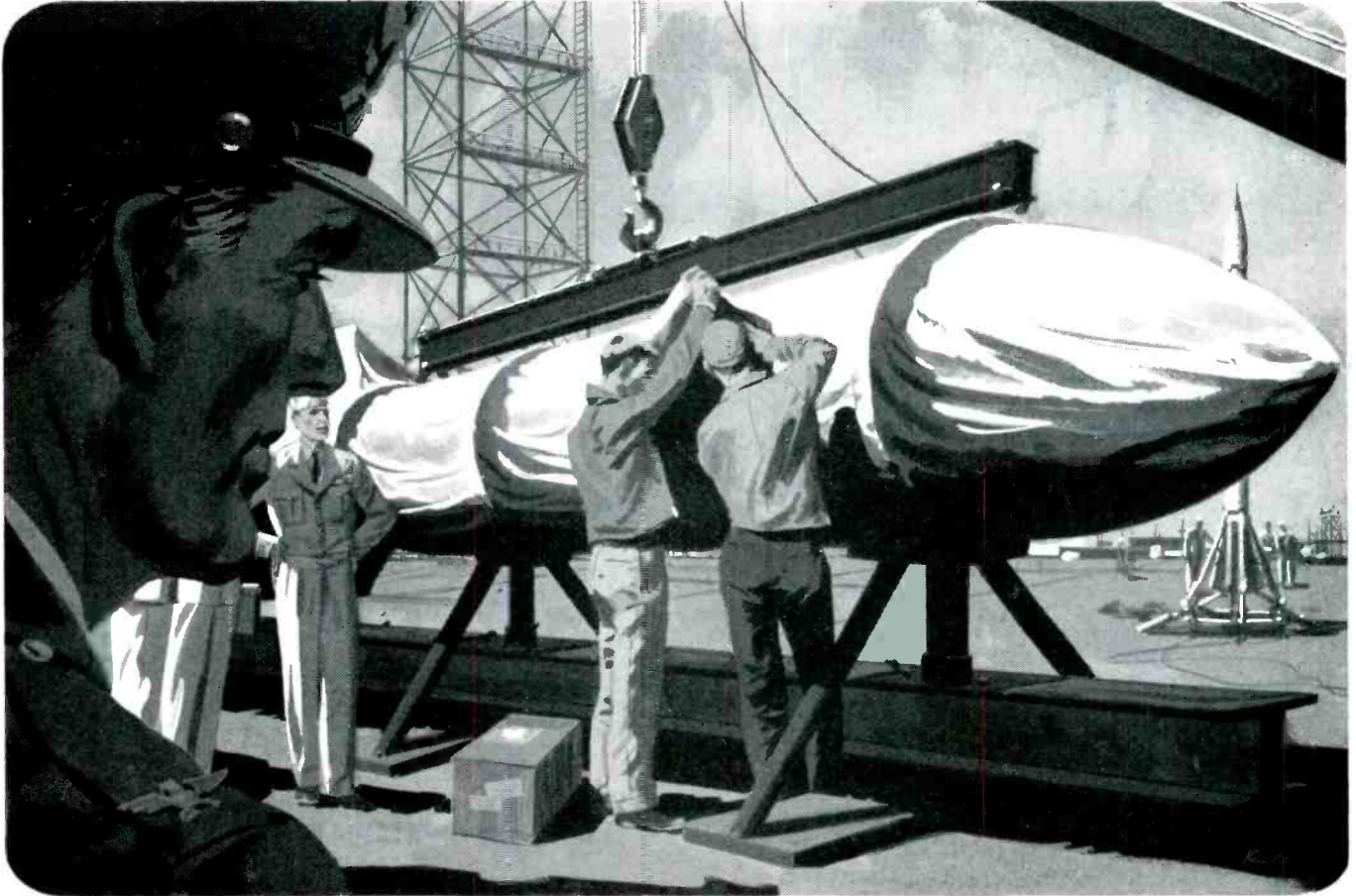

Development of the Sergeant

The Jet Propulsion Laboratory is a stable research and development center located north of Pasadena in the foothills of the San Gabriel mountains. Covering an 80 acre area and employing 1600 people, it is close to attractive residential areas.

The Laboratory is staffed by the California Institute of Technology and develops its many projects in basic research under contract with the U.S. Government.

Opportunities open to qualified engineers of U.S. citizenship. Inquiries now invited.

Announced as a successor to the Corporal is another highly accurate surface-to-surface ballistic missile named "The Sergeant." This weapon will continue the United States Army's advance in the development of mobile firepower.

The latest techniques in guidance, air-frame design and rocket propulsion are being applied to the development of this rugged weapon which is capable of operating in any area.

The Jet Propulsion Laboratory, designer of this new missile, has the same prime technical responsibility to provide the development of the complete Sergeant system

as it had for the Corporal weapon system.

In addition to weapon development the "Lab" carries on supporting research in all areas related to guided missile work. These supporting research and weapon development activities complement and extend each other to produce superior end results.

This fact, coupled with ideal facilities and working conditions at JPL, is a prime attraction for scientists and engineers of unusual ability because of their close integration with such vital programs. At the same time, other varied and interesting activities in weapon development are providing new challenges and openings for qualified people.

JOB OPPORTUNITIES
ARE NOW AVAILABLE

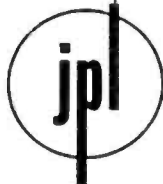

IN ALL FIELDS OF ENGINEERING AND THE PHYSICAL SCIENCES

COMPUTERS • APPLIED MATHEMATICS • DATA HANDLING • INSTRUMENTATION
APPLIED PHYSICS • TELEMETERING • RADIO AND INERTIAL GUIDANCE • GUIDANCE ANALYSIS
SYSTEMS ANALYSIS • ELECTRO-MECHANICAL • MICROWAVES • PACKAGING
MECHANICAL ENGINEERING • AERONAUTICS • MECHANICAL • STRUCTURES • DYNAMICS
PROPULSION • APPLIED MECHANICS • INERTIAL ELEMENTS • METALLURGY
CERAMICS • SOLID STATE PHYSICS • OPERATIONS RESEARCH

JET PROPULSION LABORATORY

A DIVISION OF CALIFORNIA INSTITUTE OF TECHNOLOGY
PASADENA • CALIFORNIA

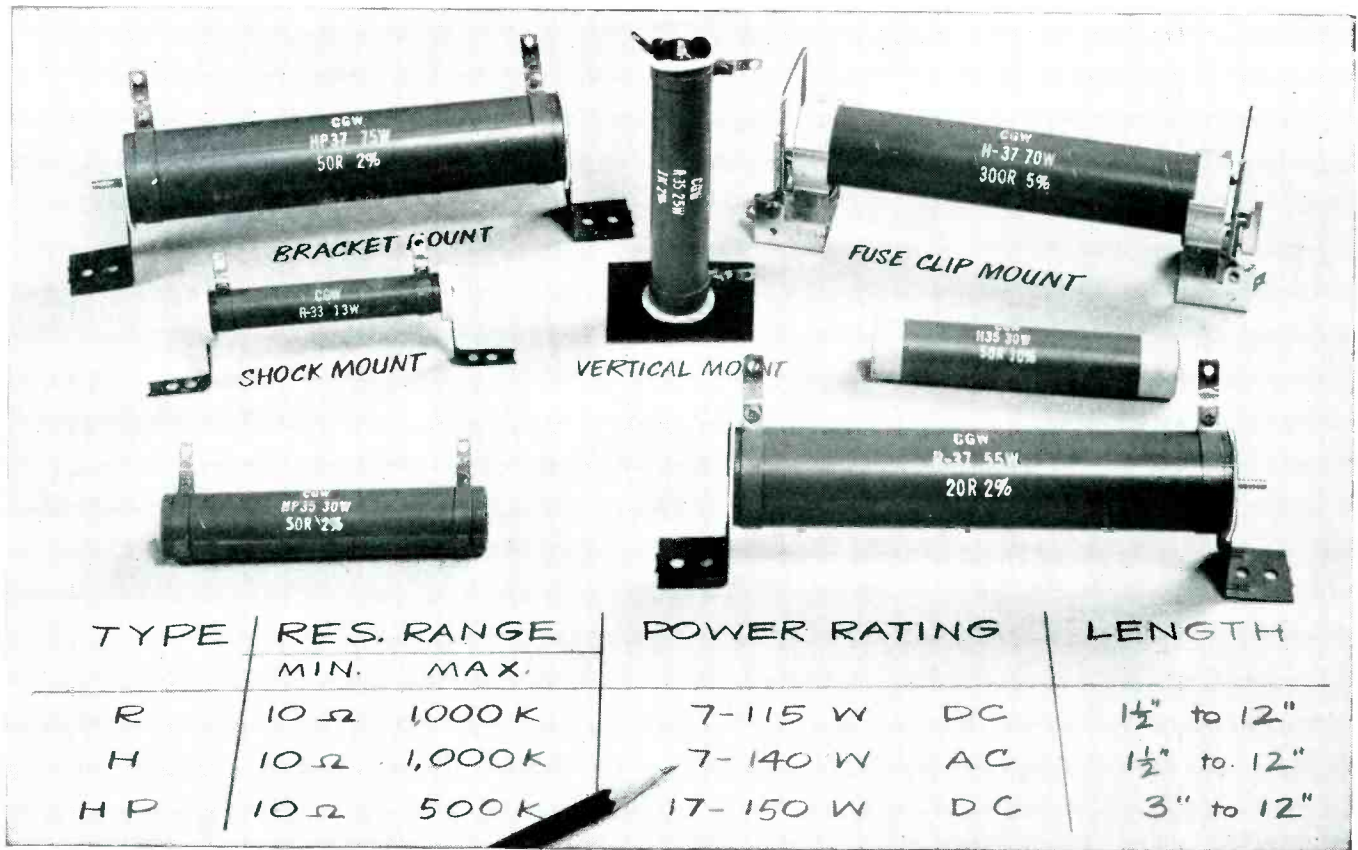

TYPE	RES. RANGE		POWER RATING		LENGTH
	MIN.	MAX.			
R	10 Ω	1000 K	7-115 W	DC	1½" to 12"
H	10 Ω	1,000 K	7-140 W	AC	1½" to 12"
HP	10 Ω	500 K	17-150 W	DC	3" to 12"

Why Corning High-Power, High-Frequency Resistors meet your most exacting circuit requirements

You'll find Corning High-Power and High-Frequency Resistors designed for stable, long-life service—even under the most difficult operating conditions.

With Corning Resistors you get the highest resistance range for a given physical size compared to wire-wound resistors.

Their thin-film construction makes them inherently non-inductive. The noise level of these resistors is so low it's difficult to measure. The resistive film is a metallic oxide, fused to the PYREX glass core at red heat to form a permanent bond. This special glass insures highest core resistivity even at elevated temperatures, great resistance to chemical attack and to mechanical and thermal shock.

These Corning Resistors are remarkably stable regardless of moisture and humidity.

The chart in the next column gives you a quick idea of their exceptional frequency characteristics.

The ranges and ratings shown in the illustration are for our standard lines, but we can design and build resistors to match your own requirements for all usable frequencies. We've made specials with ratings up to 150 kw. and we can go higher.

Within the standard range of these resistors, we can give you wide variations in mounting hardware. You can get hardware for vertical or horizontal mountings and mountings to absorb mechanical shock and severe vibration. Ferrule-type terminals are available for use with standard fuse clips.

Our catalog sheets give far more complete details than we are able to here. We'll be glad to send you copies with current price lists.

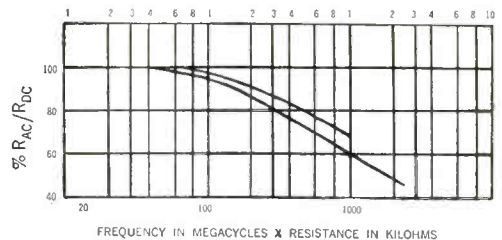

Other products for Electronics by Corning Components Department: Fixed Glass Capacitors*, Transmitting Capacitors, Canned High-Capacitance Capacitors, Sub-miniature Tab-Lead Capacitors, Special Combination Capacitors, Direct-Traversal and Midget-Rotary Capacitors*, Metallized Glass Inductances, Attenuator Plates.

*Distributed by Erie Resistor Corporation

Ask for information on these other Corning Resistors:

Low-Power—3-, 4-, 5-, and 7-watt sizes. Highest resistance range of any low-power resistor.

Type S—Stable performance to 200° C. Meet MIL-R-11804A specs. Values to 1 Megohm.

Type WC-5—5 KW water-cooled. Range, 35 to 300 ohms. Versatile, adaptable.

Type N—Accurate grade. Made to meet all requirements of MIL-R-10509A. Characteristics X and R.

Specials—To your specifications—Co-axial Line Elements, Dummy Loads, HF Elements, Peak Pulse Loads, High-Voltage Resistors.



CORNING GLASS WORKS, 94-2 Crystal Street, CORNING, N. Y.

Electronic Components Department

Corning means research in Glass

HERE'S HOW GENERAL ELECTRIC'S

New PM-20 Oscillograph Helps Reduce Costs

NEW EASY-ACCESS DESIGN, MANY CONVENIENCE FEATURES MAKE
OPERATION AND MAINTENANCE EASIER, SAVE TIME AND MONEY

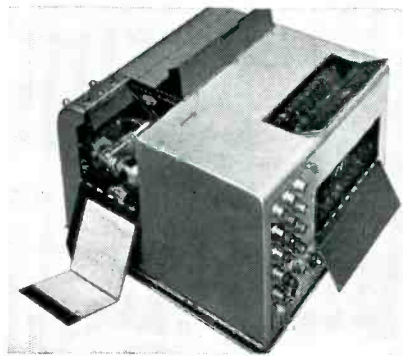
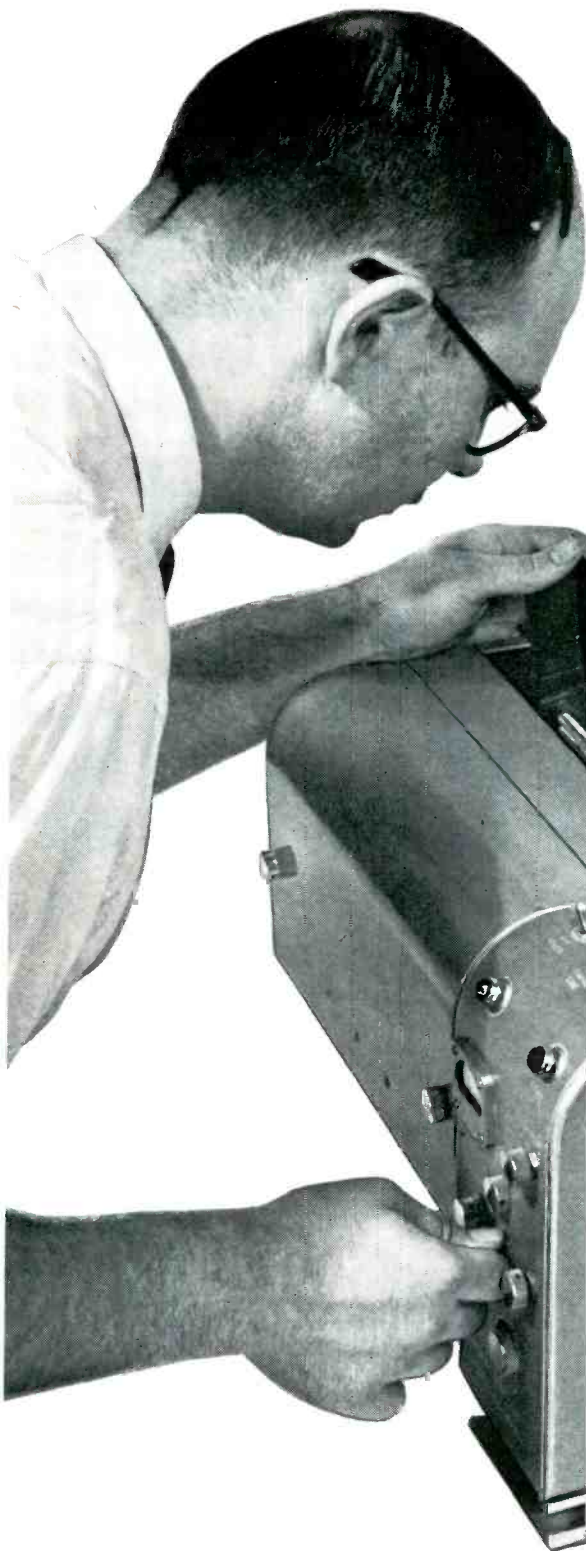

EASY-ACCESS DESIGN permits reaching all parts easily through hinged doors. For complete access, simply turn 3 fasteners and entire cover may be quickly removed.

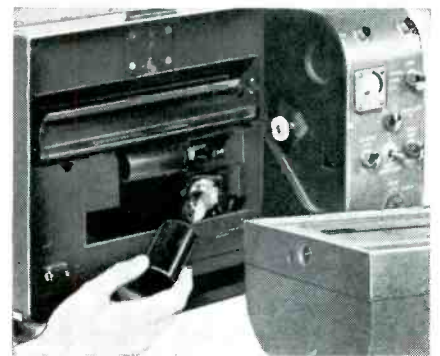

SEPARATE VIEWING LAMP permits viewing without disturbing the recording lamp adjustment. Both lamp holders swing out for easy lamp removal and replacement.

NEW G-E FEATURES SAVE TIME

General Electric's new general-purpose oscillograph, the PM-20, is uniquely designed for easier, time-saving operation and convenient maintenance.

UNIQUE 71-GALVANOMETER CAPACITY in two banks gives you new versatility in measuring and recording many variables simultaneously. A wide range of frequencies—from d.c. to 6000 cps—can be recorded at speeds from 0.8 to 100 inches per second with the new oscillograph.

ONLY TWO IDLER GEARS TO CHANGE for entire speed range, and both are always in use, eliminating storage and the chance of loss. No tools are needed for changing idler gears to get new ranges.

MAGNETIC SPOOLS in the record holder reduce loading time. No fumbling—the spools automatically position themselves correctly in the record holder.

AUTOMATIC SHUTTER on record holder closes as the record holder is removed, preventing fogging of records.

AUTOMATIC RECORD NUMBERING, timing lines, the trace interruption for identification, and automatic record-length control are additional features which give you easy, reliable operation.

FOR MORE INFORMATION, contact your nearest G-E Apparatus Sales Office or write for Bulletin GEA-6348 to Section 585-36, General Electric Company, Schenectady 5, New York.

GENERAL  ELECTRIC

No blue sky... just to back up our belief that you and Collins

We're going to build a proposition which we believe deserves your most serious consideration, if you are a mechanical or electrical engineer. This proposition is built on pure and simple fact—no high flown promises or broad generalities. Our proposition: you and Collins should get together. We present these facts to support it.

FACT NUMBER 1:

Collins Radio Company's sales have increased 10 fold in each of three successive seven year periods. 1933 sales were \$100,000; 1940 sales, \$1,000,000; 1947 sales, \$10,000,000; 1954 sales, \$100,000,000, and 1956 sales, \$126,000,000. (Note graph.) This company *has grown, and is growing* at a phenomenal rate. Total employment is 9,000 of which 24% are research and development personnel.

You grow when the company you work for grows.

FACT NUMBER 2:

As shown in the graph at right, the employment of research and development personnel has increased steadily despite fluctuation in sales. Notice that even during periods of national sales regression Collins continued to strengthen its engineering staff.

Collins has based its growth on the solid foundation of stability in the engineering department.

FACT NUMBER 3:

At Collins, the ratio of engineers to total employees is extremely high, far higher than the average among established companies engaged in both development and production. First and foremost, Collins is an engineering company.

Engineering is king at Collins—never takes a back seat to production expediency.

FACT NUMBER 4:

Collins' reputation for quality of product is universally recognized. It has led to Collins' phenomenal sales record. At Collins there is no compromise when quality is at stake.

If you're the man we want, you'll get real satisfaction out of this quality-consciousness.

FACT NUMBER 5:

Electronics is Collins' only interest. In no way is it subsidiary to the manufacture of industrial or consumer products. Collins builds electronic equipment, not airplanes or vacuum cleaners. Every research, development and production facility is devoted to progress in electronics.

If electronics is your interest, you'll like the climate at Collins.

FACT NUMBER 6:

There is a limitless variety of fields and types of work for the Collins engineer. Recent Collins work in air and ground communication, and aviation electronics include developments in transhorizon "scatter" propagation; single side-band; microwave and multiplex systems; aircraft proximity warning indicator; aviation navigation, communication and flight control; broadcast; and amateur equipment.

There is big opportunity for your special talents.

Right now we are prepared to offer you a technical or supervisory assignment in one of many interesting fields. And the sky is the limit as far as responsibility and salary are concerned.

You will work in one of Collins' new research and development laboratories located at Cedar Rapids, Iowa; Dallas, Texas; and Burbank, California. Offices and subsidiary companies are located in New York; Washington, D. C.; Miami; Knoxville; Seattle; Hickman Mills, Missouri; Toronto, Canada; London, England; and South America.

All your moving expenses are paid. Company benefits are tops in the industry.

We repeat—if you are a mechanical or electrical engineer, you and Collins should get together. Take the first step now, send your resume today to:

L. R. NUSS
Collins Radio Co.
Cedar Rapids,
Iowa

FRED AIKEN
Collins Radio Co.
2700 W. Olive Ave.
Burbank, California

HAROLD MCDANIEL
Collins Radio Co.
1930 Hi-Line Drive
Dallas, Texas



black and white facts

should get together

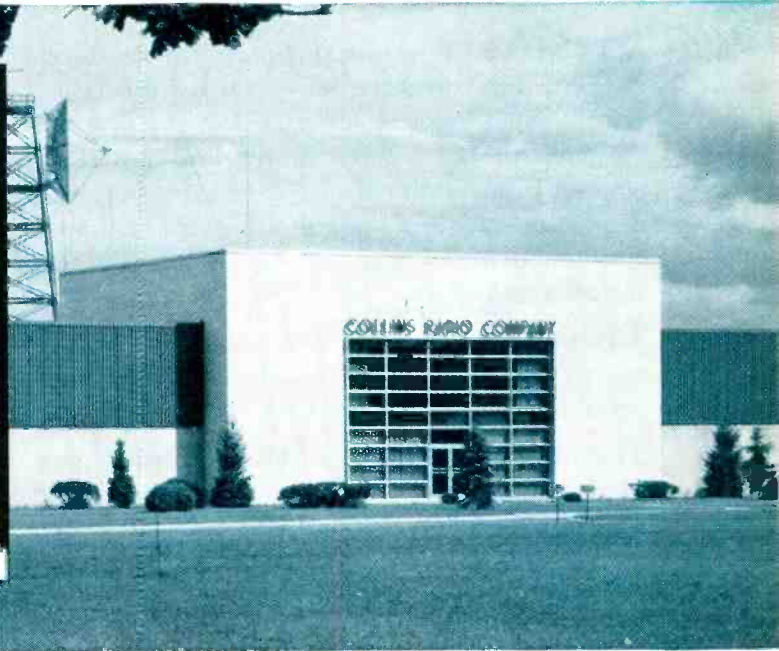
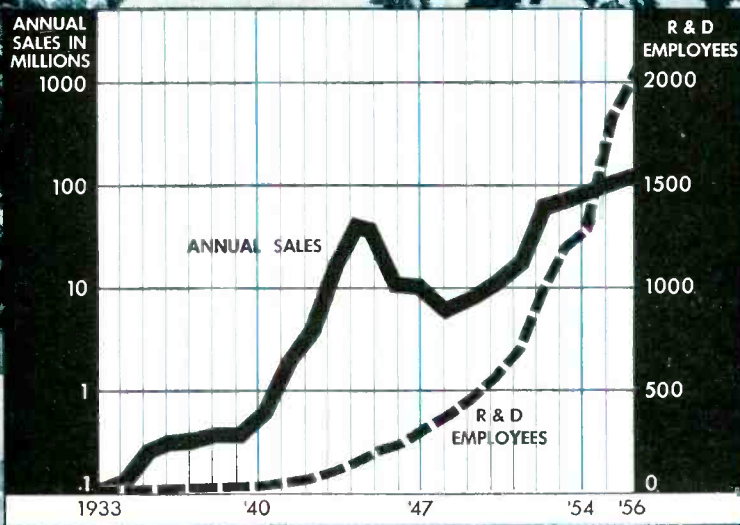

This graph shows the relationship between sales and employment of engineering personnel at Collins. Notice the steady increase in research and development employment despite sales fluctuations.

Collins new research laboratory building at Cedar Rapids, Iowa. Air-conditioned, shielded against radio waves, completely equipped.

Collins

CREATIVE LEADER IN ELECTRONICS

COLLINS RADIO COMPANY • CEDAR RAPIDS • BURBANK • DALLAS



MALLORY

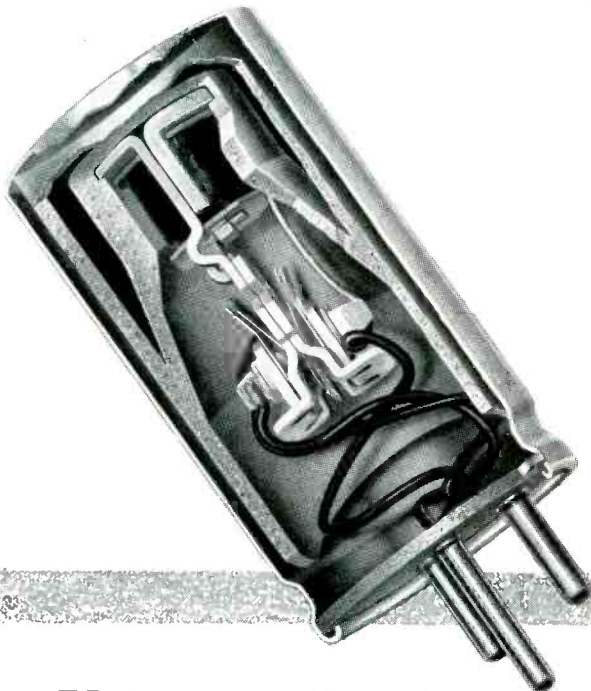

Completely new design concept eliminates usual button contact, provides larger contacting area. New units have far longer life, lowest noise level yet . . . but cost no more.

Vibrator life increased 50 to 100% . . . in newest Mallory design

STANDARDS of vibrator performance never before possible are being set by the latest development in Mallory vibrator engineering. Through the use of new design and materials, contact is made directly between vibrating reed arm and side arm—eliminating conventional contact buttons—providing far greater contacting area and longer life.

And in addition, a further refinement in the mounting of the vibrator establishes a new high standard of quieter operation.

The results of these new design concepts are important to everyone who designs, makes or uses vibrator-powered equipment.

Life is increased 50 to 100% . . . due to greater contacting area and far lower rate of wear.

Sticking of contacts is eliminated.

Serving Industry with These Products:

Electromechanical—Resistors • Switches • Television Tuners • Vibrators
Electrochemical—Capacitors • Rectifiers • Mercury Batteries
Metallurgical—Contacts • Special Metals and Ceramics • Welding Materials

Parts distributors in all major cities stock Mallory standard components for your convenience.

Complete uniformity of characteristics is made possible by this simplified design, which permits automatic production and adjustment techniques.

Extra-quiet operation. Mechanical hum is held to a new low level, due to the lighter mass of the mechanism, and to noise-squelching Mallory refinements.

Smaller size for equivalent load rating.

The new Mallory 1600 series vibrator is now available for auto radios, headlight dimmers, garage door openers and many other applications. In addition, the new leaf spring contacting concept is available in another new Mallory vibrator—the 1700 series for two-way communications equipment and other heavy duty applications.

Expect more . . . Get more from

P. R. MALLORY & CO. Inc.
MALLORY

P. R. MALLORY & CO., Inc., INDIANAPOLIS 6, INDIANA

SHIELDING'S *Universal* ENCLOSURE
PROVIDES MAXIMUM SHIELDING EFFECTIVENESS
... FOR COMPLYING WITH ALL APPLICABLE
MILITARY SPECIFICATIONS.

R. F. interference SUPPRESSED

Shielding has the practical solution to all your electro-magnetic suppression problems — the Shielding Universal Enclosure. Multi-Cell® design features either single or double shielding in cell or isolated type enclosure . . . interchangeable standard panels of solid and/or mesh material . . . a wide variety of enclosure sizes both standard and custom-built. A complete test report, performed by independent consulting engineers in accordance with military specifications, has just been completed — evaluating designs and different types of material used. For your copy of this report and the new Shielding folder giving all design details, write today to:

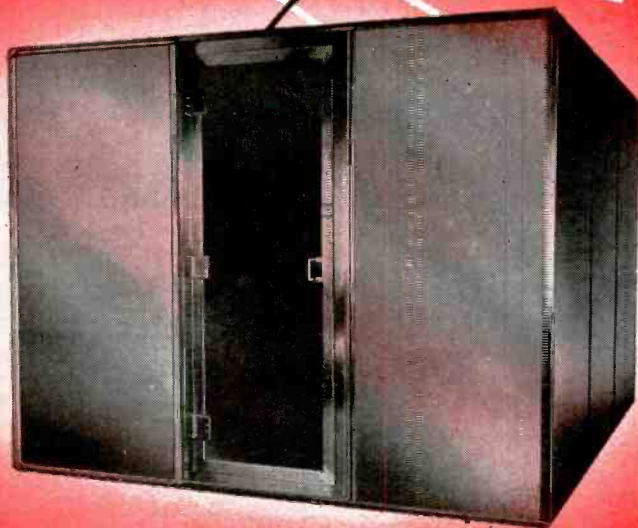

SHIELDING, INC.

12 RESERVE STREET RIVERSIDE, NEW JERSEY

SALES OFFICES:

CHICAGO — R. EDWARD STEMM

DENVER — WILLIAMS & ASSOCIATES

LOS ANGELES — CARL A. STONE ASSOCIATES, INC.

FORT WORTH — MITCHELL SPEARS COMPANY

CANADA — HJS ELECTRONICS SALES LTD., AJAX, ONTARIO

©1957

Where do you belong in



Computer Circuit Design Engineers plan electronic circuitry for advanced airborne analog and digital computers . . . design linear and pulse circuits employing transistors, tubes, magnetic devices. Opportunities also exist in airborne power supply design, or to develop new techniques for marginally checking computer performance. *Do you belong on this team?*

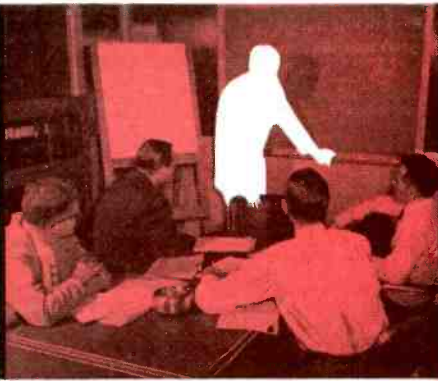

Computer Logical Design Engineers determine the systems outline of a computer and its inter-connection with external equipment. Close liaison is maintained with mathematical support, circuit design, packaging and test engineers. Computer speed, memory size, configuration and arithmetic structure are tailored to requirements of weapons systems. *Do you belong on this team?*



Systems Evaluation Engineers test and evaluate electronic analog and transistorized digital computer systems design for aircraft; evaluate new systems and improvements to insure compliance with specifications and Air Force requirements. Other assignments: tie-in testing of peripheral equipment, liaison with design, development and field engineering. *Do you belong on this team?*

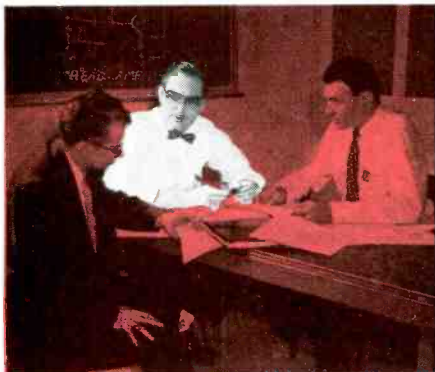

Harry Branning (center): B.S.E.E. 1950, Syracuse. Design Engineer in circuit design, 1951; October, 1954, promoted to Associate Engineer; April, 1956, promoted to Staff Engineer, Systems Planning. In June, 1956, appointed Project Engineer and Manager of the 110 Computer Circuit Design Department; discussing the performance and packaging details of a transistorized read amplifier.



William Dunn (standing): M.E. 1950, M.S.E.E. 1952, Stevens Institute. Technical Engineer, 1955; April, 1956, promoted to Associate Engineer; August, 1956, transferred to Development Engineering in charge of Logical Design for digital computers in advanced weapons systems; here discussing the logical Algebra method of optimizing the design of an airborne digital computer.



Eli Wood (left): B.S.E.E. 1950, Connecticut. IBM Customer Engineer, July, 1950; September, 1952, transferred to ACL Field Engineering. February, 1954, in charge of Field Engineering at Hunter AFB; May, 1955, Associate Engineer; appointed Project Engineer; Manager of Systems Evaluation in August, 1956; here investigating a problem in radar data presentation set evaluation testing.

The brief records of the men cited above indicate only a few of the exciting activities right now in IBM Military Products. This division, organized 18 months ago, has grown enormously. A small-company atmosphere prevails. Men work in small teams . . . individual contributions are instantly recognized. Promotions occur frequently.

As a member of IBM Military Products, you'll enjoy physical surroundings and equipment second to none. Educa-

tional programs at IBM expense lead to advanced degrees. Salaries and benefits are excellent. Stability is guaranteed by IBM's history of consistent achievement—underlined by the fact that the rate of turnover at IBM is only one-sixth the national average.

Throughout the length and breadth of the United States IBM has built modern plants and laboratories. This map points out the various locations where you might live as an IBM em-

DATA PROCESSING
ELECTRIC TYPEWRITERS
TIME EQUIPMENT
MILITARY PRODUCTS

IBM

**MILITARY
PRODUCTS**

IBM Military Products?



Systems Engineers oversee the engineering support provided by the Systems Coordination and Specification Group to the factory on the AN/ASB-4 Bombing-Navigational System. Air Force requirements are analyzed and the resulting engineering changes evaluated to determine effect on system performance and accuracy. Mathematical error analyses are run. *Do you belong on this team?*

Systems Analysts anticipate performance and recommend design criteria before and during development of equipment. Later, they compare dynamic performance accuracy and reliability characteristics with what has been anticipated. Other assignments include Digital Computer Systems Engineering, Input-Output and Analog-Digital Conversion Engineering. *Do you belong on this team?*

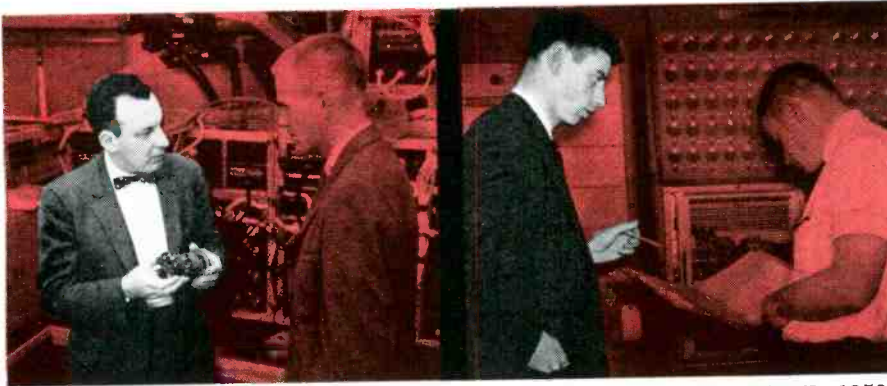

Quentin Marble (left): B.S.M.E. 1951, Syracuse. Joined IBM in 1951; promoted to Design Engineer in 1952; May, 1955, promoted to Associate Engineer, and then to Project Engineer, Manager of the Systems Coordination and Specification Group, Production Engineering Department, in February, 1956; shown here describing a unique cooling design to a new employee in his group.

Monroe Dickinson (left): B.S.E.E. 1952, W.P.I.; M.S.E.E. 1954, M.I.T. Technical Engineer in analog and alternate computer techniques for weapons systems, 1952; Associate Engineer responsible for systems design and analysis, 1954; December, 1955, Staff Engineer, responsible for research planning; here reviewing set-up on laboratory analog computer of a sampled data control problem.

Exceptional career opportunities are now open in IBM Military Products for E.E.'s, M.E.'s, physicists, and mathematicians, in the following fields:

- SYSTEMS PLANNING AND ANALYSIS
- DIGITAL AND ANALOG SYSTEMS
- INERTIAL GUIDANCE
- SERVO-MECHANISMS
- ELECTRONICS
- MECHANICAL DESIGN
- ELECTRONIC PACKAGING
- PROGRAMMING
- FIELD ENGINEERING
- RELIABILITY
- COMPONENTS
- PHYSICS
- MATHEMATICS
- HUMAN ENGINEERING
- INSTALLATION
- CIRCUIT DEVELOPMENT
- POWER SUPPLIES
- TRANSISTORS
- HEAT TRANSFER
- OPTICS
- TEST EQUIPMENT
- COST ESTIMATING
- TECHNICAL PUBLICATIONS

ployee. IBM Military Products include the Airborne Computer Laboratories located in Owego, N. Y., and the Project SAGE installations directed from Kingston, New York.

Here is a real ground-floor opportunity that you can't afford to overlook. Without exaggeration, your potential in this dynamic young field of electronic computers is virtually unlimited. Get all the facts. Write, outlining your background and interests to:

R. A. Whitehorne
 Manager of Engineering Recruitment, Dept. 402
 International Business Machines Corp.
 590 Madison Ave., New York 22, N. Y.

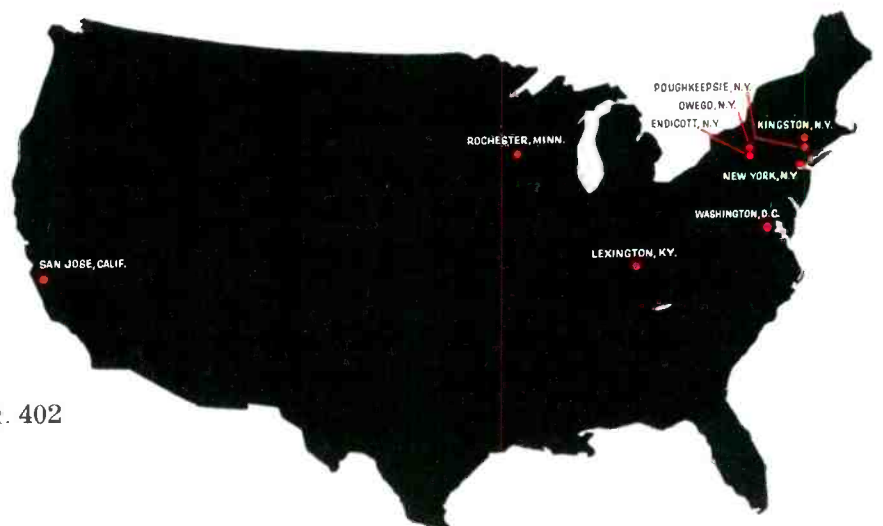

Financial Aid to Higher Education

A Fine Start, But...

This editorial has two purposes. The first is to salute American business for the fine start it has made in helping to relieve the financial plight of our colleges and universities. The second purpose is to stress the importance of having business provide more financial aid, and soon.

How Business Helps Higher Education

Business contributions to higher education doubled between 1950 and 1955. They jumped from \$40 million to \$80 million. Preliminary figures indicate they will be even higher this year.

Business firms have also shown a lot of ingenuity in devising different ways of making their contributions. The methods range from a matching of an employee's contribution to his particular alma mater to wide diffusion of the money through state and regional money-raising associations of colleges and universities. Thanks to this ingenuity, business firms now have a wide choice of ways by which to give effective aid. The way most appreciated by college administrators is the making of gifts unrestricted as to the purpose for which the money is used.

Imposing as it is, however, what business has done thus far is only a good start. Only a tiny fraction of the total number of business firms in the country are giving direct financial help to our colleges and universities; and this fraction includes fewer than half of the hundred largest corporations in the country. Also, the amount of financial help being provided by business constitutes only a very small fraction of what is needed.

Why Colleges Need More Aid

Right now our privately endowed colleges and universities need about \$350 million more in operating income a year than they are receiving to enable them to pay decent faculty salaries and be in tolerably good working order otherwise. The reasons, including a severe decline in the purchasing power of their endowment income because of price inflation, have been dealt with in the previous editorials in this series.

In addition, these institutions, together with the tax-supported schools, are faced with a tremendous increase in enrollment over the years ahead. With both a rapidly increasing population of young people and an increasing propor-

tion of them going to college, this year's enrollment of 3.2 million students is expected to reach 4.0 million by 1960, and to be doubled by 1970.

For the next ten years our privately supported colleges and universities must have an average of about \$400 million a year above what they can be expected to collect from tuition fees, income from endowment funds, etc.

This figure of \$400 million does not include what is needed for new buildings and equipment. It also does not include help for tax-supported schools above what they get from taxes, fees, etc. Business has given and will continue to give these schools substantial aid. Indeed, almost 25% of the financial help from business for our colleges and universities went to tax-supported schools in 1955.

If aid from business met their needs for increased operating income, the privately supported colleges and universities would be given a decisive lift in performing successfully their part in our system of higher education. They would still have large needs of capital equipment — buildings, dormitories, laboratories — but help from other sources, such as that provided by devoted alumni, where they are well organized, could be expected to go far toward meeting these needs. Also some companies prefer to concentrate on meeting needs of this type.

What 1% of Profits Would Do

But do business firms have the capacity to fill the gap in adequate operating income for our privately endowed colleges and universities without putting an excessive financial burden on themselves? Those who have studied this capacity carefully say that the answer clearly is yes. If, of its profits before taxes — last year an estimated \$43 billion — business were to devote 1% to helping our privately en-

dowed colleges, it would take care of present operating needs of about \$350 million a year. And the balance of \$80 million would be a big step in meeting their needs for new buildings and equipment, too.

About one half of a 1% contribution of this sort would, in effect, be made by the federal government. Up to a limit of 5%, contributions of this type are exempt from the federal corporate income tax. For corporations with incomes above \$25,000 per year this tax is 52%.

It is clear that not all business firms are in shape to devote 1% of their profits to aid to higher education. Even in this year of record-breaking prosperity, many of them will have no profits at all. But if business generally would take 1% of pre-tax profits as a target or benchmark for financial help to our privately endowed colleges and universities these institutions would again have sturdy financial foundations.

Relatively this is a very small price to pay (1) to insure a continuing supply of competently trained young men and women and (2) to buttress our freedom by assuring the successful survival of the privately supported sector of our system of higher education.

This is one of a series of editorials prepared by the McGraw-Hill Department of Economics to help increase public knowledge and understanding of important nationwide developments of particular concern to the business and professional community served by our industrial and technical publications.

Permission is freely extended to newspapers, groups or individuals to quote or reprint all or parts of the text.

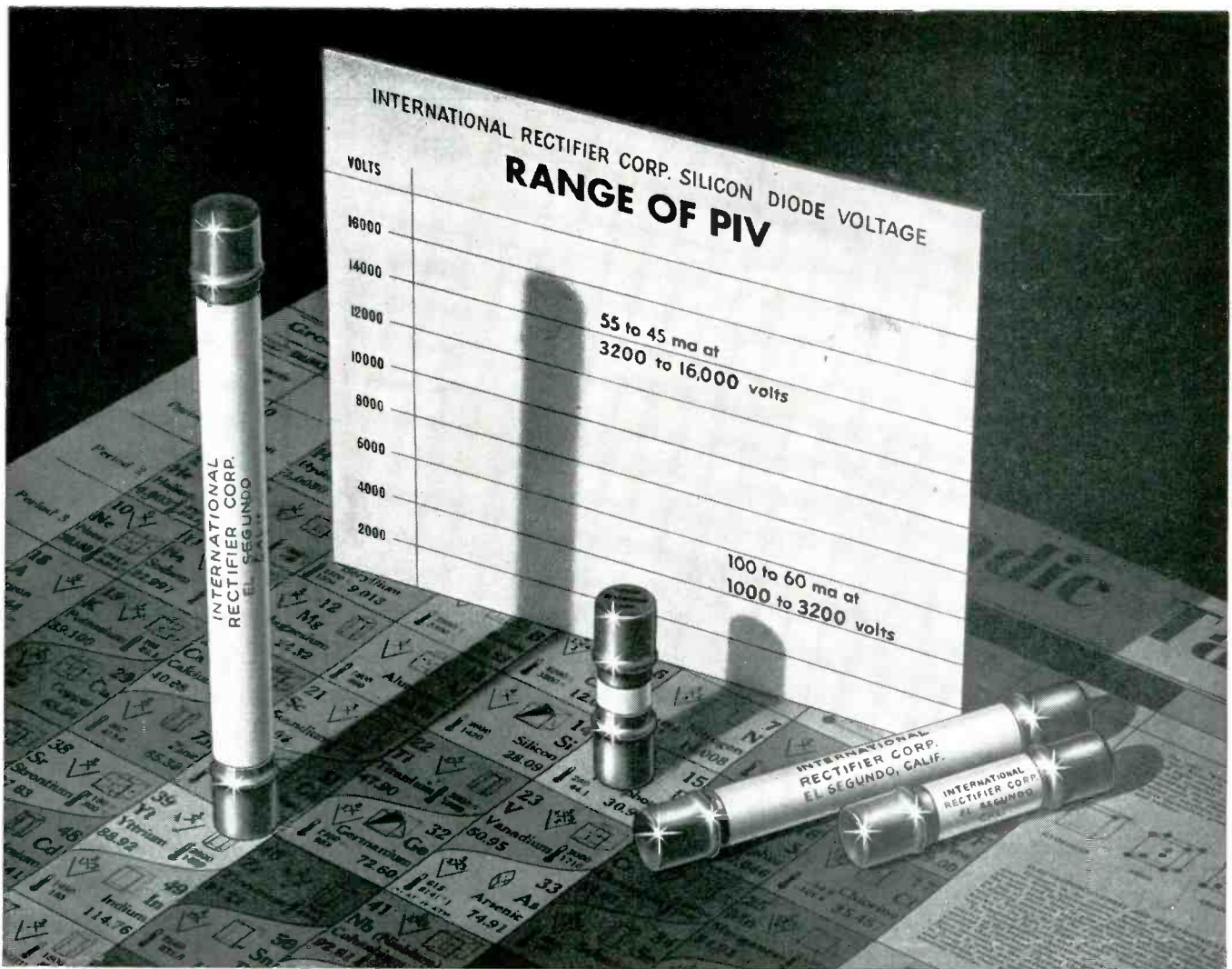

PRESIDENT

McGRAW-HILL PUBLISHING COMPANY, INC.

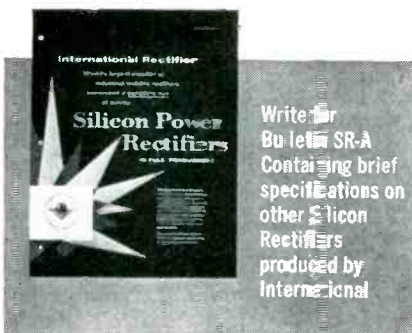

Pictured are the 4 sizes available, ranging in length from $1\frac{13}{16}$ " to $6\frac{1}{16}$ ". Diameter $\frac{3}{64}$ ".

International Silicon Diodes feature ratings to 16,000 volts PIV...require up to 95% less space!



Here is the answer to tough miniaturization problems where high temperature and high efficiency are prime design factors. International's high-voltage silicon diode series, now in full production, offers ratings ranging from 600 volts at 100ma half-wave dc output, to 16,000 volts PIV at 45ma, over a temperature range of -55°C to $+150^{\circ}\text{C}$. Constructed from selected silicon junction diodes connected in series, hermetically sealed within a metalized ceramic housing, these rectifiers feature ferrule terminals for clip-in applications into standard 30-ampere fuse clips.

This new series is ideal for those "com-

pact-packaging" jobs. For example, the 16,000 volt unit, with a diameter of $\frac{3}{64}$ ", measures only $6\frac{1}{16}$ " in length. This represents a size ratio of 20 to 1 over rectifiers of other types. This marked size and weight savings over conventional units of comparable rating cuts engineering time normally spent "designing around" bulky units... can sharply reduce the dimensions and weight of your equipment.

Write, wire or telephone our Application Advisory Department. This group of experienced rectifier engineering specialists will be happy to supply specific information on how these rectifiers can fit into your project.



International Rectifier

C O R P O R A T I O N

EXECUTIVE OFFICES: EL SEGUNDO, CALIFORNIA • PHONE OREGON 8-6281

NEW YORK: 132 E. 70TH ST., TRAFALGAR 9-3330 • CHICAGO: 205 W. WACKER DR., FRANKLIN 2-3889

IN CANADA: ATLAS RADIO CORP., LTD., 50 WINGOLD AVE. W., TORONTO, ONTARIO, RU 1-6174

THE WORLD'S LARGEST SUPPLIER OF INDUSTRIAL METALLIC RECTIFIERS

ALL VIDEO TRANSMISSION TEST

STANDARDS in a suitcase



The Original Full Rack and the Portable Unit Produce the same Precise Test Signals.



TELECHROME
INCORPORATED

Model 1003-B

Video Transmission Test Signal Generator

- ★ Completely self contained ★ Portable
- ★ Multi-frequency burst ★ Stairstep ★ Modulated stairstep
- ★ White window ★ Composite sync ★ Regulated power supply.

Now, Telechrome Video Transmission Test Equipment is available as a completely portable 12 1/4" standard-rack mounting unit.

Everyday these Test Signals generated by Telechrome equipment, are transmitted Coast-to-Coast by NBC, CBS, ABC, the Bell System, Canadian Bell and leading independent TV stations throughout the U.S. and Canada. Hundred of network affiliated TV stations and telephone TV centers thus check incoming video signals.

The compact, inexpensive, portable Model 1003-B is all that is required to generate signals for local and remote performance checking of your entire video cable, or micro-wave facilities.

DELIVERY 30 DAYS

Literature on the above and more than 100 additional instruments for monochrome and color TV by TELECHROME are available on request.

The Nation's Leading Supplier of Color TV Equipment

28 Rarick Drive Amityville, N. Y.

Lincoln 1-3160

TELECHROME
INCORPORATED



MULTI-FREQUENCY BURST AMPLITUDE vs FREQUENCY

Check wide band coaxial cables, microwave links, individual units and complete TV systems for frequency response characteristics without point to point checking or sweep generator.



WHITE WINDOW

LOW & HIGH FREQUENCY CHARACTERISTICS. Determine ringing, smears, steps, low frequency tilt, phase shift, mismatched terminations, etc. in TV signals or systems.



STAIRSTEP SIGNAL modulated by crystal controlled 3.579 mc for differential amplitude and differential phase measurement. Checks amplitude linearity, differential amplitude linearity and differential phase of any unit or system.

Model 1003-C includes variable duty cycle stairstep (0-90% average picture level).

Model 608-A HI-LO CRCSS FILTER for Signal analysis.



MODULATED STAIRSTEP signal thru high pass filter. Checks differential amplitude.

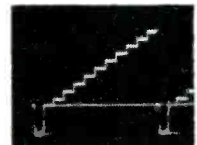

MODULATED STAIRSTEP signal thru low pass filter. Checks linearity.



521-A OSCILLOSCOPE CAMERA—Phoroid type for instantaneous 1 to 1 ratio photo-recording from any 5" oscilloscope.

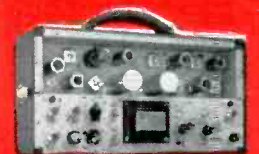

1004-A VIDEO TRANSMISSION TEST SIGNAL RECEIVER for precise differential phase and gain measurements. Companion for use with 1003-B.

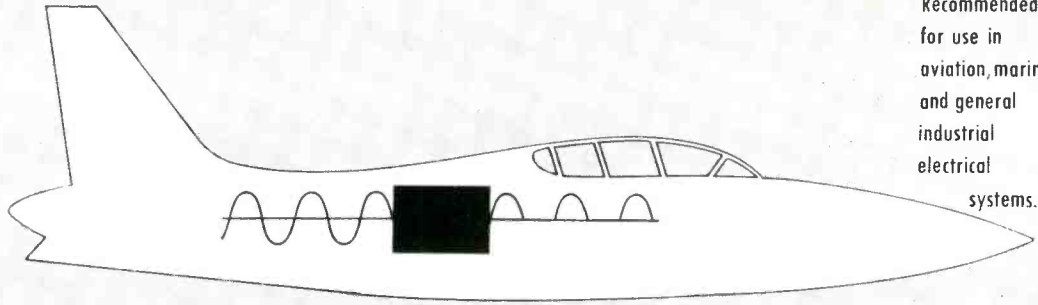
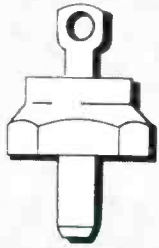

Recommended
for use in
aviation, marine
and general
industrial
electrical
systems.

WN-5051 and WN-5091 with *maximum peak inverse voltage* ratings of 50-350 v. (up to 200 amperes in bridge assemblies).

TYPICAL RECTIFIER CIRCUITS



Single phase full wave (center tap)

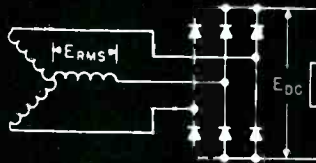

Three phase full wave bridge

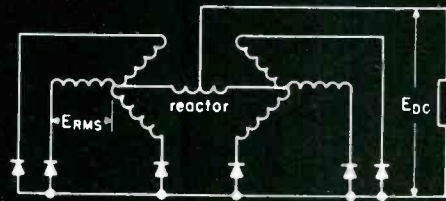

Six phase half wave



WN-5082 with
*maximum peak
inverse voltage*
ratings of 50-300v.
(300 to 5000 amperes
in bridge assemblies.)

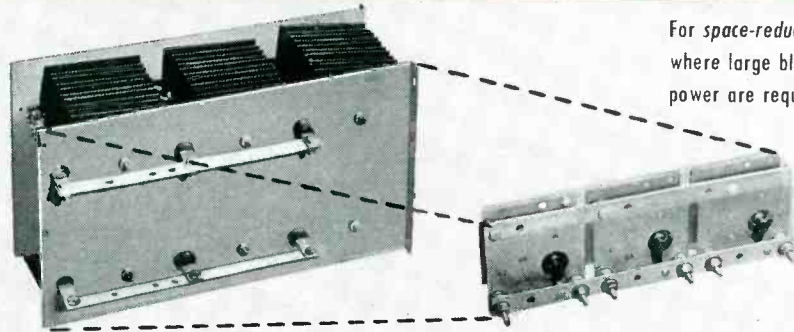

For *space-reducing* design
where large blocks of D.C.
power are required.

Westinghouse SILICON^(SI) Rectifier cells pack more power in a smaller package!

Recommended for greater reliability, highest efficiency and lowest cost

For the progressive design or application engineer in power, control or electronics . . . for anyone who builds or specifies rectifier assemblies and is constantly seeking equipment design and operational improvement that:

- Provides more power in a smaller space
- Lowers installation cost
- Insures minimum maintenance
- Results in no detectable aging
- Makes possible high ambient temperature operation
- Improves A.C. to D.C. conversion efficiency

Westinghouse Electric Corporation
Semi-Conductor Division, Dept. E-2
Youngwood, Pa.

YOU CAN BE SURE...IF IT'S Westinghouse

7ET-4101



NEW LATCHING SUB-MINIATURE RELAYS

BURTON BROWNE/New York

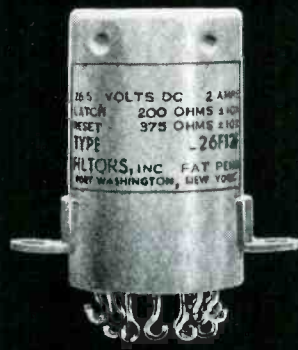

**SMALLEST—
LIGHTEST**

EXCLUSIVE
WITH **FILTORS, INC.**

*By Filtors,
smallest and lightest
hermetically sealed latching
sub-miniature relays,
magnetically held—
no power drain—
and electrically reset.
2PDT, 4PDT and 6PDT*

*High shock and vibration
resistance.*

*All made to
MIL-R-25018 (USAF)
and MIL-R-5757C.*

Dry circuit relays available

Write for catalog

*Leading manufacturers of
hermetically sealed
sub-miniature relays.*

FILTORS, INC.

*Port Washington,
Long Island, New York
Port Washington 7-3850*

Quick-Opening Fasteners

Selecting Small Fastenings for Metal Closures

*"Use captive fasteners wherever feasible . . . Avoid the use of loose washers and loose nuts . . . Fasteners on equipment covers should be operable either with no tools or with standard hand tools"**

(John D. Folley, Jr. & James W. Altman, Research Scientists, American Institute for Research)

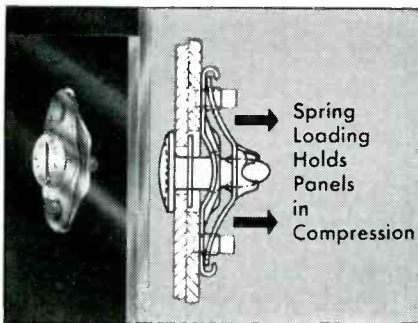

Quarter-Turn Fastener

Lion Fasteners open and close with a $\frac{1}{4}$ turn, hold sheets tightly under the compression of a rugged spring. Quickly operated and fully retained in the outer panel, they are approved under U. S. Government military specifications. Stud and receptacle float for easy alignment and simplified hole preparation. Flush, oval, wing, knurled, ring, and key head styles available. Sizes—No. 2, No. 5, and High Strength for extra heavy duty.

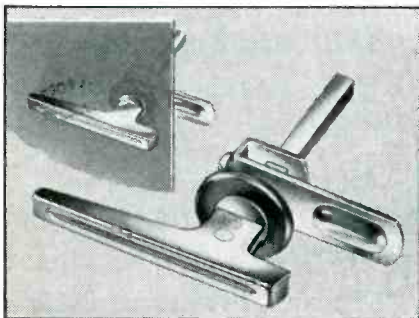

Cabinet Latch

Just drill a hole, push the fastener stem through, and slide the special push-on

clip into place. No welds, screws, bolts or rivets: the fastener is permanently installed in seconds!

Adjustable to any grip length or panel thickness, the pawl is fixed in place by a single set screw. The fastener's brightly finished knob is set off by a plated washer. Also furnished with screwdriver operated flush head.

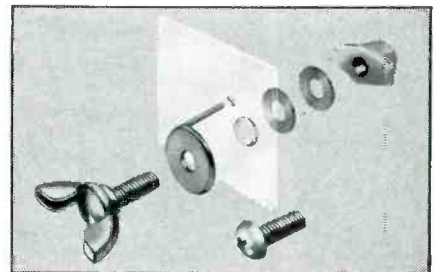

Adjustable Panel Latch

Small doors and panels can be fastened with greatest speed and lowest cost with the Southco Adjustable Latch.

The entire fastener is quickly installed through two holes punched in the door; no bolts or rivets are needed.

It operates with a quarter turn, requires no striker plate. An extra twist after the nylon pawl is engaged pulls up the door to form a seal and eliminate vibration.

Available with wing, knurled, or Phillips head.

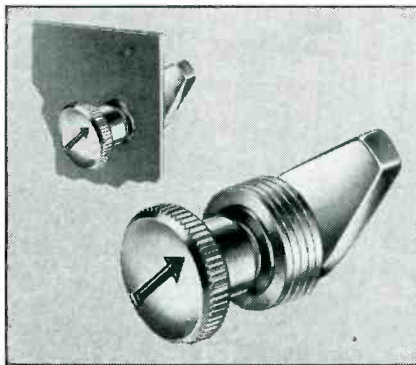

Spring Tension Latch

For fastening slide-out drawers and hinged panels the Southco Arrowhead Latch is recommended. It locks or opens with a quarter turn yet occupies less than $\frac{1}{2}$ " inside space.

Doors are held under spring tension—a push against the arrowhead knob relaxes this tension, allows operation with fingertip ease. Drill a single hole for installation—no fastening to the door is necessary. No striker plate is needed.

Pawl stop is eliminated—arrowhead shows at a glance exact position of pawl.

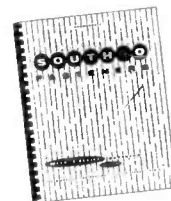

Free Fastener Handbook

Send for your free copy of Fastener Handbook No. 7, just released. Gives complete engineering data on these and many other special fasteners. Fifty-two pages, in two colors.

Write on your letterhead to Southco Division, South Chester Corporation, 233 Industrial Highway, Lester, Pa.

SOUTHCO FASTENERS
LION

© 1956

* Quotation from "Designing Electronic Equipment for Maintainability"; Machine Design, July 12, 1956.

TUBE DESIGN NEWS

GENERAL  ELECTRIC

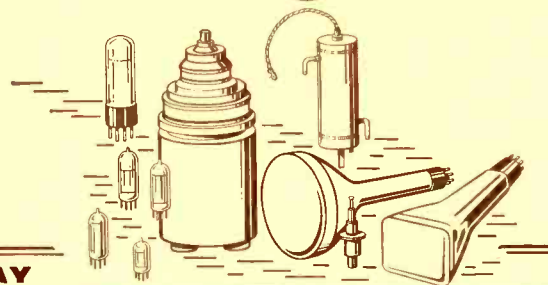

RECEIVING * POWER * CATHODE RAY

Using Low-Noise GL-6299's, Applied Research Analyzer Monitors Republic Fighter Planes for Radio Interference

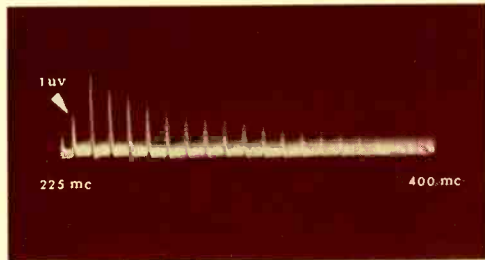

ABOVE: narrow white band across bottom of the scope portrays low noise level of the GL-6299 triode (less than 5 db) in 225-to-400-mc service. Actual (or simulated) signal impulses 1 microvolt and up show as sharp spikes, easy to detect. RIGHT: monitoring the electrical components of a Republic plane for absence of radio interference or interaction.



Applied Research Inc., Flushing, N. Y. employs 11 GL-6299 tubes in the SPA-224 visual noise-interference analyzer, developed jointly by Applied Research and Republic Aviation Corporation to detect any radio interference from airborne electrical equipment.

Super-sensitive, the SPA-224 analyzer continuously presents 225 mc to 400 mc, making possible identification of any spurious signal in this range from one microvolt up.

While an extremely low noise figure and high tube gain were primary reasons for specifying Type GL-6299 in the SPA-224 analyzer, other features were its small size (1 inch long by $\frac{1}{2}$ inch diameter), planar design, and metal-ceramic construction. The GL-6299 is suited to many advanced instrument and other applications which call for precise, dependable performance and space-saving compactness.

Wide frequency range—from v-h-f to 3,000 mc—plus tube efficiency throughout this range, make for versatility. Extensive tests show life to 2,500 hours.

GL-6299's are in full-scale production, for immediate delivery. Characteristics, ratings, and price available from any General Electric office on the next page.

46-Hour Inoperative Control Test of All G-E Five-Star Tubes Cuts Failure Rate Sharply

By operating all 5-Star Tubes for 46 hours as an additional process before life tests begin, General Electric weeds out early-life tube failures.

Consequently, as the chart at right shows, the inoperatives in any 5-Star lot on life test are only half as many, at 500 hours, as they would be without G-E inoperative control. Furthermore, at 500 hours, the percentage of G-E 5-Star inoperatives is still far below the permissible figure established for 100 hours.

Employed only by General Electric, this 100% inoperative control process helps assure that 5-Star Tubes installed in critical military and industrial sockets will perform dependably across the board.

(Continued on Page 2, Column 1)

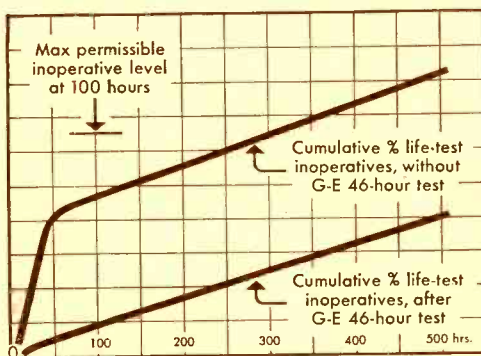

RIGHT: General Electric 5-Star Tubes on 46-hour inoperative control test. Only G.E. conducts this 100% pre-life test process on high-reliability tubes, to weed out early-life failures. ABOVE, the result: curve of General Electric 5-Star inoperatives is far lower throughout regular life test—1 to 2 at 500 hours' operation.



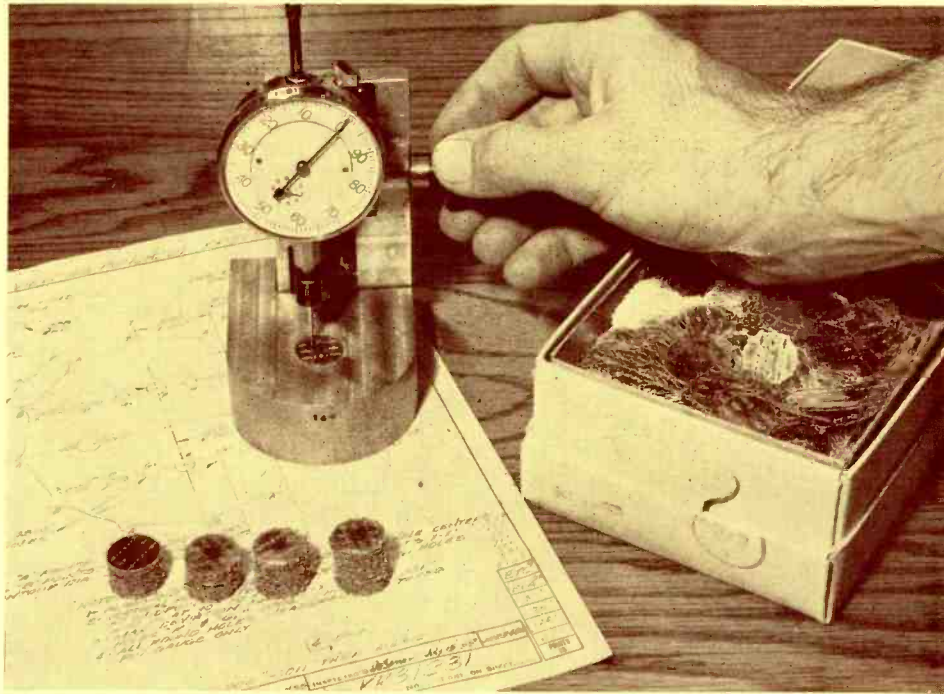

CLOSE G-E TUBE-MICA SPECIFICATIONS MEAN STEADIER TV. With tapered-pin micro-gages like that shown above, the diameter of grid side-rod apertures in G-E vertical sweep-tube micas is checked to an allowable half-mil tolerance, providing tight grid fit and minimum microphonics. By micro-measuring G-E tube micas and holding the grids to precision tolerances, image "jitter" on TV screens is virtually eliminated.

46-Hour Inoperative Control Test

(Continued from Page 1)

All 5-Star tests, as well as all product inspection—all manufacture of parts and assembly of tubes—are carried out in a special 5-Star factory set apart for the purpose, which is air-conditioned and pressurized to keep out dust and dirt. Lint-free Nylon and Dacron garments are worn throughout.

The industry's most extensive testing, plus manufacture under "Snow White" conditions, continues the quality theme that was established in the 5-Star Tube design stage, where ruggedness, reliability, and long life were the aims. For a convenient listing of these high-reliability types, ask any General Electric tube office for the 5-Star Selection Chart (ETD-1276-A) described on this page.

EASTERN REGION

General Electric Company, Tube Sales
200 Main Avenue, Clifton, N. J.
Phones: (Clifton) GRegory 3-6387
(N.Y.C.) Wlconsin 7-4065, 6, 7, 8

NEW PRODUCT BRIEFS

Receiving Tubes:

5DH8. New G-E triode-pentode for TV, especially suited to 600-ma series-string use.

6BW8. New G-E duplex-diode pentode for TV, useful as a horizontal phase detector and sound i-f amplifier, limiter, and AGC keyer.

6CX8, 8CX8. New G-E triode-pentodes for TV. Identical except for heater ratings. Also, 8CX8 is suited to 600-ma series-string circuits.

6919. New G-E twin diode for computer gating and clamping circuits. Has separate cathodes, low heater power, high perveance.

Cathode-Ray Tubes:

New radar types with high-resolution gun. 5FP7-B, 5FP14-A, 7BP7-B, 10KP7-A, 12DP7-C, 12SP7-D. Fully interchangeable with their prototypes.

ASK FOR COMPLETE INFORMATION!

CENTRAL REGION

General Electric Company, Tube Sales
3800 North Milwaukee Avenue
Chicago 41, Ill.
Phone: SPring 7-1600

Higher Resolution up to 35% from New G-E Precision C-R Gun

A new General Electric gun for military and industrial cathode-ray tubes makes possible improved image resolution, which with some types reaches the high figure of 35% at center of face-plate.

Three construction features are re-

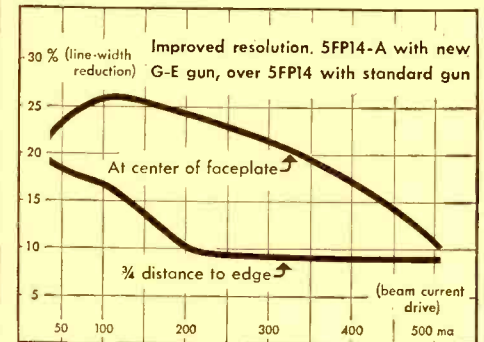

Improvement in image resolution in Type 5FP14-A with the new gun is shown by these curves of increased line-width reduction over the 5FP14 at successive beam drives. Better resolution for this tube ranges 8.5 to 26.1%.

sponsible for the new gun's efficiency: smaller grid apertures . . . less space between Grids 1 and 2 . . . closer tolerances on parts.

G.E.'s high-resolution gun has wide application—can be used in any magnetic focus and deflection tube, with any phosphor.

Six radar tubes with the new gun already are available, ranging from 5 to 12 inches. Their presentations show details that with former types were cloudy or obscure. These types are listed under **NEW PRODUCT BRIEFS** at left.

REVISED!

General Electric
5-Star Tube
Selection Chart



Up-to-the-minute . . . all types are included, with key ratings. Useful to designers of military and industrial equipment. Ask for ETD-1276-A!

WESTERN REGION

General Electric Company, Tube Sales
11840 West Olympic Boulevard
Los Angeles 64, Cal.
Phones: GRanite 9-7765; BRadshaw 2-8566

Progress Is Our Most Important Product

GENERAL ELECTRIC

162-1C2

ELECTRONIC COMPONENTS DIVISION, GENERAL ELECTRIC COMPANY, SCHENECTADY, N. Y.

**locked-in
protection
for
electrical
properties**



DAPON[®] resin

superior moisture resistance

Completely protected and locked-in—the excellent electrical properties inherent in cured DAPON resin are protected by the *resistance of DAPON resin to moisture in all forms.*

DAPON resin is the *new prepolymer* of diallyl phthalate—a dry white powder with improved properties. It is *easy to handle and store.* Its advent has made possible the use of diallyl phthalate in *all processing methods* for thermosetting resins.

Because the cure of DAPON resin involves addition polymerization, and not condensation, *moisture formation is non-existent* during cure.

Think of an electrical connector with *volume resistivity higher than that of porcelain* with complete protection that guarantees the retention of these properties under the most adverse conditions. This is DAPON resin.

Rid yourself of the moisture problem. Be assured of locked-in initial properties and locked out moisture. *Write now for technical literature containing properties, uses and methods of application for DAPON resin.*

Molding compounds containing DAPON resin are produced by Acme Resin Corporation, Durez Plastics Division, and Mesa Plastics Company.

OHIO-APEX DIVISION
Food Machinery and Chemical Corporation
Nitro, West Virginia
Department 13



FMC CHEMICALS INCLUDE: WESTVACO Alkalies, Chlorinated Chemicals and Carbon Bisulfide • BECCO Peroxygen Chemicals • NIAGARA Insecticides, Fungicides and Industrial Sulphur • OHIO-APEX Plasticizers and Chemicals • FAIRFIELD Pesticide Compounds and Organic Chemicals • WESTVACO Phosphates, Barium and Magnesium Chemicals

UNIVAC talks your language



The man of science speaks a language of his own . . . a specialized language. He is a special kind of person and needs a special kind of atmosphere in order to do his best work. The working conditions, facilities, incentives, satisfactions to be found at Univac create this kind of atmosphere. Univac is an organization founded by engineers, built by engineers, with a staff that is predominantly professional, with a program specifically designed to meet your special needs . . . to help you achieve your full stature, professionally and financially. Univac talks your language. Talk to Univac about your future soon.

NATIONAL ENGINEERS' WEEK

FEBRUARY 17-23, 1957

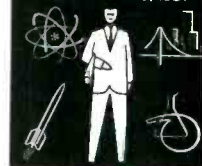

ENGINEERING...America's Great Resource



IMMEDIATE OPENINGS FOR MECHANICAL ENGINEERS

For development engineering work in computer input mechanisms consisting of cards, tapes and keyboard devices, computer memory devices and high-speed output printing mechanisms. Will design cabinet structures, component packaging, cooling and ventilating systems and miniaturized components.

Send Complete Resumé to

Remington Rand Univac

DIVISION OF SPERRY RAND CORPORATION

Dept. SF-2

1902 W. MINNEHAHA AVE., ST. PAUL W4, MINNESOTA

Mechanize Component Assembly with **DYNASERT**

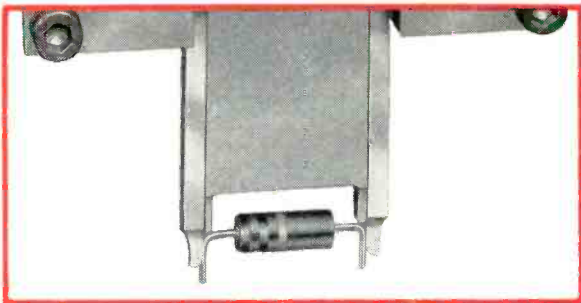

- Cut component assembly costs
- Reliable, uniform assembly to printed wiring
- Reduce operator fatigue

For large volume or limited production of printed wiring assemblies there is Dynasert equipment that will help make your assembly work more efficient. Write today for full information and literature on DYNASERT.

INDUSTRIAL SALES DIVISION

United

SHOE MACHINERY CORPORATION
140 Federal Street, Boston 7, Massachusetts

PRODUCTION EQUIPMENT FOR ELECTRONICS

Individual Dynasert Component assembly machines let you realize maximum speed and lower costs in placing components in printed wiring assemblies.

This Dynasert machine feeds, trims leads, forms, inserts and clinches leads in a single stroke. Up to 800 components can be inserted per hour on a single set-up. Rejects are low. Other Dynasert machines handle jumper wires or a variety of electronic components as received from your supplier.

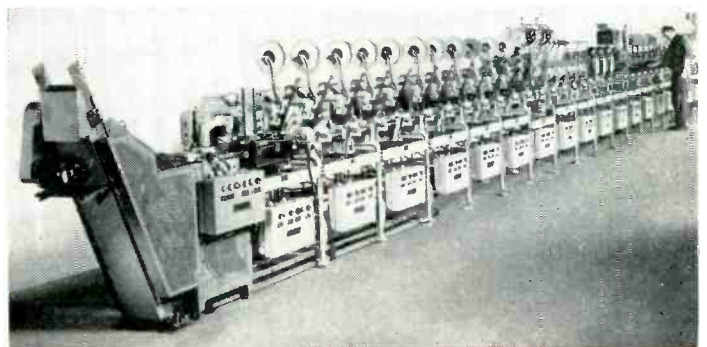

DYNASERT single-head assembly machines are closely related to fully automatic DYNASERT conveyor assembly systems. In fact, four individual bench machines can be easily converted for use on assembly lines as your production increases.

he's working for you



THIS FELLOW IS TRAINED IN YOUR BUSINESS. His main duty is to travel the country — and world — penetrating the plants, laboratories and management councils . . . reporting back to you every significant innovation in technology, selling tactics, management strategy. He functions as your all-seeing, all-hearing, all-reporting business communications system.

THE MAN WE MEAN IS A COMPOSITE of the editorial staff of this magazine. For, obviously, no one individual could ever accomplish such a vast business news job. It's the result of many qualified men of diversified and specialized talents.

AND, THERE'S ANOTHER SIDE TO THIS "COMPOSITE MAN," another complete news service which complements the editorial section of this magazine — the advertising pages. It's been said that in a business publication the editorial pages tell "how they do it"—"they" being all the industry's front line of innovators and improvers — and the advertising pages tell "with what." Each issue unfolds an industrial exposition before you — giving a ready panorama of up-to-date tools, materials, equipment.

SUCH A "MAN" IS ON YOUR PAYROLL. Be sure to "listen" regularly and carefully to the practical business information he gathers.



McGraw-Hill PUBLICATIONS

Touchdown...

FLIGHT'S CRITICAL FRACTION-OF-A-SECOND

MONITORED PERFECTLY BY MYCALEX TM55 SWITCHES

At 10 feet or 100,000 feet, test teams rely upon telemetering for flight performance data. When signals fail vital information is lost forever.

Perfect commutation of these microsecond signals is an important job of MYCALEX TM55 switches, whose specially engineered design is setting new standards of dependable, low-noise-level performance — less than 1 millivolt peak-to-peak under most conditions.

Their extreme durability (more than 5,000 hrs. continuous operation at 600 rpm) significantly reduces down time.

Individually designed to your specifications. Write to Dept. 448 for complete information.

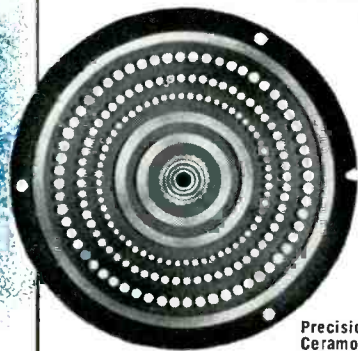

Precision-molded SUPRAMICA* 555
Ceramoplastic Commutation Plate

*SUPRAMICA is a registered trademark of
MYCALEX CORPORATION OF AMERICA
for ceramoplastic material.

MYCALEX TM55 Commutation Switch

MYCALEX ELECTRONICS CORPORATION



UNDER EXCLUSIVE LICENSE OF THE MYCALEX CORPORATION OF AMERICA
EXECUTIVE OFFICES: 30 ROCKEFELLER PLAZA, NEW YORK 20, NEW YORK
GENERAL OFFICES AND PLANT: CLIFTON BOULEVARD, CLIFTON, NEW JERSEY
SALES OFFICES: CHICAGO, CLEVELAND, LOS ANGELES, MINNEAPOLIS, WASHINGTON

WORLDWIDE LABORATORY MANUFACTURER OF GLASS BONDED MICA AND CERAMOPLASTIC SUBSTRATES

The pivot that has to be the best in the world

THE TETRAD DIAMOND PIVOT

for electrical indicating instruments

as used by

SENSITIVE RESEARCH INSTRUMENT CORP.

Manufacturers of Quality Instruments

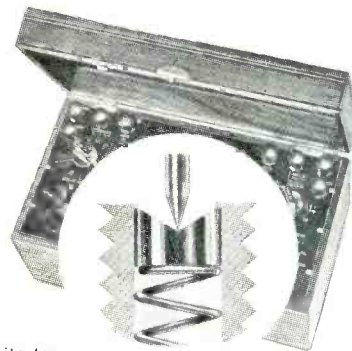

For further information concerning Sensitive Research instruments equipped with diamond pivots write to:
Sensitive Research Corp., 310 Main St., New Rochelle, N. Y.

The engineering test reports as well as extended field use of Sensitive Research have graphically demonstrated the great improvements in electrical testing equipment made possible by the Tetrad Diamond pivot.

Here are some findings of Sensitive Research:

- **Drop Test:** Pivot in ruggedized instrument survived 300 falls of 3 ft. onto concrete floor, with no alteration of sensitivity or accuracy of instrument.
- **Durability:** No discernible wear of diamond pivot or sapphire jewel after 5,184,000 oscillations over a period of 3 months.
- **Friction Free:** Highly polished riding surface and small radius of pivot eliminates tapping. Reduction of friction coefficient by better than 18 to 1 ratio.
- **No Hysteresis Effect:** Tetrad diamond pivot and mounting are completely non-magnetic.
- **Reduces Servicing:** Very economical when compared to servicing of instrument which exhibits pivot or jewel deformation.



Expert with loupe selecting stones from large quantity of original diamond parcel. Only a small percentage pass this phase of rigid quality control. These are not chips, but small individual diamond crystals.

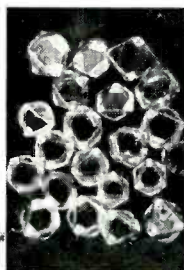

Perfect diamonds make perfect pivots. Diamonds which pass loupe inspection are then carefully and individually examined through a binocular stereoscopic microscope. Only perfect diamonds — free from flaws, inclusions and cleavages are kept for fabrication of diamond pivots.



Skilled lapidary performing one of several diamond cutting and polishing operations. Final finish of the radiused tip of the diamond pivot is made with an 0 to 2 micron diamond powder. This results in a highly polished surface with an extremely low coefficient of friction.



Shadowgraph inspection of diamond pivot. Shape and included angle are important for perfect pivot design. Each completed diamond pivot is enlarged on contour projector and rotated 360°. Tolerances are kept to within $\pm .0001$ " on radius and $\pm 1^\circ$ on included angle.



Operator setting diamond pivots into holders. Exact alignment is important. Small scale versions of drill presses, staking sets, jigs and fixtures are specially made to handle the minute diamond pivot which measures only .010"



Highly magnified photomicrograph of diamond pivot. Before diamond pivots are put into final instrument assembly they are given another microscopic check. Only one pivot is made from one diamond crystal. This permits the best orientation for strength and wear resistance.

ATTENTION ENGINEERS

Do you have an engineering application where durability, minimal friction and maintenance of shape is important? Consider Tetrad Diamond Products. Please submit specifications or drawings. Samples furnished upon request. Write to:



TETRAD

Dept. E2, 62 St. Mary St., Yonkers, 33, N. Y.

Manufacturer of
DIAMOND PRODUCTS
Pivots — Styli — Engravers —
Gauge and Embossing Points

Having your
ups
and downs?



... if they involve Wire Wound Resistors

DALOHM has the answer!

All Dalohm products are carefully designed and skillfully made to assure you of supreme quality and dependability, plus the widest versatility of application.

Outstanding examples of the Dalohm line are these miniature, silicone-sealed, wire wound resistors.

FOR THOSE TIGHT SPECIFICATIONS

You Can Depend On



TYPE PH

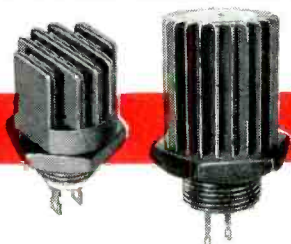

These Dalohm resistors combine high power rating with sub-miniature design. High heat dissipation and protective covering are achieved with vertical-finned black anodized aluminum housings. Vertical single hole panel mounting is provided by integral threaded base and lock nut. Ruggedized construction assures dependability under the most extreme conditions.

- Completely welded construction from terminal to terminal
- Silicone sealed for absolute protection against moisture, shock and salt spray
- Three wattages and sizes: PH-25, 25 watts; PH-50, 50 watts; PH-100, 100 watts
- Resistance values from 0.1 ohm to 60K ohms, depending on type
- Tolerances from 0.05% to 3%

Ask for Bulletin R-33

TYPE RH

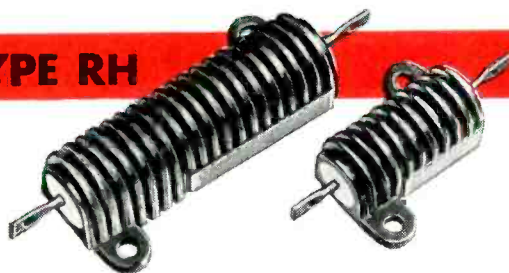

Another Dalohm resistor that resolves power and space problems in tight specifications. Black anodized finned housing provides protection and maximum heat dissipation. Mounting lugs provided for horizontal mounting.

- Completely welded construction from terminal to terminal
- Silicone sealed for absolute protection against moisture, shock and salt spray
- Three wattages and sizes: RH-25, 25 watts; RH-50, 50 watts; RH-250, 250 watts
- Resistance values from 0.1 ohm to 100K ohms, depending on type
- Tolerances from 0.05% to 3%

Ask for Bulletin R-21C

**JUST
ASK
US**

You are invited to write for the complete catalog of Dalohm precision resistors, potentiometers and collet-fitting knobs.

If none of our standard line fills your need, our staff of able engineers and skilled craftsmen, equipped with the most modern equipment, is ready to help solve your problem in the realm of development, engineering, design and production.

Just outline your specific situation.

DALE PRODUCTS, Inc.

1300 28th Avenue Columbus, Nebraska, U.S.A.

• In Canada: Charles W. Pointon, Ltd.
6 Alcina Ave.
Toronto, Ont.

• Export Dept: Pan-Mar Corp.
1270 Broadway
New York 1, N. Y.

New miniature diode construction for cool operation

Shown
actual
size



Now, designers can incorporate Sylvania's new miniaturized diode in equipment where space is at a premium. It meets the standard Retma outline of .105" maximum diameter and .265" maximum over-all length and meets requirements for automatic production methods. Its construction inherently assures greater reliability and superior performance.



Metal eyelet—fused to glass tubing—provides strong construction and builds in provision for cooler operation. In Sylvania's metal to-glass package, heat is dissipated by the eyelets and leads.



Preassembled cartridge—By pre-assembly of the diode cartridge, the metal-to-glass design affords another advantage. The whisker and die of the diode are not subjected to excessive sealing heats. There is no danger of breaking down the conductive characteristics of the diode.

features metal-to-glass ruggedness and

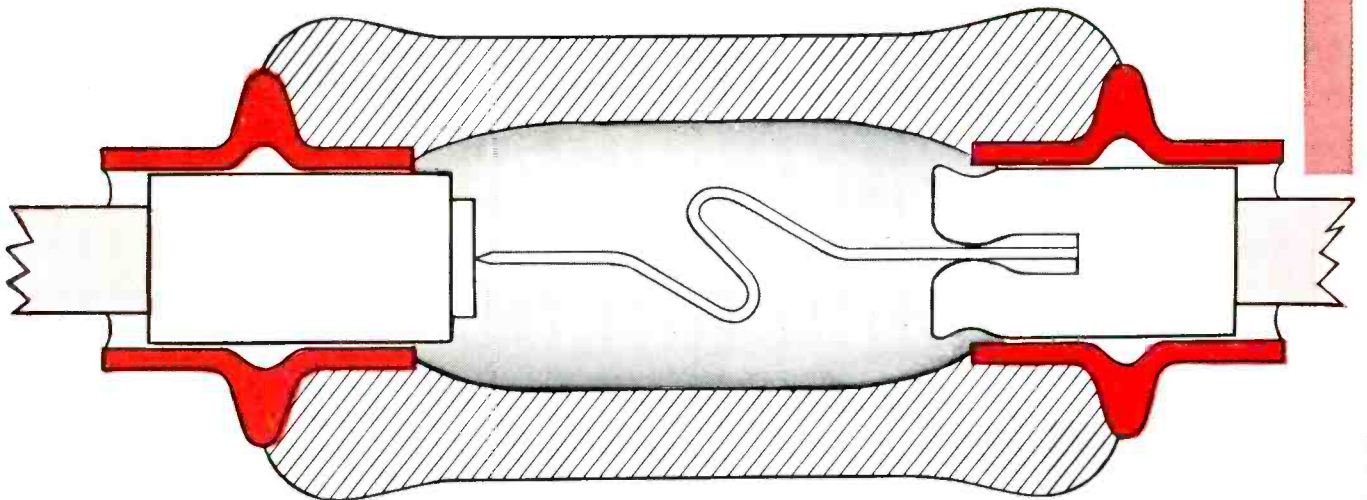

Nickel-plated Steel pin—butt-welded to copper lead adds structural strength and provides coupling between the internal diode structure and the metal eyelet for greater heat dissipation. Nickel plating insures strong welds, and good solder sealing.

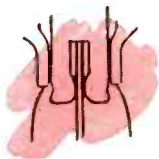

New whisker mounting—The use of a crimp hold rather than impulse weld to mount the whisker eliminates the possibility in production of overheating the tungsten whisker. Thus, the conductive properties remain undisturbed, assuring more reliable performance over longer life.

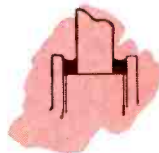

Smooth Solder Seal—is possible only with glass-to-metal construction. It adds reliability by preventing cracks and chips when leads are bent at right angles for mounting in printed circuit boards.

Write for complete details on this important new diode development.
Address Dept. B20R

SYLVANIA ELECTRIC PRODUCTS INC.
1740 Broadway, New York 19, N. Y.
In Canada: Sylvania Electric (Canada) Ltd.,
Shell Tower Bldg., Montreal



SYLVANIA

LIGHTING • RADIO • TELEVISION • ELECTRONICS • ATOMIC ENERGY



new

Formica

Exceeds NEMA standards for XXP...meets
UL requirements for printed circuitry ...
meets MIL SPEC 3115B for type PBE-P

New Formica Cirprint is far superior to any XXP ever made. The latest product of Formica-4 research, it is the first and only copper clad especially designed to meet the requirements of large volume manufacturers.

Check these Cirprint properties against your requirements:
High IR: 250,000 megohms after 96 hours at 35° C and 90% relative humidity.

Cold punching: up to and including 1/16".

Low moisture absorption: 0.80% in 1" x 3" x 1/16" sample after 24 hours immersion.

FORMICA

4

subsidiary of

CYANAMID

1st choice in laminated plastics

Application engineering • Fabricating • Research

TV—Radio—Phonograph and other electrical/electronic product manufacturers can benefit from Cirprint, the first copper clad laminated plastic ever to offer exactly the right combination of properties for this application. If you're a large volume consumer of circuitry, it will pay you to check Cirprint today.

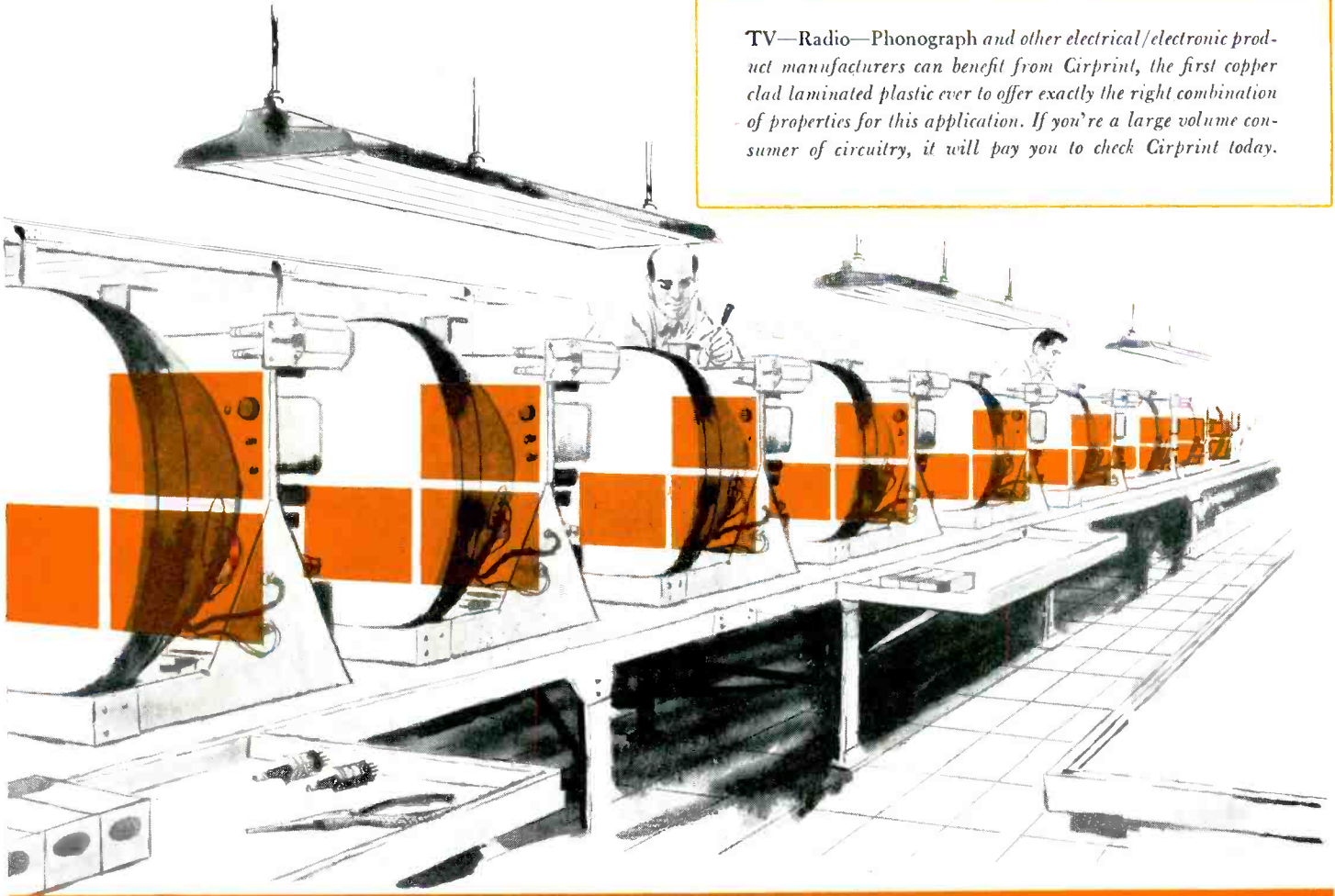

CIRPRINT[®]

Cirprint watermarking gives you quick, positive, visual identification. Eliminates costly and ineffective factory records and marking systems.

You can *see* the quality because Cirprint is translucent. Its smooth structure is free of all impurities. Translucency also permits a visual check on the register of circuits printed on opposite sides of a sheet.

Enthusiastic reports from manufacturers who have tested Cirprint state it's the best XXP ever made . . . and that its outstanding properties are most useful.

Evaluate the contribution Cirprint can make to your electrical/electronic products. Send today for free bulletin 755. Use the handy coupon below, or write Formica Corporation, subsidiary of American Cyanamid, 4530-7 Spring Grove Ave., Cincinnati 32, Ohio.

*Formica Corporation, Sub. of American Cyanamid
4530-7 Spring Grove Ave., Cincinnati 32, Ohio
Please send me a copy of Cirprint bulletin 755.*

Name _____
 Company _____ Title _____
 Address _____
 City _____ Zone _____ State _____



Customer stock service

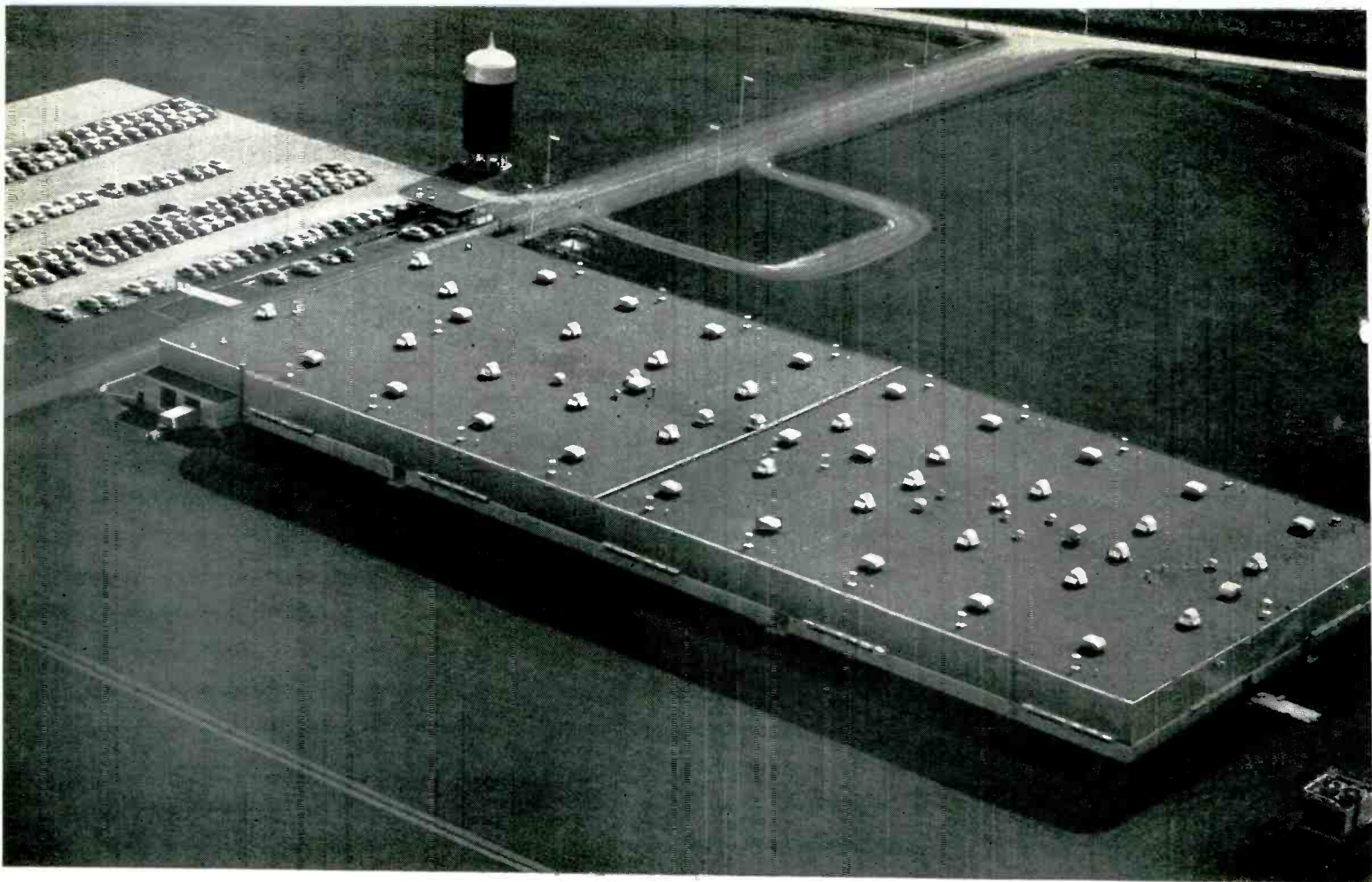

New 2½-acre Owensboro plant is fourth General Electric receiving-tube facility for serving TV manufacturers!

WELL over a million dollars in building costs have gone into General Electric's new receiving-tube factory on the outskirts of Owensboro, Ky. Another large investment is for advanced automatic machinery. Located on a 90-acre site, the plant itself is 500 feet long and 200 feet wide, with special ventilation and air-filtering to keep out dust and lint.

Here the tube needs of TV designers and builders are being met by new facilities unmatched in the industry. Here the prime targets are: still more dependable tube performance . . . even longer tube life . . . even greater values that help to keep down the curve of TV manufacturing costs.

Now, more than ever—from circuit stage through mock-up to receiver assembly—it will profit you to keep in touch with General Electric on *all* your tube requirements! *Electronic Components Division, General Electric Co., Schenectady 5, N. Y.*

Irvine D. Daniels (seated), general manager, General Electric receiving tube department, points out to three members of the G-E field commercial engineering staff—from central, western, and eastern regions—how facilities in the new plant are being systematically brought up to full production. ▼



Progress Is Our Most Important Product

GENERAL  **ELECTRIC**

162-1A1

Relay Sales

Telephone Relays

Midget Relays

Keying Relays

Rotary Relays

Sealed Relays

Sensitive Relays

Latching Relays

Stepping Relays

Delay Relays

Timers

Contactors

Motor Starting Relays

Differential Relays

Polarized Relays

AN Approved Relays

Write for Catalog
1957-C8

Relay Sales

why wait for RELAYS

**LEADING MAKES-
LATEST TYPES
IN STOCK!**

AUTOMATIC ELECTRIC
Type BQA and Many
Others in Stock

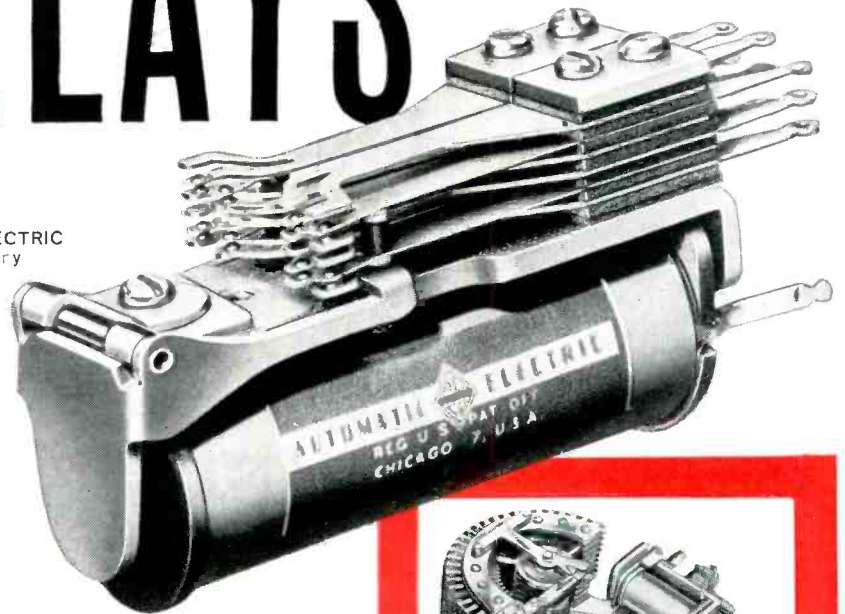

We maintain complete distributor stocks of the following makes:

Advance Relays	Phillips Controls
Automatic Electric	Struthers-Dunn
Clare	Leach Relays
Neomite-Elgin	Terado and Others

We Anticipate Your Relay Needs

Relay Sales cannot get better delivery from manufacturers than you. Relays now in stock were ordered as long as 10 months ago and selected by men who have specialized in supplying relays to the industry for many years. The items illustrated are typical of hundreds of thousands in stock. They are available in all popular coil ratings and contact arrangements. Why wait for relays? Call us today!

Write or Phone for Same Day Shipment

Phone: West Chicago 1100

RELAY SALES, INC.

P.O. Box 186-A

West Chicago, Ill.

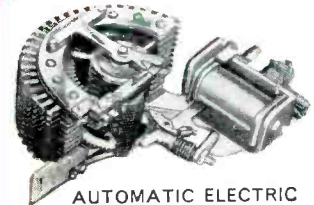

AUTOMATIC ELECTRIC
Type 45 Stepper
Wide Selection

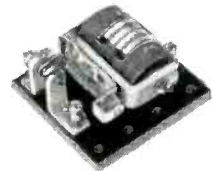

STRUTHERS DUNN
Keying Relay
Many Types in Stock

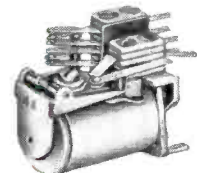

PHILLIPS CONTROL
9QA Midget for Sub Chassis
Mounting. Many Others
in Stock



(Actual Size)
NEOMITE-ELGIN
Sub Miniature Hermetically Sealed
Relay. All Advance Types in Stock

The Greatest Names in British Electronics use

Mullard Tubes

R.G.D. (RADIO GRA
O. LTD.) REGENTONE
MICHAEL ENGLISH ELEC
YOY FERGUSON H. J. LEAK
ERTS VORTEXION TRIX EL
RAMPIAN RAYMOND BURN
EVELOPMENT E.A.R. SPECTO
AMPHONIC R.G.D. (RADIO GRA
) REGENTONE PYE BERECK ECK
ENGLISH ELECTRIC ALBA BAIR
USON H. J. LEAK INVICTA DECCA
RTS BEAM-ECHO TRIX ELECTRICAL
AMPIAN RAYMOND BURND EPT BE
EVELOPMENT E.A.R. SPECTO LOWTHE
GLISH ELECTRIC ALBA RADIO GRA
EVELOPMENT CO. LTD.) REGENTONE
FERRANTI McMICHAEL ENGLISH ELEC
BAIRD TANNOY FERGUSON H. J. LEAK
VORTEXION TRIX ELECTRICAL PARME
AN RAYMOND BURND EPT BEAM-ECH
MENT E.A.R. SPECTO PARMEKO BUSH
(RADIO GRAMOPHONE DEVELOPMENT
NE DECCA OF ENGLAND REGENTONE
FERRANTI McMICHAEL ENGLISH ELEC
BAIRD TANNOY FERGUSON H. J. LEAK
VIDOR ROBERTS VORTEXION TRIX EL
RMEKO GRAMPAN RAYMOND BURN
GERS DEVELOPMENT ECKD SPECTO
MPHONIC R.G.D. (RADIO GRAMOPH
LTD.) ROGERS DEVELOPMENT EC
EL ENGLISH ELECTRIC ALBA BA
USON H. J. LEAK INVICTA DECC
TS VORTEXION TRIX ELECTRI
PIAN RAYMOND BURND EPT
MENT E.A.R. SPECTO LOWTHER
LECTRIC ALBA REGENTON
McMICHAEL ENGLISH ELE
YOY FERGUSON H. J. LEAK
TRIX ELECTRICAL PARME
URND EPT BEAM-ECH
O. LOWTHER BUSH

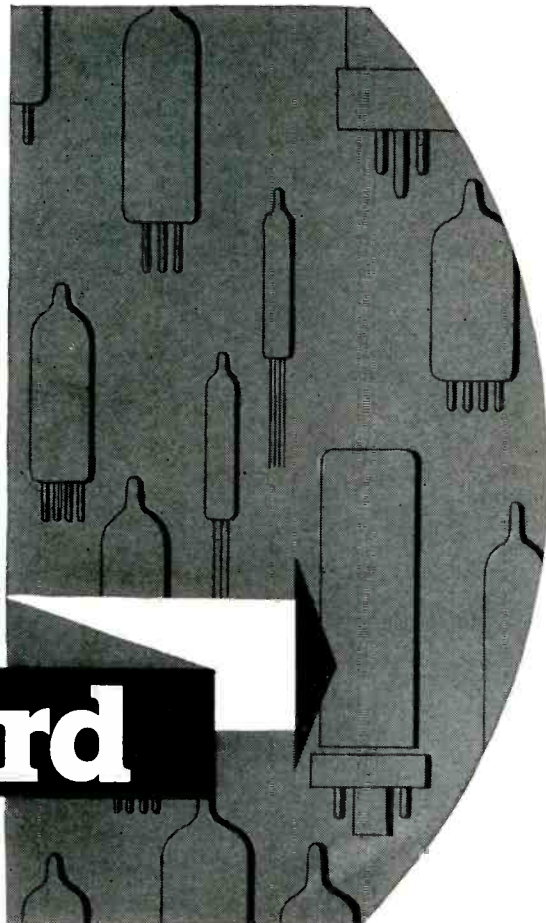

British equipment manufacturers are making a vital contribution to the development of electronics in all fields of application.

Their products are being exported to every corner of the world, earning a universal reputation for advanced techniques and excellent performance.

The majority of these electronic equipment manufacturers consistently use Mullard tubes. This choice is decided upon because they prefer the greater assurance of efficiency and dependability, and because the vast manufacturing resources of the Mullard organisation guarantee ready availability of Mullard tubes wherever they are needed.

Supplies of Mullard tubes for replacement in British equipments are available from the companies mentioned below:—

In the U.S.A.

International Electronics Corporation,
Department E2,
81, Spring Street, N.Y. 12,
New York, U.S.A.

In Canada

Rogers Majestic Electronics Limited,
Department 1B,
11-9 Brentcliffe Road,
Toronto 17, Ontario, Canada

Mullard

Electronic Tubes — used throughout the world

MULLARD OVERSEAS LTD., MULLARD HOUSE, TORRINGTON PLACE, LONDON, ENGLAND

Mullard is the Trade Mark of

Mullard Ltd. and is registered in most of the principal countries of the world



MEV 45



*Make the
right move...*

check the many advantages of

ALSiMAG[®] Alumina Ceramics

Industry-approved ALSiMag Aluminas are doing an outstanding job in more and more exacting applications calling for **superior electrical characteristics** at high temperatures and frequencies . . . **rugged** resistance to mechanical shock and vibration . . . **chemical inertness** . . . **resistance to repeated hot-cold shock**. ALSiMag Alumina ceramics are **hard**, measuring 9 on Mohs' scale . . . **strong**, offering extremely high compressive, flexural and tensile strengths. **Precision tolerances** can be maintained. Can be supplied in any quantity.

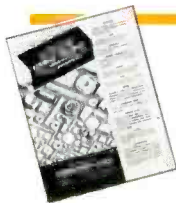

Write for free copy of Bulletin No. 562 which gives complete details on the most popular of the wide range of special-characteristic ALSiMag Aluminas available.

AMERICAN LAVA

A Subsidiary of
Minnesota Mining and
Manufacturing Company



CORPORATION
CHATTANOOGA 5, TENN.
55TH YEAR OF CERAMIC LEADERSHIP

For service, contact Minnesota Mining & Manufacturing Co. Offices in these cities (see your local telephone directory): Atlanta, Ga. • Boston, Newton Center, Mass. • Buffalo, N. Y. • Chicago, Ill. • Cincinnati, O. • Cleveland, O. • Dallas, Texas • Detroit, Mich. • High Point, N. C. • Los Angeles, Calif. • New York: Ridgefield, N. J. • Philadelphia, Pa. • Pittsburgh, Pa. • St. Louis, Mo. • St. Paul, Minn. • So. San Francisco, Calif. • Seattle, Wash. **Canada:** Minnesota Mining & Manufacturing of Canada, Ltd., P. O. Box 757, London, Ont. **All other export:** Minnesota Mining & Manufacturing Co., International Division, 99 Park Ave., New York, N. Y.

When you think of

SILVER

Think of Handy & Harman
Because . . .

- Handy & Harman is the leading manufacturer of silver and silver alloys for industry.
- During 90 years in precious metals, Handy & Harman has helped develop many of the uses of silver by industry.
- Experience and research have established Handy & Harman as the Number 1 authority on silver.

This experience and knowledge is at your call. Whatever your silver requirements, Handy & Harman is anxious to be of service.

Here are some of the forms Handy & Harman manufactures:

- Fine Silver (wire, strip and foil)
- Silver anodes and grain for plating
- Silver contact alloys
- Silver powders
- Silver flakes and paints
- Silver brazing alloys
- Silver electronic solders
- Silver sintered metals
- Solder-flushed silver alloys
- Silver chloride and oxide
- Coin Silver (wire and strip)
- Silver Bi-metals

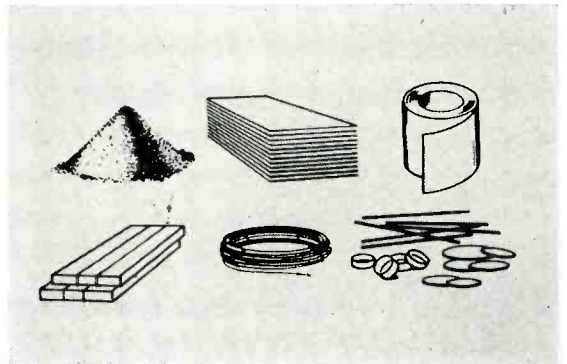

For your information file

We have four Technical Bulletins giving engineering data on the properties and forms of Handy & Harman Silver Alloys. We would like you to have any or all of those that particularly interest you. Your request, by number, will receive prompt attention.

- | | |
|--------------------------------------|--------------|
| Fine Silver | Bulletin A-1 |
| Silver-Copper Alloys | Bulletin A-2 |
| Silver-Magnesium-Nickel | Bulletin A-3 |
| Silver Conductive Coatings | Bulletin A-4 |

Your NO. **1** Source of Supply and Authority on Silver Alloys



HANDY & HARMAN

General Offices: 82 Fulton St., New York 38, N. Y.

OFFICES and PLANTS • BRIDGEPORT, CONN.
PROVIDENCE, R. I. • CHICAGO, ILL. • CLEVELAND,
OHIO • DETROIT, MICH. • LOS ANGELES, CALIF.
TORONTO, CANADA • MONTREAL, CANADA



TUNG-SOL®

12AL8

TRIODE / SPACE CHARGE TETRODE

*another successful application
of the space charge grid principle of tube design
for hybrid auto radios*



see other side for additional information



TUNG-SOL



12AL8

TRIODE SPACE CHARGE TETRODE

The widespread use of hybrid car radios today is proof of Tung-Sol's long-held conviction that tubes could be made to operate directly off a 12-volt power supply—an accomplishment made possible by the advent of the transistor. Vacuum tubes can now be designed to perform at the same low voltages for which transistors are most suitable.

The 12AL8 is a further utilization of the space charge grid principle . . . and Tung-Sol's engineering of this tube has

resulted in circuit simplification and reduction of costs.

The 12AL8 is an electrically smaller version of the 12K5, plus an independent triode. It is designed to drive the relay that controls the motors of signal-seeking mechanisms. This combination tube can also provide the additional versatility needed in automotive receivers, such as in the audio amplifier portions of the circuitry.

MECHANICAL DATA

Coated unipotential cathode			
Outline drawing	RETMA 6-3	Bulb	T-6 1/2
Base	RETMA E9-1	Miniature button	9 pin
Maximum diameter			7/8"
Maximum overall length			2 3/4"
Maximum seated height			2 3/4"
Base pin connections:		RETMA	9GS
Pin 1—triode plate		Pin 6—tetrode plate	
Pin 2—tetrode grid #2		Pin 7—tetrode cathode	
Pin 3—tetrode grid #1		Pin 8—triode grid	
Pin 4—heater		Pin 9—triode cathode	
Pin 5—heater			
Mounting position			ANY

ELECTRICAL DATA

Heater Characteristics*

Heater voltage—nominal	12.6	VOLTS
Heater current—nominal	0.45	AMP.

Direct Interelectrode Capacitances

Triode input: (G to K+H)	1.5	μμf
Triode output: (P to K+H)	.3	μμf
Triode grid to plate	12	μμf
Tetrode input: (G ₂ to G ₁ +K+H)	8.0	μμf
Tetrode output: (P to G ₁ +K+H)	1.1	μμf
Tetrode grid to plate	.7	μμf
Coupling: (tetrode grid #2 to triode grid #1)	.013	μμf

*This tube is intended to be used in automotive service from a nominal 12-volt battery source. The heater is therefore designed to operate over the 10.0 to 15.9 voltage range encountered in this service. The maximum ratings of the tube provide for an adequate safety factor such that the tube will withstand the wide variation in supply voltages.

ELECTRICAL DATA

Ratings—Interpreted According to Design Center System

Maximum tetrode plate voltage	30	VOLTS
Absolute maximum positive tetrode grid #1 voltage	16	VOLTS
Maximum negative tetrode grid #2 voltage	20	VOLTS
Maximum tetrode grid #2 circuit resistance	10	MEGOHMS
Maximum triode plate voltage	30	VOLTS
Maximum triode cathode current	20	MA.
Maximum triode grid circuit resistance	10	MEGOHMS
Maximum heater—cathode voltage	±30	VOLTS

Operating Conditions and Characteristics

Class A ₁ Amplifier—single tube	Triode	Tetrode	
Heater voltage	12.6		VOLTS
Plate voltage	12.6	12.6	VOLTS
Grid #1 (space-charge grid) voltage	—	12.6	VOLTS
Control grid voltage	—0.9A	—0.8A,B	VOLTS
Plate current	0.25	25	MA.
Grid #1 (space-charge grid) current	—	50	MA.
Plate resistance	27000	1000	OHMS
Amplification factor	15	8.0	
Transconductance	550	8000 ^C	μMHOS

Resistance-coupled amplifier—single tube

Plate (space-charge grid & heater) supply voltage	12.6	VOLTS
AF signal voltage	.13	VOLTS
Plate current (tetrode)	13	MA.
Grid #1 (space-charge grid) current	50	MA.
Load resistance (tetrode)	800	OHMS
Total harmonic distortion (max.)	10	PERCENT
Power output	20	MW.

A—Average bias developed across a 2.2 megohm grid resistor.

B—Grid #2. C—From grid #2 to plate.



TUNG-SOL

ELECTRON TUBES AND SEMICONDUCTORS

Information about the 12AL8 and other special purpose tubes is available upon request to Tung-Sol Commercial Engineering Division.

TUNG-SOL ELECTRIC INC., Newark 4, N. J.

Sales Offices: Atlanta, Ga.; Columbus, Ohio; Culver City, Calif.; Dallas, Tex.; Denver, Colo.; Detroit, Mich.; Irvington, N. J.; Melrose Park, Ill.; Newark, N. J.; Seattle, Wash.



FEBRUARY, 1957



MINIATURE LAMPS



SEALED BEAM HEADLAMPS



SIGNAL FLASHERS



RADIO AND TV TUBES



ALUMINIZED PICTURE TUBES



SPECIAL PURPOSE TUBES



SEMICONDUCTOR PRODUCTS

NO TUBES
to replace . . .

NO TRANSISTORS

NO MOVING PARTS
to wear out

STABILINES type TM (Tubeless Magnetic) are the newest automatic voltage regulators offered by The Superior Electric Company. Without tubes, moving parts or transistors, the TM's provide constant voltage regardless of line or load changes. Where failure at any time under the most adverse operating conditions cannot be tolerated or where maintenance is not a possibility for long periods of time, a STABILINE type TM is a necessity.

STABILINE* TYPE TM

(Tubeless Magnetic)

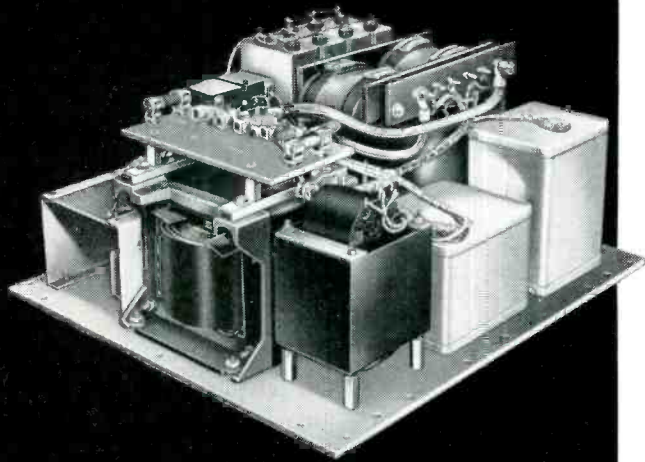

TYPE TM7105 (without cabinet)

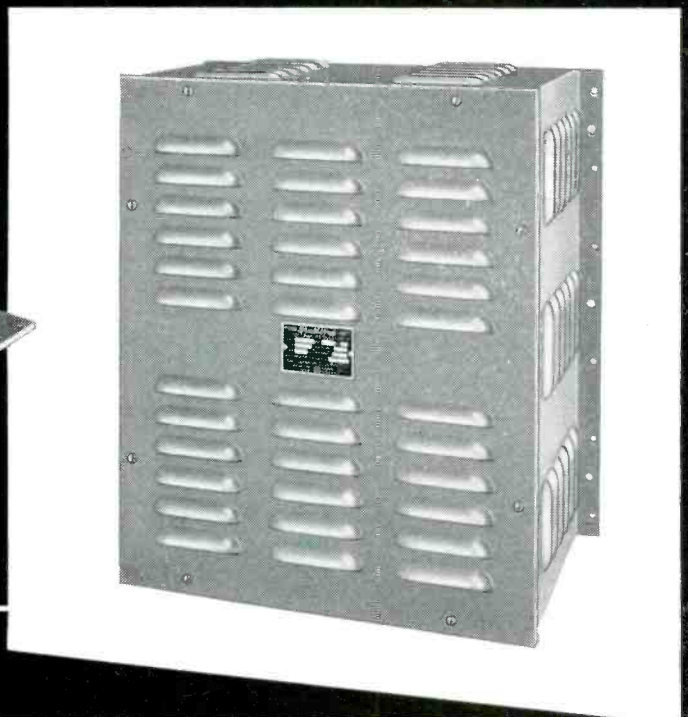

TYPE TM7105 (with cabinet as mounted on wall)

FOR UNATTENDED LOCATIONS

- Microwave relay stations
- Remote installations

FOR CRITICAL APPLICATIONS

- Where sudden need for tube replacement can be costly (at a critical time in a process) or impossible (at an unattended location)
- Where conditions cannot tolerate moving parts.

Be sure to see SUPERIOR ELECTRIC'S
Mobile Display when it is in your area.

Branch Offices: Los Angeles, California • San Francisco, California • Toronto, Ontario, Canada • Miami, Florida • Chicago, Illinois • Baltimore, Maryland • Detroit, Michigan • New York, New York • Cleveland, Ohio • Dallas, Texas • Seattle, Washington

*Trademark Reg. U. S. Pat. Off.

STABILINE TYPE TM CHARACTERISTICS

INPUT: 95-135 volts, single phase on nominal 115 volt types

195-255 volts, single phase on nominal 230 volt types

OUTPUT: Adjustable 110-120 volts on nominal 115 volt types
Adjustable 220-240 volts on nominal 230 volt types

ACCURACY: 1 volt band for line voltage variations and/or load magnitude and power factor changes

FREQUENCY: 60 cycles \pm 5%

WAVEFORM DISTORTION: 4% maximum

RESPONSE TIME: Less than 1/2 second for ordinary line and/or load changes. For extreme conditions of line and load changes, maximum response time is 2.0 seconds. (Response time is measured from the time of initiation of transient to the time when output voltage is within and remains within rated limits)

LOAD: Available in 1.0, 3.0 and 5.0 KVA ratings

POWER FACTOR: 0.5 lagging to 1.0



THE SUPERIOR ELECTRIC COMPANY
202 MIDDLE STREET, BRISTOL, CONNECTICUT

Please send STABILINE Bulletin S157
Have your representative call

Name

Company

Address

City Zone State



**THE MARCONI
S.H.F.
WAVEMETER
Type TF 1059**

**ACCURACY 5 PARTS IN 10⁴...
and rugged!**

The Marconi TF 1059 is a 4-10 KMC cavity wavemeter in which ruggedness and dependability take equal place with high accuracy. The resonating system with its precision-built micrometer tuning is guarded from knocks and dust by total enclosure in a conventional instrument case. Micrometer adjustment is by means of a panel knob and friction drive; micrometer setting is viewed through a port incorporating a magnifying lens. The meter, which responds to inputs as low as 1 mw, is protected against overload by a cut-out relay. A coaxial input connector, a sensitivity control, and terminals for coupling to an extra-sensitive external meter, are further features contributing to the all-round utility of the Marconi TF 1059.



SPECIFICATION

FREQUENCY RANGE
4 to 10 KMC

ACCURACY
0.05%

DISCRIMINATION
0.02 to 0.03%

SENSITIVITY
A meter reading of greater than 15% f.s.d. is obtained for 1 mw input.

**MARCONI
INSTRUMENTS**

Marconi-since 1897

44 NEW STREET · NEW YORK 4

CANADIAN MARCONI COMPANY
6035, COTE DE LIESSE,
MONTREAL 9, CANADA

HEAD OFFICE: MARCONI INSTRUMENTS LTD., ST. ALBANS, HERTS., ENGLAND

TC 87

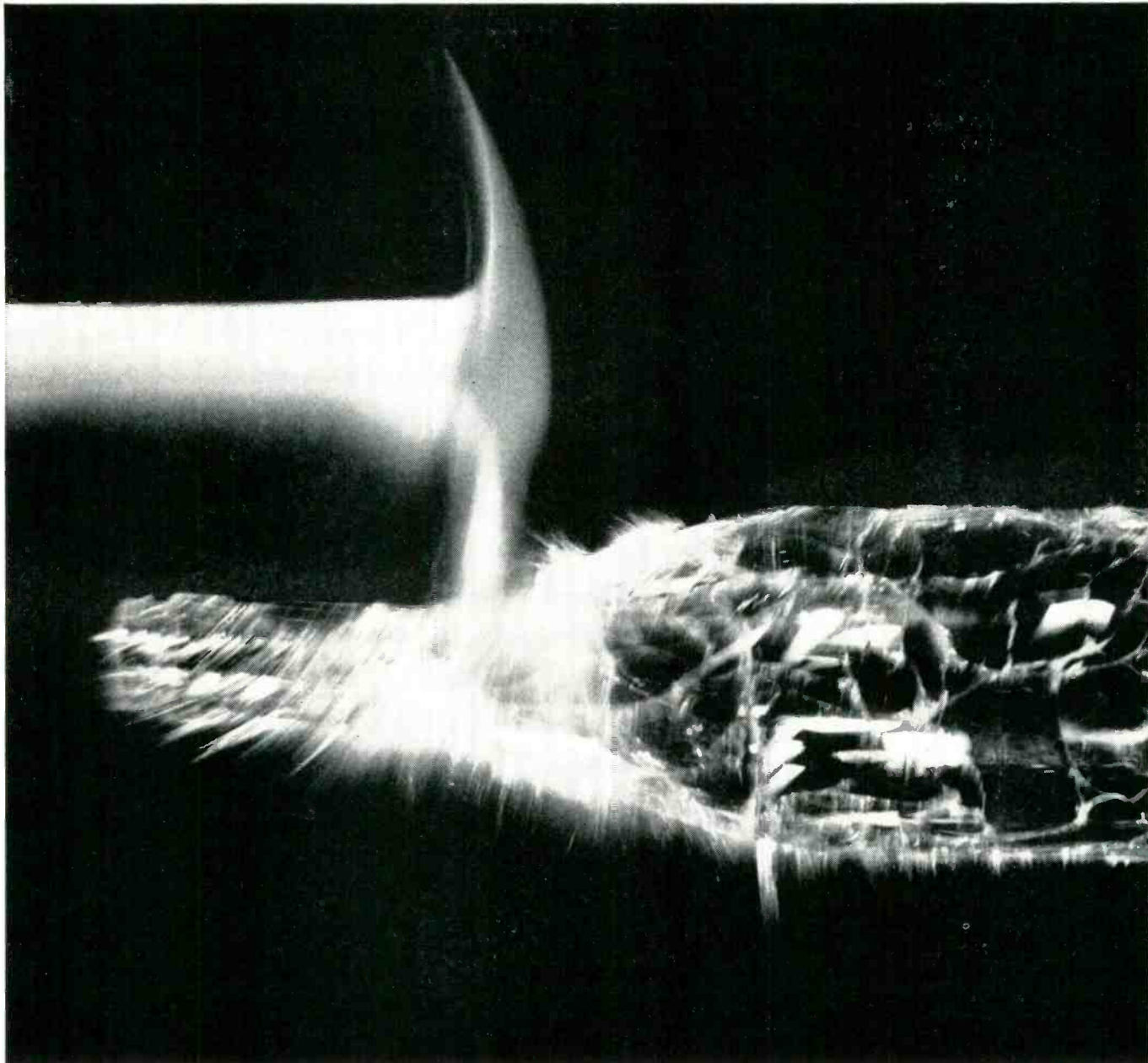

IMPACT

It takes the impact of specialized engineering to break bottle-necks that block the practical application of automatic control, data handling and other system problems in both the civilian and military fields.

DAYSTROM SYSTEMS DIVISION takes full responsibility for the conception, design, assembly, testing and installation of complete systems, including the training of user personnel.

DAYSTROM SYSTEMS engineers are qualified to integrate and apply to systems problems, equipment from the electronic, electrical, optical, hydraulic, pneumatic, mechanical and other fields. Whenever DAYSTROM or other existing equipment does not meet optimum system specifications, the DIVISION will design and manufacture special components. Full advantage will be taken of

the extensive experience of the entire DAYSTROM organization with servo-mechanisms, controllers, aircraft systems, computer and memory devices, gyroscopes, telemetering equipment and digital systems.

A DAYSTROM designed system is the key to more efficient, more profitable operations. For further information, call or write for our **FACILITIES REPORT**. See us at the I·R·E Show in New York, March 18-21, Booth 2907-15.



DIVISION OF DAYSTROM, INC.
5640 LA JOLLA BOULEVARD
LA JOLLA, CALIFORNIA
GLENCOURT 4-0421

VARO

400 cps

PRECISION FREQUENCY

STANDARDS

METERS

CONTROLS

POWER SUPPLIES

For

GUIDANCE AND FIRE CONTROL SYSTEMS GROUND POWER AND LABORATORY SYSTEMS

VARO 400 cps SPEED CONTROLS provide the power, reference standards and measurement means to insure accurate performance of systems functions. Write for complete details or assistance on any of your design problems.

VARO ELECTRONIC PRECISION EQUIPMENT

Precision frequency rotary, electronic and transistor inverters. Speed controls for alternators — motor, turbine, or engine driven.

TUNING FORKS

FREQUENCY METERS

FREQUENCY GENERATORS

FREQUENCY SENSITIVE RELAYS

REGULATED D. C. POWER SUPPLIES

FIXED STATION AND MOBILE VHF TRANSMITTERS AND RECEIVERS

REGULATED OUTPUT AMPLIFIERS

REMOTE TONE CONTROLS

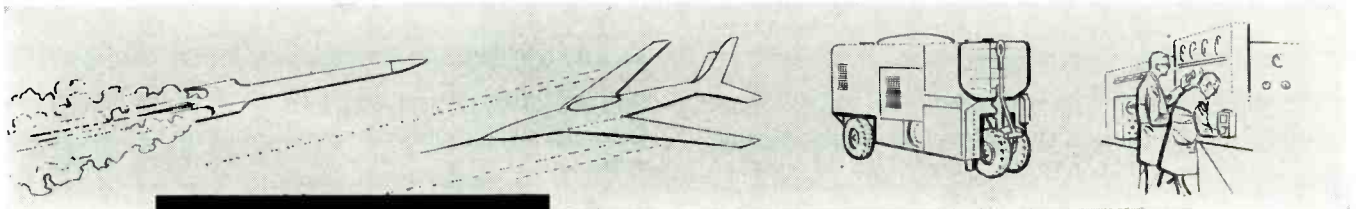

VARO

Mfg. Co., Inc.

2201 WALNUT STREET, GARLAND, TEXAS

FACTORY REPRESENTATIVES

J. B. Steed
P. O. Box 459
Utica, New York
Phone 4-2061

Ray Gilmer
638 South Van Ness
Los Angeles, California
Phone REpublic 4-0154

R. H. Bouchard
941 North Highland
Arlington, Virginia
Phone JAckson 5-2283

Phil McDaniel
P. O. Box 553
Far Hills Branch
Dayton, Ohio
Phone OXmore 4364

EXPORT

Steven P. Nagel, 1626 "Eye" St., N. W., Washington, D. C., Phone METropolitan 8-3543

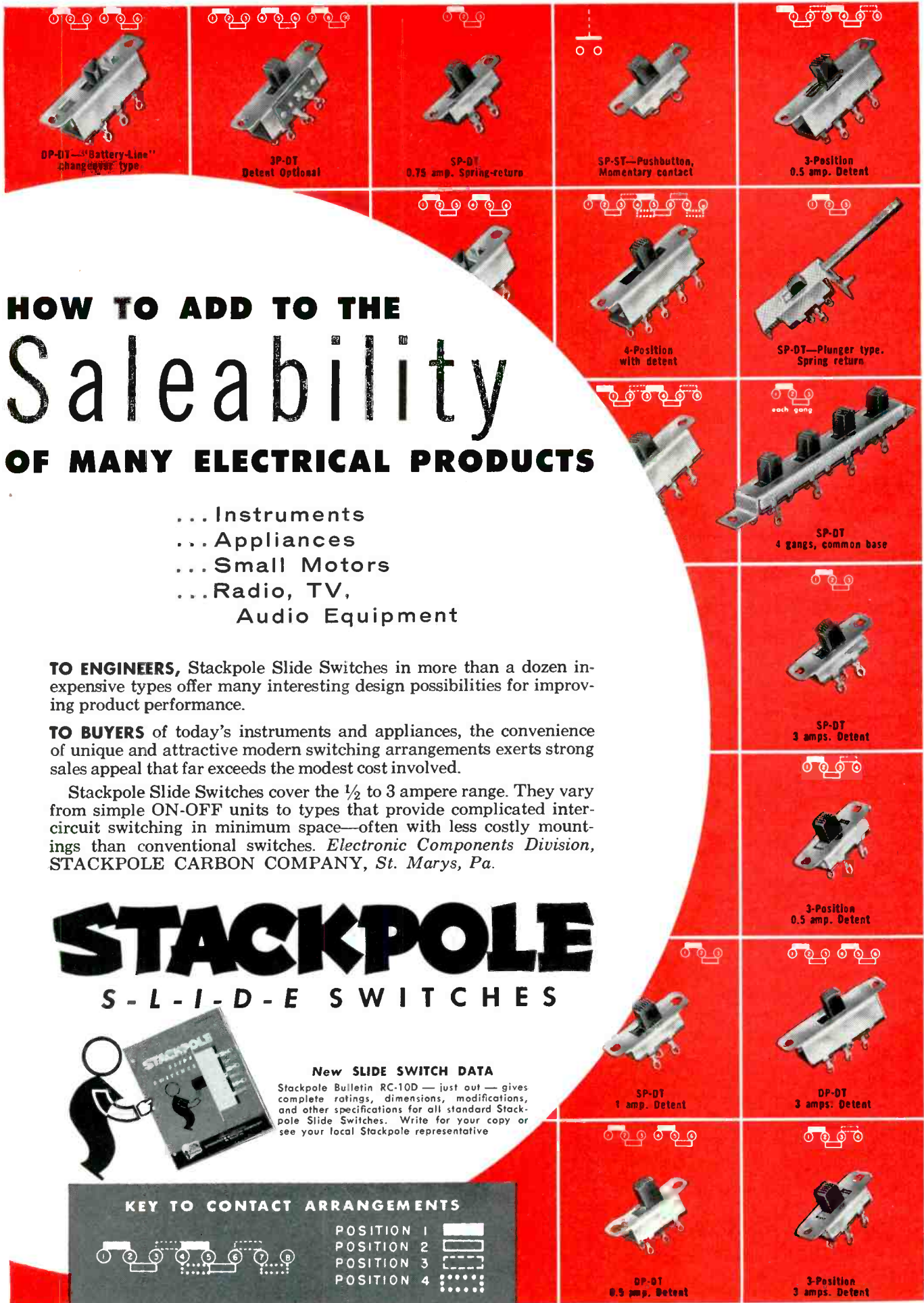

HOW TO ADD TO THE Saleability OF MANY ELECTRICAL PRODUCTS

- ... Instruments
- ... Appliances
- ... Small Motors
- ... Radio, TV,
Audio Equipment

TO ENGINEERS, Stackpole Slide Switches in more than a dozen inexpensive types offer many interesting design possibilities for improving product performance.

TO BUYERS of today's instruments and appliances, the convenience of unique and attractive modern switching arrangements exerts strong sales appeal that far exceeds the modest cost involved.

Stackpole Slide Switches cover the 1/2 to 3 ampere range. They vary from simple ON-OFF units to types that provide complicated inter-circuit switching in minimum space—often with less costly mountings than conventional switches. *Electronic Components Division, STACKPOLE CARBON COMPANY, St. Marys, Pa.*

STACKPOLE S-L-I-D-E SWITCHES

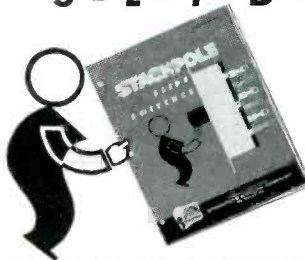

New SLIDE SWITCH DATA

Stackpole Bulletin RC-10D — just out — gives complete ratings, dimensions, modifications, and other specifications for all standard Stackpole Slide Switches. Write for your copy or see your local Stackpole representative

KEY TO CONTACT ARRANGEMENTS



- POSITION 1
- POSITION 2
- POSITION 3
- POSITION 4

AEROCOM'S 1046 H. F. TRANSMITTER



POWER + STABILITY

1000 WATTS

WITH

.003% STABILITY

Rugged, versatile general purpose H. F. transmitter—Aerocom's 1046 packs 1000 watts of power and high .003% stability under normal operating conditions (0° to +50°C.). Excellent for point-to-point or ground-to-air communications.

Multi-channel operation on telegraph A1, or telephone A3 with GM-8A modulator... new Aerocom 1046 can be *remotely controlled* with TMC-R at control position and uses only one pair of telephone lines. In A3 operation, the local dial control panel is located in modulator cabinet.

Transmitter cabinet has 8 $\frac{3}{4}$ inch panel space available for either local dial control panel or frequency shift keyer.

Model 1046 operates on 4 crystal-controlled frequencies (plus 2 closely spaced frequencies) in the band 2.0—24 Mcs. Operates on one frequency at a time; channeling time 2 seconds. Operates into either balanced or unbalanced loads. Operates in ambient -35° to +50° C. Power supply: nominal 220 volts, 50-60 cycles, single phase.

Complete technical data on request

Now! Complete - package, lightweight airborne communications equipment by Aer-O-Com! Write us today for details!

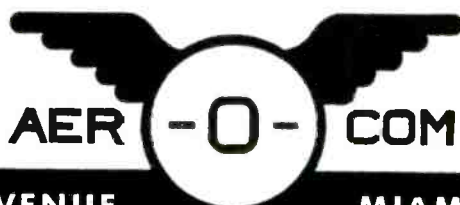
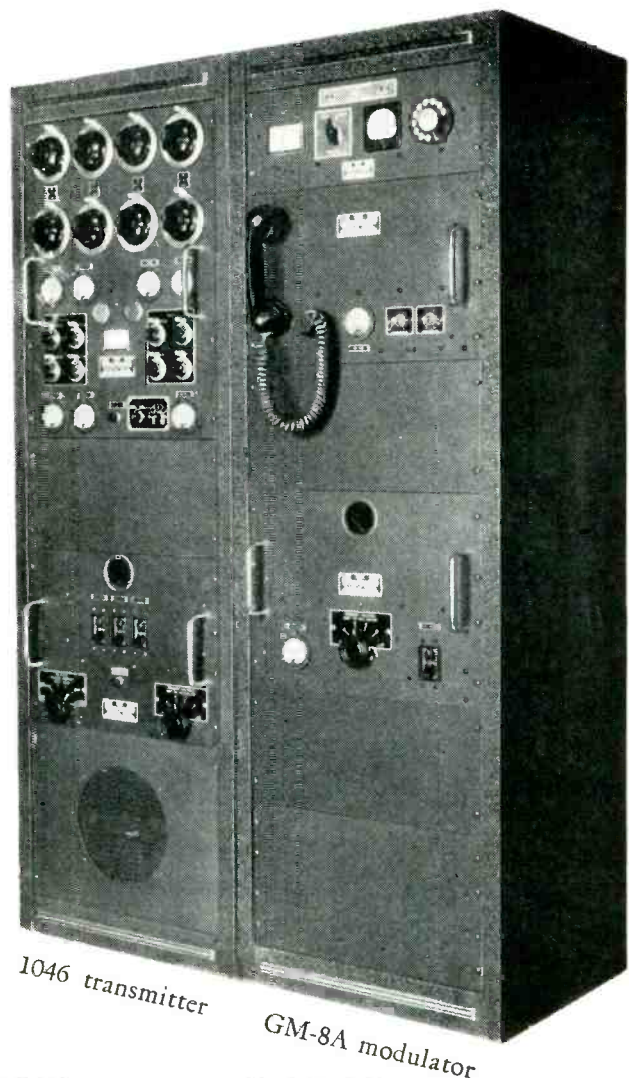

3090 S.W. 37th AVENUE

MIAMI 33, FLORIDA

A DEPENDABLE SUPPLIER FOR 61 YEARS

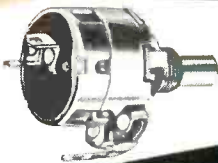
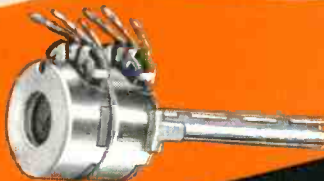
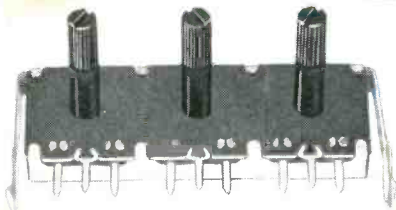
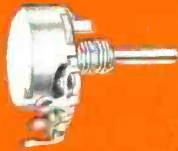

A CTS control can be tailored to your specific requirement. Consult CTS SPECIALISTS on your current variable resistor problems. Ask for 62 page catalog.

Variable resistors shown 2/3 actual size

WEST COAST MANUFACTURERS:

Many types of variable resistors now in production at our South Pasadena plant. Your coil, transformer and compression molding business also invited. Prompt delivery. Modern versatile equipment. L. A. phone Clinton 5-7186.

Specialized Technical Skills—
1500 job-trained, class-trained specialists . . . with a world-wide reputation for delivering variable resistors exactly as specified.

Tremendous Production Facilities—
323,000 sq. ft. plant devoted to variable resistors.

Your changing Requirements Anticipated—continuous research develops new materials, designs and methods to meet your new requirements.

Economical Uniform Assembly—on a precision mass production basis.

Dependable Delivery—exceptionally good delivery cycle.

Complete Line—variable resistors for military, color and black and white TV, radio, and other commercial applications.

BURTON BROWNE ADVERTISING

WEST COAST SUBSIDIARY
Chicago Telephone of California, Inc.
105 Pasadena Avenue
South Pasadena, California
L. A. Phone: Clinton 5-7186
TWX LA 1105

EAST COAST OFFICE
130 N. Broadway
Camden 2, New Jersey
Phone: Woodlawn 6-1668
TWX Mo. Camden NJ 380
Phila. Phone: Market 7-3129

SOUTH AMERICA
Jose Luis Pontet
Buenos Aires, Argentina
Montevideo, Uruguay
Rio de Janeiro, Brazil
Sao Paulo, Brazil

CANADIAN SUBSIDIARY
C. C. Meredith & Co., Ltd.
Streetsville, Ontario
Phone: 310

SOUTHWESTERN U.S.A.
John A. Green Company
137 Parkhouse
Dallas 7, Texas
Phone: Riverside 3266

OTHER EXPORT
Sylvan Ginsbury
8 West 40th Street
New York 18, New York
Phone: Pennsylvania 6-8239

FOUNDED



1896

CHICAGO TELEPHONE SUPPLY
Corporation

ELKHART, INDIANA

The Exclusive Specialists in Precision Mass Production of Variable Resistors

Volts— Microfarads and Miniaturization

.....for Transistor Circuitry



The daily progress of transistor usage is calling for smaller, yet better components. Mallory is proud of their continuous contribution to miniaturization—smaller components without sacrifice of reliability.

In the power supply field, Mallory is a pioneer in the development and production of mercury cells. Their techniques have made possible mass production at highest quality levels. The constant voltage discharge characteristic is ideally suited for transistor operation.

Mallory subminiature Silverlytic[®] capacitors offer high capacity in a minimum space. Types TAP and TAW are available in a broad range of capacities at several voltage ratings. The newest, a tantalum capacitor designated as type TNT, is only .145 inch in diameter by $\frac{3}{8}$ inch long. It is available in five basic sizes ranging from 80 mfd at 3 volts to 8 mfd at 50 volts.

Mallory will be glad to consult with you on specific problems of miniaturization and transistor application components, or supply full technical data on battery, capacitor and other Mallory products. Write us, or contact the Mallory representative—today.

Serving Industry with These Products:

Electromechanical — Resistors • Switches • Tuning Devices • Vibrators
Electrochemical — Capacitors • Mercury and Zinc-Carbon Batteries
Metallurgical — Contacts • Special Metals • Welding Materials

Expect more . . . get more from



Parts distributors in all major cities stock Mallory standard components for your convenience.

CROSS TALK

► **CONSOLIDATION . . .** Technical progress has a habit of occurring in spurts. In between spurts there are lulls, or what appear to be lulls. Actually, these are often periods in which progress is being made on seemingly little things, too little to make the headlines in themselves. But these little things, in combination, are often the stuff of which important commercial developments are eventually made.

We seem to be momentarily in such a period. Many interesting technical developments are being reported to us but few of them appear to warrant page-one handling. Similarly, there is much commercial news but little of it is sufficiently different from the news of the past six months to have long-range significance. Rather, the industry appears to be gathering ideas and strength for the next big push, whatever and whenever this may be.

The key to 1957 may be consolidation of past gains.

► **MACHINE OF PARTS . . .** Designers of electronic equipment frequently use computers to predict the performance of new circuits. Usually, the values of the component parts to be initially used in the circuit are more or less arbitrarily chosen on the basis of past experience. If circuit performance is not what is desired new compo-

nent values are substituted and the computer tries again.

Now comes a computer that eliminates still more cut-and-try. The design engineer feeds in information about the proposed circuit itself. He also feeds in the conditions to be satisfied by the circuit. The machine then tries various values of component parts in critical positions and delivers a complete answer so that the first prototype does the required job.

What comes next? Maybe a computer that designed itself.

► **BULLS . . .** Bearish attitude exhibited by many potential manufacturers of color-television receivers is not shared by technical personnel of non-color television stations.

Station engineers are itching for color, wait impatiently for their front offices to give the go ahead, wish the public would stir up the situation.

► **GRASSROOTS . . .** No shift in educational emphasis can do more than help reduce the shortage of engineers in the immediate future but more and more people are agreeing that the key to tomorrow is the phrase "Catch 'em young."

One way to interest promising youngsters in electronic engineering as a career is to invite grade-school and high-school pupils to tour plants, and particularly re-

search laboratories. Teachers are a good point of contact.

If the electronics industry had started on this tack when the shortage first became apparent during the war, instead of scrambling each year since then for college graduates, the situation would be easier.

► **D.O.A. . . .** We haven't harped on the need for more careful assembly, inspection and packaging of electronic equipment for over a year but a recent experience causes us to pluck this string once again.

One unit of a pair of transceivers carried home for a tryout through the New York rush-hour proved to be dead on arrival. Inspection of the jangling innards disclosed that a vibrator had jumped its socket.

The particular point of this story is the fact that the equipment was designed for use in the Citizens' Radio band. The user is not supposed to open the little black box for any reason whatsoever.

► **HEADACHE, UNDERWATER . . .** One particular type of acoustical torpedo homes on the noise made by exploding air bubbles, and such bubbles are made by cavitation around a submarine's propellers.

Sub's countermeasure is to release a king-size Alka-Seltzer tablet, which makes bigger and better bubbles, luring the torpedo into an area where the sub ain't.



Typical studio setup uses conventional tv camera housing as flying spot source. Strobe units provide general lighting during blanking

Color TV System Uses

By **HAROLD MATE**

*Technical Products Division
Allen B. Du Mont Laboratories, Inc.
Clifton, New Jersey*

THERE has been a need in color-tv broadcasting for a high-quality live pickup device which is low cost and relatively simple to maintain and operate. To meet this need, the Vitascan system was developed. Although it can not replace the image-orthicon color camera, the system has features which can be used advantageously in commercial broadcasting.

System Operation

The system, shown in Fig. 1, is based on an extension of the flying-spot scanner principle.

The light from an unmodulated scanned raster is focused on the scene to be televised. The flying spot of light, which is reflected from the scene, is intercepted by eight pickup scoops, each of which contains four phototubes; two of the phototubes in each pickup scoop are connected to the red-processing amplifier, one phototube is connected to the green-processing amplifier and the fourth phototube is connected to the blue-processing amplifier. A filter of appropriate spectral transmission is placed in front of each phototube so the electrical output from the tube is a measure of the intensity and color of the reflected light from the scene.

In the processing amplifier, each signal is properly clipped, phosphor

corrected, gamma corrected and has the proper amount of pedestal added. The final output consists of three simultaneous color signals which can be applied to an encoder or simultaneous color monitor.

The system can be thought of as the reverse of a conventional studio camera setup. The phototube pickup scoops replace studio lighting fixtures and the cathode-ray-tube light source replaces the image-orthicon camera.

No light other than that created by the scanning beam can be allowed to fall on the phototubes during scanning time. Any extraneous light would produce noise in the picture. The studio must, therefore, be constructed so that it is light tight.

To provide light for studio per-

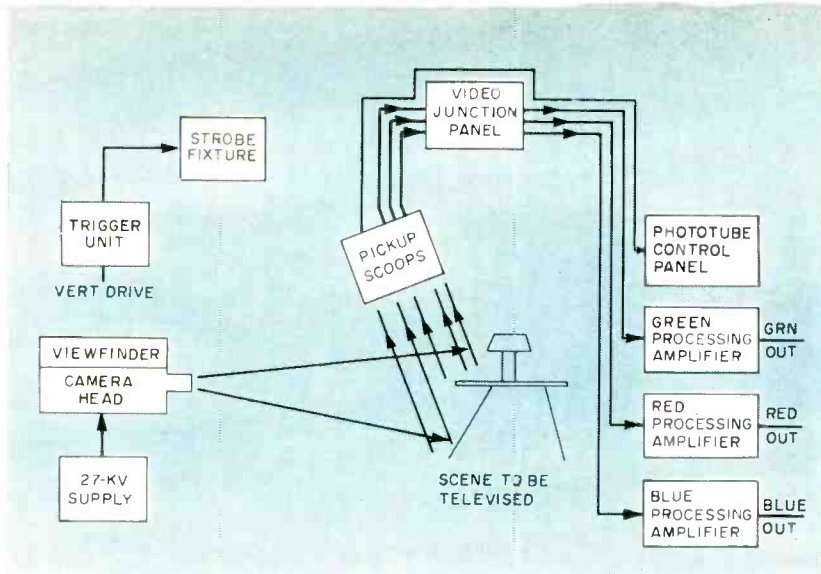

FIG. 1—Vitascan system for live color-tv pickup shown in block form

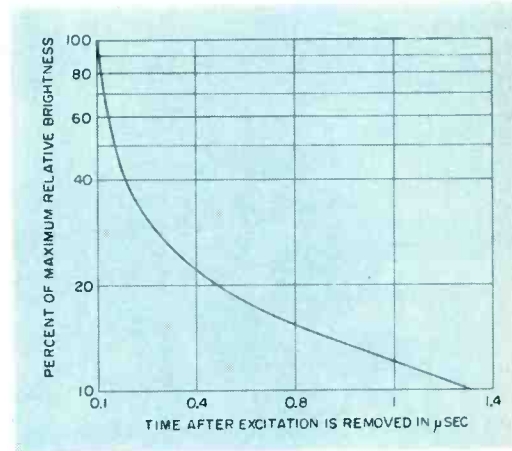

FIG. 2—Persistence characteristic of P24 phosphor

SUMMARY — Flying-spot scanner in camera head illuminates scene in darkened room. Reflected light is picked up by red, green and blue-sensitive phototube banks to form luminance and chroma signals. Strobe lights provide general studio illumination during blanking periods. System is applicable to live pickup for commercial broadcasting and for industrial applications

FLYING-SPOT SCAN

sonnel to see by, a bank of xenon lamps is ionized and deionized during vertical blanking time.

Camera Light Source

The mobile camera utilizes a 5AUP24 tube as the light source. The tube is mounted within the camera housing on a rack assembly that can be moved back and forth for best optical focus.

The tube is operated at 27-kv final anode potential, is electrostatically focused and draws approximately 300- μ a cathode current. About 30 percent of the cathode current is utilized by the focusing electrode and the remainder is the final anode current.

The P24 phosphor is specifically used for flying-spot scanner tubes because of its short decay charac-

teristic, which is shown in Fig. 2. The gun structure and small grain size of the phosphor in the 5AUP24 permit the scanning raster to be reduced in size and still maintain adequate picture resolution.

The reduced raster size allows shorter focal length lenses to be used for the same viewing angle. Table I shows the depth of field of these lenses. The short focal lengths considerably increase the depth of field of the system.

The standard complement of lenses for the camera is 101 mm, 150 mm and 210 mm, which corresponds to the 50 to 150-mm complement for an image-orthicon camera.

The camera sweep circuits are conventional. Both horizontal and vertical sweep can be adjusted to

within 2-percent linearity over the entire raster.

Sweep Loss Protection

To protect the crt against loss of sweep, the protection circuit shown in Fig. 3 is provided. The vertical flyback pulse is applied to the plate of V_{14} and rectified, charging C_1 to 165 volts.

The negative pulse from the horizontal output transformer is applied to the cathode of V_{10} , which restores the tip of the horizontal pulse; the total of the charge on C_1 and the average horizontal pulse voltage appears across R_1 and R_2 . A portion of this voltage is then applied to the grids of V_2 so that the tube conducts as long as horizontal and vertical pulses from their respective output transform-

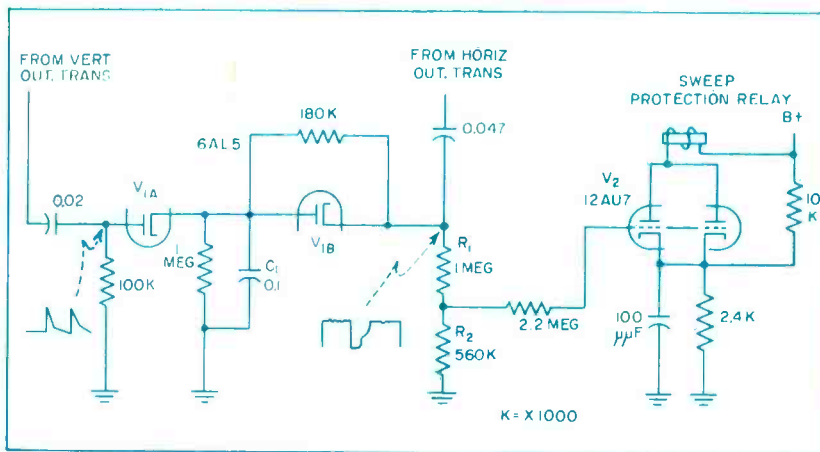
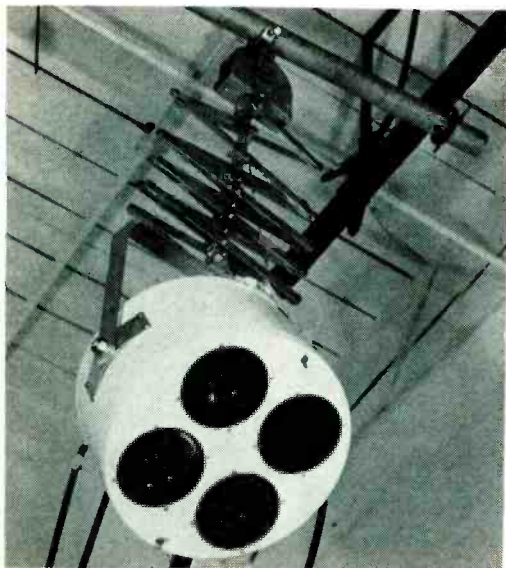

FIG. 3—Protection circuit prevents damage to crt in case of sweep loss

Phototube scoops are hung from studio ceiling with pantographs

ers are present. If one or both pulses fail, V_2 cuts off and deenergizes the relay which biases the crt to cutoff.

Focus voltage for the crt is obtained from a bleeder placed between the high-voltage input and ground, as shown in Fig. 4. Resistor R_1 adjusts the bias on the 6BD4A which varies the plate-to-ground impedance and determines the focus voltage.

High-Voltage Supply

High voltage for the crt is supplied by a Du Mont 5313-B high-voltage power supply. This unit supplies 27 kv at 600 μ a. The output of a blocking oscillator is coupled to a pair of 6CD6 tubes driving an autotransformer which supplies a 24-kv peak-to-peak pulse. The pulse is applied to a ladder-arranged high-voltage rectifier-quadrupler circuit in a lucite container. This container is filled with Dow Corning 200 Silicone fluid which eliminates corona and breakdown.

High-voltage regulation is accomplished by sampling a portion of the high voltage and feeding it through a d-c amplifier. The amplifier output determines the voltage on the screens of the 6CD6 drivers.

A standard image-orthicon viewfinder is placed on top of the camera head to permit framing and focusing. The video signal for the viewfinder is obtained from the monitor output of one of the video-processing amplifiers.

The photocells used to pick up the reflected light from the scene are K1416 red pickup cells and K1420 blue-green pickup cells. The cells are of the end-window type with 10-stage box-type dynode multipliers.

Average cathode sensitivity is 60 μ a per lumen, optimum photoelectron collection is accomplished by adjustment of the potential between the separate shield and the photocathode. The box-type dynode results in low leakage currents because of the long leakage paths in the tube.

To properly shape the red, green and blue channel sensitivities for color tv, color filters are placed in front of the phototubes. Figure 5 shows the spectral output of the crt and the spectral response of the color filters and the photocell. The normalized resultant R, B, G sensitivities are obtained by taking the product of the three spectral re-

sponses and multiplying by a factor which will make the area under all three curves equal.

Red Boosted

The most serious loss of signal is in the red channel because of poor red response in both the crt and the photocell. The red output is doubled by using two red phototubes for every green and blue tube. To obtain equal R, G, and B signals for equal-energy white balance, it is necessary to adjust the negative voltage applied to the cathodes of the photocells. A photocell voltage control panel is available for this purpose.

The video output of each pickup-scoop color channel terminates at a video junction panel located within the studio; from the junction panel the video is coupled to the proper processing amplifier.

Since the cable is not terminated at the junction panel, connecting cable from the pickup scoop must be kept short to minimize the capacitance at the junction point. For long video cables, a mixing amplifier would properly terminate the output of each photocell.

Processing Amplifiers

The video signals developed at the junction box are applied to the processing amplifiers (Fig. 6) through 185-ohm coaxial cable. To limit the high positive white peak on the grid of the second stage caused by the pulsed light source

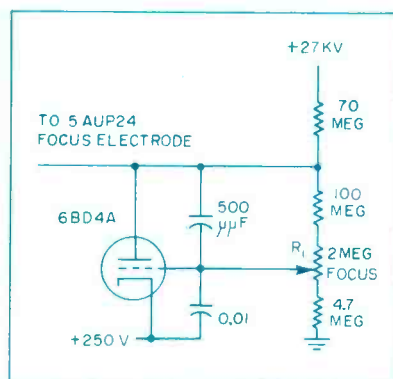

FIG. 4—Focus voltage-regulator circuit

required for illumination of the studio, a white clipper is added between the plate of V_1 and the grid of V_2 .

This clipper takes the form of a crystal diode so biased that conduction will not occur when the positive pulse exceeds a prescribed level. The clipper is set so the pulse is not positive enough to drive the second video stage into grid current and yet is not clipped so low that compression of the video signal occurs.

Because of the finite decay time of the P24 phosphor (Fig. 2), it is necessary to insert peaking into the video amplifiers to correct the transient response of the system.

It might be assumed that a different frequency compensation would be needed for the transition from black to white than for the change from white to black since the phosphor excitation is practically instantaneous while the phosphor decay is exponential. If the spot were to scan from black to white, the photocell pickup would at first see a maximum brightness; then, as the spot moved, it would still provide the maximum instantaneous brightness plus the decaying brightness.

The light input to the photocell is, therefore, proportional to the integral of the original light decay

Table I—Depth of Field of Vitascan Camera Lenses

Focal Length (mm)	Subject Distance (feet)	Depth of Focus (inches)	Scanned Area
101 <i>f</i> 2.8	5	10.7	23.4" x 37.8"
	10	42.8	53.5" x 78.5"
	20	171	9.93' x 13.3'
150 <i>f</i> 2.8	5	3.24	19.2" x 25.6"
	10	19.3	40.6" x 54.1"
	20	77	6.93' x 9.24'
210 <i>f</i> 3.5	5	3.0	13.1" x 16.5"
	10	12.0	23.4" x 37.8"
	20	49.0	4.9' x 6.5'

characteristic. Since the decay characteristic is an e^{-t} function, its integral is of the same form.

Assuming that the light output as a function of time rises instantaneously and decays according to the function $L(t) = Ae^{-at} + Be^{-bt}$, the black to white signal is

$$S = \int_0^t L(T) dT = \int_0^t (Ae^{-aT} + Be^{-bT}) dT$$

$$S = \frac{A}{a} + \frac{B}{b} - \left(\frac{A}{a}\right)e^{-at} - \left(\frac{B}{b}\right)e^{-bt}$$

At t infinity, $S = A/a + B/b$. Starting from this level of signal, when the spot goes behind a mask

$$S = A/a + B/b - \int_0^t L(t) dt = \left(\frac{A}{a}\right)e^{-at} + \left(\frac{B}{b}\right)e^{-bt}$$

The shape is typical of the square-wave response of a circuit in which high frequencies are deficient.

Peaking

Peaking is accomplished in the first four stages of the amplifier by placing R-C time constants in the cathodes of these stages. The time constants can be adjusted so they peak at low, medium and high frequencies.

After phosphor correction, the black positive waveform at the grid of V_6 is clamped to blanking level by V_{11} during each horizontal blanking period.

The circuit in the cathode of clamped amplifier V_6 allows the gamma characteristics of the video amplifier to be adjusted as desired. At peak white, minimum signal to the grid of V_6 , the three crystal diodes which shunt the cathode resistor are nonconducting and the stage gain is set by the 1,800-ohm resistor in the cathode. When the signal changes progressively from white to black, the three diodes

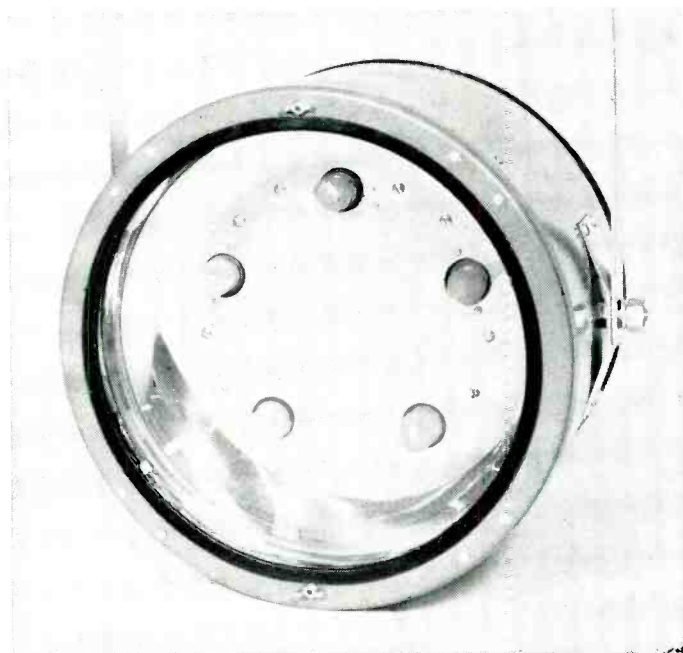

Strobe lighting fixture contains five xenon-gas lamps which are triggered by negative vertical drive pulses

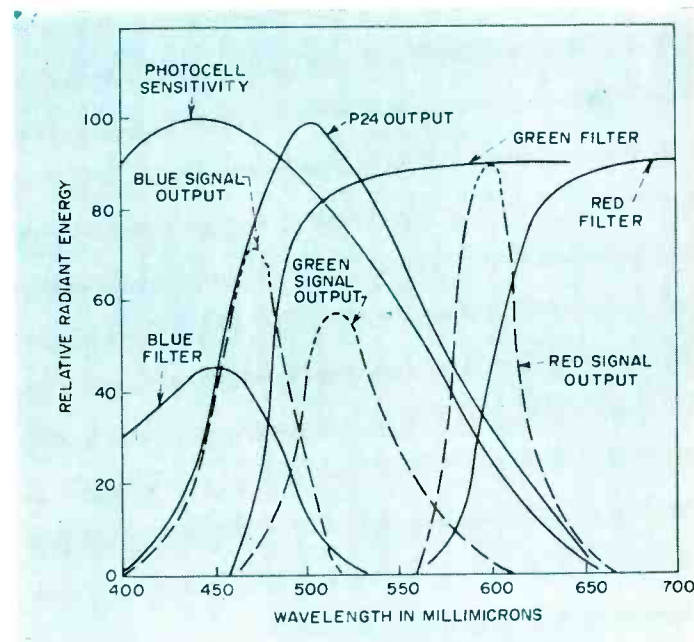

FIG. 5—Spectral response characteristics of crt, filters, phototubes and R, B, G outputs

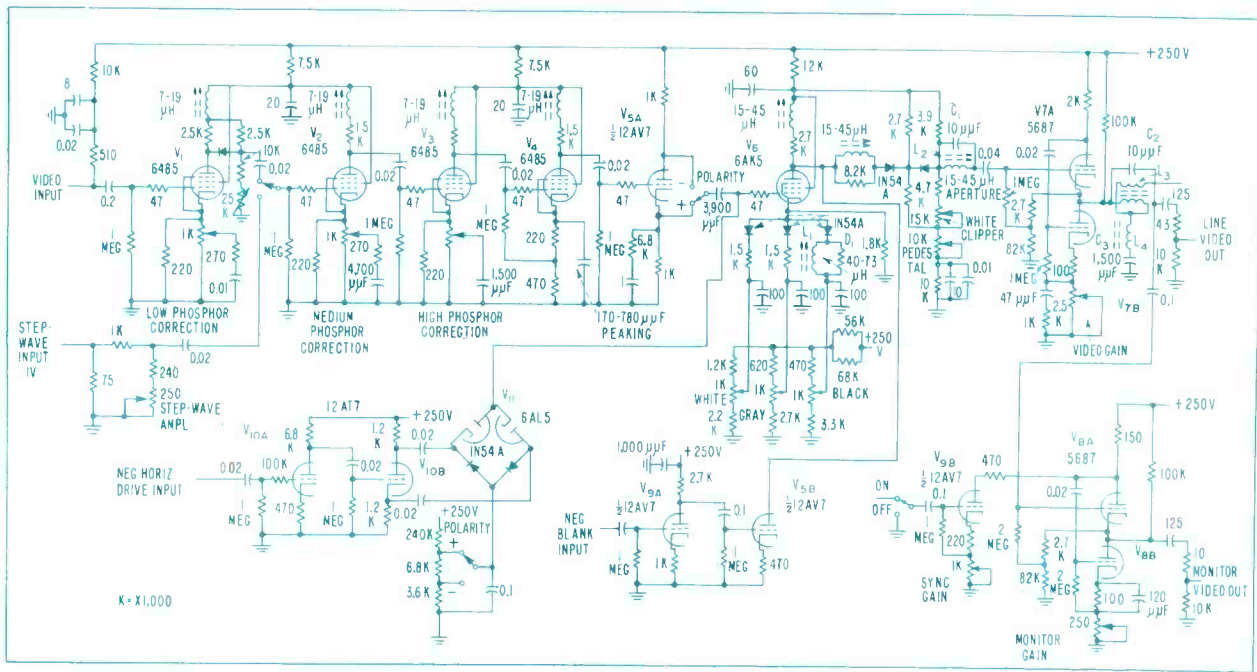

FIG. 6—Processing amplifier provides phosphor, aperture, gamma and other corrections for video signals from phototube banks

conduct in turn to lower the cathode impedance of V_6 .

As each diode conducts, the lower cathode resistance causes increased gain in the stage; reaching maximum with a black picture. The three controls permit adjustment of the resulting characteristic curve of the amplifier stage in the separate portions designated by the titles White, Grey and Black.

Since stage gain is maximum at black level, the noise may become objectionable. To minimize the effect of the higher noise content of the black video, coil L_1 is inserted in series with black-stretch diode D_1 to cause high-frequency degeneration above 2.5 mc.

Addition of a large blanking pulse permits control of pedestal setup. The pedestal control consists of a crystal diode inserted between the plate of V_6 and the grid of V_{7A} .

During the time of normal video, the anode of the diode is more positive than the cathode. When the negative blanking is added, its voltage drives the diode plate less positive than the cathode and so cuts off the signal. Changing the diode cathode voltage with the pedestal control changes the point of cutoff and so sets the pedestal level.

Aperture Correction

Network L_2C_1 is used to improve the high-frequency detail lost by

the system optics; L_2 permits the peaking to be adjusted from 7 to 12.5 mc.

Since the relative phase shift of the aperture correction network, C_2 , L_3 , L_4 and C_3 , is inserted so that the total phase shift will be zero.

The output stages, V_7 and V_8 , used in the processing amplifier are essentially double cathode followers, each capable of producing a $1\frac{1}{2}$ -v signal with good linearity and frequency response along with low power consumption.

Assuming a g_m of 5,000 micromhos for each half of the 5687, the midfrequency gain from the grid of V_{7A} to the video output termination, with the video gain control at maximum, is 0.475. Under these conditions, the output impedance is 32 ohms. To match the im-

pedance of the 75-ohm coaxial cable, a 43-ohm resistor is inserted in series with the output.

The stage response is about 1 db down at 10 mc.

Sync Light System

To produce the pulsed light for studio illumination, an Amglo U-35K lamp is used in the sync light equipment. This lamp is a U-shaped tube containing xenon gas with electrodes located at each end of the tube. The high voltage trigger potential is applied to bands wrapped around the outside of the tube. When the trigger voltage is applied, the gas is ionized and the d-c potential applied between the ends of the tube causes gas current flow; the gas produces blue-white light output.

To provide a suitable light level, five xenon lamps are used in each light fixture and four fixtures are used with each system.

The light trigger unit consists of a negative vertical drive pulse amplifier and a thyatron which develop the trigger pulse applied to the high voltage transformer in the light fixture.

When the high-voltage trigger pulse ionizes the xenon gas, a capacitor connected across the xenon lamp discharges through the lamp producing the blue-white glow used for lighting.

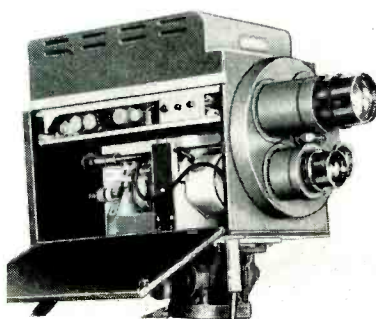

Camera head contains crt light source

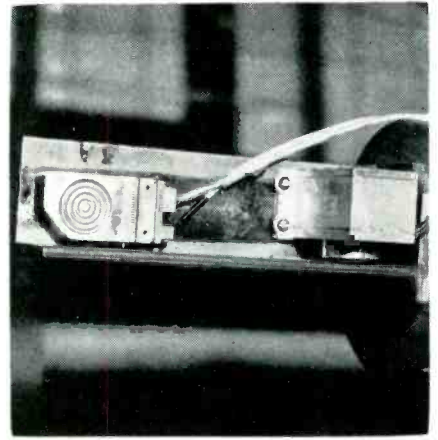
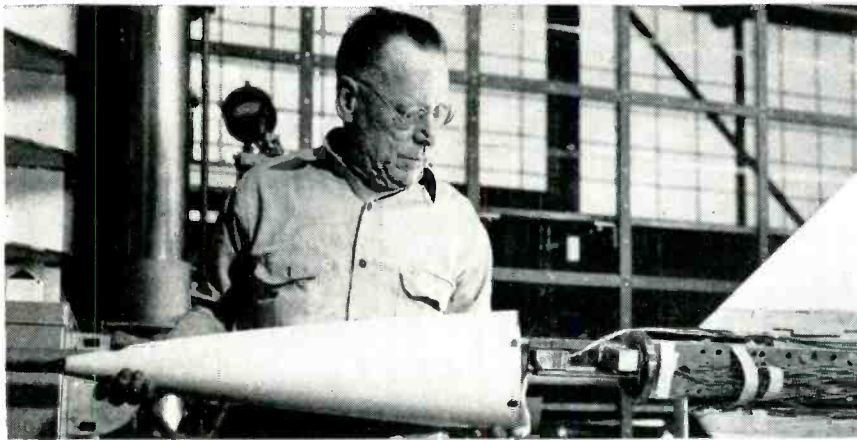

Capacitance-pickup gage in body of model is checked before nose assembly is installed. Close-up (right) shows installation

Capacitance Pickup Measures Small Forces

By JOHN DIMEFF and THOMAS B. FRYER

*Aeronautical Research Scientists
National Advisory Committee for Aeronautics
Ames Aeronautical Laboratory
Moffett Field, California*

SUMMARY — Noncontacting arm on angle-of-attack potentiometer reduces friction to permit measurement of very small forces acting on airplane models in wind tunnel. Accuracy and repeatability of unit is within ± 0.02 degree of rotation over temperature range from 0 to 150 F at pressures from 0 to 70 psi

WIND-TUNNEL testing requires a small device that can be mounted inside a test model to measure angle of attack, or the rotation of the model about a horizontal axis. Accuracy must be maintained while the model is subjected to large excursions of ambient pressure and temperature and to rotations of ± 40 deg about the two axes perpendicular to this horizontal axis.

A resistance-potentiometer element suspended as a pendulum and moving past a wiper is the simplest system usable in the tunnel en-

vironment. A method devised to overcome the restrictions of friction associated with the potentiometer wiper has also provided improvements in problems of resolution, linearity and hysteresis.

Contactor

Undesirable effects of wiper friction are eliminated by moving the contactor slightly away from the resistance element, so that direct mechanical connection is removed. Electrical connection is maintained by electrostatic coupling. The contactor, or coupling plate, thus be-

comes a capacitance plate in close proximity to certain portions of the resistance element and greatly removed from others.

The arrangement of the contactor is shown in Fig. 1A. The equivalent circuit of this frictionless contactor is shown in Fig. 1B. An alternating potential, applied across the resistance R , causes the flow of current through the capacitance formed between the coupling plate and those elements of resistance in close proximity to the coupling plate.

The magnitude of current flow

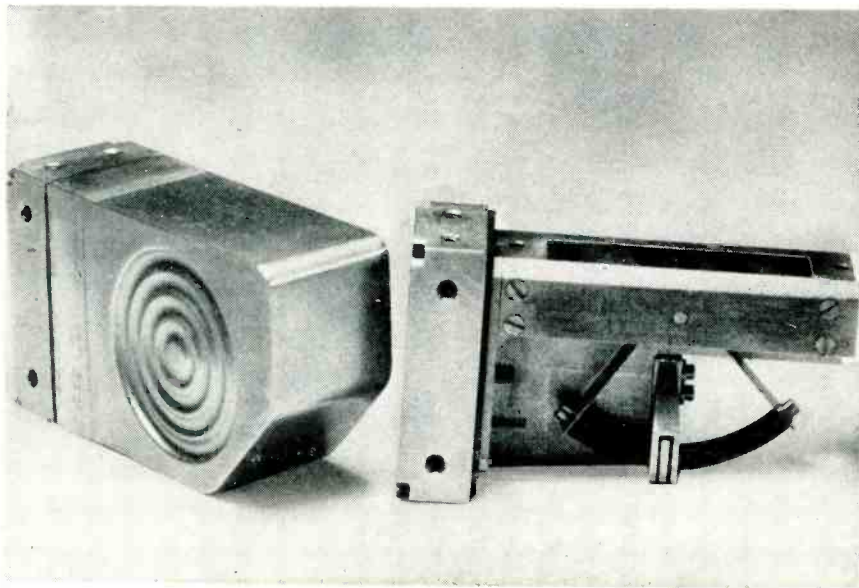

Angle-of-attack transducer uses resistance element pivoted as pendulum on jeweled bearings passing through capacitance pickup arm

is determined by the position of the coupling plate, the effective capacitance between resistance element and the coupling plate, and the impedance of the circuit between the lead to the detector unit and the return to the alternating potential source.

The operation of the normal slidewire-type potentiometer element is thus altered in several important respects. Frictional restraint and wear are eliminated. Since the modified device depends on electrostatic coupling which

gradually shifts from one wire to the other, greater resolution is obtained. Electrostatic effects of the various elements of the resistance wire within the region of influence of the coupling plate are effectively averaged by the plate. Local nonlinearities are averaged over the length of the coupling plate and the effective linearity of the transducer is thereby increased.

Bridge Circuit

Since the magnitude of the coupling capacitance could be

greatly altered by small physical shifts of the resistance element in a direction perpendicular to the direction of motion and since electrical leads to remote indicators might present large and nonconstant-impedance loads, an indicating circuit must be utilized which allows accurate detection of the angular position of the coupling plate in the presence of these variable electrical quantities.

The basic circuit shown in Fig. 1C is satisfactorily insensitive to impedance in the detector circuit. The resistance element of the basic transducer is divided into two parts, R_1 and R_2 , formed between the electrical center of the coupling plate and the two ends of the resistance element. These two parts are connected in a resistance bridge, the remaining two parts of the bridge, R_3 and R_4 , being formed by a remote resistance potentiometer of conventional type.

The movable contact of the remote potentiometer is grounded. Under balance conditions, the electrical lead to the capacitance coupling plate is, therefore, at ground potential. Since the shield of the coaxial cable connecting the transducer to the remote detector is also at ground potential, no current flows in the circuit at bridge balance, and therefore, the circuit is insensitive to coupling, cable and detector impedances.

Construction

The angle-of-attack transducer utilizing this technique is shown in the photographs. The pendulum formed by the resistance element moves past a stationary coupling plate by rotating on an axle supported at its two ends by jeweled pivot bearings.

All elements of the coupling plate circuit are shielded to prevent coupling to extraneous elements of the resistor or its leads. Accuracy and repeatability of the unit are limited predominantly by the friction of the jeweled bearings and have been found to be within ± 0.02 degree of rotation. Overall rotational range of the instrument as designed is ± 30 deg.

Effects of temperature from 0 to 150 F and pressure from 0 to 70 psi are negligible. Rotation of ± 40 deg about axes perpendicular

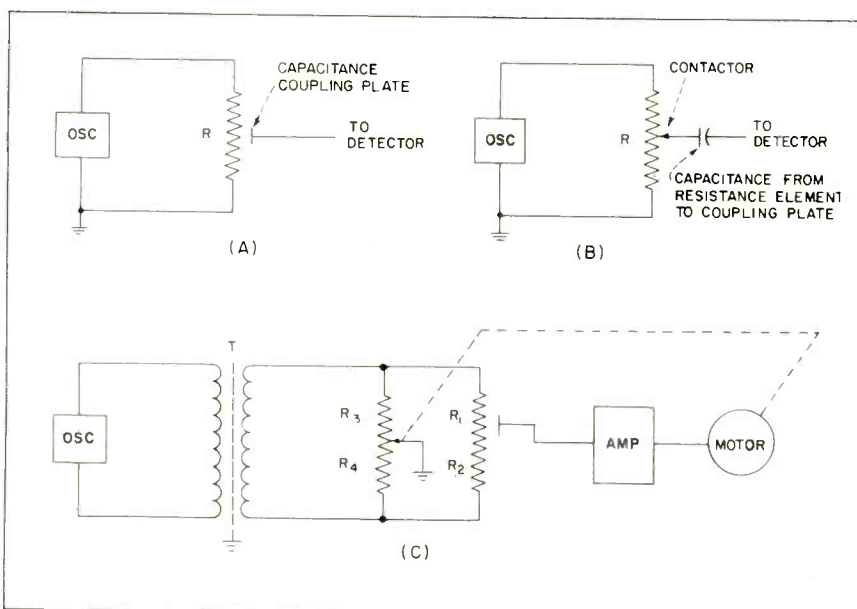

FIG. 1—Capacitance-coupled potentiometer (A) and its equivalent circuit (B). Bridge arrangement (C) permits balancing out cable capacitances

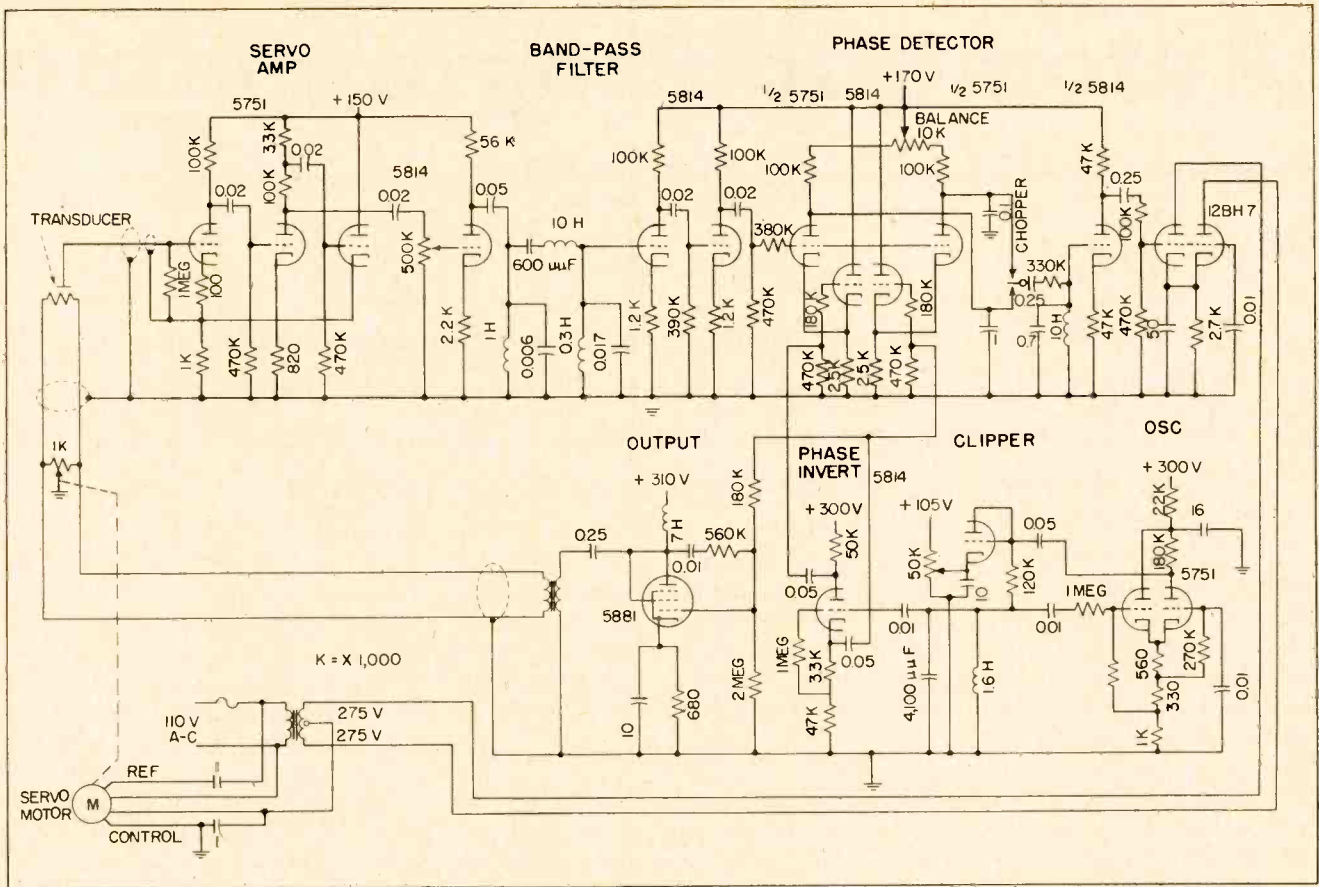

FIG. 2—Complete self-balancing system uses 2-kc oscillator to drive transducer bridge. Error signal is balanced out by servo-driven potentiometer fed from output of servo amplifier through phase detector

to the sensitive axis produced no change in calibration of the unit.

The circuit used in the final installation is shown in Fig. 2. The servo-balancing bridge of this circuit is supplied with a 10-volt rms, 2-kc signal. Choice of the operating frequency is not critical.

A 5751 tube is used as a 2-kc oscillator with one section of a 5814 connected as a diode clipper to regulate amplitude. The other half of the 5814 is used as a buffer amplifier and a phase inverter to drive a 5881 output tube. To avoid capacitance unbalance in the bridge, a well-shielded power transformer is used to couple the 5881 to the resistance bridge.

The first two tubes of the servo amplifier amplify the error signal between the servo potentiometer and the capacitance-coupled potentiometer, and provide a low-impedance source for driving the inner-shield of the triaxial cable. If the inner shield of this cable is maintained at the same potential as the center wire the value of effective cable capacitance is reduced

to zero.

The circuit has a gain of approximately 0.99 from the center wire to inner shield giving an effective reduction in capacitance by a factor of 100. Since the coupling capacitance in the potentiometer is only 3 to 10 $\mu\mu\text{F}$, a reduction by a factor of 100 in the cable capacitance makes possible the use of long cables without excessive reduction in the error signal.

The 5814 tube is followed by a pi-section bandpass filter that has a fairly broad characteristic (± 100 cps at 2-kc) but which effectively reduces signal harmonics and extraneous noise. The signal is further amplified and applied to a phase-sensitive demodulator.

Demodulator

The phase-sensitive demodulator is a full-wave cathode-switched circuit. The input signal is connected to the grids and the detected signal appears between the plates of the 5751 tube. This signal is modulated by a 60-cps chopper and amplified to drive a servo motor. The

motor is in turn coupled to the servo-potentiometer and rotates that potentiometer in such a direction as to reduce the error signal sensed by the amplifier.

Although the capacitance between the coupling plate and potentiometer resistance element in the angle-of-attack unit is of the order of 2 $\mu\mu\text{F}$, the circuit shown in Fig. 2 has allowed use of one-hundred feet of cable between transducer and servo.

The substitution of a capacitance coupling plate for the direct contacting wiper of the normal resistance potentiometer provides considerably increased resolution and linearity. The elimination of contactor friction resulting from use of such a device allows measurement of displacement where forces are so small that hysteresis introduced by wiping friction of the normal contactor would be prohibitive. By proper design of electronic circuits used with the capacitance contactor, the undesirable effects resulting from high contactor impedance can be greatly reduced.

Automatic Programming

By ED C. MILLER

Technical Director
Inland Broadcast Co.
Weiser, Idaho

SUMMARY — Subsonic tones control operation of automatic record player and tape recorder to permit small station to prearrange one-hour program of records and commentary in 3 to 10 minutes recording time.

Control console can be operated by nontechnical personnel

AUTOMATIC control systems have been used for years in the radio broadcast field for frequency control of transmitters, lightning arc suppression and overload reset. Larger stations and network feed points have used many more automatic devices. Small stations have just now begun to exploit automatic control in programming, logging and filing. The system described here handles microphone and turntable switching and fading that takes up much of the time of a disc

jockey at a small station, and concentrates his time for introduction of records and reading of spot announcements into a continuous period of talk.

Operation

This control unit works in conjunction with an Ampex tape recorder and Seeburg automatic music system. Switching is accomplished in each case by making and breaking the motor leads to both units and is controlled by a 20-cps

tone and 1.8-sec time delay. The 20-cps tone is superimposed on the tape when it is recorded. This tone trips the music system to set up the next record. The end of the tone stops the tape transport and switches the faders, fading the tape output and increasing the music level. The 1.8-sec time delay occurring at the end of a musical selection reverses the fader operation, starting the tape and stopping the music system. A 35-cycle tone can be superimposed on the tape when it is recorded to switch to an alternate tape machine at its release. Then, whichever tape machine is operating continues to operate until a 35-cps tone appears at which time it switches to the other tape.

Figure 1A shows the basic circuit of the tape-phono control. With no signal input from tape or phono, V_1 and V_2 are conducting. When a 20-cps tone passes the selective amplifier into the tape input, it is rectified by V_3 , and filtered by C_1 , R_1 , and C_2 only enough to prevent the V_1 relay from chattering. This negative d-c cuts off the grid of V_1 and deenergizes its relay, closing the contacts to the music-system motor. The other contacts of the relay open the grid of V_2 , it continues to conduct and RE_2 remains closed.

This condition exists until the tone stops, at which time the fast discharge of C_1 causes V_1 to conduct again, closing V_1 relay, opening the phono motor circuit. The phono unit continues to operate since the motor in the music system is locked on during the playing of a record,



Automatic programming system uses portable tape recorder and automatic record selector-player mounted on wall

in Small A-M Stations

and is released after the record trips at the end of play. The other relay contacts return the grid of V_2 to V_5 so the charge which has been slowly acquired by C_3 through R_2 , appears on the grid of V_2 , cutting this tube off.

The opening of RE_2 stops the tape motor, switches the faders and also applies a positive voltage through R_3 to the grid of V_1 to assure that it continues to conduct while the tape is stopping. This prevents any extraneous noises on the tape after the end of the tone from reactivating the two relays.

The slow discharge of C_3 through R_4 and R_5 keeps V_2 cut off for about seven seconds. During this time, relay RE_2 is open and its contacts have opened the motor lead to the tape recorder transport and switched the faders in favor of the music system input. This time is ample to cover any dead grooves at the beginning of the record and as soon as the music level is rectified by V_6 , it is filtered by R_6 and C_1 and applied to the grid of V_2 to keep it cut off.

Thus, relay RE_2 remains deenergized during the playing of the record and for a period of time after the record has ended, determined by the discharge rate of C_1 and R_5 (in this instance, 1.8 seconds), at which time V_2 conducts, starting the tape transport and switching the faders. To prevent tripping RE_2 by noise from the music system, the cathode of the phono-isolation amplifier is made positive when RE_2 is energized.

Fading

The basic fader circuits are shown in Fig. 1B. As can be seen from the circuit, T-pad electronic attenuators are used, with control provided by positive voltage applied to alternate grids. Because grid current flows during times when the grid of either fader is positive, large electrolytic capacitors are used to provide the time constants for attack and release. By using



Small recording console controls tape recorder, inserts tones and indicates elapsed time during recording of announcements

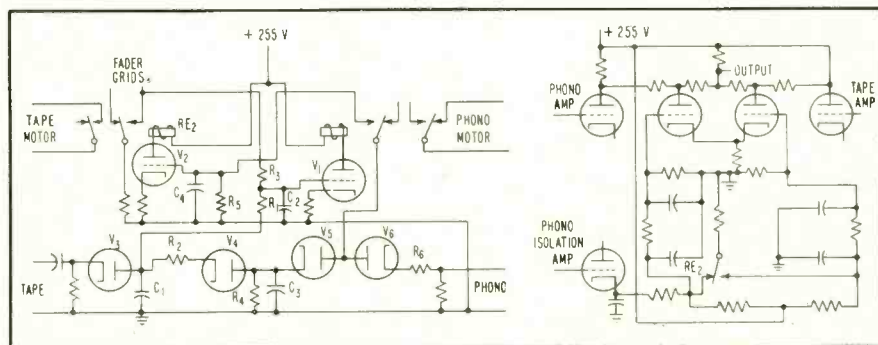

FIG. 1—Tape and phono-motor control section (A) and fader section (B) of automatic programming control system

the switching arrangement shown, the actual switched voltage is about 10 volts. Resistors are placed from each grid to ground to limit the voltage across the capacitors in the event of tube failure, or if the B+ voltage should be present before tube heaters have reached operating temperature.

The cathode of the phono-isolation amplifier is connected to the

switch contact of the phono fader. When that contact is opened and its voltage goes positive, it cuts off the phono isolation amplifier and fades the phono input.

It is not considered advisable, from a programming standpoint, to fade the phono more than about 15 db. The 20-cps tone can be placed in advance of the end of the voice on the tape, which will allow the

record to be placed on the turntable and music to start while the announcer's introduction is being presented on the tape. This permits introductions over the musical introduction on the record and allows more versatile operation that more nearly approaches manual programming in results.

Figure 2 shows the complete schematic, including the isolation amplifiers, selective amplifier, delay circuits, control circuits and faders.

The amplifiers are straightforward circuits. The selective amplifier uses a twin-triode with a bridged T in the negative feedback circuit, to provide amplification only at 20 cps. A form of volume limiting is provided by clipping in the first stage of this amplifier. Clipping of the phono level is done in the triode driver of the phono rectifier.

Control Circuit

Because the control unit is used by nontechnical personnel, it is nec-

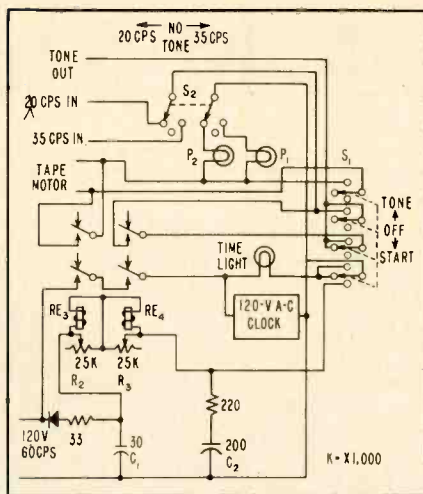

FIG. 3—Dual input control circuit provides automatic switching between record player and tape unit

essary to have a recording console that applies the proper tone of correct duration, and records the elapsed talking time in as automatic a manner as practical.

The schematic of the console is shown in Fig. 3. In operation, S_1 is switched to the start position

when it is desired to start recording. Its contacts close the circuit for relays RE_3 and RE_4 across the 115-volt d-c supply and discharge C_2 through the 200-ohm resistor. The contacts of RE_3 close the motor circuit for the tape recorder. Contacts of RE_4 apply 115-volts a-c to the clock and it begins timing the talk. Light P_1 or P_2 will also operate, indicating the tape transport is moving and indicating also which switching function, tape to music (20 cps), tape to tape (35 cps) or no tone, will be accomplished at the end of the talk period.

No tone is used at the end of a break spot, for example, if the next program is a live program, given at the broadcast time. Thus, if the board operator is a little slow in switching off the tape, there will be no tone present to insert the first record of the next program, prematurely.

When S_1 is returned to its neutral position, RE_3 , RE_4 remain closed for an additional period of time determined by the combined R-C time constants of C_2 , RE_3 and R_2 and RE_4 and R_3 . Variable resistances are used across each relay to compensate for minor differences in drop-out current.

If S_1 is moved to the tone position, the tape transport control and tone contacts of RE_3 and RE_4 are shorted out by the contacts of S_1 and the tone and transport continue to operate until S_1 is returned to the off position or for the duration of the time constant whichever is longer. The duration of this time constant is set by R_2 and R_3 to about 6 seconds.

The timing clock starts running when S_1 is switched to the start position and stops 6 seconds after S_1 is switched to the off or tone position. The time light comes on when the tone starts and stays on for 6 seconds. When the time light goes off, it provides a visual indication to the operator that music has started in the background.

The clock runs only when the tape is running and there is no music. This makes it possible for the operator to total his music time, subtract this figure from the actual program time, and arrive at the total talking time available.

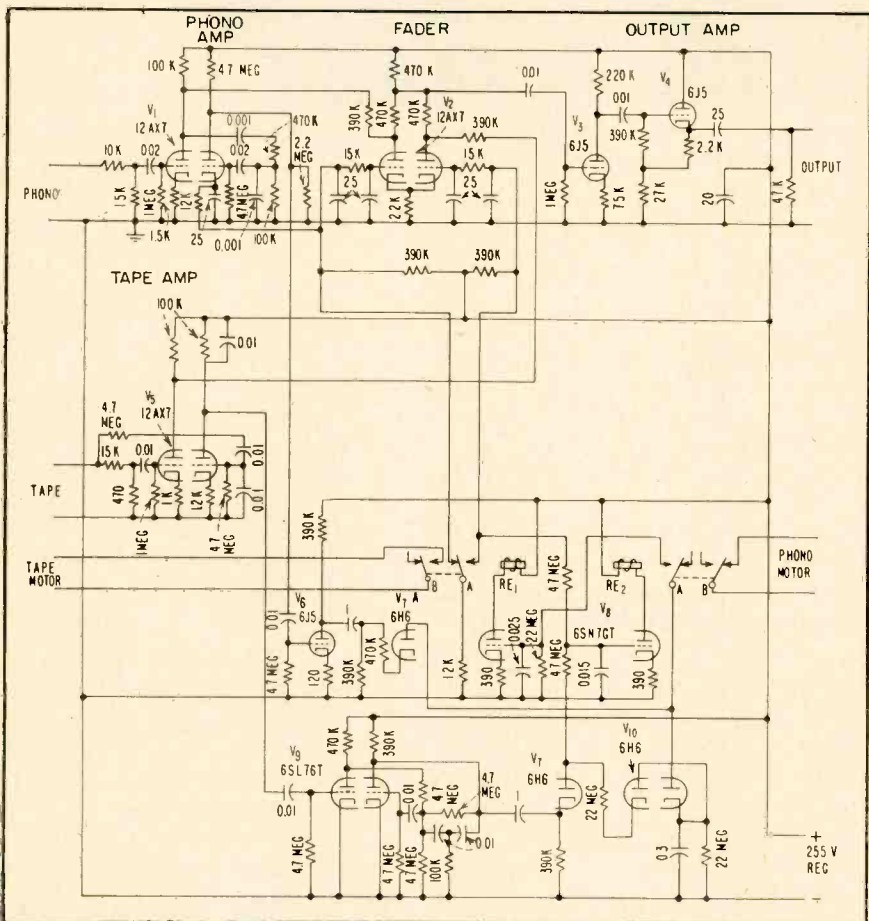
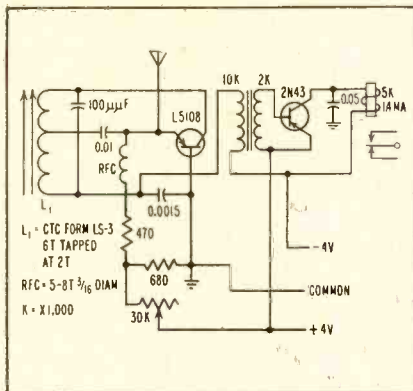
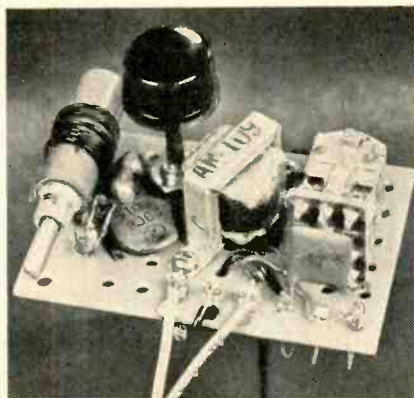

FIG. 2—Recording console places tones on tape and indicates elapsed time during recording of commentary



Circuit uses a Philco surface barrier transistor operating at 27 mc



Tuning coil and fixed capacitor, squelch control, audio transformer and remote control relay above chassis with two transistors beneath (right)

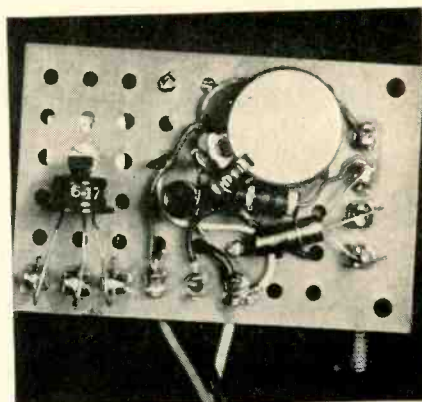

Remote Control Receiver

By EDWIN BOHR

Huntsville, Ala.

SUMMARY — A lightweight device capable of actuating electrical circuits comprises a two-transistor superregenerative receiver operating on the 27.255-mc Citizen Radio frequency for which formal license is not required

ADVANTAGES of a completely transistorized remote-control receiver are realized in the circuit described below. Superregenerative operation at the license-free frequency of 27.255 mc is obtained through use of the L-5108 surface barrier transistor.

Because the detector functions at a power level insufficient to operate a normal remote-control relay, an additional transistor stage amplifies the quench frequency to drive a conventional plate relay.

The detector operates with a grounded base. Feedback is tapped from the tuned circuit to the emitter through a rather large value of coupling capacitance. This coupling capacitor periodically quenches the detector oscillations. Rectification of the oscillator frequency by the emitter charges this capacitor sufficiently negative to block oscillation.

The Q of the tuned circuit and in general the vigor of the oscillator determines the build-up time of

this blocking action. The decay of the blocking depends upon the value of the coupling capacitor and the Thevenin equivalent resistance of the bias supply.

Using a low value of emitter-bias resistance results in much the same action as returning a vacuum-tube superregenerator grid leak to the plate supply.

Quench Frequency

An interruption frequency from 10 kc to 30 kc seems to yield the greatest sensitivity. In addition to the usual quench frequency, there is a lower frequency component available at the detector output. This lower-frequency component is somewhat greater in amplitude than the high-frequency quench. In addition, it is a submultiple of the high-frequency quench, falling somewhere near the resonant frequency of the coupling transformer and collector bypass capacitor. A typical frequency for this low-frequency component is 3 kc.

The received signal from the remote-control transmitter advances the initial oscillator build up, increasing the quench frequency. A reduction in the quench amplitude also accompanies this action.

A strong signal will reduce the quench amplitude by a factor greater than two-to-one. It is this effect that operates the relay.

A 2N43 relay-driving amplifier receives the quench components through the coupling transformer. The low winding resistance of this transformer accounts for the low value of collector leakage current. A representative 2N43 in this circuit with no signal input between base and emitter may have a quiescent collector current of only 20 microamperes at room temperature.

The relay-driving amplifier both rectifies and amplifies the quench components. The resulting current pulses at the collector are smoothed by the 0.05- μ f ceramic plate capacitor.

SUMMARY — Capacitor-discharge unit for extremely thin, highly conductive metals provides up to 10,000 amperes in single millisecond pulse. Voltage regulator tube in simple control circuit stops recharging of capacitor bank at exact voltage level called for by heat control potentiometer. As charging voltage approaches this level, regulator tube current applies increasingly greater negative bias to grids of thyatron rectifiers in power supply. Welder cannot fire until weld pressure is exactly correct, thereby insuring repeatable perfect welds

By **W. W. ROBINSON**

*Chief Engineer
Pacific Welding Co.
Los Angeles, Calif.*

Precision Spotwelder

ATTEMPTS to spotweld fine wires or thin foils are often unsatisfactory because the uncontrolled high-energy discharge of conventional welding machines damages the extremely thin, highly conductive metal. The resulting unsightly weld joints often require considerable reworking before the materials can be plated or otherwise finished. Because of this, many fine wires and foils have been considered unweldable.

A solution to this problem was found in the development of a stored-energy spotwelder that delivers controlled high peak current at the electrode tip and repeats the exact discharge for each succeeding weld. The energy is stored in a capacitor bank for intermittent use by welding electrodes. Secondary current at the electrode tips may have a high peak magnitude (up to about 10,000 amperes), completely discharged in 0.0030 to 0.0166 second for each spotweld.

Circuit Description

As indicated by Fig. 1, storage-capacitor bank C_3-C_4 is supplied

with energy at a level of approximately 1,500 volts d-c by a full-wave rectifier power supply. The capacitor bank is connected to the primary of the welding transformer through thyatron firing tube V_6 , which is normally biased below cutoff so that the tube functions as a switch when the bias is momentarily removed.

When the switching action of the thyatron takes place, the capacitor bank is discharged through welding transformer primary T_2 so that current will flow in the secondary and energize electrodes closed on a workpiece.

Primary power is supplied to transformer T_1 and to all tubes when a heater switch and safety interlock are closed. A six-minute time-delay cycle prevents damage to the tubes before they are adequately warm.

At the end of the warm-up cycle, a relay removes power from a time-delay motor. A high-voltage switch can then be closed to apply primary power to T_2 and energize relay K_2 , removing shorting resistors R_2 and R_3 from across the capacitor bank.

Rectifiers V_3 and V_4 now charge capacitor bank C_3-C_4 .

Charging Control

When the d-c voltage between the cathodes of voltage regulator tube and B + is large enough to cause the voltage regulator tube to pass current, a negative voltage appears at the anode and acts in series with the a-c voltages on the grids of the rectifier tubes. This bias serves to hold off the rectifier tubes for a part of each a-c cycle.

As the capacitor bank becomes more and more fully charged, the bias voltage produced by the regulator tube increases and holds off the rectifier tubes for a correspondingly greater portion of each a-c cycle.

When the capacitor bank is charged to the level corresponding to the setting of the heat control, regulator tube current has increased to the point where the rectifiers are cut off and charging ceases. This insures that the capacitor bank is charged to the same level after each weld, no matter



Operator adjusts spotwelder controls. Welding transformer is in box at right

FIG. 1—Heat control and capacitance selector determine energy supplied to welding transformer by capacitor bank

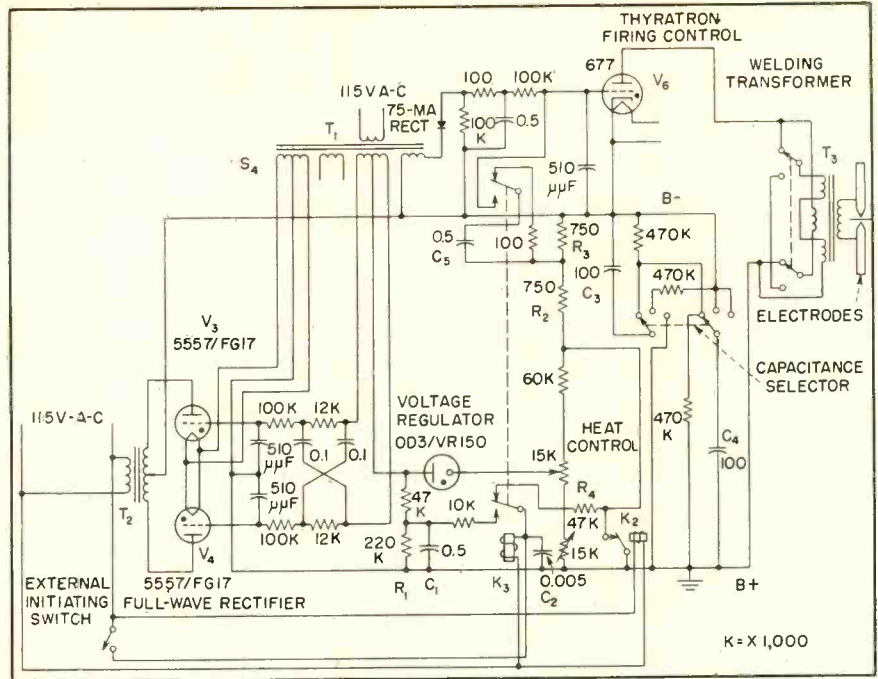

HANDLES METAL FOILS

how long the operator takes to load in a new part.

The voltage to which the capacitor bank is charged depends on the setting of heat control R_4 . This voltage is applied to the output circuit by closing the external initiating switch to pull in firing relay K_3 .

Welding Cycle

When the firing relay is energized, a negative charge is transferred from C_2 to C_1 , so as to make rectifiers V_3 and V_4 nonconductive during the welding period. Relay K_3 also connects capacitor C_5 to the grid of thyatron V_6 , driving this grid positive and firing the thyatron for the time required to discharge capacitor bank C_3 - C_4 through the primary of the welding transformer. At the end of the welding cycle, relay K_3 is open so that C_1 - R_1 cause the rectifiers to become conductive once again and recharge the capacitor bank for the next weld.

The capacitance selector switch gives a choice of 50, 100 and 200 μf for positions 1, 2 and 3 respec-

tively, with 470K across each 100- μf unit for the series connection in position 1. If the capacitance selector switch is set for 100 μf , twice as much energy is applied as in using 50 μf and the heating effect is doubled.

The voltage level at which energy is stored is governed by the heat control, which provides a range of 650 to 1,500 volts.

Primary windings in the welding transformer may be connected in series or parallel by means of a series-parallel switch to give different output voltages.

Weld Pressure

Welding pressures ranging from $\frac{1}{2}$ to 18 psi are obtained by adjusting a metal bellows unit which supports the floating lower electrode. The design of this unit is such that, when the upper electrode is depressed or lowered by pressure applied to a foot pedal, it halts the downward electrode movement and actuates a snap-action switch. This initiates the welding cycle when the parts to be welded are under a predetermined amount of pressure.

Where the parts comprise extremely thin sheet or foil materials, this may amount to less than 1 psi.

Applications

Materials that have been welded with the welder include nickel to molybdenum, copper and tantalum-tungsten; brass to brass, bare or tinned copper, platinum, iridium, palladium and phosphor bronze; copper (bare, tinned or plated) to copper, phosphor bronze and bare or plated steel; Kovar to Kovar, carbonized steel, tungsten-platinum, nickel, molybdenum and Dumet; as well as many other materials.

Fusion temperatures and energy requirements were selected on the basis of the same considerations that would apply to the use of any resistance welder with only one exception. Due to the high peak current discharged in a very short time, the spotwelder develops heat so quickly that little energy is dissipated in the metals being welded. Besides keeping the weld area small, this feature avoids the use of power that would normally cause burning.

Reference Generator

By M. I. JACOB

Manager
Communications and
Navigation Section
Electronics Division
Westinghouse Electric Corporation
Baltimore, Maryland

SUMMARY — Applicable to scatter propagation, equipment uses stable frequency generator employing phase-locked oscillators to provide accurate reference frequencies for ssb generator. Beam-switching tube used in frequency-dividing circuits permits coverage of 2 to 30-mc range in 1-kc steps

PROPER OPERATION of single side-band system depends upon the ability of the associated transmitters and receivers to be accurately adjusted to assigned frequency channels and upon their ability to remain on these assigned frequencies after initial adjustment. As a result the excitation frequencies of transmitters and the local oscillator frequencies of receivers are frequently derived from a single highly accurate and stable source. The stable frequency gen-

erator and ssb generator to be described are designed to fill these requirements.

Generator

Operating from a 5-mc internal or external source, the frequency generator derives frequencies suitable for exciters or receivers operating in the h-f (2 to 30 mc) band. A unique system of phase locking free running oscillators to the stable reference frequency provides, in practically continuous 1-kc steps,

spurious-free (80-db attenuation) injection frequencies.

The block diagram of Fig. 1 shows the output frequencies of the stable frequency generator as produced by stabilized oscillators. The stabilizer reference frequencies are produced by synthesis from the single 5-mc source. These synthesized frequencies are not radiated but are used only as stabilizer references.

Since the output frequencies are phase locked to the 5-mc standard,

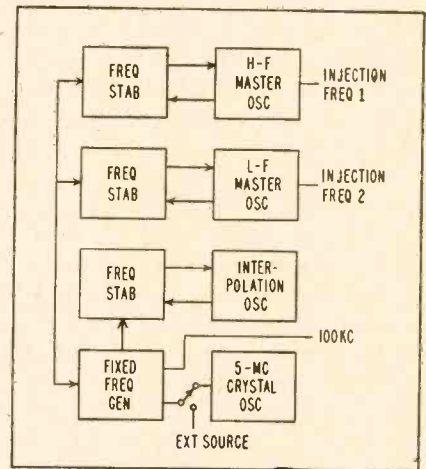
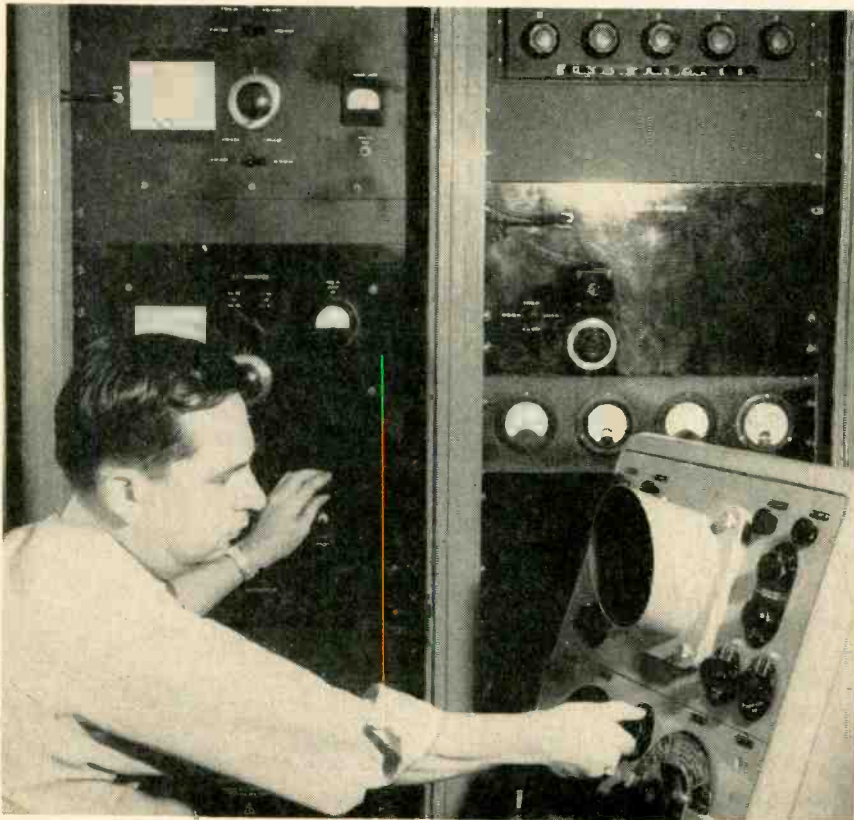

FIG. 1—Stable frequency generator uses either a 5-mc internal source or an external source

Intermodulation distortion tests are made on ssb exciter containing stable frequency generator

for SSB SYSTEMS

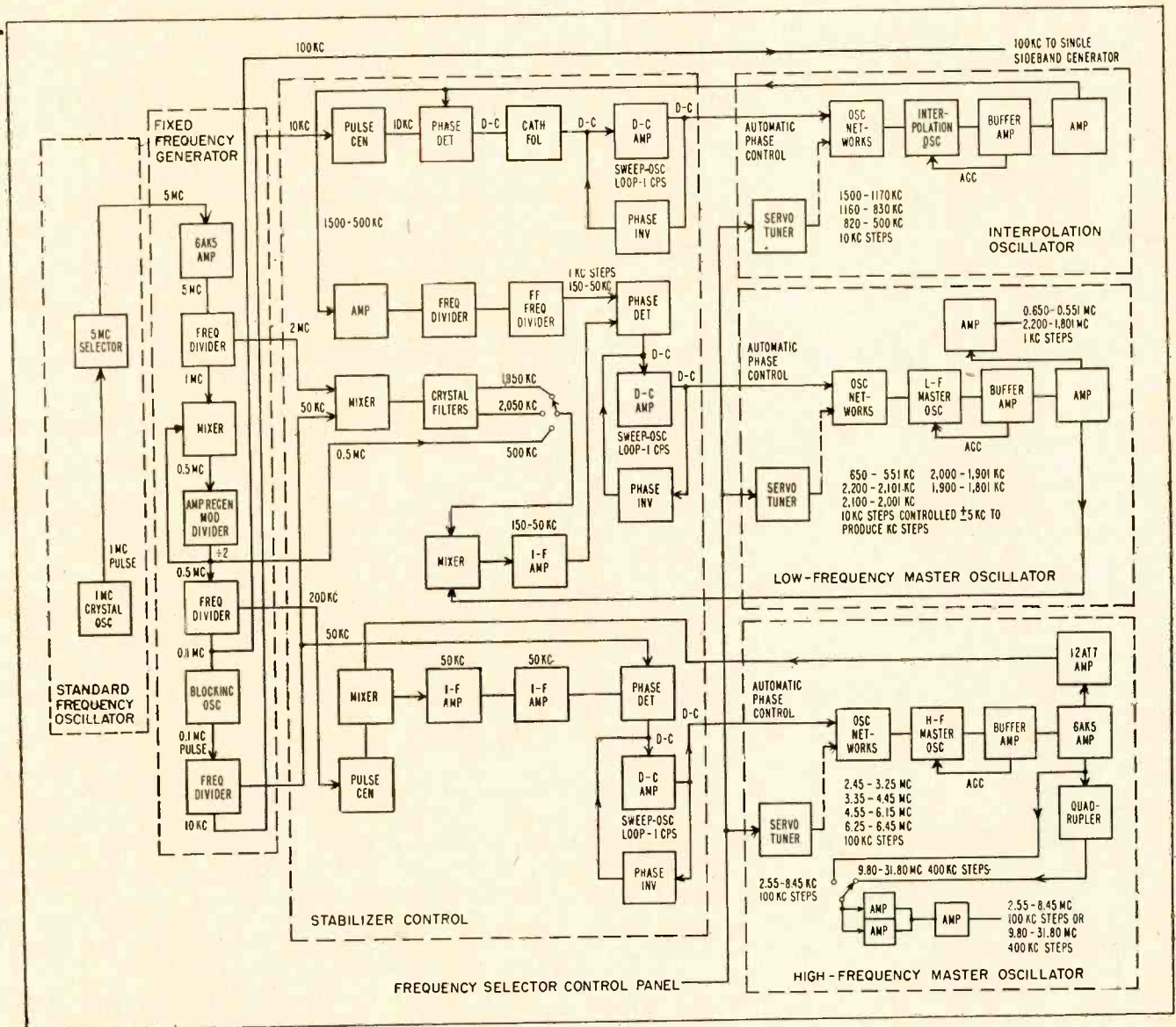

FIG. 2—Detailed block diagram of stable frequency generator shows frequency division method

the accuracy and stability of these frequencies is the same as the standard. Standards having a performance capability of holding 1 part in 10^8 over 24 hours under military conditions are available today.

To promote maximum reliability, the design uses a minimum number of tubes consistent with the high performance requirements. Thirty-four tubes of eight types are employed.

Tuning controls on the stable frequency generator consist of a group of ten-position switches each controlling a dial reading one digit

of the desired operating frequency. Since the ssb generator or ssb receiver with which this unit works covers the 2-to-30-mc bank in 1-kc

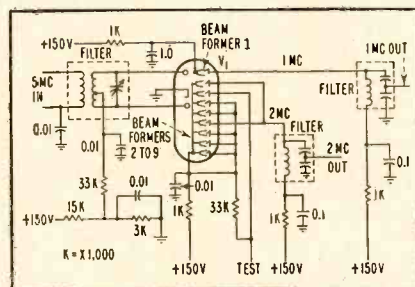

FIG. 3—Beam switching tube frequency divider

steps, five controls are required. These controls operate switches that provide signals to a servo positioning system that physically tunes the unit's free running oscillators.

This servo is a 60-cps device that provides a frequency setting accuracy of a 0.03 percent, which is well within the pull-in range of the stabilizer circuits.

In Fig. 2, a detailed block diagram shows how injection frequencies are generated with relation to the basic 5-mc standard.

The circuitry employed in the stable frequency generator falls

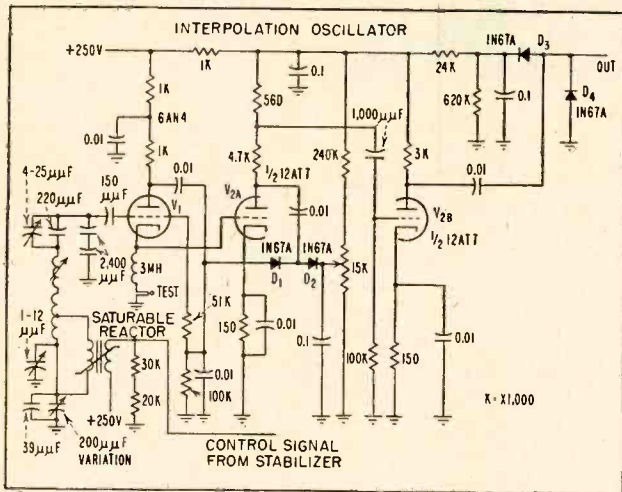

FIG. 4—Saturable reactor is used to stabilize νf_0

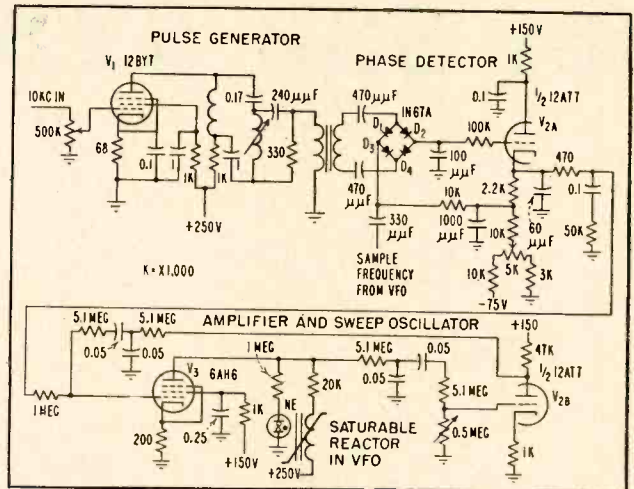

FIG. 5—Frequency stabilizer provides signal for saturable reactor

into four major functional categories, the reference oscillator, the frequency dividers, the stabilized oscillators and the stabilizers.

The reference oscillator can be one of a number of available types, the selection being dependent on the accuracy and stability required. The particular unit utilized is a Sulzer type¹, 1-megacycle standard oscillator with a frequency stability better than 1 part in 10^9 per 24 hours after six months of continuous operation. The unit is variable over the range of approximately on cycle and is capable of being reset to 5 parts in 10^{10} .

Frequency Dividers

An example of the application of a multielement tube is illustrated in Fig. 3. The tube employs a magnetically focused electron beam that can fall on any one of a total of ten plates in the tube. This state is stable and once it is formed will remain.

However, the beam can be advanced from plate to plate by excitation applied to the control grids of the tube. Thus by application of a signal on the grid to advance the beam and by making connection to one of the plates, it is possible to obtain one pulse for every ten applied to the grid.

As arranged in the circuit of Fig. 3 the input steps are applied in push-pull and therefore are effective at twice the driving frequency and the overall division ratio of the circuit is 5 rather than 10. By tying two of the plates together, pulses can be obtained at

twice the revolution rate, which is equivalent to dividing by 2.5.

For frequency generator applications where a number of fixed frequencies are required, providing more than one division ratio simultaneously with one tube is useful.

Oscillator

All frequencies delivered from the stable frequency generator originate in three variable frequency oscillators. Because these oscillators are referenced back to the master standard through stabilizer units, they are not required in themselves to maintain minute frequency tolerances.

Figure 4 illustrates the type cir-

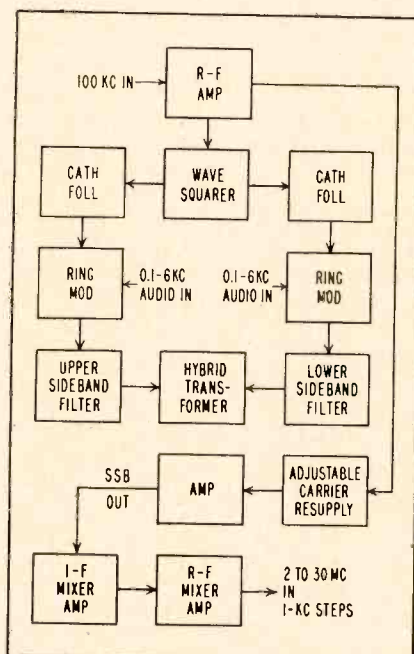

FIG. 6—Block diagram of sss generator which uses stable reference frequencies

cuitry involved in these oscillators. The oscillator covers the range from 500 to 1,500 kc and is tuned in 10-kc steps. The output is later divided by 10 to furnish 50 to 150-kc frequencies in 1-kc intervals to interpolate between the coarser steps of the next oscillator.

Stabilizing

A variable reactance in the form of a saturable ferrite reactor is included to apply automatic frequency control to the oscillator. The control current is produced by the stabilizer unit and is related to the frequency of the standard reference associated with the frequency generating portion of the circuit. Automatic gain control is provided by tube V_2 and related components.

Action of the agc circuit is to produce, by the voltage doubling and rectifying action of diodes D_1 and D_2 , a d-c voltage proportional to the amplitude of the oscillations emanating from the tank circuit of V_1 . This d-c is then used as bias to maintain a fixed amplitude output from V_1 . The oscillation amplitude is set by an adjustable positive bias on diode D_2 . The addition of the 0.01- μf capacitor from the plate of V_1 back to the agc control line provides stability for the agc circuit which necessarily has a high loop gain.

This feedback circuit operates by sampling the signal developed across the 1,000-ohm resistor in the plate of V_1 . The rate of change of this signal is out of phase with the rate of change of oscillations on the

grid of V_1 , resulting in negative rate feedback being applied to the age line. This is found to be effective in stabilizing the agc circuit. Circuitry associated with V_2 provides conventional amplification and limiting to the gain stabilized oscillator output.

Phase Locking

The absolute frequency output of the three oscillators is determined by the standard reference frequency and is a function of the phase-locking stabilizer servo system. Control signals from the error detecting circuits of the stabilizer are fed back to variable reactance elements tapped across the frequency determining networks of each vfo. The stabilizer circuit controlling the frequency of the 500-to-1,500-kc oscillator is shown schematically in Fig. 5.

The circuit is in three functional sections; a pulse generator, a phase detector and an amplifier and sweep oscillator. Essentially the 10-kc reference signal is converted into a pulse suitable to produce harmonics up to 1,500 kc.

The pulses are generated by passing the circulating current of a tuned circuit in the plate of V_1 through a small saturable reactor. Pulses then appear at each of the current zeros. These pulses are fed into a balanced phase detector and compared with a sample of the vfo output. A d-c error signal is generated and fed through this amplifier to the reactance controlling device in the vfo.

Associated with the amplifier is a sweep oscillator whose purpose is to provide a sweeping control voltage to pull the vfo within the lock-in range of the servo loop. This sweep system will automatically start sweeping when the servo loses control. This happens because the time constant of the frequency-correcting servo loop is much faster when in lock than that of the sweep circuit.

Thus when the sweep circuit tries to oscillate and change the vfo frequency, the servo overrides the error and prevents oscillation. If the servo loop gets out of lock, the sweep oscillator is free to oscillate at its one-cycle rate and will sweep the controlled vfo over a

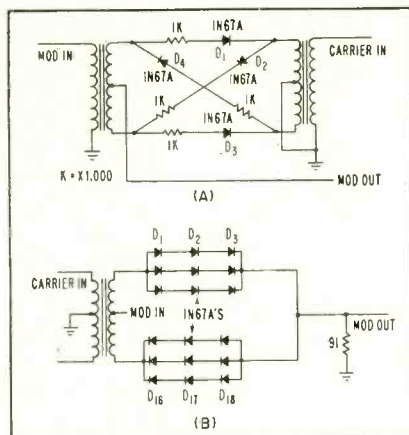

FIG. 7—Balanced ring modulator (A) is used for low-frequency conversions, while unbalanced modulator (B) converts high-frequencies

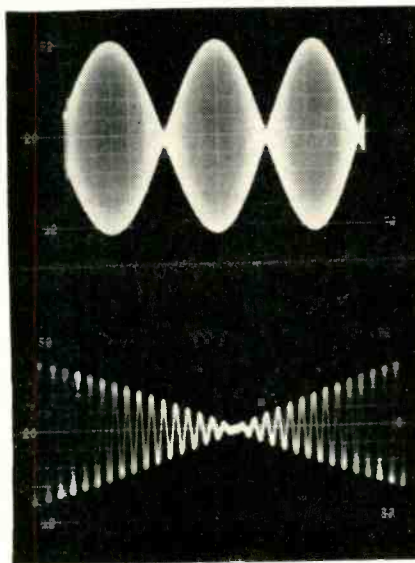

FIG. 8—Conventional two-tone waveforms appearing at first modulator output

range compatible with the phase detector output.

When supplied with proper injection frequencies, the single sideband generator provides a source of ssb emission in the h-f 2- to 30-mc band. The unit accepts two separate 6-kc wide modulation signals and converts them to independent sideband signals around a common suppressed carrier. Crystal filters remove unwanted carrier and sidebands after conversion.

The unwanted sideband is attenuated 70 db and out-of-band spurious is rejected 80 db. The carrier is emitted with the minimum level 50 db below the desired sideband level. Intermodulation products are 60 db below the level of one tone on a two-tone test. Operation of the ssb generator is shown

in the block diagram of Fig. 6.

Two independent channels of audio each approximately 6-kc wide can be fed simultaneously to the ssb generator. These signals are introduced into balanced modulators where they are heterodyned to 100 kc. Since these are balanced modulators their outputs consist of two sidebands, each containing both channels of audio, with the 100-kc carrier suppressed 35 db. These signals are now fed to crystal-lattice filters at which point the carrier is attenuated an additional 15 db and one sideband is removed.

The independent upper and lower sideband signals are then combined in a hybrid transformer and fed to a series of converter stages where they are heterodyned to the final output frequency. Spurious products generated in the mixing stages are attenuated more than 80 db below the desired signals by the i-f and r-f networks.

Mixers

Crystal diodes were employed as mixing elements in the modulators. In the lower frequency conversions, 100 kc and 2 mc, balanced modulators of the type shown in Fig. 7A were utilized. In the final conversion (2 to 30 mc) it was more practical to use the circuit of Fig. 7B. This circuit requires only one balanced transformer, which is an advantage when such a wide frequency range must be covered.

The series-parallel arrangement of a number of diodes was necessary to keep the power dissipation per diode below rated levels. This combination of modulator circuits produced single sideband signals with intermodulation products — 60 db below the level of the test tones on a standard two-tone test. The classical two-tone test waveforms appearing at the output of the first modulator are shown in Fig. 8. The frequencies involved were 2,200 cps and 600 cps with a 100-kc carrier. The expanded view (approximately 4 to 1 expansion) at the bottom shows in detail the form of the wave at the null or crossover point.

REFERENCE

- (1) P. G. Sulzer, High Stability Bridge Balancing Oscillator, *Proc IRE*, 43, p 701, June 1955.



Pickup coils at front wheels guide feeding carts along rows of coops following buried wire layout

Transistorized Guidance

SUMMARY — Semiautomatic equipment for large chicken farm uses carts following buried wire for distributing feed and collecting eggs along rows of coops. Transistor amplifiers feed position data to steering motors from magnetic pickup coils at front of cart. A third amplifier automatically stops cart if it goes off path

STEERING of a small, slowly moving cart over a desired path is achieved by the method to be described.

The path is marked out by a buried wire carrying approximately one ampere of 60-cps alternating current. The guidance unit senses the position of the cart

relative to the wire by the magnetic field surrounding the wire. If the cart is off course, an error signal is sent to the power steering unit to bring about the necessary correction.

Use of transistors allows operation directly from the 12-v storage battery which supplies motive

power for the vehicle, and also eliminates the maintenance problems associated with vibrator type high-voltage supplies. Transistors also allow the unit to give reliable operation in spite of the vibration experienced on the moving cart.

The advantages of this type of guidance over a rail system are obvious. The path is simple and inexpensive to lay out or change. Also, switching can be done electrically from a fixed point by energizing the proper branch at a junction.

Basic Operation

Two small pickup coils are suspended about six inches over the ground in front of the vehicle, and are placed about one foot apart. As shown in the photograph of the

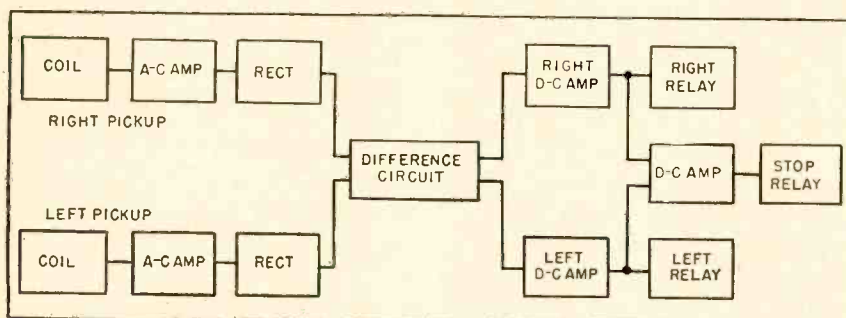

FIG. 1—Block arrangement of circuits used in cart control system

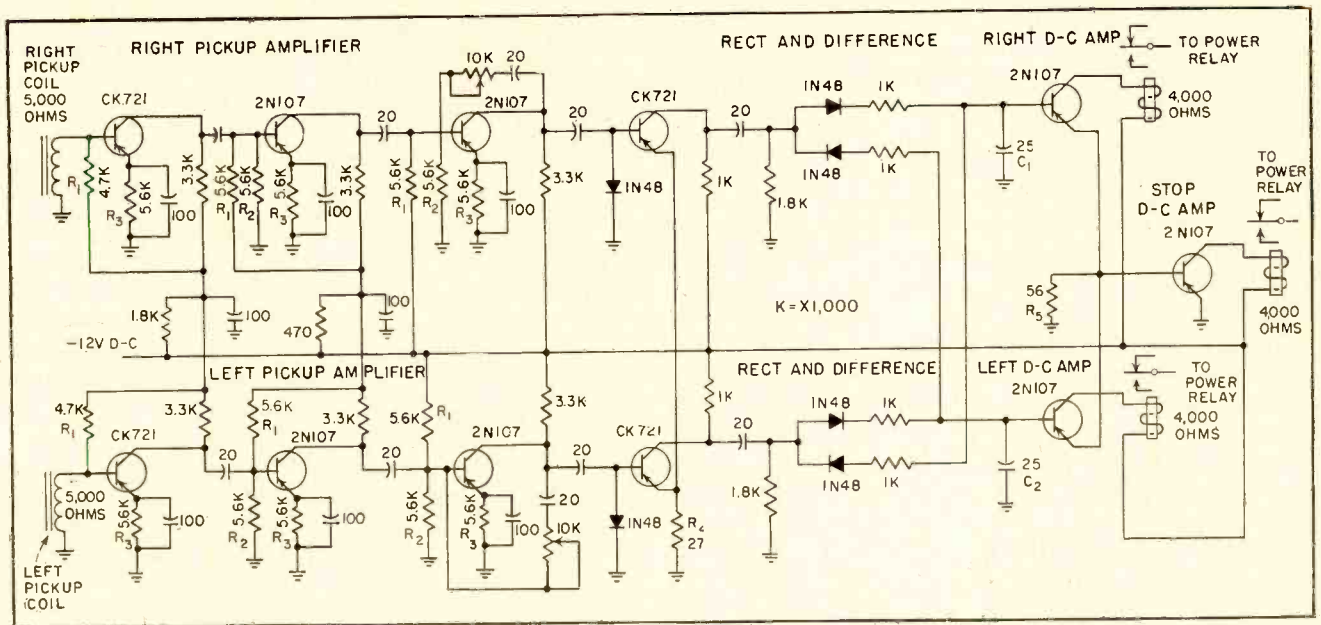

FIG. 2—Four-stage transistor amplifiers boost signals picked up by coils to control steering motors for cart

System Feeds Chickens

By **SHELDON KNIGHT**

*K & R Development Co.
Hughson, California*

cart, the two coils are mechanically connected to the front wheels in such a way that they move from side to side as the wheels turn with steering. When the vehicle is on course, the buried wire is midway between the two coils, and so the voltages induced in the coils by the magnetic field surrounding the wire will be equal. If the vehicle drifts off course, one coil will move slightly closer to the wire, producing a difference in the induced voltages.

Each coil feeds a four-stage transistor a-c amplifier as shown in block form in Fig. 1. The output of each amplifier is rectified and the two d-c signals combined to produce a difference output to the d-c amplifiers. The magnitudes of the outputs are proportional to the

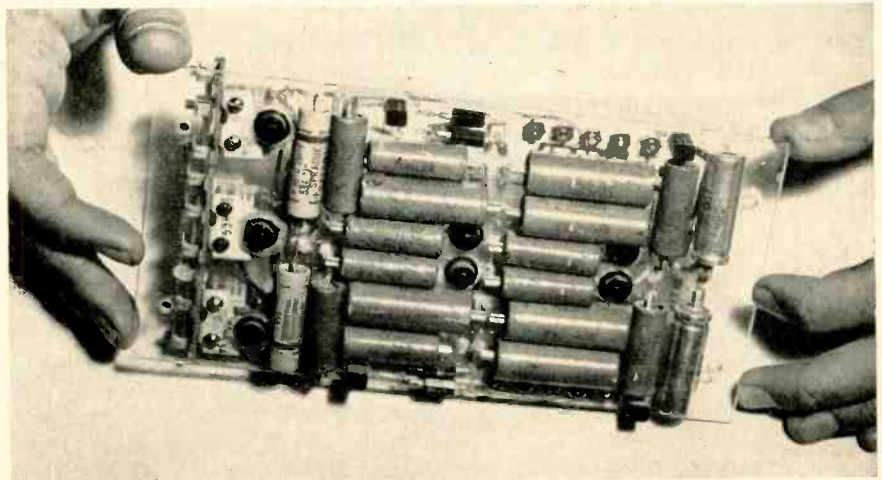

All control circuit components including relays are mounted on polystyrene board

difference between the rectified outputs of amplifiers. But the polarities are opposite.

As the vehicle moves off course to the left, the rectified output from right-pickup amplifier increases and the output from the left-pickup amplifier decreases, causing a negative d-c voltage to be developed in the right side final output and a positive d-c voltage to be developed in the left channel.

When the vehicle is on course the output of both amplifiers will

be equal and the final outputs will be zero.

Each final output drives a single stage d-c amplifier which controls a sensitive relay. The transistors in these d-c amplifiers are connected in the grounded-emitter configuration, and collector current is low in the absence of an input signal to the base. When the base is driven negative the collector current increases and closes the relay.

The relays actuate power-control relays which operate the electric

steering motor to make the proper correction.

Since the pickup coils are moved laterally as the front wheels turn, they will be in a position of balance over the buried wire after the wheels have turned a few degrees towards the course. Thus, the steering motor will be stopped leaving a small correction to intercept the course.

As the vehicle approaches the course again, the coils which are turned with the wheels, give an error indication in the opposite direction. This starts the steering motor to straighten the wheels, moving the coils back to their normal position, restoring balance and completing the correction cycle.

This is far from the ideal error-actuated servo system. However, it has the advantage of simplicity since no error-time derivative signal is required and since the follow up is purely mechanical. At the one to two miles per hour speed at which this cart operates, the system has proved entirely satisfactory.

A third d-c amplifier and relay is connected with the steering control d-c amplifiers in such a way that if the collector current of either steering amplifier exceeds a preset amount it will close and, through a power control relay, cut off the main motive power to the vehicle. This is a safety measure which will automatically stop the cart should it get more than a maximum distance off course due to some malfunction of the guidance system.

Electronic Details

The complete diagram of the electronic unit is shown in Fig. 2. The four-stage a-c amplifiers use conventional grounded-emitter configurations. A high degree of temperature stability in each stage is provided by stabilizing networks R_1 and R_2 together with emitter resistors R_3 .

A slight increase in stability is provided by the method of obtaining gain control. A potentiometer does this by providing variable negative-current feedback around the third stage.

There is a considerable excess of gain provided by the four stages,

so during normal operation considerable negative feedback is used. Extending the feedback loop to include more stages is not practical because of low-frequency stability problems which arise from the coupling and decoupling capacitors and the low impedances associated with the transistors.

Because the desired final output is the difference between the two amplifier outputs, and also because there is some loss in the difference circuit, the fourth stage must operate at a fairly high power level. To avoid excessive dissipation in this stage, the bias current is developed by rectifying the signal feeding the stage with the diode in the base input circuit. This maintains the bias and hence the collector current at the lowest possible level consistent with the signal level.

At first glance it would appear that the low forward resistance of the base-emitter section of the fourth-stage transistor would serve this purpose; however this proved to be too high to allow adequate charging of the input capacitor and so the diode was added. This variable bias circuit also eliminates the need for the temperature stabilizing resistors used in the first three stages.

A small amount of cross coupling is provided between channels by the common-emitter resistor R_4 in the fourth stage of the two amplifiers. The input coils are connected to the amplifiers so that the amplifiers are excited in phase. Thus the signal developed across R_4 due to either amplifier is of such polarity as to reduce the output of the other amplifier. If the output of either amplifier increases, the output of the other amplifier will decrease even if the input to the other amplifier has not changed. This cross coupling feature further increases the differential in the amplifier outputs. The rectifier and difference circuit is a conventional diode system.

The emitters of both d-c amplifiers are grounded through the common resistor R_5 . These emitters are also connected to the base of the stop d-c amplifier. Thus a part of the emitter current of either d-c amplifier must flow through the base input circuit of the stop am-

plifier. If this base current exceeds a certain maximum, the collector current of the stop amplifier will increase sufficiently to close the relay.

Possible Modifications

This unit was designed and built for one specific application. In this capacity it worked well, so no further development effort has been expended on it. However, usage has pointed out some possible improvements that could be incorporated in subsequent designs.

Bias stabilizing networks, R_1 and R_2 , produce more stability than is really necessary, and so introduce an unnecessary loss of gain. These resistors could possibly be increased to as high as 27,000 ohms, depending upon the range of temperature variation expected, and the resulting increase in gain would allow the unit to operate satisfactorily with only three instead of four stages of a-c amplification.

There is a slight lag in the response of the unit due to the time required for charging capacitors C_1 and C_2 . This lag places a low limit, in the neighborhood of three miles per hour, on the forward speed of the vehicle. With 60-cps current in the buried wire, the capacitance cannot be reduced below 25 μ f and still maintain adequate filtering. For higher forward speeds the wire should be fed from a higher frequency source so that the capacitor values and the resulting lag could be reduced proportionately.

The unit was built on a 4 by 8 inch sheet of $\frac{1}{8}$ -inch polystyrene. Holes were drilled in the sheet to allow wire leads to the various components to pass through from the component side of the board to the wiring side.

Components were temporarily mounted with plastic cement. The wiring itself serves to permanently mount the components. This type of construction provides a compact unit in which all parts and wiring are readily available for rapid servicing.

The unit was mounted in a small aluminum box for protection. Gain controls are mounted on the aluminum box, and so do not show in the photograph.

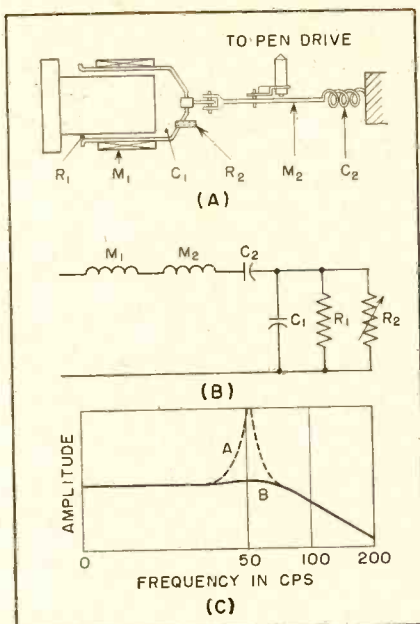
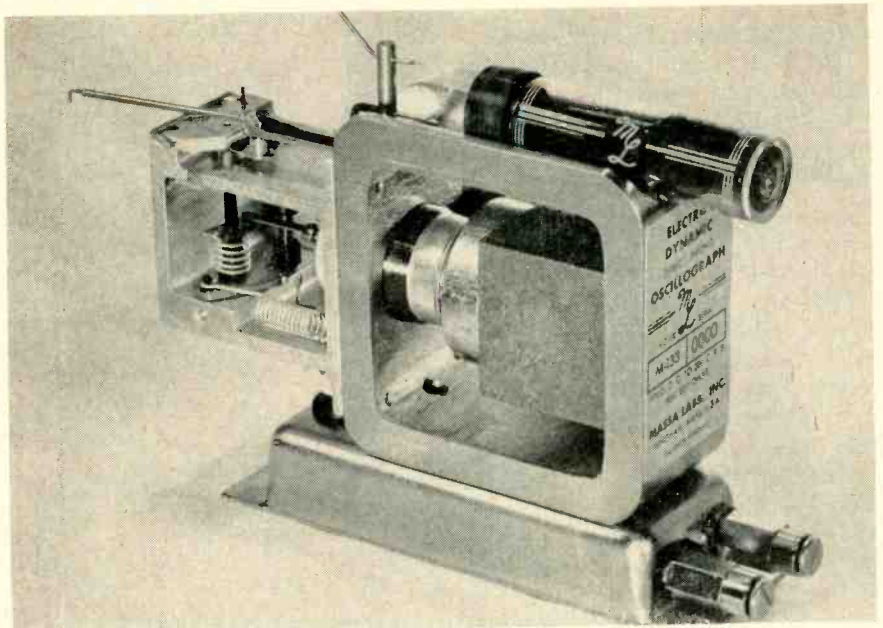

FIG. 1—Schematic of pen motor vibrating system (A), its equivalent circuit (B) and response with and without damping (C)



Dust shields have been removed from pen motor to show mechanical linkage. Unit has application in measuring time intervals among several related events such as receiving and ground echoes at various pickup stations used in geophysical exploration

PEN MOTOR For Rectilinear Recording

By FRANK MASSA and ERNEST A. MASSA

Massa Laboratories, Inc.
Hingham, Mass.

SUMMARY — High-speed rectilinear recordings are now possible with pen motor having a frequency response from d-c to 60 cps and gradual decrease in sensitivity to 200 cps. Unit is independent of amplifier compensation and can be fed from any impedance. Coaxial body prevents whipping at high frequencies and mechanical filter permits splatter-free writing to 200 cps

DIRECT-WRITING high-speed pen recorders have become popular in spite of several apparently inherent limitations in performance of available instruments. Some of these limitations, as reported, may include ink splattering at high writing speeds, curvilinear distortion of the pen tip, pen-whipping at high frequencies, lack of rectilinear motion and inherent resonance of the pen-motor system resulting in poor transient response. The direct-

inking recorder to be described overcomes many of these limitations.

Drive System

The basic drive system for the pen motor consists of an electrodynamic transducer comprising a cylindrical current coil freely supported in an annular magnetic air gap. The coil winding not only occupies the complete air-gap volume, but also projects axially on either

side of the air gap by an amount equal to the peak excursion of the coil at full-scale amplitude of operation. This design insures a constant force factor for various positions of the coil and eliminates the nonlinear distortion present with a coil placed entirely within the mechanical air gap.

Since the entire air-gap flux is used, a relatively small magnet is needed as compared to the larger magnets required in conventional

d'Arsonval structures available.

The pen motor is normally protected by dust shields. A disposable hermetically-sealed ink cartridge is easily inserted into the hypodermic ink feed and vent assembly.

Acoustic Damping

The current-carrying coil is wound on an accurately dimensioned cylindrical form which is assembled to glide smoothly over Teflon ribs held rigidly in longitudinal slots on the surface of the pole piece.

The left-hand end of the coil form is closed and the physical spacing between the periphery of the pole piece and the inner surface of the form is adjusted so the viscosity of the resulting air film critically damps the resonance of the vibrating mechanical system.

As a result of this critical air damping the pen motor has a flat frequency response characteristic, making the instrument independent of special compensating amplifiers or source impedances.

Figure 1 illustrates the effect of the various parameters in the design of the acoustic damping for the vibrating system. In the equivalent circuit of the mechanical system, the mass M_1 of the current coil is represented by the inductance M_1 . A second inductance M_2 represents the effective mass M_2 of the linkage and pen assembly and appears in series with M_1 . A series electrical capacitance C_2 represents the compliance of the control spring C_2 and, in combination with M_1 and M_2 determines the resonant frequency of the pen-motor assembly.

A trapped volume of air, C_1 cor-

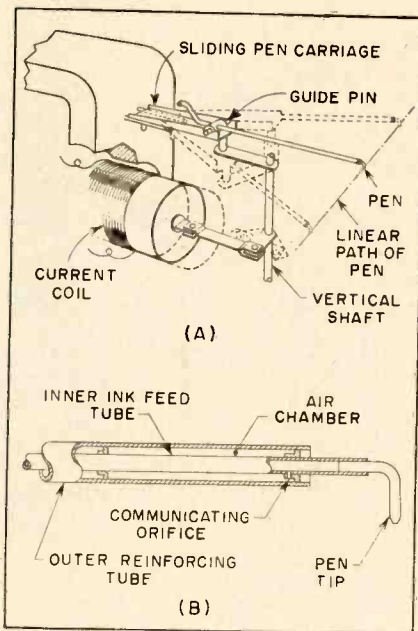

FIG. 2—Pictorial view of mechanical linkage (A) and pen construction (B). Drive coil moves in and out horizontally like loudspeaker voice coil, to move pen through linkage

responds to capacitance C_1 in the equivalent circuit. The thin film of air in the annular clearance space between coil form and pole tip introduces mechanical resistance owing to its viscosity and appears as resistance element R_1 in the equivalent circuit.

A tiny capillary tube of adjustable length is shown attached to the closed end of the coil form to establish communication between the trapped volume of air C_1 and the atmosphere. The viscosity of this air film is proportional to the length of the tube and therefore the resistance R_2 is shown as a variable resistance in the equivalent circuit.

In the conventional instrument

the current coil is open and therefore capacitance C_1 is infinite. This results in a short-circuit of resistance element R_1 . Under this condition a highly-peaked resonant system results as represented by curve A in Fig. 1C.

In the pen motor, the trapped volume of air C_1 is dimensioned so the impedance of equivalent capacitance C_1 does not shunt resistance element R_1 in the frequency range of operation. By adjusting the dimension of the film of air R_1 and tailoring the length of the capillary tubing R_2 it is possible to critically damp the resonance of the pen-motor assembly to result in the flat frequency response characteristic indicated by curve B in Fig. 1C.

Rectilinear Motion

Figure 2A shows the linkage system interposed between the closed end of the coil form and the pen carriage. Forces generated when an electric current passes through the coil are imparted to the offset portion of the vertical shaft assembly. The shaft is mounted in jewel bearings and rotates against the stiffness of a calibrated spring around the lower portion of the shaft. This spring establishes the frequency range and sensitivity of the instrument.

The top end of the vertical shaft projects through the top wall surface of the linkage housing and oscillates an offset arm coupled through the lower left-end surface of the pen carriage. The left end of the pen carriage terminates in a vertical guide pin held between parallel, hardened guide surfaces to permit free axial carriage displacement. The linkage system and pen-carriage dimensions are adjusted so as the current coil deflects, the pen carriage moves forward in progressively greater amounts such that the pen tip describes a true straight line instead of a curve.

Pen Zero-Adjustment

A mechanical pen-biasing adjustment is located behind the pen carriage assembly. Zero adjustment is achieved by anchoring the main control spring to a gear-sector plate engaged to a small pinion. The pinion is rotated by a slotted shaft

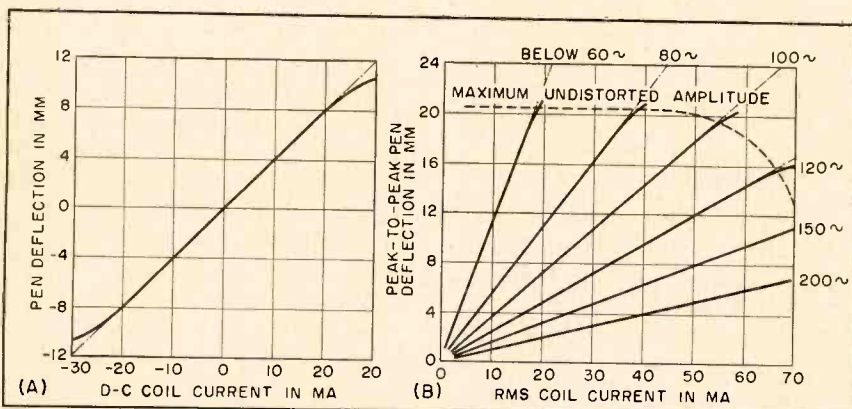

FIG. 3—Curves show linearity for d-c signal (A) and a-c signal (B)

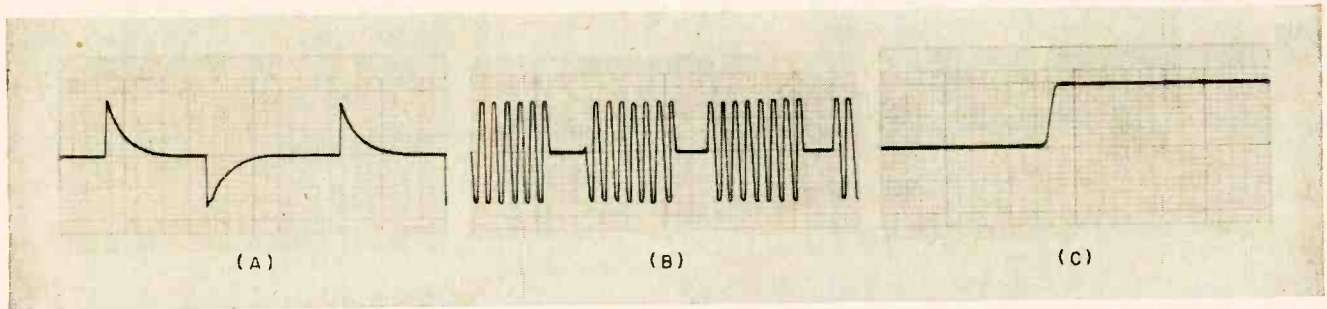

FIG. 4—Recordings show return to zero after application of step function and gradual current reduction thereafter to maximize error (A), return to zero after successive bursts of sinusoidal a-c excitation (B) and step function at high speed (C)

which projects through the top of the linkage housing.

This adjustment permits accurate alignment of the pen tip along the chart center line. The tip may be set to either chart extremity to obtain twice the normal recording amplitude for unidirectional pulses.

A second micrometer set screw adjustment in the pen-motor base permits exact axial positioning of the complete motor unit relative to the base. This set screw is located between the electrical terminals on the base.

The complete assembly weighs 1½ lbs and mounts 1¼ in. on centers in multiple-channel installations.

Whipping and Ink Splatter

One of the generally unrecognized sources of distortion results from pen whipping. Flexibility can cause bending at high frequencies, resulting in errors in the position of the pen tip. At full high-frequency amplitudes, forces of 1,000 g act on the pen to cause whipping. It was found necessary to increase the stiffness of the pen body to eliminate small amounts of pen whipping which would introduce an instantly visible curvilinear distortion into the rectangular recording.

Increased ink flow resulting from large centrifugal forces developed at high frequencies may cause the writing fluid to splash violently from side to side beyond the limits of the chart. A cross-sectional view of the pen assembly in Fig. 2B, shows the design used to prevent splatter at frequencies up to 200 cps. The inner ink feed tube is surrounded by an outer reinforcing tube which is rigidly secured through annular spacing disks to the inner tube. Thus, the stiffness

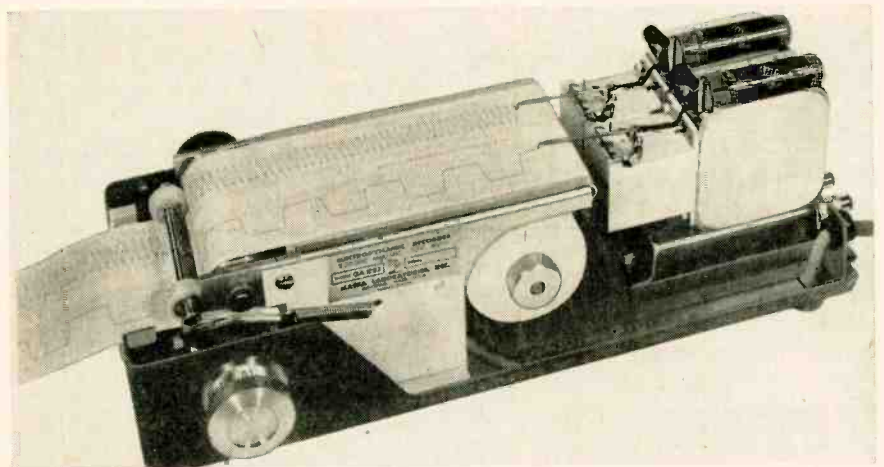

Ink reservoir cylinder is on top of magnetic frame for drive coil system

of the pen assembly is increased with a minimum increase in weight. The concentric air chamber between the two tubes and the two spacers forms the compliance element of a mechanical filter which is coupled by a communicating orifice to the inner tube which carries the ink.

Pressure changes created near the pen tip neutralize the pulsating forces which would otherwise cause high-frequency ink splattering in the absence of the filter, thereby producing continuous unbroken ink lines at all writing speeds up to 200 cps.

The graphs in Fig. 3A and 3B show the relationship between pen deflection and coil current for both d-c and a-c inputs. The linearity is near perfect up to 80 percent of full-scale deflection from d-c to 100 cps and the amplitude at full-scale deflection of ± 10 mm falls off less than about 4 percent below the straight-line value.

A common type of error encountered in direct-ink-writing oscillographs results from the inability

of the pen tip to return to the same zero point on the chart every time a signal is removed. A d-c pulse was slowly discharged through a capacitor from opposite polarities to produce the recording shown in Fig. 4A. The maximum hysteresis error was actually less than $\pm \frac{1}{4}$ mm under these most disadvantageous conditions, which amounts to an error of less than ± 3 per-

For a-c signals the hysteresis effects are still lower, as seen from the return to zero of the pen tip in Fig. 4B after successive bursts of sinusoidal excitation.

Response

Rise time is defined as the time required for a step function to rise to approximately $\frac{2}{3}$ of its full-scale value after the instant of application. The strip chart reproduced in Fig. 4C shows a step function made at a chart speed of 200 mm per sec. Since each horizontal 2-mm division on the paper represents 10 milliseconds in time, the rise time of the pen motor is about 5 milliseconds.

SENSORY AID DEFINES

SUMMARY — Miniature device using cadmium sulfide photocell, diode and two transistors to actuate a magnetic earphone gives audible indication of printing, meter readings or location of maximum ambient light. Unit, including accessory lamp bulb, is powered by 1.5-volt battery

AN ELECTRONIC device that provides an audible signal with frequency proportional to the intensity of a received light signal is a useful tool for the blind. Such a device has been described¹ by the late Dr. C. E. Witcher of this laboratory. The original device employed a neon-bulb relaxation oscillator and therefore required a 90-volt battery supply.

This supply was physically large and resulted in fairly expensive (\$2.50 to \$3.00) replacement cost. To eliminate these two disadvantages the optical probe has recently been transistorized and redesigned mechanically. The complete unit including the small pen-light bulb now operates on a single 1.5-volt cell.

Light Sources

The probe provides an audible signal whose frequency is proportional to the intensity of the received light. The received light may originate from ambient sources external to the device or from a tungsten bulb that may be attached to the device.

A photograph shows the disassembled unit, together with a

meter-reading attachment. The 4.5-inch cylindrical tube contains an optical lens, an electronic package, a battery and a switch in the screw cap. The V-shaped attachment is secured to the tube by a twist-lock feature and contains a small prefocused penlight bulb. The bulb is contained in a holder that can be secured to either of two attachments by another twist-lock. Overall length of the device is approximately 5.5 inches.

The lens has a diameter of 0.5 inch and a focal length of 0.5 inch. It is mounted in a movable tube. A milled slot shown at the left end of the barrel provides two prefixed focal distances for the lens. Focus at infinity is used with ambient light sources and a focus at 1 inch is for use with attachments.

The circuit is a two-stage, capacitance-coupled, free-running multivibrator. The transistors are

low-noise *pn*p junction types. The frequency of oscillation is controlled by the time constant

$$T = C_1 \frac{R_1 R_d}{R_1 + R_d}$$

where C_1 is the value of capacitance of the coupling capacitor, R_1 is the equivalent resistance of the photocell and R_d is the sum of the diode and transistor resistances under reverse bias conditions.

Since the effective resistance of the photocell is approximately an inverse function of the intensity of the received light, the frequency will be related linearly to the received light intensity. The silicon diode is employed to make the value of R_d large compared with R_1 in low levels of light intensity. Since the dark resistance of the photocell may easily exceed 10^8 ohms, whereas the input resistance of the transistor with reverse bias applied may be as

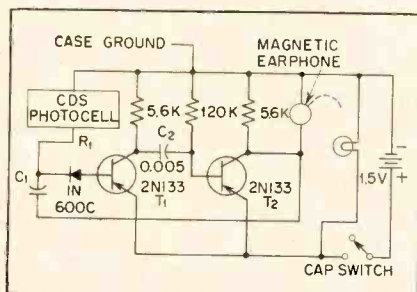

Circuit of the transistorized sensory aid is essentially a multivibrator

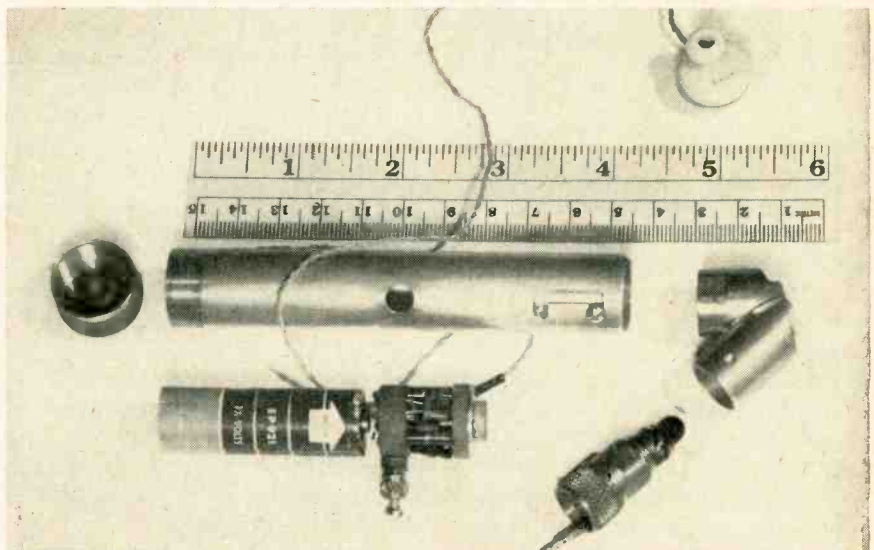

Elements of the audible reader show lamp (lower right) transistor-photocell-diode assembly (center) battery and case. Hearing-aid type earphone upper right

LIGHTS AND MARKS

By C. R. HURTIG

*Research Laboratory of Electronics
Massachusetts Institute of Technology
Cambridge, Mass.*

high as 10^9 ohms, the diode is necessary to extend the frequency range of operation.

Under normal conditions, the waveform of the multivibrator is highly asymmetrical. If the probe is employed in direct sunlight, the photocell resistance becomes very low and the mode of operation becomes more symmetrical, with a final limit of sinusoidal operation. The transistors are not bias-stabilized; however, no difficulty with thermal instability was noted.

Frequency Range

The frequency variation is from a few pulses per second to several thousand pulses per second. At low light levels the nonlinear characteristics of the photocell and diode cause the loop gain to fall below unity; hence the oscillation fails. If operation at low light-intensity is necessary, sustained oscillation can be maintained by the use of a supply voltage of 3 volts or greater.

Current drawn by the transistor circuit varies from 650 to 550 μ a as a function of light intensity. Thus, the operating life of the battery is a few hundred hours with the bulb disconnected.

With the bulb connected, the battery life is a few hours, since the bulb current is approximately 200



To read a meter the plastic card with embossed indices is placed over the glass face of the meter and the location of the pointer found and related to the raised marks. Any meter can be used without alteration

ma. If the attachments requiring bulb operations are to be used continuously, it is advantageous to employ an external 1.5-volt d-c supply operated from a convenient line source.

The probe is shown in the photograph as it is normally used to read the deflection of a meter needle. A transparent plastic overlay with a series of raised markings is placed on the glass surface. The probe is moved over this overlay until the large change in frequency, indicating the location of the meter needle, is observed. The center of the probe is then measured tactually with respect to the raised markings. The probe is designed to focus at a depth below the overlay of approximately 0.19 inch,

which corresponds to the vertical locations of the needle.

The printed numbers and markings on the meter scale cause background noise but the change in frequency caused by these sources is small compared with the change caused by the needle. For some meters—those having a needle width that is small compared with its depth—the location of the needle and the shadow of the needle created by the angular incidence of the light from the bulb are difficult to distinguish. With the present arrangement the location of the needle can be detected within an accuracy of a few percent.

Two other attachments are provided. One is used for detecting the presence of printed matter on paper, second for tracing patterns from ambient sources such as an oscilloscope or detecting the presence of sun-lighted windows.

The work described was supported in part by U. S. Army, U. S. Air Force and U. S. Navy agencies.

CAUTION AGAINST OVEROPTIMISM

THE AMERICAN Foundation for the Blind has appropriated sufficient funds for the construction of fifty of these sensory units by Dunn Engineering Associates, Cambridge, Mass.

These units are to be distributed on a loan basis to determine possible applications that may result in a higher level of employment for the blind.

The difference between a useful tool and an interesting device is that the cost of a tool will be either self-liquidating by a higher employment level or it will open new avenues of information-gathering to the blind.

The usefulness of this device remains to be determined by the American Foundation for the Blind

REFERENCE

(1) Pointer and Line Locator Aids Blind, *ELECTRONICS*, p 194, Feb. 1954.

PRECISE HEAT for

SUMMARY — Drawing a large single crystal of silicon from a crucible heated by r-f induction requires control within 0.25 deg C at 1,400 C over the period of an hour. Saturable core-reactors controlling r-f energy receive d-c signals from 100-deg full-scale recorder actuated by thermopile

ROUTINE production of large single crystals of silicon for use in transistor manufacture requires precise control of high temperature. The semiconductor, heated in a crucible by induction from an r-f generator, is controlled to within 0.25 or 0.30 deg C of its crystallization point for about an hour. Such control is needed to produce smooth crystals, as shown in the photograph.

The temperature limit of 0.25 deg is not a limit of error of measurement, but only a limit of drift from a set temperature of about 1,400 C. The problem is severe, because there is so little room for such factors as mechanical error of the recorder-controller, changes in cali-

bration of the temperature detector and development of stray potentials in the circuits.

Temperature Sensing

Either thermocouple or thermopile (Rayotube) can be used as a detector for the electronic potentiometer recorder-controller, as shown in the block diagram, Fig. 1.

A thermopile equipment used by Philco Corp. at the Lansdale, Pa. plant is shown in the photograph. The thermopile in the housing below the crucible has a lens and mirror system that focuses radiation from the crucible bottom onto the pile. A small flow of inert gas in the path from pile to crucible keeps out dust and fumes, preserv-

ing the brightness and accuracy of the optical system.

The Le Carbone air cells are used to supply the recorder potentiometer circuit since they have good current output stability for the time required to grow a crystal. The Speedomax recorder-controller's expanded range covers 60 deg C.

Dual Control

Essentially two control loops are shown in Fig. 1 (outer). In the primary loop, an error signal, which is proportional to the deviation of measured crystal temperature from a set point, is developed by the control slidewire in the temperature recorder-controller *B* and delivered to the high-speed current-output controller *C*. Here the error is continuously analyzed to determine the corrective action necessary to restore the melt temperature to set point.

An output signal, ranging from 0 to 5 ma d-c is generated in accordance with this analysis and fed to magnetic amplifier *D* where it is changed to the level required to operate saturable core reactors, which adjust the power supply to a 300-kc induction furnace. This in turn controls the energy transfer to the melt and thus regulates its temperature.

In the secondary loop, the primary measuring element, its associated recording equipment and the process itself, together with their intrinsic time delays, are bypassed through the use of a pick-up coil that detects the energy level delivered to the melt and develops a proportional d-c signal that is fed back directly to the controller.

It is by this circuit that the con-

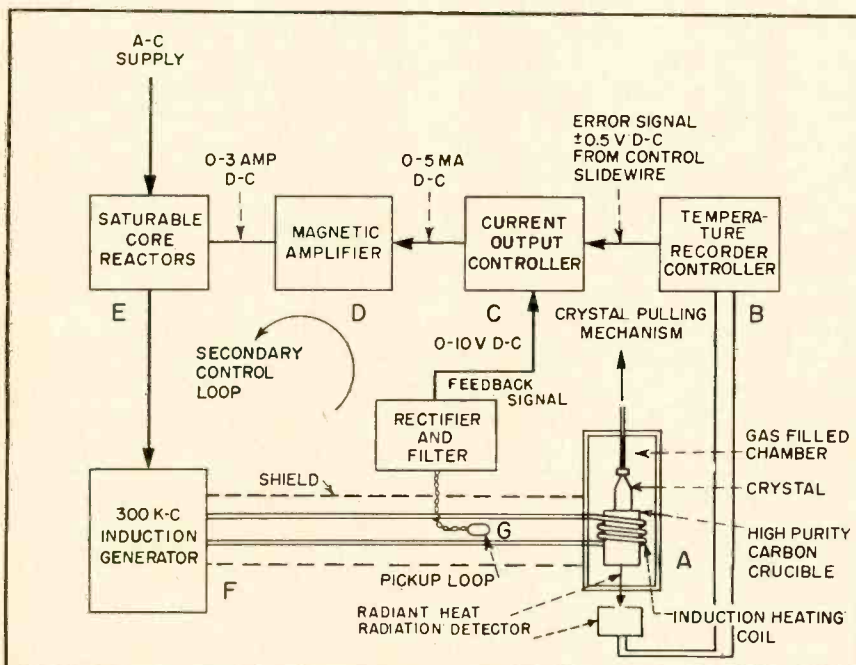
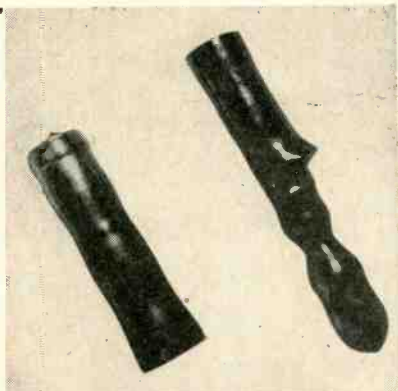

FIG. 1—Block diagram shows elements of the temperature control equipment including primary and secondary control loops

Growing Silicon Crystals

By E. T. DAVIS,
W. B. ALDEN
and F. H. WYETH

Leeds and Northrup Co.
Philadelphia, Pa.



Effect of temperature control in growing silicon. Crystal at right cannot be used



Growing a semiconductor crystal from induction-heated bath

Control compensates promptly for line voltage change and other spurious effects that upset the temperature of the crystal growing process.

Crystal-Pulling Procedure

The procedure of crystal-growing is to fasten a seed crystal to a motor-driven pulling apparatus, touch it to the surface of the molten silicon and pull it away slowly as the crystal grows on the end. The seed is a piece of a previously-grown crystal, machined to about a quarter-inch square and an inch long. It is fastened to the puller head's rod by a chuck.

With the seed in place, the operator heats the charge to good fluidity, which occurs at about 1,425 C. Melting takes 15 or 20 minutes. When the charge is thoroughly fluid, the operator reduces the power and watches the surface for the first trace of cloudiness as the molten silicon cools. By gradually lowering the set point of the temperature controller, the operator brings about a balance of heat input such that the surface develops and maintains this trace of cloudiness. It is in maintaining this condition that the temperature limit of about 0.25 deg is essential.

The operator now lowers the seed until it touches the surface and then starts the puller. The shape of the meniscus is his guide; he watches it and adjusts speed of pulling and temperature as experience indicates. The crystal is made to grow continuously, by accretion from the surface of the molten silicon. Pulling takes 60 to 90 minutes. Total preparation time is one to two hours a crystal.

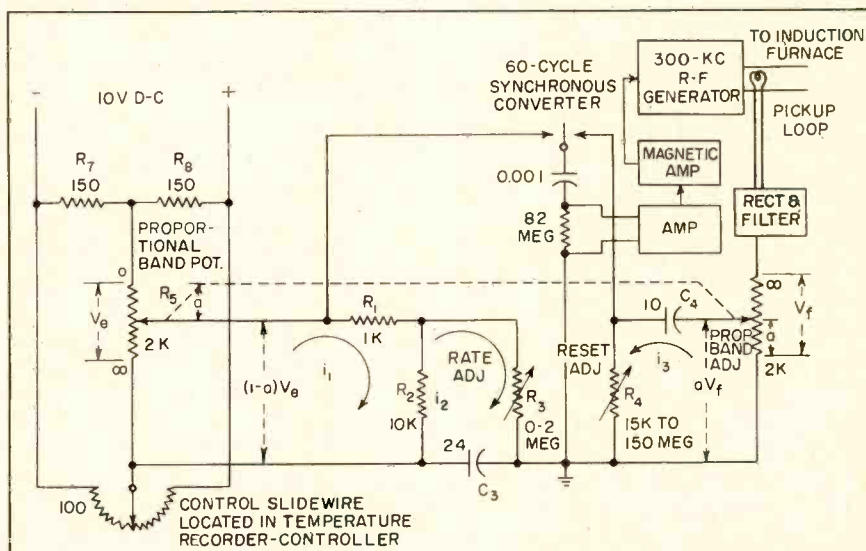

FIG. 2—Simplified computer circuit for current output controller

The current-adjusting controller *C* in Fig. 1 is an all-electronic unit in which output is related to its input on a three-function basis. A proportional component varies directly with the magnitude of the input signal to give proportional control. An integral component varies both with the magnitude of the input signal and its duration, to provide reset action. A derivative component varies with the rate of change of the input signal to supply rate action.

These three actions are suitably combined to produce the desired control signal for the process. Calibrated dials allow separate adjustment of each control function in

accordance with the characteristics of the process under control to provide optimum control response.

The controller computing circuit used to derive the three basic control functions is shown in Fig. 2. At the left, a d-c Wheatstone bridge establishes an error voltage proportional to any deviation of temperature with respect to set point.

The control slidewire in temperature recorder-controller *B* is positioned by its control point setter. It is supplied with 10 v d-c and the voltage at its midpoint is just equal to a 5-v reference potential established at the junction of equal-valued resistors R_7 and R_8 .

that are tied across the same 10-v supply.

The sliding contact is driven by the recorder-controller balancing mechanism, its position varying directly with temperature. The error voltage developed across the proportional band potentiometer R_s varies from +5 v d-c when temperature is low, through 0, to -5 v d-c when temperature is high. The reference point is at the sliding contact of the control slidewire. Voltage V_e therefore indicates any deviation of the melt temperature from the set point and is equal to zero when temperature and set point are the same.

At the right side of Fig. 2 is the feedback circuit that develops a signal V_f proportional to the square root of the power delivered to the melt. This signal is obtained directly from the induction furnace input through a pickup loop that couples a small part of the r-f energy back to a rectifier and filtering unit. This in turn delivers a direct current to the controller. Over a reasonably small range, this current can be said to vary directly with furnace input. The feedback

signal is converted into a voltage V_f through potentiometer R_s and an adjustable portion of it is used by the controller computer circuit in developing the desired control action.

The passive network constituting the computer section of the controller may be analyzed mathematically to yield the following control equation

$$V_f = \frac{(1-a)K}{a} V_e \left[1 + 10 \frac{T_3 p}{T_3 p + 1} + \frac{1}{T_4 p} \left(1 + 10 \frac{T_3 p}{T_3 p + 1} \right) \right]$$

Where K = a controller constant
 a = the angular position of the proportional band potentiometer expressed as a percentage

$\frac{(1-a)K}{a}$ = the reciprocal of the proportional band adjustment

T_3 = the rate circuit time constant $R_3 C_3$

T_4 = the reset circuit time constant $R_4 C_4$

and p = the operator $\frac{d}{dt}$

V_f = the feedback voltage developed across R_6

V_e = the error voltage across R_s

From the above control equa-

tion, three functions will be observed. The first is a pure proportional action $(1-a)K/a$, which depends only upon the proportional band adjustment a . The second is an approximate rate action that approaches a true derivative function for slow changes in the measured variable (where $T_3 p$ is much smaller than 1) but which reaches a limiting value of $10(1-a)K/a$ when the measured variable changes rapidly.

The third function is a reset action that integrates the sum of proportional plus rate action with respect to time. The combination is thus a three-action control circuit that can be tuned to the process through the suitable selection of a (proportional band), T_3 (rate) and T_4 (reset).

Signal Comparison

The current-adjusting type controller is actuated by the presence of an unbalanced condition at its input. A differential amplifier compares the error signal derived from the measuring bridge (suitably operated upon by the computer circuit) with the feedback signal from

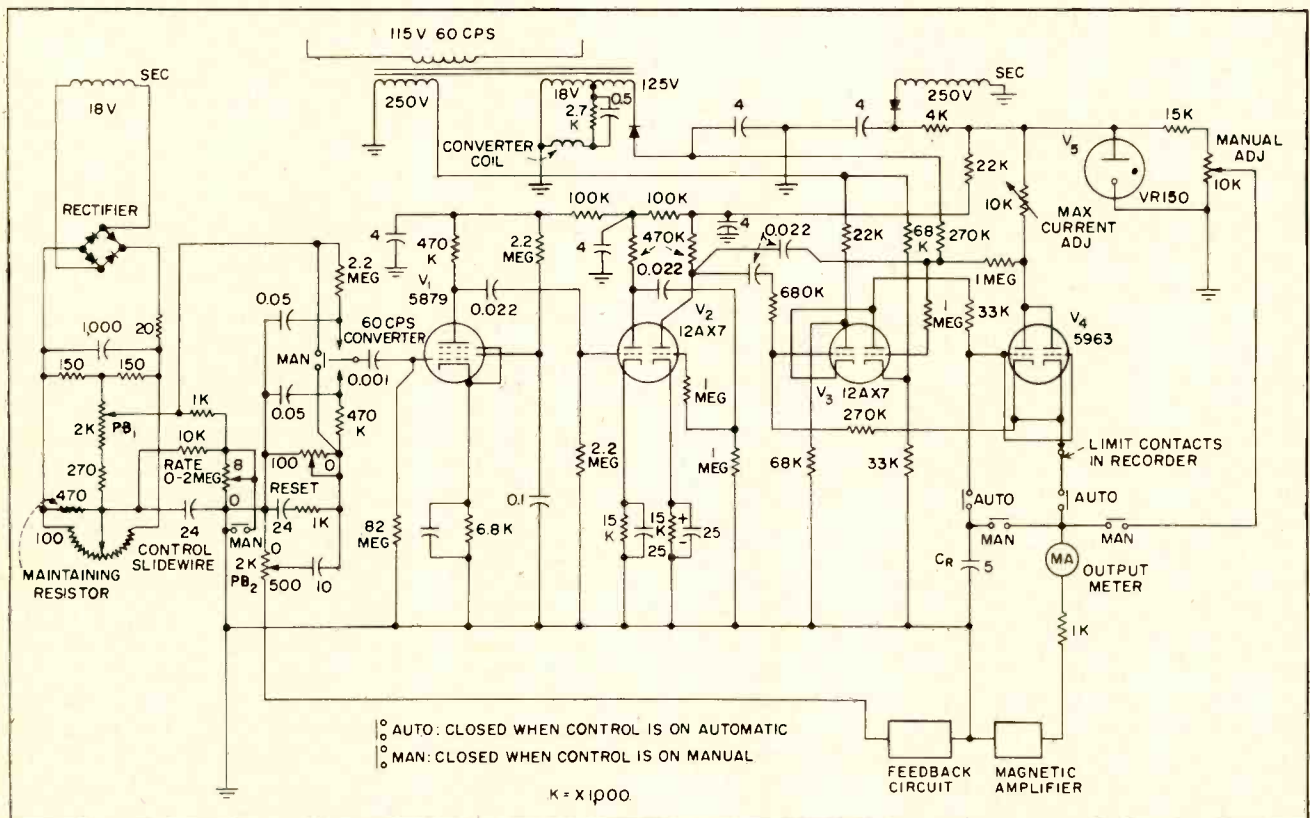

FIG. 3—Complete circuit diagram showing basis of temperature control

the furnace output (also operated upon by the computer). Any discrepancy between these two signals is seen by a 60-cycle synchronous converter that passes the resulting a-c voltage representing their difference to a high-gain amplifier.

Figure 3 shows in schematic form the controller amplifier and current adjusting circuit. Tubes V_1 and V_2 comprise a three-stage amplifier whose output, as measured on the final plate, is a 100-volt maximum peak-to-peak square wave reached when the input differential is one millivolt.

The phase of this square wave is the same as that of the line voltage supplied to the controller when the feedback signal indicates that the furnace input is too low. It is 180 deg out of phase with the line when this input is too high. The square wave thus derived is used as a gating signal to control the action of a phase sensitive charge-discharge tube V_3 .

The output stage V_4 is essentially a cathode follower and delivers current to the magnetic amplifier load in accordance with the potential maintained at its grid by the charge-discharge tube operating into capacitor C_R . The operation of this circuit can be described by assuming that the furnace temperature is low. In this case, the differential amplifier produces a square wave at its output that is in phase with the line. This signal is applied to the grids of both the charge and discharge tubes, suitable d-c bias being maintained to limit or prevent conduction when the square-wave signal is absent.

Charge-Discharge

To make the charge and discharge sections of V_3 phase sensitive, they are fed from a 60-cycle voltage source. The plate of the charge section and the cathode of the discharge section swing with the line so that the former is blocked during the negative half cycle while the latter is blocked during the positive half cycle. Charging and discharging the capacitor C_R is therefore a function of the phase relationship between the signal present at the amplifier output and the line.

When these two voltages are in

phase, as in the case under consideration, the charge tube is permitted to conduct during the positive half cycle since both its grid and plate have become positive with respect to its cathode. The discharge tube remains inoperative because its cathode is made positive with respect to its plate during the half cycle that its grid is moved in a positive direction. This results in a charging of capacitor C_R once each cycle until such time as the input signal to the amplifier is again brought into balance.

As C_R is charged, the output current from the controller increases in accordance with the requirements of the output tube characteristics, thus causing the furnace temperature to rise. A maximum current adjustment is provided in the plate circuit of V_4 to prevent the output from exceeding the value required for maximum furnace input. This adjustment sets the point at which the grid potential will exceed the potential of the cathode and thus prevent further charging of reference capacitor C_R .

The controller output current varies from 0 to 5 ma and operates through a total resistive load in the cathode circuit of 5,000 ohms. Thus the cathode of the output stage swings from zero to 25 v. The reference capacitor C_R voltage changes from -12 v at cutoff to +25 v at full output.

Error Signal

To function properly the current-output controller must maintain a close balance between the charge and discharge tubes over its relatively wide operating range. A small error signal is required at the input of the amplifier to hold a given output level. This is necessary to compensate for tube and other circuit component variations.

The size of this error signal tends to be a function of current output so that automatic internal adjustments are required for uniform controller operation. This is accomplished by changing the bias levels on these two tubes to compensate for the charge variation on capacitor C_R . As this latter voltage changes, the cathode of the charge tube and the plate of the

discharge tube change in like manner. For this reason, the bias on the charge tube is driven in a positive direction with increasing output current, through a 270,000-ohm resistor, which connects to the cathode of the output stage.

This resistor is necessary to compensate for the cathode potential that is also moving in a positive direction. Similarly the bias on the discharge tube must go in a negative direction with increased current output, to compensate for its plate potential, which is becoming more positive. This action is achieved by running the grid circuit back to a voltage divider located between the plate of the output tube and a negative voltage source. Since the plate voltage of V_4 swings in a negative direction with increasing output current, the desired operating voltage for the discharge tube grid is obtained.

Current output of the controller in the order of 0 to 5 ma is fed to a magnetic amplifier where it is converted to a current ranging from 0 to 3 amperes.

Power Control

These reactors are connected in series with the r-f generator and regulate the power delivered to the equipment through changes in their reactance. The d-c control signal is fed to the reactor through a special winding, the ampere-turns being such as to saturate the core when 3 amperes flow.

Under this condition its reactance becomes negligible and the generator operates with maximum voltage supplied to its plates. Conversely, when the current to the reactor drops to zero, its reactance becomes a maximum and most of the supply voltage is dropped across the reactor, leaving little for the generator.

The magnetic amplifier and saturable-core reactors used for this application will respond to input changes in 0.1 sec or less, so the secondary or stabilizing control loop has an overall response time of about 0.5 second.

Among those who have contributed to the application of this control method are C. S. Duncan of Westinghouse Electric Co., S. L. Parsons and W. Moll of Philco.

INSTANTANEOUS

By CHARLES R. RUTHERFORD

Temco Aircraft Corp.
Dallas, Texas

SUMMARY — Maximum range of air-to-ground communications systems is extended up to 100 percent by use of speech compressor combining advantages of clipper and agc types. Use of transistors permits construction of unit that plugs into carbon microphone jack

MILITARY tactical requirements have increased the required distance for communication by 25 to 50 percent over the maximum range obtainable with existing communication equipment.

Communication range with an amplitude-modulated transmitter is a function of the transmitted sideband power and is independent of the transmitted carrier power. Because of the wide variations in amplitude of normal speech, voice peaks producing 100-percent modulation will give an average modulation of only 30 percent. A 30-percent modulation level results in the sideband power being down 10.5 db from the 100-percent modulation level.

Since intelligibility, not quality of speech, is the primary requirement for field communications, a transistorized speech clipper would increase maximum range on many existing communication sets.

The increase in maximum range

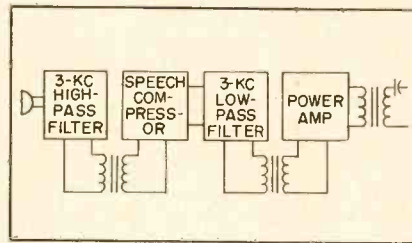

Fig. 1—Filters before and after compressor increase intelligibility



Speech compressor mounted beneath transmitter feeds microphone input

when a speech clipper is used would be due to two factors: Higher average percent modulation would give a higher average transmitted side-band power, and the power of the intelligence carrying consonant sounds would be a larger percent of the total speech power. Assuming that a 50-percent word intelligibility is the minimum for useful communication, tests show that use of a 24-db speech clipper is equivalent to increasing transmitter power by 14 db. This increase

is equivalent to a power gain of 25.

The ratio of the peak voltage of the average vowel to the peak voltage of the average consonant is about 12 to 15 db. Clipping can be used to make the intelligence carrying consonant sounds at least equal to the vowel sounds.

One type of simple speech clipper is a vacuum tube that is biased such that speech will drive the tube from cutoff to plate current saturation. A serious disadvantage of the saturation type of speech clipper is that when the talker is in a noisy location, such as an airplane, the speech clipper seriously decreases the speech-to-background noise ratio.

To prevent degradation of speech-to-background noise ratio, conventional automatic gain control circuits have been used to control average percent modulation. This type of speech compressor will hold the average level of speech, and therefore the average percent modulation, constant. However, the circuit will not hold constant the peak values of the voice signal. With the agc type of speech com-

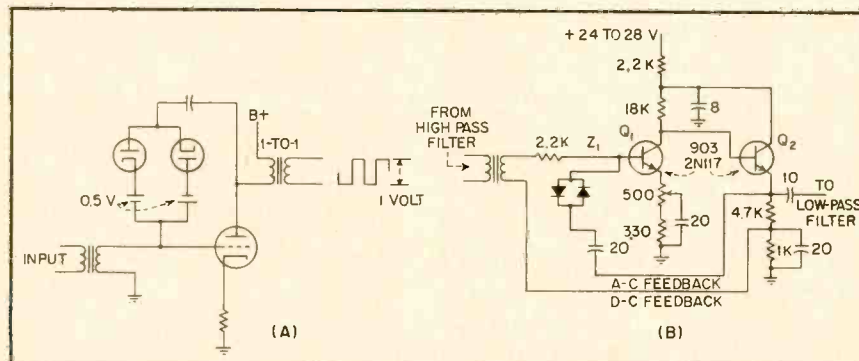

FIG. 2—Vacuum tube a-c feedback type compressor (A) operates in manner similar to the transistorized unit (B) used for air-to-ground communications

SPEECH COMPRESSOR

pression, normal speech will have peak voltages that are 12 db above the average voltage.

Circuit Operation

The instantaneous speech compressor system, shown in block form in Fig. 1, combines the advantages of both the clipper and the compressor and does not appear to have the disadvantages of either system.

As a-c feedback would decrease the background noise by the same factor as the voice signal, the circuit uses a delayed type of a-c feedback. Figure 2A uses a vacuum tube to illustrate the system principle. For signals with an a-c value at the plate of the tube less than 0.5 v the circuit will act like a conventional amplifier. For an instantaneous voltage that is greater than 0.5 v, one of the diodes will conduct and the signal will be fed back to the grid with a 180-deg phase reversal. If resistances of the diodes and batteries are low and gain of the tube is high, the waveform in the output circuit will be the same as the waveform obtained with a conventional speech clipper. However, as both signal and noise are fed back when the diodes are conducting, the speech-to-background noise ratio remains about the same.

A schematic of the transistorized instantaneous compressor circuit is shown in Fig. 2B. Basically, this circuit is a common-emitter amplifier direct coupled to a common collector stage. The bias for the first transistor is obtained from a d-c voltage divided in the emitter of the second transistor. As a common-emitter circuit gives a phase reversal, while a common collector circuit gives an in-phase signal, this method of obtaining bias for the first transistor results in a circuit with a high degree of d-c stability. The common-collector

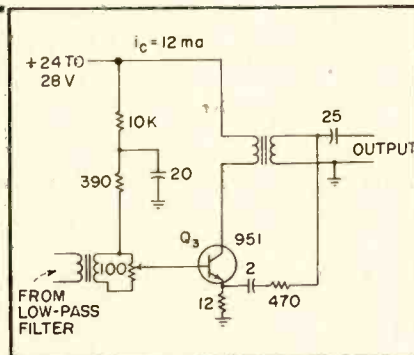

FIG. 3—Output amplifier feeds into aircraft radio microphone jack

stage gives a low-impedance source for driving a low-pass filter in the output and the a-c feedback circuit to the base of the first transistor. The transistors used are low-gain silicon type 903 having an alpha of 0.9 to 0.95.

The unique feature of this circuit is the use of silicon diodes in the a-c feedback circuit. The diodes will not conduct in the forward direction until a voltage of about 0.5 or larger is impressed across the diode. As a result, the forward resistance of the diode is very high until the instantaneous value of the a-c feedback signal is greater than 0.5 v. Above this level, the impedance of the diode is low. In addition to the compression obtained by feedback, compression is also caused by the sudden decrease in input impedance of the first transistor. When the diodes are not conducting, the impedance Z_i is about 4,000 ohms as compared to 300 ohms when conducting.

Output Amplifier

The output amplifier, shown in Fig. 3, uses type 951 silicon power transistor. A feedback network from the secondary of the output transformer to the emitter resistor minimizes phase shift in the output transformer. The 25- μ f capacitor in the secondary of the output transformer isolates the transformer winding from the d-c voltage applied to the microphone.

To check the effect of the instantaneous speech compressor on the speech-to-background noise

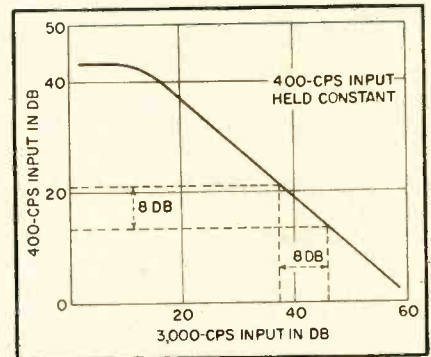

FIG. 4—Tests show ratio of voice to noise signal remains constant

ratio, a 400-cps signal of fixed amplitude and a 3,000-cps signal whose amplitude could be varied were fed to the input of the compressor. Figure 4 is a plot showing how the 400-cps output from the compressor varied as the amplitude of the 3,000-cps input signal was increased. When the 3,000-cps input is increased the 400-cps output must decrease if the speech-to-background noise ratio is to remain constant.

Intelligibility of speech in the presence of low-frequency noise can be greatly increased by using proper filtering before and after a speech clipper. The filter preceding the clipper attenuates the low frequencies at the rate of 6 to 12 db per octave. The filter following the clipper attenuates the high frequencies at the rate of 18 to 24 db per octave.

Although controlled intelligibility tests have not been made, short-range tests on two pieces of military equipment have shown that sideband power is increased at least by a factor of 4 when the speech compressor is used.

A disadvantage of the instantaneous speech compressor is that when the talker is in a noisy location, the amplitude of the noise between speech will be practically the same as the amplitude of the speech. However, tests at the Harvard Psycho-Acoustic Laboratory have shown that noise that is present only between words does not affect the intelligibility of the message.

Portable TV Station

By L. E. FLORY, G. W. GRAY, J. M. MORGAN and W. S. PIKE

RCA Laboratories
Princeton, New Jersey

SUMMARY — Designed to be carried on a man's back, nineteen-pound television transmitting station includes camera, monitor, sync generator, 2,000-mc transmitter and power supply. Total transistor complement of 72 is employed in addition to vidicon, kinescope and transmitter tubes. Camera delivers 1.5-v p-p composite video signal to line or transmitter

BROADCASTERS have need for lightweight portable television pickup equipment for spot news coverage and other events. An experimental portable television transmitting station has been developed that generates a picture of adequate quality for remote-broadcast purposes and transmits it for over a distance of approximately one mile. This equipment was used at recent political conventions to make possible remote pickups that would not have been possible by any other method.

System Description

Employing 72 transistors, the equipment includes, in addition to the camera, a sync generator, picture monitor and transmitter, as illustrated in the block diagram of Fig. 1.

The camera contains a video pre-amplifier, horizontal and vertical deflection circuits and a blanking

amplifier in addition to the vidicon with its yoke and focus magnet. Horizontal drive pulses, vertical drive pulses and mixed blanking pulses, as well as d-c voltages are supplied to the camera over a four-foot cable from the backpack. The video signal from the camera video preamplifier is sent back to the backpack on a coaxial conductor braided into the same cable.

As in the miniature transistorized television camera described in the Jan. 1, 1957 *ELECTRONICS*, use is made of a new miniature vidicon only one-half inch in diameter.

The monitor contains horizontal and vertical deflection circuits and a video amplifier.

A switch on the backpack permits the operator to monitor either the video signal at a suitable point in the modulator or a rectified and amplified sample of the transmitter output. The latter gives the operator an instantaneous indication

of transmitter overmodulation. The electronic viewfinder also permits the cameraman to check the vidicon electrical focus, which would be impossible with an ordinary optical viewfinder.

The backpack contains a rechargeable battery, a transistor power converter to supply high voltage for the camera, monitor and transmitter tubes, a crystal-controlled sync generator, a 2,000-mc transmitter, a modulator amplifier in which d-c level setting, sync addition and set-up addition are performed, and a small auxiliary video amplifier and rectifier which samples the transmitter output. The transmitting antenna projects from the top of the backpack.

Compared to similar vacuum tube equipment built by the authors several years ago¹, the camera with its viewfinder weighs four pounds while the earlier unit, which used a one-inch vidicon and a similar monitor tube, weighed eight pounds. The backpack unit weighs 15 pounds and is 3 by 12 by 13 inches in size. The present equipment consumes 30 watts and operates for nearly five hours on a smaller size battery.

Camera

The circuit of the camera video preamplifier is shown in Fig 2, along with the blanking amplifier and the vidicon beam, focus and target voltage controls.

Common-emitter amplifier Q_4 is directly connected to the vidicon cathode. Negative mixed-blanking

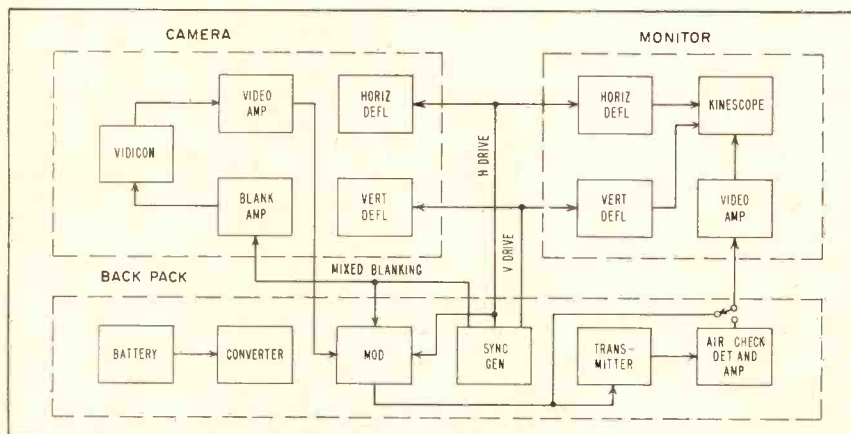

FIG. 1—Diagram of principal units of system—camera, monitor and backpack

for Remote Pickups

signals from the sync generator in the backpack are applied to its base. Twenty volts peak-to-peak of positive mixed blanking are available at the collector of Q_1 . This is adequate to prevent landing of the vidicon beam under any conditions during the horizontal and vertical retrace periods.

It has been established that in video amplifiers the best signal-to-noise condition is obtained if the vidicon is operated into a high impedance even though the input circuit has high capacity. The effect of this high capacity is compensated by a high-peaker circuit.

The input amplifier employs transistors, Q_1 , Q_2 and Q_3 and exemplifies in Q_1 and Q_2 a type of feedback pair which has been freely used in later stages, particularly in the modulator. The pair consists of transistors of opposite conductivities, with feedback from the collector of the second to the emitter of the first.

This arrangement is d-c stable, has high input impedance and has low output impedance from which either output polarity may be derived. In this case, the collector of the second transistor is d-c connected to the base of the third, Q_3 .

The response of this circuit is maintained flat to six mc with peaking inductance L_1 and by shunting the emitter resistor of Q_3 with C_1 .

Bias control R_1 sets the operating point for this circuit.

Stage Q_4 is an ordinary common-emitter stage which drives the high peaker. High-frequency response is maintained by C_2 and overall low-frequency compensation is provided by C_3 .

Stages Q_5 through Q_9 are ordinary common-emitter amplifiers. They are, however, overcompensated as far as high-frequency response is concerned; the cumulative effect of overcompensation supplies aperture correction.

Video gain control R_2 , compensated by C_4 , is inserted between Q_8 and Q_9 . Transistors Q_{10} and Q_{11} comprise another feedback pair

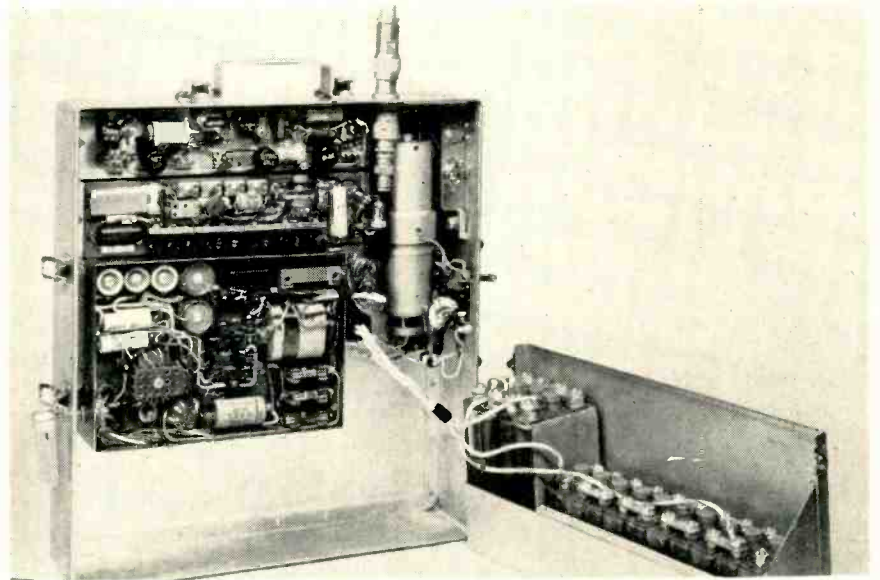

Backpack houses sync generator (top left), power converter (lower left), transmitter (center) and rechargeable cells (right)

which drives the interconnecting cable. The latter feedback pair delivers about 0.5 v of six-mc video signal to the 75-ohm line with good linearity. In this case, output is taken from the emitter of the second transistor of the pair.

Camera Deflection

The camera deflection circuits are shown in Fig. 3. The sync generator in the backpack supplies

negative horizontal and positive vertical drive pulses to the camera. The negative horizontal pulses turn on Q_{31} . Amplified positive horizontal pulses appear at its collector.

Output transistor Q_{32} is driven by a step-down transformer. It acts as a switch to interrupt the build-up current in the coil. Ringing is prevented by the damper diode.

The vertical deflection circuit is driven by the positive vertical drive

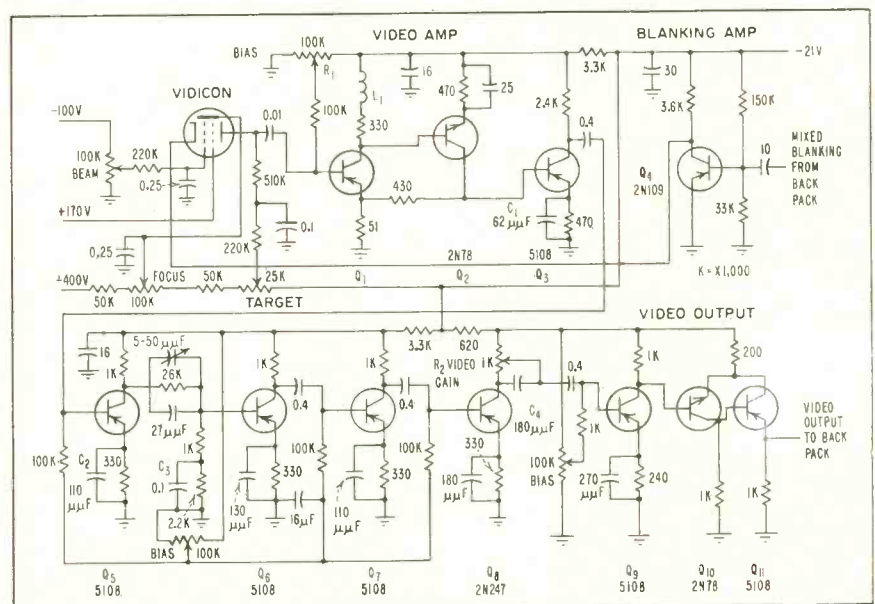

FIG. 2—Camera preamplifier employs 11 transistors and miniature vidicon pickup tube

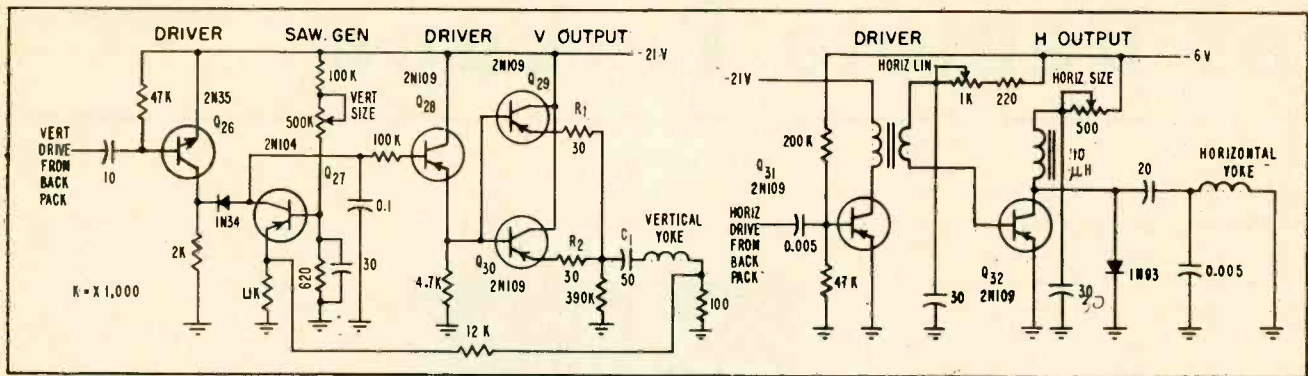

FIG. 3—Camera vertical (left) and horizontal (right) deflection circuits use low-power transistors because of miniature vidicon's modest deflector requirements. Vertical and horizontal drive are supplied via cable from backpack

pulses. These are inverted by Q_{26} , which drives a sawtooth generating circuit comprising Q_{27} and its associated components.

The vertical drive to the yoke is provided by two paralleled emitter followers, Q_{29} and Q_{30} . Resistors R_1 and R_2 equalize the currents in the transistors.

Negative feedback assists in linearizing the yoke current and circumventing the shortcomings of the necessarily small coupling capacitor, C_1 .

Modulator and Transmitter

The modulator and transmitter are shown in Fig. 4. The transmitter, depicted at the upper right of this diagram, is a self-excited cavity-stabilized planar triode oscillator which is grid modulated. Output frequency is adjustable from 1,900 to 2,100 mc. The maximum output power with the voltages available is about 0.5 w.

A video signal of one to two volts amplitude is sufficient to modulate fully the transmitter. This signal is supplied by transistors Q_{12} through Q_{16} .

The camera video signal is coupled from cable termination R_1 into the base of Q_{12} through a relatively small capacitor, C_1 . A keyed clamp sets the d-c level at this point at the start of each horizontal line. This action is provided by Q_{17} , which is turned on by negative mixed-blanking pulses applied to its base. In somewhat unconventional fashion this also clamps the base of Q_{12} during the entire vertical blanking interval. The clamping potential is adjustable by the bias control, which is bypassed by C_2 .

Since d-c information is rein-

serted into the signal, the following stages must be d-c coupled for this information to appear in the output signal. By employing alternate *n*pn and *p*np transistors, a five-stage amplifier of adequate stability has been constructed. The stage gains of this amplifier are not high; the large number of stages is necessitated by the many other functions which must be performed. Mixed sync, for example, from sync amplifier Q_{31} is inserted on the emitter of Q_{12} . Adjustable set-up is inserted on the base of Q_{14} , by feeding in a small amount of mixed blanking of the correct polarity at this point.

Feedback pair Q_{12} and Q_{13} , is similar to others previously used. This circuit is advantageous here because it presents a high impedance to the clamp circuit and thus does not discharge C_1 . This would cause horizontal shading. Stage Q_{14} has been included to get a low-impedance point from which to drive auxiliary amplifiers Q_{15} and Q_{16} , as well as the actual modulator output stage which comprises feedback pair Q_{15} and Q_{16} . This stage will deliver about 1.5 v of video signal to the transmitter.

Emitter follower Q_{18} drives the line to the monitor amplifier when the monitor input selector switch is in the video position. Stage Q_{19} provides an auxiliary video output if it is desired to operate into a video line rather

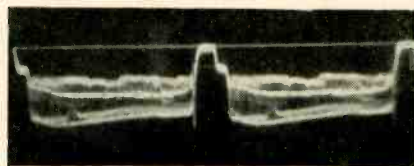

Composite video output from camera

than use the transmitter.

Transistors Q_{29} and Q_{30} amplify the output of diode D_1 , which rectifies a sample of the transmitter output. When the monitor input selector switch is in the air-check position, the output of this amplifier drives the video line to the monitor.

Voltage Regulator

Regulator Q_{20} assists in maintaining the correct operating point of the transmitter as the batteries discharge during operation. It was found that as the six-volt portion of the battery discharged, the slight change in the voltage of the transmitter heater was sufficient to upset its operating point.

As regulation of the 0.9-ampere current of this heater would be a difficult task, it was found that a slight readjustment of the transmitter bias would accomplish the necessary correction. However, the sense of the requisite bias change is opposite to the sense of the change of heater voltage causing the trouble; Q_{20} accomplishes the necessary sense reversal. Its base is connected to the 6-v battery, through the network comprising R_2 , R_3 , R_4 and D_2 , which sets the base potential at the correct d-c operating point.

The collector of Q_{20} is connected to the potentiometer which sets the clamp potential, thus inserting the required correction at this point. Direct-current degeneration in this compensating circuit is provided by R_5 , with the loop gain adjusted to maintain nearly perfect compensation during the useful operating life of the battery.

For stability reasons, it is also

necessary to regulate the supply voltages of all these amplifiers. Regulated buses of six and 12 volts are supplied. The 12-v regulator comprises emitter follower Q_{25} , with the base potential set by zener diode D_3 . The six volt regulator is Q_{24} , with base potential set by a potentiometer across the regulated 12-v supply.

Monitor

The monitor is shown in Fig. 5. As no suitable commercially available cathode-ray tube could be found for this unit, a special 1½-inch tube was made in the laboratory. The tube is magnetically deflected and electrostatically focussed. With an ultr voltage of 2,000 v, its resolution exceeds 300 lines. It fits a standard one-inch vidicon yoke, which requires about 400-ma peak-to-peak horizontal deflection current.

Complementary symmetry and negative feedback are used in the vertical circuit. Here Q_{37} and Q_{38} are power transistors with rated dissipations of one watt each, without heat sinks.

The video signal from the backpack is amplified by Q_{42} and Q_{43} . This circuit is a transistor version of the familiar electron tube long-tailed pair, providing a push-pull output with the cathode and grid of the monitor simultaneously driven in antiphase. By this means, the effective video drive on the monitor is made about 35 v peak-to-peak.

Driven clamp Q_{41} , which sets the d-c level of the monitor amplifier, is identical to that in the modulator except that only horizontal pulses from the monitor deflection circuit are used to drive it.

Sync Generator

The synchronizing generator, located in the backpack has two sections. The master oscillator and divider chain, comprising the first, is shown in Fig. 6 and the wave-shaping circuits and line drivers comprising the second, is shown in Fig. 7.

Operating at twice the 15.75-kc horizontal scanning frequency, master oscillator, Q_{44} in Fig. 6, is a negative-resistance oscillator. Use is made of the fact that a parallel

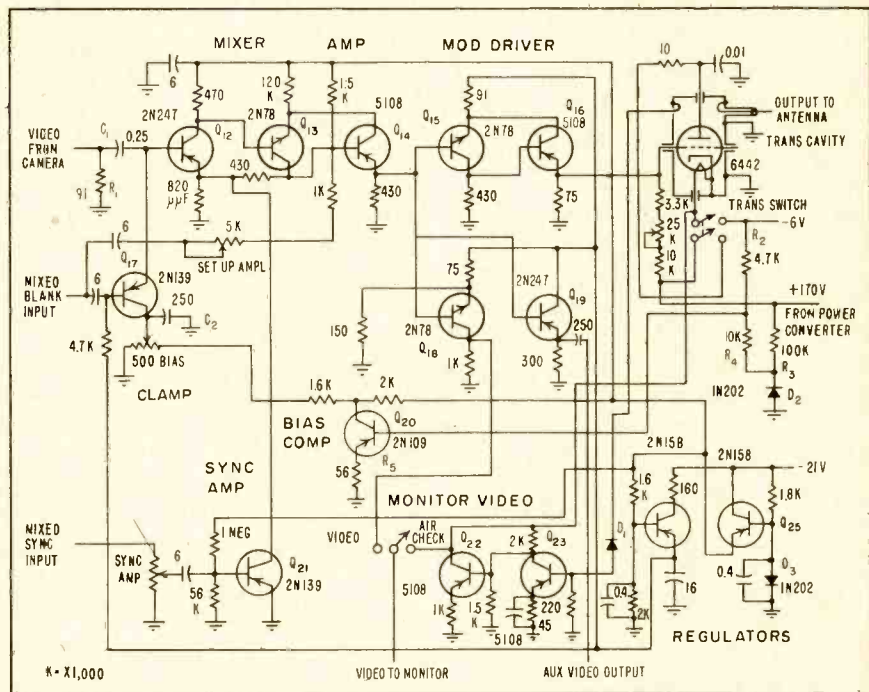

FIG. 4—Two-thousand-mc transmitter, video modulator and associated circuitry

L-C circuit in the emitter of a grounded-collector transistor amplifier will cause a negative resistance to appear at the base terminal of the transistor at frequencies for which the emitter load is capacitive. With a quartz crystal placed in the base circuit, a large negative resistance appears in series with it, if the resonant frequency of the emitter circuit is less than the operating frequency of the crystal, and oscillation occurs.

Output is taken across R_1 in the collector circuit to drive isolation amplifiers Q_{52} and Q_{55} .

Horizontal Divider

The horizontal divider, which divides by two, is blocking oscillator Q_{53} using an autotransformer

wound on a small toroidal ferrite core. A positive pulse of a few volts amplitude and about 1.5- μ sec duration appears at the collector of Q_{53} each time the blocking oscillator fires. This is called the positive horizontal trigger and is used, after some processing, to initiate the leading edge of the horizontal blanking and drive pulses.

A delayed trigger pulse is derived from Q_{54} . An auxiliary winding on T_1 drives this transistor. The waveform on this winding is a considerably distorted single cycle of a sine wave; the width of each half-cycle is about 1.5 μ sec. The winding polarity is such that the positive going half-cycle occurs first; Q_{54} does not conduct during

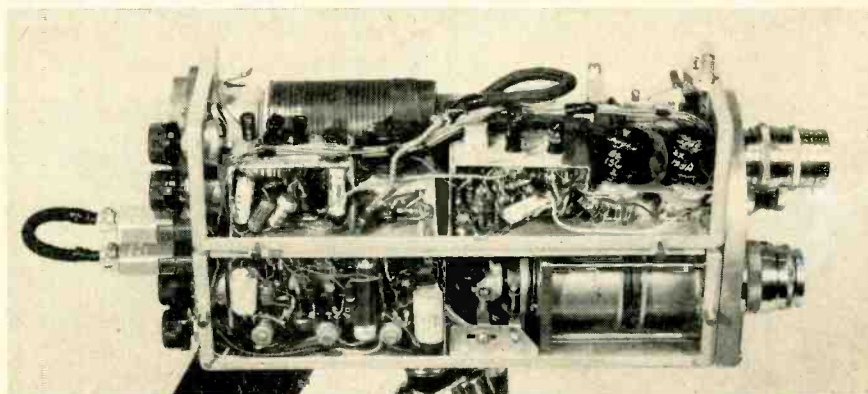

Side view of camera (bottom) and monitor (top) shows vidicon and kinescope yokes

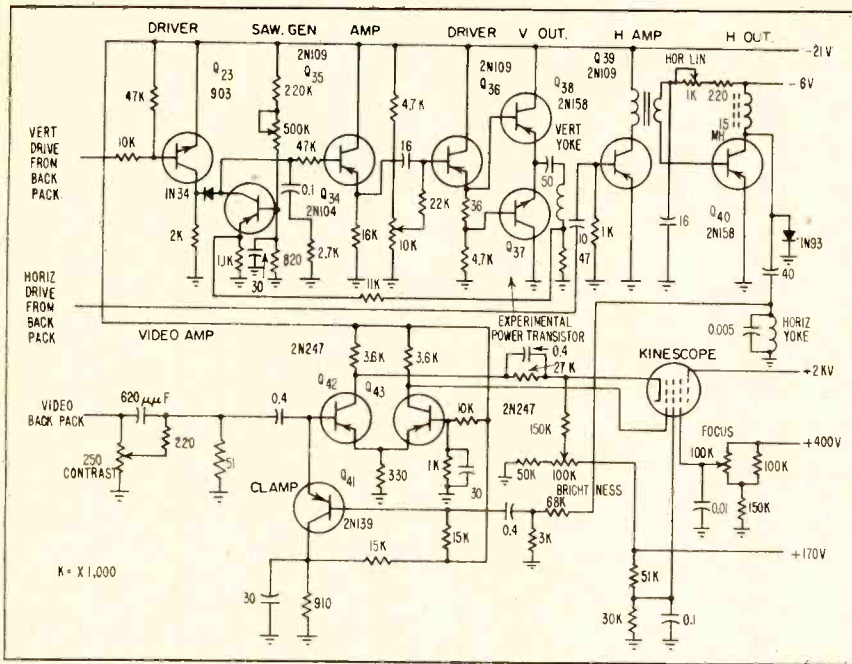

FIG. 5—Complete monitor circuitry for camera; kinescope is 1½ in. in diameter

this portion of the cycle.

On the following negative half-cycle, Q_{64} conducts and a positive pulse is generated at its collector. This pulse is delayed, with respect to the pulse from the collector of Q_{58} by about $1.5 \mu\text{sec}$ and is used as the delayed horizontal trigger pulse. The leading edges of the horizontal sync pulses and the serrations in the vertical sync pulses are derived from this delayed trigger.

This scheme sets the width of the front porch of the composite video output at $1.5 \mu\text{sec}$, or the amount by which the delayed horizontal trigger lags the undelayed trigger.

Vertical Divider

The vertical divider chain comprises Q_{46} through Q_{49} . Each is a blocking oscillator with feedback from collector to base and the R-C

circuit controlling the repetition frequency in the emitter.

Temperature stability of this circuit is superior to that of other circuits in which the frequency-determining elements are in the base circuit because it isolates these elements from the effects of the temperature-dependent base-to-collector leakage current I_{c0} .

As space is limited in the sync generator, the frequency determining elements of each divider are fixed and the amount of sync injection has been made adjustable to control the division ratio. Capacitors C_1 through C_4 are used for this purpose and require appreciably less volume than adjustable potentiometers. Voltage divider R_2 R_3 biases all the divider stages.

The vertical frequency pulses at the output of the last divider, Q_{49} , are too narrow to be used directly. Vertical pulses of the desired width

are generated by the flip-flop comprising Q_{50} and Q_{61} . Each time Q_{49} fires, a pulse from its collector cuts off Q_{61} . The usual regenerative action in the flip-flop assists this and turns on Q_{50} . This action is reversed on the 15th, 21st or 35th cycle of the master oscillator after the firing of Q_{49} by a pulse taken from the collector of Q_{47} and fed to Q_{60} . This scheme causes the flip-flop to generate clean positive and negative vertical pulses, set at widths of $7\frac{1}{2}$, $10\frac{1}{2}$ or $17\frac{1}{2}$ horizontal lines by adjustment of the order in which the usual divisors of three, five, five and seven are assigned to the various dividers.

Pulse Forming

The output pulses from the divider chain consists of four kinds of pulses: positive horizontal trigger pulses, positive delayed horizontal trigger pulses, negative vertical pulses and positive vertical pulses. The waveshaper, shown in Fig. 7, synthesizes the following signals from these trigger pulses: positive vertical drive pulses; negative horizontal drive pulses; positive and negative mixed blanking pulses and negative composite sync pulses.

Vertical drive pulses are formed from the positive vertical pulses at the divider output by the amplifier and line driver comprising Q_{60} and Q_{70} . These are connected in the same feedback pair configuration used in the monitor. This amplifier makes positive vertical pulses of about five-volts amplitude available at a relatively low impedance.

Horizontal drive pulses are formed by an identical amplifier, Q_{67} and Q_{68} , driven from the undelayed horizontal trigger pulses at the divider output.

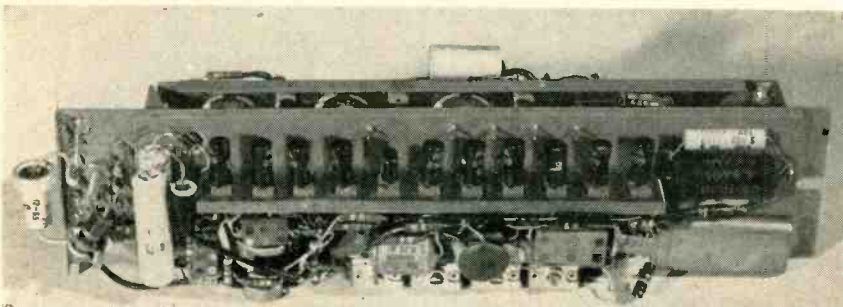

Sync generator consists of pulse shaper (left) with master oscillator chassis attached at rear (right) by hinge

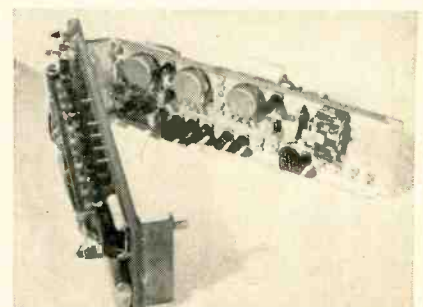

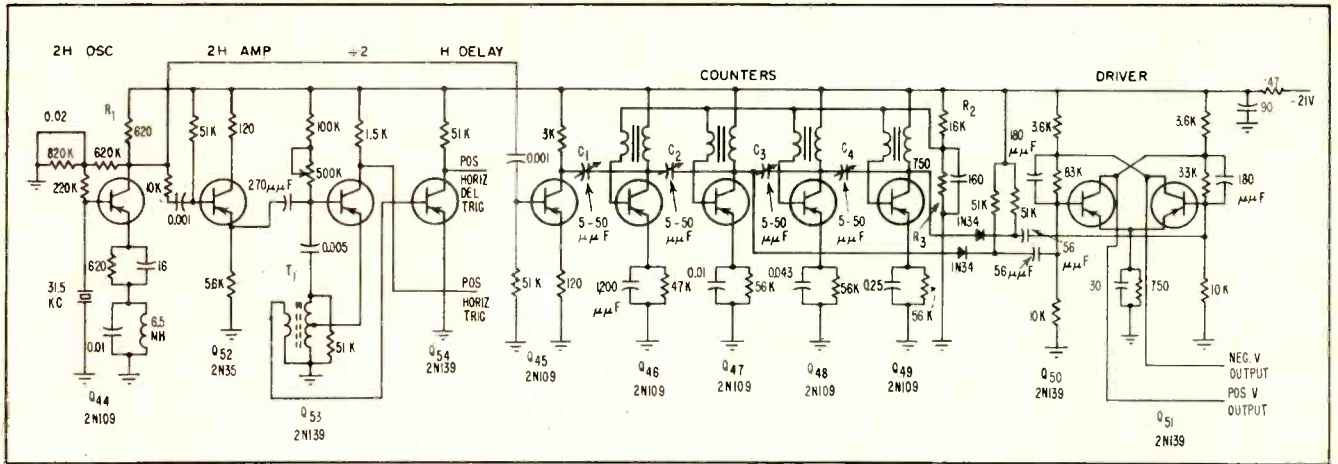

FIG. 6—Timing portion of sync generator includes 2H crystal-controlled master oscillator and blocking-oscillator count-down chain

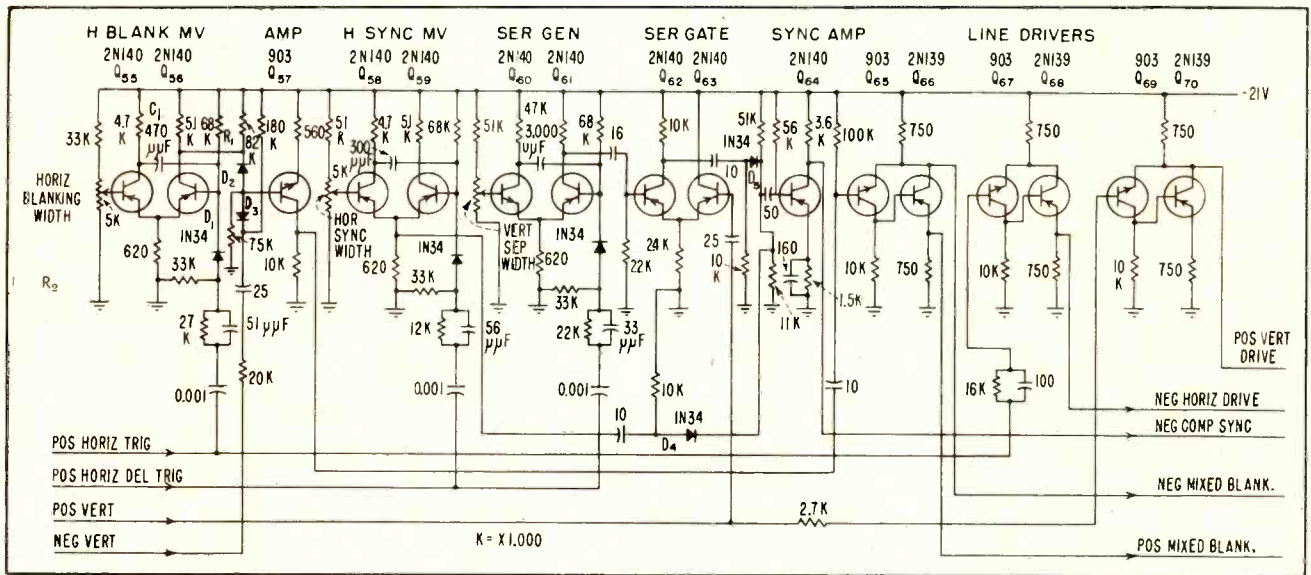

FIG. 7—Pulse shaping and gating section of sync generator turns out mixed blanking, composite sync and drive signals

Mixed blanking signals are synthesized from the undelayed horizontal trigger pulses and the negative vertical pulses from the divider by Q_{55} , Q_{56} , Q_{57} , Q_{58} and Q_{60} . Monostable emitter-coupled multivibrator Q_{55} Q_{56} determines the horizontal blanking width. Normally Q_{55} is off and Q_{56} on. Horizontal

trigger pulses are applied to the base of Q_{60} via diode D_1 ; each pulse turns off Q_{60} and turns on Q_{55} . The circuit remains in this state for a period of time determined by time constant of C_1 , R_1 and the voltage at the slider of R_2 . It then flips back to its original state. Adjustment of R_2 varies the

horizontal blanking pulse width between the limits of five and 15 μ sec.

Negative horizontal blanking pulses from the collector of Q_{56} are mixed with the negative vertical pulses from the divider in an or gate comprising D_2 and D_3 . The gate output is applied to Q_{58} and then to line driver Q_{65} Q_{66} from which both polarities of mixed blanking are available.

The three outputs from the sync generator just discussed must be transmitted via cable to the camera and monitor. Line driving amplifiers are provided for this reason.

The remaining transistors, Q_{58} through Q_{61} , are employed in generating composite sync. This signal is nonstandard, as illustrated in Fig. 8, in that there are no equal-

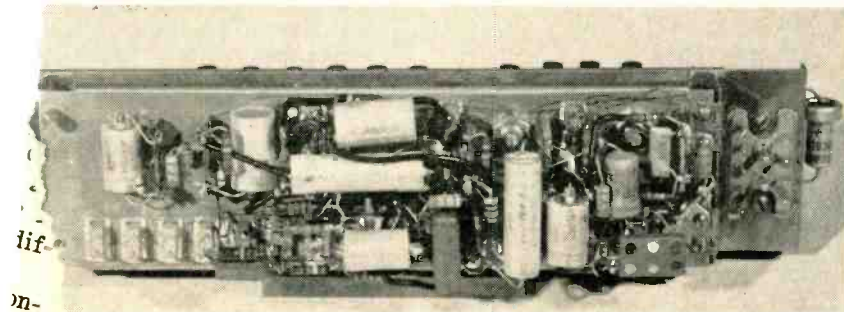

View of sync generator shows master oscillator and counter chassis

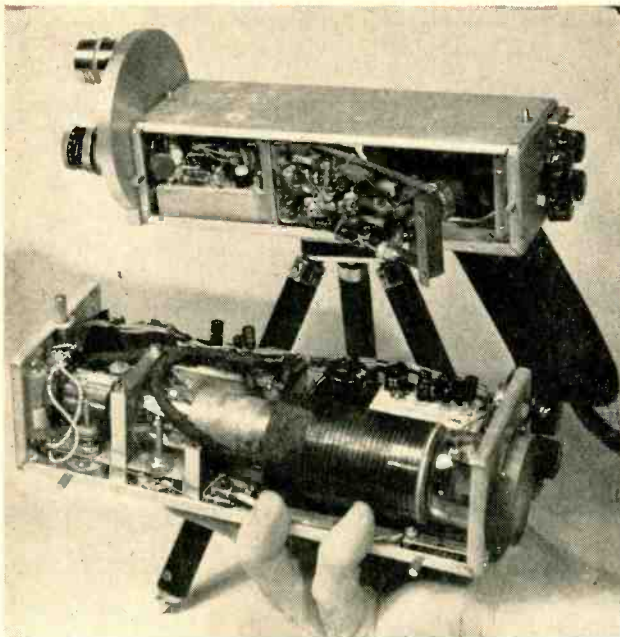

Close up of monitor-viewfinder detached from camera

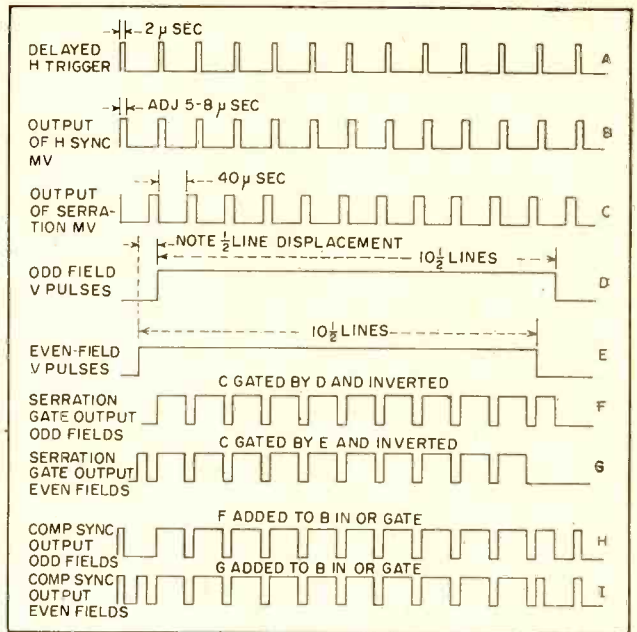

FIG. 8—Synthesis of sync pulses in circuit of Fig. 7

izing pulses. The vertical synchronizing interval is the same length as vertical blanking and there are serrations in the vertical sync pulses at horizontal frequency.

Sync signals are synthesized from the delayed horizontal trigger pulses and the positive vertical pulses from the divider chain. Monostable multivibrator Q_{68} Q_{69} , similar to that used to generate horizontal blanking pulses, generates horizontal sync pulses adjustable in width between the limits of five and eight μ sec.

A similar multivibrator, Q_{60} Q_{61} , generates serration pulses of about 40 μ sec width. The output of the

serration multivibrator is gated by serration gate Q_{82} Q_{83} . This gate is open only during the vertical pulses from the divider.

The output of the serration gate thus consists of bursts of serration pulses which are timed to occur during each vertical pulse from the divider. This signal is mixed with the output from the horizontal sync multivibrator in another or gate comprising D_4 and D_5 . It is then amplified and clipped by the sync output amplifier Q_{64} .

The power converter, shown in Fig. 9, steps up the low voltage available from the battery to the

high voltages necessary to operate the transmitter, monitor and camera tubes.

Power Oscillator

Basically two transistors are used as a form of power oscillator to convert d-c to a-c. The latter is then transformed up to the desired voltage levels and reconverted to d-c by rectification. As the switching speed of the transistors is high, a 1,000-cps operating frequency, considerably above that of commercial vibrators, is employed to reduce the weight and size of the iron-cored components.

The power converter oscillator is similar to that described by Uchirin and Taylor⁴. However was found advantageous to slightly modify their circuit. Separate transformers are used to control the frequency of oscillation and effect the necessary voltage transformation.

Transformer T_1 in Fig. 9 wound on a small toroidal core is designed to handle only the driving power for the base circuit of the transistors. A 1,000-cps square wave of about 90 v peak-to-peak appears from collector to collector of Q_{71} and Q_{72} . This signal is applied to the power transformer which steps it up to several different voltages.

Most of the power from the converter is delivered to the plus 170

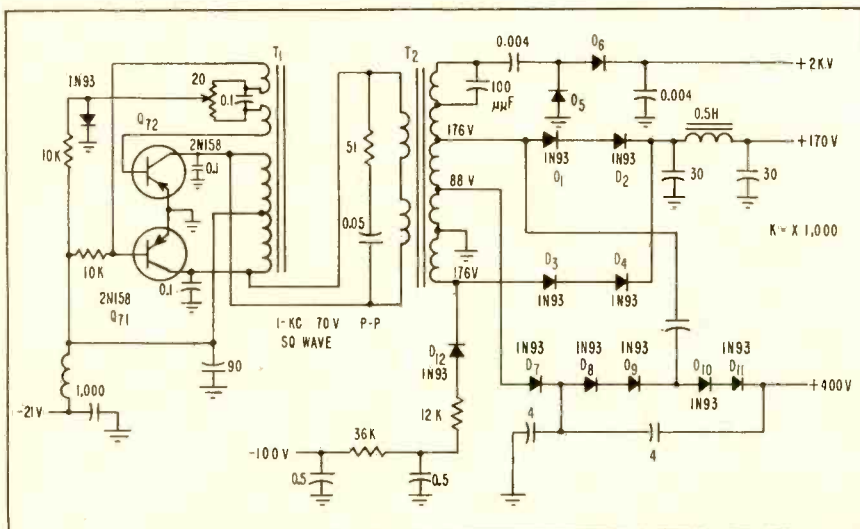

FIG. 9—Power converter uses one-kc square-wave generator for high-efficiency

bus. The principal load, about 50 ma, is the transmitter. This is supplied by the full-wave rectifier comprising D_1 through D_4 . The 2,000-v ultor voltage for the monitor tube is supplied by the doubler comprising D_5 and D_6 driven by an additional winding.

The 400-v bus which supplies accelerating and focus potentials for the vidicon and monitor is served by the tripler comprising D_7 through D_{11} . The minus 100-v bus, which is used only for bias on the vidicon, is fed by half-wave rectifier D_{12} .

Overall efficiency of the power converter is about 90 percent.

Primary power for the entire unit is supplied by a bank of Yardney Silvercell batteries. Four LR-10 cells in series supply the six-volt bus which powers the heaters of the tubes and portions of the horizontal deflection circuits. Nine LR-5 cells in series with the six-volt portion of the battery power the 21-v bus. The flat voltage characteristic of these cells during discharge helps maintain stable operation of the more critical circuits, such as the sync generator dividers. This battery complement will operate the equipment for about five hours, before recharging.

Pickup Tube

The experimental miniature pickup tube, which was developed in an independent program of the Electronic Research Laboratory by A. D. Cope, has features which make it adaptable to transistor circuitry. The half-inch by three-inch vidicon operates in an axial

z
ne
div

M
tivity
horiz
mally

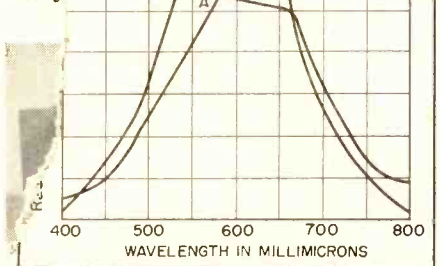

FIG. 10—Spectral response of miniature vidicon for equal values of radiant flux at all wavelengths

electromagnetic or permanent magnet field of about 80 gauss.

Power required to deflect the tube electromagnetically is about 20 ampere-turns or approximately $\frac{1}{3}$ that for the larger vidicon. This modest power requirement falls within the capabilities of low-power transistors of the audio amplifier variety.

The gun dissipates approximately 0.8 watt, a fourth that of the larger tube. Beam spot has been made smaller by reduction of the limiting gun aperture and path length so that the resolution is not greatly sacrificed over larger tubes, even though the scanning raster is only 0.24 by 0.18 in.

Photosurface

With such a small photolayer area, the use of a photoconductor having the sensitivity of that used in conventional vidicons would require an excessively fast lens or an increase in scene illumination. A new photoconductor surface has been developed which has sufficient operating sensitivity to more than offset the reduction in light-collecting area.

The photoconductive layer used has a sensitivity in the range from 1,000 to more than 2,000 μa per lumen when operating at signal levels of the order of 0.02 to 0.05 μa . The spectral response for the higher-sensitivity layers peaks at 650 millimicrons, as shown by curve A in Fig. 10. A more panchromatic layer with a peak response at 550 millimicrons, as shown by curve B, can also be made.

The gamma of the photosensitive surface depends upon the current density. At low illumination levels the signal varies linearly with light. At higher levels, for an output signal of 0.05 μa or greater, the gamma drops to 0.5.

The signal decay as a function of time for the new photosurface when compared with the photosurface used in earlier vidicons is somewhat different. The initial decay is not as rapid, but there is a smaller long term component of lag. This makes exact comparison difficult by subjective tests.

Tests were conducted with an experimental one-half inch vidicon and a typical one-inch tube operat-

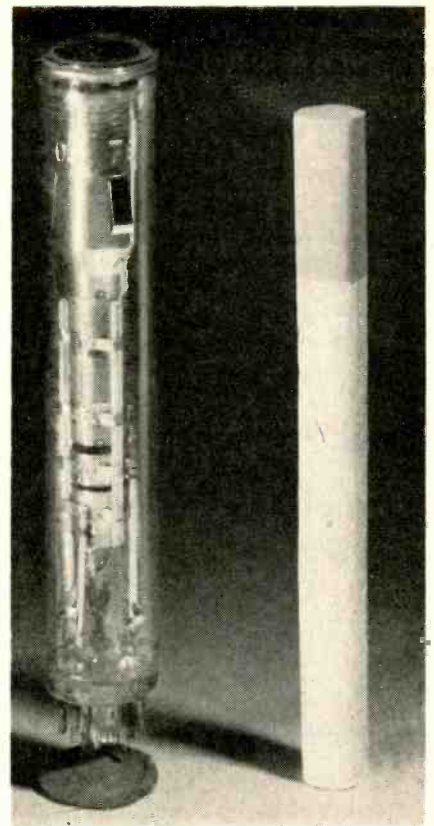

Experimental pickup tube has half-inch diameter and is three inches long

ing in the same type of equipment and producing comparable images of the same scene. With 10 to 20 footcandles falling on the scene, equivalent output signals with comparable lag were observed in each picture when the small camera was operating with the lens at $f/4$ and the lens of the large camera at $f/2$. The combined difference of two lens stops and the four-to-one area difference indicates an operating sensitivity for the small tube 16 times greater than for the larger tube.

The authors wish to acknowledge the direction of V. K. Zworykin in this project and the cooperation of A. D. Cope who supplied the miniature vidicon. The assistance of Lawrence A. Boyer in design and construction contributed materially to the success of the work.

REFERENCES

- (1) L. E. Flory, J. E. Dilley, J. M. Morgan and W. S. Pike, A Developmental Portable Television Pickup Station, *RCA Rev*, p 58, Mar. 1952.
- (2) G. C. Uchirin and W. O. Taylor, A New Self-Excited Square Wave Transistor Power Oscillator, *Proc IRE*, p 99, Jan. 1955.
- (3) A. D. Cope, A Miniature Vidicon of High Sensitivity, *RCA Rev*, Dec. 1956.

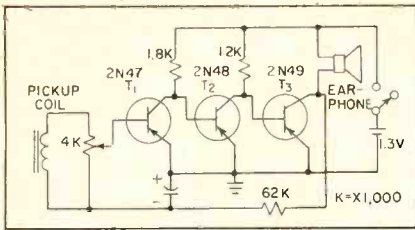

FIG. 1—Circuit of three-transistor portable receiver. Direct-coupled amplifier has feedback from output to input

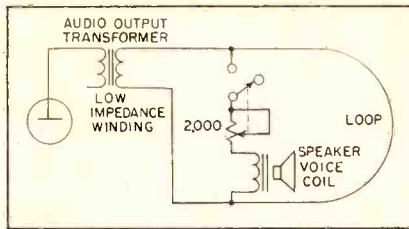

FIG. 2—Parallel operation of loudspeaker and paging system with separate volume control for speaker

Table I
Wire Size vs Impedance

AWG	Ohms per 1,000-ft length
16	3.8
14	2.7
12	1.9
10	1.2
8	0.75

SUMMARY — Transistor device smaller than a cigarette lighter and weighing one ounce provides sound reception without wires connected to the user for radio-frequency transmission requiring a license. Audio amplifier serves as the paging source, eliminating customary lights, gongs or loudspeakers

By RAY ZUCK

Government and Industrial Div.
Philco Corp.
Philadelphia, Pa.

AUDIO INDUCTION

ENERGY flowing through a loop of wire around the listening area is picked up by the miniature loop of a receiver, then amplified and converted to sound for the wearer of the instrument in this inductive paging system.

Because the sending loop is low impedance, it can be fed directly from the output of an audio amplifier, a tv set or a radio. Input to the audio amplifier can be a microphone for paging purposes or an f-m or a-m tuner for radio reception on planes, buses or trains. In the home, the tv set, record player or tape recorder could be used for the signal source.

Signal Propagation

The equation in the box indicates that radiated field strength is proportional to I , inversely proportional to λ and inversely proportional to distance d from the antenna. At the antenna, electric and magnetic fields are greater in magnitude and different in phase from the radiated field calculated from Maxwell's equations. The induction

field diminishes at a faster rate with distance from the antenna than the inverse relationship of the radiation field and becomes negligible at a distance of a few wavelengths from the antenna or loop.

At a small fraction of a wavelength, the induction field is much stronger than the radiation field. For a loop antenna, the induction magnetic field is much stronger

than the induction electrostatic field, while the reverse is true of the straight-wire induction field. The stronger induction magnetic field of the loop antenna is used in this system.

Interference from 60-cycle equipment such as transformers is limited to the induction source and this area is directly proportional to current. For 60-cycle equipment not over 1,000 watts in size, this interference distance is limited to a few feet.

Radiation from a Wire

The strength E of the radiated field from an elementary antenna is given by

$$E = \frac{60 \pi L}{d \lambda} I \cos \omega \left(t - \frac{d}{c} \right) \cos \theta$$

E = field strength in millivolts per meter

L = length of wire in meters

d = distance from antenna in meters

λ = wavelength in meters

I = current magnitude

t = time

C = velocity of light = 3×10^8 meters per sec

θ = angle of elevation from plane of antenna

Circuit Description

Low-impedance pickup coil (Fig. 1) is coupled to an audio taper volume control at the input of T_1 . Output of T_1 is loaded by the input impedance of T_2 and T_1 output voltage conveniently provides bias for T_2 which, in turn, provides bias for T_3 . Output stage, T_3 is biased to provide maximum undistorted current swing across the earphone.

The earphone acts as a d-c load for the stabilizing energy, which is fed back to the input resulting in low-frequency degradation and

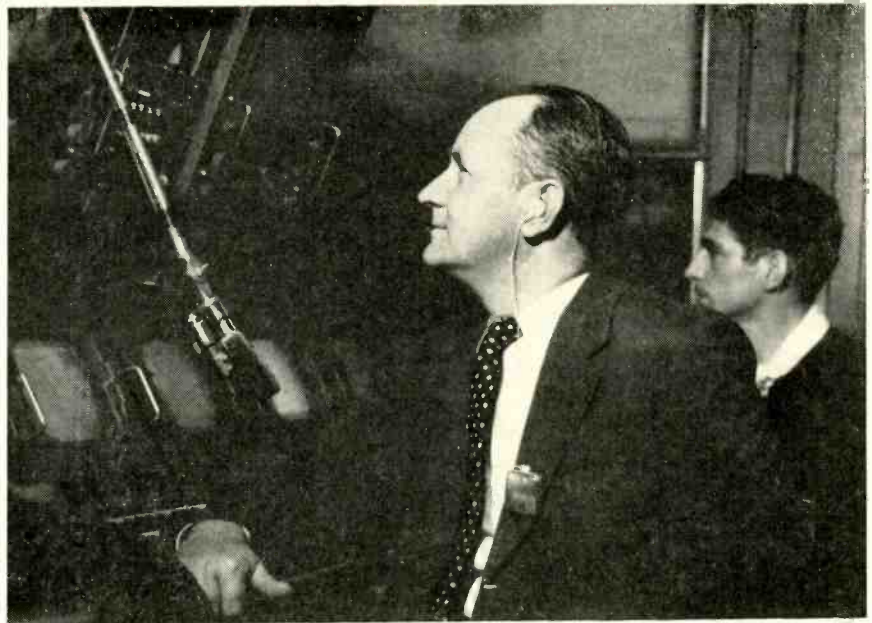
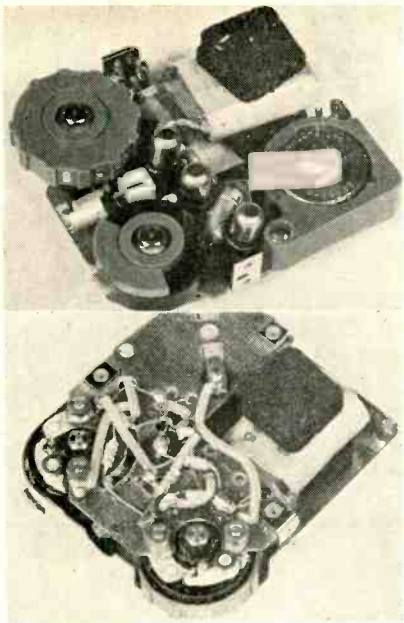

Internal views of the miniature induction receiver show transistors and battery (top) wiring board (below). Audipage units find practical application in television studios allowing production personnel freedom of movement and instant liaison with control (right)

PAGING SYSTEM

25-db gain per stage at higher audio frequencies. With V_{ce} of T_1 equal to V_{be} of T_2 , the point of quiescent operation is near the knee of the E_c-I_c curves. However, since the output of T_1 and T_2 is fed into the low impedance of T_2 and T_3 respectively the shunting effect of R_c ($1-\alpha$) is negligible and allows operation of the amplifier down into and below the knee region of the E_c-I_c curves.

As the collector-to-emitter voltage falls toward zero from this knee region, alpha also approaches zero. Keeping alpha near normal and consequently maintaining the circuit gain limits the operating point to this knee region or above.

Power gain G_p of a common emitter transistor amplifier is expressed as

$$G_p = \frac{R_L}{R_{iN}} \times \left(\frac{\alpha}{1-\alpha} \right)^2$$

when R_L is the load resistor and R_{iN} is input impedance.

When $R_L = R_{iN}$, that is, T_2 provides the load for T_1 and T_2 and T_3 , the gain becomes

$$G_p = \left(\frac{\alpha}{1-\alpha} \right)^2 = 1,520 = 31.8 \text{ db}$$

where $\alpha = 0.975$

The above represents the maximum available gain of a direct-cascaded common-emitter configuration. Approximately 25 db per stage is realized in this direct-coupled circuit. Approximately the same gain results from a common-base amplifier configuration but represents only one component per stage (a resistor) for amplification.

Installation

The loop of wire that sets up the magnetic field is low impedance and is fed from the output of an audio amplifier. Any size of wire from No. 20 to No. 8 awg can be used for the loop. For best reception, the loop impedance should be matched to the output impedance of the driving transformer. Typical impedances for a loop length of 1,000 feet are shown in the table.

A small radio, battery portable or tape recorder provides sufficient

drive for a home or office area 20 by 30 feet. For larger areas the power required is calculated on the basis of 50 to 500 milliwatts per 1,000 sq ft depending upon the ambient background noise of the paging area. For areas larger than 5,000 sq ft, multiloops fed in series and phased so that the magnetic flux is additive, will improve performance.

Multiloop Use

In multifloor buildings, loops on different floors must also be in phase to prevent cancellation of flux. For widely separated areas, one amplifier can be used with distribution lines to step-down matching transformers for each loop. The area of adequate listening signal level outside and in the plane of the loop is equal to approximately three times the area of the loop.

The distance perpendicular to the plane of the loop for adequate pickup is approximately equal to plus and minus the smallest dimension of the loop.

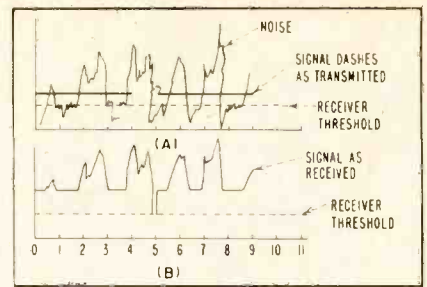
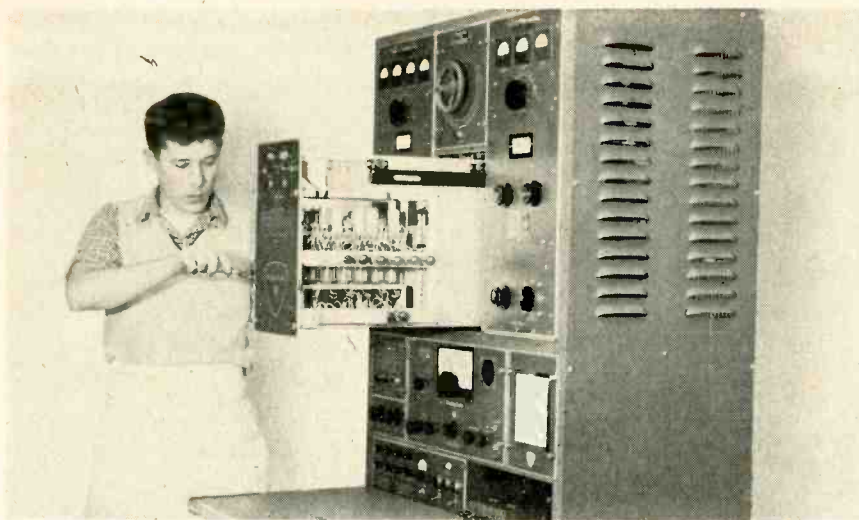

FIG. 1—Modification of autoalarm signal by noise

Autoalarm unit (left) mounts in rack of marine transmitting and receiving equipment

SHIP AUTOALARM Uses

SINKING OF THE S. S. TITANIC on April 14, 1912 with a heavy loss of life, despite the relative proximity of potential rescue ships, focused attention of the major maritime countries upon means for enhancing the safety of life at sea.

Since failure of radio calls from the *Titanic* to alert nearby ships was regarded a paramount cause for the casualties, international agreements on radio installations and on distress calls have been major aspects of minimal standards since set up. Because most merchant ships carry only one radio operator, continuous aural monitoring on the 500-kc international marine distress is not generally feasible.

Accordingly, an international

autoalarm standard was adopted, specifying that a ship in distress shall transmit for 1 minute a series of 4-second dashes separated by 1-second spaces prior to transmission of SOS calls. It is required that ships be equipped with an autoalarm tuned to 500 kc, which upon reception of 3 or 4 consecutive dashes of the signal shall actuate warning bells aboard the ship. Tolerances on the transmitted signal allowed dashes 3.5 to 4.5 sec and spaces 0.5 to 1.5 sec.

The possible case illustrated in Fig. 1 indicates that a signal transmitted within specified timing limits can be modified to constitute, as received, a signal differing considerably from that transmitted. Such random modification of an autoalarm signal may consist in

extending the duration of a 4.0-sec transmitted dash beyond 4.5 sec as received; there may be an effective filling up of a transmitted space with a consequent duration of the space as received of less than 0.5 second. Apparent gaps in a transmitted dash can result from blocking of the autoalarm receiver.

Because of discrepancies between transmitted and received signals, new standards have been adopted for which the major technical requirements are shown in Table I.

The medium frequency marine autoalarm described here automatically monitors the 500-kc international distress channel while a ship's radio operator is otherwise engaged.

Receiver Design

The sole function of an autoalarm receiver is to mark for the associated selector the presence or absence of on-frequency signals above the receiver signal threshold. While the international marine distress channel from 492 to 508 kc is designated primarily for distress and safety traffic, the channel serves also for intership and shore-ship calling. Accordingly, except during the international silent periods from 15 to 18 and from 45 to 48 minutes after each hour calls from a number of radiotelegraph

Table I—Autoalarm Specifications

The autoalarm shall respond to reception of four consecutive dashes timed as follows:

- minimum duration of each dash is 3.5 seconds,
- maximum duration of each dash is 6.0 seconds,
- minimum duration of each space is 10 milliseconds or less,
- maximum duration of each space is 1.5 seconds.

The autoalarm shall respond to signals between 100 microvolts and 1 volt.

The autoalarm shall respond to the alarm signal through interference (provided it is not continuous) caused by atmospheric and powerful signals other than the alarm signal. In presence of atmospheric or interfering signals, the autoalarm shall automatically adjust itself so that within a reasonably short time it approaches, insofar as is practicable, the condition in which it can most readily distinguish the signal

SUMMARY — Automatic alarm for distress signal, required by law for certain vessels not covered 24 hours a day by licensed operator, has often been subject to malfunction resulting from interference and atmospheric. New device meeting more stringent FCC requirements is entirely electronic, using gate and counter circuits

By **E. R. SARRATT** and **H. H. ABELEW**
Chief Engineer *Asst. Chief Engineer*

*Marine Division
 Mackay Radio and Telegraph Co.
 Div. of I. T. and T.
 Clark, N. J.*

Computer Techniques

stations, transmitting simultaneously, are present on this channel.

Such radiotelegraph interferences are superimposed upon the diurnal and the noncyclic variations in intensity of atmospheric. They result in conditions whereby the level of sensitivity required for optimum discrimination of the autoalarm signal may change radically during unattended autoalarm watches. Earlier autoalarms, provided with manual gain controls,

can be effectively disabled unless the gain control is readjusted to match alteration in the intensity of atmospheric and radiotelephone interference.

In such equipments, a warning lamp on the bridge lights to indicate that the receiver manual gain control requires resetting. Conventional gain control circuits are not suitable for an autoalarm receiver, since the receiver sensitivity, if instantaneously controlled by ampli-

tude of signals, permits a stronger interfering signal effectively to capture the channel with consequent loss of a weaker alarm signal.

Reception of an autoalarm signal can be regarded as reception of a sequence of four intervals, 3.5 to 6.0 seconds long, during which the autoalarm receiver is in the signal-on state and these signal-on periods are separated by intervals not exceeding 1.5 seconds during

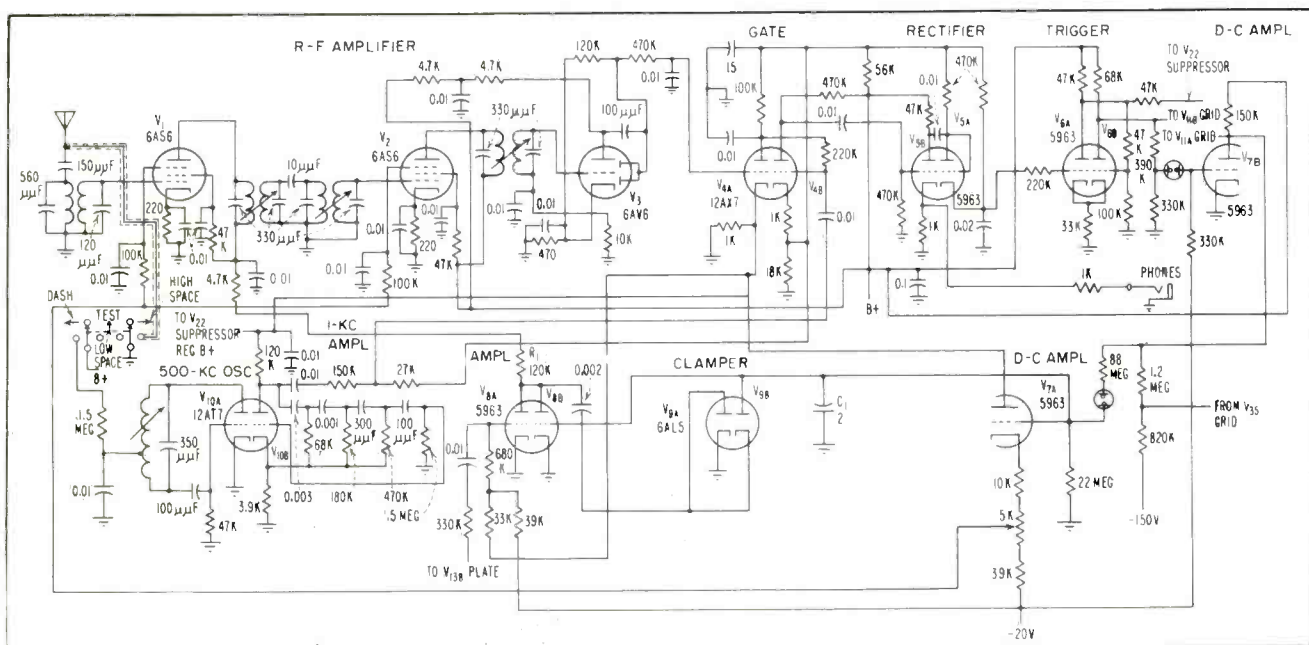

FIG. 2—Receiver used to pick up 500-kc signals is interconnected with selector circuit shown in Fig. 3

which the receiver is at least once in the signal-off state.

Gain Requirement

It is only when the interfering signals and atmospherics are sufficiently dense to keep the receiver from discriminating at least one gap each half-second that the receiver is incapable of responding to an autoalarm signal and requires a decrease in sensitivity. Improved performance should result from any system of age in which the receiver threshold sensitivity is proportional to an integral with respect to time of a voltage step function. Such a characteristic could result in a linearly decreasing sensitivity during receiver signal-on states and an increasing sensitivity during signal-off states.

The rates of sensitivity increase and decrease should be contrived to prevent too rapid a decrease in sensitivity during an interval of 24 sec, which represents the maximum duration of an acceptable autoalarm signal and to result in constant sensitivity over periods during which the receiver discriminates at least one gap during each half-second.

The function of an autoalarm selector are:

- (1) To time the durations of signal-on and of signal-off intervals.
- (2) To register the number of consecutive acceptable signal dashes.
- (3) To erase recorded dashes upon interruptions of an acceptable signal sequence by either a dash or a space outside the tolerances specified for each.
- (4) To actuate warning bells upon reception of four consecutive acceptable and properly spaced dashes.

Since international minimal recommendations, which form the basis for the specifications drawn up by each maritime administration, do not include tolerances on duration of acceptable dashes and of acceptable spaces, such tolerances are specified by each administration and differ widely.

The autoalarm receiver shown in Fig. 2 is fixed tuned to 500 kc with a passband of 16 kc. The three stage signal frequency

amplifier, V_1 , V_2 and triode section of V_3 , utilizes two 6AS6 tuned stages, with age voltage applied to grid 3 of each and an aperiodic triode stage. The signal grids of the 6AS6 stages return directly to ground to assure rapid recovery from impulse static and strong signals.

A locally generated voltage at 1,000 cycles is rectified by V_{6A} and serves to control a Schmitt-type trigger stage V_6 , which in conjunction with the cascaded two-stage d-c amplifier V_7 provides all output voltages required by the associated selector. The incoming signal, rectified and filtered for audio as well as r-f, is used only to control application of the 1,000 cps voltage to the Schmitt stage through gated amplifier V_4 . A 500-kc signal generated locally by V_{10A} serves for testing the operation of the entire autoalarm.

As described below, the onset of a signal above the receiver threshold initiates in the associated selector a square voltage wave at 2.5 cps. This voltage is applied to the signal grid of V_{8A} , which serves as a variable-gain amplifier. The square-wave output of V_{8A} is clamped to ground by V_{8B} , while its negative excursions are applied by V_{8B} to charge capacitor C_1 .

The staircase accumulation of charge on C_1 is linearized by applying the negative voltage across the capacitor to control the current drawn by V_{8B} through the common plate resistor R_1 . This form of feedback serves to increase the amplitude of the charging pulses with increase of charge on C_1 , resulting in effective linearization of the voltage across the capacitor. This voltage is applied to the grid of cathode-coupled triode V_{7A} , the output of which serves to control the gain of signal frequency amplifiers V_1 and V_2 . Gaps in the signal allow capacitor C_1 to discharge.

In the presence of steady unbroken signals or static too dense to be resolved by the receiver the gain of the receiver decreases until the level of the unbroken static is just above the receiver threshold. At this level, the 2.5 cps square wave swings the gain control voltage, thereby effectively injecting gaps into the solid signal.

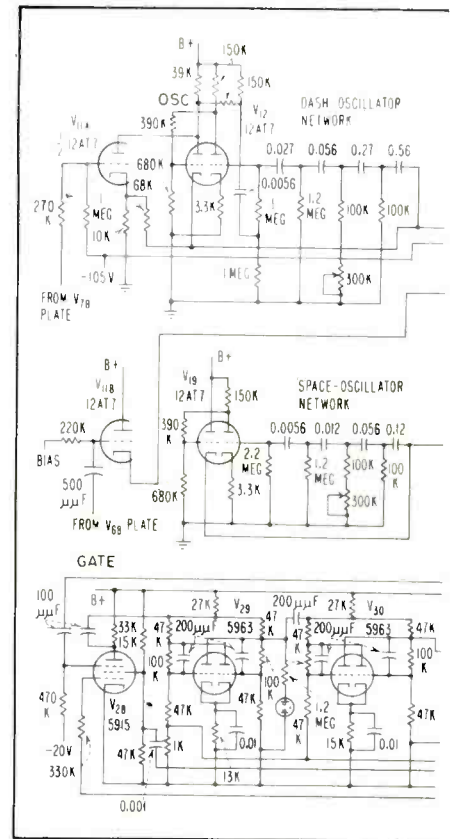
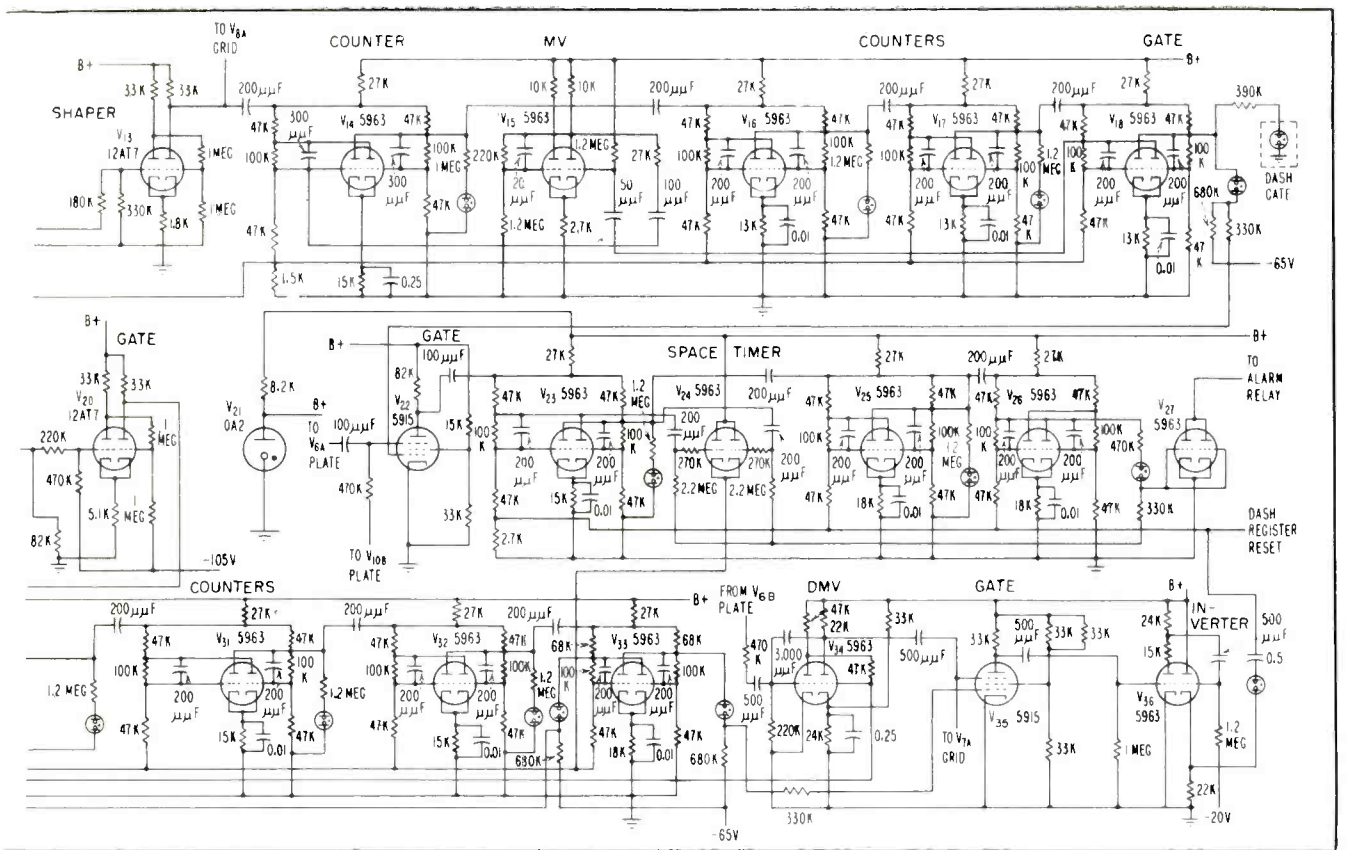

FIG. 3—Selector discriminates between

These forced gaps arrest further decrease in receiver sensitivity and the autoalarm, in this condition, can respond in a normal manner to an alarm signal above the level of the unkeyed signal or of the solid static. In the presence of impulse static or of several simultaneous radiotelegraph interfering signals, the gain of the receiver is reduced by the age to a level at which signal gaps (occurring in a random manner in such interference) are within the resolving capability of the receiver. Gain is maintained at the level at which the receiver discriminates at least one gap per half second.

Duration of receiver signal-off states is timed by gated oscillator-regenerative shaper V_{12} and V_{13} in Fig. 3. The step-voltage generated by the receiver Schmitt stage V_6 turns the oscillator on and off by means of gating triode V_{11A} . An additional connection from V_{11A} plate to the V_{12} grid provides tighter phase-lock in starting and stopping of the oscillator. The tapered four-mesh phase-shift oscillator is sufficiently accurate for current



signal gaps caused by noise and those of the autoalarm signal. Interconnected with receiver (Fig. 2)

American tolerances.

Output from V_{13} is a square wave with a period of 0.4 second. This wave is applied to the four-stage dash-timing binary counter comprising V_{14} , V_{15} , V_{17} and V_{18} . The final counter stage V_{18} serves to control gated pulse amplifier V_{22} . The onset of a signal, as well as the end of each signal break, resets the dash timing counter through triode V_{11D} . The counter then operates to open gate V_{22} at the predetermined count of eight (corresponding to a signal duration of 3.2 seconds) and closes the gate at the count of 15.

The trailing edge of each signal is applied to gate V_{22} and any unbroken signal that terminates with an elapsed time t such that $3.2 \leq t \leq 6.0$ sec results in an output pulse from the gate. This pulse is recorded by the dash-registering three-stage binary counter comprising V_{23} , V_{25} and V_{26} . Monostable multivibrator V_{15} serves to impose the 8/7 duty cycle on the dash-counter gate controlling stage V_{18} . This multivibrator can be connected to result in V_{18} duty cycle ratios corresponding to ratios of

integers such as $1/1$, $n/(15-n)$, $n/(14-n)$ and so on. Selection of a particular duty cycle ratio with a corresponding selection of the dash-timing oscillator frequency can modify the device to accept dashes of duration other than 3.2 to 6.0 seconds.

Dash Timer

The dash register at the count of four actuates the warning bell circuit by cutting off V_{27} . A space-timing oscillator-shaper similar to the dash-timing oscillator operates at a frequency of approximately 10 cps. The output of this oscillator is applied through gated amplifier V_{28} to the space-timing five-stage binary counter comprising V_{29} , V_{30} , V_{31} , V_{32} and V_{33} . The final counter stage V_{33} serves to control gate V_{28} . The trailing edge of any acceptable dash is recorded by the dash register, as described above and simultaneously resets through V_{34} the space timer thereby opening gate V_{28} .

During the approximately 1.6 seconds elapsing before gate V_{28} is closed by the final counter stage V_{33} , the dash register reset cir-

cuit is rendered ineffective by gate V_{30} . This prevents noise pulses as well as keyed Morse signals during the 1.6 sec intervals following an acceptable dash from resetting the dash register. At the end of the 1.6 sec interval immediately following termination of an accepted dash, V_{33} applies a reset pulse to V_{31} which, provided no signal is present, resets the dash register. The signal, if present during the 1.6 sec time, can then terminate either as an acceptable dash or a dash too long or too short.

Registration

If this signal terminates as an acceptable dash, it is registered and the space timer proceeds through its timing cycle during 1.6 sec following the end of the acceptable dash. If, however, this signal terminates as a dash longer than 1.6 seconds but shorter than 3.2 seconds, the dash is not acceptable and its trailing edge actuates V_{13} to reset the dash register. If this signal terminates as a dash longer than 6.0 seconds, it serves to reset the dash register in the same manner as a dash too short.

By **CARL DAVID TODD**

Semiconductor Products Department
General Electric Co.
Syracuse, New York

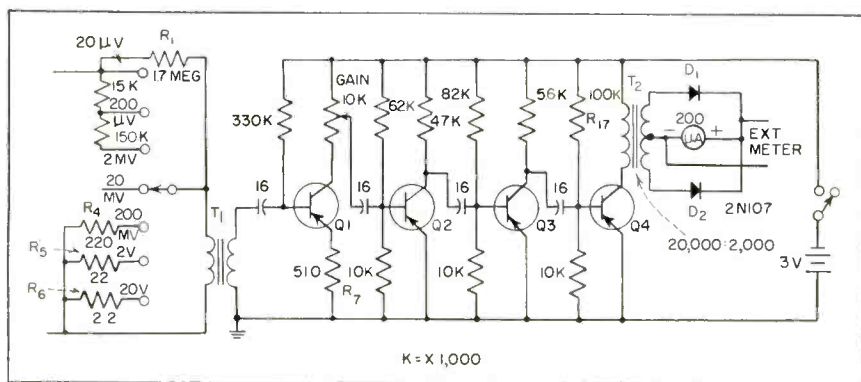

FIG. 1—Four-stage amplifier uses low current-gain transistors

SUMMARY — Designed for use in laboratory, production line and shop, instrument has seven input ranges from 20 μ v to 20 v. Readily available transistors are used in four-stage amplifier circuit. Expensive junction diodes, required for accurate low-voltage detection, are replaced by inexpensive transistors providing equal characteristics. Construction details are given

Transistor Null Detector

IMPORTANT CHARACTERISTICS of a null detector are high sensitivity, low internal noise, moderately fast response to changes in input levels, and an ability to withstand a large overload.

Circuit Description

The complete schematic diagram of a null detector with these characteristics is given in Fig. 1. It is basically a high-frequency audio amplifier whose output is rectified and fed into a sensitive d-c microammeter.

The input impedance varies

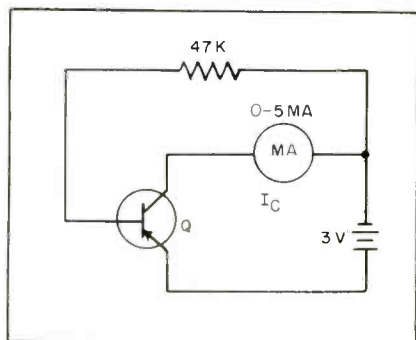

FIG. 2—Test circuit measures relative current gain h_{fe} of transistors

when switching from the 20-microvolt range to the 20-millivolt range. After reaching the 20-mv range, it remains constant. This was done to avoid high resistance values normally required for the higher voltage ranges and also partially to eliminate noise in the input.

The input transformer is a modified push-pull driver transformer. The center-tapped secondary was modified to give two identical windings. By breaking the center lead and bringing out both wires separately a unity ratio transformer is obtained.

The input impedance to the null-detector amplifier was approximately 20,000 ohms. With the transformer connected, the input impedance dropped to 2,000 ohms.

The four-stage transistor amplifier uses low current-gain transistors. The amplification is sufficient. High-gain transistors may be used with slightly better results accompanied by a higher price tag.

The amplifier output is fed into a transformer originally designed as the driver interchange trans-

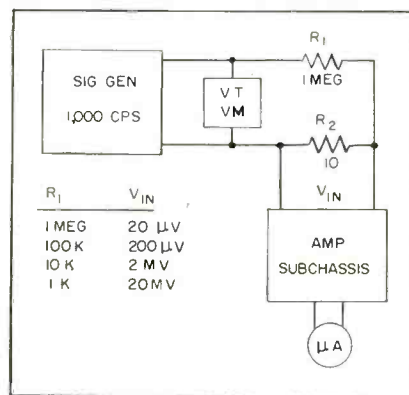

FIG. 3—Test set-up to determine values of detector input attenuator resistors

former for a push-pull amplifier. The centertap allows full-wave rectification without need of a bridge.

To achieve good results at low voltages, junction diodes are required for the rectifiers. At the present time, junction diodes are expensive. Type 2N107 transistors sell for much less and make excellent junction diodes. Either the emitter-base diode or the collector-base diode may be used. Both diode sections can not be used since they



Null detector fits in 5 by 7-in. case

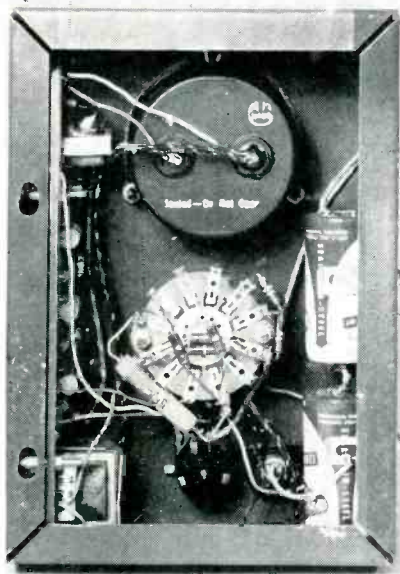

Internal view shows parts layout

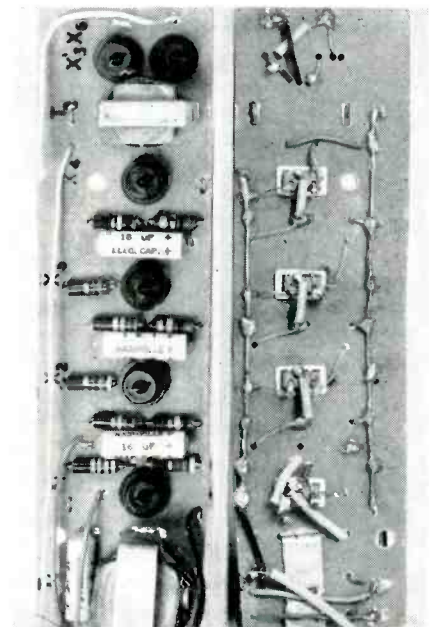

Subchassis parts layout and wiring

Has HIGH SENSITIVITY

are not independent.

Terminals are provided so the 200-microampere meter may be used for external functions. No switching is necessary to disconnect the output circuit from the meter since the diodes isolate the meter from the null detector whenever current is supplied to the external terminals.

Construction

The null detector was built in a 5 by 7 by 2-in. aluminum chassis. The amplifier and rectifier circuitry are mounted on a Textolite board subchassis. This is in turn mounted to the side of the main chassis. Printed circuit techniques are not used, but rather, small wires are employed to connect the various components together.

The current gain h_{re} of the transistors used as diodes is not important. It may be wise, therefore, to use the two lowest h_{re} units for this function saving the others for the amplifier.

The test circuit shown in Fig. 2 may be used to measure relative

gains of the transistors. The transistor that has the highest collector current will, in general, have the highest h_{re} .

The transistors had an h_{re} ranging from 18 to 40. If transistors with current gains greatly different from this are used, it will be necessary to change the resistors supplying the d-c base-bias current. As a general rule, the base-to-supply resistor should give a collector current of about 0.5 ma.

Tests

A 1,000-cps signal applied to the amplifier input as shown in Fig. 3 allows measurement of the input voltage in the microvolt range. The exact values of the resistors used in the attenuator depend on the 1,000-cps voltage amplitude and the lowest voltage that may be measured by a vtvm or an oscilloscope.

The values shown are for use with a signal generator capable of delivering 2 volts rms. When two volts are applied to the input attenuator, 20 microvolts will appear across the 10-ohm resistor. This

voltage should produce a deflection on the meter. If there is no deflection, the gain of the amplifier may be too low. To determine this, increase the input voltage by using a smaller series resistor R_1 . Several values are given in Fig. 3. Once a deflection is obtained, the transistors should be swapped back and forth to maximize the gain.

Final gain adjustment is done by varying the value of resistor R_7 .

The input-attenuator resistors are best determined by using a potentiometer for the resistor, applying the desired full-scale voltage to the input as shown in Fig. 3, then adjusting the potentiometer to give a full-scale meter reading.

The resistors should be determined in numerical order. With resistor R_1 connected in place, resistor R_2 is selected to give full-scale deflection with 200 microvolts applied. Resistor R_3 is selected in a similar manner.

Resistors R_4 , R_5 and R_6 when placed across the amplifier input should produce full-scale readings at the desired voltages.

L NETWORK Design

SUMMARY — Technique for using Smith chart to speed design of L matching networks for transmission lines and waveguides using lumped parameters. Shaded-area charts show at a glance impedance ranges that can be matched with each type of L network

THE FAMILIAR Smith chart for transmission lines is also a useful tool for designing matching networks. As an example, consider the case where it is desired to match an impedance $Z_L = (0.3 - j1.6)R_o$ to R_o with the L matching network shown in Fig. 1. It is assumed that the inductances are lossy so that $R_1 = X_1 \tan \theta = 0.2X_1$, and $G_2 = -B_2 \tan \theta = -0.2B_2$. All impedances and admittances are normalized with respect to R_o and $G_o = 1/R_o$, respectively.

Let $Z_A = Z_L + R_1 + jX_1$, and $Y_A = 1/Z_A$. Since $Y_A + G_2 + jB_2 = 1$, Y_A must lie on curve $Y = 1 - k(\tan \theta - j)$, where k is a real variable. This curve is circle OA' with center C . To locate C , lines OC and OD are drawn as indicated in Fig. 1. Point D bisects its line. Point C is located as indicated.

Point C is inverted to obtain C' on line OC so that $C'O = OC$. Since Y_A must lie on circle OA' , Z_A must lie on circle OH whose center is C' . To determine Z_A ,

By H. F. MATHIS
Goodyear Aircraft Corp.
Akron, Ohio

plot curve $Z = Z_L + p(\tan \theta + j)$, where p is a real variable. Point A , where this curve intersects circle OH , is the desired value of Z_A . The value of Y_A is found by inverting point A to obtain A' . Finally, $R_1 + jX_1 = (Z_A - Z_L)R_o = (0.498 - j0.610) - (0.3 - j1.6)R_o = (0.198 + j0.990)R_o$ and $G_2 + jB_2 = (1 - Y_A)G_o = 1 - (0.803 + j0.985)G_o = (0.197 - j0.985)G_o$.

General Procedure

In general, for L matching networks plot Z_L or Y_L first on the Smith chart. Next, plot the impedance or admittance into which Z_L is to be transformed, and find a suitable path connecting these points.

It is impossible to match all possible values of Z_L with a given type of L network. For example, if $Z_L = 0.5R_o$, the matching network shown in Fig. 1 could not be used. Impedances which may be matched with a given type of L network are shown as areas on Smith charts in Fig. 2. It is assumed that it is desired to transform Z_L into R_o and that Z_L is normalized with respect to R_o .

BIBLIOGRAPHY

P. H. Smith, Transmission-Line Calculator, *ELECTRONICS*, p 29, Jan. 1939.
P. H. Smith, An Improved Transmission-Line Calculator, *ELECTRONICS*, p 130, Jan. 1944.

(Continued on page 188)

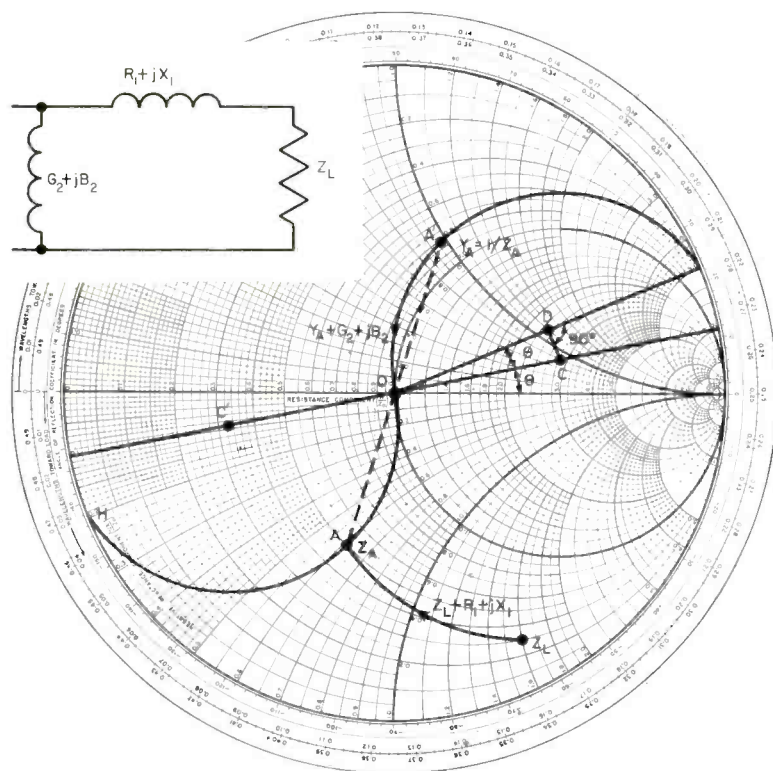
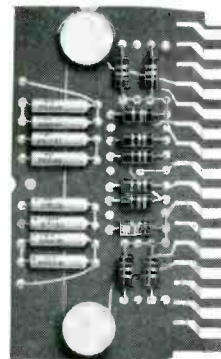

FIG. 1—Smith-chart procedure for determining parameters of L matching network

CONSIDER a typical design in which there are 1200 packages each of which averages 25 connections—a total of 30,000 connections.

If these are wired by hand in the traditional manner, the time required to wire the device is but one of the very costly aspects of the problem. There are equally important difficulties such as the many varieties of wiring errors due to the human element which will occur even though the wiring is done by skilled technicians and which must be located and corrected by skilled personnel through laborious wire tracing methods.

The tremendous advantages gained by using package organization in an electronic device are reduced appreciably by having to use an inadequate technique for interconnecting these packages.



Component board (Typical printed wire package assembly).

NOW THE CINCH PRINT-A-CON

TRADE MARK

INSURES

EASE, PERFECTION . . . INTERCONNECTING IN PACKAGE TYPE ORGANIZATION OF CIRCUITRY

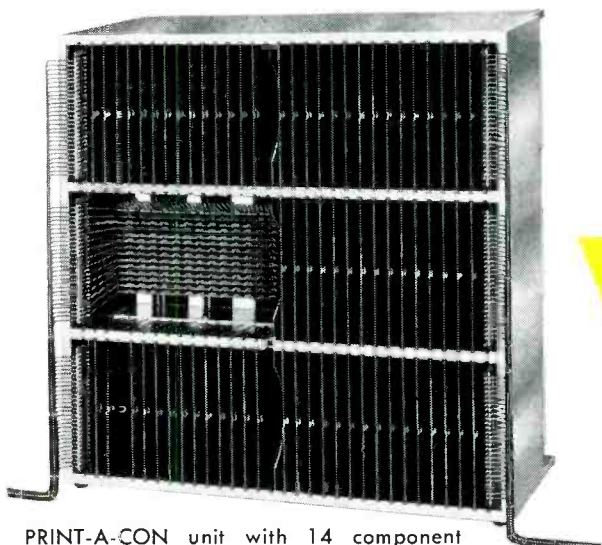

PRINT-A-CON unit with 14 component boards at left removed, showing horizontal and vertical wiring boards in back, also showing a view of the edge connectors mated with the interconnecting boards of the unit. PRINT-A-CON unit shown here is approximately 1½ ft. square by 1 ft. deep.

A multitude of horizontal and vertical wiring paths are available between all points on all component boards in the unit integrally with a means of interconnecting these paths in any desired pattern.

PRINT-A-CON opens the door to countless other approaches in the realm of mass producing complex circuitry and although it was developed initially for use in computers and control devices, its usefulness is not necessarily limited to these.

It is a newly developed component available to the electronics engineer with possibilities as unlimited as the imaginations of those who use it.

Centrally located plants at Chicago, Illinois; Shelbyville, Indiana; La Puente, California; St. Louis, Missouri.

Fig. 4—Cutaway showing "short" wires on top side and "long" wires on under side interconnected by an eyelet. This interconnection may also be made by plating through holes which have been punched prior to final fabrication.

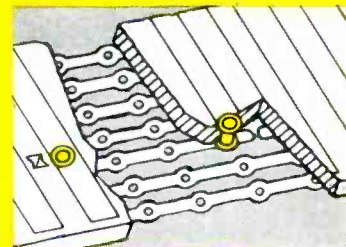

Send for descriptive, illustrated 8-page circular.

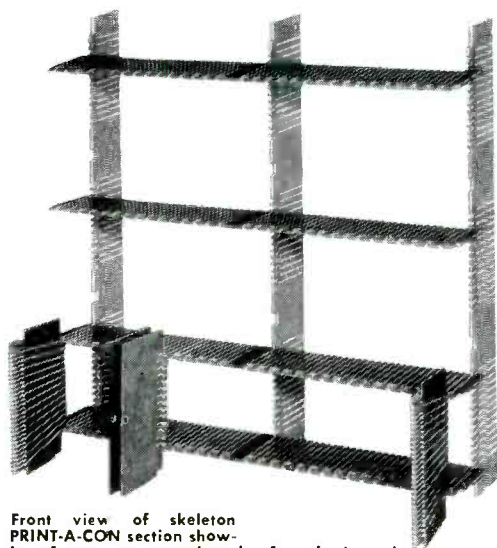

Front view of skeleton PRINT-A-CON section showing four component boards, four horizontal wiring boards and three vertical wiring boards.



Cinch
ELECTRONIC
COMPONENTS

CINCH MANUFACTURING CORPORATION

1026 South Homan Ave., Chicago 24, Illinois

Subsidiary of United-Carr Fastener Corporation, Cambridge, Mass

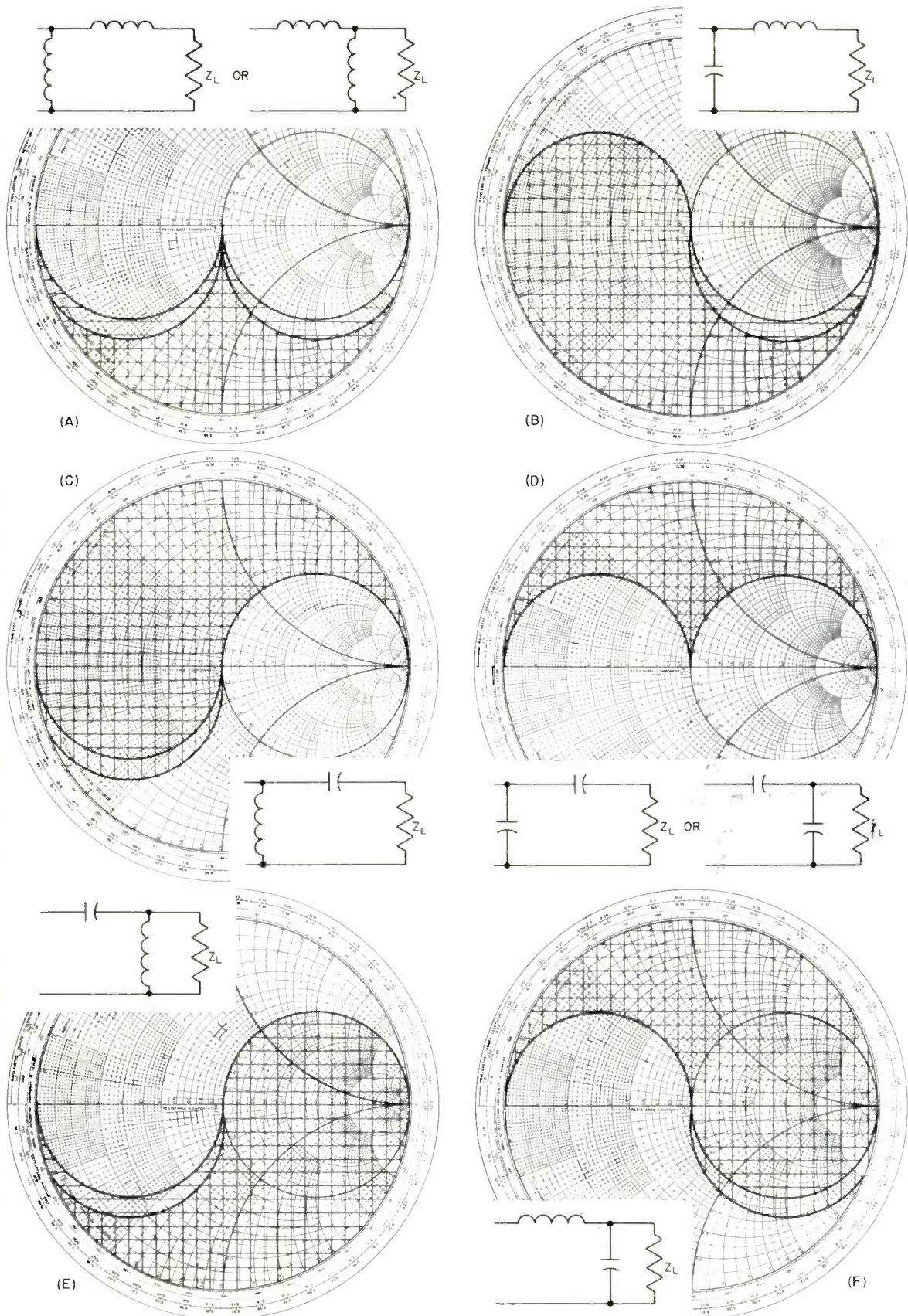
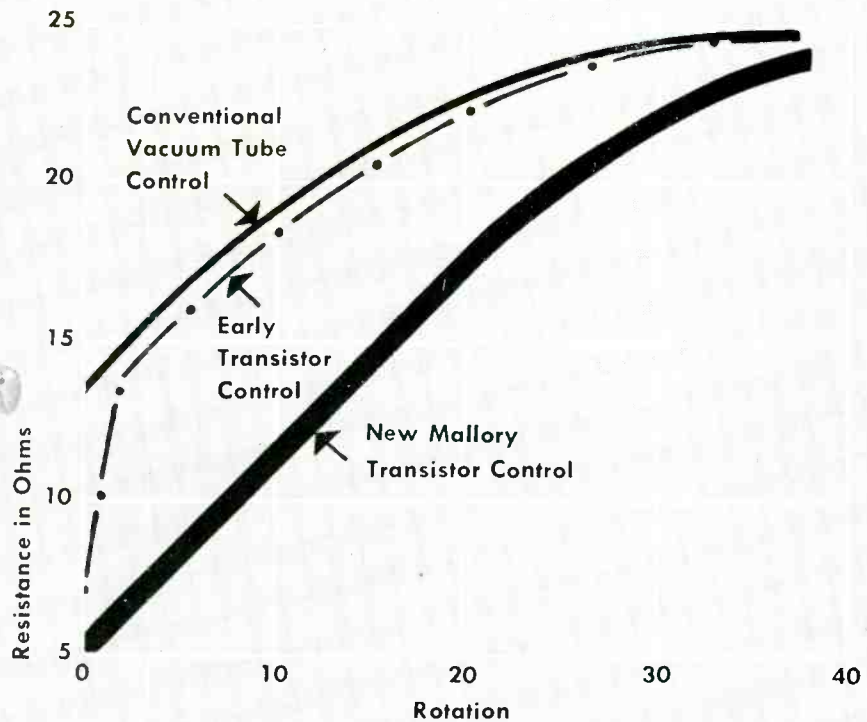

FIG. 2—For each network, horizontally shaded areas on accompanying Smith chart show impedances which may be matched with lossless reactance. Vertically shaded areas may be matched with reactances for which $\tan \theta = 0.2$



EXPANDED "LO-END" CURVE

Now...

A Control with Low-end Taper Especially Designed for Transistor Circuits

A new Mallory volume control, created specifically for use with transistors, provides characteristics not previously available to designers.

Low "hop-off" or zero rotation resistance

gives exceptionally low minimum volume level in low impedance circuits... permits full turn-down of volume level.

Special "low-end" taper

Starting from the "hop-off" value, resistance rises gradually through the first 20 to 30 degrees of rotation... thus providing smooth control of transistor circuit volume throughout the entire volume range.

Printed circuit design

Several models of the new control are available for use

in printed circuits, for mounting vertical to or horizontal to the printed circuit panel.

Push-pull switch*

Available on all models... new Mallory push-pull line switch. Conventional rotary action switches can also be supplied with these new "low-end" taper controls.

Each sample control is supplied with a tag on which are given its overall resistance-rotation curve, plus a new "low-end" curve showing detailed resistance characteristics in the minimum volume range. Write to Mallory today for a sample in the resistance value, taper and mounting arrangement that you are considering for new designs... and for a consultation by Mallory control specialists on your particular requirements.

Serving Industry with These Products:

Electromechanical — Resistors • Switches • Tuning Devices • Vibrators
 Electrochemical — Capacitors • Mercury and Zinc-Carbon Batteries
 Metallurgical — Contacts • Special Metals • Welding Materials

Parts distributors in all major cities stock Mallory standard components for your convenience.

*Patent applied for

Expect more... get more from



Satellite Equipment Being Assembled



Electronic circuit package held by Naval Research Lab employee fits into baby-moon shell shown below. Printed wiring typical of that used can be seen on boards at bottom of picture. Eighteen units of this kind are now under construction. They will be launched from three-stage rockets during the International Geophysical Year

Flat Tube Suitable For Color TV

DRASTICALLY cutting the depth required for a television kinescope, a developmental type invented by Denis Gabor may prove to be commercially feasible (ELECTRONICS, p 14, Jan. 1, 1957) for color.

Figure 1 shows the cross-section of the beam. Although they come from three separate cathodes, the color beams merge during most

of their transit and only at the end strike the screen at different angles to activate the appropriate phosphor strip at the desired point.

As indicated in Fig. 2, the final bending and scanning takes place as the result of a potential phenomenon. Just behind the scanning array is a metallic plate that acts as a magnetic screen. The scan-

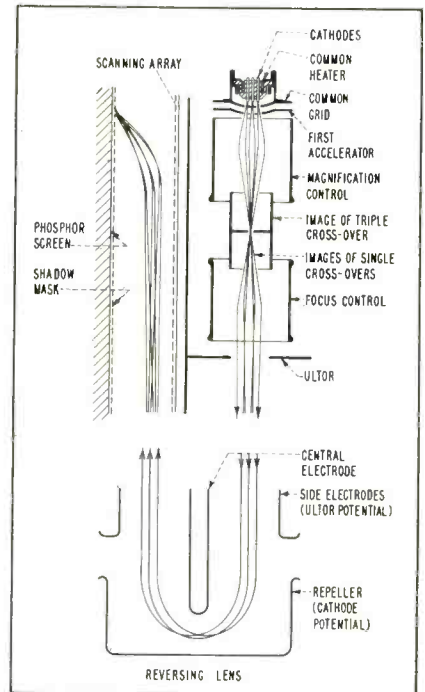

FIG. 1—Principle of self-scanning by the writing beam

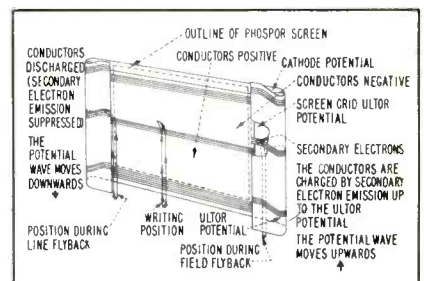

FIG. 2—Printed circuit scanning array

ning array itself comprises about 120 horizontal conducting lines printed upon a flexible insulating base.

► **Printed Lines** — At the sides, where the base is bent, the conducting lines are staggered upwards. In operation, a potential wave travels down this array vertically. Up to a certain level, the conductors are charged to maximum positive potential. Above, there occurs a transition zone of lesser potential. When the beam reaches the transition zone it is bent towards the screen.

When a beam has completed line



VOLTAGE REGULATED POWER SUPPLIES

*for Transistors • Strain Gages
Relays • Filament Power*

MODEL	Volts	Current	Regulation		Ripple	Recovery Time*	Stability For 8 Hours	Output Impedance		Dimensions			Price
			Line 105-125	Load 0-Max.				DC-20	20 ~ -100 KC	W	H	D	
2600	0-60	0-2 Amp.	5 Mv.	5 Mv.	1 Mv.	50 μ sec.	10 Mv.	0.002 Ω	0.0005 Ω	19"	10½"	17"	\$690
2650	0-60	0-5 Amp.	5 Mv.	5 Mv.	1 Mv.	50 μ sec.	10 Mv.	0.001 Ω	0.0002 Ω	22½"	28"	19"	\$1190

Good stability
Fast recovery time
Low output impedance
Excellent regulation
Low ripple

POWER REQUIREMENTS: 105-125 volts, 60 cycles.
FUSE PROTECTION: Input and output fuses on front panel. Time delay relay is included to prevent unregulated voltage from appearing at the output terminations.

OUTPUT TERMINATIONS: DC terminals are clearly marked on the front panel. Either positive or negative terminal of the supply may be grounded. DC terminals are isolated from the chassis. A binding post is available for connecting to the chassis. All terminals are also brought out at the rear of the unit. Two terminals are mounted at the rear of the chassis to provide for picking up the error signal directly at the load. This connection compensates for the voltage drop in the wires (and ammeter) connecting the power supply to the load.

METERS: Ammeter: 0-2 amperes, 4" rectangular for Model 2600
0-5 amperes, 4" rectangular for Model 2650

Voltmeter: 0-60 volts. 4" rectangular

CONTROLS: Power on-off switch, DC on-off switch, remote error signal on-off switch, coarse and fine voltage controls. The coarse voltage control is a ten turn potentiometer which varies the voltage from 0-60 volts. The fine voltage control is a ten turn potentiometer which varies the voltage 1 volt. The voltage divider network allows a 61 volt variation in output voltage.

*Recovery time is less than 50 microseconds. The excursion in the output voltage during the recovery period is less than 50 millivolts for line fluctuations from 105-125 volts or load variations from 0-to maximum current.



MODEL 2600



MODEL 2650



FOR COMPLETE LINE
WRITE FOR CAT. B-568

KEPCO LABORATORIES, INC.

131-38 SANFORD AVENUE • FLUSHING 55, N.Y. • INDEPENDENCE 1-7000

scan, after rapid flyback, it rests in the loop at the left and falls on the conductors in the transition zone. These are partially dis-

charged, moving the zone a little downwards. Since this zone runs down as a wave the lines are self-scanned. With the line stopped and

the beam resting in the loop at the right, a screen grid causes the array conductors to charge, the beam creeps up to repeat the cycle.

Television Expands Teaching Staff

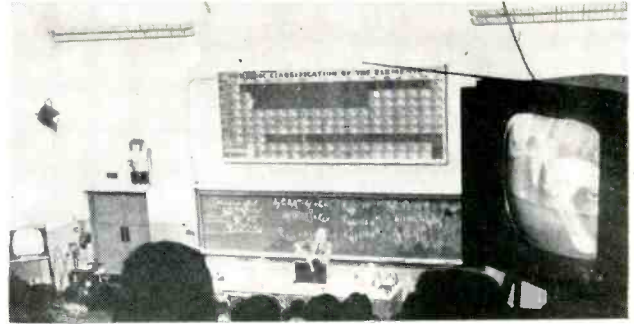
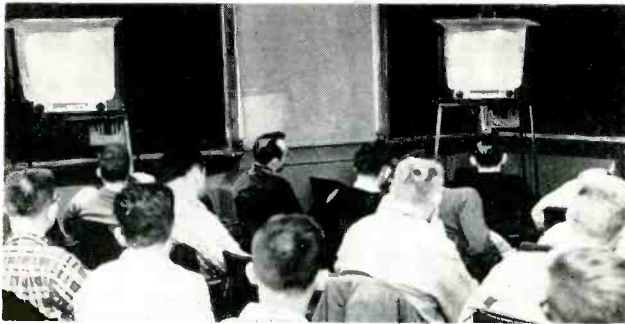

Demonstrations in a general chemistry class are made visible in more detail to those in the rear of the lecture hall as well as to students in other classrooms at Pennsylvania State University

UNDER a grant from the Fund for the Advancement of Education, Pennsylvania State University has been using closed-circuit television to administer a part of their instruction to some 4,700 students in

30 sections of 13 courses.

Original equipment included two Dage dual-camera vidicon television systems. Six 24-inch Westinghouse receivers were modified to accept video from the control console at the receiver video amplifier input.

Fuel Injection Triggered By Engine Needs

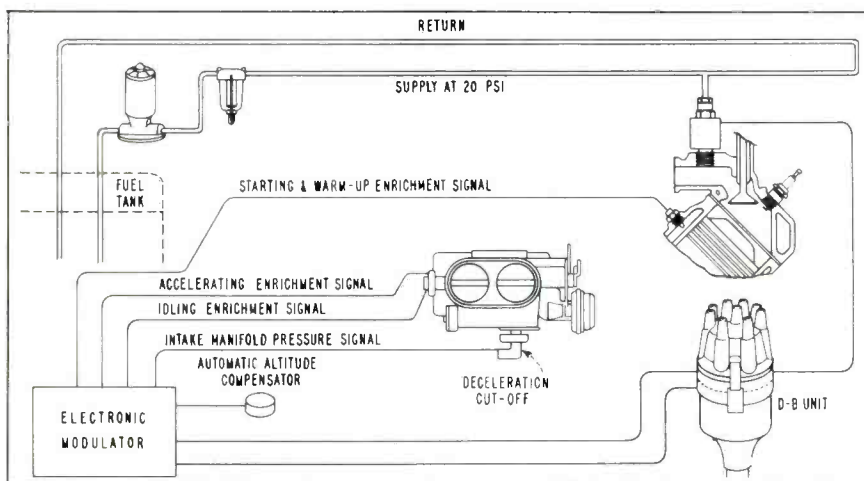
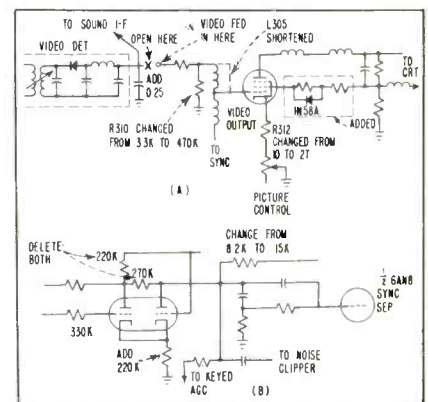

Diagram shows the intercommunication of sensors and controls in Electrojector system

ENGINE needs are automatically sensed as driving conditions vary or as altitude changes. A so-called modulator circuit integrates incoming signals from various sensors, such as inlet manifold pressure, starting enrichment thermistor or acceleration enrichment control. An output pulse varies in width to suit transient engine demands. Pulse current is amplified and dis-

tributed to operate fuel injectors. Ignition breaker points are synchronized with injector-timing points to send out spike signals that trigger a multivibrator. In typical tests, brake reaction torque was about 20 ft-lb higher from 800 to 3,600 rpm in a car equipped with the new system as compared with one using a four-barrel carburetor. This system is built by Bendix.



Connection of video to modified receiver (A) and changes made to Westinghouse receivers to stabilize sync (B)

Sound was carried at r-f on channel 4 to the antenna terminals. To connect the video into the receiver and allow sound to remain unchanged the video amplifier was cut from the detector output and a 1N58A crystal added for d-c restoration as shown at (A) in the circuit diagram.

The agc tube (6AU6) was removed because voltage developed by the strong video signal was sufficient to cut off r-f and i-f tubes

Another product surprise from Helipot!



Helipot... Vintage '57

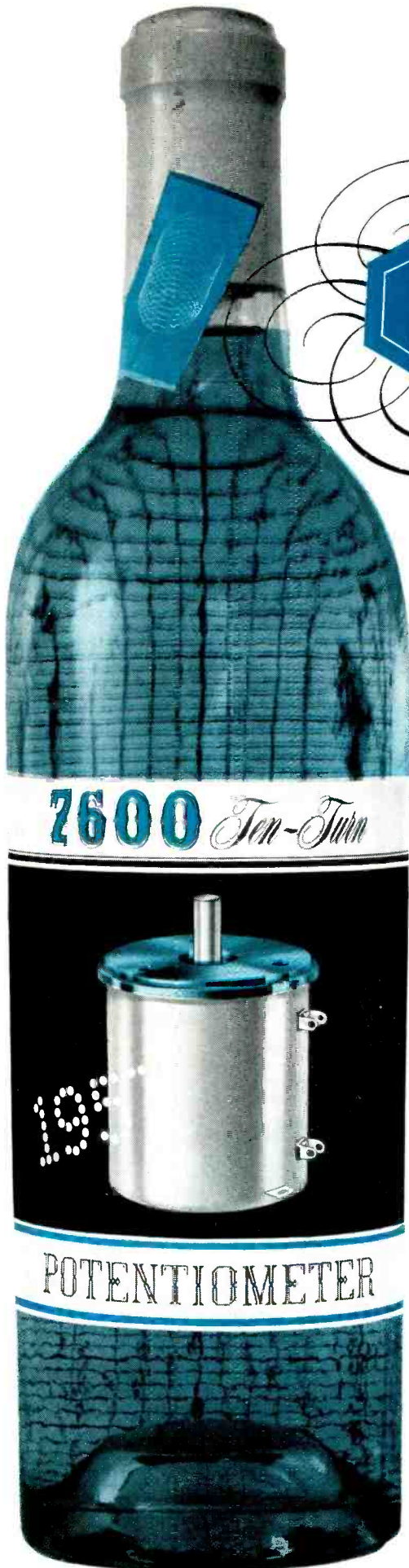

Here's health to your system . . . when you specify Helipot's series 7600 potentiometer.

Here's strength . . . and here's accuracy!

Here's how it's done. The robust housing of Resinox 10900 is molded in one shot, lathed in one set-up . . . gives you greater mechanical conformity and stability . . . corks up electrical leakage.

The rotor-and-slider-block design pours ruddy health into the 7600 . . . gives you 38-inch-pound stop-load strength, lowered torque and inertia . . . drains off every last drop of backlash.

Cheers for the 90° coil extension that improves end-coil linearity . . . for the internally expanding ring that emphatically clamps lid to housing, eliminates screws.

The full-bodied facts about the 10-turn, 1-13/16" diameter series 7600 are soberly presented in data file 221. Try one today!

Beckman®

Helipot Corporation

Newport Beach, California

a division of Beckman Instruments, Inc.

Engineering representatives in principal cities

THE FRONT COVER

THE cover picture shows the test setup for 300 feet of line being tested for vswr and attenuation at the Andrew Corp. transmission line testing site. For the vswr measurements, a slotted line was used at each end with readings taken every megacycle over the range. The load was tuned to a vswr of 1.01 or less for each frequency recorded. The vswr of this line is under 1.05 for 300 feet.

Attenuation was also measured on 300 feet of line by shorting the far end and measuring vswr at the generator end. From these measurements, the power rating of the line was calculated. Attenuation and power rating vary from 0.037 db per 100 ft and 350 kw at 100 mc to 0.082 db and 158 kw at 400 mc. Peak power rating for pulse use is in the megawatt range and depends upon pulse length and duty cycle.



The new line has a characteristic impedance of 50 ohms. The inner conductor is supported on Teflon peg insulators. In the photograph, a clamp is being placed on the flange to hold two sections of line together.

and prevent sound from passing through. To stabilize sync, R_{100} was changed to 15,000 ohms and R_{410} and R_{100} removed as shown at (B). A 220,000-ohm resistor was added in series with the cathode of the 12AT7 sync control tube.

However, with an audio-video

mixer added to the control room equipment, both picture and sound are used to modulate an r-f carrier on channel 4 and this output is fed through a 72-ohm cable to each room. This arrangement obviates the need for modifying the receivers.

Forty-Meter Transistor Transmitter

POWERED by two flashlight cells, the crystal-controlled transmitter shown in the diagram has been used in the amateur 7-mc band to communicate with stations all over the United States, parts of Canada and the Hawaiian Islands.

The equipment requires 120 milliwatts input. Several precautions have been taken to insure stable operation. Grounded base is used in the amplifier to reduce feedback, obviating the need for neutralization. The small amount of capacitive feedback is regenerative but no instability has resulted.

► **Stabilization** — A minimum resistance in the emitter is essential to temperature stability and to lessen the danger of current runaway, but series dropping resistors are otherwise minimized. Capacitor C_1 is a phasing adjustment to be set at the point of best stable operation of the oscillator under keying. It also permits slight frequency change.

For maximum output, the sbdt transistor can be immersed in a silicone-oil bath or other appropriate means of removing heat. The circuit and equipment described has been operated by Forrest Bigelow, W3FBL, Laverock, Pa. and the information has been furnished by Philco Corp.

(continued on page 196)

Test and Pumping Equipment for Microwave Tubes

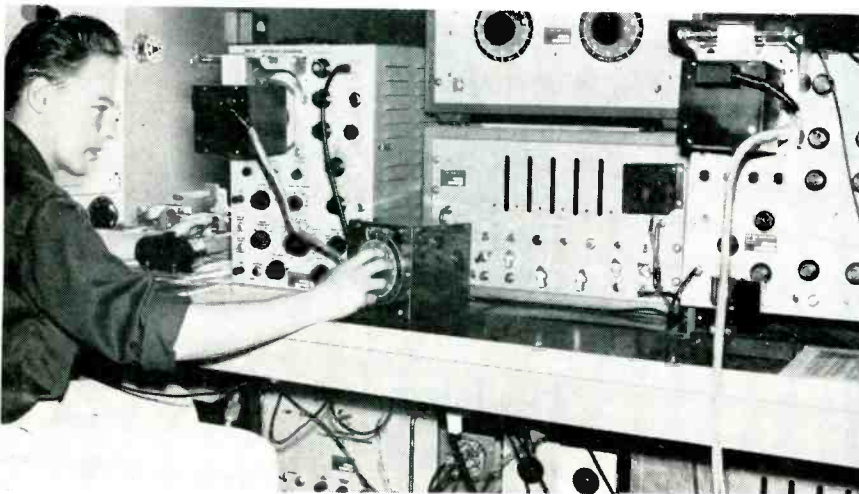

Frequency, time and amplitude-jitter tests performed on the equipment at left have reduced measurement time in klystrons from eight

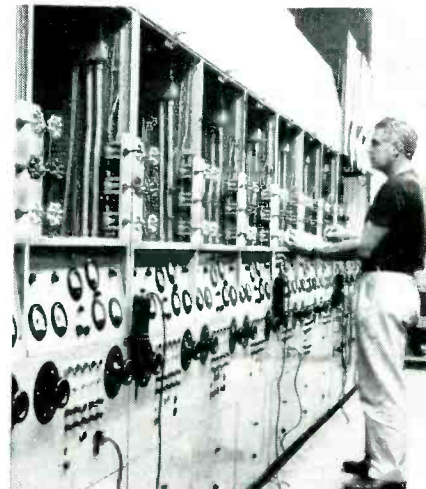

man hours to 15 minutes. Elaborate exhaust equipment is used at Litton Industries in San Carlos, Calif. for micro-wave tubes (right)

Transitron

MILITARY type silicon diodes



1N457
1N458
1N459
1N251

TRANSITRON'S Military type silicon diodes are designed to meet the requirements of MIL-E-1, and are characterized by reliability under the most severe operating conditions.

Their subminiature size and rigid specifications make them ideal for a wide range of applications. Types 1N457, 1N458, and 1N459 are intended for low and medium frequency uses, requiring voltage ratings up to 175 V. Type 1N251 is a high frequency diode especially designed for detector and high speed pulse units.

In addition to these four military types, silicon diodes meeting many other application requirements are also available. These include high conductance types, as well as fast switching-high voltage diodes.

Type	Minimum Forward Current at +1 v (ma)	Inverse Current at Specified Voltage (μ a)	Maximum Operating Inverse Voltage (volts)	MIL-E-1 TSS #
1N457	20	.025 @ -60 V	60	1026
1N458	7	.025 @ -125 V	125	1027
1N459	3	.025 @ -175 V	175	1028
1N251 *	2	.2 @ -10 V	30	1023

*Inverse recovery time under .15 microseconds

SEND FOR
BULLETIN TE 1350

Transitron

electronic corporation • wakefield, massachusetts



DURANT

MFG. CO.

Specials

For RADAR, ELECTRONIC
and INSTRUMENT APPLICATIONS

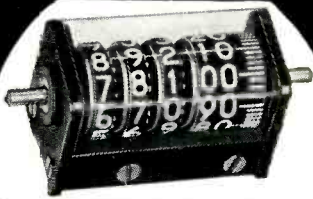

High speed, non-reset, direct reading counter to indicate increment of measurement in radar navigation instruments.

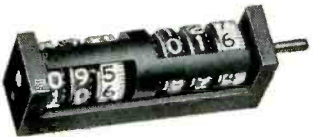

High-speed dual bank counter for use in navigating instruments. Shutter operates to close off either bank when in the minus side.

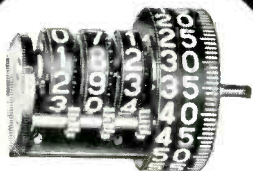

Counter assembly component of navigating instrument to indicate increments of measurement for fast, legible, direct "read-out".



Special counter for use on Tape Recorder to indicate the position of tape passing through the recorder.

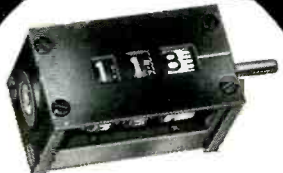

Direct reading counter for navigating and directional instruments. Unit wheel graduations permit reading of 150,000 increments per minute.

Representatives in Principal Cities

WRITE FOR LITERATURE

DURANT MANUFACTURING CO.

1912 N. Buffum St. Milwaukee 1, Wis.
12 Thurbers Ave. Providence 5, R. I.

PRODUCTIMETERS
SINCE 1879 *Count Everything*

Want more information? Use post card on last page.

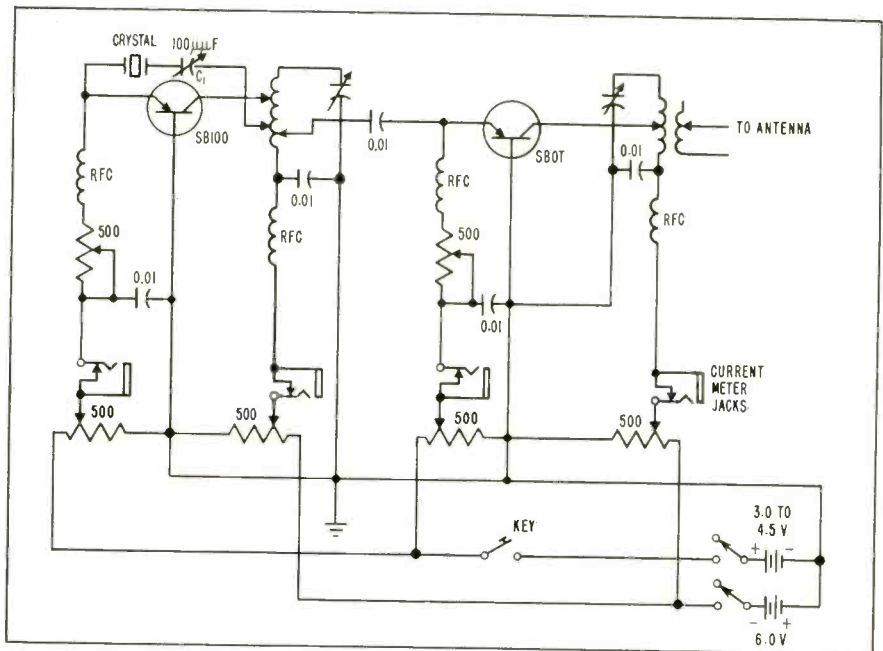

Circuit of the two-transistor 7-mc transmitter described on the previous page

Fork-Driven Dual Tone Standard

BY BYRON H. KRETZMAN
*Erco Radio Laboratories
Garden City, N. Y.*

IN TUNING the selective amplifiers of an a-f type radioteletypewriter the usual method is to use a tunable audio oscillator as a signal generator designed for 850-cycle shift,

the usual method is to use a tunable audio oscillator as a signal generator. Some means of accurately

Computer Solves Power Dispatch Problem

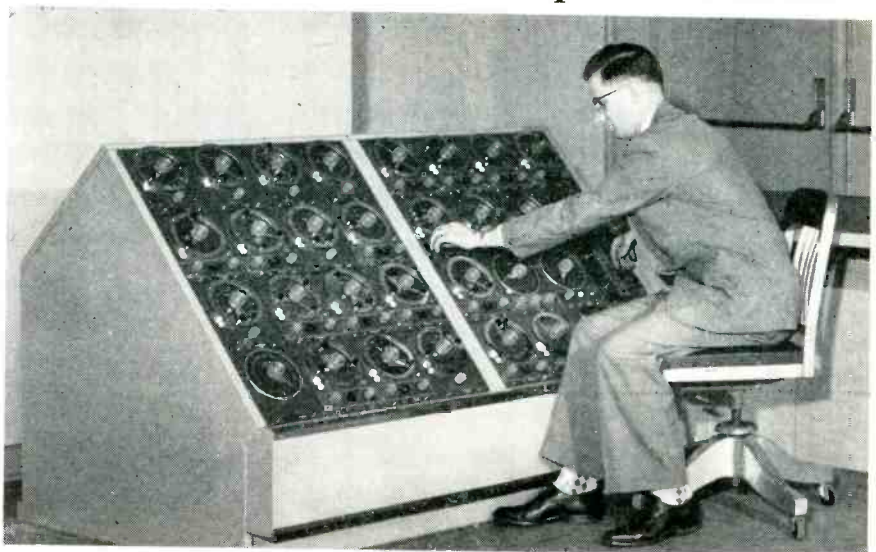

Principal inputs, such as station costs and constants of the transmission system are set on dials of the automatic dispatch computer shown. Curves corresponding to the combination of units in service are selected. With all other information set in, the operator indicates total required generation. The computer then positions automatically to show optimum dispatch of power for various units of the system. Westinghouse has delivered this unit to West Penn Electric Co.

FIRST silicon transistors meeting NAVY SPECS

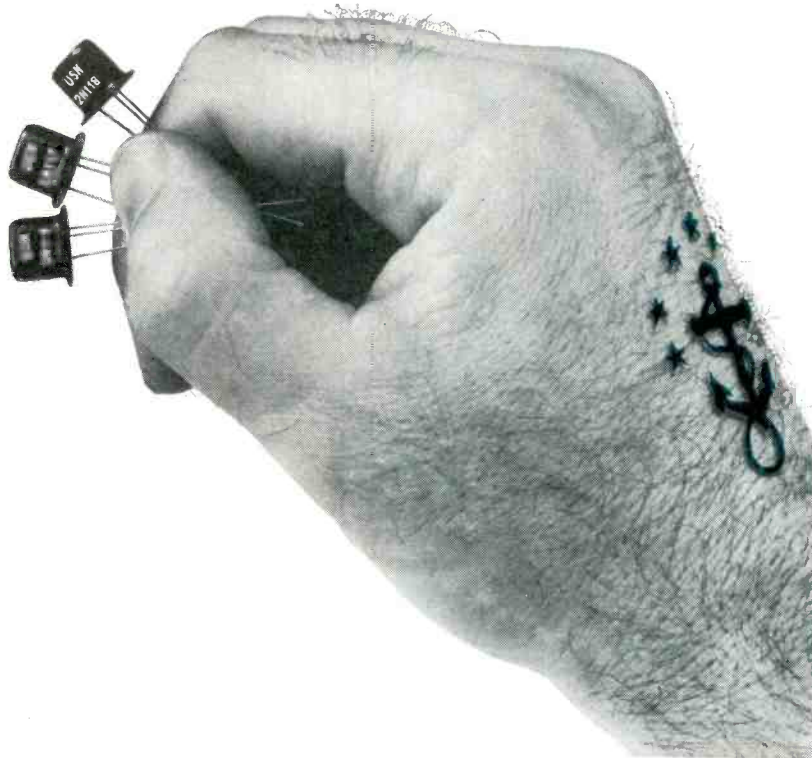

For *reliability* under *extreme* conditions... design with TI's military silicon transistors... built to give you high gain in small signal applications at temperatures up to 150°C. Made to the stringent requirements of MIL-T-19112A (SHIPS), MIL-T-19502 (SHIPS), and MIL-T-19504 (SHIPS) — these welded case, grown junction devices furnish the tremendous savings in weight, space, and power you expect from transistors...

... *plus* close parameter control that permits you to design your circuits with confidence.

All 20 Texas Instruments silicon transistor types have proved themselves in military use. First and largest producer of silicon transistors, TI is the country's major supplier of high temperature transistors to industry for use in military and commercial equipment.

degradation rate tests for TI's USN-2N117, USN-2N118, and USN-2N119

test	condition	duration	end point at 25°C
lead fatigue	three 90-degree arcs	—	no broken leads
vibration	100 to 1000 cps at 10 G	3 cycles, each x, y, and z plane	$I_{CO} = 2 \mu A$ maximum at 5V $h_{ob} = 2 \mu mhos$ maximum $h_{fb} = -0.88$ minimum (USN-2N117) $h_{fb} = -0.94$ minimum (USN-2N118) $h_{fb} = -0.97$ minimum (USN-2N119)
vibration fatigue	60 cps at 10 G	32 hours, each x, y, and z plane	
shock	40 G, 11 milliseconds	3 shocks, each x, y, and z plane	
temperature cycle	-55°C to +150°C	10 cycles	
moisture resistance	MIL-STD-202	240 hours	
life, intermittent operation	$P_c = 150 \text{ mW}$, $V_c = 30V$	1000 hours, accumulated operating time	
life, storage	150° C, ambient	1000 hours	
salt spray	MIL-STD-202	50 hours	no mechanical defects interfering with operation

LOOK TO TI FOR: SILICON HF, MEDIUM POWER, POWER, AND SMALL SIGNAL TRANSISTORS
SILICON DIODES AND RECTIFIERS • GERMANIUM VHF, POWER, RADIO, AND GENERAL PURPOSE TRANSISTORS

**pioneer producer of
silicon transistors**



**TEXAS INSTRUMENTS
INCORPORATED**
6000 LEMMON AVENUE DALLAS 9, TEXAS

Vital to Semiconductors!



Alpha UHP* ultra high purity metals—

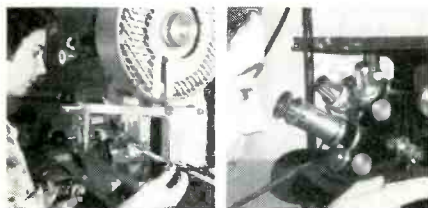

Modern precision equipment is used for rolling, extruding and punching.

Precision devices for accurate inspection are part of our standard equipment.

what are they—and what do they mean to

SEMICONDUCTORS?

The performance of semiconductors are vitally effected by *small bits of rare metals* such as INDIUM, GALLIUM, ANTIMONY, ARSENIC and others, which must possess the highest degree of purity... be critically close in tolerance... and offer complete alloy uniformity.

Alpha, a pioneer in high purity metals, offers all of the metals and their alloys, commonly used in semiconductor manufacture, in a complete range of uniform sizes and shapes. All pellets, discs, washers and spheres are processed from metals approaching 99.999 in purity.

Whether you are interested in Alpha's semiconductor UHP products for experiment or production, they are available to you in minimum quantities and any shape or alloy that suits your needs.

For further information, write Dept. CS today.



Other ALPHA Products
Cored & Solid Wire Solder
Wide Range of Fluxes... Soft Solder Preforms

*Trade Mark

Want more information? Use post card on last page.

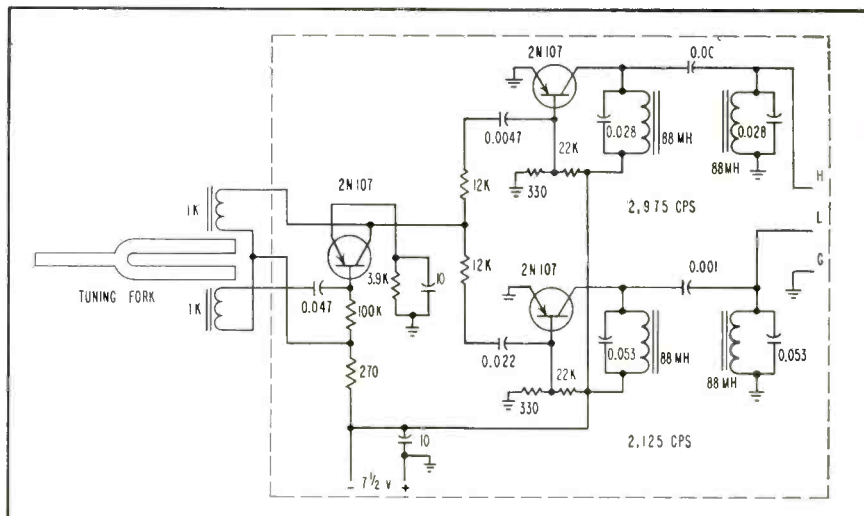

Circuit of the tuning-fork controlled standard with two outputs

setting the oscillator to either of the standard mark and space frequencies, namely 2,125 and 2,975 cycles, is necessary.

Common practice is to compare the frequency of the tunable oscillator with a 425-cycle tuning fork standard. Lissajous figures on an oscilloscope are then obtained in the 5-to-1 and 7-to-1 ratios as required. This procedure may prove unreliable if the a-f oscillator is unstable. Described below is a fork-driven standard that provides 2,125 and 2,975 cycles directly. Using this

standard, it is unnecessary to employ an a-f oscillator or even an oscilloscope to align a converter. Operation is simplified by using transistors and a self-contained battery power supply.

Construction is simplified by using an etched or printed-circuit wiring board. The transistor oscillator is a pulse-generator driven by a 425-cycle tuning fork. Transistor amplifiers tuned to the fifth and seventh harmonics amplify the 2,125 and 2,975-cps components.

► **Construction** — Physically, the tone standard is built on a 3.5 by 7

Atomic Flashlight Burns Years

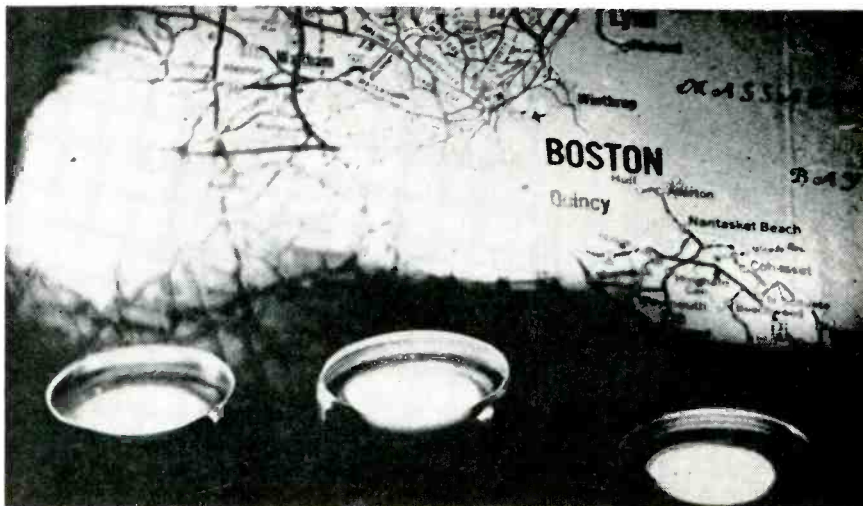

Using an essentially nonhazardous radioisotope, a new type of light source is available in several different colors for dial markers, critical controls and other markings in electronic equipment. The material furnishing the illumination has a half life of about 12 years, according to New England Nuclear Corp., developers. The map shown was photographed in the illumination from three of the new lamps

Got Your Neck Out On A Cable Problem?

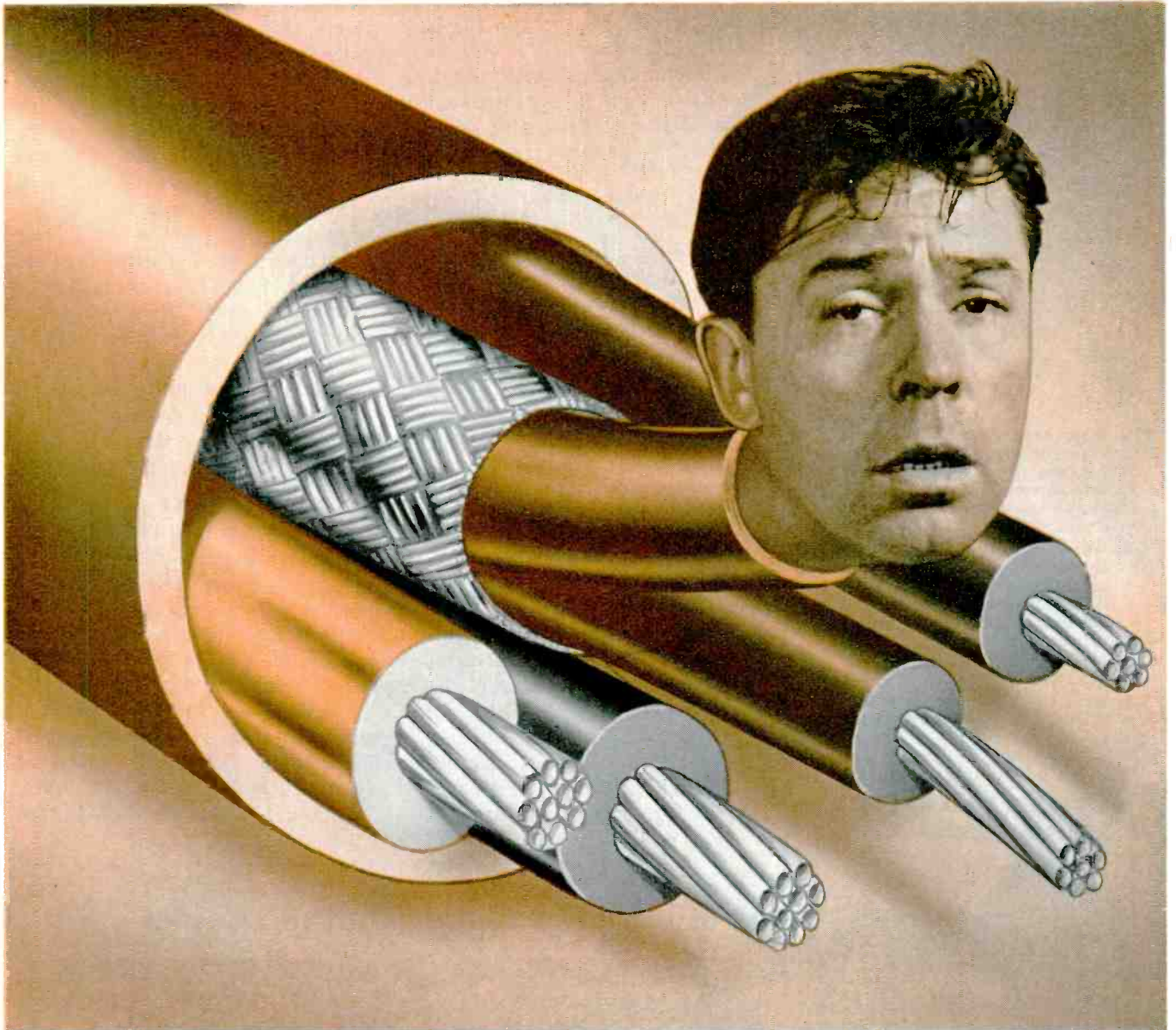

PHALO Will Haul It In For You!

Here is a pretty painful spot . . . and many necks are lost this way!

If your neck is out where the wrong cable decision could materially damage it . . . make the move that will put your adam's apple in back of your collar again . . . the move to PHALO!

Be among the necks that stay unstretched

when the problem is custom cables . . . or wires . . . or cord sets.

This catalog will tell you a lot — ask for it!



PHALO

PLASTICS CORPORATION

Corner of Commercial Street

WORCESTER, MASSACHUSETTS

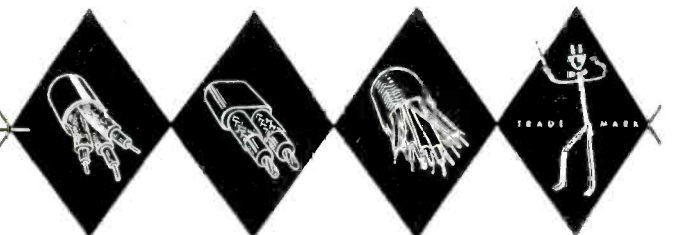

When to specify
**VULCAN ELECTRIC
STRIP HEATERS**

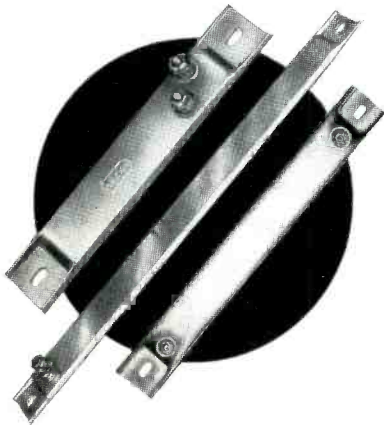

1. When application is for: Contact heating of dies, platens, molds, or any items with flat surfaces to which elements may be clamped. Also air heating source for ovens, air ducts, dryers.
2. When specifications call for: Seamless one-piece sheath; rugged non-oxidizing terminal posts; steel sheath for sheath temperatures to 750°F; Chromalloy sheath for sheath temperatures to 1200°F; 8" to 42½" lengths (or longer); 150 to 1500 watts (or higher).
3. When you have "hot" problems: Vulcan Engineers are ready to supply special heating units — engineered to your needs.

**VULCAN ELECTRIC
BAND HEATERS**



Constructed basically like the strip heaters, Vulcan Electric Band Heaters are designed for clamping around tanks, pipes, injection heads, etc. Standard width is 1½"; inside diameters from 6" to 15" (special smaller or larger sizes available). Semi or full circular bands. Equipped with mounting tabs or clamping bands.

Write for free catalog.



ELECTRIC COMPANY

DANVERS 10, MASS.

Cartridge • Strip • Tubular • Immersion Electric Heaters
• Soldering and Branding Irons
• Solder and Glue Pots

in. aluminum plate, ¼ in. thick. Steel was avoided to insure a magnetic circuit only through the fork itself. The aluminum plate is mounted on four vibration-isolating shock mounts to prevent mechanical transmission of the tuning fork vibrations to the table.

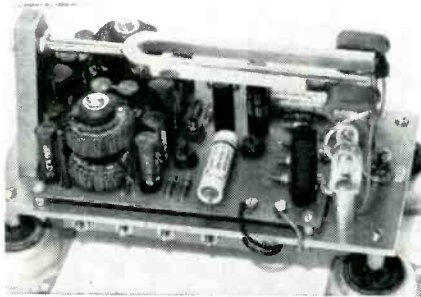

Complete transistorized dual-tone audio generator operates from a 7.5-v battery beneath the chassis

This treatment was found to be necessary, since the vibrations resonating through the workbench can be both annoying and confusing. A 7.5-volt C battery is clamped underneath the aluminum plate. A control toggle switch is mounted through the plate at one end.

The printed circuit wiring board in 3.5 by 5 in. Screw terminals for the exciting coil connections, bat-

tery supply and output were made by tapping, with a 4-40 tap, hollow rivets after they were soldered in place. In laying out the printed circuit, as much copper as possible was left for these screw terminals to reduce the possibility of separating the copper foil from the board while soldering.

Three holes, properly spaced, were drilled for the transistor leads in an open spot. The leads were not trimmed. Small tubing was slipped over these leads as some of the printed circuit wiring is crossed.

All capacitors, except for the two low-voltage electrolytics, are molded tubulars, made for end-mounting on printed circuit boards. Both leads come out the same end.

► **Magnetic Circuit** — Originally, the standard was a 435-cycle fork. The softer crotch part was notched with a good round file to move the frequency lower, comparing it with another fork of the correct frequency. Not much filing is necessary to move only 10 cycles.

Exciting coils for the fork were obtained from a high-impedance headphone. Each coil measured about 1,000 ohms d-c resistance. Magnetic bias for the fork is sup-

Profile Cutter Makes Multiple Copies

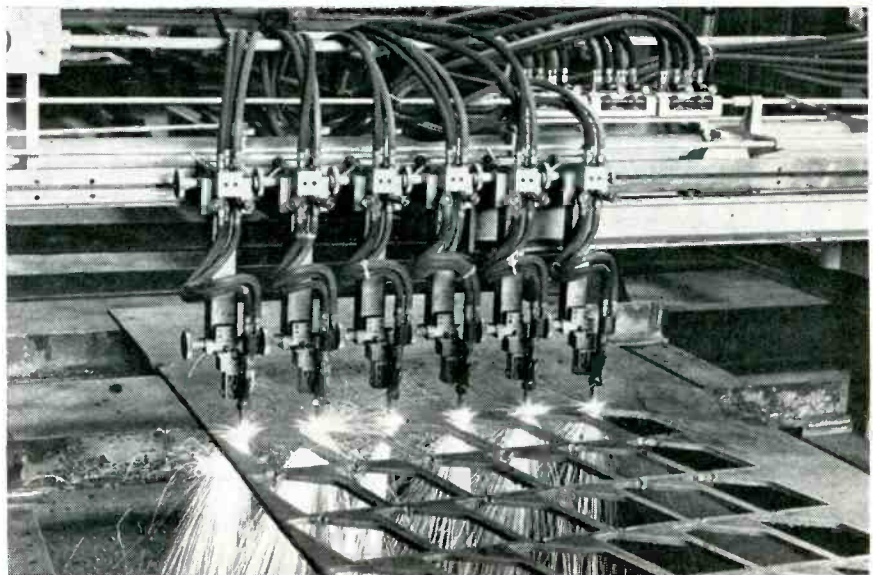

The oxygen cutting machine shown above is half of a double unit that can cut steel plate from ¼ inch to 15 inches thick from a few square inches up to 10 by 60 feet. A black and white drawing is used as the pattern and followed on the cutter by photo-electric means. The electronically controlled cutter was developed by Messrs. Hancock & Co., Ltd. of Croydon, England

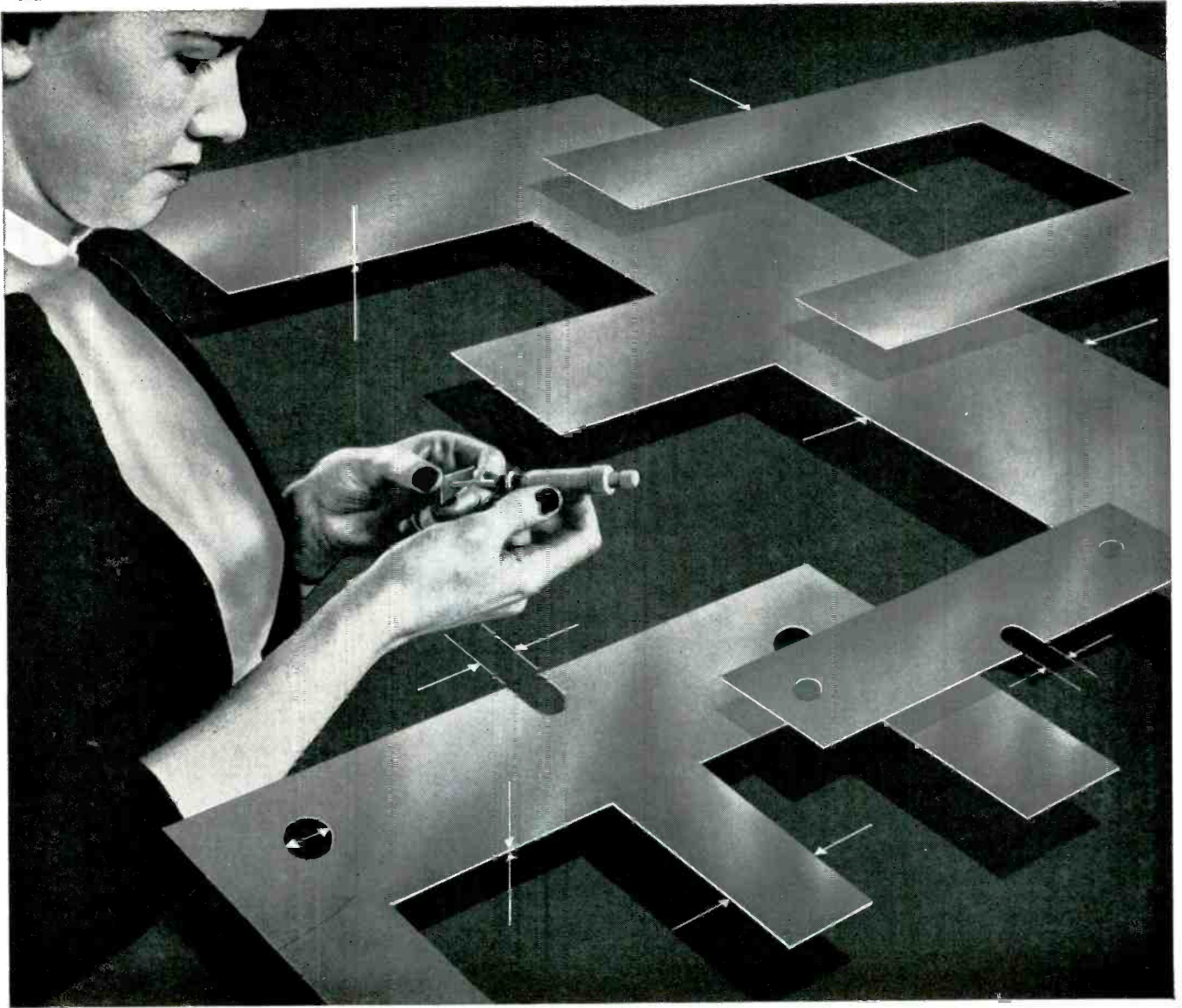

what are the new Performance-Guaranteed laminations?

Whenever our tungsten-carbide dies have produced enough nickel-iron laminations of a new shape to permit stocking them for immediate delivery, we let you know, because we get so many requests for "what's new in Performance-Guaranteed laminations?"

It's rather sensible, the emphasis our customers put on this "Performance-Guarantee." They know it's a guarantee based upon our *higher* quality hydrogen annealing, vital for high permeability laminations.

You see, small percentages of impurities, particularly carbon, oxygen and sulphur, have a deleterious effect on magnetic properties—and they are present in every alloy at the beginning despite the most rigid control of the metallurgy of the heats. In this as-rolled state, *the steel will develop as little as 5% of its ultimate permeability.*

Now everyone "hydrogen" anneals—but not everyone *dry-hydrogen* anneals. You can't use bottled hydrogen, without leaving a surface oxide injurious to magnetic properties and making soldering virtually impossible. So we dry our hydrogen to a dewpoint of -60°C , removing

the water vapor which is produced by the reduction of hydrogen. Carbon reduces to methane, sulphur to sulphur dioxide, and both are removed by the continuous flow of dry hydrogen during the 24-hour cycle.

As a result of our superior annealing, *we* develop better magnetic properties and clean lamination surfaces, and *you* get that valued "Performance-Guarantee."

New Performance-Guaranteed shapes, in stock, immediately available: EE 28-29, UI-312, F-21, DU-1, DU-37, rotor, stator and head laminations. Why not write today for Catalog ML-201 and full information on these and all other clean, flat, burr-free laminations we manufacture. *Magnetics, Inc., Dept. E-33, Butler, Pennsylvania.*

MAGNETICS inc.

CABLE: MAGNETICS

BALLANTINE Sensitive, Wide Band Electronic Voltmeter

measures 1 millivolt to 1000 volts
from 15 cycles to 6 megacycles

Accuracy 3% to 3 mc; 5% above

Input impedance 7.5 mmfds shunted by 11 meg

When used without probe, sensitivity is increased to 100 MICROVOLTS but impedance is reduced to 25 mmfds and 1 megohm

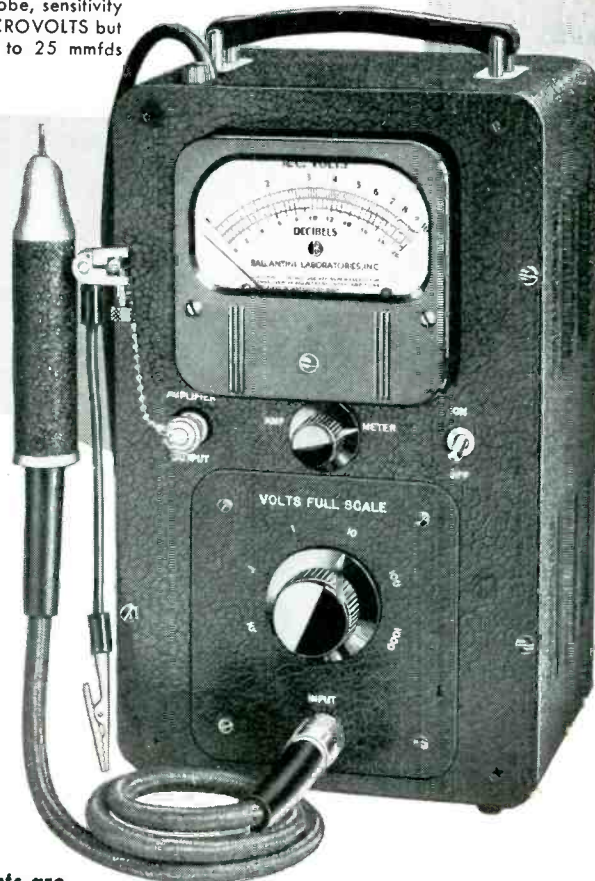

MODEL 314
Price \$285

All Ballantine instruments are

SENSITIVE - ACCURATE - DEPENDABLE

- Same accuracy at ALL points on a logarithmic voltage scale and a uniform DB scale.
- Only ONE voltage scale to read with decade range switching.
- No "turnover" discrepancy on unsymmetrical waves.
- Easy-to-use probe with self-holding connector tip and unique supporting clamp.
- Low impedance ground return provided by supporting clamp.
- Stabilized by generous use of negative feedback.
- Can be used as 60 DB high fidelity video pre-amplifier.

Write for catalog for more information about this and other BALLANTINE voltmeters, amplifiers, and accessories.

BALLANTINE LABORATORIES, INC.



100 FANNY ROAD, BOONTON, NEW JERSEY

plied from a $\frac{1}{2}$ -in. round by $\frac{1}{2}$ -in. long permanent magnet from a small a-c/d-c set speaker. Hex-head $\frac{1}{4}$ -20 steel bolts were soldered to each end of the magnet to extend the magnetic circuit to the coil pole pieces. An air gap of about $\frac{1}{16}$ -in. is between each of the pole pieces and the tines of the fork. The handle of the fork was threaded with a $\frac{1}{4}$ -28 die and bolted to a triangular mounting bracket.

► **Electrical Circuit**—The oscillator uses a 2N107 *pnp* transistor. The circuit is that of a pulse generator whose repetition rate is controlled by the mechanical resonance of the tuning fork. Resistance-capacitance coupling is used to couple to the amplifiers, each of which also uses a 2N107 transistor in a grounded-emitter circuit.

Toroidal inductors paralleled with capacitors tune each collector output circuit to the correct harmonic. Each collector circuit, in turn, is capacitance coupled to another similar tuned circuit to further peak the desired frequency.

With the nominal 88 mh toroids used, it was found that approximately 0.053 μ f was required for resonance at 2,125 cycles. At 2,975

Luminous Panels



Enameling steel coated with a mixture of ceramic and phosphor, a tin salt solution and then a transparent conducting surface of a tin compound forms the basis of Sylvania's Panelescent lamps. Sheets 0.02-inch thick are cut to desired shapes and processed with several coatings and firings. Light is produced through the phenomenon of electroluminescence

Attention! All Users of Nickel Alloys...

New Driver-Harris Vacuum Melting Service Now in Operation

After many years of experience with vacuum melting programs, Driver-Harris now offers a complete vacuum melting service for almost all of the 132 special purpose alloys made by this company.

The specific benefits gained by vacuum melting in the production of nickel-chrome alloys are today clearly established. They are:

1. Much closer control of analysis—particularly in alloying with the highly reactive elements, Titanium, Aluminum, Columbium, Calcium, and Zirconium. The normally high affinity for nitrogen and oxygen these elements have is completely eliminated in vacuum melting, thereby opening new avenues in alloy production.

2. Great reduction in inclusions, especially oxides and nitrides, results in higher ductility and tensile properties. In fine wires, the improvement in properties is frequently so great that wire sizes may be reduced without sacrifice of strength. An example of the greatly improved microstructure is illustrated in the metallographs shown.

3. Complete elimination of gas, not from the surface only but from the entire mass. Alloys so produced are therefore more desirable in the manufacture of electron tubes.

4. General improvement in electronic, electrical, and mechanical properties to meet specifications. Because closer control of analysis is a primary advantage of vacuum melting, we can now achieve these specific improvements with remarkable certainty.

Almost all of the Driver-Harris Alloys now vacuum melted and processed under close physi-

*T. M. Reg. U. S. Pat. Off.

cal and analytical control show improvement in one or more of the above ways. If you are seeking further improvements in the D-H Alloys you use, inquire now for information on how Driver-Harris Vacuum Melting Service can help you. Address your inquiry to Dept. VMS.

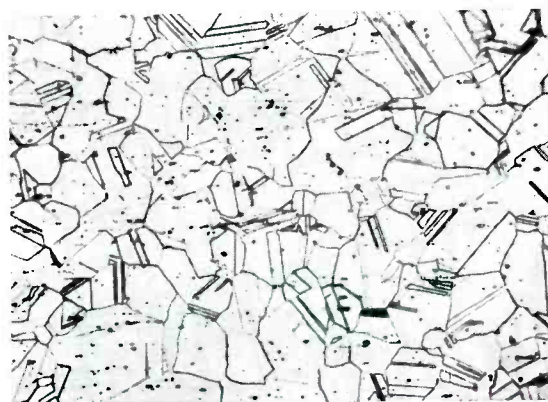

Polished and etched sample of Air Melted NICHROME V in annealed condition.*

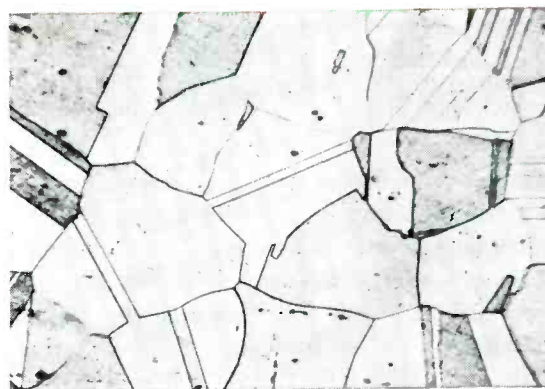

Vacuum melted NICHROME V, annealed. Note that reduced inclusions result in much larger grain size for the same annealing treatment.



Driver-Harris
COMPANY

HARRISON, NEW JERSEY

BRANCHES: Chicago, Detroit, Cleveland, Louisville, Los Angeles, San Francisco In Canada: The B. GREENING WIRE COMPANY, Ltd., Hamilton, Ontario

MAKERS OF THE MOST COMPLETE LINE OF ALLOYS FOR THE ELECTRICAL, ELECTRONIC, AND HEAT-TREATING INDUSTRIES

MINIATURIZATION



with
*Increased
Reliability*

AMPHENOL *Micro* RIBBON CONNECTORS

Since their release in early 1956, thousands of AMPHENOL's miniature Micro-Ribbon connectors have been purchased for use in production and prototype electronic equipment. Engineers have been quick to realize the electrical and mechanical superiority of Micro-Ribbons—and are specifying these amazing connectors wherever *increased reliability* is as important as *miniaturization*.

In Micro-Ribbons there are no tiny pin contacts to bend or misalign, but self-wiping, self-cleaning sturdy *ribbon* contacts that provide easy, smooth insertion and extraction even in blind entrance locations. Both mating members are active, flexing members, assuring excellent double contact action at all times.

At 5 amperes, Micro-Ribbons are rated at 700 Volts D.C. at sea level and 200 Volts D.C. at 70,000 feet altitude. They are available in 14, 24 and 36 contacts. Dielectric is blue diallyl phthalate, contacts are gold-plated.



AMPHENOL ELECTRONICS CORPORATION
chicago 50, illinois
AMPHENOL CANADA LIMITED toronto 9, ontario

cycles, approximately $0.028 \mu\text{f}$ was required for resonance.

Output is high impedance, in the order of two to three volts rms. Distortion, measured at 2,125 and 2,975 cycles is less than 3 percent, which is a usable value. By careful selection of the capacitors tuning the toroids to resonate the circuits as closely as possible, distortion could be further reduced to less than 1 percent.

Loading the output circuit increases distortion. Wherever possible, coupling to the amplifier being aligned should be to a grid, through a blocking capacitor.

Audio Clipper Extends Coverage

By R. B. SEALS
Engineer
Collins Radio Co.
Dallas, Texas

AIRLINE services operating outside the continental U. S. and a few within desire the additional range that the Collins 17L4 transmitter might give if the average percentage of modulation were maintained at a reasonably high level. To extract maximum communications ability from the transmitter an audio clipping and filtering circuit has been designed for addition to the equipment.

The unit for which the circuit is shown in Fig. 1 employs two Texas Instruments, type 601C silicon diodes in a biased clipping circuit

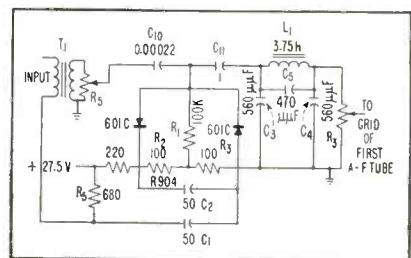
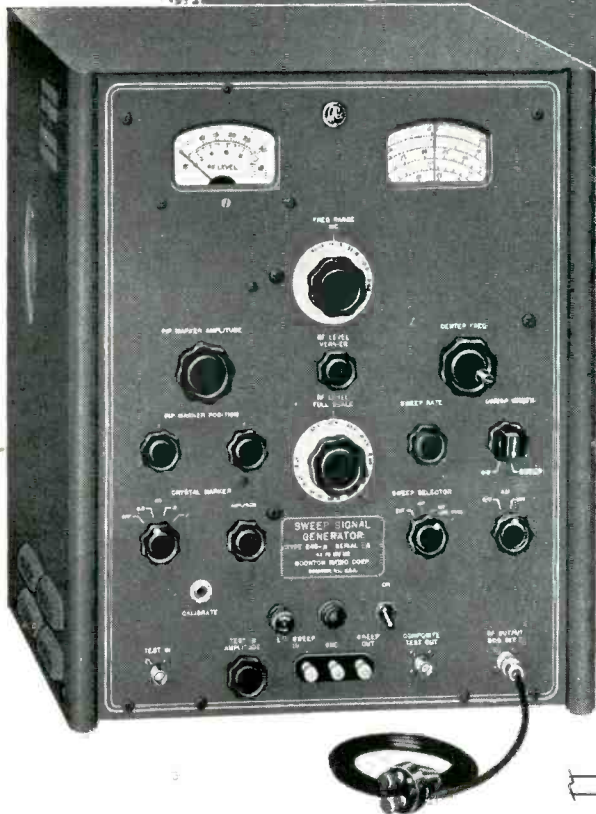

FIG. 1—Circuit diagram of the clipper

operating from the high impedance secondary of the microphone transformer T_1 . Biasing voltages are obtained from the primary 27.5-volt bus and dropped to proper voltage by a divider network made up of R_1 , R_2 , and R_3 . Filtering is ac-

Sweep Frequency Coverage



with this
BRC SWEEP SIGNAL GENERATOR
Type 240-A

having Crystal-Referenced Birdie-Type
 Markers and two individually controlled
 Pip Interpolation Markers

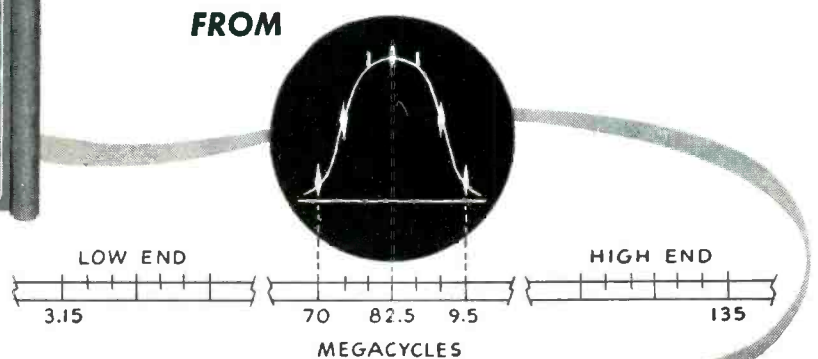

USE THIS SWEEP GENERATOR FOR

- (1) The determination of selectivity and sensitivity of test circuits,
- (2) The study of band-pass characteristics,
- (3) The adjustment of stagger tuned circuits,
- (4) The determination of linearity of FM discriminators, and
- (5) The study of crystal modes.

Features include (A) Crystal-Referenced Birdie-Type Markers, (B) Adjustable Pip-Interpolation Markers, and (C) A composite signal containing the markers added to the response of the system under test. Provisions have also been made for operation as a C.W. or A.M. Signal Generator.

CENTER FREQUENCY: 4.5 MC to 120 MC, accurate to $\pm 1\%$, continuously variable in five self-contained ranges. Output frequencies are fundamental oscillations.

SWEEP WIDTHS: Continuously variable from $\pm 1\%$ to $\pm 30\%$ of center frequency or ± 15 MC, whichever is smaller.

PRICE: \$1375.00 F.O.B. Boonton, New Jersey

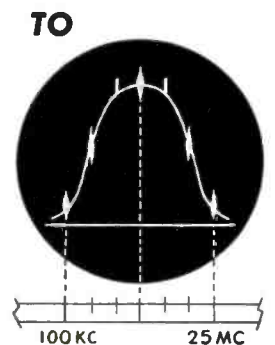

TYPE 203-B UNIVERTER

This accessory, a frequency converter having unity gain, effectively extends the low-frequency range of the Type 240-A Sweep Signal Generator down to approximately 100KC.

PRICE: \$345.00 F.O.B. Boonton, New Jersey

BOONTON
ADIO
BRC CORPORATION



Boonton, New Jersey

Packing for a journey into space?

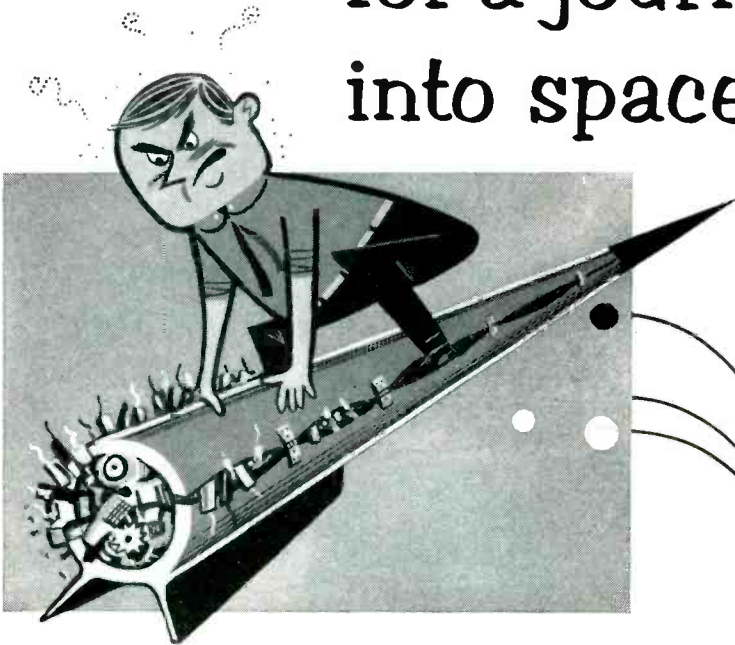

better check 30% SPACE SAVING with Wheeler's new CAST EPOXY wound components

Yes, Wheeler now offers the latest engineering, manufacturing and test facilities for Epoxy resin casting of electronic wound components, including inductors, transformers and subminiature assemblies of tuned circuit elements.

Use of this new encapsulating process permits a space saving of up to 30% compared with hermetically sealed canning, while at the same time producing finished components highly resistant to conditions of humidity and thermal shock and capable of meeting the rigid requirements of Government Specification MIL-T-27-A.

Exhaustive tests, and many thousands of units produced to date, have proved the exceptional quality of these new Wheeler facilities . . . another important addition to the custom engineering and production services Wheeler now offers in the following classifications. Consult us.

- Electronic transformers to 1 kva.
- Precision wound coils and components.
- Custom electro-mechanical assemblies.
- Custom electronic and power supply assemblies.
- Custom electrical harness assemblies.

THE WHEELER

INSULATED WIRE COMPANY, INC.
Division of Sperry Rand Corporation
1101 East Aurora Street, Waterbury 20, Connecticut

1WH57

completed by R_1 and C_2 , a 50- μ f tantalum capacitor, which also serves to produce a low impedance bias source at audio frequencies.

A coupling network from T_1 to the clipping diode and thence to the audio filter is made up of C_{10} and C_{11} . These capacitors serve for d-c blocking and also modify the frequency response of the system by rolling off the lows. Frequency response that is down approximately 10 db at 300 cps reduces distortion at low harmonic frequencies that cannot be filtered in the output filter.

The output filter made up of L_1 , C_3 , C_4 and C_5 comprises two m -derived half-sections with m set equal to 0.6 and cutoff frequency

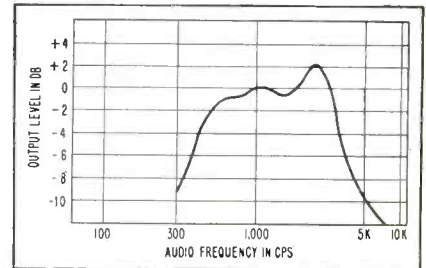

FIG. 2—Output level versus audio frequency

selected at 3,750 cps. The compensation of the coupling net and the filter produces the frequency response shown in Fig. 2.

The input variable potentiometer R_5 is used to set the a-c voltage level at that point and can thus determine the input voltage that will overcome the bias and produce clipping. The variable output potentiometer R_3 is used to set the a-c voltage level to the grid of the first audio tube and thus determines the modulation level.

Operating parameters are selected so 0.2 volt a-c rms at the input to the microphone transformer will just produce the 5 v a-c rms at the grid of the first audio tube necessary to produce 95-percent modulation. At these levels the clipper is just beginning to clip. Any increase in level above the 0.2-v a-c input thus may be clipped proportionately.

By appropriate adjustment clipping in the order of 6 to 8 db is produced by the output of a typical

Tiny, Tough and Terrific!



New TDI Type 1202A Voltage
Controlled Oscillator*

Actual Size of Unit (Height: 3/4", Width: 1 1/16", Depth: 1 1/16", Weight: 8 ounces).

*Pat. Pending

This new TDI voltage-sensing subcarrier oscillator weighs in at only 8 oz.—is approximately one-half the size of previous oscillators—contains only two tubes, compared to present day five-tube circuits—but these are no indication of its outstanding performance! Reliability under typical (and that means extreme) environmental conditions is nothing short of amazing.

Interested? You can learn more by sending today for free technical data and detailed specifications of TDI's newest precision component for in-flight telemetering. Bulletins of other TDI remote instrumentation products sent on request.

BUILT FOR ENDURANCE!

TEMPERATURE—Designed for operation from -65°C to $+100^{\circ}\text{C}$

ALTITUDE—Center frequency stability within $\pm 1\%$ of design bandwidth with variation in altitude from sea level to 80,000 feet (temp. constant)

ACCELERATION—Center frequency stability within $\pm 1.0\%$ of design bandwidth under constant acceleration of 50g in each direction of each major axis

SHOCK—Center frequency stability within $\pm 3\%$ of design bandwidth after being subjected to 60g, 10 millisecond duration impact shock in each direction of major axis

VIBRATION—Center frequency stability within $\pm 3\%$ of design bandwidth when subjected to sweep vibration of 0.06 inches double amplitude from 10 to 55 cps and 10g from 55 to 2000 cps (three minute duration total) in each major axis. Noise output less than 3% peak to peak of DBW.

TDI's newest office is now located at 305 Washington Avenue SE, Albuquerque, New Mexico

- TELEMETERING
- MISSILE GUIDANCE
- GROUND ELECTRONICS SYSTEMS
- AIRBORNE ELECTRONICS SYSTEMS

TELE-DYNAMICS INC.

A Raymond Rosen Corporation

32ND AND WALNUT STREETS, PHILADELPHIA 4, PENNSYLVANIA
Western Regional Office: 15016 Ventura Blvd., Sherman Oaks, Los Angeles, California
Formerly, Raymond Rosen Engineering Products, Inc.

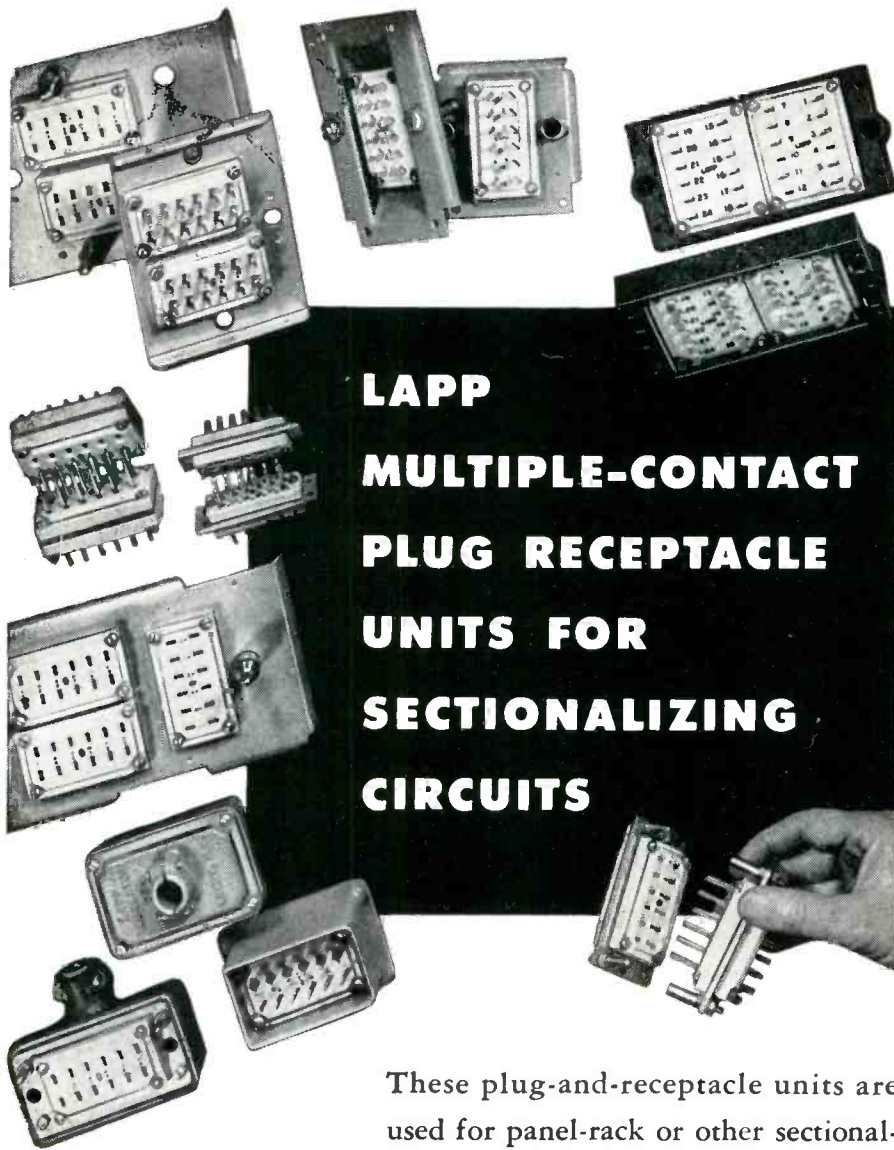

LAPP MULTIPLE-CONTACT PLUG RECEPTACLE UNITS FOR SECTIONALIZING CIRCUITS

These plug-and-receptacle units are used for panel-rack or other sectionalized circuits where a number of connections must be made or broken. Any number of contacts can be provided (in multiples of twelve). Male and female contacts are full-floating for easy alignment and positive contact. Contacts are silver-plated brass and phosphor bronze with terminals tinned for easy soldering. Ceramic blocks are steatite, white glazed . . . non-carbonizing even under leakage flash-over caused by contamination, moisture or humidity. Write for specifications of available units or engineering recommendations for your requirement. Lapp Insulator Co., Inc., Radio Specialties Division, 909 Sumner Street, LeRoy, New York.

Lapp

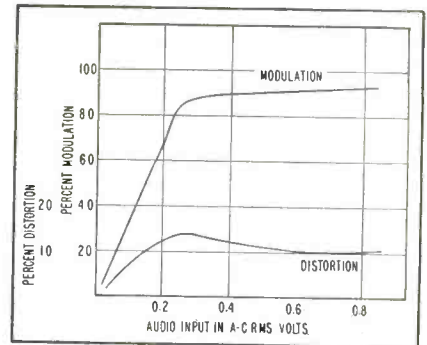

FIG. 3—Modulation percentage and distortion vs 1-kc audio input

carbon microphone. The frequency response of the transmitter audio system, with the clipper-filter unit installed, is ± 10 db of 1,000 cps response from 300 to 3,000 cps. Distortion does not exceed 15 percent throughout the operating frequency of 300 to 3,000 cps. Figure 3 indicates modulation percentage and distortion vs input voltage that points out the clipping thresholds and the amount of clipping available at various input voltages.

Nike Hercules Guidance

AUGMENTING defense installations already existing around many American cities, equipment for use by Army Ordnance in the Nike Hercules program is now coming off production lines.

The first set of ground guidance equipment has just been released from Western Electric's Burlington, N. C. plant.

Field Direction Oscillator

BY FRED M. LEWIS
Fairchild Aerial Surveys, Inc.
AND ALLAN R. RADER
Herbert E. Hill Advertising
Los Angeles, Calif.

EXPERIMENTS on an electromagnetic device utilizing transfer of energy between coils that are magnetically perpendicular appear to show a wide range of potential applications including distortion-free magnetic amplification.

Called the field direction oscillator, the device has a core in the form of a hollow toroid. Outer (toroidal) and inner (annular) coils are interlocked such that the

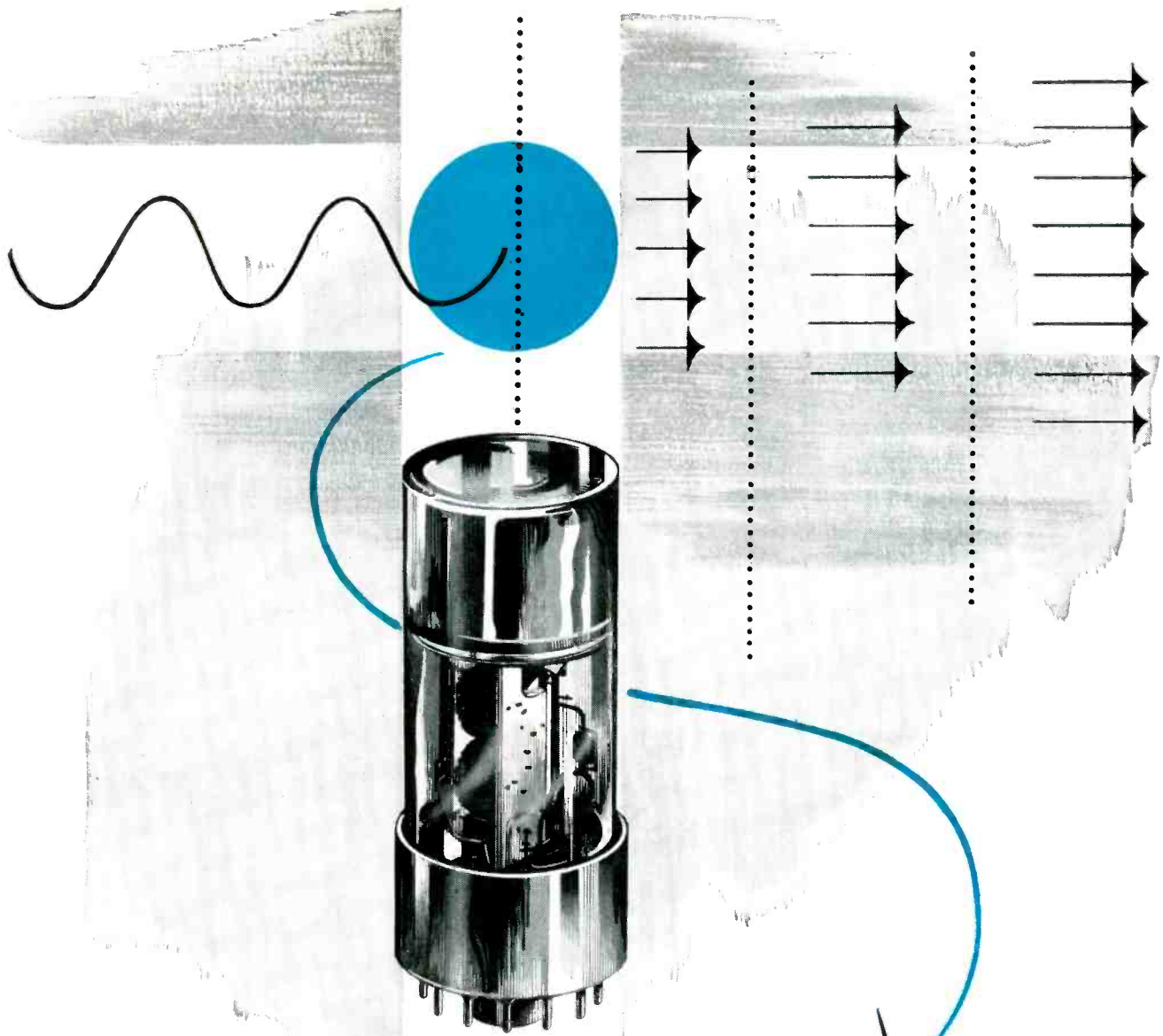

Precise

PHOTOELECTRONICS*

*The conversion of light input to highly magnified electrical output in a dependable, precise relationship.

Depend on Du Mont Multiplier Phototubes for precise quantitative and qualitative measurements. Available in a wide selection of sizes and electrical characteristics for every photoelectronic need.

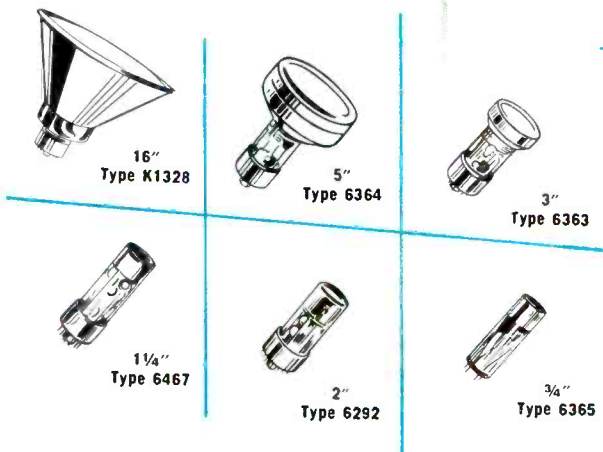

DU MONT®

Industrial Tube Sales, ALLEN B. DU MONT LABORATORIES, INC. 2 Main Ave., Passaic, N. J.

ENGINEERS: *Electronic & Mechanical* PHYSICISTS

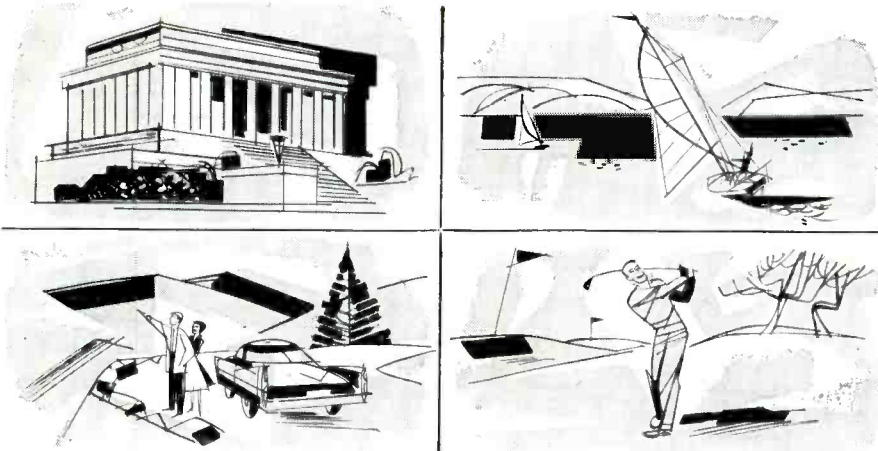

Finer climate & living... yours at MELPAR

Melpar is advantageously located in a residential suburb in Fairfax County, Virginia, 10 miles from Washington, D. C. Attractive new homes and apartments are within a few minutes traffic-free drive of our Laboratories. Modern shopping centers make trips to the city unnecessary except for enjoyment of its many cultural and recreational offerings.

Regardless of whether you choose suburban, country or city living, you'll enjoy our proximity to mountains, beaches, and other recreational and scenic attractions. Our climate is pleasant with its short winters, beautiful spring and fall seasons, and its average summer temperature of only 77°. Outdoor living is enjoyed 215 days of the year.

The Laboratory's "climate" is ideal, too. Our project group basis of organization enables you to participate in *complete* engineering problems and gain diversified experience. The range and complexity of our projects assure you of assignments which will stimulate your creative and analytical talents.

Qualified applicants may visit the area as our guests to inspect Melpar.

We Are Engaged in The Following Fields:

Flight Simulators. Radar and Countermeasures. Network Theory. Systems Evaluation. Microwave Techniques. Analog & Digital Computers. Magnetic Tape Handling. UHF, VHF, or SHF Receivers. Packaging Electronic Equipment. Pulse Circuitry. Microwave Filters. Servomechanisms. Subminiaturization. Electro-Mechanical Design. Small Mechanisms. Quality Control & Test Engineering. Field Engineering. Antenna Design.

For detailed information on Melpar and living in the Washington, D.C. area
Write: TECHNICAL PERSONNEL REPRESENTATIVE



MELPAR, Incorporated

A Subsidiary of Westinghouse Air Brake Company

3629 Arlington Boulevard, Falls Church, Virginia
10 Miles from Washington, D. C.

Positions also available at our laboratories located in Watertown and Boston, Massachusetts.

two magnetic fields generated when the coils are energized separately are perpendicular to each other at all points. When one of the two magnetically perpendicular coils is energized with a-c and the other

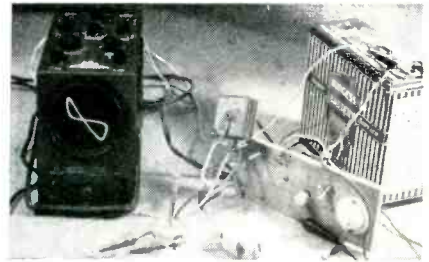

Experimental equipment used in making studies on field direction oscillator

with d-c, the resultant magnetic field appears to oscillate in twist.

Core and windings are shown in Fig. 1A and the directional dotted curve of Fig. 1B suggests the instantaneous pitch and polarity of an arbitrary resultant field. Pitch is determined by the ratio of input ampere-turns in the perpendicular coils. Polarity is determined by the combination of polarities of the perpendicular inputs.

When the toroidal winding is energized with unbiased a-c and

One-Day Memory



Naval Research Lab scientist Franklin H. Harris holds memory tube capable of storing a radar map or other electronic display for hours. Denominated by its inventor as a REO (regenerated electrical output) the storage device has been developed primarily for military use and is not available commercially

NEW!

MICROWAVE SWEEP GENERATOR

1,000 to 15,000 mc

- 7 Bands...
- Interchangeable Units...
- Stable Backward Wave Oscillators...



- Sweeps full frequency range of unit
- Rapid sweep or fixed frequency operation
 - Direct reading frequency dial
 - Power monitor and attenuator
- High power output, from 10 mw to one watt
- Pulse rise time less than 0.15 microsecond (external modulation)
 - Provision for amplitude modulation from external source
 - Internal 1000 cps and 456 kc square wave modulation
- No moving parts, assuring long equipment life and reliable operation

Polarad Model ESG Microwave Sweep Generator makes possible rapid, dynamic testing of broadband and narrowband microwave systems and components. Its operation is completely electronic, eliminating the need for point-by-point measurement. An integral variable r-f attenuator is provided with each microwave oscillator unit, and the r-f power output level is continuously monitored. This versatile instrument may be used for fixed frequency measurements. Frequency is read directly on face of meter.

Model ESG can be used with the Polarad Rapid Scan Ratio-Scope for direct and instantaneous measurement of reflection or transmission coefficients.

TEST:

receivers, amplifiers, preselectors, jammers, intercept equipment, beacons, antennas, T/R tubes, crystal mounts, fixed and tunable filters, as well as complete radar and microwave systems.

SPECIFICATIONS

Basic Unit: Model E-B

MODEL	FREQUENCY RANGE	POWER OUTPUT
Model E-L1	1000 to 2,000 mc	80 to 1000 mw
Model E-L2	1600 to 3,200 mc	80 to 1000 mw
Model E-S1	2000 to 4,000 mc	80 to 800 mw
Model E-C1	3600 to 7,200 mc	25 to 400 mw
Model E-C2	4800 to 9,600 mc	20 to 150 mw
Model E-X1	6500 to 11,000 mc	20 to 100 mw
Model E-X2	7500 to 15,000 mc	15 to 40 mw

Sweep Width: Continuously adjustable to full frequency range of Microwave Oscillator Unit in use.

Sweep Rate: 60 cps

Internal Modulation Rate, during Sweep Operation:

(a) 1000 cps square wave. (b) 456 kc square wave.

Modulation capabilities, during non-swept Operation:

(a) 1000 cps square wave. (b) 456 kc square wave. (c) External modulation.

Output when modulated with external pulse:

(a) Pulse rise time less than 0.15 microsecond. (b) Minimum pulse width less than 0.3 Microsecond.



AVAILABLE ON EQUIPMENT LEASE PLAN

ELECTRONICS CORPORATION

43-20 34th Street • Long Island City 1, New York

**maintenance
available by field
service specialists**



REPRESENTATIVES: Albuquerque, Atlanta, Baltimore, Boston, Buffalo, Chicago, Cleveland, Dayton, Denver, Fort Worth, Kansas City, Los Angeles, New York, Philadelphia, Portland, St. Louis, San Francisco, Schenectady, Syracuse, Washington, D. C., Winston-Salem, Canada; Arnprior, Ontario. Resident Representatives in Principal Foreign Cities

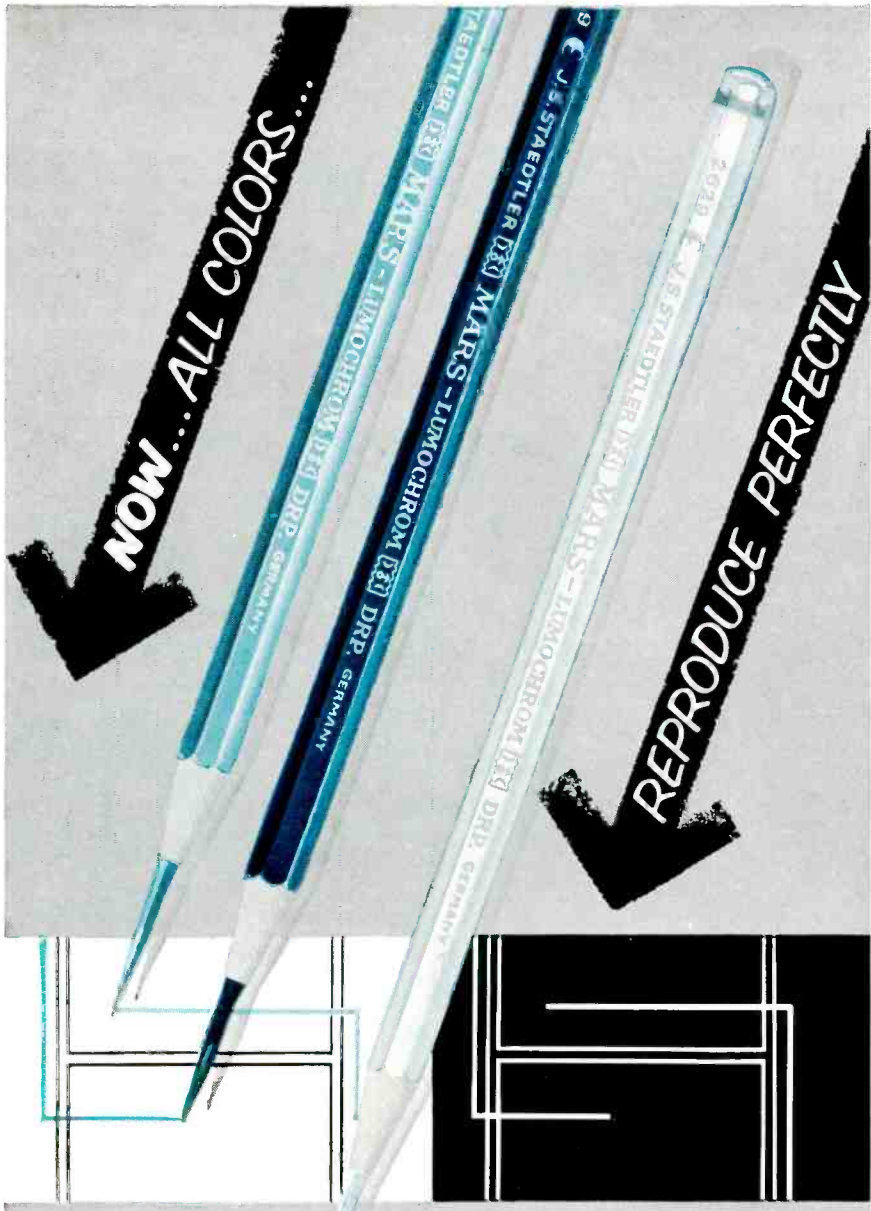

MARS-LUMO CHROM

makes possible an important new drafting technique. It's not just a colored pencil; it's a color-drafting pencil. Twenty-four colors—and every one reproduces perfectly. Lets you draft with as many colors as you need. Saves time, prevents mistakes.

- won't fade • won't smear • really waterproof
- erases perfectly • keeps finest point

Send for free sample

Other new Mars products include: the Mars-Pocket-Technico for field use, the Mars "Draftsman's" Pencil Sharpener with the adjustable point-length feature, and the efficient, clean Mars lead sharpener. All available — along with the established standards: Mars-Lumograph black graphite drafting pencils, Mars-Technico lead holder and leads, and Tradition-Aquarell painting pencils — at all leading engineering and drafting supply dealers.

J.S. STAEDTLER, INC. HACKENSACK, NEW JERSEY

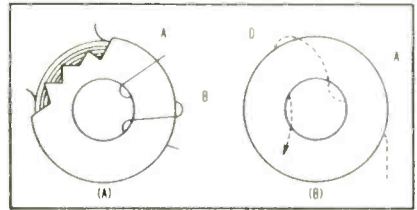

FIG. 1—Toroidal and annular windings (A) when properly excited produce twisted field (B)

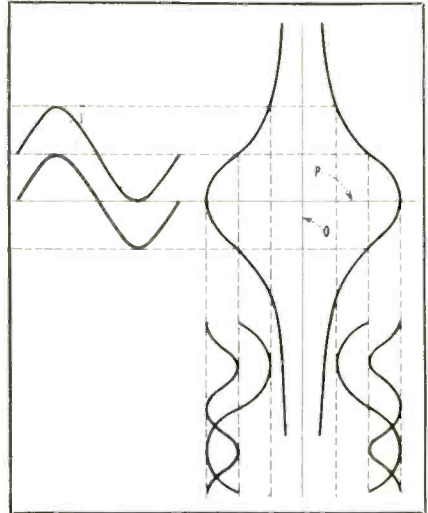

FIG. 2—Effect of applying a-c to one winding and control d-c to another

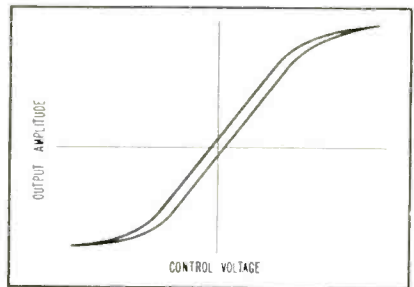

FIG. 3—Output amplitude versus control current

control direct current in the annular winding is zero, the induced field oscillates in intensity and polarity, retaining an annular orientation and no signal will be induced in the annular output winding.

But with appreciable control d-c applied, a-c with double frequency will be induced in the output coil as shown in Fig. 2. Illustrated are two cases of exciting a-c, one unbiased, the other biased to eliminate frequency doubling. Likewise shown are two conditions of control d-c having equal magnitude and opposite polarity.

With the effects of hysteresis

Your Air Freight Line to Everywhere

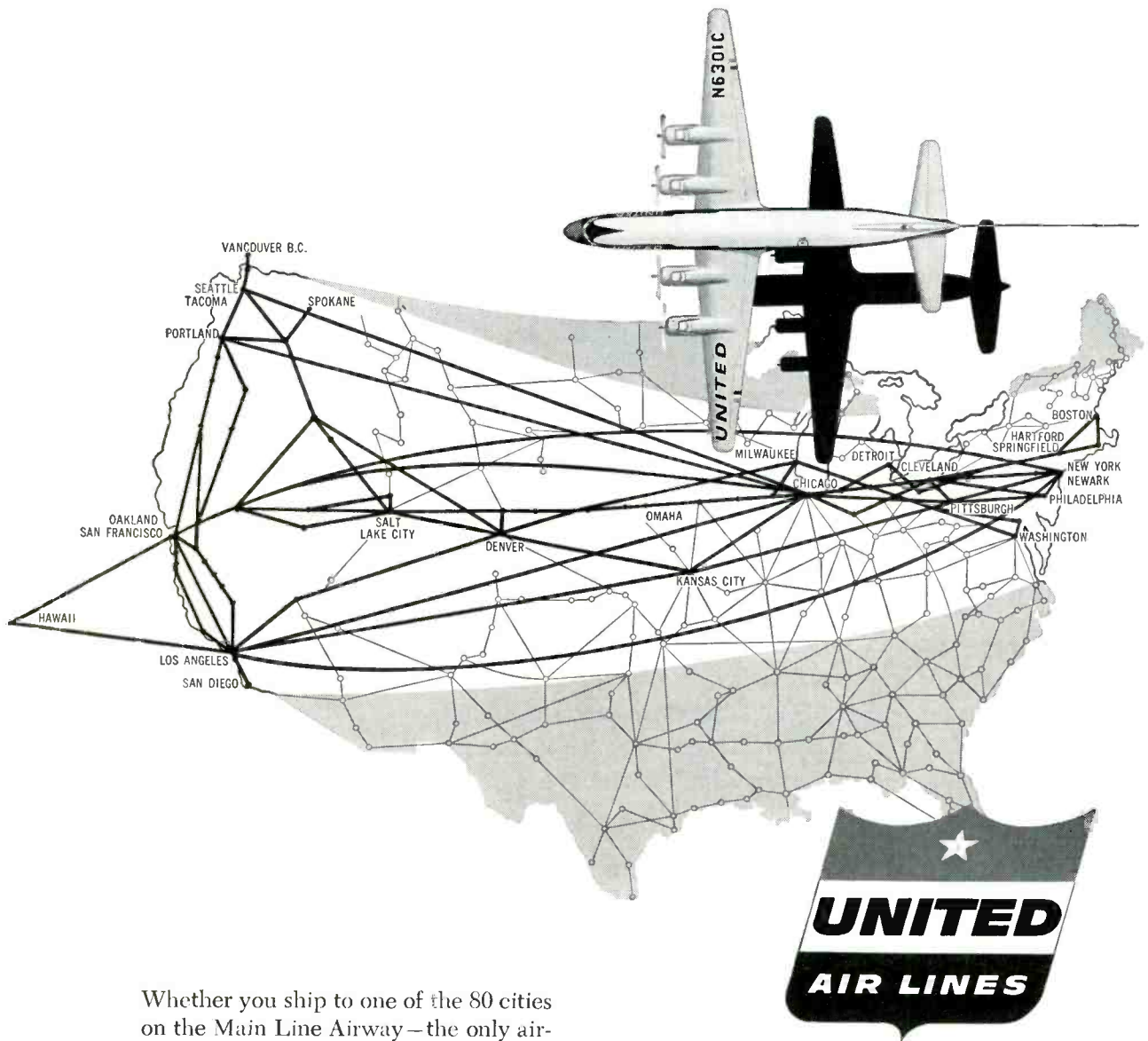

Whether you ship to one of the 80 cities on the Main Line Airway—the only airline route linking the East, the great Midwest, all the Pacific Coast and Hawaii—or to any other point in the nation or the world, ship United!

United's Reserved Air Freight (space cleared and held for your shipment on any United flight), frequent schedules, single airbill and door-to-door delivery service all help to speed your shipment and simplify your shipping.

Whenever you ship, wherever you ship, call United first!

Examples of United's low Air Freight rates

	per 100 pounds*
CHICAGO to CLEVELAND	\$4.78
DENVER to OMAHA	\$6.42
NEW YORK to CHICAGO	\$7.50
SEATTLE to LOS ANGELES	\$12.02
PHILADELPHIA to PORTLAND	\$24.15
SAN FRANCISCO to BOSTON	\$27.00

*These are the rates for most commodities. They are often lower for larger shipments. Rates shown are for information only, are subject to change, and do not include the 3% federal tax on domestic shipments.

For service, information, or free Air Freight booklet, call the nearest United Air Lines Representative or write Cargo Sales Division, United Air Lines, 36 South Wabash Avenue, Chicago 3, Illinois.

SHIP FAST . . . SHIP SURE . . . SHIP UNITED

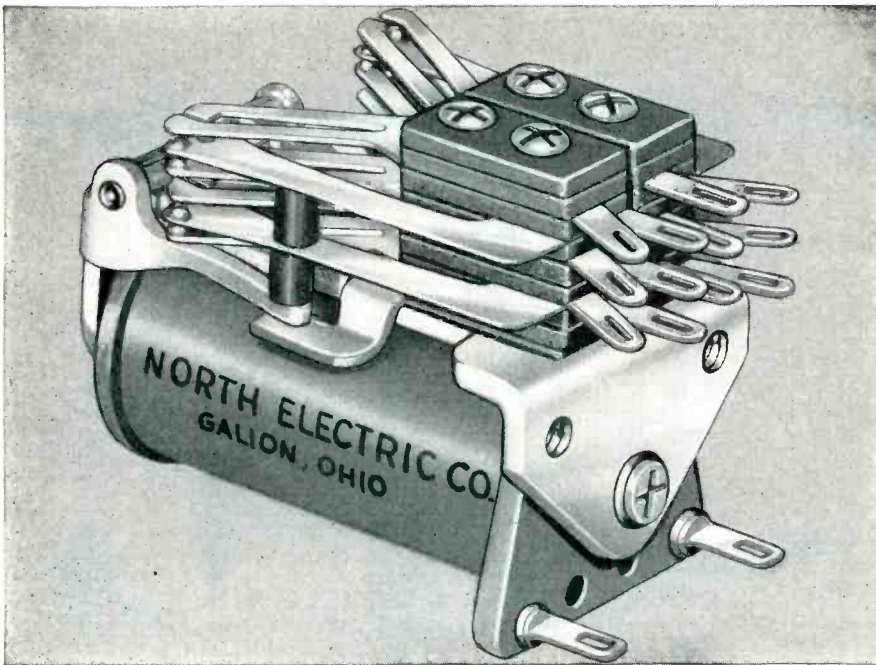

NORTH TYPE "E" RELAYS FOR INDUSTRY

in production for early delivery

North's new addition to its extensive line of relays, the industrial standard Type E Relay, is now in production and available for delivery. The large scale production and engineering facilities of NORTH assure you a reliable source of supply to meet your requirements for Type E Relays.

- Available with:
Solder Terminals
8-11-20 pin plug-in terminals
Taper pin coil terminals
Taper tab spring terminals
- Up to 10 springs maximum per pile-up.
- Contact Materials:
Gold, Palladium, Silver
- Overall length with solder terminals 2 1/4".
- With adjustable screw-type residual and fixed nylon flap-type residuals.
- Standard range of coil resistances from 5 to 21,000 ohms.
- Mountings:
Two #6-32 screws on 3/4" spacing. Standard plug-in mountings available with or without auxiliary hold-down brackets.

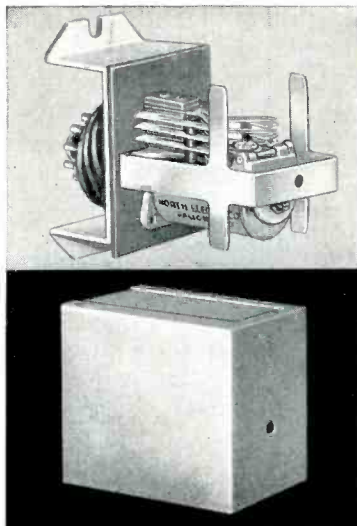

"BUILDING 'BRAINS' IS OUR BUSINESS"
Trademark

INDUSTRIAL DIVISION

NORTH ELECTRIC COMPANY

772 S. Market St.

Galion, Ohio

considered, the qualitative prediction of output amplitude versus control current takes the form shown in Fig. 3. Besides its use as a modulator, the device can also be used as a variable inductance.

Mobile Communications Impulse Signaling

By A. E. OLSON

*Nor-Cal Tele-Radio System
Eureka, Calif.*

NEED arises at times for the driver of a mobile radio unit to signal a base station whose operator may not be monitoring all calls, as in an industrial system, where mobile units normally talk only to each other, with the base station operator performing other duties. The equipment described will enable a mobile unit operator to signal the base station operator by pressing his microphone button 4 or 5 times in rapid succession. This will operate a relay to sound a bell or other

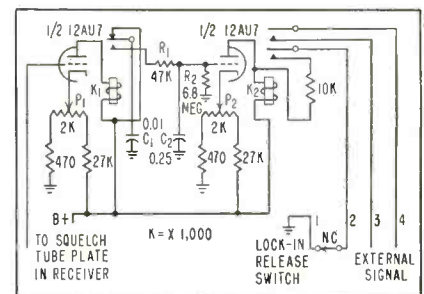

Circuit of the impulse signal device that operates from receiver squelch tube plate

signal. Provision is made to lock in a circuit indicating the receiver alarm is actuated. This is particularly helpful if multiple receivers are used.

► **Squelch Actuated**—The method of operation is to connect a load to the receiver squelch tube plate. This will operate K_1 through the first triode section. Each time this relay operates C_1 receives a charge from the B plus bus and discharges it through R_1 into C_2 .

Values are chosen such that four rapid squelch breaks will transfer from C_1 to C_2 sufficient voltage to operate relay K_2 in the second tri-

Introducing . . .

DATAGRAPH

0-250 cps
direct-writing
oscillograph



Consolidated Electrodynamic

300 North Sierra Madre Villa, Pasadena, California

NATIONWIDE COMPANY-OWNED SALES & SERVICE OFFICES

WHAT IS IT? A completely new, direct-writing oscillograph/amplifier system for providing an immediate, permanent record of rapidly varying voltages. Its frequency response, portability, flexibility are beyond those of any similar equipment on the market today.

WHAT ARE ITS FEATURES? Excellent square-wave and transient response, and frequency response to 250 cycles. It will record at 1" double amplitude throughout the frequency range of 0 to 250 cycles! The recording system uses no ink . . . traces are clean and easily interpreted. Push-button speed selector provides instantaneous change of the record's time base.

WHERE CAN YOU USE IT? Datagraph can be used to record voltages from many sources . . . e.g., magnetic-tape playback units, carrier amplifiers, audio amplifiers, d-c amplifiers, telemetering discriminators, etc. Its high input impedance adapts it to a myriad of input devices.

WHAT ARE THE SYSTEM SPECIFICATIONS?

FREQUENCY RESPONSE . . . flat $\pm 5\%$ from 0 to 250 cps.
RECORD SPEEDS 0.05, 0.2, 1, 5, 10 and 20"/sec.
NUMBER OF CHANNELS 2
RECORD SIZE 70 mm x 500 ft.
AMPLIFIER INPUT IMPEDANCE 100,000 ohms
SENSITIVITY 1 inch per volt; 1 inch maximum peak-to-peak amplitude
DIMENSIONS AND WEIGHT:
Oscillograph 9" x 10½" x 17¼", 60 lbs.
Amplifier 9" x 10½" x 17¼", 50 lbs.

WHERE'S THE COMPLETE STORY OF DATAGRAPH?

In a new CEC bulletin, just released. Send for your copy of Bulletin CEC 1569-X7.



HOLD IT!

You can etch Soldered Circuits FASTER in HUNT S.C.E.

(Solder Circuit Etch)

Hunt saw the need for an etchant that was faster, would work at normal temperatures and was more reliable in its action than the commonly used sulphuric-chromic acid solution.

Hunt now offers you Hunt S.C.E. (Solder Circuit Etch) a ready-prepared product designed to etch solder plated circuit boards . . . designed to do it more easily, more effectively than it has ever been done before. You'll find that Hunt S.C.E.:

1. Etches rapidly at room temperatures.
2. Has a fairly high capacity for copper.
3. Never attacks the solder-plated circuit.
4. Has guaranteed uniformity, and is of the highest quality because of rigid laboratory control.

Hunt S.C.E. is essentially an oxidizing solution with the capacity to keep the oxidized copper permanently in solution. Although many acids will etch copper, S.C.E. solution has the peculiar property of not attacking the solder . . . but giving fast, odorless etching of the copper.

HUNT R.C.E. (RAPID CIRCUIT ETCH) FOR PRINTED CIRCUITS

Hunt R.C.E. is a proprietary etchant, formulated to etch printed circuits fast and to speed up production.

It offers these 6 big advantages:

1. 15% increase in etching speed.
2. Immediate action over entire circuit.
3. Uniformly smooth etching.
4. Easily removed by washing.
5. Substantial increase in capacity.
6. Freedom from fumes.

A temperature between 100°F and 120°F is recommended as optimum etching temperature. With splash etching and 110°F temperature, a printed circuit board should etch in 2½ minutes in fresh R.C.E. solution.

Both etchants are described in Technical Bulletins No's 1 & 3 available from your nearest Hunt branch or Palisades Park, N. J.



Hunt S.C.E. solution is supplied in 125 lb. carboys; Hunt R.C.E. solution in 145 lb. rubber drums.

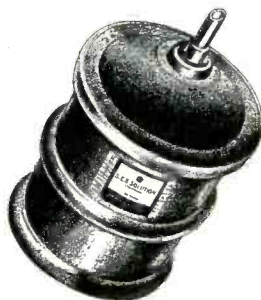

PHILIP A. HUNT COMPANY

PALISADES PARK, N. J.

Chicago • Cleveland • Cambridge • Brooklyn • Atlanta • Dallas • Los Angeles • San Francisco

ode circuit. This relay will signal by a device connected to terminals 3 and 4 that a call has been received.

Normal operation of the receiver with single squelch breaks now and then will not operate the device, since the energy transferred at a slow rate from C_1 into C_2 is dissipated too rapidly by R_2 for the second tube to reach the point of relay closure. Potentiometers P_1 and P_2 adjust tube operation for satisfactory relay performance in the two circuits.

If it is desirable to provide a lock-in on the circuit, a normally closed switch is connected to terminals 1 and 2. Pressing this switch will restore the circuit to normal.

Integrating Circuit For Direct Recorder

By W. E. GILSON and JOHN ANDREA
Department of Medical Electronics
University of Wisconsin Medical School
Madison, Wisconsin

In cardiovascular research it is customary to use a planimeter to measure blood-pressure tracings to obtain an approximation of the mean pressure. Recent introduction of an integrating circuit in the carrier-amplifier strain-gage channel of rectilinear and ink writing polygraphs has eliminated the need for this measurement, as it averages the pressures of several cardiac cycles.

The following circuit modification for application to the Sanborn direct writing instrument is pre-

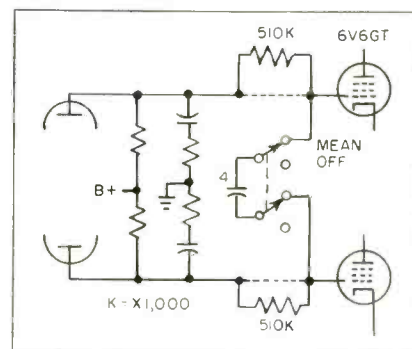

FIG. 1—Circuit modification of Sanborn strain-gage amplifier to obtain mean pressure reading

THE ONE UNIVERSAL METER

MICROVOLTS TO KILOVOLT



The KAY LAB Model 203 is a combination DC microvolt-ammeter and amplifier. It provides an exceptionally wide range of measurements. Fifteen voltage ranges cover from 100 microvolts full scale to 1000 volts full scale, with 100 megohms input impedance. Ten current ranges cover from 100 micro-microamperes full scale to 100 milliamperes full scale. As little as 10 microvolts or 10 micro-microamperes may be measured with accuracy. The uncluttered zero-center meter face instantly indicates polarity on a mirrored scale. When used as a DC amplifier, the instrument features exceptionally low drift with high gain, very high input impedance and low output impedance. Gains up to 80 db with less than 10 microvolts drift may be obtained. The Model 203 utilizes KAY LAB's unique chopper stabilized circuit to provide high sensitivity with previously unobtainable drift-free stability and high input impedance.

APPLICATIONS: Electronic, medical, geophysical, chemical, metallurgical research and development... transistor production and circuit design... thermocouple calibration... null detector... recorder driver amplifier... and as a general purpose laboratory instrument wherever dc voltages and currents are measured or amplified.

SPECIFICATIONS

Voltage Range (full scale)..... 100 μ v to 1000v
 Current Range (full scale)..... 100 μ ma to 100 ma
 Input Impedance..... 10 megohms below 10 mv,
 30 megohms at 30mv,
 100 megohms above 30mv
 Impedance Accuracy..... \pm 1.5%

Accuracy on All Ranges..... \pm 3% of full scale
 Maximum Gain as Amplifier..... 80 db \pm 1.5%
 Output Rating..... 1v across 1000 Ω
 Output Impedance..... less than 5 Ω
 Drift (after 15 min. warmup).... 10 μ v equivalent input
 Price..... \$550.00

Rack Mounting available as Model 203R



STABILITY  *Locked in!*
 WITH CHOPPER AMPLIFIERS

5725 KEARNY VILLA ROAD • SAN DIEGO 11, CALIFORNIA • BROWNING 7-6700

ACCURATE, DEPENDABLE TRIMMING

with
Temperature Compensation



ERIE

CERAMIC TRIMMERS CUSTOM CERAMIC TRIMMER ASSEMBLIES

for

ELECTRONIC INSTRUMENTS, TEST EQUIPMENT and MILITARY APPLICATIONS

ERIE Resistor Ceramic Trimmers are all notable for their fidelity to specifications, their excellent stability, and their straight-line capacity change throughout the total range.

The Ceramic Base Trimmers feature a unique connecting strap which eliminates the possibility of intermittent contact between the adjusting shaft and the silver pattern.

ERIE Ceramicon Trimmers and ERIE Custom Ceramicon® Trimmer Assemblies are available in a wide variety of temperature compensating characteristics, and exceed the electrical requirements for MIL-C81A.

These ERIE Trimmers are widely used in electronic instruments, test equipment, and military applications.

**A NEW ERIE TRIMMER
for Printed Circuit Boards**



**STYLE
3192**

Write for new Engineering Bulletin
on ERIE Style 3192 Trimmer.

Complete description of all ERIE Standard Trimmers is included in Catalog 314-1 . . . Write for it.

ERIE
electronics

ERIE ELECTRONICS DIVISION
ERIE RESISTOR CORPORATION
Main Offices and Factories: ERIE, PA.
Manufacturing Subsidiaries
HOLLY SPRINGS, MISSISSIPPI • LONDON, ENGLAND • TRENTON, ONTARIO



FIG. 2—Pressure curve shows effects of integration

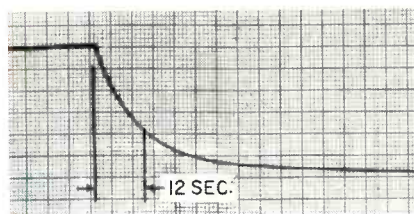

FIG. 3—Recorder chart shows 12-sec response time

sent here for possible use by others.

The circuit changes consist of placing a 4- μ f 600-v oil-filled capacitor across the grids of the power output stage after inserting 500,000-ohm series grid resistors. This modification gives a time constant of about 12 seconds and is shown in Fig. 1. A pressure recording and the mean pressure record obtained with this circuit are shown in Fig. 2 while Fig. 3 shows the time constant obtained.

Transistor Tuned Oscillators

BY H. L. ARMSTRONG

National Research Council
Ottawa, Ontario
Canada

FOR TRANSISTOR oscillators, as for those using vacuum tubes, it is convenient in the lower frequency range to use resistors and capacitors as the frequency-determining elements. The possibilities include the feedback oscillator, using a two-stage amplifier with feedback through a network whose transmission peaks at the desired frequency. The phase shift oscillator uses a one-stage amplifier with feedback through a network that produces a phase reversal at the desired frequency.

While the networks used in vacuum-tube oscillators may be applied directly to transistors, they are often not the most advantageous. With tubes, the networks work from a fairly high output

tensile yield strength 1,000 psi

tensile yield strength of Dow magnesium alloys after 100 hours at temperature

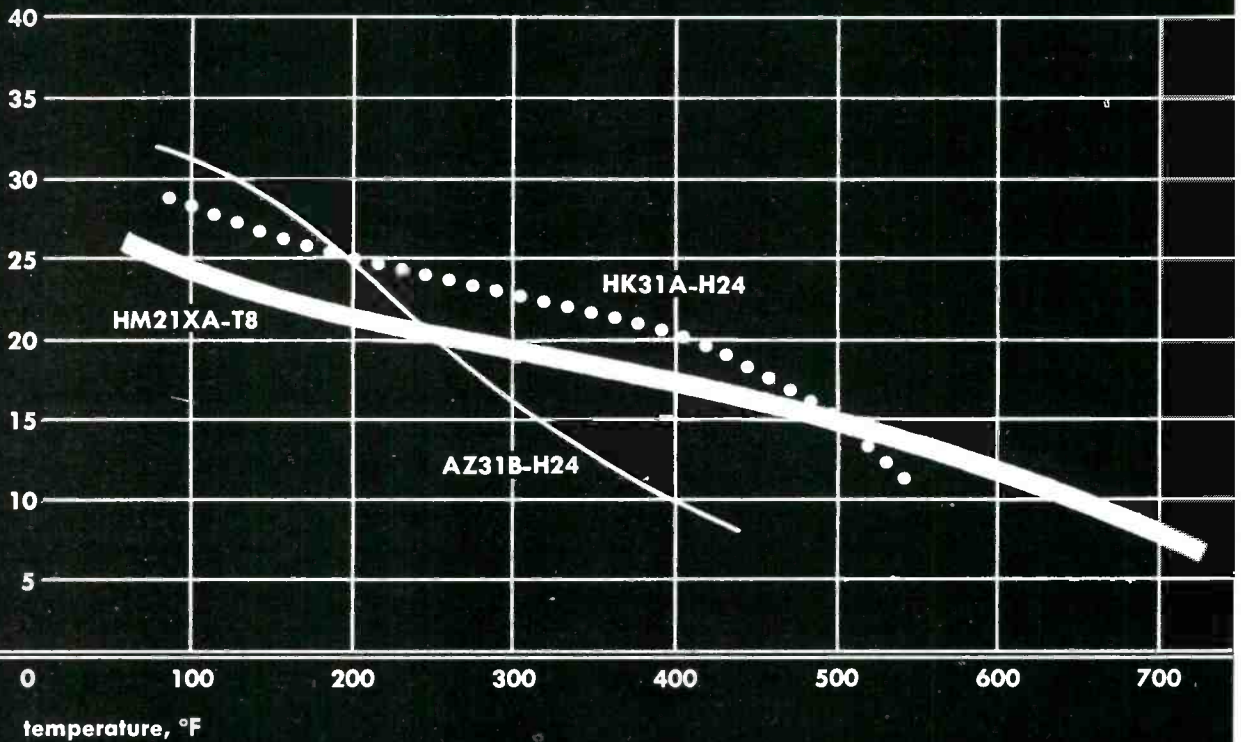

New magnesium alloy holds properties for 100 hours up to 700°F.

Dow Magnesium HM21XA-T8 alloy extends further the range of conditions under which light metals can be used in aircraft design. Second in the series of sheet alloys designed specifically for elevated temperature applications, it supplements the excellent characteristics of HK31A alloy.

HM21XA-T8 retains its properties at temperature during long periods of time. Even one hundred hours at 700°F. results in relatively little change in tensile yield, creep and elastic modulus.

Magnesium lightness is combined with strength at elevated temperature in HM21XA-T8, offering new ways to save weight or gain increased rigidity in the design of missiles and aircraft. This alloy is supplied in the -T8 temper and can be formed in this temper without the need for further heat treatment after fabricating. Samples of HM21XA-T8 along with detailed information are available. Contact your nearest Dow Sales Office or write to THE DOW CHEMICAL COMPANY, Midland, Michigan, Department MA 1400M.

YOU CAN DEPEND ON

DOW

FOR
COMPLEX
AUDIO
FILTERS
LIKE
THIS
CALL ON

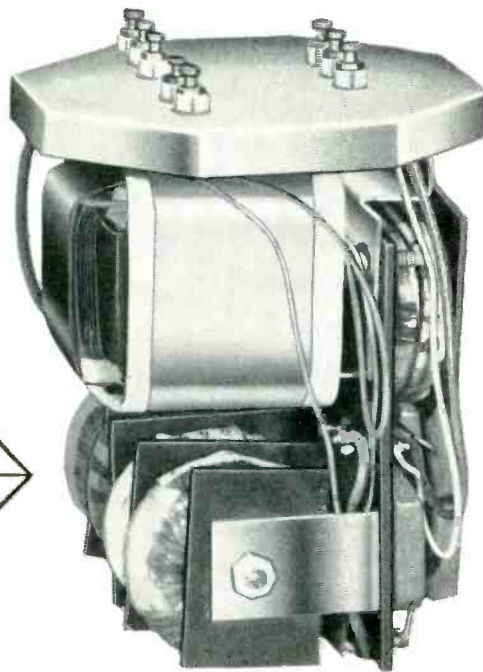

CHICAGO STANDARD

• Because Chicago Standard design and production engineers have built so many audio filters . . . of all types . . . they can quickly solve your filter problem with a unit **built to meet your exact specifications.**

Chicago Audio Filters are known for their sharp discrimination, low loss, maximum output and unusually compact construction. They are effectively shielded in drawn steel cases, hermetically sealed, or with the famous Chicago "Sealed-in-Steel" construction.

Write Today outlining the specifications you require. Your inquiry will receive prompt attention.

a typical unit is LOW PASS FILTER LPF-2

A stock unit for aircraft, amateur, police and other voice communication equipment.

- Cut-off frequency, 3000 cps;
- Input impedance, 50,000 ohms;
- Output impedance, 50,000 ohms;
- Insertion loss 0.8 db.;
- Maximum input signal, 10 volts RMS;
- Dimensions, 2 1/8" x 2 1/4" x 1 1/16"
- Weight, 6 1/2 oz.

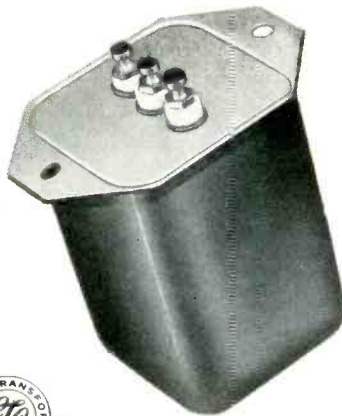

**CHICAGO STANDARD
TRANSFORMER CORPORATION**
ADDISON & ELSTON • CHICAGO 18, ILLINOIS

Export Sales:
Roburn Agencies, Inc.
431 Greenwich St.
New York 13, N. Y.

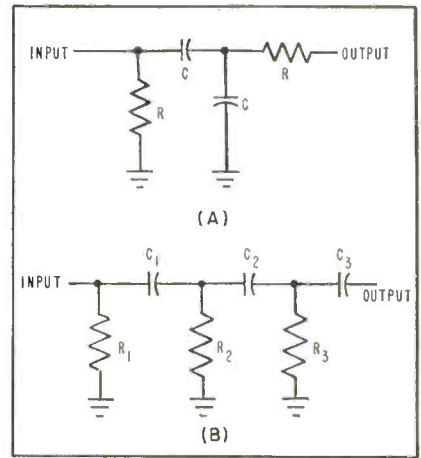

FIG. 1—Network used for oscillator (A) peaks transmission at desired frequency while network with phase reversal is shown at (B)

impedance into a very high input impedance. With transistor circuits they work from a fairly high output impedance into a low input impedance. Thus, for transistor circuits, it is advantageous to consider, not the voltage, but rather the current transmission of the networks.

Figure 1A shows a network whose current transmission, when it works out of a very high im-

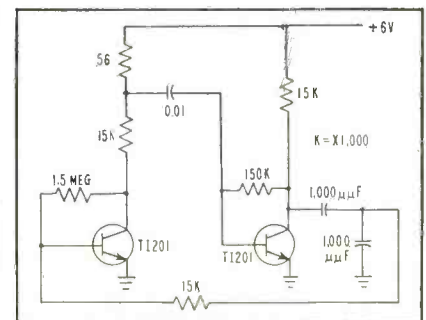
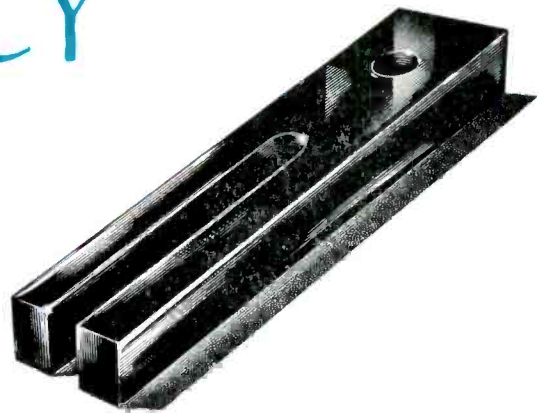

FIG. 2—Two-stage feedback oscillator uses network shown in Fig. 1A

pedance into a very low impedance peaks at the frequency $f = \frac{1}{3\pi RC}$, at which frequency the phase shift is zero. Figure 2 shows a two-stage feedback oscillator using this network. One resistor of the feedback network serves also as the load resistor for one transistor.

The resistors between the collector and base on each transistor provide bias current. This manner of obtaining the bias provides a measure of stabilization for the circuit. The actual frequency is about 10 kilocycles; the difference between this and the theoretical

TUNING FORK RESONATORS • THE ULTIMATE IN PRECISION AUDIO FREQUENCY CONTROL



PHONE OR WRITE for complete information regarding
component type Tuning Fork Resonators, or
variously packaged Tuning Fork Frequency Standards.



PHILAMON LABORATORIES INC.

90 Hopper Street, Westbury, Long Island, N. Y. EDgewood 3-1700

Grafting metal skin on glass eyes

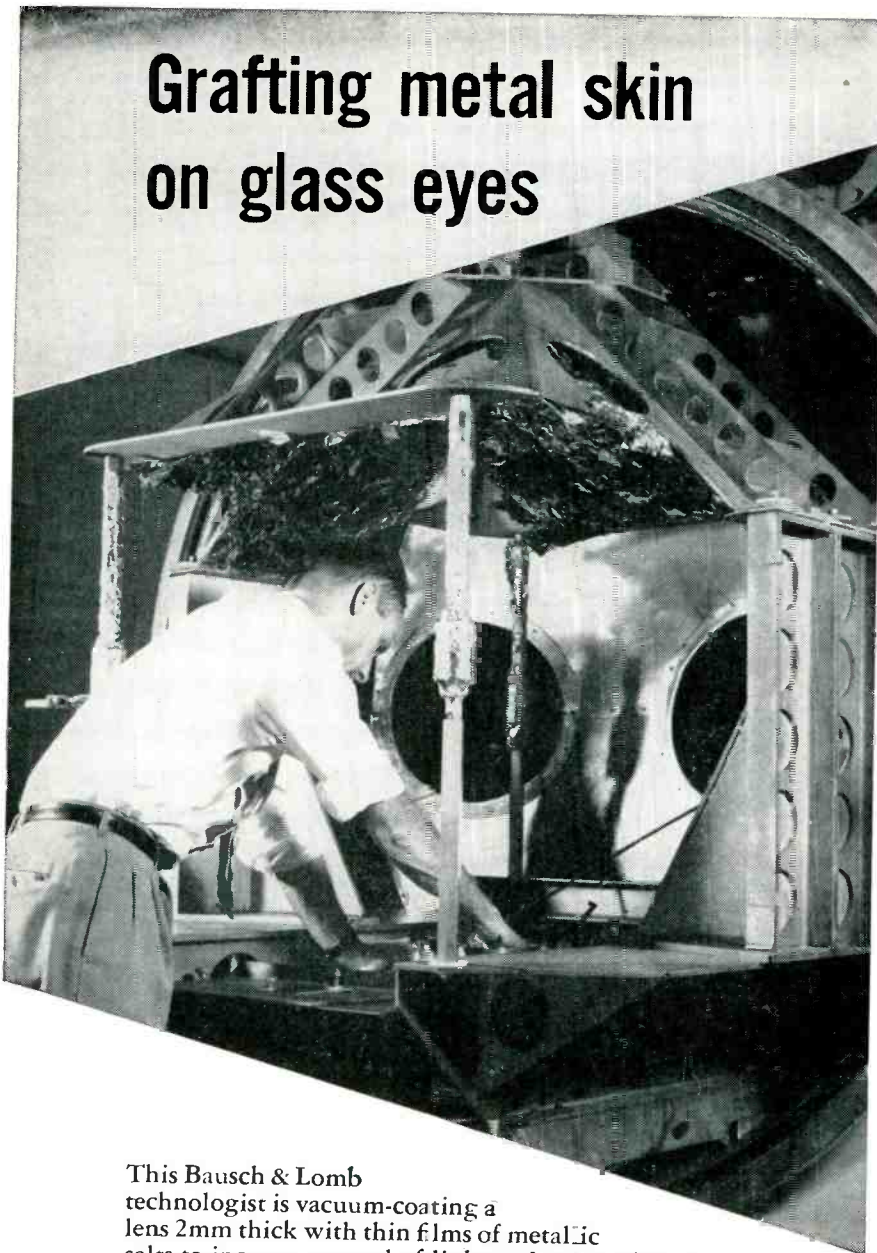

This Bausch & Lomb technologist is vacuum-coating a lens 2mm thick with thin films of metallic salts to increase control of light and color. If the lens were enlarged to the height of Mt. Washington (6,288'), the lens coating would be equivalent to a four-inch transparent layer. This submicroscopic surfacing method, developed by B&L, makes possible miracles in selective reflectance and transmittance of light of any specified wavelengths. Practical applications range from color TV to directional control of guided missiles. How does this kind of advance technology fit in with your contract plans?

WRITE FOR COMPLIMENTARY COPY OF LIMITED EDITION, "OPTICAL COMPETENCE" (on official letterhead, please, indicating title). Bausch & Lomb Optical Co., 81214 St. Paul Street, Rochester 2, New York.

BAUSCH & LOMB

SINCE  1853

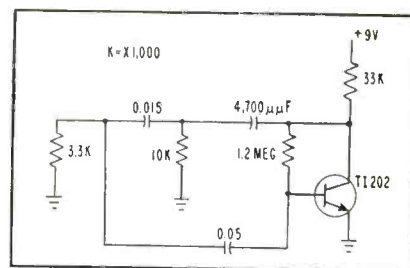

FIG. 3—Phase-shift oscillator uses circuit of Fig. 1B

value may be ascribed to phase shift in the coupling circuit between the two transistors. It is necessary in this circuit to keep the amplitude small if distortion is to be avoided.

Figure 1B shows a network whose current transmission will have a phase reversal at some frequency. If the network is sufficiently tapered so $R_1 \gg R_2 \gg R_3$ and $C_1R_1 = C_2R_2 = C_3R_3 = CR$ this frequency is given by $f = 1/2\pi\sqrt{3CR}$. By having the network tapered, its loss is decreased and a lower transistor gain will suffice for

WMGM Tests CSSB



Compatible single-sideband transmitter adapter shown was developed by Kahn Research Laboratories for use at broadcast station WMGM, New York. Tests started in mid-January will permit measurements of reduction in bandwidth and interference, improvement in fidelity and reduction in fading distortion. Similar transmissions from Voice of America's Munich megawatt transmitter can be received on conventional a-m receivers without distortion

Project Vanguard

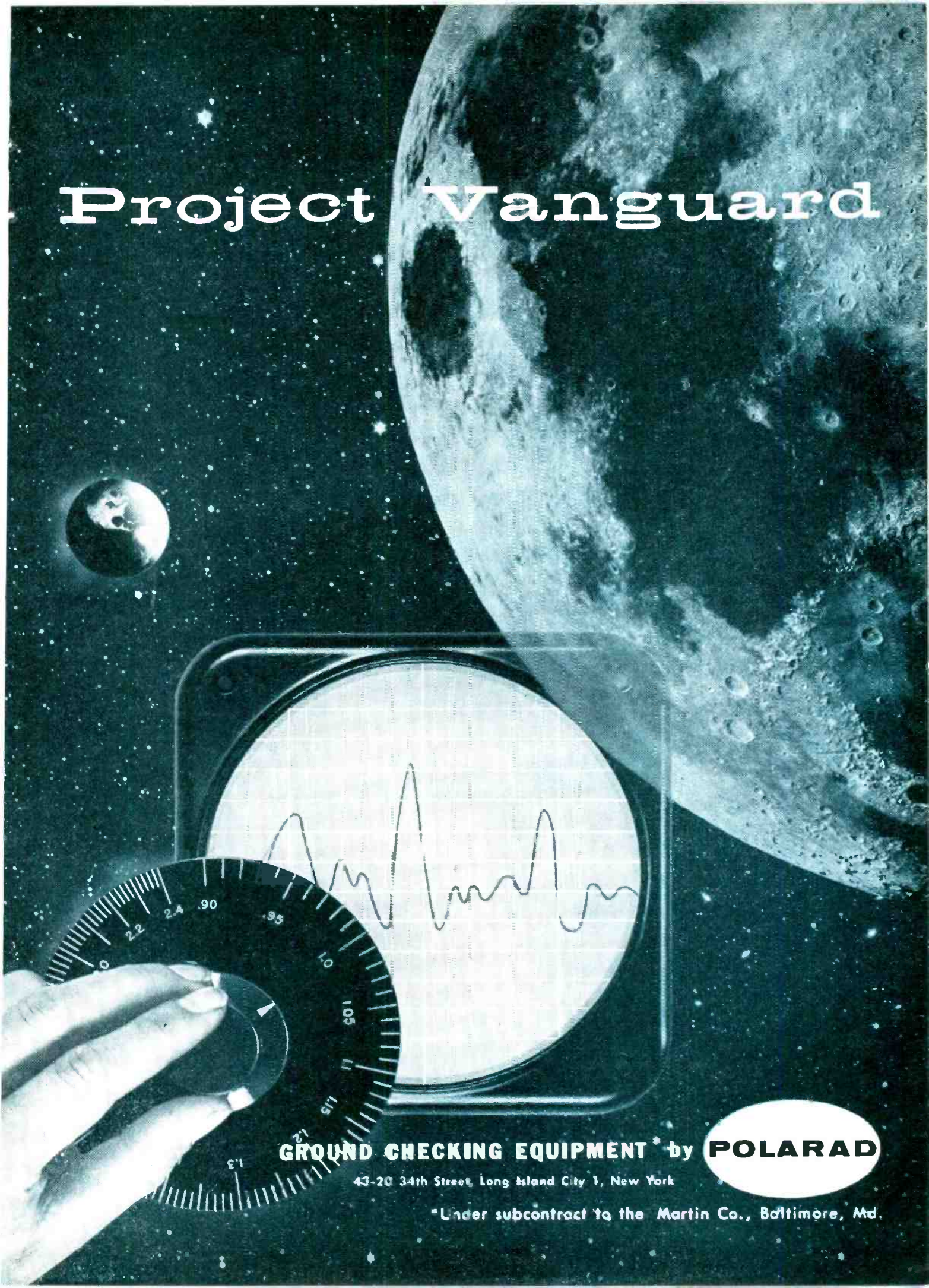

GROUND CHECKING EQUIPMENT* by POLARAD

43-20 34th Street, Long Island City 1, New York

*Under subcontract to the Martin Co., Baltimore, Md.

The Vacuum Switch Goes to Work

SWITCHING

TRANSMITTER ANTENNAS



No longer is it necessary to manually switch high voltage rf circuits. No longer is it necessary to fight problems of changing contact resistance or rectification due to the oxides that form on contacts in air.

Jennings vacuum switches have solved these problems. Their clean contacts stay clean since contamination is impossible in a vacuum. And in addition the high dielectric strength of a vacuum makes possible small solenoid actuated relays that can interrupt high voltage circuits with contacts that have to move only a fraction of an inch.

Turn therefore to Jennings with all of your rf switching problems. "Hot" or "cold" rf circuits can be remotely operated at any power level and at any transmission line frequency. Jennings vacuum switches can be used to switch antennas from transmit to receive, from the final amplifier to the driver stage, or from a main transmitter to a standby transmitter. They can be used to isolate a transmitter from its antenna, to switch to one of several antennas or to switch from an antenna to a dummy load. They can also be used for tap changing on rf coils or for switching antenna tuning coils.

We can suggest a relay for many difficult rf, dc, or 60 cycle switching problems if you will send us your circuit conditions.



Type JGF-RE2
Transfer Relay for
switching aircraft
antennas

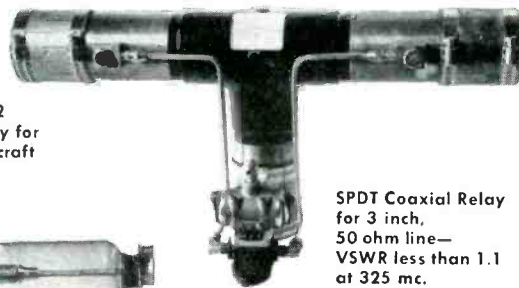

SPDT Coaxial Relay
for 3 inch,
50 ohm line—
VSWR less than 1.1
at 325 mc.

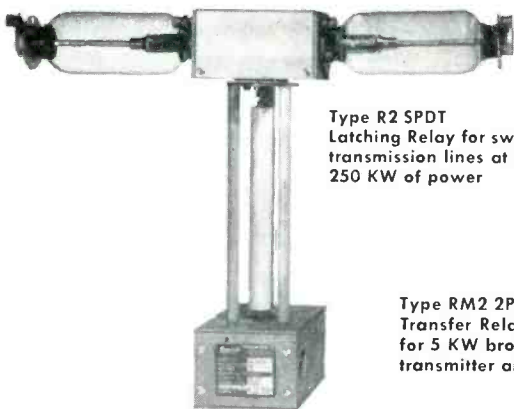

Type R2 SPDT
Latching Relay for switching
transmission lines at up to
250 KW of power



Type RM2 2PDT
Transfer Relay suitable
for 5 KW broadcast
transmitter antennas

oscillation. The taper is the opposite of that used with vacuum-tube circuits, the impedance level decreasing along the network.

Figure 3 shows a phase-shift oscillator using this network. Again the load resistor is part of the phase-shift network, and the bias is arranged as it was in the other oscillator. Frequency is about 500 cycles.

The taper in the phase-shift network is only by a factor of about three but this seems helpful. It is easier to get a good waveform with this oscillator than with the other, probably because this circuit provides strong negative feedback for higher harmonics of the waveform, tending to decrease them.

High Speed Strobe Checks Tube Vibrations

By KENNETH LEIB and
NORMAN RITCHEY

*Product Development Laboratory
Sylvania Electric Products, Inc.
Kew Gardens, N. Y.*

DURING development work on military-type vacuum tubes, it is often advantageous to examine tube element motion under vibration at high g levels at those frequencies giving highest microphonic output. In the majority of cases, these frequencies are above the fundamental ranges of commercial stroboscopes.

Above 2,000 cps many stroboscopes work on a harmonic of their operating range with the result that micro-movements are not readily observed since the light source illuminates the subject on alternate cycles for the second harmonic, once every third cycle for the third harmonic, and so on. To overcome these limitations, Type R1131C slow modulator tubes were used. Variation of tube current provides a modulated light output of high intensity. In many cases it was possible to leave the filament of the tube under test on and thereby maintain electrical microphonic output without loss of movement detection ability.

The Type R1131C cold-cathode light modulating tube has a crater-type cathode which provides a high ionization density and a narrow light beam particularly useful in

JENNINGS RADIO MANUFACTURING CORPORATION • 970 McLAUGHLIN AVE.
P.O. BOX 1278 • SAN JOSE 8, CALIFORNIA

new **OAK** chopper needs no phase-shift circuit!

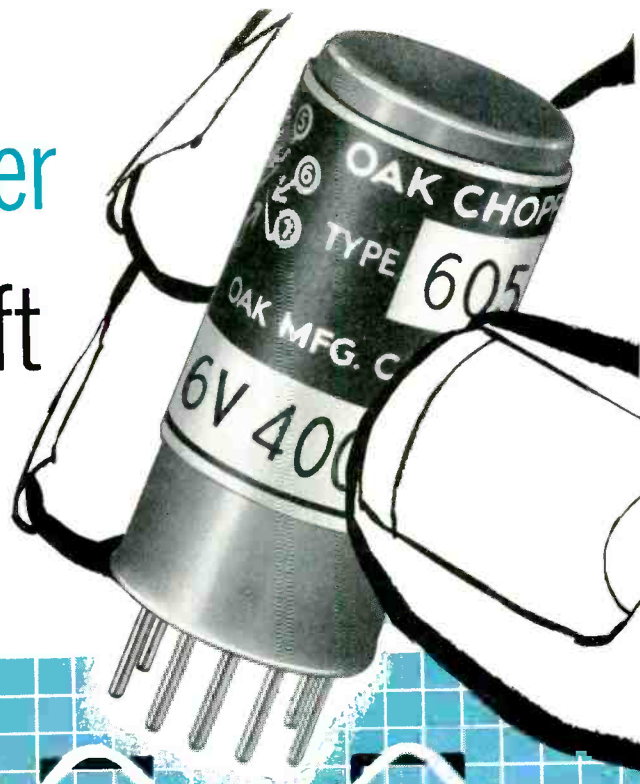

**HAS 0° or 180°
PHASE-LAG
"DESIGNED-IN"**

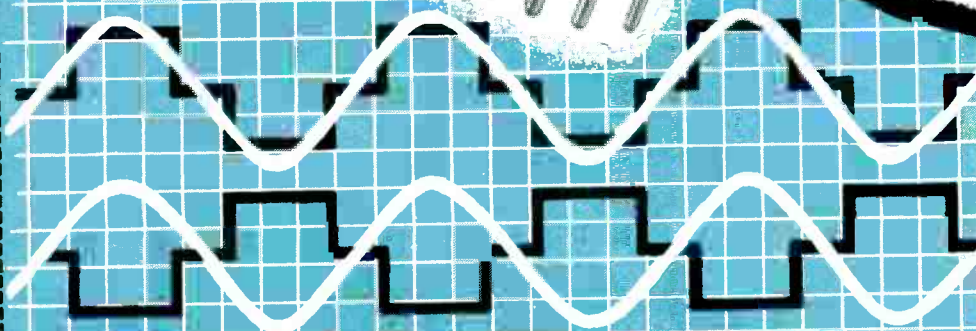

SPECIFICATIONS

Coil: Current, 25 ma; impedance, 190 ohms; resistance, 160 ohms.

Contacts: Dwell time, 150-160°; rating, 100 V, 2 ma. Resistance, less than 200 milliohms.

Phase Change: $\pm 10^\circ$ At constant 400 cps under all conditions of use and life.

Noise: Less than .5 millivolt RMS into 1 meg.

Vibration: 10-55 cps.

Weight: Less than 1 oz; dia. 11-16".

Height: Seated, 1 5/8".

Inherent in every device of the vibrating reed type are two phase-lags—an electrical phase angle resulting from the current lagging the applied voltage in the drive coil, and a mechanical angle due to the inertia of mass in the moving reed, lagging further behind flux from the driving current. In OAK's new Type 605 Chopper, these two lags have been carefully brought to a total of 180°. Thus, the chopper can be so wired to be exactly 180° out of phase, or reversed to be 360° out (in phase). This design eliminates the R-C circuit ordinarily needed to bring this coincidence of voltage and output phase—saving circuitry, parts, and weight.



Shown at the left is the new chopper with side mount. Also available with flattened and pierced pins, solder loops, or as a vertical flange mount unit.



Dept. G, 1260 Clybourn Ave., Chicago 10, Illinois
Phone: MOhawk 4-2222

Switches • Rotary Solenoids • Special Assemblies • Choppers • Vibrators

Designed for

 Application

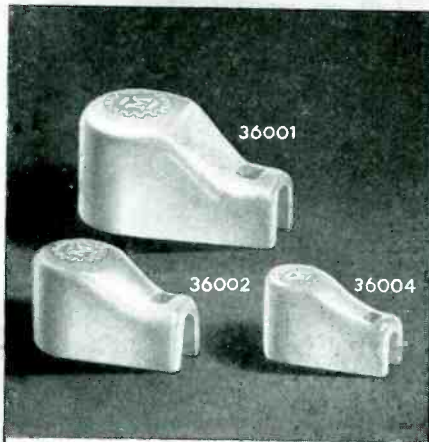

36000 SERIES
 Ceramic Plate or Grid Caps

A new addition to this series of exclusive Millen "Designed for Application" products is the 36004 for use on tubes with 1/4" diameter contacts. Efficient, compact, easy to use and neat appearing. Soldering lug and contact one-piece. Lug ears annealed and solder dipped to facilitate easy combination "mechanical plus soldered" connection of cable. No. 36001 for 9/16" tube terminals. No. 36002 for 3/8". No. 36004 for 1/4".

**JAMES MILLEN
 MFG. CO., INC.**

MAIN OFFICE AND FACTORY
MALDEN
 MASSACHUSETTS

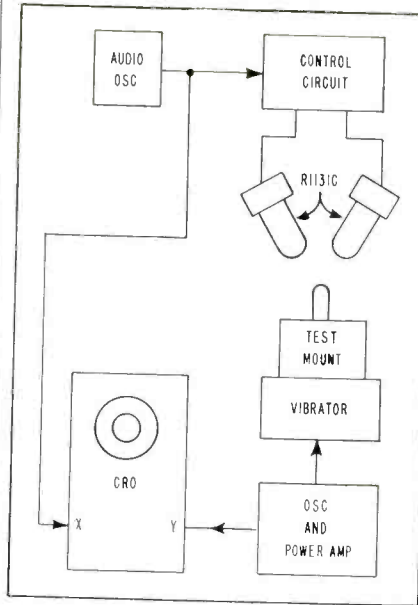

FIG. 1—Simple control circuit for two cold-cathode light-modulator tubes

the investigation of microphonics in tubes with T_3 to T_2 envelopes. The cold-cathode tube has been used for several years in facsimile equipment as well as in picture transmission applications.

The R1131C is connected as the load of a triode connected 6L6 in the circuit of Fig. 1. Sufficient fixed bias is used so that the tube barely conducts. The light output although steady is quite low. Application of 25 to 30 volts rms to the grid results in a light output of high intensity, with the light quite sufficient for the observation of moving parts. The tube current during operation shows in Fig. 2. Fig. 2.

Although various modifications can be effected as conditions warrant, the modulation-type stroboscope was employed as in the block

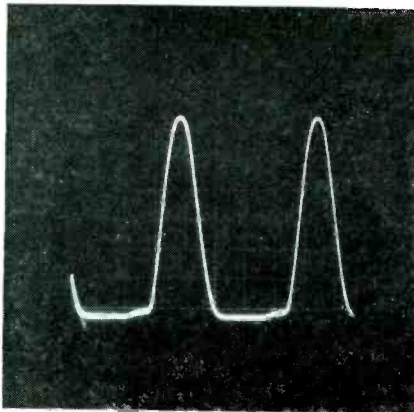
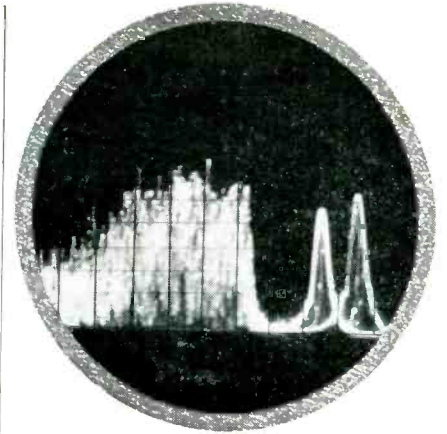

FIG. 2—Waveform of current through modulator tubes



**COMMUNICATIONS
 SYSTEMS
 ENGINEERS**

The expanding scope of advanced communications projects has created several unique positions in fields related to VHF, UHF, microwave transmission and reception, forward scatter and single sideband applications at Hoffman. Electronics engineers with appropriate backgrounds will find these new assignments professionally stimulating and financially rewarding. Please address Vice President of Engineering:



Hoffman

LABORATORIES, INC.

3761 South Hill Street
 Los Angeles 7, California
 Telephone: RIchmond 9-4831

A SUBSIDIARY OF
 HOFFMAN ELECTRONICS CORP.

ANOTHER EXAMPLE OF HOFFMAN LEADERSHIP

TRACKING THE SUN TO POWER A ROBOT WEATHERMAN

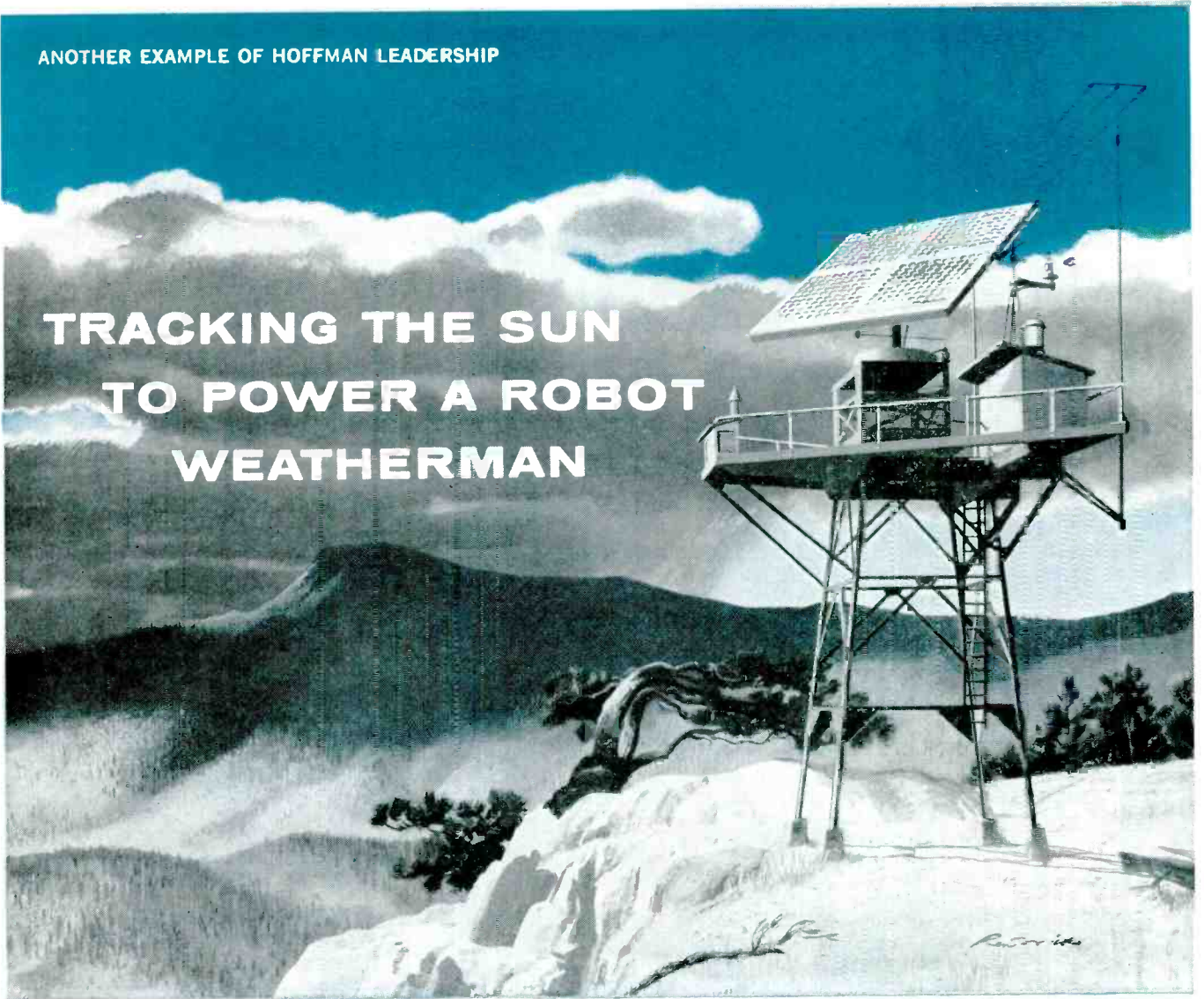

BIG BERTHA Solar Energy Converter Panels

Powering unmanned weather stations is just one of the many uses for Big Bertha—newest, most exciting product of Hoffman electronics research. Solar Energy Converter Panels like this can be installed wherever an economical and efficient source of electrical energy is needed to power transistorized signal, telemeter, communications and similar electronic equipment.

Hoffman silicon junction Solar Cells blanket the face of Big Bertha, convert sunlight directly into electricity to charge batteries and operate equipment—produce 80 watts of power output for each square yard of surface. Panels of almost any size or configuration can be built at modest cost.

Important potential applications for Hoffman Big Bertha Converter Panels include: untended telephone repeaters, unmanned radio relay stations, pipeline transmitters, Forestry Service radio units, telemetering equipment, railroad signaling apparatus, and all types of transistorized radio, TV, telephone and telegraph equipment.

Solar Energy Converter Panels can be supplied in tracking and non-tracking models, with special mounting stands or brackets designed to meet individual requirements. For additional technical information, please write the Applications Engineering Division, Hoffman Electronics Corporation, 3817 South Grand Avenue, Los Angeles 7, Calif.

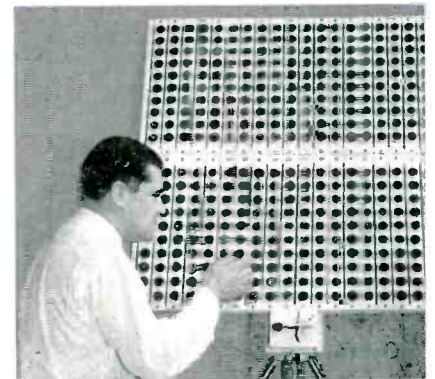

BIG BERTHA consists of banks of Hoffman Solar Cells interconnected to attain specified power requirements—produces 80 watts per square yard of surface.



SUN TRACKER automatically turns Converter Panel to "follow" sun's transit across sky, assures maximum conversion efficiency throughout the daylight hours.

Hoffman

**ELECTRONICS
CORPORATION**



Where the temperature hits 200°C. or the dry circuit is downright arid, your best bet for reliability is a "Diamond H" Series R miniature, hermetically sealed, aircraft type relay. Their shock and vibration resistance you may take for granted.

On the other hand, Series R relays (4 PDT) also give excellent reliability at -65°C. and will carry up to 10 amperes in power circuits . . . or even 20 amperes for short life requirements. In other words, they offer an extremely wide range of performance characteristics from which "Diamond H" engineers will be happy to work out a variation to meet your specific requirements. Just ask.

TYPICAL PERFORMANCE CHARACTERISTICS

Vibration Resistance:	10-55 cycles at 1/16" double amplitude 55-500 cycles at 15 "G" 55-1,000 cycles at 15 "G" 55-2,000 cycles at 20 "G"
Temperature Range:	-55° to +85°C. -65° to +125°C. -65° to +200°C.
Coils:	Resistances—1 ohm to 50,000 ohms Arrangements—single coil; two independent coils, either or both of which will operate unit
Insulation Resistance:	1,000 megohms at room temperature 100 megohms at 200°C.
Dielectric Strength:	450 to 1,000 V., RMS
Operating Time:	24 V. models 10 ms. or less; dropout less than 3 ms.
Contacts:	30 V., D.C.; 115 V., A.C.; 2, 5, 7½ and 10 A., resistive; 2 and 5 A. inductive. Minimum 100,000 cycles life. Low interelectrode capacitance—less than 5 mmf. contacts to case; less than 2½ mmf. between contacts. Special Ratings: to 350 V., D.C., 400 MA., or other combinations including very low voltages and amperages or amperages to 20.
Operational Shock Resistance:	30, 40 and 50 "G" plus
Mechanical Shock Resistance:	up to 1,000 "G"
Mounting:	9 standard arrangements to meet all needs —plus ceramic plug-in socket.
Size:	1.6 cu. in.
Weight:	4 oz. or less

Bulletin R-250 gives more complete data. Send for a copy.

THE HART MANUFACTURING COMPANY
202 Bartholomew Avenue, Hartford, Conn.

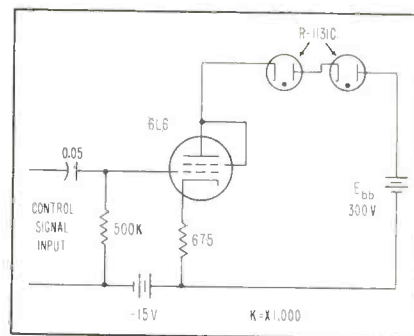

FIG. 3—Block system of setup for examining microphonic tubes

diagram of Fig. 3. Under this setup, the tube under test was vibrated through the frequency range of interest. Where a peak signal is noted, the light source is focused on the tube under test and adjusted to a frequency a few cycles different from the vibrator drive frequency, by use of a Lissajou pattern. To date, the highest frequency at which movement has been observed is 7,400 cps in a T₂ envelope even though the R1131C modulating range is from 15 to 15,000 cps. The present application utilized two modulator tubes to eliminate or minimize shadows. With slight modifications, this could readily be extended to three or possibly four glow tubes if required.

The photograph shows the system used during the analysis of a subminiature tube type. The stroboscopic system, including the power supplies, oscillator and monitoring oscilloscope, can be combined on one chassis and inserted in a 3-in. oscilloscope case. In addition to the advantages of a unified control, this can minimize required bench space.



Miniature tube on vibrator is illuminated by glow modulator tube on left for examination under vibration conditions

*If forward voltage drop is a problem
in your diode circuitry...see the*



**GOLD
BONDED**

RADIO RECEPTOR

Germanium Diode DR 385

*Available now in
production quantities
for immediate delivery*

with controlled forward voltage drop
between 0.34 and 0.37V at the
10MA level

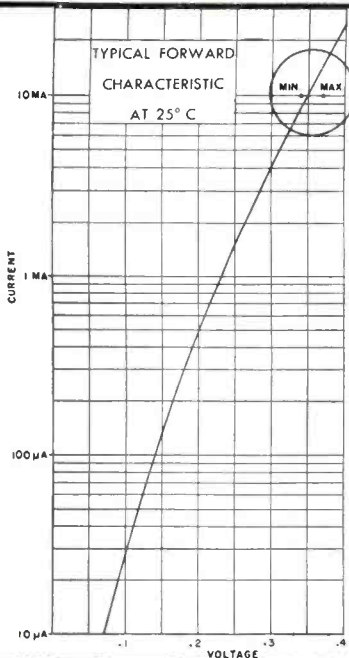

Design engineers working with transistorized circuits, computers and other applications will find that RRco. Type DR 385 has extremely low forward voltage drop as well as other desirable features... The specifications speak for themselves!

Characteristics at 25° C

Forward voltage drop @ 10MA	
Minimum	0.34V
Maximum	0.37V
Maximum reverse current at -10V	10UA
Peak inverse voltage	60V

Maximum Ratings at 25° C

Maximum inverse operating voltage	50V
Continuous DC forward current	100MA
Surge current for 1 second	500MA
Average power dissipation	80MW
Derating above 25° C	10MW/10° C

*DR 385 exhibits fast transient response and similar diodes
can be offered fully tested to your recovery conditions.*

Further information on DR 385, or any other RRco. diode type will be sent you at once upon request to section E-2.



*In Radio and
Electronics Since 1922*

Semiconductor Division
RADIO RECEPTOR COMPANY, INC.

240 Wythe Avenue, Brooklyn 11, N. Y. • EVERgreen 8-6000

Radio Receptor Products for Industry and Government: Selenium Rectifiers • Germanium Diodes
Thermatron Dielectric Heating Generators & Presses • Communications, Radar & Navigation Equipment

Chassis Rack Pivots and Rotates on Test Bench

WHEEL-LIKE chassis-holding racks designed by the Naval Aviation Service Department hold and conveniently position airborne transceivers for rapid servicing and maintenance. The rack is made by American Measuring Instruments Corp., 240 W. 40th St., New York.

The rack consists of a frame mounted on two large wheels that ride freely in four grooved wheels attached to a moveable base which revolves about a center pivot point. The chassis to be serviced is mounted on the frame between the large wheels and can then be moved in any position. Since it is necessary, when aligning AN/ARC-2 transceivers, to work on at least three sides of the equipment, the rotating rack is an excellent time-saver for this piece of equipment. In addition, it is used for servicing AN/ARC-1, AN/ARC-27 and AN/ARN-21 (Tacan) equipment, as well as a variety of other electronic units. Chief advantage is ability to turn over a chassis almost instantly without damaging components, wires or subassemblies.

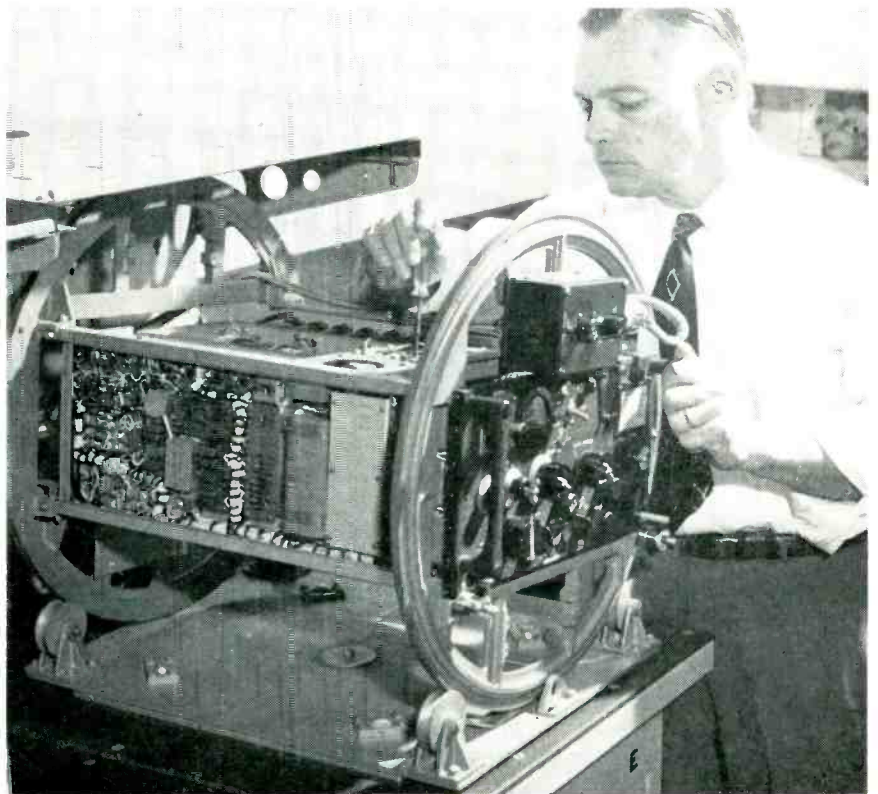

Method of using pivoted rotating rack for servicing airborne transceiver AN/ARC-2 (made by Collins Radio Co.) at Servicing Unit of Naval Receiving Station, Washington, D. C. Circular outer support rings ride freely in grooved wheels mounted on base that is supported just enough by pivot to clear top of bench

Cool Ultraviolet Shows Fungicidal Varnish During Application

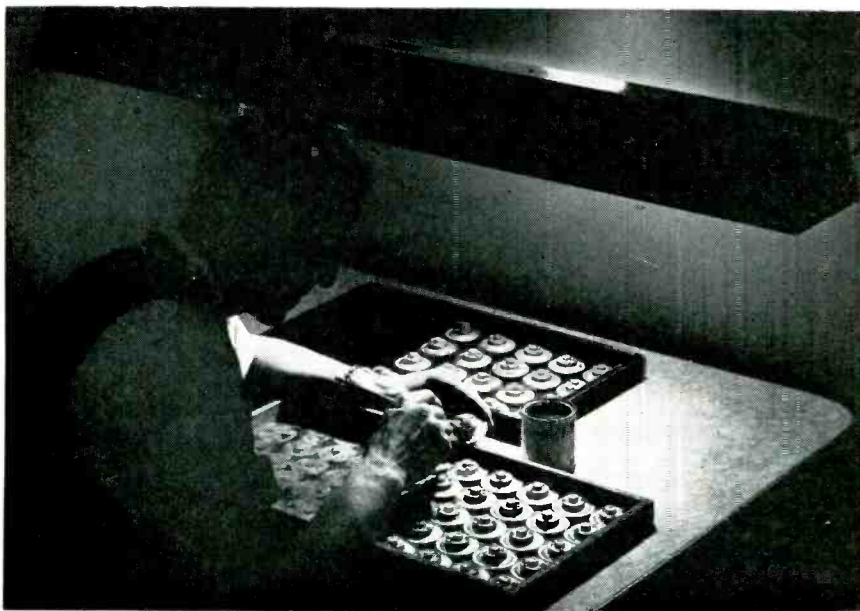

Applying fluorescent fungiproofing varnish to microphone terminals under long-wave lamp that plugs into any 115-volt a-c outlet and operates like standard fluorescent lamp. Varnish glows bright green where applied, so operator detects misses himself

REJECTS BY military inspectors because of missed coatings on connections have been cut to zero at American Microphone Co. in Pasadena, Calif. by checking with ultraviolet light at the time that the moisture-proofing fungicidal varnish is applied. This varnish contains an additive which fluoresces a vivid bright green under activation by 3,660 Å long-wave ultraviolet.

Although such light was used heretofore for inspection, the man who applied the varnish had to work in the dark, so to speak, because the varnish is transparent under ordinary light. Use of a new Blak-Ray cool 4-foot lamp (available from Black Light Eastern Corp., Long Island City, N. Y.) at each terminal-painting position gives adequate fluorescence despite normal room illumination, so the

**"DAD, WHAT'S
'OLD PRO'
MEAN?"**

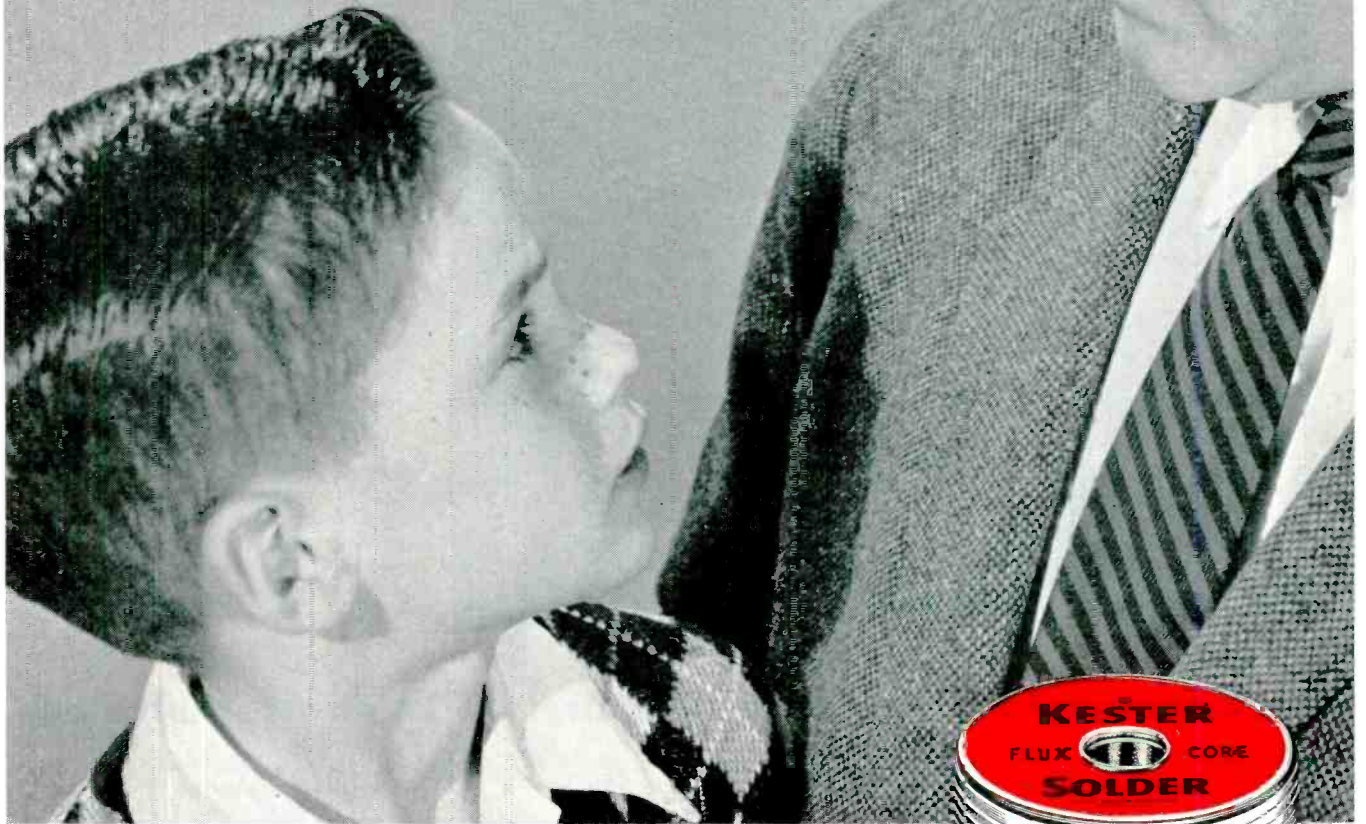

KESTER FLUX-CORE SOLDER

Leave it to a child to get to the heart of the matter quickly. No gobbledygook or double-talk is going to turn him aside from his single-minded objective.

It's like that with solder. No meager test dependent upon a "sample" or even a "one-line operational test" is going to prove conclusively the merits of a "Johnny-come-lately" solder from

that second source of supply. The wise buyer knows that the solder used on his production line must do the job he requires day-in and day-out without question.

And KESTER SOLDER has been time-tested and industry-proved for over 50 years.

That's what we mean by "old pro," Sonny!



SEND TODAY for your copy of the 78-page Kester textbook, "Solder ... Its Fundamentals and Usage." It's free!

KESTER SOLDER *Company* 4204 Wrightwood Avenue, Chicago 39, Illinois
Newark 5, New Jersey • Brantford, Canada

operator can see when he misses a spot or a complete connection. The change in setup speeds application of the varnish and eliminates costly

retouching of misses detected by the military inspector under conventional hot-quartz long-wave light. The technique is particularly

valuable with complex assemblies because it eliminates need for re-membering which terminals have been painted after an interruption.

Automatic Turntable Feeds Transistor Cap Welder

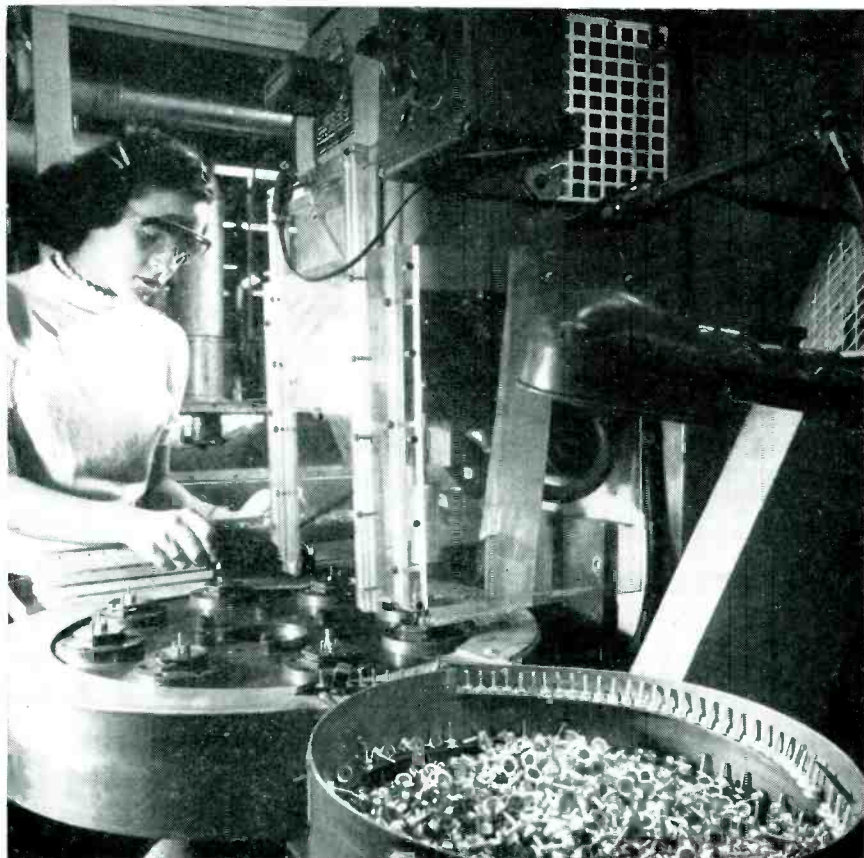

A STANDARD COMMERCIAL welder has been adapted by General Electric at its Semiconductor Products plant at Syracuse, N. Y., for welding the two basic subassemblies of a transistor together. By welding the transistor cap onto the header which holds the germanium or silicon wafer and leads, rather than soldering the two parts together, greater reliability of the device is assured. Leakage of contaminating air, the bugaboo of transistor reliability, is thus avoided.

The machine is capable of handling better than 800 transistors an hour. The table used as the electrode base and conveyor moves the eight welding stations counter-clockwise. As each station moves into the proper position, an air-operated index locks the electrodes.

Operator loads headers into pockets of turntable manually, after which Syntrol work feeder setup drops caps over headers automatically. Vertical plastic slides hold plastic window used to block flashes of molten metal; window is raised here to show welding position

Mark-Sensing Cards Aid Quality Control on Tacan Assembly Lines

USE OF MARK-SENSING punched cards now expedites the collection and analysis of routine quality control data during manufacture of Tacan airborne units and other electronic equipment.

Mark-sensing is a variation of the punch card system wherein the original information is entered directly on a card form by making a mark with a special lead pencil. A machine then transforms the marks into punched holes by means of timed electronic impulses. This contrasts with the key punch method whereby the original raw data is transferred from data sheets to the card form manually by a key punch operator.

record the necessary basic information pertaining to the act of inspecting equipment. It contains spaces for identifying such items

By LEAH HAZARD
Coordinator—Quality Control
Federal Telephone and Radio Co.
Division of I.T.&T.
Clifton, N. J.

Date		Equip	S	No.	Majors				Minors				Control								
Month	Day	Chassis	U	Insp.	S	W	Sh	A	F	O	M	S	W	A	H	M	M	M	H	Misc	(M)
1	1	1	1	1	1	1	1	1	1	1	1	1	1	1	1	1	1	1	1	1	1
2	2	2	2	2	2	2	2	2	2	2	2	2	2	2	2	2	2	2	2	2	2
3	3	3	3	3	3	3	3	3	3	3	3	3	3	3	3	3	3	3	3	3	3
4	4	4	4	4	4	4	4	4	4	4	4	4	4	4	4	4	4	4	4	4	4
5	5	5	5	5	5	5	5	5	5	5	5	5	5	5	5	5	5	5	5	5	5
6	6	6	6	6	6	6	6	6	6	6	6	6	6	6	6	6	6	6	6	6	6
7	7	7	7	7	7	7	7	7	7	7	7	7	7	7	7	7	7	7	7	7	7
8	8	8	8	8	8	8	8	8	8	8	8	8	8	8	8	8	8	8	8	8	8
9	9	9	9	9	9	9	9	9	9	9	9	9	9	9	9	9	9	9	9	9	9

► **Record Cards**—A special inspection record card was developed to

Example of marked card covering inspection of five AN/ARN-21 if amplifier units. Two defects are checked, one in minor wiring and the other in control hardware. Card is standard size, 7 $\frac{3}{8}$ inches wide and 3 $\frac{1}{4}$ inches deep

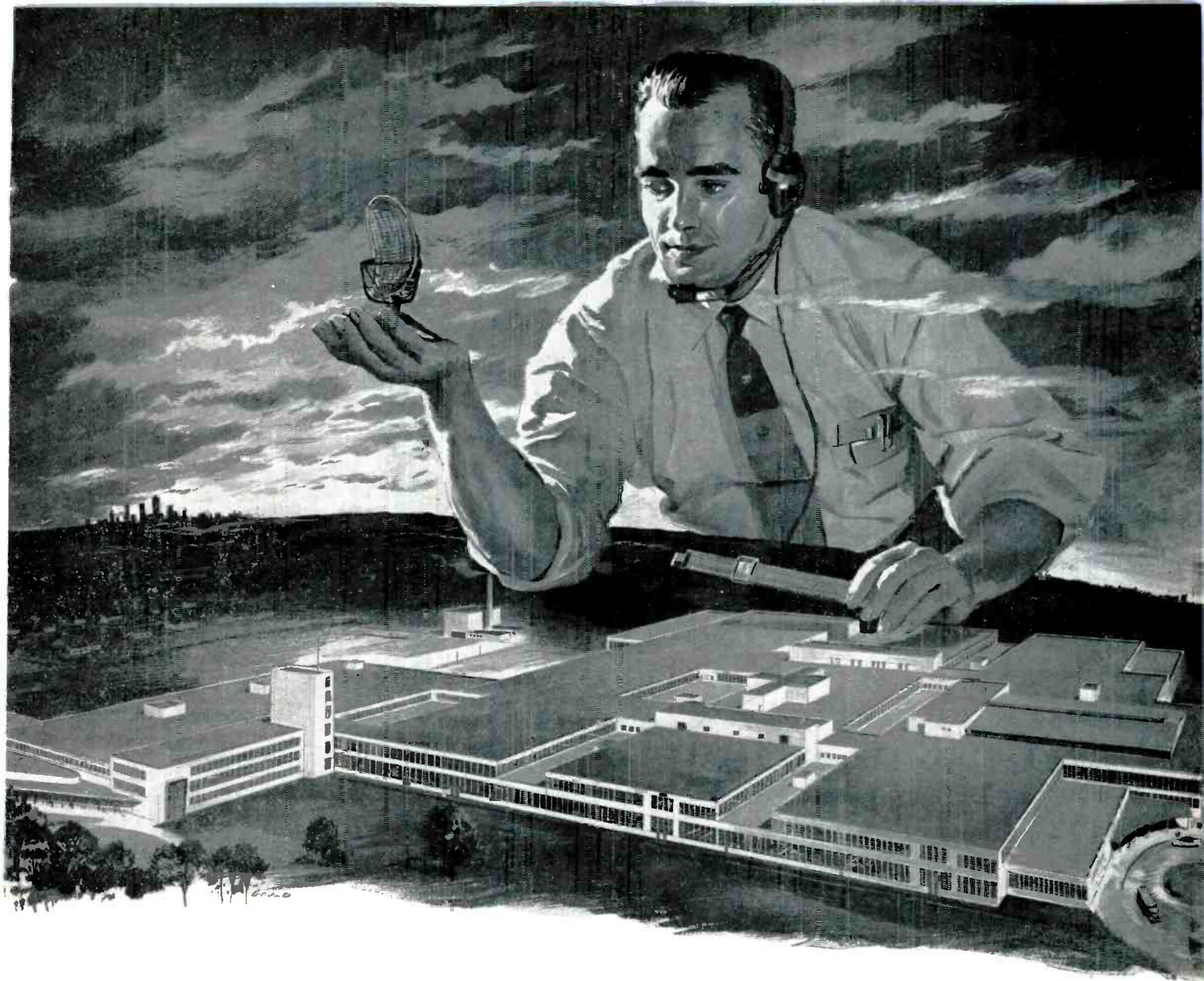

Electronics center for the atomic age

Your guess is as good as anyone's as to whether our Government or our industrial customers give us the more interesting challenges.

Take TACAN—or an ARN-32 marker beacon—or missile guidance systems, countermeasures, automatic test equipment, automatic assembly techniques, on all of which we are privileged to work. Certainly, they demand the utmost in precise engineering and manufacture.

Then, on the civilian front, there are projects like completely transistorized telephone switchboards, and electronic systems for recording data about every freight car in transit over a railroad.

These also require nothing less than perfection.

The net result of America's insatiable appetite for electronic research and production has been a phenomenal growth in our business and the establishment of the new Stromberg-Carlson "Electronics Center"—the 800,000 square foot plant pictured above. Every inch and every person in it are dedicated to continuous advances in national security and the home-front economy. We're proud to be at your command.

And there are plenty of career opportunities for engineers who wish to grow with electronics' finest. Write to Mr. R. W. Holmes for further information.



STROMBERG-CARLSON COMPANY

A DIVISION OF GENERAL DYNAMICS CORPORATION

General Offices and Factories at Rochester, N. Y.—West Coast plants at San Diego and Los Angeles, Calif.





Inspection position at which defects in airborne unit of Tacan equipment are marked on inspection record card. Complete unit mounted in quick-flipover plastic enclosure provides convenient visual comparison guide

as date of inspection, unit of equipment, production supervisor responsible for producing it and the number of units inspected. These items take up the first 10 vertical columns of the card. The remaining 17 columns provide space for recording the frequency of occurrence of defects in workmanship.

Workmanship defects are separated into categories of Major, Minor and Control, in accordance with the degree of effect each would have on the life or operation of the equipment. Within these categories the separate columns are given a letter heading to signify the type of defect to be recorded. The individual letters are translated as follows: S—Soldering; W—wiring and cabling; SH—shorts; A—assembly; FO—foreign objects; Ms or Misc—Miscellaneous; H—hardware; M—marking.

The character M heads a column which is used by quality control personnel to assist in the preparation of a quality rating of production supervisors. Items tallied in this column are those major defects found by inspection which are not directly chargeable to the supervisor responsible for the unit. Such defects, for example, might be found on a subassembly produced under another supervisor.

► **Summary Reports**—The inspection cards are normally collected

at the close of each shift. Cards are processed and summary reports are made ready for the next starting time of that shift. The summary report is a printed compilation of information contained in the deck of inspection cards, together with computations of process averages for each chassis. Tabulating and electronic calculating machines perform the necessary computations. Such summary reports can be issued daily, weekly, monthly or at any desired time.

► **Advantages** — Machines can process cards much more rapidly



Mark sense reproducer machine in foreground converts pencil-marked cards into standard punched cards suitable for machine at rear that is printing data summary on special report sheet

To the ENGINEER of high ability

Through the efforts of engineers The Garrett Corporation has become a leader in many outstanding aircraft component and system fields.

Among them are:

- air-conditioning
- pressurization
- heat transfer
- pneumatic valves and controls
- electronic computers and controls
- turbomachinery

The Garrett Corporation is also applying this engineering skill to the vitally important missile system fields, and has made important advances in prime engine development and in design of turbochargers and other industrial products.

Our engineers work on the very frontiers of present day scientific knowledge. We need your creative talents and offer you the opportunity to progress by making full use of your scientific ability. Positions are now open for aerodynamicists . . . mechanical engineers . . . mathematicians . . . specialists in engineering mechanics . . . electrical engineers . . . electronics engineers.

For further information regarding opportunities in the Los Angeles, Phoenix and New York areas, write today, including a resume of your education and experience.

Address Mr. G. D. Bradley

THE GARRETT CORPORATION

9851 So. Sepulveda Blvd.
Los Angeles 45, Calif.

DIVISIONS
AiResearch Manufacturing,
Los Angeles
AiResearch Manufacturing,
Phoenix
AiResearch Industrial
Rex — Aero Engineering
Airsupply — Air Cruisers
AiResearch Aviation
Service

AiResearch MISSILE AUXILIARY POWER UNIT

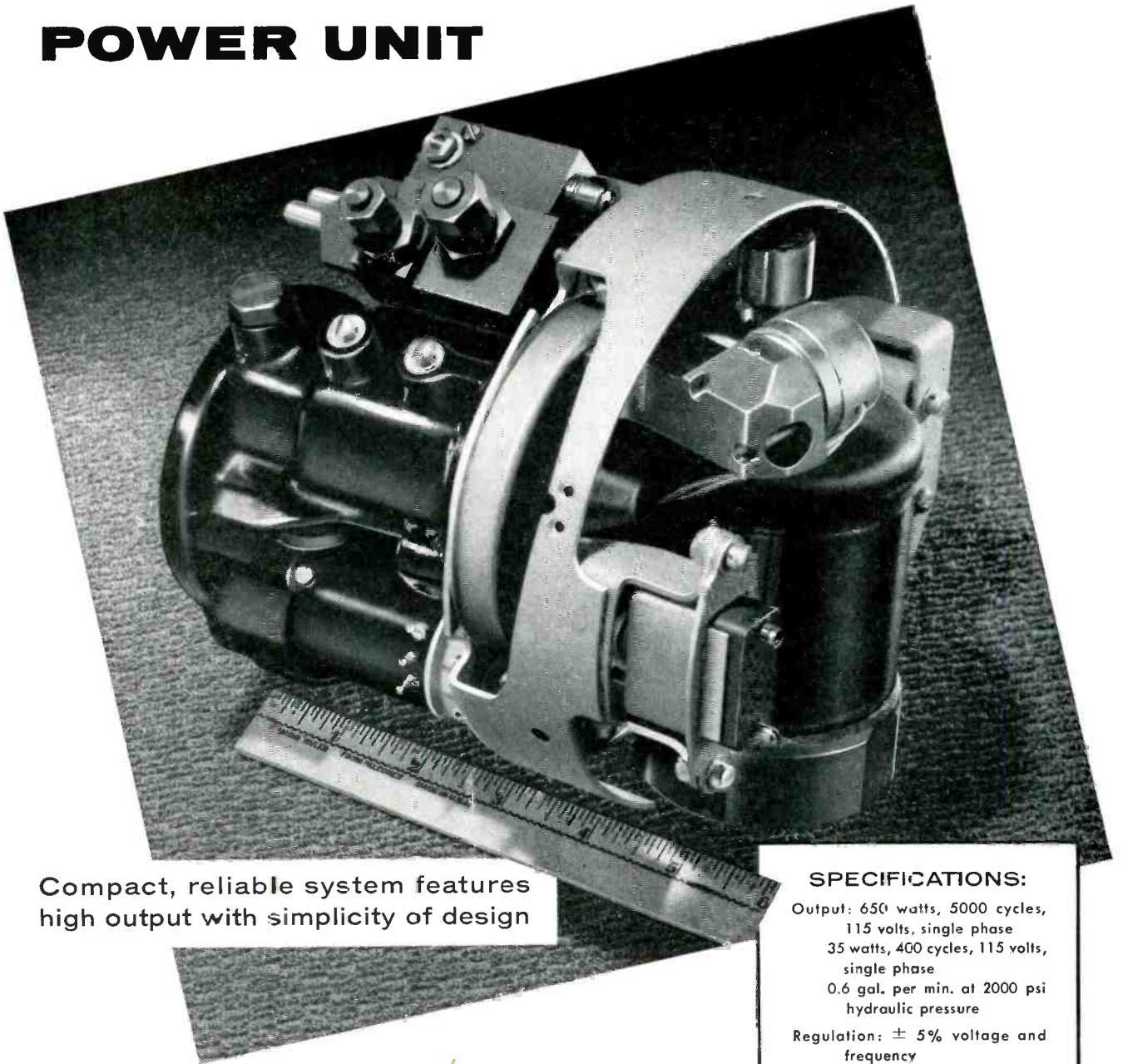

Compact, reliable system features high output with simplicity of design

This AiResearch auxiliary power package operates the vital electrical and hydraulic systems in a missile.

Gases from a solid propellant spin the unit's turbine wheel at 50,000 rpm. The turbine's shaft drives the following: a 650 watt generator which supplies electrical power to run the missile's guidance system; a 35 watt generator which runs the missile's gyros; a hydraulic pump which in turn powers the servos that control

the movable flight surfaces of the missile's airframe.

The hydraulic system features drilled passages which eliminate the need for potentially troublesome plumbing. It includes reservoir, filters, temperature compensator, relief valve, check valve, and squib valve within a single housing.

This auxiliary power system is an example of AiResearch capability in the missile field. Inquiries are invited

SPECIFICATIONS:

Output: 650 watts, 5000 cycles, 115 volts, single phase
35 watts, 400 cycles, 115 volts, single phase
0.6 gal. per min. at 2000 psi hydraulic pressure

Regulation: $\pm 5\%$ voltage and frequency

Duration: 27 seconds

Weight: 9.5 pounds

Size: 6.14 in. diam.,
6.74 in. long

Ground power: compressed air

regarding missile components and sub-systems relating to air data, heat transfer, electro-mechanical, auxiliary power, valves, controls and instruments.

THE GARRETT CORPORATION
AiResearch Manufacturing Divisions

Outstanding opportunities for qualified engineers

Los Angeles 45, California . . . Phoenix, Arizona

Designers and manufacturers of aircraft and missile systems and components: REFRIGERATION SYSTEMS • PNEUMATIC VALVES AND CONTROLS • TEMPERATURE CONTROLS
CABIN AIR COMPRESSORS • TURBINE MOTORS • GAS TURBINE ENGINES • CABIN PRESSURE CONTROLS • HEAT TRANSFER EQUIPMENT • ELECTRO-MECHANICAL EQUIPMENT • ELECTRONIC COMPUTERS AND CONTROLS

Why Hamilton Auto-Shift drafting tables save you money

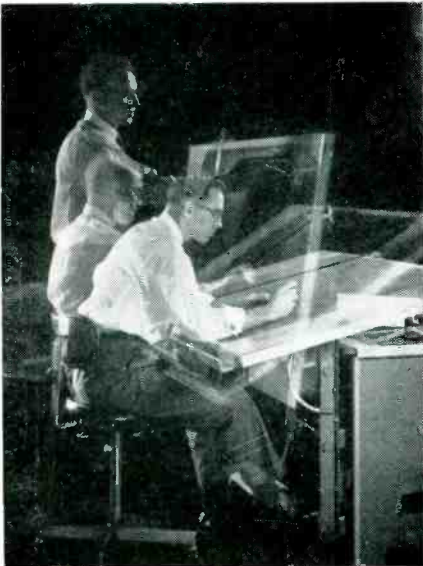

Draftsmen with Auto-Shift tables *produce more*. Two simple controls adjust board height and slope so easily that working angle can be frequently changed—board is instantly, effortlessly shifted to most convenient working position.

And Auto-Shift tables put *more draftsmen* to work in available space. Designed for row installations, there's a reference desk behind each draftsman. *Six men* work where *four* do now! Get the whole story—write Auto-Shift, Hamilton Manufacturing Company, Two Rivers, Wisconsin.



Hamilton

drafting equipment

Want more information? Use post card on last page.

Equipment		Date		Unit	Sup	No. Insp	MAJOR DEFECTS					MINOR DEFECTS					CONTROLS			Supervisor						
		Sold	Wrt	Short	Assm	Cor	Q	Misc	Total	Proc.	Avg	Sold	Wrt	Assm	Short	Cor	Misc	Total	Proc.	Avg	Material	Misc		Proc.	Avg	
1/30	102	6	57																							
1/30	102	6	54																							
2/3	102	6	40																							
2/07	102	6	88																							
2/07	102	6	99																							
2/09	102	6	81																							
2/09	102	6	95																							
2/10	102	6	99																							
2/10	102	6	99																							
2/20	102	6	27																							
2/23	102	6	43																							
2/23	102	6	43																							
2/25	102	6	76																							
2/25	101	6	6																							
2/02	109	6	5																							
2/04	109	6	7																							
2/24	101	6	6																							
2/23	103	6	12																							
2/25	101	6	6																							
1/30	104	6	42																							
1/27	104	6	4																							
2/01	104	6	22																							

Portion of summary report that is printed automatically by card-sorting machine. Actual form is approximately 15 inches wide and 11 inches deep

and accurately than can human beings. Therefore, the new system, which requires no extra time and energy on the part of the inspector (the card was substituted for a former data sheet) saves time, energy and money with respect to correlating, analyzing and distributing the information gained by inspection.

The speed with which information can be disseminated provides opportunity for rapid preventive as well as corrective action. This in turn reduces poor workmanship and reduces the percentage of future scrap and rework.

Analysis of inspection informa-

tion and useful reporting of the findings can be extended to include wider and more detailed areas without increase in indirect labor, because of the saving of time through use of computing machines.

Cards can be sorted to provide a picture of the quality of workmanship performed on any group of equipments or on any single unit group under the direction of any supervisor. Cards can also be sorted to provide a picture of the quality of any workmanship characteristic, either for purposes of investigation and training or for comparison.

Localized Plating of Etched Wiring

SELECTIVE ELECTROPLATING of terminals on etched wiring boards and flanges on waveguides can be achieved at high speed by the Dalic process, originally developed by the Laboratoires Dalic in France. The required electrodes and supplies are now available from Marlane Development Co., 153 E. 26th St., New York City. The technique is also suitable for build-up of worn components and for numerous other applications where high-speed deposition is required on small areas without stopping-off or dismantling.

► **How It Works**—The principle is similar to that of ordinary contact plating, whereby a cotton pad dipped in plating solution is connected to the anode bar and the work is connected to the cathode bar. The new development lies in the use of insoluble graphite anodes and a

wide range of organic plating solutions. These solutions are nontoxic, give off no harmful fumes and are quite safe to handle without protective gloves.

Another feature is the high rate of deposition afforded by the high current densities used with these organic solutions. The deposits obtained have good mechanical properties with high adhesion and little or no porosity, because the current for the process is supplied by a specially designed transformer and rectifier unit operating from a 220-v single-phase a-c line and delivering up to 40 amperes d-c at low voltage. With a small plating pad this can give current densities as high as 6,000 amperes per square foot.

The cathode lead is connected to the workpiece with a large insulated crocodile-type clip. The anode lead plugs into various types



Punch PRINTED CIRCUITS Cold...

with **WALES Fabricator-Duplicator**

The **WALES Fabricator** combined with **WALES positive Duplicator** is the modern, low cost answer to printed circuit hole punching. You get holes with sharp definition, clean walls and minimum bell mouth. This equipment is perfect for short runs from one piece to thousands. Change dies for hole sizes in seconds with a range up to 3½" dia. Accuracy is automatic and positive. Make your own templates, too, on the **Fabricator**. No need for drilling machines or jig-borers. The **WALES Fabricator-Duplicator** is a complete punching shop in itself.

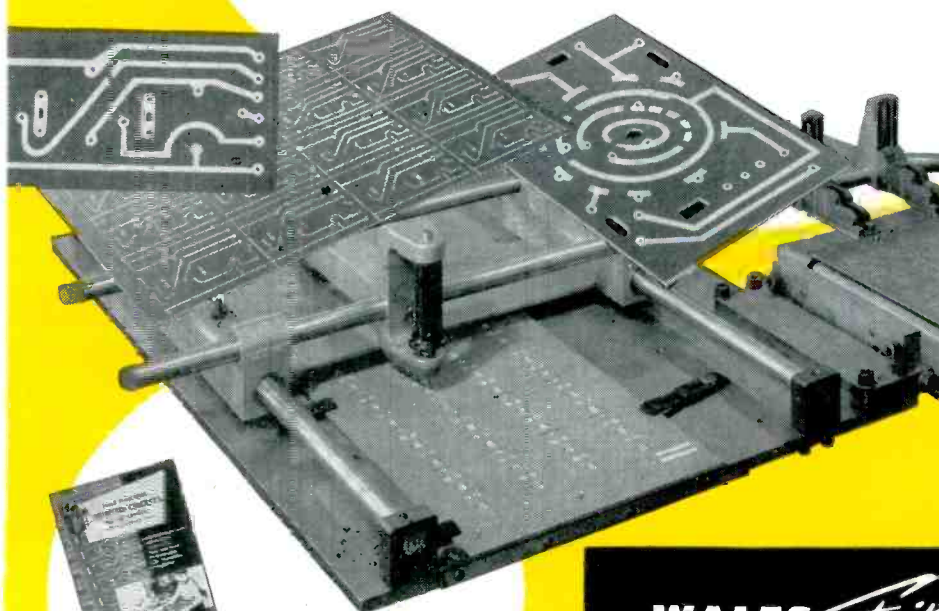
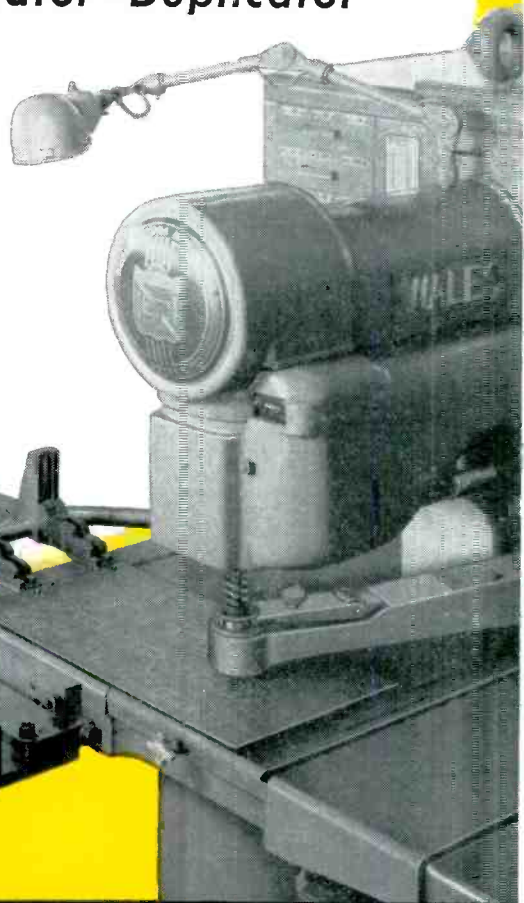

SEND FOR BULLETIN NO. 13A
Complete specifications and capacities
are yours for the asking.

WALES Strippit COMPANY
"...the Wales-Way is the PLUS-PROFIT way"
AKRON, NEW YORK

WALES-STRIPPIT OF CANADA LTD., HAMILTON, ONT.

**ELECTRONICS
ENGINEERS
PHYSICISTS**

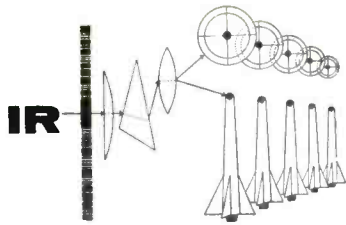

Infra-Red Is Ultra-Modern

In the post-war years, the development of infra-red devices has attained the dimensions of a technological breakthrough. In this period, the Electronics and Guidance Division of Aerojet-General Corp. has become the national leader in the development and manufacture of infra-red equipment.



Aerojet-General is a vigorous company staffed with men who are enthusiastic about their work and confident of the future. Here are some of the things you might do at Aerojet:

Electronics Engineers

Design and develop detection, tracking and guidance systems. Design and develop guidance, aircraft search, tracking, communication and gunsight systems.

Physicists

Investigate special guidance techniques, systems and devices. Conduct studies and experimental work in the field of optics, and infra-red and other types of radiation.



CORPORATION
A Subsidiary of
The General Tire
& Rubber Company
THE GENERAL TIRE
PLANTS AT AZUSA
AND NEAR
SACRAMENTO, CALIFORNIA

Write: Director of Scientific and Engineering Personnel,
Box 296UU, Azusa, Calif.

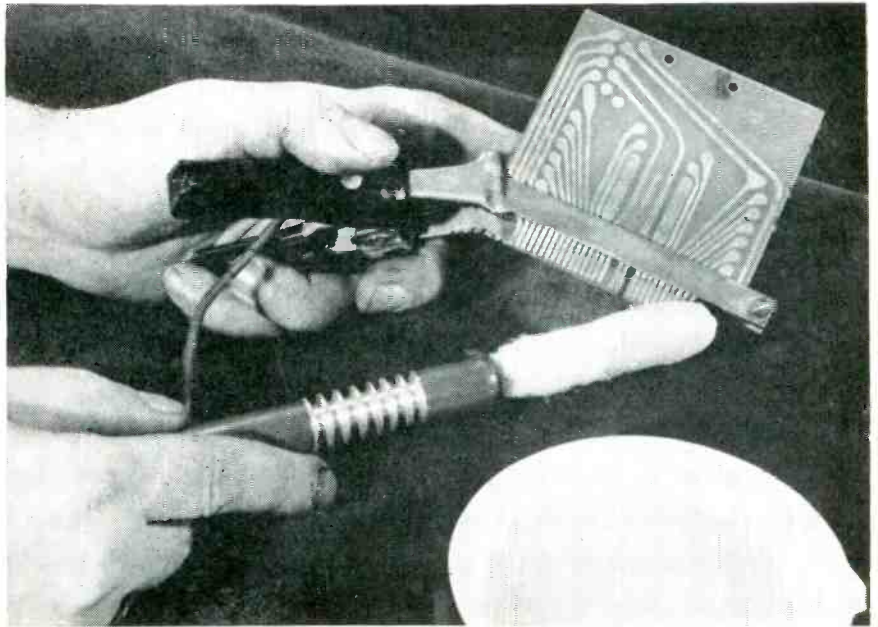

Cotton-wrapped graphite plating anode is dipped in electrolyte in dish, then wiped over sliding contacts of etched wiring board to place 0.00015-in. deposit of gold on them, followed similarly by 0.00005 in. of rhodium. Combination of metals improves conductivity and minimizes wear. Metal bar across board makes contact with all parts of printed circuit and serves as stop-off for plating

of anode holders, most of which are fitted with air-cooling fins. The electrolyte is applied by means of a pad of absorbent cotton wrapped around the graphite anode. The wrapped anode is merely dipped into the solution of the required metal and applied to the material to be plated with a rubbing motion, the current density having been

preset on the power unit. The current quickly raises the solution to boiling point and plates rapidly, as indicated in Table I. Times are for plating an area equal to that of the pad electrode used. There is no residual problem; the solutions are organic compounds and at boiling point the radicals are decomposed. The only subsequent treatment

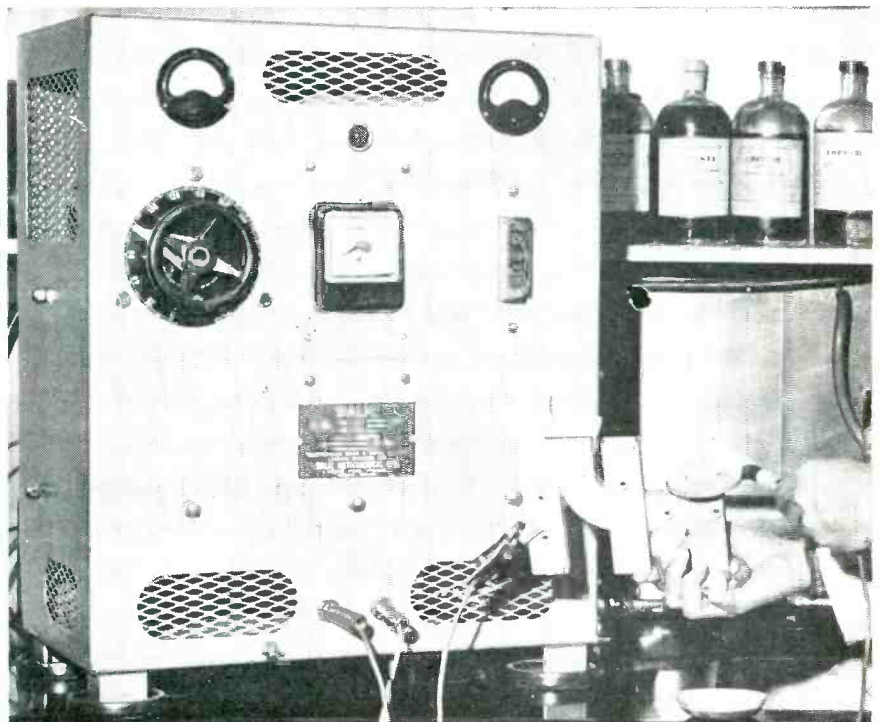

Complete bench-top plating setup, here being used to plate 0.5 to 1 mil of indium on butt joint area of waveguide to provide ductile compression gasket

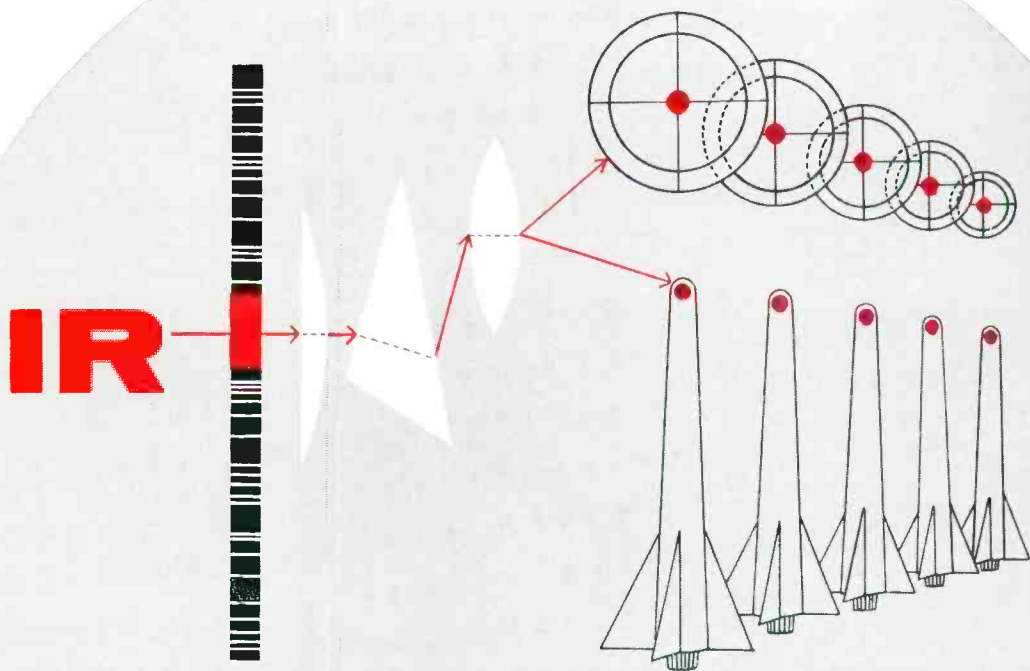

INFRA-RED

1944...RESEARCH • 1956...MASS PRODUCTION

For 13 years Aerojet-General has pioneered the research and development of infra-red devices. Now, Aerojet and Aerojet alone has perfected the high-volume production of infra-red systems for:

- GUIDANCE
- WIDE-ANGLE SEARCH
- AUTOMATIC TRACKING
- GUNFIRE CONTROL

Aerojet-General CORPORATION

A Subsidiary of
The General Tire & Rubber Company



AZUSA, CALIFORNIA
SACRAMENTO, CALIFORNIA

Electronics engineers...physicists...Aerojet invites you to pinpoint your own targets, "lock on" your own future... in the dynamic new field of infra-red.

NEW

CALIDYNE model 174 SHAKER

1500 lbs. force output



a basic shaker
for 6 different
CALIDYNE
Vibration
Test Systems

SYSTEM NUMBER	1 174/203	2 174/184	3 174/80	4 174/186	5 174/186	6 174/80
Type	Sinusoidal	Sinusoidal	Sinusoidal*	Sinusoidal*	Random or Sinusoidal	Random or Sinusoidal
Power Supply	Electronic	Rotary	Electronic	Electronic	Electronic	Electronic
Force Output	1250 lbs.	1500 lbs.	1500 lbs.	1500 lbs.	1500 lbs.	1500 lbs.
Frequency Range	5-3500 cps.	5-2000 cps.	5-3500 cps.	5-3500 cps.	5-3500 cps.	5-3500 cps.
Max. Load 10 g.	105 lbs.	130 lbs.	130 lbs.	130 lbs.	130 lbs.	130 lbs.
Max. Load 20 g.	42.5 lbs.	55 lbs.	55 lbs.	55 lbs.	55 lbs.	55 lbs.

*Also adaptable for Random Vibration Testing.

CALIDYNE'S Model 174 Shaker featuring high frequency operation and low input requirements has been so designed that it can be utilized in any one of six CALIDYNE Vibration Test Systems.

The versatility of the Model 174 Shaker extends the range of vibration testing for which this shaker can be used. It further advances CALIDYNE Systems of vibration control, enabling equipment manufacturers to: create vibratory forces over a wide range, measure them, use them for testing and measuring the test results.

Typical vibration testing applications of these Model 174 CALIDYNE Shakers include:

1. **Brute force** shaking at frequencies simulating the worst conditions of ultimate operation.
2. **Structural response** to determine mode shape, frequency and damping characteristics.
3. **Fatigue testing** for high stress providing deflections many times greater than normal usage.
4. **Random vibration testing** for more exact simulation of true environment.

Complete performance data on each of these 6 CALIDYNE Series 174 Shaker Systems are contained in New Bulletin 17400. For engineering counsel in applying the destructive force of vibration to your own research and testing problems, call us here at CALIDYNE.



THE CALIDYNE COMPANY

120 CROSS STREET, WINCHESTER, MASSACHUSETTS

SALES REPRESENTATIVES

NEW ENGLAND, NORTHERN NEW YORK
Technical Instruments, Inc.
Waltham, Mass. (Twinbrook 3-1400)
Syracuse, N. Y. (Syracuse 3-7870)

NEW YORK CITY, LONG ISLAND,
NEW JERSEY, DELAWARE,
EASTERN PENNSYLVANIA

G. Curtis Engel & Associates
Ridgewood, N. Y. (Gilbert 4-0878)
Spasies, L. J., N. Y. (Walnut 1-5095)
Philadelphia, Pa. (Chestnut Hill 8-0892)

OHIO, WESTERN PENNSYLVANIA,
EASTERN MICHIGAN

M. F. Gsell Company
Westlake, Ohio (Trinity 1-8000)
Dayton, Ohio (Oregon 4411)
Pittsburgh, Penna. (Freemont 1-1231)
Detroit, Michigan (Broadway 3-5399)

VIRGINIA, MARYLAND, WASHINGTON, D. C.
F. R. Jadan, Inc.
Washington, D. C. (Oliver 2-4406)

SOUTH CAROLINA, GEORGIA, ALABAMA,
FLORIDA, SOUTHERN TENNESSEE
Specialized Equipment Corp.
Cocoa Beach, Fla. (Cocoa Beach 3328)

INDIANA, ILLINOIS, WISCONSIN,
MINNESOTA, WESTERN KENTUCKY,
WESTERN MICHIGAN, N. DAKOTA,
S. DAKOTA, EASTERN IOWA
Hugh Marston and Co.
Chicago, Ill. (Ambassador 2-1555)
Indianapolis, Ind. (Glendale 3803)
Minneapolis, Minn. (Colfax 7949)

ARKANSAS, LOUISIANA, OKLAHOMA,
TEXAS (Except El Paso)

John A. Green Co.
Dallas, Texas (Riverside 3266)
Houston, Texas (Jackson 3-1021)
Tulsa, Oklahoma (Riverside 2-4657)

CALIFORNIA, ARIZONA, COLORADO,
NEW MEXICO, NEVADA, OREGON,
WASHINGTON, IDAHO, WESTERN MONTANA

Gerald B. Miller Co.
Hollywood, Calif. (Hollywood 2-1195)
San Diego, Calif. (Academy 2-1121)
Belmont, Calif. (Lytel 3-3438)
Tucson, Arizona (Tucson 4-4255)
Denver, Colorado (Acoma 2-9276)
Albuquerque, New Mexico
(Albuquerque 5-8006)

Table I—Plating Times and Current Densities

Metal Being Deposited	Maximum Current Density in Amp per Sq Ft	Time in Seconds to Deposit 0.0001 Inch
Bismuth	1,500	7.5
Cadmium	6,000	2.5
Chromium	4,000	63.0
Cobalt	1,500	7.6
Copper	6,000	2.5
Gallium	1,000	17.5
Gold	2,000	6.2
Indium	4,000	2.5
Iron	3,000	10.0
Lead	5,000	3.8
Nickel	5,000	5.0
Palladium	1,500	10.0
Platinum	3,000	17.5
Rhodium	3,000	70.0
Silver	1,250	5.0
Thallium	2,000	12.5
Tin	5,000	2.5
Zinc	3,000	3.8

needed is a rinse under a tap.

► **Preparation**—For the removal of light rust or for new parts, the work is connected to the negative lead and cleaned and deoxidized with the cleaner supplied. This is applied by the cotton-wrapped anode dipped into the solution. The work is rinsed with water and is then ready for plating.

Aluminum, stainless steels and hard steels can be plated easily but require a slight etch, obtained with a special solution supplied, and a little abrasion with aluminum oxide. After vapor blasting, titanium and molybdenum can also be plated successfully, the latter being coated with platinum by many electronic equipment manufacturers in Europe.

► **Applications**—For electrical and electronic contacts the process is particularly effective. Contacts are usually only plated over a small area and consequently extensive stopping-off is ordinarily necessary. With this process even the smallest sections can be silver or gold plated, with additional rhodium plating for abrasion resistance if desired, at relatively low cost. Silver-plating aluminum bus bar is also an important application.

Metal inserts and contact faces in molded plastic parts, which

MANY THANKS FOR YOUR "VOTE" OF

confidence

• We appreciate your having given Photocircuits Corporation so many orders for Printed Circuitry and allied electronic sub-assemblies. We believe you will continue to do so because of our . . .

1) Technological LEADERSHIP. Pioneering, and our policy of promoting the free exchange of engineering information, have been the "role" of Photocircuits Corporation in the relatively new field of printed circuitry. The recently published "Standard Printed Circuit TOLERANCES" has been well received. After quickly dispensing 15,000 copies, we are heavily backlogged with requests for additional copies.

2) Production EXPERIENCE and CAPACITY. Over 7000 different applications of printed circuits and associated assemblies have been produced to date by Photocircuits Corporation! This is the kind of experience in production that has led to the building of our large new plant shown below . . . exclusively for the research, development and production of the industry's expanding printed circuit requirements.

3) Reputation for QUALITY. "Ask the man who . . .", to paraphrase a famous slogan, and you will receive testimony other than our own self-appraisal! A recent, impartial, survey placed Photocircuits "first" by a factor of 3 over our nearest competitor among those considered in purchasing printed circuitry! Our aim is to continue to merit your CONFIDENCE.

Photocircuits

C O R P O R A T I O N

Pioneers in Cost-Cutting Printed Circuit Techniques
Glen Cove 4-8000 • FLushing 7-8100

Cable Address: PHOCIRCO



BOSTON: 25 Huntington Ave. • C O m m o n w e a l t h 6-7705
CHICAGO: 3347 W. Irving Park Rd. • K E y s t o n e 9-7555
ROCHESTER: 650 Linden Ave. • H i l l s i d e 5-0580
LOS ANGELES: 7407 Melrose Ave. • W E b s t e r 3-7276
DAYTON: 25 Main Building South • F U I l t o n 6377
KANSAS CITY, MO.: 4210 Main St. • W E s t p o r t 1-7564
CHARLOTTE, N. C.: 222 Providence Rd. • F R a n k l i n 5-8958
COCOA, FLA.: 209 Beverly Rd. • C O c o a 201M
DENVER: 1013 15th St. • K E 4-5091
SPOKANE: P. O. Box 835 • T e m p l e 8-2287



The information indicated in the coupon is yours on request.

PHOTOCIRCUITS CORPORATION
Dept E-2, GLEN COVE, N. Y.

Please send us the literature items checked:

- Photocircuits' Engineering Brochure
- P-1 Fabrication
- P-2 Base Materials
- P-3 Platings & Plated-Thru Holes
- P-4 Etched or Plated Conductor Characteristics
- P-5 Printed Components
- P-6 Switch Plates & Commutator Discs
- P-7 Assembly & Dip Soldering
- P-8 Layout & Design
- P-9a Standard Printed Circuit Tolerances

NAME.....
COMPANY.....
ADDRESS.....
CITY.....ZONE.....STATE.....

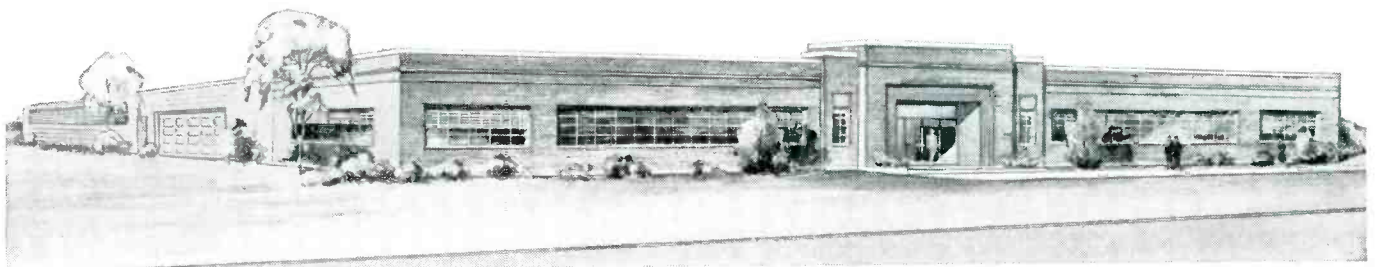

THE ONLY PERMANENTLY EFFECTIVE MAGNETIC SHIELDING

ECONOMICAL *FERNETIC** *CO-NETIC**
HELPS MINIATURIZATION

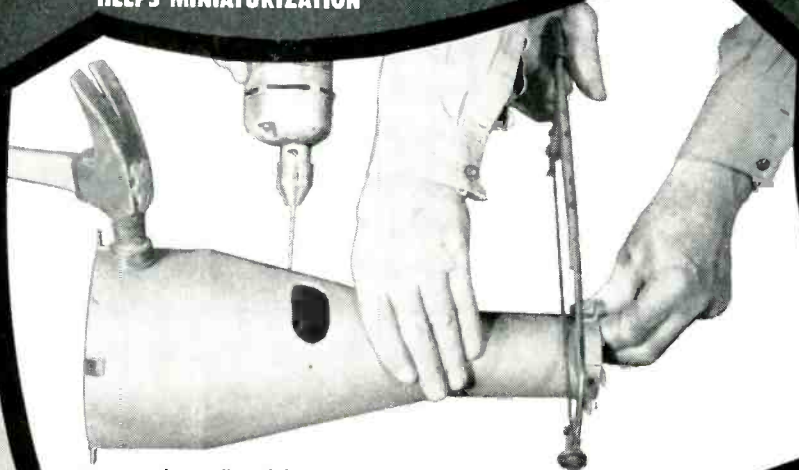

Permanently unaffected by shock or vibration from usage, drilling, punching, bending, etc. For maximum effectiveness, all possible joints are heliarc welded.

Provides simultaneous high and low intensity shielding as well as high and low frequency shielding, or any one of them.

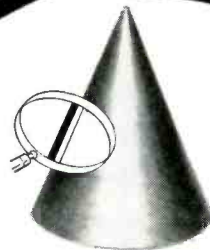

Sheds magnetic forces like a duck's back sheds water. Will not become magnetized. Permanently non-retentive (no residual magnetism).

Miniaturize by placing components close together, even mounted on the shield itself, reducing bulk circuit and costs and increasing efficiency.

Economical—competitively priced. Lasts indefinitely. Never requires rejuvenation. No need to buy new shielding periodically.

Comparatively lightweight.

CONSTRUCTION FEATURES

*Fernetic** is a special medium permeability high saturation steel rolled specifically for high intensity shielding and coated with ferrite and ferrous powders.

*Co-Netic** is an extremely high permeability steel rolled specifically for low intensity shielding and coated with ferrite and ferrous powders.

Material rendered permanently insensitive to shock and non-retentive by unique controlled magnetic aging process accomplished by the special coating which reduces circulating currents, raises the saturation point and holds the domains of the steel in random order as annealing places the domains in random directions.

NOTE: You may order these special steels uncoated and fabricate your own parts. Coating may be done in our plant or in yours as desired.

Permanently effective *Fernetic** *Co-Netic** is the only magnetic shielding material whose protective qualities continue undiminished indefinitely—regardless of shock, vibration or length of service.

Successfully used in hundreds of applications. Specify economical, reliable *Fernetic** *Co-Netic** for your magnetic shielding problems. Write for complete technical data.

To help us help you faster, send full details on your shielding problems today.

MAGNETIC SHIELD DIVISION
PERFECTION MICA COMPANY

20 N. Wacker Drive, Chicago 6, Illinois

Phone: DE 2-6130

Originators of Economical, Permanently Effective *Fernetic** *Co-Netic**
Magnetic Shielding

*Copyrighted trade names

See these products
at the IRE show

cannot usually be immersed in a bath of plating solution without risk of distortion or erosion of the plastic material, can be plated easily.

When gallium and indium are being used for forming a vacuum seal for tubes, a small ridge is machined on one of the nonferrous (usually copper) mating surfaces. This ridge is gold-plated, after which the mating surfaces are coated with gallium or indium by the process. Hand pressure at room temperature for gallium, or a low-temperature furnace for indium, creates diffusion of the metals, forming an alloy and producing a tight seal.

Among other uses are the plating of radar waveguides and platinum plating of molybdenum wire for electronic tubes to control secondary emission. This is being done on a commercial scale by automatic operation. The wire, unwinding from a reel, passes through a series of padded styluses which are dripped with the solutions, the intermediate rinsing being carried out by sprays.

Jig Transits Speed Antenna Tower Welding

JIG SETUP TIME for making prefabricated sections of television towers has been greatly reduced by using Keuffel & Esser jig transits for alignment in the North Wales, Pa. plant of Stainless, Inc. With this optical tooling instrument, the



Examples of tower sections welded with aid of precisely aligned fixture

BURTON BROWNE ADVERTISING

NEW

STRIP CHART

POTENTIOMETER RECORDER

\$ 395

THE G-11 . . . VARIAN'S NEWEST ACHIEVEMENT



PANEL MOUNT

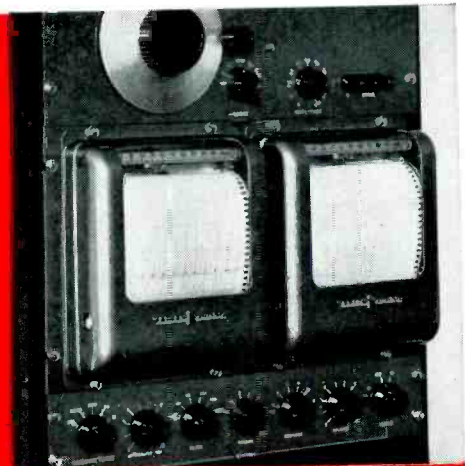

RACK MOUNT

PORTABLE



This new, low-cost recorder with **unitized measuring circuit** makes field adjustment to your requirements as simple as changing a tube. Quantity production from precision tooling assures uniformly high quality and fast delivery.

- 9 mv to 100 mv span, continuously adjustable
- 1 sec. balancing time — 1% limit of error
- High permissible source resistance — in excess of 50 K ohms
- Weighs less than 15 pounds
- Compact: only 8 $\frac{5}{8}$ " x 10 $\frac{3}{8}$ " x 7 $\frac{3}{4}$ " (5 $\frac{1}{4}$ " behind panel)

WRITE TODAY FOR COMPLETE SPECIFICATIONS
on the new G-11 Recorder and its unique companion, the G-10 Graphic Recorder.

Microwave Tubes • Instruments



Representatives in all principal cities

PALO ALTO 1 CALIFORNIA

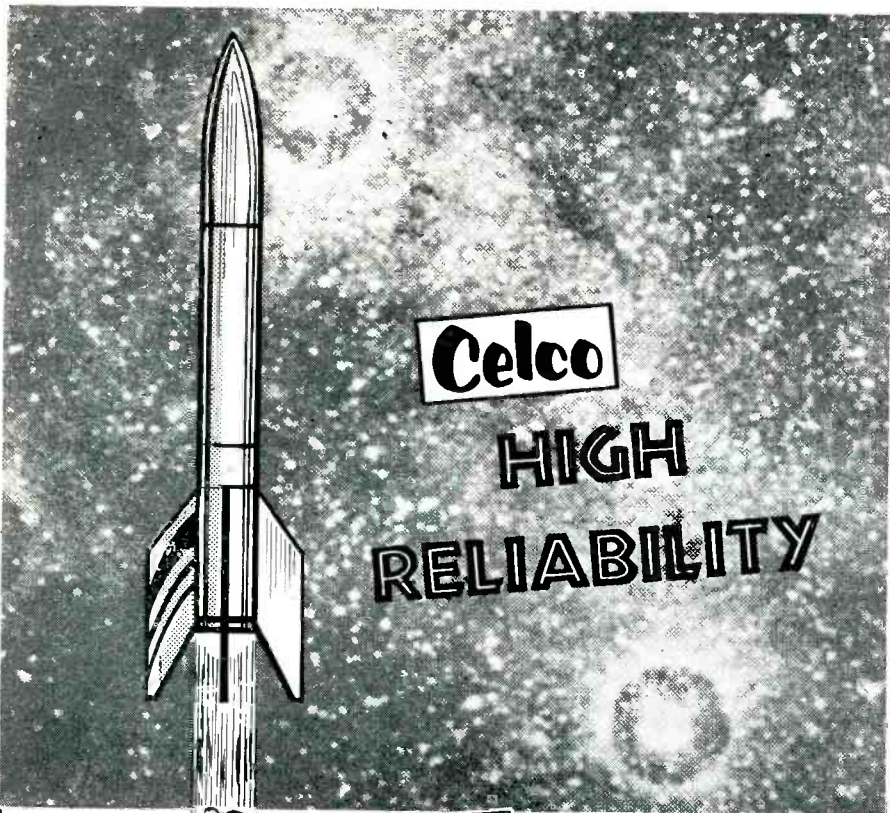

Celco
HIGH
RELIABILITY

Celco breaks through to higher performance ratings in:
**Magnetic Amplifiers,
Precision Transformers,
and Saturable Reactors.**

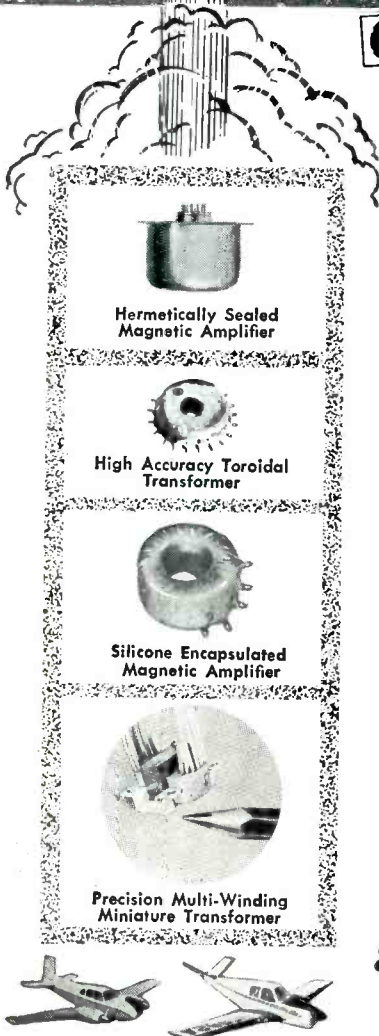

Hermetically Sealed
Magnetic Amplifier

High Accuracy Toroidal
Transformer

Silicone Encapsulated
Magnetic Amplifier

Precision Multi-Winding
Miniature Transformer

Celco developments on these components include precision high temperature windings and impregnation to permit higher operating temperatures, with reduced size and weight, with high reliability.

Units are available hermetically sealed or encapsulated, with epoxy resins or silicone rubber. For the maximum performance with difficult space requirements, Celco specialized experience can prove invaluable in the development of your new high reliability components.

Send us your specifications, or call Ramsey 9-1123 . . . today . . . for engineering consultation on your critical applications.



Constantine
Engineering Laboratories Co.
MAHWAH, N. J.

Your plant is only hours away by the Celco Air Fleet

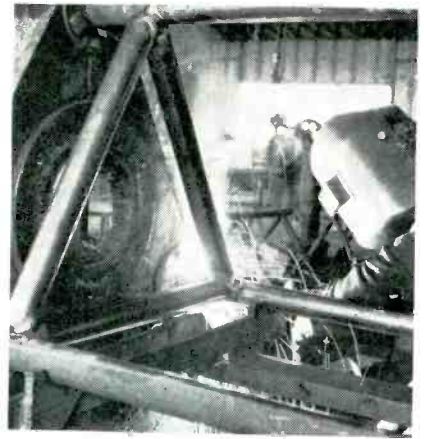

Welding tower tubing to flange bolted to pad on base plate

towers are now being held to tolerances of 0.001 inch, whereas formerly it had been difficult to hold the towers to tolerances of 0.008 inch when using a conventional surveyor's transit.

► **The Problem**—The antennas are manufactured in sections 20 or 25 feet long, for on-the-spot bolting to form guyed towers up to 1,200 feet high for uhf and vhf television transmitters, microwave repeaters and other uses. In a tower this high, perfect alignment without the slightest twist or tilt is highly important because a tower which is not completely plumb is potentially dangerous.

In constructing prefabricated triangular sections of a television tower which will rise one-fifth of a mile into the air, a chief difficulty is to make the six ends of each triangular section completely parallel, so that when 50 or more sections are fastened end to end the resulting tower will be rigidly perpendicular.

The individual triangular sections, which are usually of a welded lattice-work construction using tubular members, are set up in horizontal jigs between reference pads on two vertical plates, each having three reference pads for



Welding tower section in aligned fixture

XEMPIKA*

INDUSTRY FINDS A "FOUNTAIN OF YOUTH" IN THIS SELF-REJUVENATING CLARE RELAY

*EUREKA—It is Found (Greek)

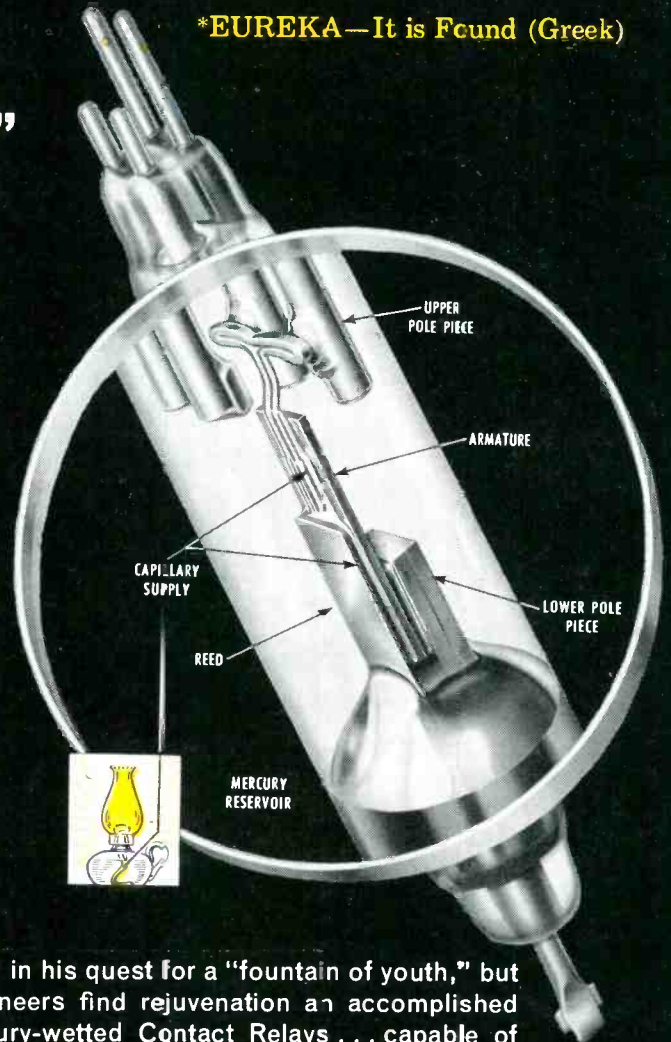

Drawings (left) from stroboscopic photographs show the cycle. (a) Filament of mercury forms between the contacts as they separate. (b) This becomes narrower in cross section and (c) finally parts at two points, allowing a globule of mercury to fall out. Mercury flows up the capillary path, replaces amount lost, restores the equilibrium. (d) The momentary bridging of the parting contacts—and the extremely fast break that ends it—minimizes the arc and adds greatly to contact load capacity. Contact closure between the two liquid surfaces bridges mechanical bounce and prevents any chatter from appearing in the electrical circuit.

Ponce de Leon failed in his quest for a "fountain of youth," but modern design engineers find rejuvenation an accomplished fact in CLARE Mercury-wetted Contact Relays . . . capable of billions of operations.

Contacts of these relays are constantly renewed. By capillary action, like that of a lamp wick, a new film of mercury coats the contacts with every make and break.

The magnetic switch is sealed in a high-pressure hydrogen atmosphere in a glass capsule. Surrounded by the operating coil, the capsule is enclosed in a vacuum-tube-type steel envelope.

Unlike ordinary relay contacts, these contacts never wear out; never get dirty; never lock or weld; never get out of adjustment; never bounce.

Send for CLARE Engineering Bulletins No. 120 and 122. Address C.P. Clare & Co., 3101 Pratt Blvd., Chicago 45, Illinois. In Canada: C. P. Clare & Co., 659 Bayview Avenue, Toronto 17. Cable Address: CLARELAY.

CLARE RELAYS

FIRST in the industrial field

Here's the fastest way to produce finished wire leads!



Allen-Bradley Co., producers of motor controls, use several Artos CS-6 automatic wire cutting and stripping machines in their Milwaukee plant.

high speed ARTOS AUTOMATIC MODEL CS-6

3000 STRIPPED WIRE LEADS in one hour ... each precision-cut with both ends perfectly stripped. That's the speedy pace set by the Artos CS-6 in producing wire leads up to 15 inches in length! Production rates vary in proportion to the length cut.

Highly accurate machine operation reduces work spoilage to an absolute minimum. Errors due to the human element are eliminated. *There is no cutting of strands or nicking of solid wire.*

PROVED PERFORMANCE

Time-consuming hand stripping jobs which once were a bottleneck in many plants are gone forever. As a result, Artos automatic wire strippers are paying their way in the mass production of television and radio sets, electrical appliances, motor controls and instruments of all kinds.

Plan now to cut wire stripping costs in your plant... with the high speed, automatic Artos CS-6.

CS-6 CAPACITY

Finished Wire Leads Per Hour:

lengths to 15", 3000; 64"-97" lengths, 500.

Stripping Length: 1½" max. both ends.

Cutting Length: max., 97"; min., 2"; special, ⅞".

WRITE FOR BULLETIN

Descriptive technical sheet tells how the Artos CS-6 can save you money, manpower and time.

ARTOS ENGINEERING CO.

Automatic Wire Cutting and Stripping

2743 South 28th Street • Milwaukee 46, Wisconsin

**MEASURES,
CUTS and
STRIPS
wire, cord
and cable
at speeds up to
3000
pieces per hour**

2-Conductor Twisted Wire

Single Conductor Solid Wire

2-Conductor Parallel Stranded Wire

300 Ohm Television Wire

SJ Cord

Heater Cord

Braided Cord With Rubber Jacket

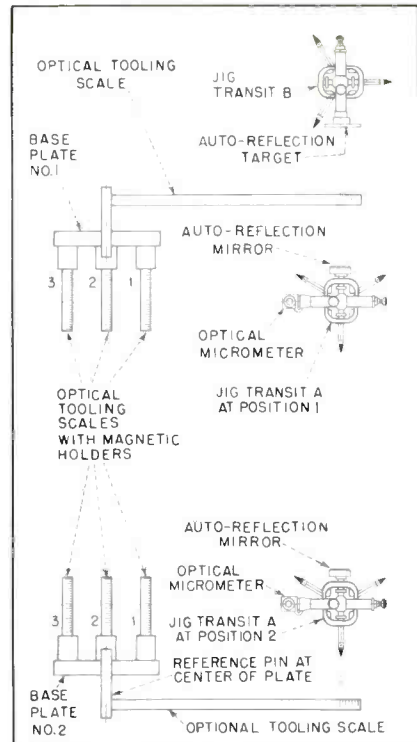

FIG. 1—Steps in aligning base plates between which a 20-foot antenna tower section is assembled and welded

the tower rods. Before welding begins, it is essential that these reference pads be parallel to each other and perpendicular to a reference line through the center of the jig.

► **The Tool**—Fundamentally, the jig transit is a surveyor's transit without horizontal or vertical circles and verniers and with only a single center such as is used in a conventional level.

► **Procedure**—The first checking step in the setup procedure, as developed by John Amey of the antenna firm, is to buck in a jig transit on vertical base plate No. 1 to check its vertical plane. As shown in Fig. 1, jig transit A is mounted on a mechanical lateral adjuster supported on a tripod at position 1. Optical tooling scales with magnetic holders are placed on two of the tower flange locations, such as at pads 1 and 3.

The jig transit is now placed so the telescope line of sight is parallel to the plane of the fixture head. The instrument tripod is set up in line by eye first. A pair of adjacent leveling screws is now loosened and the leveling head is rotated until

Selected **MINIATURES** for **TRANSISTOR** and **PRINTED CIRCUIT** **APPLICATIONS**



Good-All
capacitors

Design and component engineers are invited to acquaint themselves with the wide variety of miniature low voltage capacitors developed by Good-All Electric. These compact new designs are ideal companion items for use with transistors and other printed circuit components.

Many space-saving Good-All types are as useful for military as for civilian applications. This is particularly true of the molded-in-Epoxy types. It has also proven to be the case with "wrapped" mylar designs which lend themselves to use in potted subassemblies.

Mylar* dielectric is frequently selected for Good-All miniatures because of its superior electrical characteristics — high I.R., low power factor and excellent stability with life. The space-saving it offers in low voltage designs is also an attractive feature.

Good-All offers a wide selection in 50 Volt miniature designs

REPRESENTATIVE TYPES

TYPICAL SIZE COMPARISONS

Cap. Volts Diam. Lgth.

AXIAL LEAD

600UE . . . Mylar dielectric winding molded in dense, moisture-resisting Epoxy.	.01	50	.312 x 15/16
	.1	50	.438 x 1-3/16
	.47	50	.562 x 1-15/16
663UW . . . Mylar dielectric winding with tough plastic film case and thermo-setting end seals.	.01	50	.188 x 11/16
	.1	50	.281 x 15/16
	.47	50	.437 x 1-15/16
613G . . . Mylar dielectric winding, extended foil construction, hermetically-sealed metal housing.	.01	50	.173 x 23/32
	.1	50	.313 x 27/32
	.47	50	.50 x 1-3/16



GOOD-ALL

RADIAL LEAD

600RE . . . This novel design combines features of conventional tubular capacitors and upright mounting types. The mylar dielectric winding is completely encapsulated in Epoxy. In addition to its attractive glossy red appearance the Epoxy formulation developed by Good-All yields a tough, durable coating with excellent dielectric strength.	.01	50	.250 x 11/16
	.1	50	.375 x 15/16
	.47	50	.50 x 1-3/4



GOOD-ALL

UPRIGHT MOUNTING

600UPE . . . Mylar dielectric winding molded in dense, moisture-resisting Epoxy.	.01	50	.438 x 15/16
	.1	50	.562 x 1-3/16
	.47	50	.688 x 1-15/16
620UPB . . . Mylar dielectric winding with molded bakelite housing and thermo-setting plastic end seal.	.01	50	.375 x 1
	.1	50	.375 x 1-1/4
	.47	50	.625 x 1-7/8
620PM . . . Mylar dielectric winding encapsulated in a plastic impregnated paper tube.	.01	50	.343 x 15/16
	.1	50	.410 x 1
	.47	50	.562 x 1-3/4



GOOD-ALL

EPOXY COATED CERAMIC DISCS

These Epoxy coated discs are ideal for use on printed circuit boards that are to be dip soldered, since no wax coating is necessary. The available types of ceramic discs are too numerous to describe in detail. A complete brochure with specifications on each type will be mailed to you upon request.

Dimensional information is contained in the Good-All ceramic disc brochure.



GOOD-ALL

*DuPont's trademark for polyester film.

Write or phone for
consultation on
specific design
problems or to
secure detailed
specifications on the
various capacitor
types shown.



GOOD-ALL ELECTRIC MFG. CO.

OGALLALA, NEBRASKA

A leading manufacturer of Tubular and Ceramic Disc Capacitors

SYSTEMS RAKSCOPE

by

Waterman

MODEL S-12-C

INDIVIDUAL
SYSTEMS
ADAPTATIONS

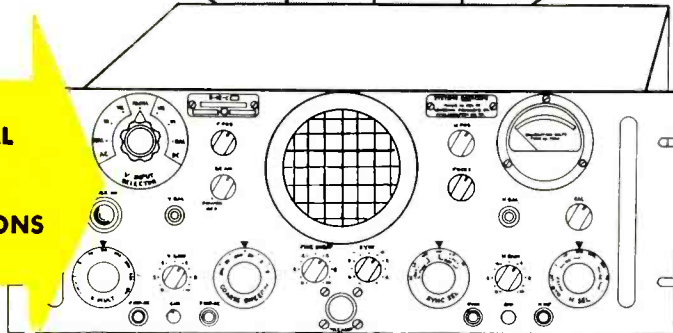

7" HIGH

10" DEEP

ANOTHER EXAMPLE OF *Waterman* PIONEERING...

The S-12-C series of Systems RAKSCOPES have been developed for the dual purpose of monitoring and troubleshooting of rack-mounted equipment. These oscilloscopes obtain a new degree of flexibility with the multiple input selector making possible selection of different signal sources. This optional vertical input selector, with built-in attenuators, selects either front panel connectors for troubleshooting or rear mounted connectors for systems monitoring. This permits the omission of an entire switching panel from an overall system resulting in circuit and space economies. A ruggedized construction philosophy has been carried throughout. Vertical and horizontal amplifiers are identical, each having a frequency response from dc to 700 kc (-2 db). Their sensitivities are 50 and 72 millivolts rms per inch of deflection. Signal amplitude calibration employs a direct reading meter. The time base is operative in either trigger or repetitive modes with a range from 1/2-cycle to 50 kc. Synchronization is independent of polarity. Sync. lockout circuits are employed for stable operation over wide range of writing speeds and amplitudes. A unique plug-in elliptical sweep network makes frequency calibrations more simplified. Power requirements: 105-125 volts, 50 to 400 cycles. Accessory probes available; attenuator and amplifier types.

WATERMAN PRODUCTS CO., INC.

PHILADELPHIA 25, PA.
CABLE ADDRESS: POKESCOPE

MANUFACTURERS OF

- PANELSCOPE*
- S-4-C SAR PULSESCOPE*
- S-5-C LAB PULSESCOPE*
- S-11-A INDUSTRIAL POKETSCOPE*
- S-12-B JANIZED RAKSCOPE*
- S-12-C SYSTEMS RAKSCOPE*
- S-14-A HIGH GAIN POKETSCOPE*
- S-14-B WIDE BAND POKETSCOPE*
- S-14-C COMPUTER POKETSCOPE*
- S-15-A TWIN TUBE POKETSCOPE*
- RAYONIC* Cathode Ray Tubes
and Other Associated Equipment

*T. M. REG.

MEMO
Write for
details
today!

W*

WATERMAN PRODUCTS

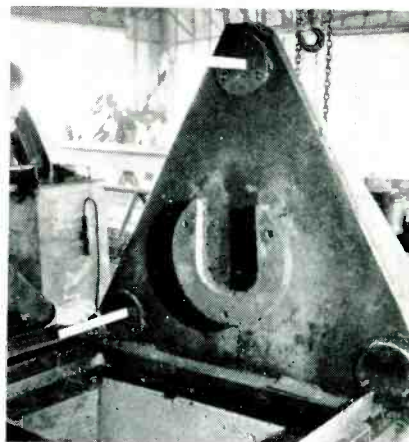

Base plate at end of fixture, showing scales with magnetic holders on two of the three pads for the lower flanges



Checking base plate No. 1 with first jig transit

a pair of opposite leveling screws is roughly in line with the vertical plane to be established. The two plate bubbles on the transit are centered. The transit telescope is aimed at a graduation on the far scale, then aimed at the near scale without turning the instrument about its vertical axis.

After noting where the line of sight falls on the near scale, the instrument is moved with the mechanical lateral adjuster until the line of sight has moved in the direction of, and slightly beyond the corresponding graduation on the near scale. The photo bubbles are recentered, the telescope is reaimed at the far scale, the near scale is checked again, and the adjustments are repeated until the line of sight checks out the same on both scales.

One of the scales is now moved to pad 3 on base plate No. 1 and this point is similarly checked by

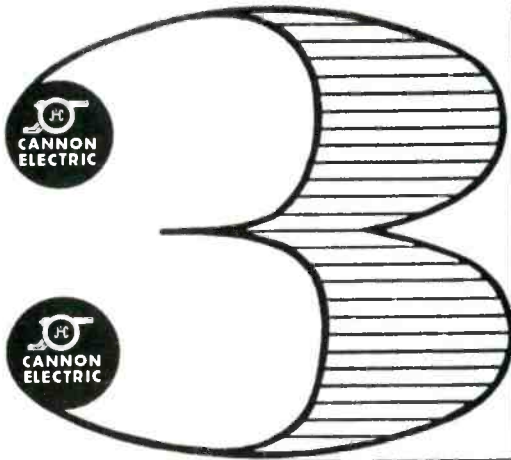

IMPORTANT ANNOUNCEMENTS

FOR BUYERS OF MULTI-CONTACT ELECTRIC CONNECTORS!



DIAMOND DIVISION MOVES TO SALEM, MASS.

On December 1, 1956 the Diamond Division of Cannon Electric Co. moved headquarters and all manufacturing facilities from Wakefield, Mass. to the Salem Industrial Center, Salem, Mass., in the heart of the Eastern Electronics Industry.

Faster Service. The new location has excellent sea, air, truck and rail facilities and will provide faster service for all Cannon Electric customers east of the Mississippi.

Duplicate Tooling. The new Salem plant has 100,000 square feet which leaves plenty of room for expansion. Duplicate tooling is planned of many of Cannon proprietary items, which will give you, our customers, a dual source of supply. In addition to supplying Cannon coaxial connectors, the Salem plant will produce the D miniature line, and the DPX connectors to start with, additional lines and items being added later. Further expansion is planned, including modern molding and die-casting facilities, which will practically be duplicating facilities of our parent plant in Los Angeles.

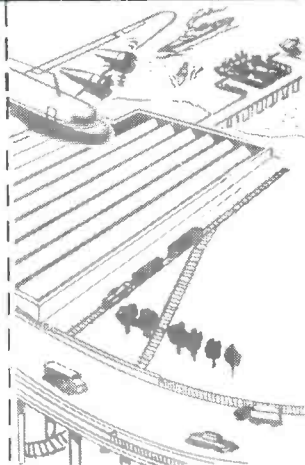

CHANGES NAME TO EASTERN DIVISION, CANNON ELECTRIC CO.

Effective December 1, 1956 the Diamond Division Cannon Electric Co., has been changed to EASTERN DIVISION, Cannon Electric Co.

EAST OF THE MISSISSIPPI

Send Orders for standard AN's, audio connectors, D miniatures, coaxial connectors, K miniatures and standard K connector distributor items to:
CANNON ELECTRIC CO., EASTERN DIVISION
 PINGREE & LEAVITT STS., SALEM, MASSACHUSETTS
 Telephone: PT 5-0700 - Teletype: Salem, Mass. 784

WEST OF THE MISSISSIPPI

Send Orders for all Cannon products to:
CANNON ELECTRIC CO.
 3208 HUMBOLDT ST.
 LOS ANGELES 31, CALIFORNIA
 Telephone: CApitol 5-1251
 Teletype: Los Angeles, Calif. 872



WILL CONSOLIDATE FACILITIES AND SERVICES WITH THOSE OF EAST HAVEN, CONN. PLANT

All East Coast Facilities Under One Roof. On March 1, 1957 all manufacturing and service facilities of the East Haven, Conn. plant of Cannon Electric Co.

will be moved to the Salem, Mass. plant. These operations, combined with the former Diamond Division equipment, will give a consolidated plant offering the most modern manufacturing, engineering, design, and laboratories available on the East Coast for the production of high-reliability multi-contact electric connectors.

Service Store Operation Expanded. Greatly expanded facilities, and expanded inventories, will provide better "off-the-shelf" service by the Cannon East Coast Service Store, which will also be at the Salem plant (moving from East Haven) after March 1.



Cannon Electric Co. is the world's largest manufacturer of multi-contact electric connectors for the aviation, electronics, broadcasting and automation industries. Plants in Los Angeles, Salem, Mass., Toronto, Can., Melbourne, Austl., London, Eng. Manufacturing licensees in Paris and Tokyo.

Manufacturers Representatives,
 Sales Engineers, Authorized Stocking Distributors
 Available Everywhere to Serve You!



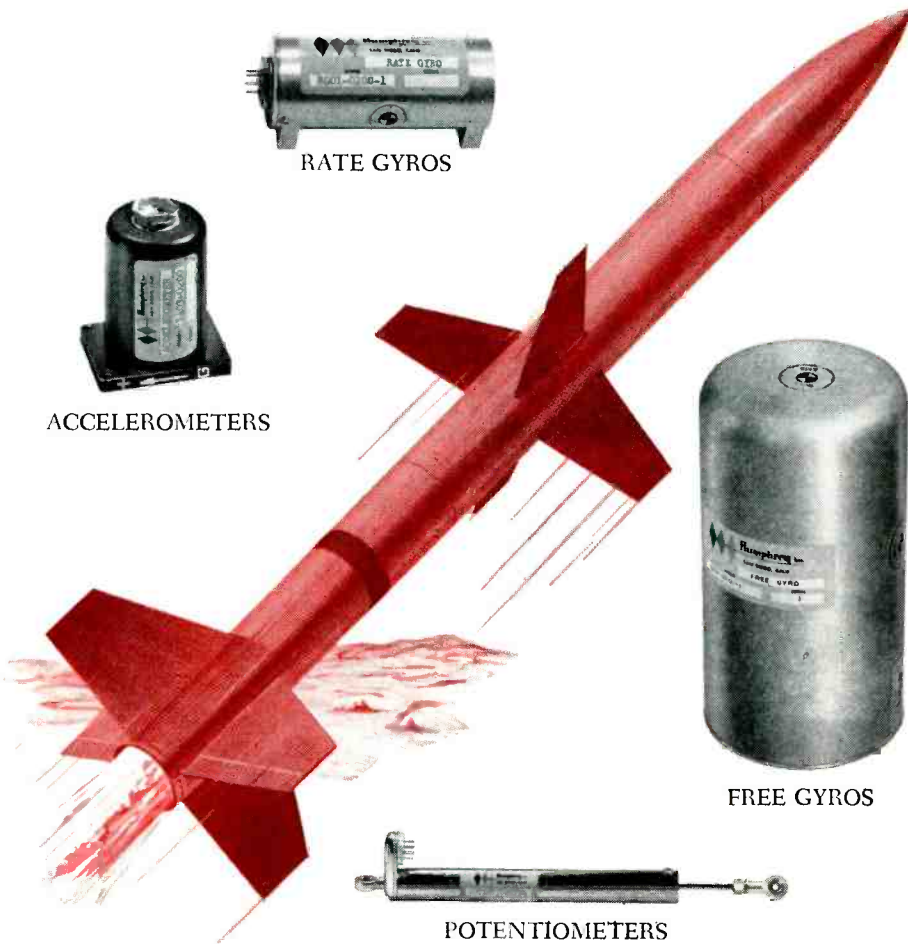

RATE GYROS

ACCELEROMETERS

FREE GYROS

POTENTIOMETERS

Humphrey instruments for your entire missile system

For maximum performance in your missile intelligence system, specify *Humphrey* free gyros, rate gyros, accelerometers, and precision potentiometers. Ten years exclusive experience furnishing instruments for most advanced aircraft and missile systems — plus complete engineering, production, and quality control facilities — guarantee performance.

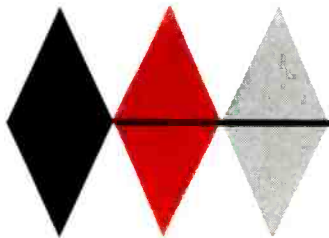

Humphrey Inc.

ELECTRO-MECHANICAL INSTRUMENTS

2805 CAÑON STREET

SAN DIEGO 6, CALIFORNIA

WRITE
FOR
FREE
CATALOG

HUMPHREY INC. • DEPT. E-2 • 2805 Cañon St., San Diego 6, Calif.
Please send me your new catalog as soon as it is off the press.

NAME _____
COMPANY _____
ADDRESS _____
CITY _____ STATE _____

swinging the telescope up and down. If the third point is not in line, the pad on the base plate is adjusted until it does line up with the other two pads in a vertical plane.

► **Setting Second Transit** — The next step is placing jig transit B in position so its line of sight is exactly at right angles to that of jig transit A. This part of the procedure utilizes an auto-reflection mirror on jig transit A and an auto-reflection target on the telescope of jig transit B. The position of the second transit is so adjusted that the image of the target as seen in the mirror with the telescope is clearly centered on the viewing cross-lines of jig transit B. This

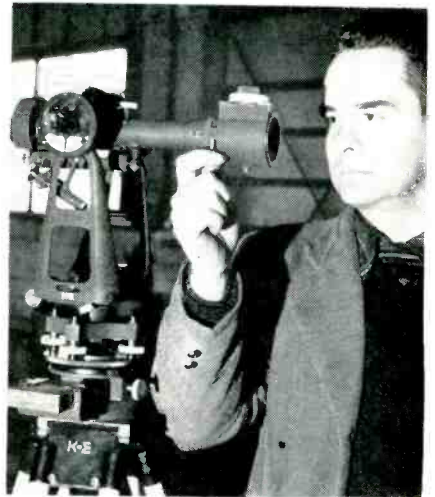

Auto-reflection mirror is mounted at end of telescope axle, and optical micrometer fits over barrel of telescope as shown

transit now establishes a line of sight at right angles to the plane of base plate No. 1, hence parallel with the tower section.

► **Checking Base Plate No. 2** — Transit A is now moved to position 2 in Fig. 1 and placed in the line of sight of transit B by adjusting until the image seen in the mirror is again centered on the cross-line of transit B. Transit A now establishes a vertical plane parallel to the plane of base plate No. 1. The scales are now transferred to the pads of base plate No. 2 and the telescope is swung up and down to determine whether base plate No. 2 is parallel with the other plate within the acceptable tolerance limits. If parallel, the telescope

Silicone Molding Compound Has Superior Insulation Resistance

While Dow Corning 301 Molding Compound is frequently specified for electrical parts because of its outstanding resistance to high temperatures, this versatile material also has electrical properties superior to comparable plastics at room temperature. Take insulation resistance, for example—

The accompanying graph traces a summary of tests run on four miniature 26-contact connectors molded by Continental Connector Corporation, Long Island City, N. Y. All plugs were identical in physical form, but each was molded from a different material as indicated on the graph.

Not only did the plugs made of 301 Molding Compound have the highest initial insulation resistance, but their margin of superiority broadened substantially after 240 hours at 96% RH. These tests were

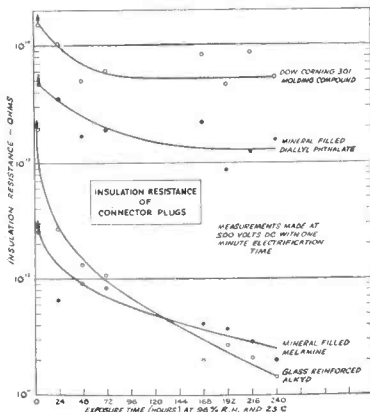

conducted at room temperature; at elevated temperatures the superiority of the silicone molding compound is even more pronounced.

Performance like this is one of the reasons why Continental, among the world's largest producers of connectors, reports increasing interest in "301" molded units. Already undergoing tests in guided missiles, industrial ovens and even kitchen ranges, 301 Molding Compound is manufactured to meet Specification MIL-M-14E, Grade MSI-30. Continental has announced that its entire connector line will soon be available in 301 Molding Compound. No. 41

Protect Current Transformer With Silastic Encapsulation

Encapsulation in Silastic*, Dow Corning's silicone rubber, has proved to be an ideal solution to the problem of protecting electrical and electronic components from vibration, heat, moisture and corrosive conditions. An excellent example is found in the new Type 5-kv current transformer made by Westinghouse.

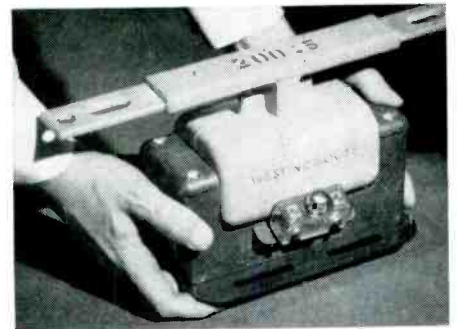

A highly compact unit designed for indoor metering or relaying applications, the SM-5 transformer is the smallest, lightest and most durable 5-kv unit ever built. Silicone insulated throughout, the SM-5 easily meets all ASA and NEMA standards.

To further assure top dependability, the entire core-coil assembly is encapsulated in an attractive, one-piece silicone rubber jacket. This jacket remains resilient and

retains its original dielectric properties even in locations subject to extreme changes in temperature and humidity. The silicone rubber also expands and contracts with the coil. As Westinghouse aptly describes it, "transformer performance is sealed in to stay." *T. M. REG. U. S. PAT. OFF. No. 42

New Pressure Sensitive Tape Offers Outstanding Adhesion at -65 to 500 F

Designers looking for new ways to cut production costs or to improve product performance are certain to find many applications for Permacel EE-3621, a glass-cloth-reinforced tape coated with a pressure sensitive Dow Corning silicone adhesive.

Adhesion values for the new Permacel tape are exceptionally high at extreme temperatures. A 1-inch strip holds—

- 50 ounces at 150 F
- 30 ounces at room temperature
- 74 ounces at -65 F

TYPICAL ADHESIVE STRENGTH OF EE-3621 ON VARIOUS SURFACES

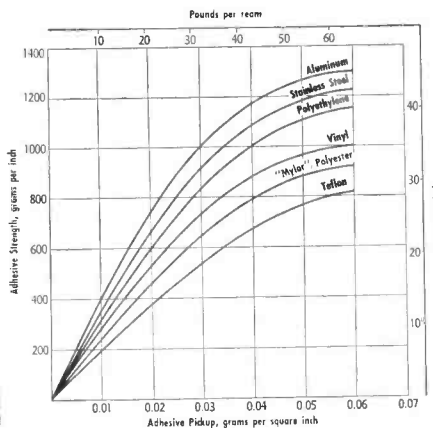

The tape remains tacky and flexible at -65 F and does not become hard or brittle in service at 500 F. It retains excellent moisture resistance and dielectric strength at all temperatures.

Permacel EE-3621 is supplied with a corrugated glass cloth backing to minimize slippage of wire bundles in the production of electrical components.

Although designed primarily for use in Class H motors and transformers, the silicone adhesive permits EE-3621 to be used for many taping applications where extreme temperatures are the order. No. 43

Send Coupon for More Information

DOW CORNING CORPORATION - Dept. 4814
Midland, Michigan

Please send me 41 42 43

NAME

TITLE

COMPANY

STREET

CITY ZONE STATE

POSSIBILITIES UNLIMITED

bring yourself
up-to-date on
INDIUM
... and what it
can do for you

ORBITS
O-3
N-18
M-18
L-18
K-8
2

49 ^{2P}_{1/2}
indium $r^l=2,4$

In ⁵⁸ ^{5p}₁

114.76 ¹¹⁴_⊖ ³_×

117 ⊖ 116 ⊖ 115 ⊖
113 ⊖ 112 ⊕ 111 ⊕ 110 ⊕

QUALITY

at the Indium Corp. of America means: purity of metals, and strict adherence to specifications.

SERVICE

means prompt delivery to customers, and technical help in specific uses of Indium.

RESEARCH

means "forward looking" with respect to new products and techniques.

WRITE TODAY

for new Indium bulletin... "Nomographic Charts of Pellets and Spheres - Weights per Thousand in Grams."

INDIUM... the metal of unlimited possibilities... is the "element of success" in many startling engineering achievements.

Its unique stabilization properties have made possible revolutionary metallurgical advances in the electronics and aircraft fields.

INDIUM may have significant applications in your own product development!

Why not discuss your problems with us?

AVAILABLE IN COMMERCIAL QUANTITIES

- Indium metal (specially refined 99.999% pure)
- Indium metal (99.97+ % pure)
- Indium wire • Indium foil and ribbon
- Intermediate "indalloy" solders
- Indium pellets • Indium spheres • Indium powders

The **INDIUM** Corporation of America

1676 Lincoln Avenue

Utica, New York

SINCE 1934... PIONEERS IN THE DEVELOPMENT AND APPLICATIONS OF INDIUM FOR INDUSTRY

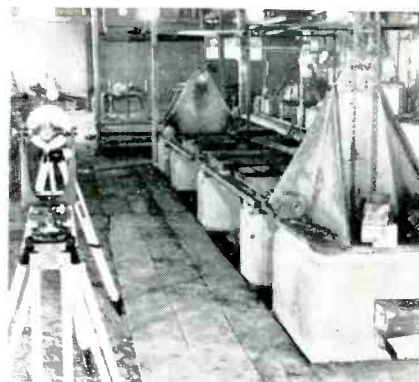

Setup for establishing line of sight parallel to bed of fixture, after checking base plate No. 1 in foreground

sees the same scale reading at each of the three pads. An error as small as 0.001 inch can be detected.

The bed of the fixture is checked by measuring with an optical tooling scale from a center reference pin on each base plate to the line of sight established by jig transit B. The scale is read at each position with an optical micrometer attached to jig transit B. The distance between the base plates is measured with steel tape.

Plastic Cases Protect Airborne Radar Jammers

HIGH-SPEED mass production of fibrous glass reinforced plastic shipping containers for GE airborne radar jammer units has been



New process molds nonuniform sections automatically without hand positioning of fibrous reinforcement. Knob is stacking lug, formed in final molding operation in upper half of container. Bottom half has corresponding indentations

Where the switching job is big, but the space is small...

Specify... THE ORIGINAL DOUBLE-POLE SWITCH WITH EIGHT CONTACTS.
Makes possible a wide variety of circuit combinations.

- THE ORIGINAL DOUBLE-POLE SWITCH WITH SIMULTANEOUS "MAKE AND BREAK" ACTION.
Reduces arcing, prolongs switch life, increases electrical capacity and permits unusual applications.
- THE SMALLEST DOUBLE-POLE SWITCH.
Saves weight and space; allows more compact designs.

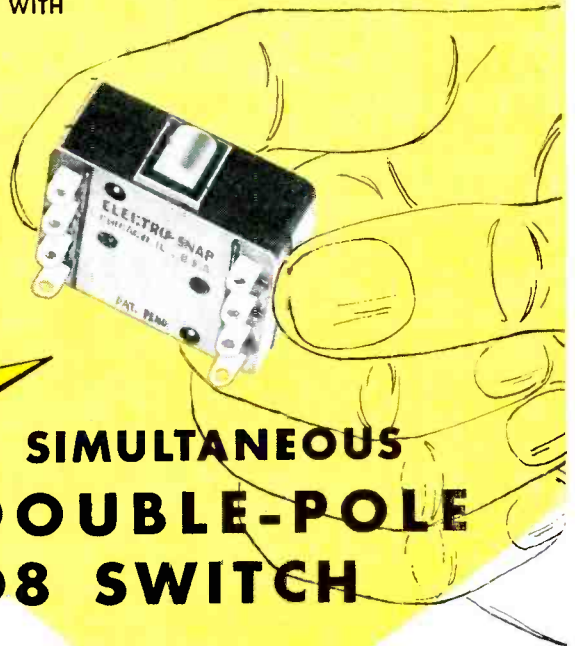

the original



SIMULTANEOUS DOUBLE-POLE D8 SWITCH

Look What You Can Do With It...

Control Four Circuits with ONE Snap

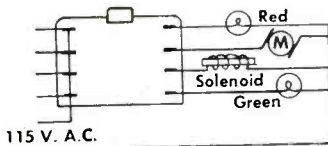

Used in motor control device at left, switch, when actuated, (1) turns off red pilot light; (2) completes circuit to motor winding, starting motor; (3) opens circuit to solenoid latch; locking door to motor gear box; and (4) turns on green pilot light.

Start, Stop, Reverse Three-Phase Motors

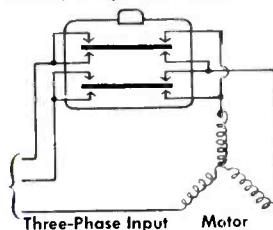

Because this new double-pole switch can simultaneously break or reverse current flow through *two* windings of a three-phase motor, you can use it as an inexpensive limit switch on three-phase lathes and drills. Use it to control automatic sequences, to limit motion of machine members driven by three-phase motors and as a start-and-stop switch.

Wire Movable Poles in Series to Switch High Current or High Voltage

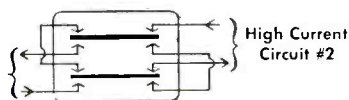

High Voltage
Circuit #1
110 V. D.C.

As proof of simultaneous action, you can connect the two movable poles in series to increase contact area for high current applications and to increase number of contact breaks for high voltage switching.

Eliminate Expensive Relays and Additional Switches in Many Applications

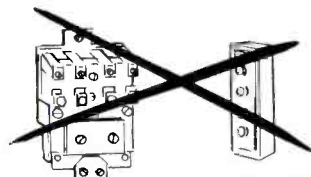

This double-pole switch offers designers a wide variety of circuit hook-ups that were formerly possible only with complicated relays or a number of separate switches. Controlling three-phase motors is but one example.

Equip with Actuator

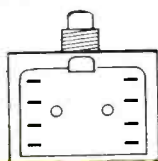

Push-button actuator may be added for panel mounting or for long overtravel. Switch is rated at 15 amps 125/250 v. AC or 10 amps inductive, 30 v. DC. Case dimensions are only 1 1/2" x 7/8" x 1/2". Weighs only 20 grams.

OTHER ELECTRO-SNAP PRECISION SWITCHES

- Standard Basic Switch
- Sub-Miniature Basic Switch
- Immersion-Proof Switch
- Industrial Limit Switches
- Hermetically-Sealed Switches

GET FULL DATA

ELECTRO-SNAP SWITCH AND MFG. COMPANY

4236 West Lake Street
Chicago 24, Illinois

Please send full information on the original Electro-Snap D8 Double-Pole Switch to:

Name _____
Title _____
Company _____
Street _____
City _____ Zone _____ State _____



MAKES THE DIFFERENCE

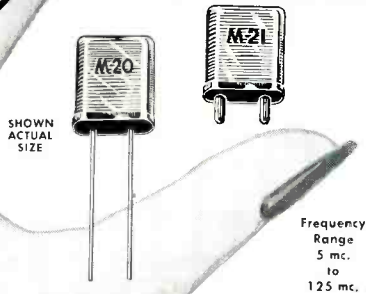

SHOWN ACTUAL SIZE

Frequency Range
5 mc.
to
125 mc.

You can't see it . . . feel it or weigh it. Only by observing their unexcelled performance can you appreciate the assurance of super dependability that regular users of McCoy crystals have come to take for granted. Discover it for yourself. Next time you order crystals—insist that they be . . .

. . . the real McCoy

Frequency Range
500 kc.
to
125 mc.



SHOWN ACTUAL SIZE

McCoy ELECTRONICS COMPANY

MT. HOLLY SPRINGS, PA.

DEPT. E-2

Phone 376 and 377



Preformed sides, tops and bottoms for containers are oven-dried for 65 minutes at 160 C

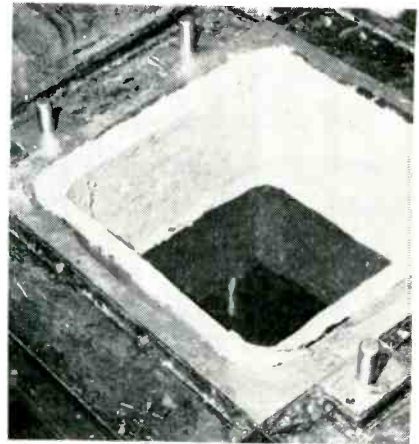

Preformed sections are placed in chromium-plated steel mold, liquid polyester resin is poured in, mating portion of mold is brought down by press and pressure is applied for approximately 4 minutes at 100 C to distribute thermosetting resin evenly through entire preform

achieved by Pressurform Container Corp., Swarthmore, Pa. through use of precision low-cost preforms that eliminate time-consuming layup of reinforced areas. The new process, fully automatic and continuous, makes possible low-cost production of products of nonuniform thickness.

The preforms are the shape of the finished product but consist only of reinforcing material. Ribs, bosses and other protuberances become integral parts of the preform in one operation. The reinforcement is varying proportions of glass fibers and one of several organic materials. The preform, along with a resin such as liquid polyester, is placed in a mold under

Compact
amplifier-voltmeter
with millivolt
sensitivity

High frequency
extended range
oscillator

Low-distortion,
wide-band
bridge type
signal generator

BIG PERFORMANCE IN SMALL PACKAGES



Type 346 double-duty meter instrument. Serves simultaneously as vacuum tube voltmeter and highly sensitive a-c voltage amplifier.

METER RANGES: 0.001, 0.003, 0.01, 0.03, 0.1, 0.3, 1.0, 3.0, 10.0, 30.0, 100.0, and 300.0 volts full scale. **ACCURACY:** $\pm 3\%$, 20 cps to 1 mc, $\pm 5\%$, 10 cps to 2 mc. **STABILITY:** $\pm 1\%$ at any line voltage between 105 and 130 volts ac. **INPUT IMPEDANCE:** 10 megohms — shunted by 24 uuf. **AMPLIFIER:** Maximum voltage gain 1000; maximum output voltage 1 volt. **OUTPUT IMPEDANCE:** 600 ohms resistive. **HUM AND NOISE:** One minor division max. **OVERLOAD:** Automatic overload protection. **POWER REQUIREMENTS:** 117 volts $\pm 10\%$, 50-400 cps 40 watts. **SCALE:** Illuminated $4\frac{1}{4}$ " damped meter movement. **DIMENSIONS:** $6\frac{1}{2}$ " high, $4\frac{1}{4}$ " wide; and $7\frac{1}{2}$ " deep overall. Weight: $6\frac{1}{2}$ lbs.

PRICE **\$200***

* Price slightly higher in 50 cycle areas.



Type 347 extended range oscillator featuring extended high frequency range, low waveform distortion, constant level output and remarkably small physical size.

FREQUENCY RANGE: 18 cycles to 1.1 mc in five overlapping ranges. **DISTORTION:** Total harmonic distortion of waveform less than 2/10 percent when operated into 10K ohms or higher load. **CONSTANT OUTPUT:** Output voltage constant to within $\pm \frac{1}{2}$ db from 18 cps to 200 kc for any output over 0.1 volt. High range ± 2 db. **OUTPUT LEVEL:** 10 volts open circuit. Maximum load current: 4 ma. rms. **OUTPUT CONTROL:** Logarithmic control calibrated in volts. **INTERNAL IMPEDANCE:** Approximately 400 ohms. **CALIBRATION ACCURACY:** $\pm 2\%$ (+1 cycle) from 18 cps to 210 kc, $\pm 10\%$ to 1.1 mc. **STABILITY:** $\pm 0.3\%$ for line voltage range of 105 to 130 volts, and $\pm 0.5\%$ for temperature range of 0 to 50°C . **HUM AND NOISE LEVEL:** 3.0 Millivolts or 60 db below output signals, whichever is greater. **DIMENSIONS:** $6\frac{1}{2}$ " high, $4\frac{1}{2}$ " wide, $6\frac{1}{2}$ " deep overall. Weight: 6 lbs.

PRICE **\$150***



Type 348 signal generator provides low distortion sinewave signals between the frequencies of 0.9 cps and 510 kc. Just right for design investigations of magnetic amplifiers, servomechanisms, computers and general laboratory and field use.

FREQUENCY CHARACTERISTICS
RANGES: 0.9 cps to 510 kc in six ranges. **STABILITY:** $\pm 0.5\%$ for frequencies up to 100 kc for line-voltage variations 105 to 130 volts and temperature within 0 to 50°C . **CALIBRATION ACCURACY:** $\pm 2\%$ ($+\frac{1}{2}$ cycle) above 10 cps; $\pm 5\%$ below 10 cps. **DISTORTION:** Less than 0.1% over most of the useable range rising to less than 0.3% at 30 cps.

AMPLITUDE CHARACTERISTICS
OUTPUT LEVEL: 50 volts, $\pm 10\%$ 2 watts or 40 ma maximum. **OUTPUT RANGES:** Continuously variable from 0 to 0.05V; 0.5 volts; 5.0 volts; 50.0 volts. **STABILITY:** ± 0.5 db referred to 1 kc over the entire frequency range. **OUTPUT IMPEDANCE:** At the 50 volt output range — 6 ohms in series with 1000 microfarad; 5 volt output range — 6 ohms in series with 1000 uf; 0.5 volt range — 55 ohms; 0.05 volt range — 6.2 ohms. **POWER SUPPLY REQUIREMENTS:** 117 volts ac, $\pm 10\%$; 50-400 cps, 110 watts. Fuse protection; 1.6 amperes, slow-blow. **DIMENSIONS:** $9\text{-}7\frac{7}{8}$ " high, $7\text{-}5\frac{1}{16}$ " wide, $10\text{-}11\frac{1}{16}$ " deep overall. Weight: 19 lbs.

PRICE **\$325***

DU MONT[®]

DESIGNS FOR THE TIMES
Oscilloscopes • Pulse Generators • Signal Generators • Vacuum Tube Voltmeters • Electronic Switches
Recording Cameras • Industrial Television • Scanning Systems • Electronic Components • Pulse Transformers

Write For Complete Details

Technical Sales • ALLEN B. DU MONT LABORATORIES, INC. • Clifton, N.J.



**HERE'S THE RELAY
THEY'RE TALKING ABOUT**

ELGIN'S NEOMITE

Designers are excited about the unique advantages of Elgin's new *NEOMITE* Relay. It's the world's smallest, weighing just .09 ounces, and requires only 100 milliwatts of power to open and close electrical circuits. *There's nothing like it for size or performance . . . and now they're available from leading distributors.*



SPECIFICATIONS

Relay Type	NMIC 50	NMIC 200	NMIC 500	NMIC 1K	NMIC 2K
D. C. Coil Resistance ($\pm 10\%$ @ 20°C)	50 Ohms	200 Ohms	500 Ohms	1000 Ohms	2000 Ohms
Coil Voltage	3-5 V.D.C.	6-10 V.D.C.	9-15 V.D.C.	12-21 V.D.C.	18-30 V.D.C.
Pickup	44 MA Max.	22 MA Max.	14 MA Max.	10 MA Max.	7 MA Max.

Duty: Continuous

Dropout: 30 to 60% of pickup

Contact Rating: .25 AMP at 28 V.D.C. resistive load

Operation Time: 4 milliseconds max. @ rated voltage

Dielectric Strength: Sea level: 500-V RMS. High altitude: 500 V RMS

Shock: Shock test: 50 G. without damage

Vibration: 10 G to 500 cps

Contact Arrangement: SPDT Form C

Ambient Temperature Range: -55°C to $+85^{\circ}\text{C}$

Life: 1,000,000 operations at rated load

Contact Resistance: .05 Ohms

pressure to produce the finished product.

Preforms can be turned out by the new Pressurform process in 30 seconds to 2½ minutes, depending on design.

The precision with which the preform is made permits use of the entire preform in the mold, eliminating the waste of pinchoffs. The process also achieves a product of uniform density by maintaining a constant ratio between the glass reinforcement and the resin regardless of varying container wall thickness. Different proportions of glass to other reinforcements can



Removing container half from mold, completely finished and ready for attachment of hardware

be used to meet different strength and cost requirements.

First commercial mass production of military containers of reinforced plastic went to the Light Military Electronic Equipment Department of General Electric Co. in Utica, N. Y. for use with radar jammer units.

► **Problems**—In recent years, the military supply system has been attempting to find an acceptable container for packaging various components. Many different models are now being accepted in spite of the fact that they cannot meet pressure retention requirements after undergoing the rough handling tests prescribed in MIL-P-116B.

Rust and distortion are not the only enemies of a container. The concept of air-lifting military

YOU'LL FIND WHAT YOU WANT IN ELGIN'S ADVANCE RELAY LINE



Midget Antenna
AM Series



Latching
LE & LH Series



Coaxial
CB Series



Power Control
PC Series



Power Transfer
PV Series

. . . it's the most complete line of relays to meet almost every need. And they're available from stock at leading distributors all over the country. Write today for catalog information.



ELECTRONICS DIVISION
ELGIN NATIONAL WATCH COMPANY
Elgin, Illinois



UCRL

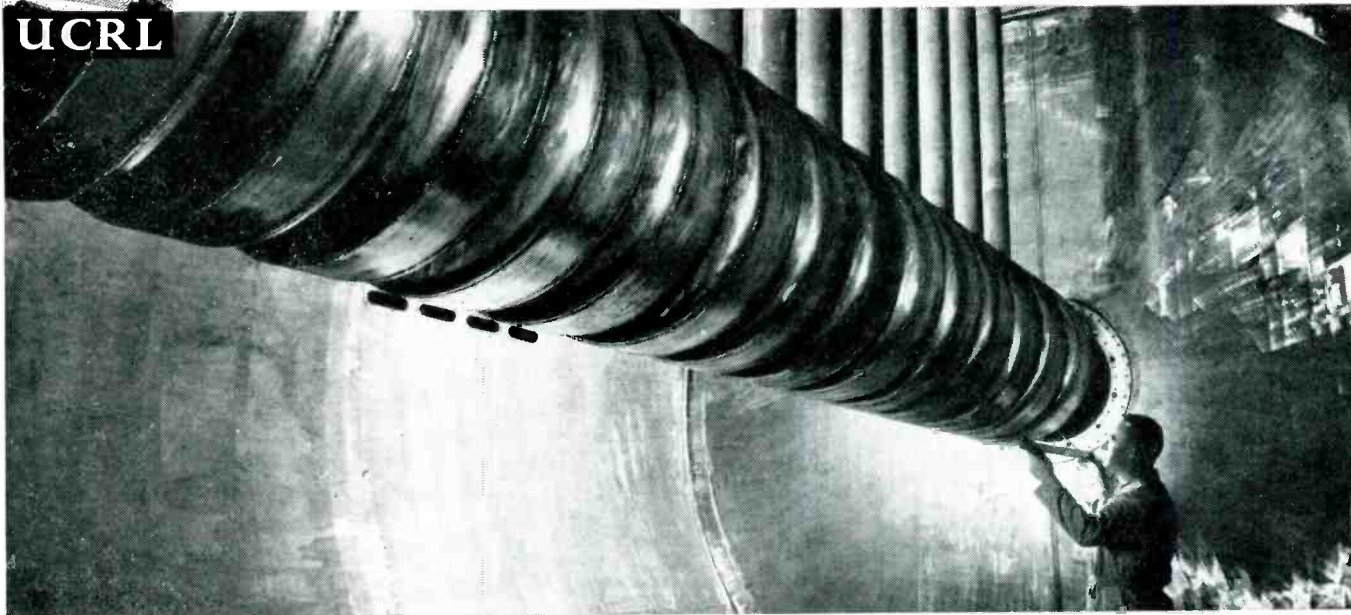

At UCRL's Livermore, California, site—interior view of drift tubes in high-current linear accelerator designed to deliver 250 ma of 3.6 Mev protons or 7.8 Mev deuterons

Could you help advance these new frontiers?

New techniques... new equipment... new knowledge—all are in constant growth at Livermore and Berkeley, California as some of America's most challenging nuclear frontiers are met and passed by the University of California Radiation Laboratory's unique scientist-engineer task force teams.

There are many such teams. And what you can do as a member, is limited only by yourself—your ability and your interest.

For UCRL is directed and staffed by some of America's most outstanding scientists and engineers. This group offers pioneering knowledge in nuclear research—today's most expansive facilities in that field... and wide-open opportunities to do what has never been done before.

nuclear physics, high current linear accelerator research, and the controlled release of thermonuclear energy.

In addition, you will be encouraged to explore fundamental problems of your own choosing and to publish your findings in the open literature.

And for your family—there's pleasant living to be had in Northern California's sunny, smog-free Livermore Valley, near excellent shopping centers, schools and the many cultural attractions of the San Francisco Bay Area.

You can help develop tomorrow—at UCRL today

Send for complete information on the facilities, work, personnel plans and benefits and the good living your family can enjoy. © UCRL

63-2-4

IF YOU are a **MECHANICAL** or **ELECTRONICS ENGINEER**, you may be involved in a project in any one of many interesting fields, as a basic member of the task force assigned each research problem. Your major contribution will be to design and test the necessary equipment, which calls for skill at improvising and the requisite imaginativeness to solve a broad scope of consistently unfamiliar and novel problems.

If you are a **CHEMIST** or **CHEMICAL ENGINEER**, you will work on investigations in radiochemistry, physical and inorganic chemistry and analytical chemistry. The chemical engineer is particularly concerned with the problems of nuclear rocket propulsion, weapons and reactors.

If you are a **PHYSICIST** or **MATHEMATICIAN** you may be involved in such

fields of theoretical and experimental physics as weapons design, nuclear rockets, nuclear emulsions, scientific photography (including work in the new field of shock hydrodynamics), reaction history, critical assembly,



DIRECTOR OF PROFESSIONAL PERSONNEL
UNIVERSITY OF CALIFORNIA RADIATION LABORATORY
LIVERMORE, CALIFORNIA

Please send me complete information describing UCRL facilities, projects and opportunities.

My fields of interest are _____

Name _____

Address _____

City _____ Zone _____ State _____

Better solders, fluxes and alloys for better electronic components

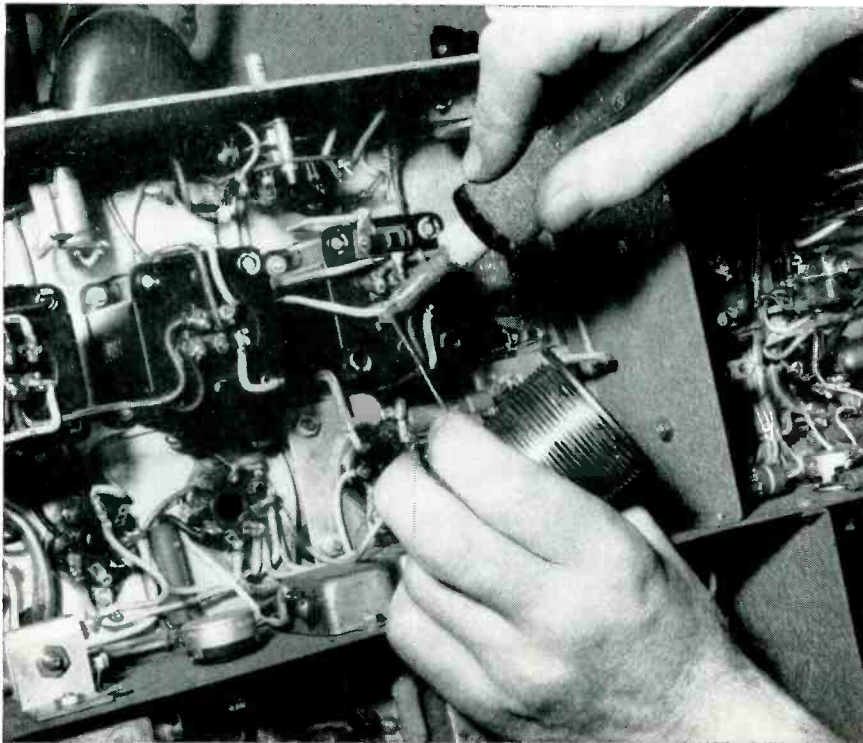

For volume production components, Federated supplies these quality-controlled alloys and non-ferrous supplies:

1. Counter-electrode alloys that are spectrographically or quantometrically tested. Samples from each heat meet exacting specifications to assure proper performance.
2. Rosin Core and Activated Rosin Core Solders of uniform quality for high-speed production, competitively tested to assure maximum efficiency and non-corrosive characteristics.
3. Liquid fluxes that surpass government corrosion-free requirements.
4. High-fluidity Castomatic® Solder for printed circuits, automatically cast under pressure in air-tight machines to minimize dross formation, gives better results in the dipping pans.

All Federated products are produced under the supervision of ASARCO's Central Research Laboratory, where spectrographically pure metals are refined for electronic experimentation.

No other producer of non-ferrous materials gives you such assurance of constant quality. Try Federated products. It will pay you well.



Federated Metals



Division of

AMERICAN SMELTING AND REFINING COMPANY

120 Broadway • New York 5, N.Y.

hardware and spare parts has added several new problems to those previously encountered. At present, transport planes fly at an average altitude of 25,000 feet. Future planes are expected to cruise at 40,000 feet. This makes it necessary to consider the variations in pressure and temperature that are encountered when an air-tight container is carried from sea level to an extreme altitude. The pressure differential between sea level and 40,000 feet is approximately 12 pounds. With this in mind, Wright Air Development Center included in its specifications a 10 pounds per square inch test for all containers, not as a check of the seal but to ascertain whether or not the container would rupture or distort when subjected to high internal pressure.

With aluminum and steel containers this problem can be licked by the use of pressure relief valves that allow air to escape as the plane climbs but prohibit air from entering. A manually operated air valve must then be installed to allow air to be bled back into the container under controlled conditions after landing. If this were not done, the partial vacuum would make it impossible to open the container.

Fibrous reinforced plastic con-



GE packaging engineer Richard H. Thomas demonstrates how top cover is closed after setting electronic unit in recess of rubberized fiber inner cushion



Unretouched photographs magnified four diameters.

Hand assembled diodes ↑ **COMPARE** ↑ Automatically assembled CBS diodes

UNIFORMITY by and for automation

The increasingly automatic assembly of electronic equipment is placing serious limitations upon component manufacturers. Rigid, tight tolerances must be maintained to avoid jamming the automatic machines. This spells automation for components, too.

CBS has done something about it. On seven integrated machines, CBS glass diodes are automatically assembled, packaged, tested. The picture tells the story . . . compares the results of this automatic assembly with that of ordinary hand assembly. The controlled uniform quality is apparent. As you would expect, the uniformity is both mechanical and electrical.

Take advantage of CBS Advanced-Engineering. Specify CBS glass diodes for uniformity . . . for dependability . . . for automatically controlled quality.



semiconductors

Reliable products
through Advanced-Engineering

CBS-HYTRON

Semiconductor Operations, Lowell, Mass.

A Division of Columbia Broadcasting System, Inc.

Lightweight! SERVO Magnetic Amplifiers

The servo amplifiers illustrated are typical standard types. Other models, including higher power types, are available for systems engineering. The complete MA line offers the designer a choice of compact, low cost types, amplifiers featuring fast response at high gain and all-magnetic models providing highest performance.

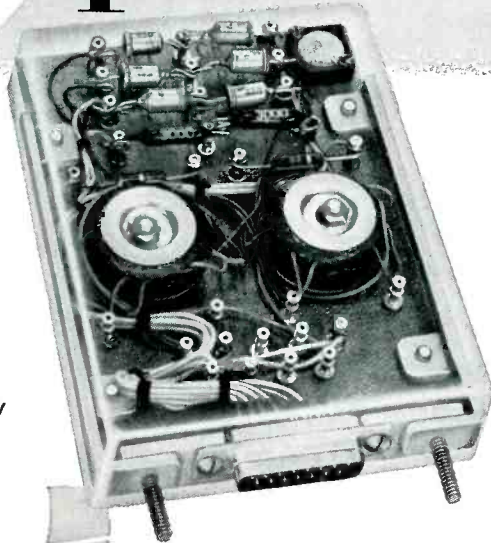

In addition to standard types, custom designs can be produced for special applications, or complete servo and automatic control systems can be engineered to your requirements.

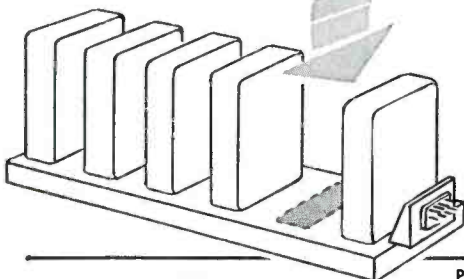

TYPE	SUPPLY	POWER OUTPUT	SENSI-TIVITY	RESPONSE TIME-SEC.
LIGHTWEIGHT SUB-MINIATURE MAGNETIC AMPLIFIER	115 volts 400 cps.	½, 3, 5, 10 watts	.02 volts	.003
MAGNETIC PRE-AMP + SATURABLE TRANSFORMERS	115 volts 400 cps.	3, 5, 6, 10, 18 watts	1 volt AC	.03
MAGNETIC PRE-AMP + HIGH GAIN MAGNETIC AMPLIFIER	115 volts 400 cps.	5, 10, 15, 20 watts	0.1 volt AC	.008 to .1
TRANSI-MAG*: TRANSISTOR + HIGH GAIN MAGNETIC AMPLIFIER	115 volts 400 or 60 cps.	2, 5, 10, 15, 20 watts	.08 volt AC into 10,000 ohms	.01

Call or write for new illustrated bulletins.

Magnetic Amplifiers • Inc
632 TINTON AVE., NEW YORK 55, N. Y.—CYpress 2-6610
West Coast Division
136 WASHINGTON ST., EL SEGUNDO, CALIF. — EAstgate 2-2056



Ordinary pliers suffice for tightening or loosening quick-opening fastener used on containers. Aluminum gasket retaining rings inside facing surfaces provide airtight seal when container is locked. All four sides have locks

tainers eliminate the need for costly and weight-consuming valves because the plastic can expand easily and contract to adapt to atmospheric or environmental conditions without distorting or rupturing.

Automatic Tapper for Vacuum-Tube Testing

By R. J. MEAGHER
Senior Product Engineer
Receiving Tube Operations
CBS-Hytron
Danvers, Mass.

HAND TAPPING of tubes to reveal intermittent opens or shorts during electrical testing is satisfactory if done properly all the time in a vacuum-tube manufacturing plant. The standard JAN method is to tap the tube three times and then three times again at right angles to the first three blows, using a standard cork mallet. The prescribed distance of swing is usually 4 inches. It is extremely difficult to keep a group of test operators tapping properly, however, since it is considerable effort to swing a mallet 2,000 to 3,000 times an hour.

Previous industry attempts to achieve automatic tapping all seemed to be a compromise between cost of the unit, repeatability, and reliability. The project for mechanizing the tapping operation was therefore divided into

Rugged E-I Compression Seals are the industry's standard for superior performance in commercial and military service. Practically indestructible, they provide the maximum immunity to shock, vibration and temperature changes.

Available in miniature or sub-miniature types, these super-dependable hermetic seals are supplied in economical standard types to meet practically any sealing requirement.

**Keyed to
your electronic
future...**

E-I GLASS-TO-METAL SEALS*

For complete information on the E-I line or recommendations on particular requirements, call or write:

**ELECTRICAL
INDUSTRIES**

44 SUMMER AVENUE, NEWARK 4, N. J.



**Patents Pending—all rights reserved*



Single Lead Terminals—Available in standard or custom designs.



Plug-in Connectors—for vibrator, chopper, lock-in and noval sockets.

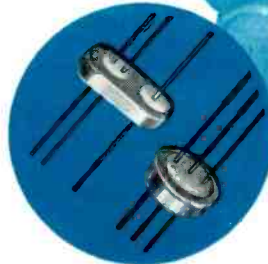

Transistor Closures—Standard sealed bases, cans and diode closures available.



Multiple Headers—for every hermetic sealing requirement.

Get them **NOW**

GUARDIAN[®] Industrial Controls

for prototype units and
initial production requirements

Off the Shelf
at
your nearby
GUARDIAN
franchised
distributor
in the U.S. & Canada



GUARDIAN STEPPERS

SIMPLIFY YOUR CIRCUIT REDUCE WIRING

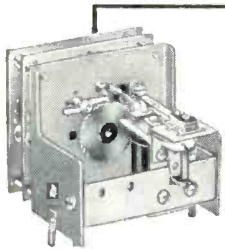

P.C.
CONTINUOUS
ROTATION
STEPPER

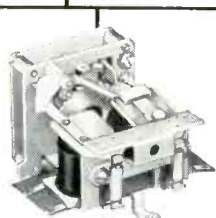

M.E.R.
ELECTRICAL RESET
MIDGET STEPPER

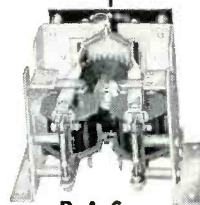

R.A.S.
ADD AND SUBTRACT
STEPPER

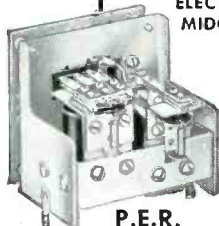

P.E.R.
ELECTRICAL RESET
STEPPER

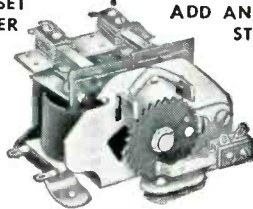

M.A.S.
ADD AND SUBTRACT
MIDGET STEPPER

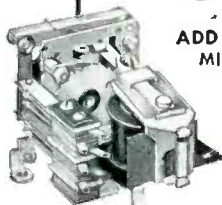

M-120
CYCLING RATCHET
MIDGET STEPPER

**2 GUARDIAN STEPPERS
ARE KNOWN TO
REPLACE 20
INDIVIDUAL CONTROLS!**

write
for Guardian
Bulletin
SD-11

GUARDIAN POWER RELAYS

- NO SOLDER CONNECTIONS REQUIRED!
- INTERCHANGEABLE COIL

25 AMPERE, 230 v., A.C.
Power Relays for motor
starting, heater loads, and
similar applications. Inter-
changeable coils rated at
6, 24, 115, or 230 v., A.C.



built to
U/L specifications

GUARDIAN Series 1200 RELAYS

available in a variety of voltages

Rugged midget relays
are rated at 8 AM-
PERES, 115 v., A.C.
Contacts range up to
3 P.D.T. Coils for 6 v.,
24 v., 110 v., A.C.
or D.C.



write for name and address of your nearby Guardian Franchised Distributor

GUARDIAN ELECTRIC

1625-B W. WALNUT STREET CHICAGO 12, ILLINOIS
"Everything Under Control"

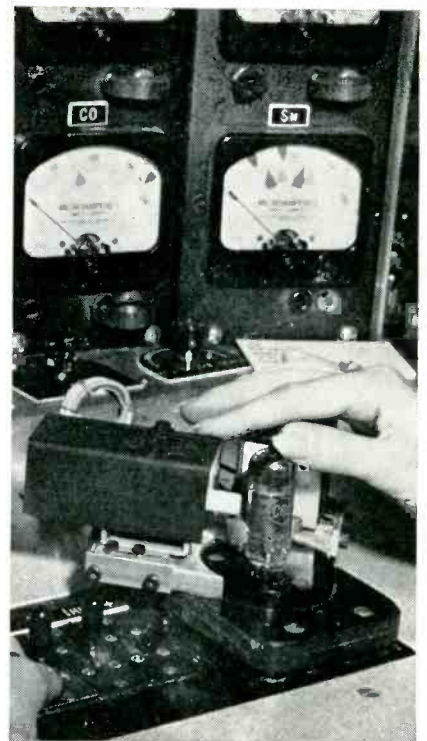

New automatic tapper in use

five steps: (1) Design and construct the tapping device; (2) establish a primary standard device having proven correlation to hand tapping; (3) design a secondary standard device, easily portable for maintenance; (4) prove the reliability and improvement in inoperables testing; (5) equip production test equipment with automatic units.

► **Problems**—A copy of an old two-unit tapper, with the drive supply separate from the tapper head, was made and tried out. It had all three undesirable characteristics in that it was not repeatable, required a great deal of maintenance and was expensive.

The inner bearing surfaces of the solenoids were bored out and a loose-fitting Oilite bearing was installed as in Fig. 1. This elimi-

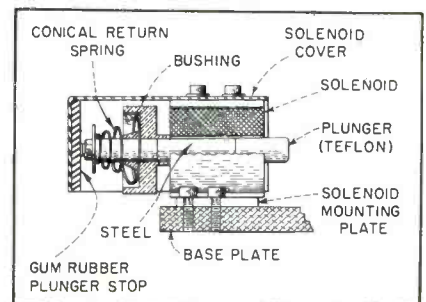
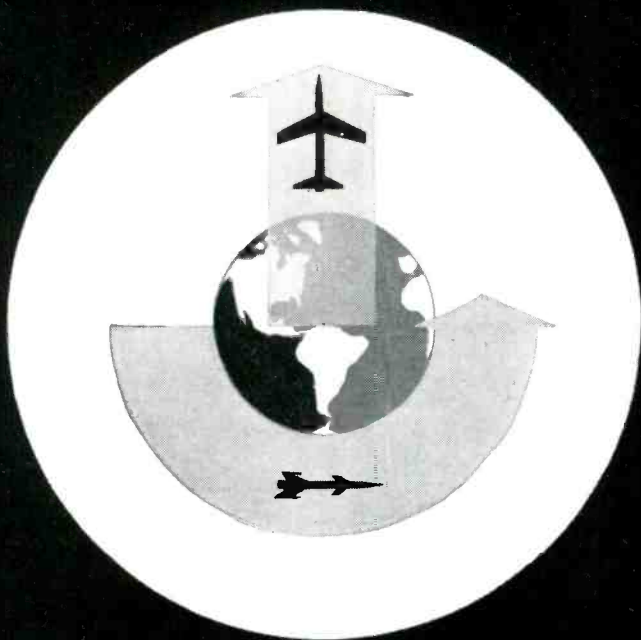

FIG. 1—Construction of tapper solenoid



PROGRESS

BREEDS OPPORTUNITY at **BELL**

BELL AIRCRAFT IS A FAST MOVING, dynamic organization. Imaginative solutions to challenging problems and dramatic progress and accomplishments in many fields are its stock in trade. And because Bell is growing and progressing, it offers unusual career opportunities for the engineering and technical personnel listed at the right—opportunities at all levels to move fast and go far with highly capable associates in congenial surroundings.

Thanks to Bell's wide diversity of interests, you'll find the broadest possible scope for professional growth and the development of your talents at Bell. If you're bored with your present assignment or limited in your opportunities to grow, contact Bell.

Write: Manager, Engineering Personnel,
Dept. H, **BELL AIRCRAFT CORPORATION**, P. O. Box One,
Buffalo 5, New York.



- Aerodynamicists
- Aeronautical Engineers
- Automatic Control Designers
- Chemical Engineers
- Combustion Research Engineers
- Communications Engineers
- Design Checkers
- Development Engineers
- Digital Computer Development Engrs.
- Dynamic Engineers
- Electronic Engineers
- Electronic Standards Engineers
- Engineering Computers
- Environmental Specialists
- Field Test Engineers
- Flight Test Engineers
- Flight Test Programmers
- Fuel Injection Specialists
- Gear Designers
- Guidance Engineers
- Gyro Specialists
- Heat Transfer Engineers
- Hydraulic Engineers
- IBM Programmers
- Instrumentation Specialists
- Laboratory Test Engineers
- Magnetic Amplifier Specialists
- Mathematical Analysts
- Mechanical Engineers
- Microwave Engineers
- Miniturization Engineers
- Operations Analysts
- Physicists
- Power Plant Designers
- Pressure Vessel Designers
- Project Engineers
- Publication Engineers
- Radar Systems Engineers
- Rocket Test Engineers
- Servo Systems Engineers
- Servo Valve Engineers
- Statisticians
- Stress Engineers
- Structures Engineers
- Specification Writers
- Technical Writers
- Test Equipment Engineers
- Transformer Design Specialists
- Transistor Application Engineers
- Thermodynamic Engineers
- Telemetry Engineers
- Turbine Pump Designers
- Vibration & Flutter Analysts
- Weapons Systems Engineers
- Wave Guide Development Engineers
- Weights Engineers

truly
UNIVERSAL *

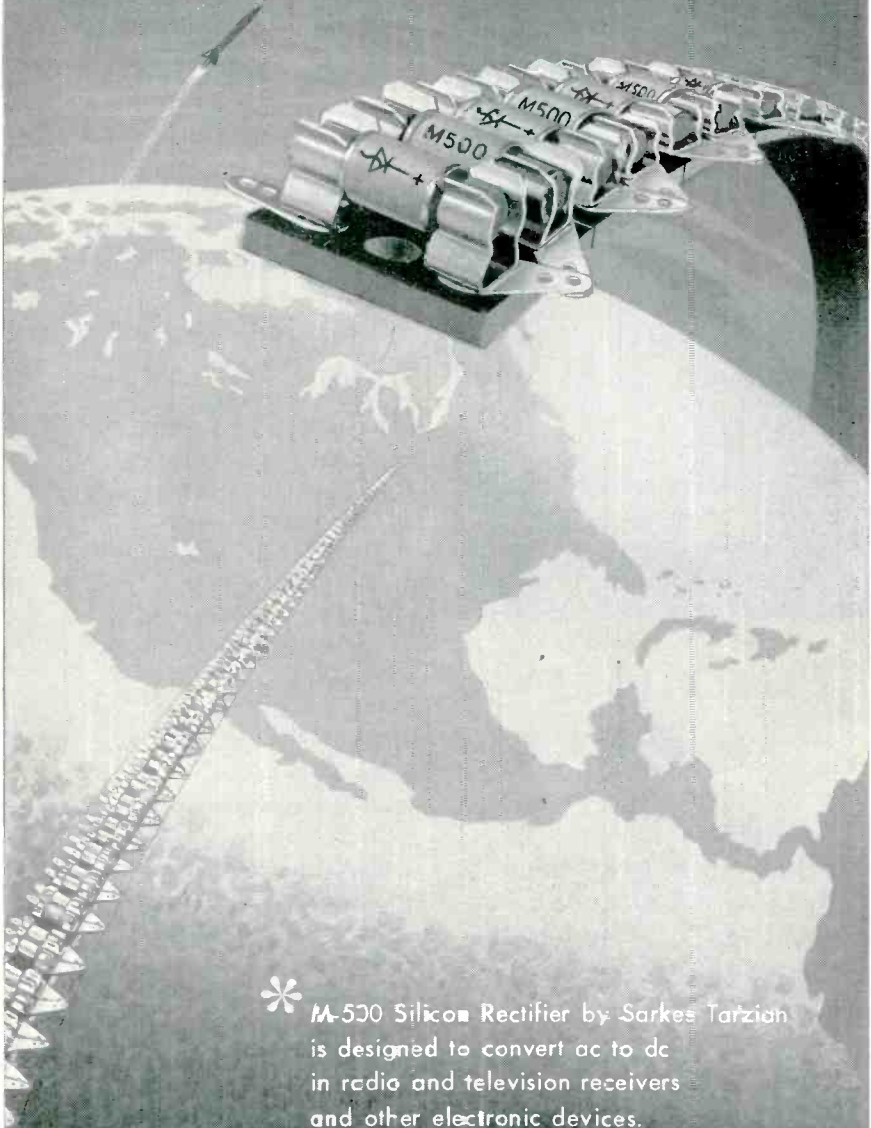

* M-500 Silicon Rectifier by Sarkes Tarzian is designed to convert ac to dc in radio and television receivers and other electronic devices.

Sarkes
Tarzian, INC. RECTIFIER DIVISION

415 N. COLLEGE AVE., BLOOMINGTON, INDIANA

In Canada: 700 Weston Rd., Toronto 9, Tel. Rogers 2-7535 • Export: Ad Auriema, Inc., New York City

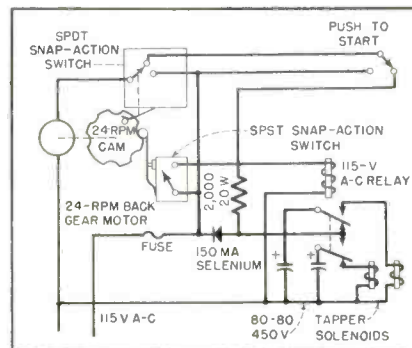
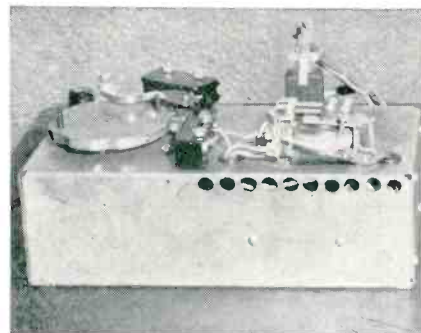

FIG. 2—Complete circuit of tapper

nated binding of the tapper.

All types of materials were tried for the tapping plunger tip, ranging from sponge rubber tips to solid Bakelite. None were satisfactory until Teflon was tried. This material has ideal characteristics in that it is resilient, has a slippery surface and does not wear to any degree. These two steps corrected the repeatability problems.

► **Solutions**—The maintenance troubles all occurred in the drive unit, since the old system was a multivibrator-thyatron-relay system which had numerous possibilities of failure. The new system is a motor-driven cam unit with only one relay, using the circuit of Fig. 2. The electromechanical tapper drive unit is designed to energize the two tapping solenoids alternately three times each. Closing the push-to-start initiating switch removes the d-c braking voltage from the motor and applies a-c line voltage to the motor. The motor turns and cam-actuates a snap-action switch that actuates a relay. This relay in turn applies d-c (from a capacitor-discharge supply) alternately to one solenoid and then the other. The rate of tapping and number



Tapper drive unit. Motor-driven cam at left actuates two snap-action switches

ANNOUNCING THE 104 MEMO-SCOPE

The MEMO-SCOPE Model 104 is a new memory oscilloscope with a selection of 5 plug-in preamplifiers that will satisfy the most critical production, test and laboratory requirements. MEMO-SCOPE incorporates the famous Hughes-developed Memotron direct-display storage tube that captures and retains any number of traces indefinitely at a constant intensity until intentionally erased. Traces are readily visible in a brightly-lighted room, and may be easily photographed for file records.



MEMO-SCOPE 104 SPECIFICATIONS

ERASURE: internal waveform generator triggered by front panel push button or by external switch.

DC BLANKING: CRT grid direct coupled to external or internal blanking gate allows beam to be turned off except during sweep and insures constant sweep-time intensity over any sweep duration.

DEFLECTION PLATES: available at rear terminal strip for direct connection.

MAIN VERTICAL DEFLECTION AMPLIFIER: frequency response of DC to 700 kilocycles within 3db. Rise Time of 1/2 microsecond.

TRIGGERED LINEAR SWEEP: range of 10 μ sec to 10 seconds per division, adjustable continuously or in 18 calibrated steps. Trigger: vertical amplifier signal, AC line or external pulse, either polarity, DC or AC coupled. Minimum external trigger amplitude: 0.1 volt. Neon ready lamp indicates sweep is at left side of screen, ready for trigger.

AMPLITUDE CALIBRATOR: available at front panel terminal—one kilocycle square wave with peak-to-peak amplitude of 0.01, 0.1, 1.0 or 10 volts, within 3%.

BEAM POSITION INDICATORS are four neon lamps showing position of writing beam when not on screen.

ILLUMINATED GRATICULE: scale calibrated in 1/3" squares in 10 X 10 array.

RACK MOUNTING: Model 104 available on standard 14" X 19" relay rack panel.

DIMENSIONS: 13" wide, 14" high, 20" deep. Etched circuit epon-glass electrical chassis. Hinged camera mount optional.

OPTIONAL PLUG-IN PREAMPLIFIERS INCREASE FLEXIBILITY

(All units with frequency response from DC to 250 kilocycles down 3db.)

WB/4. Wide Band, DC.

WB/SE/5. Wide Band, DC plus Speed Enhancement.

HS/6. High Sensitivity—1mv/division differential.

HS/SE/7. High Writing Speed, High Sensitivity.

HS/D1/10. High Sensitivity, Dual Input.

For additional information or demonstration of the new Model 104

write to HUGHES PRODUCTS
ELECTRON TUBES
International Airport Station
Los Angeles 45, California

HUGHES PRODUCTS

© 1957, HUGHES AIRCRAFT COMPANY

Why Do Ambitious Engineers Like General Mills?

Let's be realistic. The answer is real technical competence in the company you work for, and real opportunity for yourself!

Our people start with good salaries, share in liberal company benefits. It's not necessary that they move from company to company to improve their salaries or to find more challenging opportunities. We recognize ability, make promotions and salary adjustments accordingly. And with new projects being started almost weekly, promotions come rapidly.

But our people like General Mills for other reasons too:

FINANCIAL SECURITY . . . they know they work for one of the nation's largest and most diversified companies, paying dividends without reduction since 1929.

TUITION REIMBURSEMENT . . . many of them take advanced degrees at the University of Minnesota, under our tuition re-imbusement plan.

FRIENDLY ATMOSPHERE . . . they work with congenial people who share the same interests as they.

LOWER COST OF LIVING . . . their dollars buy more, they can save more—enjoy things not possible before.

DELIGHTFUL RESIDENCES . . . many of them live in "dream" homes in resort-like settings, only minutes from work.

TIME FOR FUN . . . they relax and enjoy themselves, because here there is time and opportunity for all kinds of activity in the land of 10,000 lakes.

We'd like you to investigate **your future** with General Mills. Talk it over with your wife. We think she'll like it here too. Minneapolis is a wonderful town in which to raise a family—while you do big things in the field you like best.

Join in the excitement at General Mills, where important things can happen to you, in any of these fields:

- MISSILES
- APPLIED MECHANICS
- GEOPHYSICS
- UNDERWATER ORDNANCE
- ELECTRONIC COUNTERMEASURES
- DIGITAL & ANALOG COMPUTERS
- INSTRUMENTS AND CONTROLS
- SOLID STATE PHYSICS
- MICROWAVES & ANTENNAS
- INFRARED SYSTEMS
- INERTIAL SYSTEMS
- SYSTEMS ANALYSIS & DESIGN
- SERVO MECHANISMS
- BALLOON SYSTEMS
- INDUSTRIAL AUTOMATION
- UPPER ATMOSPHERE RESEARCH
- FINE PARTICLE TECHNOLOGY
- SURFACE CHEMISTRY
- OPTICS
- MECHANICAL DESIGN
- AIRBORNE EARLY WARNING
- RADAR SYSTEMS
- INFORMATION THEORY
- ELECTRONIC EQUIPMENT DESIGN and MINIATURIZATION

MECHANICAL DIVISION OF



PETER D. BURGESS, Personnel Director—H
 Mechanical Division General Mills
 1620 Central Avenue Northeast
 Minneapolis 13, Minnesota

Name

Address

City State

College Degree Year

We'd like to send you more information, in complete confidence. Complete the coupon for a quick reply.

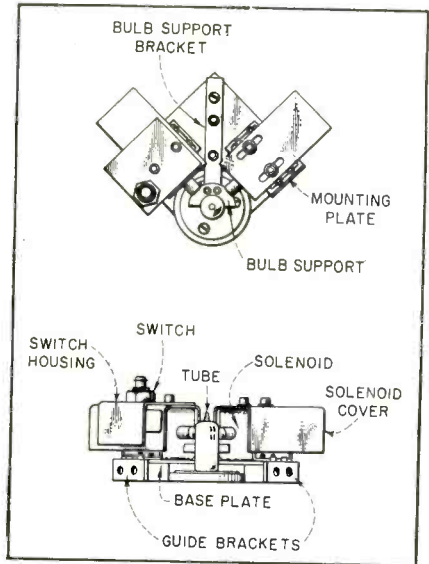

FIG. 3—Tapper solenoid mounting

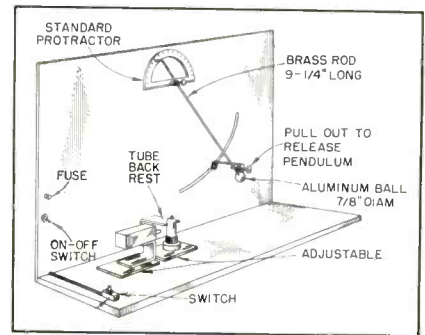

FIG. 4—Details of calibrating pendulum

of blows are predetermined by motor speed and cam design. Tapper solenoid mounting details appear in Fig. 3.

► **Calibration**—A pendulum standard was constructed in Fig. 4 and ten good operators were selected. With a tube in the socket of the standard, each operator tapped the tube ten times on the side opposite the pendulum while the pendulum ball rested against the tube. The rebound reading of each tap on the pointer scale above the pendulum was recorded. Eliminating wild taps, they caused the pendulum to swing back between 6 degrees and 8 degrees. Thus 7 degrees was accepted as the standard blow. Now, one solenoid of an automatic tapper was mounted in the same position as for hand tapping and the tapper was adjusted for a 7-degree blow. This became the primary standard with its own check device.

► **Dummy Standard**—The second-

TECHNIQUES and DEVELOPMENTS in oscillographic recording

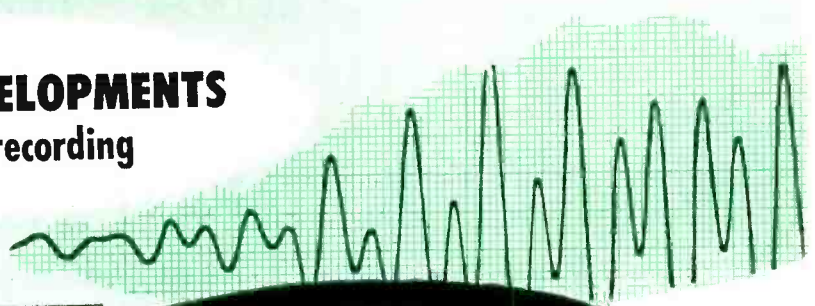

FROM SANBORN

PHASE SENSITIVE DEMODULATOR PRE-AMPLIFIER PROVIDES A DC VOLTAGE PROPORTIONAL TO AN INPHASE COMPONENT OF AN AC VOLTAGE WITH RESPECT TO A REFERENCE.

THE measurement of the amplitude of an AC voltage component is often necessary in performance studies of servo systems or of suppressed carrier signals over the carrier frequency range from 60 to 10,000 cps. In such cases the demodulator responds to inphase signals and rejects quadrature signals.



A circuit with these characteristics for use in an oscillographic recording system can be seen in the Model 150-1200 Servo Monitor (Demodulator) Preamplifier. It was developed by Sanborn as one of twelve interchangeable, plug-in front ends for "150" Series equipment, to be used with the appropriate Driver Amplifier-Power unit in any channel of a "150" system. Elements comprising the circuit from input to output, include: compensated stepped attenuator and cathode follower input circuit, phase inverter, push-pull mixer and demodulator stages, differential DC output amplifier and low pass filter. In addition, the chassis contains a VTVM to facilitate accurate adjustment of the reference voltage, and an overload indicator which lights a warning lamp when excessive quadrature voltages exist.

Adaptability to a fairly wide variety of applications is accomplished through broad input voltage, reference voltage and frequency ranges. In order, these are 50 mv to 50 v (for full scale 5 cm deflection), 10 v to 125 v; 60 cps to 10kc. Rise time with low frequency plug-in demodulation filter is 0.1 seconds; with high frequency filter, 0.01 seconds. Quadrature rejection is better than 100:1; for carrier frequencies up to 5000 cycles.

Two representative uses of the Servo Monitor Preamplifier are in the design and adjustment of servo systems, and with instruments used in the design, development or adjustment of other apparatus. The first is illustrated by use of the Preamplifier and associated equipment in the recording of the output shaft amplitude and driving frequency of an AC positional servo; the second by recordings made with a similar setup of the difference between output signals from a gyroscopically-controlled stabilizing device and the "pitch" and "roll" signals generated by a "Scorsby Table" used for testing the device under dynamic conditions.

For a detailed discussion of the principles and design considerations involved in the Servo Monitor Preamplifier, refer to the February, 1955 issue of the Sanborn RIGHT ANGLE, for Dr. Arthur Miller's article on "Measurements with the Servo Monitor Preamplifier."

Technical literature and engineering assistance on specific problems are always available from our engineering department.

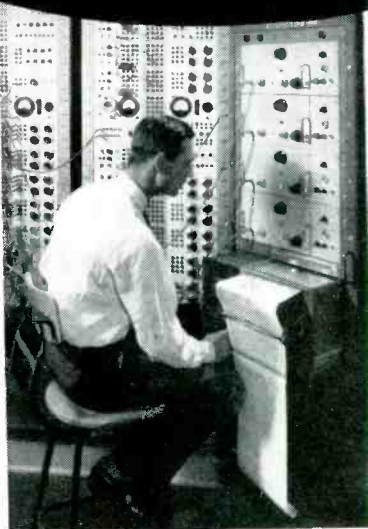

**BASIC
FACTORS
IN SELECTING
OSCILLOGRAPHIC
RECORDING
EQUIPMENT**

WHEN considering any oscillographic system or equipment for your application, three useful "yardsticks" to apply are (1) the recording method, (2) equipment adaptability, and (3) variety of equipment available. Here are the answers to the three, as they apply to Sanborn systems. In the record, rectangular coordinates accurately correlate multiple traces, simplify interpretation and eliminate errors. Permanent traces, produced by a hot ribbon stylus without ink, provide sharp peaks and notches, and clearly reveal all signal changes. One percent linearity results from current feedback driver amplifiers and high torque galvanometers of new design; maximum error is 1/4 mm in middle 1/4 cm of chart, 1/2 mm across entire chart. From the standpoints of "adaptability" and "variety", Sanborn "150" equipment offers the versatility of 13 different plug-in front ends for any basic system . . . the choice of one- to eight-channel systems . . . the variety of nine chart speeds, timing and coding controls, console or individual unit packaging . . . availability of equipment as either complete systems or individual amplifier or recorder units.



The purpose of the foregoing information is to better acquaint industry with typical oscillographic recording problems and their answers, design considerations in Sanborn equipment, and basic data on what Sanborn makes and how it is being used.

SANBORN COMPANY

INDUSTRIAL DIVISION

175 WYMAN STREET, WALTHAM 54, MASS.

New twist in testing ... a torsional exciter

TORSIONAL testing has been done with rectilinear motion shakers by applying ingenuity in linking table to specimen. But here's a new MB exciter that produces torque *directly*. Its performance characteristics permit you to use it as a *calibrator* for torsional pickups and accelerometers . . . as well as for testing gyros and relays (as examples), or checking torsional vibrations of armatures, or determining torsional modes in various rotating parts.

OPERATING FACTS

At free-table, no load, this MB Model CA 1050 Exciter oscillates at up to 1600 cps without resonance in moving elements. It develops 110 ft. lbs torque, which produces angular accelerations as high as 1570 radians/

sec/sec. Maximum total displacement is 45°

A MATCHED SYSTEM

Any one of several MB electronic power supplies drives the equipment, depending on the specific frequency range, power, and performance you want. The MB Model T51 Power Supply shown comes with automatic cycling controls if desired.

SEND FOR DETAILS

Technical data available. And for more information on how and where to use this unusual equipment, contact our staff of vibration specialists. You can't come to a better qualified authority on the subject . . . nor to one more willing to help on your specific vibration testing problems.

 **manufacturing company**
A DIVISION OF TEXTRON INC.

1075 State Street, New Haven 11, Conn.

HEADQUARTERS FOR PRODUCTS TO ISOLATE . . . EXCITE . . . AND MEASURE VIBRATION

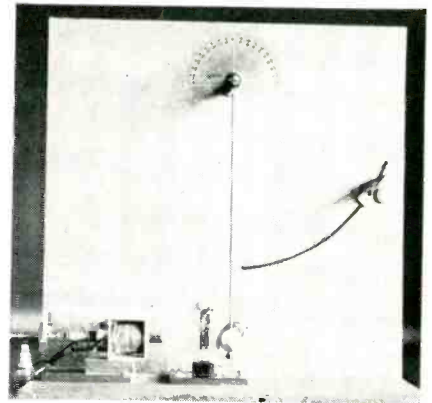
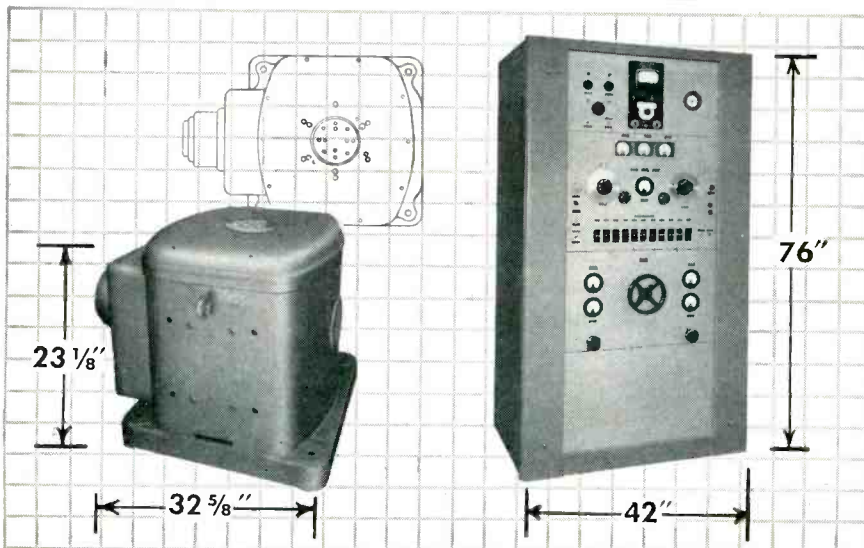

Pendulum-type primary standard

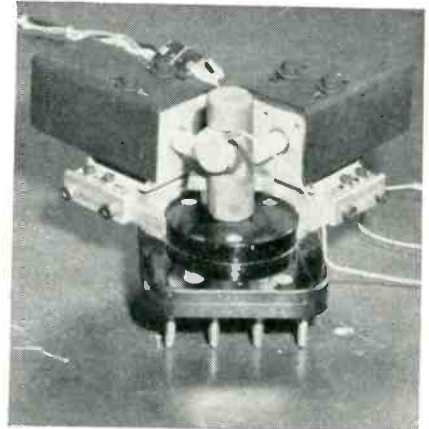

Dummy tube with attached hearing-aid earphone serves as secondary standard. Banana plugs permit plugging tapper into any tube test set

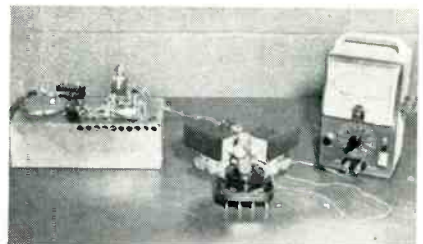

Complete tapper-calibrating setup

ary standard was made up by mounting a hearing aid earphone on a dummy tube made of fibre rod. This hearing aid was directly connected to an a-c vacuum-tube voltmeter. This dummy was mounted in the primary standard, tapped with the preset tapper and the reading on the vtm noted. This dummy could now be inserted in any tapper and its solenoid position adjusted to give the same vtm reading. Only the first blow is used, because additional taps would occur while the meter needle is still in motion from the first blow. Since each tap varies somewhat, an average must be taken and a range set around it.

Continental Connectors TAPER PIN TERMINAL BLOCKS

... machine tapered for precision,
molded-in for ruggedness

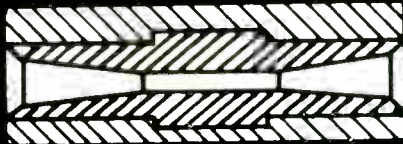

Precision machine tapered
feed-through receptacle
is permanently
molded-in.

HERE IS AN IMPROVED terminal block design featuring precision reamed taper pin receptacles. *Molded-in* for maximum durability, these receptacles maintain a permanently secure electrical and physical contact with AMP Series "53" solderless taper pins.

Continental can supply all types of taper pin blocks and connectors for conventional wiring and printed circuitry in any combination of feed-through shorting or non-shortening terminals. Our Engineering Department will gladly cooperate in solving your taper pin application problems. For technical information write to *Electronic Sales Division*, DeJUR-AMSCO Corporation, 45-01 Northern Boulevard, Long Island City 1, New York.

SPECIFICATIONS

TAPER RECEPTACLES

Brass, gold plated over silver for low contact resistance. 9 lbs. minimum gripping pressure on AMP Series "53" solderless taper pins.

BODY

Molded of high impact Plaskon reinforced (glass) Alkyd 440A (MIL-P-14D, Type MAI-60). Other molding materials on request.

Series 145-58



SINGLE ROW TAPER PIN TERMINAL BLOCKS. Available in any combination of feed-through shorting or non-shortening terminals. Molded holes for stacking or mounting.

Series 145-60



TAPER PIN TERMINAL BLOCKS FOR PRINTED CIRCUITRY. Precision tapered molded-in right angle terminals for dip soldering to printed circuit boards.

Series 145-48

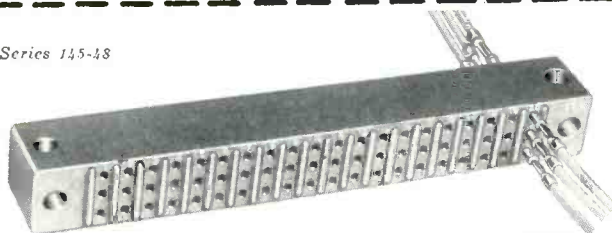

TRIPLE STACKED TAPER PIN TERMINAL BLOCKS. Continental can supply stacked taper pin blocks in any combination of feed-through shorting or non-shortening terminals. Molded holes for right angle and perpendicular mounting.

Series "MB"

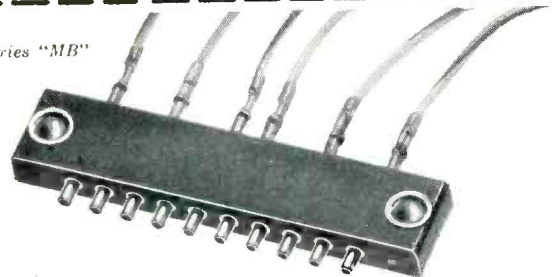

TAPER PIN TERMINATION FOR CONVENTIONAL WIRING. Solder cups are provided for terminating conventional wiring to solderless taper pins.

You're
always
sure
with

DeJUR

electronic
components

New Products

Edited by WILLIAM P. O'BRIEN

81 New Products and 53 Manufacturers' Bulletins Are Reviewed
... Control, Testing and Measuring Equipment Described and
Illustrated ... Recent Tubes and Components Are Covered

PRECISION POTS

for printed circuits

WATERS MFG., INC., P. O. Box 368, South Sudbury, Mass. Simplifying installation in miniaturized assemblies that use printed-circuit techniques, the model APP- $\frac{1}{2}$ precision potentiometer is provided with a three-prong base that fits standard three-circuit microphone

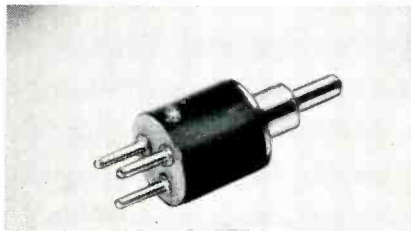

sockets. The plug-in connection afforded by this unit is also advantageous in automated assemblies for precise positioning and rapid installation.

The potentiometer is available in resistance ranges of 10 ohms to 100,000 ohms, with standard accuracy of five percent below 50 K and two percent above 50 K. **Circle P1 inside back cover.**

D-C POWER SUPPLY

mag-amp controlled



UNIVERSAL ELECTRONICS Co., 1720 Twenty-Second St., Santa Monica, Calif. The Unireg model U32-10 is a wide-range magnetic amplifier controlled d-c power supply. Voltage range extends from 0 to 32 v continuously variable without switching, at currents from 0 to 10 amperes.

This rugged, tubeless unit is regulated for line or load to +1 percent. Ripple is 0.25 percent for all load and line conditions. Transient response is faster than 0.2 sec. Line input range is from 105 to 125 v a-c at 50 or 60 cycles.

Dimensions are 8 $\frac{1}{2}$ by 19 by 14 $\frac{1}{2}$ in. It is available for either rack or cabinet mounting. Net weight is approximately 125 lb. **Circle P2 inside back cover.**

MOLDED CAPACITORS

nine different sizes

GENERAL ELECTRIC Co., Schenectady 5, N. Y., announces a new line of molded PVZ capacitors. They operate from -55 C to +125 C without voltage derating and are for applications in computers, missiles, telephone equipment and other high grade military and commercial equipment. Available in 100, 200, 300 and 400 v ratings, they can be supplied from 0.00047 to 0.022 μ f in the 400-v range and from 0.00047 to 0.15 μ f at 100 v.

The molded PVZ capacitor is a paper tubular capacitor impregnated with a high temperature organic material which is poly-

merized into a solid resin. The solid capacitor rolls are contained

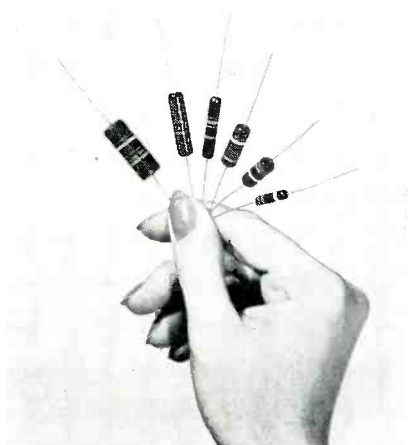

in a mineral filled phenolic plastic. After molding, the unit is completely solid and has excellent shock and moisture resistance and vibration properties. **Circle P3 inside back cover.**

CIRCUIT PRINTER allows faster output

GRANT PRODUCTION Co. LTD., 4 Rathbone Place, London, W. 1., England, announces a compact printing unit in which a new kind of light source allows much faster output of printed circuits.

Printed circuits are produced by an ordinary photoengraving process using an improved sensi-



our
 leadership
 protects
 yours...

Our reputation as the world's most Consistently Dependable producer of capacitors has been maintained for over 46 years. But *any* reputation can be lost overnight. That's why we resist the temptation to gain temporary advantage through methods that risk *our* reputation or yours. C-D's Consistently Dependable products can mean PLUS dollars to you.

Widest Choice of Impregnants and Dielectrics to meet your needs:
 More than a score of liquid and solid impregnating media

and dielectrics, including Polystyrene, Mylar*, Teflon, metallized paper and metallized Mylar, are readily available to meet your temperature, size and other circuit requirements. Operating temperature ranges from -40°C to $+85^{\circ}\text{C}$ and -60°C to $+200^{\circ}\text{C}$. Whatever your capacitor problems, depend on Cornell-Dubilier to fulfill your needs most promptly, most economically and most satisfactorily.

Write for catalog to Cornell-Dubilier Electric Corporation, South Plainfield, New Jersey.

(*DUPONT TM)



CONSISTENT HI-DEPENDABILITY
CORNELL-DUBILIER CAPACITORS

SOUTH PLAINFIELD, N. J.; NEW BEDFORD, WORCESTER & CAMBRIDGE, MASS.; PROVIDENCE & HOPE VALLEY, R. I.; INDIANAPOLIS, IND.; SANFORD, FUGUAY SPRINGS & VARINA, N. C.; VENICE, CALIF.; & SUB.: THE RADIART CORP., CLEVELAND, OHIO; CORNELL-DUBILIER ELECTRIC INTERNATIONAL, N. Y.

tizer. The process consists of printing a film negative of the original diagram on a copperfoil-clad sheet of Bakelite. The copper foil is cleaned, dried and then coated with a light-sensitive emulsion. The film negative of the circuit diagram is positioned on the sensitized copper and exposed to light on a printing frame.

The Mervac printer contains an

exposing unit which, instead of the traditional carbon arc, has a totally enclosed mercury vapor light source which cuts normal exposure time to less than one-third and yet provides an image of outstanding definition and strength. Two Mervac models are available. The first, particularly suitable for experimental work in research laboratories, has an exposure time

of three minutes. The second is a production model, having an automatic vacuum catch, with an exposure time of only 1½ minutes.

The new printer can be used to produce the film negatives as well as to make the actual printed circuits. The whole unit is operated at bench height and occupies a floor space of only four by three ft. **Circle P4 inside back cover.**

CERAMIC MAGNET

stronger by 3½ times

THE INDIANA STEEL PRODUCTS CO., Valparaiso, Ind. Indox V, a new oriented ceramic permanent magnet material that produces a high peak energy product, and makes possible substantial savings in both magnetic material and space, has been announced. Made of a new ferrite magnetic material which is oriented in the direction of pressing, Indox V produces a peak energy product of approximately 3.5 by 10°. Its light weight (0.181 lb per cu in.) makes its energy comparable to Alnico V. Because of its 2,000-oersted coer-

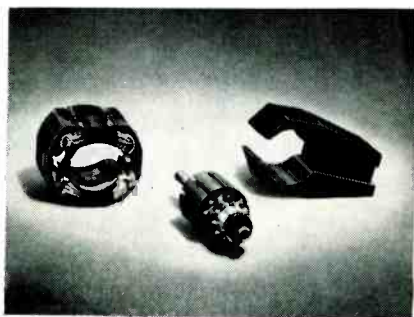

sive force, the length of Indox V required is only 28 percent that of Alnico V at optimum operation.

Residual induction is 2,840 gauss. The new product provides

a wider high-efficiency operating range than Alnico V because the maximum energy product does not have a sharp peak.

Indox V contains noncritical materials, features high resistivity and a low incremental permeability. It is well suited for such uses as d-c motors, synchronous drives, tv focusers, twt's, loudspeakers and magnetic clutches.

The illustration shows, left to right, an electromagnetic stator, a rotor and an Indox V stator. Additional information on Indox V permanent magnets, with various shapes and sizes available, may be found in catalog No. 16. **Circle P5 inside back cover.**

ACCELEROMETER

weighs only 3 oz



HUMPHREY INC., 2805 Canon St., San Diego 6, Calif., is introducing a miniature accelerometer, weighing only three oz, for use in instrumentation and control systems. Series LA03-0200 is simply and ruggedly designed, has a high output potentiometer pickoff and a pressure-sealed case, and is already in use on target drones and missile systems.

Available with or without connector, the latter uses solder ter-

minals instead. In this design the case height is only 1.5 in.

► **Features**— Operating temperature ranges from -50 C to +100 C. The unit withstands vibration from 0 to 2,000 cps to 10 g and is shock resistant to 40 g. Linearity is 0.5 to 1.5 percent. Hysteresis is rated at 0.2 to 1.0 percent; friction at 0.15 percent to 1.0 percent; natural frequency at 50 cps (± 15 g). Pickoff potentiometer 500 to 10,000 ohms; resolution to 0.3 percent. **Circle P6 inside back cover.**

TRIPOLAR CRYSTAL

for military applications

SYLVANIA ELECTRIC PRODUCTS INC., 1740 Broadway, New York 19, N. Y., has announced a new microwave video detector crystal for military applications which will operate at temperatures up to 150 C. Type IN630 small tripolar

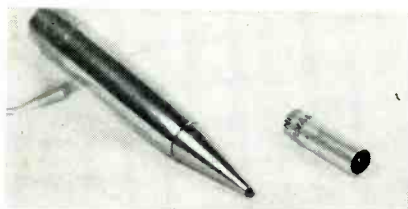

crystal operates over a frequency of 1,000 to 12,400 mc, providing a tangential sensitivity of -40 dbm over the range. It differs from conventional crystals in that it provides for a second signal terminal on the coaxial crystal in contrast to the ordinary single-ended construction. This design

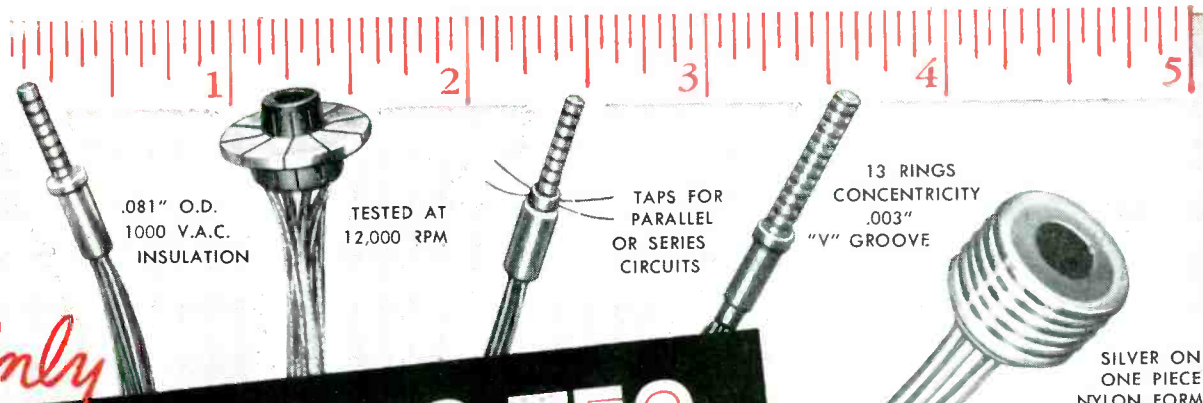

Only

ELECTRO TEC
 PRECISION-MINIATURE
slip ring assemblies
AND COMMUTATORS
offer all these advantages:

EXCLUSIVE* ELECTRO TEC TECHNIQUES
*insure closer tolerances, absolute uniformity,
 and the ultimate in miniaturization*

Electro Tec units are the product of an exclusive manufacturing technique that results in accuracy unattainable by conventional fabricating methods. In this process a plastic is moulded around the wire leads. Accurate machining reduces this blank to the proper shape, complete with grooves. Hard silver is deposited into the grooves by electroplating to produce the required rings. Final machining insures concentricity and dimensional accuracy. The result is one-piece, unitized construction with conducting rings of 70 to 95 Brinell hardness.

Diameters of these assemblies range from .045" to 24" cylindrical or flat. Cross-sections may range from .005" to .060" or more. Rings are polished to a jewel-like finish and can be held to 4 micro-inches or better. Even the smallest sizes withstand a 1000 V.A.C. breakdown test. Most types easily withstand rotational speeds up to 12000 rpm.

**ELECTRO TEC Assemblies are Specified by the Nation's
 Leading Precision Instrument and Equipment Manufacturers for Proven
 Greater Dependability, Longer Life, Smoother Functioning.**

The uniformly superior performance of Electro Tec slip ring and commutator assemblies in thousands of industrial and governmental applications has resulted in wide adoption of these component units by most leading manufacturers of precision instruments and equipment. Although these products provide improved performance and extra dependability, prices are strictly competitive. Write today for fully illustrated literature.

ELECTRO TEC CORPORATION
 SO. HACKENSACK NEW JERSEY

PRODUCTS OF PRECISION CRAFTSMANSHIP BY A NEW AND REVOLUTIONARY PROCESS

13 RINGS
 CONCENTRICITY
 .003"
 "V" GROOVE



SILVER ON
 ONE PIECE
 NYLON FORM

RINGS
 ANCHORED
 IN DOVETAIL

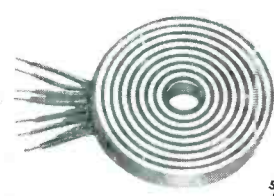

8 FLAT
 RINGS
 WITHIN
 5/8" RADIUS

- ONE PIECE, UNITIZED CONSTRUCTION
- ABSOLUTE MINIMUM TORQUE FRICTION
- DIAMETERS FROM .045" TO 24.0"
- MINIMUM 1000 V.A.C. HI-POT INTER-CIRCUIT
- UNIFORMLY HARD SILVER RINGS PLATED INTO GROOVES ON PRECISION MACHINED ONE PIECE PLASTIC FORM
- SPECIAL SURFACE DEPOSITS PREVENT TARNISH, MINIMIZE FRICTION, BRUSH NOISE AND PRACTICALLY ELIMINATE WEAR

ACTUAL SIZE

ULTRA-MINIATURIZED SLIP RING ASSEMBLY

- 6 Insulated Contact Rings
- Ring Width .030"
- Barrier Width .015"
- Ring Diameter .045"
- Weight 5.5 Grains (1/80 Ounce)
- Rings 70-95 Brinell
- Fine Silver
- Tarnish Resistant
- Friction Minimizing Surface Deposits
- 1000 Vol. Hi-Pot Between Rings
- Color Coated Leads

*PAT. NO. 2,696,570

ACEPOT*
ACETRIM*

Sub-Miniature Potentiometers and Trimmers

1/2" size, precision wire-wound,
up to 250K, $\pm 0.3\%$ linearity

setting new standards
for dependability
in sub-miniaturization

Let the facts speak for themselves! ACE Sub-Miniature Precision Wire-Wound Potentiometers and Potentiometer Trimmers are the result of 4 years development and over a year of successful use by leading electronic equipment manufacturers. Users have conclusively proved that ACEPOTS and ACETRIMS meet requirements for space and weight saving compactness, while at the same time meeting MIL specs' most stringent qualifications for performance and dependability. Why invite trouble with untested components when you can protect your reputation with ACEPOT and ACETRIM . . . the subminiature potentiometers and trimmers proved in actual use.

Condensed Engineering Data

	ACEPOT (potentiometer)	ACETRIM (trimmer)
Resistance Range	200 \sim to 250K $\pm 2\%$	10 \sim to 150K $\pm 3\%$
Linearity	$\pm 0.3\%$	$\pm 0.3\%$
Resolution	extremely high	excellent
Ambient Temperature	-55°C to 125°C *	-55°C to 125°C
Torque	low or high	low or high

The above specifications are standard — other values on special order.

Available in threaded bushing, servo, flush tapped hole or flange mounting, and ganged units. All units sealed, moistureproofed, and anti-fungus treated. Meet applicable portions of JAN specs and MIL-E-5272A standards.

*New X-500 ACEPOT operates to a new high of 150°C .

*Expedited delivery on prototypes; prompt servicing of production orders.
Send for Fact File and application data sheets.*

*trademarks applied for

ACEPOT*
ACETRIM*

ACE ELECTRONICS ASSOCIATES

Dept. E, 101 Dover St. • Somerville 44, Massachusetts

NEW PRODUCTS

(continued)

has made possible the simplification and reduction in cost of crystal holders. Circle P7 inside back cover.



DELAY NETWORK

available in four models

ADVANCE ELECTRONICS LAB., INC., 451 Highland Ave., Passaic, N. J., announces the type 801 continuously variable delay networks with incremental time delay less than 0.08 millimicrosecond and total time delay up to 1,000 μsec . There are four models available each with different total delay. Input impedance is 500 ohms and output impedance is 1,000 ohms for all types.

The temperature coefficient is less than 0.005 percent per deg C. Circle P8 inside back cover.

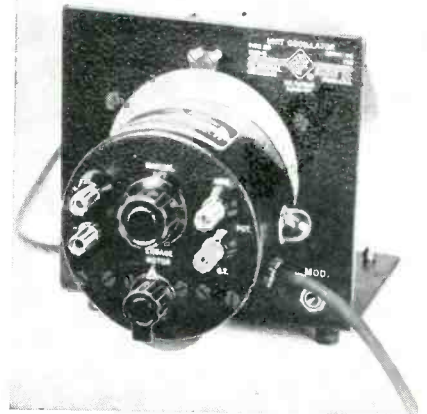

X-Y DIAL DRIVE for automatic plotting

GENERAL RADIO Co., 275 Massachusetts Ave., Cambridge 39, Mass. Automatic sweeping techniques can be used with existing test equipment with the new X-Y dial drives. The new drives make it possible to use a two-axis plotter to obtain permanent and precise recordings of data. The task of reading, logging and plotting point

WHERE ELECTRONICS MEETS THE EYE

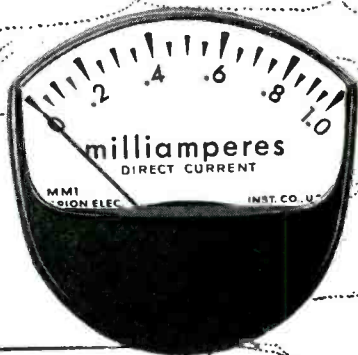

marion
MEDALIST
meters

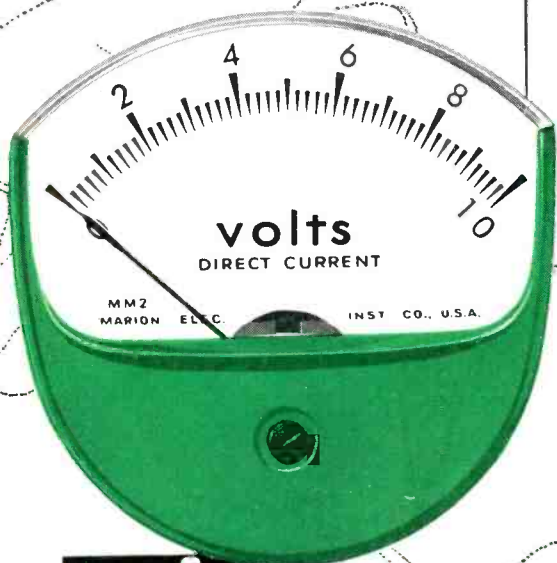

marion
advancement
in instrument
design

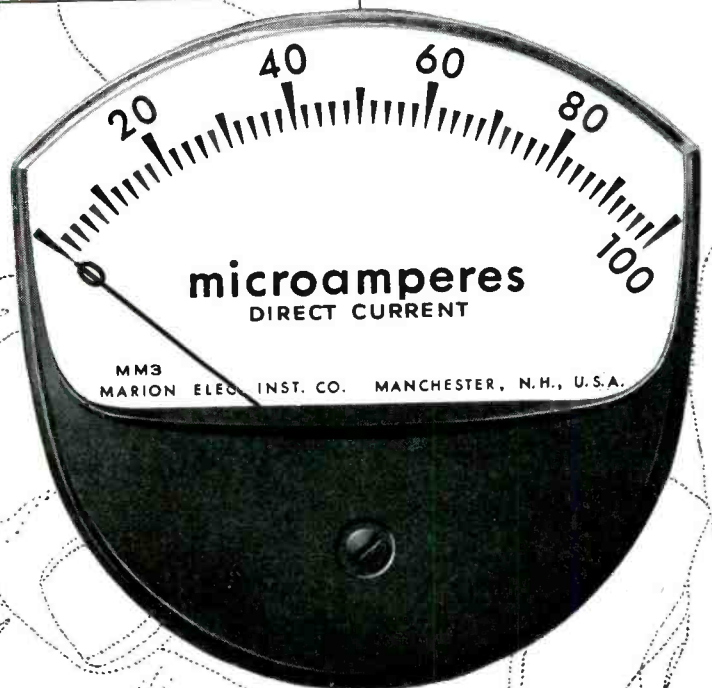

Three things set Medalists apart from other panel instruments: style, color and readability. Their distinctive shape enhances whatever equipment they become a part of; standard or custom-matched case and dial colors further improve equipment appearance. Longer scale length, larger numerals and better over-all dial illumination vastly increase their readability.

Medalists are made in all standard ranges, in 1½", 2½", and 3½" sizes. They provide a functional beauty that is unique among panel instruments today.

marion electrical instrument company

GRENIER FIELD, MANCHESTER, NEW HAMPSHIRE

At the I. R. E. Show, March 18-21:
Booth 2126

Copyright © 1957, Marion

FOR PROVEN RELIABILITY

Specify

HUSKY RELAYS

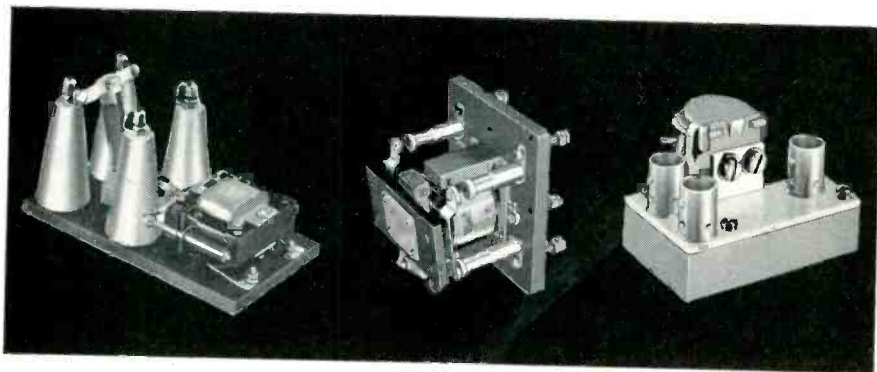

Husky Relays are precision-engineered to give peak performance under all conditions. Exhaustive laboratory tests, quality-controlled production and a demanding inspection program insure that each Husky Relay will deliver maximum service on the job.

The complete Husky Line contains relays designed to meet standard needs. If you have a special design problem, send us your specifications for engineering review.

Don't underestimate the importance of the "Right" relay in your design. Remember, you can rely on Husky Relays!

NEW PRODUCTS

(continued)

by point values is thus eliminated in either laboratory development or production testing.

Two sizes of drives are available, one for four-in. and the other for six-in. gear-driven precision dials. In each size two speeds are offered, one eight times the other. All models use synchronous motors.

The potentiometer included in the X-Y dial drive is used with a source of d-c to provide a d-c voltage proportional to the independent variable. The output characteristic as a d-c signal is used to drive the Y axis of the recording pen.

All models are priced at \$55 each and can be easily installed on General Radio oscillators covering the 20 cps to 2,000 mc range. Separate gear driven dials are available for equipment not already having suitable dials. **Circle P9 inside back cover.**

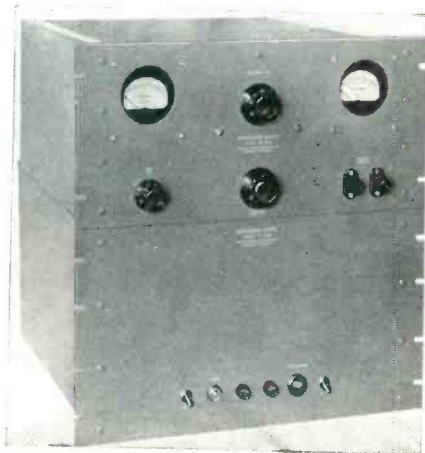

H-V POWER SUPPLY

is closely regulated

DRESSEN-BARNES CORP., 250 N. Vinedo Ave., Pasadena, Calif., has announced a closely regulated, h-v power supply for use with h-v tubes, twt's, klystrons, photomultipliers and in tube development work. Output range is 400 to 4,000 v d-c, continuously variable without switching; current rating is 0 to 100 ma. Regulation for output voltage range of 2,000 to 4,000 v d-c is 0.1 percent no-load to full-load; below 2,000 v d-c the regulation is 0.25 percent no-load to full-load. For line voltage of 115 v a-c ± 8 percent, the change in out-

Price Electric
CORPORATION

1500 Church St., Frederick, Maryland



Creative Engineers:

Work where imaginative engineering becomes intelligent hardware...in quantity!

It takes a special kind of scientific imagination and engineering freedom to develop and design intricate automatic systems for inertial guidance, flight control, armament control and data processing. At AUTONETICS, your opportunity to be creative in these fields is practically unlimited—because you know your ideas can be brought to life on the production line.

LABORATORY PERFECTION COMES TO THE ASSEMBLY LINE

To build just *one* of these electro-mechanical brains or muscles is a technological triumph. But today—with facilities and standards of precision that rival those of an operating room—AUTONETICS is delivering these advanced and reliable systems at a quantity-production pace.

TOOLS AND TECHNIQUES TO IMPLEMENT YOUR IDEAS

AUTONETICS' precision machine shops are capable of millionths of an inch precision in either developmental or volume quantities. Electronics capability includes micro-miniaturized components, complete computers and

transistorized circuits. AUTONETICS' new, modern facilities include an Auto-navigation Building which provides the precisely controlled environment for large-scale development and manufacture of advanced inertial guidance systems. Extensive production and development test equipment includes automatic electronic check-out systems and the latest environmental equipment...as unique as the electro-mechanical controls they evaluate.

ARE THESE THINGS IMPORTANT TO YOU?

Do you need the engineering freedom that this kind of production capability creates? You can have it at AUTONETICS—one of the few companies in the world that can design and quantity-produce complete automatic control systems for both military and industry.

LET US KNOW what kind of creative engineering interests you (please include highlights of your education and experience).

Write today to: Mr. W. D. Benning, Engineering Personnel, Dept. 991-2EL, AUTONETICS, Box AN, Bellflower, Calif.

THREE AUTONETICS ENGINEERS ON THEIR WAY UP



In just 6 years, Elliott Buxton has risen from Servo Research Analyst to Group Leader responsible for Preliminary Engineering in Autonetics' Flight Control Program. Among his other professional achievements, "Buck" has several patents filed in his name—including an aircraft maneuver stabilizer and a load-factor anticipation switch.



Ronald Greenslade (BSEE Michigan) is Group Leader in charge of development and design of electro-mechanical components for aircraft armament control systems at Autonetics. From Southern California's many fine residential communities, Ronald chose Long Beach, where he lives with his wife and two young daughters.

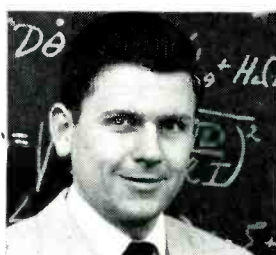

Dave Kimball joined Autonetics in 1950 with a BSEE from the University of New Mexico. Only 29, he is already Group Leader in the challenging field of Inertial Guidance Engineering. Dave lives with his wife and two children in nearby Fullerton, California—an ideal center for his favorite diversions: softball, bowling and skin-diving.

Autonetics 
A Division of North American Aviation, Inc.

AUTOMATIC CONTROLS MAN HAS NEVER BUILT BEFORE

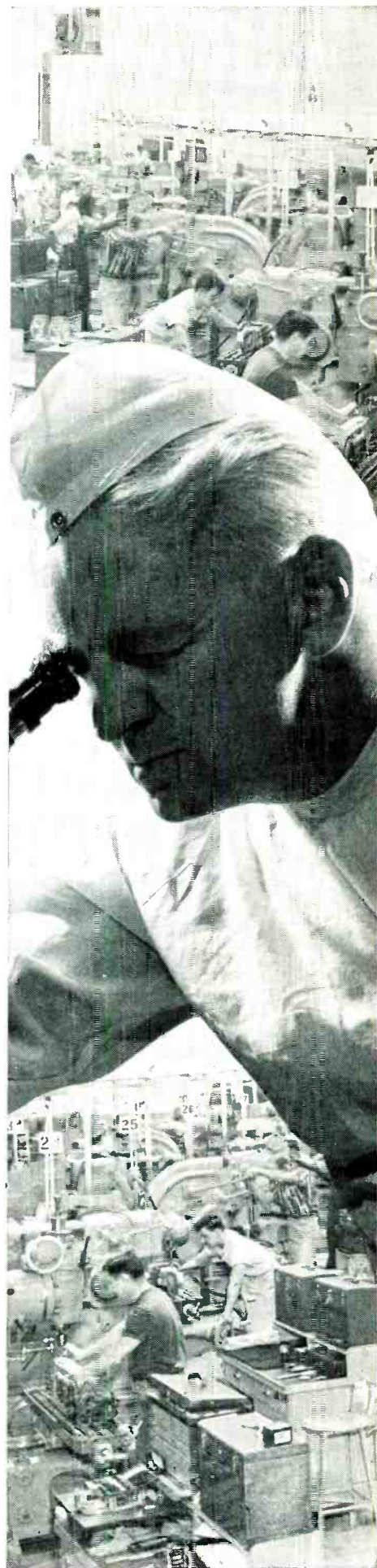

SIE

MODEL R-1 VOLTMETER



Designed and Engineered for DESIGN ENGINEERS

DC VOLTS 1 mv to 1000 v: accurate to 1½% of full scale
 AC VOLTS 1 mv to 1000 v: accurate to 3% of full scale
 OHMS Zero to 500 megohms: expanded scales

The SIE Model R-1 Voltmeter incorporates Distended DC Scales permitting accurate measurement of voltage changes as small as one part in 10,000. Fully regulated power supply prevents inaccuracies resulting from line transients. D-C amplifier with voltage gain of 200 is flat within ½ db to 100 kc.

Available in bench or rack mounted models.

DRIFT: Less than 3 mv/hr.
 TUBE COMPLEMENT: 13
 WEIGHT: 34 lbs.

Bench Model \$620
Rack Model \$700



**SOUTHWESTERN INDUSTRIAL
 ELECTRONICS COMPANY**

P. O. BOX 13058 2831 POST OAK ROAD
 HOUSTON 19, TEXAS

NEW PRODUCTS

(continued)

put voltage from 2,000 to 4,000 v d-c is 0.15 percent. Below 2,000 v d-c the change is 0.3 percent.

Ripple and internal noise are below five mv rms for any voltage or load within the rating. The unit is equipped with positive or negative grounding switch, and three-turn Helipot for vernier adjustment of output voltage. Designed for standard 19 in. rack panel mounting, model 4K-100B is 19½ in. high and 18 in. deep. Literature is available. Circle P10 inside back cover.



HIGH-POWER KLYSTRON for radar, linear accelerators

EITEL-MCCULLOUGH, INC., San Bruno, Calif. The X626 klystron is capable of generating 100,000 w of average r-f power and more than 1,000,000 w of peak pulse power. It will be used in radar and linear accelerator operation. The king-size tube, 10 ft 5 in. in length, is the first of a series of super-power Eimac klystron tubes. Circle P11 inside back cover.



REJECTION FILTER for the vhf band

ENTRON, INC., 4902 Lawrence St., Bladensburg, Md. Model DBR is a vhf band rejection filter which

Now-Stronger Passive Cathodes!

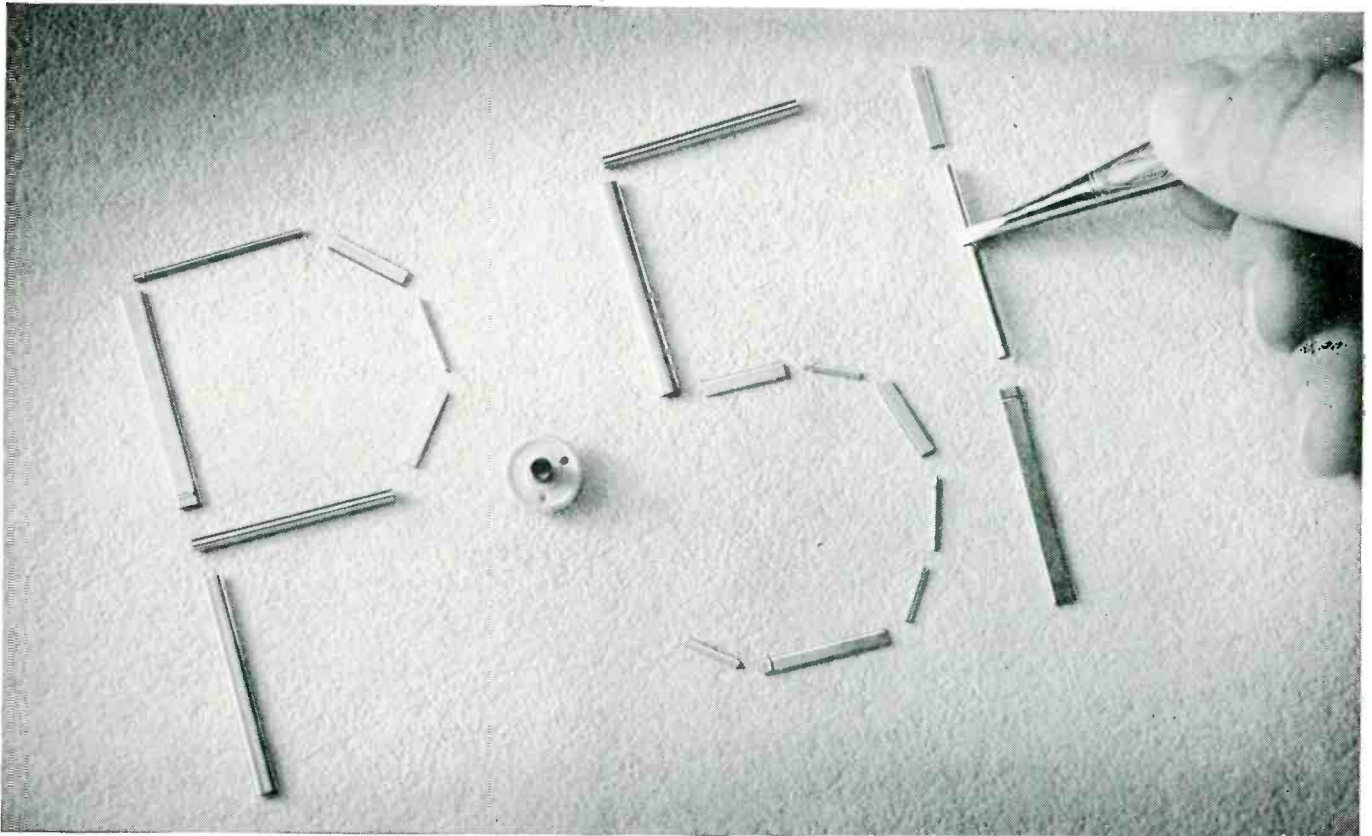

Superior announces Cathaloy P-51

— a new passive cathode material

- 100% stronger than Cathaloy P-50, ideal for ruggedized tubes
- Free of sublimation and grid emission troubles; low interface impedance
- Available in seamless, Weldrawn® and Lockseam* forms

Latest addition to Superior Tube's family of Cathalloys is Cathaloy P-51—a passive cathode material with entirely new properties.

NEW INGREDIENT

Cathaloy P-51 is similar to Cathaloy P-50 in chemical composition and electrical characteristics. But the addition of approximately 4% tungsten greatly increases its strength.

HIGH HOT STRENGTH

Tests prove that Cathaloy P-51 is twice as strong as Cathaloy P-50 at operating temperatures. This means it is especially useful in ruggedized tubes. In all tubes, it reduces the risk of failure from shock and of bowing. As with all Cathalloys, the composition of Cathaloy P-51 is carefully controlled by Superior. Every melt is checked in an electron tube before being approved for production.

UPGRADE YOUR TUBES

Cathodes made from Cathaloy P-51 are available in either seamless, Weldrawn or Lockseam form, and can be fabricated to your exact dimensional specifications. Write for technical information, Superior Tube Company, 2500 Germantown Ave., Norristown, Pa.

*Manufactured under U.S. patents.
NOTE: Cathaloy is a trademark of Superior Tube Co., Reg. U.S. Pat. Off.

Superior Tube

The big name in small tubing
NORRISTOWN, PA.

Johnson & Hoffman Mfg. Corp., Mineola, N. Y.—an affiliated company making precision metal stampings and deep-drawn parts

THE OFFNER DYNOGRAPH

...rectilinear recording

...curvilinear recording

...heat sensitive recording

...electric recording

...ink recording

IN A SINGLE OSCILLOGRAPH!

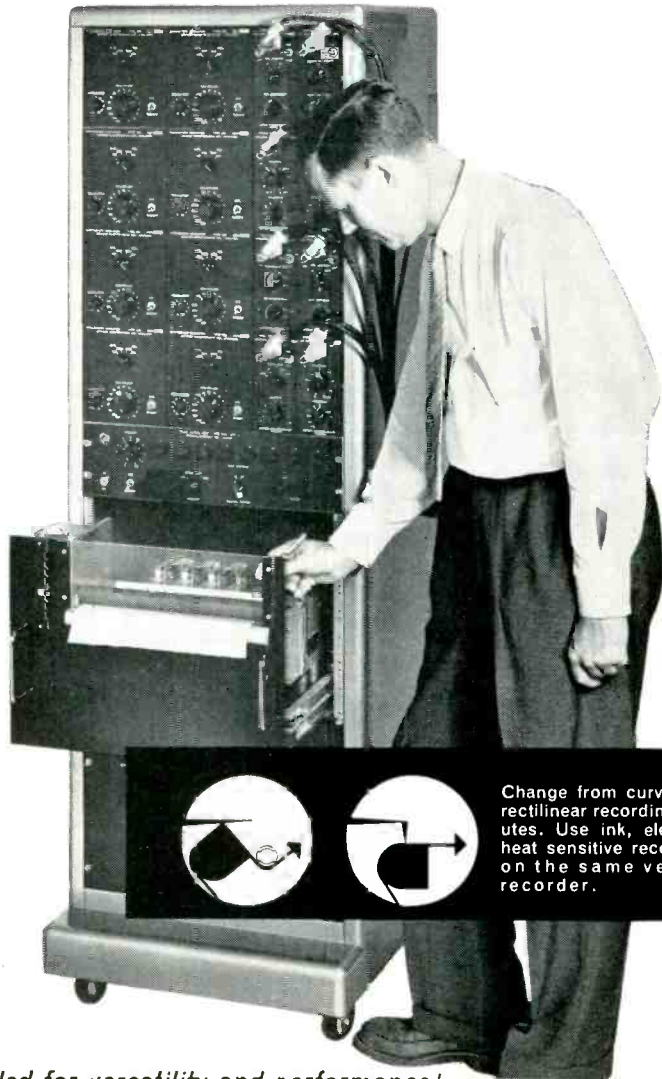

Change from curvilinear to rectilinear recording in minutes. Use ink, electric, or heat sensitive recordings—on the same versatile recorder.

unequaled for versatility and performance!

High sensitivity—up to 15 microvolts d-c per mm. Stable—absolute zero base-line drift. No "warm-up"—immediately stable and ready for use. One percent linearity—over 8 centimeters deflection. One amplifier—for all recording applications.

Write for 12 page, 2 color catalog—gives specifications and details.



OFFNER ELECTRONICS INC.

5324 N. KEDZIE AVE. • CHICAGO 25, ILL.

NEW PRODUCTS

(continued)

achieves extreme stability and flexibility with separately tuneable high Q rejection sections. It is especially useful in eliminating adjacent broadband interference or multiple spurious signals and is particularly well suited for use in removing interference to color tv signals. This unit has a nominal 0.5-db insertion loss and ± 0.5 -db passband response. Twelve superimposed asymmetrical notches permit a great variety of precision response shapes to be easily achievable. Typical adjustments provide a rejection band 600 kc wide with minimum attenuation of 90 db, 1 mc wide with 75 db attenuation or 6 mc wide and 25 db attenuation.

As a bandpass filter, it will provide 60-db attenuation approximately 1 mc outside the passband with 35-db attenuation 6 mc outside the passband.

Current model (DBR-26) is tuneable in the range of 50 mc to 100 mc. Circle P12 inside back cover.

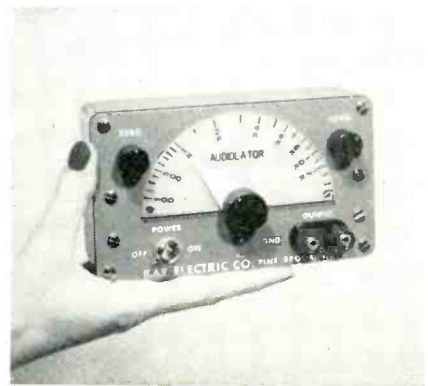

AUDIOLATOR

an all-transistorized bfo

KAY ELECTRIC Co., 14 Maple Ave., Pine Brook, N. J., has announced the Audiolator, a fully transistorized beat-frequency audio oscillator designed for field service, industrial, commercial and military applications. Powered by long-life batteries, a single sweep of the dial covers the audio range of 50 cycles to 15 kc.

The unit features constant output, built-in stability, no hum and flat output, constant with frequency, of one db over range. No grounds are needed for the instru-



Better Things for Better Living
... through Chemistry

ELECTRONIC DESIGN

LATEST PROPERTY AND APPLICATION DATA ON

TEFLON® tetrafluoroethylene resin

NEWS

Du Pont TEFLON® resists temperature extremes in electronic aircraft equipment

Lead-through bushings of TEFLON® feature hermetic sealing

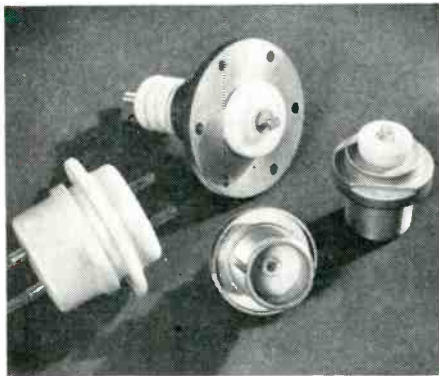

LEAD-THROUGH BUSHINGS made with Du Pont TEFLON have excellent corona, arc and ohmic resistance . . . are hermetically sealed against gases, vapors, liquids. (Manufactured by the Joclin Manufacturing Company, North Haven, Connecticut.)

Sensitive tests with the mass spectrometer have proven that gases, conventional insulating oils, silicone oils and their vapors cannot penetrate through connectors using TEFLON tetrafluoroethylene resin as their dielectric. The bushings maintain their seal when cycled repeatedly over a temperature range from -85° F. to +302° F.

In addition, the connectors are resistant to shock. The specially prepared insulators of TEFLON provide mechanical resilience not possible with the usual rigid construction. The moisture-repellent qualities of TEFLON make it possible to use the bushings under the most adverse conditions of humidity. They conform to the applicable sections of Specification MIL-E-5272A.

Where components are subjected to a wide range of temperature, pressure, humidity and mechanical shock and vibration, Du Pont TEFLON provides outstanding performance. In your designs, too, components of TEFLON may well be the decisive factor in meeting acceptance standards.

Wire insulated with TEFLON is used in new transistorized flight-control system

The transistorized PB-20 is the latest development in the field of automatic flight-control equipment. It has been specified for use in many advanced aircraft, such as the Boeing 707 jet transport. The PB-20 depends extensively on wire coated with TEFLON for reliable operation.

Tough and durable TEFLON can be used up to 500° F. and displays excellent properties at sub-zero temperatures. Thin-walled coatings on wire will not burn, melt or decompose when connections next to it are soldered. The dielectric strength and arc resistance of TEFLON are excellent. Its dissipation factor of less than 0.0003 from 60

cycles to 3,000 megacycles assures low losses in high-frequency communications equipment. Very few chemicals exist which can injure TEFLON . . . it is not affected by aircraft fuels, lubricants or solvents. It is inert to fungus, rot and mildew and will not absorb moisture. Articles of Du Pont TEFLON will meet the requirements of many military specifications relative to jet-aircraft applications.

You can meet the increasing demands for extreme temperature range, higher frequencies, higher voltages and greater resistance to corrosive environments by specifying TEFLON. Find out now how TEFLON can improve your products.

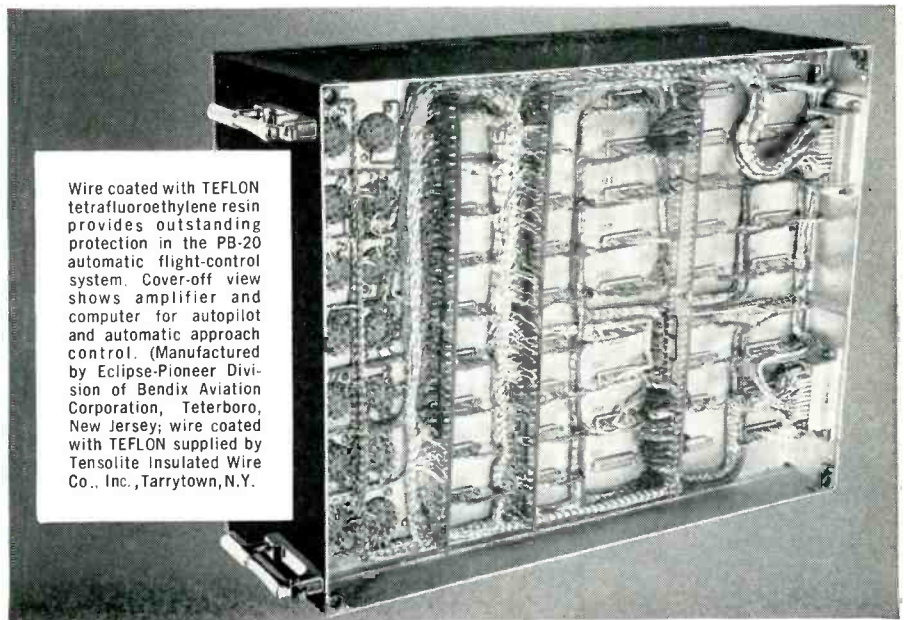

Wire coated with TEFLON tetrafluoroethylene resin provides outstanding protection in the PB-20 automatic flight-control system. Cover-off view shows amplifier and computer for autopilot and automatic approach control. (Manufactured by Eclipse-Pioneer Division of Bendix Aviation Corporation, Teterboro, New Jersey; wire coated with TEFLON supplied by Tensolite Insulated Wire Co., Inc., Tarrytown, N.Y.)

TEFLON®

is a registered trademark . . .

TEFLON is the registered trademark for Du Pont tetrafluoroethylene resin, and should not be used as an adjective to describe any other product or any component part; nor may this registered trademark be used in whole, or in part, as a trade name for any product.

SEND FOR INFORMATION

For additional property and application data on Du Pont TEFLON tetrafluoroethylene resin, mail this coupon.

E. I. du Pont de Nemours & Co. (Inc.), Polychemicals Dept.
Room 182, Du Pont Building, Wilmington 98, Delaware

Please send me more information on Du Pont TEFLON tetrafluoroethylene resin. I am interested in evaluating these materials for _____

Name _____

Company _____ Position _____

Street _____

City _____ State _____

Type of Business _____

In Canada: Du Pont Company of Canada (1956) Limited, P. O. Box 660, Montreal, Quebec

GAMEWELL

POTENTIOMETER DATA SHEET

NOW! Unlimited Phasing with Extreme Compactness

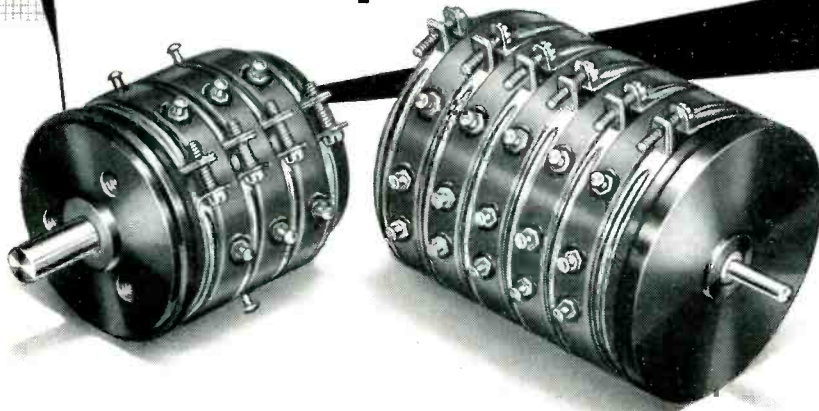

Phasing clamps available on three sizes of Gamewell RL-270A Blue Line Precision Potentiometers

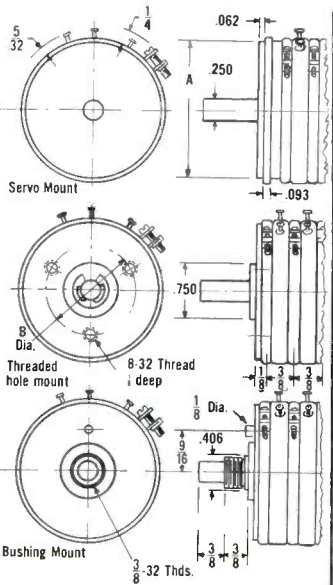

This special Gamewell Phasing Clamp design has two important extras: Extreme compactness and High Temperature compatibility. Check these features . . .

- Only $\frac{3}{8}$ " depth per section • Continuous service up to 150C available • Stainless steel clamps give unlimited phasing • Large number of taps, limited only by physical spacing • Exclusive Gamewell high unit pressure contacts give permanent, low resistance tap connection, no linearity distortion • Will withstand High "G" and operation under severe vibration • Three styles of mounting: Servo, Bushing and 3-hole bushing • Available in ball or sleeve bearings, shafts as specified • Comes in RL-270A-1 $\frac{3}{8}$;

Additional information, prices and delivery available from Gamewell representatives or write:

THE GAMEWELL COMPANY
NEWTON UPPER FALLS 64, MASS.



PRECISION POTENTIOMETERS

SPECIAL I Send for New Gamewell Catalog on complete line.

GA 6-13

MODEL	MAX. DIA.	A	B
RL-270A-1 $\frac{3}{8}$	1 $\frac{1}{8}$	1.312	1.000
RL-270A-2	2	1.875	1.250
RL-270A-3	3	2.875	1.750

NEW PRODUCTS

(continued)

ment—it can be placed across any transmission system.

► **Partial Specifications**—Frequency range is 50 cps to 15 kc; output voltage, one v at 600 ohms; output impedance, 600 ohms; output flatness, one db over entire range; attenuator, 0 to maximum, continuously variable.

Complete information and detailed specifications are available. Circle P13 inside back cover.



ACCELEROMETER for l-f measurements

GULTON INDUSTRIES, 212 Durham Ave., Metuchen, N. J. Slowly varying environmental phenomena, from steady state to 40 cps, can now be measured by a new series of differential transformer accelerometer. The Glennite ADT-700 series feature high output with high resolution, no friction and small size.

The line includes units with range of from one g to 10 g, linearity within one percent, and sensitivities from 10 mv per g per v input to 100 mv per g per v input. Other specifications include hysteresis of less than 0.25 percent, output impedance of 1,900 ohms at 400 cps and a weight of three oz. Circle P14 inside back cover.

COMPONENT OVEN used on 115 v circuits

WILLIAMSON DEVELOPMENT Co., Inc., 317 Main St., West Concord, Mass., has announced a component oven that controls temperature of crystals and electronic circuitry. A standard unit is available for use on 115-v circuits, having a 35-w heater and bimetal thermostat control. The oven has inner and outer metal cans with Terne

The 7 Old-Fashioned Villains of Tape Recording

...and How

irish FERRO-SHEEN
BRAND

Foiled Them All

Once upon a time, 7 Old-Fashioned Villains like this  were wreaking endless woe on Decent People with Tape Recorders. The 1st Villain was Oxenscheid the Oxide Shedder.

He scraped away at the crumbly oxide coating of old-fashioned tape and gummed up tape recorders with the shedding particles. The 2nd Villain was Wearhead the Head Wearer.

He filed down the magnetic heads with the abrasive coating of old-fashioned tape. The 3rd Villain was Frickenshaw the Frequency Discriminator.

He dragged down the high-frequency response of old-fashioned tape through inadequate contact between the "grainy" coating and the head. The 4th Villain was Noysenhiss the Noise Generator.

He generated tape hiss and modulation noise as a result of the random vibrations and irregular flux variations caused by the uneven magnetic coating of old-fashioned tape. The 5th and 6th Villains were Dropofsky the Drop-Out Artist and Pringlethorpe the Print-Through Bug.

They put nodules and agglomerates into the oxide emulsion of old-fashioned coated tape, causing "drop-outs" whenever these trouble spots lost contact with the record or playback head, and inducing "print-through" on the recorded tape when the extra flux at the trouble spots cut through adjacent layers on the reel. The 7th Villain was Brattleby the Embrittler.

He dried out the plasticizers in old-fashioned coated tape and embrittled irreplaceable recordings. Then: OCTOBER, 1954! That's when a very un-old-fashioned little man by the name of

F. R. O'Sheen announced that he had developed the revolutionary new **irish FERRO-SHEEN** process of tape manufacture and presto!

the 7 Old-Fashioned Villains were sent a-scurrying with cries of "Confound it— Foiled again!" Yes, F. R. O'Sheen had made the new magnetic oxide lamination of **irish FERRO-SHEEN** tape so smooth-surfaced and non-abrasive, so firmly anchored and homogeneously bonded to the base, so free from nodules and agglomerates, that the

7 Villains were evicted—for good! **Moral:** Don't let Old-Fashioned Villains do you out of your hi-fi rights!

Just say "No, thanks" to ordinary coated tape and ask for F. R. O'Sheen **irish FERRO-SHEEN**, that is! ORRadio Industries, Inc., Opelika, Alabama.

Inquiries Invited on
irish
BRAND
FERRO-SHEEN
INSTRUMENTATION
AND
COMPUTER TAPE

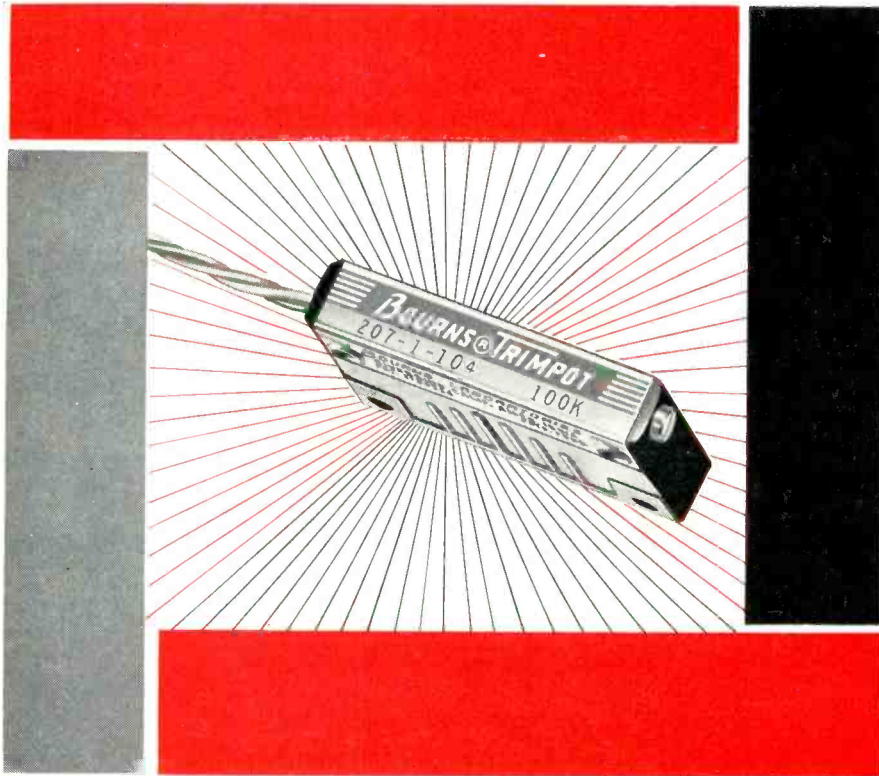

BOURNS TRIMPOT[®]

MODEL 207 HI-R*

High Power—2 watts
High Resistance—100,000 ohms
High Temperature—175°C

The latest addition to the expanding line of Bourns TRIMPots is the new high power, high temperature, Hi-R.

The Hi-R will dissipate 2.0 watts at 50°C and has a maximum operating temperature of 175°C. Model 207 is available in total resistances of 100 ohms to 100K; Model 208, the variable resistor counterpart, is offered in 100K, 150K and 200K. High resistance values are combined with the excellent temperature coefficient and stability of a wirewound resistance element.

In addition to these many outstanding features, the Hi-R is miniature in size: only $\frac{3}{32} \times \frac{13}{16} \times 1\frac{1}{4}$ —0.28 cubic inches. The 25-turn adjustment shaft is self-locking, thus insuring stable settings under extreme conditions of shock, vibration and acceleration.

Delivery from stock on standard resistances. Send for Bulletin 207.



BOURNS LABORATORIES, INC.

General Offices: 6135 Magnolia Ave., Riverside, Calif.
 Plants: Riverside, California—Ames, Iowa

*Trade Mark

COPR. BL

TRIMPOTS • LINEAR MOTION POTENTIOMETERS • PRESSURE TRANSDUCERS AND ACCELEROMETERS

plate finish to facilitate hermetic sealing. The space between the cans is insulated with glass wool and asbestos. The standard unit will control to 5 C at a setting of 75 C in an ambient of 0 to 60 C. Inside dimensions of the standard unit are $3\frac{1}{8}$ by $3\frac{1}{2}$ by $5\frac{3}{8}$ deep. Special sizes may be had on request. **Circle P15 inside back cover.**

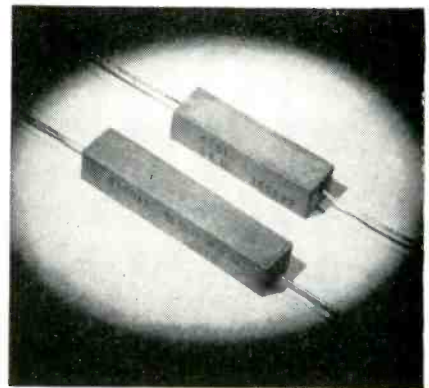

POWER RESISTORS

square-body type

CLAROSTAT MFG. CO., INC., Dover, N. H., has announced square-body Greenohm Jr. miniature power resistors, series C7GL and C10GL. The wirewound resistance element is placed in a square-body steatite casing and imbedded and sealed in inorganic cement. Axial pigtail leads provide connections and also support for the resistor in point-to-point wiring. The square-body shape facilitates certain kinds of assembly and wiring operations. They are available in seven-w and 10-w ratings, $1\frac{3}{8}$ in. and $1\frac{1}{2}$ in. long, respectively and of the same $\frac{3}{8}$ by $\frac{11}{16}$ in. cross-section. Resistance values are from one ohm to 6,000 ohms, and one ohm to 11,000 ohms, respectively. **Circle P16 inside back cover.**

RIGHT ANGLE SOCKET

mounts tubes horizontally

AEROVOX CORP., 2724 South Peck Road, Monrovia, Calif. A new alkyd-base tube socket that mounts tubes horizontally to reduce space requirements has been especially designed for use with printed circuits.

The sockets mount at right angles to the plane of the wiring

You owe it to yourself *and your family* to compare these multiple advantages offered only by Consolidated . . .

Find out now how CEC's engineers enjoy a combination of advantages unique in electronics, and made possible by executives with both scientific and professional management backgrounds. CEC's policy of recognition for the

individual has built a pioneering, multi-million dollar organization—the recognized leader in the application of electronics to chemical analysis, process monitoring, dynamic and static testing, and automatic data processing . . .

YOUR CREATIVE IMAGINATION PAYS OFF AT CEC

In development engineering laboratory, George M. Slocomb (center), 31, supervisor of digital data processing section, explains new test procedure in transistor circuitry for digital data handling. Viewing bread-board demonstration are engineers Bob Kelly (left) and Wayne Hodder. *CEC's substantial R&D budget is 2-3 times greater than normal budgets—totals 10-15% of sales.*

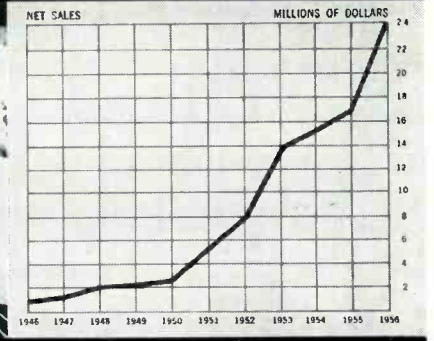
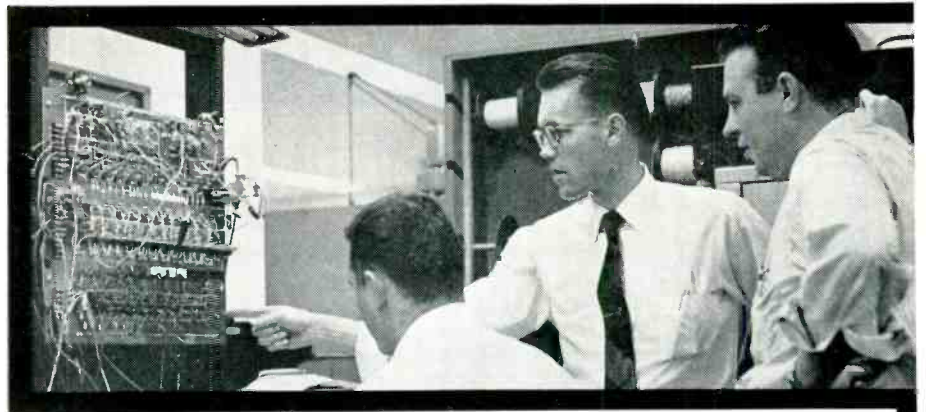

TOP MONEY for professional engineers in all classifications: Development, Design, Systems, Test and Service. CEC's fast, continuing growth offers great opportunity in a stimulating professional atmosphere.

HOW TO ENJOY YOUR WORK and make your family happy . . . CEC's progressive administration emphasizes *excellent working conditions in modern buildings. Your family will enjoy the beauty of CEC's non-industrial location!*

PROFIT SHARING SECURITY *plus* exclusive life, health, accident plans. CEC's profit sharing enables you to participate in the Company's growth—backed by rising sales (\$24 million in 1956 . . . \$35 million anticipated in 1957).

Don't take our word for it . . . ask our engineers . . . WRITE TODAY FOR COMPLETE DATA.

Consolidated Electrodynamics

300 North Sierra Madre Villa, Pasadena, California



NATIONWIDE COMPANY-OWNED SALES & SERVICE OFFICES

ELECTRONICS — February 1, 1957

Joseph H. Lancor, Vice President & Director of Engineering
Consolidated Electrodynamics Corporation, Dept. E-2
300 North Sierra Madre Villa, Pasadena, Calif.

Please send Consolidated information to:

NAME _____
(Please print or type)

ADDRESS _____

CITY _____ ZONE _____ STATE _____

CALL Pacific Automation Products for your Systems Cable Requirements

The multi-conductor cables shown below are only a very few of the many varieties of **neoprene jacketed cables** that Pacific Automation Products processes every day for systems applications.

These cables are designed to perform under extreme environmental conditions and adhere to existing military specifications.

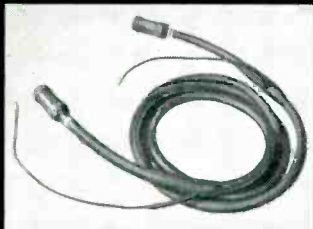

Co-axial conductor breakout.



Special rack and panel connector molded to cable.



Cable with umbilical connectors.

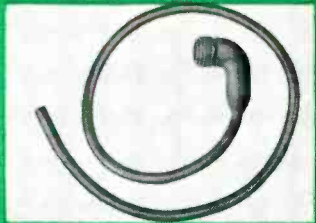

Molded 90° backshell.

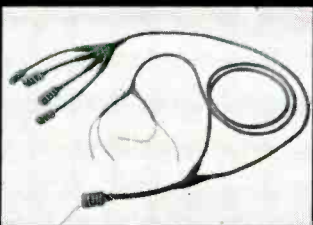

Multi-breakout harness assembly.

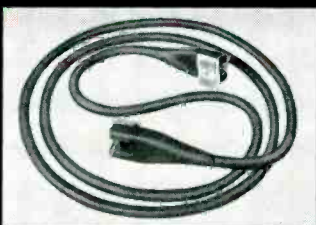

Rack and panel connectors with molded 90° cable attachment.

Whatever your requirements for system engineered cable—for military or commercial uses—Pacific Automation Products is your best bet. Call, wire or write today.

Write for Bulletin 158



Pacific Automation Products, Inc.

1000 AIR WAY, GLENDALE 1, CALIFORNIA
Chapman 5-6871 • TWX: GLN 7371
137 Walnut Hill Village, Dallas, Texas
Fleetwood 2-5806

Engineers and technicians will find a challenging and fascinating career with us. Your qualifications are welcomed.

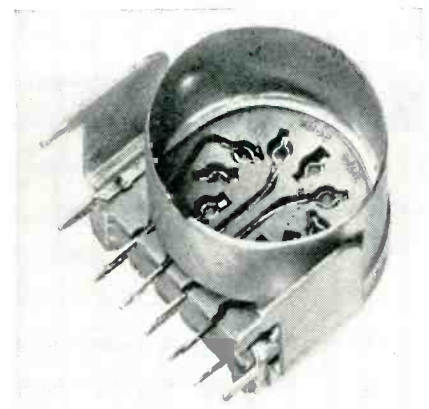

board. This places the longitudinal axis of the tube parallel to the plane of the board. Beside saving space, the lower position of the tube mass reduces strain on the socket caused by acceleration in the plane of the mounting surface. The new sockets are suited for hand or mechanized insertion into printed wiring boards utilizing in-line, punched round holes. The leads are simply dropped in and soldered.

Plaskon alkyd was selected for the body of the socket because of its superior properties of arc resistance, great dielectric strength, dimensional stability and high resistance to heat and moisture. **Circle P17 inside back cover.**



SERVO UNIT motor-gearhead-clutch

SERVOMECHANISMS, INC., 625 Main St., Westbury, N. Y., has available a miniature motor-gearhead-clutch Bu Ord size 10, (0.938 in. in diameter), with a maximum length of 1½ in., and designed to operate directly from either a 115 or a 26-v line.

This 400-cycle servo unit has motor and gearhead enclosed in a common aluminum housing. The housing design minimizes alignment and assembly problems while the use of aluminum makes pos-

Potter & Brumfield engineering is in this picture

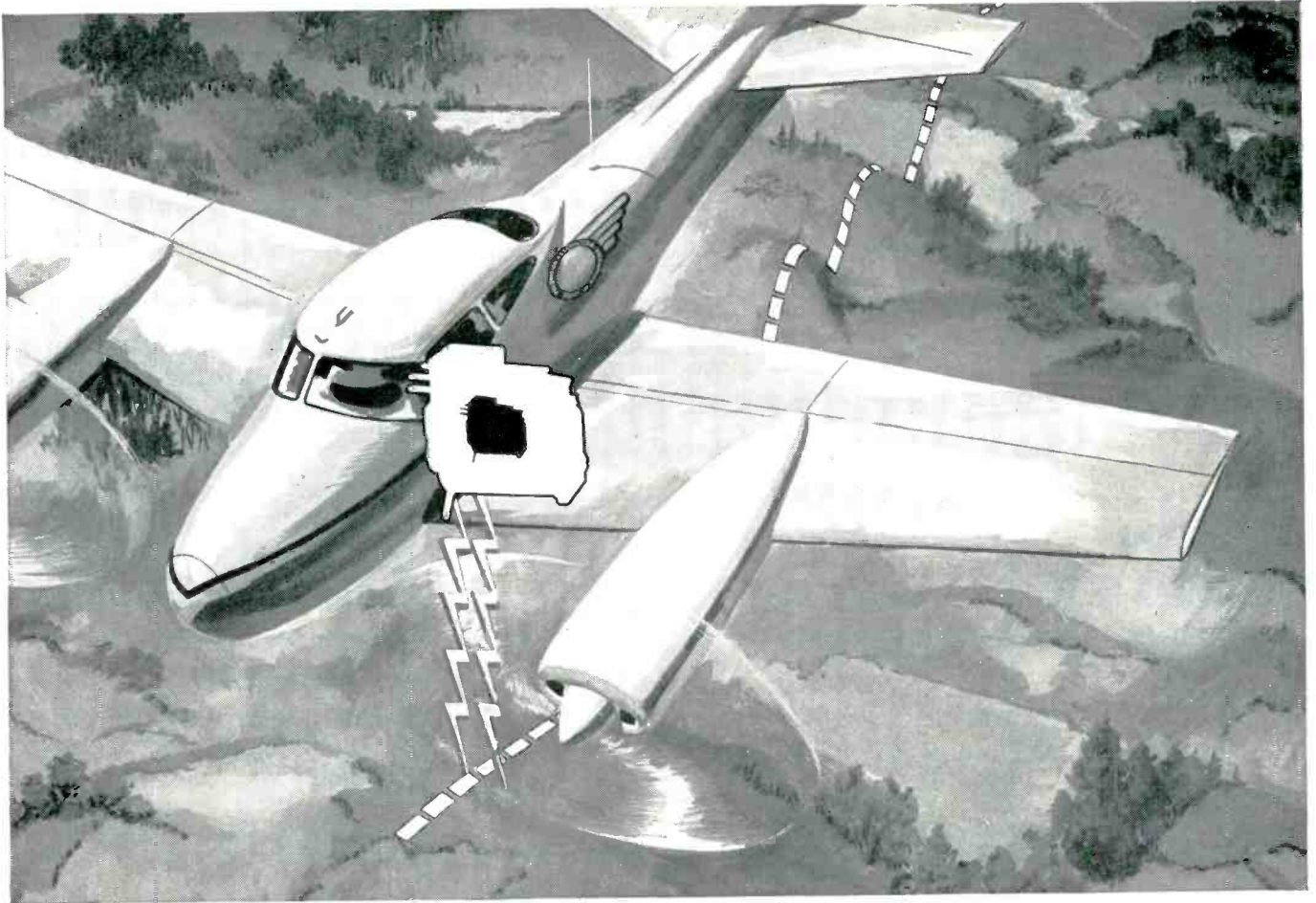

Which P&B relay did Television Associates specify
FOR THEIR AIRBORNE COMPUTER?



MH Series



MB Series

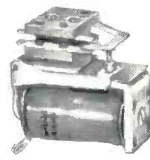

MC Series

Surveys for pipe lines, electric transmission routes and microwave paths are now made from the air, by radar. Television Associates of Indiana, Inc. developed this speedy new technique—and the equipment—which provides clients with detailed profiles of the terrain to be crossed.

Part of the equipment, an intricate airborne computer, requires relays that are fast-acting, light weight, versatile. They must have high shock and vibration resistance and remain operative in temperatures ranging from -45°C to $+85^{\circ}\text{C}$.

Modified MH relays by P&B were specified. These miniature relays meet all Television Associates' requirements and provide high reliability in a mighty small package. Challenging relay problems are solved daily at P&B. Twenty-five years of creative engineering are behind every P&B relay. Write today for our new catalog.

ENGINEERING DATA

SERIES: MH Miniature Telephone.

CONTACTS: Up to 18 springs, maximum 9 in each stack, forms A, B, C, D, E, X and Y. AC relays are limited to a maximum of 2 poles. Various contact material available.

VOLTAGE RANGE: DC-.05 to 110 V.—AC-6 to 230 V. 60 cycle.

COIL RESISTANCE: 22,000 ohms maximum.

TEMPERATURE RANGE: High temperature range (DC) -55°C . to $+135^{\circ}\text{C}$.

Standard DC -55°C . to $+85^{\circ}\text{C}$.

Standard AC -45°C . to $+40^{\circ}\text{C}$.

Other temperature ranges available to specification.

TERMINALS: Standard pierced solder lug holes will take (2) No. 18 hook-up wires. Adaptable for printed circuits.

ENCLOSURES: Dust cover plus wide range of hermetically sealed covers and types of terminations.

DIMENSIONS: 1-9/16" L. x 25/32" W. x 1 3/8" H. (4c Relay).

P&B RELAYS AVAILABLE AT MORE THAN 500 DISTRIBUTORS IN ALL PRINCIPAL CITIES

Potter & Brumfield, inc. PRINCETON, INDIANA

Subsidiary of AMERICAN MACHINE & FOUNDRY COMPANY • Manufacturing Divisions also in Franklin, Ky. and Laconia, N. H.

PROJECT:

QUALITY CONTROL

TARGET:

EVEN BETTER PERFORMANCE!



RESISTANCE ALLOYS

Wilbur B. Driver
Precision
RESISTANCE ALLOYS



Experimental Vacuum Melting Furnace



Chemical Laboratory

Better Performance - on every electrical and electronic application because... from ingot to final inspection, every test known to science safeguards the quality of Wilbur B. Driver Precision Alloys. These tests assure performance as specified! Why not consult a Wilbur B. Driver sales engineer for recommendations on precision alloys for your applications.

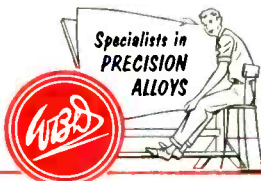

Wilbur B. Driver Co.
NEWARK 4, NEW JERSEY

For Over Thirty-five Years Manufacturers of Dependable Electrical, Electronic, Chemical and Mechanical Alloys

sible a minimum weight and temperature rise.

Gearing and loads are protected by an integral slip clutch. The use of this clutch as a control element is especially important when confronted with the high stall torques resulting from the use of high gear ratios. Circle P18 inside back cover.

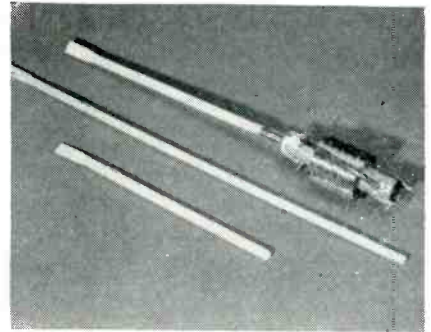

EXTENSION SHAFTS with flattened ends

ANCHOR PLASTICS Co., INC., 36-36 36th St., Long Island City 6, N. Y., has developed highly rigid, heat-resistant nylon extension shafts. They can be used in applications where greater torque is encountered.

The company has also developed automatic machinery to produce these shafts with flattened ends which eliminates the necessity for knobs. Illustrated is a coil using one of the shafts. Circle P19 inside back cover.



V-R POWER SUPPLY with low ripple

KEPCO LABORATORIES, INC., 131-38 Sanford Ave., Flushing 55, N. Y. The new model 2500 voltage-regulated power supply features a 0-2,500 v, 0-50 ma continuous duty d-c output. In the range 0-2,500 v,

meet
FRANK ROBERTS
 ...he's paid
 to solve your problems

Frank is chief engineer, components division, at National Company. He heads the proficient engineering group whose job is to modify present catalog items, develop new components to meet your specifications, and to help solve your components problems. While our catalog lists over 300 different parts, over 60 per cent of orders received are for "other than catalog items;" therefore, National is geared to provide many types of special services.

The capabilities and facilities of National's components engineering division are as excellent as they are varied. Some of our facilities are illustrated.

Our capabilities include the design and development of:

1. Commercial and precision type variable capacitors.
2. Communications type filters and networks.
3. Chokes and special coils.
4. Knobs and precision vernier dial mechanisms.
5. The design and fabrication of special hardware for the electronic industry including coil forms, shaft locks, dial locks, insulated bushings and captive nuts.

In addition our components division offers:

1. Complete model shop facilities.
2. Efficient, low cost production facilities.
3. Reliability test programs. U.S.A. approved environmental test facilities.

If you have special components requirements or a design and development problem—we suggest you—write, wire or call NATIONAL (Malden, Mass. 2-7950) at once. Put National's 42 years of experience and expanded new facilities to work for you.

The sooner you have men like Frank Roberts working for you the sooner your components problems will be solved.

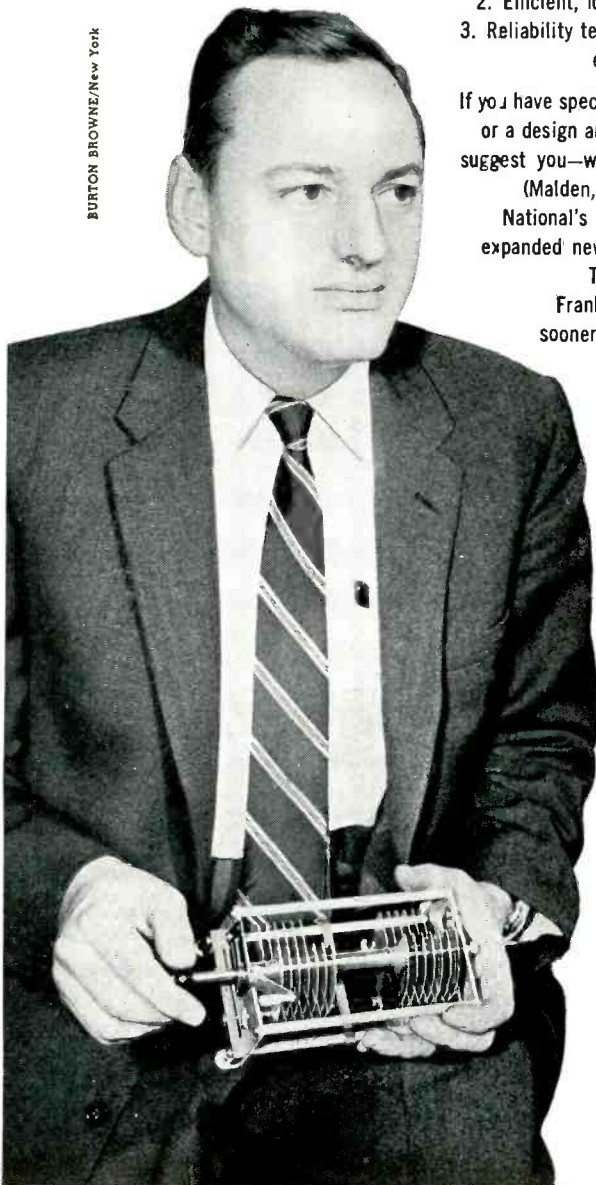

Model shop facilities

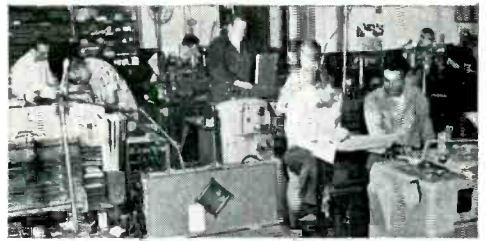

Section of choke engineering labs



Assembly line, components division



Mechanical engineering sector, components division



Environmental test facilities, AR a titude chamber

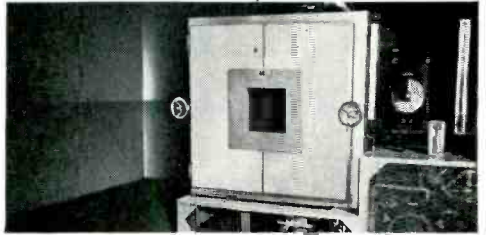

Engineers at work in components lab. No. 3

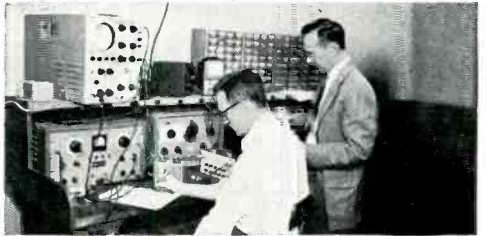

MEET THE MEN FROM NATIONAL
 AT THE I.R.E. SHOW—
 Booths 1401-1407

Eight out of every ten U.S. Navy ships use National Receivers



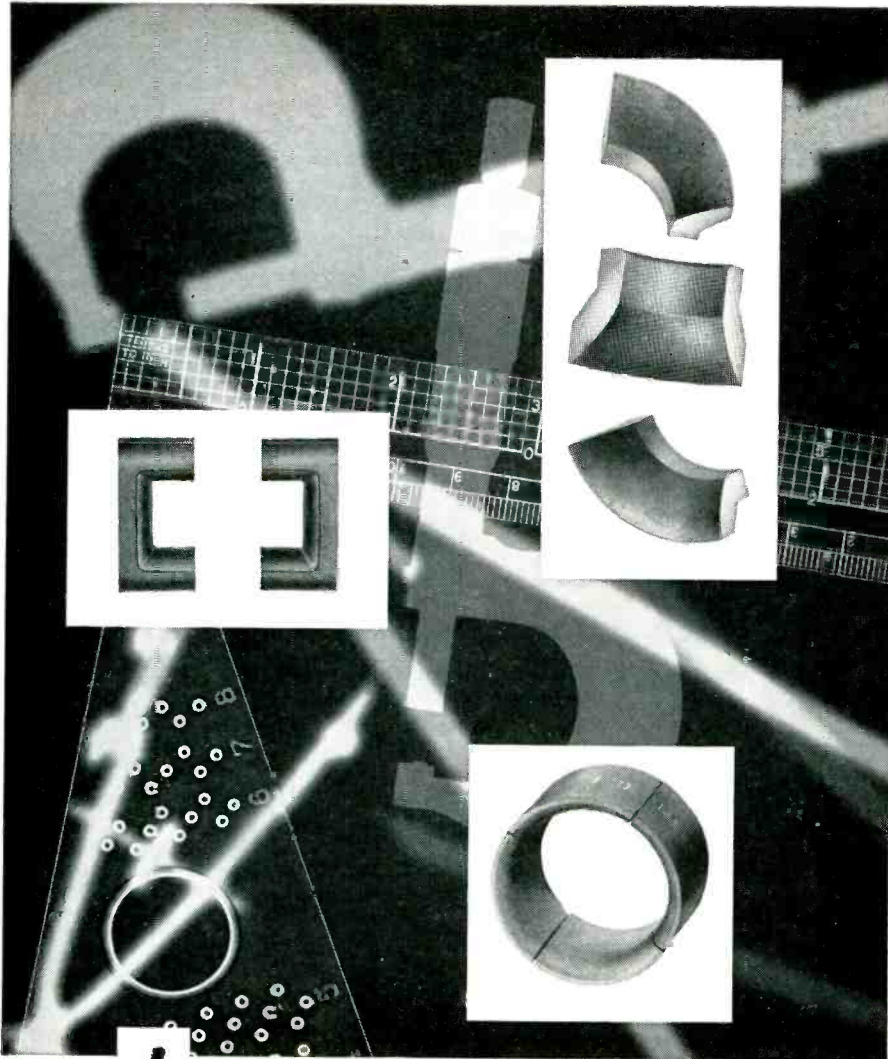

*Imagination—
your only limit!*

FERRITE COMPONENTS

Imagination is your only limit in applying Ferrite Components, when you work with our resourceful custom engineering group—backed by the vast research facilities of General Electric. Beyond standard shapes such as the “C” Cores and Yoke Segments above, our engineers stand ready to work with you in bringing your particular Ferrite designs to rapid, economical and uniform quantity production—held to close physical and electrical tolerances, at an advantageous cost level. Whether it's general data on Ferrite Components, specifications on available parts, or design assistance for tomorrow's lines, write or wire General Electric Co., Specialty Electronic Components Department, Section 2527, Auburn, N. Y.

Progress Is Our Most Important Product

GENERAL  ELECTRIC

the output voltage variation is less than 0.1 v for load variations from 0 to maximum current and less than 0.2 v for line fluctuation from 105 to 125 v. Ripple is less than three mv rms. Recovery time is less than 50 μ sec. Stability for a period of eight hours is within 0.2 v. Output impedance is less than 0.1 ohm from 20 cps to 100 kc and less than 0.5 ohm from d-c to 20 cycles.

Height of the unit is 12 $\frac{1}{2}$ in.; width, 19 in.; depth, 17 in.; weight, 65 lb. This supply is available with or without meters. Circle P20 inside back cover.

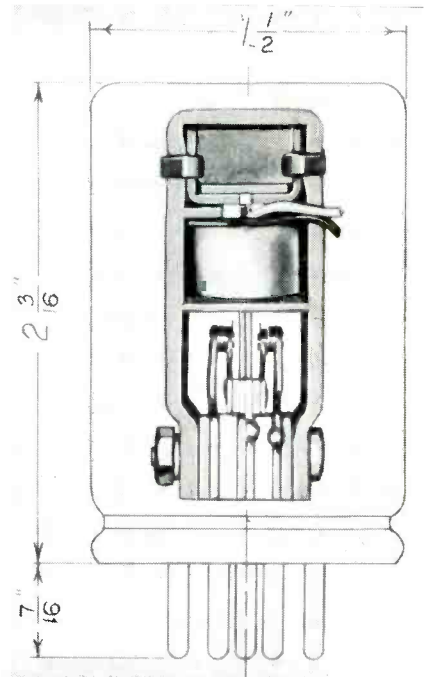

INSTRUMENT CHOPPER
has 6.3 v, 60 cps driving coil

JAMES VIBRAPOWR Co., 4050 N. Rockwell, Chicago 18, Ill. Model C-1800 commercial type instrument chopper is designed for systems with moderate low level signal requirements. It is a spdt chopper with a 6.3-v, 60-cps driving coil. The base is a standard octal type with neoprene seal. Through use of a unique mounting assembly, costly silicone cushioning has been eliminated.

Coil current is 175 ma maximum; phase lag, 26 ± 7 deg; contact on time, 150 ± 15 deg; contact symmetry, 15 deg; contact bounce, 4 deg maximum in initial 10 deg on time; contact rating, 50 v at 1 ma; life,

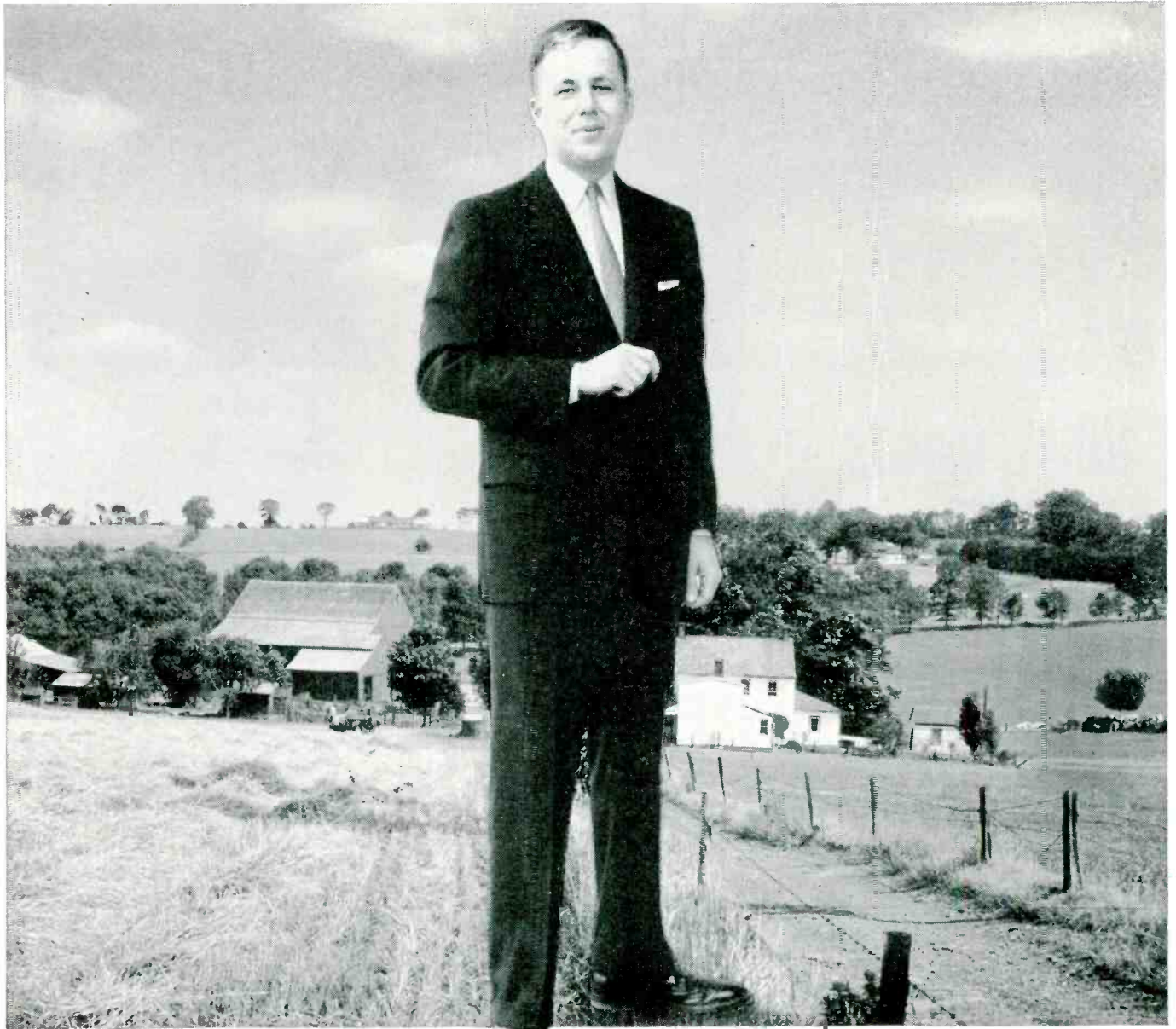

"I WORK AT DELCO RADIO.

The laboratory is 10 minutes or less from this homey spot in central Indiana. I earn a big-city salary and enjoy many opportunities to see my ideas used in the finished products of General Motors."

Delco Radio, first organization to develop and use high-power germanium transistors for automotive applications, offers challenging positions to men qualified to pioneer new ideas in the field of semiconductors and electronics. Good pay, permanent General Motors employee benefits, modern work facilities are only a few of the advantages you'll enjoy at Delco

Radio. Opportunities for recognition and achievement are not limited. Why don't you write and tell us about your background and ambitions, including information on your education, experience and accomplishments. Please address your letter to: Personnel Director—L, Delco Radio, Division of General Motors, Kokomo, Indiana.

QUALIFIED SCIENTISTS AND ENGINEERS with baccalaureate and advanced degrees—also those with electrical, chemical, mechanical, metallurgical, physical, or physical chemistry experience—are urgently needed at Delco Radio for permanent positions in research, development and design of semiconductor devices, and their applications and production.

The New 411A

From LFE's

Special

Products

Division-

Immediate Delivery



What makes the difference in OSCILLOSCOPES?

\$1210.

without plug-ins
F.O.B. BOSTON

Basically, oscilloscopes are much the same. Like LFE, several have the "Big 3"—wide bandwidth, fast rise time, excellent sensitivity—but extras make the difference!

- Diversification of the X-Axis System through plug-in adapters — an LFE exclusive.
- Direct-reading, continuously variable sweep speeds, 0.1 us/cm to 0.1 s/cm, 5% accuracy. Calibration accuracy 1% with gated marker generator plug in.
- Simple operation — direct-reading, functionally-grouped controls throughout.

LFE's new 411A gives you ALL these plus:

Full DC to 10mc/s bandwidth @ 20 mv/cm sensitivity, 0.035 us rise time.

Clean, brilliant trace and DC amplifier stability.

Direct-reading, continuously-variable square-wave calibrating voltage from 0.1 to 100 volts, 5% accuracy.

Versatile triggering facilities — external, internal, recurrent 500 to 5,000 cps — trigger on any part of leading or trailing edge of signal.

Internal trigger and sweep gate outputs, Z-Axis input for intensity modulation.

Elevation rack for easy viewing.

Plug-in adapters now available:

- extended range trigger generator
- sweep delay generator
- 2-channel video switch
- gated marker generator
- TV trigger shaper
- long sweep generator

411A is a precision scope for advanced electronic research. For complete details, simply write Special Products Division, Laboratory for Electronics, 75 Pitts St., Boston, Mass.

An outstanding instrument welcomes comparison

LABORATORY FOR ELECTRONICS, INC.

75 PITTS STREET

BOSTON, MASSACHUSETTS



NEW PRODUCTS

(continued)

1,000 hours nominal; residual noise, 1 mv as measured into one-megohm impedance — proportionally lower with reduced input impedance. Circle P21 inside back cover.



CAPACITORS

designed for ultrasonics

FILM CAPACITORS, INC., 3400 Park Ave., New York 56, N. Y. The new type U line of capacitors utilize a special high-breakdown plastic film dielectric and have high insulation resistance. Capacitance stability is of the order of 0.5 percent. As a result, optimum Q and stability can be maintained in the ultrasonic circuits themselves. A typical capacitor rated at 0.07 μ f is 2½ in. in diameter by 1½ in. long and can carry 500 circulating volt-amperes. Detailed literature is available on request. Circle P22 inside back cover.



FUEL GAGE TESTER

for aircraft applications

TELECTRO INDUSTRIES CORP., 35-18
37th St., Long Island City 1, N. Y.,

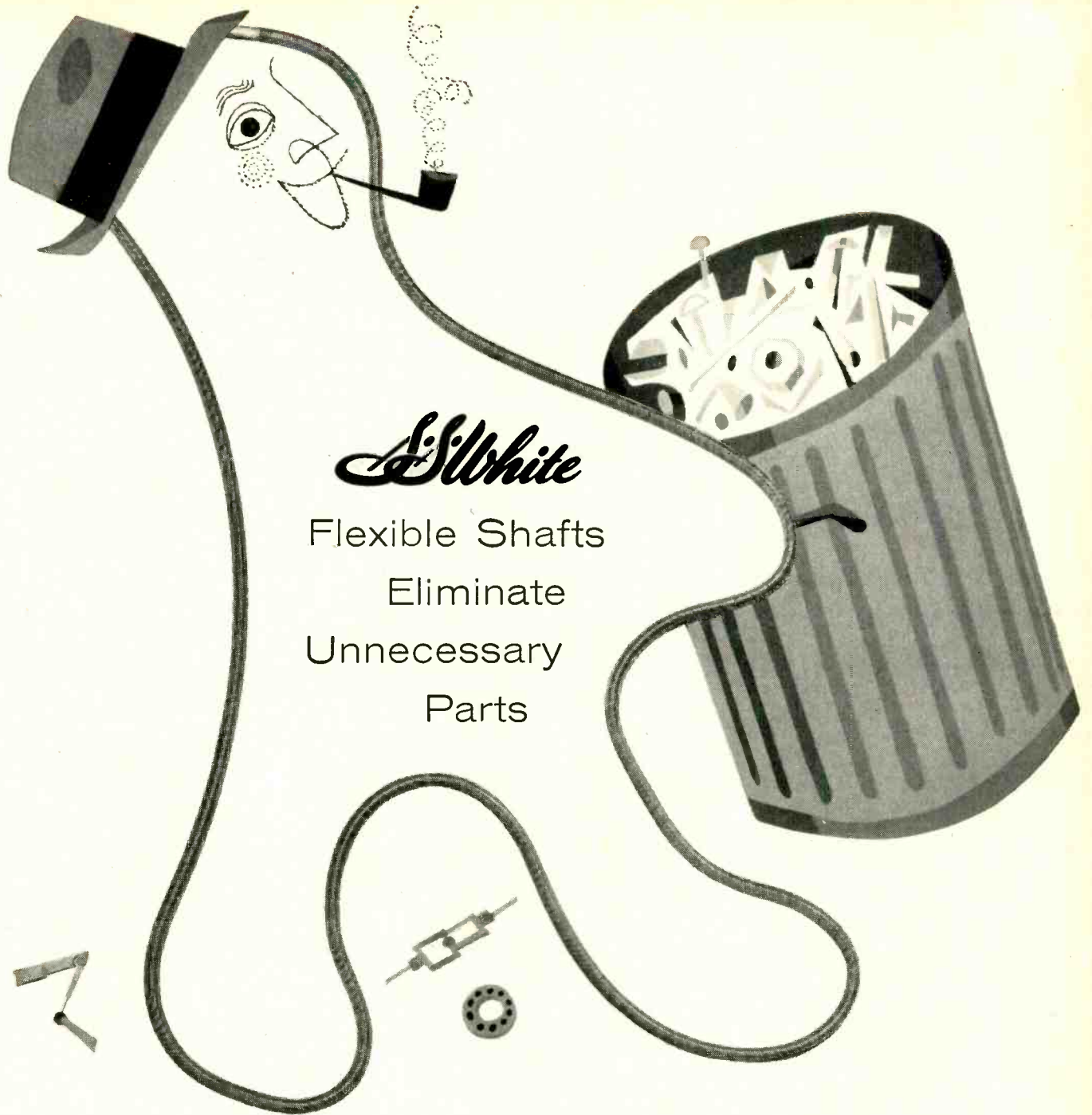

S.S. White
 Flexible Shafts
 Eliminate
 Unnecessary
 Parts

One manufacturer used flexible shafts to replace 35 parts in a Hydraulic Power System . . . cut costs by 90%. Four flexible shafts replaced a 35-part remote-control system . . . simplified design . . . made assembly easier . . . eliminated alignment problems . . . improved performance!

This is only one of hundreds of remote control and power drive problems these quality

flexible shafts are solving in every industry today. Can S.S. White flexible shafts help improve *your* product? Perhaps make it lighter in weight . . . cut production costs . . . eliminate unnecessary parts?

If you'd like to know more about flexible shafts, the advice of our engineers costs you nothing. Just write to

S. S. White Industrial Division, Dept. E, 10 East 40th Street, New York 16, N. Y.
 Western Office: 1839 West Pico Blvd., Los Angeles 6, Calif.

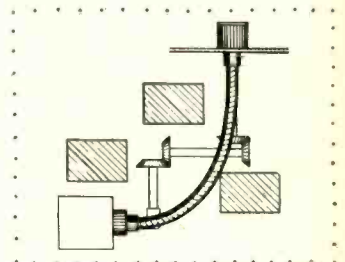

S.S. White

FIRST NAME _____
 IN FLEXIBLE SHAFTS



Useful data on how to select and apply flexible shafts! Write for Bulletin 5601.

Send for this FREE SAMPLE FOLDER



Contains 25 different test samples of high - dielectric INSULATING TUBING and SLEEVING

Includes samples and descriptions of . . .

VARGLAS SILICONE—Class H tubing, sleeving, lead wire, tying cord. Withstands temperature from -85°F to 500°F .

PERMAFIL-IMPREGNATED VARGLAS TUBING—Fiberglas impregnated with General Electric Permafil.

VARGLAS SLEEVING AND TUBING—synthetic-treated, varnished, lacquered, saturated and others.

VARGLAS NON-FRAY SLEEVING—three types available. Withstands temperatures up to 1200°F .

VARFLO TUBING AND SLEEVING—full range of colors, sizes and grades. Vinyl coated Fiberglas.

VARFLEX COTTON TUBING AND SLEEVING—varnish or lacquer impregnated—all NEMA grades.

SYNTHOLVAR EXTRUDED TUBING—listed by UL for use at 105°C . Various formulations to meet unusual requirements.



MAIL COUPON TODAY FOR SAMPLE FOLDER

VARFLEX CORPORATION
506 W. Court St., Rome, N. Y.

Please send me free folder containing samples of your electrical tubing and sleeving.

I am particularly interested in insulation for

Name

Company

Street

City Zone State

announces availability of the type MD-1 aircraft fuel gage tester designed specifically to test and calibrate aircraft capacitance type fuel gages. It qualifies under AF Spec MIL-T-8579 and meets all its requirements.

The MD-1 is a direct reading variable capacitor with a range of 10 to 6,200 μf . Accuracy is 0.1 percent and through the use of a mina dial and a vernier dial, capacitance values in increments of 0.1 μf are readily obtained. The dial is designed with a special positive locking device and a mechanical arrangement that eliminates backlash.

No external power source is required. The tester is lightweight, portable, rugged and sealed against moisture, and is supplied with nine accessory cables for connecting to all types of aircraft capacitance fuel gages. Circle P23 inside back cover.

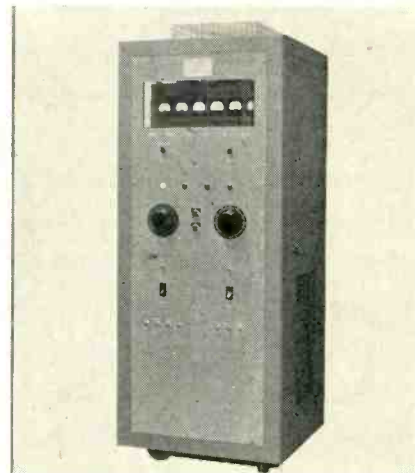

POWER SUPPLY filament-focus unit

LEVINTHAL ELECTRONIC PRODUCTS, INC., 760 Stanford Industrial Park, Palo Alto, Calif. Developed for klystrons with bombarded cathodes, model PC51 power supply provides 0 to 3 kv d-c at 0.9 ampere with less than 0.5-percent ripple, 0 to 20 v a-c at 60 amperes and 0 to 750 v d-c at 20 ma. All three supplies are insulated at 30 kv d-c above ground for operation with a separate beam power supply. Meters are available for measuring bombarder voltage and current, filament voltage and cur-

General NEW HI-SPEED SWITCHING TRANSISTORS Assures Computer Reliability

Computer engineers long seeking PNP transistors in applications requiring high current and fast switching will specify General Transistor's new 2N315, 2N316, and 2N317 for peak reliability.

2N317: As developed by General, a typical switching speed of .3 of a microsecond at 400 milliamps of collector current is possible with only 20 ma. of drive current.

The series resistance of these GT transistors, when conducting, is 1/2 ohm; the nonconducting series resistance is as high as 10 megohms with a result that approaches optimum efficiency at high current levels.

Computer manufacturers know they can depend on General's engineering and development as well as their quality and service. That's why GT is the largest supplier of transistors for computers.

CHARACTERISTICS

Parameter	Conditions	Min	Typical	Max
Collector-Base Voltage (V_{cb0})	$I_c = -25\mu a$	-20V	-30V	
Collector Cut-off Current (I_{c0})	$V_{cb} = -5V$ Emitter Open	-1 μa	-2 μa	
D.C. Current Gain (hfe)	$I_c = -400ma$ $V_{ce} = -2V$	20	30	50
Alpha Cut-off Frequency ($f_{\alpha b}$)	$V_{cb} = -5V$ $I_c = -1ma$			20mc

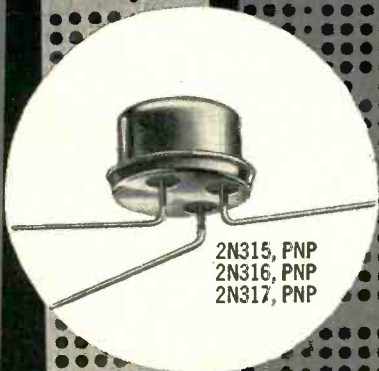
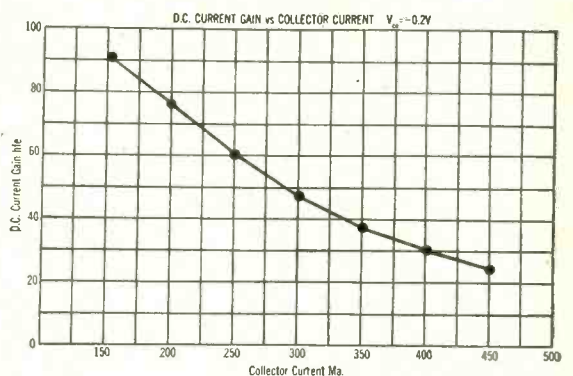
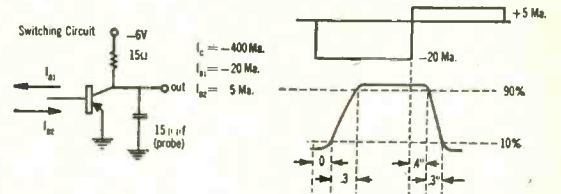

2N315, PNP
2N316, PNP
2N317, PNP



Write for GT's special Computer Transistors Specifications Bulletin.

GENERAL TRANSISTOR CORP.

Richmond Hill 18, N. Y.—Virginia 9-8900

Cable: Transistor New York

PRECISION

The Only COMPLETE COIL FORM SERVICE

Available...

- SQUARE TUBES
- ROUND TUBES
- RESINITE COIL FORMS
- BOBBINS
- MANDRIL SERVICE
- FABRICATING SERVICE

SQUARE AND RECTANGULAR TUBES

Produced in any length, shape or size from $\frac{1}{16}$ " to 8", wall thickness from .010 to .125. Fabricated from dielectric kraft, fish paper, quintera or combinations, including mylar. Bowed sidewall or Di-Formed construction.

ROUND TUBES

Produced in any decimal size up to 8" I.D. Fabricated from kraft, fish paper, cellulose acetate, mylar, polystyrene, quintera, fibre glass and other dielectric materials.

RESINITE COIL FORMS

These coil forms have the highest resistivity of any resinated product. Furnished plain, embossed, internally threaded or triangular shape... also flyback transformer forms.

BOBBINS

Supplied round, square or rectangular. Cores fabricated from any of the above materials. Metal, asbestos, plastic or fibre flanges. Constructed to fit smaller spaces and permit multiple winding.

MANDRIL SERVICE

Accurately ground steel and aluminum coil mandrils at cost economy comparable to commonly used undependable wood or undersized steel mandrils.

FABRICATING SERVICE

We have modern high speed equipment to provide you with any special shape or form... rolled, spun, flared, punched or formed to your particular requirement.

Ask about Precision's complete coil form service.
Request informative bulletin.



PRECISION PAPER TUBE COMPANY

2041 West Charleston Street, Chicago 47, Illinois

Plant No. 2: 1 Flower Street, Hartford, Conn.

Representatives throughout United States and Canada

rent, and focus-electrode voltage and current.

The unit is completely protected by interlocks and has appropriate time-delay and sequential operation built in, to prevent operation of any supply before the filament is on and hot and the bombardier supply is on and up. Circle P24 inside back cover.

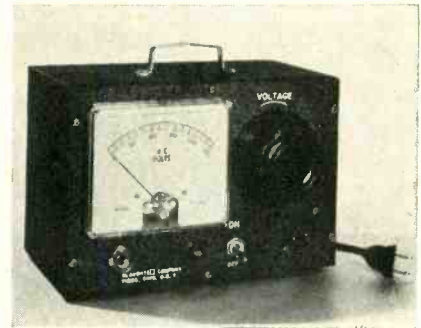

A-C POWER SUPPLY for general utility service

SLAUGHTER Co., Piqua, Ohio. Model 109 a-c power supply features a fuse protected variable autotransformer, a neon pilot light and a highly legible $4\frac{1}{2}$ -in. voltmeter with an essentially linear scale. Nominal input is 115 v, 60 cps and output rating is 3 amperes, with voltage infinitely variable from 0 to 135 v.

With this unit it is practical to conduct all operating tests under controlled input voltage conditions, regardless of line voltage, as well as to simulate the effect of abnormally high and low voltages. Circle P25 inside back cover.



KLYSTRON MODULATOR one-megawatt equipment

LEVINTHAL ELECTRONIC PRODUCTS, INC., 2760 Fair Oaks Ave., Redwood City, Calif., has available model PC43 modulator designed for high-power tube-development applica-

Wanted!

Engineers to sign on for one of the most exciting scientific expeditions of our time:

The SM-64 Navaho Missile



The men behind this invitation are pioneers in missile development. Ten years ago they started from scratch. There were no texts to consult, no rules to follow. Today their technological achievements are so great ... their jobs so broad ... there is room at every level of engineering for additional mindpower.

Accept this challenge and you can travel faster and farther than you ever thought possible on one of the most important programs in the free world today—North American's complete weapons system responsibility for the Air Force SM-64 Navaho Intercontinental Strategic Guided Missile.



DOUGLAS K. BAILEY received his BS degree from the University of California. He joined North American ten years ago as a senior design engineer. Today he is chief, Missile Design Section—responsible for missile design engineering and analysis. Doug and his family live in Long Beach where he participates in golf, bowling and sports car activities. He is currently organizing road races in Southern California for the Long Beach MG Club.

Unprecedented programs have been completed and more are to come. Others are being developed, modified and perfected as we enter another exciting phase following a successful flight test program at Patrick Air Force Base using a test vehicle known as the X-10.

The fascinating nature of this work has already at-

tracted the world's best informed missile men. Top-tier men have opportunities in almost every field of engineering—including some of the most advanced work being done today in aerodynamics, thermodynamics, high temperature materials and aero-elasticity.

Solving these problems is bringing forth new formulae and new production techniques. One example is Chem Mill, the process of shaping metals—including titanium and newest alloys—to previously unattainable designs by chemical etching. This method reduces weight ... increases strength. The idea came from a North American Missile engineer.

This is the kind of opportunity open to you. You can share our knowledge and add to it.

Recent graduate engineers can step into established groups. Experienced men will find even greater opportunities in the new groups that are being formed. And you'll do this in a management climate that stimulates personal growth and rewards it with responsibility, professional recognition and material benefits. Further, you can continue your studies with the aid of North American's Educational Refund Plan ... live and work in Southern California ... in near-ideal climate.



Navy vet **GEORGE W. JEFFS** earned both his BSAE and MSAE from the University of Washington. About 9 years ago he started his professional career with North American as a junior aerodynamics engineer. Now, 5 promotions later, this 30-year old veteran of missile work is chief, Advanced Design Section. He lives in Downey, California with his wife and 3 children. His hobbies include fresh-water fishing and hunting for quail and pheasant.

Let us know what kind of creative engineering interests you. (Please include highlights of your education and experience.)

Write today to: Mr. R. L. Cunningham, Engineering Personnel Manager, Dept. 91-2-EL
Missile Development Division, 12214 Lakewood Blvd., Downey, California.

NORTH AMERICAN AVIATION, INC.





Deliquescent Domains

Western Electric has announced that their relays will no longer be available for sale to manufacturers. The problem—obviously—will be to find satisfactory equivalents.

The Sigma Type 72AOZ-160TS can replace the WE 255A polar telegraph relay. It is functionally interchangeable by design and mechanically interchangeable by means of an adapter. The "72" has been exposed to such varied field service that comparative experience for most applications can be cited.



COMPARISON—WE 255A AND SIGMA 72AOZ-160TS		
	255A	72AOZ-160TS
RESISTANCE PER COIL, OHMS	136 ± 10%	160 ± 10%
TURNS PER COIL	3200	2400
INDUCTANCE PER COIL, HENRY	0.9 *	1.0
CONTACT GAP, NORMAL MINIMUM, INCHES	.004	.004
CURRENT SENSITIVITY, ONE COIL, MA.	0.56 - 1.5	0.6 - 1.4
NORMAL RANGE OF SIGNAL LEVEL, MA.	10 - 60	10 - 60
MAXIMUM INTELLIGIBLE SPEED, PULSES/SEC. (70% CONTACT EFFICIENCY)	—	500
WORDS/MIN. EQUIV.	—	1350
BIAS DISTORTION ALLOWED, 5 MA. SIGNAL 60 CPS	—	2%
PERCENT BREAK, 100 WORDS/MIN., 20 MA. SIGNAL	—	4%
TOTAL COIL DISSIPATION FOR 40° C. RISE, WATTS	2.2 *	1.3

* AS MEASURED IN SIGMA LABORATORY

As for the WE 280, there is no exact Sigma replacement. We do have five different polar relays which, depending on your application, may be equivalent even though not interchangeable.

Thus, if you do not need an exact duplicate of a Western Electric polar relay, there is undoubtedly a suitable Sigma polar relay available immediately. If you do, your comments may be all the incentive we need for providing a new design.

SIGMA

SIGMA INSTRUMENTS, INC.,
62 Pearl Street, So. Braintree, Boston 85, Massachusetts

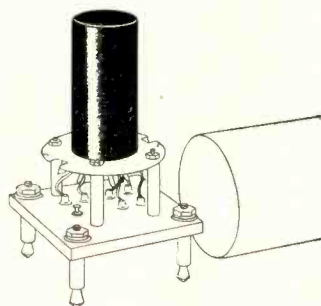
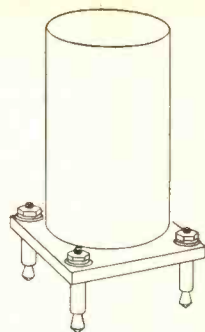

tions. Equipment consists of a 40-kw X-band magnetron driver; a 15-kv power supply rated at 1.6 ampere with less than 0.1-percent ripple; a complete control console for remotely operating the klystron and all associated equipment; a line-type modulator operating with a pulse length of 0.5 μsec at repetition rates from 10 to 4,000 cps; and a pulse transformer tank including a 140-kv 60-ampere pulse transformer and a capacitance voltage divider, as well as peak-current and average-current monitoring circuits.

The modulator uses five 1754 hydrogen thyratrons to handle the average power. These tubes are sequentially switched by a unique ring system that keeps the pulse-to-pulse jitter below 0.05 μsec. An inverse-current circuit with adjustable overload protection as well as a linear charging choke, hold-off diodes and a pfn are included in the unit. Circle P26 inside back cover.



PROXIMITY CONTROL may be used in many ways

MACHINERY ELECTRIFICATION, INC., Northboro, Mass., has announced the development of the MEK-3030 electronic proximity control. It detects the presence of an insulator or conductor at the detecting point without making contact with the surface.

The MEK-3030 can be used as a limit switch which does not require physical contact with the controlling surface; as a level control of such materials as soap, coal or oil; and as an interface control between two dissimilar fluids. It

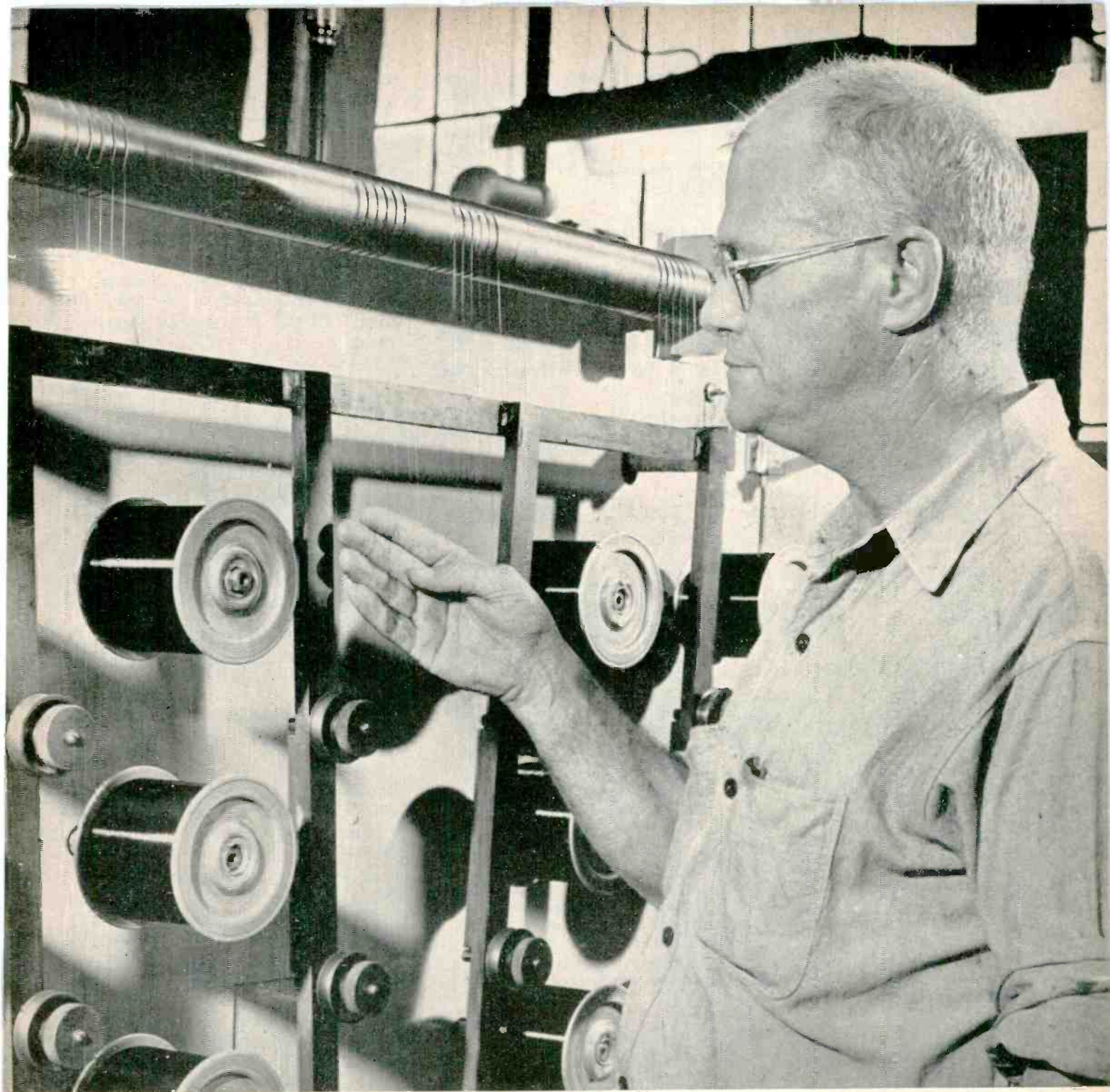

Inspector checks finished enameled wire to insure customers' requirements are met.

THIS MAN CAN HELP YOU

Eliminate cost of incoming magnet wire inspection!

This inspector acts as customers' agent in the Anaconda magnet wire mill.

Result: Anaconda Magnet Wire complies with such exactness to specifications that many customers have felt it possible to *eliminate incoming inspection*... at considerable savings in money, time and manpower.

More than this, customers say Anaconda quality control pays off in smoother winding room performance... and helps them produce a consistently high quality product at lowest cost.

Talk to the Man from Anaconda about a trial run of Anaconda wire to prove it to yourself. Call or write: Anaconda Wire & Cable Company, 25 Broadway, New York 4, New York.

56322

ASK THE MAN FROM **ANACONDA**[®]
FOR **MAGNET WIRE**

miniature
ENCAPSULATED

pulse transformers

custom-wound for your needs

Type MILX... for extreme environmental conditions

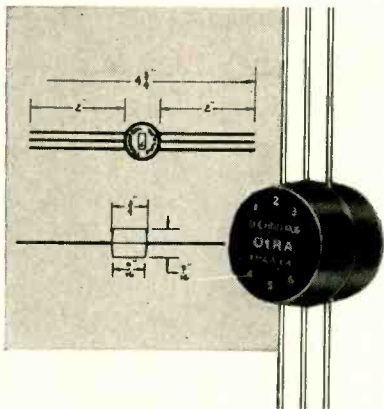

Type M... for subminiature and transistor circuits

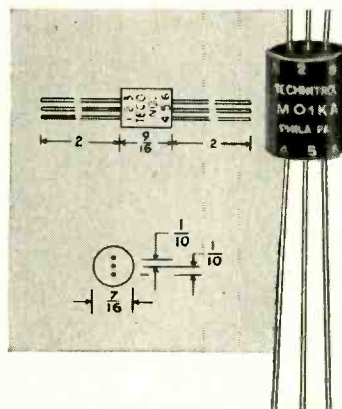

Technitrol is equipped to design and produce pulse transformers to meet your particular requirements. Simply let us know your performance specifications. Technitrol's staff of engineers will test sample transformers under actual circuit conditions—assuring proper performance. All charges for this service are included in our low sample quantity price.

Technitrol also makes a full line of lumped and distributed parameter Delay Lines. You may choose from a variety of mountings, or again, our engineers will aid you in developing special designs.

*for additional information,
write for Bulletin E166.*

TECHNITROL

engineering company

1952 East Allegheny Avenue • Philadelphia 34, Pennsylvania

features voltage regulation, plug-in relay and visible contacts.

► **Specifications**—Input voltage is 115, 60 cps; line consumption, 25 va; relay capacity, five amperes, 115 v; contact available, spdt.

The unit works on a principle of h-f energy. Complete information is available from the company. Circle P27 inside back cover.

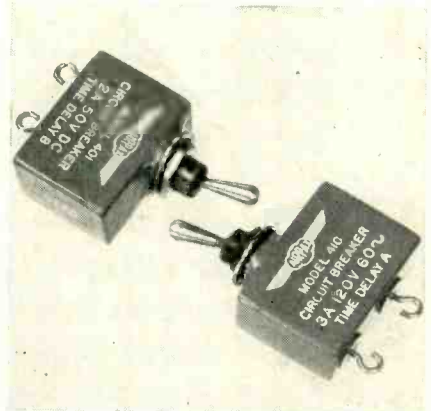

CIRCUIT BREAKER
has improved design

AIRPAX PRODUCTS Co., Middle River, Baltimore 20, Md., announces several significant improvements in its miniature magnetic circuit breaker. This breaker is specially built for use in protecting electronic equipment.

On earlier units it was 0.06 in. total excursion from 10 to 55 cps. Newer production units also withstand 10 g at 55 to 1,000 cps. The trip level has also been raised to 135 percent of rated load current. Units are available for interrupting 50 volts d-c at currents from 0.05 to 10 amperes and for interrupting 120 volts rms, 60 or 400 cps, at currents from one to 10 amperes. The toggle bushing of this breaker is the same as on conventional ON-OFF switches. Circle P28 inside back cover.

TRANSIFIER
video transistor amplifier

KAY ELECTRIC Co., 14 Maple Ave., Pine Brook, N. J. Model 126A Transifier, a completely transistorized broadband video amplifier, is a true modular plug-in unit

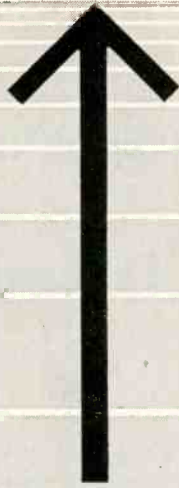

WHAT IS TIME ?

Anything that can be postulated is possible, says science—including *timelessness*.

The latest table-talk among the rocket and missile men has to do with the physics (and metaphysics) of photon propulsion: thrust for a space vehicle derived by shooting incredibly concentrated beams of light (photons) from its tail. Result—speeds approaching that of light! Round trips to

distant galaxies could thus be accomplished in a single generation of the crew. Meanwhile, however, the Earth would have passed through a billion years—possibly into cosmic oblivion!

The space-time ratio is increasingly a factor in the calculations of a brand new field of science known as astronautics...Work in this field at Martin is already at the threshold of tomorrow.

MARTIN
BALTIMORE · DENVER · ORLANDO

Question: What Makes N W L Transformers Superior? The Answer: 36 Years "Built In" Experience

This means long life
dependability, and low
cost operation to you.

Nothelfer Transformers are vacuum-pressure impregnated . . . all joints over 10 amperes are silver plated, conservative copper and steel. Laminations, oriented and most silicone steels are annealed in accurately controlled nitrogen atmosphere electric furnaces.

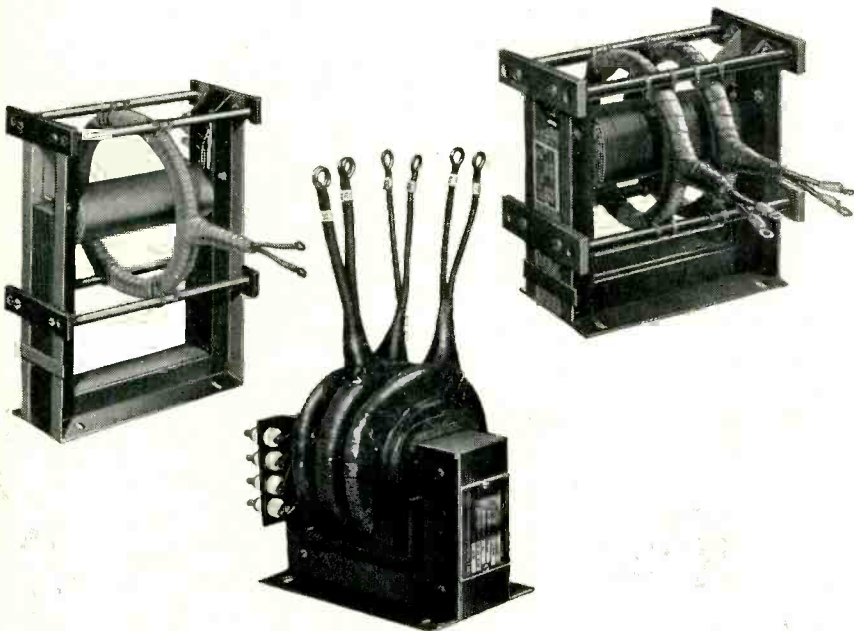

Among various N W L Transformers, these OPEN FRAME TYPES are designed for use in dry locations, such as inside panel and construction bay racks. They are designed for 55° C (class A) and 80° C (class B) rise above ambient, in 24 hour a day service.

ALSO CASED TRANSFORMERS and SPECIAL UNITS



ESTABLISHED 1920



Nothelfer

WINDING LABORATORIES, INC.
P. O. Box 455, Dept. 102, TRENTON, N. J.



with feedback circuit built in for stabilized signal gain. All the advantages provided by transistors—small size, lightness, portability, long-life, rugged operation, low power consumption and high conversion efficiency—are offered by this tubeless instrument.

► Uses—Among the uses served are the following: as a preamplifier for oscilloscopes and vtvm's; as a humless audio amplifier; as a wide-band video amplifier; and as a modular in control circuitry and all types of audio-video electronic devices.

Complete technical specifications are available from the company. Circle P29 inside back cover.

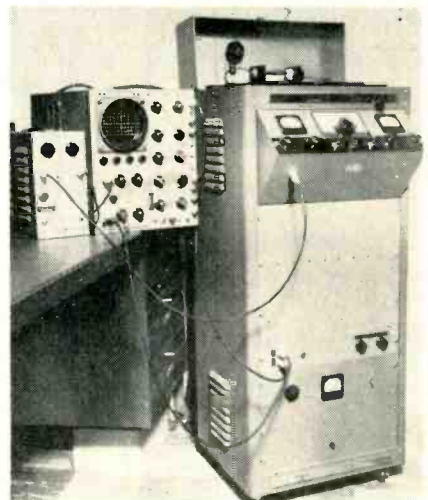

TEST SET

shows semiconductor lifetime

MARVELCO ELECTRONICS division of National Aircraft Corp., 3411 Tulare Ave., Burbank, Calif. Now available to electronic laboratories is a new test set for deter-



PW DATA SYSTEMS

MULTICHANNEL DATA TRANSMISSION OR RECORDING, USING RF CARRIER, FM SUBCARRIER, OR SINGLE MAGNETIC TAPE TRACK

Pulse width coding and time division multiplexing techniques result in systems of large numbers of data channels, excellent accuracy, and exceptional simplicity of operation.

TYPICAL SYSTEM PERFORMANCE

NUMBER OF DATA CHANNELS...	26	41	86
SAMPLES/CHANNEL/SECOND.....	30	20	10
FREQUENCY RESPONSE, CPS.....	5	3.3	1.6
Linearity.....	Better than 0.5% of full scale		
Stability.....	Long term drift less than 1% of full scale		

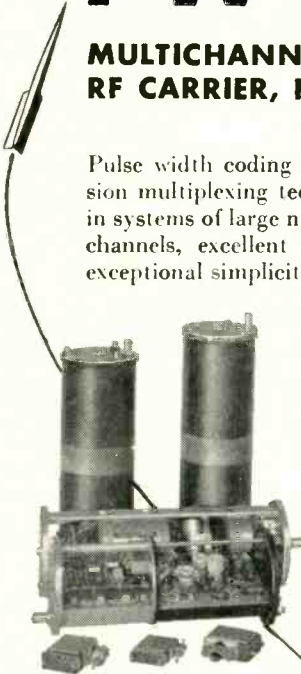

F SERIES MISSILE TELEMETERING SETS

For short life applications, where the ultimate in compactness, ruggedness, and performance are required. Standard packages as shown are available for 30x30 and 45x20 operation. Special configurations, using standard functional components may be ordered. Some components are sold separately.

D SERIES MULTICODERS AND TELEMETERING SETS

For applications where repeated use is required. Available for 30x30, 45x20, and 90x10 operation, 0 to 5 volt or 0 to 30 millivolt sensitivity, 28 volt DC or 115 volt 400 cycle primary power, for RF carrier, FM subcarrier, or magnetic tape recording. 45 watt RF power amplifier available.

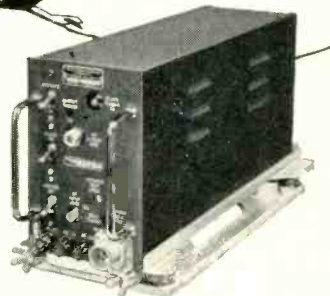

M SERIES PW GROUND STATIONS

Operate on pulse width signals from RF receiver, Subcarrier discriminator, or magnetic tape playback unit to produce visual monitoring of all data channels and reduced graphic output records of selected channels, in real time.

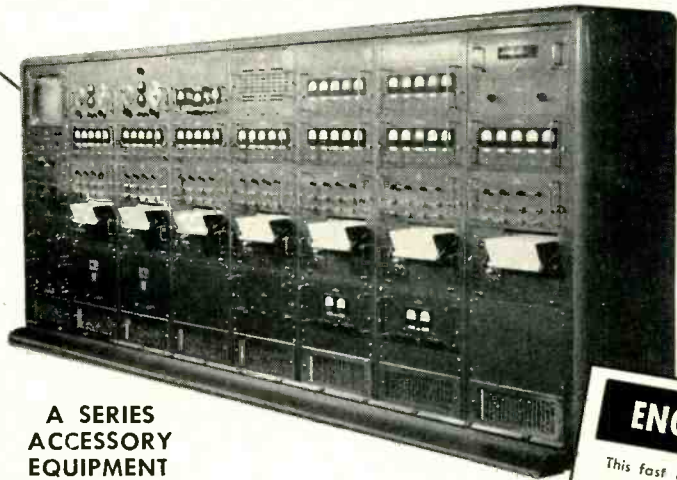

A SERIES ACCESSORY EQUIPMENT

RF Pre-amplifier units, for greatly increased receiving range, and RF Multicoupler, for operation of up to 4 receivers from a single Pre-amplifier or antenna. Broad band operation 215 to 235 megacycles.

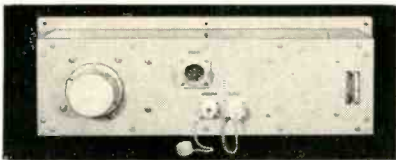
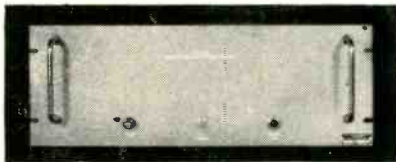

G SERIES FIXED INSTALLATION MULTICODERS (Not shown)

PW Multicoders for multichannel tape recording or transmission from fixed installations. Operate from standard 60 cycle power lines... Designed for long life... easy accessibility.

ENGINEERS

This fast growing organization has immediate openings for:

Systems & Product Engrs.
Senior R. F. Engrs.
Transistor Engrs.
Sales Engrs.

Send Resumes to our Princeton office



APPLIED SCIENCE CORP. OF PRINCETON

P. O. Box 44, Princeton, N. J. • Plainsboro 3-4141

1641 S. LaCienaga Blvd.
Los Angeles, Calif., Crestview 1-8870



*LOOK... Every electronics engineer
needs one. You'll take
yours right out of the MARCH 1st
issue of *Electronics*.*

**YOUR 1957
RHEEM ELECTRONIC PRODUCTS FILE**

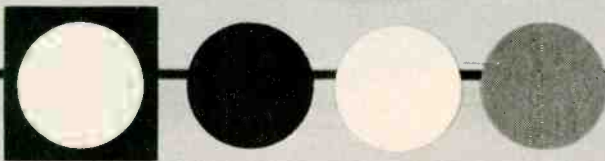

mining minority charge carrier lifetime of a semiconductor material. The system is made up of three units: a test cabinet, a 535 Tektronix oscilloscope with a 53/54C dual beam plug-in unit and a Tektronix 121 preamplifier.

A trigger and two signals are supplied to the scope from the pulse generator and test specimen. One signal is the decay characteristic of the crystal, the other is a standard decay characteristic. For comparison the R-C standard is variable by a calibrated control on the test cabinet. Comparison of the two signals, by using a chopped sweep for simultaneous display, provides a method of reading lifetime directly to an accuracy of 5 percent by adjusting both curves for coincidence. Circle P30 inside back cover.



BEAM POWER TUBE of the glass-octal type

RADIO CORP. OF AMERICA, Harrison, N. J. The 6DG6-GT is a beam power tube of the glass-octal type designed primarily for service as an output tube in audio amplifier applications. Having a 6.3-v, 1.2-ampere heater and a maximum heater-cathode voltage of ± 90 v, the tube is intended especially for use in audio equipment requiring a tube having high power sensitivity and high efficiency at relatively low plate and No. 2 grid voltages.

For example, in class A1 a-f service, a single 6DG6-GT operating at a plate voltage of 200 v and a grid No. 2 voltage of 125 v, will deliver 3.8 w of audio power with a peak a-f signal-grid voltage of

New technique shapes future of transistors...
LEADS TO THREE MAJOR INVENTIONS

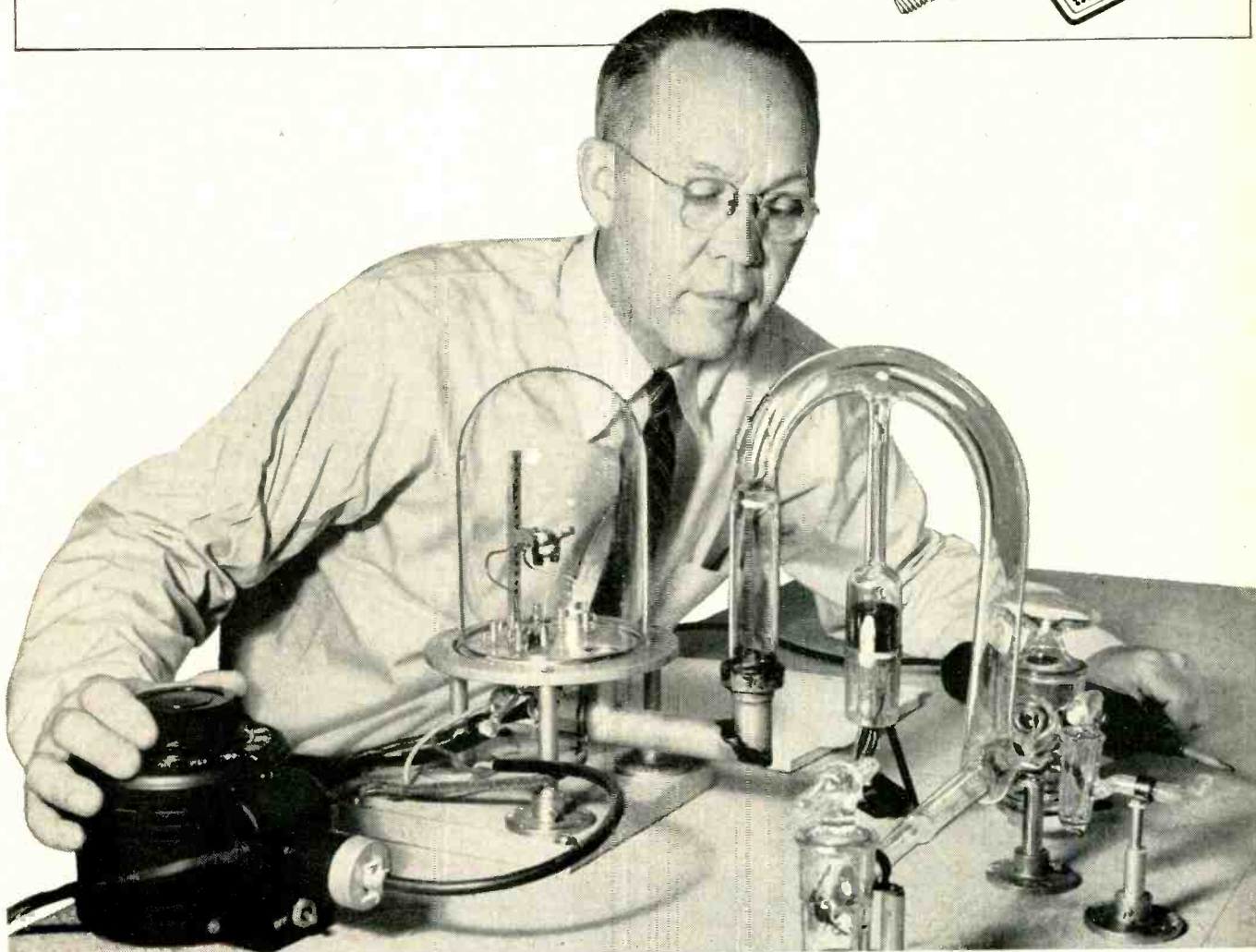
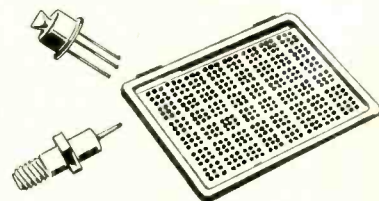

Calvin S. Fuller, Ph.D. in Physical Chemistry from the University of Chicago, is a pioneer in development of the diffusion technique. Here he controls

a heating current through a strip of silicon while diffusing into its surface a film of aluminum less than 1/50th of a hair's breadth in thickness.

Transistor makers have a very difficult problem. They must add a mere trace of an "impurity" to a semiconducting metal. But they must add it only in very thin layers, without affecting the bulk of the material.

Bell Laboratories scientists developed an efficient new way to produce such layers. They expose the metal to a hot gas containing the impurity. Atoms bombard the surface and—through a process known as "diffusion"—force their way into the metal to

form a microscopic film which can be controlled in thickness to a few millionths of an inch.

The diffusion technique opened the way to three major Bell Laboratories inventions in the semiconductor field; the Bell Solar Battery, Silicon Power Rectifier and the Diffused Base Transistor. Right now the technique is providing a key to many other developments of great promise for telephony. It is another example of how Bell Labs works to improve telephony through fundamental research in materials.

BELL TELEPHONE LABORATORIES



WORLD CENTER OF COMMUNICATIONS RESEARCH AND DEVELOPMENT

Want more information? Use post card on last page.

only 8.5 v. Circle P31 inside back cover.

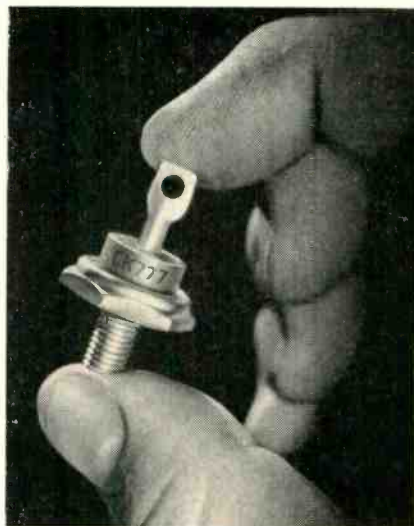

SILICON RECTIFIERS

have piv rating of 325 v

RAYTHEON MFG. Co., 55 Chapel St., Newton 58, Mass., has added to its line of silicon power rectifiers the new type CK777 having a peak inverse rating of 325 v and an average current rating of 5 amperes at 125 C. Maximum reverse current at the piv of 325 v is only 5 ma and the maximum forward voltage drop at 10 amperes is only 2 v. The addition of type CK777 provides a line of 5-ampere, 125 C silicon rectifiers having peak inverse ratings from 25 to 325 v. Data are available from the company. Circle P32 inside back cover.

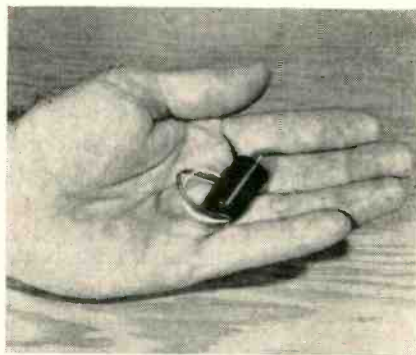

TINY SERVO MOTOR

a high-precision unit

FORD INSTRUMENT Co., Division of Sperry Rand Corp., 31-10 Thomson Ave., Long Island City 1, N. Y. With nominal dimensions of only

military test equipment

TS-505 B/U MULTIMETER



AC volts 0-150
DC volts 0-1000
DC res. 0-1000 megs
RF up to 500 mc

AN/USM-26 FREQUENCY COUNTER

10 cps to 220 mc

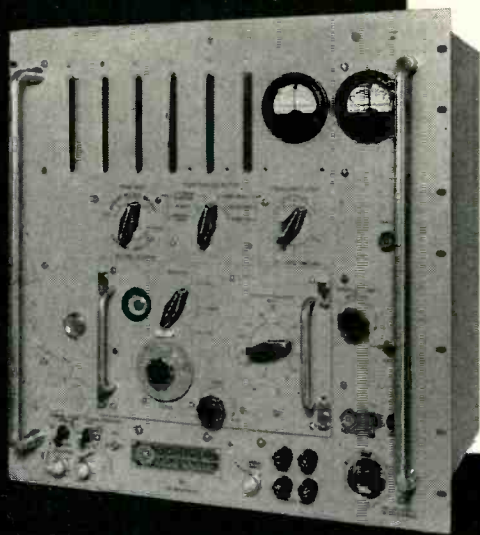

AN/UPM-33 SPECTRUM ANALYZER

8470 to 9630 mc



northeastern engineering

Manchester



New Hampshire



PACKAGED FREQUENCY MANAGEMENT

JK SULZER FREQUENCY STANDARD

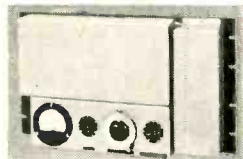

JK Sulzer Frequency Standard: For your most precise laboratory measurements, the JK SULZER 1 megacycle Frequency Standard provides stability of better than 1 part in 10^9 per day. Frequency is variable over a range of 0.9 cycles or more, and capable of being reset to 5 parts in 10^{10} .

JK THERMYSTAL

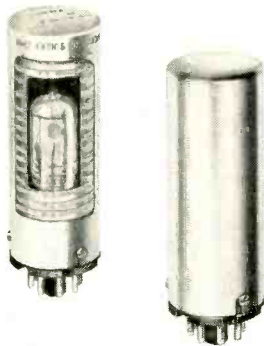

JK Thermystal: An advanced-design frequency control unit combining plug-in simplicity with extreme precision. *Frequency stability:* 30 to 900 kc, $\pm .0001\%$; 1000 kc to 150 mc, $\pm .00005\%$.

JK TRANSISTOR OSCILLATOR

JK Transistor Oscillator: Complete, compact, precise plug-in signal source providing fixed temperature and humidity environment for transistor and circuitry elements. *Frequency stability:* (24-hr. period) 1 part in 10^6 .

JK CRYSTAL FILTERS



JK Crystal Filters: Compact, rugged, hermetically-sealed and stable, JK CRYSTAL FILTERS (band pass filters) have a *Frequency Range:* 1 mc to 17.5 mc., and are available for special filtering purposes to 150 mc. *Band Width* at 6 db: 0.01% to 4% of nominal on all frequencies, and up to 12% for certain frequencies.

JK GLASLINE CRYSTALS

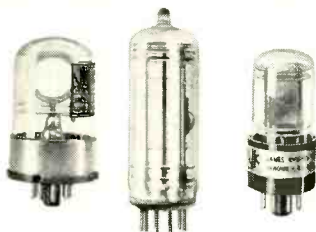

JK Glasline Crystals: For ultra stable frequency control, JK GLASLINE CRYSTALS provide unprecedented stability and reliability. Compact, evacuated and hermetically-sealed against moisture, contamination, shock, and barometric pressure. Over a complete range of 800 cycles to 5 mc. and up.

JK MILITARY TYPES

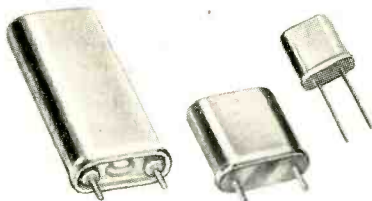

JK Military Types: Hermetically-sealed, JK MILITARY TYPE CRYSTALS are metal-cased and in *Frequency Ranges:* 16 kc to 100 mc.

JK OVENS



JK Ovens: Capable of maintaining set temperatures around components or circuitry with less than $\pm 1^\circ \text{C}$. variation over the range of -55° to $+100^\circ \text{C}$, JK OVENS are light, compact, inexpensive, uniform and reliable.

Farnsworth

HAS THE ANSWER



...before the button
is pushed

Four ... three ... two ... one ... Fire!
a tense finger pushes a button.

WHOOSH ... and a fiery missile unerringly heads for its target. It worked!

Of course, it *had* to work. In atomic warfare there's no second chance. Farnsworth, a division of International Telephone and Telegraph Corporation, developed the uncanny electronic test equipment that knows—before the button is pushed. This not only avoids costly mis-fires or missed targets—it actually safeguards our very lives.

This is another answer supplied by Farnsworth Electronics Company, where scientists and engineers of many related skills are applying the vast experience and facilities of IT&T to solve many complex problems in the fields of electronics and communications for industry and the military.

Farnsworth

CAREER OPPORTUNITIES: There are important new openings on our professional staff for graduate engineers and scientists. Write for complete information. Confidential.



FARNSWORTH ELECTRONICS COMPANY, Fort Wayne 1, Indiana
A DIVISION OF INTERNATIONAL TELEPHONE AND TELEGRAPH CORPORATION

$\frac{3}{8}$ in. diameter by 1 in. long (plus shaft extension) the SM-58 servo motor weighs under 1 oz. It is widely applicable to servomechanisms, computers, indicating devices, missile control systems, aircraft control systems and similar equipment.

► **Technical Data**—Featuring extremely high torque to inertia ratio, it operates on 26 v 400 cps, with a control voltage range of 0 to 26 v. Typical characteristics include: 2½-w input; 1/10-w output; 0.063 in.-oz stall torque; 8,800-rpm no-load speed; 0.00038 oz-in.² rotor inertia and 64,000-rad/sec² theoretical acceleration at stall. Ambient range is -75 to +200 F. Circle P33 inside back cover.



DECADE CAPACITORS with polystyrene dielectric

GENERAL RADIO Co., 275 Massachusetts Ave., Cambridge 39, Mass. Polystyrene capacitors are now offered in the form of decade units. The individual capacitor units are noninductively wound with purified high-molecular-weight polystyrene tape and carefully heat treated. Units are hermetically sealed in brass cans with Teflon insulators. Polystyrene and Teflon are used as dielectrics in the decade switches. The decade assembly has an insulation resistance of greater than 10¹² ohms at 100 v. Dissipation factor is specified to be less than 0.0002 in the audio range and is usually

New

Allen-Bradley developments

GREATER COLOR PURITY—BETTER CONVERGENCE

1.

FULL ROUND YOKE CORES

**FOR COLOR TV
ALSO BLACK AND WHITE**

Allen-Bradley has developed a method of producing ferrite deflection yoke cores as a full 360° ring! Unlike cores made from quarter rounds, the new full round cores are perfectly concentric and have parallel inner surfaces. They require no grinding. The round rings are "cracked" into halves and taped for shipment. Assembly is quick and economical. The tape is rolled back, the core is slipped over the coils, and the tape put back in place. The core's concentricity assures better convergence and greater color purity.



These ferrite yoke cores are produced as full rounds, and are "cracked" into halves and taped, as shown, for easy assembly.

2.

FLARED YOKE FERRITE CORES

FOR NEW 110° TUBE . . . SAVES WEIGHT

For the new 110° picture tube, Allen-Bradley has developed a flared yoke ferrite core whose outer surface is also shaped to reduce the amount of material required. This makes possible a weight reduction of approximately 30% over conventional cylindrical cores.

The new flared yoke is produced as a solid piece but, with the Allen-Bradley method, the yoke is "cracked" into halves, yet a perfect ring is maintained. Available in Allen-Bradley Class WO-1 ferrites which are to be preferred because of their uniform magnetic characteristics.

Allen-Bradley Co.
110 W. Greenfield Ave.
Milwaukee 4, Wis.

In Canada—
Allen-Bradley Canada Ltd., Galt, Ont.

FERRITE SAVED
BY CURVED SHAPE



ALLEN - BRADLEY

RADIO, ELECTRONIC, AND TELEVISION COMPONENTS

QUALITY

ENGINEERS & PHYSICISTS *Electronics*

The Johns Hopkins University Applied Physics Laboratory

ANNOUNCES

... important openings on our guided missile research and development staff for men who wish to identify themselves with an organization whose prime purpose is scientific advancement.

Because the Applied Physics Laboratory (APL) exists to make rapid strides in science and technology, staff members require and receive freedom to inquire, to experiment, to pursue tangential paths of thought. Such freedoms are responsible for findings that frequently touch off a chain reaction of creativity throughout the organization.

As a staff member of APL you will be encouraged to determine your own goals and to set your own working schedule. You will associate with leaders in many fields, all bent on solving problems of exceptional scope and complexity. The resources of our 350,000 sq. ft. laboratory are complemented by those of the 18 universities and industrial organizations who are working under our technical direction on prime contracts.

Equidistant between Baltimore, Md., and Washington, D. C., our new laboratory allows staff members to enjoy suburban or urban living and the rich cultural, educational and research facilities offered by both cities.

Openings Exist In These Fields:

ANALYSIS: *Dynamic analysis of closed-loop control systems; analysis and synthesis of guidance systems; counter-counter-measures systems; electrical noise and interference.*

DESIGN: *Control and guidance circuitry; telemetering and data-processing equipment; microwave components, antennas, and radomes; transistor and magamp applications; external missile systems.*

TEST: *Prototype engineering and field test evaluation.*

SEND NOW FOR OUR NEW 30-PAGE PUBLICATION DESCRIBING IN DETAIL THE SCOPE OF THE LABORATORY'S PROGRAMS AND THE UNIQUE ENVIRONMENT IN WHICH STAFF MEMBERS WORK AND LIVE.

WRITE:

Professional Staff Appointments

The Johns Hopkins University
APPLIED PHYSICS LABORATORY
8609 Georgia Avenue • Silver Spring, Maryland

about half that amount.

Individual type 980 decade capacitor units in steps of 0.001, 0.01, and 0.1 μf are available as well as a 3-dial type 1419-A decade capacitor with a range to 1.11 μf in steps of 0.001 μf . Circle P34 inside back cover.



VACUUM CAPACITOR designed for strenuous use

DOLINKO & WILKENS, INC., 1907 Summit Ave., Union City, N. J. Type VC500-32 high-capacitance, high-voltage, high-current vacuum capacitor is designed for strenuous application in electronic heating and transmitting equipments. Constructed of OFHC copper with Pyrex glass seals and bulb it gives low-loss, low-inductance service in r-f tank usage. It is rated at 500 μf , 32 kv peak and 120 rms amperes. Dimensions are 7 $\frac{5}{8}$ in. overall length, 3 $\frac{1}{8}$ in. diameter; mounting centers are 6 $\frac{5}{8}$ in. and contact diameter 2 in. Circle P35 inside back cover.



DELAY LINES large delay to size ratio

MAG ELECTRIC, Electronic Division, National Aircraft Corp., 3411 Tulare Ave., Burbank, Calif. Designed for both commercial and military applications, the new



HOW ARE YOUR COMMUNICATIONS ?

Do the booklets, pamphlets, and manuals you use really *work* for you? Are these vital publications, that tell the story of your products and your company, as effective, readable, well designed and illustrated as they can be? Today more than ever, your entire operation is judged by each annual report, employee manual, and public relations piece that you produce. Have you examined your communications lately? If you have any doubt as to the impact of your instructional and promotional literature, remember . . .

COMMUNICATION IS OUR BUSINESS

For a good many decades McGraw-Hill has stood for complete coverage in the business literature field. Now the McGraw-Hill TECHNICAL WRITING SERVICE offers a new approach to your publication problems — an *integrated* writing, editing, illustrating, and printing service for the *custom* production of: INSTRUCTION MANUALS, PRODUCT BULLETINS, TRAINING AIDS, INDUSTRIAL RELATIONS LITERATURE, ANNUAL REPORTS, COMPANY HISTORIES, PROCEDURAL GUIDES and other collateral literature. More than 150 editorial and graphic experts are at your disposal, ready to prepare high-quality material to your own or government specifications. Save time, save money . . . and make your communications work! Let *our* staff be your staff for technical and business publications.

McGraw-Hill Book Co. TECHNICAL WRITING SERVICE

Write or phone Technical Writing Service, McGraw-Hill Book Co., Inc.
330 West 42nd Street, New York 36, N. Y. • LOnacre 4-3000

This service is available through ad agencies.

**YOU can't
BURN
it out!**

HICKOK
MODEL 455



• Exclusive overload cut-out system.

• Protection of all practical ranges.

• Protects meter and entire internal circuit against accidental burn-outs.

Greatest engineering achievement in VOM history

Latest Design

VOLT-OHM-MILLIAMMETER

The Model 455 is a new portable multimeter that incorporates the latest engineering advancements including the new technique that protects both meter and the entire internal circuit against accidental burn-outs. In fact, any high voltage or current may be applied directly across any function, including ohms, without danger to the meter movement or associated components.

This instrument is available in two models: Industrial Model 455 . . . has a sensitivity of 20,000 ohms per volt AC or DC; Audio Model 456 . . . has a sensitivity of 20,000 ohms per volt DC and 1,000 ohms per volt AC. The 456 also includes DB ranges and provision for output measurements.

THE HICKOK ELECTRICAL INSTRUMENT CO.
10527 Dupont Avenue • Cleveland 8, Ohio

Ask for a demonstration of this most practical VOM from your Radio-Electronic Parts Jobber today! . . . Or write direct for technical details.

IN CANADA: M.J.S. Electronic Sales Ltd., Ajax, Ont.

model ED delay lines are now available, which provide exceptionally large delay to size ratio. Featured are hybrid forms of bank and other layer type windings.

The units discussed are cast in resin and are equipped with hole or stud type mountings and can be furnished with taps.

Specifications include: delay range—0.1 to 20.00 μ sec in multiples of 0.1 μ sec; rise time, 10 to 15 percent of delay times; impedance range, 500 to 5,000 ohms, ± 10 percent. Attenuation is 2 percent per μ sec delay; distortion, less than 5 percent; operating temperature, -55 to $+125$ C; working voltage, 500 v d-c. Circle P36 inside back cover.



POWER SUPPLY

constant current, voltage

MATTHEW LABORATORIES, 146 Riverdale Ave., Yonkers, N. Y. Model CVPS-105 is a dual purpose power supply designed to provide either constant current or constant voltage as desired, for use in semi-conductor and electronics research, or as a general laboratory supply. The required current or voltage remains constant at the selected value under varying load or input line conditions. Regulation is provided by feedback loops, a control amplifier and series regulator tubes. The current or voltage, at any desired value from zero to maximum, is set by continuously variable coarse and fine controls.

The output is monitored by a multirange combination voltmeter-milliammeter. On constant current, the output is 0 to 130 ma, with the voltage automatically ad-

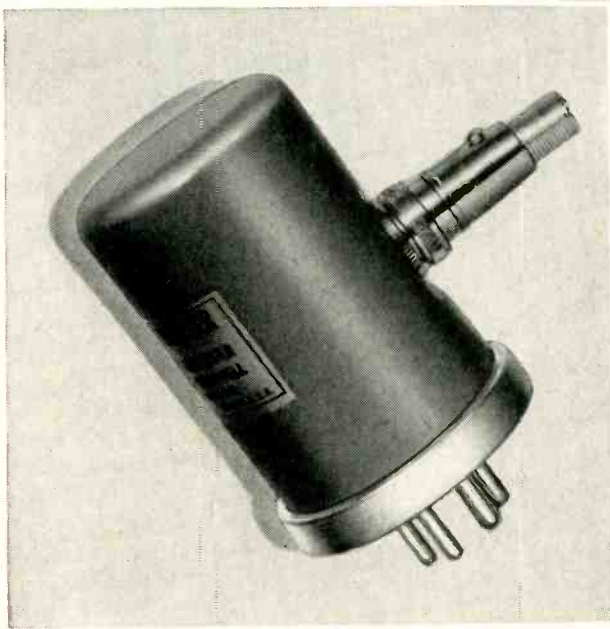

Brown Converters

put stable performance in your measuring and servo loops

THESE synchronously-driven choppers convert d-c signals as low as 10^{-8} volt to ac, with freedom from pickup and exceptionally low thermal noise.

Ideal for radar, computers, servomechanisms and null balance circuits, Brown converters are built for long, dependable service. Thousands of them have been used for continuous duty for years in *ElectroniK* instruments.

In standard models, each contact closes for 55% of the cycle. Other closure cycles can be supplied. Output signal lags line voltage by $17^\circ \pm 5$. Power rating is 0.1 milliwatt.

Four standard models are available. In addition, many variations can be provided for special requirements.

• **ORDER NOW!** Prices from \$36.00 (even more favorable depending on quantity).

MINNEAPOLIS-HONEYWELL REGULATOR Co., *Industrial Division*, Wayne and Windrim Avenues, Philadelphia 44, Pa.—in Canada, Toronto 17, Ontario.

Available in these ratings

Nominal frequency, cps	25	40	50-60	400
Synchronous range, cps	23-28	36-44	45-66	360-440
Driving coil	6.3 volts, 60 ma.			18 volts, 94 ma.

Other Brown components for servo systems

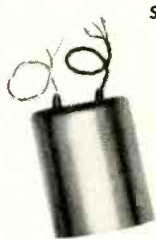

Shielded low-level transformers, for input or coupling circuits, faithfully handle low-frequency a-c, or chopper-modulated d-c signals from 0.0005 to 200 millivolts. Highly effective electrostatic and magnetic shielding. Wound for maximum cancellation of strays. Three models; impedances 1,300, 7,500 and 50,000 ohms input at 60 cycles. Prices from \$21.00.

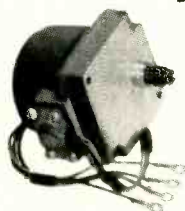

Brown Servo Motors.

2-phase reversible motors with high torque at low speed. Totally enclosed. Permanently lubricated. 60-cycle models with no-load shaft speeds of 27, 54, 162, 333 and 1,620 rpm. 25-cycle models also available. Prices from \$42.00.



MINNEAPOLIS
Honeywell

BROWN INSTRUMENTS

First in Controls



for Super-Fine Cutting
of Hard, Brittle Material...
the *S.S. White* Industrial
Airbrasive Unit

Many unusual operations — some on a mass-production basis — can be performed with our industrial Airbrasive Unit. This photograph dramatically illustrates its precise, delicate cutting ability. Developed from the Air-Dent equipment made by S. S. WHITE for the dental profession, the unit gas-propels a stream of abrasive particles at high speed to provide a fast, *cool* and *shockless* cutting action.

The unit can be used to etch glass, cut crystals such as germanium and other crystalline forms, remove deposited surface coatings. It can also be used to etch, drill and light-deburr hard, brittle materials.

This is not all — many other practical uses have been found for the Airbrasive Unit.

We'll be glad to test the airbrasive process on your sample parts. For further information, just drop us a line.

S.S. White

First Name in Airbrasive Cutting

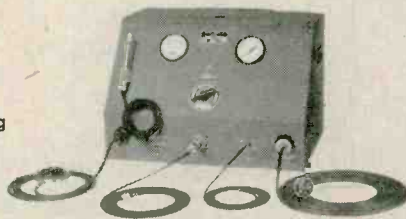

S. S. White Industrial Division, Dept. D., 10 East 40th Street, New York 16, N. Y.
Western Office: 1839 West Pico Blvd., Los Angeles 6, Calif.

justing itself between 0 and 400 v. On constant voltage, the output range is 0 to 500 v and 0 to 200 ma. In addition, 6.3 v a-c at 4 amperes is provided. Circle P37 inside back cover.

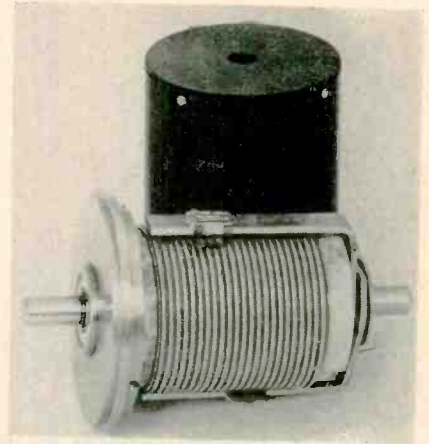

PRECISION POT
in several ganged versions

LITTON INDUSTRIES, 5873 Rodeo Road, Los Angeles 16, Calif. Model No. MD20 2-in. diameter ultraprecision potentiometer is available in several ganged versions designed for use under extremely rugged environmental conditions. Utilizing a new design, independent linearity may be provided as close as 0.01 percent. For highest stability, the resistance coil is externally wound on a nonhygroscopic ceramic core which is chemically inert and dimensionally stable. For greatest physical strength and dimensional accuracy, all operating parts are supported by a new one piece, central aluminum hub.

Length of the 10-turn MD20 is $1\frac{3}{4}$ in. In a length of $2\frac{1}{8}$ in., it can be supplied with two gangs of 10 turns, a single gang of 15 or 20 turns and other combinations of turns not readily available previously.

Rugged metal-to-metal traveling-nut-stops withstand 500 in.-oz. The wiper arm operates independently of the stops and, to minimize wear, only the wiper touches the resistance element. Electrical angle is 3,600 deg with 90-deg overtravel at each end. Resistance values of 1,000 to 100,000 ohms are standard for the two-gang 10-turn version. Torque on

Henry Rempt (center), head of the Electronics and Armaments Systems Division, discusses advanced data transmission and data handling systems for A.E.W. aircraft with Systems Engineer Bruce MacDonald (left) and Dominick Amara, head of the Advanced Systems Dept.



To electronics engineers who seek a wide range of assignments

■ Electronics systems engineering appeals particularly to engineers who require varied outlets for their abilities. And at Lockheed's California Division, engineers interested in systems endeavor find the broadest field for their efforts. For Lockheed's activities and assignments cover virtually every type of aircraft — radar search planes, high-speed fighters, cargo and passenger transports, bombers, jet trainers and other classified projects.

These brief facts illustrate the extent of Lockheed diversification and varied assignments — 15 models of aircraft are in production; 48 major projects are in research and development stages.

Career-minded engineers will find recent organizational changes at Lockheed of great interest. To keep pace with its increasing emphasis on electronics, Lockheed has expanded and centralized electronic research and development under the Electronics and Armament Systems Division. The expanded division originates and develops all complex electronics and armament systems for new Lockheed aircraft.

Technical management positions are open in fields of:

Fire control, countermeasures, inertial systems, weapons, communications, infra-red, optics, sonics, magnetics, antennas and micro-waves.

Systems engineers in these areas will supervise and participate in conceiving advanced systems and then performing research, development and evaluation up to production stages on all Lockheed aircraft.

Previous systems experience is not necessary to join Lockheed. Inquiries are welcomed from engineers who have been specializing in a narrow field of electronics and wish to broaden their approach.

NATIONAL ENGINEERS' WEEK

FEBRUARY 17-23, 1967

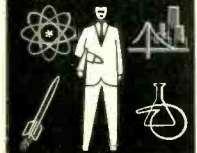

ENGINEERING... America's Great Resource

Electronics Engineers possessing experience or keen interest in systems activities are invited to write E. W. Des Lauriers, Dept. 0902

California Division

LOCKHEED

AIRCRAFT CORPORATION • BURBANK

CALIFORNIA

HOMELITE

will meet your specs for
LIGHTWEIGHT GENERATORS

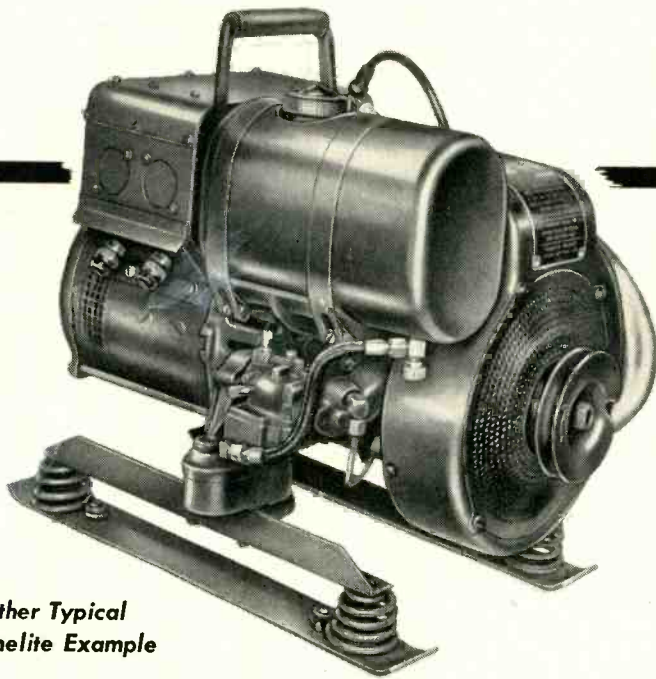

*Another Typical
Homelite Example*

To meet the requirements for lighter, smaller and more powerful auxiliary gasoline-engine-driven generators for both rotary and fixed wing aircraft, Homelite has designed and built several special units.

Typical of these new Homelite generators is the Model 34D28 shown above.

Weighing only 67 pounds . . . almost half the weight of previous auxiliaries with comparable power . . . this Homelite develops 70 amperes at 28.5 volts DC and is capable of starting 700 h.p. aircraft engines either directly or with a small battery floated on the line.

Requiring less than 3 cubic feet of storage space, this unit is equipped for push button or manual starting and starts without preheating in temperatures as low as minus 40 degrees Fahrenheit.

Meeting specifications for light-weight, powerful generators . . . for both military and commercial applications . . . is the specialty of the house with Homelite. We've been doing it for close to half a century.

No matter how new, how different or how tough your requirements . . .

turn them over to Homelite. The chances are you'll get the most satisfactory answer . . . faster.

Write and our engineers will get in touch with you.

Homelite builds generators in sizes from .15KW up to 5KW in all voltages and frequencies... with either gasoline engine or electric motor drive.

Manufacturers of Homelite
Carryable Pumps
Generators • Blowers
Chain Saws

Canadian Distributors: Terry Machinery Co., Ltd., Toronto, Montreal, Vancouver, Ottawa

PERFORMANCE • DEPENDABILITY
SERVICE

HOMELITE

A DIVISION OF TEXTRON INC.
6802 RIVERDALE AVENUE
PORT CHESTER, N. Y.

NEW PRODUCTS

(continued)

dual section versions is as low as 1.5 in.-oz. Circle P38 inside back cover.



FERRITE YOKE CORES for tv picture tubes

ALLEN-BRADLEY Co., 136 West Greenfield Ave., Milwaukee 4, Wisc., has announced a new ferrite full-round deflection yoke core for use in tv picture tube assemblies. The yoke core is pressed as a ring of perfectly uniform section and circularity. It is then cracked into two halves for later assembly over deflection coils and fitting to the tube. The mated halves are shipped held together mechanically to avoid possible damage in transit. Such circular yokes eliminate the grinding, fitting and setting necessary with quarter-round sections. Inner and outer surfaces are always perfectly concentric and parallel. Result is better convergence, greater color purity and reduced assembly time. Circle P39 inside back cover.

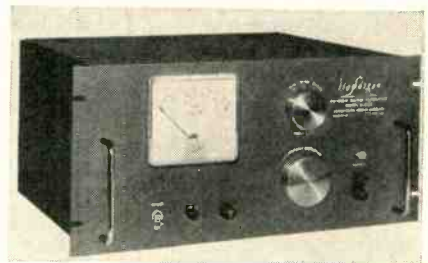

VOLTAGE GENERATORS use computer circuitry

INTERCONTINENTAL DYNAMICS CORP., 170 Coolidge Ave., Englewood, N. J., has announced a line of random voltage generators, producing 1-f noise with precisely

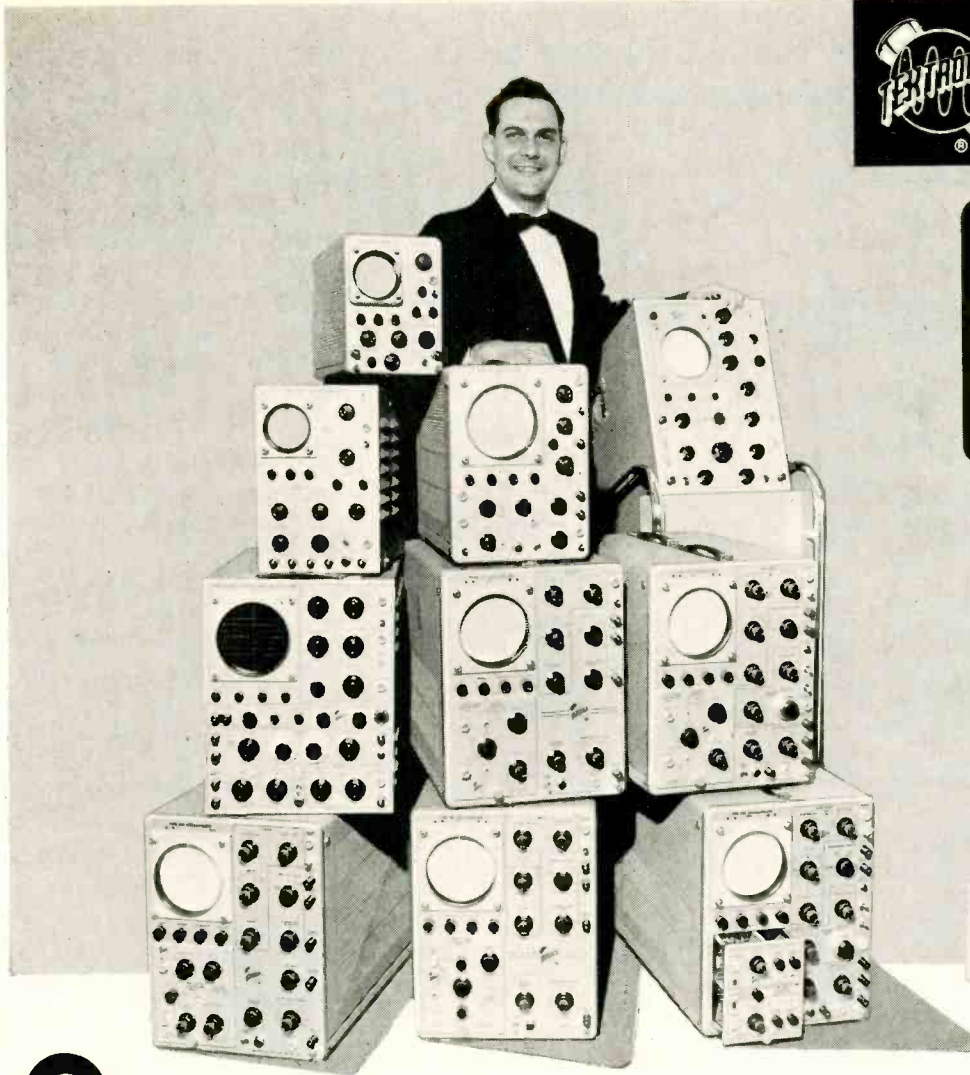

- A. Tektronix Field Engineer.
- B. Type 310 Oscilloscope. 3" portable, dc to 4 mc, weight only 23½ lbs. Price \$595.
- C. Type 315D Oscilloscope. 3" portable, dc to 5 mc, weight only 36 lbs. Price \$770. Rack-mounting model also available.

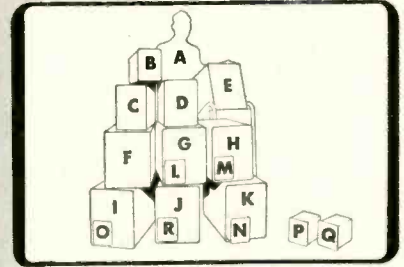

- D. Type 515 Oscilloscope. 5" portable, dc to 15 mc. Weight only 40 lbs. Price \$750.
- E. Type 517A High-Speed Pulse Oscilloscope. Seven-millimicrosecond risetime, 24 kv accelerating potential. Price \$3500.
- F. Type 524AD Television Oscilloscope. DC to 10 mc, 0 to 25 millisecond sweep delay. Price \$1180.
- G, H, I, J, K. Oscilloscopes using plug-in preamplifiers. Seven Plug-in Units available. Extra wide sweep range. Extreme versatility.

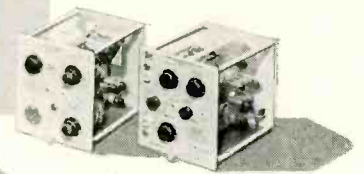

- G. Type 531 Oscilloscope. DC to 10 mc, 10 kv accelerating potential. Price, without plug-in units, \$995.
- H. Type 535 Oscilloscope. DC to 10 mc, 10 kv accelerating potential, 1 µsec to 0.1 sec sweep delay. Price, without plug-in units, \$1300.
- I. Type 532 Oscilloscope. DC to 5 mc, 4 kv accelerating potential, 8-cm linear vertical deflection. Price, without plug-in units, \$825.
- J. Type 541 Oscilloscope. DC to 30 mc, 10 kv accelerating potential. Price, without plug-in units, \$1145.
- K. Type 545 Oscilloscope. DC to 30 mc, 10 kv accelerating potential. 1 µsec to 0.1 sec sweep delay. Price, without plug-in units, \$1450.

PLUG-IN UNITS

- L. Type 53/54A Wide-Band DC \$85
 - M. Type 53/54B Wide-Band High-Gain125
 - N. Type 53/54C Dual Trace Fast-Rise DC275
 - O. Type 53/54D Differential High-Gain DC145
 - P. Type 53/54E Differential Low-Level AC165
 - Q. Type 53/54G Differential Wide-Band DC175
 - R. Type 53/54K Fast-Rise DC. 125
- All prices f.o.b. Portland, Oregon

One of these oscilloscopes may belong in YOUR picture

If an oscilloscope with the right characteristics will help speed progress in your work, you'll be interested in the performance range covered by these ten Tektronix Oscilloscopes. Each has been designed for a particular application, from the compact Type 310 Portable Oscilloscope to the Type 517A, specialized for high-speed pulse analysis. Each of the five oscilloscopes designed to work with interchangeable plug-in preamplifiers offers an extremely high degree of versatility in a single instrument.

Your complete oscilloscope requirement may be satisfied by one of the more versatile instruments. Or, you may have an unusual requirement that can be satisfied only by a highly-specialized oscilloscope. In selecting the right oscilloscope for your present and future needs, a consultation with your Tektronix Field Engineer can be very helpful. It's a matter of great importance to him that you make the best possible selection, because his term of responsibility parallels the useful life of your Tektronix instrument... and that's a huge chunk of his future.

ENGINEERS—interested in furthering the advancement of the oscilloscope? We have openings for men with creative design ability. Please write to Richard Ropiequet, Vice President, Engineering,

Tektronix, Inc.

P. O. Box 831 • Portland 7, Oregon

Phone CYPRESS 2-2611 • TWX-PD 265 • Cable: TEKTRONIX



Edited by DON FINK

The MASTER reference in television technology

- to speed your work
- answer your questions
- help you get better results

TELEVISION ENGINEERING HANDBOOK

- Prepared by a staff of 33 Specialists
 - 1483 pages, 6 x 9
 - Hundreds of charts, circuits, tables, and illustrations
- \$15.00**

Full 10 days' examination before you decide to purchase. See coupon.

All your design work is made easier and faster with the help of this comprehensive guidebook. It covers the entire field of television technology, including not only the basic fundamentals, but practical design data for transmitters, receivers, and networks. Monochrome and color television are treated in equal detail, and there is coverage of the related topics of vision, photometry, illumination, optics, and colorimetry.

Look to this handbook for quick help on the countless questions arising in your daily work—on television standards for scanning, modulation, synchronization—on band and channel designations—on camera and picture tubes—on circuit functions and design—on transmission lines and radiators—and many other topics, covered in the 20 big, authoritative sections of this new working tool.

TRANSISTORS

HANDBOOK OF SEMICONDUCTOR ELECTRONICS

Edited by LLOYD P. HUNTER

Senior Physicist, International Business Machines Corporation, Poughkeepsie, N. Y.
604 pages, 6 x 9, 484 illustrations, \$12.00

This book gives you a rounded view of semiconductor devices—all the help you need to prepare for practical circuit design and engineering of applications utilizing transistors, diodes, or photocells. Emphasis is on actual circuit design. The extensive section on this subject covers the use of semiconductor devices in band-pass and video amplifiers, computers, measuring instruments, industrial control equipment, oscillators, etc. In addition, theory of semiconductor devices, important aspects of how they are made, and background of analysis and measurement is given, to provide engineers with an intensive one-volume treatment of this growing new field.

CONTROL CIRCUITS

HANDBOOK OF INDUSTRIAL ELECTRONIC CONTROL CIRCUITS

By JOHN MARKUS and VIN ZELUFF

Electronic
352 pages, 8 1/2 x 11, illustrated, \$8.75

Here are the circuits you need for sorting, timing, measuring, and counting; for sweep control, triggering, temperature and motor control, and hundreds of other industrial uses—each with concise description, performance characteristics, component values, and practical applications. Save hours of search and preliminary work to find basic circuit ideas for particular applications—consult this big, handy collection of tested circuits—selected from recent issues of *Electronics* and classified and indexed for quick use.

controlled power frequency spectra and predetermined amplitude probability characteristics. The generators are designed to provide ultrastable, accurate statistical functions for computer analysis, missile system analysis, instantaneous servo transfer function derivation, radar countermeasure studies, as a driving source for truly random vibration and shaker testing, and for general l-f noise analysis purposes.

► **Ranges**—Available in six different models covering the frequency ranges from 0.01 to 50, 1,000, 3,000 and 5,000 cycles and to 1 and 5 mc, the generators provide noise signals whose amplitude distribution with time is accurately Gaussian, at an output level of 5 v rms into 600 ohms with direct-reading calibrated attenuation.

Complete specifications are available on request. Circle P40 inside back cover.



DAMPER DIODE for tv receivers

RADIO CORP. OF AMERICA, Harrison, N. J. The 19AU4 is a half-wave rectifier tube of the glass-octal type intended for use as a damper diode in horizontal-deflection circuits of black-and-white tv receivers. This tube is designed with an 18.9-v, 600-ma heater having a controlled heating time to insure dependable performance in tv receivers utilizing series-heater-string arrangement.

Rated to withstand a maximum peak invert plate voltage of 4,500 v (absolute), the tube can supply

JUST MAIL THIS FREE EXAMINATION COUPON

McGraw-Hill Book Company, Inc., Dept. L-2
327 West 41st St., New York 36, N. Y.

Send me book(s) checked below for 10 days' examination on approval. In 10 days I will remit for book(s) I keep, plus few cents for delivery costs, and return unwanted book(s) postpaid. (We pay delivery costs if you remit with this coupon—same return privilege.)

- Fink—Television Engg. Hdbk., \$15.00
- Hunter—Hdbk. of Semiconductor Electronics, \$12.00
- Markus & Zeluff—Hdbk. of Indus. Electronic Control Circuits, \$8.75

For price & terms outside U. S., write McGraw-Hill Intl. N. Y. C.

(Print)
Name

Address

City & Zone

State

Company

Position

L-2

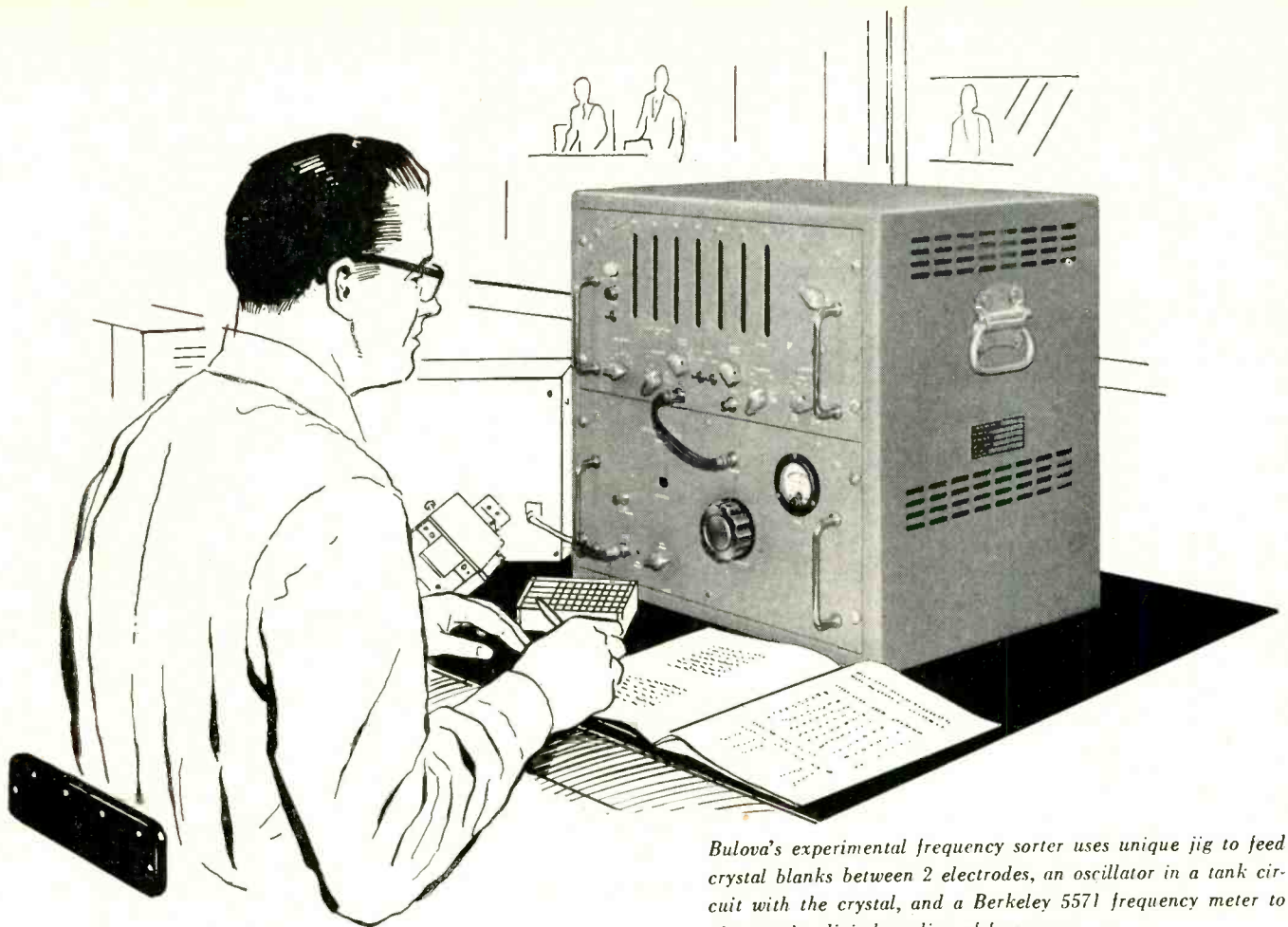

Bulova's experimental frequency sorter uses unique jig to feed crystal blanks between 2 electrodes, an oscillator in a tank circuit with the crystal, and a Berkeley 5571 frequency meter to give precise digital reading of frequency.

Doing a day's work in 12½ minutes!

Mechanizing military crystal production posed plenty of problems for Bulova Research and Development, Inc. The Signal Corps wanted 50,000 crystal blanks a day processed, a sizeable increase over the 1500 a day by current techniques.

From the experimental setup pictured above, they developed an automatic frequency sorter with a capacity of 2 blanks per second, or 1500 in 12½ minutes, (now being built by Berkeley Systems Engineering group). Tolerance is 0.005% of normal frequency, range is 4 to 54 mc.

Without the Berkeley 5571 frequency meter as a basis, this development would not have been possible. The services of Gawler-Knoop, Berkeley's engineering representative in the New York area, were equally invaluable in making this 5571 application and subsequent service a success for Bulova.

If your work involves measurement of frequency ratio, frequency period, or frequency from 0 cps to 1100 mc it will pay you to investigate the versatile 5571—the meter that literally “grows with the job.”

118

*Write now for technical data;
please address Dept. G-2.*

Beckman®

Berkeley Division

2200 Wright Avenue, Richmond 3, California
a division of Beckman Instruments, Inc.

RADIO INTERFERENCE AND FIELD INTENSITY *measuring equipment*

Stoddart equipments are suitable for making interference measurements to one or more of the following specifications:

AIR FORCE—MIL-I-6181B

150 kc to 1000 mc

BuAer—MIL-I-6181B

150 kc to 1000 mc

BuShips—MIL-I-16910A (Ships)

14 kc to 1000 mc

SIGNAL CORPS—MIL-I-11683A

150 kc to 1000 mc

SIGNAL CORPS—MIL-S-10379A

150 kc to 1000 mc

The equipments shown cover the frequency range of 14 kilocycles to 1000 megacycles.

Measurements may be made with **PEAK**, **QUASI-PEAK** and **AVERAGE** (Field Intensity) detector functions. **QUASI-PEAK** values meet **ASA** recommendations and can be provided to meet **CISPR** (International) recommendations.

F.C.C. PART 15—Now in effect, the revised F.C.C. Part 15 places stringent requirements upon radiation from incidental and restricted radiation devices. Stoddart equipment is suitable for measuring the radiation from any device capable of generating interference or c-w signal within the frequency range of 14 kc to 1000 mc.

Write Stoddart Aircraft Radio Co., Inc., for your free copy of the new revised F.C.C. Part 15.



NM-10A (AN/URM-6B)
14 kcs to 250 kcs



NM-20B (AN/PRM-1A)
150 kcs to 25 mcs



NM-30A (AN/URM-47)
20 mcs to 400 mcs

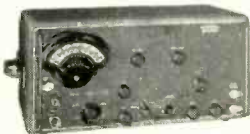

NM-50A (AN/URM-17)
375 mcs to 1000 mcs



The Stoddart NM-40A is an entirely new radio interference-field intensity measuring equipment. It is the commercial equivalent of the Navy type AN/URM-41 and is tunable over the audio and radio frequency range of 30 CPS to 15 kc. It performs vital functions never before available in a tunable equipment covering this frequency range. Electric and magnetic fields may be measured independently over this range using newly developed pick-up devices. Measurements can be made with a 3 db bandwidth variable from 10 CPS to 60 CPS and with a 15 kc wide broadband characteristic.

STODDART Aircraft Radio Co., Inc.

6644-A SANTA MONICA BLVD., HOLLYWOOD 38, CALIFORNIA • Hollywood 4-9294

NEW PRODUCTS

(continued)

a maximum peak plate current of 1,050 ma and a maximum d-c plate current of 175 ma. A technical bulletin is available. Circle P41 inside back cover.

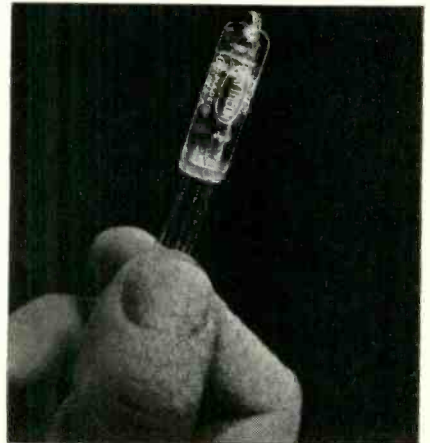

TINY TWIN TRIODE
with low microphonics

RAYTHEON MFG. Co., 55 Chapel St., Newton 58, Mass. Designed especially for d-c amplifier and computer applications, the type CK6832 is a subminiature twin triode with unusually low microphonics and grid current. It is controlled for balance between the two sections including stability with time, shock and variation in heater voltage.

The CK6832 is electrically similar to the miniature type CK5755. Circle P42 inside back cover.

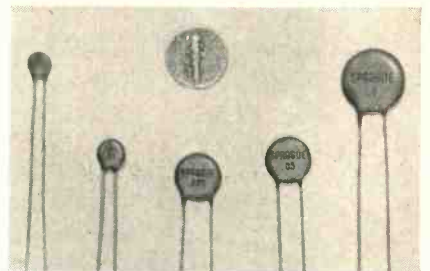

TINY CAPACITORS
high-dielectric constants

SPRAGUE ELECTRIC Co., 125 Marshall St., North Adams, Mass., has standardized for mass production a new subminiature series of high-dielectric constant Cera-mite capacitors. Intended for transistor radios and similar applications, they are rated at 50 v d-c. They have been tooled for volume pro-

THE
A B C

OF

1 2 3

Why is COUNTROL important in every business today?

Countless times a day, every business needs to know "how many? . . . how much? . . . how far? . . ." and many other questions that can be answered only by facts-in-figures. But how to get these figures . . . from so many different machines, processes, operations and systems? Veeder-Root Counters are doing it every day, by means of:

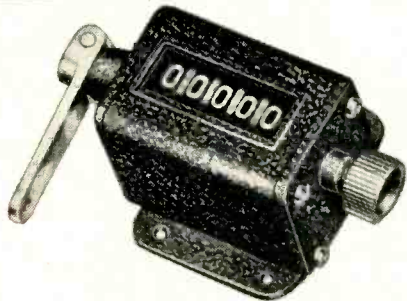

MECHANICAL COUNTING

Small Resets count strokes, turns, or pieces . . . are used by thousands for moderate duty in parts inspection, quality control, conveyors, machine tools, light presses, etc.



HAND COUNTING

Where objects or units cannot be counted electrically or mechanically, hand-operated counters like this Hand Tally do the job. For instance, quick spot checks of production or performance, traffic count, inventory, etc. Fits palm of hand, counts one for each pressure of thumb lever, resets to zero by turning knob.

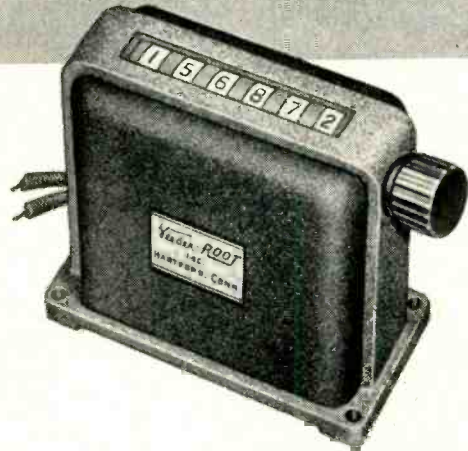

ELECTRICAL COUNTING

These remote-indicating counters bring your production machines as close as your office wall. AC or DC, they can be connected in series with any simple switch, and will transmit production figures *instantly* over any distance. May be panel-mounted in groups.

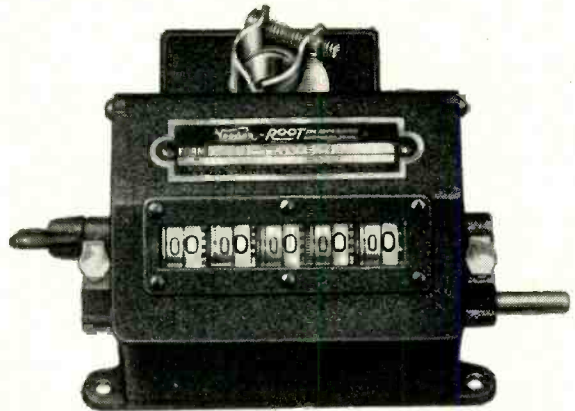

CONTROLLING

Set it for the exact number of turns, pieces, or operations required . . . and this Predetermining Counter will control the run *exactly* . . . preventing over-runs and shortages. When the predetermined number is reached, counter will light a light, ring a bell, or actuate a stop-motion.

IN SUM: *If it can be counted or controlled . . . count on Veeder-Root to do it. Get in touch with your Industrial Supply Distributor for standard counters for application to your production machines and processes. And get in touch with Veeder-Root for counters to be built into original equipment. Veeder-Root Inc., Hartford 2, Connecticut.*

Insist on Standard
**VEEDER-ROOT
COUNTERS**

from your Industrial
Supply Distributor



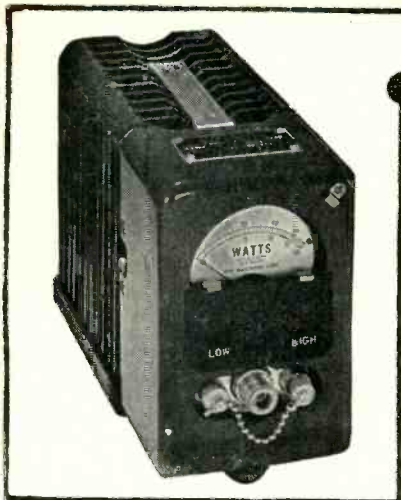

TERMALINE DIRECT READING R. F. WATTMETERS

(DUAL RANGE)

MODEL 611—0-15 and 0-60 Watts

MODEL 612—0-20 and 0-80 Watts

IMPEDANCE—51½ Ohms

Models 611 and 612 are popular instruments in research and design laboratories, vacuum tube plants, transmitter manufacturing plants, and in fixed and mobile communication services.

They are ruggedly built for portable use, and are as simple to use as a D.C. voltmeter. The power absorbing load resistor is non-radiating, thus preventing transmission of unwanted signals which interfere with message traffic in communication services.

Frequency range: 30 to 500 MC (30 to 1,000 MC by special calibration)

Impedance: 51.5 OHMS—VSWR less than 1.1

Accuracy: Within 5% of full scale

Input connector: Female "N" which mates with UG-21 or UG-21B. Adapter UG-146/U is supplied to mate with VHF plug, PL259.

Special Scale Model "61s" are available as low as ½ watt full scale, and other models as high as 5 KW full scale.

Catalog Furnished on Request



BIRD
ELECTRONIC CORP.
1800 EAST 38TH ST., CLEVELAND 14, OHIO
TERMALINE Coaxial Line Instruments

VAN GROOS
COMPANY
Sherman Oaks, Cal.

NEED TUBE CRADLES?

You Specify . . . We'll Satisfy

Augat cradles are life-savers for your sub-miniature tubes, resistors and capacitors. They hold components firm and steady and provide definite assurance of long life against shock and vibration.

You can order Augat cradles in many types, diameters ranging from .175 to one inch, normally made from 1065 hardened steel cadmium plated, beryllium copper alloy 25 heat treated and silver plated or heat treated silver magnesium nickel. Special finishes may be obtained to your specifications.

If your requirements are not listed in our catalog, write us for information on cradles made to your specifications.

AUGAT BROS. INC.

31 PERRY AVENUE • ATTLEBORO, MASS.

duction in standard capacitances of 0.005, 0.01, 0.025, 0.05 and 0.1 μ f.

Full performance characteristics on the bantam capacitors are given in engineering data sheet 6121. Circle P43 inside back cover.

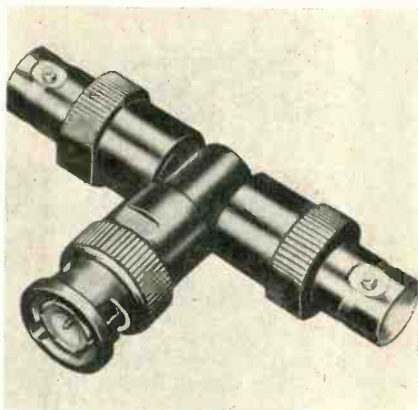

TINY COAX PARTS incorporate BNC connectors

MICROLAB, 71 Okner Parkway, Livingston, N. J., announces a new line of miniaturized coaxial components incorporating type BNC connectors. The line is designed for airborne and other applications requiring compact, light-weight components.

Included are fixed pad attenuators, coax terminations, low pass and high pass filters, power dividers, crystal mounts and double stub tuners. The line provides considerable space and weight conservation for missile and aircraft designers without sacrificing electrical performance. A complete catalog of miniaturized components is available on request. Circle P44 inside back cover.

SOLDER RESIST for printed circuits

LONDON CHEMICAL CO., INC., 1535 N. 31st Ave., Melrose Park, Ill. A new solder resist which permits selective soldering, minimizes bridging over close tolerances and reduces solder waste has been developed for printed circuits. The PC No. 33 solder resist is an organic coating which affords high insulating resistance across the circuit pattern. It has a low temperature cure of 200 F and requires a cure time of only 20 to

the delicate touch . . . is repeated hundreds of times in many different ways to build a rugged Varian klystron cathode.

In airborne use, the cathode must operate with complete reliability . . . withstand constant shock and vibration without malfunction or failure.

It takes a delicate touch in the use of intricate fabrication techniques to build small yet rugged cathodes. For example, the tiny cathode button — often not much larger than the head of a pin — is carefully electropolished, then spray-coated with a precisely controlled mixture of rare earth oxides. Why?

To assure uniform emission of electrons . . . vital factor in reliable performance.

Optimum structural rigidity is achieved by skillful metallic bonding of each electrode to a ceramic disc . . . connections are individually brazed with a copper-gold alloy. Pressure-ventilated assembly benches are used to keep air superclean . . . prevent contamination from microscopic particles which might affect performance or cause failure.

Painstaking techniques like these exemplify Varian's manufacture of more than 60 different klystrons for every application.

THE
MARK OF
LEADERSHIP

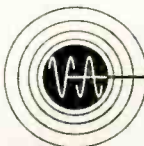

VARIAN associates

PALO ALTO, CALIFORNIA

Representatives in all principal cities

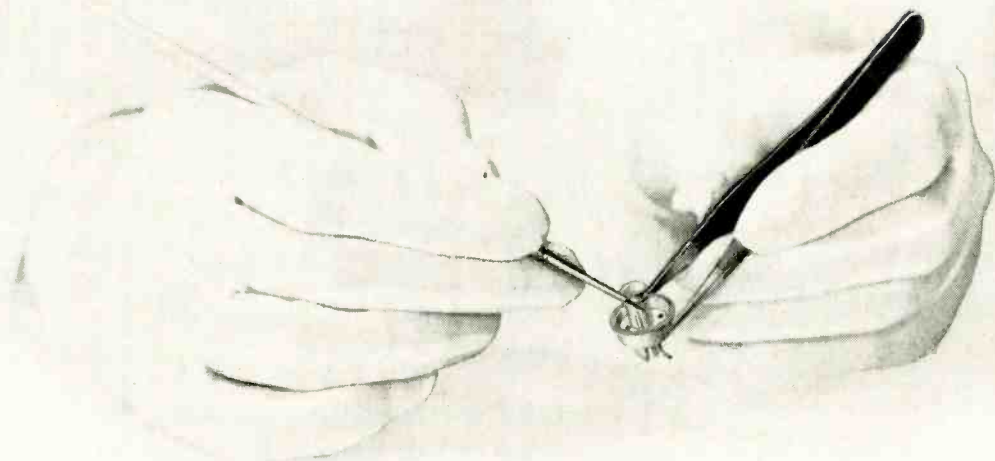

FOR COMPLETE INFORMATION . . . write for the Varian Klystron Catalog . . . address Applications Engineering Department K-2.

KLYSTRONS, TRAVELING WAVE TUBES, BACKWARD WAVE OSCILLATORS, LINEAR ACCELERATORS, MICROWAVE SYSTEM COMPONENTS, R. F. SPECTROMETERS, MAGNETS, MAGNETOMETERS, STALOS, POWER AMPLIFIERS, GRAPHIC RECORDERS, RESEARCH AND DEVELOPMENT SERVICES



Launcelot's Sitting Pretty



"Forsooth," quoths Sir Launcelot (ye Smart Buyer of Industrial Furniture), "methinks *Royal* bids fair to convert ye whole world to ye use of goode factory seating.

"Exceeding function with comfort doth add zest to endeavor . . . prolong aptness, alertness . . . out-bounty ye fabled 'king's ransom'."

Yes, *Royal* Adjustable Chairs and Stools bring to the assembly table, drafting room, factory office, and production machine a complete array of sturdy steel seating designed by correct-posture specialists.

Thy most stalwart Knight . . . thy fairest Maiden . . . thy Earl of Exchequer (ye Prince of ye Pocketbook) . . . all will applaud fatigue-free *Royal* Seating. Each piece is a crowning achievement.

For the world's finest industrial chairs and stools—for wardrobes, cabinets, machine stands, foremen's desks, and efficient vertical files—see your *Royal* Dealer, or mail ye coupon now!



Model 515 Model 625 Model 624 Model 511

ROYAL METAL MANUFACTURING COMPANY
175 N. Michigan Ave., Chicago 1, Ill., Dept. 30-C

Please send me free 24-page Catalog No. 7001, "*Royal* Seating for Modern Industry;" Complete information on *Royal* Verti-File Vertical Filing.

Individual _____

Company _____

Street _____

City & State _____



30 minutes. The film it deposits is resistant to peeling, pitting or blistering and will not break down at high solder pot temperatures up to 650 F, with immersion of 10 to 15 sec.

► **Application**—Recommended procedure calls for screening circuits with a 165-mesh stainless-steel or equivalent silk screen, after which they are cured for 20 to 30 minutes at 200 F. Regular assembly, fluxing and soldering can proceed immediately after the circuit cools.

The resist can be applied as received or thinned to desired viscosity with PC No. 33 solder resist thinner. Circle P45 inside back cover.



MATCHING UNIT used with audio oscillator

WAVEFORMS, INC., 333 Sixth Ave., New York 14, N. Y., announces a new device for use with the 510B audio oscillator. The T-10 matching unit consists of a repeat coil and resistive network designed to furnish a balanced signal of up to +8 dbm. Impedances of 150 or 600 ohms ± 5 percent over the range 18 cps to 50 kc are selected by straps at the binding posts.

The unit is housed in a sheet metal enclosure which forms a permanent part of the oscillator assembly. Price \$40. Circle P46 inside back cover.

RESISTOR BOBBINS composed of expoxide resin

NORRICH PLASTICS CORP., 35 E. 32 St., New York, N. Y. A new line of bobbins, used for the construction of hermetically sealed re-

ACME ISONEL WIRE

Plus Acme #150 VARNISH
Equals Class B
Equals MIL-T-27A Class S

Freed Transformer Co., Inc., Brooklyn, N. Y., a leader in engineering and manufacturing of transformers and reactors for the electronics industry, has found in the above equation the solution to the manufacturing and performance problems of Class B (MIL-T-27A, Class S) Commercial and Military units.

Acme Isonel Wire is a Class B (MIL-T-27A Class S) wire. However, optimum insulation system performance can only be achieved when this wire is impregnated with a compatible varnish. Acme #150 is that varnish.

Acme #150 Varnish does not require a high temperature cure. It has excellent resistance to oils.

Acme #150 Varnish meets all the requirements of specifications MIL-V-1137A, Class CB, Type M for government equipment. In fact, it exceeds the heat resistance requirements of this specification by 50%.

Acme #150 Varnish improves thermal stability, while maintaining dielectric strength when used in Class B (MIL-T-27A Class S) windings.



ACME WIRE CO.

NEW HAVEN, CONN.

MAGNET WIRE • COILS
VARNISHED INSULATIONS
INSULATING VARNISHES
AND COMPOUNDS



McGraw-Hill Mailing List Will Help You

- Merchandise your advertising
- Conduct Surveys
- Get leads for your salesmen
- Get inquiries about your product or service
- Pin-point geographical or functional groups
- Sell Direct
- Build up weak territories
- Aid Dealer Relations

Direct Mail is a necessary supplement to a well rounded Business Paper advertising program.

600,000 actual names of the top buying influences in all the fields covered by the McGraw-Hill publications make up our 150 mailing lists. These lists are built and maintained primarily for our own use, but they are available to you for Direct Mail purposes. Pick out a list of YOUR prospects from our Industrial Direct Mail Catalogue.

More and more, progressive companies are using Industrial Direct Mail regularly as an advertising medium. They effectively allocate a portion of their ad budgets to this second medium at the same time as they concentrate on the best business publications.

For complete, detailed information about our service, fill in the coupon or write for your copy of our free Business and Industrial Direct Mail catalogue.

for Results



USE
Mc GRAW-HILL
DIRECT MAIL LIST SERVICE

Direct Mail Division

McGraw-Hill Publishing Co., Inc.
330 West 42nd St., N. Y. 36, N. Y.

Please forward my free copy of the
McGraw-Hill "Industrial Direct Mail Catalogue."

NAME _____

COMPANY _____

ADDRESS _____

CITY _____ STATE _____

NEW GENERAL PURPOSE RELAY

[SERIES 130 RELAY]

THE MOST USEFUL RELAY FOR INDUSTRIAL APPLICATION

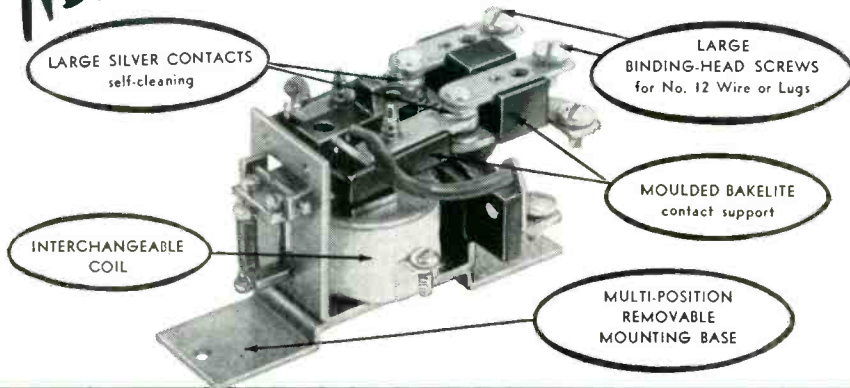
**NO OTHER RELAY IS SO VERSATILE****SPECIFICATIONS**

CONTACTS	RATINGS	COILS	MOUNTING BASE
Single-and-double pole	20 amp. at 115 V	AC & DC to 230 V	Metal strap or bakelite.
Single-and-double throw	60 Cy. AC or 24 V DC	(Interchangeable)	Base can be rotated 90 degrees either direction for mounting convenience.
Aux. DT contacts available	U.L. Approved	Power—2 watts	
DIMENSIONS		Base—1" x 3 3/8"	

Request complete data on Series 130 Relay.

Wheelock **SIGNALS**
INC.
RELAYS  LONG BRANCH, N. J.

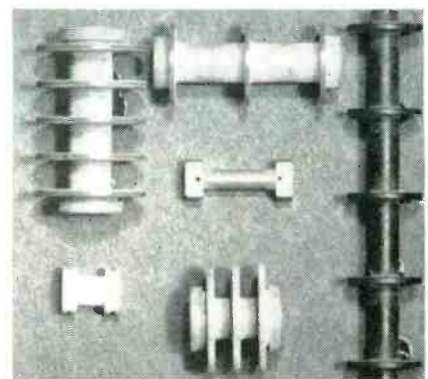

sistors, are machined from filled thermosetting epoxide resin rods. This resin was selected because of its exceptional electrical and mechanical properties. Its outstanding adhesion quality is ideal for hermetic sealing of wire wound resistors.

The bobbins are not affected by extremes in humidity, altitudes nor corrosive influences. The potting compound used for the encapsulating of the resistors is composed of the same resin as the bobbin form. This technique insures the hermetically sealed condition of the resistor at extreme temperatures, since the bobbin and encapsulation contract and expand to the same degree. Circle P47 inside back cover.

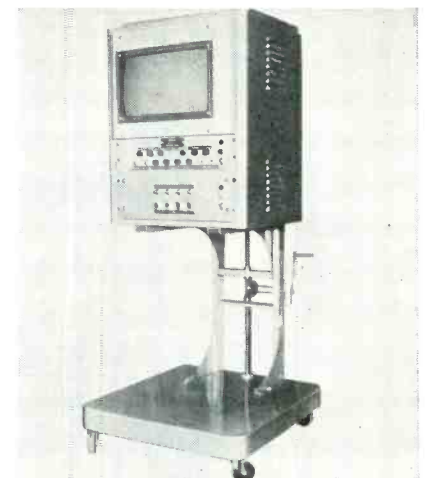
**MONITORSCOPE**
aid to the medical field

ESSENTIAL ELECTRONICS CORP., 1011 Power Ave., Cleveland 14, Ohio. The MonitorScope permits instantaneous observation of the electrocardiograms, electroencephalograms and electromyograms of a patient in the operating room or in the laboratory. It is an oscil-

D-79 GAUSSMETER

Means More
In **MAGNETICS**..

HERE'S WHY:

- Reads 10 to 30,000 Gauss Flux Fields
- Probe is only .025" thick
- Active area .01 square inches
- Net Weight 10-1/2 lbs.
- Power Supply 105-125 Volts, 50-60 Cycle
- Overall size 13" high, 10-1/2" wide, 6-3/4" deep

Precision built to give accurate flux density measurement and determine "flow" direction. The unit also locates and measures "stray fields," plots variations in strength, and is ideal for checking production lots against a standard. Simple to operate, the D-79 gives no ballistic reading... doesn't jerk or pull. Comes in protective carrying case.

Write for literature—Dept. E-257

**DYNA-EMPIRE, Inc.**

1075 STEWART AVE.
GARDEN CITY, N. Y.
Phone
Pioneer 1-2700

TAYLOR

Laminated Plastics
Vulcanized Fibre

Shop Talk

TAYLOR FIBRE CO.

Plants in Norristown, Pa. and La Verne, Calif.

PHENOL—MELAMINE—SILICONE—EPOXY LAMINATES • COMBINATION LAMINATES • COPPER-CLAD LAMINATES • VULCANIZED FIBRE

Tips for designers

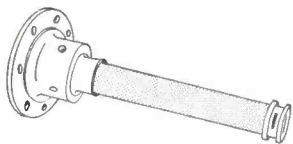

Aircraft fuel gage tank unit uses a tube of Taylor epoxy glass base laminate . . . an unusual material noted for excellent corrosion resistance and electrical insulation over a wide humidity range.

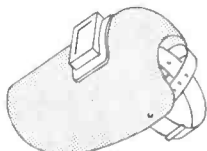

Welders' helmets are fabricated from tough durable Taylor vulcanized fibre . . . readily formed to many desired contours.

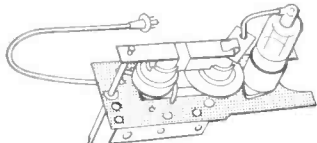

Base plate for high-voltage TV component, punched from Taylor canvas melamine laminate, has high dielectric strength and arc resistance.

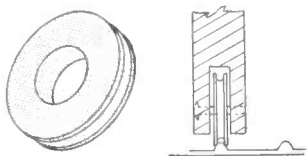

Rollers for flush doors are now being made from Taylor paper base tubing with ball bearing insert . . . providing smooth, silent operation at a low cost.

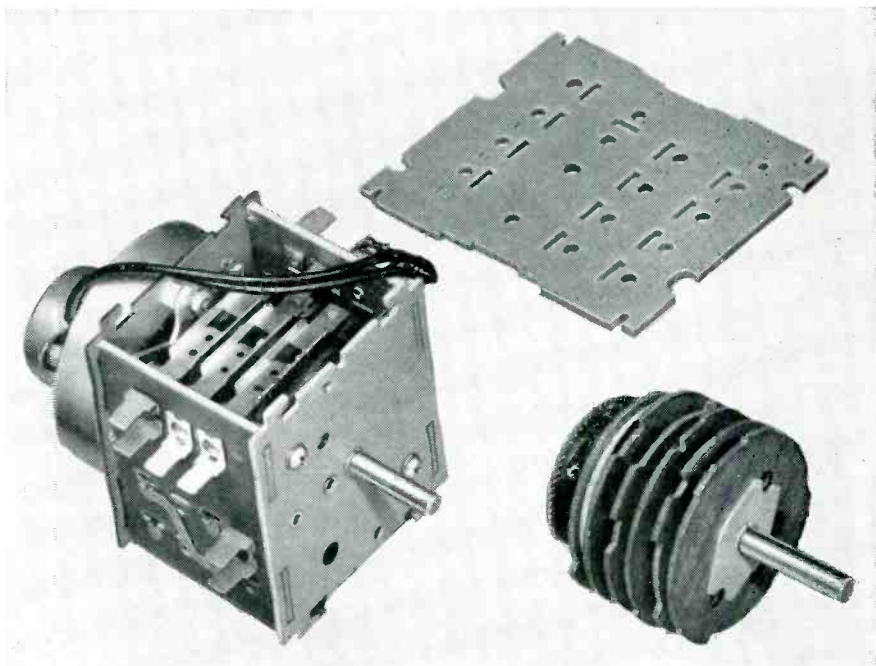

Interval timer switches, made by P. R. Mallory & Co. Inc., use various grades of Taylor paper base phenol laminates for cams and terminal boards. These laminates provide electrical insulation, strength, dimensional stability.

Tough specifications? check Taylor phenol laminates

Choose from over 30 grades of Taylor phenol laminates, for the combination of electrical, physical, and machining properties you want. These rugged, versatile laminates can meet your most demanding specifications, improve end-product performance . . . and bring you major savings in material and fabrication costs.

These laminates, consisting of a paper, cotton fabric, asbestos, glass cloth or nylon base impregnated with Phenol resins, were developed to meet the need for dependable, moisture resistant insulation. They possess high dielectric and mechanical strength. Unaffected by heat or cold (except extremely high temperatures) they resist oils and most chemicals, and are especially suited to the punching and machining of accurately-sized parts. Because of their high moisture-resistance qualities,

Taylor phenol laminates will not readily warp or become distorted when subjected to alternating wet and dry conditions.

You'll like the way these laminates handle in the shop . . . how they punch and stake cleanly, how they readily machine to hairline tolerances. And you'll like the way they perform in product application, how they retain their original characteristics over long periods of time and under severe operating conditions.

Taylor offers the service of its field specialists to help you choose the grade of material that matches the exact requirements of your application. Check with Taylor now. Write for the general catalog of Taylor materials. And contact your nearest Taylor sales engineer for a discussion of your particular requirements.

NEW TAYLOR COPPER-CLAD LAMINATES

Taylor GEC (glass-epoxy) Copper-Clad and Taylor XXXP-242 cold punching (paper-phenol) Copper-Clad. Taylor uses high purity rolled copper on base materials with outstanding electrical properties.

BEST ANSWER for Tower Jobs—ROHN

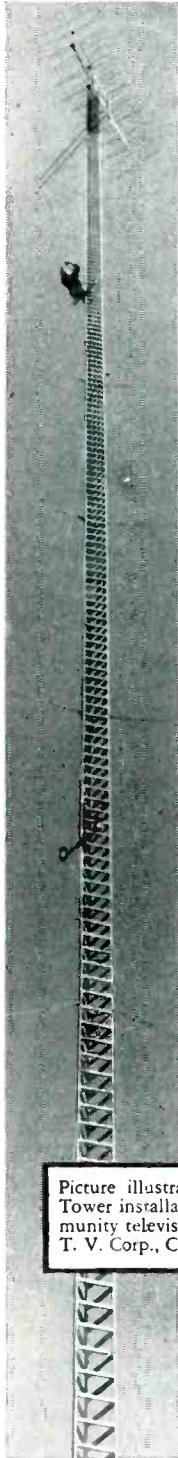

**AMERICA'S FINEST
COMMUNICATIONS
TOWER OF ITS KIND
... WITH EXCLUSIVE
BUILT-IN ECONOMY**

- **REDUCE COSTS** by getting the right tower for the right job. When a job calls for a medium weight tower from 200-300 ft. guyed, or self-supporting from 50-66 ft., a Rohn tower can do the job at far less cost. Check your particular tower needs against the "job-rating" a Rohn tower has and you'll save money.

- **HOT DIPPED GALVANIZED** finishes are available. The erection is quick and easy as all towers are in 10 ft. sections. Rohn towers are designed for economy in erection as no specially trained help is required.

- **PROVEN DESIGN** that has been tested with thousands of installations. Workmanship is unexcelled. Mass production machinery is used for precision fabrication yet a big reduction in labor cost.

Picture illustrates 300 ft. Rohn No. 40 Tower installation as being used for community television by Caspian Community T. V. Corp., Caspian, Michigan.

Write, wire or phone for data and prices and nearest source of supply. ROHN representatives are coast-to-coast to serve you.

ROHN Manufacturing Co.

116 Limestone, Bellevue
Peoria, Illinois

"Pioneer Manufacturers of TV and Communication Towers of All Kinds."

NEW PRODUCTS

(continued)

loscope distinguished by its 17-in., multichannel, long-persistent c-r screen; its mobility; its adaptability and its operating room safety.

With either two or four channels (optional) that may be operated independently and simultaneously, the Monitorscope displays the EKG, EEG or EMG in large complexes, each channel appearing as a separate horizontal trace. When all channels are not needed, the unused traces may be turned off.

For safety of operation during surgery, the Monitorscope is equipped with a frame which elevates the cabinet above 5 ft for operating room service and lowers it for transport. Each unit is equipped with an output jack for operating either direct-writing or photographic recorders, so that recording as well as monitoring is possible simultaneously. Direct photography of the large screen is also possible.

Further information and an illustrated brochure are available. Circle P48 inside back cover.

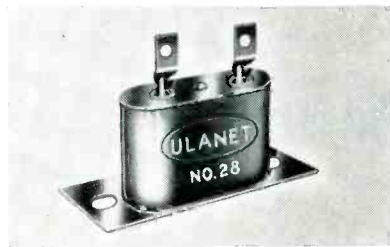

SMALL THERMOSTAT is hermetically sealed

GEORGE ULANET Co., 425 Market St., Newark 5, N. J., has available in quantity a hermetically sealed surface-sensing miniature thermostat that meets stringent aircraft and military applications. New design shortens the heat path between the mounting surface and thermal-sensing element thus decreasing the response time over 50 percent.

Units are precalibrated to specified temperature and adjustment screw is sealed. Strain relief construction prevents calibration drift when the unit is subjected to temperature variation between -50 C and +200 C.

Size is $\frac{1}{8}$ in. wide, $\frac{1}{8}$ in. high



MODEL MH15A For mounting on drums having as few as 30 channels or as many as several hundred. Simple Design—Flexible Operation—Low Noise—High Voltage Insulation. Moisture Proof unit completely encapsulated.

CHARACTERISTICS

Recording System; Non-return to zero. Drum Speed; 2300 in. per sec. Writing Current; 70 ma. Cell Density; 100 bits per in. Head to Drum Spacing; .001 inch. Drum Coating; Red oxide, .001 in. thick. Output; 1 volt peak to peak. Track Width; .125 in. Core Width; .090 in.

The performance characteristics of Model MH15A can be incorporated in the MH10A case if desired.

LIBRASCOPE READ-RECORD HEADS

Specifically Designed for Reading or Recording on Magnetic Drum Memory Systems

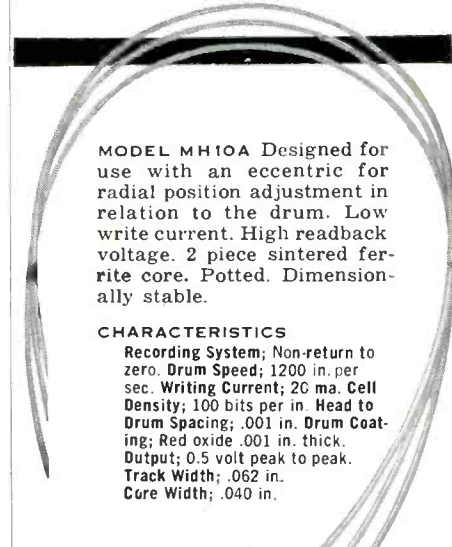

MODEL MH10A Designed for use with an eccentric for radial position adjustment in relation to the drum. Low write current. High readback voltage. 2 piece sintered ferrite core. Potted. Dimensionally stable.

CHARACTERISTICS

Recording System; Non-return to zero. Drum Speed; 1200 in. per sec. Writing Current; 20 ma. Cell Density; 100 bits per in. Head to Drum Spacing; .001 in. Drum Coating; Red oxide .001 in. thick. Output; 0.5 volt peak to peak. Track Width; .062 in. Core Width; .040 in.



Other models available...
write for brochure.

LIBRASCOPE

A SUBSIDIARY OF GENERAL PRECISION EQUIPMENT CORPORATION

808 WESTERN AVENUE • GLENDALE, CALIFORNIA

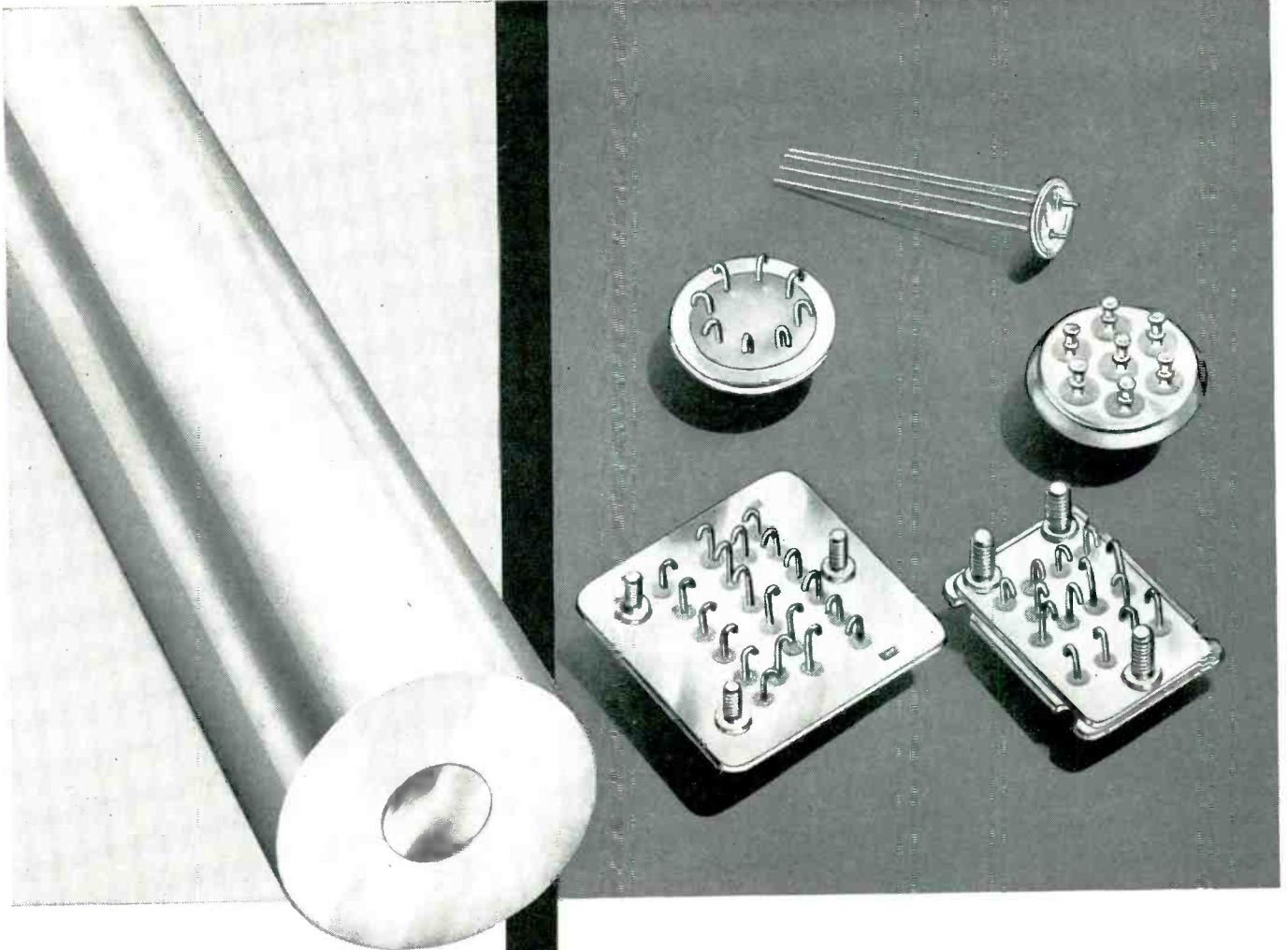

NEW

General Plate COPPER CORED Glass Sealing Alloy Wire

Increases Electrical Conductivity — Saves Time — Cuts Cost

Here's a case where two metals are much better than one. Built around a 30% copper clad core, General Plate Glass Sealing Alloy Wires have up to three times more electrical conductivity than solid lead wires of the same size.

This means you can substantially increase the current carrying capacity of your solid sealed leads without going to larger diameters — or, if you have a miniaturization problem, you can reduce sealing wire diameters correspondingly by using General Plate Cored Wire.

General Plate Copper Cored

Glass Sealing Wires are being used more and more for better performing glass-to-metal seals in hermetically sealed devices such as switches, relays, coils, controls and vacuum tubes.

General Plate Copper Cored Glass Sealing Wires are now avail-

able in #52 alloy, Type 446 Stainless, low carbon steel and other glass sealing alloys. Write for Technical Data Bulletin 706.

For full details on the complete line of General Plate Clad Metals, write today for your free copy of our new PR-700A Catalog.

You can profit by using General Plate Clad Metals

METALS & CONTROLS

General Plate Division



CORPORATION

1302 Forest Street
Attleboro, Massachusetts

NEED A "Multi-Switch"?

Check with . . .

SWITCHCRAFT
INC.

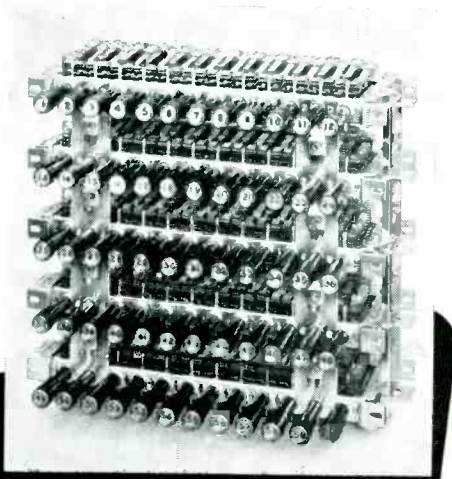

Can it be engineered?
How soon can we get delivery?
How much will it cost?
These are points to check with Switchcraft—one of the largest producers of Multi-Switches.

- Flexible tools make possible easy adaptation to your requirements.
- Functions to meet your needs.
- Single or multiple bank assemblies.
- Illuminated or non-illuminated push-button designs.

Proven for 36 months
in hundreds of different applications

SWITCHCRAFT
INC.

1336 N. Halsted St., Chicago 22, Ill.

Canadian Rep: Atlas Radio Corp., Ltd.,
50 Wingold Ave., Toronto, Canada

See this "Multi-Switch" and many other new
Components at the
Radio Engineering Show
March 18 to 21
NEW YORK COLISEUM • BOOTH 2228

GRC small nylon coil bobbins

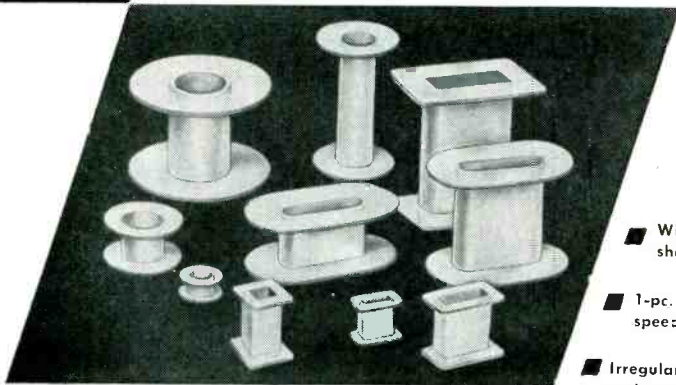

- Wide range of shapes and sizes
- 1-pc. Nylon molding speeds winding
- Irregular shapes and special materials to order
- Accurate, uniform, ready-for-use

NOW available from stock

NOW Gries offers a wide variety of nylon coil bobbins from stock. Automatically mass produced at low cost—ready for use. Stock sizes from 1/4" diameter x 1/4" long minimum up to 7/8" diameter x 7/8" long—round, square, rectangular, oval shapes. Check Gries for your bobbin needs—either from stock—or to your size, shape and material specifications on special order.

WRITE FOR FULL
INFORMATION

GRIES REPRODUCER CORP.

151 Beechwood Ave., New Rochelle, N.Y.
New Rochelle 3-8600

GRIES 

World's Foremost Producer
of Small Die Castings

exclusive of terminals, 3/8 in. long. Ratings are: 5 amperes 28 v d-c noninductive load; 5 amperes 115 v a-c. Circle P49 inside back cover.



OSCILLOGRAPH TUBE for pulse-modulated uses

RADIO CORP. OF AMERICA, Harrison, N. J. The 5FP14-A is a 5-in. oscillograph tube featuring high resolution capability and a medium-long persistence characteristic. It is intended particularly for pulse-modulated applications, such as radar indicator service.

Employing magnetic focus and magnetic deflection, the tube is designed with a high-resolution gun capable of providing a line whose width will not exceed 0.010 in. measured with ultron current of 200 μ a, ultron voltage of 4,000 v. and 49-line shrinking raster. The 5FP14-A has a deflection angle of 53 deg and a minimum useful screen diameter of 4 1/4 in. Circle P50 inside back cover.

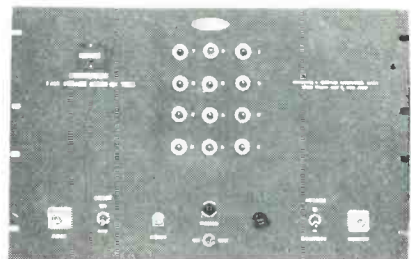

DECADE SCALER with long term reliability

ELECTRICAL AND PHYSICAL INSTRUMENT CORP., 42-19 27th St., Long Island City 1, N. Y. The model

Engineers wanted for this assignment:

TAKE MAN HIGHER...FASTER ...THAN EVER BEFORE

The men who create tomorrow's hypersonic, high flying aircraft will have to engineer them to withstand the weird phenomena of the stratosphere. Here in deep blue space, violent 200-mile-per-hour winds fight each other. Fantastic air temperatures and aerodynamic heating become incredible, contradictory forces.

The airplane of the future will have to overcome *all* the problems of this eccentric environment, and do one more thing—house and protect a human pilot.

At two times the speed of sound the lowest temperature anywhere on the airplane is 250°—hot enough to rob aluminum alloy of 20% of its strength. At Mach 3 temperatures zoom to a blood-boiling 650°. And yet thermodynamics is just one package of problems confronting today's aircraft engineer. There are many more to be unwrapped before this space-age accomplishment is real.

The aeronautical researcher has, however, an outline picture of his airplane

of the future. He knows that its configuration will be designed to reduce friction ... its wing will be razor-thin ... the nose needle-sharp to avoid detached shock waves. He also knows that his brainchild will have to prove itself high above the atmosphere!

One day soon this missile-like airplane will take man where he's never been before ... to the very frontier of space.

If you accept this challenge we promise you a management climate that stimulates personal growth and rewards initiative. Engineers have constantly guided the long-range technological advancement of North American where research and development on the X-15—a manned aircraft for the investigation of speeds and temperatures at very high altitudes—is now in progress.

Write today for full particulars to: Mr. T. J. Wescombe, Engineering Personnel Manager, Dept. 2EL, North American Aviation, Inc., Los Angeles 45, California.

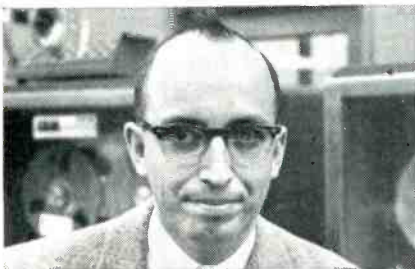

CHUCK PRICE earned a BS in 1944, MS in 1947, and a PHD in Mathematics in 1950—all from the University of Chicago. In 1953 he joined North American's Advanced Design Department. Since then he has earned three promotions and is now a Group Leader supervising 36 engineers working on a new aircraft design. His Group's objective—to select the aircraft configuration best suited to perform a specific mission.



MIT graduate **HAROLD RAIKLEN** received his BS in Mechanical Engineering in 1947—his MS two years later. His first North American assignment was to analyze and test dynamic stability and response of powered flight controls. Today, less than four years after joining the Company, Hal heads a section devoted to design and study of mechanized components, including flight control systems—his third supervisory position.

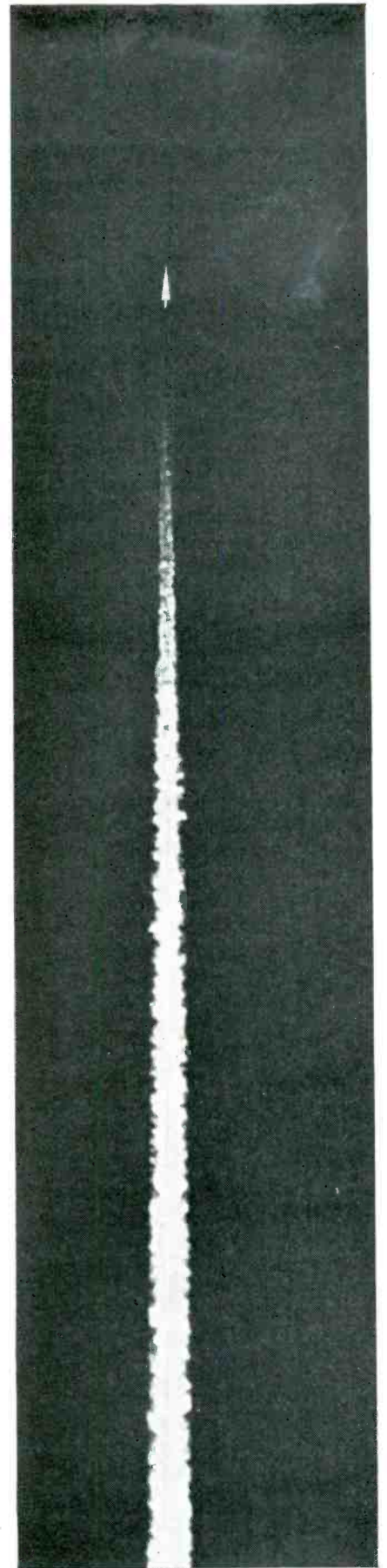

NORTH AMERICAN AVIATION, INC.

NORTH AMERICAN HAS BUILT MORE AIRPLANES THAN ANY OTHER COMPANY IN THE WORLD



RELAYS

Custom-engineered
to YOUR Specs

Class 33 - Midget,
Sub-miniature -
D.C. Also available
in special low ca-
pacitance model.

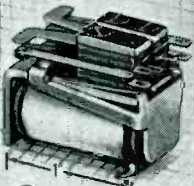

Class 11 - Versa-
tile D.C. Latch-
ing Type also
available.

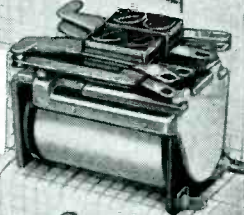

Class 22 - Versatile
A.C. or D.C. Wide
selection of varia-
tions.

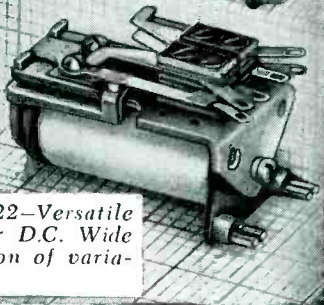

Engineered and manufactured to highest standards of reliability.

Available with resistance to shock, vibration and temperature change to meet military specs.

Special variations engineered to meet exacting service and application requirements.

Whatever your service, just tell us what you need.

Send for Catalog describing Class 33, Class 11 and Class 22 Relays for A.C. or D.C., open, plug-in, dustproof, hermetically sealed and many special models.

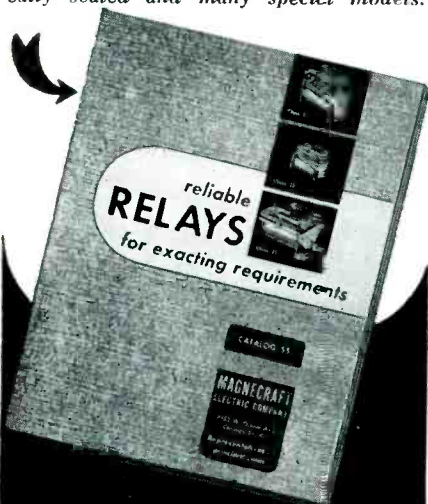

MAGNECRAFT ELECTRIC CO

33508 W. Grand Ave. Chicago 51, Ill

NEW PRODUCTS

(continued)

414 fast decade scale of 1,000 has been designed to allow accurate high speed counting with a long term reliability previously approached only in much slower equipment. The gated decade system does not use feedback and makes possible a decade with a large bias range and an inherent reliability approaching that of a binary. Diode input coupling to each flip-flop in the 10-mc and 1-mc sections and at the input of the slower decades further enhance reliability.

A high capacity forced air blower system keeps operating temperature and moisture content low.

A five-digit electrical register which resets automatically with the scaling stages follows a scale of 1,000 which can be increased on special order up to a scale of 1,000,000. Pulse resolution is 0.1 μ sec and continuous counting rates to 10 million per sec can be provided. Circle P51 inside back cover.

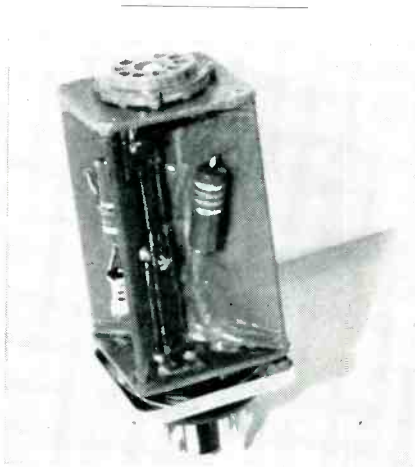

PLUG-IN MODULE uses printed circuits

ARTHUR ANSLEY MFG. Co., New Hope, Pa., has announced a new modular construction using standard printed-circuit materials and techniques with standard components. Called the Plus module, it features compactness, rugged mechanical construction, great flexibility of design and easy accessibility of the components for servicing.

A standard size is offered, approximately 1 $\frac{3}{8}$ in. sq and 2 $\frac{1}{2}$ in. high, either with an octal plug-in

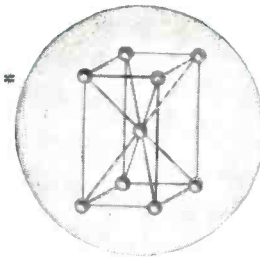

*PURE TIN plated on Somers Thin Strip.

Somers engineers have developed a special hot tin plate process which now will provide the smooth surface, solderability, adherence and complete absence of slag so essential to manufacturers of:

PRINTED CIRCUITS CAPACITORS CABLE WRAPPING

Tin coatings of .00002 to .00008 and .0002 to .0003 are available on brass, copper, bronze and other Thin Strip metals in gauges from .012 down to .002, widths from $\frac{1}{8}$ " to 6" and wider.

And, of course, Somers exacting standards for tolerance, tensile strength and other physical properties are rigidly maintained.

Whatever your requirements for tin plated thin strip, you can depend on Somers long experience and modern equipment for a quality product.

Write for further information and confidential data blank. Somers will gladly analyze your problem without obligation.



Somers Brass Company, Inc.
112 BALDWIN AVE., WATERBURY, CONN.

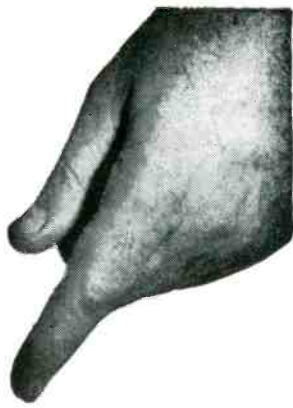

**How to keep
informed on
the "with what"
part of
your business**

AT YOUR FINGER TIPS, issue after issue, is one of your richest veins of job information—advertising. You might call it the "with what" type—which dovetails the "how" of the editorial pages. Easy to read, talking your language, geared specifically to the betterment of your business, this is the kind of practical data which may well help you do a job quicker, better—save your company money.

Each advertiser is obviously doing his level best to give you helpful information. By showing, through the advertising pages, how his product or service can benefit you and your company, he is taking his most efficient way toward a sale.

Add up all the advertisers and you've got a gold mine of current, on-the-job information. Yours for the reading are a wealth of data and facts on the very latest in products, services, tools . . . product developments, materials, processes, methods.

You, too, have a big stake in the advertising pages. Read them regularly, carefully to keep job-informed on the "with what" part of your business.

**McGRAW-HILL
PUBLICATIONS**

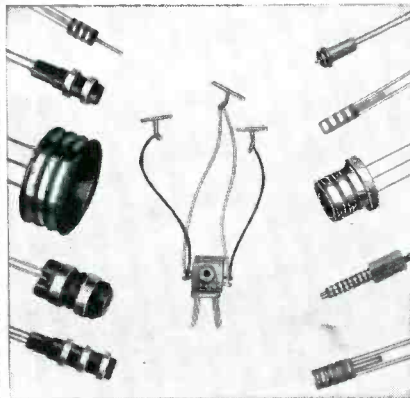

Miniature and Sub-Miniature
**SLIP RING ASSEMBLIES
BRUSH BLOCK ASSEMBLIES
COMMUTATORS**

and other
Electro-Mechanical Components

**PRECISION MADE
TO YOUR OWN SPECIFICATIONS**

Precision molded products with exacting tolerances in precious and non-precious solid metals of all alloys. All types of Thermo-Plastic and Thermo-Setting materials.

Slip Ring Assemblies fabricated or one-piece precision molded to your specifications in Nylon, Kel-F, Mineral filled Mellamine, Phenolic, and other materials. Rings and leads spot welded or brazed together for positive electrical circuit.

Our Swiss methods and techniques are geared to meet exacting requirements. We invite your inquiries.

COLLECTRON CORPORATION

MUrray Hill 2-8975 • 216 East 45th Street • New York 17, N. Y.

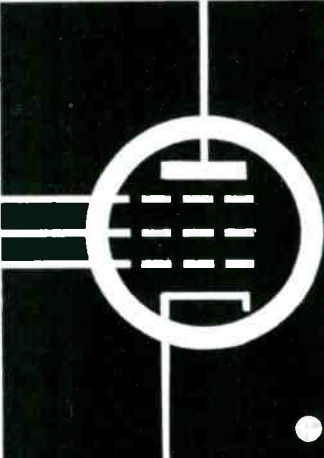

ENGINEERS

Challenging assignments for engineers with broad experience in

- TUNER DESIGN
- TV CIRCUITRY
- A.G.C. AND SYNC CIRCUITRY DESIGN & DEVELOPMENT

Many excellent company-paid benefits, attractive salaries and challenging assignments for those who can qualify.

Write, wire or call • Mr. Martin E. Flynn

ALLEN B. DUMONT LABORATORIES, INC.

35 Market Street, East Paterson, N. J. • MUlberry 4-7400

FANSTEEL

STA

SOLID TANTALUM CAPACITORS

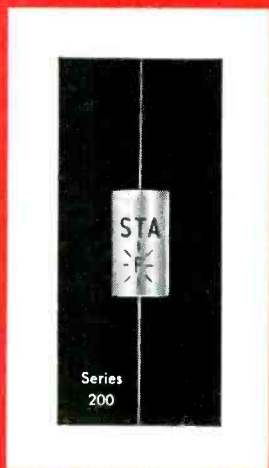

Here Are the Sizes Available:

	CATALOG NUMBER	CAPACITY IN MFD*	WORKING VOLTAGE	SURGE VOLTAGE
100 SERIES	STA-155	3.5	10	12
	STA-160	2.0	15	18
	STA-165	1.5	20	24
	STA-170	1.2	30	36
	STA-175	1.0	35	42
200 SERIES	STA-255	17	10	12
	STA-260	11	15	18
	STA-265	8	20	24
	STA-270	6	30	36
	STA-275	5	35	42
300 SERIES	STA-355	70	12	12
	STA-360	45	15	18
	STA-365	35	20	24
	STA-370	23	30	36
	STA-375	20	35	42

*Standard Capacity Tolerances are minus 15%, plus 25%.

NOW AVAILABLE IN PRODUCTION QUANTITIES

(Write for bulletin 6.112)

FANSTEEL METALLURGICAL CORPORATION

North Chicago, Illinois, U.S.A.



CS/2A

TANTALUM CAPACITORS... DEPENDABLE SINCE 1930

NEW PRODUCTS

(continued)

base which makes the unit directly interchangeable with many hand-wired modules, or with a new type of plug known as the Plug base that provides up to 32 contacts. A 7 or 9-pin tube socket is incorporated in the top of the unit or it can be adapted to transistors or subminiature tubes. Other sizes and shapes can be made, supporting two or more tubes.

The company offers engineering help in converting circuits to the new construction and is prepared to furnish the complete modules assembled and dip soldered. A standard laboratory unit is also available with a printed-circuit grid which permits engineers to experiment with the new module in their own applications. Circle P52 inside back cover.

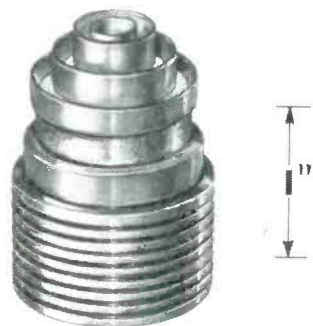

RCA - 6816

BEAM POWER TUBES with ceramic-metal seals

RADIO CORP. OF AMERICA, Harrison, N. J., has developed two new extremely small transmitting-type uhf beam-power tubes (types 6816 and 6884) weighing only 2 oz each, with a diameter of 1 1/4 in. and a length of 1 1/8 in. The tubes were developed for oscillator, multiplier and amplifier applications in communications equipment where light weight and physical compactness are important. They have a continuous-wave useful power output of 80 w at 400 mc and 40 w at 1,200 mc.

Through the use of one-piece construction which combines each electrode, its support and its external contact surface, all welding of tube elements to their individual supports and internal leads

is eliminated. This provides low-inductance, high-conductivity paths to the electrodes themselves. The coaxial-electrode structure with its ring-type ceramic-metal seals having graduated diameters, facilitates use of these tubes in circuits of the coaxial-cylinder cavity type. The 6816 has a 6.3-v, 2.1-ampere heater; the 6884, a 26.5-v, 0.52-ampere heater. Circle P53 inside back cover.



D-C POWER SUPPLY
is mag-amp regulated

ARNOUX CORP., 11924 W. Washington Blvd., Los Angeles 66, Calif. Designed to supply regulated, d-c voltage for powering airborne electronic equipment from 115 v, 400 cps, single-phase source, this new line of packaged power supplies operates reliably under aircraft and missile environments.

Regulation, provided entirely through magnetic amplifiers, is 0.10 percent; ripple, 0.05 percent. Units meet MIL E-5272A and 1-6181B specs and are potted in hermetically sealed drawn-steel cans. AN connectors or solder headers are available. Mounting is through studs projecting from base.

Standard sizes are 100 to 600 v d-c, up to 1,000 ma. Circle P54 inside back cover.

VOLTAGE DIVIDER

accurate to 0.0001 percent

JULIE RESEARCH LABORATORIES INC., 556 W. 168th St., New York 32, N. Y. The VDR-106 is a six-decade Kelvin-Varley type voltage divider. It provides an output volt-

FANSTEEL

Silicon

RECTIFIERS

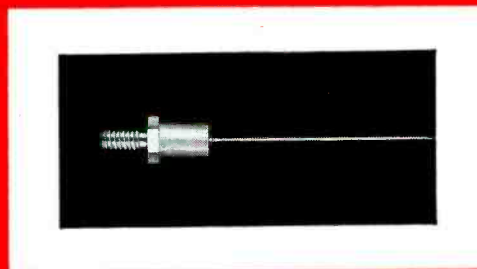

Minimum Size.....

Maximum Performance...

Fansteel Dependability

½ AMPERE RATING

WILL OPERATE AT 170°C (338°F)
CASE TEMPERATURE WITHOUT
A HEAT SINK

WRITE FOR SIZES AND RATINGS



FANSTEEL METALLURGICAL CORPORATION

North Chicago, Illinois, U. S. A.

DEPENDABLE RECTIFIERS SINCE 1924

Epsco

HIGH-PERFORMANCE MINIATURIZED Magnetic SHIFT REGISTERS

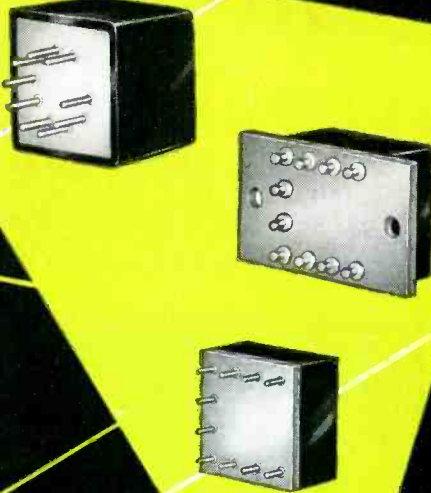

APPROX.
ACTUAL
SIZE

Featuring...

- ▶ **Extremely low power consumption** —less than 0.25 watt peak power for 3 kc rate; 0.6 watt peak power for 100 kc rate
- ▶ **Wide operating tolerances** —pulse width may vary ± 50 percent
- ▶ **Minimum space requirement** —below $\frac{1}{4}$ cu. in. per binary unit
- ▶ **Surpass applicable MIL specifications**
- ▶ **Standard packages** — 9-pin miniature base, dip-solder terminals for printed circuits, and solder-lug panel with mounting ears; standard Epoxy resin cases, hermetically sealed corrosion-resistant container, or custom packaging to your specifications. Package sizes range from $\frac{3}{4}$ " long x $\frac{3}{4}$ " wide x $\frac{3}{8}$ " high to 1-7/32" long x 1-1/64" wide x 11/32" high. Semi-conductor diodes may be encapsulated with the storage element.

SHIFT PULSE	Pulse Rate — Kc	0.3	0.16	0.100	0.200
Nominal current (ma)		40	60	100	300
Pulse width (50% ampli.) in μ sec		19	12	2.0	1.0
Rise time (10% to 90%) in μ sec		6.0	6.0	0.6	0.3
Fall time (90% to 10%) in μ sec		1.0	1.0	0.2	0.2
Max. voltage drop (volts)		6.0	6.0	6.0	6.0
Peak pulse power (watts)		0.24	0.36	0.6	1.8
INPUT PULSE					
Recommended current (ma)		3	3	5	10
Recommended duration (μ sec)		10	10	10	10
OUTPUT PULSE					
Minimum signal voltage		10	10	16	10
Signal-to-noise ratio		8:1	8:1	8:1	6:1
Minimum load impedance (ohms)		1,000	1,000	1,500	2,500
RECOMMENDED DIODE					
Transition type number		1N279	1N279	75G	1N279

We will cooperate in your design or application problems. Engineering brochure describing Epsco Magnetic Shift Register available on request.

Epsco also produces a complete series of pulse transformers and lumped-constant delay lines.

Check the above specifications with your requirements in data processing, computation and related fields.

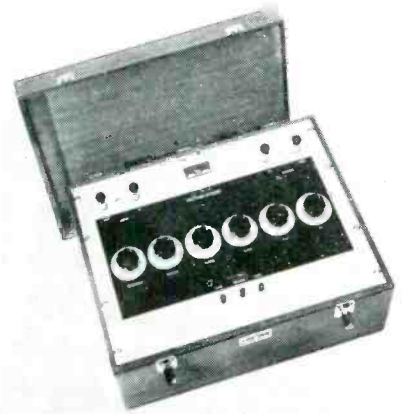

age which is a precisely settable fraction of applied voltage. Six panel-mounted dials permit the voltage division ratio to be set to any discrete value between 0.000000 and 1.000000 with an accuracy and resolution of 0.000001. The effective resolution may be conveniently increased by a factor of 10 by interpolation with the null detecting device.

The device also features switch-operated fixed oil-immersed resistors in all decades, eliminating the conventional interpolating potentiometer. Thus no accuracy determining component is subject to mechanical wear.

Input impedance is 100,000 ohms permitting input voltages of up to 300 v. Case dimensions are 20 by 15 by 9 $\frac{1}{4}$ in. with an inner metal case suitable for relay rack mounting. Circle P55 inside back cover.



V-T MILLIVOLTMETER for field measurements

FISHER RESEARCH LABORATORY, INC., 1961 University Ave., Palo Alto, Calif. Direct, accurate, in-the-field measurements of small potentials are easily and quickly made with this new battery operated v-t millivoltmeter. Essentially infinite input resistance, 10 megohms, on all ranges provides minimum disturbance to the cir-

Epsco

incorporated

minimum disturbance to the circuit under test. Six full-scale ranges between 0-25 and 0-1,000 mv and two additional ranges, 0-10 and 0-100 v, are provided. Scale divisions are divided on the 0-25 mv scale so that measurements to 50 μ v are possible. The instrument is available in both d-c and a-c models.

An entirely new circuit provides a stable, reliable and all-electronic method of obtaining measurements. Instrument accuracy, ± 1.5 percent on all ranges, is completely independent of tube and battery variations due to a unique amplifier design providing infinite gain in the amplifier circuit combined with 100-percent negative feedback. Size is 5 by 8 by 4 in. Weight is 5 lb complete with leather carrying case. Circle P56 inside back cover.

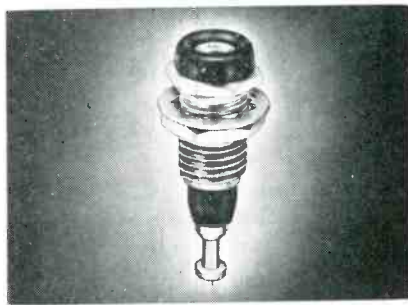

TEST JACK
designed for long life

RAYTHEON MFG. CO., 100 River St., Waltham 54, Mass., has announced a new standard test jack, developed for use in both military and commercial applications. Designed for long electrical and mechanical life, it meets all requirements of MIL-STD-242 (Ships). It features a beryllium copper-spring pin contact which insures consistently smooth insertion and withdrawal of standard 0.080-in. diameter test prods. A nickel-plated brass mounting bushing provides secure mounting under extreme conditions of shock and vibration. The mounting bushing is insulated from the contact assembly by a full-length nylon sleeve.

The entire contact assembly is silver plated with gold wash, providing extremely low contact resistance with the test prod and facilitating fast, strong solder

Epsco

Lumped-constant Precision DELAY LINES

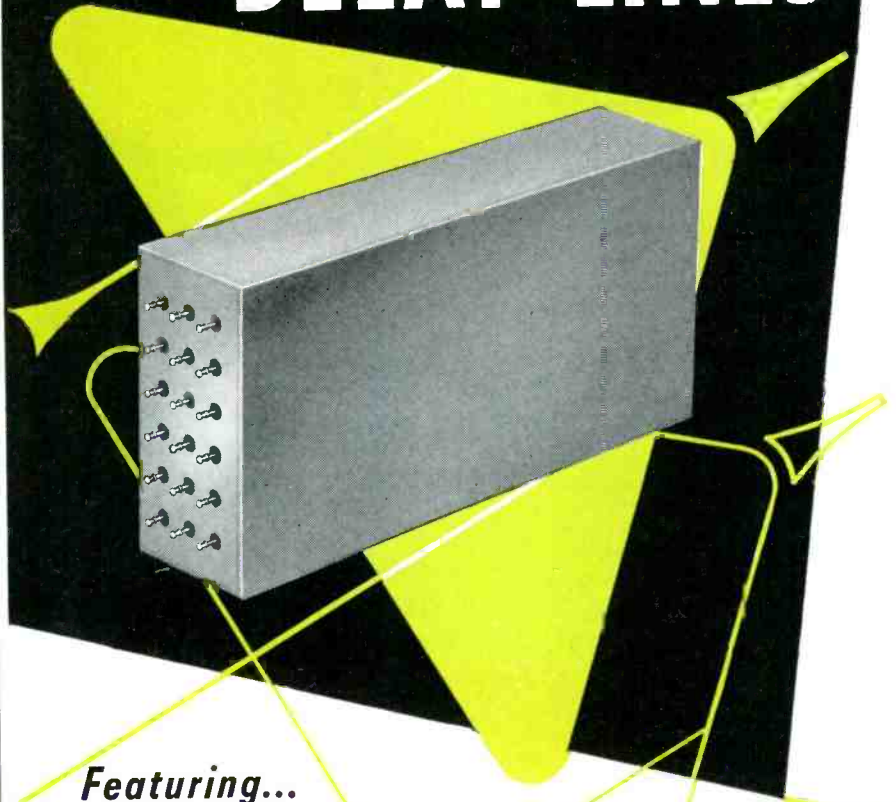

Featuring...

Extremely long delay accurate to $\pm 1\%$, low attenuation, and excellent phase linearity from 1% to 80% of cut-off frequency, are important features of these standard Epsco precision audio delay lines.

Delay μ sec	Rise Time μ sec	No. of Taps	Z ohms	Attenuation	Cut-off Freq.	Size-in. Rack Mtg.	Catalog No.
1000	40	50	600	3 db @ 9 kc 6 db @ 13 kc	20 kc	19x3 $\frac{1}{2}$ x9	0600-200/50
5000	100	125	1000		9.5 kc	19x5 $\frac{1}{4}$ x9	1000-400/125
5000	100	125	600	3 db @ 3 kc 6 db @ 6 kc	9.5 kc	19x5 $\frac{1}{4}$ x9	0600-400/125
5000	100	125	510		9.5 kc	19x5 $\frac{1}{4}$ x9	0510-400/125

Epsco will design and build special delay lines to your performance requirements. Characteristics of typical custom-engineered units are given below.

Delay μ sec	Rise Time μ sec	No. of Taps	Z ohms	Atten. db.	Temp. range °C	Dimensions inches	Catalog No.	Feature
1.5	.08	45	600	.3	-45+85	6x3 $\frac{1}{2}$ x $\frac{1}{2}$	0300-0033/45	Low attenuation
18.0	.65	60	1000	1.8	-55+105	7x4x1	1000-03/60	Low attenuation
20.3	0.62	84	1000	4.0	-55+125	2.3x2.3x3.3	1000-0242/84	Miniature size
23.76	.75	83	180	3.0	-55+105	8x2x4	0180-029/83	Low attenuation
24.0	0.65	120	100	5.0	-45+85	1 $\frac{1}{4}$ x1 $\frac{1}{2}$ x27 $\frac{1}{2}$	0100-02/120	Form factor
36.0	0.85	120	600	4.0	-55+85	13 $\frac{1}{2}$ x3x1 $\frac{1}{2}$	0600-03/120	Low attenuation
200	6	100	390	13	-65+150	7 $\frac{1}{2}$ x4 $\frac{3}{4}$ x1 $\frac{1}{2}$	0390-20/100	Temp. coefficient less than 10 PPM/°C

An engineering bulletin giving useful data on delay lines and their application is available on request.

Epsco also produces a complete line of pulse transformers and magnetic shift registers



588 COMMONWEALTH AVE.,

BOSTON 15, MASSACHUSETTS



HYCON FILTER APPLICATIONS ARE MANY...

Whether tracking signals from outer space or dispatching a fleet of radio equipped taxicabs, Hycon Filters are finding wide application in many of today's advanced receiver installations. Listed herewith are a number of users of Hycon Filters. It will pay you to investigate how Hycon Filters can help solve your selectivity problems.

A C The Electronics Division
General Motors Corporation
Air Force Cambridge Research Center
Allen B. DuMont Laboratories, Inc.
American Radio Relay League
Applied Physics Laboratory
The Johns Hopkins University
Bell Telephone Laboratories, Inc.
Canadian Marconi Company
Collins Radio Company
Crosley Division
Avco Manufacturing Corporation
Ewen Knight Corporation
Fada Radio & Electric Co., Inc.
Federal Telecommunication Labs.
General Electric Company
General Precision Laboratory, Inc.
Gilfillan Brothers, Inc.
Hughes Aircraft Company
Kahn Research Laboratories
Laboratory For Electronics, Inc.
Laboratory Procurement Office
The Army Signal Supply Agency
Lear, Inc.
Massachusetts Institute of Technology
Lincoln Laboratory
Motorola, Inc.
National Bureau of Standards
National Company, Inc.
Naval Research Laboratory
Philco Corporation
Pye Ltd. . . . Cambridge, England
Radio Corporation of America
Radio Engineering Laboratories, Inc.
The Ramo-Wooldridge Corporation
Raytheon Manufacturing Company
Siemens New York Incorporated
Stromberg-Carlson Company
Sylvania Electric Products Company
University of Colorado
Westinghouse Electric Corporation
Wilcox Electric Company, Inc.



HYCON EASTERN, INC.

75 Cambridge Pkwy., Cambridge 42, Mass.

Affiliated with HYCON MFG. CO., Pasadena, Calif.

NEW PRODUCTS

(continued)

connections at the solder terminal. The nylon insulator is available in nine brilliant colors for convenient visual circuit identification. Mounting hardware consists of a nickel-plated brass nut and phosphor-bronze lock washer. Circle P57 inside back cover.

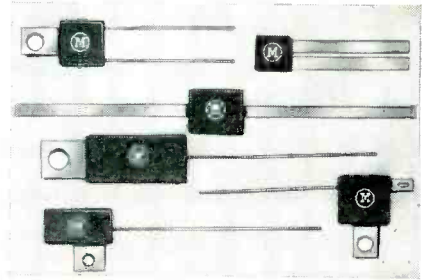

with a great variety of lead arrangements of wire, ribbon or tab leads to fit a wide range of terminal requirements. For extremely tight space applications where high capacitance is required, connecting leads may be ordered of any desired number or thickness, radially or axially arranged, or in any other configuration to provide the most efficient assembly operation. Lower inductance for uhf is obtained with ribbon leads.

The shapes of the ceramic elements vary from square to rectangular with thickness as little as 0.065 in. if needed. Where larger values of capacitance are required in the same area, two or more plates are stacked and connected in parallel.

Wide application of these capacitors are in the fields of transistor circuitry, guided missiles, computers, radio and tv, filters, radar and uhf. Bulletin F2 is available. Circle P59 inside back cover.

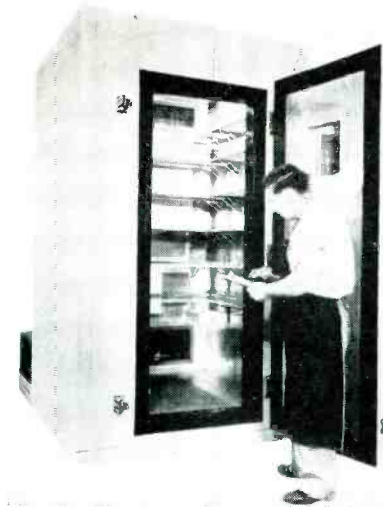

TEST ROOMS walk-in environmental type

HUDSON BAY Co., Div. of Labline, Inc., 3070 W. Grand Ave., Chicago 22, Ill., has available a complete line of walk-in environmental test rooms, ranging in size from 4 by 4 by 7 ft high to 4 by 8 by 7 ft high, or other sizes to suit specific needs.

Units are all self-contained, complete with refrigeration, humidity and temperature controls. Temperature ranges from 30 to 200 F and relative humidity, 20 to 95 percent. Interiors are made of heavy gage aluminum, Heliarc welded.

All rooms are double-wall construction, with vapor-sealed fibre glass insulation. Doors have triple seal door gaskets, with multiple panel Thermo-Pane windows.

Interiors can be equipped with aluminum shelving for either work space or storage of samples. Circle P58 inside back cover.

CERAMIC CAPACITORS versatile lead arrangements

MUCON CORP., 9 St. Francis St., Newark 5, N. J., has available subminiature ceramic capacitors



VACUUM RELAY has three h-v terminals

JENNINGS RADIO MFG. CORP., P. O. Box 1278, San Jose, Calif. The type RE4 spdt vacuum transfer relay has three h-v terminals that are equally spaced on a 2½-in. diameter glass bulb giving the longest possible flashover path in a relay this size. Its operating

voltage rating is 25 kv peak and for high altitude operation at this voltage it is provided with a flange that can be soldered to the side of an oil filled or pressurized container. When used in this manner its 26.5 v d-c, 5-w actuating coil can still be removed from below the flange mount.

The vacuum dielectric and high temperature processing of this relay insures clean contacts that stay clean, eliminates contact sticking or welding and makes possible small contact actuating mechanisms that resist vibration and shock forces. These features make it especially well suited for antenna switching, d-c pulse switching and straight d-c switching in airborne equipment. Circle P60 inside back cover.

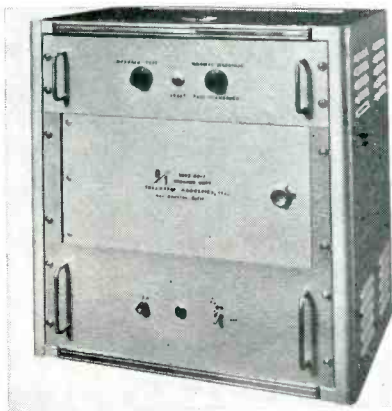

STORAGE UNIT has 1092 character capacity

TELEMETER MAGNETICS, INC., 2245 Pontius Ave., Los Angeles 64, Calif. The 1092-BU-7 coincident-current magnetic core storage unit has unique properties which make it ideal for application as a temporary store, buffer or delay unit in data-processing, computing and automation systems. It has a capacity of up to 1,092 characters, each of which may be up to 7 binary digits in length. The seven bits of each character are loaded and unloaded from the memory in parallel. The characters are introduced into the store sequentially and are immediately available at the output in the same sequence as the loading sequence. Minimum time for loading or unloading operation is 14 μ sec per character with 6 μ sec

Now . . . only 1 Conversion from VHF to Audio

HYCON EASTERN



Shown $\frac{1}{2}$ size
Crystal Filter Model 13MA
patent pending

CRYSTAL FILTERS

**IMMEDIATE DELIVERY
MODEL 13MA**

Hycon Eastern is now producing standard Crystal Filters with extremely high selectivity at frequencies which eliminate the need for multiple conversions. Among these are Model 13MA and Model 13MB for use in VHF FM receivers. Model 13MB may be used in AM receivers as well as in the proposed split channel FM systems. Their low insertion loss, linear transfer characteristics and non-microphonic qualities permit their location at any point of low signal level such as between the mixer and the i.f. amplifier. For FM applications Hycon Eastern has available standard Crystal Discriminators centered at 13Mc which may be used in conjunction with Model 13MA or Model 13MB.

- SMALL SIZE — ONLY 3 $\frac{1}{16}$ " X 1" X 1 $\frac{1}{2}$ "
- FREQUENCY SHIFT LESS THAN $\pm .005\%$ TOTAL FROM -55° C. TO $+85^{\circ}$ C.
- NON-MICROPHONIC
- UNAFFECTED BY IMPEDANCE VARIATIONS COMMONLY ENCOUNTERED IN TRANSISTOR CIRCUITS
- WORKS DIRECTLY TUBE-TO-TUBE OR TRANSISTOR-TO-TRANSISTOR WITH NO PADDING
- HERMETICALLY SEALED, NO ALIGNMENT OR READJUSTMENT NECESSARY

ELECTRICAL SPECIFICATIONS — MODELS 13MA and 13MB

Center Frequency: 13Mc
 Bandwidth at 6 db Attenuation: 30 Kc (Model 13MA)
 Bandwidth at 6 db Attenuation: 15 Kc (Model 13MB)
 Shape Factor: $\frac{60 \text{ db Bandwidth}}{6 \text{ db Bandwidth}} = \frac{1.8}{1}$
 Power Insertion Loss: 6 db Maximum
 Passband Response Variation: ± 1 db Maximum
 Ultimate Attenuation: 80 db Minimum

Write for Crystal Filter Bulletin

HYCON EASTERN, INC.

75 Cambridge Parkway Dept. A-2 Cambridge 42, Massachusetts
 Affiliated with: HYCON MFG. COMPANY, Pasadena, California



1500 VOLT

single junction

welded case

SILICON

RECTIFIERS

from

Texas Instruments

You can now obtain maximum rectifier miniaturization along with nearly double the operating voltage previously obtainable from silicon rectifiers — with new TI single element grown junction silicon rectifiers. This two-fold advance — single element construction plus 1500-volt operating voltage — results in immediate extension of design limits in guided missile and other military applications. Also, these welded case rectifiers are ideal for use in series in cathode ray tube power supplies and similar high voltage circuits.

TI miniaturized silicon rectifiers feature forward current ratings to 125 ma and operate stably to 170°C. They require no filament power... no warm-up time. Five production types give you a choice of axial and stud half-wave types in welded case and full-wave plug-in model.

Write today for complete information



TEXAS INSTRUMENTS
INCORPORATED
6000 LEMMON AVENUE DALLAS 9, TEXAS

NEW PRODUCTS

(continued)

being required to switch from a loading to an unloading operation or vice versa. Circle P61 inside back cover.

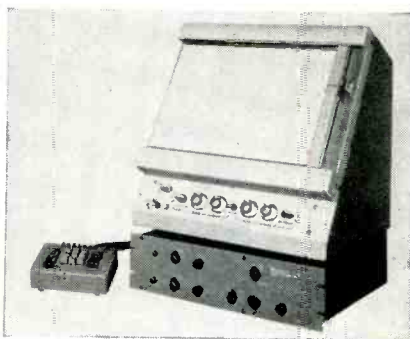

KEYBOARD for X-Y recorders

ELECTRO INSTRUMENTS, INC., 3794 Rosecrans, San Diego 10, Calif., now offers a keyboard accessory for its 11 in. by 17 in. X-Y recorders. Model 175 consists of a 10-key keyboard (6 in. by 6 in.) and a rack-mounted program and memory unit (5½ in. by 19 in.). The keyboard uses the touch system and can be operated by either left or right-hand operators. Six digits are entered serially, with a point or symbol plotting automatically on the sixth digit entry. Indicator lights show the number of digits entered. A "minus" sign, "clear keyboard" and "hold X hold Y" controls are added. No plot or plus operations are required. Circle P62 inside back cover.

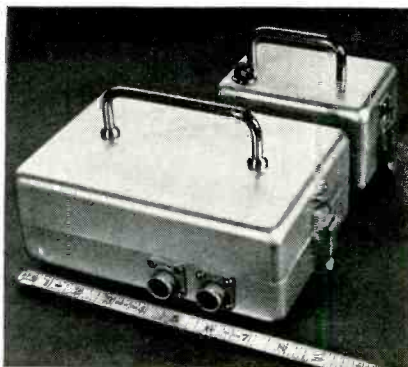

LIQUID-LEVEL DETECTOR completely transistorized

SOUTHERN ENGINEERING, 5874 Dayton Blvd., Chattanooga 5, Tenn., has available compact, completely transistorized, high reliability,

single and multichannel conductivity-type liquid-level detectors. Detection accuracy is better than 0.02 in.

An excitation frequency of 1 kc assures high-speed operation. The controlling current through the liquid is only a few microamperes. Explosion-proof, portable and conduit-box packaging, together with operation from 28 v d-c, 117 a-c or self-contained batteries, are standard. Signal output is by relay operation.

Germanium transistors are employed for normal environmental conditions and silicon units for high ambient temperatures. Circle P63 inside back cover.

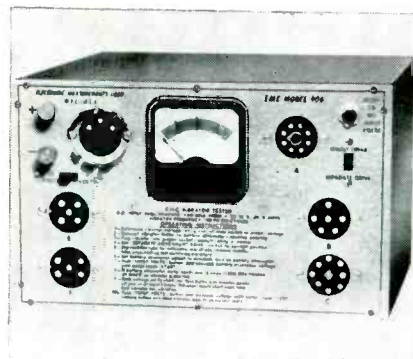

VIBRATOR CHECKER an inexpensive unit

ELECTRONIC MEASUREMENTS CORP., 280 Lafayette St., New York, N. Y. Model 906 vibrator checker is a ruggedly constructed instrument that checks both 6-v and 12-v vibrators reading condition on a BAD-GOOD scale. It checks both interrupter and self-rectifier type for proper starting point as well as quality of operation and can be used with any battery eliminator such as the model 905.

Model 906 is available at \$28.90 wired and tested and \$15.50 in kit form. Circle P64 inside back cover.

POWER TUBES three-electrode types

CENTRAL ELECTRONIC MANUFACTURERS, INC., Denville, N. J. Tube types 5680 and 6366 are general purpose, three-electrode power tubes specially designed for industrial and communication appli-

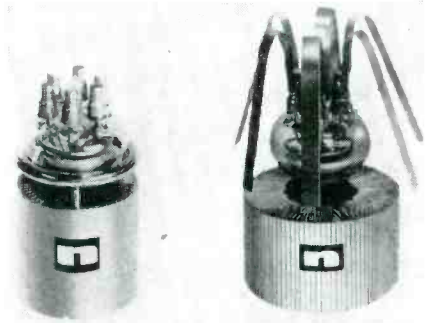

TYPE 5680

TYPE 6366

cations. Each type features a sturdily supported, double spiral thoriated tungsten filament for long life. Greater protection against mechanical stress and thermal shock is insured by ruggedly fabricated Kovar grid and filament seals. The flexible leads of the 6366 are constructed of OFHC copper which can be tailored to individual requirements. Full input ratings apply to 30 mc, reduced ratings to 50 mc.

Partial specifications for the type 5680 include: anode dissipation, 2,500 w; plate input, 12,000 w. Type 6366 has a high-efficiency low-pressure-drop radiator, an anode dissipation of 3,000 w and plate input of 7,000 w. Circle P65 inside back cover.

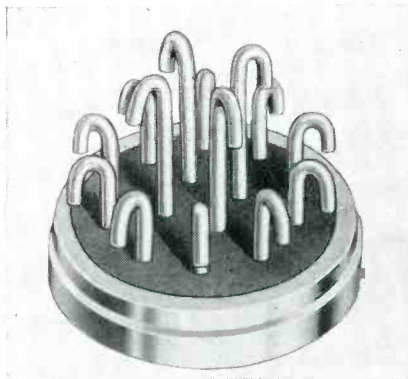

TERMINALS

resist vibration and shock

FUSITE CORP., 6000 Fernview Ave., Cincinnati 13, Ohio, has announced a new line of glass-to-steel terminals for application in electronics. Based on the company's new formula V-24 glass, the new headers are made with solid glass interfusion between glass and electrodes plus controlled compression. They offer greater resistance to vibration and mechanical and

TEFLON[†]
INSULATIONBERYLLIUM-COPPER
CONTACT

ACTUAL SIZE

SEAELECTRO'S

"PRESS-FIT"^{*}

**New SKT-10
FOR "TOPS" IN
TEST POINT JACKS!**



Yes, still another Seaelectro development! The exclusive SKT-10 is the only test point jack that meets severest requirements such as spelled out in MIL specs. Combines resilient TEFLON[†] with resilient BERYLLIUM-COPPER, for ideal installation.

Designed for standard .080" test probe, yet takes oversized .083" without deforming, or holds .077" pin with minimum of 2-ounce retention. Regardless of chassis thickness, the insertion and extraction ease remains unimpaired.

It's a genuine "Press-Fit" terminal. Just press-fit, that's it—in either drilled or punched hole, by means of simple insertion tool.

- Beryllium-copper rod machined for one-piece metal insert.
- Four-leaf floating contact. Maximum and lasting spring temper
- Heat-treated after machining—not pre-tempered stock. Gold-over-silver plated.
- Superlative insulating properties of Teflon. Unbreakable. Corrosion- and heat-resistant.
- Marked savings in material and labor by eliminating mounting hardware and fussy seals.
- Mounts in thin aluminum stock. Eliminates thick insulating panels.

- Available in eight RETMA code colors.

SAMPLE AND LITERATURE . . .

Write on business stationery for an SKT-10 Test Point Jack and engineering details. Make your own tests!

*Trademark

†Registered trademark, E. I. Du Pont de Nemours & Co.



Seaelectro
CORPORATION

610 Fayette Avenue • Mamaroneck, N.Y.





NOW
greater accuracy for
ANALOG COMPUTERS
with the
VERNISTAT®
a.c. potentiometer

In analog computer design, where system accuracy is directly related to the accuracy of the computing elements, the new VERNISTAT a.c. potentiometer meets the most exacting design requirements. The VERNISTAT overcomes the severe limitations placed on computer performance up to now by the use of conventional potentiometers. Errors introduced by loading, phase shift and wear are substantially reduced.

The VERNISTAT a.c. potentiometer represents a truly fundamental advance in precision potentiometer design. The combination of a tapped autotransformer and an interpolating resistance element overcomes the limitations of the purely resistive potentiometer. The VERNISTAT principle provides inherently high linearity, low output impedance, very small phase shift and long life. Relatively high output current capability and the ease with which nonlinear functions may be generated are plus features of the VERNISTAT. The unit is normally supplied as a ten-turn version and it may also be arranged for continuous rotation.

Use of the VERNISTAT potentiometer in analog systems results in a general improvement in performance characteristics. Greater simplicity, through elimination of isolation amplifiers is often an added dividend.

For further information write to:

vernistat®
division
PERKIN-ELMER CORPORATION
Norwalk, Connecticut

heat shock. There will be less rejects due to in-plant handling.

Four different base designs are available in the new line. One to 21 electrode pins may be mounted in each base depending on size and type. There are six different electrode pin styles. Altogether, there are 88 types with 37 different pin layouts in three series.

Insulation resistance of 100,000 megohms and hot tin dipped finish are standard features of these terminals. Volts rms range from 1,400 to 2,500. Circle P66 inside back cover.

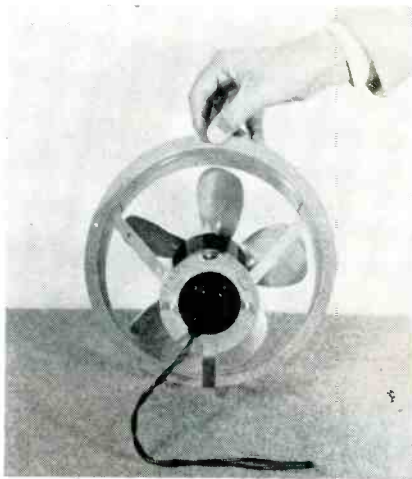

COOLING FAN
for electronic cabinets

MCLEAN ENGINEERING LABORATORIES, P. O. Box 228, Princeton, N. J., announces production of a new fan suitable for a variety of electronic cooling applications. Model 1E80 features air deliveries of 330 or 395 cfm at zero pressure. Dimensions are 8 in. fan diameter and 10½ in. o-d. Motors are available totally enclosed or open and operate on 15 v, 60 cps at 1,500 rpm.

This fan may be used in any position and is available in other sizes and modifications with air flow push or pull over motor. Further information is available. Circle P67 inside back cover.

ELECTRONIC RECORDER
housed in a 5-in. sq case

THE BRISTOL Co., Waterbury 20, Conn., has announced a new self-balancing electronic potentiometer

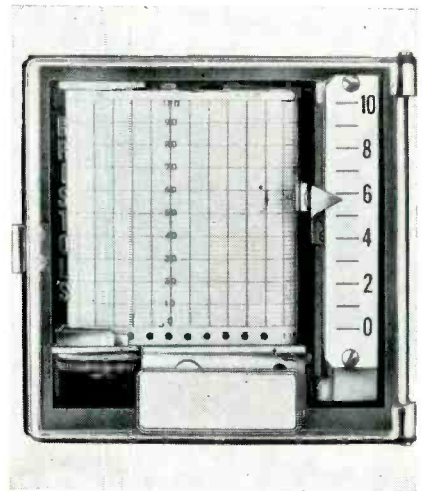

ter which gives a continuous record on a 3-in. strip-chart.

The small-size self-balancing instruments are furnished in indicating models also. The indicating and recording chassis are both built for full plug-in service and can be interchanged with each other in a matter of seconds. Offered in either potentiometer or a-c bridge models, the new instruments can be used to measure and indicate or record any variable which can be converted into an electrical quantity, such as temperature, pressure, flow, speed, pH, smoke density or resistance.

With these new electronic recorders and indicators, a complete process can be monitored with miniature instruments, making possible a complete graphic panel or console-type operation, where desired. Additional information is available in bulletin P1271. Circle P68 inside back cover.

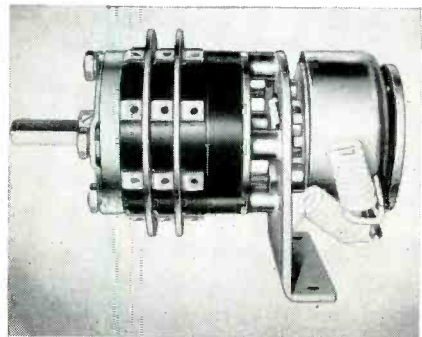

ROTARY SWITCHES
are solenoid-operated

ELECTRO SWITCH CORP., 167 King Ave., Weymouth 88, Mass. Heavy-duty switches assembled with solenoid rotating devices that

drive the switch through the cycle of contact positions, provide remote automatic or semiautomatic control of a series of complex circuits. The indexing stroke of the solenoid device is matched to the degree of rotation between contact positions of the switch and drives the rotor one position each time the solenoid circuit is closed. This circuit may be closed by pushbutton or by simple mechanical motion of the governed machine, providing the control needed for automation.

Solenoid-operated switches are custom-built by the company to customer's specifications. Circle P69 inside back cover.

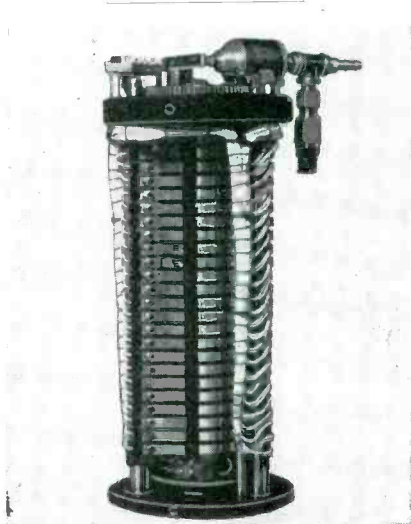

SLIP RING ASSEMBLY
a versatile system

ELECTRO-MINIATURES CORP., 1060 Elm Ave., Ridgefield, N. J., has announced a new type of slip ring assembly. The new construction provides continuously variable remote control of brush pressure by means of a miniature air cylinder built into the brush housing assembly.

Among the many advantages of this versatile system are: (1) Positive, continuous compensation to permit minimum wear on both brush and ring surfaces to attain minimum noise levels. (2) Adaptability to applications requiring either high or low brush pressure. (3) Extended life at all speeds.

This variable brush pressure can be incorporated into strain gage and thermocouple slip ring assemblies, power slip ring units

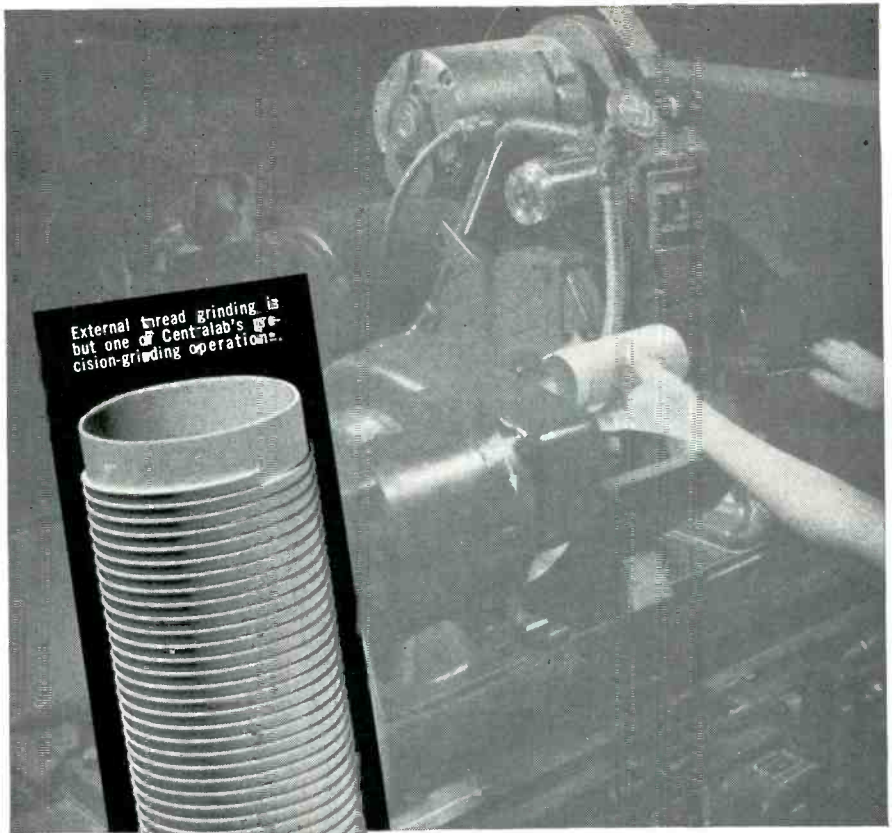

Now — threaded ceramics that permanently hold precision tolerances!

Centralab
Engineered
Ceramics ...

- can be extruded or molded
- can be worked before firing the same as metal
- ground, drilled, threaded, or tapped
- can be metallized

Another reason to insist on Centralab

- ◊ Threads ground into the ceramic itself — after firing. There's no shrinkage to cause variations in width and depth.
- ◊ Other fired-ceramic precision-grinding operations include centerless, cylindrical, disc, surface, and lap grinding — to precision tolerances previously unavailable.
- ◊ Ask Centralab to quote on your requirements.

Write for Centralab's Ceramic Buyer's Guide, Bulletin 42-221. Or refer to it in Sweet's Product Design File.

Centralab

A DIVISION OF GLOBE-UNION INC.
914B East Keefe Avenue • Milwaukee 1, Wisconsin
In Canada: 804 Mt. Pleasant Road, Toronto, Ontario



SPECIFY

Chassis-Trak

ROLLER BEARING
CABINET
SLIDES

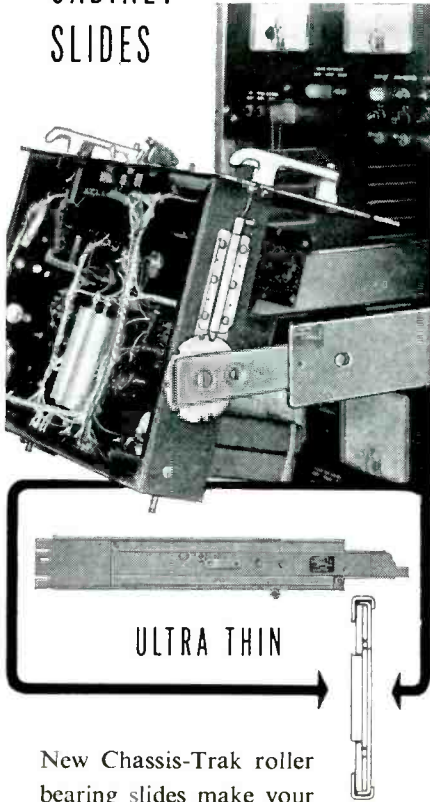

ULTRA THIN

New Chassis-Trak roller bearing slides make your electronic equipment more accessible . . . faster and easier to service. Chassis Trak's ultra thin design, wider bearing rollers support up to 175 lbs. with chassis extended. Rollers assure permanent, smooth slide operation.

PLUS:

- Ultra thin slide design (.350") for maximum use of cabinet interior
- Permanent, dust-repellent, dry lubricant finish
- High corrosion resistance
- Easy installation
- 8 stock lengths, standard width
- Push button emergency chassis removal

WRITE: DEPT. 2E

Chassis-Trak, Inc.

525 S. WEBSTER AVENUE
INDIANAPOLIS 19, IND.

NEW PRODUCTS

(continued)

and a broad variety of other applications. **Circle P70 inside back cover.**



FILTER for r-f noise suppression

ASTRON CORP., 255 Grant Ave., East Newark, N. J., has designed and manufactured a miniature r-f noise suppression filter for the industry. Model AE1047 is protected from environmental conditions, hermetically sealed and unaffected by elevated operating temperatures or extreme shock and vibration. The eight-section filter contains 11 capacitor sections, 11 toroids and two resistors.

The lightweight filters can be custom designed without shape limitations for use in missile, portable, or airborne applications and surpass government specifications. Technical data are available on request. **Circle P71 inside back cover.**



JACK PANEL with indirect lighting

HOLLAND ELECTRONICS, 2133 Central Drive South, East Meadow, L. I., N. Y., has developed an illuminated jack panel for use in darkened areas such as tv and radar control rooms.

Circuit designations are legible in total darkness and may be printed on any translucent material such as tracing paper. Illumination is provided by standard

miniature lamps and may be regulated by a simple rheostat. The space which may be utilized for designations is almost double that of previously available panels, allowing up to 3 lines of large easily read type.

Either Western Electric or A.D.C. jacks may be used and spacing is suitable for single or double-plug patch cords. Standard relay rack mounting is provided. **Circle P72 inside back cover.**



JUNCTION TRANSISTOR used in computer switching

RADIO CORP. OF AMERICA, Somerville, N. J., has developed a junction transistor of the germanium *pn*p type designed especially for use in switching circuits of electronic computers. The 2N269 has a maximum emitter current and collector current of 100 ma, a minimum large-signal d-c current transfer ratio of 35 at a collector-to-emitter voltage of only -0.15 v, and a minimum alpha cutoff frequency of 4 mc.

The transistor discussed is hermetically sealed, utilizes an insulated metal envelope and has flexible leads which may be soldered or welded into associated circuits. It measures 0.24 in. in diameter and 0.405 in. in body height. **Circle P73 inside back cover.**

CRYSTAL OVEN weighs only 4.6 oz

JAMES KNIGHT Co., Sandwich, Ill. The JKO-12 crystal oven is relatively small, weighing only 4.6 oz, yet is capable of meeting a spec-

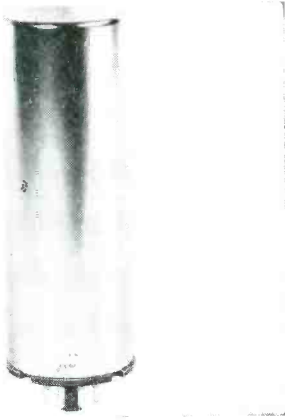

ification of less than ± 1 -C temperature variation over a temperature range of -55 C to $+75$ C. Other features include a quick detachable cover, new high temperature heater bonding tape, bifilar low-inductance heater winding and radio interference filter.

The oven houses one G-9 crystal or HC-15U holder, plugs into an octal base and is available in a choice of heater voltages from 6.3 v to 115 v, a-c or d-c. Its warmup time is 15 minutes at -55 C. Maximum power consumption is 40 w.

The JKO-12 is supplied in heights to a maximum of $4\frac{1}{2}$ in. Circle P74 inside back cover.

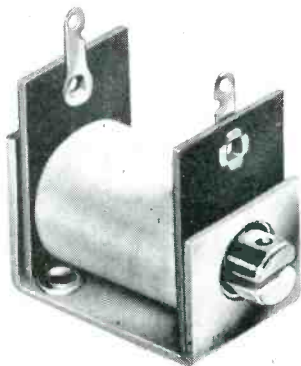

SOLENOID

small, light, low-cost unit

ARTISAN ELECTRONICS CORP., Morristown, N. J. Designed for both continuous and intermittent duty in industrial and commercial use, model DS solenoid is suitable for a-c and d-c applications in automatic machines requiring a moderate amount of power.

The coil of the new model is varnish impregnated to protect it under conditions of high humidity. A smooth brass tube provides low

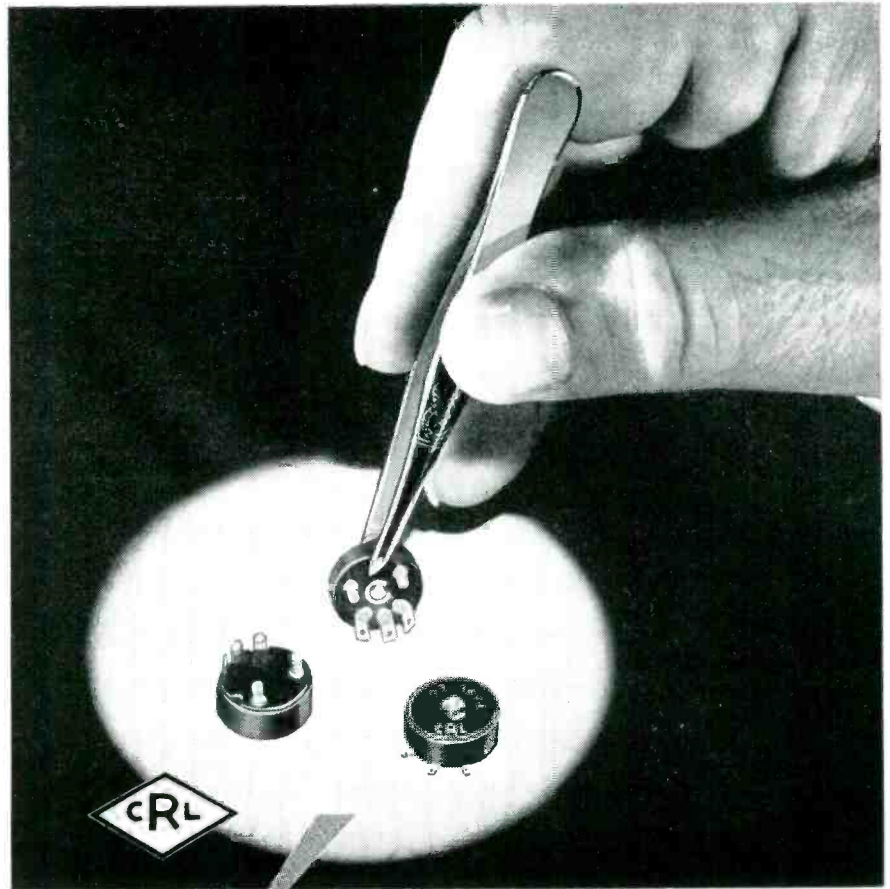





New, Ultra-Miniature Model 6 1/10-Watt Variable Resistor

Resistance range, 500 ohms to 10 megohms

For applications where small size and high quality are factors...

*Hearing aids
Transistor radios
Telephone equipment
Military applications*

-  Only $\frac{1}{2}$ inch in diameter. Without switch, .127 thin. With switch, .200 thin.
-  On-off switch completely enclosed within control. Rated 2.5 amps. at 2.0 v.d.c.; 0.1 amp. at 45 v.d.c.
-  Tested to a minimum of 25,000 complete cycles. Seven standard tapers.
-  Smooth, noise-free operation.
-  Variety of mountings available.

Technical Bulletin EP-77 gives complete engineering data. Write for it.

Centralab

A DIVISION OF GLOBE-UNION INC.

914B East Keefe Avenue • Milwaukee 1, Wisconsin
In Canada: 804 Mt. Pleasant Road, Toronto, Ontario



Specify

DKE for - PRECISION QUALITY Components

OF TUNGSTEN,
MOLY, NICKEL CLAD WIRE,
ALLOYS, KOVAR*

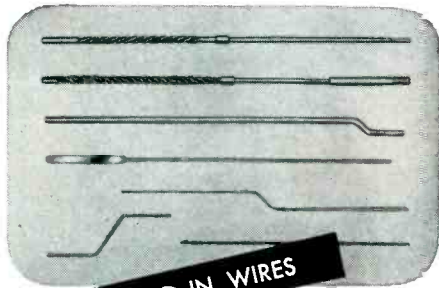

• DKE LEAD IN WIRES

Quality controlled throughout production with Tungsten hard glass leads produced under General Electric Timing Control. Each tungsten lead is microscopically inspected for flaws. DKE offers highest quality and LOW PRICES. Send drawings for quotations and let us prove the economy of our prices.



• DKE TUBE BASES

The Engineering Company can give you immediate delivery on following bases: 50 Watt, 3303B, 412 Industrial Base, Giant 7 Pin Bayonet, 4310 Four Pin Jumbo, Tetrode, Hydrogen Thyatron Bases in both Aluminum and Copper up to 6.50 dia. etc. All bases to JAN-1A/MIL-E-1B and subjected to weights and strength tests.

DKE HYDROGEN THYRATRON TUBE BASES



CALL OR WRITE FOR QUOTATIONS

*Registered trademark of the Westinghouse Electric Corp.

THE engineering co.

27 WRIGHT ST., NEWARK 5, N.J.

NEW PRODUCTS

(continued)

friction characteristics; all ferrous parts are cadmium plated to prevent corrosion. The plunger stop is constructed of Armco iron to prevent the plunger from sticking.

The new solenoid has a maximum stroke of $\frac{3}{8}$ in. and is available in three mounting styles for operating from 3 to 115 v. It is also available for operation under high temperature conditions. Circle P75 inside back cover.

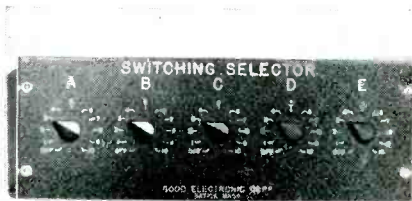

SELECTOR SWITCH a fifty-channel unit

GOOD ELECTRONIC CORP., P. O. Box 406, Natick, Mass. A new 50-channel selector switch is mainly designed for strain gages, thermocouples, transducers, accelerometers and multichannel testing. The change in contact resistance of any switch point does not exceed 0.48 milliohm and averages 0.08 milliohm.

Alphex insulation is used throughout. The unit is suitable for bench use or standard 19 in. relay rack. Low loss switching is assured. Circle P76 inside back cover.

CHOPPER

operates to 125 C

AIRPAX PRODUCTS Co., Middle River, Baltimore 20, Md. Type 310 chopper is rated for operation at 400 cps. Contacts handle up to 2 ma at 100 v. Phase angle lies between 50 and 80 electrical degrees lagging from -20 C to +100 C, between 50 and 88 electrical degrees from -65 C to -20 C, and between 45 and 80 electrical degrees from +100 C to +125 C. Drive coil is rated for 6.3 v rms. Units are permanently adjusted at the factory and hermetically sealed to assure uniform

operation in any atmosphere at any barometric pressure. Circle P77 inside back cover.

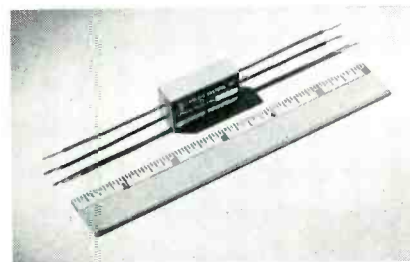

CRYSTAL FILTER

occupies $\frac{1}{2}$ cu. in. in volume

HYCON EASTERN, INC., 75 Cambridge Parkway, Cambridge 42, Mass. A miniature crystal filter, weighing approximately one oz, can be used for single conversions from uhf or vhf in a-m or f-m receivers. Center frequency is 20 mc. Bandwidth at six db attenuation is 50 kc. Insertion loss is three db maximum. Technical bulletins are available. Circle P78 inside back cover.

LOAD ISOLATOR

covers from 12.4 to 18.0 kmc

CASCADE RESEARCH CORP., 53 Victory Lane, Los Gatos, Calif., introduces another broad-band Uni-line load isolator, the model KU-143. It covers a frequency range of 12.4 to 18.0 kmc, over which vswr is less than 1.10, insertion loss 0.5 db.

Load isolation is 20 db at band center, 13 db at band edges. Power rating is 100 w average, 100 kw peak. Waveguide is RG91/U (0.702 in. by 0.391 in.). Flanges are UG419/U. Circle P79 inside back cover.

MAGNETIC AMPLIFIER

potted in epoxy resin

FEEDBACK CONTROLS, INC., 899 Main St., Waltham 54, Mass., has introduced the Blue-Line premium magnetic amplifiers. Magnetic output stage model D-4 delivers 4 w, half-wave, 400 cps to Bu Ord MK14 servomotor or equivalent. Chief features are precision matched cores, heavy Formvar magnet wire and silicon diodes



coupled with component selection and in-process quality control. Model D-4 has control windings for both transistor and v-t pre-amplifiers. Complete specifications are available. Circle P80 inside back cover.

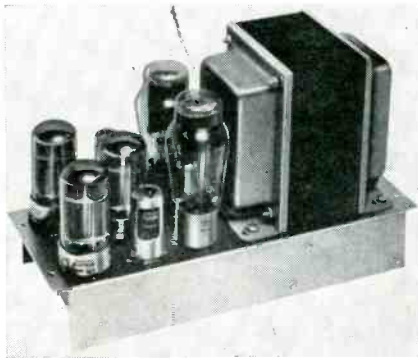

D-C POWER SUPPLY compact and adjustable

DRESSEN-BARNES CORP., 250 N. Vinedo Ave., Pasadena, Calif., announces a regulated sub-chassis-mounted d-c power supply which is adjustable. Output of the unit, 500 v d-c at 300 ma maximum, may be adjusted to provide any voltage between 300 and 500 v d-c by minor internal changes. The unit also supplies 6.3 v a-c filament voltage at 6 amperes maximum.

Regulation for a line voltage of 105 to 125 v a-c is 0.5-percent change in output voltage; for no-load to full-load, output voltage change is one percent. Ripple is below 10 mv rms for any voltage or load within ratings. Model 5-300XA measures 12½ in. long, 5 in. wide, 5⅜ in. above chassis and 2 in. below chassis. Weight is 23 lb. Circle P81 inside back cover.

INCOMPARABLE ACCURACY IN THE SMALLEST SPACE

Specify **TIC** linear and non-linear potentiometers

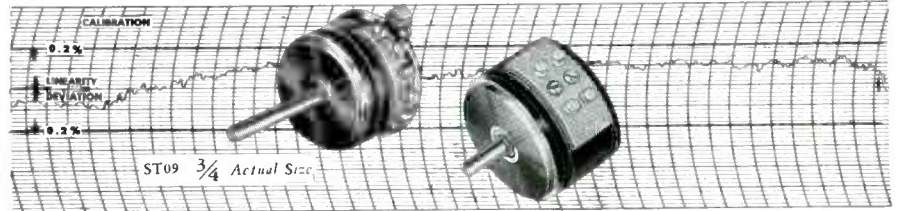

It's true!

TIC's general line of linear and non-linear potentiometers provide more accuracy per unit area than any other potentiometers on the market.

RVP1 3/4 Actual Size

ST18 3/4 Actual Size

Compare

ST20 3/4 Actual Size

ST09 7/8" diam. Linearity of 0.25%

RVP1 1" diam. Linearity of 0.15%

ST18 1 3/4" diam. Linearity of 0.15%

ST20 2" diam. Linearity of 0.12%

NEW
EXPANDED
PRODUCTION
FACILITIES
(doubled)
ASSURES
PROMPT
DELIVERY!

These are not laboratory or model shop curiosities! . . .

They have been *delivered in substantial production quantities* to our customers.

The high accuracy of TIC precision potentiometers are the result of a combination of unique design features . . . high standards of quality control . . . and construction of watchlike precision. Years of experience in supplying precision potentiometers for operational equipment designed to meet military specifications assure high *accuracy* throughout the long life of the unit . . . and under all types of adverse environmental conditions.

An added advantage of specifying TIC potentiometers is the tremendous production facilities and the wide selection of sizes that permits custom-like design in your application. Whether it be high accuracy linear potentiometers, standard function or empirical non-linear potentiometers, you can depend on TIC to provide greater accuracy throughout the long life of the potentiometer. Complete specs on request!

TECHNOLOGY INSTRUMENT CORP.

569 Main Street, Acton, Mass. COLonial 3-7711
West Coast Mail Address, Box 3941, No. Hollywood, Calif. POplar 5-8620

HIGH POWER at TRANSISTOR VOLTAGES

Model DV 60-2 Transistor POWER SUPPLY



\$110



Thorough and versatile! Efficiently powers all transistor circuits. Unparalleled performance and price.

- **AC OPERATED**, delivers 0-60 volts DC at currents up to 1000 milliamperes.
- **SUPERIOR** to conventional DC power supplies specified for vacuum tube high voltage range and offering erratic reactions when used at low transistor voltages.
- **CONTINUOUSLY VARIABLE**, equivalent to a battery. High power.
- **RIPPLE SUPPRESSION** below 0.2% at rated current, by two section choke input filter.
- **COMPLETE CONTROLS**, front panel switch-type magnetic circuit breaker, neon pilot light, Powerstat output control, multirange voltmeter and milliammeter and output binding posts. Meters accurate to 2%, readable at distance. Height 10³/₈" , Width 7" , Depth 9¹/₄" , 21 lbs.

WRITE FOR CATALOG
OF ENTIRE LINE
**MODEL RECTIFIER
CORPORATION**
1065 Utica Ave.
Brooklyn, New York

New Literature

Delay Line Lab Report. ESC Corp., 534 Bergen Blvd., Palisades Park, N. J., offers a complete laboratory report with every delay line prototype. The report includes the customer's electrical requirements; a list of the test equipment used, so that test procedures are reproducible; a series of photo-oscillograms indicating input and output pulse shape and output rise time; an evaluation of photographs and conclusions which cover all pertinent electrical characteristics.

The lab report, evidencing the electrical characteristics of a delay line, can be used effectively as a guide for redesigning samples and reevaluating requirements and serves as an additional production check in maintaining delay line quality. **Circle L1 inside back cover.**

Differential Transformers. Minatron Corp., Belle Mead 14, N. J. Two new price and specification sheets have been issued on differential transformers. Present units cover a range of ± 0.003 in. to a new model with a range of ± 3.00 in. They feature infinite resolution, Teflon leads, and epoxy potting.

They are available from stock for 220 F, and to order for 500 F continuous ambient temperature. If request is made on company letterhead, a copy of *Technical Application Notes* will also be included. **Circle L2 inside back cover.**

Time Delay Relays. The A. W. Haydon Co., Waterbury, Conn., has released a new bulletin to supersede pages 1 and 2 of their current catalog. Bulletin AWH TD403 contains details on the function of the three basic time delay relays, along with catalog part numbers for the standard ranges and voltages in a-c, d-c and 400 cps. These timers are now available in improved extruded aluminum dust covers.

The bulletin sheet is clearly blocked out, with readable size type and illustrations including photos of the models, diagram of

wiring, principle of operation and overall and mounting dimensions, along with a complete chart of catalog part numbers for the three series. The bulletin is part of the company catalog. **Circle L3 inside back cover.**

Test Equipment. Industrial Instruments, Inc., 89 Commerce Road, Cedar Grove, Essex Co., N. J., has available a new 24-page catalog of test equipment. Catalog No. 21 lists electronic measuring and control equipment for use in the laboratory and on the production line.

Included in the catalog are automatic component testers, cable and arc resistance testers, voltage breakdown testers, capacitance and resistance decades, decade potentiometers, limit and wheatstone bridges, ohmmeters and megohmmeters, switches and test fixtures.

Complete technical specifications, schematic diagrams and photographs of each unit are included along with comprehensive charts and tables. **Circle L4 inside back cover.**

Toroidal Coil Winder. Donald C. Harder Co., 3710 Midway Drive, San Diego 10, Calif. A single-page bulletin covers the model 0-3 subminiature toroidal coil winding machine. The instrument described operates on an application of the basic Harder patents covering the combination of a smooth grooved winding ring in combination with a circumferential retaining coil spring. Illustration and specifications are included. **Circle L5 inside back cover.**

Self-Calculator Disk. Federated Purchaser, Inc., 1021 U.S. Route 22, Mountainside, N. J. Engineers can save time, trouble and often error by using the Fedisc or self-calculator now being offered. Various formulas such as Ohm's law, voltage or current vs decibels, capacitance reactance vs frequency, and inductance reactance vs frequency, are covered in turn by the series. A different Fedisc may

be obtained each month free and without obligation. Circle L6 inside back cover.

Products Brochure. Milro Controls Co., Hawthorne Ave., Park Ridge, N. J., has published a brochure illustrating some of the products which it designs, develops and manufactures. The publication covers a d-c power supply, computer power supply, line voltage regulator and instrument amplifiers. Circle L7 inside back cover.

Fluxes. Accurate Specialties Co., Inc., 9-01 43rd Ave., Long Island City, N. Y., has available a technical bulletin giving a complete description, application and advantages of No. 910 mild acid flux, No. 310 nonactivated rosin flux and No. 183 activated rosin flux. The information will be of particular interest to those involved in the problems of electronic, electrical, dip and printed circuit soldering. Circle L8 inside back cover.

Ultrasonic Soldering Iron. Acoustica Associates, Inc., Glenwood Landing, Long Island, N. Y. How to solder aluminum and other light metals ultrasonically is described in bulletin SOL-109. The bulletin points out how soldering with ultrasonic soldering irons and tinning baths produces strong, non-corrosive bonds, not possible with conventional soldering.

Also revealed in a schematic drawing, is the electronic circuit for the soldering iron and the design features which enable stable nondrifting r-f output at the tip of the soldering iron during operation. Circle L9 inside back cover.

Tube Cap Connectors. Alden Products Co., 117 N. Main St., Brockton 64, Mass. A complete guide to tube cap connectors for every type of tube is now available in a new section for the Alden handbook. It contains important new designs and the latest specifications on tube cap connectors for airborne and missile equipment, power supplies and transmitters, color tv and radar equipment, radio and tv sets. Tube cap

NEWS for design engineers

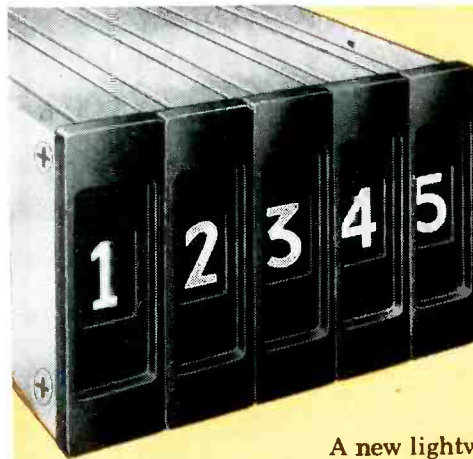

ACTUAL SIZE

UNION DIGITAL INDICATOR

A new lightweight Digital Indicator for data display has been developed by Union Switch & Signal that has many uses in aviation and other industries. It is designed for either local or remote use, on a direct wire basis, and responds to binary code. The indicator reads out directly and has a non-dissipating storage facility. Data can be printed out if necessary. Write for Bulletin 1011.

UNION

MINIATURE RELAYS AC or DC

A wide variety of UNION AC or DC Miniature Relays, with all standard mountings, is stocked for immediate shipment. Contacts are gold alloy or palladium for maximum reliability. Coil resistance up to 13,500 ohms. Vibration resistance up to 2000 cycles at 30 G's, and shock in excess of 50 G's. Write for Bulletin 1010.

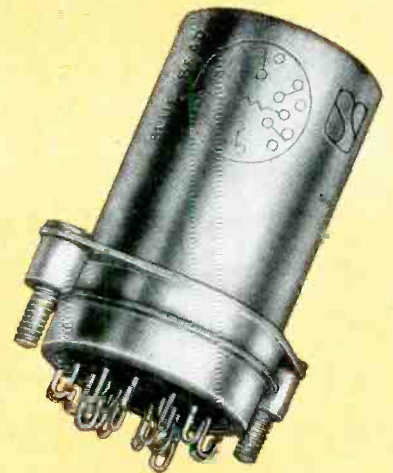

ACTUAL SIZE

RECTIFIERS: UNION Copper Oxide and Selenium rectifiers are available for a wide variety of commercial applications. Write for information.

GENERAL APPARATUS SALES



UNION SWITCH & SIGNAL

DIVISION OF WESTINGHOUSE AIR BRAKE COMPANY

PITTSBURGH 18, PENNSYLVANIA

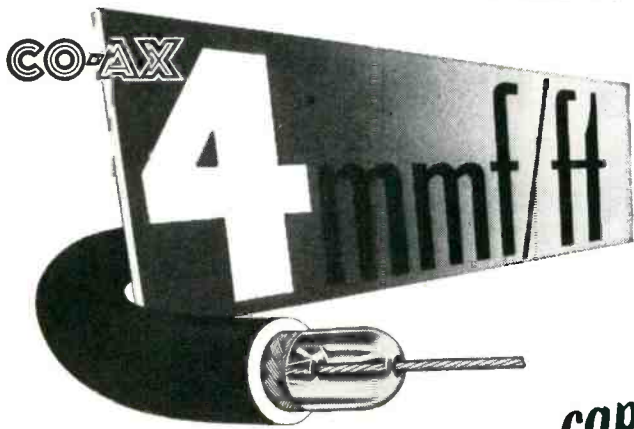

★ ULTRA LOW capacitance & attenuation

WE ARE SPECIALLY ORGANIZED
TO HANDLE DIRECT ORDERS OR
ENQUIRIES FROM OVERSEAS
SPOT DELIVERIES FOR U.S.
BILLED IN DOLLARS—
SETTLEMENT BY YOUR CHECK
CABLE OR AIRMAIL TODAY



NEW 'MX and SM' SUBMINIATURE CONNECTORS
Constant 50Ω-63Ω-70Ω impedances

TYPE	μm F/ft	IMPED.Ω	O.D.
C 1	7.3	150	.36'
C 11	6.3	173	.36'
C 2	6.3	171	.44'
C 22	5.5	184	.44'
C 3	5.4	197	.64'
C 33	4.8	220	.64'
C 4	4.6	229	1.03'
C 44	4.1	252	1.03'

TRANSRADIO LTD. 138A Cromwell Rd. London SW7 ENGLAND CABLES: TRANSRAD, LONDON

connectors are classified by cap size, then grouped by types. Circle L10 inside back cover.

Capacitance/Inductance Measurement. Kay Lab, 5725 Kearney Villa Road, San Diego 12, Calif. A single-sheet bulletin illustrates and describes the model 402-B dynamic Micro-Miker for measuring capacitance and inductance under operating conditions. Applications, circuit description, specifications and price are included. Circle L11 inside back cover.

Quick Recovery Diodes. Hughes Products, a division of the Hughes Aircraft Co., International Airport Station, Los Angeles 45, Calif. Specifications DS-38 covers a line of quick recovery silicon junction diodes. The diodes described are high-speed, high-voltage, high-temperature devices which can replace vacuum and germanium diodes in most high frequency or fast switching circuits. They are applicable to computer and pulse circuitry design. Circle L12 inside back cover.

Ceramic Capacitors. Centralab, a division of Globe-Union Inc., 900 E. Keefe Ave., Milwaukee 1, Wisc. An eight-page technical bulletin gives basic data on ceramic capacitors. Included are background material, illustrations, advantages and characteristics, and specifications for various types. Data to furnish on inquiries are also given. Circle L13 inside back cover.

Antenna-Pattern Transmitter. Color Television Inc., 1445 Old County Road, Belmont, Calif. Illustrated and described in a new leaflet is the model 119 X-band antenna-pattern transmitter, a convenient r-f source designed for antenna-pattern measurements. As illustrated in the literature, the equipment includes a weather-proofed housing for the modulator and a remote control unit which can be located anywhere on the antenna range. Comprehensive specifications are included covering the antenna assembly, the modulator and the re-

Inertial Guidance

for ICBM and IRBM

R-W's broad systems responsibility for ICBM and IRBM has created unusual technical and project opportunities in the field of inertial guidance. Positions are open in Los Angeles, the Midwest, in the New York area, and at Patrick Air Force Base, Florida.

The field of Inertial Guidance is an important one in guided missile research at Ramo-Wooldridge, where engineers and scientists are providing systems engineering and technical direction for the Air Force Ballistic Missile Programs.

The systems team concerned with inertial guidance represents many technical specialties. Among them are: controls . . . inertial components . . . airborne computers . . . data processing . . . ground support equipment . . . test planning and analysis . . . packaging . . . and mechanical design.

The essential function of Project Engineering supplements these technical specialties. Project Engineers are responsible for technical management liaison with other organizations participating in these missile programs.

Please address inquiries to: Mr. W. J. Coster

The Ramo-Wooldridge Corporation

5730 ARBOR VITAE STREET • LOS ANGELES 45, CALIFORNIA

mote control unit. **Circle L14 inside back cover.**

Computing System. Remington Rand Univac Div. of Sperry Rand Corp., 1902 W. Minnehaha Ave., St. Paul, Minn., has published a nine-page operational guide to the new Univac scientific 1103A electronic computing system. The letter-size booklet includes a three-page section on the terminology of the system, containing definitions of word length, instruction word, address allocations, control registers, input-output registers, magnetic tape and magnetic drum storage, program sequence control and automatic program interruption.

A keyed block diagram of the system together with general descriptions of the computer's characteristics and mode of operation are also included. Ask for form LSC-56,000. **Circle L15 inside back cover.**

TV Receiving Tubes. Radio Corp. of America, Harrison, N. J. A single-page chart covers 15 new receiving tubes intended for use in tv receivers utilizing 450-ma series-heater strings. The types shown have heaters with the same controlled warmup time to minimize voltage unbalance during starting. In addition these types have heater-cathode voltage ratings sufficiently high to insure dependable performance in series-string circuitry. **Circle L16 inside back cover.**

Slotted Line. Hewlett-Packard Co., 275 Page Mill Road, Palo Alto, Calif. Volume 8 No. 1-2 of the *Journal* contains an article illustrating and describing a micrometric 12 to 40-kmc waveguide slotted line with interchangeable sections and untuned probe. Specifications and prices are given. Also included is an index to Vol. 7 of the *Journal*. **Circle L17 inside back cover.**

Militarized Line Voltage Regulator. General Radio Co., 275 Massachusetts Ave., Cambridge 39, Mass. Volume 31 No. 6 of the *Experimenter* contains an illustrated article on the type 1570-ALS15 militarized line voltage regulator. Included are outstand-



FOR:
Guide Bushings,
Vanes
and
Wear
Rings

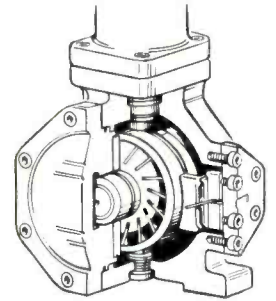

HAVE YOU CONSIDERED THE IMPORTANT ADVANTAGES OF FILLED TEFLON*?

Electronic Bushings,
Insulators
and
Tuning
Slugs



Rod & Tubing



Formed
Gaskets

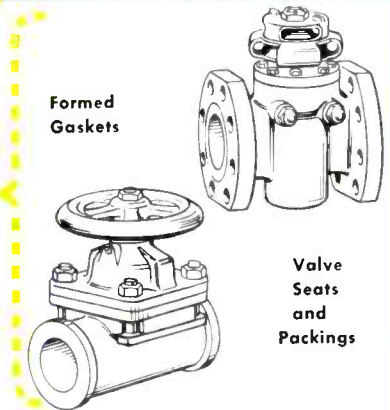

Valve
Seats
and
Packings

It has been definitely established that the value of Teflon can be considerably enhanced by the use of fillers in certain applications. Laboratory and field experience has demonstrated that the use of fillers permit Teflon to be more readily tailored to a wide variety of chemical, electrical and mechanical applications. Also, some mechanical properties can be improved. These include:

- 1) resistance to deformation under load
- 2) resistance to wear
- 3) thermal conductivity
- 4) compressive strength
- 5) hardness

By thus improving its properties, Teflon now offers even greater industrial potential. This is the reason filled Teflon has become an important item in the "John Crane" Chemlon® line of better Teflon products.

Chemlon is available with such fillers as glass fiber, carbon, graphite, copper and bronze, talc, calcium fluoride and other inorganic materials.

Tell us about your requirements. We'll tell you the advantages you can get from filled Chemlon. Request Bulletin T-104.

Crane Packing Company, 6402 Oakton Street, Morton Grove, Illinois, (Chicago Suburb). In Canada: Crane Packing Co., Ltd., Hamilton, Ont

*DuPont Trademark



New hf wave analyzer!

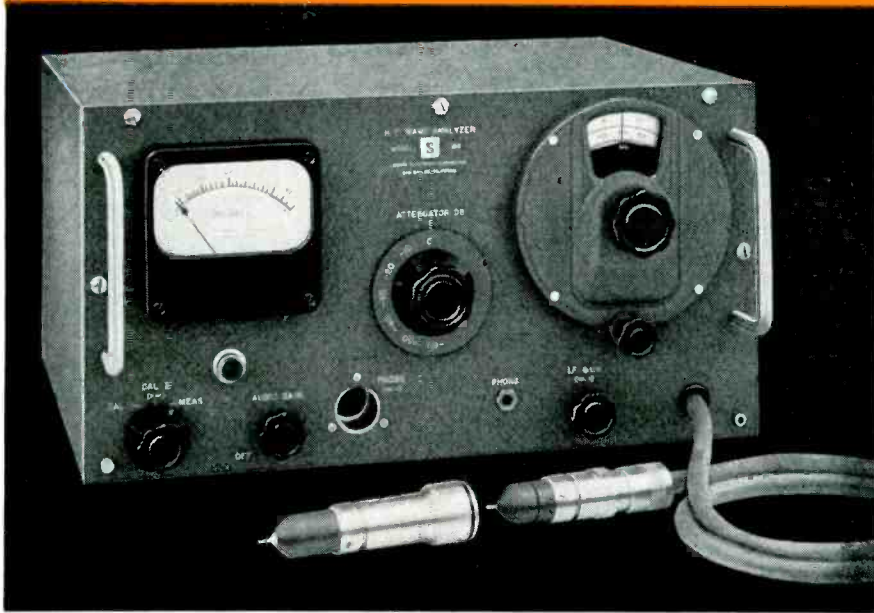

Sierra 158 High Frequency Wave Analyzer

Fast, convenient, 500 KC to 10 MC!

New Sierra 158 Analyzer is a highly selective, double superheterodyne receiver providing wave analysis data direct in dbm referred to 600 ohms impedance. The instrument uses a cathode follower input probe with two detachable capacity dividers for 20 or 40 db attenuation. It also includes a built-in attenuator adjustable in 10 db steps to a maximum of 60 db. These features, in combination with 22 db usable meter readings, provide a measurement range of 122 db, from -80 to $+42$ dbm. A measurement accuracy of ± 2 db is assured for levels above -70 dbm. Spurious components from analyzer circuits are at least 50 db below fundamental. An injection oscillator at 2 mc is provided for rapid voltage calibration. A phone jack is available for aural monitoring. The instrument also includes the Sierra-designed precision spiral-scale frequency dial. *Write for complete data.*

SPECIFICATIONS

Frequency Range: 0.5 to 10 megacycles.

Signal Measurement Range: -80 dbm to $+42$ dbm, referred to 600 ohms. ($77.5 \mu\text{v}$ to 97.5v)

Selectivity: 3 db down at 3 kc off; 30 db down at 12 kc off.

Signal Measurement Accuracy: ± 2 db above -70 dbm.

Spurious Responses: At least 50 db down.

Input Impedance: Greater than 1 megohm shunted by approximately $8 \mu\text{f}$.

Frequency Calibration Accuracy: Depends on stability and calibration accuracy of the 22.5 - 32 mc variable oscillator, which is maintained within 0.25%. This results in dial accuracy ranging from $\pm .056$ mc to $\pm .080$ mc.

Operating Power Requirements: 105 to 125 volts, 50/60 cps, 95 watts drain.

Cabinet Dimensions: 17 inches wide, 9 $\frac{1}{8}$ inches high, 13 $\frac{1}{2}$ inches deep.

Weight: Approximately 40 pounds.

Data Subject to Change Without Notice

Sierra Electronic Corporation

San Carlos 2, California, U. S. A.

Sales representatives in major cities
Manufacturers of Carrier Frequency Voltmeters, Wave Analyzers, Line Fault Analyzers, Directional Couplers, Wideband RF Transformers, Custom Radio Transmitters, VHF-UHF Detectors, Variable Impedance Wattmeters, Reflection Coefficient Meters.

3288



ing features and specifications. Price of the unit discussed is \$625. Circle L18 inside back cover.

Decade Resistance Units. Muirhead & Co. Ltd., Beckenham, Kent, England. Publication 1742-A illustrates and describes the type D-805 decade resistance units which are arranged for panel mounting and occupy the minimum of mounting space. The units discussed incorporate a new and improved switch which insures extremely low and constant contact resistance and abolishes the need for lubrication of the contact surfaces. Specifications, dimensional drawing and tables of standard models are included. Circle L19 inside back cover.

Closed-Circuit Television. Radio Corp. of America, Camden, N. J. A comprehensive, illustrated guidebook to the company's latest broadcast equipment and systems for color and black-and-white closed-circuit tv service in medical, educational, industrial and business fields has been announced.

The 28-page booklet employs color and monochrome photographs, diagrams and sketches to describe the nature and applications of the equipment. Also provided are case-history presentations of typical RCA closed-circuit tv installations. The booklet is available on letterhead request. Circle L20 inside back cover.

Magnetic Shielding. Magnetic Shield Division Perfection Mica Co., 20 N. Wacker Drive, Chicago 6, Ill. A new 33-page technical brochure entitled Data Sheets 101 completely describes construction features, performance characteristics and typical applications of nonshock sensitive nonretentive Fernetic and Co-Netic magnetic shielding material. Included are 12 pages of technical data, five pages of performance graphs, 14 pages of illustrations and a handy two-page comprehensive index. Circle L21 inside back cover.

ITV Equipment. Graybar Electric Co., Inc., 420 Lexington Ave., New York 17, N. Y. A new 64-page booklet describes a wide selection

of video, audio, lighting, transmission and distribution equipment and accessories. It also contains procedures for the servicing and maintenance of its equipment, as well as several pages of engineering data permitting approximate layouts and costs of its systems to be determined. **Circle L22 inside back cover.**

Grid Circuit for Thyratrons. Hanson-Gorrill-Brian, Inc., 85 Hazel St., Glen Cove, N. Y. A technical data sheet illustrates and describes the model 181-1 Thyra-Pulse. The unit discussed can be used in half-wave, full-wave and three-phase circuits, providing one-cycle fast response for critical control applications. Operation is based upon the saturation time of a magnetic core. Complete specifications are given. **Circle L23 inside back cover.**

Thermal Imaging Device. Baird Associates-Atomic Instrument Co., 33 University Road, Cambridge 38, Mass. Bulletin RD515 describes the Evaporograph, a direct thermal imaging device, which can be used for locating and monitoring either hot or cold spots. Applications of the instrument discussed include testing temperatures of electronic components in service, insulation studies and temperature studies of combustion equipment and determinations of cooling efficiency in certain types of electronic assemblies. Schematics, curves and engineering drawings, as well as specifications are included. **Circle L24 inside back cover.**

Ceramic Parts for the Electronics Industry. Electro-Ceramics Inc., 975 East Fifth South Street, Salt Lake City, Utah. A four-page folder covers the high-strength, low electrical loss G-73 Electro-Ceramics Alumina body. Properties, shapes available and advantages are discussed. Applications listed include vacuum tube envelopes, internal vacuum tube parts, metal-to-ceramic hermetic seals, and stand-off, lead-through and other types of insulators. **Circle L25 inside back cover.**

Fixed Composition Resistors. International Resistance Co., 401 N. Broad St., Philadelphia 8, Pa. Catalog data bulletin B-1A covers the type BT fixed composition resistors. The 12-page bulletin contains comprehensive data on construction, characteristics, solderability, heat dissipation, color coding, resistance values and tolerances. New design features and reliability data are shown. Detailed charts and graphs are given. **Circle L26 inside back cover.**

Waveguide and Coax Test Equipment. Admittance-Namco Corp., Farmingdale, L. I., N. Y. Waveguide and coaxial test equipment engineered and produced by the company is shown in an illustrated, 12-page, 2-color catalog just published. Tees, tuners, attenuators, couplers, crystal mixers, crystal mounts, probes, loads and other items are shown, with pertinent specifications. Copies are available on request. **Circle L27 inside back cover.**

Switch Catalog. Haydon Switch Inc., Waterbury, Conn. Catalog No. 5 is a handy permanent switch idea folder. Shown are the Haydon switch standards in hermetically sealed switches. Included are subminiature switches, the standard single blade, double blade and a page of special switches designed for custom applications. Also included are pages of standard and special actuators.

Complete data are given for component and electrical specifications of each switch. Typical schematic drawings are included for each series with engineering data. **Circle L28 inside back cover.**

Impedance Meters. The Narda Corp., 160 Herricks Road, Mineola, L. I., N. Y. Two models of coaxial impedance meters, operating in the frequency range of 1,500 to 12,400 mc and six models of waveguide impedance meters, operating in the frequency range of 2,600 to 18,000 mc are described

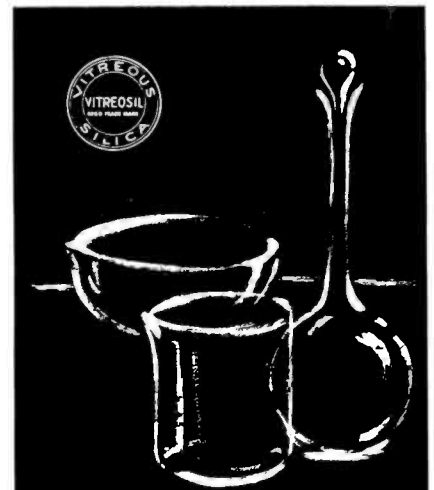

Look no further—

If you're looking for

"HIGH PURITY"

fused quartz

LABORATORY WARE

The world's largest producer of fused quartz products can help you with your most critical and exacting needs for your laboratory ware.

Vitreosil® products can be supplied in an unusually large variety of types and sizes. Also fabricated to specification to meet semiconductor requirements for the production of silicon metal.

TRANSPARENT VITREOSIL

For ultra-violet applications, metallurgical investigations, chemical research and analysis, photochemistry, spectroscopy and physical, optical and electrical research.

Send specifications for your requirements. Please use coupon below.

**THERMAL AMERICAN
FUSED QUARTZ CO., INC.**
18-20 Salem Street, Dover, New Jersey

Please send technical data on

Company _____

Name & Title _____

Street _____

City _____ Zone _____ State _____

REGULATED POWER SUPPLY

0.001% Regulation at 1/2 Ampere



MODEL UHR-240

KROHN-HITE Model UHR-240 POWER SUPPLY provides up to 1/2 amp. at 0-500 volts with 0.001% regulation and less than 100 microvolts of ripple. Line voltage stabilization is 0.003%. The internal impedance is less than 0.005 ohms for low frequencies and d-c, and less than 0.1 ohms for frequencies as high as 100 kc. A 0-150 volt, 0-5 ma bias supply is available with 0.05% stabilization and less than 2 millivolts of ripple. A 2.5 amp. d-c heater supply, adjustable from 5 to 13 volts with less than 20 millivolts ripple, is included in addition to two independent 6.3 volt a-c heater supplies of 10 amp. capacity. The ultra-high regulation applies over the entire operating range. Full maximum current can be drawn continuously at any output voltage, from 105 to 125 volt line. Price \$625.00 f.o.b. factory.



For Further Details Write Dept. E

Krohn-Hite Instrument Co.

580 Massachusetts Avenue • Cambridge 39, Massachusetts

in a recent data sheet. Photographs, features, specifications and prices are included. Circle L29 inside back cover.

Component Packaging. American Rondo Corp., 100 Sanford St., Hamden 14, Conn. A four-page brochure deals with the modern packaging of electronic components. Process and design of packaging miniature and subminiature tubes, capacitors, diodes, resistors and special tubes are illustrated and described. Advantages of the system are listed. Circle L30 inside back cover.

Universal Testing Machines. Tinius Olsen Testing Machine Co., Easton Road, Willow Grove, Pa. A 40-page bulletin describes the complete line of Electromatic universal testing machines. In the machines described, load is applied by an electronically controlled mechanical system to assure positive crosshead speeds under load or no-load. Loads are then weighed and indicated electronically on the large Selectorange dial.

Bulletin No. 54 also covers Olsen compression and XY testing machines, electronic recorders, instrumentation and accessories. Circle L31 inside back cover.

Fabricated Metal Products. D. E. Makepeace Co., Pine and Dunham Sts., Attleboro, Mass. A fabricated-metal-products brochure suggesting solutions for a variety of electrical and electronic manufacturing problems has been published. Completely illustrated, it describes products the company is prepared to produce on a custom basis. Included are slip-ring assemblies, microwave assemblies and a variety of contacts. Circle L32 inside back cover.

Ultrasonic Fluxless Brazing. Aero-projects Inc., 310 East Rosedale Ave., West Chester, Pa. A four-page leaflet discusses Sonobrazing, the ultrasonic equipment for fluxless brazing and for coating of aluminum. Sonobrazing is particularly suited to the joining of unstripped enameled aluminum wire.

Bulletin SBR-6A tells what

QUALITY knight-kits

FOR LAB, SERVICE & INDUSTRIAL USE

fine electronic equipment in easy-to-build form



knight-kit 5" WIDE BAND OSCILLOSCOPE KIT

- 2 Printed Circuit Boards
- 5 Mc Width for Color TV
- Hor. Sweep to 600 Kc
- 25 mv-inch Sensitivity
- DC Positioning Controls
- Z-Axis Input

Only \$69.00

Outstanding value in a quality scope, ideal for Color TV work and high-frequency lab applications. Wide-sweep range from 15 to 600,000 cps. Locks in at frequencies as high as 9 mc. Only 1 db down at 3.58 color burst frequency. Vertical response: ± 3 db, 5 cycles to 5 mc. Vertical sensitivity, 25 rms mv/inch, 20 mmf input capacity. Special features: cathode-follower vertical and horizontal inputs; 2nd anode of 1400 volts for high intensity trace; p-p vertical and horizontal amplifiers; faithful square wave response; positive and negative locking for excellent synch on complex waveforms; frequency-compensated input attenuator; Z-axis input, 1-volt peak-to-peak calibrating voltage; internal astigmatism control; blanking circuit to eliminate retrace lines, etc. Complete with all tubes (including CRT), parts, punched chassis, case, full assembly instructions. Shpg. wt., 40 lbs.

Model 83 YZ 144. Wide-Band Oscilloscope Kit. Net \$69.00



knight-kit VOLTAGE CALIBRATOR KIT

Only \$12.75

Permits use of any scope as a precision peak-to-peak AC voltmeter. Puts a true square-wave voltage on scope screen. Range switch and calibrated potentiometer selects any voltage between .01 and 100 volts in 4 ranges. Fifth position feeds external signal to scope for comparison. Has voltage regulator tube—output voltage stays constant with line variation from 80-135 volts. Accuracy, ± 6% on all ranges. Shunt capacitance only 15 mmf. Includes control for providing precision initial setting. Direct coupling of output provides ground reference for DC scopes. Complete kit includes all parts, case, full instructions. Shpg. wt., 5 lbs.

Model 83 Y 136. Voltage Calibrator Kit. Net \$12.75

FREE 356-PAGE CATALOG

ALLIED'S 1957 Catalog lists dozens of other low-cost quality Knight-Kit test instruments, as well as the world's largest stocks of electron tubes, transistors, parts, audio equipment—everything in Electronics for Industry. Write for FREE copy today.

All Prices Net F. O. B. Chicago

ORDER FROM

ALLIED RADIO

Dept. 11-B-7, 100 N. Western Ave. Chicago 80, Illinois

Our 35th year



Sonobraze is, what it does, how it works and shows its advantages. Sonobraze equipment is also discussed. Circle L33 inside back cover.

Precision Instrument Components. PIC Design Corp., Division of Benrus Watch Co., Inc., 477 Atlantic Ave., East Rockaway, L. I., N. Y., announces release of the new catalog No. 11 which lists over 4,000 precision instrument and servo parts available from stock. It includes 128 pages of compact and concise engineering data for use in the electronic and instrumentation fields. Circle L34 inside back cover.

Receiving Tube Data. Westinghouse Electric Corp., Electronic Tube Division, Route 17, Elmira, N. Y. A 44-page booklet of essential data on Reliatron receiving tubes is now available. It presents more than 450 Westinghouse receiving tubes. Features incorporated are: large clear tube socket diagrams on the same page as the associated data, bold tube type numbers for quick location and open style data for easy readability. The booklet is priced at 35 cents a copy. Circle L35 inside back cover.

Thermal Conductivity Analyzer. The Hays Corp., Michigan City, Ind. A new 12-page color catalog, 56-1008-59, explains principle, construction, operation and features of both the Condu-Therm analyzer and the Acratron electronic recorder. The analyzer discussed can be used for determining amount of CO₂, H₂, H₂O, CH₄ and the like, and employs the thermal conductivity method of analysis. The catalog contains a special section on gas sampling systems and how and why this analyzer is used. Circle L36 inside back cover.

Auto-Navigation. Belock Instrument Corp., College Point, N. Y. A four-page folder illustrates and describes the company's dead reckoning analyzer and loran receiver which combine to form an automatic navigation system that will accurately indicate a ship's position anywhere at sea irrespective of atmospheric conditions or

TRACER-GUIDED DRILLING

100 HOLES P. M.

WITH NEW HERMES *Engravo* *graph*

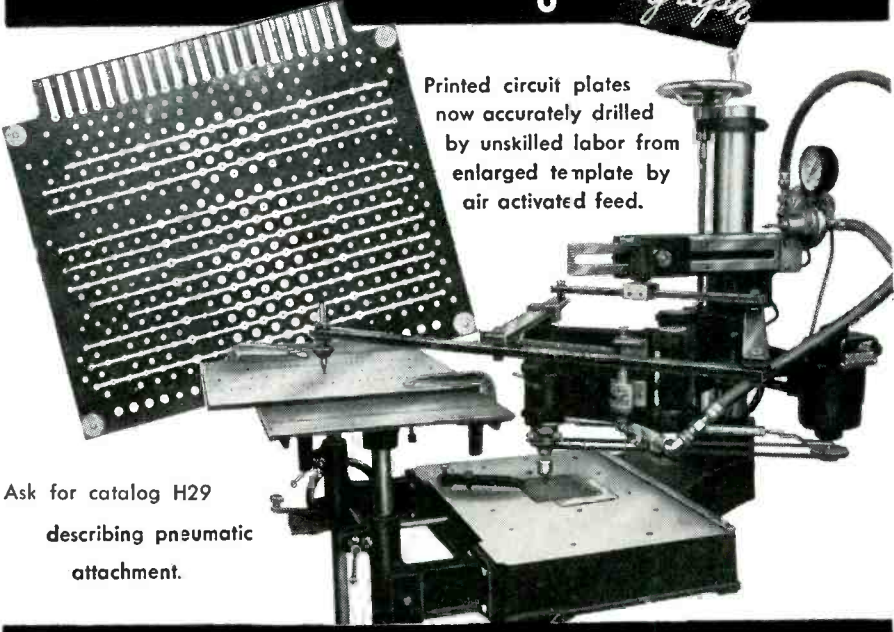

Printed circuit plates now accurately drilled by unskilled labor from enlarged template by air activated feed.

Ask for catalog H29 describing pneumatic attachment.

new hermes ENGRAVING MACHINE CORP.
13-19 University Place, New York 3, N.Y.

A REVOLUTIONARY "First"



**SERVICE-FITTED
SERVICE-TESTED
SERVICE-APPROVED**

**SILICONE IMPREGNATED
FIBERGLAS CUSHIONED
CLAMPS**

Withstand Jet Engine Heat or Stratospheric Cold...

ADEL has the answer to the need for a rugged, heat and abrasion-resistant clamp that can withstand the attack of the stratosphere's sub-zero cold and the intense heat of today's aircraft, missile and rocket power plants. **TEMPERATURE CHARACTERISTICS:** Far above +550° F. to well below -90° F. Performance far beyond specifications of any other clamp.

Easily installed on "bundle" or removed, and they retain their firm, cushioned grip despite severe vibration and extreme temperatures. Cut maintenance and replacement costs...cushions won't tear during engine harness assemblies and if material chars, due to extremely high temperatures, there still remains a safe, non-conductive layer—A positive "design-fix" for jet engines.

SAMPLES & SPECIFICATIONS: Aircraft, Component & Guided Missile Manufacturers mail coupon today for samples and detailed information on how CLAMPS fit your specific needs.

 PRECISION PRODUCTS A Division Of General Metals Corporation	HUNTINGTON DIVISION 1444 Washington Avenue, Huntington 4, West Virginia
	Name _____
	Company _____
	City _____ Zone _____ State _____

107-A TEST SET and FIELD INTENSITY METER

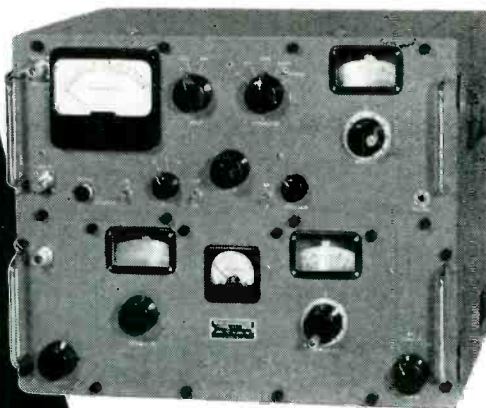

The 107-A Test Set and Field Intensity Meter combines in one portable unit a radio receiver of laboratory quality with metered output and an accurately calibrated signal generator. These instruments, which can be used separately for a variety of test purposes, cover a frequency range of 54 to 240 megacycles without band changing.

SPECIFICATIONS

RECEIVER

- Input Impedance 51 ohms
- I.F. Frequency 21.4 MC
- I.F. Bandwidth 300 KC
- Sensitivity at input term. as a voltmeter 1.0 uv
- Field Strength at 54 MC 1.6 uv/m
- Field Strength at 240 MC 6.5 uv/m
- Max. input using external pad supplied 10.0 V
- Field Strength at 54 MC 16.0 V/M
- Field Strength at 240 MC 65.0 V/M
- Output Indicator Panel meter (approx. Logarithmic scale)
- Output: 1. To operate at 1.0 milliampere recorder. 2. Audio for headphones.

SIGNAL GENERATOR

- Output 1.0 uv to 0.1 V
 - Output Impedance 51 ohms
- POWER REQUIREMENTS**
- 117 volt a-c, 50-400 cycle 60 watts—or
 - 6 volt, d-c 8 amperes

NEMS



CLARKE

Incorporated

919 JESUP-BLAIR DRIVE SILVER SPRING, MARYLAND

For further information write Dept. P-2

Specialists in the Unusual

Precision Produced MATERIALS for TRANSISTORS and DIODES

- **GOLD** doped with N-type or P-type elements—supplied in the form of wire, sheet or ribbon and cut or stamped pieces.
- **INDIUM** electroplated base or precious metal wires.
- **WELDED RIBBONS**—Dissimilar metal ribbons of the same width can be continuously welded together, within close overlap tolerances.

Wait for
List of
Products

Since  1901

SIGMUND COHN CORP.

121 SOUTH COLUMBUS AVE., MOUNT VERNON, N. Y.

the time of day or night. Specifications are included. **Circle L37** inside back cover.

Panel Meters. Simpson Electric Co., 5200 West Kinzie St., Chicago 44, Ill. A new six page panel meter bulletin 2057 contains descriptions and specifications along with latest prices of over 800 models. The pages illustrate with photographs of meter styles and various types of meter movements available, also dimensional drawings for meter mounting. Additional information is also provided concerning the company's line of shunts and current transformers. **Circle L38** inside back cover.

Controls Literature. Servo Corp. of America, 20-20 Jericho Turnpike, New Hyde Park, N. Y. A new periodical "Around the Servo Circuit" is now being issued. New developments in infrared control systems, a question and answer column describing special problems, and reports on new literature available are among items covered in the first issue. The newsletter is designed to keep engineering and other interested personnel informed of the company's latest developments in the control field. **Circle L39** inside back cover.

Thyratron Pulse Modulator. Dormitzer Electric & Mfg. Co., Inc., 5 Hadley St., Cambridge, Mass., has published a circular illustrating and describing its model 12 laboratory modulator designed specifically for research in the fields of pulse power generation. The unit described has a rated peak power (into 50 ohms load) of 250,000 w. **Circle L40** inside back cover.

Computer Tubes. Sylvania Electric Products Inc., Emporium, Pa. Three engineering data service bulletins cover types 6211, 6814 and 6888 computer tubes. Included are electrical and mechanical data, direct interelectrode capacitances, ratings and average characteristics. **Circle L41** inside back cover.

Vacuum Seals. Glasseal Products Co., Inc., 1111 E. Elizabeth Ave.,

Linden, N. J. Manufacturers of electronic components that use glass-to-metal vacuum seals will find the new 12-page color catalog a valuable reference. Featuring the exclusive use of the Duro-Vac process, the catalog shows cross-sectional drawings, charts, descriptions and photographs of multiheaders, feed-throughs, stand-offs seals, AN connectors, transistors and diode terminals. The complete catalog is available to anyone requesting it on his letter-head.

Portable Potentiometer Pyrometer. Technique Associates, 211 E. South St., Indianapolis 25, Ind. A new eight-page bulletin 9B describes the improved Pyrotest, a portable potentiometer pyrometer with interchangeable direct-reading scales. The instrument discussed checks and calibrates all types of thermocouple-actuated temperature instruments and many electrical instruments. Temperatures or millivolts are read directly—without charts, graphs or conversion tables. Circle L42 inside back cover.

Wide - Band Oscilloscope. Tektronix, Inc., P. O. Box 831, Portland 7, Ore. An eight-page folder completely describes and illustrates the small, light and versatile type 515 wide-band oscilloscope. Chief features and specifications are shown. Price of the unit discussed is \$750. Circle L43 inside back cover.

Flat Selenium Rectifiers. Radio Receptor Co., Inc., 240 Wythe Ave., Brooklyn 11, N. Y. Bulletin 237 covers the Siemens flat type selenium rectifiers which feature long life, smaller sizes, higher efficiency, low forward drop and low reverse leakage. Sizes, terminal arrangements and equivalent circuit ratings are shown. Circle L44 inside back cover.

System Test Equipment. Link Aviation, Inc., Binghamton, N. Y., has available a 22-page brochure, "Systems Evaluation Test Equipment," LP-3528, which explains the philosophy of system test



DC-AC CHOPPERS

For 60 Cycle Use

Built to rigid commercial specifications.

Twenty-two types, both single and double pole.

Long life.

Low noise level.

Extreme reliability.

Write for Catalog 370.

STEVENS INCORPORATED ARNOLD

22 ELKINS STREET SOUTH BOSTON 27, MASS.

S/A-10

Make springs yourself . . . fast, exact! WITHOUT USE OF ARBORS

For a replacement or experimental spring, any shape, diameter or pitch from flat or round wire sizes .005" to .125", you can produce it in a matter of seconds with Perkins Precision Spring Coiler. You eliminate arbors, yet turn out precision springs — torsion, compression, extension, tapered, or special springs, coiled either

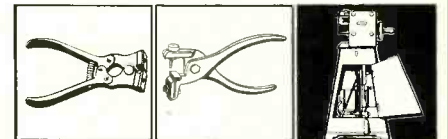

Starret adjustable jaw cut nippers (left) and Gardener Hook-Kon spring looping tool (center) — handy, precision, time-saving accessories for spring coiling. Perkins Spring Coiler available as bench model or power model shown here, (right) for tool shop or continuous runs.

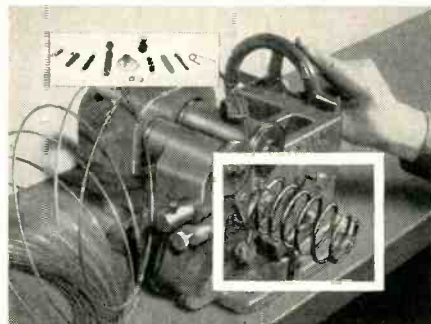

left or right hand, in any desired length, any diameter from 3/32" to 12" and larger, with or without initial tension, and with open or closed ends. Eliminate expensive special orders and costly production delays! Make your own springs to exact specifications as replacements or experimental work. Make them fast, right in your own shop!

Perkins Machine and Gear Co.
Special Machinery Division, Dept. C3
W. Springfield, Mass.
Please send information and prices on Perkins Spring Coiler.
Hand Model Power Model

Name.....Title.....
Company.....
Address.....
City.....State.....

Longer Tube Life



with G-E Inductrol* Voltage Regulators

Undervoltage can destroy gas-filled tubes in minutes, dangerously overheat vacuum tubes. As little as 5% overvoltage can cut tube life in half.

Economical Inductrol voltage regulators precisely control (within $\pm 1\%$) a-c voltage, help assure proper tube operation. This means longer tube life, less downtime, more efficient operation.

For more information, write Section 425-5, General Electric Co., Schenectady 5, N. Y., or call your nearest General Electric sales office or agent.

*General Electric Trade-mark for induction voltage regulators.

Progress Is Our Most Important Product

GENERAL  ELECTRIC

equipment for military electronic systems. It presents complete application information and design concepts of specific "go-no-go" testing devices which the company has custom built for use in conjunction with an existing analog bombing system.

The brochure describes typical applications of systems evaluation test equipment for testing complete systems and checking components within a system. It also discusses the economic advantages of this advanced approach to electronic testing. **Circle L45 inside back cover.**

Instrument Eyelets. Circon Component Co., Santa Barbara Municipal Airport, Goleta, Calif. A single sheet bulletin describes a line of instrument eyelets used for terminals, contacts, bushings, fasteners, grommets and printed circuits. Chief features and application data are included. **Circle L46 inside back cover.**

Receiving Tube Manual. Radio Corp. of America, Harrison, N. J. A new edition of the RCA receiving tube manual, revised, expanded and brought up-to-date, has been prepared. Designated RC-18, it contains technical data on more than 575 receiving tubes, including types for black-and-white and color tv and series-string applications. In addition, more than 75 picture tubes, including color types, are treated. Price is 75 cents. **Circle L47 inside back cover.**

D-C Power Supply. Consolidated Electrodynamics Corp., 300 North Sierra Madre Villa, Pasadena, Calif. Bulletin 1570 covers the type 3-131 26-v d-c power supply which increases versatility of airborne oscillographs. Included are an illustrated description, component information and a listing of specifications. **Circle L48 inside back cover.**

Thermostats. Stevens Mfg. Co., Inc., P. O. Annex 1007, Mansfield, Ohio. Bulletin 5000 describes a line of Stemco type C thermostats. Both hermetically sealed and semi-

this is important enough to read twice!

Now, for the first time, you can obtain 1, 2, or a dozen prototype *high alumina ceramics* parts for development work in your own plant . . . at low cost. This new service is available to "custom-make" any small-lot number of ceramic parts to your exacting specifications. Here's an opportunity to "research" high alumina ceramics for new products as well as existing ones, without the barrier of buying production run quantities. Want to know more? Write, outlining your problem. Ask, too, for a copy of our properties chart.

frenchtown

PORCELAIN COMPANY
86 Muirhead Avenue • Trenton 9, N.J.

California Representative: Edwin E. Starr, 4101 Rhodes Ave., N. Hollywood, Cal. STanley 7-5879.

Lepel

HIGH FREQUENCY
Induction

HEATING UNITS

BRAZING
ANNEALING
HARDENING
SOLDERING
MELTING

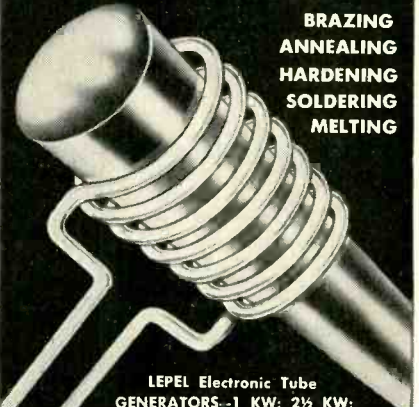

LEPEL Electronic Tube
GENERATORS—1 KW; 2½ KW;
5 KW; 10 KW; 20 KW; 30 KW; 50 KW;
75 KW; 100 KW.

LEPEL Spark Gap Converters
2 KW; 4 KW; 7½ KW; 15 KW; 30 KW.

WRITE FOR THE NEW LEPEL CATALOG . . . 36 illustrated pages
packed with valuable information.

All Lepel equipment is certified to comply with the
requirements of the Federal Communications Commission.

**LEPEL HIGH FREQUENCY
LABORATORIES, INC.**

55th STREET and 37th AVENUE, WOODSIDE 77,
NEW YORK CITY, N. Y.

enclosed types are covered.

Punched for insertion in standard three-ring binders, the bulletin describes operating principles, gives dimensional data, ratings and materials of construction. Available terminal and mounting arrangements are illustrated with photographs. **Circle L49 inside back cover.**

Precision Potentiometers. Helipot Corp., Newport Beach, Calif. Improved operating characteristics of the series B precision potentiometers are included in data sheet 54-18. The significant changes listed include more favorable values for best practical linearity tolerances above 999 ohms. For example, from 1,000 to 9,999 ohms, the best practical linearity tolerance is now ± 0.015 percent rather than ± 0.025 percent; for 10,000 ohms and above, it is ± 0.01 percent. **Circle L50 inside back cover.**

Facilities Brochure. United States Dynamics Corp., 1250 Columbus Ave., Boston 20, Mass., has available an eight-page booklet stating the present position, aims and objectives of USD, a company organized to manufacture electronic components and systems, mechanical and electromechanical devices, and to conduct research and development for commercial and military applications. Also available are a number of silicon power rectifier data sheets covering a variety of types, as well as a price list. **Circle L51 inside back cover.**

Aircraft Hook-Up Wires. Revere Corp. of America, Wallingford, Conn. A series of single conductor, 600-v, high-temperature aircraft hook-up wires, designed to meet applicable requirements of military specification MIL-W-7139, are described in bulletin No. 1906. The wires discussed possess outstanding dielectric characteristics over the continuous temperature operating range from -68 F to $+410$ F. Available in sizes from 22 to 12 gage, the wires are insulated with Teflon and Teflon-impregnated glass to form a rugged insulation highly resistant to abrasion and corrosion. **Circle L52 inside back cover.**

FOR LESS THAN 30¢ A DAY

A graphic instrument will tell you what happens to a machine, the output of a department or whole plant, will serve as a continuous inspector of products or processes—

While you are working elsewhere

In no other way can the engineer be in so many places at once. And at a cost of less than 30 cents a day per recorder. You can't afford to be without graphic instruments in your plant. Ask for Bulletin 939A—What You Can Do With a Graphic Wattmeter.



• PRODUCT REPRESENTATIVES IN MOST* PRINCIPAL CITIES

The ESTERLINE-ANGUS Company, Inc.

Pioneers in the Manufacture of Graphic Instruments

Dept. E2, P. O. Box 596, INDIANAPOLIS 6, INDIANA

NEW 1957

MINIATURE TRANSFORMER CATALOG

HUNDREDS OF MINIATURE
TRANSFORMERS AVAILABLE
OFF THE SHELF

NEW

TRANSISTOR TRANSFORMERS

Approved MIL-T-27A designs

HERMETIC, MOLDED, OPEN OR CASED
SERVO, MISSILE, AIRBORNE TYPES

Write for
Detailed 1957 Catalog

MICROTRAN[®]
company,
inc.

145 E. Mineola Avenue, Valley Stream, L. I., New York

IMMEDIATE DELIVERY AT AUTHORIZED STOCKING DISTRIBUTORS

California, Oakland
W. D. Brill Company

California, Los Angeles
Graybar Electric Co.

Connecticut, Hartford
Moses Radio Electronics Co.

District of Columbia, Washington
Kenyon Radio Supply Co.

Massachusetts, Cambridge
Electrical Supply Corp.

New York, Jamaica
Peerless Radio Distributors

New York, Utica
Wolmar Distributors

Pennsylvania, Philadelphia
Harold H. Powell Company

Texas, Beaumont
Montague Radio Supply

Washington, Tacoma
C & G Radio

Electronics manufacturers expand plants and facilities by acquisition, leases or new construction. Top engineers and executives in the industry are promoted and move to new responsibilities. Technical societies honor leading scientists

Sangamo Dedicates Capacitor Plant In South Carolina

THE SANGAMO ELECTRIC COMPANY'S \$5 million plant in Pickens, South Carolina is in operation. Some 1,000 persons are employed in the 200,000 sq ft facility.

The company will produce electrolytic capacitors, power capacitors, motor generators, converters, dynamotors, and Navy electronic equipment there. South Carolina's Governor George B. Timmerman, Jr. and Senator Strom Thurmond participated in dedication formalities. C. H. Lanphier, Sangamo president, was the recipient of a bronze plaque commending the firm for its choice of a South Carolina site for the plant.

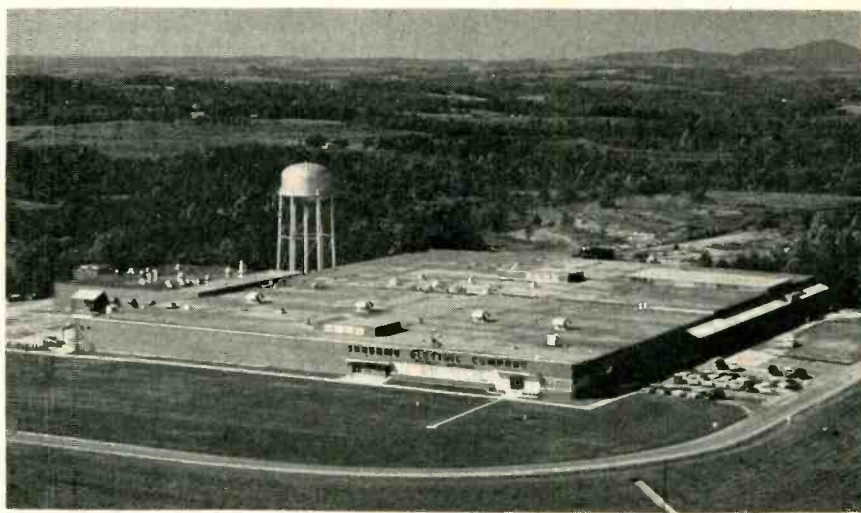

Sangamo Electric's new capacitor plant in South Carolina

Hoffman Electronics Elects New Laboratory President

JAMES D. MCLEAN, formerly of Philco Corp., was elected president and general manager of Hoffman Laboratories.

McLean resigned as vice-president and general manager of the government and industrial division of the Philco Corp. to head the wholly-owned Hoffman subsidiary.

He succeeds John B. Moss who becomes chairman of the executive committee of the Laboratories and remains as a director of Hoffman Electronics Corp. He joined Philco in 1947 after 9 years with GE in engineering and sales.

McLean will have full responsibility for all phases of work carried

on by Hoffman for the armed forces in the engineering, design and production of advanced electronics and electromechanical projects. The Laboratories have more than 50 active projects.

He will have supervision of over 400 engineers and 2,200 employees as well as the 12 service areas.

Sylvania Appoints Osgood Manager Of Waltham Laboratories

RICHARD M. OSGOOD has been appointed manager of the Waltham laboratories of Sylvania Electric.

He formerly was manager of the avionics laboratory at the Waltham facility. Before joining Sylvania, he was chief of the electronic defense systems division of the Air Material Command, U. S. Air Force. He succeeds Dr. O. G. Haywood, who has resigned to accept a top executive post with Emerson Electric Manufacturing Co., St. Louis, Mo.

In his new post, Osgood will have responsibility for the avionics laboratory, the missile systems labora-



Richard M. Osgood

tory, and the applied research laboratory, the three activities con-

stituting the Waltham laboratories.

Osgood joined Sylvania in 1955 as manager of equipment fabrication at the Waltham Laboratories, becoming manager of the avionics laboratory in 1956.

As chief of the electronic defense systems division of the Air Material Command, Osgood held the rank of Colonel. He was responsible for the coordination of the design, production, and installation of a semi-automatic air defense system for the continental United States and for the "DEW Line".

Osgood began his research and development work in military elec-

MISSILES to MACHINERY

Century MODEL 420 ELECTROGRAPH

covers the oscillograph recording field

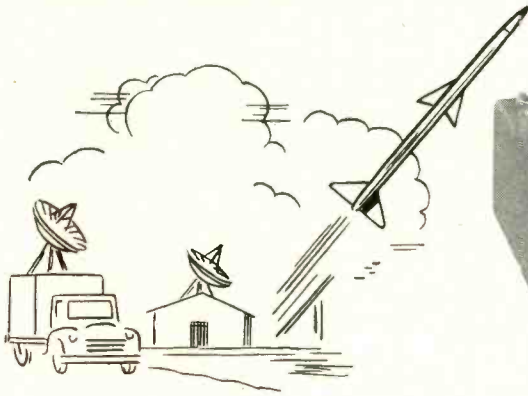

TELEMETRY APPLICATIONS

- QUICK-LOOK monitoring in the telemetry ground station permits continuous observation of missile in-flight programing results.
- ON-THE-SPOT monitoring permits making in-flight function corrections in controlled missiles or piloted aircraft.
- A NATURAL for mobile telemetry vans . . . compact, rugged, low power consumption, record is PERMANENT, no fading or fogging when exposed to direct sunlight.

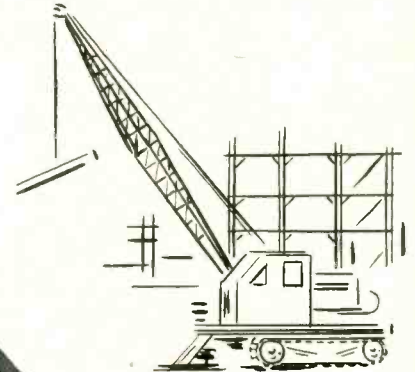

INDUSTRIAL APPLICATIONS

- STRESS-STRAIN RECORDING with "first-hand" read-out during test.
- PERMANENT record obtained at test site may be stored indefinitely for purpose of future data reduction.
- PORTABLE — extremely useful for field test applications where a "multiplicity" of data must be collected with the least amount of instrumentation.
- No amplifiers required for many applications.

USES a variety of tubular mirror galvanometers pioneered by Century

ENGINEERS . . .

Check your requirements against these FEATURES!

- Permanent continuous record produced within recorder.
- Developed record may be viewed an INSTANT after exposure.
- HIGH CONTRAST photographic qualities . . . black intelligence traces are recorded on light colored background.
- As many as 24 intelligence channels may be recorded on the 8-inch x 200-foot record roll.
- Record is REPRODUCIBLE without loss of contrast by Ozalid, Bruning, etc., processes . . . NO deterioration due to ultra-violet exposure.
- Eliminates need for costly darkroom facilities.

COSTS NO MORE THAN OLD-FASHIONED METHODS



Century Electronics & Instruments, Inc.

1333 NO. UTICA, TULSA, OKLAHOMA

For further information, call on our nearest representative:
EXPORT OFFICE: 149 BROADWAY, NEW YORK CITY — TEL.: BARCLAY 7-0562

PHILADELPHIA, PA.
Test Equipment Sales Co.
4447 N. Bodine St.
Tel.: Michigan 4-1822

LONG ISLAND CITY, N. Y.
Test Equipment Sales Co.
29-46 Northern Blvd.
Tel.: Stillwell 4-7120

DALLAS, TEXAS
Arnald Barnes Co.
5526 Dyer St.
Tel.: Emerson 6716

TUCSON, ARIZONA
G. S. Marshall Co.
3686 Baker Place
Tel.: East 7-1501

REDWOOD CITY, CALIF.
G. S. Marshall Co.
2015 El Camino Real
Tel.: Emerson 6-8214

SAN MARINO, CALIF.
G. S. Marshall Co.
2065 Huntington Drive
Tel.: Ryan 1-6781

SAN DIEGO, CALIF.
G. S. Marshall Co.
3525 5th Avenue
Tel.: Cyprus 8-8234

DENVER, COLORADO
Barnhill Associates
6520 West 62nd Ave.
Tel.: Harrison 4-7733

ATLANTA, GEORGIA
E. G. Holmes & Associates
309 Pharr Road, N. E.
Tel.: Cedar 7-7801

CLEVELAND, OHIO
Electro Sales Associates
281 E. 216th St.
Tel.: Redwood 2-7444

DAYTON, OHIO
Electro Sales Associates
512 Orangetown Drive
Tel.: Walnut 5426

ORLANDO, FLORIDA
E. G. Holmes & Associates
56 W. Columbia St.
Tel.: 3-3524

tronics for the Air Force following his graduation from the United States Military Academy at West Point in 1941.

Meyer Leifer has been appointed assistant director of the electronic defense laboratory of Sylvania Electric, in California.

Before being named to the newly created post, he was engineering manager of the laboratory. In this assignment he headed the research and development program of the laboratory since it began operations in Mountain View, Calif. in 1953.

Leifer joined Sylvania in 1946 as an engineer in the physics labs.

NATO Electronics Chief Named

JOHN HESSEL, director of the radio communication division at Fort Monmouth since 1947, has been appointed by the State Department as chief of the electronics section, production division, North Atlantic Treaty Organization.

From 1942 to 1946 he served with the Army Signal Corps during which he was awarded the Legion of Merit with Oak Leaf Cluster. He held the rank of Colonel.

He has been employed at the Signal Corps Engineering Laboratories since 1931.



John Hessel

Motorola Opens New Home Radio Plant, Selects Military Head



New Motorola home and automobile radio plant in Illinois

MOTOROLA BEGAN operations in its new \$2 million manufacturing facility in Quincy, Ill. The 185,000 sq ft plant was viewed by 7,500 area residents prior to going into the exclusive production of home and

automobile radios. Total employment exceeds 1,500, and officials estimate more than 1,000,000 radios of various types will be manufactured in the plant in 1957.

The east wall of the new plant

is 500 feet in length and is movable for future expansion. The plant is completely conveyORIZED and is equipped with automatic and semi-automatic manufacturing devices.

Motorola also announced that Major General Samuel R. Brentnall, U.S.A.F., retired, has been named vice-president and assistant general manager of the military electronics division.

General Brentnall, formerly Air Force assistant chief of staff for guided missiles, will supervise military electronics in Phoenix, Riverside, California and Chicago, and will administer the work of more than 2,500 persons.

Former posts held by Gen. Brentnall include chief, production engineering section, Wright Field, and special assistant to chief of staff for the B-47 program.

Kittel Awarded Buckley Solid State Physics Prize For 1957

AMERICAN PHYSICAL SOCIETY has awarded the \$1000 Oliver Buckley Solid State Physics Prize for 1957 to Dr. Charles Kittel, professor of physics at the University of California in Berkeley.

Dr. Kittel was selected for his applications of magnetic resonance methods to investigations of the electronic solids." This work was judged by the Society as "a most important contribution to the advancement in solid state physics" in the last five years.

Dr. Kittel has developed new theoretical techniques for investigating the electronic structure of solids by utilizing the interaction in a magnetic field of high frequency radio waves with the magnetic and electric properties of the electrons in solids.

Related experimental work on a number of these problems has been carried out by Dr. Arthur Kip, professor of physics. Drs. Kittel and Kip developed a "solid state cyclotron"—a tiny crystal—in which

they whirl electrons through solid matter.

The Buckley award was established by the Bell Telephone Laboratories in honor of one of its last presidents, and it is administered by the American Physical Society.

The award will be presented to Dr. Kittel at the annual meeting of the Society in New York. At that time Dr. Kittel will deliver the Buckley Lecture, on "The Role of Magnetic Resonance Studies in the Physics of Solids."



Specify SYLVANIA WIRE

TUNGSTEN

50/50 TUNGSTEN-
MOLYBDENUM

MOLYBDENUM

...when your product demands the highest standard of uniformity

BECAUSE of high metal purity plus exceptional uniformity in size and physical properties, Sylvania wire will help you hold rejection losses to a minimum . . . help you maintain consistently higher product performance standards.

Quality-controlled to the exacting standards known to be needed for producing the world's finest vacuum tubes—every step in the wire-making process is done in Sylvania's own plants. From metal refining to drawing and finish plating . . . one manufacturer bears the entire responsibility of supplying the exact kind and quality of wire you need.

There is a Sylvania wire for every vacuum and gas tube application, in a full range of sizes down to the finest available—bare or plated with gold, rhodium, silver or nickel. Extra-long lengths can be supplied on order.

As the specifications for tube characteristics vary—so your wire requirements will vary. Next time you need standard or special wires, call in your Sylvania sales engineer. He will help you get exactly what you need, *when you need it!*

SYLVANIA ELECTRIC PRODUCTS INC.
Tungsten and Chemical Division, Towanda, Penn.

TUNGSTEN

MOLYBDENUM

CHEMICALS

PHOSPHORS

SEMI-CONDUCTORS



SYLVANIA



Lighting • Radio • Electronics • Television • Atomic Energy

TRANSISTOR MAKING EQUIPMENT

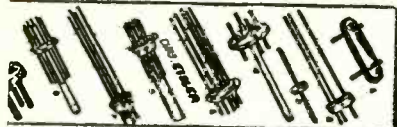

DIODE MACHINERY AUTOMATIC OR SEMI-AUTOMATIC

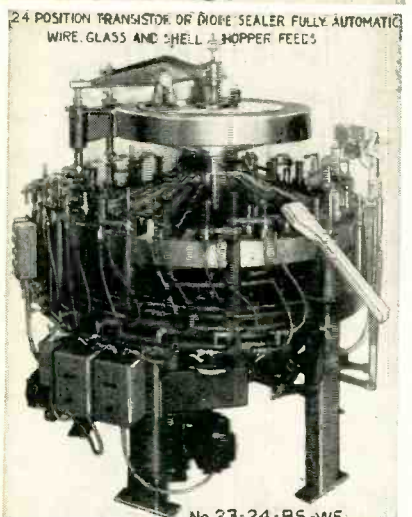
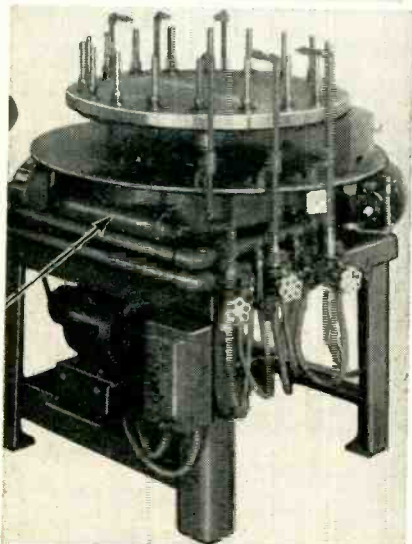
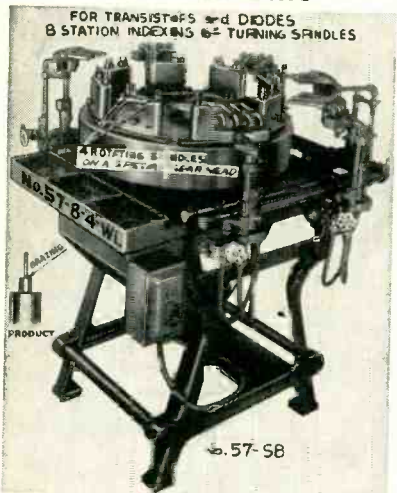

Send for Catalog Dr. Chas. Eisler, M.E. Founder
CHAS. EISLER, JR., PRES.

EISLER ENGINEERING CO., INC.
751 So. 13th St. NEWARK 3, N. J.

Want more information? Use post card on last page.

Air Force Inspects Lewyt Factory

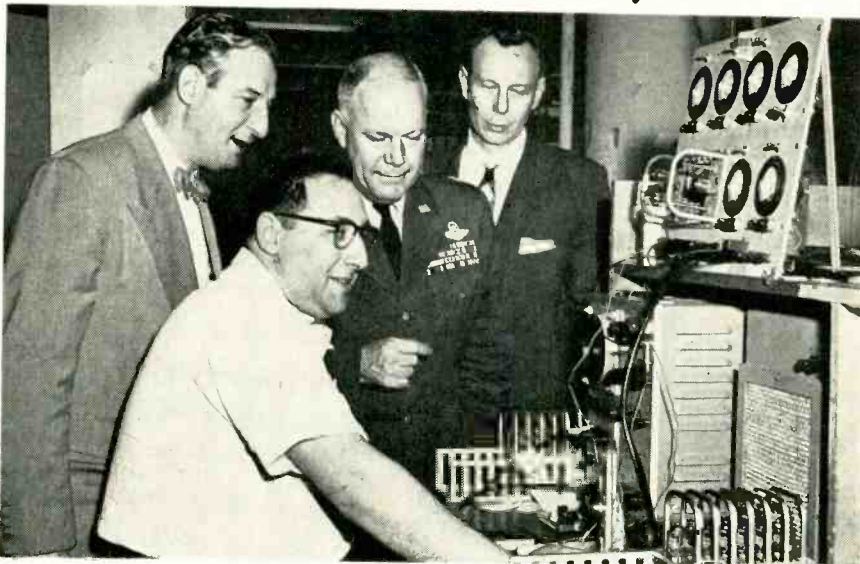

General Wray, head of Air Defense Engineering Service, tours Lewyt plant

ALEX LEWYT, president, Jerome L. Strauss and Arnold Wolf, vice-presidents, of the Lewyt Manufacturing Corp., recently were hosts to Brig. General Stanley T. Wray and Colonel O. M. Scott of the Air Force, S. P. Schwartz and Donald Wilkes of Western Electric and

C. Shorey of the Cambridge Research Center, at the company's Long Island City plant.

On a tour, they were shown Lewyt's production of the Coordinate Data Transmitter AN/FST-1 and Coordinate Data Monitor OA-947/FST-1—used in SAGE.

Westinghouse Selects Research Head

CLARENCE ZENER has been appointed director of the Westinghouse research laboratories.

He assumes his new post after five years as an associate director and a year as acting director of the 800-member staff of the laboratories, which only recently occupied completely new research facilities in Churchill Borough, ten miles east of downtown Pittsburgh.

Formerly a professor in the Institute of Metals and department of physics at the University of Chicago, Dr. Zener is author of the Zener theory of ferromagnetism which explains why certain materials are strongly magnetic, and of

the Zener effect, a theoretical explanation of the electrical breakdown in semiconductors such as germanium and silicon.

Since coming to the Westinghouse research laboratories as an associate director in 1951, Dr. Zener has initiated and helped develop a new approach to metallurgical research. In this approach alloys of metals are "pre-designed" with certain "built in" characteristics that depend upon the magnetic structure of the metal atoms. This technique eliminates much of the tedious traditional approach in which different metals are mixed in varying proportions and are then tested for properties.

Vacuum Tube Products Builds New Plant

GROUND has been broken for the new 13,000 sq ft plant of Vacuum Tube Products Co. in Oceanside, Calif.

In 1946, when Harold Ulmer first formed V T P Co., it was located in the garage and basement of his

home in Oceanside, Calif. Ulmer had years of experience in the electronic tube business with Raytheon and IT&T.

The company was established in 1946 on an experimental and developmental basis and, until 1955, it

ran as an advisory and research development.

James J. Sutherland formerly of Sylvania, is vice-president and general manager. Vacuum Tube Products employs 40 people, and has a half million dollars in backlog orders for the four classes of products it makes. When the new plant is completed, employment is expected to be about 200.

Radio Club Honors Eastham



Melville Eastham

RECOGNITION for outstanding contributions to the art of precision measurements in the field of radio and electronics was accorded Melville Eastham at the recent annual banquet of the Radio Club of America.

The recipient of the Armstrong Medal was a founder of the Clapp-Eastham organization before the formation of General Radio Co. where he served as chief engineer and also as president.

The citation indicates in part that Eastham made available reliable test equipment of a standardized nature that previously did not exist or had to be especially assembled as a laboratory setup.

Raytheon Starts Lab, Appoints Manager

A new electronics laboratory at Maynard, Mass. with primary responsibility to design and develop airborne electronics equipment, has been formed by Raytheon Manufacturing Co.

The laboratory will work on such

High-Speed Recording

with
instantaneous
readout

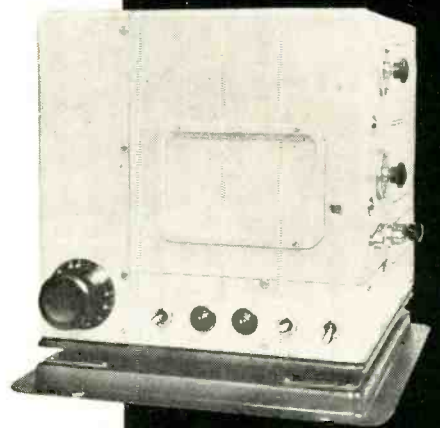

- **FAST**
100 usec rise time
- **ACCURATE**
± 0.2% [5-inch tape]
± 0.1% [12-inch tape]
- **DIRECT READING**
No processing necessary

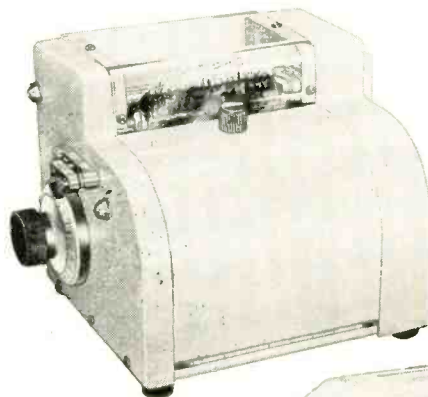

MODEL R1021-D [5-INCH]

MODEL R1021-1B [5-INCH]

MODEL R-1047-10 [12-INCH]

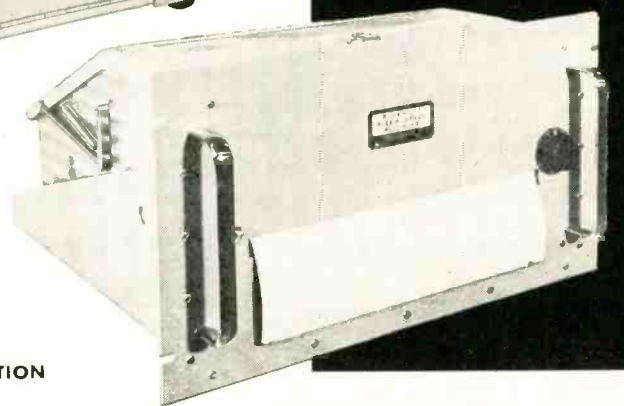

WRITE FOR
COMPLETE INFORMATION
Dept. K



RADIATION Inc.

Melbourne, Fla.
Orlando, Fla.

Electronics • Avionics • Instrumentation

PERSONNEL INQUIRIES INVITED



the people
you want

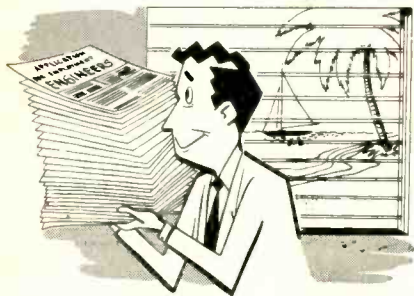

want to live here

Why can Greater Miami manufacturers **select** from literally dozens of applicants for every position...even in hard-to-find categories like engineers...skilled technicians? Because South Florida offers the happy, healthy, out-of-doors way of life that an ever-increasing number of people want, and metropolitan Miami provides big city cultural, amusement and recreational activities.

There's a **hard dollar reason** for locating your plant in Greater Miami — you can **attract** all the skilled employees you want — **select** from supremely well-qualified applicants.



For a **complete statistical analysis** of America's No. 1 area for personnel recruitment, send, on your letterhead, for 30-page Fact File.

GREATER MIAMI INDUSTRIAL DIVISION

DADE COUNTY ADVERTISING DEPT. 198
141 N. E. 3rd AVE. • MIAMI, FLORIDA
PHONE FR 1-3611

devices as Doppler navigation instruments, aircraft intercept radars, altimeters, surface radars, and other classified items for the Defense Department.

The laboratory is housed in a 65,000 sq ft area presently leased by Raytheon in the former Assabet Mills textile center in Maynard.

Initially the laboratory will employ about 275 engineering and non-engineering personnel. The expected first year's growth will be about 20

percent, according to the firm.

Named as laboratory manager was Homer C. Knauss, who was promoted from his position as airborne systems branch manager at Raytheon's Wayland Laboratory radar department.

With Raytheon, Knauss has worked on various radar and communications systems. He was primarily responsible for a high-speed bombing radar system now being produced for the Air Force.

Sperry Builds New Plant In Arizona

SPERRY RAND'S Sperry Phoenix Co. began construction of an initial manufacturing facility in Phoenix, Ariz.

An 81,000-sq ft plant unit, which will cost about \$3 million to build and equip, is expected to be completed and operating by next August. It will employ approximately 500 persons.

The initial 81,000 sq ft area

plant unit will be utilized to manufacture various components of flight and engine controls systems.

The company begins preliminary manufacturing operations in 14,000 sq ft of leased space at the Arizona State Fair Grounds. A limited number of technical specialists, already selected, will be employed there and regular employee recruiting programs will begin later in 1957.

Bendix Acquires Firm, Appoints Two

BENDIX AVIATION plans to acquire the business and assets of the Sheffield Corp. of Dayton, O., a privately owned manufacturer of gauging and measurement instruments, and industrial inspection and quality control systems.

Bendix will issue approximately 230,000 shares of its common stock to acquire Sheffield. The firm will continue to operate under its present management as a wholly owned subsidiary of Bendix.

Annual sales of Sheffield run about \$24 million having risen from \$1 million sixteen years ago. It has 1,000 employees, and operates plants in eight cities.

Louis Polk will become a director, vice-president and group executive of Bendix and will continue as president of the Sheffield subsidiary.

► **Engineers**—Donald C. McDonald has been appointed to a new position of director of engineering by the Friez Instrument division of Bendix Aviation Corp.

He will be responsible for all engineering phases of divisional activity, ranging from research through production in the fields of weather instrumentation, automa-



Donald C. McDonald

tion, and electronics.

Previously he was assistant director and chief engineer of Cook Research Laboratories. He also was employed as a division supervisor at the Willow Run Research Center of the University of Michigan in the controls and instrumentation division. In addition, he has served as a project supervisor of the Doelcam Corp., and as senior research engineer at the M.I.T. servomechanisms laboratory.

Charles E. Miller has been ap-

pointed head of engineering services for Bendix Pacific.

He will be in charge of the reliability and standards, production procedures, design drafting and records, publications, environmental facilities, technician control, and instrument service and calibration groups.

GE Promotes Three To New Posts



Irvin D. Daniels

IRVINE D. DANIELS has been appointed as general manager of GE's receiving tube department.

Daniels has been manager of the Owensboro tube plant since 1950. He succeeds L. B. Davis who was advanced to the post of general manager of the firm's electronic parts division several months ago. In his new position, Daniels assumes responsibility for all operations of the entire department which includes receiving tube plants at Tell City, Ind., and Anniston, Ala., in addition to two factories in Owensboro.

He joined the engineering department of the former Ken-Rad Tube and Lamp Corp. in 1932. He assisted in setting up the factory engineering section and in developing new manufacturing techniques.

After General Electric purchased the Ken-Rad corporation in 1945, he was named assistant works engineer and a year later was appointed works engineer. He was promoted to assistant to the plant manager in 1948, and in 1950 was appointed plant manager. Notable advances

A New Broad Band **Kearfott**



Model W177-2C-1

FERRITE ISOLATOR for Laboratory Test Bench Use

Use this Ferrite Isolator in your microwave setup for maximum frequency stability.

Typical Performance Curves

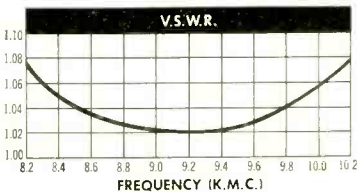
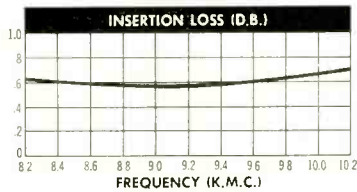
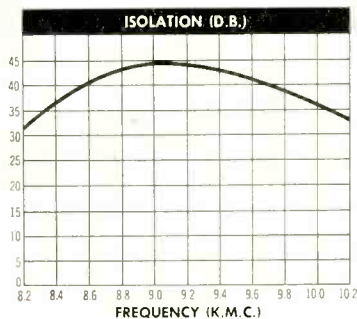

CHECK THESE FEATURES:

Broad Band—Usable from 8.2 to 10.2 KMC

High Isolation—A minimum of 25 db over the band

Insertion Loss—Less than 1 db

Small & Compact—Only 2½ inches long—weighs only 1½ lbs.

Flanges—Cover type. Mates with UG39/U flanges. Will absorb up to 10 watts reflected power

Price—\$135.00 each f.o.b., Van Nuys, Calif.

Delivery—From stock

Order—Model W177-2C-1

For custom-made isolators for specific radar & microwave application, you can depend on the skill of the Kearfott organization.

Kearfott, Western Division, has complete facilities for waveguide production, with qualified experts to assist in solving your problems. Let us help you.



For detailed information, ask for bulletins on new Ferrite Isolators and Radar Test sets.

Kearfott COMPANY, INC.

LITTLE FALLS, NEW JERSEY

WESTERN DIVISION
MICROWAVE DEPARTMENT

14844 OXNARD ST. - VAN NUYS, CALIF.

SALES OFFICES

Eastern Office:
1378 Main Ave.
Clifton, N.J.

Midwest Office:
188 W. Randolph St.
Chicago, Ill.

South Central Office:
6115 Denton Drive
Dallas, Texas

Western Area Office:
253 Vinedo Ave.
Pasadena, Calif.

under his management, include the construction of a new manufacturing building in Owensboro, and the development of the "Snow White" manufacturing program.

Walter Hausz was appointed a member of the technical staff in the technical military planning operation (TEMPO) of GE's defense electronics division.

Hausz has been on special assignment in Washington, D. C. for the past several months. Prior to that, he was manager of the advanced electronics center at Cornell University in Ithaca, N. Y. The center is an applied research and advanced

development laboratory primarily devoted to military systems studies. Projects at the center involve work on air defense, air-surface warfare, counter-measures, communications, navigation, detection, and automation.

Prior to his Ithaca assignment, Hausz was manager of development engineering at the G-E electronics laboratory in Syracuse, N. Y.

Herbert D. Barnhart was appointed manager-instrumentation, materials and processes laboratory of GE. He joined the firm in 1946 and has been in measurement engineering since 1950.

RCA Appoints Missile Engineers



Max M. Tall

THE MISSILE AND SURFACE RADAR DEPARTMENT of RCA has appointed Max M. Tall to head its expanding reliability program for missile con-

trol projects and activities.

He was formerly associated with Vitro Laboratories and the National Radio Institute of Washington, D. C. He is general chairman of the Third National Symposium on Reliability and Quality Control in Electronics.

Charles F. Woll has been appointed to the newly created post of manager of value engineering in the missile and surface radar department.

He will serve on the engineering staff with responsibility for effecting maximum economy in development and design programs.

Woll has spent the majority of his engineering career in the field of military electronics.

Consolidated Buys Firm, Names Two

CONSOLIDATED ELECTRODYNAMICS Corp. purchased the R. A. Castell & Co. of Glendale, California, electronic components manufacturer.

Formed in 1949, the components firm has specialized in electronic sub-assembly work as a sub-contractor in the missile field and in the development of miniature electrical connectors suitable for high-voltage operation at great altitudes and under adverse environmental conditions. Consolidated plans to broaden activities in these areas when Castell commences operations as the Glendale Division of the firm. R. A. Castell will serve as general manager of the division.

Glenn D. Maxwell was appointed assistant director of the advanced



Glenn D. Maxwell

electronic data laboratory of Consolidated.

The AEDL, known as "Datalab," develops advanced equipment in the

the specs are the proof...
the BEST BUYS are **EICO**
for COLOR & Monochrome TV servicing



NEW COLOR
and Monochrome
DC to 5 MC LAB & TV
5" OSCILLOSCOPE

#460
Factory-wired
and tested \$129⁵⁰
Also available as kit \$79⁹⁵

• Features DC Amplifiers!

Flat from DC-4.5 mc, usable to 10 mc. VERT. AMPL.: sens. 25 rms mv/in; input Z 3 megs; direct-coupled & push-pull thruout; K-follower coupling bet. stages; 4-step freq-compensated attenuator up to 1000:1. SWEEP: perfectly linear 10 cps-100 kc (ext. cap. for range to 1 cps); pre-set TV V & H positions (30 & 7875 cps); auto. sync. ampl. & lim. PLUS: direct or cap. coupling; bal. or unbal. inputs; edge-lit engraved lucite graph screen; dimmer; filter; bezel fits std photo equip. High intensity trace CRT. 0.06 usec rise time. Push-pull hor. ampl., flat to 400 kc, sens. 0.6 rms mv/in. Built-in volt. calib. Z-axis mod. Sawtooth & 60 cps outputs. Astig. control. Retrace blanking. Phasing control.



NEW TV-FM
SWEEP GENERATOR
& MARKER

#368
Factory-wired
and tested \$119⁹⁵
Also available
as kit \$69⁹⁵

Entirely electronic sweep circuit (no mechanical devices) with accurately-biased inductor for excellent linearity. Extremely flat RF output: new ACC circuit automatically adjusts osc. for max. output on each band with min. ampl. variations. Exceptional tuning accuracy: edge-lit hairlines, 6:1 vernier. Swept Osc. Range 3-216 mc in 5 fund. bands. Variable Marker Range 2-75 mc in 3 fund. bands; 60-225 mc on harmonic band. 4.5 mc Xtal Marker Osc., xtal supplied. Ext. Marker provision. Sweep Width 0-3 mc lowest max. deviation to 0-30 mc highest max. dev. 2-way blanking. Narrow range phasing. Attenuators: Marker Size, RF Fine, RF Coarse (4-step decade). Cables: output, 'scope horiz., 'scope vertical.

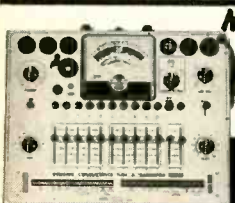

NEW DYNAMIC
CONDUCTANCE
Tube &
Transistor Tester

#666
Factory-wired
and tested \$109⁹⁵
Also available
as kit \$69⁹⁵

COMPLETE with steel cover and handle.

SPEED, ease, unexcelled accuracy & thoroughness. Tests all receiving tubes (and picture tubes with adapter). Composite indication of Gm, Gp & peak emission. Simultaneous sel of any 1 of 4 combinations of 3 plate voltages, 3 screen voltages, 3 ranges of continuously variable grid voltage (with 5% accurate pot). New series-string voltages: for 600, 450, 300 ma types. Sensitive 200 ua meter. 5 ranges meter sensitivity (1% shunts & 5% pot). 10 SIX-position lever switches: free-point connection of each tube pin. 10 push-buttons: rapid insert of any tube element in leakage test circuit & speedy sel. of individual sections of multi-section tubes in merit tests. Direct-reading of inter-element leakage in ohms. New gear-driven rollehart. Checks n-p-n & p-n-p transistors: separate meter readings of collector leakage current & Beta using internal dc power supply.

See the 50 EICO models IN STOCK at your neighborhood distributor. Write for FREE Catalog E-2

Prices 5% higher on West Coast

EICO BROOKLYN 11, N. Y.

Want more information? Use post card on last page.

magnetic-tape data-processing field.

Maxwell joined Consolidated as a project engineer in 1953. He became assistant supervisor, magnetic tape group, in 1955, and supervisory engineer, Datalab, in 1956.

Herbert I. Chambers has been appointed assistant chief development engineer of Consolidated.

He had been supervisor of electro-mechanical development. He joined the firm in 1954.

Previously, Chambers was supervisor of new product development for Electric Auto-Lite Co.; senior mechanical designer, Strong Electric Corp.; senior tool engineer, Electric Auto Lite Co., and tool designer, Toledo Scale Co.

Kaiser Promotes Production Head

JOHN ROWE has been appointed assistant to the vice-president of Kaiser Aircraft and Electronics Corp., and will be in charge of manufacturing and other supporting departments at the Richmond, Calif. machining plant. Rowe has been at Richmond since 1951, working as project engineer, chief inspector, quality control manager and production superintendent.

Ampex Adds Space For Recorders

A NEW \$350,000 building is under construction in Redwood City, Calif. and will be leased to Ampex Corp. to house expanded production facilities.

The new plant contains 70,000 sq ft of space bringing the firm's total to 230,000 sq ft in the Redwood City area. The facilities are for the production of magnetic tape recorders. The company has long range plans to move its plant from Redwood City to Stanford Industrial Park, in Palo Alto, Calif.

Stackpole Elects New President

H. S. CONRAD was elected president of Stackpole Carbon Co to succeed Lyle G. Hall, and J. Hall Stackpole was re-elected chairman of the board of directors. A. A. Haberberger was elected vice-president

IF IT'S NEW...IF IT'S NEWS...IT'S FROM **ELCO**

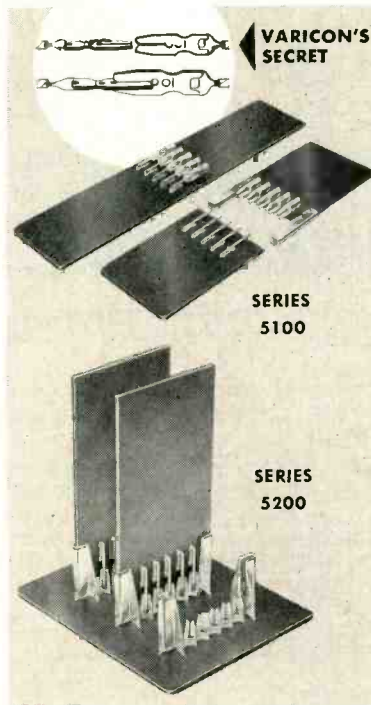

BOARD-TO-BOARD PRINTED CIRCUITS VARICON CONNECTORS

Elco's new Varicon printed-circuit board-to-board connectors permit direct tandem connection (Series 5100) or right-angle connection (Series 5200) without insulators or housings. Contacts are staked directly to boards in both Series. In 5100 Series tandem connection, both boards utilize same style contact. In 5200 Series right-angle connection, stand-off type contact is utilized on one board and same contact as in 5100 Series is employed on other board. All contacts are supplied mounted in plastic strips at required spacing in multiples of .200", ready for assembly in prepunched board. Tools for staking contacts to board are available for staking 1, 5 or 10 contacts at a time. The contacts for 5100 Series will accommodate 1/16" or 3/32" thick boards. Contacts for 5200 Series will accommodate 1/16", 3/32" or 1/8" mother board, and 1/16" or 3/32" sub-module board. Guide brackets can be furnished to accommodate the same thicknesses of boards as indicated for the contacts.

(See Inset) Varicon's better contact conductivity results from large contact area and contact pressure at all times from all 4 sides.

For Detailed Bulletins: ELCO CORPORATION, M below Erie, Phila. 24, Pa., CU 9-5500

PAYS FOR ITSELF IN SAVINGS

• ELIMINATES DISADVANTAGES OF
MANUAL PRE-WEIGHING . . . INCOMPLETE OR
FROTHY MIXING . . . PRODUCT LOSS . . . INTER-
RUPTED PRODUCTION . . . MANUAL POURING



HARDMAN
TRIPLEMATIC
METERS • MIXES • PUMPS
IDEALLY SUITED FOR
PRODUCTION OR LABORATORY
MIXING-METERING
PUMP FOR TWO-PART
POURABLE EPOXY RESINS

CHOOSE FROM 8 MODELS • POTTING • CASTING
Can Be Modified To Meet Many Other Requirements
ACCURATE • FLEXIBLE • SIMPLE
ECONOMICAL • SAFE

Priced from \$1985. Call or Write

H. V. HARDMAN CO. INC.

BELLEVILLE 9, N. J.

PLYMOUTH 9-1242

Since 1906 . . . Formulating Dependable Potting Compounds

INSURE **TOP** INSTRUMENT Performance

with *Bird* jewel assemblies

Made under rigid quality-control throughout manufacture. Bird complete jewel assemblies come ready to install . . . saving production time . . . eliminating rejects . . . cutting costs.

Bird jewels are custom mounted to your specifications, by skilled craftsmen. All assemblies are thoroughly inspected . . . carefully packaged . . . shipped to meet critical production schedules.

And the cost — far less than trying to make the same assemblies in your own plant — actually only pennies to insure perfect performance for your instruments.

Why not discuss the use of jewel bearings or special assemblies with the Bird engineering staff — they are always at your service for all types of jewel bearing problems — no obligation of course.

For information on Bird Jewel Assemblies write for Bulletin 5.

Over 40 years of serving industry with Quality jewel bearings

Richard H. Bird & Co., Inc.

1 Spruce Street, Waltham 54, Mass.

SAPPHIRE AND GLASS JEWELS, PRECISION GLASS GRINDING,
JEWEL MOUNTING AND ASSEMBLY, SAPPHIRE STYLII

new

CB

**WIDE RANGE
SIGNAL
GENERATOR (10 MC—490 MC)**

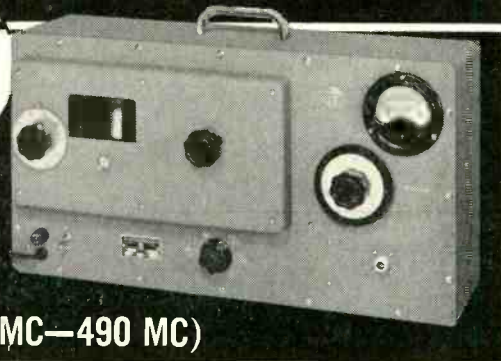

All these precision features in a low-priced instrument:

BROAD FREQUENCY COVERAGE—
10 MC—490 MC

FINE FREQUENCY READABILITY—
Interpolating vernier with resettable zero

ACCURATE FREQUENCIES—
½% Calibration

HIGH FREQUENCY STABILITY—
Completely regulated plate & filament supplies

NEW PISTON ATTENUATOR—
0.2 microvolt to 0.2 volts output

CLEAN CARRIER—
Oscillator tube dc operated, filament & plate

CONVENIENCE MODULATION—
C.W., 400 cycles, 1000 cycles, with standby switch

This instrument is ideal for use in the communication ranges for both design and maintenance work where the highest performance must be had. Elimination of gadgetry and "sales features" permits inclusion of the finest operational qualities at moderate cost.

CB

THE CLOUGH-BRENGLE CO.

6014 Broadway, Chicago 40, Illinois

and general works manager and E. J. Hammer was elected vice-president and director of industrial relations.

Hall was re-elected as treasurer and chairman of the executive advisory committee, as were Harrison C. Stackpole as secretary; R. A. Scholes as assistant treasurer, and B. F. Goodrich as controller. Lyle G. Hall, Jr., was elected assistant secretary.

H. A. Williams was named general manager, electronic components division, and Harrison C. Stackpole, general manager, carbon division. These men have the overall responsibility for the sales and research and development activities of their respective divisions. Haberberger has responsibility for all of the manufacturing activity of the company.

Hall has been active with the company since 1912 and has served as its treasurer since 1916 and president since 1938.

The new president, Conrad, has been identified with the company since 1914. He was named vice president in charge of sales in 1923 and in 1929 was elected vice-president and general manager, a position he has held until this time.

Pacific Automation Names Two Engineers



Joseph J. Malneritch

JOSEPH J. MALNERITCH has been appointed chief engineer of Pacific Automation Products in Glendale, Calif. The company engineers and manufactures electronic cable. Malneritch was formerly with Northrop Aircraft as assistant superin-

**NO FOOLING!
TOOLING!**

Get
Specials
FAST

with the
**COLMAN
UNIVERSAL
KNOB SYSTEM**

● Any Knob you need — QUICKLY
From Stock — AT LOW COST
On Sizes and Colors Normally Con-
sidered Specials.

For Replacement — Experimental and
Model Work. — Short Run Production.
— Emergency Production Needs. —
— Pilot Runs. —

Choose your Knob
1 any shape
any type
any color

2 Choose your
stem — proper
shaft type —
right length.

3 Push together.

4 PRESTO
the Knob
you need

Write Today for Full Particulars to
**COLMAN TOOL & MACHINE
COMPANY**
P. O. Box 7026, Amarillo, Texas

**OPPORTUNITY
UNLIMITED**

FOR AIRCRAFT OR ELECTRONIC
ENGINEERING OR
MANUFACTURING

129 Mi. from New York
81 Mi. from Philadelphia
13,000 SQ. FT.

- ★ Brand new one-story plant on 10 acres. 30 acres adjoining available for expansion. (Airport).
- ★ Heavy power wiring; fine offices; high ceilings.
- ★ Ample skilled and unskilled labor; surplus area.
- ★ Immediate possession.

Exclusive Agent
ROBERT J. KAHN
Realtor
Lewis Tower Building
Philadelphia 2, Pa. Kingsley 5-2224

Want more information? Use post card on last page.
ELECTRONICS — February 1, 1957

tendent guidance manufacturing. He will be responsible for supervision and administration of product design and development.

Henry A. Burr was appointed as field service director. He was previously with Northrop Aircraft as staff engineer. He will direct and coordinate all technical field activities.

**New Firm Formed
In California**

LEE CAHN, formerly chief project engineer for Beckman Instruments, formed the Cahn Instrument Co. The new company will design, manufacture, and sell scientific instruments. It is located in Downey, Calif.

Before Beckman, Cahn was with North American Aviation, and the Askania Regulator Co.

**Western Adds
Plant Space**

WESTERN ELECTRIC will add a half-million square feet to its North Andover, Mass., plant opened some six months ago. The building will increase production space by about 50 percent. The firm has two other plants in this Merrimack Valley area. They are at Haverhill and Lawrence, Mass. Employment at the three is now about 6,400.

**Kay Lab Promotes
Production Manager**

GEORGE D. RICE, production manager of Kay Lab of San Diego, Calif., was elected vice-president in charge of manufacturing and a member of the board.

He joined the firm in 1956. He was associated with Stromberg-Carlson since 1947 as assistant production manager and assistant chief electronics engineer.

**Federal Sets Lab
In Palo Alto**

FEDERAL TELECOMMUNICATION LABORATORIES has established a branch communications laboratory in Palo Alto, Calif. Director of the new laboratory is W. S. Chaskin, former manager of carrier development at

**LINE VOLTAGE
VARIATIONS?**

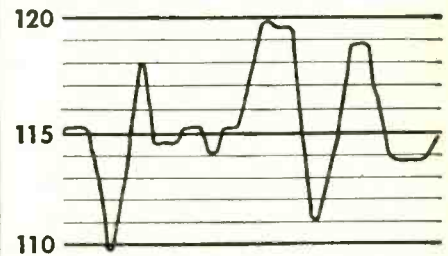

**SMOOTH 'EM OUT
WITH RAYTHEON
Voltage Stabilizers**



± 1/2% Stabilization

If your equipment depends on a well-regulated power supply, Raytheon Voltage Stabilizers assure you top performance under virtually all conditions.

- Guaranteed stabilization to ± 1/2%
- Up to 50% increased tube life
- Regulated to temperature and frequency changes
- Response time within 3 cycles
- Compact, rugged, dependable, low cost.

26 STANDARD MODELS AVAILABLE

Available in a wide variety of input and output voltages from 15 to 2000 watts and where needed, harmonic filtered models for 250, 500 and 1000 watts. Special models can be built on order to your specifications.

For full information see your electronic supply house or write Dept. 6120 — request bulletin 4-260.

"Excellence in Electronics."



RAYTHEON MANUFACTURING CO.
COMMERCIAL EQUIPMENT DIVISION
Waltham 54, Mass.

Want more information? Use post card on last page.

An Invitation TO MANUFACTURERS OF ELECTRONIC EQUIPMENT

1. Friendly labor supply.
2. Unusual city, county, and state tax advantages.
3. Industrial sites plentiful.
4. Good banking facilities.
5. Full cooperation guaranteed.
6. Strategic location.

for
SMALL
or
MEDIUM
INDUSTRIES

Businessmen of Lakeland, Florida will cooperate fully and furnish complete information to manufacturers who will consider relocating or establishing a branch unit in this fast-growing central Florida city

INDUSTRIAL COMMITTEE

LAKELAND CHAMBER of COMMERCE

P. O. BOX 979-F, LAKELAND, FLA.

These **PILOT LIGHTS**
give you
180° VISIBILITY
for the most effective indication
plus
BUILT-IN RESISTORS
(a patented Dialco feature)
for operation on 105-125V. or 210-250V.

The required **RESISTOR** is an integral part of the unit — **BUILT IN** (Pat. No. 2,421,321). Also, simple external resistors for all higher voltages.

Every assembly is available complete with lamp.

SAMPLES ON REQUEST AT ONCE — NO CHARGE



FREE Brochure on "Selection and Application of Pilot Lights"

Also write for our latest Catalogues.

DIALCO

For NEON Lamps

Choice of fluted or clear caps; binding screws or soldering terminals.

Available for both 9/15" and 11/16" mounting clearance holes.

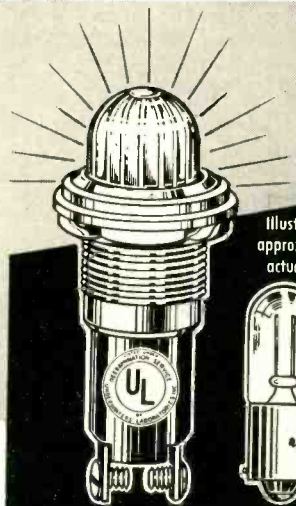

No. 521308-991

NE-51

Foremost Manufacturer of Pilot Lights

DIALIGHT

CORPORATION

60 STEWART AVE., BROOKLYN 37, N. Y. • HYACINTH 7-7600

PLANT AT
BROOKLYN, N. Y.

Lenkurt Electric Co.

The new laboratory, presently in temporary quarters, has a staff of approximately 12 people. Present plans include a move early in 1957 to an approximately 4,000-sq ft plant in the same general area. Technically a branch of the Federal Telecommunication Laboratories in Nutley, N. J., the new facility is associated with the branch laboratory in San Fernando, California. Intended to concentrate on research and development, the new installation will be concerned with the development of a new line of telephone equipment and related communications accessories which will be manufactured by other groups within the IT&T family.

Radiation Adds Space, Picks Chief Engineer



Parker Painter, Jr.

RADIATION'S new instrumentation division building adds 28,000 sq ft to company facilities. The building will house offices, laboratories and hangar space for the instrumentation of aircraft, missiles, and other test vehicles. Also contemplated for the 320-acre site near Orlando, Florida, is a landing strip for company aircraft.

The quarter-million dollar addition brings total plant capacity to 120,000 sq ft in nine buildings at Orlando and Melbourne, Fla. Primarily engaged in electronic research and development, the firm now employs over 600 people.

Parker Painter, Jr., has recently been appointed chief engineer of Radiation. He will be responsible, under the director of engineering, for the operation and administra-

tion of the entire engineering department. Painter, who has been with the company since its early days, was previously head of its instrumentation division at Orlando, Florida.

Bell Appoints Electronic Engineers

Two appointments were made by Bell Aircraft's new avionics division.

Frank H. Andrix was appointed director of engineering. He joined Bell in 1946 to assist with the engineering of automatic guidance components for the firm's guided missile program and later was appointed chief servomechanisms engineer.

J. D. Schantz was named assistant to division manager. He was employed by Bell in 1949 as an electronics engineer and became head of the electronics department in 1951.

Formation of the avionics division was announced by Bell in line with a company re-organization. It is part of the new weapon systems division, of which Roy G. Sandstrom is vice-president and general manager.

Sanborn Completes New Plant

SANBORN COMPANY'S new \$1 million building in the Waltham, Mass., has been completed. Operations will be moved from Cambridge, Mass.

The new 128,000 sq ft building was completed in ten months.

The company, employee owned, manufactures industrial instruments. It employs 750 persons, and for 1956 its volume of sales will top ten million dollars.

Electromation Acquires Hallen

ELECTROMATION Co. of Santa Monica, Calif., acquired the corporate structure of Hallen Corp. of Burbank, magnetic film recording equipment firm.

Electromation acquired Kinevox, a motion picture sound equipment firm, a year ago. In 1956, it acquired Cado Manufacturing Co. of Santa Monica. Cado manufactures



WELMET

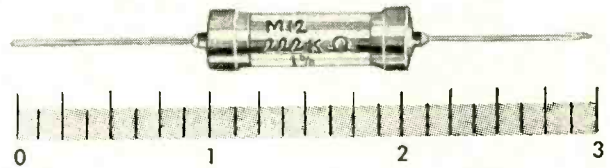

METAL FILM RESISTORS

The Welwyn Welmet provides considerably greater stability than is obtainable in deposited carbon types. A Welmet, in fact, closely approximates the stability of a wire-wound resistor, yet is smaller in size and lower in cost.

Resistance Range 1000 to 1,000,000 ohms.

Tolerance . . . $\pm 1\%$, $\pm 2\%$ or $\pm 5\%$ — closer tolerance in matched pairs can be supplied to special order.

Stability . . . The resistance value will not change more than 0.05% over a period of six months.

Stability Under Load . . . The long term change in ohmic value due to full power loading will not exceed 0.1%.

Temperature Coefficient:

The temperature coefficient depends on resistance value, and lies between 300 and 360 parts per million per degree centigrade. The coefficient is positive in all cases, and in general the lower ohmic values have the higher temperature coefficient in the stated range.

Welwyn Welmet resistors are available in small production quantities for test and laboratory purposes.

Complete specifications and prices on request Dept. PB-7

Welwyn International, Inc.

3355 Edgecliff Terrace, Cleveland 11, Ohio

manufactured in England and Canada

A Growing Company + *An Expanding Sales Organization* = *unique opportunity for Executive Quality Sales Engineers*

When a company is growing the way Collins Radio Company is growing. When a company has the earned reputation for leadership in its field which Collins has earned. There are big, important opportunities for men with the where withal to make the most of them. Right now, Collins, creative leader in electronics, needs high caliber sales engineers for direct sales, staff positions, and military liaison in the following fields:

- AVIATION SALES**
- UHF/VHF communication systems
 - VHF navigation systems
 - Flight director systems
 - Autopilot systems
 - Proximity indicator systems
 - Airborne electronic systems
- GENERAL COMMUNICATION**
- Microwave systems
 - Scatter propagation systems
 - HF SSB systems

Write, wire or telephone today, in complete confidence, to: Mr. John D. Mitchell, Collins Radio Company, 1930 Hi-Line Drive . . . Dallas, Texas.

Requirement: BS degree or equivalent in EE or Physics and 4 to 10 years experience in the above fields.

Collins

CREATIVE LEADER IN ELECTRONICS
Dallas • Cedar Rapids, Iowa • Burbank



DEFLECTION YOKES

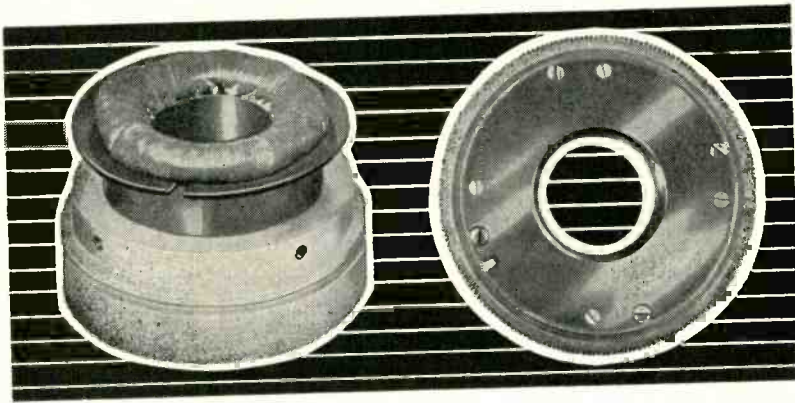

We specialize in the design and manufacture of precision deflection yokes for military and commercial applications. Phone or write for immediate engineering evaluation of your critical display problems.

Celco

Phone: RAMsey 9-1123

Constantine Engineering Laboratories Co.

Island Avenue

Mahwah, N. J.

Brew Delay Lines meet exacting specifications

Whatever your delay line requirements, from prototype to large scale manufacture of production units, Brew offers you the design-engineering experience and complete facilities to supply your most exacting specifications.

Brew Delay Lines are custom made to your requirements and are available covering an extremely wide range of characteristics. A Laboratory Report accompanies every prototype showing your specifications and the characteristics of the prototype.

Send us specifications on your requirements or send for your copy of catalog 54.

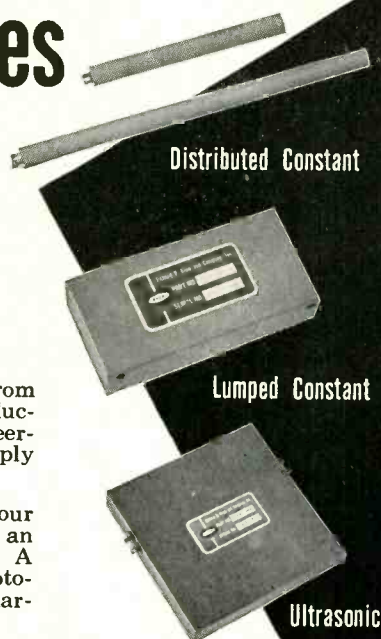

Richard D. Brew and Company, Inc.

design

development

Concord, New Hampshire
manufacture

microwave switching components.

Harold L. Powel, former president of Hallen Corp., will supervise the combined Kinevox-Hallen enterprise, as a division of Electromation Co.

Melco Names Engineering Head



William J. Field

MELCO PRODUCTS of Minneapolis, Minn., transformer manufacturers, appointed William J. Field as director of engineering.

During the past ten years Field was with Remington Rand's Univac division in charge of component design and development. He was a specialist in design of pulse, audio and power transformers. He had previously been employed by Minneapolis Honeywell and Bell Telephone Laboratory as a design engineer.

Field was appointed a consultant on inductors and transformers to the National Military Research and Development Board.

New Firm Formed In Boston

THE APPLIED ELECTRONICS CORP. has been formed in Boston, Mass.

It is engaged primarily in research, development and production for both industry and government agencies in the fields of digital and analog computation, data handling and conversion, and automation systems.

Principle officers of the new corporation are George H. Wayne, president, and George F. George, vice-president and treasurer. Wayne

previously was chief engineer of the systems engineering department of Electronics Corporation of America while George was manager of military operations.

NYT And Essex Merge Activities

ESSEX ELECTRONICS of North Hollywood, Calif. has merged with NYT Electronics of Burbank, Calif.

Essex produces transformers and coils and special encapsulated assemblies and networks.

NYT Electronics, an affiliate of New York Transformer Company, Alpha, N. J., manufacturers of transformers and electro-magnetic devices for industrial electronics, is also engaged in producing components.

Kollsman Promotes Production Heads



Philip E. Weber

A MAJOR reorganization of executive functions has taken place at the Kollsman Instrument Corp., subsidiary of Standard Coil Products Co.

Philip F. Weber, formerly Kollsman's factory manager has been appointed assistant to the president with the responsibility for monitoring production, providing interdepartmental liaison and maintaining central analysis for all instrument systems.

Frank Dupre has been appointed to the position of manager of manufacturing, and William McGurn is the new superintendent of the assembly department.

Weber, the new assistant to the president, joined Kollsman in 1935

Another EECO FIRST!

TIMING, SEARCH, AND CONTROL SYSTEM FOR TAPE RECORDERS

- Automatically locates information on tape recording in a matter of seconds.
- Provides second-by-second identification, during recording and playback, re-cycling every 24 hours.
- Incorporates easy-to-read decimal indicators for hours, minutes, and seconds.

- 1 TIME DISPLAY—accepts timing signal from tape recorder and displays time code during playback.
- 2 TIME SELECTOR—compares playback code with preset code and controls tape recorder during search operation.
- 3 CODE GENERATOR—generates and displays timing code and prepares it in form for recording.
- 4 POWER SUPPLIES—furnish ± 200 volts and filament voltage. Two power supplies required.
- 5 COMPLETE SYSTEM (less tape recorder) mounted in standard cabinet (panels 19 inches wide, chassis 16 inches deep).

For complete description and specifications, ask for Bulletin S-2856-E.

ELECTRONIC ENGINEERS AND PHYSICISTS

Interesting and challenging work in systems and related projects offers unusual employment opportunity at EECO. Send a resume of your qualifications to the attention of R. F. Lander.

This EECO system provides a means of identifying information as it is recorded on magnetic tape, and of making a rapid search of the recording afterwards for purposes of selective playback, editing, dubbing, erasure, or other treatment. A full two-hour tape recording may be searched from end to end in approximately 57 seconds. Because a one-per-second signal and continuous signal (carrier) on the tape are used to synchronize decoding operation, variations in tape speed during search do not cause errors. During recording operation, time signal can be shifted to nearest 1/100th second to synchronize with standard time transmissions. After initial synchronization, drift is less than one second in 30 days.

The system consists of five basic units: A Code Generator and Power Supply used in the recording operation; a Time Display, Time Selector, and second Power Supply used in the playback operation. The configuration of equipment is entirely flexible, depending upon the desired application. The entire system may be assembled at one location, as illustrated, or the recording and playback functions may be separated for use with different tape machines.

Operates with any tape recorder meeting these primary requirements:

1. Two or more tracks, one for the time code.
2. Provision for remote control.
3. Capability of playback at fast forward and rewind speed.
4. Bandpass adequate to reproduce the time code faithfully at any tape speed encountered during search operation.



Electronic Engineering Company of California

180 SOUTH ALVARADO STREET • • • LOS ANGELES • 57 • CALIFORNIA

We perfected the highest quality capacitor, for military uses!

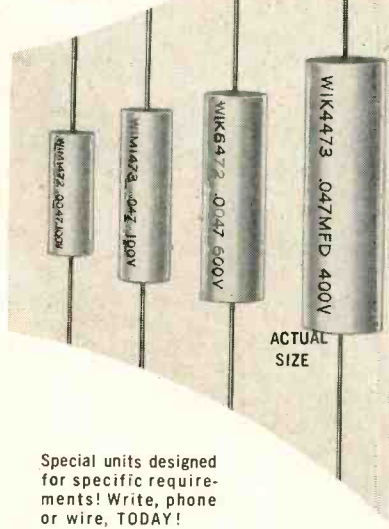

Special units designed for specific requirements! Write, phone or wire, TODAY!

Send for Literature!



NOW this renowned engineering quality experience is offered in the

NEW

CO-THERM[®]
HIGH TEMPERATURE
CAPACITORS
FOR INDUSTRIAL USES!

Highest quality paper and foil sub-miniature capacitors, encased in highly dense Steatite tube. Outstanding for TV, radio and other compact circuitry requirements. No voltage derating necessary over temperature range of -55°C to $+125^{\circ}\text{C}$. Noted for exceptional capacitance stability. Also available in new plastic film dielectrics. Co-Therm capacitors in all standard values and tolerances. Prompt delivery!

ACTUAL
SIZE

12900 Foothill Blvd.

San Fernando, Calif. • EMPIRE 1-8693

Offices in Washington, D.C. and San Francisco

I Bought My Wife a Sports Car with the **EXTRA MONEY**



I earned in Mobile-Radio Maintenance!

Sure, an engineer's pay is good—but mine just wouldn't stretch far enough to give my family all the nice things they deserve. So in my spare time I'm servicing commercial mobile-radios in my home town. And I'm mighty proud to think of my wife driving that new Thunderbird!

This can be your story, too. Send coupons for your free copy of "HOW TO MAKE MONEY IN MOBILE-RADIO MAINTENANCE." Published by Lampkin Laboratories, Inc., manufacturers of the 105-B Micrometer Frequency Meter & 205-A FM Modulation meter. Easy monthly payment plan available!



105-B

205-A

LAMPKIN LABORATORIES, INC.
Instruments Div., Bradenton, Fla.

At no obligation to me please send "HOW TO MAKE MONEY IN MOBILE-RADIO MAINTENANCE."

Name _____

Address _____

City _____ State _____

Designed for Aircraft, Industrial and Scientific Instrumentation



Beattie **VARITRON**
Electric Camera - Model D

- Radar Scope recording
- Oscilloscope recording
- Panel instrumentation
- Aerial spotting
- Security surveillance
- Personnel survey
- Identification
- Manometer panel recording
- Test surveillance
- Inspection records

Here is the versatile data recording camera that saves you time and labor, and gives you a permanent, accurate record. Rugged construction... interchangeable lenses... available in different camera body lengths for special applications.

Write for complete detailed literature today.

Photographic
Products Inc.

1000 North Olive St. • Anaheim, California

as project engineer and became factory manager in 1945.

Joining Kollsman in 1939, Frank Dupre, the new manager of manufacturing, was superintendent of the assembly department for the past thirteen years.

William McGurn is promoted from assistant superintendent to superintendent of the assembly department. He joined Kollsman in 1940.

The firm employs about 4,600 people. New facilities in Syosset, N. Y., provide the firm with an additional 160,000 sq ft of plant space for its production of precision navigation and flight instruments.

Hall-Scott Adds Roesch Division

HALL-SCOTT, is integrating the operations of its subsidiary, Douglas Roesch, into its electronics plant at Burbank, Calif.

Douglas Roesch, acquired by Hall-Scott earlier this year, is to be known as the Douglas Roesch cable division of Hall-Scott. Orville W. Nickel will continue to head the division and all key Roesch personnel are being retained.

Norden-Ketay Expands Plant

NORDEN-KETAY CORP. has signed a lease for a new plant to be built as an extension to the Commack, L. I. plant of the precision components division. The new plant will have 31,000 sq ft for manufacturing and engineering activities and will increase the operations to over 85,000 sq ft. The precision components division produces servo mechanism components for aircraft, missiles and automation. General manager of the precision components division is Bernard Levine.

Varian Moves Carnahan To New Post

C. WESLEY CARNAHAN, vice-president and general manager of Varian of Canada Ltd., is now serving as technical assistant to H. Myrl Stearns, executive vice-president and general manager of Varian Associates. He continues as vice-presi-

McGraw-Hill MAILING LISTS WILL HELP YOU

- Merchandise your advertising
- Conduct Surveys
- Get leads for your salesmen
- Get inquiries about your product or service
- Pin-point geographical or functional groups
- Sell Direct
- Build up weak territories
- Aid Dealer Relations

Direct Mail is a necessary supplement to a well rounded Business Paper Advertising program.

600,000 actual names of the top buying influences in all the fields covered by the McGraw-Hill publications make up our 150 mailing lists. These lists are built and maintained primarily for our own use, but they are available to you for Direct Mail purposes. Pick out a list of YOUR prospect from our Industrial Direct Mail Catalogue.

More and more, progressive companies are using Industrial Direct Mail regularly as an advertising medium. They effectively allocate a portion of their concentrate on the best business publication.

For complete, detailed information about our service, fill in the coupon or write for your copy of our free Business and Industrial Direct Mail catalogue.

for Results



McGraw-Hill
DIRECT MAIL LIST SERVICE

Direct Mail Division,
McGraw-Hill Publishing Co., Inc.
330 West 42nd St., N. Y. 36, N. Y.

Please forward my free copy of the McGraw-Hill "Industrial Direct Mail Catalogue."

Name _____
Company _____
Address _____
City _____ State _____

Want more information? Use post card on last page.
ELECTRONICS — February 1, 1957

dent of Varian in Canada.

Carnahan joined the firm in 1953, as an applications engineer specializing in guided missiles after 5 years as electronics research manager for Sandia Corporation in Albuquerque. He previously served in research capacities with Farnsworth, Sylvania, Zenith and Submarine Signal Co.

Nader Appoints Chief Engineer



Leon F. Edelson

NADER MFG. Co. of Monrovia, Calif., appointed Leon F. Edelson as chief engineer. He will be responsible for research and development on all semi-conductor applications.

He was formerly with the Jet Propulsion Laboratory, Pasadena, for 3 years as a research engineer transistorizing guided missile circuits.

Former chief engineer of the firm, Robert T. Schultz, is now general manager. Nader manufactures transistorized power supplies and transistorized digital counters, and develops semi-conductor applications. The plant was recently expanded to 10,000 sq ft.

Stromberg Division Adds Space

A FOURTH building in the West Los Angeles area has been leased by Electronic Control Systems, an affiliate of the Stromberg-Carlson division of General Dynamics Corp. The division makes Digimatic systems for the numerical control of machine tools, and other electronic equipment.

direct measurements on TRANSISTORS!

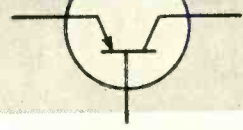

... using MEASUREMENTS' STANDARD TEST SET for Transistors

Model 505



- Provides rapid "go-no go" transistor testing — important for quality control, production, engineering groups.
- Useful for comparison of incoming or untested transistors with a reference transistor which meets device specifications.
- Extremely flexible — utility and type of measurement can be established by use of auxiliary equipment — makes all measurements.
- Other parameters are measured by connecting external test equipment to applicable jacks and terminals on front panel.

Measurements' Model 505 Standard Test Set for Transistors is a self-contained, battery-powered instrument designed for rapid d-c measurement of important junction transistor parameters. Permits multiple testing of PNP and NPN small-signal, medium-power, and switching (computer) transistors.

SPECIFICATIONS

DIRECT MEASUREMENTS: Makes fundamental d-c measurements on small-signal, medium-power, and switching transistors operating in the common-emitter configuration.

Measures collector-to-emitter leakage current from 0 to 10 ma; measures collector current from 0 to 10 ma.

Measures direct current gain (d-c Beta) or "incremental current gain" from 0 to 200, or as calibrated. Indicates G_m from 0 to 0.39 mhos.

AUXILIARY MEASUREMENTS: External test equipment can be used for measurement of other parameters and switching transistor characteristics for selected values of operating biases.

POWER SUPPLY: Collector supply voltages of 6 and 12 volts from internal batteries, or from suitable external power supply.

Laboratory Standards



MEASUREMENTS CORPORATION
BOONTON • NEW JERSEY

Want more information? Use post card on last page.

HIGHER EFFICIENCY H-F POWER TRANSFORMERS

THIS IS A TYPICAL FERROXCUBE
MAGNETIC CORE DESIGN

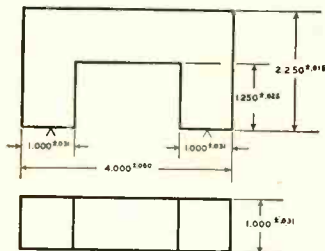

Smaller, lighter and less costly H-F power transformers of outstanding efficiency are being designed around Ferroxcube magnetic cores. The unique advantages of Ferroxcube are particularly marked in transformers required to handle up to 2 kilowatts of power in the frequency range from 2 kilocycles to 2 megacycles.

Ferroxcube-cored transformers are being used successfully in applications as diverse as ultrasonic power generators and rectifier power packs operating from an aircraft's normal a-c supply. In the latter application, the low leakage field of Ferroxcube eliminates the need for external shielding—for further reduction in transformer size and weight.

Ferroxcube cores are designed and produced to specifications. Our engineering department offers a complete, prompt service to assist in the design of Ferroxcube cores for specific applications. Your inquiry will receive immediate attention.

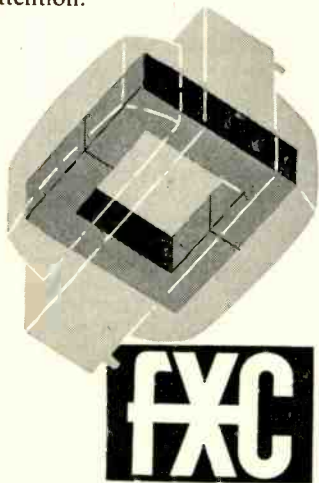

FERROXCUBE CORPORATION OF AMERICA

A Joint Affiliate of Sprague Electric Co. and Philips Industries
Managed by Sprague

35 EAST BRIDGE STREET • SAUGERTIES, NEW YORK

Want more information? Use post card on last page.

New Books

Circuit Theory and Design

By J. L. STEWART

John Wiley and Sons Inc., New York, 1956, 474 p. \$9.50.

WITHIN the past decade, the classical steady-state RLC circuit theory has become but a chapter of a much broader theory which includes the theory of active circuits and other types of linear systems. The text under review clearly reflects this fact. Unlike the more conventional texts on circuit theory, it ventures into the design of servomechanisms, feedback amplifiers and even oscillators. In addition, it contains a good deal of material on modern network theory which is not included in older texts.

► **Introductory Material**—The first three chapters of the book are introductory in nature. Chapter 1 is given over to a review of elementary circuit analysis and covers rather briefly the setting up of loop and node equations, basic circuit theorems, and the notions of duality and reciprocity. The concept of complex frequency is introduced in Chapter 2, following which some of the basic properties of functions of a complex variable are established. In Chapter 3 the material of the preceding chapter is applied to network functions and, in addition, an abbreviated exposition of the Laplace and Heaviside methods is presented.

► **Network Synthesis**—The introductory chapters are followed by: a chapter on elementary synthesis procedures; a chapter on approximation in the frequency domain, with emphasis on the approximation to ideal low-pass and pure-delay type of characteristics; a chapter on some of the more modern methods of synthesis such as the Darlington method. In the space allotted to this chapter (30 pages), the author can hardly be expected to treat the vast subject of network synthesis in any degree of detail. Of necessity his exposition of synthesis techniques is sketchy and, in places, quite inadequate.

► **Amplifiers**—The remainder of

the text deals in the main with the design of electronic circuits, particularly low-pass and band-pass amplifiers. In addition, the design of feedback amplifiers is touched upon and a brief discussion of servomechanism functions is included.

Despite the very considerable effort which has gone into the writing of this book, the result has some negative features. Thus, the author's exposition is somewhat lacking in depth and not infrequently is marred by minor inaccuracies, ambiguities and excessive sketchiness. On the positive side, the text presents much information which heretofore has not been readily accessible. On balance, it is a welcome addition to the literature of network theory.—L. A. ZADEH, *Columbia University, New York 27, N. Y.*

Automatic Digital Computers

By M. V. WILKES.

John Wiley & Sons, Inc., New York, 1956, 305 p. \$7.00.

IN the opinion of this reviewer, this book is the most noteworthy attempt to date to cover the fundamentals of large-scale digital computer design and use. The emphasis in this volume is on logical design, programming and some of the practical problems concerning the efficient use of computers; electronic circuit techniques are mentioned only briefly and qualitatively. Although most of the material in this volume can be found in various journals, the book is of particular value in that it presents an overall integrated picture to the reader.

► **History**—The first chapter presents a fairly extensive history of the development of digital computers up to about the year 1949. Later machines such as the IBM 701 and the Remington Rand UNIVAC receive only superficial coverage at various points throughout

Johnson FIXED or VARIABLE INDUCTORS

FOR ...

- Commercial and Military Transmitters
- Electronic Heating Equipment
- Electronic Medical Devices

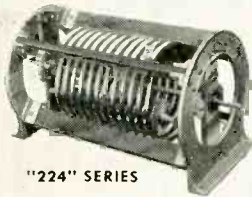

"224" SERIES

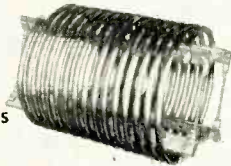

"202" SERIES

Wondering about an inductor for high power RF equipment? Your best choice is a standard inductor made by Johnson, pioneer manufacturer in the commercial inductor field. Johnson builds a complete line of heavy duty RF components, unmatched for choice of types and sizes. Inductors are available in both fixed and variable units, wire-wound, edgewise-wound and tubing-wound for high or low power applications.

For detailed information on Johnson's complete RF component line, write today for your free copy of catalog 535!



the remainder of the text. Of course, any criticism of this nature must be viewed in the light of the tremendous task of writing a book on such a rapidly expanding subject as digital computers.

For the newcomer to the field, the book has much to offer. The chapters which are concerned with logical design, storage and electronic-switching and computing circuits are thorough, well-written and contain many important practical considerations which obviously have resulted from the author's close contact with these aspects of computer development.

The failure to mention some of the more modern techniques for minimization and general manipulation of Boolean algebra expressions, such as the map method of Karnaugh, is regrettable. Also disappointing is the omission of important new techniques developed from replacing static flip-flop circuits with dynamic one-bit storage circuits, such as those used in the National Bureau of Standards' SEAC and DYSEAC and the International Business Machines' NORC.

► **Programming**—A detailed introduction to the principles of programming is one of the outstanding features of the work. Subjects such as the use of subroutines, floating addresses, and the use of multiaddress codes are covered thoroughly enough so that the engineer can evaluate his work from the viewpoint of the programmer after having read and understood these sections. Again from the engineer's viewpoint, study of this section on programming will allow him to venture into the very important field of diagnostic programming, and therefore, help him to bridge the gap between the builder and the user of digital computers.

For the engineer who has no profound interest in programming techniques, but who has had some computer design or development experience (and therefore presumably has been exposed to the copious literature covering logical design, storage systems and switching circuitry), the last chapter of

Johnson INDUSTRIAL & BROADCAST RF COMPONENTS

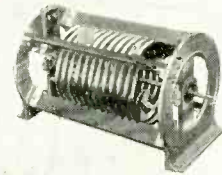
High Power
Fixed and
Variable
Inductors

Pioneers in the commercial inductor field, Johnson's complete inductor line contains small wire-wound units for low power stages as well as large, high power copper tubing models. This wide line offers you an unmatched choice of types and sizes: fixed or variable units, wire-wound, edgewise-wound or tubing-wound for high or low power applications.

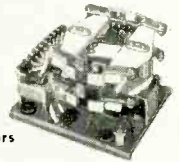

RF Contactors

Designed for high voltage RF switching—suitable for many other applications. Fast action—rugged and compact. Two sizes: 17 KV and 22 KV peak. Current: 25 amps per contact, no holding current required. Mounts in any position.

Tower
Lighting
Filters

Low impedance to 60 cycle current—high impedance to RF. Antenna radiation resistance changed less than 1% to comply with FCC regulations. Also serves as a static drain device when used with grounded AC circuits. Three windings rated 10 amps each at 60 cycles—impedance 0.3 ohms. Available for panel mounting or in weather-proof cabinet.

For detailed information on Johnson's complete RF component line, write today for your free copy of catalog 535!



E. F. Johnson Company

2311 Second Ave. S.W. • Waseca, Minn.

E. F. Johnson Company

2310 Second Ave. S.W. • Waseca, Minn.

MINIATURE ELECTRONIC INSTRUMENTS



Millivolts . . . microamperes . . . ohms
 . . . phase angle . . . From 8 standard
 shapes and sizes and 65 stock models,
 hundreds of special instruments have
 been delivered to meet exact customer
 requirements. Write for complete catalog.

Dept. E 2

• *Quality*

specially
 designed
 for
PANEL MOUNTING
 by
trio

• *Reliability*

trio LABORATORIES, INC.

4025 merrick road • seaford, new york

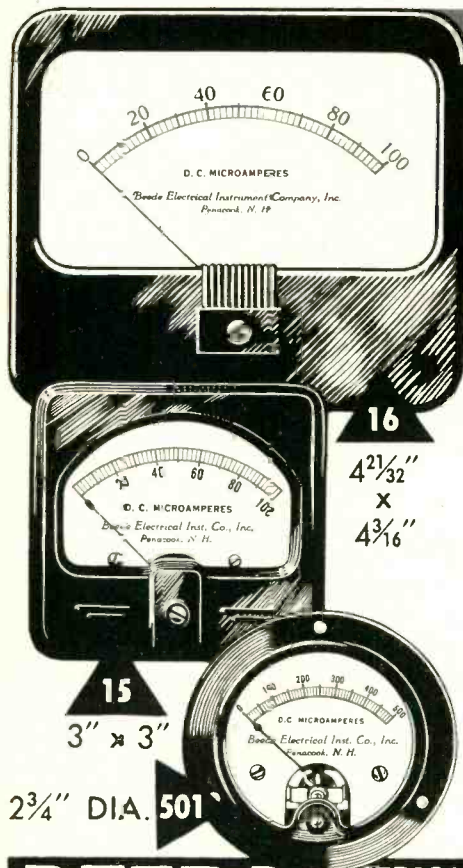

16
 $4\frac{21}{32}$ "
 X
 $4\frac{3}{16}$ "

15
 3" X 3"

2 $\frac{3}{4}$ " DIA. 501

BEEDE



ELECTRIC METERS

FOR SMALL POWER-UNIT PANELS
 INDUSTRIAL TEST UNITS
 COMMUNICATION EQUIPMENT
 AND MANY OTHER USES

ACCURATE TO THE DOT!

CATALOG ON REQUEST

BEEDE ELECTRICAL INSTRUMENT CO., INC.
PENACOOK, N. H.

the book entitled "The Design and Operation of Digital Computers" should be of more than routine interest. The subject of the relationship of the logical design of a computer to its efficient use from the points of view of the programmer, the maintenance engineer, the designer and the computing bureau administrator, is handled admirably. Controversial subjects among computer people, such as the use of error-detecting circuits, marginal checking, physical design, choice of order code and the organization of a scientific computer center, receive a very objective analysis from the author in this section.

This book will undoubtedly be useful as a text for courses introducing the subject of digital computers to electrical engineering students; the need for a text in this field has certainly been very great.—D. E. ROSENHEIM, *IBM Watson Laboratory at Columbia University, New York, N. Y.*

Kristallogen Technik

By R. Rost, Dr.-Ing, and H. M. ERNST.
Wilhelm Ernst & Sohn, Berlin, 1956, 439 p.

THIS book is the second and greatly-enlarged edition of "Kristallogen Technik", which first appeared in 1954. The word Kristallogen has been coined from the Greek root *ode*, meaning path, and is a broad term that the author applies to any device that bases its operation on the semiconducting properties of a crystal.

The first few chapters contain a brief discussion of semiconductors and the physical-electronic principles of germanium and silicon diodes and transistors. Several chapters are devoted to the manufacture of germanium and silicon diodes and transistors. In succeeding chapters, the application of transistors and diodes are discussed and representative circuits are presented.

► **Material Sources** — The book leans heavily on the pioneering work and advancements in the state

of the art that have been presented in the American literature and by American industry.

The final chapters present characteristics data of typical germanium and silicon diodes and transistors currently manufactured by German industry.

Since the book is in German, it will have a rather limited appeal to the reader of *ELECTRONICS*, especially since several good books in English are already available. For those concerned with the state of the germanium and silicon diode and transistor art in Germany, or for those who have to refer to characteristics of German diodes and transistors, the book will be of value.—HORST A. POEHLER, *General Precision Lab., Inc., Pleasantville, N. Y.*

Electrical Circuits: Direct And Alternating Current

BY CHARLES S. SISKIND

McGraw-Hill Book Co. Inc., New York, 1956, 516p, \$6.75.

THE prime purpose, particular approach and broad scope of this excellently written two-semester text are, perhaps, best stated in the author's own words: "The circuit is the basis of all energy conversions and transformations associated with electrical equipment: it is logical, therefore, to precede the study of electrical machines and systems by a first course that thoroughly prepares the student to deal effectively with electric, magnetic and dielectric circuits.

► **Purpose**—"In organizing and developing the subject matter in this book [for such purpose] the author has endeavored to build a foundation of circuit principles that is both rigorous and consistent with good engineering practice. The wide range of topics is divided into two major sections: Part I deals with circuits in direct-current systems, while Part II builds upon the former and is concerned with alternating-current systems. Much emphasis is placed on similarities and differences between circuits that

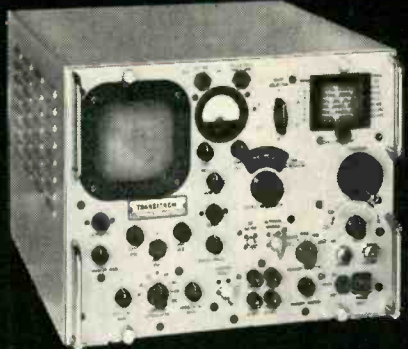

Model SG-132

PRECISION VHF-UHF SWEEP GENERATOR

Combines all the essential features of a Standard CW and AM Signal Generator and a Wide Band Sweep Generator of unusual characteristics.

OUTSTANDING FEATURES

- Center frequency range — 15 to 400 mc, fundamental
- FM deviation 1 to 40% at any center frequency
- Internal crystal markers accurate to $\pm 0.01\%$
- Dial accuracy 0.01% crystal corrected; 0.5% nominal
- Calibrated output ± 1 db; 0.1 to 150,000 μ V
- Integral D.C. coupled Oscilloscope
- Power output variation ± 0.25 db

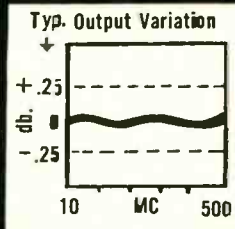

TRANSITRON, INC.

186 GRANITE ST., MANCHESTER, N.H.
Subsidiary of Van Norman Industries Inc.



Model T-4

HIGH VOLTAGE INSULATION TESTER

A precision instrument designed for insulation leakage resistance measurements and non-destructive breakdown tests on motor windings, ignition systems, wiring harnesses, insulators, connectors, electrical and electronic components, etc.

OUTSTANDING FEATURES

- 1 to 15 KVDC, continuously adjustable
- All meters protected against overload
- Measures actual leakage current
- 115 VAC; 6, 12 or 24 VDC Input
- Makes measurements rapidly; no capacity errors

POSITIONS AVAILABLE FOR QUALIFIED ENGINEERS

YOKE

SPECIALISTS

COMPLETE LINE for every Military and Special purpose.



- Yokes for 7/8", 1-1/8", 1-1/2", 2-1/8" neck diameter CR tubes.
- Rotating and fixed coil designs.
- Core material to suit your requirements.

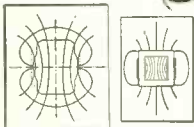

Series aiding field and parallel (bucking) field designs.

Special test instruments can establish your yoke deflection parameters to an accuracy of $\pm 0.1\%$.

Consult Dr. Henry Marcy or Bernard Cahill on your new applications today.

Phone: Terrace 4-6103

170 Industrial Road • Addison, Ill.

Syntronic
INSTRUMENTS, INC.

NEW BOOKS

(continued)

are energized by direct current and by alternating current and on relationships that involve combinations of electric, magnetic and dielectric circuits."

► **Contents**—The disposition, relative emphasis and essential scope of content directed to these just-stated ends may be summarized as follows: Part I comprises a concise outline of the basic concepts of charge, current, electromotive force, resistance and of their mutual interrelationships; calculation of the resistance of cylindrical conductors, including dependence on temperature and resistivity; interrelation of power and energy and calculation of equivalent resistance of various regular combinations of conductors; a good account of Kirchoff's laws, the superposition and maximum-power-transfer theorems, Thevenin's Theorem, Δ -Y and Y- Δ transformations; basic concepts and calculation of flux density at points in the fields produced by solenoids and rectilinear conductors; calculation of fluxes and magnetomotive forces pertinent to the magnetic-material and air-gaps of multibranch magnetic cores; principles of operation, details of construction and some application of more commonly used d-c instruments and measuring devices; concepts of self and mutual inductance, principles of self and mutual induction, calculation of equivalent inductance, current transients in R-L circuits; concept of capacitance, calculation of equivalent capacitance, current transients in R-C circuits.

Part II comprises basic aspects of generation and calculation of sinusoidal voltages and currents; basic relationships in various circuits comprised of R, L and C parameters; complex-number computation and calculation of equivalent impedances; a detailed account of the principal phenomena of resonance in series and parallel circuit configurations; graphical delineation of voltages, currents and impedances in simple circuits with a variable parameter; the a-c counterparts of the d-c theorems and laws treated in Part I; calculation of current and voltages in coupled circuits with emphasis on the air-

See our Complete Display at the IRE Show

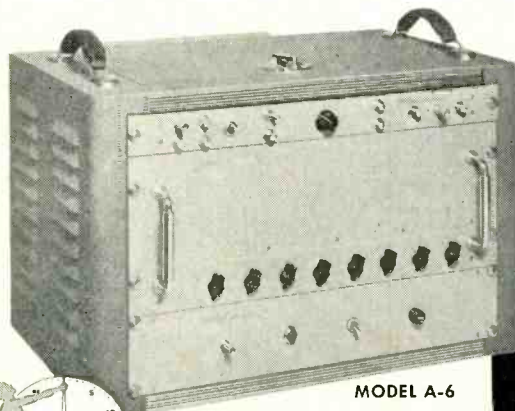

MODEL A-6

Rutherford

presents a
LOW JITTER

**DIGITAL
TIME DELAY
GENERATOR**



- Provides accurate and variable delays from 1 μ s to 100 seconds in steps of 1 μ s.
- Available also are units with maximum delay ranges of 1,000 μ s, 10,000 μ s, 100,000 μ s, 1 second or 10 seconds.
- Optionally available: jitter-reducing circuit permits low-jitter operation (.04 μ s) with random triggering.

Write for complete data on our DIGITAL Time Delay Generators: Bulletin E-A-6

For our ANALOG Time Delay Generator data, ask for:

Model A-2 (1 μ s to 100,000 μ s): Bulletin E-A-2

Model A-4 (.00001 to 10 secs): Bulletin E-A-4

Rutherford **ELECTRONICS CO.** Telephone: TEXAS 0-4362
3707 S. ROBERTSON BLVD.
CULVER CITY, CALIFORNIA

Tough Heyco Nylon STRAIN RELIEF BUSHINGS

Insulate and anchor the
power supply cord to
your housing . . .

no need for grommets,
wire knots or costly
labor.

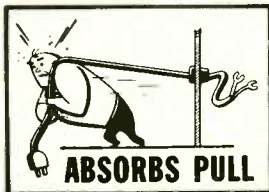

Send for samples to fit your wire, today!

**HEYMAN
MANUFACTURING COMPANY**
KENILWORTH 2, NEW JERSEY

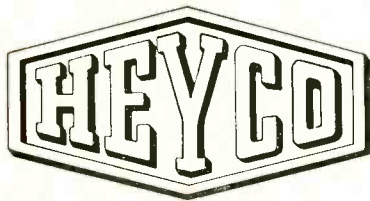

**HEY MAN!
... SAY HEYMAN**

Want more information? Use post card on last page.
ELECTRONICS — February 1, 1957

NEW BOOKS

(continued)

core transformer and kindred devices; principles of operation, details of construction and applications of a selection of commonly-used instruments and measuring devices; a detailed account of calculation of voltage current and power in balanced and unbalanced three-phase circuits; a concise introduction to analytic and graphic determination of Fourier series representation of nonsinusoidal voltages and currents and power calculations therewith.

A subsequent appendix comprises derivation of certain equations merely stated in the context.

► **Features**—A careful reading revealed many admirable features, excellent physical details, accurate statement of theory, clear explanation of details of procedure and a systematic presentation of numerical computation. A wealth of auxiliary supporting detail includes a large number of fully worked-out at the end of each chapter a detailed set of questions provides an outline of the essential points covered in the chapter. An accompanying set of problems are sufficiently varied in scope to exemplify all the theory of the chapter and sufficiently great in a number to enable ample variation in assignments from year to year.

► **Practical Aspects** — A special and well-fulfilled effort of the author is to inculcate a practical bent to the text by providing: illustrations that are “counterparts of practical systems, devices and machines”; illustrative examples and problems that “correspond to existing electrical systems”; a treatment of the whole that “provides a realistic approach to courses in circuits and machines that are more advanced in character” and, finally, a stress of basic aspects of circuit theory, rather than special phases, so as to “provide the necessary background material for the study of most branches of electrical engineering”.

These last-named merits, and the particular aspects noted above, yield a well-integrated, accurately-written and excellently supported

NEW
magnetically
-controlled
**COUNTER
-DIVIDER**

Magnivider



Using a “ladle-bucket” principle, magnetic cores in the unique Magnivider circuit set a new high of reliability and ruggedness wherever counting, scaling or frequency division is required.

Self-contained Magnivider plug-ins are ideal for your new equipment designs. Compared to conventional four-tube counters, one-tube Magnividars offer

- one-third the size
- 50% less power drain
- twice the reliability
- compatible scales of 9-10-11
- counting rates from 0 to 50 Kc.
- both low and high impedance outputs
- direct cascading without buffers

Magnividars have a wide range of applications

- Random counting
- Preset counting
- Cycle counting
- Frequency division
- Timing chains
- Synchronizing circuits
- Accumulators

Write for our Technical Bulletin 145 to obtain complete information and specifications.

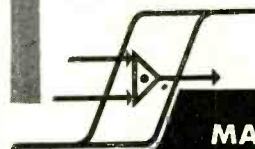

Dept. Dept. 103

**MAGNETICS
RESEARCH
COMPANY**

255 GROVE STREET
WHITE PLAINS, N. Y.

Want more information? Use post card on last page.

Dress Up Your Products

with these

NEW KNOBS

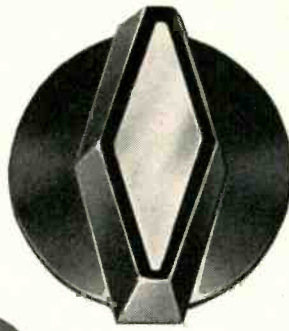
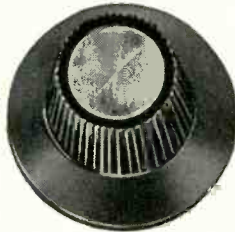

Designed by
Robert Podall

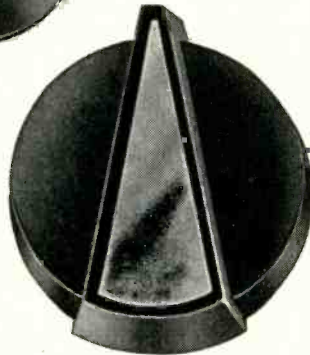

These new knobs feature decorative metal inserts, in a choice of chrome, copper, satin brass and gold. Available in a variety of thermosetting materials, both phenolic and urea. Send for details.

ROGAN BROTHERS

8031 N. Monticello Ave., Skokie, Illinois

text of such considerable values that the reviewer warmly recommends it to the teacher in a technical institute who seeks a textbook for a two-term course in basic electric circuit analysis; to the teacher in an engineering school who would use this book for a course in circuit analysis for non-electrical engineering students; and—most highly—to the technician or engineer in practice who wishes to gain, or renew, a basic knowledge of electric circuit analysis through self-study.—THOMAS J. HIGGINS, *Professor of Electrical Engineering, University of Wisconsin, Madison, Wisconsin.*

Transistors Handbook

By WILLIAM D. BEVITT
Prentice-Hall inc., New Jersey, 1956,
390 p., \$9.00.

A HANDBOOK is a compact volume containing the essentials of a subject. It is a reference book which surveys a field and serves as a guide in the pursuit of further investigation of the subject or any portion of it. With the above definition in mind, the "Transistor Handbook" has a limited claim to the title of handbook.

► **Subject Division** — The author, attempting to review the entire field of transistor electronic circuits, has divided his book in two. The first half covers device characteristics and their measurements and transistors as circuit elements and their behavior. The second half covers applied circuitry. Highlights of most of the classic papers on transistor circuits and applications written between 1948 and 1953 are presented. A good bibliography is at the end of each chapter.

Many examples of the state of the art of circuit development to 1953 are given. Here the author emphasizes completed circuits rather than the methods used to design them. The reader must go to the source material to determine the considerations in the circuit design. The text intentionally avoids the physics associated with tran-

GATES Sta-level



In the progress towards automation, the Gates "Sta-Level" offers broadcasters a highly efficient average level amplifier that relieves the operator of most gain riding. Rated at 1% or less distortion at 30 Db. compression at +20 Db. output threshold level. — "Sta-Level" is 100% self-contained including regulated power supply and drop down to service front panel. Rack size only 5 1/2" x 19". — All Gates products include tubes in the selling price. "Sta-Level" complete only \$235.00.

GATES RADIO COMPANY, Quincy, Ill., U. S. A.

MANUFACTURING ENGINEERS SINCE 1922

TELEX TAKES PLEASURE

... in presenting L. H. Josefson, new Sales Manager of our Electro-Acoustics Division, a post he assumes after varied experience in other divisions of the Telex organization.



L. H. JOSEFSON

Formerly manager of research for Superior Separator Co., and a member of the product development staff for General Mills' Mechanical Division. Josefson has wide product development and marketing experience. He is a graduate of the University of Minnesota.

Mr. Josefson is thoroughly familiar with our design, production, engineering and marketing facilities. Right at your desk he'll discuss your problems in component and assembly miniaturization, and can suggest some ingenious techniques in shrinking the dimensions of design—as well as wide know-how in encapsulation. "Joe" Josefson will be calling on you soon. If you'd like an early visit, just drop us a line, or wire, and we'll make immediate arrangements.

TELEX



ELECTRO-ACOUSTICS DIVISION

TELEX PARK

ST. PAUL 1, MINN.

DANO COILS

BUILD

Customer Confidence

From making the most precision coils required in electronically operated relays, timers, switches and devices to meeting most exact specifications of coils for high temperature application—*Dano Coils Build Confidence.*

- Encapsulated coils . . . in either polyester or epoxy resins.
- Coils for high temperature applications.
- Bobbins coils.
- Paper section coils.
- Cotton interweave coils.

TRANSFORMERS MADE TO ORDER



Want more information? Use post card on last page.
ELECTRONICS — February 1, 1957

sistor devices, as well the mathematics of transistor circuits.

In the fast-moving field of transistor electronics, the task of presenting typical characteristics and circuits is most difficult. In this respect many of the circuits illustrated are already obsolete and some of the transistors shown are no longer produced.

The presentation of device characteristics and their behavior, which are fairly stable, could have been extended to increase the value of the text as a handbook; for example: a generalized equivalent circuit with its various frequency band approximations; interrelation of α , h etc., transistor parameters; include surface barrier transistor, field effect transistor and double-based diode characteristics; solid state diodes.

Despite its limitations the book should be of interest and aid to those surveying the transistor field and some of its circuit problems and accomplishments. The experienced transistor circuit designer must wait for a handbook to help him solve his problems.—F. BRONSTEIN, *Design Engineering Dept., Ford Instrument Company, Long Island City, N. Y.*

Radio Handbook, 14th Edition

EDITED BY WILLIAM I. ORR.

Editors and Engineers Ltd., Summerland, Calif., 1956, 761 p., \$7.50.

THE 14th edition of the Radio Handbook is designed to provide a concise overall view of the radio segment of electronics and is slanted toward practical engineers, technicians, amateurs and radio men.

► **Contents**—The Handbook contains 32 chapters which run the gamut from basic circuit and tube concepts to design principals of receiving and transmitting equipment. Of particular interest today are the chapters dealing with semiconductors and single-sideband operation.

In the chapter on semiconductors the characteristic curves of transistors are drawn in the same way

Reliable Sensitive Relays

Now available for quick delivery



the electronics division of IRON FIREMAN

is now mass-producing its new 400 series sensitive relay. This new relay possesses high sensitivity and reliability even under extremely severe environmental conditions. Many leading manufacturers with prime military contracts for electronic systems are using these 400 series Iron Fireman sensitive relays.

A 60-page Certified Qualification Report*

showing compliance of this relay to military specifications is now in the hands of the Iron Fireman Electronics representatives listed here. They will be pleased to go over this report with you.

M. B. Gilbert Co.
6214 W. Manchester Ave.
Los Angeles 45, California

Jules J. Bressler Co.
4808 Bergenline Ave.
Union City, New Jersey

Massey Associates
529 Brookhurst Ave.
Narberth, Pennsylvania

Massey Associates
1 Thomas Circle N. W.
Washington, D. C.

Seatronics, Inc.
911 Western Ave.
Seattle 4, Washington

*Qualified to MIL-R-5757B.



Send today for "Sensitive Relay Data File" Contains specification sheets, operational charts, temperature conversion charts, and other helpful information.

IRON FIREMAN Sensitive Relays

2810 S. E. Ninth Avenue, Portland 2, Oregon
Want more information? Use post card on last page.

Hunting a Plant Site?

Get the right information

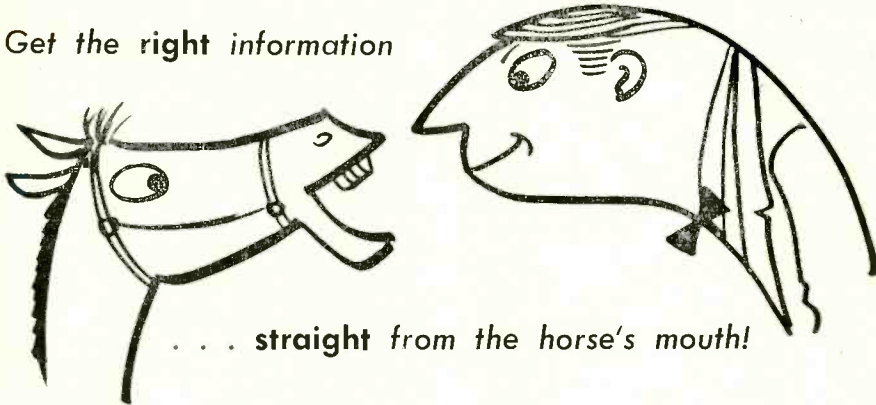

The Jacksonville Committee of One Hundred industrial staff members are old hands at this business of being really helpful to firms looking for plant sites. They can save you untold time

because they know the available locations like the inside of their hats. They can also save you plenty of money by keeping your business strictly in confidence.

JACKSONVILLE

FLORIDA . . . Where Your Secrets Are Kept!

The CITY OF JACKSONVILLE, Florida

Electric and Water Utilities

Phone, Wire or Write for The Jacksonville Story

THE COMMITTEE OF ONE HUNDRED

Jacksonville Chamber of Commerce

604 Hogan Street

Phone ELgin 3-6161 • Jacksonville, Florida

Little Mag Says:



**MAGNATRAN MEANS
RELIABILITY IN MAGNETIC
COMPONENTS. THAT'S WHY
IT IS USED IN WHITE ALICE
UHF SYSTEM**

reliability (ri/li/ə bil/i tē), quality of being reliable.
trustworthiness; dependability. n. 12.
reliable (ri/li/ə bəl), worthy of trust; that can be
depended on. Send for the book.

**WHITE ALICE EQUIPMENT
MUST BE RELIABLE →**

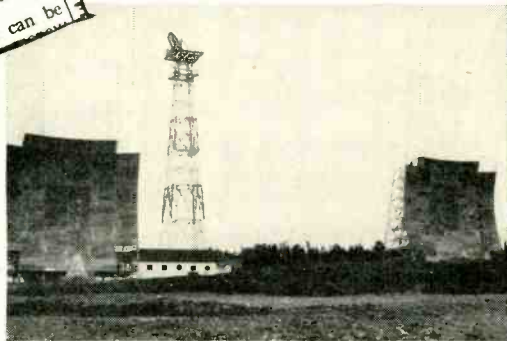

**Unitized Rectifiers® • Modulation Transformers •
Reactors • Filter Reactors • Filament Transformers
• Amplifiers • Rectifiers • Rectifier Plate Transformers.**



MAGNATRAN incorporated

P.O. Box 211 KEARNY, NEW JERSEY, U.S.A.

as those for vacuum tubes. While this may not be new, it does represent a deviation from the general practice and may prove to be a worthwhile change since quite often the method used hereofore could prove confusing to those used to working with vacuum tube characteristic curves.

► **SSB**—The chapter on single-sideband transmission covers the commercial aspects of ssb, deviation and generation of ssb signals as well as reception and adjustment of ssb. Complete information is also given on the construction of an 80-meter filter-exciter for ssb operation.

The handbook is easy to read and should be interesting to all those engaged in electronics whether they are specifically allied to the radio end of the business or not.—
JMK

Thumbnail Reviews

Hi-Fi From Microphone to Ear—Modern Sound-Recording and Reproduction Technique. By G. Slot, Philips Technical Library, Eindhoven, Holland, 1956, 169 p. \$2.75. Though intended for nontechnical audio enthusiasts, this book includes much in the way of important basic concepts, which are not found in this country's publications on the same subject, to interest the engineer hobbyist. May be ordered directly from publisher, with no charge for postage.

Rapid TV Repair. By Warren Heath, Gernsback Library, Inc., New York, 1956, 224 p, \$2.90 (paper). Reference guide for tv service technicians to aid rapid servicing of tv sets in the home. Troubles are listed alphabetically and cross-indexed.

An Introduction to Cybernetics. By W. Ross Ashby, John Wiley & Sons Inc., New York, 1956, 295 p, \$6.50. Principles of cybernetics for those without a background in electronics and with only an elementary knowledge of mathematics. Techniques and principles of modern electronics, as presented here, offer an invaluable aid to the biological scientist interested in a behavioristic approach to the understanding of such complex mechanisms as the human being and human societies.

Backtalk

Thank You

DEAR SIRs:

IT CERTAINLY isn't often that quantity and quality are found in the same publication, but your magazine *ELECTRONICS* has been consistently maintaining the combination. In addition to the very fine articles, the advertising adds much information and valuable reference material.

While I have only been subscribing since November 1955, my brother has been a subscriber for more than 10 years. Recently, he gave me issues that he has been keeping since 1950, and gradually I am getting them read.

Again I must say that your magazine is the best in the field and you can expect to get a renewal from me in the near future.

ROBERT A. RAY
Columbus, Ohio

F-M and PCM

DEAR SIRs:

IN his last article on noise (Part V, "Reducing Noise in Communications Systems," *ELECTRONICS* p 148, July, 1956), W. R. Bennett claimed that pulse-code modulation is the "most efficient" method for reducing noise in a communication system. The use of the term "most efficient" is somewhat dubious.

Undoubtedly, pulse-code modulation serves quite well for special applications such as teletype communications or the transmission of certain types of continuously-variable numerical data. But the implication that such a system is much superior to frequency modulation seems to be unjustified if no reservations are made.

From time to time people familiar with frequency modulation hear rumors to the effect that if the FCC had it to do over again, it would probably choose a broadcast system using pulse modulation rather than f-m. But, when all the pros and cons are considered, it seems very unlikely that such a

choice would have been a wise one.

In the first place, pulse-modulation systems require a much greater bandwidth than f-m. (Pulse-code modulation seems to be the worst offender, taking perhaps nine times the bandwidth needed in f-m) The larger bandwidth not only shows a poor economy of spectrum, but also allows more radio noise to get a chance to override the signal.

Secondly, through the use of properly designed receivers,* f-m is capable of suppressing radio interference which all but equals the amplitude of the desired signal. (Bennett and I seem to disagree on this point.) Since ordinary pulse modulation systems require that the received signal be at least twice the amplitude of the noise, this is a definite advantage for f-m. In particular, severe cochannel, adjacent-channel, and multipath interference can be dealt with more effectively in f-m than in ordinary pulse-modulation systems.

*REFERENCES

- (1) Arguimbau, L. B. and Granlund, J. "The Possibility of Transatlantic Transmission by Means of Frequency Modulation," International Radio Congress, Rome, Sept.-Oct. 1947.
- (2) Arguimbau, L. B. and Granlund, J. "The Possibility of Transatlantic Communication by Means of Frequency Modulation," *NEC Proc.*, Chicago, Nov. 1947.
- (3) Granlund, J. "Interference in Frequency-Modulation Reception," MIT Res. Lab. of Electronics: Technical Report No. 42 (Jan. 20, 1949).
- (4) Arguimbau, L. B. and Granlund, J., *ELECTRONICS*, Dec. 1949, p 101.
- (5) Arguimbau, L. B. "Frequency Modulation", *Jour. Madras Inst. Tech.*, Nov. 1953, p 153.
- (6) Baghdady, E. J. "Frequency-Modulation Interference Rejection with Narrow-Band Limiters," *Proc. IRE*, Jan. 1955, p 51.

BRUCE G. CRAMER
Harrisburg, Pennsylvania

DEAR MR. CRAMER:

RESPONSE to the articles on noise has been highly gratifying and I would like to express my thanks to you and others for taking the trouble to write letters about the subject.

I did not intend to claim unconditional superiority of pcm over all other transmission systems in combatting noise. Individual transmission problems require individual scrutiny and certainly there are cases where f-m, for example, is a more sensible choice. In fairness to pcm, however, I would like to add

another product ^{surprise} from Helipot!

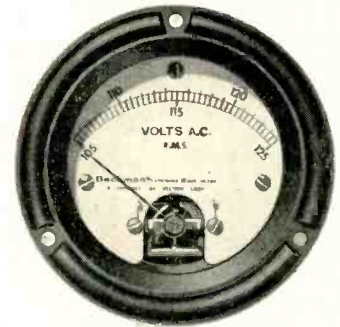

Beckman AC & DC Expanded Scale Voltmeters

What good's accuracy... if it takes a bug-eyed monster to detect it? That's why we've made our panel-mounting voltmeters as *readable* (by homo sap.) as they're *accurate* (as close as 0.3% of center-scale voltage). And we make 'em as small as 2 1/2" dia.

Logical question: Are you kidding? That size, with those features?

Enthusiastic answer: S'true! The trick's in the expanded scale. Conventional meters have all the numbers and increments... from zero to full-scale voltage... jammed in with a shoe horn. Not ours. We took the meat part of the scale, expanded it, and made it linear... eliminating the fat and gristle. Now there's room enough for all you need to read... and boy, is it easy! So easy, it would take a conventional meter 12 times larger to achieve the same readability. (Can you imagine the damping factor you'd need for a 2-foot needle?)



Q. Who are they for?

A. They're as great for groundlings as they're fine for flyboys. The AC voltmeters, incidentally, provide true rms readings.

Q. How many models?

A. We've got eight basic models in a variety of shapes, sizes, standard scales and accuracies... to suit your mood and installation.

Interested? Write for data file 241.

Beckman® Helipot
Corporation

Newport Beach, California
a division of Beckman Instruments, Inc.

Engineering representatives
in principal cities

890

Want more information? Use post card on last page.

Anywhere . . .
At sea, in the icy cold of the antarctic! S.S. WHITE Molded Resistors in values up to 50,000 megohms retain their characteristics.

in Any Weather
Airborne, in the steaming heat of the tropics! S.S. WHITE Molded Resistors are made of coated, non-hygroscopic material that resists moisture.

S.S. White
"ALL-WEATHER"
Molded Resistors
Withstand Temperature
and Humidity

FIXED RESISTANCE VALUES RANGE
FROM 1000 OHMS TO 10,000,000
MEGOHMS!

65X Molded Resistor — 1 watt
80X Molded Resistor — 3 watts

While bargain buys in resistors are wearing out and being replaced, durable S.S. WHITE "All-Weather" Molded Resistors are still giving top performance in hundreds of commercial, industrial and scientific applications.

Our resistors are characterized by low noise level . . . precision . . . stability . . . have negative temperature and voltage coefficients. Compact . . . excellent stability and mechanical strength . . . values do not deteriorate due to age.

We'll be glad to cooperate with you in applying these high-quality resistors to your product. For our Bulletin 5409, just drop a line to

S.S. White
INDUSTRIAL DIVISION
10 East 40th Street
New York 16, New York

Want more information? Use post card on last page.

a few reservations to your reservations.

With regard to your statement that pcm requires a greater bandwidth than f-m, it is important to keep in mind that the transmission quality within the band in the two cases may be quite different. You state that it is possible to suppress many kinds of interference with f-m even when the amplitude of the interference all but equals that of the desired signal. I agree that this may be feasible in single-hop systems provided that you do not mean absolute elimination, but only a sufficient reduction in amount of interference relative to signal to make the received signal quality acceptable.

One must distinguish here between single-hop applications and radio relay. Interference which produces a negligible effect in one hop may, when added to a number of like contributions from successive repeaters, become disastrous. The unique advantage of pcm is that it is able to exploit bandwidth of mediocre quality by regenerating the signal and thereby preventing accumulation of trouble.

Each link of a pcm relay can contain noise, interference and waveform distortion in any amount short of causing actual recognition errors. In an f-m relay, on the other hand, the output signal-to-noise ratio from the first link must be made considerably better than the requirements on the entire system since defects add from link to link.

A monograph by C. B. Feldman and myself deals with a number of these problems in more detail. There is no claim for an all-inclusive set of answers.

W. R. BENNETT
Bell Telephone Labs, Inc.
Murray Hill, N. J.

DEAR MR. BENNETT:

I WAS pleased to receive your reply to my letter regarding f-m and other modulation systems. Thank you also for the copy of the 106-page monograph by Feldman and yourself.

Since I am presently writing a magazine article, I can well appreciate the amount of work that must have gone into your series of five

**FOR FASTER WORK
MORE PERFECT WORK**

USE **Busch**



**CUTTING BURS &
MOUNTED STONES
FOR LIFETIME SERVICE**

Control the quality of your product with these high quality German Tungsten Vanadium Steel Burs. (Famous Since 1905) . . . They are sharper . . . keep keen edge longer. Over 1001 Shapes and Sizes . . . One to meet every need . . . every operation. Can be used on any flexible shaft machine or drill on plastics, metals, etc., also Reamers and Mounted Stones.

**SAVE MONEY IN YOUR
PLANT NOW**

Write today for FREE FOLDER
& Price List.

PFINGST & CO., INC.

(Exclusive U. S. Importers)
58 Cooper Square New York 3, N. Y.

high-vacuum
high-voltage
rectifier tubes

DUNLEE

also a complete line of
industrial x-ray tubes

DUNLEE CORPORATION
4560 West Congress Street
CHICAGO 24, ILLINOIS

Want more information? Use post card on last page.

articles. I have not yet had the time to read the first four, but an engineer friend of mine speaks quite highly of your work and tells me he has found these articles very informative.

In my letter to *ELECTRONICS* magazine it was my intention to be concerned only with broadcast systems rather than the more general approach which you used. In particular I first wanted to say a reassuring word about the advantages of f-m over various pulse modulation systems for the transmission of high-quality audio.

Secondly, I wanted to point out that the theoretical threshold for f-m quieting lies where the interference is 100 percent of the desired signal rather than 50 percent or less. Since the inception of f-m there has been a gross misunderstanding on this point which still seems to be widespread. As Argimbau and Granlund mentioned (reference 4 in my other letter), "this idea of a threshold perhaps arose from the difficulties of computing the interference from ratios near unity and from the fact that with heavy interference receivers depart from our idealized notions of what they should do."

Receiver Problem

On pages 90 and 91 of your monograph I notice that you consider the f-m interference due to an undesired signal which differs from the desired signal by a frequency equal to $(q - p)$. As you show, the output from an f-m broadcast receiver under this condition would be an infinite series of harmonic tones whose fundamental frequency would be $(q - p)$. If we consider only a small amount of interference the harmonics of $(q - p)$ can be neglected—only the fundamental remains important.

Many investigators in the past have found this mathematical expedient too tempting to pass up. When it was found that conventional receivers reacted poorly under 25 percent or more interference, the harmonics were blamed for it.

With new and surprisingly simple mathematical artillery, Granlund (reference 3) has shown that an

FREQUENCY-SHIFT V-F CARRIER-TELEGRAPH SYSTEM

Provides one, two, or three frequency-shift teletype channels above the voice on a 3400-cycle telephone circuit

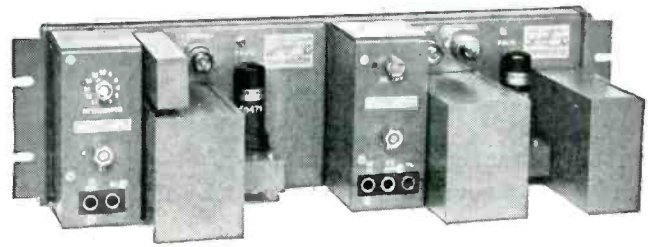

A send and a receive panel require 5/4" of mounting space on a standard 19" rack

This system provides an economical trouble-free method of obtaining up to three full-duplex 100 wpm telegraph channels at the upper end of a broad-band telephone channel, and still retain a 2950-cycle voice circuit. Mid-channel carrier frequencies of 3120, 3240 and 3360 cycles are employed. The mark frequencies are 30 cycles below and the space frequencies are 30 cycles above the mid-band frequencies. The three telegraph channels are transmitted in the band 3080 to 3400 cycles, leaving the band below 2950 cycles for the voice channel.

Fault-free teletype circuits are obtained,

even where the telephone circuit on which they are superimposed suffers from noise or abrupt level variations which may be so great as to render on-off keyed signals unintelligible. Frequency-shift signals do not suffer deterioration from non-linear transmission, such as is caused by overloading in voice-frequency, carrier or radio equipment. Under most circumstances a signal-to-noise ratio per channel as low as 20 db is satisfactory, and under some conditions even lower ratios result in fault-free operation. This equipment meets the requirements of current MIL specifications wherever applicable.

RADIO ENGINEERING PRODUCTS

1080 UNIVERSITY STREET, MONTREAL 3, CANADA

Telephone: UNiversity 6-6887

Cable Address: Radenpro, Montreal

MANUFACTURERS OF CARRIER-TELEGRAPH, CARRIER-TELEPHONE AND BROAD-BAND RADIO SYSTEMS

CONDENSER SPECIALISTS SINCE 1923

COSMIC CONDENSERS

ELECTROLYTIC & PAPER TUBULAR

For A.C., D.C. Sets - Radio, Television
Phonographs, etc.

COSMIC CONDENSER CO.
853 WHITTIER ST., BRONX, N. Y.
Phone: LUdlow 9-3360

STABILITY AND RELIABILITY

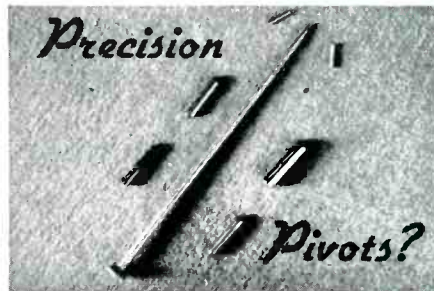

The "spike" in the center is a common pin. The others are VK precision pivots.

Call VK

Steel, chromium plated, or carbide precision pivots to .013" diameter. 1 RMS or finer surface finish. Diameter tolerance to .000010". Chamfers, radii, lapped ends, etc.

Also volume production lapping of flat or round production parts.

Send us your specifications.

The VAN KEUREN COMPANY
176-D WALTHAM ST. WATERTOWN, MASS.

ENGINEERS . . . SPECIFY *HOYT* FOR Accuracy Appearance • Economy

You get big advantages—optimum performance at minimum cost—when you specify HOYT Instruments incorporating more than 50 years' Manufacturing experience. HOYT offers you a complete Line of Panel and Portable Meters in a variety of sizes, ranges and cases . . . Milliammeters, Microammeters, Millivoltmeters, Ammeters, Voltmeters and others—Moving-Coil, Repulsion and Rectifier Types.

NEW SIZE! $3\frac{1}{2}$ inch square meter with clear polystyrene case. Details on request.

Take advantage of HOYT's lower costs. Write today for catalog and prices.

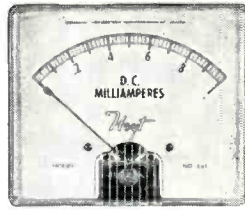

POLYSTYRENE CASES
ANTI-STATIC TREATED



BAKELITE CASES
ROUND & SQUARE



METAL CASES
FLUSH & SQUARE



HOYT ELECTRICAL INSTRUMENTS
Sales Div.: BURTON-ROGERS COMPANY
42 Carleton Street • Cambridge 42, Mass., U. S. A.

RIBBONS • STRIPS

of
★ PURE TUNGSTEN ★ THORIATED TUNGSTEN
★ MOLYBDENUM ★ SPECIAL ALLOYS

and OTHER METALS
IN

ULTRA THIN SIZES

to
TOLERANCES CLOSER THAN COMMERCIAL STANDARDS
by

OUR SPECIAL ROLLING TECHNIQUE

Note: for highly engineered applications—strips of TUNGSTEN
and some other metals can be supplied

ROLLED DOWN TO .0003 THICKNESS

- Finish: Roll Finish—Black or Cleaned
- Ribbons may be supplied in Mg. weights if required

For HIGHLY ENGINEERED APPLICATIONS

DEVELOPED AND MANUFACTURED BY

H. CROSS CO.

15 BEEKMAN ST., N. Y. 38, N. Y.
TELEPHONE: WOrth 2-2044
COrthand 7-0470

f-m receiver need not exhibit more than 4.44 per cent interference so long as the noise remains less than the signal. And when the radio interference is 50 per cent, a good detector will show no more than 1.48 percent noise. (These figures assume a 75-kc deviation and a 75- μ sec time constant.) Of course, in the more normal situation the radio interference is dispersed throughout the 200-kc bandwidth, making most of the noise super-audible.

The references I listed in my letter tell what is wrong with conventional receivers and just what to do about it. (I should also have referenced Arguimbau's text: *Vacuum Tube Circuits*.)

I consider it unfortunate that the large majority of receiver manufacturers have remained ignorant about the facts of good receiver design although much technical information has appeared on the subject since 1947. Out of a list of 38 "Hi-Fi" tuner manufacturers only three can claim a high capture ratio.

Relay Systems

As you indicate, the telephone company is most concerned with multiple hops to carry messages 3,000 miles or so. Disregarding scatter propagation systems, the transmitter power used in such hops is microscopic when compared to high-power broadcast stations. Due to its unique noise property, pcm seems like a truly clever innovation for this assignment.

Some f-m broadcast stations, however, have been used in multiple hops to provide various f-m networks. The quality of the audio from the last station in a line of six or eight has often been quite poor. The major blame in this particular case is not with the transmission medium or the system of modulation. Instead the trouble lies in the fact that at each transmitter the signal is demodulated (often by questionable equipment), processed and then remodulated.

This trouble could be solved by limiting and heterodyning the received signal to its new carrier frequency without any demodulation taking place. So far as I know, no

PROFESSIONAL SERVICES

Consulting—Patents—Design—Development—Measurement

in

Radio, Audio, Industrial Electronic Appliances

BRIGGS ASSOCIATES, INC.

Engineering Services

ELECTRONICS MECHANICAL
Development — Manufacturing — Consulting
Special Machines — Instrumentation — Automation
Electron Tube Design, Materials, Reliability

10 DeKalb St. Broadway 9-2120 Norristown, Pa.

NIAGARA ELECTRON LABORATORIES

CONSULTATION - DESIGN - CONSTRUCTION
MFG. THE THERMOCAP RELAY

Specializing in solution of problems of electronic and electro-physical instrumentation for the research or analytical laboratory. Industrial plant problems also invited.

An-lover, New York Cable Address: NITRONLAB

CROSBY LABORATORIES, INC.

Murray G. Crosby & Staff

Radio - Electronics
Research Development & Manufacturing
Communication, FM & TV

Robbins Lane, Hicksville, N. Y.
WE 1-3191

PICARD & BURNS, INC.

Consulting Electronic Engineers

Analysis and Evaluation
of Radio Systems

Research Development and Production
of Special Electronic Equipment

240 Highland Ave. Needham 94, Mass.

DELAWARE PRODUCTS CO.

Analog Voltage to Digital Conversion
Digital Voltage Recording Systems

Design-Development-Manufacturing

300 Broadway Camden 3, N. J.

ALBERT PREISMAN

Consulting Engineer

Television, Pulse Techniques, Video

Amplifiers, Patent technical consultation.

616 St. Andrews Lane, Silver Spring, Maryland.
JU 1-9151

ELECTRONIC RESEARCH ASSOCIATES, INC.

"TRANSISTORIZE" YOUR PRODUCT!
Complete Service in consulting, research, development, and production on Transistor circuitry, products and instrumentation.

67 East Centre Street Nutley, N. J.
NU 2-5410

TELECHROME MFG. CORP.

Electronic Design Specialists

COLOR TELEVISION EQUIPMENT

Flying Spot Scanners, Color Synthesizers, Keyers, Monitors, Oscilloscopes and Related Apparatus, Telemetry for Guided Missiles.

J. R. Popkin-Clurman Pres. & Dir. of Eng.
28 Ranick Dr. Amityville, L. I., N. Y.

ERCO RADIO LABORATORIES, INC.

Radio Communications Equipment

Engineering - Design - Development - Production
Our 27th Year in Air to Ground
Communications and Radio Beacons

Garden City • Long Island • New York

TRANSISTOR CONSULTANTS, INC.

TRANSISTOR ENGINEERING

Consultant; cost analysis; training programs.
Engineering systems and Design Studies.
Instrumentation; Prototype Construction.
New Processes and Component Designs for Transistorized Computers; Servos; Radios.
Laboratory Investigations; "Life-Test"; "Fringe Area" Evaluations.

P. O. Box 333 Morris Plains, N. J.

General Atronic Corporation

David E. Sunstein George J. Laurent
Dr. Robert W. Roop Bernard D. Steinberg
Consulting Services—Electronics, Acoustics, Technical
Planning Operations Research for Industrial
Consumer and Government Products.
125 City Line Av. Bala-Cynwyd, Pa. (Phila. suburb)
MOhawk 4-8090

WHEELER LABORATORIES, INC.

Radio and Electronics

Consulting — Research — Development

R-F Circuits — Lines — Antennas

Microwave Components — Test Equipment

Harold A. Wheeler and Engineering Staff
Great Neck, N. Y. HU 2-7876

THE KULJIAN CORPORATION

ELECTRONICS DIVISION

Consulting Electronic Engineers

Research Development. Production of
Automatic Controls — Special Instrumentation
1200 No. Broad St., Philadelphia 21, Pa.
Stevenson 2-9000

YARDNEY LABORATORIES

Research-Design-Development

Electro-Chemical Generators of Energy

40-48 Leonard Street WOrth 6-3100
New York 13, N. Y.

Measurements Corporation

Research & Manufacturing Engineers

HARRY W. HOUCK MARTIAL A. HONNELL
Specialists in the Design and
Development of Electronic Test Instruments
Boonton, New Jersey

Consult

these SPECIALISTS

Let them save your time by bringing their
broad experience in their specialty to
bear on your problems.

• CONTACTS •

FOR THE FIELD OF
ELECTRONICS

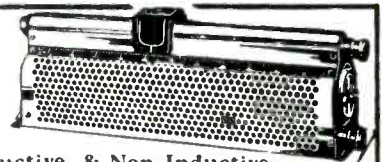

Inductive & Non-Inductive
Rheostats & Resistors
Toroidal Coil Winding Mach.



Taping Machines

Winding Machines

REX RHEOSTAT CO.

BALDWIN, SO. L. I. N. Y.



MANUFACTURERS' REPRESENTATIVES

IN THE ELECTRONIC INDUSTRY

As a service to readers, ELECTRONICS presents the advertisements for some of the leading manufacturers' representatives in the electronic industry. These firms are qualified to help the Manufacturer with his distribution problems: the Buyer with his product needs.

PENNSYLVANIA

SAMUEL K. MACDONALD, INC.

Manufacturers representatives over 25 years
1531 SPRUCE STREET, PHILA. 2, PA.

Territory:
Pennsylvania • New Jersey
Delaware • Maryland
Virginia • West Virginia
District of Columbia

Other Offices:
Pittsburgh
Baltimore
Washington, D. C.

NEW ADVERTISEMENTS

received by February 5 will appear
in the March 1st issue, subject to
space limitations.

Address copy to the
Classified Advertising Division

Electronics

P. O. Box 12

New York 36, N. Y.

f-m station has done this. (Incidentally, this method offers the additional advantage of rebroadcasting multiplexed programming without the use of multiplex equipment at any but the originating station).

You are certainly correct in stating that noise is additive in f-m repeaters. However, it seems possible to rebroadcast high-quality signals from high-power f-m transmitters. For example, the programs from WQXR-FM, New York, are rebroadcast by WFMZ in Allentown, 80 miles distant. Even at this distance their excellent location allows them to receive WQXR-FM on a piece of twin-lead just 5 feet off the ground.

It would seem reasonable to expect perhaps no more than 1 or 2 percent interference (r-f) using a well-placed highly directional antenna. This, multiplied by the 30 or 40 transmitters necessary to hop across the country, would give from 1 to 2.5 percent audio noise in San Francisco! Again, we would probably be limited by the additive tube noise from each station. (Of course, as you say, even this would be taken care of by pcm.)

The plan seems practical. I am told that Major Armstrong had hopes of establishing a nation-wide f-m network.

I have taken this opportunity to try to bring to light some of the facets of f-m radio, especially the results of Arguimbau's work. The technical difficulties must be cleared away before we can expect f-m to assume its proper niche in broadcasting.

BRUCE G. CRAMER
Harrisburg, Penna.

Goose Egg

DEAR SIRs:

IN your October issue on page 404 you ran a notice about Pacific Automation Products, Inc.

However, you show the address as 10000 Air Way, Glendale 1, and it should be 1000 Air Way, Glendale 1.

WENTWORTH W. MANN
Los Angeles, Calif.

WHY NOT TRY TURRETS?

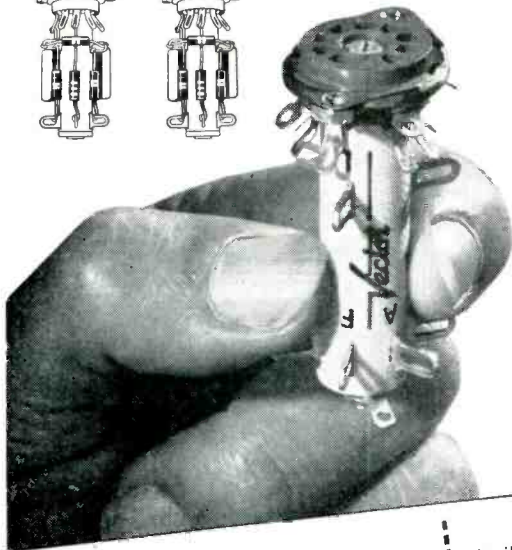
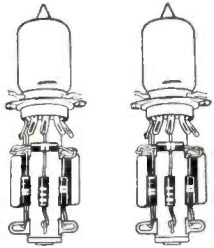

Vector

SOCKET TURRETS

...simplify wiring, cut down assembly time and make up into compact, sturdy structures... Eliminate useless lead length and thus improve performance... Save design time for engineers. Also available in military version.

Vector
STRUCTURES FOR CIRCUITRY

Available in many sizes and types to fit every need:—Post, Deck, Wall and Tinker Turrets; with plugs and cases as required.
— Write for Catalog.

VECTOR ELECTRONIC COMPANY, 3352 San Fernando Road, Los Angeles 65, Calif. • Tel. CLevland 7-8237

DE MORNAY-BONARDI

first in ultramicrowave equipment



A complete line of research instruments covering frequencies up to 90,000 mc... proved in laboratories the country over.



DE MORNAY-BONARDI • 780 SOUTH ARROYO PARKWAY • PASADENA, CALIFORNIA

**PRECISION
PLASTIC
CAPACITORS
AT
COMPETITIVE
PRICES!**

POLYSTYRENE and MYLAR*

Capacitance From .001 mfd to any value
Voltage From 50 V.D.C. to 30 KV
Tolerance Polystyrene From $\pm 0.1\%$ to $\pm 5\%$
Mylar* From $\pm 1\%$ to $\pm 10\%$

SMALLEST CASE SIZES

TUBULAR—BATHTUB—RECTANGULAR

Very Good Deliveries *DuPont T.M.

PRECISION CAPACITORS, INC.

150 W. Cypress Ave. Burbank, Calif.

REPLIES (Box No.): Address to office nearest you
 c/o This publication Classified Adv. Div.
 NEW YORK: P. O. Box 12 (36)
 CHICAGO: 520 N. Michigan Ave. (11)
 SAN FRANCISCO: 68 Post St. (4)
 LOS ANGELES: 1125 W. 6th St. (17)

POSITION WANTED

Large Company Electronics Engineering Ex-
 executive, 33 years old, interested in position
 with small or medium sized firm. Excellent
 education and experience. PW-3923, Elec-
 tronics.

SELLING OPPORTUNITY WANTED

Electron tubes—Special import and export
 firm located in West Germany, experienced in
 East European trade, will sell for you in
 West and East Germany as well as East
 and Southern Europe electronics, transistors,
 diodes. Send your offers to SA-3481, Elec-
 tronics.

EDWARDS

EMPLOYMENT AGENCIES, INC.
EXECUTIVES—ENGINEERS
 73 Warren St., N.Y. 17, N.Y. • BA 7-3672
ELECTRONIC AND MECHANICAL EN-
GINEERS for positions as directors, scient-
 ist, physicists, staff, project, departmental
 heads, designers
 for: guided missiles • radar
 analog computers • tubes
 field engineering • pulse
 servomechanism • antennas
 communications • packaging
 transformers • TV and radio
 transistors • audio systems
 • instrumentation •
 microwave research & development
 Discreet service. Hundreds of client com-
 panies from coast to coast. Mostly fee-
 paid positions. Send resumes. Confidential.

**ELECTRONIC ENGINEERS
 PHYSICISTS and related
 TECHNICAL PERSONNEL**

B.S. M.S. Ph.D.
Salaries \$5,000 to \$15,000+
 Many openings listed here with private industry,
 universities and government divisions. Apply in
 person or send resume. No placement fee.
ENGINEERING & SCIENCE UNIT
 A highly specialized placement service.
NEW YORK STATE EMPLOYMENT SERVICE
 119 Fifth Ave. New York 3, N. Y.

ENGINEERS

If you have been looking for an Employment Agency
 that is skilled in the **STATE OF THE ART** of
 Technical Recruitment and **RELIABILITY OF IN-**
FORMATION concerning positions, why not com-
 municate with us at once! **ALL POSITIONS FEE**
PAID.
FIDELITY PERSONNEL SERVICE
 1218 Chestnut St. Phila. 7, Pa.
Specialists in Aviation and Electronics

ENGINEERING MGR. V.P.

Broad engineering background in Electronic and
 magnetic products. Must be good on Administra-
 tive, and ability to organize and follow through,
 to conclusion, on a variety of development projects.
 Salary \$18,000 to \$20,000 plus. Send complete re-
 cord or write for application. Confidential. Estab.
 1915.
HARRISON PERSONNEL SERVICE
 20 W. Jackson Blvd. Chicago 4, Ill.

TEST EQUIPMENT ENGINEER
 \$10,000 Per Yr. Plus

Looking for a E.E. or M.E. who perhaps has a
 couple of yrs. experience as a Test Equipment En-
 gineer. This position will be a newly created one in
 their Manufacturing Div. Principal Products are in
 the Electro-Mechanical Field. Co. assumes all ex-
 penses. Your confidence respected.
 28 E. Jackson Blvd. Chicago 4, Ill.
MONARCH PERSONNEL

**WANTED IN PASADENA
 ELECTRONIC, MECHANICAL AND
 ELECTROMECHANICAL ENGINEERS**

See our full page advertisement;
 refer to advertiser's index.
**CEC CONSOLIDATED
 ELECTRODYNAMICS**



EMPLOYMENT OPPORTUNITIES

The Advertisements in this section include all employment opportunities—execu-
 tive, management, technical, selling, office, skilled, manual, etc.

Positions Vacant	Civil Service Opportunities	Employment Agencies
Positions Wanted	Selling Opportunities Wanted	Employment Services
Part Time Work	Selling Opportunities Offered	Labor Bureaus

DISPLAYED

The advertising rate is \$25.25 per inch for all adver-
 tising appearing on other than a contract basis.
 Contract rates quoted on request.

An advertising inch is measured 7/8" vertically on a
 column—3 columns—30 inches to a page.

Subject to Agency Commission.

Send **NEW ADS** to **ELECTRONICS**, 330 W. 42nd St., N. Y. 36, N. Y., for March, issue closing February 5th.

RATES

\$2.40 per line, minimum 3 lines. To figure advance
 payment count 5 average words as a line.

Box Numbers—counts as 1 line.

Discount of 10% if full payment is made in advance
 for 4 consecutive insertions.
 Not subject to Agency Commission.

UNDISPLAYED

ENGINEERING OPPORTUNITIES

Aircraft Radio Corp., the industry's leader in avi-
 onics for over 30 years, has openings on its staff
 for forward thinking engineers in the following
 fields:

- **TRANSISTOR CIRCUIT
 PROJECT ENGINEER**
- **SERVO AND INSTRUMENT ENGINEER**
- **ENVIRONMENT—TEST ENGINEER**
- **COMPONENTS ENGINEER**
- **CHIEF ENGINEER TO HEAD SERVO AND
 INSTRUMENT DEPT.**
- **ADVANCED TECHNICIANS**

WRITE OR CALL COLLECT: *Personnel Manager*



AIRCRAFT RADIO CORPORATION

BOONTON, NEW JERSEY

Deerfield 4-1800 Ext. 238

**Electronic
 Engineers**

**DIGITAL COMPUTER
 DESIGN**

**PROCESS CONTROL
 AUTOMATION**

**SPECIALIZED
 INSTRUMENTATION**

**TECHNICAL PROBLEM
 CONSULTATION**

IF YOUR ABILITIES & AMBITIONS ARE STYMIED,
 YOUR TIME IS VALUABLE IN RESEARCH AT
CONTINENTAL OIL COMPANY
 PONCA CITY, OKLAHOMA
 SEND DETAILED RESUME TO PERSONNEL DIVISION

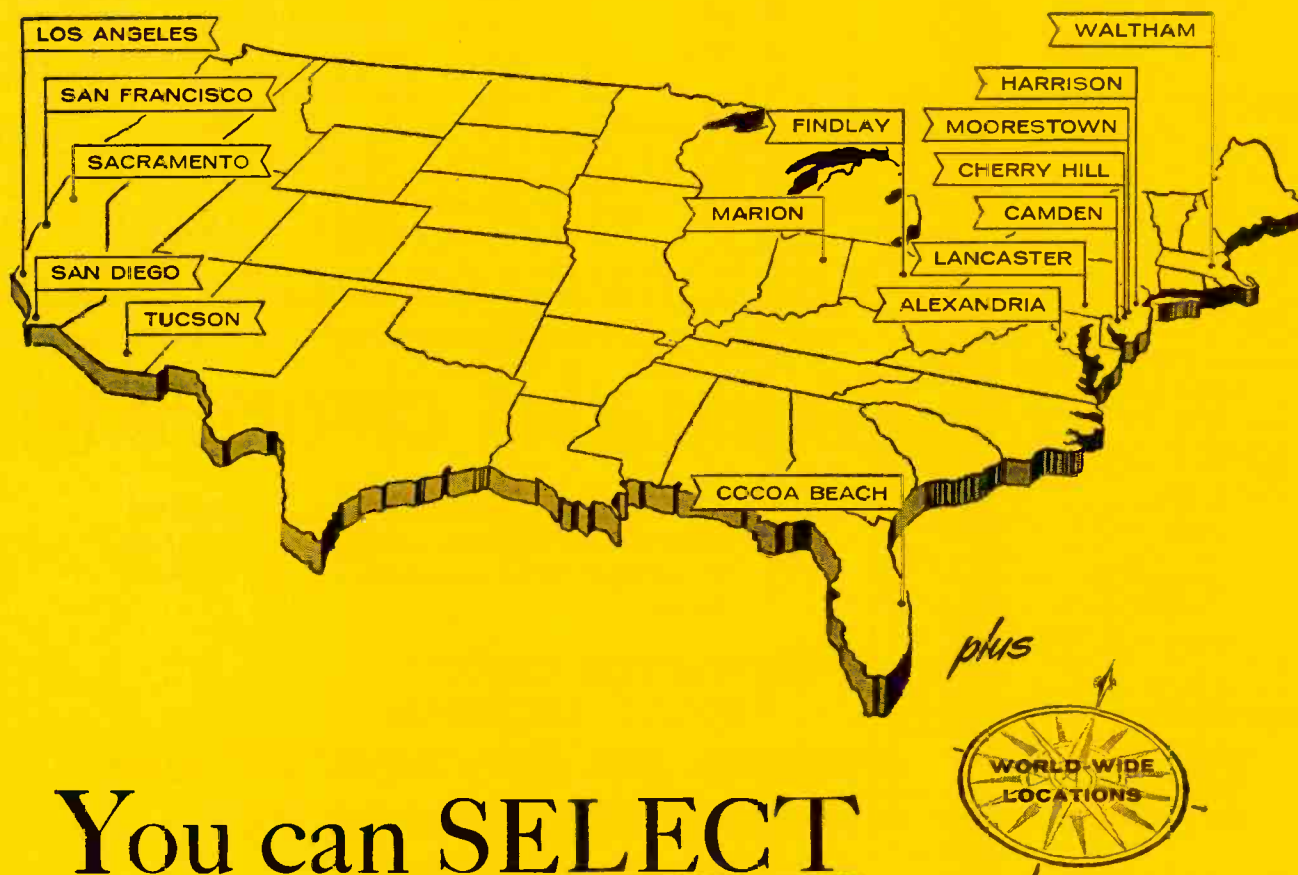

You can SELECT at RCA!

... New Opportunities ... 17 + Locations ... One Best For You And Your Family

**Can anyone but RCA offer you
a choice of locations like this?**

At Camden, Moorestown or Cherry Hill, you enjoy cultural advantages of Greater Philadelphia, live at moderate cost in pleasant suburban communities. Waltham offers at-home opportunities for New England engineers. Four ideal West Coast locations. Harrison borders on Greater New York. Lancaster, Marion and Findlay have small-town advantages. There's pleasant year-round outdoor living in Cocoa Beach, on Florida's central east coast. RCA Service Company and International Division assignments include ideal locations in the United States, and wherever RCA electronic equipments are installed and serviced throughout the world.

Individual Recognition—

RCA organizes engineering activities into groups small enough to allow broadest scope for your individual accomplishment. The average group has just 11 engineers. Yet, in all activities, you are supported by the entire facilities and engineering resources of RCA.

Salaries—

RCA engineering salaries average measurably higher than other companies' in the field. Intermediate engineers, \$5000-\$8500; senior engineers, \$8500-\$15,000; staff and supervisory salaries open.

Advancement—

Scheduled, objective appraisal of your work speeds promotion. Professional and financial progress is just as sure as your achievements make it.

Professional Status—

RCA bases world leadership in electronics on the abilities of exceptional men at every organizational level. Many have notable engineering and scientific reputations. You work in day-by-day association with men of this caliber.

Benefits—

There's a complete program at RCA. A very liberal Tuition Refund Plan. Company-paid life, sickness and accident, hospital-surgical insurance for you and your family. Modern retirement plan. Relocation expenses paid. Suggestion and patent awards.

Now, Pinpoint Your Future

...Here are the Opportunities!
...Here are the Locations!

FIELDS OF ENGINEERING ACTIVITY		MANAGERS	TYPE OF DEGREE AND YEARS OF EXPERIENCE PREFERRED															
			Electrical Engineers			Mechanical Engineers			Physical Science			Ceramics Glass Technology Metallurgy						
			0-2	2-3	4-15	0-2	2-3	4-15	1-2	2-3	4-15	1-2	2-3	4-15				
• SYSTEMS <i>(Integration of theory, equipments and environment to create and optimize major electronic concepts.)</i>	AVIATION ELECTRONICS • CONTROLS		W	W	W	C	W	W	W	C	W	W	W	C				
	DIGITAL DATA HANDLING DEVICES	M	C	M	C	M	C		C	C		C	C					
	MISSILE ELECTRONICS • RADAR	M	W	M	W	M	W	W	M	M	W	M	M	W	W	X		
	INERTIAL NAVIGATION			W	W		W	W		W	W		W	W				
	COMMUNICATIONS			C	C	N	N							C	N			
• DESIGN • DEVELOPMENT MISSILE WEAPONS SYSTEMS —Planning and Design—Radar—Fire Control—Servo Mechanisms—Computers	M	M	M	M	M	M	M	M	M	M	M	M	M	M	X	X		
AVIATION ELECTRONICS —Radar—Computers—Servo Mechanisms—Shock and Vibration—Circuitry—Remote Control—Heat Transfer—Sub-Miniaturization—Automatic Flight—Automation—Transistorization	W	W	W	W	W	W	W	W	W	W	W	W	W	W	W	X		
RADAR —Circuitry—Antenna Design—Servo Systems—Gear Trains—Intricate Mechanisms—Fire Control—Information Handling—Displays	M	C	M	C	M	C	M	C	M	C	M	C	M	C	X	X		
COMPUTERS —Systems—Advanced Development—Circuitry—Assembly Design—Mechanisms—Programming—Digital Data Handling Devices		C	C	X	M	C	C	C	X	M	C	C	C	C	M	C		
KINESCOPIES (B & W and Color), OSCILLOSCOPES —Electron Optics—Instrumental Analysis—Solid States (Phosphors, High Temperature Phenomena, Photosensitive Materials and Glass to Metal Sealing)		L	L	Y	L	Y	L	L	Y	L	Y	L	L	Y	L	Y	L	Y
RECEIVING TUBES —Tube Design—Test and Application Engineering—Chemical and Physical Development—Methods and Process Engineering—Advanced Development		H	H	H		H	H		H	H		H	H		H	H		
SEMICONDUCTORS —Transistors—Semiconductor Devices—Materials		V	V	V	V	V	V	V	V	V	V	V	V	V	V	V	V	V
MICROWAVE TUBES —Tube Development and Manufacture (Traveling Wave—Backward Wave—Magnetron)	H		H	H		H	H		H	H		H	H		H	H		
GAS, POWER AND PHOTO TUBES —Photosensitive Devices—Glass to Metal Sealing—UHF and VHF—Power		L	L	L	L	L	L	L	L	L	L	L	L	L	L	L		
COMMUNICATIONS —Specialized Systems—Microwave—Mobile—Aviation—Audio—Propagation Studies—Acoustics—Transducers		C	C	C	N	N	C	C	C	C	C	C	C	C	C			
BROADCAST AND TV —Monochrome and Color Studio Equipment—Cameras—Monitors—High Power Transmitters		C	C	C	C	C	C	C	C	C	C	C	C	C				
• SYSTEMS APPLICATION <i>Evaluation and Planning—Design and Development—Modification—Specification</i>																		
MISSILE TEST INSTRUMENTATION (Data Acquisition and Processing)—Radar—Telemetry—Timing—Communications—Optics—Computers	F	F	F	F	F	F	F	F	F	F	F	F	F	F	F			
RADAR —Airborne—Surface—Shipboard—Sonar—Fire Control	F	F	F	F	F	F	F	F	F	F	F	F	F	F	F			
COMMUNICATIONS —Radio—HF—VHF—JF—Microwave—Telephone—Teletype—Telegraph Terminal Equipment—Wave Propagation	F	F	F	F	F	F	F	F	F	F	F	F	F	F	F			
• MACHINE DESIGN Mechanical and Electrical—Automatic or Semi-Automatic Machines		L	L		L	L	H	Y	C	H	Y		L	L				

Locations: C—Camden, N.J. F—Cocoa Beach, Fla. H—Harrison, N.J. I—Clark, N.J. (periodic foreign assignments). L—Lancaster, Pa. M—Moorestown, N.J. N—New York, N.Y. S—RCA Service Co. (Cherry Hill, N.J.; Alexandria, Va.; Tucson, Ariz.; San Diego, Sacramento, San Francisco, Calif., Foreign Assignments). V—Somerville, N.J. W—Waltham, Mass. X—West Los Angeles, Calif. Y—Marion, Ind.



Please send resume of education and experience, with location preferred, to:

Mr. John R. Weld, Employment Manager
Dept. A-165, Radio Corporation of America
30 Rockefeller Plaza, New York 20, N.Y.

RADIO CORPORATION of AMERICA

Copyright 1956 Radio Corporation of America

**THIS
IS THE KIND OF
ENGINEERING
HELP
WE NEED!**

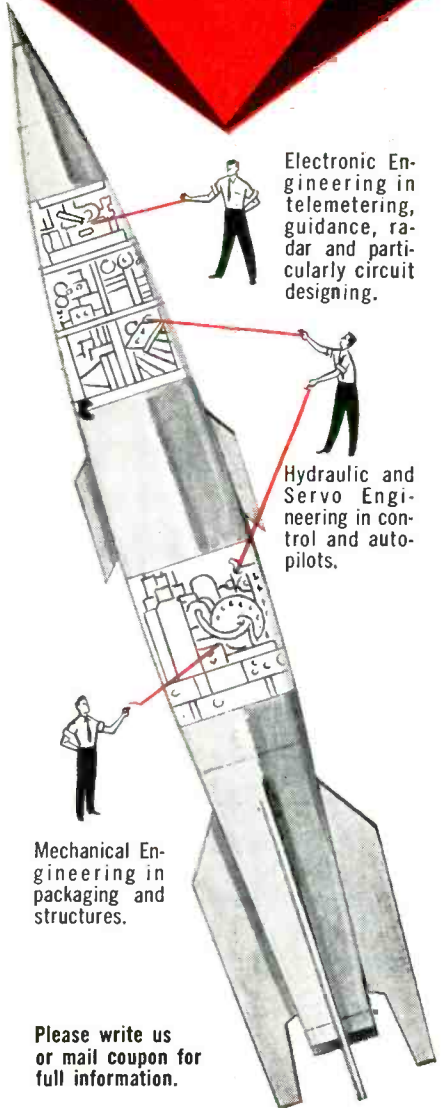

Please write us or mail coupon for full information.

W. C. Walker, Engineering Employment Mgr.
Pacific Division, Bendix Aviation Corp.
11608 Sherman Way, North Hollywood, Calif.

I am interested in this engineering field _____
I am a graduate engineer with _____ degree.
I am not a graduate engineer but have _____ years experience.

Name _____
Address _____
City _____
Zone _____ State _____

To the electronics engineer who can write...

here
is
your
IVORY TOWER

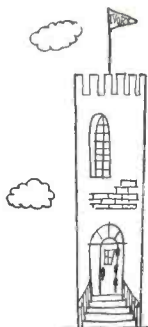

You'll live in a clean, progressive, thriving community . . . a city of beautiful homes and broad tree-lined streets . . . a cultural and recreational center of the Midwest. The way of life is pleasant and relaxed. It's the kind of town you like to raise a family in.

You'll write for the creative leader in electronics. There'll be a sense of accomplishment and satisfaction in your work. A feeling of contributing in a major way to the advancement of the science of electronics. And, at the same time, you'll have the opportunity to learn and advance yourself technically in electronics.

The place — Cedar Rapids, Iowa

The job — technical writing.

Check into the opportunities Collins offers technical writers, in the fields of:

- | | | |
|-----------------------|----------------|-------------------|
| Microwave Relay | SSB Systems | Guided Missiles |
| Navigation Systems | Computers | Radio Astronomy |
| Communication Systems | Flight Control | Amateur Equipment |
| | Radar Systems | |

Collins offers you top salary, rapid advancement, company benefits, liberal moving expense. Electrical Engineers or Physicists are desired. Actual writing experience is not necessary. U.S.A. citizenship is required.

Positions also open in Dallas and Burbank.

Send resume to:
Industrial Relations Director
COLLINS RADIO COMPANY
Cedar Rapids, Iowa

OPPORTUNITIES

IN DESIGN & ENGINEERING FOR PROJECT OR SYSTEMS,
ENGINEERS • ELECTRONIC ENGINEERS • DESIGN ENGINEERS
ELECTRICAL ENGINEERS • FIELD ENGINEERS

Kollsman's expansion in the airborne equipment field has created openings for additional engineers and electromechanical designers, and offers unusual scope to alert, capable and enthusiastic professional men. For engineers, a degree in Mechanical Engineering, Electronic Engineering or Physics is necessary, plus experience or a strong interest in airborne instrumentation or allied fields.

The congeniality at Kollsman, plus the modern facilities and top professional men provide an atmosphere conducive to creative effort and achievement. Here are designed America's finest aircraft instruments.

Please submit resumes to T. A. DeLuca

Confidential interviews will be arranged.



kollsman INSTRUMENT CORPORATION

80-08 45th AVENUE, ELMHURST, NEW YORK • SUBSIDIARY OF Standard COIL PRODUCTS CO., INC.

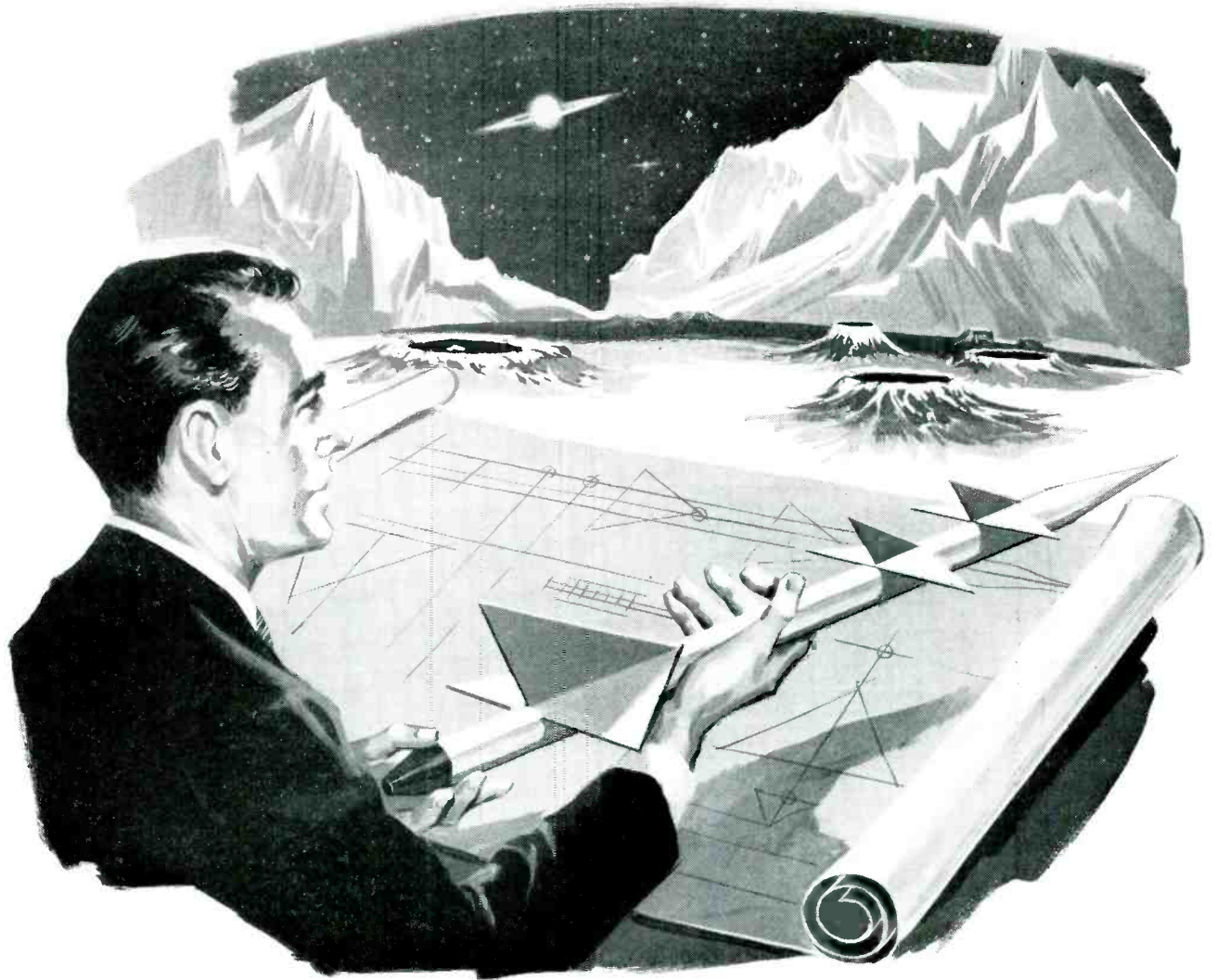

How to put *Wings* on ideas

YOU'RE an idea man—as are all creative engineers. And like other thoughtful young men, you're eager to lend wings to your visions.

Here at Goodyear Aircraft, we offer an unlimited ceiling for soaring imaginations. Here wait boundless opportunities in your chosen field—whether it be airships, structural materials, electronic equipment, plastics, missile components—or countless other exciting and challenging activities.

Here, too, is an atmosphere in which ideas can gain altitude. For there exist no barriers to individual thought and expression, no height which your inspiration cannot attain. And in fulfillment of their dreams, Goodyear Aircraft engineers can utilize the most modern facilities, including one of the largest computer

laboratories in the world.

If you have faith in your ideas and confidence in your ability to make them work, a rewarding career can be yours at Goodyear Aircraft. Our continued growth and diversification have required expansion of our engineering staffs in all specialties at both Akron, Ohio, and Litchfield Park, Arizona.

Salaries and benefits are, of course, liberal. And if you wish to continue your academic studies, company-paid tuition courses leading to advanced degrees are available at nearby colleges.

For further information on your career opportunities at Goodyear Aircraft, write: Mr. C. G. Jones, Personnel Dept., Goodyear Aircraft Corporation, Akron 15, Ohio.

They're doing big things at **GOODYEAR AIRCRAFT**

The Team To Team With in Aeronautics

From conception to catapult... this missile was guided by design engineers

Due aboard Fleet surface and submarine units soon is a new package of striking power. It's Chance Vought's supersonic Regulus II surface-to-surface missile, a complete weapons system and an advanced attack concept. Vought engineers not only conceived and designed this missile—they tailored it for Fleet operation. And they achieved unique success largely

because it was a job they knew from experience. For 11 years they've had pilotless weapons on the board, in the shop, or in the air. Their Regulus I ship-to-shore missile has been a standard Fleet weapon for two years—on station, ready to go. Against this background, Vought's missile design team appears just as significant as the weapon it developed.



5

IMMEDIATE OPENINGS FOR DESIGN ENGINEERS

Senior missile airframe designer. To develop, design and test missile structural members, including control surfaces and linkages. Degree, or equivalent, with at least three years mechanical structural design experience.

Designer for missile and piloted aircraft ground-handling equipment. To develop ground-handling tools ranging from special wrenches to engine-change dollies. Offers opportunity for first-hand observation of Fleet operations. Requires engineer with flair for mechanical design, degree or equivalent experience.

Electronics designer for missile and piloted aircraft check-out equipment. Desire designer with E.E. degree or equivalent, plus three to five years electrical or electronic design experience.

Cockpit designer and stylist. To specialize in functional, attractive cockpit design. Requires at least two years experience in industrial styling plus two years practical design experience and strong creative ability.

Design specialist in problems of ground-level escape. Desire engineer with at least three years concentration on pilot escape mechanisms, plus two to three years practical design experience.

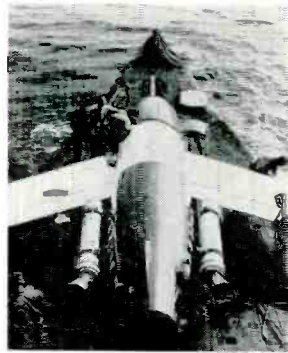
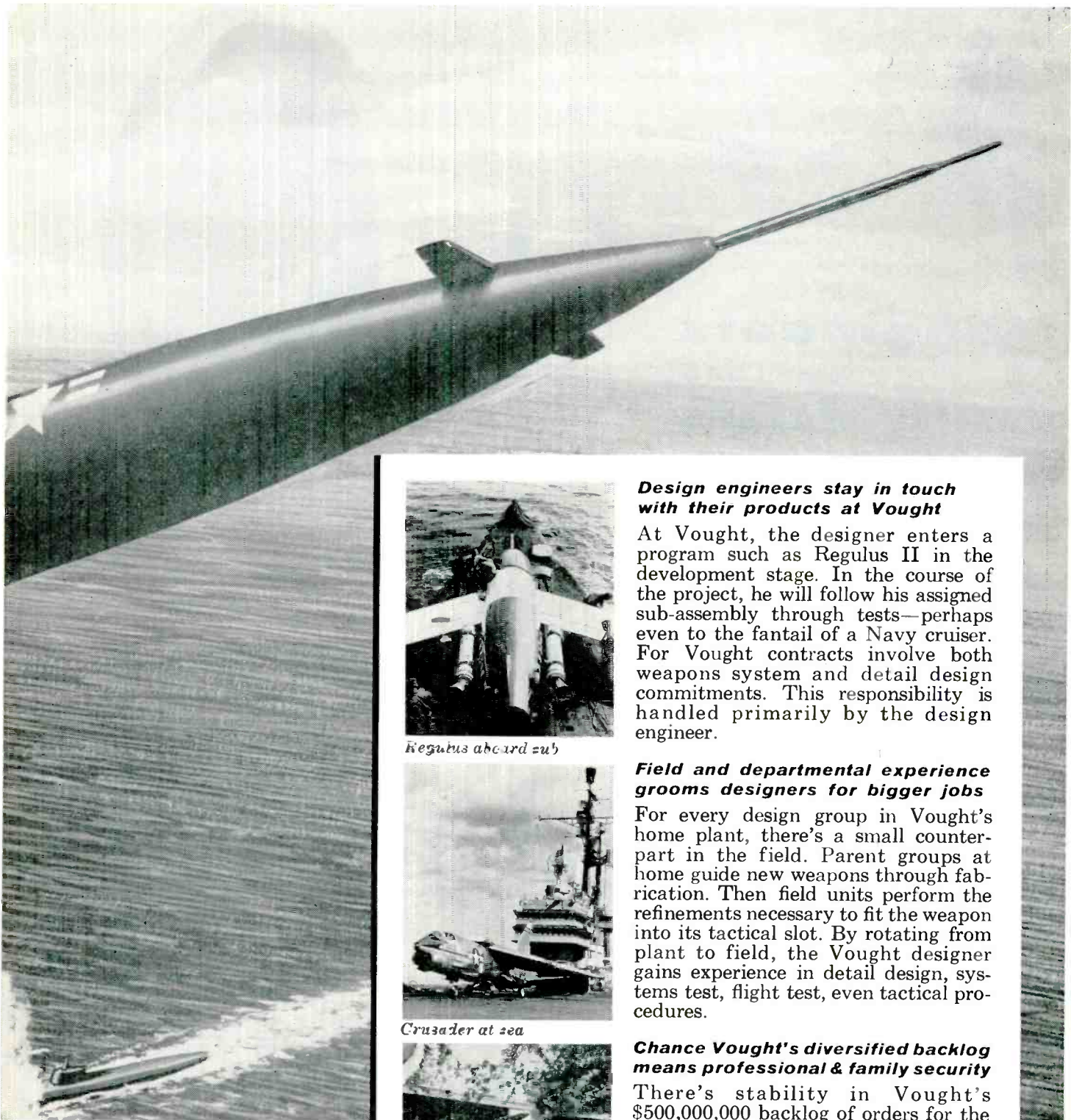

Regulus aboard sub

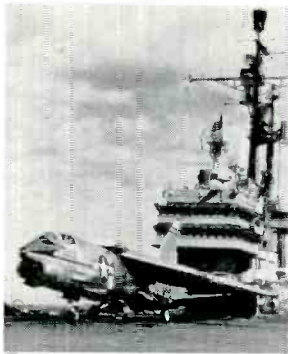

Crusader at sea



If you are interested in our approach to missile and fighter design, arrange to visit Chance Vought for a personal interview. Or, for a confidential report on our openings, write to:

Mr. J. W. Larson,
Ass't. Chief Engineer
Engineering Personnel Dept. 1-E

Design engineers stay in touch with their products at Vought

At Vought, the designer enters a program such as Regulus II in the development stage. In the course of the project, he will follow his assigned sub-assembly through tests—perhaps even to the fantail of a Navy cruiser. For Vought contracts involve both weapons system and detail design commitments. This responsibility is handled primarily by the design engineer.

Field and departmental experience grooms designers for bigger jobs

For every design group in Vought's home plant, there's a small counterpart in the field. Parent groups at home guide new weapons through fabrication. Then field units perform the refinements necessary to fit the weapon into its tactical slot. By rotating from plant to field, the Vought designer gains experience in detail design, systems test, flight test, even tactical procedures.

Chance Vought's diversified backlog means professional & family security

There's stability in Vought's \$500,000,000 backlog of orders for the 1,000-plus-mph Crusader fighter and for Regulus missiles. In addition, Vought's Dallas location means low-cost living—outstanding housing and year-round outdoor enjoyment. Building, heating and clothing costs are low, and in Dallas, too, there's freedom from sales taxes and city and state income taxes.

CHANCE **VOUGHT AIRCRAFT**
INCORPORATED

Dallas, Texas

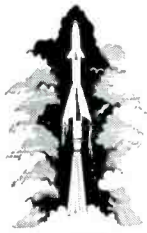

MISSILES

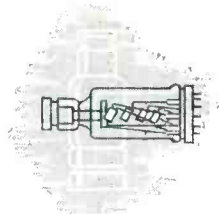

SPECIAL PURPOSE TUBES

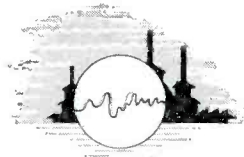

INDUSTRIAL ELECTRONICS



SOLID STATE AND APPLIED PHYSICS

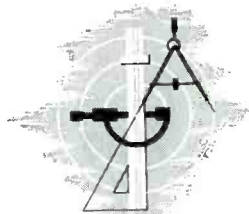

PRODUCT ENGINEERING

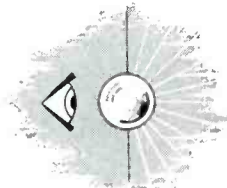

INFRA-RED

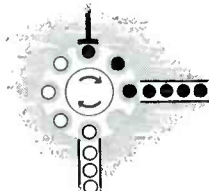

PRODUCTION

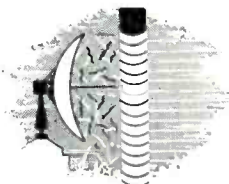

COUNTER-MEASURES

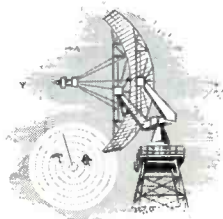

RADAR

engineers and physicists

you'll find your field
of interest at

Farnsworth



Farnsworth is one of the newest electronics divisions of the International Telephone and Telegraph Corporation. IT&T is the world's most extensive combined research, development, manufacturing and operating organization in telecommunications and electronics.

Association with an organization slated for major success can lead to highly satisfying individual responsibility and awards, and result in a stimulating and fruitful career.

Scientists and engineers possessing the professional potential and personal characteristics that equip them to participate in our programs are invited to send their resumes to

Technical Employment Director

FARNSWORTH ELECTRONICS COMPANY

a division of International

Telephone and Telegraph Corporation

FORT WAYNE, INDIANA

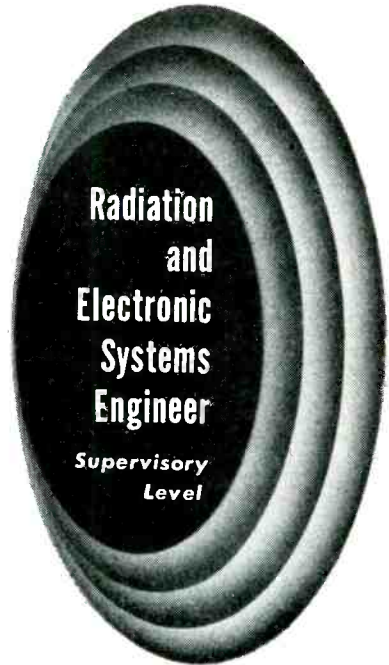

The Missile & Ordnance Systems Department of General Electric, prime contractor for the development of the ICBM and IRBM nose cones, has a responsible opening for a qualified engineer or scientist in its Nuclear Ordnance Projects Component Equipment Design Operation.

Position Responsibilities: Design, development, and evaluation of passive and active radiation type systems (i.e., radar, infra-red, ultra-violet, optical, etc.) as applied to arming and fuzing of missile systems.

Qualifications:

- **BS or MS in Physics or Electrical Engineering**
- **Five to ten years' experience in design, development, and evaluation of electronic components and systems, preferably proximity fuzing for missile or related applications.**
- **Ability to direct technical work of six to eight engineers.**

The environment is completely technical and professional. We are a research and development laboratory affiliated with one of the world's largest, most diversified and progressive industrial organizations. We hold prime contracts of a long-term nature with all of the armed services. Salary and benefits are liberal. Philadelphia location. Excellent facilities and equipment.

The Manager of our Arming and Fuzing Component Equipment Design Operation would be pleased to review your resume. A personal interview with him in Philadelphia will be arranged at our expense, if your qualifications are appropriate. If you prefer, you need not reveal your present employer.

Please send resume in confidence to:
Mr. John Watt
Technical Recruiting, Room 571-2



MISSILE & ORDNANCE SYSTEMS DEPT.

GENERAL ELECTRIC

3198 Chestnut St., Philadelphia 4, Pa.

MAKING THE BIG DECISION?



BRIGHT FUTURE

MONOTONY

NO FUTURE

NEW HORIZONS

OLD SALT MINE

INTERESTING WORK

FIELD ENGINEERING WITH A FUTURE - AT RAYTHEON

Wondering about your next step? Raytheon field engineering gives you a real chance to up-grade your future. Many Raytheon executives are former field engineers.

Interesting, stimulating work with our Design and Engineering Departments evaluating and testing the latest equipment gives you valuable experience. Assignment to one of these missile, sonar, counter-measures, bombing or fire control radar programs prepares you for a key field position.

Primarily, we're interested in men with an E.E. degree and field experience, but you get full consideration when you have radar, sonar, missile or similar background. Men with mechanical and hydraulic experience also are needed.

Your Raytheon future includes an attractive salary; assistance in relocating; insurance; educational programs, etc. Interviews in most U.S. cities, Japan, some European countries. Write E. K. Doherr for full details.

Excellence in Electronics



RAYTHEON MANUFACTURING COMPANY

Government Service Department

100 River Street, Waltham 54, Massachusetts



AN UP-TO-EARTH VIEW OF THE FUTURE IN SERVO CONTROLS AND INSTRUMENTATION

The Martin launching vehicle of the first man-made Earth satellite will be the opening gun of a new and endless age of exploration into space.

There are many exciting new opportunities at Martin in the fields of servo controls development and instrumentation engineering.

If you are doing some down-to-earth thinking on this fabulous future you'd do well to contact J. M. Hollyday, Dept. E-2, The Glenn L. Martin Company, Baltimore 3, Maryland.

MARTIN
BALTIMORE

Admiral®

has specific openings
for experienced
engineers in:

Television Military and and Civilian

UHF RECEIVER DESIGN

With experience in low noise wide band front ends and I F circuits for military television systems.

TUNER ENGINEER

To design tuners for UHF and VHF systems—military and civilian. To pursue a program of original ideas in this field at the developmental level.

DEFLECTION CIRCUITRY

With experience in designing horizontal and vertical oscillators, control circuits and associated components.

EXPORT TELEVISION

TV receiver engineer for work on a line of export receivers. Familiarity with tuners and I.F. systems for European standards and conditions useful in this work. Will consider a non-citizen with practical TV experience.

MILITARY TV

Airborne and ground systems including receivers, transmitters, cameras, antennas, sync generating systems, and displays, as well as printed circuit and transistor applications.

Career-minded men with several years specialized experience are invited to join our rapidly expanding programs in communications projects.

Current openings offer excellent income and employee benefits including retirement plan, paid group insurance and college tuition refund plan plus ideal working conditions.

If you are an engineer with qualifications in any of these fields explore *your* opportunity with Admiral today. Write Mr. Walter Wecker, Personnel Manager.

Admiral Corporation

3800 W. Cortland Street
Chicago 47, Illinois

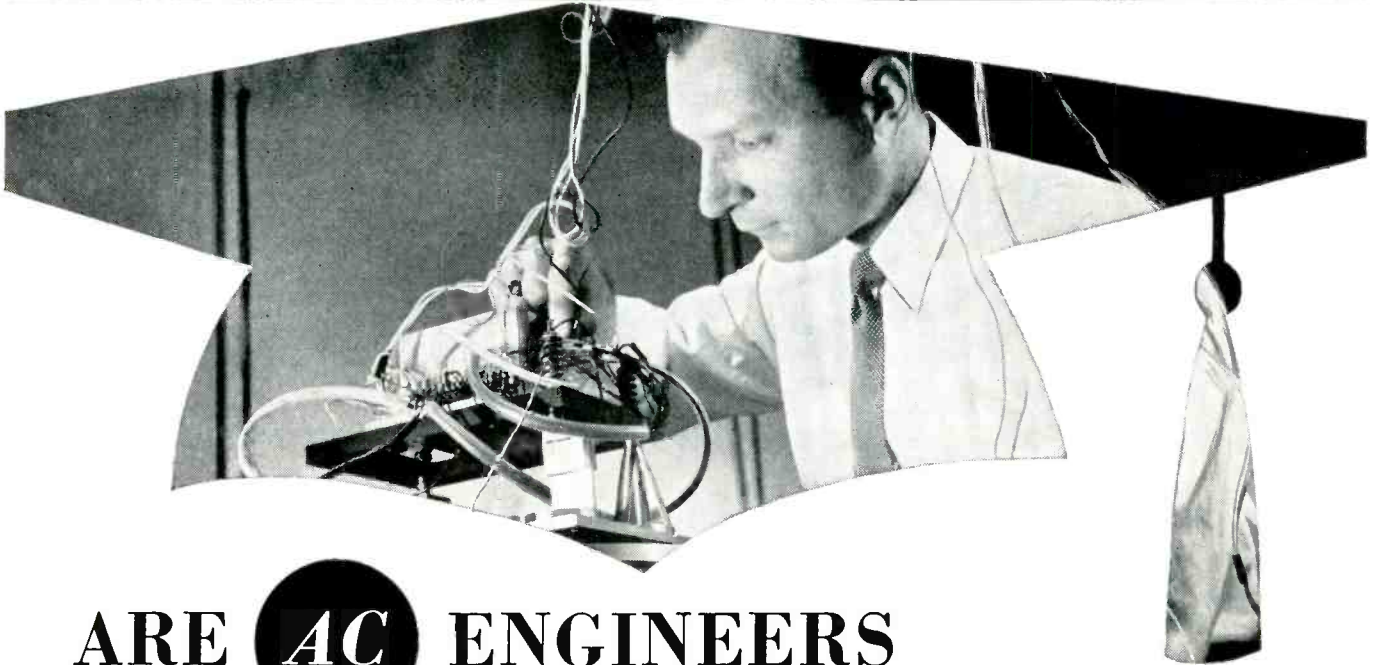

ARE **AC** ENGINEERS really smarter?

Many are the absolute top men in their respective fields.

Currently, we are actively engaged in the fields of Avionics, Missile Guidance, (IRBM), Computers (Digital and Analog), Jet Engine Fuel Controls, Land to Air-Shore-to-Ship Communication Equipment, etc.

We are permanently dedicated to **RESEARCH** and **DEVELOPMENT** in every conceivable field of **ELECTRONICS**.

Opportunities for your personal development are unlimited. G.M.'s policy of decentralization creates exceptional opportunity for individual advancement. Starting wages are high, you work with the finest of equipment on challenging problems. Construction is already under way for an additional plant (225,000 square feet) in an exclusive Milwaukee suburb.



MASTER'S DEGREE GRADUATE PROGRAM

AC has worked out a Master's Degree Graduate Program (evenings) at the University of Wisconsin, Milwaukee. AC pays all tuition fees for this program.

Undergraduate programs are also available at Wisconsin, Marquette and Milwaukee School of Engineering.

For your future's sake, you too be smart—send for complete facts and employment application form to Mr. John F. Heffinger, Supervisor of Technical Employment.

AC THE ELECTRONICS DIVISION
GENERAL MOTORS CORP.

Milwaukee 2, Wis.

Flint 2, Mich.

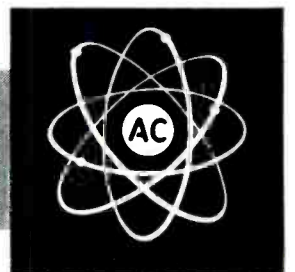

ENGINEERS...PHYSICISTS

NEW opportunities

at MOTOROLA

YOUR CHOICE OF 3 LOCATIONS

New Motorola research laboratories are expanding, creating outstanding career advantages—your opportunity to get in on the ground floor of a swiftly expanding company. You'll enjoy working in these modern laboratories... with liberal employee benefits, including an attractive profit sharing plan. Salary levels are open and commensurate with ability.

POSITIONS AVAILABLE IN: two-way communications • missile electronics • radio & TV (color) • weapons systems • computer application & design • transistor research & production • microwave systems • servo-mechanisms • physical chemistry • metallurgical eng. • field eng. • electronic sales eng. • drafting, design, & layout • aerophysics • radar & military electronics

PHOENIX, ARIZONA



Outdoor, relaxed living the year-round, with lots of room to grow (on the job and off) in this land of sunshine.

RESEARCH LABORATORY

write to: Mr. R. Coulter, Dept. A 3102 N. 56th St., Phoenix, Ariz.

SEMI-CONDUCTOR LABORATORY

write to: Mr. V. Sorenson, Dept. A
5005 E. McDowell Rd., Phoenix, Ariz.

RIVERSIDE, CALIFORNIA



Planned communities, modern shopping centers, advanced schools, fine buys in homes. There's room to grow and more fun in Riverside.

write to: Mr. C. Koziol, Dept. A Box 2072, Riverside, Calif.

CHICAGO, ILLINOIS



Live a relaxed midwest life in one of the beautiful suburbs, yet have all the "big city" advantages—cultural, social, and educational.

write to: Mr. L. B. Wrenn, Dept. A
4501 Augusta Blvd., Chicago, Ill.



MOTOROLA

ELECTRONIC ENGINEERS

RESEARCH DEVELOPMENT

Expansion of our engineering department requires electronic engineers with radar, servo, sonar or transistor circuit experience. Excellent opportunity for advancement with top-calibre associates. New modern plant in the suburbs with ideal laboratory facilities and well-trained technical assistants.

Other Opportunities in the following areas:

- **TECHNICAL WRITERS**
- **DRAFTING** Electrical Layout
- **DETAILING** Electrical - Mechanical

DESIGN ENGINEERS

Must have EE degree or equivalent, with 3-5 years experience in one of the following:

- Flight Simulators
- Analog Computers
- Radar & Sonar Trainers
- Radar Guidance & Fire Control Systems
- Redesign, Modification & Testing of Radar & Electronic Systems
- Electronic Installation & Maintenance
- Coil & Transformer Design
- Packaged Power Supplies

Other Openings For:

COMMUNICATIONS EQUIPMENT DESIGNERS

COMPUTER DESIGNERS

FIELD ENGINEERS

(*) Must have E.E. degree or equivalent with 5-10 yrs. experience.
*Positions located throughout USA

LOCATION:

On U. S. Highway 22, thirty miles (45 minutes) from New York City.

ENVIRONMENT:

One of the finest plants of its kind... spacious, modern, air-conditioned. Conducive to bringing out the best of your abilities!

ABOUT THE COMPANY:

Organized in 1945. Engaged in research, design and development for the Armed Services.

ITS BENEFITS:

- Pension Plan
- Group Life Insurance
- Paid Holidays
- Paid Sick Leave
- Paid Vacations
- Education & Tuition Assistance
- Other Group Insurances

Interviews in Your Community by Appointment

Send complete resume, write or call personnel director.

STAVID Engineering, Inc.

U.S. Highway 22,
Watchung, P.O.
Plainfield, N. J.
Plainfield 7-1600

ELECTRONIC ENGINEERS

Consider the significance of your profession!

The shape of things to come is being designed by electronic engineers of professional stature, the exceptional engineers who—by education and experience—are qualified to fulfill an important destiny. Such men are needed at Bendix Radio to do research and development on the most advanced electronic systems in both military and commercial fields.

Nowhere are the professional aspects of the engineer's career held in higher regard than they are at Bendix Radio!

At Bendix you will be given the opportunity for important accomplishment while working on the most advanced electronic systems. These include:

- MISSILE GUIDANCE & TRACKING SYSTEMS
- RADAR WARNING SYSTEMS
- MILITARY ELECTRONICS RESEARCH & DEVELOPMENT
- AUTOMOTIVE ELECTRONIC RESEARCH
- AIRBORNE ELECTRONICS SYSTEMS
- MOBILE COMMUNICATIONS SYSTEMS

At Bendix Radio, the importance of *your* career is fully recognized. You are given the opportunity for rapid professional growth while working with leading engineers who are pioneers in their fields. You are backed up by skilled sub-professional people and kept well-informed as to the status of company work and project developments. You work in a modern plant with the latest equipment and will receive an excellent salary, periodic merit reviews and complete company benefits, including assistance in graduate education.

The attitude, the way of life and the vision of the future is designed for the man of professional stature at Bendix Radio. We invite you to take up this way of life in our beautiful residential area and look upward toward a bright future.

Drop us a postal card, briefly stating your education and experience. We'll act fast . . . and confidentially!

Address: Employment Supervisor, Dept. J



Bendix

DIVISION OF BENDIX AVIATION CORP., BALTIMORE 4, MD.

Radio

**Mr. ENGINEER
Why Not Consider
FIELD ENGINEERING**

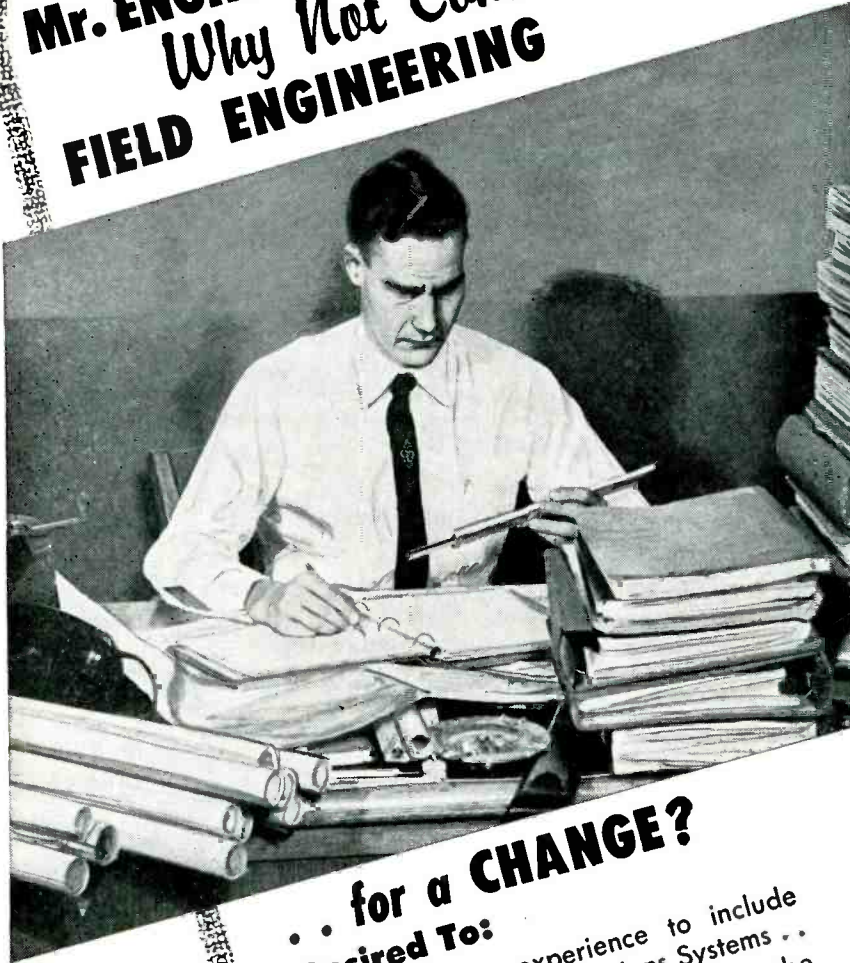

Have YOU Ever Desired To:

- **EXPAND** your experience to include World Wide Communications Systems . .
- **BECOME** fully experienced in the world's most advanced electronic systems and equipment . .
- **ENJOY** the freedom of locating anywhere in the world . .
- **INCREASE** your earning potential and provide greater security for your family . .

• If you find yourself answering yes to any of these questions, let us send you our new, full color, illustrated employment brochure which explains the challenge as well as the positions now open for PHILCO Field Engineers. Write NOW . . . get the facts on . . .

"PHILCO . . . First IN EMPLOYMENT OPPORTUNITIES"

PHILCO TECHREP DIVISION

DEPT. 19, 22nd & Lehigh Avenue,
Philadelphia, Pa.

ENGINEERS

PARTS APPLICATION

(Reliability)

ME or EE degree with design experience and/or application experience. Job will be to recommend types of parts to be used and how these parts shall be used.

Qualified men will become a vital part of a Reliability Group.

GM

**INERTIAL GUIDANCE
SYSTEM PROGRAM**

• **ELECTRONICS DIV.,**

Milwaukee 2, Wis.

Flint 2, Mich.

Enjoy Challenging Opportunities in the most versatile Laboratories in the country. Work with the top men in the field and with the finest test, research and development facilities. We are in the process of a Major, Permanent, Expansion Program. New Plant facilities being added in suburban Milwaukee area.

To aid you in your professional advancement AC will provide financial assistance toward your Master's degree. A Graduate Program is available evenings at the University of Wisconsin, Milwaukee.

GM's Electronics Division aggressive position in the field of manufacture and GM's long-standing policy of decentralization creates individual opportunity and recognition for each Engineer hired.

**Recent EE,ME
Graduate Inquiries
Also Invited**

Milwaukee offers ideal family living in a progressive neighborly community in cool, southern Wisconsin where swimming, boating, big league baseball and every shopping and cultural advantage is yours for the taking.

To arrange personal, confidential interview in your locality send full facts about yourself today to

Mr. John F. Heffinger
Supervisor of Technical Employment

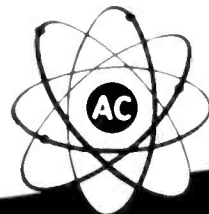

**Electronics Div.
General Motors Corp.**

FLINT 2, MICHIGAN
MILWAUKEE 2, WISCONSIN

SYSTEMS ENGINEERS

At Sylvania —

An Integrated Engineering Approach

1. New Concepts
2. Integrated Systems Studies
3. Systems Design, Development & Testing
4. Engineering Models

Your interests may be analytical, design or development. Our engineering programs include a complete range of problems from feasibility studies through the design of engineering models.

HERE ARE THE CAREER POSITIONS NOW OPEN:

SYSTEMS ENGINEERS

To perform radar systems design studies, radar data processing, guidance and control systems analysis, and UV and IR systems analysis.

COMPUTER DESIGN ENGINEERS

Responsible for general and special purpose digital computers including core memory systems, input and output systems; also transistorization of special computer circuits and design of data handling and processing systems.

ELECTRONIC DESIGN AND DEVELOPMENT ENGINEERS

With responsibility for very high power radar systems, including pulse modulators, transmitters, radar data handling circuitry, special VHF receivers, transmission line devices and instrumentation.

ANTENNA ENGINEERS

For work on element design arrays, power dividers, RF linkages and other general transmission problems.

PROJECT ENGINEERS

General responsibility for ECM, computer and other electronic systems including internal projects coordination and technical relations with contracting agencies.

PACKAGING AND TEST ENGINEERS

For supervisory responsibility for design of advanced electronic and electromechanical systems. Also engineers responsible for environmental testing of electronic equipment and design instrumentation of test facilities and equipment.

Two avenues of advancement open to systems engineers are Systems Management or Scientific Systems Specialties with parallel salary scales for both.

Sylvania offers excellent salaries recognizing individual achievements, and suburban Boston living, near outstanding colleges and extensive cultural and recreational facilities.

Undergraduate and graduate students in EE or Applied Physics who will be completing degree programs in February, June and August of 1957 are also encouraged to apply.

If you are interested in any of these positions, please send your resume immediately (in strictest confidence, of course) to:

ERLING MOSTUE
100-77 FIRST AVENUE
WALTHAM, MASSACHUSETTS

WALTHAM LABORATORIES
ELECTRONIC SYSTEMS DIVISION



SYLVANIA

SYLVANIA ELECTRIC PRODUCTS INC.

Career opportunities
in BOSTON

are better
than ever!



Long range research, engineering and production programs at Honeywell in Boston have created new and unusual career opportunities in the instrument and semiconductor fields. In addition to professional and financial advancement, these career opportunities offer the *recognition* that goes with working in a small compact engineering group of an autonomous division and *advancement* through association with the world's largest producers of automatic controls.

Gyro and Accelerometer Design Engineers

Data Handling Amplifier Design Engineers

Electrical Design Engineer for Automation Equipment

Semi-Conductor Engineers for R & D and Production

Chemical, Mechanical, Metallurgical Process Engineers

Write Mr. F. L. Mannix, Personnel Director, Minneapolis-Honeywell, Boston Division, 1400 Soldiers Field Road, Boston 35, Mass., or call ALgonquin 4-5202.

MINNEAPOLIS
Honeywell



B O S T O N D I V I S I O N

P
H
O
N
I
X
P
H
O
E
N
I
X

At the crossroads of opportunity for men with vision in Electronic Engineering and other related fields:

**GOODYEAR
AIRCRAFT
CORPORATION**

ELECTRONIC LABORATORY

Arizona Division
Litchfield Park, Arizona

A Subsidiary of the
GOODYEAR TIRE & RUBBER CO

We have openings in our modern Laboratories at all levels of experience in the branches of Engineering listed below. We urge you to investigate the opportunities here for employment. We think you will like the friendly, informal atmosphere of our laboratory. The stimulation of working with top level engineers and scientists will make your work interesting and challenging.

Complete Missile and Electronic Systems
Microwaves, Servomechanisms
Radars and Stabilized Antennas
Transistor Application, Electronic Packaging
Electronic Ground Support Equipment

Long range research and development projects

University of Arizona graduate studies available under the Goodyear Fellowship Program, or company financed evening courses.

Leisure Living At Its Best
"In the Valley of the Sun"

Modern Inexpensive Housing

Send resume to: A. E. Manning
Engineering and Scientific Personnel

GOODYEAR AIRCRAFT

LITCHFIELD PARK
PHOENIX, ARIZONA

Similar opportunities available in our Akron, Ohio Laboratory

A New Lab

for AIRCRAFT ELECTRONIC SYSTEMS

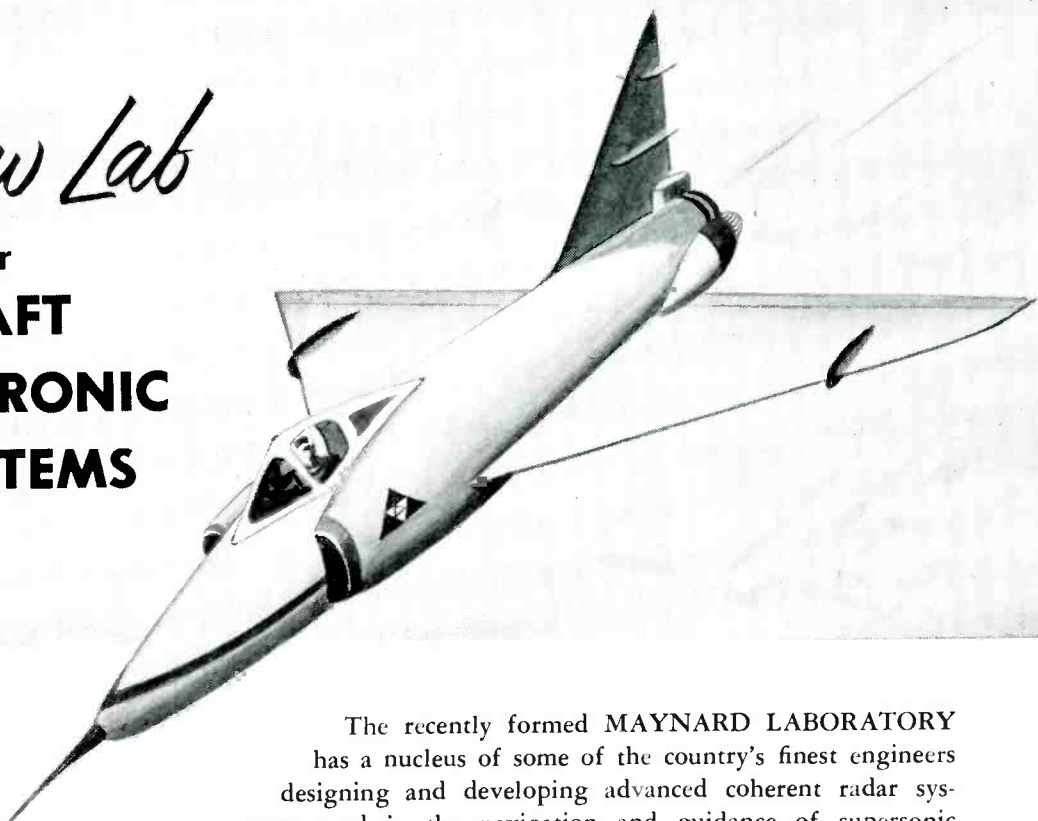

The recently formed MAYNARD LABORATORY has a nucleus of some of the country's finest engineers designing and developing advanced coherent radar systems used in the navigation and guidance of supersonic aircraft.

The application of ELECTRONICS to the needs of the rapidly expanding AIRCRAFT INDUSTRY provides unmatched opportunities for the engineer who wants challenging, interesting work with prospects of real progress.

In addition to advancement possibilities occasioned by the expansion of our laboratory, Raytheon offers excellent starting salaries, periodic reviews for merit increases and liberal company benefits including subsidized graduate study programs. Our plant is located approximately 22 miles from Boston and offers a choice of urban or suburban living in beautiful New England.

Reasonable relocation allowances and assistance in finding appropriate housing are also provided.

Our company is largely managed by engineers which creates an exceptional environment for our design engineering staff. At present we have need of men at all levels with experience and interest in:

RADAR SYSTEMS
CIRCUIT DESIGN
ENGINEERING PHYSICS
TUBE APPLICATIONS
RELIABILITY
MICROWAVE DESIGN

RF DESIGN
ANALOG COMPUTER DESIGN
MECHANICAL PRODUCT DESIGN
ELECTRONIC PRODUCT DESIGN
TEST EQUIPMENT DESIGN
TECHNICAL WRITING

To discuss your future at Raytheon, contact: John J. Oliver



THE MAYNARD LABORATORY
P. O. Box 87, Maynard, Mass.

Tel: TWinoaks 7-2945, Ext. 246



AVCO MANUFACTURING CORPORATION
Crosley Division

Foremost in Electronics

Offers Engineers Many Advantages!

WHEN THE PILOT CAN'T SEE
“Volscan” BRINGS

Him Down . . . SAFELY! SURELY!

One of the major advances in aviation history is “Volscan”. This remarkable electronic device enables the pilot to come in even though he can't see where he is or where he is going. Wouldn't you like to play a part in important achievements such as this? If so, we have top openings for engineers in many different categories.

- | | |
|---|--|
| <ol style="list-style-type: none"> 1. Guided Missiles 2. Computer and Analytical Services
<small>(Design and Development)
(Programming and Application)</small> 3. Ground Radar 4. Air Traffic Control 5. Antennas & Micro-Waves | <ol style="list-style-type: none"> 6. Communications
<small>(Airborne Transmitters and Receivers)</small> 7. Airborne Fire Control 8. Airborne Defense Systems 9. Servo Mechanisms 10. Transistorized Equipment |
|---|--|

Contact us and find out where you can fit into the major programs now being started. There are numerous company benefits and you will be paid generous relocation expenses.

SEND A RESUME TO:

Mr. Nick M. Pagan,
 Employment Manager, CC
AVCO Manufacturing Corp.
 Crosley Division
 2630 Glendale-Milford Road
 Evendale, Cincinnati 15, Ohio

SENIOR ENGINEER

CIRCUIT
 AND
 COMPONENT
 APPLICATION
 TO
\$12,000

A large electronics organization has a need for a specialist in the application of components such as transformers, relays, resistors, capacitors, semi-conductors, and rotary equipment for large military electronics systems to assure maximum reliability.

The candidate for this position should have a minimum of six years experience in electronic design and component application. He will serve in a consulting capacity with emphasis on technical suitability and circuit application of special components.

He should be able to counsel and guide young engineers lacking broad technical experience. He must have the ability to deal effectively with vendors and engineering project groups and must take an active part in industrial and professional symposiums, exhibitions and committees to encourage the development of component parts and their applications.

Please send resume indicating education and experience to

P-3985, Electronics,
 Class. Adv. Div. P. O. Box 12, N. Y. 36, N. Y.

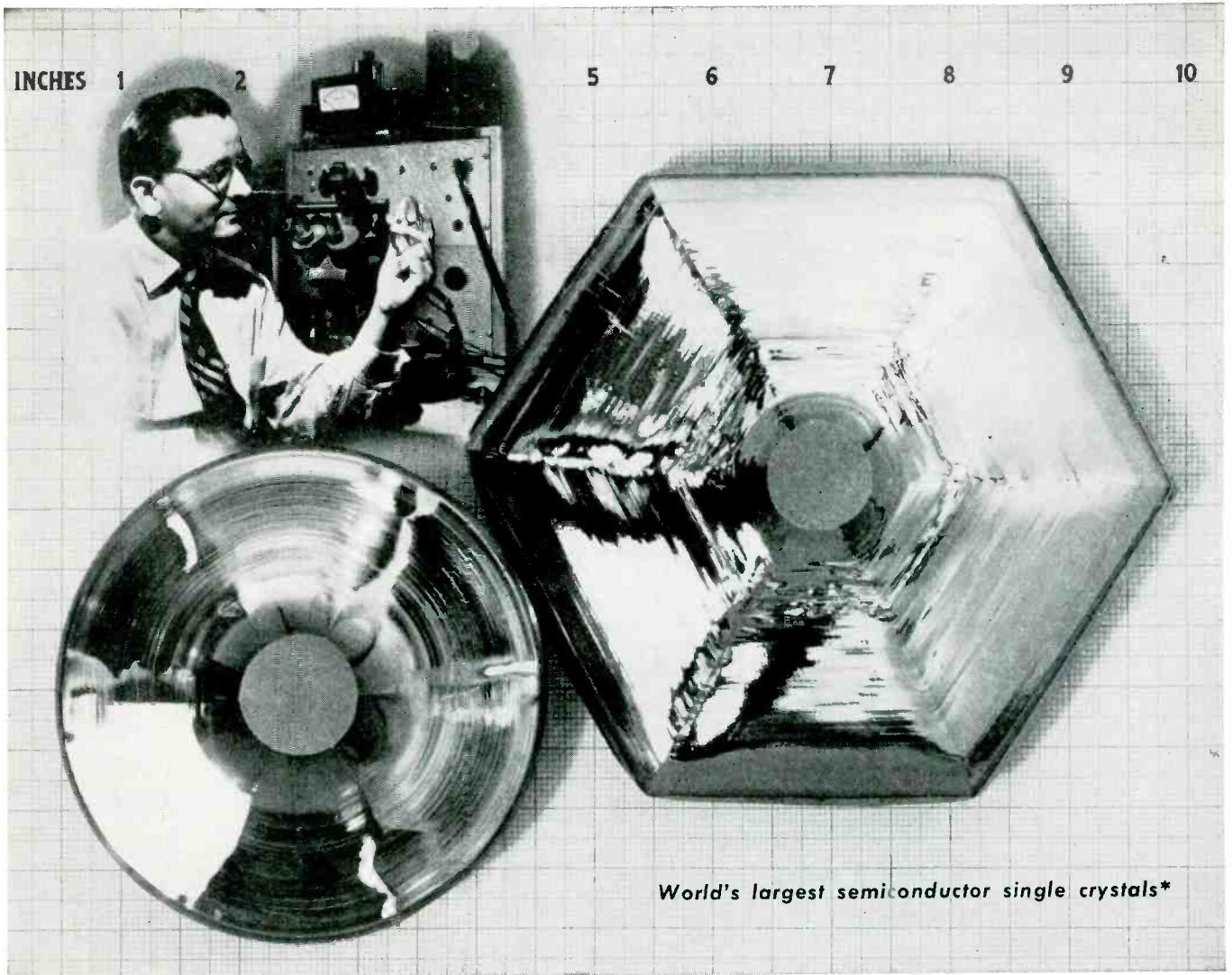

*World's largest semiconductor single crystals**

ENGINEERS / PHYSICISTS

You are invited to join one of these expanding programs at Texas Instruments — where recognition of individual achievement has contributed to its fifteenfold growth in the last ten years. Advanced personnel policies include company-sponsored educational assistance, profit sharing, insurance and pension plans.

The TI plant is within Dallas, yet away from downtown traffic... within 5 minutes of fine residential areas, churches, and public and private schools. Your home will be within 15 minutes of year-around recreational, amusement, and cultural facilities.

* Produced in connection with the many investigations into solid state physics and electrical phenomena being carried on by Texas Instruments Incorporated... leading manufacturer of semiconductor products... 26-year-old pioneer and leading supplier of geophysical exploration services... currently engaged in design, development, and manufacture of electronic components, instruments, optics, and military apparatus — at a \$44 million volume.

SEMICONDUCTOR DEVICES AND OTHER COMPONENTS

transistors • transistor circuits
diodes • rectifiers
transformers • resistors
panel meters
test equipment

Address
SEMICONDUCTOR-COMPONENTS
replies to:
Mr. William C. Spaller

ELECTRONIC AND ELECTRO-MECHANICAL APPARATUS

radar • sonar • infrared
navigation • magnetics
telemetry
communications
computers

Address
APPARATUS replies to:
Mr. Robert E. Houston



TEXAS INSTRUMENTS
INCORPORATED
6000 LEMMON AVENUE DALLAS 9, TEXAS

BURROUGHS RESEARCH CENTER NEEDS *Good* ENGINEERS

**THAT
CERTAIN
MAN**

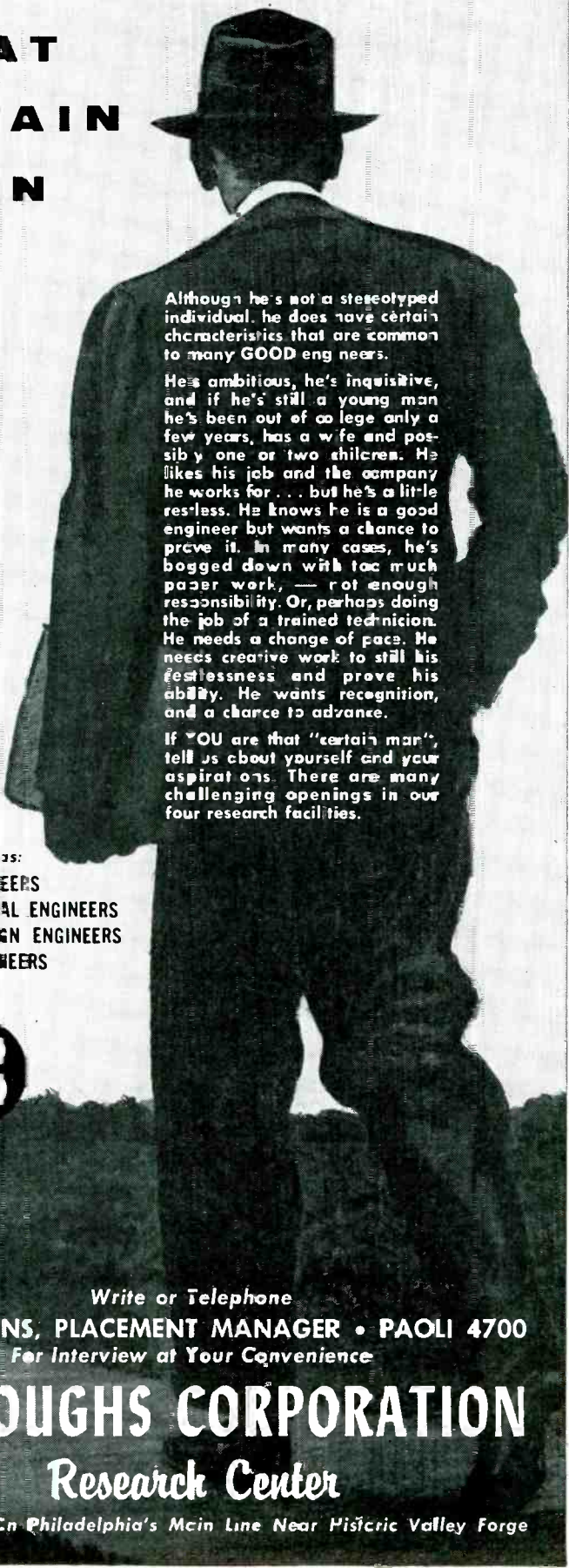

Although he's not a stereotyped individual, he does have certain characteristics that are common to many GOOD engineers.

He's ambitious, he's inquisitive, and if he's still a young man he's been out of college only a few years, has a wife and possibly one or two children. He likes his job and the company he works for... but he's a little restless. He knows he is a good engineer but wants a chance to prove it. In many cases, he's bogged down with too much paper work, — not enough responsibility. Or, perhaps doing the job of a trained technician. He needs a change of pace. He needs creative work to still his restlessness and prove his ability. He wants recognition, and a chance to advance.

If YOU are that "certain man", tell us about yourself and your aspirations. There are many challenging openings in our four research facilities.

Inquiries are invited from those qualified as:

- ELECTRICAL ENGINEERS
- ELECTROMECHANICAL ENGINEERS
- MECHANICAL DESIGN ENGINEERS
- MECHANICAL ENGINEERS
- MATHEMATICIANS
- PHYSICISTS



Write or Telephone

M. E. JENKINS, PLACEMENT MANAGER • PAOLI 4700

For Interview at Your Convenience

BURROUGHS CORPORATION

Research Center

PAOLI, PA. • On Philadelphia's Main Line Near Piscric Valley Forge

Admiral.

has a future for
Engineers—Physicists in
**NUCLEAR RADIATION
DAMAGE CONTROL**

SENIOR PHYSICIST

Ph.D. with nuclear engineering background, to evaluate nuclear radiation damage to electronic components, to develop techniques in radiation instrumentation and to develop methods and materials suitable for use in components subjected to high level nuclear environments. Work involves experimentation with reactors and multikilocurie cobalt source.

NUCLEAR INSTRUMENTATION

Engineer familiar with Geiger counters and ionization chamber radiac instruments, to assist group leader in developing contract and proprietary items in the nuclear instrument field.

Career-minded men with several years specialized experience are invited to join our rapidly expanding program. Current openings offer excellent income and employee benefits including retirement plan, paid group insurance and college tuition refund plan plus ideal working conditions. On-the-job training for junior and intermediate engineers.

If you are qualified in either of these fields, explore your opportunity with Admiral today. Write Mr. Walter Wecker, Personnel Manager.

Admiral Corporation

3800 W. Cortland Street
Chicago 47, Illinois

THE UNIVERSITY of MICHIGAN
**ENGINEERS and
SCIENTISTS**

Unusual opportunities for outstanding and experienced men are available at The University of Michigan's Willow Run Laboratories. Research Engineers and Physicists with advanced degrees and/or experience in the fields of:

- DIGITAL COMPUTER • LOGICAL DESIGN • INFRARED • ACOUSTICS • DIGITAL COMPUTER PROGRAMMING • ELECTROMAGNETIC THEORY • COMMUNICATIONS CIRCUIT DESIGN • COMPONENT DEVELOPMENT • RADAR • OPTICS ENGINEERING • SYSTEMS DESIGN

Salary commensurate with training and experience. Excellent working conditions. Liberal vacation policy along with other fringe benefits. Unusual opportunity to carry on University graduate studies while working full time. Moving expenses paid. U. S. Citizenship required.

Write, giving details of education and experience to

Technical Personnel Representative

The University of Michigan
Willow Run Laboratories
Ypsilanti, Michigan

ENGINEERS . . .



• *Market Development*



• *Visit Customer Plants*



• *Plant Engineer Contacts*

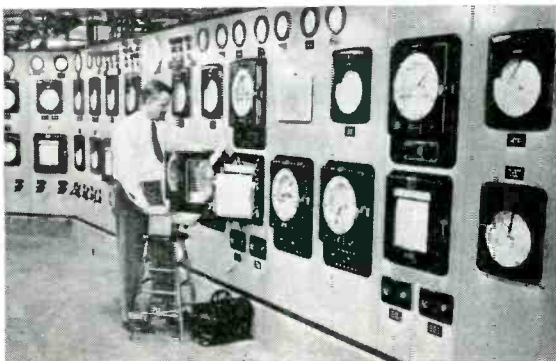

• *Servicing Customers' Instruments*



Step into the Expanding Field of Instrumentation

Ever Think of MARKETING As a Career?

Marketing, as we practice it, consists largely of analyzing problems and finding the answers. It is far removed from "ringing doorbells", because the doors are already open. And it is far removed from "pushing" anything or anybody, because buying and selling in industry are based on reason, not emotion. Industrial Marketing includes careful engineering, good judgment, and expert knowledge of the equipment you're discussing.

For our open positions in Marketing a college degree in science or engineering is necessary plus a normal liking for people and an ability to get along with them. Our specifications are as follows:

MARKET DEVELOPMENT: 3-5 years experience in the following areas of specialization. Instrumentation and control knowledge desirable: Aluminum or Steel, Glass or Cement, Electric power, Combustion Control, Nucleonics, Electrical Measurements, Data Processing, Petroleum or Chemical Process Instrumentation. Location—Philadelphia

SALES ENGINEERING: 1-3 years experience in selling instrumentation and controls to basic process industries. Location—District Sales offices listed below

SERVICE ENGINEERING: 2-5 years experience in Steam or Electric Power plant instrumentation. Location—Chicago, Philadelphia, Houston, Cincinnati, Atlanta

This can be a career of infinite variety, great usefulness and excellent income. Why not let us set up an interview with some of the managers of our Marketing Departments.

We also have several openings for experienced technical personnel in Research, Development and Engineering.

Address your reply to:

Wayne L. Besselman, Coordinator of Technical Employment



4979 Stenton Ave., Philadelphia 44, Pa.

Atlanta
Boston
Buffalo
Chicago
Cincinnati
Cleveland

Columbus
Denver
Detroit
Houston
Indianapolis

Los Angeles
Milwaukee
New York
Philadelphia
Pittsburgh
San Francisco

Seattle
St. Louis
Tulsa
Integra, Leeds
& Northrup,
Birmingham, Eng



BENDIX OFFERS THE FINEST GUIDED MISSILE OPPORTUNITIES IN THE MIDDLE WEST

It isn't often that you can combine ideal living conditions with outstanding advancement opportunities. At Bendix Guided Missiles we sincerely believe we can offer you both.

We are sure that you would enjoy living in an attractive community convenient to metropolitan centers and recreational areas.

And, we are equally confident that as prime contractor for the important and successful Talos Missile, no one can offer a greater variety of interesting and challenging job opportunities in the guided missile field.

If you would like proof of these strong

statements, why not fill out the coupon and send for a copy of our thirty-six-page booklet "Your Future in Guided Missiles". It not only gives a detailed story of guided missile operations, but it also presents interesting facts about living conditions in the area, the many special employee benefits, and the wide range of specific job opportunities we have to offer.

Send for your copy of "Your Future in Guided Missiles" today.

Bendix — prime contractor
for the TALOS MISSILE

Bendix Products Division—Missiles
403 J, Bendix Drive, South Bend, Indiana

Gentlemen: I would like more information concerning opportunities in guided missiles. Please send me the booklet "Your Future In Guided Missiles".

NAME _____

ADDRESS _____

CITY _____ STATE _____

ENGINEERS AND SCIENTISTS

with degrees in
E.E., M.E., Ch.E. or PHYSICS

Honeywell

BROWN INSTRUMENTS

First in Controls

LEADS THE WAY IN A WORLD OF OPPORTUNITIES

■ **THE COMPANY**—Judging a company on its past performance constitutes sound logical thinking. Looking over BROWN INSTRUMENTS record of accomplishment tells a reassuring story of continuous growth during nearly a century of pioneering in the industrial instruments and control field.

■ **ASSIGNMENTS**—Diversified . . . permanent, non-routine, in the newest scientific field of NUCLEAR INSTRUMENTATION and AUTOMATION. The bulk of our work is for industrial use.

■ **COMPENSATION**—Rewarding . . . salaries are competitive with those offered in other industries. Our benefits include free group health insurance, hospitalization and surgical benefits, as well as an excellent retirement plan. Relocation assistance.

■ **GROWTH**—Unlimited . . . your performance and salary is re-evaluated twice yearly. Our policy to promote from within is responsible for present management.

■ **EDUCATION**—Excellent . . . financial assistance for those desirous of furthering their education at one of several renowned Philadelphia colleges or universities.

Men with the vision to create and the will to act can find an abundant outlet for their creative talent in either RESEARCH, DESIGN and DEVELOPMENT APPLICATION or SYSTEMS ENGINEERING. Whatever the choice, you and only you will be able to control and measure your progress with this company which leads the way in a world of opportunities . . .

Write to D. R. GARVEY
Manager Employment,
Dept. E

Honeywell

BROWN INSTRUMENTS DIV.
Wayne & Windrim Aves.
Philadelphia 44, Pa.

Are You Looking For A Job... Or A Career?

For A Real Career Position... Read About These 12 Outstanding Openings At

WESTINGHOUSE-BALTIMORE

The 12 positions listed below are not just job opportunities — they are permanent career positions with an established leader in the electronics field. Westinghouse-Baltimore is an engineer's company — one that respects the engineer and rewards him for his contributions. The company's two new plants offer the very finest modern facilities and equipment for advanced work on vital projects that challenge the imagination and assure steady professional growth. These 12 opportunities may be the chance for which you've been waiting. Investigate them—and get in on the ground floor of tomorrow's electronic developments — at the rapidly expanding Baltimore Divisions of Westinghouse.

CURRENT OPENINGS EXIST FOR:

AIRBORNE RADAR SYSTEMS ENGINEERS

Overseas assignments on a research and development type project. An E.E. degree from an accredited college or university with additional training or experience on airborne radar systems is desirable. Applicants should be single, or willing to spend periods of six months to one year away from their families.

TROPOSPHERIC SCATTER SURVEY ENGINEERS

To work with the Air Force. Those selected would travel considerably here and overseas. The company would provide living allowances and salary bonuses for overseas service. Applicants should have an E.E. degree from an accredited university and two to four years experience with microwave communications systems. Additional experience in surveying and laying out microwave systems would be helpful.

ELECTRIC WAVE FILTERS ENGINEERS

To assist in the design and development of audio, i-f and r-f filters, to meet the increasingly difficult requirements of modern SSB receivers and transmitters, both high and low power, at frequencies up to and including UHF.

MISSILE RADAR SYSTEMS ENGINEERS

To do analysis of over-all systems requirements. Must be able to translate to block diagram requirements.

MATHEMATICIANS

Some radar systems experience is desired, or experience in the following related fields: Noise analysis, Anti-jamming or Electrical Counter Measures, Communications systems.

MICROWAVE DEVELOPMENT ENGINEERS

To do development for the functional block diagram state to a complete bread board model. Theoretical and practical knowledge in the field is desired.

MECHANICAL DESIGN ENGINEERS

For the mechanical design of X-ray equipment, and for the designing of equipment to permit use of isotopes for medical treatment while protecting hospital personnel. An M.E. degree is required.

SALES ENGINEERS

To work with regional sales force on preparation of diagrams of the customers' organization, knowledge of the functions of the various elements, definition of procurement cycles, indication of important people and recommendations on over-all relations; detailed planning and coordination of sales strategy and proposal preparation; direction of contact efforts; liaison with Product Planner; and dissemination of product information.

DIGITAL COMPUTER ENGINEERS

For the extensive application of present and future digital techniques to military problems. Applicants with background and interest in digital coding, digital programming, and in the necessary hardware to implement such systems would find immediate application in our present digital work and would be expected to originate future digital programs.

ELECTRONIC TRANSFORMER ENGINEERS

To assist in the design and development of audio, i-f and r-f coils, flea-power to 600×10^6 v-a, frequencies up to 1000 MC, both linear and saturable, involving problems of balance, shielding, bandwidth, insulation, heat transfer, wave shape, efficiency and regulation.

COMPONENTS ENGINEERS

For testing, evaluation and developing reliability programs for Electrical Components such as: switches, diodes, triodes, tubes, meters, resistors, capacitors, chokes, etc. Applicants must be qualified for standardization of components and interpretation of military specs.

MISSILES RADAR TEST ENGINEERS

To design intricate test equipment and assist in the testing and evaluation of developmental missiles target seeker systems.

TO APPLY:

For a confidential interview, send a resume of your education and experience to:

Dr. J. A. Medwin, Dept. 584
WESTINGHOUSE ELECTRIC CORPORATION
P. O. Box 746 • Baltimore 3, Maryland

WESTINGHOUSE-BALTIMORE

"An Engineer's Company"

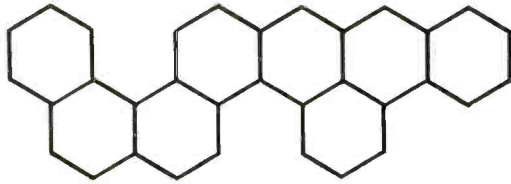

ANALYTICAL ENGINEERS

At Hawthorne, in Southern California, Northrop Aircraft has a continuing need for experienced engineers seeking new opportunities. There are attractive positions open in the following fields: Aerodynamics, Dynamics, Thermodynamics, Stress, Loads, Performance Analysis.

In Northrop's superbly equipped multi-million-dollar engineering and science center, now nearing completion, you will be given constantly fresh and challenging assignments. Present programs include Northrop's new supersonic trainer airplane, the Snark SM-62 intercontinental guided missile, plus advanced aircraft and missile projects yet to be revealed.

You'll be associated with a high-calibre engineering team that has established an outstanding record in aeronautical design and development. Your initiative and ideas will be recognized, encouraged and rewarded, for at Northrop Aircraft the progress of personnel is as important as the progress of projects.

Besides attractive remuneration, you will enjoy other benefits unexcelled in the entire industry—retirement plans, health and life insurance, college educational reimbursement plan, regular vacations plus extra year-end vacations with pay. Easily-reached mountain, desert and beach resorts in sunny Southern California offer year 'round attractions for you and your family.

You will find the career opportunity you are seeking at Northrop, pioneer in the design and production of all weather and pilotless aircraft. If you qualify for one of these attractive positions, contact the Manager of Engineering Industrial Relations, Northrop Aircraft, Inc., ORegon 8-9111, Extension 1893, or write to: 1015 East Broadway, Department 4600-T, Hawthorne, California.



N O R T H R O P

NORTHROP AIRCRAFT, INC., HAWTHORNE, CALIFORNIA

Producers of Scorpion F-89 Interceptors and Snark SM-62 Intercontinental Missiles

Electronic Electrical ENGINEERS

If you are interested in gaining diversified experience as well as utilizing your creative ability, our expanding Research and Development projects in ELECTRONIC COMPONENTS offers you this opportunity.

The COMPONENTS field is one of rapidly growing importance, and our staff is currently engaged in projects involving Materials, Fundamental Design, Measurements, High Temperature Application, and Reliability Problems. Positions are available at all levels of professional attainment and participation in these and other projects should be particularly interesting to engineers who desire breadth and variety in their profession.

Advantages of employment at Armour Research Foundation include tuition free graduate study, generous re-location allowance, as well as competitive pay and excellent working conditions.

If you are interested in this excellent opportunity to advance professionally, please write:

J. A. Metzger

ARMOUR RESEARCH FOUNDATION

of Illinois Institute of Technology

10 West 35th St. Chicago 16, Illinois

OPPORTUNITIES ALSO AVAILABLE
IN TUCSON, ARIZONA

TRANSFORMER ENGINEERS

to \$9,000

Outstanding growth opportunity with established leader in advanced airborne electronics for engineers with sales-type personality and 2 to 4 years' experience in design and/or evaluation of transformers utilized in power circuits or pulse circuitry. Familiarity with MIL and JAN specs.

Will consult with design engineers to establish what transformers will best serve particular circuit . . . with vendors to keep abreast of current transformer types and discuss specifications for the design and construction of new transformers. Will evaluate ability and resources of vendors to supply transformers.

GOOD ADVANCEMENT OPPORTUNITIES

Promotion-from-within. Outstanding employee benefits including liberal aid for graduate study.

Please send your reply in confidence to:

P-3979—Electronics

Classified Adv. Div.,
P. O. Box 12, New York 36, N. Y.

WANTED COMMUNICATIONS ENGINEER

For large Railroad System. Some experience necessary. Desire B.S.E.E. or equivalent. Salary over \$700. month. In reply state age, educational and employment history, military status. All replies will be held confidential. Location Mid-West.

P-4000, Electronics
520 N. Michigan Ave., Chicago 11, Ill.



**“My Dad’s with
EMERSON ELECTRIC!”**

...and there’s lots of room for your Dad, too!

- **Electronic Engineers (radar, computer, servo)**
- **Electronic Packaging Engineers**
- **Electronic Test Equipment Designers**
- **Electrical Engineers**
- **Liaison Engineers (electronics background)**
- **and Recent Graduates**

Big, new developments in our tremendous long range expansion program have created excellent career opportunities. Your position will be highly important and advancement rapid due to the dynamic pace of our growth.

Emerson Electric is medium sized (5000 employees, 850 engineers). Our Electronics and Avionics Division is a leader nationally, since 1940, in design, development and production of electronic fire control systems, missiles, supersonic airframe structures, radar assemblies and aircraft components.

Our Commercial Division, established 1890, produces comprehensive lines of fans, motors, air conditioners and power tools. The perfect balance of electronic, aircraft and consumer production assures stability and security.

Advanced education, undergraduate and graduate, is worked out to fit individual needs. Benefits range from unusual salary arrangements, group insurance and pension to fully paid moving expenses. We’re ideally located in a suburban St. Louis residential area with shopping centers and no traffic congestion. St. Louis combines four seasons with a delightful ‘national climate’ averaging extremes of 32.5° in January and 80° in July.

WRITE TODAY to R. L. Middleton, Employment Manager, for more details.

EMERSON ELECTRIC

E

E

Electronics and Avionics Division
8100 W. Florissant
St. Louis 21, Mo.

Name _____

Address _____

Years of Experience _____ Degree _____

Assignment Desired _____

GLance at
OFFERS TOP
OPPORTUNITY

Electronic Engineers
Physical Chemists
Physicists

If you have a degree and experience in: Design and development of approved electronic components—Knowledge of dielectrics and chemistry of dielectrics and insulators—Molecular engineering—circuitry and electro-mechanical devices for aircraft—Development of gas tubes—Glass and/or ceramic to metal seals—CONSIDER

GLA engineers enjoy unusual individual freedom while working for a growing and progressive company near New York’s famous vacationland. Salaries are commensurate with experience and ability.

Send resume: Attn;

Mr. R. E. Powers, Personnel Manager

**General Laboratory Associates,
Inc.**

Engineers and Manufacturers of Aircraft Ignition and Electronic Equipment

Plant #2, Norwich, New York

HRB

**‘smaller
company?’**

HRB is a small company. It has remained small by choice. Electronic engineers and physicists will find country quiet and metropolitan opportunity at HRB. Individual recognition for creative initiative is only one of the many advantages offered. A sincere interest in the progress of each engineer is standard policy in this internationally recognized “small” research company.

For application form, write:
 Technical Personnel Officer
 Haller, Raymond & Brown, Inc.
 State College, Pennsylvania

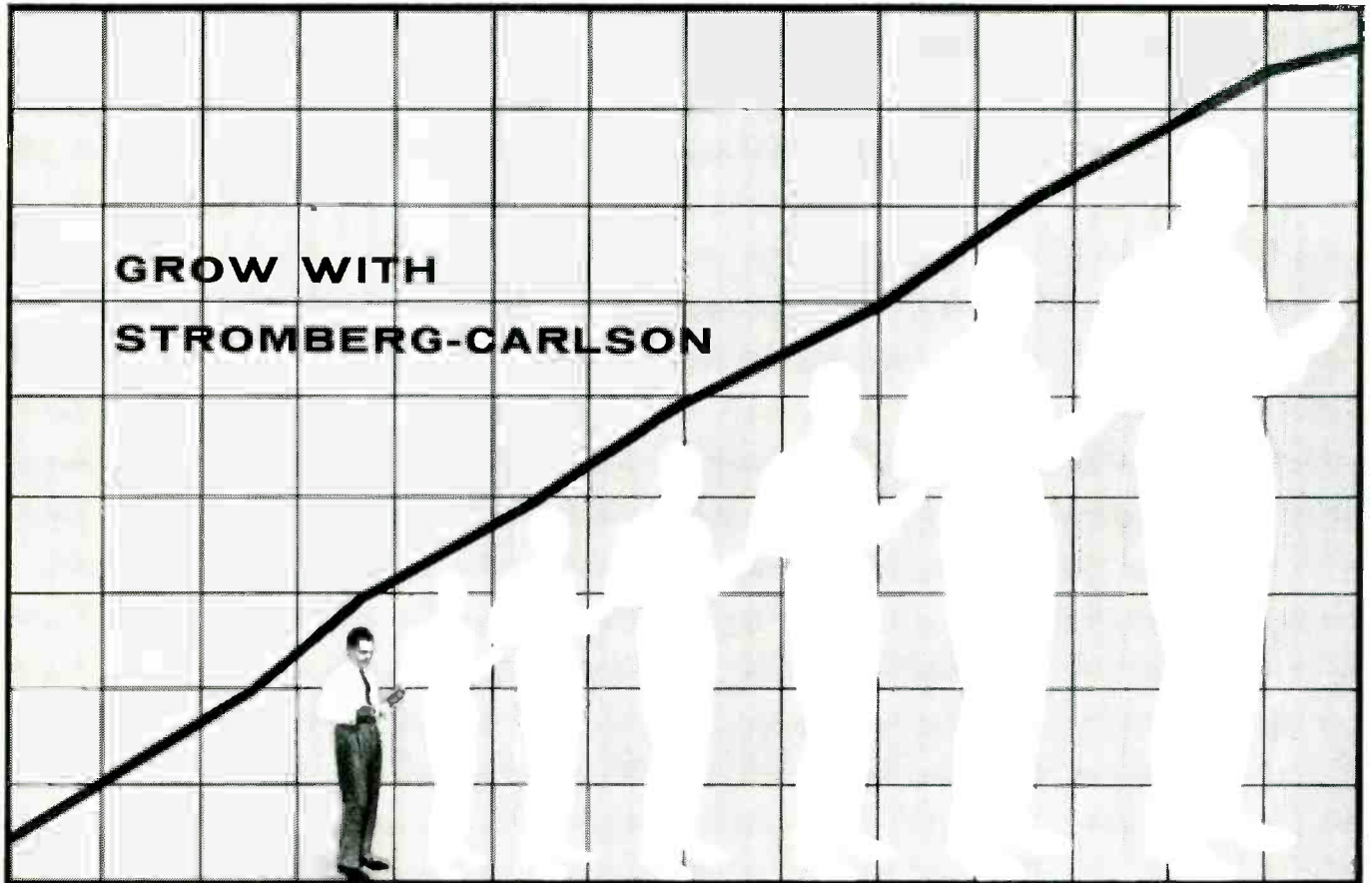

Electronics Engineers— Chart your personal and professional growth with STROMBERG-CARLSON

Your growth curve in Stromberg-Carlson's booming Electronics Division goes steadily—and rapidly—upward. Here's why:

1. The company itself is one of the "hottest" in the electronics industry today.
2. Three-times expansion of the Electronics Division means rapid advancement for you right from the start.
3. Liberal management attitudes encourage your own initiative . . . your ideas don't get lost in the shuffle.

In addition to opportunities for personal and professional growth, we offer challenging, interesting work. Check this list of assignments to see where you fit best:

Components and
Specifications
Countermeasures
Data Systems
Digital Techniques

Field Engineering
Microwave Circuits
Navigational Systems
Radar
Transistor Engineering

Communication Systems
Missile Guidance Systems
Sales Engineering
Systems Test Equipment
Writers—Technical

Send your letter or resumé now to
R. W. HOLMES, Electronics Engineering

ROCHESTER . . . a great place to live



New Community War Memorial is the scene of major league sports, ice shows and other spectacles.



Nearby lakes provide outstanding facilities for boating, swimming, fishing and other water sports.



University of Rochester is among the country's finest institutions, as are the city's public and private primary and secondary schools.



STROMBERG-CARLSON COMPANY
A DIVISION OF GENERAL DYNAMICS CORPORATION



18 Carlson Road, Rochester 3, N. Y.

electronic engineers

SENIOR and JUNIOR

*Continued Expansion
Opens Up New Opportunities with*



Greenwich, Connecticut

Excellent positions are available with the General Engineering Laboratories of American Machine & Foundry Company, a recognized leader in the design, development and manufacture of atomic, electronic and mechanical equipment for the consumer, industry and defense.

If you qualify in any of the fields listed below, investigate these opportunities now:

- *High power radar system development*
- *Tropospheric scatter systems*
- *Microwave theory & component design*
- *Electronic packaging*
- *Missile control and handling systems*
- *Antenna design*
- *Electronic countermeasures*
- *Telemetry*
- *Data handling*
- *Circuit theory*
- *Navigation systems*
- *Instruments*



Good opportunities for advancement through advanced education on the premises as well as at nearby graduate schools in addition to a liberal tuition reimbursement plan, excellent employee benefits and an ideal location in Connecticut, surrounded by fine suburban communities. Relocation expenses paid.

Advanced electronic equipment recently designed by **AMF**

*Please send your resume to Mr. J. F. Weigandt
OR for additional technical information,
contact Mr. D. R. Barker or Mr. H. R. Holloway
NOrmandy 1-7400*

General Engineering Laboratories

American Machine & Foundry Company

Fawcett Bldg. • Fawcett Place
Greenwich, Connecticut

DO YOU NEED ENGINEERS WITH EXPERIENCE IN:

- Research
- Development
- Design
- Instrumentation
- Servomechanisms
- Missiles
- Audio Systems
- Control Systems
- Radar
- Computers
- Transistors
- Other Fields

Place an "ENGINEERS WANTED" advertisement in this SEARCHLIGHT SECTION of ELECTRONICS. It's an inexpensive, time saving method of selecting competent personnel for every engineering job in the electronics industry. The selective circulation of ELECTRONICS offers you an opportunity to choose the best qualified men available throughout the industry.

For Rates and Information

Write:

CLASSIFIED ADVERTISING DIVISION

P. O. Box 12

McGraw-Hill Publications

New York 36, N. Y.

Bendix

of
South Bend
Indiana

Pioneers and Leaders

in

AIRCRAFT ENGINE
CONTROL SYSTEM

has continuing
need for

ENGINEERS

in

TURBOJET

TURBOPROP

ROCKET

NUCLEAR

ENGINE

CONTROLS

involving

Magnetic Amplifiers
Servo Mechanisms
Computers
Transistorization
Vibration Analysis
Systems Evaluation

Graduate study available
evenings with Bendix
financial assistance

Send resume of experience and educa-
tion to

Technical Employment Department
Bendix Products Division
Bendix Aviation Corporation
South Bend 20, Indiana

CONVAIR
1st in Electronics

DYNAMICS

AERODYNAMICS

THERMODYNAMICS

OPERATIONS RESEARCH

HYDRAULICS

MECHANICAL DESIGN

LABORATORY TEST
ENGINEERING

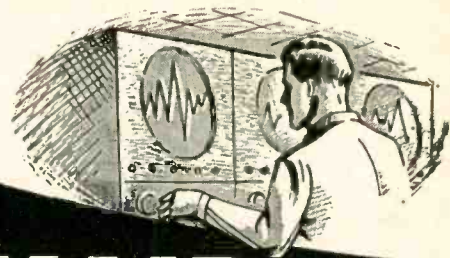

**UNEQUALLED
OPPORTUNITIES
IN ENGINEERING**

Now is the time . . . Convair is the place! Yes! If you are planning for a career in engineering look to Convair Pomona, the leader in Electronics. America's fastest growing young industry. Now engaged in Design, Development, Engineering and production of Electronic equipment and complex weapons systems. Convair-Pomona is the country's only exclusive guided missile plant, with the most modern, best equipped engineering facilities. Be first with Convair, live in the beautiful Pomona Valley only minutes from Los Angeles, the mountain, seashore and desert playgrounds. Country living near the city at its best!

Generous travel allowance to Engineers who are accepted. Write now enclosing a complete resume to:

Employment Dept. 3-G

CONVAIR

A DIVISION OF
GENERAL DYNAMICS
CORPORATION

POMONA
CALIFORNIA



ELECTRONIC ENGINEERS

for component development

- ▶ delay lines
- ▶ shift registers
- ▶ magnetic storage elements

for equipment

- ▶ airborne electronic converters
- ▶ discriminators

for systems

- ▶ analogue and digital conversion links
- ▶ data reduction for process control

YOU might be interested to know that

- Our average management age is under 32.
- At least one new permanent employee joined Epsco each working day in 1956.
- Without exception, our engineers have been given more responsibility at Epsco than in any previous position.
- During the past two years, our engineering team has developed and put into production more than ten commercial products for the data processing field.

If you have ever wanted responsibility and haven't been given a chance, why not contact our Personnel Manager? He would be happy to tell you more about the opportunities for you in our growing company.



588 Commonwealth Avenue, Boston, Massachusetts

WARWICK MANUFACTURING CORPORATION

a vigorous, expanding, multiplant manufacturer of home commercial electronic products announces the availability of two outstanding key positions in a newly-formed Research Department.

COLOR TELEVISION

Responsibility for a wide area of applied research in theory, circuit design, and picture tubes.

ADVANCED CIRCUITS

Responsibility for a wide variety of research projects ranging from solid state devices to automation techniques.

Applicants should have 3 to 7 years experience, a degree, and preferably advanced studies, and ability to direct junior personnel.

Work will be supported by technicians, modelmakers, and clerks and will be supplemented by mechanical engineers, mathematicians, and physicists.

There will be opportunities for patents and publications.

Work will be in a modern, air-conditioned laboratory located in a convenient northwest suburb of Chicago.

Mail inquiries to:

DIRECTOR OF RESEARCH

WARWICK MANUFACTURING CORPORATION

7300 N. Lehigh Avenue

Niles, Illinois

ARE YOU IN NEED

OF ENGINEERS

or of

HIGHLY TRAINED TECHNICIANS

for your Personnel Program?

We offer a free booklet especially prepared to help you solve this problem. It is called the "RESERVOIR OF ENGINEERS and TECHNICAL MEN."

This booklet shows, through a listing of the major job titles held by readers of McGraw-Hill Publications, how these men are gathered in convenient, compact groups that you can economically reach with your advertising. Here are no huge, swollen circulations, with expensive price tags where maybe not one reader in a thousand would have the necessary job qualifications.

In a recent advertisement one of the leading aircraft manufacturers restated a well known, but seldom practiced principle:

A trained, experienced engineer in one specialty can be retrained in almost any other engineering specialty with a minimum of time and effort expanded.

It is one of the purposes of this booklet to show how you can best reach men specifically trained for your needs or technicians who can be easily and quickly retrained.

For your free copy of this booklet write us on your letterhead. You are under no obligation whatsoever. There is a limited supply so write us now.

**McGraw-Hill
Publishing Co., Inc.**

Classified
Advertising
Division

P. O. Box 12
New York 36, N. Y.

opportunities in

OPERATIONS RESEARCH

The Operations Research Office of The Johns Hopkins University offers exceptional opportunities for scientists who prefer the challenge of operational problems of unusual scope and diversity to routine design and development work.

Our current research program has openings for men qualified in electronics and physics who are particularly interested in:

- Mathematical Analysis
- Determining applications of known photographic, acoustic, infrared and radar techniques to military problems
- Military communications systems planning, analysis and evaluation
- Electronic Countermeasures Analysis

Please send your resume to
Research Personnel Officer

THE OPERATIONS RESEARCH OFFICE

**THE
JOHNS HOPKINS
UNIVERSITY**

7100 Connecticut Avenue
Chevy Chase, Md.

STRAIGHT TALK

About an

ENGINEERING CAREER

at

OTIS ELECTRONIC DIVISION

The full resources of the century-old Otis Elevator Company are available for expansion of its new Electronic Division.

Under prime contract, this division is conducting basic development work in the most advanced areas of bombing navigation systems, radar systems and missile launching test equipment. Current openings are for engineers with knowledge of servomechanisms, analog computers, digital techniques, sweep circuits, or pulse techniques.

Otis' Electronic Division expects to explore commercial applications in the future . . . assuring job stability as well as a full measure of liberal benefits for which Otis is well known.

Send resumes to
WILLIAM B. DeFRANCIS
for confidential interview.

ELECTRONIC DIVISION
OTIS ELEVATOR Co.



35 Ryerson St.,
Brooklyn 5, N. Y.

HOW DO YOU GROW AT ARMA?

Through diversification!

In our recent advertisements, we spoke of the growth opportunities offered by Arma. Almost immediately, perceptive engineers began writing us, asking for more information.

"How does an engineer grow at Arma — precisely?"

Our answer, in a word, is *diversification*. Arma offers one of the *broadest programs of work diversification* in the electronics field.

At Arma, an engineer follows a project from original design, right through final production. As a result, our engineers and scientists are exposed to many activities not usually found under one roof — areas into which they can grow, as their abilities and interests lead them.

Here are some of the areas — 59 examples — in which Arma concentrates its efforts in:

**MISSILE CONTROLS & GUIDANCE
and FIRE CONTROL**

1.0 SYSTEMS DEVELOPMENT

- 1.1 Digital Computers
- 1.2 Autopilots
- 1.3 Infrared
- 1.4 Electromagnetic Devices
- 1.5 Gyroscopics
- 1.6 Inertial Platforms
- 1.7 Missile Guidance
- 1.8 Fire Control
- 1.9 Servos

2.0 PROJECT ENGINEERING

- 2.1 Airborne Fire Control
- 2.2 Airborne Armament
- 2.3 Air-to-Air Missiles
- 2.4 Semi-Automatic Test Equip.
- 2.5 Air Traffic Control
- 2.6 Optical Systems
- 2.7 Stabilizing Devices
- 2.8 Submarine Fire Control
- 2.9 Electronic Test Equipment

3.0 FIELD EVALUATION

- 3.1 Data Handling
- 3.2 Telemetry
- 3.3 Data Reduction
- 3.4 Test Equipment
- 3.5 Field Site Planning

4.0 SYSTEMS ENGINEERING

- 4.1 Trajectory Analysis
- 4.2 Airframe Performance
- 4.3 Weapons Control
- 4.4 Operations Research
- 4.5 Radar
- 4.6 Error Analysis
- 4.7 Reliability

5.0 COMPONENTS

- 5.1 Transistors
- 5.2 Magnetic Amplifiers
- 5.3 Synchros
- 5.4 Tachometers
- 5.5 Accelerometers
- 5.6 Resolvers
- 5.7 Integrators

6.0 RADAR

- 6.1 CW Doppler Systems
- 6.2 Antenna Design
- 6.3 Components
- 6.4 Pulse Circuitry
- 6.5 Countermeasures
- 6.6 Laboratory Evaluation

7.0 PROJECT ADMINISTRATION

- 7.1 Project Planning & Control
- 7.2 Sub-Contracted Liaison
- 7.3 Contracts Evaluation
- 7.4 Project Coordination

8.0 DIGITAL COMPUTERS

- 8.1 Logical Design
- 8.2 Dynamic Analysis
- 8.3 Circuit Development
- 8.4 Component Development
- 8.5 Packaging
- 8.6 Field Evaluation

9.0 ENVIRONMENTAL

- 9.1 Vibration
- 9.2 Shock
- 9.3 System Test
- 9.4 Component Test
- 9.5 Materials Analysis
- 9.6 Dynamics

If you want to participate in the growth that *must* come to a man working in so diversified an environment, write and tell us the area in which you're most interested. (Or use the coupon below.) Your confidence will be respected, and you will hear from us promptly. If you prefer, forward confidential resume. No reference contact without your permission.

Technical Personnel Department E-674



Division of American Bosch Arma Corporation
Roosevelt Field, Garden City, Long Island, N. Y.

Gentlemen:

- Please send me additional information concerning the job numbered _____
- Or, additional information concerning the area of _____
(state interest if not in above listing)

NAME _____
ADDRESS _____
CITY _____
ZONE _____ STATE _____

*Servo
Engineers*

**ELECTRICAL
MECHANICAL**
Inertial
Guidance
System
Program



Enjoy Challenging Opportunities in the further development and systems testing of Inertial Guidance Systems and their Servo Loops in the most versatile laboratories in the country.

Work with the top men in the field and with the finest test, research and development facilities. New plant being added in suburban Milwaukee as a part of Major, Permanent, Expansion Program.

AC will provide financial assistance towards your Master's Degree. A Graduate Program is available evenings at the University of Wisconsin, Milwaukee.

GM's long-standing policy of decentralization creates individual opportunity and recognition for each Engineer hired.

Milwaukee offers ideal family living combining small town hospitality with every metropolitan shopping and cultural advantage.

For personal, confidential interview in your locality send complete resume to

Mr. John F. Heffinger
Supervisor of Technical Employment



THE ELECTRONICS DIVISION

GENERAL MOTORS CORPORATION
FLINT 2, MICH. • MILWAUKEE 2, WIS.

Recent EE, ME
Graduate
Inquiries
Also Invited

Engineers Needed for Research and Development Positions in the

Design of electronic instrumentation for underwater ordnance, including high gain amplifiers, conventional filters, power amplifiers, oscillators and detectors in the ultrasonic range.

Analytical and experimental treatment of scientific research problems in the fields of hydrodynamics, acoustics, electronics, network theory, servomechanisms, mechanics, information theory and noise analysis including analogue and digital computations.

Design of transducers, fundamental problems in underwater acoustics involving transmission, attenuation, reflection, etc. Problems in sound control and noise reduction. Acoustical aspects of systems research including operations research and feasibility studies.

**EXCELLENT WORKING CONDITIONS
LIBERAL VACATION POLICIES
OPPORTUNITIES FOR GRADUATE STUDY
UNIVERSITY FACULTY APPOINTMENTS**

Send Resume to ARNOLD ADDISON, Personnel Director

**THE PENNSYLVANIA STATE UNIVERSITY
ORDNANCE RESEARCH LABORATORY**

UNIVERSITY PARK

PENNSYLVANIA

Electronic Engineers
Mechanical Engineers
Advancement... Security
...Responsibility

Professional personnel needed at all levels to fill responsible openings at this steadily expanding Division of Bendix Aviation Corporation. It's your chance to get specific assignments at the peak of the art in ELECTRONICS and MICRO-WAVE DEVELOPMENT and DESIGN. Good salaries, all employee benefits, ideal suburban living conditions. Whether you be a Department Chief or a Junior Engineer with less than one year's experience, we have the opening and the shoes for you to fill.

Address: Chief Engineer Dept. H

Bendix
AVIATION CORPORATION
York
DIVISION

York, Penna. York 47-2611

Admiral.

has specific openings
for experienced engineers in:

RADAR

L BAND

Project level work on L band radar and beacon coding, decoding, and pulse train generating and processing circuits.

AIRBORNE RADAR

In X band range. An experienced man at project level to improve and modify existing systems and to contribute ideas for proprietary systems.

RADAR DESIGN-ECM

To analyze, develop and design advance radar techniques and electronic countermeasures.

Career-minded men with several years specialized experience are invited to join our rapidly expanding programs in communications projects. On-the-job training for junior and intermediate engineers.

Current openings offer excellent income and employee benefits including retirement plan, paid group insurance and college tuition refund plan plus ideal working conditions.

If you are an engineer with qualifications in any of these fields explore your opportunity with Admiral today. Write Mr. Walter Wecker, Personnel Manager.

Admiral Corporation

3800 W. Cortland Street
Chicago 47, Illinois



REAC[®] FIELD SERVICE ENGINEERS

GRADUATES OR EQUIVALENT EXPERIENCE

Electronic Technicians or Engineers, preferably with some experience in analog computers, military or commercial, who have a real interest in Field Service, including the *Travel* aspects, are needed for Computer Field Service.

Here is an opportunity to join an expanding organization with an exceptional reputation in the Electronic Field.

The REAC (Reeves Electronic Analog Computer) is the foremost general purpose computer widely used by industry and military installations.

Free Hospitalization and Surgical benefits for you and your dependents.

Excellent starting salary—opportunity to advance. No Overseas travel required.

Interviews can be arranged Daily until 6 P. M.
Telephone or write Mr. Tom Waters

REEVES INSTRUMENT CORP.

Subsidiary of Dynamics Corp. of America

East Gate Boulevard, Roosevelt Field, Garden City, L. I., N. Y., Pioneer 6-8100

WHAT "CAREER OPPORTUNITY"

Means to an Electronic Engineer at General Electric

"CAREER OPPORTUNITY"...two words you see used everywhere.

WE USE THEM a lot at Electronics Park. But with this difference. To every man who comes to work with us, "career opportunity" has a specific meaning.

And for a very good reason.

ELECTRONICS PARK is where many new concepts in electronics are born. The G-E organization here is primarily in the business of designing and developing *new* things—components, systems, equipments. Often a whole new product line results from applied research activities here—and after prelimi-

nary production and sales in this area, a new department is organized to handle it—a new plant built in another area—and a new management staff appointed to direct it.

AND MANY of the supervisory and specialist positions in such a new G-E department are drawn from the experienced development staff at Electronics Park.

JOIN US NOW...if you have a BS, MS or PhD degree in Electrical or Mechanical Engineering or Physics AND/OR electronic experience. Send the coupon below...or if you prefer, write us personally in complete confidence.

TO: GENERAL ELECTRIC.
Electronics Pk.,
Syracuse, N. Y.
ATT: Dept. 2-7-E
Technical Personnel

I am interested in...
... Advanced Development
... Design
... Field Service
... Technical Writing
... Sales

In the field of...
... Military Radio & Radar
... Multiplex Microwave
... Mobile
... Communications
... Semiconductors
... Electronic Components
... Computers
... Tubes & Antennas
... Television Receivers
... Industrial Television

FROM:
NAME _____
ADDRESS _____

DEGREE _____

GENERAL  ELECTRIC

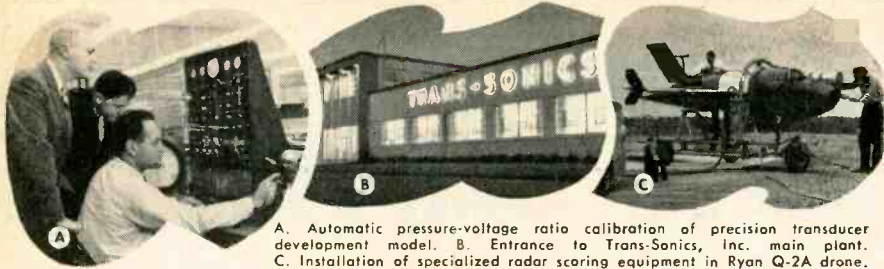

A. Automatic pressure-voltage ratio calibration of precision transducer development model. B. Entrance to Trans-Sonics, Inc. main plant. C. Installation of specialized radar scoring equipment in Ryan Q-2A drone.

Do these pictures fit into your future?

The experience of Trans-Sonics, Inc. in the development of airborne microwave electronic systems and the design and manufacture of precision temperature and pressure transducers has made it one of America's fastest growing electronic firms. The rapid expansion necessary to keep pace with this progress has created a number of long-term opportunities in key engineering positions.

If you are a career-conscious engi-

neer who seeks to improve his future by becoming associated with a company where:—

you will have greater responsibility working with a small, flexible integrated group . . . you will enjoy recognition and promotion that are not tied to seniority

then you should investigate one of the following positions.

**RESEARCH & DEVELOPMENT DEPT.
AIRBORNE RADAR EQUIPMENT**

ELECTRONIC ENGINEER

Overall responsibility for Field Test Program.

ELECTRONIC DESIGN ENGINEER

Group leader for advanced designs.

**ENGINEERING DEPT.—PRECISION
TEMPERATURE & PRESSURE TRANSDUCERS**

ELECTRICAL OR MECHANICAL ENGINEER

Technical direction, programming and supervision of qualification and environmental tests.

Write to Mr. Elmer G. Guilmartin or call collect BUrlington 7-2011.

Trans-Sonics, Inc.

LEXINGTON 73, MASSACHUSETTS

**COMMUNICATIONS
SYSTEMS
ENGINEERS**

The expanding scope of advanced communications projects has created several unique positions in fields related to VHF, UHF, microwave transmission and reception, forward scatter and single sideband applications at Hoffman. Electronics engineers with appropriate backgrounds will find these new assignments professionally stimulating and financially rewarding. Please address Vice President of Engineering:

Hoffman LABORATORIES, INC.

A SUBSIDIARY OF HOFFMAN ELECTRONICS CORP.
3761 South Hill St., Los Angeles 7, Calif.
Telephone: RIchmond 9-4831.

**RESEARCH AND
DEVELOPMENT ENGINEERS**

Career opportunities in Central Research Laboratory of stable, growing company. Electronic engineers with B.S. or M.S. for advanced circuit design on audio systems, magnetic recording, transistor control circuits for aircraft instrumentation and high frequency instruments. Positions offer opportunity for creative work in stimulating environment. Send resume to: Frank V. Paley, Professional and Technical Employment Manager,

THOMAS A. EDISON, Inc.
WEST ORANGE, N. J.

*Industrial Engineers
advance in the
mushrooming
field
of*

MICROWAVE TUBES



Write Gordon McClure
SYLVANIA ELECTRIC PRODUCTS INC.
500 Evelyn Avenue, Mountain View, California

NEED ENGINEERS

Place an "Engineers Wanted" advertisement in this EMPLOYMENT OPPORTUNITIES section. It's an inexpensive, time saving method of selecting competent personnel for every engineering job in the Electronics industry. The selective circulation of ELECTRONICS offers you an opportunity to choose the best qualified men available throughout the industry.

13,000 ENGINEERS

Will Change Jobs in 1957

WHY?

Primarily Lack of Challenge.

Our requirements for Senior Engineers in the Electronics field (many of our areas of study are new and unsearched) offer a definite and strong challenge to engineers experienced in

RD-Receiver
DME Systems
Servo Design
RF Design
Digital Techniques
Systems

If you are qualified for R&D work in any of these areas at a truly professional Engineering level, write or phone



5575 KEARNY VILLA ROAD
SAN DIEGO 11, CALIFORNIA
BRowning 7-6780

Research Scientists

At the AVCO *Research Laboratory* a young, creative scientist can find satisfaction in a small, youthful, progressive laboratory which is moving rapidly along in the modern, scientific world.

Integrated here in a university-type atmosphere are the fields of physics, aerodynamics, and physical chemistry. You derive individual satisfaction working in these broad areas of knowledge in intimate contact with a top-notch scientific group. You receive individual recognition for your contribution for a new understanding of scientific fundamentals through publication of research results in the standard journals.

The *Research Laboratory* is engaged in the study of gases and gas dynamics at high temperatures. We are interested in the phenomena accompanying the dissociation and ionization of gases and in the application of these phenomena. Future plans call for research in non-competitive fields for application to defense and commercial products.

There are many more satisfactions to be derived from a research career with the AVCO *Research Laboratory*, including excellent salaries, promotion on merit (individual achievement), and an exceptional benefits program with retirement provisions and an educational aid plan (pays full tuition).
Relocation expenses paid.

If you are interested in genuine research activity and have related research experience, you will be interested in these positions:

Jr. Scientists — Degree in Physics or Aerodynamics.

Associate Scientists — Degree in Aerodynamics.

Sr. Scientists — Degree in Physical Chemistry or Physics or Mathematics or Electronics.

Sr. Electronic Physicist — Advanced Degree in Physics or Electrical Engineering to lead a group which invents, designs, and develops electronic research techniques for the Laboratory.

Send resume to Mr. Robert M. Hale.

AVCO
RESEARCH
LABORATORY

A Unit of the Research and Advanced Development
Division AVCO MANUFACTURING CORP.
2364 Revere Beach Parkway
EVERETT, MASSACHUSETTS

EMPLOYMENT PROBLEM?

When you are in need of specialized men for specialized jobs, contact them through an employment ad in this publication.

COMMUNICATIONS ENGINEERS and TECHNICIANS

EXCELLENT SALARIES
MINIMUM PREREQUISITES

ENGINEER EE Graduates with 3 years experience
TECHNICIAN 2 years technical school in communications and 3 years experience.

Require installation adjustment and maintenance experience with communication receivers and associated terminal equipment. Also, men with similar experience with high-powered transmitters, antennas, transmission lines.

Must be willing to travel in United States and Overseas

Page Communication Engineers, Inc.
710 Fourteenth St., N.W., Washington 5, D.C.

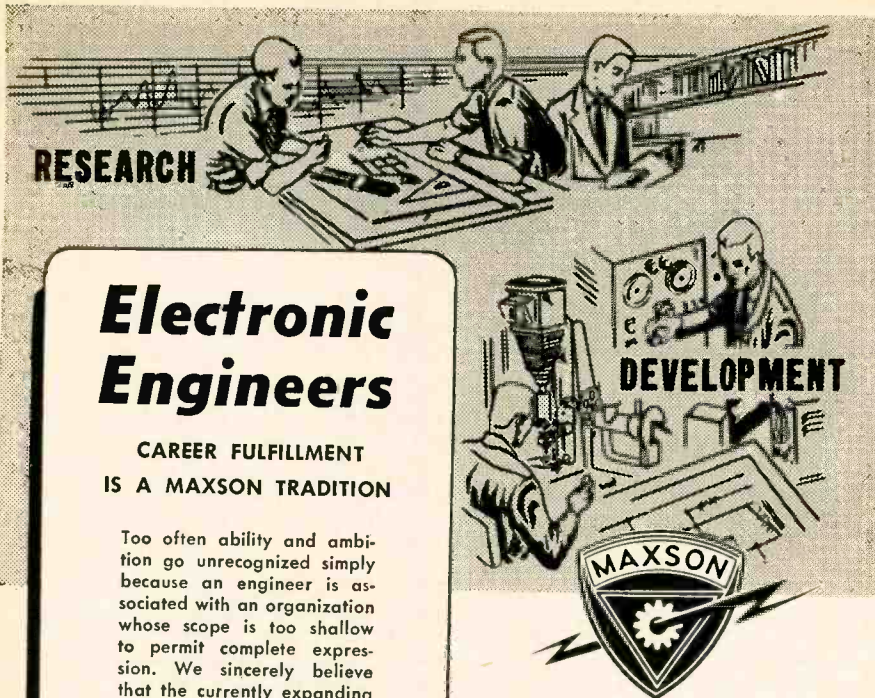

Electronic Engineers

CAREER FULFILLMENT
IS A MAXSON TRADITION

Too often ability and ambition go unrecognized simply because an engineer is associated with an organization whose scope is too shallow to permit complete expression. We sincerely believe that the currently expanding activities of The W. L. Maxson Corporation offer the creative engineer a limitless range of assignments for career fulfillment.

Responsible positions now available in the fields of research and development. Kindly send resume and salary requirements to:

Mr. L. W. Albright
Technical Placement Manager

THE W. L. MAXSON CORPORATION

460 W. 34th St.,
New York 1, N. Y.

ENGINEERS & PHYSICISTS —

- small expanding company
- engineer owned and operated
- location—Cambridge, Massachusetts, Silver Spring, Md.

GEL offers excellent opportunities to individualists who desire professional growth, responsibility, and good salary. Positions now available at all levels for electronic and mechanical engineers in the following fields:

Servos	Receivers
Antennas	Countermeasures
Microwaves	Electronic Packaging
Pulse Circuitry	Pedestal Design

For further information—contact: L. Billig, Chf. Eng.

GENERAL ELECTRONIC LABORATORIES, INC.

18 Ames St. UN 4-8500 Cambridge, Mass.

YOUR ORGANIZATION

Is it complete? Are you expanding it? Making replacements?

Naturally, you are anxious to secure the most suitable man or men available. You want men with the special training that will make them an asset to your organization. You can contact such men through an advertisement in this Employment Opportunities Section of ELECTRONICS.

Classified Advertising Division

ELECTRONICS P.O. BOX 12
330 W. 42nd St. New York 36, N. Y.

engineer-ee

ELECTRONIC

STANDARDS

An advisory position is now open with the Missile & Ordnance Systems Department of General Electric, prime contractor for the ICBM and IRBM nose cones. Responsibilities include developing standards for electronic components for missile nose cones; participating in industry, government and technical society standards development; and advising all elements of the department regarding electronic standards.

Ability to cooperate effectively with diverse groups and individuals, plus a demonstrated capacity for analytical thought are essential. Preparation for this position should either include: at least 2 years professional experience in the field of electronic standards engineering; or, more extensive experience in the general electronics field, at least 2 years of which were concerned with components rather than systems or end items.

Salary and benefits are liberal, and the facilities and equipment are excellent. We hold prime contracts of a long-term nature with all of the armed services. Our Manager of Engineering Administration will review your resume and, if your qualifications are appropriate, invite you to visit our Philadelphia location at our expense for a personal interview. You need not reveal your present employer.

Please send resume
in confidence to:

MR. JOHN WATT
Technical Recruiting, Room 606-1



MISSILE & ORDNANCE SYSTEMS DEPT.
GENERAL ELECTRIC

3198 Chestnut Street Philadelphia 4, Pa.

**Engineers
Who Want to
Be Engineers**

... rather than glorified draftsmen,
paper jockeys or rehash artists

Come to Sanders and Go to Work...

... ON ACTUAL, PRACTICAL, THOUGH INTRICATE, OFF-BEAT AND INTRIGU-
ING PROBLEMS IN ADVANCED ELECTRONICS AND ELECTRO-MECHANICS.

*Sanders is particularly interested in engineers
versed in:*

- hydraulic servo systems, gyroscopes, accelerometers, circuit design & development, magnetic amplifiers, receivers & transistors.
- Men with similar experience, interested in sales engineering, have real opportunity here.
- Also openings for Physicists and Applied Mathematicians.

You'll be working on projects to meet specific customer requirements—not making plans to gather dust in filing cabinets—and you'll be doing it in the company of first rate minds, men who have sparked Sanders' many "firsts"—Panar, Dare pulse doppler radar and seekers, counter-measure systems and special fusions.

This is a company owned by engineers, run for engineers, in the interests of better engineering. If engineering is more to you than a name on an imposing organization chart . . . if the opportunity to make a genuine contribution to the state of the art ranks higher than a fancy location (though we think ours is pretty nice) . . . than we'd welcome the opportunity to read your resume. A convenient interview will be arranged. Please address
D. H. Johnson.

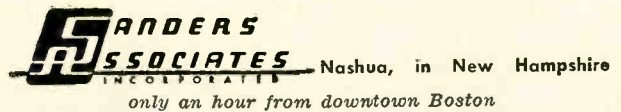

ELECTRICAL ENGINEERS

Challenging positions open for high caliber Electrical Engineers to work in interesting research and development programs in instrumentation and circuitry.

We offer an opportunity to do non-routine research with some of the leading engineers in the field. This is an opportunity to be creative and experience satisfaction of accomplishment and contribution.

Excellent employee benefits, good salary, and working conditions. Please send complete resume to:

E. P. BLOCH

ARMOUR RESEARCH FOUNDATION

of
Illinois Institute of Technology
10 West 35th Street
Chicago, Illinois

NEED ENGINEERS?

An employment advertisement in this EMPLOYMENT OPPORTUNITIES section will help you find the engineers you need. It's an inexpensive, time saving method of selecting competent personnel for every engineering job in the electronics field. The selective circulation of ELECTRONICS offers you an opportunity to choose the best qualified men available.

YOU HAVE THE ENGINEERING ABILITY ...

WE HAVE THE ENGINEERING FUTURE !

Great combination . . . your ability and the opportunities only a pioneer and leader in commercial electronics can offer! Join this team of creative-minded engineers and your ability wins first the recognition and then the responsibility it deserves in a small-group engineering organization.

The future looks practically limitless, speaking from our position today in the vanguard of precedent-shattering electronics developments. Current and appealing openings exist in:

- | | |
|------------------------------------|--|
| Data Handling and Computers | Scientific and Industrial Equipment |
| Broadcast Equipment | Sound Products |
| | Communications |

Attractive salaries to start . . . advancement on merit. Liberal company-paid benefits make your future even more secure.

Senior or Junior EE's or ME's . . . men who will accept no measurements for their future except their own achievements . . . you are invited to send a complete resume to

P-4014, Electronics,
Classified Adv. Div., P. O. Box 12, New York 36, N. Y.

DEVELOPMENT ENGINEER

for
Electronic
Organs

An excellent opportunity with the leading manufacturer of quality electronic organs, for an electronic engineer interested in the organ and electronic music field.

Position involves development and engineering. A qualified applicant will find a career in this rapidly growing, progressive company. Excellent working conditions in modern plant beautifully situated fifteen minutes from Allentown, Pa. and all city conveniences.

Send complete resume and salary requirements to:

ALLEN ORGAN COMPANY
MACUNGIE, PENNSYLVANIA

MAN HUNTERS

... ATTENTION!

When you are in need of specialized men for specialized jobs—from general managers to supervisors—contact them through the EMPLOYMENT OPPORTUNITIES SECTION of McGraw-Hill publications.

The EMPLOYMENT OPPORTUNITIES SECTION is the national market place for those wanting the services of men in technical, engineering and operating capacities in the fields served by these publications.

AMERICAN MACHINIST
AVIATION WEEK
BUSINESS WEEK
CHEMICAL ENGINEERING
CHEMICAL WEEK
COAL AGE
CONSTRUCTION METHODS AND EQUIPMENT
ELECTRICAL CONSTRUCTION AND MAINTENANCE
ELECTRICAL MERCHANDISING
ELECTRICAL WHOLESALING
ELECTRICAL WORLD
ELECTRONICS

ENGINEERING AND MINING JOURNAL
ENGINEERING NEWS-RECORD
FACTORY MANAGEMENT AND MAINTENANCE
FLEET OWNER
FOOD ENGINEERING
NATIONAL PETROLEUM NEWS
NUCLEONICS
PETROLEUM PROCESSING
PETROLEUM WEEK
POWER
PRODUCT ENGINEERING
TEXTILE WORLD

The men you need are the men who read the
EMPLOYMENT OPPORTUNITIES SECTION of

McGraw-Hill Publications

Classified Advertising Division
P. O. BOX 12, NEW YORK 36, N. Y.

Over 400 electronic control circuits

now available
for quick, easy
reference



Here are the circuits you need for sorting, timing, measuring, and counting; for sweep control, triggering, temperature and motor control, and hundreds of other industrial uses—each with concise description, performance characteristics, component values, and practical applications. Save hours, even days, of search and preliminary work to find basic circuit ideas for a particular application—consult this big, handy collection of tested circuits—selected from recent issues of *Electronics* and classified and indexed for quick use.

Just Out!

Handbook of INDUSTRIAL ELECTRONIC CONTROL CIRCUITS

By John MARKUS and Vin ZELUFF
Electronics Magazine
352 pages, 412 diagrams, \$8.75

Following each description is a reference to the original source where you can get more details on related mechanical problems or study graphs of performance characteristics. In the index, each circuit is cross-indexed as many as a dozen times, to permit locating specific circuits quickly when they are known by a variety of names.

a companion volume . . .

Handbook of INDUSTRIAL ELECTRONIC CIRCUITS

By Markus and Zeluff

Contains 433 different industrial electronic circuits for immediate practical use. For each circuit there is a clearly-drawn diagram along with a brief yet comprehensive description. 272 pages. 433 diagrams \$7.50.

10 DAYS' FREE TRIAL

McGraw-Hill Book Co., Inc. Dept. FL-2
327 W. 41st St., N. Y. 36.

Send me book(s) checked below for 10 days' examination on approval. In 10 days I will remit for book(s) I keep, plus few cents for delivery costs, and return unwanted book(s) postpaid. (We pay delivery costs if you remit with this coupon—same return privilege.)

Markus & Zeluff—Indust. Elect. Control Circ.—\$8.75

Markus & Zeluff—Indust. Elect. Circ.—\$7.50

(PRINT)

Name

Address

City Zone State

Company

Position

For price and terms outside U. S. FL-2
Write McGraw-Hill Int'l., N. Y. C.

Engineers have always been **VIP's** at **GPL**

At General Precision Laboratory engineers are very important people indeed. They have *always* been—in this advanced electronics organization that was founded by top scientists and has been run by them ever since.

As you would expect with this type of management, the basic operating policies of the Lab put continuing emphasis on availability of the most advanced equipment . . . small research teams that give every man a chance to show what he can do . . . following each career closely . . . prompt recognition.

The brilliant work of its engineers has brought the Company into front rank in little over a decade. A few notable GPL achievements: airborne navigation systems that are the most accurate in operational use today . . . stereophonic sound reproduction equipment that pumped fresh life into the motion picture industry . . . closed-circuit television systems so flexible and so simple that they find new fields of usefulness every day.

Success means growth—growth in both the size and the range of our activities. We need more engineers and scientists with a solid background in advanced electronics, creativeness and the perseverance and practical know-how that transform bright ideas into realities.

For such men we have unusual opportunities—opportunities that not only provide notable returns in pay and benefits now, but that also build lifetime careers. If you are such a man, we are interested in knowing about you—what you have done and what you hope to do. Write Richard E. Hoffman, Employment Manager. Interviews can be arranged for any time, including weekends. We will pay expenses of qualified applicants.

Currently, GPL seeks engineers interested in:

**Missile Guidance,
Radar Navigation
and Bombing Systems**
(Doppler & Inertial)

Research • Development • Applications
Systems Analysis • Systems Test
Administrative Engineering • Mechanical Packaging
Field Engineering • Technical Writing
Component Specification and Test
Production Follow-Up

Computers • Magnetic Amplifiers
Servos • Microwave Techniques
Pulse Circuitry • Transistorization



*in semi-rural Westchester,
just one hour
from New York City*

General Precision Laboratory
Incorporated

63 Bedford Road, Pleasantville, N. Y.

A SUBSIDIARY OF



TEST ENGINEERS

WILL YOU REACH YOUR MAXIMUM POTENTIAL?

No matter what your ability, you **MUST HAVE** the job opportunity and the **BEST** of **TOOLS** and **FACILITIES** to develop your talents to the fullest.

Investigate the Environment created at AC for its Advanced Development Programs on Missile Guidance and Aircraft Fire Control Systems.

OUR ENVIRONMENTAL LABORATORY

is one of the most versatile laboratories in the country and we are in the process of a Major, Permanent Expansion. 225,000 square feet plant being added in suburban Milwaukee.

Our men enjoy working with the finest of test equipment and lab facilities and with the top men in the field.

We are currently engaged in the following types of Test Activities.

- VIBRATION TESTING
- COMPLEX WAVE ANALYSIS
- LOW TEMPERATURE—ALTITUDE
- HIGH TEMPERATURE
- RELIABILITY EVALUATION
- INSTRUMENTATION

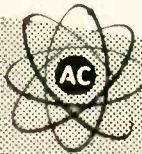

Mr. John F. Heffinger, Supervisor of Technical Employment

THE ELECTRONICS DIVISION

GENERAL MOTORS Corporation

FLINT 2, MICH.

MILWAUKEE 2, WIS.

Electronic Engineers—Research

The newly created Research Division of the Curtiss-Wright Corporation has expanded its facilities to include the fields of Electronics and Ultrasonics. The Research Division, which offers the atmosphere of a small organization conducive to research, is located in the picturesque mountain area of north western Pennsylvania, approximately twenty miles north of Clearfield. Permanent positions are available for individuals of all levels, with two or more years of work experience in electronic circuit design. Although advanced degrees are desirable, applicable experience with analytical ability in the field of electro mechanical instrumentation, servo mechanisms, communications, or computer systems will suffice.

EMPLOYEE BENEFITS:

- Free Hospitalization, Surgical and Medical Care
- Free Family Hospitalization
- Free Life Insurance
- Sickness and Accident Insurance
- Liberal Pension and Retirement Programs
- Six Month Merit Review Program
- Educational Assistance

For interview call R. L. Hauck, collect, at GREGORY 1-3000 in Clifton, New Jersey, Monday through Friday, 9 a.m. to 5 p.m., or send typewritten resume giving complete details of education, past experience, and current earnings to: R. G. Conrad, Manager, Engineering Recruitment, Dept. RD-4, Curtiss-Wright Corporation, Wood-Ridge, New Jersey.



UNDISPLAYED RATE

\$2.40 a line, minimum 3 lines. To figure advance payment count 5 average words as a line.

BOX NUMBERS count as one line additional in undisplayed ads.

DISCOUNT of 10% if full payment is made in advance for four consecutive insertions of undisplayed ads (not including proposals.)

Send NEW ADS or inquiries to Classified Adv. Div. of Electronics, P. O. Box 12, N. Y. 36, N. Y., for March 1st issue closing February 5th

The publisher cannot accept advertising in the Searchlight Section, which lists the names of the manufacturers of resistors, capacitors, rheostats, and potentiometers of other names designed to describe such products.

DISPLAYED RATE

The advertising rate is \$21.75 per inch for all advertising appearing on other than a contract basis. Contract rates quoted on request.

AN ADVERTISING INCH is measured 7/8 inch vertically on one column, 3 columns—30 inches—to a page.

EQUIPMENT WANTED or FOR SALE ADVERTISEMENTS acceptable only in Displayed Style.

TUBES

NEW! GUARANTEED!
LOWEST OPEN MARKET QUOTES!

BROADCAST TUBES

2C39A	\$11.00	810	\$10.00
2H21	60.00	813	9.00
2E27	7.00	814	2.50
4X150A	21.50	815	2.50
4X150D	25.00	828	9.00
4X150G	25.00	829B	8.50
4-65A	16.00	830B	3.50
4-125A	18.00	836	1.25
4-250A	30.00	838	1.00
4-400A	50.00	838W	3.50
6A3	.80	843	.50
6D7	6.00	845	5.00
6X4	14.50	849	17.50
F125B	2.50	851	15.00
203A	55.00	852	4.00
220B	17.50	858	100.00
250TL	24.00	860	3.00
310A	3.95	866A	1.45
349A	5.00	872A	1.15
356B	6.00	880	250.00
450TH	40.00	889A	100.00
450TL	35.00	1500T	75.00
508	275.00	1603	4.75
575A	12.50	1611	2.50
HW-654	17.50	1620C	2.95
750TL	39.95	5763	1.15
807	1.25		

RECTIFIERS & REGULATORS

SR	\$2.00	6-11	\$1.00
SC	1.95	7H4B	1.00
OB2	.75	100R/8020	7.50
OB3	.65	1001G	12.50
OD3	.70	250R	2.00
IV	.90	314A	80.00
X2	.50	371A	1.00
X2A	1.75	371B	1.95
3B24	1.00	515A RCA	13.50
3B24W	2.00	575A	10.00
3B28	5.00	816	1.00
5R4GV	1.35	836	1.25
5R4WGV	4.00	866A	1.45
5V3GT	.44	889B	32.50
5V3WGT	1.90	872A	1.15
5X3	1.20	876	.75
6-4	1.00	878	.90
6-7	1.00	8013	2.95

MAGNETRONS

2J22	\$4.50	4J26	\$45.00	QK62	\$22.50
2J26	4.50	4J24	35.00	QK284	95.00
2J27	4.50	4J42	35.00	706CV	15.00
2J34	15.00	4J50	80.00	714A	10.00
2J55	45.00	4J58	100.00	725A	3.75
2J56	45.00	4J61	100.00	558A	Ordn.
2J61	12.00	4J64	250.00	Cart.	150.00
2J62	5.50	5J26	125.00	5607A	150.00
4J21	100.00	QK60	22.50	5760	300.00

SCOPE TUBES

2AP1	\$4.00	3W2P1	\$50.00	5JP1A	\$25.00
3AP1	2.85	3EP1	1.25	5NP1	2.00
3CP1	5.00	5BP1A	1.00	7CP1	1.99
3DP1	6.00	5BP4	1.00	7UP7	12.50
3DP2	15.00	7CP1	7.00	91P7	12.00
3FP1	2.00	5CP11	8.00	12DP7	12.00
3GP1	1.95	5FP1A	2.50	902P1	2.50
3JP1	7.50	5JP1	18.00		
3RP1	9.00	5JP1A	25.00		

COMPUTER TUBES

2G21	\$2.00	5964	\$1.00
6AN5	2.25	5965 ETC.	1.00
6211	1.35		

DIODES

1N21C	\$3.00	1N25	\$2.25	1N38A	.60
1N23B	7.50	1N32	8.00	CK705	.40
1N23C	2.50	1N58	.50		

RUGGEDIZED & NON-RUGGEDIZED

6AB7	\$1.00	6F6	\$95
6AC5G	.90	6J4	1.90
6AC7	.70	6J4WA	3.50
6AC7W	1.20	6M8GT	.95
6AC7WA	2.00	6L6	1.00
6AC7WA	4.00	6L6CA	1.15
6AG7	.70	6L6C	1.00
6AG7Y	1.25	6Q5E5	3.20
6AM6	1.00	6SK7GY	.69
6AJ	1.15	6SK7Y	.75
6AK6	.65	6SN7GT	.65
6ALS	.60	6SN7W	1.20
6ANSWA	3.75	6SN7WGT	1.98
6AQ5W	1.70	6SK7W	1.90
6A5E	2.75	6X4W	1.75
6AT6	.55	6X5WGT	1.40
6BA6	.58	7F8W	2.00
6BA7	.79	12A7WA	3.00
6BF7	1.25	5960	40.00
6BFW	3.50		

MISCELLANEOUS POWER TUBES

2C42	\$9.00	5A6	\$2.00
2C43	9.00	VT-388R	POR
2C46	6.00	ML-322	10.00
3E29	8.50	RT-434	25.00
4E27	8.00	592A	18.50

KLYSTRONS

5RX-16	\$100.00	3K30	\$100.00
2K25	38.50	V-45	POR
2K28	27.50	V-82	POR
2K48	45.00	722A/B	POR
2K49	30.00	726C	7.50
2M54	15.00	726C	15.00
8BL6	32.50	8611	48.00
8BM6	32.50	8611	48.00
6BM6A	37.00	6116	250.00
2K55	15.00		

TR. AND ATR. TUBES

1B27	\$10.00	1B63A	\$20.00	532A	\$1.00
1B35	4.25	1B58	42.00	6232	60.00
1B39	7.50	1Q22	70.00	709A	.90
1B40	2.00	CA4	2.50		

THYRATRONS

CIK	\$5.75	FG-154	\$15.00
1C	.80	FG-172	19.95
2D21	.80	FG-271	37.50
2D21W	1.20	KU-627	10.00
3C22	1.50	677	30.00
3C45	7.00	715C	10.00
4B25	8.00	885	.75
6B8	1.90	VT-158	11.90
EL5B	7.00	VC1258	17.00
5C22	22.50	2050	1.00
6W/5528	17.50	2050W	2.00
FG-32	3.75	2051	1.00
FG-105	10.00	5528/C61	10.00

5,000 SERIES & UP

5517	\$1.35	5829	\$1.00
5578/C6L	2.75	5876	4.95
5559	10.00	5842/464A	13.00
5588	POR	5842/417A	12.50
5581	4.75	5844	4.00
5596	12.00	5851	4.00
5607	250.00	5854	1.30
5610	1.60	5876	11.00
5611	48.00	5896	4.50
5633	6.00	5896A	5.25
5635	12.50	5898	7.50
5636	2.95	5899	4.00
5637	5.50	5899A	7.00
5640	6.00	5902	6.00
5641	6.00	5902A	6.00
5642	1.00	5932	5.00
5643	1.60	5933	2.85
5644	7.50	5934	28.00
5645	6.00	5960	40.00
5646	6.00	5967	10.00
5647	5.00	5969	10.00
5651	1.40	5977	3.75
5654/6AK5W/		5977A	4.50
6096	5.00	5995	4.50
5663	1.25	5998	5.00
5670	1.00	6005	2.00
5670WA	4.50	6021	4.50
5678	.90	6028/408A	2.00
5680	115.00	6032	POR
5684	2.75	7044	30.00
5691	4.75	6045	3.50
5692	5.00	6080	4.75
5693	4.75	6096	1.40
5696	.90	6098CT	1.90
5702	1.65	6099	1.40
5702WA	6.00	6100	2.00
5703	1.50	6101/6J6WA	4.25
5703WA	4.50	6110	7.50
5718	6.00	6112	6.00
5718A	4.85	6116 Kiys	125.00
5719	1.75	6147	3.00
5722	4.75	6152	7.00
5725/6AS6W/		6159	2.95
6187	4.00	6161	70.00
5725	4.00	6189	2.50
5726	.60	6201	3.00
5726/6ALS/		6211	1.45
6097	3.50	6232	15.00
5732	2.50	6263	12.50
5744	1.25	6293	POR
5749	2.25	6326	POR
5750	3.00	6328	POR
5763	1.15	6364 Phot.	
5763	4.75	6364 Phot.	40.00
5783WB	5.50	6386	5.00
5784	4.00	6392 Phot.	
5784WA	6.50	6392 Phot.	30.00
5787	4.85	8005	5.00
5794	5.00	8020/100R	2.95
5797	5.00	9002	5.00
5799A	POR	9003	1.35
5814	.75	9006	.20
5814WA	3.25		

All items F.O.B. Los Angeles, subject to prior sale and change of price without notice

V & H RADIO and ELECTRONICS

2029-2047 W. VENICE BLVD. LOS ANGELES 6, CALIF. REpublic 5-0215

CONSISTENTLY HIGH QUALITY ELECTRON TUBES

AT SENSIBLE PRICES!
Largest stock in the country.

• ALSO •
Large diversified selection of
TEST & COMMUNICATIONS EQUIP.

WRITE
For latest comprehensive
catalog and tube price sheet
BARRY ELECTRONICS CORP.

512 Broadway, N. Y. 12, WALKer 5-7000

Superior Vacuum Tube Patents

Eleven U. S. Patents for sale or license. Cover superior, practical, standard vacuum tubes for UHF, VHF, FM, TV, Radio, Power, Transmitting, Industrial Applications.

BINNEWEG TELEVISION 5330 Colgate Ave. Oakland 18, Calif.

ENGINEERING DEGREES

(Under and Postgraduate)
E. E. Option Electronics
Earned Through Home Study
Residential Courses Also Available
PACIFIC INTERNATIONAL UNIVERSITY
American College of Engineering
Box 27724 Hollywood 27, Calif.

"SEARCHLIGHT" Can Help You!

Hundreds of miscellaneous business problems that confront you from time to time, can be solved through the use of the SEARCHLIGHT SECTION of ELECTRONICS.

When you want to buy or sell used or surplus new electronic equipment and/or accessories, or have other business wants — advertise them in the SEARCHLIGHT SECTION for quick, profitable results!

ELECTRONIC

WAR TERMINATION INVENTORIES

WRITE OR WIRE FOR INFORMATION ON OUR COMPLETE LINE OF SURPLUS ELECTRONIC COMPONENTS. ALL PRICES NET F.O.B. PASADENA, CALIFORNIA

C&H SALES CO.

2176-E East Colorado St.
Pasadena 8, California
RYan 1-7393

INVERTERS

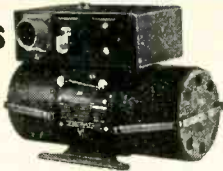

- 10042-1-A Bendix
DC Input 14 volts; output: 115 volts; 400 cycles. 1-phase; 50 watt **\$35.00**
- 12116-2-A Bendix
Output: 115 VAC; 400 cyc; single phase; 45 amp. Input: 24 VDC, 5 amps. **\$35.00**
- 12117 Bendix
Output: 26 volts; 400 cycles, 6 volt amperes, 1 phase. Input: 24 VDC; 1 amp. **\$15.00**
- 12121 Bendix
Input: 24 volt D.C. 18 amp. 12000 r.p.m. Output: 115 volts, 400 cycle, 3-phase, 250 volt amp, 7 pf. **\$49.50**
- 12123 Bendix
Output: 115 V; 3 phase; 400 cycle; amps. .5 Input: 24 VDC; 12 amp. **\$49.50**
- 12126-2-A Bendix
Output: 26 volts; 3 phase; 400 cycle; 10 VA; 6 PF. Input: 27.5 volts DC; 1.25 amps. **\$24.50**
- 12130-3-B Bendix
Output: 125.5 VAC; 1.5 amps. 400 cycles single phase, 141 Va. Input: 20-30 VDC. 18-12 amps. Voltage and frequency regulated. **\$49.50**
- 12137 Bendix
Output 250 VA, 115 volts, 3 phase, 400 cycle, 1.25 amp., 0.8 pf. Input 27.5 volt DC, 20 amp. **\$59.50**
- 12142-1-A Bendix
Output: 115 volts, 3 phase, 400 cycle, 250 VA. Input: 27.5 VDC, 22 amps. Voltage and frequency regulated **\$99.50**
- 12147-1 Pioneer
Output: 115 VAC 400 cycles; single phase. Input: 24-30 VDC; 8 amps. **Price \$39.50 each**
- 778 Bendix
Output: 115 volt 400 cycle; 190 VA; single phase and 26 volt, 400 cycle, 60 VA, single phase. Input: 24 VDC. **\$37.50**
- 10285 Leland
Output: 115 volts AC; 750 VA, 3 phase, 400 cycle, .90 pf and 26 volts. 50 VA single phase, 400 cycle, .40 pf. Input: 27.5 VDC 60 amps. cont. duty, 6000 rpm. Voltage and frequency regulated. **\$59.50**
- 10339 Leland
Output: 115 volts; 190 VA; single phase; 400 cycle, .90 pf. and 26 volts; 60 VA; 400 cycle, .40 pf. Input: 27.5 volts DC, 18 amps. cont. duty, voltage and freq. regulated. **\$49.50**
- 10486 Leland
Output: 115 VAC; 400 cycles; 3-phase; 175 VA; .80 pf. Input: 27.5 DC; 12.5 amps.; cont. duty. **\$70.00**
- 10563 Leland
Output: 115 VAC; 400 cycle; 3-phase; 115 VA; 75 pf. Input: 28.5 VAC; 12 amps. **\$35.00**
- PE109 Leland
Output: 115 VAC, 400 cyc.; single phase; 1.53 amp.; 8000 rpm. Input: 13.5 VDC; 29 amp. **\$50.00**
- PE218 Leland
Output: 115 VAC; single phase pf. .90; 380/500 cycle; 1500 VA. Input: 25-28 VDC; 92 amps.; 8000 rpms.; Exc. Volts 27.5. BRAND NEW **\$30.00**
- MG149F Holtzer-Cabot
Output: 26 VAC @ 250 VA; 115 V. @ 500 VA; single phase; 400 cycle. Input: 24 VDC @ 36 amps. **\$40.00**
- MG153 Holtzer-Cabot
Input: 24 VDC; 52 amps. Output: 115 volts —400 cycles, 3-phase, 750 VA. Voltage and frequency regulated. **\$95.00**
- DMF2506M Continental Electric
24-30 volts input; 5.5-45 amps.; cont. duty. Output: 115 volts; .44 amps.; 400 cyc.; 1 phase; pf. 1.0; 50 watts **\$39.50**
- AN 3499 Eicor, Class "A"
Input: 27.5 volts at 9.2 amps. AC. Output: 115 volts 400 cycles; 3 phase 100 voltamp; continuous duty. **Price \$39.50 each**

VARIABLE SPEED DRIVE BALL INTEGRATORS

Forward & Reverse 4-0-4. Input shaft 5/16" dia. x 3/4" long. Output shaft 15/64" dia. x 9/16" long. Control shaft 11/64" dia. x 11/16" long. Cast aluminum construction approx. size 4 1/2" x 4 1/2" x 4".



No. 146
\$17.50 ea.

Forward & Reverse 2 1/4-0-2 1/4. Input shaft spline gear 12 teeth 9/32" dia. 3/8" long. Output shaft 15/64" dia. x 15/32" long. Control shaft 11/32" x 3/8" long. Cast aluminum construction. Approx. size 3" x 3" x 2 3/4".



No. 145
\$17.50 ea.

All Shafts on Both Ball Bearing Supported

SELSYNS-SNYCHROS



- 1CT Cont. Trans. 90/55V 60 cy. **\$37.50**
- 1DG Diff. Gen. 90/90V 60 cy. **37.50**
- 1F Syn. Mtr. 115/90V 60 cy. **37.50**
- 1G Gen. 115V 60 cy. **37.50**
- 1SF Syn. Mtr. 115/90V 400 cy. **12.50**
- 2J1F1 Gen. 115/57.5V 400 cy. **7.50**
- 2J1F3 Gen. 115/57.5V 400 cy. **10.00**
- 2J1FA1 Gen. 115/57.5V 400 cy. **7.50**
- 2J1G1 57.5/57.5V 400 cy. **5.00**
- 2J1H1 Diff. Gen. 57.5V 400 cy. **7.50**
- 2J5D1 Cont. Trans. 105/55V 60 cy. **17.50**
- 2J5F1 Cont. Trans. 105/55V 60 cy. **17.50**
- 2J5H1 Gen. 115/105V 60 cy. **17.50**
- 2J5M1 Gen. 115/57.5V 400 cy. **17.50**
- 5CT Cont. Trans. 90/55V 60 cy. **34.50**
- 5D Diff. Mtr. 90/90V 60 cy. **34.50**
- 5ODG Diff. Gen. 90/90V 60 cy. **34.50**
- 5F Syn. Mtr. 115/90VAC 60 cy. **34.50**
- 5G Syn. Gen. 115/90VAC 60 cy. **34.50**
- 5HCT Cont. Trans. 90/55V 60 cy. **42.50**
- 5SDG Diff. Gen. 90/90V 400 cy. **12.50**
- 6DG Diff. Gen. 90/90V 60 cy. **25.00**
- 6G Syn. Gen. 115/90VAC 60 cy. **34.50**
- 7G Syn. Gen. 115/90VAC 60 cy. **42.50**
- R110-2A Kearfott Cont. Mtr. 115V 400 cy. **17.50**
- R200-1-A Kearfott Cont. Trans. 26/11.8V 400 cy. **15.00**
- R210-1-A Kearfott Trans. 26/11.8V 400 cy. **15.00**
- R220-T-A Kearfott Receiver 26/11.8V 400 cy. **20.00**
- R235-1A Kearfott Resolver 26/11.8V 400 cy. **22.50**
- C56701 Type 11-4 Rep. 115V 60 cy. **20.00**
- C69405-2 Type 1-1 Transm. 115V 60 cy. **20.00**
- C69406 Syn. Transm. 115V 60 cy. **20.00**
- C69406-1 Type 11-2 Rep. 115V 60 cy. **20.00**
- C76166 Volt. Rec. 115V 60 cy. **10.00**
- C78248 Syn. Transm. 115V 60 cy. **12.50**
- C78249 Syn. Diff. 115V 60 cy. **5.00**
- C78863 Repeater 115V 60 cy. **7.50**
- C79331 Transm. Type 1-4 115V 60 cy. **20.00**
- 851 Bendix Autosyn Mtr. 22V 60 cy. **7.50**
- 403 Kollsman Autosyn. Mtr. 32V 60 cy. **7.50**
- FFE-25-1 Diehl Servo Mfr. 75/115V 60 cy. **22.50**
- FFE-43-1 Resolver 400 cy. **25.00**
- FJE-43-9 Resolver 115 V 400 cy. **25.00**
- 999-0411 Kollsman 26V 400 cy. **15.00**
- 1377-0410 Kollsman 26V 400 cy. **10.00**
- 15158-0410 Kollsman 26V 400 cy. **20.00**
- 10047-2-A Bendix 26V 400 cy. **12.50**
- 2900 Transicoll 115 V 400 cy. **15.00**
- 15CX4a Synchro Transmitter MK 22 MOD 1 **\$15.00 ea.**

SIMPLE DIFFERENTIAL



Stock No. 101

Size: 2-5/32" long x 1 1/4" dia.; bearing one end 1/2" O.D.; Shaft Size: 1" long, threads 8-32-3/4" long, with bearing shaft 1/8" dia. x 1/4" long. Gear on shaft end 1-7/16" dia., gear on bearing end 1 1/4" dia. Drive gear 25/32" dia.

\$3.95 ea.

SIMPLE DIFFERENTIAL



Stock No. 106

1:1 reverse ratio, 60 teeth on large gear; 1/4" shaft. Size: 3" long with 1-15/16" dia.

\$3.95 ea.

DIFFERENTIAL



Stock No. 148.

Size 2-11/16" long 1-11/16" dia. 1-1 reverse ratio. 1/4" shaft on each end; one shaft 25/32" long, one shaft 15/32" long. Input and output gear 15/16" dia. 60 teeth.

\$3.50 ea.

Dual Simple Differential



Stock No. 180

1:1 reverse ratio or both. Size: 3 1/4" long x 1-7/16" dia. Shaft size 1/8" and 5/32".

\$7.50 ea.

SMALL DC MOTORS



- (approx. size overall 3 3/4" x 1 1/4" dia.)
- 5067126 Decc PM, 27 VDC, 125 RPM, Governor Controlled **\$15.00 ea.**
 - 5069600 Decc PM 27.5 VDC 250 rpm **12.50**
 - 5069230 Decca PM 27.5 VDC 145 rpm. **15.00**
 - 5068750 Decca 27.5 VDC 160 rpm w. brake 6.50
 - 5068571 Decca PM 27.5 VDC 10,000 rpm (1x1x2") **5.00**
 - 5069625 Decca 27.5 VDC 120 rpm w/governor **15.00**
 - 5069790 Decc PM, 27 VDC, 100 RPM, Governor Controlled **15.00 ea.**
 - 5BA10A118 SE 24 VDC 110 rpm **10.00**
 - 5BA10AJ37 SE 27 VDC 250 rpm reversible **10.00**
 - 5BA10AJ52 27 VDC 145 rpm reversible **12.50**
 - 5BA1AJ150, G.E., 12 VDC, 140 R.P.M., **15.00**
 - 5BA10FJ32, G.E., 12 VDC, 9.5 R.P.M., **15.00**
 - 5BA10FJ33, G.E., 12 VDC, 56 R.P.M., reversible **15.00**
 - 806069 Oster series reversible 1/50 h.p. 10,000 rpm 27.5 VDC 1 5/8" x 3 1/2" **5.00**
 - C-28P-1A 27 VDC 1/100 h.p., 7,000 rpm **3.00**
 - 7100-B-PM Hansan 24 VDC 160 rpm **7.50**
 - SSFD-6-1 Diehl PM 27.5 VDC 10,000 rpm **4.00**

COMMUNICATIONS EQUIPMENT CO

RADAR — SHORAN — LORAN

SO-1

10 cm. with a range of 4, 20, and 80 miles. PPI presentation on a 5 inch screen. 360 deg rotation of antenna with a pattern 8 deg in horiz. and 18 deg in vert. plane. Operates from 115 vdc. Set consists of following: antenna, m/g—modulator, xmtr-rcvr, PPI unit, accessory control, and rectifier power unit. FOR*

MK-10

GUN RADAR. Extremely accurate, rugged and compact. Designed for ship board use to direct naval gun turrets. Antenna utilizes conical scanning for accurate pointing. Max. range is 20,000 yards with an error of pm 15 yds pm 1% of range. Pointing accuracy is pm .25 deg. Pulse dur. 0.5 usec. at prr of 3600 cps. Pk. power output is 25 KW. Primary power consumption is 1300 watts. Operates from 115V. 60 CPS Source. BRAND NEW, COMPLETE WITH SPARES AND INSTRUCTION MANUAL FOR*

- AIA*
- ABA-1
- APA-9
- APG-5*
- APG-15*
- APQ-13*
- APS-2*
- APS-3*
- APS-4
- APN-1*
- APN-2*
- APN-3*
- APN-4*
- APN-7*
- APN-9*
- APN-19*
- ASB-7
- ASD*
- MK IV
- MK 10
- SCR 545
- SCR 515
- SCR 585
- SG-1
- SJ-1
- SO-8
- IFF

*Major Components and/or Spare Parts

SYNCHROSCOPE/TS 28/UPM

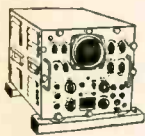

This unit is an instrument originally designed for testing beacons and radar sets, but may be used for general laboratory work. The scope is equipped with a type 5CP1 CR tube and uses triggered sweeps ranging from 1 to 6 usec/inch. Free-running sawtooth rates are 20 to 3000 cps. Positive and negative output triggers having rep rates of 330/500/L. 000/2000 and 4000 cps are supplied. Marker periods are 2/10/ and 25 usec accurate to 1%. The 2-stage video amplifier has a bandwidth of 5mc and a gain of 100. Used, in excellent condition FOR†

†FOR—Price on request.

DYNAMOTORS

TYPE	INPUT		OUTPUT		Price
	VOLTS	AMPS	VOLTS	AMPS	
BDA R83	14		375	.150	\$6.50
POSX-15	14	2.8	220	.08	8.95
DM33A	28		540	.250	3.95
B-19	12	9.4	275	.110	6.95
DA-3A*	28	10	300	.260	3.95
			150	.010	
PE 73 CM	28	19	14.5	5.	10.50
BD 69†	14	2.8	220	.08	8.95
DAG-33A	18	3.2	450	.06	2.50
BDAR 93	28	3.25	375	.150	6.95

† Less Filter. * Replacement for PE 94.
PE 94—Brand New 5.95

\$250,000 WORTH OF TEST GEAR

- Boonton 110-A QX Checkers
- Boonton Assorted 111-A Coils
- Brush BL-1502 Deviation Test Bridge
- General Radio 106-L Standard Ind.
- General Radio 107-K Variable Ind.
- 107-D General Radio Variable Ind.
- General Radio 219-M Decade Cond.
- General Radio 516-B Audio Freq. Microvoltage
- General Radio 583-A Output Power Meter
- General Radio 722-D Precision Condenser
- General Radio 731-B Modulator Monitor
- General Radio 732-B Dist. & Noise Meter
- General Radio 732-P1 Range Ext. Filter
- General Radio 740 Cap. Test Bridge
- General Radio 1021-P2 UHF Generator & Power Supply
- General Radio V-5 Varlac
- General Radio 715-A Direct Current Amp.
- General Radio 1000-P6 Crystal Diode Modulator
- General Radio 487-A Megohmmeter
- General Radio 1551 Sound Survey System
- 1262-A General Radio Power Supply
- General Radio 1021-P2 UHF Unit
- Gertsch FM-3 Frequency Meter
- Hewlett-Packard 320-A Distortion Analyzer
- Hewlett-Packard 400-AC VTM
- Hewlett-Packard 325-B Noise Dist. Meter
- Hewlett-Packard 430-B Wattmeter
- Kay Electronics Dual Mega Marker Sr.
- Kay Electronics Mega Pix
- Kay Electronics Mega Marker Sr.
- Kay Electronics Mega Sweep
- Kay Electronics Mega Marker Sr.
- PRD 904 UHF/VHF Generator & Diode
- Sensitive Research ESH Electrostatic VTM
- Sensitive Research IDCHI Kilovolt Meter
- Sensitive Research Model F Fluxmeter
- Sensitive Research Model GM Mutual Cond. Dynamometer
- Sensitive Research Model S DC Voltmeter
- Shallcross Power Factor % Standard
- Siemens & Halske Galvanometer
- Signal Corps 1-22A Signal Generator
- Simpson 276 Osc. Calibrator
- Spencer Kennedy 212CTV TV Amplifiers
- Sylvania 400 Oscilloscope
- Tarc 1051-AR Distribution Amplifier
- Telechrome 1603AR1/1603AR2/513 ARM/Rack—Phase Delay Line Generator
- Telechrome 1600-AR Cal. Phase Shifter
- Tel-Instrument 2113 Signal Generator
- 1211 Tel-Instrument UHF Wobblator
- Tel-Instrument 1900 RF Generator
- Tel-Instrument 1212 RF Wobblator
- Tel-Instrument 1902-A AM/FM Generator

- Tel-Instrument 1210 RF Wobblators
- Tel-Instrument 1500-B Wobblators
- Tel-Instrument 1500 Wobblators
- Tel-Instrument 1910 Single Frequency Generator
- Telechrome Type 1051 ARM 5 Chan. Hi-Level Video Distr. Amp.
- Telechrome Reg. Power Supplies
- Tarc Type S-Channel Hi-Level Video Distr. Amp.
- Taro Reg. Power Supplies
- Tarc VS-100 Video Line Selector
- Tarc DA-7100 Video Line Amplifier
- Telematic UM14-83 UHF Booster
- Telechrome 600-AR Patch Panel
- General Electric 8KT9F3 Timer
- Harvey 205TS Oscilloscope
- Industrial Transformer 1230 AC High Voltage Tester
- Instrument Electronics AC VTM
- J.B.T. 30FX Line Freq. Meter (48-52; 58-62) in case
- Jones 711-N Micromatch
- Landa Electronics 25 Reg. Var. Vtge. Power Supply
- Lambda Electronics Reg. Var. Power Supply
- Measurement 62 VTM
- Measurement M-286 Balun
- Measurement 62 VTM
- Measurement 58Z12 Hi-Imp. Probe
- Monarch 41 Output Meters
- Monarch 14 Signal Generator (Broadcast Band)
- Monarch 60-cycle Multi-Vibrator
- A.T.R. 110BT Inverter
- Beta Electric 102 Kilo Voltmeter
- Barker Williamson Sine Wave Clipper
- Boonton 509-A 20 db Attenuator
- Boonton 509-B 20 db Attenuator
- Clough-Bregline 182-A Audio Sween Generator
- Cornell-Dubilier CDC-5 Decade Cap. Box
- Daven OP961 Power Output Meter
- Dumont 274-A Oscilloscope
- Dumont 264-B Voltage Cal.
- Dumont 164-E Scope
- Eico 221 VTM
- Eico 241 VTM (Incomplete)
- Ferris 10-B Microvoltage
- Ferris 20 B Microvoltage
- Leeds & Northrup #1553 Ratio Boxes
- General Radio 804 CS Signal Generator, 8-330 MC.
- TS 13 X-Band Signal Generator and Power Meter/Wavemeter/Monitor
- TS 47/APR VHF Oscillator, 50-500 mc, 110 vac, 50-400 cy.
- TS 100 Oscilloscope/range calibrator
- Sherry Klystron Power Supply and Modulator
- TS 35/AP. X-Band signal generator, 115V, 50-800 cy.
- RCA UHF Oscillator, 380-560 mc.
- General Radio 224 Precision Wavemeter

9000MC TEST SET

TS-146/UP, Radar Test Set, 9285-9465 mc. F-M 723A/B osc. attenuators, freq. meter, thermistor bridge, sawtooth generator, etc. in one convenient package. Power supply so well regulated that line may be 109-121 volts, 50-1200 cy. Measures transmitter spectrum width, freq., power, recovery time of T-R and R-T cavities, checks magnetron pulling, tunes radar receivers, tunes T-R and R-T cavities, measures receiver sensitivity and band width, checks AFC circuits. In excellent condition. Price on Request.

AN/FRR-3 DUAL DIVERSITY RECEIVING EQUIPMENT. Complete set-up consisting of 2 superhet receivers covering 2-26 mc, a 10-tube high frequency and BFO panel. Motor-driven band switching. Entire equipment is mounted in rack-panel cabinet (with doors 84 inches high. Mfg. Press-wireless \$750

R34/APR-2. Scan and search receiver; automatically scans the spectrum 90-1,000 mc and records signals on paper strip. Can also be used for single-frequency reception. Operates from 115 v. 400-1600 cps. . . \$195

343 Canal St., N. Y. 13, N. Y. Phone: Canal 6-4882 - Chas. Rosen

Mail orders promptly filled. All prices F.O.B. New York City, N.Y. or check. Only shipping sent C.O.D. Rated concerns sent P. O. parcels in excess of 20 pounds will be shipped via cheapest truck or railcar.

CONSISTENTLY HIGH QUALITY

ELECTRON TUBES

AT SENSIBLE PRICES!
Largest stock in the country.

• ALSO •
Large diversified selection of
TEST & COMMUNICATIONS EQUIP.

WRITE
For latest comprehensive
catalog and tube price sheet
BARRY ELECTRONICS CORP.
512 Broadway, N. Y. 12, Walker 5-7000

FOR RATES OR INFORMATION

About Classified Advertising,

Contact
The McGraw-Hill
Office Nearest You.

- ATLANTA, 3
801 Rhodes-Haverty Bldg.
WAlnut-5778
R. POWELL
- BOSTON, 16
350 Park Square Bldg.
HUBbard 2-7160
H. J. SWEGER
- CHICAGO, 11
530 No. Michigan Ave.
MOhawk 4-5800
W. HIGGINS
J. BRENNAN
- CINCINNATI, 37
1825 Yorktown Rd.
SWifton Village, Apt. 2
REdwood 1-3238
G. MILLER
- CLEVELAND, 15
1510 Hanna Bldg.
SUperior 1-7000
W. SULLIVAN
- DALLAS, 2
Adolphus Tower Bldg., Main
& Akard Sts.
Riverside 7-5064
G. JONES
- DETROIT, 26
856 Penobscot Bldg.
WOodward 2-1793
W. STONE
- LOS ANGELES, 17
1125 W. 6th St.
MAdison 6-9351
C. DYSINGER
D. McMILLAN
- NEW YORK, 36
330 West 42 St.
LOngacre 4-8000
S. HENRY
D. COSTER
R. LAWLESS
R. HATHAWAY
- PHILADELPHIA, 3
17th & Sansom St.
RIttenhouse 6-0670
H. BOZARTH
- ST. LOUIS, 8
3615 Olive St.
JEfferson 5-4867
W. HIGGINS
- SAN FRANCISCO, 4
68 Post St.
DOuglas 2-4600
R. ALCORN

Jsh SALES CO.

TUBES

★ NEW ★ NAME BRANDS ★ IMMEDIATE DELIVERY
★ LOW PRICES ★ UNCONDITIONAL GUARANTEE

1108 Venice Boulevard • Los Angeles 15, California

Richmond 9-7644

Cable Address: JASHELEC

Telegraph: FAX

OA2	50.70	2J62A	50.00	5Y3WGTA	3.75
OA2WA	3.00	2K22	13.50	5ZP16	60.00
OA5	3.50	2K23	12.00	6A67A	1.00
OB2	.60	2K25	11.00	6AC7W	1.00
OB2WA	3.00	2K26	45.00	6AK5W	1.00
OB3VR50	.85	2K28	30.00	6AN5	2.25
OD3	.60	3K33	100.00	6AR6	1.50
1AD4	1.00	2K33A	60.00	6A56W/5Z5	2.70
ELC1B	1.00	2K33B	100.00	6A57C	2.50
1B22	1.10	2K34	85.00	6AUGWA	2.50
1B23	2.75	2A11	100.00	6BF7W	2.50
1B24	5.00	2K42	110.00	6BL6	30.00
1B24A	12.50	2K43	110.00	6BM6	30.00
1B26	1.25	2K44	110.00	6RM6A	35.00
1B27	10.00	2K45	35.00	6CZ1	15.00
1B29	2.50	2K46	200.00	6D4	1.75
1B32	1.00	2K47	75.00	6F4	1.75
1B35	3.50	2K48	55.00	6J4	1.75
1B36	4.00	2K50	150.00	6J4WA	2.50
1B40	2.00	2K54	5.00	6J6W	1.00
1B42	5.00	2K56	50.00	6K4	2.25
1B44	15.00	2K2A	9.00	6LWGB	3.75
1B45	25.00	VR3B	25.00	6L6Y	2.00
1B47	4.00	3AP1	1.50	6SK7W	1.00
1B51	6.75	3B22	1.45	6SL7W	1.25
1B58	Q	3B24	1.00	6SU7GT	2.25
1B62	4.00	3B24W	4.75	6X4WA	2.25
1B63A	19.50	3B26	3.00	6X5WG	1.25
1N21B	1.25	3C25	6.00	7UP7	20.00
1N21C	3.00	3C22	65.00	7YP2	150.00
1N23B	.90	3C23	3.75	SRC-12	150.00
1N23BM	3.00	3C24	2.50	12A Y7	1.70
1N25	2.20	3C31	1.00	12DP7	15.00
1N26	3.50	3C33	6.50	12GP7	15.00
1N28	6.00	3C45	7.00	12SP7	25.00
1N31	1.90	3PD11A	6.00	X-13	150.00
1N32	9.00	3D21A	3.00	BL-15	Q
1N38A	.60	3E29	8.50	BL-16	Q
1N40	4.75	3FP7A	2.50	PG-17	3.95
1N42	8.00	3J1	7.50	PK-21	3.50
1N46	.60	3J3	35.00	PJ22	3.00
1N52	.65	J31	35.00	HK24	3.00
1N63	1.40	3K22	150.00	2A7GT	3.00
1N69	.40	3K23	150.00	2E6WG	2.50
1P21	30.00	3K30	100.00	RRK-28A	2.50
1P24	1.50	4-65A	14.50	W-29A	7.00
1P25	45.00	4-125A	19.50	WE-39A	4.50
1P28	7.50	4A25	2.00	WE-39A	3.00
1P30	1.35	4B23	4.00	WE-39A	3.25
1V5	.90	4B26	7.50	FP-400	20.00
1W5	.90	4B31	20.00	WE-403A	1.50
1Z2	2.50	4C27	7.50	WE403B/5591	2.75
2AP1	3.00	4C28	25.00	WE-403A	2.00
2AP1A	6.00	4A25	13.50	WE-407A	4.00
2A515	4.75	4D21	19.50	WE-408A	2.25
2B22	2.00	4E27	7.50	WE-412A	3.75
2B24	.80	4J22	100.00	GL-811	1.25
2C33	.75	4J26	100.00	WE-416B	37.50
2C35	2.50	4J27	100.00	417A	2.50
2C36/846B	30.00	4J28	100.00	WE-417A	12.50
2C39A sealed	11.00	4J29	100.00	WE-418A	16.00
2C40	7.50	4J30	100.00	WE-421A	7.00
2C42	8.50	4J31	150.00	WE-422A	10.00
2C43	8.75	4J32	45.00	WE-423A	5.75
2C44	.30	4J34	25.00	WE-428A	40.00
2C46	5.00	4J42	25.00	GL-434A	5.00
2C50	6.00	4J50	99.50	WE-438A	40.00
2C51	3.95	4J52	50.00	445B	1.00
2C52	2.75	4J63	49.50	WL-456	59.50
2C53	10.00	4J64	49.50	464A	1.95
2D21	7.75	4PR60A	37.00	X-481D	50.00
2D29	.80	4X150D	25.00	CK501A X	1.00
2E24	2.50	4X150G	30.00	RH-507	20.00
2E25	3.75	4X250M	35.00	508/6246	150.00
2E26	3.25	5ABP1	20.00	527-104A	2.00
2E27	1.00	5ADP1	20.00	WL-530	17.50
2E32	1.00	5CB	1.00	559	.40
2E41	2.25	5BP2A	2.95	CUE578	8.50
2H21	60.00	5CP1	1.95	579B	Q
2J22	4.25	5CP1A	7.50	581	2.00
2J31	12.25	5CP7	6.00	HF-610	3.50
2J32	10.00	5CP7A	8.00	KU-627	7.50
2J33	29.50	5CP11A	9.50	KU-628	7.50
2J34	10.00	5C22	27.50	WL-652	20.00
2J36	29.50	5JP1	10.00	HK-654	18.50
2J39	25.00	5JP1A	30.00	6G-672	20.00
2J48	35.00	5JP2	5.00	WE-701A	2.50
2J50	35.00	5JP5	6.50	702A	.50
2J51	200.00	5JP11A	7.50	WE-703A	1.25
2J54	25.00	5MP1	2.95	WE-704A	.60
2J55	32.50	5NP1	2.00	WE-705A	7.50
2J56	40.00	5R4GY	1.25	706A Y-GY	10.00
2J61	15.00	5R4WGA	4.00	707B	2.50
2J61A	50.00	5R4WGY	2.50	WE-708A	.75
2J62	5.00	5Y3WGT	1.75	WE-709A	1.50

WE245A	6.45	715A	1.75	1636	.75	5750	3.00
249B	2.50	715B	3.00	1641	1.35	5751	2.50
249C	3.00	715C	10.00	2000T	150.00	5755/420A	6.50
250-R	4.50	717A	.50	2050	1.00	5763	1.20
250TH	21.00	720A Y-EY	35.00	2051	.65	5779	70.00
250-TL	12.50	721A	.75	2051	.65	5783WB	6.50
WE-251A		721B	7.00	HK3054	100.00	5784WA	7.00
	49.50	722A	.75	ZB3200	99.50	5785	1.50
WE-252A	7.50	723A/B	7.50	4210	3.00	CK-5787	4.75
QK253	Q	725A	5.00	R-4330	9.00	5814	.65
	2.50	726A	15.00	R-4340	9.00	5814WA	3.00
WE-254A	2.50	726B	15.00	5516	5.50	5819	35.00
FG-258A	80.00	726C	15.00	5517	1.00	5825	7.95
WE-258B	5.00	7300	7.50	5531	Q	5829	1.00
V-260/VA-6310	75.00	750A	35.00	5544	25.00	5837	50.00
V-262	1.00	750TL	35.00	5544	25.00	5840	3.50
FP-265	20.00	801A	.35	5551/FG271	25.00	5840A	5.00
WE-269A	6.00	802	2.00	5553/FG258A	80.00	5841	5.00
FG-271	25.00	804	8.00	5559/FG57	10.00	5842/417A	12.50
271A	.90	807W	1.20	5560	16.50	5844	1.50
WE-274B	9.00	808	1.00	5561	29.50	5847/404A	15.00
FG-280	27.50	809	2.25	5568	110.00	5851	4.00
WE-282A	2.75	811	2.90	5593	55.00	5852 TE5	6.00
WE-282B	5.00	812A	3.50	5593	55.00	5853	Q
WE-283A	5.50	813	9.00	5606	125.00	5876	8.00
QK283A	150.00	814	1.35	5611	45.00	5879	1.25
QK284A	150.00	815	1.50	5634	6.50	5881	2.50
WE-285A	5.00	816	8.00	5636	2.95	5883	9.00
WE-286A	5.00	818	2.20	5639	6.50	5894	15.50
287-A	2.20	829B	8.50	5639A	7.00	5896	3.00
WE-290A	7.00					5898	Q
GB-302	5.00					5899	4.00
304TL	12.50					5902	4.50
WE-305A	2.85					5902A	5.50
307A/RK75	.75					5902A (CL)	2.50
WE-308B	12.50					5904	14.00
WE-310A	4.00					5906	11.00
WE-311B	4.00					5907	14.00
WE-312A	1.50					5910	.60
WE-315A	10.00					5915	.50
WE-316A	.50					5916	Q
QK-319	Q					5932	3.50
WE-323A	10.00					5933/807W	2.00
WE-336A	5.00					5948/1754	250.00
WE-337A	5.00					5956	35.00
WE-338A	5.00					5964	.80
WE-348A	6.00					5965	1.00
WE-349A	5.00					5967	3.00
WE-350A	2.50					5977A	3.00
350B	2.00					5981	70.00
354C	5.00					5982	149.50
WE-355A	9.95					5987	9.50
WE-356B	3.50					5993/TE-10	9.00
368AS	2.50					6005/6AQ5W	1.75
385A	Q					6021-A	4.50
WE-388A	1.00					6028/408A	2.00
WE-392A	4.50					6037/QK243	75.00
WE-394A	3.00					6038	8.50
WE-396A	3.25					6046	15.00
FP-400	20.00					6046	7.75
WE-403A	1.50					CK-6050	2.00
WE403B/5591	2.75					6073	2.25
WE-403A	2.00					6074	2.50
WE-407A	4.00					6080	6.75
WE-408A	2.25					6080WA	4.00
WE-412A	3.75					6080WA/ATR407	6.75
GL-811	1.25					6088	22.50
WE-416B	37.50					6095	1.50
417A	2.50					6095	2.00
WE-417A	12.50					6096	1.30
WE-418A	16.00					6097	1.50
WE-421A	7.00					6100/6C4WA	2.25
WE-422A	10.00					6101/6J6WA	2.25
WE-423A	5.75					6110	6.00
WE-428A	40.00					6111	4.00
GL-434A	5.00					6112	4.50
WE-438A	40.00					6115	150.00
445B	1.00					6117	60.00
WL-456	59.50					6130	7.50
464A	1.95					6134	3.00
X-481D	50.00					6136	2.50
CK501A X	1.00					6147	3.00
RH-507	20.00					6159	3.00
508/6246	150.00					6161	60.00
527-104A	2.00					6169	Q
WL-530	17.50					6177	75.00
559	.40					6189/12AU7WA	3.00
CUE578	8.50					6201/12AT7WA	3.00
579B	Q					6203	2.75
581	2.00					6205	4.50
HF-610	3.50					6211	1.25
KU-627	7.50					6264	11.50
KU-628	7.50					VA-6310/V260	75.00
WL							

**SAVE UP TO 70%
OF
WHOLESALE COST**

COAXIAL CONNECTORS

PL-259.....\$.40	UG-87/U.....\$.40
SO-239......40	UG-88/U......65
MO-359......30	UG-146/U.....1.75
UG-21B/U......85	UG-201/U.....1.50
UG-27/U......75	UG-255/U.....1.70
UG-29/U......75	UG-260/U......65
UG-58A/U......75	UG-273/U.....1.10
UG-83/U.....1.50	UG-274/U.....1.95
UG-85/U......45	UG-290/U......65

Complete Listing of Factory Fresh JAN Approved Connectors Available at Similarly Low Prices !!

**TYPE "J" POTENTIOMETERS
1/2 Watt Carbon**

Full Range of Values Available From Stock for Immediate Delivery
Single Type J Units.....\$.95 Ea.
Dual Type JJ Units.....2.95 Ea.
Triple Type JJJ Units.....3.95 Ea.
SEND FOR COMPLETE LISTING

**PRODUCTION
QUANTITIES**

PRECISION POTENTIOMETERS

50K 10 Turns 0.5% Linearity—
Van Dyke Instr. Miniature Type
3/4" dia. x 2-1/4" lg.\$ 7.95 Ea.
20K 10 Turns 0.1% Linearity—
Gibbs Micropot.....\$ 6.95 Ea.
10K 25 Turns 0.1% Linearity—
Helipot.....\$19.50 Ea.
10K 10 Turns 0.5% Linearity—
Helipot.....\$ 6.95 Ea.
10K 10 Turns 0.1% Linearity—
Helipot.....\$ 7.50 Ea.
2K 10 Turns 0.1% Linearity—
Helipot.....\$ 6.95 Ea.
Helipot Duo Dials available for above.

**HI CURRENT
FILAMENT TRANSFORMERS**

AMERTRAN TYPE W-PRI-105-125v 60cy
1 ph-SEC. 5V, 190amp-35KV Ins Ea. \$29.50
KENYON-S-14940 PRI-105-125V 60cy
1 ph-SEC. 5V 115 amp.....Ea. \$19.50
MIL-T-27 Type-PRI-115/230V 50/60 cy-
SEC. 5V 10 AMP 10 KV Ins.....Ea. \$62.5

**ALL COMPONENTS
1ST QUALITY AND
100% GUARANTEED**

TUBES

NEW—COMPLETELY GUARANTEED

750TL \$19.95 Ea.	807W \$1.75 Ea.
FG-172 \$15.00 Ea.	8002R \$12.95 Ea.

FULL LINE OF RECEIVING TUBES, POWER TUBES, MAGNETRONS, KLYSTRONS, CRYSTAL DIODES AVAILABLE AT SIMILARLY LOW PRICES.

**IMMEDIATE
DELIVERY**

**KOLLSMAN SERVO MOTORS
WITH TACH GENERATOR**

TYPE 890-0160640-MOTOR-115V-60Cy.
2 Ph. 3350 RPM-5 Watts Output.
GEN. 6.5V/1000 RPM.....\$ 59.50 Ea.
TYPE 1623B-0410120 Motor-26V-400 Cy.
2 Ph.-6500 RPM .045 Watts Output.
GEN. 0.34V/1000 RPM.....\$42.50 Ea.

SOUND POWERED PHONES

Head and Chest Set
U. S. NAVY TYPE "M"
Heavy Duty Includes Headset,
Chest Mike and 20 Ft. Cord.
.....\$14.88 ea.
T.S. 10 Type S.P. Handset.
.....\$9.48 ea.

Terms: 20% cash with order, bal. C.O.D. unless rated. All prices net. F.O.B. our warehouse Phila., Pa. subject to change without notice.

Special Discounts on Quantity Purchases

**WE INVITE YOUR
INQUIRIES FOR ALL YOUR
ELECTRONIC NEEDS**

SYNCHROS

COMPLETE LINE OF COMMERCIAL ARMY AND NAVY TYPES

1CT.....\$37.50	5N.....\$22.50
1DG.....37.50	5SDG.....12.50
1HCT.....42.50	5SF.....29.50
1F.....37.50	5SG.....29.50
1G.....37.50	6G.....34.50
3D.....62.50	6DG.....27.50
3HCT.....62.50	6HG.....42.50
5B.....22.50	7G.....42.50
5C.....24.50	7DG.....47.50
5HCT.....42.50	2CX6.....45.00
5F.....34.50	21F1.....4.95
5G.....34.50	21G1.....3.95

MANY OTHER TYPES IN STOCK QUOTATIONS ON REQUEST

**PULSE TRANSFORMERS
OVER 50 TYPES LOW AND HIGH
POWER TYPES IN STOCK FOR
IMMEDIATE DELIVERY**

MFD. BY UTAH, G.E., HAYTHEON, PHILCO, WESTINGHOUSE, WESTERN ELECTRIC, ETC.
132AW2F 7P1 \$6.95
134B2F 7P4 6.95
176AW2F 7P10 7.50
139DW2F 7P13 5.95
148DW2F 7P15 7.60
Utah X124T2-9262 12.50
Utah X139T1-9278 3.75
G.E. 68G82B 14.50
G.E. 68G627 16.50
SEND US YOUR INQUIRIES

POLYSTYRENE CAPACITORS

1% Tolerance
Hermetically Sealed—200VDCW—500VDC
0.5 MFD.....\$7.50 Ea.
1 MFD.....\$12.10 Ea.
Mfd. by Western Electric.....Brand New

**WRITE FOR
A COMPLETE
LIST OF SURPLUS
EQUIPMENT**

**FROM ONE OF THE
LARGEST INVENTORIES
IN THE U.S.A.**

TEST EQUIPMENT

BC-321 FREQUENCY METER 125KC to 20,000KC—Accur. .05%\$115.00
TS-33/AP FREQUENCY METER 8700-9500MC—Accur. .03%\$145.00
TS-34/AP OSCILLOSCOPE 30cps to 1MC—Portable.....\$195.00
LAE-1 Signal Gen. (510-1300MC).....\$225.00
LAF Signal Gen. (90-600MC).....\$325.00
LAG Signal Gen. (1200-4000MC).....\$375.00
LP-5 Signal Gen. (9.5KC-50MC).....\$425.00
Measurements 79B Pulse Generator \$165.00
Waterman 3" Rakscope S-12-B.....\$325.00
Hewlett Packard 325-B—Distortion Analyzer.....\$220.00
Dumont 208 Oscilloscope.....\$ 80.00

GENERAL RADIO

GR 222L Precision Condenser 1500MMF.....\$55.00
GR 572B 1KC Hummer.....7.50
GR 668A Decade Res.—1 Ω Steps.....6.50
GR 668B Decade Res.—1 Ω Steps.....7.50
GR 700P1 Volt. Divider.....27.50
GR 713B Bent. Freq. Osc.....\$225.00
GR 715 AE DC Amplifier-50MC).....\$425.00
GR 720A Het. Freq. Meter.....275.00
GR 722N Precision Capacitor.....\$95.00
GR 723C VT Fork 1KC.....89.50
GR 726A VTVM.....\$85.00
GR 727A VTVM (Battery Oper.).....\$105.00
A items as w except where noted * (Excel least Used—Guaranteed)

2.4KVA POWERSTAT

Superior 5649
Input—115/230V 60 cy. 1 ph.
Output—0-270V 9 Amps.
Brand New.
Special Price \$37.50 Ea.

LECTRONIC

RESEARCH LABORATORIES

715-19 Arch St., Phila. 6, Pa. • Market 7-6771-2-3
Cable Address: LECTRONIC, Philadelphia



KOILED KORDS 3 wires \$126
22 inches long stretches to 9 ft.

1 Amp G.E. Mercury Switches, 2 for \$1.00, 12 for \$5.00
5 Amp Durakool Mercury Switches, 2 for \$1.50, 8 for \$5.00

G.E. Switchettes All types—75¢ ea
115 V. AC RELAYS DPDT.....\$2.90
10 for \$6.00 100 for \$50

TELECHRON Motors
2 RPM.....\$2.90 | 1 RPM.....3.95
3 RPM.....3.90 | 3 R.P. Hr. 2.95
4 RPM.....2.90 | R.P. 2 Hr. 2.80
2K 10 Turns 3.15 60 RPM.....4.85
1 RPM—50 Cycles, \$1.85
Laboratory Special 1 of Each Motor \$25

GONIOMETER
TYPE CFT-47372 — 250 to 1500 K.C.

PLEASE INCLUDE POSTAGE

BLAN EST. 1923
64 K Dey St. New York 7, N. Y.

General Radio VARIACS in stock. Special Sale on a few 200-B (1 amp.) removed from equip't.....\$8.95

HAND WOUND 10 Sec. to 24 Min. TIMER SWITCH.....\$1.35

6 Watt Most POWERFUL TELECHRON MOTOR 110V 60 Cy
6 RPM reversible.....\$10.00
1 RPM.....\$6.50



HAYDON TIMING MOTORS
110v 60 cycle 30 RPM.....\$2.60
110v 60 cycle 1 RPM.....2.60
230v 52 RPM.....1.00
60 cy/1 RPM.....1.00
HANSEN Synchro 4 rpm \$4.24
CRAMER 4 rpm \$4.65

DIEHL-DELCO
P.M. motors. Made for 24 volts. Will work at lower speed at 12v. or 6v. Battery or Rectifier. Size 1"x1"x2". \$375



**CONSISTENTLY HIGH QUALITY
ELECTRON TUBES**

AT SENSIBLE PRICES!
Largest stock in the country.
• ALSO •
Large diversified selection of

TEST & COMMUNICATIONS EQUIP.

WRITE
For latest comprehensive catalog and tube price sheet

BARRY ELECTRONICS CORP.

512 Broadway, N. Y. 12, Walker 5-7000

New Advertisements

received by February 5th will appear in the March 1st issue subject to space limitations.

Classified Advertising Division

ELECTRONICS

P. O. Box 12

New York 36, N. Y.

A N C O N N E C T O R S

FAST DELIVERY

FROM STOCK

LOW PRICES

Let us quote on your requirements.

All comply with government specifications

Wilgreen Industries

99 MURRAY ST., NEW YORK 7, N. Y.
WO 4-2490-1-2

Cadmium or olive drab finish.

CONDENSERS

4 mfd.—600 V . . . \$.95
 Inverted cylindrical cap. single term. Mount through 3/4" hole in chassis. Hardware included. Factory cartons. Qua. disc.

16 mfd.—600 V . . . \$1.89
 Dual 8 mid oil filled cond. hermetically sealed and packed. Tube type PT-SC-11 measuring 3 3/4"x2 3/4"x2 3/4". Stud mntg. centers 2". Plugs into standard four prong socket.

10 mfd.—400 V . . . \$.65

Mfd	Volts	Price	Mfd	Volts	Price	Mfd	Volts	Price
.001	50KV	24.95	.5	2000	1.19	4	15KV PUR	
.005	15KV	9.75	.5	2500	1.29	5	220AC	1.19
.005	25KV	20.95	.5	3000	2.39	5	330AC	1.39
.005	50KV	29.50	.5	5000	3.05	5	1000	1.89
.01	1500	6.65	.5	7500	5.75	5	1500	2.45
.012	25KV	12.95	.5	12.5KV	37.50	5	5000	27.50
.015	16KV	14.50	.5	25KV	39.95			
.02	8000	4.75						
.02	10KV	5.25						
.02	20KV	10.95						
.025	50KV	32.95						
.03	5000	4.25						
.03	16KV	6.95						
.04	17KV	8.95						
.05	7500	4.25						
.05	25KV	16.50						
.05-.05	12KV	9.95						
.08	12.5KV	8.95						
.1	1250	.29						
.1	1500	.39						
.1	2000	.58						
.1	2500	.79						
.1	3000	.99						
.1	4000	1.39						
.1	5000	3.25						
.1	6000	2.25						
.1	7500	.95						
.1	7500	4.25						
.1	10KV	8.25						
.1	12KV	6.95						
.1	12.5KV	12.50						
.1	15KV	15.95						
.1	20KV	19.50						
.1	25KV	24.50						
.125	27.5KV	27.50						
2x.1	2000	.89						
2x.1	6000	2.29						
.2	10KV	8.50						
.2	13KV	11.50						
.2	15KV	13.90						
.2	50KV	69.50						
3x.2	4000	2.85						
.25	1500	.88						
.25	2000	.98						
.25	3000	1.45						
.25	4000	1.98						
.25	6000	.89						
.25	15KV	15.95						
.25	20KV	19.95						
.25	25KV	40.00						
1.3	2000	.49						
2x.25	2000	.98						
4	10KV	10.90						
2x.4	7500	5.25						
5	600	.39						
.5	1500	.59						

Mfd	Vdc	Price	Mfd	Vdc	Price	Mfd	Vdc	Price
.00001	600	.20	.0004	2500	.29	.004	1200	.49
.000024	2500	.35	.0004	5000	1.95	.004	2500	.91
.000025	1200	.29	.0007	2500	.40	.005	600	.35
.00003	600	.24	.0005	600	.23	.005	1200	.45
.00003	1200	.28	.0005	1200	.29	.005	2500	.98
.00003	2000	1.25	.0005	2000	.39	.005	3000	1.65
.00003	2500	.35	.005	3000	1.25	.006	600	.36
.000047	2500	.30	.0005	5000	2.45	.006	1200	.55
.00005	600	.23	.005	7500	2.95	.006	1500	1.65
.00005	1200	.29	.0062	3000	1.25	.0062	2500	.94
.00005	2500	.33	.0068	2500	.28	.0075	3000	1.75
.00005	3000	1.25	.00089	1200	.28	.008	600	.35
.000051	5000	1.75	.001	600	.23	.008	1200	.57
.00007	2500	.26	.001	1200	.32	.01	600	.48
.000075	5000	1.45	.001	2500	.49	.01	1000	.50
.0001	600	.24	.001	4500	1.65	.01	1200	.69
.0001	1200	.27	.001	5000	2.25	.01	1250	.69
.0001	2500	.36	.001	8000	3.98	.01	2500	.94
.0001	5000	1.99	.0015	600	.23	.012	1200	.64
.00015	600	.21	.0015	2500	.53	.014	600	.45
.00015	2500	.33	.0015	5000	2.25	.014	1200	.64
.00015	5000	1.95	.002	600	.27	.015	600	.55
.0002	600	.23	.002	1200	.39	.015	2000	1.75
.0002	1200	.29	.002	2500	.63	.02	600	.21
.0002	2500	.34	.002	5000	2.25	.02	1200	.99
.0002	5000	1.95	.002	6000	2.40	.02	2000	.98
.00025	600	.23	.0024	5000	2.25	.024	600	.45
.00025	1200	.19	.0025	600	.28	.025	600	.65
.00025	2500	.35	.0025	1200	.43	.03	600	.65
.00025	5000	1.95	.0025	2500	.65	.03	1200	1.18
.00027	1200	.27	.003	600	.31	.03	2000	1.98
.00027	2500	.36	.003	1200	.52	.03	600	.67
.0003	600	.23	.003	2500	.73	.05	1500	1.95
.0003	2500	.36	.003	3000	1.65	.025	250	1.95
.0003	5000	1.95	.003	5000	2.25	.4	600	.25
.0004	600	.26	.004	600	.29	2x.1	250	1.98
.0004	1200	.29	.004	600	.29	.115	2000	4.65

BATH TUB CONDENSERS
 — ALSO —
PILLAR MICA & CHANNEL CONDS.
CARBON & WW. POTS.
POWER RESISTORS & RHEOS.
MONMOUTH
RADIO LABS
 Box 159 Long Branch 6-0121 Oakhurst, N. J.
 Art Hankins, Owner

SPECIAL PURPOSE TUBES

OA2	.75	4C27	7.50	VX-32B	7.50	WE-420A	7.50	5636A	3.50
OA3/VR75	1.00	4C33	75.00	FG-33	15.00	446A	.50	5637	3.75
OA4G	1.00	4C35	17.50	VX-33A	5.00	446B	1.25	5638	6.50
OA5	3.50	4E27	7.00	35T	3.00	450TH	35.00	5639	6.00
OB2	.60	4J38	100.00	35TG	3.00	450TL	35.00	5639A	6.50
OB3/VR90	.75	4J39	100.00	VX-41	5.00	464A	2.00	5640	6.50
OC3/VR105	.60	4J46	25.00	FP-54	25.00	CK-503AX	.75	5641	5.00
OD3/VR150	.60	4J52	50.00	HK-54	3.00	GL-575A	10.00	5642	1.00
EL-C1A	6.00	4J61	100.00	VX-55	7.00	631-P1	6.00	5644	6.50
1AD4	.90	4X100A	10.00	FG-57	10.00	WE-701A	1.50	5645	5.50
1AE4	1.00	4X150A	18.50	RK-60/1641	1.00	707B	2.00	5646	4.00
1AF4	2.50	4X500F	50.00	KK-61	2.75	715B	2.50	5647	5.00
1AG5	2.00	5A6	2.00	RK-65/5D23	6.50	715C	2.00	5650	60.00
1B22	1.00	5ABP1	20.00	FG-67	8.00	717A	.35	5651	1.35
1B23	2.00	5AP1	5.00	HY-69	2.00	719A	15.00	5651WA	3.50
1B24	6.00	EL-5B	5.50	RK-73	.75	721A	.50	5654	1.35
1B35	3.50	5BP1	2.50	RK-75/307A	.50	721B	7.00	5656	6.00
1B35A	7.50	5BP1A	7.50	75TL	7.50	723A/B	7.50	5663	.95
1P21	35.00	5BP2A	5.00	FG-81A	3.50	WE-725A	2.50	5670	1.85
1P22	5.00	5C22	25.00	FG-95	15.00	726A	4.50	5672	1.00
1P28	7.50	5CP1	2.00	100R	2.50	726B	15.00	5675	7.00
2AP1	3.00	5CP1A	7.50	100TH	5.00	726C	20.00	5676	1.00
2AP1A	6.00	5CP7	6.00	F-1115	1.00	802	2.50	5678	1.00
2C36	35.00	5CP7A	8.00	WE-121A	1.50	803	2.50	5685	12.00
2C39	5.00	5CP11A	9.50	WE-122A	1.50	804	7.50	5686	2.00
2C39A	10.00	5CP12	10.00	WE-123A	2.50	805	5.00	5687	2.85
2C40	8.00	5FP14	6.50	WE-124A	3.50	807	1.15	5687WA	5.50
2C42	8.00	5GP1	3.50	VT-127	1.50	807WA	1.50	5691	4.50
2C43	8.50	5HP1	2.00	F-128A	7.50	808	5.00	5692	5.00
2C46	5.00	5HP1A	10.00	VXR-130	1.50	808	1.00	5693	4.50
2C50	6.00	5J29	4.00	VT-158	10.00	809	2.00	5696	1.00
2C51	3.00	5J30	8.00	FG-172	15.00	810	10.00	5703	1.00
2C52	2.75	5JP1	4.50	FG-190	2.50	811	3.00	5719	2.00
2C53	10.00	5JP2	5.00	HF-200	10.00	812	2.50	5720	15.00
2D21	7.00	5JP2A	7.50	CE-203	5.00	813	10.00	5725	2.25
2D21W	90	5JP4	5.00	203A	2.50	814	2.00	5726	.75
2E22	2.50	5JP5A	10.00	WE-211D	8.00	815	.90	5727	1.25
2E24	2.25	5JP11A	10.00	233	250.00	816	1.25	5728	8.00
2J21A	2.00	5LP1	8.00	CE-235A	5.00	826	.75	5734	12.50
2J26	2.50	5LP2A	10.00	FG-235A	55.00	828	8.00	5740	25.00
2J50	35.00	5R4G	1.25	WE-242C	10.00	829	3.50	5750	2.50
2J51	150.00	5R4WG	2.50	QK-243	50.00	829B	8.50	5751	2.50
2J52	50.00	5RP1A	17.50	WE-244A	7.50	832	2.50	5755	7.50
2J53	2.50	5RP11A	35.00	WE-245A	6.50	832A	5.00	5762	125.00
2J54	25.00	5S1	50.00	WE-249B	3.50	836	1.25	5763	1.15
2J55	35.00	5X3	2.50	WE-249C	2.50	837	1.25	5771	275.00
2J56	50.00	5XP1	50.00	250R	5.00	845	3.00	5787WA	6.00
2J59	50.00	5Z2P7	25.00	WE-251A	50.00	849	25.00	5796	10.00
2J61	15.00	5Z4P11</							

WANTED

We will buy the equipment listed below
REGARDLESS OF CONDITION!

Special Price Paid For R. C. 286 Antenna

JUNCTION BOXES

CBY-62018—CW-22081—CBY-62008A—CBY-23049

RELAYS

5059R—5058—5055—5053M—5053—Price Bros. Relay #10
A-18259—Antenna Switching Relay Box—BG-AN-198—BC-408

TUBES

35T—Eimac—53A—VT-127A—WL-530—100TH—250TH
450TL—750TH—15E

TRANSFORMERS

D 163248—RET. D 163250—D 163254—D 162899—D 183254
D 165964—KS 9273—KS 9012—XS 9536—KS 9336
KS 9608—KS 9602—KS 9605—KS 9117—KS 9607
KS 8984—KS 9153—KS 8983—X 330005—A 14987

AIRCRAFT SPARK PLUGS

RB-19R—RB-48552—590 52—613 52—RB 5/2—RD 5/3—RB 5/4
RB 5/5—RB 23-R—RP-43-5—63-5*—64-5—LE-44—LE-45—LS-48
AC-181—AC-281—RB-212 52—RB-312 52—RC-9R—RS-14-1R
RZ-14-R—R-214—RB 27-R—RB-23—RS 19-2R—RN-5/3

We also purchase new or used magneto points.

RADIO and ELECTRONIC SURPLUS

14000 Brush Street • Detroit 3, Michigan

Phone: TOWnsend 9-3403

we will pay you
TOP \$\$\$.

for an AN/ARC-3

Also pay fabulous prices
for R-77/ARC-3 & T-67/ARC-3

Phone us collect on
ARC-3 components •

Stanley 7-0406

What else do YOU have?

BC-788? I-152?
R5/ARN-7? RT-18/ARC-1?
TEST SETS TS? ETC.?

ARROW SALES, INC. Dept. E.

7460 VARNA AVE., NO. HOLLYWOOD, CAL.

CASH PAID! Sell your surplus electronic tubes. Want unused, clean transmitting, special purpose, receiving, TV types, magnetrons, Klystrons, Broadcast, etc. Also want military & commercial lab test and communications gear. We swap too, for tubes or choice equipment. Send specific details in first letter. For a fair deal write, wire or telephone: Walker 5-7000
Barry, 512 Broadway, New York 12, N. Y.

WE WANT TO BUY!

BC-224, BC-348 RECEIVERS

ARC-3 BC-788 R5/ARN-7

Cash or trade. Immediate action. Top \$\$\$!

HARJO SALES CO., Dept. B

503 N. Victory Blvd., Burbank, Calif.

Desire to purchase three each

Signal Generators, General Radio 805C.

Reply H. FINNEGAN, 49 Washington Ave.,

Little Ferry, New Jersey.

WANTED
ART-13/T47A Transmitters \$175.00
ART-13/T47 Transmitters \$125.00
BC-788C Alt. \$175.00
A R C - 3 Transceiver Complete \$325.00
R5/ARN-7 Radio Compass \$175.00
Ship via Express C.O.D. Subject to inspection to H. FINNEGAN, 49 Washington Ave. Little Ferry, N.J.

Current purchase of
RECEIVING, TRANSMITTING AND SPECIAL PURPOSE RADIO TUBES
Send special offers with net price and types to:
W-1882, Electronics
Class. Adv. Div., P.O. Box 12, N.Y. 36, N.Y.

NEED METERS?
STANDARD or SPECIALS
ANY QUANTITY—NEW—MILITARY
FOR ELECTRONIC—MILITARY
AIRCRAFT—HAMS
ALL MAKES—MODELS
RANGES—SIZES
METERS REPAIRED
RESCALED
RECALIBRATED

WRITE - PHONE - WIRE
INSTRUMENT SERVICE
76-14 Woodside Ave.
Elmhurst 73, N. Y.
CAA No. 4264 Ltd. HA 9-2925

A BARGAIN FOR YOU in a . . .

SOLA *Constant Voltage* TRANSFORMER

**End
Fluctuating
Line
Voltage**

OVER 60% OFF . . .
the factory price of a 1-input 2,000 VA unit! And here's another bonus! This Air Forces 2,000 VA overstock, Sola Cat. No. 30768, has 4 inputs! 90-125 V., 190-250 V., 60 cy. or 50 cy. Isolated secondary is constant 115.0 V. ± 1% from no-load to full-load of 17.4 amp. So, if you choose, use it as a 220:115 V. step-down. And slash \$147.50 off the factory 1-input price! Brand new in original wood box. 4 cu. ft. Ship. wt. 254 lbs. F.O.B. Pasco, Wash. Only **\$97.50**

(EXPORTERS: Note choice of 50 cycles.)
THE M. R. COMPANY
P. O. Box 1220-B Beverly Hills, Calif.

RADAR

P.P.I. REMOTE REPEATERS

- VD 7" Upright
 - VE-7" Table Type
 - VF-5" "B" Scope "5" P.P.I.
 - VG-"24" Plotting Table
 - VJ-12" Upright
 - VK-12" Upright
 - VL-12" Upright R.H.I. IND.
- All indicators are 110v 60 cyc.

AN/APR-4

38-4000 MC RECEIVER



RDO

NAVY SEARCH RECEIVER

The RDO is a very elaborate radar search receiver greatly improved over the APR-4. The set uses APR-4 tuning units, but is much more versatile, having input metering, D.B. output meter, automatic noise limiter, and greater selectivity and sensitivity. The RDO is recommended when only the very best will do. Input 110v 60 cyc.



AN/ASQ-1 AIRBORNE MAGNETOMETER

This is an airborne chart recording magnetometer. The set consists of an amplifier, oscillator, detector head, chart profile recorder, power supply. The equipment has a sensitivity of 2 gamma. The AN/ASQ-1 records on an Esterline angus recorder disturbance in the earth's magnetic field. An indicator is provided that gives a bearing on a magnetic disturbance. Input is 28v DC. Weight about 130 lbs.

SHORAN

AN/APN-3-AN/CPN-2

The AN/APN-3 and AN-CPN-2 are Precision distance measuring installations. This equipment operates on 225 mc. The range is 250 miles with an accuracy of 25 feet. This equipment is widely used by geological companies for prospecting and mapping. Power input is 110v 400cyo and 28v DC.

RADALAB INC.

87-17 124th St., Richmond Hill 18, New York, N. Y.

Phone Virginia 9-8181-2-3

OVERSEAS CUSTOMERS CALL US DIRECTLY BY TELEX OVERSEAS TELETYPE TWX N. Y. *4-4361

AN/GSQ-1 SPEECH SCRAMBLER

This is a unit designed to be attached to either a radio or telephone circuit to scramble speech or code. This equipment utilizes coded cards in each terminal equipment. Unless the properly numbered card is inserted on the receiving end the speech can not be unscrambled. This provides an excellent privacy system. 24 VDC input. Mfg. Western Electric.

AN/TPS-1B

200 MILE AIR SEARCH RADAR

The TPS-1B is a very late type L-band mobile or portable air search radar. This set will detect aircraft up to 200 miles and up to 40,000 ft. The set is composed of small portable carrying cases that are bolted together to make up the set. A 7" P.P.I. and a 5" "A" scope are provided. This set is in use by the Air Force and Marine Corps. Complete sets available. P.O.R.

AN/TPS-3-AN/TPQ-3

Airsearch or artillery shell tracking radar. The AN/TPS-3 is a 600mc airsearch portable radar. The set has a range of 120 miles on aircraft up to 40,000 ft. This set has a 7" P.P.I. and a 5" "A" scope. The AN/TPQ-3 is a modification of the AN/TPS-3 to provide mortar and artillery shell tracking and plotting. A computer is provided to compute shell trajectories and provide information for counterbattery fire. This set is completely portable and can be set up in the field in a few hours. Complete sets avail. P.O.R.

AN/TRC-1-3-4

100 MC RADIO-RELAY EQUIPMENT

The AN/TRC series is a mobile portable set for duplex or simplex radio telephone point to point communication. This set will operate with the CF series carrier systems to provide multi channel operation. The TRC operates on 100 MC with an output of 10-50 watts. The set is crystal controlled. Complete sets avail. with all components. Input 110v 60 cyc.

CARRIER EQUIPMENT

- CF-1 4 CHAN. VOICE AND TELEG. TERMINAL 115v 230v A.C. 12v D.C.
- CF-2 4 CHAN. TELEGRAPH AND TELETYPE TERMINAL 115v 230v A.C. 12v D.C.
- CF-3 4 CHAN. INTERMEDIATE REPEATER 115v, 230 A.C. 12v D.C.
- CF-4 CARRIER CONVERTER. Used to adapt the CF-1 and 2 for operation on a simple 2 wire trans. line instead of using spiral A, 115v, 230v A.C. 12v D.C.
- TH-1 TELEGRAPH TERMINAL

SCR-536 HANDI-TALKIE

Freq. range 3.75 Mc crystal controlled battery operated handi-talkie. The range of this equipment is approximately 2 miles. We can supply these sets to your specified freq. Completely reconditioned and guaranteed.

WE CAN SUPPLY OVER 1500 OF THESE SETS

MISC. EQUIP.

- SCR-193 1.5-18 mc field radio
- SCR-291-A 1.5-20 mc direction finder
- SCR-300 40-48 mc walkie-talkie
- SCR-389 1.5 mc-18 mc mobile radio
- SCR-499 1.5 mc-18 mc field radio
- SCR-508-528 28 mc FM field radio
- SCR-608-628 30 mc FM field radio
- SCR-506-A field radio
- SCR-694 field radio
- AN/ARN-6 Airbourne D.F.
- AN/ARN-7 Airbourne D.F.
- AN/APN-9 Lorain
- AN/APA-11 pulse analyzer
- AN/APA-17 300-10,000 direction finder
- AN/APR-1 38-4000 mc receiver
- AN/APR-5 1,000-3,100 mc receiver
- AN/APR-6 3,000-10,000 mc receiver
- AN/ART-3 THRU 11 jammer
- AN/ARQ-1 THRU 12 jammers
- AN/APQ-2 THRU 9 jammers
- AN/PRT jammers
- AN/ARC-1 100-156 radio set
- AN/AN/ARC-12 200-325 mc radio set
- AN/ARC-7 100-156 mc walkie talkie
- AN/APR-2 THRU 34 Airbourne radar
- AN/PRC-6 handi-talkie FM
- AN/PRC-8, 9, 10 walkie talkie FM
- AN/GRC-9 field radio
- AN/GRC-3 8 FM field mobile radio sets
- AN/TXC-1 page printing facsimile
- AN/TRC-7 100-156 mc walkie talkie
- AN/UPN-1, 2, 3, 4 radar beacons S & X Bands
- AN/CPN-6 & 8 radar beacons S Band
- SCS-51 Instrument landing systems
- RC-115B 75 mc marker ground set
- SA, SC, SK, SO, SX, other navy radars

Noise and field strength measuring equipment
Commercial mobile, portable radio sets, Motorola, G.E., Halliercrafters, RCA, Etc.

Test sets TS-1 THRU 800

We specialize in radar and radio, countermeasures equip.

Spare parts for all types of radio and radar equipment

We have many late types of MIL equip. made after WWII. Write

Many types of AN/types of test sets in stock

If what you want is not listed write anyway

AN/ARC-12

AIRBORNE 225-350 MC TRANSCEIVER

TUBES • ALL FAMOUS ADVERTISED BRANDS ONLY • TUBES

RMA GUARANTEE—From 10% to 95% Below Manufacturers Price—Look and Compare

Special Prices to Quantity Buyers. Most of Our Tubes are Jan.—95% are Original boxed — Brands such as R.C.A., G.E., Ken-Rad., Sylvania, Tung-Sol and Raytheon.

Type	Price	Type	Price	Type	Price	Type	Price	Type	Price	Type	Price	Type	Price
AB-150	51.99	VR-150	.79	2K22	14.50	5BP1	2.49	12A07	.76	271A	12.99	706A	7.15
C3J	6.35	OA2	.74	2K23	16.50	5BP1A	8.99	12A7	12.95	274A	5.95	706B	14.50
C5B	.48	OB2	.89	2K24	18.99	5BP4	2.99	15R	1.25	27AB	1.79	706C	17.50
C6J	7.99	1B22	1.69	2K28	29.50	5C22	25.00	15RGT	.39	276A	7.25	706D	35.00
CK-551AX/2E1	1.79	1B24	5.99	2K33A	59.95	5C22A	3.99	26AT	2.99	276A	7.25	829B	9.95
CRP RK-72	.49	1B29	9.95	2K43	72.50	5C24	12.49	26C6	1.19	282A	6.49	820B	2.99
EF-50	1.99	2A/G	1.10	2K54	8.95	5C27	9.99	28D7	6.89	282B	7.25	820C	7.49
EF148	.78	2AP1	3.99	2K55	9.50	5C28A	14.99	28F7	7.89	282C	6.49	820D	11.59
EM-3GA	39.50	2AP1A	6.44	2V3/G	1.39	5D21	6.99	91P7	5.00	304TH	7.95	820E	1.98
F123A	5.99	2B11	1.89	2K2	.34	5F1P	16.99	24R	1.89	307A	1.85	820F	1.98
FG17	4.50	2C21	.49	3AP1	5.95	5F4	14.99	35T	4.99	310A	3.99	820G	3.49
FG-105	14.99	2C22	.39	3AP11A	4.95	5J32	65.00	35TG	7.25	316A	.69	820H	6.49
FG-154	14.99	2C26A	.49	3B23	3.25	5J33	7.99	53A	2.29	329A	4.49	820I	16.50
FG172	24.95	2C33	.49	3B23A	1.49	5L1P	13.99	5K-62	24.50	347A	3.88	820J	3.49
HF-100	7.49	2C39	4.99	3B24	2.99	5R4WGY	3.19	5D23	14.95	384A	14.99	820K	1.79
HK-24	3.69	2C39A	11.50	3B24W	4.99	6AC7	19.95			388A	2.95	820L	1.79
HK-54	3.69	2C40	10.99	3B27	3.49					388A	2.95	820M	2.69
HY-65	1.20	2C42	9.75	3B28	4.69					388A	2.95	820N	1.45
HY-114B	6.49	2C43	10.99	3B28	4.69					388A	2.95	820O	1.45
KU-610	3.49	2C44	7.49	3B29	3.99					388A	2.95	820P	1.45
		2C46	7.49	3B31A	6.35					388A	2.95	820Q	1.45

CRYSTAL DIODES	Price	Type	Price	Type	Price
1N21	.19	1N23B	1.10		
1N21A	.55	1N23C	3.55		
1N21B	.99	1N23D	.61		
1N22	.49	1N34	.49		
1N23A	.49	1N34A	.64		

Manufacturers, exporters, and large quantity users—Inquire on your letterhead for our inventory listing of receiving tubes, special purpose tubes, resistors, condensers, and other radio and television parts.

HY-65	1.70	2C51	2.75	3C21	1.29	6AC7W	1.50	89Y	.15	WL-417A	2.74	725A	3.99	874	1.25	5751	2.15
REL-21	1.00	2C53	9.90	3C22	64.95	6AC7	.79	100TH	6.95	GL-434A	6.66	726A	9.50	876	.89	5760	2.95
RK-34	1.39	2E24	2.49	5C23	5.99	6AJ5	14.19	203A	5.99	446A	1.49	726B	25.00	878	1.90	5763	1.29
RK-59	1.84	2E27	.95	3C24	1.50	6AK5	6.45	205B	1.99	446B	1.79	726C	24.50	881	1.10	5814	1.35
RK-60	1.99	2D21	.79	3C28	5.95	6AK5W	1.35	205D	3.99	446B	1.79	728A/B/Y	24.50	885	1.10	5815	1.25
RK-61	3.50	2D21W	1.39	3C33	8.99	6AR6	1.49	211	49.50	WL-460	8.99	728A/B/Y	24.50	885	1.10	5815	1.25
RK-65/5D23	14.99	2E21	2.99	3C45	6.25	6A56	1.19	215A	3.25	WL-464A	4.25	728A/B/Y	24.50	885	1.10	5815	1.25
RK-73	.69	2E21A	4.95	3CP1	1.25	6A57/G	62.49	217A	7.99	471A	1.25	728A/B/Y	24.50	885	1.10	5815	1.25
RK-233A	3.69	2E27	4.99	3D23	4.99	6B6W	39.50	217C	4.99	CK-508AX	1.10	730A	7.95	800	1.29	931A	3.89
VT25/10	.49	2E26	2.50	3D24	1.88	6C4	4.99	221A	3.99	CK-521AX	1.10	801A	1.29	801	1.29	931B	3.89
VT25A/10Y	.39	2E27	5.99	3E29	10.25	6D4	2.99	221C	3.99	CK-521AX	1.10	801B	1.29	801	1.29	931C	3.89
VT67/38 Spec.	.25	2I30	14.50	3E27	1.88	6F4	2.99	242C	8.00	527	14.50	801C	1.29	801	1.29	931D	3.89
VT-158	17.50	2A31	14.50	3F27	2.95	6J4	2.50	249B	2.99	WL-530	19.50	801D	1.29	801	1.29	931E	3.89
VU-111	.15	2I33	13.50	3G21	2.95	6J4W	6.99	249C	2.99	532A	.99	801E	1.29	801	1.29	931F	3.89
CB32/532A	.99	2I33	13.50	3H27	2.95	6J6W	1.29	250TH	24.95	70A/B/C/D	.99	801F	1.29	801	1.29	931G	3.89
QK-59	29.50	2I34	13.50	3J21	49.94	6K4	9.99	250TL	13.95		10.99	801G	1.29	801	1.29	931H	3.89
QK-61	32.00	2I38	14.00	4A-11	4.49	6K4W	1.49	253A	3.99	701A	4.99	801H	1.29	801	1.29	931I	3.89
QK-185	99.00	2I49	39.50	4C27	8.95	7B1P	9.95	259A	5.99	702A	2.25	801I	1.29	801	1.29	931J	3.89
VR-78	.89	2I61	16.40	4C28	35.50	12A6	2.99	263A	3.90	703A	1.90	801J	1.29	801	1.29	931K	3.89
VR-90	.49	2I62	9.60	5AP1	3.95	12AT7	.85	264C	3.90	704A	1.90	801K	1.29	801	1.29	931L	3.89
VR-105	.79					12DP7A	16.95	269A	13.50	705A	1.25	801L	1.29	801	1.29	931M	3.89

FAY-BILL DISTRIBUTING CO. DEPT. E1
418 Broome St., N. Y. 13, N. Y.
Telephone CAnal 6-8404

All boxed and fully guaranteed. Special quantity discount—10% on 100 or more of same type. Minimum order \$10.00. Thousands of other types in stock. Send us your requirements to P.O. Box 25, New York 25% deposit with order or if paid in advance save C.O.D. charges. Rated firms net 10 days. Prices subject to change without notice. For fast service ask for Sy.

COAX CONNECTORS

SO239	M359A
24¢	15¢
831R	831AD

Over one million tubes in stock

TUBES

RCA • KEN-RAD • SYLVANIA • CBS
WESTINGHOUSE • WESTERN ELECTRIC

Type	Price	Type	Price	Type	Price	Type	Price	Type	Price
0A2	\$.75	3E29	8.45	RK72	.25	420AW.E.	6.00	861	10.00
0B3	.75	3FP1	3.50	CV88	2.00	421AW.E.	3.75	876	.75
0C3	.60	3GP1	2.00	101D-W.E.	2.50	422AW.E.	7.50	884	1.00
0D3	.55	3HP14	1.75	464B	1.50	464A	2.00	891	.75
1B26	1.25	3JP7	3.45	101F-W.E.	2.50	VU1115	.75	893A	375.00
1B32	.25	KC4	27.00	114B	.50	WL468	15.00	923	1.25
1B35	3.50	KC4-3	27.00	H500	35.00	H500	35.00	955	.25
1B38	25.00	4J25	25.00	RX-120	20.00	CK502AX	1.00	991	.30
1L33	22.00	4J29	75.00	F-127A	15.00	CK503AX	1.25	1616	.35
1P21	1.75	4J30	90.00	F-128A	7.50	CK505AX	1.00	1619	.25
1P41	2.50	4J33	75.00	GL-152	10.00	CK506AX	1.00	1625	.25
2C22	.25	4X150A	20.00	FG-154	10.00	CK507AX	1.25	1626	.25
2C26	.35	5BP1	1.25	204A	25.00	CK522AX	1.25	1629	.10
2C27	5.00	5BP4	3.50	A V209	5.00	WL532A	.25	1631	1.00
2C33	.50	5B21	1.25	215AW.F.	20.00	705AW.E.	.65	1632	.20
2C34	.25	5C22	17.50	217C	1.75	706AY	15.00	1680	1.00
2C39A	10.00	5D21	5.00	220B	90.00	707B	2.50	1846	50.00
2C46	5.00	5D23	10.00	221A	100.00	713A	.25	2051	.65
2E22	2.75	5D24	15.00	222AW.E.	100.00	715A	2.00	5517	1.25
2E25	2.50	5JP2	6.00	249B	3.00	717A	.35	5518	275.00
2E36	1.35	5MP1	2.75	250TL	12.50	718CY	25.00	5650	50.00
2U49	25.00	5R4WGY	2.50	253AW.E.	2.00	720BY	35.00	5651	1.25
2K26	35.00	5SP7	50.00	254A-W.E.	2.50	721A	.75	5672	1.00
2K33	100.00	5SP11	50.00	259B	5.00	722A	.75	5676	1.00
2K33A	50.00	5SP11A	50.00	274AW.E.	2.50	724B	.50	5693	4.50
2K33B	100.00	6AC7W	1.00	285AW.E.	5.00	730A	5.00	5719	1.50
2K37	100.00	6C21	15.00	313C	3.00	730A	5.00	5726	.75
2K39	75.00	6A4W	1.00	348AW.E.	4.75	801A	.25	5744	1.00
2K56	50.00	7BP7	2.75	356BW.E.	3.00	803	2.00	5814	1.00
2X2	.15	9GP7	10.00	368AW.E.	2.00	805	5.00	5825	6.25
EL-3C	3.45	12DP7	10.00	374AW.E.	1.75	807	1.25	5827X	5.00
3B27	3.75	12DP7A	20.00	375AW.E.	10.00	811	3.00	5838	5.00
3BP1	1.25	15R	35.00	387AW.E.	5.00	813	9.50	5933	1.50
3C37	20.00	28D7	1.00	394A	2.50	829B	8.45	6035	10.00
3CP1	2.50	FG32	3.50	402AW.E.	12.50	832A	6.25	6038	5.00
3CP151	2.00	RK-34	.50	404AW.E.	15.00	836	1.25	608CT	2.00
3DP152A	7.50	L40CT	2.00	416AW.E.	Q	841	.29	6099	1.00
3D21A	3.25	HK54	4.00	416BW.E.	Q	842	1.00	8068	1.00
		RK59	1.75	417AW.E.	15.00	843	.35	8078	1.00
		RK60	1.25	419AW.E.	90.00	845	5.00	D178461W.E.	Q

Partial list, many additional types in stock are not listed here. Export Facilities.

CALVERT ELECTRONICS, Inc.

Calverton, N. Y. Telephone CA 6-7400

Dept. E, 536 Broadway, New York 12, N. Y., U. S. A.

SAVE dough! / HARJO!

RCA TV CAMERA



NEW Surplus
100's SOLD!
Only few left
at this price!

Ideal for labs, industry, prisons, TV technicians, swim pools, medics—"mechanical eye" for closed circuit TV, 1846 Iconoscope, 6-stage video amplifier and clipper. THE REAL THING! Send for new, free, complete technical data: SOLD AT FRACTION OF REAL VALUE!

\$197.50

TEST EQUIPMENT

- AN/GPM-14
- LAG
- TS-10C
- TS-13
- TS-15
- TS-16
- TS-19
- TS-24
- TS-32
- TS-33
- TS-34
- TS-35
- TS-36
- TS-45
- TS-47
- TS-59
- TS-89
- TS-92
- TS-110
- TS-125
- TS-143
- TS-182
- TS-184
- TS-204
- TS-251
- TS-261
- TS-268
- TS-294C
- TSX-45E
- I-56
- I-122
- I-166
- I-177
- I-222
- IE-12
- IE-19
- IE-36

GROUND ELECTRONICS

- ARB
- ART-13
- BC-191
- BC-222
- BC-224
- BC-312
- BC-314
- BC-342
- BC-344
- BC-348
- BC-375
- CRT-3
- TCS-12

AIRCRAFT ELECTRONICS

- ARC-1
- ARC-3
- ARC-4
- ARC-5
- ARC-12
- ARN-6
- ARC-27
- MN-62
- MN-55
- LP-21
- LP-31
- AS313-B

RADAR EQUIPMENT

- APA
- APS-4,-6
- APS-15
- SCR-717,-720
- SL
- APQ-13
- T-116/APT-5A

POWER ELECTRONICS

- DY-11
- DY-12
- DY-17
- PIONEER 12143-2A
- PIONEER 12117
- PIONEER 12123
- PIONEER 12133
- PIONEER 12142
- PE-206
- 5D21NJ3A

1,000's of other items
Tell us your needs!

1-222 SIGNAL GENERATOR-MICROVOLTER
Freq. range: 8-15 Mc. & 150-230 MC. Complete with all tubes and 5 MC. Calibrating Crystals. Self-contained 110 V. and 60 cycle power supply. With Schematic. Cost the Govt. approx. \$49.95
\$700.00 Brand New.....

IMPORTERS-EXPORTERS!

Write us in fullest confidence. Lowest prices. Dependable merchandise, certified by CAA if desired, quick delivery and prompt action on foreign inquiries in all languages!

Harjo Sales Co.

Office-Warehouse: 503 N. VICTORY BLVD. BURBANK, CALIF. Phone: Thornwall 5-2613

Your inquiry will have Special value . . .

If you mention this magazine, when writing advertisers. Naturally, the publisher will appreciate it . . . but, more important, it will identify you as one of the men the advertisers wants to reach with this message . . . and help to make possible enlarged future service to you as a reader.

SPECIAL TOOLING TO MANUFACTURE "JAN" SWITCHES for sale

at a fraction of original GAC (\$140,000.00)
Built at USAF expense to produce 5,000 switches, etc., per hour. Has produced as recently as January 1966. Designed to make:

- AN3021 single pole toggle, 1 hole mount.
- AN3022 single pole toggle, 3 hole mount.
- AN3023 double pole toggle, 3 hole mount.
- AN3226 three pole toggle, 3 hole mount.
- AN3227 four pole toggle, 3 hole mount.
- AN3211 Rotary selector switch.
- AN3028 and AN3333 Switch guards.
- AN3220-3 KNOB Pointer.

Over 65 dies for metal stamping and plastic molding operations. Over 100 special tools, jigs, fixtures, etc., for machine shop operations, assembly, testing, etc. Complete blueprints and bill of materials. Experienced engineering services available if desired.

Offering subject to prior sale. Principals only—NO broker protections. Inspection at our Chicago storage sites on request.

HARBER INDUSTRIALS

1312 W. Arthington St.
Chicago 7, Illinois

CONSISTENTLY HIGH QUALITY ELECTRON TUBES

AT SENSIBLE PRICES!
Largest stock in the country.
• ALSO •
Large diversified selection of

TEST & COMMUNICATIONS EQUIP.

WRITE
For latest comprehensive catalog and tube price sheet
BARRY ELECTRONICS CORP.
512 Broadway, N. Y. 12, Walker 5-7000

COMMUNICATIONS & TEST EQUIPMENT

Top quality communications and test equipment at low prices.
Here are a few leaders

- ARC-1,-3,-27 etc.—Airborne Transmitter-Receiver.
- BC-375—Complete two cases, export, packed, unused ground transmitting equipment.
- AN/ARN-6 & 14—Radio compass equipment.
- ART-13—Transmitter 100 W Airborne or ground.
- AN/APR-4—Laboratory receiver with tuning units.
- TS-147D/UP—X band test equipment Signal generators.
- TS-323/UR—Frequency meter.
- 334-E—Control box.

Prices on request only
Immediate Delivery

We buy clean communications and test equipment unmodified. Top prices.

MONTGOMERY EQUIPMENT CO.

14315 Bessemer St.
Van Nuys, California
Telephone: State 6-4657
Telegraph Station YHV
Cable Address MONTEQUIP

Write - Wire or Phone for:

NEW FREE FLYER!

Hundreds of excellent buys in air and ground electronics, air frame and electrical parts, components, etc. Get your copy.

SEE INFRA-RED! PHOTOGRAPH INFRA-RED!

IP25A TUBE: Just released! Infra-red image converter made by Farnsworth, Limited quantity. Do not delay! With application data. Brand new. Only..... **\$24.95**

WIDE RANGE RECEIVER: 80-3,000 MC!

Far more sensitive than a radar receiver! We believe it is designed to detect radar signals beyond the effective range of the radar. To measure carrier frequencies from 80-3,000 mc and pulse repetition rates from 50-8,000 cps. In addition it is a direction finder. A special antenna installation is included for this purpose. Also includes its own power supply (115 V., 60-2400 cy.), a test oscillator for frequency calibration, audio amplifier with cathode follower output, visual indicator for tuning sharply, metered pulse amplifier and counter, and an elaborate antenna and RF detector unit. Brand new and complete with instruction and Maintenance Manual. A real steal at only..... **\$95.00**

ASK FOR OUR NEW RELAY CATALOG!

Here are examples of buys to be found:
 1. **ELECTROSTATIC RELAYS:** Plug-in, hermetically sealed, one SPST N.O., one SPST N.C., which operate on 1 mw-second of energy! No magnets! No coils! No magnetic coils! No magnets - period! Uses electrostrictive ceramic to transfer the silver-palladium contacts when charged to 200 **\$9.95**
 2. **WESTON SENSITROL MODEL 705 TYPE 6:** SPDT. Polarity at 40 ohm coil determines which contact makes. 400 microamps (16 mv) sensitivity. Stationary contacts are permanent magnets which latch the moving contact. Contacts latch ultra-conservatively at .1 A. DC. Resets by monetary application of 115 V., 60 cy. to the reset coil. Brand new and a **\$93.50** value **\$12.95** for only
 ALSO: Stepping switches, time delays, polarized Sigma sealed sensitives, latches, etc.

PAY LESS THAN \$18.00 FOR \$800.00 FREQ. METER!

Brand new Navy, original packing, with instruction book containing schem. and operating instr. Crystal-cali., with harmonics past 470 mc. In file. freq. meter and Sig. Gen. Output of 10 mw either CW or 90% AM with 30 kc sine wave or 100% AM with 10 u-sec pulse at 1 kc. The RF pulse also available at 50 & 8,000 ohms. RF radiated from antenna supplied. Input 80 or 115 V., 50 to 800 cy. This power supply alone is worth more than our **GIVE AWAY PRICE!** With headset, cords, & attenuator, plus complete tech manual.
 LU-1: 470-493.5 mc. Cat. No. 2806TY2. **\$17.95**
 Shpg wt 65 lbs. BRAND NEW! ONLY.
 LU-3: 465-498.5 mc. Cat. No. 2006TY1. **\$19.95**
 Shpg wt 65 lbs. BRAND NEW! ONLY.

BRAND NEW IMPEDANCE-BRIDGE SPECIAL

Designed not only to measure reactance and resistance of components, but also to measure antenna and transmission line resistance and reactance at frequencies from 25 kc to 5 mc. Complete with accessory box of plug-in standards and educational instruction book with a special section devoted to antenna measurements. No power is required for the bridge. Carry it anywhere you carry your field generator. This is what you have always needed to load and trim antennas to get all the power of your customers' transmitters into the air. Here is accurate laboratory equipment, made for the U. S. Navy to exactly duplicate a commercial bridge presently being sold for \$390. Shpg. wt. 60 lbs. Only **\$125.00**

NEW ARRIVALS

All unused Excellent condition
 TS-3/AP \$95.00
 TS-3A/AP \$125.00
 TS-92/AP \$97.50
 TS-667/AP for APA-44 \$72.50
 1-203-A RF WATTMETER \$79.50
 For SCR-720
 And MANY more What do YOU Need?

All prices F.O.B. subj. to change without notice. Items subj. to prior sale.

ARROW SALES, Inc.

OFFICE AND MAIN WAREHOUSE:
 7460 VARNA AVE., NORTH HOLLYWOOD, CAL.
 Mail to: BOX 3007-E, NORTH HOLLYWOOD, CAL.
 Phones: Stanley 7-0406 Poplar 5-1810
 Telegraph: WUX, NO. HOLLYWOOD
 Cable: ARROWSALES, NO. HOLLYWOOD
 CENTRAL WAREHOUSE & SALES SHOWROOM
 2441 S. MICHIGAN AVE., CHICAGO 16, ILL.
 OTHER WAREHOUSES IN:
 Atlanta, Ga., San Antonio, Tex., Pasco, Wash.,
 Sacramento, Cal., Burbank, Cal., Los Angeles, Cal.

BEARINGS

MINIATURES; PRECISION; STAINLESS STEEL; SPECIAL SIZES, TOLERANCE & CONSTRUCTION.
 BEARING DIV. Raway Sales
 4-8 Forsyth St. Walker 5-8150 N. Y. C., N. Y.

KURMAN GENERAL ELECTRIC NORTH ELECTRIC GUARDIAN
 PRICE ELECTRIC CLARE WESTERN ELECTRIC
A LARGEST STOCK OF RELAYS IN THE WORLD!
 STRUTHERS DUNN ADVANCE AUTOMATIC ELECTRIC
 SIGMA POTTER BRUMFIELD LEACH

OVER 1,000,000 RELAYS IN STOCK—MOST MAKES—MANY TYPES

LEDEX & OAK ROTARY SOLENOIDS

	BDOE	BD3E	BD5S	BD6S
D Diameter.....	7/8"	1-5/16"	1-7/8"	2-1/4"
L Length.....	5/8"	25/32"	1-1/64"	1-5/16"
AS Axial Stroke (Approx.).....		.0315"	.055"	.066"
SL Stud Length.....		7/16"	1/2"	5/8"
SR Stud Radius.....		7/16"	5/8"	23/32"
ST Stud Thread.....		5-40	8-32	10-32
Weight (Approx-Bare).....		3-1/2 oz	9 oz	18 oz
Torque lbs-inches.....		1.0	4.0	7.5
Finish.....		Nickel or Black Nickel		

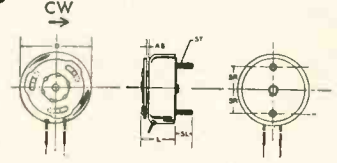

† The Torque values given are average and are based on the ampere-turns for a normally intermittent duty cycle.

In the Leduc rotary solenoid the magnetic pull moves the armature along the solenoid axis. This linear action is effectively converted into a rotary motion by means of ball bearings on inclined races.

Listed below are Leduc solenoids from our stock. These all have a 45° stroke. Both continuous and intermittent duty voltages are indicated. The intermittent voltage listed is for ten seconds or less and the "off" time is nine times the "on" time. Under these circumstances the units should be installed so that there is free circulation of air around them.

Type	Rot.	Stroke	Wire	Ohms	Volts DC	Return	Finish	X Features	Stk #	Ea*
BD6SR45-22X7X8	CW	45°	22	2.2	8.3	26	yes	Cad. Dust Cover	R1219	3.75
BD5SL45-23X3	CCW	45°	23	2.0	6.0	19	no	Blk 5/16" L. Shaft Extension	R1220	2.00
BD5SL45-25X3	CCW	45°	25	5.0	9.5	30	no	NKL 5/16" L. Shaft Extension	R824	2.00
BD5SL45-26X3	CCW	45°	26	7.7	12	38	no	NKL 5/16" L. Shaft Extension	R825	2.00
BD5SR45-33X2	CW	45°	33	185	60	190	no	NKL Forward Engaging Pawl	R597	2.00
BDOER45-29X5	CW	45°	29	5.0	5.2	16	no	Blk Offset Drive Pin	R827	1.50
BDOER45-32X5	CW	45°	32	22	11	32	no	NKL Offset Drive Pin	R826	1.50

LEDEX & OAK STEPPERS

Leduc Rotary Solenoids provide the mechanical power to drive the gang of rotary, wafer type switches. Self-imposed oscillation of the solenoid operated relay can be obtained by the cam operated commutating switch combined with a solenoid armature return spring. Ratchets transmit the oscillating action of the rotary solenoid to the switch rotor shaft. A Control Wafer may be used on the Leduc Relay to determine the position of the switch rotor shaft when the oscillation of the solenoid is stopped. Circuit wafers may be designed for specific applications thereby making many switching patterns possible. External pulsing, of course. All units with shafts are supplied with hardware for mounting standard wafer switches.



Type	Shaft	Rot. Length	Stroke	Self Pulsing Deck	Wire Size	Ohms	Volts Cont.	Int.	Spring	X Features	Stk #	Ea*
BD3ER30-28X8	CW	7/8"	30°	yes	28	8	8.4	26.5			R1222	4.75
BD3ER30-28X8X9	CW	7/8"	30°	yes	28	8	8.4	26.5		Dust Cover	R1223	5.00
BD3ER30-37X9	CW	1-1/4"	30°	no	37	426	67	210		Mtg Flange	R1224	5.00
BD5SR30-33X6	CW	1-1/4"	30°	yes	33	176	60	190		Threaded Holes	R1225	4.00
BD5SR30-34X6	CW	1-1/2"	30°	yes	34	270	76	240		Threaded Holes	R1226	4.00
BD5SR45-26X9	CW	7/8"	45°	yes	26	5	8.4	26.6			R1227	5.00
BD5SR30-26X7	CCW	1-1/2"	30°	yes	26	5	8.4	26.6		Terminal Board	R1228	5.50
BD5SR30-26X7	CCW	1-1/2"	30°	yes	26	5	8.4	26.6		Mtg Flange	R1229	5.50

ALL MERCHANDISE IS GUARANTEED AND MAY BE RETURNED FOR FULL CREDIT.

Prices listed with asterisk (*) are subject to QUANTITY DISCOUNTS
 1-9 as quoted
 10-49 10%
 50-99 15%
 over 100 20%

324 CANAL ST., N.Y.C., 13, N. Y. Walker 5-9642

Universal general corp.

Ask for Mr. Herzog or Mr. Greenberg

IF THERE IS Anything you want

that other readers of this paper can supply

OR—

Something you don't want

that other readers can use, advertise in the

Searchlight Section

GUIDED MISSILE BEACON

FILTER CAVITY F-28/APN-19

2700-2900 mc, 1.5 db max. loss at ctr. freq. over band, 3db at 15 mc band ends. JAN spec. Ideal as standard reference cavity. Brand new. \$37.50.
 CRYSTAL DETECTOR assembly p/o AN/APN-19 and 60. 10cm. Low level converter with matching transformer from RF line to crystal. New \$19.50.
 AIRBORNE POWER SUPPLY DY30/APN-19 Complete shock mounted package input 19.5 volts DC 2.7 amps. Output 360 volts at 60 ma. and 100 volts at 10 ma. Will operate 2C40 and 2C43. Part of guided missile radar beacon AN/APN-60. Fully regulated. \$44.50.

RADIO-RESEARCH INSTRUMENT CO.

550 Fifth Ave. PAUL J. Phone
 New York 19, N. Y. Plishner JU 6-4991

NEW YORK TUBE & MICROWAVE TEST EQUIPMENT EXCHANGE

Special! TS45 X BAND GENERATOR—\$99⁰⁰

NEW UNUSED SURPLUS TS 259 K BAND
23400-24500 MEGACYCLES SIGNAL GENERATOR

SPECIAL! 5,000 V. POWER SUPPLY

For 1P25 Infrared Image Converter from 3 V. Battery Source. **\$990**
NEW, Complete with RCA 1654 Tube

NEW

MICROWAVE TEST EQUIPMENT
TS148/UP SPECTRUM ANALYZER
TS147D SIGNAL GENERATOR

Field Type X Band Spectrum Analyzer. Band 8430-9580 Megacycles.
Will Check Frequency and Operation of various X Band equipment such as Radar Magnetrons, Klystrons, TR Boxes. It will also measure pulse width, c-w spectrum width and Q, or resonant cavities. Will also check frequency of signal generators in the X band. Can also be used as frequency modulated Signal Generator etc. Available new complete with all accessories, in carrying case.

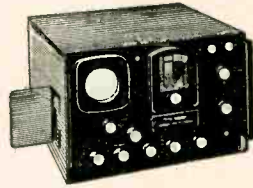

OTHER TEST EQUIPMENT USED CHECKED OUT SURPLUS

- | | | | | |
|---------|-----------|----------|---------------|--|
| TSK1/SE | T35/AP | TS108 | TS226 | SURPLUS EQUIP.
APA10
APA38
APS3 APS4
APR4
APR5A
APT2-APT5
and many others |
| TS3A/AP | TS36/AP | TS110/AP | TS239A-TS239C | |
| RF4/AP | 1-96A | TS125/AP | TS251 | |
| TS12/AP | TS-45 | TS126/AP | TS258 | |
| TA13/AP | TS47/APR | TS147 | TS270 | |
| TS14/AP | TS65/AP | TS174/AP | TS418 | |
| TS33/AP | TS100 | TS175/AP | TF890/1 | |
| TS34/AP | TS102A/AP | TS182 | 834 | |

SPECIAL

Thousands of tubes available at special prices

PARTIAL LIST

2AP1	6H6	307A	5691
4C27	6X8G	274A	5692
4C28	6AR6	274B	5693
5A6	5R4WG Y	262B	5639
5BP4	5W4GT	328A	5814
4J52	OZ4A	357A	9001
2A4G	6AC7	450TH	9002
6C21	28D7	450TL	9003
6J5GT	VT52	957	9006
	89	MANY OTHER TYPES	

WHOLESALE and EXPORT ONLY
Minimum tube order \$25



LIBERTY ELECTRONICS, INC.

Phone: ORegon 4-7070

119 PRINCE ST.
NEW YORK 12, N. Y.
Cable: TELESERUP

FOR SALE

General Electric Television Slide Projector Type PF-4A.

Provides for dissolves between dual sections and accepts slides, cards, small objects and strips of the following size:
1—3 1/4"x4", mat opening; 2 1/4"x3", standard transparent glass slides or opaques.
2—Opaque strip material 4" wide and any length.
3—Display material not exceeding 2 1/4"x3" in area and up to 1" in thickness.
Dimensions H-52", L-33 5/8", W-20"; weight 195 lbs; projection 43" for iconoscope; input 110 volts, 60 cycles, 1800 watts maximum.
Original cost \$3,953.50.

This unit is in new condition but has been replaced in our operation by a 2 1/4"x2 1/4" slide projector. Will sacrifice. Offers considered.

Address: Canadian Broadcasting Corporation,
701 Hornby Street, Vancouver, B. C.

INFRARED SNOOPERSCOPE TUBE

TYPE 6032—Infrared Image Converter Tube. Electrostatic focusing. Size 2x1 1/2". List \$150.00. Requires 20,000 volt, 0.05 millamp supply. This tube is in current use in all U. S. military infrared equipment & is 2 to 3 times superior to the old 1P25 in definition and performance. Diagram for simple power-supply included. A \$120.00 saving—NEW SURPLUS. Guaranteed. ONLY \$29.95 postpaid.

INFRARED LIGHT SOURCE

Snooperscope Part #1364A.—Input 6 volts, 5 amps. Has special 5% dia. #A-1529 glass filter & goldplated reflector. Projects a powerful beam of invisible infrared radiation (free of all visible light) that illuminates objects for infrared viewing up to 400 feet. For any infrared system. Complete with bulb.

STK. #L-5458—NEW, ONLY \$7.95 Ppd.

STK. #L-5462.—Used, New Condition \$5.95 Ppd.

IMAGE TUBE POWER SUPPLY

Part #1450A.—Power-pack for 1P25 Tube (will also supply CV-147 Tube) Input 6 V.D.C. output 4,250 V.D.C. and additional focusing voltages. Checked-out, complete & operating with 1654 tube. Gov't cost \$68.00. Used. NEW CONDITION \$7.95 Ppd.

McNEAL ELECTRIC & EQUIPMENT CO.
4736 Olive St. Dept. E-2 St. Louis 8, Mo.
Terms: Prices Include Postage. Cash With Orders. Well Rated Concerns (D & R) Net 10 Days Cash.

McGraw-Hill BOOKS FOR YOUR READY-REFERENCE LIBRARY

RELIABILITY FACTORS FOR GROUND ELECTRONIC EQUIPMENT

JUST PUBLISHED! Methods and working data to help designers build greater reliability into military electronic equipment. Pinpoints causes of poor reliability. Discusses electrical and mechanical factors, human engineering, and components. Gives results of failed-parts studies. Edited by Keith Henney. 280 pp., 196 illus., \$7.50

ELECTRONIC ENGINEERING

JUST PUBLISHED! Techniques of circuit analysis for radar, television, electronic control, instrumentation, and computers. Gives alternate methods for many circuits, and provides means for combining circuits of different types. Examples relate techniques to practice. Discusses solid state theory, and transistors as circuit elements. By Samuel Seely, Prof. & Chrmn., Dept of Elec. Engrg., Syracuse U. 525 pp., 782 illus., \$8.00

RANDOM PROCESSES IN AUTOMATIC CONTROL

JUST PUBLISHED! Presents theory and practical techniques for analyzing linear control systems subjected to random inputs. Treats concepts of probability and random time functions in detail. Develops techniques for designing systems containing constant and time-varying components. Provides computational methods for use on computers. By J. H. Laning, Jr., and R. H. Battin, Instrument. Lab., Mass. Inst. of Tech. 429 pp., illus., \$10.00

AN INTRODUCTION TO REACTOR PHYSICS

Covers elementary nuclear physics and theory of thermal reactors, giving background for reactor design. Calculations, shielding, instrumentation, and radiation are treated. Evaluates a gas-cooled, graphite moderated, natural uranium reactor. Sufficient theory developed for understanding problems in designing all types of thermal reactors. By D. J. Littler and J. F. Raffle, British Atomic Energy Res. Estab. 196 pp., illus., \$4.50

THE MIGHTY FORCE OF RESEARCH

JUST PUBLISHED! FORTUNE Magazine editors tell how 4 billion dollars for research is opening new business opportunities. Reveals who does research, who pays, how it is carried out, what is accomplished and what it means to you. By Editors of FORTUNE. 308 pp., 21 illus., \$4.00

10 DAYS' FREE TRIAL

McGraw-Hill Book Co., Inc., Dept. L-6
327 West 41st St., N. Y. 36, N. Y.

Send me book(s) checked below for 10 days' examination on approval. In 10 days I will remit for book(s) I keep, plus few cents for delivery costs, and return unwanted book(s) postpaid. (We pay delivery costs if you remit with this coupon—same return privilege.)

- Henney—Reliability Factors for Ground Electronic Equipment—\$7.50
- Seely—Electronic Engineering—\$8.00
- Laning & Battin—Random Processes in Automatic Control—\$10.00
- Littler & Raffle—An Introduction to Reactor Physics—\$4.50
- FORTUNE—The Mighty Force of Research—\$4.00

(PRINT) Name

Address

City Zone State

Company

Position

For price and terms outside U.S., write McGraw-Hill Int'l., N.Y.C.

L-6

A & J SCOPE TS-100

A precision instrument providing a circular time base as well as a linear base for the range measuring of various radar equipments. In addition, this instrument will detect jitter, will provide for adjustment of slope and zero range controls; can be used for determining and adjusting division rate; and will perform the general functions of a conventional synoscope. Supplied complete with accessories and instruction certificate, and remanufactured by the original manufacturer. Quantity available. Complete specifications upon request.

RANGE CALIBRATOR TS-102A/AP

This brand new currently manufactured range calibrator generates a sign wave 327.8 kilocycle corresponding to a radar range of 500 yards. It features a triggered pulse of .8 microseconds width at up to 50V into 72 ohm load. Pulses are either positive or negative. Rise time is less than .5 microsecond. PRF rates are 400, 800, 1600, 2000. Also provides ± marking pulse of a .4 microsecond. An unusually stable device complete with cords and instructions. Price \$550.00

BOLTON
Laboratories, INC.
BOLTON, MASSACHUSETTS, U. S. A.

CONSISTENTLY HIGH QUALITY ELECTRON TUBES

AT SENSIBLE PRICES!
Largest stock in the country.
• ALSO •

Large diversified selection of
TEST & COMMUNICATIONS EQUIP.
WRITE

For latest comprehensive
catalog and tube price sheet
BARRY ELECTRONICS CORP.
512 Broadway, N. Y. 12, Walker 5-7000

Radio & T.V. Components

- 5,000 6SG7 tubes 35¢ ea.
- 700 8020 tubes 75¢ ea.
- 6,000 7193 tubes 6¢ ea.
- Two million feet #22 wire 75 different colors SRIR type stranded \$2.95 per 1,000 ft. (min. 1 reel)
- 100,000 1 & 2 watt precision tubular resistors, 1%, 1 w 3c, 2 w 5c. (Write for list)
- 20,000 .01 mica CM40 type 3¢ ea.
- 10,000 250 M F D 6 v. condensers paper ea. 5c.
- Special quantity prices—wholesale & export.

BELVISION, INC.

254 Greenwich St. N. Y. 7, N. Y.
Barclay 7-6063

HIGH SPEED MOTORS:

JOHN OSTER TYPE C2BP-1A—KS-5829-01—27 VDC/100 HP, 7000 RPM, DC Series Motor \$2.95
2" D x 3" L. Shaft Size: 1/2" x 1" Wt. 1 lb.
GENERAL ELECTRIC 5BA25AJ32B—Flange type motor, 24 VDC @ 2.9 A, 7000 RPM, 3 wire reversible with Magnetic brake. Size: 2-1/2" x 4-1/4" L. Shaft size: 3/16" x 3/8". Splined. Wt. 2-1/4 lbs. Price \$3.95
Motor only
GENERAL ELECTRIC 5BA25D300—Flange type motor, 24 VDC @ 2 A, 4000 RPM, Governor controlled with Magnetic brake. Size: 2-1/2" D x 5-3/4" L. Shaft size: 3/16" x 3/8". Splined. Wt. 2-1/4 lbs. Price—Motor only \$3.95
AIR ASSOCIATES EEI430M2 SPEC. No. KS-5875L-01—Flange mount, 27 VDC @ 20 A, 1/2 HP 3800 RPM. Size: 4-1/4" x 4-1/4" x 6-3/4" L. Keved shafts 1/4" x 1-1/2" with gear attached. \$7.95
Wt. 9-3/4 lbs.
GENERAL ELECTRIC 58A25MJ424—Type BA—24 V @ 4.2 A, 7100 RPM 1/20 HP. Flange mount. Motor size: 2-1/2" x 5". Shaft size: 3/4" x 1". \$3.95
Wt. 3-1/2 lbs.

MINIATURE BLOWERS:

MOTOR and BLOWER—DELCO 5068571. 27 VDC Reversible PM Motor, 6000 RPM, with Blower. Overall size, including Blower: 2 1/2" x 2 1/4" x 3". Wt. 9 oz. As picture shown to left. Price only \$4.50
DELCO 5069267—27 VDC, 6000 RPM, 1.5 oz. in torque. Reversible Shunt Motor. Flange Mounted. Size: 2 3/4" x 2 3/4" L. Flange 2 1/4" D. Shaft: 1/4" x 1". Blower Fan attached. No. 10D267 \$2.95
24 VOLT 10 CFM BLOWER—Housed in a cast aluminum case. Shunt Type Motor 24 VDC @ 6 A, 5000 RPM with motor noise Filter. Size: 3 3/4" D x 4 1/4" L x 4 1/4" L x 4" H. Wt. 1 lb. 10 oz. No. SS2345 \$5.95
115 VAC 400 CY. 10 CFM BLOWER—7200 RPM 1/100 HP. Bakelite blower Housing. Overall size: 3 1/2" x 3 1/4" x 4 1/2". Wt. 1 lb. 7 oz. Eastern Air Devices No. J31A. \$5.95
10 CFM BLOWER—OSTER MOTOR C2BP-1A—27.5 VDC 1/100 HP, 7000 RPM, Bakelite blower Housing. Overall size: 3 1/2" x 3 1/4" x 4 1/2". Wt. 1 lb. 4 oz. Price. \$5.95

115 V. 60 CYCLE BLOWERS:

115 VAC 60 Cycle SINGLE TYPE—100 CFM—2 1/4" intake; 2" outlet. Complete size: 5" x 6". \$9.95
No. 1C939
115 VAC 60 Cycle DUAL TYPE—100 CFM—4" intake 2" Dis. Each Side. Complete size: 8 1/2" x 8" No. 1C830 \$14.95
115 VAC 60 cycle COMPACT TYPE—108 CFM: Motor built inside squirrel cage; 4-1/2" Intake: 3-3/4" x 3" Dis. Complete size 4-1/2" W x 8-3/4" H x \$15.95
8-1/4" D—No. 2C067
115 VAC 60 cycle FLANGE TYPE—140 CFM: 3-1/2" Intake: 2-1/2" Dis. Complete size: 7-1/2" W x 7-1/4" H x 6-3/4" D—No. 1C807. \$14.95
115 VAC 60 cycle FLANGE TWIN—275 CFM: 4-1/2" Intake: 3-1/4" x 3" Dis. Complete size: 11-3/4" W x 2-3/4" H x 8-1/16" D—No. 2C069 \$22.95

DYNAMOMOTORS

INPUT VOLTS	OUTPUT VOLTS	MA	STOCK NO.	PRICES USED NEW
12 VDC	220	80	DM-34	\$2.95 \$4.95
12	625	225	DM-35	9.95
12	230	90	PE-133	4.95 6.95
12 or 24	540	450	DA-12	14.95
12 or 24	230	100	DA-14	8.95
14	220	70	DM-24	7.95
12	250	60	DM-32/12V	5.95
14	425	163	WE-377	5.95 8.95
14	250	50	DM-25	6.95 8.95
24	250	60	PE-86	6.95 8.95
28	1000	350	PE-73	8.95

Gear Reduction MOTORS:



DELCO 5069370 (Shown at left) 27 VDC Reversible PM Motor and Gear Assy. in an aluminum case. Output speed is 80 RPM through a friction clutch to a double shaft: 1/4" x 3/4" on one side, 3/4" x 1 1/4" on the other. Size complete Assy. 3 3/4" x 2" x 1 1/4" excluding shaft. Has built-in noise filter system. Wt. 1 lb. \$5.95
Same Motor as used in above Assy. Size: 1 3/4" x 1 1/2" x 2 1/4". Wt. \$3.95
REVERSIBLE SHUNT MOTOR—Oster Type KU-1L-1R, 28 VDC @ 8 A. Heavy duty gear reduction motor. 2 1/2" lb. ft. torque, to 100-200 RPM. Size: 10" L x 7" W x 4 1/4" H. Shaft: size: 7/16" D x 3/4" \$7.95
Wt. 1 1/2 lbs.
PHILCO Gear Reduction No. 411-1008—24 VDC—Output speed 3.7 RPM 40 lb. inch torque. Size 4 1/2" x 3 3/4" x 5 1/2". Shaft size: 5/16" x 3/4". Wt. \$5.95
3 lb. 12 oz.
WINDSHIELD WIPER MOTOR—24 VDC. Very powerful. May be used wherever an oscillation motion is desired, such as stirring or agitation. Size: 2" x 3 3/4" x 3 3/4". Shaft extends out 1 1/2" from motor. Wt. 1 lb. 10 oz. Stock No. 10D24. \$2.95
EMC 41314 110 VAC 60 Cy. Induction Motor with mounting feet. 1550 RPM through a gear reduction to 24 RPM. Right angle drive. Size: 4" x 3 1/2" x 7 3/4". Shaft size: 5/16" x 3/8" with removable Gear. Wt. 5 lb. 13 oz. \$9.95
WESTERN ELECTRIC RWC 2505—Holtzer Cabot No. KS5078-01. 115 VAC 60 Cy. 11 Watt. 65 RPM 75 oz. inch torque—Reversible. Size: 2 1/4" x 2 1/4" x 2 3/4". Shaft size: 3/16" x 1/2". Wt. 2 \$9.95
lb.

GENERAL ELECTRIC 5BA10AJ32—27 V @ 65 A. Gear reduction 145 RPM output on a 1/4" x 3/8" Splined shaft, 14 oz. inch torque. Motor size: 1 3/4" x 3 1/2". Wt. 8 oz. (Pictured at right) \$4.95



G E 5BA10AJ370 \$4.95
DELCO APPLIANCE 5069625—27 VDC—Gear reduction to 120 RPM output. Governor controlled speed. Size: 1 3/4" x 4 1/4". Shaft size: 3/4" x 3/8". Wt. 8 oz.
HOLTZER CABOT Type 2505—115 VAC 60 Cy. 9 Watt 1.9 RPM Reversible 75 oz. torque. Has multiple disc order wheel with micro switch mounted on bracket assy. Overall size: 3 3/4" x 4 3/4" x 4". \$9.95
Wt. 3 lb. 2 oz.
AIR ASSOCIATES EEI530—Gear reduction, 24 VDC @ .8 A. 25 lb. inch torque, 5 RPM Reversible. Size: 4 1/2" x 3 1/2" x 5 1/2". Keved shaft: 1/2" x 1 1/4" \$7.95
with a 4" arm attached. Wt. 5 lb.
JOHN OSTER Shunt Motor E-9-1—27 1/2 VDC @ .7 A. 5600 RPM. Aluminum cased motor and gear assy. Motor is flange mounted to gear case. Two gear reductions 22 and 5 1/2 RPM on 1/4" x 1 1/4" shafts. Size: 2 3/4" x 3" x 7". \$3.95
Wt. 1 lb. 14 oz.
BENDIX LM1081—24 VDC 1/25 HP—15000 RPM Series Motor. Geneva Low Actuator. Shaft rotates 1/4 revolution and stops, is locked in place until next contact is made, then the cycle is repeated. Time per cycle: approx. 3 seconds. Size: 4" x 2 1/4" x 5 1/4". Shaft size: 1/4" x 1/4". \$7.95
Wt. 1 lb. 14 oz.
24 VAC Gear Motor No. 14-343—3 RPM output. Size: 5" x 2 3/4" x 1 1/4". Shaft size: 5/32" x 1 1/4". Wt. 1 lb. 2 oz. \$1.95

New List—Just Out—Including many other Motors, Blowers, Dynamotors, etc. Free—Write for copy today!

FAIR RADIO SALES • 132 SOUTH MAIN ST. LIMA, OHIO

FOR MORE QUALITY-PER-DOLLAR, BUY RECONDITIONED

TEST EQUIPMENT

WE WILL QUOTE ON NEW AND USED TOP-QUALITY COMMERCIAL BRANDS AND SELECT MILITARY SURPLUS ITEMS IN OUR CHOICE STOCK, TO YOUR NEEDS.

AN/APR-4 LABORATORY RECEIVERS

Complete with all five Tuning Units, covering the range 38 to 4,000 Mc; wideband discone and other antennas, wavetraps, mobile accessories, 100 page technical manual, etc. Versatile, accurate, compact—the aristocrat of lab receivers in this range. Write for data sheet and quotations.

We have a large variety of other hard-to-get equipment, including microwave, aircraft, communications, radar; and laboratory electronics of all kinds. Quality standards maintained. New Reduced Prices On: LARGE POWER UNITS, DYNAMOMETERS, SHAKETABLES. SPECIAL: NEW SURPLUS RAYTHEON 5721 WIDE-BAND KLYSTRONS, \$85.00.

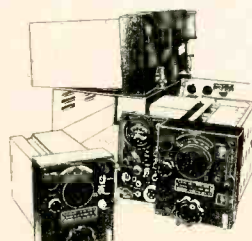

ENGINEERING ASSOCIATES

434 PATTERSON ROAD

DAYTON 9, OHIO

"TAB" THAT'S A BUY

NEW G.E. PHONO CARTRIDGES
Original Boxed—Money Back Gtd.

- RPX050A 001 & 005 \$6.75
- RPX052A Gold Treasure 19.25
- RPX053A Gold Treasure 28.00
- RPX040A Single (8) 003 5.08
- RPX041A Single (8) 001 5.08

Diamond Replacement Needles Gtd.
 RPJ010 or RPJ03D Single Dia. @ \$9.98
 RPJ012A Dual Diamond. @ \$16.98
 RPJ013A Dia. & Sapphire. @ \$10.98

HI-MEG HI-VOLT NEW RESISTORS

2 Meg/10w/10KV.	90 @	12/59
.75 Meg/10w/15KV MVP.	90 @	12/59
1 Meg/10w/10KV.	90 @	12/59
2 Meg/4w/15KV VEG.	54 @	12/510
2.5 Meg/5w/7.5KV MVT.	54 @	12/510
2.5 Meg/20w/25 KV MVA.	\$1.50	12/516
5 Meg/10w/15KV MVP.	\$1.50	12/516
5 Meg/10w/15KV MVT.	\$1.50	12/516
7 Meg/10w/15KV MVP.	\$1.50	12/516
10 Meg/4w/5KV MVP.	\$1.50	12/516
10 Meg/10w/10KV.	\$1.50	12/516
10 Meg/10w/15KV MVP.	\$1.50	12/516
10 Meg/25w/10KV MVP.	\$2.00	12/516
20 Meg/10w/15KV MVP.	\$3.50	12/536

Deduct 10% Disc Qty's—100 May Be Ass'd

REGULATED POWER SUPPLY

LAB & HIFI, LAB Built & ready to work. HIFI uses "SOLA" constant voltage Filament & Power Xfmr w/rectifier tubes. Low Resistance Brite Work Filter. Furnishes 400VDC @ 250 ma from filter system & 3% regulated & 12V @ 5A filtered D.C. for filaments. 45 lbs. "TAB" \$39.00

INFRARED SNOOPERSCOPE

SEE IN DARK TUBE
 Selected, GTD & Tested for resolution. 1st class image converter viewing tube. Hi-Sensitivity simplified design 2" dia. Williams screen. Resolution up to 350 lin. in. Tube & Data "TAB" SPECIAL \$4.75/2/5
 New Snooperscope Voltage Power Supply Model PS2002, 4500VDC—Using new improved tripler circuit. Housed in case of chassis. Replaces "TAB" MODEL PS2003, Snooperscope Doubler Power Supply. LESS chassis @ \$13.95

IN23B NEW Crystal Diode

"TAB" SPECIAL 89¢ ea; 10 for \$5
 IN21
 MA408 VIDEO DIODE Spl. \$3 @ 2 for \$5
 MA418 VIDEO Crystal Diode \$5 @ 2 for \$8
 IN22 S1 @ 1.10/2 S2 @ 1.20/2 S3 @ 1.30/2
 CK5697/CK570AX Submin Triode \$2 @, / \$310

SPECIALS! LATE ARRIVALS

OAX-1/USN HYDROPHONE UNDERWATER PORTABLE SOUND

Testing Equipment complete with 60 feet underwater cable & hydrophone. Op 115V/60cy used for underwater sound. Useful for fishing & detection visual (depth) & sound—in heavy duty metal case \$1200 cost. SPECIAL \$75

RALS/USN RADIO RECEIVER 0.3 to 23 mc. Marine Lab New with 700 Peak SPECIAL \$185

RALS/USN Used less power supply. \$100

RALS/USN 60 to 6600 & 1.9 to 24 mc Receiver & Amp. \$125

MICROWAVE ANTENNA A749A/APR4 \$10

MICROWAVE ANTENNA A8-125/APR \$10

SCANNER APG13 & Motor & Parabolic used. Carter DC-AC Converter 115 VDC/115 VAC/230 Watts. \$54

AN-PR513/USN Detector Geographical. \$54

AN-CR23/UHF Radio Transmitter. \$3

MICRO Transmitter Citizens band 200 to 550 mc. \$35

30mc IF STRIP lens tubes Hignin. \$5

E65 Telephone Test Set. \$10

RM29A & Case NEW Telephone Remote & ringer generator. \$5 @, 2 for \$9

W.E. Model 2A Terminating Network for balancing multi 600 & 200 ohm lines. \$25

FG-1/USN Pulse-Graphic Recorder. \$125

0-2500VDC Insulation Tester & factory megger. Various contact. Shock & foot pedal included. Weston 2500V mtr & V Regulator & autout. \$50

G. E. Magnetic Contactor 3HP/5 Pole/4Break 115VAC/60cy in metal box. 130 @, 2 for \$18

ADVANCE Relay 12VDC/3PDT 52 @, 6 for \$10

Scope Tube 5RP11A DuMont. \$50

6116/2K50 Raytheon. \$135

MICO #501 L-20 to 75 Cm Wavemeter. \$45

MICO #433 L-20 to 75 Cm Wavemeter. \$45

AN/PDR/T18 GEIGER COUNTER. \$45

TS174U Freq Meter 20 to 250 mc. \$65

TS174U F.M. 20 to 250 mc AC operated. \$25

I-222 Signal Generator. \$50

New Variable Voltage X-fms

SUPERIOR-GR-STACO
 0-132V-1.25A \$7.23
 0-135V/3A 10.63
 Cased 0-135V/7.5A 15.30
 Cased 0-270V/2A 22.83
 Cased 0-270V/3A 17.00
 Cased 0-135V/15A 39.10
 Cased 0-270V/15A 39.10
 Cased 0-270V/3A 31.60
 Cased 0-270V/15A 124.39
 Cased 0-270V/30A 154.70

"TAB" TESTED INSPECTED GUARANTEED !!!

0A2	5.74	2M29	28.85	6B17	Q	245A	15.00	717A	.29
0A2/VR75	.60	2K30	66.4	6C4	2.99	30T1L	12.00	723AB	8.00
0B2	2K33	120.00	6F4	2.99	252A	7.95	726B	25.00	
0B3/VR90	.84	2M39	100.00	6H6	4.95	252A	4.00	725C	21.75
0C3/VR105	.59	2K45	85.00	6L6	1.55	274B	1.95	807	1.19
0D3/VR150	.77	2K45	85.00	6L6	1.55	274B	1.95	808	1.75
1A04	1.00	2K50	165.00	6Q5G	3.65	275A	3.45	809	2.75
1A04	1.00	2K50	165.00	6Q5G	3.65	275A	3.45	811	3.85
1B1G	6.75	2V4C	.98	6SN7GT	.72	303A	6.75	812	3.85
1B23	5.00	3A4	.58	6SU7GT	2.75	304TH	11.00	813	10.00
1B24	4.95	3A5	.45	6Y6GT	.59	304TH	18.00	814	2.98
1B26	1.00	3B4	2.00	6X4	1.00	307A	.59	815	2.25
1B27	10.80	3B22	1.50	6Y6	.75	31A	1.50	827	4.85
1B29	9.95	3B74W	5.00	7C4	4.39	BL135	3.00	829B	8.49
1B35	4.50	3B22	5.00	8D21	150.00	322	6.90	832A	5.00
1B37	6.00	3C28	7.00	12AL5	.40	323	10.50	837	1.95
1B41	50.00	3C33	7.50	12AT6	.40	324A	6.90	86A	1.25
1B42	4.00	3C34	4.95	12AU7	.50	348A	6.90	872A	1.29
1B46	1.25	3C45	8.00	12AX7	.72	349A	10.00	876A	18.00
1B56	30.00	3B21A	3.95	12A7K	.50	350	3.00	889A	75.15
1B63	19.00	3D23	4.98	12H6	.63	353	3.75	931A	4.50
1D21	4.95	3K75	150.00	12K6	.89	354	15.00	991	.20
1L4	.58	4B27	2.70	SR312	200.00	355	12.00	1005	.35
1T4	.62	4B36	4.75	15E	1.25	356	4.00	1620	3.00
1Z2	1.38	4J31	235.00	NE4L7C	.75	359	1.70	1625	.30
2A3	.98	4J51	235.00	SRX16	125.00	366	Q	1629	.30
2A4G	1.98	4J52	50.00	FG17	2.60	368AS	3.85	2050	2.10
2C4	1.00	4X100A	22.50	83V	1.25	CK502	2.50	5813	8.05
2C44	3.00	4X150A	22.50	25A5	1.65	380A	4.00	5844	.85
2C51	3.95	4X500A	65.00	25T	3.35	387A	4.00	5870	98.00
2C52	2.75	5A4	1.17	28D7	.75	388A	1.15	5875	2.05
2D21	7.75	5C22	19.10	35T	3.00	394A	1.85	5879	2.95
2E30	1.95	5D21	7.95	RK59	1.88	394A	4.50	5965	1.85
2E31	1.75	5R4WGY	3.00	FG67	12.00	403B	2.65	8088	3.00
2E35	2.95	5T6	1.95	CK681	3.00	421A	6.90	8011	1.50
2E36	1.95	5C6A	6.59	82	1.20	460	17.00	8013A	3.95
2E36	2.15	5AG7	1.14	83	2.25	WE417A	15.00	9001	1.25
2E37	1.50	5A6H5	.75	83V	1.25	CK502	2.50	9003	1.65
2E37	1.50	5A6H5	.75	FG105	11.00	CK503	1.00	9004	2.28
2J21	2.95	5A6K5	.55	FG166	6.75	CK525	2.95	5BP1	4.49
2J27	2.99	5A6N5	2.25	FG172	19.50	CK526	1.75	5BP4	2.95
2J34	14.50	5A05	.45	FG190	7.00	CK531	2.89	5CP1A	3.00
2J48	10.00	5A05W	1.95	HE200	3.50	CK536	1.55	5LP1	16.50
2J55	35.00	5A5E	1.20	20A4	25.00	53BDC	.98	5LP2	27.50
2J56	40.00	5A57G	2.50	RK233A	27.00	707B	3.95	55P7A	95.00
2K23	12.50	6B4AA	8.73	242C	12.50	715B	3.85	78P1	9.00
2K25	15.00	6B16	31.00	24A7	15.00	715C	12.00	10KP7	35.50

WE | ALL TYPES | BUY. TUBES | TOP \$\$\$ PAID FOR LAB TEST EQUIPMENT Kay, G.R., H.P., L.N., G.E., RCA, DuMont, Tektronix, Weston, Boonton, Measurements, Ballentine & others.

NEW "TABTRON" SELENIUM RECTIFIERS*

ENGINEERED FOR AUTOMATION & INDUSTRY
 Technical Apparatus Builders mfrs. Power Rectifiers to your specs. From one amp up to and above 1000 amps.

* FULL WAVE BRIDGE • DATED & ONE YEAR GTD

Max Amp	18VAC* 14VDC	36VAC* 28VDC	45VAC* 42VDC	72VAC* 56VDC	130VAC* 100VDC	226VAC 217VDC	Clr Tap AC/Dc 30/12	3 Phase 120VAC 150VDC	Bridges 240VDC 300VDC
1	\$1.40	\$2.80	\$3.75	\$4.45	\$7.40	\$25.00	\$2.40	\$17.10	\$33.25
2	2.00	3.40	5.30	5.85	10.25	29.00	2.70	18.25	45.00
3	2.90	4.30	6.50	7.15	12.70	37.00	3.00	20.00	48.50
4	3.50	6.40	11.25	14.30	25.00	45.00	3.40	21.70	55.75
6	3.95	7.70	12.75	17.25	29.65	58.00	3.70	24.00	59.90
10	5.75	11.35	18.40	24.75	43.75	85.00	4.20	42.00	84.25
12	7.20	14.25	22.00	29.50	43.85	100.00	6.80	Q	Q
20	13.00	25.00	37.00	48.00	78.00	161.00	9.15	Q	Q
24	15.00	28.50	44.75	57.50	Q	Q	Q	Q	Q
30	17.85	34.25	56.25	70.50	Q	Q	Q	Q	Q
36	22.35	42.00	64.75	86.50	Q	Q	Q	Q	Q
50	29.45	54.00	105.00	118.00	Q	Q	Q	Q	Q

WRITE FOR DC POWER CATALOG Q—Write for latest prices.

Heavy Duty Battery "Fast" Charger Rectifier

13-0-13V (CT) 100 Amp Fan Cooled or 34 Amp Air Cooled. Rep'tmt 8V Booster Chg. Reg. \$13
 Model CR16 \$13
 16-0-16V (CT) Fan Cooled for 12V 60A and 6V100A Booster Chargers. Model CR30 \$18

Return Dtd Deduct 10%

High Current Power Supplies

ONE YEAR GUARANTEE
 Variable 0-28VDC. Completely Built, ready to go. Full Selenium & Rectifier. Transformer Varied. Volt & Amp Meters. Switch, Terminals & Fuse. Evt. Duty Steel Cabinet 8 1/2" x 11 1/2" x 11 1/2" Input or 220V 1 (3 phase) to order.

230 to 115 V Autoformers

For 220V/50cy Input. To 110-120V or Step up. With Cord Plug & Receptacle.
 TPA050/50W \$2.55
 TPA075/75W 3.65
 TPA100/100W 4.00
 TPA200/200W 6.75
 TPA250/250W 8.25
 TPA500/500W 11.79
 Model TPA 1000 Watt. 1kw 16.95
 TPA1600/1600W. 3.22.50 TPA2000/2KW. 534
 *Less Cord, Plug & Receptable.

"TABTRON" Rectifier Chokes

CR6001/1 Amp/0.1 HY/1.4 Ohm	\$3.95
CR6002/2 Amp/0.1 HY/0.87 Ohm	5.95
CR6003/3 Amp/0.07 HY/0.8 Ohm	7.95
CR6004/12 Amp/0.1 HY/1.0 Ohm	14.95
CR6005/24 Amp/0.01 HY/0.8 Ohm	29.95
CR6006/50 Amp/0.01 HY/0.01 Ohm	55.95

"TABTRON" Rectifier Xfms

Sec'd Volts (DUAL) 0-9-15-18 & 0-9-15-18 Series Series Sec's 0-3-6-9-12-15-18-21-24-27-30-33-36 Volts

TR5007 1 Amp	\$5.25
TR5008 2 Amp	6.35
TR5001 5 Amp	8.65
TR5002 12 Amp	16.65
TR5003 24 Amp	35.65
TR5004 50 Amp	59.95
TR5005 100 Amp	108.65
18 Volt 2 Amp	\$1.98; 2 for \$3.50

1/2Wdts In Series at Ratings shown Parallel 2X Current. Voltage 0-9-15-18.
 *Dual Pri 115 & 220V 60 cy

PRECISION POTENTIOMETERS

HELIPOT. G.R. MULTIPOINT, MICROPOT FAIRCHILD, BURNS, DEJUR.

MULTIPOT 25, 100, 300, 2000, 5000, 10000, 20000 Ohms (0.5%)
 10 Turns Equiv. HELIPOT
 HELIPOT Also 30K, Each \$5.98
 Helix & Multiplot 10, 70, 5K, 50K ohms/0.5% 3 Turn. Each \$5.98

SERVOPOT "G"/200 ohms/0.5% \$3.95
 G.R. DeJure. Multiplier potentiometers
 GR#301/10,000 ohm/4Watt \$5.95
 GR#314/50,000 ohm/8Watt 2.45 @
 GR#214/20 ohm/10Watt 1.35 @
 Multiplot 0214/50 ohm/10Watt 1.50 @
 DeJure 20,000 ohm/12Watt 3.00 @
 TRIPOT Miniature 2000 ohms C.W. 1.50 @
 Fairchild #746/2.5Watt = 5% 5K, 5K, 5K, 10K, 20K, 40K DUAL \$4 @, TRIPLE \$6 @

NEW MICA CONDENSERS GTD.

MFD	WVDC	Price
.03	600	45c/100/\$35
.01	1200	35c/100/\$25
.001	100	20c/100/\$15
.002	1200	35c/100/\$30
.015	2500	75c/100/\$58
.002	2500	45c/100/\$35

HI-FI RECORDING TAPE

Sold on Money Back Guarantee

7" REEL, 1200 FOOT Highest Quality Precision Coated & silt, FERRO-SHEEN processed quality controlled, constant output. Noise Free Plastic tape. Splice Free. Freq. 7 1/2 IPS 40-15 KC Oxide Wind In. "TAB" SPECIAL @ \$1.59 EA. 3 @ \$1.50 EA. 12 FOR \$1.45 EACH. 1000'S SOLD

New list quality "MYLAR" 2400 ft.—7" Reel. Ferro-Sheen processed Recording Tapes @ \$4.49 "TAB" Special @ 3/512 12/\$45

CIRCUIT BREAKER

Heineman El. Mfg. Bkr. Amp: 5, 5, 9, 10, 12, 35, 80 @ \$1.5

INDEX TO ADVERTISERS

Ace Electronics Associates.....	274	Chassis-Trak Corporation.....	344
Ace Engineering & Machine Co.....	66	Chicago Standard Transformer Corp.....	220
Acme Wire Co.....	324	Chicago Telephone Supply Corp.....	135
Adams & Westlake Co.....	81	Cinch Mfg. Corp.....	187
Adel Precision Products, a Div. of General Metals Corp.....	355	City of Jacksonville.....	386
Advance Electronics Lab, Inc.....	450	Clare & Co., C. P.....	245
Aerojet-General Corp.....	238, 239	Clearprint Paper Co.....	95
Aeronautical Communications Equipment Inc.....	134	Clevite Transistor Products.....	55
Aircraft-Marine Products, Inc.....	52, 53	Clough-Brengle Co.....	370
Airpax Products Co.....	93	Cohn Corp., Sigmund.....	356
Allegheny Ludlum Steel Corp.....	54	Coleman Tool & Machine Co.....	371
Allen-Bradley Co.....	309	Collectron Corp.....	333
Allied Radio Corp.....	354	Collins Radio Co.....	100, 101, 373
Alpha Metals, Inc.....	198	Communication Accessories Company.....	75
American Lava Corporation.....	127	Computer-Measurements Corp.....	37
Amphenol Electronics Corp.....	204	Consolidated Electroynamics, Corp.....	215, 285
Anaconda Wire & Cable Co.....	299	Continental-Diamond Fibre Div. of the Budd Company, Inc.....	27
Andrew Corporation.....	61	Cornell-Dubilier Electric Corp.....	271
Applied Science Corp. of Princeton.....	303	Corning Glass Works.....	98
Armco Steel Corp.....	76	Cosmic Condenser Co.....	389
Arnold Engineering Co.....	13	Coto-Coll Co., Inc.....	446
Artos Engineering Co.....	246	Crane Packing Co.....	351
Assembly Products, Inc.....	450	Cross Co., H.....	390
Augat Bros., Inc.....	322	Crucible Steel Company of America.....	49
		Curtiss Wright Corp.....	447
Baker & Co., Inc.....	79	D & R Ltd.....	448
Ballantine Laboratories, Inc.....	202	Dale Products, Inc.....	119
Barry Controls, Inc.....	21	Dano Electric Co.....	385
Bausch & Lomb Optical Co.....	222	Daven Company.....	3rd Cover
Beede Electrical Instrument Co., Inc.....	380	Davies Laboratories, Inc.....	30, 31
Belden Manufacturing Co.....	80	Daystrom Systems, Div. of Daystrom, Inc.....	131
Bell Aircraft Corp.....	263	DeJur-Amsco Corporation.....	269
Bell Telephone Labs.....	305	Delco Radio, Div. of General Motors.....	94, 291
Bendix Aviation Corp. Red Bank Div.....	46	DeMornay Bonardl.....	392
Bentley, Harris Mfg. Co.....	32	Dialight Corporation.....	372
Berkeley Div., Beckman Instruments, Inc.....	319	Dow Chemical Company.....	219
Bird & Co., Inc., Richard H.....	370	Dow Corning Corporation.....	251
Bird Electronics Corp.....	322	Driver Co., Wilbur B.....	288
Bolling Industries.....	446	Driver Harris Co.....	203
Boonton Radio Corp.....	205	Dumont Laboratories, Inc., Allen B.....	209, 255, 333
Bournes Laboratories, Inc.....	284	Dunlee Corporation.....	388
Brew and Co., Inc., Richard D.....	374	DuPont de Nemours & Co., (Inc.) E. I. Polychemicals Dept.....	281
Burnell & Co., Inc.....	9	Film Dept.....	51
Burroughs Corp.....	68, 69	Durant Manufacturing Co.....	196
Bussmann Mfg. Co.....	33	Dyna-Empire, Inc.....	326
C B S-Hytron, A Division of Columbia Broadcasting System, Inc.....	259	Eastern Industries, Inc.....	60
Calidyne Company.....	240	Edo Corporation.....	64
Cambridge Thermionic Corp.....	92	Eisler Engineering Co., Inc.....	364
Cannon Electric Co.....	249	Eitel-McCullough, Inc.....	45
Celco-Constantine Engineering Laboratories Co.....	244, 374	Elco Corporation.....	369
Centralab, A Division of Globe-Union Inc.....	343, 345	Electric Auto-Lite Co.....	64A, 64B, 64C, 64D
Century Electronics & Instruments, Inc.....	361	Electrical Industries.....	261
		Electro-Snap Switch & Mfg. Co.....	253

ESSEX

Custom-Designs

ENCAPSULATED AND
HERMETICALLY SEALED

DELAY LINES

*to Your
Specifications*

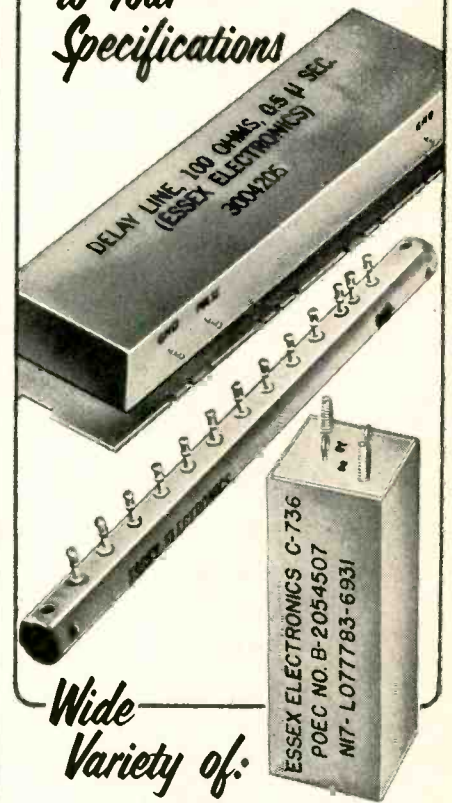

*Wide
Variety of:*

DISTRIBUTED CONSTANT DELAY LINES designed for fast rise time and low attenuation made in flexible, metal-shielded and stick types.

LUMPED CONSTANT DELAY LINES feature high fidelity as well as compact size.

The name, Essex Electronics, is your reassurance of highest possible product quality, efficiency, performance and satisfaction.

Send specifications as detailed as possible for prompt cost quotations.

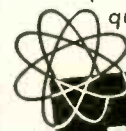

**ESSEX
ELECTRONICS**

Exec. Off. & Main Plant.

Berkeley Heights, New Jersey
CRestview 3-9300

Other Plants at:
7303 Atoll Ave., No. Hollywood, Calif.
Trenton, Ontario—Canada

Want more information? Use post card on last page.

LESSON IN ECONOMY

*Reduce Unit Cost
Speed Up Production
Buy In Quantities
You Need*

NIEMAND

**BROS.
PAPER
TUBE PRODUCTS**

No wonder so many manufacturers find NIEMAND BROS. PAPER TUBE PRODUCTS so practical. Diameters—.093" to 2" and up. Materials—high dielectric kraft, fish paper, foils, special protective coated and laminated papers, Mylar*. Printed or plain.

Precision drawn paper and Mylar* caps from .141"-2" dia. Die cut washers and custom parts.

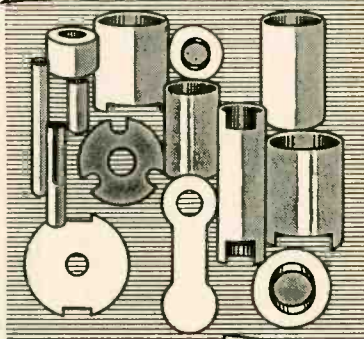

*DuPont's reg. t.m. for its polyester film.

Further Information on Request

A Niemand Bros. Technical Man will be glad to consult with you on your applications.

NB NIEMAND BROS., INC.
Specialists in Paper Tube Products for Electrical Applications
37-05 Thirty-Fifth Avenue • Long Island City 1, N. Y.

Electrical Coil Windings

For 40 years . . . specializing in all types of coils to customers' specifications. Design or engineering assistance available on request.

COTO-COIL CO., INC.

SINCE 1917
65 Pavilion Avenue Providence 5, Rhode Island

SILK SCREENS

from your finished art or sketch

- ★ CERAMIC CAPACITORS
- ★ PRINTED CIRCUITS
- ★ SCHEMATICS

SILK OR WIRE MESH SCREENS TO TOLERANCES OF .001 FOR PRODUCTION RUNS. SHIPPED 48 HOURS ON RECEIPT OF ART. WRITE FOR ESTIMATES.

bolliing Industries INC. 1117 N. MAIN AVE. SCRANTON 2, PA.

Electro Tec Corp.	273
Electronic Engineering Co. of California.	375
Electronic Instrument Co., Inc. (EICO)	368
Elgin National Watch Co., Electronics Div.	256
Engineering Co., The	346
Epsco, Inc.	336, 337
Erie Electronics Division, Erie Resistor Corp.	218
Essex Electronics	445
Esterline-Angus Company, Inc.	359
Fansteel Metallurgical Corp.	334, 335
Farnsworth Electronics Co.	308
Federated Metals Div. of American Smelting & Refining Co.	258
Ferrocube Corp. of America	378
Film Capacitors, Inc.	451
Filters, Inc.	111
Formica Corp., Subsidiary of American Cyanamid Co.	122, 123
Freed Transformer Co., Inc.	452
Frenchtown Porcelain Co.	358
G-V Controls, Inc.	40, 41
Gamewell Co.	282
Garrett Corporation	234, 235
Gates Radio Co.	384
General Electric Co. Apparatus Dept.	99, 358
Electronics Components Div.	112A, 112B, 124
Metallurgical Products Dept.	84, 85
Semiconductor Products	57
Specialty Electronic Components Dept.	290
General Mills, Mechanical Div.	87, 266
General Radio Co.	17
General Transistor Corp.	295
Good-all Electric Mfg. Co.	247
Grant Pulley & Hardware Corp.	70
Greater Miami Industrial Div.	366
Gries Reproducer Corp.	330
Guardian Electric Mfg. Co.	262
Hamilton Mfg. Co.	236
Handy & Harman	128
Hardman Co., Inc., H. V.	369
Hart Manufacturing Co.	228
Heath Company	447
Heiland, a Div. of Minneapolis-Honeywell	48A, 48B, 48C, 48D
Helipot Corp., Div. of Beckman Instruments, Inc.	193, 387
Hewlett-Packard Company	72, 73
Heyman Manufacturing Co.	383
Hickok Electrical Instrument Co.	312
Hoffman Electronics Corp.	227
Hoffman Laboratories, Inc.	226
Homelite, a Division of Textron, Inc.	316
Hopkins Engineering Co.	376
Hoyt Electrical Instruments	390
Hughes Products, a div. of Hughes Aircraft Co.	59, 265
Hughes Research and Development Laboratories	58
Humphrey, Inc.	250

Hunt Company, Philip A.	216
Hlycon Eastern, Inc.	338, 339
Indiana Steel Products Co.	83
Indium Corp. of America.	252
Industrial Timer Corp.	48
International Business Machine Corp.	104, 105
International Rectifier Corp.	108
International Resistance Co.	38, 39
Iron Fireman	385

Jennings Radio Manufacturing Corp.	224
Jet Propulsion Laboratory	97
Johns Hopkins University Applied Physics Laboratory	310
Johnson Company, E. F.	379
Jones Div., Howard B., Cinch Mfg. Co.	448

Kahle Engineering Co.	15
Kahn, Robert J.	371
Kay Electric Co.	29
Kay Lab	217
Kearfott Co., Inc.	367
Kepeo Laboratories	191
Kester Solder Co.	231
Knights Company, James	307
Krohn-Hite Instrument Co.	354

Laboratory for Electronics, Inc.	292
Lakeland Chamber of Commerce	372
Lampkin Laboratories, Inc.	376
Lapp Insulator Co., Inc.	208
Leach Corporation	77
Lepel High Frequency Laboratories, Inc.	358
Librascope, Inc.	328
Linde Air Products Co., a Div. of Union Carbide & Carbon Corp.	448
Lockheed Missile Systems Div.	315
Los Alamos Scientific Laboratory	88, 89

M B Manufacturing Co., a Division of Textron, Inc.	268
MacDonald, Inc., Samuel K.	391
Magnatran, Inc.	386
Magnecraft Electric Co.	332
Magnetic Amplifiers, Inc.	260
Magnetic Research Corp.	383
Magnetics, Inc.	201
Mallory and Co., Inc., P. R.	102, 136, 189
Marconi Instruments, Ltd.	130
Marion Electrical Instrument Co.	275
Martin Company, Glenn L.	301
McCoy Electronics Company	254
McGraw-Hill Book Co.	318
Measurements Corporation	377
Melpar, Inc.	210
Metals & Controls Corp., General Plate Div.	329
Micro Switch a Div. of Minneapolis-Honeywell Regulator Co.	62, 63



Fastest Voltage Regulator Available

THE CURTISS-WRIGHT LINE REGULATOR

The Curtiss-Wright Model EE 100 Distortion Eliminating Voltage Regulator provides faster recovery time than any other regulator on the market—less than 1/50th cycle, or 330 microseconds. It also reduces typical power line distortion to less than 0.3%. Capacity is 1.4 KVA.

Now being installed in a rapidly growing number of laboratories and production test departments, it provides simpler, more accurate calibration of meters, better design of transformers, synchros and motors . . . easier testing with fewer rejects, more accurate measurement of magnetic properties and receiver sensitivity . . . better a.c. computer performance, elimination of fast line transient effects. Write for details.

Electronic Component & Instrument Sales Department



Simultaneous recordings of response to step change in 60 cps voltage.

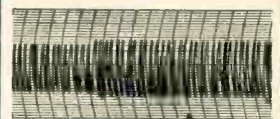

Typical electromechanical regulator output. Recovery time over 4 seconds.

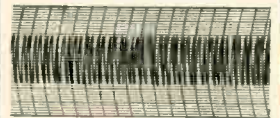

Curtiss-Wright DEVR output. Full recovery 330 microseconds.

for service and lab. work

Heathkit PRINTED CIRCUIT OSCILLOSCOPE KIT FOR COLOR TV!

① Check the outstanding engineering design of this modern *printed circuit* Scope. Designed for color TV work, ideal for critical Laboratory applications. Frequency response essentially flat from 5 cycles to 5 Mc down only 1 1/2 db at 3.58 Mc (TV color burst sync frequency). Down only 5 db at 5 Mc. New sweep generator 20-500,000 cycles, 5 times the range usually offered. Will sync wave form display up to 5 Mc and better. Printed circuit boards stabilize performance specifications and cut assembly time in half. Formerly available only in costly Lab type Scope. Features horizontal trace expansion for observation of pulse detail — retrace blanking amplifier — voltage regulated power supply — 3 step frequency compensated vertical input — low capacity nylon bushings on panel terminals — plus a host of other fine features. Combines peak performance and fine engineering features with low kit cost!



Heathkit TV SWEEP GENERATOR KIT ELECTRONIC SWEEP SYSTEM

② A new Heathkit sweep generator covering all frequencies encountered in TV service work (color or monochrome). FM frequencies too! 4 Mc — 220 Mc on fundamentals, harmonics up to 880 Mc. Smoothly controllable all-electronic sweep system. Nothing mechanical to vibrate or wear out. Crystal controlled 4.5 Mc fixed marker and separate variable marker 19-60 Mc on fundamentals and 57-180 Mc on calibrated harmonics. Plug-in crystal included. Blanking and phasing controls — automatic constant amplitude output circuit — efficient attenuation — maximum RF output well over .1 volt — vastly improved linearity. Easily your best buy in sweep generators.



d&r
dependable & reliable

WIDEBAND FLUTTER METER

in use at Lockheed Missiles

FOR MEASURING AND EVALUATING WIDE BAND FLUTTER

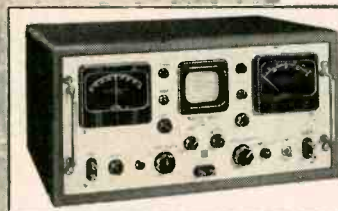
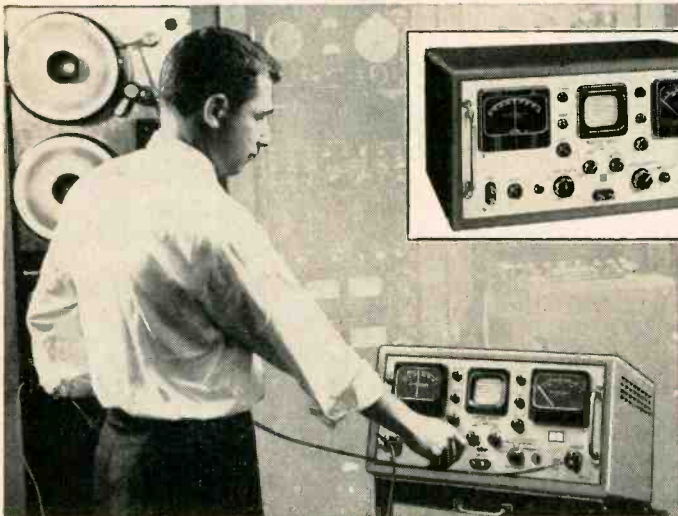

\$910⁰⁰
COMPLETE WITH CABINET

Model FL-4A
... for manufacturers and users of high speed tape recorders, who are engaged in instrumentation, telemetering and data transmission systems

Lockheed Photo

Features:

- Measures flutter frequencies dc to 5000 cps
- Internal 24 db/octave filters for analysis
- 3" oscilloscope for detailed flutter studies

Specifications:

Carrier frequency: 14.5kc from crystal oscillator
Indicators: $\pm 2\%$ drift and rms flutter meters
Range: 0.2, 0.6, and 2.0% rms full scale
Flutter filters: 0.5 to 30 cps; 30 to 300 cps; 300 to 5000 cps
Dimensions: 8 $\frac{3}{4}$ " x 19" standard rack

Order Direct or write us for name of nearest representative

Manufacturers: Electronic and Electro-Mechanical Equipment & Components

d&r
LTD.

406 East Gutierrez Street
P. O. Box 1500, Santa Barbara, California
Telephone: WOODLAND 5-4511

Microtran Co., Inc.	359
Millen Mfg. Co., Inc., James	226
Minneapolis-Honeywell Regulator Co. Industrial Div.	313
Model Rectifier Corp.	348
Moloney Electric Co.	56
Muirhead & Co., Ltd.	5
Mullard Overseas, Ltd.	126
Mycalex Electronics Corp.	117

National Co.	289
National Lead Company	67
Natvar Corporation	82
Nems-Clarke, Inc.	356
New Hermes Engraving Machine Corp.	355
Niemand Bros., Inc.	446
North American Aviation, Inc. Autonetics Div.	277
Missile Development Div.	297
Los Angeles Div.	331
North Electric Co.	214
Northeastern Engineering	306
Nothelfer Winding Laboratories, Inc.	302

Oak Mfg. Co.	225
Offner Electronics, Inc.	280
Ohio-Apex Division of Food Machinery and Chemical Corp.	113
Ohmite Mfg. Co.	32A, 32B
Orradio Industries, Inc.	283

Pacific Automation Products, Inc.	286
Panoramic Radio Products, Inc.	449
Perfection Mica Co.	242
Perkin-Elmer Corp.	342
Perkin Engineering Corp.	25
Perkins Machine and Gear Co.	357
Pfingst & Co., Inc.	388
Phalo Plastics Corp.	199
Phelps-Dodge Copper Products Corp., Inca Mfg. Div.	90, 91
Philamon Laboratories, Inc.	221
Phileo Corporation	96A, 96B, 96C, 96D
Photocircuits Corporation	241
Photographic Products, Inc.	376
Polarad Electronics Corporation	34, 35, 211, 223
Potter & Bromfield, Inc.	287
Precision Capacitors, Inc.	392
Precision Paper Tube Co.	296
Price Electric Corp.	276
Proceedings of the I. R. E.	78

Radiation, Inc.	365
Radio Corporation of America	4th Cover
Radio Engineering Laboratories, Inc.	23
Radio Engineering Products	389
Radio Materials Corp.	42
Radio Receptor Co., Inc.	229
Ramo-Wooldridge Corp.	350
Raytheon Mfg. Company	18, 19, 371

For consistently high purity...

"LINDE" M.S.C. RARE GASES
Trade-Mark
(Mass Spectrometer Controlled)

- Helium
- Argon
- Neon
- Krypton
- Xenon

In radar electronic equipment, nuclear radiation counters, cosmic ray cloud chambers, and thyratrons, where the purest rare gases are demanded, LINDE M.S.C. Grade gases meet the specifications. They are produced under continuous mass spectrometer control to assure you of gases of known purity and consistently high quality. LINDE, the world's largest producer of gases from the atmosphere, can meet your individual needs of volume, mixture, and container.

For information on the physical, chemical, and electrical properties of these gases, send for the booklet, "LINDE Rare Gases."



LINDE AIR PRODUCTS COMPANY

A Division of
Union Carbide and Carbon Corporation
30 E. 42nd Street **UCC** New York 17, N.Y.

In Canada:
LINDE AIR PRODUCTS COMPANY, Division of Union Carbide Canada Limited, Toronto
The term "Linde" is a registered trade-mark of Union Carbide and Carbon Corporation.

HERE'S BIG HELP IN TERMINAL WIRING!

The New
JONES FANNING STRIP



The correct wire to correct terminal every time!

Connections are made through Fanning Strip, on bench or anywhere apart from barrier strip, and quickly slipped into assembly.

Use with Jones Barrier Terminal Strips, Nos. 141 to 142, for 1 to 20 terminals.

Simplifies soldering. Insures correct connections. Saves time. Ideal for harness or cable assembly. Brass terminals, cadmium plated. Bakelite mounting. Send for complete data.

Jones **HOWARD B. JONES DIVISION**
CINCH MANUFACTURING CORPORATION
CHICAGO 24, ILLINOIS
SUBSIDIARY OF UNITED-CARB FASTENER CORP.

Reeves Instrument Corp.	43
Relay Sales, Inc.	125
Remington Rand Univac Div. of Sperry Rand Corp.	114
Resistance Products Co.	65
Rex Rheostat Co.	391
Rheem Manufacturing Co.	304
Rogan Brothers	384
Rohn Mfg. Co.	328
Rome Cable Corp.	96
Royal Metal Manufacturing Company... ..	324
Rutherford Electronics Co.	382
Sanborn Company	267
Sarkes Tarzian, Inc.	264
Sealectro Corp.	341
Shielding, Inc.	103
Sierra Electronic Corp.	352
Sigma Instruments, Inc.	298
Sola Electric Co.	86
Somers Brass Company	332
Sorensen & Co., Inc.	4
Southco Div., South Chester Corp.	112
Southern Electronic Corp.	44
Southwestern Industrial Electronics Co..	278
Sperry Gyroscope Co.	71
Sprague Electric Co.	11
Stackpole Carbon Co.	133
Staedtler, Inc., J. S.	212
Stevens Arnold, Inc.	357
Stoddart Aircraft Radio Co., Inc.	320
Stromberg-Carlson Company	233
Superior Electric Company	129
Superior Tube Co.	279
Switchcraft, Inc.	330
Sylvania Electric Products, Inc.	80A 80B, 80C 80D, 120, 121, 363
Syntronic Instruments, Inc.	382
Taylor Fibre Co.	327
Technitrol Engineering Co.	300
Technology Instrument Corp.	347
Tektronix, Inc.	317
Telechrome, Inc.	109
Tele-Dynamics, Inc.	207
Telex Electro-Acoustics Div.	385
Tetrad	118
Texas Instruments Incorporated... ..	197, 340
Thermal American Fused Quartz Co., Inc.	353
Transitron Electronic Corp.	195
Transitron, Inc.	381
Transradio, Ltd.	350
Trio Laboratories, Inc.	380
Tung-Sol Electric, Inc.	128A, 128B
Ucinite Co.	74
Union Switch & Signal Div. of Westing- house Air Brake Company	349
United Air Lines	213
United Carbon Products Co., Inc.	36

Panoramic's unique

AUDIO RESPONSE TRACING SYSTEM

- Shows response to fundamental frequency only
- Discriminates against noise and hum
- Has virtually unlimited dynamic range
- Gives a single line presentation
- Features log and linear amplitude scales
- Provides direct reading

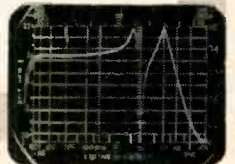
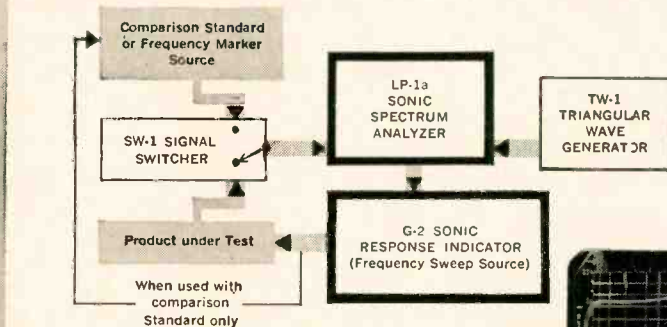

Response of low pass filter with tap; log freq. vs. log amp.

Here is a unique frequency response tracing system invaluable for testing audio frequency networks and devices which tend to produce distortion products . . . where hum and noise are present . . . or where measurements through large dynamic ranges must be made. Ideal for acoustic devices, filters (particularly band stop), transmission lines, amplifiers, hearing aids, etc.

The system centers on the Model LP-1a Panoramic Sonic Analyzer and Model G-2 Sonic Response Indicator.

As a slave to the LP-1a, the Model G-2 Sonic Response Indicator produces a swept audio frequency which is precisely tracked by the LP-1a as it automatically tunes through the spectrum. When a filter or other device is interposed between the G-2 and the LP-1a, an accurate, directly read, single line response curve of frequency vs. amplitude is presented on the LP-1a screen. The selective characteristic of the LP-1a assures response to fundamental frequency only . . . discriminates against hum . . . minimizes the effect of noise . . . provides virtually unlimited dynamic range. The G-2 has an output voltage range of 50 microvolts to 5 volts through a 10 step 100 db attenuator. Output impedances of 100, 300 and 3000 ohms.

The swept frequency range of the G-2 is controlled by the Model LP-1a Panoramic Sonic Analyzer. Ranges are 40 cps to 20kc logarithmic or linear segments of 200, 1000 or 5000 cps centered anywhere between 0 to 20 kc. Two amplitude scales on the indicating screen are provided, 20 db linear and 40 db log. Internal scanning rate is 1 cps.

To overcome the problems of time delays and ringing of sharply attenuating networks, the Model TW-1 Triangular Wave Generator may be added to the system. The TW-1 produces a continuously variable linear bi-directional time base enabling establishment of the proper scan rate in order to insure presentation of a true response. Range 0.05 cps to 60/sec.

And to complete the broad scope of Panoramic's unique audio curve tracing system, Panoramic's SW-1 Signal Switcher may be used to present the signal from the device under test alternately with a comparison standard or frequency marker source.

Result? An exceptional system for quickly, visually, and reliably checking complex audio equipment and devices. For ultrasonic frequencies (1 kc to 300 kc) ask about Panoramic's SB-7aZ and G-3.

Write, wire, phone TODAY for complete details and catalog sheets.



G-2



LP-1a



TW-1



SW-1

Use the LP-1a, too, for vibration and general waveform analyses!



10 So. Second Ave., Mount Vernon, N. Y. • Phone: Mount Vernon 4-3970
Cables: Panoramic, Mt. Vernon, New York State

CONTINUOUSLY VARIABLE DELAY NETWORKS

801 SERIES

FEATURES: Incremental time delay less than 8×10^{-11} sec. (.08 millimicrosecond.)

Total time delay over 1000 microseconds.

SPECIFICATIONS

RISE TIME: Less than 5% of the time delay at any point.

RESOLUTION TIME: The smallest incremental time delay, which can be adjusted with panel controls, is less than 8×10^{-11} sec. (.08 millimicrosecond.)

TOTAL TIME DELAY: 55.55 microseconds for Type 801a; 111.1 microseconds for Type 801b; 555.5 for Type 801c; 1111 microseconds for Type 801d.

IMPEDANCE: The input impedance is 500 ohms, and the output impedance is 1000 ohms for all types.

ACCURACY: 1.5% at any point.

PANEL SPACE: The front panel is $5\frac{1}{4}'' \times 19''$ with standard rack mount slots.

TEMPERATURE COEFFICIENT: Less than 0.005% per degree centigrade

PRICE: \$410.00 & up.



500 SERIES

Less than 8×10^{-11} second Resolution Time

SPECIFICATIONS

RISE TIME: Less than 8% of the time delay at any point.

TOTAL TIME DELAY: More than ten different models available, .05 microsecond to 1.2 microseconds.

IMPEDANCE: 150 ohms to 700 ohms.

PHYSICAL SIZE: $1'' \times 4'' \times 4''$

PRICE: \$59.00 each and up

ADVANCE

Electronics Lab., Inc.
249-259 Terhune Ave.,
Passaic, N. J.



Want more information? Use post card on last page.

United Shoe Machinery Corp.	115
United Transformer Co.	2nd Cover
University of California Radiation Laboratory	257
Van Keuren Company	389
Varflex Corporation	294
Varian Associates	243, 323
Varo Mfg. Co., Inc.	132
Vector Electronic Co.	392
Veeder-Root, Inc.	321
Vulcan Electric Company	200

Waldes Kohlnoor, Inc.	47
Wales Strippet Company	237
Waterman Products Co., Inc.	248
Welwyn International, Inc.	373
Wenco Manufacturing Co.	450
Westinghouse Electric Corp.	110, 116
Weston Electrical Instrument Corp., a Subsidiary of Daystrom, Inc.	50
Wheeler Insulated Wire Co., Inc.	206
Wheelock Signals, Inc.	326
White Dental Mfg. Co., S. S.	293, 314, 388

MANUFACTURERS REPRESENTATIVES 391

PROFESSIONAL SERVICES 391

CLASSIFIED ADVERTISING
F. J. Eberle, Business Mgr.

EMPLOYMENT OPPORTUNITIES...393-431

EDUCATIONAL 432

EQUIPMENT
(Used or Surplus New)
For Sale432-444

WANTED
Equipment 438

SINCE 1920 QUALITY PRODUCTS

WENCO

SPADE BOLTS

Specialists in designing and manufacturing of all-purpose fasteners and wire forms. Toolled to produce over 1000 styles in any screw size, material, finish, quantity, to your specifications.

Serving Industry for Thirty-Five Years
— OTHER PRODUCTS —

Simplex

WIRE STRIPPERS & CUTTERS

• TOOLS • DIES • STAMPINGS

Bulletins on complete line on request

WENCO MANUFACTURING CO.

1133 W. Hubbard St., Chicago 22, Ill., U.S.A.

NEW METER-RELAYS FROM 0-5 MICROAMPERES-UP

Ruggedized - Sealed, Black Bakelite or Clear Plastic Cases

D'Arsonval meters with locking contacts for sensitive and accurate control or alarm.



TRIP POINT ADJUSTABLE to any point of scale arc. Sensitive to changes as little as 1%. One contact on moving pointer. The other on adjustable pointer. When pointers meet, contacts close and lock. Holding coil wound on moving coil. Locking is electro-magnetic. Manual or automatic reset. Spring action kicks contacts apart. Ranges: From 0-5 microamperes, 0-5 millivolts or 0-300°F up.

Model 461-C, 10-0-10
Ua DC \$83.25

Standard Contact Rating 5 to 25 milliamperes DC. Can be up to 100 milliamperes DC. Ruggedized-Sealed metal cases, $2\frac{1}{2}''$, $3\frac{1}{2}''$ or $4\frac{1}{2}''$ round, shock-mounted movement, gasket-sealed.

Black Bakelite case, $4\frac{1}{2}''$ rectangular. Clear Plastic cases, $2\frac{1}{2}''$, $3\frac{3}{4}''$ or $4\frac{1}{2}''$ rectangular.



Model 255-C, 0-10
V DC \$42.50

Panel meters and indicating pyrometers also in ruggedized-sealed, black bakelite or clear plastic cases. Write for new 40 page Catalog 4A on meter-relays, meters, pyrometers and automatic controls.

Assembly Products, Inc., Chesterland 4, Ohio
Hamilton 3-4436 West Coast: P.O. Box XX,
Palm Springs 4, Calif. Phone DHS 4-3133
Booth 3916, IRE Show, Mar. 18-21, Colliseum, NYC

Want more information? Use post card on last page.

EMPLOYMENT OPPORTUNITIES
ADVERTISER'S INDEX

Admiral Corp. 402, 412, 424
Aircraft Radio Corp. 393
Allen Organ Co., Inc. 430
American Machine & Foundry Co. 420
Arma Div., American Bosch Arma Corp. ... 423
Armour Research Foundation of Illinois
Institute of Technology 416, 429
Avco Manufacturing Corp., Crosley Div. ... 410
Avco Research Lab., Div Avco Mfg. Corp. ... 427

Bendix Aviation Corp.
Products Division Missiles 414
Radio Division 405
York Division 424
Pacific Division 396
Burroughs Corp. 412

Chance Vought Aircraft Inc. 398, 399
Collins Radio Co. 396
Consolidated Electro-dynamics. 393
Continental Oil Co. 393
Convair, A Div, of General Dynamics
Corp. 421
Cubic Corp. 427
Curtiss-Wright Corp. 431

Edison Inc., Thomas A. 426
Edwards Employment Agencies. 393
Emerson Electric Manufacturing Co. 418
Epsco, Inc. 422

Farnsworth Electronics Co. 400
Fidelity Personnel Service. 393

General Electric Co.
Philadelphia, Pa. 400, 428
Syracuse, N. Y. 425

General Electronics Laboratories, Inc. 428
General Laboratory Associates, Inc. 418

General Motors Corp.
AC Electronics Div. 403, 406, 424, 431

General Precision Laboratory Inc. 431

Goodyear Aircraft Corp.
Akron Ohio 397
Litchfield Park Arizona. 408

Haller Raymond & Brown Inc. 418

Harrison Personnel Service. 393

Hoffman Electronics Corp. 423, 426

Honeywell Brown Instruments
Boston 408
Philadelphia 414

Johns Hopkins University. 423

**HIGHEST
INSULATION RESISTANCE
and
CAPACITANCE STABILITY**

**LOWEST
POWER FACTOR
and
SOAKAGE**



OPERATING TEMPERATURE
up to 85°C. for Polystyrene
up to 200°C. for Teflon

AVAILABLE IN
hermetically sealed glass tubes
with metal end caps

style CP06 metal shells
with glass-seal buttons

bathtub cases with low-loss
glass terminals

style CP70 metal cans with
low-loss glass terminals

**SPECIAL UNITS — INCLUDING MULTI-SECTION BLOCKS —
AVAILABLE ON SPECIAL ORDER OR MADE TO SPECIFICATIONS**



ELECTRICAL CHARACTERISTICS

	POLYSTYRENE	TEFLON
Operating Temp. Range.....	-55°C. to +85°C.	-55°C. to +200°C.
Voltage Range, DC.....	100 to 30,000	100 to 30,000
Capacitance Range.....	.001 to 20 mf	.001 to 20 mf
Power Factor.....	.02% @ 1 kc	.02% @ 1 kc
Dielectric Absorption.....	.01%	.01%
Voltage Derating at 85°C.....	none	none
Voltage Derating at 125°C.....	not operable	none
Voltage Derating at 150°C.....	not operable	none
Voltage Derating at 200°C.....	not operable	33%
Temperature Coefficient.....	-100 ppm/°C.	-50 ppm/°C.
I.R. at Room Temperature.....	10 ⁷ megohms/mf	10 ⁷ megohms/mf
Capacitance Stability.....	0.1%	0.1%

fci film capacitors, inc.

3400 Park Ave., New York 56, N.Y. • Phone CYpress 2-5180

FREED

MIL-T-27A POWER FILAMENT, PULSE & AUDIO TRANSFORMERS

FOR IMMEDIATE DELIVERY FROM STOCK

POWER TRANSFORMERS-STANDARD

All primaries 105/115/125 v., 60 c.p.s.

Cat. No.	Hi Volt Sec.	ct	DC Volts	DC Amps	Filament #1		Filament #2		MIL Case Size
					Volt	Amp.	Volt	Amp.	
MGP1	400/200	✓	185	.070	6.3/5	2	6.3	3	HA
MGP2	650	✓	260	.070	6.3/5	2	6.3	4	JB
MGP3	650	✓	245	.150	6.3	5	5.0	3	KB
MGP4	800	✓	318	.175	5.0	3	6.3	8	LB
MGP5	900	✓	345	.250	5.0	3	6.3	8	MB
MGP6	700	✓	255	.250					KB
MGP7	1100	✓	419	.250					LB
MGP8	1600	✓	640	.250					NB

FILAMENT TRANSFORMERS-STANDARD

All primaries 105/115/125 v., 60 c.p.s.

Cat. No.	Secondary		Test VRMS	MIL Case
	Volt	Amp		
MGF1	2.5	3.0	2,500	EB
MGF2	2.5	10.0	2,500	GB
MGF3	5.0	3.0	2,500	FB
MGF4	5.0	10.0	2,500	HB
MGF5	6.3	2.0	2,500	FB
MGF6	6.3	5.0	2,500	GB
MGF7	6.3	10.0	2,500	JB
MGF8	6.3	20.0	2,500	KB
MGF9	2.5	10.0	10,000	JB
MGF10	5.0	10.0	10,000	KB

PULSE TRANSFORMERS

Cat. No.	Block & Use.	Int. Comp'g	Low. Pow. Out.	Pulse Voltage Kilovolts	Pulse Duration Microseconds	Duty Rate	No. of Wags.	Test Volt. KV/VRMS	Char. Imp. Ohms
MPT1	✓	✓	✓	0.25/0.25/0.25	0.2-1.0	.004	3	0.7	250
MPT2	✓	✓	✓	0.25/0.25	0.2-1.0	.004	2	0.7	250
MPT3	✓	✓	✓	0.5/0.5/0.5	0.2-1.5	.002	3	1.0	250
MPT4	✓	✓	✓	0.5/0.5	0.2-1.5	.002	2	1.0	250
MPT5	✓	✓	✓	0.5/0.5/0.5	0.5-2.0	.002	3	1.0	500
MPT6	✓	✓	✓	0.5/0.5	0.5-2.0	.002	2	1.0	500
MPT7	✓	✓	✓	0.7/0.7/0.7	0.5-1.5	.002	3	1.5	200
MPT8	✓	✓	✓	0.7/0.7	0.5-1.5	.002	2	1.5	200
MPT9	✓	✓	✓	1.0/1.0/1.0	0.7-3.5	.002	3	2.0	200
MPT10	✓	✓	✓	1.0/1.0	0.7-3.5	.002	2	2.0	20C
MPT11	✓	✓	✓	1.0/1.0/1.0	1.0-5.0	.002	3	2.0	50G
MPT12	✓	✓	✓	0.15/0.15/0.3/0.3	0.2-1.0	.004	4	0.7	700

AUDIO TRANSFORMERS

Catalog No.	Application	All Case Sizes All						
		Impedance				DC Current		
		Prim. Ohms	ct	Sec. Ohms	ct	Prim. Max. Vol. Inhib. MA	Max. Level DBM	
MGA1	Single or P.P. Plates to Single or P.P. Grids	10K	✓	90K Split	✓	10	10	-15
MGA2	Line to Voice Coil	600 Split		4, 8, 16		0	0	-33
MGA3	Line to Single or P.P. Grids	600 Split		135K	✓	0	0	-15
MGA4	Line to Line	600 Split		600 Split		0	0	-15
MGA5	Single Plate to Line	7.6K 4.8T		600 Split		40	40	-33
MGA6	Single Plate to Voice Coil	7.0K 4.8T		4, 8, 16		40	40	-33
MGA7	Single or P.P. Plates to Line	15K	✓	600 Split		10	10	-33
MGA8	P.P. Plates to Line	24K	✓	600 Split		10	1	-30
MGA9	P.P. Plates to Line	60K	✓	600 Split		10	1	-27

Send for further information on these units, or special designs. Also ask for complete laboratory test instrument catalog.

FREED TRANSFORMER CO., INC.

1722 Weirfield Street
Brooklyn (Ridgewood) 27, New York

Want more information? Use post card on last page.

Kollsman Instrument Corp.....	396	Blan	436
		Bolton Laboratories	443
Leeds & Northrop Co.....	413	C&H Sales Co.....	443
		Calvert Electronics, Inc.....	440
Martin Co., Glenn L., (Baltimore Div)....	402	Canadian Broadcasting Corp.....	442
Maxson, W. L.,	428	Communications Equipment Co.....	434
Michigan, University of.....	412		
Monarch Personnel	393	Engineering Associates	443
Motorola Inc.	404		
		Fair Radio Sales.....	443
		Fay-Bill Distributing Co.....	439
New York State Employment Service.....	393	Finnegan, H.	438
Northrop Aircraft Inc.....	416		
		Harber Industrials	440
Otis Elevator Co.....	423	Harjo Sales Co.....	438, 440
		Instrument Service Co.....	438
Page Communications Engineers Inc.....	427		
Pennsylvania State University.....	424		
Philco Technical Representative Div.....	406	JSH Sales Co.....	435
		Lectronics Research Laboratories.....	436
Radio Corp, of America.....	394, 395	Liberty Electronics Inc.....	442
Raytheon Manufacturing Co.....	401, 409, 417		
Reeves Instrument Corp.....	425		
		M. R. Co., The.....	438
		McNeal Electric & Equipment Co.....	442
Sanders Associates Inc.....	429	Monmouth Radio Labs.....	437
Stavid Engineering Inc.....	404	Montgomery Equipment Co.....	440
Stromberg-Carlson Co A Division of General Dynamics Corp..	419		
Sylvania Electric Products Inc Mountain View, Calif.....	426	Pacific International University.....	432
Waltham Mass	407		
		Radalab Inc	439
		Radio & Electronics Surplus.....	438
Texas Instruments Inc.....	411	Radio Research Instrument Co.....	441
Trans-Sonics, Inc.....	426	Raway Sales	441
Warwick Manufacturing Corp.....	422	"TAB"	444
Westinghouse Electric Corp.....	415		
		Universal General Corp.....	441
		V&H Radio & Electronics.....	432
		Western Engineers	437
		Wilgreen Industries	436

SEARCHLIGHT SECTION ADVERTISER'S INDEX

Arrow Sales Inc.....	438, 441
Barry Electronics Corp.....	432, 434, 436, 438, 440, 443
Belvision Inc.	438, 443
Binneweg Television	432

This index is published as a convenience to the readers. Every care is taken to make it accurate, but ELECTRONICS assumes no responsibility for errors or omissions.

Size has nothing to do with accomplishment

Inside these fully encapsulated miniature precision wire wound resistors, Daven furnishes the solution to problems presented by space limitations. A new winding technique permits the use of extremely fine sizes of resistance wire to obtain two or three times the resistance value previously supplied on a miniature bobbin. This new development more firmly establishes DAVEN'S leadership in the field of miniature and standard size precision wire wound resistors.

Types and Specifications

Type	Dia.	Length	Max. Res.	Wattage Rating	Terminals
1273	1/4	5/16	400K	.1	One End #22 Gauge
1283	1/4	5/16	400K	.1	Axial #22 Gauge
1274	3/16	3/8	100K	.1	Axial #22 Gauge
1284	1/4	27/64	.5 Meg.	.25	One end #20 Gauge
1192	1/4	1	1.0 Meg.	.75	Axial #22 Gauge

- Fully encapsulated.
- Meet and exceed all humidity, salt water immersion and cycling tests as specified in MIL-R-93A, Amendment 3.
- Operate at 125°C continuous power without de-rating.

- Can be obtained in tolerances as close as $\pm 0.05\%$.
 - Standard temperature coefficient is $\pm 20\text{PPM}/^\circ\text{C}$.
- Special coefficients can be supplied on request.

For maximum resistance in minimum space:

Daven's new winding technique cuts giants down to size

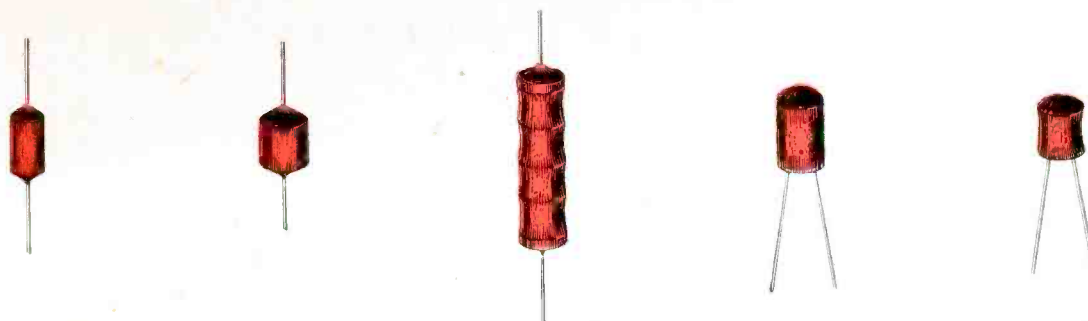

THE **DAVEN** CO.

526 West Mt. Pleasant Ave.
Route 10, Livingston, N. J.



Write for complete resistor catalog.

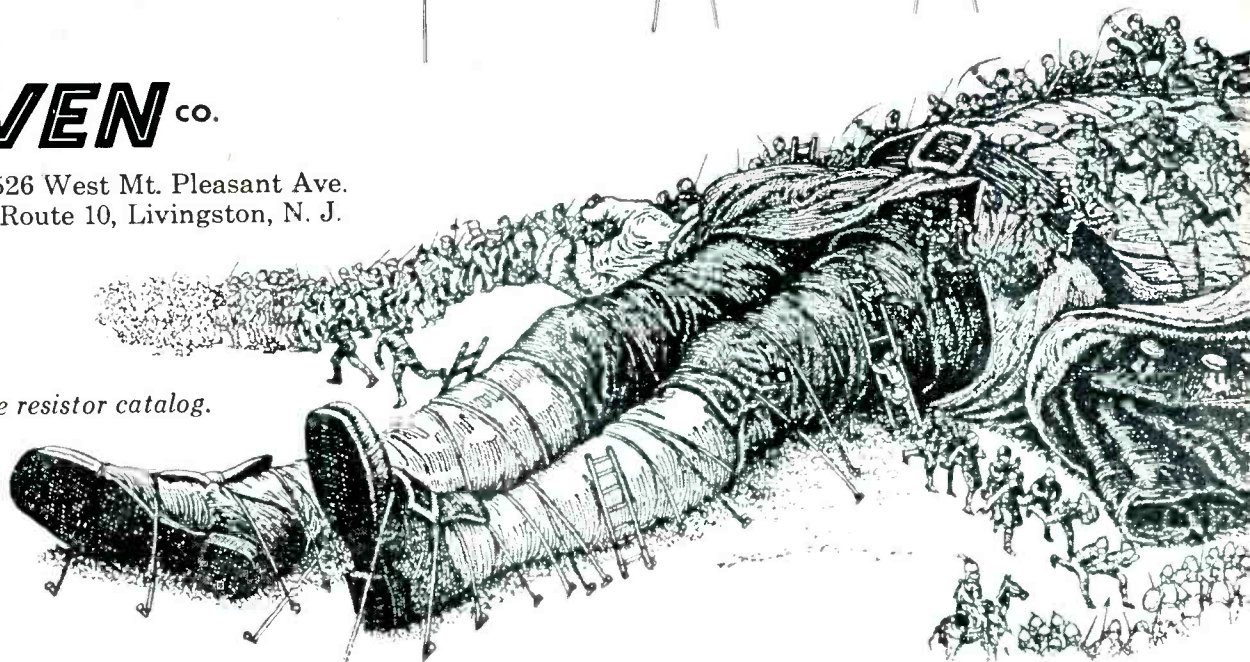

WORLD'S LARGEST MANUFACTURER OF ATTENUATORS



NEW

RCA PREFERRED TUBE TYPES PROGRAM

answer to a growing design problem
...in home-entertainment receivers



Again RCA meets the needs of TV, AM, FM receiver designers and manufacturers... with the new and up-to-date Preferred Tube Types List tailored to the industry's requirement for a minimum number of tube types having the greatest over-all usefulness.

First introduced by RCA in 1940, the Preferred Tube Types Program aimed at concentrating production on the most useful radio receiver types to improve tube quality by longer, more efficient production runs—and to increase tube availability by decreasing stocking requirements. Was it effective? Yes! By the end of 1940, five million receivers had been designed and built around 36 RCA Preferred Tube Types—and 20 receiver manufacturers publicly endorsed the program!

Today—after two years of careful engineering analysis of radio and TV requirements—RCA offers a comprehensive selection of 61 Preferred Tube Types capable of handling

virtually every TV, AM, and FM receiver circuit function now covered by hundreds of types available to the industry. The benefits to you: (1) Lower tube costs, (2) More uniform tube quality, (3) Standardization on fewer types of circuit components, (4) Better tube availability and faster delivery to support continuous production schedules, (5) Simplification of stocking and warehousing problems, (6) Increased customer satisfaction through ready tube availability from RCA Tube Distributors.

So whether you are interested in black-and-white or color TV receivers, portables or car radios, AM or FM sets or phono amplifiers, it will pay you to design around RCA Preferred Tube Types. For technical data on any Preferred Tube Type, refer to your RCA Tube Manual or RCA Receiving Tube Handbook. For further details on the RCA Preferred Tube Types Program, call your RCA Field Representative.

Rectifiers and Diode Detectors:	Converters	Amplifiers, Oscillators, and Mixers					Output Amplifiers
		Triodes		Pentodes			
		Twin	With Diodes	Sharp Cutoff	Remote Cutoff	With Diode	
5Y3-GT 6AL5 12X4 35W4	1R5 6BE6 12BE6 6X8	6CG7 12AX7	6AV6 12AV6 12BF6	1U4 6AU6	1T4 6BA6 12BA6	1U5	3V4 6AO5 35C5 50C5 12AB5

Amplifiers and Detectors						
IF	Video	Audio	Deflection	HV Reg. Type	Deflection Oscillators & Control Types	Sound and Video Detectors
3CB6 6CB6 3AU6 6AU6 3BZ6 6BZ6	6AW8-A 12BY7-A	5A05 6AQ5 6AV6	6S4-A 6W6-GT 12W6-GT 6CM7 6DQ6-A 12DQ6-A 6DQ6-CA 6CB5-A**	6BK4**	6CG7 3BY6 6BY6 6CM7	3AL5 6AL5 3DT6 6DT6
Tuner Tubes			Rectifiers			
RF Amplifiers	Osc.-Mixers	High Voltage	Low Voltage	Damper Types		
6BZ7 3BC5 6BC5	2AF4-A* 6AF4-A* 6X8 6X8 5CG8 6CG8	1B3-GT 3A3** 1V2**	5U4-GB	6AX4-GT 12AX4-GTA 6AU4-GTA		

*For UHF Oscillator **For Color TV only

NEW RCA BROCHURE ON PREFERRED TUBE TYPES

New book outlines the new RCA Preferred Tube Types Program. For your copy, write RCA, Commercial Engineering, Section B19Q1 Harrison, N. J. Or ask your RCA Field Man.



RADIO CORPORATION OF AMERICA
Tube Division

Harrison, N. J.