

# electronics

A MCGRAW-HILL PUBLICATION • PRICE 75 CENTS

FEBRUARY • 1956

## ELECTRONIC CONTROLS FOR MACHINE TOOLS

page 122

Diffused H-F Transistors.....137

VHF Broadband Antenna .....130

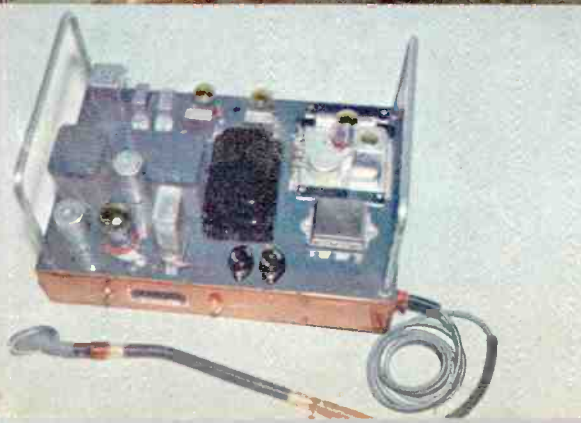
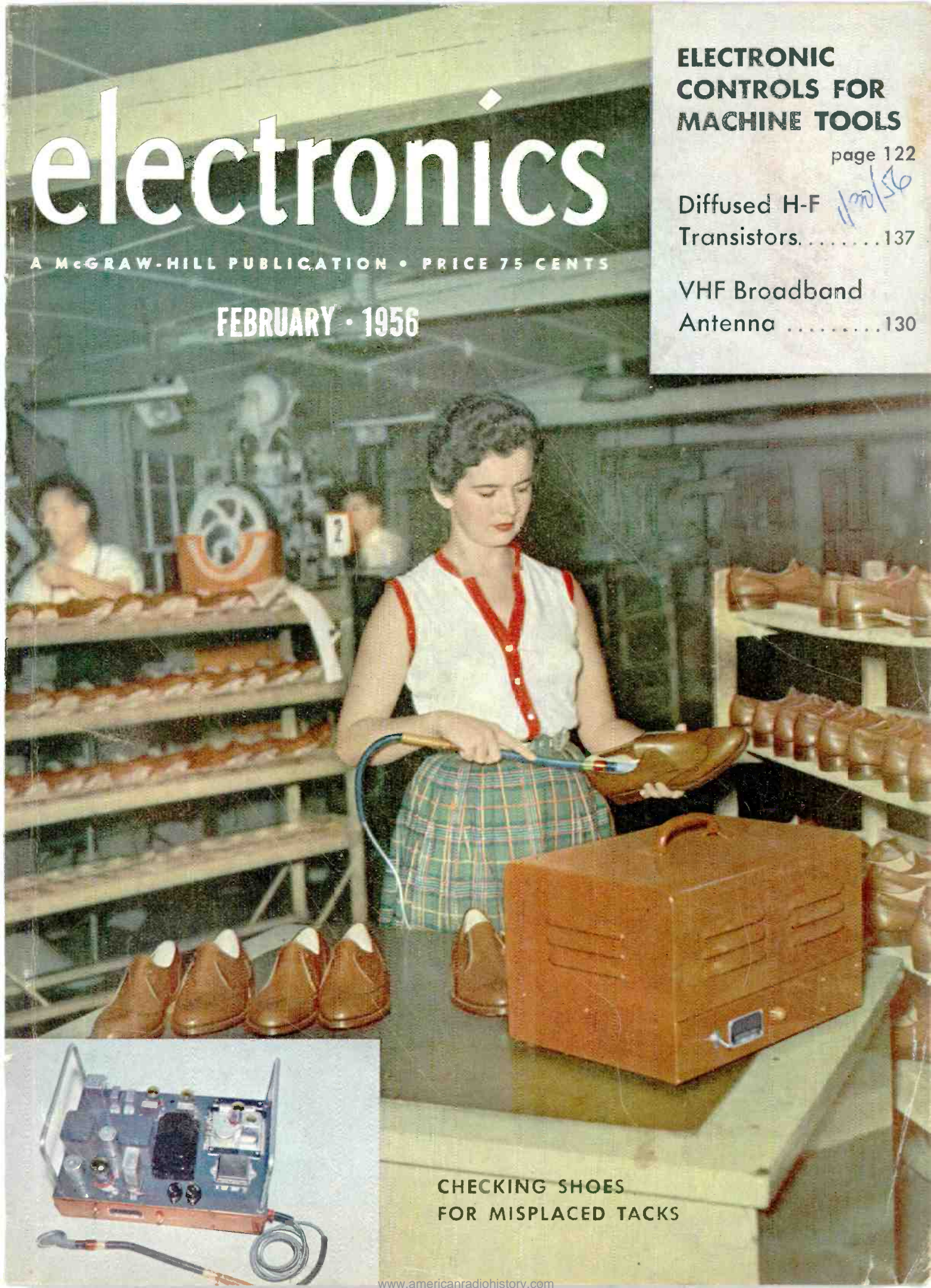

CHECKING SHOES  
FOR MISPLACED TACKS

# Deci-Ouncer Transformers



## DOTS for short REVOLUTIONARY TRANSISTOR\* TRANSFORMERS

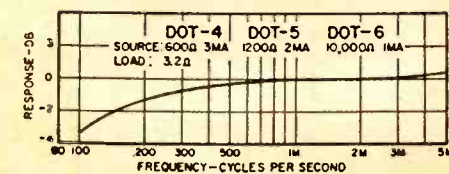
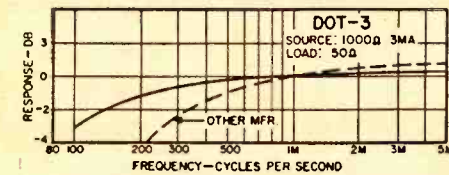
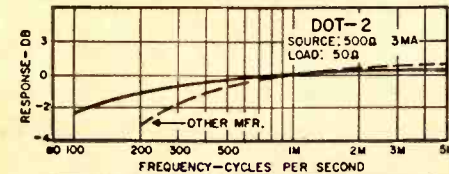
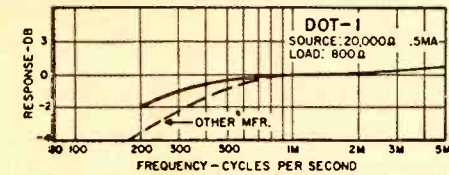
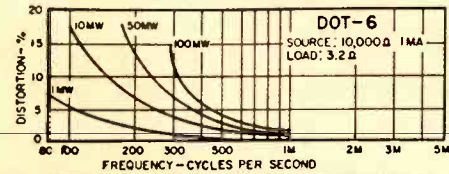
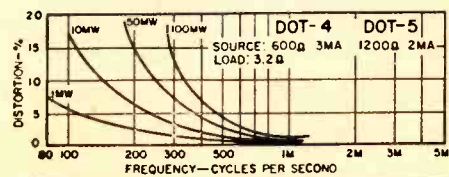
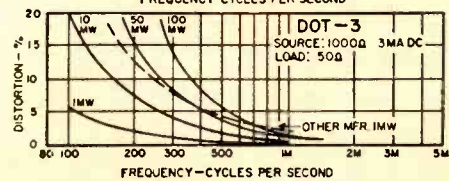
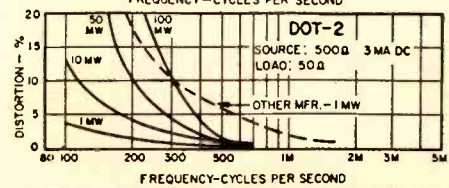
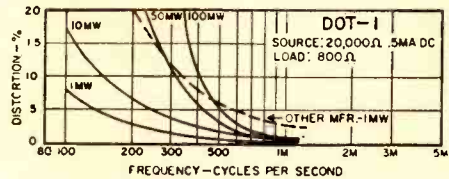

UTC has been the leader in miniaturization for over twenty years. In view of this, it was surprising to many people that UTC did not quickly bring out a series of transformers designed for use and comparable in size to transistors. Unfortunately, extremely miniature transistor transformers of standard construction had poor general characteristics, poor reliability characteristics, and were woefully inadequate for a large number of applications. Instead, UTC started a development program to evolve a new transistor transformer structure designed to provide full performance in extremely miniature size. The culmination of this development is found in the new DOT series\*\*. Listed below are the standard types of DOTS now being made and curves showing their general characteristics in typical transistor application. To fully appreciate the unprecedented performance of these revolutionary transistor transformers, the curves also show characteristics of similar size units now on the market.

Special DOT units (some even smaller in size) are available on production order.

**High Power Rating . . .** up to 100 times greater.

DOT-1 has 5% distortion at 100 mw, other mfr. 6% at 1 mw.

**Excellent Response . . .** twice as good at low end.

DOT-3 is down 1 db at 200 cycles, other mfr. is down 4 db.

**Low Distortion . . .** reduced 80%.

DOT-1 shows 3% distortion where other mfr. shows 20%.

**High Efficiency . . .** up to 30% better.

DOT-1 has 850 ohm pri. resistance, 125 ohm sec.; other mfr. approx. 1200 and 200.

**Moisture Proof . . .** processed to hermetic specs.

DOT units are hermetic sealed compared to other mfr. open structures.

**Rugged . . .** completely cased.

DOT units can withstand all mechanical stresses.

**Anchored leads . . .** will withstand 10 pound pull test.

Lead strain completely isolated from coil winding.

**Printed Circuit Use . . .** plastic insulated leads at one end.

Other variations available.

1.3 X ACTUAL SIZE



**DOT CASE**

Diameter . . . . . 5/16"

Length . . . . . 1 3/32"

Weight . . . . . 1/10 oz.

Type No.	Application	Level Mw.	Pri. Imp.	D.C. Ma. In Pri.	Sec. Imp.	Pri. Res.	Sec. Res.
DOT-1	Interstage	50	30,000 20,000	.5 .5	1200 800	850	125
DOT-2	Output	100	600 500	3 3	60 50	60	8
DOT-3	Output	100	1200 1000	3 3	60 50	115	8
DOT-4	Output	100	600	3	3.2	60	.5
DOT-5	Output	100	1200	2	3.2	115	.5
DOT-6	Output	100	10,000	1	3.2	1000	.7
DOT-7	Input	25	200,000	0	1000	3700	100
DOT-8	Reactor	3.5 Hys. at 2 Ma. DC,	630 ohms. DC res.				

\*DOT units have been designed for transistor applications only . . . not for vacuum tube service \*\*Pats. Pending

**UNITED TRANSFORMER CO.**

150 Varick Street, New York 13, N. Y. • EXPORT DIVISION: 13 E. 40th St., New York 16, N. Y.

CABLES: "ARLAB"

# electronics

FEBRUARY • 1956

A McGRAW-HILL PUBLICATION

**H. W. MATEER**, *Publisher*

**W. W. MacDONALD**, *Editor*

**VIN ZELUFF**, *Managing Editor*

JOHN MARKUS, *Associate Editor*

ALEXANDER A. MCKENZIE, *Associate Editor*

JOHN M. CARROLL, *Associate Editor*

WILLIAM P. O'BRIEN, *Assistant Editor*

WILLIAM G. ARNOLD, *Assistant Editor*

DAVID A. FINDLAY, *Assistant Editor*

HAIG A. MANOOGIAN, *Assistant Editor*

GLORIA J. FILIPPONE, *Editorial Assistant*

ARLENE SCHILP, *Editorial Assistant*

FRANCES SULLIVAN, *Editorial Assistant*

CAROLE A. MORRIS, *Editorial Assistant*

GLADYS T. MONTGOMERY, *Washington Editor*

HARRY PHILLIPS, *Art Director*

**WALLACE B. BLOOD**, *Manager*

R. S. QUINT, *Buyers' Guide Manager*

FRANK H. WARD, *Business Manager*

GEORGE E. POMEROY, *Classified Manager*

DONALD H. MILLER, *New York*

JAMES GIRDWOOD, *New York*

WM. S. HODGKINSON, *New England*

JAMES T. HAUPTLI, *Philadelphia*

CHARLES WARDNER, *Chicago*

BRUCE WINNER, *Chicago*

HENRY M. SHAW, *Cleveland*

T. H. CARMODY, *San Francisco*

R. C. ALCORN, *San Francisco*

CARL W. DYSINGER, *Los Angeles*

WM. D. LANIER, *Atlanta*

JAMES H. CASH, *Dallas*

KEITH HENNEY, *Consultant*

**CHECKING SHOES FOR MISPLACED TACKS**—Inspection of shoe insoles for protruding metal is speeded at E. W. Wright & Co. factory by using detector developed by United Shoe Machinery engineers (see p 144) . . . COVER

**SHOPTALK** . . . . . 2

**FIGURES OF THE MONTH** . . . . . 6

**INDUSTRY REPORT** . . . . . 7

Government Outlines Spending . . . . .	7	New Models Ready For '56 . . . . .	20
SAGE Readies Sunday Punch . . . . .	7	Will Sun Spots Boost Sales? . . . . .	20
Shield Receivers, FCC Warns . . . . .	8	TV Stations Equip For Color . . . . .	22
Industry's Future Grows Brighter . . . . .	8	Small-Boat Electronics . . . . .	22
Transistors Progress . . . . .	10	Equipment Emphasizes Batteries . . . . .	22
Scatter Circuit Authorized . . . . .	12	Transmitter Antenna Sales Up . . . . .	24
Research And Development Gains . . . . .	12	Conclrad Extends Radio Blackout . . . . .	24
F-M Stations Take On New Business . . . . .	12	Selenium Shortage May Be Eased . . . . .	24
Magnetic Recording Sales Rise . . . . .	14	Financial Roundup . . . . .	26
TV Networks Swing To Microwave . . . . .	14	Marines Land Radar . . . . .	26
Germanium Rectifiers Save Space . . . . .	16	Future Meetings . . . . .	26
Automatic Production Makes Jobs . . . . .	16	Industry Shorts . . . . .	26
Finance Firms Take To Electronics . . . . .	20		

**CROSSTALK** . . . . . 121

## FEATURES

<b>Electronic Controls for Machine Tools</b> . . . . .	122
By David A. Findlay	
<b>Broadband Antenna for Field-Intensity Meters</b> . . . . .	130
By Edward N. Singer and Herschel R. Caler	
<b>Character Recognition for Business Machines</b> . . . . .	132
By M. H. Glauberman	
<b>Diffusion Transistors Raise Frequency Limits</b> . . . . .	137
By John M. Carroll	
<b>Magnetic Amplifier Two-Speed Servo System</b> . . . . .	140
By Joseph John Suozzi	
<b>Tack Detector for Shoe Production</b> . . . . .	144
By Robert W. Bradley	
<b>Airborne Weather Radar Uses Isoecho Circuit</b> . . . . .	147
By F. W. Ruppert and J. M. Smith	
<b>Automatic Measurement of Voltage Tolerances</b> . . . . .	150
By A. J. Strassman	

CONTINUED ON NEXT PAGE

Measuring R-F Parameters of Junction Transistors .....	152
By W. N. Coffey	
Silencer Kills Audio Output On Noise Peaks .....	156
By Albert A. Gerlach	
Ferrite-Core Memory is Fast and Reliable .....	158
By M. A. Alexander, M. Rosenberg and R. Sturzf-Williams	
Universal Shutter Tester .....	162
By Austin B. Wessel	
Thyratron Inverter Uses Controlled Firing Time .....	164
By Francis Lawn	
Transistor Preamplifier Feeds Tubeless Servo .....	168
By H. R. Zeller, Jr	
Cross Pulse Pickup in Twisted-Pair Cable .....	170
By J. Gregg Stephenson	

## ELECTRONS AT WORK .....

Trans-Caribbean Television .....	174	Plug-In Antenna .....	178
Proton Measurement .....	174	Automatic Dial Calibrator .....	178
Propagation of Signals .....	174	Time-Voltage Pulse Discriminator .....	178
Supersonic Gun Aids Research .....	176	Multivibrator 500-Kc Sweep .....	186
Transistor Processing Improved .....	176	Staircase Generator .....	192
Field Emission Cathode .....	176	Computation of Guide Wavelength .....	196
Aircraft Approach Speed .....	176	Direct Current Signal Source .....	198
Emergency Navigation Aid .....	176	Internal Tube Shielding .....	204
Checking Impeller Stress .....	178	Electronic Controller .....	208
Recording The ICBM .....		210	

## PRODUCTION TECHNIQUES .....

Parts-Bin Ferris Wheels .....	212	Rollers Apply Tinning Compound .....	232
Assembly of Core Memory Planes .....	214	Air Gun Inserts Trimmer Disks .....	238
Etched Wiring Board Template .....	228	Clamping Fixture For VHF .....	
Cutting Glass Cloth .....	230	Tuners .....	242
Making Microwave Reflectors .....		244	

## NEW PRODUCTS .....

## LITERATURE .....

## PLANTS AND PEOPLE .....

## NEW BOOKS .....

## THUMBNAIL REVIEWS .....

## BACKTALK .....

## INDEX TO ADVERTISERS .....

# SHOP

► **THIS MONTH** . . . Operating transistors at high frequencies has usually meant sacrificing power-handling ability. Manufacturers designed transistors that represented a compromise between frequency and power.

Some time ago we started to hear about transistors that might offer both high-frequency operation and satisfactory power-handling ability. Associate editor Carroll saw one such device, the diffused junction transistor, under development at Bell Telephone Laboratories.

The engineers working on it were still too deeply engrossed to spare the time for writing it up. But they made information on its characteristics and fabrication available to Jack. See page 137.

► **SOME PROGRESS** . . . For several months we have been watching the upward climb of the Electronics Output Index (curve on page 6). Not as it is usually watched, however.

Our concern has been caused by the mechanics of the publishing business. In the January issue the curve went to 276, and the top line is 275. No serious problem.

But the thermometer broke in the February issue. We didn't do as someone in the office suggested, run the curve off the top of the page. A new grid line has been added and the matching headpiece of Industry Report on page 7 has been made 2.5 inches high instead of the 2.25 inches it has always been.

# electronics

FEBRUARY, 1956 Vol. 29, No. 2



Member ABC and ABP

# TALK

It would have been much simpler if the industry had held back a few months, until all of the 1955 statistics are in. Then we drop out the whole year 1949 and move the curve down to start at 100 instead of 75.

The electronics industry moved upward a quarter inch faster than was expected.

► **PROBLEMS** . . . In studying manuscripts for future articles editors ask themselves many questions, seek to find the answers in many places, often "feel the direction of the wind" to determine technical trends and other intangibles. Some of the answers are hinted at in the author's letter accompanying the manuscript.

We appreciate the opportunity we get to have the "first look" at many manuscripts.

Such letters often say,

"I would appreciate having your comments at your earliest convenience. I should like to know your decision BEFORE contacting other periodicals in this field."

► **REACTIONS** . . . In our contacts with readers we often get suggestions for additions to the magazine. One such suggestion comes in increasing numbers during the last few months of each year.

"You should publish an index to the articles annually."

This puzzles us, because we do. Every year, in the December issue.

For instance, the December 1955 issue has an eleven-page index to

the technical articles of the year, starting on page 434. For the business-minded reader, the index to Industry Report appears on page 30 of the same issue.

► **THANKS** . . . Some of the holiday greeting cards we received at the office have an electronic motif.

Tube and component symbols have been popular for some years, but the modern trend is emphasized by one card. It contains etched lettering on a printed circuit board.

An editor's contacts in the field are cumulative. Early in his career he is embarrassed to find that they already number in the hundreds and that it is not feasible to acknowledge individually all cards received.

To all, however, our sincere appreciation.

► **SPEED UP** . . . In keeping with the crowded tempo of modern living, we feel that the average reader doesn't have very much time. He wants to be informed quickly as to the contents of a technical article so that he can decide whether he should read it entirely now or put it off for a more appropriate leisure moment.

That's why we go to a lot of extra trouble to make the headline, the summary and the illustrations tell the salient features of the article. If these tell the engineer that he needs the details for his current project, he reads on.

To present the highlights quickly, each item in the New Products department has a headline that reads into another line (called a bank-head) and contains bold-face side-heads in the text. Studies of reading habits and use of such techniques show that reading time is speeded up. We hope it does it for you.

► **NEXT MONTH** . . . The electronics engineering fraternity encompasses many specialists. To mention only a few diverse ones, there are tv designers, computer experts, microwave specialists and the itinerant engineer who is ruled by a magpie-like curiosity that takes him into many corners of the field.

Whatever his specialty, the electronics engineer works with information, and information exists only to the extent that a signal can be distinguished from the irreducible level of electrical noise.

Noise is a problem common to all branches of our business. To help the readers of ELECTRONICS better understand and deal with noise Bill Bennett of Bell Telephone Labs was asked to bring our readers up to date on this subject.

His first article, "Characteristics and Origins of Noise" begins in the March issue. Subsequent articles will discuss noise-generating devices that put noise to constructive use, scales for measuring noise and ways to avoid its deleterious effects.

Published monthly with an additional issue in June by McGraw-Hill Publishing Company, Inc., James H. McGraw (1860-1948), Founder, Executive, Editorial and Advertising Offices: McGraw-Hill Building, 330 W. 42 St., New York 36, N. Y. Longacre 4-3000. Publication Office, 99-129 North Broadway, Albany 1, N. Y. Donald C. McGraw, President; Paul Montgomery, Executive Vice-President; Joseph A. Gerardi, Vice-President and Treasurer; John J. Cooke, Secretary; Nelson Bond, Executive Vice-President; Publications Division; Ralph B. Smith, Vice-President and Editorial Director; Joseph H. Allen, Vice-President and Director of Advertising; J. E. Blackburn, Jr., Vice-President and Circulation Director.

Subscriptions: Address correspondence to Electronics—Subscription Service, 330 W. 42nd St., New York 36, N. Y. Allow one month for change of address. Subscriptions are solicited only from persons engaged in theory, research, design, production, maintenance and use of electronic and industrial control components, parts and end products. Position and company connection must be indicated on subscription orders.

Single copies 75¢ for United States and possessions, and Canada; \$1.50 for Latin America; \$2.00 for all other foreign countries. Buyers' Guide \$3.00. Subscription rates:—United States and possessions, \$6.00 a year; \$9.00 for two years. Canada, \$10.00 a year; \$16.00 for two years. Other western hemisphere countries and the Philippines, \$15.00 a year; \$25 for two years. All other countries \$20.00 a year; \$30.00 for two years. Three-year rates, accepted on renewals only, are double the one-year rate. Entered as second-class matter August 29, 1936, at the Post Office at Albany, N. Y., under act of Mar. 3, 1879. Printed in U.S.A. Copyright 1956 by McGraw-Hill Publishing Co., Inc.—All Rights Reserved.

BRANCH OFFICES: 520 North Michigan Avenue, Chicago 11, Ill.; 68 Post Street, San Francisco 4; McGraw-Hill House, London, E. C. 4; Washington, D. C. 4; Philadelphia 3; Cleveland 15; Detroit 26; St. Louis 8; Boston 16; 1321 Rhodes-Haverty Bldg., Atlanta 3, Ga.; 1125 West Sixth St., Los Angeles 17; 919 Oliver Building, Pittsburgh 23. ELECTRONICS is indexed regularly in The Engineering Index.

SEND FOR

New

SORENSEN CATALOG

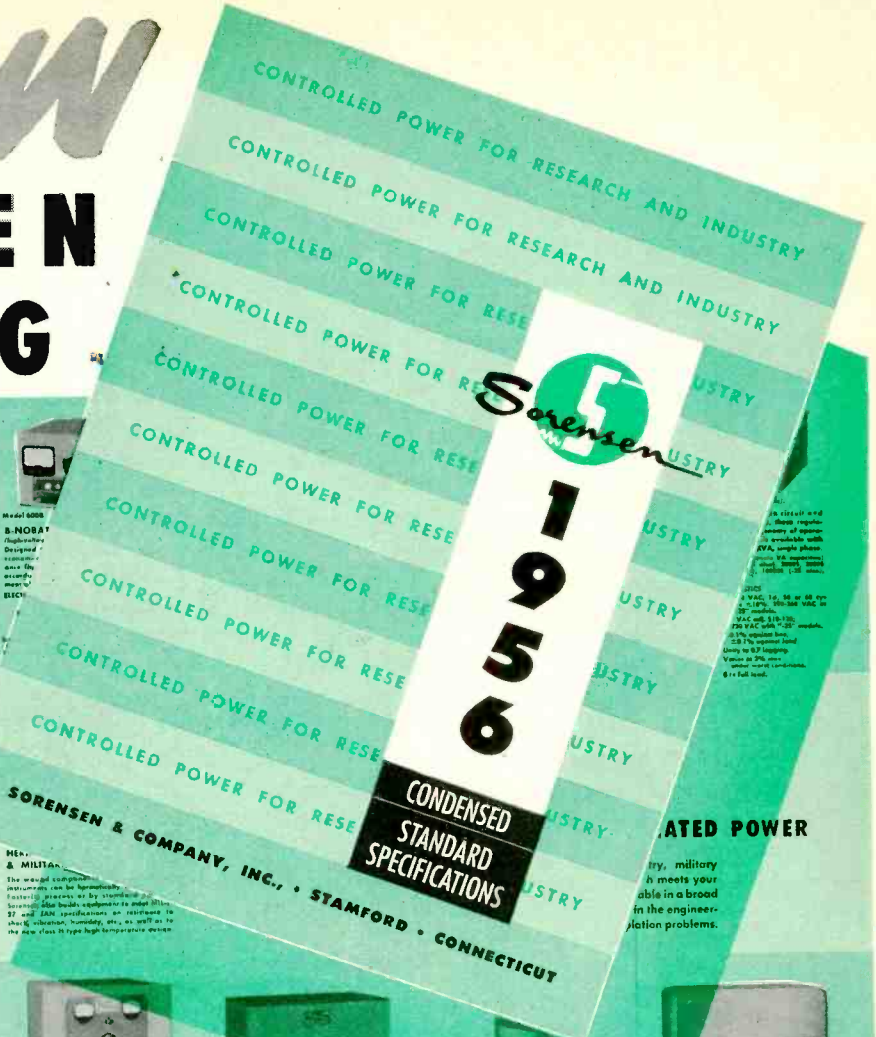

**NOBATRONS** (See U.S. Pat. Off.)  
(Over-voltage, high-current, regulated DC source.)  
Provide stability comparable to batteries and eliminate recharging requirements. Flame and oil hazard, maintenance difficulties.  
Models available: 2-6-15A, 2-6-15B, 2-6-15C, 2-6-15D, 2-6-15E, 2-6-15F, 2-6-15G, 2-6-15H, 2-6-15I, 2-6-15J, 2-6-15K, 2-6-15L, 2-6-15M, 2-6-15N, 2-6-15O, 2-6-15P, 2-6-15Q, 2-6-15R, 2-6-15S, 2-6-15T, 2-6-15U, 2-6-15V, 2-6-15W, 2-6-15X, 2-6-15Y, 2-6-15Z.  
ELECTRICAL CHARACTERISTICS:  
Input: 100-120 VAC, 50, 60 cycle  
Reg. accuracy: ±0.5%  
Output: 5-100 mA, 1-100 VDC  
Ripple: 0.1-1.0 mV  
Recovery time: 0.1-10 sec.



**NOBATRON-RANGERS**  
These versatile and rugged instruments have electrical characteristics similar to the Nობatron except that output voltage is continuously adjustable.  
Model 353  
ELECTRICAL CHARACTERISTICS:  
Input: 100-120 VAC, 50, 60 cycle  
Reg. accuracy: ±0.5%  
Output: 5-100 mA, 1-100 VDC  
Ripple: 0.1-1.0 mV  
Recovery time: 0.1-10 sec.



**NOBATRON-500B**  
Designed to meet the needs of the military and aircraft.  
ELECTRICAL CHARACTERISTICS:  
Input: 100-120 VAC, 50, 60 cycle  
Reg. accuracy: ±0.5%  
Output: 5-100 mA, 1-100 VDC  
Ripple: 0.1-1.0 mV  
Recovery time: 0.1-10 sec.



**FILTER SECTIONS FOR NOBATRONS**  
The ripple voltage of all Nobatrons is 1% of the nominal output voltage setting, under normal conditions. This is adequate for most applications. If, however, less ripple is required, filter sections are available for use with varying up to 50 percent, which will reduce the ripple to 0.1%.



**400 CYCLE INPUT NOBATRONS**  
These instruments are not normal products, but are available on an extended delivery schedule.  
ELECTRICAL CHARACTERISTICS:  
Model 400-100-10  
Input voltage: 100-120 VAC, 50, 60 cycle  
Reg. accuracy: ±0.5%  
Output: 5-100 mA, 1-100 VDC  
Ripple: 0.1-1.0 mV  
Recovery time: 0.1-10 sec.



**MAGNETIC RANGER**  
(Wide-range variable regulated DC source)  
A rugged, tubular DC source requiring negligible maintenance, the MR3215 is a highly accurate and providing continuously adjustable output voltage.  
ELECTRICAL CHARACTERISTICS:  
Input: 100-120 VAC, 50, 60 cycle  
Output: 5-100 mA, 1-100 VDC  
Reg. accuracy: ±0.5%  
Ripple: 0.1-1.0 mV  
Recovery time: 0.1-10 sec.



**TUBELESS REGULATED DC SOURCES**  
Designed for laboratory industrial applications, these instruments utilize magnetic amplifier principle and offer the utmost in reliability.  
Model MA551  
ELECTRICAL CHARACTERISTICS:  
Input: 100-120 VAC, 50, 60 cycle  
Output: 5-100 mA, 1-100 VDC  
Reg. accuracy: ±0.5%  
Ripple: 0.1-1.0 mV  
Recovery time: 0.1-10 sec.



**400 CYCLE AC REGULATORS**  
These instruments are available in models D1503AH, D2003AH, D1903AH, D22003AH, D1903BH, etc. (1000 VA output).  
ELECTRICAL CHARACTERISTICS:  
Input: 100-120 VAC, 50, 60 cycle  
Output: 5-100 mA, 1-100 VDC  
Reg. accuracy: ±0.5%  
Ripple: 0.1-1.0 mV  
Recovery time: 0.1-10 sec.



**MVR's** (magnetic voltage regulators).  
These magnetic voltage regulators use tubes but, give utmost reliability with good regulation. Very compact, they are ideally suited for transportation on commercial airlines in capacities of 15, 30, 60, 120, 250, and 500 VA. A 1000 VA model is in design. MVR's with 0.5, 1.25 and 2.5 ohm output can also be planned.  
ELECTRICAL CHARACTERISTICS:  
Input: 100-120 VAC, 50, 60 cycle  
Output: 5-100 mA, 1-100 VDC  
Reg. accuracy: ±0.5%  
Ripple: 0.1-1.0 mV  
Recovery time: 0.1-10 sec.



**TUBELESS AC REGULATOR**  
For unattended installations requiring maximum dependability and accurate regulation, the tubular MA100DS offers stable long-life performance with an absolute minimum of maintenance.  
ELECTRICAL CHARACTERISTICS:  
Input: 100-120 VAC, 50, 60 cycle  
Output: 5-100 mA, 1-100 VDC  
Reg. accuracy: ±0.5%  
Ripple: 0.1-1.0 mV  
Recovery time: 0.1-10 sec.

SPECIFICATIONS — PERFORMANCE DATA —  
condensed information on regulated power equipment for every application

The new 1956 Sorensen condensed catalog gives you specifications on more than 65 different types of regulated power supplies — a cross section of Sorensen equipment engineered to create new standards of accuracy, dependability, ruggedness and appearance.  
Included are new precision tubeless and transistorized AC and DC sources . . . a tubeless wide-range regulated DC supply . . . a 750 volt AC voltage reference source . . . heavy duty tubeless regulated DC sources for critical industrial applications . . . plus advanced versions of Sorensen's complete line of regulators and Nobatrons.  
The new 1956 Sorensen catalog is a quick, one-stop guide to equipment for your needs — engineered, tested and backed by the reputation of Sorensen . . . "the world's authority on regulated power."



CONTROLLED POWER FOR **Sorensen** RESEARCH AND INDUSTRY  
SORENSEN & COMPANY, INC. • 375 FAIRFIELD AVENUE • STAMFORD, CONNECTICUT

# VIBRATION

...the enemy  
of industry



Mechanical vibration waveforms can now be measured and analyzed with the greatest accuracy, using the revolutionary MUIRHEAD-PAMETRADA Model D-489 Wave Analyzer. Complex vibration waveforms can now be isolated and measured

within a wide frequency range, overcoming amplitude and frequency fluctuation and the proximity of component frequencies.

The MUIRHEAD Wave Analyzer operates as a negative feedback, tuned band-pass filter insuring constant selectivity at all frequencies, and simplifying frequency selection. Output voltage is available at tuned frequency for viewing or recording.

This highly versatile instrument has a wide diversity of applications in many industries: aviation, automotive and manufacturing, shipbuilding and electric power generation, to name only a few.

## FEATURES

- No internal oscillator—eliminates drift
- R/C-tuned circuits—reduces hum and noise pickup
- Choice of 4 bandwidth characteristics: In-tune High, In-tune Medium, Narrow Band and  $\frac{1}{3}$  Octave.
- High selectivity characteristic (1% bandwidth for greatest discrimination)
- Auxiliary pre-amp permits use of high-impedance pickups or transducers.

## SPECIFICATIONS

- Frequency range—19 c/s to 21 kc (extendable down to 2 c/s)
- Frequency Stability— $\pm 0.3\%$  over most of range
- Measurement Accuracy— $\pm 1$  db over several days
- Output Voltage—10 v
- Input Voltage—1 mv to 300 v rms (FSD)
- Input Impedance—0.1 megohms
- Hum and Noise Level—Equivalent to .05 mv input at maximum gain
- Power Supply (external)—100/120 v, 60 or 400 cycles, 130 w
- Dimensions—12 $\frac{3}{4}$ " x 13 $\frac{1}{2}$ " x 17 $\frac{1}{2}$ "
- Weight—55 pounds

Write TODAY for your FREE brochure on Vibration Measurement and Waveform Analysis.

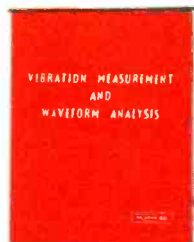

**MUIRHEAD**

**MUIRHEAD INSTRUMENTS, Inc. 677 Fifth Ave., New York 22, N.Y.**

United States Sales and Service for MUIRHEAD & CO., LTD. • Beckenham • Kent • England



## FIGURES OF THE MONTH

	Latest Month	Previous Month	Year Ago
<b>RECEIVER PRODUCTION</b>			
(Source: RETMA)			
Television sets, total	Nov. '55 631,654	Oct. '55 759,735	Nov. '54 858,501
With UHF	114,645	109,574	168,563
Color sets	nr	nr	nr
Radio sets, total	1,580,797	1,500,206	1,098,725
With F-M	44,357	38,920	17,364
Home sets	389,316	398,087	327,973
Clock radios	275,049	282,393	272,583
Portable sets	181,573	168,709	93,716
Auto sets	733,859	651,017	404,453

	Nov. '55	Oct. '55	Nov. '54
<b>RECEIVER SALES</b>			
(Source: RETMA)			
Television sets, units	591,366	746,274	779,105
Radio sets (except auto)	865,602	724,305	669,166

	Nov. '55	Oct. '55	Nov. '54
<b>RECEIVING TUBE SALES</b>			
(Source: RETMA)			
Receiv. tubes, total units	45,965,000	48,119,000	38,781,863
Receiv. tubes, value	\$34,788,000	\$35,105,000	\$27,618,868
Picture tubes, total units	1,086,999	1,224,990	1,157,866
Picture tubes, value	\$20,894,647	\$23,507,620	\$27,140,693

	Oct. '55	Sept. '55	Oct. '54
<b>SEMICONDUCTOR SALES</b>			
Germanium diodes, units	2,000,000	1,850,000	1,500,000
Silicon diodes, units			

	Quarterly Figures		
	Latest Quarter	Previous Quarter	Year Ago
<b>INDUSTRIAL TUBE SALES</b>			
(Source: NEMA)			
Vacuum (non-receiving)	3rd '55 \$9,027,845	2nd '55 \$8,933,453	3rd '54 \$8,803,740
Gas or vapor	\$3,438,835	\$3,365,008	\$3,570,586
Magnetrons and velocity modulation tubes	\$10,998,967	\$13,193,395	\$13,112,244
Gaps and T/R boxes	\$1,421,138	\$1,677,574	\$1,476,407

	Latest Month	Previous Month	Year Ago
<b>BROADCAST STATIONS</b>			
(Source: FCC)			
TV stations on air	Dec. '55 482	Nov. '55 477	Dec. '54 439
TV stations CPs—not on air	108	109	137
TV stations—new requests	29	28	19
A-M stations on air	2,824	2,808	2,669
A-M stations CPs—not on air	111	115	105
A-M stations—new requests	229	217	172
F-M stations on air	540	536	552
F-M stations CPs—not on air	17	20	7
F-M stations—new requests	3	4	8

	Nov. '55	Oct. '55	Nov. '54
<b>COMMUNICATION AUTHORIZATIONS</b>			
(Source: FCC)			
Aeronautical	43,939	43,648	40,737
Marine	53,622	53,426	48,255
Police, fire, etc.	19,637	19,377	16,757
Industrial	27,427	27,091	22,742
Land transportation	8,381	8,216	7,127
Amateur	142,408	140,799	126,021
Citizens radio	14,147	13,862	9,116
Disaster	319	319	306
Experimental	666	662	636
Common carrier	2,056	2,040	1,771

	Oct. '55	Sept. '55	Oct. '54
<b>EMPLOYMENT AND PAYROLLS</b>			
(Source: Bur. Labor Statistics)			
Prod. workers, comm. equip.	406,100-p	389,100-r	370,100
Av. wkly. earnings, comm.	\$75.12-p	\$74.16-r	\$70.88
Av. wkly. earnings, radio	\$71.40-p	\$69.95-r	\$69.32
Av. wkly. hours, comm.	41.5 -p	41.2 -r	40.5
Av. wkly. hours, radio	40.8 -p	40.2 -r	40.3

	Dec. '55	Nov. '55	Dec. '54
<b>STOCK PRICE AVERAGES</b>			
(Source: Standard and Poor's)			
Radio-tv & electronics	451.5	438.4	409.3
Radio broadcasters	519.1	502.7	449.0

p—provisional; r—revised  
nr—not reported

## FIGURES OF THE YEAR

	TOTALS FOR FIRST ELEVEN MONTHS			1954 Total
	1955	1954	Percent Change	
Television set production	7,151,895	6,513,292	+ 9.8	7,346,715
Radio set production	13,108,365	9,138,955	+ 43.4	10,400,530
Television set sales	6,487,617	6,223,332	+ 4.2	7,317,034
Radio set sales (except auto)	5,532,583	5,272,155	+ 4.9	6,430,743
Receiving tube sales	441,752,000	347,180,000	+ 27.2	385,089,458
Cathode-ray tube sales	9,992,769	8,904,106	+ 12.2	9,913,504



# INDUSTRY REPORT

electronics—February • 1956

## Government Outlines Electronics Spending

**Guided missile money increases by one-third with about half going into electronics**

EXPENDITURES for electronics and communications in fiscal 1957 will be higher than 1956, according to the President's budget message.

The category designated electronic and communications equipment will remain high.

However, large expenditures for electronic equipment are hidden in other categories. For example, expenditures for guided missiles will increase by more than one third over 1956. About half the tab will go for electronics.

► **Radar** — The Continental Defense System will increase during fiscal 1957. Much of the increase will be earmarked for electronics. The number of radar stations in the U. S. will increase. Work will go ahead on the Mid-Canada warning line and on the Distant Early Warning (DEW) line in the far north. SAGE soon will be in operation.

► **Dollars** — The breakdown of the budget is as follows (all figures in millions of dollars):

EXPENDITURES	Fiscal Year		
	1957	1956	1955
Missiles	\$1,276	\$ 917	\$ 569
Elec. & Comm.	745	671	637
R & D	1,430	1,370	1,364
Total	\$3,451	\$2,958	\$2,570
APPROPRIATIONS			
Guided Missiles	\$1,776	\$ 938	\$ 345
Elec. & Comm.	1,009	347	414
R & D	1,532	1,420	1,297
Total	\$4,317	\$2,706	\$2,056



Long-range search radar at South Truro, Mass. was used in initial tests of SAGE in the Cape Cod system

## SAGE Readies Sunday Punch

**Communications, radar, computers constitute fast defense umbrella**

REVEALED at MIT's Lincoln Laboratory, SAGE (semiautomatic ground environment) proves to be the method of directing air defense of the North American continent. While few engineers will be surprised, the military has, for the first time, spelled out the interrelation of defense projects long talked about piecemeal.

► **What It Does**—In a word, SAGE would make available to defense personnel comprehensive and detailed information about enemy air attacks if the outer defense ring is breached. Sources may be land-based radar (like Dewline), Navy

picket ships, Texas Towers or Early Warning planes.

Telephone lines or uhf radio link these radars to a high-speed digital computer. Information is continuous and automatic. Other data comes from Ground Observer Corps, height-finding stations, flight plans and weather stations. Automatic, tv-like displays show development of an air battle.

► **Scramble**—With the computer calculating best application of defense weapons, the officer in charge of the Direction Center (heart of the operational unit) sets into flight interceptor planes and long-range missiles that are guided automatically by the system to targets.

► **Pushbutton Warriors** — Shock troops in the new type of defense include scientists and technicians

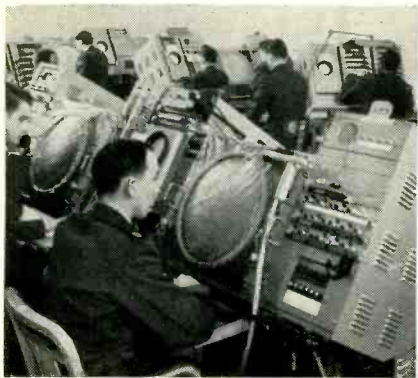

Data received at the Barta Building in Cambridge, Mass. is processed by Whirlwind I computer and displayed

from Lincoln Lab, from IBM, Bell Labs, Burroughs and the Rand Corp. Air Force is the contracting agent.

## Quiet Motors, Shield Receivers, FCC Warns

Scope of Commission authority is widened to cover motors, tv receivers and other devices

ACCORDING to recent FCC interpretation any device that sends out a radio-frequency emanation is a radio transmitter. This takes in a lot of territory. Specifically mentioned as incidental radiation devices are electric motors, switches and automotive ignition systems.

If interference is caused to authorized radio services, says FCC, the operator of the device must promptly take steps to eliminate interference. The deadline is Feb. 1.

There is a limitation to the amount of radiation to be permitted from radio receivers operating between 30 and 890 mc, which takes in f-m and tv sets. Receivers manufactured after Mar. 1, 1956 will be required to bear a seal stating that they comply.

► **Voluntary Compliance**—A majority of set manufacturers is already meeting the requirements, according to James Secrest of RETMA. Television sets for uhf placed in production after Dec. 31, 1956 and all such receivers manufactured after June 30, 1957 must comply.

# Industry's Future Grows Brighter

Dollar volume estimates are revised upwards as business increases

ELECTRONICS industry dollar volume will rise to \$10.8 billion in 1956, nearly a billion dollars more than the 1955 level, according to Sylvania Electric's latest appraisal of future business prospects.

The firm estimates that the industry's volume will exceed \$15.6 billion by 1960 and \$22 billion by 1965.

The new estimates are substantially larger than those made about a year ago by the firm. At that time 1955 volume was estimated at \$9 billion and was seen reaching \$15 billion by 1958-1960 and \$20 billion by 1964. (ELECTRONICS, May 1955 p 12). Major revisions were in tv set sales, industrial electronics, distribution revenues and broadcasting volume estimates.

► **TV**—Television set sales to the public in 1956 are estimated at 7.5 million, about 200,000 being color sets, with a total factory value around the billion dollar mark. In 1960 color and monochrome sales combined are expected to total about 9.6 million with a dollar value of \$1.5 billion.

In 1965 a volume of 11.6 million sets sold for a factory volume of nearly \$2 billion is foreseen. An estimated 31 percent of all sets sold to the public in 1960 will be color sets rising to 72 percent in 1965, according to the firm. Previous total tv sales estimates were \$1.2 billion for 1958-60 and \$1.5 billion for 1964.

► **Equipment**—Dollar volume of electronics products for industry and commerce such as computers, closed-circuit tv and other nonentertainment applications totaled about \$670 million in 1955 according to the company and is expected to reach nearly \$800 million in 1956.

In 1960 the total will be around \$1.2 billion and reach nearly \$1.9 billion by 1965. Previous estimates

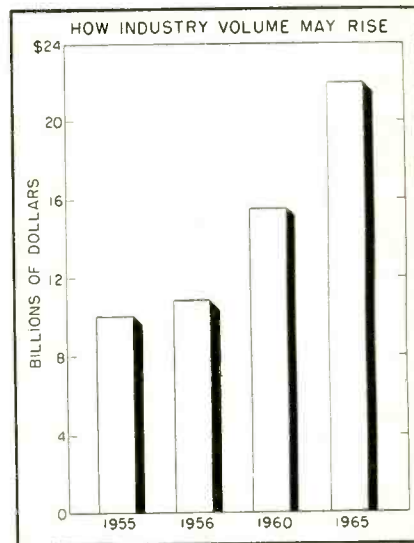

were \$900 million for 1958-60 and \$1.4 billion for 1964.

► **Defense**—Sylvania estimates that 1955 government purchases of electronics totaled just under \$2.5 billion and will go well over that figure in 1956. It sees government purchases reaching \$3.3 billion by 1960 and nearly \$4 billion in 1965.

► **Radio**—In radio, sales of 6 million sets valued at \$120 million in 1956, 7 million sets at \$133 million in 1960 and 7.3 million sets for \$140 million by 1965 were foreseen.

Auto set sales were predicted at 6 million worth \$150 million in 1956, 5.5 million at \$137 million in 1960 and 6 million at \$150 million in 1965.

Records and phonograph volume was seen rising from \$121 million in 1955, \$123 million in 1956, \$135 million in 1960 to \$144 million in 1965.

► **Parts**—Sales of tubes and components for repair were predicted as \$680.4 million in 1955, \$800 million in 1956, \$1.2 billion in 1960 and over \$2 billion in 1965.

► **Distribution**—Revenues from sales of parts and end products through distribution channels were estimated at \$2.2 billion for 1955, \$2.3 billion for 1956, over \$3.3 billion in 1960 and over \$4.8 billion in

(Continued on page 10)

HIGHLY SENSITIVE . . . COMPACT IN SIZE!

# SYLVANIA PHOTODIODE 1N77A

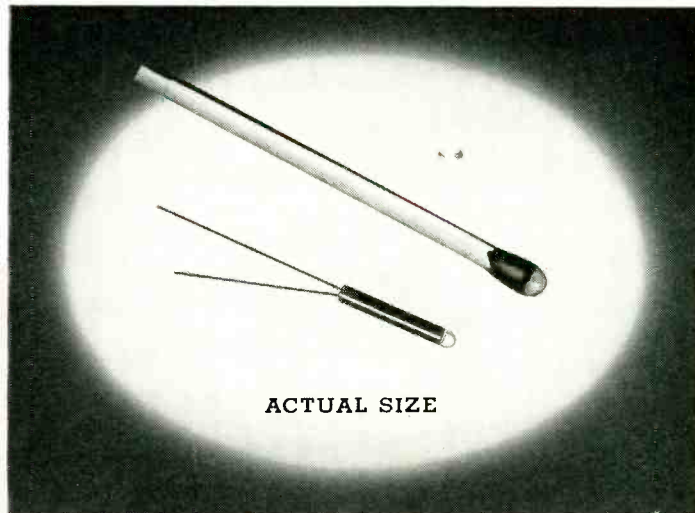

**T**HE Sylvania 1N77A is a highly sensitive compact junction photodiode.

Its useful sensitivity covers the visible spectrum and extends into the infrared region where it peaks at approximately 15,000 Angstrom Units.

*Consider these advantages:*

1. Hermetically sealed in glass.
2. Extreme stability in operation.
3. Uniform high sensitivity (18.7 volts min. to 37.5 volts max. peak-to-peak across a 100 k-ohm load).
4. Low dark current (100ua @ -50 volts).

The high sensitivity and compact packaging of the 1N77A should provide the answer to many light-sensing application problems. *"Still more reasons why it pays to specify Sylvania."*

## DETAIL DRAWING

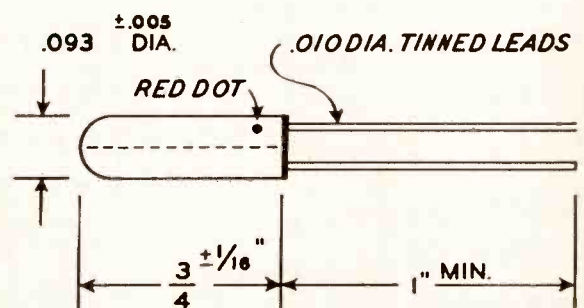

FOR FULL DETAILS about the complete line of Sylvania diodes write to Dept. B20R at Sylvania.

 **SYLVANIA**®

SYLVANIA ELECTRIC PRODUCTS INC.  
1740 Broadway, New York 19, N. Y.  
In Canada: Sylvania Electric (Canada) Ltd.  
University Tower Bldg., Montreal

LIGHTING • RADIO • ELECTRONICS • TELEVISION • ATOMIC ENERGY

1965. Previous distribution estimates were \$2.8 billion in 1958-60 and \$4.2 billion in 1964.

► **Service**—Repairmen's revenue is expected to rise from \$930 million

in 1955, nearly \$1 billion in 1956, over \$1.2 billion 1960 to about \$1.7 billion in 1965. Previous estimate for 1964 was \$1.4 billion.

► **Broadcasting** — Television and

radio broadcasting revenues in 1955 were estimated at \$1.4 billion and were seen going to \$1.9 billion in 1956, \$3.4 billion in 1960 and over \$5.4 billion in 1965. Previous 1964 estimate was \$5 billion.

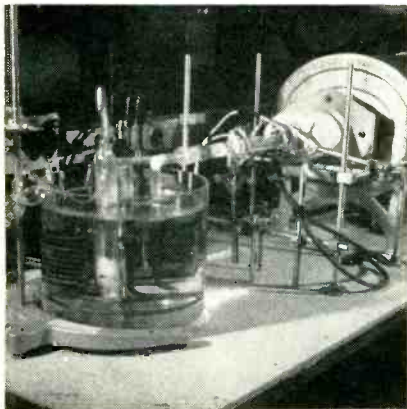

Bell Labs diffusion oven,

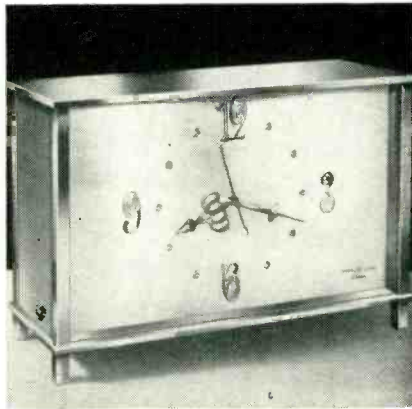

GE electronic clock and



Japanese tape recorder show how

## Transistors Progress, Applications Multiply

### New fabricating techniques and circuit applications mean more business in 1956

THIS year may be a big one for transistor manufacturers. Several firms are talking about transistors with frequency and power-handling ability equal to or better than many commonly used electron tubes. Meanwhile, several companies have announced transistors selling retail around one dollar.

► **High Frequencies**—A contribution to high-frequency transistors has been made by Bell Labs with the diffused junction transistor. (See page 137.) Extremely thin base layers result when vapor impurities diffuse into a solid crystal.

Both germanium and silicon units have been made. Germanium units operate up to 600 mc with 150 mw permissible collector dissipation. Silicon units attain only 120 mc but can dissipate up to 500 mw.

Germanium transistors are in pilot-plant production at Murray Hill with full-scale production of silicon and germanium types for military applications slated for later this year.

► **Processes** — Fused-junction *pn*p silicon transistors have been produced by Raytheon. Most silicon units are grown-junction *npn*. The *pn*p transistors provide current gains up to 24 with 50 mw collector dissipation at 135 C.

A variation of the *pn*p fusion technique, announced by Westinghouse, has paid off in high-frequency transistors and sensitive photodiodes. A cooling period is introduced to provide controlled uniform regrowth at junctions.

► **Electronic Clock** — A cordless electronic clock announced by GE keeps time using 60-cps inductive pickup to synchronize a tuned oscillator which in turn powers a low-friction p-m motor. A ferrite antenna picks up the a-c; three 2N43 transistors and one 1N67A germanium diode on a printed wiring board comprise the electronic elements. The clock runs off flashlight cells.

► **Auto Radio**—GM's Delco Radio Division has announced a hybrid radio for the Chevrolet Corvette. Power transistors made by Delco will be used in the output stage and as an oscillator to replace the vibrator in the power supply.

Reportedly under development are transistor auto radios that can either run off a 12-v storage battery or from a self-contained mercury battery when removed from the car's dashboard.

► **Tape Recorder**—A transistorized tape recorder announced by Tokyo Tsushin Kogyo of Japan uses eight *npn* alloyed germanium transistors. The recorder provides one hour recording time at slow speed. It utilizes a special magazine that accommodates ¼-in. tape. Tape speed is 1½ or 3¼ in. a second. Designed for professional use, the unit will sell for about \$300.

Three transistors are used in separate record and playback amplifiers. The arrangement permits monitoring the tape while recording. Two transistors are used in the 25-kc bias oscillator. The recorder will operate 40 hours on mercury cells. Input is a small dynamic microphone; output is a crystal headphone.

► **Production**—Two junction transistors announced by RCA are aimed specifically at the auto-radio market. The 2N139 is a 455-kc i-f amplifier that provides 30-db gain.

(Continued on page 12)

*subminiature, metal-clad*

# metallized paper capacitors

*Operate at temperatures to 125°C  
without voltage derating*

*Withstand dielectric test of twice  
rated voltage*

*Insulation resistance higher than  
any other metallized paper capacitor*

*Self healing dielectric*

Here are the finest capacitors which the present state of the art can produce.

In the application of stringent quality controls, Sprague has gone so far as to metallize its own paper . . . the only commercial manufacturer to do this. Thus Sprague is the only capacitor manufacturer with *complete* control over the end product. And in no other type of capacitor does quality in manufacture play so important a part in performance.

# SPRAGUE®

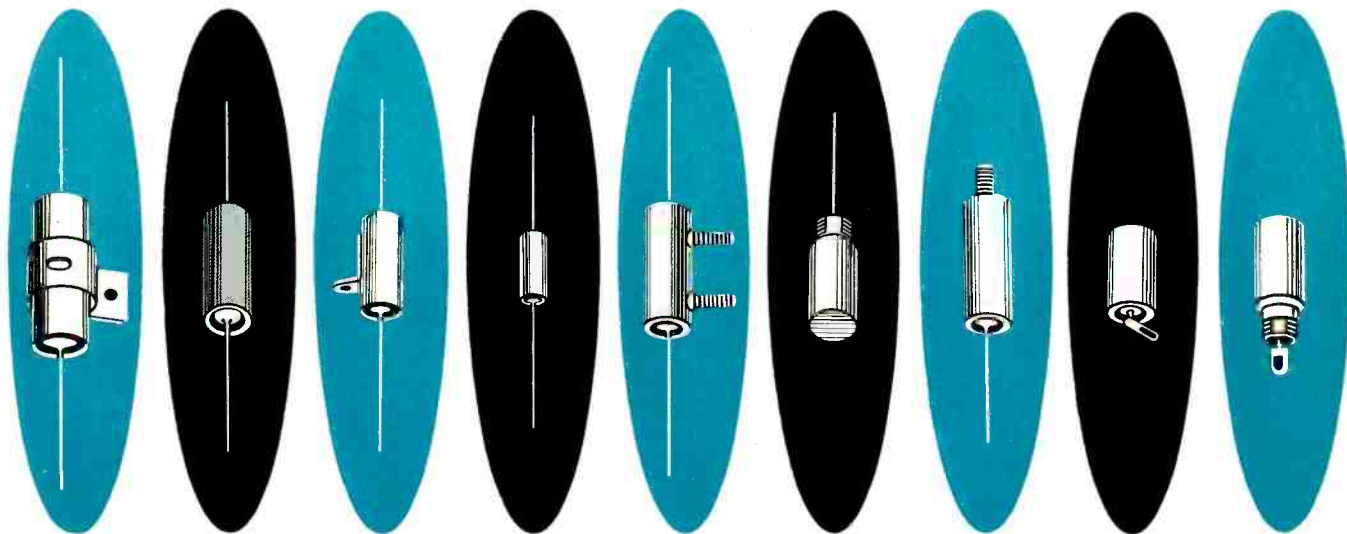

A complete range of ratings and sizes, hermetically sealed with glass-to-metal solder-seals in corrosion-resistant cases, is available in numerous mounting and terminal styles. Write for Engineering Bulletin 224 on your letterhead.

# SPRAGUE®

*world's largest capacitor manufacturer*

Sprague Electric Company,

35 Marshall Street, North Adams, Massachusetts

Export for the Americas: Sprague Electric International Ltd., North Adams, Massachusetts. CABLE: SPREXINT.

The 2N140 is a mixer that provides a conversion power gain of 27 db.

Germanium power transistors in pilot-plant production by Mallory may be useful as single-ended output stages in auto radios. The 441 operates at 12 v and provides a grounded-emitter current gain of 90 with 5 w permissible collector dissipation. It sells for \$12.50 in lots of 50 or more. Another unit can handle 30 w with a current gain of 30. Cut-off frequency is below 15 kc.



Sun powered GE radio receiver

► **Sun Power**—Experimental sun-powered radio receiver developed by GE will run continuously in daylight and up to 500 hours in darkness without recharging. The pocket-sized unit weighs 10 oz, contains four transistors, seven selenium solar cells and other components in a transparent plastic case. Output is to an earplug. In the absence of sunlight, the radio will operate from a 100-w bulb.

## Commercial Scatter Circuit Authorized

A NONGOVERNMENT long-distance radio circuit employing ionospheric scatter techniques will be set up by Aeronautical Radio, Inc. Designed to handle fixed communications between Miami, Florida and San Juan, Puerto Rico, the link stretches 1,040 miles.

► **Assignment**—FCC has no frequencies specifically set aside for circuits employing ionospheric scatter. The aeronautical fixed stations KIC32 and WWQ78 will be granted modification of license to employ 29,820 and 24,940 kc. Power of 20 kw will be used.

# Research And Development Gains

## Research and development costs and employment are highest in electronics

THE electronics-electrical equipment industry leads all other U.S. industries in the scale of its research and development activities. Costs totaled about \$778 million in 1953, more than 20 percent of the grand total of \$3.7 billion for all U.S. industry. The aircraft industry, which is heavily engaged in electronics research and development, ranked second with costs of \$758 million.

Number of firms in the industry conducting r & d totaled 1,140 or 7.3 percent of the nation's 15,560 r & d firms. These were some of the conclusions of the recently released National Science Foundation preliminary report on research and development costs.

► **Manpower**—The survey showed that there were 61,000 scientists and engineers employed in the industry in 1954, representing 11 percent of the country's 553,800 engineers and scientists. Of the 61,000, 51,000 were engineers, 3,000 were chemists; 900 were metallurgists, 2,200 were physicists, 700 were mathematicians and 3,200 were in other classifications.

The electronics-electrical industry had more scientists and engineers in research and development work than any other industry. Of the total of 61,000 in the field, 23,800 or 48 percent were so engaged. Of these, 24,600 were engineers, 1,100 were chemists and 3,100 were in other classifications.

► **Size**—Small firms in the electronics-electrical field accounted for more research and development in terms of cost than small companies in any other industry. For firms in the industry with less than 500 employees, r & d costs totaled about \$96 million in 1953. Next highest, the machinery industry, had costs of \$73 million.

Nevertheless, the bulk of the money for electronics was spent by large companies with 5,000 and

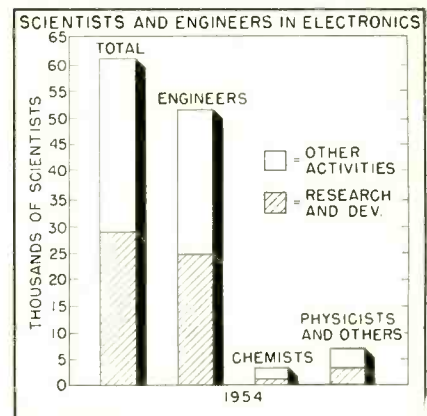

more employees. These firms accounted for \$516.9 million or 66 percent of the industry's total \$778 million. Small firms accounted for only 12 percent. Medium-size companies accounted for the rest.

► **Basic Research**—The study shows that the industry spent \$18.7 million on basic research in 1953, representing 2.4 percent of its total r & d cost. But as a proportion of the industry's total r & d cost, it was among the lowest of any industry.

Basic research, for the purposes of the survey, was defined as projects which are not identified with specific product or process applications, but rather have the primary objective of adding to the overall scientific knowledge of the firm.

## F-M Stations Take On New Business

### Two services are helping to arrest the downward trend in f-m broadcasting

NUMBER of f-m broadcasting stations on the air in the U.S. has declined steadily in the past five years. In the past 12 months the number dropped from 554 to 536 stations. However, f-m broadcasting has made gains in noncommercial education stations and in the functional music field.

► **School**—There are 125 noncom-

(Continued on page 14)

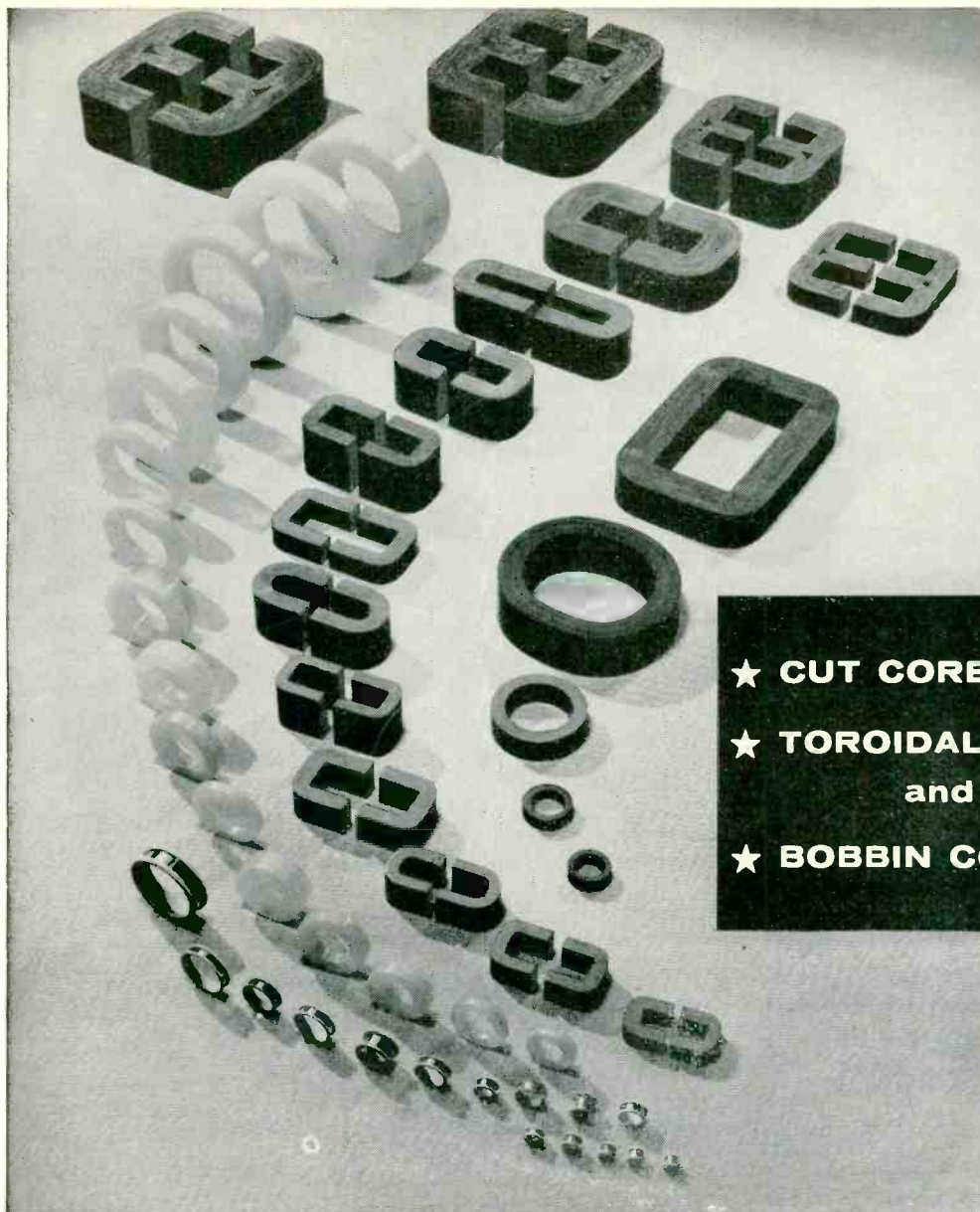

- ★ CUT CORES, Types C and E
- ★ TOROIDAL CORES, Cased and Uncased
- ★ BOBBIN CORES

## It's **ARNOLD** for **EVERYTHING** in **TAPE-WOUND CORES**

### *Applications*

Let us help you with your core requirements for Pulse and Power Transformers, 3-Phase Transformers, Magnetic Amplifiers, Current Transformers, Wide-Band Transformers, Non-Linear Retard Coils, Reactors, Coincident Current Memory Systems, Static Magnetic Memory Elements, Harmonic Generators, etc.

### *For Complete Details*

#### Write for Bulletins:

- ★ SC-107—Cut Cores, Types C and E
- ★ TC-101A—Toroidal Cores, cased and uncased
- ★ TC-108—Bobbin Cores

**ADDRESS DEPT. E-62**

**MATERIALS:** Deltamax, 4-79 Mo-Permalloy, Supermalloy, Mumetal, 4750, Monimax, Silectron, Permendur: all are available for tape wound core applications. The choice of material will depend upon the specific properties required.

**GAUGES:** The following standard tape thicknesses are available for Arnold tape wound cores in most of the magnetic materials mentioned above: .012", .004", .002", .001", .0005", or

.00025". Bobbin cores are made from tape .001" to .000125" thick.

**SIZES:** Cores weighing from a fraction of a gram to many hundreds of pounds can be supplied. Toroidal cores are made in 27 standard sizes with nylon cases. Types "C" and "E" cut cores are made in a total of 530 standard sizes. Many special sizes and shapes of both gapless and cut cores are manufactured for unusual requirements. ● *Let us work with you.*

W&D 5818

## **THE ARNOLD ENGINEERING COMPANY**

SUBSIDIARY OF ALLEGHENY LUDLUM STEEL CORPORATION

General Office & Plant: Marengo, Illinois

DISTRICT SALES OFFICES . . . New York: 350 Fifth Ave.

Los Angeles: 3450 Wilshire Blvd.

Boston: 200 Berkeley St.



mercial educational f-m stations on the air today compared to 117 a year ago. Leading states with school f-m are California and Indiana, with 11 stations authorized, followed by Ohio with 9, Wisconsin with 8, and Texas and Pennsylvania with 7 each. Philadelphia, Boston, Dallas and Louisville each have three educational f-m authorizations.

► **Background Music**—Last March, FCC amended its rules to permit f-m stations to enter the functional music field as an addition to their regular f-m broadcasting service. The service is limited to background music furnished to commercial and industrial organizations, storecasting and transcasting to passengers on public vehicles.

Under a subsidiary communications authorization an f-m station may transmit functional music on a multiplex basis at any time. Until July 1, 1956, stations may broadcast functional music on a simplex basis during the time not devoted to the required 36 hours a week of f-m broadcasting. Formerly, all f-m stations were required to broadcast a minimum of 42 hours a week with at least 6 hours broadcasting daily.

► **Growth**—The first subsidiary communications authorizations for f-m stations were made last October. Now there are about 44 f-m stations in the functional music field. All of them operated on a simplex basis until January, when two began commercial multiplex.

By the July 1, 1956 deadline, it is expected that at least 40 or 50 stations will be on multiplex. Nine or ten multiplex stations are expected by mid-February.

► **Equipment**—Multiplex Services Corp. of New York City has a basic multiplex transmitter available for \$4,500. Receivers and adapters sell for \$169, including crystal. The firm estimates that in early January, about 50 multiplex receivers were in use but expects more when more transmitters go on the air. Its transmitters are being built by Gates Radio and its receivers by Browning Laboratories.

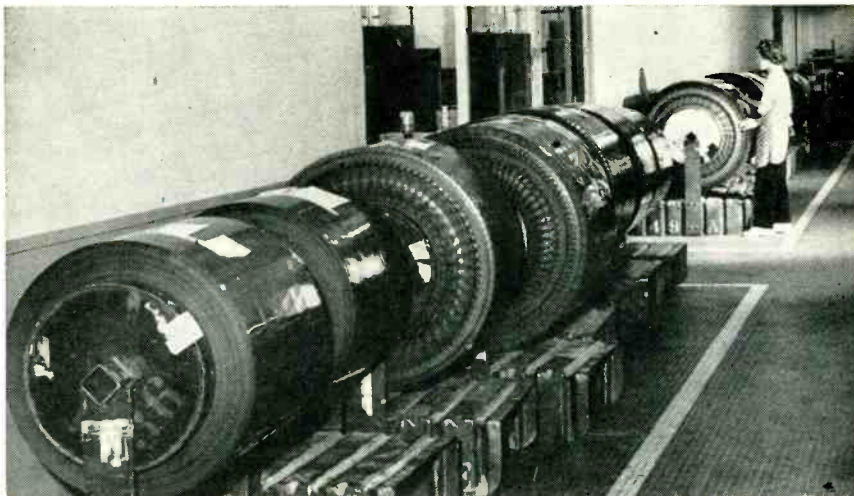

**JUMBO** rolls of magnetically coated acetate film, ready for slitting, are produced at Minnesota Mining as

## Magnetic Recording Sales Rise

Volume in 1955 exceeds mid-year estimates.

Tape sales gain sharply

SALES of magnetic tape recorders and of magnetic tape in 1955 topped many of the most optimistic estimates. Latest estimate by Minnesota Mining and Manufacturing shows that some 360,000 recorders of all types were sold in 1955, exceeding 1954 sales by nearly 100,000 units.

► **Gains**—Major increase was made in sales to the home market in which recorders selling for under \$300 make up the bulk. An estimated 300,000 units priced under \$300 were sold in 1955 compared to about 255,000 units in 1954. Sales of recorders in the \$300 to \$600 price class reached about 50,000 units in 1955.

In the professional tape recording equipment field, units selling for more than \$600, some 10,000 units were sold last year, the only segment of the business that did not exceed expectations. About the same number were sold in 1954.

Based on an average price for each category, total tape recording dollar volume probably exceeded \$77.5 million in 1955, not including recording tape or accessory sales. Minnesota Mining estimates that sales of magnetic tape alone reached \$8.1 million last year com-

pared to \$7.2 million in 1954.

► **Expansion**—There are about 100 companies in the field compared to 75 a year ago. Tape recorder manufacturers are making expansion plans. RCA recently announced a \$2.7 million plant expansion for the production of tape recorders and hi-fi instruments.

Magnetic tape is used to call floors and make other announcements in a Westinghouse automatic elevator. Tape units have been adapted for supermarkets to tell shoppers where to find food items. Three Atlantic Coast Line trains have magnetic tape systems to provide background music for passengers.

## Television Networks Swing To Microwave

Facilities are revamped for color as intercity cable-radio relay system expands

SEVEN-YEAR progress report by the Bell System shows television intercity network facilities have expanded from 900 channel miles in 1948 to 70,000 channel miles today.

Channel miles is the distance between points multiplied by the number of tv channels available. Facili-

(Continued on page 16)



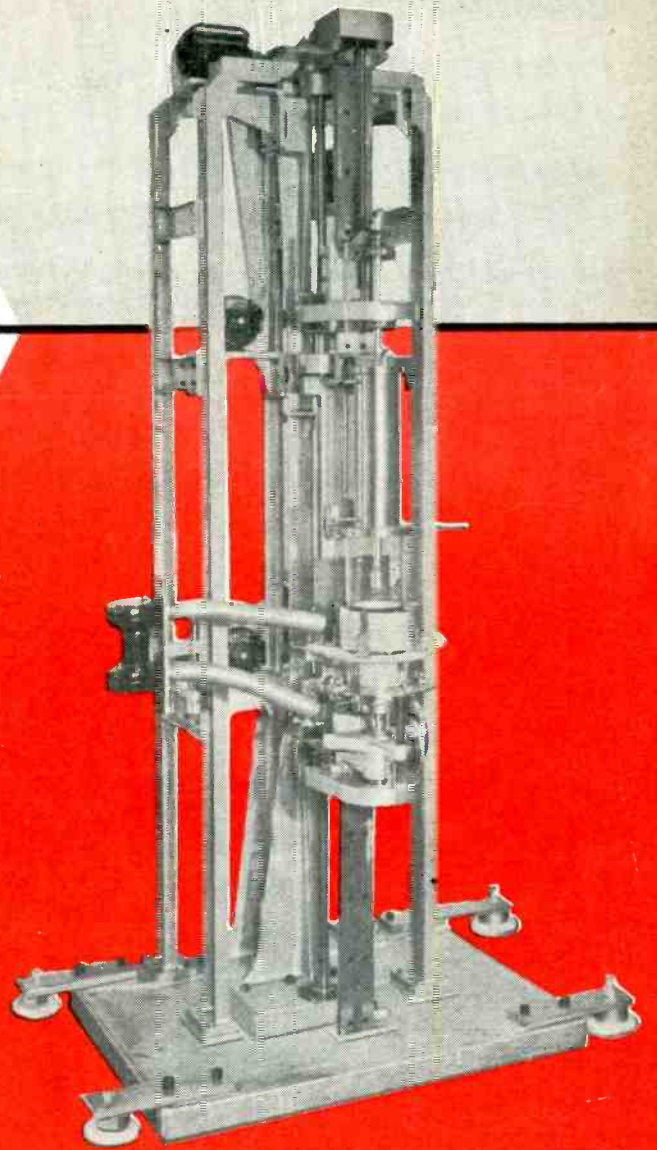

Rate-Growing Single-Crystal Machine # 2650

# KÄHLE

**AUTOMATIC  
MACHINES**

**WILL  
PRODUCE  
YOUR**

## germanium or silicon single-crystal ingots

**FASTER, MORE UNIFORMLY**

Perfected for production, Kahle's high precision Rate-Growing Machines are based on the insertion of a Germanium or Silicon seed into a similar molten metal and form single crystals by the Rate Growing Process. Consistent characteristics are insured by controlled seed rotation and vibration-free traverse, together with latest precision Temperature Control and Cycling. Machines can be supplied in all sizes and types and with or without automatic programming. "Custom-engineered" models can be quickly furnished.



Send for  
**KÄHLE'S**  
valuable file  
on automatic  
equipment  
—today!

**Kähle** ENGINEERING COMPANY

1319 Seventh Street North Bergen, New Jersey

DESIGNERS, AND BUILDERS OF AUTOMATIC AND SEMI-AUTOMATIC EQUIPMENT FOR ALL INDUSTRIAL OPERATIONS

ties link 391 stations in 262 cities.

►**Color**—Additional channel bandwidth and increased transmission fidelity is required for handling color television signals. Intercity tv facilities suitable for color transmission number 51,000 channel miles and link 190 stations in 134 cities.

The requirements of color may have stimulated the change from coaxial cable to microwave radio relay. At the end of 1948, 77 percent of tv

network facilities was coaxial cable and 23 percent radio relay. By the end of 1954 the balance was 70-30 in favor of microwave.

►**Investment** — The Bell System has \$250,000,000 invested in tv network facilities. Operation and maintenance require 1,000 engineers and technicians. Coordination requires 24,000 miles of telephone and 20,000 miles of teleprinter service. The system includes about 1,500 microwave stations.

## Automatic Production Creates New Jobs

### Labor Department describes six job types for the electronics industry

INCREASING use of automatic production techniques in the electronics industry has created new jobs for production workers. Here are descriptions of some of the new jobs as listed by the U.S. Department of Labor.

►**Automation Machine Operator**— Operates radio or tv automatic machines to insert and fasten parts on circuit boards. Requisitions and expedites production parts. Receives production orders and allocates machine time to produce required units. Tabulates production records and arranges for lot shipment to other areas. Requests machine adjustments to correct sub-standard work.

►**Automation Assembler** — Loads parts into automatic feed channels of automatic machines. Checks completed circuit boards for missing or loose parts and makes insertions or repairs as necessary. Matches color codes, reads production part numbers and uses simple hand tools.

►**Automation Machine Tender**— Operates automatic machines to insert and fasten tube sockets, resistors, jumper wires and capacitors on circuit boards. Clears operating mechanisms, removes jammed parts and restarts machine making simple adjustments as required. Rethreads machine with jumper wire.

►**Stager**—Checks prepared plates for bubbles, blisters and unexposed areas prior to etching operation. Touches up imperfections using paint and brush. Scrapes excessive printing as necessary.

►**Printed Circuit Sprayer** — Sets up and operates spray gun to lacquer surfaces. Cleans and adjusts spray gun. Assists in other produc-

(Continued on page 20)

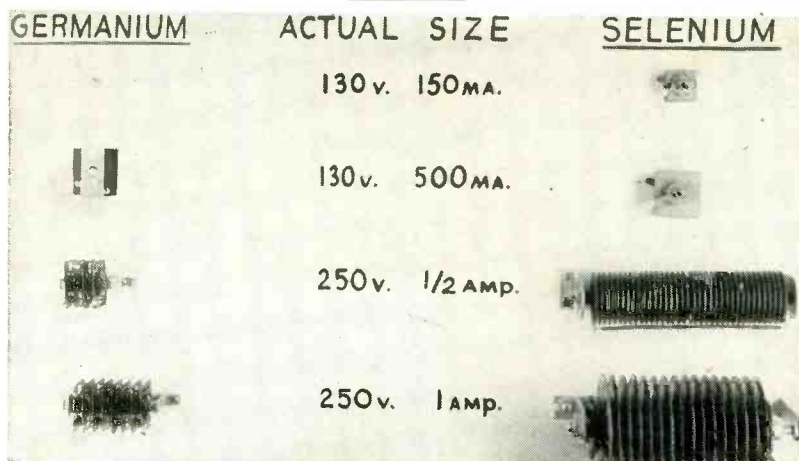

Size comparison between equivalent GE germanium and GE selenium rectifiers indicates how . . .

## Germanium Rectifiers Save Space

### Production moves ahead faster to meet increased industrial and military needs

OUTPUT of germanium power rectifiers was negligible before 1952 and gained relatively slowly in the next two years due mainly to production problems. In the past year, gains have been made in breaking the production bottleneck and output has increased substantially. General Electric estimates that cumulative industry production reached about 6 million units in 1955.

►**Firms**—A handful of firms are responsible for 90 percent of the output. The amount of development required for the units is large and the facility investment is substantial.

►**Application** — Although germanium rectifiers can be used for almost any application where d-c is

required, most of the units have been used in military and commercial equipment. They have found increasing application in military gear because they are lighter in weight, in some cases 100 times lighter, than rectifiers of other types.

►**Gain**—Aiding the increasing use of germanium rectifiers has been the continuing selenium shortage. Also, silicon rectifier production has remained relatively small although higher production is expected in 1956. For germanium units, GE estimates that the market will more than double this year over 1955.

Increasing output of the units has helped to decrease prices. For large quantities, they range in price from about \$1 to \$25 each. Germanium power rectifier stacks, in large quantities, range from about \$8 to \$50 each.

# Automatic Sweep

## for Any of your Manually-Operated Devices

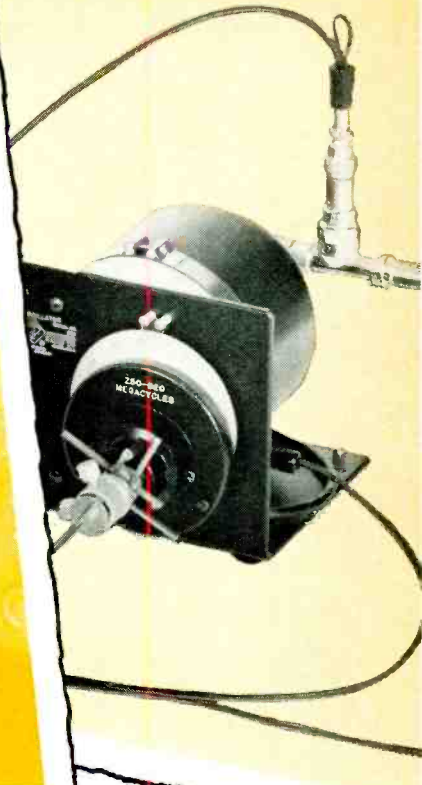

Used in combination with G-R's popular line of Unit Oscillators, the Sweep Drive makes available sweep generators for the frequency ranges: 500 kc to 50 Mc, 50 Mc to 250 Mc, 65 Mc to 500 Mc, 250 Mc to 920 Mc, or 900 Mc to 2000 Mc. The device can be coupled to either the generator, slow-motion drive for sweeping over small ranges or coupled directly to the main shaft to take advantage of the extremely wide frequency ranges of G-R Unit Oscillators.

### G-R Type 1750-A Sweep Drive \$400

Would you like to be able to take any one of your manually-driven oscillators off the shelf and convert it to a sweep device, as the need arises? The instrument is now available which permits you to do this. *One* instrument, G-R's Type 1750-A Sweep Drive, makes it possible for you to have as many sweep generators as you have hand-operated oscillators.

The Sweep Drive readily attaches to a wide variety of shafts, knobs or dials for automatic mechanical sweeping of a wide variety of equipment. Sweep Arc, Speed and Center Position are all continuously variable, even while the Drive is in motion.

While the display of amplitude-frequency characteristics on an oscilloscope has proven an important use for the Sweep Drive operating a signal source, this versatile device is not by any means limited to this application. The Drive can be used to turn shafts automatically for almost any purpose . . . for driving a receiver or analyzer to obtain panoramic response . . . to open or close a shutter or switch . . . to modulate light, sound or heat.

The uses for this instrument in engineering or production-test department are countless. The wide variety of data which can be conveniently displayed on a CRO as a continuous function of an independent variable, makes the Sweep Drive an invaluable time saver for the engineer.

**Wide Range of Speeds** — 0.5 to 5 cps, reciprocating motion.

**Sweep Arc** — adjustable from 30° to 300°

**Center-Position of Sweep Arc** — adjustable to any position; on reduction drives, may be set to any point within eight full turns — is not affected by arc of sweep.

**Universal Coupling System** — four adjustable spider-like arms readily attach to knobs and dials, 1" to 4" diameter and shafts 1/4" and 3/8" — shaft height also adjustable.

**Limit-Switch Circuit** — disconnects and brakes the motor if preset limits of shaft travel are accidentally exceeded.

**CRO Deflection Circuit** — provides a voltage proportional to shaft angle for application to the horizontal deflection plates of an oscilloscope.

**Blanking Circuit** — eliminates the return CRO trace and produces a reference base line.

**Rated Maximum Torque** — 24 oz.-in.

## GENERAL RADIO Company

275 Massachusetts Avenue, Cambridge 39, Massachusetts, U.S.A.

90 West Street NEW YORK 6

8055 13th St., Silver Spring, Md. WASHINGTON, D. C.

1150 York Road, Abington, Pa. PHILADELPHIA

920 S. Michigan Ave. CHICAGO 5

1000 N. Seward St. LOS ANGELES 38

We Sell Direct. Prices shown are net, f.o.b. Cambridge or West Concord, Mass.



ADMITTANCE METERS  
AMPLIFIERS  
COAXIAL ELEMENTS  
DISTORTION METERS  
FREQUENCY MEASURING APPARATUS  
FREQUENCY STANDARDS  
IMPEDANCE BRIDGES  
LIGHT METERS  
MEGOhmmeters

MODULATION METERS  
MOTOR CONTROLS  
NULL DETECTORS  
OSCILLATORS  
PARTS & ACCESSORIES  
POLARISCOPIES  
PRECISION CAPACITORS  
PULSE GENERATORS  
R-L-C DECADES  
R-L-C STANDARDS

SIGNAL GENERATORS  
SOUND & VIBRATION METERS  
STROBOSCOPES  
TV & BROADCAST MONITORS  
U.-H.F. MEASURING EQUIPMENT  
UNIT INSTRUMENTS  
VARIACS  
V.-T. VOLTMETERS  
WAVE ANALYZERS  
WAVE FILTERS

now available for the first time!



Actual size

# PNP HIGH TEMPERATURE SILICON TRANSISTORS



now offers PNP Silicon Transistors having these outstanding advantages:

- **Collector Saturation Voltage** — averages 1 volt or less at 20 mA dc collector current.
- **Reverse Emitter Voltage** — 22 volts
- **Rugged and Reliable** — manufactured by Raytheon's dependable fusion-alloy method!

The improved electrical performance, reliability and mass production advantages of Raytheon's fusion-alloy process are now available in silicon transistors. Raytheon PNP High Temperature Silicon Transistors are ideal for use in low frequency amplifiers, switching circuits and as replacements for relays in airborne electronic equipment operating at high ambient temperatures.

The superiority of the Raytheon perfected fusion-alloy process has been proved through the successful manufacture of several million PNP Germanium Transistors by Raytheon, the largest manufacturer of transistors. The new plant of the Raytheon Semiconductor Division is ready to mass produce both Silicon and Germanium Transistors to meet your needs.

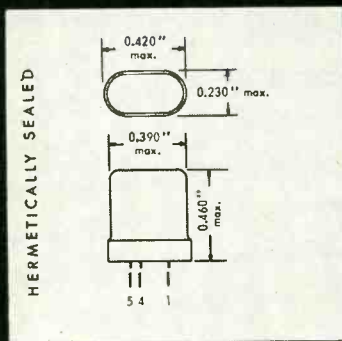

#### ABSOLUTE MAXIMUM RATINGS

Types:  
**CK790 • CK791 • CK793**

Collector Voltage (diode)	-100 Vdc
Emitter Voltage (diode)	-22 Vdc
Emitter Current	50 mA dc
Collector Dissipation at 135°C	50 mw

#### AVERAGE CHARACTERISTICS

Type	Reverse Current at -24V		Beta	Base Resistance ohms	Collector Resistance kilohms	Noise Factor db (max.)	Collector Capacity $\mu\mu\text{f}$	Alpha Freq. Cutoff KC
	Collector $\mu\text{A}$ (max.)	Emitter $\mu\text{A}$ (max.)						
<b>CK790</b>	0.2	0.2	14	1200	500	30	30	400
<b>CK791</b>	0.2	0.2	24	1400	500	30	30	600
<b>CK793</b>	0.2	0.2	16	1300	500	15	30	500

Above characteristics are average except where noted and are taken at  $I_c = 1 \text{ mA dc}$ ;  $V_c = -6 \text{ Vdc}$ ; Ambient temp. 25°C.

## RAYTHEON TRANSISTORS

more in use than all other makes combined

here's the whole story on



# BONDED SILICON DIODES



Actual size

Low reverse current and excellent stability at high temperature over long periods distinguish these Raytheon Bonded Silicon Diodes.

Every Diode receives four temperature cycles of one hour at  $-55^{\circ}\text{C}$  and one hour at  $+150^{\circ}\text{C}$ , followed by thirty-six hours at 95% relative humidity and  $70^{\circ}\text{C}$ . Exact characteristics are maintained.

RAYTHEON Type	Peak Inv. Voltage 25°C	Forward Current at +1.0 V (min.) 25°C	Reverse Current at -10 V (max.) 25°C	Reverse Current at specified voltage (max.) 25°C	Rectified Current (max.) 100°C	Rectified Current (max.) 150°C
1N300	15 V	8 mA	.001 $\mu\text{A}$	.001 $\mu\text{A}$ at 10 V	23 mA	12 mA
1N300A	15	30	.001	.001	50	25
1N432	40	10	.005	.005	30	15
1N432A	40	20	.005	.005	48	22
1N301	70	5	.01	.05	23	12
1N301A	70	18	.01	.05	40	20
1N460	90	5	.01	.1	23	12
1N460A	90	15	.01	.1	40	18
1N303	125	3	.01	.1	23	10
1N303A	125	12	.01	.1	35	16
1N433	145	3	.01	.1	23	10
1N433A	145	10	.01	.1	30	16
1N434	180	2	.01	.1	20	10
1N434A	180	7	.01	.1	25	13
1N302	225	1	.01	.2	15	8
1N302A	225	5	.01	.2	23	12

## RAYTHEON BONDED SILICON REFERENCE DIODES

Type	Zener Voltage	Zener Impedance (max.)		Zener Temp. Coeff. %/°C
		at 0.5 mA	at 5.0 mA	
1N436	3 to 5 V	100 ohms	10 ohms	0.03 max.
1N437	5 to 7	100	10	0.05
1N438	7 to 9	100	10	0.08
1N439	9 to 11	100	10	0.08

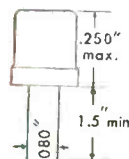
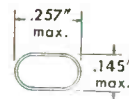
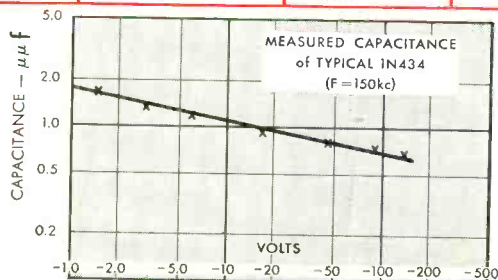

HERMETICALLY SEALED



manufacturing co.

## SEMICONDUCTOR DIVISION

Silicon and Germanium Power Rectifiers, Diodes and Transistors

Home Office: 150 California Street  
Newton, Mass. • DEcatur 2-7177  
For application information write  
or call the Home Office or:

9501 Grand Ave., Franklin Park (Chicago), Ill.,  
TUxedo 9-5400 • 589 Fifth Ave., New York 17,  
New York, PLaza 9-3900 • 622 South La Brea  
Ave., Los Angeles 36, Calif., WEbster 8-2851

tion operations as required.

►**Printed Circuit Machine Operator**—Operates a variety of short-cycle machines to prepare, expose and etch production parts for pre-designated lengths of time. Scrubs, sensitizes and etches parts with nontoxic solutions of prepared strength. Assists in other printed circuit operations as required.

## Finance Firms Take To Electronics

### Growth of the field and attendant money problems bring specialized lenders

WITHIN the past three years the number of new companies entering the electronics field has increased steadily. In California alone at least one new electronics company a week has been formed in the past year.

Many new firms unable to obtain bank credit have turned to commercial financing companies. A number of commercial financing companies now specialize in electronics financing.

►**Volume** — Coastal Commercial Corp. of New York reports that its business is nearly 60 percent composed of small electronics firms.

The firm estimates that approximately \$100 million will be needed by some 10,000 small companies in the electronics, metal machine work and sheet-metal parts business in the next 12 months.

►**Need** — Often applicants for loans are referred to the specialized lender by banks, although some are referrals from larger manufacturers seeking to help put subcontractors and suppliers on a financially sound basis.

About 26 months is the average period of relationship between borrower and specialized lender. By then a firm can usually operate through ordinary banking circles. Loans range between \$5,000 and \$100,000 with the average outstanding balance running about \$36,000.

## New Models Ready For '56

### Color sets, transistorized radios and remote controlled black-and-white sets shown

MANY major radio and television receiver manufacturers have announced new models. New color sets and more transistorized portables highlight the new sets. Many black-and-white receivers introduced incorporate remote and automatic tuning devices.

►**Color**—Admiral, Emerson, Philco and RCA were among the manufacturers introducing new color receivers. Sylvania has announced plans to begin production on two or three models with 28 to 30 tubes in April. Capehart and Hoffman are presently producing their own color sets. New plans of Motorola have yet to be announced. CBS-Columbia, GE and Zenith have not announced new color production plans.

Most of the manufacturers who introduced new color sets limited them to one or two models. RCA offered three new models bringing the number in its color line to five sets ranging in price from \$695 to \$995. The sets all have 21-inch picture tubes and 26-tube circuits.



Cordless, all transistor home radio that operates on six transistors and a self-contained battery is CBS-Columbia chairside model

►**Transistors**—In the past month Emerson introduced two transistor portables, one using 6 transistors and the other using 3 transistors and 3 tubes. CBS-Columbia displayed a battery-operated home radio using 6 transistors and a personal portable using five.

►**Monochrome**—The Zenith line of 45 models represented perhaps the largest new tv line introduced. Most other manufacturers introduced fewer sets as fill-in models. Major changes in the new sets were in automatic and remote control tuning devices.

GE introduced three new portable tv receivers that use aluminum in the cabinet and chassis pan instead of steel for a 20-percent reduction in weight. Fifty percent of all circuits in the sets are printed and 80 percent of the connections are made by automatic dip-soldering. The CBS-Columbia line featured two new chassis, one with 30 tube functions and the other with 23.

## Will Sun Spots Boost Mobile Sales?

### Increased reflection from ionosphere beginning to disrupt vhf communications

OPERATORS of communications services are being urged by FCC to consider moving out of the 25-to-50 mc region into the higher bands.

Reason for the warning is the upswing in the sunspot cycle that improves the ability of the upper layer of the ionosphere to reflect signals. An 11-year peak is expected to occur during the winter of 1956-57.

►**Sales Potential**—Not all users of the principally affected frequencies will need to move—only those requiring nearly complete protection from interference. According to a recent survey, special industrial radio users already encounter occa-

(Continued on page 22)

**Here's Why Clifford Specifies  
ALL-ANGL Barry Mounts  
to Protect Reliability  
thru Every Flight Attitude  
of the F-100 Super Sabre**

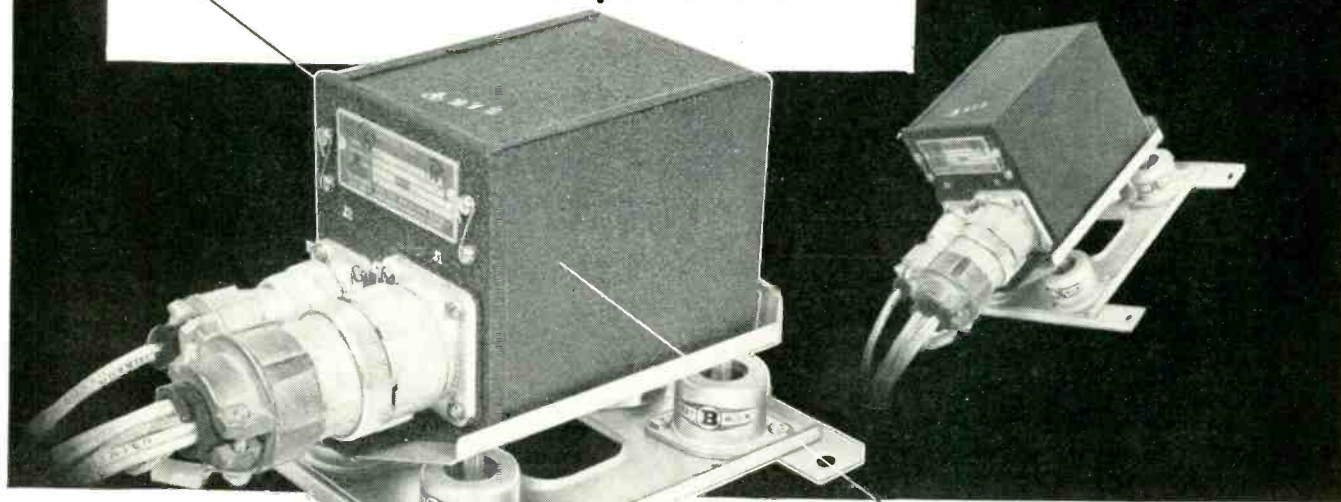

Clifford miniaturized heat-control unit — only 3-1/8 inches high.

**It's an important story  
of engineering for shock and vibration control**

North American Aviation, builders of the F-100 Super Sabre, specify that the control box must be able to mount at any angle. MIL-E-5272A requires the mount to operate under vibration as high as 0.080" double amplitude. Temperature requirements preclude the use of rubber mountings. And experience demands that the mounting system handle the load bias added by large connectors and cables — often a serious problem with miniaturized equipment.

Because they are specifically designed for jet and missile service, ALL-ANGL Barry Mounts meet all these requirements. So Clifford's choice of this mount assures the protection of their new miniaturized heat control under every operational condition.

The ALL-ANGL Barrymount® isolators used in the Clifford base are standard miniature size. These advanced-design mountings are also available in MIL-size 1 and (Feb. 1) MIL-size 2. Write for data sheets.

When your problem is protection through all flight attitudes, your answer is ALL-ANGL Barry Mounts. For recommendations, call your Barry Sales Representative.



**BARRY CONTROLS**

INCORPORATED

SALES REPRESENTATIVES IN ALL PRINCIPAL CITIES

*New engineering opportunities are open in Barry's expansion program, at all levels in all departments. Send resumé.*

**707 PLEASANT STREET, WATERTOWN 72, MASS.**

ELECTRONICS — February, 1956

Want more information? Use post card on last page.

sional cochannel interference that completely disrupts communications. Relative percentages for the different bands are: under 30 mc, 27; 30-40 mc, 18; 40-50 mc, 11; 152-174 mc, 8.

## TV Stations Equip For Color

### Network affiliates and owned stations continue to gird for color

As of the end of 1955 there were approximately 225 tv stations equipped to broadcast network color shows. Fifty-five had color film and slide equipment and 17 had "live" color equipment. The total represents a minimum equipment investment of some \$10 million.

► **Network** — Currently 106 of NBC's affiliates are equipped to transmit network color shows, 32 have slide and film equipment and 11 can originate live color shows. At the beginning of 1955 only 81 of its stations were equipped for network color.

RCA plans to lease color tv mobile units to its color stations.

► **Gain**—CBS in a December status report of equipment for network and local color shows reported that 110 affiliates were equipped for network color, 6 with studio, film and slide equipment, 24 with film and slide equipment and 1 with slide equipment only. Eleven additional

There are reports of police radio systems jammed for hours at a time. Since it is impracticable to convert 50-mc equipment to 150 mc or higher, nature's freakishness may prove a business bonanza.

CBS affiliates were definitely scheduled for color in 1956.

► **Others**—ABC reports that it does not plan to equip its owned stations for color until there are a sufficient number of color tv receivers in use.

Du Mont's New York outlet is equipped for color but as yet, its station in Washington, D. C. is not.

General Teleradio reports that although some of its stations have experimented with color equipment, none of them is currently equipped for color transmission.

## Small-Boat Electronics Gets Industry Nod

### RCA groups take over additional duties to serve \$1-million dollar market

OVER 20 million Americans use some 5 million pleasure boats. About 4.5 million of these are power craft, a potential haven for broadcast, communications and direction-finding equipment. The owners of such craft and owners of commercial boats provide a market for lightweight developments in the field of radar, sonar, depth-finding and safety-at-sea.

► **Reorganizing** — Recognizing a trend, RCA is streamlining its functions to provide marine equipment and services most economically. Functions of Radiomarine Corporation of America may be distributed throughout other RCA subsidiaries.

With approval of FCC, marine radio traffic will be handled by RCA Communications, service will be performed by RCA Service Co. while engineering, manufacture and sales of equipment will be taken into RCA manufacturing divisions.

## Recent Equipment Emphasizes Batteries

### Military electronics and test equipment markets up sales of small batteries

SALE of all types of batteries, dry and storage, is running at \$75 million annually according to estimates by one large manufacturer. The dry-battery market amounts to \$35-40 million of which \$16 million goes to the military.

► **Dry Batteries**—In some applications the common dry cell, which uses an electrochemical couple of zinc and manganese dioxide, is being supplanted by cells using silver or mercuric oxide. These latter cells are higher priced but feature high ampere-hour capacity and small size.

The mercury cell is used in hearing aids and as a reference in measuring instruments. Use as an auxiliary supply for transistor auto radios is under study. Market for mercury cells is \$9-10 million of which 30 percent is military. Sales include many for air-sea rescue work.

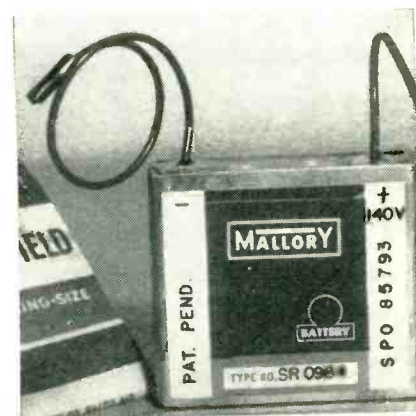

High-voltage battery

► **High-Voltage**—A pile developed by Mallory puts out 200 v a cubic inch. Its current output is about 0.1 microampere. Shelf life is 18-24 months. Use is foreseen in ion chambers, Geiger counters, scintillation counters, bias cells and in charging capacitors to detonate fuzes.

The battery comes in sizes up to

(Continued on page 24)



Color tv mobile units such as this will be leased by RCA to tv broadcasters for local events



# BUTTON-STEM BASE OF G-E 5-STAR SUBMINIATURES INCREASES RELIABILITY... LENGTHENS TUBE LIFE!

- ① G-E 5-Star subminiature leads—spaced out circumferentially—are more than twice as far apart as with pressed-stem base construction, where the leads are in line. Also, spacing is more accurate and uniform. These widely-spaced leads help ward off glass electrolysis (which increases rapidly with higher temperatures) in the area where leads pass through the seal of the tube envelope. *Means a longer-life seal and tube*, since electrolysis, a result of electrical leakage, breaks down the glass to a point where vacuum is impaired and tube failure can occur.
- ② 5-Star leads within the tube and seal are short, and parallel one another for a minimum distance—unlike pressed-stem internal leads, which are long and extend side-by-side. Result: *5-Star tube capacitance is lower*, giving improved circuit performance, especially at high frequencies.
- ③ 8 external leads in all are available with 5-Star subminiatures, against a maximum of 7 for pressed-stem tubes. With many tube types, this *provides increased flexibility for the circuit designer*. For example, only button-stem subminiature twin triodes can offer the designer separate cathode connections!
- ④ Button-stem base construction makes 5-Star subminiatures *nearly 10% shorter (approx 1/8 inch) than pressed-stem tubes*. Equipment designers who face strict space limitations, benefit from G-E 5-Star compactness!

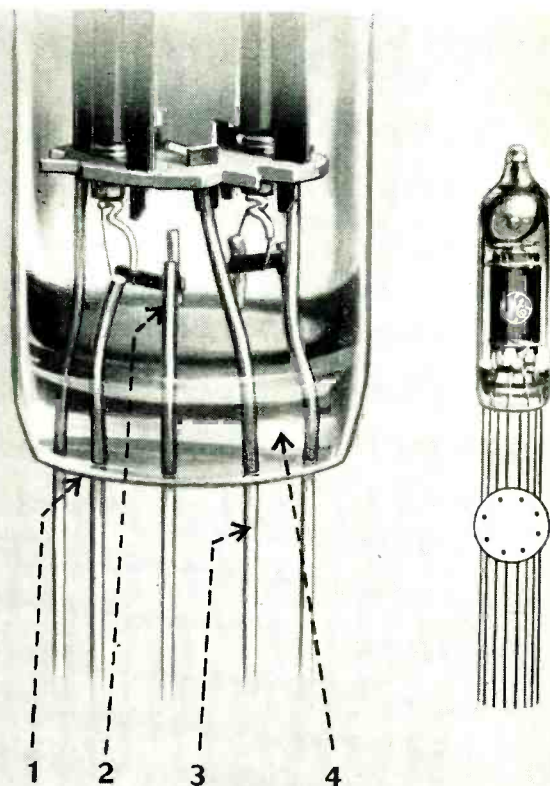

Right: actual size. Seated height of tubes is only 1.375 inches (max). Circular diagram over base pins shows how circumferential arrangement of leads in G-E 5-Star subminiatures, spaces them more widely apart than the in-line leads of pressed-stem tubes.

Add to these advantages of button-stem base construction, special 5-Star design throughout—sturdy, shock-resistant, electrically efficient and dependable! Add painstaking tube manufacture by selected, trained G-E 5-Star workers, in a separate 5-Star building where employees wear lint-free garments, and the air is pressured, filtered, and dehumidified to keep out dust!

General Electric 5-Star tubes are the most reliable subminiatures you can install. Specify them for critical military and commercial applications! *General Electric Company, Tube Department, Schenectady 5, New York.*

18 G-E 5-Star subminiatures are available, for a comprehensive range of circuit applications:

5718	5896	6021
5718-A	5896-A	6021-A
5719	5899	6111
5719-A	5899-A	6111-A
5840	5902	6112
5840-A	5902-A	6112-A

*Progress Is Our Most Important Product*

**GENERAL**  **ELECTRIC**

150 v which size is designed for charging a 0.1-microfarad capacitor. Voltage is developed by a couple consisting of a chrome-plated copper disk and a pressed-powder disk of barium permanganate with lead dioxide. This couple gives 1.62 v. Other combinations can achieve higher voltage or lower voltage and higher permissible current drain

► **Low Temperature**—The pile uses a solid ionic conductor as electrolyte. This is a pressed disk of amorphous stannous sulphate powder. The battery delivers stable open-circuit voltage at ambient temperatures from 70 to -40 C.

The battery at present would sell from 2 to 3 cents a volt. Target price is one cent a volt.

and similar functions. Unless otherwise directed, this class of station must cease operation upon receipt of a radio alert.

## Transmitter Antenna Sales Up

TV stations seek more coverage with higher towers. Forward-scatter antennas take hold

CONTINUING growth in the number of tv, radio and communications stations has increased the business volume of antenna makers. In fiscal 1955, the number of antenna applications processed by FCC exceeded all previous years, with a total of 9,131, an increase of some 100 applications per month over 1954. However, fewer tv antenna applications were processed.

The number of antenna applications filed also reached a record high during fiscal 1955 totaling 9,856, an increase of more than 200 applications per month over fiscal 1954. Antenna applications for broadcast and common carrier services decreased slightly while safety and special radio proposals increased from 5,357 to over 8,000.

► **Television Skyhooks**— At the close of fiscal 1955, 28 tv towers 1,000 feet in height or higher, were in operation and construction permits for 13 additional towers over 1,000 feet high were outstanding.

Among the higher towers are: WFAS-TV and KRLD-TV in Dallas, Tex., with a height of 1,521 feet; KSWB-TV, Roswell, N. Mex., 1,610 feet; and KGEO-TV, Enid, Okla., 1,356 feet.

FCC made an initial decision approving the move of KGEO-TV to the 1,356-foot tower but the Defense Department asked for reconsideration of the decision. Also awaiting approval by the FCC are WSLA, Selma, Ala. for a 1,993-foot tower and WHAS-TV, Louisville, Ky., for a 2,003-foot tower, which would be

the world's highest structure.

► **Distance Increases** — Forward-scatter developments have spurred antenna sales activity in the communications field. A number of antenna fabricators now have forward-scatter antennas on the market and more companies are planning to make them. One manufacturer reports that it has sold about fifty 28-foot transhorizon antennas.

Another manufacturer has announced plans to produce forward-scatter equipment. Equipment for 2,000 mc is expected to be available in five to ten months at a total cost of \$42,000 to \$52,000. Transmitting and receiving 28-foot parabolas, including tower and ground mounts, would cost about \$12,000.

## Conelrad Extends Radio Blackout Regulations

DENIAL of direction-finding transmissions to hostile aircraft has been insured through the Conelrad program that rotates operation of a-m broadcast stations during an alert. Requirement of radio silence during alert periods has been gradually extended to other radio services.

► **Hams and Cops**—Latest groups expected to go off the air at a moment's notice are amateurs and the public safety radio services. According to FCC's latest annual report there were more than 132,000 amateur transmitters licensed, but the number is growing (see latest Figures of the Month, p 6).

Public safety services include more than 200,000 transmitters in police, fire, highway maintenance

## Selenium Shortage May Be Eased

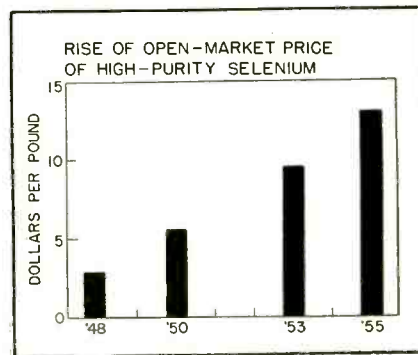

Production from Wyoming deposit may double world supply by midyear

DAILY production of 1,200 to 2,000 pounds of commercial-grade selenium is the goal of the Shawano Development Corp., operators of a Baggs, Wyoming selenium deposit. Discovered last fall, the deposit contains ore assayed to be 0.69-percent selenium, which is roughly equivalent to 13 pounds of commercial grade per 100 pounds of ore. A plant is being erected and pilot production is expected by May. Full daily production would approximately double the present world supply.

► **Current Situation**—Demand for high-purity selenium by rectifier manufacturers has caused prices to quadruple within the last five years to a high of about \$13 a pound, as shown in the graph. The economic feasibility of refining the selenium ore is based on these high market prices. Shawano estimates that it can make a profit on its operation if the commercial-grade selenium sells for a minimum of \$8.00 a pound. Commercial-grade material requires additional refining to qualify as high-purity selenium.

(Continued on page 26)

# For VARIABLE CAPACITORS...

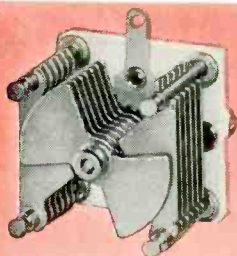

"BFC" butterfly-type capacitor with isolated rotor, very low minimum capacity and low inductance. For VHF applications as series capacitor with no rotor connection.

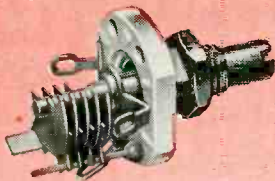

"MAC" Low minimum capacity and very low inductance. Ideal for VHF-UHF applications. Designed for use in miniaturization. Also available as butterfly type "MACBF".

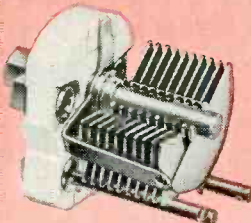

"APC" A compact, high quality air dielectric trimmer. Extremely high resistance to temperature changes, moisture and vibration.

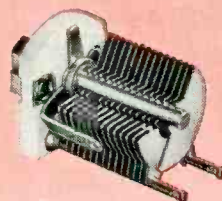

"MAPC" A scaled down version of the "APC". Designed to fill the needs of miniaturization. Suitable for VHF use.

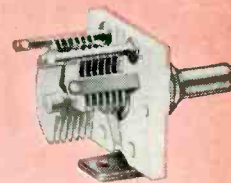

"HF" A high frequency design featuring extra long sleeve bearing and positive contact nickel-plated phosphor bronze wiper. Also available as a dual unit.

*naturally,*

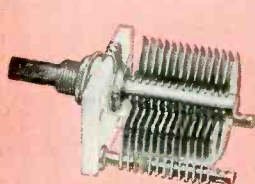

"HFA" Similar to "HF" model, but with larger air gaps for higher breakdown ratings. Used for high-frequency, low-power transmitting. Also available as dual unit.

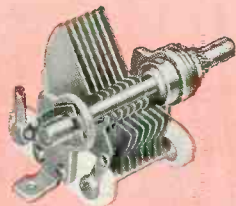

"MC" Designed for maximum versatility in mountings, connections and capacity characteristics. Rotor stop permits 180° clockwise rotation with increasing capacity. Also available as dual unit.

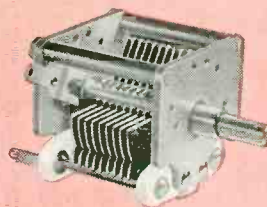

"RMC" Similar to "MC-S" but featuring extra rigid design. Heavy frame of aluminum tie rods and end plates.

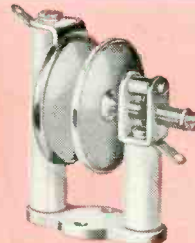

"NZ" Compact transmitting neutralizing capacitor designed for easy and accurate adjustment. Long leakage paths to ground from both rotor and stator.

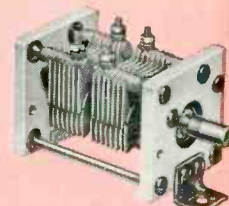

"VU" Permits use of "lumped constant" circuits up to 500 MC. Two sections in series eliminate rotor wiper. Pyrex glass ball bearings eliminate noise from usual metal-to-metal bearings.

*it's*  
**HAMMARLUND**



● Send for your copy of Bulletin E256

For commercial, military and industrial applications, you just can't beat Hammarlund Variable Capacitors for uniformly high quality design, materials and workmanship. The capacitors illustrated here are just a small representative portion of the complete Hammarlund line. In addition to stock designs, Hammarlund offers you unparalleled variable capacitor know-how in development, design and production. Whatever your needs, when it comes to special or standard variable capacitors, naturally, come to Hammarlund.

**HAMMARLUND MANUFACTURING COMPANY, INC.**  
460 West 34th Street, New York 1, N. Y.

## Financial Roundup

More companies report on 1955 net profits, make security offerings

MANUFACTURERS reporting net profits in the past month showed mixed results compared to 1954. Several firms announced security offerings.

Following are the net profits for 9 firms for the fiscal periods indicated:

Company	Net Profit	
	1955	1954
Aeroquip 12m	\$1,425,303	\$1,115,092
ACF Industries 6m	3,874,775	2,528,554
Am. Electronics 9m	177,377	190,186
Consolidated Electronics		
Ind. 12m	861,989	*202,190
Electronic Engineering 9m	15,698	
General Inst. 9m	241,994	*158,207
W. L. Maxson 12m	1,498,000	1,496,000
Raytheon 6m	1,368,000	2,396,000
Westinghouse 9m	43,839,000	62,644,000
*loss		

► **Securities**—Electronics Corp. of America placed \$2 million of subordinate convertible notes, due Dec. 1, 1975. Proceeds will be used for general corporate purposes and additional working capital.

Varian Associates offered \$2 million in debentures, due Dec. 1, 1970 at 100½ percent and accrued interest. Proceeds are to be used for general corporate purposes including purchasing land, building and equipment and for other expansions and working capital.

## Marines Land Radar

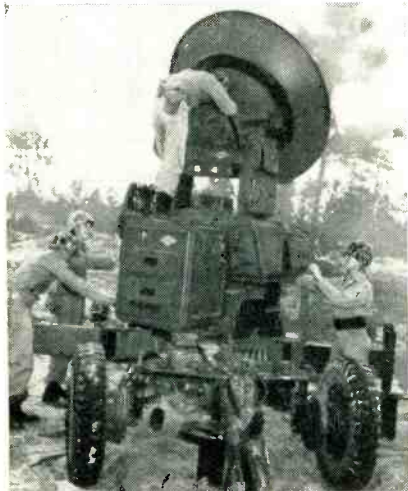

U. S. Marines are now using the Army's special radar system for detection of enemy mortars. Device was a joint development of Army Signal Corps and Sperry Gyroscope

## FUTURE MEETINGS

JAN. 30-FEB. 3: Winter General Meeting, AIEE, Hotel Statler, New York, N. Y.

FEB. 2-3, 1956: IRE National Symposium on Microwave Techniques, University of Pennsylvania, Philadelphia.

FEB. 7-9: 1956 Western Joint Computer Conference & Exhibit, Fairmount Hotel, San Francisco, Calif.

FEB. 9-11: Annual Southwestern Regional IRE Conference and Electronics Show, Oklahoma City, Okla.

FEB. 15-17: 1956 Conference On High-Speed Computers, Louisiana State University, Baton Rouge, La.

FEB. 16-17: IRE, AIEE, Univ. of Pa. Conference on Transistor Circuits, University of Pennsylvania, Philadelphia, Pa.

FEB. 27-29: Second Annual Electronic Conference & Exhibit, AMA, Hotel Commodore, New York, N. Y.

FEB. 28-29: Scintillation Counter Symposium, IRE, AIEE, Shoreham Hotel, Washington, D. C.

MARCH 6-7: Conference on Radio Interference Reduction, Armour Research Foundation, Chicago, Ill.

MAR. 15-16: AIEE Fifth Annual Spring Conf., Cleveland, Ohio.

MAR. 19-22: IRE National Convention, Waldorf-Astoria Hotel, Kingsbridge Armory, New York, N. Y.

APRIL 2-4: Harvard University,

Air Force Cambridge Research Center, IRE Symposium on Microwave Properties and Applications of Ferrites, Harvard University, Cambridge, Mass.

APRIL 5-6: IRE, AIEE, ISA, Magnetic Amplifier Conference, Hotel Syracuse, Syracuse, N. Y.

APRIL 9-22: International Exhibition on Instrumentation-Automation, Oslo, Norway.

APRIL 10-12: Twelfth Annual Meeting and Metal Powder Show, Hotel Cleveland, Cleveland, Ohio.

APRIL 11-13: 1956 IRE 7th Regional Technical Conference, Hotel Utah, Salt Lake City.

APRIL 13-14: Tenth Annual Spring Television Conference, IRE, Engineering Society Building, Cincinnati, Ohio.

APRIL 23-24: New England Radio Engineering Meeting, IRE, Sheraton Plaza, Boston, Mass.

APRIL 23-25: International Conference on Electron Physics, NBS, College Park, Md.

APRIL 25-27: Symposium On Nonlinear Circuit Analysis, II, Polytechnic Institute of Brooklyn, New York, N. Y.

APRIL 26-27: Conference On Recording and Controlling Instruments, AIEE, ASME, ISA, Bradford Hotel, Boston, Mass.

APRIL 29-MAY 3: Fourth Annual Semiconductor Symposium, Electrochemical Society, Mark Hopkins Hotel, San Francisco, Calif.

## Industry Shorts

► **Breakdown** of Army's electronic test equipment at White Sands Proving Ground shows \$21,500,000 worth belongs to Ordnance and \$24,000,000 to Signal Corps.

► **Denying** application to split channels in the industrial radio service, FCC says technical parameters are now well documented and no further developmental grants to test the technique will be made except on designated channels.

► **Number** of closed-circuit tv installations made by the end of 1956 will total at least 5,000 compared to 1,500 at the end of 1955, according to Dage Television. The firm plans to install about 1,700 cameras this year.

► **Americans** will spend \$300 million to replace picture tubes in 6 million tv sets in 1956. More than 150 million vacuum tubes in radios and tv will also be replaced during the year, according to GE. Average picture tube life was estimated at four years by the firm.

# KAY

## NOISE FIGURE MEASUREMENT 10-3000 MC



### SPECIFICATIONS

- Frequency Range: 10 mc to 3,000 mc
- Output Impedance: 50 ohms unbalanced into Type N Connector
- Noise Figure Range: 0 to 20 db
- Filament Voltage Supply: From regulated supply
- Meter Calibration: Linear in db noise figure; logarithmic in D.C.M.A.
- Fuse Protection: One Type 3AG, 2 amps
- Tubes: 1 Eclipse Pioneer TTI Diode
- Power Supply Source: 117 Watts  $\pm$  10% 60 cps A.C. Available for 50 cps
- Power Consumption: 130 Watts
- Price: \$790.00 FOB Plant

## NEW! . . . KAY *Mega-Node-Sr.*

- Absolutely no modulation on noise output
- Built-in stability
- Longer life on noise diode
- Ease of operation due to front panel design
- All power supplies regulated.

A calibrated random noise source providing an output from 10-3,000 mc, the Mega-Node Sr. may be used to measure noise figure and receiver gain and for the indirect calibration of standard signal sources.

At the lower end of the frequency range noise figure may be obtained directly from the meter. For greater accuracy at higher frequencies, corrections for diode transit time and termination mismatch are available from charts supplied with each instrument.

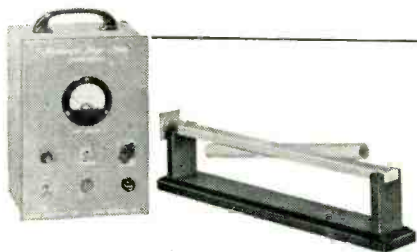

### KAY Microwave Mega-Nodes

Calibrated random noise sources in the microwave range, used to measure noise figure, and receiver gain and calibrate standard signal sources in radar and other microwave systems. Available in following waveguide sizes to cover range of 960-26,500 mc.

RG-69/U . . . \$400.	†RG-51/U . . . \$195.
†RG-48/U . . . 195.	†RG-52/U . . . 195.
†RG-49/U . . . 195.	RG-91/U . . . 250.
†RG-50/U . . . 195.	RG-53/U . . . 250.

Available with fluorescent or inert gas (argon or neon) tubes. Noise output fluorescent tubes, 15.8 db  $\pm$  .25 db; argon gas tubes, 15.2 db  $\pm$  .1 db\*; neon tubes, 18.0 db  $\pm$  .5 db\*.

\*Noise output of inert gas tubes independent of operating temperature.

Universal Power supply for both fluorescent or argon gas and all wave-guide sizes: \$100.

†\$167. per Guide when 3 or more are purchased with \$100. Power Supply.

NEW! WR-770; WR-650—\$595.00 each; WR-510; WR-430; WR-340—\$495.00 each. All WR numbers fluorescent only.



### KAY Mega-Node

Calibrated random noise source reading direct in db, for measurement of noise figure, receiver gain and for indirect calibration of standard signal sources. Frequency range, 5 to 220 mc; Output impedances, unbalanced—50, 75, 150, 300, Infinity; balanced—100, 150, 300, 600, Infinity; noise figure range, 0-16 db at 50 ohms 0—23.8 db at 300 ohms.

Price . . . \$295.  
FOB plant

IRE Show Booths 207, 242, 244, 246 Instruments Avenue

For Complete Information Regarding These, and Other Kay Instruments, Write:

## KAY ELECTRIC COMPANY

DEPT. E-2, 14 MAPLE AVENUE PINE BROOK, N. J.  
CALDWELL 6-4000

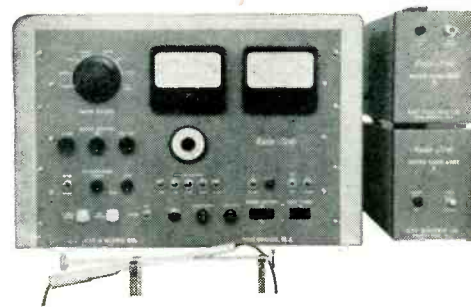

### KAY Rada-Node

Complete radar noise figure measuring set for IF and RF, including attenuators, detector and noise sources. Complete with power supplies. Frequency range: 5 to 26,500 mc; noise figure range, up to 21 db, in lower part of spectrum. Prices on request.

# MAGNETIC FREQUENCY DETECTOR

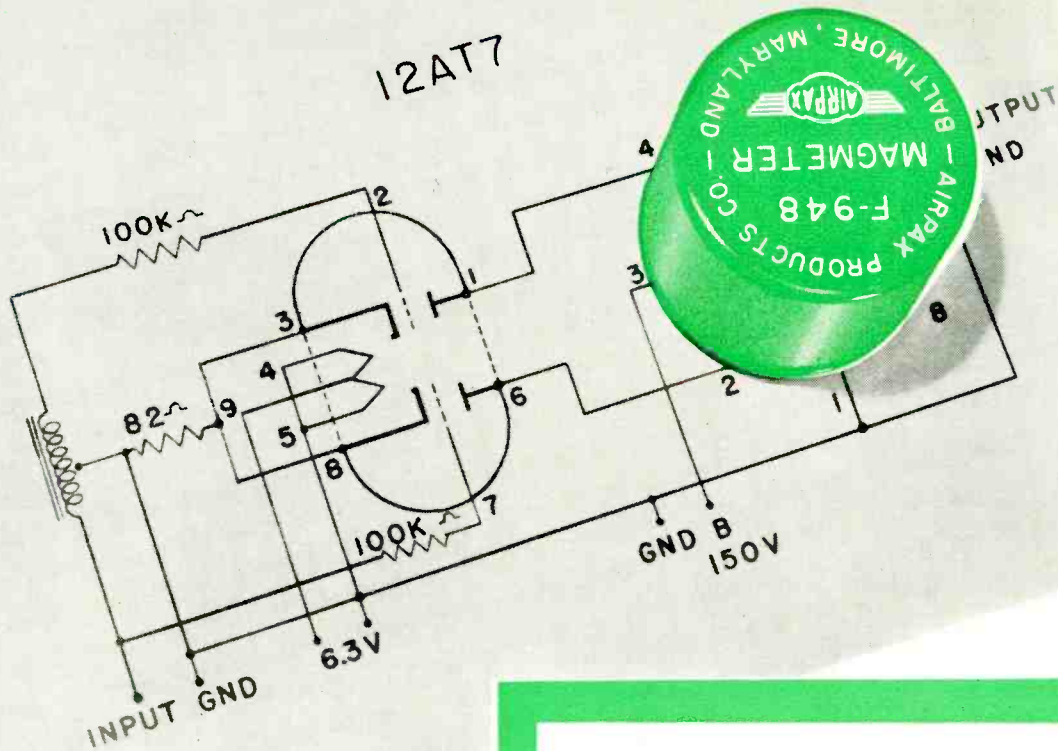

## Measures Audio Frequencies Directly

Magmeter is an entirely new product—the result of Airpax leadership in developing magnetic components. The Magmeter produces an output signal directly proportional to the input frequency.

In the circuit shown, the 12AT7 dual triode drives the Type F-948 Magmeter over the rated frequency range of 0 to 500 CPS. A 0-500 microampere meter, connected to the Airpax Magmeter, indicates frequency directly. A resistor in series with the meter calibrates the circuit when it is installed. Once adjusted, the Magmeter holds the calibration for long periods of time to at least 2% of full scale.

The Magmeter is completely contained in a can  $1\frac{1}{4}$  inches high and  $1\frac{1}{2}$  inches in diameter with a standard octal base. This compact component weighing only 3.4 oz. can be used wherever frequency is measured: in test equipment, AC servos, speed indicators and controls, and power frequency regulators.

You probably have an application in which this one component can replace considerable circuitry. We have a detailed data sheet ready for you, just write to

### CHARACTERISTICS

**RANGE:** 0 to 500 CPS (other ranges available on special order)

**ACCURACY:**  $\pm 2\%$  of full scale plus temperature variation of 500 ppm/C

**WAVEFORM SENSITIVITY:** less than 1% change in indication for sine, triangular, and square waves of same rectified average value

**SHOCK:** 30g shocks of  $11 \pm 1$  milliseconds duration in each plane, case clamped

**VIBRATION:** 10g in each plane at 10 to 55 CPS, case clamped

**TEMPERATURE:**  $-55\text{C}$  to  $+72\text{C}$  operate;  $-65\text{C}$  to  $+85\text{C}$  storage

**LIFE:** comparable to that of a well made transformer

**ENCLOSURE:** hermetically sealed



MIDDLE RIVER

BALTIMORE 20, MD.



## Why spend \$1.04 for this knob?

Sure, you could pay less for an ordinary knob, but the premium price of the Raytheon Standard Control Knob is well worth the difference! Here's why:

Raytheon knobs conform to government specifications for material, high and extreme temperature, humidity, salt spray, vibration, impact and torque. They are handsomely designed and molded of "Tenite II." They have anodized aluminum inserts with dual Allen head set screws. Most important, Raytheon knobs offer the smartly turned professional look that adds so

much to the fine appearance of your product. You put time, skill, money *inside* your equipment. You incorporate the finest circuitry; you select each component with care—your goal is quality *outside*, too. The right knobs, the finest knobs give the important finishing touch. They help convince your customers that yours is thoughtful, thorough craftsmanship.

Let us send you complete information on the finest control knobs available today. Write Dept. 6120, or see your electronic supplier.

### OTHER FINE RAYTHEON STANDARD CONTROL KNOBS

Prices range from  
69¢ to \$3.10



Round



Skirted  
Round



Pointer



Skirted  
Pointer



Crank Knob



### RAYTHEON MANUFACTURING COMPANY

Equipment Marketing Division

Waltham 54, Mass.



CAPACITORS

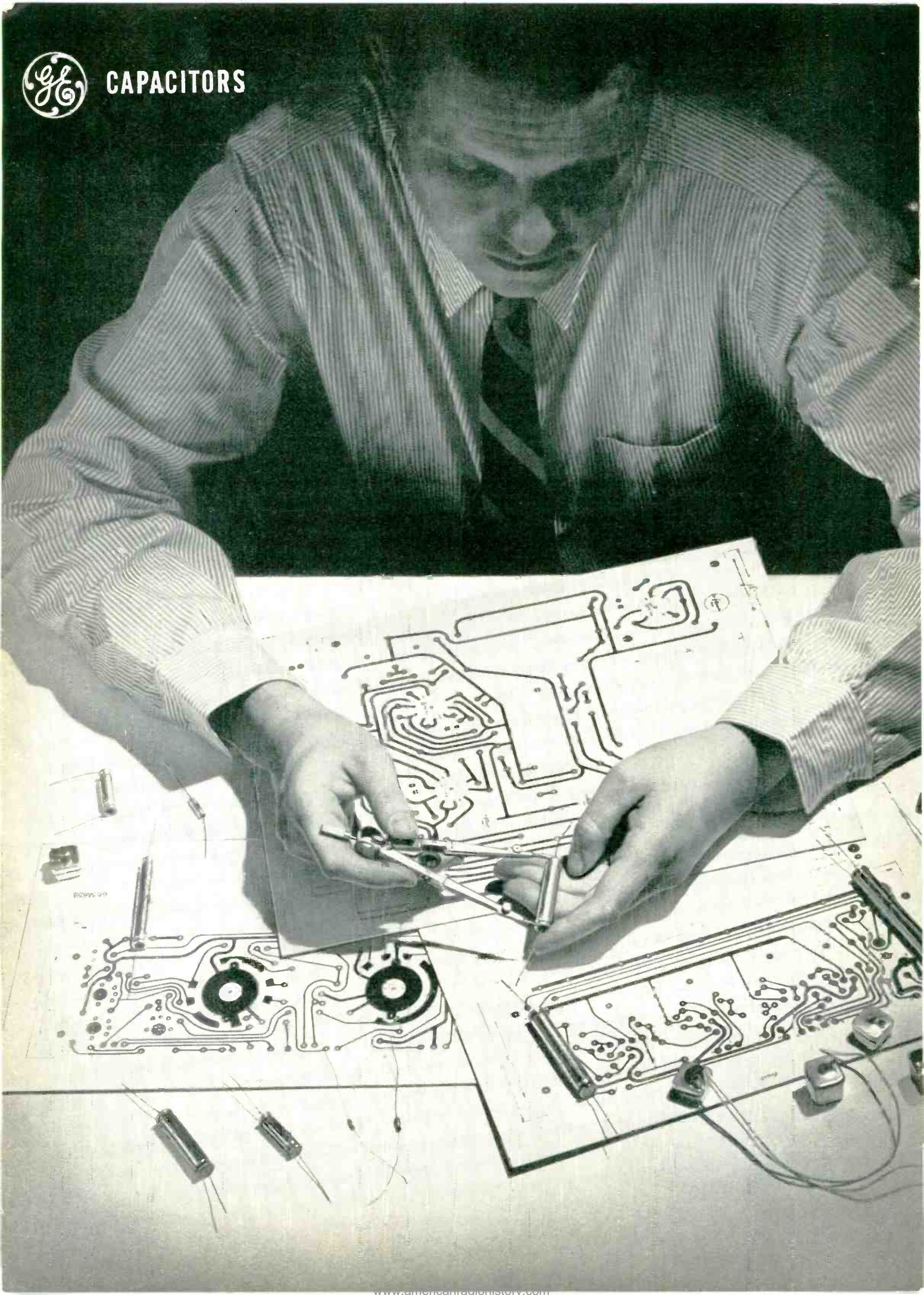



# How G-E Tantalytic\* Capacitors help solve your critical design problems

Three separate lines of G-E tantalum electrolytic capacitors to meet your size and temperature needs

No matter what capacitor problems you face in your most critical electronic applications, you're almost sure to find an answer in the three proven lines of Tantalytic capacitors now offered by General Electric.

**Is size your problem?** G-E Tantalytic capacitors carry extremely high uf ratings per cubic centimeter, especially in the 0-150 VDC range. In some ratings, Tantalytic capacitors are actually less than 1% the size of comparably rated paper capacitors.

**Is high reliability your problem?** Where small size and high reliability are "musts," as they are in communications equipment for example, G-E Tantalytic capacitors meet the challenge. Their high quality assures long, more reliable operation — at a real saving in circuit space.

**Is high temperature your problem?** For extremely high ambient temperatures, as found in

high-speed aircraft and guided missile applications, you can count on G-E high-temperature Tantalytic capacitors. They operate at full rated voltage from -55C to +125C. Rectangular and tubular designs are available to meet the varying requirements of modern electronic design.

General Electric engineers have accumulated a wealth of life test and other data through a long period of testing tantalum capacitors under every conceivable condition of operation. As a result, G-E Tantalytic capacitors may be relied upon for mechanical and electrical stability and maximum efficiency in operation.

Let your G-E Apparatus Sales Representative show you how these capacitors can answer your particular problems. Or, if you would like further information (ratings and specifications) on G-E Tantalytic capacitors write directly to the General Electric Company, Section 442-30, Schenectady 5, N. Y.

\*Reg. trade-mark of General Electric Co.

*Progress Is Our Most Important Product*

GENERAL  ELECTRIC

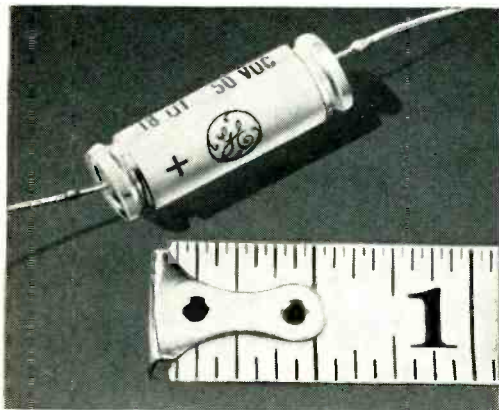

**85 C TANTALYTIC CAPACITORS** for circuits requiring low leakage current, long shelf life. Available in polar or non-polar types for a-c and d-c. Ratings 0.25-580 uf, 3.75-150 v. Tol.  $\pm 20\%$  (plain foil), -15 to +75% (etched). Temp. range -55 to +85 C. Write for Bulletins GEC-808 and GET-2333.

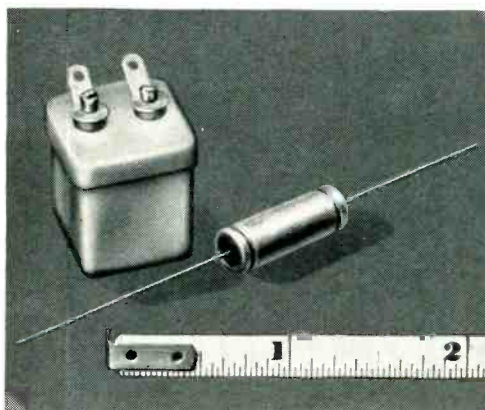

**125 C TANTALYTIC CAPACITORS** for high-speed aircraft and guided missile electronic systems where quality, long life, small size are main requirements. Available in plain or etched foil, in rectangular or tubular designs. Ratings 0.25-180 uf, 10-100 v. Tol.  $\pm 20\%$  (plain foil), -15 to +75% (etched). Temp. range -55 to +125 C. Write for Bulletins GEA-6258, GET-2502, and GET-2513.

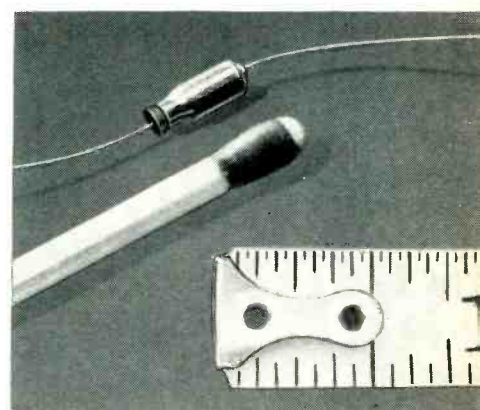

**MICRO-MINIATURE TANTALYTIC CAPACITORS** for low-voltage d-c, transistorized electronic equipment such as hearing aids, pocket radios. Ratings 1-8 uf at 4 VDC, 1 uf at 8 VDC, 0.5 uf at 16 VDC. Tolerance -0 to +200%. Temperature range -20 to +50 C. Bulletins GEA-6065 and GET-2405.



**BH VINYL-SIL 8000  
Fiberglas Sleeving**

**with insulations . . .  
check the MINIMUM, first**

For effective product protection, only an insulation's minimum rating can be trusted. With BH Vinyl-Sil 8000 you get a tested rating of 8,000 volts minimum dielectric breakdown . . . 3,000 volts above the NEMA standard for Grade B-A-1.

But that's not all. When resistance to moisture . . . or flow . . . or high and low temperatures . . . or corrosion is needed, it's BH Vinyl-Sil 8000 you need. Advantages like these have led many manufacturers of electrical and electronic equipment to use this new product for their tough insulation jobs. Yet, the price isn't premium. Even with its unique combination of braided Fiberglas coated with stabilized vinyl resins and those of the silicone group, BH Vinyl-Sil 8000 costs no more than previously available sleeveings with far lower ratings.

You can easily determine BH Vinyl-Sil 8000's advantages. Simply send for testing samples and data sheets today. Then you'll see what it can do.

BENTLEY, HARRIS MANUFACTURING CO.  
1302 Barclay St.  
CONSHOHOCKEN, PA. TELEPHONE: CONSHOHOCKEN 6-0634

**BENTLEY, HARRIS.**

*Fiberglas\**  
**SLEEVINGS**

\*BH Non-Fraying Fiberglas Sleeveings are made by an exclusive Bentley, Harris process (U.S. Pat. Nos. 2393530; 2647296 and 2647288). "Fiberglas" is Reg. TM of Owens-Corning Fiberglas Corp.

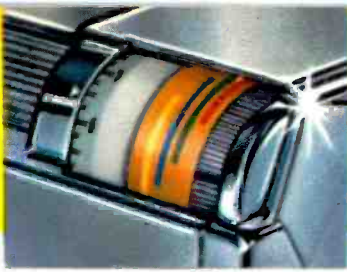

Simplest copy control ever...  
it's the *DIAL THAT DOES IT!*

*New*

# ALL-PURPOSE\* COPY MAKER

*...copies anything*

IT'S THE BRAND NEW

**APECO**

DIAL-A-MATIC

*Auto-Stat*

Now get copies of anything written, printed, typed, drawn, photographed or blueprinted. All copies made the same easy way right in your own office.

Here is the one copy maker that fulfills all copying requirements of offices large and small. The new Apeco Dial-A-Matic Auto-Stat offers hundreds of money and time saving uses. It is so low cost it pays for itself in less than a year... even when less than 5 copies a day are needed. It's fast, economical, and so easy to operate with revolutionary finger tip dial control. It's light weight... compact to fit on the corner of any desk and styled in gleaming mirror finish stainless steel... free lifetime service guarantee.

**\*IT'S ALL-PURPOSE**

Copy any color, opaque or transparent original printed on one or both sides. Make copies up to 15" wide, any length! Anything on the original *must* appear on the error-free, permanent and legally accepted Apeco copy.

Styled by  
Charles E. Jones & Assoc.



American Photocopy Equipment Co. (Dept. E-26)  
1920 W. Peterson Ave.  
Chicago 26, Ill.

Rush me, without obligation, your free booklet on new Apeco Dial-A-Matic Auto-Stat copying. I understand this factual report will show me how I can improve the efficiency of my business as well as increase work output.

Name \_\_\_\_\_

Address \_\_\_\_\_

Firm \_\_\_\_\_

City \_\_\_\_\_ State \_\_\_\_\_

In Canada: Apeco of Canada, Ltd., 134 Park Lawn Rd., Toronto, Ont.

Have you read this  
**NEW BOOKLET?**

Mail this air mail postage  
paid card for your

**FREE  
BOOK**



**AMERICAN PHOTOCOPY EQUIPMENT CO.**  
Chicago 26, Ill.





# COPY ANYTHING AUTOMATICALLY



*It's  
All-Purpose*  
One machine copies  
everything. It's the easiest  
way ever to speed up  
routine office  
copying.

## New FREE booklet tells you how!

Your free copy of this new booklet is packed with pictures and details about this revolutionary new copying method. Tells what Apeco Dial-A-Matic Auto-Stat copies are and how you can use these copies in your business. You, as well as every executive member of your staff, should read this worthwhile informative, factual report on this important new copy maker. You will find out how you can save time and money by speeding production, by cutting costly office paper work, by expediting shipping and receiving and hundreds of other ways to increase the efficiency of your business.

**APĒCO**  
DIAL-A-MATIC *Auto-Stat*



**FIRST CLASS**  
Permit No. 26670  
(Sec. 34.9 P. L. & R.)  
Chicago 26, Ill.

Via Air Mail

**BUSINESS REPLY CARD**  
No postage stamp necessary if mailed in the United States

5c—Postage will be paid by—

**AMERICAN PHOTOCOPY EQUIPMENT CO.**  
1920 W. Peterson Ave.  
Chicago 26, Ill.



Use this tear-out postage paid air mail card  
**MAIL CARD TODAY**  
for Free Booklet

**2 TO 36  
VOLTS  
@ 15 AMPS  
DC POWER SUPPLY**

The **NEW PERKIN**

**MODEL MR532-15A**

with  $\pm 1/2\%$  **REGULATION**

**IMMEDIATE  
DELIVERY!**

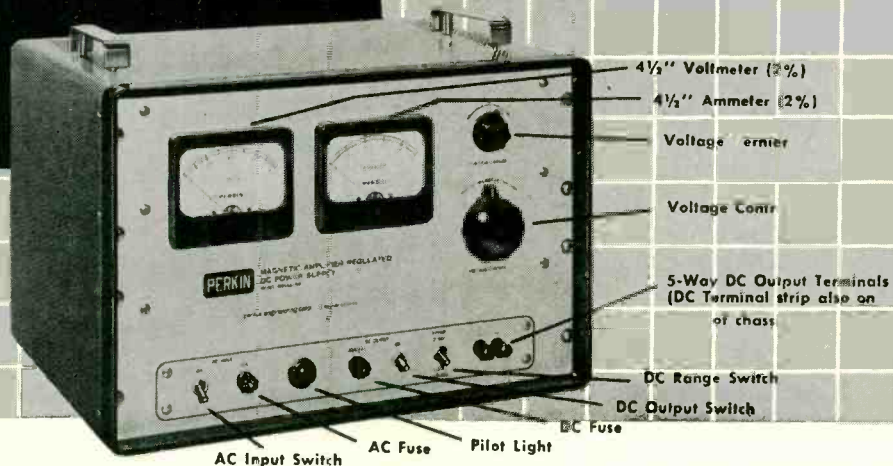

**Now...for Your Laboratory...the most versatile TUBELESS,  
Regulated and Filtered Power Supply**

For PROMPT REPLY, wire the factory collect or phone our nearest sales office.

New York City:	HUnter 2-7784
Philadelphia:	NOrristown 5-2600
Chicago:	Dlversey 8-6885
Los Angeles:	SYcamore 8-5790
St. Louis:	DElmar 7701
Kansas City, Mo.:	JEfferson 7221
Dallas:	FOrrist 8-8306
Denver:	MAIn 3-0343
San Francisco:	ULmar 1-7129
Syracuse:	2-1167
Pittsburgh:	WAInut 1-2959
Minneapolis:	Mldway 2-7884
Seattle:	MOhawk 4895
Albuquerque:	5-9632
Boston:	Mlssion 8-0756
Atlanta:	ELgin 3020
Winston Salem, N.C.:	4-0750
Ontario, Canada	AXminister 3-5771

- REMOTE SENSING • VERNIER VOLTAGE CONTROL
- NO TUBES, MOVING PARTS OR VIBRATING CONTACTS

Specifications . . . .

**REGULATION:** 5-32V Range:  $\pm 1/2\%$  for combined line changes of 105-125VAC and load of 0-15A. DC.

2-5V Range:  $\pm 2\%$  for combined line changes of 105-125VAC and load changes of 0-15A. DC.

32-36V Range:  $\pm 2\%$  for combined line changes of 110-125VAC and load changes of 0-15A. DC.

**RIPPLE:** 1% rms max. @ 36 volts and full load. Increases to 2% @ 2 volts and full load.

**AC INPUT:** 105 to 125 volts, 1 phase, 60 cps. (8 amps, Input)

**RESPONSE TIME:** 0.1 to 0.2 seconds maximum.

**DIMENSIONS:** 19 1/2" wide x 15 1/2" deep x 13 1/4" high with cabinet. (19" wide x 14 1/4" deep x 12 1/4" high rack panel construction)

**FINISH:** Gray Hammerlone      **WEIGHT:** Approx. 135 lbs.

Write for Bulletin MR 532-15A



**PERKIN ENGINEERING CORP.**  
345 KANSAS ST. • EL SEGUNDO, CALIF. • DRegon 8-7215 or EAstgate 2-1375

AEROCOM'S 1046 H. F. TRANSMITTER

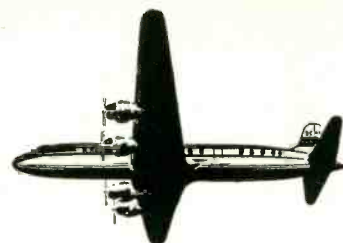

# POWER + STABILITY

1000 WATTS

WITH

.003% STABILITY

Rugged, versatile general purpose H. F. transmitter—Aerocom's 1046 packs 1000 watts of power and high .003% stability under normal operating conditions (0° to +50°C.). Excellent for point-to-point or ground-to-air communications.

Multi-channel operation on telegraph A1, or telephone A3 with GM-8A modulator... new Aerocom 1046 can be *remotely controlled* with TMC-R at control position and uses only one pair of telephone lines. In A3 operation, the local dial control panel is located in modulator cabinet.

Transmitter cabinet has 8 $\frac{3}{4}$  inch panel space available for either local dial control panel or frequency shift keyer.

Model 1046 operates on 4 crystal-controlled frequencies (plus 2 closely spaced frequencies) in the band 2.0—24 Mcs. Operates on one frequency at a time; channeling time 2 seconds. Operates into either balanced or unbalanced loads. Operates in ambient -35° to +50° C. Power supply: nominal 220 volts, 50-60 cycles, single phase.

*Complete technical data on request*

**Now! Complete - package, lightweight airborne communications equipment by Aer-O-Com! Write us today for details!**

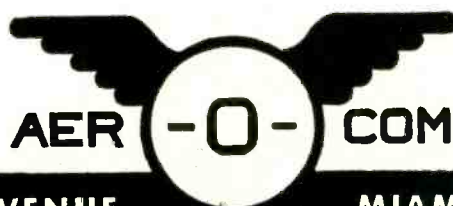
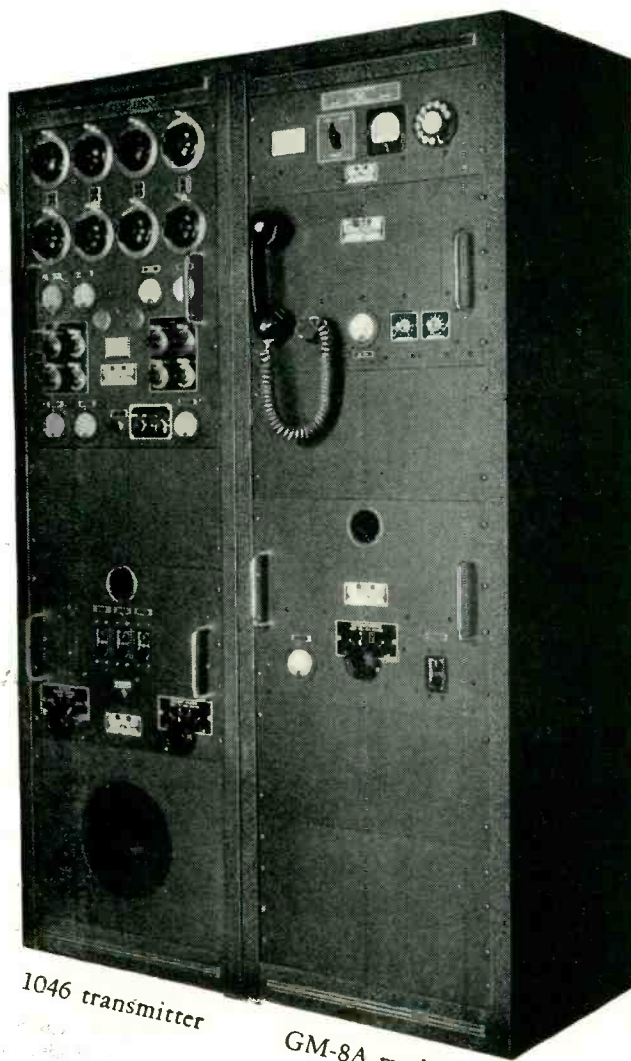

3090 S.W. 37th AVENUE

MIAMI 33, FLORIDA

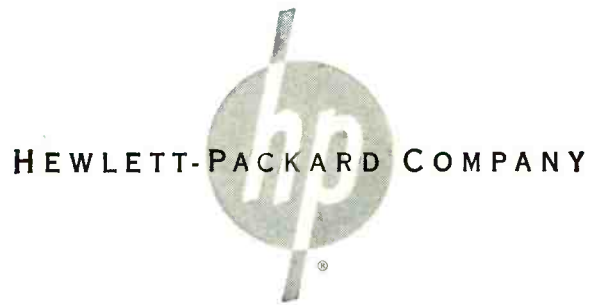

## WHY LEADING MANUFACTURERS USE RAYTHEON MAGNETRONS AND KLYSTRONS

*Excellence in Electronics*



**RAYTHEON MAKES:**

Magnetrons and Klystrons, Backward Wave Oscillators, Traveling Wave Tubes, Storage Tubes, Power Tubes, Receiving Tubes, Transistors

A good test of any product is the company it keeps. The famous trademarks above belong to only four of the many distinguished companies which use Raytheon magnetrons and klystrons in their microwave equipments.

Manufactured under precision controls by skilled men and women, Raytheon microwave tubes give you the utmost in first-rate performance, long life, and continuous duty under demanding conditions.

**RAYTHEON MANUFACTURING COMPANY**  
Microwave and Power Tube Operations, Sec. PT-45  
Waltham 54, Mass.

# only **SOUTHCO** drive rivets offer all these benefits!

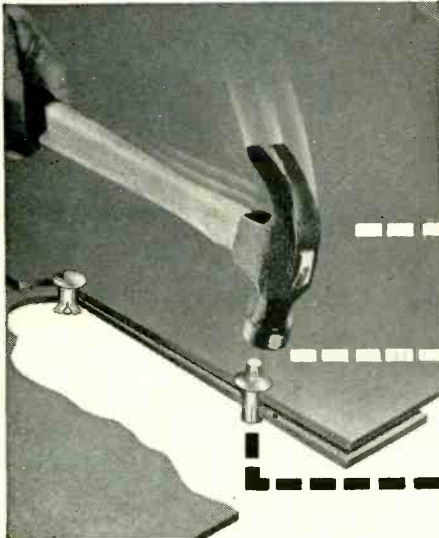

Rivet and Mfg. Patented.

**A HAMMER IS THE ONLY TOOL**

**DRIVE LIKE NAILS**

**AUTOMATIC "PULL-UP" ACTION FORCES PARTS TOGETHER**

## Note

No special tools to buy or maintain, no bucking up, no finishing, no noise, no material waste.

Just hit the pin, the rivet's in . . . that's all.

On your production line, where can savings be made with Southco Drive Rivets? Write for complete data. Southco Division, South Chester Corporation, 233 Industrial Highway, Lester, Pa.

**FOR BLIND APPLICATIONS**

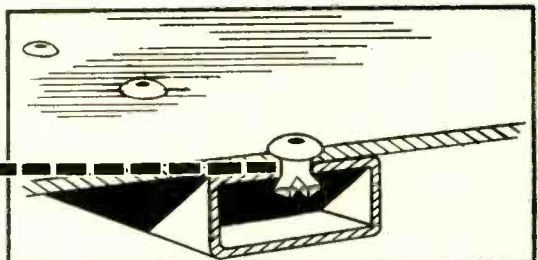

**FOR ACCESS APPLICATIONS**

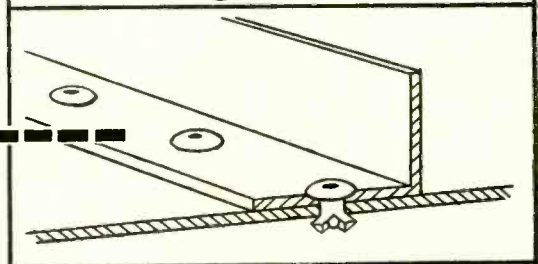

**FOR METAL-TO-WOOD APPLICATIONS**

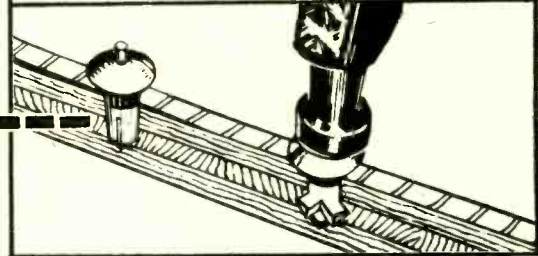

**SPEED ASSEMBLY . . . CUT COSTS**

**SOUTHCO**

**FASTENERS**

**PAWL • SCREW AND SPRING • DRIVE RIVETS • ANCHOR NUTS • ENGINEERED SPECIALTIES**

**OFFICES IN PRINCIPAL CITIES**

WHEREVER TWO OR MORE PARTS ARE FASTENED TOGETHER; STANDARD AND SPECIAL DESIGNS FOR IMPROVED PERFORMANCE AND LOWER PRODUCTION COSTS



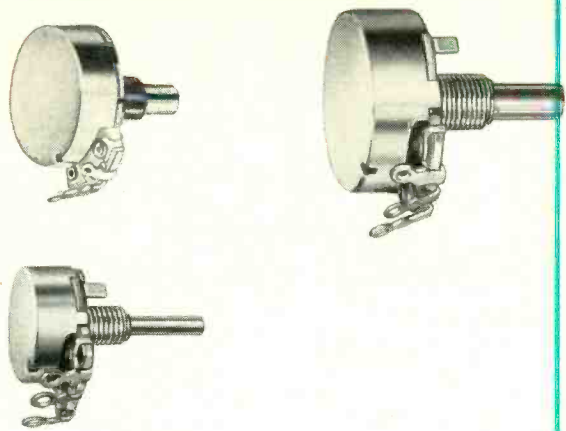

# VARIABLE RESISTORS

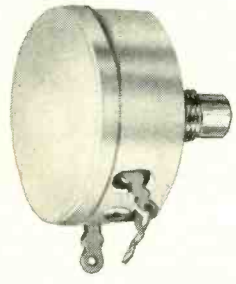
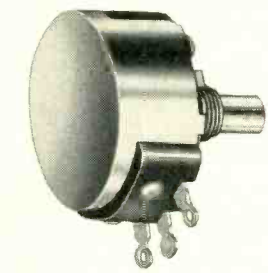
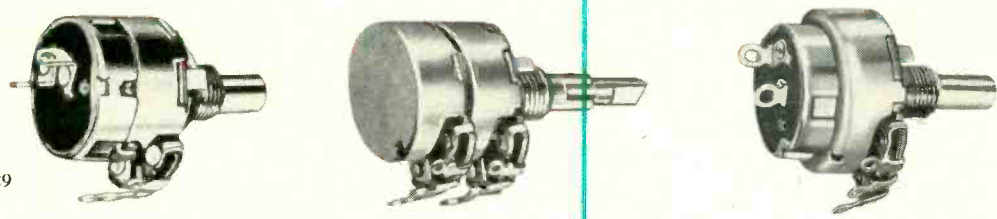

**EAST COAST OFFICE**  
Henry E. Sanders  
130 N. Broadway  
Camden 2, New Jersey  
Phone: Woodlawn 6-1668  
TWX No. Camden NJ 380  
Phila. Phone: Market 7-3129

**WEST COAST OFFICE**  
Robert A. Stackhouse  
928 S. Robertson Blvd.,  
Los Angeles 35, Calif.  
Phone: Crestview 4-5931  
TWX No. BEV H 7666

**SOUTHWESTERN U.S.A.**  
John A. Green Company  
6815 Oriole Drive  
P.O. Box 7224  
Dallas 9, Texas  
Phone: Dixon 9918

**CANADIAN DIVISION**  
C. C. Meredith & Co., Ltd.  
Streetsville, Ontario  
Phone: 310

**SOUTH AMERICA**  
Jose Luis Pontet  
Buenos Aires, Argentina  
Montevideo, Uruguay  
Rio de Janeiro, Brazil  
Sao Paulo, Brazil

**OTHER EXPORT**  
Sylvan Ginsbury  
8 West 40th Street  
New York 18, New York  
Phone: Pennsylvania 6-8239

275,000 sq. ft. plant area . . . 1500 employees . . .  
making ALL TYPES of variable resistors by the million . . . for  
ALL TYPES of military and commercial applications.

Dependable delivery. Exceptionally good delivery  
cycle due to enormous mass production facilities.

A CTS control can be tailored to your specific requirement.  
Refer your control problems to CTS specialists today.



**CHICAGO TELEPHONE SUPPLY**  
*Corporation*

ELKHART \* INDIANA  
FOUNDED 1896

*The Exclusive Specialists in Precision Mass Production of Variable Resistors*



# Ucinite Magnetron Connectors

Ucinite manufactures a variety of special connectors for the heater and heater-cathode terminals of magnetrons. Many of these have been adapted for special applications as to size and function to meet the sealing and mounting requirements of high temperature and high altitude operation and other special conditions.

Connectors are coaxial in construction and can be supplied with built-in capaci-

tors for added protection. Connecting leads of any length can be furnished to customer's specifications.

With an experienced staff of design engineers, plus complete facilities for volume production, Ucinite is capable of supplying practically any need for metal or metal-and-plastics assemblies. Call your nearest Ucinite or United-Carr representative for full information or write directly to us.



**The**  
**UCINITE CO.**  
*Newtonville 60, Mass.*  
Division of United-Carr Fastener Corp.

*Specialists in*  
**ELECTRICAL ASSEMBLIES,  
RADIO AND AUTOMOTIVE**



The *Citation* Model No. F35-B

• for school, business, home, the educator, and industry. Ideal for churches, offices, stores and institutions.



The *Hi-Fi Pro* Model No. S36-B

• for musicians, sound engineers, lecturers, and industrial applications.

The *Finest* precision built  
Tape Recorders of the century

*Magnecord*, The Choice of Professionals



The *Editor* Model No. P60-A

• for broadcasting studios, recording studios, electronic measurements, educational and sales management applications.



The *Professional* Model No. M90

• for radio and TV studios, orchestral, industrial and electronic applications, and a great boon to the moving picture industry.

Every model carries the greatest line of operating features ever to be incorporated in any portable or console Tape Recorder!



A new booklet just published by Magnecord briefly outlines 207 valuable uses for a tape recorder in today's modern living, at home or away, at work or play. It segregates the 207 uses into classifications such as professional, educational, church, business, recreation, etc. Write, phone, or stop in for your copy.

**Magnecord, Inc.**

1101 SOUTH KILBOURN AVENUE, CHICAGO 24, ILL.

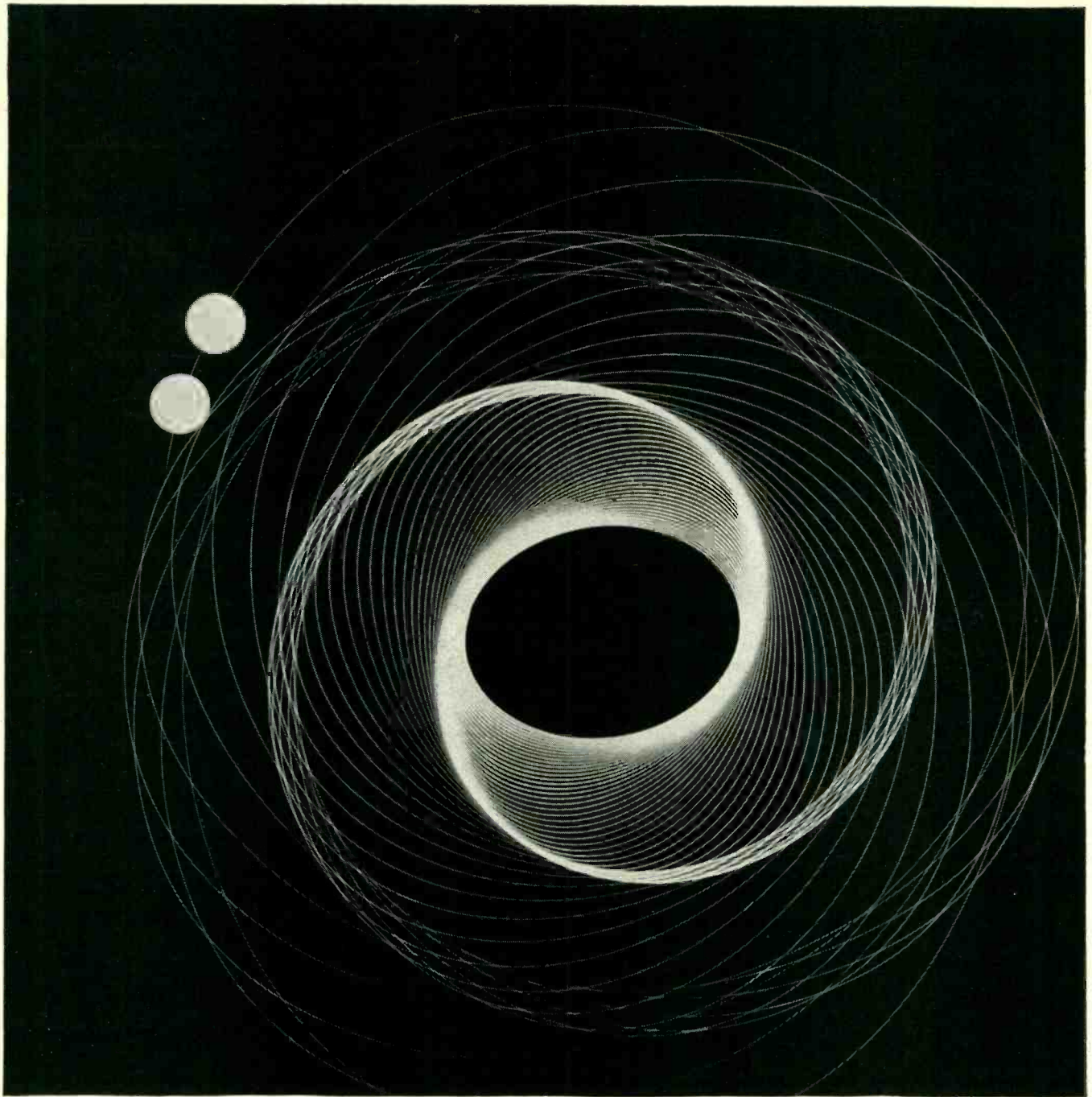

If you control movement of machines, traffic or materials, it'll pay you to use

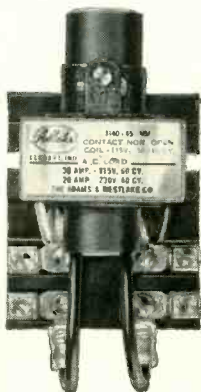

# Adlake mercury relays

The new Adlake Mighty Midget relay, like *all* Adlake relays, requires no maintenance whatever... is quiet and chatterless... free from explosion hazard. Dust, dirt, moisture and temperature changes can't affect its operation. Mercury-to-mercury contact gives ideal snap action, with no burning, pitting or sticking. Write for catalog and information.

**The Adams & Westlake Company**

Established 1857 • ELKHART, INDIANA • New York • Chicago  
the original and largest manufacturers of mercury plunger-type relays



# Waldes Truarc Rings Permit Better and More Economical Design—Fewer Parts, Faster Assembly, Minimal Rejects!

## Viewlex's Change-O-Matic

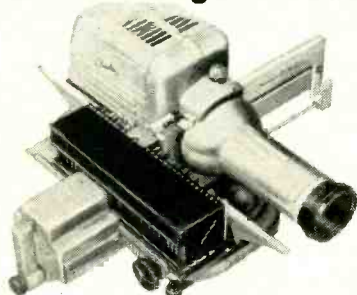

Viewlex, Inc., L. I. C., N. Y. solves a variety of fastening problems in their new model Change-O-Matic automatic slide changer. Assembly time is speeded, parts eliminated, rejects lowered, and compact, economical product design achieved.

## Connecting Arm Assembly

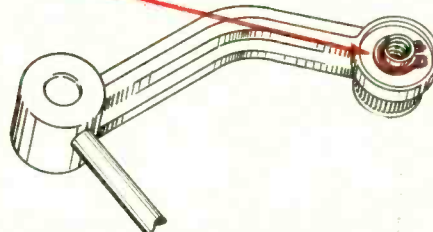

Use of one Waldes Truarc Ring (Series 5100) eliminates time-consuming riveting over the flange, retains and holds the connecting knob captive. A compact, neat design is made possible, rejects caused by poor riveting eliminated.

## Actuating Plate and Pawl Assembly

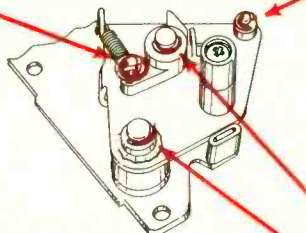

Three types of Waldes Truarc Retaining Rings are used in this assembly. One circular self-locking ring (Series 5105) retains pawl return spring. One external E-ring (Series 5133) retains roller used to prevent gear motion during transport cycle. One crescent ring (Series 5103) retains pawl which indexes gear. Second crescent ring retains sub-assembly. Truarc Rings speed assembly, cut rejects, eliminate parts.

## Detent Lever Assembly

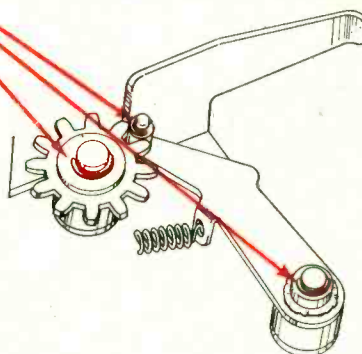

Truarc E-ring (Series 5133) eliminates use of tapped hole and shoulder screw, retains roller which prevents over-travel of gear. Assembly is rapid.

Whatever you make, there's a Waldes Truarc Retaining Ring designed to improve your product... to save you material, machining and labor costs. They're quick and easy to assemble and disassemble, and they do a better job of holding parts together. Truarc rings are precision engineered and precision made, quality controlled from raw material to finished ring.

36 functionally different types... as many as 97 different sizes

within a type... 5 metal specifications and 14 different finishes. Truarc rings are available from 90 stocking points throughout the U. S. A. and Canada.

More than 30 engineering-minded factory representatives and 700 field men are available to you on call. Send us your blueprints today... let our Truarc engineers help you solve design, assembly and production problems... without obligation.

For precision internal grooving and undercutting... Waldes Truarc Grooving Tool!

Send for new catalog supplement

**WALDES**  
**TRUARC**<sup>®</sup>  
**RETAINING RINGS**

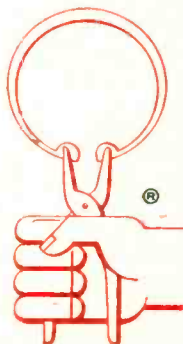

Waldes Kohlnoor, Inc., 47-16 Austel Place, L. I. C. T., N. Y.  
Please send the new supplement No. 1 which  
brings Truarc Catalog RR 9-52 up to date.  
(Please print)

Name.....  
Title.....  
Company.....  
Business Address.....  
City..... Zone..... State.....

EO28

WALDES TRUARC Retaining Rings, Grooving Tools, Pliers, Applicators and Dispensers are protected by one or more of the following U. S. Patents: 2,382,948; 2,411,426; 2,411,761; 2,416,852; 2,420,921; 2,428,341; 2,439,785; 2,441,846; 2,455,165; 2,483,379; 2,483,380; 2,483,383; 2,487,802; 2,487,803; 2,491,306; 2,491,310; 2,509,081; 2,544,631; 2,546,616; 2,547,263; 2,558,704; 2,574,034; 2,577,319; 2,595,787, and other U. S. Patents pending. Equal patent protection established in foreign countries.

**Flushed with DRY air,  
filled with DRY oxygen...**

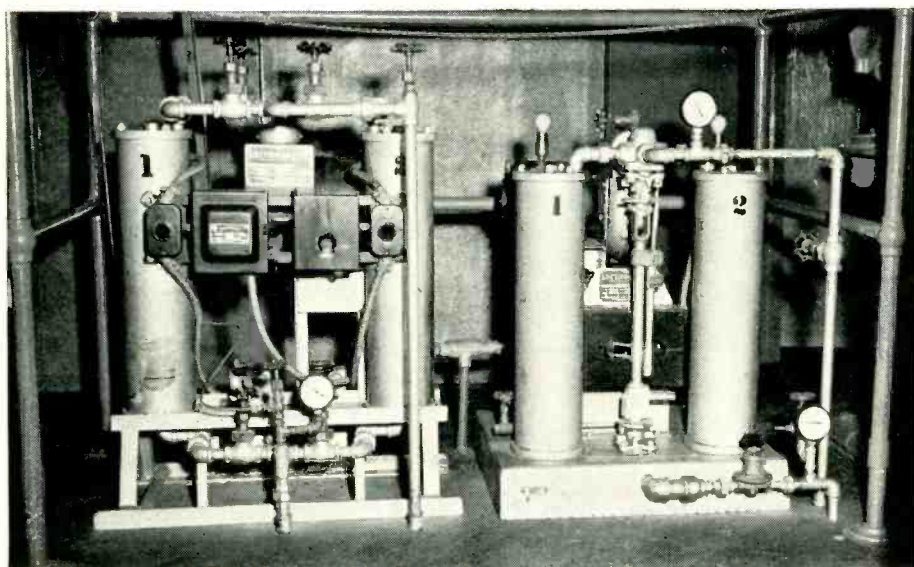

**dried to  $-70^{\circ}$   
dewpoint**

*DRY air and DRY oxygen are supplied to Flashbulb filling machines at Sylvania Electric Products, Inc., Montoursville, Pa., by these two BAC-O Lectrodryers.*

**T**HE PROMINENT POSITION occupied by these two Lectrodryers\* in the heart of this Sylvania plant is evidence of the importance of DRYing in this process. The air with which Flashbulbs are flushed, and the oxygen with which they are filled, are dried to  $-70^{\circ}\text{F.}$  dewpoint. Thus Sylvania makes certain of the high quality demanded in these products.

DRYing, as here at Sylvania, is an ingredient in certain processes; air, gases and organic liquids are specified to be free of all entrained and vaporous moisture. DRYing is a production tool in

many manufacturing operations. It speeds up the coating of television tubes, for example, and the curing of transformer insulation. Stockrooms, where finished products are stored, must be kept DRY to safeguard their quality.

Whatever your troubles with unwanted moisture, Lectrodryer engineers can help you solve them. The book, *Because Moisture Isn't Pink*, tells how they've helped others. For a free copy, write Pittsburgh Lectrodryer Corporation, 359 32nd Street, Pittsburgh 30, Pennsylvania.

In England: Birlec, Limited, Tyburn Road, Erdington, Birmingham.  
In France: Stein et Roubaix, 24 Rue Erlanger, Paris XVI.  
In Belgium: S. A. Belge Stein et Roubaix, 320 Rue du Moulin, Bressoux-Liege.

**LECTRODRYERS DRY  
WITH ACTIVATED ALUMINAS**

**LECTRODRYER**

\* REGISTERED TRADEMARK U. S. PAT. OFF.



## See why we don't use Automation?

It's not that we are old-fashioned, here at Karp. Far from it. We have one of the best tooled and equipped sheet metal fabrication plants in the world. Many of our machines, indeed, are equipped with electronic timing controls.

If the time ever comes when we feel that automation can give you finer work than our several hundred skilled craftsmen... we'll install automation. But that time is not now—nor in the foreseeable future.

You see, Karp was founded upon a perfectionist's idea about custom craftsmanship. Our methods are paying off because our painstaking work to exact specifications results in quality products to you, often at "ready-made" economies. And remember—our men who were skilled craftsmen ten or twenty years ago are even more highly skilled craftsmen today.

Let us quote you on your next requirement.



**KARP METAL PRODUCTS CO.**  
 Division of H & B American Machine Co., Inc.  
 214 63rd Street, Brooklyn 20, N. Y.

Custom fabricators of enclosures, chassis, panels in any metal • All welding facilities U. S. Air Force Certified • Air-conditioned spray room • Complete baking facilities • Over 3,000 dies available Complete sub-assembly facilities

# Why do so many Leading Industries Specify STANDARD PRECISION TIMING INSTRUMENTS for test cell, control room and laboratory?

Whether you are counting revolutions per minute, or measuring time, you can rely on the split-second precision of Standard Timers and Chrono-Tachometers for accurate, reliable readings.



*Engineer checks action of automatic transmission, with water simulating the flow of oil. His hand rests on a Standard timing instrument in the foreground.*

*Left: In this interesting test cell control room photograph a Standard Chrono-tachometer is located in the right foreground.*

"Precision and accuracy, plus simple, rugged, trouble-free construction" is the policy which has guided us for over 70 years in the design and manufacture of instruments for indicating and measuring time.

With the increasingly rigid requirements for precision in every phase of research and development, this policy of the Standard Electric Time Company assumes greater importance than ever before . . . If yours is a problem of extremely close tolerances in the measurement of time or in the checking of R.P.M.'s . . . let our engineers help you.



*The complex instrument panel in the control room of Control Point, Yucca Pass, Nevada Proving Grounds . . . The Precision Timers on the fourth and seventh sections are by Standard.*

SINCE **STANDARD** 1884

## The STANDARD ELECTRIC TIME CO.

97 Logan Street • Springfield 2, Massachusetts

PRECISION TIMERS • CHRONO-TACHOMETERS • LABORATORY PANELS • PIPELINE NETWORK ANALYZERS



...another

first

by

**Fansteel**

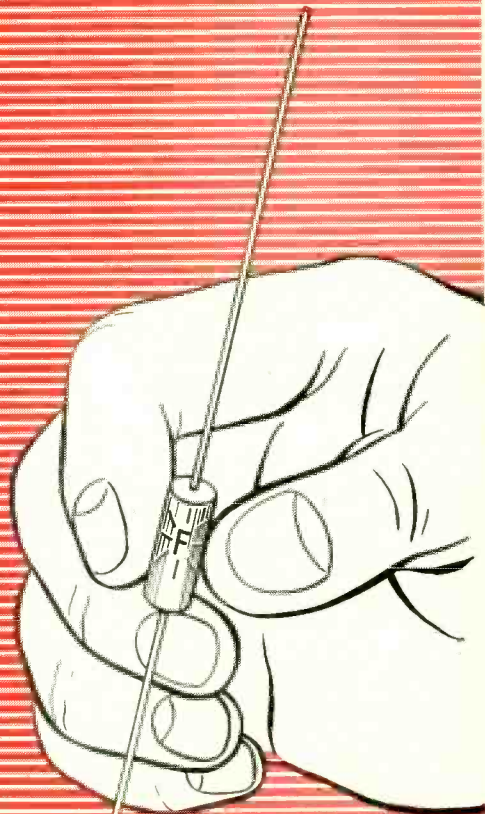

*the New*

**S-T-A**  
**SOLID TANTALUM**  
**CAPACITOR**

a brand new *concept*  
in **Capacitor engineering!**

**Fansteel Metallurgical Corporation**

**NORTH CHICAGO, ILLINOIS**

C562

**Olympic**  
TELEVISION

**CROSLEY**



**Spartan**

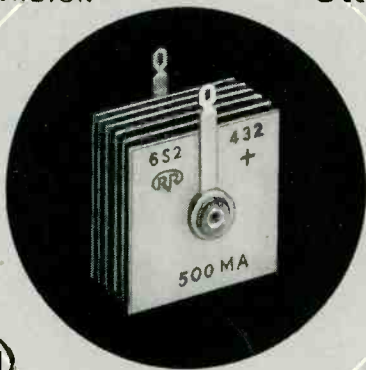

**MOTOROLA**

*Emerson*



**Sentinel**

**Admiral**

**CBS TV Sets**

**HOW'S THIS FOR  
A CONTINUOUS  
PERFORMANCE  
RECORD?**



**hallicrafters**

# RADIO RECEPTOR

*Selenium Rectifiers have*

*been original components in leading radio and TV sets since 1948*

These famous trademarks represent just a few of the many long-time users of RRco. Selenium Rectifiers . . . The complete list reads like a "Who's Who" in electronics.

We're proud of that list, and our old customers' continuing confidence in our products. RRco. rectifiers constantly prove their dependability in every kind of performance test.

When selecting rectifiers for *your* circuitry, remember that Radio Receptor units have been giving complete field satisfaction through the years in hundreds of different applications. The *millions* in actual operation today turn in the top performance you expect, month after month. Let us study *your* specifications now and offer recommendations. No obligation, of course.



*Semiconductor Division*  
**RADIO RECEPTOR COMPANY, INC.**  
*In Radio and Electronics Since 1922*

Sales Offices: 240 Wythe Avenue, Brooklyn 11, N. Y., Telephone: Evergreen 8-6000

RADIO RECEPTOR PRODUCTS FOR INDUSTRY AND GOVERNMENT: SELENIUM RECTIFIERS • GERMANIUM DIODES  
THERMATRON DIELECTRIC HEATING GENERATORS & PRESSES • COMMUNICATIONS, RADAR & NAVIGATION EQUIPMENT

# TUNING FORK RESONATORS THE ULTIMATE IN PRECISION AUDIO FREQUENCY CONTROL



**PHONE OR WRITE** for complete information regarding  
component type Tuning Fork Resonators, or  
variously packaged Tuning Fork Frequency Standards.



**PHILAMON LABORATORIES INC.**

90 Hopper Street, Westbury, Long Island, N. Y. EDgewood 3-1700

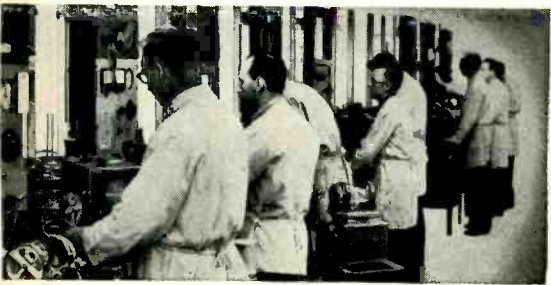

# LEAR PRODUCES

*This roster of Lear aviation products is, of necessity, incomplete. Many of these products are frequently combined to form an infinite variety of additional products or systems. Only enough typical devices are shown here to demonstrate Lear's mastery of a field of science and technology that uses thousands of such building blocks for meeting the highly specialized requirements of modern aircraft and missiles.*

## ∂ flight control systems

- Automatic altitude controllers
- Automatic approach couplers
- Automatic Mach number controllers
- Automatic pilots (lightplane)
- Automatic pilots (high-performance)
- Automatic pitch, yaw, and roll dampers
- Automatic rudder controllers
- Automatic wing flap systems
- Missile control systems
- Test equipment

## σ flight reference systems

- No-gimbal-lock vertical gyro indicators
- Stable platforms
- Test equipment
- Three-axis gyro indicators
- Vertical gyro indicators

## γ navigational systems

- Automatic radio direction finders
- Glide slope receivers
- High-latitude gyro compass systems
- Integrated ADF-magnetic compass systems
- Localizer receivers
- Marker beacon receivers
- VHF Omirange receivers

## ξ electro-mechanical systems

- Artificial feel systems
- Camera positioners
- Canopy control systems
- Carburetor air door controllers
- Convertiplane rotor positioning systems
- Cowl flap positioners
- De-icing valve positioners
- Engine throttle controllers
- Gas, hydraulic, fuel, valve positioners
- Inlet screen retraction systems
- Inlet vane angle controllers
- Jettison systems
- Landing gear lock systems
- Mechanical advantage ratio changers
- Oil cooler flap controllers
- Parachute door systems
- Precision remote positioning systems
- Supercharger blower shifters
- Test equipment
- Throttle friction controllers
- Trim tab positioners
- Turbo-prop clutch valve controllers
- Wing flap positioning systems

## λ electro-mechanical components

- Linear actuators
- Rotary actuators
- Servo actuators
- Power units
- Actuator controls
- Alternators
- Capstans

- Freewheeling clutches
- Friction clutches
- Magnetic clutches
- Slip overload clutches
- Electromagnetic brakes
- Flex drive h's, hex's, L's, and r's
- Flexible shafts
- Gearboxes
- Handcranks
- Motors (AC and DC)
- Enclosed fan motors
- Explosion proof motors
- Gearhead motors
- High frequency motors
- High temperature motors
- Miniature motors
- Pneumatic motors
- Servo motors
- Torque motors
- Screwjacks
- Load limit switches
- Position limit switches
- Programming switches

## ζ instruments

- ADF indicators
- Attitude indicators, 2-axis
- Attitude indicators, 3-axis
- Directional indicators
- ILS indicators
- Integrated ADF-magnetic indicators
- Trim indicators
- Tuning meters
- Omnirange indicators

## μ instrument components

- Altitude transducers
- Vacuum tube amplifiers
- Magnetic amplifiers
- Printed and etched circuit amplifiers
- Transistor amplifiers
- Displacement gyros

Executive Offices : Santa Monica, Calif. • Grand Rapids Division : Grand Rapids, Mich.



*for the precision needs of aviation*

Dynamic pressure transducers  
Gravity-sensing switches  
Magnetic modulators  
Magnetic powder clutches  
Ac and dc servo motors  
Electric gyro motors  
Flag motors  
High-frequency motors  
Torque motors  
Power converters  
Rate generators  
Rate gyros  
Resolvers  
Synchros  
Synchro repeaters

$\psi$  *communications systems*

UHF, VHF, HF, MF, and LF receivers  
VHF transceivers  
VHF, HF, and MF transmitters  
ADF receivers  
Airport traffic transceivers  
Monitoring transceivers  
Portable transceivers  
Telemetry receivers  
Test equipment

$\epsilon$  *communications components*

Audio frequency amplifiers  
Vacuum tube amplifiers  
Magnetic amplifiers  
Power amplifiers  
Printed and etched circuit amplifiers  
Transistor amplifiers  
Aircraft broadband antennas  
Ground plane antennas  
LF-MF whip antennas  
Loop antennas  
Mobile antennas  
Trailing wire antennas  
UHF-VHF whip antennas  
VHF Omnidirectional antennas

Antenna fairleads  
Antenna reels  
Antenna tuning coils  
Cable assemblies  
Coil assemblies  
Crystals  
Dynamotors  
Headsets  
Loudspeakers  
Amplifying loudspeakers  
Noise-cancelling microphones  
Radio noise filters

$\phi$  *test equipment*

Bench test cable assemblies  
Electronic test sets  
Field strength meters  
Pressurizing test kits  
Universal electro-mechanical test stands  
Universal motor test stands

$\eta$  *fluid handling equipment*

Absolute pressure switches  
Bombsight and instrument desiccators  
Canopy seal pressurizing kits  
Cooling units for electronic assemblies  
Dehydrators  
Fuel flow dividers  
Pneumatic actuators  
Pressurizing control panels  
Alcohol pumps  
Anti-detonant injection pumps  
Ballast pumps  
Bilge and refueling pumps  
Dry air pumps  
Electric motor driven pumps  
Ethylene glycol and coolant pumps  
Ethylene oxide pumps  
Fuel pumps  
Fuel booster pumps  
Fuel filter de-icer pumps  
Fuel transfer pumps

Hand operated pumps  
Heater fuel pumps  
Hydraulic pumps  
Hydraulic oil booster pumps  
Hydrogen peroxide pumps  
Lube oil and scavenge pumps  
Multiple-element pumps  
Oil transfer pumps  
Scavenge pumps  
Smoke pumps  
Submerged fuel booster pumps  
Vacuum pumps  
Water pumps  
Radar pressurizing kits  
Rocket engine fueling nozzles  
Air relief valves  
Check valves  
Hydraulic valves  
Hydraulic servo valves  
Isobaric relief valves  
Pressure regulating valves  
Vacuum valves

$\pi$  *miscellaneous*

Airborne television installations  
Airplane brake modernization kits  
Auxiliary power supplies  
Electronic chassis assemblies  
Executive airplanes  
Periscope prism selectors  
Precision remote positioners  
Printed circuits  
Radomes  
Wire harnesses

**LEAR**



CP-13

project for '56... join the

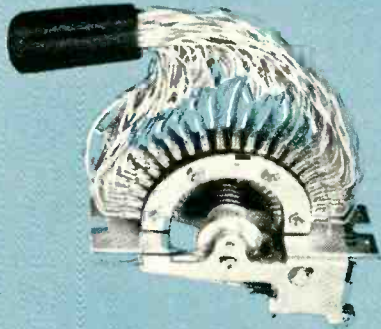

Visit us at the  
booths 770-772  
kingsbridge armory  
new york city

**I**  
**R**  
**E**  
SHOW

**AMP**

Aircraft-Marine Products, Inc.

®

**A-MP****taper****parade**

Are you in step with the more progressive manufacturers of BUSINESS MACHINES—AIRCRAFT—GUIDED MISSILES—ELECTRONIC EQUIPMENT—who have approved and are profiting by the use of A-MP TAPER TECHNIQUE?

There is still room on the A-MP TAPER TECHNIQUE Band Wagon for you to join the leaders. You, too, can increase speed of assembly, improve reliability, and save money by using A-MP TAPER PINS, TAPER TAB RECEPTACLES, TAPER BLOKS and TAPER TIPS.

And you'll be "cheered on" by the many alert manufacturers of electrical and electronic components who have modified their standard products to help you enjoy the advantages of A-MP TAPER TECHNIQUE.

Make it a **MUST** to specify A-MP TAPER TECHNIQUE in your **PROJECTS** for 1956.



GENERAL OFFICES: HARRISBURG, PENNSYLVANIA

1. A-MP of Canada, Ltd. Toronto, Canada • 2. A-MP—Holland N.V.'s-Hertogenbosch, Holland  
• 3. Aircraft-Marine Products (G.B.) Ltd., London, England • 4. Societe A-MP de France, Courbevoie, Seine, France

®Trademark

# Mid-Century's MC-400 Computers Star at

## ECLIPSE-PIONEER

DIVISION OF BENDIX AVIATION CORPORATION

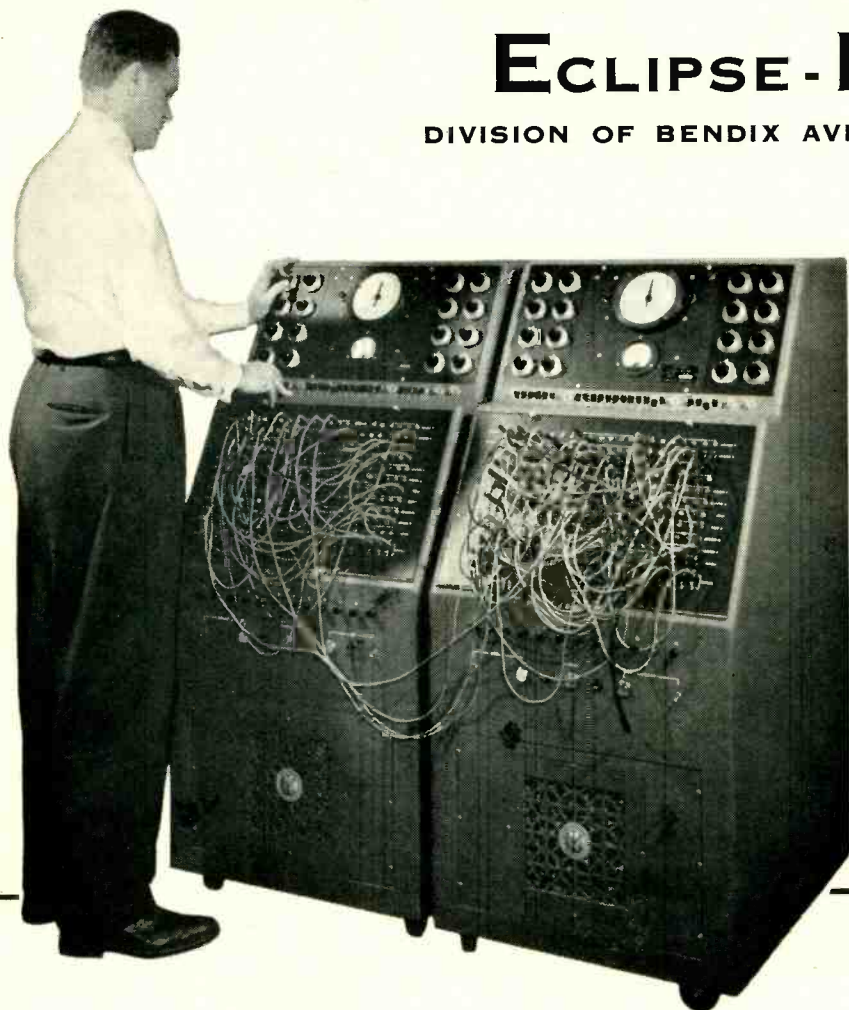

*Because they  
are ideal,  
low-cost  
laboratory  
tools!*

These small, compact computers were especially designed to meet the requirements of a desk-side computer, training device, dynamic tester, laboratory tool, or as a building block which may be either expanded or appended to other equipment. And, they have all of the quality, amplifier precision and power supply to make them equal to and, in some cases, better than the larger machines now available.

### The MC-400 Portable Computer contains:

- ▶ Six Integrating-Summing chopper stabilized amplifiers.
- ▶ Six chopper stabilized summing amplifiers.
- ▶ Two amplifier driven relays.
- ▶ Sixteen scale factor potentiometers.
- ▶ One multiplying servo with indicator dial.
- ▶ Four diode limiters.
- ▶ All necessary power supplies for independent operation (line voltage 110 volts 60 cycles).



"precision is our business"

## MID-CENTURY INSTRUMATIC CORP.

611 BROADWAY, NEW YORK 12, N. Y.

Find out how a Mid-Century 400 analogue computer can solve specific problems in your business... just write or phone our nearest office today.

- SALES OFFICES
- 2000 Warrensville Center Rd. • Cleveland 21, Ohio • Evergreen 2-6160
- 5525 Wilshire Boulevard • Los Angeles 36, Calif. • Webster 4-0102
- 1313 Wellington Street • Ottawa, Ont., Canada • Telephone 8-6065



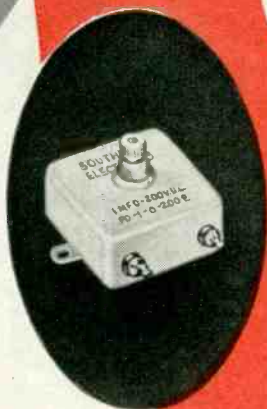
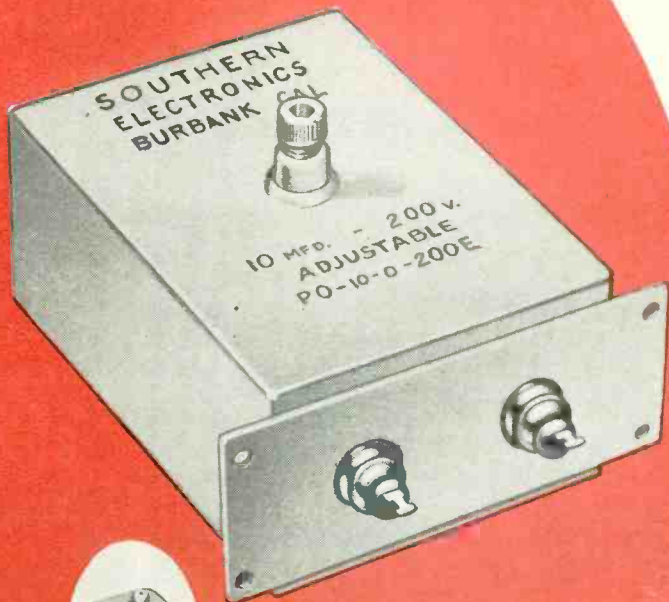
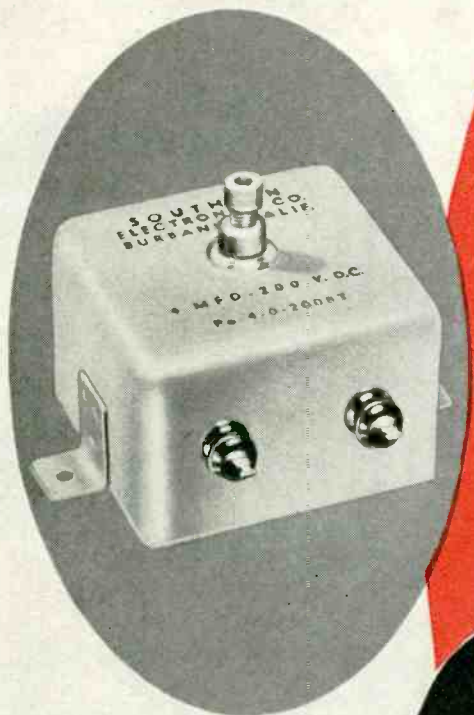

**NOW AVAILABLE FROM  
0.1 M.F.D. to 10 M.F.D.**

Check these outstanding features:

- Accuracy in the order of 0.1% or better!
- Long Time stability in the order of 0.03%!
- I.R.—@ 25° C— $10^{12}$  OHMS
- Dielectric Absorption—0.015%
- Dissipation Factor—0.0002
- Temp. Coeff. (—20° to 140° F.) 100 P.P.M. per °C

Excellent for Computer Integration, Test Equipment or Secondary Standards.

America's electronic leaders specify Southern Electronics' polystyrene capacitors for their most exacting requirements. Goodyear Aircraft, Beckman Instruments, Reeves Instrument Corp., Electronic Associates, Inc., Convair, M.I.T., Calif. Inst. of Tech., and many others. Make sure you're getting the finest—always specify S.E.C.!

Wire, write or phone for complete catalog today!

**ADJUSTABLE**  
precision  
polystyrene  
capacitors

... WITH PERFECT  
HERMETIC SEAL TO  
INSURE EXTREMELY  
LOW LEAKAGE!



**SOUTHERN ELECTRONICS**  
*Corporation*

239 West Orange Grove Ave., Burbank, California

# 3 NEW *hp* OSCIL

**6 cps to 6 KC. -hp- 200J** replaces -hp- 200I, for interpolation, frequency measurement, etc., where frequencies must be known precisely. New 160 mw balanced output, less than 0.5% distortion, frequency stability  $\pm 2\%$  or 0.2 cps. Six spread-scale frequency ranges, effective scale length 80" for maximum resettability. Calibration accuracy is  $\pm 1\%$ , frequency response  $\pm 1$  db full range. Output 160 mw or 10 v into 600 ohms, or 20 v open circuit, balanced to ground. Hum voltage less than 0.1% of output. \$275.00.

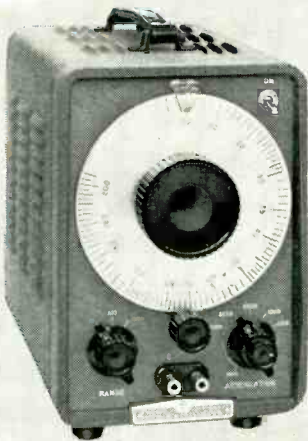

**20 cps to 20 KC. -hp- 201C.** Like popular -hp- 201B but more accurate attenuator, compact cabinet, lower price. Provides low distortion, high accuracy output for amplifier, loudspeaker, frequency comparison and other high fidelity measurements. Frequencies covered in 3 bands, calibration accuracy  $\pm 1\%$ , frequency stability  $\pm 2\%$  or 0.2 cps, frequency response  $\pm 1$  db full range. Output 3 watts or 42.5 v into 600 ohms. Distortion less than 0.5% above 50 cps. Output attenuator adjusts voltage 0 to 40 db, provides either low or constant 600 ohm impedance. \$225.00.

**1 cps to 100 KC. -hp- 202C.** New, multi-purpose instrument replacing -hp- 202B. Excellent wave-form for subsonic, audio, supersonic measurements in laboratory, field, factory. New broad frequency range, 160 mw balanced output, less than 0.5% distortion, high frequency stability, short recovery time (5 secs. at 1 cps), lowered price. Frequencies covered in 5 bands; frequency response  $\pm 1$  db full range, output 160 mw or 10 v into 600 ohms, 20 v open circuit, balanced to ground. Hum voltage less than 0.1%. \$300.00.



# LATORS

## finest built, reasonably priced

Utmost convenience and precise accuracy. Low distortion, high stability, wide frequency range, simple operation without resetting or adjustment. Attractive new cabinets, light and portable, yet rugged and compact.

The famous RC oscillator circuit, pioneered by *-hp-*, today refined to a high new level of performance and capability.

*-hp-* quality construction. Long-life electrolytic condensers, premium cost surface treated insulators, precision mechanical assemblies, specially built, 100% inspected transformers. All are standard in *-hp-* instruments to insure freedom from electrical and mechanical trouble, or the effects of dust, humidity and hard use.

These are the basic features of the three new *-hp-* oscillators now joining the 60,000 other *-hp-* RC oscillators in use throughout science, the military and industry.

These same features are fundamental in every *-hp-* oscillator. Every instrument bearing the Hewlett-Packard name is designed for the utmost in convenience, dependability, accuracy—the standard of quality in instrumentation, the very finest of its type made anywhere—yet available to you at a reasonable price.



provides complete coverage of your oscillator requirements

### Oscillators—.008 cps to 10 MC

Instrument	Primary Uses	Frequency Range	Output	Price
-hp- 200AB	Audio tests	20 cps to 40 KC	1 watt/24.5 v	\$120.00
-hp- 200CD	Audio and ultrasonic tests	5 cps to 600 KC	160 mw/20 v open circuit	150.00
-hp- 200J	Interpolation, frequency measurements	6 cps to 6 KC	160 mw or 10 v/600 ohms; 20 v open circuit	275.00
-hp- 200T	Telemetry, carrier current tests	250 cps to 100 KC	160 mw or 10 v/600 ohms; 20 v open circuit	350.00
-hp- 201C	High quality audio tests	20 cps to 20 KC	3 watts or 42.5 v/600 ohms; one terminal grounded	225.00
-hp- 202A	Low frequency measurements	.008 to 1200 cps	20 mw/10 v	465.00 <sup>△</sup>
-hp- 202C	Low frequency measurements	1 cps to 100 KC	160 mw or 10 v/600 ohms; 20 v open circuit	300.00
-hp- 205AG	High power tests, gain measurements	20 cps to 20 KC	5 watts	440.00 <sup>△</sup>
-hp- 206A	High quality, high accuracy audio tests	20 cps to 20 KC	+ 15 dbm	565.00 <sup>△</sup>
-hp- 233A	Carrier test oscillator	50 cps to 500 KC	3 w/600 ohms	475.00
-hp- 650A	Wide range video tests	10 cps to 10 MC	15 mw/3 v	490.00 <sup>△</sup>

<sup>△</sup> Rack mounted instrument available for \$15.00 less.

Data subject to change without notice. Prices f.o.b. factory.

### HEWLETT-PACKARD COMPANY

3552A PAGE MILL ROAD • PALO ALTO, CALIFORNIA, U.S.A.  
SALES ENGINEERS IN ALL PRINCIPAL AREAS  
CABLE "HEWPACK" DAVenport 5-4451

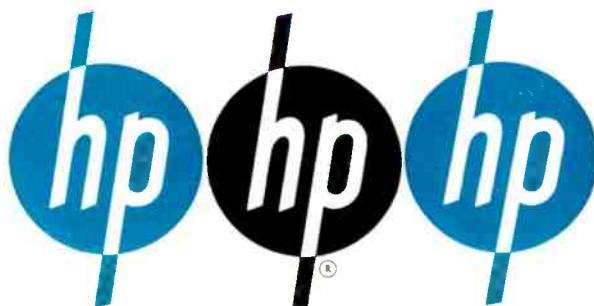

WORLD'S MOST COMPLETE LINE OF HIGH QUALITY ELECTRONIC MEASURING INSTRUMENTS

# "Bellows Action in Printed Circuit

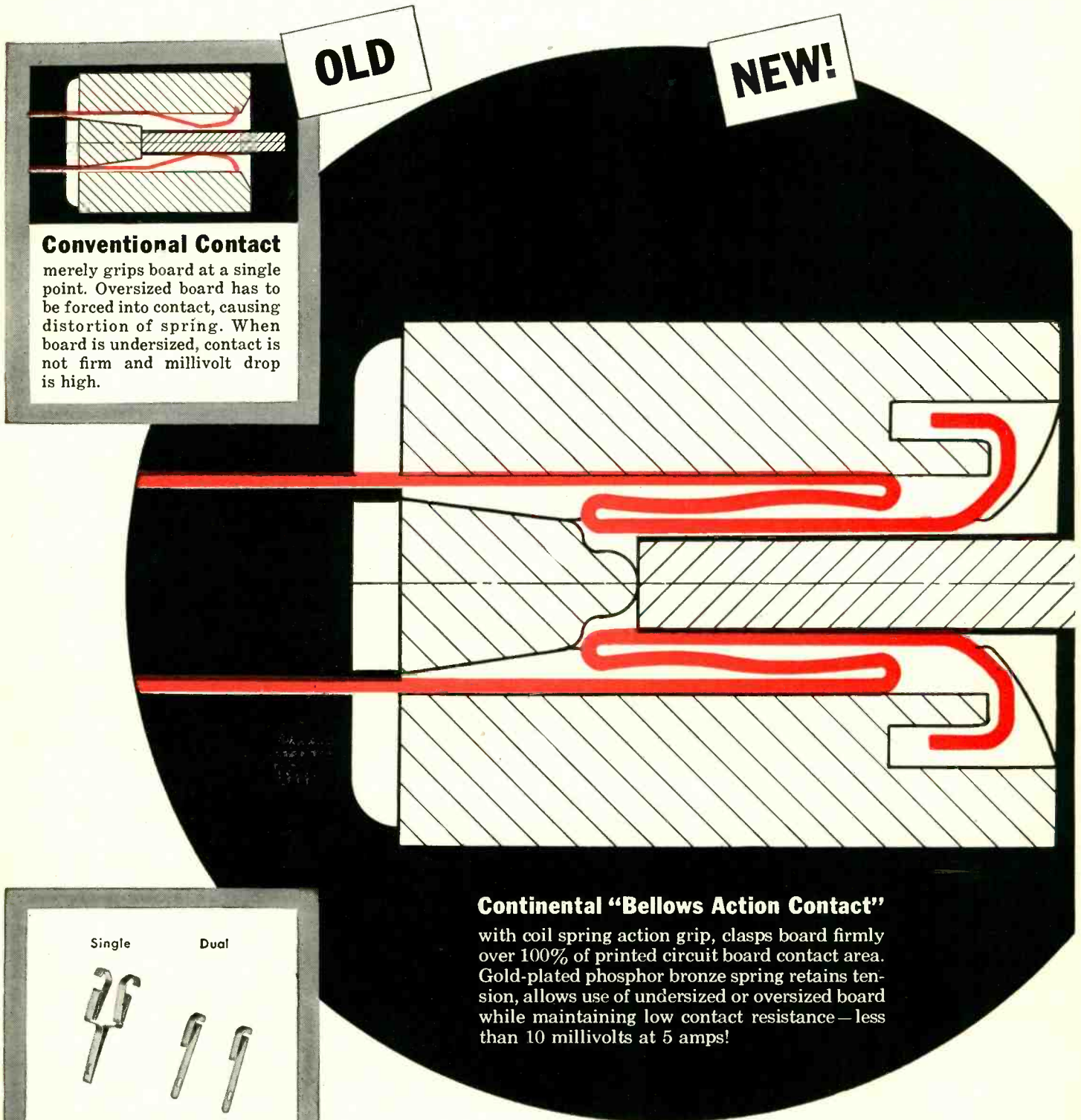

## Conventional Contact

merely grips board at a single point. Oversized board has to be forced into contact, causing distortion of spring. When board is undersized, contact is not firm and millivolt drop is high.

## Continental "Bellows Action Contact"

with coil spring action grip, clasps board firmly over 100% of printed circuit board contact area. Gold-plated phosphor bronze spring retains tension, allows use of undersized or oversized board while maintaining low contact resistance — less than 10 millivolts at 5 amps!

Single

Dual

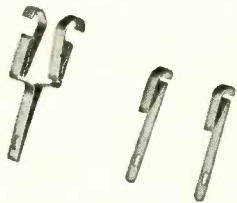

Actual Size

## "Bellows Contacts"

Actual photograph of single and dual "Bellows Contacts."

Patent Pending

# Contact...now Connectors by Continental Connectors

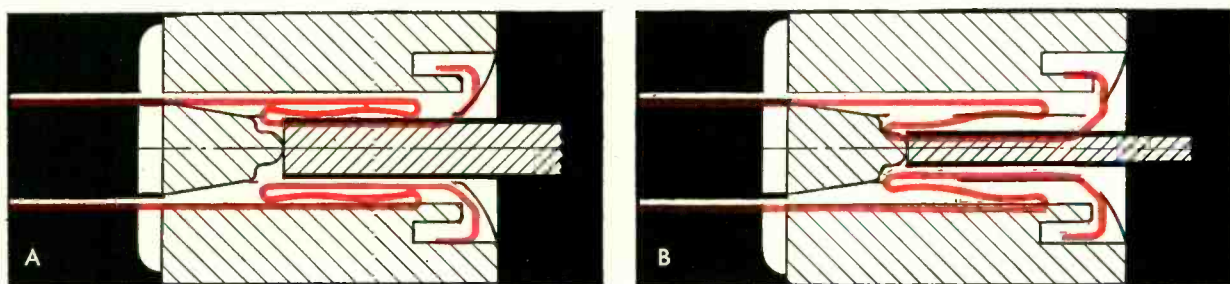

## Illustrations demonstrate how "bellows contact" eliminates board tolerance problems

(A) Illustration shows how .135" board is gripped firmly by new Continental "Bellows Type Contact." No distortion or stress occurs because of bellows action.

(B) Same contact springs back to maintain retention for minimum board thickness of only .115". Bellows spring-grip action gives equal contact surface area for minimum board thickness.

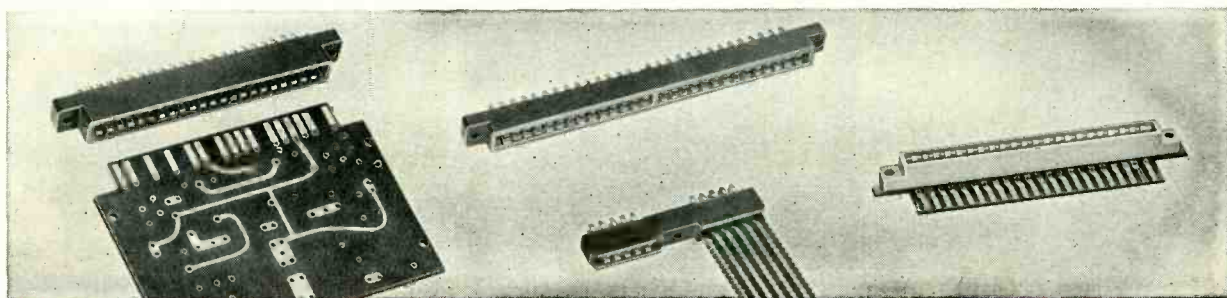

## New Continental "bellows type contacts" available for for 1/8", 3/32" and 1/16" size boards...3 molding compounds ...three wiring styles... and 6 to 28 contacts

Shown above are four of many styles available in the new "Bellows Type Contact" Printed Circuit Receptacles.

CONTACTS: 6, 10, 15, 18, 22, 28 contacts in either single or double rows. (Double row of 28 permits 56 separate connections.)

WIRING STYLES: Available with eyelet lug for soldering, lugs for wire wrap, or contacts can be dip soldered directly to board by bending soldering

leads 90° (see photo).

MOLDING COMPOUNDS: Moldings can be ordered in Mineral filled Melamine, Plaskon reinforced (glass) Alkyd 440A, or Orlon filled Diallyl Phthalate.

Additional technical data on these connectors, and special designs requiring the use of sub-miniature, hermetic seal, pressurized, high voltage or power connectors are available on request. Write today on your company letterhead for complete catalog.

electronic sales division

DE JUR-AMSCO CORPORATION

45-01 Northern Boulevard, Long Island City 1, N. Y.

# DeJUR



# ONLY THE LEADER

*always  
steps  
ahead*

**FIRST-**

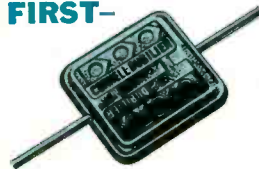

"Silver-Mike"\* capacitors.

**FIRST-**

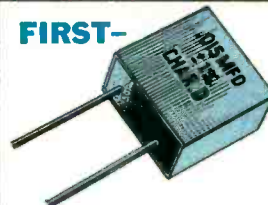

Super-Micadon\* mica capacitors.

**FIRST-**



postage stamp (Micadon\*)  
mica capacitors.

In the parade of progress as in the manufacture of capacitors it takes vision to lead. That is why, we, at Cornell-Dubilier, have proven our leadership with constant foresight . . . by always being first to develop new and more efficient capacitors to meet tomorrow's demands. Too, this vision has given

## C·D...45 YEARS OF FAMOUS FIRSTS

Shown here are three examples of C-D's "Famous Firsts" — proof that whatever your capacitor requirements, a C-D engineer can show you money saving answers. Write to Cornell-Dubilier, Dept. K-26, South Plainfield, N. J.



# CONSISTENTLY DEPENDABLE CORNELL-DUBILIER CAPACITORS

PLANTS IN SO. PLAINFIELD, N. J.; NEW BEDFORD, WORCESTER AND CAMBRIDGE, MASS.; PROVIDENCE AND HOPE VALLEY, R. I.; INDIANAPOLIS, IND.; SANFORD AND FUGUAY SPRINGS, N. C.; SUBSIDIARY, RADIART CORP., CLEVELAND, OHIO.

THERE ARE MORE C-D CAPACITORS IN USE TODAY THAN ANY OTHER MAKE

# Look at this progress in vibration exciters

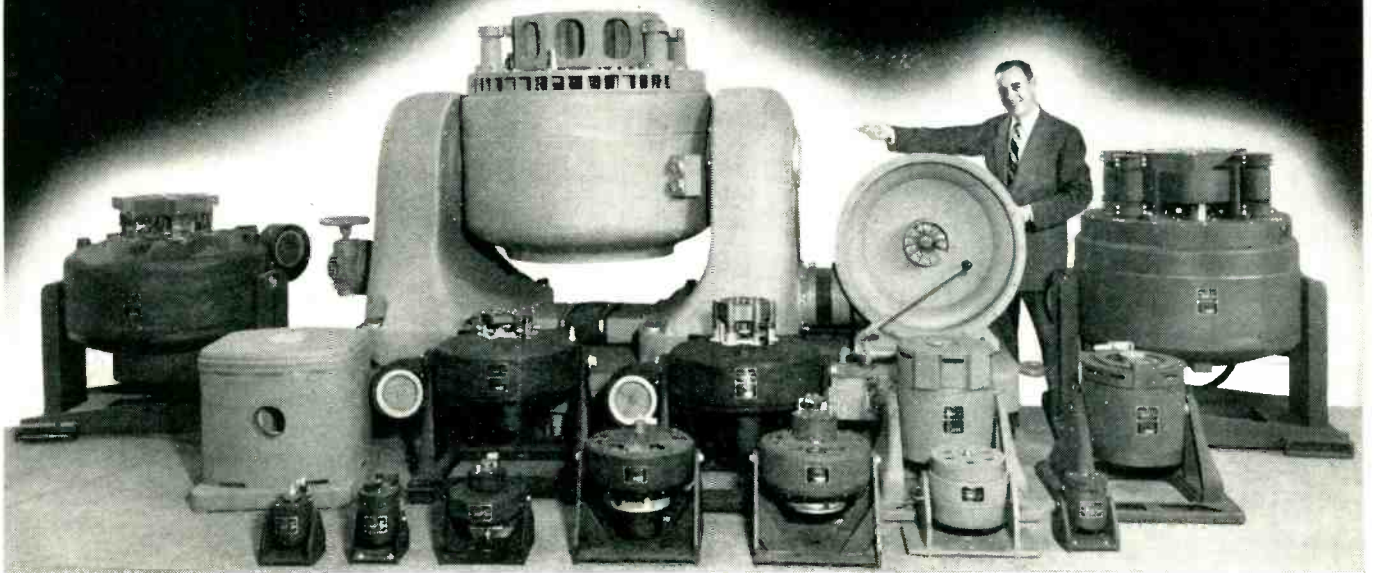

*A whole range of MB Shakers developed to handle any vibration testing program... deliver reliable, quantitative data*

One pound to over twelve thousand pounds . . . that's the range of force outputs in this group of MB electrodynamic vibration exciters. On the way are shakers for 25,000, 50,000 and even 100,000 pounds! All operate over substantial frequency range. What a far cry from the limited scope of mechanical shakers . . . the only type available just a short ten years ago.

But force and frequency range are not the only improvements. MB has long recognized the need for *pure* table motion if test results were to be quantitative and reliable.

Thus, in MB Shakers, moving-element structures are very rigid. This minimizes table motion distortion in the testing range. Also, because MB power supplies are designed for negligible harmonic distortion, table waveform is pure over the whole frequency range.

There's more. MB has designed complex wave testing systems that shorten test time and give truer reproduction of actual service conditions. Also oil-filled exciters capable of operation at "100,000 ft. altitude," -100 to +200°F, and 20 to 95% relative humidities. Also cycling systems that do time-consuming test procedures *automatically*.

If you're working on projects that call for environmental testing, or fatigue testing, or noise determinations... you can benefit from vibration testing with MB shakers. Work with a leading source of help and information in this growing field . . . contact MB. For details and specifications on MB Exciters, send for Bulletin 420-5.

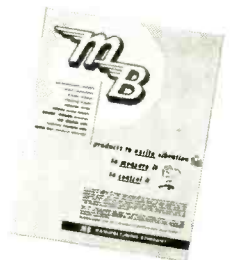

**manufacturing company**

*A division of Textron American, Inc.*

1060 State Street  
New Haven 11, Conn.

HEADQUARTERS FOR PRODUCTS TO ISOLATE VIBRATION... TO EXCITE IT... TO MEASURE IT.

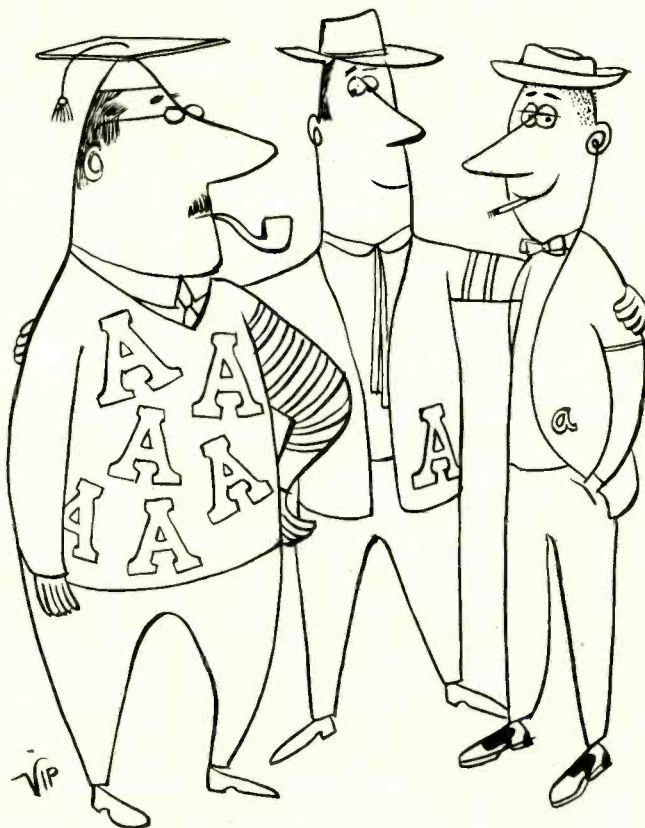

## Brain and Brawn

*Some of the young fellows on our staff have been analyzing our files of personal data regarding scientists and engineers here at Hughes. What group characteristics would be found?*

*With additional facts cheerfully contributed by their colleagues they have come up with a score of relationships—some amusing, some quite surprising. We shall chart the most interesting results for you in this series.*

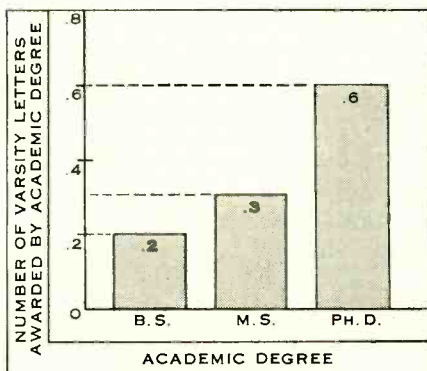

Contrary to popular belief, higher academic study goes hand in hand with increased school athletic activity—as shown in the above chart. This is based on data obtained from a 20% random sample of the 2,200 professional engineers and scientists of Hughes Research and Development Laboratories.

In our laboratories here at Hughes, more than half of the engineers and scientists have had one or more years of graduate work, one in four has his Master's, one in 15 his Doctor's. The Hughes research program is of wide variety and scope, affording exceptional freedom as well as exceptional facilities for these people. Indeed, it would be hard to find a more exciting and rewarding human climate for a career in science. Too, the professional level is being stepped up continually to insure our future success in commercial as well as military work.

Hughes is pre-eminent as a developer and manufacturer of airborne electronic systems. Our program includes military projects in ground and airborne electronics, guided missiles, automatic control, synthetic intelligence. Projects of broader commercial and scientific interest include research in semiconductors, electron tubes, digital and analog computation, data handling, navigation, production automation.

SCIENTIFIC STAFF RELATIONS

## Hughes

RESEARCH AND DEVELOPMENT  
LABORATORIES

Culver City, Los Angeles County, California

*DUE TO THE expanding use of Hughes electronic systems, new positions are open for engineers who have demonstrated ingenuity and inventive ability in the areas of product design.*





# HUGHES

GERMANIUM POINT-CONTACT



# DIODES

ARE RIGHT FOR YOUR CIRCUIT APPLICATIONS

Hughes Semiconductors offers an extensive selection of standard diode types—both germanium point-contact and silicon junction. Available too are more than two hundred special types. Most electronic circuit requirements can be met by diodes selected from among these existing devices of standard manufacture.

Yet, every once in a while, a requirement arises for a diode embodying very particular electrical characteristics. Different appli-

cations might call for one or more specified characteristics, in varying combinations: Recovery Time . . . Forward Conductance . . . Voltage . . . Back Resistance.

For instance, while one application requires very fast recovery together with high forward conductance, another circuit might call for high forward conductance at very low voltage (less than one volt), and with moderate to good recovery.

With the knowledge gained from long

experience and leadership in the semiconductor field, Hughes is able to modify standard production techniques to the degree necessary to produce devices with just such a delicate balance of special characteristics.

So let us know about your application problems. Most probably you will find just the right diode—the diode to fit your requirements perfectly—at Hughes. And, if it's a Hughes diode, you know that it's First Of All . . . For RELIABILITY.

*Our field Sales Engineers will welcome the opportunity to discuss your particular semiconductor requirements. For the address of the office nearest you, or for descriptive product literature, please write:*

**HUGHES**

PRODUCTS DIVISION

*Aircraft Company, Los Angeles 45, Calif.*



**SEMICONDUCTORS**

SEMICONDUCTORS  
**HUGHES AIRCRAFT COMPANY**  
PRODUCTS DIVISION  
INTERNATIONAL AIRPORT STATION  
*Los Angeles 45, California*

# New Stokes

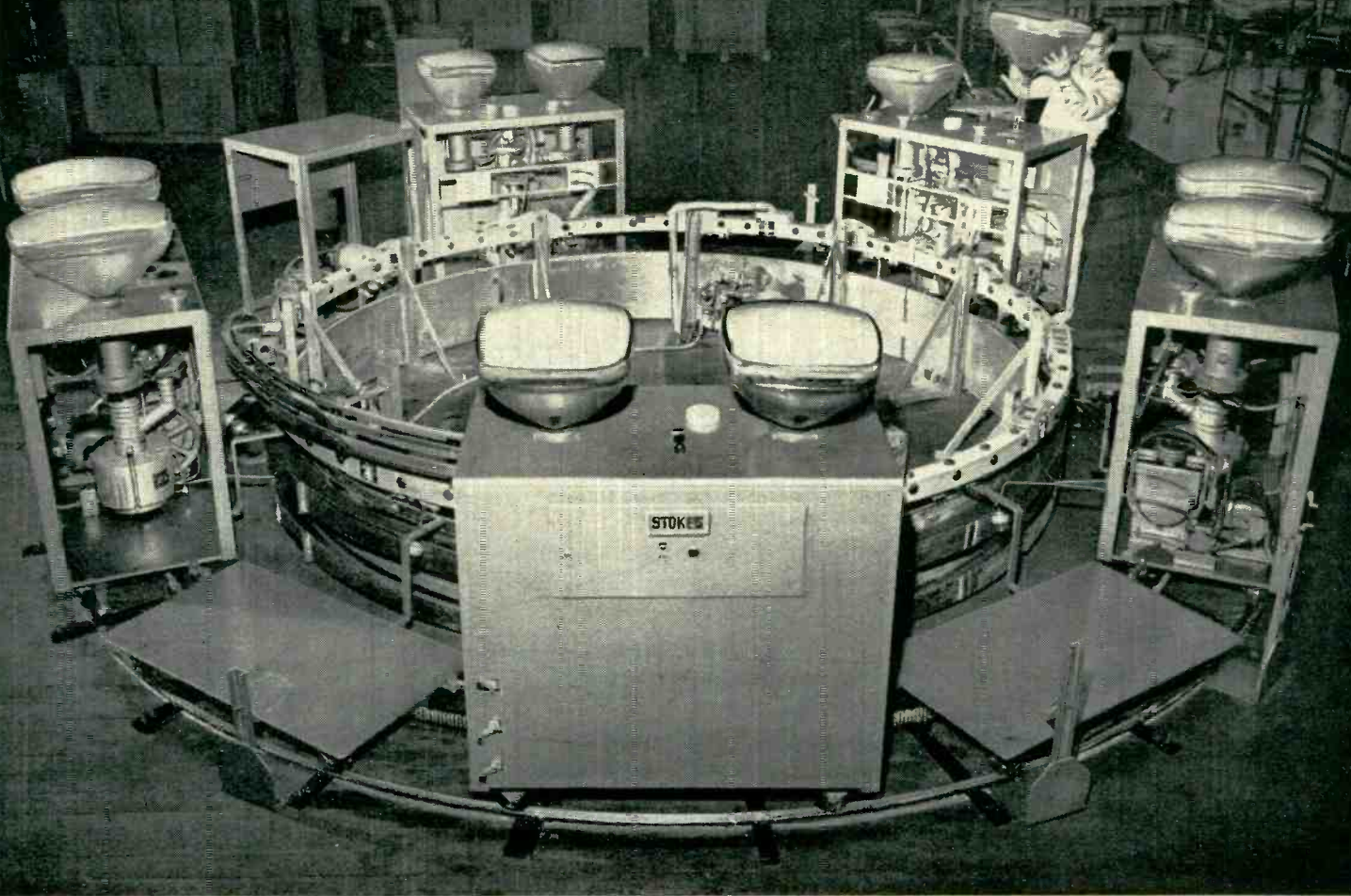

*New Stokes dual-tube in-line aluminizing system is setting high standards of economy and productivity at Thomas Electronics, Inc., Passaic, New Jersey.*

## **Electronic equipment manufacturers are profiting from other STOKES Vacuum Equipment...**

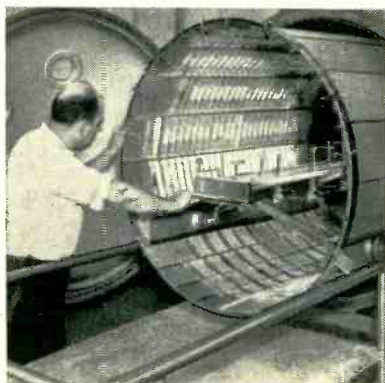

**Vacuum Metallizers.** Stokes manufactures a complete line of vacuum metallizing equipment to plate selenium rectifiers, printed circuits and other conductive coatings on non-conductive materials.

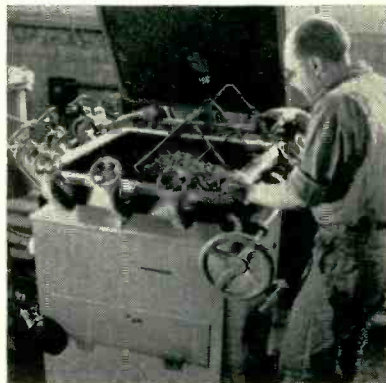

**Vacuum Impregnators.** Manufacturers of electronic equipment use Stokes vacuum impregnation systems to obtain improved characteristics of coils, condensers, capacitors and other components.



**Vacuum Furnaces.** Stokes melting and heat-treating furnaces permit electronic manufacturers to pre-process raw and semi-finished materials with less contamination, for increased life and performance.

# 5 Cart In-line TV Dolly System Aluminizes 96 Tubes Per Hour

***New system at Thomas Electronics, Inc.—largest independent manufacturer of cathode ray tubes — affords increased production . . . reduces initial cost . . . requires less floor space and maintenance***

**T**ODAY's big news in TV picture tube production is the new Stokes aluminizing system. This high-production equipment evacuates and aluminizes *two tubes per cart* with one pumping system. The new design affords several cost-cutting and production-boosting advantages:

**Greater production.** Using a mechanical pump and 4-inch high speed "Ring-Jet" booster, overall cycle time is 6½ minutes with 21-inch tubes—96 per hour with the standard five cart system.

**Lower first cost.** Fewer carts are needed . . . the basic unit, consisting of five carts with ten dollies, costs less than comparable single-tube systems.

**Lower maintenance.** There is only *one* pumping system for every *two* tubes.

**Less floor space.** Circular track is only 17 feet in diameter.

**Flexibility.** Five additional carts can be added to the standard dollies to produce 21-inch tubes at a rate of 192 per hour. Tubes up to 27-inch can be accommodated.

The system is fully automatic. Operator loads . . . and then unloads completely aluminized tubes. Filament replacement is simplified by removable holders. Internal cooling coils provide for rapid cooling of oil in the booster pump before vacuum is released.

A Stokes engineer will be glad to discuss how this new system for black and white or color tubes can be integrated into your production line. He'll also welcome the opportunity to talk over your specialized requirements . . . to apply Stokes' extensive experience in high vacuum engineering and automatic production technology. F. J. STOKES MACHINE COMPANY, 5503 Tabor Road, Philadelphia 20, Pa.

## **Reference Data:**

Microvac Pumps—Catalog 750  
Diffusion and Booster Pumps  
Specification and performance data  
Story of the Ring-Jet Pump  
How to Care for Your Vacuum Pump—  
Booklet 755  
Vacuum Impregnation—Catalog 760  
Vacuum Furnaces—Catalog 790  
Vacuum Metallizing—Catalog 780  
Vacuum Calculator Slide Rule



**STOKES**

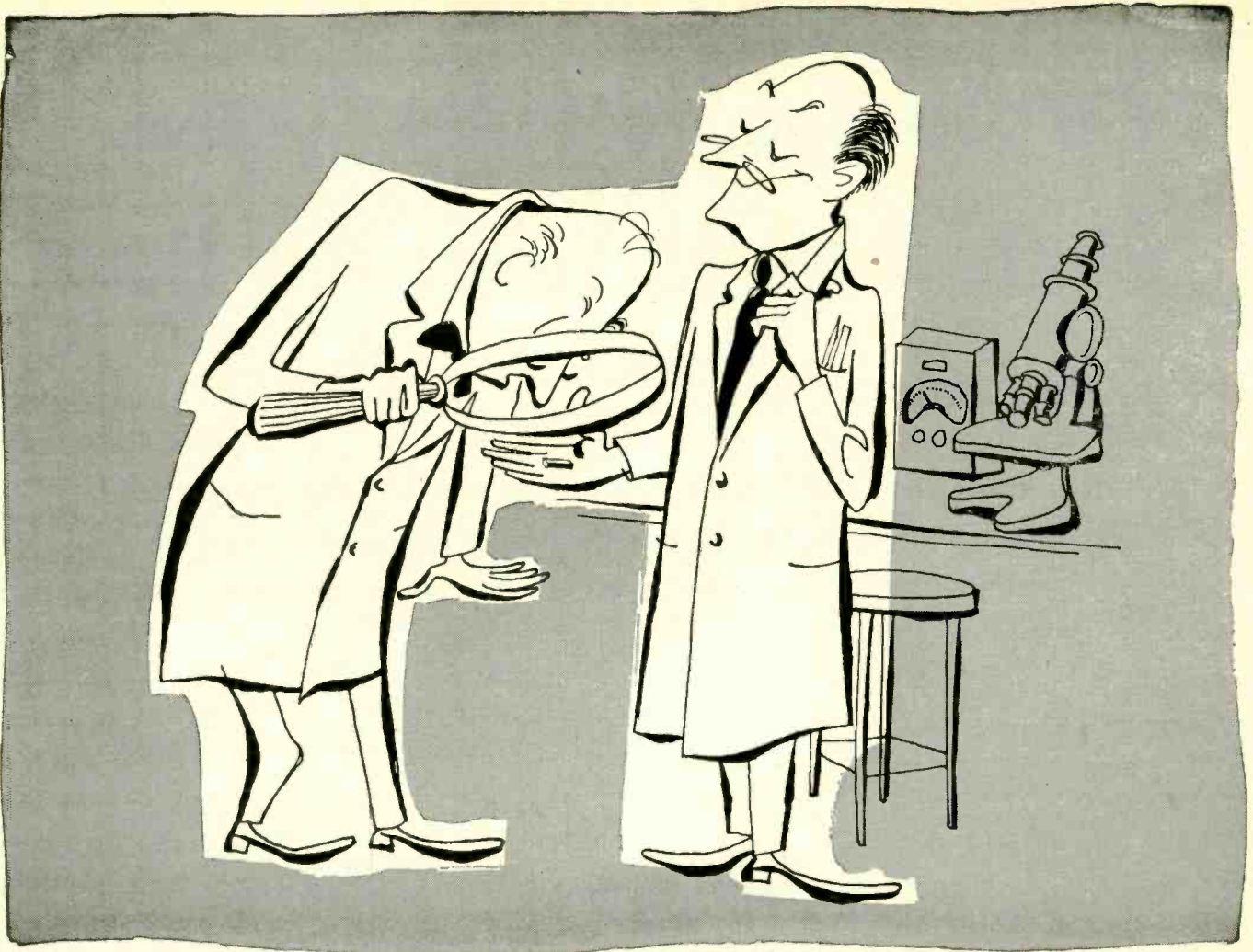

## How to make a Magnetic Core that's really small? Use PERMENDUR!



Write for  
your copy

### "MAGNETIC MATERIALS"

This 32-page book contains valuable data on all Allegheny Ludlum magnetic materials, silicon steels and special electrical alloys. Illustrated in full color, includes essential information on properties, characteristics, applications, etc. Your copy gladly sent free on request.

ADDRESS DEPT. E-74

When the conditions of service make it imperative for you to hold the size and weight of magnetic cores at an absolute minimum, that's the place to use Permendur. With it you can push the flux density up to 20 kilogausses, and practically eliminate weight as a consideration.

Along with its suitability for cores wherever the premium is laid on compactness, Permendur is just the thing for sonar magnetostriction applications, too. We maintain proper annealing facilities for this

alloy. Write for technical data on it, and let our engineers help you to cash in on its possibilities.

In addition to Permendur, we offer a range of high-permeability alloys, oriented silicon steels and other electrical alloys that is unmatched in its completeness. Our services also include the most modern facilities for lamination fabrication and heat treatment.

Let us supply your requirements. Allegheny Ludlum Steel Corporation, Oliver Building, Pittsburgh 22, Pa.

**STEELMAKERS** to the Electrical Industry

# Allegheny Ludlum



W&D 5443



# Transitron

500

and

600 volt

**silicon** power  
**rectifiers**

now available

Transitron's high voltage silicon rectifiers are now available in 500 and 600 volt grades. In addition, the production of 400 volt types has been expanded so that delivery is now rapid. The 300, 200, and 100 volt silicon rectifiers are available from stock.

If your requirement involves high temperatures, high voltages, and high currents, the Transitron silicon rectifier offers a major improvement in reliability, efficiency, and miniaturization. Write for bulletin TE1321.

#### HIGH VOLTAGE TYPES

TYPE	P.I.V. (Volts)	Idc (ma)	Ib (ma)
TM62	600	400	.3
TM63	600	200	.3
TM52	500	400	.3
TM53	500	200	.3

Ratings at 100° C

#### STANDARD TYPES

TYPE	P.I.V. (Volts)	Idc (ma)	Ib (ma)
1N332	400	400	.1
1N341	400	400	.5
1N334	300	400	.1
1N343	300	400	.5
1N336	200	400	.1
1N345	200	400	.5
1N338	100	1000	.1
1N347	100	1000	.5

Ratings at 135° C

**Transitron**  
electronic corporation  
melrose 76, massachusetts



Glass Diodes



Transistors



Power Transistors



Silicon Diodes



Silicon Rectifiers



# HITEMP'S

teflon\*  
magnet wire...

Your assurance  
of highest performance

If miniaturization is your design-factor problem; if your components must withstand today's new high temperatures . . . then Hitemp's "Teflon" insulated magnet wire is your answer.

Designed for Class H service, or better, Hitemp's "Teflon" insulated magnet wire has a low loss factor, low dielectric constant, high volume resistivity, and excellent dielectric strength. All characteristics remain stable at temperatures from -90 C. to +250 C. "Teflon" insulation is nonflammable and completely inert to moisture and all known commercial solvents.

Available in sizes from 14 to 50 AWG and in single, heavy, triple and quadruple thicknesses.

"WHEREVER HIGH TEMPERATURES EXIST . . .

THAT'S THE PLACE FOR HITEMP'S WIRE AND CABLE!"

\*Dupont make this under their trade name  
POLYTETRAFLUOROETHYLENE

**HITEMP WIRES INC.**  
26 WINDSOR AVE., MINEOLA, NEW YORK

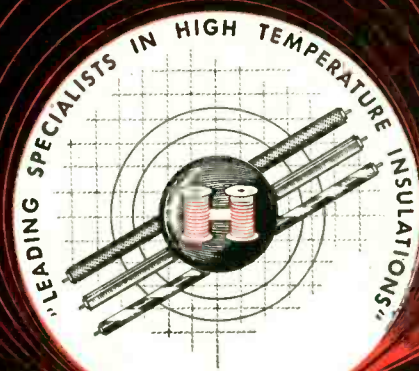

#### NATIONAL REPRESENTATIVES

CANADA, ALA., GA., LA.,  
MISS., PA., VA., W. VA.  
Aironic Accessory Co.  
151 Orinoco Drive  
Brightwaters, N. Y.  
NEW YORK & NEW JERSEY  
Par Distributors  
240 Old Country Rd.  
Hicksville, N. Y.

MD. & DEL.  
Sol W. Goodman  
32 W. Biddle St.  
Baltimore, Md.  
ILL. & WIS.  
Wesley L. Wilson  
2750 West North Ave.  
Chicago, Ill.

TEXAS  
General Power Equipment  
4515 Prentice Street  
Dallas, Texas  
MICHIGAN  
James B. Morrow  
85 Louise Ave.  
Highland Park, Mich.

CONNECTICUT  
Richard Whitehead, Jr.  
Gulford, Conn.  
FLORIDA  
Larry Johnson  
117 N. W. 103rd St.  
Miami, Florida

WASH. D.C.—GOVT.  
John W. Houston Jr.  
748 Washington Bldg.  
Washington S. D. C.  
UPPER NEW YORK STATE  
Philip L. Kirsh  
223 Windemere Road  
Rochester, N. Y.

N. C., S. C. & TENN.  
Gienn & Larson  
123 Bravard Court  
Charlotte, N. C.  
ARIZ. & N. MEX.  
Russell Engineering  
2140 Westwood Blvd.  
Los Angeles 25, Cal.

ARK., IOWA, KAN.,  
MO., NEB.  
White Supply Co.  
4343 Duncan Ave.  
St. Louis, Mo.  
KENTUCKY & OHIO  
Gallagher Company  
15 Ritchie Avenue  
Cincinnati, Ohio

MAINE, N. H., MASS.,  
VT., R. I.  
Ward F. Humphrey  
13 East Plain St.  
Conchituate, Mass.  
EXPORT  
Ballthraill Trading Co.  
1505 Race St.  
Phila. 2, Pa.

INDIANA  
Richard C. Warner  
Box 338  
South Whitley, Ind.  
CALIF. & WASH.  
Standard Wire & Cable  
3640 Overland Ave.,  
Los Angeles, Calif.  
210 Post St., Rm. 915,  
San Francisco, Cal.

# Business Investment Holds Key To Both Growth and Stability

**W**hat federal tax policy will best promote both growth and stability in the American economy? The Joint Economic Committee of Congress has been asking this crucially important question in public hearings. This editorial suggests one vital part of the answer.

The proposition advanced here is that—

Tax policy must encourage a continuing high level of business investment in new plant and equipment, because such investment makes a special contribution to *both* economic growth and economic stability.

## Growth Needed for Security

We must have both growth and stability.

A vigorous economic growth is essential to our national security. As Congressman Wilbur D. Mills said in launching the Joint Committee's hearings, "The present complexion of world affairs places a premium upon strength and growth in our national economy." Growth is likewise a major ingredient of a healthy domestic economy. Growing enterprises and growing communities offer far more opportunities for satisfying careers than those which are not growing.

A reasonably stable economy, without violent

ups and downs, is also essential to our national welfare. Extravagant booms and their more or less inevitable result, severe depressions, waste labor and resources and cause great human misery. Both major political parties have accepted the obligation imposed by the Employment Act of 1946, that the federal government work to maintain high and stable employment.

There is general agreement that **the key to economic growth is investment in new plant and equipment.** Growth depends decisively on new facilities to increase production, and also to produce new and better products in new and better ways. At the same time, new plant investment provides employment for the important, and well-paid, one-fourth of our industrial workers who manufacture and build new production facilities. So if the process of business investment is kept on an even keel, the result is not only growth but also stability in a substantial sector of our economy.

**But authorities disagree on the possibility of maintaining a high level of business investment for any great length of time. Some fear that it will lead to an excess of producing capacity and the glutting of markets, with recession or depression not far behind**

The history of our country offers some basis for the fear that it is dangerous to maintain a very high level of business investment. There have been times when the economy has suffered under the weight of excess producing capacity. **This fear, however, has been made obsolete by the recent course of our economic history which, in its earlier phases, nourished the fear.**

## The World Has Changed

Here are some of the major considerations, cited at the Joint Committee hearings, which support the conclusion that we not only *can have* a high level of business investment and economic stability but that we actually *need* a high level of such investment to assure stability.

(1) Over the next 20 years our population is expected to increase by about one-third. But most of the population increase will come in age groups younger or older than normal working ages, and people will probably work fewer hours per week. Thus hours worked are not expected to increase more than 15%. Consequently, we must have a relatively large increase in the amount of production equipment per worker if our standard of living is not to suffer. This means a high level of new investment.

(2) About half of our present business investment goes to replace worn-out equipment, rather than to expand capacity as was true during the early stages of our industrial development.

(3) Thanks largely to the impact of organized research—for which we as a nation now spend about \$4 billion a year—a large share of capital investment now goes to provide new products and new processes, rather than to expand existing capacity.

These developments make it unlikely that we shall develop the burden of excess capacity that plagued the economy in earlier periods. **Moreover, most capital investment plans are**

**now made on a long-range basis. Companies are building facilities to anticipate their needs for several years ahead. This increase in long-range planning has reduced the disturbing effects of temporary shortages and excesses in producing capacity.**

The record of recent years speaks for itself. Business spending for new plant and equipment in 1955 was over \$29 billion. This continued the high level of investment that has been maintained for the past ten years—a decade remarkable for both impressive growth and gratifying stability. A McGraw-Hill survey of preliminary plans for 1956 indicates another year of increasing investment, and expanding business activity.

**Tax policy, to be successful, must consider this impressive contribution of business investment to both growth and stability.**

Of course, the level of investment depends on many factors other than federal tax policy. The degree of business confidence is important. So is the strength of consumer markets. So is the attitude of organized labor toward the use of more efficient machinery. But tax policy is a crucially important factor. And it is becoming more so with new developments in our changing economy. These developments indicate that tax policy **must be geared to foster a high level of business investment, if the dual objectives of economic growth and economic stability are surely to be attained.**

*This message is one of a series prepared by the McGraw-Hill Department of Economics to help increase public knowledge and understanding of important nationwide developments that are of particular concern to the business and professional community served by our industrial and technical publications.*

*Permission is freely extended to newspapers, groups or individuals to quote or reprint all or parts of the text.*

*Donald C. McGraw*

PRESIDENT

McGRAW-HILL PUBLISHING COMPANY, INC.



# ALL SANBORN 150 SERIES OSCILLOGRAPHIC RECORDERS PROVIDE THESE

## SPECIFIC ADVANTAGES

THE three foremost operating advantages of a Sanborn "150" are evident in the record, and are given at the right. Equally popular with industrial users is the *wide versatility* of these systems. Each one comprises a basic assembly to which the user adds his choice of an interchangeable, plug-in type preamplifier for each channel. Presently available different preamplifiers now number *eleven*.

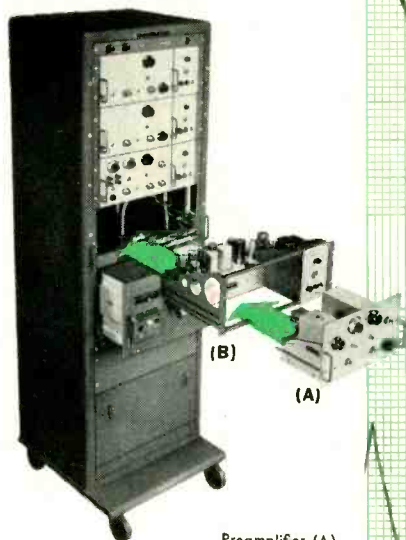

Preamplifier (A) shown in position to plug into a Driver Amplifier with Power Supply (B) which are normally already in place in the Basic Cabinet Assembly

### RECTANGULAR COORDINATE RECORDING

is a Sanborn feature that is especially valuable in multi-channel recording. The user of a 2-, 4-, 6- or 8-channel "150" system can record interrelated events simultaneously on one strip of record paper, and then correlate them against time quickly and accurately, even during the recording.

### CLEAR, SHARP, INKLESS TRACINGS

The nichrome ribbon tip "150" heated stylus removes the white opaque surface of Sanborn recording paper (Permapaper) permitting the black undercoating to show. Tracings are permanent, will not fade or smudge.

### IMPROVED OVER-ALL LINEARITY

resulting from current feedback design of Driver Amplifiers and new shorted coil frame, high torque (200,000 dyne cm.) galvanometers. Maximum error over middle 4 cm. of chart: 0.25 mm . . . over entire 5 cm. chart width: 0.5 mm.

Sanborn "150" Series available in 1-, 2-, 4-, 6- and 8- Channel Systems.



INDUSTRIAL DIVISION  
**SANBORN COMPANY**  
195 MASSACHUSETTS AVENUE, CAMBRIDGE 39, MASS.

A new "150" Catalog provides complete descriptive data, specifications and prices on all 150 Systems, Accessories and Cabinets. A copy will be sent on request.

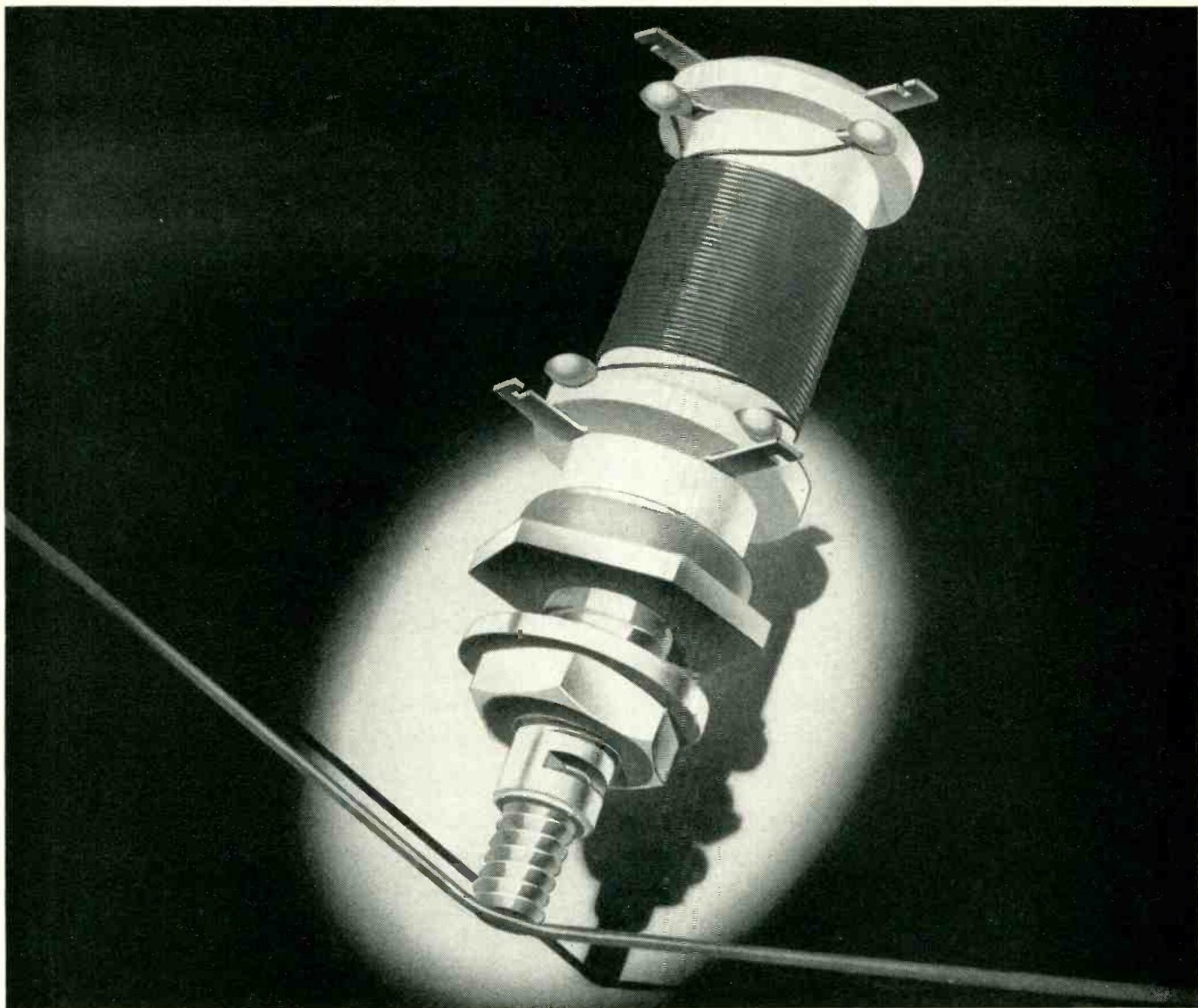

CTC Slug Tuned Coils are made in single layer or pie type windings to your specifications. Forms are of grade L-5 silicone impregnated ceramic. Mounting studs are cadmium plated brass; silicone fibreglas collars facilitate termination of simple or multiple windings.

## Death-defying performance

You can depend upon CTC Coils to give a steady, star performance whether you use ten or ten thousand! They won't go dead even under severe temperature, climate or vibration conditions. Here's why:

All CTC coils are precision-made to meet individual specifications — and to meet, or better, government specifications. Continuous quality control is maintained. As a result, you get a *guaranteed* electronic component — custom or standard.

Precision-made CTC components that benefit from CTC high quality standards include terminals, terminal boards, capacitors, swagers, hardware, insulated terminals and coil forms. For all specifications and prices, write Cambridge Thermionic

Corporation, 437 Concord Avenue, Cambridge 38, Mass. A West Coast stock is maintained by E. V. Roberts, 5068 West Washington Blvd., Los Angeles 16 and 988 Market St., San Francisco, Calif.

CTC Capacitor family: Metallized ceramic forms. From left to right — CST-50, in range 1.5 to 12.5 MMFD's. CST-6, in range 0.5 to 4.5 MMFD's. CS6-6, in range 1 to 8 MMFD's. CS6-50, in range 3 to 25 MMFD's. CST-50-D, a differential capacitor with the top half in range 1.5 to 10 MMFD's and lower half in range 5 to 10 MMFD's.

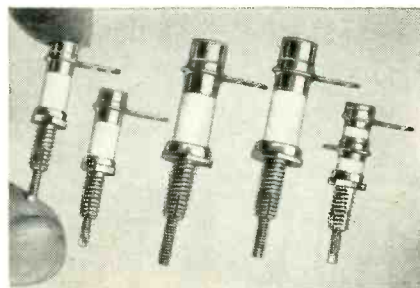

# CTC

**CAMBRIDGE THERMIONIC CORPORATION**

*makers of guaranteed electronic components  
custom or standard*



# Performance... not promises!

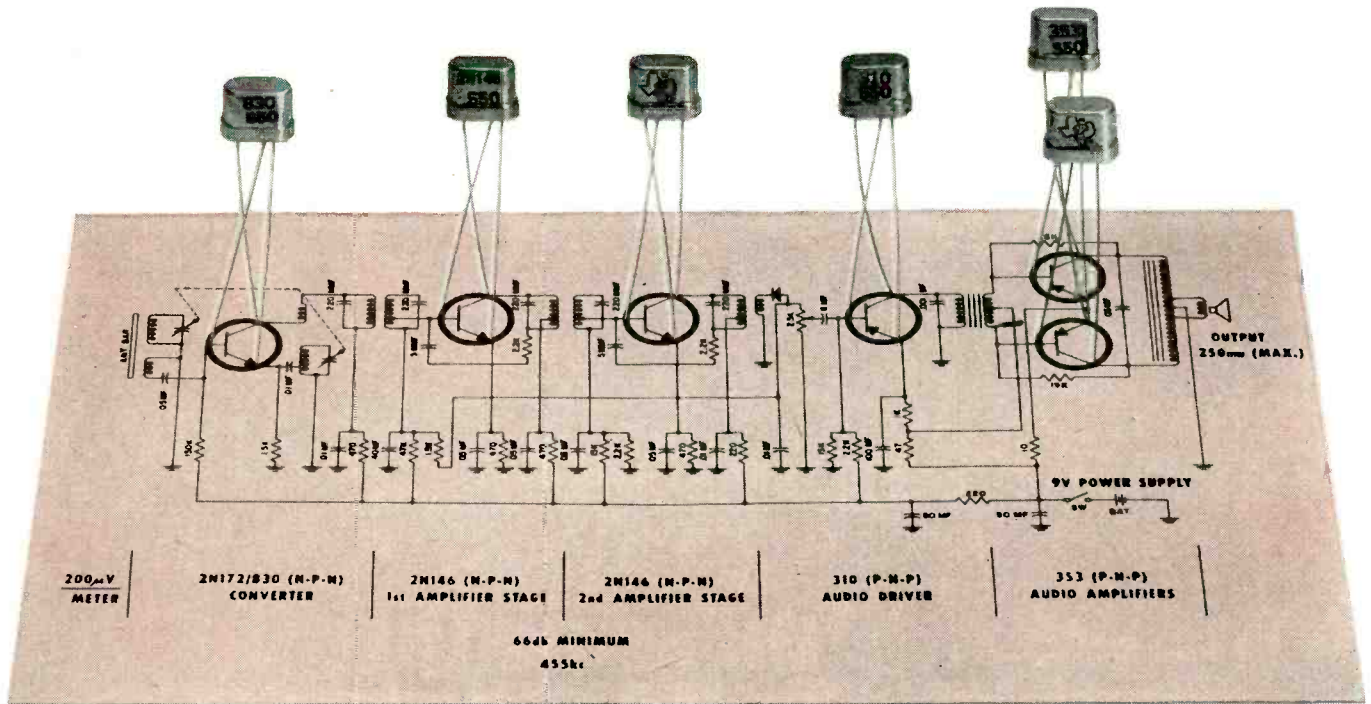

Texas Instruments germanium transistors are used in 85% of the many brands of transistorized radios now being manufactured! Since TI transistors made possible the FIRST transistorized radios 15 months ago, improved mass production methods have rapidly increased performance and decreased prices.

In less than a year and a half, progress in TI transistors and radio circuits has been so swift that the following improvements are now production realities:

	1954	1955
Sensitivity . . . . .	2000 $\mu$ v/m	200 $\mu$ v/m
Operating Voltage . . . . .	22½V	6, 9, or 12V
IF Gain & Frequency . . . . .	31db @ 262 kc	35db @ 455 kc
IF Output Capacity (Cob) . . . . .	30-40 $\mu$ mf	1 $\mu$ mf
IF Neutralizing Capacity . . . . .	Selected	Fixed
Audio Output Power . . . . .	20mw	250mw
Typical IF Transistor Price (In complete OEM kit)	\$2.50	\$1.75

**IN THE CIRCUIT  
ILLUSTRATED ABOVE:**

Left to right: a 2N172/830 germanium N-P-N graded junction converter, two 2N146 germanium N-P-N graded junction IF amplifiers, a 310 germanium P-N-P fused junction driver, and two 353 germanium P-N-P fused junction outputs. This is a typical TI circuit designed for optimum performance.

Your own transistorized product development will also benefit from Texas Instruments progress which gives you proven products, immediate availability in production quantities, and economical prices. *First* with transistors in commercial radios, *first* with high gain, low voltage IF transistors, *first* with high temperature silicon transistors ... Texas Instruments consistently leads the industry in development and manufacture.

**LOOK TO TI FOR: GERMANIUM RADIO AND GENERAL PURPOSE TRANSISTORS • SWITCHING TRANSISTORS • SILICON SMALL SIGNAL AND POWER TRANSISTORS • SILICON JUNCTION DIODES**

Texas Instruments has produced more radio transistors than any other manufacturer!



**TEXAS INSTRUMENTS**  
INCORPORATED  
6000 LEMMON AVENUE DALLAS 9, TEXAS

*servicing industry  
through*

*coordinated precision technology*



Kearsott gyros; used for stabilization or guidance in the majority of aircraft and missiles in production today. Vertical, directional and rate-integrating gyros shown.

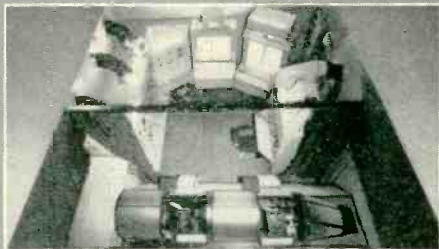

Link Aviation F-89D; jet flight simulator duplicating exactly cockpit of the F-89D interceptor; Link simulators for more advanced planes may not be shown.



Automatic Airborne Navigation System; a product of the coordinated techniques and resources of General Precision Laboratory Incorporated and other GPE Companies.

CAPACITIES OF THE GPE PRODUCING COMPANIES

- PRECISION MECHANICS, OPTICAL DEVICES, CERAMICS
- ELECTRICAL EQUIPMENT & COMPONENTS
- ELECTRONICS
- HYDRAULICS, LIQUIDS PROCESSING, HEAT EXCHANGE
- TELEVISION  
STUDIO, THEATRE, EDUCATIONAL, BUSINESS, INDUSTRIAL
- INSTRUMENTS, SERVOS, CONTROLS  
HYDRAULIC, PNEUMATIC, MAGNETIC, ELECTRONIC
- AIRCRAFT & MISSILE GUIDANCE, CONTROL, SIMULATION
- AUTOMATIC COMPUTERS & COMPONENTS
- RADAR, MICROWAVE, ULTRASONICS
- MOTION PICTURE & AUDIO EQUIPMENT
- NUCLEAR POWER COMPONENTS & CONTROLS
- SYSTEMS ENGINEERING  
AERONAUTICAL, NAVAL, INDUSTRIAL

THE PRODUCING COMPANIES



INTERNATIONAL PROJECTOR CORPORATION—BLOOMFIELD, N. J.



THE GRISCOM-RUSSELL COMPANY MASSILLON, OHIO



J. E. McAULEY MFG. CO. CHICAGO



GENERAL PRECISION LABORATORY INCORPORATED—PLEASANTVILLE, N. Y.



THE HERTNER ELECTRIC COMPANY—CLEVELAND



KEARFOTT COMPANY, INC. LITTLE FALLS, N. J.

One of a series telling  
how the producing companies of  
General Precision Equipment Corporation  
are contributing to America's progress.



# AVIATION

is one of more than a dozen major industries many of whose needs are anticipated and met by the research and development activities of the producing companies of General Precision Equipment Corporation. The highly advanced aeronautical products and systems manufactured by the several GPE Companies which devote substantial resources to progress in this field are responsible for conspicuous advances in aviation and are setting new standards of performance.

The skills and resources of the producing companies of General Precision Equipment Corporation form the building blocks of GPE Coordinated Precision Technology. Through this basic GPE operating policy, each company's specialization in its areas of competence is supplemented by the resources of other GPE Companies, wherever relevant. An outstanding example of GPE Coordinated Precision Technology is the recent achievement of quantity production of the most advanced automatic airborne navigation system known. This system is the successful culmination of eight years of intensive research and development activity centered in General Precision Laboratory Incorporated and supported by the facilities and personnel of other GPE Companies.

This mutuality of ideas, techniques and tools, so effective in solving aviation problems, has likewise resulted in a diversified line of precision equipment of superior design and performance which has wide application over an extensive range of other industries.

A brochure descriptive of GPE Coordinated Precision Technology and the work of the GPE Companies is available. Address your request, or inquiries on specific problems, to:

## *General Precision Equipment Corporation*

92 GOLD STREET, NEW YORK 38, NEW YORK



AMPRO CORPORATION  
CHICAGO



LINK AVIATION, INC.  
BINGHAMTON, N. Y.



THE STRONG ELECTRIC  
CORPORATION—TOLEDO



ASKANIA REGULATOR  
COMPANY—CHICAGO



BLUDWORTH MARINE  
NEW YORK



LIBRASCOPE, INCORPORATED  
GLENDALE, CALIFORNIA

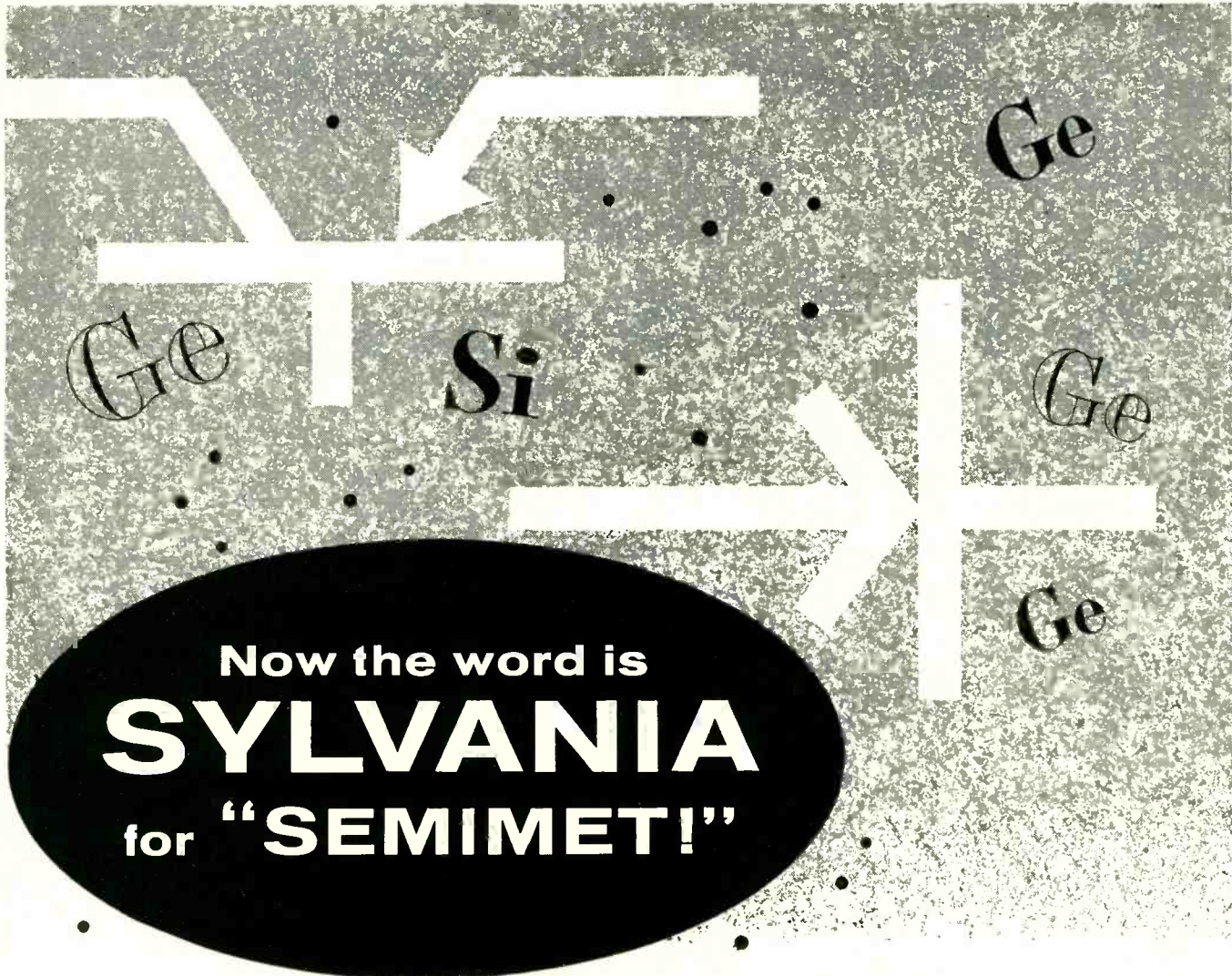

Now the word is  
**SYLVANIA**  
 for "SEMIMET!"

... your single source for both  
 transistor-grade silicon and germanium

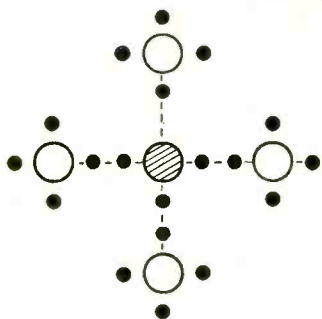

Ge

Si

Sylvania has long been a primary refiner of high-purity germanium. Now, newly completed facilities for the production of high purity silicon are operating on a pilot plant basis, producing the semimetal in needle or densified form, of spectrographic purity. Full production is expected in the spring. At present, transistor-grade samples are available for your testing on a letterhead request basis.

Specifications for Sylvania germanium dioxide and semimetal include ingot as-reduced (guaranteed 5 ohm cm resistivity) and polycrystalline ingot (guaranteed minimum 30 ohm cm resistivity). Which-

ever grade you prefer, you can be sure of continuing high quality and uniformity when you order from Sylvania.

If you use semimetals in your products . . . or plan to in the future . . . write for technical specifications and quotations on Sylvania silicon and germanium. Remember, too, that our engineering staff is always ready to help you solve semimetal application problems.

SYLVANIA ELECTRIC PRODUCTS INC.  
 1740 Broadway, New York 19, N. Y.  
 In Canada: Sylvania Electric (Canada) Ltd.,  
 University Tower Bldg., St. Catherine St.,  
 Montreal, P. Q.

 **SYLVANIA®**

LIGHTING • RADIO • ELECTRONICS • TELEVISION • ATOMIC ENERGY



**natfab**

**The FINEST SOURCE**

**For Approved Quality Components**



- \* Printed Circuit Sockets
- \* Molded Sockets and Plugs

- \* Laminated Sockets
- \* Terminal Strips

- \* Receptacles
- \* Contacts and Lugs
- \* Tube Shields

**NATIONAL FABRICATED PRODUCTS**

2658 West Belden Avenue • Chicago 47, Ill. 60618  
 Licensed by Western Electric Co., Inc.  
 Manufacturers of the NATFAB Solar Battery

A Division of Hoffman ELECTRONIC CORPORATION

# WIRE FOR EVERY ELECTRONIC PRODUCT



TV CAMERA CABLE



TV TRANSMISSION WIRE



MAGNET WIRE—  
HOOK-UP WIRE



MICROPHONE CABLE

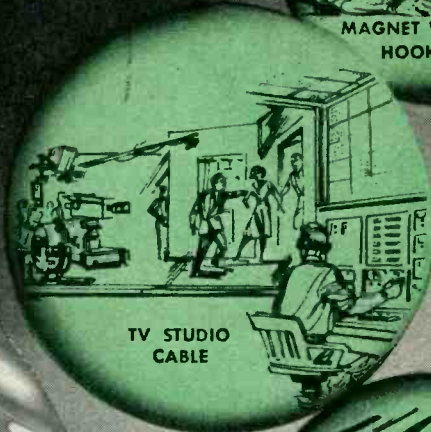

TV STUDIO CABLE



BROADCAST  
AUDIO CABLES



INTERCOM CABLE

SOUND SYSTEM CABLES



# Belden

WIREMAKER FOR INDUSTRY  
SINCE 1902

CHICAGO





**Only UNITED AIR LINES offers  
Reserved Air Freight space on all equipment**

For extra convenience and dependability, United Air Lines can guarantee you space for your shipments through its Reserved Air Freight plan. And only United makes this available on all equipment—over its own routes and world wide as well.

Reserved Air Freight space is just one of the reasons why so many businesses in practically every field are turning to United Air Lines Air Freight. Another is United's route, which links the East, the Midwest, all the Pacific Coast and Hawaii—a total of 82 markets.

And at every point along its Main Line Airway, United can furnish fast, convenient connections to speed your shipments throughout the nation and the world.

Whatever you ship, wherever you ship it, call on United Air Lines for the utmost in air freight convenience, dependability and economy.

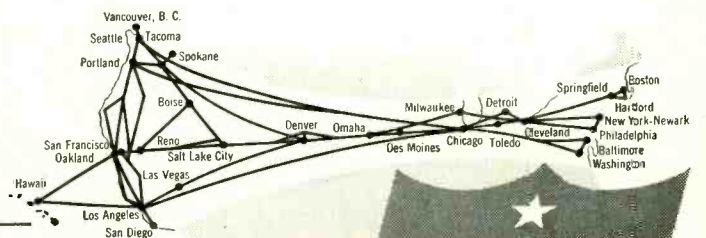

For service or information, call or write the nearest United Representative. Or write for booklet, "Industry's Flying Partner," Cargo Sales Division, Dept. V-2, United Air Lines, 5959 S. Cicero Ave., Chicago.



# AXEL ELECTRONICS EXPANSION

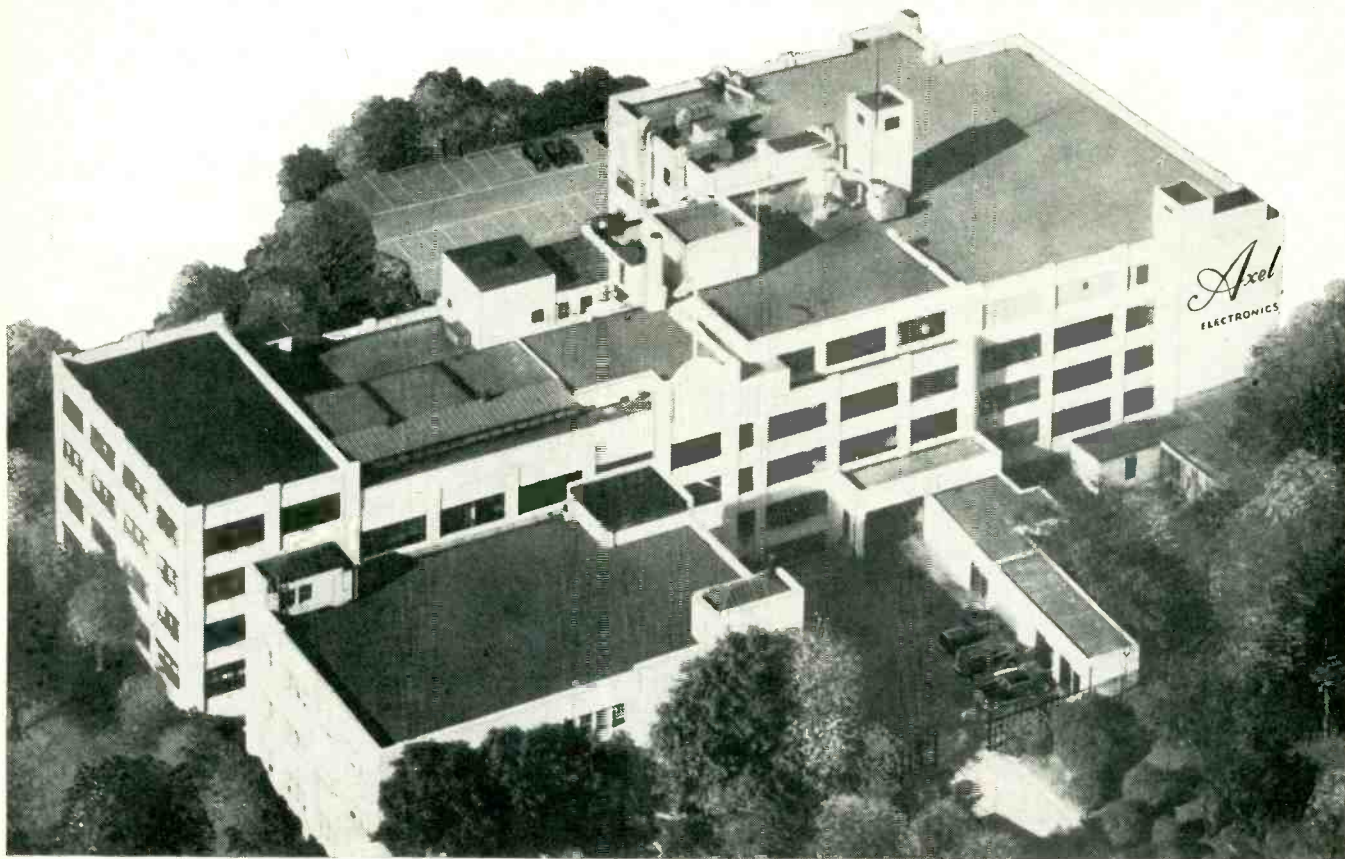

## and what it means to YOU...

### Expanded Building...

With greatly enlarged space in a new convenient location geared to provide top quality products with speedy, efficient service.

### Expanded Staff...

Headed by five new top sales and design engineers — each of them a specialist, expertly skilled in progressive design.

### Expanded Equipment..

Modern production, laboratory and test equipment — designed to meet the high standards of quality and reliability made famous by Axel Bros.

#### PRECISION MANUFACTURERS OF

- Paper & film dielectric capacitors
- Precision wire wound resistors
- Radio noise filters
- Pulse networks
- Delay lines



#### WRITE US

We will be pleased to send you our regular Engineering Bulletins. Address: "Dept. E"

*Quality and Precision Since 1916*

*Axel* BROS., INC. *Electronics Division*

134-20 JAMAICA AVENUE, RICHMOND HILL 18, NEW YORK • REPUBLIC 9-1700

# MICROWAVE SIGNAL GENERATORS AND SIGNAL SOURCES

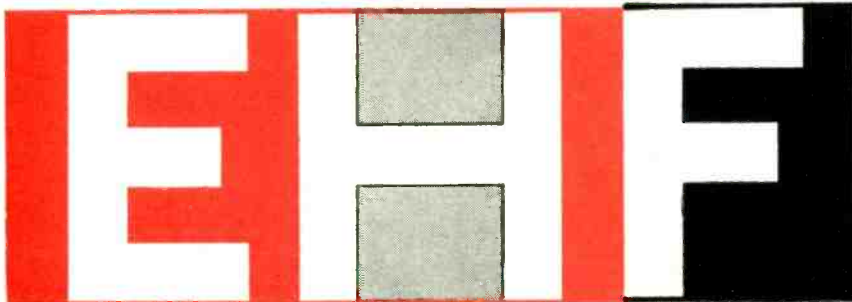

*for extremely  
high frequencies  
12,400 to 50,000 mc*

Rugged, compact, completely integrated units. Designed to save engineering manhours in the laboratory and on the production line. Operate simply with direct-reading continuously variable dials. No calibration charts.

Frequency is measured by direct-reading reaction-type wave-meters that assure extreme accuracy. VSWR is exceptional—Signal Generators 1.7 to 1; Signal Sources 1.7 to 1 when attenuated. Calibration accuracy is given special attention.

Consult Polarad on all your EHF problems.

SG-1218

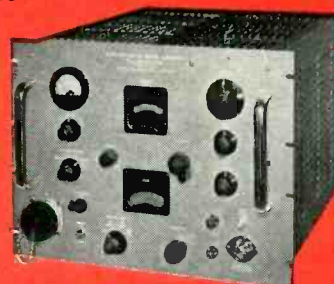

POLARAD MICROWAVE SIGNAL GENERATORS  
12.4 TO 39.7 KMC

SS-1218



POLARAD MICROWAVE SIGNAL SOURCES  
12.4 TO 50.0 KMC

Frequency Range	SIGNAL GENERATORS		SIGNAL SOURCES	
	Model Number	Output Power	Model Number	Power Output (Average)
12.4 to 17.5 KMC	SG 1218*	-10 DBM	SS 1218	15 mw
18.0 to 22.0 KMC	SG 1822	-10 DBM	SS 1822	10 mw
22.0 to 25.0 KMC	SG 2225	-10 DBM	SS 2225	10 mw
24.7 to 27.5 KMC	SG 2427	-10 DBM	SS 2427	10 mw
27.27 to 30.0 KMC	SG 2730	-10 DBM	SS 2730	10 mw
29.7 to 33.52 KMC	SG 3033	-10 DBM	SS 3033	10 mw
33.52 to 36.25 KMC	SG 3336	-10 DBM	SS 3336	9 mw
35.1 to 39.7 KMC	SG 3540	-10 DBM	SS 3540	5 mw
37.1 to 42.6 KMC	* External Source Power Measurement Range +10 to +30 DBM Accuracy with Correction: ±2 DB		SS 3742	Approx. 3 mw
41.7 to 50.0 KMC			SS 4150	Approx. 3 mw
Modulation: 1. Internal 1000 CPS Square Wave 2. External a. Pulse Pulse Width: 0.5 to 10 Microseconds PRF: 50 to 10,000 PPS Pulse Amplitude: 10 volts Pk to Pk Min. Polarity: Positive b. Sawtooth or Sinusoidal Frequency: 50 to 10,000 CPS Amplitude: 15 Volts RMS Min.				

### SPECIAL FEATURES OF EHF SIGNAL GENERATORS

- Unique power measurement system employs waveguide components of unusual design — allows continuous and front panel monitoring.
- Attenuation is independent of power set and frequency.
- 1000 cycles cps square wave modulation and external fm or pulse modulation provided over entire frequency range.

For complete information write to your nearest Polarad representative or directly to the factory.

**AVAILABLE ON EQUIPMENT LEASE PLAN**

**FIELD MAINTENANCE SERVICE AVAILABLE THROUGHOUT THE COUNTRY**

A complete line of Microwave Signal Generators available in a range of 950 to 11,500 MC and Signal Sources available in a range of 650 to 10,750 MC.



**ELECTRONICS CORPORATION**  
43-20 34th STREET, LONG ISLAND CITY 1, N. Y.

REPRESENTATIVES • Albuquerque • Atlanta • Baltimore • Boston • Buffalo • Chicago • Dayton • Englewood • Fort Worth • Los Angeles • New York  
Philadelphia • San Francisco • Syracuse • Washington, D. C. • Westbury • Winston-Salem • Canada, Arnprior, Toronto—Export: Rocke International Corporation

U

H

F

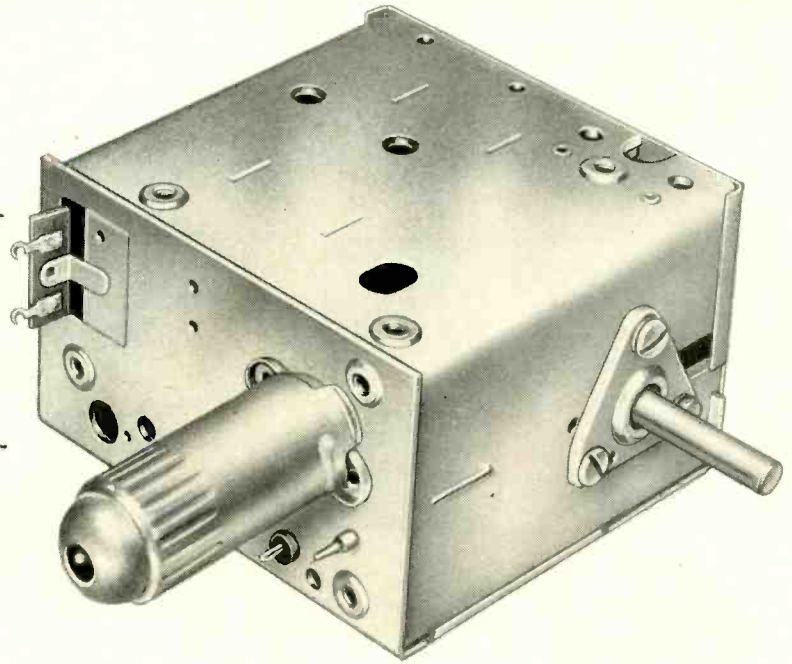

## how we cut tuner costs without cutting quality corners

The hotly competitive TV market has long wanted high quality tuners at low prices. But everytime we took a production tuner and cut enough circuit and package "corners" to effect a significant price cut, we wound up with a product unworthy of our R/C trademark.

But last year we had our Engineering Department design a new series of tuners from scratch . . . requesting top performance and bottom costs. What we got was remarkable performance—better than requested—but no appreciable price differential. Until production got into the act, that is. Production designed and sold management on setting up a line of mechanized production equipment. And that equipment brought costs down to the desired level.

The result is evident in the T-90 uhf TV tuner illustrated. Double-circuit tuned, it features oscillator radiation fixes . . . meets all RETMA spurious radiation requirements. Performance is just what you would expect from Radio Condenser, *but the T-90 costs you far less than any previous R/C uhf tuner!*

If you want information on the new R/C line of low cost tuners, we'll be happy to have one of our engineers call at your convenience.

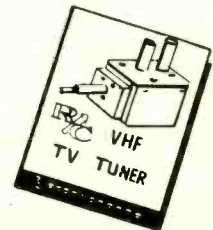

Get Complete Engineering and Performance Data.  
Write Radio Condenser for your free copy of Bulletin T-90

## RADIO CONDENSER CO.

Davis & Copewood Streets • Camden 3, New Jersey  
EXPORT: Radio Condenser Co., International Div., 15 Moore St., N.Y. 4, N.Y.  
CABLE: MINTHORNE  
CANADA: Radio Condenser Co. Ltd., 6 Beirmondsey Rd., Toronto, Ontario

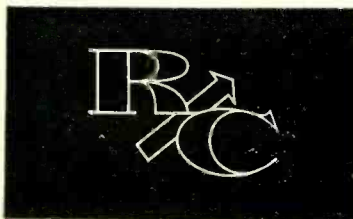



# Textolite® COLD PUNCH 11570

a laminate  
for today's  
automation  
trends...

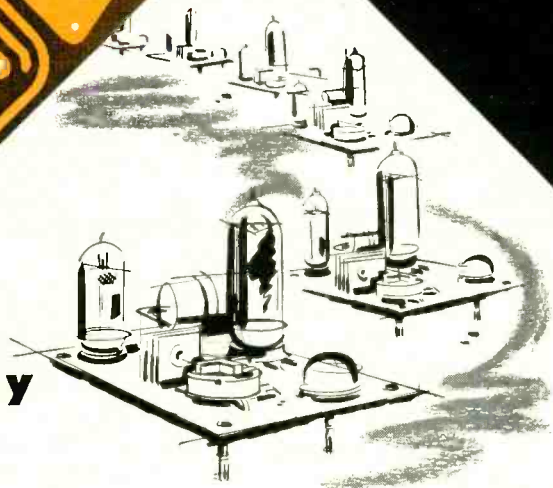
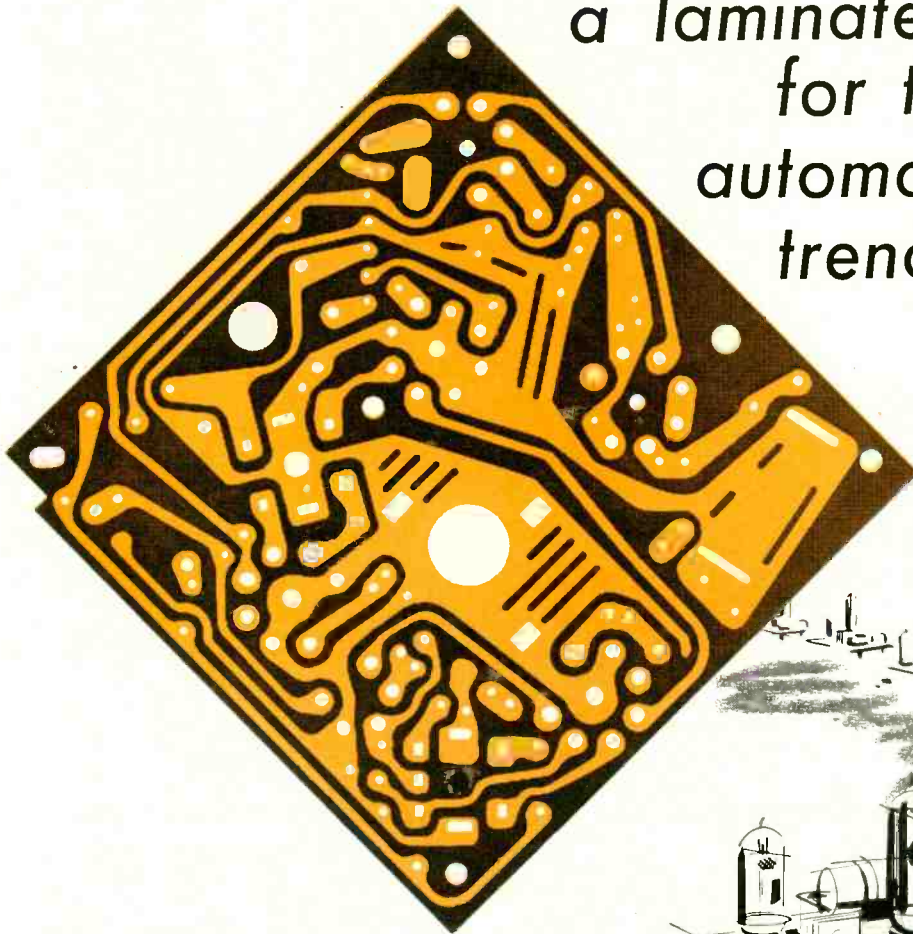

## new precision registry for printed circuits

G-E TEXTOLITE Cold Punch 11570, a phenolic paper-base laminate, adds new concepts to mechanized printed circuitry. This high insulation resistance XXXP laminate can be punched at normal room temperatures—eliminating dimensional changes in the material, as is the case of grades that are heated prior to punching.

The cold fabricating quality of G-E TEXTOLITE 11570 makes possible precision registration of printed circuits, and affords manufacturers the opportunity to use automatic assembly equipment in mounting components.

Other outstanding features of G-E TEXTOLITE 11570 include high flexural strength, very low power factor, high heat resistance, and optimum uniformity. The translucency of TEXTOLITE 11570 permits a visual check for accuracy of circuit registration.

This new G-E TEXTOLITE Cold Punch 11570, with superior electrical and mechanical properties, now offers new opportunities to electrical and electronic manufacturers.

*when the properties have to be right  
specify G-E Textolite*

Send the attached coupon for the factual booklet "A Laminate For Automation." It gives all the important facts about G-E TEXTOLITE COLD PUNCH 11570.

*Progress Is Our Most Important Product*

## GENERAL ELECTRIC

G-E Textolite® Laminated Sheets, Rods & Tubes •  
Irrathene® Irradiated Polyethylene • Silicone Insulation •  
Mica and Mica Mat Insulation • Insulating Varnishes •  
Varnished Cloth and Tapes • Sealing and Filling Compounds •

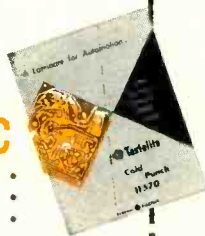

General Electric Company  
Laminated and Insulation Products Department  
Section EL-26 P. O. Box 5911, Cleveland, Ohio

- Please send me your new booklet,  
"A Laminate for Automation."  
 Please have your representative call.

Name .....

Firm .....

Street .....

City ..... Zone ..... State .....

# SPECIFY C-A-C TOROIDS

• IMMEDIATE DELIVERY • MIL. SPECS. • ADVANCED ENGINEERING • SUB-MINIATURE DESIGNS

Your research engineering, model development and pre-production engineering can be speeded up by utilizing quantities and varieties of toroids carried in our stock—available for immediate delivery. Because of our completely expanded and accelerated production facilities, regular orders of toroids can be filled in minimum time. Eliminate your toroid problems—specify CAC!

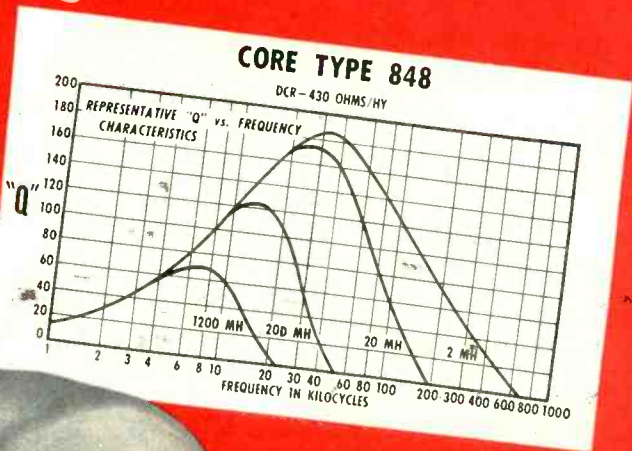
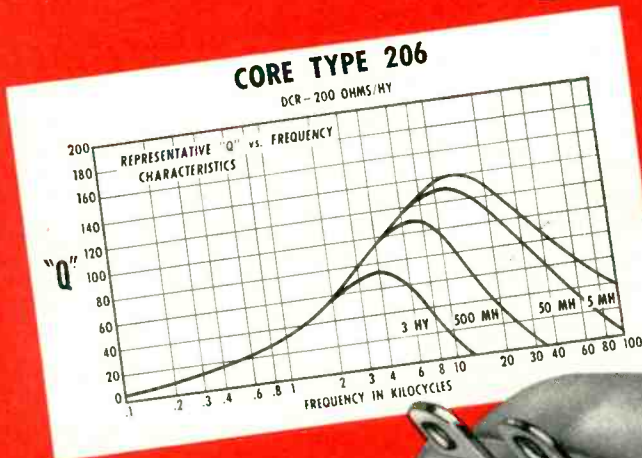

## ORDER FROM STOCK

A wide variety of molded plastic and hermetically sealed toroidal units are available for delivery same day as orders are received.

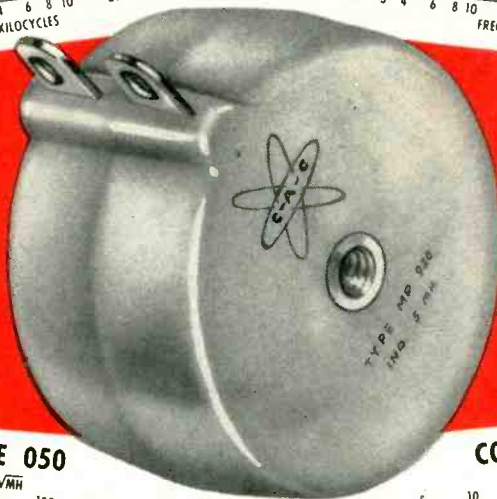

## A NEW SERVICE FOR ENGINEERING ORDERS.

Uncased coils and small orders are quickly produced in our specially equipped and staffed "rush order" department.

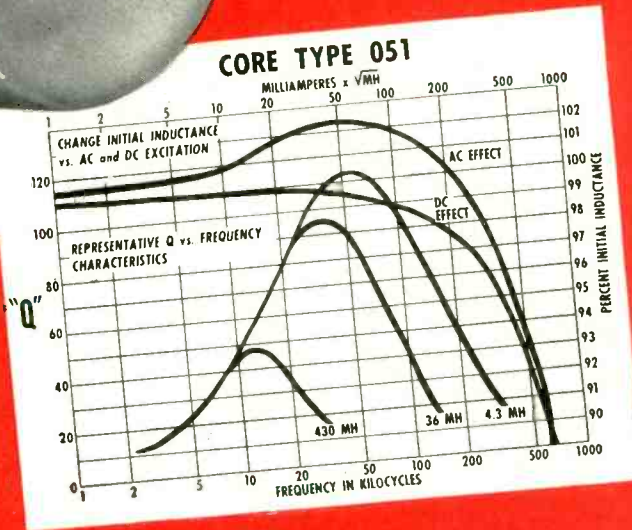
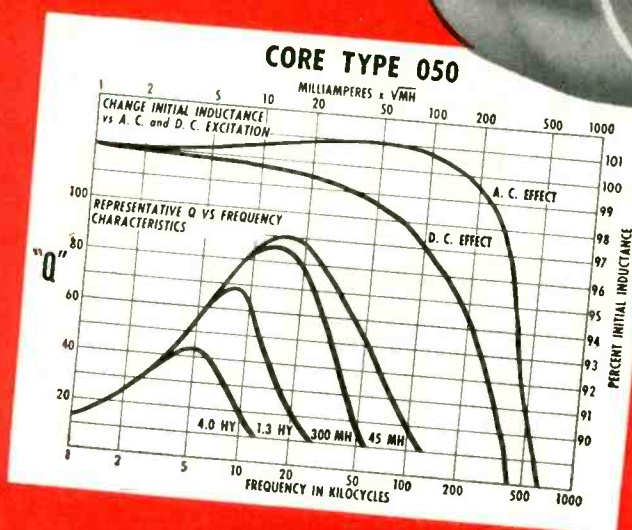

*Precision Delivery Quality*

There is a CAC man near you—write, wire or phone for complete information.

# Communication Accessories Company

HICKMAN MILLS, MISSOURI • PHONE KANSAS CITY, SOUTH 1-5528

Want more information? Use post card on last page.

# PRECISION RESOLVERS

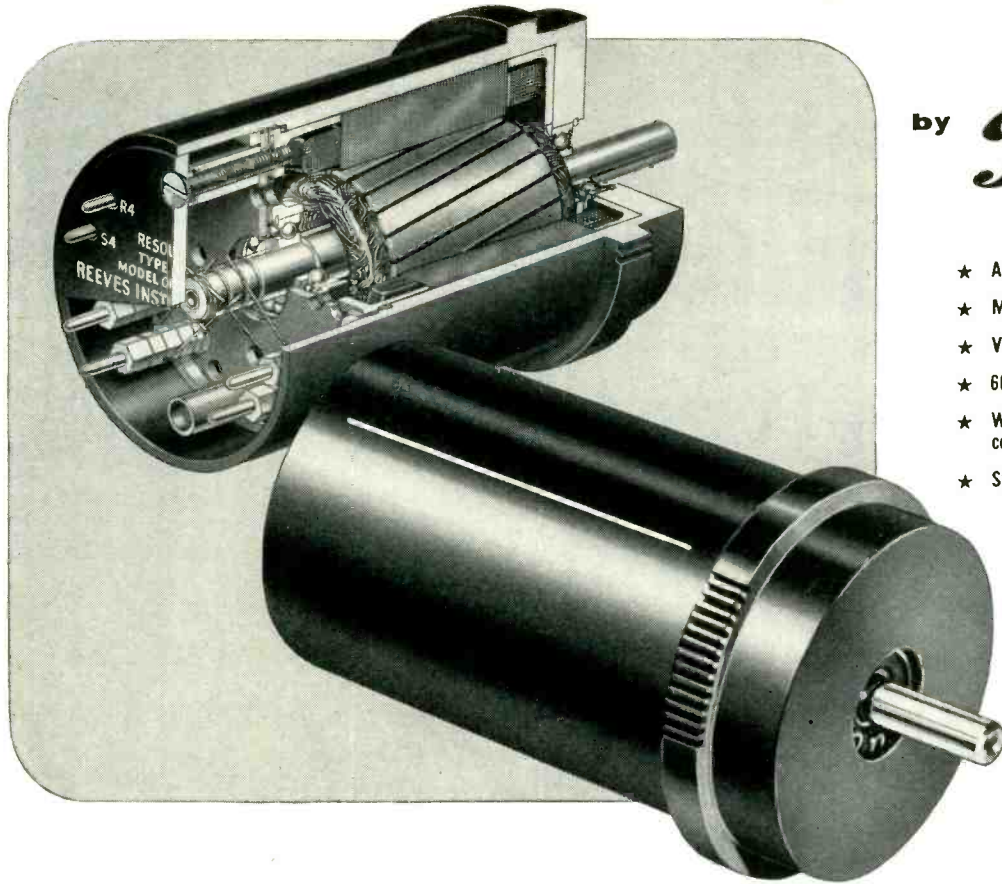

by **Reeves**  
INSTRUMENT CORPORATION

- ★ Accuracy better than 0.05%.
- ★ Maximum interaxis error as low as 1'.
- ★ Very low distortion.
- ★ 60 or 400 cps. or wide band.
- ★ With or without booster amplifier compensation.
- ★ Standard military frame sizes.

## the HIGHEST PRECISION resolvers available

### REEVES PRECISION RESOLVERS AND RELATED COMPONENTS



MINIATURE  
PRECISION  
RESOLVERS

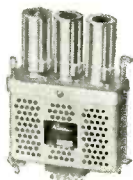

BOOSTER  
AMPLIFIERS

Reeves' many years of experience as a pioneer in the field has made it possible to manufacture these compact precision resolvers in quantity production to a functional accuracy of 0.05% without culling—or to an accuracy of 0.03% on special order. Harmonic distortion and null voltages are held below one-tenth of one per cent.

Reeves resolvers are primarily designed for 60 and 400 cps. operation, with or without booster amplifier compensation. Special units are available for use at over 100 kc bandwidth. The Reeves R600 series is the standard of comparison among precision resolvers. Miniature resolvers of highest precision are also available.

Write for the Reeves Resolver Handbook.

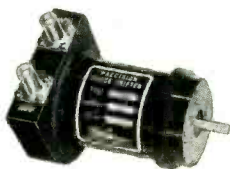

PHASE  
SHIFTERS



CONTINUOUS  
RESOLVER  
CHECKER



### REEVES INSTRUMENT CORPORATION

A Subsidiary of Dynamics Corporation of America

201 East 91st Street, New York 28, New York

**for Safe**  
**“Trouble-free”**  
**Electrical**  
**Protection**

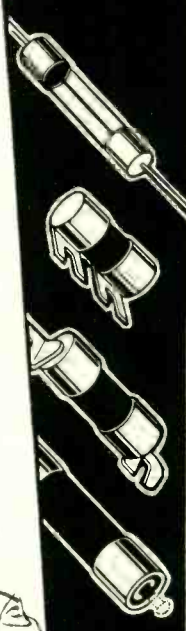

**Standardize**  
**on BUSS Fuses!**

Today, Industry, the Trade and the Public accept BUSS fuses without question. The BUSS reputation for fuses of unfailing dependability has been established over the past 41 years by millions upon millions of BUSS fuses used in homes, on farms, in industries, as well as in electronic equipment.

To assure top quality and proper operation under all service conditions — every BUSS fuse normally used by the Electronic Industries is tested in a sensitive electronic device. Any fuse not correctly calibrated, properly constructed

and right in all physical dimensions is automatically rejected.

That's why you can rely on BUSS fuses to open and prevent further damage to equipment when there is trouble on the circuit. And just as important, BUSS fuses will not cause needless shutdowns by blowing when trouble doesn't exist.

There's a complete line of BUSS fuses and fuseholders available. So be profit wise — and rely on dependable BUSS fuses to help safeguard the good name of your product or service as surely as they protect users.

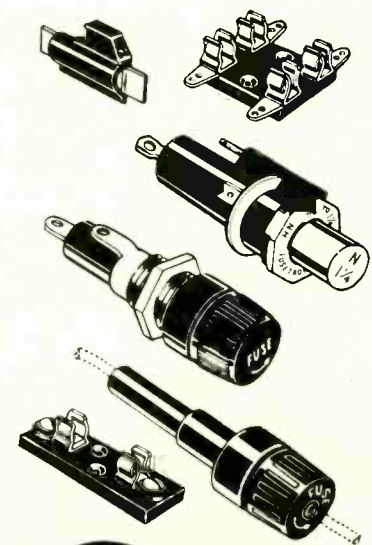

ELRC  
 856

Makers of a complete line of fuses for home, farm, commercial, electronic, automotive, and industrial use.

**BUSSMANN MFG. CO.**

University at Jefferson,



Div. of McGraw  
 Electric Co.

St. Louis 7, Mo.





Now Fairchild is able to miniaturize potentiometers and still give you the accuracy and reliability you need.

This advance is made possible by Fairchild's continuous and extensive research on new materials such as epoxy-resin and halogenated polyethylene insulating materials, and precious metal alloy resistance wire, and by thorough evaluation of these materials in our own environmental testing facilities. These advances are maintained by our rigid quality control program on materials, processes, and manufacturing.

## **MINIATURIZATION** without **sacrificing performance**

Fairchild miniature precision potentiometers meet applicable portions of MIL-E-5272A for humidity, vibration, temperature cycling, fungus resistance and salt spray. These units, in  $\frac{7}{8}$ " and  $1\frac{1}{8}$ " diameters, meet the same requirements for accuracy and reliability as most standard precision units up to 2" in diameter.

No matter what factors govern your choice of precision potentiometers, you'll find the answer in Fairchild's complete line. Write Dept. 140-59A2, Fairchild Camera and Instrument Corporation, Potentiometer Division, 225 Park Avenue, Hicksville, Long Island, New York.

**FAIRCHILD**  
**PRECISION POTENTIOMETERS**



**Yes, MARCONI'S**  
*have just what*  
*is needed!*

*Marconi instruments include a range of Signal Generators designed to meet practically every requirement.*



As the Signal Generator is the basic tool in radio research, it is not surprising that Marconi Instruments have had long and unrivalled experience in this fundamental field. Generators are available which will fulfil practically every requirement, and new types are continually being added to the already large range at present available.

**F.M./A.M. SIGNAL GENERATOR**  
**TYPE TF 1066**

*For particulars of other Generators please see the Complete Catalogue of Marconi Instruments*

Carrier Frequency Range: 10 to 470 Mc. • No spurious sub-multiple outputs; r.f. oscillator generates direct at carrier frequency on all bands. • F.M. monitored and variable up to 100 kc deviation. • A.M. monitored and variable up to 80% depth. • Output Level variable from 0.2 microvolt to 200 millivolts. • Precision Incremental Tuning with frequency change indicated on a directly-calibrated meter.

VACUUM TUBE VOLTMETERS · FREQUENCY STANDARDS · OUTPUT METERS  
 F.M. & A.M. SIGNAL GENERATORS · DEVIATION METERS · WAVEMETERS  
 WAVE ANALYSERS · Q METERS · AUDIO AND VIDEO OSCILLATORS

*Full data and prices will be mailed immediately on request*

**44 NEW STREET · NEW YORK 4**

**CANADA: CANADIAN MARCONI COMPANY,  
 MARCONI BUILDING, 2442 TRENTON AVENUE,  
 MONTREAL.**



**ENGLAND:** Head Office: Marconi Instruments Ltd., St. Albans, Herts. Managing Agents in Export: Marconi's Wireless Telegraph Co. Ltd., Marconi House, Strand, London, W.C.2

TC75



Better Things for Better Living  
... through Chemistry

## ELECTRONIC DESIGN

PROPERTY AND APPLICATION DATA ON THESE  
VERSATILE ENGINEERING MATERIALS: "ZYTEL,"  
"ALATHON," "TEFLON," "LUCITE."

# NEWS

## Heat resistance, low friction of TEFLON® solves design problem in miniaturization of potentiometers

Du Pont ZYTEL® provides needed insulation in strong, lightweight parts

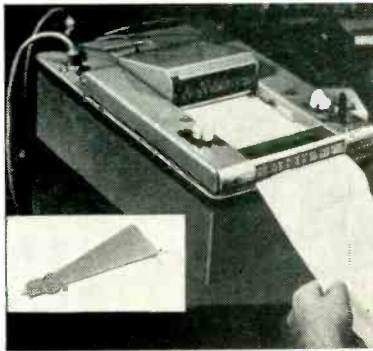

Marking electrodes, housed in Du Pont "Zytel" nylon resin, trace impulses on electro-sensitive paper. "Zytel" is used because of its insulating properties and its strength in thin sections. (Recorder manufactured by Alden Electronic & Impulse Recording Equipment Co., Alden Research Center, Westboro, Mass.)

With the Alden 30-channel recorder, up to 30 machines can be monitored remotely and their records studied for optimum scheduling, and downtime. Tiny motion switches mounted on the machines and activated by machine motions transfer electrical currents to the recorder. The currents then activate electrodes that mark out lines on electro-sensitive paper, providing a permanent record of operating cycle, and downtime.

One of the problems in developing the recorder was to find a material to house the marking electrodes. It had to be lightweight, strong, provide good insulating properties, and be economical to produce.

The manufacturer solved the problem with Du Pont "Zytel" nylon resin. This engineering material is strong, even when molded in thin sections. The metal inserts form an integral part of the marking electrodes because "Zytel" can be injection-molded around these inserts. With this method there are fewer parts, and assembly costs are reduced. The holders of "Zytel" can be produced in a variety of attractive colors.

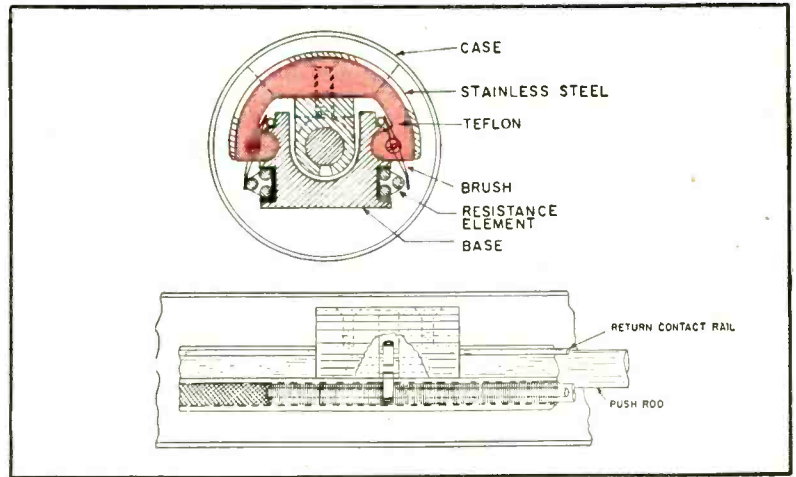

Cross section of typical dual rectilinear potentiometer with insulation of "Teflon." Du Pont "Teflon" protects the core from heat and friction.

Miniaturization in guided missiles and other airborne equipment necessitates improvement in design and insulation of potentiometers. Du Pont "Teflon" tetrafluoroethylene resin fills the insulation requirements. A trunnion pin fitted into two shoes of "Teflon" holds the double-leaf brush in the new line of high-temperature potentiometers manufactured by the Pacific Scientific Company, Los Angeles, California.

The importance of "Teflon" in this application stems from its high heat resistance and low coefficient of friction. In use, this potentiometer must operate at temperatures as high as

400°F. and intermittently to 550°F. "Teflon" insulates the potentiometer and protects the core. The movement of the sleeve calls for a material with a low coefficient of friction. "Teflon" solves this problem, too.

"Teflon" offers a combination of electrical, chemical and mechanical properties that makes it well suited for use in high-frequency, high-temperature and some high-voltage applications; in applications such as this, where miniaturization and compactness of design are essential; and for uses where equipment is exposed to corrosive action.

### NEED MORE INFORMATION?

CLIP THE COUPON for additional data on the properties and applications of these Du Pont engineering materials.

\*"Teflon" and "Zytel" are registered trade-marks of E. I. du Pont de Nemours & Co. (Inc.).

E. I. du Pont de Nemours & Co. (Inc.), Polychemicals Department  
Room 222, Du Pont Building, Wilmington 98, Delaware  
In Canada: Du Pont Company of Canada Limited,  
P. O. Box 660, Montreal, Quebec.

Please send me more information on the Du Pont engineering materials checked:  "Teflon"\* tetrafluoroethylene resin and  "Zytel"\* nylon resin.

I am interested in evaluating these materials for \_\_\_\_\_

NAME \_\_\_\_\_

COMPANY \_\_\_\_\_ POSITION \_\_\_\_\_

STREET \_\_\_\_\_

CITY \_\_\_\_\_ STATE \_\_\_\_\_

TYPE OF BUSINESS \_\_\_\_\_

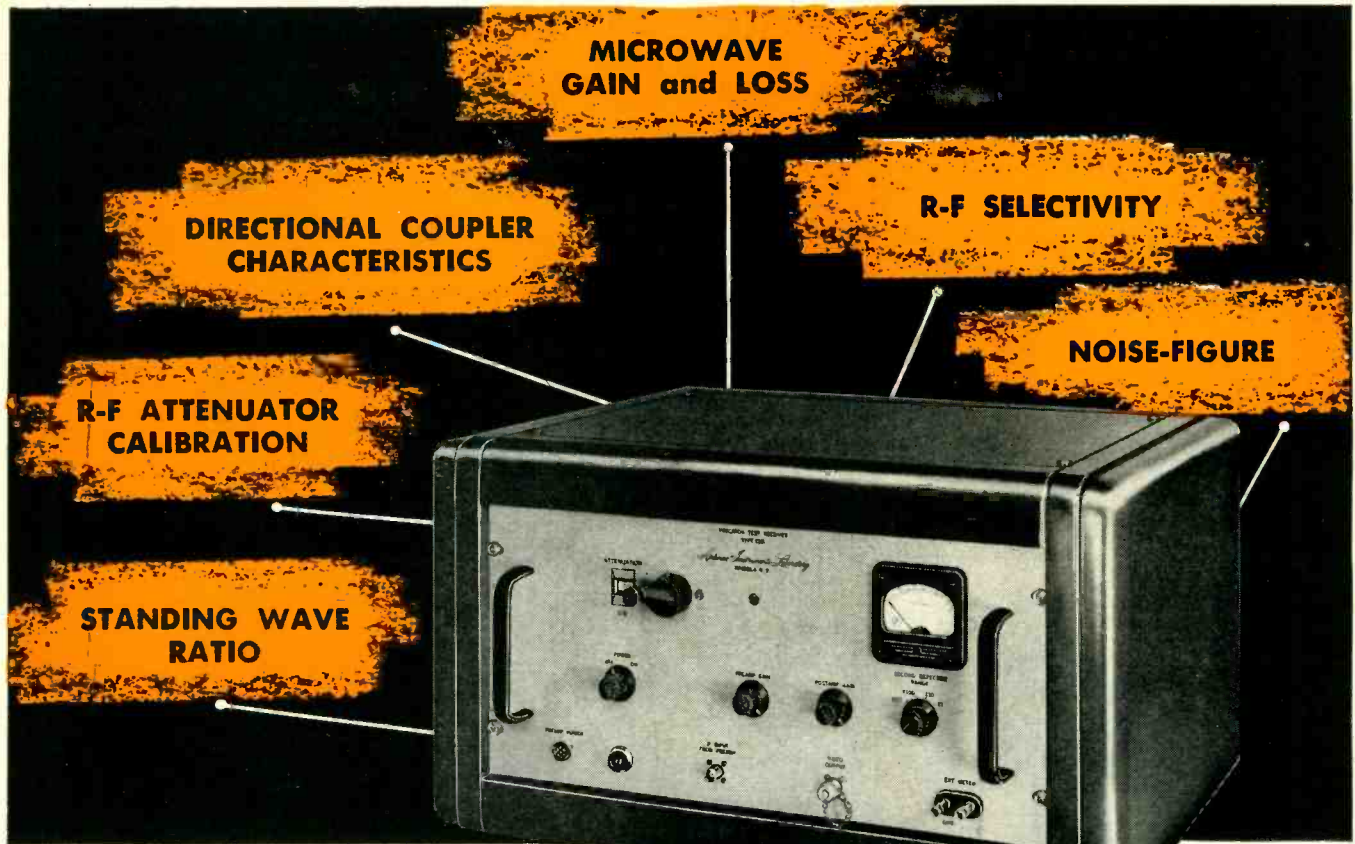

**with all these measurements**



## **PRECISION TEST RECEIVER** **offers complete versatility**

How often have you put together a breadboard setup of a pre-amplifier, post-amplifier, attenuator, power supply, output indicator, bias control and the rest of the haywire needed to make the multitude of measurements which require an intermediate frequency receiver?

AIL's engineers did it often enough to force the design of a single package for their own use. As a result, the type 130 Receiver is an engineer's design for engineers' use.

The AIL Type 130 Precision Test Receiver is a versatile instrument combining a high-gain, low-noise-figure i-f receiver and a secondary standard of attenuation. It is designed to operate from the i-f output of a wide variety of standard microwave mixers. In combination with such mixers and a suitable local oscillator, the Receiver becomes a sensitive detector of microwave energy. It can be used wherever accurate measurements of the differences of r-f or i-f power levels are required.

*The complete AIL Type 130 Precision Test Receiver is priced at \$1,350.00. The standard model is available for 30MC use. Prices on models operating at other frequencies will be provided on request. F.O.B. Mineola, N. Y.*

**SEND FOR  
DESCRIPTIVE  
LITERATURE**



**AIRBORNE  
INSTRUMENTS  
LABORATORY**

I N C

160 OLD COUNTRY ROAD, MINEOLA, L. I., N. Y.



**EIMAC KLYSTRONS** are used in  
**Continental Defense forward-scatter networks**

Collins Radio Company's pioneering of circuits and equipment has contributed greatly to the success of the revolutionary new art of forward-scatter communications. From the beginning of this program, Eimac tubes have provided the high power necessary to make scatter propagation practical. In Collins newest high power microwave transmitters for beyond-the-horizon communications in Continental Defense networks, only Eimac klystrons are used as final amplifier tubes.

*Third in a series of advertisements emphasizing the extensive application of Eimac amplifier klystrons and circuit components, negative grid tubes and rectifiers by leading manufacturers of forward-scatter UHF/microwave transmitters.*



Collins two and ten kilowatt forward-scatter transmitters utilize Eimac amplifier klystrons, negative grid tubes and rectifiers.

**Eimac**  
THE POWER  
FOR FORWARD-SCATTER

**EITEL-McCULLOUGH, INC.**  
SAN BRUNO • CALIFORNIA  
The World's Largest Manufacturer of Transmitting Tubes

# BUDD-STANLEY presents 2 outstanding services

## Exclusive New Casting Process for Producing Waveguide Assemblies as shown below:

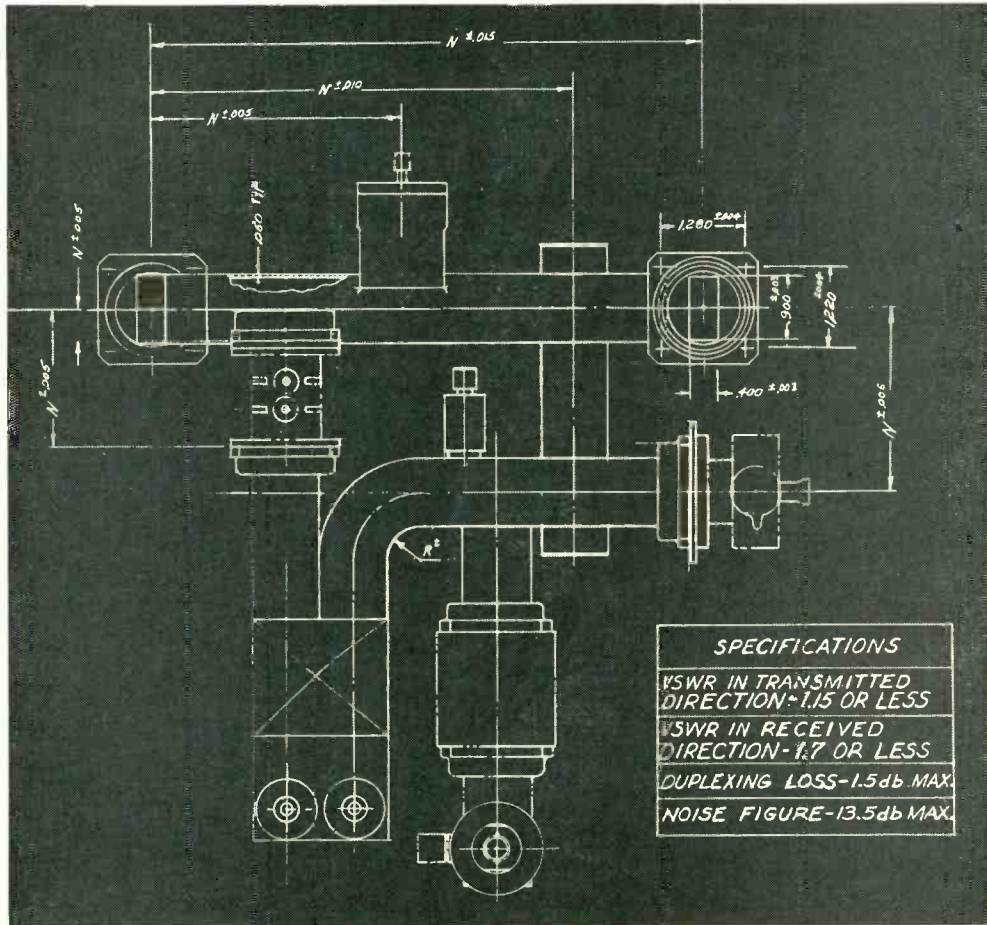

- ✓ Produces waveguide assemblies of a quality higher than your specifications at lower cost.
- ✓ Waveguides requiring complex structures not believed possible can now be cast to meet your most exacting requirements. Castings in brass, aluminum and magnesium.
- ✓ Guaranteed uniformity of electrical and mechanical parameters.
- ✓ Interchangeability and electrical performance guaranteed.
- ✓ Complete meeting of all electrical and mechanical specifications.

We shall be glad to send you complete details. Write or Wire.

## BUDD-STANLEY CO. INC.

43-01 22nd St., Long Island City 1, N. Y.  
Phone Stillwell 6-1706  
Cable Address "BUDDSTAN"

### For further information get in touch with:

Asbury Park, New Jersey  
I. E. ROBINSON CO.  
702 Mattison Avenue  
Dunkirk 9-2404

Baltimore, Maryland  
HORMAN ASSOCIATES  
635 St. Johns Rd.  
Hopkins 7-2290

Bogota, New Jersey  
RMC ASSOCIATES  
114 East Main Street  
Diamond 2-5343

Camp Hill, Pennsylvania  
I. E. ROBINSON CO.  
2120 Market Street  
Regent 7-5541

Chicago, Illinois  
HOWER & PRETAT  
4 N. Cicero Avenue  
Columbus 1-3146

Downsview, Ontario  
BEECHEY ENTERPRISES  
20 Nash Drive  
Toronto, Cherry 1-2150

# in microwave transmission components!

## RF HEADS

complete with electron tubes and all accessories  
from  
**ENGINEERING  
CONSULTATION**  
to  
**COMPLETE  
PRODUCTION  
MANUFACTURING**

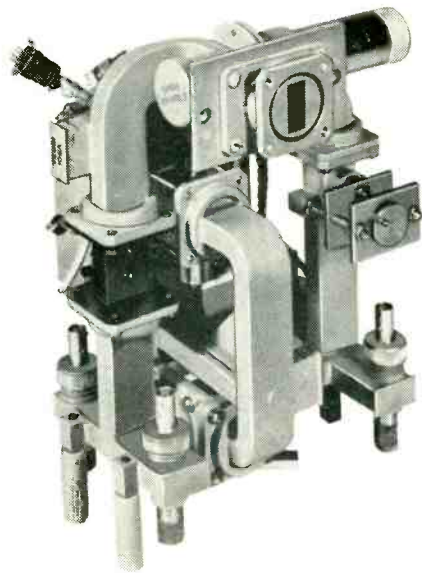
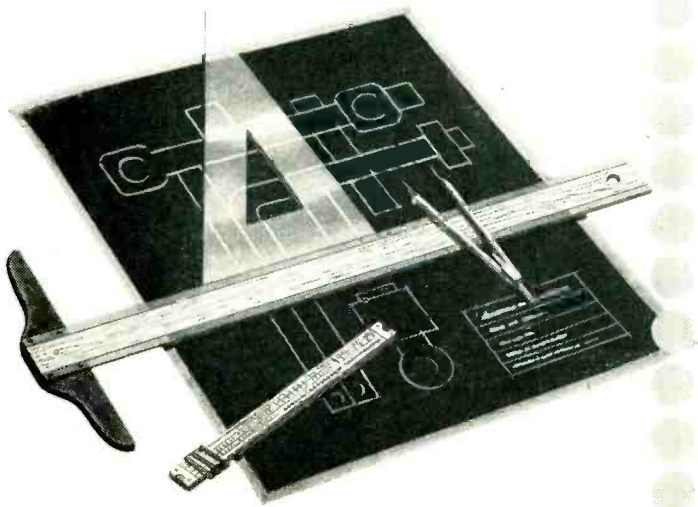

according to your specifications and design  
fully tested and ready for installation in your system

Including Mixers; Duplexers; AFC Mixers; Beacon Circuits;  
Local Oscillator Mounts; Directional Couplers; Antenna Feeds;  
Rotary Joints.

- Save assembly time
- Save purchasing time
- Save inspection time



**Quality**  
**Economy**  
**Dependability**

You can depend on Budd • Stanley production skill, engineering know-how, experience and manufacturing methods to produce waveguide and microwave transmission equipment from the simplest to the most intricate assembly.

Liverpool, New York  
WADSWORTH MFG. ASSOCIATES  
509 Balsam Street  
Liverpool 69-7043

Los Angeles, California  
JACK BERMAN CO.  
1141 So. LaCienega Blvd.  
Bradshaw 2-9138

New York, New York  
RMC ASSOCIATES  
170 East 80th Street  
Trafalgar 9-2023

San Francisco, California  
E. L. BERMAN CO.  
758 Natoma Street  
Underhill 3-0317

Upper Darby, Pa.  
I. E. ROBINSON CO.  
7404 West Chester Pike  
Sherwood 8-1294

Washington, D.C.  
HORMAN ASSOCIATES  
2017 S Street, N.W.  
Decatur 2-5705

ARE YOU, LIKE SYLVANIA,

*Pushing to Higher  
Frequencies?*



Dr. R. G. Hutter, manager of Sylvania's Physics Research Laboratories, under whose direction basic research in traveling wave tubes is carried on, discussing problems with engineer R. I. Harrison. Dr. Hutter is holding a Sylvania low level 2000-4000 mc amplifier tube in his hands.

When Sylvania started out on a traveling wave tube program, their research engineers specified PRD test equipment. High quality was an important factor in their choice. In addition, they wanted a line of test equipment covering a wide frequency range to take care of future developments in higher frequencies.

If you, like Sylvania, are pushing to higher frequencies, you will be interested in PRD's full coverage and especially in the —

## **PRD MILLIMETER WAVEGUIDE TEST EQUIPMENT**

Why? Because:

1. Precision really counts with millimeter equipment
2. PRD has pioneering experience in this field
3. The equipment is available now.



Write for  
Complete  
Catalog A

*Polytechnic* **RESEARCH  
& DEVELOPMENT CO., INC.**

202 TILLARY STREET  
BROOKLYN 1, N. Y.  
Telephone: ULster 2-6800



Midwest Sales Office:  
1 SOUTH NORTHWEST HIGHWAY, PARK RIDGE, ILLINOIS — TAlcott 3-3174.  
Western Sales Office:  
737-41, SUITE 7, NO. SEWARD STREET, HOLLYWOOD 38, CAL. — HO 5-5287



**BEST COMPONENTS  
for  
BEST PRODUCTS**



Specify  
Moloney HyperCores for  
electronic applications which require  
cores of exact performance characteristics  
plus size and weight advantages. The lower  
losses and greater flux carrying capacity of  
Moloney HyperCores guarantee performance  
which has become the standard of the industry.  
Specify Moloney HyperCores to complement  
your product. Production in quantity is  
available—if you require smaller size  
and less weight in your electronic cores.

ME86-1

**MOLONEY ELECTRIC  
COMPANY**

**HYPERCORE  
SELECTOMETER...**

an eight-inch circular slide rule, so arranged that after dialing the desired core area, the corresponding window dimensions, catalogue number, weight, and net price can be read directly. Write today for free HyperCore Selectometer!



**New HYPERCORE  
CATALOG SR206...**

provides complete data including performance characteristics, sizes, weights, list prices and quantity discounts on cores for electronic applications. Send for your free copy today!



Power Transformers • Distribution Transformers • Load Tap Changing Transformers • Regulating Transformers • Step Voltage Regulators • Primary Unit Substations • Secondary Unit Substation Transformers • Network Transformers • Series Street Lighting Transformers • Subway Transformers • Industrial Dry Type Transformers • Capacitors • Magnetic Components for Electronics  
**SALES OFFICES IN ALL PRINCIPAL CITIES • FACTORIES AT ST. LOUIS 20, MO. AND TORONTO, ONT., CANADA**

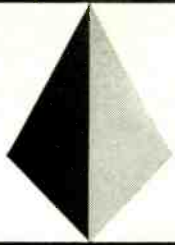

**NO.65**

# PYRAMID technical bulletin

**GENERAL**

Pyramid subminiature, solid-impregnant Type R "Glasseal" tubular capacitors are the latest addition to the line of fixed DC paper-dielectric capacitors, hermetically sealed in metallic cans. They are being produced in response to the demand for more rugged capacitors capable of withstanding the vibrational stresses of high acceleration and frequency as well as severest



shock conditions. They meet the performance requirements for Characteristic K capacitors of U.S. Government Military Specification MIL-C-25B.

**QUALITY AND RELIABILITY**

As a result of continuous testing and quality control progress throughout the manufacturing process, Pyramid Capacitors meet the highest standards of quality and reliability. Production tests for voltage breakdown, capacitance, power factor, insulation resistance and seal are performed on 100% basis. Each production lot also is subjected to a group of sampling tests consisting of life, temperature and immersion cycling, vibration, and corrosion tests.

**CONSTRUCTION**

**External Construction:** Type R "Glasseal" capacitors are assembled in nonmagnetic cases and utilize the new, rugged, compression-seal type, glass-to-metal solder-seal terminals. These provide mechanically superior performance and a permanent gas-tight seal with generous air strike and creepage distance. They will not rotate or work loose under any conditions.

**Internal Construction:** Solid-impregnant Type R "Glasseal" capacitors are available in either the inserted-tab or extended-foil construction. Both types are noninductively wound. For normal applications, either type may be used. Inserted-tab capacitors should not be used at voltages lower than 10 volts without preview of the application by the Pyramid Engineering Department. Extended-foil capacitors may be used down to zero volts.

**TEMPERATURE RANGE**

"Glasseal" capacitors have a functional operating range of from -55°C to +125°C. The capacitors are thoroughly impregnated and filled with a solid impregnant of the thermosetting resin type. This prevents any movement of the section within the case and is the basis of the exceptional vibration-and-shock-test performance of these capacitors.

**CAPACITANCE TOLERANCE**

The standard tolerance is ±20%. Closer tolerances are available on request.

**VOLTAGE BREAKDOWN TEST**

Type R "Glasseal" capacitors will withstand, at 25°C, a d.c. breakdown test voltage of twice the rated operating voltage, between terminals, and between terminals and case, for a maximum period of two minutes. The test voltage is applied through a resistance sufficient to limit the current, on breakdown, to 5 milliamperes.

**LIFE TEST**

Type R "Glasseal" capacitors will withstand application of a d.c. voltage 1.4 times the rated working voltage for 250 hours at 125°C.

**VOLTAGE DERATING AT ELEVATED TEMPERATURES**

Type R capacitors are designed for a minimum continuous service-life expectancy of 2,000 hours at 125°C without any reduction of the rated d.c. working voltage. For a life expectancy of one year (8,800 hours), a voltage derating of 30% at 125°C, or a limitation of the maximum operating temperature to 85°C without any voltage derating is necessary.

**INSULATION RESISTANCE**

Insulation resistance is measured after an electrification period of two minutes. Capacitors rated below 600 volts d.c. are tested at 100 volts d.c.; those rated at 600 volts d.c. or above are tested at 500 volts d.c. The minimum value of insulation resistance for a particular capacitor may be determined from the following table:

Temperature (°C)	Minimum Megohms x MF*	"Need Not Exceed" Value (Megohms)	Capacitance Range (MF)
25	4,000	12,000	.001 to .33 .33 and over
85	100	1,000	.001 to .1 .1 and over
125	10	150	.001 to .066 .066 and over

\*It is not practical, in the manufacture and measurement of capacitors of low capacitance value, to adhere to the Megohms x MF values given in the column under the latter heading. Consequently, the values given in the "Need Not Exceed" Value column are those values of insulation resistance which are considered satisfactory for low capacitance units. Where the Megohms x MF value governs, the minimum value of insulation resistance is determined by dividing the Megohms x MF figure by the capacitance in microfarads. For example, the minimum insulation resistance required for a 0.25 mf capacitor at 85°C is

$$\frac{100 \text{ (Megohms x MF)}}{0.25 \text{ (MF)}} = 400 \text{ megohms.}$$

**POWER FACTOR**

When measured at, or referred to, a frequency of 1,000 cycles per second at 25°C, the power factor will not exceed 1%.

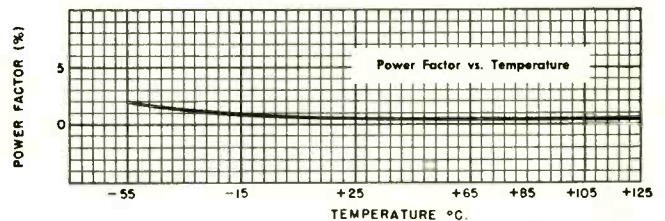

**CAPACITANCE CHANGE AT LOW TEMPERATURES**

At -55°C, the capacitance change (decrease) will not exceed 10% of the capacitance measured at 25°C.

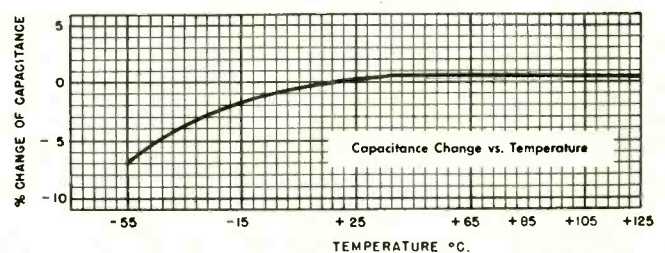

PYRAMID IS THE BIG NAME IN CAPACITORS AND SELENIUM RECTIFIERS TODAY!

**PYRAMID ELECTRIC CO.** North Bergen, New Jersey

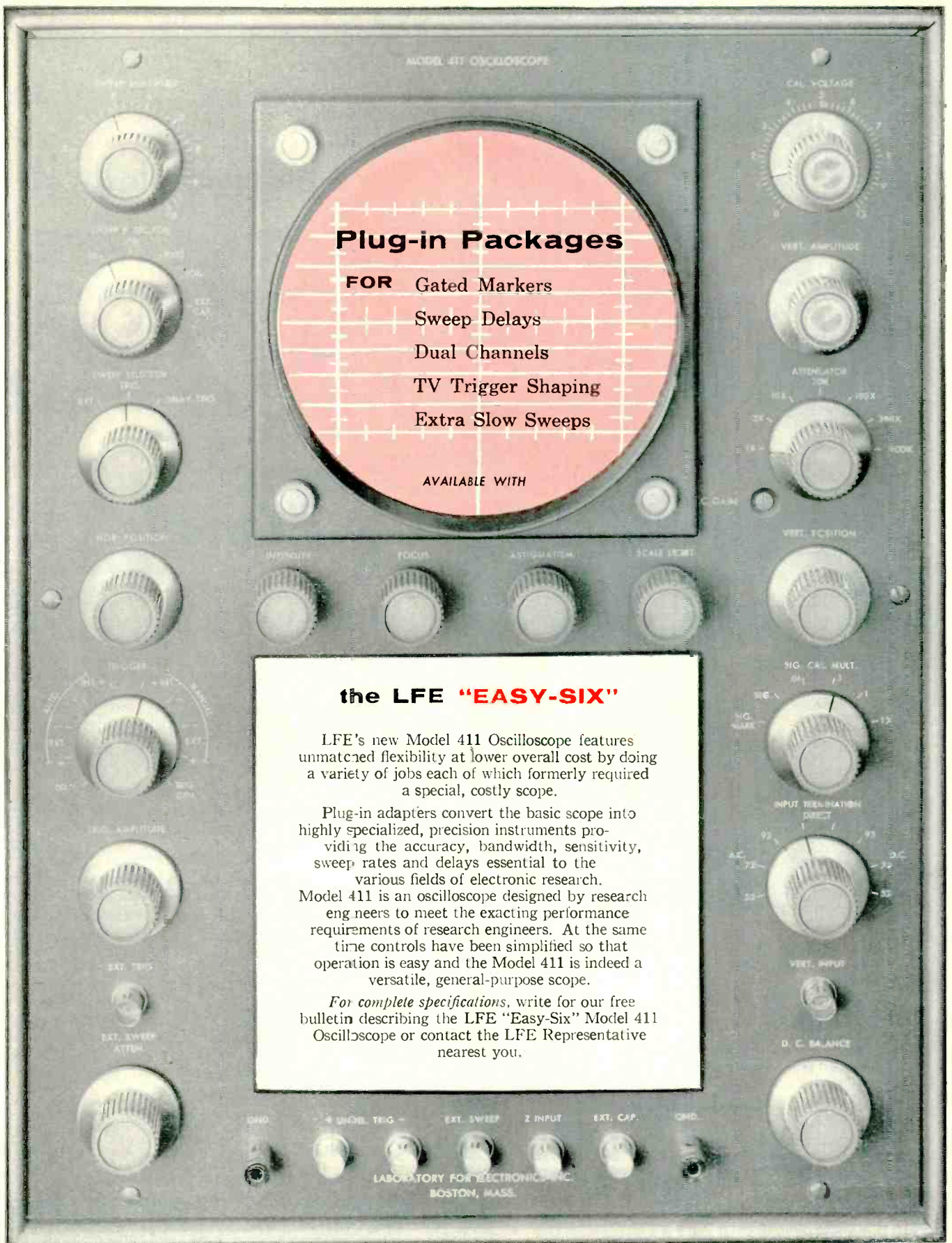

**Plug-in Packages**

- FOR** Gated Markers
- Sweep Delays
- Dual Channels
- TV Trigger Shaping
- Extra Slow Sweeps

AVAILABLE WITH

**the LFE "EASY-SIX"**

LFE's new Model 411 Oscilloscope features unmatched flexibility at lower overall cost by doing a variety of jobs each of which formerly required a special, costly scope.

Plug-in adapters convert the basic scope into highly specialized, precision instruments providing the accuracy, bandwidth, sensitivity, sweep rates and delays essential to the various fields of electronic research. Model 411 is an oscilloscope designed by research engineers to meet the exacting performance requirements of research engineers. At the same time controls have been simplified so that operation is easy and the Model 411 is indeed a versatile, general-purpose scope.

For complete specifications, write for our free bulletin describing the LFE "Easy-Six" Model 411 Oscilloscope or contact the LFE Representative nearest you.

**LABORATORY FOR ELECTRONICS, INC.**

75 Pitts Street, Boston 14, Massachusetts

FOR EXPORT SALES, CONTACT ANDREW SZUCS, INC., 50 BROAD ST., NEW YORK 4, NEW YORK



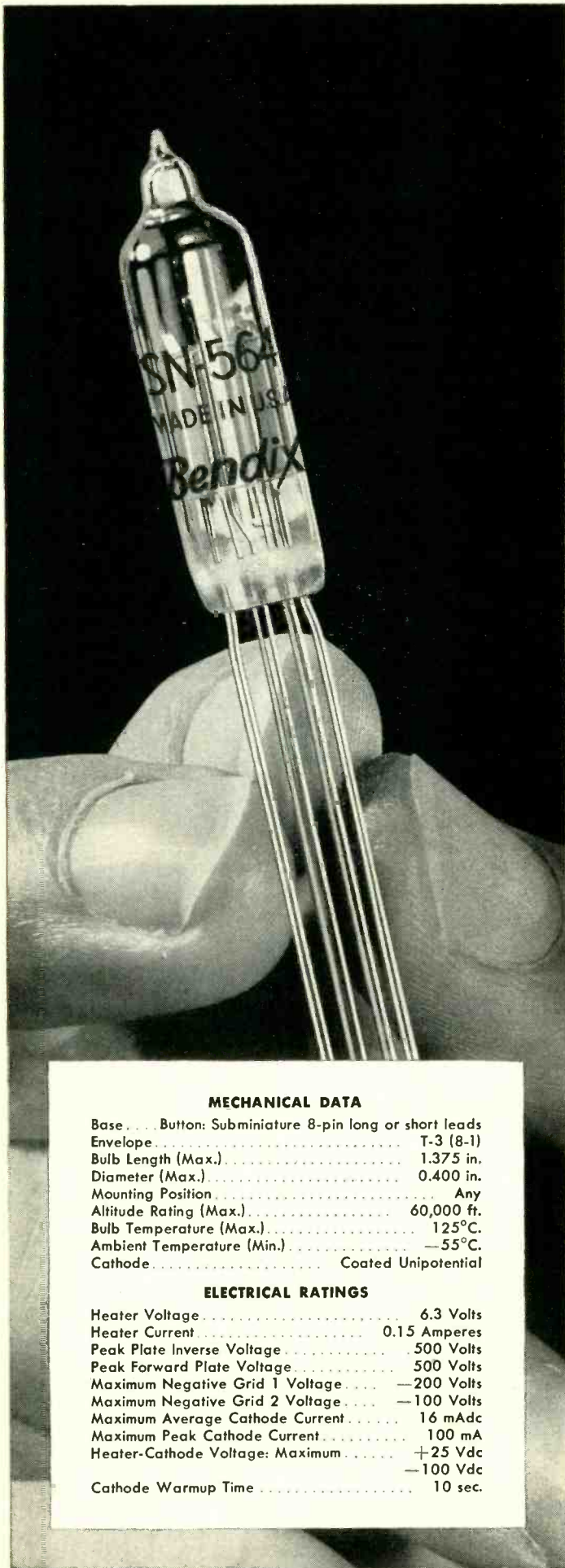

Now available—  
subminiature xenon  
tetrode thyatron

## RETMA 5643



### Improved Type TD-17

**APPLICATIONS:** Counters, grid control rectifiers, gyro erection systems, missile systems, automatic flight control systems, and other control circuits requiring utmost degree of reliability.

**ADVANTAGES:** Freedom from early failure . . . long service life . . . uniform operating characteristics . . . ability to withstand severe shock and vibration.

**FEATURES:** Advanced mechanical and electrical design plus 100% microscopic inspection during manufacture . . . special heater-cathode construction minimizes shorts . . . 24-hour run-in tests under typical overload conditions.

The TD-17 is but one of many electron tubes designed and built by Bendix Red Bank for special-purpose applications. For full information on the TD-17, or on other tubes for other uses, write RED BANK DIVISION, BENDIX AVIATION CORPORATION, EATONTOWN, NEW JERSEY.

West Coast Office: 117 E. Providencia Ave., Burbank, Calif.

Canadian Distributor:  
Aviation Electric Ltd., P. O. Box 6102, Montreal, P.Q.

Export Sales and Service:  
Bendix International Division, 205 E. 42nd St., New York 17, N. Y.

#### MECHANICAL DATA

Base . . . . .	Button: Subminiature 8-pin long or short leads
Envelope . . . . .	T-3 (8-1)
Bulb Length (Max.) . . . . .	1.375 in.
Diameter (Max.) . . . . .	0.400 in.
Mounting Position . . . . .	Any
Altitude Rating (Max.) . . . . .	60,000 ft.
Bulb Temperature (Max.) . . . . .	125°C.
Ambient Temperature (Min.) . . . . .	-55°C.
Cathode . . . . .	Coated Unipotential

#### ELECTRICAL RATINGS

Heater Voltage . . . . .	6.3 Volts
Heater Current . . . . .	0.15 Amperes
Peak Plate Inverse Voltage . . . . .	500 Volts
Peak Forward Plate Voltage . . . . .	500 Volts
Maximum Negative Grid 1 Voltage . . . . .	-200 Volts
Maximum Negative Grid 2 Voltage . . . . .	-100 Volts
Maximum Average Cathode Current . . . . .	16 mA
Maximum Peak Cathode Current . . . . .	100 mA
Heater-Cathode Voltage: Maximum . . . . .	+25 Vdc
	-100 Vdc
Cathode Warmup Time . . . . .	10 sec.



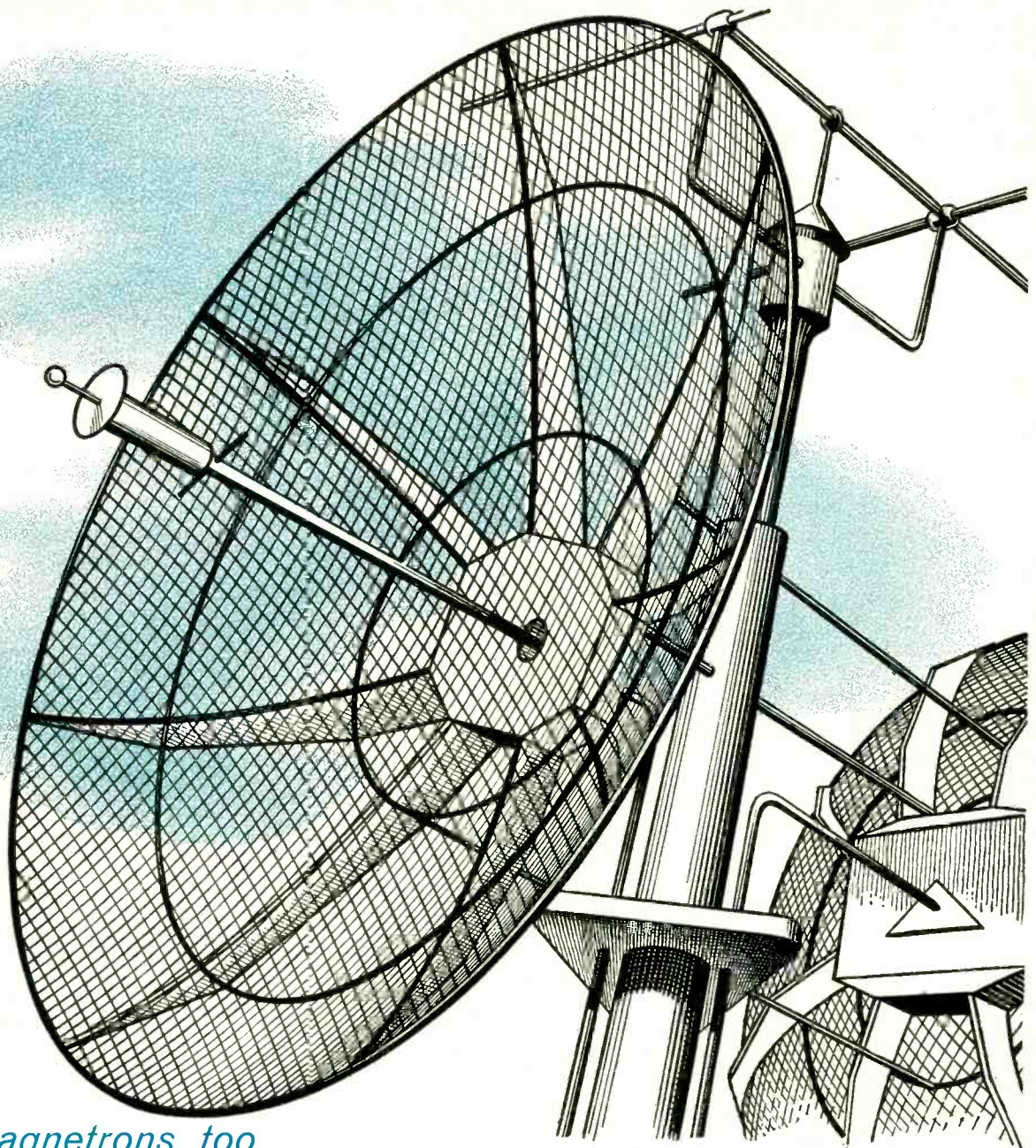

*In magnetrons, too*

## **CRUCIBLE PERMANENT MAGNETS**

*provide maximum energy... minimum size*

In designing magnetrons for radar systems — or any very high-frequency oscillator application — you can be sure of a *consistently higher* energy product with Crucible alnico magnets. *This means more power from a minimum size magnet!*

Crucible alnico permanent magnets are made to meet practically any size requirement from a fraction of an ounce to several hundred pounds. And they're sand cast, shell molded

or investment cast to the exact size, shape, tolerance and finish you need.

Crucible has been one of the largest producers of permanent magnets since the development of alnico alloys. Its unsurpassed magnet experience is backed by over 50 years of fine steelmaking. That's why the best solution to magnet problems starts with a call to Crucible. *Crucible Steel Company of America, Henry W. Oliver Building, Pittsburgh 22, Pa.*

**CRUCIBLE**

first name in special purpose steels

**Crucible Steel Company of America**

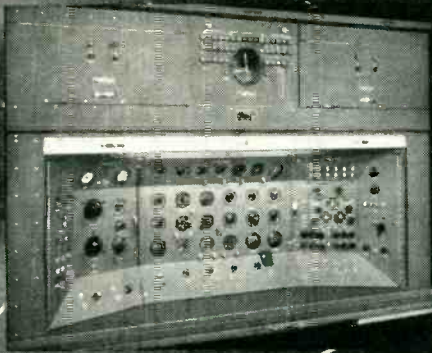

Instructor's Console for AN/APQ-22A  
Air Force F-4 Phantom II Trainer



PBM Flying Boat Machine  
Gun Turret with Automatic  
"Fire Interrupter" Control

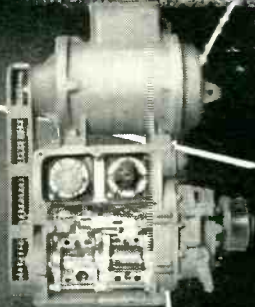

Precision Fire  
Control Equipment

ELECTRONIC  
DIVISION

from the  
102-year  
world leader  
in elevating...

**OTIS YONKERS and HARRISON WORKS**

43 acres — 1,415,530 square feet of  
floor space. Tremendous variety  
of processes, techniques,  
facilities equipment.



**OTIS ELECTRONIC DIVISION**

150,000 square feet of air-conditioned  
floor space. Facilities for  
approximately 1500 productive workers.  
Supported by every engineering,  
production and managerial resource of  
the entire Otis Elevator Company.



**AN/APQ-T2A Bombing and Navigational Radar Trainer for U. S. Air Force**

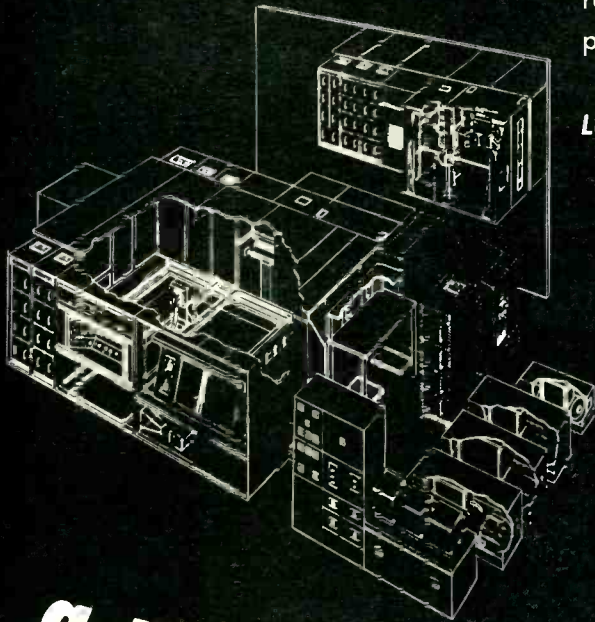

Under the banner of Otis, the Electronic Division is a performance-proven integral facility for large Government Services electronic systems. In every sense it is a **complete engineering unit** — from research and development right through lower-cost production and on-time delivery.

**Latest achievements include:**

- (1) development and production of the AN/APQ-T2A Bombing and Navigational Radar Trainer
- (2) reduction of the Government's cost of this trainer by approximately 50%
- (3) shipment of these trainers 3 to 4 months ahead of schedule
- (4) training and supplying maintenance and technical representatives for the Armed Services
- (5) R and D tasks for the B-52 and B-66 programs
- (6) R and D projects on guided missiles
- (7) R and D tasks on radar countermeasures
- (8) research, development and production for new radar applications to the AN/APQ-T2A Trainer

**a new integral power for defense electronics**

Here is a diversified facility with highly specialized personnel and experienced management ideally suited for mass-scale research, development, manufacture and maintenance of large electronic weapons systems such as:

- gunfire control systems
- missile guidance and control
- fire control systems
- servomechanisms
- computers
- radar and counter measures
- search devices
- electro-mechanical components
- simulators and training devices
- testing devices

**For engineering achievements, rely on engineering-minded management — rely on Otis Electronics. Write on your letterhead for 32-page history and facilities report.**

**this is the OTIS organization**

16,941 stockholders  
 Total employees — 22,937  
 5,166 employees in 268 offices distributed throughout the U. S.  
 3,766 general production employees in the Electronic Division, Harrison and Yonkers Works.  
 1,005 employees in Executive Headquarters.  
 Over 13,000 employees outside the U. S.  
 Otis does business from 173 branch offices in 31 countries outside the U. S. and has manufacturing plants in 14 of them.



**OTIS ELEVATOR COMPANY**  
**ELECTRONIC DIVISION**

35 RYERSON STREET, BROOKLYN 5, N. Y. ULster 5-6800

# GET THE FACTS YOU NEED AT ONCE

*with Brush Recording Systems*

This advanced instrumentation gives you immediate answers in writing. No plotting or charting of data. Direct written charts made while tests are underway save you hours of engineering time.

Here are a few of the ways design and development groups are now using Brush Recording Systems:

- checking strain on hydraulic systems: presses, pipelines, controls
- recording characteristics of electrical equipment
- measuring stress and strain on structures and machines
- analyzing performance of equipment and personnel in operational simulators
- recording telemetered data from aircraft and missile test flights
- readout from analog computers

Engineers are scarce—so it's wise to use your engineering manpower at top efficiency. Use Brush instrumentation.

For a copy of complete bulletin, *Modern Measurements*, write Brush Electronics Company, Dept. K-2, 3405 Perkins Ave., Cleveland 14, Ohio

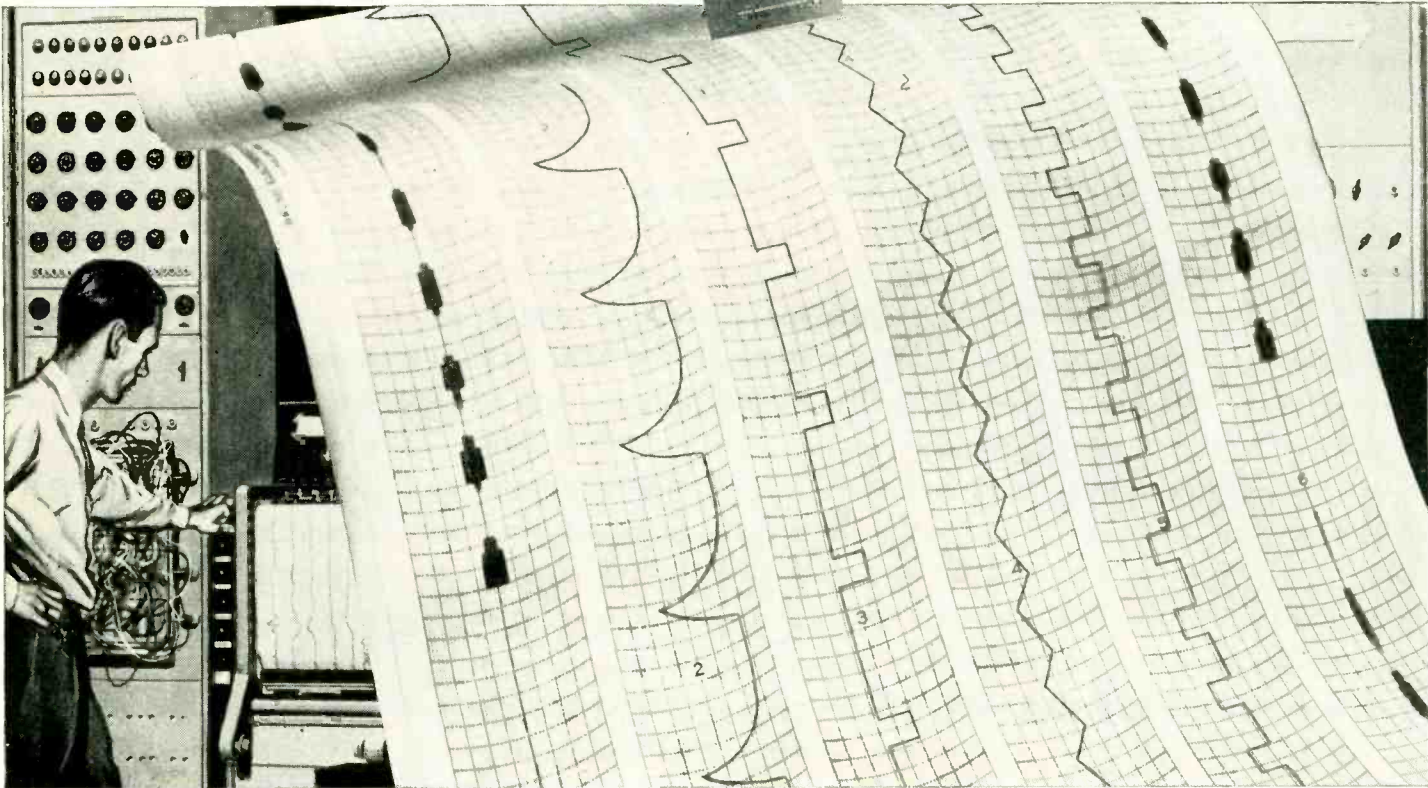

*Illustration Courtesy Grumman Aircraft Engineering Corporation.*



# Look for these features in recording instruments

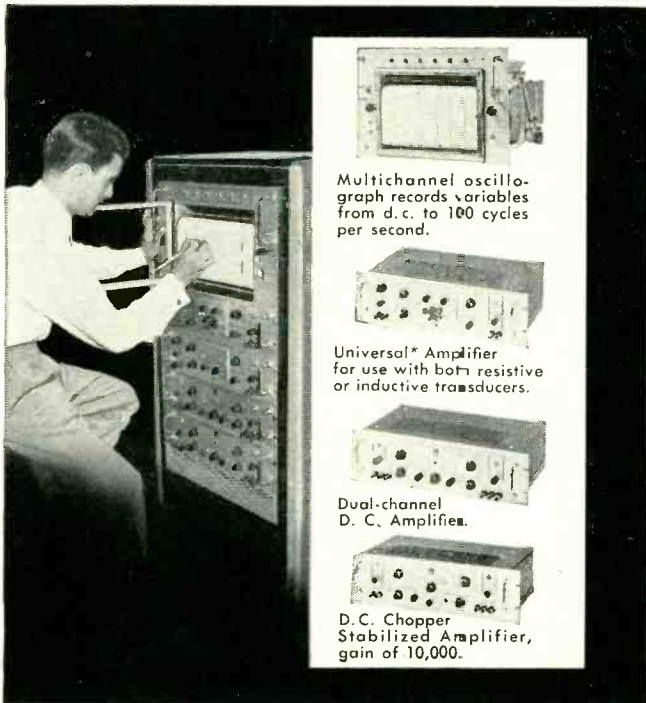

Multichannel oscillograph records variables from d. c. to 100 cycles per second.

Universal\* Amplifier for use with both resistive or inductive transducers.

Dual-channel D. C. Amplifier.

D. C. Chopper Stabilized Amplifier, gain of 10,000.

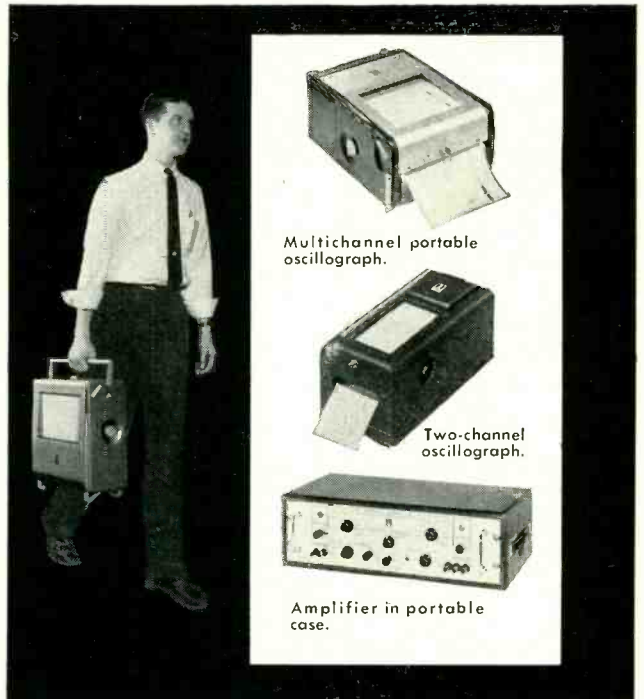

Multichannel portable oscillograph.

Two-channel oscillograph.

Amplifier in portable case.

**FLEXIBILITY**—Four and six channel oscillographs are physically interchangeable. A four channel unit, selected to meet present requirements, can be expanded to a six channel unit later. All oscillographs and amplifiers mount in standard 19-inch racks or consoles. Complete selection of amplifiers.

\*Trade Mark

**PORTABILITY**—Complete systems designed for portable use simplify field testing and measurements. Units are light in weight, durable, easy to set up. Typical weights for oscillographs: 2-channel 25 lbs., 4-channel 38 lbs., 6-channel 51 lbs.

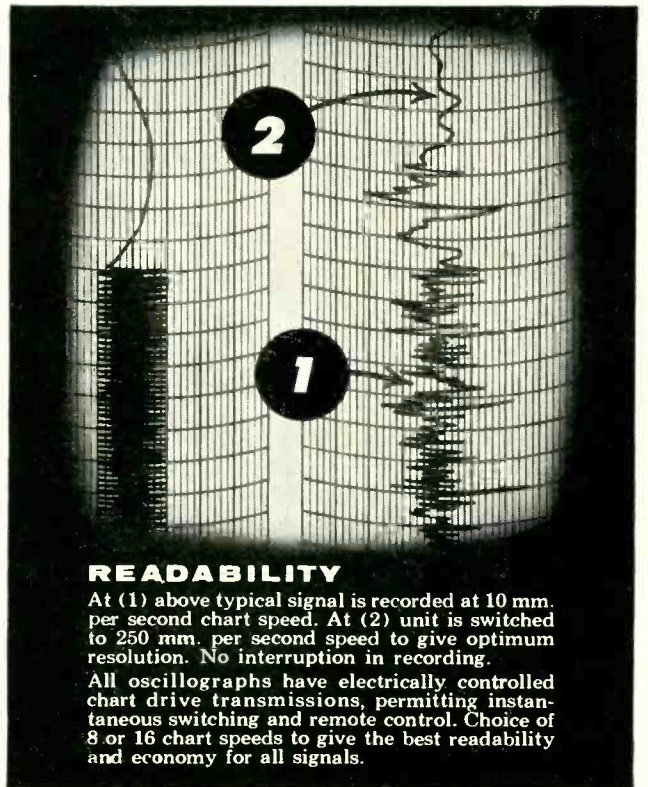
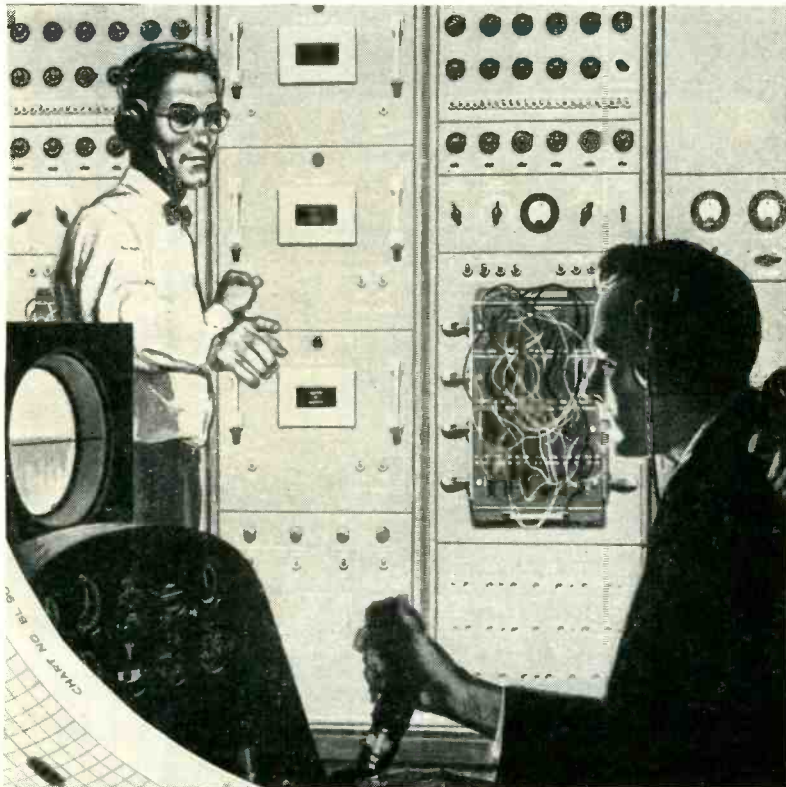

## READABILITY

At (1) above typical signal is recorded at 10 mm. per second chart speed. At (2) unit is switched to 250 mm. per second speed to give optimum resolution. No interruption in recording.

All oscillographs have electrically controlled chart drive transmissions, permitting instantaneous switching and remote control. Choice of 8 or 16 chart speeds to give the best readability and economy for all signals.

**BRUSH ELECTRONICS**

INDUSTRIAL AND RESEARCH INSTRUMENTS  
PIEZOELECTRIC MATERIALS • ACOUSTIC DEVICES  
MAGNETIC RECORDING EQUIPMENT AND COMPONENTS



**COMPANY**

Division of  
Clevite Corporation

# BRUSH ...complete systems for noise or vibration measurement

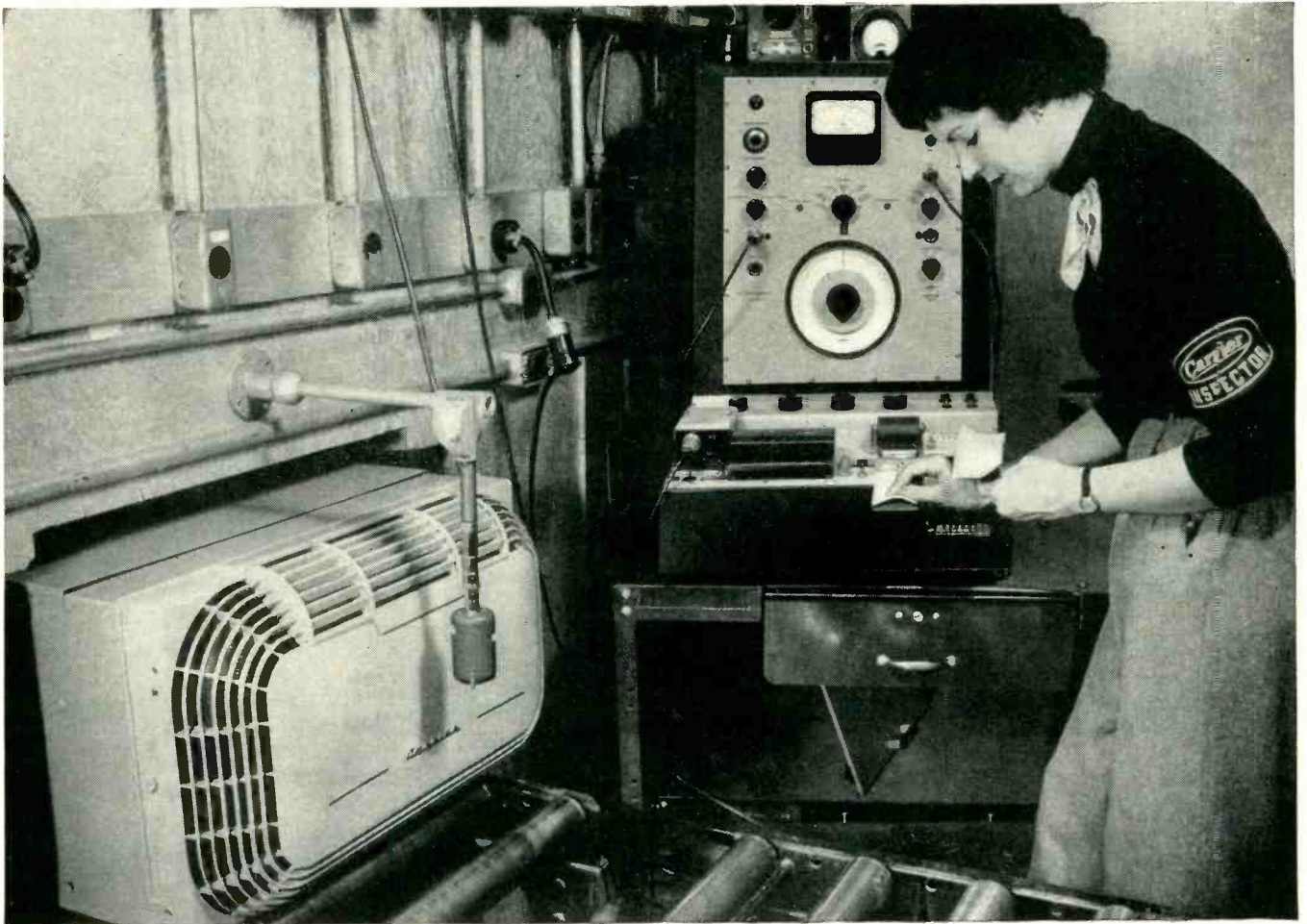

## Carrier keeps cool air quiet

**T**HIS PRODUCTION-LINE TEST of Carrier room air conditioning units checks quietness of operation in a jiffy. The Brush Spectrum Recorder automatically scans and records sounds from 35 cycles to 18,000 cycles per second in one-third octave steps. The complete test takes only 51 seconds.

Brush Sound Measuring systems can help you *analyze and record* noise, vibration, strain and other phenomena in the audio frequency range. The Brush versatile signal source and control systems provide complete facilities for:

- Automatic frequency response measurements
- Mechanical resonance tests
- Excitation and regulation of shaker systems for environmental vibration testing

Call your nearest Brush representative or write for bulletin "Sound Measurement". Brush Electronics Co., Dept. K-22, 3405 Perkins Avenue, Cleveland 14, Ohio.

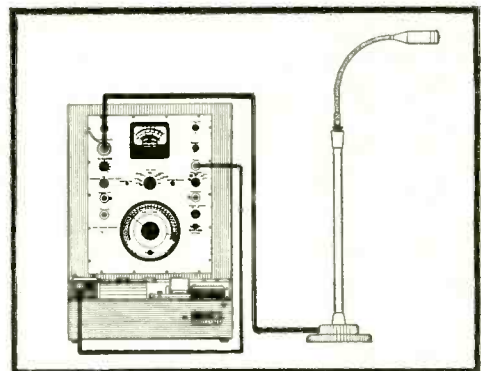

Test setup shown requires only a measurement microphone and Spectrum Recorder.

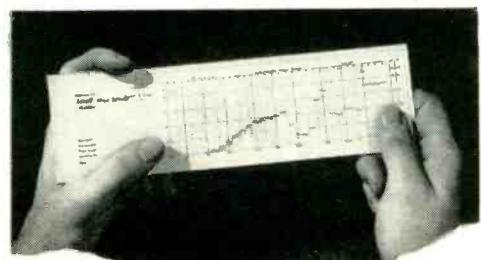

The complete noise spectrum analysis graphically recorded provides immediate, fool-proof and permanent measurement data.

**BRUSH ELECTRONICS COMPANY**

INDUSTRIAL AND RESEARCH INSTRUMENTS  
PIEZOELECTRIC MATERIALS • ACOUSTIC DEVICES  
MAGNETIC RECORDING EQUIPMENT AND COMPONENTS



Division of  
Clevite Corporation

a "tough nut" in more ways than one...

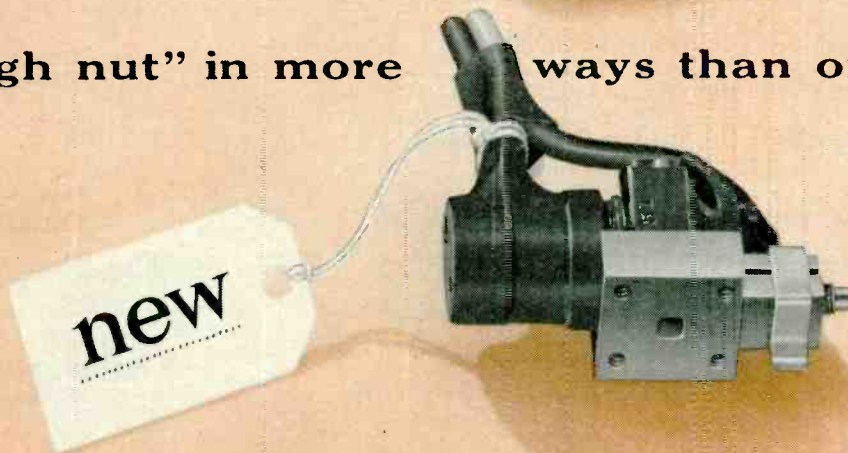

**IT'S THE NEW VARIAN VA-97 KLYSTRON** ... a tough, reliable local oscillator tube with performance and design features unmatched by any other klystron in the frequency range of 34.0 to 35.6 kMc ... ideal as the microwave power source for airborne radar and similar applications.

**RUGGED** — provides reliable operation under severe environmental conditions.

**COMPACT** — small size and light weight takes up less high premium aircraft space.

**HIGH PERFORMANCE AT LOW VOLTAGE** — means better equipment design.

**EXCEPTIONAL FREQUENCY STABILITY** under all conditions, due to Varian's advanced external tuning cavity design.

**SLOW TUNING** — gives you more reliable system operation with less maintenance.

**RATED FOR USE AT ANY ALTITUDE** without pressurization.

These important features allow maximum latitude in equipment design and result in savings of time, space and money. A companion klystron — the VA-94 — is also available, providing comparable performance characteristics in a frequency range of 16.0 to 17.0 kMc.

	Frequency	Resonator Voltage	Power	Electronic Tuning Range
VA-97	34.0 - 35.6 kMc	400 V	15 mW	90 Mc
VA-94	16.0 - 17.0 kMc	300 V	40 mW	75 Mc

**FOR TEST EQUIPMENT AND LABORATORY MEASUREMENT** ... Varian's V-39C and V-40C klystrons feature separate external cavities that afford an extremely wide tuning range for testing and laboratory research applications, in frequency ranges between 10.0 and 21 kMc.



**NEW VARIAN KLYSTRON CATALOG** ...

Now available, this fully-illustrated 16-page catalog describes the complete line of commercially available Varian klystrons and related microwave equipment.

Write for your copy today.

THE  
MARK OF  
LEADERSHIP

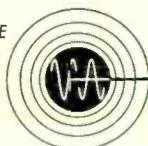

**VARIAN associates**

PALO ALTO 1, CALIFORNIA

Representatives in all principal cities.

KLYSTRONS, TRAVELING WAVE TUBES, BACKWARD WAVE OSCILLATORS, R.F. SPECTROMETERS, MAGNETS, STALOS, UHF WATERLOADS, MICROWAVE SYSTEM COMPONENTS, GRAPHIC RECORDERS, RESEARCH AND DEVELOPMENT SERVICES

# NOW

## $1/8$ , $1/4$ and $1/2$ watt Molded Precistors

IRC *molded* Deposited and Boron Carbon

Precistors are now available in  $1/8$ ,  $1/4$  and  $1/2$  watt sizes. These 1% precision film type resistors combine the advantages of high stability, small size and low cost in either deposited carbon or boron carbon units. Ratings are based on full load at 70°C. ambient.

The *molded* plastic housing provides complete mechanical protection, minimizes the effect of moisture and improves load life characteristics.

Equivalent In Size To IRC's Popular Types BTS • BW $1/2$  • BTA

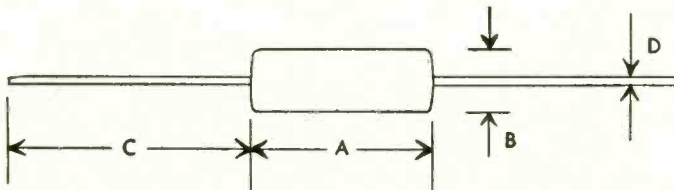

Precistor Types	IRC Size Equivalent	Dimension			
		A	B	C	D
MDA — MBA	BTS	$1\frac{3}{32}$ "	$1/8$ "	$1\frac{1}{2}$ "	.025"
MDB — MBB	BW $1/2$	$3/8$ "	$3/16$ "	$1\frac{1}{2}$ "	.025"
MDC — MBC	BTA	$2\frac{3}{32}$ "	$1/4$ "	$1\frac{1}{2}$ "	.032"

### MOLDED DEPOSITED CARBON PRECISTORS

Type MDA —  $1/8$  Watt

Type MDB —  $1/4$  Watt

Type MDC —  $1/2$  Watt

### MOLDED BORON CARBON PRECISTORS

Type MBA —  $1/8$  Watt

Type MBB —  $1/4$  Watt

Type MBC —  $1/2$  Watt

Precision Wire Wounds • Ultra HF and Hi-Voltage Resistors • Low Value Capacitors • Selenium Rectifiers • Insulated Chokes • and Hermetic Sealing Terminals

*Wherever the Circuit Says*

Voltmeter Multipliers • Boron & Deposited Carbon Precistors • Controls and Potentiometers • Power Resistors • Low Wattage Wire Wounds • Germanium Diodes • Insulated Composition Resistors

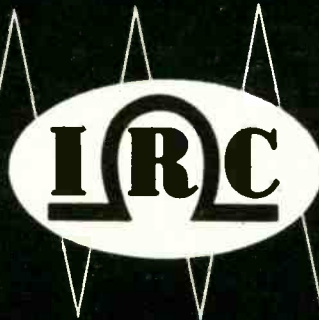

### INTERNATIONAL RESISTANCE CO.

Dept. 231, 401 N. Broad St., Philadelphia 8, Pa.

In Canada: International Resistance Co., Ltd., Toronto, Licensee

Send me data on:

- Molded Deposited Carbon Precistors  
 Molded Boron Carbon Precistors

Name \_\_\_\_\_

Company \_\_\_\_\_

Address \_\_\_\_\_

City \_\_\_\_\_ State \_\_\_\_\_

# NOW

## 3 new wire wound resistors

IRC's new power wire wounds are lower cost per watt than any other power type. At 4, 7 and 10 watts, they offer savings of several cents each in any application requiring compact, low cost, efficient power resistors. Types PW-4, PW-7 and PW-10 resistors assure safe operation in circuits where stability and low wattage dissipation are needed.

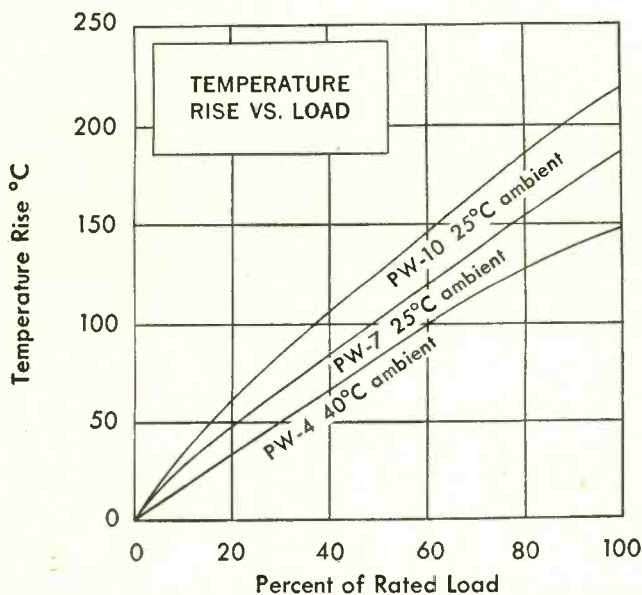

### 4 WATT

Type PW-4 allows safe operation with hot-spot temperatures up to 165°C. Fully insulated housing will not burn or support combustion.



### 7 WATT

Types PW-7 and PW-10 allow safe operation with hot-spot temperatures up to 275°C.

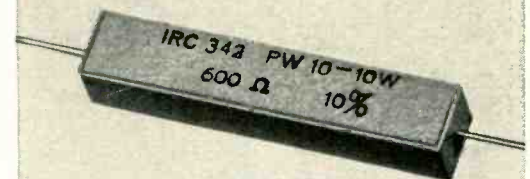

### 10 WATT

UNUSUAL DESIGN AND ASSEMBLY TECHNIQUE PROVIDES LOWER COST PER WATT.

SEND COUPON FOR DATA BULLETINS

Voltmeter Multipliers • Boron & Deposited Carbon Precistors • Insulated Composition Resistors • Power Resistors • Volume Controls • Low Wattage Wire Wounds •

*Wherever the Circuit Says*

Precision Wire Wounds • Ultra HF and Hi-Voltage Resistors • Selenium Rectifiers • Insulated Chokes • Hermetic Sealing Terminals •

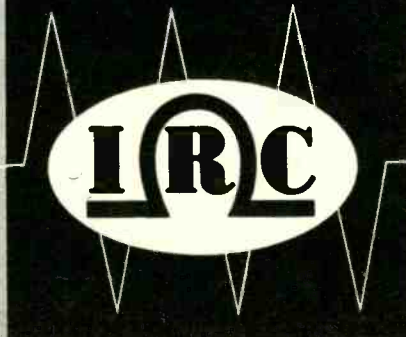

**INTERNATIONAL RESISTANCE CO.**  
Dept. 231, 401 N. Broad St., Philadelphia 8, Pa.

In Canada: International Resistance Co., Ltd., Toronto, Licensee

Please send  Bulletin P-1 on PW-4 Resistors  
 Bulletin P-2 on PW-7 and PW-10 Resistors.

Name \_\_\_\_\_

Title \_\_\_\_\_

Company \_\_\_\_\_

Address \_\_\_\_\_

City \_\_\_\_\_ State \_\_\_\_\_

# Phelps Dodge modern fits new



support  
**Junior Achievement**  
PUTTING YOUTH  
IN BUSINESS

*First for Lasting Quality—from Mine to Market!*

# enamel wire

## exacting coil designs !

*New processes and controls  
assure uniform quality:*

- 1** Uniform over-all size — for uniform windings.
- 2** Uniform softness with high tensile strength for tighter windings, reduced breakage.
- 3** Uniform spooling, larger packages for lower-cost windings.
- 4** Uniform property balance for good flexibility, solvent resistance and dielectric strength.

*Any time magnet wire is your problem,  
consult Phelps Dodge for the quickest, easiest answer!*

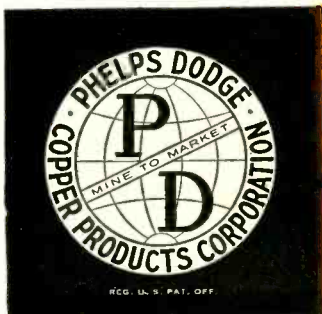

***PHELPS DODGE COPPER PRODUCTS***  
**CORPORATION**

**INCA MANUFACTURING DIVISION**  
FORT WAYNE, INDIANA

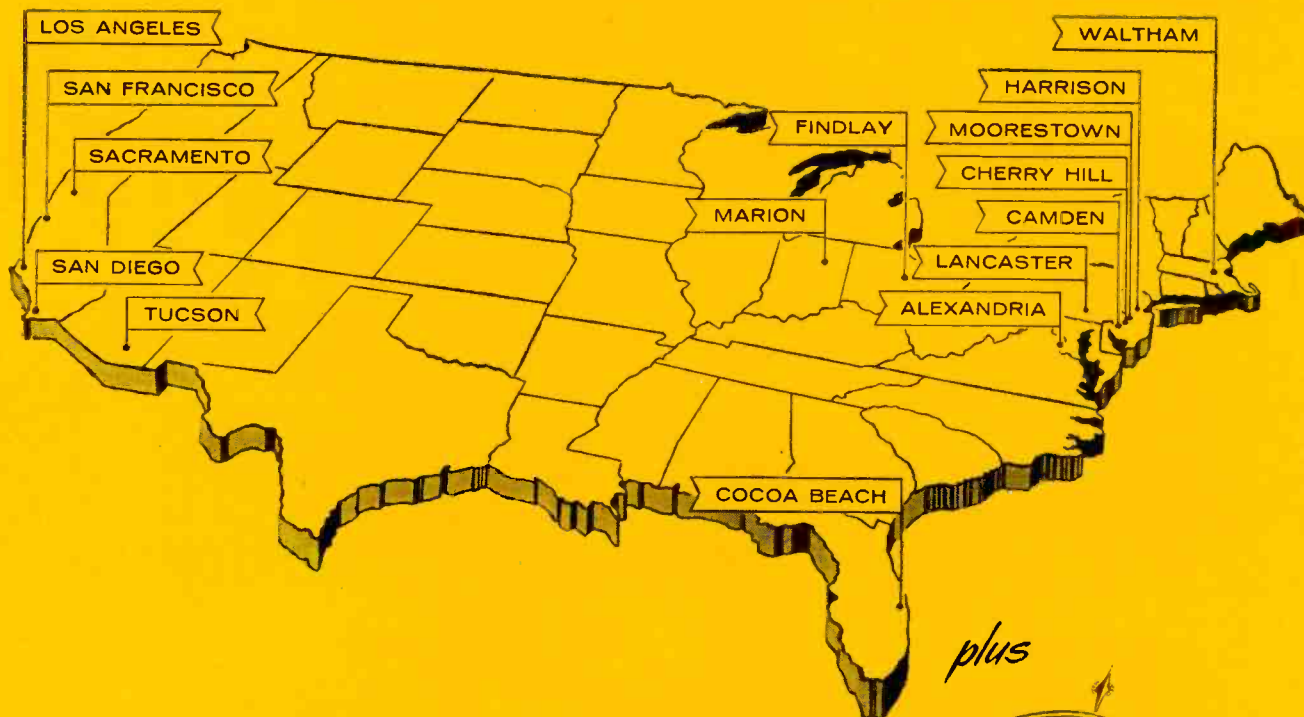

# You can SELECT at RCA!

... New Opportunities ... 17 + Locations ... One Best For You And Your Family

**Can anyone but RCA offer you  
a choice of locations like this?**

At Camden, Moorestown or Cherry Hill, you enjoy cultural advantages of Greater Philadelphia, live at moderate cost in pleasant suburban communities. Waltham offers at-home opportunities for New England engineers. Four ideal West Coast locations. Harrison borders on Greater New York. Lancaster, Marion and Findlay have small-town advantages. There's pleasant year-round outdoor living in Cocoa Beach, on Florida's central east coast. RCA Service Company and International Division assignments include ideal locations in the United States, and wherever RCA electronic equipments are installed and serviced throughout the world.

**Individual Recognition—**

RCA organizes engineering activities into groups small enough to allow broadest scope for your individual accomplishment. The average group has just 11 engineers. Yet, in all activities, you are supported by the entire facilities and engineering resources of RCA.

**Salaries—**

RCA engineering salaries average measurably higher than other companies' in the field. Intermediate engineers, \$5000-\$8500; senior engineers, \$8500-\$15,000; staff and supervisory salaries open.

**Advancement—**

Scheduled, objective appraisal of your work speeds promotion. Professional and financial progress is just as sure as your achievements make it.

**Professional Status—**

RCA bases world leadership in electronics on the abilities of exceptional men at every organizational level. Many have notable engineering and scientific reputations. You work in day-by-day association with men of this caliber.

**Benefits—**

There's a complete program at RCA. A very liberal Tuition Refund Plan. Company-paid life, sickness and accident, hospital-surgical insurance for you and your family. Modern retirement plan. Relocation expenses paid. Suggestion and patent awards.



# Now, Pinpoint Your Future

... Here are the Opportunities!

... Here are the Locations!

FIELDS OF ENGINEERING ACTIVITY	MANAGERS	TYPE OF DEGREE AND YEARS OF EXPERIENCE PREFERRED																					
		Electrical Engineers			Mechanical Engineers			Physical Science			Chemistry Ceramics Glass Technology Metallurgy												
		0-2	2-3	4-15	0-2	2-3	4-15	1-2	2-3	4-15	1-2	2-3	4-15										
<b>• SYSTEMS</b> <i>(Integration of theory, equipments and environment to create and optimize major electronic concepts.)</i>	<b>AVIATION ELECTRONICS • CONTROLS</b>																						
	<b>DIGITAL DATA HANDLING DEVICES</b>																						
	<b>MISSILE ELECTRONICS • RADAR</b>																						
	<b>INERTIAL NAVIGATION COMMUNICATIONS</b>																						
<b>• DESIGN • DEVELOPMENT</b>																							
<b>KINESCOPIES (B &amp; W and COLOR), OSCILLOSCOPES</b> —Electron Optics—Instrumental Analysis—Solid States (Phosphors, High Temperature Phenomena, Photosensitive Materials and Glass to Metal Sealing)												L	L	L	L	L	L	L	L	L	L	L	L
<b>RECEIVING TUBES</b> —Tube Design—Test and Application Engineering—Chemical and Physical Development—Methods and Process Engineering—Advanced Development												H	H	H	H	H	H	H	H	H	H	H	H
<b>SEMI-CONDUCTORS</b> —Transistors—Semi-Conductor Devices—Materials												H	H	H	H	H	H	H	H	H	H	H	H
<b>MICROWAVE TUBES</b> —Tube Development and Manufacture (Traveling Wave—Backward Wave—Magnetron)												H	H	H	H	H	H	H	H	H	H	H	H
<b>GAS, POWER AND PHOTO TUBES</b> —Photosensitive Devices—Glass to Metal Sealing—UHF and VHF—Power												L	L	L	L	L	L	L	L	L	L	L	L
<b>AVIATION ELECTRONICS</b> —Radar—Computers—Servo Mechanisms—Shock and Vibration—Circuitry—Remote Control—Heat Transfer—Sub-Miniaturization—Automatic Flight—Automation—Transistorization												W	W	W	W	W	W	W	W	W	W	W	W
<b>COMPUTERS</b> —Systems—Advanced Development—Circuitry—Assembly Design—Mechanisms—Programming												C	C	C	C	C	C	C	C	C	C	C	C
<b>RADAR</b> —Circuitry—Antenna Design—Servo Systems—Gear Trains—Intricate Mechanisms—Fire Control—Information Handling—Displays												M	M	M	M	M	M	M	M	M	M	M	M
<b>COMMUNICATIONS</b> —Specialized Military Systems—Microwave—Aviation—Audio—Propagation Studies												C	C	C	C	C	C	C	C	C	C	C	C
<b>MISSILE ELECTRONICS</b> —Systems Planning and Design—Radar—Fire Control—Shock Problems—Servo Mechanisms												M	M	M	M	M	M	M	M	M	M	M	M
<b>COMPONENTS</b> —Transformers—Coils—TV Deflection Yokes (Color or Monochrome)—Resistors—Ferrites (Material and Parts)												C	Z	Z	C	Z	Z	C	C	C	C	Z	Z
<b>• SYSTEMS APPLICATION</b> <i>(Evaluation and Planning—Design and Development—Modification—Specification)</i>																							
<b>MISSILE TEST INSTRUMENTATION</b> (Data Acquisition and Processing)—Radar—Telemetry—Timing—Communications—Optics—Computers												F	F	F	F	F	F	F	F	F	F	F	F
<b>RADAR</b> —Airborne—Surface—Shipboard—Sonar—Fire Control												F	F	F	F	F	F	F	F	F	F	F	F
<b>COMMUNICATIONS</b> —Radio—HF—VHF—UHF—Microwave—Telephone—Teletype—Telegraph Terminal Equipment—Wave Propagation												F	F	F	F	F	F	F	F	F	F	F	F
<b>• MACHINE DESIGN</b> Mechanical and Electrical—Automatic or Semi-Automatic Machines												L	L		L	L	L	C		L	L		

Locations: C—Camden, N.J. F—Cocoa Beach, Fla. H—Harrison, N.J. I—International Div. L—Lancaster, Pa. M—Moorestown, N.J. S—RCA Service Co. (Cherry Hill, N.J.; Alexandria, Va.; Tucson, Ariz.; San Diego, Sacramento, San Francisco, Calif.; Foreign Assignments). W—Waltham, Mass. X—Los Angeles, Calif. Y—Marion, Ind. Z—Findlay, Ohio



Please send resume of education and experience, with location preferred, to:

Mr. John R. Weld, Employment Manager  
 Dept. A-15B, Radio Corporation of America  
 30 Rockefeller Plaza, New York 20, N.Y.

## RADIO CORPORATION of AMERICA

Copyright 1956 Radio Corporation of America

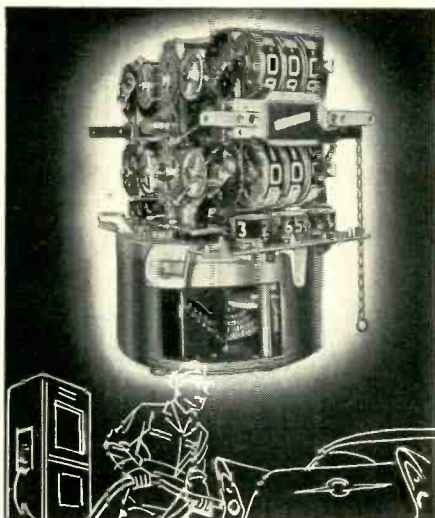

Computing Head for Gasoline Pumps



"Master Meter Duplicator" prints receipts for fuel oil delivered from trucks



"Vary-Tally" Multi-Unit Reset Manual Counter



Rev-Counter for all types of engines

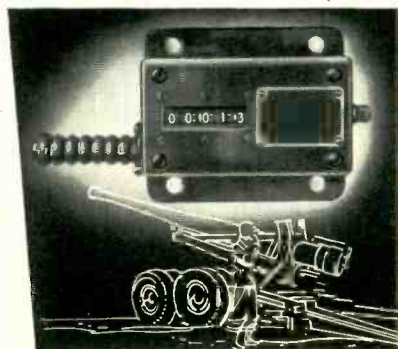

Recoil Counter for new 280 mm atomic cannon



2-3-4 Convertible Counters (and others) for textile machinery

# Everyone Can Count on VEEDER ROOT

Everywhere you look in everyday life, you see a familiar face . . . the face of a Veeder-Root Counter or Computer. From gasoline pumps to fuel oil trucks to textile mills . . . in the home, on the farm, in business and commerce, in modern automated industry . . . Veeder-Root standard and special devices are keeping everything under *Control* . . . manually, mechanically, electrically. And the mathematical probabilities are mighty high that you can count on Veeder-Root, too . . . to your advantage and profit. Why not let us figure out how, *right now?*

VEEDER-ROOT INC. • HARTFORD 2, CONN.



Fuel-Remaining Counter for aircraft . . . subtracts as fuel is used

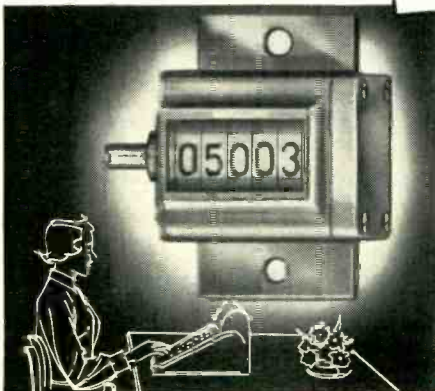

Small Square-Case Counters for office and other machines

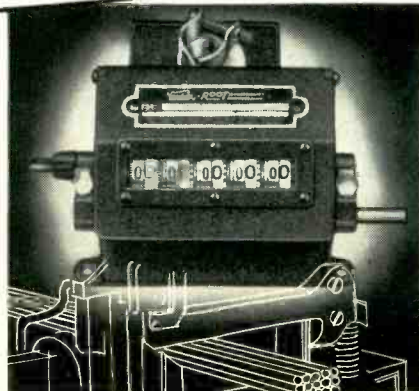

Predetermining Counters for preventing short and over-runs on production machines

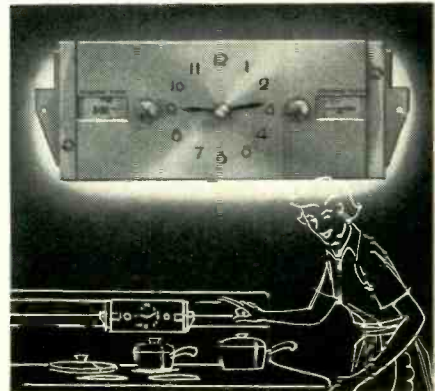

Range Timer . . . easy to react . . . easy to set

STOCKS OF STANDARD COUNTERS AVAILABLE AT—Greenville, S. C. • Chicago 6, Ill. • New York 19, N. Y. • Los Angeles • San Francisco  
Montreal 2, Canada • Offices and Agents in Other Principal Cities

# ALSiMAG<sup>®</sup>

advanced  
ALUMINA CERAMICS

with new

# HIGH

temperature  
strength  
quality  
production

Greatly enlarged facilities now produce high quality, pace-setting ALSiMag Alumina ceramics in quantity lots. Complete range of up-to-the-minute Alumina compositions now permit you to design to higher temperatures and higher strengths. Advantages include improved electrical characteristics at elevated temperatures—beyond the melting point of most metals. Higher tensile and impact strengths. Greater resistance to corrosion and abrasion. Smoothness of texture. Close dimensional tolerances. Custom formulations for special needs.

Volume production in a complete range of precision parts, including electron tube shapes processed to be highly porous, readily degassed, thicknesses as low as .009".

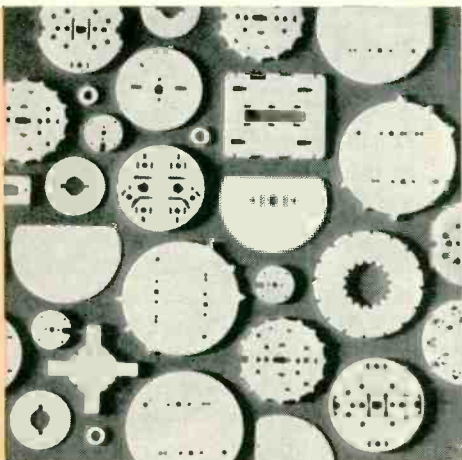

• An outline of your requirements, enclosing a blueprint or sketch, will bring you full details.

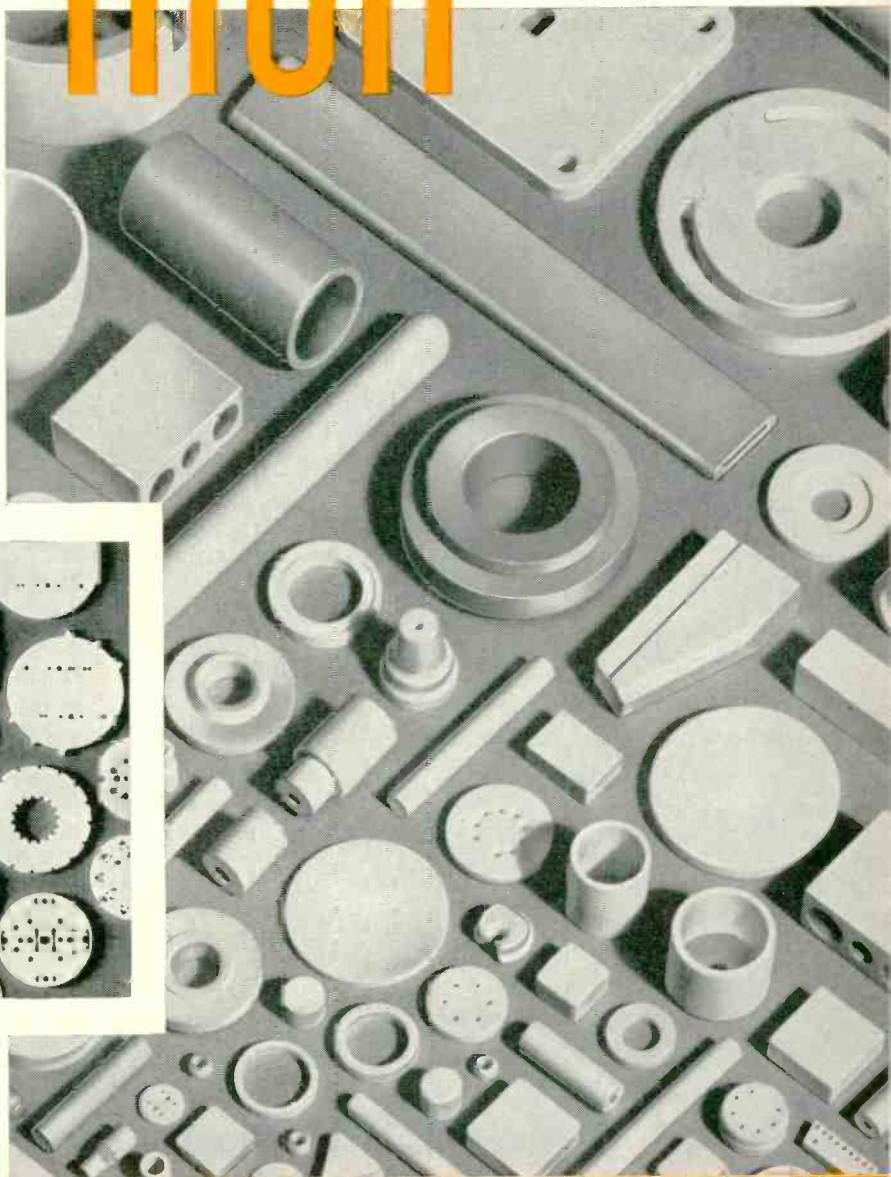

54TH YEAR  
OF CERAMIC  
LEADERSHIP

## AMERICAN LAVA CORPORATION

CHATTANOOGA 5, TENNESSEE  
A Subsidiary of  
Minnesota Mining and Manufacturing Company

Branch offices in these cities (see your local telephone directory): Cambridge, Mass. • Chicago, Ill. • Cleveland, Ohio • Dallas-Houston, Texas • Indianapolis, Ind. • Los Angeles, Calif. • Newark, N. J. • Philadelphia, Pa. • St. Louis, Mo. • South San Francisco, Calif. • Syracuse, N. Y. • Tulsa, Okla. Canada: Irvington Varnish & Insulator Div., Minnesota Mining & Mfg. of Canada, Ltd., P. O. Box 757, London, Ontario. All other export: Minnesota Mining & Mfg. Co., International Division, 99 Park Ave., New York, N. Y.

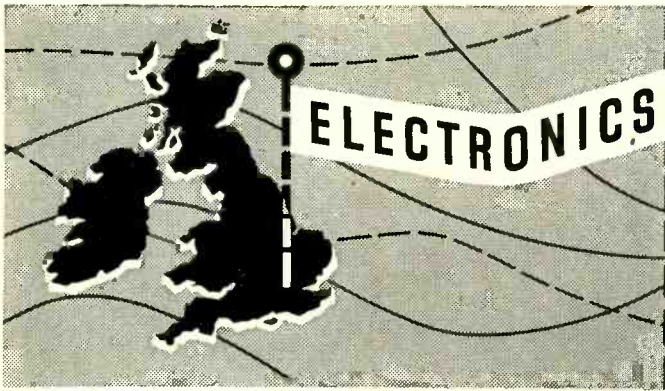

*in Britain*

**ELECTRONICS**

The British Electronics Industry is making giant strides with new developments in a variety of fields. Mullard tubes are an important contribution to this progress.

**Principal Ratings**

Heater	6.3V, 0.2A
Max. plate dissipation	1W
Max. screen dissipation	0.2W
Max. cathode current	6mA

**Characteristics**

Plate voltage	250V
Screen voltage	140V
Grid voltage	-2V
Plate current	3mA
Screen current	0.6mA
Transconductance	1800 $\mu$ mhos



**Base**

Small button noval 9-pin

**Supplies available from:—**

In the U.S.A. International Electronics Corporation,  
Dept. E2, 81 Spring Street, N.Y. 12,  
New York, U.S.A.

In Canada Rogers Majestic Electronics Limited,  
Dept. IF, 11-19 Brentcliffe Road,  
Toronto 17, Ontario, Canada.

# EF86

## Another Mullard contribution to high fidelity

The Mullard EF86 audio frequency pentode is one of the most widely used high fidelity tubes in Britain today. It has been adopted by the leading British manufacturers whose sound reproducing equipment is enjoying increasing popularity in the United States and Canada.

The marked success of this tube stems from its high gain, low noise and low microphony characteristics.

By careful internal screening, and by the use of a bifilar heater, hum level has been reduced to less than 1.5 $\mu$ V. Over a bandwidth of 25 to 1,000c/s equivalent noise input approximates 2  $\mu$ V.

When operated below 1,000c/s, internal resonances of the EF86 are virtually eliminated. Even at higher frequencies chassis and tube socket damping are usually sufficient to make vibration effects negligible.

Supplies of the EF86 are now available for replacement purposes from the companies mentioned here.

# Mullard

## ELECTRONIC TUBES

*used throughout the world*

MULLARD OVERSEAS LTD., CENTURY HOUSE, SHAFTESBURY AVE., LONDON, ENGLAND

Mullard is the Trade Mark of Mullard Ltd. and is registered in most of the principal countries of the world.



MEV 34



*this is tough*



*this is tougher*



*this is the toughest yet!*

## "System-designed" Leach relays serve all three

Yes, the missile age is the toughest challenge yet for electronic components... and supersonic inhabited aircraft aren't far behind in their demands for reliability. Just meeting specifications is no longer enough. In this newest family of electronic-aircraft-missile relays, LEACH does more, offers reliability *beyond* specs... dependability based on design and manufacturing experience second to none.

These relays were *system designed*... Leach Engineers started with the framework of today's *system* demands, they built a family of relays not merely to satisfy specifications but *to do a job*. Here are some of the features that help insure *system reliability* in your electronic, aircraft and missile work...

HERMETIC SEALING — *every relay checked by mass spectrometer*

OPTIONAL LEADS — *solder terminals, potted leads or plug-in bases*

SQUARE CANS — *20% more relays in the space required by round cans*

SHOCK RESISTANCE — *vibration and shock properties exceed MIL specs*

HIGH-TEMPERATURE — *dependability assured at 120°C ambient*

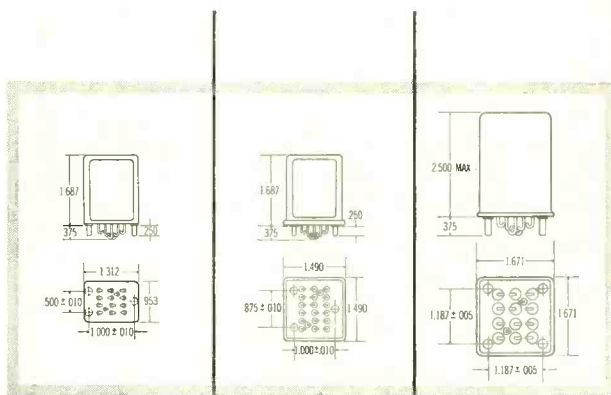

	9220	9226	9230
Contact arrangement	4PDT	6PDT	4PDT
Operating voltage	18-30 VDC	18-30 VDC	18-30 VDC
Contact rating at 28 VDC			
Resistive	5 amp	5 amp	10 amp
Inductive	1.5 amp	1.5 amp	7 amp
Coil resistance	250 ohms	200 ohms	150 ohms
Duty	Continuous	Continuous	Continuous
Weight	.25 lb.	.25 lb.	.5 lb.

COMPLETE SPECIFICATIONS on these three new relays will be sent on request. *Write for them today.*

# LEACH

## CORPORATION

## LEACH RELAY DIVISION

5915 AVALON BOULEVARD, LOS ANGELES 3, CALIF.

DISTRICT OFFICES AND REPRESENTATIVES IN PRINCIPAL CITIES OF U. S. AND CANADA

# DC-to-30MC Oscilloscope retains GENERAL-PURPOSE utility

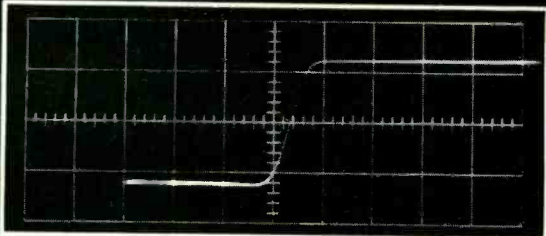

Leading edge of pulse displayed on 0.02  $\mu\text{sec}/\text{cm}$  sweep shows clean response of the Type 541 with the Type 53/54K Plug-In Unit.

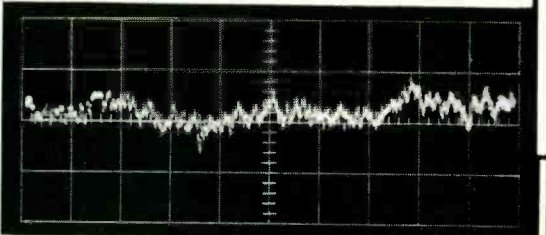

Noise generated by a 1-megohm carbon-film resistor with 45 v dc applied, displayed on 2 msec/cm sweep of the Type 541 with the Type 53/54E Plug-In Unit at 50  $\mu\text{v}/\text{cm}$  sensitivity.



No longer do you require a highly specialized oscilloscope for your high-speed pulse applications. These applications are now capably handled with an oscilloscope that has general-purpose qualifications, too... the Tektronix Type 541.

The Type 541, although priced lower than specialized instruments, combines an extremely wide sweep range and the inherent characteristics of the high-speed oscilloscope with a flexibility possible only through interchangeable plug-in pre-amplifiers. You can apply the Type 541 to all ordinary and many unusual tasks with complete confidence. In the many areas covered by this versatile instrument your time and amplitude measurements will be accurate, your waveform displays will be true.

**NEED SWEEP DELAY?** The Tektronix Type 545 offers flexible sweep delay in addition to all the characteristics of the Type 541. Delay is accurately calibrated from 1  $\mu\text{sec}$  to 0.1 sec — can be operated in the conventional manner, or triggered for jitter-free display.

**Vertical-amplifier characteristics.** With the Type 53/54K Plug-in Pre-amplifier, frequency response is dc to 30 mc, risetime is 12 millimicroseconds. Sensitivity is 0.05 v/cm to 20 v/cm in 9 calibrated steps. Input capacitance is 20  $\mu\text{mf}$  direct, 8  $\mu\text{mf}$  with 10x probe.

**Triggering facilities.** Amplitude-level selection, automatic triggering, and high-frequency sync in addition to all standard triggering modes.

**Sweep characteristics.** Linear sweeps from 0.02  $\mu\text{sec}$  to 12 sec/cm (600,000,000-to-1 ratio), with 24 calibrated steps from 0.1  $\mu\text{sec}/\text{cm}$  to 5 sec/cm. 5x magnifier is accurate on all ranges.

**Display characteristics.** Full 4-cm by 10-cm linear display, 10-kv accelerating potential, writing rate of 250 cm/ $\mu\text{sec}$ .

**Versatility.** Available plug-in units provide for low-level dc differential and micro-sen-

sitive applications in addition to fast-rise applications. Plug-in units covering many other applications are ready for production.

**Type 541 — \$1145**

**Type 545 — \$1450**

plus price of desired plug-in units

**Type 53/54K Fast-Rise Plug-in Unit . \$125**

Prices f.o.b. Portland (Beaverton), Oregon

## ENGINEERS —

interested in furthering the advancement of the oscilloscope? We have openings for men with creative design ability. Please write to Don Kepler in Portland, or contact him at booths 129 and 131 during the I.R.E. show.

See these and many other oscilloscopes at the Tektronix exhibit, booths 129 and 131, March IRE show.

# Tektronix, Inc.

P. O. Box 831, Portland 7, Oregon

CYpress 2-2611

Cable: TEKTRONIX

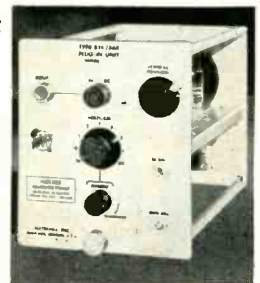

Efficiency  
Economy  
Guaranteed

in RMC type B DISCAPS

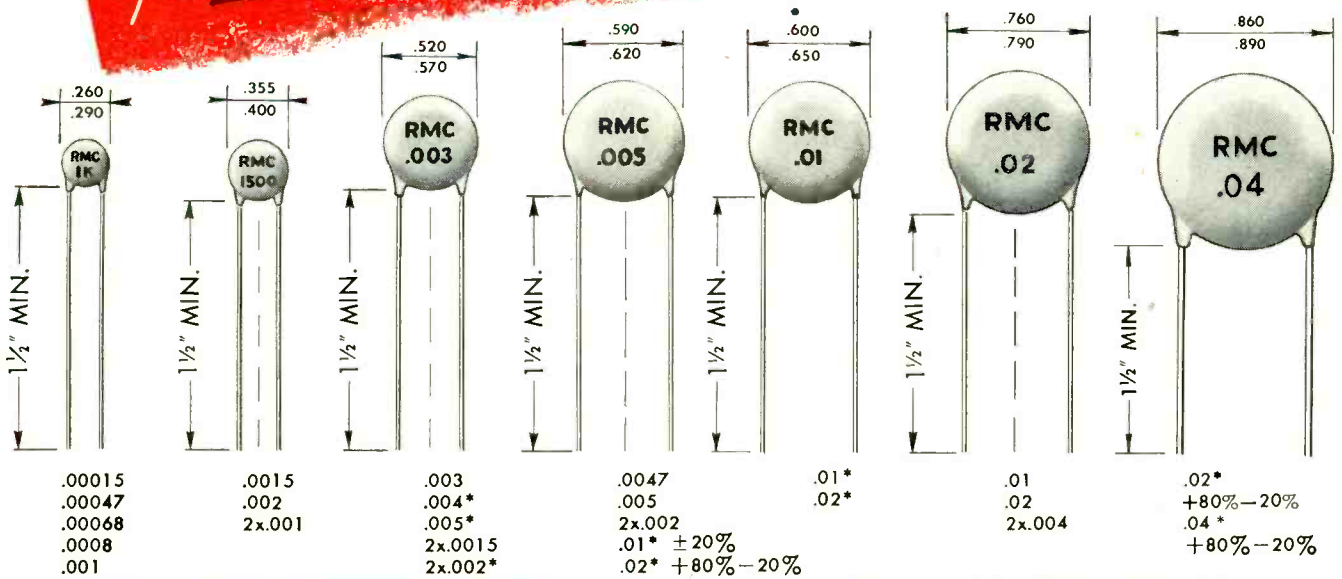

\*Rated 600 V.D.C.W. Flash test 1200 V.D.C

## SPECIFICATIONS

### Guaranteed Minimum Value

POWER FACTOR: 1.5% Max. @ 1KC (initial)

POWER FACTOR: 2.5% Max. @ 1 KC (after humidity)

WORKING VOLTAGE: 1000 V.D.C.

TEST VOLTAGE (FLASH): 2000 V.D.C.

LEADS: No. 22 tinned copper (.026 dia.)

INSULATION: Durez phenolic—vacuum waxed

INITIAL LEAKAGE RESISTANCE: Guaranteed higher than 7500 megohms

AFTER HUMIDITY LEAKAGE RESISTANCE: Guaranteed higher than 1000 megohms

RMC Type B DISCAPS are designed for all by-pass or filtering applications and meet or exceed the RTMA REC-107-A specifications for Z5U ceramic capacitors. The efficiency of Type B DISCAPS in all types of electrical and electronic equipment has been proven over the years. New lower prices guarantee initial economy while additional economies are effected in faster production line handling.

Type B DISCAPS are rated at 1000 V.D.C.W. and are available in capacities between 150 MMF and 40,000 MMF.

It will pay you to investigate the advantages offered by RMC DISCAPS. Write today for expert engineering help on your capacitor problems.

DISCAP  
CERAMIC  
CAPACITORS



**RADIO MATERIALS CORPORATION**  
GENERAL OFFICE: 3325 N. California Ave., Chicago 18, Ill.  
Two RMC Plants Devoted Exclusively to Ceramic Capacitors  
FACTORIES AT CHICAGO, ILL. AND ATTICA, IND.

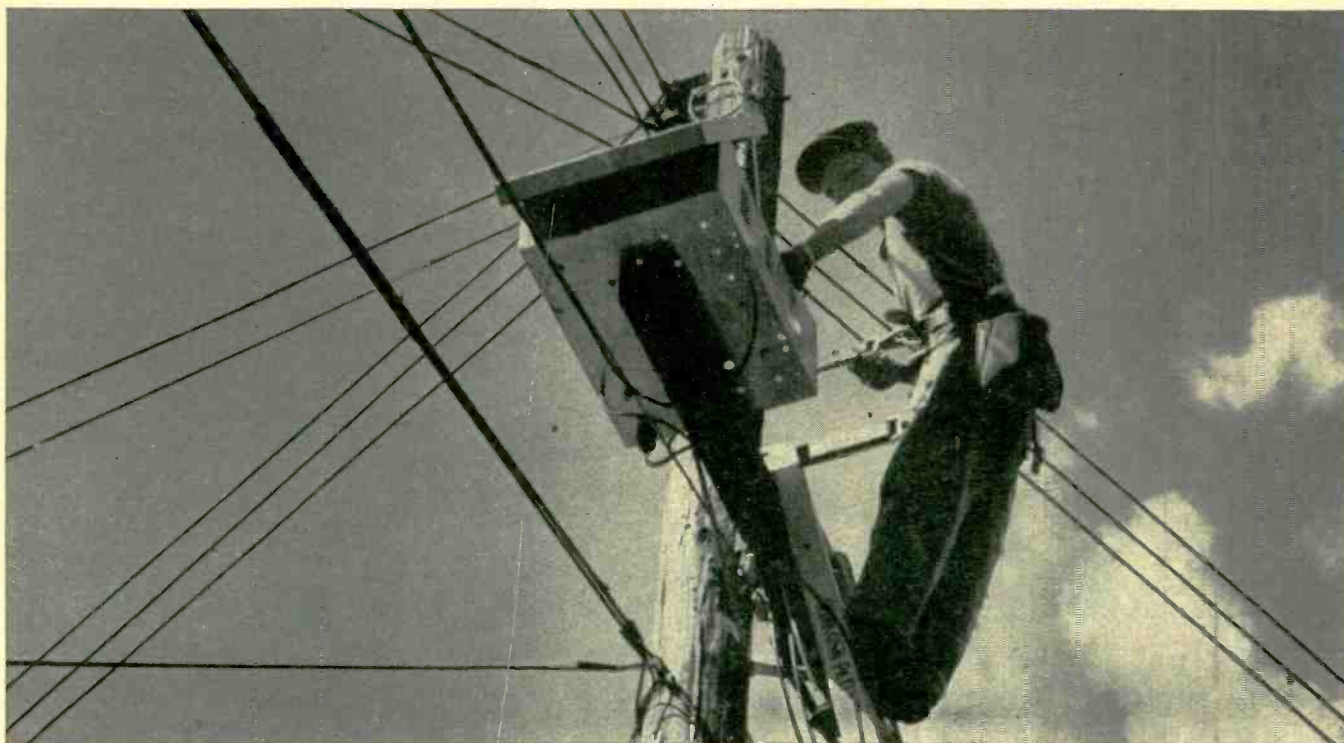

The key to high quality reception for Dubuque TV viewers is provided by Jerrold's high-gain, low-distortion signal amplifying equipment. "Right down the line" — at the an-

tenna site, at the distribution hubs, and at the pole line feeders (above) — these amplifiers depend on built-in and accessory Sola Constant Voltage Transformers.

## From Head End to Pole Line Feeders, Sola Constant Voltage Transformers Regulate Dubuque Jerrold TV System

The Jerrold community television system from Dubuque, Iowa, is an excellent example of system-wide use of *regulated* supply voltage to insure top performance and low maintenance costs.

To provide Dubuque viewers with the highest quality picture possible, the system uses high-gain receiving antennas, mounted on a 420' tower. Jerrold high-gain amplifiers then forward signals through 12 miles of coaxial cable, branching into an amplified distribution network of 130 miles of coaxial cable embracing the whole of the city.

Peak performance of amplifiers and other electronic system components requires maximum stabilization of supply voltages throughout the system. For this reason Sola Constant Voltage Transformers are an integral part of line amplifier power supplies, and are used as accessories with other equipment.

Sola standard static-magnetic regulators provide automatic, instantaneous output voltage unaffected by changes in input voltage. Their regulation is within  $\pm 1\%$  regardless of primary voltage swings of 30%. They have no moving parts, no tubes, require no manual adjustments and are self-protecting against short circuit.

If you require a maintenance-free source of stabilized voltage, Sola Constant Voltage Transformers may be your answer. Call a Sales engineer, or write for Circular 7B CV-170D.

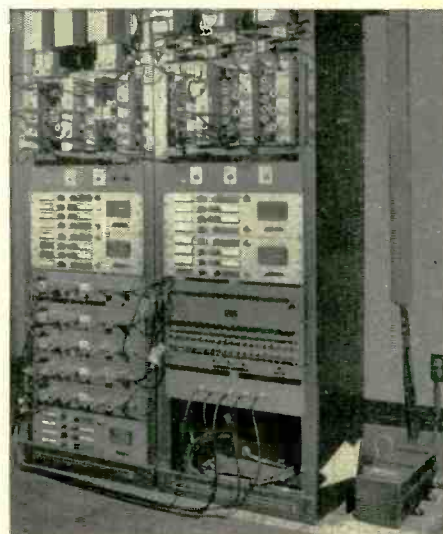

Stabilized voltage for Dubuque Jerrold system head end equipment, such as pre-amplifiers and converters shown here, is provided by the stock 500va Sola Constant Voltage Transformer (arrow) installed as an accessory.

# SO LA *Constant Voltage* TRANSFORMERS

CONSTANT VOLTAGE TRANSFORMERS for Regulation of Electronic and Electrical Equipment • LIGHTING TRANSFORMERS for All Types of Fluorescent and Mercury Vapor Lamps. • SOLA ELECTRIC CO., 4633 West 16th Street, Chicago 50, Illinois, Bishop 2-1414 • NEW YORK 35- 703 E. 125th St., TRafalgar 6-6464 • PHILADELPHIA: Commercial Trust Bldg., Rittenhouse 6-4988 • BOSTON: 272 Centre Street, Newton 58, Mass., Blgelow 4-3354 • CLEVELAND 15: 1836 Euclid Ave., Prospect 1-6400 • KANSAS CITY 2, MO.: 406 W. 34th St., Jefferson 4382 • LOS ANGELES 23: 3138 E. Olympic Blvd., ANgelus 9-9431 • TORONTO 9, ONTARIO: 617 Runnymede Rd., RO 7-1654 • Representatives in Other Principal Cities



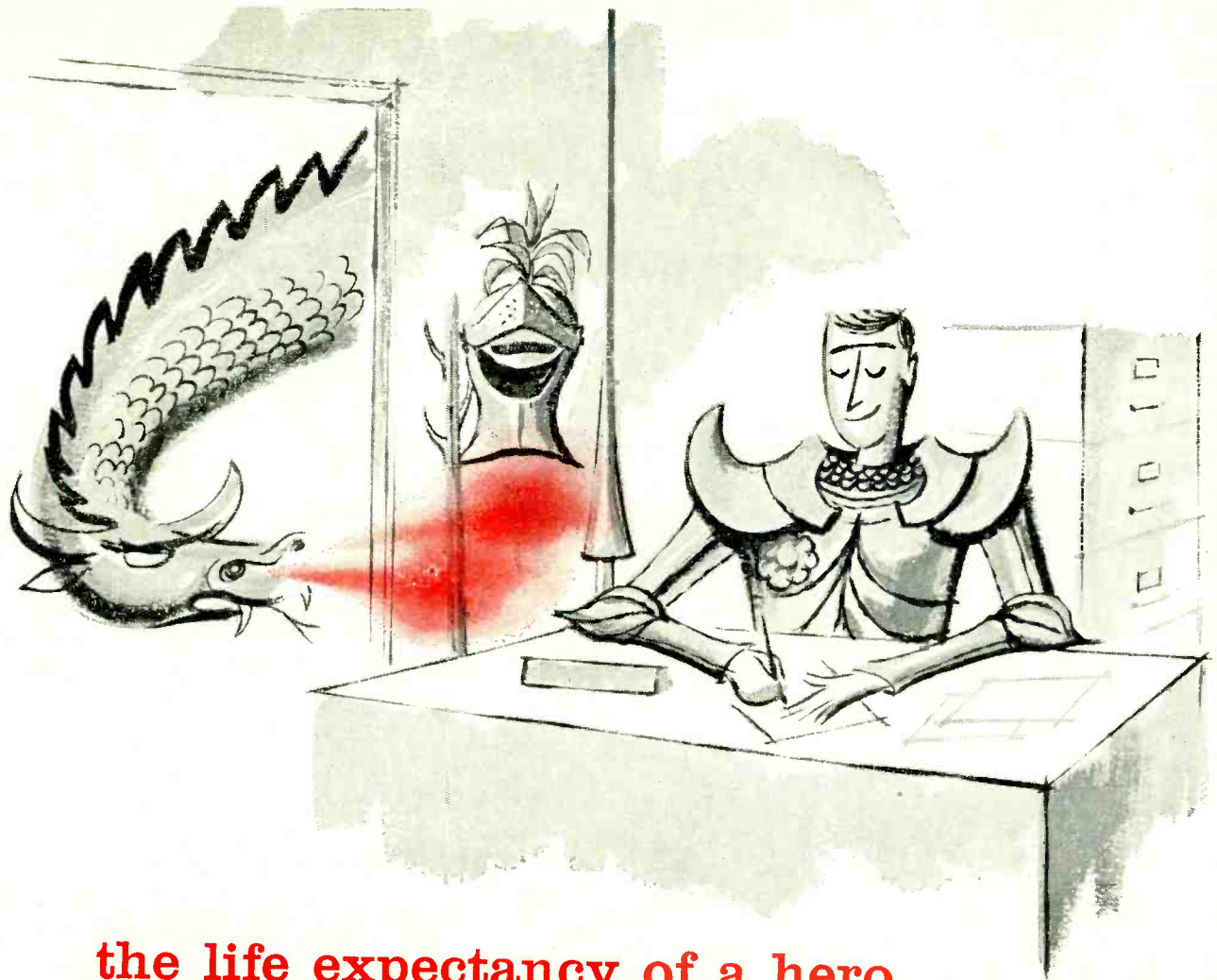

## the life expectancy of a hero

... is directly proportional to the reliability  
of the products he purchases

To you, heroes of purchasing and engineering departments, HERMETIC offers the most reliable hermetic seals manufactured... the most diverse line to meet your every requirement.

There are three good reasons why heroes always remain heroes when they specify HERMETIC as their one source of supply:

1. *The most technologically advanced production techniques are employed in every manufacturing step.*
2. *Vigorous testing procedures assure the dependability of HERMETIC'S complete line under the most critical operating conditions.*
3. *HERMETIC offers long experience in the design, development and manufacture of standard, as well as specially designed seals for economical solutions to procurement problems.*

**Heroes:** write for a complete set of catalogs and engineering assistance.

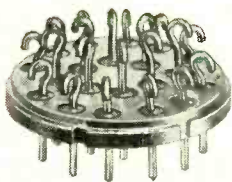

## Hermetic Seal Products Company

31 South 6th Street, Newark 7, New Jersey

California Associate: Glass-Solder Engineering, Pasadena

FIRST AND





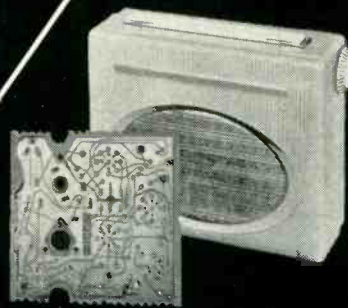

FOREMOST IN MINIATURIZATION

This  
is  
now  
a Packaged  
Electronic  
Circuit



Don't confuse  
with this...called a  
printed circuit

**It pays to know the difference!**

-  A Centralab Packaged Electronic Circuit (P.E.C.\*) is a complete circuit, which can include capacitance, resistance, and inductance... in addition to wiring.
-  Circuit performance can be guaranteed with Centralab P.E.C.'s, because they are manufactured and tested on a performance basis.
-  A Centralab Packaged Electronic Circuit offers (a) Operating life many times that of conventional components; (b) Reduction in size, weight, and assembly cost; (c) Saving in soldering time; (d) Elimination of wiring errors.
-  Over 160 standard P.E.C. designs are available for your immediate use. For your special requirements, ask for custom design.
-  60 million Centralab P.E.C.'s are in use in the electronics industry.

For complete basic data, write for Technical Bulletin 42-227.

\*Trademark

**Centralab**  

**A DIVISION OF GLOBE UNION INC.**

914B E. Keefe Avenue, Milwaukee 1, Wisconsin In Canada: 804 Mt. Pleasant Road, Toronto, Ontario



VARIABLE RESISTORS



SWITCHES



CERAMIC CAPACITORS



ENGINEERED CERAMICS

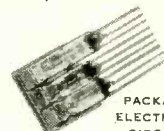

PACKAGED ELECTRONIC CIRCUITS

SINCE 1922, INDUSTRY'S NO. 1 SOURCE OF STANDARD AND SPECIAL COMPONENTS



# MEMO

FROM: THE ENGINEERING STAFF AT NJE

TO: OVERWORKED PROJECT ENGINEERS

SUBJECT: NIGHTMARES...

We have a saying around the lab that "anyone can build a good power supply, but it takes an expert to make it seem difficult!"

Nevertheless, we're proud of the creative engineering and skilled workmanship that successfully designed and built over 1000 different custom power supplies last year... including some real nightmares, like this one:

### CS-3503\* Mass Spectrometer Supply

Three inter-referenced supplies: 100-400 volts positive, 100-400 volts negative, and 2500-10,000 volts positive, each at 0-10ma. Stable to 25 parts per million! By modulating (by voltage or resistance variation) the negative supply with a 5 cps sawtooth, all three supplies are automatically modulated in synchronism, to an accuracy of 25 parts per million! Ripple on all supplies, 5 millivolts, p-p. precision temperature-stabilized dividers permit adjustment of ratio of one supply to another to 5 parts per million. Delivery accomplished in 14 weeks. Price \$5,500.00.

\*Customer's name on request.

Do you have a power-supply nightmare you feel like farming out?

... Or an important special you wouldn't trust to "just anyone", but don't have time to build yourself?

The staff and facilities that created CS-3503 are at your service. You dream them up... we'll build them.

Write, wire, phone....

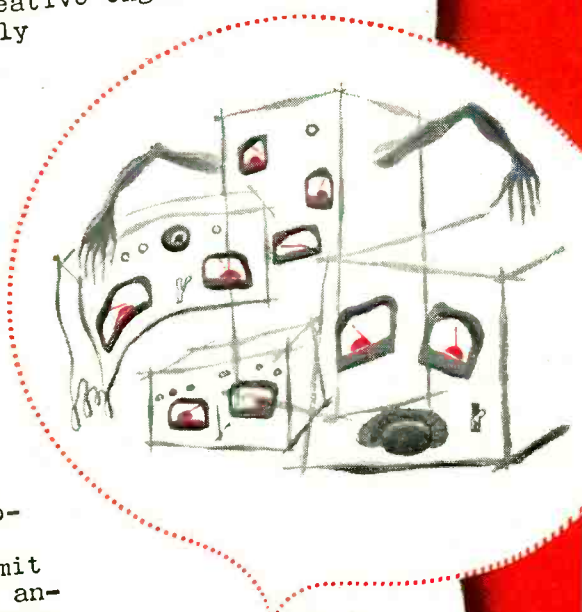

or our complete line of electronic power supplies See electronics pp. 113-120 BUYERS' GUIDE

# NJE corporation

*Electronic Development & Manufacturing*

345 CARNEGIE AVENUE, KENILWORTH, NEW JERSEY

Competent Engineering Representation Everywhere | Rapid, complete, competitive custom quotes from 1000 Amperes (low voltage) to 250 KV (low current.)

P O W E R S U P P L I E S U N L I M I T E D

**MALLORY**

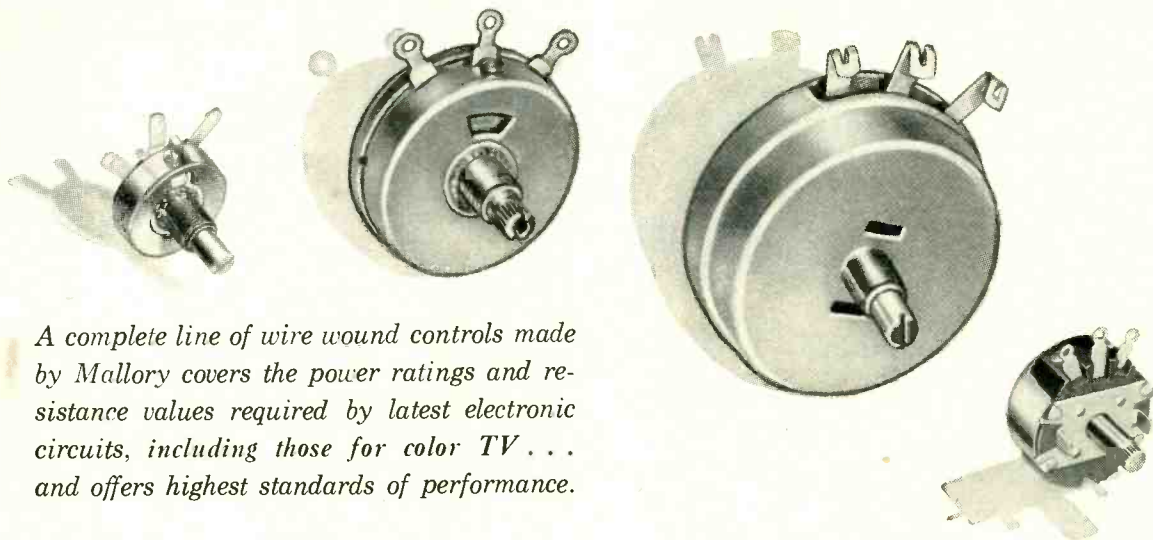

*A complete line of wire wound controls made by Mallory covers the power ratings and resistance values required by latest electronic circuits, including those for color TV . . . and offers highest standards of performance.*

# Wire wound controls with the ratings, resistances and reliability you want

## Mallory Wire Wound Resistors *for heavy duty service*

A comprehensive line of vitreous enamel power resistors made by Mallory meets the requirements of many electrical and electronic circuits where high power dissipation is needed . . . in voltage dividers, bleeders, load or shunt resistors.

Mallory resistors are space-wound on high quality steatite cores, using large gage wire with matched temperature coefficients of all parts. They are designed for maximum heat dissipating area, to assure cool operation. A special non-porous, non-alkaline vitreous enamel coating gives effective protection of the winding.

Fixed and adjustable types are available in ratings from 5 to 200 watts. Write for data.

When your new circuit designs call for controls with higher power dissipation, plan to use the dependable, trouble-free performance that you can get with Mallory wire wound controls. These are true precision products, made to exacting standards to guarantee complete uniformity and adherence to specifications on every control you receive.

The Mallory line of wire wound controls includes a broad range of designs, wattage ratings and resistance values. All ratings are conservative . . . no need to over-design to allow for extra safety. You can choose from models with insulated or grounded rotors . . . all fitted with standard  $\frac{3}{8}$ " mounting bushing and short screwdriver-slotted shaft. The following types are available:

Model	Watts	Resistance range—ohms	Rotor connection
R	2	1- 20,000	insulated
C	2	$\frac{1}{2}$ - 15,000	grounded
M	4	$\frac{1}{2}$ -100,000	insulated
E	7	3-150,000	grounded

For complete information, write to Mallory today for Technical Bulletin. A Mallory control specialist will be glad to lend personal assistance on your commercial or military applications.

**Expect more . . . get more from**

**P. R. MALLORY & CO. Inc.**  
**MALLORY**

P. R. MALLORY & CO., Inc., INDIANAPOLIS 6, INDIANA

**Serving Industry with These Products:**  
**Electromechanical**—Resistors • Switches • Television Tuners • Vibrators  
**Electrochemical**—Capacitors • Rectifiers • Mercury Batteries  
**Metallurgical**—Contacts • Special Metals and Ceramics • Welding Materials

Parts distributors in all major cities stock Mallory standard components for your convenience.

# CROSS TALK

► **LAG . . .** When a circuit diagram is found packed with a piece of apparatus it is logical, we submit, to assume that said apparatus is wired as per accompanying circuit. Surprisingly enough, such is frequently not the case.

It seems that manufacturers often make changes in wiring and component parts without transferring these changes to new circuit diagrams. The soldering iron is, as it were, quicker than the drafting pen.

In such cases we'll take our apparatus sans circuit diagram. There is no future whatever in looking over a diagram that shows what the apparatus ain't.

## ► **AVIATION ELECTRONICS . . .**

We are indebted to N. E. Edlfsen of North American for this frankly exaggerated word picture of what an airplane looks like to some electronics engineers:

"Large airframe with huge engines and propulsion system; fuel tanks and flight personnel (unacquainted with electronics) everywhere; a tiny primary power supply fully loaded by airframe demands,  $\pm 50$  percent variations in supply voltage and frequency; an air conditioning system with barely enough capacity to keep all the people alive; a perfectly smooth exterior contour (no radomes) except for unexplainable aerodynamic gargoyles; randomly scattered inaccessible spaces

of a few cubic inches each for the electronic equipment—with no provision for connecting cables or cooling ducts.

"The plane starts with a high-g jerk; it flies with high-g vibration at all audio frequencies; temperatures oscillate between  $-65$  F and  $+140$  F through frequent dew point conditions; it encounters high-g accelerations during flight; it lands with a high-g jolt; and, after landing, a large crew of airframe maintenance men do excellent footwork all over the electronic equipment while they service the airframe and fight off the poor electronic maintenance man (who really knows nothing about the equipment anyway)."

► **BUSY BOOKWORMS . . .** Electronics and electrical engineers probably read more technical books than any other comparable group, with chemical engineers a close second. This, at any rate, is the impression we gather in our travels, and the boys downstairs in the McGraw-Hill Book Company think it could be.

There is a good reason why electronics engineers are such avid readers. They have to be. The art is moving so rapidly, in so many directions, no one can afford to start any new project from scratch without referring to the literature. Some of the answers are almost certain to be found in a book or in a magazine.

## LOOKING AHEAD . . .

Latest military planning places even greater emphasis upon guided missiles, increasing electronics' share of government dollar

*Cheap and plentiful radioactive materials will greatly alter character of x-ray business in next few years, eliminating need for high voltage in many cases*

Automobile turbine engine development may reduce need for electronic ignition systems but parts designed for this purpose should have other industrial applications

*Demand for further standardization of component parts continues to build up as result of growing trend toward more automatic equipment assembly*

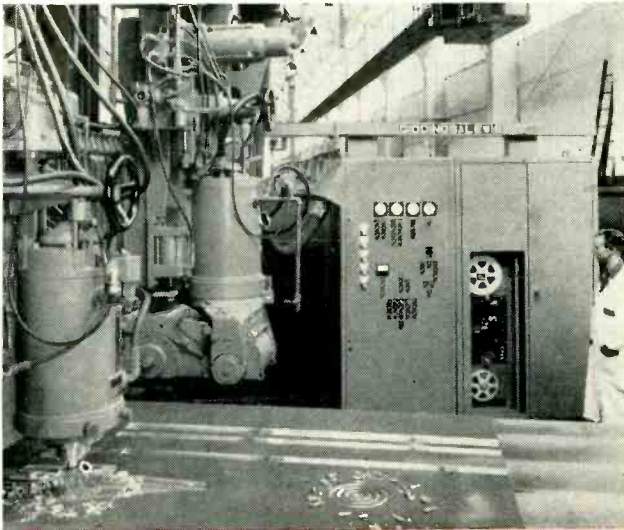

MILLING BY TAPE

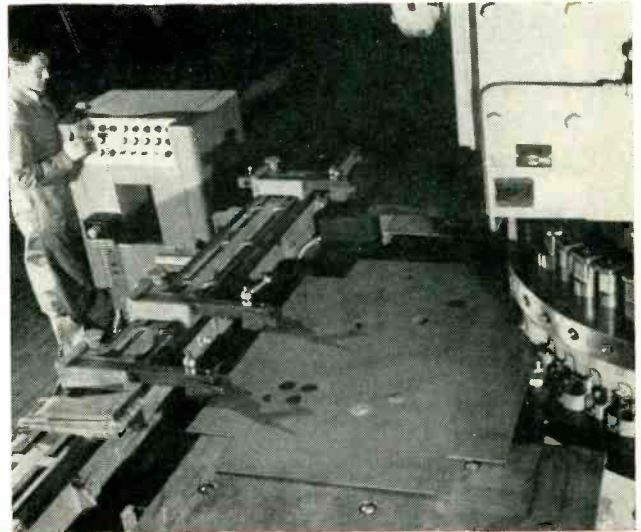

PUNCHING BY CARD

# Electronic Controls for

**SUMMARY** — Increased interest in automatic production has spurred the growth of electronics in the machine tool field. Applications range from complete control of complex milling operations by tape to systems for following operator's orders in proper sequence

**E**LECTRONIC equipment is being used to control many machining operations. These are mainly systems for moving the tool or work table in one, two or three dimensions to cut the desired shape. The simplest form of control is in the single-dimensional machine where a plugboard is used to set spindle speeds and feed rates. In lathe operations where a symmetrical piece is being turned tracer or magnetic-tape control can be used to change the position of the cutter.

Punch press and drilling machine controls position the work table under the drill. Position information in rectangular coordinates is recorded on punched tape, cards or magnetic tape. A servo system is used to position the table.

Milling machines, used to cut complex forms, require programming information to raise or lower

**By DAVID A. FINDLAY**

*Assistant Editor*  
ELECTRONICS

the cutting tool as well as to move the table in two directions. Rectangular coordinate data can be processed in a computer to provide a step or continuous tool motion, with the computer calculating the tool path between points according to equations inserted by the programmer. Tracer-controlled millers use deflection of a stylus on a three-dimensional model to provide control information to the cutting head.

### **Program-Controlled Machines**

In milling machines, for aircraft wing members or three-dimensional cams for fuel control, the complete cutting operation is under control of signals recorded on punched or magnetic tape.

In the Bendix cam milling machine, shown in Fig. 1, the problem of programming a three-dimensional contour of jet-engine fuel-control cams is reduced to a two dimensional one by fixed gearing between the work spindle and the longitudinal carriage. In this method, the information required by the machine control is the difference in radius in relation to the angular interval.

The basic increment in tool position is 0.0002 in. and radius difference is punched on eight-hole paper tape in terms of these increments. An increase in radius of 0.03 in. corresponds to  $\pm 150$  increments. Two hole positions are used to indicate angular intervals and may be 5, 10, 20 or 80 degrees. The larger intervals are used on sections where the contour is mild.

Data from the tape, giving the

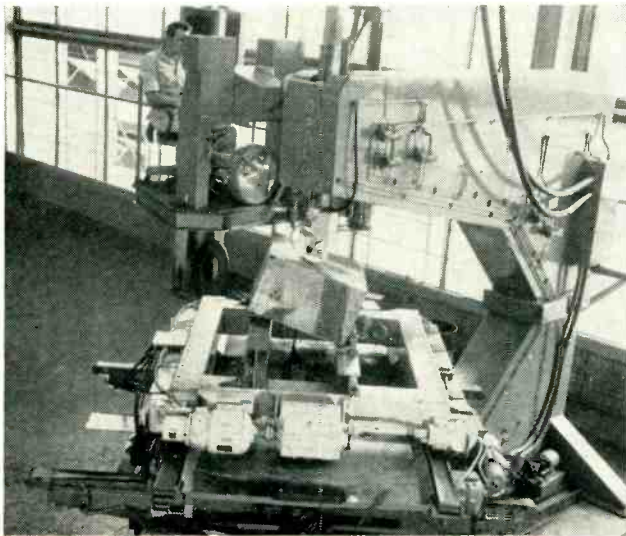

SAWING BY WHEEL



TURNING BY PLUGBOARD

# Machine Tools

change of cutter position for each angular interval, is fed to an interpolating unit together with pulses fed back from the spindle and indicating its angular position. The pulse generator is connected to the spindle drive motor and produces 50 pulses per degree of rotation.

The interpolator consists of a binary multiplier and two flip-flop storage registers. While cutting is

being done under control of the first storage register information for the next interval is being read into the second register.

The multiplier is controlled by the difference information in the storage register. A binary counter accepts pulses from the spindle-drive pulse generator and generates a command pulse to the cross-slide servo in accordance with the angu-

lar interval indicated on the tape.

The cross-feed position is sensed by a reversible binary counter which accepts command pulses in one sense and feedback pulses from the cross-feed digitizer in the other sense. The feedback information to the interpolator is the difference between number of command pulses received and number of feedback pulses from the digitizer. This difference count is converted to a proportional voltage by a resistor-rectifier decoding matrix and used as an error voltage by the servo amplifier.

As shown in one of the photographs appearing here, the tape is held on a large reel with the tape reader placed in the center. One complete circulation of the tape through the reader corresponds to a complete cutting pass along the axis of the cam.

For larger-scale milling operations, a three-axis milling machine for aircraft spars is now being constructed. It will employ the same basic techniques as developed for the cam-milling machine. The method of data handling is similar to that developed by MIT and now being used by Giddings and Lewis

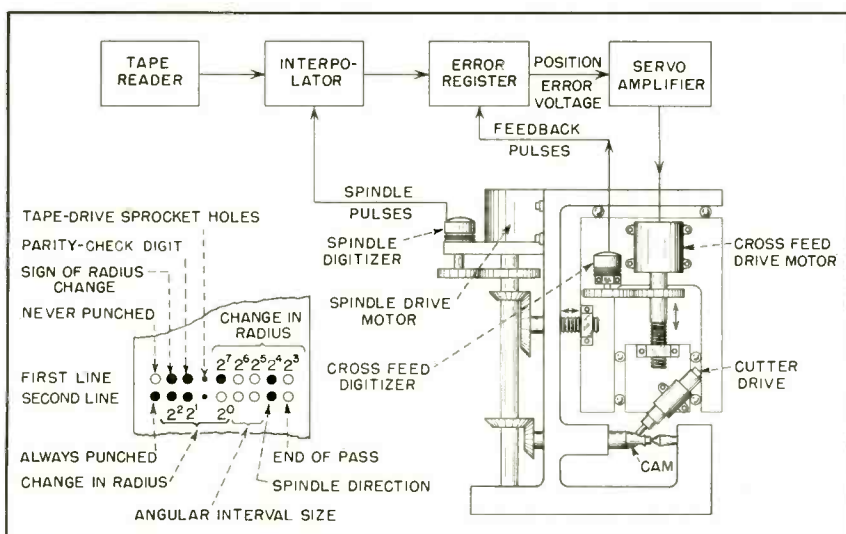

FIG. 1—Milling machine for three-dimensional fuel control cams. Tape section at left shows distribution of punched information

in their numerically-controlled miller.

In the spar milling machine made by Giddings & Lewis, data from blueprints are punched into paper tape as control signals for five machine axes and 22 auxiliary machine functions. The digital data is converted into a phase-modulated continuous function with the computer interpolating the curves and linear motions required to connect the discrete point information on the punched tape. The phase-modulated signals recorded on magnetic tape are used to control tool and table motion through an amplidyne servo.

A system now under development by Electronic Control Systems-Stromberg-Carlson is shown in Fig. 2. In the planning section, coordinate data is entered from a ten-key adding machine. This data is fed to a storage register along with cutting-speed information and equations for curve type selected on the control panel. The special-purpose com-

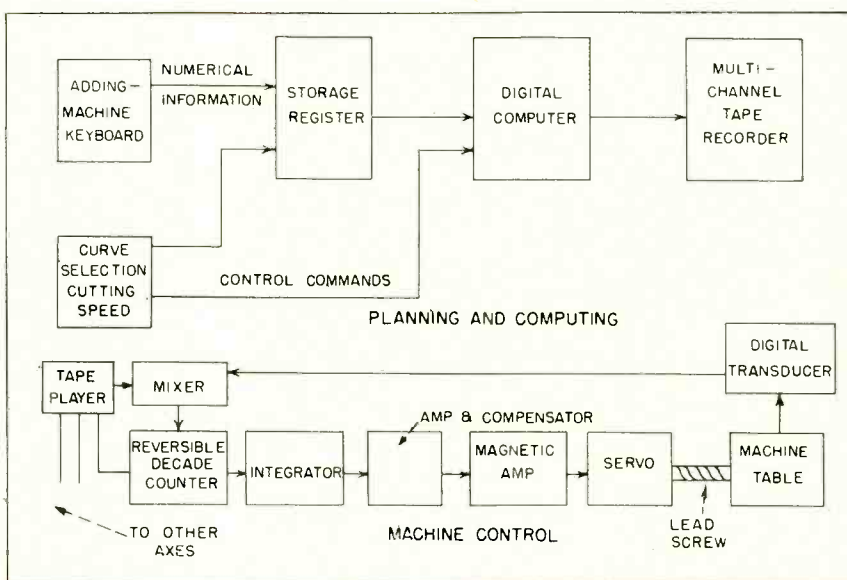

FIG. 2—Computing and control sections of ECS path-control system. Special purpose computer supplies interpolation to calculate continuous curves

puter calculates the tool path along first and second degree contours rather than as chord approximations. Output from the computer consists of a series of pulses recorded on three separate channels

of a tape recorder. For straight-line sections, the pulse trains on each channel have constant spacing.

In the machine-control section, the pulse output from the tape player is mixed with information fed back from a digital transducer on the machine table. The sum-or-difference signal is then fed through an integrating circuit to provide a varying d-c voltage to the magnetic-amplifier controlled servo.

In a similar system developed by Ferranti Ltd., digital feedback information is obtained through a phototube-grating arrangement shown in Fig. 3. A length of grating ruled with 5,000 lines per inch is mounted on the machine table. A second shorter section is fixed to a stationary part of the machine so that movement of the table will cause the long section to traverse the other with their surfaces almost in contact. The fringe pattern produced by this motion is used to modulate a light beam. Two phototubes are situated so that the modulated light will reach them in different phase relation. Using this system the number of cycles will give the distance moved, frequency will give velocity and phase relationship will provide direction.

A programming system for recording pulsed control information on recorded tape is shown in Fig. 4. In this control, developed by the Automation Corp. of America, each axis of the machine is driven by

Table I—Systems for Programmed Machining

Manufacturer	Data Storage	Modulation	Notes
Automation Corp. of America	35-mm magnetic tape	f-m	Machine drive through mechanical differential and synchronous motors
Bendix Aviation Corp.	punched plastic tape	pulse	Special purpose machine for milling fuel control cans
Bendix Aviation Corp.	magnetic tape	phase	Under development for Martin Aviation Corp.
ECS-Stromberg Carlson	magnetic tape	pulse	Tool path computed as continuous curve rather than chord approximation
Farrand Controls Corp.	punched tape	pulse	
Ferranti, Ltd.	magnetic tape	pulse	Tool path computed as continuous curve rather than chord approximation
General Electric Co.	magnetic tape	phase	Program tape recorded from operation by hand or tracer
Giddings & Lewis	magnetic tape	phase	Based on design developed at MIT
Monarch Lathe Co.	plugboard		Programs up to five operations and spindle speeds on lathe
Oerlikon Tool & Arms Co.	Translator for converting from punched tape to phase modulated magnetic tape for GE tape control		



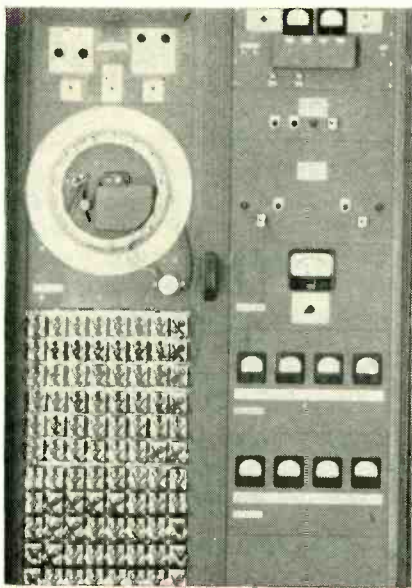

Control panel of Bendix cam milling machine. Tape reel is at left

two synchronous motors through a mechanical differential. One motor is driven by a reference signal recorded on the 35-mm magnetic tape and the other is driven from a second tape channel at a speed determined by the programmer. When both motors receive signals of the same frequency, their speeds are equal and the output from the mechanical differential is zero. Varying the frequency of the signal to one motor above or below the reference frequency will produce an output to the table at a speed and direction determined by amount and direction of the variation.

In the programming unit, tape speed is synchronized with the recorded data by a basic timing pulse obtained from a phototube-disk arrangement on the tape sprocket drive. With the X, Y and Z-rate counters set at frequencies to give the desired rate, speed and direction of movement, a pulse from the phototube starts these and the reference counter and their outputs are recorded on the tape. The reference counter also supplies distance information to a counter controlling the brake and sprocket drive motor. When the required distance has been moved, as set up on the distance counter, tape motion is stopped and the machine is ready for the next motion.

A plugboard selector is used on the Monarch Lathe Co. program-

mer to preset turning operations. Five separate work cycles can be programmed for spindle speed, cutting tool travel and feed rate. An analog-to-digital converter pulses the control unit at the end of each work cycle to switch to the next operation.

Systems developed by Airborne Instrument Laboratory and Pratt & Whitney gage the output of the machine to control cutter position. Three consecutive pieces must be oversize before the tool is reset.

The General Electric tape control system is shown in Fig. 5. In preparing a tape, the workpiece is turned out by hand and outputs from synchros attached to the lathe controls are recorded on tape as phase-displaced 200-cps square-wave signals. On playback, the phase displaced signal is discriminated and drives an amplidyne motor control to position the tool.

A programmer developed by Oerlikon Tool and Arms Corp., will program magnetic tape for the GE control unit from punched paper tape. Rectangular coordinate data punched into the tape is translated into phase-displaced 200-cps square waves. This information is recorded on magnetic tape as a continuous signal proportional to time.

### Tracer Controlled Machines

In tracer-controlled milling machines the device for following the model contours can be a resolver potentiometer, variable-reluctance transformer or similar device for converting stylus displacement into a voltage change. In the Pratt & Whitney Velvetrace, a noncontacting follower uses a changing spark-

gap potential between the stylus and metal model to control the raising and lowering of the cutter and cross-feed speed of the table.

The Raytheon two-motion duplicator, shown schematically in Fig. 6, has been applied to machines for working large round parts to maintain a constant tangential cutter velocity with changes in shape of the part. A variable-reluctance follower has two sets of sensing elements aligned with the machine axes being controlled. This provides a direct measure of the pressure vector along each axis. The output of the transformer, with deflection of the stylus, will be two in-phase signals one each for the X and Y axis. These signals are fed to an amplifier and phase-shifting circuit where the signals are displaced 45 deg so that they will be 90-deg out of phase at the input to the vector adder. Here the signals are added vectorially, producing a signal vector representative of the deflection vector at the stylus with its magnitude indicating the magnitude of stylus deflection and its phase representing the direction.

To keep the stylus in contact with the model regardless of contour, a modulator vector must be added perpendicular to the signal vector in a direction depending on whether the stylus deflection is greater or less than normal.

The modulator section is a balanced circuit consisting of two 6L7's. The screen grids are held a reference potential, with the stylus signals applied to the control grids through a four-phase detector. As the slope of the template changes the output of the phase detector will

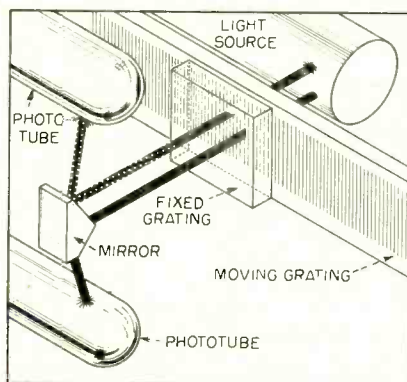
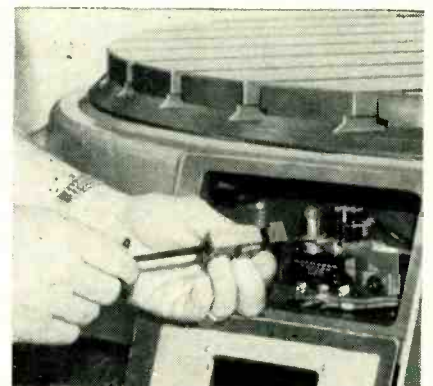

FIG. 3—Phototube-grating arrangement to obtain digital motion data from table



Inserting magnetic locating device in Pratt & Whitney rotary table

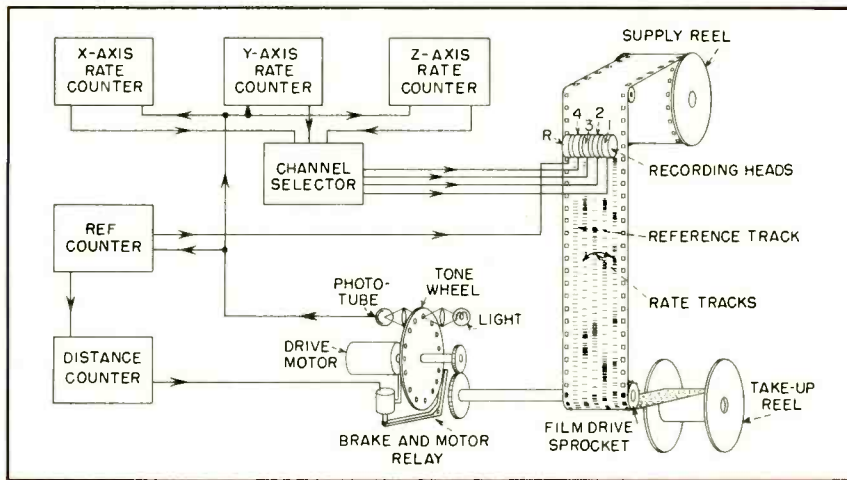

FIG. 4—Counter programming system obtains synchronizing signal from tape drive so that reference and rate tracks will be independent of tape speed

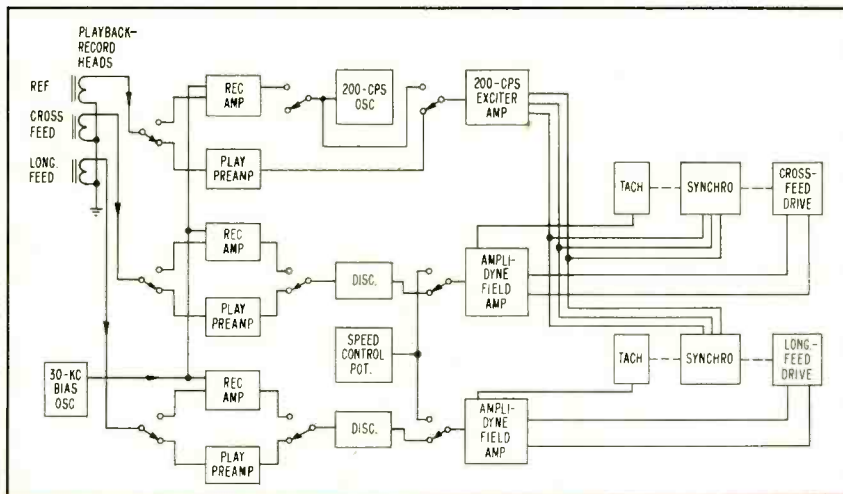

FIG. 5—Tape recorded from machine motions by synchros can be played back into lathe to duplicate parts

Table II—Programmed Positioning Systems

Manufacturer	Data Storage	Notes
Arter Grinding Machine Co.	punched tape	
Farrand Controls Corp.	keyboard input mechanical drum storage	
General Electric Co.	punched cards	Synchros positioned by pins from digital data
Laboratory for Electronics	punched tape	Positioning system for printed circuit boards (under development)
Pratt & Whitney	cards, tape or keyboard	Resolver-null balance using magnetic pickup
Radio Corp. of America	punched tape	Positioning system for printed circuit boards
Stromberg-Carlson	punched tape or cards	

change, producing a modulator output. The modulator output will have a phase relationship of zero or 180 deg to the signal vector with an amplitude dependent on the change of slope of the contour. This vector is added to the signal vector in the second vector adder and is then resolved into components 90 deg apart for discrimination. The phase-sensitive discriminators produce d-c outputs proportional to the cosine of the phase angle of the signals and the reference potential at their plates. These signals drive amplidyne systems controlling the X and Y axes motors.

### Table Positioning Systems

Continuous changing of table positioning under direct control of the operator is used in the DoAll band-saw used for cutting extrusion dies for aluminum. A block diagram of the system is given in Fig. 7 and the circuit is shown in Fig. 8.

Three separate feed motions are required to machine a curved surface using a band-saw with a single cutting edge. It must be possible both to rotate the work and to move it linearly in rectangularly coordinated directions. In the DoAll band-saw, two tables providing linear motions in rectangular coordinates are mounted on a rotary table with the saw blade located in the center of the rotary table.

Sawing a straight line requires movement of only the linear feeds while cutting a curved surface required simultaneous operation of all three feeds. The rotary table maintains the tangent relationship to the saw blade while the feed into the blade is obtained from linear motions. Since the linear tables are mounted on the rotary tables, movement of the rotary table changes the direction of feed. During any rotary motion of the supporting table the motions of the individual linear-feed drives must constantly change in order to maintain feed at a constant direction and rate with relation to the saw blade.

The three feed drives are simultaneously controlled from a single wheel by a combination of a positioning-control system for the rotary table and a resolver speed-control for the linear motions.

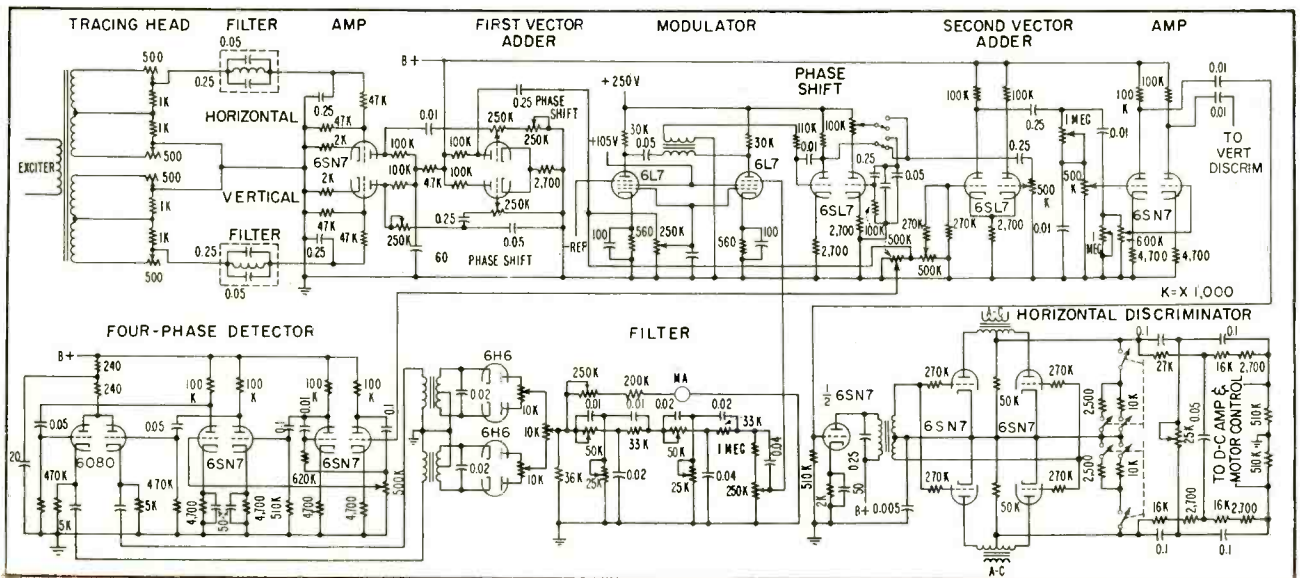

FIG. 6—Tracer control for machining circular parts holds tangential velocity of cutting tool constant with changing contour

When rotated, the main control wheel actuates a transmitter synchro which controls the movement of the rotary table. When the steering wheel is moved longitudinally it actuates a speed-control potentiometer and establishes the magnitude and direction of feed. A resolver potentiometer actuated by the rotary table divides the feed-speed signal into two components for independent control of each of the linear-feed drives as shown in Fig. 7. Control winding on the resolver produces signals which have a sine and cosine relationship varying with the angular position of the resolver and rotary table.

When work is being fed into the saw in a direction parallel to the X-axis drive, the full control signal is fed through the resolver to the amplidyne driving that axis. Rotating the work table will change the position of the resolver potentiometer slider, decreasing the drive signal to the X axis and increasing the signal to the Y-axis drive. Turning the table a full 90 deg, so that feed is parallel to the Y axis, positions the resolver so that the full signal is transmitted to the Y-axis control.

Discrete positioning of a work-piece under a drill or punch requires control of table motion in two coordinates. In the General Electric punch-card positioner, conversion from decimal to analog is performed by feeding the units, tens,

hundreds and thousands column data into separate synchros geared in a ten-to-one ratio. Pins representing values from zero to nine are spaced evenly around each synchro. The pin actuated by the card reader is moved into position to stop the synchro at the proper point in its revolution.

The operating cycle is initiated

by the card entering the reader. The synchros are rotated approximately one revolution away from their zero position and then start to return until they are stopped by a pin selected by the card reader.

Because of the gearing between synchros, the position of the units synchro will modify that of the tens, which will in turn modify the

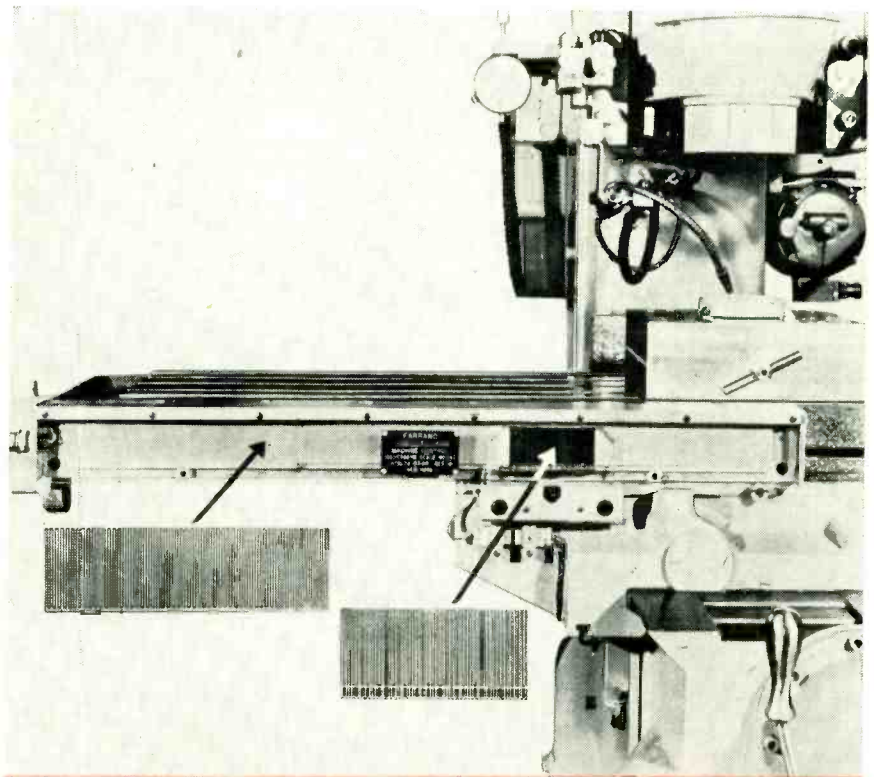

Inductive-strip pickup on Farrand machine control provides resolver output of table position for feedback information

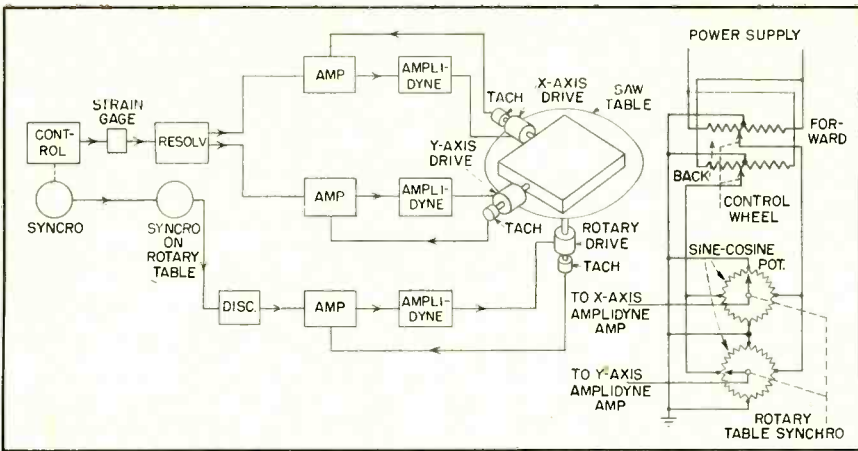

FIG. 7—Control system for band-saw table uses resolver potentiometers to change axis drive speeds with rotation

position of the hundreds. A position synchro matched to each command synchro is driven from the machine table and provides difference information between the desired table position and the present position.

The difference signal from the four synchros is mixed and amplified. A discriminator gives an output to motor-control circuits of a magnitude and polarity dependent on the phase and amount of error.

In the Reeves Instrument Co. positioning system, voltages corresponding to distances along the table travel are set up on a group of potentiometers. Resolver potentiometers driven by the table are

used to balance this voltage.

In the Pratt & Whitney system used on a table and on a rotary table for angular positioning, a bar of magnetic material is used as a sensing unit for table position, as shown in one of the photographs. A pickup head senses accurately placed projections on the bar. On the rotary table, the bar projections are placed by hand. A snap-action switch contacts the positioning block as it approaches the sensing head, slowing the drive speed.

A table positioning system developed by Farrand Controls, Inc. is pictured. A keyboard and mechanical memory drum is used to program decimal values of X and Y

coordinates for up to 15 drilling locations. A linear strip along the bed of the machine has continuous hairpin wiring along its length. A noncontacting inductively coupled slider mounted on the worktable has 32 pairs of poles on its surface. When energized with single-phase a-c, a sine wave output, similar to that of a resolver driven by a rack-and-pinion arrangement, is obtained.

A keyboard is used to insert positioning information. Keys for course values (down to 0.01) are connected to the carriage drive motor through a servo amplifier with error feedback from a geared potentiometer. Positioning to less than 0.01 in. is accomplished through the inductive slider. Transfer from course to fine is made by a relay when the error signal reaches a predetermined value.

An automatic sizing control circuit applied to a Micromatic Hone Corp. cylinder hone is shown in Fig. 9. An expanding cutting tool rotates inside the cylinder to remove excess material. When the workpiece comes to the required size, a gage ring closes the sizing switch, removing negative bias from the trigger tube. The trigger tube conducts, closing a relay in the plate circuit that stops the cutter feed. Another contact on the relay grounds the cathode of the timer tube. This tube does not fire immediately because of the negative charge on the 1- $\mu$ f grid capacitor. During the time that it takes the capacitor to lose its charge, the cutter is rotating without feeding into the work. This run-out period gives the final finish to the honed surface. When the capacitor has discharged its bias the timer tube conducts, closing its plate relay to collapse the cutting tool and energize the solenoid to lift it from the work.

### Solid-State Control Equipment

The circuit of a basic decision element made by Minnesota Electronics Corp. is shown in Fig. 10A. These units can be used to form *and*, *or*, or *flip-flop* circuit in logical machine-tool control systems. A unidirectional four-phase clock supplies pulses to set and reverse the state of the cores. The input wind-

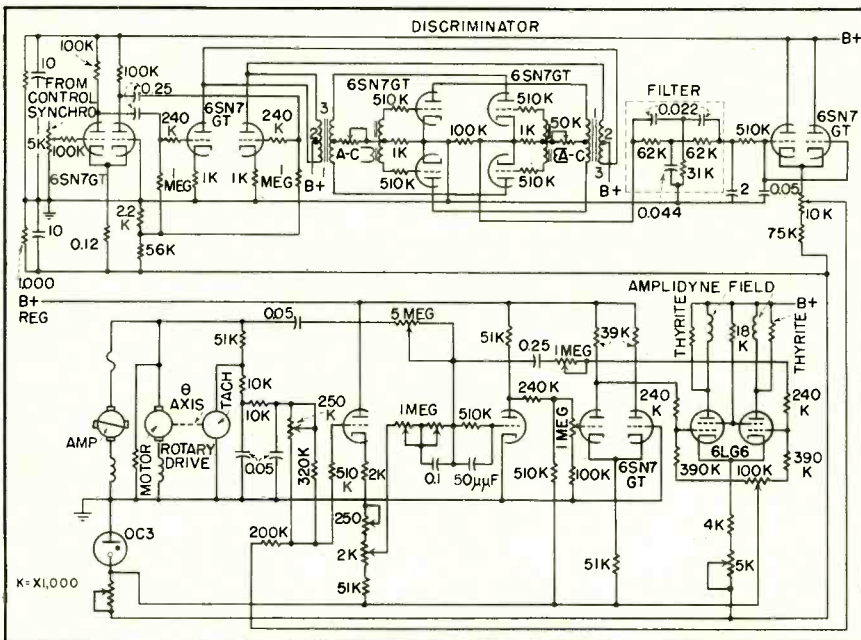

FIG. 8—Rotary table control circuit for DoAll band saw. Amplidyne sections for X and Y axes are same as shown for rotary table

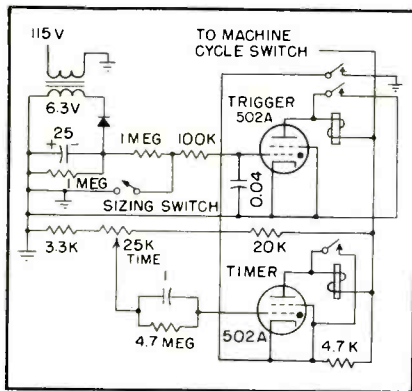

FIG. 9—Control and timing circuit for precision cylinder hone

ing and upper output winding are similarly sensed, so that if a pulse energizes the input winding the next clock pulse will find a low impedance in the upper winding and will produce an output pulse. The lower output winding, being oppositely sensed, will offer a high-impedance to the clock pulse. Thus, the element provides output on the upper element for an input pulse and an output on the lower winding for no input pulse.

An *and* circuit is formed by applying inputs to either end of the input winding. With two inputs through mixing diodes of pulses large enough to saturate the core an *or* circuit is produced. Two decision units combined as shown in Fig. 10B, form a flip flop. With no input on the set line, the lower winding produces a series of pulses to the input of the second element, saturating the core so that it will not pass a pulse on the lower winding. Inserting a pulse to the input will stop a pulse to the second element, permitting it to supply a pulse to the input, thus maintaining that state. A reset pulse inserted at the time of the zero output from the first element will set the flip-flop to its original state.

An application of solid state logical elements to machine control is shown in the punch press circuit of Fig. 10C. In this Westinghouse Cypac system the operator presses two run buttons to actuate an air clutch connecting the punch head to the drive power. When the buttons are pushed the input to the first *not* circuit is removed. This provides an output through the lower contacts of the run button to the *on* input of the flip-flop and

Table III—Tracer Control Systems

Manufacturer	Transducer	Notes
General Electric Co.	potentiometer balance	
Moog Valve Co.	potentiometer balance	Error signal controls four-way hydraulic valve to position cutter
Raytheon Mfg. Co. (two motion)	differential transformer	Maintains constant tangential velocity on miller for circular parts
Raytheon Mfg. Co. (single and dual motion)	differential transformer	Single and dual motion control use similar circuits

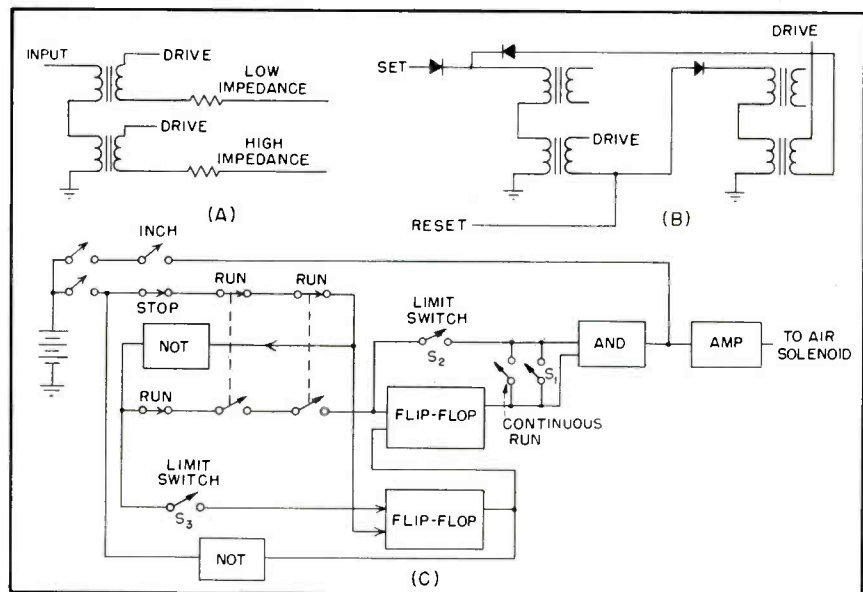

FIG. 10—Decision element (A) provides *or*, *and*; or *not* circuit. Combined as a (B) a flip-flop is formed. Control (C) was designed by Westinghouse for punch press

through limit switch  $S_2$ , giving a second input to the *and* circuit. With both inputs present, the *and* circuit provides an output to actuate the air clutch solenoid. As the punch moves down, limit switch  $S_2$  opens and  $S_1$  closes. The operator can then release the run buttons without stopping the cycle. If the operator does not release the run buttons until after limit switch  $S_2$  closes, the machine will stop. If he does release them and depresses them after limit switch  $S_2$  has opened, the machine will continue into the next cycle.

Tilting the cutting head of a miller in response to information from a cam is an application using magnetic amplifiers. In this, system designed by Magnetic Amplifiers Inc., the input synchro is positioned by a cam arrangement

which sets the prescribed tilt according to the position of the machine table.

A synchro control transformer coupled to the tilt drive senses the degree of tilt and has an output proportional to the difference between the desired angle and the actual angle. A phase-sensitive demodulator produces a d-c output proportional to the a-c error signal from the synchro. The demodulator output is fed to a high gain magnetic amplifier which produces two output signals to the tilt-head hydraulic valve control. The two outputs of the magnetic amplifier are equal with a zero input signal. Input to the magnetic amplifier from the phase-sensitive demodulator unbalances the valve control to change the flow of hydraulic fluid to the tilt-actuating piston.

# Broadband Antenna for

**SUMMARY** — Unity-gain antenna and balun cover range from 88 to 400 mc without adjustment for frequency. Biconical construction and balun design can be modified to cover any 4.5-to-1 frequency range

**M**ANY UHF AND VHF radio interference and field-intensity meters use a standard resonant dipole antenna as a pickup device. This dipole requires several adjustments for every frequency measured. In addition, a balun shorting stub must also be measured and adjusted to its proper length. These adjustments make radiation measurements over a wide frequency range cumbersome and time-consuming.

A broadband antenna and balun requiring no adjustment over a range from 88 to 400 mc has been developed for use with meters having a 50-ohm coaxial input. The design of the antenna has been calculated in general terms so that antennas may be constructed for any 4.5-to-1 frequency coverage in the uhf and vhf spectrum.

Voltage gain of the broadband antenna should ideally be the same as a resonant dipole to enable direct substitution. The resistance of the antenna should be fairly constant and the reactance comparatively small over the entire frequency range. The orientation of the field intensity patterns should be con-

stant with frequency over the entire range.

The biconical type of antenna was selected after a study of different types of broadband antennas. There are two determining physical parameters for a cone. They are the length  $L$  and the flare angle  $\alpha$  as illustrated by the longitudinal conical sections in Fig. 1.

A cone with a flare angle of 70 deg will give a voltage gain approximately the same as a resonant dipole antenna over a wider frequency range than any other flare angle.<sup>1</sup> Therefore, the flare angle of the cone was fixed at 70 deg.

Maximum length of the cone was determined by the breakup of the horizontal field-intensity pattern when the length of the cone is greater than  $\frac{3}{4}$  wavelength. As cone length is increased the side lobes become larger until at  $\frac{3}{4}$  wavelength they are only slightly less than the main lobe. This fixes maximum cone length at  $\frac{3}{4}$  wavelength.

Minimum length of the cone was determined by the sharp decrease in resistance and increase in reactance when the cone is small compared to the wavelength. Figure 2 is derived

from experimental data<sup>1</sup> and shows variation of resistance and reactance as length of cone varies with respect to wavelength.

## Impedance Matching

A large change in resistance or reactance with frequency makes impedance matching of the antenna difficult. For this reason the minimum length of the cone was fixed at  $\frac{1}{4}$  wavelength. Ratio of minimum to maximum length is 4.5-to-1, which is the maximum frequency range. Within these limits the resistance varies from 80 to 180 ohms. Reactance over most of this frequency range is relatively small.

This physical size of the cone may be reduced somewhat by closing the end. Figure 1 shows a comparison of open-ended and closed-end cones of the same flare angle,  $\alpha$ , and the same electrical length,  $L$ .

Solid cones at vhf are generally impractical because of their size. Since solid antenna forms may be simulated by rods or wires that closely follow the shape of the form this type of construction was used.<sup>2</sup>

Each cone is attached to a small copper stud mounted in the junc-

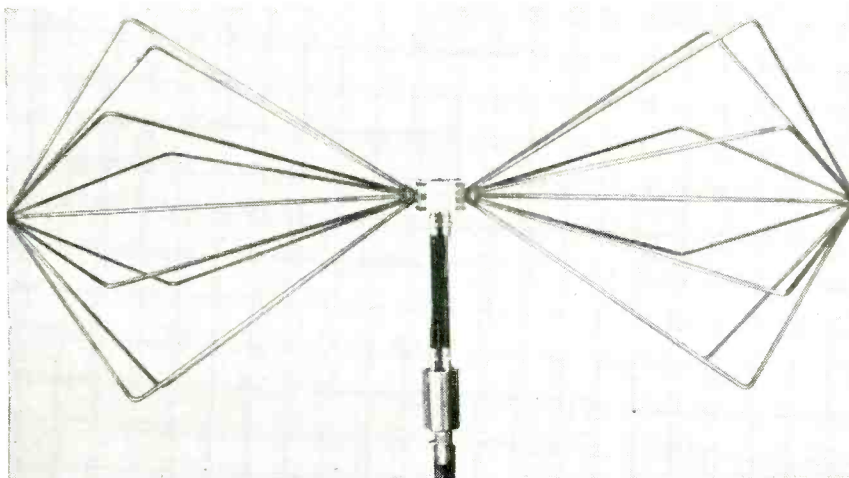

Biconical antenna design provides unity gain over a 4.5-to-1 frequency range. Closed-end construction gives same electrical length as a flare but is sturdier and more compact

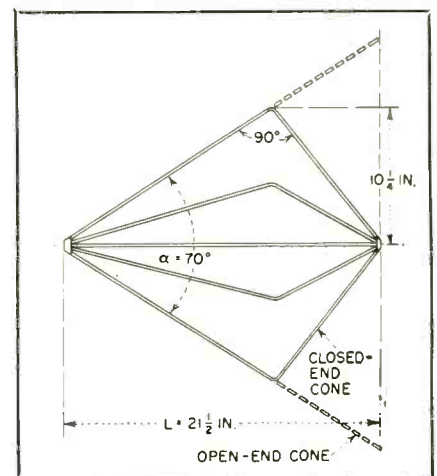

FIG. 1—Dimensions of single cone for unity gain antenna.

# Field-Intensity Meters

By **EDWARD N. SINGER** and **HERSCHEL R. CALER**

*Radio Propagation and Standards Section  
U. S. Naval Material Laboratory  
New York Naval Shipyard  
Brooklyn, N. Y.*

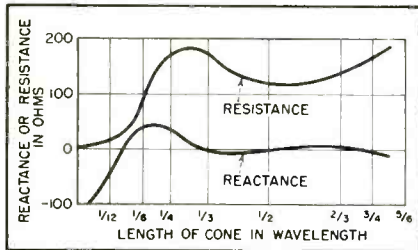

FIG. 2—Antenna resistance and reactance as a function of wavelength

tion box. This stud adds  $\frac{3}{4}$  inch to the length of each cone bringing the total length to 22 $\frac{1}{2}$  inches which is approximately  $\frac{1}{2}$  wavelength at the lowest frequency, 88 mc.

## Balun Design

Figure 2 shows that the antenna resistance varies from approximately 80 to 180 ohms for the design chosen.

The balun is a modified version of the elevator type.<sup>3</sup> It matches a 50-ohm coaxial impedance to a 200-

ohm shielded balanced output over a 4.5-to-1 frequency range. Figure 3A shows a simplified form of this balun.

Two 100-ohm transmission lines are connected at the lower end in parallel to form a 50-ohm coaxial connection and are connected at the upper end in series to make a balanced 200-ohm output. The two 100-ohm coaxial lines form a shielded output.

It is necessary in the elevator type of balun to have the two-wire transmission lines bifilar wound in the form of coils. The number of turns used should make each two-wire transmission line approximately a quarter-wavelength long at the lowest frequency used. The exact number of turns may be determined empirically.

Seventeen and a half bifilar turns were used on each form. The ridges of the scalloped coil form act as dielectric spacers.

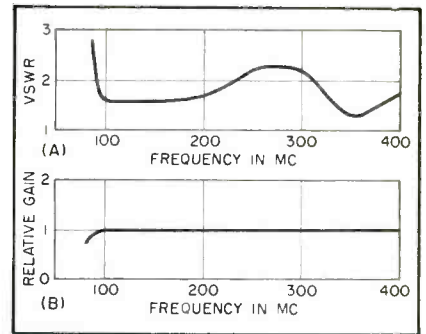

FIG. 4—Plot of vswr (A) and relative gain (B) for biconical antenna and balun assembly

The impedance of a two-wire transmission line wound on a scalloped form is

$$Z = \left( 120 \cosh^{-1} \frac{D}{d} \right) \left[ 1 + \left( \frac{E-1}{S} \right) W \right]^{1/2}$$

where  $D$  is distance between centers of wire,  $d$  is diameter of wire,  $E$  is dielectric constant of spacer,  $W$  is thickness of spacer and  $S$  is distance between spacers.

A value of 25 mils was chosen for  $D$  as a convenient practical value. For the desired impedance of 100 ohms and with the parameters of the coil form in Fig. 3B the value of  $d$  was calculated to be 14 mils. This corresponds to No. 27 wire, B & S gage.

The vswr of the antenna-balun with a 50-ohm cable was measured by a slotted line from 88 to 400 mc. The results are as shown in Fig. 4A. Highest vswr measured 2.8 at 88 megacycles. The lowest vswr measured was 1.28. The relative voltage gain of the biconical antenna is shown in Fig. 4B.

The authors thank George C. Neuschaefer and Robert Fairweather for their helpful suggestions and encouragement.

## REFERENCES

- (1) G. H. Brown and O. M. Woodward, Experimentally Determined Radiation Characteristics of Conical and Triangular Antennas, *RCA Rev*, 13, 1952.
- (2) An Investigation of Problems Associated with Broad-Band Interference Measurements, Rensselaer Polytechnic Institute, Signal Corps Contract No. DA 36-039-sc-42488.
- (3) E. O. Johnson and R. F. Kolar, Practical TV Antennas for UHF, paper presented before IRE Convention, N. Y., March 1952.

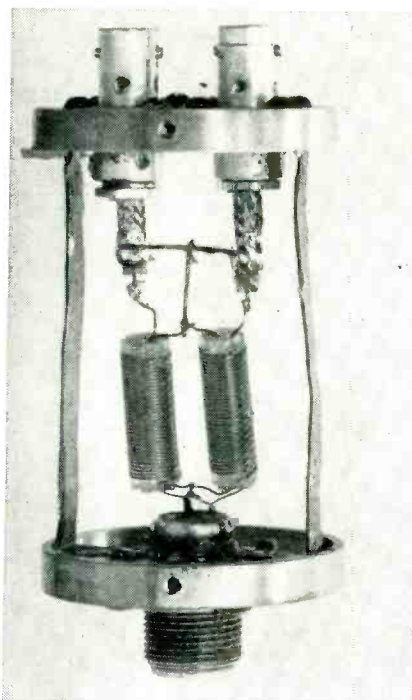

Internal construction of broadband balun with bifilar coils at center

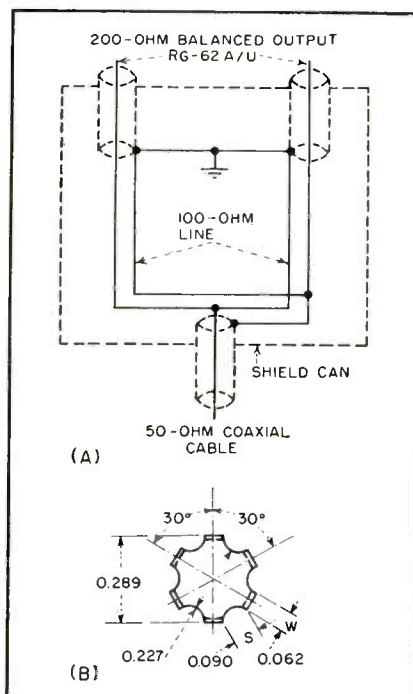

FIG. 3—Circuit of balun (A) and cross-section of balun coil form (B)

# Character Recognition

**SUMMARY** — Photoelectric scanner analyzes printed numerals and provides electrical output usable in computers and other business machines. Reader recognizes 400 characters per second. Operation is independent of type style or size of number above minimum width



Numerals printed by character reader

By **M. H. GLAUBERMAN**

Senior Engineer  
Laboratory for Electronics, Inc.  
Boston, Massachusetts

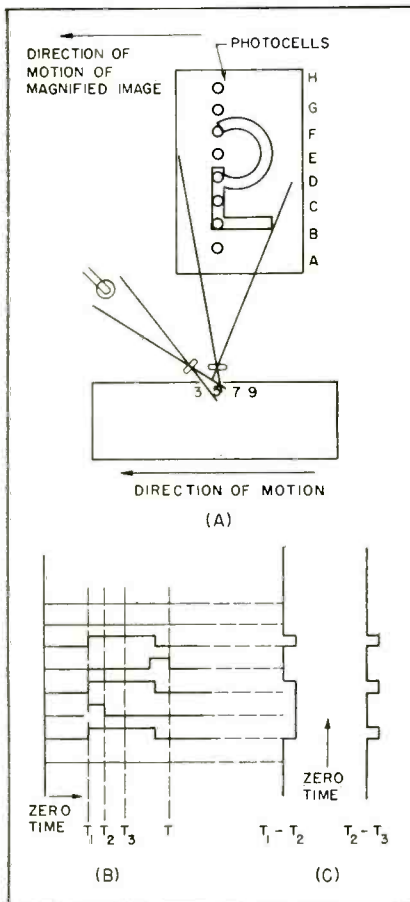

FIG. 1—Optical system of photoelectric scanner

**T**HIS READER recognizes Arabic numerals as printed matter passes through it.

Paper is not restricted as to color, thickness, opacity, roughness or quality. Ink need have no special qualities. The depth of the impression on the paper is of no significance, and at no time does the reader come into contact with the paper.

The character reader cannot read all type styles, but is not dependent on any one style. Minimum type width is approximately  $\frac{3}{16}$  in. for the widest digit. There is no restriction on maximum type width. The reader is not dependent on the height of the type providing the size is not larger than the aperture of the reading station. A common type height is about  $\frac{1}{8}$  inch. Most print imperfections will not impair recognition.

With checks moving into the reader at 16 per second, it recognizes 400 characters per second. The reader is able to read 1,600 characters per second, however, and could be made to operate at twice this speed.

The reader is designed to operate

serially and sorts by successive passes.

### Photoelectric Scanner

The scanner consists of a column of photocells whose outputs are modulated by the black portions of characters. The photocells are sequentially gated into a common buffer. Figure 1A shows how a magnified image of a number is projected on the photocells. Figure 2 shows the scanner circuits.

Figure 1B shows the photocell outputs. The effect of sequentially gating the outputs into a common buffer is shown in Fig. 1C.

Table I—Pulse-Code Combination

Total Pulses Per Scan	Long-Black Pulses Per Scan	Coded Combination
1	0	10
1	1	11
2	0	20
2	1	21 } 21'
2	2	22 } 22'
3	0	30 } 30'
3	1	31 } 31'

Note that the first digit of the coded combination represents the total number of black pulses per scan and the second digit represents the number of long black pulses per scan



# for Business Machines

There are photocells above and below those required to cover the number to accommodate changes in the vertical registry. See Fig. 3. Each photocell is an input to a gate whose other input is connected to a tap of a multiple-tapped delay line. The outputs of the gates are combined in the common buffer *B*.

Each photocell is individually connected to network *B* by sending a pulse down the multiple-tapped delay line. A pulse sent down the delay line corresponds to a scan. No attempt is made to synchronize the start of a scan with the entry of a character under the column of photocells.

The uncertainty of the start of the scan with respect to the edge of the character to be scanned is called horizontal registry. The character reader overcomes this registry problem by utilizing the first scan not to recognize the character but to tell the recognition circuit to look for recognition on the second scan.

## Pulse Generator

The waveforms at the output of combining network *B* appear as in Fig. 1C. The total pulse generator produces one pulse for each black region of the number and serves as a noise filter in that an input pulse must exceed a certain width for an output pulse to be generated.

The long-black pulse generator (see Fig. 4) is also a pulse-width detector. In this case a pulse must exceed a predetermined length for a long-black pulse to be generated. For example, a pulse must equal or exceed the length shown in Fig. 1C.

The output of the total pulse generator and of the long-black pulse generator, along with the system trigger, are next sent to the encoder unit. Three pulses, each appearing once during every scan period, are derived from the tapped delay line and also sent to the encoder. These pulses, in the order of their time sequence, are the comparison pulse, the read-out pulse and the reset pulse.

Six instructions constitute the

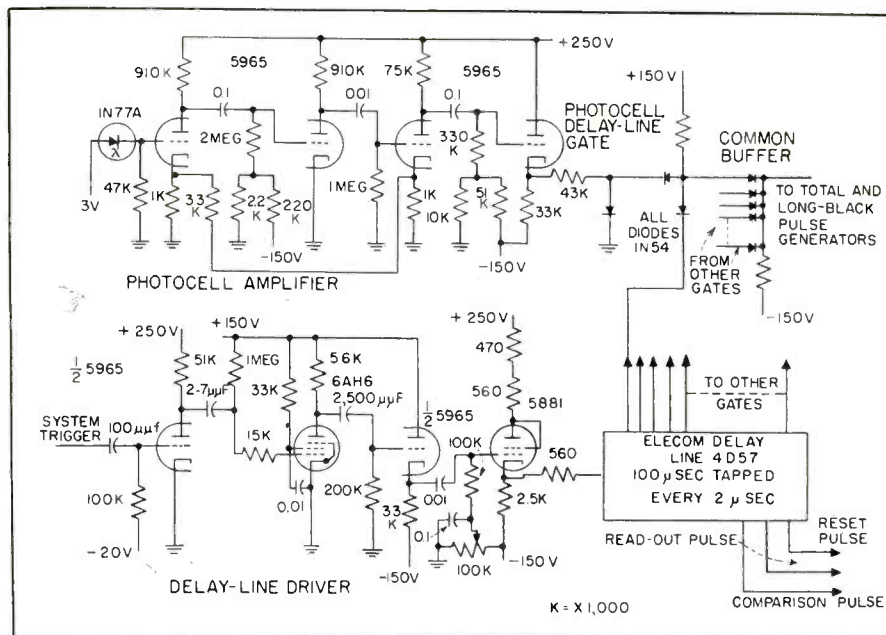

FIG. 2—Input section showing photodiode and delay line

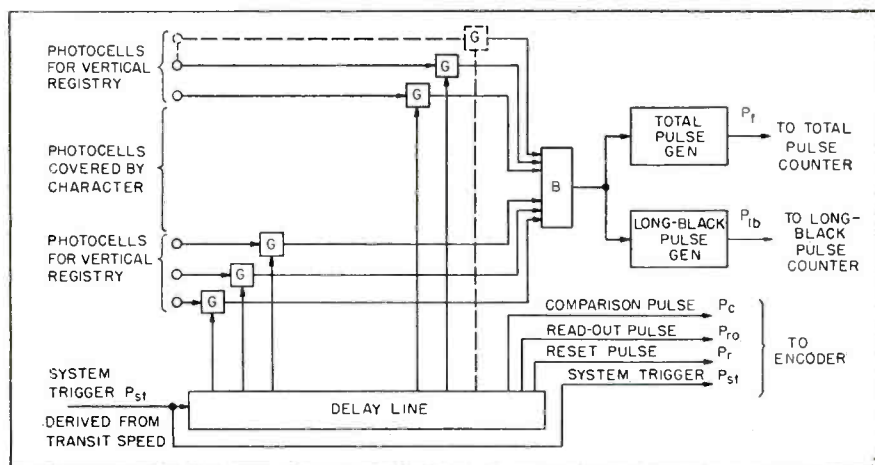

FIG. 3—Scanning station of character reader

program of the character reader.

(1) Count the total number of black pulses per scan.

(2) Count the number of long-black pulses per scan.

(3) Combine the results into discrete combinations as shown in Table I.

(4) If adjacent scans are not identical, put the most recent scan into shift-register storage and shift the register.

(5) If adjacent scans are identical, put nothing into storage and do not shift the register.

(6) When there is no character under the reading station, advance

the register but put nothing into storage.

A block diagram of the encoding unit shown in Fig. 5. The system trigger  $P_{st}$  operates an electronic switch which routes the total pulses  $P_t$  alternately into total-pulse counter *A* and total pulse counter *B* through gates  $G_a$ . The electronic switch also routes the long-black pulses  $P_{lb}$  into long-black counter *A* and long-black counter *B*, alternately, through gates  $G_b$ .

## Scan Comparison

Alternately switching input information  $P_t$  and  $P_{lb}$  into pairs of

**Table II—Shift Register Storage (Numeral Three)**

1 Scan	2 Total	3 Long	4 Code	5 Identity	6 Read-in	7 Shift	8 Interrogate	9 1st read-in in core row	10 2nd read-in in core row	11 3rd read-in in core row	12 4th read-in in core row
1	1	0	10	no	yes	yes	no	1	—	—	—
2	2	0	20	no	yes	yes	no	2	1	—	—
3	2	0	20	yes	no	no	no	2	1	—	—
4	2	0	20	yes	no	no	no	2	1	—	—
5	2	0	20	yes	no	no	no	2	1	—	—
6	3	0	30 <sup>1</sup>	no	yes	yes	no	3	2	1	—
7	3	0	30 <sup>1</sup>	yes	no	no	no	3	2	1	—
8	1	1	11	no	yes	yes	no	4	3	2	1
9	0	0	—	no	—	yes	no	5	4	3	2
10	0	0	—	no	—	yes	—	6	5	4	3
11	0	0	—	no	—	yes	next shift pulse yes	7	6	5	4
12	0	0	—	no	—	yes	—	x	7	6	5

identical counters provides for comparing adjacent scans for identity. The counters hold the input information until they are reset by reset pulse  $P_r$ , which is electronically switched through gates  $G_c$  once each scan alternately to reset both  $B$  counters and both  $A$  counters.

The comparison is accomplished in gates  $G_a$  once each scan after the counters have received their input information and at a time determined by the comparison pulse  $P_c$ . One of the six comparison gates will respond only when the input data  $P_i$  and  $P_{ib}$  have remained constant from one scan to the next.

Scan-to-scan identity in the long-black counter allows the comparison pulse to appear at the output of buffer  $B_{di}$ . Scan-to-scan identity in the total-pulse counter allows the comparison pulse to appear in the

output of buffer stage  $B_{di}$ . A pulse appears at the output of both of the buffer stages only when scan-to-scan identity is indicated by both the total-pulse and the long-black counters. This is the necessary condition to pass the signal through gate  $G_s$  to the identity-gate generator.

After the  $A$  and  $B$  counters have been compared for identity they are read out by read-out pulse  $P_{ro}$ . If there has been no identity the read-out pulse appears at the output of gate  $G_n$ . The electronic switch then allows the read-out pulse to appear alternately at the input of the  $G_r$  gates. It enables the outputs of either the  $A$  or the  $B$  counters to appear at the outputs of the appropriate  $G_r$  gates.

The  $B_j$  buffers then show the accumulated count per scan inde-

pendently of whether the counts appear in the  $A$  counters or the  $B$  counters. The first scan of the character is detected in buffer  $B_k$  and used to generate an inhibiting signal whose duration is  $1\frac{1}{2}$  scan periods. This inhibiting signal, applied to gate  $G_o$  prevents the recognition of an identity on the first two scans of the character. Subsequent scans of the character are prevented from generating additional inhibiting gates by the  $1\frac{1}{2}$ -character-period gate generator applied to gate  $G_i$  to disable it for the duration of the number.

**Coding**

The coded combination (Table I) of total-pulse and long-black counters is formed by the  $G_m$  gates. Only one or none of these five combinations can appear during one scan. The prime combinations are obtained in the  $B_m$  buffers.

The instruction to put into storage is accomplished implicitly whenever a signal appears on one of the five code-combination lines. The storage register is shifted or advanced by the system trigger  $P_{st}$ , when the trigger is enabled to appear at the output of gate  $G_n$ . System trigger  $P_{st}$  appears and the register is enabled to advance when a permissive signal appears on either one of the two inputs to the  $B_n$  buffer. One input is connected to the identity-gate generator and allows the register to shift unless there is an identity.

Between characters, the outputs of both the total-pulse counter and the long-black counter are zero. This combination of 00 is not sensed for identity in the  $G_a$  gates; therefore no identity signal can be generated. Also, since the code combination 00 has not been explicitly

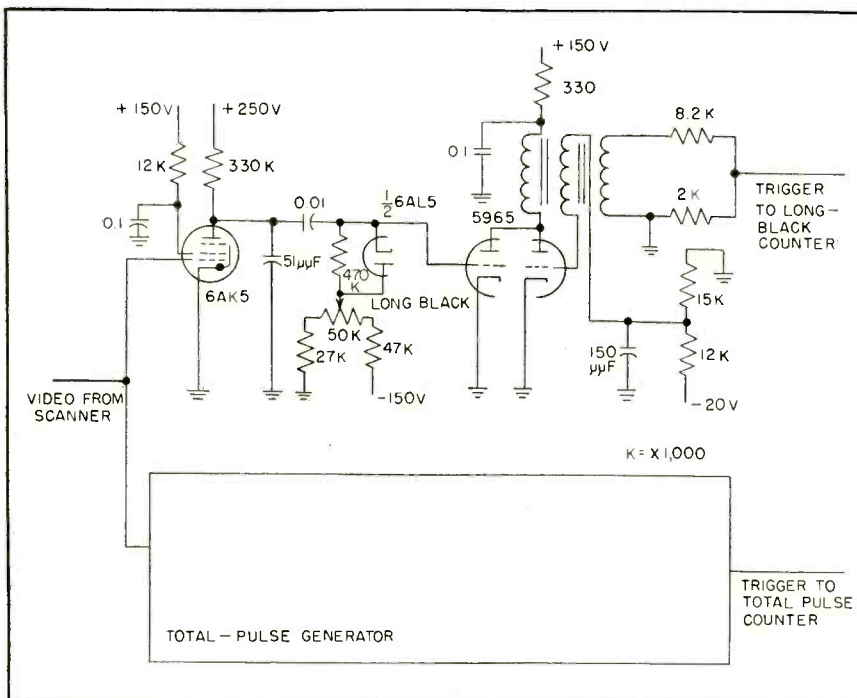

**FIG. 4—Long-black pulse generator is pulse-width detector**

formed in the  $G_m$  gates, there is nothing to put into storage.

Readiness for interrogation is detected in buffer  $B_o$ , which is connected to the seventh and last stage of storage. The first signal at the output of  $B_o$  passes through gate  $G_o$  and generates a gate whose duration is  $1\frac{1}{2}$  scan periods. This gate connected to  $B_n$  enables the register to advance on the next system trigger.

Subsequent signals at the output of  $B_o$  during the character storage time are prevented from passing through gate  $G_o$  by the  $1\frac{1}{2}$ -character-period gate generator, the latter

being energized by the system trigger that occurs after the first output signal at  $B_o$ . This particular system trigger is broadened in the matrix interrogation-pulse generator and is then used in the diode matrix.

### Shift Register Storage

Each block in Fig. 6A represents one magnetic core. There are thirty-five cores arranged in five columns of seven each. Each of the five columns is used to store one of the five discrete code combinations.

Information is always read into row 1 and remains in row 1 until

a shift signal is applied whereupon the content of row 1 is advanced to row 2.

Access to the information in the cores is available only during the shift-pulse time. As indicated in Fig. 6A, a single shift signal suffices to advance all thirty-five cores.

Figure 6B shows the scanned character THREE. The total number of pulses  $T$  in scan one is one. There are no long pulses  $L$  (code 10). For scan two:  $T = 2, L = 0$  for code 20. Scans three, four and five also yield code 20. In scans six and seven,  $T = 3, L = 0$  for code 30. Scan eight contains only one long pulse

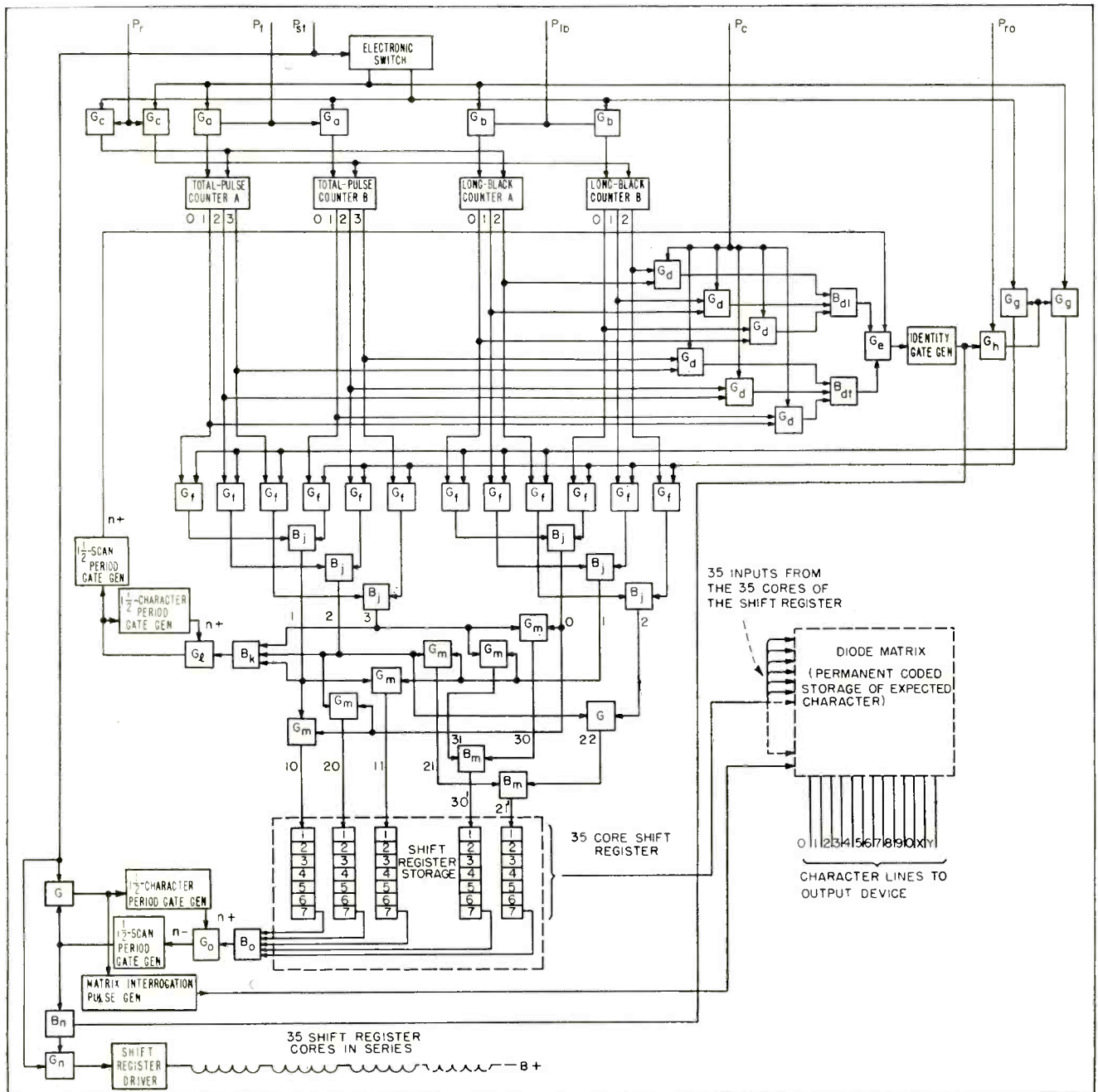

FIG. 5—Encoding unit which carries out the instructions comprising the program of the character reader

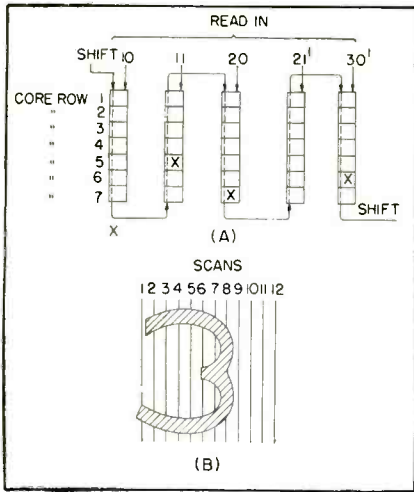

FIG. 6—Shift register storage with blocks representing magnetic cores (A) and the character THREE to be scanned (B)

which is indicated by code 11.

During scans nine through twelve there is nothing under the reading station;  $T = 0$ ,  $L = 0$  and no code exists for this combination. The contents of this paragraph are tabulated in columns 1 through 4 of the chart in Table II. The remainder of the columns show how the coded data gets into storage and is advanced to a known position.

Column 5 shows whether or not the code combinations of adjacent scans are identical. Although scans 9 through 12 are similar to the naked eye, the encoder does not indicate identity because it does not explicitly sense for the 00 combination. This is the significance of the 4 dash marks at the bottom of column 4.

Column 6 indicates that information is read into the shift register only on scans 1, 2, 6 and 8. Referring to column 4, information is read into the core columns that store 10, 20, 30' and 11 in that time sequence. Column 7 shows that the register is advanced whenever there is no scan-to-scan identity (column 5).

Column 9 shows how the first bit of information (code 10) read into the register progresses from the first to the seventh row of cores and then out of the cores. Columns 10, 11 and 12 show that the subsequent read-ins (codes 20, 30 and 11) will occupy core rows 6, 5 and 4 respectively at the time the first read-in is at core-row 7.

When the first read-in has been shifted out of the cores, codes 20,

30 and 11 occupy rows 7, 6 and 5. The blocks in Fig. 6A indicate the positions in storage of the four code combinations that result from scanning the figure THREE. This is in accordance with the basic instructions built into the character reader at the time the interrogation pulse appears to check which character has passed under the reading station. The signal derived from the first scan shifting out of the register signifies to the reader that the scanned character has now been read into a known position in storage. The register must be interrogated for recognition on the next system trigger.

### Diode Matrix

The diode matrix indicated on the encoder block diagram of Fig. 5 is shown in detail in Fig. 7. It consists of five groups of vertical lines, seven lines per group, which can be interlaced as many times as there are characters to be recognized. Each of the seven vertical lines per group is connected to one horizontal row of the shift-register cores.

The expected character configuration in a known position in the register is stored by connecting horizontal and vertical lines through gates and buffers. Take, for example, the number THREE whose code is 10, 20, 30, 11. When the 10 is shifted out of the seventh row of cores the machine is instructed to interrogate the matrix at the time

the next shift pulse occurs.

At this new time the 20 will be in core-row 7, the 30 in row 6 and the 11 in row 5. Referring to horizontal line A in Fig. 7, gate  $G_a$  is formed from the first wire of the 20 register, the second wire of the 30 register and the third wire of the 11 register. The references to wires are respectively synonymous to first, second and third coded scans. The final connection to gate  $G_a$  is the interrogation pulse.

The output of gate  $G_a$  is called the THREE wire and its significance is that whenever the reader recognizes the number THREE a pulse appears on this and only this line. The pulse then operates terminal equipment such as a sorter, printer or accumulator.

Horizontal group B represents a more general case where a number can be represented by two sequences of coded scans. Recognition of the character yields a pulse at the output of either one of the two gates and the buffer combines the two possible output lines to a single line.

The remaining horizontal wires are shown to indicate that the reader will recognize the remaining nine decimal digits.

The author thanks M. Hale, S. Butcher, R. Preece and other members of the Laboratory for Electronics for their contributions to this work. This development was sponsored by the Chase Manhattan Bank.

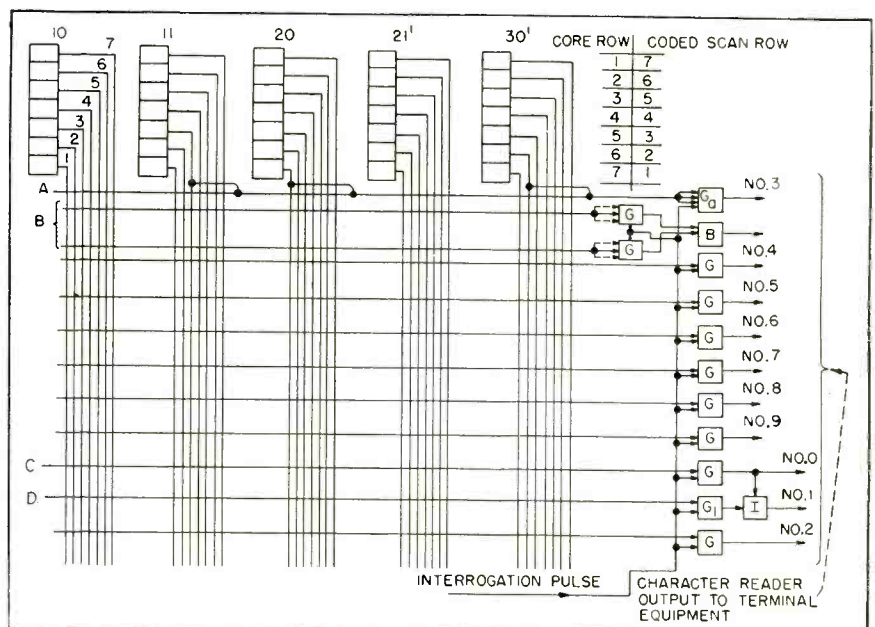
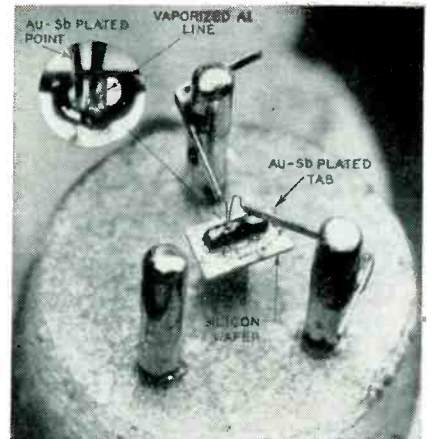

FIG. 7—Diode matrix gives permanent coded storage of expected character



Fabricating diffusion transistors: left, adjusting temperature of vacuum oven in which solid-state diffusion occurs; center, evaporating metal contacts to transistor prior to attaching wire leads. Silicon double-diffusion transistor is shown at right

# Diffusion Transistors Raise Frequency Limits

By JOHN M. CARROLL

Associate Editor, ELECTRONICS

**SUMMARY** — Extremely thin base regions produced by solid-state diffusion of impurities provide high-frequency operation without sacrificing power-handling ability. Silicon operates up to 120 mc with 500-mw collector dissipation. Germanium works up to 600 mc and dissipates 150 mw

**T**HICKNESS of the base region may seriously restrict a transistor's upper frequency limit. High-frequency operation can be obtained in a grown-junction tetrode, but at the expense of power-handling capability. Transistors made by a diffusion technique can achieve both high-frequency operation and power-handling ability.

In the solid-state diffusion process, impurity atoms in the vapor phase diffuse into the body of a solid semiconductor crystal. This takes place in a controlled atmosphere at about 750 C for germanium and a higher temperature

(about 1,100 C) for silicon.

Two processes for making transistors by diffusion are currently used. In the diffused-base method, the mother crystal forms the collector layer onto which the base layer is diffused. The emitter is alloyed to the base layer. Base diffusion is used to make germanium units.

In the double-diffusion process, both base and emitter layers are diffused onto the mother crystal. This process has manufacturing advantages for making silicon units. However, silicon transistors are also made by base diffusion.

Bell Telephone Laboratories is in pilot-plant production of germanium units at Murray Hill, New Jersey. Silicon units are approaching this stage. Quantity production of both types for government applications is planned for this year at the Western Electric plant in Laureldale, Pa.

## Frequency and Power

Diffusion transistors with base regions 0.04 mil thick have been made by Bell from germanium. Germanium transistors have alpha-cutoff frequencies from 400 to 600 mc with permissible collector power

**Table I—Bell Labs Comparison of Diffusion Transistors and Other High-Frequency Germanium Transistors**

Transistor Type	Alpha-Cutoff Frequency in mc	Max Collector Dissipation in mw
Grown junction triode	60	10-50
Alloy junction triode	10	50
Point contact	50	50-150
Grown junction tetrode	50-200	50
Surface barrier	70-100	5-10
Diffused silicon	100-120	100-500
Diffused germanium	400-600	150

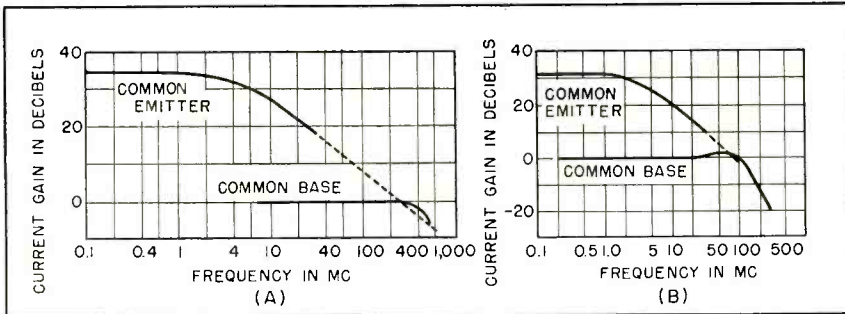

FIG. 1—Common-emitter and common-base current gain as a function of frequency for germanium (A) and silicon (B) diffused junction transistors

dissipations of 150 milliwatts. Silicon units have been made with base layers 0.15 mil thick. They have alpha-cutoff frequencies from 100 to 120 mc. Since silicon transistors can withstand higher junction temperatures, they have permissible collector dissipations up to 500 mw.

The thicknesses achieved by diffusion contrast with the 0.3-mil base region of better grown or fused-junction transistors manufactured to date.

A 200-mc experimental oscillator using a diffused-base germanium transistor delivered 69 mw with an efficiency of 36 percent. A two-stage video amplifier gave a 40-db current gain to flat  $\pm 0.5$ -db from audio +0 20 mc.

Diffusion transistors of the *pnip* and *npin* types may further extend frequency and power-handling ability. In these structures a layer of intrinsic germanium or silicon is interposed between base and collector regions. It permits high-frequency operation by reducing collector junction capacitance, without limiting power-handling ability.

**Electrical Characteristics**

Table I contrasts alpha-cutoff frequencies and collector dissipations for diffused silicon and germanium transistors with other transistor structures. Table II lists operating characteristics of diffused silicon and germanium units. Note low values of collector capacitance, high values of short-circuit common-base current gain (alpha) and low collector-cutoff currents. High-speed switching characteristics are extremely good, especially for germanium units.

Figure 1A shows alpha and the short-circuit common-emitter current gain (beta) in decibels plotted

against frequency for a typical diffused-base germanium unit. Figure 1B shows the same characteristics plotted for a double-diffused silicon unit. The increase in alpha above unity at 50 mc is caused by reactance gain error in the common-base measurement.

Static collector characteristics for a double-diffused silicon transistor are shown in Fig. 2. At zero emitter current, collector current is too small to be shown. Although collector current does not truly saturate, collector junction resistance is high. Resistances of several hundred megohms at a reverse bias of 10 v are common.

In the lumped-constant high-frequency equivalent circuit of the diffused transistors two additional series resistances need be considered. Resistance  $r_e'$  in the emitter circuit represents resistance of the emitter point contact. Resistance  $r_c'$  is the ohmic resistance between collector terminal and effective collector junction. These resistances exist in all grown-junction transistors but become significant only at high frequencies.

**Diffused-Base Transistor**

Description of the fabrication of a diffused-base *pnip* germanium transistor illustrates manufacturing techniques. Bars were cut from monocrystalline *p*-type germanium of about 0.8 ohm-cm resistivity, then lapped and polished. After a slight etch, the bars were washed with deionized water and placed in the diffusion oven. Arsenic-doped germanium was used as the source of *n*-type impurity.

After diffusion, which creates the *n*-type base region, the bar was masked and a film of aluminum 1,000 A thick and 1-by-2 mils in area was evaporated onto it. The bar was heated to alloy the aluminum, thus forming the emitter region.

The bar was again masked and a film of gold-antimony 3,000-4,000 A thick and 1-by-2 mils in area evaporated onto the base region. The bar was heated to the gold-germanium eutectic temperature to form an ohmic base contact. The base contact was parallel to the emitter and 0.5 to 1 mil away from it.

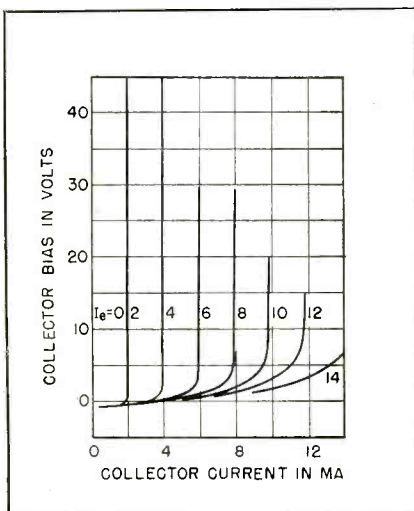

FIG. 2—Static collector characteristics for a double-diffused silicon transistor; collector cutoff current is extremely small

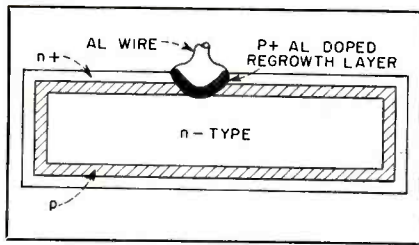

FIG. 3—How base connection is made to double-diffused silicon unit by alloying through emitter region

Strip-type emitter and base contacts are especially useful in high-frequency transistors. For other units, the emitter may take the form of a dot of aluminum centered in a ring of evaporated and alloyed gold-antimony which makes ohmic contact to the base region.

A platinum tab with indium was then soldered to the back of the unit. Enough indium was used to alloy through the surface *n*-region. The emitter and base regions were both masked with a 6 to 8-mil diameter dot of wax and a collector area formed by etching. The unit was washed in solvent to remove the wax and mounted in a header. Contact to the emitter and base regions was made by an electrolytically pointed 1-mil phosphor-bronze wire.

### Double-Diffusion

The diffusion coefficient of a Group III acceptor such as aluminum is 10 to 100 times that of a Group V donor such as antimony. Thus by simultaneous diffusion of selected donor and acceptor impurities into *n*-type silicon, an *npn* structure will result. The first *n*-layer forms because the surface concentration of the donor is greater than that of the acceptor. The *p*-region forms because the donor diffuses faster than the acceptor and gets ahead of it. The final *n*-region is the background doping of the *n*-type silicon bar. However, in some cases one of the impurities must be started ahead of the other in a prior diffusion.

After diffusion, the silicon bar is completely covered with diffused *n* and *p*-layers. Base contact is made by alloying directly through the *n*-type emitter region.

If the surface concentration of the donor diffusant is not too great,

it is possible to alloy an aluminum wire directly through the outer *n*-region. The contact to the aluminum is rectifying in the emitter region and ohmic in the base region. The *n*-layers produced by diffusing elemental antimony are below critical concentration and here direct aluminum alloying is feasible. This technique is illustrated in Fig. 3.

Experimental double-diffused silicon transistors were prepared from 3 ohm-cm silicon using antimony and aluminum as diffusants. The base contact was produced by masking the bar and evaporating a line of aluminum 100,000 Å thick and 2 by 6 mils in area onto the surface. The line was then alloyed through the emitter region.

Contact to the emitter is achieved by alloying a gold-antimony film to the outer surface of the bar. Since this alloy will produce an *n*-type regrowth later, it is necessary only to be sure that the film does not alloy through the base region and short the emitter to the collector. This may be achieved by evaporating the film on. However, in the unit described, a gold-antimony plated tungsten point was brought into pressure contact with the emitter layer and alloyed to it by passing a controlled electrical pulse from emitter to collector.

Ohmic contact to the collector is achieved by alloying the silicon bar to a Kovar tab plated with gold-antimony. An area 6 mils in diameter was masked about the base region and the bar etched to

remove unwanted layers. The unit was mounted in a header. Collector contact was made by soldering to the tab. A tungsten-point pressure contact was made to the aluminum of the base region.

### Silicon Diodes

Diffusion has also been used in making diodes. Diffused silicon junction diodes have maximum current densities up to 2,000 amperes per sq cm. This makes the diffusion process ideal for making power rectifiers. The diffusion process was first used in this connection.

The units are expected to have an almost unlimited life span and will be capable of operating continuously at temperatures up to 400 F. Their efficiency is more than 98 percent of the theoretical limit.

Two of the new rectifiers, which are about the size of peas, linked together and mounted on a cooling fin, will furnish more than 20 amperes d-c at 100 v with 20 w lost as heat. They provide 5,000 times more current than conventional rectifiers of the same size.

The author is indebted to many members of the technical staff of Bell Telephone Laboratories who have made information available to him.

### BIBLIOGRAPHY

- (1) J. A. Morton, *Transistors Today* (address).
- (2) M. Tanenbaum and D. E. Thomas, *Diffused Emitter and Base Silicon Transistors*, *BSTJ*, p 1, Jan. 1956.
- (3) C. A. Lee, *A High-Frequency Diffused base Germanium Transistor*, *BSTJ*, p 23, Jan. 1956.

Table II—Diffused Junction Transistor Typical Operating Parameters

Parameter	Double-Diffused Silicon	Diffused-Base Germanium
Alpha-cutoff frequency ( $f_{\alpha c}$ )	100-120	400-600 mc
Collector capacitance ( $C_c$ )	0.5 $\mu\text{f}$	0.5 $\mu\text{f}$
Max collector dissipation	500 mw	150 mw
Max ambient temperature	150 C	75 C
Collector voltage ( $V_c$ )	10-30 v	10 v
Emitter current ( $I_e$ )	1-15 ma	10 ma
Collector cutoff current ( $I_{c0}$ )	0.005 $\mu\text{a}$	1-2 $\mu\text{a}$
Alpha	0.95-0.98	0.95-0.98
Equivalent-circuit collector resistance ( $r_c$ )	>100 meg	2 meg
Equivalent-circuit collector series resistance ( $r_c'$ )	~150 ohms	~80 ohms
Equivalent-circuit base resistance ( $r_b$ )	15-100 ohms	15-100 ohms
Equivalent-circuit emitter resistance ( $r_e$ )	15 ohms at 3 ma	3 ohms at 10 ma
Common-emitter current gain in decibels at 50 mc	7 db	16-20 db

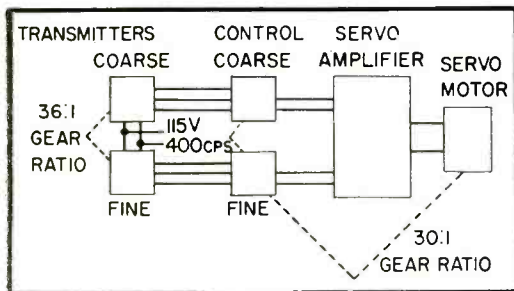
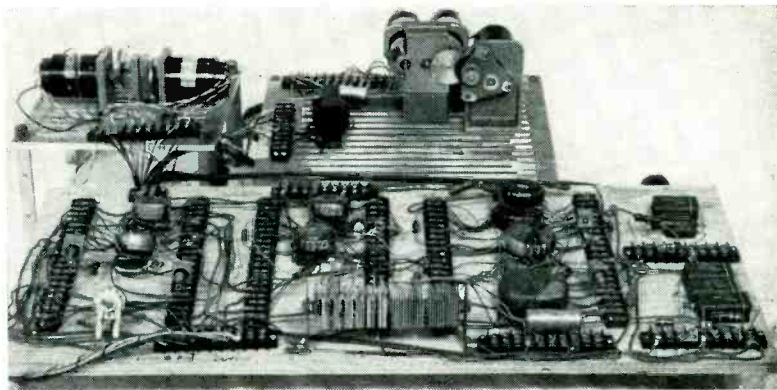

FIG. 1—Functional block diagram of servo system. Fine and coarse control transformers are of the 1-volt/degree type with 36-to-1 gear ratio. The two-phase servomotor rotates at 7,200 rpm. Gear ratio to fine control transformer is 30 to 1



Breadboard model of the magnetic-amplifier servo system to be described

# Magnetic-Amplifier

FREQUENTLY, in a servo system, the same requirements which can be met by an electron-tube amplifier with high input impedance and high voltage gain can also be met by a magnetic amplifier with lower input impedance and lower voltage gain. A standard electron-tube amplifier driving a high-impedance two-phase a-c servo motor in a two-speed servo system was therefore replaced by a three-stage half-wave magnetic amplifier using a full-wave slave output stage and proper synchronizing networks.

The present system consists of a

fine and coarse control transformer of the 1-volt/degree type, with a gear ratio of 36-to-1 between coarse and fine shafts. The two-phase a-c servo motor is a Transicoil high-impedance 7,200 rpm motor. The gear ratio between the fine control transformer and motor is approximately 30-to-1.

The servo amplifier consists of three voltage-amplifier stages driving two 6V6's in push-pull capable of supplying 10 watts to the control phase of the motor. A functional block diagram is shown in Fig. 1.

The design of a magnetic ampli-

fier was undertaken with the following requirements set up as a guide: bandwidth—10 to 15 cps, velocity constant — 1,000/second, resonant rise—3 db, and overall accuracy—less than  $\frac{1}{2}$  degree.

The magnetic amplifier should be completely replacable with the existing electron-tube amplifier. Thus, the magnetic amplifier had to be designed to drive a high-impedance motor, whereas a low-impedance motor would be more suitable.

## Magnetic Amplifier

The magnetic amplifier consists of two conventional half-wave bridge-type stages driving a full-wave slave-type output stage. A schematic of the amplifier is shown in Fig. 2. The output of the amplifier is fed into autotransformer  $T_1$  to match the motor impedance. When using a low-impedance motor, the autotransformer may be eliminated.

The first stage consists of two Orthonol cores with appropriate power windings  $N_1, N_2, N_3, N_4$ , and selenium rectifiers  $D_3$  and  $D_4$ , doubler connected. Three control windings,  $N_5, N_6, N_7$  and  $N_8, N_9, N_{10}$  are placed on each core, one for signal input and one each for lead-and-lag compensation. The output is fed directly into the control windings of the second stage which is approximately the same type stage as the first minus the extra control windings.

Resistors  $R_{13}, R_{14}, R_{15}$  and  $R_{16}$  are all used to set the quiescent firing

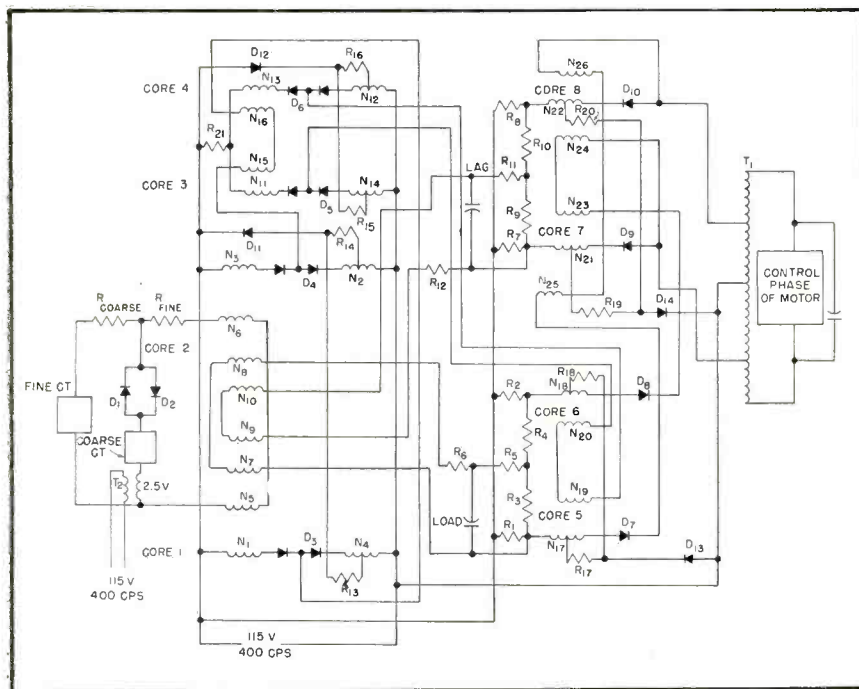

FIG. 2—In-phase control of the fine and coarse control transformer voltages of this magnetic amplifier is achieved by mechanical rotation of the outside frames



**SUMMARY** — Half-wave magnetic amplifier with full-wave slave output replaces electron-tube amplifier in two-speed servo system. Design data on the amplifier and compensating networks are given as well as tabular design information on a number of systems

By **JOSEPH JOHN SUOZZI**

*U. S. Naval Ordnance Laboratory  
White Oak, Silver Spring, Maryland*

# Two-Speed Servo System

angles of the cores in the two stages. The output of the second stage is fed into a set of control windings on the main cores of the output stage. The output stage consists of four cores connected as shown in the schematic. When cores 5 and 6 are supplying output, they reset cores 7 and 8 by windings  $N_{23}$ ,  $N_{24}$ ,  $N_{25}$  and  $N_{26}$ . Hence, when cores 5 and 6 are resetting, cores 7 and 8 supply output in the opposite direction.

Proper choice of windings  $N_{23}$ ,  $N_{24}$ ,  $N_{25}$  and  $N_{26}$  will give symmetrical output across the transformer. Full-wave output can then be realized across the load while

maintaining the simplicity of half-wave circuitry. The power output into the motor was greater than 10 watts. The gain of the amplifier is shown in Fig. 3.

### Crossover Network

A two-speed synchro increases the static accuracy of a synchro system.

The voltages from the coarse and fine-control transformers should be in the same phase at low signal levels.

This condition can be attained by mechanically rotating the outside frames of the control transformers. The coarse signal is a measure of the actuating signal for

**Table I—Component Values in Magnetic Amplifier Shown in Fig. 2**

Core data: first and second stages					
Cores 1, 2, 3 and 4 — Orthonol, 0.002-in. tape, 3/4 × 1 × 3/8 in.					
Winding data					
Core 1	Core 2	Core 3	Core 4	Turns	Wire Size
$N_1$	$N_3$	$N_{11}$	$N_{13}$	1,250	No. 34
$N_2$	$N_4$	$N_{12}$	$N_{14}$	1,250	No. 34
				Tapped at 650	
$N_5$	$N_6$			600	No. 37
$N_7$	$N_8$			300	No. 37
$N_9$	$N_{10}$			1,000	No. 37
		$N_{15}$	$N_{16}$	100	No. 34
Output stage					
Cores 5, 6, 7 and 8 — Orthonol, 0.002-in. tape, 1 × 1 1/4 × 1/4 in.					
Winding data					
Core 5	Core 6	Core 7	Core 8	Turns	Wire Size
$N_{17}$	$N_{18}$	$N_{21}$	$N_{22}$	4,000	No. 32
				Tapped at 500	
$N_{19}$	$N_{20}$	$N_{23}$	$N_{24}$	7	No. 32
		$N_{25}$	$N_{26}$	7	No. 32
Rectifier data					
$D_3, D_4, D_5, D_6$ — 6 plates, selenium, 1 in. square, doubler-connected					
$D_7, D_8, D_9, D_{10}$ — 6 plates, selenium, 1 in. square					
$D_{11}, D_{12}, D_{13}, D_{14}$ — 6 plates, selenium, 1/2 in. square					
Resistor data					
$R_{13}, R_{14}, R_{17}, R_{18}, R_{19}, R_{20}$ — 56,000 ohms, 1/2 watt					
$R_{15}, R_{16}$ — 100,000 ohms, 1/2 watt					
$R_{21}$ — 150 ohms, 5 watt					
$R_1$ through $R_{12}$ , } — vary depending on amount of compensation					
$R_{\text{fine}}$ and $R_{\text{coarse}}$ }					
Capacitor data					
$C_3$ — 0.1 $\mu$ f, 400 v, paper					
$C_1$ and $C_2$ — vary depending on amount of compensation					
Transformer data					
$T_1$ — Westinghouse, Hypersil cut core, No. 6H					
Windings 1,200 turns No. 30 wire					
Tap at 400 turns					
600 turns					
800 turns					
$T_2$ — 115/2.5-v transformer for stickoff voltage					

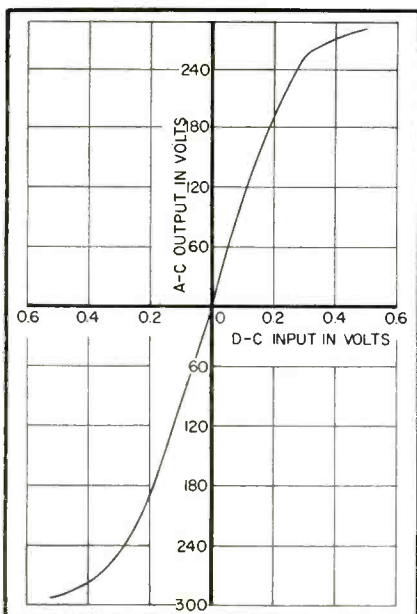

**FIG. 3—Gain characteristic of the magnetic amplifier shown in Fig. 2**

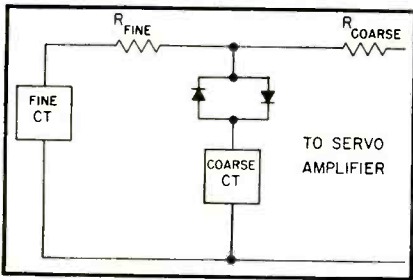

FIG. 4—Limiter-type synchronizing network used to switch in the fine control transformer at low signal levels

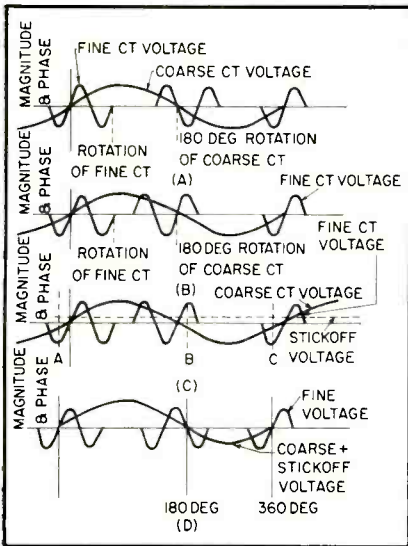

FIG. 5—System voltage versus magnitude and phase when an odd gear ratio is used between the fine and coarse control transformers (A), an even gear ratio (B), even gear ratio after addition of stickoff voltage before rezeroing (C) and after rezeroing (D)

any position of the controlled shaft while the fine signal is a measure only of the actuating signal for one revolution of its shaft. Consequently, a method of switching in the fine control transformer at low signal levels is essential for proper operation of the system.

Since the coarse signal is a true measure of the correct position of the controlled shaft, it should initiate the switching process at the correct time to avoid false nulls. Theoretically, a coarse voltage corresponding to one revolution of the fine control transformer is the greatest voltage at which the switching should occur. For practical reasons, the voltage chosen is usually one which corresponds to  $\frac{1}{4}$  revolution of the fine shaft. In a 36-to-1 system, this voltage is  $(1) (360)/(36) (4) = 2.5$  volts. The synchronizing circuit, Fig. 4, was used in the magnetic amplifier.

In this case, both fine and coarse voltages are applied to the amplifier with large actuating signals, while only the fine voltage appears at low signal levels.

When an odd gear ratio is used between fine and coarse control transformers, the system can null at only one position provided the synchronizing network is properly adjusted. Figure 5A shows the conditions which would exist if an odd gear ratio were used between coarse and fine control transformers. At the 180-deg rotation point of the coarse control transformer, the fine control transformer is also at its 180-deg rotation point. Therefore, there can be no false null.

In many applications a 36-to-1 gear ratio is desirable for ease in reading shaft angles on two dials. When this ratio is used, the conditions of Fig. 5B would exist. The servo system can null at the 0-deg and 180-deg rotation point of the coarse control transformer since the fine control is at 0 deg in both cases. To eliminate this false null at 180-deg, a stickoff voltage is added in series with the coarse control transformer.

Figure 5C shows the magnitudes and phases of the voltages from coarse and fine control transformers together with the stickoff voltage which is a constant-amplitude, constant-phase, 400-cycle voltage. Since the stickoff voltage is always

of the same phase, it will add to the coarse voltage for  $\frac{1}{2}$  revolution and subtract from it for the next  $\frac{1}{2}$  revolution. By proper choice of the magnitude of the stickoff voltage, the coarse plus stickoff voltage will have nulls at A, B and C which would correspond to  $\frac{1}{4}$ -revolution points on the fine control transformer. By rotating the frame of the coarse control transformer, the conditions of Figure 5D can be achieved. At 180-deg rotation of the coarse control, the conditions are the same as with an odd gear ratio and no false null is possible.

The magnitude of the stickoff voltage can be found by determining the voltage of the coarse control transformer which corresponds to a  $\frac{1}{4}$  revolution of the fine control

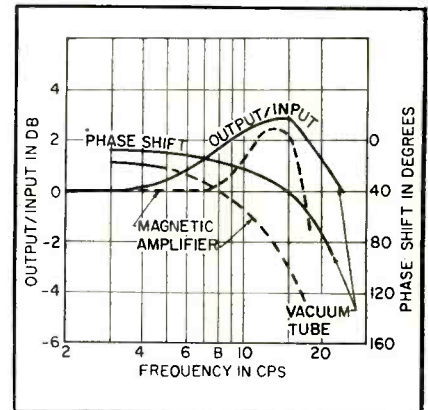

FIG. 6—Phase and magnitude curves for electron-tube and magnetic-amplifier servo systems

Table II—Magnetic Amplifier Servo System of Fig. 6

Bandwidth	= 15 cps
Resonant rise	= 2.28 db
Velocity constant	= 1,800/second
Static accuracy	= $\pm 2$ deg (fine control transformer)
$R_{\text{fine}}$	= 10,000 ohms
$R_{\text{coarse}}$	= 10,000 ohms
Lead network	Lag network
$R_1 = R_2 = 60$ ohms	$R_7 = R_8 = 60$ ohms
$R_3 = \text{Open}$	$R_9 = 30,000$ ohms
$R_4 = 0$	$R_{10} = 10,000$ ohms
$R_5 = 3,700$ ohms	$R_{11} = 39,000$ ohms
$R_6 = 7,000$ ohms	$R_{12} = 55,000$ ohms
$C_1 = 10\mu\text{f}$	$C_2 = 20\mu\text{f}$

Table III—Magnetic Amplifier System of Fig. 7A

Bandwidth	= 15 cps
Resonant rise	= 3.8 db
Velocity constant	= $\infty$
Static accuracy	= $\pm 0.2$ deg (fine control transformer)
$R_{\text{fine}}$	= 10,000 ohms
$R_{\text{coarse}}$	= 10,000 ohms
Lead network	Lag network
$R_1 = R_2 = 60$ ohms	$R_7 = R_8 = 60$ ohms
$R_3 = \text{Open}$	$R_9 = 25,000$ ohms
$R_4 = 0$	$R_{10} = 0$
$R_5 = 3,400$ ohms	$R_{11} = 29,000$ ohms
$R_6 = 8,000$ ohms	$R_{12} = 55,000$ ohms
$C_1 = 4\mu\text{f}$	$C_2 = 20\mu\text{f}$

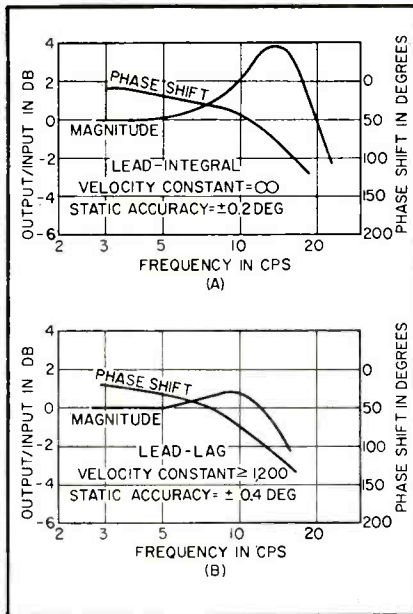

FIG. 7—Phase shift and input-output ratio in db plotted against frequency

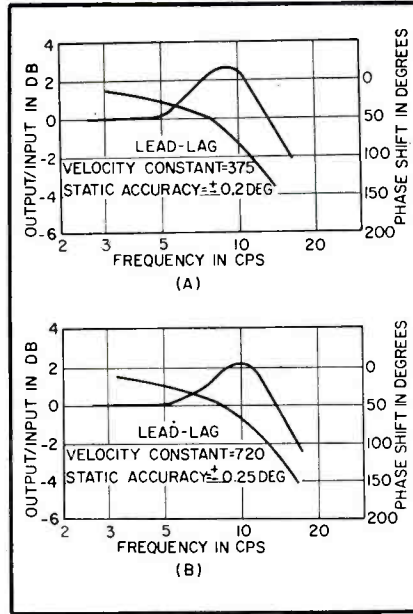

FIG. 8—Frequency versus phase shift and input-output ratio in db

Table VI—Magnetic Amplifier System of Fig. 8B

Bandwidth	= 12 cps
Resonant rise	= 2.28 db
Velocity constant	= 720/second
Static accuracy	= $\pm 0.25$ deg (fine control transformer)
$R_{fine}$	= 10,000 ohms
$R_{coarse}$	= 10,000 ohms
Lead network	Lag network
$R_1 = R_2 = 60$ ohms	$R_7 = R_8 = 60$ ohms
$R_3 = \text{Open}$	$R_9 = R_{10} = 30,000$ ohms
$R_4 = 0$	$R_{11} = 39,000$ ohms
$R_5 = 4,000$ ohms	$R_{12} = 55,000$ ohms
$R_6 = 7,000$ ohms	$C_2 = 10 \mu f$
$C_1 = 10 \mu f$	

transformer. Utilizing 1 volt/degree synchros and a 36-to-1 gear ratio, the stickoff voltage should be  $(1) (360)/(4) (36) = 2.5$  deg or 2.5 volts. This voltage was supplied from a 2.5-volt transformer as shown in Fig. 2.

### Servo Compensation

Half-wave magnetic-amplifier servo systems can easily be compensated for the proper servo characteristics by the use of simple R-C networks. Both lead and lag circuits were used in this system. The

necessary lead function for extension of the system-break frequency is provided by the magnetic amplifier utilizing negative integral feedback around it. The corner-frequency extension is a function of the d-c gain of the amplifier.

Since the output of the slave stage is a-c, this type of compensation cannot be achieved by taking a portion of the output and feeding it back directly. However, since the output stage is essentially two half-wave stages, compensation can be achieved by inserting resistors

in the bridge and taking the d-c voltage which appears across  $R_1$  and  $R_2$  and feeding it back through the R-C network. This can be done on the slave portion of the output stage also. Proper adjustment of the values of resistance and capacitance will give different servo characteristics.

The lag network can be made to integrate by proper choice of the resistance and capacitance values.

### System Performance

Phase shift and magnitude curves for the electron-tube and magnetic amplifier are shown in Fig. 6.

Bandwidth and resonant-rise measurements were made with a signal level of 0.2 volt to the amplifiers. Velocity-constant measurements were made by reading error at the fine control transformer while driving the control transformer at a constant speed of approximately 360 deg/sec. Additional data and component values on this and other magnetic-amplifier systems are given in Fig. 7 and 8 and in the tables.

To illustrate the versatility of the half-wave bridge-type magnetic amplifier, a number of systems utilizing the same magnetic amplifier but different compensating networks were tested. Magnitude and phase-shift curves are plotted for each system.

Table IV—Magnetic Amplifier System of Fig. 7B

Bandwidth	= 12 cps
Resonant rise	= 0.8 db
Velocity constant	= 1,200/second
Static accuracy	= $\pm 0.4$ deg (fine control transformer)
$R_{fine}$	= 10,000 ohms
$R_{coarse}$	= 10,000 ohms
Lead network	Lag network
$R_1 = R_2 = 60$ ohms	$R_7 = R_8 = 60$ ohms
$R_3 = \text{Open}$	$R_9 = 30,000$ ohms
$R_4 = 0$	$R_{10} = 0$
$R_5 = 5,000$ ohms	$R_{11} = 39,000$ ohms
$R_6 = 4,000$ ohms	$R_{12} = 55,000$ ohms
$C_1 = 10 \mu f$	$C_2 = 20 \mu f$

Table V—Magnetic Amplifier Servo System of Fig. 8A

Bandwidth	= 10 cps
Resonant rise	= 2.6 db
Velocity constant	= 375/second
Static accuracy	= $\pm 0.2$ deg (fine control transformer)
$R_{fine}$	= 10,000 ohms
$R_{coarse}$	= 10,000 ohms
Lead network	Lag network
$R_1 = R_2 = 60$ ohms	$R_7 = R_8 = 60$ ohms
$R_3 = \text{Open}$	$R_9 = 20,000$ ohms
$R_4 = 0$	$R_{10} = 0$
$R_5 = 5,000$ ohms	$R_{11} = 10,000$ ohms
$R_6 = 5,000$ ohms	$R_{12} = 22,000$ ohms
$C_1 = 10 \mu f$	$C_2 = 20 \mu f$

## The Front Cover



Checking shoe insoles for projecting tacks is speeded by r-f detector using oscillator loading to signal presence of metal

# Tack Detector for

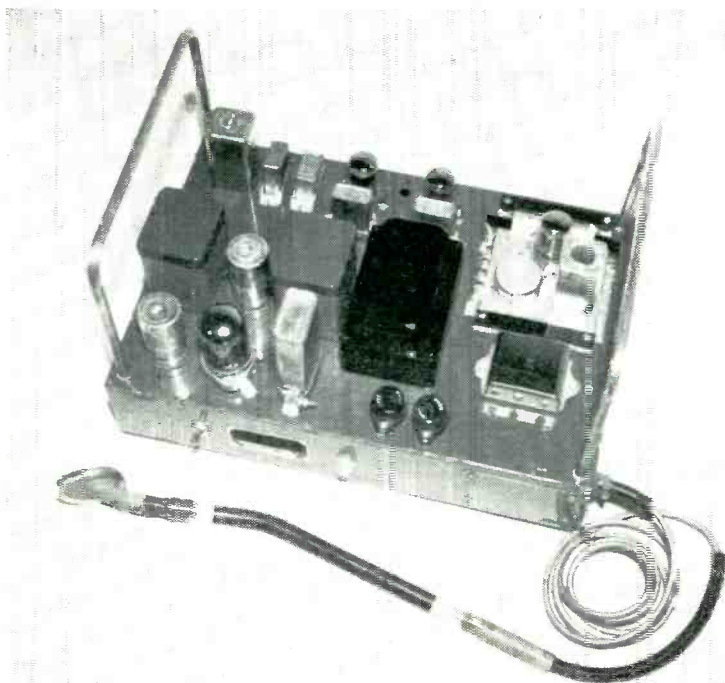

**P**ERMANENT metal fastenings and metal supports are used in the manufacture of several types of shoes. In addition, temporary tacking is used to position insoles and uppers.

Inspection of the finished shoe is necessary to insure that temporary fastenings have been removed and that all permanent tacking remains in the body of the shoe and does not protrude through the insole. Heel nails should be clinched over below the heel line, and not extend above the heel seat.

Hand-searching inside the shoe forepart and heel seat requires about one second per shoe and this rapid work carries with it the danger of painful finger cuts.

The tack detector described here is the result of several years of de-

Chassis of tack detector with long probe used for searching forepart of shoe

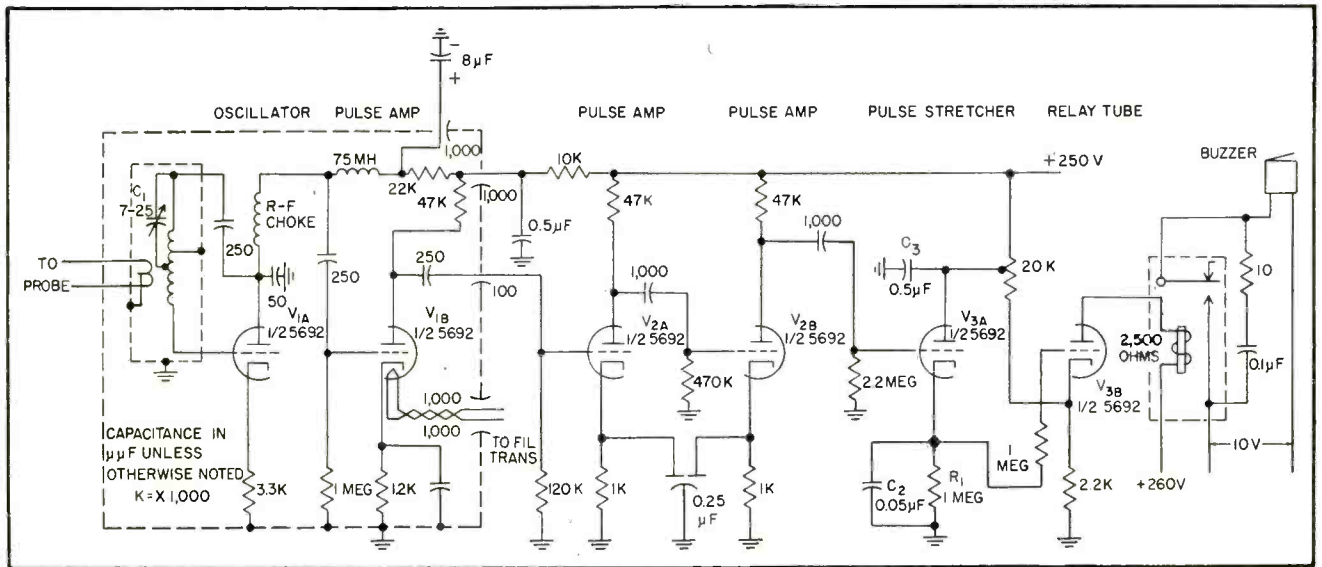

FIG. 1—Plate-current pulse caused by loading of tack-detector oscillator is amplified and stretched to trigger alarm

**SUMMARY** — Loading of oscillator probe by contact with metal tack triggers alarm in production checker for shoes. Operator can inspect 440 dozen pair per day, detecting tacks projecting only a few thousandths of an inch above insole

# Shoe Production

velopment work. It is a bench-type device consisting of a completely enclosed electronic unit and a probe attached to the unit by a flexible cord.

For general design requirements the unit must be rugged, have long component life and be uniformly sensitive over long periods of time. The device must be free from factory electrical disturbances causing pretriggering or false signalling. It also must be free from r-f radiation.

In use, the probe is inserted in the shoe by hand and passed over the surface of the insole. When contact is made with a fixed or free metallic substance, as small as  $\frac{1}{16}$  of an inch long, an audible signal is emitted from a buzzer within the unit. Unwanted metal is then removed by hand. The tack detector can be equipped with various size

## By ROBERT W. BRADLEY

Senior Electronic Engineer  
Research Division  
United Shoe Machinery Corp.  
Beverly, Massachusetts

probes for men's, women's or children's shoes.

Theoretically the device must signal the presence of a tack protruding a few thousandths of an inch above the insole surface, yet it must not signal a tack just below the surface. It is also desirable to locate staples in the forepart lining as high as  $\frac{1}{16}$ -inch above the insole.

Because of these severe requirements, usual concepts of metal detection principles did not apply to this problem.

### Theory

Operation is based on the audio and ultrasonic noise created when a piece of metal is touched to a radio-frequency resonant circuit.

If a piece of metal, such as a tack, touches a high-frequency oscillator grid connection, an intermittent contact is made, loading the oscillator and causing an abrupt plate-current change. This transient in plate current contains audio-frequency components which may be amplified and stretched to control a buzzer.

A resonant circuit probe head is link-coupled through a low-impedance transmission line to the oscillator coil in the main unit. Audio-frequency signals are taken from the oscillator plate circuit. Seventy db of audio amplification is sufficient to drive the pulse stretcher which in turn operates a sensitive 2,500-ohm relay controlling a buzzer.

Overall tack detection sensitivity is adjusted by tuning the oscillator to a frequency near the natural fre-

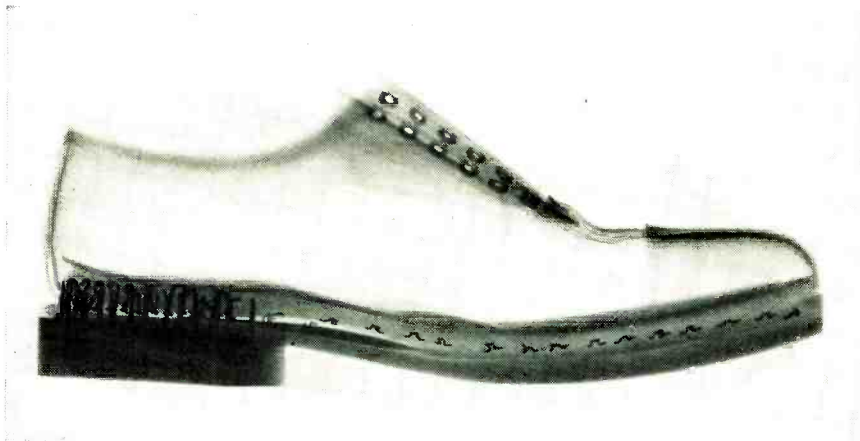

X-ray photograph showing permanent tacks and staples in finished shoe

quency of the probe head. The sensitivity may be increased to the point where free pieces of metal so small they can hardly be seen with the naked eye will signal a response. In practice, the sensitivity is set for buzzer response from touching a  $\frac{1}{8}$ -inch long by 0.020-inch diameter free metal piece resting on a polystyrene board.

### Probe

The probing element must be light and easily wielded yet be capable of severe usage. Use of high radio frequencies requires a strong, flexible low-loss probe-head rubber.

The probe is composed of a resonant head system attached to a Plexiglas and rubber handle. Flat oval stainless-steel rings serve as tack-searching plates and as the resonant-circuit capacitor. Each ring is flexibly connected through the probe-head rubber to opposite ends of an inductor wound on the coil handle. A one-turn pickup loop around this inductor is connected to terminals at the cord end of the handle. No shielding of the probe head or of wires in the probe han-

dle was found necessary. Low-loss material having a natural-rubber base with proper mechanical properties was developed for the probe head, giving  $\tan \delta = 0.00147$  and dielectric constant  $\epsilon = 4.2$  in the 30 mc region.

The natural resonant frequency of the entire probe, with 10 feet of transmission line link-coupled to the main-unit oscillator coil, is 31.75 mc. Manufacturing variation of this response frequency is from 31 to 32.5 mc.

Final choice of the probe-cord transmission wire was the result of experiment. Heavy and light tinsel wires were found to cause too much attenuation. Flexible motor cables were heavy and subject to quick breakage at terminals. The cord finally decided upon is a No. 18, 41-strand, 2-conductor cable. Excess cable length is stored in a housing at the front of the main unit.

### Circuit

Oscillator frequency is varied from 26 to 33.5 mc with capacitor  $C_1$  in Fig. 1. The one-turn coupling loop is spaced  $\frac{1}{4}$  inch from the tank coil. Such loose coupling was found necessary to prevent false triggering from probe mechanical shock and to eliminate frequency pulling of the oscillator frequency by the probe head resonant system.

The amplifier low-frequency response is reduced to avoid false signalling from power-supply hum and mechanical shock of the probe. The amplifier is operated at full gain and, as shown in Fig. 2, peaks at 20 kc.

The pulse stretcher and relay-tube system require a peak input



Tack detector with probe is a compact bench-type unit for production checking

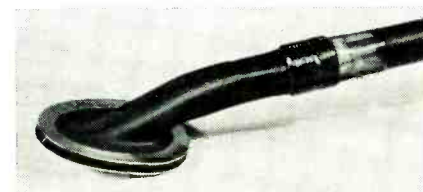

Probe heads are interchangeable and shaped to fit various types of shoes

signal of 13 volts to actuate the relay. Positive input voltage on the grid of the pulse stretcher charges the 0.05- $\mu$ f cathode capacitor  $C_2$  from  $C_3$  through triode  $V_{3A}$ . The voltage across  $C_2$  discharges slowly through 1-megohm resistor  $R_1$ , maintaining the relay tube conductive for a sufficient period to insure reliable operation of the sensitive relay and the buzzer.

### Radiation

Radiation field strength measurements were made to certify the unit for compliance with the requirements of the FCC. A 50- $\mu$ f capacitor with short leads from the oscillator plate to the ground and a 7.0 millihenry r-f choke placed in series with the oscillator plate eliminated parasitic oscillations so that there was no measurable radiation in the tv bands. Fundamental frequency radiation is negligible.

The tack detector will not pre-trigger from unwanted signals such as those generated by an electric drill or a high-frequency sparker one foot away from the probe or probe cord.

Successful field use shows that production, quality and design requirements were met. Packing room inspection by one operator averages 440 dozen pair of shoes per day.

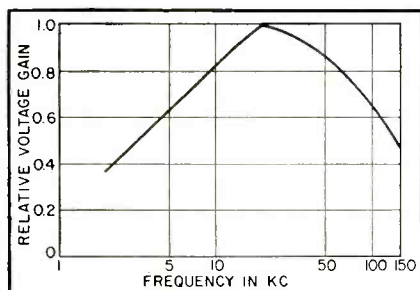
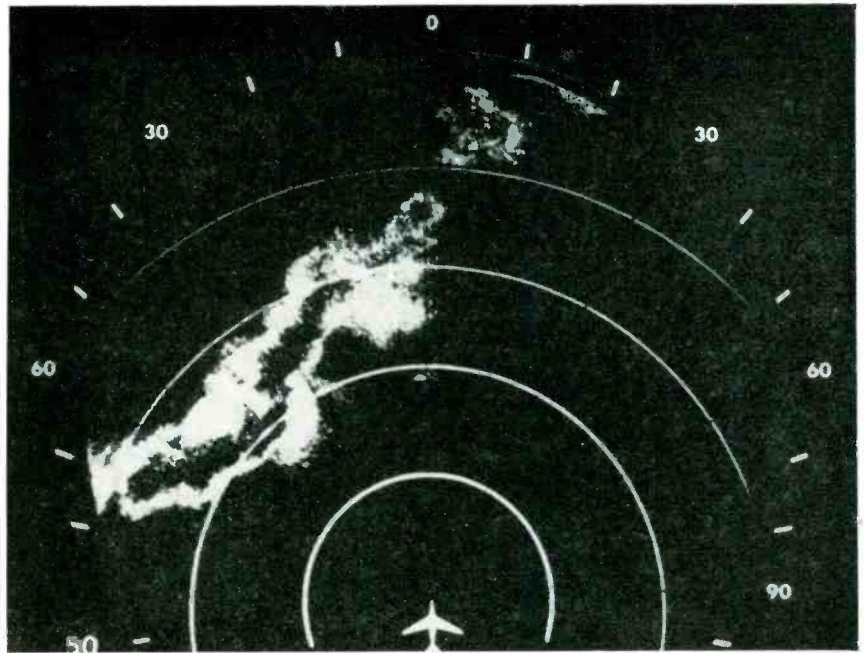

FIG. 2—Response curve for tack-detector amplifier is peaked at 20 kc

Radar ppi shows storm cells within clouds when isoecho contour circuit is connected

By **F. W. RUPPERT**  
and **J. M. SMITH**

*Bendix Radio Communications Div.  
Bendix Aviation Corp.  
Baltimore, Md.*



# Airborne Weather Radar Uses Isoecho Circuit

**SUMMARY** — Dynamic range of a cathode-ray oscilloscope screen is insufficient to display desired intensity of radar reflection from storm areas. A novel circuit changes direction of intensity after a preset level, creating on the screen a dark spot surrounded by illumination

**F**ACILITIES for storm detection, ground mapping and terrain avoidance are combined in a light-weight, airborne radar equipment designed particularly for commercial and executive aircraft.

Five units, including the synchronizer-amplifier-power supply illustrated, weigh less than 130 pounds. Of prime importance in space conservation is the duplexer-mixer assembly, which includes local oscillator, two atr tubes, a t-r tube and three crystal holders.

Besides employing new-style contact atr tubes, the unit contains a folded hybrid and balanced mixer. An integral crossguide directional coupler is a part of the assembly and is terminated in a test jack. A flexible, tapered transition twist section to the magnetron gives mechanical flexibility and isolates the duplexer and mixer sections

from the magnetron.

The flexible twist section, comprising a tapered transition from large guide to small guide employs a split-clamp type of mounting for the magnetron and a miniaturized contact flange to mate with the duplexer.

Physical placement of the radar circuits plays an important role in reducing size, weight and power requirements. An example of economy is the handling of indicator sweep driver tubes.

## **Circuit Simplification**

On a radar previously used in standard military aircraft installations, two 6L6 tubes, located on a synchronizer chassis removed by 30 feet from the indicator, were required to drive sweeps. These tubes have been replaced and identical driving requirements fulfilled by

one miniature tube located in the ppi package a few inches from the c-r tube and its associated sweep circuits.

Encapsulation was used for nearly all transformers in the system. This treatment provides a unit sealed against moisture. It is likewise electrically insulated and thoroughly impregnated against moisture while adding only a fraction of an inch to the overall size.

As contrasted with oil-filled can types, drastic size reductions have been possible. This is especially true for high-voltage transformers in which the oil-filled type of construction requires large insulating terminals because of the metal enclosure.

A triple savings was effected in size, weight and power consumption by using selenium instead of vacuum-tube rectifiers in the plate

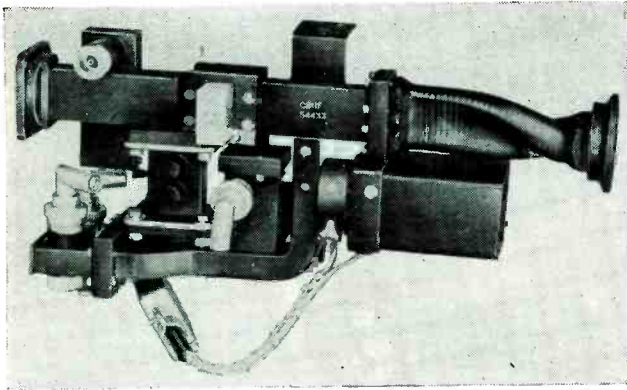

Duplex-mixer assembly is the entire internal waveguide system used. Local oscillator housing at lower right

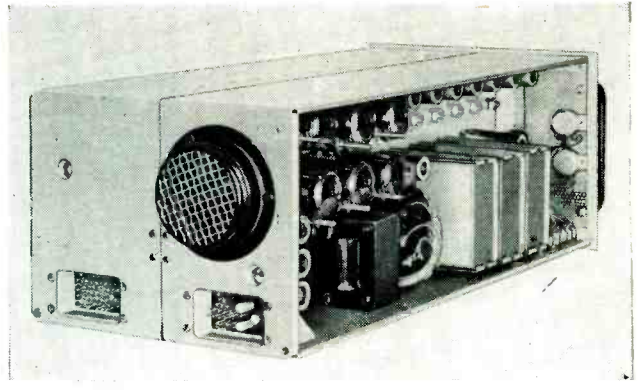

Synchronizer, amplifier, power supply unit removed from case shows packaging of components viewing left side and rear

supplies. These savings were realized from elimination of rectifier heater power and from resultant decrease in the amount of heat generated. Reduction in cooling requirements allowed greater component density on the chassis.

By means of unique design, the antenna provides maximum vertical beam deflection with minimum vertical reflector tilt. This is accomplished by means of a fixed radiator with a tilting reflector to multiply the deflection of the radiated beam through the mirror action of the reflector.

One function of this equipment is to furnish weather information by means of radar echo displays, thereby enabling the pilot of an aircraft to avoid the turbulence associated with thunderstorms. The display further acts as a pathfinder to guide the pilot through soft spots in a storm without serious reduction in speed and with much greater safety and passenger comfort.

### Isoecho Contour

When examining a rain or storm area, the intensity of the return signal will vary depending upon the concentration of moisture reflecting the beam. Although the intensity of the return signal may vary, the normal ppi presentation of moisture-bearing cloud formations may appear almost uniform.

This condition results from inability of the phosphorescent material in the cathode-ray tube to distinguish more than a limited range of light intensities. The isoecho contour circuit in the receiver eliminates this condition. When energized, this circuit alters the normal radar presentation to display high

rainfall rates as black holes in the signal return.

Action of the contour circuit is relatively simple and functions by erasing radar return signals greater than a preselected level, thus making the detection of the more intense rain areas possible. The areas of greatest turbulence within thunderstorm clouds are associated with the areas of greatest rainfall rate gradient and it is essential to distinguish these areas from those of relatively little turbulence.

The display resulting from contour-circuit action on the return signal shows areas of high rainfall rate as black holes surrounded by light areas (relatively light rainfall) making the visual evaluation of varying degrees of light intensity in the display unnecessary.

The photograph shows a ppi display of a thunderstorm area. Sweep range is 50 miles with range marks

spaced at 10-mile intervals. The outer edge of the white area of the rain-return signal defines the minimum rainfall rate at which echoes are visible on the radar (near zero rain). The outer edges of the black holes in the rain-return centers outline the areas within which the rainfall rate is greater than this by a preset amount, usually 12 to 16 db.

Where the rate of rainfall changes rapidly, maximum turbulence is normally found. Therefore, where the white line between the no-rain area and the heavy-rain area is thinnest, there is greatest turbulence.

Figure 1 shows the video amplifier and contour circuits included in the receiver. When contour relay  $K_1$  is open, contour tube  $V_{3A}$  is biased so far beyond cutoff that it is effectively out of the circuit and no contour action results. The

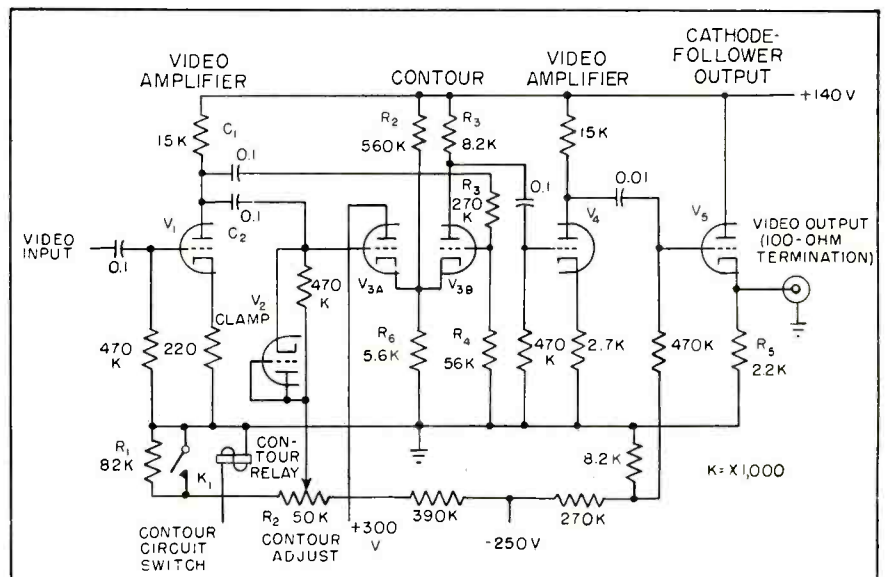

FIG. 1—Contour circuit reverses intensity of illumination on radar display above preset level of video signal



circuit acts as a video amplifier.

When the contour relay is closed, divider resistor  $R_1$  is shorted out and contour tube  $V_{3A}$  is biased to some degree below cutoff; the degree of bias is determined by the setting of contour potentiometer  $R_2$ . Contour tube  $V_{3B}$  is normally slightly conducting.

### Video Amplifier

In operation, detected signals are applied to the control grid of video amplifier tube  $V_1$  in the form of negative-going video pulses as shown in Fig. 2A. The pulses are amplified, inverted and coupled through capacitors  $C_1$  and  $C_2$  to both control grids of  $V_3$ . Positive-going pulses applied to  $V_{3B}$  will be attenuated by the voltage dividing resistors  $R_3$  and  $R_4$  and their amplitude will be approximately one-fifth that of the positive-going pulses applied to  $V_{3A}$ .

Positive pulses at the grid of  $V_{3B}$  immediately result in negative pulses at its plate, but the positive pulses at the grid of  $V_{3A}$  will have to overcome the applied bias before  $V_{3A}$  will conduct. Therefore, all signals below a level predetermined by the setting of contour potentiometer  $R_2$  will be blocked at  $V_{3A}$  but will see  $V_{3B}$  as a video amplifier and will appear as amplified, positive-going video pulses across cathode resistor  $R_6$  of the cathode-follower output tube  $V_6$ . All such pulses will appear as bright displays on the face of the cathode-ray indicator tube in the ppi, indicating moisture-bearing cloud formations lacking storm cells of dangerous magnitude.

### Stronger Signal

When the radar beam encounters rain of sufficient density to increase the return signal amplitude by approximately 12 to 16 db (depending upon the setting of  $R_2$ ) above the mds (minimum discernible signal) level, the signal at the grid of  $V_{3A}$  will come above cutoff and the tube will begin to conduct. When  $V_{3A}$  conducts, more current flows through cathode resistor  $R_6$ , increasing the voltage drop across it and increasing the bias on  $V_{3B}$  proportionately.

As the signal on the grid of  $V_{3A}$  increases above cutoff the tube conducts more heavily biasing  $V_{3B}$  at a

level sufficient to override the attenuated signal on its own grid. When this happens the signal is effectively erased, since no display results when the output of  $V_{3B}$  equals or is more positive than when the tube is conducting normally.

Illustrations in Fig. 2 (H-J) are scope photographs of the video output pulses appearing across cathode resistor  $R_6$  of cathode-follower video-output tube  $V_6$ .

The pulse in (H) results from a return signal of amplitude below the threshold level of  $V_{3A}$  and is not affected by contour action. The level of such a signal may be up to approximately 10 db above mds level. An mds would be returned from a cloud area of near-zero-rain. Such a pulse will appear as a bright spot on the ppi.

The pulse at (I) is from a return signal of amplitude just above the threshold level of  $V_{3A}$ , with contour circuit operating. At this input signal level, approximately 13 db above mds,  $V_{3A}$  just starts to conduct and the effect can be seen as a partial erasure of the signal.

### Bias Reduction

Pulse (J) comes from a return signal of amplitude greater than necessary to overcome completely the bias on  $V_{3A}$ . The level of such a signal may be approximately 12 db to 16 db or more above the mds level, depending on the setting of contour potentiometer  $R_2$ . Such a signal would be returned from a heavy rain area. In this case part of the resulting video output at  $V_6$  cathode is negative, which has the effect of a blacker-than-black signal, since only a positive pulse output will produce a bright display on the ppi.

Clamp tube  $V_2$ , operating as a diode, prevents changes in contour action, or level, with changes in signal duty cycle. Contour potentiometer  $R_2$  simultaneously adjusts clamping level of  $V_2$  and bias on  $V_{3A}$ .

Tube  $V_4$  is ideally biased as a video amplifier with a restricted dynamic range, while cathode-follower output tube  $V_6$  is biased very near cutoff. Three advantages are gained by holding the bias of  $V_6$  near cutoff. A conservation of power is realized, the demand on the

contour circuit is reduced and negative overshoot of the output pulse is held to a minimum.

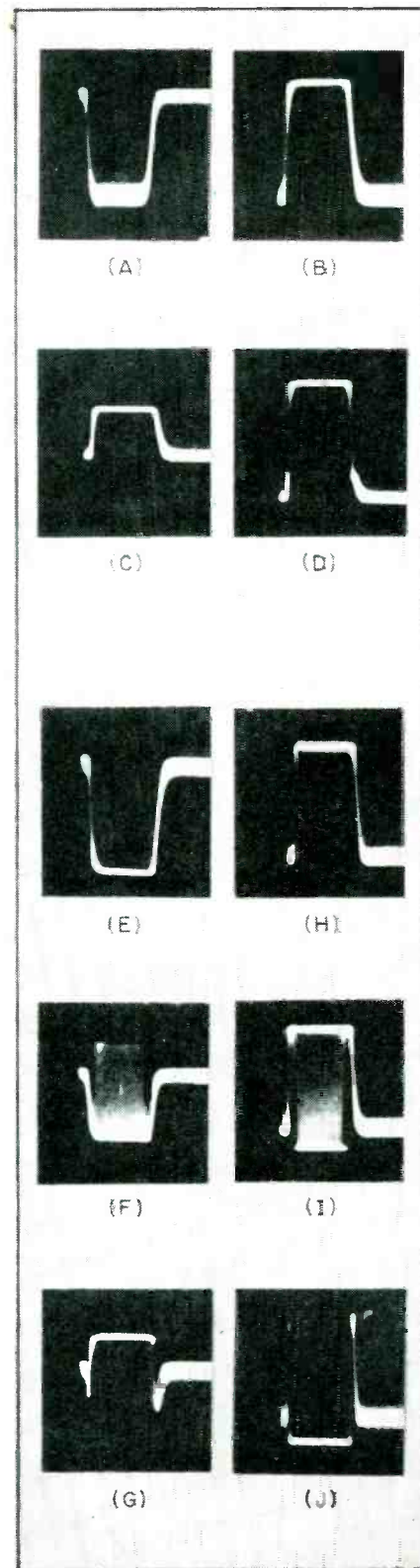

FIG. 2—Input pulse to  $V_1$  (A) and output (B). Pulse at cathode of  $V_6$  with contour off (C) and on (D). Pulse at plate of  $V_{3B}$  with contour off (E) and on, but partial erase (F) and full erase (G). Video output at  $V_6$  with light (H) medium (I) and heavy (J) rain return

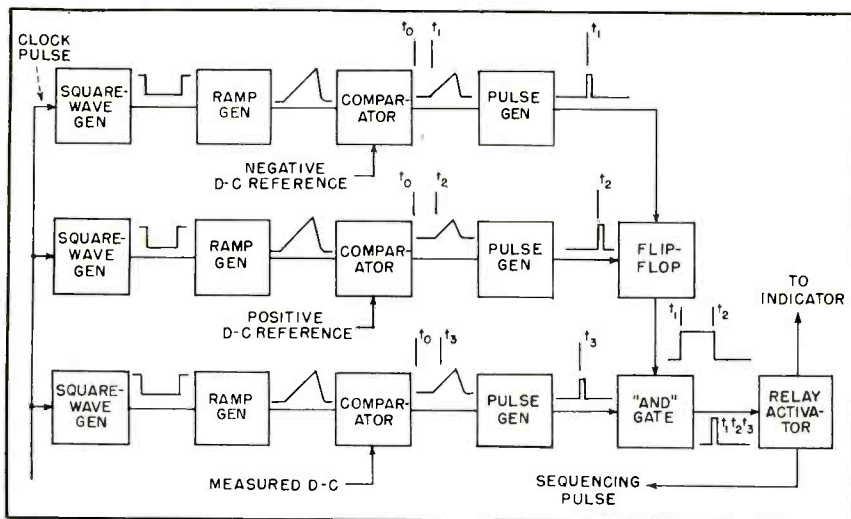
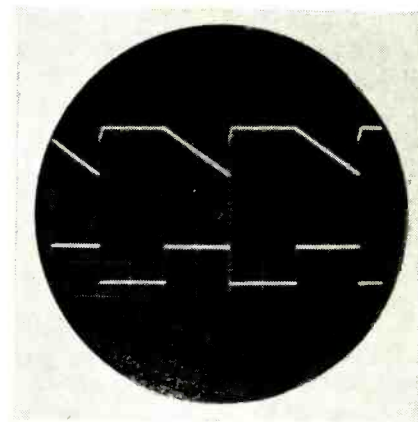

FIG. 1—Block diagram of complete automatic test-actuating system for production lines



Dual-beam oscilloscope presentation showing square-wave input to ramp generator and resultant sawtooth output produced during negative pulse time.

# Automatic Measurement

By A. J. STRASSMAN

Ground System Department  
Hughes Weapon Systems Development Laboratories  
Hughes Aircraft Co., Culver City, Calif.

WHEN TESTING electronic equipment it is often necessary to monitor, by visual or aural means, a d-c voltage level before the test can proceed to its completion. Although the actual value of this voltage may be unimportant, its presence is essential for the test to continue. If this presence could be detected automatically and in being noted cause the test to continue, or if the lack of this voltage could cause the testing to be stopped, it would remove part of the operator's task and allow for speedier testing.

The automatic testing system shown in Fig. 1 achieves this goal. Fundamentally, the method involves producing several pulses that are delayed in time, each by an amount proportional to a preset d-c level. The basic stages consist of a square-wave generator whose output is used to develop a linearly rising voltage with respect to time, and a comparator which allows a pulse generator to operate at a preset time interval dependent upon the d-c level impressed on the comparator.

If one comparator is adjusted to provide an output pulse that will be delayed in time by an amount equivalent to the lower d-c tolerance limit, the two pulses will be separated in time by an interval proportional to the prescribed d-c tolerance levels. The third comparator receives the measured voltage value and causes a pulse to occur if it is within the specified tolerance, some place between the upper and lower limit pulses.

The two tolerance pulses are applied to a flip-flop where the

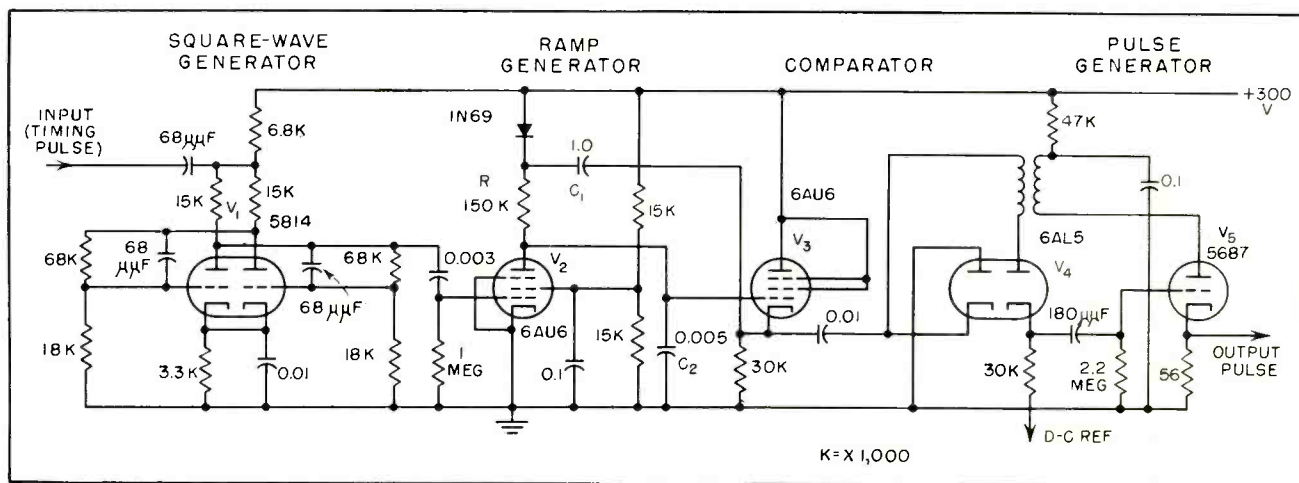
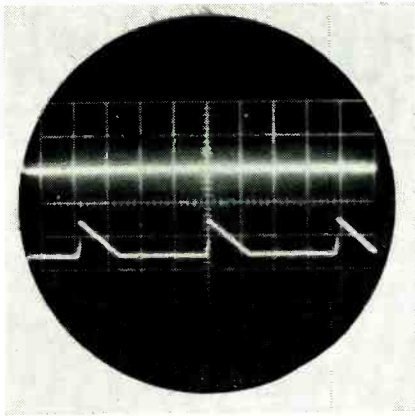
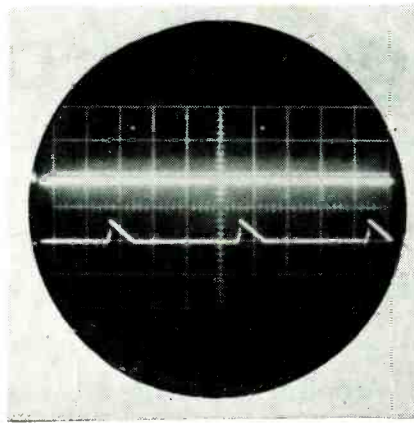

FIG. 2—Generator chain for one of the three identical channels used to feed flip-flop and gate



Upper pattern represents d-c level of sawtooth for lower tolerance limit to which automatic tester is set, and lower pattern shows pulse produced for that level



Sawtooth level and resultant pulses for upper tolerance limit. Best results are obtained with highest possible amplitude of input waveform to comparator

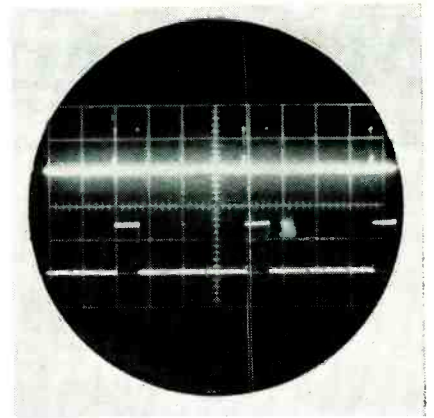

Lower pattern represents rectangular waveform at output of flip-flop as produced by upper and lower tolerance level pulses shown in upper half of pattern

# of Voltage Tolerances

**SUMMARY** — Test circuit is activated only when a measured d-c voltage is within specified tolerances. Generator chains produce pulses that are time-delayed in proportion to an applied d-c voltage

lower-limit pulse produces a positive-going pulse and the upper-limit pulse produces a negative-going pulse. The square wave so produced defines tolerance limits. The square wave is then applied to a gate tube that operates only when the pulse derived from the measured value falls within this gate derived from the upper and lower tolerance limits. When coincidence occurs between these pulses a relay tube is activated to cause an indicator lamp to light and at the same time provide a pulse to allow the test to proceed.

The circuit of the square-wave generator, ramp generator, comparator and pulse generator for the lower limit tolerance are shown in Fig. 2. Identical circuitry is used to provide the required pulse for the upper limit and the measured value.

## Sweep Circuit

A timing pulse derived from a central source is applied to a standard driven multivibrator ( $V_1$  in Fig. 2) which produces the negative-go-

ing pulse 500 microseconds wide. This negative pulse is applied to the grid of the input tube of bootstrap sweep circuit  $V_2$  which serves as a ramp generator. During the period of positive input to  $V_2$  the tube is bottomed (the plate voltage is near ground potential) and the 1N69 crystal diode is conducting.

When  $V_2$  is cut off by the negative pulse, the plate voltage tends to rise at a rate dependent on the time constant of  $R$  and  $C_1$ . This rise is cathode-followed by  $V_3$  and applied at the bottom end of diode  $V_4$  through  $C_1$ . The diode ceases to conduct when the voltage at its cathode goes higher than that of its grounded plate.

If  $C_1$  is sufficiently large so that a constant voltage is maintained across  $R$ , the charging current to  $C_2$  is held constant, thus producing a linearly rising waveform. To discharge  $C_2$  to its fullest extent, which gives a sharp sawtooth, the grid of  $V_2$  should be allowed to go slightly positive. When  $C_2$  is charged, the grid of  $V_2$  should be cut off.

The comparator is used to develop a pulse that will be referenced in time by an amount proportional to the d-c level introduced at the cathode of the right-hand section of the double-diode  $V_4$ . This diode will remain nonconducting until such time as the voltage applied to its plate rises above the d-c reference voltage impressed on its cathode. Output voltage then is

$$E_o = (E_{in} - E) \frac{R}{R_2 + R_d} \quad (1)$$

where  $E_{in}$  is input voltage,  $E$  is impressed voltage,  $R_2$  is the diode load resistor and  $R_d$  is diode resistance.

This output voltage is impressed upon the grid of  $V_6$ , a standard blocking oscillator circuit which fires to produce a pulse that is delayed some amount in time proportional to the d-c level impressed on the cathode of the comparator.

The d-c restoration is used to make certain that the starting level of the input voltage is held at a constant level at all times. This tends to minimize errors caused by voltage variations.

# Measuring R-F Parameters

**SUMMARY** — Equipment and techniques for measuring small-signal  $h$  parameters of triode and tetrode junction transistors in the range from 1 to 24 mc are described. Amount of error introduced in measurement by output terminations is considered

**B**ECAUSE OF the inherent nature of the transistor, the most readily measured network coefficients are the series-parallel or  $h$  parameters.<sup>1,2</sup> Once the four  $h$  parameters are known at a given frequency and for a given set of d-c operating conditions, such quantities as power gain, voltage gain, input impedance and output impedance of the transistor in a transmission circuit may be calculated for the same frequency and d-c operating conditions.<sup>3</sup>

This article describes methods and equipment which can be used to determine the four grounded-base  $h$  parameters of junction transistors from 1 to 24 mc.

Under small-signal conditions the electrical behavior of a transistor can be described by considering it as a linear two-terminal-pair active network, with the four differential terminal voltages and currents related to four network parameters.

## Short-Circuit Input Impedance

The electrical symbol for the transistor and the direction of instantaneous current flow and voltage rise, together with the two network equations, are shown in

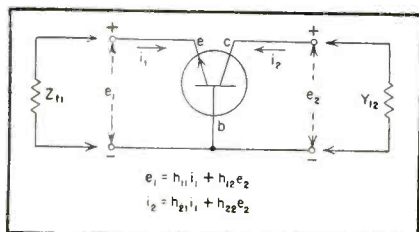
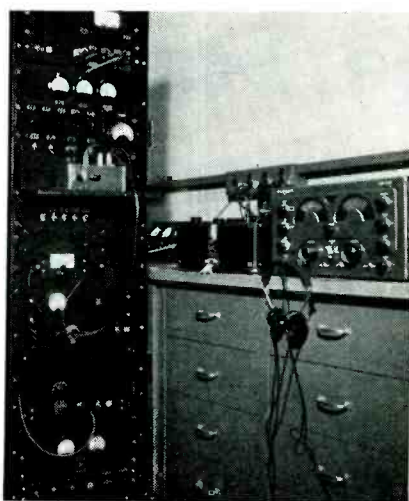

FIG. 1—Two-terminal-pair representation of transistor



Rack-mounted  $h$ -parameter measuring equipment. At the right may be seen one of r-f bridges and communications receiver. Both are mounted on a conducting ground-plane

Fig. 1. For convenience, transistors are shown as  $nnp$  units, triode or tetrode;  $pnp$  transistors can be measured if the polarity of the bias supplies is reversed.

At radio frequencies the four  $h$  parameters are of the form  $h_{ij} = a \pm jb = C \angle \theta$ . In Fig. 1

$$a \pm jb = h_{11} i_1 + h_{12} e_2 \quad (1)$$

$$i_2 = h_{21} i_1 + h_{22} e_2 \quad (2)$$

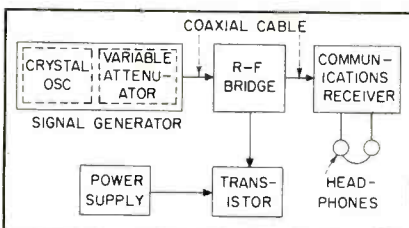

FIG. 2—Setup for measuring  $h_{11}$  parameter of transistors

where  $h_{11}$  is the short-circuit input impedance parameter and  $h_{12}$  is the open-circuit voltage-feedback parameter;  $h_{21}$  is the short-circuit current-transfer parameter and is equivalent to  $a$ , except for a 180-deg phase difference. The quantity  $h_{22}$  is the open-circuit output admittance.

A fifth parameter is the short-circuit output admittance,  $y_{22}$ . This quantity may be found in terms of the  $h$  parameters by setting  $e_1 = 0$  in Eq. 1 and combining the result with Eq. 2 so

$$\frac{i_2}{e_2} = y_{22} = h_{22} - \frac{h_{12} h_{21}}{h_{11}} \quad (3)$$

As can be seen in Eq. 1, driving-point impedance  $Z_{in}$  at the input terminals will be equal to  $h_{11}$  if  $e_2$  is zero. This condition will prevail only if terminating admittance  $Y_{12}$  at the output terminals is infinite. Since this condition can be approached but never attained, it is of interest to find the error introduced in the determination of  $h_{11}$  by a finite terminating admittance  $Y_{12}$ . The following equation is therefore derived from Eq. 1 and 2. With

$$Z_{in} = h_{11} \left[ 1 - \frac{e_2 = -i_2/Y_{12}}{Y_{12} (1 + h_{22}/Y_{12}) h_{11}} \right] \\ = h_{11} \left[ \frac{1 + y_{22}/Y_{12}}{1 + h_{22}/Y_{12}} \right] \quad (4)$$

Hence if  $Y_{12} \gg h_{22}$  and  $Y_{12} \gg y_{22}$ , then  $h_{11} \cong Z_{in}$ .

In the test circuit used for measuring  $h_{11}$ ,  $Y_{12}$  is the terminating admittance obtained from a bypass capacitor strapped between the collector and base connections

# of Junction Transistors

By **W. N. COFFEY**

General Electric Research Laboratory  
Schenectady, New York

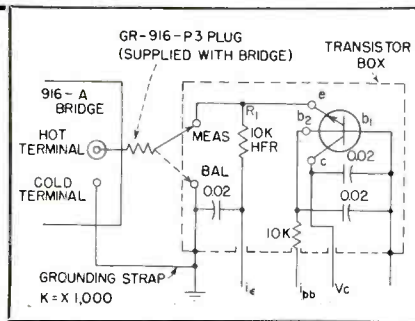

FIG. 3—Transistor-box circuit for  $h_{11}$  measurement

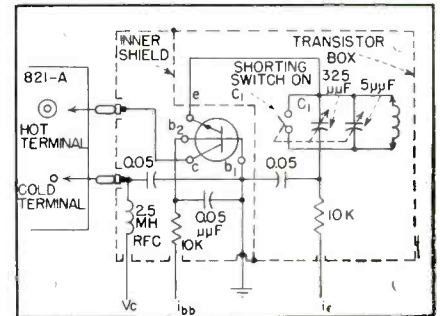

FIG. 4—Transistor-box circuit for  $h_{22}/Y_{22}$  measurement

of the transistor. The magnitude of  $Y_{12}$  is maintained  $\geq 0.1$  mho over the frequency range and thus is many times greater than either  $h_{22}$  or  $Y_{22}$ .

The short-circuit input impedance is of the form  $h_{11} = r_{11} \pm jx_{11}$  in ohms and is measured with a General Radio model 916-A radio-frequency bridge as shown in Fig. 2. Additional equipment includes a crystal-controlled signal generator with 8 test frequencies from 1 to 24 mc and a communications receiver which serves as a detector. All of the equipment is placed on a sheet aluminum ground-plane. Connections to the bridge are made with double-shielded coaxial cable.

The transistor is connected to the bridge and its power supply as shown in Fig. 3. This circuit is contained in a 2 by 2 by 4 inch metal box fastened to the bridge close to the unknown terminals. Direct current for the emitter is fed in shunt with these terminals through  $R_1$ . The box is provided with a sub-miniature tube socket into which the transistor plugs.

## Correction Factors

The admittance of the parallel combination of  $R_1$ , the shunt capacitance to ground of the emitter circuit wiring in the box and the shunt capacitance to ground of the GR-916-P3 connecting lead may have to be accounted for in determining the true  $h_{11}$  parameter. This will be required generally if  $|h_{11}| > 200$  ohms and if the frequency is greater than 10 mc. Corrections for the inductance effects in the

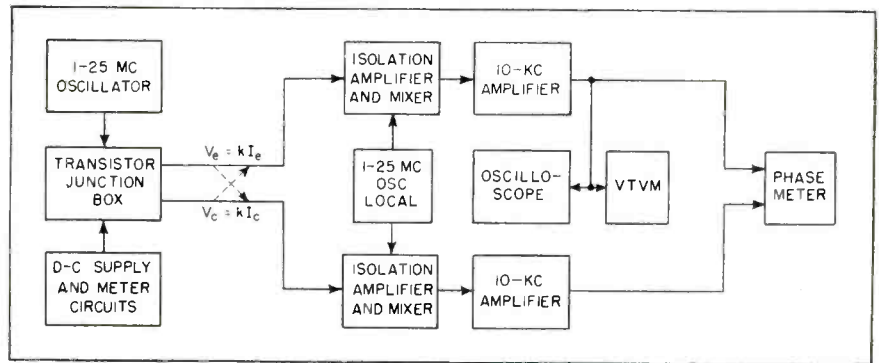

FIG. 5—Equipment necessary to measure  $\alpha$  at high frequencies

bridge may be necessary if the frequency is greater than 14 mc.

The open-circuit output admittance,  $h_{22} = g_{22} + j\omega C_{22}$  ( $\mu$ mho), can be measured as a driving-point admittance at the output terminals in Fig. 1 provided  $i_1 = 0$ , input terminals open-circuited. This parameter is measured with a GR model 821-A impedance-measuring circuit, in an arrangement similar to that shown in Fig. 2.

The transistor is connected to its d-c bias supply and to the impedance bridge by the circuit shown in Fig. 4. This circuit is contained in a small metal box and is provided with two banana jacks which plug into the bridge UNKNOWN terminals. The d-c collector current is fed through the inductance which forms part of a tuned circuit within the bridge. This inductance is connected directly across the unknown terminals.

Likewise, the d-c emitter current is fed through the inductance of a parallel-resonant circuit used to provide a high impedance in the external emitter-base circuit. The error introduced by using a finite,

but large, rather than infinite terminating impedance,  $Z_{t1}$ , is given in the following equation. With  $e_1 = -i_1 Z_{t1}$ , then

$$Y_{out-oc} = h_{22} \left[ 1 - \frac{h_{12} h_{21}}{Z_{t1} \left( 1 + \frac{h_{11}}{Z_{t1}} \right) h_{22}} \right] = h_{22} \left[ \frac{1 + z_{11}/Z_{t1}}{1 + h_{11}/Z_{t1}} \right] \quad (5)$$

where  $z_{11}$  is the open-circuit input impedance,  $(h_{11} - h_{12}h_{21}/h_{22})$ .

For  $Y_{out-oc}$  to be a measure of  $h_{22}$  with small error, it is necessary that  $Z_{t1} \gg h_{11}$  and  $Z_{t1} \gg z_{11}$ . In the test circuit used in this measurement, the minimum  $Z_{t1}$  afforded by the parallel-resonant circuit over the frequency range is 25,000 ohms, which is adequate.

## Procedure

After the bridge is initially balanced with the junction box plugged in, the tuned circuit is adjusted to resonance by placing it across the UNKNOWN terminals of the bridge and measuring its admittance. This is easily done by strapping through the transistor connection, emitter

to collector. The strap is then removed and the transistor is inserted in the circuit for measurement. Correction for frequency effects within the bridge may be necessary above 14 mc.

As an alternative to measuring the  $h_{12}$  parameter directly, the short-circuit output admittance,  $y_{22} = g'_{22} + j\omega C'_{22}$ , ( $\mu\text{mho}$ ), is measured. In this case the termination required at the emitter-base terminals is a very low impedance, ideally a short-circuit.

Parameter  $y_{22}$  is measured after the  $h_{22}$  measurement, before the bridge and the terminating tuned circuit are readjusted to a different frequency. To measure  $y_{22}$  it is only necessary to turn tuning capacitor  $C_1$  in Fig. 4 to full mesh, so the bent tip of one of the rotor plates makes contact with the adjacent stator plate. This short-circuits the tuned circuit and drops the terminating impedance to a few ohms or less.

### Open-Circuit Voltage-Feedback Parameter

The open-circuit voltage-feedback parameter,  $h_{12} = |h_{12}| \angle \Psi$ , is equal to the ratio  $e_1/e_2$  if  $i_1 = 0$ , as shown in Eq. 1. To make  $i_1 = 0$ , an

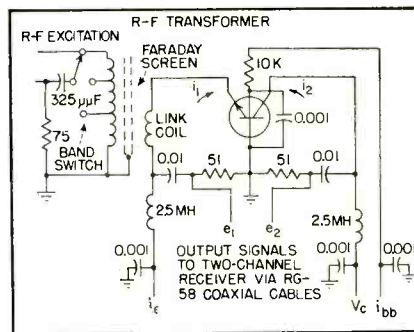

FIG. 6—Transistor junction box used for  $h_{21}$  measurement

infinite terminating impedance  $Z_{i1}$  is required. A voltage generator  $e_2$  could be placed across the output terminals in Fig. 1 and the feedback voltage  $e_1$  in the microvolt range, measured with a high-impedance voltmeter across the terminals. This voltmeter impedance, plus an additional parallel impedance to allow d-c emitter current to flow would result in a finite  $Z_{i1}$ . The error introduced by having a finite rather than infinite terminating impedance is determined from the relationship

$$\frac{e_1}{e_2} = \frac{h_{12}}{(1 + h_{11}/Z_{i1})} \quad (6)$$

Probe-type vacuum-tube volt-

meters which can measure in the microvolt region are available, but are accurate for frequencies up to only several mc. For measuring  $h_{12}$  with such a device one could provide a parallel-resonant circuit at the emitter-base terminals and tune out the capacitive reactance of the vtm probe and associated wiring. At the same time, d-c emitter current could flow through the inductance. Moderately high values of operating Q in this circuit will make  $Z_{i1} \gg h_{11}$  so that a measure of  $e_1/e_2$  will be a good measure of  $|h_{12}|$ .

Because of the frequency limitations involved with commercially available microvoltmeters as well as the difficulty in measuring the phase angle of  $h_{12}$ , it was felt desirable to measure  $h_{12}$  indirectly using the following relationship which involves the directly measured parameters already discussed

$$h_{12} = \frac{h_{11}}{h_{21}} \frac{(y_{out-oc} - y_{out-sc})}{\left[ 1 + \left( \frac{Z_{i1-sc}}{h_{11}} \right) - 1 + \frac{Z_{i1-oc}}{h_{11}} \right]} \quad (7)$$

If  $Z_{i1-sc} \ll h_{11}$  and  $Z_{i1-oc} \gg h_{11}$ , then  $h_{12} \approx (h_{11}/h_{21})(y_{out-oc} - y_{out-sc})$  (8)

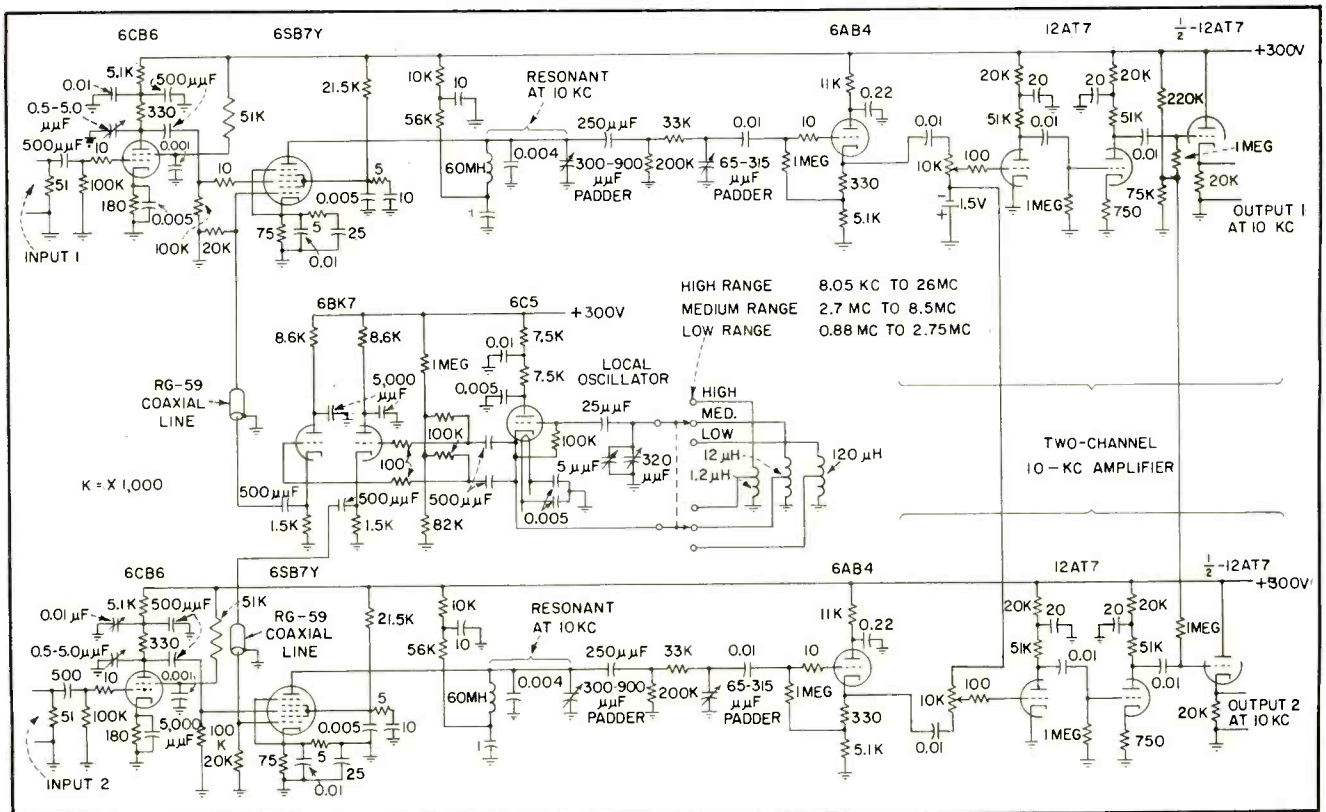

FIG. 7—Two-channel superheterodyne receiver covers frequency ranges of 8.05 to 26, 2.7 to 8.5 and 0.88 to 2.75 mc

$$\text{If } Z_{1-sc} = 0 \text{ and } Z_{1-oc} = \infty, \text{ then} \\ h_{12} = (h_{11}/h_{21})(h_{22} - y_{22}) \quad (9)$$

### Short-Circuit Transfer Parameter

The short-circuit transfer parameter is  $h_{21}$  or  $a$ , where  $-a = h_{21} = |h_{21}| \angle \theta$ .

As shown in Eq. 2,  $i_2/i_1 = h_{21}$  if  $e_2 = 0$ . This will be obtained if a short-circuit exists at the output terminals in Fig. 1. In the method of measurement to be described the two currents are measured as voltage drops across two low resistances of equal magnitude. Because each of these two voltages is developed across a low impedance, the circuit is not seriously disturbed when the reactance associated with the input capacitance of the vacuum-tube stage is connected across this impedance.

The value of  $h_{21}$  measured in this manner will have an error dependent upon the magnitude of the admittance used in the collector circuit  $Y_{12}$  according to the equation

$$\frac{i_2}{i_1} = \frac{h_{21}}{1 + h_{22}/Y_{12}} \quad (10)$$

In the circuit used to measure  $h_{21}$ ,  $Y_{12}$  is 0.04 mho, hence  $h_{22}/Y_{12} \ll 1$ .

One method of measuring the magnitude and phase difference angle of two r-f voltages in the microvolt range is to heterodyne these two voltages down to a much lower frequency, say to 10 kc.<sup>3</sup> The equipment used is shown in Fig. 5.

The r-f signal used to excite the transistor, as well as the d-c bias currents and voltages, is applied to the transistor in the circuit of Fig. 6. This circuit is contained in a brass box and includes an r-f transformer equipped with a Faraday screen. The primary is a tapped coil to cover the frequency range and is series-resonated at the operating frequency with the 325- $\mu\mu\text{f}$  capacitor. The secondary is a two-turn link winding which is in series with the transistor emitter-base circuit.

The r-f voltage induced in the link winding causes an r-f current,  $i_1$ , to flow and the transistor in turn generates current  $i_2$ . A voltage  $e_1$  proportional to  $i_1$  is fed to a pentagrid-mixer tube and voltage  $e_2$  proportional to  $i_2$  is fed to a second pentagrid-mixer tube. If both mixers are excited with a

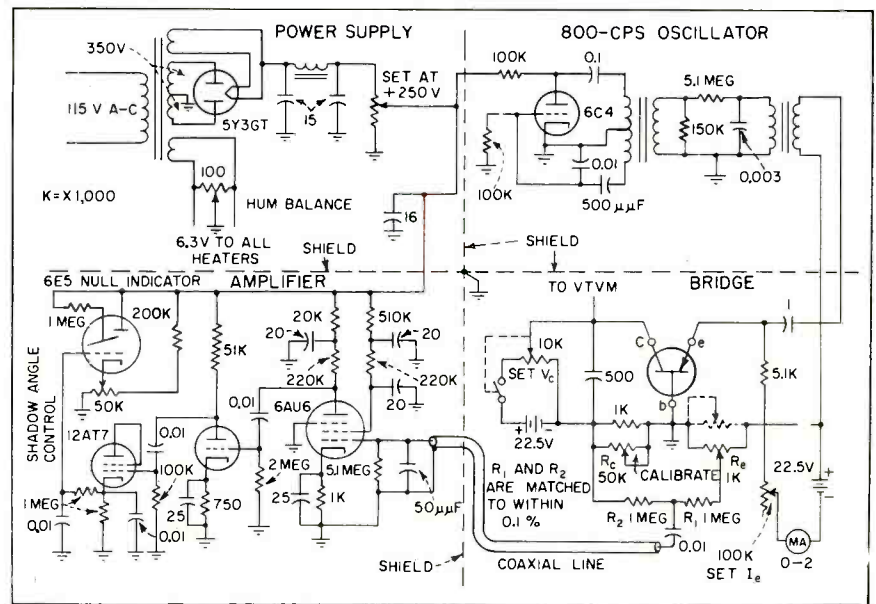

FIG. 8—Complete circuit of h-f  $\alpha$  measurement meter

common local-oscillator signal, 10 kc higher than the frequency of  $e_1$  and  $e_2$ , the two difference-frequency signals will have the same amplitude ratio and phase-angle difference as  $e_1$  and  $e_2$ , provided the amplitude and phase responses of the two channels are equal.

The bandwidth of the two 10-kc i-f channels is limited by a tuned circuit following the mixers to increase the signal-to-noise ratio of the system. An audio-frequency phasemeter indicates the angle of  $h_{21}$  directly.

To eliminate the necessity of having equal gain in both channels, voltages  $e_1$  and  $e_2$  are each switched into a common channel and the decibel ratio of  $e_2/e_1$  is read on the Ballantine model 300 vacuum-tube voltmeter.

### Two-Channel Receiver

The schematic diagram of the  $h_{21}$  two-channel receiver is shown in Fig. 7. The high-pass R-C filter shown following the tuned circuit at the output of each mixer stage attenuates the voltage induced in the inductance of this tuned circuit by stray 60-cps magnetic fields. The 65 to 315  $\mu\mu\text{f}$  variable capacitor is used to equalize the phase shift between the two 10-kc i-f amplifier channels.

To determine the grounded-base alpha-cutoff frequency, the low-frequency  $h_{21}$ , designated as  $h_{210}$ , must be known. The frequency at which  $|h_{21}|$  is 0.707 of, or 3db down from,

its low-frequency value ( $h_{210}$ ) is the alpha-cutoff frequency. The low-frequency value of  $a$  can be measured in a variety of ways.<sup>4,5</sup>

An instrument for obtaining a rapid answer is shown in Fig. 8. This is a bridge circuit, operating at about 800 cps. The bridge is balanced by adjusting multiterm-potentiometer control  $R_e$  until a null is observed on the 6E5 electron-ray tube. The value of  $h_{210}$  is then read directly off the multiterm-potentiometer dial with an accuracy of  $\pm 0.2$  percent.

To insure that it is the small-signal h-parameters that are being measured, the amplitude of the r-f excitation from the generator is varied over wide limits by the attenuator. If the value of the parameter does not change with signal level, the transistor is operating as a linear or small-signal device.

The writer is grateful to R. H. Johnston for his help in the construction of the equipment and is also indebted to R. L. Pritchard for his criticism and encouragement during the writing of this report.

### REFERENCES

- (1) D. A. Alsberg, Transistor Meterology, *IRE Conv Rec*, Part 9, p 39, 1953.
- (2) R. L. Pritchard, Small Signal Parameters for Transistors, *Elec Eng*, p 902, Oct. 1954.
- (3) D. A. Alsberg, Principles and Applications of Converters for High Frequency Measurements, *Proc IRE*, p 1,195 Oct. 1952.
- (4) G. Knight, Jr., R. A. Johnson and R. E. Holt, *Proc IRE*, p 983, Aug. 1953.
- (5) A. R. Boothroyd and J. Almond, *Proc Inst. Elec Eng*, Part III, p 314, 1954.

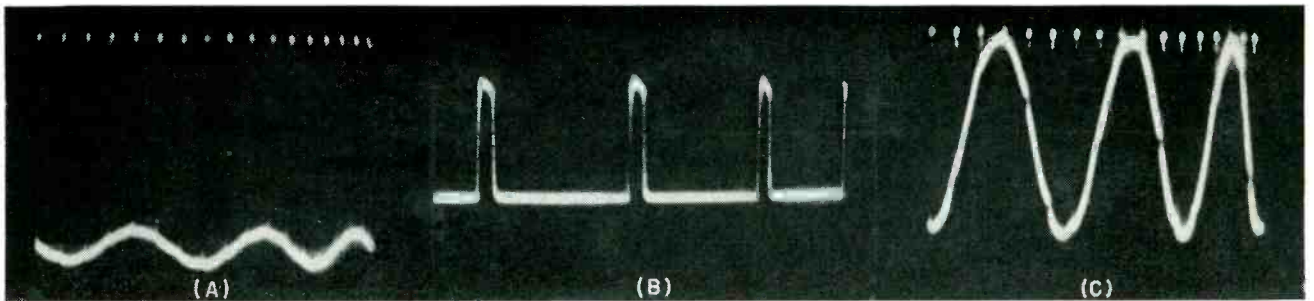

Comparison of limiter and audio silencer performance. Waveforms show input signal with pulses (A) and pulses alone (B); limiter

# Silencer Kills Audio

**SUMMARY** — Unique silencer circuit acts as electronic switch cutting off audio on noise peaks. This differs from Lamb silencer which acts on r-f and i-f stages. Article contrasts basic noise suppression techniques: filters, limiters and silencers. Waveforms compare limiter with audio silencer

By **ALBERT A. GERLACH**

*Technical Director,  
Instrumentation Section  
Cook Research Laboratories  
Skokie, Illinois*

**N**OISE SUPPRESSORS are based on frequency, amplitude and time filtering. Frequency filtering is employed where the undesired perturbations are continuous in time and confined to a relatively narrow frequency spectrum. Amplitude and time filtering are employed when the undesired perturbations are high-amplitude in-

termittent pulses in the time domain.

Figure 1A illustrates the operation of an ideal frequency-domain filter. The upper curve represents an ideal band-pass filter and ideal low-pass filter. The lower curve represents an ideal band-rejection filter. Such filters discriminate a signal from noise when the noise is outside the spectral range of the signal or is confined to small bands within the spectrum of the signal.

Figure 1B illustrates an ideal amplitude-domain filter. The upper

curve represents an ideal low-pass amplitude filter such as a limiter or clipper circuit. The lower curve represents an ideal band-pass amplitude filter such as a slicer circuit. Amplitude filters discriminate between a desired message and high-level noise impulses.

Figure 1C illustrates the ideal time-domain filter. The upper curve represents an ideal low-pass time filter such as a switch in series with the signal line. The switch is closed up to time  $T_1$ , then is suddenly opened, blocking the passage of the

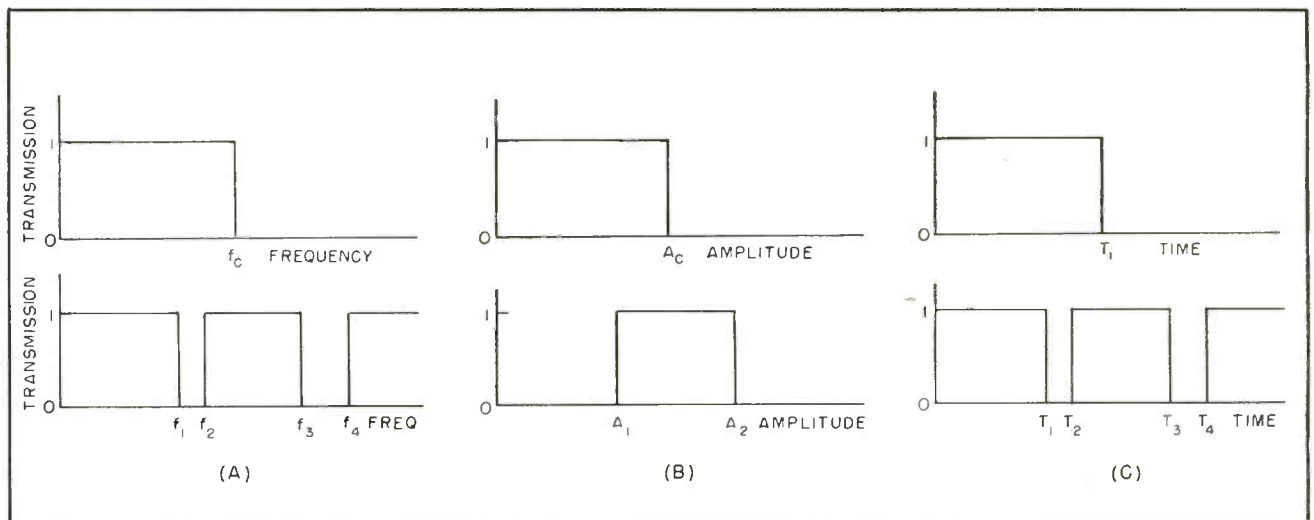
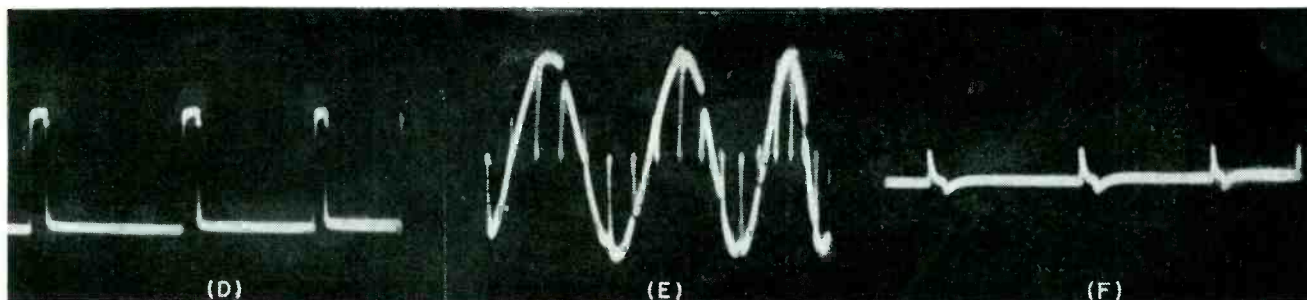

FIG. 1—Operation of ideal filter (A), limiter (B) and time filter or audio silencer (C)





output, signal and pulses (C) and pulses alone (D); silencer output, signal and pulses (E) and pulses alone (F)

# Output on Noise Peaks

signal. The lower curve illustrates a band-rejection filter in the time domain. Such filters are desirable in suppressing high-level impulse noise.

## Circuits

Figure 2A illustrates a simple time-domain filter for suppressing high-level impulse noise. The triode acts as a switch which is normally open in the absence of an interfering pulse. This allows the input signal to appear at the output. When a noise pulse appears, the grid is driven positive, closing the switch and shorting the output for the duration of the pulse.

Figure 2B illustrates a practical circuit for incorporating the time filter into the detector of a communications receiver. Such a circuit was constructed, and subjective listening tests made to compare the time filter with conventional limiters. Results indicated that the time filter was appreciably more effective in reducing the overall annoyance due to the noise impulses. This is due to the fact that there is much less average noise power in the output of the time filter than in the output of the limiter.

Oscillographs show the effect of both types of noise suppressors on a combined pulse and sine wave. In the absence of the sine wave, there still appears an appreciable pulse output from the limiter circuit while for the time filter the output is nearly free of interfering pulses.

Letting  $A$  be the peak level of the signal,  $p(e)$  the amplitude probability distribution function of the

signal and  $e(t)$  the voltage of the signal ( $-A \leq e(t) \leq A$ ), the amplitude of the output noise pulse, for the amplitude filter will be

$$n_a = A - e(t) \quad (1)$$

and for the time filter will be

$$n_t = e(t) \quad (2)$$

The average noise output power in each case will be proportional to the average square of the noise-pulse amplitudes. From Eq. 1 and 2

$$\overline{n_a^2} = \frac{A}{2} + \frac{1}{A} \int_0^A e^2 p(e) de \quad (3)$$

since  $p(e)$  is an even function. Also

$$\overline{n_t^2} = \frac{1}{A} \int_0^A e^2 p(e) de \quad (4)$$

Thus  $\overline{n_a^2}$  is greater than  $\overline{n_t^2}$  by the quality  $A/2$ . The ratio of the noise-power outputs from Eq. 3 and 4 is

$$P_a/P_t = \overline{n_a^2}/\overline{n_t^2} = 1 + \left[ \frac{A^2/2}{\int_0^A e^2 p(e) de} \right] \quad (5)$$

Assuming  $p(e)$  is a normal distribution function with standard deviation equal to  $A/2$ , Eq. (5) reduces to

$$P_a/P_t \approx 1 + \left[ \frac{\pi^{1/2}}{\int_0^\infty x^2 \exp(-x^2) dx} \right] = 5 \quad (6)$$

## Conclusion

Output noise power using the amplitude limiter is thus about five times greater than would be present if the time filter were employed. In practice the saving in noise power is generally greater because of speech pauses.

Time filtering of impulses has been employed in the past,<sup>1</sup> but only in the r-f and i-f portions of the receiver. Unfortunately, the effect is identical to amplitude filtering because zero transmission in the time domain on the signal space is equivalent to the negative peak of a 100-percent modulated wave. This is equivalent to peak clipping at the 100-percent modulation level.

The author acknowledges the assistance of M. J. Fenton and P. D. Padva in the construction and the testing of equipment.

## REFERENCE

(1) J. J. Lamb, Silencing Circuits for Radio Receivers, U. S. Patent 2,101,549, *Official Gazette*, U. S. Patent Office, 485, No. 1, Dec. 1937.

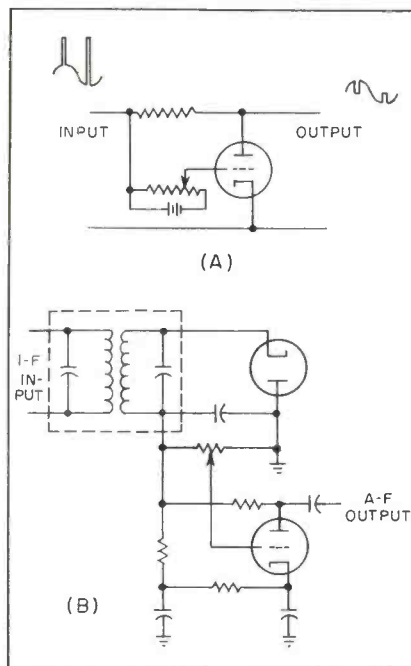
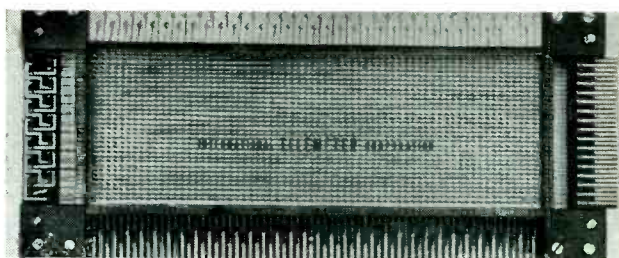

FIG. 2—Basic circuit (A) and circuit for use in communications receiver (B)



Ferrite-core memory is designed for JOHNNIAC computer



Magnetic switch

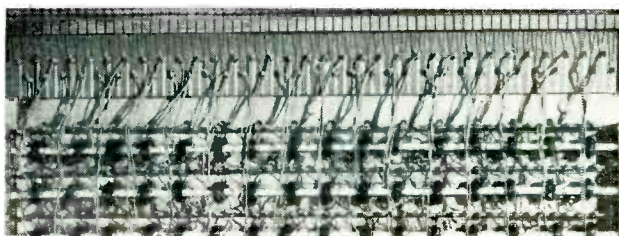

Storage matrix

# Ferrite-Core Memory

**SUMMARY** — Matrix wiring and pulse-switching circuits enhance reliability of 168,960-core memory for JOHNNIAC computer. Reading time is 4.5 microseconds, write time 10 microseconds. Mean error free operating time exceeds 35 hours

**S**QUARE-LOOP ferrite cores used in high-speed random-access memories for digital computers may be set in two remanent magnetic states. One of these states is defined as ZERO and the opposite state as ONE. Reading is accomplished by detecting the voltage induced in an output loop when the magnetic state of the core is changed.

In the usual arrangement, the cores are mounted in rows and columns. All cores in each row are linked by the common *X* line and all cores in each column by the common *Y* line. To select a given core (Fig. 1) it is necessary to energize each of two lines linking it with half the current necessary to change its magnetic state. Only the core at the junction of the selected *X* and *Y* lines will receive the necessary magnetomotive force. A current pulse sufficient to drive a core into the ZERO state is referred to as a *P* pulse; a pulse driving a core into the ONE state as an *N* pulse.

A reading winding linking all the

cores detects a change in the magnetic state of the selected core. As the core changes its magnetic state, the flux will induce in the reading winding a voltage which is amplified. Other functions performed by the electronic circuits of the memory are selection of proper coordinate lines and generation of

precisely controlled current pulses.

The memory to be described was designed to work with the Rand JOHNNIAC computer. A block diagram is shown in Fig. 2.

## Design

The unit was designed to fit on top of the computer and is 10 feet

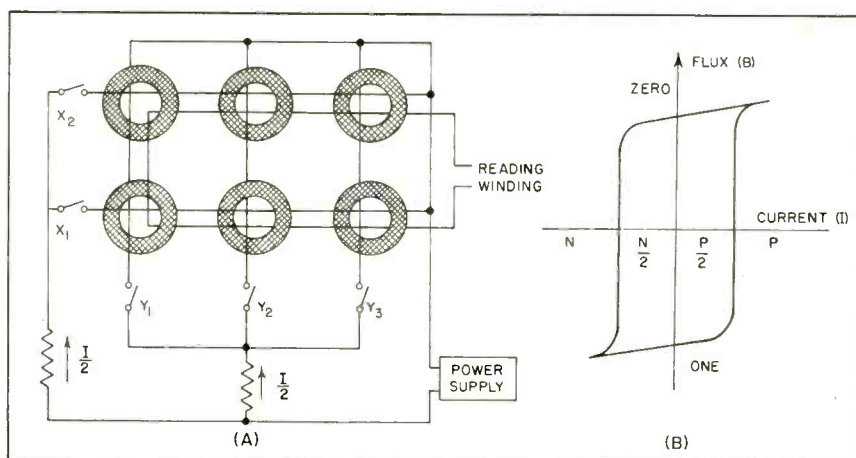

FIG. 1—Basic wiring of ferrite-core matrix (A) and square-loop magnetic characteristic of cores (B)

By **M. A. ALEXANDER,**  
**M. ROSENBERG** and  
**R. STUART-WILLIAMS**

*International Telemeter Corp.*  
*Los Angeles, California*

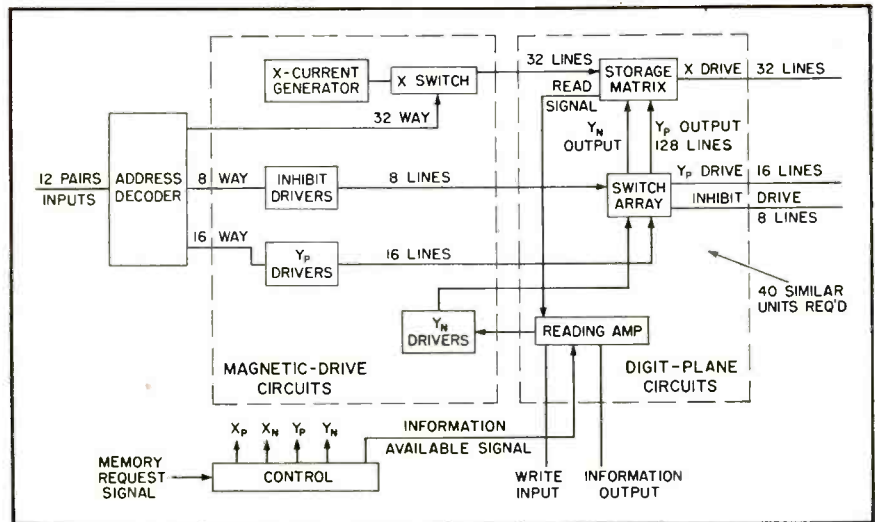

FIG. 2—Complete memory showing relation of electronic driving circuits to ferrite-core matrices

# is Fast and Reliable

long, 39 inches wide and 19 inches high. The unit contains 1,207 tubes, 288 germanium diodes, 5,120 switch cores and 168,960 storage cores, some of which are built-in spares. The equipment consumes 6 kw of B+ power and 6 kw of filament power.

On a read order, the memory interrogates itself at the selected word address and makes 40 parallel bits available to the computer. This operation is completed in  $4\frac{1}{2}$  microseconds. During the next 10 microseconds, the memory writes back the information that was presented to the computer. On a write cycle, the memory readout signals are ignored and the write information is made available from the computer. The read-write orders are separated into four partial substitution groups of 8, 12, 13 and 7 bits each. An individual choice, read or write, may be made in each group.

The information is stored in 40 matrices of 4,096 cores each. One bit of each word is stored in each matrix. The matrices are rectangular and the selection of cores is made by drive currents applied to the X and Y coordinate drive wires.

In the X direction (32 lines) each core is linked by 3 turns and

each line is common to the 40 matrices. Each matrix contains 132 Y lines, of which four are spares. The Y lines link each core with one turn. The Y lines drive only one matrix.

Each matrix includes a single-turn reading winding that links every core in the matrix. The winding is illustrated in Fig. 3.

## Driving Waveforms

Waveforms which drive the memory are shown in Fig. 4. The X current is set up first and drives every core on the selected X line in the P direction of Fig. 1B. When all the electromagnetic and electrostatic disturbances due to the application of this pulse have died down, a pulse is applied on a selected Y line—also in the P direction. The core receiving the sum of these two currents is the selected core. The output of the matrix is sensed during the application of the Yp pulse and the reading signal is affected only by the disturbances caused by the Yp pulse.

The pulse applied to the Y line is routed through a magnetic switch of which the Y line is the output winding. There are 40 magnetic switches driven in cascade provid-

ing a drive pulse to each array. Since the X pulse is also common to 40 arrays, there are 40 selected cores providing 40 output signals in parallel.

In a single matrix 128 cores receive a half-excitation when the X pulse is applied. There are 32 cores similarly excited when the Yp pulse is applied. Since the minor-loop disturbances in the X winding are allowed to die down before the core output is read, the problem is one of coping with the disturbances due to 32 cores on the selected Y line.

The reading winding links alternate cores on the Y line in opposite directions. Some cancellation also occurs in the X line due to the method of lacing the reading winding on a fold matrix.

Because of the matrix construction and program drive, the matrices are simplified since the reading winding does not have to be diagonally interlaced but runs parallel to the X lines. Since cancellation is required from only a single Y line of 32 cores it can be done accurately. This will improve the dynamic reading ratio which is a function of the cores on the selected Y line. The  $32 \times 128$  configuration allows optimum design of

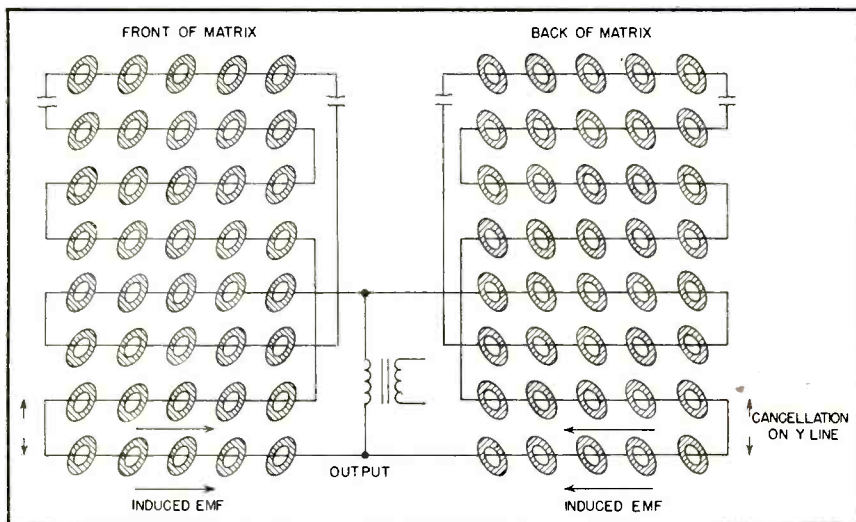

FIG. 3—Reading-winding layout contributes to memory's reliable operation

the driver circuits, particularly on the  $Y$  switch drive side.

Referring to Fig. 4, the part of the pulse cycle, up to and including the  $Y_p$  pulse, is the read part. The 40 output toggles which supply the outputs are either set into the ONE state by a ONE signal from the matrix or left in the ZERO state to which they have been cleared by a register-reset pulse at the beginning of each memory cycle.

These toggles are associated with the reading amplifiers which feed them and with the  $Y_v$  core drivers which perform the write operation during the last 10 microseconds of the cycle. The binary state of the toggle will determine which of two  $Y_v$  pulses will be used. An individual decision is made in each of the 40-bit positions. At the end of the read part of the cycle, all the selected cores are in the zero state.

To write zero, the  $Y_v$  pulse, which is also routed through the magnetic switch, subtracts from the existing  $X_p$  pulse. The net mmf is zero and the core moves on a minor loop to the  $+B_r$  or zero state. The write zero,  $Y_v$  pulse returns the switch core to its  $-B_r$  value and closes the switch-core flux loop, see Fig. 5A.

To write one, the storage core must be driven from the  $+B_r$  or zero state to the  $-B_r$  or one state. The  $Y_v$  pulse is combined with an  $X_v$  pulse and the storage core is set in the one state. In each case, the driving switch core is reset.

The cycle is a symmetrical one. The net flux change is zero whether a read or write cycle is used.

The memory uses  $4,096 \times 40$  storage cores and  $128 \times 40$  switch cores.

Storage cores are of square-loop material with a one-microsecond turnover time and have dimensions of 100-mil o-d, 70-mil i-d and 30-mil thickness. The storage cores are 0.360 in. o-d, 0.245 in. i-d and 0.118 in. thick.

#### Drive Pulses

The storage-core drive pulses are  $\frac{1}{2} P = 0.475$  ampere-turn and full  $P = 0.95$  ampere-turn. The output signals from a single-turn reading winding are shown in a photograph. The storage cores are tested and graded over a range of drive currents before they are built up into a matrix. Their working tolerance is distributed between the  $X$  and  $Y$  drivers, with more tolerance

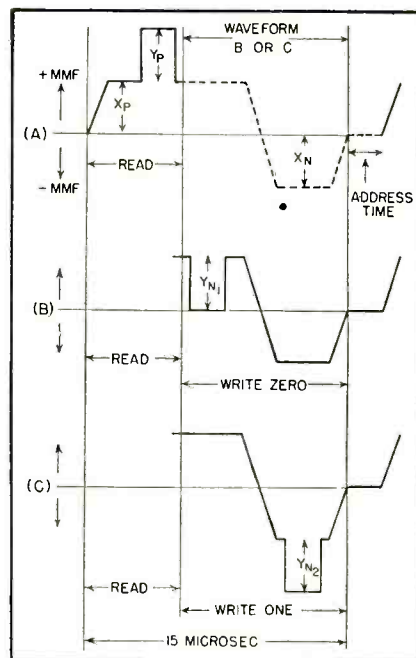

FIG. 4—Driving waveforms for memory

given to the  $Y$  drivers. This compensates for variations in switch-core characteristics.

A switch-core array consists of 128 cores divided into eight groups of 16. Each group is connected to an inhibitor circuit which biases the switch cores well into the  $-B_r$  region. There are 16  $Y_p$  pulse drivers which link one core in each inhibit group. Both the inhibitor and  $Y_p$  lines drive through the 40 switch arrays in series.

There are also 40  $Y_v$  drivers, one for each switch array. The  $Y_v$  line links every core in its array. See Fig. 5B.

The 12-bit address inputs from

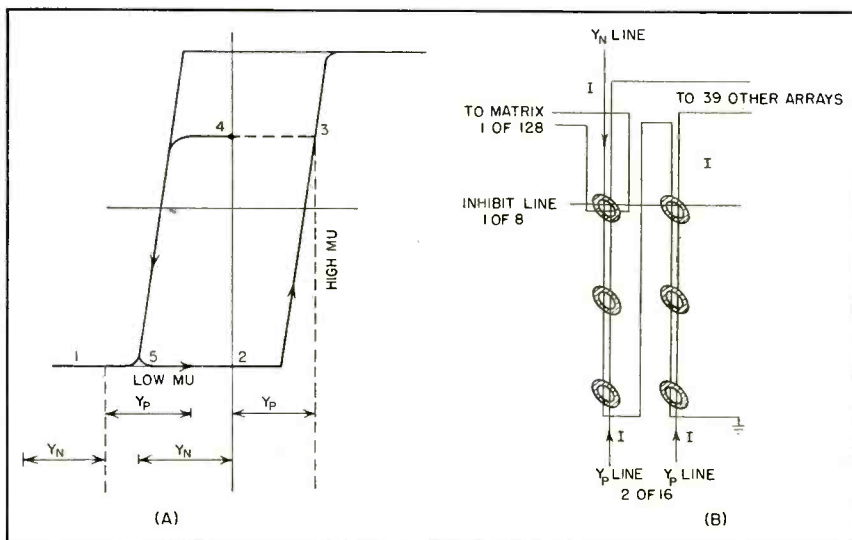

FIG. 5—Switch-core operating loop (A) and switch wiring scheme (B)

the computer are split into three groups. The five least significant bits select one of the 32  $X$  lines. The next 4 bits select the appropriate  $Y_p$  switch driver. The last 3 bits select an inhibit circuit which removes the bias current from the switch row.

The  $Y_p$  circuits drive one switch core in each inhibit group and select one of the 128  $Y$  lines in a matrix. The  $Y_{N1}$  or  $Y_{N2}$  pulse is applied to the switch driving every core in a direction opposite to the  $Y_p$  drive and only the selected switch core will generate the flux required to produce a  $Y_v$  pulse in the output line. This address information is set up before the memory request cycle is made.

The  $X$  winding and the reading winding are in parallel and employ quadruple Formvar-coated wire. The  $Y$  wires are quadruple Formvar-coated Nichrome.

### Electronic Circuits

The  $X$  line has a delay of one microsecond, a characteristic impedance  $Z_0$  of 300 ohms and may be driven with a pulse whose rise time is 0.75 microsecond. Pulse amplitude is 160 milliamperes and the line produces a 48-volt drop.

The method of driving the memories is shown in Fig. 6. During an  $X_p$  pulse, the  $C$  tube is cut off and one of the 32  $D$  tubes is switched on. This routes the  $X_p$  current through one  $X$  line of every matrix in the  $P$  direction. During an  $X_v$  pulse, the  $A$  tube is cut off and one of the 32  $B$  tubes is turned on. This routes the  $X_v$  current through the matrix. The output impedance of the current stabilizers is high. This takes care of impedance variations from line to line and reduces to small proportions the change in line current caused by the increased voltage drop across the switch tubes as they age.

The  $Y_p$  and  $Y_N$  driver circuits are similar. A basic circuit is shown in Fig. 7. The tendency of the output-tube amplification factor and the cathode resistance to give a high variational impedance at the plate is increased by the feedback loop. The control of the current drawn through the feedback resistor,  $R_1$ , allows the pulse-current amplitude to be adjusted. Means are provided

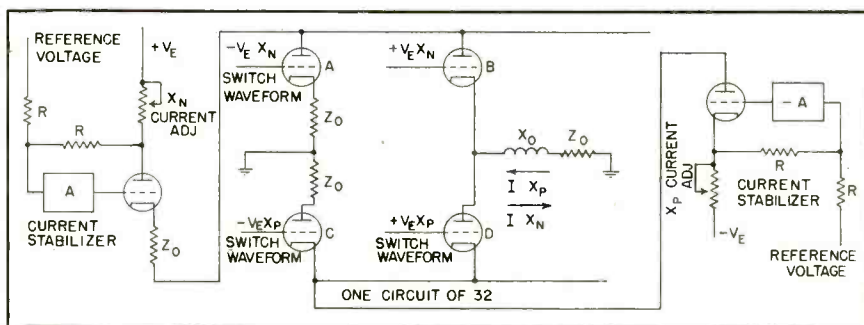
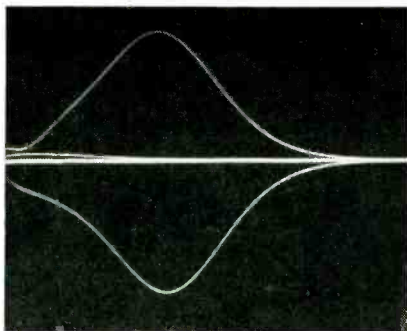

FIG. 6—Simplified  $X$  driver. Current stabilizers compensate for impedance variations from line to line



Output signals from reading winding

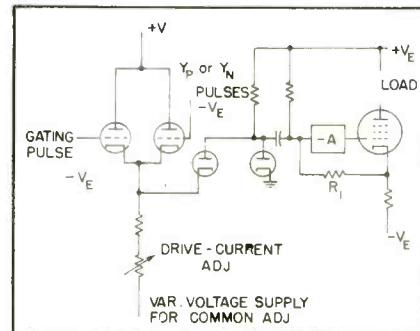

FIG. 7—Simplified  $Y$  driver

for individual or common adjustment of drive-pulse amplitude.

### Readout Circuits

The reading circuits accept the output from each matrix and amplify it to a level which will set the output toggle circuits. This input signal may be positive or negative because of the canceling connection used in the matrix. The reading amplifier must deal with signals of either polarity and provide unidirectional outputs to the logical circuits.

The signal applied to the amplifier input is not the clean, well-defined signal which is obtained from a single core. The  $X$ -signal disturbance is large and high-frequency disturbances are coupled into the reading winding. Electrostatic pickup is present due to the  $Y$  signal.

Capacitive coupling between the  $X$  winding and the reading winding causes the reading winding to shift its d-c level by an amount greater than the turnover signal amplitude.

The reading winding is coupled to the amplifier input by a balanced low-capacitance stepup transformer. This transformer, in conjunction with additional components in the circuit, forms a low-pass filter

with an appropriate passband.

The reading amplifier is a differential amplifier with a high common-mode rejection which deals with the d-c shift problem. Feedback gives defined gain and frequency response. The push-pull amplifier output is fed to a high-impedance differential-rectifier circuit which provides a single-polarity ONE signal of 15 volts at its output. The read signal is strobed after the signal has been subjected to a defined amount of integration in the reading amplifier. The control unit provides timing pulses to the rest of the equipment and the circuits follow standard computer procedures. Specifications called for a mean free time of five hours. However, in its first six months of operation, the memory has had an average mean free time in excess of 59 hours.

There was to be an acceptance test of 72 hours during which no preventive maintenance was permitted. During these 72 hours, the memory was not to make more than 14 random errors. The memory completed the 72 hours of continuous operation with no random errors and only one tube failure. In the first six months of operation, the memory has made only one random error.

# Universal Shutter Tester

**SUMMARY** — Direct-reading device measures camera shutter-speed deviation in accordance with ASA rating method. Circuit incorporates d-c amplifier that has no drift with heater-voltage variations of up to one volt

**N**EED HAS EXISTED for some time for a photographic-shutter tester that measures between-the-lens and focal-plane type shutters with equal facility.

This article describes an electronic shutter tester which provides a rapid indication of the speed deviation of both types of shutters.

## Shutter Operation

The between-the-lens shutter is placed close to the optical center of the lens and consists of a number of interleaved blades that open from the center outward, remain open a set length of time and then close. The opening and closing times remain constant regardless of the length of time the blades remain in a fully open position. A light-transmission plot of duration and quantity will show a trapezoidal form, as in Fig. 1. Line *AB* represents the effective shutter speed, *CD* the total length of time any light passes through the shutter and *EF* the time the blades remain fully open.

The focal-plane shutter operates in front of the focal point of the lens and has two basic forms. One is made of several slots of different widths cut in a roll of opaque-fabric curtain.

The other type utilizes two curtains and constant curtain velocity. Exposure is varied by changing the distance from the leading edge of the second to the trailing edge of the first curtain, for shutter speeds above 1/25 of a second. At slower speeds one curtain completes its run before the other curtain is released. Effective exposure time for this type of shutter is the time required for the shutter slit to move its own width.

The effective shutter speed, line *AB* or the time it takes the slit to

By **AUSTIN B. WESSEL**

*W. B. A. Chec-A-Shutter  
Los Angeles, California*

travel its own width, can be measured by placing the shutter in a beam of collimated light and measuring the duration of light passage by using an infinitely small light pickup whose energy, when illuminated, is transferred to a time computer. The block diagram of Fig. 2 outlines a practical modification of this concept.

The filament image of a standard 32-candlepower automobile lamp is focused with a 2-inch focal-length condensing lens upon a very narrow slit 0.004 to 0.005 inch wide. Positioned about  $\frac{1}{4}$  inch below the slit is a germanium photodiode. Light falling on this transducer changes its resistance. This resistance change and the resulting voltage change are amplified by a d-c

amplifier to a potential of from 18 to 20 volts. This is clipped to a 15-volt level before being applied to the timing network, which consists of a number of fixed resistors, one for each indicated time interval, switched in series with a fixed capacitor. The amount of charge on the capacitor is measured by a meter calibrated 0 to 150. A reading of 100 on the meter indicates that the shutter being tested is 100 percent accurate; any deviation from this norm may be read directly as a percentage of shutter error.

## Circuit

Light striking the germanium photodiode develops a voltage across load resistor  $R_1$  in Fig. 3. This voltage is fed directly to the grid of amplifier  $V_{1A}$ . The other half of this tube,  $V_{1B}$  forms an arm of a bridge circuit. The output of  $V_{1A}$  is directly coupled to  $V_{2A}$ , it's replica except for bias. In a static dark-diode condition, the grid of  $V_{1A}$  is about 0.7 volt negative and the grid of  $V_{2A}$  is at chassis-ground potential. A light pulse striking the photodiode changes the 0.7-volt bias to approximately 0.5 volt and results in the grid of the  $V_{2A}$  being driven nearly to cutoff. Since the grid of the cathode follower  $V_{3A}$  is also at chassis ground under no light conditions, it is driven 20 to 22 volts positive.

For between-the-lens shutters and focal-plane shutters of the fixed-slit-width, variable-speed type, the readable accuracy of the meter is 3 percent. For 35-mm focal-plane shutters of the constant-velocity, variable-slit-width type, the same figure applies up to speeds of 1/250 second. At 1/500 second, accuracy is 4 percent and at 1/1,000 second it is 6 percent maximum.

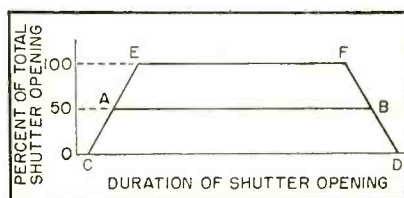

FIG. 1—Light transmission through shutter as function of shutter opening

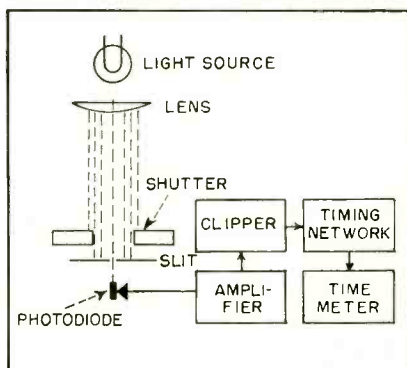

FIG. 2—System block diagram

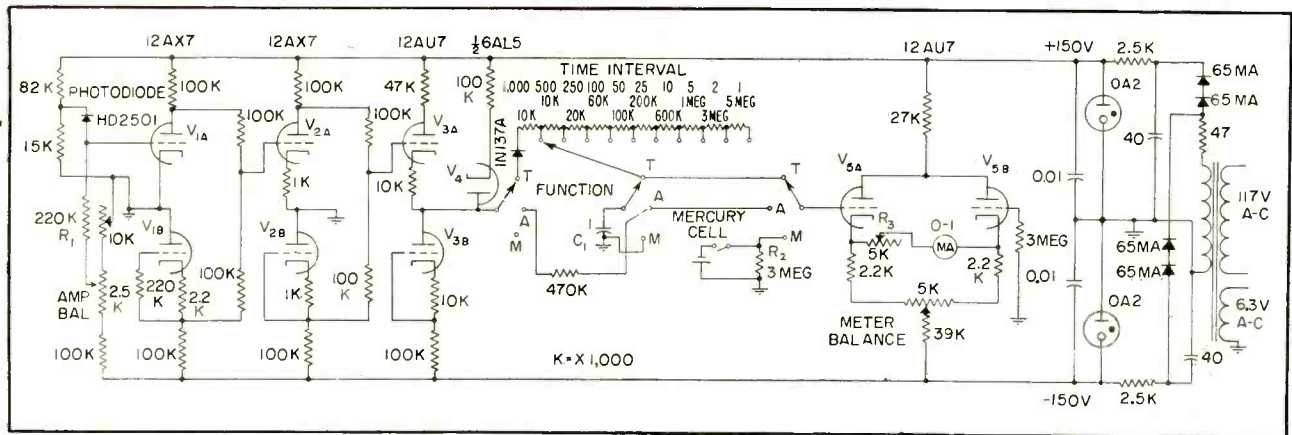

FIG. 3—Amplifier portion of circuit has gain of 300 and requires two +150-volt supplies or one tapped +300-volt supply

The variation in accuracy is tied in with the ratio of aperture-plate-slit width and curtain-slit width.

The overall gain of the d-c amplifier from the input grid to the grid of the cathode follower is 300. A 2,000 cps square wave shows no distortion. With 2,200-ohm cathode resistors in the second amplifier stage and a sine-wave input, the amplifier is flat to 22,000 cps and down 3 db at 26,000 cps.

When constructing this device a very low-noise photodiode must be picked. If a group to select from is not at hand, the safest thing to do is to eliminate the second amplifier stage. This will also require changing the clipper bias, reversing the polarity of the 1N137 diode, reducing the resistor values in the timing decade to 1/10 the values given and hand calibrating the meter as the scale will no longer be linear.

Diode load resistor  $R_1$  should be just large enough to give the required 18 to 20-volt swing at the cathode-follower output. The 6AL5 clipper should be removed from its socket while making this test. The 220,000-ohm load resistor specified may have to be varied if another type of photodiode is used. Should this change be necessary, the grid resistor in the other half of the 12AX7 should be of the same value as the new load resistor.

The reference to chassis ground does not infer no bias at static condition. The cathode of the second amplifier is about 0.5 volt positive and that of the cathode follower is 4 volts positive.

This fulfills a requirement of the capacitor in the timing network that no potential exist across it prior to light striking the photodiode.

### Timing

The timing network is designed around the equation  $T = RC$ . This formula is usefully solved only by the assumption of the application of a known voltage. Since the measured charge on  $C$  provides the visible indication of the time interval being measured, the voltage applied to the network must be of a constant value. To assure this condition, the 18 to 20-volt cathode-follower swing is clipped to a constant 15 volts positive by biased clipper  $V_4$ .

The time-interval switch has 10 positions each identified as the reciprocal of the actual time to be measured. Resistors inserted by this switch are ten times the  $T = RC$  calculated value. This is allowable as the vtvm has a sensitivity of about 1.7 volts full-scale and the voltage applied to the timing network is 15. The result is operation on the most linear portion of the universal-time-constant curve allowing the use of a uniformly divided meter scale.

The 1N137A silicon diode connected between the arm of the timing switch and timing capacitor  $C_1$  has negligible forward resistance and high back resistance. This allows the capacitor to be readily charged, but to be discharged slowly holding the meter needle deflection at peak capacitor charge

long enough to be easily read. A secondary advantage of this discharge blocking action is the removal of any time-lag error, which might result from friction and inertia in the meter movement.

The vtvm circuit is extremely stable after warm up because of its balanced design and voltage-regulated B + supply.

Moving the function switch to the  $M$  position breaks the connection from the cathode follower, shorts out the timing capacitor and establishes contact between grid resistor  $R_2$  and the input grid of the vtvm tube. This allows the voltmeter circuit to be zero balanced with the  $METER BAL$  potentiometer.

Indexing the switch to  $A$  allows the plate of the lower half of the cathode follower  $V_{3B}$  to be balanced to ground. The filtering action provided by the series R-C circuit is necessary to prevent needle jitter caused by random noise in the photodiode and also gives a slight amount of float to the  $AMP BAL$  control. In the time position,  $T$ , one or more resistors in the timing decade are placed in series with  $C_1$  completing the  $T = RC$  equation.

### Calibration

Calibration is done with a master shutter of the focal-plane type driven by a synchronous motor. Potentiometer  $R_3$  in series with the meter is used to bring the needle swing to the 100 mark on the meter dial. After proper adjustment the switch in series with the mercury cells is closed and the meter reading recorded.

# Thyratron Inverter Uses

**SUMMARY** — Circuit permits control of a-c output voltage without cumbersome saturable reactor, with improved regulation, efficiency and response speed. One thyratron serves as control tube for extinguishing the conducting power tube at any desired time up to 180 degrees

By FRANCIS LAWN

Chief Engineer  
Lawn Electronics Co.  
Freehold, N. J.

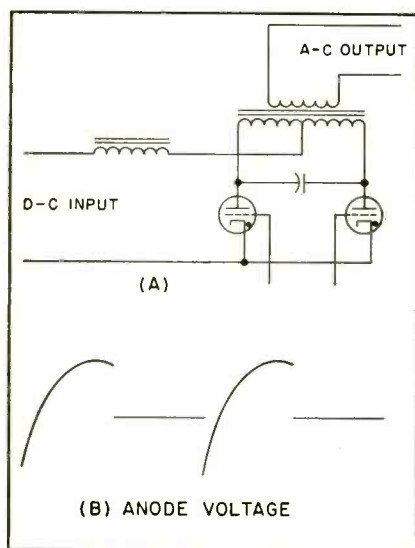

FIG. 1—Conventional thyratron inverter

**S**TATIC INVERTERS using thyratron tubes have been used successfully for a number of years. They generally find application where loads are fairly constant or variations in load or d-c input voltages are relatively slow. This article introduces a new system for controlling thyratron-type inverters. The system increases the usefulness and reliability of the thyratron inverter by providing a fast, simple method of regulating the output voltage and therefore allowing greater and faster load or input voltage variation. This new method of controlling the output power of the inverter eliminates the need for cumbersome and bulky saturable reactors and also eliminates the time delay associated with these elements.

The important variation in this circuit is that the inverter power

tubes are not required to conduct for a full 180 degrees of the frequency of operation. The circuit uses three thyratron tubes instead of the usual two. The function of the third or control tube is to extinguish the conducting power tube after any desired time up to 180 degrees. This unique feature can be utilized to provide regulation of the output voltage with an almost instantaneous response.

Figure 1A is the schematic of a conventional thyratron inverter circuit. Each tube is fired by a positive pulse from the grid circuit, and must continue to conduct current until its anode voltage is driven negative with respect to the cathode by the firing of the next or opposite tube. The output voltage of this inverter, after the component values are fixed, depends on the load and the d-c input voltage. The wave shape of the voltage on the anode of each thyratron tube is indicated in Fig. 1B.

### Drawbacks of Basic Inverter

The regulation of this type of inverter is poor and constant output voltage is generally obtained by placing a saturable reactor in series with the load. The reactor can be controlled to keep the output voltage constant but there are many disadvantages to this system.

The conventional inverter must invert the v-a required for the re-

actor drop as well as the load, thus limiting efficiency and power that can be obtained from a given set of tubes or a given output transformer. Changing the reactor impedance to compensate for line or

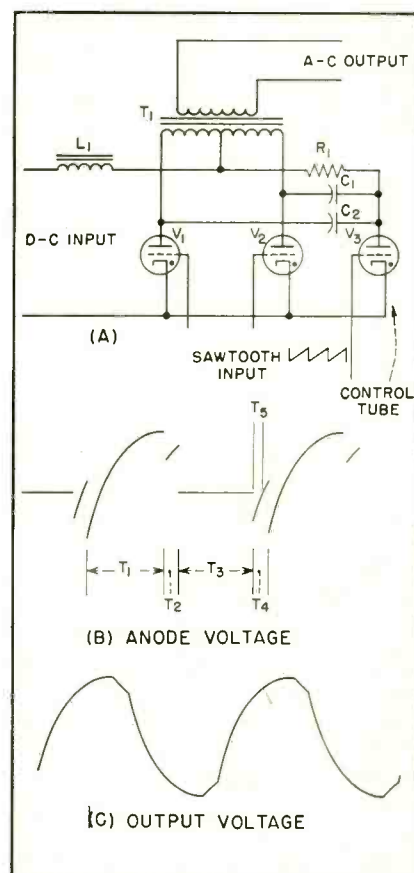
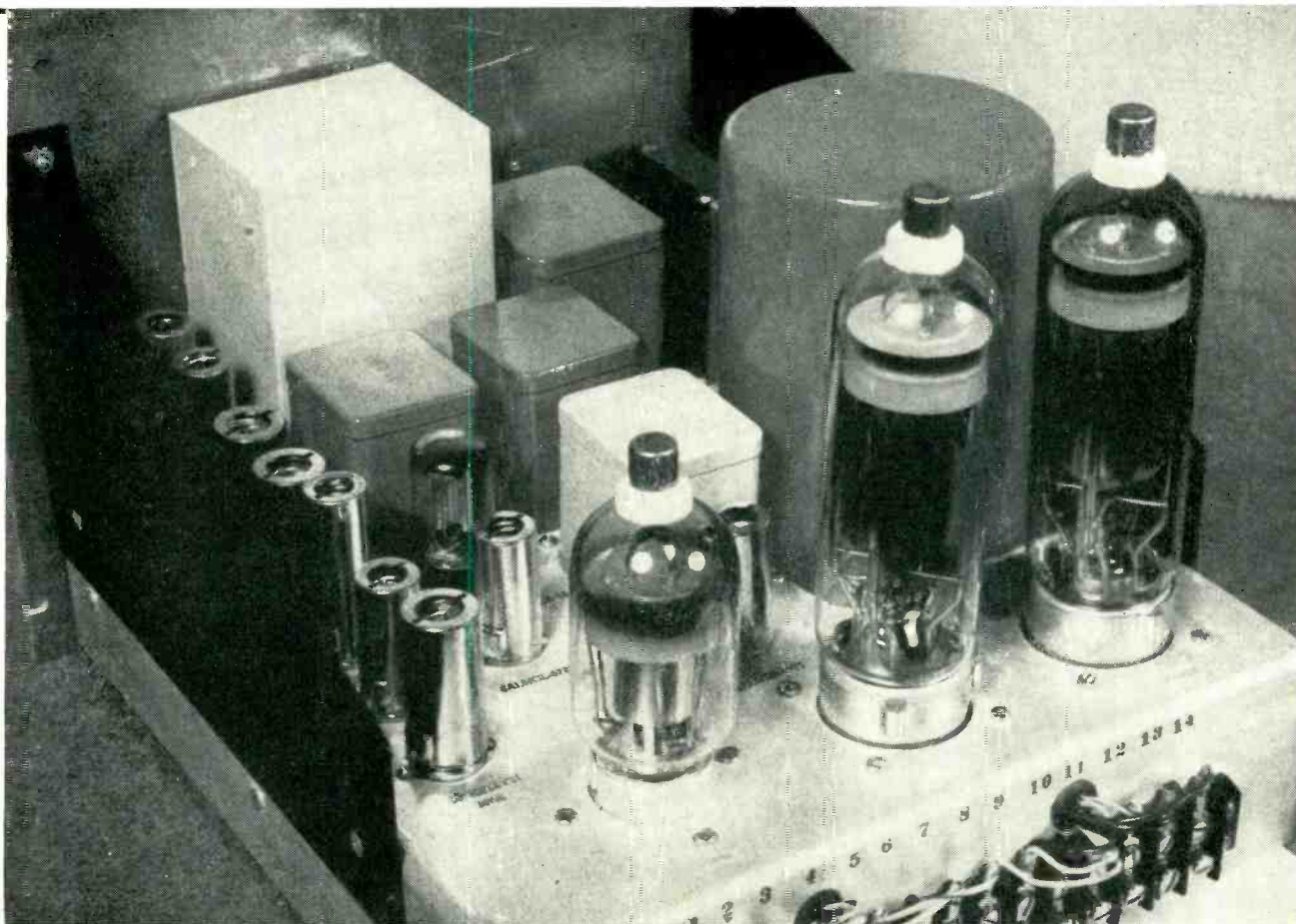

FIG. 2—Basic circuit of new controlled-firing-time inverter



# Controlled Firing Time



Rear view of controlled-firing-time inverter, showing frequency-determining and wave-shaping tubes (left), control tube (at left rear on chassis) and power thyatrons serving as inverters for changing d-c input power to a-c output power at 60 cps

load variation changes the power factor of the inverted load, which limits the load range. Also, saturable reactor response is generally slow. This time lag limits the rate of allowable load variation.

Figure 2A is the schematic of a controlled-firing-time inverter, showing the third or control tube and the commutating capacitors between the control tube anode and the anodes of the power tubes. Power tubes  $V_1$  and  $V_2$  are fired alternately 180 degrees out of phase with each other. If the control tube is not fired the circuit operates the same as that of Fig. 1.

If the control tube is fired, its anode will drop to approximately 8 volts. The voltage across commutating capacitors  $C_1$  and  $C_2$  cannot change instantaneously. Thus

the anodes of both power tubes will be driven in a negative direction.

The voltage on the anode of the conducting power tube was approximately 8 volts, so when it is driven in a negative direction the tube will cease to conduct. If this action takes place before the power tube has conducted for a full 180 degrees full power will not be delivered to the load.

When the control tube is fired at twice the frequency of the power tubes it will extinguish each power tube in turn and the firing of the next power tube will extinguish the control tube, thus completing the cycle of operation. The amount of power delivered to the load is a function of the length of time, or number of degrees, that the power tubes conduct. Therefore

the amount of power delivered to the load can be controlled by changing the phase of firing of the control tube which in turn controls the conducting time of the power tubes.

Figure 2B indicates the wave shape of the voltage on the anode of power tubes  $V_1$  or  $V_2$  when these tubes are conducting for 150 degrees and control tube  $V_3$  is conducting for 30 degrees each half-cycle. During time  $T_1$  the opposite power tube is conducting. During times  $T_2$  and  $T_4$  the control tube is conducting. The power tube being viewed conducts during the time  $T_3$ , and  $T_5$  is the time allowed for the power tube to deionize before positive plate voltage is reapplied.

Figure 2C indicates the wave shape of the output voltage under

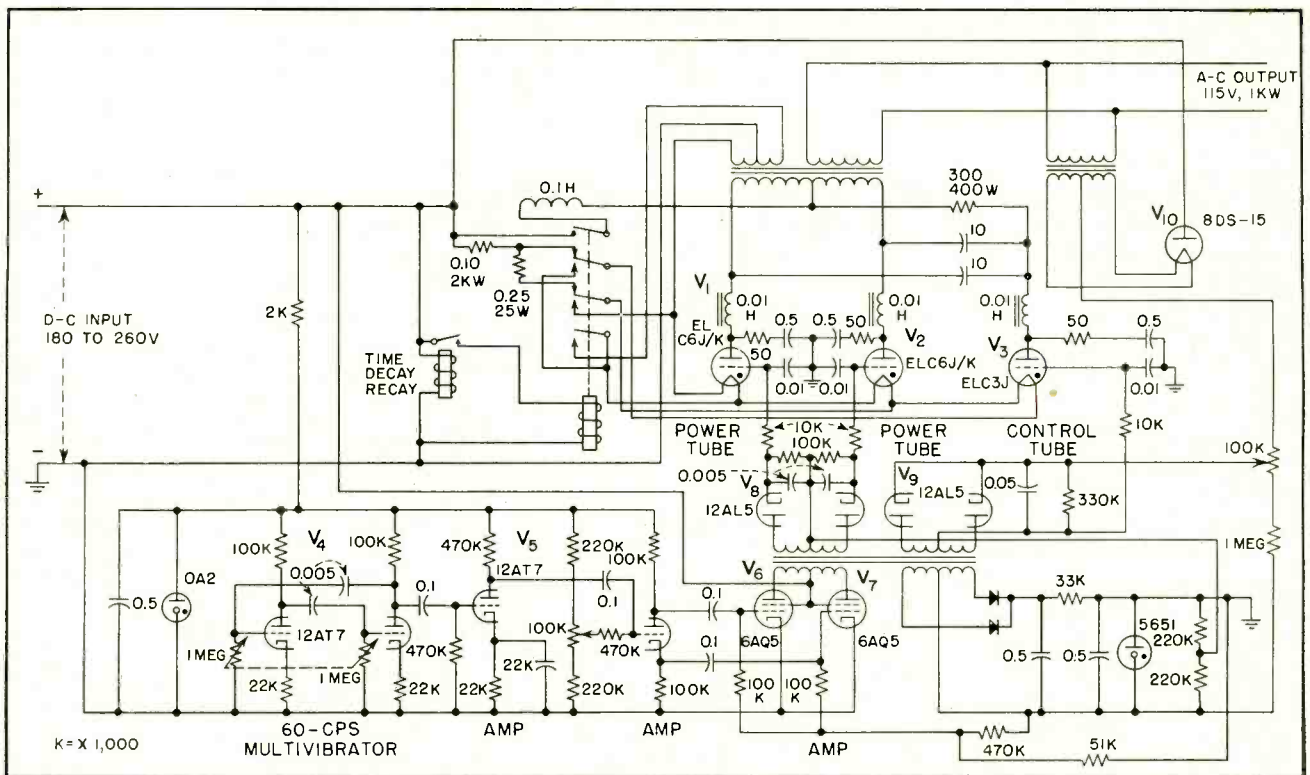

FIG. 3—Complete circuit of controlled-firing-time inverter, including frequency-determining multivibrator. Relay starts heaters or filaments on d-c, then changes over to a-c operation

the conditions of firing mentioned above. The sharpness of the breaks in this wave can be removed by cushioning circuits on the power tubes.

### Advantages

Some of the advantages of this circuit are:

- (1) The power tubes and output transformer provide only the v-a required at the load, and therefore more power can be obtained from a given set of tubes and a given output transformer.
- (2) No saturable reactor is required. This fact in conjunction with a smaller output transformer leads to a smaller and lighter inverter.
- (3) The power factor at the output of the inverter is dependent only on the load and is not affected by any reactor changes.
- (4) The response time of this regulating system is limited only by the sensing element. The system can act within the half-cycle of operation.
- (5) Deionization of the power tubes is more reliable because the anode is driven negative a second time by the firing of the opposite

power tube of the inverter pair.

When the anode of a conducting thyatron tube is driven negative it does not remain negative, but immediately begins to rise as shown in Fig. 2B. The tube will start to conduct when its anode voltage becomes positive unless enough time has passed to allow the tube to deionize so that the grid can regain control. The time that the tube anode remains negative in Fig. 2B is determined by the values of commutating capacitors  $C_1$  and  $C_2$  and resistor  $R_1$  of Fig. 2A. The values chosen depend on two important factors: (1) Large values of  $C_1$  and  $C_2$  and small values of  $R_1$  keep the tube anode negative for longer periods, thus allowing time for deionization; (2) small values of  $C_1$  and  $C_2$  and large values of  $R_1$  provide higher efficiency for the circuit.

The time constant of  $C_1$  or  $C_2$  and the load determines the rate of voltage increase on the anode of the tube but the time constant of  $R_1$  with  $C_1$  and  $C_2$  determines the initial negative voltage on the anode of the tube. The values of  $C_1$ ,  $C_2$  and  $R_1$  must be such that they allow ample deionization time but the

circuit should be designed to obtain the shortest possible deionization of the power tube to obtain the highest efficiency from the circuit.

The amount of time required for the thyatron tube to deionize depends on a number of factors, some of which are the physical structure of the tube, the gas filling, the current it carries, the applied voltage, the grid circuit impedance and the negative grid voltage.

### Choice of Thyatrons

The structure and the gas filling can be considered in the choice of a proper tube. The current and the applied voltage are determined by the required power output and the d-c input voltage. The grid impedance and the negative grid voltage can be determined by the designer. The grid impedance should be kept as low as possible but must hold the grid current within the limits for the tube being used. Some systems for obtaining the proper grid impedance are explained in the literature on thyatron operation.

The negative grid voltage should be as large as possible but again must be held within the limits of

the tube. Tube ratings should be considered carefully because the allowable grid voltage is a function of the applied plate voltage.

### Complete Inverter

Temperature and deionization time considerations led to the use of inert gas tubes (ELC6J/K) in the complete inverter circuit of Fig. 3. This circuit shows one simple method of obtaining the voltage for the grid of the control tube.

In this operating circuit inductors have been placed in series with the anodes of the thyatron tubes and capacitors and resistors have been connected across the tubes. These components were not mentioned in the theory of operation of the inverter because their purpose is to insure long tube life.

The rate at which current ceases to flow and inverse voltage is applied to inert gas tubes is limited. The limit, called the commutation factor, is the product of voltage change per microsecond and current change per microsecond.

The inductors and capacitors are included in the circuit to decrease the commutation-factor duty on the tubes and therefore increase tube life. If these components were not included in the circuit the anode of the conducting tube would be driven negative at a high rate when  $V_3$  fired, and tube current would drop at a correspondingly high rate. The inductance in series with the anode of the tube causes the current to continue to flow for a short time after  $V_3$  has fired, and the capacitor across the tube causes the anode voltage to change at a slow rate. The value of these components must be chosen so that oscillation does not occur and the commutation factor is within the tube rating.

The tubes used in this circuit have a high commutation-factor rating and do not actually require the capacitor-resistor combination, but most other inert-gas thyatrons do require this cushioning. The cushioning helps remove the sharp breaks in the output wave shapes.

### Stability

The circuit shown operates from a d-c source that can vary from 180 to 260 volts. The unit supplies

1 kva at 115 volts, 60 cps. The output voltage remains constant within 2 volts for full input voltage swing and simultaneous load changes from full to 10 percent load. Frequency remains constant within 0.25 cps. The wave shape of the output voltage varies with the phase of firing of the control tube; in the range from 70 percent to full load the wave shape of the output voltage is nearly sinusoidal.

The 60-cps frequency of operation is obtained from multivibrator  $V_4$ . The plate voltage for this is held constant by a type 0A2 voltage-regulating tube to obtain reasonable frequency stability. The output is amplified by  $V_5$ ,  $V_6$  and  $V_7$  for feeding the grids of power tubes  $V_1$  and  $V_2$  and the grid of control tube  $V_3$  and for feeding a bias supply to hold the grids below ground.

The filaments of the tubes are supplied by the d-c input voltage to start the inverter. Once the inverter is started filament power is obtained from its output.

### Rectifier Circuits

The wave shape with a sharp leading edge for firing the power tubes is obtained by feeding each power tube grid through a half-wave rectifier ( $V_8$ ). The wave shape for firing the control tube is a sawtooth with a sloping leading edge and a sharply drooping trailing edge. This wave, having twice the output frequency, is obtained from the negative side of full-wave rectifier  $V_9$ , feeding a capacitor and bleeder resistor. The positive peaks of this wave lead the peaks of the grid waves on the power tubes by a few degrees. The lead should be as small as possible so that the power tubes will be under control up to nearly 180 degrees of conduction. A sloping front edge is used on the waveform of the grid of the control tube, so that varying the d-c potential on the grid circuit causes the grid wave to intersect the critical grid voltage at varying points, thus changing the phase of firing of the control tube.

The d-c potential for the grid of the control tube is controlled by temperature-limited diode  $V_{10}$  whose filament is fed from the output of the inverter. An increase in in-

verter output voltage increases the d-c voltage on the grid of the control tube, thus causing the tube to fire earlier in phase and decrease the output voltage.

Various systems of sampling could be used in place of the temperature-limited diode, which has some time lag. One fast method of control would be to use a full-wave rectifier fed directly from the output voltage and let the output of this rectifier feed the control tube grid. If this rectifier has a resistive load the peak voltage of the output would be controlled within each half-cycle of operation. Capacitance could be added to the circuit to control the average output voltage.

### Conclusions

The regulation obtainable from the controlled-firing-time inverter is entirely dependent upon the reference voltage. The speed of response of the regulating system can be increased to the point where no peak output wave will go above a chosen limit. The frequency stability of the inverter depends on the frequency source, which could be crystal or tuning-fork controlled. The regulating system affects the time of extinguishing the tubes and therefore does not cause frequency jitter in the firing of the tubes.

This system has the advantage of inverting only the v-a required at the load, thus keeping the output transformer size at a minimum and obtaining the maximum power from the thyatron tubes. The smaller output transformer and the elimination of the saturable reactor lead to a much smaller and lighter inverter. The extremely fast regulating system leads to more dependable operation during line or load variations, even to the point of switching loads.

The efficiency of the system depends on the range of line and load variation for which the system must compensate, and is a function of the time allowed for storing energy in the commutating capacitors to deionize the power tubes. A considerable increase in efficiency will be realized in high-power units using ignitron tubes due to the deionization characteristics of these tubes.

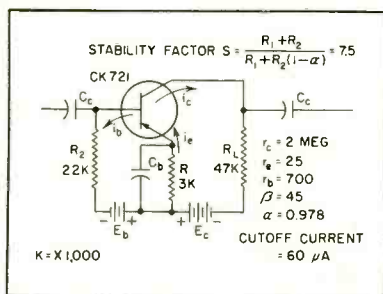

FIG. 1—Basic grounded-emitter transistor circuit used in amplifier, with design characteristics and data

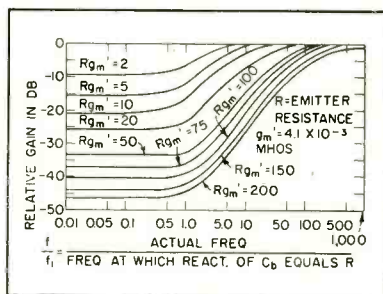

FIG. 2—Gain curves at low frequencies in R-C amplifier as result of resistance-capacitance emitter impedance

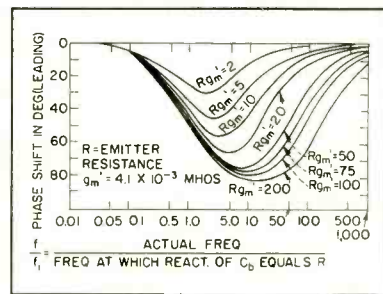

FIG. 3—Phase shift of output voltage at low frequencies in transistor amplifier having R-C emitter impedance

# Transistor Preamplifier Feeds Tubeless Servo

**SUMMARY** — Four-transistor circuit permits use of choppers, thermocouples or strain gages with 60-cps combination transistor-magnetic amplifier servo. Power gain of preamplifier is over 100 db for 40-cps bandwidth

WITH THE development of servo amplifiers using magnetic amplifiers and transistors there was a need for a high-gain preamplifier for the servo amplifier, to permit use with thermocouples and strain gages in conjunction with d-c to a-c converters. This article describes a flexible high-gain transistor preamplifier which has been used successfully with a 60-cps transistor magnetic servo amplifier and is adaptable to most carrier-type servo systems.

The unit is stabilized for temperature ambients of 0-50C in that this temperature range will not affect the operation of the amplifier by a severe shift of operating points. It has a minimum of 100-db power gain with a signal-to-noise ratio of 60 to 1. Passband is approximately 40 cps at 60 cps. Three identical stages and a transformer-coupled output stage make it possible to utilize one, two or three of the stages, depending on the gain requirements of the servo system.

The grounded-emitter R-C coupled amplifier stage used is shown in Fig. 1, with the various currents and voltages marked. For the amplifier

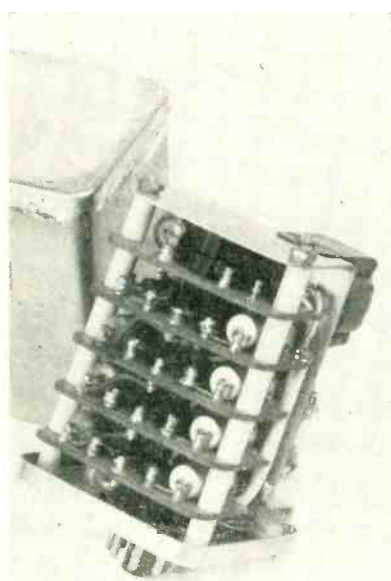

Complete four-stage transistor preamplifier for coupling low-level input transducers to standard servo amplifier

to be stable over temperature ranges of 0-50C, the stability factor must be as low as possible since any change in the cutoff current of the transistor is multiplied by the stability factor and appears in the collector current, shifting the d-c operating points. For this amplifier a stability factor of 7.5 gave satisfactory results.

### Design Criteria

The major difficulties in the development of a transistor amplifier for a frequency as low as 60 cps were the loss in amplification and the phase shifts associated with the R-C coupling networks and bypass networks. Due to the extreme sensitivity of the basic servo amplifier to the phase of the input signal, the phase shift of the preamplifier had to be a minimum and the gain a maximum to reduce the number of stages to a practical figure.

The emitter resistance must be bypassed by a capacitor of considerable size (100  $\mu$ f) to reduce the

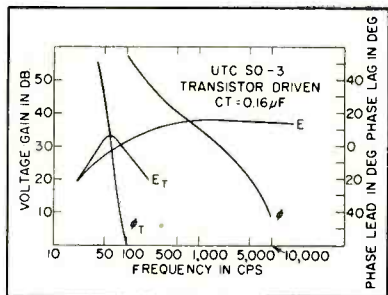

FIG. 4—Effect of tuned output circuit (T curves) on voltage gain and phase shift, as compared to untuned output

By H. R. ZELLER, JR.

Research Division  
Raytheon Manufacturing Co.  
Waltham, Mass.

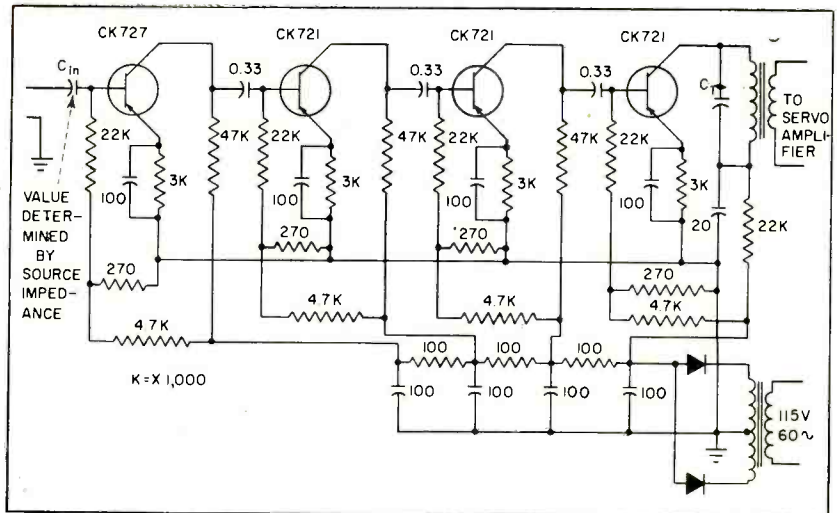

FIG. 5—Complete circuit of four-transistor preamplifier, operating from germanium-rectifier power supply

phase shift and loss of amplification at low frequencies. Figures 2 and 3 show this effect on amplification and phase shift.

Another important component with respect to low-frequency gain is the coupling capacitance, which produces additional low-frequency attenuation and phase shift in the amplifier. A coupling capacitance of large physical size increases susceptibility to noise pickup. A coupling capacitance of 0.33 μf produces a minimum loss in amplification and minimum phase shift at 60 cycles, at a reasonable physical size.

### Output Impedance

The output impedance of a grounded-emitter amplifier stage is high and the input impedance of the transistor magnetic servo amplifier is approximately 1,500 ohms. Therefore, transformer coupling was necessary between the preamplifier and the servo amplifier. A few commercially available miniature transformers are usable if tuned for 60 cycles with a capacitor across the primary winding.

This capacitor provides a convenient means of phase correction for the preamplifier when used in conjunction with a d-c to a-c chopper, due to the inherent phase shift of the chopper. The capacitor also

reduces the noise level by narrowing the passband.

The effect of the tuned output stage is shown in Fig. 4. A small change in capacitance will provide phase correction without a great effect on the 60-cycle gain. This is necessary since the servo amplifier requires an input in phase or 180 deg out of phase with the line voltage applied to it.

The disadvantage of transformer-coupled output is that the output transistor is forced to swing over a large voltage range to compensate for the impedance ratio of the transformer. However, this can be done if the output is restricted to 3 volts peak to peak. This is more than sufficient for full output from the servo amplifier.

### Gain

If four stages of amplification are required, coupling between these stages through the power supply can be reduced to a minimum by individual bleeder networks for each stage. These networks divide the supply voltage for the collector supply and the base bias. The power transformer and germanium rectifiers supply 50 volts d-c at 40 ma, which is filtered by three R-C networks.

The four-stage preamplifier

shown in Fig. 5 is sensitive to inputs of 1 to 7 microvolts, 3 microvolts producing the required output of 3 volts peak to peak. The gain of the preamplifier depends largely on the transistors used, but is usually 120 db with a total phase shift of approximately 35 deg leading. At full output with approximately 10-percent distortion, the equivalent noise input is 0.012 microvolt, giving a signal-to-noise ratio of approximately 60 to 1. The passband of the amplifier is from 40 to 80 cycles, ± 3 db.

At this time the addition of more stages does not seem practical, due to the fact that the input stage is already close to noise level.

There are many types of input circuits which can be used with this combination. A d-c to a-c chopper has been mentioned previously, its main difficulty being its associated phase lag, which must be corrected by capacitance across the primary of the output transformer. An a-c strain gage is another possible input, as are differential transformers and potentiometers.

If potentiometer input is used, the input capacitor to the preamplifier must be of sufficient size in relation to the impedance of the potentiometer to minimize phase shift and loss in amplification.

# Cross Pulse Pickup in Twisted-Pair Cable

**SUMMARY** — To reduce bulk and expense in station layouts, engineers are often tempted to use twisted-pair cable instead of coaxial cable. Chart showing pickup in various kinds of cable indicates when this practice is acceptable

**W**HERE PULSED video signals must be connected to many different points in large electronic systems, the conservative approach is to use coaxial cables throughout. This ensures against cross pickup of signals between circuits, but can be expensive because of the cost of cable, terminations and installation labor. The bulk of the cable trunks can present problems in the layout of the system.

Tests on a sample length of twisted-pair communication cable and subsequent system experience have shown that certain types of pulsed signals, gate waveforms etc can be transmitted appreciable distances over twisted pairs without difficulty due to cross pickup. The feasibility of this method for a given application will depend on the steepness of pulses, sensitivity of other circuits to spurious interfering transients, length of cables etc.

It is important that the designer have some idea of the magnitude of the attenuation of cross pickup between pairs that can be expected under various conditions. The following information may help in deciding whether coaxial cable or twisted pairs can be used in a specific case.

A series of measurements was

**By J. GREGG STEPHENSON**

*Airborne Instruments Laboratory, Inc.  
Mineola, New York*

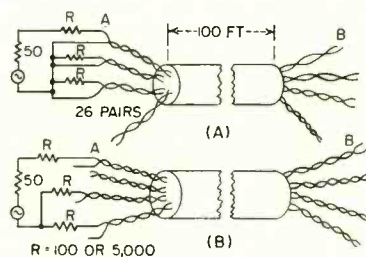

**FIG. 1**—Method for observing cross pickup in twisted pairs (A) and in single wires (B)

made on the cross pickup of pulses in a 100-foot length of standard, vinyl-jacketed, 26-pair communication cable, made with No. 22 solid copper wire with plastic insulation.

The connections for testing are shown in Fig. 1. Pair No. 25 was driven by a pulse generator with 10-microsecond pulses at 1,000 pps and 50 volts amplitude. The internal impedance of the generator was adjusted until the rise time of the pulse on the driven pair was 1 microsecond. Under these conditions the decay time was also found to be approximately 1 microsecond. The peak amplitude and nature of the transient on each of the other wires or pairs in the cable was then observed

and recorded on a wide-band oscilloscope.

Various impedance levels on the other wires or pairs were set by the value of resistors R. The attenuation data plotted in Fig. 2 were taken at the sending end of the cable, point A. Cable reflections complicate the nature of the transient observed at the far end of the cable, point B, but the general level of peak transients is about the same as that recorded at point A. The attenuation figures refer to the level of the observed peak of the transient due to cross pickup in decibels below the 50-volt input pulse on the driven pair. The attenuation figures actually represent a voltage ratio  $20 \log_{10} 50/V_a$  where  $V_a$  is the peak voltage amplitude of the transient due to cross pickup. Strictly speaking, this is not in decibels because of the differing impedance levels.

Typical transients observed as a result of cross pickup are shown in Fig. 3.

## Conclusions

The measured results lead to the following conclusions, which apply specifically to a 100-foot length of standard communication cable.

- (1) With no grounded wires

(Continued on page 172)

# CINCH ★ STANDARD COMPONENTS



**AUTOMATION**...automatically made, therefore made with precision metal and electrical components. CINCH automatically assembled parts assure the uniformity and quality mandatory for use in **AUTOMATION** in the end users equipment.

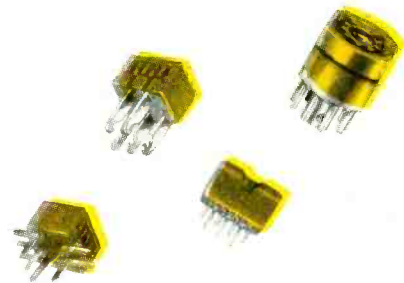

**CINCH SUB-MINIATURE SOCKETS** insure positive electrical control, hold tubes securely in place, permit easy maintenance replacement, yield maximum insulation and minimum high frequency loss.

Cinch components available at leading electronic jobbers —everywhere.

Centrally located plants at Chicago, Shelbyville, Pasadena and St. Louis.

## CINCH SOCKETS

**CINCH MANUFACTURING CORPORATION**

AND

**HOWARD B. JONES DIVISION**

TUBE (RECEIVER, TRANSMITTER AND SPECIAL): BATTERY, ALL TYPES

C-R TUBE

CRYSTAL

ELECTROLYTIC

GLASS TYPE; 4 TO 7 PRONG LAMINATED

INFRA-RED RAY TUBE

HIGH ALTITUDE AIRBORNE TYPES

KINESCOPE; MAGNAL, DUODECAL, DIHEPTAL

LOKTAL-MINIATURE-MULTIPLUG-NOVAL-OCTAL (MOLDED BAKELITE, STEATITE, TEFLON, KEL-F AND LAMINATED)

PLEXICON

PRINTED CIRCUIT

SPECIAL SOCKETS TO SPECS

SUB-MINIATURE; HEARING AID TYPES

TV; 110V CIRCUIT BREAKAWAY

VIBRATOR

PENCIL TUBE TRANSISTOR DIODE



**Quantity production of low loss Mica components.** Finest molding machines and equipment operated under most experienced guidance and engineering supervision with adequate and unequalled facilities has advanced CINCH to the foremost in production of low loss Mica components in quantity.

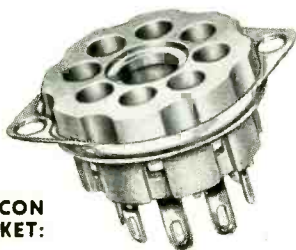
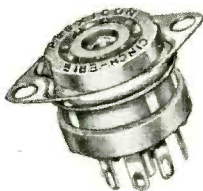

### CINCH-ERIE PLEXICON VACUUM TUBE SOCKET:

With built-in ceramic condensers, Plexicon Tube Sockets, no larger than standard receiver socket, provide the most effective method of by-passing . . . with condenser close to tube element providing shortest path to the ground . . . capacity up to 1,000 MMF—the tube element may be coupled or by-passed as desired.



**Cinch**  
ELECTRONIC  
COMPONENTS

(SHOWN ENLARGED)

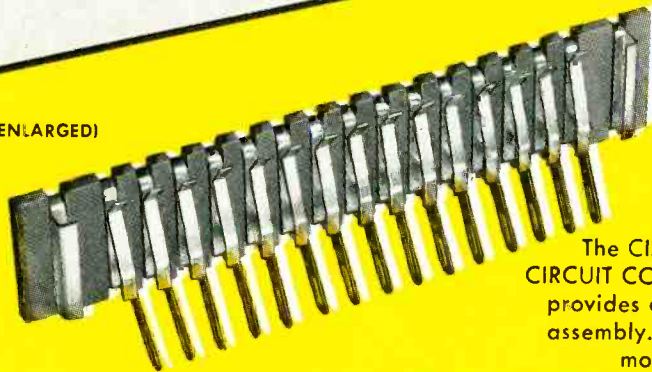

The **CINCH EDGE CIRCUIT CONNECTOR** provides quick, easy assembly. Eliminates moisture trap.

Allows more flexible tolerances. Lower cost. Available in materials for both Military and Commercial use.

★ **CINCH** metal plastic assemblies fully perform the service for which they were designed and often have anticipated the engineering needs of the future. So that today, judged by demand and usage, CINCH components are "the standard".

**CONSULT CINCH**

**CINCH MANUFACTURING CORPORATION**

1026 South Homan Ave., Chicago 24, Illinois

Subsidiary of United-Carr Fastener Corporation, Cambridge, Mass.

# Cross Pulse Pickup in Twisted-Pair Cable

(Continued from page 170)

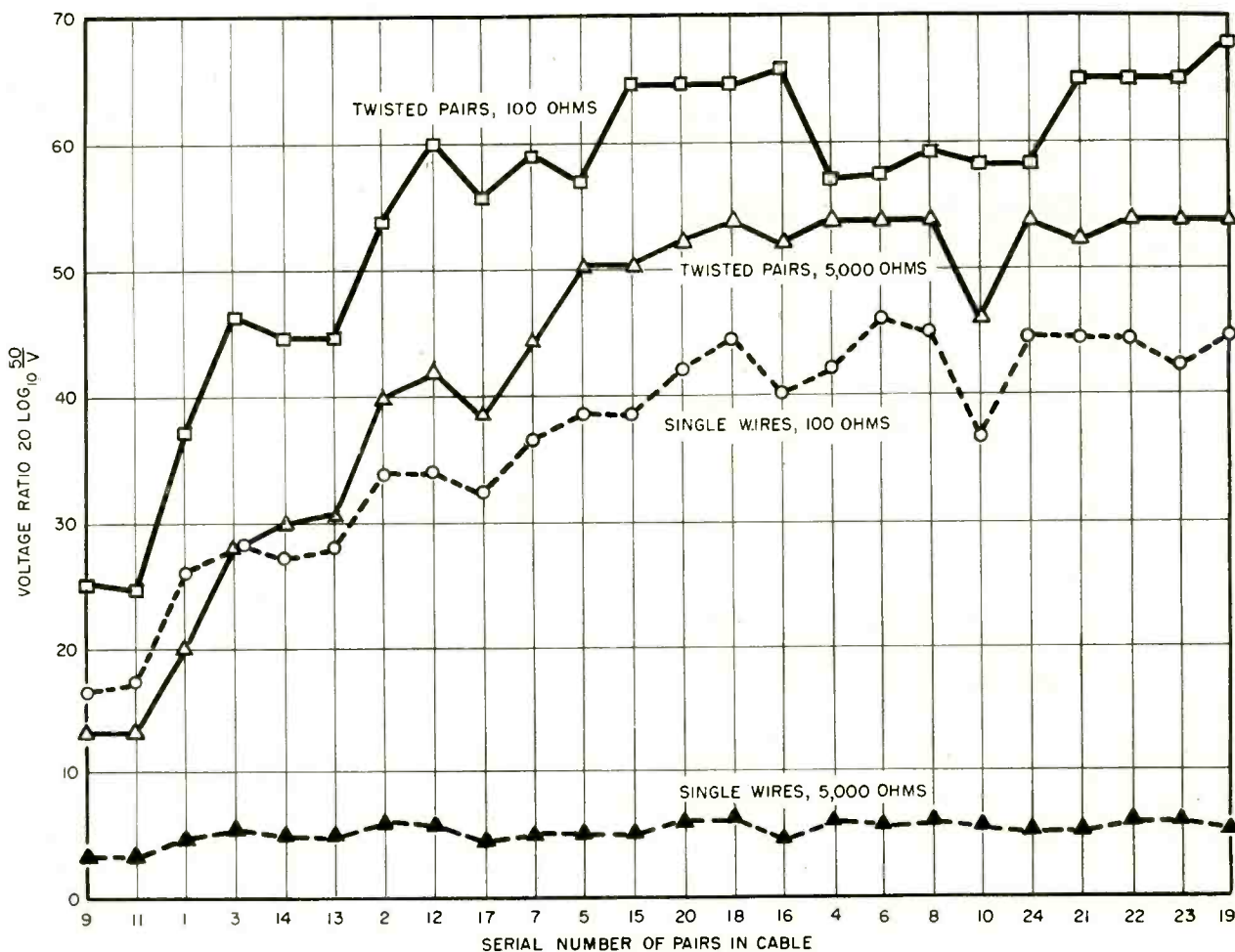

FIG. 2—Attenuation versus serial number of pairs in Alpha 1312 cable 100 ft long with 26 pairs of No. 22 solid wire; 50-v input pulse is applied to pair No. 25

in the cable, the cross pickup on individual wires of the other pairs is attenuated only 3 to 6 db.

(2) With no grounded wires in the cable, the cross pickup on individual wires of the other pairs improves to a level between 16 and 44 db when the impedance level is reduced to 100 ohms.

(3) Using twisted pairs, with one wire of each twisted pair grounded and serving as a partial shield, the attenuation of cross pickup increases markedly. At a 5,000-ohm impedance level, twisting improves the attenuation by 10 to 48 db. At a 100-ohm impedance level, twisting increases the attenuation by 9 to 26 db.

(4) The best conditions for attenuation of cross pickup were observed at a 100-ohm impedance level with twisted pairs.

The total attenuation varied from 24 to 68 db on various pairs. At a 5,000-ohm impedance level with twisted pairs, the attenuation varied from 13 to 54 db.

(5) The worst cases of cross pickup were observed on the

pairs physically nearest to the driven pair in the cable lay (pairs 9 and 11). The really bad cases appear to be limited to about 10 percent of the pairs in the cable. All others show at least 10 db more attenuation than the few worst pairs.

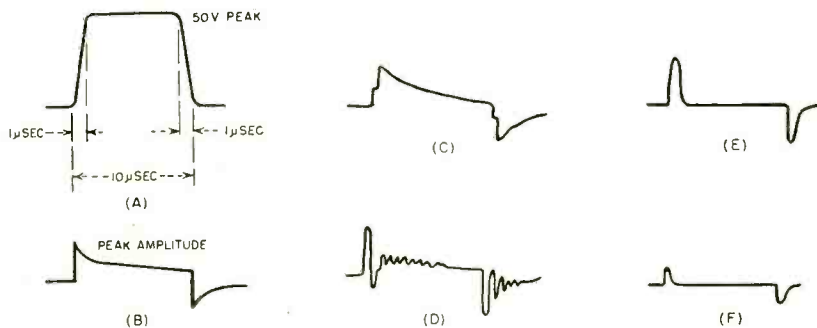
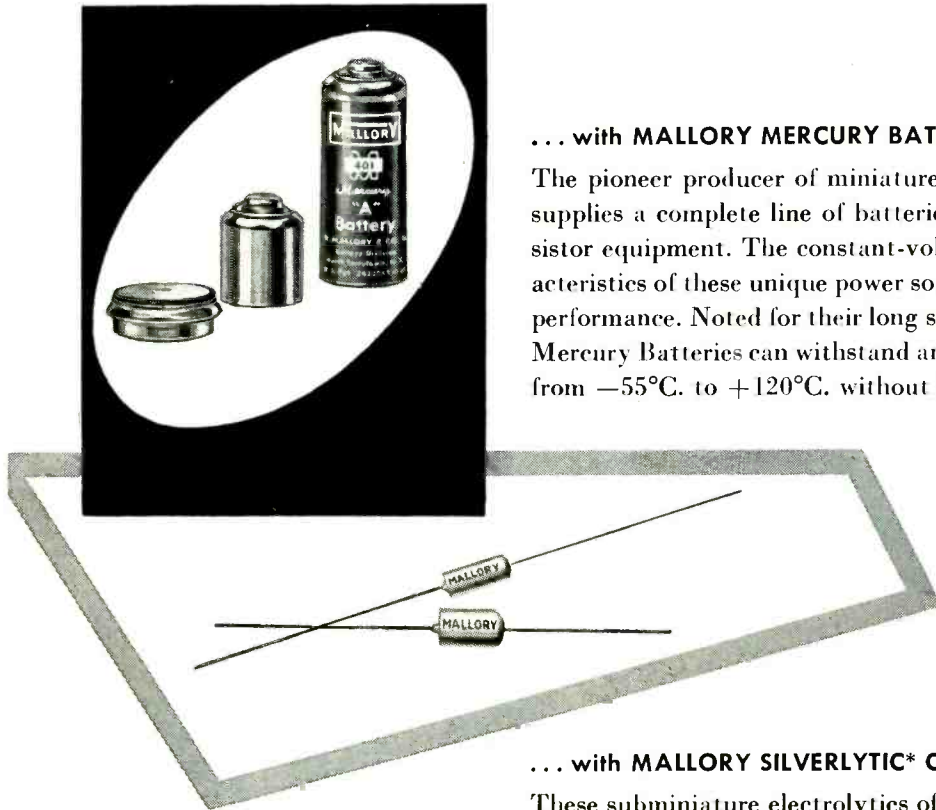

FIG. 3—Typical transients: 50-v input pulse (A), pickup at 5,000-ohm level, single wire (B), 5,000-ohm level, twisted pair (C), 5,000-ohm level, single wire at unterminated end (D), 100-ohm level, single wire (E) and 100-ohm level, twisted pair (F)



# Save Space and Assure Dependability in Transistor Circuits



## ... with MALLORY MERCURY BATTERIES

The pioneer producer of miniature mercury batteries, Mallory supplies a complete line of batteries and Power-Paks for transistor equipment. The constant-voltage, constant-current characteristics of these unique power sources provide peak transistor performance. Noted for their long service and shelf life, Mallory Mercury Batteries can withstand ambient temperature extremes from  $-55^{\circ}\text{C}.$  to  $+120^{\circ}\text{C}.$  without impairment of output.

## ... with MALLORY SILVERLYTIC\* CAPACITORS

These subminiature electrolytics offer top quality for service in miniaturized equipment. Two different types are available:

**Type TAP.** Values up to 30 mfd. at 6 volts, and in higher voltages as well. Measures  $\frac{7}{32}$ " in diameter by  $\frac{3}{8}$ " long. Rated for  $-55^{\circ}\text{C}.$  to  $+85^{\circ}\text{C}.$

**Type TAW.** Five basic capacitance values from 1 mfd. at 24 volts to 6 mfd. at 4 volts. Each capacitance value also available at lower voltage ratings at slightly less cost. Just 0.145" in diameter by  $\frac{3}{8}$ " long.

*Expect more...*

*Get more...*

from **MALLORY**

Plan to utilize the excellent electrical performance of these Mallory miniature components in your transistor equipment... or in any low-voltage electronic circuits where space must be conserved. For complete technical data, write or call Mallory today.

Parts distributors in all major cities stock Mallory standard components for your convenience.

### Serving Industry with These Products:

**Electromechanical**—Resistors • Switches • Television Tuners • Vibrators  
**Electrochemical**—Capacitors • Rectifiers • Mercury Batteries  
**Metallurgical**—Contacts • Special Metals and Ceramics • Welding Materials

\*Trade Mark



# Electrons At Work

Edited by ALEXANDER A. MCKENZIE

## Trans-Caribbean Television Broadcast



Bridging the 250-mile distance between Havana, Cuba and the mainland of Florida, radio engineers used an aircraft flying at 11,000 feet to relay television signals. Signals from CMBF on channel 7 were picked up in a C-47 plane of Cubana de Aviacion. A directive receiving antenna was trained by hand as the operator watched a field-strength meter. Engineers of the CMQ network used another directional array to retransmit the signal on channel 13 with 18 watts on sync peaks. Picked up at Miami Beach, the program was put on the NBC network. Enrique Pages of CMQ and Lew Hathaway of NBC are shown seated before the equipment in the aircraft

## Proton Measurement Uses New Nuclear Microscope

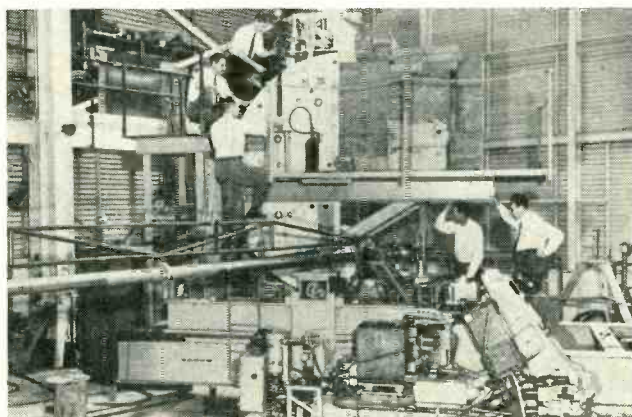

Stanford University physicists hope eventually to measure protons using a technique developed under a contract to the Air Research and Development Command. Instrumentation involves use

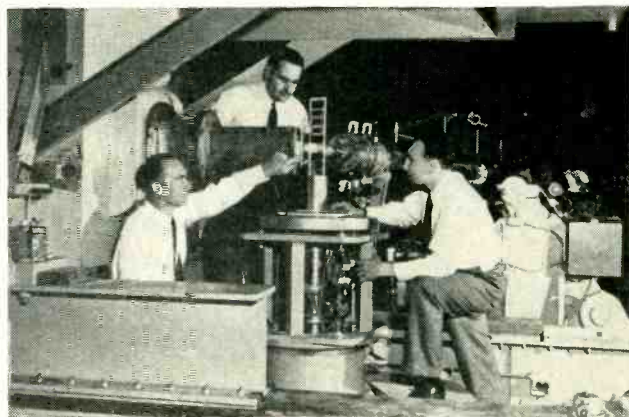

of a 220-foot electron linear accelerator coupled to a 55-ton, 16-foot-high magnetic spectrometer. The equipment is said to make nuclear particles appear about 100,000 times bigger

## Propagation of VHF and UHF TV Signals

ANOMALIES in earlier propagation theory brought about the so-called freeze of television allocations. An Ad Hoc committee completed, in 1949, a statistical study from which new empirical propagation curves were evolved, although the basic data were scanty.

In a recent FCC report entitled "Present Knowledge of Propagation in the VHF and UHF TV Bands" by William C. Boese and Harry Fine it is noted that present FCC uhf tropospheric curves do not adequately represent data collected since 1949.

In particular, quantitative data concerning propagation in the vicinity of the horizon are needed. However, the brochure points out, since the establishment of a reference file last June by FCC, no broadcast data has been filed.

*(Continued on page 176)*

# KEPCO

# NEW!

## 1.5 Ampere

# SERIES

## VOLTAGE REGULATED POWER SUPPLIES

for powering  
electronic equipment

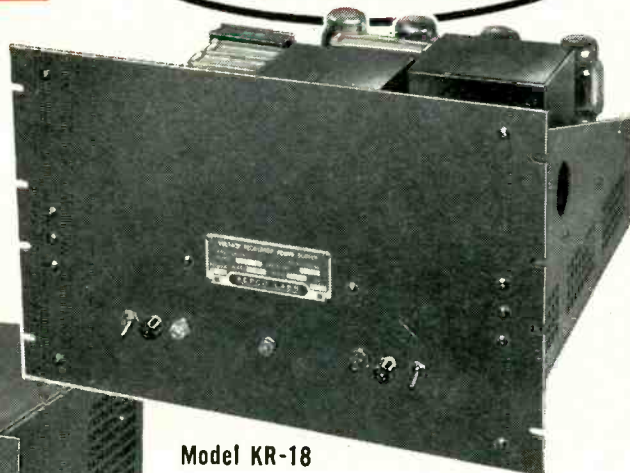

Model KR-18

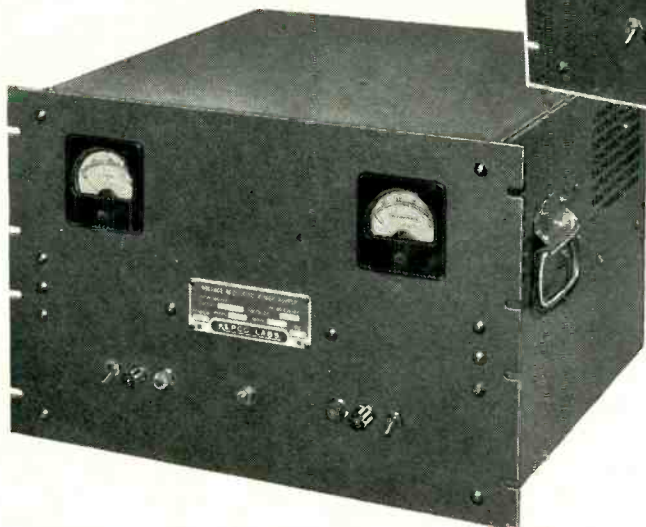

Model  
KR-18MC

### FEATURES:

- Fast Recovery Time, Suitable for Square Wave Pulsed Loading.
- Voltage Range continuously variable without Switching.
- Either Positive or Negative may be Grounded.
- Oil Filled Condensers.
- Wire Harness and Resistor Board Construction.
- Power Requirements 105-125 volts, 50-60 cycles.
- Terminations on rear of unit.
- Locking type voltage control, AC, DC Switches, Fuses, and Pilot Lights on Front Panel.
- Color Grey Hammertone.
- Guarantee One Year.

Build these compact Power Supplies into your equipment!

**KR** Voltage Regulated Power Supplies are conservatively rated and are designed for continuous duty at 50°C ambient.

**REGULATION:** Less than 0.2 volts for line fluctuation from 105-125 volts and less than 0.2 volts for load variation from 0 to maximum current.

**RIPPLE:** Less than 3 mv. rms.

To Include 3" Current and Voltage Meters, Add M to Model number (e.g. KR 16-M) and Add \$30.00 to the Price.  
To include Dust Cover and Handles for Table Mounting, Add C to Model number (e.g. KR16-C) and Add \$10.00 to the Price.  
To include Meters, Dust Cover and Handles, Add MC to Model number (e.g. KR-16 MC) and Add \$40.00 to the Price.  
PRICES F.O.B. Flushing.

### 1.5 Amp. **KR** SERIES

Model	Volts	6.3V AC	Rack Mount			Price
			W	H	D	
KR16	0-150	Each supply	19"	12¼"	17"	\$625
KR17	100-200	has two	19"	12¼"	17"	\$625
KR18	195-325	15 Amp.	19"	12¼"	17"	\$695
KR19	295-450	outputs	19"	12¼"	17"	\$695

The KEPCO KR SERIES in the above voltage ranges are available in 600 Ma. — 300 Ma. — 125 Ma. series.

### A LINE OF 50 MODELS

Available from Stock - Catalog on Request



# KEPCO LABORATORIES

131-38 SANFORD AVENUE • FLUSHING 55, N.Y. • INDEPENDENCE 1-7000

# Supersonic Gun Aids Missile Research

PROJECTILES fired at velocities many times the speed of sound point the way to proper design of missiles and rocket ships. The gun recently developed by Universal Winding of Providence, R. I., for Aberdeen Proving Ground is capable of firing 1-ounce projectiles at speeds up to Mach 11 (12,000 feet a second).

Low density and high acoustic velocity of hydrogen gas makes this a suitable propelling medium. The gun becomes an important research

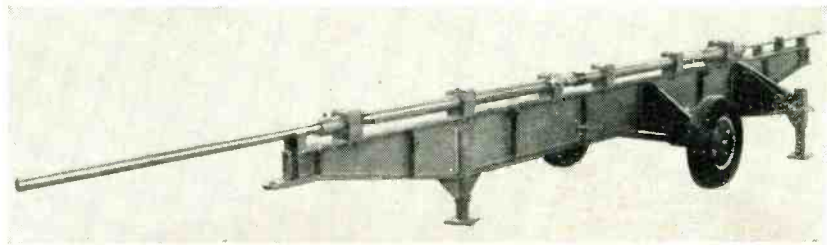

Hypersonic research weapon for study of the heat barrier as it affects electronic equipment in space vehicles

device in studies of the heat barrier, described as the crucial limit-

ing factor in design of hypersonic missiles and electronic cargoes.

## Transistor Processing Improved

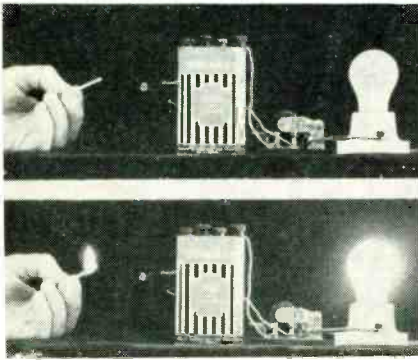

New photodiode, relay and 1.5-volt battery turn on bulb when the photosensitive device is triggered by light from a match

IMPROVED technique for making transistors and other solid-state devices has been announced by Clarence Zener of Westinghouse Research Labs. Originated by R. L. Longini, the development is an improved means of making junction-type *pnp* germanium transistors.

He explained that a thin slice of *n*-type germanium is ordinarily placed between two layers of the metal and heated. Metal atoms dissolve inward through the germanium, forming two outside layers of *p*-type germanium and leaving a very thin layer of *n*-type between. The thinner and more uniform the *n* layer, the better the performance of the finished transistor.

Too high a processing temperature melts away the layer; too low a temperature leaves the layer too

thick. The Westinghouse process is said to involve a cooling off period during the heating of the transistor. This treatment allows the critical *n*-layer to build up to the desired thickness and uniformity instead of being dissolved.

Applied to photodiodes, the new process is said to have produced devices that are supersensitive to light. Although not yet used in production manufacture, the technique has permitted laboratory fabrication of transistors that can be operated at high radio frequencies.

## Field Emission Cathode

INEXPENSIVE and simple, a newly developed method for producing electrons can lead to better flash x-ray photography and generation of electromagnetic waves shorter than those now in common use.

The principle of field emission is not new, having been reported in 1897 by Robert W. Wood, but attempts toward practical application were unsuccessful. Newer techniques have been employed by the physics department of Linfield College, McMinnville, Oregon, under the direction of W. P. Dyke.

Electrons are customarily produced by heating a metal filament in vacuum. The field emission technique releases electrons by application of difference of potential. The field emitter developed under Office of Naval Research contract is a tiny tungsten needle less than 0.0001

inch in diameter. When several needles are mounted in a comb array, currents up to 20 amperes at a peak power of more than a million watts have been obtained.

## Aircraft Approach Speed

EYES focused on the carrier deck instead of the instrument panel may assure a pilot safer touchdown. Such procedure may be possible by adoption of a system under consideration by Bureau of Aeronautics and scheduled for tests at Naval Air Development Center, Johnsville, Pa.

If his speed is correct, the pilot

## Emergency Navigation Aid

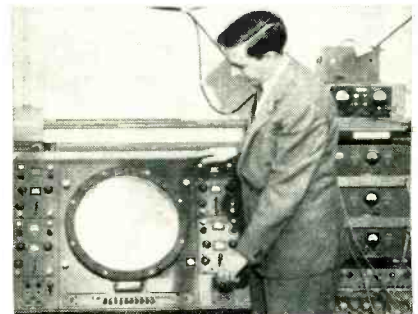

Exact position of aircraft can be determined using new equipment that projects a map of the desired area on a cathode-ray screen. Lines emanate from direction-finding units to corresponding points on the map. Built by Bendix for Rome Air Development Center, the device helps airport personnel to spot exact location of plane in nearly zero-zero conditions

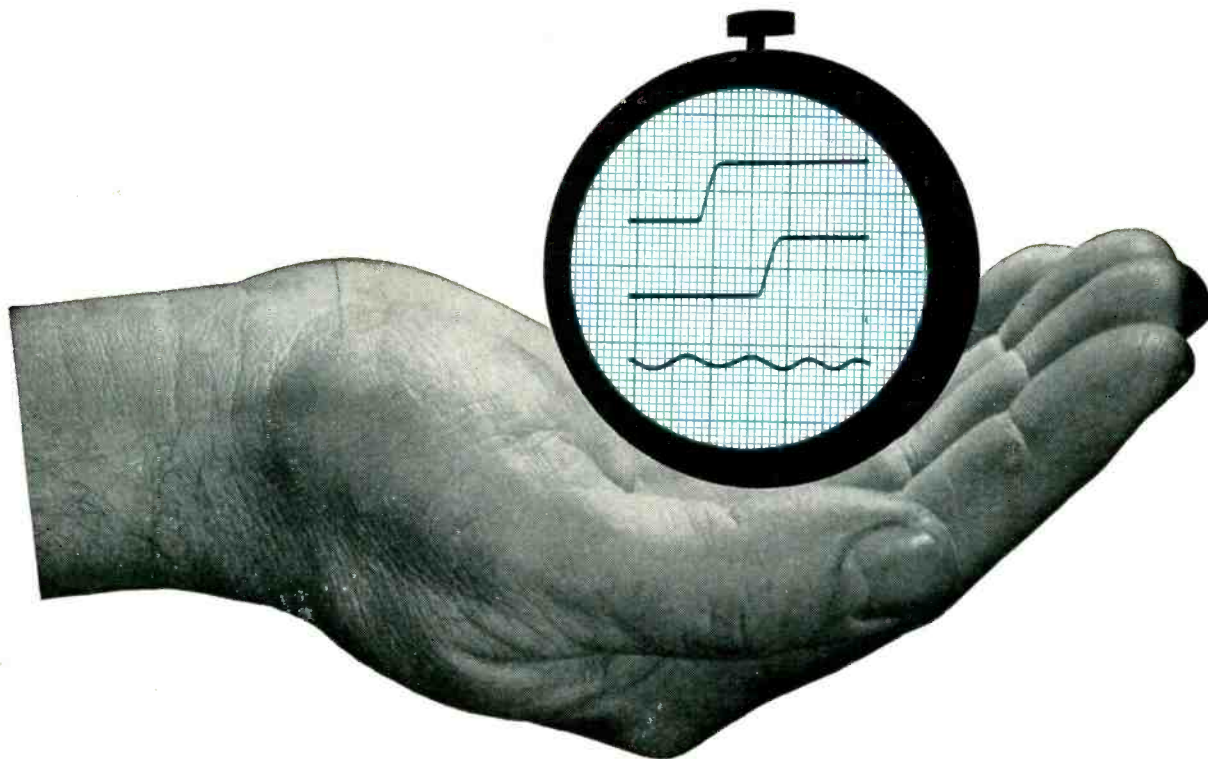

## time on our hands

Here's a handful of microtime . . . doled out in hundredths of a millimicro-second. It's our new HELIDEL\* delay line.

It's precise . . . wide-band . . . continuously variable. This is not an adwriter's pipedream . . . it's an engineer's, come true.

Which means that definitions are in order.

Precise = delay increments of only  $2 \times 10^{-11}$  sec; resolution 0.01% and better; linearity "better than  $\pm 1\%$ " . . . actually, so fine it can't be measured.

Wide-band = transmission of pulse signals up to 20 mc with negligible phase-distortion, overshoot, or distortion of waveshape.

Continuously variable = a distributed-constant, electromagnetic type . . . dreamed up in 1946 . . . developed in helical form since 1951, by Helipot and DuMont.

The HELIDEL is already used successfully in color-TV broadcasting and oscilloscopes . . . and as a trimmer in transmission systems.

What can you dream up?

 **Helipot** *first in precision potentiometers*

*Helipot Corporation / South Pasadena, California*  
*Engineering representatives in principal cities*  
*a division of BECKMAN INSTRUMENTS, INC.*



*To help you dream,  
there's a 10-page technical  
paper on the HELIDEL,  
presented at the 1954  
WESCON . . . and a new data  
sheet, with complete specs.  
For your copies, write  
for Data File 201.*

444 \*TRADEMARK

30-10000

approaching the carrier hears a steady tone in his earphones. If approaching too fast, he hears a high-pitched pulsed tone. The tone is low pitched if speed is too slow. Rate of tone pulsation increases with departure from desired approach speed. Such a system is already in use on British carrier aircraft.

## Checking Impeller Stress

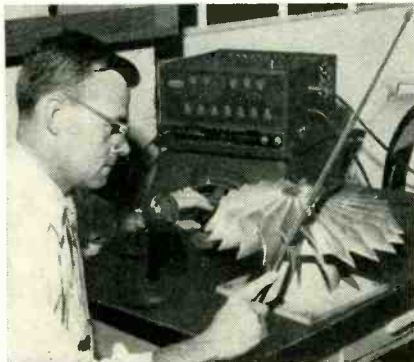

If the natural frequency of a particular blade in an inducer wheel is excited by aerodynamic disturbances, the blade will vibrate and may interfere with operation of the jet power plant. The engineer at Fairchild Engine Division draws a cello bow across the part and measures its frequency to check characteristics

## Plug-In Antenna

NOVEL means suggested for picking up television programs uses a coupling loop and folded dipole equivalent to a half wave at the lowest frequency. The device plugs into a wall outlet, the most effective one being chosen by experiment.

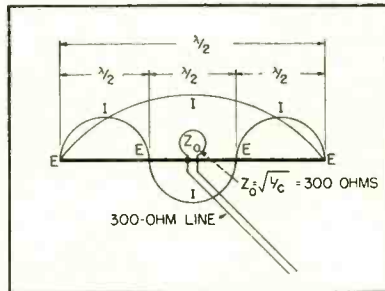

Impedance of the coupling loop is independent of frequency

Most favorable location is the outlet situated at a current-loop position of standing waves on house wiring and conduit system. As shown in the circuit drawing, the colinear antenna is coupled to a loop having an impedance  $Z_0$  that can be adjusted. Designed by A. L. Munzig, the unit is manufactured by Rytel.

## Automatic Dial Calibrator Speeds Standardization

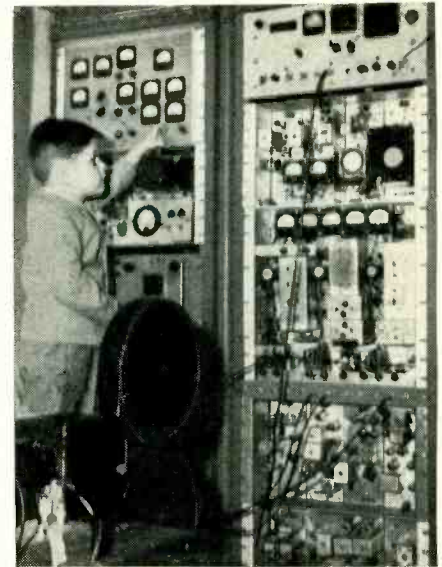

So simple a child can operate (see photograph) an electronic device developed by Lavoie Laboratories at a cost of \$100,000, calibrates and standardizes metered devices 48 times faster than human hand and is accurate to one part in 100,000. In one application, a frequency meter is provided a direct-reading film dial that shows markings of a master frequency standard

## Time-Voltage Pulse Discriminator

By CHARLES E. LOWE  
Fenton, Michigan

MOST SYSTEMS of measurement or difference detection compare the order of magnitude of the two quantities being measured. Sensitivity to small differences becomes less as the values increase in magnitude. In the method of error detection to be described here, a voltage difference that is detected at repeated time intervals is given a discrete interval of time in which to create an output signal.

By not sharing the output signal time with the main magnitudes formed of the equal quantities in the values being compared, an existing difference is set apart as a discrete unit, a pulse, that is definitely present or is not present. Thus time and voltage can be used to separate a difference quantity from a voltage and error detection

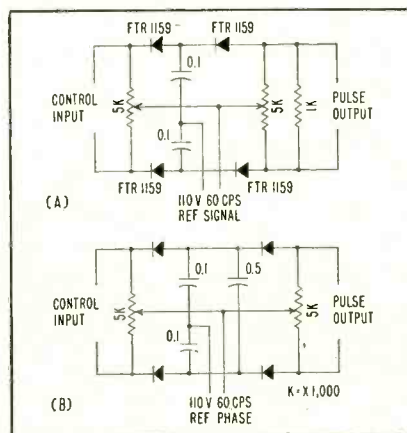

FIG. 1—Basic discriminator circuit (A). Addition of 0.5- $\mu$ f capacitor (B) increases height and width of output pulse. Null indicating meter replaces resistance across potentiometer

becomes a function of the small circuit voltage required for pulse formation.

The basic circuit is shown in Fig. 1. It is a simple network of passive

components. The input portion is similar to conventional discriminator circuits in the charging of two identical capacitors. It is the voltage-controlled switching action of the output half that is different.

Under balance conditions, the two capacitors are equally charged and discharged by the reference alternating potential and produce no output signal. Since the discharge rectifiers are turned off on the charging cycle, balance is indicated by a highly undisturbed zero. Input and output potentiometers permit separate adjustment for the initial balance.

Since the charging paths of each capacitor include resistance, the capacitor voltages will lag the voltages of the reference phase. On each cycle as the charging voltage reaches its peak and starts to decline, it will meet and pass the rising capacitor voltages. When the

## A COMPLETE LINE OF DEPENDABLE ENCAPSULATED RESISTORS



# PERMASEAL®

## PRECISION WIREWOUND RESISTORS FOR 85C AND 125C AMBIENTS

When you have applications requiring accurate resistance values at 85C and 125C operating temperatures, in units of truly small physical size—you'll find the resistor you want is one of the 46 standard PermaSeal designs in tab and axial lead styles.

They meet or exceed requirements for all types of military and industrial electronic apparatus and instruments. They are "extra-protected" by a special Sprague-developed plastic embedding material that performs beyond the se-

vere humidity resistance specifications of MIL-R-93A and Proposed MIL-R-9444 (USAF).

PermaSeal winding forms, resistance wire and embedding material are matched and integrated to assure long term stability at rated wattage over the operating temperature range.

These high-accuracy units are available in close resistance tolerances down to  $\pm 0.1\%$ . They are carefully and properly aged for high stability by a special Sprague process.

# SPRAGUE

FOR COMPLETE DATA  
WRITE FOR COPY  
OF SPRAGUE  
ENGINEERING  
BULLETIN NO. 122A



SPRAGUE ELECTRIC COMPANY • 35 MARSHALL ST. • NORTH ADAMS, MASS.

# Laboratory Standards

## MEASUREMENTS CORPORATION



MODEL 65-B



MODEL 79-B



MODEL 71

### STANDARD SIGNAL GENERATORS

MODEL	FREQUENCY RANGE	OUTPUT RANGE
65-B	75 Kc.-30 Mc.	0.1 microvolt to 2.2 volts
80	2 Mc.-400 Mc.	0.1 to 100,000 microvolts
80-R	5 Mc.-475 Mc.	0.1 to 100,000 microvolts
82	20 cycles to 200 Kc. 80 Kc. to 50 Mc.	0-50 volts 0.1 microvolt to 1 volt
84-TRV	400 Mc.-1000 Mc.	0.1 microvolt to 0.5 volt
84	300 Mc.-1000 Mc.	0.1 to 100,000 microvolts

### SQUARE WAVE GENERATOR

MODEL	FREQUENCY RANGE	WAVE SHAPE
71	Continuously variable 6 to 100,000 cycles	Rise time less than 0.2 microsecond

### PULSE GENERATOR

MODEL	REPETITION RATE	PULSE WIDTH
79-B	60 to 100,000 pulses per second	Continuously variable from 0.5 to 40 microsecond

### VACUUM TUBE VOLTMETERS

MODEL	VOLTAGE RANGE	FREQUENCY RANGE
62	0-1, 0-3, 0-10, 0-30 0-100 volts AC or DC	30 cycles to over 150 Mc.
67	.0005 to 300 volts peak-to-peak	5 to 100,000 sine-wave cycles per second

### MEGACYCLE METERS

MODEL	FREQUENCY RANGE	FREQUENCY ACCURACY
59 LF	0.1 Mc. to 4.5 Mc.	Within $\pm 2\%$
59	2.2 Mc. to 420 Mc.	
59 UHF	420 Mc. to 940 Mc.	

### CRYSTAL CALIBRATORS

MODEL	FREQUENCY RANGE	FREQUENCY ACCURACY
111	250 Kc.-1000 Mc.	$\pm 0.002\%$
111-B	100 Kc.-1000 Mc.	

### AMPLITUDE MODULATOR

The Model 115 Amplitude Modulator provides 100% modulation with negligible incidental FM. It is designed for use with any conventional a-m or f-m signal generator or oscillator within its frequency range.

#### SPECIFICATIONS:

CARRIER FREQUENCY RANGE: 100 kc. to 50 mc.

CARRIER INPUT & OUTPUT IMPEDANCE: 50 ohms

#### MODULATION FREQUENCY

RANGE: Flat within  $\pm 5\%$  from 30 cycles to 15 kc. Approx. 10 volts across 100,000 ohms required for 100% modulation.

AMPLITUDE MODULATION 0 to 100% with less than 3% envelope distortion at 100% modulation.

MODULATION ACCURACY:  $\pm 5\%$  of full scale from 0 to 100%.



MODEL 115

MODEL 62



MODEL 59



MODEL 111



capacitor voltages rise above the main charging voltage from the reference phase, the charging rectifiers are turned off and the discharge rectifiers are turned on.

If charging conditions are such that the two capacitor voltages rise equally, or are equal at a particular instant of time, the decreasing charging voltage will meet and pass both capacitor voltages simultaneously. Then both capacitors will start to discharge at the same time. This equal form of discharge does

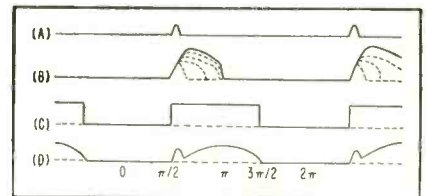

FIG. 2--Normal pulse output (A) larger pulse produced by adding capacitor across discharge circuit (B) and square wave produced by adding d-c bias voltage (C). Waveform (D) shows normal pulse masked by unbalance in discharge circuit

not produce an output signal.

However, if one capacitor is charged to a higher value than its companion, it will start to discharge first. This single discharge is not balanced by one in the parallel discharge path and the resultant current flow across the output resistance provides an output signal.

If the declining charging voltage should reach the voltage of the second capacitor before the first had completely discharged the difference in voltage that existed at the start of discharge, an equal form of discharge between the two capacitors may never occur. Under these requirements it is desirable to have the lesser charged capacitor wait for the two capacitor voltages to become equal before it starts to discharge.

If fast time constants are used, the discharging capacitors may be able to follow the reference voltage all the way down and become equal to each other in voltage without waiting. But when this is not allowable, the lesser charged capacitor may be made to wait for its companion by a voltage balancing action of the discharge rectifiers as they vary their resistance with voltage and with back voltages im-

Measurements Corporation  
BOONTON, N. J.



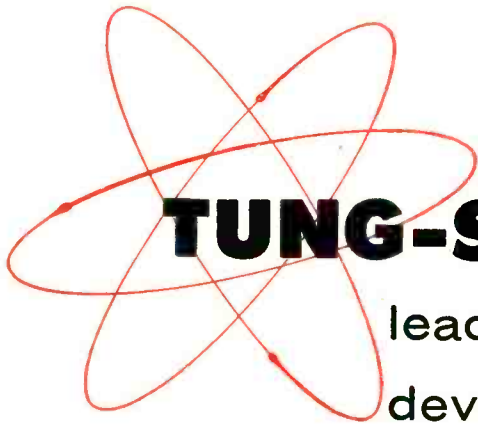

# TUNG-SOL

Acknowledged quality leadership . . . in research, design, development and manufacture . . . of all the basic components on which the science of electronics is founded.

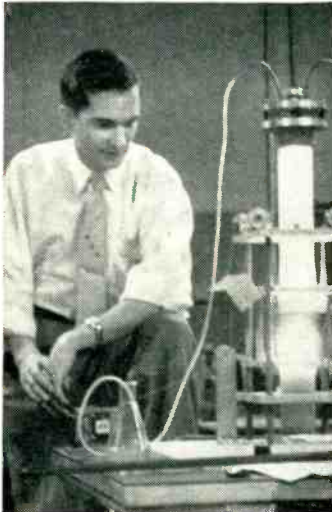

Research



Design

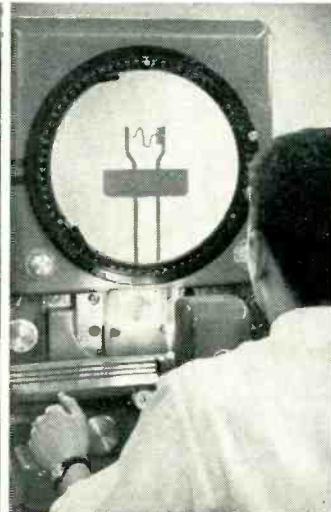

Development



Manufacturing

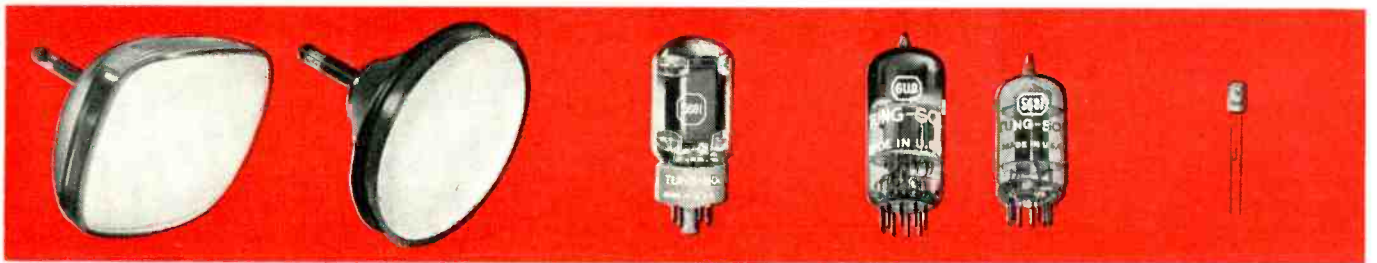

Aluminized Picture Tubes

Color Picture Tubes

Special Purpose Tubes

Radio and TV Tubes

Semiconductors



**TUNG-SOL ELECTRIC INC.,** Newark 4, New Jersey

**SALES OFFICES:** ATLANTA, CHICAGO, COLUMBUS, CULVER CITY, DALLAS, DENVER, DETROIT, NEWARK, SEATTLE.

# Shallcross

for precision resistors

SINCE 1929

## AKRA-OHM Precision Wirewounds



Bulletin L-35

High-quality, yet moderately-priced precision resistors suitable for the majority of applications. Reverse-pi wound on accurately-machined ceramic bobbins. Coated, if desired, with moisture-resistant varnish. Std. tolerance—1%, 0.5%, 0.25%, 0.1%, and 0.05%. Meets MIL-R-93A. Five mounting styles available.

## "P" TYPE Encapsulated Wirewounds



Bulletin L-30

Small, hermetically-sealed resistors at a truly low price. Unmatched stability for critical applications. Std. tolerance—same as Akra-Ohm types above. Meet and exceed MIL-R-93A requirements including salt water immersion tests. Radial leads, axial leads, or lug type terminals.

## CASTOHM® Ceramic Power Resistors



Bulletin L-29

Unusually light-weight wirewound power resistors with a unique integral core and coating having exceptional resistance to thermal shock and excellent heat conductivity. Ten humidity-resistant, tab-terminal styles available with ratings from 8 to 225 watts at 350°C. hot-spot. Meet MIL-R-10566, Amendment 1.

## CMP and MP Miniature Power Wirewounds



Bulletin L-36

Lead-mounting, miniature power wirewounds for crowded chassis or printed circuits. MP types enclosed in a Fibreglas sleeve and coated with silicone-impregnated ceramic. CMP types encased in ceramic tube with ends hermetically sealed with silicone cement. Designed to MIL-R-26B. 3 to 10 watt sizes available.

## SPECIALS . . . . .

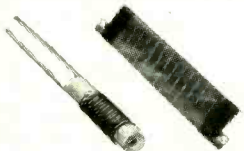

Bulletin L-37

Hermetically-sealed Steatite resistors, Ayrton-Perry resistors, high-voltage surge resistors, card-type resistors, multi-section bobbin resistors, and many other special types are regularly produced to individual specifications.

SHALLCROSS MANUFACTURING COMPANY, 522 Pusey Ave., Collingdale, Pa.

pressed upon them, to hinder the discharge of the lesser charged capacitor until both capacitor voltages are approximately equal.

This voltage-balancing action is encouraged by the presence of a low resistance across the output terminals. The lower this load resistance, the more effective is the application of a back voltage on the opposite discharge rectifier by a discharge current in the neighboring discharge path.

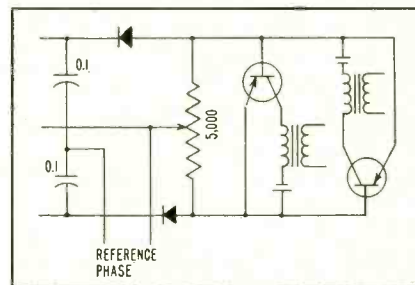

FIG. 3—Discharge circuit of discriminator replaced by transistors to amplify and separate positive and negative pulses

The width of the output pulse is a function of the time it takes the excess voltage on one capacitor to discharge. It is controllable to some extent by the use of large or small capacitors and discharge resistances.

The normal type of output pulse is shown in Fig. 2A. It occurs at approximately the peak of the charging half-cycle of the reference phase voltage because, normally, fast capacitor charging and discharging time constants are used.

The addition of a third capacitor of larger value as shown in Fig. 1B will increase the height and width of the normal pulse output. This added capacitor gives more effective pulses for meter operation. However, it has a loading effect upon the input that makes the circuit less responsive to small energy inputs.

The waveform at Fig. 2B is the type of unidirectional pulse output obtained when this third capacitor is used.

Connected across the two capacitors, it charges to the difference in voltage between them. To discharge, it attempts to send discharge current through a discharge rectifier in the back direction since the rectifiers are connected back to back in its particular discharge

# Carboloy Trends and Developments for Design Engineers...

- How complex permanent-magnet assemblies are built to desired field patterns from simple magnet shapes

## G-E Alnico magnets provide unlimited design flexibility

The fundamental problem in designing with permanent magnets is how to provide a specific magnetic flux in a desired field pattern.

In solving this problem, a designer can choose from seven General Electric Alnico grades, hundreds of styles, weights from a fraction of an ounce to a hundred pounds. He can use magnets with two poles—or many poles; with poles at the ends—or anywhere along the magnetic axis.

This all gives tremendous flexibility to the design of permanent magnets and magnet assemblies. But precisely because there are so many sizes, shapes, strengths, and other factors to be considered, this flexibility can make the designer's job far more complicated.

So, to help give a clearer understanding of what can and cannot be done with G-E Alnico permanent magnets, we have prepared this description of basic magnet shapes.

The simplest forms of a permanent magnet are the bar and rod. They are normally salient (i.e., the poles occur at the ends), and may be of any cross-sectional area.



U- and C-shaped magnets are simply bars "bent" to bring both poles to the same plane.



Carry the bending process to its ultimate conclusion and you have the cylinder (see top of next column) with or without the hole. A cylindrical magnet can be magnetized with as many poles as desired on the outside diameter (A), or the inside diameter (B). Not only can the size

and shape of the hole be varied, but the magnet can be made salient (B), or nonsalient (A).

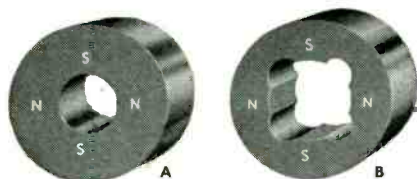

All other forms are merely variations on the original themes, even to such nonstandard shapes as these:



## Use of pole pieces adds to design possibilities

One basic use of pole pieces is to provide a return path for the magnetic flux. Pole pieces may be solid (B), or laminated, like this generator magnet (A).

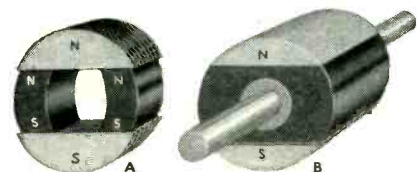

Designers can easily assemble pole pieces and properly shaped permanent magnets to obtain their required field patterns.

One version is this stator assembly, designed to provide inner poles. The

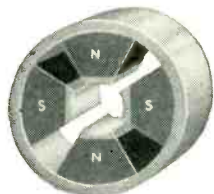

design can be altered in various ways, depending on mechanical, space, magnetic, or physical properties required.

For example, here is another 4-pole magnet using soft steel. It is also possible to construct an assembly with as many poles as required—by using a number of bar magnets or by using one 2-pole magnet.

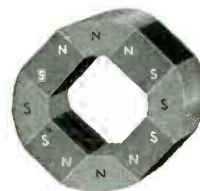

Perhaps the most important consideration in the design of magnetic assemblies is the amount of flux across the air gap. These air gaps may be single (A), double (B), or annular (C).

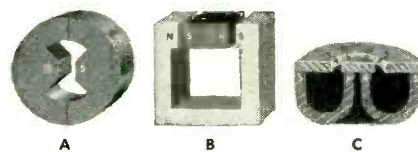

Soft-steel pole pieces are often used to complete the magnetic circuit, allowing maximum flux density through the air gap, with a minimum amount of permanent-magnet material. However, there are a considerable number of variations possible, either with or without pole pieces.

Our G-E magnet engineers have broad knowledge and experience in the design and construction of permanent magnets, pole pieces, and air gaps. They will be more than happy to share their knowledge with you. There is no obligation, and all information is held in strictest confidence. A letter to us will get them to work on your problem immediately.

And keep in mind the Carboloy products that perform a myriad of important jobs throughout industry: *cemented carbides* for combating wear; *Thermistors* for detection, measurement, and control of minute temperature variations; *Hevimet* for high-density and radioactive-shielding applications; and *vacuum-melted metals and alloys*.

"Carboloy" is the trademark for products of the Carboloy Department of General Electric Company

# CARBOLLOY

DEPARTMENT OF GENERAL ELECTRIC COMPANY

11137 E. 8 Mile Ave., Detroit 32, Michigan

CARBOLLOY CREATED - METALS FOR INDUSTRIAL PROGRESS



## RCA chooses rugged, reliable PENTA HYDROGEN PENTA THYRATRONS for AVQ-10 Weather Radar

Because of their ruggedness, dependability and long life, RCA specifies PENTA hydrogen thyratrons in its new AVQ-10 Weather-Mapping Radar. "Looking into" the weather ahead, to improve commercial airline and business aircraft flight comfort and reliability, is the important job filled by this equipment... a job requiring radar components of known dependability. PENTA tubes were a natural choice.

In developing an efficient pulse modulator tube to fit the small space limitations of the RCA radar equipment, PENTA completely re-engineered its PL-5C22 thyratron, shortening it by two full inches. The new tube, the PL-165, retains all the quality features of the well-known PENTA PL-5C22.

Dependability and durability are characteristic of all PENTA tubes—power diodes, triodes, tetrodes and pentodes. Strict quality control assures firm adherence to all specifications. Rugged construction makes PENTA tubes ideal for all mobile applications. Write for complete technical data, indicating your power tube requirements.

*representatives in principal cities*

*A complete  
line of  
high-efficiency  
power tubes.*



tetrodes



triodes

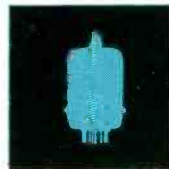

pentodes



**penta laboratories**  
312 North Nopal Street, Santa Barbara, Calif.

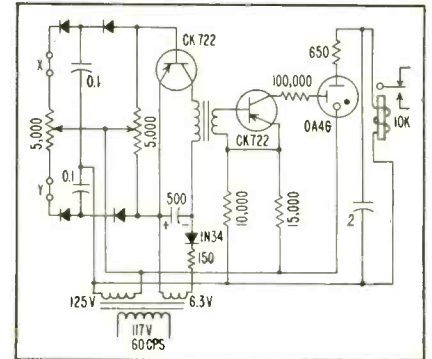

FIG. 4—Electronic switch using discriminator circuit to fire cold-cathode tube. Transducers can be inserted at points X and Y to control output

reference phase operating the circuit. It could provide a source of two-phase motor control signals in response to millivolt direct potentials.

A mismatch in the discharge portion of the discriminator circuit produces a half-cycle pulse that may mask the normal pulse. This waveform is shown for one direction of component unbalance at Fig. 2D. It can be removed by adjustment of the output potentiometer.

All of the pulse waveforms shown in Fig. 2 have been shown in the same polarity for comparison. A reversal of the conditions producing them will invert them, or completely change their polarity.

Although the circuit components are not critical as to value, some important considerations should be observed. The discharge resistances as represented by the two halves of the output potentiometer should be maintained large enough so the input signals that are used cannot send too large currents directly through the rectifiers and output resistances. The rectifiers are used at below normal current ratings with subsequent high re-

# How many places in your plant can projection gaging save time and money?



**In the toolroom?** Look at this. Prior to adopting projection gaging, a Midwestern manufacturing plant required 725 man-hours monthly to inspect flat drills, taps, special cutters, and circular form tools. Use of a Kodak Contour Projector reduced inspection time 84% to 115 man-hours; cost of the projector was returned in direct labor savings within three months. If you have a heavy inspection load in your toolroom, chances are that optical gaging with Kodak Contour Projectors could effect similar savings for you.

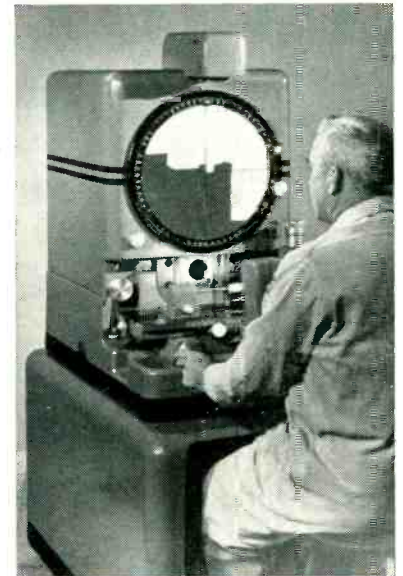

**In receiving?** Here's the experience of a leading maker of aircraft engines. Their gaging procedure on jet engine blades called for inspecting 11 dimensions (including radii and angles) on the dovetail contour, 14 additional dimensions on the blade root. Using two Kodak Contour Projectors, they checked these pieces at a rate of 150 per hour. And operators required little training. What about your receiving inspection department? Couldn't a fast, highly accurate method of inspecting all sorts of parts with multiple dimensions and complex shapes help prevent bottlenecks?

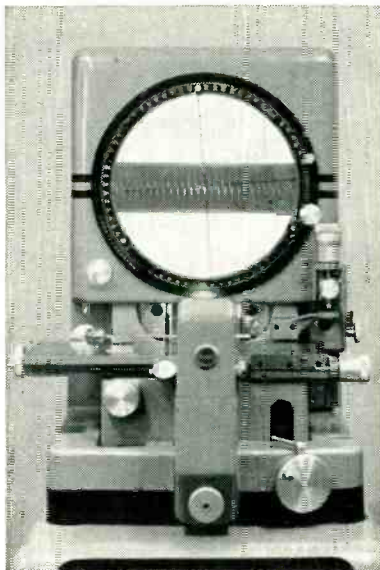

**In production?** A lot of people don't think of optical gaging in terms of production inspection. A typewriter maker did. To check the alignment of type bars to  $\pm .0002$ ", they placed a Kodak Contour Projector next to the soldering jigs on which bars are mounted on their arms. Catching errors at this point and correcting the jigs reduced alignment time in final assembly 25%. Install Kodak Contour Projectors next to production equipment and you have a fast, continuing check that insures machine settings are correct. That's a good way to keep scrap costs down and quality up.

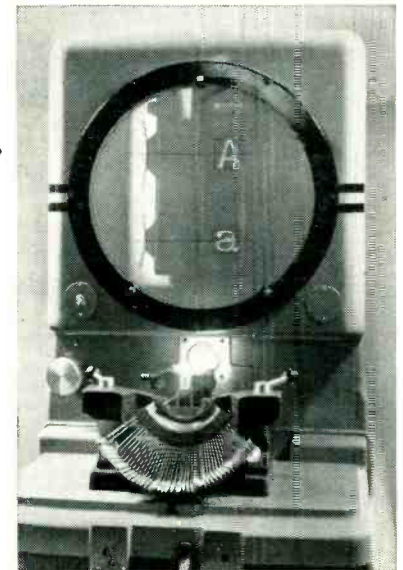

**In final inspection?** Ever have a part that was almost impossible to inspect accurately and completely? A leading West Coast electronics manufacturer did. They had to check the precise pitch of a fine wire helix mounted in its glass tube. "Without the Kodak Contour Projector," the company reported, "it would not be practical to make the measurements necessary to get a satisfactory instrument." Many times optical gaging on a Kodak Contour Projector lets you measure small or easily distorted parts with a simplicity and accuracy you can't achieve by other methods.

WHATEVER your inspection or measuring problem, there's a Kodak Contour Projector to do the work, from the bench-type Model 8 to the big Model 30 with its 30-inch screen and large part capacity.

To find out more about how optical gaging can save you time and money, improve accuracy, send for the booklet, "Projection Gaging with Kodak Contour Projectors." Write *Special Products Sales Division*.



**EASTMAN KODAK COMPANY, Rochester 4, N. Y.**

**the KODAK CONTOUR PROJECTOR**

**Kodak**  
TRADE-MARK

# YOU CAN GET BOTH ACCURACY & SPEED

WITH THE NEW

## TOROYD WINDING MACHINE by UNIVERSAL

6 Models to Wind  
#40 to #7 Wire

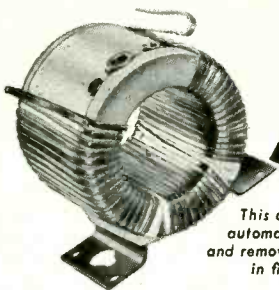

This coil is set-up,  
automatically wound,  
and removed from machine  
in five minutes.



Users report substantial savings over existing equipment with the new Toroyd Series, particularly the heavy wire models, made by UNIVERSAL, noted maker of precision instruments and special machines. Quick set up and fast operation are possible because it has been simplified. Heavy and fine wire can be wound on same core with simple tension changeover.

### HERE ARE SOME QUICK FACTS:

- Winds tighter than any other machine known; Synchronized wire feeding reduces wire breakage to minimum.
- Feeds automatic & semi-automatic in both directions. Automatic sectional winding from 0°-270° as well as 360° continuous winding.
- Automatic pre-set counter geared 1 to 1 ratio.
- 100% turn accuracy is maintained.
- Core clamps adjusts automatically to height of core.
- Fingertip opening and closing of shuttle-gear and magazine.

Toroyd winding machines can be adapted to your special requirements. ALSO we will wind Toroidal Coils to your specifications. Quotations on Request.

"ACCURACY IS A UNIVERSAL WORD"

Write or Call

See us at Booth #72 at the IRE Show

**UNIVERSAL**  **MANUFACTURING COMPANY, INC.**  
410 Hillside Ave., Hillside, N. J.

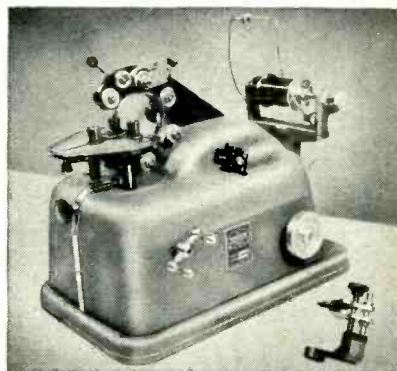

istance in the forward direction. This high rectifier resistance in combination with the capacitors forms a natural filter circuit that helps to keep the input signal from injecting itself directly in the output.

Reference phase operating voltage should be maintained large enough to keep control over the charging and discharging cycles. If the input signal is limited in magnitude, the reference phase can be operated at small voltage levels.

If inductance is present in one or more charging paths it should have less reactance than its associated capacitor at whatever frequency is used for the reference phase. If not, the direction of control may reverse for the input controlling variable. Too large an inductance will promote a highly damped oscillation in place of the unidirectional pulse output.

This circuit provides a sensitive detector of small phase shifts and its output signal is formed of pulses that give one-cycle response. These current pulses are ideally amplified by transistors without delay or resorting to d-c amplification techniques. By using transistors unbiased and back-to-back across the output, pulses of opposite polarity indicating unbalance in opposite directions are easily separated.

Fig. 3 shows the application of transistors to the output of the discriminator circuit. The input resistance of the transistors replaces the output resistor across the output terminals. The transistors will respond only to those pulses of correct polarity.

Fig. 4 shows a complete electronic switch utilizing this pulse circuit to trigger a gas tube. It is a strictly on or off device with provisions for connecting various transducers. This arrangement makes cold-cathode tubes very sensitive to small currents.

### Multivibrator 500-Kc Sweep Circuits

By LAWRENCE FLEMING  
Falls Church, Va.

RECURRENT SWEEP GENERATORS used in ordinary oscilloscopes present special design problems. The circuit

# A BILLION OPERATIONS

... with no maintenance whatsoever

... from NEW CLARE

## Mercury-Wetted Contact Relays



● Cutaway view showing sealed-in-glass, mercury-wetted contact switch, surrounded by the operating coil and encased in a metal housing mounted on an octal base.

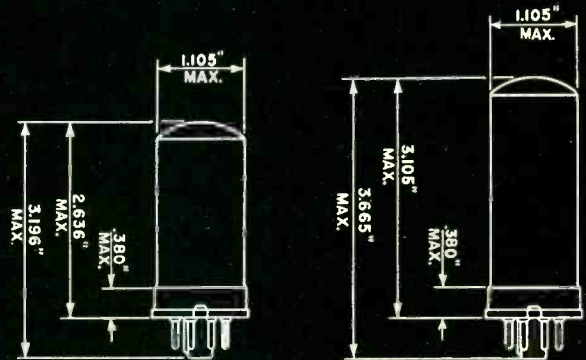

Type HG Relay

Type HGP Relay

**CLARE Type HG and HGP Relays are built to meet the exacting requirements for—**

Computing machines	Servo-mechanisms
Sorting machines	Relay amplifiers
Tabulating machines	High-speed keying relays
Totalizers	Signaling devices

All kinds of high-speed switching devices

**Outstanding features of CLARE Type HG and HGP Relays**

### ELECTRICAL FEATURES

**LONG LIFE:** Conservative life expectancy of over a billion operations when operated within ratings.

**HIGH SPEED:** Give consistent performance at speeds up to 60 operations per second.

**HIGH CURRENT**—and voltage-handling capacity (up to 5 amperes, and up to 500 volts).

**UNIFORMITY:** Operating time varies by only about 0.1 millisecond under constant drive conditions.

**CHATTER-FREE:** Mercury dampens armature vibration and bridges mechanical chatter between metal contact surfaces.

### MECHANICAL FEATURES

- Small chassis space required
- Convenient plug-in mounting
- Environment-free
- Tamperproof
- High sensitivity
- Maintenance-free
- No contact wear
- Adjustment cannot change

This first announcement of the new CLARE Mercury-Wetted Contact Relays is of especial importance to designers of high-speed switching machines and devices which demand accuracy and dependability of a high order.

In these relays, with their unique electrical and mechanical stability, you will find exactly the qualities this kind of apparatus requires—

- Long life (over a billion operations)
- High speed (up to 60 operations a second)
- High current- and voltage-handling capacity (up to 5 amperes, and up to 500 volts)
- Bounce- and chatter-free contacts
- Extraordinary uniformity of operation

These distinctive characteristics are achieved by the use of platinum contact surfaces, continuously wetted with mercury by capillary action, and the hermetic sealing of a magnetic switch in a protected glass capsule, filled with pressurized hydrogen.

CLARE Type HG Relays comprise a switch element and an operating coil. CLARE Type HGP Relays are similar but can be factory-adjusted to provide either biased or polarized operating characteristics.

*For complete information on the new CLARE Type HG and HGP Mercury-Wetted Contact Relays, contact your nearest CLARE representative or address C. P. Clare & Co., 3101 Pratt Blvd., Chicago 45, Illinois.*

Send for CLARE Sales Engineering Bulletin No.120

# CLARE RELAYS

FIRST IN THE INDUSTRIAL FIELD

# PHAOSTRON

NONE FINER

## CUSTOM PANEL METERS

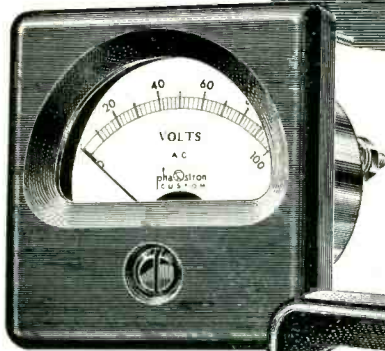

2 1/2" or 3 1/2" Square

4" x 6" Rect.  
with Mirrored Scale

4 1/2" Rect.  
Chrome or Black  
also available  
illuminated

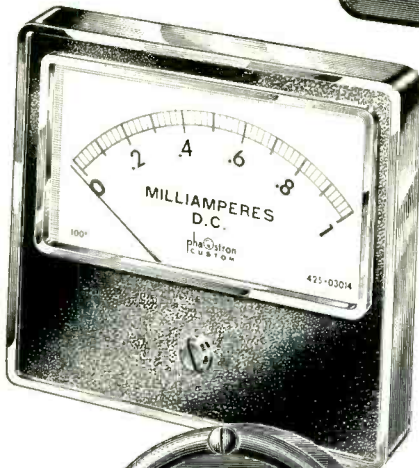
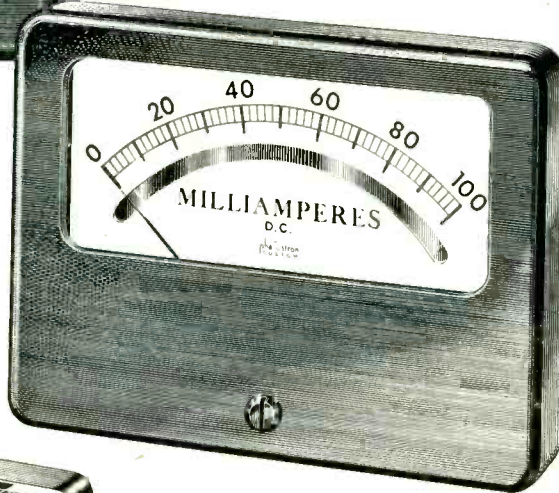

2 1/2" or 3 1/2"  
Round

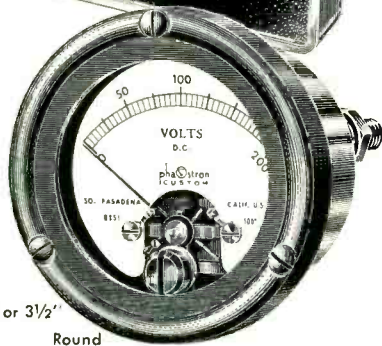

Nine Types in 77 Standard Ranges are available at your Parts Distributor. If you have a special requirement, write to the Product Development Department for a practical recommendation.

**PHAOSTRON INSTRUMENT AND ELECTRONIC COMPANY**  
151 PASADENA AVE., SOUTH PASADENA, CALIF.

The appearance of your equipment will be enhanced by PHAOSTRON meters with their high style, die cast bezels and large easy-to-read scales.

You can depend upon 2% accuracy because these meters are calibrated to within 1% of full-scale deflection with controlled, certified standards.

Continuous accuracy is assured by the UNITIZED METER MOVEMENT ASSEMBLY which provides integral mechanical stability. The aged alnico magnet of the meter is protected from the effects of stray magnetic fields by the steel case.

These units are also equipped with insulated zero adjustments.

must operate over a wide frequency range (10 cps to several hundred kc) it must be simple and inexpensive and the sawtooth amplitude must be inherently independent of frequency. In addition it must synchronize well and the sawtooth amplitude must not depend much upon the synchronizing voltage.

The gas-triode relaxation oscillator meets these requirements well except for its upper frequency limit of about 50 kc.

Displacing the gas-tube generator, in recent years the Potter mul-

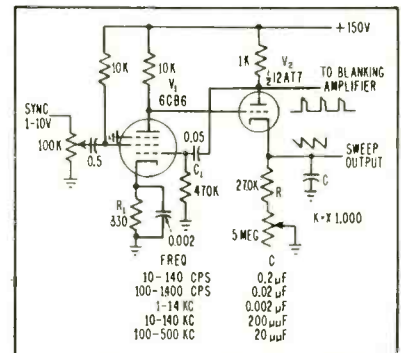

FIG. 1—Low-cost multivibrator circuit with range up to 500 kc. Sync injection is through screen of  $V_1$ .

tivibrator' has been used almost universally in general-purpose oscilloscopes. The main disadvantage of this circuit is that its upper frequency limit is in the order of 100 kc. While inherently simple, it does require simultaneous variation of two resistances and switching of two capacitors for frequency variation.

The most widely-published sweep generator<sup>2,3</sup> for oscilloscopes is that described by Puckle. Until recently it has not been put to much practical use in this country. Part of the reason is that the practical versions published have been relatively complicated.

A version of this circuit has been designed, however, which is cheaper than the conventional multivibrator circuit, has somewhat better synchronizing properties and operates easily up to 500 kc.

Figure 1 shows one version. Tube  $V_2$  is the discharge tube. The frequency-determining elements  $R$  and  $C$  are in its cathode circuit. Tube  $V_1$  can be called the control tube. During the sweep period  $V_1$  is fully conducting and  $V_2$  cut off. When the



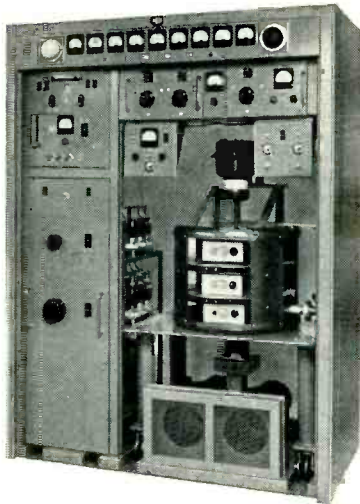

Type 825WA 1 kw Klystron amplifier

# FPTS

packaged systems

Type 799WA 10 kw Klystron amplifier

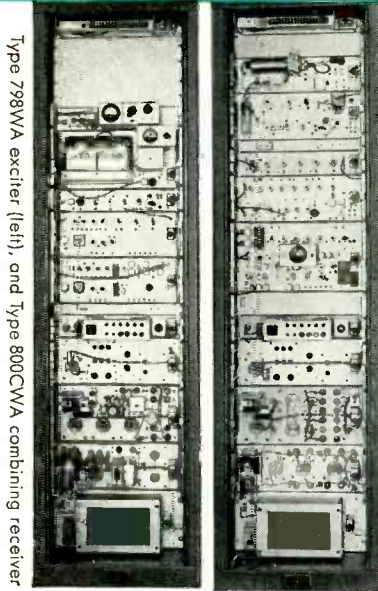
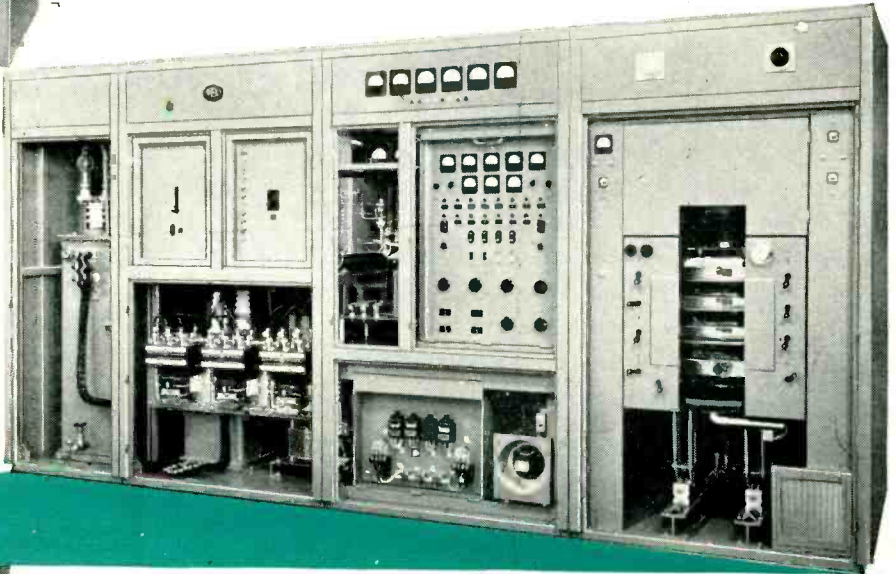

Type 798WA exciter (left), and Type 800CWA combining receiver

*The acknowledged world leader in the design and manufacture of Forward Propagation Tropospheric Scatter systems is Radio Engineering Laboratories.*

*It was REL apparatus which demonstrated in 1953 the practicability of FPTS in far northern operation. Permanent REL systems have been functioning uninterruptedly since July, 1954, and the largest yet conceived is now in production at REL.*

*Only REL offers transmission by CW FM of base bands from 200 cycles to 600 kilocycles (132 voice channels), and REL's patented Serrasoid<sup>®</sup> modulator has established a six-year record for unequalled reliability and transmission quality. Combiner receivers incorporate unique REL circuitry for lower circuit noise and increased range.*

*Your specialized radio problems deserve the experience and facilities of REL.*

## Radio Engineering Laboratories·Inc.

36-40 37th St · Long Island City 1, N Y

STillwell 6-2100 · Teletype: NY 4-2816

Canadian representative: AHEARN & SOPER CO · BOX 715 · OTTAWA



*Eighth in a series describing REL versatility*

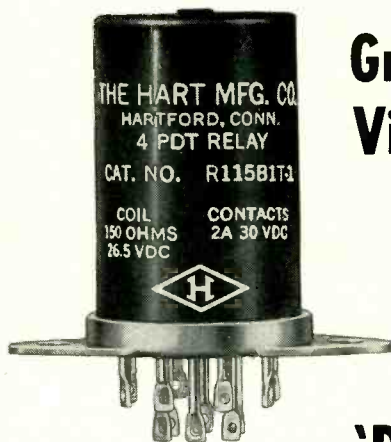

Shown Actual Size

## Greater Sensitivity, Vibration Resistance Engineered in



## 'Diamond H' Relays

Continuing development of "Diamond H" miniature, hermetically sealed, aircraft type relays is constantly widening their performance range. Now, for example, in a 4 PDT relay: sensitivity to 85 mw with vibration resistance of 500 cycles at 10 "G" and 30 "G" shock resistance; vibration resistance of 55 to 2,000 cycles at 20 "G" with 50 "G" shock resistance and maximum sensitivity of 1½ watts.

Excellent contact reliability makes "Diamond H" relays preferred choice for critical jobs in vital applications ranging from guided missiles to high speed camera equipment.

### TYPICAL PERFORMANCE CHARACTERISTICS

<b>Vibration Resistance:</b>	10-55 cycles at 1/16" double amplitude 55-500 cycles at 15 "G" 55-1,000 cycles at 15 "G" 55-2,000 cycles at 20 "G"
<b>Temperature Range:</b>	-55° to + 85°C. -65° to + 125°C. -65° to + 200°C.
<b>Coils:</b>	Resistances—1 ohm to 50,000 ohms Arrangements—single coil; two independent coils, either or both of which will operate unit
<b>Insulation Resistance:</b>	1,000 megohms at room temperature 100 megohms at 200°C.
<b>Dielectric Strength:</b>	450 to 1,250 V., RMS
<b>Operating Time:</b>	24 V. models 10 ms. or less; dropout less than 3ms.
<b>Contacts:</b>	30V., D.C.; 115V., A.C.; 2, 5, 7½ and 10A., resistive; 2 and 5A. inductive. Minimum 100,000 cycles life. Low interelectrode capacitance — less than 5 mmf. contacts to case; less than 2½ mmf. between contacts. Special Ratings: to 350 V., D.C., 400 MA., or other combinations including very low volt- ages and amperages or amperages to 20.
<b>Operational Shock Resistance:</b>	30, 40 and 50 "G" plus
<b>Mechanical Shock Resistance:</b>	up to 1,000 "G"
<b>Mounting:</b>	9 standard arrangements to meet all needs — plus ceramic plug-in socket.
<b>Size:</b>	1.6 cu. in.
<b>Weight:</b>	4 oz. or less

Call on "Diamond H" engineers to work with you in developing a variation to meet your specific requirements.

**THE HART MANUFACTURING COMPANY**  
202 Bartholomew Avenue, Hartford, Connecticut

cathode potential of  $V_2$  falls enough to start plate current flow, its plate potential drops. This drop is communicated to  $V_1$  through  $C_1$  and the regenerative cycle causes  $V_1$  to cut off and  $V_2$  to become fully conducting in a quick pulse—the retrace period.

The negative pulse appearing at the plate of  $V_2$  during retrace is the best source for retrace blanking. A one-stage blanking amplifier is gen-

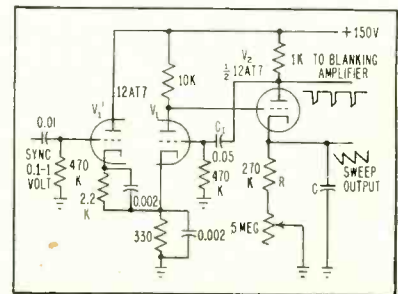

FIG. 2—Sweep generator circuit with provision for cathode sync injection

erally necessary. The plate of  $V_2$  does not carry any sync-signal information, while the plate of  $V_1$  does.

The amplitude of the sawtooth output is determined basically by the quiescent plate potential of  $V_1$ , which in turn depends on the screen voltage and the cathode resistor  $R_1$ .

Since this plate potential determines in part the point on the discharge curve of  $R-C$  at which recharging occurs, it affects also the frequency and the linearity of the sawtooth, in the usual way. A practical operating condition comprises an average cathode-to-ground potential for  $V_2$  of about 80 volts and a sawtooth output of about 8 volts peak-to-peak.

Coupling capacitor  $C_1$  transmits only negative pulses of short duty cycle, so that there is little clamping action at the grid of  $V_1$ .

Sync voltage may be introduced into the cathode, screen or suppressor of  $V_1$ . A commercial version uses screen injection, as shown. From 1 to 10 volts of sync is required. The suppressor requires a higher voltage. The sync has less effect on the sawtooth amplitude than in other comparable circuits.

Cathode sync injection requires only about 0.1 volt, minimum, with little shortening of the sweep up to 1 volt of sync. Figure 2 shows a

# LOOK!

here's  
what  
it takes



THE HAYDU BEAM SWITCHING TUBE offers these other unique advantages for various equipment including:

#### VARI COUNT

complete versatility...can use arbitrary numbers of positions

#### COUNTER DISTRIBUTOR

operate singly...or one tube will operate others in unlimited combinations

#### BEAMPLEXER

can be operated by DC, sine wave or pulsed inputs

#### RADAR and LORAN

reduce overall circuitry and related costs

#### AIRCRAFT CODER

decrease space, weight and heat — a new standard in high vacuum reliability

#### SEND FOR COMPLETE INFORMATION

Write today for copies of illustrated technical literature and applications data on Haydu Magnetron Beam Switching Tubes.

TO EQUAL

## ONE BEAM SWITCHING TUBE!

20 pentodes — 2 triodes — 22 sockets — 10 condensers — 98 resistors.

152 separate components plus related circuitry are required to duplicate all the functions of a standard MBS Tube circuit!

The Haydu Magnetron Beam Switching Tube® permits drastic reductions in the total number of tubes and other components required in most electronic systems. It is compatible with transistors and magnetic core circuitry... while performing a greater number of functions at much higher frequencies! In an unlimited number of electronic applications, the new Haydu MBS Tube switches between multi-outputs many times faster, more simply and more reliably than standard vacuum tubes, diodes or transistors... and in any sequential, simultaneous or random switching pattern. Each position is capable of producing a functional output able to operate relays without amplification.

\*MBS (Trademark)

# HAYDU

BROTHERS OF NEW JERSEY

PLAINFIELD, NEW JERSEY

SUBSIDIARY OF BURROUGHS CORPORATION 



If it's variety you want  
**Chicago Standard**  
 has it... in stock

**FREE:** CHICAGO STANDARD catalogs listing over 1100 transformers for original equipment and replacement applications.



**CHICAGO STANDARD TRANSFORMER CORPORATION**

3507 ADDISON STREET • CHICAGO 18, ILLINOIS

Export Sales: Roburn Agencies, Inc., 431 Greenwich Street, New York 13, N.Y.

circuit of this type, with an extra triode  $V_1$ , to feed the sync. Overall performance is equivalent to the circuit of Fig. 1. Sweep frequency is somewhat more stable with respect to cathode temperature than with the pentode circuit.

The circuit is highly tolerant of variations in tube and circuit parameters. Particular care must be taken to minimize stray sources of time modulation, such as hum in the power supply and in the sync voltage.

The output circuit of the sweep oscillator must look into a resistance that is high compared with the maximum value of the timing resistance  $R$ . Otherwise, the linearity suffers. Output circuit capacitance is in parallel with  $C$  and affects only the frequency.

Cathode followers, which usually form the load circuit, tend to produce small bursts of oscillation at some point of the cycle if they are designed for high input impedance and a gain close to unity. This effect of the negative reactance component of the cathode follower input impedance is readily removed by inserting a resistance in series with the cathode follower grid. A value of 2,200 ohms is typical.

Valuable suggestions were contributed by P. G. Sulzer and the late H. E. Anthony of the Heath Company, for whom the work was done and with whose permission the information is presented.

#### REFERENCES

- (1) J. L. Potter, Sweep Circuit, *Proc IRE*, 26, p 713, June 1938.
- (2) O. S. Puckle, "Time Bases", 2nd ed., Wiley, 1951.
- (3) W. A. Edson, "Vacuum-Tube Oscillators", p 278, Wiley, 1953.

## Staircase Generator

BY STANLEY I. KRAMER

Project Engineer  
 Fairchild Guided Missiles Div.  
 Fairchild Engine and Airplane Corp.  
 Wyandanch, L. I., N. Y.

A VARIATION of the classical, compensated, staircase generator, which generates a negative-going staircase is shown in Fig. 1.

The time constant of the product of  $C_1$  and  $C_2$  in series and the source impedance of the pulse generator is made small compared with the duration of the pulse. In this way the

# UNIVAC magnetic storage drums

*the basic building block for high speed electronic data reduction systems*

Magnetic Drum techniques were pioneered by Remington Rand Univac which today is recognized as manufacturer of the most dependable magnetic drums for industry and government.

## EXAMPLES OF MAGNETIC DRUM APPLICATIONS:

- *As memory units for electronic computers and data reduction systems.*
- *To store sales and inventory tallies giving management up-to-the minute intelligence on current status.*
- *To store teletype messages containing aircraft flight plans and weather reports at a central location for later automatic transmissions to pertinent airports.*
- *For special purpose functions including automation applications.*

## YOU GET ALL THESE ADVANTAGES

Information stored on magnetic drums is non-volatile, yet is instantly alterable. Univac drums are available in a wide range of storage capacities and random information is readily accessible. The performance of magnetic drums is uniform and stored records are unaffected by time. The experience of Univac engineers will be of great value to you in evaluating your drum applications.



**WRITE TODAY  
FOR BROCHURE  
#PX 71843**

## UNIVAC COMPUTING SYSTEMS

Magnetic Drums are used in Univac Scientific Computers Model ERA 1103 A, Univac File Computers, Univac Magnetic-Tape to Punched Card Converters and other Remington Rand Systems.

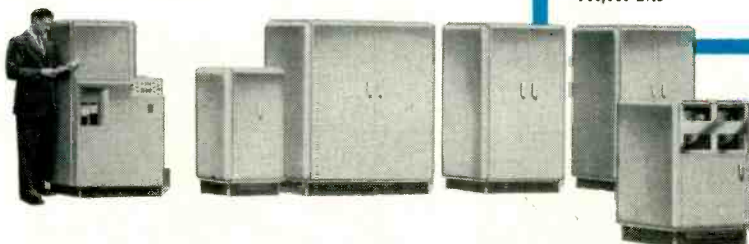

Model 1114  
Max. RZ Capacity 42,000 Bits



Model 1119  
Max. RZ Capacity 120,000 Bits



Model 1120  
Max. RZ Capacity 240,000 Bits



Model 1110  
Max. RZ Capacity 2,500,000 Bits



Model 1107  
Max. RZ Capacity 700,000 Bits



Model 1100  
Max. RZ Capacity 450,000 Bits

**Remington Rand Univac**

DIVISION OF SPERRY RAND CORPORATION  
1902 West Minnehaha Avenue, St. Paul W4, Minnesota



# Potter & Brumfield RELAYS

## Reduce Assembly Costs!

Whether your design calls for a large open relay or a miniature sealed one, P&B can supply it with any type of mounting or termination you desire. P&B's engineering foresight has anticipated your assembly problems; designing, versatility and flexibility into each of their relay types.

Let our engineering group with a quarter century of relay "know how" become part of your design team.

Send your specifications for recommendations and quotations.

Potter & Brumfield PRINCETON, INDIANA  
SUBSIDIARY OF AMERICAN MACHINE & FOUNDRY CO.



For quick delivery over 350 different standard relays stocked by 500 Franchised Electronic Parts Distributors throughout the United States and Canada.



Clip-on solderless



Pierced solder lug



Tube type octal plug



AN type connector



step amplitude appearing on storage capacitor  $C_2$  is  $C_1V/(C_1+C_2)$ .

The cathode follower is designed to have a gain as close to unity as practicable and causes the diode to clamp at this voltage. Thus the voltage applied with each succeeding pulse is not diminished by the charge on  $C_2$ . The cycle is terminated by the discharge of  $C_2$  through a blocking oscillator or thyratron  $V_2$ .

The circuit described above provides a completely satisfactory gen-

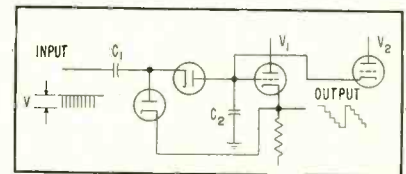

FIG. 1—Circuit that generates a negative-going wave

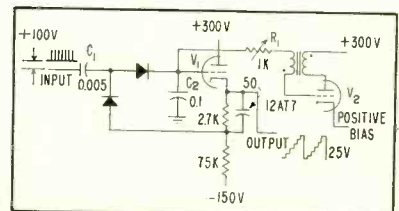

FIG. 2—Complete circuit used with positive pulse generator

erator for a negative-going staircase providing the period between pulses is short compared with the time constant of  $C_2$  and the leakage resistance. The latter is determined, principally, by the heater-cathode leakage of  $V_2$ . This is a characteristic shortcoming of recycling a negative-going waveform.

If the diodes are reversed and a positive pulse generator is used, recycling tube  $V_2$  is coupled to the storage capacitor by means of its grid and the heater-cathode leakage of  $V_2$  is replaced by that of the series diode. If a silicon-junction diode is used, leakage current can be reduced to less than  $10^{-8}$  amp at room temperature, which corresponds to a time constant of approximately 30 seconds with a  $0.1\mu\text{f}$  storage capacitor and a 10-volt step amplitude.

To minimize grid current, the bias on the cathode follower should never be less than 1 or 2 volts. The maximum capacitance of the storage capacitor is limited by the abil-

Save, save, save . . . time, trouble, money . . . when purchasing molybdenum permalloy\* Powder Cores, for there can be no waste when you buy from Magnetics, Inc. Exclusively *Performance-Guaranteed*, these cores are also graded according to inductance, and color-coded so your assemblers *know* how many turns to put on without special testing. Write today for full details . . . Bulletin PC-103 and your Color-Coding Card . . . and remember . . .

***PERFORMANCE - GUARANTEED***

.....

**Permalloy Powder Cores**

***COST NO MORE-***

.....

***WHY TAKE LESS?***

***MAGNETICS inc.***



DEPT. E-23, BUTLER, PA.

\*Manufactured under a license agreement with the Western Electric Co.



## Stopped by I. F.?

Business is good, orders 'way ahead of last year. You have to scramble among your suppliers to get the materials you need to fill them. And maybe keep your force on overtime. Your bills become due before your customers'—and meeting the payroll becomes a pressing problem.

Most growing businesses have such problems. And Textile Banking has been able to help hundreds of them keep liquid, keep growing.

If you are a manufacturer or wholesaler, with annual sales of approximately \$1,000,000, our Working Money Plan will *put your sales on a cash basis . . . strengthen your cash position . . . eliminate your credit losses.*

We can show you how to increase your present working capital without borrowing, or incurring new debt—without diluting earnings or interfering with management.

If you have any current or potential financing problem you would like to discuss confidentially with one of our officers, please write.



## Textile Banking Co., Inc.

*Providing operational financing for manufacturers and distributors of furniture, apparel, electronics, plastics and textiles.*

55 Madison Avenue, New York 10, N. Y.

ity of the recycling tube to discharge it. The shunt diode may be a conventional type or it may be another silicon unit since it is in series with the other diode. Figure 2 shows the complete circuit. The feedback is taken from a tap on the cathode follower to prevent conduction of the diodes. This results in a slight reduction of gain and linearity but if the cathode can be returned to a negative potential, a gain of 0.95 can be obtained with a tube having a short grid base.

Adjustment of step size may be made by varying either  $C_1$ ,  $C_2$  or  $V$  and the number of steps is varied by controlling the magnitude of the recycling pulse with  $R_1$ . The bias on the blocking oscillator can be used to set the level of the staircase.

## Slide-Rule Computation of Guide Wavelength

BY JORGEN P. VINDING

*Cascade Research Corp.  
Los Gatos, Calif.*

IN MICROWAVE engineering it is often necessary to compute the waveguide wavelength from the free space wavelength and the cut-off wavelength, particularly when working with a nonstandard waveguide for which curves or tables are not available.

This process involves squaring, subtraction, square rooting and division and is not very accurate because a small difference between two large numbers is used.

By introducing an angle  $\theta$  as defined below it becomes possible to carry out this computation on a slide rule with little or no mental calculation depending on the type of slide rule used. In cases where better accuracy is required a logarithm table can take the place of the slide rule, particularly when the frequency is near the cutoff frequency.

$\lambda_g$  = guide wavelength

$\lambda_0$  = free space wavelength

$\lambda_c$  = cut-off wavelength =  $2a$

$a$  = wide dimension of rectangular guide

$$\left(\frac{1}{\lambda_g}\right)^2 = \left(\frac{1}{\lambda_0}\right)^2 - \left(\frac{1}{\lambda_c}\right)^2 \quad (1)$$



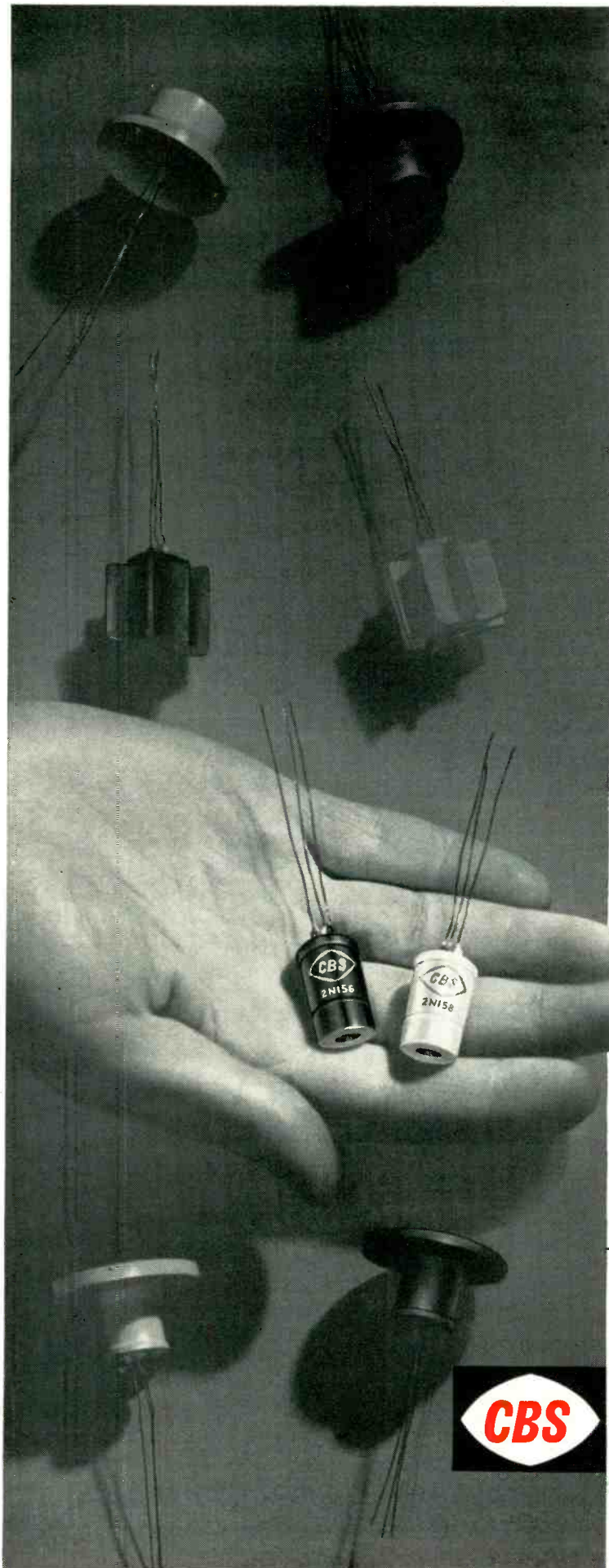

**NOW...**

**POWER TRANSISTORS**

with uniform characteristics

in production quantities

Yes, these uniform CBS power transistors are available in mass-production quantities. And in a variety of metal cases designed to solve special problems of mounting and heat dissipation.

The many *advanced-engineering* features of these PNP junction transistors . . . CBS 2N156 (12-volt) and CBS 2N158 (28-volt) . . . make them ideal for use as high-power audio amplifiers, servo amplifiers, power converters, and low-speed switches.

Note the features and typical characteristics. Write for free bulletin E-259 giving complete data. Let us help you adapt these versatile and dependable transistors to your applications.

**FEATURES OF CBS PNP JUNCTION POWER TRANSISTORS**

1. High current gain at high current
2. High power-handling capabilities
3. Stable, uniform characteristics (special selection unnecessary)
4. Low input impedance
5. Low saturation voltage
6. Low saturation current
7. Choice of hermetically sealed designs

**TYPICAL CHARACTERISTICS**

Characteristic	2N156	2N158
System voltage	12	28 volts
Current amplification I <sub>c</sub> = 25 amp. I <sub>c</sub> = 1.0 amp.	48 33	45 27
Collector dissipation*	5	5 watts
Collector peak inverse voltage	-40	-80 volts
Max. junction temperature	-40-85°C	-40-85°C

\*With suitable heat sink

*Quality products  
through Advanced-Engineering.*



**semiconductors**

**CBS-HYTRON, Danvers, Mass.**

A Division of Columbia Broadcasting System, Inc.

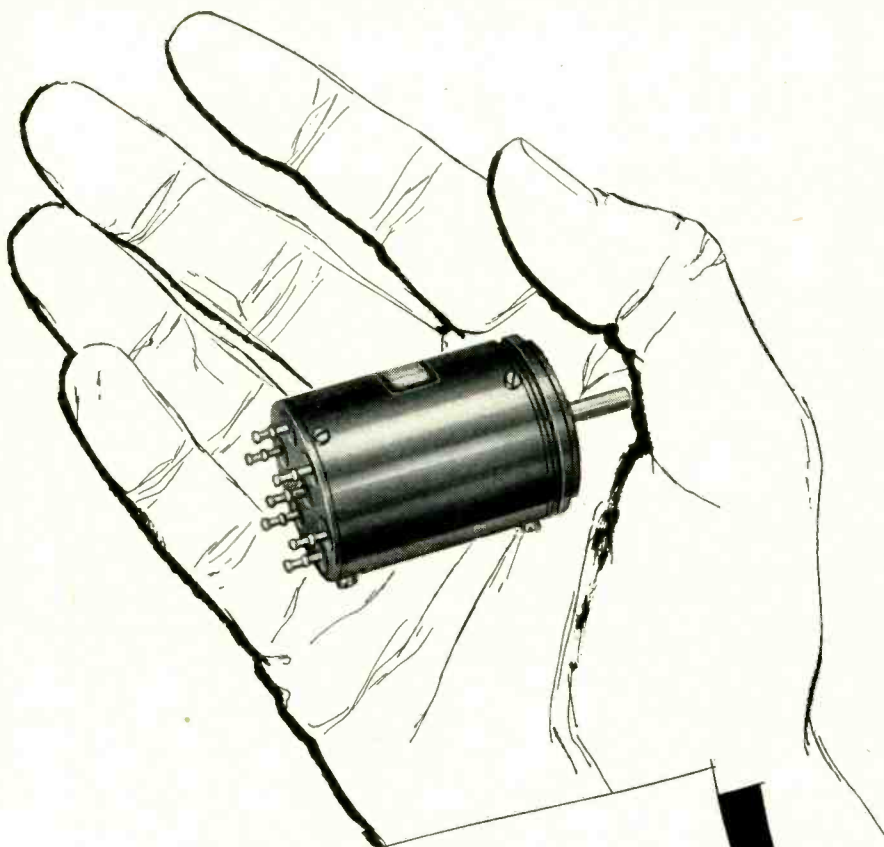

Here is the new  
**GAMEWELL**

Miniature Sine-Cosine Potentiometer

This miniature version of the conventional RL-11 and RL-14 sinusoidal potentiometers is  $1\frac{1}{16}$ " diameter x  $1\frac{1}{16}$ " long.

Functions of this new Gamewell Precision Potentiometer are accurately and smoothly developed. Four brush contacts move over a uniformly wound rectangular card and pick off output voltages that are proportional to the sine and cosine of the input angle at speeds up to 60 RPM. Standard resistance value is 18K, but resistance from 4K to 25K can be supplied. Accuracy at higher values is  $\pm 1\%$ . Power rating: 1 watt  $\pm 40^\circ\text{C}$ .

**THE GAMEWELL COMPANY**  
NEWTON UPPER FALLS 64, MASS.  
In Canada: Northern Electric Co., Ltd.

For information  
about this new sine-cosine  
Gamewell Potentiometer,  
write today.

**GAMEWELL**<sup>®</sup>

PRECISION POTENTIOMETERS

Manufacturers of Precision Electrical Equipment Since 1855

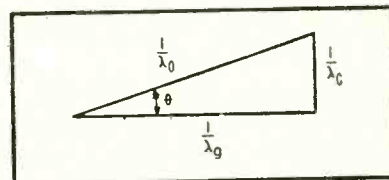

Angle defined by wavelength considerations aids calculation

Define angle  $\theta$  by

$$\sin \theta = \frac{\left(\frac{1}{\lambda_c}\right)}{\left(\frac{1}{\lambda_0}\right)} = \frac{\lambda_0}{\lambda_c} \quad (2)$$

Then

$$\cos \theta = \frac{\left(\frac{1}{\lambda_g}\right)}{\left(\frac{1}{\lambda_0}\right)} = \frac{\lambda_0}{\lambda_g} \quad (3)$$

The form of Eq. 1 is similar to the Pythagorean theorem and suggests the right-angle triangle shown.

This is simple enough so that engineers who do not use it often enough to remember the procedure given below can derive it and use it in less time than the conventional procedure would take.

Procedure using a slide rule follows:

- (1) Set  $\lambda_c$  on scale C opposite 10 or 1 on scale D
- (2) Set cursor over  $\lambda_0$  on scale C and read  $\theta$  on sin scale
- (3) Move cursor to  $\theta$  on cos scale or to  $(90 - \theta)$  on sin scale
- (4) Set  $\lambda_g$  on scale C under cursor
- (5) Read  $\lambda_0$  on scale C opposite 10 or 1 on scale D

A similar technique can be used to find  $\lambda_c$  or  $\lambda_g$ .

## Direct Current Signal Source

By RUFUS P. TURNER

*Consulting Engineer  
Los Angeles, Calif.*

IN DEVELOPMENT and maintenance of industrial electronic equipment, the need often arises for an accurate source of d-c test signals in the range extending from 1 volt downward to 1 millivolt or less.

Such a voltage calibrator is needed for checking the performance of, or presetting fix-tuned

# JPL... an Established Center of Research and Development

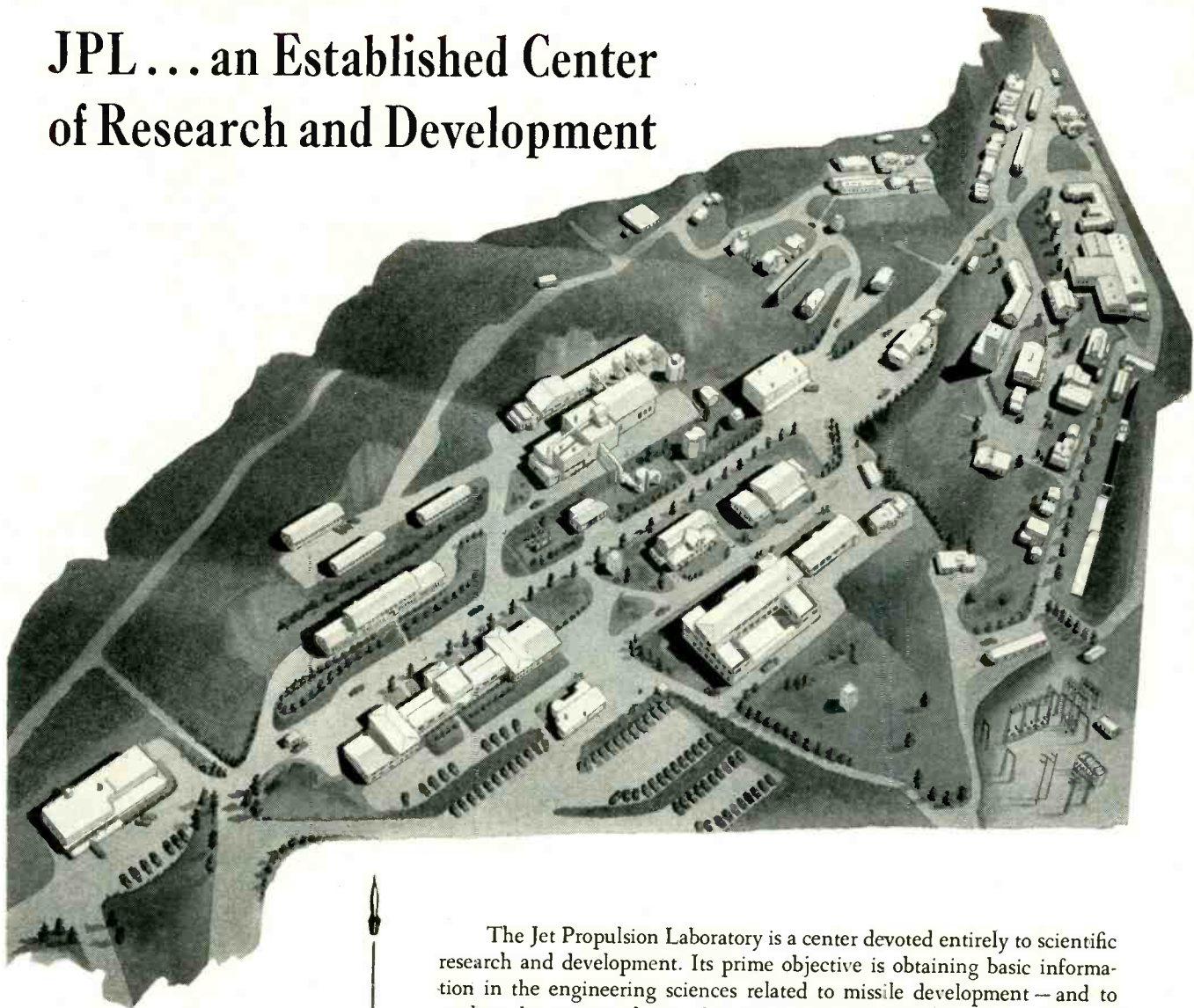

★ At this time we are particularly interested in interviewing graduate engineers and scientists in the fields of aerodynamics, aircraft structures, mechanical engineering, chemistry, chemical engineering, heat transfer, electronics, systems analysis, electro-mechanical instrument design, instrumentation, metallurgy, nuclear physics and solid state physics.

These men should be definitely interested in scientific research and development relating to the problems of the future.

The Jet Propulsion Laboratory is a center devoted entirely to scientific research and development. Its prime objective is obtaining basic information in the engineering sciences related to missile development — and to explore the various phases of jet propulsion. In addition a large share of its program is devoted to fundamental research in practically all of the physical sciences.

The Laboratory extends over more than 80 acres in the foothills of the San Gabriel mountains north of Pasadena. It is staffed entirely by personnel employed by the California Institute of Technology and conducts its many projects under contracts with the U.S. Government.

Exceptional opportunity for original research coupled with ideal facilities and working conditions have naturally drawn scientists and engineers of a very high caliber. These men, working in harmony, are building a very effective task force for scientific attack on the problems of the future.

An unusual atmosphere of friendliness and cooperation is apparent at the "Lab" and newcomers soon sense the warmth of their acceptance. New advanced projects are now providing some challenging problems — and good jobs for new people.

If you would like to develop your skill and knowledge at the "Lab" and, at the same time, help us solve some of our problems — write us today.

CALTECH

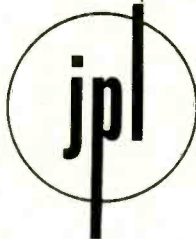

## JET PROPULSION LABORATORY

A DIVISION OF CALIFORNIA INSTITUTE OF TECHNOLOGY  
PASADENA, CALIFORNIA



TWO

# VERSATILE

## Electronic Voltmeters

### A Sensitive VOLTMETER and NULL DETECTOR

#### AS A VOLTMETER

Frequency Range..... 10 cps—2 mc  
 Voltage Range..... 100  $\mu$ v—100 v  
 Input Impedance..... 2 meg shunted by 15  $\mu$ f  
 Accuracy..... 3% 10 cps—1 mc  
 for any point on meter scale. 5% elsewhere

- Voltages as low as 40 microvolts can be measured.

#### AS A NULL DETECTOR

Frequency Range..... 5 cps—4 mc  
 Threshold Sensitivity..... <10  $\mu$ v  
 Max Scale Sensitivity..... 10  $\mu$ v/division  
 division down to 40  $\mu$ v

- Can be used also as wide-band preamplifier with max gain of 60DB and 500  $\sim$  output impedance.

Model 310A  
 \$235.



### A Sensitive VOLTMETER and DECADE AMPLIFIER

(Battery Operated)

#### AS A VOLTMETER

Frequency Range..... 2 cps—150 kc  
 Voltage Range..... 100  $\mu$ v—100 v  
 Input Impedance..... 2 meg shunted by 15  $\mu$ f  
 Accuracy..... 3% 5 cps—100 kc  
 for any point on meter scale. 5% elsewhere

- Ideal for measuring voltages in circuits above ground potential.
- Switch provided for high meter damping.

#### AS A DECADE AMPLIFIER

Frequency Range..... 2 cps—150 kc  
 Voltage Gains..... 1000, 100, 10, 1  
 Output Impedance..... approx 3000  $\sim$   
 Equivalent Input Noise..... <10  $\mu$ v

Model 302B  
 \$245.



#### Both Instruments Feature

- Single logarithmic voltage scale with decade range switching.
- Same accuracy of reading at ALL points on the scale.

## WORLD'S LEADING ELECTRONIC VOLTMETERS

Write for FREE DB calculator and for complete information on these and other Ballantine instruments.

# BALLANTINE LABORATORIES, INC.

100 FANNY ROAD, BOONTON, NEW JERSEY

controls in d-c oscilloscopes; oscillographs and similar recorders; d-c amplifiers used in conjunction with thermocouples, strain gages, accelerometers, and other transducers; automatic control devices utilizing d-c control signals; and

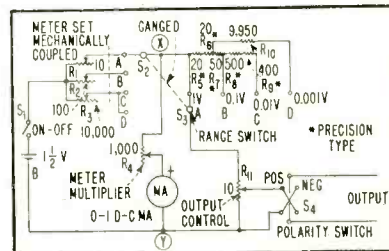

FIG. 1—Complete circuit of the d-c signal generator

d-c vacuum-tube voltmeter and millivoltmeters.

In most such applications, it is desirable that the d-c signal source have a low-resistance output circuit, and the numerous field applications of the instrument dictate its operation from a self-contained battery.

Figure 1 shows the circuit of a simple d-c signal generator. Basically, the instrument consists of a moderately heavy-duty 1½-volt source, a voltage divider comprising both stepped and continuous variation and a means for continuously monitoring the input voltage to the voltage divider and of setting this voltage to a standard reference level of 1 volt.

Operated from a single, No. 6 dry cell, the instrument is completely portable. The resistance across its OUTPUT terminals is 1 to 10 ohms, depending upon the setting of the output-control potentiometer,  $R_{11}$ . Output voltage may be varied smoothly between zero and 1 volt in four ranges: 0-0.001 v, 0-0.01 v, 0-0.1 v, and 0-1 v.

The voltage applied to the voltage divider is adjusted to 1 volt by means of one of the rheostats  $R_1$ ,  $R_2$  or  $R_3$ . These rheostats are ganged mechanically (metal belt-driven, since an inexpensive 3-gang wirewound unit is not available in the 10, 100, and 10,000-ohm combination required) and operated by a single knob.

The proper rheostat is switched into the circuit by arm  $S_2$  of the RANGE switch. The monitoring



## ALLEN-BRADLEY COPPER CLAD MOLDED RESISTORS

rated at 3 and 4 watts at 70C Ambient Temperature

A new and important addition to the Allen-Bradley line of radio, electronic, and television components are these Types GM and HM copper clad Bradleyunits, each fitted with a heavily tinned copper clamp. These new resistors are designed to be attached to a metal panel or chassis with rivets, bolts, or self-tapping screws. If attached to a metal panel four inches square and 0.050 in. thick at an ambient temperature of 70C, the maximum continuous wattage rating of the Type GM Bradleyunit is 3 watts; the Type HM Bradleyunit is 4 watts. At

40C ambient temperature, the ratings are 4 and 5 watts, respectively. However, if these copper clad Bradleyunits are suspended by their leads without being bolted to a metal panel, their respective ratings are 1 and 2 watts.

The copper clamp does not completely encircle the Bradleyunit, thus leaving a slot through which the color-code bands are plainly visible. Type GM Bradleyunits are available in all RETMA values from 2.7 to 22 megohms and Type HM Bradleyunits from 10 ohms to 22 megohms.

Allen-Bradley Co., 110 W. Greenfield Ave., Milwaukee 4, Wis. • In Canada—Allen-Bradley Canada Limited, Galt, Ont.

### OTHER QUALITY COMPONENTS FOR RADIO, TV & ELECTRONIC APPLICATIONS

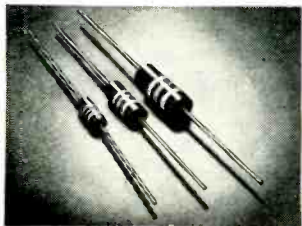

BRADLEYUNITS  
1/2, 1, 2, 3 & 4 WATT

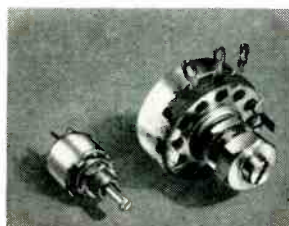

BRADLEYMETERS  
1/2 & 2 WATT

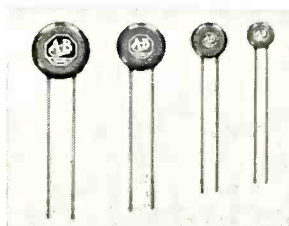

CERAMIC CAPACITORS  
0.00001 to 0.022 MFD

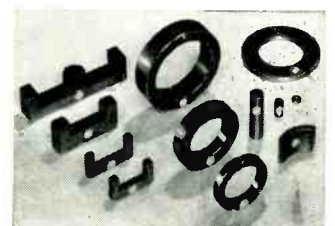

FERRITE COMPONENTS  
HIGH EFFICIENCY

# ALLEN-BRADLEY

## RADIO, ELECTRONIC AND TELEVISION COMPONENTS



## The "QUALITY" name for PHENOLIC TUBING

To make your product better . . . and at lower costs  
 . . . specify CLEVELITE!\*

High performance factors, uniformity and inherent ability to hold close tolerances, make Clevelite outstanding for coil forms, collars, bushings, spacers and cores.

Wherever high dielectric strength, low moisture absorption, mechanical strength and low loss are of prime importance . . . the combined electrical and physical properties of Clevelite are essential.

Fast, dependable deliveries at all times!

Why pay more? For Good Quality call CLEVELAND!

\* Reg. U. S. Pat. Off.

**THE CLEVELAND CONTAINER COMPANY**

6201 BARBERTON AVE. CLEVELAND 2, OHIO

PLANTS AND SALES OFFICES:

CHICAGO • DETROIT • MEMPHIS • PLYMOUTH, WIS. • OGDENSBURG, N.Y. • JAMESBURG, N.J. • LOS ANGELES

ABRASIVE DIVISION of CLEVELAND, OHIO  
 Cleveland Container Canada, Ltd., Prescott and Toronto, Ont.

**Representatives:**

NEW YORK AREA: R. T. MURRAY, 604 CENTRAL AVE., EAST ORANGE, N. J.  
 NEW ENGLAND: R. S. PETTIGREW & CO., 62 LA SALLE RD., WEST HARTFORD, CONN.  
 CHICAGO AREA: PLASTIC TUBING SALES, 5215 N. RAVENSWOOD AVE., CHICAGO  
 WEST COAST: IRV. M. COCHRANE CO., 408 S. ALVARADO ST., LOS ANGELES



voltmeter consists of the 0-1 d-c milliammeter and multiplier rheostat  $R_4$ . The latter is set initially after completion of the instrument. An accurately known 1-volt d-c potential is applied temporarily between circled points X and Y in the circuit. With switch  $S_1$  open,  $R_4$  is set for full-scale deflection of the meter.

Rheostat  $R_4$  is provided with a slotted shaft for screwdriver ad-

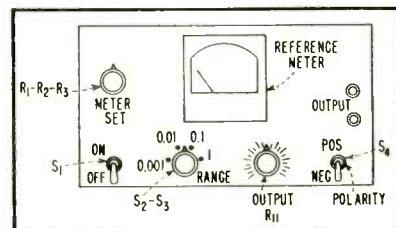

FIG. 2—Front panel layout of the d-c source

justment and is mounted inside the instrument case for protection against accidental readjustment.

In addition to the METER SET rheostat ( $R_1$ ,  $R_2$  or  $R_3$ ), the voltage divider consists of a fixed resistance (0 for the 1-volt range,  $R_5R_6R_7$  for 0.1 v,  $R_8R_9R_7R_6R_5$  for 0.01 v and  $R_8R_9R_{10}$  for 0.001 v) in series with the 10-ohm potentiometer  $R_{11}$ . The fixed resistors, selected by arm  $S_3$  of the RANGE switch, thus determine the output-voltage ranges, and potentiometer  $R_{11}$  provides smooth variation of the output voltage from zero to maximum in any selected range.

The values of range resistors  $R_5$  to  $R_{10}$  have been selected to permit use of the minimum number of stock precision resistors to obtain the required resistance values. These values are: 1 v = 0, 0.1 v = 90 ohms, 0.01 v = 990 ohms and 0.001 v = 9,990 ohms.

The dial attached to potentiometer  $R_{11}$  is graduated 0 to 1 according to its resistance settings.

A dpdt switch  $S_1$  is provided for reversing the polarity of the output voltage without disturbing the battery and meter connections.

Figure 2 shows arrangement of meter and controls on the front panel of the case which is 12 in. long, 7 in. high and 4 in. deep.

In use, throw switch  $S_1$  to its ON position. Set RANGE switch  $S_2$ - $S_3$  to

# FORD INSTRUMENT

solved one design problem by

## CASCADING RESOLVERS

### WITHOUT

## ISOLATION AMPLIFIERS

To get around a problem that arises in almost every resolver application Ford engineers recently designed a computer which, among other things, employed a chain of cascaded resolvers to solve complex trigonometric equations, without the use of isolation amplifiers. They solved such an equation as:

$$A \sin a \cos c + A \cos a \sin b \sin c + B \cos b \sin c$$

This was successfully done, without use of vacuum tubes or amplifiers in this circuit:

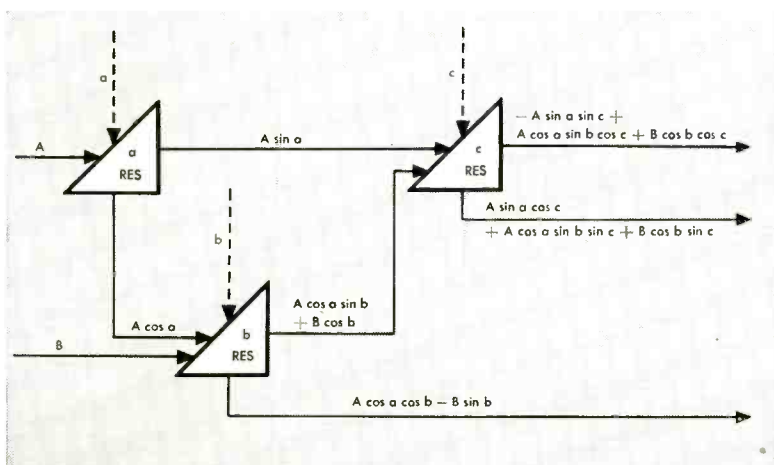

In view of the widespread use of resolvers to generate sine and cosine functions in modern electro-mechanical analogue computers, it is of great practical significance. Resolvers produced by the Ford Instrument Company have now reached such a high degree of precision, that it is possible to obtain, from an unloaded resolver (which accommodates a single angular quantity only), an accuracy to within less than one tenth of one percent. But most computing circuits call for the use of several resolvers, and once an ordinary resolver is loaded by another resolver, no matter how high its precision, the overall accuracy of the resolver cascade is seriously affected.

The conventional method of avoiding this difficulty is to use an isolation amplifier for each resolver, so that the resolver continues to operate under no-load conditions regardless of the size of the cascade. The importance of cascading without amplifiers is readily appreciated if we realize that the isolation amplifier usually increases the cost of the equipment, more than doubles the size and generates many times more heat that must be dissipated to prevent breakdown of the components. Furthermore, the use of vacuum-tube amplifiers always raises the problem of tube ruggedness and reliability, and requires an additional source of d-c plate voltage.

Have you problems which the engineers at Ford might solve by designing and manufacturing computers, controls or their elements? Write for further information.



**FORD INSTRUMENT COMPANY**

Division of Sperry Rand Corporation  
31-10 Thomson Ave., Long Island City 1, N. Y.

85

Ford's capabilities are among the finest in the country

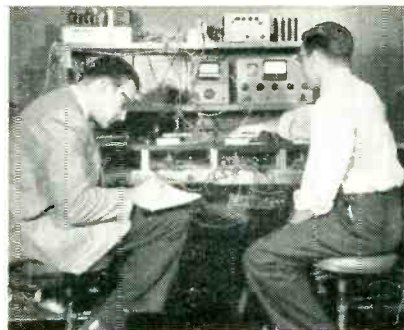

One of the Ford laboratories where a particular design project has called for careful study of resolvers and resolver cascading. Two of the engineers assigned to this project are here checking results. From this work will come one of the new, highly classified weapon systems for the armed forces.

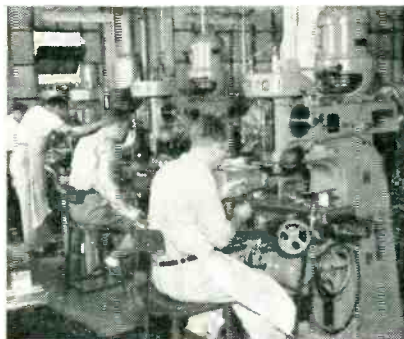

For accuracy and reliability—both vitally necessary in military instruments—experienced machinists must work to fine precision—in the order of .0005 of an inch. Here in one section of the shops of Ford Instrument Company, men are milling parts for an airborne computer.



During the past year Ford Instrument Company has been busy working on many contracts for the U. S. Air Force and the U. S. Navy Bureau of Aeronautics, designing and manufacturing complex computers, controls and their components. For over forty years, Ford Instrument Company has devoted most of its efforts in working for the government to the many problems of weapon controls.

# BIG OUTPUT

## Small Size

### DEPENDABLE!

# Fansteel

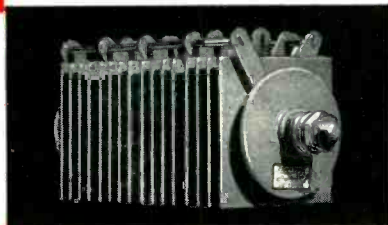

# HIGH-TEMP SELENIUM RECTIFIERS

CATALOG NUMBER	CIRCUIT	INPUT A-C VOLTS	CONT. D-C OUTPUT AT 100°C	
			VOLTS	AMPS.
TADL35L	1-35-1-H	455	402	0.004(*)
TEUH315(*)	2-8-1-D	132	254	0.020(*)
TEU100L	1-100-1-H	2600	1090	0.020
TEB328L(*)	2-11-1-D	363	297	0.150
TEW066L	4-4-1-B	132	108	0.180
TEC070L	4-5-1-B	165	135	0.300
TEX034L	4-1-3-B	33	27.8	1.59
TED200LN	2-13-1-C-N	214	-175	0.600
TEY060L	4-3-1-B	78	62.7	1.0
TEY060L	4-3-1-B	41	62.7	1.0(*)
TEEW334L(*)	2-7-1-D	231	295	2.3(*)
TEFW332L(*)	2-13-1-D	429	548	4.6(*)
TEG084L	2-1-1-C	13	10.4	5.2
TET050L	4-2-1-B	66	53.9	4.6
TET314L(*)	2-7-2-D	231	189	14.0
TER020L	6-3-1-B	66	79.5	12.9(*)
TER034L	4-1-3-B	33	27.8	25.8
TBR008L	6-1-4-B	26	32.5	51.6(*)

(\*) Capacitive Load. Ratings unmarked are for resistive or inductive loads.  
 (\*) Hermetically Sealed.  
 (\*) Two stacks required.  
 (\*) Three stacks required.  
 (\*) Resistive, inductive or capacitive load.

Continuous operation at 100°C requires *no derating whatever* in the output of Fansteel High-Temp Selenium Rectifiers. They were developed to deliver full rated power output up to this specified ambient temperature. And at higher temperatures, up to 150°C (302°F), only moderate derating is required.

All standard cell sizes and circuit arrangements are readily available. The table at left indicates only a partial list of over 100,000 types. And all Fansteel High Temperature Selenium Rectifiers are available with standard protective finishes that resist moisture, fungus or salt spray, the latter meeting MIL specifications.

Send for  
bulletin 6.401

the desired output-voltage range. Set meter to full scale by adjusting METER SET control  $R_1R_2R_3$ . Set switch  $S_1$  for the desired polarity of the OUTPUT terminals. Set OUTPUT control  $R_{11}$  for the desired output voltage level. Connect the device under test to the generator OUTPUT terminals. Readjust the METER SET control for full-scale deflection of the meter if deflection has shifted.

Whenever the instrument is in use, the meter should be watched for any shift from exact full-scale deflection.

When the instrument is in use, internal current drain from the 1½-volt cell is 100 ma on the 1-volt range, 10 ma for 0.1 v, 1 ma for 0.01 v and 0.1 ma for 0.001 v.

### Internal Shielding Effects on Bulb Temperature

By M. MARK and R. C. MACGEE, JR.  
Raytheon Mfg. Co.  
Newton, Mass.

COOLING OF VACUUM TUBES has received considerable attention with the advent of high-speed aircraft. The use of ram air for cooling becomes impractical at high speeds because of kinetic temperature rise. Therefore, if air is to be retained as the cooling medium, a refrigeration system becomes necessary. This emphasizes the need for effi-

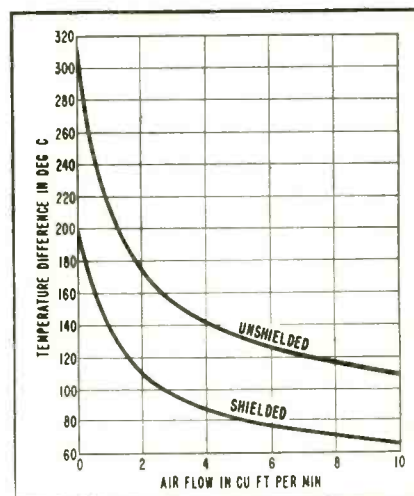

Difference in bulb temperature and inlet air temperature versus air flow for shielded and unshielded tube. Tubes, mounted in 1 7/16 in. chimney, had power input of 17.45 watts

FANSTEEL METALLURGICAL CORPORATION

North Chicago, Illinois, U.S.A.



E561A

DEPENDABLE RECTIFIERS SINCE 1924





Thomas Kearns, Traffic Manager for Garrett Corp.'s AiResearch Div., in high-altitude lab. He tells

## “How we cool off a hot pilot!”

“Above the speed of sound, air friction heats up the metal skin of the newest jets to several hundred degrees. *How do you keep the pilot cool?*”

“AiResearch’s answer: a refrigeration system including this miraculous 2-lb. turbine. Turning at 100,000 rpm’s, it cools the air entering the cabin to 40° in 2/10 of a second!

“The extreme precision required in manufacturing such devices takes time. Yet, military contract schedules call for speed. Deliveries naturally have to be fast and sure — to plane

companies located all over the country.

“How can we do it? By Air Express!”

“Air Express proves its worth to us dozens of times a day, both incoming and outgoing. We literally could not maintain our schedules without it.

“Yet on most of those shipments, *Air Express saves us money*. A 10-lb. shipment from Los Angeles to Kansas City, for instance, costs \$6.34. That’s 17¢ less than the next lowest priced air service!”



# Air Express

GETS THERE FIRST via U.S. Scheduled Airlines

CALL AIR EXPRESS . . . division of RAILWAY EXPRESS AGENCY

# designed for your SPECIAL APPLICATIONS

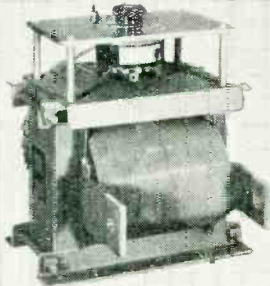
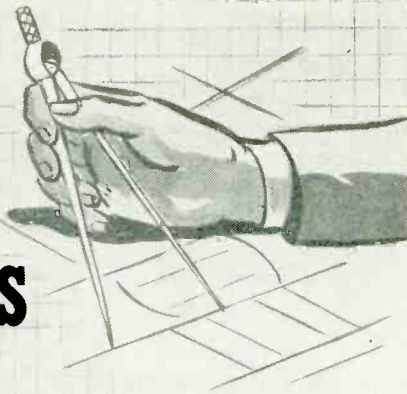

**Resistance Welding Transformer** with eight point tap-changing switch on primary winding. Used for a varying secondary current output. Unit shown is 3 KVA. Units are available from .5 to 50 KVA.

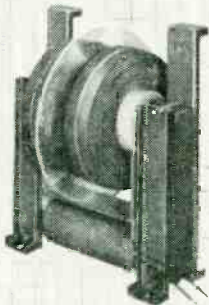

**High Voltage Plate Transformer** for use under oil with other equipment in same tank. Unit shown is 50 KV center tap grounded, 4 KVA and high impedance. Note plastic insulation shield between coils. This unit available from 100 VA to 100 KVA.

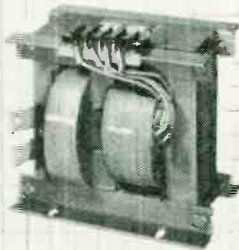

**High Impedance Transformer** for use in current limiting applications, where electrical equipment must be protected against the high initial current drawn at starting voltage. Unit shown is 2 KVA. Units available from 10 VA to 25 KVA.



**Radio Frequency (R.F.) Choke** for lowest possible capacitance and non-resonating peaks. Unit shown is 10 Ampere 200-Micro-Henry Choke (terminal is not shown). Units available in sizes 1 ampere and larger.



**Air Core Reactor** for current limiting and for obtaining lagging power factors without distortion. Unit shown is 4 KVA. Units available from 1/4 to 2000 amperes and 25 to 400 cycles.

cient cooling since the air used for equipment cooling penalizes aircraft performance.

To obtain the desired life and performance from a vacuum tube, the hot-spot bulb temperature must be maintained below some predetermined level. To accomplish this, a hollow cylinder or chimney is sometimes placed over the tube and air forced between cylinder and tube. By properly selecting the air flow and the inner diameter of the chimney with respect to the tube di-

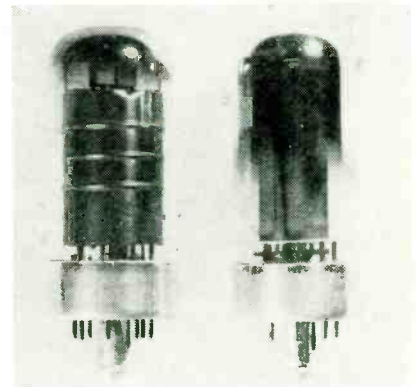

Internally shielded (left) and tube (right) without internal shield

ameter, the heat transfer from the tube surface can be controlled to give the required bulb temperature.

Since maintaining the proper hot-spot bulb temperature with a minimum of coolant is important, the effect of internal shielding on bulb temperature is of interest. Basic thermal tests were performed on two similar tubes, both pentode amplifiers with T9 bulb types, to find a satisfactory chimney design for forced convection air cooling. One of the tubes was internally shielded, while the other was internally unshielded.

The tube socket was mounted on a plywood panel which fitted into a plenum chamber. This allowed mounting and interchanging of tubes without disturbing socket and wiring. Air entered the chimney and exhausted through the tube socket. Input power was adjusted and measured for each test and the air flow was determined with a gas meter. Bulb temperatures were measured with temperature-sensitive paints.

The chart shows maximum bulb temperature less inlet air tempera-



Established 1920



*Notkelfer*

**WINDING LABORATORIES, Inc.**

P.O. Box 455, Dept. 109, Trenton, N. J.

Write for complete information, specifying particular unit and your requirements.

A **new** and **better**  
variable-phase, single-turn  
precision potentiometer

# CLAROSTAT

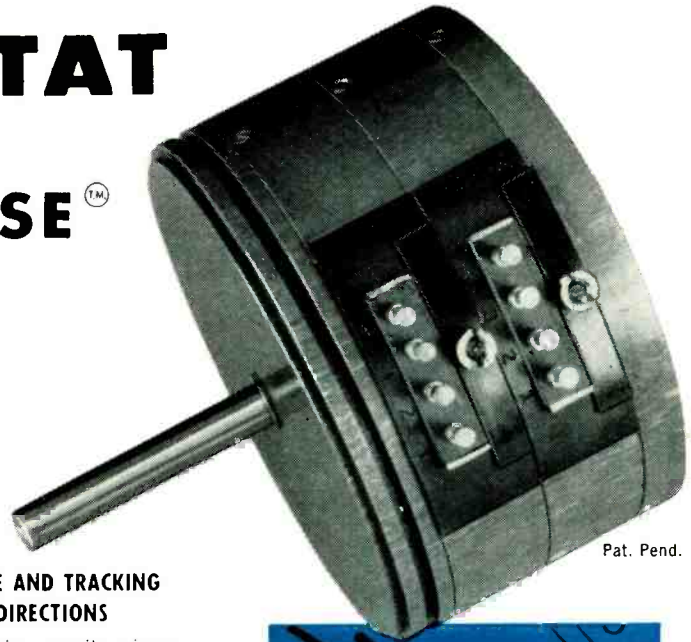
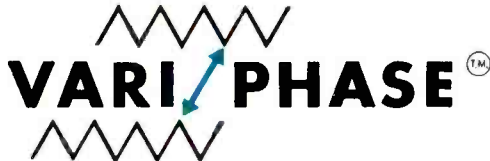

Pat. Pend.

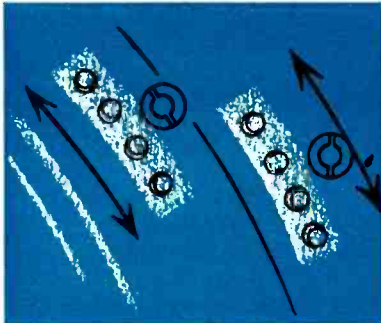

### EQUAL TORQUE AND TRACKING IN BOTH DIRECTIONS

Unique contact design permits micrometer tension adjustment at factory and assures equal torque and tracking in either direction at all times.

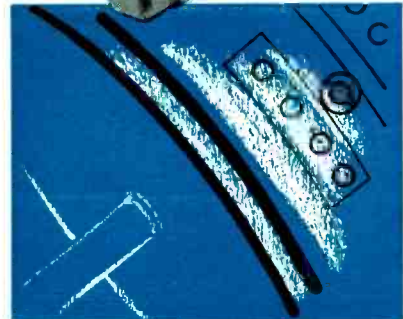

### STANDARD A.I.A. MOUNTING

Mounting per A.I.A.\* standards—others available. Meets or exceeds electrical and mechanical A.I.A. requirements.

### NO CLAMPING RINGS

Simplified phasing—External independent phasing of each cup without effecting the relationship of the others.—To phase, loosen clamping nut, move terminal board in desired direction, tighten clamping nut and it's done. Speedy phasing saves time and money. Reduced overall diameter by elimination of clamping rings.

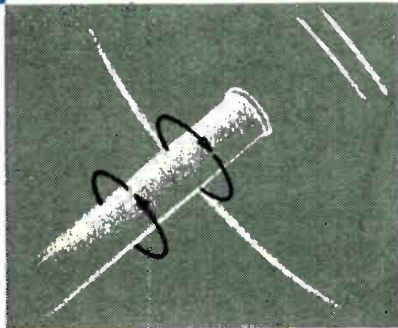

Materials selected for lightest weight possible. Design assures highest performance.  
Five sizes available—7/8", 1-1/16", 1-5/8", 2" and 3" diameters.

Another **CLAROSTAT** first. A product of advanced engineering.

WRITE FOR  
COMPLETE ELECTRICAL  
AND MECHANICAL  
SPECIFICATIONS.



**CLAROSTAT MFG. CO., INC.**  
**DOVER, NEW HAMPSHIRE**

*In Canada: Candian Marconi Co., Ltd., Toronto 17, Ont.  
Manufactured under license in Great Britain by  
A. B. Metal Products Ltd., 17 Stratton St., London W. 1,  
Concessionaires for British Commonwealth except Canada.*

\*Aircraft Industries Associated.

# Langevin TRANSFORMERS

**— to military specifications  
and for special  
performance requirements**

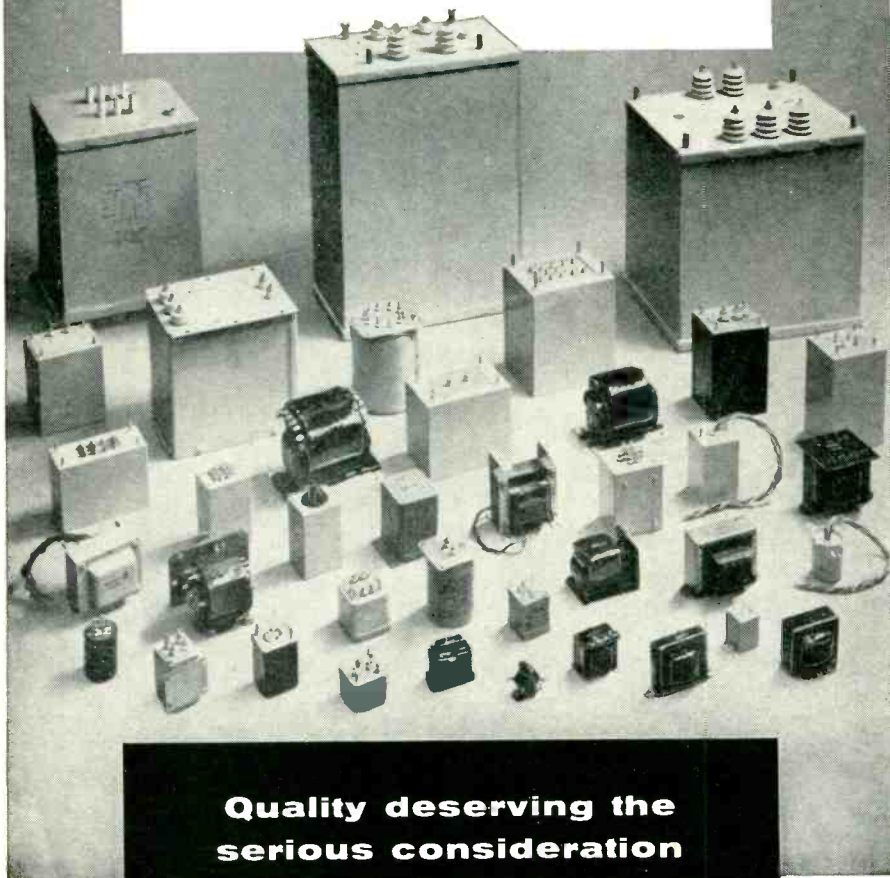

**Quality deserving the  
serious consideration  
of responsible engineers**

- Separate sample and short run facilities to provide high speed service
- Approved for in-plant MIL-T-27 qualification testing
- Quotations supplied promptly on receipt of your requirements



**LANGEVIN MANUFACTURING CORPORATION**  
47-37 AUSTELL PLACE, LONG ISLAND CITY I, N. Y.  
Telephone: RAvenswood 9-1860

**A Subsidiary of the W. L. Maxson Corporation**

ture with respect to flow for the two tubes. Bulb temperature for the shielded tube was found to be practically uniform with no hot spot. The unshielded tube had a hot spot on the tube bulb opposite the plate. At a given air flow the bulb temperature rise of the unshielded tube was approximately 50 to 70 percent greater than that for the tube with the internal shield.

Internal shielding can prevent hot spots and the accompanying large temperature gradients on the envelope by conducting heat to the entire area of the shield, reducing the heat concentration.

When possible to incorporate it into the design, the advantages of internal shielding with respect to bulb temperature and bulb temperature gradient may be significant for airborne equipments.

## Electronic Controller for Voltage and Current

BY H. L. ARMSTRONG  
AND A. KOCHMAN  
*Pacific Semiconductors, Inc.*  
Culver City, Calif.

THERE IS occasionally need to control fairly large direct currents, or alternating currents or voltages, for which the usual type of controller is unsuitable. While magnetic amplifiers and the like are suited to such applications, they are not always readily available.

The circuit described here was devised to fill such a need for an instrumentation application and was required to control up to about 1 ampere d-c at two or three volts. Other capacities can be obtained by using other sizes of components.

The circuit used is shown in Fig. 1. Transformer  $T_1$  is an ordinary power transformer, with a 115-v primary and 240-v c-t secondary rated 50 ma. It has, as well, 5-v and 6.3-v secondaries. It supplies 240 volts each to two windings of transformer  $T_2$ . This is a small power transformer with a 115-v primary, a 117-v 50-ma secondary and a 6.3-v 2-amp secondary.

The 115 and 117-v windings are in series with the 240-v windings

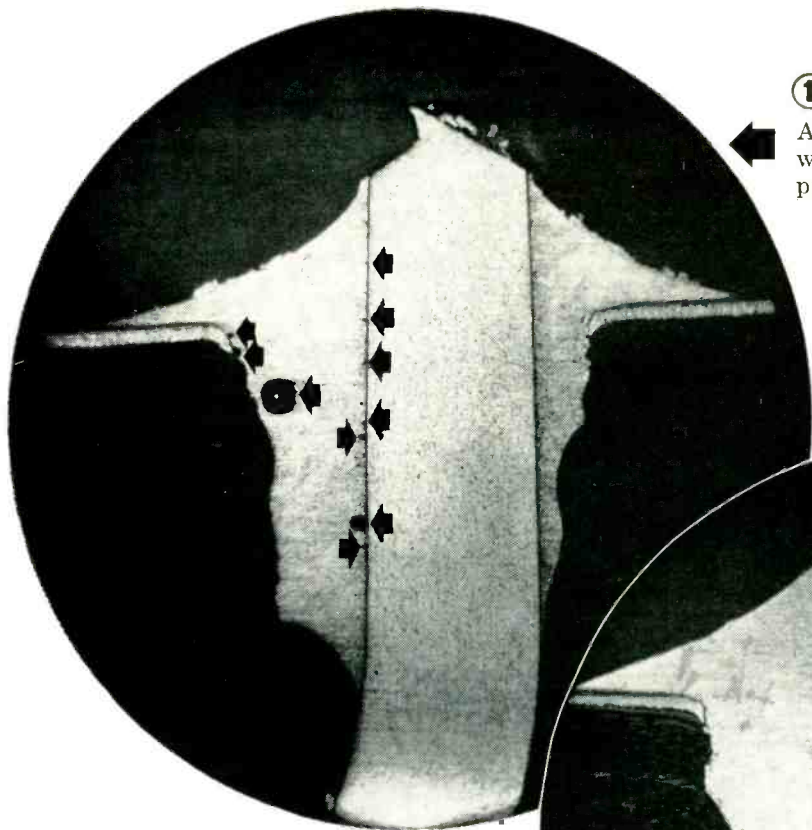

①

Arrows point out porosity that weakens the joint in this typical printed circuit soldered lead.

②

In this "Dutch Boy" joint porosity has been done away with. Joint is stronger.

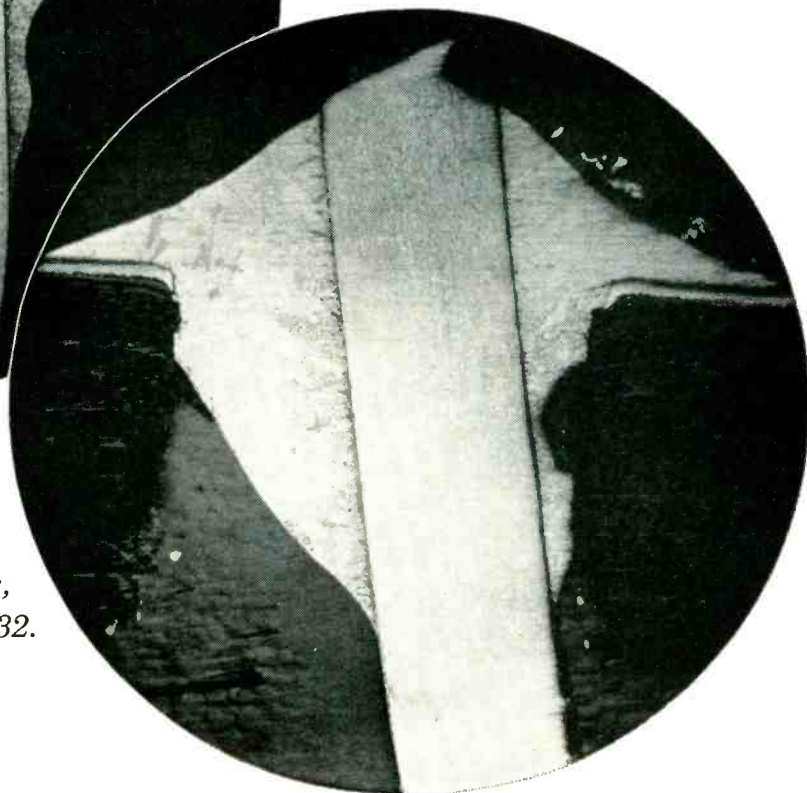

*Photomicrographs of printed circuit soldered leads, polished, etched, and magnified by 32.*

## "Dutch Boy" gets inside story on printed circuit soldering

*...develops solders and fluxes that give stronger joints, coat more uniformly, show higher conductivity*

"Dutch Boy" researchers keep a close eye on printed circuit soldering.

For example, they cross-section soldered leads, polish, and examine the polished sections under the microscope.

### Most such joints prove too weak

The photomicrograph above left shows why. Notice this typical joint is honeycombed with porosity. Arrows point to holes.

Now look at the photomicrograph on the right. This joint is strong. Non-porous.

### How was joint on the right made stronger?

No great trick. A "Dutch Boy" Solder Specialist simply worked out slight improvements in flux and solder formulae and operating conditions.

Maybe this would help improve your printed circuits.

"Dutch Boy" solders develop maximum surface tension. They don't form "tear drops" when coated boards are lifted from the bath...they improve coating uniformity. The residual flux is both non-corrosive and non-conductive, and can be left on the soldered board.

So, if you feel there is room for improvement in your printed circuit soldering, look first to "Dutch Boy". Write, giving details if possible, to National Lead Company, 111 Broadway, New York 6, N. Y.

**Dutch Boy®**  
**SOLDER AND FLUXES**





# IRGINIA

## FROM RAW GLASS TO RADAR

In 1608, the Nation's First Factory—the little "glass house" at Jamestown—sent "tryals of glasse" to England. Today, glass is one of the vital materials used in Virginia's fast growing electronic production. Your new electronics plant, too, can grow in the Old Dominion. Here are some reasons why:

**Southern Climate and Southern Manpower** are both competitive advantages for your factory. Here you enjoy them close to the great markets of the North and East—with favorable freight, rail and truck rates to the Mid-west.

**You're Close to Washington Area Research Facilities.** Raw materials from coal and resin to basic chemicals and packing cartons roll to your plant at short-haul cost. There's natural gas on tap, and you have ample, low-cost electric power.

**For Complete Facts** on taxes, zoning, wages, and available skills . . . or for confidential aid in finding a plant site or factory, write or telephone:

### DIVISION OF PLANNING AND ECONOMIC DEVELOPMENT

Virginia Department of Conservation and Development  
State Finance Bldg., Richmond, Va. • Telephone 3-3449

"Facts Favor Virginia"

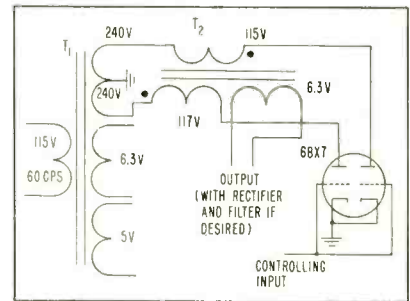

Basic circuit of the controller

of  $T_1$  and with the tubes. On each half cycle, a current pulse, whose amplitude is controlled by the voltage applied to the grids, passes through one or the other of the high voltage windings of  $T_2$ .

Since these two windings are connected in phase opposition, the effect is the same as that of an alternating current in one winding, thus an a-c output is induced in the 6.3-v winding. The amplitude of this output depends on the voltage applied to the grids; thus the a-c output can be controlled. If a d-c output is desired, the a-c can be rectified and filtered.

There is no significance in the slight difference in the two high-voltage windings of  $T_2$ . They should have been identical; such a transformer, however, was not available and the amount of unbalance actually introduced was too little to cause any trouble.

## Recording The ICBM

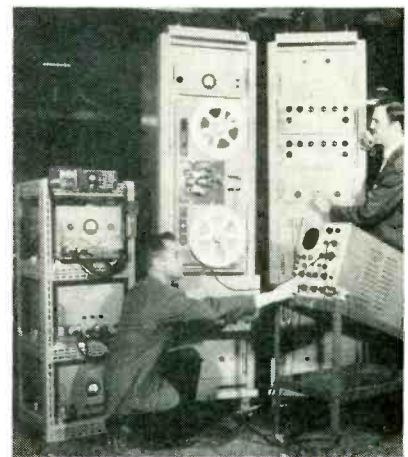

Airborne wide-band magnetic tape recorders manufactured by Bing Crosby Enterprises will record video ground return signals from intercontinental missiles

# Bendix-Pacific

## OPENS ITS NEW ENGINEERING CENTER



NO. 1 OF A SERIES

### PATTERN FOR PROGRESS

The consolidation of all the engineering resources of Bendix-Pacific into one ultra-modern facility has now become a reality at the new Pacific Division Engineering Center in North Hollywood.

Bendix-Pacific is making certain that its traditional leadership will continue in the specialized electronic fields of radar, missile guidance, telemetry and sonar as well as in hydraulics and electro-mechanics.

The new Center represents another important step in the integration of Pacific Division's engineering and development skills under the Weapons System Concept.



EAST COAST OFFICE: 475 5th AVE., N.Y. 17 • DAYTON, OHIO—1207 AMERICAN BLDG., DAYTON 2, OHIO • WASHINGTON, D.C.—SUITE 803, 1701 "K" ST., N.W.  
CANADIAN DISTRIBUTORS: AVIATION ELECTRIC, LTD., MONTREAL 9 • EXPORT DIVISION: BENDIX INTERNATIONAL, 205 E. 42nd ST., NEW YORK 17

## Parts-Bin Ferris Wheels Permit Quick Changes of Job Setups



Single-station portable ferris-wheel bin setup, with color transparencies of finished wiring board mounted in light box overhead to guide operator



Large five-station permanent ferris-wheel bin setup, with bins independently controlled by the five operators. All bins are clearly labeled for quick identification when bins are run up or down for new job setup

TOWERING VERTICAL parts bins, mounted on endless chains so they can be moved up or down by operators at the flip of a switch, speed assembly of military electronic units and save floor space at General Electric's Light Military Electronic Equipment Department in Utica, N. Y.

The bin system, developed for specific needs of job-lot military electronic assembly work, brings the parts to operators instead of their having to move to different benches for varied assembly operations. Operators take components from the bins one by one and insert them in printed wiring boards which later are dip-soldered for use in radar, navigation and other equipment.

The ferris wheel with its 3,000 individual bins occupies 150 square feet of floor space. Conventional workbenches with fixed, stacked bins would take up about 900 square feet. Between 50 and 60 job setups are carried in each of the five sections of the ferris wheel.

► **Portable Version**—A semiportable single-section vertical parts bin is also in use. This can be shifted to different sections of the factory area readily as required. As a further aid in changing job setups frequently with minimum training time, color transparencies of a completed subassembly are often used in connection with the single-section ferris-wheel bin. The transparencies are slid into a frame

on a light box mounted directly over the work station and ferris wheel.

► **How To Build**—Both small and large ferris wheels employ the same construction. A special link fitting, which replaces a standard link in the chain belt, carries the bracket that in turn carries the conveyor bin support rods. This fitting allows the entire unit to go around the top and bottom sprocket wheels with ample clearance. Bins therefore remain upright, swinging freely from the rods, as they go over the top and come down the back side.

Bins resemble home gutters, but actually are fabricated from steel for this application in the firm's Utica plant. The partitions are held in position by a bolt going through



# *Tunes* UP TIRED ASSEMBLY LINES



"44" RESIN, "RESIN-FIVE" and PLASTIC ROSIN—Kester Flux Core Solders belong at the very top of the solder hit parade when it comes to quality, speed, uniformity and economy. An unbroken record of dependability is what makes Kester a sure-fire "cure" for lagging production. Better switch now to Kester . . . a real production record maker!

WRITE TODAY for Kester's NEW 78-Page Informative Textbook, "SOLDER... Its Fundamentals and Usage."



# KESTER SOLDER

COMPANY 4204 Wrightwood Avenue, Chicago 39, Illinois; Newark 5, N. J.; Brantford, Canada

the rolled-over top of the partition piece; the front end of the bolt is a hook going over the edge of the bin. The fastening nut is at the rear. A locating pin punched with the partition goes into a mating hole in the bottom of the bin. Each bin may have any combination of sections from one to twelve.

The operator at each station controls the up or down motion of her bins by a stop-go lever at the lower right under her bench. The drive is one-speed and slow enough that bins can be positioned precisely simply by moving the lever to the stop position when the desired bin is in position.

A metal screen mounted at the rear of the ferris-wheel bin array prevents other personnel from brushing against the bins and possibly upsetting them. Bins are loaded from the front, either during the second shift or during down time. The entire plant is air-conditioned, hence dust is not a problem.

## Vacuum and Vibration Speed Assembly of Core Memory Planes

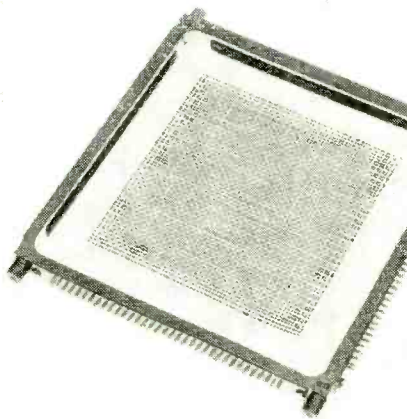

Assembly and wiring of this early 64 x 64 ferrite-core memory plane required 1 to 2 technician-weeks of tedious labor

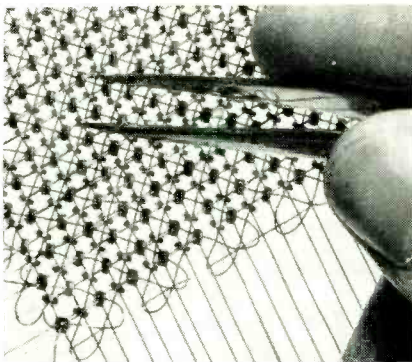

Closeup of early memory plane design, showing how four wires pass through each core—for X, Y, digit and sense



Pouring ferrite cores on to fenced-in area of vibrating form while vacuum cleaners are pulling air at full speed down through flexible hose at lower left. During pouring, form may be tilted and rotated to get one core into each of the 4,096 pockets

By E. A. GUDITZ and L. B. SMITH  
Staff Members, Lincoln Laboratory  
Massachusetts Institute of Technology

UNTIL RECENTLY, assembly of tiny ferrite rings into high-speed random-access memory arrays for digital computers has been an expensive and time-consuming process. As an example, assembly of a 64 x 64 (4,096-core) memory plane for the MIT memory test computer occupied a technician for between 1 and 2 weeks. The techniques to

be described have resulted in over a 5 to 1 reduction of assembly time through the use of inexpensive, easily obtained fixtures.

► **Core Holder**—The first requirement for an improved plane-wiring procedure was a fixture capable of holding the cores in fixed alignment for the four wires which had to be passed through each of them. The earlier technique required that the cores be counted and threaded

a row at a time. The cores would then be aligned and cross-wired.

A fixture to hold 4,096 cores in orientation is a complex machining job. For this reason, a male mold was machined from which plastic forms could be pressed as needed. The machining task was simplified by milling into the basic mold piece the shaped projections running in one direction and milling receiving slots for those running at right angles. The remaining projections

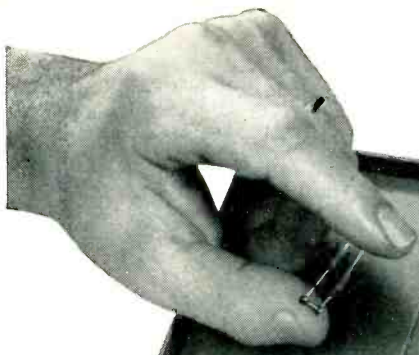

**EACH KIT CONTAINS** 36 resistors—6 of each specified type—  
packaged in attractive transparent plastic boxes, plus an  
engineering bulletin. Kits will be shipped postpaid to any point  
in the United States and Canada.

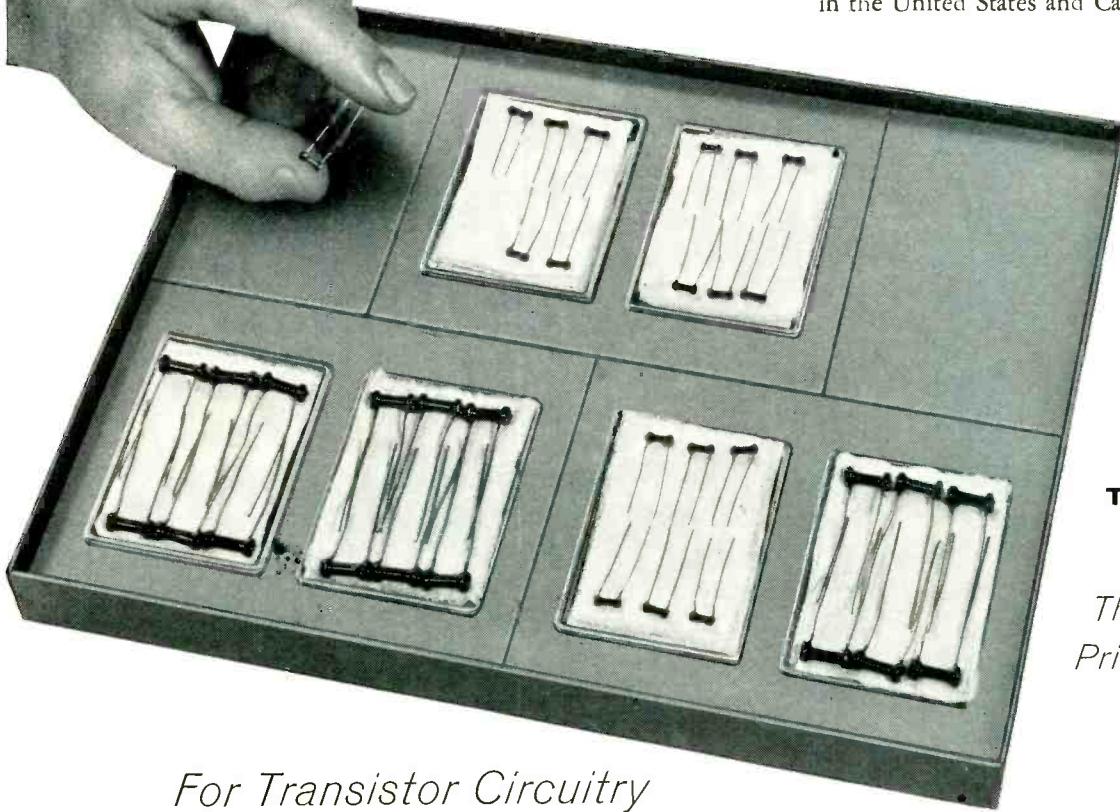

**TEST KIT  
NO. 5**  
*Type F  
Thermistors*  
Price **\$22.50**

*For Transistor Circuitry*

**NEW GLOBAR®** TYPE F THERMISTOR KIT

Quantity	Cat. No.	Body Size		Res. at 25°C ± 20%	Nominal Temp. Coeff. B Constant	Nominal Watt Loading
		Length	Diameter			
6	763F	5/8"	7/32"	5	1100	0.5
6	763F	5/8"	7/32"	10	1400	0.5
6	763F	5/8"	7/32"	20	1500	0.5
6	997F	19/64"	7/64"	40	1450	.25
6	997F	19/64"	7/64"	220	1750	.25
6	997F	19/64"	7/64"	10000	1950	.25

Where the effect of temperature on transistor circuitry presents a problem, the Type F thermistors in this test kit can help you find the answer. They were selected to provide a useful range of resistance values and temperature coefficients in body sizes suitable for this type of application.

Both Global® 997F and 763F thermistors are currently being tested in transistor circuits or have already been designed into them. The 997 size is particularly suitable for use in miniaturized equipment.

**OTHER TEST KITS** of GLOBAR® Ceramic Varistors and Thermistors now available to help solve your circuitry problems include:

**KIT NO. 1**



**\$29.25**

TYPE F  
THERMISTORS

**KIT NO. 2**

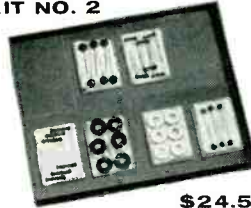

**\$24.50**

TYPE H  
THERMISTORS

**KIT NO. 3**

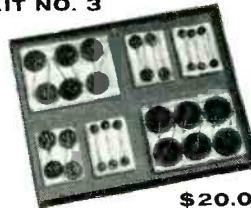

**\$20.00**

TYPE BNR  
VARISTORS

**KIT NO. 4**

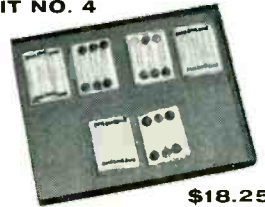

**\$18.25**

TYPE F,  
TYPE BNR THERMISTORS  
and VARISTORS

**ORDER YOUR KITS NOW!**

For further information, or for FREE Engineering Bulletin on any kit, write—

**GLOBAR® Division**  
**THE CARBORUNDUM COMPANY, Niagara Falls, N. Y.**

87-532

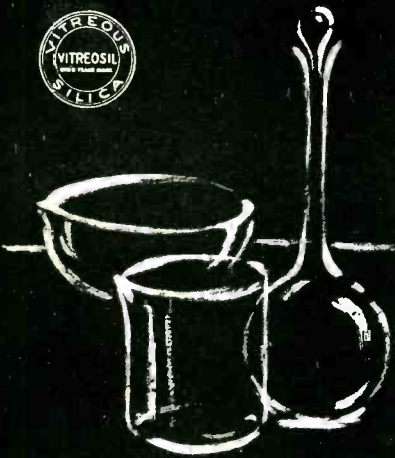

**Look no further—**  
**if you're looking for**  
**"BORON-FREE"**  
**fused quartz**

**LABORATORY WARE**

The world's largest producer of fused quartz products can help you with your most critical and exacting needs for your laboratory ware.

Vitreosil® products can be supplied in an unusually large variety of types and sizes. Also fabricated to specification to meet individual requirements.

**TRANSPARENT VITREOSIL**

For ultra-violet applications, metallurgical investigations, chemical research and analysis, photochemistry, spectroscopy and physical, optical and electrical research.

Send specifications for your requirements. Please use coupon below.

**THERMAL AMERICAN  
 FUSED QUARTZ CO., INC.**  
 18-20 Salem Street, Dover, New Jersey

Please send technical data on

\_\_\_\_\_

\_\_\_\_\_

Company \_\_\_\_\_

Name & Title \_\_\_\_\_

Street \_\_\_\_\_

City \_\_\_\_\_ Zone \_\_\_\_\_ State \_\_\_\_\_

Want more information? Use post card on last page.

were machined in strip form and later soldered into the slots.

Tests of various plastic compounds resulted in the selection of Plexiglas for the forms; several types of this material were successfully pressed in the mold and removed in one piece.

► **Bouncing and Vacuum**—A technique was devised to load one of these plastic forms with 4,096 individual cores in less than 15 minutes. The form, which has a hole in the bottom of each core pocket, is mounted as the cover of

a metal box connected to a commercial vacuum cleaner. The cores are slowly poured onto the form while a vibrator within the box shakes the entire fixture. As the cores are bounced, they are caught in the air stream and pulled into the pockets where they are held by the suction stream. When the form is filled with cores a thin plastic sheet, pulled down tightly against the tops of the cores by the suction, helps to hold them all in place for wiring. It is then possible to pass a needle through a row of cores without flipping any from

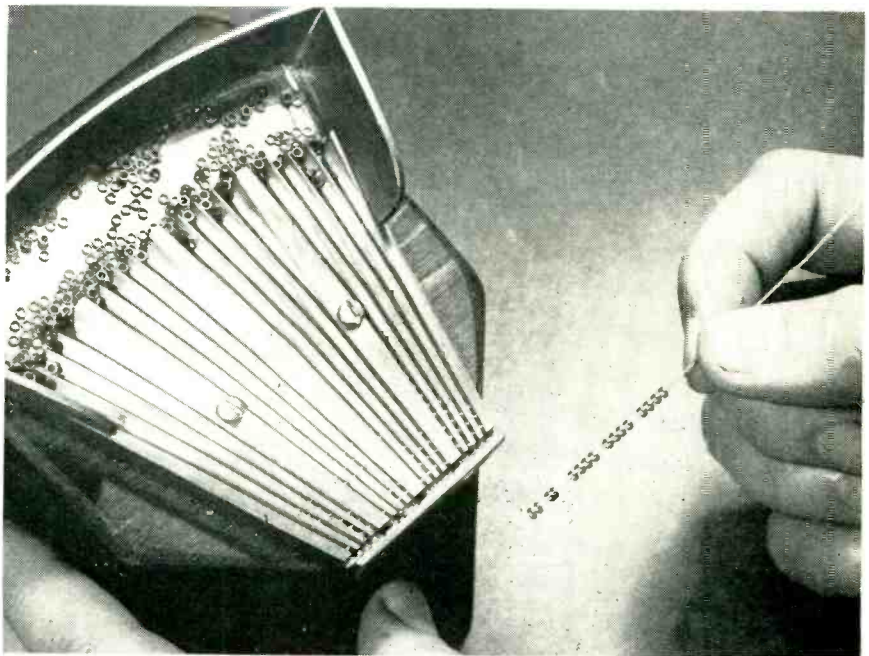

Older technique required that cores be threaded on a long needle and wired into large frame manually. The only significant mechanized aid was the counter-threader shown here, which presented 16 cores at a time to operator. Cores gradually turn to vertical position as they slide down contoured chutes to threading position at bottom

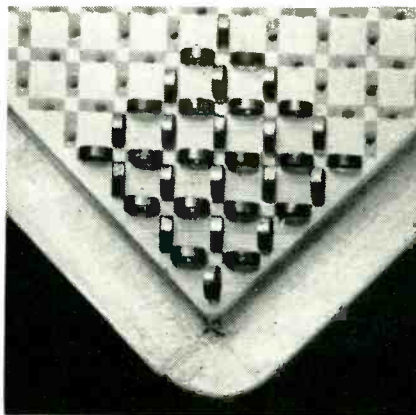

Corner of plastic form, showing 36 cores in correct orientation in the pockets. Air is sucked through hole in bottom of each core pocket at a high rate during core positioning and at a lower rate during wiring of a 4,096-core plane



Corner of brass master mold used in producing plastic assembly forms. Vertical rows of half-disks are machined out of solid sheet with milling cutter, after which parallel slots are cut and individual horizontal strips inserted

**CHATHAM** advance-designed yesterday

- in  
industry-wide  
use today!

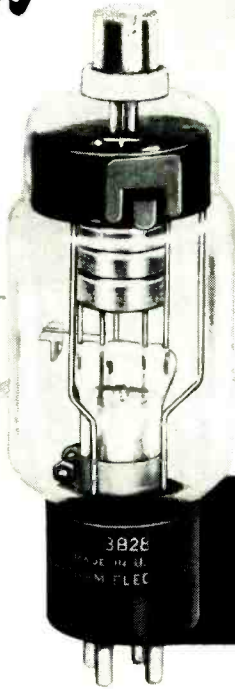
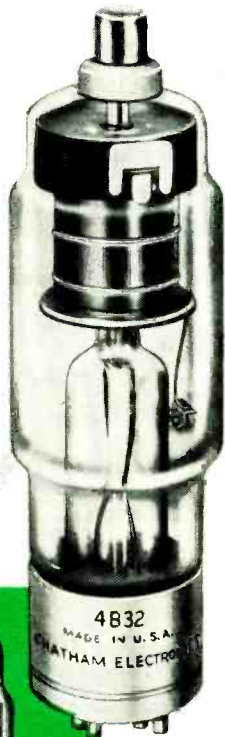

**AMPLIFIERS • REGULATORS • INERT GAS  
AND MERCURY RECTIFIERS • MERCURY,  
INERT GAS AND HYDROGEN THYRATONS**

# CHATHAM SPECIAL-PURPOSE TUBES



6336

● **3B28 RECTIFIER**

Rugged half-wave Xenon filled rectifier. Operates in any position. Ambient temperature range  $-75^{\circ}$  to  $+90^{\circ}\text{C}$ . Inverse peak anode voltage 10,000, average current .25 amps. Filament 2.5v., 5 amp.

● **4B32 RECTIFIER**

Ruggedly built, half-wave Xenon filled rectifier. Ambient temperature range  $-75^{\circ}$  to  $+90^{\circ}\text{C}$ . Inverse peak anode voltage 10,000, average anode current 1.25 amp. Filament 5v., 7.5 amp.

● **VC-1258 MINIATURE  
HYDROGEN THYRATRON**

for pulse generation. Handles 10 kw peak pulse power.

● **6336 TWIN TRIODE**

for voltage regulation. Features high plate dissipation, hard glass envelope.

● **5R4WGB RECTIFIER**

Full wave rectifier manufactured to MIL-E-1B reliable tube specifications.

● **5651-WA VOLTAGE  
REFERENCE TUBE**

Stable, rugged. Available in both commercial or reliable tube MIL types.



5R4WGB



VC-1258



5651-WA

**STANDARD TYPES DIRECT FROM STOCK  
PLUS SPECIAL DESIGNS BUILT TO REQUIREMENTS**

Chatham specializes in the development of general and special purpose tubes for both electronic and industrial applications. Many of the tubes originally developed by Chatham to fill a specialized need, now number among the most widely used tubes in the industry. For complete information on Chatham tubes — either stock items or types built to your requirements — call or write today.

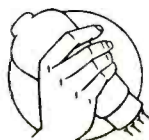

**CHATHAM ELECTRONICS**  
Division of Gera Corporation — LIVINGSTON, NEW JERSEY



# HYCOR TELEMETERING FILTERS



Hycor band-pass and low-pass telemetering filters are produced in exact accordance with accepted military standards. In addition to designs which conform to Applied Physics Laboratory specifications, miniature units are available.

Hycor telemetering filters are potted for complete protection against vibration and humidity. The finest components are used to minimize aging effects on characteristics.

Send for **Bulletin TF** which describes standard types available.

Hycor engineers will be pleased to quote on your most exacting specifications.

*Representatives in  
Principal Cities*

**HYCOR**  
*Company, Inc.*

Subsidiary of International Resistance Company

11423 Vanowen Street  
North Hollywood 1, Calif.

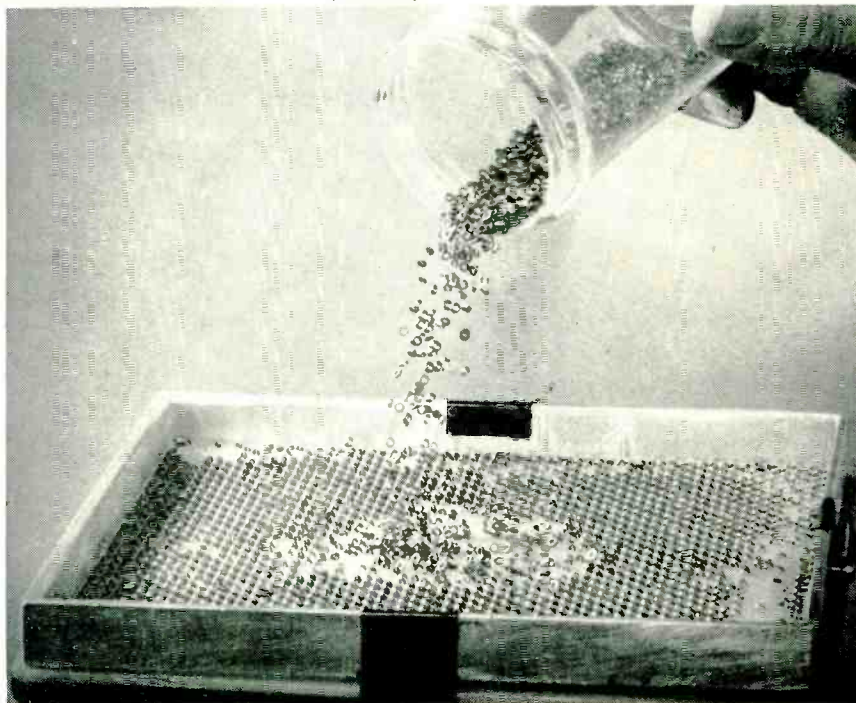

Appearance of plastic frame when most of the 4,096 cores are in position. Artist's hairbrush and tweezers are used to place the last few cores in the empty pockets, after which the assembly is covered with Saran-wrap. Core-positioning takes 15 minutes

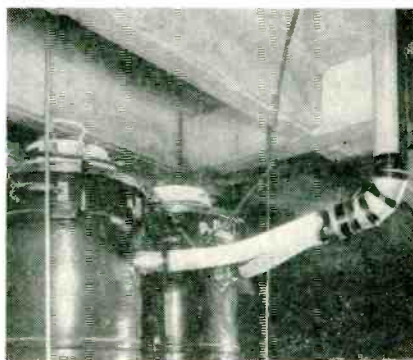

Method of mounting two Pullman industrial vacuum cleaners on platform below assembly area and coupling to single stovepipe duct running up to assembly benches

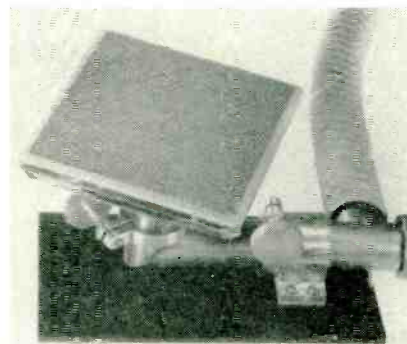

Holding fixture, showing cores in position on plastic form ready for wiring with aid of hypodermic needle. Saran-wrap covering is left in position during wiring



Wiring station, showing operator threading wire through cores held by frame of work fixture on bench. Core-positioning station at right is acoustically treated to reduce noise from vibrating jig

Want more information? Use post card on last page.

*Double check the Core Manufacturer with the low price and quick delivery promises, which do not permit intelligent engineering and careful production.*

# Only the Big

# NATIONAL MOLDITE COMPANY

Long established firms like MOLDITE, with their vast contributions to research and development of new cores and core materials, with their advanced production and testing techniques, are greatly responsible for raising the worlds standards for quality cores, molded coil forms, and ferrites. Every business has its Johnny-come-lately's without the background and goodwill that we at MOLDITE cherish and protect every day.

*When you want cores you can trust, that will guarantee the high quality of your equipment,*  
**MOLDITE**  
*is ready to serve you.*

## ALWAYS DELIVERS A HIGH QUALITY PRODUCT



*Send for our Catalog 120*

**IRON CORES • FERRITES • MOLDED COIL FORMS • E E CORES**

Robert T. Murray Co.  
604 Central Avenue  
East Orange, N. J.

Jerry Gotten Co.  
2750 W. North Ave.  
Chicago 22, Ill.

William A. Franklin  
3 Holly Road  
North Syracuse, N. Y.

Jose Luis Ponte  
Cardoba 1472  
Buenos Aires

# NATIONAL MOLDITE COMPANY

**1410 Chestnut Avenue  
Hillside 5, New Jersey**

Perlmuth-Colman & Assoc.  
2419 South Grand Ave.  
Los Angeles Cal.

John S. Plewes Co.  
52 Humbercrest Blvd.  
Toronto 9, Ontario

# THE SPRAGUE MODEL 400 INTERFERENCE LOCATOR



## PORTABLE, VERSATILE SPRAGUE UNIT PINPOINTS SOURCE OF INTERFERENCE

This newly improved Sprague instrument is an extremely lightweight, compact, rugged and sensitive interference locator—with the widest frequency range of any standard available unit!

Engineered and designed for practical, easy-to-operate field use—keyed to needs of utility industry—permits rapid pinpointing of interference sources.

The Sprague 400 operates across the entire standard and FM broadcast, shortwave and VHF-TV spectrums. In field use it operates from a self-contained storage battery or from 117 volt a-c lines, a built-in battery changer is an additional feature of the Model 400.

SEND FOR  
BROCHURE  
"THE SPRAGUE  
MODEL 400  
INTERFERENCE  
LOCATOR"



# SPRAGUE

ELECTRIC COMPANY

35 MARSHALL STREET • NORTH ADAMS, MASS.

Want more information? Use post card on last page.

their positions in the pockets.

► **Threading**—The filled form is moved to another vacuum station for wiring; the first station is used for the positioning process only. Each core is threaded by an X wire, a Y wire, the digit winding



Method of using long 26-gage hypodermic needle to pull wires through 50-mil inside diameter of cores. An X wire and the Z winding are being pulled simultaneously

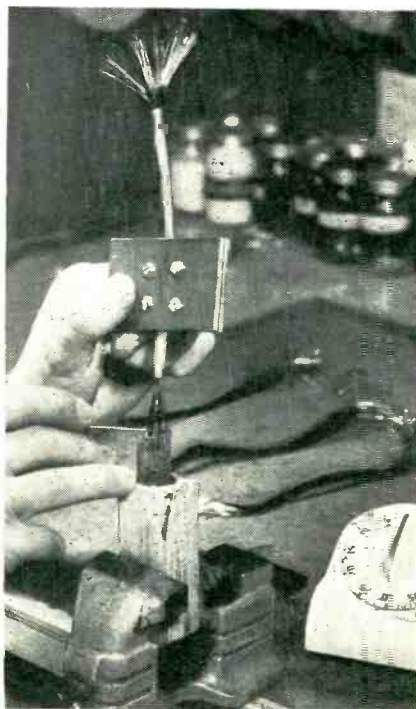

Method of using X-Var chemical stripper in test tube for stripping Formvar or Formex insulation from wires to be used in mat. Spaghetti tubing with tape seal at one end prevents stripper from creeping up too high. Squares of laminate bolted over spaghetti control depth of immersion when wire is dropped

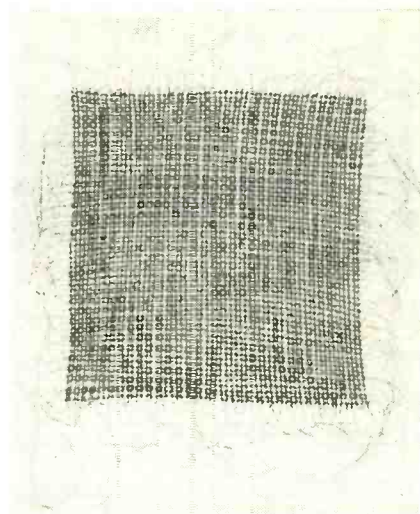

Appearance of completed mat when removed from wiring form, ready for connecting to a frame. Each mat now is produced in only 4 to 5 technician-hours, using quadruple-Formex No. 32 and No. 34 wire. Four of these wires go through each core

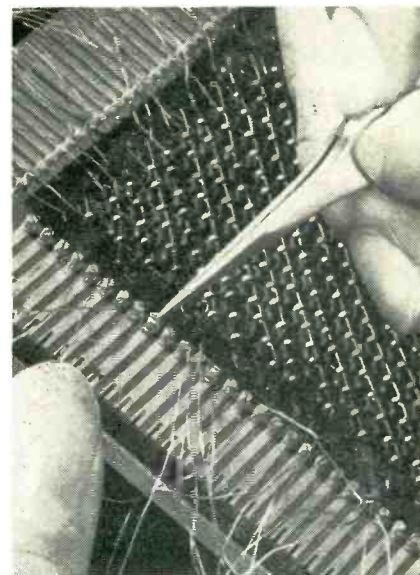

Method of using tweezers to aid in placing second loop of a Y wire in slot of sub-miniature lug on etched-wiring frame of memory plane. Between 2 and 3 hours are required to make these connections, straighten out lines of mat and clip off surplus wire

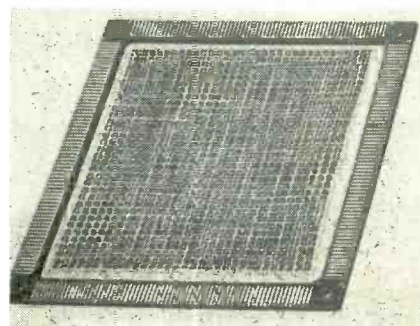

Complete memory plane ready for dip soldering of leads wrapped around lugs positioned over etched-wiring terminals



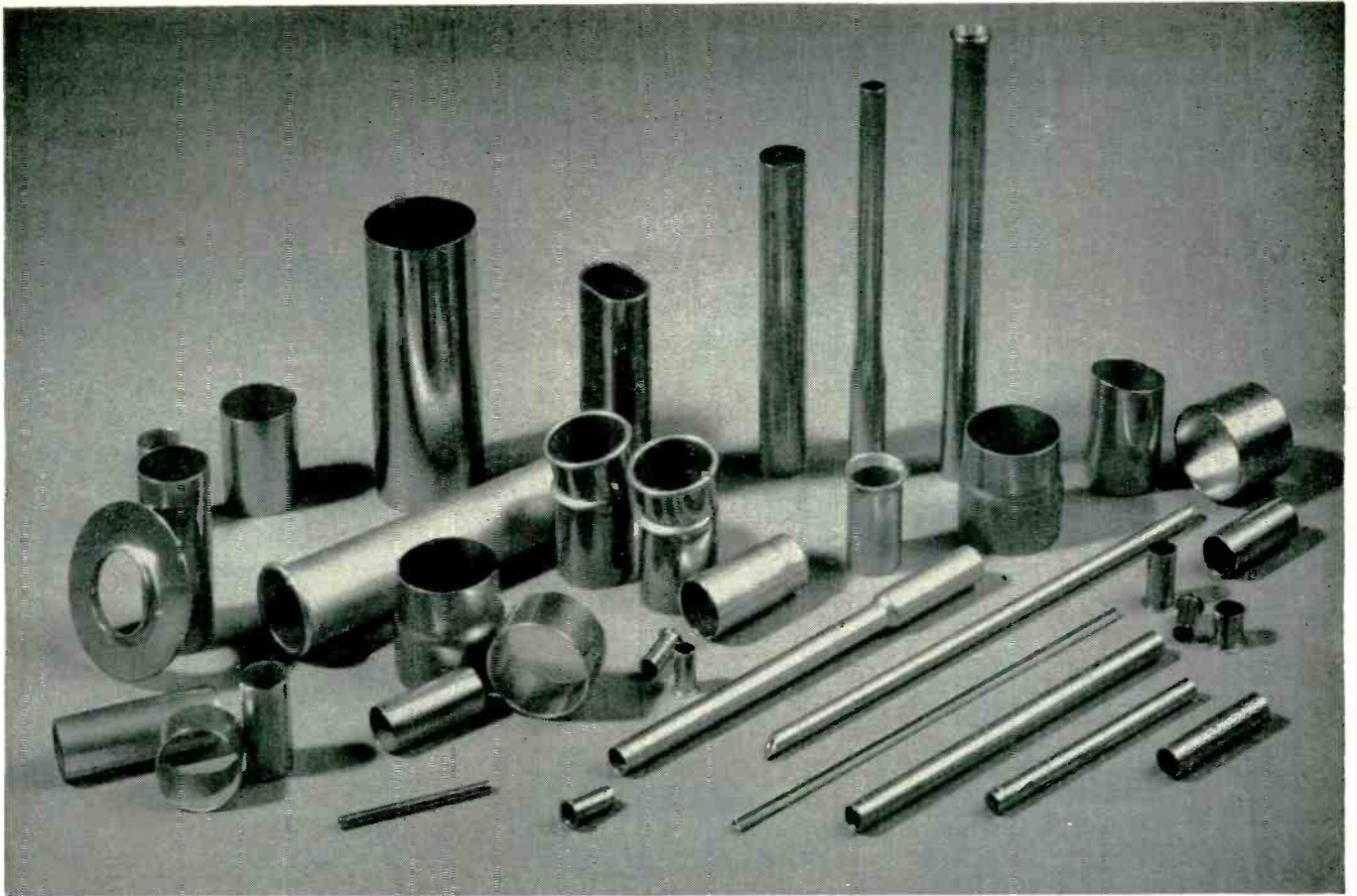

# Need close-tolerance tubular parts like these? Just send drawing

**Superior Tube has special facilities for doing complete job — efficiently, fast**

Save handling costs. When you need special close-tolerance tubular parts, let Superior Tube make them for you complete. Engineering assistance is available. Or just send drawing, indicating size, shape, metal analysis, temper and degree of finish desired.

Superior Tube's special facilities provide for flaring, cutting, deburring, expanding, bending, rolling ends, grooving, beading, coiling, flattening, punching, deep drawing, reducing, drilling, chamfering, shearing, slotting. A wide choice of different alloys of closely controlled analysis is available.

For prices and complete information on fabricated tubular parts on glass sealing alloys, write Superior Tube Company, 2500 Germantown Ave., Norristown, Pa.



## GLASS SEALING ALLOYS

Glass-to-metal seals for conductor leads into vacuum tubes, hermetically sealed chambers, or controlled atmospheres. Typical uses are shown above, left to right: voltage regulator, capacitor, capacitor cap, button terminal, recording pen, refrigeration sniffer. Superior offers six standard uniform-expansion alloys cold drawn to close tolerances in Seamless or WELDRAWN\* tubing.

\*TM Superior Tube Co., Reg. U.S. Pat. Off.

# Superior Tube

The big name in small tubing

All analyses .010" to 3/8" OD. Certain analyses in light walls up to 2 1/4" OD.

and the sense winding. The X and Y wires are short and go from one edge of the plane to the other. The digit wire is continuous and passes through each core parallel to each



THIS IS REPLACED

WITH THIS

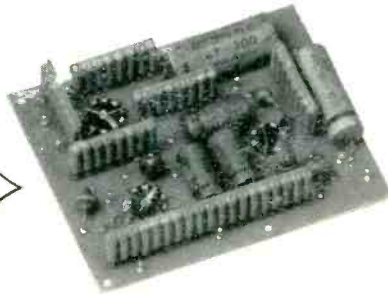
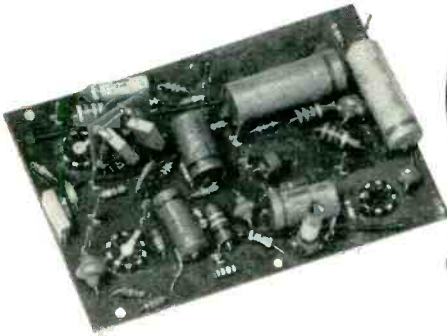

After dip soldering each of the four edges of the plane in turn, unit is ready for inspection and test



Pouring diluted Amphencil Polyweld over dip-soldered mat to cement each core at its four-wire junction below for later use

**\*PACKAGED ASSEMBLY CIRCUIT**

**PAC-Facts**

**REDUCED COSTS**

PAC requires fewer insertions. Simplified equipment. Smaller chassis area. Reduced inspections. Fewer items purchased. Fewer chassis holes. Simplified chassis wiring.

**UNIQUE TERMINAL DESIGN**

The Erie PAC terminal provides a "U"-shaped cross section and tapers in both planes to assure easy insertion, self-adjusting—rigid fit, and large contact area.

**FLEXIBILITY**

All Resistance values between 5 ohms and 50 megohms. Wide range of capacitor temperature characteristics. Parallel and series arrangements readily obtained. Excellent circuit flexibility thru use of printed wiring type base.

**REDUCED CHASSIS AREA**

Chassis area is reduced by use of the vertical plane design feature. 15 components per square inch.

Erie's new Packaged Assembly Circuit is able to reduce assembly and labor costs for electronic component users by simplifying automation. By employing standard size resistor and capacitor pins, a PAC module can be assembled simply, automatically, and economically.

PAC will drastically reduce the number of component insertions in TV, radio, computers, and other electronic equipments by combining up to 90 components into one PAC module. The illustration above clearly exemplifies how Erie's Packaged Assembly Circuit will clean up and simplify nearly any printed circuit board. The original conventional design, at left, contains 44 individual components. The electrically equivalent Erie PAC design, at right, contains but 16 individual units—a savings of 64% in the number of insertions.

Experimental PAC Design Kits have been prepared and are available at a moderate cost. The 5% PAC Kit includes 195 different resistance and capacitance values, strips, wiring boards, clips, eyelets, and other material essential for building complete PAC circuits. The 10% PAC Kit contains 105 values along with the other items, and the 20% PAC Kit has 54 values plus equipment. This Design Kit is your key to cost savings.

Write for Erie Engineering Bulletin No. 450-1

**ERIE** ELECTRONICS DIVISION  
**ERIE RESISTOR CORPORATION**  
 Main Offices and Factories: **ERIE, PA.**  
 Manufacturing Subsidiaries  
 HOLLY SPRINGS, MISSISSIPPI • LONDON, ENGLAND • TRENTON, ONTARIO

WHAT'S NEW AT BRISTOL...

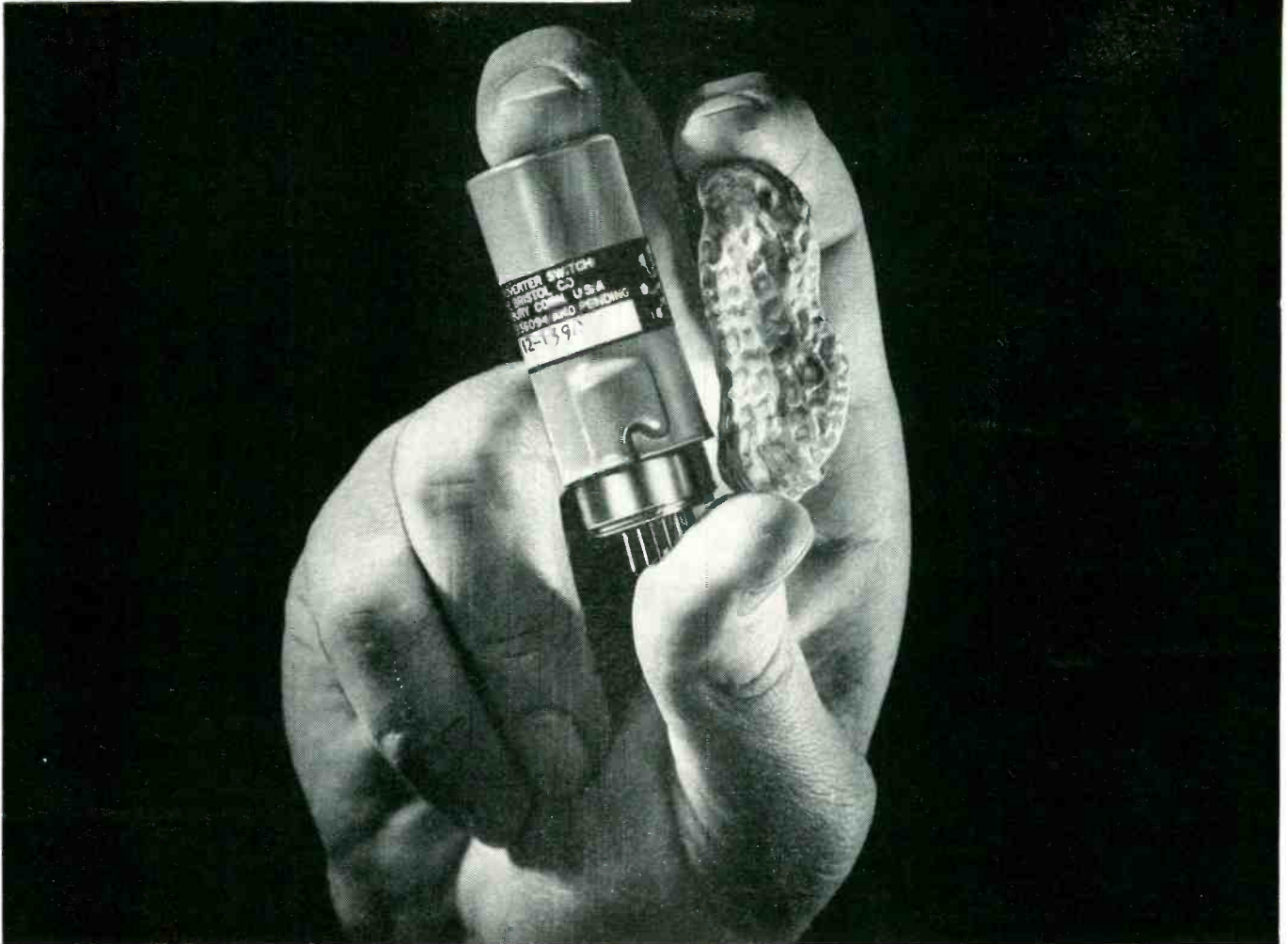

BRISTOL'S SYNCROVERTER SWITCH SHOWN ACTUAL SIZE.

## Miniature chopper sets new performance standards

### TYPICAL OPERATION

	400 cps	500 cps
<b>Coil voltage</b>	6.3V sine, square, pulse wave	6.3V sine, square, pulse wave
<b>Coil current</b>	55 milliamperes	45 milliamperes
<b>Coil resistance</b>	85 ohms	85 ohms
<b>*Phase lag</b>	$55^\circ \pm 10^\circ$	$65^\circ \pm 10^\circ$
<b>*Dissymmetry</b>	less than 4%	less than 4%
<b>Temperature</b>	$-55^\circ\text{C}$ to $100^\circ\text{C}$	$-55^\circ\text{C}$ to $100^\circ\text{C}$
<b>*Switching time</b>	$15^\circ \pm 5^\circ$	$15^\circ \pm 5^\circ$
<b>Mounting</b>	—Any position—fits 7-pin miniature socket	

\* These characteristics based on sine wave excitation

In the field only a short time, Bristol's peanut-sized new Syncroverter® Switch is drawing cheers from electronics companies all over the country.

One electronics engineer writes: "In seven years of experience in applying similar devices, we have not found a chopper as reliable . . . after our tests no deterioration in performance was found, and we believe there is no equivalent meeting our requirements." Another electronics firm writes: "The switch has passed the 1000-hour mark without the slightest degradation of the wave form."

A polarized, SPDT non-resonant switch which provides break-before-make action in synchronism with the driving current wave, the Syncroverter Switch is applicable for use over the excitation frequency range of 0-2000 cps. It is outstanding for reliability, long life, light weight (only 1.7 ounces), low noise level, and clean wave form.

We've got a bulletin ready to send to you. Write for it today to The Bristol Company, 152 Bristol Road, Waterbury, Conn.

5.9

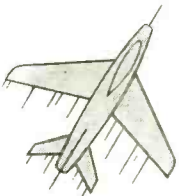

# BRISTOL

POINTS THE WAY IN  
HUMAN-ENGINEERED INSTRUMENTATION

TRADE MARK  
BRISTOL'S  
REG. U.S. PAT. OFFICE

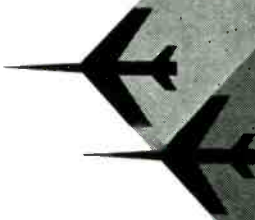
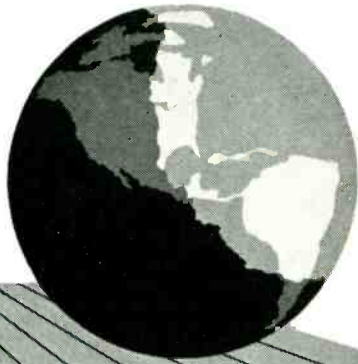

# YEAR XIV...

## ... IN THE AGE OF NUCLEAR AND THERMONUCLEAR DEVELOPMENT

Interested in it? So are we! For here at world-famous Los Alamos Scientific Laboratory, responsible for unleashing the terrifying power of the atom, we are now pioneering in harnessing this power for beneficial uses.

There is exciting adventure in the application of nuclear and thermonuclear energy to weapons, power and propulsion. Supporting these diverse activities here at Los Alamos are many challenging projects in basic physics, chemistry, metallurgy, mathematics and engineering.

Los Alamos needs men and women with imagination and research ability for permanent career positions. Interested? So are we!

Write us for an illustrated brochure describing the laboratory, its delightful mountain location and its excellent housing and community facilities. Mail your request to

DIRECTOR OF PERSONNEL  
DIVISION 503

LOS ALAMOS SCIENTIFIC  
LABORATORY IS NOW IN ITS  
14TH YEAR OF OPERATION.

los  alamos  
scientific laboratory  
OF THE UNIVERSITY OF CALIFORNIA  
LOS ALAMOS, NEW MEXICO

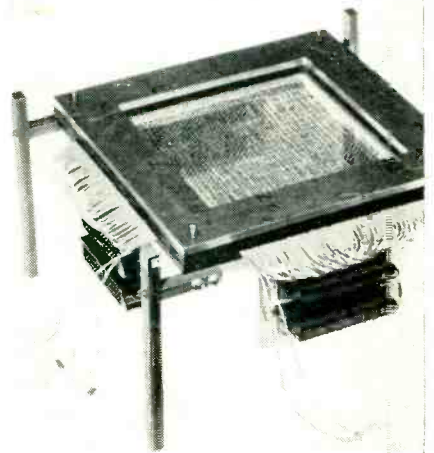

Test fixture for completed memory plane, with plane in position

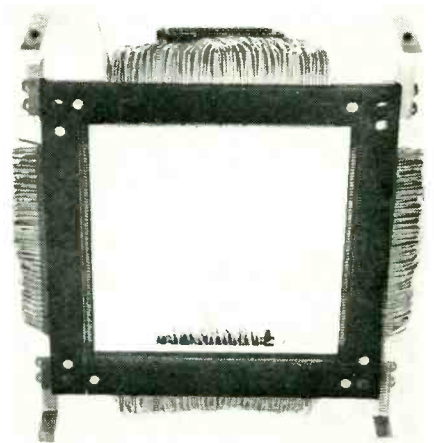

Test fixture without plane

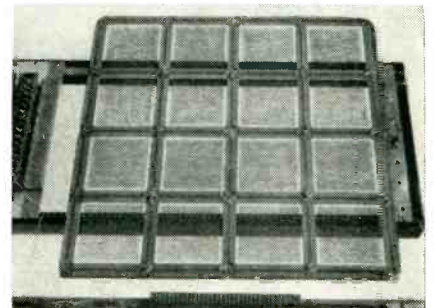

Array of 16 memory planes, interconnected by copper shims to give 256x256 memory plane. Complete random-access memory under development will have 38 of these large planes

Y wire. The sense wire also passes through each core, but in a different manner; one half of the winding is threaded through each core along alternate diagonals, while the other half is rotated 90 degrees and passed similarly through each of the remaining cores.

► **Finishing**—The wired assembly of 4,096 cores, called a mat, may be

# TAKE A GOOD LOOK

**YOU CAN ACTUALLY SEE THE DIFFERENCE!**

These are unretouched photo-micrographs (not artist's conceptions) of FERRO-SHEEN tape and ordinary tape taken under identical conditions. Magnification is 50X. See how irregular the eggshell surface of the ordinary tape appears in comparison with the smooth FERRO-SHEEN tape. See how much smaller are the shadows and highlights of the FERRO-SHEEN tape. This indicates a much greater uniformity of oxide coating and an unparalleled super-smooth surface. ▶



**irish FERRO-SHEEN HAS THE Smoothest Surface OF ALL RECORDING TAPES!**



**FERRO-SHEEN TAPE**



**ORDINARY TAPE**

## What Does This Super-Smoothness Mean to YOU?...

**1 GREATLY REDUCED HEAD WEAR:** the mirror-smooth FERRO-SHEEN surface virtually eliminates disastrous head-wear caused by the abrasive surface of ordinary tapes.

**2 NO SHEDDING OF OXIDE:** unlike ordinary tapes which shed oxide particles that gum up the heads, the FERRO-SHEEN process anchors the oxide to the base so that it cannot come off and deposit itself on the head.

**3 FLATTER FREQUENCY RESPONSE:** the super-smooth surface of FERRO-SHEEN tape makes better contact with the recording head, resulting in higher output, a very flat frequency response.

**4 REDUCED "PRINT-THROUGH":** "Print-through" is virtually eliminated, even at excessive input levels, because of unparalleled oxide uniformity in FERRO-SHEEN process tape.

**MAKE YOUR OWN TEST IN TWENTY SECONDS!▶**

Send for free Comparator Card which has strips of all of the leading tapes mounted side by side for your direct visual comparison. You will SEE the obvious difference at a glance. You will instantly recognize that irish FERRO-SHEEN process tape with its obvious smoother surface is the finest tape your recorder can use!

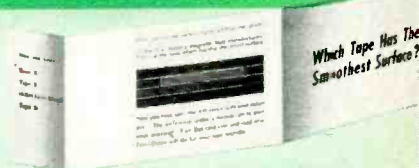

**FERRO-SHEEN IS NOW AVAILABLE IN THESE THREE QUALITY irish TAPES:**

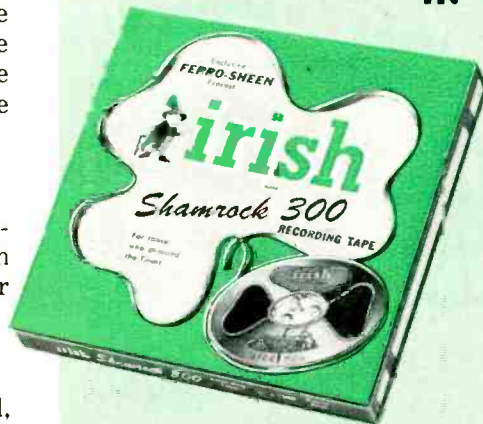

**SHAMROCK #300:** The ultimate in premium, professional tape for broadcast and studio use. 1.5 mil plastic base. Comes with 5' Mylar leader in dust-proof polyethylene bag. 1200 feet ..... on 7" reel

**LONG-PLAY #600:** Extends playing time 50% over conventional tapes on same size reel. Same premium qualities as Shamrock #300, but on Dupont's new miracle film Mylar. 1800 feet ..... on 7" reel

**SOUND PLATE #220:** The super-tough tape pioneered by ORRadio, now on 1.5 mil Mylar. Used for tape-masters, and recording under adverse climate conditions. 1200 feet ..... on 7" reel

If not available at your local dealer, write:  
**ORRADIO INDUSTRIES, INC., Opelika, Alabama**  
 World's Largest Exclusive Magnetic Tape Manufacturer  
 EXPORT DIVISION: Morhan Exporting Corp., N. Y. C.  
 IN CANADA: Atlas RADIO CORP., Ltd., Toronto, Ontario

# "PRINTED CIRCUIT OUTPUT UPPED *when we switched to HUNT R.C.E.*"

( RAPID CIRCUIT ETCH )

## —the FASTEST ETCHING SOLUTION for PRINTED CIRCUITS

Here indeed is good news for all makers of etched printed circuits. Philip A. Hunt Company, world-famous makers of photographic and photo-engraving chemicals, now offers Hunt R.C.E. Solution, a special etching solution with these BIG advantages, guaranteed:

1. Controlled rapid etching speed, permitting standardization of a high production etching schedule
2. Instant and uniform etching over entire circuit
3. Maximum etching capacity
4. Full protection of tops

Contact your nearest Hunt branch, or write us at Palisades Park, N. J., today for full information on Hunt R.C.E. Solution.

*Hunt R.C.E.  
Solution is  
supplied in  
145 lb. rubber  
drums*

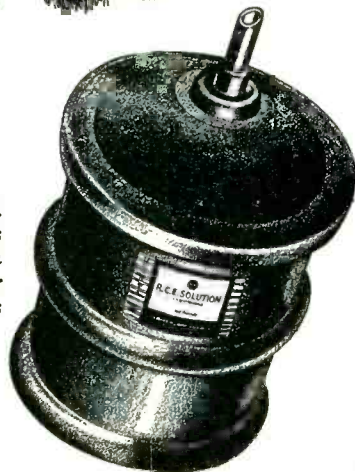

**PHILIP A. HUNT COMPANY**  
PALISADES PARK, N. J.

Chicago • Cleveland • Cambridge • Brooklyn • Atlanta • Dallas • Los Angeles • San Francisco

removed from the plastic form and connected to a simple frame. After dip-soldering the connections at the four edges, the plane is complete and ready for testing. The cores may be immobilized to prevent future possible abrasion damage to the wires by pouring a dilute solution of electrical dope or cement over the mat.

The 64 × 64 memory plane is a complete unit ready for stacking in a 4,096-word memory array. More than this, however, it is designed so that several units may be conveniently joined to form a larger plane. For example, 16 may be

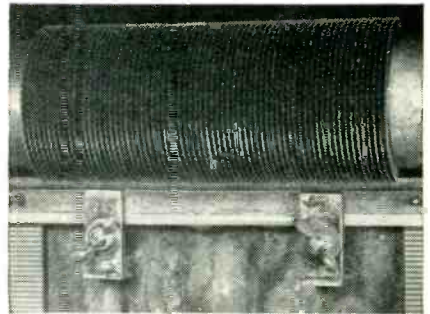

Use of gang saw to slot etched-wiring terminals of memory plane, in preparation for insertion of interconnecting shims

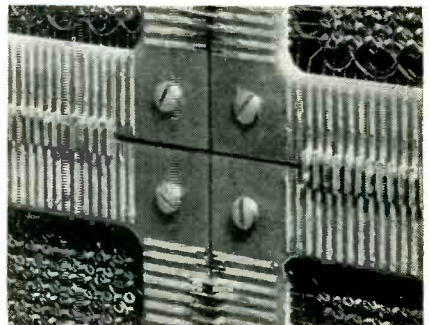

Junction of four memory plane units, showing use of interconnecting shims

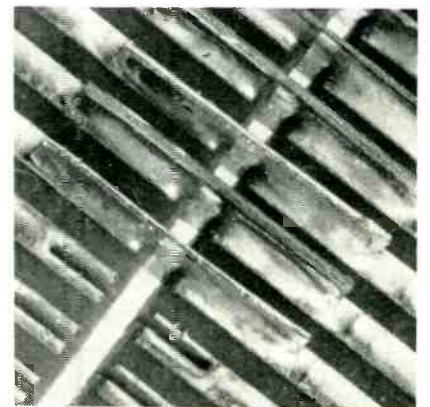

Shims are soldered to etched wiring terminals all at once by induction heating or by heating each shim individually with a soldering iron

A NEW

CORPORATE PACKAGE



## NATIONAL AIRCRAFT CORPORATION

*With 5 diversified and experienced divisions to serve industry*

The new corporate structure of National Aircraft Corporation brings together through merger and acquisition, five companies with established reputations for quality production into one well-coordinated organization. This consolidation enables each division to serve industry better since it welds the diversified research, engineering, and industrial skills of each into a single corporation of greater strength and versatility.

National Aircraft Corporation, 3411 Tulare Avenue, Burbank, California.



**MARVELCO ELECTRONICS DIVISION** . . . research and production of electronic components, missile guidance systems, computers, automation, germanium transistors, silicon power rectifiers, diodes, and associated items . . . formerly, Semi-Conductor Division of Hydro-Aire, Inc.

**MAG-ELECTRIC** . . . magnetic amplifiers, transformers, power supplies, toroids, and associated items . . . wholly owned subsidiary.

**MANUFACTURING DIVISION** . . . major aircraft components, HI-LIFT wings, hoppers, and agriculture aircraft . . . formerly Metropolitan Air Parts.

**AIRCRAFT DIVISION** . . . airframe modification, overhaul and repair of all types of aircraft . . . formerly West Coast Division of Florida Aircraft.

**AIRCRAFT ACCESSORIES DIVISION** . . . hydraulic, pneumatic, oil, fuel, mechanical, and electro-mechanical accessories.

# INDUSTRIAL POCKETSCOPE

by

**Waterman**

MODEL S-11-A

DC-COUPLED  
WORK-HORSE OF  
INDUSTRY

Size:  
11" x 5" x 7"  
8 3/4 Pounds



## ANOTHER EXAMPLE OF **Waterman** PIONEERING...

The INDUSTRIAL POCKETSCOPE, model S-11-A, has become America's most popular DC coupled oscilloscope because of its small size, light weight, and unique flexibility. This compact instrument has identical vertical and horizontal amplifiers which permit the observation of low frequency repetitive phenomena, while simultaneously eliminating undesirable trace bounce. Each amplifier sensitivity is 0.1 Volt rms/inch. The frequency responses are likewise identical, within -2 db from DC to 200 KC. Their total undistorted outputs permit effective trace expansion of twice the screen diameter. The internal sweep generator is continuously variable from 3 cycles to 50 KC and can be synchronized from positive going signals. Return trace blanking is optional. Intensity modulation is accomplished by connecting either directly to the grid of the three-inch cathode ray tube or thru an amplifier having a gain of approximately 10 and a flat response to 500 KC. Direct intensity modulation threshold voltage is approximately 1 volt rms. Additional provisions for direct access to all the deflection plates, the second anode, and the amplifier output terminals extend the usefulness of the S-11-A many fold.

## WATERMAN PRODUCTS CO., INC.

PHILADELPHIA 25, PA.  
CABLE ADDRESS: POKETSCOPE

### WATERMAN PRODUCTS INCLUDE

S-4-C SAR PULSESCOPE®  
S-5-A LAB PULSESCOPE  
S-6-A BROADBAND PULSESCOPE  
S-11-A INDUSTRIAL POKETSCOPE®  
S-12-B JANIZED RAKSCOPE®  
S-14-A HIGH GAIN POKETSCOPE  
S-14-B WIDE BAND POKETSCOPE  
S-15-A TWIN TUBE POKETSCOPE  
RAYONIC® Cathode Ray Tubes  
and Other Associated Equipment

MEMO...

Write for details today!

**Waterman**  
WATERMAN PRODUCTS

PRODUCTION TECHNIQUES

(continued)

joined to form a 256 by 256 plane. These large planes may then be stacked in a 65,536-word memory array.

The research described was supported jointly by the Army, Navy and Air Force under contract with the Massachusetts Institute of Technology. Acknowledgement is expressed to Lloyd Sanford of Lincoln Laboratory for the photographs of the arrays and assembly equipment.

## Drilling Template For Etched Wiring Boards

SMALL sample runs of large and complex etched wiring boards requiring plated-through holes are economically drilled in multiple by using an etched board as a drilling template. The etched board is placed over two or more unetched pieces of laminate and the sandwich is taped together around the edges. Two holes at diagonally opposite corners are drilled first. Steel pegs are inserted in these to insure accurate alignment during subsequent drilling. The operator then positions the sandwich manually over each terminal position in turn and drills the hole through the etched and plain boards simultaneously. Before drilling, she brings an air-actuated foot down on the boards to prevent movement during drilling, by operating a foot valve.

After all holes have been drilled, the unetched boards are ready for hole-plating, followed by conventional etching. The etched board is discarded or saved for reuse as a template since its holes cannot

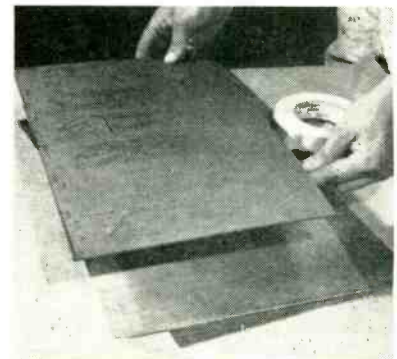

Placing etched template board over two unetched boards to prepare sandwich for drilling



# Two Metals are often Better Than One



## ...and General Plate **CONFLEX**<sup>\*</sup> is a case in point

Why not get acquainted with CONFLEX by sending for a free sample today?

If you are looking for stronger or lighter metal components, with better electrical and mechanical properties and fewer corrosion problems, or if you are interested in conserving critical metals or reducing parts costs, you should be investigating General Plate Composite Metals. Catalog PR-700 covering precious to base and base to base cladments, TRUFLEX<sup>®</sup> Thermostat Metals, composite electrical contacts, buttons and rivets, etc. sent free. Write for it!

\*Trade Mark of Metals & Controls Corporation

**You can profit by using  
General Plate Composite Metals!**

**METALS & CONTROLS CORPORATION  
GENERAL PLATE DIVISION**

32 FOREST STREET, ATTLEBORO, MASSACHUSETTS

General Plate Composite Metals, made by joining two dissimilar metals together with an inseparable bond, offer many advantages not always possible in a single metal.

Consider CONFLEX — a General Plate Composite Metal of hardenable steel faced on one or both sides with sheet copper. CONFLEX is a superior spring material, yet it offers better electrical conductivity and greater strength — at lower cost — than comparable copper alloys.

It can be easily formed before hardening — then heat treated to the desired spring characteristic with greater uniformity. In mechanical springs, such as pen and pencil clips, the copper surface is excellent for electroplated finishes.

CONFLEX is available in long length coils slit to desired widths for automatic machine feeding. All in all it offers many advantages in the manufacture of electrical and mechanical spring parts.

an  
important  
new  
drafting  
technique

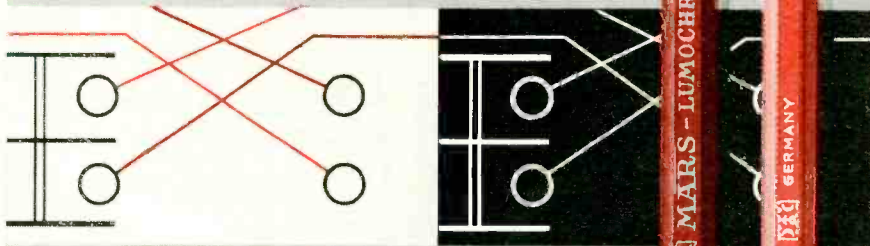

possible only with  
**MARS-LUMO CHROM**

All colors blueprint perfectly,  
making color-drafting possible.

**MARS-LUMOCHROM** does not fade  
... does not smear ... is waterproof  
... erases perfectly ... keeps finest point

Send for free sample

**S**TAEDTLER also proudly introduces the Mars-Pocket-Technico for field use, the Mars "Draftsman's" Pencil Sharpener with the adjustable point length feature, and the efficient, clean Mars lead sharpener. All available—along with the established standards: Mars-Lumograph black graphite drafting pencils, Mars-Technico lead holder and leads, and Tradition-Aquarell painting pencils—at all leading art material and drafting supply dealers.

J.S. STAEDTLER, INC. HACKENSACK, NEW JERSEY

GERMANY

2025 J.S. STAEDTLER MARS-LUMOCHROM GERMANY

2618 J.S. STAEDTLER MARS-LUMOCHROM GERMANY

24 COLORS—\$1.50 PER DOZEN, LESS IN QUANTITY



Method of drilling tape sandwich while air-operated foot presses boards firmly down on table of drill press

be plated once the conductive path is broken up by etching the wiring.

This technique greatly reduces the cost of producing sample boards needed for submission with price quotations.

### Cutting Glass Cloth

ETCHED wiring patterns produced in multiple on glass cloth are cut into the required smaller sizes with a rotary knife designed and built in the Glen Cove, N. Y. plant of Photocircuits Corp. The resulting pieces are subsequently curved and rigidized by molding techniques, for use as etched wiring boards in missile subassemblies and other subminiature equipment.

The glass cloth is slipped under a Lucite hold-down strip and positioned against a metal guide strip, much as when using an ordinary

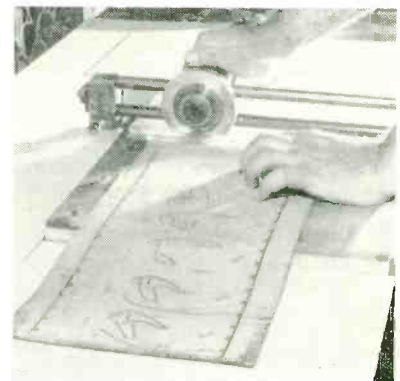

Method of using rotary knife to cut glass cloth having etched wiring

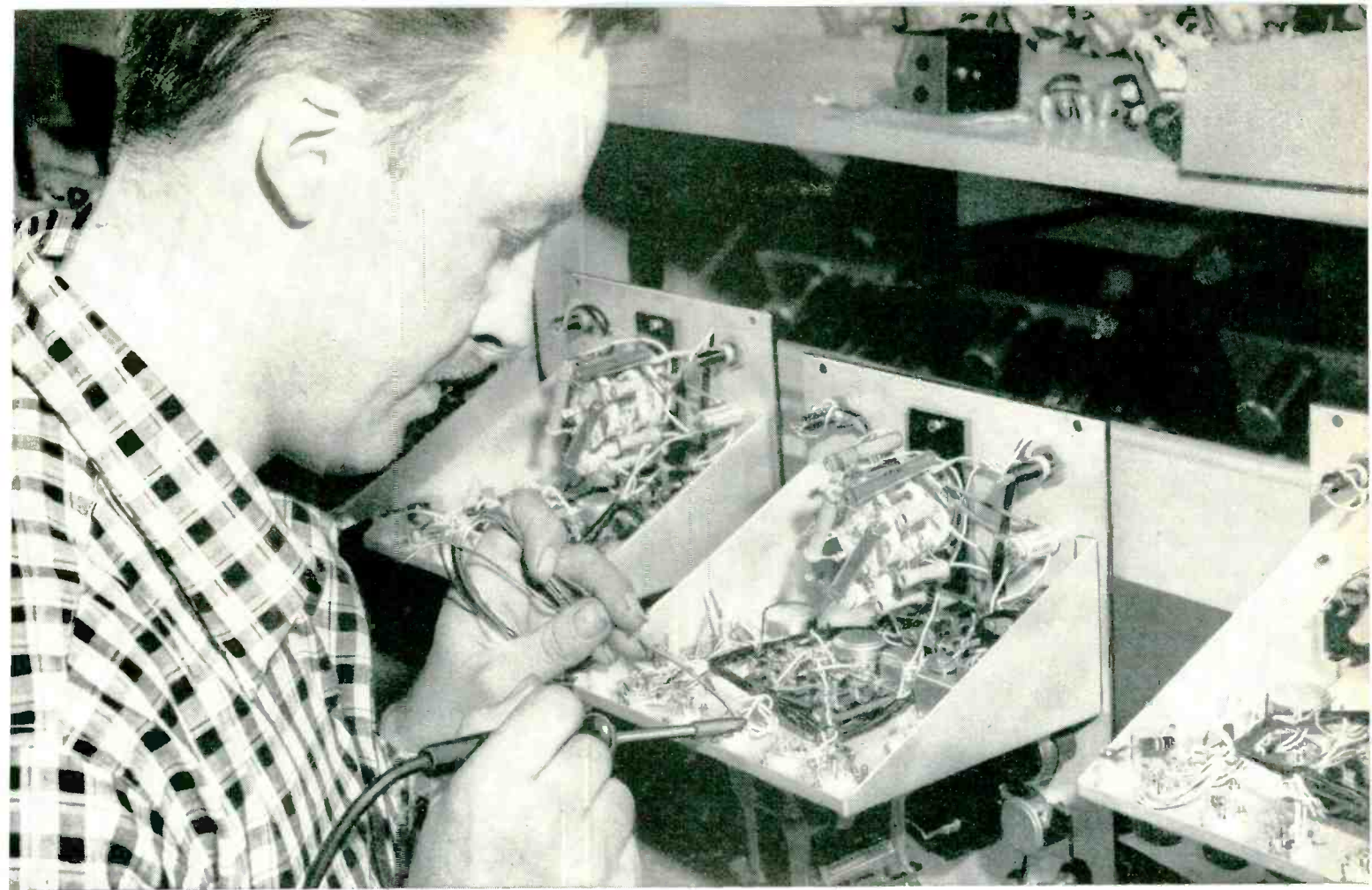

"BEST IRON WE'VE HAD in the plant," says William Fish, a production supervisor of General Radio, Cambridge, Mass. This company has switched to G-E Midget irons for soldering both

delicate and heavy joints in their Type 1862-B Megohmmeters —jobs which formerly required both a heavy and a light iron. G-E Midget iron's light weight also helps reduce fatigue.

## 50 G-E Midget irons do work of 100 former irons at General Radio Co., boost production 25%

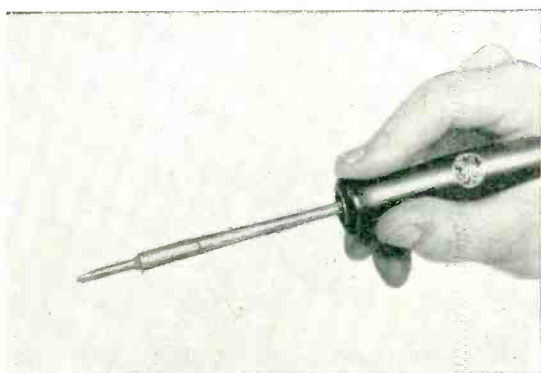

**HANDLES LIKE A PENCIL**—Weighing less than a package of cigarettes, the General Electric Midget soldering iron speeds production by reducing operator fatigue.

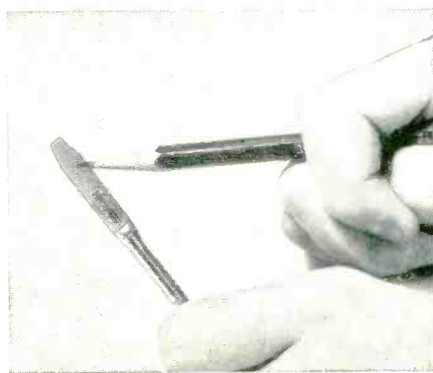

**RAPID HEAT TRANSFER** is achieved by locating the heater directly in the iron-clad-copper tip. Result—the G-E Midget iron's heat efficiency is 90%.

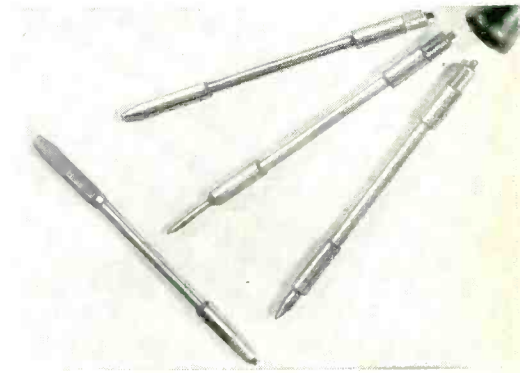

**THREE-IN-ONE IRON** with  $\frac{1}{8}$ ",  $\frac{1}{4}$ ",  $\frac{3}{16}$ " tip sizes gives you greater versatility to meet your soldering requirements. Tips can be changed in only 5 seconds.

For more information write for GED-2263, G-E Midget Soldering Iron, Section 724-3, General Electric Co., Schenectady 5, N. Y.

GENERAL  ELECTRIC

# THE **NEW** ARTOS AUTOMATIC wire-stripping and TERMINAL-ATTACHING MACHINE

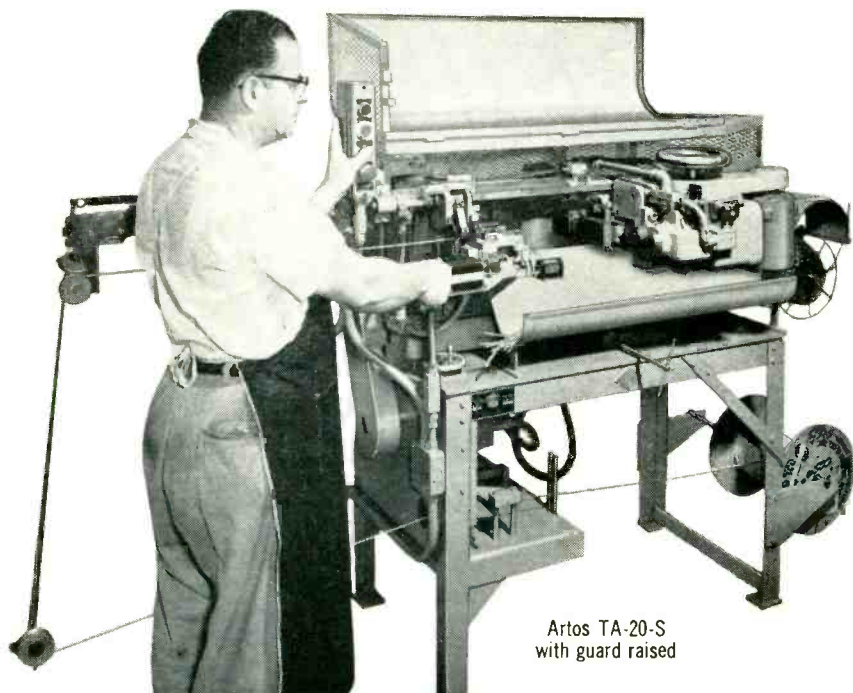

Artos TA-20-S  
with guard raised



Some examples of terminals attached by Artos Machine

This new Artos TA-20-S brings still greater speed and production economy to large-quantity users of wire leads with terminals attached. It *automatically* performs the following services *all in one operation*:

1. Measures and cuts wire to predetermined lengths.
2. Strips one or both ends of wire.
3. Attaches practically any prefabricated terminal in strip form, to one end of wire.
4. Marks finished wire leads with code numbers and letters. (Optional attachment not standard part of machine.)

**ALL OPERATIONS ARE AUTOMATIC.** Machine can be operated by unskilled labor. It is easily set up and adjusted for different lengths of wire and stripping. Die units for different type terminals simply and quickly changed. Production speeds up to 3,000 finished pieces per hour.

**ARTOS MACHINES ARE USED** by electric appliance, automotive, aircraft, electronics and other industries that want automation in the production of wire leads in quantity. Agents throughout the world.

Engineering consultation and recommendations given without obligation.

**WRITE FOR  
BULLETIN** ▶

No. 655 on the  
Artos TA-20-S



## **ARTOS ENGINEERING CO.**

2743 South 28th Street • Milwaukee 46, Wisconsin

paper cutter. The rotary knife is then moved along its overhead carriage to produce the required high-precision cut. This technique serves admirably for producing sample quantities, where the cost of producing cutting dies would not be justified.

### Applying Tinning Compound With Felt Rollers

COMBINATION solder-flux paste for pretinning mating surfaces of hermetically sealed housings is quickly and neatly applied with rotary applicators designed and



Examples of felt applicators for tinning compound



Applying tinning compound inside a hole with a small applicator. The compound is here applied to the felt with a small brush

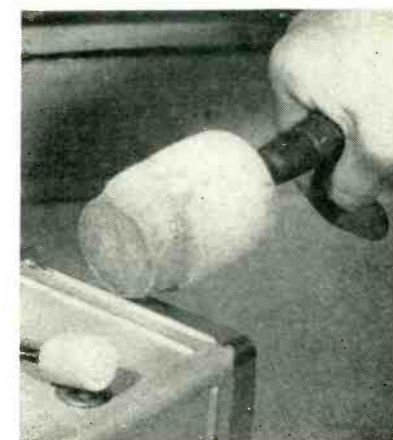

Applying compound along outer edge of housing with free-turning applicator



**TRU-OHM NEWS**

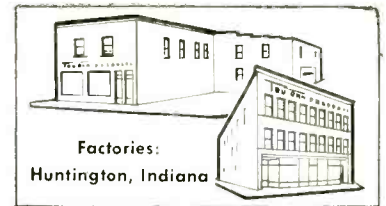

TRU-OHM PRODUCTS, division of Model Engineering & Mfg. Co., Inc., General Sales Office: 2800 N. Milwaukee Ave., Chicago 18, Ill.

Vol. 80,000,000

1955-56

No. 80,000,000

# 80 MILLION SOLD!

*TRU-OHM is Now the World's Largest Producer of Wire-Wound Resistors!*

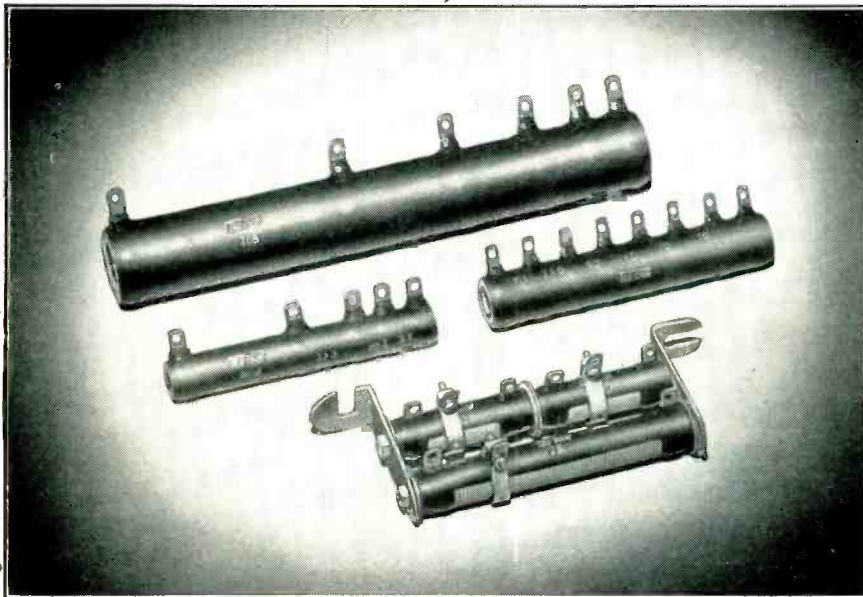

*Special size resistors: Tru-Ohm's highly skilled factory trained technicians turn out large varieties of special resistors. Complete data of these special size resistors is available.*

Chicago . . . From Tru-Ohm's general sales office. Since starting just a few short years ago, TRU-OHM PRODUCTS has grown phenomenally to ten times its original capacity. Having just produced its 80,000,000th wire-wound resistor, Tru-Ohm is now the world's largest growing and largest producers of wire-wound resistors.

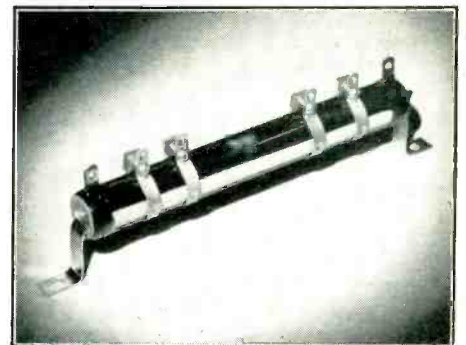

*Resistor No. 80,000,000. One of many wire-wound resistors which are turned out by the thousands daily.*

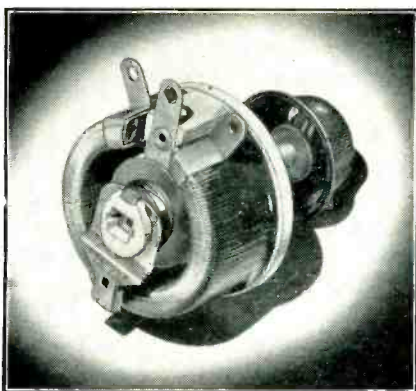

*Complete line of power rheostats . . . of finest quality with UL approval; variety from 25 watts up.*

## High Quality, Speedy Delivery Sets Record

Over 50,000 square feet of the most modern manufacturing facilities, including a brand new furnace, enable volume production . . . assure faster delivery, finer quality, better prices. And TRU-OHM EXPEDITES FOR YOU . . . ships on time.

**Inquiries Invited.** You can get the complete story of Tru-Ohm's tremendous growth and why, by writing to 2800 N. Milwaukee Ave., Chicago 18. Let Tru-Ohm's experts solve your resistor and rheostat needs.

## For Original Equipment or Replacement Needs

A complete line of resistors as well as a complete line of power rheostats are now produced for the finest industrial manufacturers in the world . . . for replacement applications . . . sold through parts jobbers.

**PRECISION  
ATTENUATION  
TO 3000 mc!**

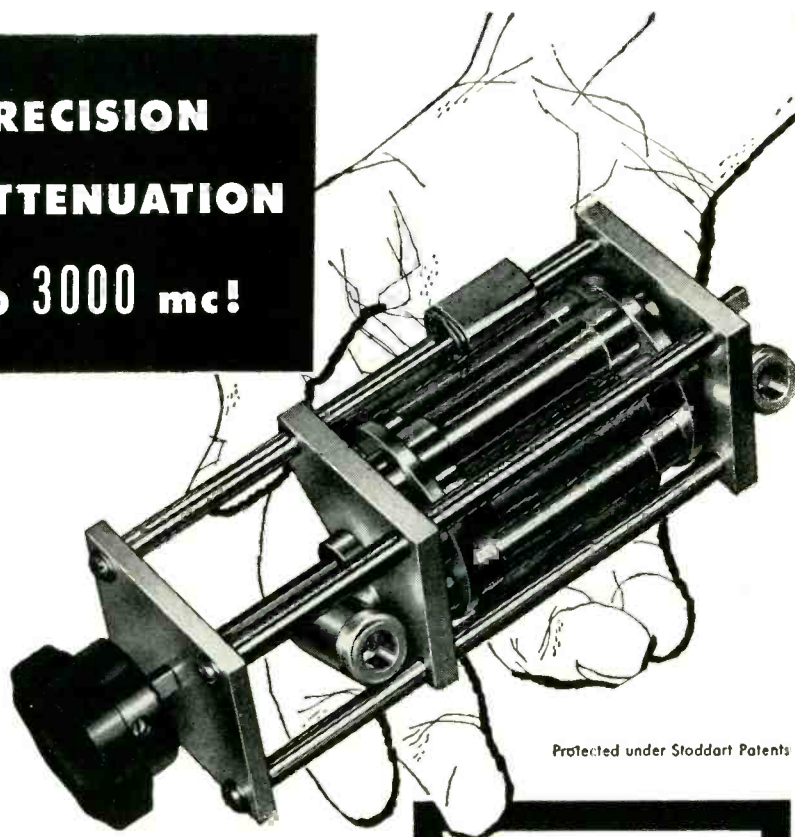

Protected under Stoddart Patents

six-position  
**TURRET ATTENUATOR**

featuring **PULL-TURN-PUSH** action

**FREQUENCY RANGE:** dc to 3000 mc.  
**CHARACTERISTIC IMPEDANCE:** 50 ohms.  
**CONNECTORS:** Type "N" Coaxial female fittings each end.  
**AVAILABLE ATTENUATION:** Any value from 1 db to 60 db.  
**VSWR:** 1.2 max., dc to 3000 mc/s, values from 10 to 60 db. As value decreases below 10 db, VSWR increases to not over 1.5.  
**ACCURACY:** ± 0.5 db.  
**POWER RATING:** One watt sine wave power dissipation.

**SINGLE "IN-THE-LINE" ATTENUATOR PADS  
and 50 ohm COAXIAL TERMINATIONS**

This new group of pads and terminations features the popular Type C and Type N connectors, and permits any conceivable combination of the two styles. For example, the two connector types, either male or female, can be mounted on the same attenuator pad, with or without flanges, so that it may serve as an adapter as well as an attenuator. Frequency range, impedance, attenuation, VSWR, accuracy and power rating are as designated above. Send for free bulletin entitled "Measurement of RF Attenuation."

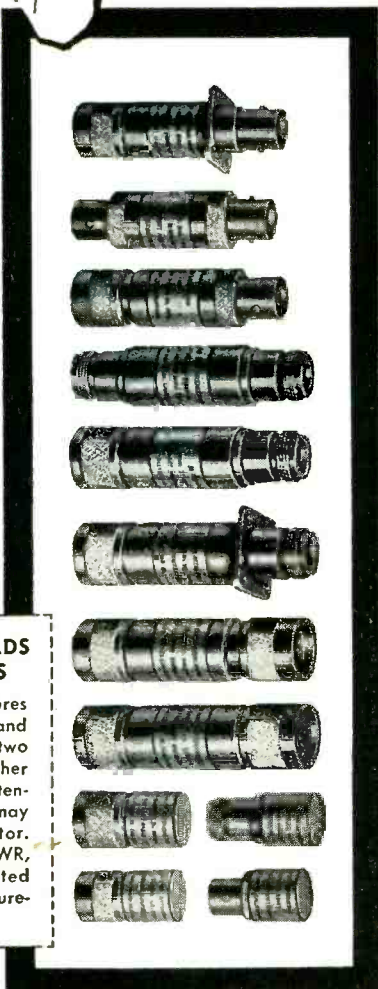

made especially for this purpose in the Long Island City, N. Y. plant of Ford Instrument Co. under the direction of Gerard Olsen.

The applicators are turned to the desired shapes on a lathe, working from standard mounted-felt polishing wheels. Most of the applicators are stepped to fit two or more diameters for applying flux inside a cylinder, inside a hole or around the edge of a hole in a housing.

The tinning compound employed is a powder form of solder com-

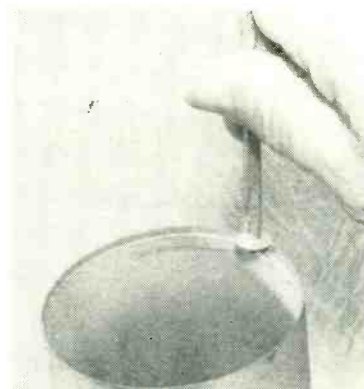

Applying compound to inside edge of cylinder to precisely controlled depth with Fibreglas brush having depth-controlling disk

posed with a flux to give a paste having the consistency of heavy paint. One example of this is Eutec-Tin Weld I. The applicator shank is held with the fingers for dipping the felt into the paste, after which the felt is inserted in the hole and rotated to leave a neat ring of compound where tinning is required. For critical locations the paste is sometimes applied to the felt with a brush to insure an even coating.

► **Roller-Type Applicators**—For pretinning the edges of a housing, one large applicator is equipped with a handle and ball bearing. After dipping in the can of compound, this applicator is rolled along the edge of the housing to coat base and edge simultaneously.

When tinning compound is to be applied in a narrow stripe around the inside edge of a component, a Fibreglas brush with a revolving disk to control depth is used.

Contoured felt applicators are used for applying the compound to

**STODDART** aircraft radio co., inc.  
6644-A SANTA MONICA BLVD., HOLLYWOOD 38, CALIFORNIA - HOLLYWOOD 4-9204



## PERHAPS WE'LL HAVE TO ADD A PINCH, FOR YOU . . .

Just ask us for an alloy we haven't got—we'll be delighted.

Because that's how each of the more than 112 resistance and electronic alloys Driver-Harris makes had its beginning. Each of these highly specialized alloys is custom-made . . . produced exactly to the specifications of our customers.

The physical and chemical properties of an electrical resistance alloy can be altered greatly by a minute difference in its constituents. Often just a few ounces to the ton can make the difference you need.

One thing you can always rely on in any Driver-Harris alloy: it is made to the most precise metallurgical checks and controls known to the industry. It is these exclusive quality controls that have made Nichrome V and Nichrome\* the standard for over 50 years by which all other electrical resistance alloys are measured.

Perhaps in a sense Nichrome is *too* well known. For we don't want people to forget that we make many other resistance alloys of sustained high quality to meet other special needs. And that, as we said at the outset, our engineers will be more than delighted to start afresh tomorrow to devise a new one, custom-made for you. Just tell us as exactly as you can what you wish to accomplish.



NICHROME V and NICHROME  
are manufactured only by

**Driver-Harris  
Company**

**HARRISON, NEW JERSEY**

**BRANCHES: Chicago, Detroit, Cleveland, Louisville,  
Los Angeles, San Francisco**

In Canada: The B. GREENING WIRE COMPANY, Ltd.,  
Hamilton, Ontario.

\*T. M. Reg. U. S. Pat. Off.

**MAKERS OF THE MOST COMPLETE LINE OF ELECTRIC HEATING, RESISTANCE, AND ELECTRONIC ALLOYS IN THE WORLD**

**Relay Sales**

Telephone Relays

Midget Relays

Keying Relays

Rotary Relays

Sealed Relays

Sensitive Relays

Latching Relays

Stepping Relays

Delay Relays

Timers

Contactors

Motor Starting Relays

Differential Relays

Polarized Relays

# RELAYS

# NOW!

Your immediate needs for one or more relays of any kind are shipped from our greatly enlarged stock which includes hundreds of types in all popular contact arrangements and coil ratings.

Complete stocks of current standard types of leading manufacturers are maintained for your convenience.

All relays are new, inspected and unconditionally guaranteed to be as represented. 24 hour delivery is routine. Phone us.



Distributors For  
**ADVANCE ELECTRIC & RELAY CO.**

All standard distributor types of Advance Relays are on hand in quantity. Save precious time — order from Relay Sales!

PRODUCTION TECHNIQUES

(continued)



Quick turn of cylinder inside block-type applicator applies compound neatly in uniform band on outside



Removing cylindrical housing from 500 F oven after tinning compound has fused

dimples and to irregular window areas.

► **Block-Type Applicators**—A felt block applicator is used for applying an even stripe of compound to the outer edge and end of a metal cylinder simultaneously while keeping the inside edge clean. The applicator is made by nailing a ½-inch board over a 1-inch board, boring a large hole in the two-layer block, lining the hole with felt, then cutting away half of the ½-inch board along with its felt. The tinning compound is applied to the felt with a brush. Rotating the end of the cylinder 180 degrees in the applicator applies the compound in a matter of seconds, with half of the felt taking care of the end and the other half applying paste to the outside.

After the tinning compound is applied, the mating parts are fitted together and placed in a 500 F oven. The parts are removed when the bright shine of molten solder re-

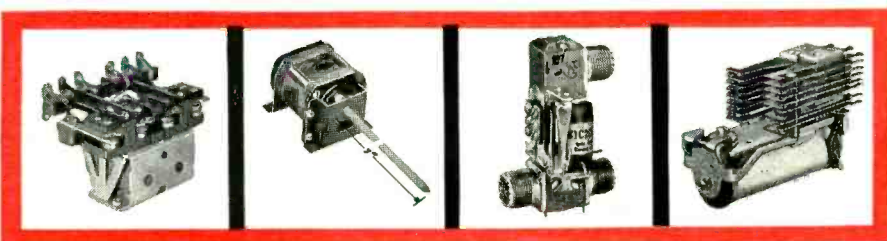

Write for

**Relay Sales**

Catalog

C-6

## RELAY SALES HAS MOVED TO THE COUNTRY!

Bigger, more efficient office, warehousing and shipping facilities are providing even faster service for our customers. Lots of parking space. Route 64 at E.J. & E. R.R.

*Please change your records*

Phone: West Chicago 1100

**RELAY SALES**

P.O. Box 186-A

West Chicago, Ill.



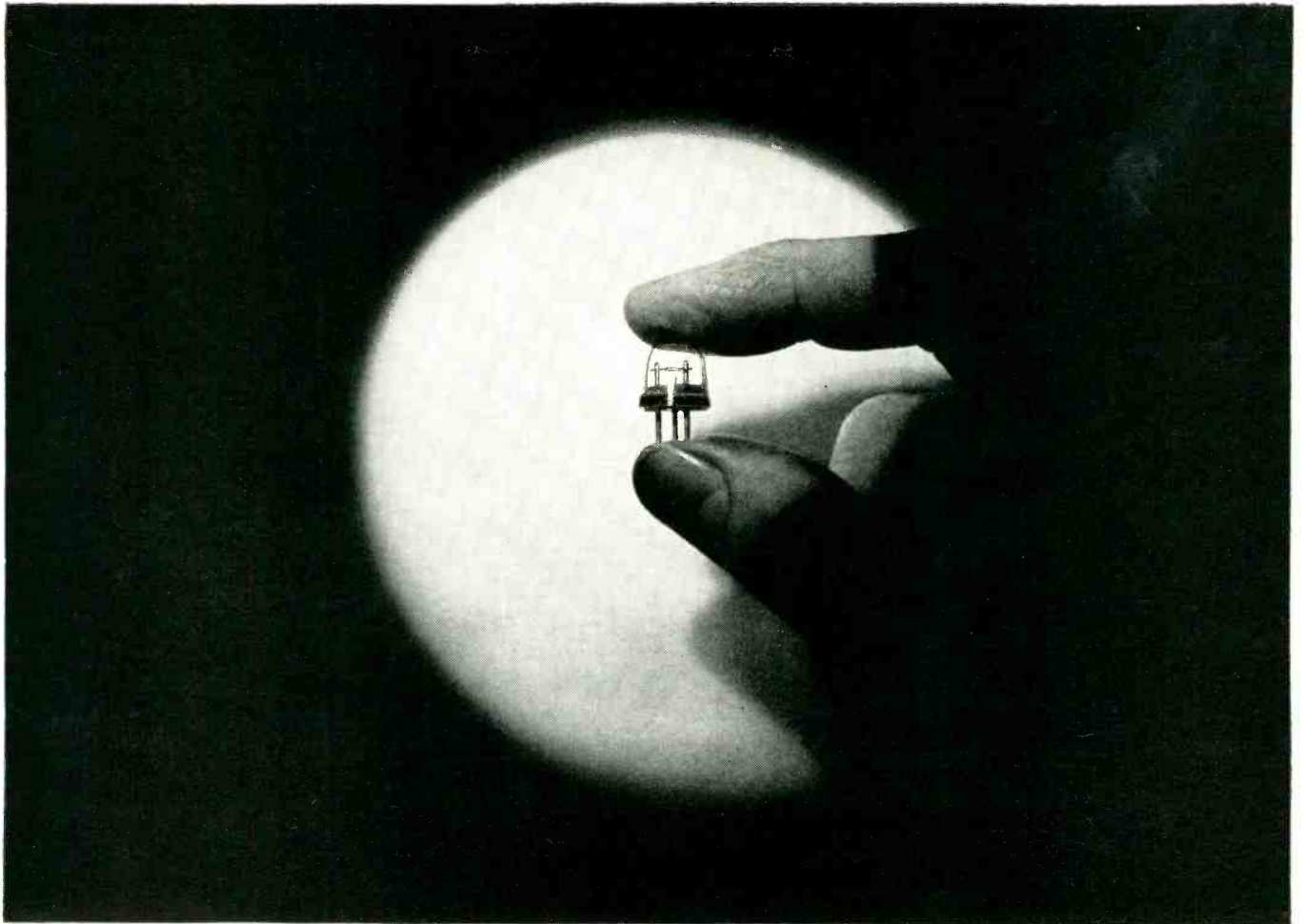

Experimental model of Bell's new high-frequency transistor. It has a cut-off frequency of at least 500 mc and can be used to amplify 2500 independent voices simultaneously.

## **THE TRANSISTOR** *that smashed a frequency barrier*

A new transistor invented at Bell Telephone Laboratories can provide broadband, high-frequency amplification never before possible with transistors. The big leap in frequency is made possible by a diffusion process that earlier enabled Laboratories scientists to create the Bell Solar Battery.

This transistor is a 3-layer semiconductor "sandwich." High-frequency operation is obtained by making the central layer exceedingly thin. This was difficult to do

economically by any known method.

The new diffusion process, however, easily produces microscopic layers of controllable thickness. Thus it opens the way to the broad application of high-frequency transistors for use in telephony, FM, TV, guided missiles, electronic brains and computers.

The new transistor shows once again how Bell Laboratories creates significant advances and then develops them into ever more useful tools for telephony and the nation.



A Bell scientist checks temperature as arsenic vapor diffuses into germanium, creating  $4/100,000$ -in. layer.

**BELL TELEPHONE LABORATORIES**



IMPROVING AMERICA'S TELEPHONE SERVICE PROVIDES CAREERS FOR CREATIVE MEN IN SCIENTIFIC AND TECHNICAL FIELDS

Want more information? Use post card on last page.

# Semiconductor Engineers and Scientists

GENERAL MOTORS offers exceptional opportunities in this field as a result of newly expanded programs of research and development—and now, also, pilot plant production.

These are permanent programs of great and increasing importance to General Motors in its electronic, automotive, aircraft engine, locomotive, household appliance and military activities—not just temporary study or short-term development programs.

Physicists, physical chemists and electronic engineers with baccalaureate or advanced degrees and those with transistor, diode, photo-cell, other semiconductor and related experiences in research, development or process and production will find:

- Important, interesting and challenging problems
- Modern facilities
- Congenial association with others skilled in these sciences

Resulting in maximum personal satisfaction, development and recognition.

Upper-level positions for those shown to qualify.

The unusual employe benefits of General Motors are provided by this 20-year-old GM electronics division. Relocation expenses are paid. Pleasant Indiana community with excellent living conditions, schools and many other advantages. Letters held in complete confidence. Give information on education, experience, military duty and personal data.

Address: Personnel Director, Department MM



*Delco Radio*

DIVISION OF

**GENERAL MOTORS**

KOKOMO, INDIANA



Method of using water-soaked felt pad in block to prevent previously soldered windows in cover from melting during final solder sealing

places the dull appearance of the paste. After tinning, the part is rinsed twice in water at 140 F to prepare it for the actual soldering, which is done with a rosin-alcohol flux.

The foregoing techniques are used in producing the outer case for the ASN-6 ground-position-indicator unit used in aircraft for navigation.

During soldering, felt-lined blocks are used in another way, to prevent loosening of previously soldered assemblies. As an example, windows are first soldered into the top cover assembly with 50-50 solder. The felted block is saturated with water, the cover is placed in it and the body tube set down into the cover for conventional hand soldering with 60-40 solder. The wet felt keeps heat away from the previously soldered windows.

## Air Gun Inserts Trimmer Disks in Printed I-F Coils

A METAL holding fixture for etched wiring boards used as i-f strips in black-and-white television receivers serves in conjunction with an air gun to drive trimmer-disk mounting screws in to a predetermined distance above the i-f coils that are etched directly on the wiring board. This technique greatly reduces the amount of time needed later for final adjustments at alignment positions on assembly lines in RCA's

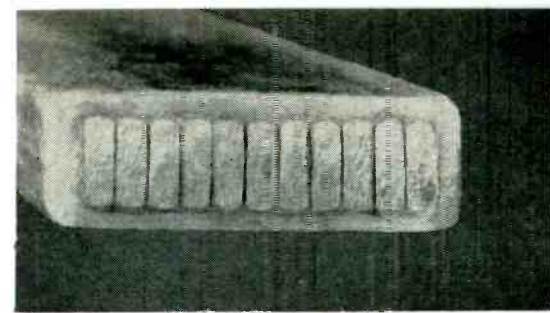

Cross-section of "Epoxy-lite" Molded Coil made by **Epoxy-lite Corp.**, Montebello, California.

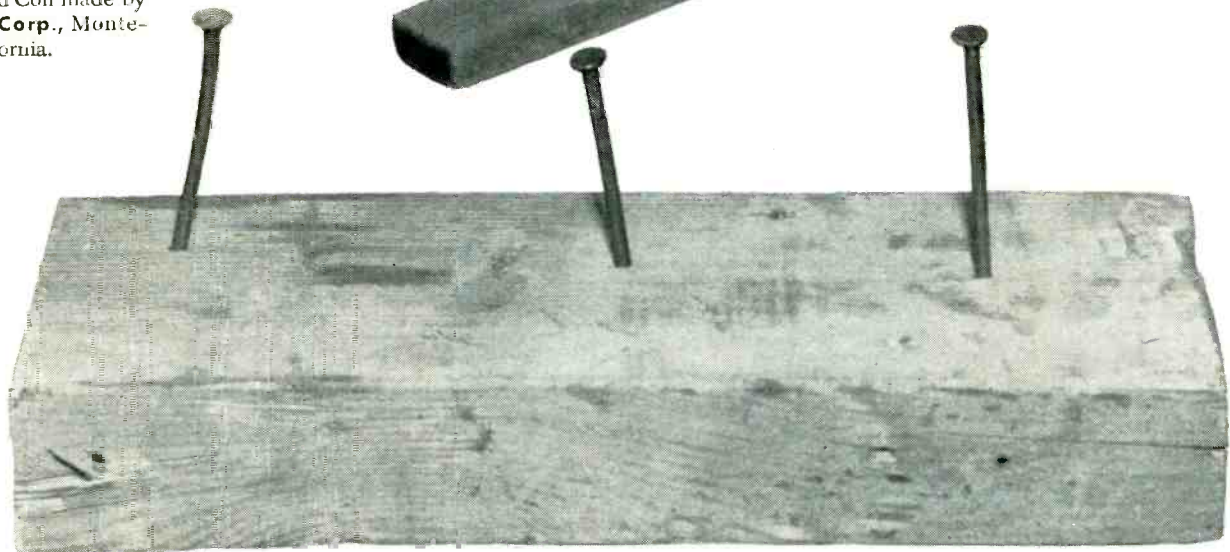

Driving nails in toughness test, epoxy molded coil gets scarcely a surface dent. Conventional coil would be worthless after such treatment. Cross-section (upper left) shows sturdy construction.

# Tough epoxy molded coil nails lid on motor breakdowns

Large (600 h.p.) Banbury motor coil after rebuilding with epoxy molded coils. Old coils wrapped with conventional materials failed after repeated carbon black penetration.

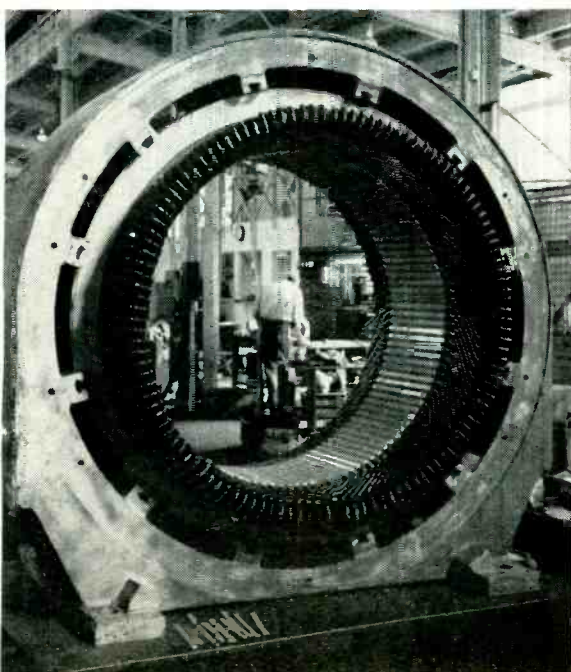

The working life of a big electric motor depends on the insulation on its form coils. Big motors develop heat and vibration that open crevices in ordinary coil wrappings. Contaminants get in, a coil fails, the motor stops.

This new coil ends that problem because it's insulated with glass cloth and a mica-filled compound based on **BAKELITE Brand Epoxy Resin**. This liquid resin is hardened with heat and pressure, and develops an extremely strong bond to the conductor. High corona resistance is one result. Tensile strengths often reach 100,000 psi.

Dense and void-free, this insulation shows the advantages of encapsulation with **BAKELITE Epoxy Resins**. It's not brittle or subject to stress cracks and can be formulated with a thermal expansion matching that of the conductor.

Moisture, caustics, acids, and other contaminants are sealed out. The glass cloth - epoxy combination even withstands immersion in boiling lye and sea water. It's effective up to 160 deg. C. Electrical properties are excellent.

**BAKELITE Epoxy-Resins** may give your product the advantages of long, trouble-free working life. For information, write Dept. MG-50.



## BAKELITE COMPANY

A Division of Union Carbide and Carbon Corporation  30 East 42nd St., N. Y. 17, N. Y.  
The term **BAKELITE** and the Trefoil Symbol are registered trade-marks of UCC

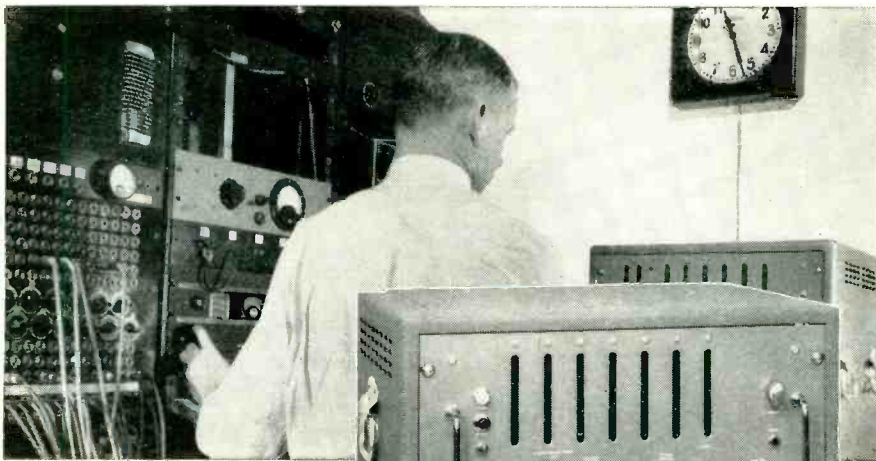

**3 reasons  
why your  
best buy is the**

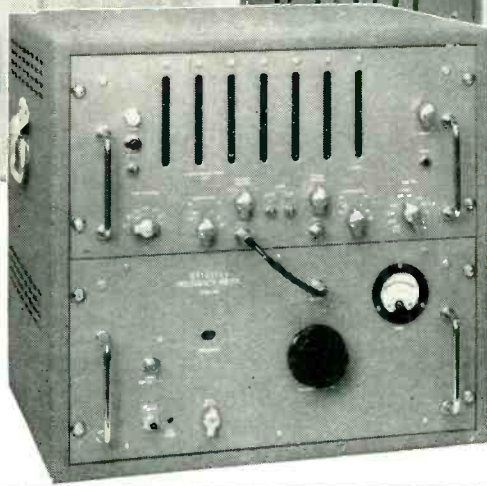

## Berkeley MODEL 5571 FREQUENCY METER...

### 1. Wider Frequency Coverage...

0-42 mc without plug-ins, extendable to 515 mc with Model 5580 VHF-UHF converter.

### 2. Universal-Instrument Versatility...

a frequency ratio meter, 0-1 mc period meter, 1  $\mu$  sec to 10,000,000 sec time interval meter, 0-2 mc EPUT<sup>a</sup> meter, or 1 mc counter.

### 3. Reasonably Priced...

unmatched in range, precision and utility at anywhere near the price.

#### FEATURES

- Direct-coupled input amplifiers
- Direct connections to digital printer, digital-to-analog converter, or data converters for IBM card punches, electric typewriters or telemetering systems
- Provision for external frequency standard input
- Coupling to WWV receiver
- Relay rack mounting if desired

#### BRIEF SPECIFICATIONS

Frequency Meas. Range: 0 cycles to 42 mc  
 Time Interval Meas. Range: 1  $\mu$  sec. to 10<sup>7</sup> seconds  
 Period Meas. Range: 0 to 1 mc (Period x 10, 0 to 100 kc)  
 Input Requirements: 0.1 v. peak to peak  
 Time Bases: Frequency: 0.000002 to 20 seconds, decade steps. Time Interval and Period Meas: 1 mc to 1 cps, decade steps  
 Accuracy:  $\pm 1$  count of unknown (or time base)  $\pm$  crystal stability  
 Crystal Stability: Temperature stabilized to 1 part in 10<sup>7</sup> (short term)  
 Display Time: 0.2 to 5 seconds  
 Power Requirements: 117 v.  $\pm$  10%, 50-60 cycles, 260 watts  
 Dimensions: 20 $\frac{3}{4}$ " W x 19" H x 16" D. Weight, 100 lbs.  
 Price: \$1,745.00 (f.o.b. factory)

No other frequency meter offers all the advantages of the Model 5571 — why settle for less? Write now for complete technical and applications data; please address Dept. G2

78

**Berkeley**

*division*

INDUSTRIAL CONTROL SYSTEMS

ANALOG COMPUTERS • COUNTERS • TEST & NUCLEAR INSTRUMENTS

BECKMAN INSTRUMENTS INC.  
 2200 Wright Avenue, Richmond 3, California

Indianapolis television set plant.

The assembled and dip-soldered strips come to the operator on a rubberized conveyor belt moving over the back of the bench. A strip is picked off the belt and placed on the positioning pegs of the fixture, wiring side up. These pegs are sufficiently high so that parts already mounted on the other side of the board will clear the base of the fixture. Metal anvils project up from the base under each of the three i-f transformers, to support the board while pressure is being applied with the air gun. Holes in the anvils provide clearance room for the screws of the trimmers.

After loading a board, the operator releases a spring-loaded pin to apply gentle pressure to the center of the board, just enough to keep it down on the positioning pins. She then places an insulating washer on a trimmer screw and manually positions the screw in its hole. This is repeated for the other two trimmers.

An air gun suspended overhead on a spring is brought down through a pilot hole in the top of the fixture and used to drive in the first trimmer. A metal collar on the shaft of the gun stops downward

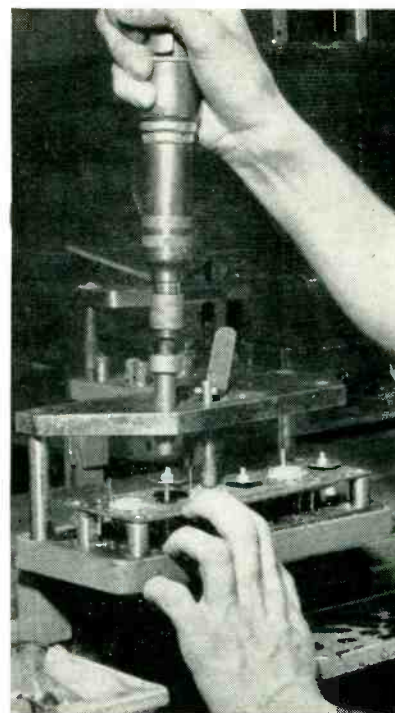

Method of lowering air gun through pilot hole in top plate of fixture in preparation for driving in trimmer disk for printed i-f transformer. Hold-down pin for board is at right of gun



**Leaders in Electronics**  
*rely* on **Good-All Capacitors**

... whether for a critical fraction of a second or for a long life of trouble-free performance. Our technical and production people gain real satisfaction from working out capacitor problems with design and component engineers. The confidence of these engineers in Good-All "know-how" has contributed greatly to our rapid growth in the industry



*Our engineers are ready to work with you on special applications. Write, wire or phone for specifications and quotations.*



**MIL TYPES**

Good-All produces a broad line of hermetically sealed tubular and bathtub capacitors to specifications MIL-C-25A. Custom designs of various metal enclosed styles can also be provided to your individual specifications.

**MYLAR TYPES**

The space-saving size and extremely high IR of Good-All Mylar\* types are ideal for many special purpose applications. These are available in several metal enclosed designs as well as in ceramic or plastic impregnated tubes.

\*DuPont's trademark for polyester film.

**GOOD-ALL ELECTRIC MFG. CO.** Goodall Bldg. • O'GALLALA, NEBRASKA

# NEW!

## 5000 MICROSECOND DELAY LINES

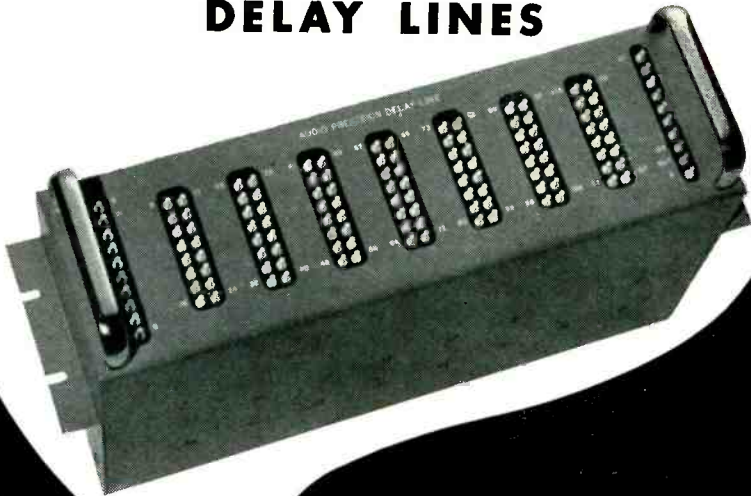

from

# EPSCO

LONG DELAY · LOW ATTENUATION · EXCELLENT PHASE LINEARITY

New EPSCO 5000 microsecond Precision Delay Lines Model DL 0510-400/125 are specifically designed for use in precision analog computing, auto-correlation, function generation and sonic and sub-sonic applications. These units have found application in the study of speech wave-forms, wow and flutter of tape transport mechanisms, sonar returns, sonar ranging and servo analysis.

They feature extremely long delay (which may be further extended by cascading several units), low attenuation and excellent phase linearity over a wide range of frequencies.

Design is based on M-derived techniques and employs very high-Q toroidal inductance assemblies and ultra-stable capacitors. Taps are brought out on the front panel by heavy double-turret lugs for easy accessibility.

SEND FOR BULLETIN ADL-6



588 COMMONWEALTH AVE. BOSTON 15, MASS.

### CHARACTERISTICS AND SPECIFICATIONS

Overall Delay	5000 $\mu$ s $\pm$ 1%
Characteristic Impedance	510 ohms*
Number of Taps	125
Delay between Taps	40.0 $\mu$ s $\pm$ 1%
Attenuation including insertion loss	Better than 3db at 4kc Better than 6db at 7kc
Low Frequency Insertion Loss	1.7db
Cutoff Frequency	9.5kc
Phase Linearity	$\pm$ 0.2% up to 6kc $\pm$ 1% up to 8kc
Size	19" x 5 1/4" x 9" for relay rack mounting
Weight	35 lbs.

\*Also available with 470; 600 and 1,000 ohm impedance

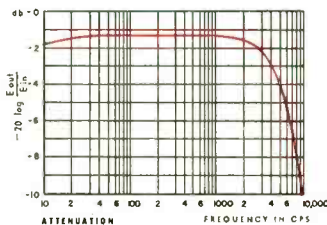
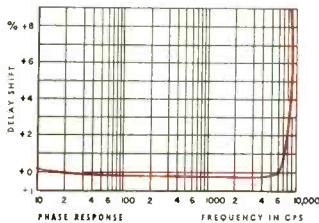

PRODUCTION TECHNIQUES (continued)

movement of the wrench when it hits the top of the fixture plate or the bottom of a counterbored hole in the plate. This counterboring technique permits driving the three trimmers to different depths while using the same fixed stop on the air gun. When the gun reaches its stop, the operator allows it to spin just enough longer so that the trimmer turns itself out of the socket of the gun and stops rotating.

When all three trimmers have been driven, a self-locking lever is pushed to bring up the board-holding pin, permitting removal of the finished board and reloading.

### Clamping Fixture Holds VHF Tuners

ASSEMBLY of metal frames for vhf television tuners is expedited in RCA's Indianapolis plant by mounting a standard quick-action holding clamp on a welded metal fixture that is attached to the assembly bench. The fixture provides a recess into which the operator places the partially assembled tuner.

The end plate of the tuner is set in position and the handle of the clamp is pushed down to hold the plate in the correct position for alignment of mounting bolts. Self-tapping screws are then quickly inserted with an air gun to complete the assembly.

An upward flip of the clamp handle brings the clamp straight



Inserting mounting bolts in tuner with air gun while clamp on welded support holds end plate in position

# ★ Control Components Digest ★

News and notes on resistors, rheostats, relays, motor controls, dimmers and other control components

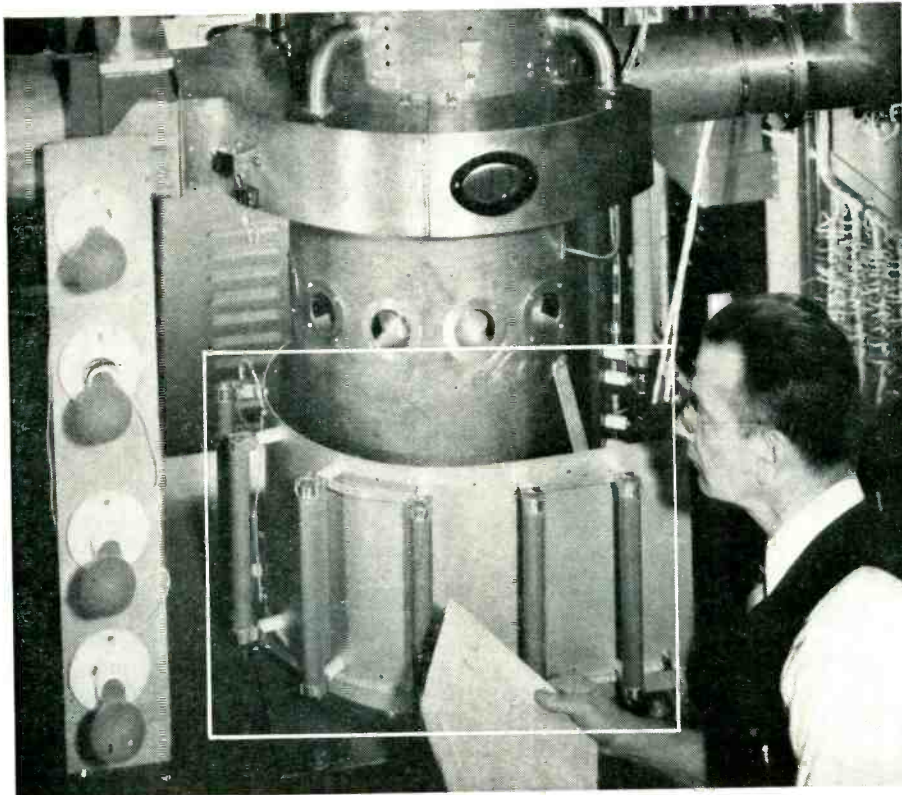

**BIG MOON RADAR** undergoing tests. Ward Leonard resistors—like those in foreground—help this gear stay on the air—or, rather, on space.

## New moon radar to explore outer space

The U.S. Army Signal Corps hasn't got a transmitter in outer space—yet.

So, for their continuing studies of radio wave propagation in space and the upper atmosphere, they bounce radio waves from their new high-powered radar, Diana, off the moon and planets and study the return pulse.

Designed and built by Radio Engineering Laboratories of Long Island City, N. Y., the new radar transmitter puts out 50 kilowatts, continuous wave, and may be pulse modulated at various pulse widths and repetition

rates. Receiver gain is 170-db at better than 3-db noise figure.

Throughout the equipment, high-stability Ward Leonard resistors, like the big Vitrohm resistors shown above, do duty as high-voltage bleeders, surge and current limiting resistors, and protective meter shunts in high-voltage circuits.

You'll find Ward Leonard Vitrohm resistors completely described in our 64-page Catalog No. 15, together with nomographs and charts to help select them. Write for your copy today.



## Relays mastermind traffic lights

Sun, rain, sleet, snow, and continuous 24-hour-a-day duty is the lot of this master traffic light controller. Four dependable Ward Leonard relays select automatic timing cycles. Two more relays allow remote control of off-duty flashing amber signals and signal shut-down. Learn more about these rugged relays in Ward Leonard Bulletin No. 110.

Photo courtesy Crouse-Hinds Co.

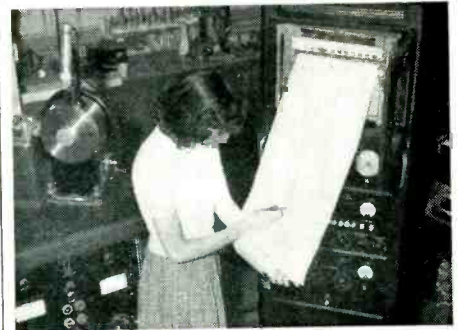

**SHE'S CHECKING CHART RECORD** from X-ray spectrometer in Ward Leonard's test lab.

## Plant X-ray speeds quality control and helps catch crooks

X-ray diffractometer and spectrometer tests insure high quality and uniformity of both raw materials and fabricated components at Ward Leonard. These instruments check crystal structure in ceramics, magnetic amplifier cores, contact metal, and resistance wire. In off hours, they help the Mount Vernon Police and Fire Department put the finger on crooks and arsonists.

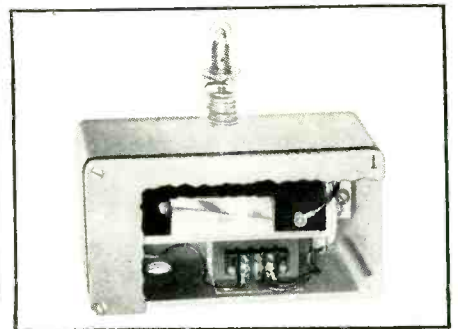

**AUTOMATION FOR MACHINE TOOLS** is simplified by this precision control potentiometer.

## Control for machine tools

Accurate electronic control component for cutting tools, winders and processing machine drives is provided by this compact, precision potentiometer.

A half-inch plunger movement drives the metal alloy contact across the special resistance element. Enclosure is compact; calibration is permanent. Standard resistance—10,000 ohms; up to 25,000 ohms on special order. Write for Bulletin 68.

63

**WARD LEONARD  
ELECTRIC COMPANY**  
31 SOUTH ST., MOUNT VERNON, N. Y.



**Result—Engineered Controls Since 1892**  
RESISTORS · RHEOSTATS · RELAYS · CONTROLS · DIMMERS

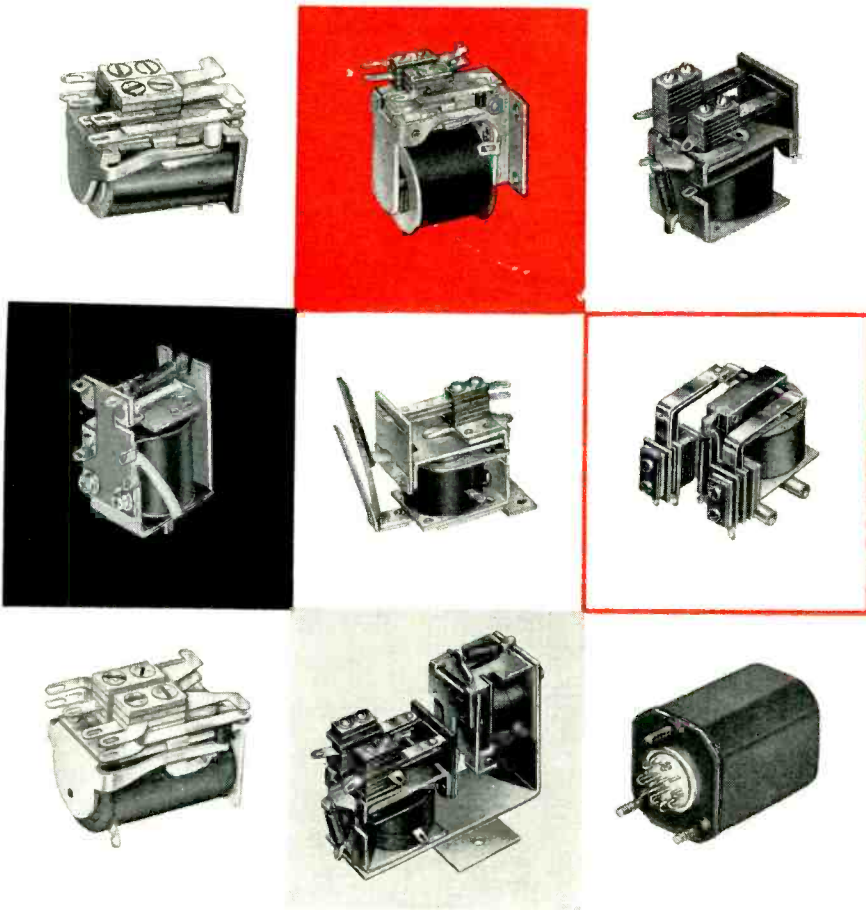

# COMAR RELAYS

made **better** to work **better**

The performance and dependability of any product is governed by the workmanship and materials used in its manufacture. Comar relays are precision engineered, made of top quality materials, fabricated to meet highest inspection standards. They're made better, to work better. In addition, Comar's "custom-manufacturing" gives you the exact physical size and electrical characteristics you want. Send for details now.

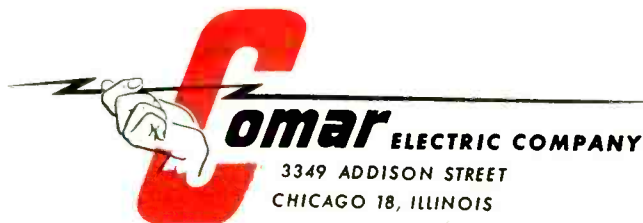

RELAYS • SOLENOIDS • COILS • TRANSFORMERS • SWITCHES • HERMETIC SEALING

up, entirely clear of the tuner, for easy removal and reloading. Parts needed for this assembly are stored in gutter-type pans having metal straps that hook over the rail bolted to the front of the bench.

## Making Plastic Reflectors for Microwave Antennas

By RICHARD E. GILDERSLEEVE  
*Electrical Engineering Department  
Syracuse University  
Syracuse, New York*

USE OF spun-glass-reinforced plastic for molding microwave antenna reflectors results in strong, lightweight, durable reflectors. This method of constructing reflectors is especially advantageous when non-standard shapes and sizes are desired, since the plastic assumes the shape of the mold and the lat-

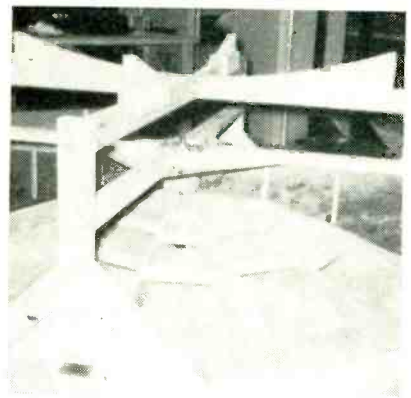

Form for plaster mold and template assembly

ter can readily be made in any desired shape and size.

Several nominally paraboloidal reflectors 6 feet in diameter were required, each having specified deviations from the true paraboloid. To fabricate these reflectors by standard spinning methods would require the construction of a hardwood pattern for each reflector, making the cost of the reflectors prohibitive.

► **General Description**—The reflectors were fabricated in essentially the same manner by which certain car bodies, boats and other large objects are made. A plaster mold was constructed to the desired shape. After drying, the plaster was coated with floor wax, buffed, then sprayed with a parting agent to assure a clean separa-



*New!*

**MULTI-PURPOSE**

# Sweep Signal Generator

4.5 to 120 mc.

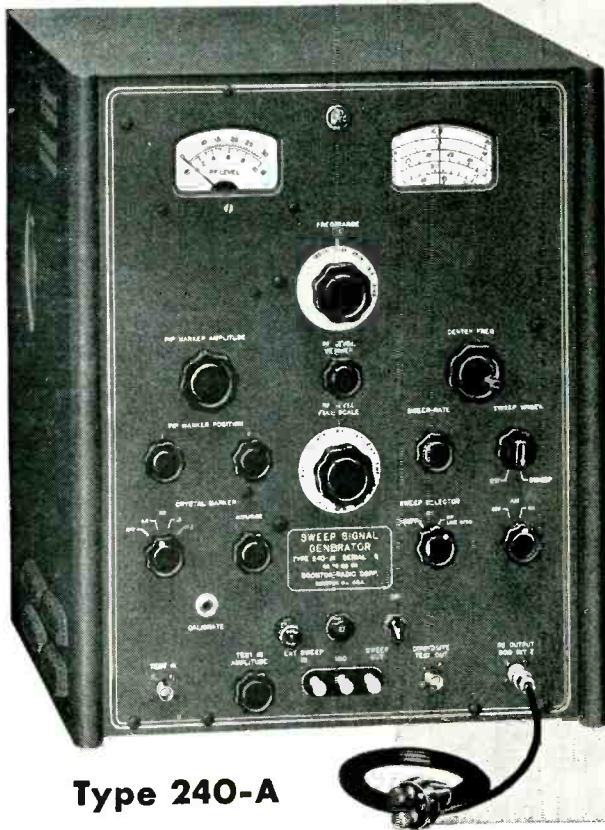

**Type 240-A**

- A wide range of continuously variable linear-frequency sweep widths.
- Crystal controlled frequency identification.
- Adjustable frequency-interpolation pip marks.
- Internal mixer for forming composite display signal.
- Accurate continuously-tuned CW with choice of internal AM.
- Internal crystal calibrator for CW.
- Wide range of calibrated output voltage.

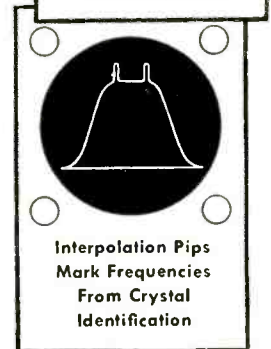
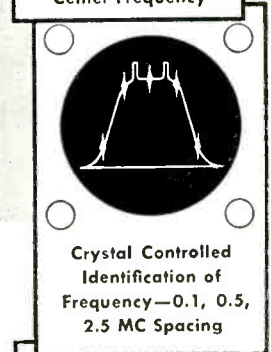
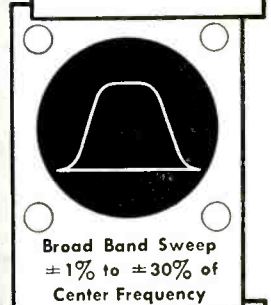
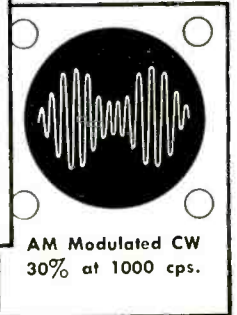
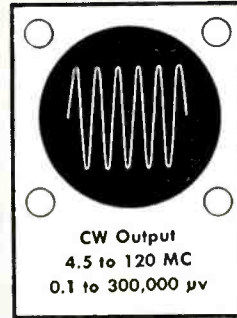

The Sweep Signal Generator Type 240-A is a continuously-tuned, accurate CW Signal Generator with internal AM. The output voltage is continuously monitored, indicated and calibrated over a wide range. The CW Signal can be calibrated against an internal crystal. Electronic sweep circuits are included which produce an output signal having an AGC-controlled constant-amplitude and a wide range of continuously-variable linear-frequency sweep widths. Two systems are included for frequency identification while sweeping. One of these is crystal controlled and the other is an interpolation system. An internal mixer adds the frequency identification information to the test receiver output signal prior to its connection to the display oscilloscope.

**SPECIFICATIONS:**

**RF FREQUENCY RANGE:** 4.5 to 120 MC continuously variable in five ranges.

**RF FREQUENCY ACCURACY:**  $\pm 1\%$ .

**RF OUTPUT VOLTAGE:** 1 to 300,000 microvolts. 0.1 to 30,000 microvolts with external attenuator.

**AMPLITUDE MODULATION:** Factory adjusted to 30% from internal 1000 cps oscillator.

**RANGE OF SWEEP WIDTHS:** Continuously variable from  $\pm 1\%$  of center frequency to  $\pm 15$  MC or  $\pm 30\%$  of center frequency whichever is smaller.

**LINEARITY OF SWEPT RF FREQUENCY:** Within 10% over middle 80% of sweep excursion, within 20% over remainder.

**FLATNESS OF SWEPT RF OUTPUT:** Within 7% under all conditions.

**FREQUENCY IDENTIFICATION MARKS:** Crystal frequency identification spaced 0.1, 0.5, 2.5 MC. Tuning dial identifies center mark. Two adjustable-position interpolation pip marks.

**PRICE:** \$1375.00 FOB BOONTON, N. J.



**BOONTON RADIO**

BOONTON · N. J. · U. S. A.

*Corporation*

# Need a sub-miniature low-inertia Servo Motor or Servo Motor Generator?

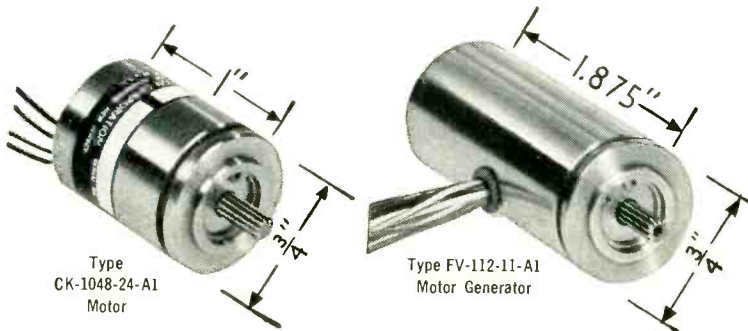

Here are two brand-new ones

by **Bendix**

### TYPICAL MOTOR CHARACTERISTICS

	CK-1048-24-A1	FV-112-11-A1
Frame Size	8	8
Voltage: Fixed Phase	18 volts	18 volts
Control Phase	18 volts	18 volts
Frequency	400 cps	400 cps
Current*: Fixed Phase	.095 amp.	.095 amp.
Control Phase	.095 amp.	.095 amp.
Impedance*: Fixed Phase	190 = 158 + j104 ohms	190 = 158 + j104 ohms
Control Phase	190 = 158 + j104 ohms	190 = 158 + j104 ohms
Power Input* (Total)	3 watts	3 watts
Stall Torque	.15 oz-in	.15 oz-in
No Load Speed	6300 rpm	6300 rpm
Rotor Moment of Inertia	.5 gm-cm <sup>2</sup>	.8 gm-cm <sup>2</sup>
Torque to Inertia Ratio	21,000 rad/sec <sup>2</sup>	13,000 rad/sec <sup>2</sup>
Weight	1.5 oz.	2.5 oz.
Operating Temperature Range	-55°C to +100°C	-55°C to +100°C

\*At stall with rated voltage applied to each phase

### TYPICAL GENERATOR CHARACTERISTICS

Voltage: Input	18 volts
Output	.250 volts/1000 rpm
Frequency	400 cps
Linearity	1/2 of 1% up to 3000 rpm
Input Impedance	178 = 135 + j115 ohms
Recommended Output Loading	100,000 ohms
Power Input	1.5 watts
Null Voltage	15 millivolts max.

These latest additions to the Eclipse-Pioneer line are now in initial production. They're another forward step in the continuing development of Bendix components to meet modern space, accuracy and weight requirements. For full details, write stating your specific needs. DEPARTMENT A, ECLIPSE-PIONEER DIVISION, BENDIX AVIATION CORPORATION, TETERBORO, N. J.

Let "by Bendix" be your guide to **BUY BENDIX**

West Coast Office: 117 E. Providencia Ave., Burbank, Calif.

Export Sales and Service: Bendix International Division, 205 E. 42nd Street, New York 17, N. Y.

**Eclipse-  
Pioneer**  
DIVISION

**Bendix**  
AVIATION CORPORATION



Burlap dipped in plaster and laid on wire mesh provides base for plaster

tion of the plastic from the mold. A thick coat of surfacing plastic was then sprayed on the mold, which furnished a smooth finish to the reflector surface, free of air holes. Two layers of spunglass mat and plastic were then applied, the plastic being thoroughly worked into each layer of mat to remove all air bubbles.

To obtain a reflecting surface for electromagnetic waves the plastic must be metallized in some manner. Several methods were considered but the method finally used employed gummed aluminum foil, which was rolled on the plastic to give a smooth finish. Adjacent strips of foil were lapped, one edge being folded under to make an electrical contact between strips. The edges were then sealed with gummed plastic tape

► **Making the Mold**—In making the plaster mold, a framework of wood was fabricated to conform roughly to the shape of the mold, and covered with 1/2-inch wire mesh. A template was cut from 1/8-inch sheet aluminum to conform to the desired reflector contour. This was mounted on a supporting framework which could be adjusted in height and level by bolts mounted on each of four legs. The legs slid in guides which provided support without constricting vertical motion. The template revolved about a central vertical axis, a sheet metal pressure plate preventing motion in any but the circular direction. This was later modified to a half template for improved operation.

The wire mesh was covered with burlap dipped in plaster to give a surface upon which plaster was

# join the "inner-circle" of ... better **STEPPER** control

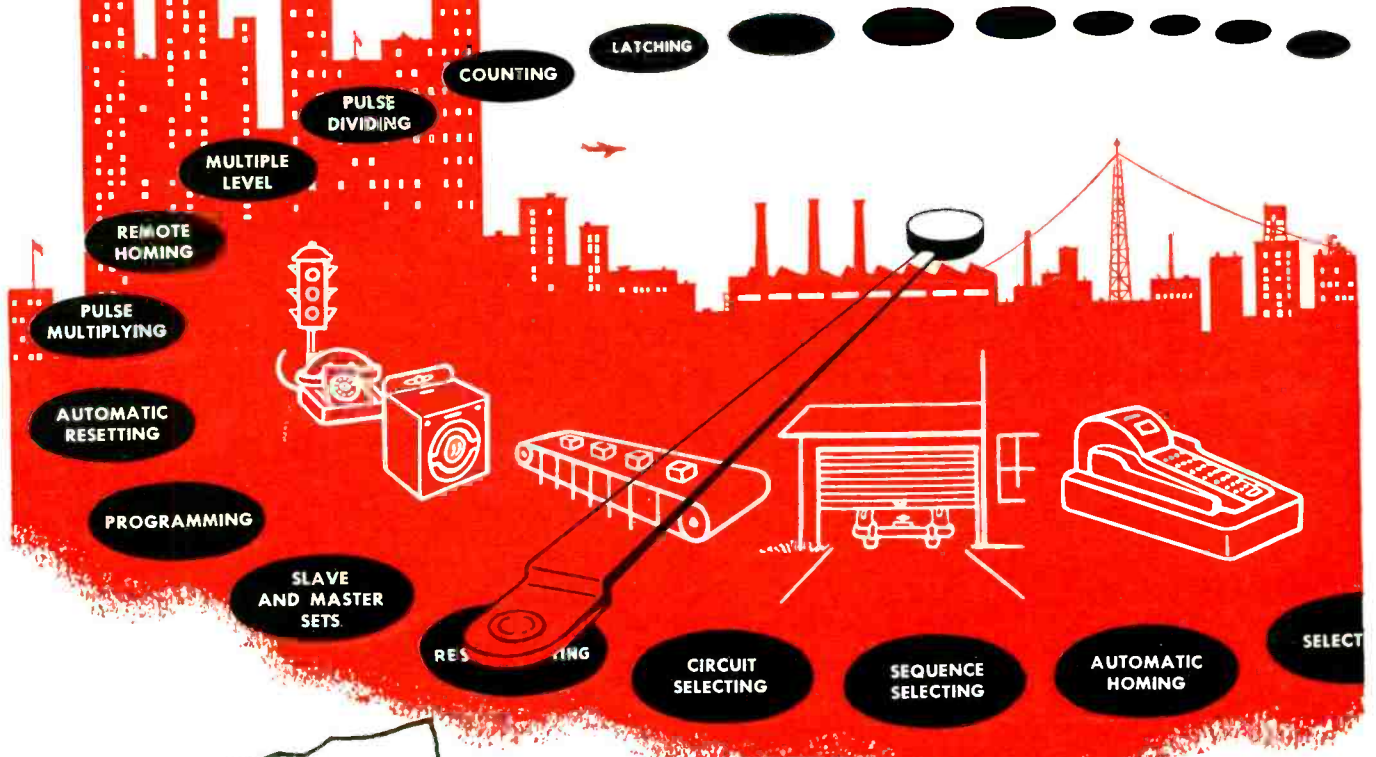

*Specify*  
**GUARDIAN<sup>®</sup>  
STEPPERS**

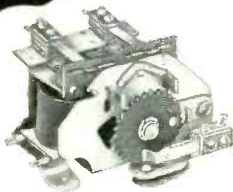

M. A. S. ADD AND SUBTRACT

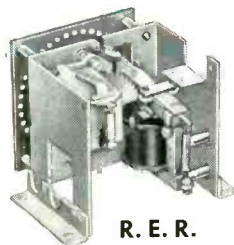

R. E. R.  
ELECTRICAL RESET

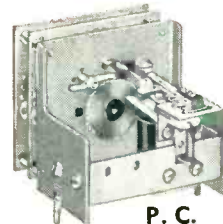

P. C.  
CONTINUOUS ROTATION

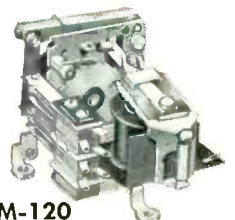

M-120  
CYCLING RATCHET

for selection and control of multiple circuits

At Guardian we strive relentlessly for perfection as exemplified here by the most versatile Stepping Relays obtainable. A dozen models, from midget types to powerful solenoid-driven units, are available in an infinite variety to meet your specific needs. Operating speeds up to 20 pulses per second. Up to 40 active contact points per disc. Up to 4 discs on some models. Included are electrical reset, continuous rotation, add/subtract and ratchet types in a variety of design groups originated by Guardian. All units are especially constructed to resist wear and vibration for dependable, long-life performance.

*write* — for your free copy of Guardian's Stepping Relay Bulletin P-84

**GUARDIAN**  **ELECTRIC**  
1625B W. WALNUT STREET CHICAGO 12, ILLINOIS

A COMPLETE LINE OF CONTROLS SERVING AMERICAN INDUSTRY

You can depend on...



America's Finest

# COLLET-FITTING KNOBS

Dalohm design permits positive locking on all standard shaft diameters full round or flatted with no damaging effect so frequently found when using set-screw type knobs.

**FIVE SIZES** 5/8" — 1 1/16" — 1 3/4" — 2 1/4" — 3"

**COLLETS INTERCHANGEABLE.** Accommodate all shaft sizes from 1/8" to 3/8"

- Precision cast of the thermo setting plastic in easy grip shapes. Match modern styling
- Knobs fit concentrically on shaft and can be positioned accurately and easily on full 360° radius
- Standard pointers and indicators available
- Aluminum dials, three basic types in four sizes; calibrated 0-100 and 100-0 in 180° and 270° rotation. Also plain dials for special applications or markings.
- Highest quality at lowest price

Write for Bulletin K-29

**DALE PRODUCTS, INC.**

Phone 2139

1300 28th Ave., Columbus, Nebraska, U.S.A.



Shaping plaster by rotating template

built up to the final shape. As plaster was added the template was rotated until the plaster conformed everywhere to the template. White molding plaster was used to give a rough shape, a smoother finish surface being obtained with a finer grade plaster. The framework supporting the template was then lifted away to give working freedom.

The plaster was waxed and buffed, using two coats of floor wax paste, then sprayed with a parting agent. The combination of wax and parting agent permitted easy separation of plastic and plaster.

► **Applying the Plastic**—A special surfacing plastic was next sprayed on the prepared mold. This prime layer of plastic not only served to prevent air bubbles in the base plastic from breaking through but also eliminated the possibility of exposed loose ends of fiber glass.

A layer of fiber-glass mat was then shaped to the contour and impregnated with plastic. The mat was cut and lapped to con-

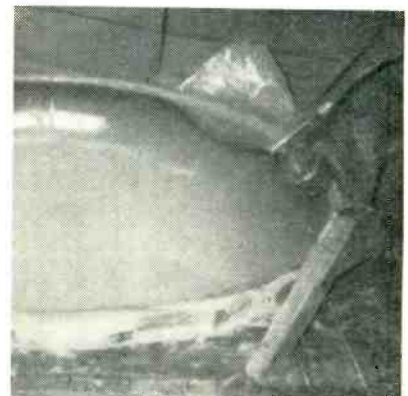

Spraying mold with initial coat of plastic over plaster

Telonic

SWEEP GENERATORS  
EXCELLENT FLATNESS

within **5%** over max. sweepwidth

Model SX-3A



MODELS COVERING, 0-1400 mc;  
WIDE SWEEP WIDTHS, up to 85% of  
center freq.; HIGH OUTPUT VOLT-  
AGE, 1 volt into 50 ohms at fundamen-  
tal frequency; LOW LEAKAGE, suffi-  
ciently low to permit measurements at maximum  
receiver gain; LOW MAINTENANCE,  
standard receiving-type tubes (6AF4A for  
UHF), laced cable harness and terminal  
board component mounting.

Complete Line of Sweep Generators

write

right

now

PLEASE SEND NEW COMPLETE LINE CATALOG
  PLEASE HAVE REPRESENTATIVE CALL

NAME \_\_\_\_\_  
 COMPANY \_\_\_\_\_  
 ADDRESS \_\_\_\_\_ City \_\_\_\_\_ State \_\_\_\_\_

Telonic

INDUSTRIES  
73 N. 2nd Ave.  
Beech Grove, Indiana

# THIS FREE BOOKLET CAN CUT YOUR METALWORKING COSTS

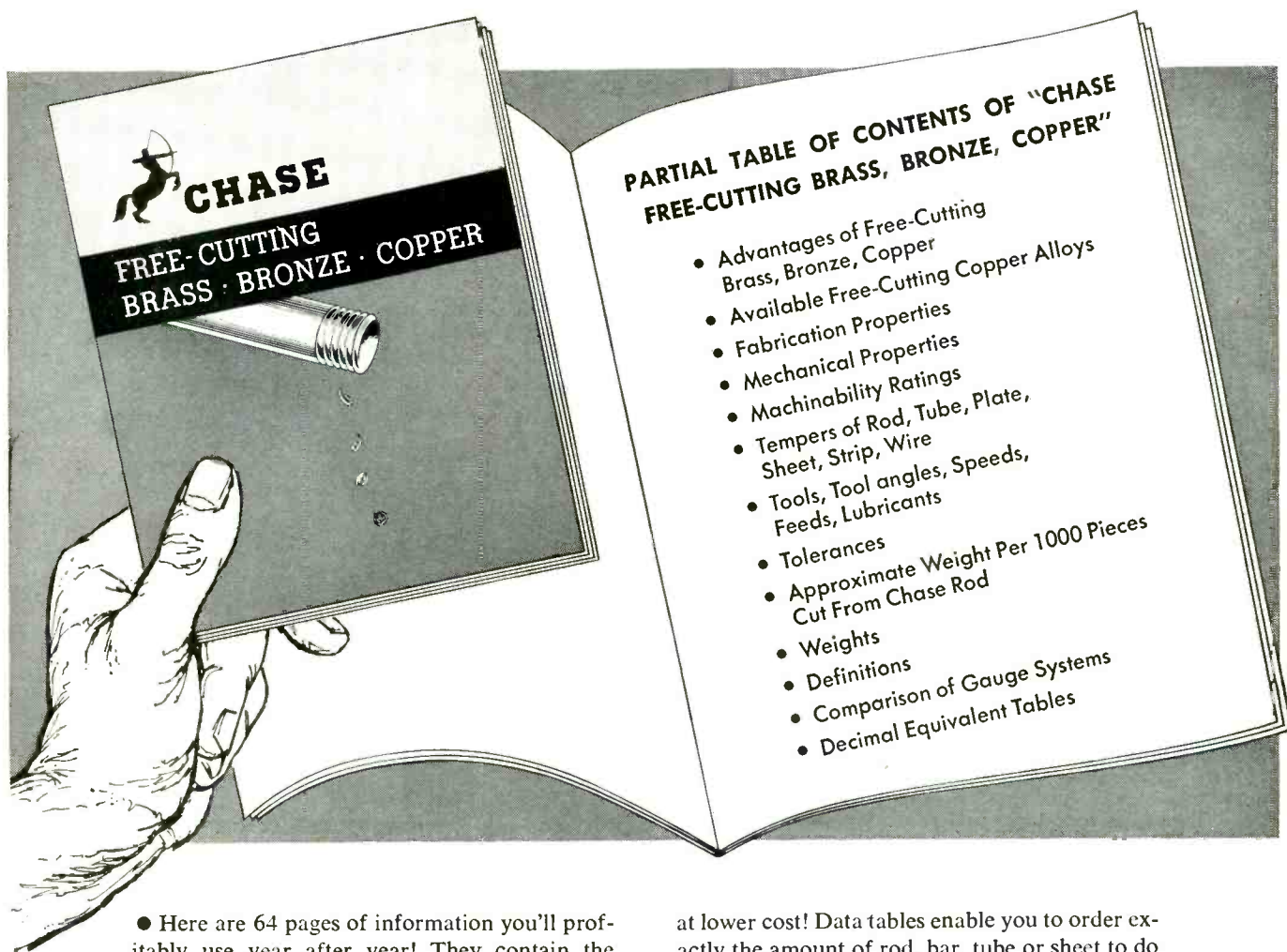

• Here are 64 pages of information you'll profitably use year after year! They contain the straight facts about all the easily-machined Chase brass, copper and bronze alloys.

"CHASE FREE-CUTTING BRASS, BRONZE, COPPER" will help you select the alloys best suited to make your products faster, better, and

at lower cost! Data tables enable you to order exactly the amount of rod, bar, tube or sheet to do any given job.

SEE CHASE'S NEWEST MOVIE, TOO! "In The Chips" gives a demonstration of copper and its alloys in use. It was produced specifically for manufacturers of screw machine products.

The booklet is free! Movie showing is free, too! Send for them today!

# Chase

**BRASS & COPPER CO.**

WATERBURY 20, CONNECTICUT • SUBSIDIARY OF KENNECOTT COPPER CORPORATION

*The Nation's Headquarters for Brass & Copper*

Atlanta	Chicago	Denver	Indianapolis	Minneapolis	Philadelphia
Baltimore	Cincinnati	Detroit	Kansas City, Mo.	Newark	Pittsburgh
Boston	Cleveland	Grand Rapids	Los Angeles	New Orleans	Providence
Charlotte	Dallas	Houston	Milwaukee	New York	Rochester
	St. Louis	San Francisco	Seattle	Waterbury	

CHASE BRASS & COPPER CO.  
WATERBURY 20, CONNECTICUT

E-256

Gentlemen:  Please send me your free booklet:  
"CHASE FREE-CUTTING BRASS, BRONZE, COPPER"  
 I would also like to see the movie, "In the Chips"

NAME .....  
POSITION .....  
FIRM .....  
STREET .....  
CITY ..... STATE .....

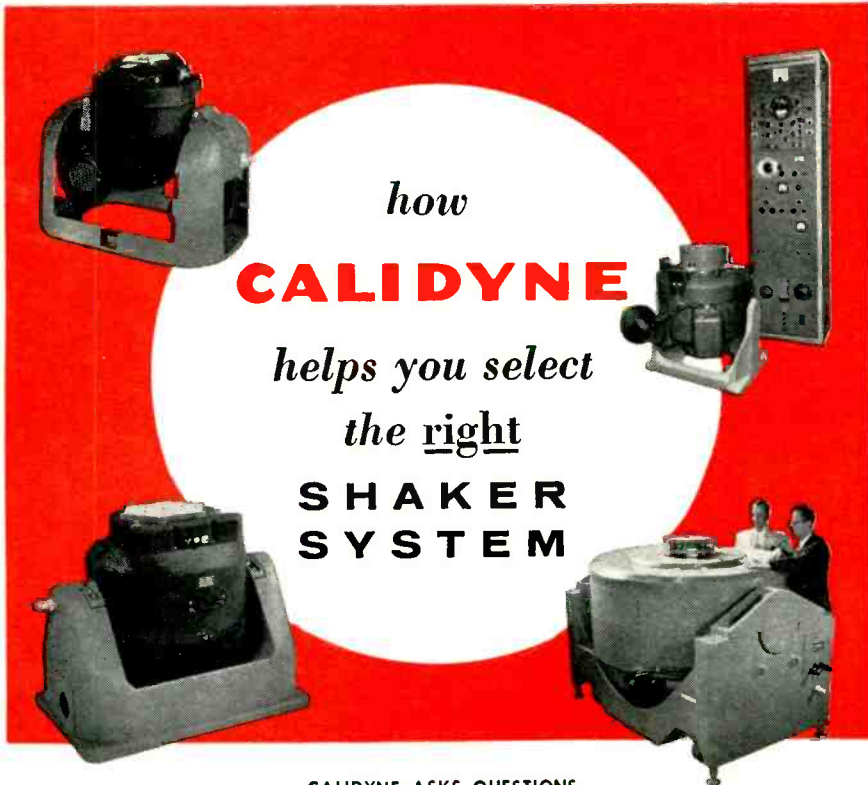

**CALIDYNE ASKS QUESTIONS**

When you inquire about Calidyne Shaker Systems, you're asked "What *type* of vibration testing is required — conventional environmental testing? Fatigue testing? Structural response determination? Mechanical noise reduction?" Further, "What are your present, and anticipated, requirements for force, frequency, and stroke?" In this way, Calidyne can recommend the equipment which will provide *maximum* usefulness for your investment, with as much flexibility as possible for future needs.

**CALIDYNE DELIVERS**

To meet your requirements, Calidyne offers complete Shaker Systems ranging in force output from 25 to 12,500 pounds. Systems consist of one or more electrodynamic Shakers, a rotary or electronic power supply, a control console and various optional accessories for monitoring, measuring or automatically cycling tests. Calidyne Shakers feature greater useful force output through lighter armatures, true linear armature motion, rugged construction. Certain Calidyne power supply units, also, will operate Shakers of widely different force outputs. Any accessory may be added to a basic system at any time, without costly revamping or modification.

**CALL CALIDYNE**

For competent help in solving your vibration testing problems, or technical data on any Calidyne Shaker System, call Calidyne now.



**THE CALIDYNE COMPANY**

120 CROSS STREET, WINCHESTER, MASSACHUSETTS

**SALES REPRESENTATIVES:**

**WALTHAM, MASS.**  
Robert A. Waters, Inc.  
Waltham 5-6900

**NEW HAVEN, CONN.**  
Robert A. Waters, Inc.  
Fulton 7-6760

**NEW YORK CITY AREA**  
G. C. Engel & Associates  
Rector 2-0091

**RIDGEWOOD, NEW JERSEY**  
G. C. Engel & Associates  
Gilbert 4-0878

**PHILADELPHIA, PA.**  
G. C. Engel  
Chestnut Hill 8-0892

**NORTHERN NEW YORK**  
Technical Instruments, Inc.  
Waltham, Mass.  
Waltham 5-8445

**CLEVELAND, OHIO**  
M. P. Odell Co.  
Prospect 1-6171

**DAYTON, OHIO**  
M. P. Odell Co.  
Oregon 4441

**DETROIT, MICHIGAN**  
F. R. Jodan, Inc.  
Superior 8-5114

**WASHINGTON, D. C.**  
F. R. Jodan, Inc.  
Hobart 2-4300

**SOUTHEAST**  
W. A. Brown & Assoc.  
Alexandria, Va.  
Overlook 3-6100

**CHICAGO, ILLINOIS**  
Hugh Marsland & Co.  
Ambassador 2-1555

**INDIANAPOLIS, INDIANA**  
Hugh Marsland & Co.  
Glendale 3803

**MINNEAPOLIS, MINN.**  
Hugh Marsland & Co.  
Colfax 7949

**DALLAS, TEXAS**  
John A. Green Co.  
Fleetwood 7-7385

**HOLLYWOOD, CALIFORNIA**  
G. B. Miller Co.  
Hollywood 2-1195

**SAN FRANCISCO, CALIF.**  
G. B. Miller Co.  
Lytell 3-3438

**ALBUQUERQUE, NEW MEXICO**  
G. B. Miller Co.  
Albuquerque 5-8606

**SEATTLE, WASH.**  
G. B. Miller Co.  
Londer 3320

**CANADA**  
Measurement Engineering Ltd.  
Annprior, Ont., Phone 400  
Toronto, Ont., Mayfair 8860

**EXPORT**  
Rocke International Corp.  
13 East 40th St., N.Y. 16, N.Y.  
Murray Hill 9-0200

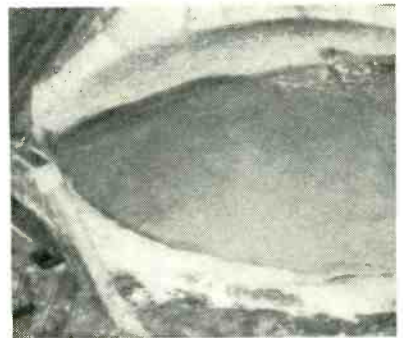

Glass mat partially impregnated with plastic

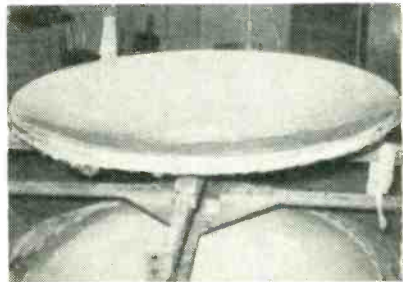

Appearance of plastic reflector after it is removed from mold

form to the mold. Several such cuts were necessary. The seam did not appear on the reflecting surface.

The plastic used was a polyester resin to which catalyst and accelerator were added just prior to use. The plastic was worked into the glass with a brush to insure a thorough impregnation and a minimum of air bubbles. As many layers of mat and plastic may be used as desired to give the required strength. Two layers were found to be sufficient for this particular application.

The plastic has a setting time of about 15 minutes after the catalyst is added, hence mixtures should be made in small quantities, about 5 pounds per man if the hand lay-up process is used. In this process the plastic is applied with a paint brush.

The reflector can be removed from the mold in about one hour.

► **Applying Aluminum Foil**—The metalization of the reflecting surface presented problems which were solved satisfactorily for this application by applying 6-inch-wide strips of gummed aluminum foil. The foil was applied with a roller to smooth out the wrinkles. To provide electrical contact between strips one edge of each strip was folded under and lapped ½

**It's a dozen  
test instruments in one!**  
—the Adjustable Span *Electronik* Recorder

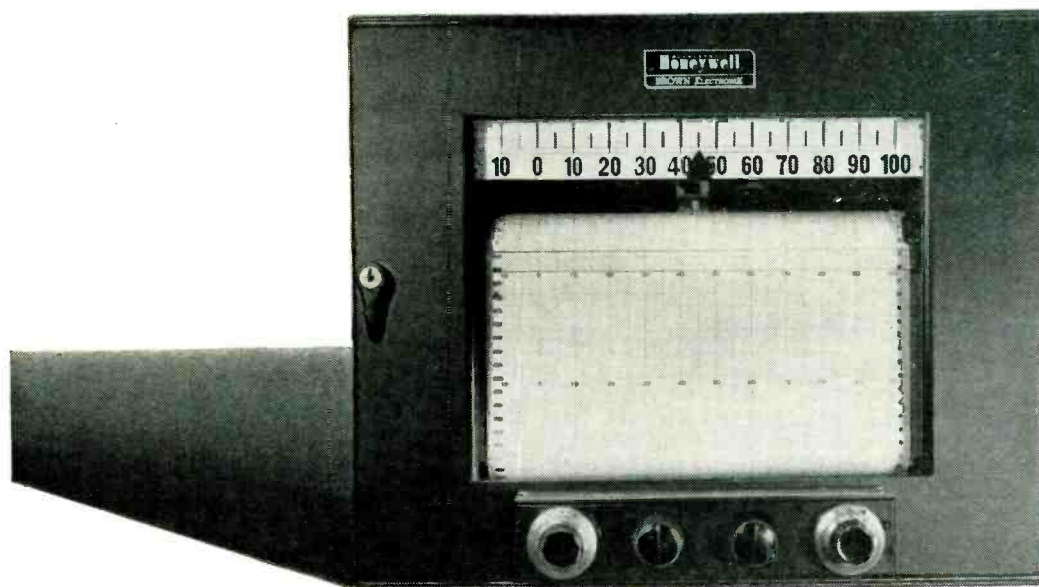

Here's a recording potentiometer that is a real jack-of-all-trades (and master of each one) in any development or test laboratory. Just turn the dials, and in seconds, you can set it up for the exact range and sensitivity you want. You don't have to do any rewiring or changing of calibrating circuits.

**50-to-1 span adjustment.** Millivolt span of the recorder is continuously variable over as much as a 50:1 range. Span adjustment is independent of zero setting.

**Variable zero suppression.** Coarse and fine adjustment dials let you move the electrical zero point up and down scale, to concentrate recording on only the part of the span in which you're interested. Zero adjustment does not affect span setting.

**Sensitivity adjustment** makes it easy to get the recording characteristics you want to match the span being used.

**Many optional features:** you can choose from recording speeds of  $\frac{1}{2}$ , 1, 2,  $4\frac{1}{2}$ , 12 or 24 seconds full scale . . . fully automatic, push-button, or solenoid-actuated remote or locally controlled standardization.

Find out how this versatile instrument can save time in your test work, by calling your local Honeywell sales engineer . . . he's as near as your phone.

MINNEAPOLIS-HONEYWELL REGULATOR Co., *Industrial Division*, Wayne and Windrim Avenues, Philadelphia 44, Pa.—in Canada, Toronto 17, Ontario.



● **REFERENCE DATA:** Write for Data Sheet No. 10.0-10a, "Adjustable Span Recorder."

MINNEAPOLIS  
**Honeywell**  
B R O W N I N S T R U M E N T S

*First in Controls*

More Engineers on A-N and civilian projects are proving—

# It pays to specify AMPERITE DELAY RELAYS and BALLAST REGULATORS

... they're finest



... cost less!

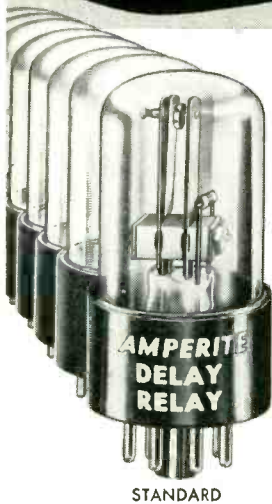

STANDARD

## Thermostatic DELAY RELAYS

**MOST COMPACT, HERMETICALLY SEALED**  
Provide delays ranging from 2 to 150 seconds.

- Actuated by a heater, they operate on A.C., D.C., or Pulsating Current.
- Hermetically sealed. Not affected by altitude, moisture, or other climate changes.
- Circuits: SPST only — normally open or normally closed.

Amperite Thermostatic Delay Relays are compensated for ambient temperature changes from  $-55^{\circ}$  to  $+70^{\circ}$  C. Heaters consume approximately 2 W. and may be operated continuously. The units are most compact, rugged, explosion-proof, long-lived, and — inexpensive!



MINIATURE

TYPES: Standard Radio Octal, and 9-Pin Miniature.

**PROBLEM? Send for Bulletin No. TR-81**

Also — a new line of Amperite Differential Relays — may be used for automatic overload, over-voltage, under-voltage or under-current protection.



T9 BULB

## BALLAST REGULATORS

- Amperite Regulators are designed to keep the current in a circuit **automatically regulated** at a definite value (for example, 0.5 amp).
- For currents of 60 ma. to 5 amps. Operates on A.C., D.C., Pulsating Current.
- Hermetically sealed, light, compact, and most inexpensive.

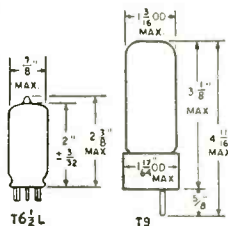

Amperite Regulators are the simplest, most effective method for obtaining automatic regulation of current or voltage. Hermetically sealed, they are not affected by changes in altitude, ambient temperature ( $-55^{\circ}$  to  $+90^{\circ}$  C), or humidity. Rugged; no moving parts; changed as easily as a radio tube.

Write for 4-page  
Technical Bulletin No. AB-51

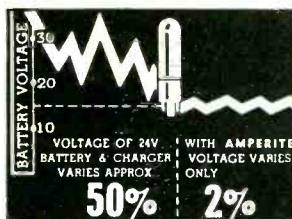

inch over the adjacent strip. The seam was closed with a 1/2-inch-wide strip of plastic tape to insure contact. The strips were oriented in the direction of polarization of the primary feed.

► **Method of Mounting**—Mounting the reflector on a pedestal is not a difficult problem since the reinforced plastic can be machined in the same manner as metal. It is not necessary to do any machining, however, if provision is made for imbedding mounting brackets in the plastic. The brackets can be removable, if desired, by forming



Reflector surfaced with aluminum-foil tape to obtain conductive surface

pockets into which the brackets may be inserted prior to the actual mounting of the reflector.

The plastic reflector is strong and light-weight but more flexible than the aluminum counterpart and hence must be mounted firmly to prevent whipping or bending.

► **Cost Figures**—The cost of materials used in fabricating a plastic reflector are small, the principle expense arising from labor costs. It is estimated that the cost of materials for a 6-foot-diameter reflector is about twenty dollars, not including the mold, molding equipment and metal surfacing. No special tools are required and no highly skilled workmen are necessary. Two men, after a little experience, could make a reflector in about half a day, including spraying parting agent on the mold.

Since plaster molds are not too satisfactory if several reflectors of the same size and focal length are to be made, a plastic mold can readily be made which will not be damaged by repeated usage, thus saving costs of repair of the plaster mold.



**AMPERITE CO. Inc., 561 Broadway, New York 12, N. Y.**

In Canada: Atlas Radio Corp., Ltd., 560 King St. W., Toronto 2B



# ANOTHER **FIRST** BY *Federal*



## **METAL ENVELOPE TRAVELING WAVE TUBES**

*—opening a new concept of ruggedness,  
dependability and long-lasting performance*

### **Featuring:**

- Plug-in design
- Greater reliability
- RF connectors as integral part of tube structure
- Tube self-aligned in the solenoid
- No adjustments necessary
- Conservative ratings

Traveling  
Wave Tube  
with  
associated  
solenoid

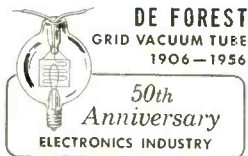

For complete engineering  
data on Federal's TWT's,  
write to Dept. K-913

Federal presents the most advanced traveling wave tube design . . . the result of continuous development by Federal since 1946.

Bringing to designers the *first all-metal envelope*, this new TWT provides greater-than-ever ruggedness, a new high in reliability and performance and longer service life.

Federal traveling wave tubes are designed for quantity production . . . are now available in these two types:

**F-6658**—2000-4000 mc. amplifier, 1 watt CW output with 30 db gain.

**F-6825**—2400-3600 mc. amplifier, 1 kw. pulse output with 30 db gain.

*(Other types currently in final development for production—including "S" and "X" band applications—will be available in the near future. Inquiries for special design applications are invited.)*

Designers: For the quality, craftsmanship and performance you want for your application, get the facts about Federal metal envelope traveling wave tubes . . . *first in the field* . . . and *Certified by a World of Research.*"

### **Federal Telephone and Radio Company**

A Division of INTERNATIONAL TELEPHONE AND TELEGRAPH CORPORATION  
COMPONENTS DIVISION • 100 KINGSLAND ROAD • CLIFTON, N. J.

In Canada: Standard Telephones and Cables Mfg. Co. (Canada) Ltd., Montreal, P. Q.  
Export Distributors: International Standard Electric Corp., 67 Broad St., New York

# *Federal*



A DIVISION OF

# ITT

# New Products

Edited by WILLIAM P. O'BRIEN

87 New Products and 53 Manufacturers' Bulletins Are Reviewed  
. . . Control, Testing and Measuring Equipment Described and  
Illustrated . . . Recent Tubes and Components Are Covered

## POWER SUPPLY

0 to 500 ma output

DELTRON INC., P. O. Box 192, Glenside, Pa. Models 900 and 900R regulated power supply have a voltage range of 0 to 500 v continuously variable, either positive or negative grounded. Output current d-c is 0 to 500 ma. Regulation is less than 0.5 percent during a-c supply fluctuation of from 105 to 125 v rms and from zero to full load current,



under any combination of supply voltage and load current within these ranges.

► **Other Specifications**—Ripple voltage is less than 10 mv rms; internal impedance, less than 2 ohms; duty cycle, 24 hr continuous. Also featured is a relay controlled preset voltage.

Price of the model 900 is \$340, and the model 900R, which is slightly smaller, is \$330.

## ELECTRONIC FILTER

with mode-selector switch



SPECTRUM INSTRUMENTS, INC., 44-05 30th Ave., Long Island City,

N. Y., has developed a new, direct-coupled, variable electronic filter with cut-off frequency tunable from 0.2 to 20,000 cps. Model LH-24 can be used as either high-pass or low-pass filter by a panel mode-selector switch.

It is completely self contained, including a double regulated power supply for stable operation from a-c lines. High input impedance permits bridging operation in most cases, while low output impedance allows direct connection to the majority of possible loads.

► **Analog Filter**—This term is derived from the mathematical equivalence of the input-output voltage-frequency characteristic to that of a properly terminated inductance-capacitance filter. The filter, however, employs no inductances achieving the desired result with resistance and capacitive elements in an active network. It is free of the familiar impedance matching problems in coupling to source and load and in cascading of units. Since tuning is accomplished with a precision wire-wound potentiometer assembly, undesirable effects associated with inductor Q-change are avoided. Price is \$445.

## H-V POWER SUPPLY

small package, low price

NEUTRONIC ASSOCIATES, 87-16 116th St., Richmond Hill 18, N. Y. Model 75BR is a complete, self-contained, r-f h-v power supply housed in a cabinet 7½ in. high by 8 in. wide by 8 in. deep, and equipped with a 3-in. voltmeter as standard equipment.

► **Features**—Voltage range is 2 kv to 7.5 kv d-c; current, 1 ma at



6 kv; and regulation, better than 1 percent.

Net price of the model 75BR is \$89.75 (\$79.75 less meter); and the model 75B is \$69.75 unregulated (\$59.75 less meter).

## DETECTOR TUBES simplify tv circuits

RADIO CORP. OF AMERICA, Harrison, N. J. The 6DT6 and 3DT6 f-m de-

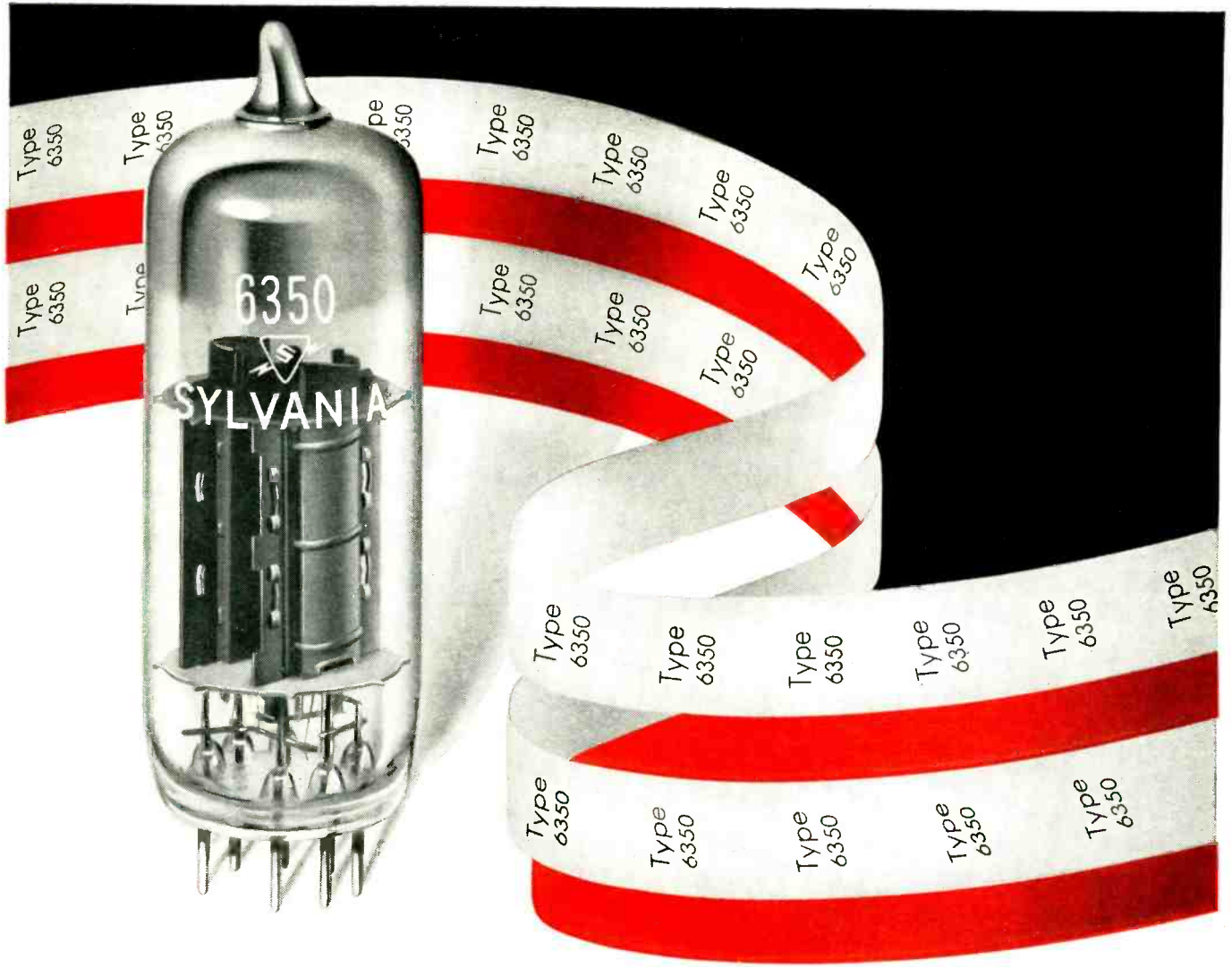

## More "soup" where you need it...

to drive magnetic cores, drums, computer read-outs

HERE IS a high perveance twin triode designed for heavy duty computer applications. It is capable of delivering peak cathode currents of 300 ma and will dissipate up to 7 watts.

The Sylvania type 6350 features separate cathodes for each section and controlled grid cutoff. Separate cathodes provide maximum flexibility in equipment design.

Cutoff is held to close tolerances facilitating the design of circuits for optimum cutoff signals. Minimum interface formation assures operation even after periods of extended cutoff.

### DESIGN CENTER RATINGS FOR THE 6350

Peak Positive Plate Voltage (Abs. Max.)	1000 Volts
Peak Negative Grid Voltage	400 Volts Max.
Peak Positive Grid Voltage	13 Volts Max.
Peak Positive Grid Current	100 Ma Max.
Peak Cathode Current	300 Ma Max.
Plate Dissipation	
Each Plate	3.5 Watts Max.
Both Plates	7.0 Watts Max.

### OTHER SYLVANIA COMPUTER TYPES

Type 5844	Medium mu triode
Type 5965	Medium mu twin triode
Type 6211	Medium mu twin triode
Type 5687	Low mu twin triode
Type 7AK7	Sharp cutoff pentode
Type 5915A	Dual control pentode
Type 6145	Sharp cutoff pentode
Type 6814	Medium mu triode

 **SYLVANIA**<sup>®</sup>

SYLVANIA ELECTRIC PRODUCTS INC.  
1740 Broadway, New York 19, N. Y.  
In Canada: Sylvania Electric (Canada) Ltd.,  
University Tower Bldg., Montreal

LIGHTING • RADIO • ELECTRONICS • TELEVISION • ATOMIC ENERGY  
SEE SYLVANIA IN BOOTH NOS. 168-172 AT THE 1956 I.R.E. SHOW

# IN THE RACE AGAINST TIME

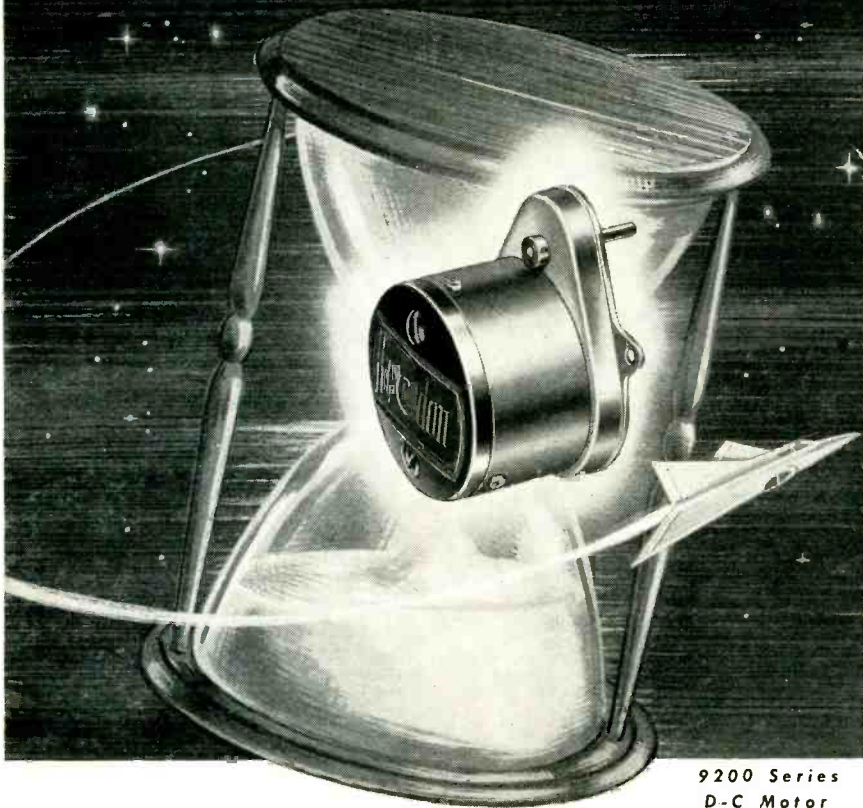

9200 Series  
D-C Motor

## HAYDON\* TIMING MOTORS

### HELP CHART the COURSE

**TIMING**—a vital factor to consider if you design or build military aircraft or components! So, HAYDON constantly applies its facilities, skills, and talents to find solutions for aero-timing problems. For d-c: Small, compact motors to control timing devices with complete dependability . . . helping airmen chart the course of time! Built to Military specifications, the HAYDON 9200 Series can be calibrated for 6-30 volts. For 28 volts, the 9250 Series may be your answer—RF filtering available. HAYDON d-c timers using these motors, are available also.

For 400 cycles: 6700 Series Motors . . . 7008 Series Elapsed Time Indicators . . . various timers.

Phone the nearby HAYDON factory-trained Field Engineer for more answers to your timing questions; or write to us outlining your requirements . . . and ask for catalogs on timing motors and devices. Write NOW—make time count for you!

\* Trademark Reg. U.S. Patent Office



A SUBSIDIARY OF GENERAL TIME CORP.

**HAYDON Manufacturing Company, Inc.**  
2426 ELM STREET, TORRINGTON, CONNECTICUT

NEW PRODUCTS

(continued)

r-f electrode terminals insulated from each other by low-loss ceramic bushings; relatively low output capacitance; low feedback capacitance; and a multistrand thoriated-tungsten filament for economical operation, high emission capability and long life.

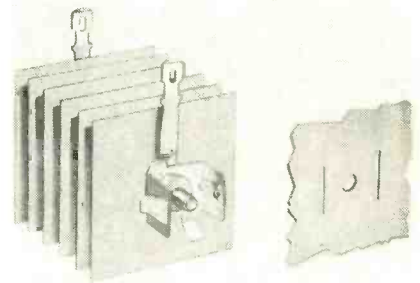

### CLIP-IN RECTIFIER for rapid installation

FEDERAL TELEPHONE AND RADIO Co., 100 Kingsland Road, Clifton, N. J. Selenium rectifiers equipped with a new spring-steel, snap-action mount permitting increased ease of assembly have been announced.

► **Advantages**—The clip-in rectifier features minimum installation cost and rapid installation. These rectifiers can even be mounted two at a time using both hands. No mounting hardware is required, and there is no need for installation tools. The rectifier can be inserted or removed instantly from the accessible side of the chassis. Terminals may be used for both soldered and solderless connections, and the mount is self-adjusting to all standard panel thickness.

The new mount can be adapted to rectifiers rated from 25 to 195 v a-c and from 65 to 750 ma d-c.

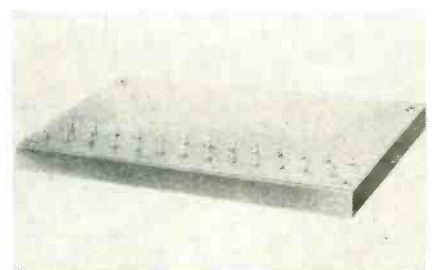

### DELAY LINES for multiplex communications

ESC CORP., 534 Bergen Blvd., Palisades Park, N. J., has available a

**TESTED 200%**

*plus!*

**Y**OU'VE probably noticed the steadily growing preference for Stackpole fixed composition resistors in critical military uses as well as in a high percentage of today's television, radio and industrial electronic equipment.

There are two main reasons: Outstandingly dependable products backed by equally dependable, personalized service.

Dependability is assured by the most modern manufacturing techniques *plus* constant testing. From preliminary sorting tests to the final 100% test and numerous quality control tests extending from raw materials through production, it is conservative to say that Stackpole resistors are tested well over 200%.

As for service in meeting resistor requirements accurately and when promised—this is a Stackpole factor that is just as carefully controlled and tested as the manufacturing processes themselves.

And it is our sincere aim to keep it that way.

Electronic Components Division  
**STACKPOLE CARBON COMPANY**  
St. Marys, Pa.

Canada: Canadian Stackpole Ltd.,  
550 Evans Ave., Etobicoke, Toronto 14, Ont.

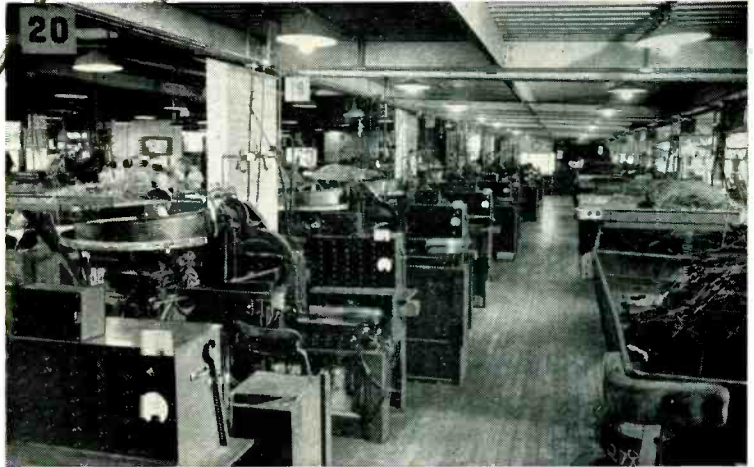

**ELECTRICAL TESTING**— Each Stackpole fixed composition resistor gets a final test on automatic machines like these. Other tests before and during production bring the total test percentage to well over 200%.



**SERVICE IN THE MAKING**— A portion of the huge fixed composition resistor stock Stackpole strives to maintain to assure prompt deliveries.



# STACKPOLE FIXED COMPOSITION RESISTORS

# HANDLES

- **SIX TYPES** and sizes to suit nearly every requirement. USECO's standard handles are made of half hard brass, nickel plated. Stainless steel handles available on special order. Other finishes include cadmium and black oxide. Supplied with or without ferrules. Furnished in 5/16" 18 thread. Available with or without nuts and washers. For Engineering Manual and complete information please address Dept. 16

**ADJUSTABLE HANDLE** (illustrated at top)  
 —An all-purpose handle with adjustable center spacing from 4 inches to a maximum of 6 inches. (On special orders an unlimited maximum center spacing can be furnished.) Height above panel can vary from 1½ to 2 inches.

HANDLE	PART NO.	WIDTH	HEIGHT
HANDLE	1005	6.437	1.750
HANDLE	1007	6.000	1.500
HANDLE	1010	4.250	1.500
CABINET HANDLE	1115	3.000	1.500
ADJUSTABLE HANDLE	1025	4" to 6"	1.500
ECONOMY HANDLE	1030	3" plus; in 1/16" increments	1.437

## U. S. ENGINEERING CO., INC.

*A Division of Litton Industries, Inc.*

521 Commercial Street, Glendale 3, California

series of custom-built portable ptm multiplex communication system delay lines.

► **Features**—Specifically intended for use as timing units, they feature: 125  $\mu$ sec delay; 3,300 ohms impedance; 1-percent accuracy; tapped in increments of 5.2  $\mu$ sec; and they meet all applicable MIL specifications.

A complete catalog is available upon request.

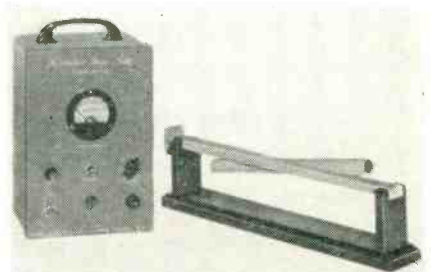

### RANDOM NOISE SOURCE for microwave frequencies

KAY ELECTRIC Co., Pine Brook, N. J., has announced a new line of Mega-Nodes, calibrated random noise sources for microwave frequencies. The new Mega-Nodes will utilize fluorescent tubes only and will cover the following frequency ranges: WR770, 960 to 1,450 mc; WR650, 1,120 to 1,700 mc; WR510, 1,450 to 2,200 mc; WR430, 1,700 to 2,600 mc; and WR340, 2,200 to 3,300 mc.

► **Other Specifications**—Noise output (all guides) is 15.8 db; accuracy, to  $\pm 0.25$  db; power source, 117 v, a-c  $\pm 10$  percent, 50-60 cps; power consumption, approximately 40 w.

Prices are as follows: WR770 and WR650 \$595 each; the other three types, \$495 each.

### LAB POWER SOURCE for transistor circuits

NJE CORP., 345 Carnegie Ave., Kenilworth, N. J., announces a flexible new laboratory power source especially intended for use in transistor circuit development. Completely tubeless, the supply provides three entirely independent floating output voltages, each well regulated against line or load changes. Low

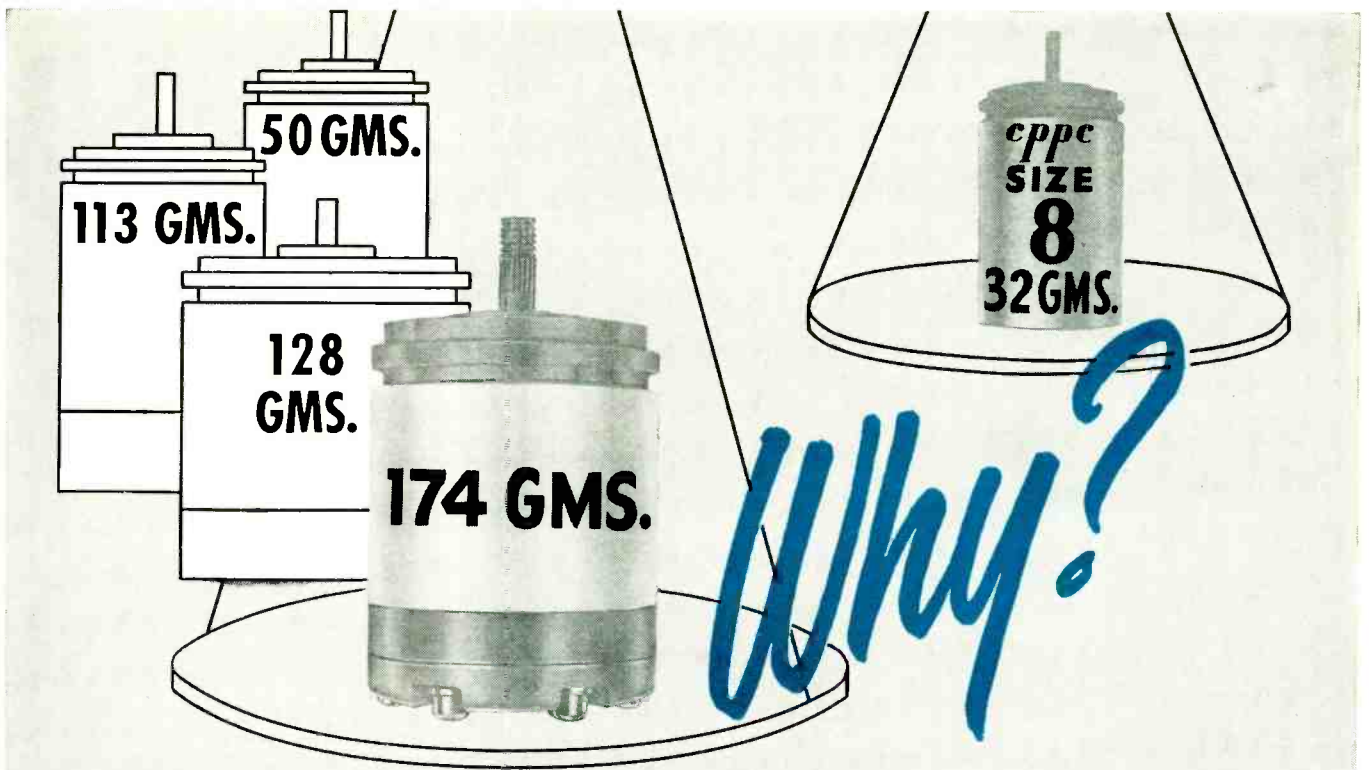

## WHY USE 1945 SYNCHROS IN 1956 DESIGNS?



Available in all Types!

ACCURACY 7 MINUTES

Function	Type Number	Primary Element	Excitation Voltage 400 cy.	Input Current (ma.)	Input Power (Watts)	Primary Impedance Secondary Open (Phase)	Primary Resistance (line)	Secondary Element	Output Voltage	Secondary Impedance Primary Open (Phase)	Secondary Impedance Primary Shorted	Secondary Resistance (line)	Phase Shift Degrees	Sensitivity mv./deg.	Accuracy Minutes Max.
Transmitter	CGC-8-A-7	Rotor 1 Phase	26.0	100	.50	54+ j260	37.0	Stator 3 Phase	11.8	12+ j45	15+ j3.5	11.8	8.0	200	7
Control Transformer	CTC-8-A-1	Stator 3 Phase	11.8	90	.23	28+ j110	24.7	Rotor 1 Phase	23.6	220+ j740	246+ j60	143	8.5	400	7
Control Transformer	CTC-8-A-4	Stator 3 Phase	11.8	37	.09	67+ j270	59.5	Rotor 1 Phase	24.0	508+ j1680	640+ j190	381	9.2	400	7
Resolver	CSC-8-A-1	Stator 2 Phase	11.8	84	.27	38+ j136	27.0	Rotor 2 Phase	23.2	280+ j600	344+ j75	230	11	400	7
		Rotor 2 Phase	26.0	39	.43	280+ j600	230	Stator 2 Phase	10.6	38+ j136	70+ j29	27.0	20	180	7
Repeater	CRC-8-A-1	Rotor 1 Phase	26.0	100	.50	54+ j260	37.0	Stator 3 Phase	11.8	12+ j45	15+ j3.5	11.8	8.0	200	30*
Differential	CDC-8-A-1	Stator 3 Phase	11.8	85	.21	27+ j120	25.0	Rotor 3 Phase	11.8	38+ j122	47+ j14	36.0	9.0	200	7 Rotor 7 Stator

Total Null max. 30mv for each unit

Also available in 115v 400 cy. primary, 90v secondary Transmitters, C.T.'s, Receivers

\*Torque 2600 mg.-mm./degree from CGC-8-A-7



In equipment which must be flown, why load on extra weight?  
Clifton's new Size 8 Synchros can take the place of larger units at very significant saving in bulk and weight.  
These new Size 8's are now in use in some of the latest and lightest avionic equipment,  
Samples are available from stock, quantities from the production line.

**CLIFTON PRECISION PRODUCTS CO. INC.**  
CLIFTON HEIGHTS PENNSYLVANIA

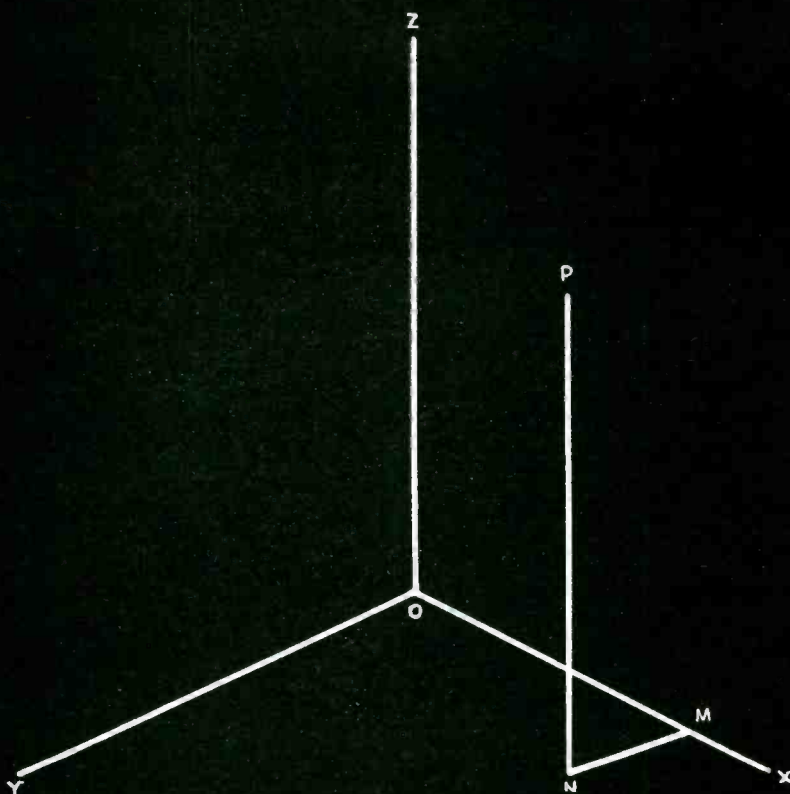

*Having difficulty extruding unusual shapes ·  
Let us help · A source for problem shape  
impact extruding — that assures you reliable  
deliveries backed by a 30 year reputation.*

**SunTube**

CORPORATION

HILLSIDE, NEW JERSEY

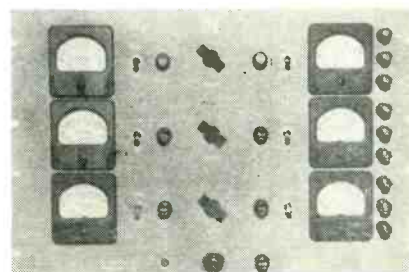

ripple and internal impedance simulate battery conditions without the expense and inconvenience of batteries.

► **Specifications**—Each of the three channels is continuously adjustable from 0 to 50 v at 0 to 10 ma, with less than 1 mv of ripple, and 0.5 percent absolute regulation at 50 v. Higher current models are available, up to 1 ampere.

Dual-range voltage and current meters are provided for each channel. The model CS-3667 is enclosed in a bench-mounted steel cabinet, and is also available for rack mounting. Meters are optional.



## POWER TRANSISTOR made from silicon

TEXAS INSTRUMENTS INC., 6000 Lemmon Ave., Dallas 9, Texas. Type 970 *npn* grown junction silicon power transistor has a maximum power dissipation of 3.5 w at the temperature of boiling water. It is ideally suited for the output stages of servo amplifiers, which convert small electrical variations into mechanical motion at a remote location.

► **Dimensions**—Type 970 weighs less than  $\frac{3}{4}$  oz complete and is hermetically sealed in a disc approximately  $\frac{1}{2}$  in. in diameter by  $\frac{1}{2}$  in. high. The mounting plate heat sink extends outward from the transistor itself to cover an area of about  $\frac{3}{4}$  in. by  $1\frac{1}{4}$  in.

► **Ratings**—Power dissipation is 8.75 w maximum at 25 C, with 3.5 w maximum at 100 C. Power gain

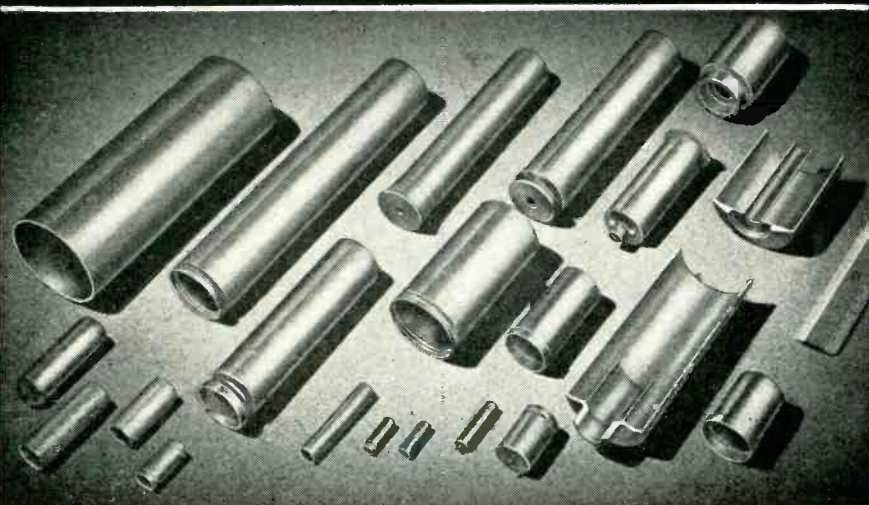

IMPACT EXTRUSIONS · CONDENSER CANS AND SHELLS.  
ALUMINUM · ZINC · MAGNESIUM · LEAD · SILVER



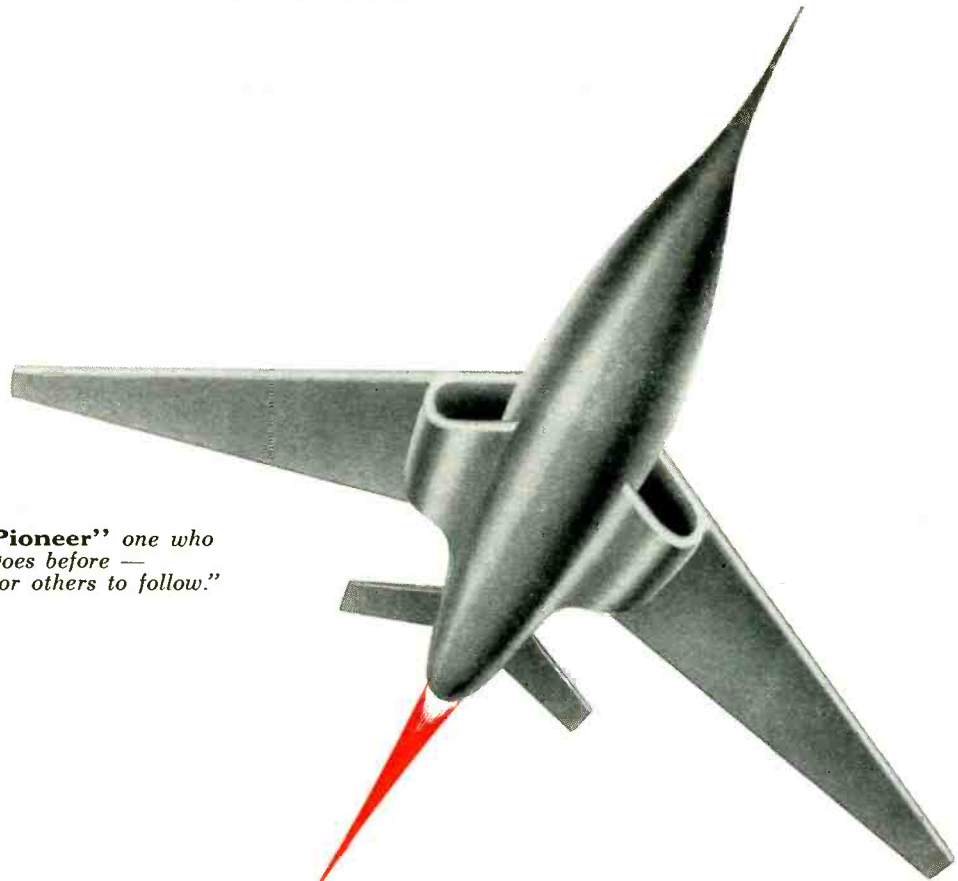

**"Pioneer"** one who goes before — for others to follow."

**IF WEBSTER IS RIGHT —**  
Then Midland Has Done It Again, this time with

# glass holders for crystals!

Absolute and permanent vacuum attainable only with glass, isolates the crystal from all factors detrimental to dependable performance. Truly, here are crystals designed with the future in mind — future requirements of application and design as well as the long life of the unit far into the future.

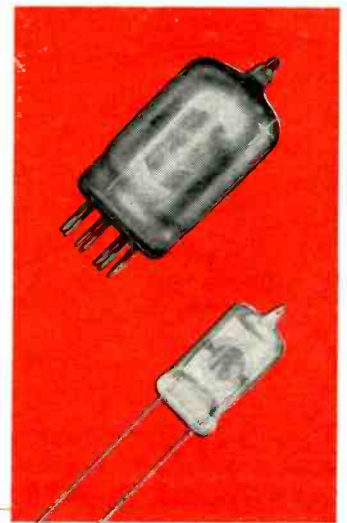
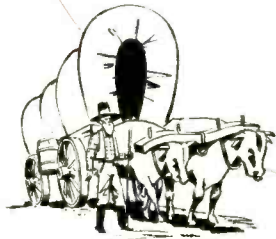

 **Midland**

**MANUFACTURING COMPANY, INC.**

3155 Fiberglas Road • Kansas City 15, Kansas

World's Largest Producer of Quartz Crystals

# New hf wave analyzer!

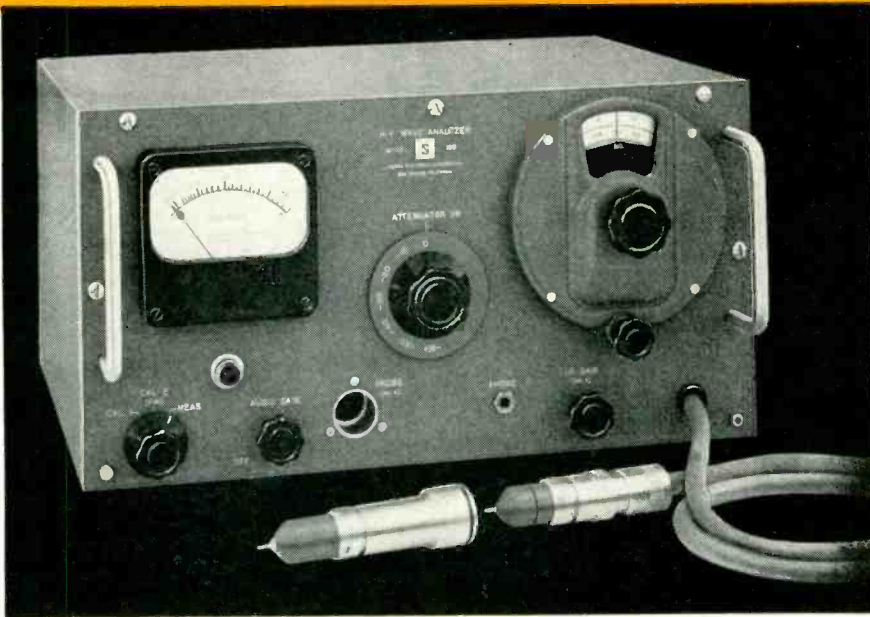

Sierra 158 High Frequency Wave Analyzer

## Fast, convenient, 500 KC to 10 MC!

New Sierra 158 Analyzer is a highly selective, double superheterodyne receiver providing wave analysis data direct in dbm referred to 600 ohms impedance. The instrument uses a cathode follower input probe with two detachable capacity dividers for 20 or 40 db attenuation. It also includes a built-in attenuator adjustable in 10 db steps to a maximum of 60 db. These features, in combination with 22 db usable meter readings, provide a measurement range of 122 db, from  $-80$  to  $+42$  dbm. A measurement accuracy of  $\pm 2$  db is assured for levels above  $-70$  dbm. Spurious components from analyzer circuits are at least 50 db below fundamental. An injection oscillator at 2 mc is provided for rapid voltage calibration. A phone jack is available for aural monitoring. The instrument also includes the Sierra-designed precision spiral-scale frequency dial. *Write for complete data.*

### SPECIFICATIONS

**Frequency Range:** 0.5 to 10 megacycles.

**Signal Measurement Range:**  $-80$  dbm to  $+42$  dbm, referred to 600 ohms. ( $77.5 \mu\text{v}$  to  $97.5 \text{v}$ )

**Selectivity:** 3 db down at 3 kc off; 30 db down at 12 kc off.

**Signal Measurement Accuracy:**  $\pm 2$  db above  $-70$  dbm.

**Spurious Responses:** At least 50 db down.

**Input Impedance:** Greater than 1 meg-ohm shunted by approximately  $8 \mu\text{f}$ .

**Frequency Calibration Accuracy:** Depends on stability and calibration accuracy of the 22.5 - 32 mc variable oscillator, which is maintained within 0.25%. This results in dial accuracy ranging from  $\pm .056$  mc to  $\pm .080$  mc.

**Operating Power Requirements:** 105 to 125 volts, 50/60 cps, 95 watts drain.

**Cabinet Dimensions:** 17 inches wide,  $9\frac{1}{8}$  inches high,  $13\frac{1}{2}$  inches deep.

**Weight:** Approximately 40 pounds.

*Data Subject to Change Without Notice*

### Sierra Electronic Corporation

San Carlos 2, California, U. S. A.

Sales representatives in major cities  
Manufacturers of Carrier Frequency Voltmeters, Wave Analyzers, Line Fault Analyzers, Directional Couplers, Wideband RF Transformers, Custom Radio Transmitters, VHF-UHF Detectors, Variable Impedance Wattmeters, Reflection Coefficient Meters.

5285

at 100 C ranges from a guaranteed 28 db at 1 w output, class A operation, to a guaranteed 18 db at 2.5 w output, class B operation.

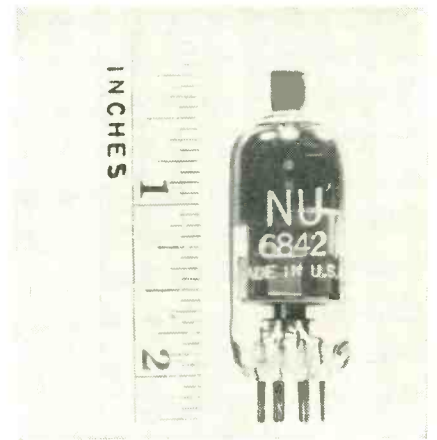

### MINIATURE TUBE for regulator operation

NATIONAL UNION ELECTRIC CORP., Orange, N. J. The NU6842 is a T-5 $\frac{1}{2}$ , 7-pin miniature tube with an overall height of 2 $\frac{1}{4}$  in., designed for use in regulated power supplies or voltage amplifier circuits operating at plate potentials of 300 v to 4 kv. It is useful as a shunt regulator or in a series regulator circuit in equipment that requires a stabilized voltage essentially independent of line voltage variations and variations in load current. It is capable of providing up to 10 ma average plate current and of dissipating as much as 8 w.

The low capacitances, high gain, and high voltage ratings also make it well suited for tv and oscilloscope sweep circuits employing electrostatic deflection.



### H-V POWER SUPPLY electronically regulated

SCIENTIFIC SPECIALTIES CORP.,  
Subsidiary of the Norden-Ketay  
Corp., Snow & Union Sts., Boston



# Another engineering FIRST... by International!

This  
thermodynamic design—  
developed in International's  
Research Laboratories  
—sets new standards for  
heat dissipation  
in Germanium Power  
Rectifier Junctions.

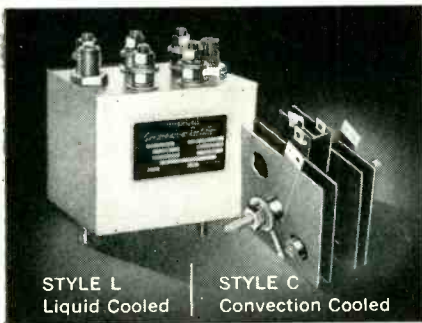
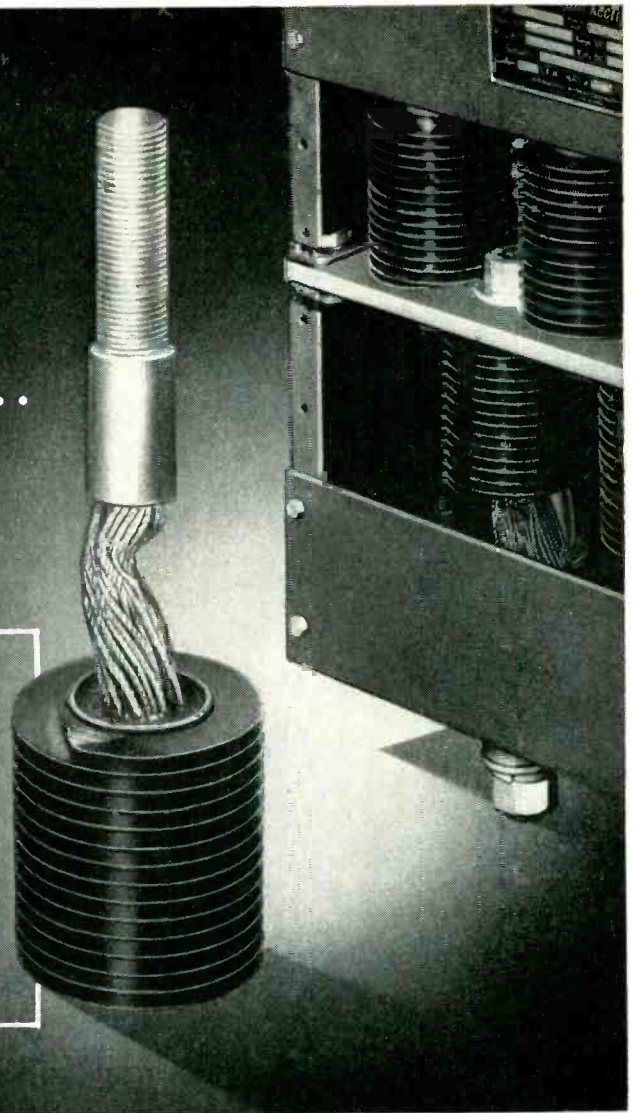

International offers a complete line of Germanium Power Rectifiers. For complete details on all types, request Bulletin GPR-1.

Finned copper housings—the most efficient heat exchangers yet adapted to power rectifiers—measuring less than 2" in diameter, provide a total cooling surface of 58.3 sq. inches! International's Style F Germanium Power Rectifier utilizes this junction, which has been acclaimed by leaders in the engineering profession as the most advanced rectifier design in the industry.

International's Research Laboratories and Production Facilities have produced a line of Germanium Power Rectifiers offering unexcelled performance. Four years of field testing indicate efficiency up to 97%, with unlimited life expectancy. 12,000-hour tests show no change in forward or

reverse resistance. Extremely low leakage current and low forward drop (lowest of all available metallic rectifiers) emphasize the advantages of these units. D.C. output current ranges up to 2250 amps per assembly, and up to 100,000 amps in combination. The input voltage ranges up to 66 volts rms per junction, with an operation temperature range from  $-55^{\circ}\text{C}$  to  $+75^{\circ}\text{C}$ .

The far-reaching research and development program of International assures you of greater rectification efficiency and reliability. A wire, letter or phone call to Application Advisory Department will bring an immediate and experienced recommendation for your application.



A WORLD OF DIFFERENCE ... THROUGH RESEARCH

## International Rectifier

C O R P O R A T I O N

EXECUTIVE OFFICES: 1521 E. GRAND AVENUE, EL SEGUNDO, CALIFORNIA \* PHONE OREGON 8-6241  
NEW YORK: 501 MADISON AVE., PLAZA 3-4942 \* CHICAGO: 205 W. WACKER DR., FRANKLIN 2-3899  
IN CANADA: ATLAS RADIO CORP., LTD., 50 WINGOLD AVE., W., TORONTO, ONTARIO, RU 1-6174

THE WORLD'S LARGEST SUPPLIER OF INDUSTRIAL METALLIC RECTIFIERS  
ELECTRONICS — February, 1956

# Adjustable LARGE CAPACITANCE TO CLOSE TOLERANCE

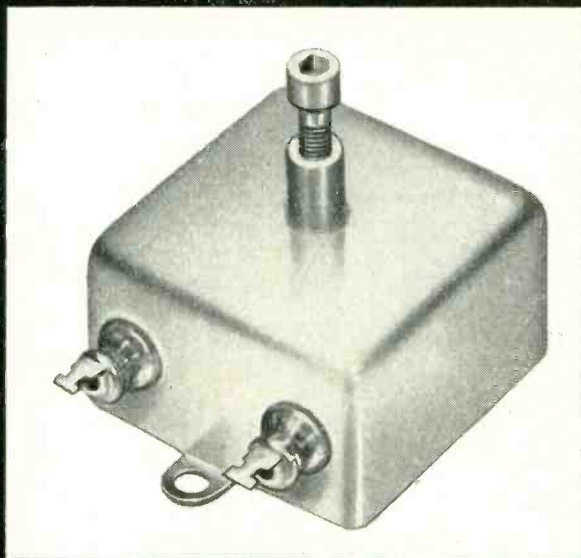

Available in one hole mounting for operation through front panel or chassis top.

## Adjustable

### POLYSTYRENE CAPACITORS by fci

$\neq$  — for ultra-precise circuits where capacitance cannot be predicted in advance due to second order effects. Capacitance is adjustable over a range of 1% of nominal value. Change of capacitance is instantaneous with the adjustment, and is linear with the rotation of the adjustment screw to better than 0.25%. Once set, capacitance is maintained within 0.1% for approximately one year. Adjustments in the original setting can be made with extreme accuracy, because the unit will track its own curve for months after setting. Standard values are 0.1, 0.25, 0.50, and 1.00 mfd. Other values supplied to order. Adjustable Teflon capacitors also available.

#### ELECTRICAL CHARACTERISTICS\*

RATED VOLTAGE	200 DC
TEST VOLTAGE	500 DC
POWER FACTOR	0.02%
SOAKAGE, etc.	0.01-0.02%
INSULATION RESISTANCE	10 <sup>6</sup> meg/mfd @ 20°C.
OPERATING TEMPERATURE	-40°F. to +160°F.
TEMPERATURE COEFFICIENT	-100 ppm/°C.

\*For complete technical data, write for catalog

## fci

### film capacitors, inc.

3400 Park Ave., New York 56, N.Y. • Phone CYpress 2-5180

35, Mass. The PS-22 electronically regulated supply is designed for use with multiplier-photo tubes, counters and other devices requiring a closely regulated, well stabilized voltage. The use of a zero-drain, thermally insulated battery voltage reference allows excellent long term stability and high absolute accuracy in setting output voltage. Both positive and negative are insulated from the chassis, and either can be grounded.

► **Technical Data**—Output voltage changes less than 0.01 percent from 0 to 1-ma load. A 10-percent change in input voltage causes less than 0.05-percent change in output. Ripple is less than 0.003 percent of output voltage.

The front panel is standard relay rack mounting 19 in. by 7 in. An extra set of output terminals is located at the rear of the instrument. All exposed components are well insulated. Price is \$195.

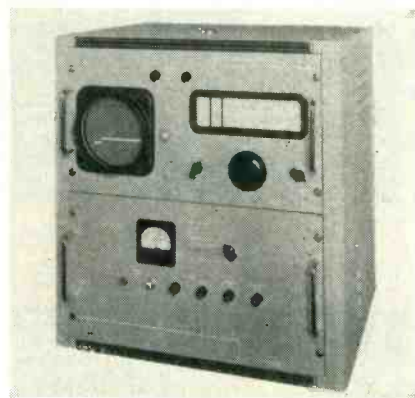

### PANORAMIC RECEIVER for vhf applications

CGS LABORATORIES, INC., 391 Ludlow St., Stamford, Conn. Covering the range from 100 to 150 mc, this Trak all-electronic receiver (model PAN-1) features three controllable inductor tuned r-f stages in a double-superheterodyne circuit which provides more than 60 db attenuation of all spurious responses and a noise figure no greater than 13 db throughout the tuning range.

► **Performance**—Seven tracked In-creductor controllable inductor tuned circuits operate without moving parts to provide vibration-free operation and virtually unlimited

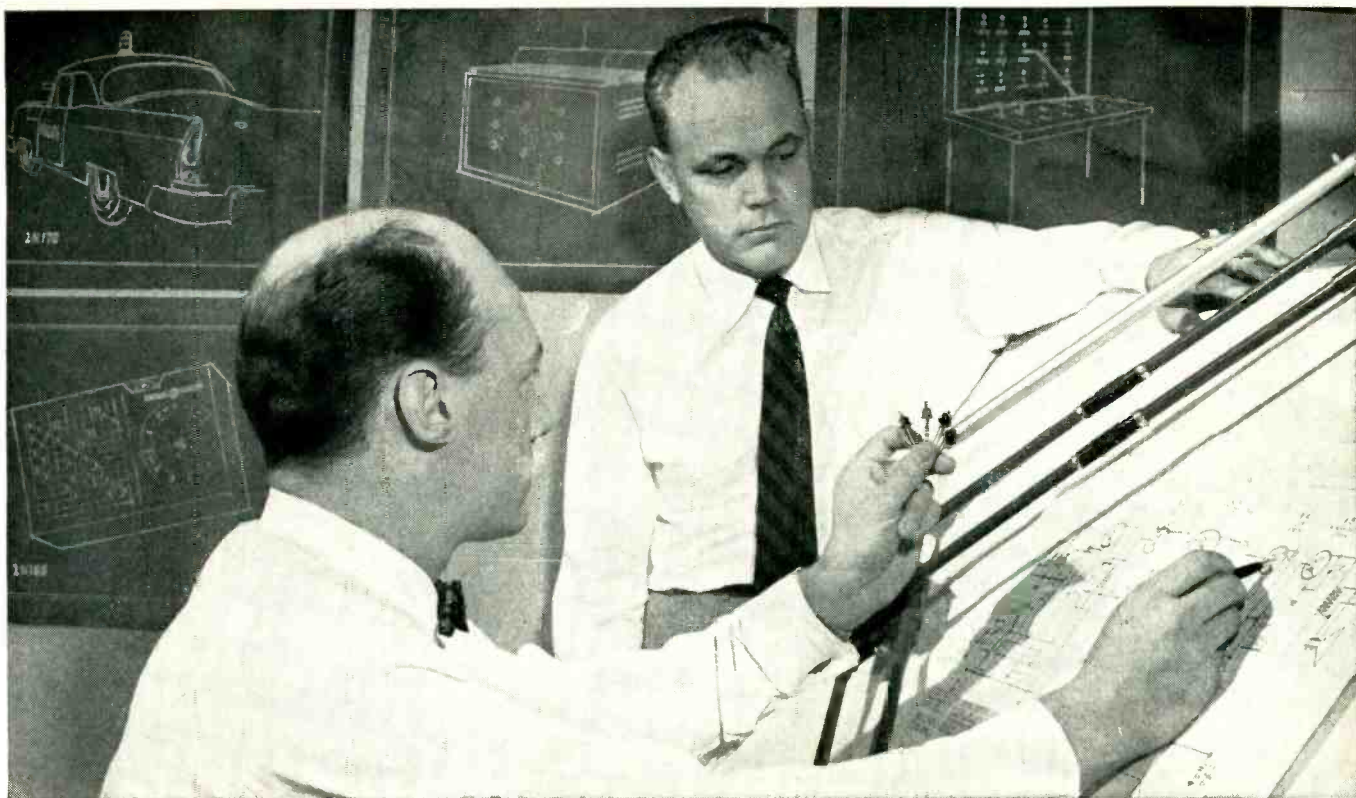

## Four New G-E Controlled Characteristic NPN Transistors Offer Opportunities Now For Practical Applications

The new General Electric NPN's — 2N167, 2N169, 2N170, 2N78 — cover a broad range of circuit applications

Now there are four NPN transistors in the G-E Semiconductor line. All are new. All designed for up-to-date circuitry needs where dependability and reliability are required. These new transistors offer a strong combination of ratings to provide everything you want from an NPN in a circuit.

All four new NPN's are produced under the exclusive G-E rate growing process, *all-welded and hermetically sealed* against impurities and contamination. General Electric's *full year warranty* assures long life, top performance.

For full specifications and application engineering assistance call in your G-E Semiconductor Specialist, your G-E distributor, or, write: *General Electric Co., Semiconductor Products, Section X426, Electronics Park, Syracuse, N. Y.*

*Progress Is Our Most Important Product*

**GENERAL**  **ELECTRIC**

### THE GENERAL ELECTRIC NPN TRANSISTOR LINE

**G-E NPN 2N167:** The first G-E NPN transistor designed specifically for computer and data processing machine circuitry. All characteristics controlled. Provides a combination of high frequency and high voltage operation, 5 mc at 30 V. Can be used in RF and IF amplifier stages.

**G-E NPN 2N169:** An NPN transistor for use in radio design. Carries characteristics needed for excellent results as a 2nd detector in broadcast receiver amplifiers.

**G-E NPN 2N170:** Designed for low level amplifiers and switching circuits. Of particular interest to novelty electronic circuits. Priced extremely low.

**G-E NPN 2N78:** A general purpose transistor of particular interest in RF and IF amplifiers. Exceptionally stable operation at junction temperatures up to 85° C.



# ELECTRONICS COMPANIES



GENERAL ELECTRIC

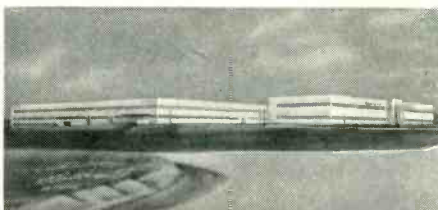

WESTERN ELECTRIC

## SPARK INDUSTRIAL DEVELOPMENT

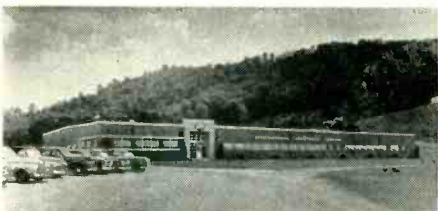

INTERNATIONAL RESISTANCE



NATL. CARBON DIV. UNION CARBIDE & CARBON

## IN NORTH CAROLINA



GREAT LAKES CARBON



WESTINGHOUSE ELECTRIC

The continuing growth of the electronics and electrical products industry in North Carolina includes multiple locations for some of America's best known names—General Electric has four, Western Electric three, National Carbon three, International Resistance two. Westinghouse Electric and Great Lakes Carbon have large plants and other leading companies have one or more in this State.

There are excellent reasons why this and kindred industries—particularly many phases of metalworking—are selecting North Carolina.

Information about desirable sites is available  
DEPARTMENT OF  
CONSERVATION & DEVELOPMENT  
Raleigh, 15, North Carolina  
Governor Luther H. Hodges  
Chairman of the Board

Native born, intelligent labor in abundant numbers is a proven asset here; workers are producing precision equipment and other complex products after surprisingly short training periods.

Plenty of POWER at reasonable rates . . . a stabilized TAX structure and a balanced budget . . . good TRANSPORTATION service and overnight accessibility to major markets . . . friendly communities and a sound, business-like State government—these are some of the reasons why forward-looking companies are locating and expanding in North Carolina.

**NORTH CAROLINA**  
Year 'Round Mid South

NEW PRODUCTS

(continued)

life. A precision marker circuit permits frequency measurements on observed signals to an accuracy of better than 1 percent.

Received signals are displayed logarithmically on a 5-in., flat-face crt. A dynamic range of 60 db is presented as a 6 to 1 variation in observed amplitude.

Price of the model PAN-1 is \$5,850.



### DIODE TESTER shows overload automatically

TELETRONICS LABORATORY, INC., 54 Kinkel St., Westbury, L. I., N. Y. Particularly useful for measuring the static characteristics of germanium, low power selenium and power type germanium diodes, the DT-100A has the added feature of a current meter overload protective circuit. Forward voltages from 0.5 to 2.0 v d-c up to 500 ma and reverse voltages from 0 to 150 v d-c up to 5 ma are provided. The reverse control also has three fixed positions normally preset at 10, 50 and 100 v for making rapid tests.

A 3-position spring return switch allows rapid transfer from forward to reverse test positions. An automatic overload circuit detects shorted or reversed diodes and indicates this condition by a lamp while limiting the current to a safe value.

### RECEIVERS for special-purpose uses

NEMS-CLARKE, INC., 919 Jesup-Blair Drive, Silver Spring, Md., has designed the 1670 series of special-purpose receivers to replace the series 167. Principal improvement consists of a complete redesign of the i-f amplifier strip. A new de-

# TAYLOR

Laminated Plastics  
Vulcanized Fibre

# Shop Talk

TAYLOR FIBRE CO.

Plants in Norristown, Pa. and La Verne, Calif.

PHENOL—MELAMINE—SILICONE—EPOXY LAMINATES • COMBINATION LAMINATES • VULCANIZED FIBRE • POLYESTER GLASS ROD

## Tips for designers

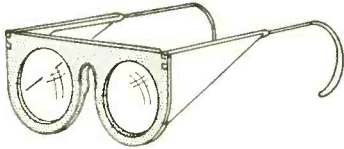

**Frames** for industrial eye-glasses, of Taylor Phenolic Laminate . . . are resistant to moisture and acids, possess high physical strength.

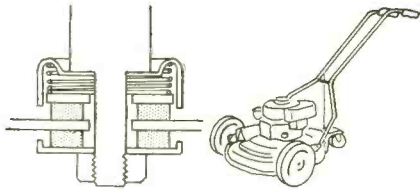

**Rotary lawn mower** utilizes abrasion resistance of Taylor Phenolic Laminate washer in slip-clutch attachment of drive shaft to cutting blade.

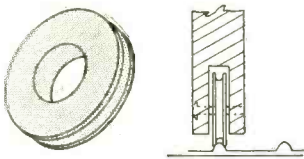

**Rollers** for flush doors are now being made from Taylor paper base tubing with ball bearing insert . . . providing smooth, silent operation at a low cost.

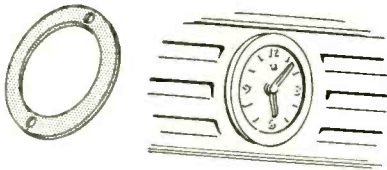

**Automobile clock** is securely and economically mounted on inside surface of metal dashboard, with a spacer fabricated from Taylor Vulcanized Fibre.

### TAYLOR FABRICATING FACILITIES

Your production problems can often be simplified . . . schedules safeguarded . . . inventory headaches cured . . . and overall costs reduced by having Taylor fabricate finished parts of vulcanized fibre and laminates to your specifications. Efficient, modern facilities are ready to serve you. Write to Taylor about your specific requirements.

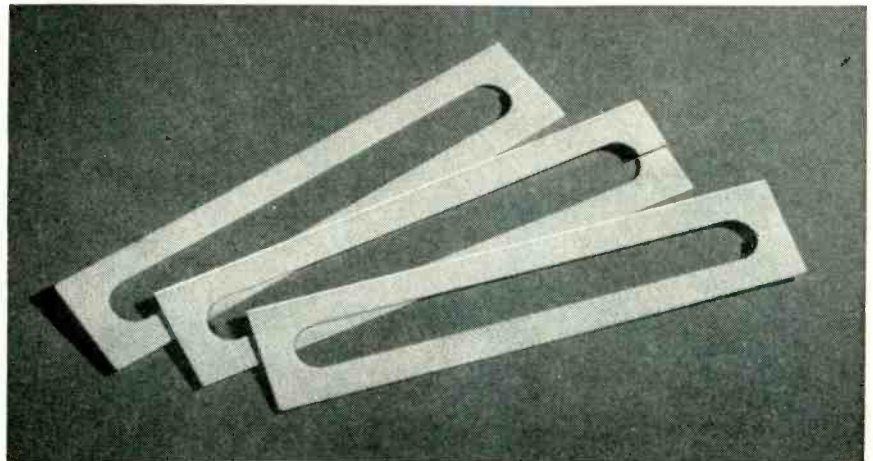

Jack & Heintz engineers selected Taylor glass base silicone laminates for dependable insulation of rotor windings in a DC generator for aircraft.

## For critical insulation requirements use Taylor glass base laminates

Looking for exactly the right laminate to handle a particularly tough electrical insulation job? You'll find what you need in the many grades of Taylor glass base laminates . . . each using a special formulation of Taylor phenol, melamine, silicone, or epoxy resin. Possessing a broad range of stable insulation qualities and high mechanical strength, these laminates are standard Taylor products rather than "specials" made up at infrequent intervals.

From this group of materials you can select not only the insulation characteristics you need but also any desired combination of: prolonged service at elevated temperatures, resistance to chemical action, retention of physical prop-

erties, and low moisture absorption. And they are available in sheets, tubes and rods, in sizes that afford maximum economy of material usage in your manufacturing processes.

Equally important in your consideration of these laminates are the specialized techniques and facilities of Taylor's Fabricating Division . . . capable of producing parts to your own specifications, promptly and economically.

Plan to take advantage of these high-performance laminates in your present products or those which you are now designing. Call on Taylor for a discussion of your specific requirements . . . for glass base laminates and for efficient fabrication service.

# extra-compact delay lines

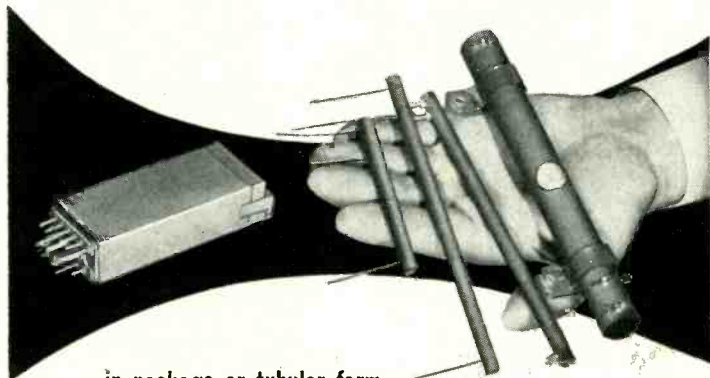

in package or tubular form

## Standard series or designed for your particular application

Continuously wound Technitrol Delay Lines assure minimum pulse distortion and are virtually unaffected by temperature variations. They are offered in a variety of mountings. Technitrol engineers are prepared to design lumped parameter or continuously wound delay lines to your specifications.

Technitrol also produces miniature Pulse Transformers, wound to your requirements. Let us know your performance specifications.

*for additional information,  
write for Bulletin E174.*



**TECHNITROL**

engineering company

2751 North Fourth Street • Philadelphia 33, Pennsylvania

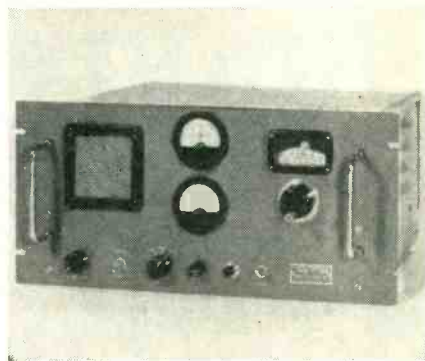

sign of i-f transformers provides greater stability, both mechanically and electrically. The new i-f strips are much easier to align. Both the i-f and discriminator transformers are temperature compensated to a high degree. Sensitivity has been improved by use of better limiters.

The output amplifier has been redesigned to provide better frequency response and substantially lower hum level.

► **Applications**—The 1670 series will find wide use in the fields of telemetering, guided-missile monitoring, radiosonde reception, television-sound rebroadcasting, and related fields.

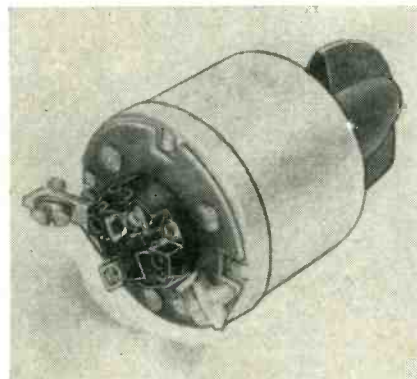

### POWER RHEOSTATS with power switch

CLAROSTAT MFG. CO., INC., Dover, N. H. To meet the demand for a power rheostat which incorporates a switch for multicircuit applications, the company announces its series 25GS and 50GS units. These are basically the aircraft type of encased power rheostats of the series AN-3155, modified to accommodate power switches of spst, spdt or dpst construction.

Operating functions are combined in one unit. This is an important engineering factor in the aircraft



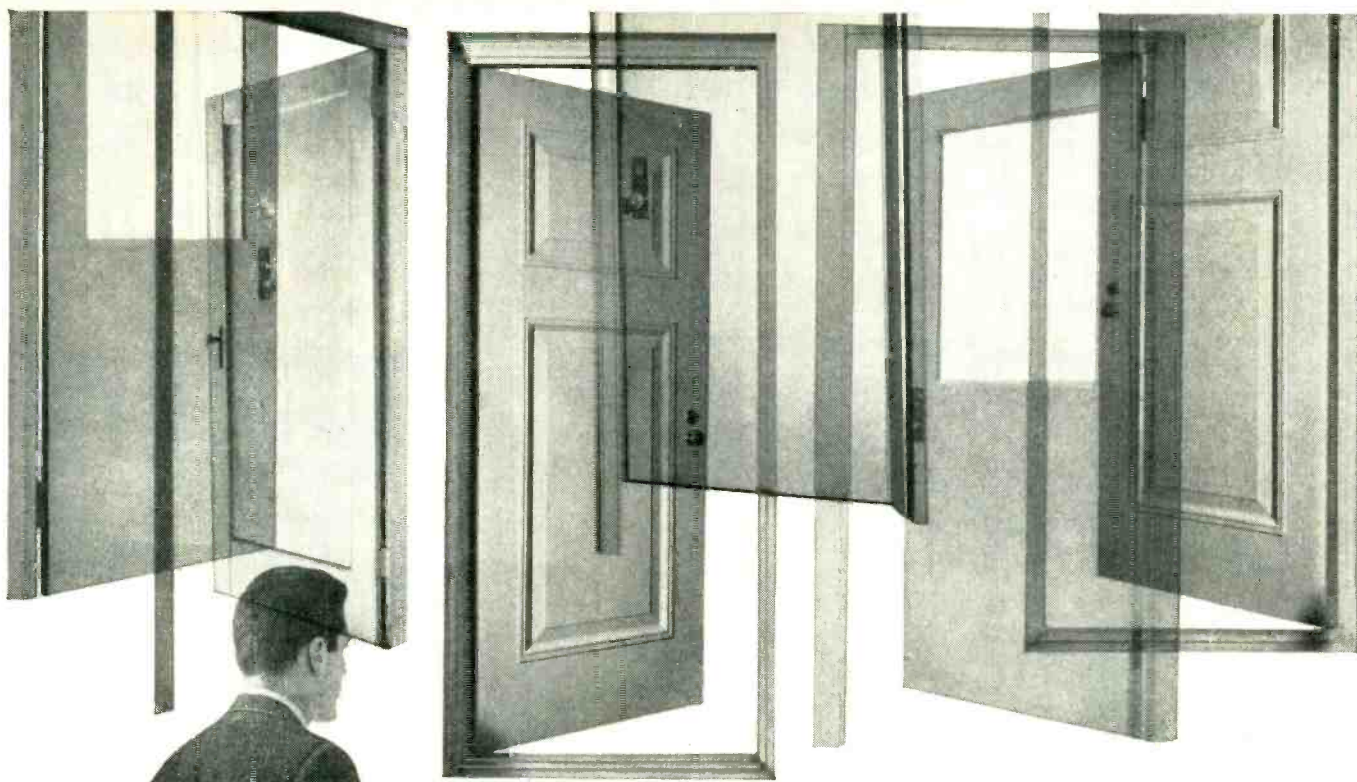

## DO ENGINEERS GET JOBS TOO EASILY?

Never before has it been so easy for an engineer to get a job. Just because jobs are so abundant, it's harder than ever to choose the *right* one—and that means choosing the *right field* and the *right company!*

One of the most striking trends in America today is the growing reliance of science, government and industry on computers.

Future growth in this field appears certain to be spectacular—offering virtually limitless opportunities to engineers.

Nowhere are prospects brighter than at IBM, creator of the first automatic large-scale digital computer. More than that, the world's largest computer is the product of IBM inventiveness. Hundreds of IBM electronic data processing machines are already in use, and many more will be installed in 1956.

IBM's proud history of electronic achievement is a direct and positive outgrowth of a distinctive engineering climate—an atmosphere that stimulates and fosters the fresh approach, the new concept.

There is unprecedented opportunity waiting for you at IBM—experience that money couldn't buy.

You owe it to yourself to investigate.

**IBM**  
®

Producer of electronic data processing machines, electric typewriters, and electronic time equipment.

Write, outlining your interests and qualifications to:  
W. M. Hoyt, International Business Machines Corp.,  
Room 402, 590 Madison Avenue, New York 22, N. Y.

who says bolometers are expendable?

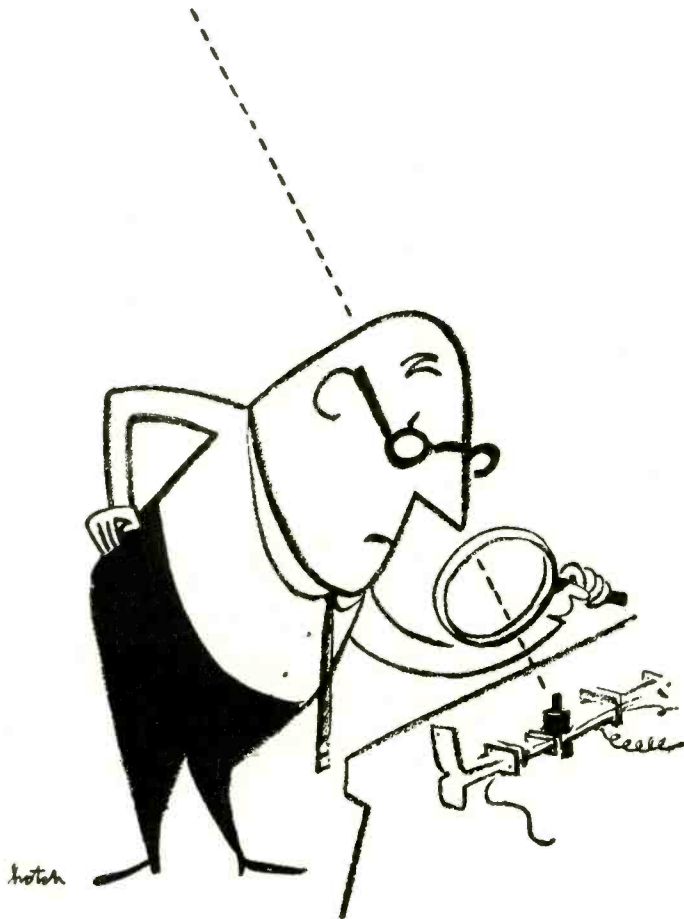

It's true that due to its nature, a bolometer is sensitive . . . and it doesn't take much to burn one out. For this reason, we don't make any exaggerated claims for the service life of Narda Bolometers, even though we make them just as carefully as we can.

And every so often, we get evidence that this care pays off. Like the N610B bolometer we sold a college\* here in the east last year. You can imagine our surprise when we heard that it had been in continuous use for 13 months . . . and in an educational lab, where the lads often give the equipment an unintentional workout!

The N610B is Narda's most widely used bolometer and costs only \$9.50. We make a complete line of bolometers and thermistors and have been making same-day deliveries on most orders. Write for our free catalog, prices and the name of our representative serving your area.



\*Name on request.

the **narda** corporation

160 HERRICKS RD., MINEOLA, N. Y. • PIONEER 6-4650

COMPLETE INSTRUMENTATION FOR MICROWAVE AND UHF

industry where manual operation of controls of all types must be kept to a minimum. The switches operate under standard military environmental conditions, while the rheostats meet MIL-R-6749 specifications.

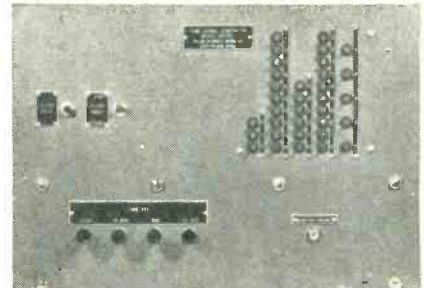

### TIME SIGNAL electromechanical generator

HALLER, RAYMOND & BROWN, INC., 124 N. Atherton St., State College, Pa. The new time signal generator system is an electromechanical device which generates a coded time signal for use in applications where a moderately accurate time reference is required. The time signal is presented as a group of 5 digits corresponding to the 24 hour clock notation. The digits are produced electromechanically in the form of an audio tone which is keyed according to a modified dot and dash Morse code.

► **Power Supply** — The standard frequency power supply, with a frequency accuracy of 0.001 percent, is used to drive the internal timing device in applications where the accuracy of the supply-line frequency is inadequate.



### PHASE OSCILLATOR for 50 to 6,000-cps range

COMMUNICATION MEASUREMENT LABORATORY, INC., 350 Leland Ave., Plainfield, N. J. Model 1440-D will provide low distortion, single,

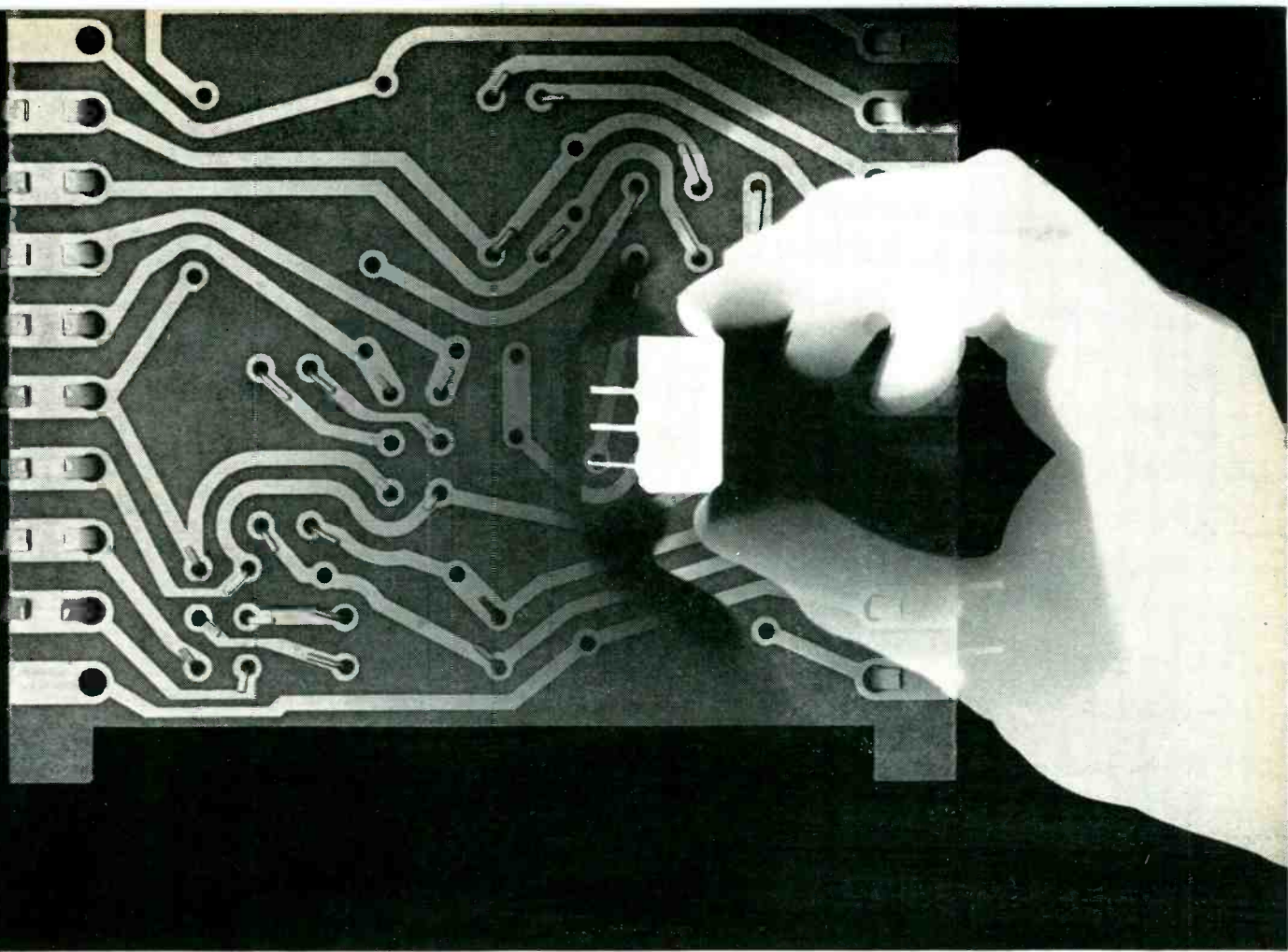

## Westinghouse miniature rectifiers plug in for printed circuits

Reliable, low-cost, d-c power supply for your military or commercial electronic and electric equipment calls for Westinghouse selenium rectifiers. A new-design enclosure featuring plug-in terminals makes them particularly well suited for printed circuits. Optimum circuit versatility is obtained through multiple terminal headers.

Westinghouse selenium rectifiers are compact, lightweight; save precious space; contribute to easy accessibility. They have low forward drop and low reverse leakage, are also available as a unit with magnetic amplifiers. Packaged in resin-sealed Moldarta\* boxes for use in potted assemblies, or hermetically-sealed nickel silver boxes for open mounting.

A wide range of Westinghouse selenium rectifiers in stack, boxed and cartridge form is ready to serve your design engineering needs. More information? Send coupon below.

J-01001

\*Trade-Mark

*Input 0 - 33 VAC per cell  
Current 0.03 - 0.2 amp  
Bridge units available to 150 VAC  
Size: 1/4 - and 1/2 -inch cell diameter  
Operation up to 75°C ambient temperature.*

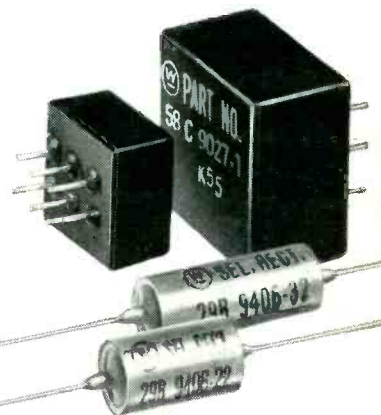

YOU CAN BE SURE...IF IT'S  
**Westinghouse**



Westinghouse Electric Corporation  
3 Gateway Center, P. O. Box 868  
Pittsburgh 30, Penna.

I'm interested in more information about:

- Selenium rectifiers     Cypak\* control  
 Magamp\* magnetic amplifiers.

NAME \_\_\_\_\_ TITLE \_\_\_\_\_

FIRM \_\_\_\_\_

ADDRESS \_\_\_\_\_

CITY \_\_\_\_\_ STATE \_\_\_\_\_

**NEW!****MINIATURE****SERVO****Magnetic Amplifiers**

**Three New  
AC Servo  
Types  
Available..**

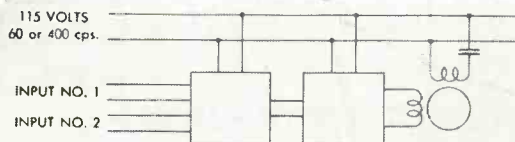
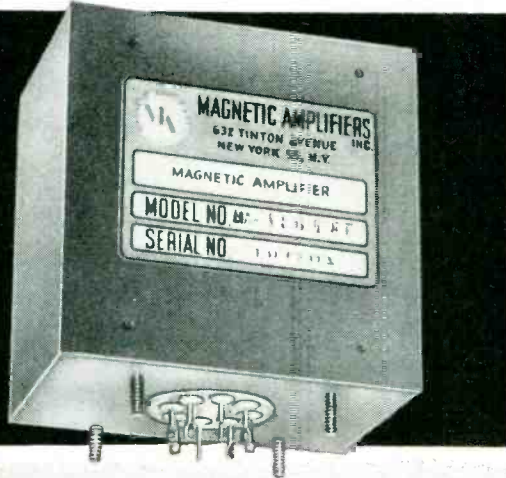

**STANDARDIZED  
SERVO SYSTEMS  
AND OTHER  
STANDARD TYPES  
FOR AUTOMATIC  
CONTROL —**

In addition to new lines illustrated, many standard and higher power magnetic amplifiers are available for applications involving automatic control.

**CUSTOM DESIGNS  
FOR SPECIAL  
REQUIREMENTS**

— we design and engineer complete servo or automatic control systems

AFFILIATE OF  
THE GENERAL  
CERAMICS  
CORPORATION



● **MAGNETIC PRE-AMP + SATURABLE TRANSFORMERS**

Supply: 115 volt 400 cps.  
Power output: 3.5, 6, 10, 18 watts  
Sensitivity: 1 volt AC  
Response Time: .03 sec.  
Lowest Cost — Smallest Size  
For further information request Form S493

● **MAGNETIC PRE-AMP + HIGH GAIN MAGNETIC AMPLIFIER**

Supply: 115 volt 400 cps.  
Power output: 5, 10, 15, 20 watts  
Sensitivity: .1 volt AC  
Response Time: .008 to .1 sec.  
Highest performance — All magnetic  
For further information request Form S496

● **TRANSI-MAG\*: TRANSISTOR + HIGH GAIN MAGNETIC AMPLIFIER**

Supply: 115 volt 400 or 60 cps.  
Power output: 2, 5, 10, 15, 20 watts  
Sensitivity: .08 volt AC into 10,000 ohms  
Response Time: .01 sec.  
Fast response at high gain  
For further information request Form S499  
(400 cps.); Form S497 (60 cps.)

\*TRADE NAME

**MAGNETIC  
AMPLIFIERS • INC**

Telephone: Cypress 2-6610  
632 TINTON AVE., NEW YORK 55, N. Y.

two or three-phase signals over the 50 to 6,000-cps range.

The displacement between phases is adjustable from 0 to 360 deg and output level is 5 v maximum across 6,000 ohms.

► **Other Features**—A test jack on the front panel allows visual monitoring of the output signals and the improved metering circuit allows measurement of both the phase voltages and the phase-to-phase voltages. The unit operates from 115 v  $\pm$ 5 percent 60 cps single phase.

Catalog E is available upon request.



**REMOTE CONTROL  
MOUNT  
for industrial television**

DIAMOND POWER SPECIALTY CORP., Lancaster, Ohio. Designed for use with either the Diamond UtiliVue or any other industrial tv camera, this remote control pan and tilt mount features rugged construction. It is being successfully used on both outdoor and indoor installations.

► **Specifications**—Rotation is full 360 deg or it can be limited to any arc desired. Tilt is 45 deg above horizontal and 45 deg below—90 deg in all. Complete 360-deg rotation is accomplished in 36 sec while 90-deg tilt requires 15 sec.

Pan and tilt motions are driven by separate motors individually and remotely controlled from a control panel located at any desired point. The mount is especially useful



**MARCH  
19 - 22**

# How **BIG** must the show be?

When a facetious critic asked, "How long should a man's legs be?" Abraham Lincoln replied, "Long enough to reach the ground!"

The 1956 Radio Engineering Show is big only because it *must be big* to be truly representative of a gigantic industry. 704 exhibitors, 1 out of every 5 firms manufacturing for the industry, will be present.

But these 704 firms represent over 80% of the industry's production. A smaller Show would give only an inadequate picture of the year's progress and new developments.

Being **BIG** pays off! This truly great event brings out the best...in people, effort and products!

Registration—IRE Members \$1.00  
Non-members \$3.00

## What you get out of it!

- You see what is new in radio-electronic products and engineering!
- You meet the men who make these products!
- You save time...seeing in days a whole year's productive effort!
- You hear the best technical papers in subjects of your own specialty!
- You meet old friends and make new ones, enjoy association and social events!

**The IRE National Convention**  
Waldorf Astoria Hotel, New York City  
**and RADIO ENGINEERING SHOW**  
Kingsbridge Armory & Palace, New York City

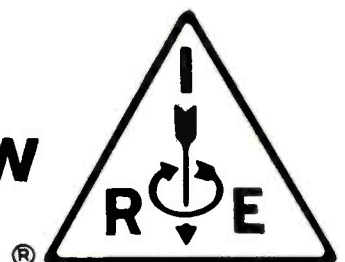



**TWO-WAY RADIO**  
communications equipment

VHF-FM FOR: MOBILE, AIRCRAFT, MARINE, MOTORCYCLE, PORTABLE, BASE

VHF-AM FOR: AIRPORT VEHICLES, GROUND STATIONS, POINT-TO-POINT

VHF: ANTENNAS, REMOTE CONTROLS, ACCESSORIES

# FLEETCOM Sr.

## MODEL 300-6/12 SERIES

The FLEETCOM Sr. is rugged, compact, universal 6/12, VHF-FM two-way mobile communications equipment for the Public Safety, Industrial, Land Transportation and other radio services.

COMCO'S 17 years experience in design leadership and production "know-how" is engineered and built into every FLEETCOM Sr. unit.

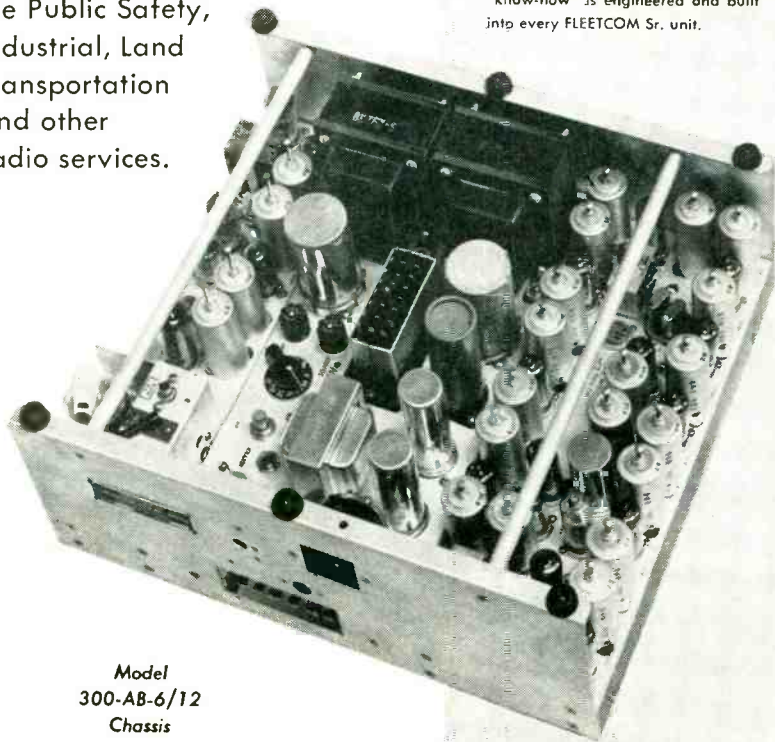

Model 300-AB-6/12 Chassis

**POWERFUL! COMPACT! EFFICIENT!**

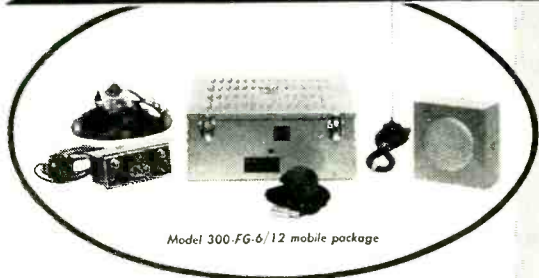

*Features:*

55 Watts output in low band  
Front or rear mounts  
Case size 14"x13 1/2"x6";  
Maximum output with minimum battery drain.

- UNIVERSAL!** Instantly convertible for 6 or 12 volt operation.
- COMPLETE!** Ready for installation and operation.
- QUALITY!** Exceptional value/price ratio.

ATTENTION DEALERS!  
Write for available territories.



DESIGNERS AND MANUFACTURERS OF RADIO COMMUNICATIONS EQUIPMENT

# COMMUNICATIONS COMPANY, Inc.

FOUNDED 1938 CORAL GABLES, MIAMI 34, FLORIDA

where it is necessary to have one camera cover a wide area.

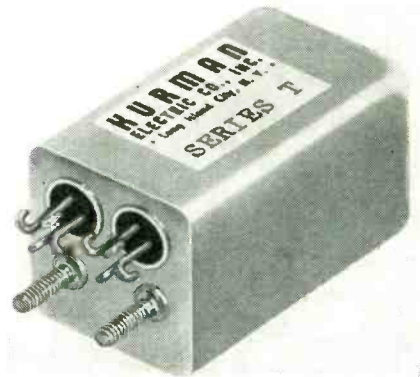

### RELAY

coil resistance to 12,500 ohms

KURMAN ELECTRIC Co., Inc., 35-18 37th St., Long Island City, N. Y. The series T relay is available with a 1 Form A through 2 Form C contact arrangement with contacts rated at 2 amperes 28 v d-c, 115 v a-c. It is supplied in an enclosure 1 in. by 1 in. by 1 1/2 in. high, weighing only 3 1/2 oz.

► **Other Specifications**—It can be adjusted to operate with as little as 5 mw of coil power. Coil resistances of up to 12,500 ohms are available with a maximum dissipation of 1.5 w. Contact resistance of less than 0.03 ohm is exhibited throughout the life of 100,000 operations minimum.

The series T relay can be supplied for high-speed keying. It is designed for -55 C to +100 C operation.

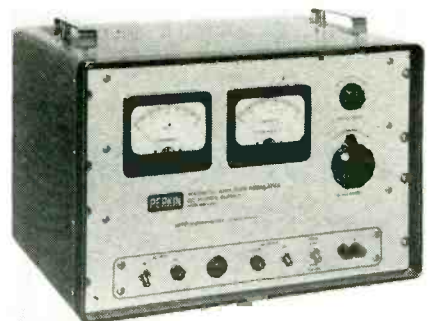

### POWER SUPPLY

is mag-amp regulated

PERKIN ENGINEERING CORP., 345 Kansas St., El Segundo, Calif., has developed a compact, light weight magnetic-amplifier regulated 2 to

Why the leaders choose **RESINOX\* 3700**  
for molding profit-making electrical parts



**Arrow-Hart & Hegeman** are making profitable use of critical electrical parts molded of Resinox 3700 in their combination starter where high arc-resistance is a must.



**Wells Manufacturing** ignition coil top molded of Resinox 3700 outperformed all others in racing car tests on Utah salt flats. Because of Resinox 3700 no spark power was lost at speeds up to 140 m.p.h.

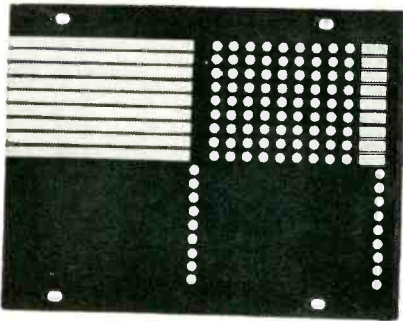

**IBM** specifies Resinox 3700 for cross bar emitter—and cuts production costs of this vital "Check Prover" part in half because Resinox 3700 has outstanding dimensional stability.



**American Bosch** uses this distributor plate molded of Resinox 3700 where its superior arc-resistance is giving top performance in the field. (Part made for them by Specialty Insulation Mfg. Co.)

**THE PREFERENCE FOR RESINOX 3700** grows every day. This thermosetting mineral-filled molding powder was developed by Monsanto for superior performance in magneto ignitions, motor control and transmission circuits, and countless other electrical applications. • It combines high arc-resistance with outstanding dimensional stability. • It eliminates undesirable after-shrinkage. • Its moldability is excellent and its impact resistance is good. • It has good transfer molding properties. • It offers superior heat resistance.

For full information on Monsanto's Resinox 3700, write today to Monsanto Chemical Company, Plastics Division, Dept. E-2, Springfield 2, Massachusetts.



*Serving Industry...  
which serves mankind*

\*RESINOX: REG. U. S. PAT. OFF.

**BETA**

## high voltage dc power supplies

**RACK-MOUNTED  
Series 1000 DC  
Power Supply**

# A POWERFUL ANSWER TO YOUR POWER SUPPLY REQUIREMENTS

BETA'S Series 1000 rack-mounted Power Supplies are the supreme achievement in reliable and safe high voltage DC power sources. Ten years of experience in the design and production of high voltage equipment are behind this compact and reliable DC power unit . . . typical of BETA'S complete line of high voltage power supplies and test equipment.

### SPECIFICATIONS

VOLTAGE OUTPUT — 1 kv to 60 kv, in 11 continuously variable ranges

CURRENT OUTPUT — 600 ma to 0.5 ma; can be drawn continuously

INPUT VOLTAGE — 105-125 v, 50/60 cycle, or to order

OUTPUT VOLTAGE CONTROL — 0.5%

RIPPLE — 1.0% standard, as low as 0.001% on special order

POLARITY — negative, positive, center-tapped or reversible

CORONA LEVELS — low, maintained to 100% rated voltage

#### STANDARD SAFETY FEATURES

- Fixed overload and overvoltage protection
- Provision for auxiliary external interlock
- Automatic output shortening mechanism
- Many additional features

#### OPTIONAL FEATURES

- Line voltage regulator
- Automatic HV period timing
- Adjustable current and voltage overload relays
- Zero start interlock, and many others

Write TODAY for catalog of the complete BETA line of Power Supplies up to 300 kv!

BETA Field Engineers are available for consultation throughout the United States and Canada.



**BETA ELECTRIC CORPORATION**  
333 East 103 Street; New York 29, N. Y.

THE "STANDARD" IN HIGH VOLTAGE

36 v at 15 ampere power supply. It is identified as model MR532-15A.

► **Specifications**—The d-c output range is 2 to 32 v; a-c input, 105 to 125 v, 1 phase, 60 cycle; ripple, 1 percent rms; voltage regulation,  $\pm \frac{1}{2}$  percent over the range of 5 to 32 v,  $\pm 2$  percent from 2 to 5 v and 32 to 36 v; response time, 0.1 to 0.2 sec maximum.

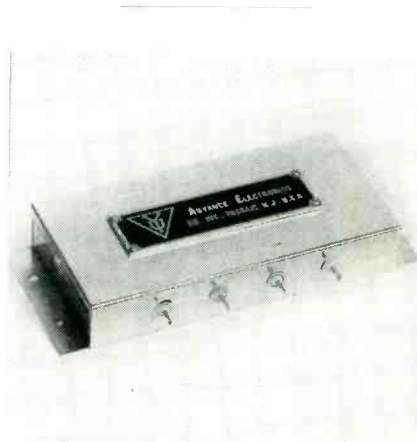

### TAPPED DELAY LINES linear phase shift type

ADVANCE ELECTRONICS CO., INC., 451 Highland Ave., Passaic, N. J. Series 7T linear phase shift tapped delay lines have been announced. A unit of these consists of 30 sections of m-derived L-C networks. Each of these networks was especially designed to achieve (1) linear phase shift beyond 70 percent of the cutoff frequency, and (2) frequency-amplitude response curve approaching Gaussian in shape. For this reason, both rise time and overshoot are much less than other delay lines with equal time delay. Temperature coefficient is less than 50 parts per million for variation of 1 deg C.

► **Features**—They are particularly suitable for incorporation into electronic equipments where time delay is needed, because both weight and size are small. These delay lines can also be plotted for hermetical sealing to meet all applicable military specifications.

► **Types**—There are 66 types available with total time delay equal to 0.3, 0.4, 0.5, 0.75, 1, 1.5, 2, up to 10  $\mu$ sec in steps of 1  $\mu$ sec.

The characteristic impedance can be chosen from the following values



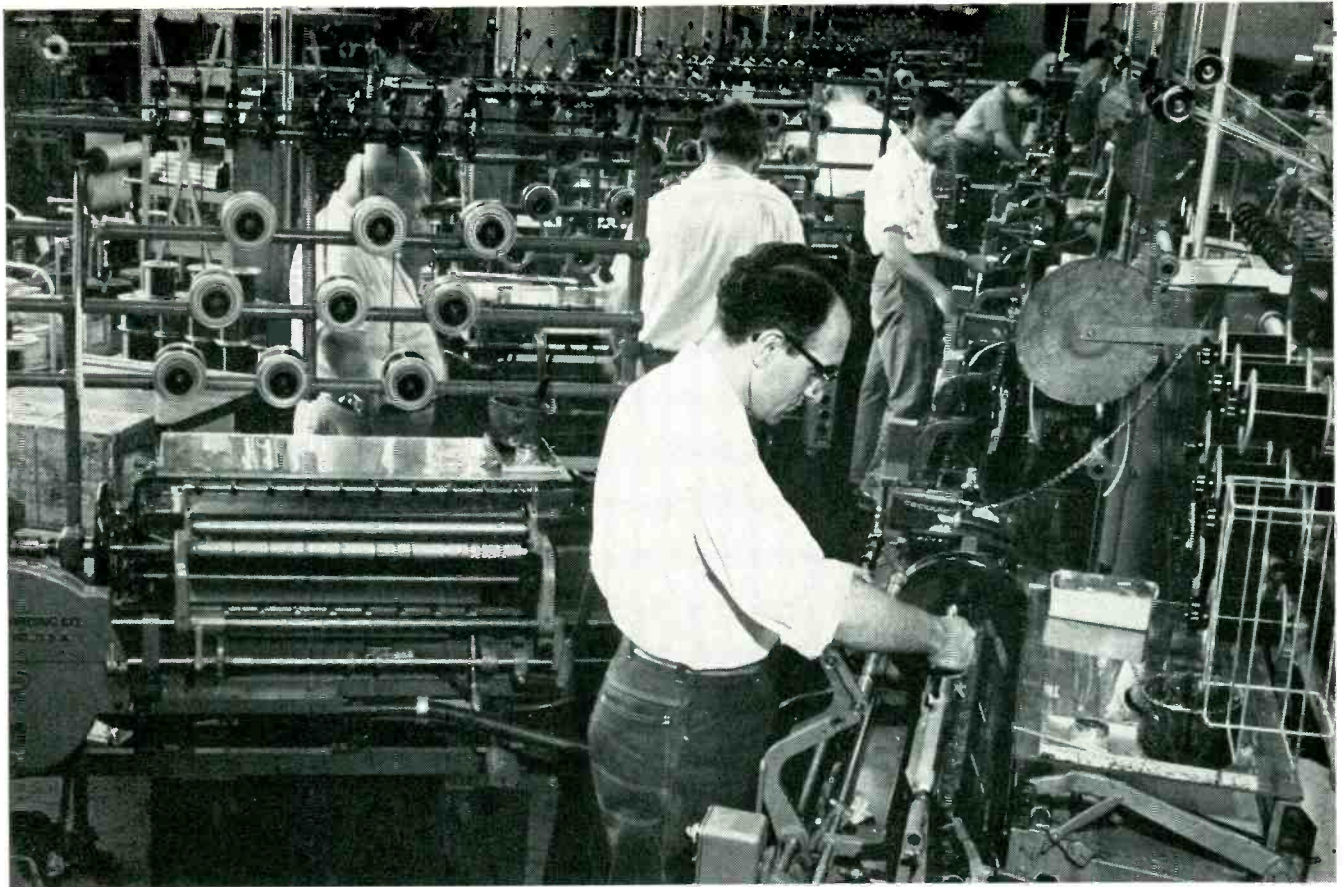

Installation of Leeson No. 107 Coil Winders at Ford Motor Company's Ypsilanti, Michigan, plant. New Paper Miss Detector enables operator to tend two machines.

## Now FORD Motor Co. winds ignition coils on Leeson No. 107 winders

*Machines stop automatically if there's a paper miss . . . one operator tends two machines . . .*

These Leeson No. 107 Coil Winders, equipped with the new Paper Miss Detector, make quantity production of high-quality stick-wound coils virtually foolproof.

Humidity changes can cause the

paper to curl and miss an insert. Ordinarily, if there's a paper miss, and the machine is unattended, it continues to wind. Result . . . a worthless stick plus money wasted in wire and time. So an operator must be in constant attendance on each machine.

The new Leeson Paper Miss Detector cures this . . . by automatically stopping the machine. Thus, constant machine attendance is unnecessary.

• One operator can handle two or

three machines.

- Operator's coil production increases.
- Rejection rate is reduced . . . when the machine stops at a paper miss the operator re-inserts the paper, starts the machine which continues to wind an excellent stick of coils.

For the full story on Leeson No. 107 Coil Winders, and other helpful information write or get in touch with Universal.

B.5.2

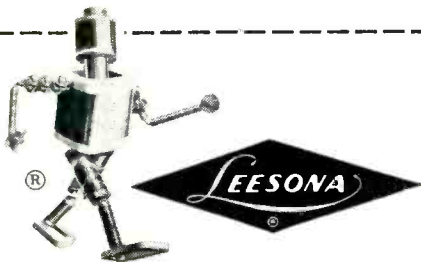

FOR WINDING COILS  
IN QUANTITY... ACCURATELY  
... AUTOMATICALLY... USE  
UNIVERSAL WINDING MACHINES

### UNIVERSAL WINDING COMPANY

P. O. BOX 1605, PROVIDENCE 1, RHODE ISLAND, Dept. 122

E. G. PAULES & COMPANY, 1762 West Vernon Avenue, Los Angeles, California  
Western Representatives

W. J. WESTAWAY & COMPANY, LIMITED, Montreal & Hamilton, Canada  
Canadian Representatives

UNIVERSAL WINDING COMPANY, 9 South Clinton Street, Chicago, Illinois

UNIVERSAL WINDING COMPANY, 1500 Walnut Street, Philadelphia, Pennsylvania

**UHF**

... ULTRA HIGH FREQUENCIES

*radio  
interference  
and  
field  
intensity\**

MEASURING EQUIPMENT



**Stoddart RI-FI\*** meters  
cover the frequency range  
14kc to 1000 mc

**VLF**

NM-10A, 14kc to 250kc  
Commercial Equivalent of AN/URM-6B.  
Very low frequencies.

**HF**

NM-20B, 150kc to 25mc  
Commercial Equivalent of AN/PRM-1A  
Self-contained batteries. A.C. supply  
optional. Includes standard broadcast  
band, radio range, WWV, and com-  
munications frequencies  
Has BFO.

**VHF**

NM-30A, 20mc to 400mc  
Commercial Equivalent of AN/URM-47  
Frequency range includes FM and TV  
bands.

**Stoddart NM-50A**  
**375mc to 1000mc**
**Commercial Equivalent**  
**of AN/URM-17**

**ULTRA-HIGH FREQUENCY  
OPERATION** . . . Frequencies  
covered include UHF and color  
television assignments and  
Citizen's Band. Used by TV  
transmitter engineers for plot-  
ting antenna patterns, adjusting  
transmitters and measuring  
spurious radiation.

**RECEIVING APPLICATIONS** . . .  
Excellent for measuring local  
oscillator radiation, inter-  
ference location, field intensity  
measurements for fringe  
reception conditions and  
antenna adjustment and design.

**SLIDE-BACK CIRCUIT** . . . This  
circuit enables the meter to  
measure the effect of the  
peak value of an interfering  
pulse, taking into account the  
shaping due to bandwidth.

**QUASI-PEAK FUNCTION** . . . An  
aid in measuring pulse-type  
interference, the Quasi-Peak  
function is just one of the many  
features of this specially  
designed, rugged unit, repre-  
senting the ultimate in UHF  
radio interference-field  
intensity equipment.

**ACCURATE CALIBRATION** . . .  
Competent engineers "hand  
calibrate" each NM-50A unit.  
This data is presented in  
simplified chart form for easy  
reference.

**SENSITIVITY** . . . Published  
sensitivity figures are based  
on the use of the NM-50A with  
a simple dipole antenna or  
RF probe. However, the sen-  
sitivity of this fine instrument  
is limited only by the antenna  
used. The sensitivity of the  
NM-50A is better than ten  
microvolts across the  
50 ohm input.

—50, 70, 75, 95, 100, 150, 200, up  
to 1,000 ohms in steps of every 100  
ohms. Rise time is less than 8 per-  
cent of the time delay at any tap.  
Time delay accuracy is better than  
+2 percent at any tap. Size is 5½  
in. by 2½ in. by ¾ in. and weight is  
less than 10 oz.

**MINIATURE TUBE**  
**for d-c power supplies**

AMPEREX ELECTRONIC CORP., 230  
Duffy Ave., Hicksville, L. I., N. Y.  
Type 5651 cold-cathode discharge  
miniature voltage reference tube is  
designed for use in d-c amplifiers,  
stable regulated power supplies,  
oscilloscope calibrators and similar  
applications.

Special processing of the tube  
and its elements insures extremely  
stable operation and freedom from  
long and short-term drift.

Operating voltage range of the  
5651 is 82 to 92 v; current range is  
from 1.5 to 3.5 ma.

**H-F/D-F SYSTEM**  
**can be operated remotely**

SERVO CORP. OF AMERICA, 20-20  
Jericho Turnpike, New Hyde Park,  
L. I., N. Y., has designed a h-f/d-f  
system to be operated remotely—  
antenna site and airport control  
tower can be as much as 5 mi apart.  
The tower operator automatically  
obtains a visual indication of an  
aircraft's bearing without inter-  
rupting his normal duties. He  
could continuously monitor the

**STODDART** aircraft radio co., inc.  
6644-A SANTA MONICA BLVD., HOLLYWOOD 38, CALIFORNIA · HOLLYWOOD 4-9294

# MICRO precision switches

...THEIR USE IS A PRINCIPLE OF GOOD DESIGN

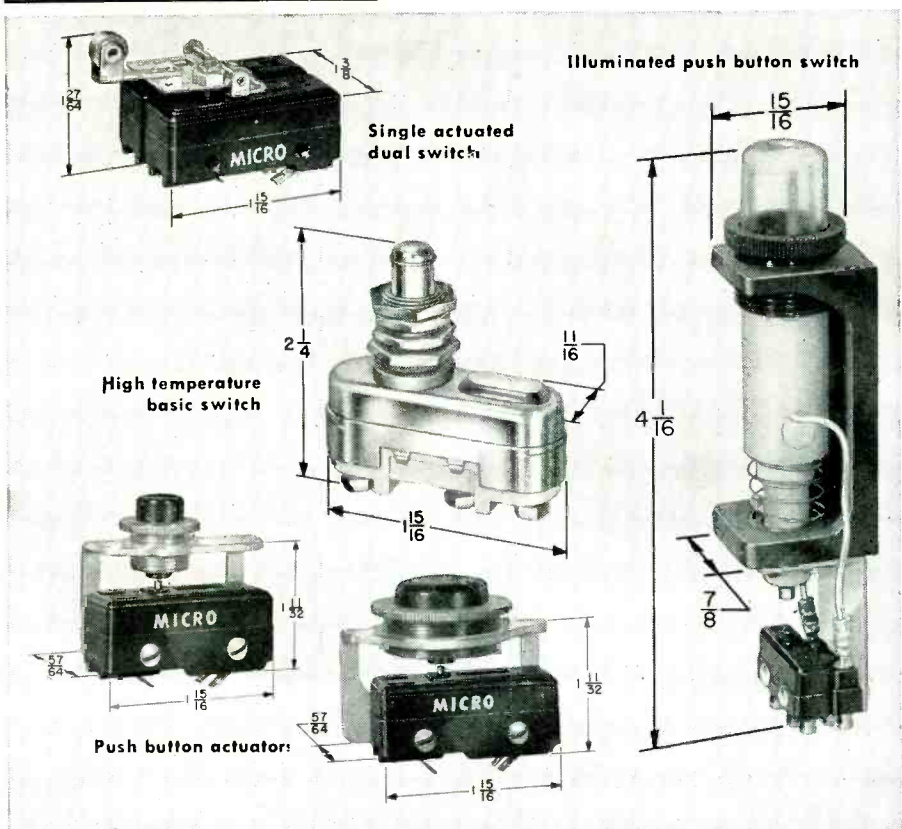

## Illuminated Push Button Switches allow mounting on one inch centers

MICRO SWITCH Illuminated Push Button Switches are outstanding for ease of operation, high pre-travel, compact design (which permits mounting on one inch centers), smooth appearance and easy-to-see pilot light. Switches are provided with sockets for a single contact miniature bayonet lamp. Removable translucent push buttons are available in clear, red, or frosted white.

## High Temperature Switch comes in three actuator types

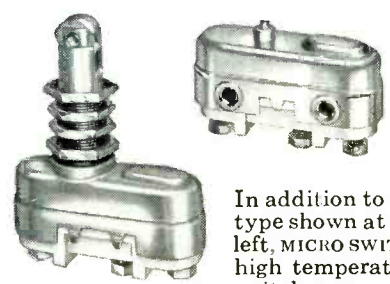

In addition to the type shown at the left, MICRO SWITCH high temperature switches are also available with pin plunger actuators for use where space is limited and small operation motion is available and roller plunger actuators for applications where cam or slide action is required.

## How Push Button Actuators are mounted to a panel

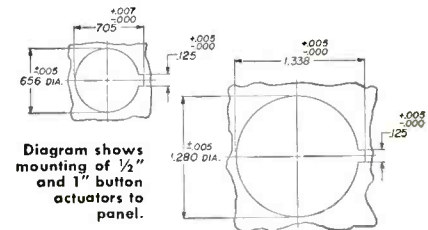

Knurled bushing assembly is inserted through the panel and threaded into the switch mounting bracket. The mounting bracket in turn is keyed to the panel, using Mounting details A or B.

## A continuous flow of Precision Switch developments anticipates designers' needs

Function of MICRO SWITCH Engineering, both at the factory and in the field, is to supply the precision switch which most exactly meets the design requirement.

Shown here are just a few recent MICRO SWITCH developments that designers have found useful in a wide variety of applications. Write to any branch office or to Freeport, Illinois for more detailed information.

**The Single Actuated Dual Switch** consists of two basic switching units operated by a roller lever actuator. The operating point of one of the basic switches is field adjustable so either simultaneous actuation or a definite sequence of operations is possible.

**The Illuminated Push Button Switch** is a low force, high pre-travel switch with an indicating light as an integral part of the push button. The high pre-travel permits movement of the button before the contacts snap over. This switch is designed for use in electronic, aircraft, mobile, marine, railway and other low voltage a-c or d-c applications.

**The High Temperature Basic Switch** is a precision snap-action switch which will operate satisfactorily in a temperature range of from -50° to

plus 1000° F. It is useful in such industrial applications as found in distilleries, foundries, vulcanizing plants and other industries which require high temperature components.

**Push Button Actuators** are of a new series available to designers of electrical computers and other types of commercial and industrial devices which require reliable panel-mounted, manually-operated switches. They are available with 1/2" or 1" buttons and combine attractive appearance and extremely long life with an exceptionally good actuation "feel".

Manufacture of precision switches is not a side line with MICRO SWITCH. It is our entire business. That is why industrial designers come to us more and more each year with switch problems of amazingly diverse types. MICRO SWITCH branches are conveniently located to serve you.

MICRO SWITCH Engineering Service is available to help you select the exact switch to meet your design problem. Call the MICRO SWITCH branch nearest you.

# MICRO SWITCH

A DIVISION OF MINNEAPOLIS-HONEYWELL REGULATOR COMPANY

In Canada, Leaside, Toronto 17, Ontario • FREEPORT, ILLINOIS



# Here is the IDEAL COIL BOBBIN for Printed Circuits

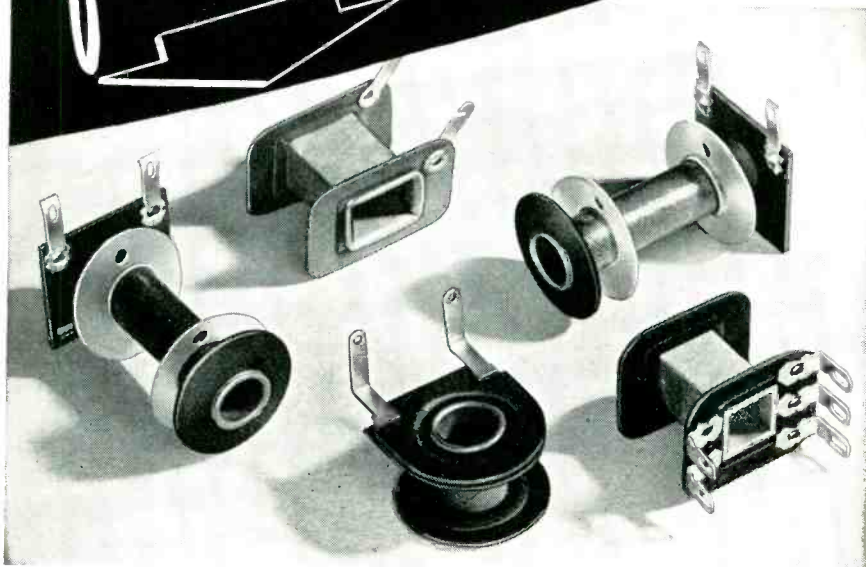

● **FURNISHED WITH ANY NUMBER OF LUGS  
ATTACHED AT A NEW LOW IN UNIT COST**

Low-cost coil bobbins can now be furnished to your specifications with any number of lugs attached. Through the development of special high production automatic equipment, Precision has eliminated the expense and difficulty of attaching terminals... especially as encountered with molded type bobbins.

The attached lug feature especially adapts these bobbins to printed circuit applications. Equally important, they can be insulated from the coil winding by washers as an integral part of the assembly. This latter advantage not only improves insulation, but greatly facilitates easier and faster production of the finished coil.

Coil bobbins with lugs attached are available in any size... with round, square or rectangular cores... flanges of all shapes. Cores are wound from dielectric kraft, fish paper, acetate or combinations, including DuPont Mylar. They can also be supplied Resinite impregnated.

**Write, wire or phone for full information**

**Sales Representatives in:**

Illinois; Indiana; Iowa; Wisconsin; Missouri; Minnesota: Chicago, Illinois, ARmitage 6-5200.  
 Indiana: Southern Ohio: Logansport, Indiana, Logansport 2555.  
 Northern Ohio: Cleveland, Ohio, ATLantic 1-1060.  
 New England: Framingham, Massachusetts, TRinity 3-7091.  
 Delaware; Washington, D. C.; Maryland; New Jersey; Metropolitan New York;  
 Eastern Pennsylvania; Virginia: Jersey City, New Jersey, Swarthmore 5-2480.  
 Upper New York: Syracuse, New York, Syracuse 4-2141.  
 CANADA: Montreal, Quebec, Canada, Walnut 0337.  
 MEXICO: Mexico 6, D. F., Telephone: 35-06-18.



**PRECISION PAPER TUBE CO.**

2041 W. CHARLESTON ST. • CHICAGO 47, ILL.

Plant No. 2: 79 Chapel St., Hartford, Conn.



bearings of all aircraft in h-f communication with him.

The control equipment is normally preset for 5 selected crystal-controlled reception frequencies. Up to 10 channels can be accommodated by the installation of additional components at the remote site. Simultaneous operation of several channels is possible.

► **Installation**—The equipment is installed in two locations. The indicator and control panel are installed in a control console at the tower. The remainder of the equipment is at the remote antenna site. Interconnecting cables carry all control and data transmission between the remote and control sites. An intercom is provided to facilitate adjustments. Power requirement for the remote installation is 2,000 w and only 1,000 w at the control point. The equipment operates from a 115/230 v, 50/60 cycle source.



**SAMPLING SWITCH  
for general instrumentation**

APPLIED SCIENCE CORP. OF PRINCETON, N. J., announces a new line of small lightweight rotary sampling switches with integral d-c drive

JOIN...

# Univac

for a secure and  
**LASTING  
FUTURE**

**A**t Remington Rand

**Univac** you will enjoy creative, challenging work in research and development on important new applications in mechanical and electronic engineering. You will work on a project team and learn all aspects of your project. Pulse circuits, magnetic cores, transistors, printed wiring, miniaturization, and precise mechanisms are used in designing computers, automatic data handling and control systems and special weapons. There are other excellent production, testing, specifications, quality control, contract administration, logical designers and technical writing positions.

**I**n ancient times it took 100,000 men over 30 years to construct the great Pyramid of Cheops.

In this Modern era, Remington Rand's Univac, operating for the United States Bureau of Census can compress 4,000 minutes of clerical time into one minute of machine time.



Send complete resume to

**Remington Rand Univac**

DIVISION OF SPERRY RAND CORPORATION

1902 WEST MINNEHAHA AVENUE, SAINT PAUL W4, MINNESOTA

MR. D. A. BOWDOIN  
Dept. FP-2  
2300 W. Allegheny Ave.  
Philadelphia, Pa.

MR. R. K. PATTERSON  
Dept. FS-2  
1902 W. Minnehaha Ave.  
St. Paul W4, Minn.

MR. FRANK KING  
Dept. FN-2  
Wilson Avenue  
South Norwalk, Conn.

OPENINGS FOR

- Electronic Engineers
- Mechanical Engineers
- Mathematicians
- Computer Sales Engineers
- Industrial Engineers
- Programmers
- Physicists

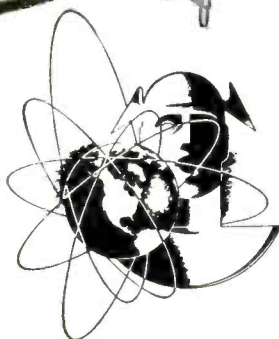

# Eccosorb CH

## Microwave Absorber

### for Darkrooms



Microwave Darkroom with Emerson & Cuming Luneberg Lens under test

Eccosorb CH is a series of broadband absorbers reflecting less than 2% of the energy incident upon its surface. It is composed of enmeshed, rubberized fibers and made in sheets 2 feet by 2 feet in various thicknesses. Eccosorb CH is light weight and flexible. It is easily mounted and its natural, white surface color gives good light reflection.

**Free Space Rooms** are easily and economically built for indoor antenna measurements. Reflections are eliminated for all practical purposes. You can build your own microwave dark room or we offer you a complete **Free Space Room ready to use.** Emerson & Cuming engineers design and build special types for unusual conditions. Send us your specifications.

Another absorber, ECCOSORB HF comes in rods, sheets or molded shapes in several volume resistivities for waveguide terminations and similar uses. If you have a problem write for information on . . .



## Plastics for Electronics

### Emerson & Cuming, Inc.

869 WASHINGTON STREET, CANTON, MASS.

**Sales Representatives**

**DAYTON**  
ROBERT G. SIFF & ASSOCIATES  
11 W. Monument Bldg., Dayton 2, Ohio  
Hemlock 1254

**KANSAS CITY**  
ENGINEERING SERVICES COMPANY  
4550 Main Street, Kansas City 11, Mo.  
Jefferson 7765

**NEW YORK**  
M. RAYMOND KALLMAN  
P. O. Box 104, Roslyn, L. I., New York  
Roslyn 3-6511

**ST. LOUIS**  
ENGINEERING SERVICES COMPANY  
6635 Delmar Blvd., St. Louis 5, Mo.  
VO 3-3661

**WASHINGTON, D. C.**  
TED BRITT  
1500 Mass. Ave., Washington 5, D. C.  
Columbia 5-2694

**WEST COAST**  
McCarthy Associates  
P. O. Box 36, Altadena, Calif  
Sycamore 8-5790

- PLASTIC FOAMS
- LAMINATING AND IMPREGNATING RESINS
- PLASTIC-FIBER GLASS LAMINATES
- HIGH DIELECTRIC CONSTANT PLASTICS
- METALIZED PLASTICS
- ELECTRONIC EMBEDMENTS
- CASTING RESINS
- LOW LOSS ROD AND SHEET STOCK
- MICROWAVE ABSORBERS

motor for use in airborne and general instrumentation applications. The phasing between poles can be manually adjusted while the switch is in operation.

► **Varieties**—This switch is available with 1, 2, 3, or 4 poles containing 24, 30 or 32 shorting (12, 15, or 16 nonshorting) contacts per pole. Motor voltages of 6, 12, or 27.5 v d-c at sampling speeds ranging from 0.1 to 10 rps can be provided.



### DIELECTRIC OVEN is fully automatic

ERDCO ENGINEERING CORP., Addison, Ill. This dielectric oven was primarily designed for experimental laboratory use for instantaneous drying of sample quantities of various solid and liquid materials. It is a radio-frequency generator of 2 kw rated high-frequency power output.

Fully automatic, the oven has a patented electronic load matching system which automatically compensates for variations in the physical properties of the heated material during the heating cycle. Thus it assures a constant power input into the sample. The power level can be adjusted from zero to full rated power, according to the need for individual tests.

► **Application** — Radio-frequency heat can be used in both industrial and university laboratories for testing biochemical samples and cultures, as well as for research in

# ACCURATE

HIGH RELIABILITY  
HIGH PRECISION  
HIGH QUALITY

LOW WEIGHT  
SMALL SIZE  
ECONOMICAL

# FREQUENCIES

## FREQUENCY STANDARD 240 to 800 Cycles

Type 50 C  
 $\pm .02\%$  at  $-65^{\circ}$  to  $85^{\circ}\text{C}$   
Type R 50 C  
 $\pm .002\%$  at  $15^{\circ}$  to  $35^{\circ}\text{C}$

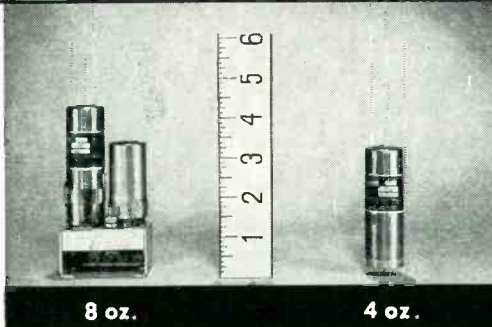

## PRECISION FORK UNIT 240 to 800 Cycles

Type 50  
 $\pm .02\%$  at  $-65^{\circ}$  to  $85^{\circ}\text{C}$   
Type R 50  
 $\pm .002\%$  at  $15^{\circ}$  to  $35^{\circ}\text{C}$

## FREQUENCY STANDARD 200 to 4000 Cycles

Type 2003 C  
 $\pm .02\%$  at  $-65^{\circ}$  to  $85^{\circ}\text{C}$   
Type R 2003 C  
 $\pm .002\%$  at  $15^{\circ}$  to  $35^{\circ}\text{C}$   
Type W 2003 C  
 $\pm .005\%$  at  $-65^{\circ}$  to  $85^{\circ}\text{C}$

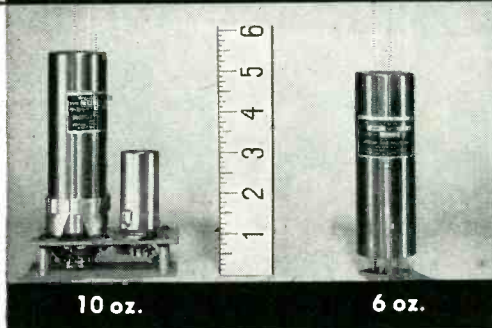

## PRECISION FORK UNIT 200 to 4000 Cycles

Type 2003  
 $\pm .02\%$  at  $-65^{\circ}$  to  $85^{\circ}\text{C}$   
Type R 2003  
 $\pm .002\%$  at  $15^{\circ}$  to  $35^{\circ}\text{C}$   
Type W 2003  
 $\pm .005\%$  at  $-65^{\circ}$  to  $85^{\circ}\text{C}$

## FREQUENCY STANDARD 200 to 2000 Cycles Sub-miniature Tube

Type 2007  
 $\pm .02\%$  at  $-65^{\circ}$  to  $85^{\circ}\text{C}$   
Type R 2007  
 $\pm .002\%$  at  $15^{\circ}$  to  $35^{\circ}\text{C}$   
Type W 2007  
 $\pm .005\%$  at  $-65^{\circ}$  to  $85^{\circ}\text{C}$

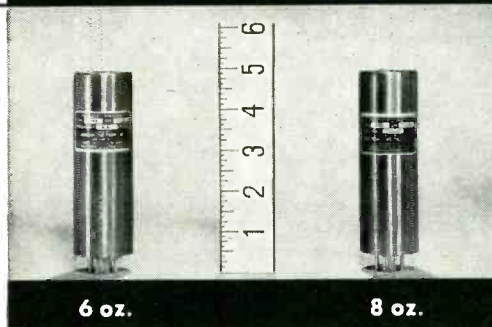

## FREQUENCY STANDARD 240 to 1000 Cycles Transistorized

Type 2007 T  
 $\pm .02\%$  at  $-65^{\circ}$  to  $85^{\circ}\text{C}$   
Type R 2007 T  
 $\pm .002\%$  at  $15^{\circ}$  to  $35^{\circ}\text{C}$   
Type W 2007 T  
 $\pm .005\%$  at  $-65^{\circ}$  to  $85^{\circ}\text{C}$

## FREQUENCY STANDARD 200 to 3000 Cycles

Type 2001-2  
 $\pm .001\%$  at  $20^{\circ}$  to  $30^{\circ}\text{C}$

WHEN REQUESTING  
INFORMATION  
PLEASE SPECIFY  
TYPE NUMBER

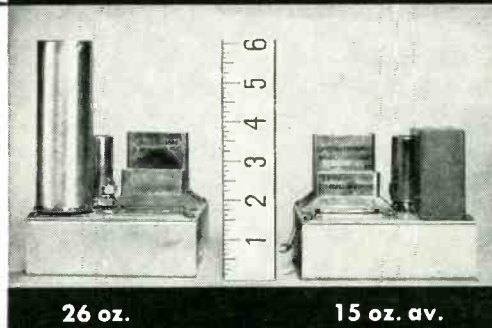

## ACCESSORY UNITS for Type 2001-2

L—for low frequencies,  
multi-vibrator type, 40-200 cy.  
D—for low frequencies,  
counter type, 40-200 cy.  
H—for high freqs., up to 20 KC  
M—Power Amplifier, 2W output  
P—Power Supply.

# American Time Products, Inc.

580 Fifth Avenue

New York 36, N. Y.

OPERATING UNDER PATENTS OF WESTERN ELECTRIC COMPANY

# American Electric Model EPM-1123

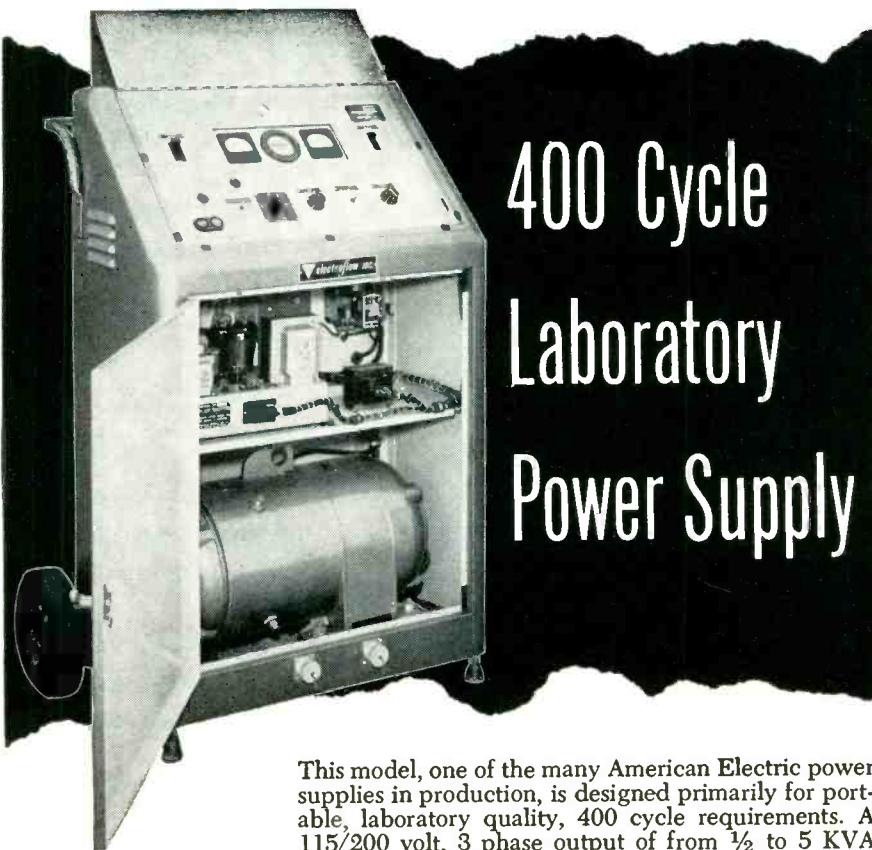

## 400 Cycle Laboratory Power Supply

An Electroflow product.

This model, one of the many American Electric power supplies in production, is designed primarily for portable, laboratory quality, 400 cycle requirements. A 115/200 volt, 3 phase output of from 1/2 to 5 KVA capacity is available in various models with voltage regulation within  $\pm 1\%$  and with voltage adjustment of  $\pm 10\%$ . These units are powered from any 220/440 volt, 3 phase, 60 cycle supply.

### ALL CIRCUITS PROTECTED

Input circuit is equipped with a 60 cycle circuit breaker and motor starter. Output circuit is protected against both current and voltage surges with a circuit breaker and over-voltage relay.

### METERING

400 cycle instrumentation includes a voltmeter, ammeter, frequency meter and a selector switch by which each phase may be checked individually.

### COMPLETE INTEGRATION

This rubber tired unit contains the complete system—American Electric Inductor-type Alternator (no wearing parts), electronic exciter and voltage regulator, complete instrumentation and two output connectors for multiple loads.

### MANY OTHER SIZES

American Electric Power Supplies are available in many high cycle variations... from 1/2 to 75 KVA, fixed or variable frequency, portable or stationary designs.

### WHATEVER YOUR HIGH CYCLE POWER REQUIREMENTS

There's an American Electric model for your immediate needs. Ask for details!

Atlanta, Boston,  
Buffalo, Chicago,  
Dayton, Dallas,  
Kansas City (Mo.),  
Los Angeles, Minneapolis,  
Memphis, New Orleans,  
New York City, Rochester,  
San Francisco, Seattle,  
St. Louis, Syracuse,  
Silver Spring (Md.), Tampa,  
Montreal, Toronto.

## American Electric Motors, Inc.

Electric Machinery & Equipment Division of



2112 Chico Avenue, El Monte, Calif.

building materials, rubber, food, chemicals, pharmaceutical products and other materials.

The standard model has an accurately rated output of 2 kw and is available with rated outputs up to 20 kw. Overall dimensions are 25 in. by 34 in. by 63 in. It is available at \$3,600 complete.



### BROADCAST TUNER germanium diode type

J. W. MILLER Co., 5917 S. Main St., Los Angeles 3, Calif., has announced the No. 595 high-fidelity, germanium diode broadcast band tuner. Coils used therein have a Q in the order of 600. The audio output of the tuner is proportional to the input signal and will vary from 0.07 v to 0.7 v for stations within a 20 to 25-mile radius.

It can be used as a selective crystal set in rural areas. With sufficient outside antenna and external ground, signals in excess of 600 air miles have been received. Requiring no power or battery supply, it is an ideal unit for civilian defense broadcasts.

Other features are tonal quality, selectivity (20 kc) and sensitivity.



### RIB-WOUND RESISTORS with spot-welded terminals

REON RESISTOR CORP., Yonkers, N. Y. Spot-welded terminals and windings are among the features found in the company's new rib-



# ADVANCED Communications

The design of modern communications equipment involves much more than electronic circuit techniques. Keyboards and coders are often required to translate the intelligence to be transmitted into "machine language." Recording and reproducing devices store intelligence until the equipment is ready to transmit it, or hold received intelligence until it can be translated back into human language by a printer or other output display device.

The combination of such mechanical and electro-mechanical techniques with the better known but still developing techniques of electronic circuit design makes of modern communications a much broader field than is commonly recognized. When such technical tools are used to provide equipment tailored to our rapidly improving understanding of propagation phenomena and information theory, the resulting practical improvements in communication are sometimes little short of spectacular.

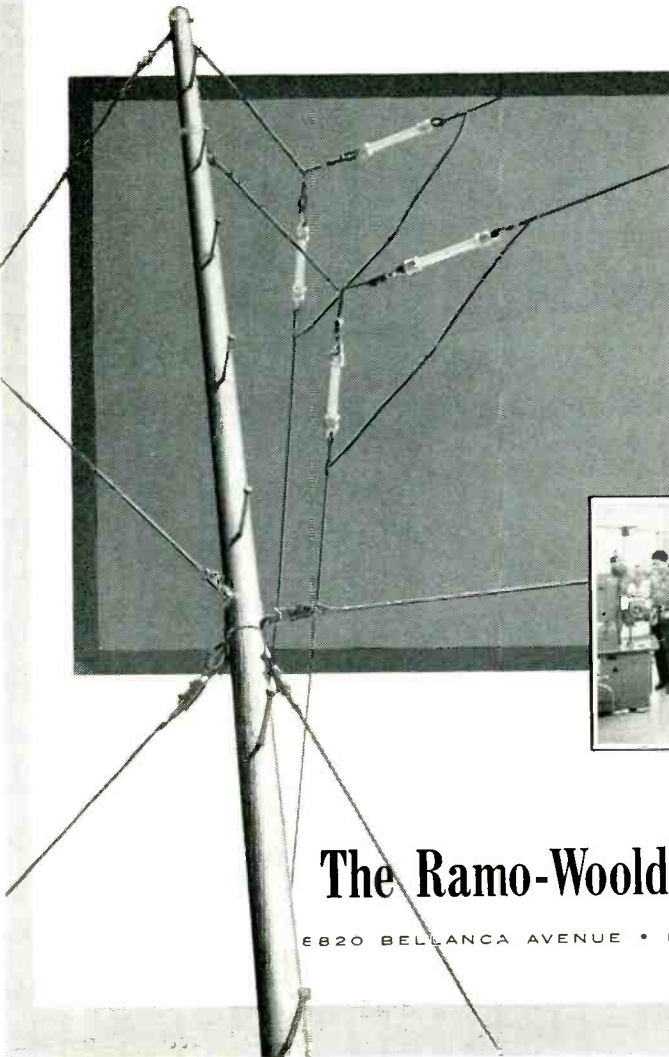

*The growing communications activities of The Ramo-Wooldridge Corporation have generated requirements for additional physicists and engineers with substantial experience in research, development, or production engineering on advanced airborne and ground-based...*

- Communication, Navigation and ECM Systems
- HF, VHF, and UHF Transmitters and Receivers
- Precision Electro-Mechanical Equipment
- Magnetic Recording Systems
- Signal Analysis Equipment
- Video and Pulse Circuitry
- Miniaturization and Packaging



Part of Communications Equipment Pilot Production Activities

## The Ramo-Wooldridge Corporation

6820 BELLANCA AVENUE • LOS ANGELES 45, CALIFORNIA

# Handles 90% of applications

## FOR EITHER SINGLE-OR DUAL-CHANNEL SCOPES



AT A  
DOWN-TO-EARTH  
PRICE

# \$975

NONE LOWER

- 2 entirely separate channels for accurate, simultaneous comparison and measurement of any two phenomena.
- Completely separate single-shaft controls for each channel assure maximum operating convenience. Concentric controls for positioning, intensity, and focus.
- Separate or common time bases with extended sweep ranges from below 2 seconds to 50,000 cps.
- High-gain, low-noise dc amplifiers.
- Illuminated graticule with dimmer for perfect viewing or photography.

model K-26  
2 signals

1 scope

NO switch

TRUE dual-channel oscillography . . . now within reach of all industry, laboratories, engineering and research departments. New features of control, sensitivity, band-width, frequency response, gain. By the originators of multi-channel scopes and multi-gun cathode-ray tubes.

# ETC

WRITE FOR ETC BULLETIN ON K-26 . . . ALSO SPECIFY  
IF YOU WANT LITERATURE ON OTHER  
ETC INSTRUMENTS AND CATHODE RAY TUBES

## electronic tube corporation

1200 E. MERMAID LANE

PHILADELPHIA 18, PENNA.

NEW PRODUCTS

(continued)

wound power wire-wound resistors. The special treatment of the terminals and windings add durability and life to the component.

► Features—A larger proportional increase in cooling area in comparison to tubular resistors of equal size is achieved by the corrugated edgewise wound ribbon wire. High thermal conducting Reon vitreous enamels permit operation at higher temperature rise without deterioration or damage.

Standard available units are up to 2,000 w and up to 200 ohms in resistance value, and are designed for high power circuits requiring units of high current and a wattage rating at low resistance values. These are adaptable to starter duty as well as continuous applications in great variety.



### POWER CONNECTORS with polarizing screwlock

DEJUR-AMSCO CORP., 45-01 Northern Blvd., Long Island City 1, N. Y. Continental E-Z release power connectors can now be supplied with the polarizing screwlock feature to provide a positive mechanical means of locking plug and receptacle against vibration or accidental disconnection. The screwlock also eliminates any need to force or pry apart plug and receptacle when disconnecting the connector.

► How Available—The E-Z 16 may be had in 12, 18, 24 and 34 contacts with solder cup for No. 16 Awg wire or solderless wiring taper pin for AMP series 53. Individually spring loaded pin contacts assure quick release with low insertion force and

# New Du Pont MYLAR<sup>®</sup>

REG. U. S. PAT. OFF.

## adds improved qualities to pressure-sensitive tape

Pressure-sensitive tapes made with new Du Pont "Mylar"<sup>®</sup> polyester film are giving superior performance in a wide variety of diversified industrial uses. That's because tapes made with "Mylar" offer long-lasting strength in conjunction with chemical resistance, dielectric strength, and thermal stability.

Whether it's masking for electroplating or harness-wrapping coils, pressure-sensitive tapes made with new Du Pont "Mylar" increase efficiency, improve performance and, in the case of electrical applications, help decrease weight and size of the finished product.

Du Pont manufactures only the base material, "Mylar." The various firms that make pressure-sensitive tapes using "Mylar" offer a variety of gauges, widths, and types of adhesives. Send in coupon below for names of manufacturers and the new booklet listing properties and applications of pressure-sensitive tapes made with "Mylar."

**Thin, yet strong . . .** gives a snug wrap over irregular, bulky surfaces.

**Amazing dielectric strength,** thermal stability, for countless electric uses.

**Dimensionally stable,** can be used over a wide range of temperatures.

**Resists effects of corrosion** and moisture over wide range of temperature and humidity.

**Resists edge fraying,** has great tear strength... is ideal for tough jobs.

**Can be metalized,** printed, used for coding pipes and wires . . . decorative effects.

\*Registered Du Pont trademark for its brand of polyester film



REG. U. S. PAT. OFF.  
BETTER THINGS FOR BETTER LIVING  
... THROUGH CHEMISTRY



Please send me further information on the basic properties of "Mylar."

Please send me your new booklet on pressure-sensitive tapes made with "Mylar" and names of manufacturers.

E. I. du Pont de Nemours & Co. (Inc.)  
Film Dept., Room E-1, Nemours Bldg., Wilmington 98, Del.

Name \_\_\_\_\_

Firm \_\_\_\_\_

Street Address \_\_\_\_\_

City \_\_\_\_\_ State \_\_\_\_\_

From the simultaneous recording of phenomena in the testing of a new aircraft . . . to automatic programming of machine tools . . . from plant inventory control . . . to insurance premium and utility rate studies—Davies data handling equipment is providing a convenient electrical memory for all kinds of functions. Why? Because Davies magnetic tape equipment is the ONLY data medium that provides so many advantages.

make  
magnetic  
tape  
your  
data medium

THE  
**Davies**

LABORATORIES  
INCORPORATED

4705 Queensbury Road  
Riverdale, Maryland

FOR RECORDING  
REPRODUCING  
AND ANALYZING

- Instrumentation
- Automation
- Telemetry
- Seismography
- Analog and Digital Computing

#### PORTABILITY—

Davies portable recorders make it unnecessary to carry an analog recorder to the data source. Record now . . . reproduce accurately, and analyze, any time later.



#### AMOUNT OF DATA—

Davies multi-track head recorders permit the most economical recording of the greatest number of phenomena simultaneously.



#### STORAGE—

Davies equipment makes possible the storage of the greatest amount of information in compact form . . . for reproduction any time later, reproduction as many times as necessary, with the same fidelity as the original signal.



#### GRAPHIC REPRODUCTION—

Davies equipment lends itself best to reproduction of data in graphic form on oscilloscopes, oscillographs, direct-writing recorders, X-Y recorders, and many others.



#### FLEXIBILITY—

Davies reproducing equipment permits change of time and frequency scales of magnetic tape recorded data to fit analog recorders . . . permits recording of digital computer output for fastest operation of line tabulators simultaneously.



#### ENGINEERS AND EQUIPMENT ... READY FOR SERVICE

As the industry's pioneer in the uses of tape for non-audio work, Davies Laboratories manufactures a complete line of recording, reproducing, and analyzing equipment, field and flight tested for all conditions, and backed by a technical staff ready to provide application engineering service for the best solution to your data handling problems. For general information on how Davies magnetic tape equipment can help you, write for Bulletin.



practically no disengagement force. Aluminum hoods, with cable clamp and cable mounting bracket for top or side cable opening, can also be supplied on order.

A choice of molding compounds includes mineral filled Melamine, Plaskon reinforced (glass) Alkyd 440A or Orlon filled diallyl phthalate.



#### MICROWAVE GENERATOR features high r-f stability

MICROWAVE DEVELOPMENT LABORATORIES, INC., 90 Broad St., Babson Park, Wellesley 57, Mass. Model 10X ultrastable microwave generator is an ideal source for Q measurements, phase measurements or any other measurements requiring a high degree of r-f stability. It consists of a klystron oscillator, a tunable reference cavity, a frequency stabilizing circuit and a power supply. The novel Strandberg stabilization circuit is simple and practical.

► **Condensed Specifications**—Frequency coverage is 8,500 to 9,600 mc X-band; short-term deviation, 1 part in  $10^8$ ; long term deviation, 1 part in  $10^5$  relative to reference cavity; power output, 10 mw; power consumption, 50 w; size,  $5\frac{1}{4}$  in. by 9 in. by 10 in.; weight, 15 lb.

#### V-R TUBES versatile gaseous types

CBS-HYTRON, a division of Columbia Broadcasting System, Inc., Danvers, Mass., has developed types 6626 and 6627 highly versatile gaseous voltage regulator tubes

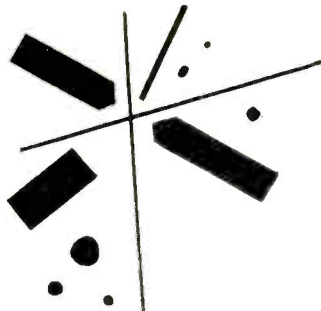

# ENGINEERS AND SCIENTISTS...

## HELP US SOLVE TODAY'S MOST ADVANCED PROBLEMS

Here is the basic challenge at Autonetics: to make missile and aircraft electro-mechanical systems and components smaller and lighter—yet able to function perfectly under blistering heat, “earthquake” shock and extreme humidity conditions.

AUTONETICS—North American’s separate electro-mechanical division—currently has nearly 100 projects in startling new concepts of systems design... principles of guidance and control—now under development and in production—that haven’t yet been printed in journals or texts.

There are many projects in guidance and control for North American’s SM-64 Navaho Intercontinental Guided Missile. Projects in ingenious autopilots and fire-control systems for today’s and tomorrow’s ultrasonic manned aircraft. And many other projects equally exciting and challenging.

The tools at your command at Autonetics include the most advanced research and test facilities... latest digital and analog computers. You’ll enjoy the professional recognition of working in this advanced atmosphere with leading scientists and engineers.

It will pay you to look into a career at Autonetics today. From every point of view, you’ll find it *the most advanced state of your art.*

### Immediate openings for:

Computer Specialists

Electro-Mechanical Designers

Environmental Test Engineers

Electronic Component Evaluators

Instrumentation Engineers

Fire Control Systems Engineers

Flight Control Systems Engineers

Relay Specialists

Computer Programmers

Computer Application Engineers

Automatic Controls Engineers

Electronic Engineering Writers

Inertial Instrument Development Engineers

Preliminary Analysis and Design Engineers

*Also openings for Draftsmen and Technicians*

Write:

Mr. D. S. Grant, Engineering Personnel Office  
Autonetics, Dept. 991-20E, 12214 Lakewood Blvd.  
Downey, California

# Autonetics®

A DIVISION OF NORTH AMERICAN AVIATION, INC.

# Memo to transmitter designers

Specify MicroMatch Directional Coupler as built-in R.F. Power and VSWR monitoring equipment. Transmitter customers stay "sold" by the coupler's continuous RF Power output indication. Its VSWR monitor is your customer's transmission line and antenna "watch-dog".

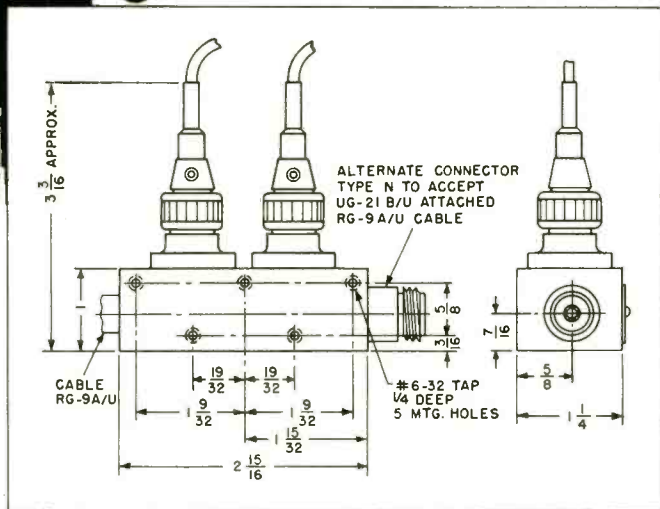

Outline Drawing Model 575N Double Coupler.

Performance proven, you will find these small, extremely low-cost MicroMatch couplers now incorporated in the most modern Government and commercial transmitters. MicroMatch Directional Couplers produce an output essentially independent of frequency over the range of 20 to 2000 megacycles. Couplers are adjusted to produce full scale meter deflection at power levels of 1.2 watts to 120 KW. Accuracy of power measurement is plus or minus 5% of full scale.

For complete details on the MicroMatch line of monitoring equipment, please consult Page 495 of Electronics Buyer's Guide, or, better still, write for our 46-page catalog.



**M. C. JONES ELECTRONICS CO., Inc.**  
BRISTOL, CONNECTICUT

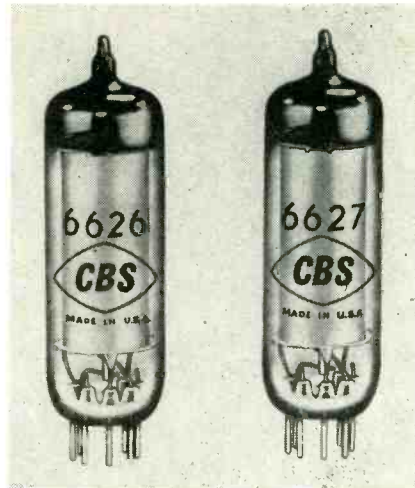

featuring greatly improved reliability.

► **Applications**—The tubes have important applications in the military and high quality commercial products fields, offering longer life, improved dark starting, and elimination of voltage shifts. They are currently recommended in such critical applications as voltage reference circuits where extreme stability and repeatability are vital factors.

When the older type tubes are shielded from all sources of radiation they become unreliable in starting. This problem has been overcome in the 6626 and 6627 by incorporating a small amount of radioactive nickel in the starting electrode.

Complete data are available on the new tube types by requesting bulletins E-253 and E-254.

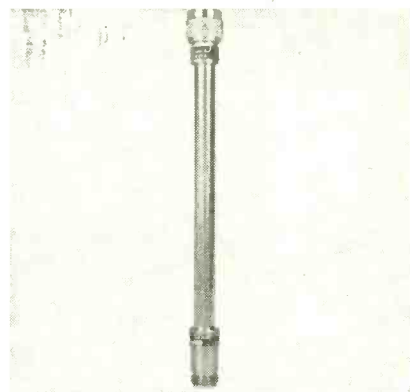

## ATTENUATOR PAD

50 ohm impedance

WEINSCHEL ENGINEERING CO., INC.,  
10503 Metropolitan Ave., Kensington,  
Md. Model 210 coaxial attenu-

# when there is no margin for error... depend on the Lavoie non-parallax scale

for accurate voltage and time measurements. The Lavoie LA-239CR (AN/U5M-50A) Oscilloscope is the only commercial scope with this feature.

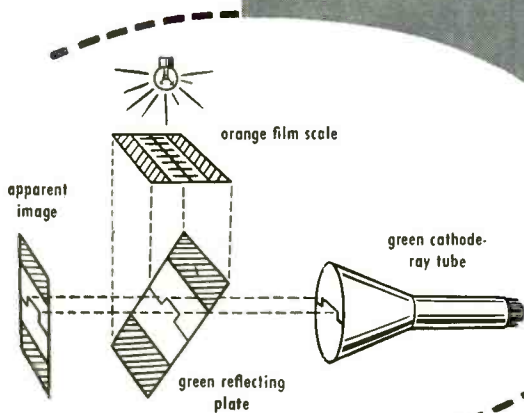

Parallax can be costly when an error in reading comparative voltage causes engineering changes. The exclusive Lavoie reflecting scale superimposes the reticule on the optical plane of the cathode-ray screen. . . . Thus there is no error of parallax. The reflecting scale does not prevent the use of a camera with the Lavoie LA-239CR Oscilloscope. A camera adapter plate is available for use with the Fairchild F-284 or F-286 camera. The same instrument is also available in the conventional flush-face version (model 239CF).

## OSCILLOSCOPE DATA

**Wider Bandwidth:** Complex waves from 5 cycles to 15 megacycles. Sine waves from 3 cycles to 20 megacycles.

**Extended Sweep Frequencies:** Linear from 10 cycles to 20 megacycles internally synchronized. Triggered sweep, from a single impulse to irregular pulse-intervals up to as high as 6 megacycles.

**Square Wave Response:** Rise time 0.022 microseconds, only 5% droop on flat-topped pulses as long as 30,000 microseconds duration.

**Greater Stability:** Electronically regulated power supplies throughout to maintain accuracy and constant operation under varying line conditions or line surges. Surges on the line from which Model LA-239CR is being powered can be displayed without distortion.

**Higher Signal Sensitivity:** Maximum sensitivity without Probe: 10.4 millivolts. With Probe: 100 millivolts. (Maximum signals, 125 V. Peak and 450 V. Peak respectively.)

**Timing Markers:** Interval: Markers of 0.2, 1, 5, 20, 100, 500 or 2,000 microseconds may be superimposed on the trace for the accurate measurement of the time base.

**Voltage Calibration:** Signal amplitude is referenced to a 1,000 cycle square wave (generated internally) the amplitude of which is controlled by a step-and-slide attenuator calibrated in peak volts. (A jack is provided to deliver 30 V. Peak for use in calibrating other instruments.)

**Sweep Delay:** Any portion of the sweep longer than a 5 microsecond section may be expanded by 10:1 for detailed study of that portion of the signal.

**Power Source:** 110 to 130 V. AC from 50 to 1,000 cycles. 295 Watts. (Fused at 4 amperes.)

**Dimensions:** In Bench Cabinets: 19½ in. wide, 15¼ in. high, 16¼ in. deep. In Rack Mounting (with cabinet removed to fit standard relay rack): 19½ in. wide, 14 in. high.

## REPRESENTATIVES

ALBANY, J. A. Reagan Co., Albany 4-7676  
ATLANTA, Southeastern Industrial Instruments, Exchange 7801  
BALTIMORE, Thomas L. Taylor, Belmont 5-9126  
CHICAGO, R. Edward Stemm, Columbus 1-2227  
DENVER, Allen I. Williams Co., Main 3-0343  
FLINT, Sam Robbins, Inc., Cedar 5-7310

FORT WORTH, Mitchell Spears Co., Webster 8811  
HARTFORD, M. S. Coldwell, Jackson 2-5832  
LOS ANGELES, T. Louis Snitzer, Webster 1-5566  
MONTCLAIR, Louis A. Garten & Associates, Montclair 3-0257  
SAN MATEO, R. L. Pfeiffer Co., Fireside 5-1134  
ST. LOUIS, Edwin H. Murty, Evergreen 5-7728

# Lavoie Laboratories, Inc.

MORGANVILLE 1, NEW JERSEY

designers and manufacturers

of Electronic Equipment



# SHURE

## Small Controlled Reluctance Microphones

*for use where  
space is limited  
stability is essential  
intelligibility is important*

These rugged, magnetic microphones are designed for use in transistor-type hearing aids, small amplifiers and transmitters, dictating equipment, magnetic recorders . . . wherever size and weight must be kept at a minimum.

SHURE microphones based on this same design principle have been used extensively by the Armed Forces in many military applications where severe operating conditions are encountered.

### MC 20

This microphone measures only  $1\frac{1}{8}'' \times \frac{3}{4}'' \times \frac{5}{16}''$ , and weighs  $9\frac{1}{2}$  grams. Its rectangular shaped case simplifies placement of other circuit components, and permits an appreciable reduction in the size of the equipment using it.

**Output Level:** 75 db below one volt per microbar ( $0.56 \times 10^{-10}$  watts for one microbar—at 1,000 c.p.s. for 1,100 ohms impedance).

**Frequency Response:** 400 c.p.s. to 4,500 c.p.s.

**Impedance:** 1,100 ohms (at 1,000 c.p.s.). Other impedances available on special order.



### MC 10

One-inch diameter microphone, less than 0.4" thick, weighing only 11 grams. Similar in construction to the MC20, for use where amplifier gain is at a premium, and a more sensitive microphone is needed.

**Output Level:** 71 db below one volt per microbar (approximately  $10^{-10}$  watts for one microbar—at 1,000 c.p.s. for 1,000 ohms impedance).

**Frequency Response:** 400 c.p.s. to 3,000 c.p.s.

**Impedance:** 1,000 ohms (at 1,000 c.p.s.). Other impedances available on special order.



### R 5

Where a still higher output is required and space is not so limited, the R5 is an ideal unit. It is  $\frac{3}{2}''$  thick and  $1\frac{3}{4}''$  in diameter, weighing only 4 ounces. Encased in its rubber mounting ring the R5 measures  $1\frac{1}{2}''$  thick and  $2\frac{1}{4}''$  in diameter.

**Output Level:** 51.5 db below one volt per microbar—at 1,000 c.p.s. for 14,000 ohm impedance.

**Frequency Response:** 100 c.p.s. to 9,000 c.p.s.

**Impedance:** 14,000 ohms at 1,000 c.p.s. Other impedances available on special order.



The SHURE Engineering staff will work with you in confidence to adapt these and other Controlled Reluctance microphones to your specific applications. Write on company letterhead to our Sales Department—explaining your requirements.

# SHURE

*The Mark of Quality*

SHURE BROTHERS, INC.

225 WEST HURON STREET, CHICAGO 10, ILLINOIS

### ENGINEERS:

Excellent employment opportunities available for men having Methods and Standards experience, Research and Development ability in Magnetic Recording, Microphones, Transducers, Phonograph Reproducers. Write Chief Engineer, Shure Brothers, Inc.

ator pads are used without derating with pulse power having a duty cycle of 1:2,000 and a pulse duration of 5  $\mu$ sec.

► **Technical Highlights**—The attenuator pads (50-ohm impedance) are available in 1-db steps from 1 to 10 db. Frequency range is 1,000 to 10,000 mc. They feature high power capability (3 db is rated for an input of 5 w average with a peak power of 10 kw); high absolute accuracy (at 4,000 mc at room temperature  $\pm 0.1$  db of nominal value); temperature coefficient,  $+0.00043$  per db per deg F; and small variation with frequency (average 3 db pad changes  $+0.3$  db between 1,000 and 10,000 mc). The military version is not damaged by shock test of MIL-T-945-A without shock mounts.

Eleven types are available ranging in price from \$37.50 to \$46.50.

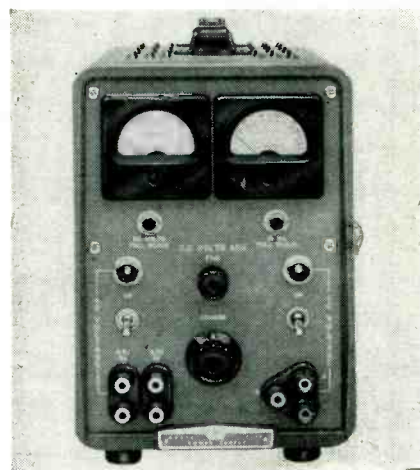

### POWER SUPPLY is a multipurpose unit

HEWLETT-PACKARD Co., 395 Page Mill Road, Palo Alto, Calif. Model 711A multipurpose power supply is designed to power all types of laboratory, field and factory electronic test setups.

The instrument offers a voltage range of 0 to 500 v and no-load to full-load regulation of better than  $\pm 0.25$  percent or 0.5 v. Ripple is less than 1 mv. There are separate current and voltage meters, with new pushbutton range switching for accurate measurement of small voltages and currents.

► **Other Advantages**—Additional features include complete overload



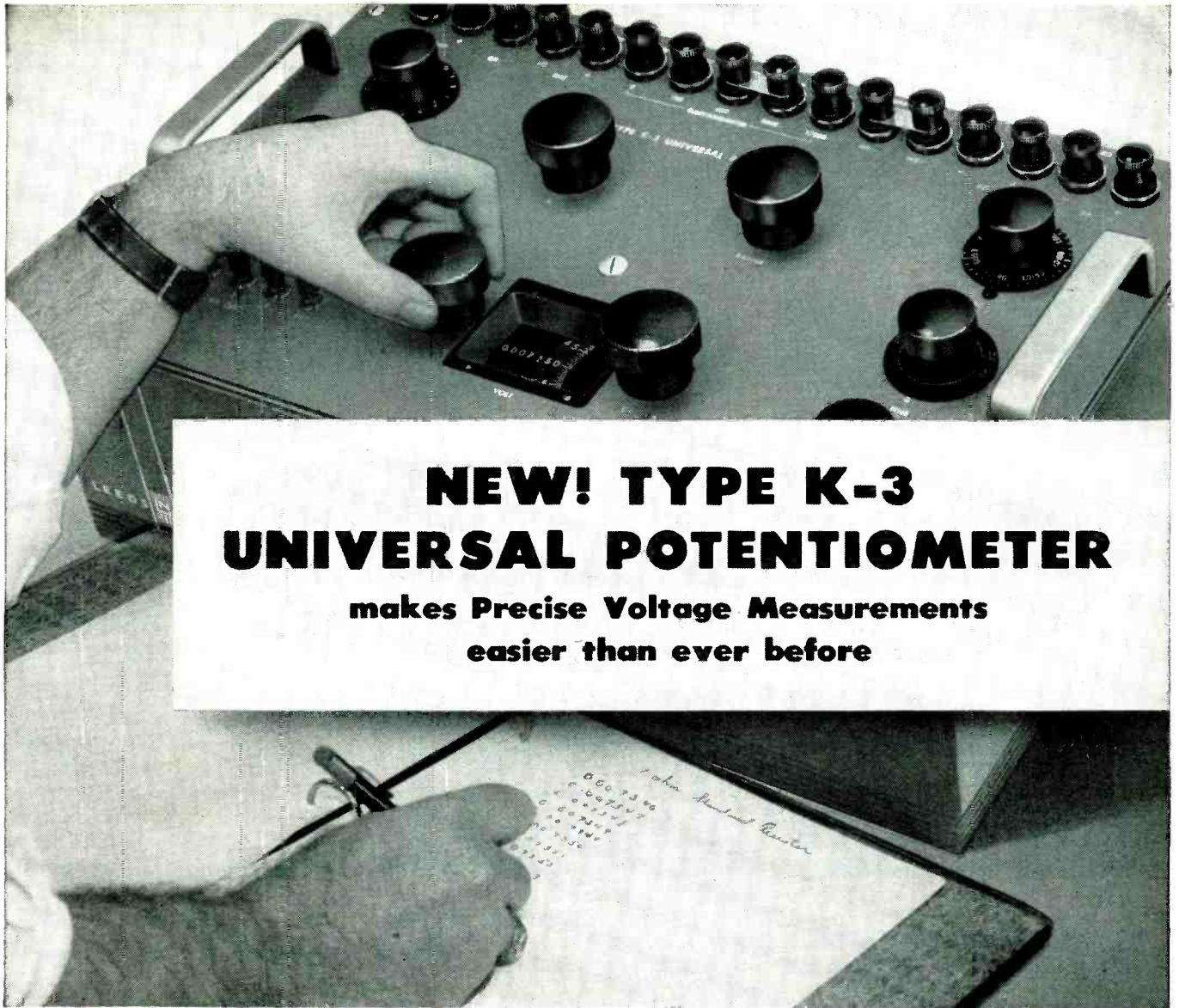

## NEW! TYPE K-3 UNIVERSAL POTENTIOMETER

**makes Precise Voltage Measurements  
easier than ever before**

- Scale reads directly in voltage
- Guarded against humidity, static, leakage of any kind
- "Thermal Free" circuit reduces voltage errors

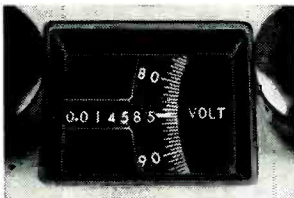

You take your readings directly from a central reading window . . . no more mental arithmetic in adding up dial settings. You can use this unique instrument in hot, humid weather . . . in cold, dry weather . . . without worrying about leakage or static.

The many new design and construction features . . . metal case for electrostatic shielding . . . guarding of battery and detector circuits . . . enclosed switches and slidewires . . . thermal free circuit construction . . . central reading window . . . make this Type K-3 Universal (Guarded)

Potentiometer the most advanced general purpose instrument available today. You will find it a worthy new addition to the Type K line . . . originated some 50 years ago . . . the world's most widely used precision potentiometers.

Six pages of data are required to give you full details. Ask for Data Sheet E-51(6); write your nearest L&N Office or 4979 Stenton Avenue, Philadelphia 44, Pa.

**LEEDS**  **NORTHRUP**  
instruments automatic controls • furnaces

# NEW!

*1/2-inch  
wire-wound*

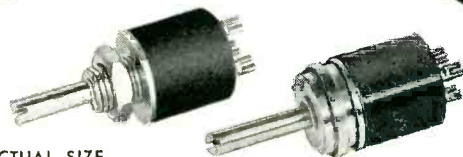

ACTUAL SIZE

## UP TO 100 K

# PRECISION POTENTIOMETERS

Now YOU CAN specify a Waters pot for your miniaturized designs that require 50K and 100K potentiometers. In the reliability-proved construction of the AP-1/2, these new, higher values give you:

- Resistances — 10 ohms to 100 kilohms
- Ganging — up to four units
- Three mounting styles — plain-bushing, split-bushing, or servo
- Three terminal styles — radial, axial, or wire-lead
- Automation models — for printed circuits
- Encapsulated designs available

**General specifications:** Centerless-ground, stainless-steel shaft can be sealed with O-ring; gold-plated, fork-type terminals; 2% standard linearity for 50K and 100K — 5% for lower values; temperature range —55 to +105C, to 125C on order; 2 watts at 80C; anodized aluminum body 1/2" diameter × 1/2" long — 5/8" long for 100K; corrosion-resistant-alloy bushing; all electrical connections spot-welded or soldered; can be furnished with stops or for continuous rotation.

Write for your copy of our new data sheet giving useful information on these compact, dependable potentiometers.



**WATERS MANUFACTURING, inc.**

*Waltham 54, Massachusetts*

APPLICATION ENGINEERING OFFICES IN PRINCIPAL CITIES

NEW PRODUCTS

(continued)

protection and grounding of either positive or negative d-c terminals.

The instrument is small and light, weighing just 18 lb, and is enclosed in an all-metal case with carrying strap.

Model 711A is priced at \$225.

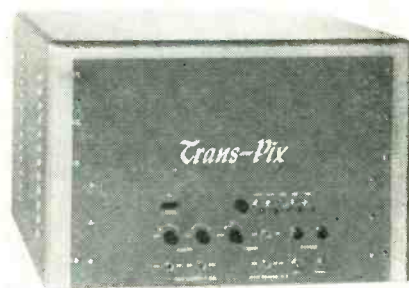

## COLOR TV TRANSMITTER a low-power r-f type

KAY ELECTRIC Co., 14 Maple Ave., Pine Brook, N. J. Designed for use with antenna or cable, the new Trans-Pix covers the l-f tv channels and fulfills the color requirements of differential phase shift and envelope delay. Two models are available—model 25 with a 25-w output, and model 2 with a 2-w output. Both units may be used for black-and-white and color tv.

► **Some Specifications** — Video response is 4.5 mc ±1 db; picture carrier, 25 w peak power into 50 ohms; power input, approximately 600 w at 117 v 50/60 cps. There are 2 outputs, each at 1/2 power into 50-ohm antennas. A single 50 ohm dummy load for 1/2 power single antenna operation is provided.

The r-f specifications, except for the power output, apply to both models. Model 2 is priced at \$2,500; and model 25, \$6,950.

## DECADE POT DIVIDER gives direct ratio reading

INDUSTRIAL INSTRUMENTS, INC., Cedar Grove, N. J. Model DP-1 decade potentiometer contains two 10,000 ohm rheostats connected so as to maintain a total resistance of 10,000 ohms at all times. Resistance between the center and either end is variable from 0 to 10,000 ohms, while resistance between center and

# SCIENCE AND ENGINEERING

## AT LOCKHEED MISSILE SYSTEMS DIVISION



### THE OPERATIONAL APPROACH TO RELIABILITY

Scientists and engineers at Lockheed Missile Systems Division apply an operational approach to Reliability in all phases of missile systems research, development and operation.

Under the Lockheed philosophy of Reliability, scientists and engineers combine their talents to study: human factors; training; design and operational safety; ground support and maintenance systems; airborne systems reliability; statistical methods; components application, including electronic, electrical, electromechanical and mechanical systems and environmental conditions.

Those possessing a high order of ability applicable to these areas of endeavor are invited to write:

Dr. Richard R. Carhart, Carl D. Lindberg, Reliability Staff Dept. Engineer, and Dr. G. B. Moan evaluate the functional and operational reliability effects of proposed revisions in the electrical power supply of a missile.

*Lockheed*

MISSILE SYSTEMS DIVISION

*research and engineering staff*

LOCKHEED AIRCRAFT CORPORATION

VAN NUYS, CALIFORNIA

# KEARFOTT FILLS THE BILL

AIRCRAFT AND MISSILE CONTROL SYSTEMS  
BILL OF MATERIAL

ITEM	PURCHASE FROM
✓ GYROS	KEARFOTT
✓ SYNCHROS	KEARFOTT
✓ SERVO MOTORS	KEARFOTT
✓ PRECISION TACHOMETERS	KEARFOTT
✓ MECHANICAL COMPUTER COMPONENTS	KEARFOTT
✓ INDICATORS	KEARFOTT
✓ PRECISE GEAR TRAINS	KEARFOTT
✓ AMPLIFIERS	KEARFOTT

REMARKS:  
*Specify KEARFOTT for all Servo System Components and Gyros!*

Long years of experience in the development and production of precision servo system components enables Kearfott to offer you the *right* component for every function in your servo system. Kearfott components are available in a wide range of miniature and sub-miniature sizes, light weights and high accuracies. Many components are suitable for high temperature applications. Engineering data sheets fully describe the many Kearfott Components in production.

Send for Bulletin describing components of interest to you.

**ENGINEERS**

Many opportunities in the field of precision components and systems are open. Write for details today.



A SUBSIDIARY OF GENERAL PRECISION EQUIPMENT CORPORATION

**KEARFOTT COMPANY, INC., LITTLE FALLS, N. J.**

Sales and Engineering Offices: 1378 Main Avenue, Clifton, N. J.  
Midwest Office: 188 W. Randolph Street, Chicago, Ill. South Central Office: 6115 Denton Drive, Dallas, Texas  
West Coast Office: 253 N. Vineta Avenue, Pasadena, Calif.

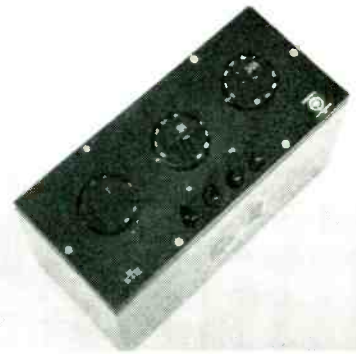

opposite end makes up the difference to total 10,000 ohms.

► **Ratios**—Switches are in ratio steps of 0.001, 0.01 and 0.1, providing ratios of 0.000 to 1.000 in steps of 0.001. Ratios are guaranteed to  $\pm 0.1$  percent at all settings above 0.01. The ratio is indicated directly on the dials of the decades at all times.

Resistors employed are bifilar wound and adjusted to  $\pm 0.05$  percent. Step switches are self-cleaning with phosphor bronze spring wipers and detent mechanism for positive location of switch points.

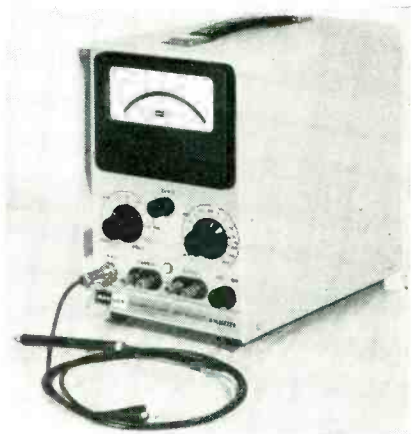

## MICROVOLT-AMMETER is chopper stabilized

KAY LAB, 5725 Kearney Villa Road, San Diego 12, Calif. Model 203 is a combination d-c microvoltmeter, microammeter and amplifier. Chopper circuitry provides high sensitivity with drift-free stability and high input impedance.

► **Wide Range**—Fifteen voltage ranges cover from 100  $\mu\text{v}$  full scale to 1,000 v full scale and 10 current ranges cover from 100  $\mu\text{a}$  full scale to 100 ma full scale. The uncluttered zero-center meter face instantly indicates polarity on two

# Make the rich Mid-Lantic Territory Your Target . . .

**PENNSYLVANIA · NEW JERSEY · DELAWARE**  
**MARYLAND · VIRGINIA · DISTRICT OF COLUMBIA**

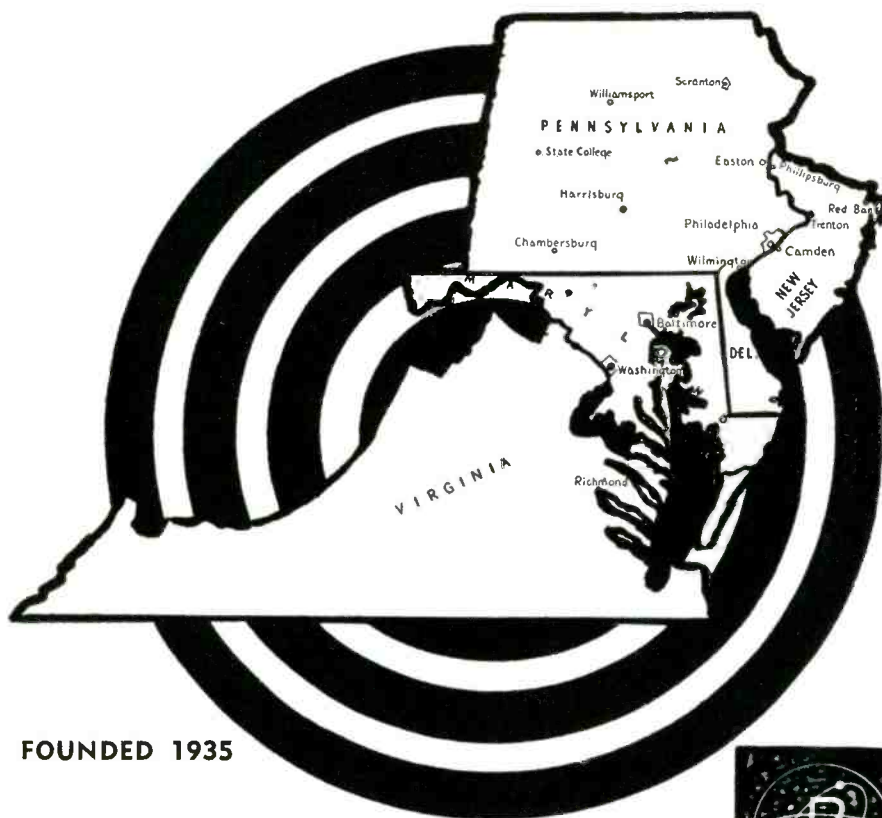

**FOUNDED 1935**

*Sales Engineering Service To The Electronic Industry*

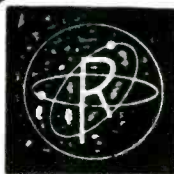

## MID-LANTIC CHAPTER "The Representatives"

**of ELECTRONIC PRODUCTS MANUFACTURERS, INC.**

*for information, contact any of the above members*

**ANDCO SALES-ENGINEERING**  
5823 Green St., Phila., Pa.

**J. ALAN BIGGS & CO.**  
Box 450, Doylestown, Pa.

**BOENECKE ASSOCIATES**  
638 Penn St., Camden 2, N. J.

**EDWARD H. BRAUTIGAM**  
4141 Stirling St., Phila. 35, Pa.

**BROOKFIELD & COMPANY**  
53 Cricket Ave., Ardmore, Pa.

**RICHARD J. COOPER**  
3507 Wellington St., Phila., Pa.

**W. HENRY CORDRAY SALES CO.**  
18 W. Chelton Ave., Phila., Pa.

**DANCO CORP.**  
Germantown Pike & Quarry Hall Rd.,  
Fairview Village, Pa.

**E. J. EDMUNDS**  
101 N. Lexington Ave., Havertown, Pa.

**H. J. FAIRBANKS CO.**  
1615 Darby Rd., Havertown, Pa.

**ANDREW A. FOLEY**  
640 Federal St., Camden 3, N. J.

**MARTIN FRIEDMAN**  
1008 Western Saving Fund Bldg., Phila. 7, Pa.

**DAVID HUMES, SALES**  
7416 Shisler St., Phila. 11, Pa.

**J-H ELECTRONIC SALES CO.**  
7101 Copeleigh Rd., Baltimore 12, Md.

**SAMUEL A. JEFFRIES**  
105 Forrest Ave., Narbeth, Pa.

**KEEFE ELECTRONIC SALES CO.**  
Haddon and Kedman Aves., Haddonfield, N. J.

**LEBAN & GRAHAM**  
1412 Manor Rd., Phila. 31, Pa.

**CHAS. W. LIENAU & CO.**  
9427 Georgia Ave., Silver Spring, Md.

**L. D. LOWERY, INC.**  
50 E. Wynnewood Rd., Wynnewood, Pa.

**SAMUEL K. MACDONALD, INC.**  
1531 Spruce St., Phila. 2, Pa.

**J. A. MAGUIRE & COMPANY**  
116 No. 7th St., Camden 2, N. J.

**HAROLD A. MOYER**  
P. O. Box 14, Haddonfield, N. J.

**JAMES C. MUGGLEWORTH**  
324 Haddon Ave., Collingswood 7, N. J.

**L. PARKER NAUDAIN**  
Rm. 230 Suburban Sta. Bldg., Phila. 3, Pa.

**C. H. NEWSON & ASSOCIATES**  
150 Terminal Ave., Phila. 18, Pa.

**PARAGON SALES COMPANY**  
111 S. 22nd St., Phila. 3, Pa.

**R. T. PEARSON SALES**  
1125 Old York Rd., Abington, Pa.

**FRANK J. PERNA**  
2015 Chestnut St., Phila. 3, Pa.

**D. G. QUINLAN CO.**  
4700 Frankford Ave., Phila. 24, Pa.

**KEN RANDALL CO.**  
121 N. Broad St., Phila. 7, Pa.

**GEORGE A. SHELPS**  
1625 Spruce St., Phila. 3, Pa.

**JOHN T. STINSON CO.**  
219 Saganore Rd., Havertown, Pa.

**ARTHUR J. STOBART**  
56-14 Revere Rd., Drexel Hill, Pa.

**C. H. STRATTON COMPANY**  
7852 Montgomery Ave., Phila. 17, Pa.

**MORRIS F. TAYLOR CO.**  
9431 Georgia Ave., Silver Springs, Md.

**TECHNICAL REPRESENTATION**  
Suite 200, 25 S. Easton Rd., Glenside, Pa.

**WILMER S. TRINKLE**  
545 Cooper St., Camden 2, N. J.

**HARRY J. WHITE CO.**  
1839 W. Albanus St., Phila. 41, Pa.

**ROBERT L. WILKINSON, INC.**  
707 Stevenson Lane, Towson 4, Md.

**VICTOR W. WILLIAMS**  
5 Circle Drive, Margate, N. J.

**AUSTIN L. WRIGHT**  
33 E. Golf View Rd., Ardmore, Pa.

# FOR *the scientist or engineer who has more to offer...*

## A limited number of positions of unusual responsibility

IBM, long a leader in the growing field of digital computers for business, science, and government, offers a limited number of long-range creative assignments to outstanding men with Master's or Doctor's Degrees in Electrical Engineering, Physics, Mathematics, Chemistry or Physical Chemistry.

- **Research in solid state materials**
  - Investigation of electronic phenomena in solids
  - Study of ferrite and semi-conductor characteristics
  - Study of the role of surface effects in semi-conductor device characteristics
  - Evaluation of sample semi-conductor or ferrite components
- **Development of new concepts, new approaches to internal handling of information in computer systems**
  - Information Theory
  - Research in Machine Organization
  - Theory of Control of Digital Devices
  - Switching Circuit Theory
  - Digital Data Transmission
- **Circuit Design, Systems Design and Analysis**
  - Electronic pulse circuits for accounting and data processing machines—arithmetic switching and logical circuitry—pulse amplifiers, shapers, gates, etc.—magnetic storage—transistor circuitry—input-output device controls.

## If you have more to offer, IBM offers you

- **Stimulation . . . Satisfaction**  
At IBM men find the kind of facilities, associates and climate which stimulate achievement.
- **Professional Growth**  
In Company growth lies personal opportunity, and IBM has an enviable record of steady and consistent growth. Over the past quarter century, IBM's business has doubled

every five years on the average. Out of respect for the unusual man's talent and promise, IBM encourages qualified candidates to visit its Poughkeepsie, N. Y. laboratory—at their convenience, and IBM's expense. Write, outlining your qualifications, to: William M. Hoyt, International Business Machines, Room 402, 590 Madison Avenue, New York, N. Y.



*Producer of electronic data processing machines, electric typewriters, and electronic time equipment.*

mirrored scales which cover all ranges. The instrument is capable of measuring as little as 10  $\mu\mu$  full scale. The amplifier has a maximum gain of 80 db.

The unit is ideally suited for transistor circuit development, research and production. Price, complete with probe, is \$550.



## ZOOM LENS for use with Vidicon tube

THE PERKIN-ELMER CORP., Norwalk, Conn. Model 16TV Auto-Zoom, a motor-driven zoom lens with a 5-1 focal length range, has been designed for use with the Vidicon tube. It can focus on any object from 6 ft to infinity, with lens speed varying from  $f/2.7$  to  $f/4.7$ .

The motor-driven zoom, focus and aperture setting of the lens may be controlled at any distance from the camera.

► **Uses**—The lens will find wide use in industrial and noncommercial applications such as observation of hazardous areas, production line monitoring and educational uses. In commercial tv it is useful for sports events, news coverage, and special and remote pickups.

Overall dimensions of the lens, including motors but not control box, are 9 in. long by 5 in. in diameter. Weight is approximately 6 lb.

## ALL-PURPOSE RELAY for aircraft and mobile use

OHMITE MFG. Co., 368 Howard St., Skokie, Ill. Model D0 general-purpose relay has a maximum con-

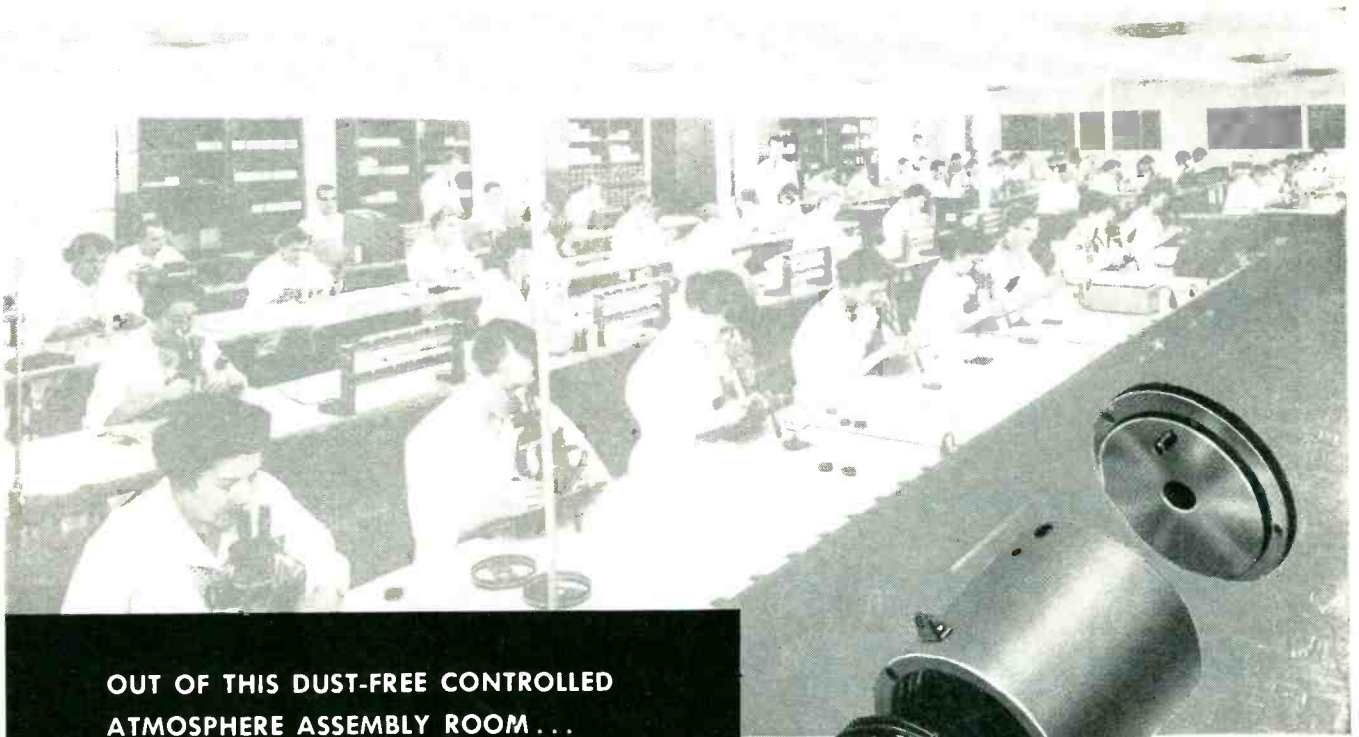

OUT OF THIS DUST-FREE CONTROLLED  
ATMOSPHERE ASSEMBLY ROOM . . .

## A big advance in hi-precision 10-turn potentiometers



priced far  
below anything of  
comparable quality  
**\$12.00** in lots of 1 to 25.  
Quantity discounts above 25 units.

### SPECTROL Hi-Precision Model 800



### QUALITY FAR BEYOND ANYTHING OF COMPARABLE PRICE

Standard Linearity  $\pm .3\%$  (as close as  $\pm .025\%$  available)  
Standard Resistance Tolerance  $\pm 3\%$   
Standard Resistance Range  $500\Omega$  to  $400 K\Omega$   
(Resistance Tolerance as close as  $\pm .5\%$  available)

Cost advantages are not made by short-cuts at Spectrol. Design and production knowhow make the cost savings. Every potentiometer is produced under the same hi-standard conditions—from precision winding to the rigid quality-controlled final assembly.

That's why the 10-turn Model 800 provides accuracy which out-classes others at comparable cost—and in addition to closer electrical tolerances—offers other quality features like

machined aluminum lids, precision-ground shafts, and dimensionally stable laminated phenolic housings.

Versatile, accurate, reliable over a long life—available in volume quantities—immediate delivery from stock—the Model 800 is a great advance.

Write or call for more details about the wide variety of special features available—and about Spectrol's miniature and single turn potentiometers—today.

# SPECTROL

### Electronics Division of Carrier Corporation

1704 South Del Mar Avenue, San Gabriel, California

Write for catalog  
or contact your nearby  
Spectrol representative—

**ALBUQUERQUE, N.M.**  
Gerald B. Miller Co.  
**ARCADIA, CALIF.**  
Gerald B. Miller Co.  
**BELMONT, CALIF.**  
Gerald B. Miller Co.  
**BOSTON**  
Gerber Sales Co.

**CHICAGO**  
Knoblock & Malone  
**DAYTON**  
Robt. B. Burtner Co.  
**DETROIT**  
Electro-Mec  
Associates

**FT. WORTH**  
Thomson Eng.  
Service  
**HOLLYWOOD**  
Gerald B. Miller Co.  
**MINNEAPOLIS**  
Fred B. Hill Co.  
**NEW YORK**  
D. R. Bittan Co.

**PHILADELPHIA**  
Samuel K.  
MacDonald, Inc.  
**PITTSBURGH**  
Samuel K.  
MacDonald, Inc.  
**SAN DIEGO**  
Gerald B. Miller Co.  
**SEATTLE, WASH.**  
Seatronics

**ST. LOUIS**  
Thomson Eng.  
Service  
**SYRACUSE**  
Wally B. Swank  
**WASHINGTON, D.C.**  
Samuel K.  
MacDonald, Inc.

# Announcing ... HYSOL 6600

**An outstanding  
new epoxy casting  
resin for transformers  
for electronics, instru-  
ment transformers,  
power bushings and  
related equipment.**

Especially Developed for  
MIL-T-27A Specification

HYSOL 6600 is the result of over two years' development and evaluation in our own and government laboratories. In addition, it has been economically used in commercial transformer production with excellent results.

Write today for the HYSOL 6600 Technical Data Bulletin and samples.



Houghton Laboratories manufactures complete lines of Electrical Insulating Materials, Adhesives and Sealants, Tooling Materials, and cast products such as rod, sheet, and tube.

FIRST IN EPOXY COMPOUNDING

**HOUGHTON LABORATORIES, INC.**  
OLEAN, NEW YORK

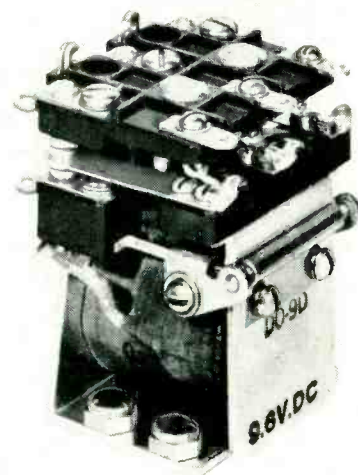

tact combination of four-pole, double-throw. It is particularly adaptable to aircraft and mobile equipment applications where severe shock and vibration are encountered.

► **Protection**—The contact and terminal insulation is of molded phenolic material. The design of the molded parts around the moving contact arms affords maximum protection against mechanical injury.

Contact rating is 10 amperes at 115 v a-c or 32 v d-c noninductive load.

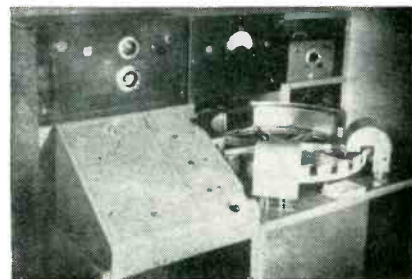

## PRODUCTION MACHINE tests capacitance

AMERICAN RADIO Co., 445 Park Ave., New York 22, N. Y., has announced an automatic production machine for measuring the temperature coefficient of ceramic dielectric capacitors. It features increased operating speed—a rate of 1 precision measurement every 40 seconds, extraordinary coefficient accuracy of 2 parts per million, and direct capacitance measurement exact within 0.0038  $\mu$ f.

► **How It Works**—Heart of the system is a compact analog computer



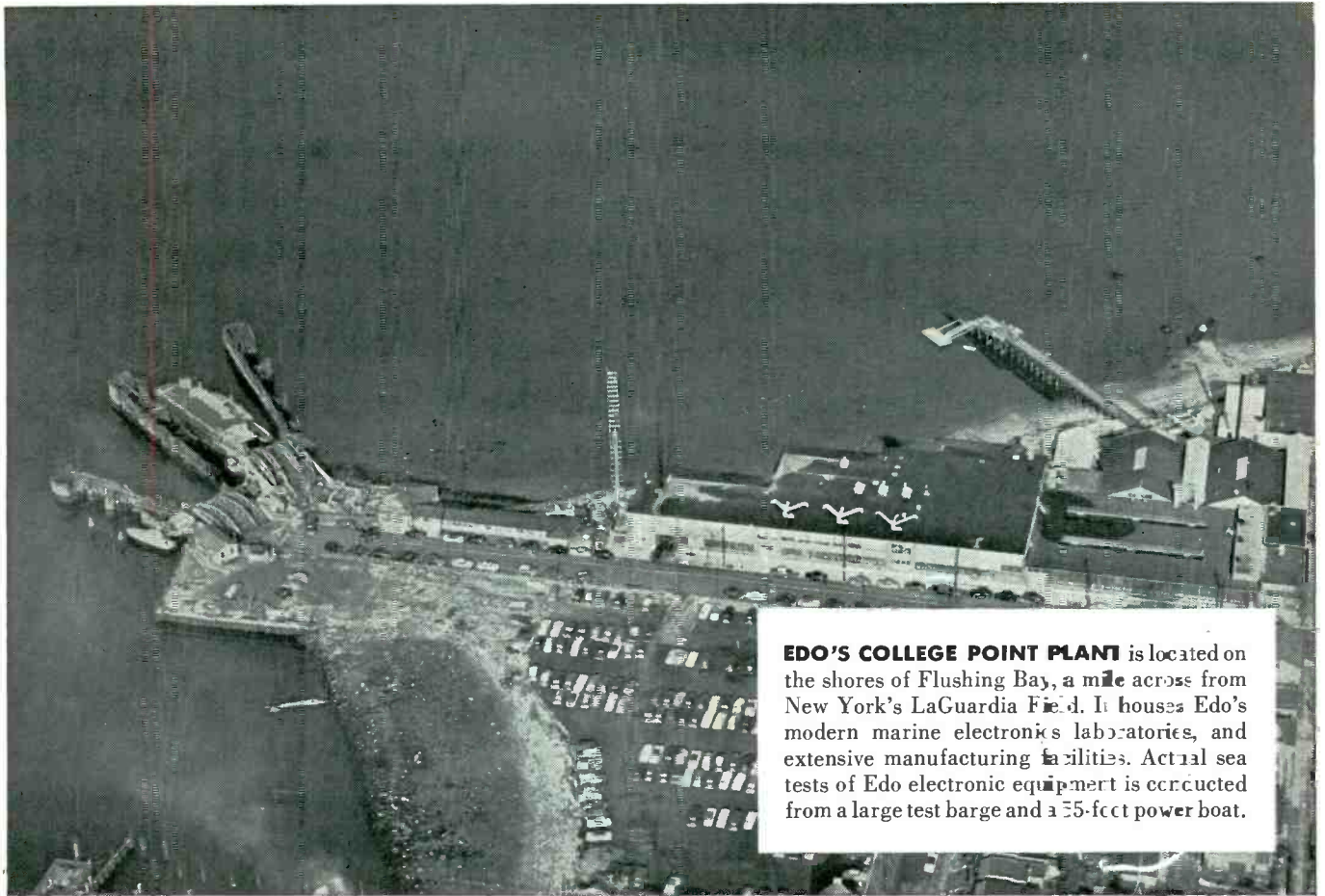

**EDO'S COLLEGE POINT PLANT** is located on the shores of Flushing Bay, a mile across from New York's LaGuardia Field. It houses Edo's modern marine electronics laboratories, and extensive manufacturing facilities. Actual sea tests of Edo electronic equipment is conducted from a large test barge and a 35-foot power boat.

## Miracle(s) at College Point have made EDO Marine Electronics Headquarters

Miracles in electronics—a steady stream of them—have marked Edo's emergence as headquarters for marine electronics development.

Out of Edo's well-equipped plant at College Point have come many *firsts* in marine electronics for a wide range of uses—both naval and commercial—to name a few:

- The first continuously indicating and recording deep depth sounder with a range of 6000 fathoms.
- Many new types of sonar equipment for surface ship and submarine use.
- The Edo Fishscope—the fish-finder that assures larger hauls in less time.
- Edo Loran—new, compact, direct-reading navigation equipment at moderate cost.
- Edo Radar—for smaller commercial boats, with patented slotted waveguide antenna.
- Edo Survey Depth Recorder—for accurate survey work.

These are but a few of the wide range of equipments developed and manufactured by Edo. Through their superior performance, accuracy, range and dependability, they have proved that the Edo flying fish emblem is the symbol of quality and satisfactory operation.



Edo has developed and manufactured all types of Sonar—echo-ranging, listening, and sounding.

**EDO CORPORATION** • COLLEGE POINT, L. I., N. Y.  Since 1925

# Parabolic MICROWAVE ANTENNAS

for all bands 2000 mc - 4000 mc

7000 mc  
X and K

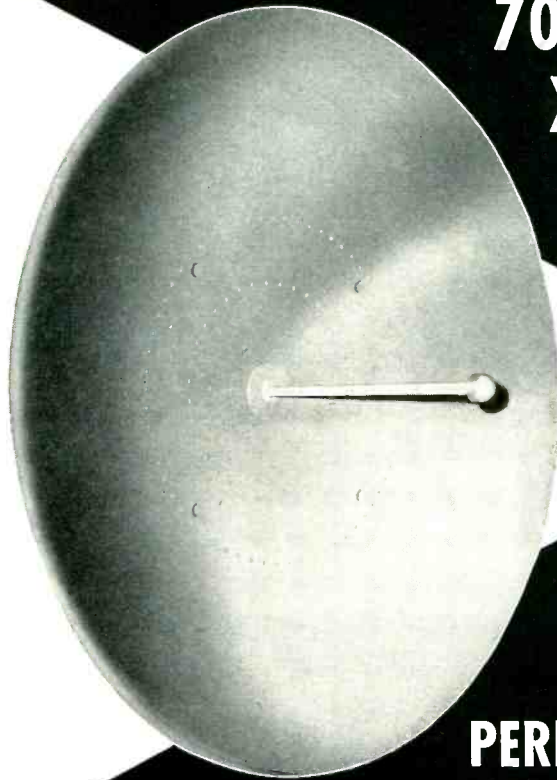

4000 mc antenna  
with Gabriel  
waveguide feed.

with these  
**PERFORMANCE  
ADVANTAGES**

- Low VSWR
- High gain
- Low side and back lobes
- Pressurized feeds
- All-weather dependability
- Ready adaptability to special service requirements

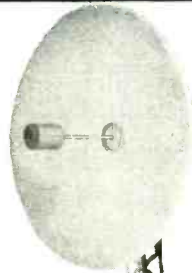

2000 mc antenna with dipole feed.

For every microwave application, Gabriel can furnish antenna equipment of proved efficiency and reliability. The experience and facilities of Gabriel Laboratories offer prompt, dependable solution of your antenna problems. And the manufacturing plant of Gabriel Electronics Division assures volume production to the Laboratories' performance specifications.

For analysis of your antenna or microwave problems, write us or telephone NEedham 3-0005 (through Boston).



**GABRIEL ELECTRONICS DIVISION**

THE GABRIEL COMPANY, Needham Heights 94, Massachusetts

operating as a capacitance meter to provide direct readings. An indexing turntable holding 24 units transports the capacitors to three measuring positions automatically, where they are cycled in 10-minute steps from 25 C ambient to 90 C back to 25 C. Heating is accomplished in a closely regulated tunnel-like oven covering the periphery of the turntable.

Less than 1 second after the capacitor is connected to the instrument, the capacitance is indicated on 2 dials. Maximum capacitance to be tested is 400  $\mu\text{mf}$ , and the maximum capacitance change during test is 10  $\mu\text{mf}$ .

## VARIABLE TRANSFORMER includes on-off switch

CONDENSER PRODUCTS Co., 140 Hamilton St., New Haven, Conn., has introduced a new variable transformer that controls input and output voltages. It is spot welded to the power supply and eliminates the need for a separate variable input transformer to control the input and output voltages.

Control dial on the transformer is calibrated in percentages of line voltage, rather than in voltage, to simplify operation.

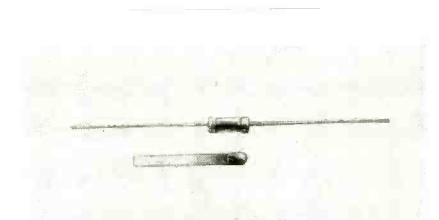

## CARBON FILM RESISTOR is glass-sealed unit

PYROFILM RESISTOR Co., INC., 8 Whippany St., Morristown, N. J. The PT500 glass-sealed carbon film resistor features extreme ruggedness, small size and high stability.

► **Features**—Stability is better than  $\pm 0.03$  percent per year at 0.25-w rating and derating to zero power at 140 C. Using 0.5-w rating, derating to zero at 160 C, stability is better than  $\pm 0.1$  percent in 1,000 hr.

► **Matched Networks**—The PT500 is particularly suited for use in

**quality  
glass-to-metal  
seals  
are as close  
to you  
as your . . . .**

Phone . . . Wire or Write us direct,  
for prompt delivery on high-quality  
glass-to-metal seals.

Constantin's proven designs, and  
progressive engineering staff  
coupled with 2-plant production facilities  
under one responsibility,  
will furnish you the finest quality seals  
used by the Electronic Industry.

*L.L. Constantin & Co.*  
MANUFACTURING ENGINEERS



Route 46, Lodi, New Jersey  
187 Sargeant Avenue, Clifton, New Jersey

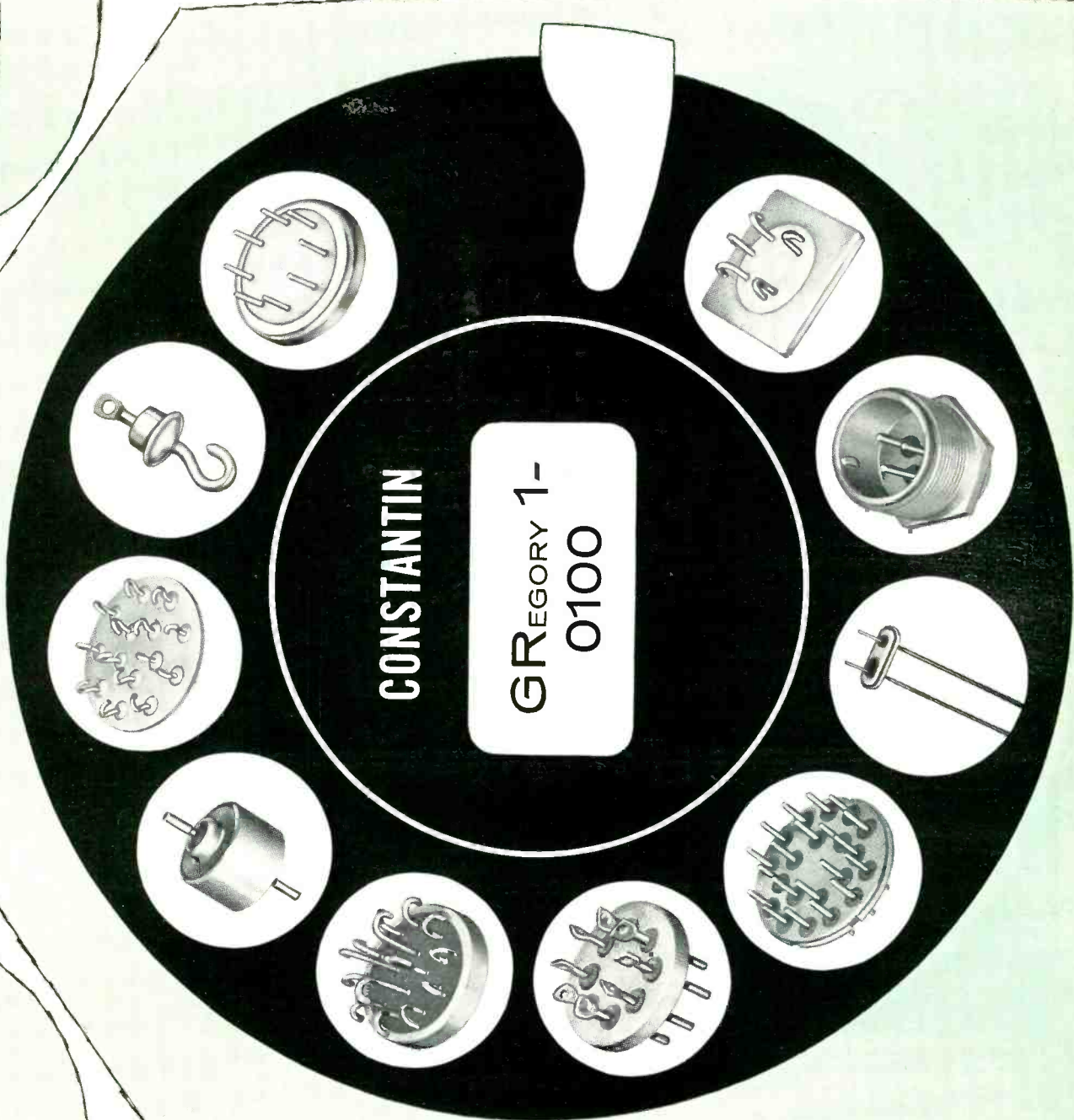

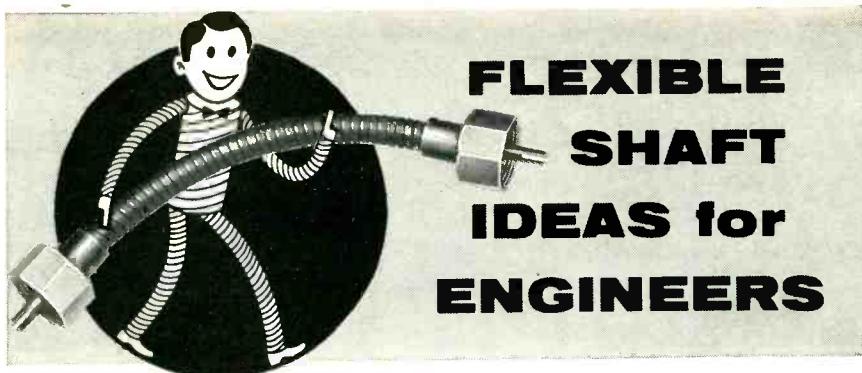

## Flexible Shafts are the key to many remote control problems

Space, operating and servicing requirements are readily met with S. S. White Metal Muscles®

MANY kinds of equipment contain internal elements which require more or less frequent adjustment from the outside. This comes under the heading of remote control.

There are various ways by which remote control can be accomplished. The simplest, of course, is to mount the element requiring control on the inside of the equipment case or housing with its shaft extending through for manual or automatic operation.

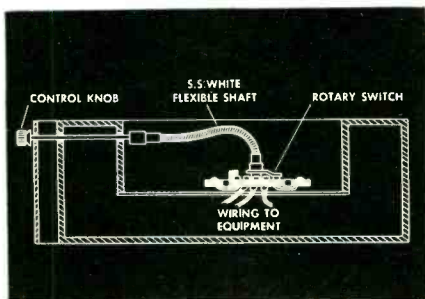

A flexible shaft used to control an inaccessible rotary switch. Note the 90° turn.

### Flexible Shaft Simplicity

However, such direct connection is frequently not feasible. Factors of space, circuit efficiency, ease of assembly and of servicing must be considered. This applies also to the selection of the method of control to use.

An S.S. White Remote Control Flexible Shaft makes it possible to satisfy these requirements in an extremely simple manner. In place of comparatively complicated gearing, universal joints and similar contrivances, a single self-contained, easily applied flexible shaft does the trick.

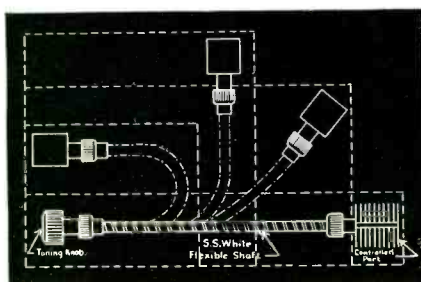

Meeting varying space requirements is easy with a flexible shaft.

### Design Freedom

But simplicity is only one advantage the flexible shaft offers for remote control. Perhaps its most valuable advantage is the freedom it gives the designer in locating the controlled element and its control knob or dial.

*The flexible shaft permits the form to be placed wherever desirable to secure top equipment efficiency, ease of assembly, space saving and convenient servicing. At the same time it allows the control to be mounted in the most convenient operating position.*

Another big advantage is the fact that it eliminates the need for accurate alignment of connected parts.

### FLEXIBLE SHAFT DATA

Bulletin 5601 has concise information on how to select and apply flexible shafts. Send for a copy.



matched networks. Small size and completely self-insulating features permit close spacing. Ruggedness is achieved by a hard borosilicate glass envelope that is fusion-sealed to the end caps.

The PT500 is available in sets with temperature coefficients matched to 1 ppm per deg C for high precision use over wide temperature ranges. Mounting may be done on leads capable of withstanding up to 15-lb pull. Actual size is  $\frac{1}{8}$  in. diameter by  $\frac{1}{8}$  in., measured the length of the resistor.

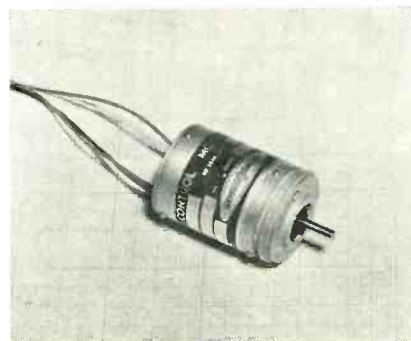

## SERVO MOTOR for high temperature use

SERVOMECHANISMS, INC., 625 Main St., Westbury, N. Y., announces the type 171 Class H 400-cycle servo motor. The 3-oz motor, which measures  $1\frac{1}{8}$  in. in diameter, is capable of withstanding continuous class H operating temperatures.

► **Life Expectancy**—The motor is designed for a minimum life of 1,000 hr of continuous operation at 150 C ambient temperature. Early tests indicate an expected life of 200 hr continuous operation at an ambient temperature of 180 C.

The motor is ideal for use in high-speed aircraft and missile applications.

## INSULATING PARTS made by new method

EPM CORP., 570B Van Sicken Ave., Brooklyn, N. Y., introduces a new inexpensive method of producing coil forms and insulating parts from  $\frac{1}{8}$  in. to 1 in. in diameter at a fraction of the cost of standard molding methods. The technique eliminates the need for expensive

F5-1

# S.S. White

**FIRST NAME**
**IN FLEXIBLE SHAFTS**

S. S. WHITE INDUSTRIAL DIVISION, DEPT. E, 10 EAST 40th ST., NEW YORK 16, N. Y.  
Western Office: 1839 West Pico Blvd., Los Angeles 6, Calif.

# Completely Automatic!

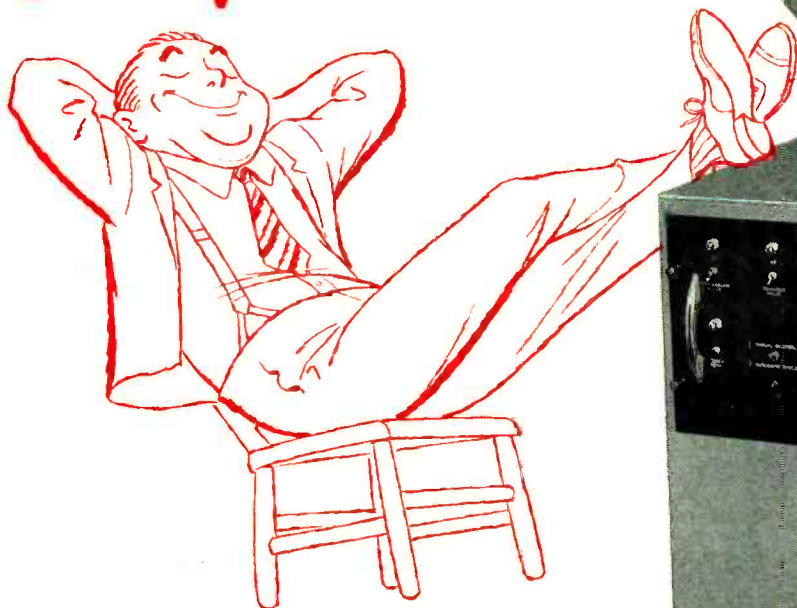

KINNEY MODEL CRS 48

## CATHODE RAY TUBE ALUMINIZER

Kinney's new compact Model CRS 48 Cathode Ray Tube Aluminizer offers completely automatic operation. This is accomplished through the use of a linear adjustment timer which can be quickly and easily readjusted to meet specific cycle requirements. The high vacuum pumps are matched to insure minimum cycle time. Other features include:

- **Simple change-over switch for manual operation when desired**
- **Regulated air admission through hollow electrode**

- **Sliding panel containing all controls**
- **Electrical operation of all components to eliminate need for compressed air**
- **Protection from glass particles and dirt of all internal parts by unique unit design**

Request complete technical data on this amazing new aluminizer. District offices in Boston, New York, Philadelphia, Cleveland, Chicago, and Los Angeles are competently staffed to discuss *all* your vacuum problems . . . and to give you full details on this new product. Call or write us today!

**KINNEY** MFG. DIVISION  
 THE NEW YORK AIR BRAKE COMPANY  
 3565 WASHINGTON STREET • BOSTON 30 • MASS.  
 INTERNATIONAL SALES OFFICE, 90 WEST ST., NEW YORK 6, N. Y.



Our Vacuum problem involves .....

Name .....

Company .....

Address .....

City ..... State .....

ACCURACY! ACCURACY! ACCURACY!  
**HERE'S THE POT THAT  
 COULDN'T BE BUILT**



**NEW  
 M10T**



Over two years ago TIC's design engineers undertook a supposedly impossible project — design of an ultra-precision potentiometer adaptable to mass production. Old techniques and designs were discarded . . . new methods and concepts were pioneered . . . advanced production methods were developed. And the result, the all-new 10-turn M10T with unmatched electrical accuracy and mechanical precision.

Custom design for precision computer, servomechanisms and electro-mechanical instrumentation service, the wound coil, multiturn M10T provides the extreme electrical accuracy and stability required by these systems. Winding techniques, specially developed for the M10T, make possible linearities of 0.025% and lower. Special resistance wire permits a  $\pm 1\%$  accuracy of total resistance . . . high temperature stability with a 0.002% per degree C temperature coefficient of resistance. Wide temperature range ( $-55^{\circ}\text{C}$  to  $+85^{\circ}\text{C}$ ) . . . high dielectric strength . . . low equivalent noise resistance . . . and high leakage resistance are other M10T features in-built for maximum electrical performance.

Extremely precise mechanical tolerances — shaft diameter, concentricity, and perpendicularity — assure complete transfer of M10T accuracy to external systems. Universal mounting surface offers choice of servo or precision-pilot and tapped-hole mounting. Spring loaded, stainless steel ball bearings eliminate radial and end play of the shaft . . . reduce running torque to 1.0 oz.-in.

New design concept places all functional parts of M10T in a one-piece unit. Stainless steel cover bonded to the one-piece base provides complete environmental protection. External surfaces are all corrosion-resistant stainless steel or anodized aluminum. The M10T has been thoroughly tested to pertinent military specifications.

*Complete specifications on the new TIC Type M10T are available upon request.*

molds heretofore required. The use of polyester, epoxide, Nylon, Teflon and many other materials is made possible because of the unique design of manufacturing.



**AN-TYPE CONNECTOR**  
 in any pin configuration

HERMETIC CONNECTOR CORP., 176 Walnut St., Bloomfield, N. J., has developed a new, more rugged AN-type connector for use where glass-to-metal hermetic sealing is required. Any pin configuration desired is available, while they can be obtained in sizes ranging from 8 STD 32.

The connectors are particularly useful in higher and lower temperature applications, or where pins must be more rugged or where vibration is a factor.

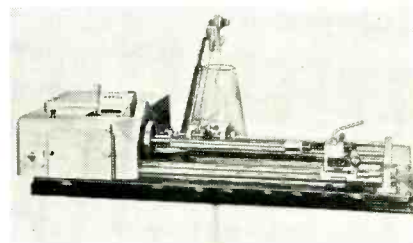

**12-IN. SPACE WINDER**  
 with instant resettability

GEO. STEVENS MFG. CO., INC., Pulaske Rd. at Peterson, Chicago 30, Ill., has available a new 12-in. space winder featuring a fingertip pressure carriage release button which permits instant resetting to identical starting point at the end of each winding cycle.

Model 431-AM has screw feed and a no-slippage driven tailstock

**TECHNOLOGY INSTRUMENT CORP.**

533 Main Street, Acton, Mass. COLonial 3-7711  
 West Coast Mail Address Box 3941, No. Hollywood, Calif. POplar 5-8620

# For increased reliability in FREQUENCY SHIFT reception specify NORTHERN RADIO . .



## VARIABLE MASTER OSCILLATOR

- Long-time stability 1 cycle per megacycle
- Variable to ANY frequency from 2 to 4 mc within 1 part per million

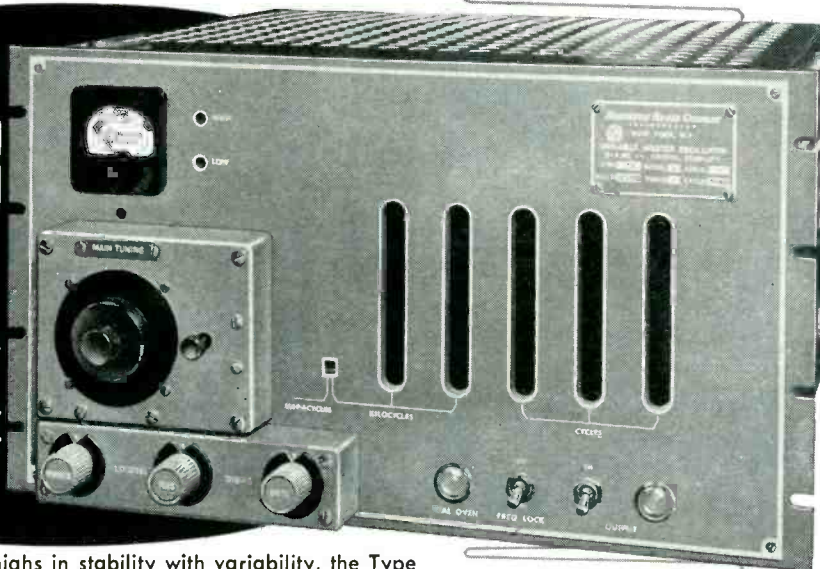

In addition to accomplishing these new highs in stability with variability, the Type 173 Model 1 is so easy to operate that it can be handled by completely unskilled personnel: frequency is continuously displayed.

It is excellent as the basic control oscillator for diversity receivers, HF transmitters, and other communication devices, or as a laboratory standard. It also provides both a crystal-controlled BFO and a time base 100 kc crystal oscillator as a secondary standard; stability of the latter is 1 part in 5 million. The power supply for this model is housed in a separate panel.

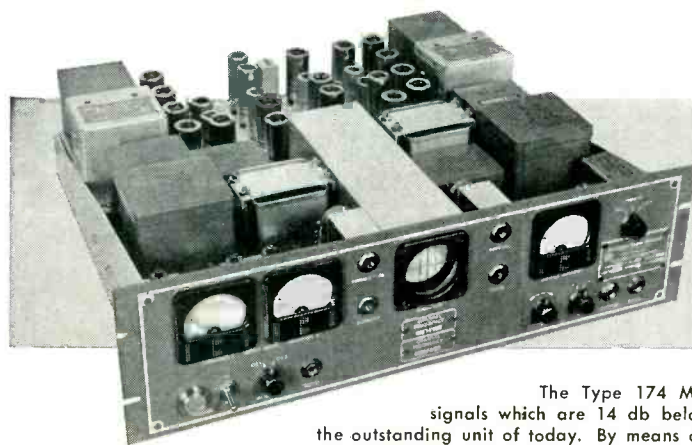

## NEW! FREQUENCY SHIFT DIVERSITY CONVERTER

- for use with either single-receiver frequency diversity systems or two-receiver space diversity systems

The Type 174 Model 1 provides solid copy of signals which are 14 db below white noise level—making it the outstanding unit of today. By means of plug-in units, any reasonable number of channels is available between the frequencies of 425 and 3315 cps for either frequency or space diversity operation. For standard FS operation, the plug-in networks provide shift adjustments from 100 to 1000 cps shift. Normal Input Level: -40 to +10 VU (Zero VU = 1 MW into 600 ohms). Satisfactory operation on fades to -60 VU.



Pace-Setters in Quality Communication Equipment

### NORTHERN RADIO COMPANY, inc.

147 WEST 22nd ST., NEW YORK 11, NEW YORK

In Canada: Northern Radio Mfg. Co., Ltd., 1950 Bank St., Billings Bridge, Ottawa, Ontario.

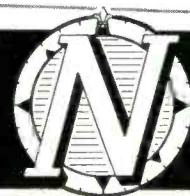

Write  
for  
complete  
information.

- Frequency Shift Keyers
- Master Oscillators
- Diversity Receivers
- Frequency Shift Converters
- Multi-Channel Tone Systems
- Tone Keyers
- Demodulators
- Monitors
- Radio Multiplex Systems
- Tone Filters
- Line Amplifiers
- Twinplex Equipment

Want more information? Use post card on last page.

**marion**  
advancement  
in instrument  
design

**WHAT  
HAPPENED  
?**

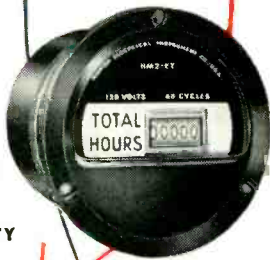

**SCHEDULE  
MAINTENANCE  
STUDY  
PRODUCTIVITY**

Glass-to-metal sealed ELAPSED TIME indicators. Compact, low cost, tamper-proof. Standard ASA-MIL dimensions, 2½" and 3½" sizes. Easy to read standard size counter registers 1/10 hour steps to 9999.9 or hour steps to 99999. Hermetically sealed. Shielded. Starts, operates continuously from -55° C. to +85° C. For 110-125 or 220-250 volt 50 or 60 cycle A.C.



Visit Us At Booth #556  
At The I.R.E. Show.

**marion meters**

marion electrical  
instrument company



GRENIER FIELD, New Hampshire's NEW Air-Industry Area  
MANCHESTER, N. H., U. S. A.

copyright 1965 M. E. I. Co

which entirely prevents strips and flexible forms from twisting during winding. The machine winds space-wound resistors, distributed-constant delay lines, heating element coils and straight wound potentiometers up to 4 in. o-d.

► Specifications — Maximum traverse for any single continuous winding is 12 in. Winding range is from 22 turns per in. to 1,520 turns per in. Winding speed is up to 6,500 rpm in the fine-wire high-speed range and up to 4,500 rpm in the low-speed high-torque range. One model T-2 tension is furnished for single winding, handling wire gages 20 to 44 on spools up to 4½ in. diameter.

Price is \$1,115.

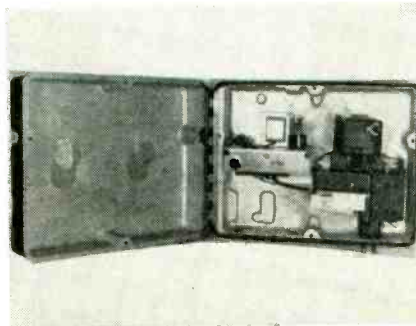

**LEVEL CONTROLLER**  
electronic and pneumatic

FIELDEN INSTRUMENT DIVISION, Robertshaw-Fulton Controls Co., 2920 N. Fourth St., Philadelphia 33, Pa. The Pneutronic level control utilizes the accuracy of electronic capacitance sensing elements to detect minute changes in levels in tanks, drums, process baths, pipelines and other conveyors. Electronic signals are then converted by the Pneutronic control into proportional pneumatic output.

Eliminated are servo motors and other rebalance mechanisms. The closed-loop control is largely unaffected by external changes in voltage, air supply, temperature and pressure.

► Uses—The level control will find broad utilization in the petroleum, chemical, food processing and other basic industries where accurate control of level and flow are important. For use in hazardous locations, the device is available in

**VULCAN**  
ELECTRIC HEATING UNITS

**On Airplanes**



in high altitudes and sub-zero temperatures, Vulcan Electric Heating Units hold lubricants in a liquid state.

They're used also as anti-potators in thermostatic control: in guided missiles and in speed indicators.

Vulcan electric heat is helping out in many new inventions for both war and peace. To assist in the further development of your ideas, Vulcan heating designers will be glad to join their know-how to yours.

See 8-page Vulcan catalog  
in Sweet's Product Design  
File for 1955

**VULCAN**  
ELECTRIC COMPANY  
DANVERS 10, MASS



**SPADE  
BOLTS**

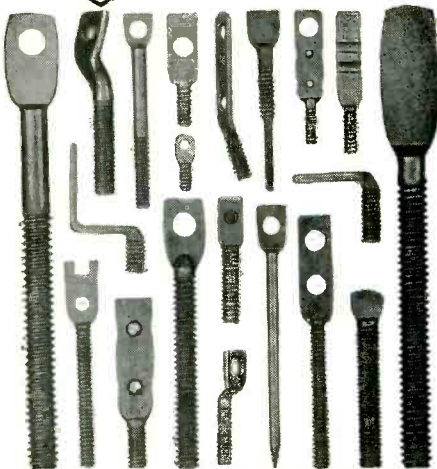

Specialists in designing and manufacturing of all-purpose fasteners and wire forms. Tooled to produce over 1000 styles in any screw size, material, finish, quantity, to your specifications.

Serving Industry for Thirty-five Years  
— OTHER PRODUCTS —

**Simplex**  
WIRE STRIPPERS & CUTTERS

• TOOLS • DIES • STAMPINGS  
Bulletins on complete line upon request

**WENCO MANUFACTURING CO.**  
1133 W. Hubbard St., Chicago 22, Ill., U. S. A.

**STAVOLT**  
POWER  
RECTIFIERS

30  
Standard  
U. L. Approved  
Models

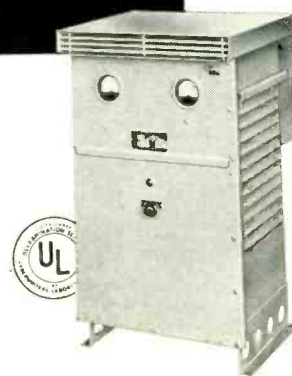

- Stationary or Mobile Types
- For Hangars, Air Fields, Missiles
- For Factories and Labs

Mag-Amp Control, Stable, Fast  
15 to 1500 amps

Write for interesting information  
on STAVOLT RECTIFIERS

**McCOLPIN-CHRISTIE CORP.**  
27th Year of Rectifier Manufacturing  
3410 W. 67th St., Los Angeles 43, Calif.



# HE CAN CHECK VIDEO ANYWHERE

## HE HAS A **NEW VIDEO TRANSMISSION TEST SET**

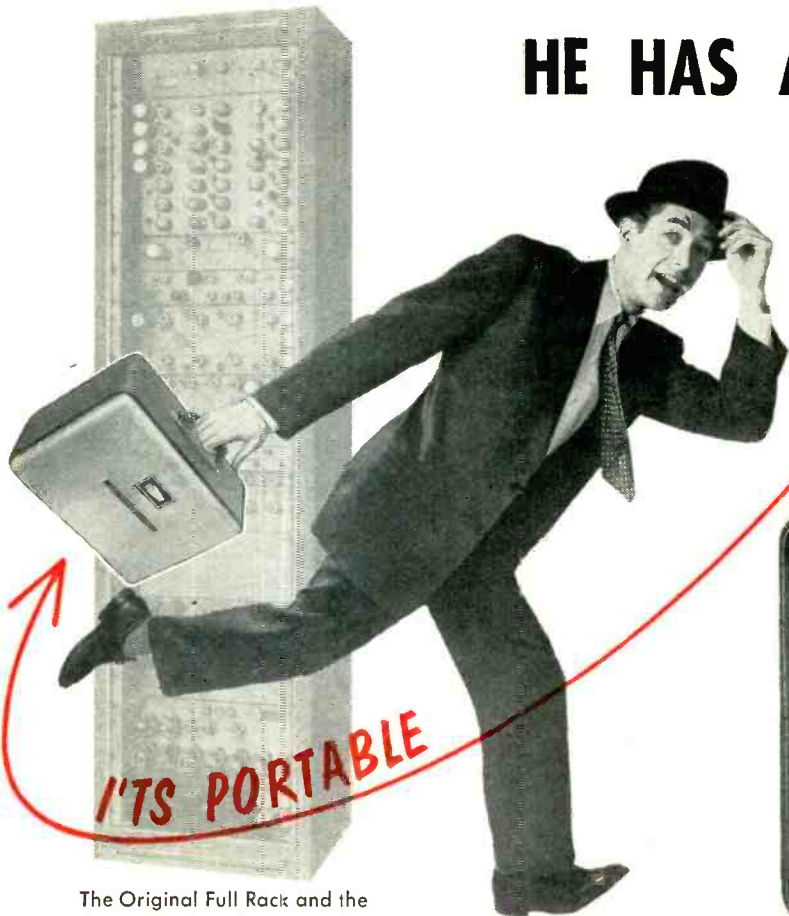

**IT'S PORTABLE**

The Original Full Rack and the Portable Unit Produce the same Precise Test Signals.



### **TELECHROME** Model 1003-A Video Transmission Test Signal Generator

- ★ Completely self contained
- ★ Portable
- ★ Multi-frequency burst
- ★ Stair-step
- ★ Modulated stairstep
- ★ White window
- ★ Composite sync
- ★ Regulated power supply.

Now, Telechrome Video Transmission Test Equipment is available as a completely portable 12 1/4" standard rack mounting unit.

Everyday these Test Signals generated by Telechrome equipment, are transmitted Coast-to-Coast by NBC, CBS, ABC, the Bell System, Canadian Bell and leading independent TV stations throughout the U. S. and Canada. Hundreds of network affiliated TV stations and telephone TV centers thus check incoming video signals.

The compact, inexpensive, portable Model 1003-A is all that is required to generate signals for local and remote performance checking of your entire video, cable, or micro-wave facilities.

1521-A OSCILLOSCOPE CAMERA  
—Polaroid type for instantaneous 1 to 1 ratio photo-recording from any 5" oscilloscope.

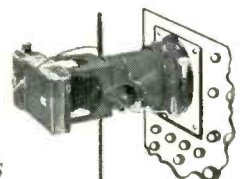

**DELIVERY 30 DAYS**

Literature on these and more than 150 additional instruments for color TV by TELECHROME are available on request.



The Nation's Leading Supplier of Color TV Equipment  
88 Merrick Road Amityville, N. Y.  
AMityville 4-4446

**MULTI-FREQUENCY BURST**

AMPLITUDE vs FREQUENCY. Check wide band coaxial cables, microwave links, individual units and complete TV systems for frequency response characteristics without point to point checking or sweep generator.

**WHITE WINDOW**

LOW & HIGH FREQUENCY CHARACTERISTICS. Determine ringing, smears, steps, low frequency tilt, phase shift, mismatched terminations, etc. in TV signals or systems.

**STAIRSTEP SIGNAL** modulated by crystal controlled 3.579 mc for differential amplitude and differential phase measurement. Checks amplitude linearity, differential amplitude linearity and differential phase of any unit or system.

Model 608-A HI-LO CROSS FILTER for Signal analysis.

**MODULATED STAIRSTEP** signal thru high pass filter. Checks differential amplitude.

**MODULATED STAIRSTEP** signal thru low pass filter. Checks linearity.

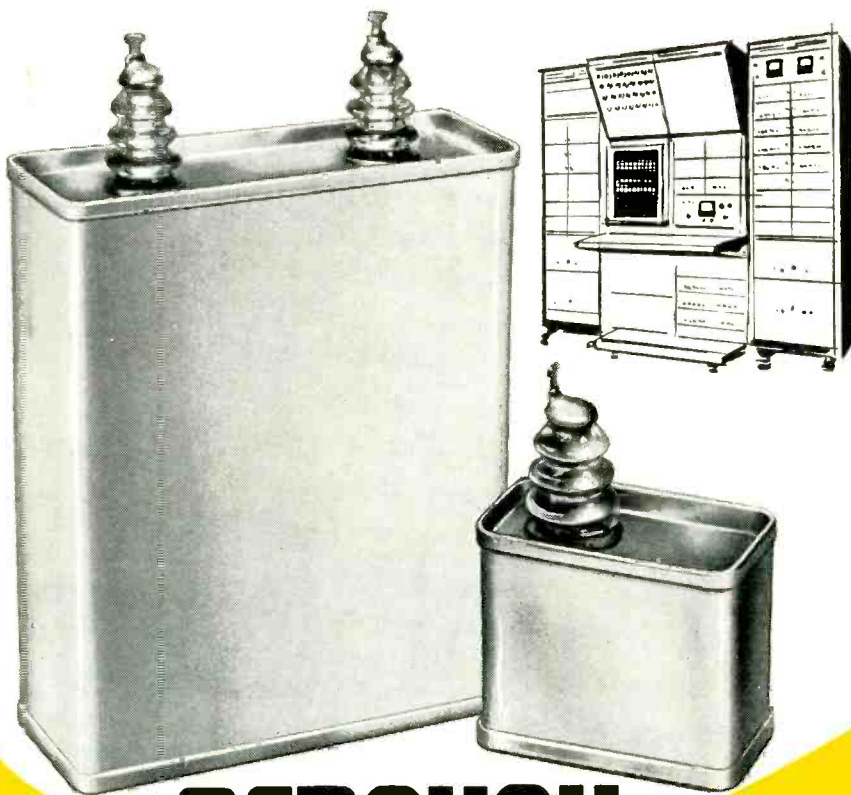

# AEROVOX

## Polystyrene

### CAPACITORS

For computing devices, tuned circuits demanding highest Q standards, capacitance bridges, timing circuits, lab standards, circuits requiring low dielectric absorption, and similar critical applications.

**OFFERING HIGH INSULATION RESISTANCE . . .** Designed to take full advantage of the unusual properties of polystyrene and therefore providing extremely high insulation resistance (long-self-time constant). Operating temperature range of metal-case units:  $-65^{\circ}\text{C}$  to  $+85^{\circ}\text{C}$ ;  $-30^{\circ}\text{C}$  to  $+85^{\circ}\text{C}$  for cardboard tubulars.

**OFFERING LOW POWER FACTOR . . .** Very low. Also very low dielectric absorption characteristics. In addition, these units provide low capacitance changes with temperature change and with time.

**OFFERING CLOSE TOLERANCES . . .** Still another decided advantage of Aerovox Polystyrene Capacitors is that they can be wound to close tolerances in production quantities.

**OFFERING WIDE CHOICE OF TYPES . . .** Generally available in such standard case designs as cardboard-case tubulars (L84), glass end-seal metal-tubular case (L123XG), metal-case bathtubs (L30), rectangular-can (L09). Also in special designs and uncased units.

WRITE ON YOUR COMPANY LETTERHEAD FOR ENGINEERING DATA



**AEROVOX CORPORATION**

NEW BEDFORD, MASS.

HI-Q DIVISION	ACME ELECTRONICS, INC.	CINEMA ENGINEERING CO.	HENRY L. CROWLEY & CO.
OLEAN, N. Y.	MONROVIA, CALIF.	BURBANK, CALIF.	WEST ORANGE, N. J.

In Canada: AEROVOX CANADA LTD., Hamilton, Ont. JO6889 ADDRESS: 740 Belleville Ave., New Bedford, Mass.  
Export: Ad. Auriema, Inc., 89 Broad St., New York, N. Y. • Cable: Auriema, N. Y.

special dust-proof and explosion-proof cases.

The unit is priced in a standard case at \$300 plus probe.



### CURVE TRACER for transistors

AMERICAN ELECTRONIC LABORATORIES, INC., 641 Arch St., Philadelphia 6, Pa., announces its model 126 and 126S *pnp-npn* transistor curve tracer.

► **Features**—Extreme flexibility is offered in wide voltage and current ranges, oscilloscope switching, and availability of various outputs to any terminal of the transistor. It features calibrated sweep current to 60.0 ma standard, 3 amperes optional; seven constant current steps up to 20 ma per step; internal calibration, and Z-axis blanking available.

Model 126 is supplied less oscilloscope enclosed in desk panel rack; model 126S with oscilloscope, in open table-type relay rack.

### VALVE ACTUATOR aids electronic control

ASKANIA REGULATOR Co., a subsidiary of General Precision Equipment Corp., 240 E. Ontario St., Chicago 11, Ill., has developed an electrohydraulic valve actuator for electronic controllers. It is a complete self-contained unit including control valve, hydraulic power source and proportional positioning mechanism which can be used with existing electronic controllers.

Outside connections consist of the signal wires from the controller and an electric power supply. The

# need quick service on **TIMERS** for automatic control?

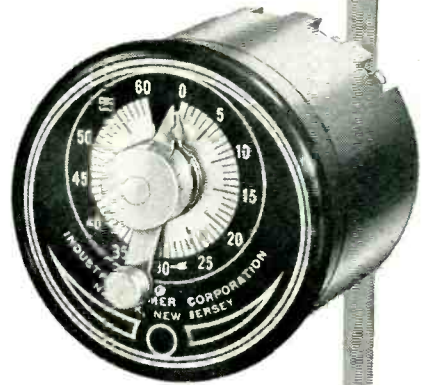

Time Delay Timers

**T**he more automatic control problems we get, the better we like it. For while it's true each automatic control job is a bit different from the rest, the record shows that our 19 years of timer experience has given us the special knowledge it takes to give you the right answers, and in near-record time.

If one of our standard timers won't do your job — or one of the 721 combinations we have thus far developed from our 17 basic units — our engineers will go right to work to develop a new combination that's the one for you. That's the way we grow — and we like it.

We manufacture a complete line of timers in these 4 broad classifications:

**TIME DELAY TIMERS • INTERVAL TIMERS  
RE-CYCLING TIMERS • RUNNING TIME METERS**

And since we maintain large stocks of our 17 basic units, we can assure you of rapid deliveries — of excellent deliveries even on special orders. So whatever your automatic control problem, you have everything to gain by submitting it to our timer specialists. They'll give you a profitable answer — almost with the speed of automatic control itself.



Interval Timers

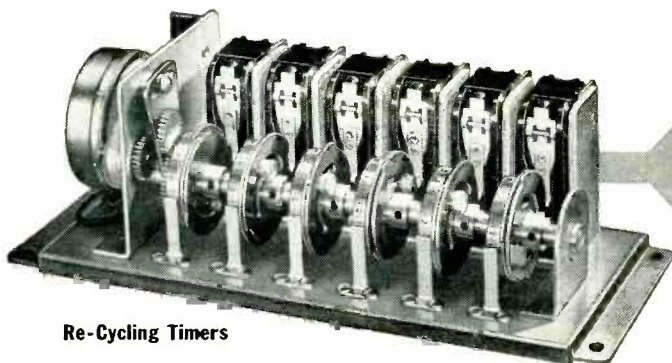

Re-Cycling Timers

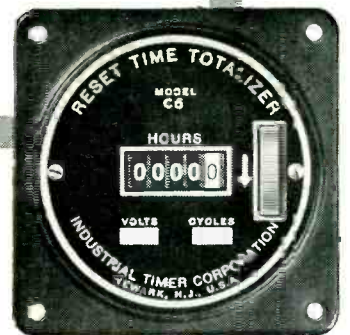

Running Time Meters

*Timers that Control  
the Pulse Beat of Industry*



**INDUSTRIAL TIMER CORPORATION**  
1409 McCARTER HIGHWAY, NEWARK 4, N. J.

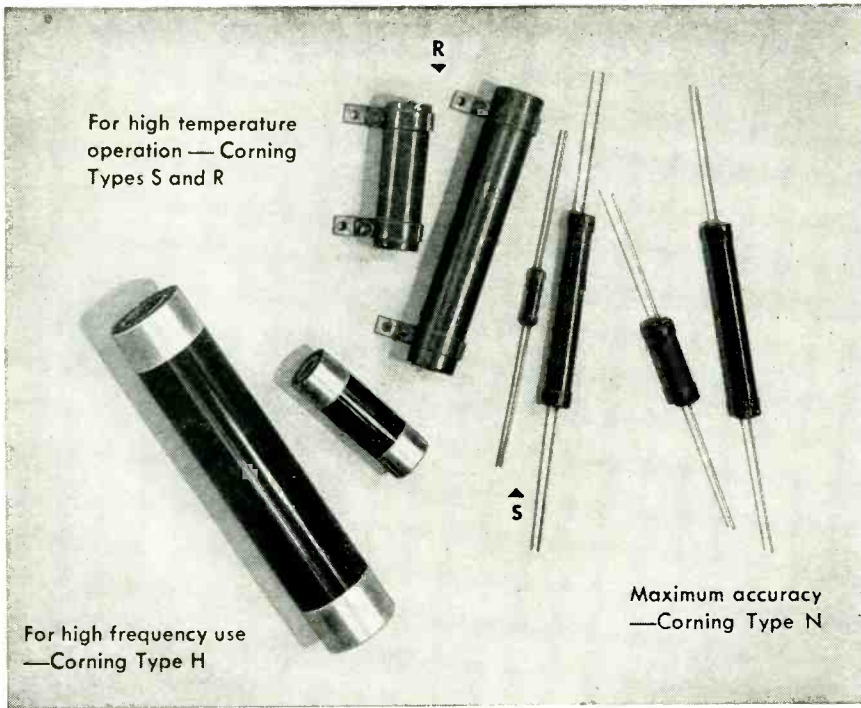

## 5 reasons why Corning film-type resistors meet your most exacting circuit needs

**1. They're Stable** • The resistive element of Corning Resistors is so stable it can be cycled from near absolute zero to red heat without impairing its electrical properties. These resistors withstand high-ambient and high-operating temperatures.

**2. They're Moisture-proof** • Corning Resistors are impervious to moisture. They meet specifications for maximum resistance change under moisture resistance tests of MIL-R-10509A and MIL-R-11804A.

**3. They're Durable** • No need to coddle Corning Resistors. Drop them or scratch them. Neither affects them. The film material is fired in at a red heat and makes an integral contact with the heat-resist-

ant base. You end special handling and assembly costs.

**4. They're Quiet** • No need to use oversize resistors to overcome solder heat noise. Fired-in-silver bands afford low-load resistance, low-noise termination. These resistors are so quiet, noise is difficult to measure. Excellent for signal-level, high-gain amplifier stages.

**5. They're Space-Saving** • You can couple Corning Resistors close—without damage or fear of creating noise.

That's not all! Corning Resistors have other important characteristics to help you. And there are 16 different types, covering a resistance range from 10 ohms to 1 megohm; ratings from ½ watt to 150 watts. Write today for technical descriptions of all of them.



signal current is applied to a high-resistance coil (3,000 ohms or more) which moves in a magnetic field.

► **Jet Pipe**—Linked to the coil is the company's exclusive jet pipe which converts an electrical signal of less than 50 mw into the powerful stroke of a control valve. The valve moves at a speed of better than 1 ips. Thrusts of 600 lb and more can be handled, with strokes presently available up to 2 in.

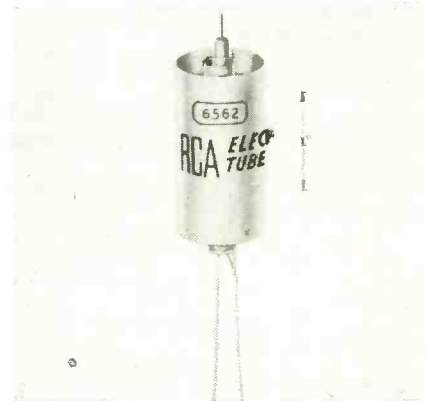

### OSCILLATOR TRIODE for radiosonde service

RADIO CORP. OF AMERICA, Harrison, N. J., has introduced a fixed-tuned, uhf oscillator triode, type 6562, having a pencil-type construction and intended for transmitting service in radiosonde applications.

► **Design**—It incorporates two integral resonators of the cavity type. One of the resonators is fixed-tuned and connected between grid



**CORNING GLASS WORKS • CORNING, N. Y.**

Electrical Components Dept.

*Corning means research in Glass*

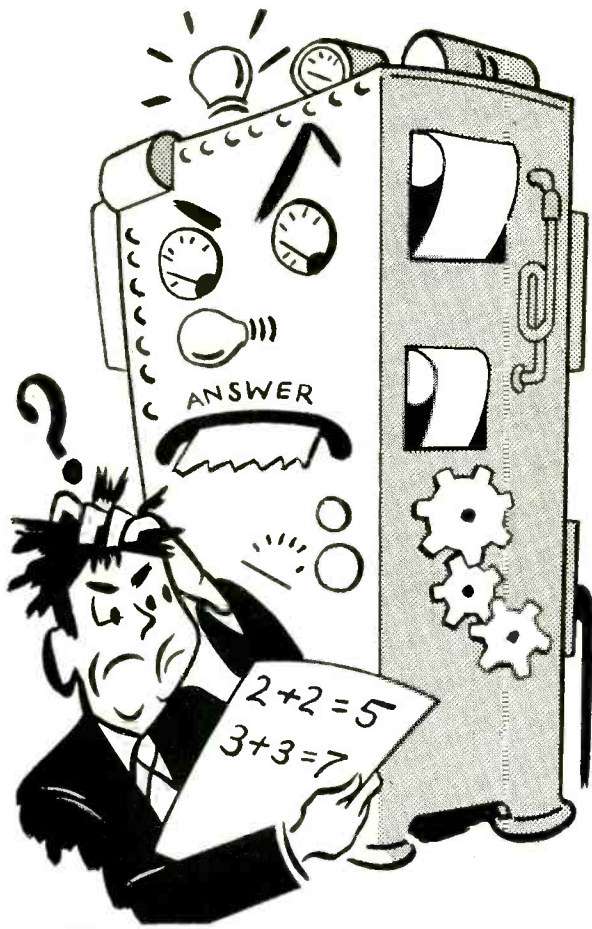

# Not Getting The Right Readings?

## Install Hubbell *Interlock* Plugs To Solve Your Wiring Problems

Modern electronic equipment depends upon small component parts for accuracy of operation. The wiring of connections to sources of power, as well as between elements within the unit, must be dependable and must be designed for fast, easy rearrangement and maintenance. Hubbell *Interlock* Plugs meet all these requirements and actually provide an extra margin of dependability.

# HUBBELL



# Interlock

### You Can Be Sure Of A Positive Connection

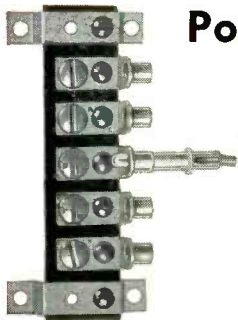

Unlike other terminals, *Interlock* Plugs are designed with a locking mechanism that permits contact on *two surfaces* and provides a constant low contact resistance. *Interlock* plugs *lock automatically* in their eyelets or jacks, can be quickly disconnected when intended, yet cannot disconnect accidentally — — and they're designed to withstand unusual strain and vibration!



### Tests Prove It!

By actual laboratory test, the Hubbell *Interlock* Type "A" Plug, capacity 10 amperes, withstands a 47 pound pull without disconnecting; the Type "B" Plug, capacity 5 amperes, a 16 pound pull; Type "C", capacity 1 ampere, 4.7 pounds; and the heavy duty Type "S" Plugs, capacity 15 amperes, up to 222 pounds.



For Further Information, Write Dept. A:

## HARVEY HUBBELL, Inc.

Interlock Electronic Connector Dept., Bridgeport 2, Conn.



## 320x MAGNIFICATION of PLATED-THRU HOLE

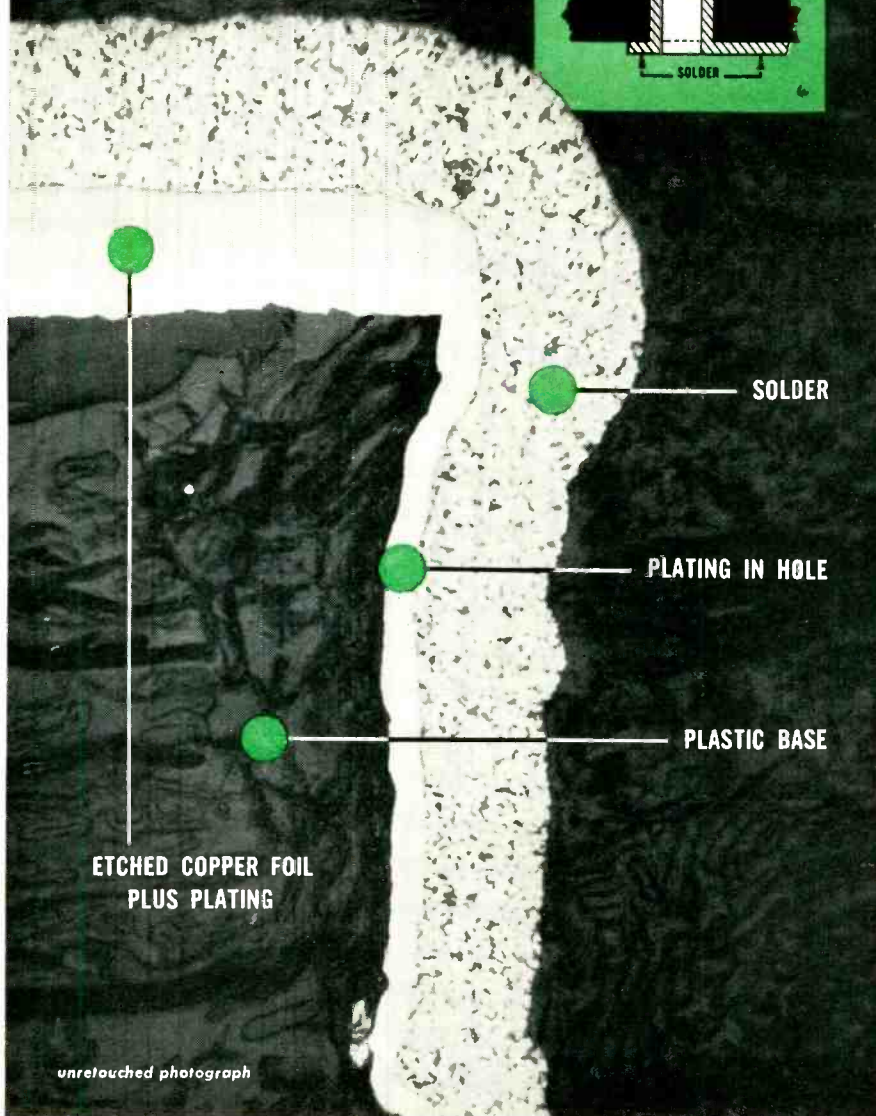

unretouched photograph

**PHOTOCIRCUITS Corporation**  
produces Plated-thru hole  
**RELIABILITY you can see...**

Reliable through-circuitry is hard to produce but here's micrographic evidence of "standard production" by Photocircuits!

The photomicrograph (enlargement is 320 times) above clearly shows you the current-carrying plating inside a hole of the circuit board.

We have produced over 40,000,000 Plated-thru Holes for one customer (name on request) and many other millions for the country's leading manufacturers. That must mean reliability!

Your own product reliability can be guaranteed with Printed Circuits by Photocircuits Corporation.

Consult our Engineering Department or any of our Sales-Engineering Field Offices.

EXCLUSIVELY PRINTED CIRCUITS  
and Associated Sub-Assemblies  
ADVANCED TECHNIQUE & RESEARCH  
MAXIMUM EXPERIENCE



Telephones:  
Glen Cove 4-8000  
Flushing 7-8100

**Photocircuits**  
CORPORATION  
Dept. E-2, GLEN COVE, NEW YORK

Sales-Engineering Field Offices: BOSTON • BIRMINGHAM, ALA. • CHARLOTTE, N. C. • CHICAGO  
DALLAS • DAYTON, O. • LOS ANGELES • PHILADELPHIA • ROCHESTER, N. Y. • SPOKANE

and cathode. The second is connected between grid and plate and is tunable over a narrow range centering at 1,680 mc.

Features in radiosonde service include high efficiency, small frequency drift, low battery drain and small size. Associated circuitry is simplified by the external connection of the cathode to one of the heater leads.

The 6562 is approximately 2½ in. high, excluding heater leads, and 1 in. in diameter.



### VARIABLE SPEED DRIVE available from ¼ to 1½ hp

MAGNETIC AMPLIFIERS, INC., 632 Tinton Ave., New York 55, N. Y., has announced the Magne-Speed variable speed drive. The line consists of two sizes covering a range from ¼ to 1½ hp. It features stepless instant starting, compact design, and 50-to-1 speed range with good regulation. Reversibility, dynamic braking, local or remote control may be specified.

Another important feature is the unit's extreme simplicity so that it may be installed without special tools or wiring.

► Prices—Depending on horsepower, size and type of control specified, prices range from \$261 to \$666.50 including motor in all cases.

### LOW-PASS FILTER used in communication centers

KAAR ENGINEERING CORP., Middlefield Road, Palo Alto, Calif. Number 8314 low-pass filter unit has wide application for use between the transmitter and antenna to attenuate spurious r-f output. It is particularly useful in installations of several transmitters and receivers to reduce interference and to



improve transmitter performance to meet FCC technical requirements.

► **Performance Data** — Insertion loss is 0.5 db maximum from 115 mc to 160 mc; 6.0 db maximum from 160 mc to 180 mc; 65 db minimum from 225 mc to 500 mc. Standing wave ratio is 1.3 maximum from 115 mc to 160 mc.



**VARIABLE COIL  
in one-piece design**

COIL WINDERS, INC., New York Ave., Westbury, N. Y., has developed a one-piece hermetically sealed variable coil designed to replace a costly two-piece molded Bakelite assembly. The molding material is an epoxide resin which meets military specifications for stability, resistance to moisture, and high dielectric strength.

► **Uses**—Originally designated as a range marker coil, designed for use in military radar equipment, this unit may be incorporated into oscillator, i-f, or wave-trap circuitry. Inductances in excess of 100 mh can be obtained without difficulty.

**CALIBRATOR  
measures voltage, current**

ELECTRO-PULSE, INC., 11861 Teale St., Culver City, Calif. Utilizing the most accurate technique for meas-



*Oregon Electronics*  
Model PR 300

**PRECISION  
REGULATED**

✓ **STABILITY**

(Long term  $\pm 100$  ppm —  
Short term  $\pm 50$  ppm per hour)

✓ **LOW RIPPLE**

✓ **LOW IMPEDANCE**

Here's a voltage reference that can be depended upon for many laboratory functions, but specifically suited for calibrating meters, powering multi-stage amplifiers and computers.

**OUTPUT TOLERANCE** for 10% line voltage variation:  $\pm .002\%$  or less.

**VOLTAGE RELIABILITY** read on decade dials: .02% or 5 millivolts, whichever is greater.

**OUTPUT VOLTAGES:** (1) 10 to 310 volts in 1 volt steps @ 150 ma. max. (2) 0-150 volts continuously variable @ 5 ma. max. (3) 6.3 volts unregulated @ 3 amperes CT.



*Oregon Electronics*  
Model 32V15A

**CLOSELY  
REGULATED**

✓ **Low Voltage—High Current**

✓ **DC POWER SUPPLY**

A Magnetic Amplifier Power Supply with output at 15 amperes continuously variable from 5 to 32 volts without switching.

**REGULATION:**  $\pm 1\%$  from no load to full load.  $\pm 1\%$  from 105 to 125 volts input.

**RIPPLE VOLTAGE:** 1% RMS @ 32 volts and full load, increasing to 2% @ 5 volts and full load.

Complete specifications and details upon request—write or wire today.



2232 EAST BURNSIDE STREET  
PORTLAND 15, OREGON  
BEI mont 6-9292

**MANUFACTURERS OF SPECIAL ELECTRONIC EQUIPMENT**



# Stupakoff Kovar HARD-GLASS Seals

## PERFECTLY FUSED BOND eliminates "leakers"

The single terminal hermetic seals shown here are among the most widely-used of literally hundreds of designs of Stupakoff Kovar Hard-Glass designs.

At the right is a typical cross-section showing how hard glass and Kovar alloy are intimately fused in an oxide bond that forms a true hermetic seal. Because the thermal expansion of Kovar exactly matches that of hard borosilicate glass, Stupakoff Seals are free from strain over the entire working temperature range.

Principal sizes available are:

Dimension A  
Over-all length . . . . . .220 in. to 3 $\frac{3}{16}$  in.

Dimension B  
Flange to lead end . . . . .110 in. to 2 $\frac{7}{8}$  in.

Dimension C  
Cup diameter . . . . .119 in. to .625 in.

Dimension D  
Terminal diameter . . . . .015 in. to  $\frac{3}{16}$  in.

Special sizes can be made if desired.

Terminals may be solid or tubular, with plain ends, or with flattened and punched or hook ends, as shown in the photograph.

WRITE for catalog 453A, which gives complete data and dimensions of all standard Stupakoff Kovar Hard-Glass Hermetic Seals.

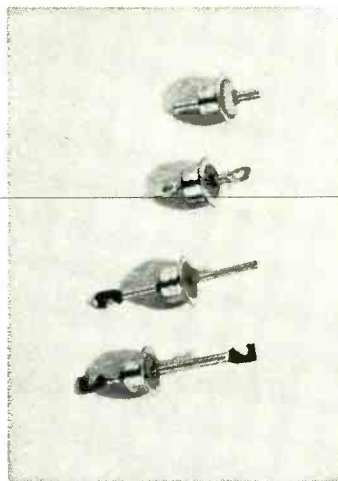
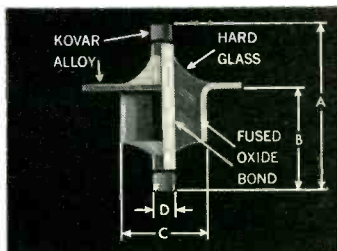

Representative terminal designs are illustrated above.

# Stupakoff

DIVISION OF

Write Dept. E  
LATROBE,  
PENNSYLVANIA

The CARBORUNDUM Company



urement of the voltage or current of nonsinusoidal wave shapes, the model 6020A voltage and current calibrator may also be used for sine wave or d-c level measurement.

► **Operation**—The waveform to be measured is compared to 2 precision 1-v reference sources, variable from 0 to 1-v by 10 turn calibrated potentiometer.

To measure waveform amplitude, one of the reference levels is adjusted until the line is superimposed on top of the waveform, after which the waveform amplitude may be read directly from the reference voltage control 1,000 division dial. Two variable reference levels are provided to enable measurement of bipolar waveforms or to set up production tolerance checks.

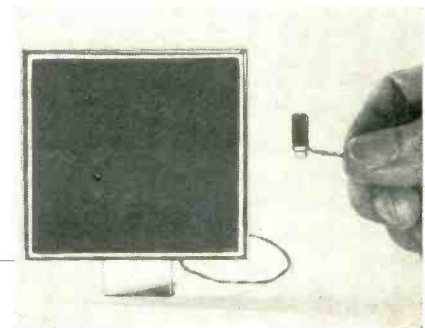

## SUN BATTERY CELLS in wide range of sizes

INTERNATIONAL RECTIFIER CORP., 1521 E. Grand Ave., El Segundo, Calif., has available a series of selenium sun battery cells. They are ideal components for transistor power supplies, control applications, photometric equipment, as well as experimental uses.

► **Production**—They are now in production in a wide range of sizes and power ratings—from 0.14 sq in. to 10.5 sq in. in photosensitive area and from 0.1 mw to 15 mw



power output in direct sunlight.

High self-generated output power is featured in the cells. Short-circuit current up to 40 ma, or open-circuit voltages up to 0.5 v per cell can be generated in direct sunlight. Long life operation can be expected from these cells which are encapsulated for moisture, corrosion and scratch resistance.

For full information and specifications, ask for bulletin SR-115.

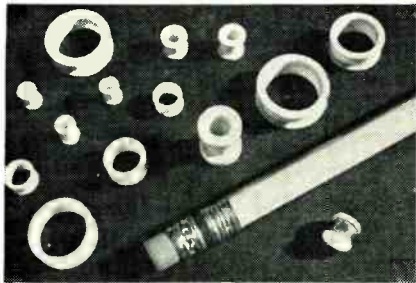

**MAGNETIC CORES**  
speed computing

WESTINGHOUSE ELECTRIC CORP., 401 Liberty Ave., Pittsburgh 30, Pa. Several thousand magnetic cores such as these recently built by the company may be used in a single computer or data processing machine.

► **Winding**—The cores are wound on ceramic spools that range in size down to 1/2 in. in diameter and 1/8 in. high. The strip with which the cores are wound—a nickel-iron alloy—is rolled as thin as one eight-thousandth of an in.

Normally a core consists of only 6 to 15 wraps of the magnetic material on the spool. These Hiperthin cores have high permeability and are more temperature stable than ferrite cores. The cores are also applicable to h-f magnetic amplifier circuits where high gain is needed.



**LITTLE CONNECTORS**  
with one-piece inserts

DEJUR-AMSCO CORP., 45-01 Northern Blvd., Long Island City 1, N. Y.,

**Stupakoff**  
**THERMISTORS**  
(Negative temperature-sensitive resistors)

**NEW DESIGNS offer longer life and precise resistance values**

Recent developments by Stupakoff have added to the service life and precision of Thermistors. For many years, Stupakoff has manufactured these useful ceramic products, employed in devices for temperature measurement and control, pressure measurement, flow measurement, time-delay and other services.

Stupakoff Thermistors are made from specially formulated ceramic bodies, with radial or axial wire leads, and with reflective or moisture-proof coatings, or uncoated as desired. Temperature characteristics are reproducible within a half-degree from minus 60 to plus 30 degrees C.

Sizes and characteristics of currently available Thermistors are:

Diameters: Tubes—.020 to .500 in. O.D.

I.D.—up to 75% of O.D.

Rods—.010 to .500 in. dia.

Resistivities: 10 ohms/cm<sup>3</sup> and up

Resistance: decreases approx. 3% for each degree C temperature rise (see curve)

Absorption: less than 0.1%

Write for complete information and samples of Stupakoff Thermistors.

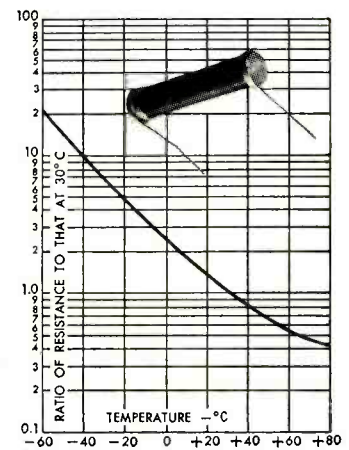

Above curve shows typical temperature-resistance characteristic of Thermistor. Resistance drops approximately 3% for each degree C temperature rise. As temperature varies up and down, resistance retraces its path precisely, regardless of number of reversals.

**Stupakoff**

DIVISION OF

**The CARBORUNDUM Company**

Write Dept. E

LATROBE,  
PENNSYLVANIA

# DIT-MCO AUTOMATIC ELECTRICAL CIRCUIT ANALYZERS CAN TEST 200 COMPLEX, INTERCONNECTED CIRCUITS IN TWENTY SECONDS!

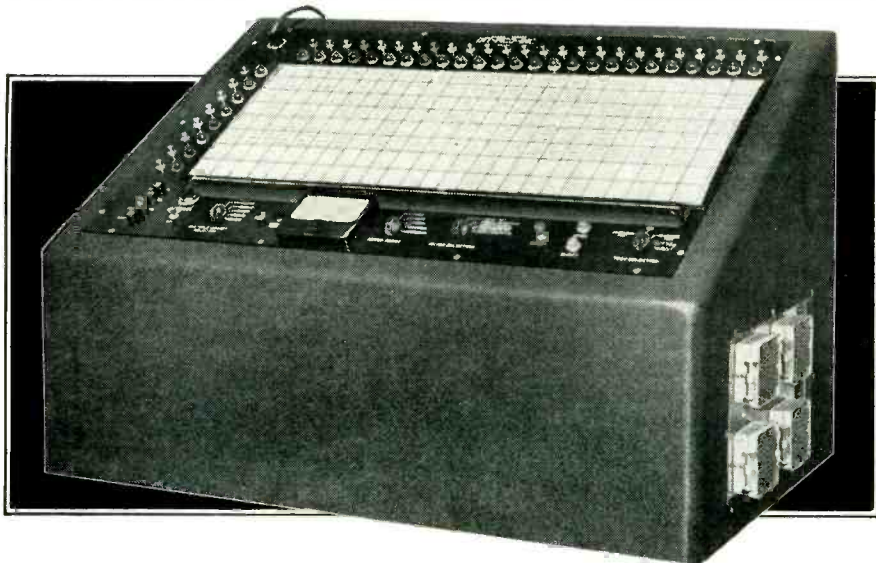

## ABSOLUTELY ACCURATE!

The DIT-MCO Analyzer defines continuity resistance to the point of rejecting  $\frac{1}{2}$  ohm, as an open circuit, at currents up to two amperes. It defines leakage resistance to the point of rejecting zero ohms to 200 megohms as a direct short. Both values pre-set as desired.

## EASY TO OPERATE!

Non-technical personnel can master it in 30 minutes or less. Frees experienced quality control and production line personnel from time-consuming hand tests.

## VERSATILE!

Tests any cabling system or panel assembly without modification. Uses simple, straightforward adapter cables.

## UNIVERSAL!

Tests for all types of errors resulting from incorrect connections, short resistance and insulation resistance.

## RUGGED!

Basic telephone type components, most of which are pluggable.

## A SIZE FOR EVERY NEED!

80 to 1600 circuit capacity available.

If your product involves complex electrical circuitry, DIT-MCO can help you make it better and faster, at less cost. Write today for full details.

## DIT-MCO INC., ELECTRONICS DIVISION

Box 02-15,911 Broadway, Kansas City, Mo. • Phone: HArrison 1-8484

**Most United States Airplane and Guided Missile Manufacturers Test Complex Circuitry with DIT-MCO Analyzers. They are Standard Equipment for Many Computer Builders and are Widely Used in Airline Maintenance.**

has added a new miniature Continental connector to its AN-type 1300 series. The connector is available with 3, 4, and 5 contacts, and features one-piece molded inserts. This construction prevents moisture traps and electrical breakdowns which often occur with conventional AN two-piece inserts.

► **Military Requirements**—The precision-machined aluminum shell is finished to meet military requirements for salt-spray test resistance. The inserts are permanently swaged into the shell to form a single cartridge unit. Floating contacts in the subminiature connectors assure self-alignment of each contact and reduce engagement and disengagement forces to an absolute minimum.

Inserts are interchangeable in the plug or receptacle shell. Precision-machined brass-pin contacts and spring-temper phosphor-bronze contacts are gold-plated for ease of soldering.



## MAGNETIC AMPLIFIERS operate from $-55\text{ C}$ to $+100\text{ C}$

TIMELY INSTRUMENTS & CONTROLS CORP., 1645 W. 135th St., Gardena, Calif. A new line of magnetic servo amplifiers are designed for use as power amplifier output stages for the control of 400 cycle 2 phase servo motors, including Navy BuOrd MK14, MK7, MK8 and their equivalents.

No d-c power supplies are necessary for operation of the amplifiers and their transistor or tube control circuit. Using no rectifiers, the

amplifiers operate over a wide ambient temperature range of -55 C to +100 C.

► **Uses**—The amplifiers find wide application in aircraft fire control systems, navigational radar auto-pilots, and missile guidance systems.

Standard output ratings of 3, 6, 10, 16 and 40 w are available.

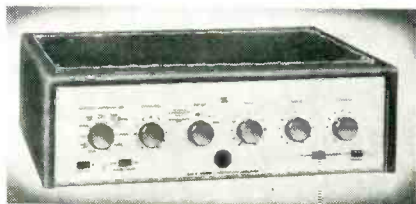

**POWER AMPLIFIER with equalizer-preamplifier**

HERMON HOSMER SCOTT, INC., 385 Putnam Ave., Cambridge 39, Mass. Type 210-D laboratory amplifier is a complete 30-watt power amplifier with equalizer-preamplifier in a single compact case. It features the dynaural dynamic noise suppressor and record distortion filter.

► **Typical Specifications** — Hum level is 80 db below maximum output; harmonic distortion less than 0.5 percent; first-order difference tone intermodulation, less than 0.25 percent; frequency response flat from 19 cps to 35,000 cps.

Net price is \$169.95.

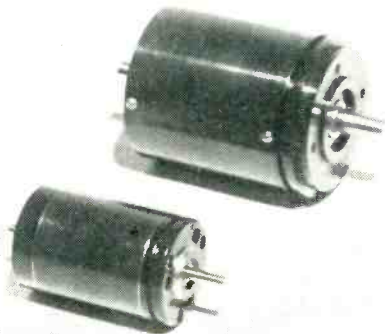

**SPEED REDUCERS universal design**

PIC DESIGN CORP., 160 Atlantic Ave., Lynbrook, L. I., N. Y. Type No. U precision speed reducers are

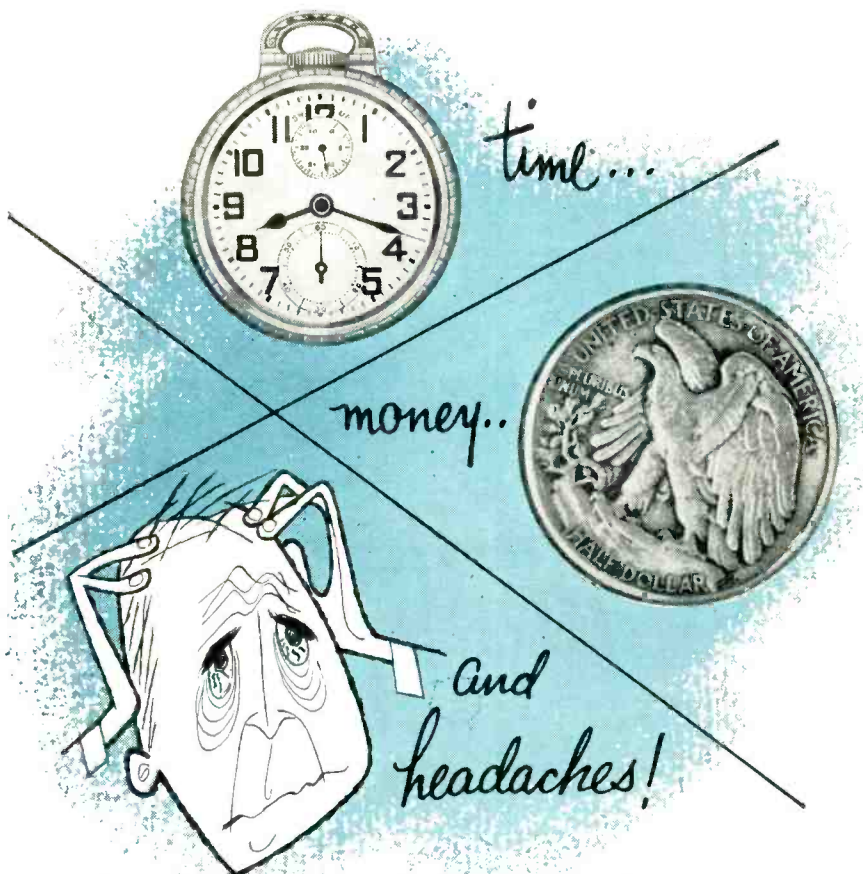

**how important are these to you?**

**Time?** No other terminals are installed as rapidly as Sealectro self-fastening, self-sealing "Press-Fit" stand-offs, feed-thrus, connectors. And understandably so, because "Press-Fit" technic reflects years of specialized engineering in closest collaboration with designers and assemblers who want the best.

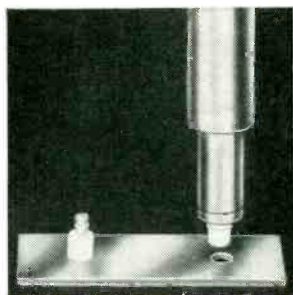

**Money?** The original one-piece, ready-for-assembly Teflon terminals minimize labor and materials. No soldering, nuts, washers, gaskets. Just press-fit — that's it.

**and No Headaches?** None. "Press-Fit" terminals are shatter-proof, heat-resistant, vibration-proof. Immune to humidity, wide temperature range, fungus, etc.

**FREE MANUAL!** Tells all you want to know about "Press-Fit" terminals. Also lists the most extensive selection of types and sizes. Copy on request.

**PRESS THEM — FORGET THEM**



**"PRESS-FIT"\*** **TEFLON\* TERMINALS**  
\*Trade-marks

by **Sealectro CORPORATION**

186 UNION AVENUE • NEW ROCHELLE, N. Y.

# UNION

## Specially designed SELENIUM RECTIFIERS fitted to your application

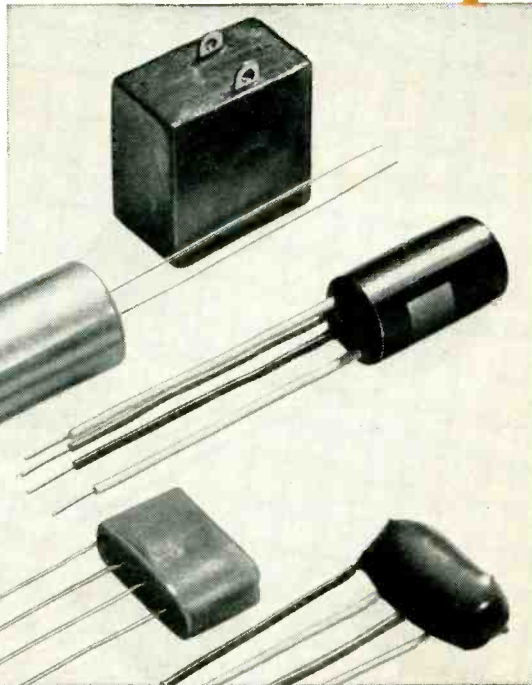
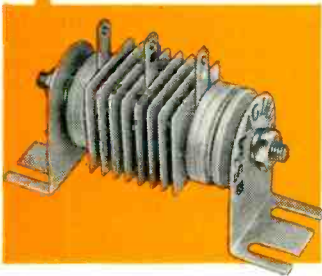

### Our Engineers Can Help You

The first metallic rectifier was developed by Union Switch & Signal engineers back in 1916. Since then, they have built up an extensive experience in rectifier applications that can be of tremendous value to you.

It's possible that you are working in rectifier problems that have already been solved in our research laboratories. The selenium rectifiers we show here are just a few of the many varieties that we are now producing.

Standard UNION selenium rectifier

cells, pencil type, range in size from  $\frac{1}{8}$ " to  $\frac{1}{2}$ " diameter rated from 2.5 to 40.0 milliamperes per cell and stack type 1" x 1" to 5" x 6" rated from .180 to 10.0 amperes per cell in a single-phase full-wave bridge basis. Special combinations can be made to fit practically any current and voltage conversion requirements in various housings or shapes.

Why not tell us what you need, and our sales engineers will help you determine the best rectifier for your application.

GENERAL APPARATUS SALES

## UNION SWITCH & SIGNAL

DIVISION OF WESTINGHOUSE AIR BRAKE COMPANY

PITTSBURGH 18



PENNSYLVANIA

NEW YORK, IVanhoe 3-2424 (Hempstead) • BOSTON (Ashland) TRinity 2-4485  
BALTIMORE, VALley 5-3431 • ST. LOUIS, JEFFerson 5-7300 • CHICAGO, LONGbeach 1-3042  
LONDON, OHIO, LONdon 1555 • LOS ANGELES, CLinton 6-2255

NEW PRODUCTS

(continued)

available from stock and have been designed as a universal unit with variable ratios from 5:1 to 3,000:1 with oil-less bearing or miniature ball bearings, ABEC-5 tolerances as required. Backlash measured through the entire train is less than 30 ft. Material is stainless steel and Naval bronze.

► **Sizes**—There are 2 unit sizes available from stock:  $1\frac{1}{4}$  in. diameter which is equal to the MK-14 series, and the  $1\frac{3}{4}$  in. diameter equal to the MK-8 series. Parts for all ratios are stocked and assembled per order.

Send for the new free 64-page catalog No. 7.

### RELAY features supersensitivity

INDUSTRIAL ELECTRONICS CO., INC., Hanover, Mass. The series 3000 supersensitive electronic relay has power amplification of approximately 10 million to 1. Input power to the relay is less than 0.00011 w, while the output circuit can carry up to 1,150 w.

► **Applications**—The relay may be used as a level control for filling containers, as a precision temperature or pressure controlling device, and in a variety of applications to measure movements of delicate devices.

The relay is of very compact design with overall dimensions of  $2\frac{1}{2}$  in. by  $5\frac{5}{8}$  in. and is of the plug-in type. Literature is available.

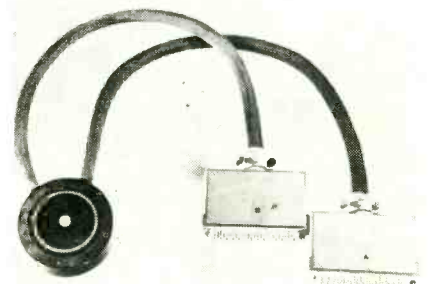

### HIGH-SPEED SWITCHES with semimolded contacts

GENERAL DEVICES, INC., P.O. BOX 253, Princeton, N. J., has an-

nounced production of high-speed switches of advanced design. The line incorporates a new semi-molded contact plate construction. Each contact pin is permanently locked into precise alignment, affording maximum dimensional stability. Convenient wire leads are permanently molded into the contact plate for ease of connection. Solder type terminals can also be had on request.

► **Available Models**—Switch types include single or multiple pole, stacked, concentric opposed, raised contact, segmented, or printed circuit designs.

All units feature extended, service-free life and more predictable performance.

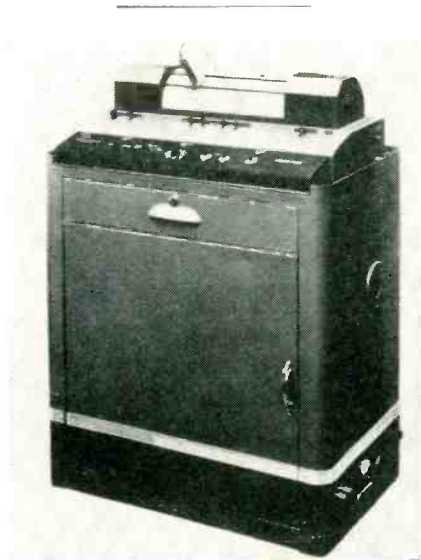

### PLOTTER-FOLLOWER solves numerable problems

LOGISTICS RESEARCH INC., 141 S. Pacific Ave., Redondo Beach, Calif., has developed a graph plotter-follower that plots one variable against another in algebraic increment steps of 1/100-in. at 20 increments per sec.

Designated Logrine, the plotter-follower is designed for use with digital differential analyzers to solve problems in trajectory analysis, cross and autocorrelation, Fourier analysis, data reduction, and conversion to digital form of functions not readily generated in a digital computer.

Logrine follows any dark continuous curve by a photoelectric light. Since the follower seeks one

# UNION

## AC Miniature Relays

designed with  
all the features  
of our DC relays

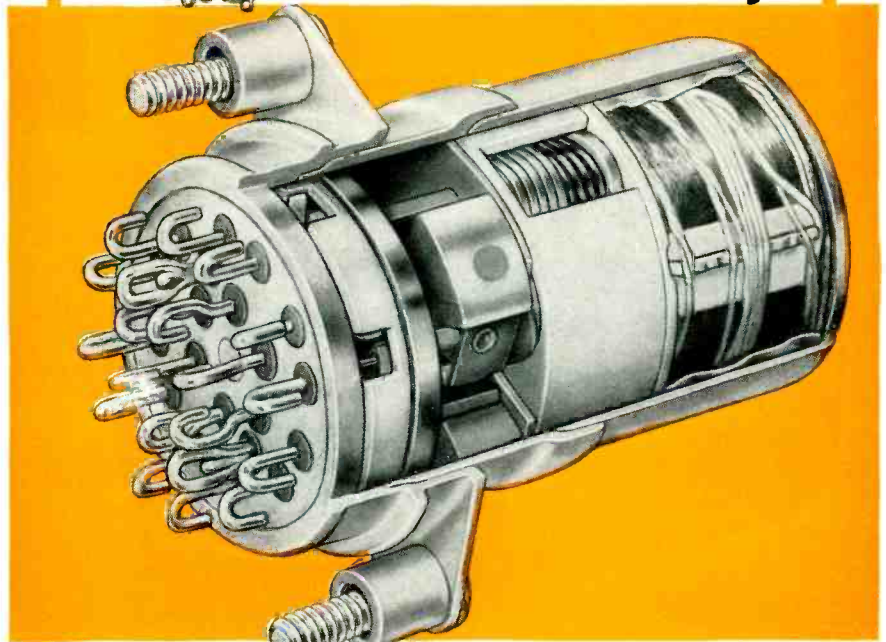

Now, in proven production, Union AC relay with self-contained rectifier has retained all the best operating characteristics of the type M DC miniature relay. All parts are precision made—assembly is quality controlled. The relay is hermetically sealed and meets or exceeds all requirements of Mil-R-5757. Note these important features:

**NYLON ENCLOSED SELENIUM RECTIFIER** of our own manufacture assures highest reliability . . . permits operation in 115 volt, 60-400 cycle airborne circuits. Temperature range—55°C. to 85°C.

**GOLD ALLOY OR PALLADIUM CONTACTS** cleaned and polished by a special process, assure a degree of contact reliability unsurpassed in this field. Relay is especially fitted for dry-circuitry applications.

**HIGH VIBRATION AND SHOCK RESISTANCE.** Withstands vibration up to 1,000 cycles at 15 G's and shock in excess of 50 G's.

**HIGH LIFE EXPECTANCY.** Tested through 1,000,000 operations.

**SMALL SIZE, LIGHTWEIGHT.** Measures only ½" higher and weighs approximately 5 oz. All other construction features are the same as the DC relay.

**TYPES AND MOUNTINGS.** Available in either 6 PDT or 4 PDT models, plug-in or solder-lug connections and all the usual mountings.

For complete information or test samples, call our nearest sales representative listed below or write to our home office.

GENERAL APPARATUS SALES

## UNION SWITCH & SIGNAL

DIVISION OF WESTINGHOUSE AIR BRAKE COMPANY

PITTSBURGH 18



PENNSYLVANIA

NEW YORK, IVanhoe 3-2424 (Hempstead) • BOSTON (Ashland) TRinity 2-4485  
BALTIMORE, Valley 5-3431 • ST. LOUIS, Jefferson 5-7300 • CHICAGO, LOngbeach 1-3042  
LONDON, OHIO, London 1555 • LOS ANGELES, VAndyke 8731

# PRECISION PHASEMETER

0.1° ABSOLUTE ACCURACY

0.01° incremental accuracy

30 to 20,000 cycles per second

0 to 360° phase range

10-megohm input impedance  
(shunted by 25  $\mu\text{f}$ )

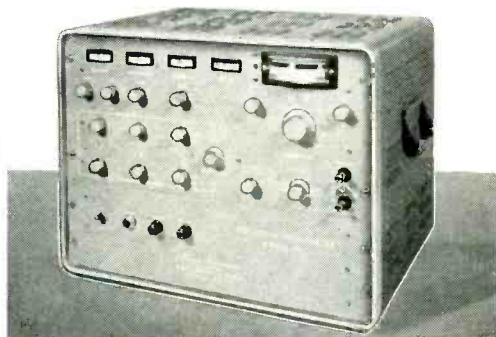

Output connection for strip-chart recorder.

Self-contained power supply for 105-125 volts, 50-60 cycles.

Adaptable to standard relay-rack mounting.

Price \$3990 net  
F.O.B. Long Island City.

THE NEW MAXSON Model 901 Precision Phasemeter is a direct-reading electronic instrument adaptable to a wide variety of demanding measurement applications in computers, synchros, and amplifiers.

The instrument measures phase difference between two sinusoidal voltages; phase angles are read from a two-degree, step control with vernier indicator having a precision of 0.01°. Built-in sensing provides direct reading of proper quadrant. Accuracy is independent of even harmonics and of third harmonics up to 1%. Input-level range is from 0.5 to 10 volts rms.

Write or phone us for further information.

## Subminiature I-F AMPLIFIERS

- High gain and sensitivity
- Wide-band response
- Rapid recovery
- 40 db manual gain adjustment
- Low noise

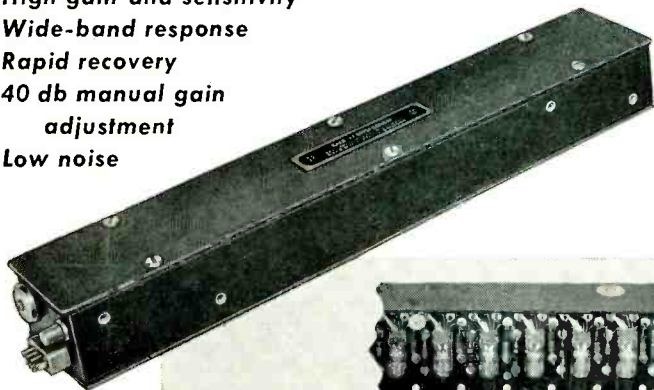

Designed for aircraft and electronic instrumentation, these amplifiers can be furnished to meet specific performance requirements. Typical specifications are given at right.

Model No.	Center frequency mc/sec	Band width mc/sec	Noise figure db	Gain
M1154	30	12	1.7	100
M1155	60	12	3.7	100
M1156	90	12	5.0	100

Maxson Instruments products include: power oscillators, I-F amplifiers, mag-amp voltage regulators, frequency regulators for aircraft inverters, high-precision phasemeters, ultrasonic flowmeters, acceleration-sensitive switches, and statistical accelerometers. For detailed information, contact our main office or the nearest Maxson District Office.

SALES OFFICES IN LOS ANGELES, DAYTON, AND WASHINGTON, D. C.

# MAXSON INSTRUMENTS

A DIVISION OF THE W. L. MAXSON CORPORATION

47-37 Austell Place  
Long Island City 1  
New York

Tel: RAvenswood 9-1850

NEW PRODUCTS

(continued)

edge rather than scanning the line, it can follow any change in slope for single values of X, and can follow a line of any slope up to and including infinity.

Prices range between \$5,700 and \$6,500.



## FILTER gives better sound effects

PULSE TECHNIQUES, INC., 1411 Palisade Ave., West Englewood, N. J. Twenty-two cutoff frequencies ranging from 50 cps to 12 kc make the HLF-3 high and low pass filter ideal for the reduction of rumble, hum, noise and distortion in music and program material. Better sound effects are possible because of more mid-range frequencies. Low cutoffs are OFF, 50, 80, 100, 150, 250, 500, 750, 1,000, 1,500 and 2,000 cps.

High cut offs are 1, 1.5, 2, 3, 4, 5, 6, 8, 10 and 12 kc and off. The circuit is constant K, 18 db per octave, 600 ohms. Shielded toroids minimize hum pickup. Rack mount is 3½ in. panel. Price is \$232.50.



## D-C POWER SUPPLY aircraft battery eliminator

GATES ELECTRONICS Co., 611 Morris Park Ave., Bronx, N. Y. Model G101F aircraft battery eliminator provides continuous and reliable d-c power for ground operation and bench testing of airborne equipment

—motors, dynamotors, relays, inverters, activators, solenoid valves and vibrators.

Large panel meters indicate d-c output voltage and current. An ammeter protection circuit eliminates the danger of needle slam during periods of high in-rush current, permitting safe starting of rotating motors, dynamotors and inverters. Other features include a delay fuse for short circuit protection and a warning light in case of overload. Ratings are 0 to 28 v d-c, 0 to 20 amperes, with 1-percent ripple.

Price is \$160.

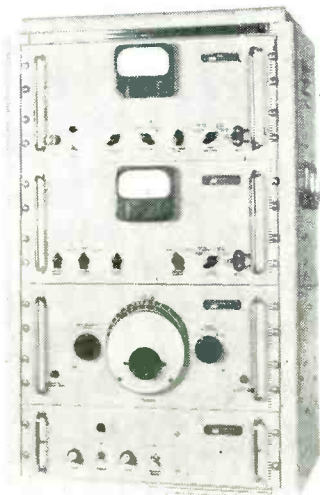

**DISTORTION ANALYZER**  
designed for laboratory use

RADIO FREQUENCY LABORATORIES, INC., Powerville Road, Boonton 3, N. J. Model 863 two-tone distortion analyzer is designed to measure the intermodulation of two signals in a nonlinear network. The equipment consists of an oscillator unit, an amplifier unit, a receiver unit and a power supply. The oscillator and amplifier units generate a variable two-tone signal with a minimum of spurious output frequencies. The two tones are of equal amplitude and spaced 400 cps apart. This signal may be transmitted over a communication system or through a nonlinear network and the intermodulation products measured at the receiver.

► **Uses**—Application will be found in measurements of intermodulation distortion on carrier telephone and carrier telegraph transmission systems in the frequency range of 1 to

*You Get The Picture . . .*

**The PHALO Custom Plug**  
*makes*  
**The Difference!**

*...on PHALO Cord Assemblies!*

Whether it's the new Phalo female type plug for projectors, business machines, etc., or any of Phalo's fine custom-made plugs, you'll find a clear picture of better power performance.

Fitting the plug and the cord set assembly to the power prob-

lem is a job Phalo does superbly as many of the country's leading appliance people will testify.

Don't let yourself in for plug slow-downs or break-downs, select the Custom Cord Set House to give you the right answer the very first time!

*Ask For The Complete Phalo Catalog*

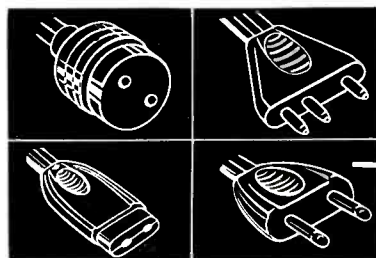

**PHALO**

PLASTICS CORPORATION

*The Custom Cord Set House*

Corner of Commercial Street  
WORCESTER, MASS.

Insulated Wires, Cables - Cord Set Assemblies

# For Quality TV Tubes

## B&A BARIUM ACETATE

### "ELECTRONIC GRADE"

Granular,  
Reagent A.C.S.



### Rigid Control Assures You Constant, Unvarying Purity!

Lot after lot, Baker & Adamson's "Electronic Grade" Barium Acetate is of the same superior quality . . . ideally suited to TV tube and other electronic equipment needs. Made by an exacting process under rigid controls, it is extremely low in halides, calcium, strontium, and other impurities. The specifications at right are an indication of the high purity requirements to which every lot of B&A Electronic Grade Barium Acetate must conform, *without exception*.

A free-flowing powder, B&A "Quality" Barium Acetate is packaged in 25, 100 and 400-lb. drums with special polyethylene bag liners to protect its purity. B&A warehouses from coast to coast assure prompt supply of your needs.



### B&A Electronic Grade Barium Acetate

#### Maximum Limits of Impurities

Insoluble	0.005%
Chloride (Cl)	0.001%
Iron (Fe)	0.0005%
Copper (Cu)	0.0003%
Nickel (Ni)	0.0001%

### Other B&A Chemicals for Electronic Use

As America's foremost producer of fine chemicals and laboratory reagents, Baker & Adamson is your safe, sure source for chemicals of the guaranteed high purity that means trouble-free performance. Call any B&A office listed below for full information, shipments or quotations.

#### Gaseous Dielectric

Sulfur Hexafluoride

#### Metal Fluoborate Solutions—For plating parts

Fluoboric Acid . . . Copper Fluoborate . . .  
Lead-Tin Fluoborate . . . Indium Fluoborate . . .  
Nickel Fluoborate

#### Mineral Acids, Reagent, A.C.S.

Acetic . . . Hydrochloric . . . Hydrofluoric . . .  
Nitric . . . Phosphoric . . . Sulfuric

#### Solvents, Reagent, A.C.S.

Acetone . . . Isopropanol . . . Toluene . . .  
Xylene

#### Others

Aluminum Nitrate . . . Barium Fluoride . . .  
Barium Nitrate . . . Bromine . . . Calcium  
Carbonate . . . Calcium Fluoride . . .  
Calcium Nitrate . . . Copper Nitrate . . .  
Hydrogen Peroxide . . . Magnesium Oxide . . .  
Manganese Dioxide . . . Mercury . . .  
Nickel Oxide . . . Potassium Fluoride . . .  
Potassium Hydroxide . . . Sodium Carbonate . . .  
Sodium Hydroxide . . . Strontium  
Nitrate . . . Thorium Nitrate . . .

100 kc. Another use will also be found for evaluating the quality of voice circuits and sound systems. The analyzer uses the CCIF method of determining intermodulation distortion.

The equipment is divided into 4 chassis which are mounted in a 19-in. rack cabinet 33½ by 21½ by 15½ in. deep. Total weight is about 160 lb.



### GEIGER COUNTER is all-transistorized

THE RADIAC Co., INC., 489 Fifth Ave., New York 17, N. Y. An all-transistorized Geiger counter features 3 methods of radioactivity indication, a continuously variable time-constant control and a meter which reads in percentage of uranium.

► **Advantages**—The panel meter, flashing lamp, and earphones all operate simultaneously to signal the presence of a radioactive substance, such as uranium or thorium ore. The transistorized circuitry, which includes an automatically regulated h-v power supply, greatly reduces current drain, resulting in fewer batteries and lighter weight overall.

It will give up to 350 hr of service. The percent meter calibration allows assay of ore samples in the field, and the variable time-constant may be set to correspond to the speed of the instrument over the area traversed.

### PULSE TRANSFORMERS in porcelain ferrite sleeves

ALADDIN RADIO INDUSTRIES, INC., Nashville 2, Tenn., has developed a new line of miniature pulse transformers, housed in porcelainized ferrite sleeves. The construction technique involves using a simple

## BAKER & ADAMSON<sup>®</sup> Fine Chemicals

GENERAL CHEMICAL DIVISION

ALLIED CHEMICAL & DYE CORPORATION

40 Rector Street, New York 6, N. Y.

Offices: Albany\* • Atlanta • Baltimore\* • Birmingham\* • Boston\* • Bridgeport\* • Buffalo\* • Charlotte\*  
Chicago\* • Cleveland\* • Denver\* • Detroit\* • Houston\* • Jacksonville • Kalamazoo • Los Angeles\* • Milwaukee  
Minneapolis • New York\* • Philadelphia\* • Pittsburgh\* • Providence\* • St. Louis\* • San Francisco\* • Seattle  
Kennewick\* and Yakima (Wash.)

In Canada: The Nichols Chemical Company, Limited • Montreal\* • Toronto\* • Vancouver\*

SETTING THE PACE IN CHEMICAL PURITY SINCE 1882

\*Complete stocks carried here



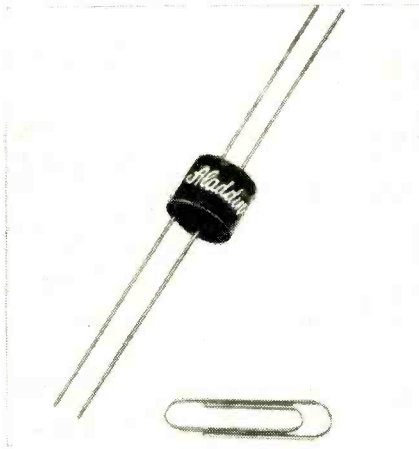

equivalent of the familiar pot-core. The moisture-proof external finish on the ferrite makes it unnecessary to add to the size and weight of the unit by molding it in plastic or canning it.

► **Step-Up Ratios**—Voltage step-up ratios as high as 15 to 1 have been achieved while maintaining reasonably low distributed capacitance. Several variations on the basic design, each developed to achieve the optimum combination of performance characteristics for a particular application, are available.

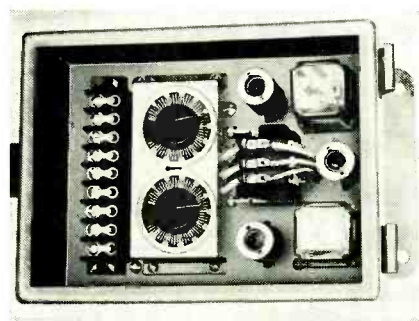

### ELECTRONIC TIMER with high load capacity

FERRARA, INC., 8106 W. Nine Mile Rd., Oak Park 37, Mich. Independently adjustable on and off time ranges are featured in the model T3 electronic timer. It is designed for use on life test equipment, proportioning controls and process or machine applications requiring on-off timing cycles.

► **Specifications**—The timer has dpdt load contacts rated at 20 amperes, 115 v a-c, noninductive load. The circuit employs cold-cathode tubes requiring no warmup time before use. Accuracy is  $\pm 1$  percent

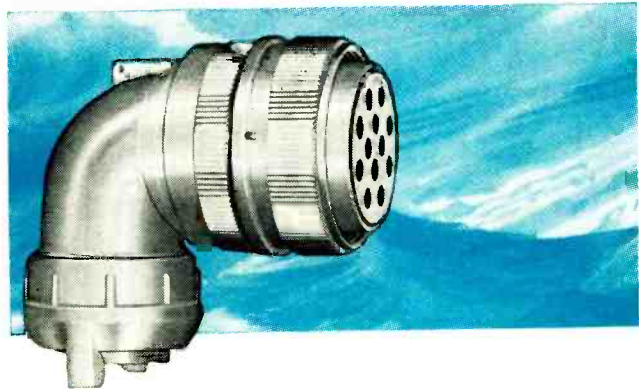

## Bendix-SCINFLEX WATERPROOF PLUGS

FOR USE WITH  
MULTI-CONDUCTOR CABLES!

These new Bendix\*-Scinflex *waterproof* plugs are a modification of our standard AN type "E" (environment resistant) connector. They are designed to meet all "E" performance requirements when used with multi-conductor cables. Each plug includes a modified AN3057B cable clamp which provides inward radial compression on multi-conductor cables. This unique feature completely eliminates cable strain—a common source of circuit trouble.

In addition, there are gaskets at all mating surfaces and an accessory sleeve is available to accommodate an extreme range of cable sizes. A descriptive folder is available on request.

\*TRADE-MARK

#### THESE BUILT-IN FEATURES ASSURE TOP PROTECTION AGAINST CIRCUIT FAILURE:

Shock and Vibration Resistant • Die Cast Aluminum Shell • Cadmium Plate—Olive Drab Finish • Moisture-Proof, Pressurized • High Arc Resistance, High Dielectric Strength • Silver-Plated Contacts • Resilient Inserts

**Bendix** SCINTILLA DIVISION OF **Bendix**  
SIDNEY, NEW YORK AVIATION CORPORATION

Export Sales and Service: Bendix International Division,  
205 East 42nd St., New York 17, N. Y.

Factory Branch Offices: 117 E. Providencia Avenue, Burbank, California •  
Brouwer Building, 176 W. Wisconsin Avenue, Milwaukee, Wisconsin •  
Stephenson Building, 6560 Cass Avenue, Detroit 2, Michigan • 512 West  
Avenue, Jenkintown, Pennsylvania • 8401 Cedar Springs Rd., Dallas 19,  
Texas • American Building, 4 South Main Street, Dayton 2, Ohio

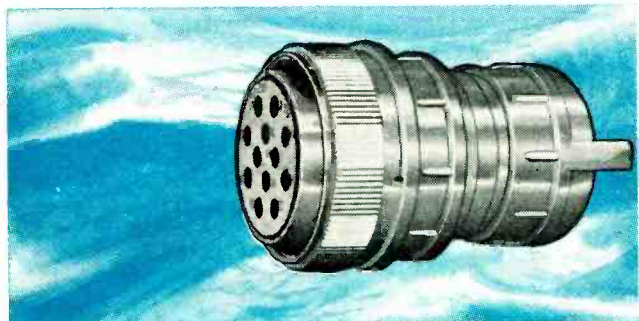

**marion**  
advancement  
in instrument  
design

**NO  
GASKETS  
NO  
CEMENTS**

The  
"ORIGINAL"

MIL-M-10304

**RUGGEDIZED  
PANEL**

**INSTRUMENT**

Hermetically sealed  
glass-to-metal

MIL 2½" and 3½" sizes. ua, ma, amp, mv, volt, kv, AC rectifier types for voltage, decibel and VU measurement, manufactured to MIL-M-10304. Standard ranges from stock. Twelve page booklet on request.

Visit us at Booth #556  
at the I.R.E. Show

**marion meters**

marion electrical  
instrument company

GRENIER FIELD, New Hampshire's NEW Air-Industry Area  
MANCHESTER, N. H. U. S. A.

copyright 1966 M. E. I. Co.



NEW PRODUCTS

(continued)

and independent of line voltage fluctuations from 105 to 125 v.

Standard available ranges are 0.3 to 25 sec per section and 0.5 to 50 sec per section, with other combinations available. Prices are as follows: open style, \$91; with NEMA XII enclosure, \$105.



**DECADE CAPACITOR  
a laboratory-type unit**

HIGH FIDELITY PRODUCTS, Box 131, Owensboro, Ky. Model 100 is a laboratory-type decade capacitor having a range of 0 to 10  $\mu$ f in 1- $\mu$ f steps. It is supplied in a standard tolerance of  $\pm 10$  percent. Closer tolerance may be had on special order.

The unit is designed for use in wave filters, loudspeaker crossover networks, equalizers and tuned circuits. It is housed in an aluminum case which is 4 in. wide, 5 in. long, and 3 in. high.

Net price is \$9.95.



**TORQUE SOURCE  
for lab or production use**

BULOVA RESEARCH AND DEVELOPMENT LABORATORIES, INC., 62-10 Woodside Ave., Woodside 77, N. Y., announces its new all-electric calibrated torque source for testing and

For consistently high purity...

**"LINDE" M.S.C. RARE GASES**  
Trade-Mark  
(Mass Spectrometer Controlled)

- Helium
- Argon
- Neon
- Krypton
- Xenon

In radar electronic equipment, nuclear radiation counters, cosmic ray cloud chambers, and thyratrons, where the purest rare gases are demanded, LINDE M.S.C. Grade gases meet the specifications. They are produced under continuous mass spectrometer control to assure you of gases of known purity and consistently high quality. LINDE, the world's largest producer of gases from the atmosphere, can meet your individual needs of volume, mixture, and container.

For information on the physical, chemical, and electrical properties of these gases, send for the booklet, "LINDE Rare Gases."



**LINDE AIR PRODUCTS COMPANY**

A Division of  
Union Carbide and Carbon Corporation  
30 E. 42nd Street **NYC** New York 17, N.Y.

In Canada:  
LINDE AIR PRODUCTS COMPANY, Division  
of Union Carbide Canada Limited, Toronto  
The term "Linde" is a registered trade-mark of Union Carbide and Carbon Corporation.

**NEW! BEACON FLASHERS**

in accordance with CAA-FCC regs.  
by HUGHEY & PHILLIPS, INC.

- your most dependable source of Obstruction Lighting Equipment
- the widest selection of Control and Alarm Apparatus in the Industry.

**THREE MODELS**

Model BF-40 is a single pole unit for flashing a single beacon. Models BF-41 and BF-42 provide two separate circuits for alternate flashing of two beacons (BF-41 — 117 volt, BF-42 — 115/230 volt)

**CHOICE OF MOUNTING**

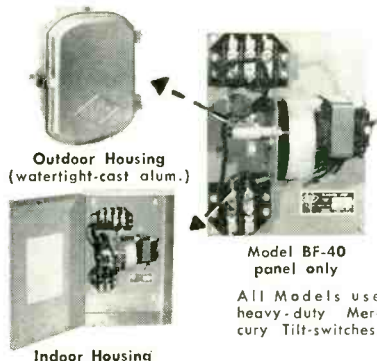

Outdoor Housing  
(watertight-cast alum.)

Indoor Housing

Model BF-40  
panel only

All Models use heavy-duty Mercury Tilt-switches.

Request Descriptive Bulletin HPS-137

**HUGHEY & PHILLIPS, INC.**

Manufacturers of

300MM Code Beacons, Obstruction Lights, Photo-Electric Controls, Beacon Flashers, Microwave Tower Control & Alarm Units, Remote Lamp Failure Indicator Systems, and Complete Tower Lighting Kits.

3300 NORTH SAN FERNANDO BLVD.  
BURBANK, CALIF.

**Almo RADIO CO.**  
IS YOUR LEADING

**INDUSTRIAL  
ELECTRONIC  
DISTRIBUTOR**

IN THE DELAWARE VALLEY AREA  
Representing only America's Foremost Mfgs.  
in the Electronic Field — such as...

- Aerovox Corp.
- American Phenolic Corp.
- Ampex Electronic Corp.
- Burgess Batteries Co.
- Cannon Electric Co.
- Corne Dubilier El. Corp.
- General Electric Co.
- International Resistance Corp.
- National Carbon Co.
- Ohmite Mfg. Co.
- Raytheon Mfg. Co.
- Sprague Products Co.
- Stackpole Carbon Co.
- Sylvania Electric Products
- Thordarson Meisner Mfg. Co.
- Triplett Electrical Inst. Co.
- Ward Leonard Electric Co.
- Westinghouse Electric Corp.

AND MANY OTHER FAMOUS NAMES TOO NUMEROUS TO LIST

TEN LOCATIONS IN FOUR STATES TO SERVE YOU

**Almo RADIO CO.**

EXECUTIVE OFFICES AND WAREHOUSE

412-16 N. 6th ST., PHILA. 23, PA.

Downtown Phila.  
509 Arch Street  
West Phila.  
6225 Market St.  
Northeast Phila.  
7540 Frankford Ave.  
Camden, N. J.  
1133-37 Haddon Ave.  
Trenton, N. J., 201-03 N. Calhoun St.

Atlantic City, N. J.  
4401 Ventnor Ave  
Norristown, Pa.  
550 Markley St.  
Wilmington, Del.  
1122 French St.  
Salisbury, Md.  
317 Park Heights Ave.

Export Orders Promptly Filled — Cable Address "ALRAD"

measuring the torque characteristics of pallet mechanisms, small gear trains, servos, springs, clutches and similar devices.

A universal chuck on the front panel, driven by a three-phase motor, supplies the torque which is read directly in oz-in. on a large easy-to-read meter.

► **Applications**—Useful for laboratory or production requirements as a torque source as well as calibrated dynamometer, model 40 has a range of 0.5 to 40 oz-in. with better than 5-percent overall accuracy at shaft speeds from 0 to 100 rpm.

Overall dimensions are 22 in. wide by 12 in. high by 15 in. deep. Designed for 3-phase, 208-220 v, 60-cycle operation, it is priced at \$495.

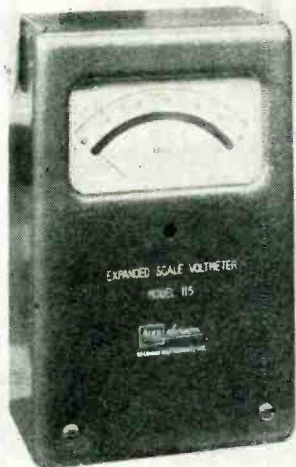

### PORTABLE VOLTMETER has-overvoltage protection

SHASTA DIVISION, Beckman Instruments, Inc., P. O. Box 296, Richmond, Calif. Use of the meter movement for just the top 5 to 10 percent of the range permits this portable single-range expanded-scale voltmeter to obtain high accuracy from a rugged, low-accuracy meter movement. Only the voltage range of interest is expanded full scale—by a patented circuit without electron tubes. Guaranteed accuracy is  $\pm 0.5$  percent of input voltage.

► **Features**—The instrument offers overvoltage protection, wide frequency range (50 to 5,000 cps) and voltage expansions of  $\pm 5$ ,  $\pm 10$ , or

# WHATEVER YOUR UHF ATTENUATION NEEDS...

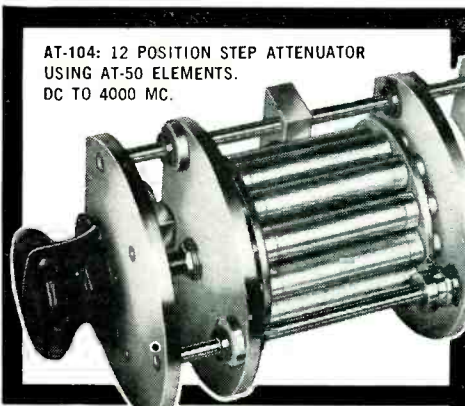

AT-104: 12 POSITION STEP ATTENUATOR  
USING AT-50 ELEMENTS.  
DC TO 4000 MC.

A COAXIAL UNIT FROM  
EMPIRE DEVICES  
WILL MEET  
YOUR REQUIREMENTS

Empire's UHF attenuators are resistive coaxial networks for the frequency range from DC to 4000 MC.

Accuracy is held to  $\pm \frac{1}{2}$  DB, VSWR is better than 1.2 to 1. Any attenuation values up to 60 DB are available. Deposited carbon elements are used for stability and operations at higher pulse levels. Standard impedance is 50 ohms, other values upon request. These units have excellent temperature characteristics and are vibration and shock resistant. Standard connectors are type "N", attenuator pads are also available with type "C".

The attenuators may be obtained as individual pads (AT-50, AT-60), or as multi-position step attenuators AT-103 (six positions) and AT-104 (twelve positions). For even greater flexibility, several step attenuators may be series connected.

For complete technical information  
about attenuators for your  
laboratory or production needs,  
write for free catalog.

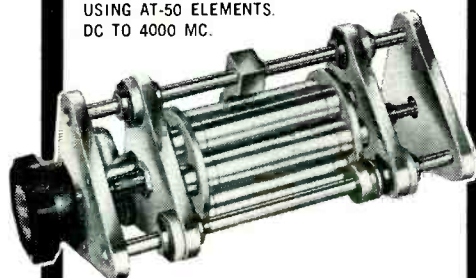

AT-103: 6 POSITION STEP ATTENUATOR  
USING AT-50 ELEMENTS.  
DC TO 4000 MC.

AT-50: ATTENUATOR PAD,  
DC TO 4000 MC.  
1 W AVERAGE, 1 KW PEAK.



AT-60: ATTENUATOR PAD,  
DC TO 3000 MC.  
2 W AVERAGE, 2 KW PEAK.

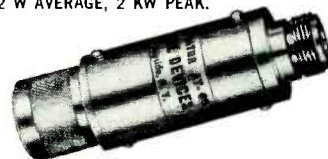

NEW YORK—Digby 9-1240 • SYRACUSE—SYRacuse 2-6253 • PHILADELPHIA—  
Sherwood 7-9080 • BOSTON—Twinbrook 4-1955 • WASHINGTON, D. C.—Dectar  
2-8000 • ATLANTA—EXchange 7801 • DETROIT—BRoadway 3-2900 • CLEVE-  
LAND—EVergreen 2-4114 • DAYTON—FULton 8794 • CHICAGO—EStebrook 9-2700  
DENVER—MAin 3-0343 • FORT WORTH—WEBster 8811 • ALBUQUERQUE—  
ALBUquerque 5-9632 • LOS ANGELES—REpublic 2-8103 • PALO ALTO—DAVen-  
port 3-4455 • CANADA: MONTREAL—REgent 3-6502 • TORONTO—WAlnut  
4-1226 • HALIFAX—HALifax 4-6487 • EXPORT: NEW YORK—MURray Hill 2-3750

## EMPIRE DEVICES PRODUCTS CORPORATION

38-15 BELL BOULEVARD • BAYSIDE 61 • NEW YORK  
manufacturers of

FIELD INTENSITY METERS • DISTORTION ANALYZERS • IMPULSE GENERATORS • COAXIAL ATTENUATORS • CRYSTAL MIXERS

Here's what  
you've been  
looking for...



### A GEAR HEAD SERVO MOTOR WITH LOW INERTIA...LOW BACKLASH AND A BIG PLUS IN FLEXIBILITY!

Norden-Ketay engineers design quality precision components that meet all your requirements. By combining low inertia and low backlash with new flexibility in servo motor design, Norden-Ketay makes possible...

**MAXIMUM GEAR RATIO VARIATIONS**—from 5:1 to 10,000:1 by simply changing gear clusters.

**MAXIMUM BACKLASH CONTROL**—backlash restricted to less than 0° 30'.

**MAXIMUM OUTPUT TORQUE**—from 50 inch ounces to 150 inch ounces.

**EASE OF MAINTENANCE**—simplified design offers quick easy assembly and maintenance.

**CORROSION RESISTANT**—built to military specifications (MIL E-5272A).

**AVAILABLE IN VARIOUS SIZES**—11, 15, 18. Other sizes available on special order.

For complete details write for data file #112.



## NORDEN-KETAY CORPORATION

PRECISION COMPONENTS DIVISION:  
555 Broadway, New York 12, N. Y.

WESTERN DIVISION:  
13210 Crenshaw Blvd., Gardena, California

SYNCHROS · RESOLVERS · RESOLVER AMPLIFIERS · SERVO MOTORS · GEARED SERVO MOTORS · INDUCTION MOTORS · TACHOMETER GENERATORS · MAGNETIC INDICATORS · SERVO AMPLIFIERS · REMOTE INDICATING DEVICES · TACHOMETER INDICATORS · INDUCTION POTENTIOMETERS · ELECTROMECHANICAL DEVICES

NEW PRODUCTS

(continued)

±15 v at 115 v. It is designed for applications where exceptional ruggedness and reading ease are required. Both meter and circuit elements are hermetically sealed. The unit is true rms reading. Price is \$105.



### CAMERA records cro patterns

ALLEN B. DUMONT LABORATORIES, Inc., 750 Bloomfield Ave., Clifton, N. J. High-resolution film images without distortion regardless of aperture setting are featured in a new continuous-motion oscillograph record camera. The new camera for making moving-film or single-frame recordings of patterns on c-r oscillograph screens is designated as type 321-A.

► **Features**—The camera uses easily obtainable 35-mm film, and the film magazines accommodate either standard 100 ft spools or any film length up to 400 ft on reels. It has electrical connections which permit it to be remotely operated, and it may be quickly turned on its side to permit recordings plotted along a vertical axis.

### VOLTAGE REGULATOR is distortion-eliminating

CURTISS-WRIGHT CORP., Electronics Division, 631 Central Ave., Carlstadt, N. J. The EE100 voltage regulator is designed to eliminate disturbing harmonics and low-frequency noise in 115-v, 60-cps power sources.

► **Regulated Power**—It furnishes 1.4 kva of ±1 percent electronically voltage-regulated power with line

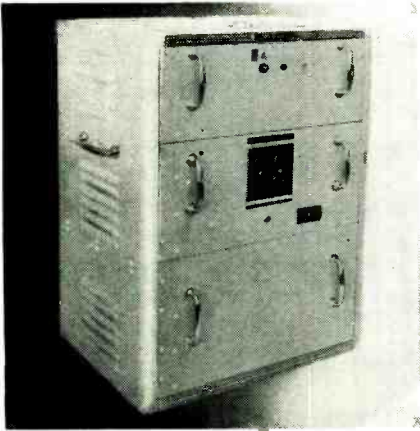

distortion reduced to less than 0.3 percent. Simultaneously, it furnishes an additional 4 kva of  $\pm 1$  percent electromechanically regulated power for those applications where normal line distortion and slower voltage regulation can be tolerated.

The instrument is also ideally suited for preventing instability and inaccuracy in a-c computer nulling operations.

Price of the unit is \$1,689.

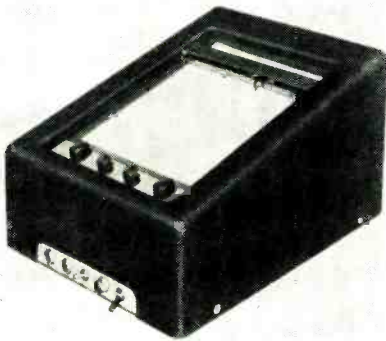

### X-Y RECORDER with flat-bed presentation

ELECTRO INSTRUMENTS, INC., 3794 Rosecrans, San Diego 10, Calif. The flat-bed presentation of the new 8½ in. by 11 in. X-Y recorder permits the plot to be visible during the entire plotting operations. This feature also permits the plot to be marked or identified in place.

The pen assembly adjusts to accommodate a full pad. To change plot paper, one simply flips the switch control, removing the pen and arm from the plotting area, and tears the plot from the pad.

► **Performance**—Pen speed is ½ sec full scale, made possible through

*Engineered for  
tomorrow's needs...today...*

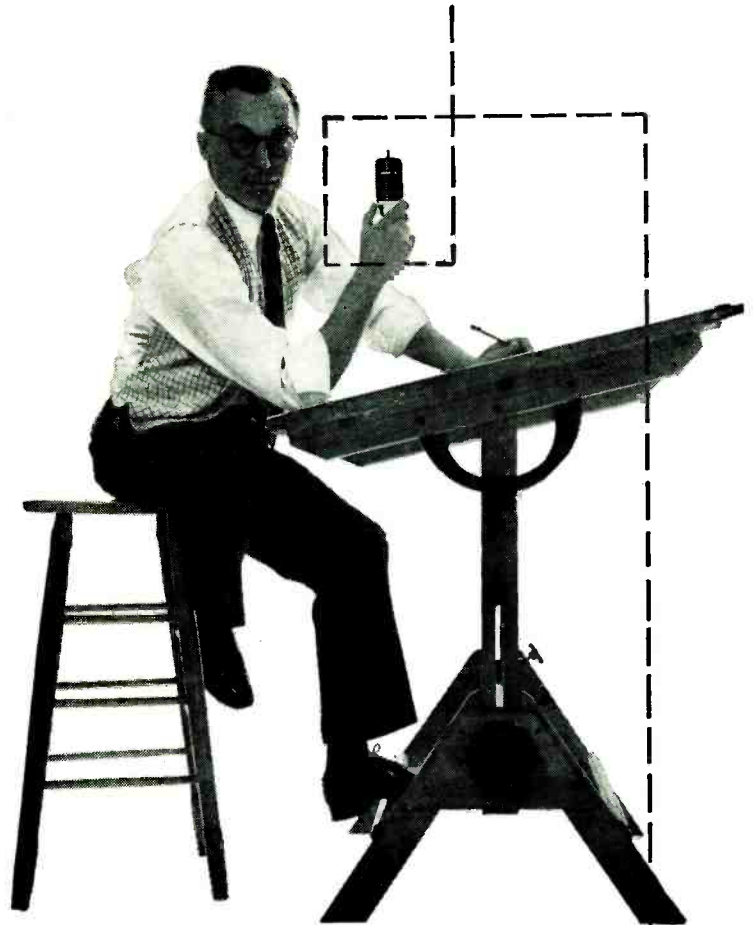

### **NORDEN-KETAY OFFERS YOU DIRECT ANALOG-TO-DIGITAL CONVERSION WITHOUT TRANSFORMATION**

Combining accuracy with compact design, Norden-Ketay's ADC-1A family of Analog-To-Digital Converters provides you with *unambiguous natural binary output*. All digits are available nearly simultaneously...allowing a high reading rate and may be read while the shaft is in motion. Both the binary number and its complement are available, simultaneously.

**RAPID READOUT**—up to 10<sup>6</sup> per second.

**PARALLEL READOUT**—greatly simplifies external circuitry.

**COMPACT DESIGN**—engineered for minimum size and weight.

**INPUT**—DC or pulse voltages.

**LOW TORQUE**—less than 0.2 inch ounces to turn input shaft.

**LOW INERTIA**—approximately 9 gram centimeters<sup>2</sup>.

**CLOCKWISE OR COUNTER CLOCKWISE OPERATION**—either is possible by selection of appropriate output leads.

**AVAILABLE IN ANY CAPACITY TO 19 DIGITS**—other capacities available on special order.

For full details write for File #112.



## **NORDEN-KETAY CORPORATION**

INSTRUMENT AND SYSTEMS DIVISION  
Wiley Street, Milford, Connecticut

Indicating Precision Pressure Gages • Remote Indicating Devices • Analog Digital Converters • Force Balance Pressure Transducers • Electromechanical Control Systems • Airborne Radar • Shipboard Line Control Equipment • Aircraft Fuel Flow Instrumentation • Accelerometers

# SIE

## MODEL E-2

# COMPARISON BRIDGE

*for fast, accurate matching and measuring of*

## RESISTORS      CAPACITORS

1 ohm to 5 megohms

500 mmfd to 2000 mfd

## INDUCTORS

3 millihenrys to 10,000 henrys

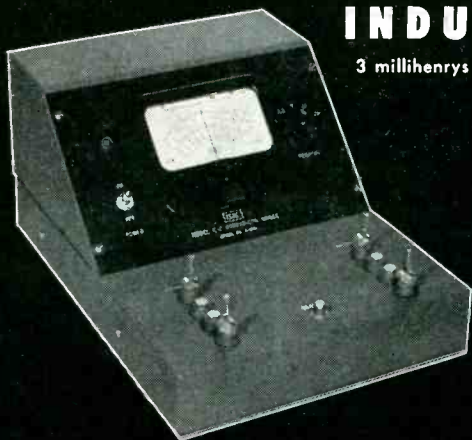

Sloping meter face and wide-spaced component clips speed production line testing. Foot operated switch\* allows two-hand operation.

Stable, high-gain, circuit permits the detection of component differences amounting to only 1 part in 10,000. Five meter ranges indicate differences at 1%, 2.5%, 10% and 25% value full scale.

In the design laboratory, or in assembly operations, the E-2 Comparison Bridge offers accuracy, flexibility, and dependability.

### ★ EASY TO USE —

Spring clip, and banana-plug terminals.

### ★ HAND OR FOOT OPERATED —

\*Foot control optional at extra cost.

### ★ ACCURATE —

Tolerance 0.1% on 1% scale.

### ★ LOW COST —

\$185 FOB Houston.

# SIE

**SOUTHWESTERN INDUSTRIAL ELECTRONICS CO.**  
INDUSTRIAL INSTRUMENT DIVISION

P. O. Box 13058    2831 Post Oak Road    Houston, Texas

205-55

REPRESENTATIVES THROUGHOUT THE WORLD

NEW PRODUCTS

(continued)

a new servo design. Jitter is effectively eliminated through the use of new circuits which eliminate 60- and 120-cycle pickup. Performance of the recorder with noisy signals is also greatly improved.

The instrument is provided in 11 scale ranges, from 5 mv to 500 v full scale. Input impedance is 200,000 ohms per v. Potentiometer input is by switch control.

Price is \$1,475 and delivery, 75 days.

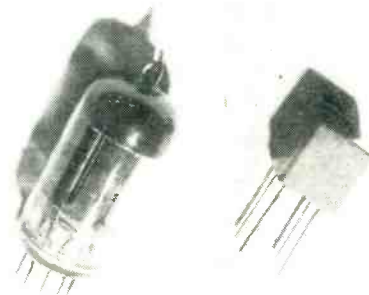

## TINY MAGNET replaces vacuum tubes

BERKELEY DIVISION, Beckman Instruments, Inc., 2200 Wright Ave., Richmond 3, Calif., has developed the Ferristor, a tiny magnetic amplifier designed to replace short-lived vacuum tubes. It will end costly downtime and production line stoppages caused by tube failure. The Ferristor, encapsulated in epoxy resin in a tiny plastic cube only  $\frac{1}{2}$  in. on each side, is immune to shock, moisture, prolonged overloading or vibration.

It is currently being used in the series 5840 magnetic dual preset controller which has only 2 vacuum tubes (as compared with 54 in the electronic model); and the model 7650 magnetic EPUT meter, which uses only 3 vacuum tubes (as compared with 35 in the electronic model).

## AUDIO AMPLIFIER miniature transistor type

MID-WEST COIL & TRANSFORMER Co., 1642 N. Halsted St., Chicago 14, Ill., announces a new miniature transistor audio amplifier in 2 styles. The tube type measures  $1\frac{1}{2}$

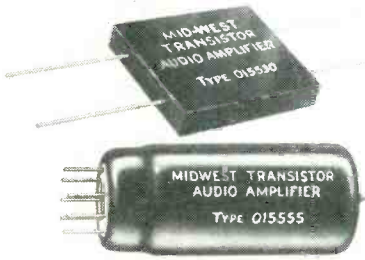

in. high by  $\frac{1}{8}$  in. in diameter. The flat type measures  $\frac{3}{8}$  in. by  $\frac{3}{4}$  in., with a thickness of  $\frac{1}{32}$  in.

► **Advantages**—Some of the features are small size and reduced weight, high gain, battery drain of about 2 ma, hermetic sealing, low noise and hum level and low distortion.

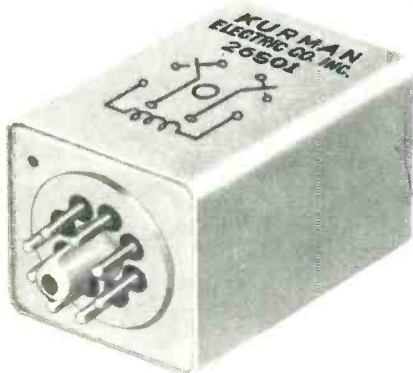

**VERSATILE RELAY is small and fast-acting**

KURMAN ELECTRIC CO., INC., 35-18 37th St., Long Island City, N. Y. The series 25S octal plug-in hermetically sealed relay is ideal for aircraft, mobile, marine and land-operated communications networks.

► **Technical Data**—Features include a-c or d-c operation, a life of 250,000 operations minimum with full contact load of 25 amperes 125 v a-c resistive or 1,000,000 operations minimum with reduced contact load of 5 amperes 125 v a-c resistive. It is fast-acting—4  $\mu$ sec with 2-w input (d-c only) and will meet MIL-R-5757B Class A.

Minimum coil sensitivity is 0.5 w d-c and 2 v-a-c; maximum coil dis-



Signal Corps Type AN/PRC-10 Walkie-Talkie. Designed and built by RCA to Signal Corps specifications.

**a complete line of JOHNSON variable capacitors**

Whether you're looking for a tiny "M" capacitor similar to the one shown above, or a rugged air variable rated to 11,000 volts, you're sure to find it in the Johnson line. All Johnson Variable Capacitors are designed to permit high standards of workmanship, yet costs are low.

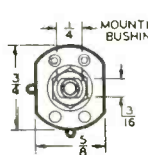

**TYPE "M" CAPACITORS**

Extremely compact and rugged—requires  $\frac{3}{8}$ " x  $\frac{3}{4}$ " panel mounting area. Soldered brass plates. Low inductance bridged stator terminals. Heavy beryllium copper rotor contact silver plated for smooth HF response—steatite impregnated end frames. Heavy nickel plating, standard—other platings available.

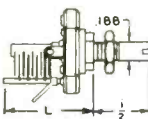

**TYPE "L" CAPACITORS**

Excellent for applications requiring extreme stability and rigidity—tie rods soldered directly to ceramic (steatite) end frames. Plates and metal parts, brass—plated with corrosion resistant Bright alloy. Heavy nickel plating standard—other platings available. Requires  $1\frac{3}{8}$ " x  $1\frac{3}{8}$ " panel mounting area.

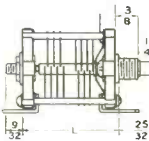
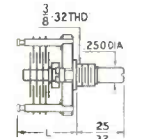
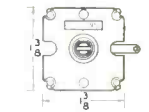

Johnson also makes a complete line of



**SHAFT COUPLINGS • FLEXIBLE SHAFTS • PANEL BEARINGS**

Flexible and rigid shaft couplings available for  $\frac{1}{4}$ " to  $\frac{1}{4}$ ",  $\frac{1}{4}$ " to  $\frac{3}{8}$ ", and  $\frac{3}{8}$ " to  $\frac{3}{8}$ ". Types available for adjustment to both axial and angular shaft misalignment.

Flexible shafts are phosphor bronze with  $\frac{1}{4}$ " nickel plated brass hubs. Permit out-of-line or up to 90 degrees angular control with minimum backlash.

Panel bearings are nickel plated brass—for  $\frac{1}{4}$ " shaft and up to  $\frac{3}{8}$ " panels. Types available with 3" and 6" nickel plated brass shafts—standard  $\frac{3}{8}$ "-24 nut furnished.

For complete information and specifications on Johnson Air Variable Capacitors or other Johnson electronic components, write for your copy of components catalog 976A.



CAPACITORS • INDUCTORS • KNOBS • DIALS • SOCKETS • INSULATORS • PLUGS • JACKS • PILOT LIGHTS



the

**Martin**

**Electronics**

**Tree**

Today, its roots are feeding research and development activities on more than a dozen top-rated projects, including 6 guided missile programs, 4 aircraft, a major air defense system, an earth satellite launching vehicle and a variety of highly specialized weapons systems.

Main branches of the Martin electronics tree include: **SYSTEMS DESIGN** for radar, guidance, communication, navigation and reconnaissance systems.

**CIRCUIT DESIGN** for tuners, receivers, digital computers, memory devices, advanced data processing equipment, and a wide range of special weapons systems components.

**THEORETICAL STUDIES** for microwave components, antennas, radomes for missiles and high-speed aircraft, and many advanced design applications.

*Electronics engineering at Martin is second to none in the industry today, and our advanced programs are creating many important new opportunities. Contact J. M. Hollyday, Dept. E-2, The Martin Company, Baltimore 3, Maryland.*

**MARTIN**  
BALTIMORE

sipation is 4 w d-c and 8.5 v-a a-c; maximum d-c coil resistance is 6,800 ohms d-c and 9,800 ohms a-c. Contact arrangement is up to three pole double throw with a maximum operating voltage of 120 v d-c or 375 v a-c.

Among the special features are solder lug terminals and special mounting construction.



**FREQUENCY COUNTER**  
with digital in-line readout

**ELECTRO INSTRUMENTS, INC.**, 3794 Rosecrans, San Diego 10, Calif. A new events-per-unit-time meter, model 250, features true digital in-line readout. This feature eliminates ambiguity and reading errors. Readings stay constant during sampling period. There are no lost readings and no hold adjustments. Sampling changes or dead-times are eliminated. Decimal coded contacts provided in the instrument give simple, direct printout.

► **Specifications**—Display is 5 in-line digits, 1 in. high letters. Accuracy is  $\pm 1$  digit; frequency response, 10 cps to 100 kc; sensitivity, 0.2 v rms; input impedance, 10 mc; time base, 1 sec crystal controlled.

Price is \$875.



**VOLTAGE REGULATOR**  
55 to 65-cps input range

**SORENSEN AND Co., INC.**, 375 Fairfield Ave., Stamford, Conn., has announced model MA1000S tubeless



a-c line voltage regulator. It uses a magnetic amplifier controller circuit with a silicone diode reference element, and is basically insensitive to frequency variations. The unit is particularly applicable to unattended installations requiring highly dependable automatic line regulation.

► **Other Features**—It offers very stable performance over long periods with a minimum of maintenance. Input frequency range is 55 to 65 cps. Regulation accuracy is  $\pm 0.5$  percent against line or load.



**POWER RECTIFIER**  
operates up to 200 C

HOFFMAN ELECTRONICS CORP., 3761 S. Hill St., Los Angeles 7, Calif. The NS-P1 silicon power rectifier is capable of operating at ambient temperatures up to 200 C. It is housed in a rugged, shock and vibration-proof plated case measuring approximately  $1\frac{1}{2}$  in. in diameter and  $1\frac{1}{4}$  in. in height.

► **Specifications** — Maximum reverse working voltage is 60 v and minimum Zener (breakdown) voltage is 70 v. Forward current density at 1 v drop is in excess of 600 amperes per sq in. of junction area.

**CENTRIFUGAL BLOWER**  
for electronic cooling

ROTRON MFG. Co., Schoonmaker Lane, Woodstock, N. Y. Model R type 3501 centrifugal blower is designed for use in applications requiring a high pressure-to-volume cooling performance. Small in size, it is particularly suitable for operation at high shaft speeds obtainable with 400 cps power supplies. Altvar motors are incorporated for



**REPEAT PERFORMANCE**

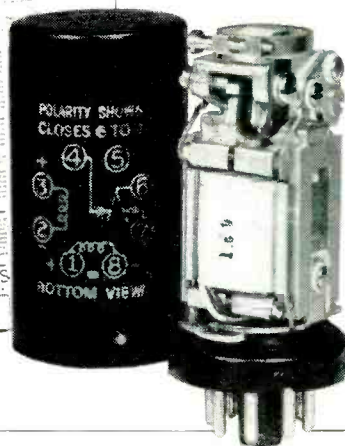

The existence of the remarkable Sigma type 72 relay has been hinted at occasionally, starting back in '53 when it was suspected that we might finally have something here. In those days we played a little hard to get because (a) we weren't quite sure, and (b) they were hard to get. It even got to the point a year or so ago that we advertised it as the WORLD'S BEST RELAY\* which was very carefully qualified: "We can't prove this, but it is the opinion of the man who designed it." By now several 72's have completed half a billion operations and more in customer's telegraph printers, without even the necessity of prying open the ingenious repair kit\*\* for contact or armature replacement. Now we're convinced and ready to give it a real below.

Basically, the 72 is a high speed polar relay whose REPEAT PERFORMANCE (get it? heh!) makes it admirably suited for telegraph service and useful for handling other forms of data up to 500 pps. Significant specifications are tabulated below, and to them we'd like to add the crucial one: Series 72 relays are available (an unusual Sigma feature).

**SPECIFICATIONS Sigma Series 72 Relays**

Operation; principal use	Polarized; telegraph service, data handling up to 500 pps.
Contact arrangement, life and load rating	SPDT; $5 \times 10^8$ @ 60 ma DC
Max. aperiodic pulse rate	500 pps
Max. following pulse rate	1200 pps
Vibration immunity	15 g to 500 cps even at highest sensitivity
Maintenance, adjustment	Bias, sensitivity adjustable; contacts, armature easily replaceable.



We won't horse around about the 72 any more. You don't have to beg us to sell them to you or for "fast" delivery. Just drop us a line and we'll see to it that you don't have a moment's peace until you buy some—we dare you.

**SIGMA**

SIGMA INSTRUMENTS, INC.  
62 Pearl St., So. Braintree, Boston 85, Mass.

# MARKEM<sup>®</sup> MACHINES

## Solve "IN-PLANT" PRINTING PROBLEMS

- FASTER - NEATER - AT LOWER COST

The Markem Model 45AF Machine prints trade name, trade mark, specifications, etc., on resistors, condensers, capacitors, diodes, triodes, transistors, etc., at production rates. Feeds, prints, and ejects automatically. Quickly insertable type provides easy change in data being printed.

Write for further information. Submit sample of item you wish to mark.

### WIRE LEAD COMPONENT PRINTING

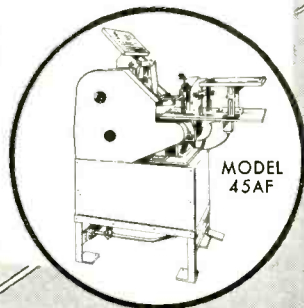

MODEL 45AF

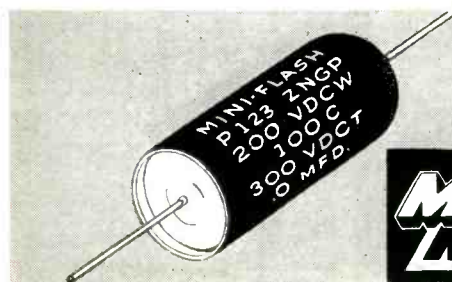
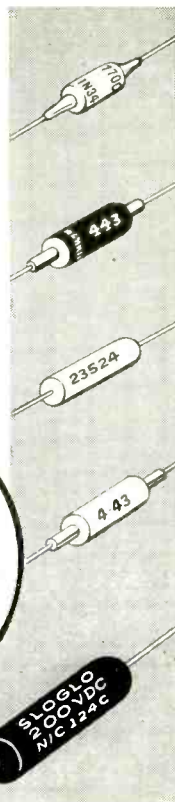

MARKEM MACHINE CO.  
KEENE 5, NEW HAMPSHIRE

NEW PRODUCTS

(continued)



constant cooling efficiency in airborne applications.

Weighing approximately 3 lb, the unit is capable of moving 25 cfm at 7.5 in. wc at 11,000 rpm. It can operate either on single or three-phase, 60-cps and 400-cps power.

to meet ALL requirements . . . specify

## USRC EDGE-LIGHTED PANELS and DIALS

that meet Spec. MIL-P-7788

STARTING WITH THE "LACKON" PROCESS to assure maximum accuracy in marking, U. S. Radium edge-lighting products have been proven in actual service to meet all other requirements in addition to dimensional accuracy.

USRC PANELS AND DIALS have also been proven superior because of their uniformity of lighting, exceptionally good contrast, reflection and gloss characteristics, scratch and humidity resistance, and ability to withstand repeated cleaning.

The unmatched quality of USRC products results from 40 years' experience in light engineering, radiation materials and associated items.

Contact our nearest sales and service office for information or assistance in the design stage.



### UNITED STATES RADIUM CORPORATION

Sales Offices at: 535 Pearl St., New York 7, N. Y.  
4624 W. Washington Blvd., Chicago 44, Ill.  
5420 Vineland Ave., N. Hollywood, Calif.  
Radelin-Kirk, Ltd., 21 Dundas Sq., Toronto, Con.  
36 Chemin Krieg, Geneva, Switzerland

Plants and Laboratories at:  
Bloomsburg, Pa.  
Whippany, N. J.  
Bernardsville, N. J.  
N. Hollywood, Calif.  
Toronto, Canada

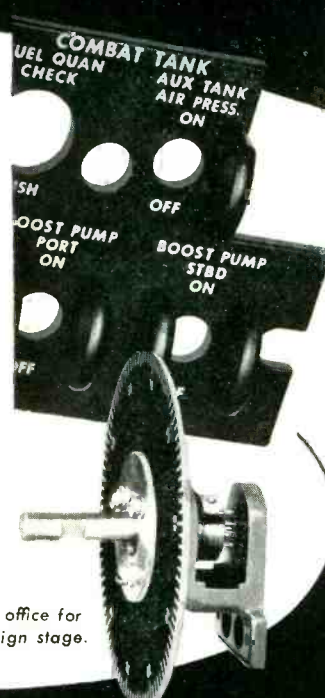

## SYNCHROS used in avionic equipment

CLIFTON PRECISION PRODUCTS CO., Inc., Marple at Broadway, Clifton Heights, Pa., has announced the new, guaranteed 7 minute accuracy size 8 synchros. The units are available as transmitters, control transformers, resolvers, repeaters and differentials. They are exceptionally corrosion-resistant due to the use of nickel alloy laminations and stainless steel bearings.

In addition to the usual 11.8 or 26 v excitation, the units are also available in 115-v 400-cycle pri-

mary, 90-v secondary transmitters, control transformers and receivers.

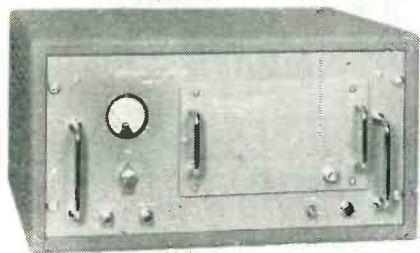

**VHF-UHF CONVERTER**  
reads frequencies to 515 mc

BERKELEY DIVISION OF BECKMAN INSTRUMENTS, INC., 2200 Wright Ave., Richmond 3, Calif. Model 5580 vhf-uhf converter measures and reads frequencies up to 515 mc in digital form. The converter is designed for use with the model 5571 frequency meter to multiply by 12 the meter's range. Its accuracy is to 1 part in  $10^7 \pm 1$  cycle.

In production with the converters are model 5581 plug-in units which cover 13 fixed bands from 42 to 515 mc to eliminate costly wide-band amplifiers.

The units consist of a mixer and multipliers for generating precise references or base frequencies from the crystal controlled frequency produced by the converter.

For this operation, the converter's multiplier circuit generates the crystal controlled frequency by taking a 1-mc pulse from the model 5571 and injecting it into the plug-in unit.

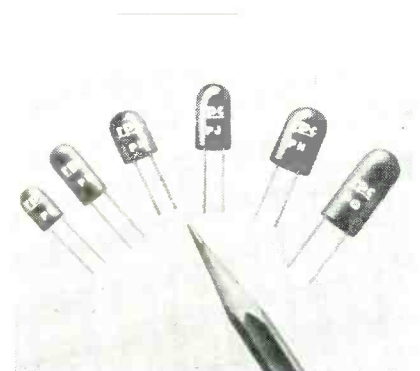

**MINIATURE RESISTORS**  
for printed circuits

RESISTANCE PRODUCTS Co., 914 S. 13th St., Harrisburg, Pa., is now producing a line of precision wire-



New!  
**COLOR**  
& BLACK & WHITE  
LAB & TV SERVICE  
**5" SCOPE**

**5 MC BANDWIDTH & DC AMPLIFIERS**

- Flat from DC to 4.5 mc to reproduce 3.58 mc sync burst and oscillator signals in color TV sets.
- 4-step freq-compensated attenuator in both AC and DC positions.
- Built-in calibrator permits peak-to-peak voltage measurement.
- Automatically syncs anything visible on the screen.
- Pre-set TV V & H sweep positions (30 cps & 7875 cps).
- Edge-lit lucite engraved graph screen with dimmer control; filter; standard bezel fits standard photographic equipment.
- 5U1 CRT

# 460 **KIT**  
Factory Wired \$129.50 **\$79.95**

- V amplifier direct-coupled and push-pull thruout; gradual roll-off beyond 4.5 mc; useful at 10 mc.
- High V sensitivity: 25 mv/in.
- Choice of direct coupling (DC) or capacitive coupling (AC).



Write for FREE New 1956 Catalog E-2 and Name of Distributor

84 Withers Street • Brooklyn 11, N. Y.

©56 Prices 5% Higher on West Coast

**NOW IN STOCK AT YOUR NEIGHBORHOOD DISTRIBUTOR . . . ORDER NOW!**

A REVOLUTIONARY "First"

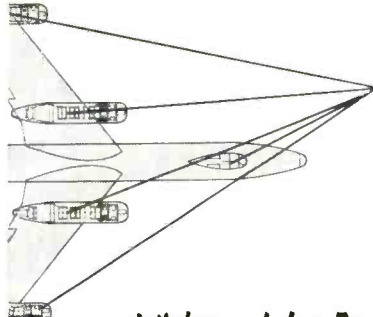

SERVICE-FITTED  
SERVICE-TESTED  
SERVICE-APPROVED

SILICONE IMPREGNATED  
FIBERGLAS CUSHIONED  
**CLAMPS**

*Withstand Jet Engine Heat or Stratospheric Cold...*

ADEL has the answer to the need for a rugged, heat and abrasion-resistant clamp that can withstand the attack of the stratosphere's sub-zero cold and the intense heat of today's aircraft, missile and rocket power plants. TEMPERATURE CHARACTERISTICS: Far above +550° F. to well below -90° F. Performance far beyond specifications of any other clamp.

Easily installed on "bundle" or removed, and they retain their firm, cushioned grip despite severe vibration and extreme temperatures. Cut maintenance and replacement costs...cushions won't tear during engine harness assemblies and if material chars, due to extremely high temperatures, there still remains a safe, non-conductive layer—A positive "design-fix" for jet engines.

SAMPLES & SPECIFICATIONS: Aircraft, Component & Guided Missile Manufacturers mail coupon today for samples and detailed information on how CLAMPS fit your specific needs.

**PRECISION PRODUCTS**  
A Division Of  
General Metals Corporation

HUNTINGTON DIVISION  
1444 Washington Avenue, Huntington 4, West Virginia

Name \_\_\_\_\_  
Company \_\_\_\_\_  
City \_\_\_\_\_ Zone \_\_\_\_\_ State \_\_\_\_\_



## DC-AC CHOPPERS

**For 60 Cycle Use**

Built to rigid commercial specifications.

Twenty-two types, both single and double pole.

Long life.

Low noise level.

Extreme reliability.

Write for Catalog 370.

**STEVENS  
INCORPORATED  
ARNOLD**

22 ELKINS STREET  
SOUTH BOSTON 27, MASS.



S/A-10

wound miniature resistors engineered expressly for use with printed circuits. These type P resistors are single-ended units made for easy rapid mounting on printed circuit panels with no support other than the wire leads needed.

Type P resistors can be safely operated at full rated load in ambient temperatures up to 125 C. They are made with high temperature epoxy resins and resistance wire with special high temperature insulation. Sizes are available rated at from 1/10 w up to 1 w.

► **Specifications**—The resistors are available in a complete line of 6 sizes ranging from 1/4 in. diameter and 3/8 in. long to 3/8 in. diameter by 3/4 in. long. Available resistance values range from 0.40 megohm up to 3 megohms. Tolerances range from 1 percent to 0.05 percent. The resistors will meet all applicable test requirements of MIL-R-3A, Amendment No. 3.

## THE BEST TEST FOR TV

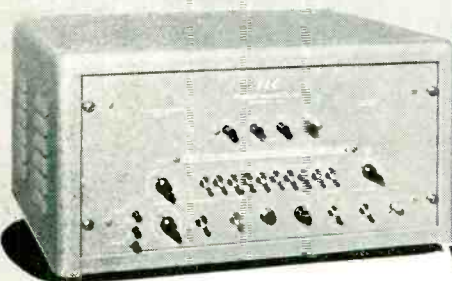

### TIC's TYPE 1105 VIDEO SWEEP GENERATOR

Price: \$600. F.O.B. Carlstadt, N. J.

- High Output
- Flat Frequency Response
- Keyed Carrier Markers to Zero Amplitude
- 75-ohm Internal Impedance
- Sawtooth Sweep Signal

Expressly designed for testing Video equipment requiring a high level signal, the Tel-Instrument Type 1105 provides a 2.0 V. Max. p-p signal from a 75-ohm source into a 75-ohm load, with a sweep range from 50 KC to 10 MC. Features include: Ten selectable crystal controlled pulse-type markers supplied at either integral megacycle point, or as desired; flat output within  $\pm 0.2$  db over entire range, attenuated over 60 db; and external markers.

TIC has a complete line of monochrome and color TV studio and production test equipment. Complete information sent at your request.

**TIC Tel-Instrument**  
**ELECTRONICS CORP.**

728 GARDEN STREET • CARLSTADT, NEW JERSEY



### INDICATOR measures strain-gage output

INDUSTRIAL CONTROL CO., Wyandanch, L. I., N. Y. The SL-1002 is a precision, servo-driven indicator designed to measure the output of conventional strain gages. It consists of an indicator, servo amplifier and control box.

An important feature is the counter presentation and small indicator size. Precision is high, with linearity of 0.2 percent. The novel gage circuit used minimizes drifts due to unbalanced thermal emf's. No additional batteries or standard cells are required as the amplifier provides the bridge excitation.

► **Applications**—The SL-1002 is especially useful where many indica-

# Electronics engineers

do you see...  
the over-all picture...

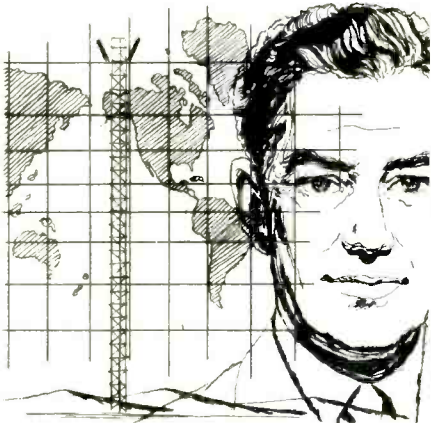

or just the details?

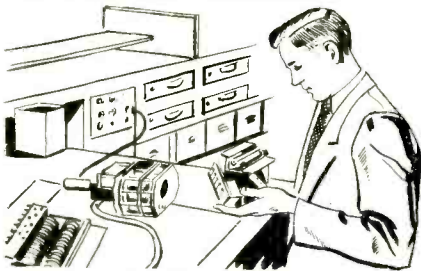

**As a Publications Engineer at COLLINS you will...**

- 1 work with the creative leader in the electronics field,
- 2 write engineering reports on over-all projects, including some of the most advanced electronic work in the industry.
- 3 write on complete systems, their operation, installation, theory and test.

**COLLINS** offers outstanding opportunities for electronics engineers in the field of technical writing on:

MICROWAVE RELAY	FLIGHT CONTROL
NAVIGATION SYSTEMS	RADAR SYSTEMS
COMMUNICATIONS SYSTEMS	GUIDED MISSILES
SSB SYSTEMS	COMPUTERS
RADIO ASTRONOMY	AMATEUR EQUIPMENT

...plus top salaries, opportunity for advancement, company sponsored life, accident, sickness and hospitalization insurance, retirement plan and liberal moving expense allowance.

Electrical Engineers or Physics Majors with good electronic background and an aptitude for writing are desired. Actual writing experience is not necessary.

OPENINGS IN CEDAR RAPIDS, IOWA, BURBANK, CALIF. AND DALLAS, TEXAS

Send Resume to: MR. L. R. NUSS

**COLLINS RADIO COMPANY**  
CEDAR RAPIDS, IOWA

NEW PRODUCTS

(continued)

tors must be photographed together. Its balancing speed is adequate for multiplexing. It can be furnished with digital readout by the addition of the proper digitizer. It can be adapted to the measurement and readout of voltage, current, resistance, temperature, flow, humidity and most other process variables. It is a building block to automation.

## Literature

**Stationary Tachometers.** Metron Instrument Co., 432 Lincoln St., Denver 3, Colorado. Bulletin No. 105 describes a complete line of stationary tachometers which have new circuits and new takeoff heads that increase the life of the company's tachometers by five times. The tachometers described have no brushes, slip rings or other parts that need regular maintenance. Hundreds of combinations are available to meet exact speed measuring requirements.

**Ore Analyzer.** Tracerlab Inc., 130 High St., Boston 10, Mass. Bulletin M-106 discusses a new instrument for determining the amount of uranium and thorium in ores. The equipment described consists of the P20 scintillation detector and a Geiger tube to be mounted on a shielded well which holds samples of ore bearing uranium and thorium. One detector takes beta counts while the other reads gamma only.

An SC-51R Autoscaler is connected with each detector and counts radiation pulses from the sample. The autoscalers are interconnected so as to stop counting simultaneously either after a predetermined interval chosen on the SC-42 preset timer or after a preset count has been obtained on one scaler.

**Plastic Film.** E. I. DuPont de Nemours & Co., Inc., Wilmington 98, Del. A new booklet shows the latest commercial uses and detailed physical and chemical properties of Mylar polyester film. Included is an easy-to-read chart detailing the characteristics of Mylar which have permitted design improvements and

## In CANNON "UA" Audio PLUGS

gold-plated contacts really pan out!

UA-3-11 Plug



UA-3-14 Wall Mounting Receptacle



UA-3-32 Wall Mounting Receptacle



UA-3-42 Microphone or Panel Mounting Receptacle



UA-3-13 Wall Mounting Receptacle



UA-3-31 Wall Mounting Receptacle

UA-3-12 Plug

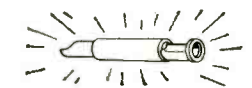

Yes! You get immense satisfaction from gold in any form... and particularly from the performance of the gold-plated contacts in Cannon's modern "UA" audio Series connectors.

Contacts are heavily gold-plated over silver plate... not just "flashed" with a light coating of gold. You get maximum protection from oxidation and deterioration... maximum protection to vital audio circuits... absolute reliability.

Cannon's thumb-pressure LATCH-LOCK prevents accidental disconnect. Available through Cannon distributors.

**WRITE FOR RJC BULLETIN!**

Refer to Dept. 120

**CANNON ELECTRIC COMPANY, 3209 Humboldt St., Los Angeles 31, Calif.** Factories in Los Angeles; New Haven; Toronto, Canada; London, England. Representatives and distributors in all principal cities.

**CANNON ELECTRIC**

Since 1915



**Just a minute—**  
*Please don't get us wrong . . .*  
*we like quantity business, too*

Just the other day an engineer told us: "I'd have asked you to quote on this order if I'd only realized you handled quantity production. But, somehow, I got the impression that you specialized in custom-built transformers in small quantities only."

"Whoa!" we shouted. "Sure we specialize in custom-built transformers, but we can make 'em custom-built in whatever quantity you need."

Maybe the fact that we do handle large quantities will help you. Why not write and ask for more information—

*Just off the press! 16-page, illustrated brochure describing Caledonia's services and facilities for custom designing and manufacturing transformers.*

## CALEDONIA

ELECTRONICS AND TRANSFORMER CORPORATION

Dept. E-2, Caledonia, N. Y.

## News of remarkable advances in ACID RESISTANT WORK CLOTHES!

Now assembled in one informative new catalog . . . all the latest outstanding developments in ORLON\* and DYNEL work clothes! See a tremendous selection of industrial apparel and service uniforms, performance-proved for every need, every purpose, every industry! Discover acid-resistant shirts, pants, coveralls, men's and women's lab coats, that outlast wool and cotton by 50 to 1! Learn about new lint-free, acid-resistant garments for super-clean conditions. Get longer wear with less care . . . savings up to 93%! Send for Worklon's FREE 1956 catalog today!

\*—DuPont Orlon acrylic fiber



WORKLON, INC., Dept. E 2  
253 West 28th St., New York 1, N. Y.

Please rush my free copy of Worklon's new 1956 catalog.

firm name \_\_\_\_\_  
 address \_\_\_\_\_  
 city \_\_\_\_\_ zone \_\_\_\_\_ state \_\_\_\_\_  
 attn. of \_\_\_\_\_ dept. \_\_\_\_\_

# WORKLON

253 West 28th Street, New York 1, N. Y.

cost reductions in many products. These properties include insensitivity to moisture, resistance to solvent and chemical attack, wide temperature operating range, plus greater tensile strength than any other plastic film.

**Facilities Bulletin.** Acton Laboratories, Inc., Acton, Mass. An 8-page booklet illustrates and describes the company's facilities for research and development, custom design and environmental testing of electronic measuring instruments and components for government and industry.

**Counters and Meters.** Spencer Mfg. Co., 3253 N. Cicero Ave., Chicago 41, Ill. A 4-page bulletin covers a line of counters and meters that add, subtract and perform many control functions. Illustrations, operating information and specifications are given for a batch counter (priced at \$99.50), an elapsed time meter (priced at \$15), and a magnetic impulse counter (priced at \$29.50). The case for the magnetic impulse counter described is an additional \$10.

**Environmental Testing Services.** General Testing Laboratories, Inc., 58 Washington Ave., Carlstadt, N. J. A 9-page brochure describes the environmental testing services rendered by the company. Illustrations and chief features are included.

**Electrically Variable Inductors.** Vari-L Co., Inc., 432 Fairfield Ave., Stamford, Conn., has available a folder containing operating principles, design information, applications and tabular data on its electrically variable inductors. Net unit price for 17 different models described ranges from \$27.50 to \$52.50. Quantity discounts are also shown.

**Adjustable Cup Core Coils.** North Hills Electric Co., Inc., 203-18 35th Ave., Bayside 61, L. I., N. Y., has available a data sheet on the series 700 standard adjustable cup core coils covering the 1.5 to 1,000 mh range completely. The units described are designed for supersonic applications, low frequency i-f amplifiers, telemetering circuits, audio applications and filters. Chief fea-

tures, technical information and quantity prices are listed.

**Precision Potentiometers.** Borg Equipment Div. of The George W. Borg Corp., 120 S. Main St., Janesville, Wisc. Systems engineers will be particularly interested in a new brochure covering all phases of precision potentiometer design and application. Complete information, graphs and charts covering physical and electrical design characteristics are included. The brochure "A Symposium of Technical Articles" is available upon request.

**Radio and Electronic Supplies.** Sun Radio & Electronics Co., Inc., 650 Sixth Ave., New York 11, N. Y., has available for free distribution to industrial users, schools, laboratories, government bureaus, a-m/f-m and tv broadcasters and armed forces the first edition of catalog 56 of radio and electronic supplies. It contains 144 pages of useful information for procurement and engineering personnel engaged in electronic design and production.

► **Handiness**—The catalog has been designed for quick easy use. The triple index system enables a person to locate any part, by manufacturer, specific product or general category. To avoid confusion, original manufacturers' part numbers are used in nearly all cases. Numerous product illustrations are included.

**Tape Recorder.** Presto Recording Corp., Paramus, N. J. Volume 7, Number 10 of the *Recorder* illustrates and describes the R-11 tape recorder, a professional quality tape transport mechanism widely used in broadcasting and commercial recording.

Price of the new model H version of the mechanism is \$775. The carrying case model is available at \$827, while the console with the A-901 amplifier sells for \$1,250.

**Radar Target.** Emerson & Cuming, Inc., 869 Washington St., Canton, Mass. Technical bulletin 6-2-3A describes the Ecco reflector, which is effective as a passive target for radar energy. Suggested applications are listed. Accompanying curves give actual performance data, compared to that of a sphere

# CONRAD, Inc.

## HOLLAND, MICH.

### TEMPERATURE AND HUMIDITY CHAMBERS

Meets MIL Specs for Temperature and Humidity cycles with full programming including MIL-E-5272-A

"F" Series — Front Opening

Range: -100° F. to +300° F.

Humidity: 10 % to 97 %

Controllable above at 35° F. D. P.

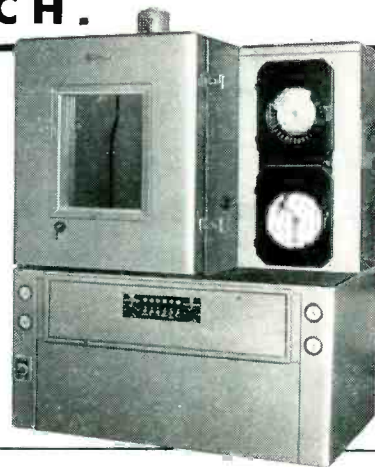

### ALTITUDE AND TEMPERATURE CABINETS

Range: -125° F. to +500° F.

Altitude: Up to 125,000 ft.

### TEMPERATURE CABINETS

Range: -150° F. to +500° F.

4, 8, 12, and 27 cu. ft. Standard Models Available — Immediate delivery



SUBSIDIARY OF CRAMPTON MFG. CO.

141 JEFFERSON ST., HOLLAND, MICH.

MEMBER OF ENVIRONMENTAL EQUIPMENT INSTITUTE

*Write for File Folder*

A GLANCE AT THIS  
HIGH PRECISION REDUCING  
GEAR TRAIN (300-1 IN 6 STEPS)  
EXEMPLIFIES THE  
SKILL AND ABILITIES OF  
BOEHME  
INSTRUMENT CRAFTSMEN

FINE PRECISION  
TOP QUALITY GEARS  
ARE NOT HARD TO GET AT  
BOEHME  
IF YOUR REQUIREMENTS  
INCLUDE UP TO AGMA PRECISION #3  
1/8" TO 5" O.D.  
16-180 D.P.  
YOUR REQUIREMENTS WILL  
RECEIVE PROMPT ATTENTION

## H. O. Boehme, Inc.

Designers and Manufacturers Communication Equipment

Precision Electro-Mechanical Apparatus

915 Broadway • New York 10, N. Y.





# ★ ULTRA LOW capacitance & attenuation

WE ARE SPECIALLY ORGANIZED TO HANDLE DIRECT ORDERS OR ENQUIRIES FROM OVERSEAS SPOT DELIVERIES FOR U.S. BILLED IN DOLLARS—SETTLEMENT BY YOUR CHECK CABLE OR AIRMAIL TODAY



**NEW** 'MX and SM' SUBMINIATURE CONNECTORS  
Constant 50Ω-63Ω-70Ω impedances

TYPE	μμ F/ft	IMPED.Ω	O.D.
C 1	7.3	150	.36
C 11	6.3	173	.36
C 2	6.3	171	.44
C 22	5.5	184	.44
C 3	5.4	197	.64
C 33	4.8	220	.64
C 4	4.6	229	1.03
C 44	4.1	252	1.03

TRANSRADIO LTD. 138A Cromwell Rd. London SW7 ENGLAND CABLES: TRANSRAD, LONDON

and a circular corner reflector of the same dimensions.

**Vibrator Converters.** Cornell-Dubilier Electric Corp., 2900 Columbia Ave., Indianapolis, Ind. Engineering bulletins EB-3500 and EB-3600 cover 375 va and 200 va vibrator converters respectively. The units illustrated and described are designed for railroad and marine service. Electrical and mechanical specifications are included.

**Sheet Metal Products and Electronic Components.** Bud Radio, Inc., 2118 E. 55th St., Cleveland 3, Ohio. A new catalog illustrates and describes the company's line of sheet metal products and electronic components. Special fabrication facilities are also outlined.

To insure ease of selection and ordering, complete sizing information is given on each product. Suggestions for uses and applications are also included.

**Audio Wire.** Alpha Wire Corp., 430 Broadway, New York 13, N. Y., has published catalog S-55 on audio wire, which contains descriptions, specifications and illustrations of the company's in-stock line of 145 audio items.

**pH Meter Tester.** Photovolt Corp., 95 Madison Ave., New York 16, N. Y. Bulletin No. 138 covers the electronic pH meter tester, model 25. It illustrates and describes a compact line-operated instrument without batteries, for quick and easy checking of the proper performance of pH meters by direct application of a voltage through a high resistance, requiring neither electrodes nor buffers for the checking test. A price list is included.

**Electrical Tapes.** Permacel Tape Corp., New Brunswick, N. J. A 4-page brochure, "From Push Buttons to Panel Boards," illustrates the use of plastic tapes as a new insulation for electrical control equipment. The 4-color brochure describes how to save time and labor by using plastic electrical tapes as an insulating agent instead of fiber board.

Also included are the latest technical data on the use of Permacel's plastic electrical tapes, Permacel 29, Permacel 30 and Permacel 302. The

## SHOCK PROOF VACUUM TUBE RETAINERS

These retainers are used to secure Vacuum Tubes and to resist side motion of Vacuum Tubes used in radio equipment which is subject to shock and vibrations. These retainers meet the requirement of all JAN specifications. The insulated portion is made of a melamine base Fibre Glass Phenol which provides 300 volts insulation to ground and withstands a temperature of 350 F. The insulated plate can readily be fastened or released by hand.

Available for envelope types T7, T8, MT8, T9, T12, ST12, T12ZDL, ST14, S14, ST16, T5½, T6½, MT-IC, ST19, T14, ST128CT-9.

Manufacturers of Electronic Components

**JAMES IPPOLITO & CO., INC.**  
1624 Stillwell Ave., Bronx 61, N. Y.



# 3 Relay Types by FILTERS, INC.

Now a Leader in the  
Sub-Miniature Relay Field

## NEW—DPDT SUB-MINIATURE

Actual Size

Engineered for critical  
Airborne and Guided  
Missile Applications

### TYPE: M26F6

CONTACT RATING:  
2 A. Res. at 26.5 vdc  
or 115 vac  
Dia.: .635  
Mtg. Ctrs.: 0.875  
Shock: 50 G  
Vibration: 10 G  
at 5 to 2000 cps  
Amb. Temp.: -65°C to +125°  
Weight: 1.3 oz.

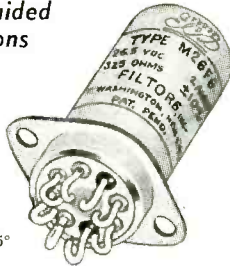

## NEW-LATCHING SUB-MINIATURE

6PDT

Actual Size

Magnetically Held—  
Electrically Reset

UNBELIEVABLY SMALL  
FOR A  
LATCHING  
RELAY

### TYPE: L26F18

CONTACT RATING:  
3 A. Res. at 26.5  
vdc or 115 vac  
Mtg. Ctrs.: 1.406  
Shock: 50 G  
Vib.: 10 G at 5 to  
500 cps  
Amb. Temp.: -65°C  
to +125°C  
(Also available in  
2PDT and 4PDT)  
Weight: 3.3 oz.

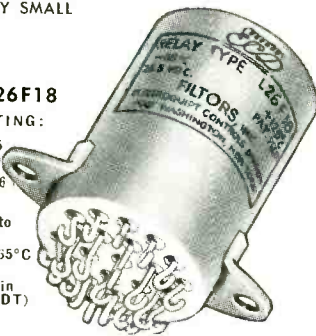

## SUB-MINIATURE 4PDT

Actual Size

The Smallest,  
Hermetically-Sealed  
4PDT Relay  
Available Today

### TYPE: 26SR12

Mtg. Ctrs.:  
1.406  
Shock: 50 G  
Vib.: 10 G at 5  
to 500 cps  
Amb. Temp.: -65°C  
to +125°C  
Weight: 2.6 oz.



### MIL SPECIFICATIONS

All Made to MIL-R-57578 and MIL-R-25018  
(USAF)

DRY CIRCUIT RELAYS AVAILABLE  
IN PRODUCTION QUANTITIES

Write Today For New Catalog Listing  
Sales & Engineering Office Nearest You

## FILTERS, INC.

30 Sagamore Hill Drive  
Port Washington, L. I., N. Y.

Canadian Office:  
MJS ELECTRONIC SALES, LTD.  
P.O. Box 240, Ajax, Ontario  
Tel.: Empire 8-3806

Export Office:  
MAURICE I. PARISIER & CO.  
1860 Broadway, New York 23, N. Y.  
Cable Address:  
MIPARISIER NEW YORK

## NEW PRODUCTS

(continued)

data include thickness, elongation, adhesion, tensile strength and dielectric strength.

**Power Supplies.** Dressen-Barnes Corp., 250 N. Vinedo Ave., Pasadena 8, Calif. A line of power supplies (electronic and magnetic amplifier types) are illustrated and described in a 6-page folder. Constant current supplies, transistor power supplies and motor speed controls are covered. Model X series closely regulated sub-chassis mounting d-c power supplies described range in price from \$33.50 to \$150.

**Transistors and Rectifiers.** General Electric Co., Syracuse, N. Y., has published an 8-page brochure containing condensed specification and rating data on transistors and rectifiers. Critical parameters for absolute maximum ratings and design center ratings are given for the complete line of GE *npn* and *ppn* transistors currently in production.

In addition, critical specifications for the complete GE germanium rectifier line include basic rectifier units, high-temperature rectifiers, magnetic amplifier rectifiers, rectifier stacks, 5-ampere power rectifier, and medium power rectifier stacks in various applications are given.

Brochure ECG-95 is cross-referenced to individual specification sheets containing complete data on the components.

**Silicone Reference Guide.** Dow Corning Corp., Midland, Mich., has published a 1956 reference guide on silicone products. The new edition describes almost 150 of the most generally used silicone products, 18 of which were first introduced within the last 12 months.

The products are grouped by physical form and cross-indexed by usage enabling them to be located by what they do, as well as by what they are.

Twelve pages, printed in two colors, cover product descriptions that are condensed and devoted to essential data. The booklet is thoroughly illustrated with charts, tables, graphs and application photographs.

**Small Motors.** Barber-Colman Co., Rockford, Ill. A new condensed catalog describes the company's line of shaded pole a-c motors for

● Low noise level

● Precision

● Stability

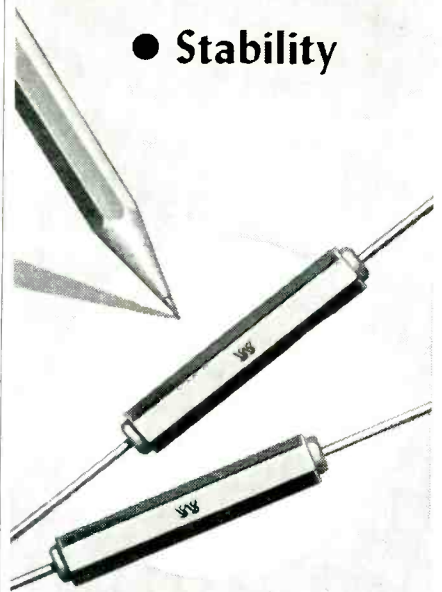

## Sillwhite 65X MOLDED RESISTORS

RATING—1 watt.

TEMPERATURE COEFFICIENT—From approx. +0.1%/°F for 5000 ohm values to approx. -0.2%/°F for 10 megohm values.

VOLTAGE COEFFICIENT—Rated at less than 0.02%/Volt.

UPPER TEMP. LIMIT—170°F for continuous operation.

NOISE LEVEL—Low noise level inherent, but at extra cost we can test and guarantee standard range resistors with "less noise than corresponds to a resistance change of 1 part in 1,000,000 for the complete audio frequency range."

VALUES—

Standard Range—1000 ohms to 9 megohms.

Extra High Value Range—Up to 10,000,000 megohms.

BULLETIN 4906  
has full details. Send for a  
copy. Attention Dept. R.

Sillwhite  
RESISTORS

THE

Sillwhite INDUSTRIAL DIVISION  
DENTAL MFG. CO.

10 East 40th St.  
New York 16, N. Y.

Western Office: 1839 West Pico Blvd., Los Angeles 6, Calif.

use in industrial instruments, projection equipment, servomechanisms and communication equipment.

Unidirectional, synchronous, and reversible motors are available with ratings up to 1/20 hp. Barcol geared-head motors will handle loads up to 100 lb in.

Ask for catalog F 4271-6.

**Time Delay Relays.** Elastic Stop Nut Corp. of America, Elizabeth, N. J. A new illustrated bulletin, SR-6R, describing models NEL and NEH Agastat time delay relays, has been announced. Model NEL features electrical interlock. The NEH features instant-action double-throw auxiliary switch plus time delay contacts.

The operation of each Agastat model is described in detail. A wiring diagram shows a contact arrangement for a model from each line. Operating voltage and contact arrangements for other models in the NEL and NEH lines are presented in chart form.

**D-C Reference Voltage Source.** Avien, Inc., 58-15 Northern Blvd., Woodside 77, N. Y. Design and performance data of the k-volt standard, new tubeless, high-stability d-c reference voltage source for measurement and control circuits, are presented in a 2-page bulletin.

Data are given for 3 a-c operated and 3 d-c operated models, with graphs showing output through ambient temperatures from  $-55\text{ C}$  to  $+100\text{ C}$ , and through supply voltage variations from 20.5 v to 32.5 v d-c and 85 v to 145 v a-c.

Included also are block schematics describing typical application of the "k-volt standard" for control systems, measurement circuits and stabilizing circuits.

**Clad Metals.** Joseph Kinney Co., Inc., Carnegie, Pa., manufacturers of copper-clad steel and steel-clad copper products has made available a publication describing new uses for clad metals. The 30-page booklet contains much technical information about new uses of copper clad metal in radio, electronics and aircraft.

**Split-Second Recorder.** Minneapolis-Honeywell Regulator Co., Wayne and Windrim Aves., Phila-

let Williams  
help you apply

**FERRIC  
OXIDES**

to the manufacture  
of your

**FERRITES**

You'll be well repaid by getting the facts on a special group of Pure Ferric Oxides, developed by Williams especially for use in the manufacture of ferrites.

Williams Ferric Oxides analyze better than 99%  $\text{Fe}_2\text{O}_3$ . They contain a minimum of impurities. They are available in a broad range of particle sizes and shapes. Among them, we're certain you'll find one that's "just right" for your requirements. The proper application of Ferric Oxides to the manufacture of Ferrites is our specialty.

Tell us your requirements . . . we'll gladly send samples for test. Chances are good that our Ferric Oxide "Know How" can save you considerable time and money. Address Dept. 25, C. K. Williams & Co., Easton, Pa.

**WILLIAMS**  
COLORS & PIGMENTS

C. K. WILLIAMS & CO.  
Easton, Pa. • East St. Louis, Ill.  
Emeryville, Cal.

**P.S.** We also produce IRN Magnetic Iron powders for the Electronic Core Industry, the Magnetic Tape Recording Industry and others. Write for complete technical information.

Designed for



Application



90672

**The No. 90672  
ANTENNA BRIDGE**

The Millen 90672 Antenna Bridge is an accurate and sensitive bridge for measuring impedances in the range of 5 to 500 ohms at radio frequencies up to 200 mc. It is entirely different in basic design from previous devices offered for this type service inasmuch as it employs no variable resistors of any sort. The variable element is an especially designed differential variable capacitor capable of high accuracy and permanency of calibration over a wide range of frequencies. A grid dip meter such as the Millen 90651 may be used as the source of RF signal. The bridge may be used to measure antenna radiation resistance, antenna resonance, transmission line impedance, standing wave ratio, receiver input impedance and many other radio frequency impedances. By means of the antenna bridge, an antenna matching unit may be adjusted so as to provide the minimum standing wave ratio on the radiation system at all frequencies.

**JAMES MILLEN  
MFG. CO., INC.**

MAIN OFFICE AND FACTORY  
MALDEN  
MASSACHUSETTS



delphia 44, Pa. Data sheet 10.2-21 covers a new split-second ElectroniK strip chart instrument. The instrument described has a full scale pen speed of  $\frac{1}{4}$  sec and facilitates recording of rapidly changing variables encountered in laboratories, research centers and experimental stations.

**Stabilizing Amplifier.** George A. Philbrick Researches, Inc., 230 Congress St., Boston 10, Mass., has released a technical bulletin describing a new stabilizing amplifier, model K2-P, recently added to the company's line of electronic analog components. General characteristics, operational details, applications, and suggested methods of applying bias are presented.

**Electrical Insulating Materials.** Insulation Manufacturers Corp., 565 W. Washington Blvd., Chicago 6, Ill. A newly revised and enlarged 32-page catalog contains descriptive information, photos, prices and ordering data on electrical insulating materials. A table of contents and an alphabetical product index are quick guides to: cords and twines, woven tapes, tubings and sleeveings, mica plates, slot wedges, varnishes, solvents, filling compound, Mylar-rag paper combinations, creased separator coils, paper, slot insulation, varnished fabrics, pressure-sensitive tapes and class H silicone insulating materials.

**Electronic Computers.** Underwood Corp., Electronic Computer Div., 35-10 36th Ave., Long Island City 1, N. Y., is now publishing the *Elecom Pulse*, a quarterly news medium for illustrating and explaining the company's electronic systems and developments.

Featured in the pilot issue is an article on the use of printed circuits in the Elecom 50 "business brain," and an operational report by an Elecom user in the petroleum industry. A new product section will appear as a standing feature.

**Electronic Measuring Instruments.** Marconi Instruments, 44 New St., New York 4, N. Y., publishes a quarterly bulletin, *Instrumentation*, which deals with the design of electronic measuring instruments. Volume 5 No. 3 describes development of an f-m signal generator for

MODEL 80F FEMALE } Size  $3\frac{1}{8}$ "  
MODEL 80M MALE } x  $\frac{3}{4}$ " dia.

VERY HANDY in lab and production test. At signal generator levels and below 5 watts, this is the last word for low VSWR.

MODEL 82

6" x  $8\frac{1}{2}$ "  
x 17"

# TERMALINE COAXIAL LOAD RESISTORS

50 ohms DC to 4000 mc—5 watts to 2500 watts

The constant resistance (Low VSWR) of the TERMALINE resistor make it the ideal dummy load and standard resistor at UHF and VHF Design is such that normal reactance is put to work producing a pure resistance over an extremely wide frequency range. Acting as a "bottomless pit" for RF energy, thousands of TERMALINE units are in daily use in high frequency applications.

Model	Cont. Power Rating	Input Connector
80F	5 watts	UG-23B/U
80M	5 watts	UG-21B/U
80A	20 watts	UG-23B/U
81	50 watts	UG-23B/U
81B	80 watts	UG-23B/U
82	500 watts	} Adaptor to fit UG-21B/U supplied
82A	500 watts	
82C	2500 watts	

Adapters or cable assemblies for standard coaxial line available.

ALL TERMALINE units, except Model 82C, are self-cooled. Substantial quantity discounts.

LITERATURE UPON REQUEST

**BIRD ELECTRONIC CORP.**  
1800 EAST 38TH ST., CLEVELAND 14, OHIO  
TERMALINE Coaxial Line Instruments

VAN GROOS COMPANY  
Sherman Oaks, Cal.  
RON MERRITT COMPANY  
Seattle

## Short Cut for Executives Considering NEW PLANT SITES

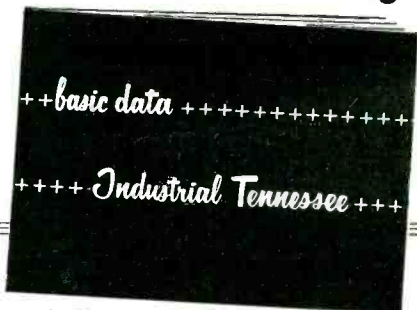

This 28-page booklet outlines, without exaggeration, the principal advantages of a state which has been designated by industrialists already located in Tennessee as "America's No. 1 Industrial Opportunity."

From the booklet you can get a clear picture of Tennessee towns and cities, markets, labor, raw materials, fuels and power, transportation, industrial capacity and diversification, living conditions, industrial

tradition, recreational facilities, and the close cooperation you will obtain from Tennessee officials in choosing the exact location you need.

Don't make any decision about a new plant site until you investigate Tennessee thoroughly. As an invaluable short-cut to this investigation, fill out the coupon below.

Mail Coupon Today

**TENNESSEE**

Industrial & Agricultural Development Commission  
L-1 Cordell Hull Building  
Nashville, Tennessee

Please send "Basic Data" booklet

• NAME \_\_\_\_\_

• FIRM \_\_\_\_\_

• ADDRESS \_\_\_\_\_

• CITY & STATE \_\_\_\_\_



Which one of these  
New **MAGNATRAN**  
Transformer Bulletins  
would you like?

WRITE TO . . . Dept. "L"  
**MAGNATRAN Incorporated**  
KEARNY, NEW JERSEY, U. S. A.

the Citizen's Band, a new r-f power meter, and includes notes on L-C oscillators and distortion meters. The bulletin will be mailed regularly to engineers upon application.

**Paper Capacitors.** Plastic Capacitors, Inc., 2511 W. Moffat St., Chicago 47, Ill. Catalog 155 covers a complete line of paper capacitors for a-c and d-c applications. Included are data on mineral oil impregnated paper dielectric capacitors in a variety of containers; synthetic oil impregnated paper dielectric capacitors; and Aroclar a-c capacitors.

Charts, diagrams, technical data and part numbers are given.

**Magnetic Shielding.** Perfection Mica Co., 1322 N. Elston Ave., Chicago, Ill., has published technical studies on its Fernetic and Conetic magnetic shielding. The new material includes 8 new charts that show the increased efficiency of different thicknesses of the various shielding products manufactured by the company.

"Assist to Engineering" also includes a detailed illustration of a Gauss meter. Purpose of this diagram is to enable engineers to build their own meters so that they can make their own measurements.

**Millimeter Waves.** Polytechnic Research & Development Co., Inc., 202 Tillary St., Brooklyn 1, N. Y. Volume 4, No. 3, of the *Reports* deals with millimeter waves. The 6-page folder is well illustrated and lists many references.

**Sweep Generators and Test Equipment.** Telonic Industries, 73 N. Second Ave., Beech Grove, Ind., has available a complete line catalog with specifications tables. The company's basic instruments are illustrated, and all outstanding performance characteristics and features are carefully explained. Ask for catalog 5-A.

**Precision Wire Wound Resistors.** The Daven Co., 191 Central Ave., Newark 4, N. J., has available a new catalog on resistors that is intended as a guide to basic data for the application and design engineer.

In addition to a complete listing



Specialists in the  
*Unusual*

**479<sup>®</sup>**

**PLATINUM ALLOY  
POTENTIOMETER  
PRECISION RESISTANCE WIRE**

- **HIGH TENSILE STRENGTH**  
To permit easy winding of Potentiometers and Coils.
- **RESISTANCE TO CORROSION**  
Platinum Content provides unsurpassed resistance to corrosion . . . long shelf life.
- **MAXIMUM STABILITY**  
of Electrical Characteristics. Available Bare or Enameled as small as .0004" diameter to as large as required. Resistance to 2500 ohms/ft.

Write for  
List of  
Products

**SIGMUND COHN CORP.**  
121 South Columbus Avenue • Mount Vernon, N. Y.

  
SINCE 1901

of all Daven types, the catalog includes new charts and data on various types of hermetically sealed, encapsulated and subminiature resistors.

Certified test data on measurements, temperature and accuracy can be furnished. Listed are JAN, MIL and other government ratings.

**Transformers and Resistors.** Hycor Co., Inc., 11423 Vanowen St., North Hollywood, Calif., has available literature on the miniature 400-cycle power transformers, the series 800 precision ratio transformers, the H series hermetically sealed precision wire-wound resistors, and series E fixed noninductive wire-wound precision resistors. Illustrations and technical specifications are included.

**Test Instruments.** EICO, 84 Withers St., Brooklyn 11, N. Y. A new catalog describes 54 models of professional electronic test instruments in both kit and factory-wired form.

Containing 12 pages in 2 colors, the catalog describes the features, applications and specifications for each model including kit and factory-wired prices. It includes such units as oscilloscopes, vtvm's, multimeters, signal and sweep generators, tube testers, signal tracers, resistance and capacitance boxes, accessory probes and high-fidelity amplifiers.

**Miniature Connectors.** The Deutsch Co., 7000 Avalon Blvd., Los Angeles 3, Calif. Miniature quick-disconnect electrical connectors that incorporate 16 industry requirements and meet the latest MIL-C-5015 AN"E" specifications for full instrument rating are described in a new bulletin. Construction and operational features are set forth.

The connectors described have a quick-disconnect that locks positively without safety wiring, is sealed automatically, and can be visually inspected for correct assembly and installation. It is moisture-sealed, vibration dampened, operative from -67 to +250 F, corrosion-resistant and unaffected by pressure variations.

It is pointed out in the bulletin that receptacle inserts are avail-

# NEW!

Standard and Preset  
**DECADE  
COUNTING UNITS**  
LOW VOLTAGE—LOW CURRENT  
GREATER RELIABILITY  
PRINTED CIRCUITRY  
BETTER HEAT DISSIPATION  
LOW COST

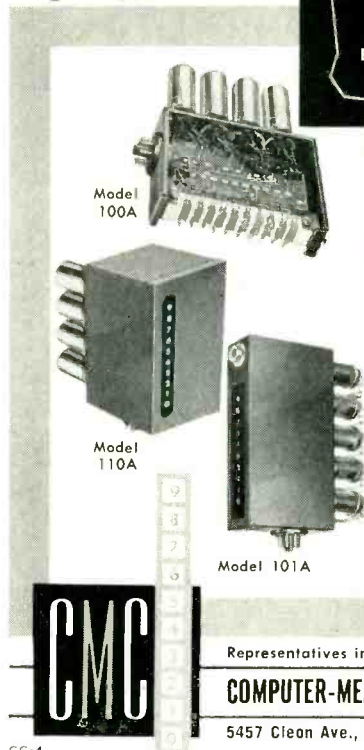

**CMC** Decade Counting Units are designed for high speed counting of electrical impulses up to 1,000,000 per second and separated by as little as 0.8 microsecond. Direct reading from 0 to 9 on an illuminated panel. Reset to 0 or 9 available. Interchangeable with most existing counting equipment.

**Applications:**  
*Frequency Counting and Division—  
Random Pulse Counting—Special Purpose Counting.*

*Write for complete catalog and prices.*

Representatives in all major areas.

**COMPUTER-MEASUREMENTS CORPORATION**

5457 Cleon Ave., North Hollywood, Calif., Dept. 78-B

CC-4

## D-79 GAUSSMETER

Means More  
In **MAGNETICS** ..

### HERE'S WHY:

- Reads 10 to 30,000 Gauss Flux Fields
- Probe is only .025" thick
- Active area .01 square inches
- Net Weight 10-1/2 lbs.
- Power Supply 105-125 Volts, 50-60 Cycle
- Overall size 13" high, 10-1/2" wide, 6-3/4" deep

Precision built to give accurate flux density measurement and determine "flow" direction. The unit also locates and measures "stray fields," plots variations in strength, and is ideal for checking production lots against a standard. Simple to operate, the D-79 gives no ballistic reading . . . doesn't jerk or pull. Comes in protective carrying case.

Write for literature—Dept. E-256



# DYNA-EMPIRE, INC.

1075 STEWART AVE.  
GARDEN CITY, N. Y.  
Phone  
Pioneer 1-2700

**ACEPOT\***  
**ACETRIM**

# Sub-Miniature

precision wire-wound

## Potentiometers and Trimmers



**ACEPOT**  
RESISTANCE 100K  
ELECTRONICS ASSOCIATES  
SOMERVILLE, MASS.

**ACEPOT**  
actual size

200  $\sim$  to 100K  
 $\frac{1}{2}$ " size  
linearity .3%  
extremely high  
resolution

10  $\sim$  to 50k  
 $\frac{1}{2}$ " size  
linearity 3%  
low price

**ACETRIM**  
RESISTANCE 10K  
ELECTRONICS ASSOCIATES  
SOMERVILLE, MASS.

**Acetrim**  
actual size

For applications where you must be sure . . . fill your potentiometer and trimmer needs with these space and weight saving, highly accurate and reliable units.

Expedited delivery on prototypes; prompt scheduling of production orders. Send for catalog sheets and application data sheets.

\* Trademarks applied for

**ACEPOT** (potentiometer) 200  $\sim$  to 100K std.,  $\pm 2\%$ , higher or lower on special order; linearity .3%;  $\frac{1}{2}$ " size; weight:  $\frac{1}{4}$  oz.; torque: .035 oz./in @ 20° C.; power: 2 watts for 60° C. rise; ambient temperature:  $-55^{\circ}$  C. to 125° C.; standard, servo or flush mountings, single or up to 6 gang units; tapped units, self-contained locking device; sealed, moistureproofed, anti-fungus treated; meets MIL-E-5272A standards.

**ACETRIM** (potentiometer trimmer) 10  $\sim$  to 50k standard,  $\pm 5\%$ ; linearity 3%;  $\frac{1}{2}$ " size; weight:  $\frac{1}{4}$  oz.; torque: low or high as required; power: 2 watts for 60° C. rise; available with panel anti-rotation pin, stops, and self-contained locking device; low price.

**ACEPOT\***  
**ACETRIM**

## ACE ELECTRONICS ASSOCIATES

Dept E, 101 Dover Street • Somerville 44, Mass.

# ELECTRONICS ENGINEERS

Now! Really challenging positions with stable futures at good salaries—open for electronics engineers—in research, development and preliminary design analysis. We need qualified men to analyze, design and predict performance of fire control computers, target tracking systems, aircraft and missile guidance systems, stability augmentation devices and autopilots, and gyroscopes—and to design and analyze computers, airplane simulators and related electronic and electro-mechanical systems.

If you qualify for these positions, North American can offer you a successful future in challenging work at a good salary. Contact Mr. Les Stevenson, Engineering Personnel, Dept. 56, North American Aviation, Inc., Los Angeles 45, California.

## NORTH AMERICAN AVIATION, INC.

able in resilient or hermetic-sealed types. The complete unit, with all components ready for assembly and installation, is delivered in a sealed and dated package.

**Transistor Power Supplies.** Electronic Research Associates, Inc., Nutley, N. J., announces a 4-page, 2-color catalog describing their expanded line of tubeless and transistor supplies.

The catalog includes technical and descriptive material on models designed for transistor applications, tubeless single and dual units, and constant current converters. Several new models are described, including all-transistor semiconductor power units.

**Electronic Systems.** Craig Systems, Inc., Danvers, Mass. An 8-page folder illustrates and describes the company's communications and navigation systems which are mobile, transportable, and stationary.

**Components for Airborne Radar.** Airtron, Inc., 1103 W. Elizabeth Ave., Linden, N. J. A complete catalog series, covering the entire range of components in the double-ridge waveguide system used in commercial airborne penetration radar, is now available.

The literature provides the aircraft and radar designer with a convenient reference source covering electrical and mechanical characteristics, construction, dimensional data, installation information, materials and finishes, flange combinations and ordering data. Photos and drawings illustrate the various ridge waveguide components.

**Timers.** G. C. Wilson & Co., 1915 8th Ave., Huntington, West Virginia, has available a 6-page brochure with current information and specifications describing the standard line of electronic timers manufactured by the company. Included in the line discussed are delay, repeat cycle and interval timers.

**Electronic Consulting Service.** Thomas H. Briggs and Associates, Township Line Road, Rd. No. 1, Malvern, Pa. A 4-page folder tells of the organization's breadth and

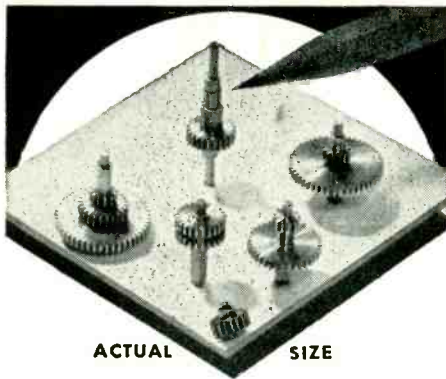

ACTUAL SIZE

## miniaturized GEARS and GEAR TRAINS

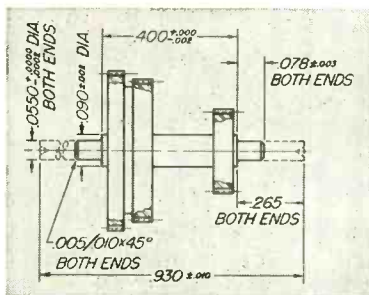

### Extreme Precision\*

#### GEARS

- Tooth to tooth composite tolerance, 0.0003"
  - Total composite tolerance, 0.0005"
  - Journal diameter tolerance, ± 0.0001"
  - 20 degree pressure angle, 80, 96 or 120 diametral pitch
  - Burnished gear teeth and burnished bearing diameters
- \*Standard production runs

#### PLATES

- Bearing centers held to ± 0.0001"
- Hole diameters held to ± 0.0001"

#### TRAINS

- High-quality, performance, long life
- Near-zero backlash

### Early Delivery—Low Cost

Gears and plates: 30 days or less  
Gear trains: 45 to 60 days

Unique manufacturing techniques plus skilled personnel means low prices. For quotations on your requirements, write or phone us.



Write for FREE pamphlet prepared by our Engineering Dept. and titled: "Gear Train Design Simplified"

QUALITY  
PRECISION  
VERSATILITY

# Washington

MACHINE AND TOOL WORKS, INC.  
1001 WASHINGTON AVE. SO., MINNEAPOLIS 15, MINN.  
Federal 5-4244

NEW PRODUCTS

(continued)

capabilities in engineering projects and products adaptable to specific needs. Informational data on development, production, systems and surveys are shown. Professional experience, and a representative listing of clients and projects served by the organization are also given.

**Custom Molded Teflon.** Sparta Mfg. Co., Dover, Ohio. A new brochure contains many graphic illustrations of the various applications of Teflon as cup, ball or shaft seals, washers, gaskets and diaphragms.

Teflon's unique properties make it an ideal material for use in certain applications where flexible materials cannot withstand severe service temperatures and/or corrosion.

**Precision Pulse Oscilloscope.** Newport Instruments Ltd., Newport Pagnell, Buckinghamshire, England. A single-sheet bulletin gives details on a new precision pulse oscilloscope. The instrument described has been designed primarily for making quantitative measurements of the characteristic features of pulsed or transient waveforms.

The information given on leaflet OSC.11 gives details of the construction and specification, and draws special attention to the high beam current crt which gives a bright, sharp trace under full daylight conditions.

**Pointer Bulletin.** Illinois Testing Laboratories, Inc., Chicago 10, Ill. An 8-page bulletin covers about 20 precision instruments for general industry. In it will be found a brief description of the salient features of each instrument in the company's line and the number of the bulletin which gives complete engineering data on the instrument.

**Servo Motor.** Servomechanisms, Inc., 625 Main St., Westbury, L. I., N. Y., has available a single-sheet bulletin illustrating and describing the class H 400-cycle servo motor, type 171. The motor discussed is designed for a minimum life of 1,000 hr of continuous operation in an ambient temperature

AMERICAN TELEVISION & RADIO CO. ST. PAUL, MINN.

introduces the  
**new**



*Front Door Console  
Receiving Sets*

UNSURPASSED  
IN BEAUTY

UNEQUALLED  
IN PERFORMANCE

UNMATCHED IN  
QUALITY  
CONSTRUCTION

exclusive  
profitable  
dealer  
franchises  
now available



*Designed  
with the  
Service man  
in mind.  
... easy to  
get at*

WRITE TODAY FOR COLORFUL  
BROCHURE SHOWING THE  
NEW LINE OF ATR TV SETS

ALSO MANUFACTURERS OF DC-AC INVERTERS,  
"A" BATTERY ELIMINATORS, AUTO RADIO VIBRATORS

**ATR** AMERICAN TELEVISION & RADIO CO.  
Quality Products Since 1931  
SAINT PAUL 1, MINNESOTA-U. S. A.

of 180 C. Small size of the unit described makes it ideal for use in high-speed aircraft and missile applications. Preliminary specifications are included.

**Facilities Brochure.** Packard-Bell Co., 12333 West Olympic Blvd., Los Angeles 64, Calif. Facilities of the company's technical products division for research, development and production of electronic equipment, both for the armed forces and private industry, are described and illustrated in a new 28-page brochure.

**Temperature Cabinets.** Webber Engineering Corp., P.O. Box 217, Indianapolis 6, Ind. Data on a complete line of temperature cabinets from 1 cu ft to 45 cu ft are contained in a new 4-page bulletin. The bulletin illustrates and describes cabinets which have temperature ranges available from +300 F using lifetime sealed electrical units to -200 F by mechanical refrigeration. All temperatures discussed are controlled in accuracy to  $\pm 0.2$  F. Nine optional features are available in addition to 27 standard features.

**Operational Equations for Computer Programming.** Berkeley Div. of Beckman Instruments, Inc., 2200 Wright Ave., Richmond 3, Calif., polishes up the operational equation to short cut electronic computer programming by speedily deriving problem setups. Data file 120 describes how this direct use of the operational nature of computing elements saves time replacing complex computing circuits with symbolic equations. The equations discussed specify every number, type and interconnection of computing component required. Matching each right with a left side variable insures completeness of setup derivation.

**Spray Paint Masks.** By-Buk Co., 4314 W. Pico Blvd., Los Angeles 19, Calif. A 4-page brochure on spray paint masking includes a long list of Kwiky-Dot overlapping masking disk sizes and custom shapes made from many types of pressure-sensitive tape, some of which are made especially to re-

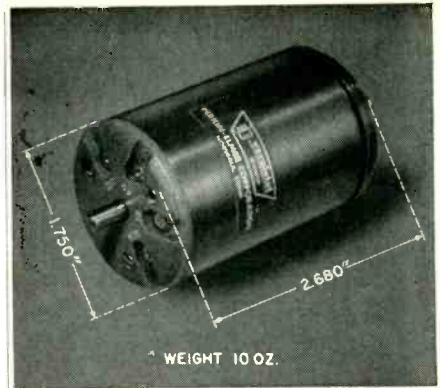

## NEW...the 400 cycle **vernistat**<sup>\*</sup> a.c. Potentiometer you asked for!

The 400 cycle Vernistat is an a.c. potentiometer-type voltage divider that combines *high* linearity and *low* output impedance. It is essentially a non-dissipative element adaptable to high temperature operation. Size and mounting dimensions are designed to the BuOrd specification for a size 18 synchro.

Here are the details:

- **high linearity**, inherent in the design principle, is *maintained* over the life of the unit.
- **low output impedance** eliminates need for isolation amplifiers in many applications.
- **high output current capability.**
- **low phase shift** — less than 90 seconds, depending on model.
- **can be coupled with synchros**, resolvers and other components — as well as ganged.
- **nonlinear functions can also be generated.**

Class 5 ball bearings, centerless ground shaft, and an aluminum housing machined to close tolerances combine to make the Vernistat a precision instrument. Shaft seals will be supplied where they are required by environmental conditions.

check these  
specifications:

Linearity Tolerance	$\pm 0.05\%$
Minimum Output	
Voltage Increment	$0.01\%$
Output Impedance	less than 130 ohms
Input Voltage	130 v max.
Input Impedance	up to 75,000 ohms

<sup>\*</sup>Trademark

# vernistat

division

PERKIN-ELMER CORPORATION  
Norwalk, Connecticut

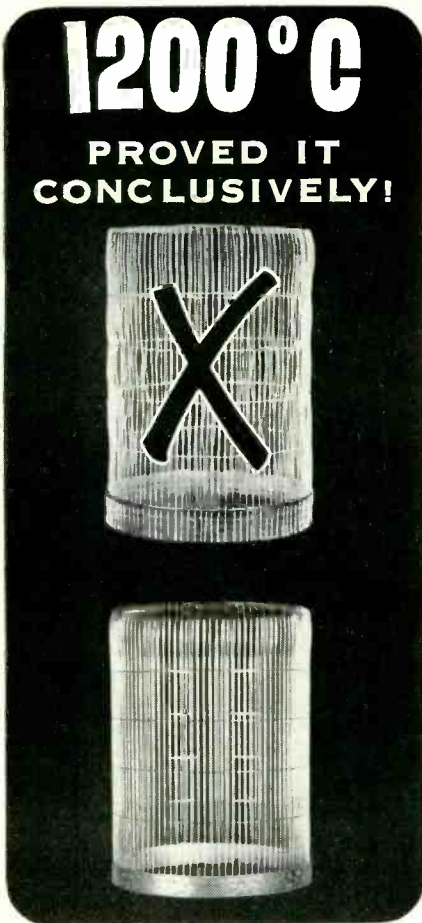

## NEW **BAKER** NON-SAG Platinum Clad Tungsten Wire

STANDS UP BEST WHERE  
HIGH TEMPERATURES ARE REQUIRED!

In scientifically controlled comparison tests to determine relative sag at elevated temperatures, both platinum clad molybdenum and platinum clad tungsten wire showed very little sag. But at 1200°C the molybdenum sagged seven times faster than the tungsten.

In addition to this advantage, tungsten shows a substantially lower degree of interaction with platinum. Baker's Platinum Clad Tungsten Wire is available in a broad range of diameters.

Send for free booklet  
"Platinum Clad Tungsten Wire."



113 ASTOR STREET, NEWARK 5, N. J.  
NEW YORK • CHICAGO  
SAN FRANCISCO • LOS ANGELES

ENGELHARD INDUSTRIES



lease from anodized aluminum and magnesium surfaces without transferring adhesive.

For the task of properly masking hermetic seal electronic terminals they have developed a line of reusable Cap-Masks. For making printed circuit master drawing they make very narrow widths of black tape—down to  $\frac{1}{16}$  in. wide—in 60 yard rolls, and also many sizes of black doughnut-type disks. All are described in the bulletin.

**Pressurized Connector.** DeJUR-Amsco Corp., 45-01 Northern Blvd., Long Island City 1, N. Y. A 2-page illustrated color bulletin describes special features, and electrical and mechanical specifications for the new 40-contact pressurized Continental connector. Mounting and clearance dimensions are also included. Write for bulletin GA.

**Ratemeter.** North American Philips Co., Inc., 750 South Fulton Ave., Mt. Vernon, N. Y. A 4-page folder gives complete data on the Norelco Eltratometer (type 12112 frequency meter). Technical information covers operation and application of the 6-digit high-speed scaler for proportional, scintillation or Geiger counting. Specifications include maximum and minimum rates, resolving time, total capacity, zero reset, connections, controls, operating characteristics, sensitivity and dimensions.

Special data are given on the 100-ke tuning fork and mechanical register stages. The ratemeter discussed can time a predetermined count or count for a predetermined time.

**Colloidal Dispersions.** Acheson Colloids Co., Division of Acheson Industries, Inc., Port Huron, Mich., has issued a newly revised 4-page booklet, listing 42 colloidal and semi-colloidal dispersions for electronics and related industries.

Products discussed include dispersions of graphite, molybdenum disulfide, mica, vermiculite, zinc oxide and acetylene black. Carriers and diluents are given for each product, along with typical applications and important physical data.

## MOBILE COMMUNICATION CENTERS

Radio Engineering Products has been continually in production of mobile communication centers for various NATO headquarters and for the U.S. Signal Corps Engineering Laboratories, over a period of several years. The centers produced have included type AN/MS-C-1, type AN/MS-C-5, and type AN/MS-C-12, which have been or are being manufactured in full accordance with U.S. Signal Corps specifications. There have also been produced systems engineered by us to the specific requirements of a headquarters.

These systems have employed in some instances trailers and tractors of modified commercial types supplied by us, in some instances standard military-type vehicles supplied by us, and in some instances the using agency has supplied standard military-type tractors, trailers and trucks.

These centers have provided in mobile form, some or all of the following functions, in some cases in very complex and extensive form:

- Operations rooms for signal officers and commanders.
- Teletype conference viewer facilities.
- Teletype switchboards up to 120 lines.
- Telephone switchboards up to 600 lines.
- Testing of military and civil wire facilities.
- V-H-F and U-H-F broadband radio-relay terminals and repeaters.
- Multi-channel carrier-telephone and carrier-telegraph systems for superposing on wire and radio facilities.
- H-F frequency-shift radio transmitting facilities, and matching dual-diversity receiving positions.
- Teletype message-center, tape-relay, and cryptographic facilities.
- Mobile diesel power plants.

Radio Engineering Products has a broad and extensive knowledge of this subject, unparalleled plant facilities, and a team of engineers, production executives, and craftsmen which place us in a unique position in this field. We will gladly supply estimates on mobile centers to specific requirements on request.

## RADIO ENGINEERING PRODUCTS

1080 UNIVERSITY STREET, MONTREAL 3, CANADA

Telephone: UNiversity 6-6887

Cable Address: Radenpro, Montreal

MANUFACTURERS OF CARRIER-TELEGRAPH, CARRIER-TELEPHONE AND BROAD-BAND RADIO SYSTEMS

## U.S.C. HERMETIC SEAL MINIATURE PLUGS

with Insured Protection  
by Double Lead Screw Locking

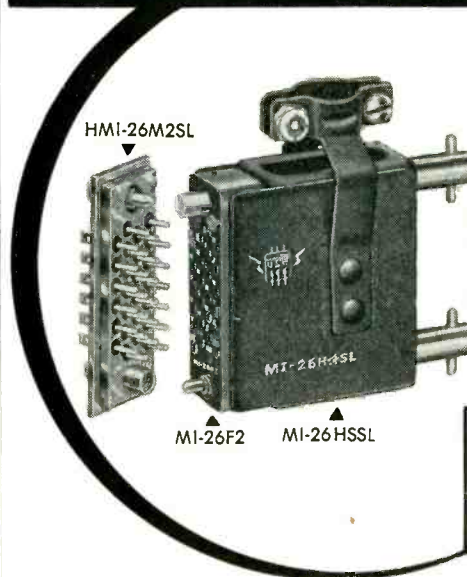

HMI-SL SERIES (HERMETIC SEAL DOUBLE LEAD SCREW LOCK VERSION) USED WITH MI-SL MINIATURE SCREW LOCK CONNECTORS PROVIDE;

- EASE OF ENGAGEMENT
- PROTECTION OF SEALED CONTACTS
- DEPENDABILITY OF ELECTRICAL AND MECHANICAL PERFORMANCE

AVAILABLE IN 7, 8-4, 14, 18, 20, 21, 26, 34, 50 and 75 CONTACTS WITH MATING SCREW LOCK HOOD OR BRACKET ASSEMBLY.

FURTHER INFORMATION ON REQUEST



**U. S. COMPONENTS, Inc.**

Associated with U. S. Tool and Mfg. Co., Inc.

454-462 East 148th Street, New York 55, N. Y. CYPress 2-6525-6

Want true ratings on your relays?



We have had  
58 years to  
get acquainted  
with these  
relays . . .

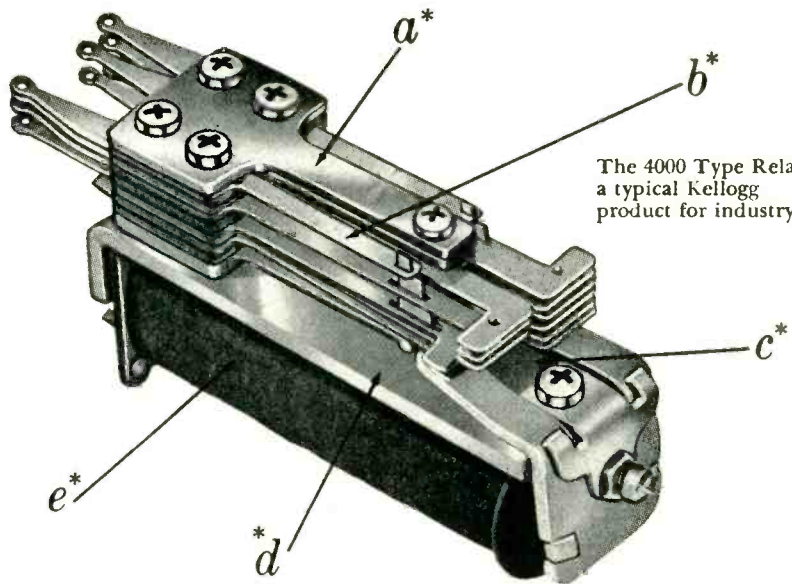

The 4000 Type Relay  
a typical Kellogg  
product for industry.

Making and improving these relays during the past 58 years has taught us to know them very well. The use of these relays in our own equipment has helped to make Kellogg the leader in the independent telephone field. You can save design time and cut production costs because our intimate experience as a relay-user as well as relay-maker enables us to develop relays that are rated to meet your requirements . . . to build them to stand up in your equipment, for a lifetime of service . . . to stock them for early delivery. For instance, we have in stock thousands of variations on the standard Kellogg 4000 Type Relay, including time-delay, twin, snap-action, multi-contact, and plug-in relays. You can anticipate their performance in any application because we have *true* ratings on every one of them.

\*  
For the A.B.C.'s of the 4000 type relay and other Kellogg relays use the coupon to send for this Kellogg Relay Bulletin.



**KELLOGG SWITCHBOARD AND SUPPLY COMPANY**  
A Division of International Telephone and Telegraph Corporation  
Sales Offices: 79 W. Monroe St., Chicago 3, Ill.

Industrial Sales Dept.

Please send me the booklet on Kellogg Relays

NAME \_\_\_\_\_

FIRM \_\_\_\_\_

STREET \_\_\_\_\_

CITY \_\_\_\_\_ ZONE \_\_\_\_\_ STATE \_\_\_\_\_



**KELLOGG SWITCHBOARD AND SUPPLY COMPANY**  
A Division of International Telephone and Telegraph Corporation  
Sales Offices: 79 W. Monroe St., Chicago 3, Ill.

QUALITY COMPONENTS FOR INDUSTRIAL CONTROL  
QUALITY COMMUNICATIONS SYSTEMS

KELLOGG Branch Warehouses and Offices:

6000 W. 51st Street  
Chicago 38, Illinois  
Reliance 5-5445

1515 Turtle Creek Blvd.  
Dallas 2, Texas  
Prospect 5191

4501 Truman Road  
Kansas City 1, Missouri  
Humboldt 7085

1663 Mission Street  
San Francisco 3, California  
Market 1-6011

410 N. Syndicate Avenue  
St. Paul 4, Minnesota  
Nestor 5878

1555 West Fourth Street  
Mansfield, Ohio  
Mansfield 7-2816

KELLOGG Branch Office:  
406 S. Main Street  
Los Angeles 13, Calif.  
Vandyke 6759

Export Distributor:  
International Standard  
Electric Corp.  
50 Church Street  
New York 7, New York

# Plants and People

Edited by WILLIAM G. ARNOLD

Electronics manufacturers continue to make plant and facility expansions and acquire other companies. Engineers and executives are promoted and move to new positions of responsibility. Industry societies elect new officers for 1956

## ElectroData Dedicates New Computer Plant, Plans Another

ELECTRODATA CORP. dedicated the first of two new computer plant facilities in Pasadena. The firm was established by Consolidated ElectroDynamics as an independent affiliate in 1954 to facilitate manufacture and sale of Datatron electronic data processing machines on a full scale basis. It has 400 employees and sales last year exceeded \$3 million.

Datatron originally was developed in 1953 by the computer division of Consolidated, at a cost of over \$1 million. Consolidated retains 36 percent of ElectroData's 910,000 shares of stock.

The new plant cost approximately \$525,000, including capital equipment, and was completed on schedule last August after eight months of construction. It provides 40,000 sq ft of manufacturing and office floor space.

Ground will be broken for a new building adjoining this one, to double the plant's capacity. Most of the new space will be devoted to pro-

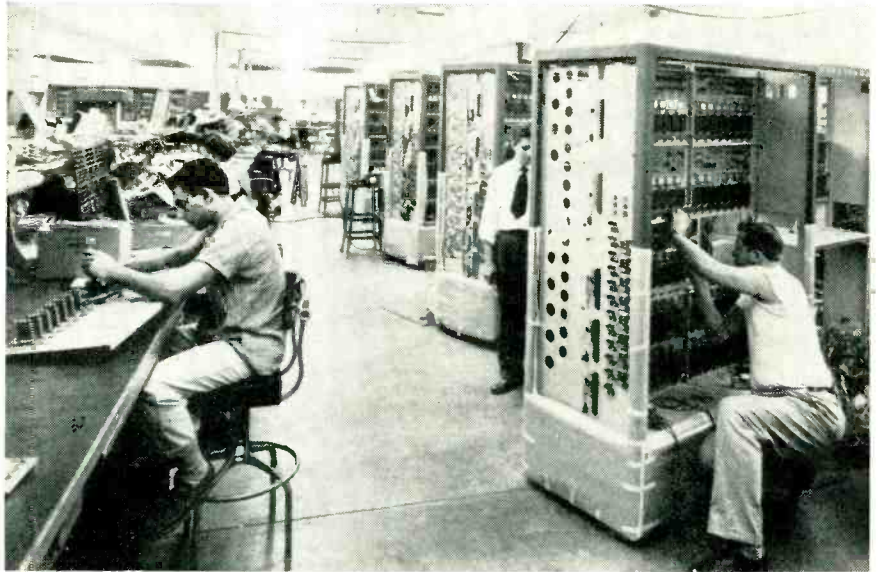

Production line at new Electro Data plant in Pasadena, Calif.

duction facilities.

ElectroData has installed 17 systems nationwide to date—ranging in application from guided missile design and oil refinery operation to billing insurance policyholders.

Because of high starting and ex-

pansion costs and the initial deferment of income from lease contracts, the company has not expected to show a profit until 1956. The firm has a backlog of nearly two dozen system orders, averaging \$200,000 each.

## NBC Promotes Weaver, Robert Sarnoff, Hammerschmidt

SYLVESTER L. WEAVER, JR. has been elected chairman of the board and Robert W. Sarnoff, president of NBC. General David Sarnoff will continue as a director of NBC.

Andrew L. Hammerschmidt, associate director of technical operations for NBC, has been named vice-president and chief engineer. He succeeds the late Robert E. Shelby, who died suddenly of a heart attack on Dec. 8.

Hammerschmidt joined NBC in New York in 1941 as a television engineer. From 1942 to 1948 he served as a development engineer for NBC and, in 1948, was named tv technical operations supervisor



A. L. Hammerschmidt

for station WNBK, NBC-owned station in Cleveland.

Four years later he was appointed assistant director of color tv systems development for NBC and headquartered in New York. In 1954, he was named to his present post of associate director of technical operations.

## General Motors Builds Electronics Plant

AC SPARK PLUG division of General Motors will build a new plant of about 75,000 sq ft near Milwaukee, Wisconsin.

The new plant will be the first of

several buildings to be erected to accommodate AC's "expanding electronic and defense manufacturing work."

AC has 3 other plants operating in Milwaukee, producing products in the fields of military bombing and fire control systems, guided missile developments, jet engine fuel controls and specialized electronics work.

Construction of the new building will begin early in 1956 and be completed in 1957.

## Texas Instruments Appoints Shepherd

MARK SHEPHERD, JR. has been promoted from assistant vice-president to vice-president in charge of the semiconductor products division of Texas Instruments.

He has been in charge of the firm's semiconductor products manufacture for three years.

As vice-president of the division, Shepherd will continue to be responsible for product development, manufacture, sales and administra-

tion. The division has grown to employ approximately 500 people and recently completed its move into a new addition on the main Dallas plant.

He served progressively in the apparatus division as project engineer, assistant chief engineer and chief engineer for semiconductor products. In 1953, when the semiconductor products division was formed, he was named asst. v-p.

## Alto Scientific Opens Instrument Plant In California

F. E. TERMAN, dean of engineering and provost of Stanford University, inspects transistorized voltmeter at Alto Scientific Company's new Palo Alto, California plant. Describing the instrument's operation is Alto president, Thomas F. Turner (left) while Alto vice-president, Dr. David Cherry (far right) and Lester Libby participate. Occasion was the formal opening of expanded laboratory, manufacturing and office facilities in which Alto will conduct research and development work, fabrication in pilot and production runs and manufacture proprietary instruments.



## Du Mont Elects Schultz President, Names Engineer



DAVID T. SCHULTZ has been elected president and director of Allen B. Du Mont Laboratories succeeding Dr. Allen B. Du Mont who continues as chairman of the board.

Schultz was senior vice-president and treasurer of Raytheon. He has been a vice-president, treasurer

and director of Raytheon for more than 25 years.

The election of Schultz is another step taken as part of a plan, voted by stockholders in October, to separate broadcasting from manufacturing operations, to change the corporate and capital structure and to revitalize management. The Du Mont Broadcasting Corp. already has been formed and "spun-off" to stockholders.

Nicholas De Falco has been named general quality control manager for all manufactured products of Allen B. Du Mont Laboratories. He served as assistant general quality control manager prior to his new appointment. He succeeds Richard F. Rollman, who has resigned.

De Falco joined Du Mont in 1947 as manager of television receiver testing. He was subsequently made technical assistant to the vice presi-

dent, quality control manager for television receivers and then assistant general quality control manager. In his new position he will supervise the operations of quality control departments in each company division.

## Bogue Unveils Canadian Plant

BOGUE ELECTRIC of Canada, formally opened its new plant at Gloucester, near Ottawa, Ontario.

An address by C. D. Howe, Minister of Trade and Commerce, and an open house highlighted the inauguration ceremonies.

The new plant will give the Canadian firm facilities for the production of motors and generators, power supplies, control systems and electronic components.

E. F. Schinman, president of Bogue, stated that the new plant

# For the most dependable printed circuits, you need the high bond strength, workability, heat-resistance of **C-D-F DILECTO<sup>®</sup> METAL-CLAD LAMINATES**

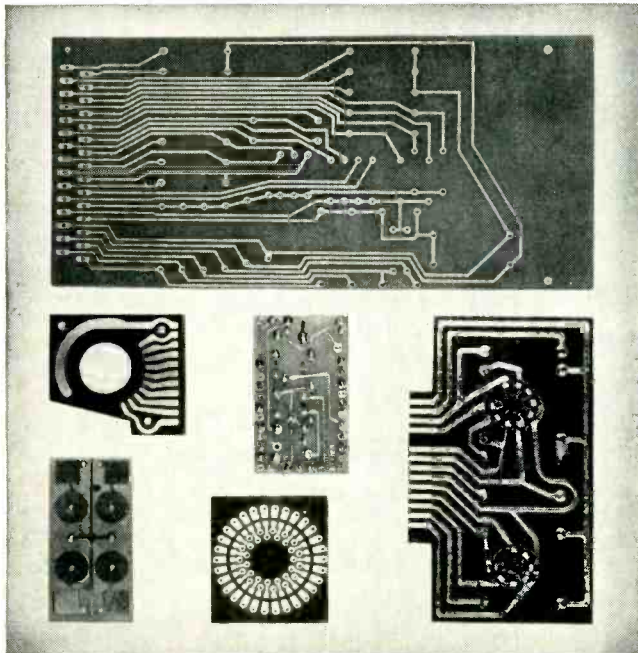

Printed circuits based on C-D-F materials are being used with great success in military electronic equipment, commercial television and radio sets, telephone switchboards—even sub-miniature radiosonde equipment and hearing aids.

Photos courtesy of Photocircuits, Inc., Glen Cove, N. Y.

**HIGH BOND STRENGTH**—C-D-F's special adhesive for metal-clad Dilecto bonds the copper foil to the plastic without affecting the laminate's superior electrical properties. Heat-resistance, dissipation factor, dielectric constant, dielectric strength, and insulation resistance of the Dilecto base remain unaffected. The closely-bonded foil can be etched cleanly and dipped in hot solder to 220°C. (428°F.) for ten seconds with a guarantee of no blistering or separating. Metal-Clad Dilecto can be punched or machined either before or after etching.

**EXCELLENT WORKABILITY**—On all five Dilecto metal-clad grades, you can solder, punch, saw, and assemble components either by hand or automatically. Thanks to the inherently superior workability of the plastics laminate over that of ceramic-type materials, Dilecto can be dropped, jammed into tight chassis, and otherwise treated roughly on the assembly line and in service.

**HIGH HEAT-RESISTANCE**—Metal-Clad Dilecto Laminates are made of phenolic, epoxy, or Teflon\* resin for various conditions of service and assembly, and have either cellulosic paper or woven glass-fabric base. All are ideally suited to printed-circuit applications in which heat-dissipation is a major problem. Continuous exposure to high ambient operating temperatures in enclosed electronic equipment has no significant effects on Dilecto's electrical and physical properties.

**UNLOAD YOUR HEADACHE HERE!** C-D-F, a big, reliable source of supply, can help you get the most for your printed-circuit money by reducing rejects, lowering fabrication costs, assuring dependable quality every time. Send us your print or problem, and we'll gladly supply appropriate test samples free. See our catalog in the Product Design File (Sweet's) or send for the new 20-page Dilecto catalog. Let your nearby C-D-F sales engineer (listed in Sweet's) help you right from the design stage!

## TYPICAL PROPERTY VALUES

	Copper-Clad PHENOLIC (Grade XXXP-26)	Copper-Clad PHENOLIC (Grade XXXP-24)	Copper-Clad EPOXY (Grade GB-116E)	Copper-Clad EPOXY (Grade GB-181E)	Copper-Clad TEFLON* (Grade GB-116T)
BOND STRENGTH—0.0014" foil (Lbs. reqd. to separate 1" width of foil from laminate)	5 to 8	5 to 8	8 to 12	8 to 12	5 to 8
MAXIMUM CONTINUOUS OPERATING TEMP. (Deg. C.)	120	120	150	150	200
DIELECTRIC STRENGTH (Maximum voltage per mil.)	800	800	700	650	700
INSULATION RESISTANCE (Megohms) 96 hrs. at 35°C. & 90% RH	50,000	50,000	30,000	20,000	Over 10 <sup>6</sup> megohms
DIELECTRIC CONSTANT 10 <sup>6</sup> Cycles	4.20	4.20	4.90	4.95	2.85
DISSIPATION FACTOR 10 <sup>6</sup> Cycles	0.026	0.026	0.019	0.018	0.0006
ARC-RESISTANCE (Seconds)	10	10	60	80	180
TENSILE STRENGTH (psi.)	16,000 x 13,000	14,000 x 11,000	46,000 x 42,000	48,000 x 44,000	23,000 x 21,000
FLEXURAL STRENGTH (psi.)	21,000 x 18,000	19,000 x 16,000	60,000 x 55,000	75,000 x 65,000	13,000 x 11,000
IZOD IMPACT STRENGTH edgewise (ft. lbs. per inch of notch)	0.40 x 0.35	0.40 x 0.35	6.5 x 6.0	13.5 x 11.5	6.0 x 5.0
COMPRESSIVE STRENGTH flatwise (psi.)	28,000	27,000	60,000	62,000	20,000
BASE MATERIAL OF LAMINATE	Cotton rag paper	Cotton rag paper	Fine-weave, medium-weight glass cloth	Medium-weave, medium-weight glass cloth	Fine-weave, medium-weight glass cloth
COLOR OF UNCLAD LAMINATE	Natural greenish	Natural Brown	Natural	Natural	Natural

All these standard grades are available with 0.0014", 0.0028", 0.0042", or thicker electrolytic or rolled copper foil on one or both surfaces. Other metal foils and other resin-and-base combinations can be supplied on special order.

\*DuPont Trademark



**CONTINENTAL DIAMOND FIBRE**  
CONTINENTAL-DIAMOND FIBRE DIVISION OF THE BUDD COMPANY, INC.

NEWARK 16, DELAWARE

for service and lab. work

**Heathkit**  
PRINTED CIRCUIT  
**OSCILLOSCOPE KIT**  
FOR COLOR TV!

① Check the outstanding engineering design of this modern printed circuit Scope. Designed for color TV work, ideal for critical Laboratory applications. Frequency response essentially flat from 5 cycles to 5 Mc down only 1½ db at 3.58 Mc (TV color burst sync frequency). Down only 5 db at 5 Mc. New sweep generator 20-500,000 cycles, 5 times the range usually offered. Will sync wave form display up to 5 Mc and better. Printed circuit boards stabilize performance specifications and cut assembly time in half. Formerly available only in costly Lab type Scope. Features horizontal trace expansion for observation of pulse detail — retrace blanking amplifier — voltage regulated power supply — 3 step frequency compensated vertical input — low capacity nylon bushings on panel terminals — plus a host of other fine features. Combines peak performance and fine engineering features with low kit cost!



**Heathkit TV**

**SWEEP GENERATOR KIT**  
ELECTRONIC SWEEP SYSTEM

② A new Heathkit sweep generator covering all frequencies encountered in TV service work (color or monochrome). FM frequencies too! 4 Mc — 220 Mc on fundamentals, harmonics up to 880 Mc. Smoothly controllable all-electronic sweep system. Nothing mechanical to vibrate or wear out. Crystal controlled 4.5 Mc fixed marker and separate variable marker 19-60 Mc on fundamentals and 57-180 Mc on calibrated harmonics. Plug-in crystal included. Blanking and phasing controls — automatic constant amplitude output circuit — efficient attenuation — maximum RF output well over .1 volt — vastly improved linearity. Easily your best buy in sweep generators.

will help to supply Canada's growing needs for industrial power supplies and control systems as well as supply her Air Force and Navy with control and communications apparatus.

Other products to be manufactured at the new plant will include water conditioning equipment, magnetic amplifiers, rectifiers, servo-systems, sonic tank gauging equipment and bearing temperature monitors.

The structure has approximately 80,000 sq ft under one roof. When the plant is in full production it will employ about 350 persons. Thomas Trumbour is factory manager.

**RCA Selects Semiconductor Head**

ALAN M. GLOVER has been appointed general manager of the newly created RCA semiconductor division.

A new \$3 million plant to house semiconductor engineering and additional manufacturing facilities is being erected at Somerville, N. J., and until it is completed in 1956, Dr. Glover will make his headquarters at the RCA plant in Harrison, N. J.

He joined RCA in 1936 as an engineer on the development of phototubes. From 1941 to 1950 he acted as manager of gas tube and phototube engineering. In 1950 he was made manager of power tubes, product administration, and in 1953 he became manager of controls and



Alan M. Glover

**An Invitation  
TO MANUFACTURERS  
OF ELECTRONIC EQUIPMENT**

1. Friendly labor supply.
2. Unusual city, county, and state tax advantages.
3. Industrial sites plentiful.
4. Good banking facilities.
5. Full cooperation guaranteed.
6. Strategic location.

for  
**SMALL**  
or  
**MEDIUM**  
**INDUSTRIES**

**Businessmen of Lakeland, Florida will cooperate fully and furnish complete information to manufacturers who will consider relocating or establishing a branch unit in this fast-growing central Florida city . . . . .**

**INDUSTRIAL DEVELOPMENT COMMITTEE OF 100  
LAKELAND TERRACE HOTEL**

**LAKELAND, FLORIDA**

standards in the power tube and cathode ray tube operations department. A year later he became manager of the semiconductor operations department.

### General Mills Promotes Engineers

AIRCRAFT and missile systems will receive greater emphasis in a staff reorganization by the mechanical division of General Mills.

Cledo Brunetti, as director of engineering, research and development, takes over the position vacated by Frank B. Jewett, Jr., who is leaving to become a vice-president of Vitro Corporation of America.

Dr. Brunetti had been director of research and development. Now he acquires responsibility for production engineering also.

Carl L. Kober, World War II German radar and guidance expert, becomes associate director in charge of systems engineering, research and development. He had been manager of systems analysis.

John E. Barkley becomes associate director of research and development. He had been manager of physics and chemistry research and now adds administrative responsibility for mechanical and electronics research.

### Sperry Rand To Build In Arizona

SPERRY RAND CORP. plans the construction in Phoenix, Ariz. of an advanced flight research center and modern plant to develop and manufacture electronic equipment for civil air industry and the military services.

Included in a three-part industrial development package will be a modern hangar and shop space at Sky Harbor Airport, utilization of a former USAF auxiliary airfield and a plant and engineering facility in the Greater Phoenix area. The firm plans initially to construct hangar and shop space on a 40-acre tract of leased land at Sky Harbor Airport.

The shop and hangar, expected to be completed within a year, will be

## LAPP STAND-OFF INSULATORS FOR MODERATE OR HEAVY DUTY



For years, Lapp has been a major supplier of stand-off insulators to radio, television and electronics industries. Wide knowledge of electrical porcelain application, combined with excellent engineering and production facilities, makes possible design and manufacture of units to almost any performance specification. The insulators shown on this page are representative of catalog items—usually available from stock—and certain examples of special stand-offs. The ceramic used is the same porcelain and steatite of which larger Lapp radio and transmission insulators are made. Hardware is brass or bronze; brush nickel plating is standard.

Write for Bulletin 301 with complete description and specification data. Lapp Insulator Co., Inc., Radio Specialties Division, 246 Sumner St., Le Roy, N. Y.

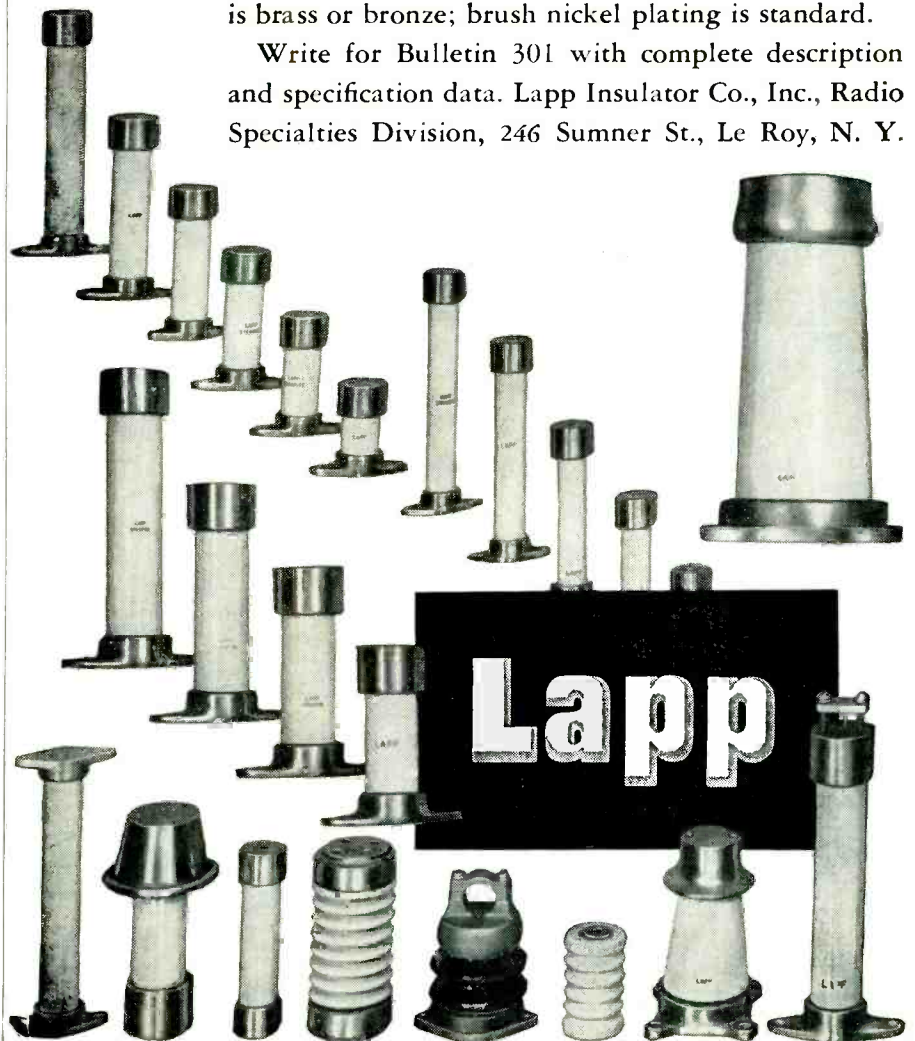

# FERROXCUBE SHIELDING BEADS

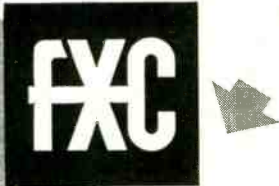
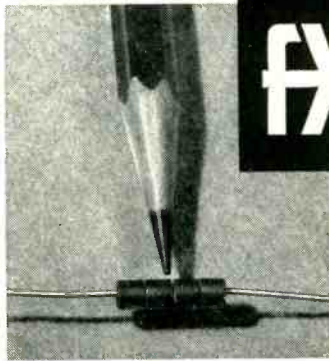

**EFFECTIVELY  
PREVENT  
PARASITIC  
RESONANCES**

Ferroxcube shielding beads on input leads provide simple, efficient decoupling so that h-f, i-f and pulse signals from output stages will not be picked up by input wiring. High-permeability Ferroxcube material increases inductance so that lead acts as h-f choke while i-f, h-f and pulse oscillations are damped by high losses that occur in Ferroxcube 3B at frequencies over 0.5 mc.

Ferroxcube shielding beads also increase the h-f effectiveness of button-type ceramic feed-thru capacitors.

SEND FOR BULLETIN FC 5112

## FERROXCUBE CORP. OF AMERICA

A Joint Affiliate of Sprague Electric Co., and Philips Industries,  
Managed by Sprague

35 East Bridge Street • Saugerties, New York

used in connection with the company's long-range programs for developing automatic flight and engine control equipment. Initial plans for a factory and lab building are being drawn and construction is expected to begin within 12 months

A. R. Weckel, vice-president, has been named to the new post of manager, special missile system division of Sperry Gyroscope Co. He will have charge of all engineering, manufacturing and contract activities of the large-scale Sparrow I air-to-air missile program for the U. S. Navy. In addition, the new division will be assigned supervision of other large-scale missile programs.

Weckel, vice-president and general sales manager until this new assignment, is a Sperry veteran of 21 years. He has been general sales manager since 1950 and a vice-president since 1955.

### IRC Elects Ehle And Marsten

INTERNATIONAL RESISTANCE Co. elected Harry A. Ehle as executive vice-president and Jesse Marsten as senior vice-president.

Ehle, formerly vice-president of sales and advertising, left Campbell Soup Co. to join the IRC organization in 1931 as foreman of its wire wound department. He became a member of the IRC sales staff in 1935 and, in 1938, was promoted to the position of assistant to the president, which he held until 1942 when he was elected to the vice-presidency. He is a member of the

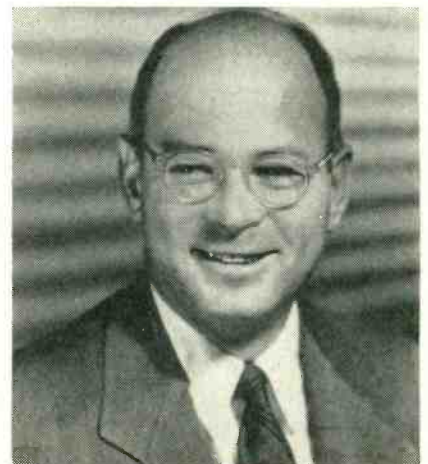

Harry A. Ehle

# ILSCO CONNECTORS

MAKE  
YOUR  
PRODUCT  
PERFORM  
BETTER

All these . . . and more . . . for  
**YOUR BEST CONNECTIONS**

U/L AND CSA TESTED	HI-RUGGED STRENGTH
PURE COPPER	RE-USABLE
100% CONDUCTIVITY	ALL WIRE SIZES
COOLER OPERATION	ECONOMICAL

WRITE FOR  
80-PAGE CATALOG

**ILSCO CORPORATION**  
5753 Mariemont Ave.  
Cincinnati 27, Ohio

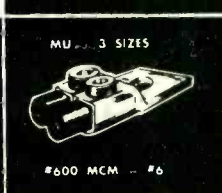
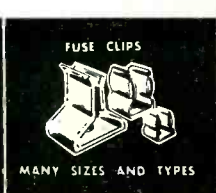
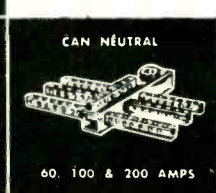
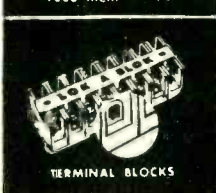
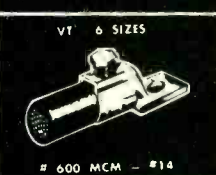



more lives  
than a cat!

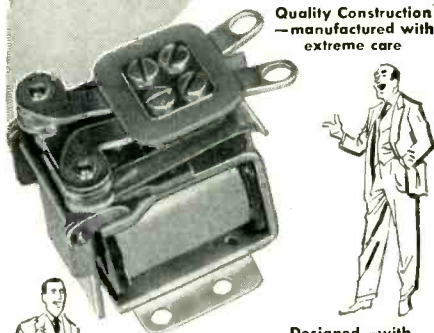

Quality Construction  
—manufactured with  
extreme care

Designed—with  
fresh, new ideas  
—manufactured  
with the newest,  
money-saving  
production techniques



## RELAYS

are standouts for  
performance  
... built to last!

One of today's most versatile relay lines, AEMCO relays are "first choice" for more than 100 of the top names in American industry. Design and construction is tops—for only the finest materials are used in AEMCO relays. Specify AEMCO and you're making your best relay buy. You'll profit by the newest production techniques that speed up delivery and save you money. You'll appreciate the prompt delivery on prototypes, the fast tool up for production. You'll find, too, that an AEMCO relay has more lives than a cat and is built to take it! Actually tested on the job, AEMCO relays are dependable and reliable . . . standouts for performance.

AEMCO relays are available in a wide variety of spring and coil combinations, operating potentials and contact ratings. Types include: Open, can, plug-in base, hermetically sealed, midgels, dual-purpose, delayed make or break, circuit control, current and potential relays. Should one of the hundreds of AEMCO relay types fail to meet your exact requirements, we will be happy to design and build a unit to meet or exceed your specifications.

**WRITE TODAY**

For more information on the standard AEMCO relay line, write for your free descriptive bulletin today!



**AUTOMATIC ELECTRIC MFG. CO.**  
83 STATE ST. • MANKATO, MINNESOTA

Want more information? Use post card on last page.

ELECTRONICS — February, 1956



Jesse Marsten

IRC board of directors and executive committee.

Marsten has been actively engaged in IRC expansion for the past 25 years. He joined the company in 1930 as chief engineer and was elected to vice-president of affiliates and engineering in 1939. He is a member of the IRC board of directors and executive committee. Prior to IRC, he was associated with Marconi Wireless Telegraph Co., RCA and Freed Eiseman Radio Corp.

### Kaye Appointed Transdyne President

LEOPOLD M. KAY has been appointed president of the Transdyne Corp. For eight years he was with CBS-Columbia and its predecessor, Air King Products Co., as vice-president for engineering. Prior to this, he was associated with Lear, Raytheon, Airadio and Pilot Radio Corp. in engineering activities.

Transdyne recently opened a new building in Maspeth, New York City. The plant will concentrate in the fields of nuclear instrumentation, information storage and handling and nuclear research equipment.

### Ramo-Wooldridge Plans Expansion

RAMO-WOOLDRIDGE Corp. of Los Angeles has secured options on 800 acres of land in the southern part of Denver, Colo. to provide for the future erection of a \$5,000,000 man-

## Opad D.C. POWER SUPPLIES

IMMEDIATE DELIVERY



OUTPUT: 0-30 V. D.C., 5 Amps.  
RIPPLE: 1/2% at Maximum Load  
REGULATION: 1/10 Load, 34.5 V.  
Full Load, 30.0 V.  
RACK MODEL (illus.) ..... KM75  
BENCH MODEL (illus.) ..... KM75B  
*Request Bulletin No. 93*



OUTPUT: 0-30 V. D.C., 10 Amps.  
RIPPLE: 1% at Maximum Load.  
REGULATION: 1/10 Load, 35 V.  
Full Load, 30 V.  
RACK MODEL (illus.) ..... KM81  
BENCH MODEL ..... KM81B  
*Request Bulletin No. 96*

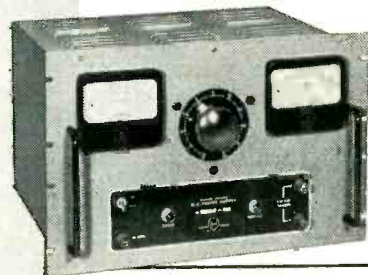

OUTPUT: 0-28 V. D.C., 20 Amps.  
RIPPLE: 1% at Maximum Load.  
REGULATION: 1/10 Load, 33 V.  
Full Load, 28 V.  
RACK MODEL (illus.) ..... KM88  
BENCH MODEL ..... KM88B  
*Request Bulletin No. 100*



UNFILTERED MODELS  
ALSO AVAILABLE  
*Request Bulletin No. 178*

**ELECTRIC COMPANY**

69-2 MURRAY STREET • NEW YORK 7, N. Y.  
Telephone: BEekman 3-7548

Want more information? Use post card on last page.

# For PILOT LIGHTS

CONSULT

## DIALCO

Your product benefits 3 ways from the use of a DIALCO Pilot Light:

**Enhanced appearance:** The glow of light and sparkle of a lens add colorful visual attraction.

**Greater safety:** A timely warning flashed by a pilot light can prevent damage to equipment.

**Added service:** Discs inserted behind lenses can be used to deliver specific messages, such as "FUEL LOW", "ON", "OFF", etc.

Let the Dialco engineering department assist you in selecting the right lamp and the most suitable pilot light for your needs.

Dialco offers the complete line of pilot lights, from sub-miniature types to giant units with 1½" lenses.

Every assembly is available complete with lamp.

**SAMPLES ON REQUEST AT ONCE — NO CHARGE**

Illustrations are approx. 70% actual size... (A) No. 8-1930-111 sub-miniature pilot light... (B) No. 521308-991, with multi-vue cap... (C) No. 922210-111, dimmer type... (D) No. 47901 with light shield cap.

Write for latest catalogues and Design Brochure.

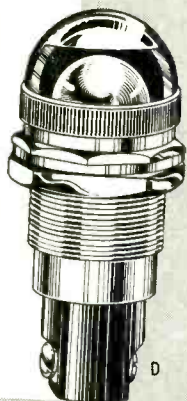
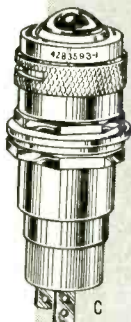
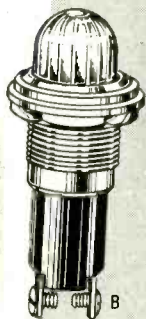

Foremost Manufacturer of Pilot Lights

## DIALIGHT CORPORATION

60 STEWART AVE. • BROOKLYN 37, N. Y.

HYACINTH 7-7600



PLANT AT BROOKLYN, N. Y.

PLANTS AND PEOPLE

(continued)

ufacturing facility.

The acquisition of the Denver site is part of a long range expansion program and will eventually provide a plant for the quantity production of electronic systems. It will employ 300 to 500 persons. According to the firm, the work to be done at Denver, while still undetermined, is not expected to have any relation to activities known to be planned by any other companies for the Denver area.

Present Los Angeles facilities of Ramo-Wooldridge in the International Airport district consist of more than 300,000 sq ft of laboratory space devoted to research and development activities in advanced electronics and in the field of guided missiles.

The company recently announced the acquisition of an additional 41 acres of land near the Los Angeles International Airport for the expansion of its research and development facilities. A 60,000 sq ft plant is to be built on the site. Construction may begin around mid-1956.

## Sylvania Selects Two Engineers

EDWIN G. SCHNEIDER has been appointed chief engineer of the electronic systems division of Sylvania Electric. Sherrerd B. Welles was named manager of the missile systems lab.

Dr. Schneider has responsibility for advanced system programs, engineering and research planning and liaison with professional and military organizations. His office is in division headquarters at the Waltham Laboratories.

Previously, he was manager of the missile systems laboratory, which is part of the new Waltham Laboratories. He joined Sylvania in 1954 as technical director of the missile systems laboratory.

Before that he was, for three years, director of the electronic research directorate of the U.S. Air Force Research Center at Cambridge, Mass. From 1947 to 1951, he was director of Project Meteor, a guided missiles project which was conducted for the U.S. Navy's Bu-

Specify

for -  
**PRECISION QUALITY Components**

OF TUNGSTEN, MOLY, NICKEL CLAD WIRE, ALLOYS, KOVAR

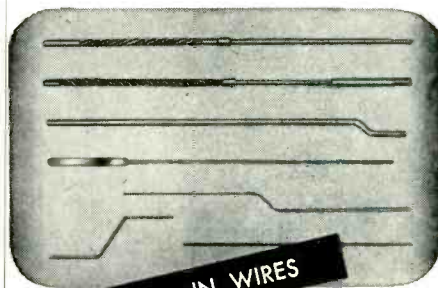

• DKE LEAD IN WIRES

Quality controlled throughout production with Tungsten hard glass leads produced under General Electric Timing Control. Each tungsten lead is microscopically inspected for flaws. DKE offers highest quality and LOW PRICES. Send drawings for quotations and let us prove the economy of our prices.

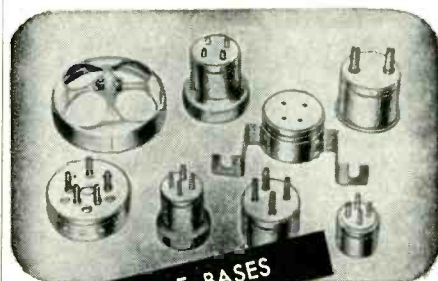

• DKE TUBE BASES

The Engineering Company can give you immediate delivery on following bases: 50 Watt, 3303B, 412 Industrial Base, Giant 7 Pin Bayonet, 4310 Four Pin Jumbo, Tetrode, Hydrogen Thyatron Bases in both Aluminum and Copper up to 6.50 dia, etc. All bases to JAN-1A/MLE-1B and subjected to weights and strength tests.

**DKE HYDROGEN THYATRION TUBE BASES**



CALL OR WRITE FOR QUOTATIONS ON YOUR SPECIFIC REQUIREMENTS

**THE engineering co.**  
27 WRIGHT ST. NEWARK 5, N. J.

reau of Ordnance by MIT.

Dr. Welles joined Sylvania a year ago as manager of the electronics department of the missile systems laboratory. In his new assignment, he succeeds Edwin G. Schneider.

Before coming to Sylvania, Welles was acting deputy for components and techniques of the electronics directorate at the U. S. Air Force's Research Center in Cambridge, Mass.

### Anton Electronics Names Engineers

MYRON YODIN has been named vice-president and assistant director of research and development at Anton Electronic Laboratories of Brooklyn, N. Y. The company also announced appointment of Adolph



Myron Youdin

Lovoff as general manager of the instrument division.

Youdin was formerly executive assistant to Nicholas Anton, president and director of research of the firm.

Lovoff joins the staff from the engineering division of Vitro Corporation of America, where he worked with Argonne National Laboratory personnel in evaluation of economic, nuclear and heat transfer aspects of boiling water reactors.

### IBM Plans New California Plant

INTERNATIONAL Business Machines Corp. will call for bids early in 1956 for a multi-million dollar plant to be built on a 190-acre tract near San Jose, Calif. The "campus" type layout will include a card plant,

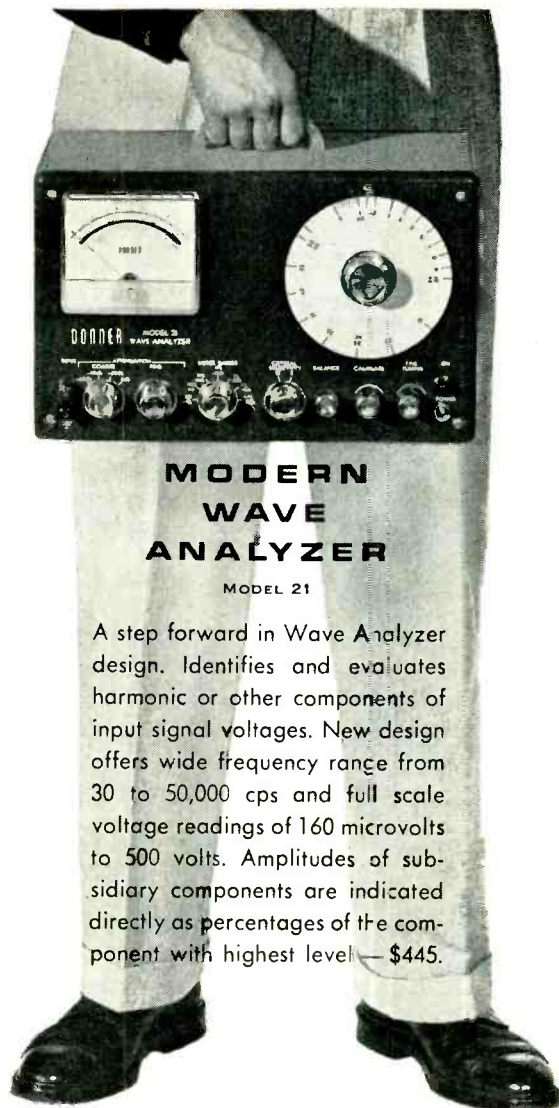

### MODERN WAVE ANALYZER

MODEL 21

A step forward in Wave Analyzer design. Identifies and evaluates harmonic or other components of input signal voltages. New design offers wide frequency range from 30 to 50,000 cps and full scale voltage readings of 160 microvolts to 500 volts. Amplitudes of subsidiary components are indicated directly as percentages of the component with highest level — \$445.

# ADVANCED INSTRUMENTATION



### WOW AND FLUTTER METER

MODEL 28

An all new instrument for measuring phenomena that can be expressed as frequency or phase modulation of an audio frequency. Completely portable. Meets all applicable requirements of the IRE, SMPTE and ASA — \$295.

## DONNER SCIENTIFIC COMPANY

2804 7th Street, Berkeley 10, California  
all prices f.o.b. Berkeley, California

Write for specification sheets on the above instruments and the complete Donner line of advanced instrumentation 2-A



where does  
**COTO-COIL**  
*figure here?*

Lightning speed business machines are a bookkeeper's best friend. And in many of the finest precision instruments, Coto-Coils make amazing rapidity and accuracy possible.

If you use coils, Coto-Coil can solve your difficult problems of design and production.

Send details to

**COTO-COIL CO., Inc.**

63 Pavilion Ave., Providence 5, R. I.

PRECISION  
**Coto**  **Coils**  
WOUND

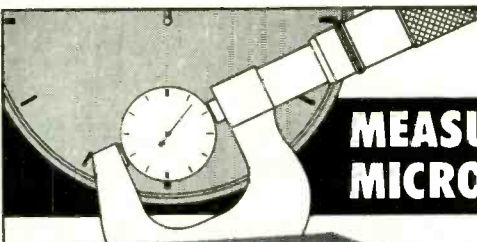

**MEASURE TIME WITH  
MICROMETER ACCURACY**



**MODEL B-4  
TIME MEASURING SYSTEM**

Direct reading for simple, fast, accurate operation

Measures time intervals to an accuracy of  $\pm 2$  millimicroseconds

Provides marker signals of .1  $\mu$ s and 1  $\mu$ s spacing on synchroscope

Incremental control calibrated to  $\pm 1$  millimicrosecond

Complete self-contained integrated system

WE ALSO MAKE PRECISION WIDE-RANGE PULSE and TIME DELAY GENERATORS—DATA SHEETS AVAILABLE

Write for complete data: our Bulletin E-B-4

**Rutherford** **ELECTRONICS CO.** 3707 S. ROBERTSON BLVD.  
CULVER CITY, CALIFORNIA

Want more information? Use post card on last page.

manufacturing building, school, product engineering building, administration building and research laboratory. The company's existing card plant and research laboratory at San Jose will be consolidated into the new plant.

**Raytheon Opens Lab,  
Promotes Engineers**

RAYTHEON opened its new industrial electronics laboratory in Wayland, Mass.

The two-story brick structure is situated on a 73-acre site. It will be used for engineering and development of advanced electronics equipment for both government and commercial applications. Total floor space is approximately 225,000 sq ft. Approximately 1,200 employees are housed in the new building.

The Wayland laboratory was begun on November 29, 1954. It cost approximately \$2,500,000. Engineering activities which were formerly carried out in seven separate localities have been consolidated in the Wayland building.

Raytheon also announced that Niles P. Gowell has been named chief engineer of its receiving tube division.

He will be responsible for all engineering functions of the division.

He joined Raytheon in 1928. During the intervening 27 years with the firm, he has held several positions of increasing responsibility, and just prior to his present appointment was head of the quality control and applications engineering departments of the division.

John M. Palmer has been appointed manager of manufacturing for the receiving tube division. He is responsible for production in the receiving tube plants at Newton and Quincy and for related functions such as process engineering, methods, scheduling and plant engineering.

He comes to Raytheon with more than 20 years' experience in tube manufacturing. He joined Sylvania Electric Company in 1933, and held various positions including that of chief industrial engineer and plant manager. In 1947 he joined Landsdale Tube Co., a subsidiary of

Philco, as plant manager, and later became general manager in charge of all phases of receiving tube, cathode ray tube and transistor operations.

In another move, Raytheon established a new division under its receiving and cathode ray tube operations, to be known as the special tube division with R. L. McCormack as manager. The new division, with headquarters in Newton, Mass., sets up separate facilities and has responsibility for all non-entertainment type tubes including industrial and special-purpose types for guided missiles, aircraft, radar and other military and commercial applications.

McCormack reports to N. B. Krim, vice-president who heads the operations. McCormack joined Raytheon in 1938 after five years as a tube engineer in Sylvania's plant in Salem, Mass.

### General Electric Changes Electronics Division

GENERAL ELECTRIC has realigned its organizational structure to better meet the needs of an industrial electronics business which is expected to double in size in the next five years.

The entire electronics division, except for home radio and tv sets, has been shifted from the Appliance and Electronics Products Group to the newly-named Electronic, Atomic and Defense Systems Group. Home radio and tv have been assigned to the newly formed Consumer Products Group along with all other of the firm's major consumer products such as major appliances and housewares.

The electronics division gains six company components operating in the field of producer's and military electronics, laboratory, an industrial computer section and an electronics business study. The six new units include the specialty control department, the x-ray department, the naval ordnance department, the special defense projects department, the aircraft products department and the Schenectady aeronautic and ordnance operation.

W. R. G. Baker, vice-president of

## SENSITIVE RELAYS that R-E-S-I-S-T



SHOCK

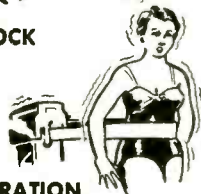

VIBRATION



TEMPERATURE



**NO BIGGER THAN A BOOK OF MATCHES**

Here are miniature sensitive relays—single or double-pole types—which fulfill the most rigid requirements of space, shock, temperature and vibration in both commercial and military applications. The Series 100—105—106 relays are hermetically sealed and have a long life expectancy. Write for Bulletin SR—6

Engineering representatives in principal cities.



**daddy — is that a tallahassee?**



No, my dear, Tallahassee is a beautiful city in North Florida.

This Capital City offers the ideal site for anyone interested in the manufacture of electronic equipment. Recent surveys show that Tallahassee citizens want your type of industry, and building financing may be arranged for responsible firms.

Two great Universities, a technical school, superb outdoor recreational facilities, low, low, taxes, excellent labor supply and a rapidly expanding market in growing Florida and the South, provides the site you are looking for. Inquire about the specific extras Tallahassee has for your electronic plant.

**WRITE TODAY!**

Send for our new 16 mm color sound motion picture "TALLAHASSEE" for private or group showings.



TALLAHASSEE, Chamber of Commerce, Dept. 8, Tallahassee, Florida.

Please send me complete information about industry in Tallahassee.

Name .....

Address .....

City ..... State .....

**WE'VE  
GOT 'EM**

**any amount  
any kind  
any time**

**plugs**



**CANNON  
PLUGS**



**U.S.  
RELAYS**

**GREMAR R.F.  
CONNECTORS**

**WOODS  
Aircraft Supply**

309 West Elmwood Avenue  
Burbank, California  
Telephones: Victoria 9-3211  
THornwall 2-8182



**The right connection  
for the right connectors**

Want more information? Use post card on last page.



I. J. Kaar

GE and general manager of the electronics division, said that the manufacturing facilities of the businesses assigned to the electronics division will not be affected by the organizational realignment. He said that no movement of the six new electronics division units nor of the manufacturing facilities of the radio and tv home receiver units is planned or contemplated.

GE also announced the establishment of a color system technical project to integrate the activities of its several departments involved in the color tv field. I. J. Kaar, formerly electronics division manager of engineering, was named by Dr. Baker to head the project. Kaar has been with GE for 30 years. He has served as section head in charge of high-power transmitter engineering, engineer in charge of all receiver developments, manager of the radio and tv department and manager of the engineering department of the electronic division.

GE also announced that John B. Russell has been appointed manager of the engineering analysis sub-section of its electronics laboratory in Syracuse, N. Y.

Dr. Russel joined the laboratory as a consultant in July of this year coming from Columbia University where he was head of the department of electrical engineering.

### Honeywell Opens Denver Plant

A NEW \$1 million manufacturing plant for the Heiland division of Minneapolis-Honeywell was re-

## Molded Units Have All-Weather Protection

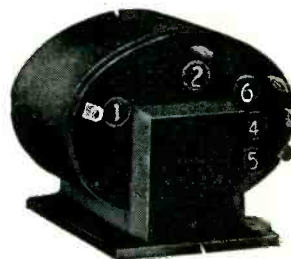

A Raytheon transformer  
molded with Acme compound

### WITHOUT METAL CASES

For example—

ACME 2002 POTTING COMPOUND is unaffected by climatic changes and assures 100% protection against extremes of temperature ranging from  $-100^{\circ}$  to  $+185^{\circ}$  F.

Developed to withstand elevated and subzero conditions, ACME 2002 forms a hard, moisture-proof seal that will not crack or become brittle when subjected even to sudden changes in temperature. Exterior casings are not necessary.

There are many Acme Compounds for various applications. Let us help you.



Integrated Electrical Products  
of Highest Quality for  
Over Fifty Years

**ACME WIRE CO.**  
NEW HAVEN, CONN.

MAGNET WIRE • COILS  
VARNISHED INSULATIONS  
INSULATING VARNISHES  
AND COMPOUNDS

Want more information? Use post card on last page.

February, 1956 — ELECTRONICS

cently opened. The new plant, a one-story, 45,000 sq ft structure, is located on a nine-acre plot in Arapahoe County, on the outskirts of Denver.

## General Precision Promotes Reichel



W. A. REICHEL has been appointed to the newly created post of senior vice-president in charge of engineering for General Precision Equipment Corp. He is a director of General Precision and executive vice-president of GPE's subsidiary, Kearfott Co. He is also a director of several other GPE subsidiaries.

Prior to joining Kearfott in 1944, Reichel had been director of engineering of Eclipse-Pioneer, division of Bendix Aviation.

GPE also announced plans to acquire a majority of the outstanding stock of Shand and Jurs Co. of Berkeley, Calif.

S & J products, ranging from simple hatch and manhole covers to complex electronics instruments, are sold principally to the petroleum and chemical industries in the U. S. and overseas. Sales of the company for the year 1955 are estimated at \$2,500,000.

General Precision is a management company with twenty-one subsidiaries whose principal activity is the design and production of instruments, components and systems for industry and defense.

## WCEMA Councils Elect Officers For 1956

THOMAS P. WALKER has been named to head the Los Angeles Council of the West Coast Electronic Manu-

# Shasta

INSTRUMENTS

designed for the user!

## MODEL 1210 DECADE INDUCTOR

### Features:

- ★ Accuracy of  $\pm 1\%$
- ★ 0.001 to 11.11 henry range in 0.001 henry steps

### Description:

SHASTA Model 1210 Decade Inductor is a general-purpose laboratory instrument designed to provide precise inductance values in the 0.001 to 11.11 henry range.

Applications include use in wave filters, tuned circuits, and equalizers for audio and supersonic frequencies.



### Brief Specifications:

Range: 0.001 to 11.11 henries, 0.001 henry steps  
Accuracy:  $\pm 1\%$   
Max. Voltage: 1000 v dc  
Dimensions: 12½" L x 4½" W x 4⅞" D  
Weight: 8½ lbs.  
Price: \$240.00 f.o.b. factory

Write today for Technical Bulletin 1210; please address Dep't. SG-2

### OTHER SHASTA QUALITY INSTRUMENTS

Expanded Scale Frequency Meters and Voltmeters  
Audio Oscillators • AC Voltmeters • Power Supplies  
Wide Band Amplifiers  
Bridges • WWV Receivers  
Decade Inductors.

# Shasta

division

BECKMAN INSTRUMENTS INC.  
P. O. Box 296, Station A, Richmond, California  
Telephone LAndscape 6-7730

S-12



## Borg 900 Series Micropots

offer everything you want in a potentiometer



- 1 Versatility — 1 to 5 gang models, single or double shaft, servo or bushing mount.
- 2 Permanent Accuracy — Resistance element integrally molded within housing. Leads, taps and terminals firmly encapsulated.
- 3 Long Life — Scanning action distributes wear across face of bar contact. Rigid, fixed lead screw.
- 4 Dependability — Mechanically and electrically stable. Effectively sealed against dust and moisture.
- 5 Absolute Linearity — Uniform resistance distribution. No external trimming required.
- 6 Specifications — Meets extreme commercial and military requirements for all applications.
- 7 Availability — Quick deliveries on production quantities.

## Borg 1100 Series Micropots

Accurate, dependable, long-lived. Has 9 inch coded leads for easy installation. Offers your products a competitive price advantage.



WRITE FOR CATALOG BED-A15B

**BORG EQUIPMENT DIVISION**  
GEORGE W. BORG CORPORATION  
JANESVILLE, WISCONSIN



Built by Borg

CONTINUOUS, DIRECT-READING

**X-BAND VSWR MEASUREMENT**

better than  
**2% overall accuracy!**

For speedy and accurate VSWR measurements in laboratory or production use, the CTI Model 1108 Measuring System reads directly, is continuously tunable from 8,500 to 9,600 mc.

**SPECIFICATIONS**

Two VSWR Ranges:	1.02 to 1.2; 1.2 to 2.5
Attenuation Scale:	0 to ∞; 1.5 db midscale
Waveguide Fitting	UG-39/U
Directional Couplers, directivity	over 40 db

**COLOR TELEVISION INCORPORATED**

SAN CARLOS 1, CALIFORNIA



factors Association for 1956. The Association includes more than two hundred member companies.

Winfield G. Wagener of Varian Associates in Palo Alto, Calif. was elected to head the San Francisco Council of the Association.

Walker is vice-president of the Triad Transformer Corp. and also senior partner in the law firm of Walker, Curry, Eilers, and Wehrle. He has been a director of the Association for two years, and chairman of its legal committee.

Named to the post of Los Angeles Council vice-chairman is Hugh P. Moore, board chairman of Lerco Electronics, Burkank electronics manufacturer. Secretary-Treasurer of 1956 is D. C. Duncan, vice-president and general manager of Helipot Corp., a division of Beckman Instruments.

The new directors of the Los Angeles association, also named for 1956 terms, include S. H. Bellue, chief of material at Hughes Aircraft Co.; Hugh F. Colvin, vice-president and general manager of Consolidated Electrodynamics Corp.; Paul R. Repath, president of Paul R. Repath Co.; and Gramer Yarbrough, sales manager of American Microphone Co.

Elected to the post of vice-chairman of the WCEMA San Francisco Council is Calvin K. Townsend, general manager of Jennings Radio Manufacturing Co. of San Jose.

New secretary-treasurer is J. A. Chartz, general manager of Dalmo Victor in San Carlos.

Directors-at-large for 1956 are: Andrew Gould of Friden Calculating Co.; G. I. Long of Ampex Corp.; H. Myrl Stearns of Varian Machine Associates and Douglas C. Strain of Electro-Measurements.

**CBS-Columbia  
Names Engineers**

A PLANNED program of expansion of the engineering department of CBS-Columbia was announced by R. T. Capodanno, vice-president in charge of engineering.

William Vassar was recently named director of engineering, the first step in the program.

Other additions to the engineering department include Ludwig

**ANCHOR RING\*,  
CONE and  
MAGNET  
INSULATOR\***

for  
**COLOR TUBES**

Perfect insulation . . . easy to attach . . . economical. From stock and to your specifications. Also: safety glass mounting channels; dust seals; flexible bumper channels. \*patented

36-36 36th Street, Long Island City 6, New York

Chicago rep:  
Pat Malone, 4000 West North Ave., Chicago, Ill.  
SPaulding 2-9892

California rep:  
W. S. Harmon Co., 121 N. Robertson Blvd.,  
Beverly Hills, Calif., CRestview 6-3027



**ANCHOR  
INDUSTRIAL  
Co., Inc.**





# ultra-sensitive relays

chosen to assure fine focusing of ATF Mastercraft Camera

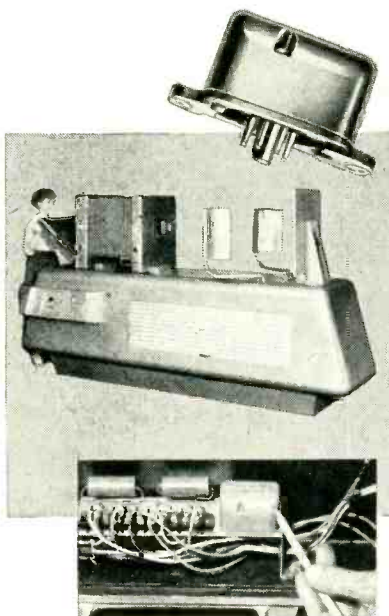

The new Mastercraft camera of American Type Founders, Elizabeth, New Jersey, embodies many new, advanced automatic operating principles. A major one of these is the precision focusing feature which lets the operator "dial in" the exact enlargement or reduction desired. In this focusing circuit a Barber-Colman Micropositioner is used. In your products, too, there is very likely a place where you can make good use of this remarkable ultra-sensitive relay. Various types... plug in, solder-lug, screw terminal, hermetically sealed. Operate on input powers of 50 to 1,000 microwatts. Ideal for use as a null detector in resistance bridge circuits, a differential relay in electronic plate circuits, and an amplifier in photoelectric circuits. Can be operated in excess of 100 cps. Write for Bulletin F-3961-4.

**Barber-Colman Company,**  
Dept. B, 1459 Rock Street, Rockford, Illinois  
Want more information? Use post card on last page.  
ELECTRONICS — February, 1956

Zucker as chief mechanical engineer. He has had more than 28 years of experience in the electronics field, and has held positions as chief mechanical engineer with several other electronic manufacturers.

Walter Lukas has been named chief electrical engineer and is responsible for all television projects, components engineering and advanced development. He brings to his new post more than 14 years in electronics experience.

Martin Perry has been appointed chief radio engineer.

Harold H. Knubbe, with the company since 1952, has been promoted to the newly established post of technical assistant to the vice-president in charge of engineering. The move represents a wide extension of his present responsibilities within the department. He has been in the electronics industry for the past 24 years.

Israel J. Melman, chief television engineer, will supervise developmental black-and-white and color tv projects. He has been with the firm since 1950.

Bernard Klibanner has been named supervisory mechanical engineer for both radio and tv products under the new realignment. He has had more than fifteen years of experience in electronics mechanical engineering work.

## Lockheed Promotes Louis Ridenour



LOUIS N. RIDENOUR, has been appointed director of the research laboratories of Lockheed's missile

# DURANT MFG. CO. Specials

For RADAR, ELECTRONIC and INSTRUMENT APPLICATIONS

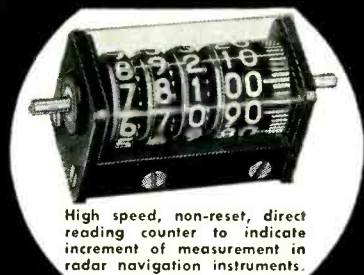

High speed, non-reset, direct reading counter to indicate increment of measurement in radar navigation instruments.

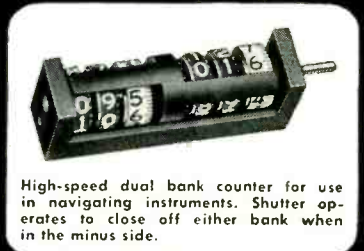

High-speed dual bank counter for use in navigating instruments. Shutter operates to close off either bank when in the minus side.

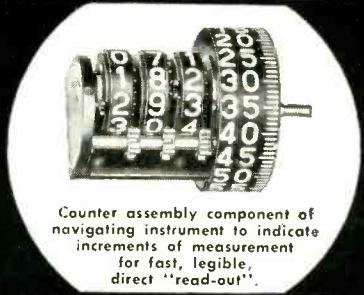

Counter assembly component of navigating instrument to indicate increments of measurement for fast, legible, direct "read-out".



Special counter for use on Tape Recorder to indicate the position of tape passing through the recorder.



Direct reading counter for navigating and directional instruments. Unit wheel graduations permit reading of 150,000 increments per minute.

Representatives in Principal Cities  
WRITE FOR LITERATURE  
**DURANT MANUFACTURING CO.**  
1912 N. Buffum St. Milwaukee 1, Wis.  
112 S. Water St. Providence 3, R. I.

**PRODUCTIMETERS**  
SINCE 1879 *Count Everything*

Want more information? Use post card on last page.

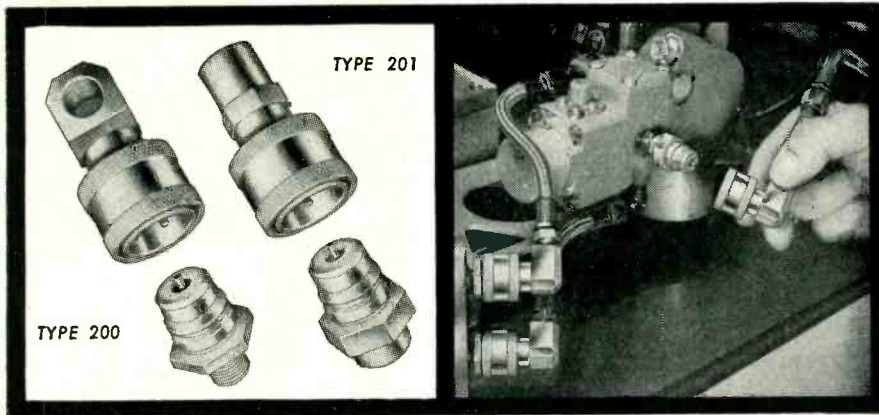

**NEW miniature**

## QUICK-DISCONNECT COUPLINGS

Eastern's new couplings are the smallest available for high pressure systems. The lightest weight coupling made, Eastern units are used in pneumatic systems, and fluid systems such as hydraulic, and high pressure fuel.

**SIZE:** 2 $\frac{3}{16}$ " overall length, .95" diameter  
**WEIGHT:** 1.24 oz. (type 200); 1.17 oz. (type 201)  
**PRESSURE:** 1500 p.s.i., maximum operating  
**FLOW:** ½ g.p.m., normal

For detailed catalog sheet, write today.



systems division in California.

He was formerly program development director at the missile division and has been associated almost a year with the entire scope of the division's work.

In taking over active direction of the division's research activities, Ridenour revealed that the research program will continue to expand substantially—both in scope and facilities.

"The division's company-sponsored program of basic research, exclusive of contract research, will be stepped up very appreciably—I might say by several hundred percent—over 1955's program." Ridenour said.

Dr. Ridenour, who was U. S. Air Force chief scientist, was chairman of the USAF Scientific Advisory Board Committee, which surveyed Air Force research and development activities. The resulting Ridenour Report led to establishment of the office of Deputy Chief of Staff, Development, and also the Air Research and Development Command. He headed development work at MIT's radiation laboratory leading to the SCR 584 radar system.

He has also served as consultant to the Office of the Secretary of War and as professor of physics and dean of the Graduate College of the University of Illinois.

# TRANSISTOR curve tracer

## ADVANCED CHARACTERISTICS

**SWEEP CURRENTS TO  
3.0 AMPERES AVAILABLE**

**MODELS AVAILABLE WITH  
AND WITHOUT OSCILLOSCOPES**

- INTERNAL CALIBRATION
- BLANKING
- QUADRANT SELECTION
- BIAS CURRENTS TO 120 Ma.
- ALL TYPES OF TRANSISTORS
- LICENSED FROM PHILCO CORP.

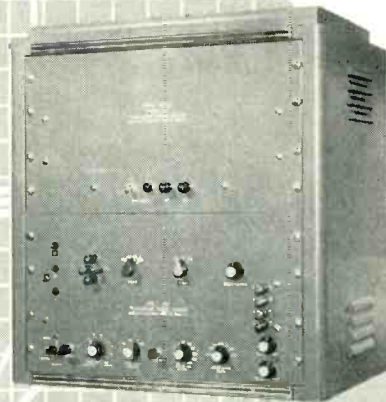

PRICE: from \$1,250.00 (fob Phila.)

### C O N T A C T

**CALIFORNIA**  
 Martin Mann Associates  
 14751 Keswick St.  
 Van Nuys, Calif.  
 STate 0-0911

**ATLANTIC COAST**  
 Norman Hardy Associates  
 2103 Glenview St.  
 Phila. 49, Penna.  
 Phone: DEvonshire 8-0716

**CANADA**  
 Electrodesign  
 736 Notre Dame St. West  
 Montreal, Canada  
 Phone: University 6-7367

**AMERICAN ELECTRONIC LABORATORIES, INC.**  
 641 ARCH STREET, PHILADELPHIA 6, PENNSYLVANIA

## Hobson, Zarem Leave Stanford Research

JESSE E. HOBSON, director of Stanford Research Institute, Menlo Park, Calif., since March 1948, has submitted his resignation, effective March 31, because of ill health.

SRI's board will start looking for a successor early this year, according to Dr. Wallace Sterling, chairman of the board and president of Stanford University.

During the nine years Hobson has been in charge of SRI, it has grown from a staff of 50 people and annual research rate of \$250,000 to a staff of 1,200 and an annual rate of \$10.5 million in active commercial and government contracts.

Immediately before his appointment to SRI, he was director of

# Couch Rugged

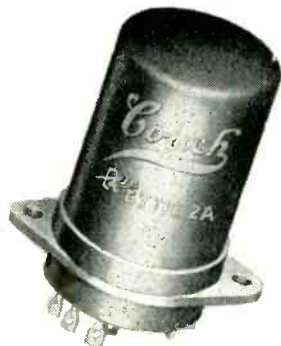

## RELAYS

Specify the COUCH MODEL 2A or 4A relay whenever HIGH SHOCK-HIGH VIBRATION capabilities are required and for DRY-CIRCUIT applications.

**VIBRATION** . . . 5 to 25 cps @ 0.4" peak to peak excursion; 25 to 2000 cps @ 20G acceleration; No contact opening, relay energized or de-energized.

**SHOCK ELECTRICAL** . . . 75G for 10 milliseconds minimum. No contact opening, relay energized or de-energized.

**SHOCK MECHANICAL** . . . 200G minimum . . . no physical damage to relay or change in electrical characteristics.

Models 2A and 4A are subminiature, hermetically sealed, D.C. relays which meet and in several respects exceed the requirements of MIL-R-5757B. They are actuated by a "balanced-armature" rotary motor. Both models are particularly suited to dry-circuit switching applications.

### LEADING PARTICULARS

Ambient Temp.:	-65°C to +125°C
Weight:	3.2 oz. maximum
Height of Case:	1½" maximum
Diameter of Case:	1¾" maximum
Terminals:	Flattened & pierced
Contact	DPDT — Model 2A
Arrangement:	4PDT — Model 4A
Contact Material:	Fine silver to molybdenum
Operation:	Simultaneous operation, simultaneous release, no contact bounce
Pull-in-power (Coil):	¾ watt — Model 2A ½ watt — Model 4A

Test Data and Literature on Request  
**Built-in Dependability**

S. H. Couch Company, Inc.

NORTH QUINCY 71, MASSACHUSETTS

Want more information? Use post card on last page.  
ELECTRONICS — February, 1956

Armour Research Foundation for four years.

Stanford also announced that A. M. Zarem has resigned his positions as assistant director and manager of the Southern California division of the Institute to enter the field of private consulting.

Dr. Zarem intends to establish an office in Los Angeles to engage in independent research counseling and advisory services to business and industrial management. He has been with SRI since August, 1948.

He invented an automatic electronic control system for operating high speed photographic equipment, a camera shutter capable of framing rates up to 100,000,000 per second, an electromechanical servo system and an electrical control method for monitoring power systems and indicating faults.

### Marvelco Appoints Research Director

HANS E. HOLLMANN has been appointed as director of research of the Marvelco electronics division of National Aircraft Corp.

Dr. Hollmann formerly was research scientist for Hydro-Aire electronics division, recently acquired by National Aircraft Corp. From 1947 to 1954 he served as the sole research scientist at the Naval Air Missile Test Center, Point Mugu, Calif.

In Germany, Hollmann managed his private research institute and acted as research consultant to Telefunken, Siemens and other companies. After World War II he became professor of high-fre-



Hans E. Hollmann

## Tough . . . Fungusproof

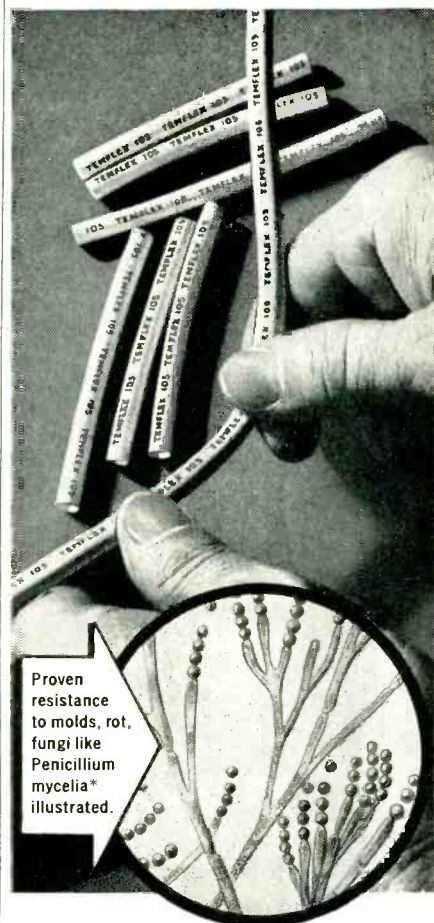

\* Seminar, Sharp & Dohme, 2-46

### High Temperature Vinyl Tubing Meets Mil-I-631B Specification

Temflex\* 105 is the first vinyl tubing to be approved under Mil-I-631B (grade c—high temperature) as being both *fungusproof* and *flame resistant* . . . the first material to add these features to excellent heat aging and high dielectric strength. Temflex 105 has higher resistance to *cut through*, too, averaging 20% over older types in standard penetration tests — also approved by UL for continuous operation at 105° C. Now more than ever, Temflex 105 tubing is your superior choice for harnessing and wire insulation.

\*T.M. Reg. U. S. Pat. Off.

**IRVINGTON**  
3M COMPANY  
DIVISION, Minnesota Mining and Manufacturing Co.  
11 Argyle Terrace, Irvington 11, N. J.

Want more information? Use post card on last page.

# 400 cycle High Frequency Power Supplies

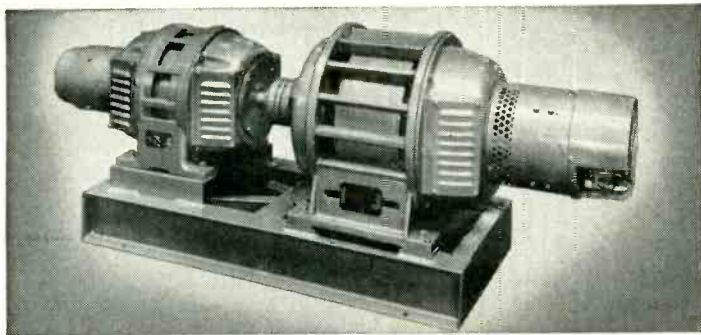

This typical 400 cycle High Frequency Generator is available from 1 KVA to 100 KVA. Variable frequency power supplies can be designed with outputs as low as 3 cycles and as high as 2000 cycles.

Hertner also manufactures high frequency motor generators that can be either synchronous motor-drive, induction motor-drive, or direct current motor-drive.

Consult Hertner for your unusual power supply requirements.



**THE HERTNER ELECTRIC COMPANY**  
12690 ELMWOOD AVE. • CLEVELAND 11, OHIO

MOTORS • MOTOR GENERATORS • GENERATOR SETS

A SUBSIDIARY OF GENERAL PRECISION EQUIPMENT CORPORATION



## GOLD INLAY KNOBS IN ANY QUANTITY!

... and Never a Tool Charge

### NEW GEE-LAR GOLD INLAY KNOBS

You can get beautiful gold inlay knobs, pointers, instrument controls . . . thousands of styles and varieties . . . in any quantity from GEE-LAR—The House of Knobs. They're available in both knurled and spring types, in either walnut or ivory backgrounds. For faster service and lower cost . . . plus the widest selection . . . get your Gold Inlay Knobs from GEE-LAR!

WRITE TODAY  
for Gee-Lar Catalog  
IT'S FREE!



THE HOUSE OF KNOBS

**GEE-LAR MANUFACTURING COMPANY**

821 ELM ST. • Rockford, Illinois



quency and electromedicine at the Friedrich Schiller University in Jena, East Germany, but left in 1947 to avoid being transferred to Russia. He came to this country under the sponsorship of the U. S. Government.

### Clevite Promotes Research Head

S. J. BEGUN, vice-president and director of the Clevite Research Center, has been appointed director of marketing for Clevite Corp.

In his new position he will supervise the company's patent and market research departments as well as help coordinate the development of new products and new markets in this country and abroad. The previous director of marketing was Willard W. Brown, now president of the company's Cleveland Graphite Bronze division.

Born and educated in Europe, Dr. Begun began his career in Germany working on telephone circuits and electro acoustics. During this period he designed a new commercially practical magnetic wire recorder.

After coming to this country in 1935, he designed an endless-tape magnetic recorder for such uses as automatic weather announcements and voice training.

He joined the Brush Development company in 1938.

### Electro Engineering Builds New Plant

ELECTRO ENGINEERING WORKS of Oakland, Calif. has broken ground for construction of a new building to house their development and manufacturing facilities. The firm manufactures precision transformers. The new 15,000 sq ft manufacturing facility will be located in San Leandro, Calif. Plans have been drawn for later construction of a 4,000 sq ft office building, in addition, on the two- and one-third acre plot purchased by Electro. Total cost for building and equipment is estimated at over \$300,000. Electro Engineering employs about 70 people at the present time and the new construction will permit an

**DIRECT READING OF  
FM DEVIATION . . .  
25 to 500 mc. At Low Cost!**



**LAMPKIN 205-A  
FM MODULATION METER**

- Indicates instantaneous modulation deviation, positive or negative up to 25 KC.
- Accuracy 10% of full scale.
- Tunable 25 to 500 MC. in one band, with fast and slow controls.
- Sensitivity 10 millivolts or better throughout range.
- Speaker for aural monitoring, oscilloscope output for visual monitoring.
- Meets FCC specs for mobile-radio maintenance.
- Size only 7" x 12" x 7/4". Weight 13 lbs.
- Price \$240.00 net. Satisfaction guaranteed or money refunded.

For measuring transmitter frequencies from 0.1 to 175 MC. (crystal-controlled transmitters to 500 MC.), within 0.005%, use the companion unit—the LAMPKIN 105-B MICROMETER FREQUENCY METER!

*Write today for technical data  
on both instruments.*

**LAMPKIN LABORATORIES, INC.**  
Instruments Div., Bradenton, Florida

***this is  
important enough  
to read twice!***

Now, for the first time, you can obtain 1, 2, or a dozen prototype *high alumina ceramics* parts for development work in your own plant . . . at low cost. This new service is available to "custom-make" any small-lot number of ceramic parts to your exacting specifications. Here's an opportunity to "research" high alumina ceramics for new products as well as existing ones, without the barrier of buying production run quantities. Want to know more? Write, outlining your problem. Ask, too, for a copy of our properties chart.

**frenchtown**

PORCELAIN COMPANY  
86 Muirhead Avenue • Trenton 9, N.J.

California Representative: Edwin E. Starr, 4101 Rhodes Ave., N. Hollywood, Cal. STanley 7-5879.

**SEALTRON CORP. IS  
E-X-P-A-N-D-I-N-G**



*. . . seeks  
top sales  
representatives*

Leading manufacturer of world's most complete line of glass-to-metal HERMETIC SEALS has several territories available for aggressive men. High income potential. For details, contact Richard Russell, Sales Mgr.,

SEALTRON CORP., P. O. Box 73, Lockland, Ohio

**DEFLECTION YOKES**

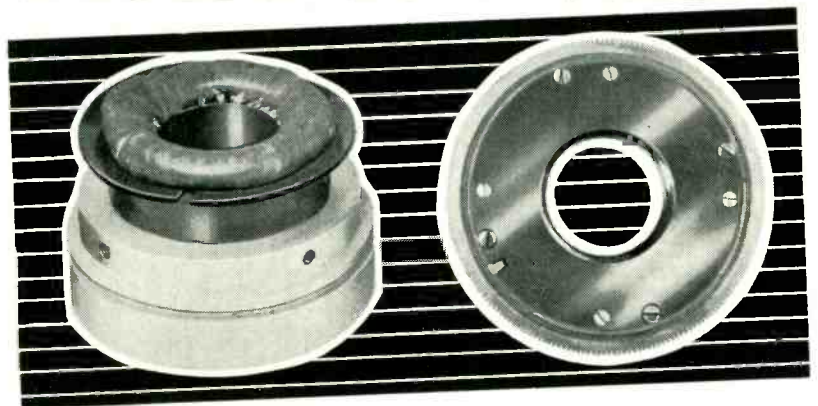

We specialize in the design and manufacture of precision deflection yokes for military and commercial applications. Phone or write for immediate engineering evaluation of your critical display problems.

**Celco**

Phone: RAMsey 9-1123

*Constantine Engineering Laboratories Co.*

Island Avenue

Mahwah, N. J.

increase to over 100 employees. L. W. Wahlgren is president of the firm. Secretary-treasurer and business manager is A. W. Fry. James J. Holloran is vice-president and chief engineer.

**Fairchild Camera Names Chaffee**

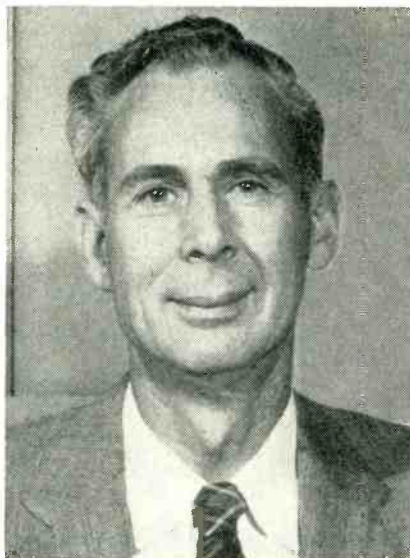

FAIRCHILD Camera and Instrument Corp. announced the appointment of Milton A. Chaffee as director of electronics and systems research.

He was formerly deputy director of systems at the Air Force Cambridge Research Center in Cambridge, Mass. During World War II, he was a member of the research staff of the Radiation Laboratory at MIT.

From 1945 to 1950 he was associated with Airborne Instruments Laboratory as supervisor of field service. He served as development planning officer for the Deputy Chief of Staff for Development, U.S.A.F. from 1950 to 1952.

During the Korean War he acted as chief civilian scientist of the Commanding General of the Far Eastern Air Force and aided in the operational use of ground control radar in Korea.

**Eitel-McCullough Selects McAulay**

WILLIAM MCAULAY has been named manager of application engineering of Eitel-McCullough in San

**CODE MARK Anything! WITH**

**INDUSTRIAL MARKING INK**

★ **CODE MARKING INKS**  
For Resistors and Capacitors. For Machine or Hand Application.

Whatever the substance, Phillips has an ink to mark it permanently and legibly—or can make one. Marking experts insist on "Clear Print" Wood Block Stamp Pads and Opaque Inks. They get clear, sharp, fast-drying impressions. Also inks for brush, pen, stencil or machine application available in a variety of colors and quantity containers.

★ **Quick Laboratory Service**  
On Your Problem Markings.

★ **To Permanently Mark . . .**  
Metals, Plastics, Glass, Wood, Paper, Leather, Ceramics—glazed, varnished or lacquered surfaces and virtually every other known material.

WRITE FOR FREE BOOKLET

CLEAR-PRINT WOOD STAMP PADS  
PROTOTYPE TYPEWRITER RIBBON  
CARBON PAPER

**L. A. PHILLIPS, President**  
**PHILLIPS PROCESS CO. INC.**  
192 MILL STREET  
ROCHESTER 14, N. Y.

INSP  
RECD  
35  
721  
PART NO 10  
RI

Want more information? Use post card on last page.

**LEADERS IN THE AIRCRAFT INDUSTRY**

**SPECIFY NEMS-CLARKE ALL-PURPOSE RECEIVERS**



**CONVAIR**

Guided Missile Plant  
Pomona, California



**LOCKHEED**

Analog Ground Station  
Van Nuys, California



**DOUGLAS**

Santa Monica  
California



**ASCOP**

M Series Ground Stations  
Manufactured by Applied  
Science Corporation  
Princeton, N. J.



**UNEQUALED PERFORMANCE**

in telemetering,  
guided-missile  
monitoring and  
radiosonde reception.

**NEMS-CLARKE Incorporated**

PRECISION ELECTRONIC INSTRUMENTS  
SILVER SPRING, MARYLAND

For Further Details Write Dept. A-3

Want more information? Use post card on last page.

Bruno, California.

He joined the Eimac field engineering department in 1954 as an assistant in the division he will now head. He has been active in the broadcasting and electronics fields for many years.

### Automatic Electric To Build \$16 Million Factory

A NEW, multimillion-dollar factory, research laboratory and general office structure will be erected by Automatic Electric Co. on the 170 acre site of the former Westward-Ho golf course in Northlake, Illinois.

The new facility is expected to cost in excess of 16-million dollars and be completed by late 1957.

The overall structure will contain approximately 1,300,000 sq ft, or 29 acres of floor space.

Facilities devoted to factory operations will be on one floor, with a straight line production flow from the receipt of supplies and raw materials to the shipment of the finished product.

Research and development laboratories together with the general, administrative, engineering and sales offices will be housed in a building of some 300,000 sq ft.

When the new factory is completed, the company will be able to consolidate into one facility all of its Chicago operations, which are now housed in fourteen different buildings.

### Boyle Metalcraft Appoints Lloyd

W. C. LLOYD has been appointed vice-president of Boyle Metalcraft Corp. of Brooklyn, N. Y.

He was formerly connected with Westinghouse meter division and with General Electric Co. of Bloomfield, N. J. in engineering and testing.

### Continental Can Forms Physics Group

PAUL ERLANDSON, former chairman of the physics department and assistant vice-president of Southwest Research Institute of San An-

## STORED-ENERGY WELDING SPEEDS VACUUM TUBE ASSEMBLY

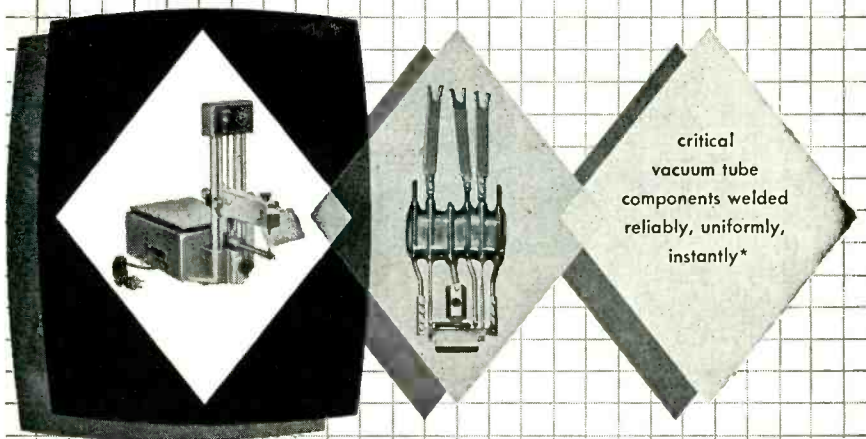

critical vacuum tube components welded reliably, uniformly, instantly\*

WELDMATIC MODEL 1015 precision welder firmly joins wires, sheets and blocks of tungsten, nickel, nichrome, steel, silver and copper in tube element assembly for mass spectrograph guns. Molybdenum and tantalum also welded in plate assemblies.

\*Made by Consolidated Engineering



UNITEK CORPORATION  
25B Halstead Avenue • Pasadena 8, California

Write for complete Technical Information on Stored-Energy Welding

# YOKE SPECIALISTS



- Military or special yokes and focus coils designed to your specifications.
- Production yokes for TV sets.

For your answer to yoke problems write Dr. Henry Marcy today.

*syntronic*

INSTRUMENTS, INC.

100 Industrial Road • Addison, Ill. • Phone: Terrace 4-6103

# Complete Reliability

from  $-70^{\circ}$  to  $+150^{\circ}\text{C}$ .



with the New, Improved 'PANCLIMATIC' Coating

This new protective coating permits the use of these resistors under the greatest extremes of temperature. In addition, it affords better moisture protection for greater stability. It resists abrasion and impact with no tackiness, and it is chemically inert to common solvents and plasticizers. Storage stability is better than 1%. Operating at 50% nominal rating, and at an ambient temperature of  $100^{\circ}\text{C}$ , the stability of these 'Panclimatic' Coated resistors is better than 1%.

The same high standards of design, construction, and performance which have established Welwyn as a leading name in the field of precision resistors, will also identify these newly developed products.



For complete data and specifications write to Dept. GB-7  
**Welwyn International, Inc.**

3355 Edgecliff Terrace, Cleveland 11, Ohio

tonio, Texas, has been named director of the department of physics of Continental Can Company's new central research and engineering division. The division will ultimately employ 75 professional scientists and 25 administrative personnel.

In his new position, Dr. Erlandson will head the company's experimental work on the application of the principles of physics to the high speed automatic equipment used in manufacturing and closing containers and closures, as well as to its future ionizing radiation sterilization program.

## American Bosch Promotes Giba



JOHN J. GIBA has been appointed vice-president in charge of the newly created contracts division of American Bosch Arma Corp. His first position was that of electrical designer at Arma, beginning in 1932. He had been assistant chief engineer since 1954.

## Burns Appointed Chief Engineer Of El-Tronics

MERYL C. BURNS has been appointed chief engineer of El-Tronics

In 1947, he joined the Berkeley Scientific Corp. as a project engineer and the following year was promoted to chief engineer.

He left that company in 1952 to organize the Digital Instrument Co. in Coral Gables, Fla. Two years later he sold the business to Brush

**HEYCO NYLON STRAIN RELIEF BUSHINGS CUT PRODUCTION COSTS AND IMPROVE PRODUCT QUALITY**

**1-SLIP OVER WIRE**  
**2-SNAP INTO HOLE**

**Approved**

With Heycos it's no longer necessary to tie wire knots or use insulating grommets. Product life is increased and product appearance is greatly enhanced.

HEYMAN MANUFACTURING COMPANY  
Kenilworth 13 New Jersey

Send wire sizes for free samples and specifications.

**THE HEYMAN ORGANIZATION WITH 25 YEARS STAMPING EXPERIENCE HAS MODERN PRESS CAPACITY FOR OVER 2,000,000 FINISHED STAMPINGS PER DAY.**

**ASK FOR BULLETIN 33**



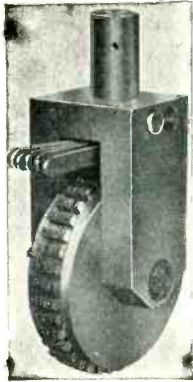

FOR —  
NUMBERING  
PANELS

**HOT**  
IN COLOR  
OR  
**COLD**  
WITHOUT  
COLOR

The quickest way is to use an  
**ACROMARK LETTERING** or  
**NUMBERING HEAD.**

Hundreds of different types of marking  
and numbering machines and tools are  
made by ACROMARK. Tell us your  
problem so we can send you complete  
information about the proper equip-  
ment for your work.

The  
**ACROMARK**  
Company

323 Morrell St., Elizabeth 4, N. J.

"The Original Marking Specialists"

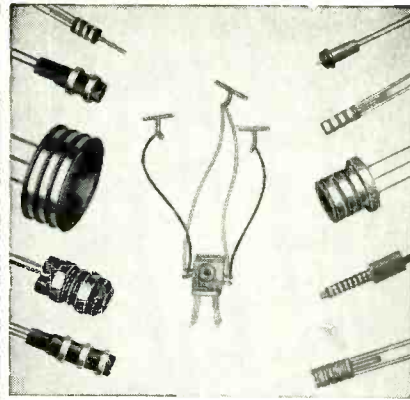

Miniature and Sub-Miniature  
**SLIP RING ASSEMBLIES**  
**BRUSH BLOCK ASSEMBLIES**  
**COMMUTATORS**

and other  
Electro-Mechanical Components

**PRECISION MADE**  
**TO YOUR OWN SPECIFICATIONS**

Precision molded products with exacting tolerances in  
precious and non-precious solid metals of all alloys. All  
types of Thermo-Plastic and Thermo-Setting materials.

Slip Ring Assemblies fabricated or one-piece precision  
molded to your specifications in Nylon, Kel-F, Mineral filled  
Mellamine, Phenolic, and other materials. Rings and leads  
spot welded or brazed together for positive electrical circuit.

**Our Swiss methods and techniques are geared to  
meet exacting requirements. We invite your inquiries.**

**COLLECTRON CORPORATION**

Murray Hill 2-8473 • 216 East 45th Street • New York 17, N. Y.

## To the Company that's Looking Ahead

If your company is growing and  
needs money, we can offer the  
following services:

- (1) Supply funds on an emergency  
basis.
- (2) Supply funds on a permanent  
basis through the purchase of  
stock or a firm underwriting for  
public distribution.
- (3) Arrange a financial program over  
a period of time to support a  
long-term expansion program.

This is our business. We are not  
brokers for others. We perform  
these and other services com-  
pletely and independently, acting  
as principals for our own organ-  
ization.

**MORRIS COHON & Co.**  
(CORPORATE DEPT.)

42 BROADWAY NEW YORK 4, N. Y.

Digby 4-5460



DE MORNAY-BONARDI

first in  
ultramicrowave  
equipment

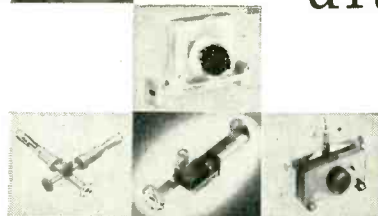

A complete line of research instruments  
covering frequencies up to 90,000 mc...  
proved in laboratories the country over.



DEMORNAY-BONARDI • 780 SOUTH ARROYO PARKWAY • PASADENA, CALIFORNIA

**M-DC-3A super-regulated  
voltage standard**

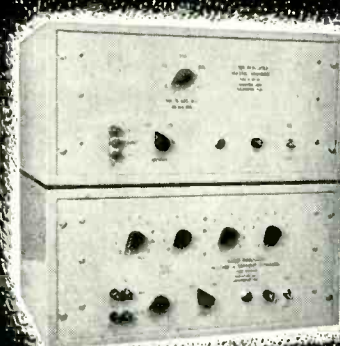

**M-DC-2A super-regulated voltage  
and current standard**

**Calibration Partners**

The two units combined, provide  
voltages up to 509.99 volts dc in  
0.01 volt steps, however, either unit  
can function independently. The  
M-DC-2A provides current outputs  
of from 0 to 109.99 ma dc in 0.01  
ma steps and voltages from 0 to  
109.99 volts dc in 0.01 volts steps.  
Overall accuracy of both units is  
within 0.05 pct. of selected voltage  
or current.



**RADIATION Inc.**

Electronics • Avionics • Instrumentation

Melbourne, Fla.  
Orlando, Fla.



## NOX-TARNISH

**P**ROVEN first truly effective product for prevention of Tarnish! NOX-TARNISH is a high grade packaging paper impregnated with a stable, non-volatile, non-toxic chemical composition capable of removing hydrogen sulfide from the atmosphere.

NOX-TARNISH eliminates production rejects because it insures bonding on soldering operations by keeping silver tarnish-free. It also keeps gold, cadmium or copper bright and free of sulfide stains.

In every case where tests have been made by industrial concerns with NOX-TARNISH, the product has proven far superior to any product on the market today. NOX-TARNISH is used by many of the largest manufacturers of electronic components, silverware and hollow ware.

Available in rolls, sheets or shredded. It can be fabricated into bags, envelopes, caseliners to meet individual packaging requirements. Write today for samples and technical bulletin N.T.

\*Patent Applied for.

Protective Packaging Division  
**DAUBERT CHEMICAL CO.**  
 formerly NOX-RUST CHEMICAL CORP.  
 333 No. Michigan Ave.  
 Chicago 1, Illinois

Manufacturers of  
 RUST PREVENTIVES • V.C.I. PAPERS  
 ADHESIVES • AUTOMOBILE UNDERCOATINGS  
 Want more information? Use post card on last page.

Electronics and was in charge of development and production design of digital type equipment for that firm at the time of his new appointment.

### Lambda Electronics Builds New Plant

LAMBDA ELECTRONICS CORP. is building a new plant in College Point, N. Y. The firm manufactures regulated and unregulated d-c power supplies.

The new building will be ready for occupancy in mid-summer. The company contemplates further expansion of its product line in 1956, including a possible entrance into several new fields of manufacture.

### Potter & Brumfield Elevate Smith

ZEKE R. SMITH has been appointed chief engineer of applications for Potter & Brumfield of Princeton, Ind. For the past two years he has been manager of the Chicago office of Potter & Brumfield. He was formerly associated with the Kansas City division of Bendix Aviation Corp. as a components engineer. During World War II, he was a radar instructor with the U. S. Air Force and later was associated successively with the Airborne Instruments Laboratory, Philharmonic Radio Corp. and Air King Products Co. Before joining Bendix he was engaged in electronic engineering projects at Wilcox Electric Co. and the Vendo Co.

### Hupp Acquires Pioneer Research

THE HUPP CORP. acquired the business and assets of the Pioneer Electric and Research Corp. of Chicago, an electronics firm engaged in manufacturing and research operations.

Pioneer Electric and Research has developed and is now manufacturing remote control equipment using new electronic techniques. The equipment, which is primarily being used in teletypewriter communication facilities, also permits central control of remotely located

## WIDE-RANGE FREQUENCY METER 85-1000 MEGACYCLES

### TS-175A/U

Government  
 Approved  
 Calibration  
 Accuracy:  
 .005%  
 Stability:  
 .0025%  
 Resettability:  
 .0025%



IMMEDIATE DELIVERY

### A VERSATILE PRECISION MEASURING INSTRUMENT

Recommended Applications:

- Precise Measurements of Frequencies
- Production Testing
- Alignment of Transmitters and Receivers
- Laboratory Testing
- Portable Field Testing
- A Secondary Frequency Standard
- Signal Generator Calibration
- U.H.F. and V.H.F. Television Alignment

## COLORTONE

ELECTRONICS, Incorporated  
 200 Frank Road, Hicksville, L. I., N. Y. HI 4-2124



### BLACK LIGHT INSPECTION CUTS REJECTS TO ZERO!

Rejects caused by inadequate coverage of protective coatings and transparent finishes are being eliminated by an economical *invisible* system known as Blak-Ray. Manufacturers report major savings in inspection costs.

Under ordinary light, "misses" are virtually undetectable. Under black light ultra-violet, a fluorescent additive in the coating makes inspection rejects a thing of the past.

Full information is contained in new Case History 115E, available from the Black Light Corporation of America, Distributors for Ultra-Violet Products, Inc., 5114 Walnut Grove Avenue, San Gabriel, California. Distributors in principal cities.

Want more information? Use post card on last page.

teletypewriters on a common circuit.

It is planned to adapt the equipment for telemetering, television program switching, power transmission control, pipe line regulation, railroad signal control and other related fields.

The business of Pioneer will be conducted as the Pioneer Electronics Division of Hupp, with J. J. McEnerney continuing as president.

### Burroughs Appoints Services Manager

JOHN H. HOWARD has been appointed manager of the engineering services division of Burroughs research activity. He is presently associate director of research and will replace DuRay E. Stromback who has been named engineering manager of the Plymouth plant. In his new position he will direct the division which supplies drafting, fabrication, components engineering, testing and other technical services.

Before coming to Burroughs as a senior research engineer in 1950, Howard had served as director of development of Engineering Research Associates, Inc. and as project engineer with the Sperry Gyroscope Co. He was appointed associate director of the activity in 1953.



John H. Howard

# PART COST CUT 1/2

with GRC die cast tiny parts!

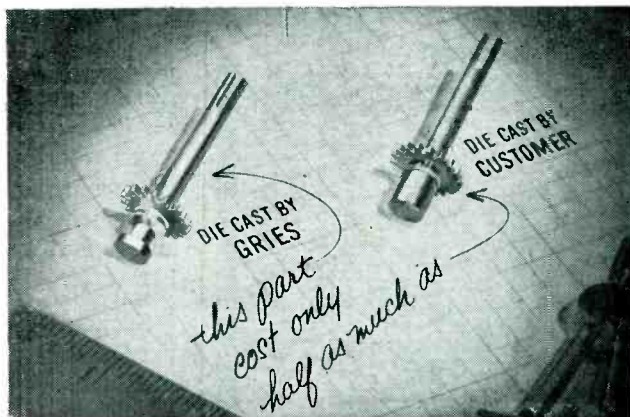

Range timer part made by Gries costs *half* as much as part die-cast by the customer

**NO MINIMUM SIZE!**

Quick deliveries on quantities of 100,000 to many millions.

Maximum weight: 1/2 oz.  
Maximum length: 1 3/4"

Many manufacturers have learned that GRC specialized techniques and facilities have cut the cost of tiny components for their products 50% and more compared with production in their own plants. Parts like the slotted gear shaft illustrated are die cast to precise specifications —trimmed, ready for use— in one automatic operation. Consult Gries about cost-cutting components for your products.

Send today for samples and bulletin.



## GRIES REPRODUCER CORP.

151 Beechwood Ave., New Rochelle, N. Y. NEW Rochelle 3-8600



## IF IT'S NEW ... IF IT'S NEWS ... IT'S FROM **ELCO**

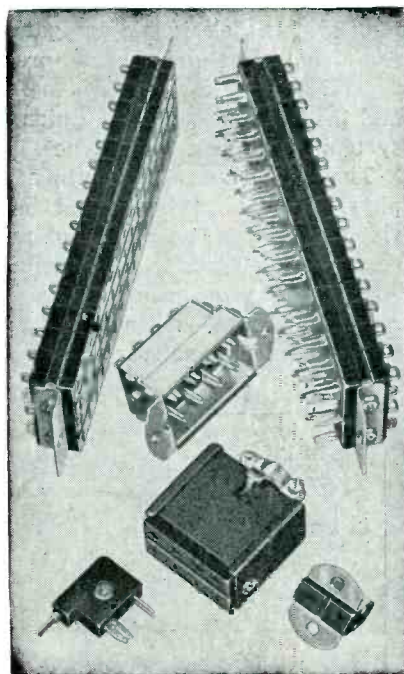

### MAKING CONNECTIONS FROM COAST-TO-COAST

Every day, more and more quality manufacturers are joining the imposing list of those "Variconizing" their designs. For Elco's Varicons offer an almost infinite number of combinations. Here, for example, are but three combinations; and all are possible from only four basic parts: end sections, center section and contacts. Elco has furnished from 2 to 64 contact Varicons, for commercial and military usage, in polarized or keyed combinations. The Varicon has been termed the "engineer's dream" — you design, we align! Available in general purpose phenolic, low loss mica, general purpose phenolic color, and alkyd (if quantity sufficiently large). Contact material, tested and approved in general use, is phosphor bronze, silver plated. Varicons are available in single tier and double tiers, with brackets, handles, covers, recessed housings — and now, for printed circuitry. Write, phone, wire for complete information.

**ELCO CORPORATION, M STREET BELOW ERIE, PHILA. 24, PA., CU 9-5500**

for compactness  
and light weight...  
use

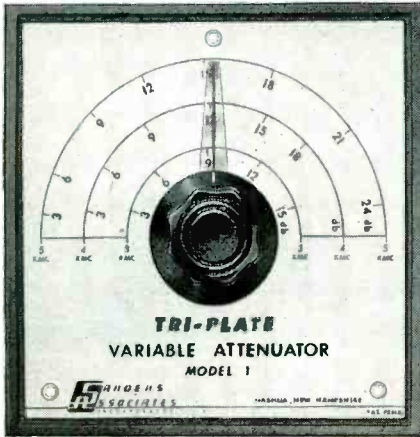

# SANDERS TRI-PLATE VARIABLE ATTENUATOR

with a new type of printed  
circuit transmission line  
developed by Sanders Associates, Inc.

This small, compact attenuator is used in the frequency range of 1000 to 6000 mc. Designed for use with a coaxial cable connection, it has low external leakage and gives broad-band performance.

**Maximum Attenuation** — linear function of frequency (20 db at 4,000 mc)

**Insertion Loss** — less than 1.5 db

**Maximum VSWR** — less than 1.25 at 4,000 mc.

**Characteristic Impedance** — 50 ohms

**Average Power Rating** — 2 watts

**Dimensions** — 5" x 5" x 1/4"

Other Tri-Plate products such as transitions, directional couplers, hybrid rings and special antennae can also be supplied.

Microwave systems will be engineered for conversion to TRI-PLATE and produced to your requirements.

For detailed specifications,  
write to Dept. E



Want more information? Use post card on last page.

## New Books

### Principles of Guided Missile Design—Guidance

By ARTHUR S. LOCKE. *D. Van Nostrand Company, Inc., New York, 1955, 729 p., \$12.50.*

SOME of the most sophisticated electronic engineering is being carried on in the field of guided missiles. Little has been published heretofore on the subject.

► **Scope**—This book gives no aid nor comfort to potential enemies nor is it the author's intention so to do. He does, however, perform a useful service in assembling the body of scientific and engineering knowledge bearing on problems of missile guidance. This will provide the engineer entering the field with an intellectual groundwork from which he can approach classified literature that will later be made available to him.

► **Content**—The first chapter orients the reader by discussing the tactical employment of missiles and broadly stating the guidance problems that arise.

In Chapter 2, the author deals with prior developments in the field. These include conventional autopilot systems, electronic navigation, radio control of glide bombs, preset control as used in the German A-4, and the German command guidance system which used audio tones.

The book then delves into some physical and mathematical considerations basic to design of missile guidance systems. This includes material on propagation of electromagnetic waves—radio and infrared—transform analysis and theory

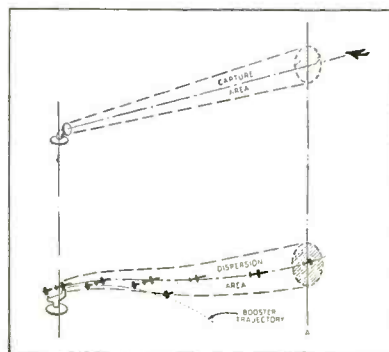

Elements of beam-riding capture

## VHS\* RELAY

(\*Very High Sensitivity)



### Model 266

Sample specs. are:  
0.2 micro-ampere, (12,000 ohms coil) or, 0.1 millivolts, (5 ohms.)



● The VHS is a balanced armature, Alnico magnet type relay. It is internally shock-mounted and resistant to vibration. The screw-on cover is gasket sealed. It can be opened and resealed. Connections: 9 pin octal style. Dimensions: 1 3/4 diameter x 2 1/4 long. Weight: 4 ounces. Sensitivity: Infinite variations from 0.2 Ua. to 10 Amp. or 0.1 Mv. to 500 volts, self contained. Higher volts or amps with external multipliers. A.C. rectifier types. Trip point accuracies to 1%. Differential 1%. The degree of resistance to shock and vibration primarily depends upon sensitivity and type of action wanted. In general, the relays will not be permanently damaged by shocks of 100 G's and vibrations up to 2,000 cps at 4 G's. The most sensitive relays may close their contacts under these conditions.

Contacts: S P S T or SPDT, 5-25 Ma. D.C. Other ratings to 1/2 Amp. A.C. A locking coil gives high pressure and chatter free contact under shock and vibration. Prices: \$20-\$80.

Delivery 4 to 6 weeks. Assembly Products, Inc., Chesterland 4, Ohio.

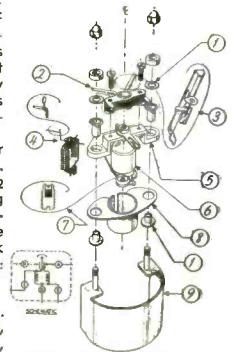

Write for explanation of symbols

Booth 311 I.R.E. Show March 19-22  
Kingsbridge Armory, New York City.

For **HEAVY DUTY**  
**WORK!** Severest Electrical  
Services!



P-506-CE  
Plug with Cap



S-506-DB  
Socket with  
deep bracket

**JONES  
PLUGS &  
SOCKETS**

500 SERIES

Proven  
Quality

For 5,000 Volts  
25 Amperes per  
Contact Alter-  
able by circuit  
Characteristics.

Socket contacts phosphor bronze knife-switch type, cadmium plated. Plug contacts hard brass cadmium plated. 2, 4, 6, 8, 10, and 12 contacts. Plugs and sockets polarized. Long leakage path from terminal, and terminal to ground. Caps and brackets, steel parkerized (rust-proofed). Plug and socket blocks interchangeable in caps and brackets. Terminal connections most accessible. Cap insulated with canvas bakelite.

Write for Jones BULLETIN 20 for full details on line.

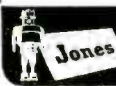

**HOWARD B. JONES DIVISION**  
CINCH MANUFACTURING CORPORATION  
CHICAGO 24, ILLINOIS  
SUBSIDIARY OF UNITED-CARB FASTENER CORP.

Want more information? Use post card on last page.

February, 1956 — ELECTRONICS

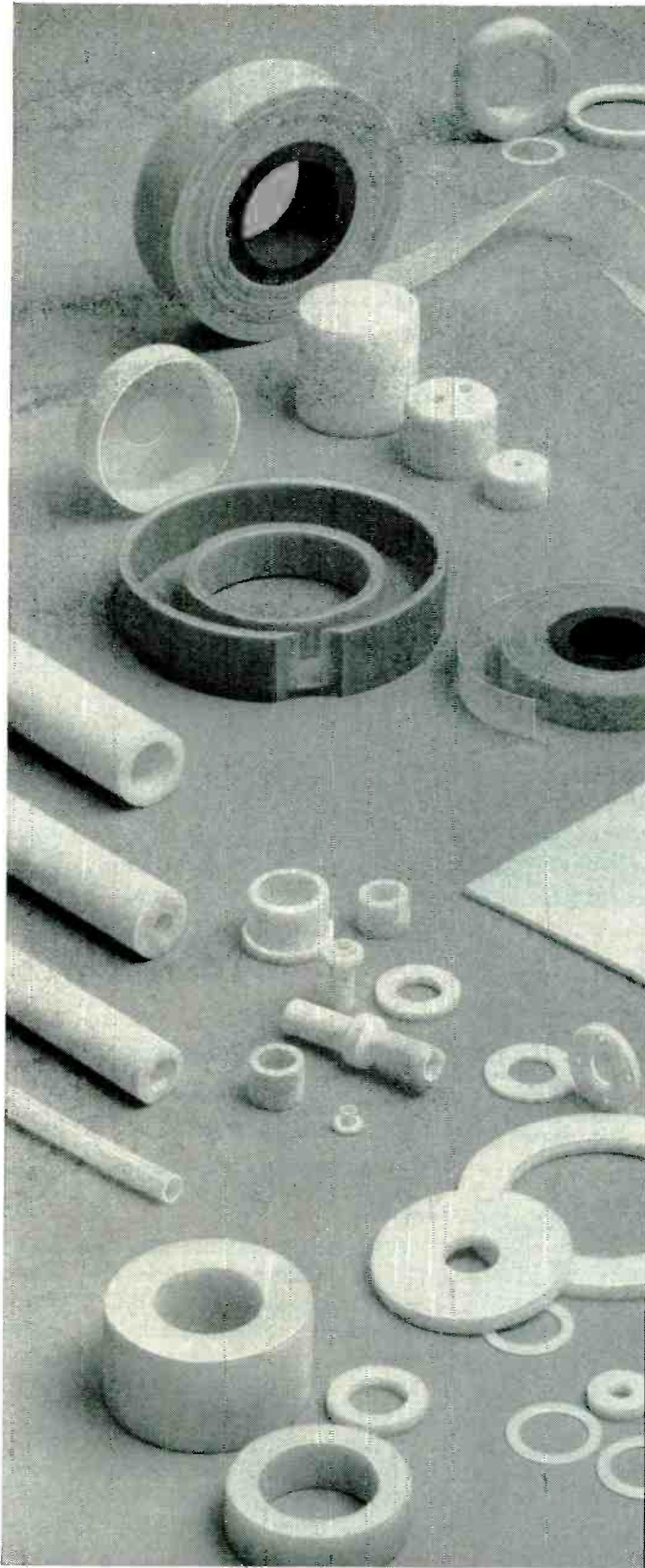

**DON'T GIVE UP  
WITHOUT TRYING AN  
R/M Teflon\*  
PRODUCT**

What are you striving for—product improvement?—better equipment performance?—a more economical process? A product made of “Teflon” by R/M could well be the missing link you’re seeking. For R/M has been working with this wonder plastic ever since it was produced and, with it, has solved some of the very toughest problems encountered in recent years by electrical and electronics engineers.

It is quite conceivable that R/M has already faced your particular problem and come up with a solution to it. So take advantage of the skill, experience and unmatched help that R/M can offer you. The many different products pictured indicate R/M’s versatility in “Teflon” manufacture. We can fabricate to your own specifications or supply you with “Teflon” in the form of rods, sheets, tubes or tape. For further information, write today.

**Properties of “Teflon”:** High dielectric strength • Moisture absorption zero • Unaffected by weather • Excellent heat stability up to 500° F. in continuous operation • As tape, leaves no carbon residue along the discharge path • High impact resistance • Nonadhesive • Stretches easily • Tensile strength 1500-2500 psi.

*\*Du Pont trademark*



**RAYBESTOS-MANHATTAN, INC.  
PLASTIC PRODUCTS DIVISION, Manheim, Pa.**

FACTORIES: Manheim, Pa. • Bridgeport, Conn. • No. Charleston, S.C. • Passaic, N.J. • Neenah, Wis. • Crawfordsville, Ind. • Peterborough, Ontario, Canada

RAYBESTOS-MANHATTAN, INC., Asbestos Textiles • Laundry Pads and Covers • Packings • Brake Linings • Brake Blocks • Clutch Facings • Fan Belts • Radiator Hose  
Rubber Covered Equipment • Industrial Rubber, Engineered Plastic, and Sintered Metal Products • Abrasive and Diamond Wheels • Bowling Balls

of servomechanisms. A chapter on tactical considerations introduces the reader to some statistical concepts and then proceeds to cover in greater detail much of the same ground as Chapter 1.

Chapters 9 and 10 on transducers, modulation systems and microwave components are thorough.

► **Analysis**—Chapters on target considerations and analyses of flight plans are highly mathematical.

The concluding chapters on guidance systems, bandwidth considerations and telemetry contain much interesting information.

► **Evaluation**—The book is interesting as a "first" in a vastly intriguing field and does indeed contain information that every young missile guider should know.

Captain Grayson Merrill, USN, is editor of a five-book library on guided missile design. Forthcoming volumes will treat aerodynamics, propulsion and structure; armament, launching and range testing; operations research and systems engineering; and space flight.—J.M.C.

### Electrical Measurements and Measuring Instruments

BY E. W. GOLDING. *Pitman Publishing Corp., New York, 1955, 913 p., \$10.00.*

MEASURING instruments described in this book are, for the most part, nonelectronic. Instruments discussed include ammeters and voltmeters, wattmeters and watt-hour meters and instruments for measuring power-line frequencies.

The book begins with discussion of electrostatic and electromagnetic theory and electrical circuit analysis. The author then introduces the reader to inductance and capacitance and methods for measuring these quantities. There follows a chapter on resistance measurement and use of a-c and d-c potentiometers. These latter sections contain some particularly good material on the various kinds of bridge circuits and when to use them.

► **Other Subjects**—Measuring tech-

# AT LAST! A SUBMINIATURE THERMAL TIME DELAY RELAY\* for GUIDED MISSILES and PRINTED CIRCUITS

The only Relay under 1" in height that offers the following:

- Time delays from 1 second to 10 minutes.
- Heater Voltages to 230 volts. Interchangeable on A.C. or D.C. of any frequency.
- Contact rating up to 6 amps.
- Hermetically sealed.
- Fully compensated for ambient temperatures of from -65°C to +125°C.
- Will withstand vibration of from 5 to 500 CPS at acceleration of 10 G.
- Shock up to 50 G.
- Rapid reoperating time.
- Available in 7 and 9 pin.
- Price of sample \$9.25 net each.



\*PATENT PENDING

## FALCON ELECTRONICS CORP.

308 WILLIAM STREET, HARRISON, N. J.

Telephone: HUMBOLDT 3-6292



**You Name It EISLER Makes it...**

Eisler tipless stem patents have been extensively used by incandescent lamp and radio tube manufacturers. Eisler patents are free and have been a source of protection to the radio tube and lamp industry. Why not consider your next machine an Eisler? Serving the Industry over 35 years.

Send for Catalog

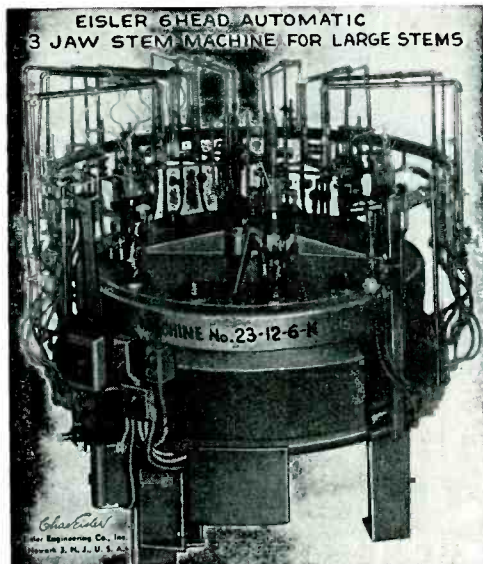

CHAS. EISLER JR., PRES.

### EISLER ENGINEERING CO., INC.

751 So. 13th St. NEWARK 3, N. J.

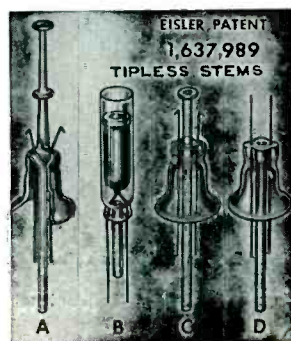

## Average Reading R. F. Power Meters

100kc to  
700mc

1.5 watts to  
6000 watts

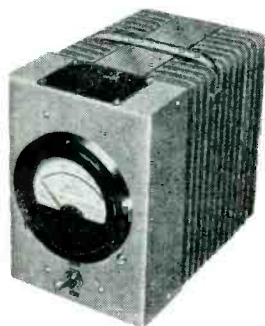

These broad band R.F. power meters are of the absorption type consisting of an oil filled, air cooled, coaxial load resistor and a voltmeter calibrated to read watts. The power meter is suitable for use as a field or laboratory test instrument, is completely shielded and non-radiating, permitting transmitter testing and adjustment without interference. The meter box is easily detached, permitting location of the load resistor at a remote point. In cases where power measurements are not required the load resistor may be used as a dummy load.

Write Today for Complete Information

### Electro Impulse Laboratory

208 River St. • Red Bank, N. J. • Red Bank 6-0404

## COMPLETE BURNER CATALOG

AGF, builders of gas burners and equipment for over 77 years offers this first complete catalog of technical data on air-gas and oxygen-gas burner equipment.

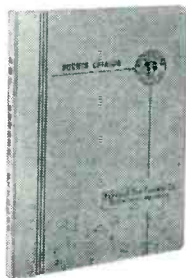

- Sharp Flame, Fish Tail, Blast and Oxygen-Hydrogen Burners.
- Blowpipes, Hand Torches and Mixing Equipment.
- Flow Meters, Fire Checks and Ball Joints.
- Many accessories and much technical data.

All of the above are available in the new AGF Burner Catalog, promptly mailed to you upon written request on your company's letterhead.



**AMERICAN GAS FURNACE CO.**

130 Spring St. Elizabeth 4, N. J.

Want more information? Use post card on last page.

ELECTRONICS — February, 1956

NEW BOOKS

(continued)

niques for several other physical quantities are described including: magnetism, illumination, high voltage and temperature. Material on eddy currents and their effects, waveforms and transients is particularly timely.

Electronic instruments discussed in the bulk of the book include: photometers, harmonic analyzers, the cathode-ray oscillograph, vacuum-tube voltmeters, self-balancing slide-wire potentiometers, stabilized power supplies and a photoelectric tachometer.

► **Electronics**—The last chapter of the book, 35 p, deals specifically with electronic instruments. The author leads off with a brief discussion of the properties of the vacuum tube followed by the characteristics of diodes, triodes, tetrodes, pentodes and thyratrons. Included are discussions of servomechanisms, negative feedback and velocity feedback. Specific circuits described are the pentode amplifier, cathode follower, servo amplifier, counting rate meter, Q meter and electronic counter.

Although the book contains information of interest to both the user and designer, its format tends to favor the user. —J.M.C.

## Principles of Nuclear Reactor Engineering

By SAMUEL GLASSTONE. *D. Van Nostrand Co., Inc., New York, 1955, 861 p, \$7.95.*

WRITTEN for the practicing engineer as well as for the senior and graduate engineering student, this book is intended to present the basic scientific facts of nuclear reactor engineering in maximum breadth and in as much depth as is

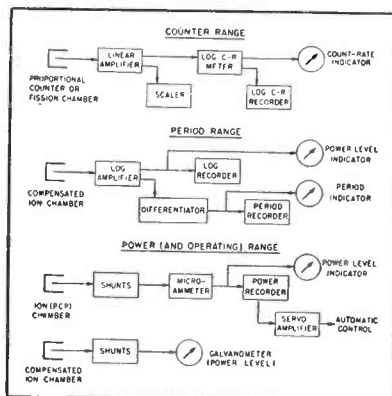

Instrumentation for reactor control

# PLASTECK

EDGELIGHTED PANELS FOR

## BOEING

HELP BUILD WORLD'S  
MIGHTIEST BOMBER



*Plasteck has been featured by Boeing, in advertisements appearing in recent issues of U.S. News, Oct. 14—Time and Newsweek, Oct. 17—Aviation Week and American Aviation, Oct. 24—and November issues of Air Force and Aviation Age. An example of one supplier furnishing component parts to assemble this "long rifle" of the Air Force.*

Look to the sky! This mightiest of the world's global jet bombers is up there protecting national security with the aid of an edgelighted instrument panel produced by Plasteck. Edgelighted panels of a non-reflective surface, high contrast and legibility are on day and night visual duty with the Strategic Air Command at bases around the world. Manufacturing five types of both laminated and coated panels exceeding MIL P-7788 specifications in today's commercial and military aircraft, Plasteck will produce your basic design and build illumination into it to meet your requirements. Our complete production and consulting services are available for your panel, dial and knob problems.

**DIALS**



**KNOBS**



3 PLANTS EQUIPPED TO  
TAKE CARE OF YOUR PANEL NEEDS

1 **Plasteck, Inc.**  
300-4 S. McKenna Poteau, Okla.  
TWX: Poteau 492

2 **California Plasteck, Inc.**  
225 E. Fourth L. A., Calif.  
TWX: L. A. 1111

3 **Plasteck Eastern, Inc.**  
200 E. Washington Hoboken, N. J.

May we be of service to you? Write Dept. EL or call any of our offices for complete information.

**"FIRST IN EDGELIGHTING"**

Want more information? Use post card on last page.



## THREE PHASE VARIABLE FREQUENCY POWER SUPPLY

CONTINUOUSLY VARIABLE FROM 360 TO 440 CPS

CML's Model 1450 Electronic Generator has a power output of 750 volt-amperes with output voltage regulation of better than 2% from no load to full load. Harmonic content is below 3% at full load.

Model 1450 is also available as a fixed frequency unit employing a tuning fork oscillator to give a frequency accuracy and stability of 1 part in 50,000. This stability is independent of line voltage or frequency.

Catalogue sheet "P" describes the Model 1450 and is available for the asking.

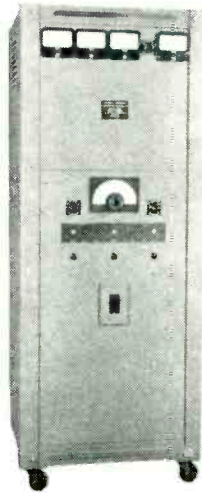

## COMMUNICATION MEASUREMENTS LABORATORY, INC.

350 LELAND AVE., PLAINFIELD, N. J.

## NEW! VERSATILE!!

PUSH BUTTON SWITCH with Features Never Before Available

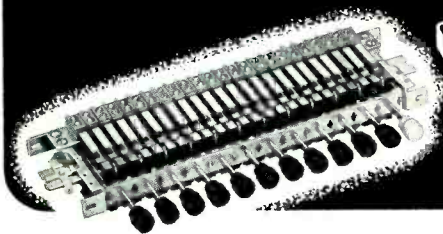

**SWITCHCRAFT**  
INC.  
"MULTI-SWITCH"

- Easily adapted to individual requirements.
- Flexible tools—2 to 12 stations possible.
- Illuminated or non-illuminated buttons.
- Functions to suit your needs. Interlock. Non-locking. All-lock and non-lock combinations. Interlock and non-lock combinations.

Write for bulletin S-550 & 161.

**SWITCHCRAFT**  
INC.

1336 N. Halsted Street  
Chicago 22, Illinois

Canadian Representative  
ATLAS RADIO CORP., LTD.

50 Wingold Avenue Toronto, Canada

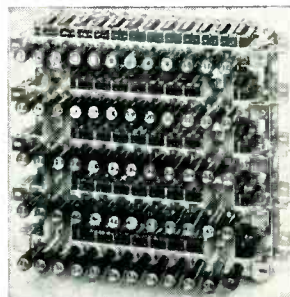

MULTIPLE BANK DESIGN

Switch assemblies available consisting of gangs connected together so that entire assembly will have interlock action. Available both illuminated and non-illuminated P.B. designs.

SEE THESE AND OTHER NEW  
COMPONENTS—  
1956 IRE SHOW—BOOTH 435  
NEW YORK—MARCH 19-22

permitted by the size of the book.

Of special interest to the electronics specialist will be the chapters entitled: Nuclear Reactor Instrumentation, Control of Nuclear Reactors, and Radiation Protection (section on radiation survey instruments).

These three chapters give rather complete coverage of the electronic instruments which are presently in use on and around nuclear reactors. It would, however, be unfortunate if the reader gained the impression that most of these instruments were needed in the operation of any one reactor, since there still exists, in fact, a need for simplification of such equipment.

There is a good treatment of reactor safety systems. The author delves sufficiently into the philosophy of reactor safety to intrigue the neophyte and to start arguments among the old-timers.

To summarize: a well-balanced, meaty contribution.—**JOHN E. BINNS, Reactor Operations Division, Brookhaven National Laboratory, Upton, N. Y.**

## Thumbnail Reviews

**Office Automation.** Richard Hunt Brown Automation Consultants, Inc., New York, 283 p, \$12.50 (loose-leaf). Includes six main sections: commercial, hardware, accounting, sociological, scientific and developmental. Highly interesting hardware section provides key information on electronic and integrated processing equipment currently available. Publisher will keep material current on a service basis.

**Control of Nuclear Reactors and Power Plants.** M. A. Schultz. McGraw-Hill Book Company, Inc., New York, 313 p, \$7.50. Discusses theory and operation of automatic reactor and nuclear power plant control mechanisms. Considers radiation detectors and operational control problems over the complete cycle of operation. Schematic diagrams illustrate appropriate electronic circuits especially those used in problem simulation.

**Two Hundred Miles Up.** J. Gordon Vaeth. Ronald Press Company, Inc., New York, 261 p, \$5. A discursive account of upper atmosphere research, covering balloons, rocket experiments at White Sands and plans for the minimum satellite vehicle. One chapter discusses instrumentation for upper atmosphere research.

**Radio-Tube Vade-Mecum.** P. H. Brans, Antwerp, Netherlands, 1955, 381 p. Twelfth edition of list of all the world's radio tubes.



## Before You Can Make a Reliable Electric Connection

1. The insulation must first be removed.
2. ALL the insulation must be removed.
3. The conductor must not be nicked or reduced in diameter.

Developing a method and equipment for a specific high-quality, high speed stripping operation requires full consideration of all the factors peculiar to that job. In most cases, standard equipment (often with adaptations) will do the job; in others, special methods must be developed.

Our specialty is studying your specific applications and recommending an efficient wire-stripping method.

Ask for **FREE 24-Page Book, "Reliable Electrical Connections"**

### Rush Wire Stripper Division

THE ERASER CO., INC.  
1068 S. Clinton St., Syracuse 4, N. Y.

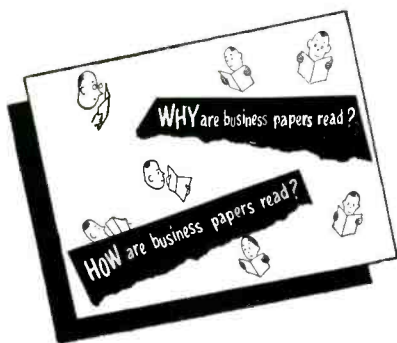

A copy of this quick-reading, 8-page booklet is yours for the asking. It contains many facts on the benefits derived from your business paper and tips on how to read more profitably. Write for the "WHY and HOW booklet."



McGraw-Hill Publishing Company, Room 2710, 330 West 42nd St., New York 36, N. Y.

*All of these Shares having been sold, this advertisement appears as a matter of record only.*

NEW ISSUE

December 16, 1955

18,035 Shares

## Cavitron Corporation

Common Stock  
(Par Value \$0.10 per Share)

Price: \$16.50 per share

*Copies of the Offering Circular may be obtained from the undersigned.*

### SCHUSTER & CO., INC.

44 Wall Street

New York 5, N. Y.



**Cosmic**  
CONDENSER SPECIALISTS SINCE 1923  
ELECTROLYTIC & PAPER TUBULAR  
**CONDENSERS**  
For A.C., D.C. Sets - Phonographs etc.  
**COSMIC CONDENSER CO.**  
853 WHITTIER ST., BRONX  
N. Y.

for

**performance**

**quality**

**price**

Phone — LU 9-3360

for complete  
selection of Basic Requirements  
for your Coil Winding needs it's . . .

*Coil Winding Equipment Co.*

write for complete  
technical literature

**COIL WINDING EQUIPMENT CO., Oyster Bay, New York**



## COLOR TELEVISION STANDARDS

**JUST OUT!** States the underlying factors relating to the choice of color television standards, and the effect of the standards on practical broadcasting and receiving equipment. Covers NTSC color TV standards and terminology, compatibility, performance, and FCC rules and regulations. **Selected Papers and Records of the National Television System Committee**, Edited by Donald G. Fink, Vice-chairman, NTSC (1950-52), Director of Research, Philco Corporation. 520 pp., 290 illus., \$8.50

## INTRODUCTION TO ELECTRONIC ANALOGUE COMPUTERS

**JUST OUT!** Covers principles, operation, and design of analog computers. Gives descriptions of components, computing elements, and procedures for arranging problems for analog computation. Emphasizes the effects of imperfections in computing elements, and means for reducing these factors. By C. A. A. Wass, Supt. of the Dynamic Analysis Division, Royal Aircraft Establishment, Farnborough, England. 237 pp., 149 illus., \$6.50

## TRANSMISSION-LINE THEORY

Systematic, rigorous, and thorough treatment of theory of transmission lines of various types. Proceeds from basic electromagnetic principles and derives the conventional transmission-line equations together with the formulas for line constants and all approximations involved. Formulation is sufficiently general to permit analysis of end effects and discontinuities as well as the more usually treated properties. By R. W. P. King, Gordon McKay Prof. of Applied Physics, Harvard Univ. 525 pp., 629 illus., \$12.00

JUST OUT

**PROFESSIONAL QUESTIONS AND ANSWERS**

**ENGINEER'S EXAMINATION**

Over 500 questions and complete answers to help engineers pass state license examinations. Covers mechanical, electrical, civil, and chemical engineering, and includes engineering economics and land surveying. Latest questions—suitable for all states. Author has worked on New Jersey examination preparation for 19 years. By William S. LaLonde, Jr., 462 pp., 234 illus., \$6.50.

**10 DAYS' FREE TRIAL**

McGraw-Hill Book Co., Inc., Dept. L-2  
327 West 41st St., New York 36, N. Y.

Send me book(s) checked below for 10 days' examination on approval. In 10 days I will remit for book(s) I keep, plus few cents for delivery costs, and return unwanted book(s) postpaid. (We pay delivery costs if you remit with this coupon—same return privilege.)

- Fink—Color TV Standards—\$8.50
- Wass—Elec. Analogue Computers—\$6.50
- King—Transmission-Line Theory—\$12.00
- LaLonde—Prof. Engr. Ques. & Ans.—\$6.50

(Print)

Name .....

Address .....

City ..... Zone ..... State .....

Company .....

Position .....

For price and terms outside U. S. Write McGraw-Hill Int'l., N. Y. L-2

Want more information? Use post card on last page.

## Backtalk

### Cathode-Compensated Amplifiers

DEAR SIRS:  
IN THE article by J. Millman and H. Taub on cathode-compensated amplifiers (p 156, Nov. 1955, *ELECTRONICS*) and in the article by H. Taub et al (p 143, same issue) it is claimed that this style of amplifier has the advantages of gain stability, linearity, and increased output with less plate current, over the uncompensated amplifier.

While the cathode-compensated amplifier does have certain virtues, it is important to remember that the improvements are obtained only at frequencies and for rise times for which the feedback is effective. Near the upper frequency limit of the uncompensated amplifier, the impedance of the cathode capacitor begins to reduce both the feedback and its resulting improvements.

In particular, at high frequencies, these amplifiers cannot produce an output greater than that of an uncompensated amplifier of equal plate current. This is true even though they may have full output at low frequencies and full bandwidth at low amplitudes.

For example, in Millman's output amplifier, the cathode impedance at 3.7 mc is less than 80 ohms, reducing the  $1+g_m R_k$  factor to about 1.8, from a value of about 5 at mid-frequency.

The output capabilities of this style of amplifier are correctly given in Valley and Wallman's Vacuum Tube Amplifiers, p 104, in general terms. For a more explicit understanding of the action, it is instructive to calculate the plate current which flows in response to a voltage input step. It is

$$i(t) = \frac{g_m e_{in}}{F} [1 + (F-1) \exp(-tF/T)]$$

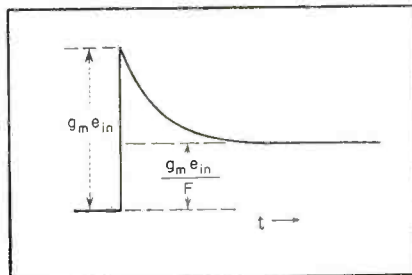

# DANO COILS

## LIFELINE TO PRODUCTION

From design engineer to the purchasing agent to Dano—a perfect "lifeline" to production.

**CALL or WRITE TODAY** and DANO'S quote will be on the way.

- Bobbin Coils
- Form Wound Coils
- Paper Section Coils
- Acetate Bobbin Coils
- Cotton Interweave Coils
- Coils for High Temperature Applications
- Encapsulated Coils—in either Polyester or Epoxy Resins

Also, TRANSFORMERS MADE-TO-ORDER



**THE DANO ELECTRIC CO.**  
MAIN ST., WINSTED, CONN.

## Beattie INTERVALOMETER

Model N-10



A Standard Method Of Supplying Operating Pulses For Flight-Test Instrumentation

The Model N-10 Intervalometer is a lightweight, compact instrument for controlling the cycle rate of camera recording devices and other electrically or electronically operated apparatus. Pulse rates per second are 1, 2, 4, 5, 8, and 10, and the pulse length is variable from 25 milliseconds to 70 milliseconds. Special pulse intervals and pulse duration may be supplied on order. The Model N-10 Intervalometer is built to meet all environmental conditions encountered in aircraft use.

Write for complete detailed specifications today



Want more information? Use post card on last page.

where  $F = 1 + g_m R_k$ , the factor by which the gain is reduced and the bandwidth extended, and  $T = C_k R_k = C_L R_L$ .

The plate current consists of the constant amount  $g_m e_{in} / F$ , plus a current peak whose initial value is  $\frac{F-1}{F} g_m e_{in}$ . Hence, just after a voltage input step, the current must swing by  $g_m e_{in}$ , exactly the same as it must in the uncompensated case. If the tube cannot supply the current, the output will distort. In some cases, the output current can be supplied in response to a positive step, if the factor  $F$  is not too large, but in the usual situation, the tube will cut off on a large, sharp, negative step.

Another way of looking at it is to regard the purpose of a video voltage amplifier as generation of a video voltage across the output capacitance. This obviously requires the passage through the output capacitance of a certain a-c current, which must be generated by the tube.

While it is true that for a given tube current, the d-c output voltage may be increased by raising the load resistance, in the a-c case the voltage must be developed, not particularly across the load resistance, but across the load capacitance, which is fixed, and there is therefore no alternative but to pass this current through the tube.

W. F. SCHREIBER

Research Department  
Technicolor Motion Picture Corporation  
Hollywood, California

### Transistor Symbol

DEAR SIRs:

IN the December edition of ELECTRONICS it was suggested by Mr. William G. Shepard in a letter in *Backtalk* to employ the symbol, XR, to designate transistors on schematic diagrams.

In the interest of reducing complex symbol notation in equipment stenciling and equipment publications, and to prevent misinterpretation, I suggest a single letter, Y, which has not been used previously by the military and industry to represent a particular electrical

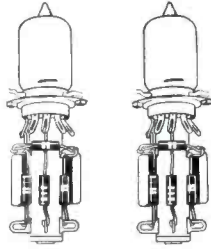

### WHY NOT TRY TURRETS?

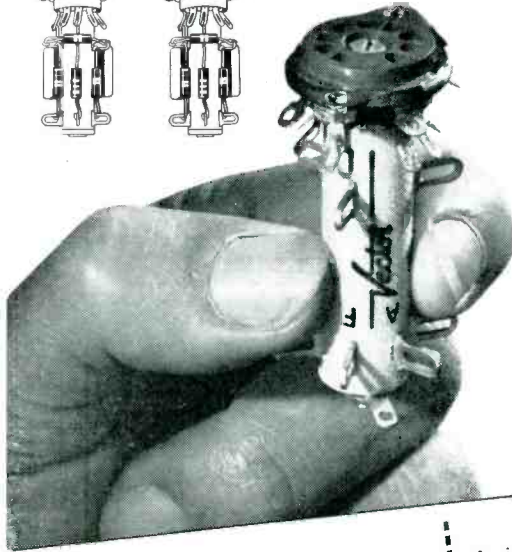

# Vector

### SOCKET TURRETS

... Simplify wiring, cut down assembly time and make up into compact, sturdy structures... Eliminate useless lead length and thus improve performance... Save design time for engineers. Also available in military version.

## Vector

STRUCTURES FOR CIRCUITRY

Available in many sizes and types to fit every need:— Post, Deck, Wall and Tinker Turrets; with plugs and cases as required.  
— Write for Catalog.

VECTOR ELECTRONIC COMPANY, 3352 San Fernando Road, Los Angeles 65, Calif. • Tel. CLevland 7-8237

## Reliance Mica Co., Inc.

### MICA SPECIALTIES

RADIO and TV TUBE SPACERS



CAPACITOR FILMS



HEAT RESISTANCE WASHERS



Reliance are specialists in the fabrication of Mica parts. For 27 years, they have met industry's specifications for critical tolerance and quality control. Our years of experience meeting close tolerance work can help you whenever you are faced with tight specifications and our quality control will meet the increasing rigid specifications of today's design

QUALITY MICAS MAKE QUALITY TUBES

Is your application of Mica correct?

Consult us for help in obtaining the proper use of Mica in your products.

**RELIANCE MICA CO., INC.**  
341-351 39th St. Brooklyn 32, N. Y.

# CONTACTS

FOR THE FIELD OF ELECTRONICS

## GIBSON GIRL TAPE SPLICERS

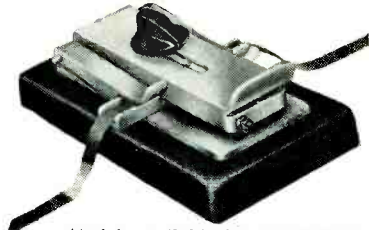

Models available for **RECORDING TAPES** up to **ONE INCH WIDE. NO SCISSORS or RAZOR BLADES NEEDED.**  
 Heavy Industrial models for computer, T.V., industrial and special purpose tapes. \$55.00 net.  
 At your dealer or write:  
**ROBINS INDUSTRIES CORP.**  
 214-26 41st Avenue Bayside 61, N. Y.

**ETCHED CIRCUITS**  
**24 HOUR SERVICE**  
 On  
**SAMPLES, MODELS & PROTOTYPES**  
**SILK SCREENS MADE TO ORDER**  
**ROWE ENGRAVERS**  
 492 E. 39 St. Paterson 4, N. J.

**Wind Perfect Coils**  
**Check Wire Tensions**  
**with the New Saxl**  
**TENSION METER**  
 Tensitron, Inc., Harvard, Mass.



**MICA**  
 India • Brazil  
**BLOCKS • FILMS • SPLITTINGS**  
 All Grades & Qualities—Warehouse Stocks  
 New York—Prompt Forward Shipments  
 Phone: WOrth 4-4192 or write  
**ASSOCIATED COMMODITY CORPORATION**  
 Woolworth Bldg., New York 7, N. Y.

**This CONTACTS Section**  
 supplements other advertising in this issue with these additional announcements of products essential to efficient and economical production and maintenance. Make a habit of checking this page, each issue.

element in equipments or on schematic diagrams.

My objection to the symbol XR is that in the event an equipment employs a plug-in resistor (an idea not completely remote) the symbol for the plug-in resistor socket would be XR. Also, insignificant as it may seem, the hand lettering or type setting of two letters instead of one would raise the cost of equipment publications which is at present an all-time high. Furthermore, the symbol for a plug-in transistor socket would become XXR, a needlessly long symbol.

**JULIAN M. SIENKIEWICZ**  
 Project Engineer  
 McLaughlin Research Corp.  
 New York, N. Y.

**EDITOR'S NOTE:** The use of a single letter does seem desirable. Any other readers care to make suggestions?

## Reliability Semantics

**DEAR SIRS:**  
 WHILE admiring American ingenuity in the coining of apt, succinct, and highly descriptive phrases, I feel driven to protest against the misuse of existing words of specific meaning when nothing is gained by so doing.

In American technical periodicals there has recently been a spate of articles on reliability. In these, the expression "expectation of life" (6 syllables) is rarely used. It is being replaced by a new and (to my mind) meaningless phrase "life-expectancy" (5 syllables).

"Expectancy" (in Britain, at least) means "full of expectation or anticipation" in the sense of the air of expectancy that precedes the rise of the curtain at a first night, and so indicates human emotion. While "expectation" does carry a shade of this meaning of personal anticipation, the expression "expectation of life" has long been accepted as denoting the probable length of time which will ensue before failure.

If syllables must be saved at all cost, I think that a better case could be made for "life expectance" if life must be adjectival. Personally, I would prefer to use "probable life" which has only four syllables.

**A. I. FORBES SIMPSON**  
 Warwickshire, England

## MANUFACTURERS' REPRESENTATIVES

IN THE ELECTRONIC INDUSTRY

As a service to readers, **ELECTRONICS** presents the advertisements for some of the leading manufacturers' representatives in the electronic industry. These firms are qualified to help the *Manufacturer* with his distribution problems; the *Buyer* with his product needs.

### MARYLAND

**MACLEN CORPORATION**  
 Manufacturers Representative  
 8616 Georgia Ave, Silver Spring, Md  
 Components & Equipment

Territory:	Government
Pennsylvania New Jersey	
Delaware Maryland	and
Virginia W. Virginia	Industry
District of Columbia	

### NEW JERSEY

**ART GERF & CO.** *Manufacturers' Representatives*  
**LEADING ELECTRONIC LINES**  
 Regular Coverage • 10 Men  
 6 States and District of Columbia  
 Phone: Mitchell 2-6734  
 744 Broad St.  
 NEWARK 2, N. J.

### PENNSYLVANIA

**SAMUEL K. MACDONALD, INC.**  
*manufacturers representatives over 25 years*  
**1531 SPRUCE STREET, PHILA. 2, PA.**

Territory:	Other Offices:
Pennsylvania • New Jersey	Pittsburgh
Delaware • Maryland	Baltimore
Virginia • West Virginia	Washington, D.C.
District of Columbia	

## REPRESENTATIVES!

This is a special section for Manufacturers' Representatives desiring advertising space in units smaller than the minimum run of book display space.

It offers you an economical means to keep in contact with the key people of the electronic industry who most naturally will be interested in your products and services as a source of supply or as a sales outlet for their products.

SPACE is available in units from one to four inches. A "one inch" space unit is an "advertising inch" measuring 7/8" deep by one column in width, 2 1/4". Larger space is by additional even lined inch units in depth, or by additional columns in width, or both. Over-sized advertisements are not accepted.

**RATES:** One insertion \$26.00 per inch, Six insertions \$24.00 per inch, Twelve insertions \$22.00 per inch. Cash discount 2%—10th of month following date of invoice. 15% Agency Commission.



## HOW ARE YOUR COMMUNICATIONS ?

Do the booklets, pamphlets, and manuals you use really *work* for you? Are these vital publications, that tell the story of your products and your company, as effective, readable, well designed and illustrated as they can be? Today more than ever, your entire operation is judged by each annual report, employee manual, and public relations piece that you produce. Have you examined your communications lately? If you have any doubt as to the impact of your instructional and promotional literature, remember . . .

## COMMUNICATION IS OUR BUSINESS

For a good many decades McGraw-Hill has stood for complete coverage in the business literature field. Now the McGraw-Hill TECHNICAL WRITING SERVICE offers a new approach to your publication problems — an *integrated* writing, editing, illustrating, and printing service for the *custom* production of: INSTRUCTION MANUALS, PRODUCT BULLETINS, TRAINING AIDS, INDUSTRIAL RELATIONS LITERATURE, ANNUAL REPORTS, COMPANY HISTORIES, PROCEDURAL GUIDES and other collateral literature. More than 150 editorial and graphic experts are at your disposal, ready to prepare high-quality material to your own or government specifications. Save time, save money . . . and make your communications work! Let *our* staff be your staff for technical and business publications.

## McGraw-Hill Book Co. TECHNICAL WRITING SERVICE

Write or phone Technical Writing Service, McGraw-Hill Book Co., Inc.  
330 West 42nd Street, New York 36, N. Y. • LONgacre 4-3000

*This service is available through ad agencies.*

# PROFESSIONAL SERVICES

Consulting—Patents—Design—Development—Measurement

in

Radio, Audio, Industrial Electronic Appliances

## ATLANTIC ELECTRONICS LABORATORIES

*Design Development Prototypes*

Specialists in

ELECTRONIC TIMING DEVICES

606 Bond St.

Asbury Park, New Jersey

## CONSULT THESE SPECIALISTS:

Let them save your time by bringing their broad experience in their specialty to bear on your problems.

## PICKARD & BURNS, INC.

*Consulting Electronic Engineers*

Analysis and Evaluation

of Radio Systems

Research Development and Production

of Special Electronic Equipment

240 Highland Ave.

Needham 94, Mass.

## AIRPAX PRODUCTS CO.

Development Division

Specialists in the

Design and Manufacture of

UNUSUAL TRANSFORMERS AND RELAYS

Middle River

Baltimore 20, Md.

## ELECTRONIC RESEARCH ASSOCIATES, INC.

*"TRANSISTORIZE" YOUR PRODUCT!*

Complete Service in consulting, research, development, and production on Transistor circuitry, products and instrumentation.

67 East Centre Street

Nutley, N. J.

Nutley 2-5410

## ALBERT PREISMAN

*Consulting Engineer*

Television, Pulse Technique, Video

Amplifiers, Phasing Networks

Industrial Appliances

Affiliated with

MANAGEMENT-TRAINING ASSOCIATES

3224 - 16th St., N. Y.

Washington 10, D. C.

## ANALYSIS INSTRUMENT CO.

*Consultants on Magnetic Problems*

Magnetic Materials Tested

Special Magnetic Devices Designed

Magnetizing & Testing Equipment Supplied

P. O. Box 7

Pequannock, New Jersey

## ERCO RADIO LABORATORIES, INC.

*Radio Communications Equipment*

Engineering - Design - Development - Production

Our 27th Year in Air to Ground

Communications and Radio Beacons

Garden City • Long Island • New York

## SUNSTEIN ENGINEERING CO.

*David E. Sunstein and Associates*

Consulting Services for Research, Engineering and Production of Industrial, Consumer, and Government Products.

464 Conshohocken State Road

Bala-Cynwood (Phila.) Pa.

MOhawk 1-0459

## H. O. BIXBY ASSOCIATES

*Consultants to the Electronic Industry*

SURVEYS — PROMOTIONS — LIAISON

PERSONNEL PLACEMENT — TECHNOLOGY

238 Main St.

Cambridge 42, Mass.

ELlot 4-9404

## HANSON-GORRILL-BRIAN INC.

*Product & Mfg. Development*

ELECTRICAL - ELECTRONIC

HYDRAULIC - MECHANICAL

One Continental Hill

Glen Cove, N. Y.

Glen Cove 4-7300

## THE TECHNICAL MATERIAL CORPORATION

*Communications Consultants*

Systems Engineering

General Offices and Laboratory

700 Fenimore Rd., Mamaroneck, N. Y.

## THOMAS H. BRIGGS & ASSOCIATES

*Electronics Consultants*

Electron Tubes - Automation - Project Surveys  
Tube Materials & Reliability - Servo-mechanisms  
Engineering and production facilities.

Box 135 RD #2 Norristown, Penn. Tel. No. 8-7671

## THE KULJIAN CORPORATION

*ELECTRONICS DIVISION*

*Consulting Electronic Engineers*

Research Development, Production of  
Automatic Controls — Special Instrumentation

1200 No. Broad St., Philadelphia 21, Pa.

Stevenson 2-9000

## TELECHROME, INC.

*Electronic Design Specialists*

COLOR TELEVISION EQUIPMENT

Flying Spot Scanners, Color Synthesizers, Keyers,  
Monitors, Oscilloscopes and Related Apparatus

J. R. Popkin-Curman, Pres. & Ch. Engr.

88 Merrick Rd.

Amtityville, L. I., N. Y.

## CROSBY LABORATORIES, INC.

*Murray G. Crosby & Staff*

Radio - Electronics

Research Development & Manufacturing  
Communication, FM & TV

Robbins Lane, Hicksville, N. Y.

WElls 1-3191

## Measurements Corporation

*Research & Manufacturing Engineers*

HARRY W. BOUCK MARTIAL A. HONNELL

JOHN M. VAN BUREN

Specialists in the Design and  
Development of Electronic Test Instruments

Boonton, New Jersey

## WALSH ENGINEERING CO.

Design and Prototypes

of Electronic Apparatus

in which Transformers and Magnetic Components  
are especially important factors in Performance,  
Size, Weight and/or Cost

34 DeHart Place

Elizabeth, N. J.

Elizabeth 2-7600

## DELAWARE PRODUCTS CO.

Analog Voltage to Digital Conversion

Digital Voltage Recording Systems

*Design-Development-Manufacturing*

300 Broadway

Camden 3, N. J.

## MINOT INFORMATIC DEVICES

AUTOMATIC RECOGNITION OF  
SHAPES, PATTERNS & INFORMATION  
RESEARCH - INVENTION - CONSULTING  
on detection and interpretation of  
complicated forms, characteristics of  
materials, printed characters, etc.

Otis N. Minot, 22 Elliot Rd., Lexington 73, Mass.  
Tel. VOLunteer 2-9465 or -3974

## WHEELER LABORATORIES, INC.

Radio and Electronics

Consulting — Research — Development

R-F Circuits — Lines — Antennas

Microwave Components — Test Equipment

Harold A. Wheeler and Engineering Staff

Great Neck, N. Y.

HUNter 2-7876

## Eldico of New York, Inc.

Pioneers of Television Interference Elimination  
from Transmitters, Induction Heaters, Diathermy  
and etc.

Donald J. S. Merten & Engineering Staff

12 E. Second St. Mineola, L. I., N. Y.

Pioneer 6-5213

## NIAGARA ELECTRON LABORATORIES

CONSULTATION - DESIGN - CONSTRUCTION  
MFG. THE THERMOCAP RELAY

Specializing in solution of problems of electronic  
and electro-physical instrumentation for the research  
or analytical laboratory. Industrial plant problems  
also invited.

Andover, New York Cable Address: NITRONLAB

## YARDNEY LABORATORIES

*Research-Design-Development*

Electro-Chemical Generators of Energy

40-46 Leonard Street

Worth 6-3100

New York 13, N. Y.



TO THE FINE ENGINEERING MIND  
SEEKING THE CHALLENGING PROJECTS IN  
**ELECTRONICS**

**ELECTRONICS ENGINEERS** are urgently needed to fill top career openings at Convair in beautiful San Diego, California. Qualifications include experience in missile guidance systems, microwave techniques, digital computers, servomechanisms, test equipment design, circuit analysis, transistor and magnetic amplifier circuit design, and electronic reliability. Antenna engineers also needed for airborne antenna research and development projects.

**CONVAIR** offers you an imaginative, explorative, energetic engineering department... truly the "engineer's" engineering department

to challenge your mind, your skills, your abilities in solving the complex problems of vital, new, long-range programs. You will find salaries, facilities, engineering policies, educational opportunities and personal advantages excellent.

**SMOG-FREE SAN DIEGO**, lovely, sunny city on the coast of Southern California, offers you and your family a wonderful, new way of life... a way of life judged by most as the Nation's finest for climate, natural beauty and easy (indoor-outdoor) living. Housing is plentiful and reasonable.

Generous travel allowances to engineers who are accepted. Write at once enclosing full resume to: **H. T. BROOKS, ENGINEERING PERSONNEL, DEPT. 914**

**CONVAIR**

A Division of General  Dynamics Corporation

**3302 PACIFIC HIGHWAY • SAN DIEGO, CALIFORNIA**

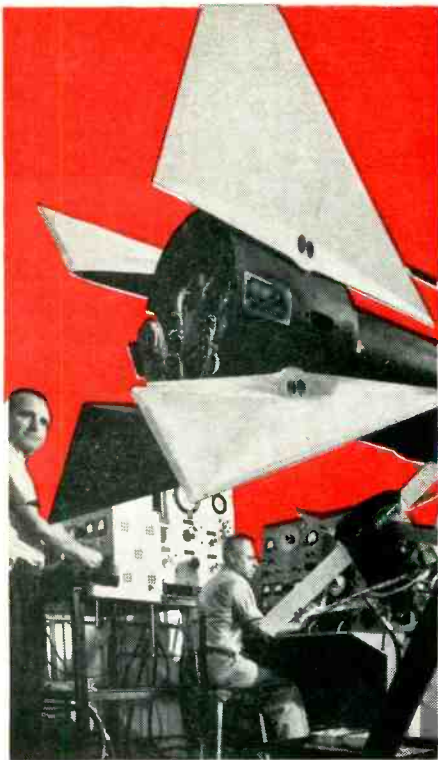

# MISSILE GUIDANCE

AT



# IN SOUTHERN CALIFORNIA

In connection with its long range Missile Guidance programs Bendix-Pacific has excellent positions for Electronic Test Equipment Designers, Circuit Designers and Microwave Engineers.

Bendix also has unusual engineering positions in electrical and mechanical design of airborne radar and telemetering.

You are invited to consider becoming a member of this far sighted engineering organization in Southern California.

Please fill in the coupon or write us for complete information.

W. C. Walker, Engineering Employment Manager  
 Pacific Division, Bendix Aviation Corp.  
 11608 Sherman Way, North Hollywood, Calif.

Please send information.  
 I am a graduate engineer with \_\_\_\_\_ degree.  
 I am not a graduate engineer but have \_\_\_\_\_ years experience.

Name \_\_\_\_\_  
 Address \_\_\_\_\_  
 City \_\_\_\_\_ Zone \_\_\_\_\_ State \_\_\_\_\_

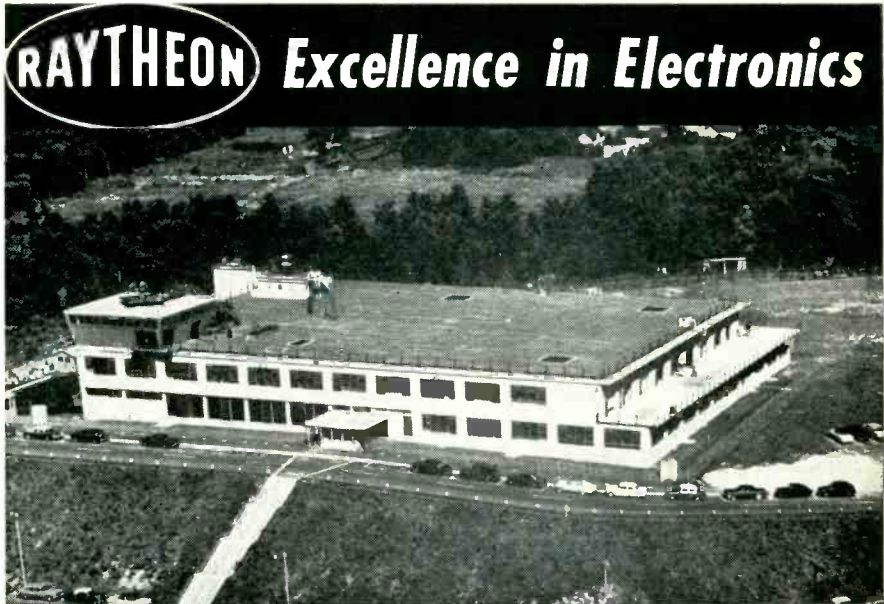

# RAYTHEON Excellence in Electronics

## Excellent for Engineers

### SPECIFICATIONS ENGINEER

Three or more years of experience in electronic design or applications engineering. Familiarity with military specifications and technical writing experience desirable.

### SYSTEM ENGINEERS

Responsible experienced engineers required for design and development of airborne electronic systems including navigational and fire control systems. Systems engineers also required for integration of missile system with aircraft fire control systems.

### CIRCUIT DESIGN ENGINEERS

Positions available at all levels from recent graduates to engineers with relevant supervisory experience. Electronic circuit design experience required. Should be capable of independent design, and analysis for work in development of circuits for complex radar and missile systems.

### SYSTEMS ANALYSIS ENGINEERS

For synthesis and analysis of complex missile guidance and radar systems. Degree in electrical engineering or physics and three or more years experience in servo, feedback control systems, and dynamics required. Familiarity with noise theory desirable.

### ELECTRONIC PACKAGING ENGINEERS

For packaging of electronic units of radar and missile systems. EE or ME degree required and three or more years experience in design or packaging.

### • MISSILE SYSTEMS DIVISION •

Continued expansion of Raytheon's Missile Systems Division has created long range opportunities for experienced engineers. This Division is engaged in all phases of missile development from study programs through design, development and flight testing to production. Prime contracts for missile systems involve overall responsibility for system design including airframe, guidance, motor and auxiliary equipment. This Division is located 20 miles from Boston, offering a choice of urban or country living, excellent recreational facilities and proximity to Boston's educational and entertainment advantages.

### GENERAL INFORMATION

Salary and advancement commensurate with ability. Liberal vacation, sick leave, group life and health insurance and a worthwhile pension system. Tuition support plan for engineering courses. Relocation expenses paid. Write, giving details on experience to G. P. O'Neil. A mutually convenient time for interview will be arranged.

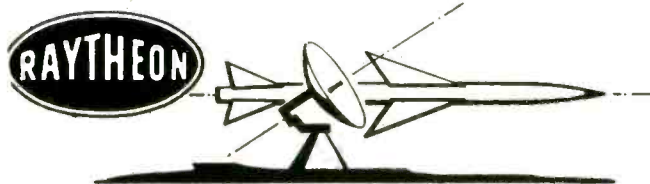

MISSILE SYSTEMS DIVISION - BEDFORD, MASS.



**E**ngineering**D**esign**R**esearch**D**evelopment

*Broad challenge, career opportunity for*  
**structural engineers**

This opportunity concerns no narrow field of endeavor.

For structural engineers it is an engaging challenge which is both continuing and unlimited in scope.

It deals with work in a variety of long-range projects under way at Goodyear Aircraft, dealing with air weapons, jet aircraft, missiles, airships, helicopters—along with boating, farm implements and radar structures.

It concerns new concepts and configurations.

It involves the utilization of a host of

materials—new laminated plastics, new alloys, new structural sandwiches.

It calls for fresh skills, the exploration of new avenues of approach.

*For the creative professional, in any of a wide variety of engineering fields, it foretells a rewarding and satisfying career.*

• • •  
**APPLICATIONS INVITED.** Forms on request, resumés appreciated and treated confidentially. Address: C. G. Jones, Personnel Department, Goodyear Aircraft Corporation, Akron 15, Ohio. Plants in Akron and Litchfield Park, Arizona.

**T**hey're doing big things at

**GOOD YEAR AIRCRAFT**

THE TEAM TO TEAM WITH IN AERONAUTICS

# Engineering for Tomorrow...

... at Convair-Pomona the country's first exclusive guided missile plant. Here in the heart of America's tremendously fast growing Electronics industry, we at Convair are engineering for tomorrow today! The engineering miracles now being developed for America's defense in the design and manufacture of guided missiles is the groundwork for the fantastic future in store for America tomorrow through electronic engineering. Join the Convair team now, work in America's finest engineering facility. Completely modern... Completely air conditioned.

*Excellent opportunities now available in:*

- ELECTRONICS**
- AERODYNAMICS**
- DYNAMICS**
- THERMODYNAMICS**
- OPERATIONS RESEARCH**
- HYDRAULICS**
- MECHANICAL DESIGN**
- LABORATORY TEST**
- ENGINEERING**

Generous travel allowance to Engineers who are accepted. Write now enclosing a complete resume to:

Employment Department 3-G

## CONVAIR

A DIVISION OF  
GENERAL DYNAMICS  
CORPORATION

**POMONA**  
CALIFORNIA



## DEVELOPMENT ENGINEERS

**PROJECT  
SENIOR  
INTERMEDIATE**

- Antenna & Microwave Systems & Components
- Pulse & Radar Circuitry
- Telemetry Systems
- Communications
- Navigational Systems

### TAKE A STEP TOWARD THE FUTURE WITH . . . . .

the progressive and well established Maryland Electronic Manufacturing Corporation.

We've grown to now number more than 300 employees . . . steady growth, too, with never a layoff. Because MEMCO is an engineering-managed organization we feel that we offer an exceptional atmosphere for personal growth, with real opportunity for your recognition and advancement.

Here's what you will find at **MEMCO**

- Modern, complete and self-sufficient engineering and production facilities in suburban College Park, Md. 6 miles from Washington, D. C.
- Attractive salaries and profit sharing plan.
- Aid and encouragement in the presentation of technical papers plus the educational opportunities at 4 nearby universities.
- Suburban living with fine schools and housing plus the cultural advantages of the nation's capitol.
- A real challenge for imaginative and energetic engineering talent.

For interview please write  
Mr. J. E. Richardson

## MARYLAND ELECTRONIC

Manufacturing Corporation  
5009 Calvert Road  
College Park, Maryland

**ENGINEERS • PHYSICISTS**

**HERE'S A *Castle* TO DREAM IN**



**New  
86,000 Sq. Ft.  
LABORATORY ADDITION**

*Ideas are born here at the Burroughs Research Center. So many, so fast, that it has been necessary to erect the new 86,000 Sq. Ft. Laboratory Addition pictured above to guarantee an uninterrupted continuity in the planned expansion of our activities for industry and government.*

PERSONNEL GAINS SINCE JAN. 1, 1955

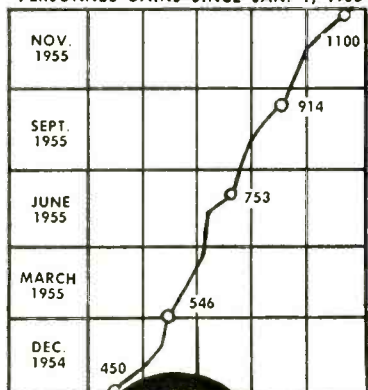

**A MAN'S CASTLE**

... consists of even more than his home and family. Yes, it includes even the arena of his professional life — the place where he can best tap the wellsprings of his ingenuity and imagination.

Here at Burroughs new multi-million dollar research facilities we sense completely these sturdy motivations of the engineers of the 20th Century. For nearly 75 years Burroughs has pioneered in the development and design of advanced equipment to aid business, government, science and the military. But, never before have so many arresting challenges been cast before us as in the creation and development of ideas for new machinery to meet the needs of the electronic age.

***We take pride in this leadership... won't you share it with us?***

OUR MAJOR ACTIVITY is presently in the fields of Computers, Solid State Techniques, Data Processing and Transmission, Automation and Process Control, offering truly challenging opportunities for experienced men or recent graduates to work on —

- GUIDED MISSILES
- TRANSISTORS
- TELEMETERING
- ELECTRONIC PACKAGING
- HIGH SPEED MECHANISMS
- MAGNETIC AMPLIFIERS
- DIGITAL & ANALOG COMPUTERS
- PAPER HANDLING DEVICES

... And Allied Products

**Burroughs**

CORPORATION

**RESEARCH CENTER**

**PAOLI, PA., ON PHILADELPHIA'S MAIN LINE**

**ACT NOW!**

Write or Telephone To

**M. E. JENKINS**

For A Personal Interview



## Engineers

### HOW INCREASED SYLVANIA SALES



### HELP YOU AS AN ENGINEER

Sylvania has quadrupled its 1947 sales and is expanding rapidly. We plow back into research and engineering an unusually high percentage of each year's income; it rates with the highest figures in industry today. These increases make for a broader based engineering while adding engineering management... creating unusual opportunities for men of talent.

At the base are recent college graduates with little or no experience. Filling in the essential positions of research direction, supervision and testing are engineers with experience and proven ability in their specialized fields.

Increasing our overall research constantly creates openings. These openings lead eventually to far greater responsibility either in engineering management or research specialties. Top engineers are key men in creating new and better products that open new markets to Sylvania.

There are openings now for experienced men at Sylvania.

#### WALTHAM Laboratories

Majors in E.E., M.E., Math, Physics. Research & Development experience in —

##### Avionics

Countermeasures  
Systems Analysis  
Transistor Applications  
Noise Studies  
Antenna Res. & Dev.  
Systems Development  
Mechanical Design  
Miniaturization  
Digital Computer  
Circuits & Systems  
Circuit Designs  
Shock & Vibration  
Technical Writing  
Missile Analysis

##### Missile Systems

Radar Research & Development  
Missile Guidance & Ground  
Equipment Analysis  
Systems Evaluation Operations  
Research

#### BUFFALO Engineering Laboratory

Majors in E.E., Math or Physics. Experience in Advanced Development and Product Design

Information Theory  
Advanced Circuit Design  
VHF-UHF Systems Design  
& Evaluation  
Logical Circuit Design  
Mathematical Analysis and/or  
Numerical Computation  
Pulse Techniques  
Data Processing Devices  
Magnetic Amplifier Techniques  
Servo Techniques & Applications  
Digital Computer Design  
Control Circuits & Devices

#### INTERVIEW & RELOCATION EXPENSES WILL BE PAID BY SYLVANIA

Sylvania provides financial support for advanced education as well as liberal insurance, pension and medical programs.

Please forward resume to: Professional Placement Supervisor

Erling Mostue | E. F. Culverhouse  
100 First Ave. | 175 Great Arrow Ave.  
Waltham, Mass. | Buffalo 7, N. Y.

Your inquiries will be answered within 2 weeks

 **SYLVANIA**   
SYLVANIA ELECTRIC PRODUCTS INC.

## ELECTRICAL AND MECHANICAL ENGINEERS

Motorola Research Laboratories, located in the healthful climate of Arizona's Valley of the Sun, has several openings for engineers experienced in the following:

Electronic circuit design and development for missile guidance, radar and VHF communications.

Mechanical design of missile-borne and vehicular electronic equipment.

Microwave antenna and wave guide design.

Transistor circuit development.

Engineers desired who have B.S. degrees or above and at least two years direct experience. Free health, life and accident insurance. Free hospitalization plan. Profit sharing. Paid holidays. Sick leave, vacations. Ideal working conditions. Plenty of housing, reasonably priced. Excellent schools. Exceptionally mild and dry winter climate.

#### WRITE:

J. A. Chambers, Manager  
Motorola Research Laboratory  
3102 North 56th Street  
Phoenix, Arizona

ELECTRONIC ENG.  
MECHANICAL ENG.  
**LARGE Company...**  
Stability &  
Security  
**SMALL Division...**  
Recognition &  
Responsibility  
*Bendix York offers both!*

As a young, expanding Division of Bendix Aviation Corporation, Bendix York is adding key personnel RIGHT NOW! . . . It's your chance to get specific assignments at the peak of the art in electronics and microwave development and design. Good salaries, all employee benefits, ideal suburban living conditions. Openings for Principal, Senior and Junior Electronic Engineers, Mechanical Engineers, designers and draftsmen.

Address: Dept. H

**Bendix**  
AVIATION CORPORATION  
**York**  
DIVISION  
York, Penna. York 5521

**ENGINEERS**

# NEW 2-FOLD RETIREMENT INCOME PLAN

## for Aviation and Missile Engineers

It's natural that a long-time leader in aviation, like Republic—with many firsts to its credit—should be a leader, too, in providing for the welfare of its staff. Right in line with this forward-looking policy is the remarkable new Republic Retirement Income Plan. Here is how it works:

**PART 1** is a basic Retirement Income plan paid for entirely by Republic Aviation.

**PART 2** is a cooperative effort. It is completely optional. But if an engineer wishes to increase his retirement fund, by making a small monthly payment, Republic will MORE THAN MATCH his contribution.

Take the case of a hypothetical engineer who joins Republic on January 1st, 1956, averages \$8,000 a year for 15 years; then retires aged 65. If he elected PART 2 of the plan, he will have a total *monthly retirement income of \$225.80*, including his social security. For this he himself will contribute *only \$8.50 a month* to the Republic Retirement Income Plan.

Of course, the MORE YOU EARN, the HIGHER your Retirement Income will be. And Republic pays a top salary scale in the industry.

### ...RETIREMENT PLAN JUST ONE OF MANY PLUS FACTORS POINTING TO A REPUBLIC CAREER

**FIRST**—there's the interest and prestige of working for a pioneer in aircraft design, creator of such famous planes as the F-84 Thunderjet, the F-84F Thunderstreak, RF-84F Thunderflash and XF-84H. (Soon to be followed on the production line by the new F-103, F-105 and RF-105.)

**SECOND**—the company is expanding sharply, providing frequent opportunities for able men to advance. In fact a \$12,000,000 increase in

the Research and Development Program has just been announced.

**THIRD**—an All-Expense Paid Relocation Plan for qualified engineers living outside the New York City and Long Island areas, which makes it easy to move to Republic. Other liberal benefits: Life, Accident and Health Insurance; Hospital-Surgical Benefits for the whole family; educational aid covering  $\frac{2}{3}$  the cost of collegiate and graduate study.

Serve your own best interests. Make full inquiries into the many advantages of joining Republic now, not the least of which is living on Long Island—the Playground of the East.

### Important engineering positions are now open at all levels:

STAFF ENGINEERING  
PRELIMINARY DESIGN  
ELECTRONICS  
WEAPONS SYSTEMS  
PROPOSALS  
OPERATIONS RESEARCH

SYSTEMS  
MATHEMATICAL  
ANALYSES  
AERODYNAMICS  
TECHNICAL WRITING  
DYNAMICS

ELECTRO-MECHANICAL  
DESIGN  
FLIGHT TEST  
RESEARCH  
THERMODYNAMICS  
FLUTTER & VIBRATIONS

STRESS  
AIRCRAFT DESIGN  
WEIGHTS  
DESIGNERS:  
Electrical  
Airframe  
Mechanical

Please address complete resume  
outlining details of your technical background to:



## REPUBLIC AVIATION

### AIRCRAFT

Assistant Chief Engineer, Administration, Mr. R. L. Bortner  
Farmingdale, Long Island, N. Y.

### MISSILES

Administrative Engineer, Mr. Robert R. Reissig  
Hicksville, Long Island, N. Y.

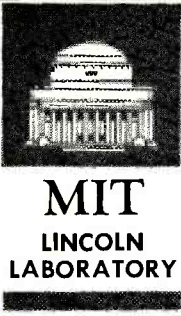

- Electrical Engineers
- Physicists
- Mathematicians

SAGE (semi-automatic ground environment)

AEW (air-borne early warning)

WHIRLWIND COMPUTER

SOLID STATE

HEAVY RADARS

MEMORY DEVICES

SCATTER COMMUNICATIONS

TRANSISTORIZED DIGITAL  
COMPUTERS

If you are interested in participating  
in any of these programs address:

**Dr. M. G. Holloway, Director**  
**M.I.T. Lincoln Laboratory**  
**Lexington 73, Mass.**

## ELECTRONIC ENGINEERS

Expansion of our engineering department requires electronic engineers with radar, servo, sonar or transistor circuit experience. Excellent opportunity for advancement with top-calibre associates. New modern plant in the suburbs with ideal laboratory facilities and well-trained technical assistants.

## TECHNICAL WRITERS

## DESIGN ENGINEERS

Must have EE degree with 3-5 years experience in one of the following:

- Flight Simulators
- Analog Computers
- Radar & Sonar Trainers
- Radar Guidance & Fire Control Systems
- Redesign, Modification & Testing of Radar & Electronic Systems
- Electronic Installation & Maintenance

## \* COMMUNICATIONS EQUIPMENT DESIGNERS

- Microwave Components & Circuits
- Signal Generators
- Microwave Test Equipment
- Video Test Equipment

## \* COMPUTER DESIGNERS

- DC Analog Circuit Design
- Digital & Analog Systems Applications
- Instrumentation & Evaluation

## \* AERODYNAMICISTS

- Jet Engine Instrumentation
- Flight Instrument Evaluation
- Flight Simulator Systems

(\* Other challenging openings in the fields of: Human Engineering, Psychology, Mathematics, Missile Guidance Systems and Low-Frequency vibration studies.

Salary and advancement commensurate with ability; liberal vacation, sick leave, 9 paid holidays, group life, sickness, accident insurance plans, and a worthwhile pension system.

**INTERVIEWS  
IN YOUR AREA  
BY APPOINTMENT**

**STAVID  
Engineering, Inc.**

U.S. Highway 22,  
Plainfield, N. J.  
Watchung, P.O.  
Plainfield 7-1600

An employment advertisement in this EMPLOYMENT OPPORTUNITIES section will help you find the engineers you need. It's an inexpensive, time saving method of selecting competent personnel for every engineering job in the electronic field.



## We have been able to tell you about *these* radars—

but are forbidden by security regulations to publicize the many other advanced radar and weapons systems we are developing. Raytheon's reputation for "Excellence in Electronics" has been greatly enhanced by the contributions it has made to the radar equipment field.

The recent expansion of our engineering facilities makes it possible to offer unusual opportunities to experienced creative engineers for the design and development of these radar and weapons systems. Your inquiries are welcomed and a postcard is supplied below for your convenience.



**RAYTHEON MANUFACTURING  
COMPANY**

*Radar Department*  
**Wayland Laboratory**  
**WAYLAND, MASS.**

**R. E. DOHERTY**  
**RAYTHEON MFG. COMPANY**  
**WAYLAND LABORATORY**  
**WAYLAND, MASS.**

Please send me a copy of your new brochure describing the Wayland Laboratory. I understand you will also send a brief resume form which I will be able to complete in a few minutes.

Name \_\_\_\_\_

Address \_\_\_\_\_

City \_\_\_\_\_ Zone \_\_\_\_\_ State \_\_\_\_\_

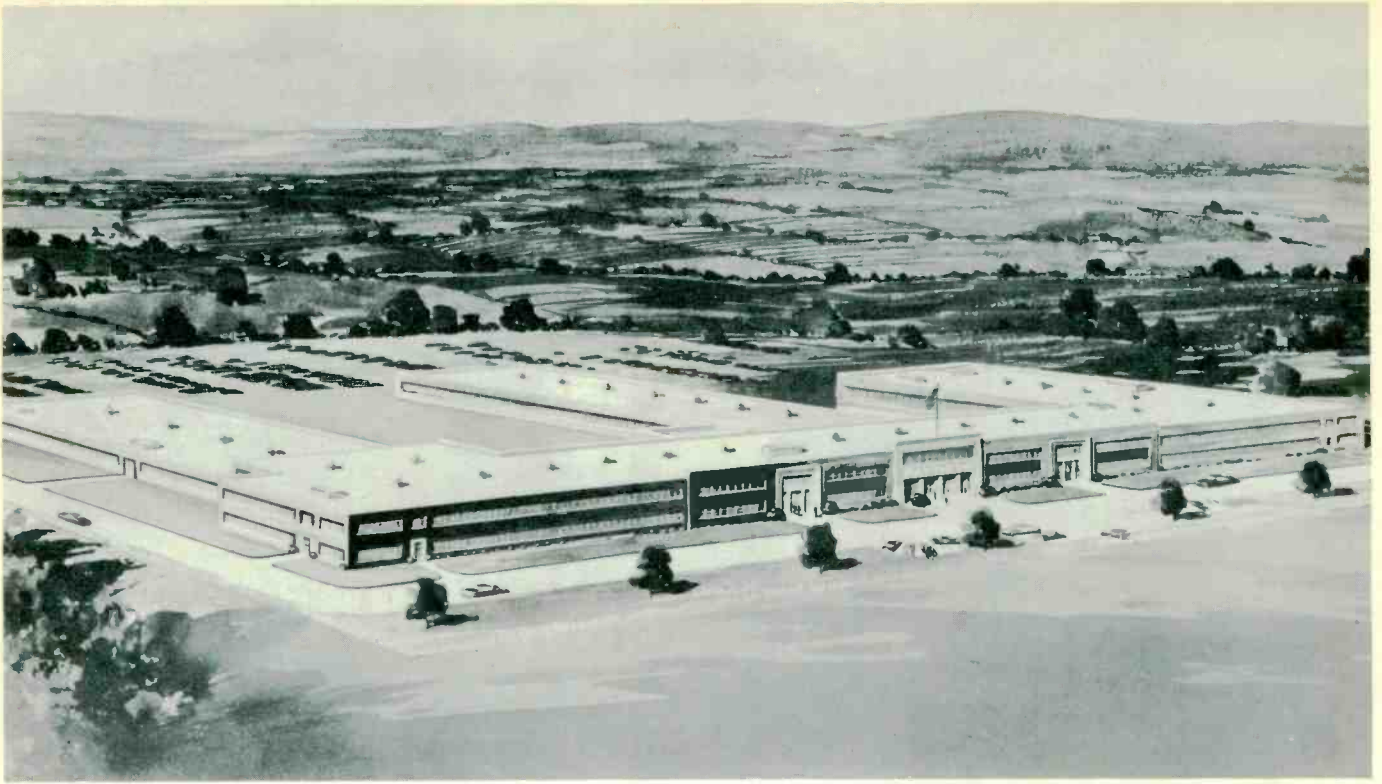

This new engineering building was opened in November 1955 and is devoted to the design and development of quality electronic equipment. Facilities are provided so that the engineer can see his programs carried completely through the environmental test stage within the building. Major development programs are conducted by the 1200 employees housed here—more than 500 of whom are engineers.

The Wayland Laboratory is located in a community that blends the urban with the rural just 17 miles from the heart of Boston offering all the advantages of a large metropolitan area. Commuting is easy because of the location within a network of major highways.

Postage  
Will Be Paid  
by  
Addressee

No  
Postage Stamp  
Necessary  
If Mailed in the  
United States

**BUSINESS REPLY CARD**

First Class Permit No. 25529 Boston, Mass.

**RAYTHEON MFG. CO.**  
**Wayland Laboratory**  
**Wayland, Mass.**

Atten: R. E. Doherty, Radar Dept.



**RAYTHEON MANUFACTURING  
COMPANY**

*Radar Department*  
**Wayland Laboratory**  
**WAYLAND, MASS.**



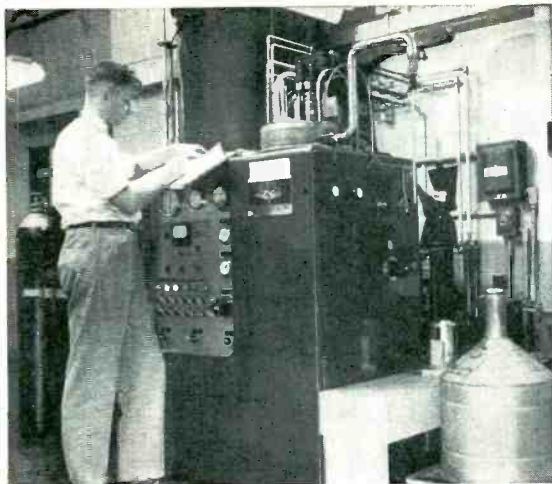

LOW TEMPERATURE

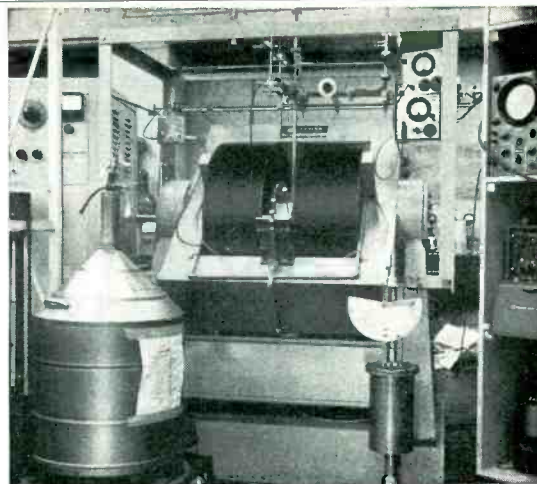

SPIN RESONANCE

# ENGINEERS, PHYSICISTS, CHEMISTS

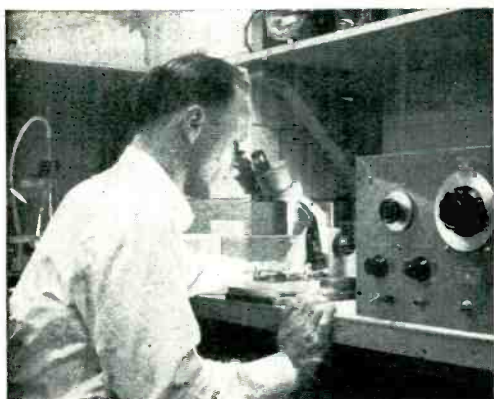

TRANSISTORS

Zenith wants to talk to you about:

- Solid State Physics
- Transistors
- Circuits for Color & Monochrome Television and Radio
- New Types of Vacuum Tubes
- Radio & TV Receiver Design
- Subscription TV (Phonevision)
- Ceramic Engineering (High Dielectric, Piezoelectric)
- Patents
- Industrial Engineering (Automation)

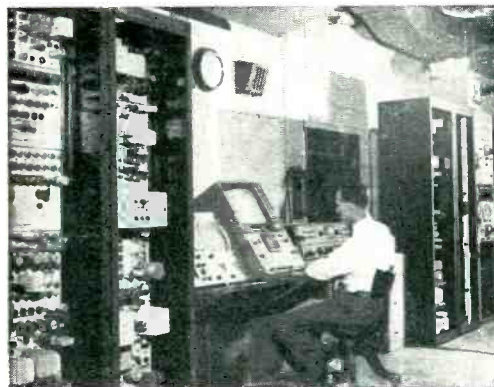

SYSTEMS ENGINEERING

Modern Air-Conditioned Laboratories  
 Attractive Profit Sharing and Insurance Plans  
 Outer Chicago Location with Opportunity for Suburban Living  
 and Graduate Study  
 Non-Classified Work—Publication Encouraged

Since 1919 Zenith has manufactured radios for home use and is one of the country's oldest companies continuously in this field. It is today a leading manufacturer of quality television sets and hearing aids. Continuity of management, a record of pioneer technical developments and a reputation for quality products are important factors for you to consider. Zenith's consistent, steady growth and unusually low engineering turnover rate indicate a desirable combination of opportunity and stability.

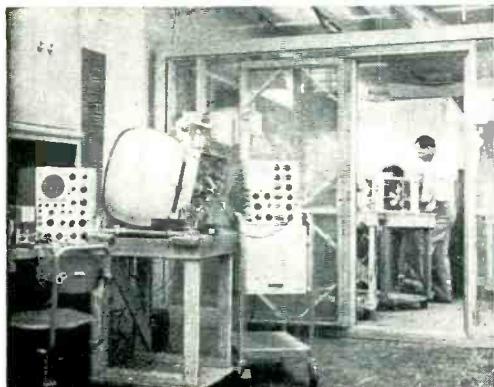

TELEVISION RECEIVER DESIGN

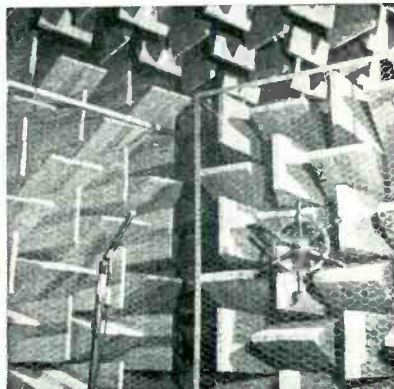

ACOUSTICS

For an appointment, write to  
 G. E. GUSTAFSON  
 Vice President, Engineering  
 Zenith Radio Corporation  
 6001 Dickens Avenue, Chicago 39, Illinois

**ZENITH**  
 ®  
**RADIO CORPORATION**



# HERE'S A CHANCE FOR A REAL CHANGE - - -

*Right Now* there are some fine career positions open in the ever expanding electronics industry. Why not write us and weigh the advantages of working with a leader in the field —

## Admiral Corporation

*Your Opportunity* may be listed below if you have background or interest in these fields:

### RADAR — MILITARY AND COMMERCIAL

Gun laying, IFF and beacons, navigational aids, air traffic control, video processing and distribution systems.

### TELEVISION — MILITARY AND COMMERCIAL

Mobile TV systems, cameras, complete systems including RF front ends, IF amplifiers and RF cavities in the UHF region.

Household TV section requires engineers at all levels who are capable of offering original ideas of values in highly competitive field, monochrome and color.

### RADIO — MILITARY AND COMMERCIAL

Airborne and ground communication systems at HF, VHF and UHF level. Domestic and export receivers, HI FI and phonographs.

### TRANSISTORS

Development group being augmented to explore all phases of transistor application.

### PHYSICISTS

Research in, and analysis of, high level nuclear radiation effects on electronic components. This concerns original investigations at reactor levels.

### TECHNICAL WRITERS

To organize, write and edit instruction books, operating and maintenance manuals for electronic equipment. Experience preferred, but will consider qualified trainees.

*Admiral engineers know the satisfaction of creative work that gives them the opportunity to explore and expand new techniques in their field.*

- *Let's discuss our mutual interests.*

Send complete resume to: Mr. Walter A. Wecker, Personnel Division

## Admiral Corporation

3800 W. Cortland St.  
Chicago 47, Illinois

M c G R A W - H I L L

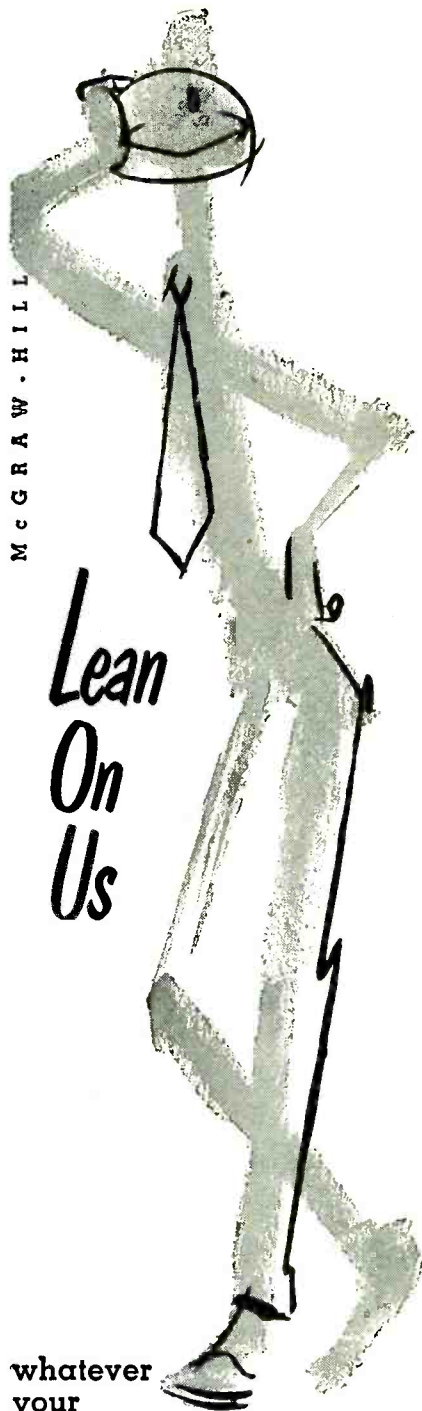

Lean  
On  
Us

whatever  
your  
publication needs ...

Equipment Manuals — Product Catalogs — Handbooks — Training Aids — Industrial Relations Literature — Procedural Guides — Engineering Presentations — — — and any type of technical literature

use our specialists in — — —

WRITING ... EDITING  
ILLUSTRATING ... PRINTING

**McGRAW-HILL**

Technical Writing Service\*  
330 West 42nd St., N.Y.C. 36  
LOngacre 4-3000

# 3 SENIOR ENGINEERING JOBS

## WELL WORTH LOOKING INTO . . .

### SYSTEMS PROJECT ENGINEER

6-10 years experience in missile or radar electronic system development. Ability to direct systems engineering at the project level.

### Senior Engineer TEST EQUIPMENT DESIGN

7-10 years experience in development and design of electronic test equipment for complete systems involving microwave and pulse techniques, adaptation of commercial instruments to special applications, preparation of proposals and the actual product design of electronic and electro-mechanical devices. Familiarity with problems of maintenance helpful. Supervisory experience and ability required.

### Senior Engineer MECHANICAL DESIGN

6-10 years experience in missile or aircraft electronic package design. Familiarity with vibration and other environmental problems essential.

Here are three especially attractive job opportunities for engineers who want to get on the ground floor in the important, interesting, and challenging phase of a new industry—guided missiles.

Qualified men are given real job responsibilities with Bendix and grow with the development of what is not only the nation's most important weapon system, but a project that will undoubtedly lead to new and im-

portant long-range commercial application.

At Bendix you will be associated with top missile authorities and have at your command unexcelled engineering and manufacturing facilities. Salaries for these top jobs and other opportunities are open for discussion. Write today to: Mr. W. L. Webb, General Manager, Missile Section, Bendix Products Division, Bendix Aviation Corporation, 401 North Bendix Drive, South Bend, Ind.

## 23 OTHER ENGINEERING POSITIONS!

Bendix also offers unusual job opportunities for assistant engineers, junior engineers, and technicians, as well as a score of other assignments. A 30-page book describing in

detail every phase of our guided missile operation will be sent to you on request. If you are interested in guided missiles, this book is bound to interest you. Write for it today.



**ENGINEERS UNLIMITED...**

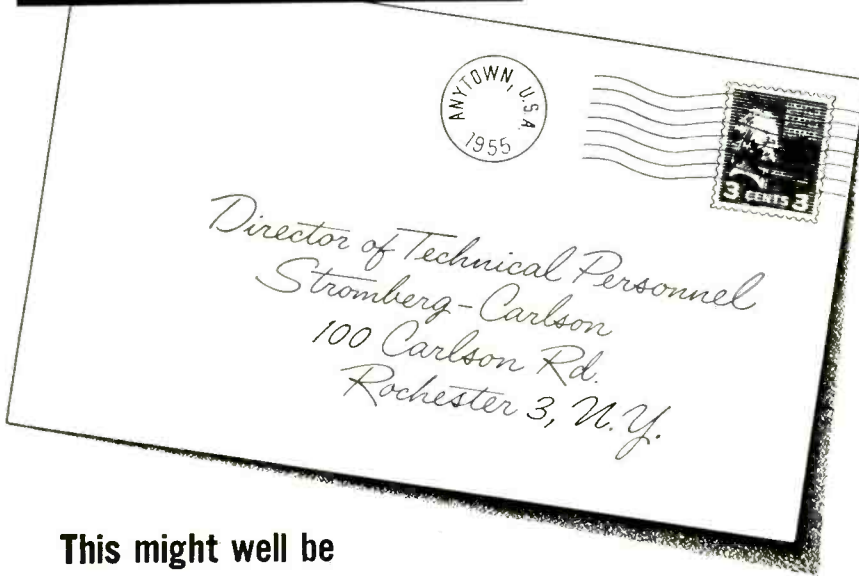

This might well be  
 the most important letter *you'll* ever write  
 . . . because it could open the door to a  
 lifetime job in a wonderful company

If you're an Electrical Engineer, with a high degree of skill and imagination in any of the twenty-odd fields listed right, we believe we can offer you the most promising opportunity in America.

Since 1940, Stromberg-Carlson's volume has increased *sixteen times*. In 1955, we became a division of the headline-making General Dynamics Corporation. Our future is as unlimited as humans can promise themselves—and you could well grow with us.

We are not looking for job-hoppers—but for men now stymied either by the limitations of a little company or the complexity of a giant. In any of the job classifications listed here, you'll find satisfaction and opportunity.

And you'll like Rochester—well-known for its grand schools, handsome residential sections and wide entertainment, vacation and cultural facilities. This firm's employee relations (including a liberal bonus plan) make it one of the state's preferred industries.

Write *today*—for an assured tomorrow!

- Audio Amplifiers
- Auto Radio
- Automation Research
- Carrier, Wire-Line
- Countermeasures
- Data Processing
- Digital Techniques
- Electro-mechanical Design
- Electronic Carillons
- Electronic Switching
- Infrared
- Intercom Systems
- Laboratory and Test Engineering
- Loudspeaker
- Magnetic Tape Recorders
- Microwave, communication
- Navigational Systems
- Radar
- Telephone Switching Technique
- Transistor Engineering
- Voice communication
- Writers—Bid Proposal
- Writers—Technical

Send your letter to Director of Technical Personnel

**STROMBERG-CARLSON COMPANY**  
 A DIVISION OF GENERAL DYNAMICS CORPORATION



**Rochester 3, N.Y.**

**PHYSICIST-  
 COMMUNICATIONS**

For laboratory operation of a large guided missile manufacturer. Requires knowledge of propagation, radiation theory and high frequency techniques, for work relating to long range problems.

A comprehensive benefit program is in force here. Excellent salary.

Primary consideration will be given to Ph.D.s with some years of experience.

**LOCATION:**

suburb of large city in the central Atlantic states

**Reply in confidence to:**

**P-8837, ELECTRONICS**  
 330 W. 42 St., New York 36, N. Y.

**Engineers**

**ELECTRONIC ENGINEERS**

Offers several opportunities to get in on the "ground floor" of a small and growing organization which is one of the leaders in the Graphic Arts field.

To the engineers who qualify, we can offer:

- (A) Permanent positions in a stable organization
- (B) Opportunity to grow with a company as it expands
- (C) Friendly informal working conditions
- (D) The satisfaction of seeing projects through from inception to completion
- (E) Salary based on individual qualifications

**REQUIREMENTS**

Degree in Electrical or Electronic Engineering or Physics and from 0 to 5 years experience in design of audio-frequency circuits, such as wave-form and pulse generators, feed-back amplifiers, analog computers, display devices or similar equipment.

Send Resume, or Call Mr. Joseph O'Farrell  
 Jamaica 6-3800

**FAIRCHILD GRAPHIC EQUIPMENT, INC.**  
 88-06 Van Wyck Expressway  
 Jamaica, New York

**NEW ADVERTISEMENTS**

received by March 2nd will appear in the April issue, subject to space limitations.

Address copy to the  
 Classified Advertising Division  
**ELECTRONICS**

330 W. 42nd Street, New York 36, N. Y.



“Engineers  
don’t make  
good managers!”

How many times have you heard or read this statement?

If it is true, then we are an outstanding exception to the rule.

If it is false, then we have played an important part in disproving it.

In either case, you owe it to yourself to investigate the opportunities in an organization managed by engineers. This is the primary reason why Microwave and Power Tube Operations make Raytheon the world leader in this field.

We need engineers with Bachelors', Masters' or Doctors' degrees in Electrical, Industrial and Mechanical Engineering or Physics to fill openings in these departments:

**TRAVELING WAVE TUBE DEVELOPMENT**—A comparative newcomer to us but we'll soon be tops. We need additional engineers to help us accomplish this.

**MAGNETRON RESEARCH AND DEVELOPMENT**—Work in this department is interesting and satisfying and of the utmost importance to National Defense.

**HIGH POWER BACKWARD WAVE OSCILLATOR DEVELOPMENT**—One of the newest and most fascinating of the microwave tube family.

**PRODUCT ENGINEERING**—Perhaps the hardest of engineering jobs but also the most rewarding.

**APPLICATIONS ENGINEERING**—Here's the opportunity to travel, to see what other companies are doing, to meet new people, and still get paid for it.

**CATHODE DEVELOPMENT**—A highly specialized job with a chance to become an expert in the field.

**METHODS AND FACILITIES DEVELOPMENT**—We are always looking for the “new” in equipment, facilities and methods of tube processing.

**KLYSTRON ENGINEERING**—An old standby in the microwave tube field but always interesting and still expanding.

**CERAMIC ENGINEERING**—Here's a brand new field of engineering as applied to the electronics industry. As usual, Raytheon leads here, too.

*Please send complete resume of your qualifications and experience to Mr. D. Hamant at:*

**RAYTHEON MANUFACTURING COMPANY**

Foundry Avenue

Waltham 54, Massachusetts

Excellence



in Electronics

Dear Joe:  
 This is a quick note on the wire I just sent telling you to get that resume to Farnsworth - fast!

Now I know why the majority of engineers who come here for an interview never leave. The enthusiasm here - for the work - the people and the town - is really amazing. Maybe it's because of the close association with top-notch scientists and engineers who have contributed a lot of "firsts" in the field of electronics.

Like our Philo Farnsworth, the inventor of electronic television, the real inspiration to all of us here. (I sound like an old timer, don't I?)  
 Fact is, Joe, that's the way they make you feel - like you belong. Here you will be heard - not just one of the herd.

The whole set-up is so good, Joe, I wish you would tell all the other fellows about the opportunities here at Farnsworth for good men in R & D guidance and control, radar, microwaves, antennas, systems test equipment, counter measures, transistor applications, closed circuit television etc.

Tell them to write to:  
 Don Dionne  
 Farnsworth Electronics Co. Fort Wayne, Ind.  
 (a division of International Telephone & Telegraph Corp.)  
 You'll be doing them and Farnsworth a big favor.

Sincerely  
 Jack

opportunities in

**OPERATIONS RESEARCH**

Operations Research Office of The Johns Hopkins University offers exceptional opportunities for scientists who prefer the challenge of operational problems of unusual scope and diversity to routine design and development work.

Our current research program has openings for men qualified in electronics and physics who are particularly interested in:

- Mathematical Analysis
- Determining applications of known photographic, acoustic, infrared and radar techniques to military problems
- Military communications systems planning, analysis and evaluation
- Electronic Countermeasures Analysis

Please send your resume to  
 Research Personnel Officer

OPERATIONS RESEARCH OFFICE

**THE  
 JOHNS HOPKINS  
 UNIVERSITY**  
 7100 Connecticut Avenue  
 Chevy Chase, Md.

**ENGINEER,  
 ME or EE**

**GYROSCOPICS**

Research facilities that enable you to test out your most revolutionary ideas and encouragement to publish original work available to the engineer experienced in precision gyroscopic equipment.

Assignments in the field of missile guidance systems will include both mechanical and electrical problems involving lubrication, temperature control, bearings, vibration and shock mounts, development work in components such as pickups, accelerometers, amplifiers and computers, plus project work on complete gyroscopic systems. ME, EE or equivalent experience required. Send resume in confidence to:

Technical Personnel Dept. 2-500

**ARMA**  
 Div. American Bosch Arma Corp.  
 Roosevelt Field, Garden City  
 Long Island, N. Y.

**Need Engineers?**  
 Contact them through this  
**EMPLOYMENT OPPORTUNITIES section**  
 Rates are low.

# electronic engineers:

## Westinghouse

BALTIMORE DIVISIONS

Offer Advanced Education  
For YOUR Professional Advancement!

YOU CAN OBTAIN YOUR M.S. OR Ph.D.  
AT COMPANY EXPENSE!

Advanced education will help to get you professional status you want . . . and at the Westinghouse Baltimore Divisions you can pursue both M.S. and Ph.D. work at company expense.

Since its inception, almost 400 employes have obtained advanced degrees under the Westinghouse Graduate Study Program, which is affiliated with both the Johns Hopkins University and the University of Maryland in the Baltimore area.

Naturally, you will find many other career benefits at the Baltimore Divisions, including interesting work in a professional atmosphere, excellent income and employe benefits, and ample housing in an ideal geographic location.

### CURRENT OPENINGS

Exist in the fields of—

CIRCUITRY

MICROWAVES

SERVOMECHANISMS

MAGNETIC AMPLIFIERS

DIGITAL COMPUTER PROGRAMMING

FIRE CONTROL SYSTEMS

PACKAGING

TRANSFORMERS

ANALOG COMPUTER DESIGN

VIBRATION

RADAR DESIGN

FIELD SERVICE

**APPLY NOW!**

*Your future may depend on it!  
Technical Director, Dept. 291  
Westinghouse Electric Corp.  
2519 Wilkens Avenue  
Baltimore 3, Maryland*

YOU CAN BE **SURE**...IF IT'S  
**Westinghouse**

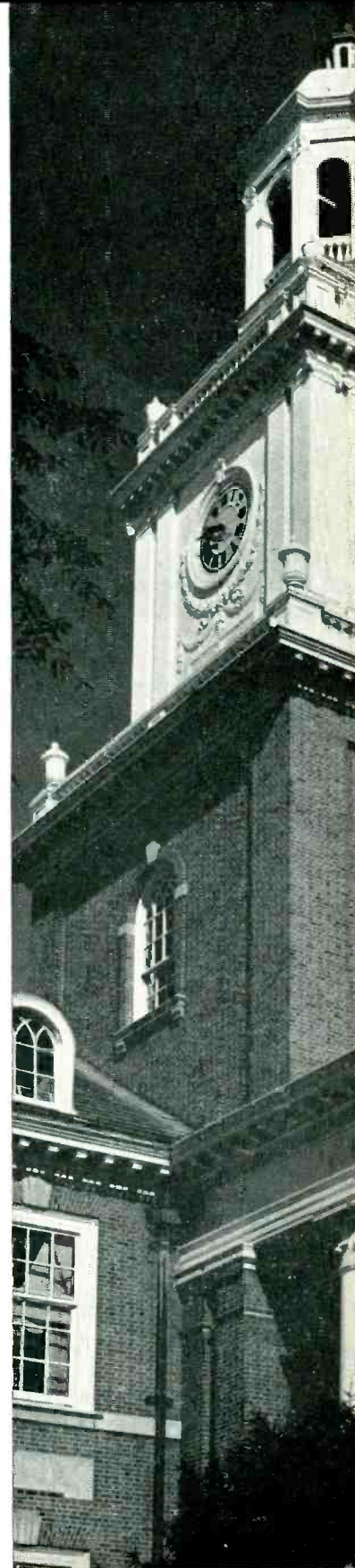



## FIELD ENGINEERING WITH A FUTURE – at Raytheon

**PLAN YOUR CAREER HERE** – Raytheon needs men like you who are qualified for field engineering and have the ability to build a future in electronics. Experience in the field has enabled many of our engineers to become executives at Raytheon. Unlimited opportunity is open to you now in the following programs:

- MISSILES ..... Air-to-Air – Ground-to-Air
- RADAR ..... Search – Fire Control  
Bombing – Countermeasures
- Other Equipment.... Ship and Airborne Sonar – Multiplexers –  
Microwave Relay Links – Communications

Raytheon has designed and built complicated electronic equipment for the past 30 years. One of its present equipment projects is the world's most publicized radar—the DEW LINE radar.

If you have a college degree, you'll rate preference. However, if you have an extensive electronic background, send in your application. Special training will be provided by our Training Facility to prepare you for your assignments.

Attractive salaries, benefits, and allowances. Domestic and overseas assignments.



**RAYTHEON MANUFACTURING COMPANY**  
100 River St., Waltham 54, Mass.

### ENGINEER

#### MISSILE & WEAPONS CONTROL SYSTEMS STUDIES

Enjoy full use of your skill and imagination, and friendly, professional give and take with top men in the field of electromechanical precision equipment.

You will perform studies related to airborne weapons control and guidance systems with the object of determining requirements, feasibility, performance and specifications of computers and over-all systems.

A degree in physics, ME or EE—or the equivalent in experience—is required. Must be able to handle problems in such diversified fields as: digital computers, digital data transmission systems, logic counting and conversion circuits, high precision gyro and gimbals structures, dynamic behavior of missiles; alignment of inertial platforms for guidance systems, and flight evaluation of guidance systems and instrumentation. Send resume in confidence to:

Technical Personnel Dept. 2-500

#### ARMA

Division American Bosch Arma Corp.  
Roosevelt Field, Garden City  
Long Island, N. Y.

### ELECTRONICS ENGINEER DESIGNING ENGINEER

#### AIRCRAFT SERVOS AND CONTROLS

Opportunity for experienced men with ability and initiative to assume responsibilities in development, design and application. Permanent positions not dependent upon gov't contract. Established manufacturer with excellent reputation. Attractive benefits and living conditions.

*Replies confidential.*

Personnel Department

**THE BRISTOL COMPANY**  
WATERBURY, CONNECTICUT

### METER LINE SUPERVISORS

We need skilled people to train to manufacture contact meter-relays.

You will train in one of the meter production lines and then take over the supervision of part of our production.

If you have experience in running a production line making small, intricate devices, please call collect, John Saint-Amour, Cleveland, Ohio. HAMilton 3-4436, or write to Assembly Products, Inc., Chesterland, Ohio.

### PROGRESSIVE L. I. FIRM

needs **ELECTRONIC ENGINEERS**  
Opportunity for self-expression and growth. Must have 2-3 yrs. exp. in the design of IF, VHF and/or UHF broad band systems. Many personal benefits. Phone or write Mr. G. W. Fellendorf, Vice Pres.

Instruments for Industry, Inc.  
Mineola, N. Y. Pioneer 2-5300



W. W. Lindsay, Jr., Electronics Committee Chairman, Sherwood C. Frey, Navy Studies Department Manager, and R. P. Buschmann, Company Studies Department Manager examine relationships between plane and radar performance.



*Expansion at Lockheed:*

## Operations Research creates new positions for physicists and engineers

**Operations Research at Lockheed** is a unique division which projects studies covering the entire spectrum of airborne systems five to twenty years into the future. It is concerned only with work of a most advanced nature.

Operations Research experience is not necessary to join the division. A high degree of scientific ability and proven analytical traits in your field of endeavor are primary requirements.

*An address by Robert A. Bailey on "Application of Operations Research Techniques to Airborne Weapon System Planning" is available to interested scientists. Address inquiries to Mr. Bailey.*

*The growing importance of this field has created new positions for:*

**Electronics Specialists** to evaluate and predict electronic equipment capabilities.

*Requirements* — advanced education in Electronics or Physics and experience in the field.

**Fire Control and Guidance Specialists** to evaluate and predict aircraft fire control and missile guidance capabilities.

*Requirements* — advanced education in Electronics or Physics and experience in the field.

**Mathematicians** to devise analytical methods and models for operations research.

*Requirements* — advanced education and experience in research.

**Physicists** to apply their knowledge of the fundamental laws of physics to the analytical solution of problems.

*Requirements* — Advanced education with experience in research.

Those interested are invited to write E. W. Des Lauriers, OR-9-2.

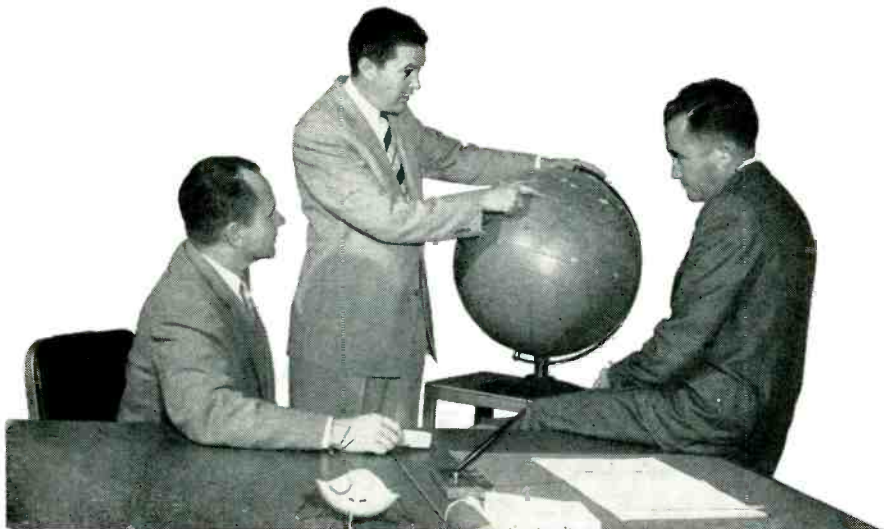

## LOCKHEED

AIRCRAFT CORPORATION

*California Division*

BURBANK

**CALIFORNIA**

W. P. Gruner, Jr., Senior Military Analyst, T. P. Higgins, Airborne Systems Engineer, and Robert A. Bailey, Director of Operations Research, discuss global implications of new concepts in air defense systems.

**ENGINEERS and PHYSICISTS**

Select Positions  
in California with Sylvania's

**Mountain View  
MICROWAVE TUBE LABORATORY**

**MANAGER OF KLYSTRON ENGINEERING**

A rare opportunity for an expert in the Klystron field... now perhaps a Laboratory Group Leader... ready to assume greater responsibility. Will spearhead expansion program on all types of Klystrons, for both commercial and government uses. This position offers unusual chance for further advancement.

*Also immediate openings  
for Engineers and Physicists  
in the following areas:*

**TRAVELING WAVE  
TUBES**

Project Leaders and Senior Engineers to work in the fields of traveling wave amplifiers, backward wave oscillators and backward wave amplifiers.

**KLYSTRONS**

Senior Engineers in the fields of single cavity oscillators, multi-cavity amplifiers and ceramic-metal tubes.

**FERRITES**

Senior Engineer in the field of design of ferrite devices for microwave application.

**APPLICATIONS**

Senior Engineer with experience in circuit applications of microwave tubes.

**PRODUCTION**

Engineers trained in fabrication and processing of metal, metal-glass and metal-ceramic microwave tubes.

*Sylvania's laboratory equipment is the last word for research, design and development of both metal-glass tubes and ferrite devices. And the beautiful San Francisco Bay area is rapidly becoming the world center of microwave development.*

*At Mountain View you will enjoy a moderate and clear climate... year 'round. Just five miles from Palo Alto, near Stanford University, Mountain View abounds in excellent schools and ample housing.*

*If you are  
interested in any of the  
above opportunities, please send your  
resume immediately, in complete confidence, to:*

Mr. Gordon McClure  
**Sylvania Microwave Tube Laboratory**  
500 Evelyn Avenue, Mountain View, California



All inquiries will be answered within two weeks. Successful candidates will enjoy all of Sylvania's supplementary employee benefits... and relocation expenses will be paid.

to all  
electronic engineers  
who are tired

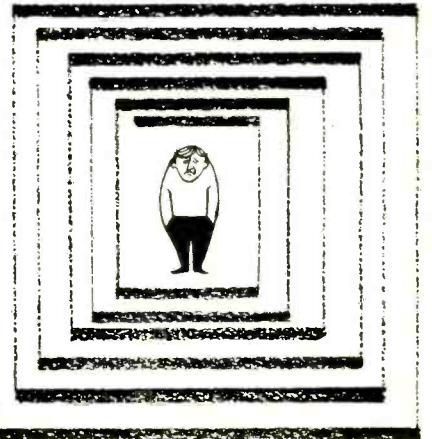

of being fenced in

■ THE FIELD OF ELECTRONICS knows no horizon. But many electronic organizations create horizons of their own that tend to curb the efforts of the creative engineer.

There are no such artificial barriers here at Electronic Engineering Company of California. Instead, you will find that every member of our experienced staff of engineers is encouraged to think boldly and is freed from procedural red tape so that he can devote full time to creative engineering.

If you are a qualified electronic engineer who is tired of being hampered by procedural barriers, we of Electronic Engineering Company would like you to join us. The wide variety of electronic projects that form our increasing backlog will give you a chance to exercise your versatility in an atmosphere of enthusiastic cooperation.

*you'll find no fences here!*

Send a resume of your background to Bob Lander

**Electronic Engineering Company  
of California**



180 SOUTH ALVARADO STREET  
LOS ANGELES 57, CALIFORNIA

# ENGINEERS

The APPLIED PHYSICS LABORATORY of THE JOHNS HOPKINS UNIVERSITY offers an exceptional opportunity for professional advancement in a well-established Laboratory with a reputation for the encouragement of individual responsibility and self-direction.

Our program of

## GUIDED MISSILE RESEARCH and DEVELOPMENT

provides such an opportunity for men qualified in

- Design and Analysis of Pulse Circuits
- Research and Development in Radar and Microwaves
- Electronic Packaging
- Development of Telemetry, Data Processing, and Special Switching Equipment
- Magnetic Amplifier Design & Analysis
- Development and Application of Printed Circuits
- Servomechanisms and Control-System Analysis

Please send your resume to  
Professional Staff Appointments

APPLIED PHYSICS LABORATORY  
THE JOHNS HOPKINS UNIVERSITY  
8609 Georgia Avenue  
Silver Spring, Maryland

TAKE AIM  
ON YOUR



## ENGINEERING FUTURE

Does an unusual career opportunity with a leader in electronics appeal to you? If it does, here's a sample of what Varian offers to qualified engineers:

- An opportunity to work with men of genuine prominence . . . engineers who know microwave electronics, have contributed more to klystron development than any other group in America.
- A significant record of growth . . . expanding research and development programs that offer many avenues for career advancement.
- An operating concept that fosters joint achievement, yet affords full recognition to individual accomplishment.
- A California location adjacent to Stanford University . . . the ideal working-living environment.

If you want to know more about engineering employment with Varian, a letter to our Personnel Director will bring full details.

**VARIAN**  
associates

Stanford Industrial Park  
611 Hansen Way  
Palo Alto, California

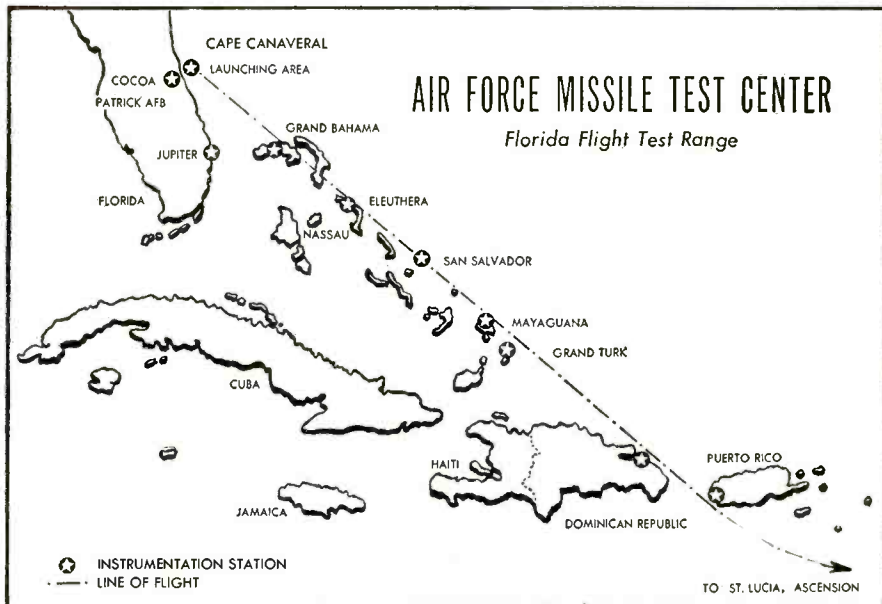

Engineers and Scientists:

## INSTRUMENTATION SYSTEMS ENGINEERING for MILITARY APPLICATIONS

SALARIES UP TO \$14,000.

IN THESE NEW PROGRAMS AT THE MISSILE TEST PROJECT, FLORIDA

Have you as an engineer or scientist considered the problems and projects associated with the instrumentation and control of a long range missile, guided over a course that extends thousands of miles?

To achieve precision performance, missile launching and guidance require a vast network of instrumentation and control. New development programs have created challenging opportunities for Electronics Engineers and Scientists who are interested in data acquisition, transmission, recording and processing systems.

A world leader in electronics provides instrumentation for the Air Force Long Range Testing Laboratory, which extends from Patrick Air Force Base, on the Central East Coast of Florida, to the Mid South Atlantic.

You will enjoy top salaries, liberal company-paid benefits, and ideal Florida living for you and your family. Relocation assistance, too.

TODAY . . . get complete information on arrangements for personal interview. Send a complete resume of your education and experience to:

PERSONNEL MANAGER  
MISSILE TEST PROJECT—Dept. N-10B  
P. O. Box 1226  
Melbourne, Florida

MISSILE TEST PROJECT  
Melbourne, Florida

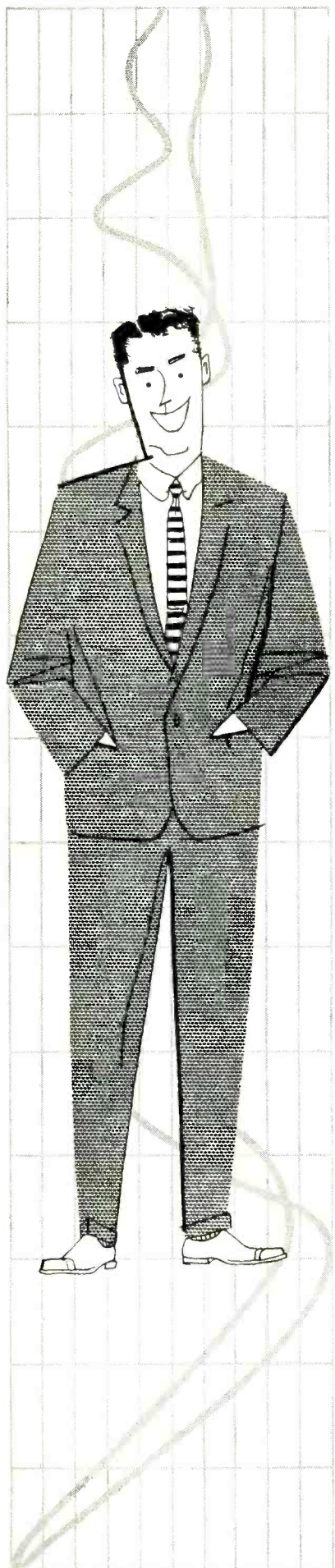

# What makes an engineer HAPPY?

First of all, most of the things that make any one else happy—security, good pay, opportunity for advancement, but, MOTOROLA believes a good engineer requires more than that. He needs a chance to use his imagination as well as his slide rule—projects to work on that require vision as well as formulas. He needs men to work with who respect his abilities—and whose abilities he, in turn, can respect.

If you are an ELECTRICAL ENGINEER, MECHANICAL ENGINEER or PHYSICIST, on a SENIOR or JUNIOR level—looking for a professional challenge—Motorola has what you are seeking.

**CHICAGO, ILL.:**

Challenging positions in Two Way Communications, Microwave, Radar and Military equipment, Television (Color) and Radio Engineering.

**PHOENIX, ARIZ.:**

Outstanding opportunities in the development and production of Military equipment and Transistor products.

**RIVERSIDE, CAL.:**

This new modern research laboratory, located 65 miles from Los Angeles, needs advanced, experienced men in Missile and Military equipment systems analysis and design.

Take this opportunity to examine how MOTOROLA CAN DO MORE FOR YOU AND YOUR FAMILY

Write:

L. B. WRENN  
Engineering Recruitment Mgr.

**MOTOROLA, INC.**

4501 W. Augusta Blvd.  
Chicago 51, Ill.



## Executives and Engineers deserving higher salary

now can *completely, confidentially* make arrangements for better positions through our unique Job Improvement Service. We have close contact with leading manufacturing and research firms in all sections of the country.

Here's what you do. Send us your name, title, company and *home address*. We will forward to your home brief forms which you fill out and return. We compare your experience and desires with our file of specific job openings. You make the decision. No obligation to you, no cost whatsoever. Our clients pay us to find you. Find out what you're really worth—today. Write, phone or wire.



### DECISION INC.

*Management and Recruitment Consultants*  
Oliver P. Bardes, President  
441 First National Bank Building  
Cincinnati 2, Ohio

## FIELD ENGINEER—LECTURER

### RADIO — TELEVISION

Nationally famous east-coast manufacturer of electronic test equipment has opening for qualified engineer to conduct lecture demonstration program involving use and application of instruments in maintenance of color and monochrome TV receivers.

Reply stating education, experience and salary desired. Must be free to travel, U.S.A.—Canada. All replies in confidence.

P-8977, Electronics  
330 W. 42 St., New York 36, N. Y.

## Your Inquiries to Advertisers Will Have Special Value . . .

—for you—the advertiser—and the publisher, if you mention this publication. Advertisers value highly this evidence of the publication you read. Satisfied advertisers enable the publisher to secure more advertisers and—more advertisers mean more information on more products or better service—more value—to YOU.

## Project Engineer . . .

with background in design of complex electronic systems, for a key position supervising a small group engaged in design and development of nucleonic instruments and systems.

Must be able to assume responsibility and contribute ideas.

If you fulfill these basic requirements, we would be pleased to have you consider the possibility of joining our team . . . the most successful team in the nuclear field.

Please write in confidence to . . .

*Tracerlab*

130 HIGH STREET, BOSTON 10, MASS.

## ELECTRICAL ENGINEERS

To work on engineering problems in development of new Regulated AC and DC supplies, transistors, semi-conductor circuitry and magnetic amplifiers. BEE, or BS with physics or math major, plus some allied experience.

**SORENSEN & COMPANY, INC.**  
375 Fairfield Avenue Stamford, Conn.

## ELECTRO-MECHANICAL ENGINEER

Electro-mechanical engineer for laboratory and production engineering with small established manufacturer of audio frequency devices. Duties involve product design, production engineering, test fixture, and equipment layout. Write supplying complete details of experience, schooling and salary requirements. Plant located in Philadelphia area.

P-8797, Electronics  
330 W. 42 St., New York 36, N. Y.

## Experienced SALES ENGINEER

having substantial successful selling experience with the ceramic, electrical insulation materials. This is a top-level opportunity for a person who has demonstrated exceptional ability as a sales engineer in the ceramics field.

**Mycalex Corporation of America**  
Box 311, Clifton, New Jersey  
Mr. J. H. DuBois

## CHALLENGING CAREERS AT RAYTHEON



Engineer locating tube resonances from a record of noise output by a tube which has been subjected to sinusoidal vibrations over a range of frequencies at 15 times the force of gravity.

## Match your ability with advancement

When you join Raytheon, you work in an atmosphere of progress. A typical program is the intensive activity maintained since 1944 for developing the improved reliability of cathode subminiature tubes. This work has achieved 5000-hour tube life at a bulb temperature rating of 265°C and with only 1/10th the vibrational noise output of competitive tubes.

At Raytheon, university graduate study is encouraged through a tuition payment plan. Openings now for engineers, scientists in many areas, including:

**microwave tubes • special purpose tubes • guided missiles transistors • diodes • receiving tubes • TV receivers • radar metallurgy • ceramics • communications • cathode ray tubes sonar • servomechanisms • solid state physics • field engineering**

Join a team where performance pays off. Please address your inquiry to L. B. Landall, Professional Personnel Section.



## RAYTHEON MANUFACTURING COMPANY

190 Willow St., Waltham 54, Mass.

Plants also located in California and Illinois

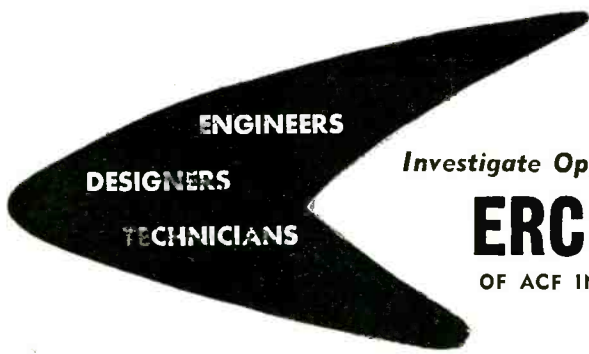

Investigate Opportunities at

**ERCO** DIVISION  
OF ACF INDUSTRIES INC.

**ERCO** Engineers have built a record of continuous progress and growth for themselves and for the Company for a quarter of a century . . . growth in physical plant, personnel, number and diversity of products and services.

**Today** this growth continues and we are constantly on the alert for new men to add fresh impetus to that progress . . . paying top salaries to capable people.

**Your** work will be interesting and stimulating . . . it might include electronic flight simulators, machine tools, guided missiles, or a variety of specialized electronic devices.

**You** can choose a home from a number of fine nearby residential areas convenient to both shopping centers and plant . . . and you can further your education at the many nearby Universities . . . you can enjoy suburban living and be within easy reach of the cultural advantages of the Nation's Capital.

**ERCO** now needs Electronic Engineers (all levels with some overseas positions available). Aerodynamicists, Analog Computer Engineers, Mechanical Design Engineers, and supporting personnel. Send resume or request for additional information to:

**ERCO** DIVISION  
OF ACF INDUSTRIES  
RIVERDALE • MARYLAND

## *semi-conductors*

An excellent opportunity for accomplishment and progress in the semi-conductor field.

A top-flight man needed to take charge of the metal evaluation procedures and interpretations of a major new program for silicon production.

Experience or formal training and a record of successful accomplishment essential.

Reply in confidence to:

Chemical & Metallurgical Division  
PROCESS DEVELOPMENT SECTION

**GENERAL  ELECTRIC**

1 Plastics Avenue  
Pittsfield, Massachusetts

# EMPLOYMENT PROBLEM?

When you are in need of specialized men for specialized jobs, contact them through an employment ad in a McGraw-Hill Publication.

Management, Engineering, Production, Maintenance, Selling . . . these represent broadly the principal functions in business and industry. And it is principally to the men and executives who fill key jobs in these important divisions that McGraw-Hill publications are directed.

## McGraw-Hill Domestic Publications

AMERICAN MACHINIST  
AVIATION WEEK  
BUS TRANSPORTATION  
BUSINESS WEEK  
CHEMICAL ENGINEERING  
CHEMICAL WEEK  
COAL AGE  
CONTROL ENGINEERING  
CONSTRUCTION METHODS AND EQUIPMENT  
ELECTRICAL CONSTRUCTION AND MAINTENANCE  
ELECTRICAL MERCHANDISING  
ELECTRICAL WHOLESALING  
ELECTRICAL WORLD  
ELECTRONICS  
ENGINEERING AND MINING JOURNAL  
ENGINEERING NEWS-RECORD  
FACTORY MANAGEMENT AND MAINTENANCE  
FLEET OWNER  
FOOD ENGINEERING  
NATIONAL PETROLEUM NEWS  
NUCLEONICS  
PETROLEUM PROCESSING  
PETROLEUM WEEK  
POWER  
PRODUCT ENGINEERING  
TEXTILE WORLD

THE MEN YOU NEED ARE  
THE MEN WHO READ THE

**McGraw-Hill Publications**

330 West 42nd St.,  
New York 36, N. Y.

**ELECTRONIC AND RADIO ENGINEERING**

*Just Published—Fourth Edition*

Completely revised edition of Terman's **RADIO ENGINEERING**. Basic guidance covers all phases of electronic and radio engineering, including vacuum tubes, transistors, electronic circuits, and radio systems. Provides essential data on circuit theory, electronic devices, antennas, wave propagation, transmitters, receivers, television, radar, and radio navigation aids. Includes new material on pulse techniques, microwave tubes, semi conductors and transistors, FM, color television, and others. Organized for quick reference. By **Fredrick E. Terman, Dean, School of Engrg., Stanford Univ.** 1078 pp., 688 illus., \$12.50



**FUNDAMENTALS OF TELEVISION ENGINEERING**

*Just Published!*

Up-to-date, theoretical treatment of the entire field of television. Analytical in approach, it covers in detail system concepts as well as circuits and techniques. Treats monochrome and color systems concurrently. Emphasis is on the television system itself, requirements to be met in achieving quality, and the analysis and design of the many component parts which make up the system. By **G. M. Glasford, Assoc. Prof. of Elec. Engrg., Syracuse Univ.** 642 pp., 565 illus., \$12.50

**LINEAR FEEDBACK ANALYSIS**

*Just Published!*

Presents a systematic treatment for negative feedback circuit research and applications. Focuses on problem of stability of the feedback loop. Discusses causes of instability, using three methods of approach. Contemporary network analysis methods, feedback concepts, and tube amplifying stage characteristics are fully described. Application of the Laplace transform, with examples, is outlined. Includes material not presented in book form before, such as analyses of single- and multi-stage amplifiers. By **J. G. Thomason, Radar Research Estab., Malvern, England.** 355 pp., 236 illus., \$8.50



*Just Published!*

**CONTROL OF NUCLEAR REACTORS AND POWER PLANTS**

Provides a servo-engineering approach to the physics problem of safety controlling nuclear reactors. Describes responses of reactors in engineering terminology and treats reactors as control elements in larger systems. Several systems are presented for research reactors and for power producing types. Gives special attention to operating control problems during startup, power level operation, and shutdown. Shows how simulators are designed, whereby control devices may be checked in laboratory without using reactor. By **M. A. Schultz, Atomic Power Div., Westinghouse Elec. Corp.** 313 pp., 232 illus., \$7.50

**10 DAY FREE EXAMINATION**

McGraw-Hill Book Co., Att: H. W. Buhrow Industrial and Business Book Dept. 327 W. 41st. St., N.Y.C. 36

Send me book(s) checked below for 10 days' examination on approval. In 10 days I will remit for book(s) I keep, plus few cents for delivery cost, and return unwanted book(s) postpaid. (We pay delivery costs if you remit with this coupon—same return privilege.)

- Terman—Electronic and Radio Engineering—\$12.50
- Glasford—Fundamentals of Television Engineering—\$12.50
- Thomason—Linear Feedback Analysis—\$8.50
- Schultz—Control of Nuclear Reactors and Power Plants—\$7.50

(Print)  
 Name .....  
 Address .....  
 City ..... Zone ..... State .....  
 Company .....  
 Position .....

For price and terms outside U.S., write McGraw-Hill Int'l., NYC

L. F2

**TOP careers for TOP ENGINEERS**

at **"FTL"**

*One of the world's great centers of electronic research and development*

Top opportunities for achievement and recognition are available at Federal Telecommunication Laboratories, a division of the world-wide International Telephone and Telegraph Corporation.

Here, a man works with the finest facilities... with recognized leaders in his field. As a part of FTL's long-range development program he has a dependable road into the future... a future of stability, achievement, and commensurate rewards.

Why not write today for your copy of the booklet that tells the fascinating story of FTL... the broad and generous employee benefits... the many opportunities for permanence and satisfying progress.

**Interesting Assignments in:**

- Radio Communication Systems • Electron Tubes
- Microwave Components • Electronic Countermeasures
- Air Navigation Systems • Missile Guidance
- Transistors and other Semiconductor Devices • Computers
- Antennas • Telephone and Wire Transmission Systems

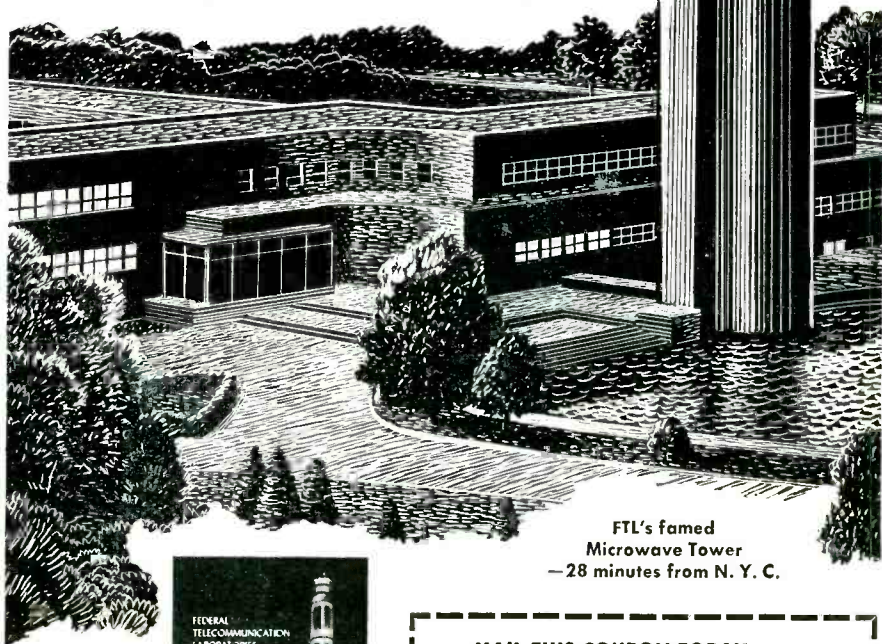

FTL's famed Microwave Tower — 28 minutes from N. Y. C.



**MAIL THIS COUPON TODAY**

Federal Telecommunication Laboratories  
 500 Washington Avenue, Nutley, N. J.  
 Please send a copy of your booklet describing opportunities at FTL.

Name .....  
 Address .....  
 City ..... Zone ..... State .....

**FTL**



**Federal Telecommunication Laboratories**

A Division of INTERNATIONAL TELEPHONE AND TELEGRAPH CORPORATION

**ENGINEERS**

Electrical • Mechanical

**PHYSICISTS**

**You can be SURE**

- . . of professional recognition
- . . of a successful financial future

AT THE ELECTRONIC TUBE DIVISION OF

**Westinghouse**

AT ELMIRA,

NEW YORK

Yes . . . you can count on a friendly and creative atmosphere . . . world-important work . . . where everybody is on your "team" . . . and your talents are tangibly rewarded. You and your family can also count on enjoying the "Elmira" way of life, a great combination of vacation-land facilities, with all city advantages.

**Openings in:**

**TUBE DESIGN & DEVELOPMENT**

**MICROWAVE TUBES:** Magnetrons, traveling wave tubes, klystrons, reference cavities, and other devices.

**PICK-UP DEVICES:** Image orthicon, vidicon, infra-red, X-ray image intensifier.

**CATHODE RAY TUBES:** Color and black-&-white.

**OTHER TUBES:** Including receiving and power tubes.

**APPLICATION ENGINEERING**  
for each of the aforementioned fields.

**TEST & MFG. EQUIPMENT DESIGN**

Seasoning and test units, induction heaters, waveguide apparatus, high-frequency oscillation test units, automatic receiving-tube test circuits.

**MANUFACTURING ENGINEERING**

Microwave, image orthicon, receiving or color TV tubes.

*Interviews in your area, or travel expenses paid for Elmira interviews.*

Send resume to: **R. M. Jarrett**  
**WESTINGHOUSE ELECTRIC CORP.**  
P. O. Box 284, Elmira, N. Y.

**DO YOU NEED ENGINEERS WITH EXPERIENCE IN:**

- Research
- Development
- Design
- Instrumentation
- Servomechanisms
- Missiles
- Audio Systems
- Control Systems
- Radar
- Computers
- Transistors

Place an "ENGINEERS WANTED" advertisement in this SEARCH-LIGHT SECTION of ELECTRONICS. It's an inexpensive, time saving method of selecting competent personnel for every engineering job in the electronics industry. The selective circulation of ELECTRONICS offers you an opportunity to choose the best qualified men available throughout the industry.

*For Rates and Information Write:*

**CLASSIFIED ADVERTISING DIVISION**  
**McGraw-Hill Publications**  
330 West 42nd St.,  
New York 36, N. Y.

**ELECTRICAL OR ELECTRONICS ENGINEER**

0-5 years experience plus degree, creative ability in automatic controls work. We offer singular opportunity to acquire breadth and scope of electronics-electrical instrumentation experience in a Massachusetts chemical plant in midst of multi-million dollar expansion program. Please send resume and salary requirements to

P-8493, Electronics  
330 W. 42 St., New York 36, N. Y.



TECHNICAL OPERATIONS, INC.

INVITES INQUIRIES FROM ELECTRONIC ENGINEERS INTERESTED IN JOINING A MODERATE SIZED RESEARCH AND DEVELOPMENT ORGANIZATION OPERATED BY SCIENTISTS FOR SCIENTISTS.

IF YOU ARE INTERESTED IN A FUTURE LIMITED ONLY BY YOUR OWN ABILITY, PLEASE CONTACT

Robert Smyth  
Technical Operations, Inc.

6 Schouler Court  
Arlington 74, Mass.

**TO BE SPECIFIC...**

ABOUT OPPORTUNITIES  
IN ELECTRONICS WITH

**GENERAL  ELECTRIC**

**ENGINEERS • PHYSICISTS**

GE has instituted a new service to aid engineers in making a career choice. Just fill out and mail the coupon below. GE will send you information on openings in your specific field of interest, and the location of these openings.

Every engineer seriously interested in the electronics field should consider what a GE career can mean: the broad scope, the varied opportunities, the exceptional chances for professional achievement. There are personal advantages too: stability, benefits, educational and advancement opportunities.

Bachelor's or advanced degrees in Electrical or Mechanical Engineering, Physics, and experience in electronics industry necessary.

If your professional goals are high, send the coupon below, to learn how and where you can begin your GE career.  
*(Or send complete resume, if you wish.)*

**TO: GENERAL ELECTRIC**

Electronics Park, Syracuse, New York  
ATTN.: Dept. 2-6-E, Technical Personnel

**FROM:** Name \_\_\_\_\_

Address \_\_\_\_\_

Degree \_\_\_\_\_

**I am interested in**

- Advanced development
- Design
- Field Service
- Technical Writing
- Sales

**In the field of:**

- Military Radar, Sonar, or Communication
- Electronic Components
- Commercial Television
- Tubes
- Semiconductors

# Electronics Engineers

expanding helicopter  
field offers you  
excellent opportunities

Both Junior and Senior electronics engineers are needed to work with those who design, test, and build rotary wing aircraft.

Challenging positions are open to men with experience or a good educational background in:

- Radar
- Flight Test Instrumentation
- Strain Gage Circuitry
- Oscillographic Data Recording Systems
- Vibration and Temperature Measuring Systems
- Work on Automatic Control Systems—  
both test and development
- Automatic Pilot and Blind Flying Instrumentation

Not only will your professional achievements be recognized, but you and your family will enjoy many personal benefits.

Apply in person or send complete resume to  
R. L. Auten, Personnel Department

## SIKORSKY AIRCRAFT

Bridgeport 1,

Connecticut

### PERSONNEL MANAGERS

# Looking for Engineers . . . Technicians?



Write  
for free  
copy of

## “RESERVOIR of ENGINEERS and TECHNICAL MEN”

The engineers and technicians you want to reach are gathered in convenient, compact groups—as this 12-page booklet points out.

It keys the job titles these men hold to the McGraw-Hill publications they read for on-the-job information. It explains how you can make contact . . . channel, concentrate your employment advertising to just the men with the job qualifications you want . . . without wasting advertising money for higher-priced space in publications with general circulation, in which you pay for perhaps 999 unqualified readers for every 1 who may meet your job requirements.

Write for your free copy to  
Classified Advertising Division  
McGraw-Hill Publishing Co., Inc.  
330 W. 42nd St., N. Y. 36, N. Y.

# WHITE-RODGERS ELECTRIC CO.

ARMAMENT  
ENGINEERING  
DIVISION  
NEEDS

## ENGINEERS

for

RESEARCH,  
DESIGN,  
DEVELOPMENT



of

MISSILE GUIDANCE SYSTEMS  
AUTOMATIC FLIGHT FORMATION  
SYSTEMS and ASSOCIATED COMPONENTS

To formulate dynamics and computer equations,  
and to design and develop experimentally  
electro-mechanical computers and instrument  
servo-mechanisms

SEND RESUME TO EMPLOYMENT MANAGER  
1201 CASS AVE. ST. LOUIS 6, MO.

# ENGINEERING MANAGER

## UNUSUAL OPPORTUNITY

We are organizing a new division to develop and apply industrial electronic process controls.

We require a progressive engineer to take charge of and build up an engineering department for this division. A knowledge of industrial plant operations and a substantial background in electronic circuits are required. The department will consist of field and laboratory personnel.

We are an established company, designing and manufacturing electronic measuring instruments and are planning an expansion into the industrial control field as an outgrowth of some of our instrument developments.

Apply in writing to the President and include information on your education and experience.

## BOONTON RADIO CORPORATION

**BOONTON, NEW JERSEY**

### RECEIVER ENGINEERS TRANSISTOR CIRCUIT ENGINEERS SUBMINIATURE EQUIPMENT ENGINEERS

Career Opportunities  
With Well Established  
Central Connecticut Firm

Challenging Projects  
Top Salaries  
Suburban Living

Replies Held in Strict Confidence  
Wire or Phone Collect  
Personnel Mgr. SHerwood 7-2741

**THE ALLEN D. CARDWELL ELECTRONICS  
PRODUCTIONS CORPORATION**  
Plainville, Connecticut

### SALES ENGINEER WANTED TO MANAGE

New N. Y. C. Office of Prominent West  
Coast Mfr. of Regulated Power Supplies.  
All Replies Kept Confidential.

P-8887, Electronics  
1125 W. 6th St., Los Angeles 17, Calif.

## ENGINEERS and BUSINESS SCHOOL GRADUATES

For supervisory positions in direction of problem analysis, sales applications and maintenance of large scale computer systems. Immediate openings for men over 25 years of age with an Electrical Engineering degree, electronic experience and good sales aptitude, or with Master or Graduate level work in business administration.

Will provide a minimum of 18 weeks of advanced training in maintenance, operation, programming and problem analysis.

Send resume to Dept. F-2.

**Remington Rand Univac**

DIVISION OF SPERRY RAND CORPORATION  
1902 WEST MINNEHAHA AVENUE, SAINT PAUL W4, MINNESOTA

permanent assignments in the field of  
**MILITARY WEAPONS SYSTEMS**

Missiles      Reliability Studies      Fire Control  
Radar      Sonar      Underwater Ordnance

**REAL CAREER OPPORTUNITIES**

You'll enjoy the advantages of a small company atmosphere in the Silver Spring Laboratory . . . along with the stability of being part of the rapidly growing Vitro Corporation of America with 5 diversified operations throughout the United States

- Suburban Location in residential community adjacent to Washington, D. C.
- Plentiful housing — modern apartments, houses to rent or buy
- Advanced courses available at 4 major universities
- Cultural advantages of the nation's capital

Vitro has similar opportunities also available at West Orange, N. J. laboratory and Eglin Air Force Base, Florida.

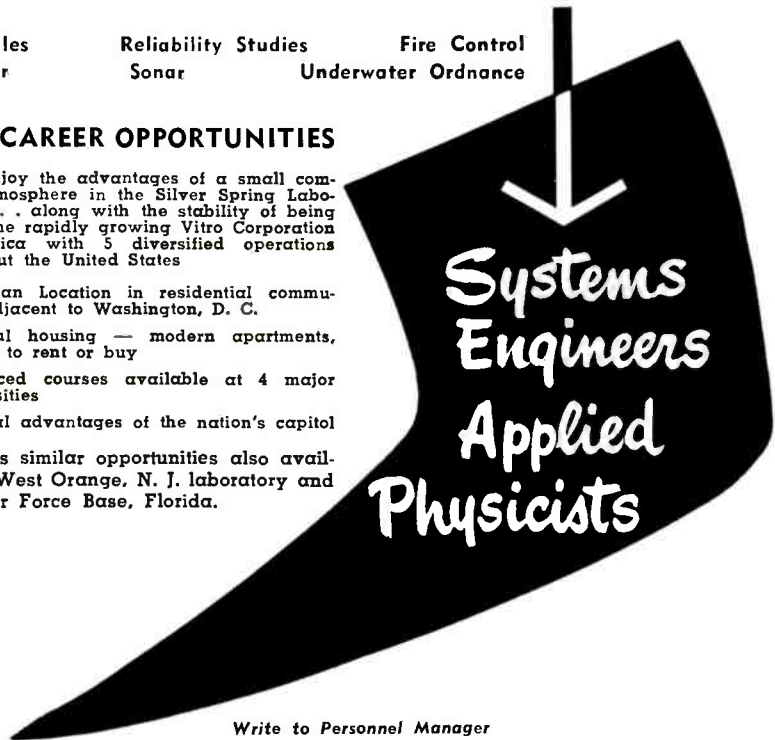

Write to Personnel Manager



**VITRO LABORATORIES**  
962 WAYNE AVE., SILVER SPRING, MD.

**ELECTRONIC ENGINEERS**

Experienced in design of electronic circuits, radio frequency, DC and video amplifiers, pulsers and IF amplifiers, electronic control circuits for gating and limiting, magnetic relays.

**PHYSICISTS**

Industrial or laboratory experience. Knowledge of wave motion in solids, sonar techniques, seismology, acoustics or ultrasonics.

**ULTRASONICS . . . . . Key to your future success**

Here is an industry which has just crossed a threshold of unlimited possibilities. Together with electronics, it is America's fastest growing industry, and Sperry Products, Inc. is a recognized leader in the field. To keep pace with expanding markets, Sperry has openings for engineers and physicists in its continuing development program.

Here are creative opportunities to develop new ultrasonic products and new applications for existing products with this long established company.

These are permanent positions with an organization that has always emphasized long term non-defense objectives. With Sperry Products, Inc. you gain outstanding company benefits, a high salary commensurate with your abilities, and relocation expenses to the charming Connecticut county of Fairfield. Please send complete resumes in confidence, to P. J. Olivo. Convenient interviews will be arranged.

**SPERRY PRODUCTS, INC.**

DANBURY, CONNECTICUT

**FOR RATES**

**OR INFORMATION**

About Classified Advertising

Contact

*The McGraw-Hill  
Office Nearest You.*

ATLANTA, 3  
1321 Rhodes-Heverty Bldg.  
WAlnut 5778  
W. D. LANIER

BOSTON, 16  
350 Park Square  
HUBard 2-7160  
P. McPHERSON

CHICAGO, 11  
530 No. Michigan Ave.  
MOhawk 4-5800  
W. HIGGENS

CLEVELAND, 15  
1510 Hanna Bldg.  
SUperior 1-7000  
C. J. LOUGHLIN

DALLAS, 2  
Adolphus Tower Bldg., Main  
& Akard Sts.  
PRespect 5064  
J. CASH

DETROIT, 26  
856 Penobscot Bldg.  
WOOdward 2-1793  
L. SEEGAR

LOS ANGELES, 17  
1111 Wilshire Blvd.  
MAdison 6-4323  
C. W. DYSINGER

NEW YORK, 36  
330 West 42 St.  
LONgacre 4-3000  
W. SULLIVAN  
D. COSTER  
R. LAWLESS

PHILADELPHIA, 3  
17th & Sansom St.  
RIttenhouse 6-0670  
E. MINGLE

ST. LOUIS, 8  
3615 Olive St.  
JEfferson 5-4867  
W. HIGGENS

SAN FRANCISCO, 4  
68 Post St.  
DOUglas 2-4600  
R. C. ALCORN

**GENERAL MOTORS**

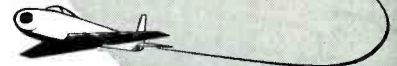

**ENGINEERS  
DESIGNERS  
NEEDED!**

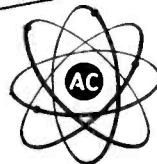

**G.M. ELECTRONICS DIVISION** offers challenging, pioneering opportunities to ambitious men. We extend a cordial invitation to every deserving Engineer and Designer to write us their wants. We may be able to supply the square hole for the square peg!

**CREATIVE OPPORTUNITIES** in the following fields: Missile Guidance Systems; Jet and Turbo Prop Engine Controls; Bombing and Navigational Computer Systems; Airborne Fire Control; U.H.F. Communications, MICROWAVE EQUIPMENT, etc.

**YOUR FUTURE** depends on your making the right connection with the right firm as quickly as possible. Why not send full facts about your education, work background, etc. We will do all we can for you and treat it with the full confidence.



**AC SPARK PLUG • THE ELECTRONICS DIVISION  
GENERAL MOTORS CORPORATION  
MILWAUKEE 2, WISCONSIN**

**physicist**

**COMMUNICATIONS  
THEORY**

A physicist familiar with generalized concepts of intelligence transmission for the laboratory of a large guided missile operation. Ph. D. required, plus some years' experience.

This is a long term opportunity, based on plans reaching far into the future. There are liberal benefits—excellent salary.

*Location: suburb of large city in the central Atlantic states*

Reply in confidence to:

P-8861, Electronics  
330 W. 42 St.  
New York 36, N. Y.

**LITCHFIELD PARK  
PHOENIX, ARIZONA**

*New Electronic Laboratory  
Now Being Staffed*

This modern laboratory is a key part of the larger well-established, and progressive AEROPHYSICS DEPARTMENTS at GOODYEAR AIRCRAFT CORPORATION in Akron, Ohio; a division of the world-wide GOODYEAR TIRE AND RUBBER COMPANY.

*Positions are open at all levels of experience in:*

**ELECTRONIC SYSTEM ANALYSIS  
MICROWAVE AND SERVOMECHANISMS  
AIRCRAFT INSTRUMENTATION  
RADAR**

Design of complete radar including receiver sections, wave guides, antennas, modulators, display circuitry

**TECHNICAL REPORT WRITING AND EDITING**

Long-range, interesting work. Inexpensive modern housing.

**WESTERN LIVING AT ITS BEST  
"IN THE VALLEY OF THE SUN"**

**GOOD YEAR AIRCRAFT**

Send resume to: MR. A. E. MANNING  
GOODYEAR AIRCRAFT CORPORATION, LITCHFIELD PARK, ARIZONA  
*Similar opportunities are open in our Akron, Ohio Plant*

# ENGINEERS

... the way to feel

## "ON TOP OF THE WORLD"

... to have long range, basic problems before you that call for your highest creative powers

... to work in an atmosphere notable for its broad, scientific outlook

... to know that your achievements will be acknowledged and rewarded by a liberal-minded management.

... and to have all this on a mind-freeing basis of permanence and stability! This, indeed, makes a creative engineer feel "on top of the world," and this he can have at GPL—research and development subsidiary of the General Precision Equipment Corporation.

Also, working at GPL means living in Westchester County, known for its beautiful countryside, spacious suburbs, and close proximity to all that New York City offers.

If you are experienced in microwave antennas, digital computers, circuits (microwave and audio frequencies), electro-mechanical development or any of the other fields mentioned below, please send details of your background to Mr. Hollis F. Ware. Expenses will be paid for qualified applicants who come for interview. We regret we can consider only U. S. citizens.

### GPL DOES RESEARCH & DEVELOPMENT WORK IN:

... Electronics ... Television, Motion Pictures ... Aircraft & Missile Control, Guidance ... Radar, Microwave ... Systems Engineering (aeronautical, industrial) ... Precision Mechanics ... Instruments, Servos, Controls (electro-mechanical, magnetic, electronic)

## GENERAL PRECISION LABORATORY INCORPORATED

A Subsidiary of General Precision Equipment Corporation

63 BEDFORD ROAD

PLEASANTVILLE, N. Y.

# ELECTRONIC DEVELOPMENT ENGINEERS

## Challenging DESIGN & DEVELOPMENT POSITIONS for CREATIVE ENGINEERS

These positions are tailor-made for highly imaginative engineers who enjoy problems of more than ordinary difficulty; problems that require a maximum of individual electronic creativity. Men selected will be entrusted with the complete electronic or electro-mechanical design and development tasks (initial circuits, systems, components, or product design) entailed in carrying a prototype project from original conception to its completion.

**REQUIREMENTS:** Senior and intermediate engineers with degrees and 4 to 8 years' experience; Junior engineers with degrees and 1 to 3 years' experience, capable of growing with our long-range, electronic design and development program in the following fields:

- |                          |                     |
|--------------------------|---------------------|
| (1) ANALOG COMPUTER      | (4) ELECTRO-OPTICS  |
| (2) RADAR BEACONS        | (5) MISSILE SYSTEMS |
| (3) MAGNETIC AMPLIFIERS  | (6) SERVOS          |
| (7) FIRE CONTROL SYSTEMS |                     |

### PROOF OF U. S. CITIZENSHIP REQUIRED

WE ARE LOCATED in a suburban area, at the Paramus exit of Garden State Pkwy., convenient to the N. J. Turnpike and only 15 minutes from Manhattan. If you choose, you can live nearby, avoiding the discomforts, costs and time wasted in commuting. Enjoy living in a clean, friendly community, minutes from work!

Interviews will be arranged at convenient locations. Send resume to:

## AVION DIVISION OF ACF INDUSTRIES INCORPORATED

Route 17, Paramus, N. J. COlfax 1-4100

Only 15 minutes from  
George Washington Bridge

# WHAT IS YOUR PROBLEM?

## PERSONNEL?

Do you need competent men for your staff? Do you need men to fill executive, sales or technical positions?

## EMPLOYMENT?

Are you one of the readers of **ELECTRONICS** seeking employment in any of the above capacities?

## BUSINESS OPPORTUNITIES?

Are you looking for or offering a business opportunity of special interest to men in the field served by this publication?

## EQUIPMENT?

Do you need equipment—Used or Surplus new? Do you have any to offer?

Read the Searchlight Section, and the "EMPLOYMENT OPPORTUNITIES" Section found in every issue of **ELECTRONICS** for the solution of these problems. Or bring your problem directly to the attention of other readers. You can get their attention—and action—at a relatively low cost by placing your ad in

# ELECTRONICS

330 West 42nd St., N. Y. 36

# ELECTRONIC ENGINEERS

*What Should  
an  
EE Know  
About  
Atomics?*

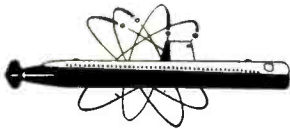

Quite a bit these days, with so many companies getting into the field. While many new firms are now starting to explore the field, Electric Boat Division of General Dynamics Corporation led the way with the building of the first nuclear powered submarines, Nautilus and Sea Wolf.

In addition to increasing its engineering force for work on new and greatly advanced nuclear submarines, Electric Boat is expanding Research and Development operations to include the development of additional practical uses for nuclear energy.

Right now Electric Boat has interesting positions for EE's versed in

servo-mechanisms, circuitry, motors and generators, radar & sonar, or electro-mechanical systems.

Study for bachelor's or advanced degrees is encouraged at Electric Boat, with courses in mathematics, naval architecture, nuclear engineering and nuclear submarine systems offered within the plant, and tuition paid by the company for study in these or other fields at leading colleges and universities.

Men interested in these openings should write complete details of background and experience including initial salary requirements. Interviews will be arranged promptly for qualified applicants. Address Mr. Peter Carpenter.

**Electric Boat Division**  
**GENERAL DYNAMICS CORPORATION**  
GROTON CONNECTICUT

*near New London on the Connecticut shore*

ENGINEER, M.E.

## ADVANCED DESIGN, RADAR ANTENNAS

A chance to use the latest techniques and methods in lightweight construction. You will direct new work in the field and can make original contributions in structural design and stress analysis involving advanced design.

Experience in radar antenna design plus additional study a "must." Training and experience should indicate ability to undertake leadership in study, application and use of latest techniques and methods.

Especially attractive working location in Berkshire mountains of Massachusetts plus advantages of proper atmosphere planned to assist creative thinking. Extensive company-paid benefit plans. Excellent salary commensurate with ability.

SEND REPLY TO:

P-8599, Electronics  
330 W. 42 St., New York 36, N. Y.

### At Your Service . . .

*These Classified Sections are at your service to bring business needs or "opportunities" to the attention of men in executive, management, sales and responsible technical, engineering and operating capacities with the industry served by this publication.*

IMMEDIATE  
OPENINGS

*As designers of America's finest aircraft instruments, Kollsman can provide excellent opportunity for professional growth. And the congenial atmosphere, the modern facilities contribute to an environment in which a man can do his best work.*

#### SYSTEMS ENGINEERS

For development, testing and field service of airborne navigational systems. Some experience with servos utilizing electronic and electro-mechanical components desirable.

#### ELECTRICAL ENGINEERS

Experience in small electro-mechanical devices, motors, synchros and induction pick-offs.

#### FIELD SERVICE ENGINEERS

For work associated with airborne navigational equipment. Should be versed in electronics circuitry and mechanical repairs. Entails some travel.

#### DESIGNERS

**Electronic, Electro-mechanical, Mechanical**

1. Electronic and electrical packaging. Knowledge of sub-miniaturized techniques. Work is associated with servos, amplifiers and components.
2. Mechanical or electro-mechanical packaging of precision flight instruments.

*Please submit resumes to the Employment Manager. Confidential interviews will be arranged.*



**kollsman** INSTRUMENT CORPORATION

80-08 45th AVENUE, ELMHURST, NEW YORK • SUBSIDIARY OF *Standard* COIL PRODUCTS CO. INC.

# EXCELLENT OPPORTUNITIES FOR ENGINEERS & SCIENTISTS

IN RESEARCH AND DEVELOPMENT OF INSTRUMENTS & EQUIPMENT

**QUALIFICATIONS:**

BS, MS or PhD degrees in mechanical, electrical, electronics and chemical engineering, physics and chemistry.

**A CAREER WITH A FUTURE:**

Permanent, responsible positions for qualified, creative men to develop, design and apply special instruments and equipment for our pilot plant and process operations.

**EMPLOYEE BENEFITS:**

Excellent working conditions, modern facilities, Retirement and Insurance Programs, Company Supplemented Savings Plan.

**GOOD LOCATION:**

Modern, medium sized Southwestern community. Pleasant surroundings with excellent family recreation, religious and educational facilities.

Reply by letter giving age, experience and other qualifications. All applications carefully considered and kept strictly confidential. Write:

Industrial Relations Manager  
 Research and Development Department  
**PHILLIPS PETROLEUM COMPANY**  
 Bartlesville, Oklahoma

## NOW! a practical engineering introduction to **COLOR TV**



Here is practical grounding in the complex techniques of color television for engineers and technicians already familiar with monochrome television. The book takes you from basic principles of color and color sensation, right through to the actual transmitters, studio equipment, and receivers reproducing a color show in the set-owner's home.

*Just Published!*

# COLOR TELEVISION Engineering

Color television is explained in simple and largely non-mathematical form. The block diagram approach is used extensively, and step-by-step derivations lead you gradually from familiar principles of monochrome television to the advanced techniques of color television. The book reviews the basic theory of color, and the problems involved in transforming color images into electrical signals, then back again into color images. Various electronic techniques used for processing, multiplexing, and transmitting color television signals are discussed in an orderly sequence.

**Covers these 4 main areas**

- ▶ Basic principles of color, color perception, and color measurement
- ▶ Principles of color reproduction, covering the application of colorimetry to color television
- ▶ Principles of color television transmission systems, including multiplexing techniques sequential color television systems
- ▶ Apparatus and circuits for color television, covering transmitters, receivers, and test equipment

Features approved, commercially important fundamentals

By John W. Wentworth  
 Manager, Television Terminal  
 Equipment Engineering,  
 Radio Corp. of America

488 pages, 6 x 9, 296 illustrations, \$8.00

**Contains these useful appendices**

- Standardized CIE Colorimetric Data
- Data for Color Mixture Curves for the FCC Primaries
- FCC Standards for Compatible Color
- Television Trigonometric Identities
- Mathematical Proof of the Two-Phase Modulation Technique

**READ THIS BOOK 10 DAYS FREE**

McGraw-Hill Book Co., Dept. LF-2A  
 327 West 41st St., NYC 36  
 Send me Wentworth's **PRINCIPLES OF COLOR TELEVISION ENGINEERING** for 10 days' examination on approval. In 10 days I will remit \$8.00, plus few cents for delivery costs, or return book postpaid. We pay delivery cost if you remit with this coupon; same examination and return privilege.  
**PRINT**  
 Name .....  
 Address .....  
 City ..... Zone ..... State .....  
 Company .....  
 Position .....  
 For price and terms outside U. S., write McGraw-Hill, Int'l., N. Y. C. LF-2A

## McGRAW-HILL MAILING LISTS WILL HELP YOU

- Merchandise your advertising
- Conduct Surveys
- Get leads for your salesmen
- Get inquiries about your product or service
- Pin-point geographical or functional groups
- Sell Direct
- Build up weak territories
- Aid Dealer Relations

Direct Mail is a necessary supplement to a well rounded Business Paper Advertising program.

600,00 actual names of the top buying influences in all the fields covered by the McGraw-Hill publications make up our 150 mailing lists. These lists are built and maintained primarily for our own use, but they are available to you for Direct Mail purposes. Pick out a list of YOUR prospect from our Industrial Direct Mail Catalogue.

More and more, progressive companies are using Industrial Direct Mail regularly as an advertising medium. They effectively allocate a portion of their concentrate on the best business publication.

For complete, detailed information about our service, fill in the coupon or write for your copy of our free Business and Industrial Direct Mail catalogue.

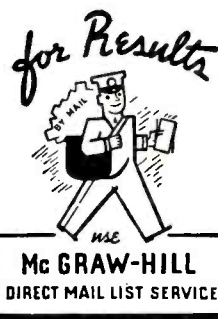

Direct Mail Division,  
 McGraw-Hill Publishing Co., Inc.  
 330 West 42nd St., N. Y. 36, N. Y.

Please forward my free copy of the McGraw-Hill "Industrial Direct Mail Catalogue."

Name .....  
 Company .....  
 Address .....  
 City ..... State .....



## Employment Opportunities ADVERTISERS INDEX

Admiral Corp.	400
Applied Science Corp. of America	422
Arma Division,	
American Bosch Arma Corp.	404, 406, 425
Assembly Products Inc.	406
Avion Division of ACF Industries Inc.	420
Autonetics, Div., of	
North American Aviation Inc.	425
Bendix Aviation Corp.,	
Pacific Div.	390
Products Div., Missile Section	401
Research Laboratories	417
York Div.	394
Boonton Radio Corp.	417, 426
Bristol Co., The	406
Burroughs Research Center	393
Cardwell Electronics Prod. Corp., Allen D.	417
Convair, A. Div. of General Dynamics Corp.,	
Pomona, Calif.	392
San Diego, Calif.	389
Cornell Aeronautical Laboratory	424
Decision Inc.	410
Drake Personnel Inc.	426
Electric Boat Div.,	
General Dynamics Corp.	421
Electronic Engineering Co. of Calif.	408
Erco Div., of ACF Industries	412
Fairchild Graphic Equipment Co.	402
Farnsworth Electronics Co.	404
Federal Telecommunications Labs.	413
General Electric Co.,	
Pittsfield, Mass.	412
Syracuse, N. Y.	415
General Motors Corp.,	
AC Spark Plug Electronics Div.	419
General Precision Lab.	420
Goodyear Aircraft Corp.	391, 419
Instruments for Industry Inc.	406
Johns Hopkins University,	
Chevy Chase, Md.	404
Silver Spring, Md.	409
Kollsman Instrument Corp.	421
Lincoln Labs.	396
Lockheed Aircraft Corp.	407
Maryland Electronic Mfg. Corp.	392
Melpar Inc.	423
Missile Test Project	409
Monarch Personnel	426
Motorola Inc.	394, 410
Mycalex Corp., of America	411
New York Transformer Co.	425
Page Communications Engineers Inc.	426
Pacific Semi Conductors Inc.	423
Phillips Petroleum Co.	422
Raytheon Mfg. Co.,	
Bedford, Mass.	390
Waltham, Mass.	403, 406, 411
Wayland, Mass.	397, 398
Republic Aviation Corp.	395
Remington Rand Univac, Div., of	
Sperry Rand Corp.	417
Sanders Assoc.	424
Sikorsky Aircraft	416
Sorensen & Co., Inc.	411
Snyder Co., Lee Grant	426
Sperry Products Inc.	418
Stavid Engineering Inc.	396
Stromberg-Carlson Co.,	
Div., of General Dynamics Corp.	402
Sylvania Electric Products Inc.,	
Buffalo, N. Y.	394
Mountain View, Calif.	408
Waltham, Mass.	394
Technical Operations	415
Texas Instrument Inc.	425
Tracerlab Inc.	411
Varian Assoc.	409
Vitro Laboratories	418
Westinghouse Electric Corp.	405
Westinghouse Electric Corp.,	
(Elmira, N. Y.)	414
White-Rodgers Electric Co.	416
Zenith Radio Corp.	399

This index is published as a convenience to the readers. Care is taken to make it accurate but CLASSIFIED assumes no responsibility for errors or omissions.

## ENGINEERS

Electronic      Mechanical

There's  
room to...

Currently we seek men  
with experience in one or  
more of the following:

- Network Theory
- Systems Evaluations
- Microwave Technique
- UHF, VHF, or SHF Receivers
- Analog Computers
- Magnetic Tape Handling
- Digital Computers
- Radar and Countermeasures
- Packaging Electronic Equipment
- Pulse Circuitry
- Microwave Filters
- Flight Simulators
- Servomechanisms
- Subminiaturization
- Electro-Mechanical Design
- Small Mechanisms
- Quality Control and Test Engineers

More and more these days you hear top engineers talk about the many growth opportunities at Melpar. With an increasing number of significant electronic projects, an enlarged staff and facilities, Melpar provides many opportunities for professional growth and advancement. Our new laboratory is an engineer's dream come true; a building conceived by and constructed for the ENGINEER - 265,000 sq. ft. of complete engineering facilities.

We are located in Fairfax County of northern Virginia where housing is reasonable and plentiful—whether you desire a private home or an apartment. Although we are in a truly suburban atmosphere, we are only 10 miles from the nation's capital with all its recreational and social advantages. Here you and your family can grow in an environment to match your professional growth.

Send resume to Technical Personnel Representative,

**melpar, inc.**

A subsidiary of the Westinghouse Air Brake Co.

3000 Arlington Blvd., Dept. E-26 Falls Church, Va.

11 Galen Street, Watertown, Mass. • 99 First St., Cambridge, Mass.

these can be  
the symbols for  
**YOUR FUTURE**

Pacific Semiconductors, Inc., has requirements for qualified Electrical Engineers, Mechanical Engineers, Physicists and Physical Chemists to expand its Research and Development and Manufacturing organizations. If you are interested in the future of semiconductor electronics and would like to join a young, dynamic organization engaged in the development, manufacture and sale of semiconductor devices of advanced design, you should investigate the available openings described below.

**Pilot Production Manager**... to direct operations of a multiple-product pilot line. Experience in assembly and fabrication of small components (e.g. resistors, capacitors, special tubes, etc.) desirable.

**Device Engineers**... with interest or experience in research, development or

engineering related to semiconductor devices.

**Applications Engineers**... with experience in development, circuit design and experimental work with audio, radio frequency, pulse or computer circuitry.

**Process Engineer**... recent graduate in E.E., Ch. E. or I.E. for assignment in process development and control.

See us... and our products... at the March I.R.E. Show in New York, where we can talk it over. Or write now to:

MR. J. C. ROSS, Industrial Relations Manager

**PACIFIC SEMICONDUCTORS, INC.**

10451 W. Jefferson Blvd., Culver City, Calif.



# ELECTRONIC ENGINEERS & PHYSICISTS

Significant and challenging programs in the fields of radar-aeronautical systems, electronics, and applied physics. The programs are categorized in a broad sense as follows:

- |   |  |
|---|--|
| <p><b>RADAR-AERONAUTICAL SYSTEMS</b></p>                        | <p>All-weather flight systems, radar control systems for airplanes and missiles, flight control computers, and specialized radar research.</p>                           |
| <p><b>ELECTRONICS AND AUTOMATIC COMPUTERS</b></p>               | <p>Communications and data processing systems, electronic computer techniques, flight simulators, with detailed electronic circuitry involved in these applications.</p> |
| <p><b>PHYSICAL &amp; ELECTRO-MECHANICAL INSTRUMENTATION</b></p> | <p>Vortex tub research, aircraft speed and vector measurement, electromechanical computers, linkages, and wind tunnel and flight instrumentation.</p>                    |

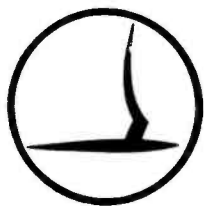

**CORNELL AERONAUTICAL LABORATORY, INC.**  
4466 Genesee St., Buffalo, New York

## ELECTRONIC ENGINEERS

**YOU CAN SHAPE THE FUTURE OF ELECTRONICS**

with Sanders Associates, Inc.

Sanders Associates, Inc. offers to Electronic Engineers the opportunity to build careers in the electronic world of tomorrow by creative engineering today. Our goal is to shape the future of the industry—not to follow in the footsteps of others. The impact of Sanders on the electronics industry in four short years has been the result of engineering performance... with such "firsts" to our credit as PANAR, tri-scan antenna, and "tri-plate" microwave plumbing.

In guidance systems, weapons systems, countermeasures, in system concepts, basic circuitry, techniques, component development, microwave antenna, electro-mechanical transducers—in every phase of the art, both military and commercial—Sanders needs ambitious, creative engineers who will move ahead, for the success of the company can only be measured in terms of the success of our people.

We would enjoy the opportunity of discussing with you your future at Sanders Associates, Inc. Drop a note to D. H. Johnson outlining your experience and we will advise you promptly. Interviews can be arranged either in Nashua or in your area.



NASHUA, NEW HAMPSHIRE  
Just one hour from downtown Boston

# INDEX TO THE SEARCHLIGHT SECTION ADVERTISERS

Allied Electronics Sales.....	436
Alltronics .....	438
Arrow Sales Inc.....	434
Barry Electronics Corp.....	435
Belevision Inc.....	436
Blan .....	438
C & H Sales Co.....	431
Communication Devices Co.....	436
Communications Equipment Co.....	433
Compass Electronics Supply Div., Compass Communications Corp.....	439
Cramer Electronics Inc.....	439
Electric Trading Co.....	430
Electroncraft Inc.....	432
Empire Electronics Co.....	434
Engineering Associates .....	437
Fair Radio Sales.....	434
Fay-Bill Distributing Co.....	437
Finnegan, H.....	438
Gould Green .....	438
Harjo Sales Co.....	437
Hodgson Co., R. W.....	438
Instrument Service Co.....	430
J & J Armature Works Inc.....	437
JSH Sales Co.....	429
Lectronic Research Labs.....	430
Legri S. Co., Inc.....	430
Liberty Electronics Inc.....	430
McNeal Electronic & Equipment Co.....	437
Mogull Co., A.....	432
Monmouth Radio Labs.....	432
M. R. Co., The.....	438
Radalab, Inc.....	434
Radio & Electronic Surplus.....	438
Red Arrow Electronic Sales Co.....	438
Relay Sales .....	436
Ruxur Electronics Corp.....	428
Sanett, Bob .....	438
"TAB" .....	410
Universal General Corp.....	428
U. S. Crystals Inc.....	437
V & H Electronic Industries.....	436, 437
V & H Radio & Electronics Supply ..	439
Western Engineers .....	427

This index is published as a convenience to the reader. Care is taken to make it accurate but Classified assumes no responsibility for errors or omissions.

come to the southwest . . . where living is easy!

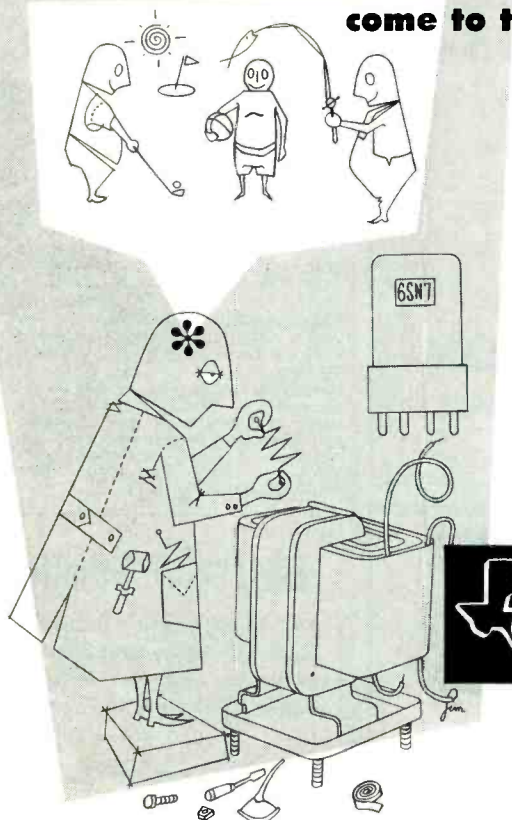

resistor . . . delay line . . . transformer

## DESIGN ENGINEERS

Your experience in electronic transformer, delay line, filter, or resistor design can lead to a rewarding career in the rapidly expanding Components Division of Texas Instruments . . . a planned growth company with 25 years of leadership in electronic and geophysical development and manufacture.

Enjoy 'ground floor' opportunity . . . long range stability . . . plus personnel advantages such as profit sharing, group insurance, retirement plans, and many others. If you qualify, we'd like for you to . . .

come and grow with us!

Write to: W. D. Coursey, Personnel Division

**TEXAS INSTRUMENTS**  
INCORPORATED  
6000 LEMMON AVENUE DALLAS 9, TEXAS

\*All these things are possible in the Sunny Southwest where the climate is pleasant and so are the people!

### ENGINEER M. E. or E. E. DIGITAL COMPUTER DEVELOPMENT

Excellent opportunity to join an expanding, stable company, with an outstanding position in the precision electronic control industry.

Opening now available for an engineer able to assume responsibility for the development of complete systems for fire control and guidance, or major portions of such systems. Work will include research and development in the field of complex analog or digital computers.

A degree in electrical or mechanical engineering is required or the equivalent in experience. Send resume in confidence to:

Technical Personnel Dept. 2-500

#### ARMA

Division American Bosch Arma Corp.  
Roosevelt Field, Garden City  
Long Island, N. Y.

### ELECTRICAL ENGINEER

Opportunity for young engineer in research and development department of expanding transformer manufacturing company. Experience in transformer design helpful but not necessary. Contact:

Personnel Department

NEW YORK TRANSFORMER CO.  
3rd Ave. Alpha, N. J.

## Experienced Electronics Writers...

Immediate Openings at AUTONETICS

For writers who can prepare trouble analyses, check-out and line-maintenance procedures for service handbooks on electronics equipment. Practical experience desired in laboratory or field work in radar, computers, receivers and transmitters.

Please write immediately to:

D. S. Grant

Engineering Personnel Office, Dept. 991-20,  
12214 Lakewood Boulevard, Downey, California

**Autonetics** 

A DIVISION OF NORTH AMERICAN AVIATION, INC.

BRC would like to talk with you about  
a position for a

## SENIOR ENGINEER, ELECTRONIC INSTRUMENTS

Call or write

W. C. Moore, Engineering Manager

### BOONTON RADIO CORPORATION

D Eerfield 4-3200

Boonton, N. J.

REPLIES (Box No.): Address to office nearest you  
NEW YORK: 330 W. 42nd St. (36)  
CHICAGO: 520 N. Michigan Ave. (11)  
SAN FRANCISCO: 68 Post St. (4)  
LOS ANGELES: 1125 W. 6th St. (17)

#### POSITIONS VACANT

**Recording Engineer, young man, some experience** in operation of mixers, tape & disc recorders, editing & splicing etc. Allegro Recording Service 1650 B'way, New York 19.

**Wanted—electronics specialist to establish** technical school here. Have bldgs., housing. L. Perry, Brier Hill 7, Pa.

#### SELLING OPPORTUNITIES WANTED

**Man'fr's reps selling components to electronic** mfrs. 50 mile radius N. Y. C. seeking additional lines. RA-8771, Electronics.

**Established Metropolitan New York salesman** seeks component lines for manufacturers and industrials. Please reply to RA-8897, Electronics.

**Personnel Managers—Need experienced Engineers** and Technicians? We offer a booklet especially prepared to help you solve this "Reservoir of Engineers and Technical Men." Searchlight Dept.—Electronics, 330 W. 42 problem. Write for your "free" copy of St., New York 36, N. Y.

## EMPLOYMENT OPPORTUNITIES

The Advertisements in this section include all employment opportunities—executive, management, technical, selling, office, skilled, manual, etc.

— RATES —

#### DISPLAYED

The advertising rate is \$21.50 per inch for all advertising appearing on other than a contract basis. Contract rates quoted on request.

An advertising inch is measured 7/8" vertically on a column — 3 columns — 30 inches to a page.

Subject to Agency Commission.

#### UNDISPLAYED

\$2.10 per line, minimum 3 lines. To figure advance payment count 5 average words as a line.

Box Numbers—counts as 1 line.

Discount of 10% if full payment is made in advance for 4 consecutive insertions. Not subject to Agency Commission.

Send **NEW ADS** to **ELECTRONICS**,  
330 W. 42nd St., N. Y. 36, N. Y.  
for April issue closing March 2nd

## YOUR ORGANIZATION

Is it complete?

Are you expanding it?

Making Replacements?

Naturally, you are anxious to secure the most suitable man or men available. You want men with the special training that will make them an asset to your organization. You can contact such men through an advertisement in the Employment Opportunities Section of **ELECTRONICS**.

Classified Advertising Division—

## ELECTRONICS

330 W. 42nd St., New York 36, N. Y.

## COMMUNICATIONS ENGINEERS and TECHNICIANS

EXCELLENT SALARIES  
MINIMUM PREREQUISITES

### ENGINEER TECHNICIAN

EE Graduates with 3 years experience  
2 years technical school in communications and 3 years experience.

Require installation adjustment and maintenance experience with communication receivers and associated terminal equipment. Also, men with similar experience with high-powered transmitters, antennas, transmission lines.

Must be willing to travel in United States and Overseas.

Page Communication Engineers, Inc.  
710 Fourteenth St., N.W., Washington 5, D.C.

## DRAKE PERSONNEL

National Placement Center for  
EXECUTIVE AND  
TECHNICAL PERSONNEL

General and Plant Managers  
Plant Superintendents—Foremen  
Accounting—Staff Personnel  
Engineers: Design—Production  
Sales Managers—Engineers

Please outline briefly your  
experience or personnel needs to:

John Cope

220 S. State St., Chicago 4, Ill.  
Harrison 7-8600

#### REPRESENTATIVES WANTED

Top West Coast Mfr., electronic and mag-amp regulated dc power supplies, seeks sales engineer reps. Quality instruments, advanced custom designs; long list of prestige clients. Open areas Northwest, Rocky Mtn., Minnesota, Chicago, Western Pa., portions of the South, Texas. State full qualifications in response.

RW-8760, Electronics  
1111 Wilshire Blvd., Los Angeles 17, Calif.

#### STAFF ASSISTANT TO MANAGER OF DEVELOPMENT ENGINEERING

Some administrative experience or potential desirable. Direct engineers and scientists on long range research and development. This work entirely divorced from immediate production problems. Adequate budgets and laboratory facilities. Company pays all fees and expenses plus starting salary of \$15,000.

#### MONARCH PERSONNEL

28 E. Jackson Blvd. Chicago 4, Ill.

## MANUFACTURERS REPRESENTATIVE

Engineer desires repeat and expendable electronic and electro-mechanical products for sale to Guided Missile and Aircraft Companies located in Southern California. Reply to:

LEE GRANT SNYDER COMPANY  
Technical Sales & Contract Administrators  
1418 N. Highland Ave. Hollywood 28, Calif.  
Phone Hollywood 9-6278

## MANUFACTURERS REPRESENTATIVE

SALES ENGINEER, BME, calling on industrials—will represent mechanical & electronic products—special or off shelf components, hardware, wire, etc. For North N.J., N.Y.C. and L.I. Seeking progressive principals that offer sales co-operation in addition to proven line.

RA-8900, Electronics  
330 W. 42 St., New York 36, N. Y.

## WANTED

## SALES ENGINEER

with a BS in Electronic Engineering or its equivalent in practical experience to work as applications engineer for leading manufacturer of electronic component parts in the Boston area. Must be capable of working in field and at home office with company representatives and engineering personnel. Short time travelling required. Up to \$10,000.00. Age 25-40. Reply in detail and be prepared to complete a talent survey at our expense. Write

P-8895, Electronics

330 W. 42 St., New York 36, N. Y.

# SPECIAL PURPOSE TUBES

OA2..... \$ .70	2K55..... 5.00	EL-C6L..... 3.75	RK-69..... 2.00	304TH..... 7.50	802..... 2.25	1623..... 2.00
OA3..... .90	2P21 (image orthicon)..... 35.00	EL-6C..... 8.00	RK-72..... .50	304TL..... 15.00	GL-803..... 2.00	1624..... .95
OA4G..... .90	2V3G..... 1.25	6AC7W..... .75	RK-73..... .50	WE-305A..... 2.85	803..... 1.40	1625..... .30
OA5..... 4.00	2X2..... .35	6AJ5..... 1.15	HY-75..... 3.00	CE-306..... 7.50	804..... 9.00	1630..... .40
OB2..... .65	2X2A..... .85	6AJ6..... 2.00	RK-75..... .85	307A..... .85	805..... 4.00	1631..... 1.40
OB3..... .75	3A4..... .50	WE-6AK5..... 1.35	VR-75..... .90	CE-309..... 2.75	806..... 5.00	1635..... 1.50
OC3..... .70	3A5..... .50	6AK5W..... 1.20	75TL..... 5.50	WE-310A..... 3.50	807..... 1.15	1636..... .85
OD3..... .65	3AP1..... 2.00	6AL5W..... .60	VR-78..... .50	WE-311A..... 5.00	807W..... 3.00	1641..... 1.35
EL-C1B..... 1.50	3B21..... 5.00	6AN5..... 2.75	FG-81A..... 5.00	WE-313C..... 2.85	808..... 1.00	1642..... .40
XFG1..... 2.00	3B23..... 3.50	6AR6..... 1.25	VR-90..... .75	316A..... .50	809..... 2.25	1649..... 1.00
1AF4..... 2.50	3B24..... .95	6AS6..... 1.25	FG-95..... 17.50	WE-323A..... 7.50	810..... 10.00	1654..... 3.50
1AG5..... 2.00	3B24W..... 5.00	6AS6W..... 1.50	VT-98BR..... 12.50	3233..... 4.50	811..... 2.65	1656..... 6.50
1B22..... 1.35	3B25..... 3.00	6ASTG..... 2.35	HF-100..... 7.50	WE-328A..... 3.50	811A..... 3.50	1661..... 6.00
1B23..... 2.75	3B26..... 2.85	6BM6..... 20.00	100R..... 5.00	WE-331A..... 7.50	812..... 2.25	1846..... 50.00
1B24..... 5.00	3B27..... 3.00	6C21..... 17.50	100TH..... 6.00	WE-337A..... 10.00	RCA-813..... 12.50	1851..... 1.75
1B27..... 10.00	3B28..... 5.00	6G4..... 2.00	WE-102D..... 2.50	WE-339A..... 10.00	814..... 1.75	1904..... 9.00
1B32..... 1.00	3B28..... 5.00	6J4..... 2.00	VR-105..... .70	WE-347A..... 3.00	815..... 1.45	1960..... .50
1B35..... 4.50	3BP1..... 2.00	6J6W..... 1.25	VU-111S..... 1.00	WE-349A..... 6.00	816..... 1.25	1984..... 10.00
1B36..... 3.75	EL-3C..... 5.00	6L6WGB..... 3.25	HY-114B..... .75	WE-350A..... 3.00	892..... 10.00	9000T..... 175.00
1B38..... 25.00	EL-3CJ..... 8.50	6SC7GT..... 2.00	WE-121A..... 3.50	350B..... 2.25	896..... .65	9050..... .95
1B40..... 2.00	CE-23..... 3.50	6SN7WGT..... 1.50	WE-122A..... 1.50	WE-352A..... 15.00	898..... 9.50	9051..... .75
1B42..... 4.00	3C24..... 2.35	6SU7GT..... 2.00	F-123A..... 2.00	F-353A..... 2.00	899..... 5.85	9172..... 10.00
1B47..... 7.50	3C31..... 1.50	7BP7..... 5.00	WE-123A..... 5.00	WE-353A..... 3.50	899B..... 8.50	9183..... 5.00
1B59..... 10.00	3C33..... 9.50	7CP1..... 12.50	WE-124A..... 3.75	WE-354A..... 14.00	830B..... .75	ZB-3900..... 72.50
1C21..... 2.00	3C37..... 10.00	7EP4..... 10.00	VT-127A..... 2.00	WE-355A..... 15.00	832..... 3.50	R-4100..... 5.75
1P23..... 2.00	3C45..... 5.85	9GP7..... 5.00	F-128A..... 10.00	WE-356B..... 7.50	832A..... 5.00	R-4330..... 8.50
1P24..... 5.00	3D21A..... 5.00	9LP7..... 3.50	HF-130..... .90	WE-368A..... 2.00	833A..... 30.00	5598..... 3.75
1P28..... 7.00	3D22..... 9.75	9MP7..... 7.50	VR-150..... .65	WE-368AS..... 2.50	834..... 4.75	5550..... 25.00
1P29..... 1.50	3DP1..... 3.00	10Y..... .25	FG-154..... 15.00	371A..... 1.00	835..... 4.85	5551..... 35.00
1P30..... 1.50	3E29..... 8.50	CE-11V..... 2.25	HK-154..... 5.00	371B..... 1.50	836..... 1.50	5553..... 100.00
1P32..... 1.00	3EP1..... 2.00	19A6..... .50	FG-166..... 15.00	WE-388A..... 1.50	837..... .95	5556..... 6.75
1P34..... 1.75	3FP7..... 2.00	19DP7A..... 25.00	FG-172..... 20.00	WE-393A..... 5.00	GL-838..... 2.00	5557..... 2.75
1P36..... 2.35	3FPA..... 3.35	19GP7..... 17.50	QK-181..... 20.00	394A..... 1.85	838..... .75	5560..... 17.50
CE-2C..... 1.50	3GP1..... 2.00	19J5WGT..... 1.50	FG-190..... 7.50	WE-394A..... 2.85	842..... 1.85	5610..... 1.00
VG-2..... 7.50	3HP7..... 3.00	19K8Y..... .50	HF-200..... 9.50	WE-396A..... 3.00	843..... .35	5632..... 8.50
2A4G..... 1.15	3J21..... 50.00	19L8GT..... .75	CE-201..... 2.75	WE-404A..... 10.00	845..... 5.00	5634..... 6.50
2AP1..... 4.00	3J31..... 35.00	LM-15..... 50.00	CE-203..... 3.50	410R..... 100.00	845W..... 8.50	5637..... 5.00
2AP1A..... 5.00	3K27..... 125.00	NE-16..... .30	903A..... 9.50	WE-417A..... 10.00	849..... 18.50	5640..... 8.50
2AS15..... 3.75	3KP1..... 6.00	FG-17..... 2.75	903Z..... 5.00	WL-417A..... 2.85	851..... 9.75	5644..... 7.50
2B21..... .90	3RP1..... 7.25	RK-19..... .85	904A..... 25.00	WE-418A..... 12.50	860..... 2.85	5645..... 6.50
2B26..... 1.25	3X2500A3..... 125.00	RK-20A..... 7.50	WE-905B..... 7.50	WE-421A..... 7.50	861..... 25.00	5650..... 85.00
2C21..... .40	4A00A..... 40.00	TZ-20..... 1.75	907..... 35.00	GL-434A..... 10.00	865..... .35	5651..... 1.25
2C22..... .35	4AP10..... 3.75	CE-21C..... 2.00	911..... .50	446A..... .45	866A..... 1.00	5654..... 1.20
2C24..... .75	4B22..... 6.50	RK-21..... .85	WE-911C..... 10.00	446B..... 1.75	866JR..... 1.25	5656..... 6.50
2C25..... .35	4B23..... 5.50	RK-22..... 3.50	WE-911D..... 8.00	451..... 5.00	868..... 2.00	5667..... 1.50
2C26A..... .40	4B24..... 5.00	CE-23C..... 1.40	WE-912E..... 25.00	WL-460..... 8.50	869B..... 30.00	5670..... 2.50
2C33..... .70	4B25..... 8.00	PJ-23..... 2.00	917A..... 1.00	464A..... 2.15	GL-872A..... 2.50	5687..... 4.50
2C34..... .35	4B26..... 3.00	RK-23..... 2.50	917C..... 2.00	WL-468..... 12.50	CE-872A..... 1.50	5696..... 1.00
2C38..... 7.50	4B27..... 2.25	HK-24..... 2.85	WL-918..... 15.00	RH-507..... 20.00	872A..... 1.30	5703..... 1.00
2C39..... 5.00	4B28..... 3.00	HK-24G..... 2.00	CE-280..... .50	CK-510AX..... .50	874..... .50	5720..... 15.00
2C39A..... 10.00	4B30..... 7.50	CE-25A/B..... 1.50	921A..... 8.00	WL-530..... 25.00	876..... .75	5725..... 1.50
2C40..... 10.00	4B31..... 30.00	RK-25..... 2.25	921A..... 2.00	WL-531..... 7.50	878..... .50	5726..... .60
2C42..... 10.00	4B32..... 10.00	25E6WG..... 4.00	CE-284..... 5.00	WL-532A..... 1.00	879..... .35	5727..... 1.40
2C43..... 7.50	4C22..... 7.50	25T..... 2.85	CE-285..... 3.00	GL-546..... 2.00	884..... .95	5728..... 9.00
2C44..... .35	4C25..... 3.00	25TG..... 2.50	CE-286..... 3.00	559..... .45	885..... .95	5740..... 44.00
2C46..... 6.00	4C27..... 5.00	CE-28D..... 2.50	WE-921D..... 9.00	GL-575A..... 10.00	889A..... 75.00	5763..... 1.00
WE-9C51..... 3.00	4C35..... 15.00	RK-28..... 2.50	235CH..... 100.00	WL-579B..... 10.00	902P1..... 2.00	5801..... 2.50
2C53..... 10.00	4E27..... 8.00	28D7..... .75	RX-23A..... .70	631-P1..... 5.75	905..... 2.00	5803..... 7.50
2D21..... .65	4J34..... 35.00	23D7W..... 1.50	CE-235A..... 5.00	WL-632A..... 17.50	913..... 20.00	5819..... 25.00
2D21W..... 1.40	4J52..... 50.00	CE-29..... 1.25	WE-248A..... 5.00	WL-655/658..... 100.00	917..... 2.25	5827..... 2.50
2E22..... 2.00	4X100A..... 18.50	CE-30C..... 1.25	WE-248C..... 8.00	WL-670A..... 8.00	918..... 1.85	5829..... 1.00
2E24..... 1.95	EL-C5B..... 1.00	Twin 30..... 7.50	WE-248D..... 7.50	WL-681/686..... 25.00	920..... 2.00	5842..... 10.00
2E25..... 1.35	EL-5BHD..... 5.00	HY-30Z..... 2.65	WE-249C..... 2.50	WE-701A..... 2.50	921..... 1.00	5847..... 10.00
2E26..... 3.25	EL-5B2.5..... 6.50	CE-31V..... 2.00	250R..... 4.75	702A..... .35	922..... 1.20	5915..... 1.00
2E29..... 1.00	5AP1..... 3.00	FG-32..... 6.00	250TH..... 17.50	702B..... .75	923..... 1.40	5932..... 4.00
2E36..... 1.25	5B21..... 2.00	FG-33..... 15.00	250TI..... 14.50	703A..... 1.50	924..... 1.35	5933..... 3.00
2E41..... 2.00	5BP1..... 2.00	RK-33..... .50	250TI..... 14.50	WE-704A..... .75	925..... 2.00	5948..... 250.00
2J21A..... 2.75	5BP1A..... 7.50	VX-33A..... 2.50	WE-251A..... 45.00	705A..... .75	926..... 2.50	5963..... 1.25
2J26..... 4.75	5BP2A..... 4.75	RK-34..... .35	WE-252A..... 9.50	706A/GY..... 12.50	927..... .95	5981/5650..... 85.00
2J27..... 4.75	5BP4..... 2.00	35T..... 4.00	WE-253A..... 3.50	707A..... 3.00	928..... 2.50	5998..... 7.50
2J29..... 15.00	5C21..... 7.50	35TG..... 3.00	WE-254A..... 4.75	707B..... 4.35	929..... 1.25	6031..... 4.75
2J30..... 15.00	5C22..... 25.00	RK-38..... 6.50	HK-257B..... 8.50	WE-708A..... 7.00	930..... 1.25	6097..... .65
2J31..... 12.50	5C30..... 1.00	RK-39..... 1.50	WE-257A..... 3.50	WE-709A..... 1.00	931A..... 3.00	6130..... 5.85
2J32..... 10.00	5CP1..... 2.00	T-40..... 2.35	FG-258A..... 100.00	713A..... .35	SN-948..... 7.50	6187..... 1.50
2J33..... 12.50	5CP1A..... 8.50	TZ-40..... 3.50	WE-261A..... 10.00	714A..... 10.00	954..... .30	6188..... 2.00
2J34..... 12.50	5CP7..... 8.50	VX-41..... 2.50	WE-262B..... 7.00	715A..... 2.00	955..... .35	R-6210..... 15.00
2J36..... 12.50	5D21..... 5.50	CE-42C..... 1.50	WE-264C..... 3.00	715C..... 3.75	956..... .35	UL-6653..... .75
2J37..... 5.00	5D23..... 7.00	RK-44..... 1.00	WE-267B..... 7.50	715D..... 11.85	957..... .35	8001..... 8.00
2J38..... 10.00	5FP7..... 1.35	QK-47..... 50.00	WE-268A..... 7.50	WE717A..... 1.00	958A..... 1.35	8002R..... 15.00
2J39..... 10.00	5FP4..... 5.00	RK-47..... 1.75	FG-271..... 25.00	717A..... .35	959..... 1.45	8005..... 4.75
2J40..... 15.00	5GP1..... 5.00	CE-48..... 1.75	WE-272A..... 5.00	WE-719A..... 9.50	972A..... 3.50	8008..... 6.00
2J50..... 35.00	5J29..... 7.50	RK-49..... 2.85	WE-274A..... 3.00	780A/EY..... 45.00	991..... .30	8011..... .75
2J51..... 100.00	5J30..... 5.00	HY-51B..... .75	WE-274B..... .90	781A..... .75	1000T..... 100.00	8012..... 1.00
2J52..... 50.00	5J32..... 15.00	FP-54..... 44.00	274B..... .35	781B..... 7.25	CK-1005..... .25	8012A..... 2.50
2J53..... 25.00	5J31..... 12.50	HK-54..... 2.00	WE-275A..... 5.00	782A..... 2.50	CK-1006..... 2.50	8013..... 2.75
2J54..... 50.00	5J32..... 6.75	T-55..... 3.50	WE-276A..... 7.50	783A/B..... 9.00	CK-1007..... .65	8013A..... 3.50
2J55..... 50.00	5J34..... 6.75	RK-57..... 4.50	276A..... 2.50	WE-784A..... .85	CK-1009..... 3.50	8016..... 2.50
2J56..... 75.00	5J35A..... 6.75	RK-58..... .90	WE-282A..... 7.00	WE-784B..... .85	CK-1026..... 3.00	8020..... 1.50
2J61..... 15.00	5JP11..... 9.00	QK-59..... 25.00	WE-283A..... 4.00	WE-785A..... 3.00	R-1100..... 5.00	8021..... .75
2J62..... 7.50	5LP1..... 6.50	QK-60..... 25.00	WE-285A..... 5.00	WE-786A..... 5.00	R-1130B..... 10.00	8022..... .75
2JB51..... .35	5LP1A..... 20.00	RK-60..... 1.35	WE-286A..... 5.50	WE-786B..... 25.00	1500T..... 115.00	8025..... 1.50
2K25..... 12.50	5NP1..... 2.50	HY-61..... 1.25	287A..... 2.50	WE-786C..... 20.00	1603..... 3.00	8025A..... 2.00
2K28..... 33.00	5R4GY..... .85	QK-61..... 25.00	WE-295A..... 5.00	WE-730A..... 7.50	1608..... 3.75	8026..... 3.50
2K30..... 100.00	5R4WGY..... 2.25	RK-61..... 2.75	WE-296A..... 25.00	WE-732A..... 2.00	1611..... 1.50	PD-8365..... 50.00
2K33A..... 50.00	5X3..... 3.00	QK-62..... 25.00	HF-300..... 15.00	WL-735A..... 9.00	1612..... 1.25	9001..... .85
2K34..... 85.00	5X3P1..... 75.00	RK-62..... 1.75	WE-300B..... 4.50	WL-741..... 1.40	1613..... 1.00	9002..... .60
2K41..... 85.00	5Z9P7..... 50.00	RK-63..... 18.50	CE-302..... 3.00	WL-759..... 12.50	1614..... 1.50	9003..... .90
2K45..... 40.00	5Z4P11..... 100.00	HY-65..... 1.35	EL-302.5..... 5.00	WL-786..... 15.00	1616..... .50	9004..... .35
2K47..... 120.00	EL-C6A..... 6.00	RK-65..... 7.00	CE-303..... 2.25	800..... 1.50	1619..... .30	9005..... 1.40
2K54..... 7.50	EL-C6J..... 6.25	FG-67..... 9.00	WE-304B..... 7.50	801A..... .35	1622..... 1.50	9006..... 2.25

The prices quoted above are FOB shipping point

**western engineers**

ELK GROVE, CALIFORNIA  
GEORGE WHITING, OWNER

All tubes are new individually cartoned, fully guaranteed

THE LARGEST STOCK OF RELAYS IN THE WORLD!

**RELAYS**



**MINIATURE RELAYS**

Automatic Electric Sales, Class S

Twin Code 0, 20 ga Contacts

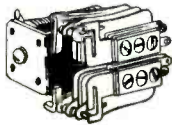

Volts D. C.	Ohms	Contacts†	Stock No.	Price Each
24	300	3A	R340	1.25
24	300	4A	R342	1.25
24	300	5A, 1B	R343	1.35
24	640	1C, 1B	R640	1.25
2.5 ma	10000	1C, 1A	R1132	2.00
8 ma	5000	5A	R1133	2.00
24	600	1C	R318	1.15
24	600	2A	R319	1.15
24	600	1A, 1C	R336	1.25
24	600	1A, 1B, 1C	R337	1.35

**Clare Type K**

24	300	1A	R344	1.00
24	300	2C	R331	1.25
24	300	1C	R345	1.15
24	17	1A	R339	1.00
3-5	30	2C	R1134	1.25
6	30	2C	R1135	1.50
48	1300	2C	R1136	1.50
24	250	1B, 2C	R1137	1.50
24			R1137	.80

Coil and Frame actuator only (No contacts).

**Allied Type TSL**

24	300	1A	R346	1.00
24	300	1C	R347	1.00
24	300	2C	R348	1.15
12	150	1A	R338	1.00

**Allied Type SK**

24	300	1C	R349	1.00
24	300	2C	R67	1.15
24	425	4C	R525	2.25

**Allied Type STK**

24	300	1A	R350	1.00
24	300	1C	R330	1.00
24	300	2A, 1C	R403	1.25

**Allied Type F & Price 1150**

6-12	120	1A	R394	1.00
12	100	2A, 1C	R395	1.25
8 ma	3000	1A	R916	1.25

**Advance Type 1504 & 1604**

24 AC	45	2A	R334	1.00
3	14.5	2C	R650	2.00
12	450	1H	R396	1.50
12	450	2A	R397	1.50

**Cook & RBM**

24	250	3A	R317	1.25
24	500	2C	R918	1.50
10 ma	6500	4A	R802	2.00

**Anti-Capacity Types**

6	40	1A	R31	1.25
12-32	500	1A	R106	.90
24	300	1C	R134	1.50
24	300	2C	R351	1.50

**Price Type 1050**

7 ma	2800	2C	R1016	2.00
5 ma	6500	2C	R1017	2.25

**Automatic Electric Mfg. Co.**

12	200	2C	R921	1.50
6	50	2C	R922	1.50

**Miscellaneous Types**

Mfg'r. & No.	Volts	Ohms	Contacts	Stock No.	Price Each
Kurman	24	1500	1C	R1139	1.00
Leach P3	12	325	1C	R1140	.80
Leach P3 Series	.02	1C		R1141	.80
G.E. G110F2	24	300	2C	R919	1.25
Price TB302	24	300	2A, 1C	R404	1.35

SEND FOR LATEST CIRCULAR. TERMS:—All Prices F.O.B. Our Plant. Rated Firms Net 10 Days; All Others Remittance with Order. Orders Under \$10.00 Remittance with Order. Plus Approximate Shipping Charges (Overage Will Be Returned). Cable address: UNIGENCOR, N. Y.

**IMMEDIATE DELIVERY PRODUCTION QUANTITIES**

**LATEST SUBMINIATURE TYPES**

ALLIED 50G MH-12; MIL-R-5757A; 24-29 VDC; 4PDT; 300 ohm; Herm. Sealed; Solder Lug Header; 2.9 oz; Operate time 8 millsec; 1 1/16" dia. X 1 5/16" H; #R1138 5.50 ea.



STRUTHERS DUNN; Same as Allied above but 6PDT; 300 ohm; Herm. Sealed; Solder Lug Header; 4.2 oz; 1 3/16" dia. X 1 5/16" H; #R1145 6.00 ea.

**STEVENS-ARNOLD Resonant RELAYS**

TYPE 182; Freq. 289 cyc; 500 ohms; SPST (1A); Sealed. Octal Plug Base; #R1146 5.00



TYPE 189; Freq. 240 cyc; 350 ohms; SPST (1A); Sealed. Octal Plug Base; #R1147 5.00



**ARC 3 & ARC 5 RELAYS**



55251 (K403, K405) Telechron; 24VDC; SPST; n.o. (1A); 300 ohm; #R754 1.25

55340 (K203) Price; 24VDC; SPST n.o. (1A); 300 ohm; #170 1.25

55342 (K206, K213) Telechron; 24VDC; (2A's); (1C); 300 ohm; Anti-Capacity Arms; Low Loss Bakelite Insulation; #R171 1.50

55476 (K101) Clare; 12-24VDC; Co-Axial Antenna Relay; SPDT (1C); 275 ohms; #R751 8.50

55526 (K109, K116) Cook; 24VDC; (1A, 1C); 300 ohm; Ceramic Insulation; #R107 1.25

55528 (K107) G. E.; 12VDC; 6PST n.o. (6A's); 150 ohm; #R426 2.00

55585 (K103) G. E.; 12-24VDC; Sealed Plug-in-Relay; SPDT (1C); 2500 ohm; #R419 4.00

55836 (K406) G. E.; 24VDC; SPDT; 250 ohm; #R402 1.50

23012-0 RBM; 24 VDC; SPDT; 250 ohms; #R172 1.25

6385 ARC; 12-24VDC; SPST n.o. (1A), 10 Amp Contacts; 200 ohm; #R213 2.00

7251 ARC; 24VDC; SPDT; (1C); 300 ohm; #R406 1.25

7252 ARC; 24VDC; DPST n.o. (2A); 300 ohm; #R354 1.25

7735 ARC; 24VDC; Antenna Relay; SPDT (1C); 200 ohm; #R799 2.50

†A=SPST, normally open; B=SPST, normally closed; C=SPDT; H=SPST, double make.

**Bargains in Brand New Surplus**

★ Starred Items Available in Production Quantities at Special Prices

These are only a few of our specials; write us your requirements

**OIL FILLED CAPACITORS**

VOLTS	MFD	Price	VOLTS	MFD	Price
25KV	1.0	★43.85	1000	28.0	5.50
25KV	0.5	★39.85	1000	2.0	.69
25KV	0.1	14.95	1000	0.5	.19
7.5KV	0.5	4.25	600	10.	1.29
6KV	0.25	1.09	600	8	1.19
3KV	0.5	1.59	600	4	★.69
3KV	0.1	★1.19	600	2	★.39
2.5KV	2.0	★2.95	600	1	★.19
2K1	.50	2.95	660AC	5	2.95
2KV	.25	.89	330AC	5	1.29

**SPECIAL SWITCHES**



SW 141 ( ) DPST normally open with or without lock-in position on push button, part of CD-318 cord set suitable for 115 V. AC

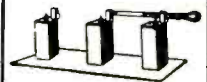

SW 224 SPDT Antenna change switch Square D Cat. No. 9320-962 SC #32K-9503 - 20 Bakelite Base 2x8x1/4

SPECIAL ★.19¢

★.49¢

Sensitive MU-Switch 15A. 125 V. AC 15/32-32 threaded bushing. SPDT—69¢

**MULTIPLE SECTION OIL CAPACITORS**

10 Mid 400 volts	9 1/2 Mid 600 volts
★59¢	★59¢
Dual 5 mid 3 term. bottom mount. Meets specs for 600 V operation at 40°C.	8 Section 2-2-2-1-1-.5-.5-5 Rated by Western Electric at —50 to +85C will pass 1000 V. test at 40°C 4 3/4x4 3/4x1 1/2

**Molded, Upright and Ceramic-Cased Mica Capacitors**

01 4LS	600WV	CM45B103J	.32
02 4LST	600WV	CM50B203G	★.45
001 A2L	2500WV	Thickness 7/16"	.49
0036 A2	2500WV	CM60F362J	★.69
0068 F2	3000WV		★.99
00015 Type 59	10,000WV	3Amp @ 1MC	★5.95
0002 Type 50	10,000WV	1.6Amp @ 1NC	★5.95

**PULSE NETWORK SPECIAL \$2.95**

Sprague 15-1-400-50 15 Kv 1.0 usec 400 P.P.S. 50 Ohm Z

Variable Transmitting Capacitor: 19 to 116mmfd 27 plates, .085" air gap. O/a dim. 4 3/4x3 1/2x2 1/4 SC# 3D 9019V-1 P/o Tuning Units TU-7A & TU-79 ★98¢

General Electric Type IRT 3 phase induction voltage regulator. 1.64 KVA. Filled with nine gal. oil. Primary 208 volts. Brand new, limited quantity. Special \$90.00

**OCTAL SOCKETS \$5.00 C**

Johnson 122-128 steatite sockets; Amphenol 49-558, steatite ring mounting; Amphenol ceramic and mica filled 1-5/16 and 1/2 mounting centers.

**R** Amperite 6NO-110 time delay relay, octal tube base 6V Heater, normally open. Contacts rated 3A .....★.99¢  
**E** Allied BO 13D35 SPST Double break normally open 24V DC. Coil Silver contacts each rated 15 Amp @ 24V DC or 115V AC .....★.98¢  
**L** Autelco Jr Type 16 115V AC coil DPDT Snap Action contacts rated 15 Amp 115V, 5 Amp 230V ..... 2.95  
**A** Cook #773 Standard Telephone Relay 900 ohm DC coil double arm 14 contacts 11A-1B-1C-1D 4"Lx1 1/2"Wx 2 1/2"H .....★1.09  
**S**

**COAXIAL CABLE & CONNECTORS**

RG 9 B/U	★15.00 C. FT
PL 259 Plug	★29¢
M 359 Angle Adapter	★23¢

Power Rheostat famous make Model J 3000 Ohm 50 Watts .....★.79¢  
 Potentiometer JLU 2000 Ohm 2w with lock nut .....★.44¢

ALL PRICES F.O.B. OUR WAREHOUSE  
 TERMS: Net 10 days to firms rated well in D.B. Others deposit or cash with order balance C.O.D. Please include postage.

**RUXUR ELECTRONICS CORP**  
 623 HUDSON ST., NEW YORK 14  
 WAtkins 4-7260

324 CANAL ST., N.Y.C., 13, N.Y. Walker 5-9642  
**Universal general corp.**

**SAVE ON TUBES BRAND NEW TUBES GUARANTEED TUBES**

OA2 .75	2J42 .60	4J50 .99	50.00	FG166 .15	371B .50	800 .15	ZB3200 .75
OA3 .90	2J48 .35	4J52 .50	50.00	FG172 .20	WE388A .12	801A .50	5517A .17
OB2 .75	2J49 .40	4X150A .22	50.00	HF-200 .10	WE393A .45	802 .25	5551 .25
OB2WA 3.00	2J50 .35	4X500A .55	50.00	WL200 .75	WE394A .30	803 .14	5553/655 .90
OC3/VR105 .75	2J51 .15	5BP2A .50	5.00	CE-203 .37	WE396A .30	804 .97	5559/FG57 .10
OD3/VR105 .70	2J55 .35	5CP1A .95	5.00	203A .50	403B/5591 .27	805 .40	5561 .29
ELC1B .15	2J56 .50	5C22 .29	5.00	207 .50	GL414 .99	806 .75	5586 .12
1AD4 .12	2J61 .15	5C30/C5B .15	5.00	211/VT4C .50	417A .27	807 .12	5591/403B .27
1B23 .27	2J62A .50	5CP7A .10	5.00	212E .15	434A .30	807W .30	5611 .75
1B24 .55	2K22 .14	5D23 .75	5.00	217A .15	446A .50	808 .12	5634 .70
1B24A .12	2K25 .12	5J2 .70	5.00	217C .20	446B .20	809 .22	5636 .22
1B26 .12	2K26 .45	5JP2 .70	5.00	WL218 .19	WL456 .59	811 .27	5637 .50
1B27 .10	2K28 .28	5JP5 .70	5.00	RX233A .75	464A .22	813 .11	5651 .14
1B35 .45	2K33 .10	5JP11A .95	5.00	FG235A .25	527 .22	814 .17	5654 .15
1B36 .40	2K33A .65	5J23 .20	5.00	QK249 .15	ML531 .40	815 .15	5656 .70
1B40 .20	2K34 .99	5J30 .50	5.00	WE249B .25	559 .50	816 .15	5657 .12
1B42 .40	2K35 .19	5J33 .50	5.00	WE249C .30	KU610 .35	826 .75	5663 .15
1B51 .67	2K39 .10	5MP1 .39	5.00	250TL .15	HY615 .50	829 .60	5667 .12
1B62 .40	2K41 .10	5NP1 .50	5.00	WE251A .47	KU627 .10	829B .85	5670 .15
1B63A .22	2K42 .12	5R4GY .90	5.00	WE252A .10	KU628 .10	830B .75	5678 .30
1N21 .75	2K43 .11	5R4WGY .22	5.00	QK253 .14	648P1 .75	832 .40	5691 .47
1N21B .12	2K45 .45	C6J .65	5.00	WE254A .50	WL652 .20	832A .60	5692 .50
1N23 .75	2K46 .20	6AJ5-JAN .12	5.00	FG258A .90	HK654 .25	836 .15	5693 .47
1N23B .15	2K47 .11	6AK5W .12	5.00	271A .10	681/686 .25	838 .75	5696 .10
1N23BM .35	2K48 .80	6AL5W .65	5.00	WE274B .10	WE701A .18	842 .20	5702 .17
1N25 .40	2K50 .12	6AR6 .12	5.00			845 .50	5709WA .60
1N26 .40	2K54 .90	6AS6 .12	5.00			849 .22	5703 .11
1N28 .50	2K56 .50	6AS7G .25	5.00			851 .10	5703WA .60
1N31 .40	2V3G .13	6BL6 .35	5.00			852 .40	5718 .30
1N34A .50	2X2A .10	6BM6 .25	5.00			860 .30	5719 .25
1N35 .15	3AP1 .29	6D21 .150	5.00			861 .15	5726 .60
1N42 .80	3BP1 .20	6F4 .32	5.00			872A .13	5727 .20
1N47 .30	3B24 .10	6J4 .25	5.00			874 .60	5744 .19
1N63/K63 .17	3B24W .50	6K4 .22	5.00			878 .50	5750 .31
1N69 .40	3B26 .30	6Q5G .39	5.00			884 .10	5751 .15
1P21 .25	3B28 .50	6L6WGB .32	5.00			GL889 .50	5763 .11
1P22 .65	3B29 .55	6SK7W .20	5.00			GL889A .65	5767 .49
1P28 .75	3C22 .60	6SN7W .20	5.00			889A .85	5814 .10
1P36 .25	3C23 .50	6SU7GT .22	5.00			902A .30	5814A .20
1W5 .10	3C27 .10	6X4W .10	5.00			902P1 .30	5819 .25
1Z2 .20	3C31 .15	6X5WGT .13	5.00			917 .25	5825 .79
2AP1 .40	3C33 .80	7C22 .50	5.00			919 .20	5829 .10
2C26A .50	3C45 .60	7C24 .90	5.00			927 .10	5837 .70
2C33 .75	3DP11A .75	NE16 .35	5.00			931A .25	5844 .30
2C35 .25	3D21A .40	RK21 .10	5.00			889A .85	5851 .40
2C37 .25	3DP1S2 .50	RX21 .40	5.00			935 .40	5899 .40
2C39 .70	3E29 .85	HK24 .30	5.00			954 .35	5901 .65
2C39A .80	3FP7A .35	D42 .40	5.00			955 .35	5905 .89
2C40 .10	3GP1 .19	HK54 .20	5.00			956 .35	5908 .79
2C42 .10	3J30 .35	QK59 .30	5.00			957 .35	5910 .45
2C43 .70	3J31 .45	QK60 .25	5.00			958A .35	5912 .40
2C44 .50	3K22 .15	RK60/1641 .13	5.00			959 .15	5932 .40
2C46 .60	3K23 .15	RK61 .29	5.00			991 .35	5933/807W .40
2C51 .30	3K30 .10	QK61 .25	5.00			CK1005 .35	5998 .15
2C52 .30	4B23 .60	QK62 .25	5.00			CK1006 .27	6005 .17
2C53 .10	4B31 .22	HY65 .15	5.00			CK1007 .75	CK6050 .20
2D21 .60	4C27 .35	RK65/5D23 .75	5.00			1603 .30	6096/CT .22
2D21W .13	4C28 .25	RKR72 .50	5.00			1620 .32	6100/6C4WA .22
2E26 .32	4C35 .13	RKR73 .50	5.00			1623 .22	6147 .30
2E27 .75	4E27 .87	ML-100 .50	5.00			1624 .10	6177 .49
2E32 .10	4J22 .35	100TH .65	5.00			1625 .30	8005 .49
2J31 .14	4J28 .35	FG105 .11	5.00			1626 .25	8012 .10
2J32 .12	4J29 .35	F123A .29	5.00			1636 .90	8025A .20
2J33 .14	4J31 .65	F128A .15	5.00			1641 .13	9001 .85
2J34 .14	4J34 .50	FG154 .15	5.00			1642 .50	9002 .65
2J36 .15	4J42 .25	VT158 .97	5.00			1645 .65	9004 .85
						2050 .10	9005 .15
						2051 .65	9006 .25
							9903/5894 .20

**SPECIAL!**  
**5" DUAL GUN TUBE**  
 Long persistency face, P7 screen, Value at \$200.00. This tube has been rejected for military use.  
 Tested Before Shipped & Fully Guaranteed. Only **\$17.95**  
  
**VACUUM CAPACITORS**  
 6 mmfd. 30 KV..... 9.00  
 50 mmfd. 32 KV..... 9.00  
 75 mmfd. 20 KV..... 12.50  
 Also Other Values!

**THIS IS ONLY A PARTIAL INVENTORY. CHECK WITH US FOR YOUR REQUIREMENTS**

Thousands of other types in stock. Send us your requirements. RECEIVING TUBES! We Carry a complete line in stock. Standard brands only.

**Jsh**  
 SALES CO.  
**ELECTRONICS**  
 Dept. E-Y  
 1100 Venice Blvd  
 Los Angeles 15  
 California

All prices F.O.B. Los Angeles, subject to change without notice. Minimum order \$5.00. Check with us for items not listed.

NEW YORK'S RADIO TUBE EXCHANGE

NEW TUBES

Standard brands. First grade only. No pull outs. No rejects. No rebrands. At lowest prices.

Type	Price	Type	Price	Type	Price	Type	Price	Type	Price	Type	Price	Type	Price
OA2	51.00	2T31	36.00	3E29	15.50	12AP4	50.00	357A	15.00	726C	45.00	958A	.60
OA3	1.10	2F36	90.00	3GT1	5.00	12DP7A	45.00	368AS	4.95	730A	22.50	959	2.25
OB2	.99	2I38	8.95	3J21	75.00	LM15	200.00	371B	1.50	750TL	45.00	E1148	.25
OB3	1.10	2I39	8.59	4B26	5.40	15E	1.75	385A	4.50	801A	.90	1280	.95
OC	.96	2I40	29.00	4C27	10.00	15R	.75	388A	1.80	802	3.95	1500T	135.00
OD3	.89	2I42	135.00	4C28	35.00	NE16	.59	393A	7.50	803	5.95	11K1554	75.00
G1B	2.95	2I49	60.00	4E27	16.00	20A	.75	394A	3.95	805	6.95	1603	5.00
1B22	1.50	2J50	55.00	4J25	50.00	KV21A	8.25	MX108U	1.50	807	1.25	1612	1.50
1B23	6.95	2J55	150.00	4J26	50.00	HK21	2.50	417A	15.00	808	1.95	1613	1.25
1B24	9.00	2J56	110.00	4J27	50.00	RX21	8.00	434A	15.00	809	2.95	1616	1.25
1B26	1.75	2J61	20.00	4J28	50.00	KH21G	1.95	416A	1.95	810	10.50	1619	.45
1B27	15.00	2J61A	25.00	4J29	50.00	25T	2.95	416B	3.95	811A	3.75	1622	1.50
1B38	35.00	2J62	15.00	4J30	30.00	35T	4.95	450TL	45.00	812A	3.95	1624	1.75
1B50	23.00	2K22	29.00	4J31	150.00	35TG	5.95	450TH	52.50	813	3.75	1625	.35
1B51	7.50	2K23	15.00	4J32	150.00	HK39	2.75	464A	7.50	814	3.75	1626	.25
1B56	35.00	2K25	19.50	4J33	150.00	HF5	1.75	471A	1.25	815	3.25	1654	2.75
1B60	35.00	2K26	68.00	4J34	100.00	HK54	4.50	527	24.00	816	1.45	1851	1.80
1N21	.55	2K28	35.00	4J35	150.00	RK72	1.00	WL530	23.00	829	11.00	2000T	150.00
1N21A	.95	2K29	35.00	4J36	150.00	RK73	1.00	WL531	22.50	829A	12.00	2050	1.80
1N21B	1.50	2K33A	75.00	4J37	150.00	FG95	19.95	WL533	15.00	829B	12.50	2051	1.00
1N21C	12.50	2K39	180.00	4J38	150.00	100TH	7.95	HK654	35.00	830B	2.00		
1N22	6.95	2K41	135.00	4J39	150.00	FG105	20.00	700A/D	10.00	832A	9.95		
1N23	.90	2K42	180.00	4J40	150.00	122A	1.75	701A	4.50	833A	40.00		
1N23A	.90	2K43	195.00	4J41	150.00	203A	7.50	703A	3.95	834	7.50		
1N23B	1.50	2K44	195.00	4J42	190.00	211	.95	704A	1.95	836	3.95		
1N23C	7.50	2K45	80.00	4J51	150.00	217C	12.00	705A	2.75	837	2.75		
1N25	4.50	2K48	95.00	4J52	225.00	242C	10.90	706AY	.90	838	5.95		
1N26	6.75	2K50	295.00	4J53	225.00	244C	9.50	FY	25.00	849	35.00	5820	475.00
1N27	3.50	2K54	35.00	5BP1	3.95	219C	4.25	707A	5.75	857B	150.00	5826	450.00
1N34A	.79	2K55	25.00	5BP2A	12.00	250TH	19.95	707B	6.75	860	3.50	8012	2.00
1N38	1.00	2K56	72.00	5BP4	3.95	250TL	19.95	714AY	36.00	861	25.00	8012A	2.50
1N43	2.25	3AP1A	10.00	5CP1	7.50	252A	3.00	715A	4.50	866A	67.50	8013A	3.50
1P25	75.00	3BP1	7.20	5CP7	9.95	275B	1.00	715B	9.00	869BX	50.00	8019	1.75
2C39A	13.50	3P24	5.50	5CP7A	18.00	304TH	10.50	715C	15.00	872A	3.50	8020	1.85
2C40	12.00	3P25	5.50	5CP12	15.00	304TL	12.50	717A	1.50	874	2.25	8025	3.97
2C43	14.50	3P26	5.00	5D21	10.60	307A	2.50	719A	15.00	878	1.50	P13635	96.00
2C44	.60	3P28	8.00	5J11	27.50	310A	4.50	720AY	.90	879	1.50	9001	1.52
2C46	7.50	EL3C	5.50	5J12	19.50	310B	6.75	GY	5.00	881	1.50	9002	.90
2D29	.99	3C22	75.00	5J14	27.50	311A	6.50	721A	7.50	885	1.50	9003	1.25
2IA	12.00	3C24	3.75	5J23	25.00	312A	3.50	721B	7.50	902P1	6.75	9001	.35
2J22	9.60	3C31	2.95	5LP11A	25.00	323A	15.00	723A/B	18.00	931A	5.00	9005	2.75
2J26	15.00	3DP1	7.50	5SP7	96.00	327A	3.75	724A	1.95	954	.35	9006	.25
2J27	15.00	3DP1A	10.00	C6A	11.00	325A	6.75	724B	2.25	955	.50		
2J31	24.00	3DP1A	C6J	7.50	350A	4.50	725A	18.00	956	.75			
2J32	29.00	52	10.00	7BP7	5.00	350B	5.95	726A	10.00	957	.25		
2J33	32.00	3EP1	5.00	7DP4	9.00	HK354C	15.00	726B	45.00				

VARIOUS 5000 AND 6000 SERIES OF NEW PRODUCTION REPAIRED RESCALED RECALIBRATED

NEED METERS?

STANDARD or SPECIALS ANY QUANTITY — NEW — SURPLUS

FOR ELECTRONIC — MILITARY AIRCRAFT — HAMS

ALL MAKES — MODELS RANGES — SIZES

METERS

WRITE - PHONE - WIRE INSTRUMENT SERVICE

455 B. 67th St. Arverne, New York CAA No. 4264 Ltd. NE 4-8594

Special! TS45 X BAND GENERATOR — \$990

NEW UNUSED SURPLUS TS 259 K BAND 23400-24500 MEGACYCLES SIGNAL GENERATOR

SPECIAL! 5,000 V. POWER SUPPLY For IP25 Infrared Image Converter from 3 V. Battery Source. NEW, Complete with RCA 1654 Tube. \$990

NEW MICROWAVE TEST EQUIPMENT TS148/UP SPECTRUM ANALYZER TS147 SIGNAL GENERATOR

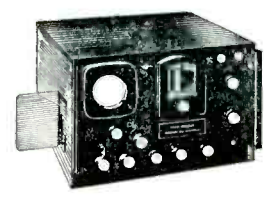

Field type X Band Spectrum Analyzer. Band 8430-9580 Megacycles. Will Check Frequency and Operation of various X Band equipment such as Radar Magnetrons, Klystrons, TR Boxes. It will also measure pulse width, c-w spectrum width and Q or resonant cavities. Will also check frequency of signal generators in the X band. Can also be used as frequency modulated Signal Generator etc. Available new complete with all accessories, in carrying case.

OTHER TEST EQUIPMENT USED CHECKED OUT, SURPLUS

TSK1/SE	T35/AP	TS108	TS226	SURPLUS EQUIP.
TS3A/AP	TS36/AP	TS110/AP	TS239A-TS239C	APA10
RF4/AP	1-96A	TS125/AP	TS251	APA38
TS12/AP	TS-45	TS126/AP	TS258	APS 3 APS 4
TS13/AP	TS47/APR	TS147	TS270	APR4
TS14/AP	TS69/AP	TS174/AP	TS418	APR5A
TS33/AP	TS100	TS175/AP	TF890/1	APT2-APTS
TS34/AP	TS102A/AP	TS182	834	

You Can Reach Us on TWXNY1-3235

Large quantities of quartz crystals mounted and unmounted. Crystal Holders: FT243, FT171B others. Quartz Crystal Comparators. North American Philips Fluorescopes Type 80. Large quantity of Polystyrene beaded coaxial cable. Minimum Order 25 Dollars



Phone: ORegon 4-7070 119 PRINCE ST. NEW YORK 12, N. Y. Cables: TELSERUP

POLYSTYRENE CAPACITORS

1% TOLERANCE 200 VDCW 500 VDCT Hermetically Sealed 0.5 MFD \$7.50 ea. 1.0 MFD \$12.10 ea. Immediate Delivery

SYNCHROS ALL TYPES IN STOCK Immediate Delivery

ELECTRONIC RESEARCH LABS. 715-19 Arch Street Phila. 6, Pa. Phone MA-7-6771

CENTRIFUGAL BLOWERS

Continuous Duty—110 V.—A.C.—60 Cycles BRAND NEW • TOP QUALITY • FULLY GUARANTEED



100 C.F.M. — 3" Diameter ROTOR Powered by shaded pole, 2 pole enclosed motor. Sturdy cast aluminum housing with attached flange on discharge. Approx. 3" inlet, 2"x2" outlet. No. BL100 Al. \$8.95 Available in DC 115 V. \$16.95

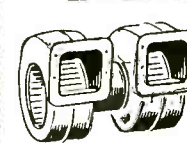

TWIN BLOWER — 520 C.F.M. — 5 1/2" DIAMETER ROTORS Redmond shaded pole four pole motor. 5" inlets and 3 1/2"x3 1/2" outlets. Discharge flanges shipped unmounted. No. BL520R \$22.50

ELECTRIC TRADING CO. 313-315 EL Canal St., New York 13, N. Y. Air Equipment Experience Since 1906

We Buy We Sell AB RESISTORS . . . Legri S Company 391 Riverside Ave. Yonkers 5, N. Y. Phone: Yonkers 9-6000



# ELECTRONIC

WAR TERMINATION INVENTORIES

WRITE OR WIRE FOR INFORMATION ON OUR COMPLETE LINE OF SURPLUS ELECTRONIC COMPONENTS. ALL PRICES NET F.O.B. PASADENA, CALIFORNIA

# C&H

SALES CO.

2176-E East Colorado St.  
Pasadena 8, California  
RYan 1-7393

## INVERTERS

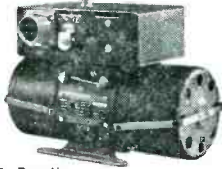

- 10042-1-A Bendix  
DC Input 14 volts; output: 115 volts; 400 cycles. 1-phase; 50 watt **\$35.00**
- 12116-2-A Bendix  
Output: 115 VAC; 400 cyc; single phase; 45 amp. Input: 24 VDC, 5 amps. **\$35.00**
- 12117 Bendix  
Output: 26 volts; 400 cycles, 6 volt amperes, 1 phase. Input: 24 VDC; 1 amp. **\$15.00**
- 12121 Bendix  
Input: 24 volt D.C. 18 amp. 12000 r.p.m. Output: 115 volts, 400 cycle, 3-phase, 250 volt amp, 7 pf. **\$49.50**
- 12123 Bendix  
Output: 115 V; 3-phase; 400 cycle; amps 5 Input: 24 VDC; 12 amp. **\$49.50**
- 12126-2-A Bendix  
Output: 26 volts; 3 phase; 400 cycle; 10 VA; .6 PF. Input: 27.5 volts DC: 1.25 amps. **\$24.50**
- 12130-3-B Bendix  
Output: 125.5 VAC; 1.5 amps. 400 cycles single phase, 141 VA. Input: 20-30 VDC. 18-12 amps. Voltage and frequency regulated. **\$49.50**
- 12133 Bendix  
Input: 26/29 volt D.C., 28 amps Output: 115 volt, 3 phase, 400 cycle, 250 volt amp., .8 pf. **\$59.00**
- 12143-2-A Bendix  
Output: 115 volts: 400 cycles; 250 VA; single phase pf. 9-1. DC Input: 26-29 VDC; 25-22 amp; voltage & frequency regulated **\$49.50**
- 778 Bendix  
Output: 115 volt, 400 cycle; 190 VA; single phase and 26 volt, 400 cycle, 60 VA, single phase. Input: 24 VDC. **\$37.50**
- 10285 Leland  
Output: 115 volts AC; 750 VA, 3 phase, 400 cycle, .90 pf and 26 volts. 50 VA, single phase, 400 cycle, .40 pf. Input: 27.5 VDC, 60 amps. cont. duty, 6000 rpm. Voltage and frequency regulated. **\$59.50**
- 10339 Leland  
Output: 115 volts; 190 VA; single phase; 400 cycle; .90 pf. and 26 volts; 60 VA; 400 cycle, .40 pf. Input: 27.5 volts DC, 18 amps. cont. duty, voltage and freq. regulated. **\$49.50**
- 10486 Leland  
Output: 115 VAC; 400 cycles; 3-phase; 175 VA; .80 pf. Input: 27.5 DC; 12.5 amps; cont. duty. **\$70.00**
- 10563 Leland  
Output: 115 VAC; 400 cycle; 3-phase; 115 VA; 75 pf. Input: 28.5 VDC; 12 amps. **\$35.00**
- PE109 Leland  
Output: 115 VAC, 400 cyc; single phase; 1.53 amp; 8000 rpm. Input: 13.5 VDC; 29 amp. **\$50.00**
- PE218 Leland  
Output: 115 VAC; single phase pf 90; 380/500 cycle; 1500 VA. Input: 25-28 VDC; 92 amps; 8000 rpm; Exc. Volts 27.5 BRAND NEW. **\$30.00**
- MG149F Holtzer-Cabot  
Output: 26 VAC @ 250 VA; 115 V. @ 500 VA; single phase; 400 cycle; Input: 24 VDC @ 36 amps. **\$40.00**
- MG153 Holtzer-Cabot  
Input: 24 VDC; 52 amps. Output: 115 volts — 400 cycles, 3-phase, 750 VA. Voltage and frequency regulated. **\$95.00**
- DMF2506M Continental Electric  
24-30 volts input; 5.5-45 amps; cont. duty. Output: 115 volts; .44 amps; 400 cyc; 1 phase; pf 1.0; 50 watts. **\$39.50**

## AEROGRAPH RECORDER



ML-320/AMQ-2; Mfg. Eclipse-Pioneer  
Used to record Pressure Millibars 200-1100; Temperature Centigrade —70° to 50°; Air Speed 70 to 300 MPH.; Relative Humidity 10 to 100%. CONTAINS: 4—Autosyns; 1—Servo Mtr.; 1—Vibrator Mtr.; 1—25Z6 Tube; many gears, relay, transformer, etc. Operation: 26 VAC 400 cycle; 2.5 amp. Approx. Dimensions: 20" long x 9 1/2" H x 5" Wide. Weight 16 lbs (approx.) A real buy at ..... **\$50.00**

## SELSYNS-SYNCHROS



- 1CT Cont. Trans. 90/55V 60 cy. **\$37.50**
- 1DG Diff. Gen. 90/90V 60 cy. **37.50**
- IF Syn. Mtr. 115/90V 60 cy. **37.50**
- 1G Gen. 115V 60 cy. **37.50**
- 1SF Syn. Mtr. 115/90V 400 cy. **\$12.50**
- 211F1 Gen. 115/57.5V 400 cy. **7.50**
- 211F3 Gen. 115/57.5V 400 cy. **10.00**
- 211FA1 Gen. 115/57.5V 400 cy. **7.50**
- 211G1 Cont. Trans. **5.00**
- 57.5/57.5V 400 cy. **7.50**
- 211H1 Diff. Gen. 57.5V 400 cy. **7.50**
- 215D1 Cont. Trans. 105/55V 60 cy. **17.50**
- 215F1 Cont. Trans. 105/55V 60 cy. **17.50**
- 215H1 Gen. 115/105V 60 cy. **17.50**
- 2115M1 Gen. 115/57.5V 400 cy. **34.50**
- 5CT Cont. Trans. 90/55V 60 cy. **34.50**
- 5D Diff. Mtr. 90/90V 60 cy. **34.50**
- 5DG Diff. Gen. 90/90V 60 cy. **34.50**
- 5F Syn. Mtr. 115/90VAC 60 cy. **34.50**
- 5G Syn. Gen. 115/90VAC 60 cy. **42.50**
- 5HCT Cont. Trans. 90/55V 60 cy. **42.50**
- 5SDG Diff. Gen. 90/90V 400 cy. **12.50**
- 6DG Diff. Gen. 90/90V 60 cy. **25.00**
- 6G Syn. Gen. 115/90VAC 60 cy. **34.50**
- 7G Syn. Gen. 115/90VAC 60 cy. **42.50**
- R110-2A Kearfott Cont. Mtr. 115V 400 cy. **17.50**
- R200-1-A Kearfott Cont. Trans. 26/11.8V 400 cy. **15.00**
- R210-1A Kearfott Trans. 26/11.8V 400 cy. **15.00**
- R235-1A Kearfott Resolver 26/11.8V 400 cy. **22.50**
- C56701 Type 11-4 Rep. 115V 60 cy. **20.00**
- C69405-2 Type 1-1 Transm. 115V 60 cy. **20.00**
- C69406 Syn. Transm. 115V 60 cy. **20.00**
- C69406-1 Type 11-2 Rep. 115V 60 cy. **20.00**
- C76166 Volt. Rec. 115V 60 cy. **10.00**
- C78248 Syn. Transm. 115V 60 cy. **12.50**
- C78249 Syn. Diff. 115V 60 cy. **5.00**
- C78863 Repeater 115V 60 cy. **7.50**
- C79331 Transm. Type 1-4 115V 60 cy. **20.00**
- 851 Bendix Autosyn Mtr. 32V 60 cy. **7.50**
- 403 Kollsman Autosyn Mtr. 32V 60 cy. **7.50**
- CK5 Bendix Mtr. 2 phase 26V 400 cy. **17.50**
- FPE-25-11 Diehl Servo Mtr. 75/115V 60 cy. **22.50**
- FPE-43-1 Resolver 400 cy. **25.00**
- FJE-43-9 Resolver 115V 400 cy. **25.00**
- 999-0411 Kollsman 26V 400 cy. **15.00**
- 1377-0410 Kollsman 26V 400 cy. **10.00**
- 1515B-0410 Kollsman 26V 400 cy. **20.00**
- 10047-2-A Bendix 26V 400 cy. **12.50**
- 2900 Transicoil 115V 400 cy. **15.00**

## ESTERLINE-ANGUS RECORDER



Model AW 0-1 MA

DC Milliammeter permanent magnet moving coil type. Spring clock dual speed drive (hour and minute). Instructions including connection diagrams and instrument data sheet with each instrument. Portable case ..... **\$200.00**

## RATE GYRO TYPE T-2004-3C-A MFG. KEARFOTT CO.



Gyro motor excitation 115V, 400 cy. 3 ph. Take off output: 26 VAC 400 cy. single phase. Rating 20°/sec. Approximate Diameter 3 3/4". Height 2 3/8". Weight 1 3/4 lbs. Hermetically sealed. Equipped with 28 VDC heater. Operates efficiently in range of —54°C to +71°C. Sensitivity .2250 volts/degree at 10K load. This is the famous Gyro used in many military units. Government cost over \$1700.00. New condition. Limited quantity @ ..... **\$150.00 ea.**

## HIGH CYCLE TRANSFORMERS

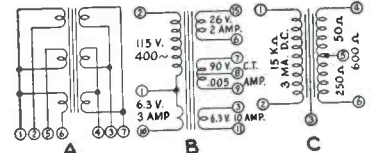

- A. **\$3.50**
- B. **\$3.00**
- C. **\$2.00**

## SMALL DC MOTORS



- (approx. size overall 3/4" x 1 1/4" dia.:
- 5069600 Delco PM 27.5 VDC 250 rpm **\$12.50**
  - 5069230 Delco PM 27.5 VDC 145 rpm **15.00**
  - 5068750 Delco 27.5 VDC 160 rpm w/brake **6.50**
  - 5068571 Delco PM 27.5 VDC 10,000 rpm (1x1x2") **5.00**
  - 5069625 Delco 27.5 VDC 120 rpm w/governor **15.00**
  - MM A-11 Globe PM 24 VDC **7.50**
  - 5BA10AJ18 GE 24 VDC 110 rpm **10.00**
  - 5BA10AJ37 GE 27 VDC 250 rpm reversible **10.00**
  - 5BA10AJ52 27 VDC 145 rpm reversible **12.50**
  - 806069 Oster series reversible 1/50 h.p. 10,000 rpm 27.5 VDC 1 5/8" x 3 1/2" **5.00**
  - C-28P-1A 27 VDC 1/100 h.p. 7,000 rpm **3.00**
  - 7100-B PM Hansen 24 VDC 160 rpm **7.50**
  - SSFD-6-1 Diehl PM 27.5 VDC 10,000 rpm **4.00**
  - 6-volt PM Mtr. mfgd. by Hansen 5,000 rpm 1 1/4" in dia. 2" long overall **4.00**

**SEARCHLIGHT SECTION**

**9 CONDUCTOR CABLE**



Army spec. CO-215 Weather-proof 9 C/107 No. 20 AWG stranded tinned copper, plastic ins., color coded, double vinyl jackets with tinned copper braid between Dia. 9/16" made by G.E. Available 1000, 1500, 2000 ft. reels. Price \$ .10 ft. Sample 100 ft. Coil. . . . \$10.00

**NEW SCR-522A EQUIPMENT**

Complete RC-624C receivers and BC-625AM Transmitters including mounting racks, plugs, connectors, dynamotor. Brand new equipment with instruction manuals. Write for full details.

**NEW REPAIR PARTS FOR BC-348**  
(Models H, K, L, R only)

- 4 gang tuning capacitor. . . . . \$ 3.95
- Aluminum front panel. . . . . \$ 3.75
- transformer assy. inc. 915 Kc. Crystal. . . . . Each \$ 2.00
- Crystal filter assy. inc. 915 Kc. Crystal. . . . . \$ 6.50
- C.W. Oscillator assembly. . . . . \$ 2.00
- R.F. Unit Assembly in can. . . . . \$12.50
- Dual Volume Control. . . . . \$ 2.75
- Spring tuning knob. . . . . \$ .50
- Ant., RF., Det. and Osc. coils for bands 1 to 6. Per Band. . . . . \$ 2.00

**RADAR ANTENNA ASSEMBLIES**

- SO-1 (10CM) assembly with reflector, waveguide nozzle and drive motor. . . . . \$279.50
- SO-3 (3CM) Surface Search type with reflector and drive motor, but less plumbing. . . . . \$99.50
- SO-13 (10CM) Complete assembly with 24" dish, dipole, drive motor and gearing. . . . . \$49.50
- ASD (CS-66ACN-1) Complete with dish, 24 volt drive mechanism, waveguide plumbing, etc. . . . . New \$39.50

**HIGH POT TRANSFORMER**

Westinghouse. Pri: 115, 60 cy. Sec: 15,000 V C.T. @ .060A. C.T. ungrounded. Excellent for high-potting tests. Size OA 12 1/2" x 8 1/2" W x 9 3/4" D. Weight 67 lbs. Fully enclosed steel case. . . . . \$29.50

**6 KVA. STEPDOWN TRANSFORMER**

G. E. Step-Down. 6KVA. Pri: 230/180. Sec: 115/125. 60 Cy. Size: 20" x 11" x 9 1/2". Weight 225 lbs. Navy grey finish, integral junction box and mounting brackets. . . . . \$49.50

**AMPLIDYNES**

- 5AM21J17. Input 27 VDC @ 15 A. Output 60 VDC @ 2.5A. 4600 RPM. New. . . . . \$34.50
- 5AM31N19A. Input 27 VDC @ 44 A. Output 60 VDC @ 8.8 A. 7500 RPM. New. . . . . \$23.50

**INVERTERS**

- Leland Elec. C. PE206A. Input: 28DC at 38 Amp. Output: 80V, 800 Cy. 1 Ph. 485W. New. . . . . \$16.50
- PE218H. Input: 28DC. Output: 115, 400 cy., 1 Ph. 1.5 KVA. New. . . . . \$32.50
- G. E. 5AS131111A. Input: 28DC. Output: 115, 400 cy., 1 Ph. 1.5 KVA. Regulated New. . . . . \$89.50

**DYNAMOTORS**

Navy type CA10-21144. Input: 105 to 130 VDC. Output: either 26 VDC at 20 amps, or 13 VDC at 40 amps. Radio filtered and complete with line switch. New. . . . . \$89.50

**SMALL DC MOTORS**

G. E. 5BA50L12A. Armature 60 VDC at 8.3 Amps. Field 27.5 VDC. at 2.3A. RPM. 400. 1/8 P. 0.5. New. . . . . \$27.50

**HI-VOLT OIL CAPACITORS SPECIAL!**

Mfd.	KV	Price
.001	50	22.95
.02	20	6.75
.025	50	17.95
.025/.025	50	34.50
1.175	4.5	2.50
.135	7.5	8.95
.2	50	29.50
.25	15	9.95
.25	20	15.95
.25	50	44.50
.25	25	39.50
1.	7.5	8.95
1.	15	29.50
1.	20	42.50
2.	5.5	9.50



1.02 mfd. 20,000 volts. 10 1/2 x 2 1/2 dia. in. A real value at only \$6.75

**TEST EQUIPMENT**

- FLUX-METER. Measures flux of magnetron magnets from 500 to 4000 gauss. New. . . . . \$14.95
- FREQ.-METER. TS-127-U. Range 375-725 Mcs. New with spare tubes and manual. . . . . \$34.50
- PANADAPTER. AN/APA-10. For 115v., 60 cy. New with 80 page tech manual. . . . . \$92.00
- 40-500 Mc TEST OSC. TS-47/APR. New. \$149.50
- RECEIVER. 158-210 Mc. BC-1068A. 60 cy. \$29.50
- RECEIVER. MX-24/APR-1. . . . . \$97.50
- PULSE TIMER. CUZ-50AGD. For 115/60.1. \$65.00
- OSCILLATOR 300-1800 Mc. AN/APM-5. New with cables, etc. Power supply. . . . . \$169.50
- OSCILLATOR 450-710 Mc. AN-APT-2. New. \$29.75
- MODULATOR BC-1203. For 115v., 60 cy. \$125.00
- MODULATOR BC-423B. Radiates 205Mc. pulsed sig. at 4.008 cps. New 60 cy. . . . . \$19.50
- PULSE ANALYZER. Airborne counter-measures model ID-59/APA-11. New. . . . . \$149.50
- FREQ.-METERS. LINK 230-D2. For testing nibble equip. One each 152.270-157.530, 152.390-157.650, 152.510-157.770, 152.630-157.890, 35.420-43.420 Mc. Price per set. . . . . \$49.50
- SIG GEN. 1-222A. 115-200 Mc. 8-15 Mc. . . . . \$89.50
- 20-250 Mc. FREQ.-METER TS-174. . . . . P.O.R.

Phone: DEerfield 7-0044

**ELECTRONICRAFT**  
27 MILBURN ST. BRONXVILLE 8, N. Y.

**BRAND NEW GUARANTEED**  
SAVINGS FROM **70-85%**  
**POWER RHEOSTATS**



"Be Right with" Famous Make  
MODELS H-J-G-K-L-N-P-R

Ohm	Watt	Each	Ohm	Watt	Each	Ohm	Watt	Each	
150(L)	5.54	25	25	1.49	500	60	1.86		
150(L)	1.98	25	25(H)	1.86	500	75(G)	3.15		
100(K)	3.79	25	50	1.06	500	100(K)	3.55		
150(L)	5.34	25	75(G)	3.15	500	150(L)	1.03		
1	25	1.75	100(K)	3.25	500	150	4.25		
1	50	1.75	150(L)	3.00	300(N)	8.42			
1	50(J)	2.34	50	1.49	585	180(L)	3.05		
1.1	50	1.98	50	1.86	750	25	1.49		
2	25(H)	1.86	60	25	1.49	750	25(H)	1.86	
2	50(J)	2.10	75	25	1.49	780	100(K)	3.55	
2.5	150	4.45	75(H)	1.86	800	25	1.49		
3	100(K)	3.79	75(G)	3.15	1000	25(H)	2.10		
5	25	1.56	75	1.86	1000	50(J)	2.22		
5	50(J)	2.10	80	500(R)	1.18	1200	3.71		
5	100(K)	3.79	100	25	1.49	1200	300	6.95	
5	25	1.56	25(H)	1.86	1250	50(J)	2.22		
6	50(J)	2.10	25	1.49	1500	150(L)	5.62		
6	75(G)	3.15	100	100(L)	3.55	1500	25	1.66	
7	75(G)	3.15	100	150(L)	3.55	1500	25(H)	2.10	
7.5	25(H)	1.86	125	250(H)	3.15	1500	50(J)	2.22	
7.5	25(H)	1.86	125	250(H)	3.15	1500	50(J)	2.22	
8	25(H)	1.86	125	250(H)	3.15	1500	50(J)	2.22	
8	50(J)	2.10	175	25(H)	1.86	2000	25(H)	2.10	
8	50	1.86	175	500(R)	1.18	2000	25(H)	2.10	
8	25	1.49	180	25	1.49	1800	150(L)	5.62	
10	25(H)	1.86	200	25	1.49	2500	25	1.66	
10	100	1.86	200	25(H)	1.86	2500	50(J)	2.22	
10	10	1.86	200	150(L)	3.55	2500	150	5.62	
12	50	1.86	250	25	1.49	2500	500(R)	12.18	
12	400(R)	12.18	25	1.49	3000	25	1.66		
13	100(K)	3.55	50	1.86	3000	100(K)	3.79		
15	25	1.49	300	50(J)	2.10	3500	25	1.66	
15	25	1.49	300	75(G)	3.15	5000	25	1.66	
15	50	1.86	350	25	1.49	5000	25(H)	2.22	
15	50(J)	2.10	350	25(H)	1.86	5000	60(J)	2.45	
15	75(G)	3.15	350	100(K)	3.55	5000	100(K)	4.04	
15	100	3.25	375	150(L)	3.55	7500	100(K)	4.30	
15	150(L)	5.05	400	25	1.49	7500	100(K)	4.30	
16	50	1.86	400	75(G)	3.15	10000	25	1.98	
20	25(H)	1.86	500	25	1.49	10000	50(J)	2.22	
20	50(J)	2.10	500	25(H)	1.86	15000	25	1.98	

Notice: Specify type shaft—% size screw driver or for knob, or we ship our own choice. Mfg. quantities available at special prices. All initial types are OHMITE.

**TYPE "J" POTENTIOMETERS**

TYPE "J"	95	TYPE "JL"	\$1.10
TYPE "JJ"	\$2.95	TYPE "JJJ"	\$4.95

Ohms	Ohms	Ohms	Ohms	Ohms	Ohms
50	2000	50 K	60-80	10K-100K	250K-250K
100	4000	100 K	600-600	25K-400K	500K-500K
150	3000	150 K	2K-2K1	40K-40K	500K-500K
200	4000	200 K	2K-25K	100K-100K	1meg-500K
300	5000	300 K	7K-10K	100K-200K	1meg-500K
400	15K	400 K	10K-10K	150K-150K	2meg-200K
500	25K	500 K	60-1K-5K	700K-700K	700K
1000	25K	1000	20-250K-15K	800K-800K	800K
1500	30K	1500	45K-27K	1000K-1000K	1meg-1meg

SPECIFY SCREWDRIVER SLOT OR KNOB TYPE SHAFT

**HIGH POWER TRANSMITTING MICAS**

G-1 (CM 75)		G-2 (CM 80)		G-3 (CM 85)		G-4 (CM 90)		G-5 (CM 95)			
.0001	6 KV	12.18	.0002	6 KV	14.00	.0001	10 KV	19.67	.0001	10 KV	19.67
.00015	6 KV	12.18	.001	6 KV	14.00	.00015	10 KV	19.67	.00015	10 KV	19.67
.00015	10 KV	14.95	.0039	6 KV	14.95	.00015	10 KV	19.67	.00015	10 KV	19.67
.00015	10 KV	14.95	.0039	6 KV	14.95	.00015	10 KV	19.67	.00015	10 KV	19.67
.00015	10 KV	14.95	.0039	6 KV	14.95	.00015	10 KV	19.67	.00015	10 KV	19.67
.00021	6 KV	12.18	.032	10 KV	15.44	.00021	10 KV	19.67	.00021	10 KV	19.67
.00024	6 KV	12.76	.04	10 KV	17.55	.00024	10 KV	19.67	.00024	10 KV	19.67
.00025	6 KV	12.76	.04	10 KV	17.55	.00025	10 KV	19.67	.00025	10 KV	19.67
.0004	6 KV	13.31	.08	10 KV	19.73	.0004	10 KV	19.67	.0004	10 KV	19.67
.0005	6 KV	14.00	.09	15 KV	20.25	.0005	10 KV	19.67	.0005	10 KV	19.67
.0001	10 KV	19.67	.0005	10 KV	19.67	.0001	10 KV	19.67	.0001	10 KV	19.67
.00015	10 KV	19.67	.002	10 KV	19.67	.00015	10 KV	19.67	.00015	10 KV	19.67
.00027	10 KV	19.67	.004	10 KV	19.67	.00027	10 KV	19.67	.00027	10 KV	19.67
.0003	10 KV	19.67	.007	10 KV	19.67	.0003	10 KV	19.67	.0003	10 KV	19.67
.00033	10 KV	19.67	.01	10 KV	20.75	.00033	10 KV	19.67	.00033	10 KV	19.67
.000375	10 KV	19.67	.03	2 KV	21.00	.000375	10 KV	19.67	.000375	10 KV	19.67
.0004	5 KV	13.50	.09	2 KV	21.00	.0004	5 KV	13.50	.0004	5 KV	13.50
.00005	20 KV	33.27	.0011	20 KV	43.50	.00005	20 KV	43.50	.00005	20 KV	43.50
.0001	20 KV	36.30	.0012	20 KV	44.62	.0001	20 KV	44.62	.0001	20 KV	44.62
.0001	25 KV	37.80	.0024	15 KV	44.57	.0001	25 KV	44.57	.0001	25 KV	44.57
.00015	20 KV	37.80	.002	12 KV	42.35	.00015	20 KV	42.35	.00015	20 KV	42.35
.0002	20 KV	38.75	.0025	12 KV	45.00	.0002	20 KV	45.00	.0002	20 KV	45.00
.00025	20 KV	39.33	.006	10 KV	45.38	.00025	20 KV	45.38	.00025	20 KV	45.38
.0003	20 KV	39.33	.015	3 KV	42.35	.0003	20 KV	42.35	.0003	20 KV	42.35
.0004	20 KV	41.15	.015	7 KV	45.50	.0004	20 KV	45.50	.0004	20 KV	45.50
.00047	20 KV	41.15	.02	3 KV	45.38	.00047	20 KV	45.38	.00047	20 KV	45.38
.0005	20 KV	41.15	.05	3 KV	45.81	.0005	20 KV	45.81	.0005	20 KV	45.81
.00055	20 KV	42.35	.15	2.5 KV	45.81	.00055	20 KV	45.81	.00055	20 KV	45.81
.001	15 KV	42.35	.25	1.6 KV	45.81	.001	15 KV	45.81	.001	15 KV	45.81
.001	20 KV	43.50				.001	20 KV	43.50	.001	20 KV	43.50
.00025	30 KV	66.35	.0066	15 KV	75.68	.00025	30 KV	75.68	.00025	30 KV	75.68
.0003	25 KV	66.35	.0075	15 KV	78.00	.0003	25 KV	78.00	.0003	25 KV	78.00
.00032	25 KV	66.35	.0081	12 KV	79.50	.00032	25 KV	79.50	.00032	25 KV	79.50
.00035	25 KV	67.50	.01163	8 KV	82.95	.00035	25 KV	82.95	.00035	25 KV	

# COMMUNICATIONS EQUIPMENT CO.

## MICROWAVE COMPONENTS

### 10 CM.—RG48/U Waveguide



**POWER SPLITTER** for use with type 726 or any 10 CM. Shepherd Klystron. Energy is fed from Klystron antenna through dual pick-up system to 2 type "N" connectors \$12.50

**LHTR. LIGHTHOUSE ASSEMBLY.** Parts of JET39 AIG 5 & AFG 15. Receiver and Trans. Cavities w/assoc. Tr. Cavity and Type N CPLG. To Recvr. Uses 2C40, 2C43, 1B27, Tunable APX 2400-2700 MCS. Silver Plated. \$15.00  
**BEACON LIGHTHOUSE** cavity p/o UTN-2 Beacon 10 cm. Mfg. Bernard Rice, each. \$27.50  
**MAGNETRON TO WAVEGUIDE** Coupler with 721-A Duplexer cavity, gold plated. \$31.50  
**721A TR BOX** complete with tube and tuning plungers. \$12.50  
**MCCALLY KLYSTRON CAVITIES** for 707B or 2K28, 2700-2900 MC. \$4.00  
**HOLMDELL-TO-TYPE "N"** Male Adapters. W. E. #D167284. \$2.75  
**BEACON ANTENNA ASS1/APN-7** in Lucite. \$14.50  
**Type "N"** feed. \$22.50  
**ANTENNA, AT49/APR: Broadband** Conical, 300-3300 MC Type "N" Feed. \$12.50  
**"E" PLANE BENDS,** 90 deg. less flanges. \$7.50  
**K-Band, X-Band** Eqpt. Available. Send for List

### X BAND—1" x 1/2" Waveguide

**PARABOLOID DISH,** 18" diam. Spun Aluminum. \$4.95  
**Focus.** For AN/AP5-8. \$4.95  
**3 CM. DIPOLE** and Feed Assembly. (May be used with above dish.) 8 inches long. \$5.00  
**FLEXIBLE SECTION** 9 in. long. Cover-to-Cover. \$5.50  
**ROTARY JOINT (APS-6)** Sperry IGT-68275, 180 deg. rotation, choke to choke. Has "Built-in" Di-Coupler. 20 DB. with "N" Takeoff. \$22.50  
**3CM. DIPOLE FEED,** 16" L. for APS-15. \$14.50  
**MITRED ELBOW,** Cast aluminum, 1 1/4" x 5/8" W.C. W.E. Planes, "E" Plane. \$3.50  
**3 CM ANTENNA ASSEMBLY:** Uses 17" paraboloid dish, operating from 24 vdc motor. Beam pattern: 5 deg. in both Azimuth and elevation. Sector Scan: over 160 deg. at 35 scans per minute. Elevation Scan: over 2 deg. TR. Over 2 deg. \$35.00  
**Cross-Guide Directional Coupler,** UG-40 output flange. Main Guide is 6" Long, with 90 Deg. "E" Plane bend at one end, and is fitted with Std. UG 39/UG 40 flanges. Coupling figure: 20 db Nominal. \$22.50  
**RG52/U Waveguide** in 5' lengths, fitted with UG 39 flanges to UG40. Silver plated. per length \$5.00  
**Rotating-joints** supplied either with or without deck mountings. With UG40 flanges. each \$17.50  
**Bulkhead Feed-thru Assembly** \$15.00  
**Pressure Gauge Section** with 15 lb. gauge. \$10.00  
**Directional Coupler,** UG-40/U Take off 20db. \$17.50  
**MAGNET AND STABILIZER CAVITY** For 2341 Mag. neutron. \$24.50  
**90 degree elbows,** "E" or "H" Plane 2 1/2" radius. \$8.50  
**ADAPTER,** waveguide to type "N". UG 31-U, p/o TS 12, TS-13, Etc. \$7.50  
**ADAPTER,** UG-163/U round cover to special BTL. Flange for TS-45, etc. \$2.50 ea.

## COAXIAL R.F. FILTERS

**F-29/SPR-2,** Hi-Pass, with 1000 mc. Cut-off. Type "N" input and output. 50 Ohms Z. \$9.50  
**F-11/SPR-1,** Hi-Pass, with 300 mc cut-off. Type "N" input and output. 50 Ohms Z. \$10.50

## AUDIO TRANSFORMERS

**LVM-11,** Multimatch Line Autotransformer. Rated 30 watts. Will match up to 10 separate 500-ohm lines. Impedances: 500/250/167/125/100/83/71/62/50 ohms. \$3.40  
**G-5604** Plate-to-Line 20,000  $\omega$  (with 32 MA. DC) to 600 ohms. Resp. 250/3500 cps.  $\pm$  2db. 15 mw. Level. \$5.95  
**W-15-21,** Hybrid. Input Trans #1: 300 w/300 ohm. Trans. #2: 600 ohm/250,000 ohms. \$1.19  
**W-15-41:** Hybrid Output Trans. #1: 300/30 ohm. Trans. #2: 300/13,000 ohm (Plate). \$1.15  
**SPECIAL:** Set of 2 Transformers: Input Trans. W-15-41 and Output Trans. W-15-21. (Above). \$1.97  
**KS-9496:** Output 9000 ohms P-P. to 9 ohm V.C. 250 watts. 100 to 10,000 cps.  $\pm$  1db. \$8.95  
**KS-9449:** Driver Trans. P-P 6V6 (8000 ohms) to P-P Grids CL "B" (805's). 10 watts 1000-10,000 cps  $\pm$  1db. \$2.45  
**SPECIAL:** Matched Transformers KS 9449 and KS 9496. (Above) \$9.95  
**AT 071:** Interstage: 10,000 ohm pp plates to 80,000 pp grids. For BC 614 Speech Amplifier. \$1.35  
**AT 199:** Output: 6000 ohm plate to line (200/600 ohms) Response: 200-12 kc. For CF1A and CF 3A. \$2.45  
**AT 037:** Mike to grid: 75 ohms to 125,000 ohms. \$3.65  
**J-871:** Output: Pri: 20,000/16,000 ohms P-P. Or 5,000/4,000 ohms. Sec: 500/167/75/375/1.25 ohms. S1-corr. hi- $\beta$ . \$2.75  
**AT SUB** Bouncer. Multimatch, 200 ohms to 15 K ohm C. T. and 100 K ohm Grids. \$3.69  
**AT501** Hi-Fi Special: PRI: 3000 ohms P-P/Sec: 4/16/12/50/200 ohms 60-10,000 CY. —1 db 50W. \$3.49  
**AT152** Hi-Fi Driver Pri: 10,000 ohms Sec: 40,000 ohms P-P Grids 50-15 KC/1 db. \$1.40  
**AT602** Output to H. S. or line PRI: 14,200 ohms SEC: 8000/600 ohms \$1.10  
**AT666** Intercon Input: Spkr (-4-8 ohms) to grid (\$250-000 ohms) \$0.69  
**AT415** Plate (18,000 ohms C.T.) to line (125 ohms) 175 w.—500-600 CY. \$1.95  
**AT858** Plate (10,000 ohms C.T.) to line (125 ohms) (12510 ohms) Hi-Fi—50 W. \$6.95  
**AT-694** Hi-Fi Output: 3 Watts. 8500 Ohms P-P to V.C. (15 Ohms) 15-15KC PM 1 db. \$1.49

## BARGAIN SPECIALS

**APT-4** Jamming transmitter. Uses 5J30 or 5J31 magnetron. Power output: 130 watts, 350-760 mc. New complete with tubes. \$95.00  
**MB 30/APT-4.** Modulator. For noise modulating of APT-4. Operates from 115 v. 400 cy. New. \$35.00  
**L & N RATIO BOX,** #1553. Basic unit for capacitance, impedance, and conductance bridge. New, complete with instruction book. \$225.00  
**FILTER,** Artificial Line WECC D163169. 650 ohms imp. insertion loss: 5 db. \$32.50  
**Barty shock mounts:** nos. 2045, C-2060, C-2070, C-2090. \$5 ea.  
**Trihedral radar reflector,** MK-1, aluminum. \$3.50  
**SPLICER** for 11/16 perforator tape. WECC # X 61859 list 20 SCS #4TW 61859-20. Complete set, with nut, bar tape dispenser. \$8.50  
**MN 28Y** Control box, unit of MN 26 compass. New. \$3.75  
**Noise filters,** Mallory NF1-1, 100 amp/35 vdc. \$1.00  
**Power supply unit,** navy type—EL-2, Input: 115 vac. 60 cy. Output: 135 vdc/10 ma. 90 vdc/5ma; 3 vdc/360 ma. New, complete with spare parts box. To be used with model TBX radio gear. \$17.50  
**Coaxial switch,** 12 position, with type "N" fittings. \$17.50  
**TS-26A-14/Split.** \$14.50  
**Amplifier,** Altec A-127, 18 Watts output with response from 20-20,000 cps. Operates from 115 v. 60 cps. Std. rack panel mtg. Used, excellent. \$103  
**Pulse analyzer,** type APA-6. With 3 in. scope. \$32.50  
**BC 602** Control box for SCR1 522 (pushbutton). \$3.75  
**24-volt Transformer.** Input 115v/60 cy. Output 24v/3A. \$1.79  
**Phase-shifter,** Helmholtz type: 0-360 deg. \$2.50  
**Capacitor,** oil-filled, 0.25 mfd./25,000 volts dc. \$15  
**Hydrophone,** MODEL M1-2. A lattice of 3 crystals in a disk-like structure. 17-37 KC. \$27.50  
**AN/CRW-24** Remote control receiver, for operating target planes, etc. New, with soundproof mounting brackets. \$31.50  
**TEL. REPEATER, EE 89,** complete with tubes and tech. manual. \$17.50  
**TEL. REPEATER, EE 99,** with 12 vdc. vibrator power supply (PE 204). \$49.50  
**F. T. & R. 101-A.** Two-wide applique, contains equalizing devices, and balancing circuits. Used for adapting 2-wire military circuits to 4-wire systems. \$47.50  
**RADAR TRAINER,** Model 15-C. Brand new, complete with pulse generator, power supply, main unit, all cables and instruction book. \$125

## POWER TRANSFORMERS

**COMBINATION—115V/60—INPUT**  
**CT-133** 150-C-150V/65MA. 6.3V/2.5A. 6.3V/0.6A. \$1.79  
**CT-127** 900V/25MA PK 5V/2A. 2V/7.5A. \$2.79  
**CT-006** 350-0-350V/10MA. 5VCT/3A. 2.5VCT/3.5A. 2.5VCT/3.5A. \$4.39  
**CT-965** 78V/0.6A. 6.3V/2A. \$1.95  
**CT-004** 350-0-350V/90MA. 5VCT/3A. 2.5VCT/12.5A. \$4.60  
**CT-002** 350-0350V/50MA. 5VCT/2A. 2.5VCT/7.5A. \$3.65  
**CT-479** 7000V/018V. 2.5V/5A/17.800 V. Test. \$22.50  
**CT-013** 400-0450V @ 200MA. 10V/1.5A. 2.5. 3.5A. 5V/3A. \$4.35  
**CT-403** 350VCT. 0.26A 5V/3A. \$2.75  
**CT-931** 585VCT. 0.86A 5V/3A. 6.3V/6A. \$4.25  
**PLATE—115V/60—INPUT**  
**PT-07** 400VCT/4.0 AMPS FOR RA43. \$1.75  
**PT 034** 125V/45MA (for Preamp). \$1.15  
**PT 133** 3140/1570V. 2.36KVA. \$85.00  
**PT 801** 22,000V/234 MA. 5.35 KVA. \$115.00  
**PT 521** 7500V/0.6A. Half Wave. \$59.50  
**PT 913** 2500V/12 MA H50 MA. \$4.95  
**PT-38-2** 37.5/40V AT 75 MA. \$2.15  
**FILAMENT—115V/60—INPUT**  
**FT-157** 4V/16A. 2.5V/2.75A. \$2.95  
**FT-101** 6V/25A. 1.5V/16V/6.5A. \$7.79  
**FT-924** 5.25A/21A. 2x7.75V/6.5A. \$14.95  
**FT-824** 2x26V/2.5A. 15V/1A. 1.2V/7A. 6.4V/10A. 6.4V/2A. \$8.95  
**FT-463** 6.3VCT/1A. 5VCT/3A. 5VCT/3A. \$5.49  
**FT-55-2** 7.2V/21.5A. 6.5V/6.85A. 5V/6A. 5V/3A. \$8.95  
**FT-38A** 6.3V/2.5A. 2x2.5V/7A 5KV Test. \$2.79  
**FT-650** 2.5V/10A-3KV TEST. LO-CAP. \$7.50  
**FT-825** 2.5VCT/10A. 0KV TEST. \$6.95

## FILTER CHOKES

Stock	Description	Price
CH-914	12HY/250 MA 2500 V. Test	\$3.25
CH-CEC	117: 9-60H/05-400 MA. 10 KV Test.	14.95
CH-113	2.5H/700 MA. 2.5 KV Test.	5.75
CH-048	6H/50 MA. 5 KV Test 50 Ohms.	6.35
CH-291	0-1H/12 A. DCR: 0.3 Ohms	12.50
CH-292	0-1H/12 A. DCR: 0.3 Ohms	12.50
CH-321	.35H/350 MA—10 Ohms DCR	2.75
CH-141	Dual 7H/75 MA, 11H/60 MA	4.69
CH-69-1	12H/120V/17 MA	2.35
CH-776	1.28H/130 MA/75 Ohms	2.25
CH-344	1.5H/145MA/1200V Test	2.35
CH-366	20H/300 MA	6.95
CH-999	15H/15 MA—400 ohms DCR	1.95
CH-445	0.5HY/200 MA. 32.2 ohms, 3000 V.T.	1.39
CH-170	2x0.5H/300 MA. 25 ohms	2.79
CH-533	13.5H. 1.0 AMP DC, 13.5 KVINS.	29.95

## VHF TEST SET

The signal generator is designed to serve as an aid in aligning 52-160 mc/cycle FM receivers. It consists primarily of a temperature controlled crystal oscillator, the plate circuit of which is tuned to the 48th harmonic of the crystal frequency. The generator provides an extremely stable output, but which can be varied continuously from zero to well over a hundred microvolts. Provision has been made for two-frequency output provided that a dual crystal is utilized.



**New, Less Crystal. \$32.50**

## PULSE TRANSFORMERS

**4P37:** Primary. 50 Ohms 750V. .001 Duty. Sec. 15KV. 1000 Ohms Impedance. Bifilar 12.6V/2.5A. \$32.50  
**RAYTHEON WX 4298E:** Primary 4KV. 1.0 USFC. SEC 18KV. 16 AMP. DUTY RATIO: 001:400 CYCL. \$32.50  
**FIL. TRANS. "BUILT-IN"** \$32.50  
**WECC D-163247** For Modulator of SCR 720. \$22.50

**GE #K-2449A**  
 Primary: 9.33 KV. 50 ohms Imp.  
 Secondary: 28 KV. 450 ohms.  
 Pulse length: 1.05/5 usec @ 635/120 PPS. PK Power Out: 1.740 KW.  
**GE #K-2748-A** 0.5 usec @ 200 PPS. PK Pwr. out is 32 KW Impedance 40-100 ohm output. Pri. volts at 2.3 KV Pk. Sec. volts 11.5 KV Pk. Bifilar rated 1.3 Amp. Fitted with magnetron well. \$24.50  
**K-2745** Primary: 3.1/2.8 KV. 50 ohms Z. Secondary: 14/12.6 KV 1025 ohms Z. Pulse length: 0.25/1.0 usec @ 600 PPS. PK. Power 200/150 KW. Bifilar. 1.3 Amp. Has "built-in" magnetron well. \$32.50  
**K-2461-A.** Primary: 3.1/2.6 KV—50 ohms (line). Secondary 14/11.5 KV—1000 ohms Z. Pulse Length: 1 usec @ 600 PPS. PK Power Out: 200/130 KW. Bifilar 1.3 Amp. Fitted with magnetron well. \$29.50  
**541318-1** 2.3 wdgts. Ratio: 1:1.1, 1.10 uh. /wdg. 2.5 ohms DCR. \$3.50  
**UTAH X-15T-1:** Dual Transformer, 2 Wdgs. per section 1:1 Ratio per sec 13 MH inductance 30 ohms DCR. \$5.00  
**UTAH X-150T-1:** Two sections, 3 Wdgs. per section, 1:1:1 Ratio, 3 MH, 6 ohms DCR per Wdg. \$5.00  
**K-904695-501:** Ratio 1:1, Pri. Imp. 40 Ohm. Sec. Imp. 40 Ohms. Passes pulse 0.6 usec with 0.05 usec rise. \$8.95

## PULSE NETWORKS

**H-616** 10KV. 2.2 usec. 375 PPS. 50 ohms Imp. \$27.50  
**H-615** 10KV. 0.85 usec. 750 PPS. 50 ohms Imp. \$27.50  
**KS8865** CHARGING CHOKES: 115-150 H @ .02A. 32 @ .08A. 21 KV Test. \$37.50  
**G.E. 2525-1-350-50 P2T, "E", CKT, 1** Microsec. Pulse @ 350 PPS. 50 Ohms Impedance. \$69.50  
**KS9623** CHARGING CHOKES: 16H @ 75 MA, 380 Ohms DCR, 9000 Vac Test. \$14.95  
**H-605:** 25 KV, "E" CKT. 1.5 usec. 400 PPS. 50 Ohms Impedance, 5 sections \$82.50

## MICROWAVE ANTENNAS

**3 cm. Horn,** 1" x 1/2", with twist and 180 deg. bend. With dielectric window. \$22.50  
**AT49/APR—Broadband** Conical, 300-3300 MC. Type N Feed. \$8.95  
**Discone Antenna** AS 125 APR 1000-3200 mc. Stub supported with type "N" Connector. \$14.50  
**AS14A/AP.** 10 CM pick up dipole assy. complete w/length of coax and "N" connectors. \$4.50  
**AS46A/APG-4** Yagi Antenna, 5 element array. \$22.50  
**30" Paraboloid Reflector** Spun Aluminum dish. \$4.85  
**AN/APA-12—Sector Scan** adaptor for APS-2 radar. Complete Kit. \$37.50  
**TPS-3,** 10 Ft. Dish, "Chicken Wire" Paraboloid. Extremely lightweight, portable. \$125.00  
**AN-154** 3 vertical dipoles working against a rectangular mesh aperture. 3'x4'. Freq. 140-200 mc. with logarithmic switch (115v. 60 cy) and portable slatted rate. Extremely rugged. \$27.95  
**LP-24** Airford. loop, for use with glide-path transmitters (AHRN-1, etc.) 100-103 mc. \$32.50

## DYNAMOTORS

TYPE	INPUT VOLTS	INPUT AMPS	OUTPUT VOLTS	OUTPUT AMPS	Price
BDAR83	14		375	.150	\$6.50
35X-059	19	3.8	405	.095	4.35
PO5X-14	14	2.8	220	.08	8.95
DM33A	28	7	540	.250	3.95
B-19	12	9.4	275	.110	6.95
			500	.050	
DA-3A*	28	10	300	2.60	3.95
			150	.010	
			14.5	5.	
PE 73 CM	28	19	1000	.350	17.50
BD 60†	14	2.8	220	.08	8.95
DAG-33A	18	3.2	450	.06	2.50
BDAR 93	28	3.25	375	.150	6.95
‡ Less Filter. * Replacement for PE 94.					
† Used, Excellent.					
PE 94.	Brand New. \$95				

## INVERTERS

**800-1B** input 24 vdc, 62 A. Output: 115 V. 800 cy. 7A. 1 phase. Used, excellent. \$18.75  
**PE-218H:** Input: 25/38 vdc, 92 amp. Output 115V/300/500 cy. 1500 Volt-ampere. NEW \$22.50  
**PE206:** Input: 28 vdc, 36 amps. Output: 80 V 800 cy. 100 volt-amp. Dim. 13 x 5 1/2 x 10 1/2. New. \$22.50  
**EICOR—ML 3011-5,** Input: 13.75 V. 18.4A. Output: 115 V/400—, 3 $\phi$ , 0.95 PF. 100 VA. New. \$59  
**PU 7/AP:** Input: 28 vdc/160A. Output: 115 VAC, 400—, 1 $\phi$ , 500 VA, 21.6 Amp. Volt. and Freq. Reg. Used. Exc. \$75

MAIL ORDERS PROMPTLY FILLED. ALL PRICES F.O.B. NEW YORK CITY. M.O. OR CHECK. ONLY SHIPPING SENT C.O.D. RATED CONCERNS SEND P. O. PARCELS IN EXCESS OF 20 POUNDS WILL BE SHIPPED VIA CHEAPEST TRUCK OR RAILX.

343 Canal St., New York 13, N.Y. Dept. E-2 Chas. Rosen Phone: Canal 6-4882

WANTED

**TDQ—TDT  
TRANSMITTERS  
RCK RECEIVERS**

# Radalab Inc.

87 - 17 124th ST.  
RICHMOND HILL 18  
NEW YORK, N. Y.

Phone Virginia 9-8181-2-3

TWX-NY-4-4361

## SCR-682-A AIR SEARCH AND WEATHER RADAR

This is a 10cm 3000 mc ground based high power search and weather radar, using a 7" P.P.I. These sets will give excellent SERVICE IN A TORNADO OR STORM WARNING NETWORK, OR AT AN AIRPORT for air surveillance up to 135 miles. Ease of operation and service will allow relatively inexperienced personnel to use this equipment with ease. The set consists of three units as follows: 1—The paraboloid antenna system which includes the pedestal, reflector, dipole and RF section mounted on reflector. 2—Modulator includes the control panel for modulator, power supply and modulator unit. 3—Desk type P.P.I. indicator. All units have built out decks that enable the set to be serviced without being taken out of operation and are fully safety interlocked.

**Technical Specifications:**

- 1—Operating freq.—3000mc 10mc.
- 2—Power output—225kw.
- 3—Pulse width—micro second.
- 4—ranges—500-240,000 yds in four ranges. 10,000 yds. 40,000 yds. 160,000 yds. and 240,000 yds.
- 5—360 scan.
- 6—azimuth accuracy 1.
- 7—7" P.P.I. indicator.
- 8—7/8" coax transmission line.
- 9—6 antenna beam width.
- 10—110v 60 cye power input.

**THIS SCR-682-A IS AVAILABLE FOR INSPECTION IN OPERATION AT OUR LABORATORY BY APPOINTMENT. WRITE OR PHONE.**

## VG-1, 2, 3—24" P.P.I. REPEATER INDICATOR

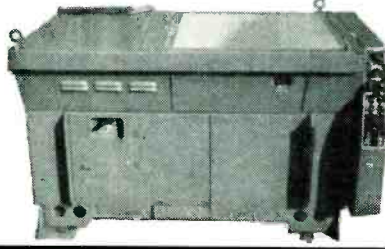

The remote P.P.I. is a projection radar repeater using a skiatron tube to project a radar image to the top of the console, which is a transparent 24" screen used as a plotting table. This set will operate very well with the SCR-682 at an airport or weather observing station. Five ranges are provided, 4, 10, 20, 80, and 200 miles. Range marks are provided. This set operates with any radar set with a P.R.F. rate of 60-1000 CFS. Power input 110v 60 cye. A very bright image allows use in a well lit room. Complete spares for this equipment in stock. Other repeaters in stock include: VC, VD, VE, VF, VK. WRITE.

## SCR-616—BC-1269

F.M. & A.M. 145-600mc communications receiver. The BC-1269 is a UHF version of the BC-312-342 series and looks very similar. The receiver is a superhet covering the 145-600mc in 2 bands. The dial is calibrated in megacycles. F.M., C.W., or A.M. reception is offered. Power input is 110v 60 cye using a RA-61 power supply or 12.6v AC and 250v DC 100 MA. This set is one of the nicest receivers designed. Write

## TEST SETS

TS-15 Flux meter  
TS-120-3 cm Beacon Test Set  
TS-155 10cm Test Set  
TS-173, 174, 175 Freq. meters  
TS-323 Freq. meters  
TS-587/U UHF noise and field strength Test Sets.  
Many others up to TS-700 series. WRITE

## OTHER EQUIPMENT AVAILABLE

AN/URC-4 145 and 250 mc. Air, sea rescue transceivers. All subminiaturized.  
AN/ARC-12 and up  
AN/APG-15 and up  
36/APR-15 and up  
AN/APR-4 and up  
AN/TRC-7 100-156mc walkie-talkie  
AN/ART-18, 23, 24 Radar relay sets  
AN/APN-19 beacon  
AN/APN-12 transponder  
AN/CPN-6, 8, 17 radar beacons  
AN/UPN-1, 2, 3, 4 S and X-band radar beacons

## AN/PRC-8, 9, 10

The PRC series of radio sets are the new F.M. high freq. back pack walkie-talkies superceding the SCR-300. These sets are completely miniaturized and weigh app. 18 lbs. complete, with battery. The PRC-8 covers 20-27.9 mc. PRC-9 covers 27 to 38.9 mc. PRC-10 covers 38-54.9 mc. The set has 16 tubes. The receiver is A.F.C. controlled and has a sensitivity of .5 microvolts. The transmitter power output is app. 1 watt F.M. A crystal calibrator is provided to check and calibrate the set. The receiver is equipped with a squelch control. This set can be used with the AN-GRA-6 to provide remote operation and automatic relay. We can supply spare parts for these sets. Write for prices.

## MOTORS:

- 24 VDC REVERSIBLE MOTOR—3.7 RPM, 40 lb. Torque. Motor size: 5-1/2" x 4-1/32" x 3-5/16". Shaft size: 21/32" x 5/16". Also operates 24 VAC. Philco No. 441-1008. \$5.95
- 27.5 VDC—6000 RPM. 1.5 oz. in. Shaft Size: 1 1/2" x 3/4". Motor size: 2 1/2" x 1 1/2". No. 5069-267. \$4.95
- 26 VOLT 60 CYCLE—60 RPM Synchronous Cramer Motor #1147. Shaft size: 1" x 1/4". \$1.95
- 110 VDC 1/70 HP., 1550 RPM. Motor size: 4" x 2 1/2". Shaft size: 1" x 3/16". Redmond #157. \$4.95
- 6 VDC 1/20 HP., 4000 RPM. Motor size: 5" x 3". Shaft size: 3/4" x 1/4". Redmond #E-50. \$4.95
- 12 VDC 1/30 HP., 4500 RPM. Motor size: 3" x 2 1/2". Shaft size: 1" x 3/16". Delco #5047520. \$4.95
- 27 VDC 1/10 HP., 3500 RPM. Shaft size: 5/8" x 1/2". Motor size: 4" x 3-1/4". Air Assoc. No. EB-763. \$6.95
- 80 VDC 1/50 HP., 3000 RPM. Shaft size: 5/8" x 1/2". Motor size: 5" x 3". G.E. #5-PN38HA10. \$8.95
- 28.5 VDC 1/35 HP., 2200 RPM. Motor size: 1 1/2" x 1 1/4". Motor size: 4 1/2" x 3 1/4". Electrolux #16876. \$5.95
- 27 VDC GEAR HEAD MOTOR—360 RPM; 1/75 HP.; 1.75 A. Size: 5" x 3". Shaft 1/2" x 3/8". Air Assoc. #EE120M1. Price: \$7.95
- 27.5 VDC GEAR HEAD MOTOR—324-1 Ratio; 4050 RPM; Right Angle Drive Motor. Size 5" x 3-1/2". Shaft: 5/16" x 3/4". Bodine Type #V10R. Price \$7.95
- 24 V. GENEVA LOC ACTUATOR MOTOR ASSY. 1/25 HP.; 15000 RPM. w/Gear Head & Limit Switches. Motor Size: 5-1/4" x 3-1/2". Angle Drive Shaft: 3/4" x 1/2". Bendix #LM-106524. Price: \$7.95
- 24 VDC GEARED HEAD MOTOR—Heavy Duty, 8 Amp 2-1/2 lb. Torque, 100/200 RPM. Shaft Size: 5/16" x 1". Right Angle Drive. \$8.95
- 27 VDC MOTOR—1.5 A.; 1/50 HP.; 3000 RPM Shunt Motor; Motor Size: 3" x 2-1/4". Shaft: 5/16" x 3/8". Oster #D8-1 or WEVS-5876. Price: \$2.95
- 27.5 VDC MOTOR—1/100 HP.; 7000 RPM; Motor Size: 3" x 1-3/4". Shaft: 3/4" x 3/8". L Oster #C2BP-1A—Price: \$2.95

## BLOWERS:



12/24 VDC—AC CAST ALUMINUM BLOWER (Pictured at left)—100 CFM; 3" intake; 2" outlet. Shunt Motor 4" x 2 1/2"; 3000 RPM @ 24 VDC. \$5.95  
6 VDC SINGLE—100 CFM—No. 6100. Used. \$4.95  
6 VDC FLANGE—150 CFM—No. 6150. \$5.95

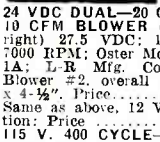

24 VDC DUAL—20 CFM—Min—No. 2120. \$7.95  
10 CFM BLOWER (Pictured right) 27.5 VDC: 1/100 HP.; 7000 RPM; Oster Motor C2BP-1A; L-R Mig. Co. Bakelite Blower #2. overall size: 3-1/2" x 4-1/4". Price: \$5.95  
Same as above, 12 VDC operation; Price: \$5.95  
115 V 400 CYCLE—10 CFM—Eastern Air Devices Motor J31A—200 RPM; 1/100 HP.; L-R #2 Blower Assy. Overall Size: 4-1/2" x 3-1/2". No. 3110. \$5.95



10 CFM BLOWER (Pictured at left)—28 VDC—6 A; 5000 RPM. Pioneer Motor SS-2345. Aluminum Blower Housing; Overall Size: 4-1/2" x 3-1/4". Price: \$5.95

## 115 V. 60 CYCLE BLOWERS:

- 115-VAC 60 cycle SINGLE TYPE—100 CFM; 2-1/2" intake; 2" outlet. Complete size: 5" x 6". No. 1C939. \$8.95
- 115 VAC 60 cycle DUAL TYPE—100 CFM; 4" intake; 2" Dis. Each side. Complete size: 8" x 6". No. 1C930. \$13.95
- 115 VAC 60 cycle COMPACT TYPE—108 CFM; Motor built inside squirrel cage; 4-1/2" intake; 3 3/8" x 3" Dis. Complete size: 4-1/2" W x 8-3/8" H. 8-1/2" D—No. 2C067. \$14.95
- 115 VAC 60 cycle FLANGE TYPE—140 CFM; 3-1/2" intake; 2-1/2" Dis. Complete size: 7-1/2" W x 7-1/2" H x 6-3/4" D—No. 1C807. \$13.95
- 115 VAC 60 cycle FLANGE TWIN—275 CFM; 4-1/2" intake; 3-3/4" x 3" Dis. Complete size: 11-3/4" W x 3-3/8" H x 8-1/16" D—No. 2C069. \$21.95
- 115 VAC 60 Cycle BLOWER—200 CFM; 4" intake; 3" x 5" outlet. Overall size: 8" x 7" x 6". Bodine Motor NSL-33. Removed from New Equipment. #BOD-200. \$14.95
- 115-VAC 60 Cycle BLOWER—100 CFM; 3-3/4" intake; 2" outlet; Rd. Flange with Flap Director. Overall size with bracket: 8" L x 6-1/2" W x 7" H. Removed from New Equipment. Diehl Motor FB-2106-6 No. FDBL-2106. \$6.95
- Same as above, but with 12" Curved Director. No. CDBL-2106. \$7.95

Items Previously Advertised Still Available!

For:

- ★ Tests Sets
- ★ Airborne Electronics
- ★ Radar
- ★ Navigation Aids
- ★ Parts—Meters—Tubes

Ask for:

**NEW CATALOG NO. 114**  
Lists latest inventory of aircraft, industrial and military electronics equipment.

## "VARIAC" (Mfg. by American Transformer Co.)

100 amp. 110 V. or 220 VAC. 60 cycle Input. Output variable from 0 to 130 V. or 0 to 240 V.

Brand new. Special. \$89.50

## ARROW SALES, INC.

P. O. Box 3007-E, North Hollywood, Cal.

Phones: Stanley 7-0406 POplar 5-1810

Telegraph Address: WUX, No. Hollywood

Cable Address: ARROWSALES, North Hollywood

## TIME DELAY RELAY

Haydon [15v 60 cy. adj. In 5 sec. steps to 40 sec. spdt mu sw. \$5.95. With 2 arms & 2 sw. \$9.95  
PULSE xfmr Utah 1059-AA. 3-50T Windings \$3.95

Hundreds of other items, see ad in Buyers Guide Issue, write for listings.

EMPIRE ELECTRONICS COMPANY

409Q Ave. L Brooklyn 30, N. Y. Cloverdale 2-4000

# FAIR RADIO SALES • 132 SOUTH MAIN ST • LIMA, OHIO

WRITE FOR  
NEW W.E.  
TUBE LIST

# CONSISTENTLY HIGH QUALITY ELECTRON TUBES

WRITE FOR  
NEW RCVG.  
TUBE LIST

GUARANTEED • UNUSED • BOXED • CRITICAL TYPES LAB TESTED FOR YOUR PROTECTION

C1A	57.25	2D21W	2.00	4J36	75.00	V45	271A	10.00	422A	10.00	872A(G.E.)	2.75	5678	4.50		
C1K	8.85	2E35	1.30	4J37	75.00	6Klystron	525.00	272A	9.00	429A	5.75	874(RCA)	5.60	5686	2.85	
TT-1	5.00	2E35	1.95	4J50	99.50	53	1.10	274A	8.00	464A	8.00	876(RCA)	85	5687	2.70	
0A6A	20.00	2J36	35.00	4J63	7.00	QK-60	25.00	274B	2.00	CM503AX	1.00	891	125.00	5691	4.95	
0B3/VR90	.85	2J37	15.00	4-65A(Surp)	16.50	QK60	1.00	275A	3.50	GL559	50.00	902/902P1	2.50	5692	6.00	
0C3/VR105	.85	2J37	10.00	4-125A(Surp)	19.00	QK61	25.00	276G	8.50	GL562	50.00	918	1.55	5693	4.75	
0D3/VR150	.85	2J49	40.00	4PR60A	50.00	QK61	2.75	287A	3.00	575-A	12.00	931A	3.00	5696	.90	
1B22	1.25	2J61A	45.00	4X150A	50.00	QK65	9.50	GL299	3.50	WL651/5552	50.00	932	1.25	5700	2.00	
1B24A	4.95	2K25	15.00	Surp	22.50	QK65	12.00	304TH(Surp)	8.75	WL-653B	110.00	SN947/5640	6.40	5704	1.90	
1B24A	35.00	2K28A	39.50	4X150G	32.50	RKR-72	.35	304TL(Surp)	10.50	HK-654	25.00	958A	.40	5718	3.00	
1B26A	2.00	2K33	30.00	4X250B	42.50	RKR-73	.50	310-A	3.00	GL673	13.00	CK-1007	.90	5718-A	5.00	
1B27	10.00	2K34	99.50	4X500A	80.00	75-TL	.50	311A	5.50	703A	1.25	1000T	137.50	5719	3.75	
1B32	2.00	2K41	95.00	4X500F(Surp)	80.00	E-(Surplus)	5.00	311B	4.50	705A	.85	CK-1301	1.75	5721	150.00	
1B35	3.50	2K45	125.00	4-750A(Surp)	50.00	E-83-F	2.75	311C	1.75	707A	4.00	1500T(Surp)	120.00	5725	2.25	
1B36	3.75	2K47	15.00	4-1000A(Surp)	85.00	90-NB	7.00	313A	3.00	707B	5.00	1521	2.50	5726/6ALSW	2.25	
1B45	37.00	2K55	15.00	5BP1	3.75	Amperex	7.00	313C	3.00	709A	1.75	1619	.30	5732	3.00	
1B63A	22.50	3B03/RK22	4.00	5BP4	3.95	FG98/550	18.00	339A	10.00	715B	3.95	1680	3.95	5744	4.75	
1B85	8.95	3B24	1.00	5D21	7.95	FG98A	20.00	347A	3.25	717A	.35	1684	2.20	5749	2.00	
1B86	7.75	3B24/W	5.00	5D22	29.95	100R(Surplus)	5.00	348A	4.95	721A	.75	5517	2.15	5751	1.50	
1N21	1.50	3B27	3.50	5D21	7.95	100TH(Surp)	6.75	350A	3.00	723A/B	9.00	GL5551/	47.50	5780	185.00	
1N21B	1.50	3B29	6.50	5FP7	1.20	EG105	15.00	355A	12.00	726A	4.50	FG271	47.50	5780	185.00	
1N21B	1.50	3B29	7.50	5D21	7.95	EG105	15.00	355A	12.00	726B	25.00	5553/655	95.00	5783	4.50	
1N34	.44	3C23	7.50	5J23	20.00	120-NB	40.00	359A	1.75	726C	35.00	591/403B	2.75	5787	5.75	
1N34A	.65	3C24	1.25	5J23	20.00	F-123	5.00	373A	3.00	750TL(Surp)	75.00	5633	8.00	5794	7.75	
1N48	.40	3C31/C1B	2.25	5J25	10.00	VT127A	2.50	374A	4.00	800	.90	5634/SD828E	7.00	5795	185.00	
1N54	.40	3C32	7.00	5J25	10.00	VXR130	1.75	387A	4.00	803	2.00	5802	2.95	5802	1.35	
1N56	.85	3D21A	3.50	5LPS	10.00	CK-155	255.00	391A	3.50	806	8.50	5637	5.50	5812	1.50	
1N64	.70	3J30	45.00	5MP1	10.00	FG172	35.00	394A	1.90	807	1.20	5638	8.00	5814	.80	
1N65	1.20	3K21	20.00	5P4	7.50	HF201A	27.50	397A/2C51	3.00	807W	1.10	5639	8.00	5814A	1.25	
1N67	.45	3K30/410R	99.50	6BVM6	22.50	QK181	35.00	403B/5591	2.75	809	9.95	5641	6.00	5819(RCA)	37.50	
1N69	.60	3BP1	2.95	CL-6(West)	19.90	QK-202	295.00	404A/5847	10.00	810	3.00	5642	1.00	5820(Icon)	50.95	
1N70	1.20	3BP1	5.00	CL-6(West)	17.00	203A	5.00	416A/3K30	99.50	811	3.00	5643	6.00	5825	7.95	
1N81	.90	3DP1	3.00	EL6CF/4B25	8.00	207	45.00	416A	36.00	812A	1.35	5644	8.50	5829	1.25	
1P23	1.90	3X2500A3	6F4	1.90	211/VTAC	207	45.00	416B	50.00	814	1.35	5644	8.50	5829	1.25	
1P20	2.00	(Surp)	88.00	6J4	3.00	227A	2.00	417A	8.00	816	1.95	5647(Sylv)	5.00	5840	16.80	
WL1P41	1.25	AB24	8.00	6K4	2.25	FT-231	12.00	417A w/vv	3.50	818	1.00	5654	1.55	5844	10.00	
1S21	2.50	4B25/EL6CF	5.00	6SN7W	1.50	245A	15.00	417A guide	2.75	838	1.00	5654	1.55	5844	10.00	
2C35	2.00	4B25/6 Amp	7C30	7.95	246A	10.00	249A	3.50	417A/5842	10.00	845	5.00	5656	6.50	5847/404A	10.00
2C39A	11.00	4E27	3.00	8D21	85.00	249A	3.50	418A	16.00	860	3.50	5672	1.25	CK-5886	3.25	
GL-2C39B	27.50	4E27	3.00	12C8	.70	251A	45.00	420A	5.25	866A	1.25	5675	.65	5890	15.00	
2C51/396A	10.75	4J30	7.50	RK28A	7.70	HM253	5.00	421A/5998	7.00	1.25	5676	.65	5890	15.00		
2C53	10.75	4J30	39.50	T-40	2.55	866B	12.00							5894/AX9903	16.00	

AND MANY OTHERS! OVER 1000 TYPES IN STOCK . . . WRITE!

### NEW RECTIFIER TRANSFORMERS

Continuous Ratings	1 Amp.	\$5.75
Pri: 115V, 60 cycles input	2 Amps.	6.75
SEC: 9, 12, 18, 24, and 36 volts.	12 Amps.	16.65
	24 Amps.	35.65
	50 Amps.	59.00
	100 Amps.	108.00

### NEW RECTIFIER CHOKES

Continuous Ratings			
1 Amp	.1 Hy	1.5 ohm	\$4.95
2 Amps	.04 Hy	.9 ohm	5.95
4 Amps	.07 Hy	.6 ohm	7.95
12 Amps	.01 Hy	.1 ohm	14.95
24 Amps	.004 Hy	.025 ohm	29.95
50 Amps	.005 Hy	.01 ohm	54.00

### FILTER CAPACITORS

Capacity	W. Voltage	Each
500 MFD	200 V.	\$1.95
500 MFD	50 V.	.85
1000 MFD	15 V.	.35
2000 MFD	50 V.	2.25

### DIRECTRON SELENIUM RECTIFIERS FULL-WAVE BRIDGE TYPE

Max. Amps.	18VAC 14VDC	36VAC 28VDC	54VAC 42VDC	72VAC 56VDC	130VAC 100VDC
1	\$1.35	\$2.35	\$3.75	\$4.50	\$7.45
2	2.00	2.75	5.35	5.90	9.15
2 1/2-3	2.95	4.15	5.85	7.85	12.75
4	3.50	6.45	11.35	14.35	21.75
6	4.00	7.75	12.85	17.30	29.75
10	5.90	11.45	19.50	24.80	41.35
12	7.25	14.35	22.10	29.75	44.25
20	13.05	25.05	37.25	48.75	78.50
24	14.25	28.75	44.50	57.65	81.00
30	17.95	34.35	56.50	71.00	109.00
36	22.45	42.35	65.00	86.95	134.00
50	29.50	54.35	105.45	115.75	174.00
100	59.50	119.00			

We build other Selenium Rectifiers, Transformers, and Chokes to your specifications. Buy from the Direct Source for Quick Delivery.

### TRANSFORMER SPECIALS

ALL NEW • ALL GUARANTEED

115 Volt, 60 cycle primary

FEDERAL Type NL-48567-1—Hermetically sealed. SECONDARY: 2.5 V., @ 5A., 2.5 V. @ 5 A., 2.5 V. @ 10 A. NET EACH . . . \$4.95

THORDARSON No. T-19F85—Open mounting with leads. SECONDARY: 5 V. C.T. @ 13 A. NET EACH . . . \$3.95

THORDARSON No. T-74F23—Surface mtg. w/side shells. Screw terms. SECONDARY: 5 1/2 V.C.T. @ 13 A. NET EACH . . . \$3.95

220 Volt, 60 cycle primary

KENYON No. S-10694—Open frame, screw terms. SECONDARY: 5 volts C.T. @ 10 amps. NET EACH . . . \$4.95

Terms: F O B—N Y C—25% Deposit with order—or send full remittance to save C O D charges—D & B Rated Firms (F2 1/2 or Better) Net 10 days. CABLE: BARRYLECT, N. Y. TELEGRAPH: BARRY ELECTRONICS, FAX, N. Y. C.

### SPECIAL PURCHASE! • LIMITED QUANTITY! KOTRON SELENIUM RECTIFIERS

ALL BRAND NEW • GUARANTEED • FIRST QUALITY

INPUT VOLTS AC	OUTPUT VOLTS DC	MAX. DC AMPERES	KOTRON NUMBER	CIRCUIT	REGULAR NET PRICE	SPECIAL SALE PRICE
10-0-10	8	1 2	20C2D1S1	Center Tap	\$2.00	\$1.60
"	"	6 4	20C2FW1S1	"	3.50	2.80
"	"	12	20C2K1S1	"	4.50	3.60
"	"	16	20C2J1S1	"	6.00	4.80
"	"	24	20C2K1S2	"	7.50	6.00
"	"	36	20C2K1S3	"	10.00	8.00
"	"	48	20C2J1S3	"	12.00	9.60
"	"	48	20C2KW1S4	"	12.00	9.60
"	"	64	20C21KW1S5	"	15.00	12.00
"	"	80	20C2KW1S6	"	19.50	15.50
"	"	84	20C2KW1S7	"	21.00	16.80
"	"	128	20C2KW1S10	"	29.00	23.20
14	12	13	14B4K1S1	Full Wave Bridge	\$7.25	\$5.80
36	28	7	36B4K1S2	Full Wave Bridge	\$9.50	\$7.55
		14	36B4K1S1		19.75	15.80
18	14.5	1 3	18B4D1S1	Full Wave Bridge	\$3.55	\$2.84
"	"	2 4	18B4E1S1	"	4.25	3.80
"	"	6 6	18B4F1S1	"	6.75	5.40
"	"	13	18B4K1S1	"	10.95	8.76
"	"	17.5	18B4J1S1	"	12.95	10.36
"	"	26	18B4K1S2	"	19.95	15.96
18	14.5	39	18B4K1S3	Full Wave Bridge	29.50	23.60
"	"	52	18B4KW1S4	"	34.50	27.60
"	"	52	18B4J1S3	"	31.50	27.60
"	"	70	18B4KW1S5	"	42.50	34.00
"	"	70	18B4J1S4	"	42.50	34.00
40	34	0 6	40B4CM1	Full Wave Bridge	\$4.45	\$3.56
"	"	0 6	40B4D1S1	"	4.45	3.56
"	"	1 2	40B4EWS1	"	5.50	4.40
"	"	2 4	40B4F1S1	"	6.50	5.20
"	"	3 2	40B4FW1S1	"	7.55	6.04
"	"	6	40B4K1S1	"	12.45	9.96
"	"	9	40B4JW1S1	"	14.75	11.80
"	"	12	40B4K1S2	"	24.50	19.60
"	"	18	40B4J1S2	"	29.50	23.60
"	"	34	40B4KW1S5	"	49.50	39.60
"	"	36	40B4JW1S4	"	52.00	47.20
120	100	0 6	40B4D3S1	Full Wave Bridge	\$10.95	\$8.76
"	"	3 2	40B4FW3S1	"	19.15	15.96
"	"	9	40B4JW3S1	"	42.50	34.00
"	"	25	40B4KW1S4	"	85.00	68.00

# RELAYS

world's largest stock

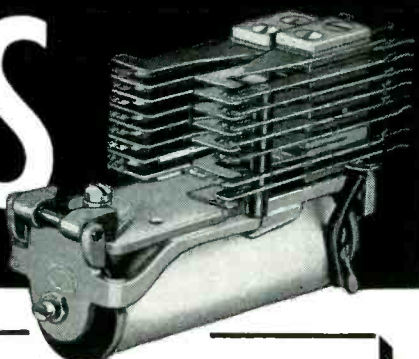

- ★ Immediate Delivery
- ★ Hundreds of Types
- ★ All Standard Makes
- ★ New-Inspected-Guaranteed

Multiple Contact  
**Standard Telephone Type Relay**  
 CODE 4 TWIN CONTACTS  
 11-Form A 1-Form B 1-Form C 1-Form D  
 Heavy duty armature bearing. Available in all standard coil resistances from 12 ohms to 12,000 ohms. Single or quantity prices on request. In stock.

**24 HOUR DELIVERY OF THESE TYPES**

Standard Telephone Relays  
 Short Telephone Relays  
 Midget Relays  
 Timers  
 Aircraft Contactors  
 Rotary Relays  
 Western Electric  
 Type "E" Relays

Keying Relays  
 Hermetically Sealed Relays  
 Voltage Regulators  
 and Cutouts  
 Differential and  
 Polarized Relays  
 Special Relays  
 BK Series

Antenna and Ceramic Relays  
 Motor and Control Relays  
 Relay Assemblies  
 Latching and Interlocking  
 Relays  
 Mechanical Action Relays  
 Ratchet and Stepping Relays  
 Time Delay Relays

Write for New Relay Sales  
 Catalog C-6



P. O. Box 186-AA, West Chicago, Ill. Phone West Chicago 1100

STANDARD BRAND, ASSORTED  
**INSULATED RESISTOR KITS**  
 83 are 1/2 w; 10 one w; 7 two w. Plastic bag 1.00

**INSULATED CERAMIC CONDENSER KITS**  
 50 ASSORTED VALUES, in Plastic Bags 1.00

**F.P. CONDENSER KITS**  
 25 ASSORTED, IN PLASTIC BAG 3.00

**EB, GB, HB RESISTORS**  
 GREEN BAND—2% TOLERANCE. 1/2, 1 & 2 W.  
 LARGE QUANTITY — WRITE FOR PRICES

**INSULATED 1B3 & 6BQ6 CAPS 4" Leads 2c**

**TUBES—GUARANTEED 1st QUALITY**  
 6J6—25c each      3BP1  
 6AQ5—in Bulk      With Socket 75c

10 OHM IRON CORE CHOKES 20c each  
 And Many Other Items  
 We Also Purchase Your Surplus Inventory

**BELVISION, INC.**  
 254 Greenwich St., N. Y. 7, N. Y. BA 7-6063

**EXPORT BUYERS!** Achtung! Regardez? Aviso!

**ELECTRONICS EQUIPMENT**

- for:
- ★ AIRCRAFT
  - ★ FIELD
  - ★ TEST SETS
  - ★ SPARE PARTS

Get our competitive quotation first!  
 Inquiries answered via air mail same day received!



**ELECTRONIC INDUSTRIES**

2033 WEST VENICE BLVD.  
 LOS ANGELES 6, CALIFORNIA

Send for free catalogue  
 Phone: REpublic 5-0215  
 Cable Address: VHRADLECT

**BRAND NEW**  
**T-350XM**  
 RADIOTELEPHONE  
 RADIOTELEGRAPH  
**TRANSMITTER**

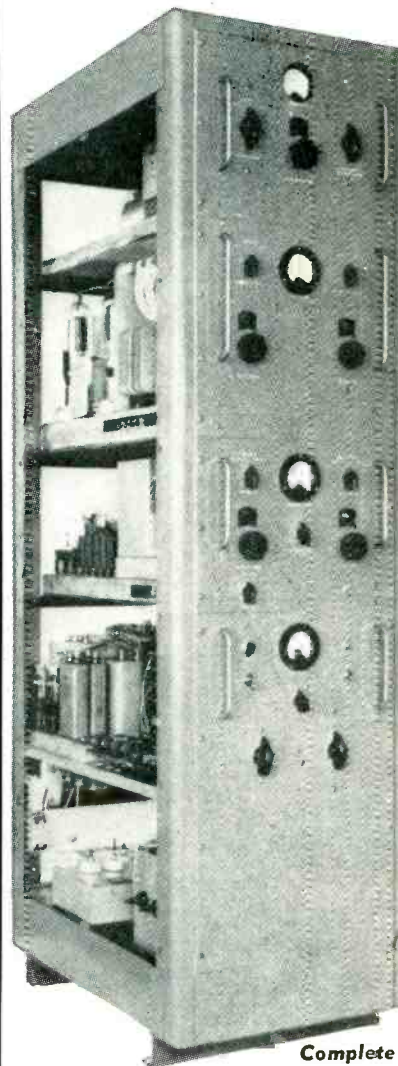

Complete

- 2,000-20,000 KCS ● 350 Watts—A1 Output ● 250 Watts—A3 Output ● Built in Master Oscillator ● 5 Crystal Positions ● Multi Range Impedance Antenna Tuning Network ● Manual or High Speed Keying ● Uses 2—813 P.A. and 2—805 Modulators Hi-Level Class B ● Speech Amplifier, Remote, Mfg. by RCA ● Technical Manuals (2) with Each Transmitter ● Size 59" x 16" x 24" ● Wt—690 Lbs. Net ● Power Input: 210/250 Volts Single Phase 50/60 Cycles ● Brand New—Complete—Unused

This modern precision built point-to-point transmitter is now available for delivery singly or in quantity to interested users at an attractive price. This transmitter is similar in characteristics to the RCA Model ET-4336. The T-350XM was manufactured by Technical Radio Corporation, San Francisco, California, for the U. S. Signal Corps. All are new, unused and export cased. Each transmitter carries our guarantee. Spare parts available. Quotations on request.

**COMPLETE STATION INSTALLATION**  
 We can supply with the T-350XM transmitter brand new receivers and complete station operating accessories.

**Communication Devices Co., Inc.**  
 2331 Twelfth Ave., N. Y. 27, N. Y.  
 TWX—NY1—223  
 Cable—Communidev, N. Y.  
 Tel. ADironck 4-6174

**ALLIED ELECTRONIC SALES**

POPULAR RUGGEDIZED and SUBMINIATURE TUBES AT SUBSTANTIAL SAVINGS  
 ALL TUBES ARE NEW and FULLY GUARANTEED

5635	4.95	5718	2.95	5819	37.50	6005/6AQ5W	1.95
5636	4.95	5721	150.00	5829	1.80	6021	4.95
5640	9.00	5722	5.95	5840	4.75	6073	1.65
5641	7.00	5725	2.25	5879	1.15	6082	3.25
5647	7.50	5726	1.10	5881	2.50	6097	1.25
5654	1.45	5744	.95	5899	7.50	6098	6.50
5663	1.25	5751	2.25	5899A	7.50	6111	6.75
5687	2.75	5755/420A	8.50	5902	7.90	9003	1.35
5696	1.25	5783	3.50	5933/807W	3.95		
5702	1.75	5814A	1.95	5964.	.75		

WRITE FOR NEW PRICE LIST

74 CORTLANDT ST., N. Y. 7, N. Y. BARCLAY 7-5839 Dept. E.  
 F.O.B. N.Y.C. Rated (D&B) Firms Open Account. Attractive Discounts To Quantity Buyers

# FAY-BILL DISTRIBUTING CO.

Partial Listing Only

LARGEST SURPLUS DEALER IN THE COUNTRY—STANDARD BRANDS—TRANSMITTING AND RECEIVING

Type	Price	Type	Price	Type	Price	Type	Price	Type	Price	Type	Price	Type	Price	Type	Price	Type	Price	Type	Price	Type	Price		
AB-150	52.94	1N22	1.29	2K55	29.95	5HP1	3.99	304TH	10.99	720A	9.99	CK1006	2.49	6AS7G	2.39	774	2.39	774	2.39	774	2.39	774	2.39
CEP-220	.99	1N27	1.89	2X2/879	1.59	5HP1	14.50	304TH	10.99	800	8.99	CK1006	2.49	6AX4	2.39	774	2.39	774	2.39	774	2.39	774	2.39
CK-508AX	.99	1P28	9.00	3A5	5.99	5HP5	7.49	307A/RK75	3.60	801A	4.44	6A13	1.99	6BA4	2.39	12A7	.99	12A7	.99	12A7	.99	12A7	.99
CK-521AX	.99	1P30	2.49	3AP1	1.49	5R2	16.50	310A	4.46	802	2.89	6B14	1.99	6BA7	2.39	12A7	.99	12A7	.99	12A7	.99	12A7	.99
CR-79	7.99	2B21	7.99	3AP1	1.49	5R2	16.50	310A	4.46	802	2.89	6B14	1.99	6BA7	2.39	12A7	.99	12A7	.99	12A7	.99	12A7	.99
DC-1250	3.99	2B22	1.49	3AP1	1.49	5R2	16.50	310A	4.46	802	2.89	6B14	1.99	6BA7	2.39	12A7	.99	12A7	.99	12A7	.99	12A7	.99
EF-50	.39	2B21	7.99	3AP1	1.49	5R2	16.50	310A	4.46	802	2.89	6B14	1.99	6BA7	2.39	12A7	.99	12A7	.99	12A7	.99	12A7	.99
EF-148	.39	2B22	1.49	3AP1	1.49	5R2	16.50	310A	4.46	802	2.89	6B14	1.99	6BA7	2.39	12A7	.99	12A7	.99	12A7	.99	12A7	.99
ECL	.39	2C23	3.99	3AP1	1.49	5R2	16.50	310A	4.46	802	2.89	6B14	1.99	6BA7	2.39	12A7	.99	12A7	.99	12A7	.99	12A7	.99
EM3GA	39.99	2C26	.22	3B24	2.49	5R2	16.50	310A	4.46	802	2.89	6B14	1.99	6BA7	2.39	12A7	.99	12A7	.99	12A7	.99	12A7	.99
F123A	5.99	2C26A	.49	3B24W	4.99	5R2	16.50	310A	4.46	802	2.89	6B14	1.99	6BA7	2.39	12A7	.99	12A7	.99	12A7	.99	12A7	.99
FG-105	14.44	2C30	4.95	3B24W	4.99	5R2	16.50	310A	4.46	802	2.89	6B14	1.99	6BA7	2.39	12A7	.99	12A7	.99	12A7	.99	12A7	.99
FG-154	16.99	2C30	4.95	3B24W	4.99	5R2	16.50	310A	4.46	802	2.89	6B14	1.99	6BA7	2.39	12A7	.99	12A7	.99	12A7	.99	12A7	.99
HF-100	6.99	2C30	4.95	3B24W	4.99	5R2	16.50	310A	4.46	802	2.89	6B14	1.99	6BA7	2.39	12A7	.99	12A7	.99	12A7	.99	12A7	.99
HF-150	15.99	2C30	4.95	3B24W	4.99	5R2	16.50	310A	4.46	802	2.89	6B14	1.99	6BA7	2.39	12A7	.99	12A7	.99	12A7	.99	12A7	.99
HF-200	10.99	2C30	4.95	3B24W	4.99	5R2	16.50	310A	4.46	802	2.89	6B14	1.99	6BA7	2.39	12A7	.99	12A7	.99	12A7	.99	12A7	.99
HF-300	19.99	2C30	4.95	3B24W	4.99	5R2	16.50	310A	4.46	802	2.89	6B14	1.99	6BA7	2.39	12A7	.99	12A7	.99	12A7	.99	12A7	.99
HK-24	3.99	2C43	10.40	3C28	4.99	5R2	16.50	310A	4.46	802	2.89	6B14	1.99	6BA7	2.39	12A7	.99	12A7	.99	12A7	.99	12A7	.99
HK-54	3.49	2C43	10.40	3C28	4.99	5R2	16.50	310A	4.46	802	2.89	6B14	1.99	6BA7	2.39	12A7	.99	12A7	.99	12A7	.99	12A7	.99
HY-114B	.69	2C43	10.40	3C28	4.99	5R2	16.50	310A	4.46	802	2.89	6B14	1.99	6BA7	2.39	12A7	.99	12A7	.99	12A7	.99	12A7	.99
HY-615	.29	2C43	10.40	3C28	4.99	5R2	16.50	310A	4.46	802	2.89	6B14	1.99	6BA7	2.39	12A7	.99	12A7	.99	12A7	.99	12A7	.99
KU-610	4.99	2C43	10.40	3C28	4.99	5R2	16.50	310A	4.46	802	2.89	6B14	1.99	6BA7	2.39	12A7	.99	12A7	.99	12A7	.99	12A7	.99
KQ-59	39.50	2C43	10.40	3C28	4.99	5R2	16.50	310A	4.46	802	2.89	6B14	1.99	6BA7	2.39	12A7	.99	12A7	.99	12A7	.99	12A7	.99
QK-61	63.60	2C43	10.40	3C28	4.99	5R2	16.50	310A	4.46	802	2.89	6B14	1.99	6BA7	2.39	12A7	.99	12A7	.99	12A7	.99	12A7	.99
QK-62	69.00	2C43	10.40	3C28	4.99	5R2	16.50	310A	4.46	802	2.89	6B14	1.99	6BA7	2.39	12A7	.99	12A7	.99	12A7	.99	12A7	.99
QK-185	110.00	2C43	10.40	3C28	4.99	5R2	16.50	310A	4.46	802	2.89	6B14	1.99	6BA7	2.39	12A7	.99	12A7	.99	12A7	.99	12A7	.99
RK-34	.29	2C43	10.40	3C28	4.99	5R2	16.50	310A	4.46	802	2.89	6B14	1.99	6BA7	2.39	12A7	.99	12A7	.99	12A7	.99	12A7	.99
RK-38	5.89	2C43	10.40	3C28	4.99	5R2	16.50	310A	4.46	802	2.89	6B14	1.99	6BA7	2.39	12A7	.99	12A7	.99	12A7	.99	12A7	.99
RK-59	1.99	2C43	10.40	3C28	4.99	5R2	16.50	310A	4.46	802	2.89	6B14	1.99	6BA7	2.39	12A7	.99	12A7	.99	12A7	.99	12A7	.99
RK-60	2.49	2C43	10.40	3C28	4.99	5R2	16.50	310A	4.46	802	2.89	6B14	1.99	6BA7	2.39	12A7	.99	12A7	.99	12A7	.99	12A7	.99
RK-65	9.95	2C43	10.40	3C28	4.99	5R2	16.50	310A	4.46	802	2.89	6B14	1.99	6BA7	2.39	12A7	.99	12A7	.99	12A7	.99	12A7	.99
RX-21A	5.99	2C43	10.40	3C28	4.99	5R2	16.50	310A	4.46	802	2.89	6B14	1.99	6BA7	2.39	12A7	.99	12A7	.99	12A7	.99	12A7	.99
UH-50	1.99	2C43	10.40	3C28	4.99	5R2	16.50	310A	4.46	802	2.89	6B14	1.99	6BA7	2.39	12A7	.99	12A7	.99	12A7	.99	12A7	.99
105-VT-25A	.99	2C43	10.40	3C28	4.99	5R2	16.50	310A	4.46	802	2.89	6B14	1.99	6BA7	2.39	12A7	.99	12A7	.99	12A7	.99	12A7	.99
VR-78	.99	2C43	10.40	3C28	4.99	5R2	16.50	310A	4.46	802	2.89	6B14	1.99	6BA7	2.39	12A7	.99	12A7	.99	12A7	.99	12A7	.99
VR-90	.82	2C43	10.40	3C28	4.99	5R2	16.50	310A	4.46	802	2.89	6B14	1.99	6BA7	2.39	12A7	.99	12A7	.99	12A7	.99	12A7	.99
VR-105	.89	2C43	10.40	3C28	4.99	5R2	16.50	310A	4.46	802	2.89	6B14	1.99	6BA7	2.39	12A7	.99	12A7	.99	12A7	.99	12A7	.99
VR-150	.00	2C43	10.40	3C28	4.99	5R2	16.50	310A	4.46	802	2.89	6B14	1.99	6BA7	2.39	12A7	.99	12A7	.99	12A7	.99	12A7	.99
VT-52	.29	2C43	10.40	3C28	4.99	5R2	16.50	310A	4.46	802	2.89	6B14	1.99	6BA7	2.39	12A7	.99	12A7	.99	12A7	.99	12A7	.99
305-VT-67	.79	2C43	10.40	3C28	4.99	5R2	16.50	310A	4.46	802	2.89	6B14	1.99	6BA7	2.39	12A7	.99	12A7	.99	12A7	.99	12A7	.99
VT-107A	2.99	2C43	10.40	3C28	4.99	5R2	16.50	310A	4.46	802	2.89	6B14	1.99	6BA7	2.39	12A7	.99	12A7	.99	12A7	.99	12A7	.99
VT-158	15.99	2C43	10.40	3C28	4.99	5R2	16.50	310A	4.46	802	2.89	6B14	1.99	6BA7	2.39	12A7	.99	12A7	.99	12A7	.99	12A7	.99
VU-111	.89	2C43	10.40	3C28	4.99	5R2	16.50	310A	4.46	802	2.89	6B14	1.99	6BA7	2.39	12A7	.99	12A7	.99	12A7	.99	12A7	.99
OA2	1.10	2C43	10.40	3C28	4.99	5R2	16.50	310A	4.46	802	2.89	6B14	1.99	6BA7	2.39	12A7	.99	12A7	.99	12A7	.99	12A7	.99
OB2	.86	2C43	10.40	3C28	4.99	5R2	16.50	310A	4.46	802	2.89	6B14	1.99	6BA7	2.39	12A7	.99	12A7	.99	12A7	.99	12A7	.99
1B24	5.99	2C43	10.40	3C28	4.99	5R2	16.50	310A	4.46	802	2.89	6B14	1.99	6BA7	2.39	12A7	.99	12A7	.99	12A7	.99	12A7	.99
1B29	1.19	2C43	10.40	3C28	4.99	5R2	16.50	310A	4.46	802	2.89	6B14	1.99	6BA7	2.39	12A7	.99	12A7	.99	12A7	.99	12A7	.99
1B32-532A	.99	2C43	10.40	3C28	4.99	5R2	16.50	310A	4.46	802	2.89	6B14	1.99	6BA7	2.39	12A7	.99	12A7	.99	12A7	.99	12A7	.99
1N22	.89	2C43	10.40	3C28	4.99	5R2	16.50	310A	4.46	802	2.89	6B14	1.99	6BA7	2.39	12A7	.99	12A7	.99	12A7	.99	12A7	.99
1N22	.89	2C43	10.40	3C28	4.99	5R2	16.50	310A	4.46	802	2.89	6B14	1.99	6BA7	2.39	12A7	.99	12A7	.99	12A7	.99	12A7	.99

We Buy Your Surplus Tubes.  
Send Us Your List For Highest Quotation  
LARGEST BUYERS IN THE COUNTRY

**FAY-BILL DISTRIBUTING CO. DEPT. E1**  
418 Broome St., N. Y. 13, N. Y.  
Telephone CA nAl 6-8404

All boxed and fully guaranteed. Special quantity discount—10% on 100 or more of same type. Minimum order \$10.00. Thousands of other types in stock. . . . Send us your requirements F.O.B. New York 25% deposit with order or paid in advance save C.O.D. charges. Rated firms net 10 days. Prices subject to change without notice. For fast service ask for Sy.

**GLASS INFRA-RED FILTERS**  
Special Designed Filter When Placed In Front Of Any Light Source, Filters Out All Visible Light But Freely Passes Invisible Infra-Red Rays. Army Sniperscope Part #A-1529. 5 1/2" Dia. By 1/2 Thick. BRAND NEW. Package Of Ten Filters For ONLY \$10.00

**LOW-VOLTAGE TRANSFORMERS**  
New Release of Government Surplus Material Model #S-9527. KENYON TRANSFORMER CO. — 2.2 KVA. Input 110/220 volts 50/60 Cy. Output 11 Volts C-T (5.5-0-5.5) At 200 Amperes! Continuous Duty. Case Size 8 1/2 x 10 1/2 x 13".

Price BRAND NEW ONLY. \$23.95 Ea. #S-9527-WE. VINCININGHOE St. Same Specs. But Single 115 V Input & Lighter Wt. NEW \$22.95

Terms: Prices FOB St. Louis. Cash With Orders. Well Rated Concerns. D&B. Net 10 Days. Cash. McNEAL ELECTRIC & EQUIPMENT CO.  
4736 Olive St., Dept. E-2, St. Louis 8, Mo.

**AN/APR-4 LABORATORY RECEIVERS**

Complete with all five Tuning Units, covering the range 38 to 4,000 Mc; wideband discone and other antennas, wavetraps, mobile accessories, 100 page technical manual, etc. Versatile, accurate, compact—the aristocrat of lab receivers in this range. Write for data sheet and quotations.

We have a large variety of other hard-to-get equipment, including microwave, aircraft, communications, radar; and laboratory electronics of all kinds. Quality standards maintained.

NEW TS-13/AP X-BAND SIGNAL GENERATORS with manual \$575.00; T-47A/ART-13 Transmitters, \$450.00; H-P, Boonton, G-R, Measurements, many others in stock.

**ENGINEERING ASSOCIATES**  
434 PATTERSON ROAD DAYTON 9, OHIO

**RCA TV CAMERA**

**NEW Surplus**  
for Labs! Export!  
Industrials!  
Medicine!  
Closed Circuit  
TV!

Ideal for labs, industry, prisons, TV technicians, swim pools, medical—mechanical eye for closed circuit TV, 1846 Iconoscope, 6-stage video amplifier and clipper. THE REAL THING! SOLD AT FRACTION OF REAL VALUE!

**Harjo Sales Co.**  
Office-Warehouse: Dept. E-2, 503 N. Victory Blvd., BURBANK, CALIFORNIA

**AN/APS-19 RADAR**

New, complete. Fulfills following functions:  
SEARCH: Aircraft, ships and land.  
MAPPING: Land and water contours, coast line identification and navigational aids.  
INTERROGATION: Detection and location of ships, land and airborne microwave beacon stations for homing and navigation.  
INDICATIONS: Identifying challenged targets. Also, interrogating pulse.  
AIM: Aim indication for firing of fixed guns.

Write or

**KOILED KORDS** 3 wires  
22 inches long stretches to 9 ft. **\$1.26**

**REVERSIBLE GEARED-MOTOR**

Delco-PM-Permanent Magnet Alnico Field Motor

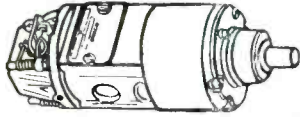

#5071895 1/4 SHAFT or 11/16 GEAR... \$17.50  
#5069600... \$18.50  
Two Types of Clamps to hold motor: \$1.50 ea.

**MERCURY SWITCHES**  
59¢ to \$6.00

**FILAMENT TRANSFORMER**  
6v-1 1/2 amps **97¢**  
Weights—1 lb.

**HG We Buy MERCURY HG**

G.E. Switchettes  
All types—75¢ ea.  
10 for \$6.00  
100 for \$50

115 v. AC  
**RELAY**  
**\$2.90**

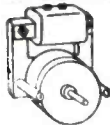

**TELECHRON Motors**

4 RPM on 50cy	3.6 RPM. 3.15
or 4 3/4 RPM	1 RPM. 3.95
on 60 cy. \$2.85	3 R.P. Hr 2.85
2 RPM .. \$2.90	1 R.P. 2Hr 2.80
3 RPM .. 3.90	1 R.P. 12Hr 3.25
4 RPM .. 2.90	60 RPM.. 4.85

Laboratory Special 1 of Each Motor \$25.

please include postage

**BLOWERS 115 Volts A. C. 60 cy.**



REDMOND 5" 18 watts...\$8.95  
DELCO 60 cfm. 40 watts.  
#5062369 used in 584 RADAR \$14.50

HAND WOUND 10 Sec. to 24 Min. **TIMER SWITCH**..\$1.25

6 Watt Most **POWERFUL TELECHRON MOTOR**  
110V 60 CY



**3" Round Elapsed Time Meter**  
Square Case **\$14.50**

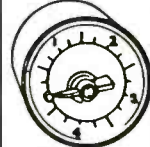

**MARKTIME 5 HOUR SWITCH**

A 10 amp. timing device. Pointer moves back to zero after time elapses. Ideal for shutting off radios and TV sets when you go to bed. Limited supply at this SPECIAL PRICE... **\$4.90**

Also available in 15 min., or 30 min. or 1 hr. at...\$6.50

**HAYDON TIMING MOTORS**

110v 60 cycle 30 RPM	\$2.60
110v 60 cycle 1 RPM	2.60
230v 1 RPM	1.00
60cy 1/2 RPM	1.00



EST. 1923 **64A Dey Street**  
New York 7, N. Y.

**LICENSE TO MANUFACTURE WANTED**

Smaller British electronics firm of repute wishes to extend its field by manufacturing under license medical or industrial products of U.S.A. design.

BO-8789, Electronics  
330 W. 42 St., New York 36, N. Y.

★ **MANUFACTURERS**

Let us handle technical sales representation of your products

★ **INVENTORS**

We will share the cost of protecting your invention if accepted for commercialization

We Specialize in Electronics, Nucleonics, Instrumentation, Servomechanisms & Cybernetics.

**R. W. HODGSON CO.**

Technical Sales Representation & Research & Development Engineering  
3408 W. Washington Blvd. Los Angeles 18, Calif.  
REpublic 2-2651

**WANTED**

ELECTRONIC TUBES, all types. Also want all types airborne electronic equipment: ART-13; BC-788; I-152; ARC-1; ARN/7, etc. Top dollar paid!

**BOB SANETT, W6REX**

1524 S. Edris Dr.  
Los Angeles 35, California

**SELLING**

- Receivers
- Transmitters
- Radar
- Special Purpose Tubes
- Relays
- Meters
- Switches
- Connectors
- Rectifiers
- Transformers
- Motors & Generators
- Wiring Cable
- Instruments
- and
- All Electronic Components

**WILL BUY ALL**

New or Used

Leach Relay #5059-R  
#5058  
#5055  
#5053-SM  
#5053

Price Bros. Relay #10  
Relay #5586  
#5587

Antenna Switching Relay  
Box # CBY 23049  
# BC-AN-198  
# BC -408

Tubes #53A  
VT-127A  
35T  
WL-530

Highest prices paid for most all types of aircraft sparkplugs any condition

**RADIO & ELECTRONIC SURPLUS**

13933-9 BRUSH STREET  
Detroit 3, Mich. TO 9-3403

Wholesale Only

Wholesale Only

**A BARGAIN FOR YOU in a....**

**SOLA Constant Voltage TRANSFORMER**

**End Fluctuating Line Voltage**

**OVER 60% OFF . . .**

the factory price of a 1-Input 2,000 VA until And here's another bonus! This Air Forces 2,000 VA overstock, Sola Cat. No. 30768, has 4 inputs! 90-125 V., 190-250 V., 60 cy. or 50 cy. Isolated secondary is constant 115.0 V. ± 1% from no-load to full-load of 17.4 amp. So, if you choose, use it as a 220:115 V. step-down. And slash \$147.50 off the factory 1-Input price!



Brand new in original wood box. 4 cu. ft. Ship. wt. 254 lbs. F.O.B. Pasco, Wash. Only. **\$97.50**

(EXPORTERS: Note choice of 50 cycles.)

**THE M. R. COMPANY**

P. O. Box 1220-B Beverly Hills, Calif.

**SURPLUS**

BOUGHT & SOLD

**GOULD GREEN** 252 Greenwich St. WOrth 4-8044—NYC 7

**"SEARCHLIGHT" RATES**

**DISPLAYED RATE**

The advertising rate is \$18.50 per inch for all advertising appearing on other than a contract basis. Contract rates quoted on request.

AN ADVERTISING INCH is measured 7/8 inch vertically on one column, 3 columns—30 inches—to a page.

EQUIPMENT WANTED or FOR SALE ADVERTISEMENTS acceptable only in Displayed Style.

**UNDISPLAYED RATE**

\$2.10 a line, minimum 3 lines. To figure advance payment count 5 average words as a line.

PROPOSALS, \$2.10 a line an insertion.

BOX NUMBERS count as one line additional in undisplayed ads.

DISCOUNT of 10% if full payment is made in advance for four consecutive insertions of undisplayed ads (not including proposals).



MOTOR GENERATORS AND CONVERTERS

50, 60, 400 and 800 cycle and DC Power Supplies

Table listing motor generators and converters with specifications like voltage, current, and price. Includes items like 28dc to 110/1/800 @ 1kva for \$49.50.

Partial Listings—Please Advise Your Needs

SYNCHROS & SELSYNS

Table listing synchros and selsyns with specifications like model number, voltage, and price. Includes items like 1F for \$55.00 and 6DG for \$34.50.

Torque Unit, Pioneer # 12602-1-A Includes CK-5 Motor and AY-43 autosyn \$34.50

MICRO WAVE ACCESSORIES

Table listing micro wave accessories with specifications like component type, size, and price. Includes items like Echo Box, Flex. Wave Guide, and Rotating Feed Arm Assy's.

... and crystal mounts, Klystron mounts, duplexers, I.f. strips, converters and many special bends and devices too numerous to list. Send sketch if possible.

TEST SETS

Hundreds of different types of test equipment, military as well as commercial types. Please advise your needs

Wholesale, Industrial and Institutional Sales Only



COMPASS ELECTRONICS SUPPLY

A Division of Compass Communications Corp.

75 VARICK ST. NEW YORK 13, N. Y. CANAL 6-7455 Cable Address: COMPRADIO, N. Y.

ELECTRONIC TUBES - All types - one dependable source!

ALL V. & H. TUBES

are new, first quality, unconditionally guaranteed! advertised here are in stock—now! are standard brands, R.C.A., Sylvania, G.E., etc. are obtainable from one source. That includes NATO, IAN, commercial, special purpose, transmitting, receiving, etc.

Large grid of electronic tube types and their prices. Columns include tube types like 6X4, 6AV6, 6BE6, etc., and prices ranging from \$1.00 to \$100.00.

PRICES AND CATALOGUES ON REQUEST.

SEND US YOUR INQUIRIES. WE BUY ALL TYPES ELECTRONIC TUBES. TOP PRICES PAID. PHONE NOW! Same Day Shipment!

V & H RADIO AND ELECTRONICS SUPPLY

2029-2047 W. VENICE BLVD. LOS ANGELES 6, CALIF. Republic 0215

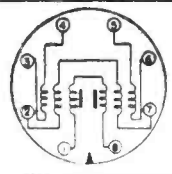

PULSE TRANSFORMER PT-3 TUBE BASE PLUG-IN TYPE

Similar characteristics to UX 7350. Precision-made. Two 100-turn and two 50-turn coils wound on high quality hypersil cores. Built into octal bakelite tube bases. Completely impregnated and sealed—humidity-resistant. Diagram on end disc of each unit provides versatility of application.



THESE PT-3 TRANSFORMERS may be used

- In Blocking Oscillator, Multivibrator and Scope Circuits.
• For Interstage coupling, impedance matching and isolation.
• Wherever accurate timing and triggering are essential.
• In circuit applications requiring the generation of low power and low voltage pulses.
• In circuits utilizing repetition rates from 0 to well over 1 MC and pulse widths from .03 microsecond.

LOW INTRODUCTORY PRICE Only \$5.95 ea. 2 for \$11.00



Cramer Electronics, Inc.

811 Boylston St., Boston 16, Mass. CO 7-4700

Write for Bulletin of late items.

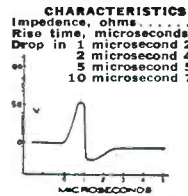

TAB TUBES



1st Quality TESTED - GUARANTEED

Table listing various vacuum tube models (e.g., OA2, OA3, OB2) and their specifications, including prices and quantities.

NEW 'TABTRON' SELENIUM RECTIFIERS

ENGINEERED FOR INDUSTRY. Technical Apparatus Builders' mfgs. Power Rectifiers to your specs. From one amp up to and above 1000 amps, convection or fan cooled, single or 3 phase. 'NEMA' & JAN. Specs. Write for catalog.

Table showing specifications for Full Wave Bridge, Dated & One GTD, with columns for Max Amp, Voltage, and other technical details.

JOBBERS—DISTRIBUTORS, WRITE FOR DETAILS

Heavy Duty Battery 'Fast' Charger Rectifier. 18-0-18V(CT) 100 Amp Fan Cooled or 34 Amp Air Cooled. Rept. Mt 0V Booster Charger. \$12.00

New Variable Voltage X-fms. SUPERIOR-GR-STACO-UT. 0-135V-1.25A. \$7.23

High Current Power Supplies. ONE YEAR GTD. Variable 0-28VDC. Completely Built. Ready to Go. Full Wave Selenium Rectifier Transformer.

BUY AS YOU NEED AT FACTORY DISCOUNTS. Large Stocks & Immediate Delivery.

Table listing various power supply models (e.g., T28V5A, T28V5ACC) and their specifications.

New Variable 0 to 6 & 12 Volt/16 Amp. DC POWER SUPPLY. Battery Eliminator Charger.

New! Quality VOLTAGE REGULATOR ONLY \$16.98. Line Voltage Stabilizer. Stabilizes line voltage within plus or minus 3% regardless of VOLTAGE, FREQ., Shift.

FILTER CAPACITORS. CE156M 6000MFD 15V. 98c; 2/51.50; 10/55

230 to 115V Autotrans. For 220V/50cy Input. To 110-120V or Step up. 1 With Cord. Plug & Receptacle. \$2.55

'TABTRON' Rectifier Xfms. Sec'd Voltages (OUAL) 18-15-9-0-0-9-15-18. Series Sec'd 36-30-18-9-0

'TAB' NEW YORK DISTRIBUTOR. Write for Discounts and Rectifier Catalog PR156

'TABTRON' Rectifier Chokes. CR6002/1 Amp/0.1 HY/1.4 Ohm \$4.50; 2 for \$8

'TAB' SPECIAL BARGAIN BUYS. Get Your Share of These Real Money Savers. NEW MINIATURE DEHL PM MOTOR—Type FD6-21, RPM 10,000/27.5VDC

DC Power Supply. 6 or 12V DC Power Supply. Full Wave Rectification. 6000MFD Condenser Filter.

NEW 'TABLITE' ELECTRONIC FLASH KIT 400 II. Compact Camera, size case 6 1/2" x 4 1/2" x 2 1/4" Depth 5" Wdth. Uses new LO-COST Flash circuit 3/4c per flash.

PHOTOFLASH & STROBE LAMPS. 'TAB' No. Replaces Max Each. TWL FA 104/F118 150 55.98

PRECISION JEWELLED D'ARSONVAL Mvt. Better than 2% accy. Readable 100-1500 scale 20 divisions. Well damped. Bakelite case. Front op. or Rear Round Face mtg. Mounts 1 1/4" hole. 4 screws 1 1/4" str. Not surplus. Millamp Shunts each \$1.35

INFRARED SNOOPSCOPE. SEE IN DARK TUBE. Selected, GTD Image-Converter Tube. Hi-Sensitivity simplified design. dia. Willemite screen. Resolution up to 350 lin./in. Tube & Data 'TAB' Special \$53.90/2/57.50

THAT'S 'TAB' THAT'S A BUY. 111 Liberty St., New York 6, N. Y. U.S.A.

HI-FI HDQTS

COMPLETE LINE OF HI-FI. GET OUR PRICE B-4-U-BUY. NEW G.E. PHONO CARTRIDGES

Table listing G.E. Phono Cartridge models (e.g., RPX050A, RPX052A) and their prices.

Repl'ment Needles 'TETRAD' diamond. RPJ010A Dual (S) .001 & .003 GE... \$1.98

Table listing Repl'ment Stylus for RPJ000 & 041 Onto. RPJ001 or RPJ005 Single (S) GE... \$1.35

NEW 15" HI-FI SPEAKERS

SOLD ON MONEY BACK GUARANTEE. Latest Design, Biggest & Best Ticalon 5DC Magnet Assembly.

NEW HI-FI TWEETER. Electrostatic New 3D Tone Range. Linear Response range 7000-20000 cps. THB70—Round 2 1/2" dia. depth 1 1/2" \$5.25; 2 for \$8.99

'TAB' HI-FI SPEAKERS. Inbuilt work 2" was needed for HF & LF Response. Famous HI-FI mfg. 15 Coaxial PM & 3/4" Tweeter.

New Collaro RC-54 Charger with Hi-Fi Crystal Pickup \$39.75

HI-FI RECORDING TAPE. Finest, \$35. Back Gtd. PRECISION COATED & SLIT

'TAB' @ \$1.68 ea.; 3 for \$4.74; 12 for \$15.96; 24 for \$31.45 ea; 72 for \$113.35 ea.

NEW LOW PRICES!

PRECISION RESISTORS. 1% Accuracy Gtd. No Mfg Choice. We Ship Types in Stk. 'TAB' Special. 10 of One Value... ea 10c. 100 of One Value... \$8.00. 10 Assorted Values... \$1.50

POCKET AC-DC Multitester. 'TAB' 27C \$7.75 ea. Hi-accuracy precision VOM

TRANSFORMERS. ALL 115V 60 CYC INPUT. 2500V/200MA, 6.3V/6A, 2.5V/3A

TRANSFORMERS. ALL 115V 60 CYC INPUT. 2500V/200MA, 6.3V/6A, 2.5V/3A

TRANSFORMERS. ALL 115V 60 CYC INPUT. 2500V/200MA, 6.3V/6A, 2.5V/3A

TRANSFORMERS. ALL 115V 60 CYC INPUT. 2500V/200MA, 6.3V/6A, 2.5V/3A

TRANSFORMERS. ALL 115V 60 CYC INPUT. 2500V/200MA, 6.3V/6A, 2.5V/3A

TRANSFORMERS. ALL 115V 60 CYC INPUT. 2500V/200MA, 6.3V/6A, 2.5V/3A

Money Back Guarantee (Cost of Mds. Only) \$5 Min. Order FOB N. Y. C. Add ship. charges or for GOD 25% Dep. Prices Subject to Change Without Notice.





he's working  
for you

THIS FELLOW IS TRAINED IN YOUR BUSINESS. His main duty is to travel the country — and world — penetrating the plants, laboratories and management councils . . . reporting back to you every significant innovation in technology, selling tactics, management strategy. He functions as your all-seeing, all-hearing, all-reporting business communications system.

THE MAN WE MEAN IS A COMPOSITE of the editorial staff of this magazine. For, obviously, no one individual could ever accomplish such a vast business news job. It's the result of many qualified men of diversified and specialized talents.

AND, THERE'S ANOTHER SIDE TO THIS "COMPOSITE MAN," another complete news service which complements the editorial section of this magazine — the advertising pages. It's been said that in a business publication the editorial pages tell "how they do it" — "they" being all the industry's front line of innovators and improvers — and the advertising pages tell "with what." Each issue unfolds an industrial exposition before you — giving a ready panorama of up-to-date tools, materials, equipment.

SUCH A "MAN" IS ON YOUR PAYROLL. Be sure to "listen" regularly and carefully to the practical business information he gathers.



McGRAW-HILL PUBLICATIONS

Want more information? Use post card on last page.

Dale Products, Inc.	248
Dano Products Co.	384
Daubert Chemical Co.	376
Daven Company	3rd Cover
Davies Laboratories, Inc.	290
DeJur-Amsco Corporation, Electronics Sales Div.	56, 57
Delco Radio Div. of General Motors	238
DeMorney-Bonardi	375
Dialight Corporation	360
Dit-Meo, Inc., Electronics Div.	320
Donner Scientific Co.	361
Driver-Harris Co.	235
DuPont de Nemours & Co. (Inc.) E. I. Film Dept.	289
Polychemicals Dept.	87
Durant Mfg. Co.	367
Dyna-Empire, Inc.	347
Eastern Industries, Inc.	368
Eastman Kodak Company	185
Edo Corp.	303
Eisler Engineering Co., Inc.	380
Eitel-McCullough, Inc.	89
Eleo Corp.	377
Electrocraft, Div. of Hamilton-Pax, Inc.	444
Electro Impulse Laboratory	381
Electro Tec Corp.	257
Electronic Instrument Co., Inc. (EICO)	337
Electronic Tube Corp.	288
Emerson & Cuming, Inc.	284
Empire Devices Products Corp.	329
Engineering Co., The	360
Epsco, Inc.	242
Eraser Co., Inc.	383
Erie Electronics Division, Erie Resistor Corp.	222
Fairechild Camera & Instrument Corp.	85
Falcon Electronics Corp.	380
Fansteel Metallurgical Corp.	45, 204
Federal Telephone & Radio Corp.	253
Ferroxcube Corp. of America	358
Film Capacitors, Inc.	266
Filtors, Inc.	343
Fisher & Crome	441
Ford Instrument Co., Div. Sperry Rand Corp.	203
Frenchtown Porcelain Company	371
Gabriel Electronics Div. of Gabriel Co.	304
Gamewell Co.	198
Gee-Lar Manufacturing Company	370
General Electric Company	
Apparatus Dept.	30, 31, 231
Electronics Dept.	267
Laminated and Insulation Products Dept.	81
Tube Dept.	23
General Precision Equipment Corp.	72, 73
General Radio Co.	17

Good-All Electric Mfg. Co.	241
Gries Reproducer Corp.	377
Guardian Electric Mfg. Co.	247

Hammarlund Mfg. Co., Inc.	25
Hart Mfg. Co.	190
Harvey Hubbell, Inc.	315
Haydon Manufacturing Co., Inc.	258
Haydu Brothers of New Jersey	191
Heath Co.	356
Helipot Corp., Div. of Beckman Instruments, Inc.	177
Hermetic Seal Company	117
Hewlett-Packard Co.	54, 55
Heyman Manufacturing Co.	374
Hertner Electric Co.	370
Hitemp Wires, Inc.	66
Hughes Aircraft Co.	61
Hughes Research & Development Laboratories	60
Houghton Laboratories, Inc.	302
Hughey & Phillips, Inc.	328
Hunt Company, Phillip A.	226
Hycor Company, Inc.	218

Ilseco Corporation	358
Industrial Development Committee of 100, Lakeland, Florida	356
Industrial Timer Corp.	313
Institute of Radio Engineers	275
International Business Machines	271, 300
International Rectifier Corp.	265
International Resistance Co.	104, 105
Ippolito & Co., Inc., James	342

Irvington Division Minnesota Mining and Mfg. Co.	369
--	-----

Jet Propulsion Laboratory	199
Johnson Company, E. F.	333
Jones Div., Howard B., Cinch Mfg. Co.	378
Jones Electronics Co., Inc., M. C.	292

Kahle Engineering Co.	15
Karp Metal Products Co.	43
Kay Electric Co.	27
Kearfott Company, Inc.	298
Kellogg Switchboard & Supply Company	352
Kepco Laboratories	175
Kester Solder Co.	213
Kinney Mfg. Div., The New York Air Brake Co.	307

Laboratory for Electronics, Inc.	95
Lampkin Laboratories, Inc.	371

# PRECISION MEASURING INSTRUMENTS

.001 CPS to 500 MC — ACCURACY 0.1°

## PRECISION PHASE DETECTOR

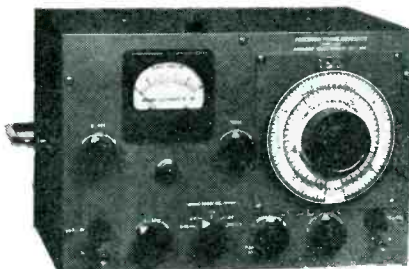

TYPE 205

- Measures time delay as small as  $8 \times 10^{-11}$  seconds
- Measures phase delay with 0.1° accuracy
- 100 KC to 15 megacycles, 0.01 volt sensitivity
- Additional step delay line with 2.95 us delay supplied with type 205A

PRICE \$445.00



## PRECISION PHASE METER

- 0.3-120 V, 8 CPS-100 KC
- No ambiguity at zero degree
- 0.25° relative accuracy

Type 405 Phase Meter has a frequency range of 8 cps to 100 kc, phase range 0-36, 0-90, and 0-180 degrees; a switch is provided for 180-216, 180-270, and 180-360 degrees. The accuracy is 1/4 degrees relative and 1 degree absolute in any range. The input impedance is 2.7 megohms shunted with 20 uuf on both channels. The meter scale is 6 1/2" long, thus a fraction of 1/4 degree can be read easily.

PRICE \$485.00



TYPE 405

WRITE FOR DATA!

# ADVANCE ELECTRONICS LAB., INC.

451 HIGHLAND AVENUE • PASSAIC, N. J.

# none others approved\*



## MIDGET WIRE-WOUND VITREOUS RESISTORS

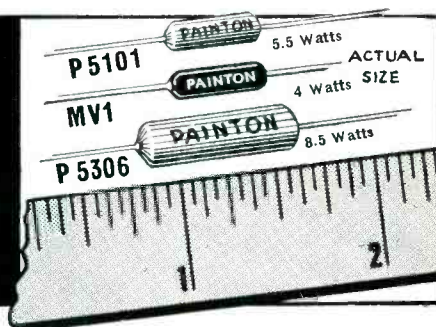

\* "One of our subminiature potted assemblies required 10,000 ohm resistors to dissipate almost 4 watts in a box ambient of up to 150° C. Dimensional limits were 1/4" Dia. x 3/4" Length. Also important were retrace characteristic and ability to withstand wattage overloads and excessive temperatures. Only Painton's P 5306 could be approved."

—Prominent U. S. Military Contractor  
(Name supplied on request)

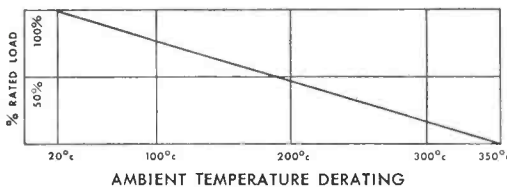

NOW! NEW! 100% hermetically sealed, fully insulated to 1000 Volts RMS, 100% inspected. Values to 150,000 ohms, temperature coefficient not exceeding .004%/°C even at the highest resistance values of the P300A Series. Paintons are insulated to 1000 megohms DC resistance even at maximum working temperature. Meets operational characteristics of MIL-R-26B. Painton resistors are readily available in the U.S.A. All orders are handled by cable and air transportation when additional production from the English plant is required.

BRITISH ELECTRONIC SALES CO., INC.  
23-03 45th RD., LONG ISLAND CITY 1, N. Y.  
Telephone EXeter 2-6660

SEND FOR FREE SAMPLES AND COMPLETE DATA

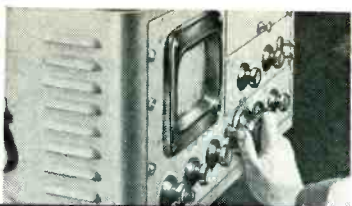

the pioneer  
is the leader

# PANORAMIC has the instrument you need for analysis and measurement problems

Get accurate answers fast with Panoramc's Spectrum Analyzers covering the sub-audio thru microwave range, Sweep Generators for sonic and ultrasonic range and Frequency Calibrators.

Send for Panoramc Catalog Digest today and find out how Panoramc can solve your problems.

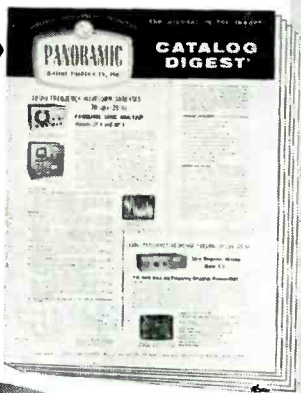

### A Partial List of Users of Panoramc Equipment:

- Convair
- Hotpoint Company
- Lockheed Aircraft Corp.
- Massachusetts Institute of Technology
- Philco Corp.
- Radio Corporation of America
- Sperry-Gyroscope Co.
- U. S. Testing Co., Inc.
- Westinghouse Electric Corp.
- Allis-Chalmers Mfg. Co.
- U. S. Atomic Energy Commission
- Bell Aircraft Corporation
- Bell Telephone Company
- Boeing Airplane Company
- Cornell University
- California Institute of Technology
- E. I. duPont de Nemours & Co.
- Eastman Kodak Co.
- General Motors Corp.
- Ford Motor Co.
- Chrysler Corp.
- Department of Defense
- Prait & Whitney Aircraft
- Curtiss Wright
- Western Electric
- General Electric Co.



- Makers of
- Panadaptor
- Panalyzer
- Panoramc
- Sonic Analyzer
- Panoramc Ultrasonic Analyzer and many others

10 So. Second Ave., Mount Vernon, N. Y. MOUNT VERNON 4-3970  
Cables: Panoramc, Mount Vernon, N. Y. State

they're new

## ELECTROCRAFT PLUGS • JACKS • CONNECTORS



Sturdy 2 and 3 conductor plugs, reduced in size, are made in a wide variety of terminal and handle styles. Metal handles are baked enamel striped . . . plastic handles in red or black. Screw type, combination clamp and solder lug or plain solder lug terminals.

Jacks make positive electrical contact with standard mating plugs by positive spring pressure. Springs are nickel silver material, insuring long life and maximum solderability. Made in two and three conductor types — open and closed circuit.

Microphone connectors, both cord and panel mounted, are ruggedly made of nickel plated brass.

Send for bulletin giving complete specifications on these new products of a long established manufacturer.



Division of Hamilton-Pax, Inc.

3743 N. Kedzie Avenue, Chicago 18, Illinois



Langevin Manufacturing Corp.	208
Lapp Insulator Co., Inc.	357
Lavoie Laboratories, Inc.	293
Leach Corp.	113
Lear, Inc.	18, 49
Leeds & Northrup Company	295
Linde Air Products Company, Div. of Union Carbide & Carbon Corp.	328
Lockheed Missile Systems Div.	297
Los Alamos Scientific Laboratory of the University of California	224

M B Manufacturing Co.	59
MacDonald, Inc., Samuel K.	386
MacLean Corp.	386
Magnatran, Inc.	346
Magnecord, Inc.	39
Magnetic Amplifiers, Inc.	274
Magnetics, Inc.	195
Mallory and Co., Inc., P. R.	120, 173
Marconi Instruments, Ltd.	86
Marion Electrical Instrument Co.	310, 328
Markem Machine Co.	336
Martin Company, Glenn L.	334
Maxxon Instruments	324
McColpin Christie Corp.	310
McGraw-Hill Book Co.	384
Measurements Corp.	180
Metals & Controls Corp., General Plate Div.	229
Micro Switch, a Div. of Minneapolis-Honeywell Regulator Co.	281
Mid-Century Instrument Corp.	52
Midland Mfg. Co., Inc.	263
Mid-Lantic Chapter "The Representatives" of Electronic Products Mfr., Inc.	299
Millen Mfg. Co., Inc., James	344
Minneapolis-Honeywell Regulator Co., Industrial Div.	251
Moloney Electric Co.	93
Monsanto Chemical Co.	277
Muirhead & Co., Ltd.	5
Mullard Overseas, Ltd.	112

N J E Corporation	119
Narda Corp.	272
National Aircraft Corp.	227
National Fabricated Products Div. of Hoffman Electronics Corp.	75
National Lead Co.	209
National Moldite Co.	219
Nemis-Clarke, Inc.	372
Norden-Ketay Corp.	330, 331
North American Aviation, Inc.	348
North Carolina Dept. of Conservation & Development	268
Northern Radio Co., Inc.	309
Nothelfer Winding Labs, Inc.	206

Opad Electric Co.	358
Oregon Electronics	317

Orradio Industries, Inc.	225
Otis Elevator Company, Electronics Div.	98, 99
Panoramic Radio Products, Inc.	444
Penta Laboratories	184
Perkin-Elmer Corporation	350
Perkin Engineering Corp.	33
Phalo Plastics Corp.	325
Phaotron Instrument & Electronic Company	188
Phelps-Dodge Copper Products Corp., Inca Mfg. Div.	106, 107
Philamon Laboratories, Inc.	47
Phillips Process Co., Inc.	372
Photocircuits Corp.	316
Photographic Products, Inc.	384
Pittsburgh Leetrodyer Corp. Div. of H & B American Machine Co., Inc.	42
Plasteck, Inc.	381
Polarad Electronics Corporation	79
Polytechnic Research & Development Co., Inc.	92
Potter & Brumfield, Subsidiary of American Machine & Foundry Co.	191
Precision Apparatus Co., Inc.	446
Precision Paper Tube Co.	282
Pyramid Electric Company	94
Radiation, Inc.	375
Radio Condenser Co.	80
Radio Corporation of America	108, 109, 4th Cover
Radio Engineering Laboratories, Inc.	189
Radio Engineering Products	351
Radio Materials Corp.	115
Radio Receptor Company, Inc.	46
Railway Express Agency, Air Express Div.	205
Ramo Wooldridge Corp.	287
Remington Rand Univac, Div. of Sperry Rand Corp.	193, 283
Raybestos-Manhattan, Inc.	379
Raytheon Mfg. Co.	18, 19, 29, 35
Reeves Instruments Corp.	83
Relay Sales	236
Reliance Mica Co., Inc.	385
Robins Industries Corp.	386
Rowe Engravers	386
Rutherford Electronics Co.	362
Sanborn Company	69
Sanders Associates, Inc.	378
Schuster & Co., Inc.	383
Scintilla Div., Bendix Aviation Corp.	327
Sealectro Corp.	321
Sealtron Corp.	371
Shallcross Mfg. Co.	182
Shasta, Div. Beckman Instruments, Inc.	365
Shure Brothers, Inc.	294

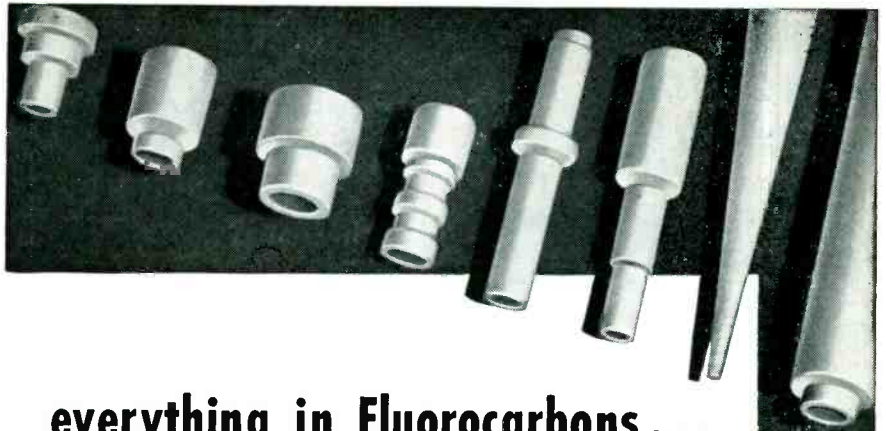

## everything in Fluorocarbons... the most complete service in parts and stock

■ United States Gasket Company offers precision parts fabricated from duPont TEFLON, Kellogg KEL-F, BAKELITE Fluoroethene and other plastics. U.S.G. facilities provide cold molding and sintering techniques, compression molding, extruding and injection molding—quality controlled “from powder to part,” to assure uniform electrical, chemical and physical characteristics of the highest quality.

U.S.G. also maintains a machine shop specially equipped for the precision machining of parts from fluorocarbon stock.

Come to U.S.G. for all your requirements—sheets, rods, tubing, tape, cylinders, bars, beading, electrical spaghetti—as well as custom-molded and machined parts.

Write for Catalog No. 300.

**United States Gasket Company**  
CAMDEN 1, NEW JERSEY

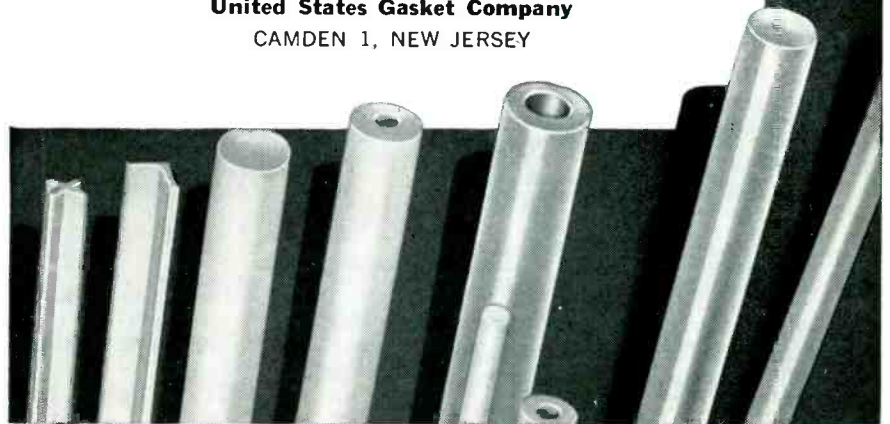

**FABRICATORS OF FLUOROCARBONS  
AND OTHER PLASTICS**

Representatives in principal cities throughout the world

# TUBE TESTING CAN BE INCLUSIVE... CONCLUSIVE...

## WITH THE **PRECISION** SERIES 10-12 *Electronamic* TUBE PERFORMANCE TESTER

Testing a tube for mutual conductance alone or for any other single factor, does not determine its ability to satisfy a wide range of dynamic operating conditions.

In the *PRECISION Electronamic* circuit, the tube under test is dynamically swept over a complete "path of operation"—on a sinusoidal time base, encompassing a wide range of plate family characteristic curves.

This widely inclusive "path of operation" is integrated by the indicating meter in the positive performance terms of "Replace-Weak-Good."

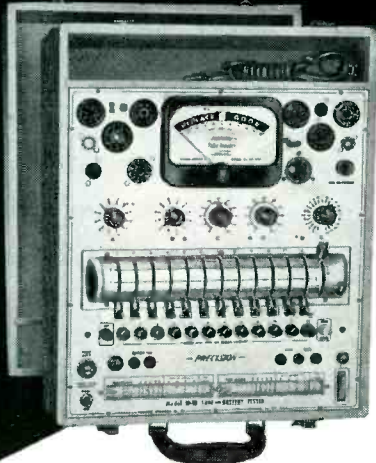

- Individual element selector facilities accommodate up to 12 tube elements.
- Filament voltages from 3/4 to 117 volts on 24-position selector switch.
- Tests series-string 7 and 9 pins; subminiatures; 5 and 7 pin acorns; double-capped H.F. amplifiers; low-power transmitting tubes; etc.
- Built-in stainless-steel pin-straighteners for small 7 and 9 pin tubes.
- Dual short-check sensitivity for special-purpose tube selection.
- Built-in hi-speed, brass-g geared roller chart.
- 5 1/4" wide-angle PACE Meter.

PLUS special radio-type dry battery testing facilities, under dynamic load conditions.

Model 10-12-P Deluxe (illustrated): with 2-color satin-brushed aluminum panel and contrasting dark-blue control knobs. Rubbed, natural-finish, sloping hardwood cabinet. Size 17 1/4 x 13 3/4 x 6 3/4 in. Net Price: \$117.50

Model 10-12-P Standard: with black and white anodized panel. Net Price: \$112.50

Write for latest complete catalog

### **PRECISION** Apparatus Co. Inc.

70-31 84th Street, Glendale 27, L. I., N. Y.  
Export: 458 Broadway, New York 13, U. S. A.  
Canada: Atlas Radio Corp., Ltd., 50 Wingold Ave., Toronto 10

Want more information? Use post card on last page.

446

Sierra Electronic Corp.	264	Varian Associates	103
Sigma Instruments, Inc.	335	Vector Electronic Co.	385
Signal Engineering & Mfg. Co.	363	Veeder-Root, Inc.	110
Sola Electric Company	116	Virginia Department of Conservation & Development	210
Sorensen & Co., Inc.	4	Vulcan Electric Co.	310
South Chester Corp.	36		
Southern Electronics Corp.	53		
Southwestern Industrial Electronics Co.	332	Waldes Kohinoor, Inc.	41
Spectrol Electronics Div. of Carrier Corp.	301	Ward Leonard Electric Co.	243
Sprague Electric Co.	11, 179, 220	Washington Machine & Tool Works, Inc.	349
Stackpole Carbon Co.	259	Waterman Products Co., Inc.	228
Staedtler, Inc., J. S.	230	Waters Manufacturing, Inc.	296
Standard Electric Time Co., The	44	Welwyn International, Inc.	374
Stevens Arnold, Inc.	338	Wenco Manufacturing Co.	310
Stoddart Aircraft Radio, Inc.	234, 280	Westinghouse Electric Corp.	273
Stokes Machine Co., F. J.	62, 63	White Dental Mfg. Co., S. S.	306, 343
Stupakoff Ceramic & Manufacturing Co., Div. of the Carborundum Co.	318, 319	Williams & Co., C. K.	344
Sun Tube Corp.	262	Woods Aircraft Supply	364
Superior Tube Co.	221	Worklon, Inc.	340
Switchcraft, Inc.	382		
Sylvania Electric Products, Inc.	9, 74, 255		
Syntronic Instruments, Inc.	373		

Tallahassee Chamber of Commerce	363
Taylor Fibre Co.	269
Technitrol Engineering Co.	270
Technology Instrument Corp.	308
Tektronix, Inc.	114
Telechrome, Inc.	311
Tel-Instruments, Electronics Corp.	338
Telonic Industries	248
Tennessee Industrial & Agricultural Commission	345
Tensitron	386
Texas Instruments, Inc.	71
Textile Banking Co., Inc.	196
Thermal American Fused Quartz Co., Inc.	216
Transitron Electronic Corp.	65
Transradio, Ltd.	342
Tru-Ohm, Div. of Model Engineering & Mfg. Co.	233
Tung-Sol Electric, Inc.	181

#### MANUFACTURER'S REPRESENTATIVES 388

#### PROFESSIONAL SERVICES 388

#### CLASSIFIED ADVERTISING

F. J. Eberle, Business Mgr.

#### SEARCHLIGHT ADVERTISING 427-440 ADVERTISERS INDEX 424

#### EMPLOYMENT OPPORTUNITIES 389-426 ADVERTISERS INDEX 423

This index is published as a convenience to the readers. Every care is taken to make it accurate, but ELECTRONICS assumes no responsibility for errors or omissions.



# WHERE DEPENDABILITY IS VITAL

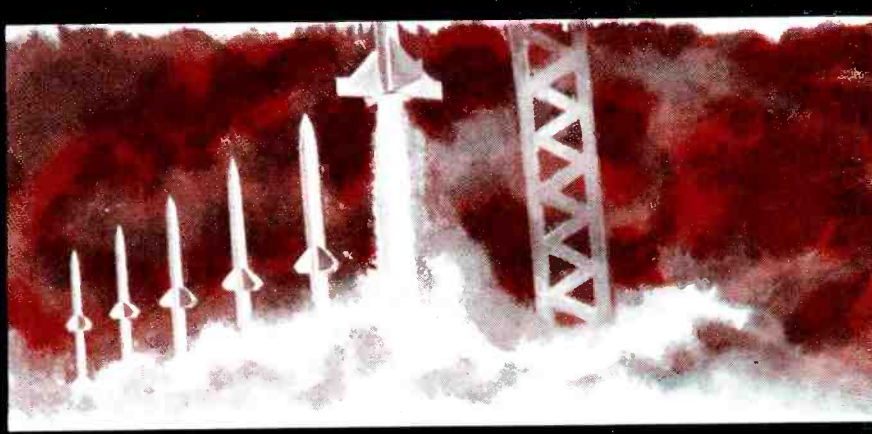
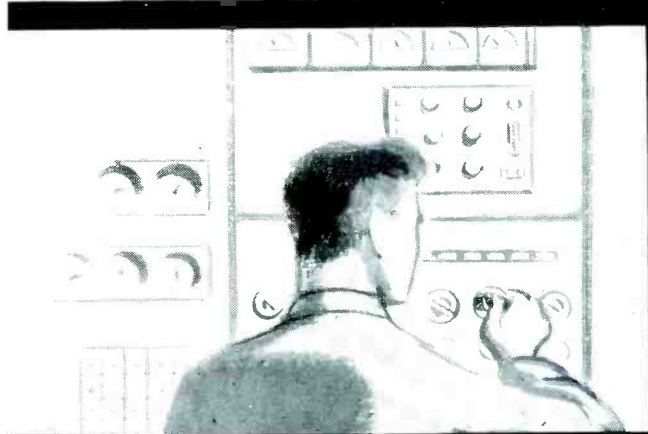

## DAVEN ROTARY SWITCHES ARE SPECIFIED

**Here's why:** Positive solutions to critical rotary switch requirements can be found within the thousands of combinations of poles, positions and decks available from DAVEN's complete line of precision rotary switches.

- *Patented knee-action rotor*—ensures low and uniform contact resistance. It also provides tamper-proof and trouble-free operation over the life of the switch.
- *One-piece combination contact and solder lug*—solid-silver alloy contacts, gold plated to resist corrosion.
- *Turret-type solder lugs* for excellent mechanical and electrical connections.
- *Roller-type detent* gives positive indexing action.
- As many as *Eight poles* available on each deck—where minimum space is a factor.

Write for complete data, catalog and engineering information.

Action	Type	Maximum Number of Positions Per Pole	Number of Poles/Deck	Size
Shorting	11-BM	24	one	1 $\frac{3}{4}$ Dia. x 1 $\frac{1}{8}$ Depth
Shorting	12-CM	32	one	1 $\frac{3}{4}$ Dia. x 1 $\frac{1}{8}$ Depth
Shorting	25-EM	48	two	2 $\frac{3}{4}$ Dia. x 1 $\frac{1}{8}$ Depth
Non-shorting	85-EB	6	eight	2 $\frac{3}{4}$ Dia. x 1 $\frac{1}{8}$ Depth
Shorting	45-DM	23	four	2 $\frac{1}{4}$ Dia. x 1 $\frac{1}{8}$ Depth



THE **DAVEN** CO.

526 West Mt. Pleasant Avenue  
Route 10, Livingston, New Jersey

TODAY. MORE THAN EVER. THE DAVEN Ⓞ  
STANDS FOR DEPENDABILITY!



# Now Commercially Available

## RCA TRANSISTORS

### FOR IF AND CONVERTER SERVICE



...with uniformity of characteristics  
from unit to unit!

RCA-2N139 and RCA-2N140 are produced under exacting manufacturing controls to enable complete interchangeability of these types within their respective circuits of suitable design *without circuit adjustments!* Both are hermetically sealed germanium-alloy p-n-p junction types and feature *excellent stability throughout long-life.*

RCA-2N139 . . . for 455-Kc if-amplifier applications . . . is capable of providing a power gain of 30 db at 455 Kc when used in suitable common-emitter circuits of quantity-produced receivers.

RCA-2N140 . . . for converter and mixer-oscillator applications in the Standard AM Broadcast band . . . features a conversion power gain of 27 db at the center of this band when used in suitable common-

emitter circuits. Moreover, satisfactory converter operation will be obtained from batteries approaching the end of life.

**IMPORTANT NOTE TO EQUIPMENT DESIGNERS OF ALL-TRANSISTOR PORTABLE RADIOS—**RCA now offers high-quality transistors for converter, intermediate-frequency, and audio stages . . . speakers . . . batteries.

**New, miniature RCA speaker—**generic design XS-7834—for compact portable radios . . . measures approximately 5/8" deep, 2 1/4" diameter! **Three new types of long-life RCA batteries—**VS300, VS301, and VS400—for all-transistor and "hybrid" radios.

**CONTACT YOUR RCA FIELD ENGINEER FOR COMPLETE DATA, DETAILS, AND SPECIFICATIONS—AT THE DISTRICT OFFICE NEAREST YOU.**

#### TRANSISTOR DATA

	RCA-2N109	RCA-2N139	RCA-2N140
<b>MAXIMUM RATINGS</b> (Absolute Values):			
Collector Volts	-25	-16	-16
Collector Ma	-70	-15	-15
Collector Dissip. (mw)	50	35	35
Operating Temperature (°C)	50	70	70

Typical Operation:	Class B Amp.	455-Kc IF Amp.	Converter
DC Collector Volts	-9	-9	-9
DC Emitter Ma	-2††	1	0.4
Useful Power Gain (Approx. db)	33	30	—
Useful Conversion Power Gain (Approx. db)	—	—	27
Typical Noise Factor (Approx. db)	—	4.5	—
Power Output (mw)	160*	—	—

#### Parameters and Characteristics:

Feedback Capacitance (uf)‡	—	9.5	9.5
Feedback Conductance (umhos)‡	—	0.25	0.2
Base Resistance (ohms)‡	—	75	90
Current Amplification Ratio†	70**	48	45
Figure of Merit for High-Frequency Performance (Mc)‡	—	74	16
Cutoff Frequency (Mc)	—	4.7	7

† In common-emitter circuit at ambient temperature of 25°C.

\* For 2 transistors in class B of circuit, and maximum distortion at 10%.

‡ Based on one-generator, small-signal, hybrid- $\pi$  equivalent circuit for the common-emitter connection.

†† Zero-signal condition. \*\* For large signal.



**RADIO CORPORATION of AMERICA**

TUBE DIVISION

HARRISON, N. J.

**EAST: Humboldt 5-3900**  
744 Broad Street  
Newark 1, N. J.

**CENTRAL: Whitehall 4-2900**  
Suite 3181  
Merchandise Mart Plaza  
Chicago 54, Ill.

**WEST: Raymond 3-8361**  
6355 E. Washington Blvd.  
Los Angeles 22, Calif.