

# electronics

A MCGRAW-HILL PUBLICATION

**AUGUST · 1955**

PRICE 75 CENTS

8/2

Figures of the  
Month ..... 6

How To Design  
I-F Transistor  
Transformers . . . 156

Important New  
Products ..... 232

**TRANSMITTER TO REACH MOON**

LARGEST PRODUCERS IN THIS FIELD FOR TWO DECADES...

# HIGH Q INDUCTORS FOR EVERY APPLICATION

FROM STOCK... ITEMS BELOW AND 650 OTHERS IN OUR CATALOGUE B.



## MQ Series Compact Hermetic Toroid Inductors

The MQ permalloy dust toroids combine the highest Q in their class with minimum size. Stability is excellent under varying voltage, temperature, frequency and vibration conditions. High permeability case plus uniform winding affords shielding of approximately 80 db.

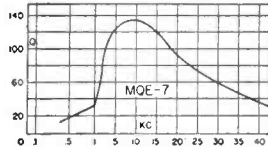

**MQE**  
15 stock values from 7 Mhy. to 2.8 Hy.

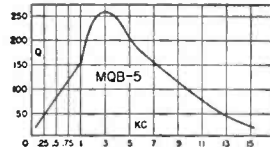

**MQB**  
12 stock values from 10 Mhy. to 25 Hy.

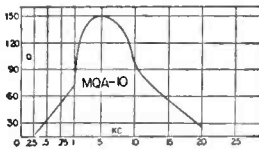

**MQA**  
19 stock values from 7 Mhy. to 22 Hy.



MQ drawn case structure.

	Length	Width	Height
MQE	1/2	1-1/16	1-7/32
MQA	1 1/16	1-9/32	1-23/32
MQB	1-5/16	2-9/16	2-13/16

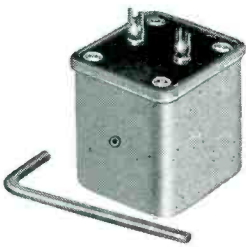

**VIC case structure**  
Length 1-1/4 Width 1-11/32 Height 1-7/16

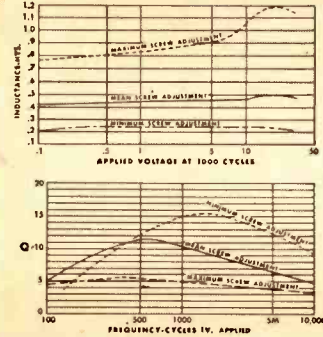

Type	Mean Hys.	Type	Mean Hys.
VIC-1	.0085	VIC-12	1.3
VIC-2	.013	VIC-13	2.2
VIC-3	.021	VIC-14	3.4
VIC-4	.034	VIC-15	5.4
VIC-5	.053	VIC-16	8.5
VIC-6	.084	VIC-17	13.
VIC-7	.13	VIC-18	21.
VIC-8	.21	VIC-19	33.
VIC-9	.34	VIC-20	52.
VIC-10	.54	VIC-21	83.
VIC-11	.85	VIC-22	130.

## VIC Variable Inductors

The VIC inductors have represented an ideal solution to the problem of tuned audio circuits. A set screw in the side of the case permits adjustment of the inductance from +85% to -45% of the mean value. Setting is positive.

Curves shown indicate effective Q and L with varying frequency and applied AC voltage.



**MQL-1** 2.5/10 Hys.  
**MQL-2** 5/20 Hys.  
**MQL-3** 50/200 Hys.  
**MQL-4** 100/400 Hys.

**MQL case**  
1-13/16 dia. X 2-1/2" H.

## MQL Low Frequency High Q Coils

The MQL series of high Q coils employ special laminated Hipermalloy cores to provide very high Q at low frequencies with exceptional stability for changes of voltage, frequency, and temperature. Two identical windings permit series, parallel, or transformer type connections.

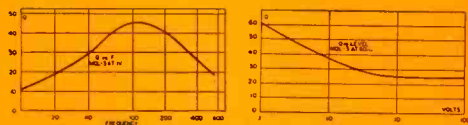

## DI Inductance Decades

These decades set new standards of Q, stability, frequency range and convenience. Inductance values laboratory adjusted to better than 1%. Units housed in a compact die cast case with sloping panel ideal for laboratory use.

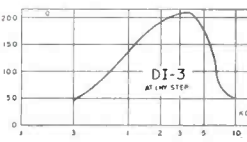

**DI-1** Ten 10 Mhy. steps.  
**DI-2** Ten 100 Mhy. steps.  
**DI-3** Ten 1 Hy. steps.  
**DI-4** Ten 10 Hy. steps.



**DI DECADE**  
Length 4 1/2"  
Width 4 3/8"  
Height 2 3/8"

## HVC Hermetic Variable Inductors

A step forward from our long established VIC series. Hermetically sealed to MIL-T-27... extremely compact... wider inductance range... higher Q... lower and higher frequencies... superior voltage and temperature stability.

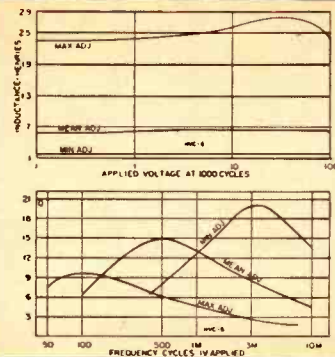

Type No.	Min. Hys.	Mean Hys.	Max. Hys.
HVC-1	.002	.006	.02
HVC-2	.005	.015	.05
HVC-3	.011	.040	.11
HVC-4	.03	.1	.3
HVC-5	.07	.25	.7
HVC-6	.2	.6	2
HVC-7	.5	1.5	5
HVC-8	1.1	4.0	11
HVC-9	3.0	10	30
HVC-10	7.0	25	70
HVC-11	20	60	200
HVC-12	50	150	500



**HVC case structure.**  
Width 25/32 Length 1-1/8 Height 1-7/32

**SPECIAL UNITS TO YOUR NEEDS**  
Send your specifications for prices.

# UNITED TRANSFORMER CO.

150 Varick Street, New York 13, N. Y. EXPORT DIVISION: 13 E. 40th St., New York 16, N. Y. CABLES: "ARLAB"

# electronics

AUGUST • 1955

A MCGRAW-HILL PUBLICATION

**H. W. MATEER**, *Publisher*

**W. W. MacDONALD**, *Editor*

**VIN ZELUFF**, *Managing Editor*

JOHN MARKUS, *Associate Editor*

ALEXANDER A. McKENZIE, *Associate Editor*

JOHN M. CARROLL, *Associate Editor*

WILLIAM P. O'BRIEN, *Assistant Editor*

WILLIAM G. ARNOLD, *Assistant Editor*

DAVID A. FINDLAY, *Assistant Editor*

HAIG A. MANOOGIAN, *Assistant Editor*

EDMUND B. PALMQUIST, *Assistant Editor*

GLORIA J. FILIPPONE, *Editorial Assistant*

ARLENE SCHILP, *Editorial Assistant*

GLADYS T. MONTGOMERY, *Washington Editor*

HARRY PHILLIPS, *Art Director*

ELEANORE LUKE, *Art Assistant*

**WALLACE B. BLOOD**, *Manager*

R. S. QUINT, *Buyers' Guide Manager*

FRANK H. WARD, *Business Manager*

GEORGE E. POMEROY, *Classified Manager*

DONALD H. MILLER, *New York*

JAMES GIRDWOOD, *New York*

WM. S. HODGKINSON, *New England*

JAMES T. HAUPTLI, *Philadelphia*

CHARLES WARDNER, *Chicago*

BRUCE WINNER, *Chicago*

HENRY M. SHAW, *Cleveland*

T. H. CARMODY, *San Francisco*

R. C. ALCORN, *San Francisco*

CARL W. DYSINGER, *Los Angeles*

WM. D. LANIER, *Atlanta*

JAMES H. CASH, *Dallas*

KEITH HENNEY, *Consultant*

**TRANSMITTER TO REACH MOON**—Big pulse transmitter (50-kw c-w) built by Radio Engineering Laboratories, installed at Evans Signal Laboratory, Belmar, N. J., for wave-propagation research that includes bouncing pulses from the moon. Photo by Syd Karson. Details on p 166.....COVER

SHOPTALK..... 2

FIGURES OF THE MONTH..... 6

INDUSTRY REPORT..... 7

Western States Host 1955 Wescon.....	7	What's Ahead in Plant Expansions.....	20
Navy Sees \$7.0 Billion For 1955.....	7	Computer Controls Parts Inventory.....	20
Broadcasters 54 TV Business.....	8	Oil Industry Goes Automatic.....	22
Electronics In Military Contracts.....	8	FCC Okays Low-Power TV Stations.....	22
Tubes in Total Industry.....	10	Big Business in Electronics.....	22
Transistors In Consumer Products.....	12	Tubes Process Travelers' Checks.....	24
Auto Industry Eyes Electronics.....	12	Fewer Firms Failed in 54.....	24
Electronics Industry Spreads Out.....	14	Mack Named to FCC.....	24
Arizona Companies Face State Tax.....	14	1956 IRE Show Returns To Bronx.....	26
Businessmen Adopt Citizens' Radio.....	16	Industry Shorts.....	26
Color Tube Output is Small.....	16	Future Meetings.....	26

CROSSTALK..... 105

## FEATURES

**Designing Ultrasonic Alarm Systems**..... 106

By Samuel S. Bagno

**Decade Counter Employs Silicon Transistors**..... 112

By Paul Krenitsky

**Differential Gain Tests TV Color**..... 114

By John O. Schroeder

**Target Discriminator for Countermeasures**..... 118

By M. Weiss and S. R. Sixbey

**Impulse Magnetizer for Permanent Magnets**..... 121

By George M. Moore

**Linear Power Amplifier for SSB Transmitters**..... 124

By W. B. Bruene

**Squirrel-Cage Motor Speed Control System**..... 126

By Millard C. Spencer

**F-M Antenna Inside the A-M Tower**..... 130

By M. W. Scheldorf and Granville Klink, Jr.

**Anode-Dynode Beam Deflection Amplifier**..... 132

By Herbert J. Wolkstein and Alfred W. Kaiser

CONTINUED ON NEXT PAGE

UNITED COMMUNITY CAMPAIGNS



# contents

continued

Relay Contact Bounce Measurements .....	137
By Richard Jiu	
Synchronizing Magnetic Drum Storage Speed .....	140
By Ernest W. Bivans	
Dielectric Lens for Microwaves .....	142
By K. S. Kelleher and C. Goatley	
Dynamic-Diode Limiter for F-M Demodulators .....	146
By Frank Mural	
Differential Amplifier for Null Detection .....	148
By W. E. Barnette and L. J. Giacoletto	
A-M System Tunes Aircraft Antennas .....	152
By David T. Geiser	
High-Voltage Supply Uses Electronic Filter .....	154
By Victor Wouk	
How To Design I-F Transistor Transformers (Reference Sheet) .....	156
By Roger R. Webster	

## ELECTRONS AT WORK .....

162

Geophysical Exploration Speeded ..162	Chassis Design for I-F Amplifiers ..182
Music-Speech Discriminator .....	Broadband Horn Antennas .....
Airborne Wave Propagation Lab ..164	Improving C-F Response .....
The Front Cover .....	Plug-In Rectifier Replaces Tube ..198
Diana Antenna Tracks Planets ..166	Criss-Cross D-C Amplifier .....
Infinite Impedance Deter-Amplifier ..168	Two-Terminal Push-Pull Oscillator ..202
Regulator for Constant Current ..170	House Analog .....

## PRODUCTION TECHNIQUES .....

208

Quality Control Panel .....	Color-Coded Overhead Conveyor ..212
Induction Generator Bonds Strands ..208	Lint Control in Tube Plant .....
Air-Actuated Catwhisker Machine ..210	Numbered Clips Aid Reworking ..228
Piercing With Squeeze Riveter .....	

## NEW PRODUCTS .....

232

## LITERATURE .....

331

## PLANTS AND PEOPLE .....

346

## NEW BOOKS .....

371

## THUMBNAIL REVIEWS .....

378

## BACKTALK .....

380

## INDEX TO ADVERTISERS .....

423

# SHOP

**NEXT MONTH**—"Mechanized Production of Electronic Equipment" is the title of a comprehensive 24-page report on the subject by associate editor John Markus, scheduled for publication in September. He has made an exhaustive survey of representative firms and their new automatic techniques, many of them until now so close held that special permissions and clearances of material were necessary before he was allowed to visit the plants.

The newest techniques of etched wiring, component preparation, machine assembly, dip soldering and automatic testing will be described in detail and the design of huge automatic assembly machines costing around \$100,000 each will be discussed and compared.

More than fifty unique photographs will illustrate the report along with a tabular comparison of the construction and performance characteristics of the three types of multi-station in-line machines now used in industry.

**CLOSED CIRCUIT**—A technique for using commuting time efficiently has been worked out by Leon Hillman, chief engineer of Production Research Corporation, Thornwood, N. Y.

He has a file of **ELECTRONICS** in his office and another at his home in Englewood, N. J. Thus, he can consider engineering problems while riding, and tie up loose ends by referring to back copies of our magazine at both ends of each trip.

## electronics

AUGUST, 1955

Vol. 28, No. 8



Member ABC and ABP

# TALK

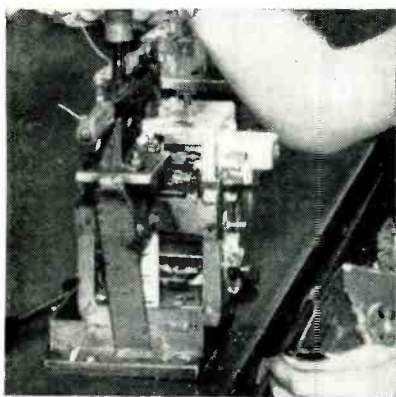

JIG for holding tv tuner and the photographs of it in use that started the discussion among the editors

**WHICH DO YOU PREFER?**—Pictures that show production techniques have always been taken with the worker in a normal operating position, such as the one at center, above. In directing the taking of the shot, associate editor Markus had extreme difficulty convincing the plant photographer that it should be taken this way.

It seemed to offend his sense of the photogenic, not that we admit that any **ELECTRONICS** editor is one whit lacking in appreciation of the fine points of photogenic pulchritude.

The problem was solved temporarily by letting the photographer take two shots, one our usual view, and one his way, with the young lady facing the camera. Now the editorial staff is divided into two camps as to which picture should be used.

Technically the important point of the picture is the welded fixture

on the bench that clamps a tv tuner while the operator attaches mounting bolts with an air gun. Accompanying text will describe operation of the device when it appears in *Production Techniques*.

During the year the editors crop for best effect the more than 2,000 pictures that we publish. However we don't often have an opportunity to direct the camera work.

## INDUSTRY ACCELERATES—

There is probably no direct connection, but since we commented on the health of engineering activity as reflected by the increase of new products (*Shoptalk*, June) we have been almost flooded by new product releases.

In this August issue, for example, the New Products department would fill more than 24 pages, if arranged solid. This is the greatest amount of space and largest number of items in history of the magazine.

Most companies send new product releases directly to the editors in our New York office but occasionally one goes to a business representative in one of our branch offices.

We quote, without comment, a letter that accompanied a release:

"Because we are cognizant that the business representatives of any publication are duly forthright—almost religious—about protecting the honor and integrity of their editorial brethren, we implore you not to dazzle these impressionable and unworldly gentlemen with the locked-in brilliance of your charms, influence, etc. when you rhapsodize about the merits of our new product.

"Just a friendly note from you attached to our news release and directed at your editorial side saying something like 'This looks like page one stuff' or 'What are we using on the cover this month' would probably be in order."

Published monthly with an additional issue in June by McGraw-Hill Publishing Company, Inc. James H. McGraw (1860-1948), Founder, Executive Editorial and Advertising Offices; McGraw-Hill Building, 330 W. 42 St., New York 36, N. Y. Longacre 4-3000. Publication Office, 99-129 North Broadway, Albany 1, N. Y. Donald C. McGraw, President; Paul Montgomery, Executive Vice-President; Joseph A. Geradi, Vice-President and Treasurer; John J. Cooke, Secretary; Nelson Bond, Executive Vice-President, Publications Division; Ralph B. Smith, Vice-President and Editorial Director; Joseph H. Allen, Vice-President and Director of Advertising; J. E. Blackburn, Jr., Vice-President and Circulation Director.

Subscriptions: Address correspondence to **Electronics**—Subscription Service, 330 W. 42nd St., New York 36, N. Y. Allow one month for change of address. Subscriptions are solicited only from persons engaged in theory, research, design, production, maintenance and use of electronic and industrial control components, parts and end products. Position and company connection must be indicated on subscription orders.

Single copies 75¢ for United States and possessions, and Canada; \$1.50 for Latin America; \$2.00 for all other foreign countries. Buyers' Guide \$3.00. Subscription rates—United States and possessions, \$6.00 a year; \$9.00 for two years. Canada, \$10.00 a year; \$16.00 for two years. Other western hemisphere countries and the Philippines, \$15.00 a year; \$25.00 for two years. All other countries \$20.00 a year; \$30.00 for two years. Three-year rates, accepted on renewals only, are double the one-year rate. Entered as second-class matter August 29, 1936, at the Post Office at Albany, N. Y., under act of Mar. 3, 1879. Printed in U.S.A. Copyright 1955 by McGraw-Hill Publishing Co. Inc.—All Rights Reserved.

BRANCH OFFICES: 520 North Michigan Avenue, Chicago 11, Ill.; 65 Post Street, San Francisco 4; McGraw-Hill House, London, E. C. 4; Washington, D. C. 4; Philadelphia 3; Cleveland 15; Detroit 26; St. Louis 8; Boston 16; 1321 Rhoads-Haverty Bldg.; Atlanta 3, Ga.; 1111 Wilshire Blvd., Los Angeles 17; 738-9 Oliver Building, Pittsburgh 22. **ELECTRONICS** is indexed regularly in *The Engineering Index*.

Build SORENSEN REGULATION into your products with these new

# MAGNETIC VOLTAGE REGULATORS

CAPACITIES — 15VA, 30VA, 60VA, 120VA, 250VA, 500VA.

TUBELESS — *trouble free*

COMPACT — *saves space in your equipment*

LIGHTER *than comparable regulators*

GOOD APPEARANCE — *enhances your product*

THERMALLY ISOLATED CASE — *simplifies your design problems*

## ELECTRICAL SPECIFICATIONS

Input voltage range 95-130VAC, 1 $\emptyset$ , 60 cycles.

Output range 115VAC, RMS, 1 $\emptyset$ .

Regulation accuracy  $\pm 0.5\%$  against line changes.

Load conditions  $\pm 0.5\%$  against line at any given load from 0 to full.

Time constant From .2 to 6 cycles for line changes.



MVR15

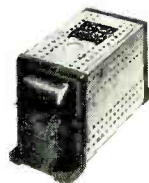

MVR60



MVR250

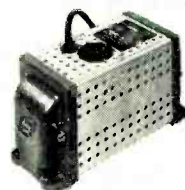

MVR30



MVR120

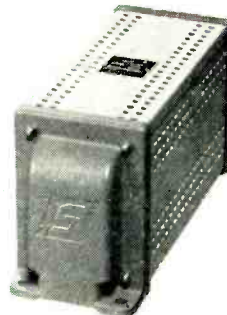

MVR500

GET MORE INFORMATION: Catalog MVR2 is yours for the asking; gives complete data on the new Magnetic Voltage Regulator line. Contact your local Sorensen representative, or write to General Sales Department, Sorensen & Co., Inc., 375 Fairfield Ave., Stamford, Conn.

CONTROLLED POWER FOR



RESEARCH AND INDUSTRY

# S O R E N S E N

# A DECADE OSCILLATOR WITH CONTINUOUS TUNING



## D-650-B MUIRHEAD-WIGAN DECADE OSCILLATOR

Some users of the decade oscillator, whilst appreciating its superior frequency accuracy and stability, have hitherto found the lack of a continuous tuning facility something of a disadvantage. With the new D-650-B Oscillator this drawback has been largely overcome by the provision of a continuously variable calibrated control, which permits interpolation between any two adjacent steps on the lowest decade and can be used up to 11,110c/s.

All the features which have made the decade oscillator so popular for precision work have, however, been retained. The frequency accuracy at any setting is  $\pm 0.2\%$  or  $\pm 0.5\text{c/s}$ , improving between 20c/s and 10kc/s to  $\pm 0.1\%$  or  $\pm 0.25\text{c/s}$ . Moreover, if the oscillator is standardized at any frequency between 1kc/s and 10kc/s an even higher accuracy can be obtained over a range of  $\pm 500\text{c/s}$  from the selected value, thus enabling the instrument to be used as a variable frequency sub-standard.

### BRIEF SPECIFICATION

Frequency range	1—11,110c/s and 10—111,100c/s
Frequency accuracy	$\pm 0.2\%$ or $\pm 0.5\text{c/s}$
Hourly stability	$\pm 0.02\%$
Maximum output	2W into 8,000 ohms above 20c/s 50mW into 8,000 ohms below 20c/s
Harmonic content	1% at 1W above 20c/s
Hum level	—80db below maximum output at 1000c/s
Power supply	100—120V, 60c/s or 200—250V, 50c/s
Dimensions	17½ wide x 10½ in high x 13 in deep (43.8cm. x 26.7cm x 33cm)
Weight	83 lb (38kg)

**MUIRHEAD**

PRECISION  
ELECTRICAL INSTRUMENTS

Write under your business letterhead for Publication 4683

**MUIRHEAD & CO. LIMITED • BECKENHAM • KENT • ENGLAND**

**Sales & Service U.S.A.**

**MUIRHEAD INSTRUMENTS INC • 677 FIFTH AVENUE • NEW YORK 22 • N. Y.**

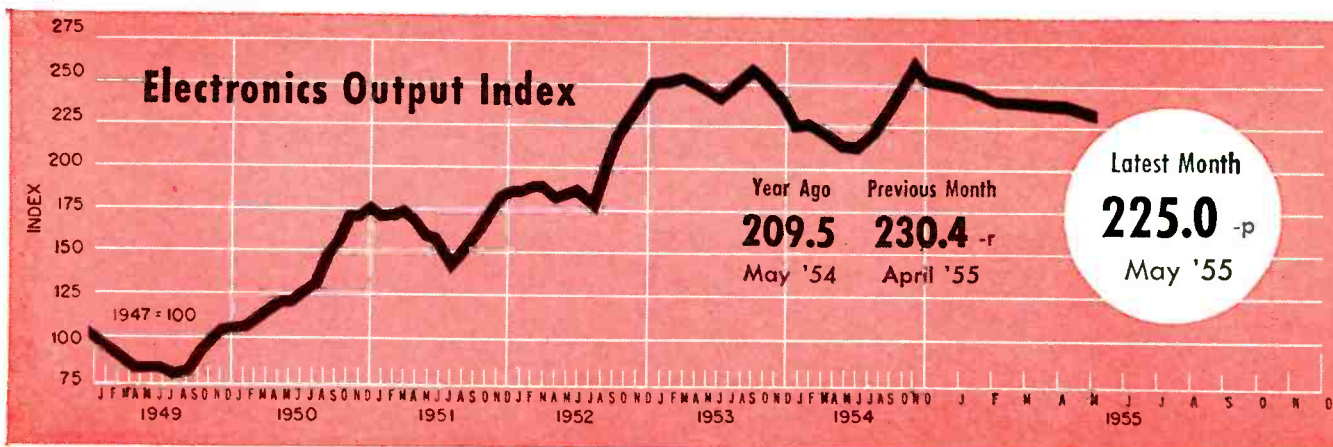

## FIGURES OF THE MONTH

	Latest Month	Previous Month	Year Ago
<b>RECEIVER PRODUCTION</b>			
(Source: RETMA)			
Television sets, total	467,394	583,174	396,287
With UHF	61,784	103,088	86,790
Color sets	nr	nr	
Radio sets, total	1,114,035	1,099,775	722,104
With F-M	8,726	13,894	9,819
Home sets	161,357	193,431	173,480
Clock radios	130,608	72,602	57,370
Portable sets	258,701	265,866	174,735
Auto sets	563,369	567,876	316,519

	Latest Month	Previous Month	Year Ago
<b>RECEIVER SALES</b>			
(Source: RETMA)			
Television sets, units	416,908	411,748	308,728
Radio sets (except auto)	398,449	367,841	386,152

	Latest Month	Previous Month	Year Ago
<b>RECEIVING TUBE SALES</b>			
(Source: RETMA)			
Receiv. tubes, total units	32,920,310	35,426,153	28,650,825
Receiv. tubes, value	\$25,914,821	\$26,779,586	\$20,465,451
Picture tubes, total units	779,324	788,317	584,782
Picture tubes, value	\$14,572,518	\$14,620,075	\$12,062,269

	Latest Month	Previous Month	Year Ago
<b>SEMICONDUCTOR SALES</b>			
(Source: RETMA)			
Germanium diodes, units	1,419,245	1,674,762	994,949
Silicon diodes, units			

	Latest Quarter	Previous Quarter	Year Ago
<b>INDUSTRIAL TUBE SALES</b>			
(Source: NEMA)			
Vacuum (non-receiving)	\$9,338,181	\$8,803,740	\$9,467,331
Gas or vapor	\$3,498,123	\$3,570,586	\$4,854,222
Phototubes	nr	nr	\$405,000
Magnetrons and velocity modulation tubes	\$15,249,651	\$13,112,244	\$13,073,095
Gaps and T/R boxes	\$1,788,780	\$1,476,407	\$1,707,730

### TV SETS INSTALLED

	Latest Month	Previous Month	Year Ago
(Source: NBC Research Dept.)			
Total sets	36,100,000	35,809,000	30,411,000

### BROADCAST STATIONS

	Latest Month	Previous Month	Year Ago
(Source: FCC)			
TV stations on air	458	454	402
TV stations CPs—not on air	124	124	171
TV stations—new requests	16	16	14
A-M stations on air	2,732	2,711	2,583
A-M stations CPs—not on air	108	103	114
A-M stations—new requests	222	217	158
F-M stations on air	540	540	553
F-M stations CPs—not on air	12	12	16
F-M stations—new requests	6	4	5

### COMMUNICATION AUTHORIZATIONS

	Latest Month	Previous Month	Year Ago
(Source: FCC)			
Aeronautical	42,396	42,045	41,374
Marine	50,187	49,261	45,762
Police, fire, etc.	18,149	17,827	15,438
Industrial	24,347	24,045	21,313
Land transportation	7,579	7,499	6,887
Amateur	137,199	134,720	122,283
Citizens radio	11,816	11,193	5,706
Disaster	315	313	282
Experimental	619	600	567
Common carrier	1,934	1,917	1,613

### EMPLOYMENT AND PAYROLLS

	Latest Month	Previous Month	Year Ago
(Source: Bur. Labor Statistics)			
Prod. workers, comm. equip.	351,700-p	352,300-r	346,400
Average weekly earnings, comm.	71.15-p	\$70.80-r	\$66.30
Average weekly earnings, radio	\$69.03-p	\$68.68	\$65.35
Average weekly hours, comm.	40.2 -p	40.0 -r	39.0
Average weekly hours, radio	39.9 -p	39.7	38.9

### STOCK PRICE AVERAGES

	Latest Month	Previous Month	Year Ago
(Source: Standard and Poor's)			
Radio-tv & electronics	508.4	471.4	308.7
Radio broadcasters	586.2	537.0	325.5

p—provisional; r—revised  
nr—not reported

## FIGURES OF THE YEAR

	1955	1954	Percent Change	1954 Total
Television set production	3,238,820	2,301,005	+ 40.8	7,346,715
Radio set production	5,853,954	4,048,904	+ 44.6	10,400,530
Television set sales	2,772,648	2,453,875	+ 11.5	7,317,034
Radio set sales (except auto)	2,007,631	1,873,399	+ 7.2	6,430,743
Receiving tube sales	185,682,583	134,677,745	+ 37.9	385,089,458
Cathode-ray tube sales	4,207,129	3,275,301	+ 28.4	9,913,504



# INDUSTRY REPORT

electronics—August • 1955



CIVIC AUDITORIUM in San Francisco will be the nation's electronic showplace when . . .

## Western States Host at 1955 Wescon Meeting

**Convention and exhibits to update technical and commercial progress in electronics**

ENGINEERS and executives of the electronics industry will once again have the opportunity personally to size up technical and business developments in their fast moving industry at the annual WESCON (Western Electronic Show and Convention) to be held August 24 to 26 in San Francisco.

► **Program**—Headquarters for the show and convention will be Civic Auditorium and the Fairmount Hotel. The technical program which is published in this issue of ELECTRONICS, beginning on page 365 will feature 32 sessions where 160 technical papers will

be presented. On Wednesday, Aug. 24, show and technical sessions in Civic Auditorium will be scheduled concurrently between 9 a-m and 6 p-m while on Thursday and Friday Aug. 25 and 26, show hours will be 1 p-m to 10 p-m. Shuttle bus serv-

ice is planned between show and convention headquarters.

► **Scope**—Wescon has become national in scope in terms of attendance and exhibits. For example, in 1954, there were 245 eastern exhibitors and 197 western.

## Navy Sees \$7.0 Billion For 1955

**Half-billion dollar rise over last year's billings is predicted for end-equipment firms**

ELECTRONIC end-item manufacturers plan to produce about \$7,041,800,000 worth of equipment this year, almost \$500 million more than last year's sales of \$6,596,500,000. That is the highlight of

a report by the Office of Naval Materiel's electronics section based on information from 509 companies, both large and small.

The report deals only with electronic end items, systems, equipments, major assemblies or subassemblies and piece parts produced for direct assembly by the fabricator. Data applicable to research and development, piece

parts manufactured and sold as such and nonelectronic products have been omitted.

► **Size**—Of this year's planned production, \$555 million will be produced by 368 small business firms, defined as those having less than 500 employees. A total of 141 large business firms (over 500 employees) expect to produce \$6.4 billion. In 1954, sales of the small firms totaled \$531.6 million whereas big business reached \$6.0 billion.

The total production capacity of the 509 companies, on a one-shift basis, is estimated to be \$9.6 billion. Of this, small business capacity is \$1.3 billion while large business capacity is \$8.3 billion.

► **Orders**—The industry's total military backlog on Jan. 1, 1955 was \$4.5 billion compared to \$6.1

billion a year earlier. Of the 1955 backlog, about \$3.5 billion represents military prime contracts and \$1.9 billion represents military subcontracts.

Industry plans to produce in 1955 about \$3.2 billion worth of military equipment. Approximately 46 percent of this year's total output will go to the military.

► **Workers**—The average total number of all employees in the industry, including production and overhead workers, is 458,318 of whom 417,144 are employed in firms with over 500 employees and 41,174 work for companies with less than 500 employees.

► **Drop**—Last year's estimate of industry production was \$7.5 billion whereas it produced only \$6.5 billion due in large part to a reduction in military orders.

## Broadcasters Add Up 1954 TV Business

TOTAL television broadcast revenues during 1954 were \$593.0 million, 37 percent above 1953. Profits, before Federal income tax, amounted to \$90.3 million, 33 percent above those for 1953.

► **VHF**—The total 1954 revenues of 92 pre-freeze vhf stations were \$200.9 million, 15 percent higher than in 1953. Their profits of \$67.6 million were about 12 percent higher than the previous year.

Total revenue of \$60 million and a loss of about \$4 million was reported by 177 post-freeze vhf stations. The 125 post-freeze uhf stations had total revenues of \$25.4 million and a loss of \$10 million during last year.

## Electronics Holds Its Own In Military Contracts

Although dollar volume is lower, industry moves into second place in awards

DURING the three-year Korea period, July 1, 1950 to June 30, 1953, the Department of Defense made prime contract awards totaling \$98,723,000,000.

The leading 100 contractors received awards totaling 64 percent of this amount. These have been classified according to type of business receiving awards as follows:

Classification 100 Leading Contractors	Awards in Millions Korea Period
Aircraft	\$24,533.7
Automotive	14,431.2
Electronics & Comm.	12,794.5
Heavy Manufacturing (A)	2,860.6
Chemicals & Munitions (B)	1,688.2
Tire & Rubber (C)	1,499.2
Food & Clothing (D)	1,371.9
Light Manufacturing (E)	1,175.7
Oil & Gasoline (F)	919.4
Smelting & Mining (G)	715.2
Contracting Materials (H)	693.7
Shipbuilding (I)	482.3
	\$63,165.6

A second list of 100 leading Department of Defense prime contractors has just been released covering the 18-month period immediately following the Korea in-

cident. The contracts placed in the later period totaled \$16,377.2 millions, of which \$11,109.1 millions, or 68 percent was placed with the 100 leaders. A measure of the reduction in magnitude of general military procurement is given by the fact that it required a minimum contract booking of \$100 million to become one of the leaders during Korea but only \$14 million to make the post-Korea list.

The turnover in the two lists shows striking changes; over forty

substitutions occurred, with the automotive group as the heaviest losers, the aircraft group the greatest gainers, while only electronics held its share of the total market.

► **Rate**—The average annual Korea period contracting rate was \$32.9 billions; it fell to \$10.9 billions annually during the post-Korea period, which is only one-third of the former rate. The notable gains

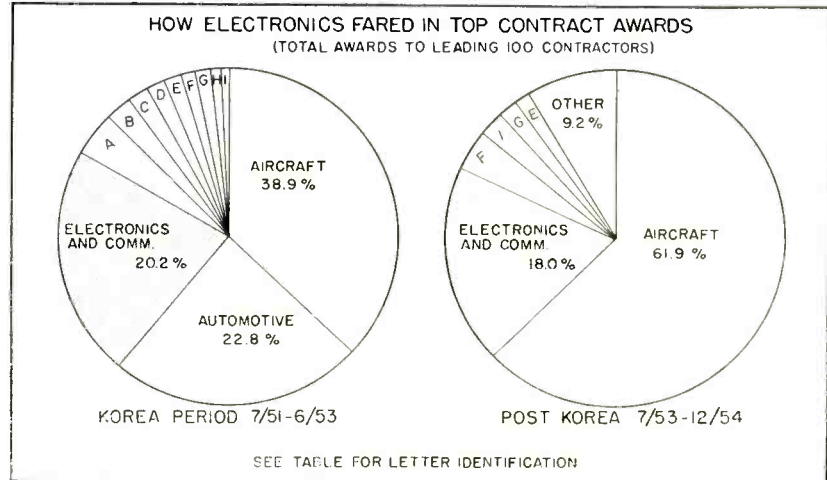

(Continued on page 10)

## Typical current

### Amplification characteristics

Checked against similar types  
Sylvania's Power Transistor consistently provides higher current gains.

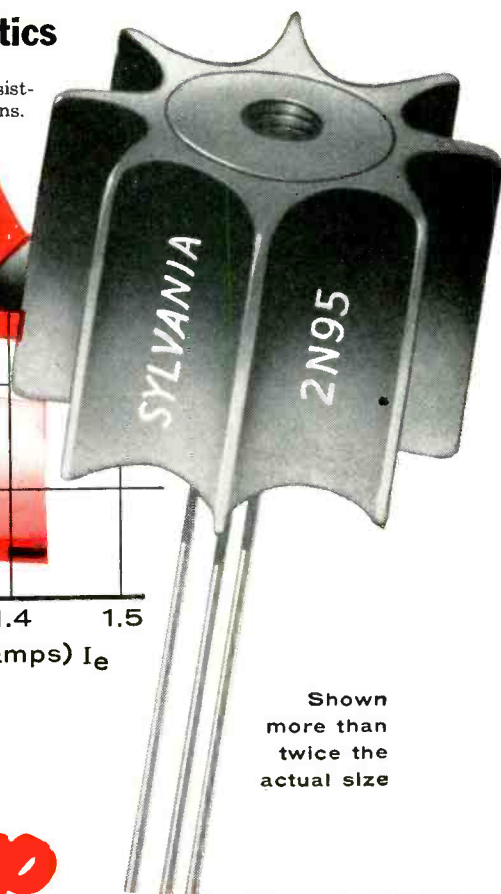
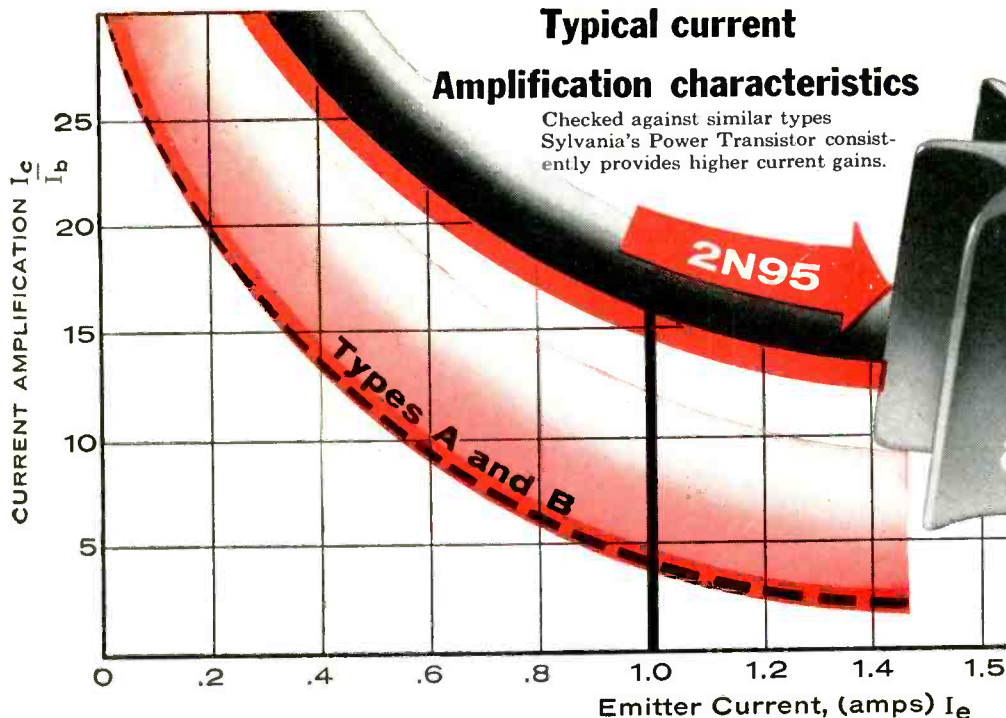

Shown more than twice the actual size

## Sylvania NPN Power Transistor 2N95 Exhibits

# 3 1/2 times more gain

Operated at 1.0 amp emitter-current, the Sylvania 2N95 Transistor typically provides a current gain of 17... 3 1/2 times that of comparable types A and B. Even at 1.5 amp emitter current the 2N95 typically exhibits a high gain of 13... in fact, as the curve shows, the Sylvania 2N95 provides the highest gain over the widest range of operating current conditions.

In addition, Sylvania's 2N95 com-

bines all the important features you want in a power transistor, whatever your application. If, for example, yours is a switching application, the 2N95 offers high gain at high currents.

Designed for low thermal resistance, the Sylvania 2N95 Transistor provides dissipation up to 2 1/2 watts without an external heat sink and up to 4 or more watts with a suitable heat sink. This insures stable operation in high ambient temperatures.

### You compare

Check the Sylvania 2N95 against similar Transistor types yourself—for current gain as well as all of these important power Transistor features.

Does the Sylvania 2N95 offer—	answer
1. lower cost	yes ✓
2. low input impedance	yes ✓
3. low thermal resistance	yes ✓
4. high current switching	yes ✓
5. high current gain	yes ✓
6. mounting for air cool or heat sink	yes ✓
7. hermetic seal	yes ✓

A smaller version for heat sink mounting, the Sylvania 2N102 is also available with the above features.

*"another reason why it pays to specify Sylvania"*

# SYLVANIA®

SYLVANIA ELECTRIC PRODUCTS INC.  
1740 Broadway, New York 19, N.Y.

In Canada: Sylvania Electric (Canada) Ltd.  
University Tower Building, Montreal

Check your application for complete data on other

Sylvania Transistors

High gain, low frequency  
Types 2N34 and 2N35

High power, low frequency  
Types 2N95 and 2N68  
Types 2N101 and 2N102

High frequency  
Types 2N94 and 2N94A

Dept. H20R

Sylvania Electric, 1740 Broadway, New York 19, N.Y.

Name \_\_\_\_\_

Company \_\_\_\_\_

Address \_\_\_\_\_

LIGHTING • RADIO • ELECTRONICS • TELEVISION • ATOMIC ENERGY

of the aircraft industry are obvious and tend to overshadow the fact that the electronics industry is the only other one which held its new and substantial one-fifth share of military contracting. The balance of the list is principally the regular sources of supplies and services to the military with a volume proportionate to the time-length of the reported interval.

Classification 100 Leading Contractors	Awards in Millions Post-Korea Period
Aircraft .....	\$ 6,884.1
Electronics & Comm.....	2,004.7
Oil & Gasoline (F).....	408.2
Shipbuilding (I).....	311.2
Smelting & Mining (G).....	249.1
Light Manufacturing (E).....	242.3
Other .....	1,009.5
	\$11,109.1

The balance of the list is not of special interest to electronics executives. However, the automotive industry fell from its strong second place position to tenth place. It received only 1.3 percent of the total awards with a net value of only \$145.3 millions, as compared with 22.8 percent and \$14,431.2 millions. The principal influences in this precipitate drop in government awards arose from completion of the tank program and heavy cancellations of jet engine production.

► **Share**—The awards to the 100 leaders amounted to \$11,109.1 millions or 68 percent of the total awards in the 18-month post-Korea period. This sample is large enough to suggest that electronics is currently attracting nearly 20 percent of total contract awards to Department of Defense suppliers. This share of total contracting for all electronics industry awards for the 12 months of fiscal 1955 makes an estimate of \$1.9 billion in awards a well authenticated figure.

Since the rate of awards fell somewhat behind the appropriation rate during fiscal year 1955, a gain in electronics contracting of at least 10 percent for fiscal 1956 is a reasonable expectancy. This would mean about \$2.4 billions in awards to electronics manufacturers in fiscal 1956. This is about 25 percent more than the \$1.9 billion estimated annual total awards for fiscal 1955.

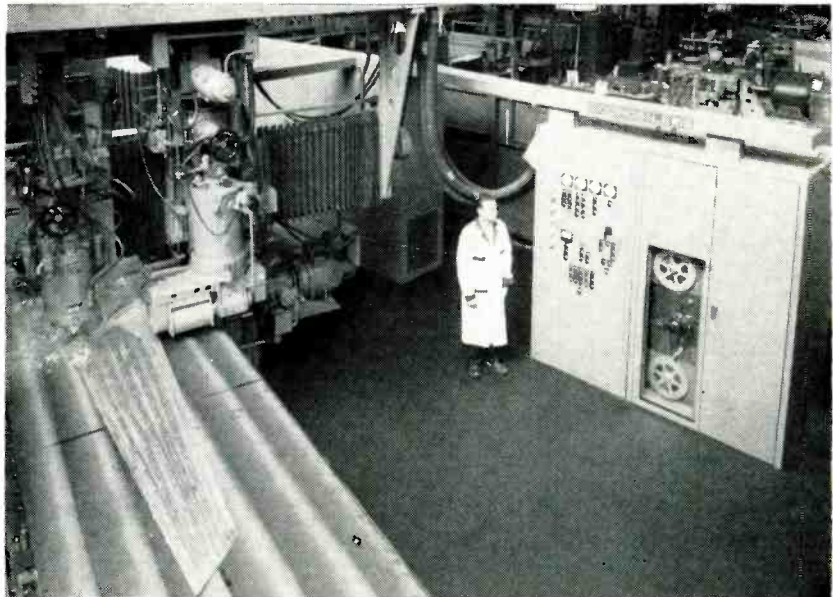

HUGE spar and skin milling machine is controlled by magnetic tape as . . .

## Tubes Punch Clock in Tool Industry

### New control system operates giant machine tools with substantial time savings

A CONTROL system that electronically prepares magnetic tapes directly from numerical data for automatic control of heavy-duty machines is now commercially available. Manufactured by Giddings and Lewis, Wisconsin tool builders, it is the result of three years of research at MIT and GE and work by the Burroughs Corp.

► **Unit**—With the system, called Numericord, machining cycles involving as many as 5 machine axes and 22 auxiliary functions are completely planned and engineered by mathematical computation.

► **How It Works**—Four major components make up the Numericord: a paper-tape preparation unit, which punches a master tape with previously calculated decimal information from part drawings, tooling data and machine feed rates; an electronic computing director, which converts digital information on the paper tape into phase-modulated, time-coordinated command signals recorded on proper parallel channels of magnetic tape; electronic play-back circuitry, which

reads commands off the magnetic tape and sends appropriate electrical control signals to the machine; and electromechanical, machine-control units which operate in closed-loop-feedback, phase-shift, synchro-servo systems to position machine axes in accordance with taped command signals.

Machine auxiliary functions and nonfeed controls are operated automatically through relay circuits from simultaneous command impulses on other parallel tape channels. Parts can be made to tolerances limited only by the machine tool.

► **Savings**—Such nonproductive operations as tool setting, gaging, template changing and positioning are reduced or eliminated with the device. Time and material losses resulting from wasted operation motions, lack of skill, miscalculations and human error are avoided.

For aircraft work, similar to that shown for the horizontal stabilizer for the new North American F-100D Super Sabre, the system can effect savings of at least 50 percent in machining time over present manual methods. In addition, the system can store skills on tape, permitting release of machine-tool operators to other duties.

(Continued on page 12)

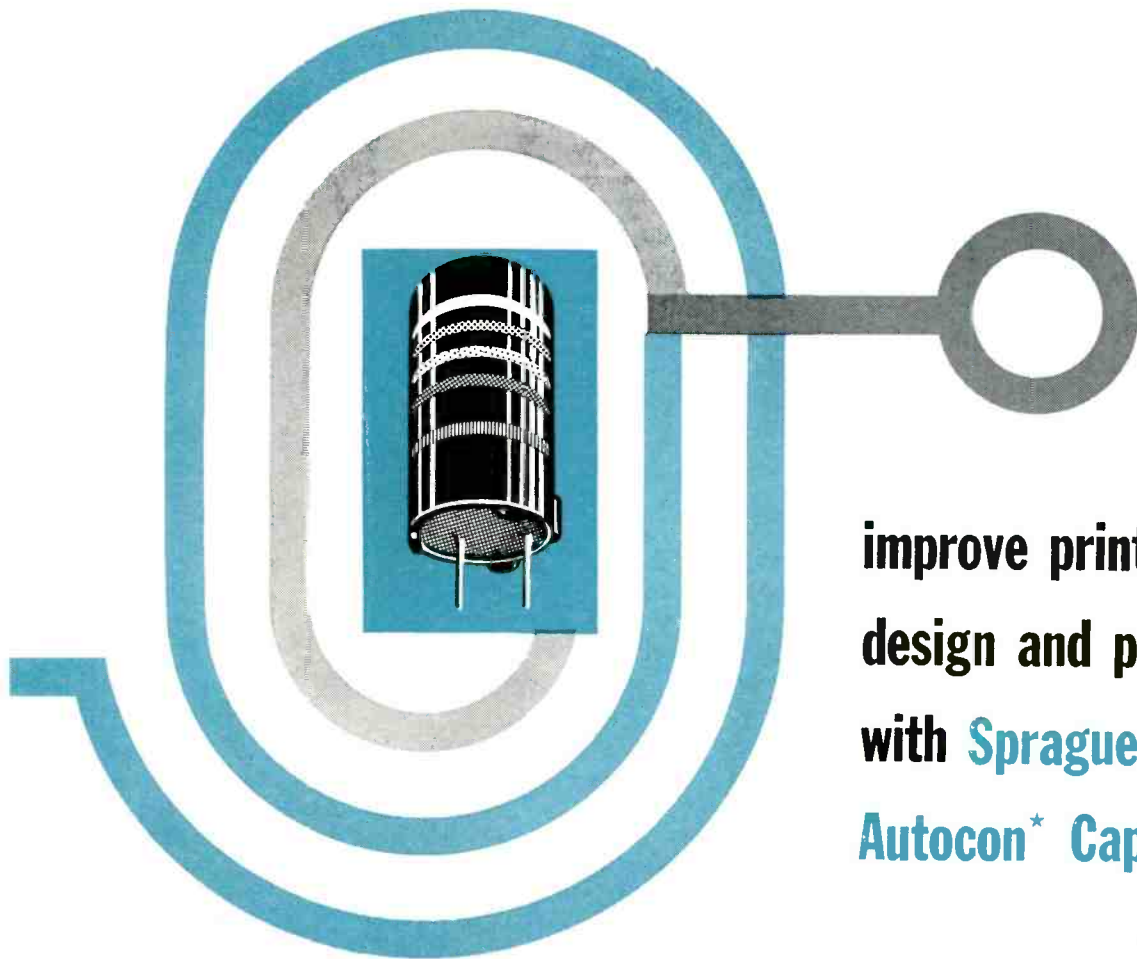

improve printed circuit  
design and performance  
with **Sprague**  
**Autocon\*** Capacitors

Plug Sprague Autocon capacitors into your printed wiring boards and you immediately gain greater freedom in circuit design... more reliable circuit performance. That's because Autocon capacitors are the first "one-ended" case paper capacitors designed to satisfy *all the special requirements* of printed wiring board assemblies.

These new capacitors are enclosed in a pre-molded cylindrical shell of non-flammable thermosetting plastic, with the capacitor section securely sealed against the entry of moisture by a plastic resin endseal bonded to the phenolic housing. The two short straight leads which issue from the endseal are held at a closely controlled distance from each other.

An index key molded in the phenolic housing adjacent to the outside foil lead facilitates identification of the lead for automatic insertion machinery or hand operators. In addition, three stand-off feet raise the endseal and shell proper

above the printed wiring board, avoiding moisture and dust trap formed by capacitors with a flat circumference on the housing. The feet also permit use of double-sided wiring boards without causing low resistance shorts between top side conductors through accumulated dust around the circumference of the capacitor.

The new Type 89P Autocon capacitors are of the solid dielectric type, and are impregnated with HCX,\* a new and exclusive Sprague development. This hydrocarbon material has superior insulation resistance, lower power factor, and flatter capacitance change vs. temperature characteristics than polyester solid-dielectric capacitor impregnants.

Complete performance data, ratings and sizes are in Engineering Bulletin 222, available on letterhead request to the Technical Literature Section, Sprague Electric Company, 35 Marshall Street, North Adams, Massachusetts.

Sprague on request will provide you with complete application engineering service for optimum results in the use of molded paper tubular capacitors.

\* Trademark

*world's largest capacitor manufacturer*

**SPRAGUE**

Export for the Americas: Sprague Electric International Ltd., North Adams, Massachusetts. CABLE: SPREXINT.

SEE US AT THE WESCON SHOW—BOOTHS 1001-1002

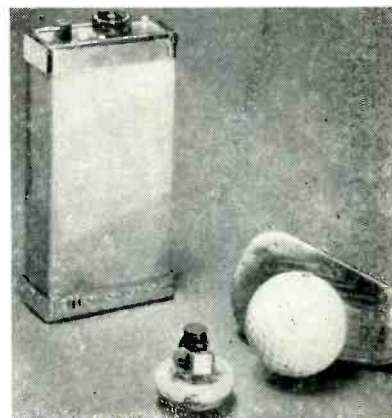
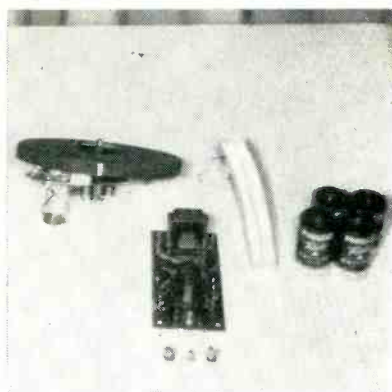

APPLICATIONS to another portable radio, a portable phono and an experimental golf ball appear as . . .

## Transistors Invade More Consumer Products

### Manufacturers begin to utilize the device in mass volume items

IN the past month, at least three transistor home products have been introduced and plans for others have been announced.

► **Portables**—Mitchell Manufacturing, Chicago air-conditioner manufacturer, introduced the transistor pocket radio shown, measuring 3 by 5 by 1½ inch thick and weighing 12 ounces. It utilizes four germanium *npn* transistors and a germanium diode detector.

Power is supplied by a single hearing-aid type 22.5-volt battery. The set is equipped with a 2¼-inch permanent magnet loudspeaker. It has been in mass production for several weeks, according to the firm, and deliveries are being made to stores throughout the country. The set has an introductory price of \$49.95.

► **Phonos**—Philco, which recently announced a transistor auto radio, introduced the portable phonograph shown in which 3 transistors take the place of all vacuum tubes. The firm also introduced an all-transistor hearing aid, marking Philco's entry into the hearing-aid field.

The phonograph will be available for sale to the public early this fall. It will play 45-rpm records for 150 hours using current from four flashlight batteries. The set has a

4-volt motor weighing less than 3 ounces.

The phonograph uses a printed-wire chassis, a 4-inch loudspeaker and has a speed control to compensate for loss of power as batteries wear out. The tone arm serves as the on-off switch and automatically shuts off the turntable and the set after each record.

► **Golf**—The experimental transistor golf ball shown was developed by Motorola to demonstrate possible transistor applications. Such a ball would become almost unlosable because the one-transistor transmitter inside sends out a signal sufficiently strong to be picked up by a portable,

pocket-sized receiver. By rotating the receiver as a direction finder the ball's location can be determined.

► **Set**—The pocket-sized receiver shown with the golf ball is tuned to a fixed frequency of 121.95 kc. It can be used as an electronic watch because it picks up time signals broadcast at two-hour intervals by Naval Radio NSS.

The receiver uses 6 transistors, has three i-f stages, a beat-frequency oscillator, a detector and an audio amplifier. It uses a ferrite loopstick antenna 3 inches by 23/32 inches by 5/32 inches. Power is provided by two 1.5-v penlight batteries in series.

## Auto Industry Eyes Electronics

### Automobile and parts firms acquire electronics plants or start own departments

ROLLCALL of manufacturers of automobile parts and motor vehicles reveals more than a dozen firms that are in the electronics business either directly or through affiliates or subsidiaries.

► **Recent Mergers**—Thompson Products, maker of piston rings and other parts has in recent years acquired four electronics firms: Bell Sound Systems, Dage Electronics, Antenna Research Lab (dissolved) and Ramo-Wooldridge.

American Bosch, which manufactures diesel engine parts and ignition systems, merged with the Arma Corp., a producer of servomechanisms and fire-control equipment.

Gabriel Corp., manufacturer of coil springs and shock absorbers, acquired Ward Products and Workshop Associates, both antenna manufacturers.

Reynolds Spring Co., a maker of auto springs, acquired the Haydon division of North American Philips whose business is precision motors for servo systems. Afterwards the company name was changed to Con-

(Continued on page 14)

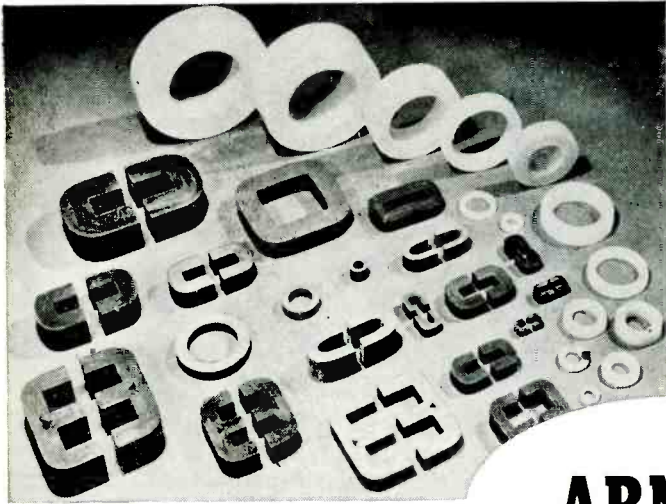

**ARNOLD**

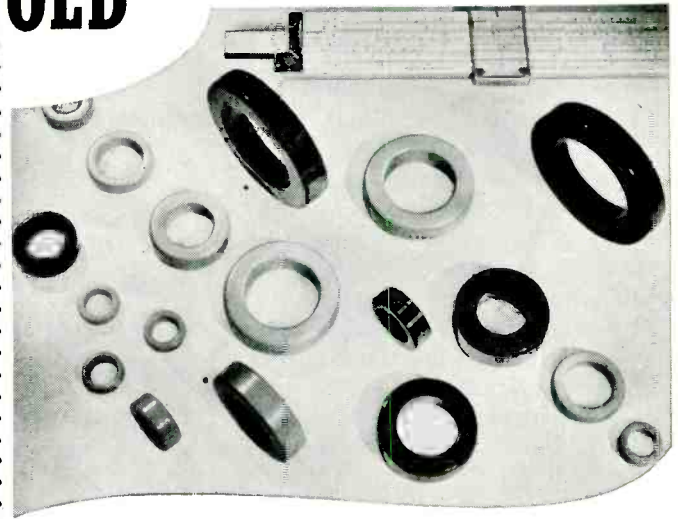

**YOUR ONLY SOURCE**  
**of a Complete Line of MAGNETIC MATERIALS**

**TECHNICAL DATA ON  
 ARNOLD PRODUCTS... Write  
 for your copy.**

**Bulletin GC-106 A** . . . General information on all Arnold magnetic materials: permanent magnets, tape-wound and powder cores, etc.

**Bulletin TC-101 A** . . . "Properties of Deltamax, 4-79 Mo-Permalloy and Supermalloy"—28 pages of technical data on Arnold Tape-Wound Cores.

**Bulletin PC-104 A** . . . "Molybdenum Permalloy Powder Cores"—16 pages, complete technical data.

**Bulletin SC-107** . . . "Arnold Silectron Cores"—52 pages of valuable data, covering a complete range of core shapes, sizes, tape gauges, etc.

**ADDRESS DEPT. E-58**

Arnold products include all grades of Alnico permanent magnets (cast and sintered) . . . tape-wound cores of high-permeability alloys, such as Deltamax, Permalloy and Supermalloy . . . types "C" and "E" cut cores of Silectron in any size or weight range from a fraction of an ounce to hundreds of pounds (50 lbs. max. on 12-mil C cores); also round, square and rectangular Silectron cores . . . powdered Mo-Permalloy cores . . . Cunife, Vicalloy, Permendur and other magnetic materials. Special magnetic components can be produced to meet your specific requirements; and such products as powder cores, tape-wound cores, and C and E cores are carried in stock in a wide range of standard sizes for immediate delivery. Many sizes of cast and sintered Alnico magnets also are stocked.

In other words, Arnold magnetic materials can answer *any* requirement you may have. It is the *only* complete line in the industry; and in addition, Arnold maintains complete control over every production step from raw materials to finished products. Such a source can bring you advantages in long experience and undivided responsibility, and in unequalled facilities for quality production and control. • *Let us supply your needs.*

W&D 5545

**THE ARNOLD ENGINEERING COMPANY**  
 SUBSIDIARY OF ALLEGHENY LUDWIG STEEL CORPORATION  
 General Office & Plant: Marengo, Illinois  
 DISTRICT SALES OFFICES . . . New York: 350 Fifth Ave.  
 Los Angeles: 3450 Wilshire Blvd. Boston: 200 Berkeley St.



solidated Electronics Industries.

Hall-Scott Motors of Berkeley, Calif., an engine manufacturer, bought Bardwell & McAlister of Burbank which designs and manufactures electronic equipment, makes sheet-metal fasteners and television lighting equipment.

Mack Trucks acquired White Industries, aircraft electronics manufacturer, and Radio Sonic.

► **Other Firms**—Titeflex, which manufactures flexible waveguide, also makes engines and has interest in Indian Motorcycles.

Great American Industries includes Lyan Coach and Truck, manufacturer of front-wheel drives, and Connecticut Electronic Alarm. Great American is considering merging with Air Associates.

Borg-Warner is in electronics through its Pesco Products division and is reported planning a merger with Byron Jackson, manufacturer of oil equipment and electronic devices.

Aerophysics Development Corp. is a subsidiary of Studebaker-Packard.

► **Departments**—General Motors is in electronics through its Delco Radio division which does government work and makes car radios. The GM A-C Spark Plug division manufactures radar fire-control equipment and an airborne gun-bomb-rocket sight.

The Budd Company, Philadelphia manufacturer of auto bodies, is reportedly buying electronic components for experimentation.

Recently Budd acquired Continental-Diamond Fibre, a manufacturer of printed wiring boards and insulating products.

► **Old Timers**—Sparks-Withington, manufacturer of auto horns, produces the Sparton line of radio and television sets. Stewart-Warner, maker of grease guns and speedometers, also puts out radio and tv sets. Globe Union, known for storage batteries, spark plugs and roller skates, makes printed circuits and switches at its Centralab division.

Clevite, a manufacturer of bearings and bushings, controls Brush Electronics and Transistor Products.

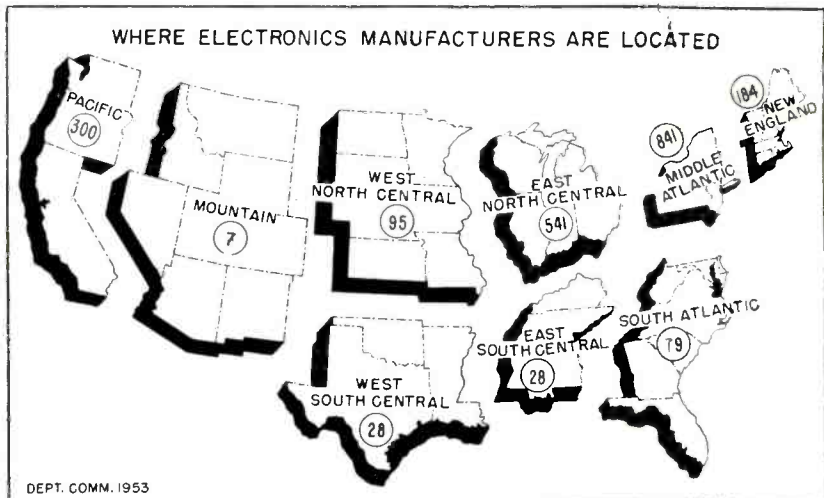

REGIONAL DISTRIBUTION of company locations shows that . . .

## Electronics Industry Spreads Out

Study shows concentrations of electronics manufacturing remain in east and midwest

THROUGH its collections for all types of Old Age and Survivors' Insurance covered employment the Health, Education and Welfare Department keeps track of the various industries in the U. S.

The latest report, covering the year 1953, gives the number of reporting units or manufacturers in communications equipment manufacturing by state, county and region along with payrolls and employment.

There were 541,987 employees in the industry in mid-March 1953. Total taxable payroll for January to March 1953 amounted to \$502.8 millions. The number of manufacturers in the communication equipment classification paying OASI payments was 2,103.

► **Size**—Breakdown by number of employees of the 2,103 firms is given in the following figures: 0 to 3 employees, 376 firms; 4 to 7, 280; 8 to 19, 363; 20 to 49, 319; 50 to 99, 177; 100 to 249, 227; 250 to 499, 135; 500 or more, 226.

► **Areas**—As shown in the chart, the rank of the 9 regions of the U. S. in terms of number of electronic firms has remained pretty much as it has in the past with

Mid-Atlantic, East North Central and Pacific regions holding the top three spots. In terms of OASI payroll, the top three regions are Mid-Atlantic, \$188.1 million; East North Central, \$169.6 million and Pacific, \$55.8 million.

In the number of employees the top areas were Mid-Atlantic, 199,144, East North Central, 183,044 and New England, 64,653. The state of Illinois led all other states in industry employment and payroll with 102,518 workers and a payroll of \$106.6 million for the first quarter of 1953. New Jersey and New York followed as second and third largest in this regard. In number of firms, however, New York was first with 492 and Illinois second with 323.

## Arizona Companies Face State Tax

BUDDING electronics business in Arizona (ELECTRONICS, p 16, June '55) has run into a state tax problem.

The Corporation Commission has upheld a sales tax assessment against AiResearch Mfg. Co., makers of electronics equipment, on grounds federal government sales are taxable.

Under the commission ruling now

(Continued on page 16)



there is a  
**KAHLE  
 MACHINE**  
 to speed  
 every  
 operation  
 in the  
 manufacture  
 of

- **DIODES**
- **TRANSISTORS**
- **ELECTRONIC TUBES**

Illustrated are typical examples of Kahle machines that give maximum production efficiency, speed and economy.

Can we help you? Write today — give us your requirements or special problems.

***Kähle***

**ENGINEERING COMPANY**

1355 SEVENTH STREET  
 NORTH BERGEN, N. J.

Designers and builders of  
 special automatic and semi-  
 automatic equipment for  
 all industrial operations.

(CONT.)

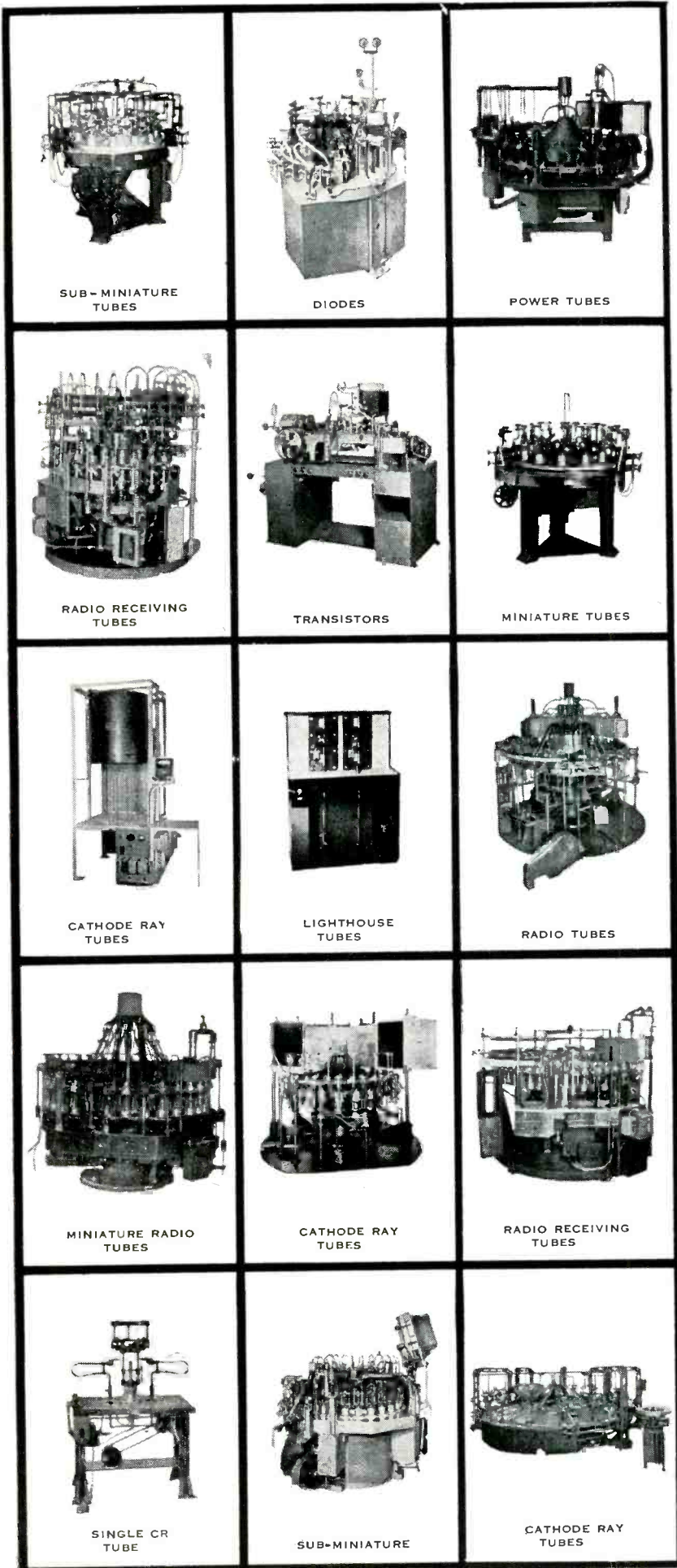

made final, the company must pay about \$14,000 for the sales period starting July 9, 1954, when the law went into effect, until Dec. 31, 1954. The tax is based on two percent of sales to the federal government.

Taxes for 1955 have not been set.

► **Stunts Growth**—Stanley Womer, manager of the Arizona Development Board, saw in the decision a blow to development of Arizona's electronics industry. He indicated there will be a tendency of electronics firms planning to move to Arizona to stay where they are until

the law is changed.

About 200 machine shops in the Phoenix area have been supplying AiResearch with tax-free parts. Presumably the company will have to absorb taxes on this too, Womer said.

Melpar, Inc., research and development subsidiary of Westinghouse Air Brake Co., announced plans, previous to the ruling, to open a branch at Tucson, Ariz. The company has received a \$990,000 contract from the Army Electronics Proving Ground at near-by Fort Huachuca.

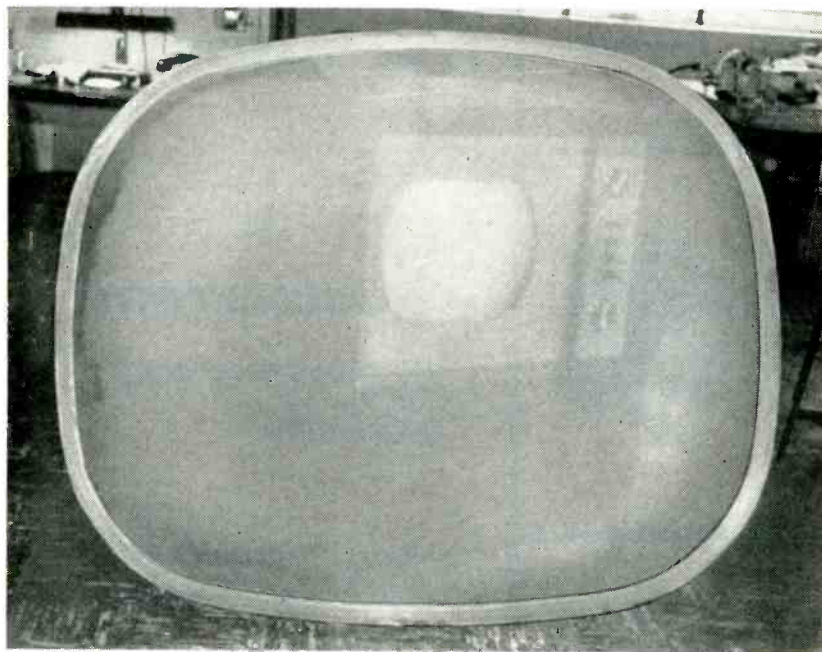

FABRICATION of shadow masks is underway at Volkert Stampings but . . .

## Color Tube Output Is Still Small

**Production rate is low but now volume output may come later this year**

VIRTUALLY every color tube produced uses the shadow mask. Production of these components is an index of color picture tube output.

Approximately 80,000 masks have been produced. About 50,000 were made for the 19-inch and 21-inch color tubes and most of the remainder were for the 15-inch tube. About 2,000 masks have been pro-

duced for the 22-inch rectangular color tube.

► **Stock**—Most of the masks produced have been used and stockpiling has largely been of the completed tubes. However, one color tube manufacturer has about 5,000 color masks on hand. These factors along with wait-and-see attitude on future color tube production has brought present mask-making activity to a virtual standstill. Mask makers seem to feel that it will be late fall before volume increases.

## Businessmen Adopt Citizens' Radio Band

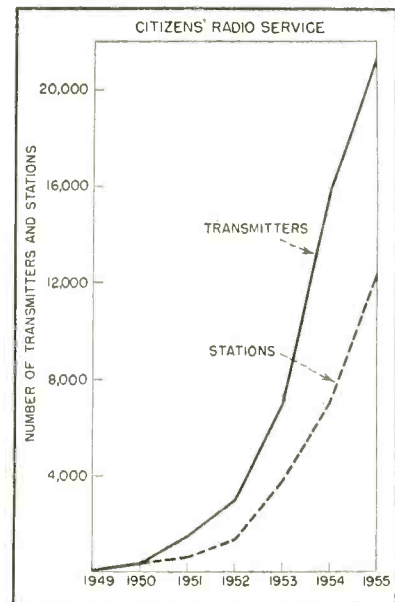

**Party-line operation no bar to users ineligible for other radio services**

TRANSMITTERS authorized in the citizens' radio service now total 21,300. This includes both mobile units and fixed-station transmitters. Station authorizations number 12,334. The chart illustrates the increasing rate with which the service is growing. During the month of June 518 stations were added.

► **Ground Rules**—The service was inaugurated in 1949 to provide for private, personal and business communications, signaling and remote control. The communications service works on a kind of party-line basis (no frequency assignments) in the band 460 to 470 mc. The citizens' radio service also encompasses crystal-controlled 27.-255-mc transmitters of 3-w input or less used for controlling model planes and boats and opening garage doors.

Currently the major users of the citizens' band are business firms or organizations who require radio communications but cannot obtain authorization to use one of

(Continued on page 20)

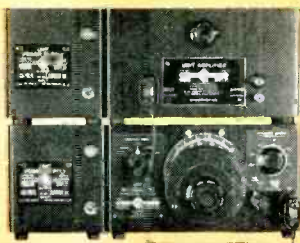

For More Power... Type 1210-B becomes 3-watt R-C Oscillator with Type 1206-B Unit Amplifier, \$85 and Unit Power Supply, \$40.



Becomes Sweep Generator... with easy-to-attach Type 908-P Synchronous-Dial Drive, \$27.50 and Type 1210-P1 Discriminator, \$75 (at right), for supplying CRC voltages.



Automatic Data Taking... with pen-type recorder or CRO eliminates laborious point-by-point measurements... in photo, frequency response of small loud-speaker is recorded.



Network Transient Investigations... with R-C oscillator square waves; one measurement gives information on both amplitude and phase characteristics... in photo, engineer observes and records filter characteristics of G-R Type 1550-A Octave-Band Noise Analyzer.



As Bridge Generator... shown with new G-R Universal Audio-Frequency Bridge and Type 1212-A Unit Null Detector, \$145.



As Modulator... Unit R-C Oscillator square-wave modulates the recently announced Type 1218-A UHF Unit Oscillator, \$465., with 900-2000 Mc range.



Five G-R Unit Oscillators.

For Coverage from 20 Cycles to 2000 Megacycles...



# NEW R-C Oscillator



Type 1210-B Unit R-C Oscillator, \$140, with Type 1203-A Unit Power Supply, \$40.

The new Type 1210-B Unit R-C Oscillator is a unique audio, supersonic and radio-frequency generator... providing both square waves and sine waves over the range from 20 cycles to 0.5 Mc. Its wide range, multiple output system, easy adaptability to sweep operation and extreme versatility, make it a must for every development and measurement laboratory. Features include:

- ★ Slow-Motion Frequency Control: for small frequency increments; each decade covered by  $4\frac{1}{2}$  turns of knob.
- ★ Precision Dial: can be motor driven by Type 908-P Synchronous-Dial Drives for automatic display of amplitude-frequency characteristics; 908-P1 covers one frequency decade in 50 sec, 908-P2 takes  $6\frac{2}{3}$  sec per decade... \$27.50 for either.
- ★ Three Outputs:
  - Low-Voltage, Low-Impedance (0 to 7 v, 50  $\Omega$ ): constant within  $\pm 1$  db to 200 kc; less than 1% no load distortion from 200 c to 20 kc, less than 1.5% over entire range; hum at least 60 db down.
  - High-Voltage, High-Impedance (0 to 45 v, 12.5 k $\Omega$ ): constant within  $\pm 1$  db and less than 5% distortion at no load from 200 c to 200 kc (decreases to 2.5% under load); hum at least 50 db below maximum output.
  - Square waves (0 to 30 v peak-to-peak): 2500  $\Omega$  output impedance; less than 0.25 $\mu$ s rise time and 1% overshoot; hum at least 60 db down.
- ★ Adjustable Output Control: logarithmic, calibrated 0-50 db.
- ★ AVC System: fast response, insures constant output under fluctuating line voltage.
- ★ Power Supply: Type 1203-A recommended for use on 115 v, 50-60 cycle power; Type 1202-A Unit Vibrator Power Supply for field operation from standard 6 v or 12 v storage battery.
- ★ Rack Mounting Provision: Type 480-P4U3 Relay Rack Panel, \$12.50, for laboratory use.

The G-R Unit R-C Oscillator is the latest addition to the ever growing, ever more useful line of G-R Unit Instruments.

G-R Unit Oscillators are now available for coverage from 20 cycles to 2000 Mc... the Unit Pulse Generator provides pulse durations of 0.2-60,000  $\mu$ sec with repetition rates from 30 c-100 kc, and rise times of 0.05  $\mu$ sec... the Unit Null Detector has better than 40  $\mu$ v sensitivity... a Unit Amplifier is available with 3-watt maximum output and 20 c-to-250 kc range... the Unit Crystal Oscillator has short-term stability of 1 ppm... the Unit I-F Amplifier is a basic component in the 50-5000 Mc G-R High-Frequency Null Detector... this apparatus, compact, interconnectable, rugged and reliable in performance, represents the most in instrumentation value per dollar available anywhere.

WE SELL DIRECT. Prices are net, F.O.B. Cambridge or West Concord, Mass.

## GENERAL RADIO Company

90 West Street NEW YORK 6  
8055 13th St., Silver Spring, Md. WASHINGTON, D. C.  
1150 York Road, Abington, Pa. PHILADELPHIA  
920 S. Michigan Ave. CHICAGO 5  
1000 N. Seward St. LOS ANGELES 38





the world's foremost producer  
of **SEMICONDUCTORS**

presents this comprehensive range of Raytheon  
DIODES, having the characteristics and the  
uniformly dependable performance that warrant your complete  
confidence and your specification as first choice

Preserve this Ready Reference Chart ▶

You'll find it a useful and dependable source of  
up-to-date information on Raytheon Diodes.

**RAYTHEON  
MANUFACTURING  
COMPANY**

*Semiconductor Division*

Home Office: 55 Chapel St., Newton 58, Mass., Bigelow 4-7500  
For application information write or call the Home Office or:  
9501 Grand Ave., Franklin Park (Chicago), Ill., TUxedo 9-5400  
589 Fifth Avenue, New York 17, New York, PLaza 9-3900  
622 South La Brea Ave., Los Angeles 36, Calif., WEbster 8-2851

**RAYTHEON MAKES ALL THESE:**  
RELIABLE SUBMINIATURE AND MINIATURE TUBES • SEMICONDUCTOR DIODES AND TRANSISTORS  
NUCLEONIC TUBES • MICROWAVE TUBES • RECEIVING AND PICTURE TUBES

# RAYTHEON POINT CONTACT GERMANIUM DIODES

These diodes combine good transient response, low capacity and high frequency capabilities with low cost and dependability. Ambient temperature range -50 to +100°C.

Type	Dimension Outline	Peak Inverse Volts	Average Rectified mA (max.)	Peak Rectified mA (max.)	Maximum Inverse Currents				Forward mA at +1v
					at -5v	at -10v in $\mu$ A	at -50v	at -100v	
1N66 (CK705)	A	60	50	150		50	800		5.
1N67	A	80	35	100	5		50		4.
1N68 (CK708)	A	100	35	100				625	3.
1N294 (CK705A)	A	60	50	150		10	800		5.
1N297 (CK707)	A	80	35	100	10		100		3.5
1N298 (CK713A)	A	70	50	150		250 $\mu$ A (max.) at -40v. (50°C)			30mA (min.) at +2v.
CK801	A	60	50	150			50		5.
CK802	A	80	50	150			100		7.5
<b>VHF and UHF</b>									
1N82A	B	5	50	150	UHF mixer	14 db max. noise — see data sheet for test circuit			
1N295 (CK706A)	A	40	35	125		200	Video detector		
CK715	A	40	35	125		Special tests for VHF to UHF freq. multiplier			
<b>Multiple Assemblies</b>									
CK709	C	Four 1N66 matched within 2.5% at +1.5 and -10 volts for bridge circuits							
CK711	C	Four 1N67 matched from 0 to +3 volts. 30 $\mu$ A (max.) at -50v. for bridge circuits							
CK717	C	Four 1N66 matched within 2.5% at +1.5 and -10 volts for common anode circuits							
CK719	C	Four 1N67 matched from 0 to +3 volts. 30 $\mu$ A (max.) at -500							

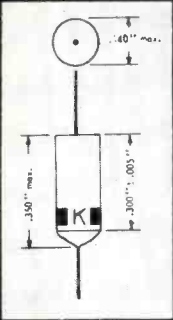

A

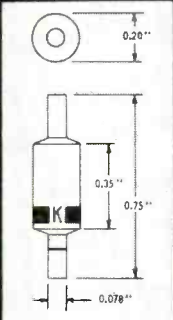

B

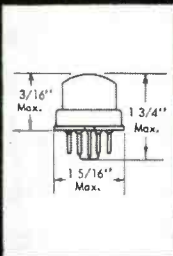

C

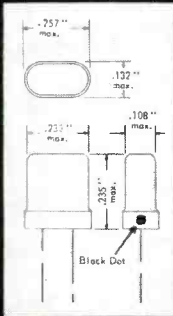

D

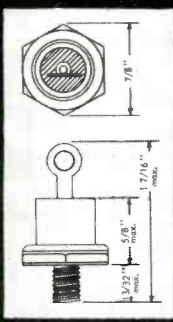

E

# RAYTHEON GOLD BONDED GERMANIUM DIODES

This group of diodes features small size, high forward conduction, high back resistance, and good temperature characteristics. Because junction area is increased over that of point contact types, capacity is slightly higher, transient response slightly slower.

Type	Dimension Outline	Peak Inverse Volts (max.)	Average Rectified mA (max.)	Peak Rectified mA (max.)	Maximum Inverse Currents				Forward mA		Ambient Temperature Range °C
					at -10v	at -20v in $\mu$ A	at -50v	at -100v	at 0.8v	at 1.0v	
1N305 (CK739)	D	60	125	300	2.0		20		100		-55 to +70
1N306 (CK740)	D	15	150	300	2.0				100		-55 to +70
1N307 (CK742)	D	125	50	300	5.0			20		100	-55 to +70
1N308 (CK741)	A	10	100	350	500 $\mu$ A at -8 volts				300		-55 to +90
1N309 (CK747)	A	40	100	300		100			100		-55 to +90
1N310 (CK745)	A	125	40	100		20		100		15	-55 to +90
1N312 (CK748)	A	60	70	250			50			30	-55 to +90
1N313 (CK749)	A	125	40	100		10		50		15	-55 to +90

Note: 1N305-6-7 have very high back to forward ratio, high back resistance, sharp Zener characteristic, average transient response  
1N308-13 have good transient response with good forward characteristics, high back resistance

# RAYTHEON BONDED SILICON DIODES

Raytheon Bonded Silicon diodes provide high back resistance, a sharp Zener characteristic and fair transient response (large overshoot, fast recovery) over an ambient temperature range of -55 to +150°C.

Type	Dimension Outline	Peak Inverse Volts	Average Rectified mA	Peak Rectified mA	Maximum Reverse Currents			Forward mA at -1v	100°C Average Rectified mA	Max. Reverse mA at -10v
					at -5v	at -10V in $\mu$ A	at Volts shown			
1N300 (CK735)	D	15	40	120		0.001		8	15	0.01
1N301 (CK736)	D	70	35	110		0.01	0.05 at -50	5	12	0.2
1N302 (CK737)	D	225	25	80		0.01	0.2 at -200	1	8	0.2
1N303 (CK738)	D	125	30	100		0.01	0.1 at -100	3	10	0.2
1N432 (CK856)	D	40	40	120		0.005		10	20	0.05
1N433 (CK860)	D	145	30	100		0.03	0.3 at -125	3	15	0.5
1N434 (CK861)	D	180	30	100		0.05	0.5 at -160	2	15	1.0
1N438 (CK852*)	D	7	100	200	10			50	50	

\*8 volt Zener regulator

Note: All ratings at 25°C unless otherwise indicated.

# RAYTHEON SILICON POWER RECTIFIERS

This new Raytheon silicon rectifier is the first to give high current rectifying capacity in extremely small volume. The rectifiers operate to 175°C, to 200 volts peak and to over 99% efficiency. Back to forward resistance ratio is over 100,000.

Type	Dimension Outline		Maximum Voltage		Maximum Current		Typical Dissipation Watts
			RMS Volts	Peak Volts	Peak Amperes	Average Amperes	
CK775	E	Case Temp. 30°C*	40	60	50	15	40
		Case Temp. 170°C*	40	60	15	5	10
		No Heat Radiator					
		Ambient Temp. 25°C	40	60	6	2.0	3.0
CK776	E	Ambient Temp. 170°C	40	60	2.0	0.5	0.5
		Case Temp. 30°C*	125	200	50	15	40
		Case Temp. 170°C*	125	200	15	5	10
		No Heat Radiator					
Ambient Temp. 25°C	125	200	6	2.0	3.0		
	Ambient Temp. 170°C	125	200	2.0	0.5	0.5	

### ADDITIONAL RATINGS (25°C)

Both CK775 and CK776 have maximum drop at 5 amperes of 1.5 volts  
CK775 has maximum reverse current at -60 volts of 25 mA  
CK776 has maximum reverse current at -200 volts of 25 mA

\*maintained by external heat radiator

the other land-transportation or special or industrial services.

► **Users**—A few typical users include: radio and television servicemen; coal and fuel oil suppliers; heating and air conditioning servicemen; trucking firms; local civil defense units; boys' camps; petroleum companies; construction out-

fits; a glass company and suppliers of ready-to-pour concrete.

Eight manufacturers of type-approved equipment are listed by the FCC: Motorola (10 models), Stewart-Warner (4), RCA (4), McNabb Company (2), Royalcall, Connecticut Telephone & Electric, Electronic Protection Co., and Multi-Products.

## What's Ahead in Plant Expansions

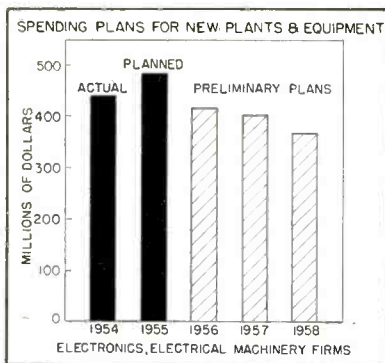

### Companies in electronics have increased plans for capital spending in 1955

FIRMS in the electrical machinery classification, which includes electronics, will spend 10 percent more for plant and equipment this year than in 1954, according to the eighth annual McGraw-Hill Survey of business' plans for new plants and equipment.

A total of \$483 million is to be spent compared to \$439 million in 1954. About 40 percent of this amount is accounted for by electronics manufacturers. Preliminary plans by the industry for the future show that \$415 million may be spent in 1956, \$401 million in 1957 and \$367 million in 1958.

► **Up**—Practically every manufacturing industry has increased its plans for capital spending since last fall, including electronics. At that time, a survey of preliminary plans for 1955 showed capital spending by the industry would decrease by about 6 percent in 1955 compared to 1954, from \$461 million to \$431 million (Electronics, p 5, Dec. '54).

Previous surveys have shown that

preliminary plans for years ahead are always sharply lower than plans for the current year. Thus, though preliminary capital spending plans by the industry for 1956-1958 show a decline, actual spending in these years may be considerably higher.

Over the past 5 years the industry has expanded its capacity tremendously as is indicated by the following index (1939 = 100): 1950, 325; 1952, 400; 1953, 452; 1954, 488. Planned expansion for this year will raise capacity to 522 and by 1958 to 600.

► **Use**—The electrical machinery industry plans to use 52 percent of its total capital expenditure of \$483 million for plant expansion in 1955 and 48 percent for replacement and modernization. This compares to 51 percent and 49 percent respectively in 1954.

The survey shows that 73 percent of the industry's total expenditure this year will be for new equipment and 27 percent for construction costs. Of the companies studied, 35 percent estimated that new equipment should pay off in three years and 31 percent estimated 5 years. The remaining estimates varied up to 9 or more years.

► **Sales**—A major factor behind the expansion plans of electronic firms is the high optimism about increased sales in 1955 and through 1958.

The companies expect sales this year to be 6 percent higher than last. By 1958 they expect sales to be higher by 29 percent, on the average, than they were in 1954, for the largest increase anticipated by any of the industries covered in the survey.

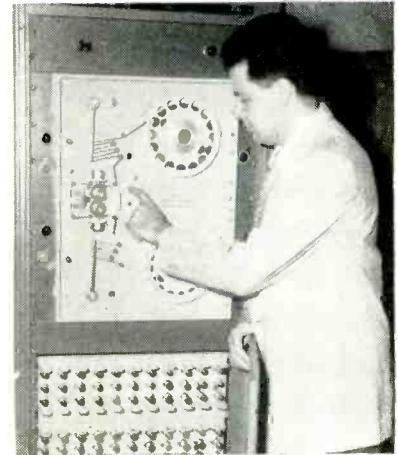

**TAPE UNITS** like this will process 20,000 transactions daily when . . .

## Computer Controls Parts Inventory

**Specially designed machine will handle 35,000-item inventory for elevator firm**

YEARLY savings of \$120,000 are expected to accrue when Otis Elevator puts an electronic digital computer to work controlling its \$10-million inventory.

The computer, under development by Nuclear Development Associates of White Plains, N. Y., will cost \$200,000. It will handle 20,000 transactions daily: controlling 35,000 items and recognizing 20,000 others.

► **Operation**—During the day ten typists will enter inventory transactions on punched paper tape. The machine will process the tapes overnight. In the morning, a typed output will disclose item and quantities to be reordered, shortages and the sale and purchase contracts affected by them and transactions not controlled by the machine which must be processed manually.

► **Technical Layout**—The machine makes use of Flexowriter input and output. A converter writes the data onto 5-in. 8-channel magnetic tape. A sorter which includes four tape mechanisms is used to split, merge and sort data. The computer proper contains two 60-character

(Continued on page 22)

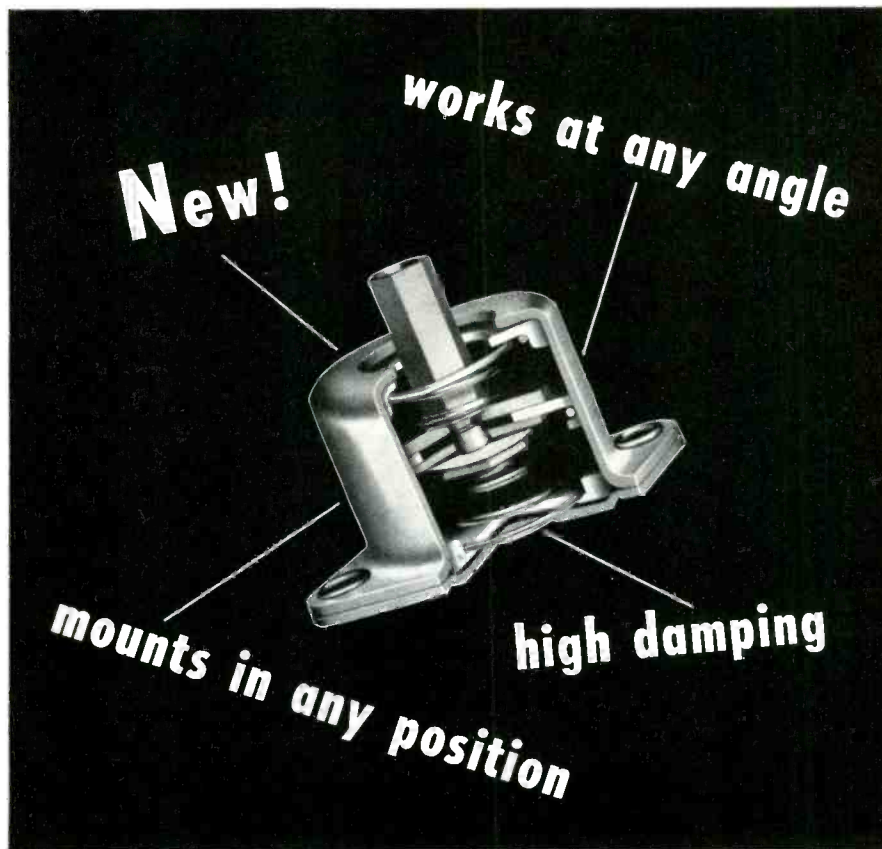

## Nothing Less than this **ALL-ANGL Mount** gives sure protection in **JETS and MISSILES**

WHY? Because this Barry mount is independent of operating or mounting position. Through every operational maneuver of jets, VTO's, and missiles, the ALL-ANGL gives the same effective shock and vibration protection as in level flight.

### *These are the vital performance characteristics of the ALL-ANGL Mount:*

- Equal stiffness in all directions
- Equal damping in all directions
- Low transmissibility at resonance — less than 3
- Isolation under superimposed steady state accelerations up to 5 g

Maximum load ratings of Size 0 ALL-ANGL mounts now available are 0.5 to 3.0 pounds per mount, in four ranges.

Write today for Data Sheet W5. For specific recommendations, call your nearest Barry Sales Representative.

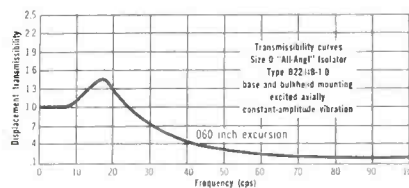

Typical transmissibility curve for ALL-ANGL mount, both base and bulkhead mounting, excited axially at constant amplitude.

# BARRY CONTROLS

INCORPORATED  
*Formerly The Barry Corporation*

707 PLEASANT STREET WATERTOWN 72, MASS.

SALES REPRESENTATIVES IN ALL PRINCIPAL CITIES.

shift registers and two 30-character registers. The machine utilizes unitized construction and employs 100-kc magnetic shift registers.

► **Other Duties**—One of the computer's unique functions will be determining the optimum time and optimum quantity for reordering parts. It will take into account: past usage over 15 months, fluctua-

tion in past usage, business forecasts, monthly value and cost of maintaining inventory, cost of placing an order and cost if a shortage of the item should occur.

The order lot arrived at will be compared automatically with the next largest quantity on which the vendor gives a discount. The machine is scheduled for installation in early 1956.

## FCC Okays Low-Power Television Stations

IN an effort to encourage construction of tv stations in smaller communities, the FCC has authorized operation of tv stations on power as low as 100 watts starting in August.

No minimum antenna height is specified. The action applies to all communities regardless of population.

► **UHF**—The Commission also has proposed to increase the maximum effective radiated power for uhf stations from 1,000 to 5,000 watts. Comments on this proposal are in order until Sept. 1.

► **Networks**—As of August 1, FCC forbids tv stations in one city from entering into network arrangements that would prevent stations in nearby cities from carrying the same programs. The ruling is designed to help new tv stations, especially uhf, to get the network programming necessary for financial stability.

In the past, an affiliate had first claim on network shows within its service area, thus barring other stations in the same approximate area from acquiring them. First-call privilege now goes to the community in which the affiliate is located. The rule applies to all tv broadcast stations, including those owned by the networks.

## Big Business' Stake In Electronics Grows

Of 500 largest U. S. industrial firms, 101 have interest in electronics

THE ELECTRON TUBE and its younger cousin, the transistor, are major factors in America's economic structure. Nearly three million wage earners are involved, in one way or another, in the manufacture of electronic equipment and the com-

(Continued on page 24)

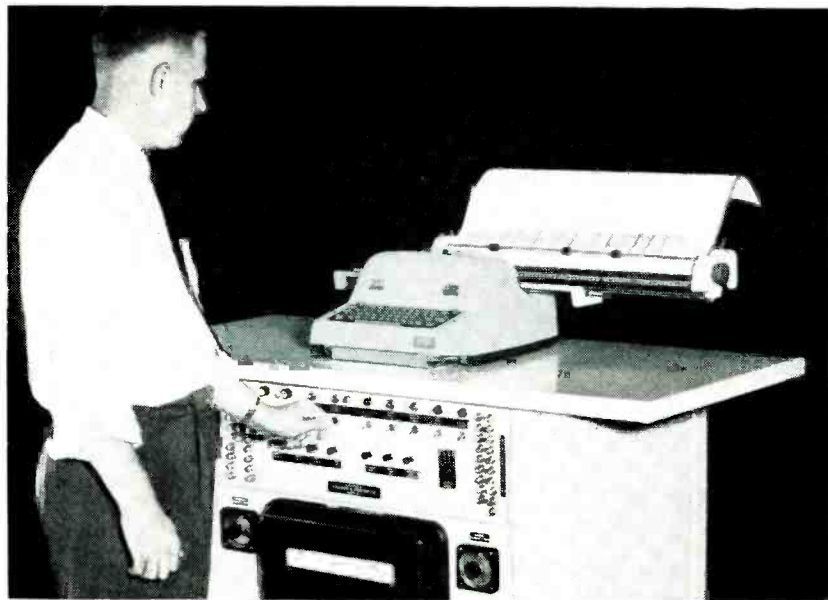

AUTOMATIC LOGGER records process variables in refinery as . . .

## Oil Industry Goes Automatic

Refineries to increase spending for electronic measurement and control

CURRENT trend in petroleum refinery instrumentation is automatic logging—centralized recording of measurements taken throughout the refinery to provide a detailed record of operations.

► **Installation**—A \$50,000 setup to monitor, analyze and record 480 process variables will be installed by Fischer and Porter in Canadian Petrofina's new Montreal refinery. The plant will have a 20,000-barrel per day capacity.

The logger will type out on a single log hourly the value of all variables. In case of trouble the out-of-line condition and its location will be typed out. The instru-

ment will also compute total flow, efficiency ratios and yield factors and punch significant data into paper tape or cards for preparing summary reports to management.

► **Other Jobs**—About ten refineries have installed logging systems. These cost from \$5,000 to \$50,000. More than 100 systems are currently hanging fire. Potential market might run to over 700 systems.

Firms making the equipment include Beckman Instruments, Consolidated Engineering, Minneapolis-Honeywell and others.

► **Future**—Next step after centralized measurement will be complete automatic control. However, small loops will be closed one at a time rather than converting entire refineries and petrochemical plants to automatic operation.



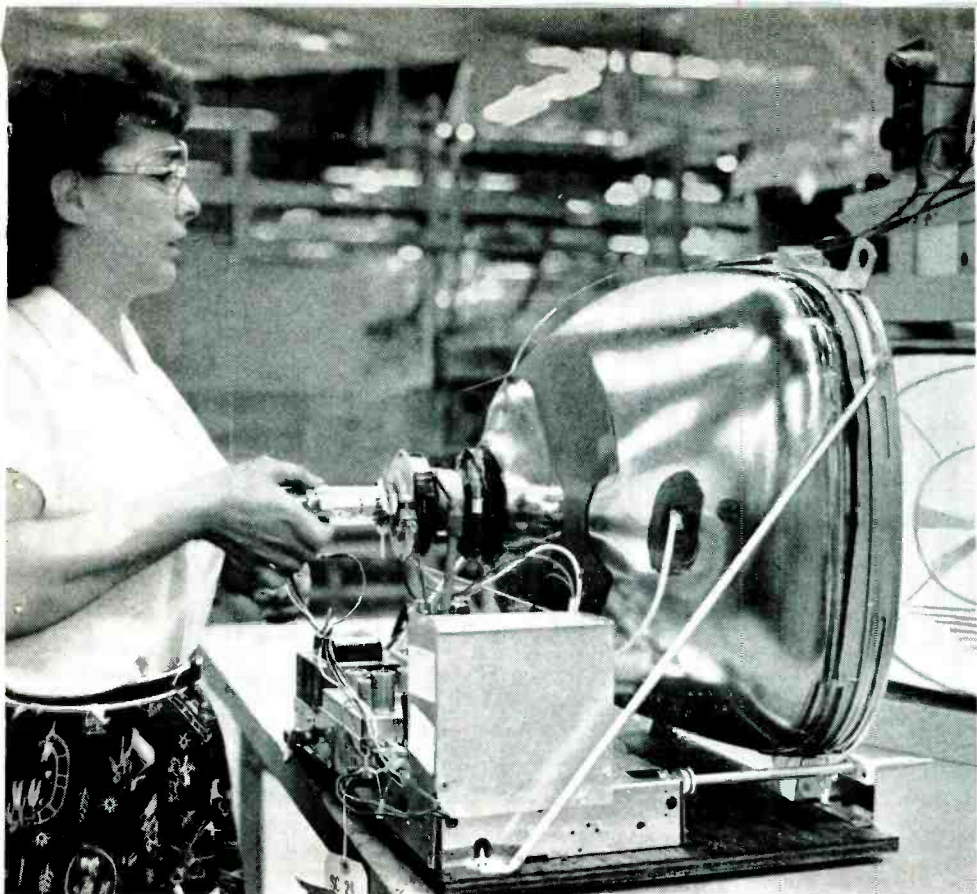

You can cross this operation (ion-trap magnet adjustment) off your list of production processes, with General Electric straight-gun picture tubes. Cost of magnet is a further saving.

**INTER-ELECTRODE ARCING AT HIGH VOLTAGES IS GREATLY REDUCED BY:**

Increased spacing between focussing electrode and anode.

Increased spacing between supports holding electrodes to glass beading, also fewer supports.

Fewer welds, fewer parts. Both the field electrode and anode are one-piece construction.

Saddle straps with polished surfaces—part of the new support construction—offer no rough edges to draw arc-overs.

New glass beads of uniform internal structure will not break down under high voltage.

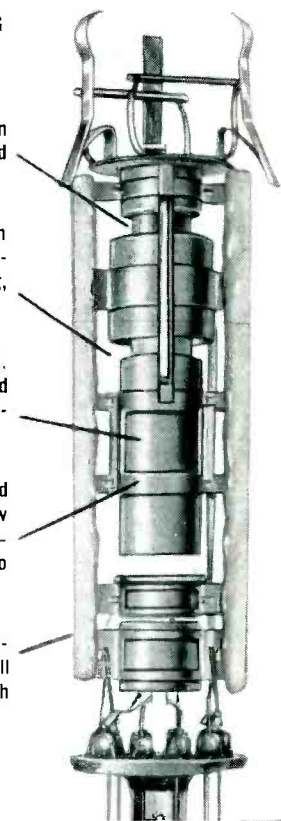

The new design features of G.E.'s straight gun also cut your receiver rejects. They mean fewer arc-overs at high voltage; consequently, a much more dependable tube and picture.

## Eliminate ion trap and adjustment... improve TV reliability with G.E.'s new straight-gun aluminized picture tubes!

THE controlled-thickness aluminum "mirror" in G.E.'s new electrostatic-focus tubes does a second, important job—it bars harmful ion penetration to the phosphor screen. This has enabled G-E tube designers to do away with the ion trap, and utilize a straight gun, having (1) improved simplicity and strength, and (2) perfect concentricity with locked-in focus.

You benefit as a TV manufacturer because you have no ion-trap magnet to buy, no magnet installation or adjustment to make. Also, you cut your

production-line set rejects, because—when designing the new straight gun—G.E. added a number of features that join to reduce high-voltage arc-overs to a minimum.

No ion-trap problems—at your plant or after sets are shipped—is one reason you should ask for full information about the new G-E straight-gun picture tubes. More dependable tube performance, favorably affecting your production quality, is another. Wire or write *General Electric Co., Tube Department, Schenectady 5, N.Y.*

- 21BAP4 . . . . . 21", 90°
- 21BNP4 . . . . . 21", 90°
- 21BCP4 . . . . . 21", 70°
- 21BDP4 . . . . . 21", 72°
- 24ZP4 . . . . . 24", 90°

*Progress Is Our Most Important Product*



ponents that go into it.

► **Widespread Interest**—Big business has a large and growing stake in electronics. Out of the 500 largest U. S. industrial concerns—each with annual sales of \$50 million and over—101 have some interest in the electronics business. This interest may range all the way from manufacturing radio and television sets almost exclusively to support of a small electronic research and development subsidiary or production of insulation, plastic board, wire, magnets or chassis sheet metal. The 101 firms have annual sales of more than \$40 billion and assets of nearly \$26 billion.

► **Electronics firms**—There are 62 of the 500 largest companies whose business includes manufacture of electronic equipment or components peculiar to electronic equipment such as tv tuners, flyback transformers, resistors and capacitors. The electronic portion of each firm's business varies widely with regard to total sales. For a few companies, business is 100 percent electronic. For others, manufacture of electronic equipment or components represents 5 percent or less of total sales. Total sales of electronic equipment and components only by these 62 firms amount to nearly \$7 billion.

## Fewer Electronic Firms Failed In 1954

TOTAL of 26 companies failed in 1954 compared to 33 in the previous year. Total resulting liabilities also declined going from \$24.8 million in 1953 to \$14.4 in the 1954 fiscal period according to RETMA.

► **Types**—Of 26 electronic manufacturers having financial difficulties during the last fiscal year, 12 were components producers, 5 made radio and tv sets, 3 manufactured instruments, 3 produced hi-fi or phonograph equipments, 2 manufactured recorders and 1 produced hearing aids. The average age of the 26 companies was 6½ years.



PHOTOELECTRIC reader controls card-punching operation as . . .

## Tubes Process Travelers' Checks

**Automatic unit handles 7,200 checks an hour, doing work of 50 clerks**

TRAVELERS' checks returned from all over the world to the First National City Bank of New York are processed automatically at the rate of 7,200 checks an hour by an electronic machine currently undergoing field test. The machine is a product of the Control Instrument Co., a subsidiary of Burroughs Corp.

► **Performance**—During peak loads the bank handles up to 130,000 checks daily. Fifty girls are required for the operation which involves punching each check's serial number into an individual business-machine card.

The check-processing machine consists of two desk-size units—a reader and punch. An operator loads checks and card stock and removes the machine's output. Accuracy is better than 1/10 of one percent as against one-percent error for manual processing.

► **How It Works**—Printed numbers in the upper left hand corner of a check identify it as to denomination and serial number. The check

reader uses a photoelectric circuit to sense the characters and convey the information to electron-tube storage circuits that in turn control the operation of the card punch. The phototube picks up key points that serve to identify each character.

► **Application**—Similar equipment can be adapted to process stocks and bonds, income tax withholding statements, loan accounts and other documents. The machines' output could be written on magnetic tape if the equipment were to be used with an electronic computer.

## Mack Named To FCC Succeeding Hennock

NEW MEMBER of FCC Richard A. Mack, Democrat of Florida, was sworn in on July 7, 1955. He succeeds Commissioner Frieda B. Hennock whose term expired June 30. The appointment is for seven years.

► **Background**—Commissioner Mack comes to the FCC from the Florida Railroad and Public Utilities Commission, of which he had

(Continued on page 26)



*When you need a special capacitor...*

# The 5000 different "specials" we've designed and built may mean substantial savings for you!

Five thousand, when compared to the national debt, is a small number. But when one company has manufactured over 5000 different types of special capacitors, this number becomes impressive. Yet, Hammarlund has done just that, in addition to turning out a line of standard variable capacitors. The majority of these special types were designed by us to meet customers' specifications — others were built to customers' designs. Some were quite large and intricate, while others were tiny enough to do a big job in miniature devices. They all have one thing in common: They are all built to Hammarlund's rigid quality standards—built to give optimum results.

If you have a problem calling for a special capacitor, it will pay you to check Hammarlund first. For among these 5,000 special capacitors there probably is one to meet your specification. If this is the case we have the dies; tool costs are nil and delivery is prompt. If, however, none of our existing "specials" can fill the bill, our experienced engineering staff will be happy to work with you to design a capacitor that will.

For detailed information on special and standard capacitors, write to The Hammarlund Manufacturing Co., Inc., 460 West 34th Street, New York 1, N. Y. Ask for Bulletin 105.

 **HAMMARLUND**  
SINCE 1910



Richard A. Mack

been a member since 1947 and chairman in 1951-1952. He was also second vice-president of the National Association of Railroad and Utilities Commissioners and represented NARUC on FCC panels, having twice participated in common carrier hearings.

## 1956 IRE Show To Return To The Bronx

NEXT year's IRE show will be held at Kingsbridge Armory and Kingsbridge Palace in the Bronx, N. Y. on March 19-22, according to latest word from the IRE and New York's Triborough Bridge and Tunnel Authority.

Previously, lease arrangements had been signed by IRE with the Authority to hold the show in New York's Coliseum, now under construction in Manhattan. (ELECTRONICS, p. 202, July '55) At that time, it was thought that the building could be completed on March 1, 1956, as originally scheduled, despite a construction collapse that took place in May of this year. Now, however, completion of the Coliseum is not expected until April or May of 1956, too late for the show. Both IRE and the TBTA say that the 1957 IRE show will definitely be held in the Coliseum.

## FUTURE MEETINGS

- AUG. 22-23: Symposium on Electronics and Automatic Production sponsored by Stanford Research Institute and NICB, San Francisco, Calif.
- AUG. 24-SEPT. 3: The National Radio Show, Earls Court, London, England. Preview for overseas visitors August 23.
- AUG. 24-26: 1955 WESCON, Civic Auditorium and Fairmount Hotel, San Francisco, Calif.
- AUG. 26-28: Sixteenth Annual Summer Seminar, Emporium Section IRE, Emporium, Pa.
- AUG. 26-SEPT. 4: Great German Radio, Gramophone and TV Exhibition, Dusseldorf, Germany.
- SEPT. 12-16: Tenth Annual Instrument Conference & Exhibit, ISA, Shrine Exposition Hall and Auditorium, Los Angeles, Calif.
- SEPT. 14-16: 1955 Annual Meeting of the Association for Computing Machinery, University of Penn., Philadelphia.
- SEPT. 17: Symposium on Automation, Cedar Rapids IRE, Cedar Rapids, Iowa.
- SEPT. 19-20: Symposium on Electronic Automation, University of Penn., Irvine Auditorium, Philadelphia, Pa.
- SEPT. 26-27: RETMA Symposium, Electronics For Automation and Automation For Electronics, Philadelphia.
- SEPT. 26-27: Sixth Annual Meeting and Conference of the IRE Professional Group on Vehicular Communications, Multnomah Hotel, Portland, Ore.
- SEPT. 26-28: IRE Symposium, Aeronautical Communications—Civil and Military, Utica, N. Y.
- SEPT. 28-29: Industrial Electronics Conference, AIEE, Rackham Memorial Auditorium, Detroit, Mich.
- OCT. 3-5: National Electronics Conference, Hotel Sherman, Chicago, Ill.
- OCT. 12-15: 1955 Convention of the Audio Engineering Society concurrent with the Audio Fair, Hotel New Yorker, New York, N. Y.
- OCT. 17-19: RETMA Radio Fall Meeting, Hotel Syracuse, Syracuse, N. Y.
- OCT. 20-22: Eighth Annual Gaseous Electronics Conference, GE Research Lab., The Knolls, Schenectady, N. Y.
- OCT. 24-25: First Annual Technical Meeting, IRE Professional Group On Electron Devices, Shoreham Hotel, Washington, D. C.
- OCT. 25-27: International Conference on Electronic Digital Computers and Information Processing, Darmstadt, Germany.
- OCT. 28-29: 1955 Symposium of Philadelphia ISA, Penn Sherwood Hotel, Philadelphia, Pa.
- OCT. 21-Nov. 1: 1955 East Coast Conference on Aeronautical and Navigational Electronics, IRE, Lord Baltimore Hotel, Baltimore, Md.
- OCT. 31-Nov. 1: International conference on scientific basis of applied solar energy, University of Arizona, Tucson.

## Industry Shorts

- **Taxes** on radio and television equipment used in business may be lifted, according to a decision by the House Ways and Means Committee. The 10-percent federal excise tax on sets for entertainment, would, however, remain.
- **Objections** to several of the Federal Trade Commission's newly-revised and extended trade practice rules for the radio and tv industry have been raised by RETMA. It has asked for more time for its members to consider the rules.
- **Contracts** for \$27 million to build radar and electronics equipment for guided missiles and drone air-

craft have been placed with Melpar, Inc.

- **Recording** of simulated musical sounds produced by RCA's electronic music synthesizer is now on sale.
- **Fighter** planes carried about 1,500 pounds of electronic equipment ten years ago. Today, U. S. interceptors carry over 2,400 pounds of the gear, according to General Irvine.
- **KUAM**, privately-owned commercial radio station on the Island of Guam, has appealed to FCC concerning the proposed Armed Forces tv station for the island which it fears will offer unfair competition.

# KAY

## NOISE FIGURE MEASUREMENT

### 10 - 3000 MC



#### SPECIFICATIONS

- Frequency Range:**  
10 mc to 3,000 mc
- Output Impedance:**  
50 ohms unbalanced into Type N Connector
- Noise Figure Range:**  
0 to 20 db
- Filament Voltage Supply:**  
From regulated supply
- Meter Calibration:**  
Linear in db noise figure; logarithmic in D.C.M.A.
- Fuse Protection:**  
One Type 3AG, 2 amps
- Tubes:**  
1 Eclipse Pioneer TTI Diode
- Power Supply Source:**  
117 Watts  $\pm 10\%$ , 60 cps AC  
Available for 50 cps.
- Power Consumption:**  
130 Watts
- Price:**  
\$995. FOB plant

## KAY

### Mega-Node-Sr.

A calibrated random noise source providing an output from 10—3,000 mc, the Mega-Node Sr. may be used to measure noise figure and receiver gain and for the indirect calibration of standard signal sources.

At the lower end of the frequency range noise figure may be obtained directly from the meter. For greater accuracy at higher frequencies, corrections for diode transit time and termination mismatch are available from charts supplied with each instrument.

### KAY Rada-Node ▶

Complete radar noise figure measuring set for IF and RF, including attenuators, detector and noise sources. Complete with power supplies. Frequency range: 5 to 26,500 mc; noise figure: range, up to 21 db, in lower part of spectrum. Prices on request.

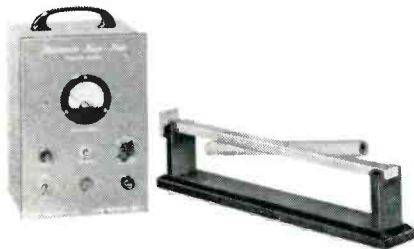

### KAY Microwave Mega-Nodes

Calibrated random noise sources in the microwave range, used to measure noise figure, and receiver gain and calibrate standard signal sources in radar and other microwave systems.

Available in following waveguide sizes to cover range of 960—26,500 mc.

- |                   |  |
|-------------------|--|
| RG-69/U .. \$400. | Available with fluorescent or inert gas (argon or neon) tubes. Noise output fluorescent tubes, 15.8 db $\pm 2.5$ db; argon gas tubes, 15.2 db $\pm 1$ db*; |
| †RG-48/U .. 195.  | neon tubes, 18.0 db $\pm 5$ db*.   |
| †RG-49/U .. 195.  |  |
| †RG-50/U .. 195.  |  |
| †RG-51/U .. 195.  | *Noise output of inert gas tubes independent of operating temperature.   |
| †RG-52/U .. 195.  |  |
| RG-91/U .. 250.   | Universal Power supply for both fluorescent or argon gas and all waveguide sizes: \$100.   |
| RG-53/U .. 250.   |  |

†\$167. per Guide when 3 or more are purchased with \$100. Power Supply

NEW! WR-770; WR-650—\$595.00 each; WR-510; WR-430; WR-340—\$495.00 each. All WR numbers fluorescent only.

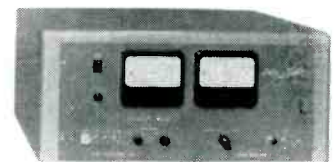
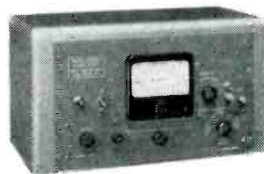
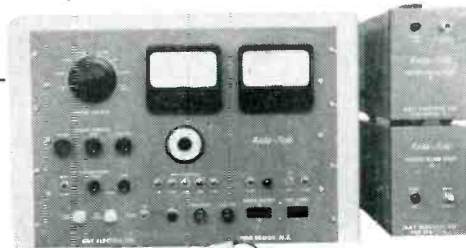

### KAY Auto-Node

Designed for production-line noise figure measurement from 5 to 26,500 mc., the Auto-Node provides continuous interpolation over VHF, UHF and microwave frequencies. Two models are available:

MODEL TV	MODEL RADAR
Freq. Range: 5—220 mc.	Freq. Range: 2 IF Strips 30 and 60 mc; other IFs available.
IF Strips: 20 or 40 mc. extra IF Strips available.	IF Noise Figure: 0—7 db
Noise Figure Range: 0—24 db	Price: \$950. with 2 IF strips, FOB plant.
Price: \$795 FOB plant. Additional IF strips, \$125.00	

For Complete Information Regarding these, and other Kay Instruments, Write:

## KAY ELECTRIC COMPANY

Dept. E-8, 14 Maple Avenue

Pine Brook, N. J.

# Let's face it!

## HAVE YOU A DISASTER PLAN FOR YOUR PLANT?

**BOMBS...OR FIRE...OR FLOOD...OR TORNADO  
... you can handle them if you act now.**

Let's face it... the threat of war and the atomic bomb has become a real part of our life—and will be with us for years. Fires, tornadoes and other disasters, too, can strike without warning.

Whatever the emergency is, everybody's going to want help at the same time. It may be hours before outside help reaches you. The best chance of survival for you and your workers—and the fastest way to get back into production—is to know what to do and be ready to do it. Disaster may happen TOMORROW. Take these simple precautions TODAY:

**Call your local Civil Defense Director.** He'll help you set up a plan for your offices and plant—a plan that's safer, because it's integrated with community Civil Defense action.

**Check contents** and locations of first-aid kits. Be sure they're adequate and up to date. Here, again, your

CD Director can help. He'll advise you on supplies needed for injuries due to blast, radiation, etc.

**Encourage personnel** to attend Red Cross First-Aid Training Courses. They may save your life.

**Encourage your staff** and your community to have their homes prepared. Run ads in your plant paper, in local newspapers, over TV and radio, on bulletin boards. Your CD Director can show you ads and official CD films or literature that you can sponsor locally. Set the standard of preparedness in your plant city. There's no better way of building prestige and good community relations—and no greater way of helping America.

*Act now . . . check off these four simple points . . . before it's too late.*



# Dependability

in guided missile,  
military and all other  
critical applications means

**RAYTHEON**  
**RELIABLE**

**SUBMINIATURE  
TUBES**

**RAYTHEON**  
**MANUFACTURING CO.**

Special Tube Division — Home Office: 55 Chapel St.,  
Newton 58, Mass., Blgelow 4-7500

For application information  
write or call the Home Office  
or: 9501 Grand Avenue,  
Franklin Park (Chicago), Ill.,  
TUxedo 9-5400

589 Fifth Ave., New York 17,  
New York, PLaza 9-3900  
622 South La Brea Ave.,  
Los Angeles 36, Calif.,  
WEbster 8-2851



*Excellence in Electronics*

Get This RAYTHEON TRAN-  
SISTOR APPLICATION BOOK!  
116 pages — over 50 practical  
circuits including timers, receivers,  
oscillators, etc. all using low cost  
Raytheon transistors. For your copy  
send 50¢ to Department P11,  
Raytheon Mfg. Co., Newton 58  
Massachusetts.



## Raytheon Reliable Subminiature Tubes Now Available

TYPE	DESCRIPTION	Vibration Output mVac* (max.)	TYPICAL CHARACTERISTICS									
			Heater		Plate		Grid Volts	Screen		Amp. Factor	Mut. Cond.	
			Volts	mA.	Volts	mA.	or Rk	Volts	mA.			
CK5639	Video Amplifier Pentode	100	6.3	450	150	21	100 ohms	100	4	—	9000	
CK5702WA	RF Amplifier Pentode	50	6.3	200	120	7.5	200 ohms	120	2.6	—	5000	
CK5703WA	High Frequency Triode	10	6.3	200	120	9.4	220 ohms	—	—	25.5	5000	
CK5744WA	High Mu Triode	25	6.3	200	250	4.2	500 ohms	—	—	70	4000	
CK5783WA CK5783WB	Voltage Reference	50	Operating voltage approximately 86 volts between 1.5 and 3.5 ma.									
CK5784WA	RF Mixer Pentode	100	6.3	200	120	5.2	-2	120	3.5	—	3200	
CK5787WA	Voltage Regulator	50	Operating voltage approximately 98 volts between 5 and 25 ma.									
CK5829WA	Dual Diode	—	6.3	150	Max. I <sub>o</sub> = 5.5 ma. per plate							
CK6021	Medium Mu Dual Triode	50	6.3	300	100	6.5	150 ohms	—	—	35	5400	
CK6111	Medium Mu Dual Triode	50	6.3	300	100	8.5	220 ohms	—	—	20	5000	
CK6112	High Mu Dual Triode	25	6.3	300	100	0.8	1500 ohms	—	—	70	1800	
CK6152	Low Mu Triode	25	6.3	200	100	10.0	270 ohms	—	—	17.5	5100	
CK6247	Low Microphonic Triode	2.5	6.3	200	250	4.2	500 ohms	—	—	60	2650	
CK6533	Low Microphonic Triode	1.0	6.3	200	120	0.9	1500 ohms	—	—	54	1750	

\*At 40 cycles, 15 g.

Note: All dual section tube ratings (except heater) are for each section.

# Ampli-FILM<sup>®</sup>

DIELECTRIC CONSTANT 4.9

- **CAPITRON Capacitors**
- **Pulse Forming Networks**
- **Pulse System Packages**
- **Power Packs**

TEMPERATURE-STABLE TO 250° C.

are made from this unique dielectric material. In these end-products, the remarkable properties of AMPLIFILM permit reductions in size and weight greater than any other known dielectric for given performance, as well as extreme flexibility in design and outstanding stability and reliability.

AMPLIFILM is free from pinholes and occluded foreign matter. AMPLIFILM readily bonds to most adhesives, has indefinite shelf life.

For more complete details, send for our comprehensive and informative, "AMPLIFILM Handbook of Capacitor and Network Design."

POWER FACTOR 0.0025

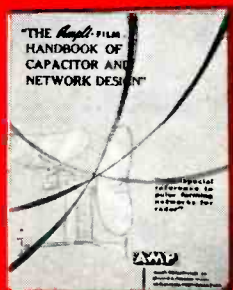

INSULATION RESISTANCE  $10^{15}$  OHM — CENTIMETERS



INSOLUBLE • INCOMPRESSIBLE • INELASTIC

CORONA RESISTANT



A sample 1 mil. thick has  
a breakdown strength  
between ball electrodes  
under oil on 60 cycles of  
10,000 volts peak.



**AIRCRAFT-MARINE PRODUCTS, INC.**  
*Chemicals & Dielectrics Division*

© A-MP 155 Park Street Elizabethtown, Pennsylvania



**60% more protection  
at no extra cost . . .**

***BH Vinyl-Sil 8000 Fiberglass Sleeving***

When it comes to product protection, you're not interested in what a sleeving *might* do, you want to know what it *will* do.

BH Vinyl-Sil 8000 Fiberglass Sleeving has a tested rating of 8,000 volts *minimum* dielectric breakdown — 3,000 volts over the NEMA standard for Grade B-A-1. Here is a tremendous product safety margin at a cost no more than that of previously available sleeveings with far lower ratings.

In insulations, the only thing you can really count on is the *minimum* dielectric breakdown. BH Vinyl-Sil 8000 offers that positive protection. It has other advantages too . . .

- high heat-aging resistance
- high flow resistance
- high oil and chemical resistance
- high abrasion resistance
- high cut-thru resistance
- excellent low temperature flexibility
- no capillary attraction to water

BH Vinyl-Sil 8000 was deliberately made to rate above requirements for two reasons. First, to supply emergency protection for unexpected loads. Second, to save on inventories by providing a sleeving for a wider range of applications than ever before possible. Data sheets and samples are yours for the asking. Write for them, then make your own tests.

BENTLEY, HARRIS MANUFACTURING CO.  
1308 Barclay St.

CONSHOHOCKEN, PA. Telephone: Conshohocken 6-0634

**BENTLEY, HARRIS**

*Fiberglass\**

**SLEEVINGS**

\*BH Non-Fraying Fiberglass Sleeveings are made by an exclusive Bentley, Harris process (U.S. Pat. Nos. 2393530; 2647296 and 2647288). "Fiberglass" is Reg. TM of Owens-Corning Fiberglass Corp.

# New Improved "SCOTCH" 39 Electrical Tape

*...King of the paper tapes!*

LONGER SHELF LIFE

HIGH DIELECTRIC  
STRENGTH

50%  
MORE TACK

THINNER

HIGH TEAR  
RESISTANCE

GREATER SOLVENT  
RESISTANCE

TRUE THERMOSETTING  
ADHESIVE

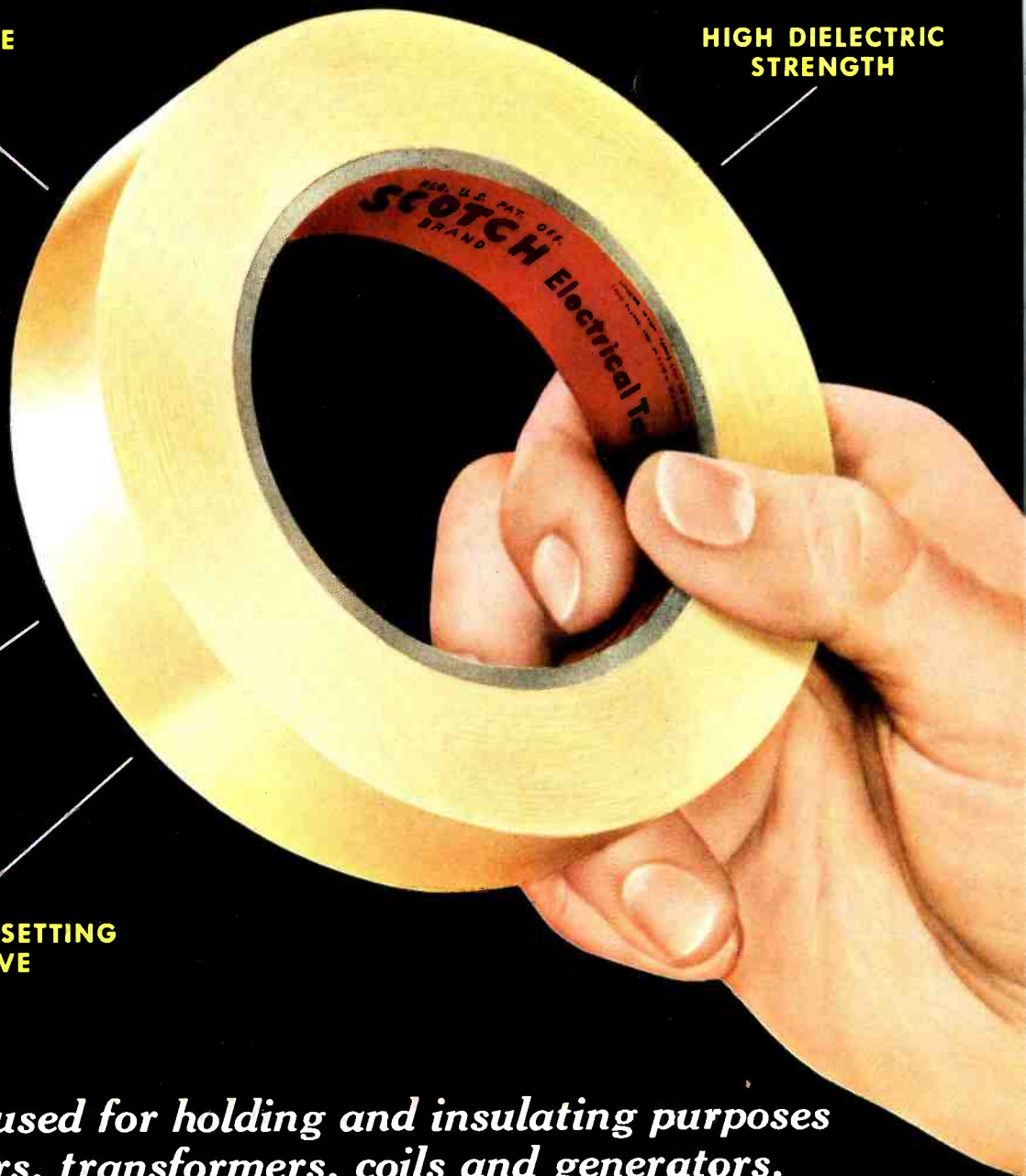

*Widely used for holding and insulating purposes  
on motors, transformers, coils and generators.*

The term "SCOTCH" and the plaid design are registered trademarks of Minnesota Mining and Manufacturing Company, St. Paul 6, Minn. Export Sales Office: 99 Park Avenue, New York 16, N.Y. In Canada: P.O. Box 757, London, Ontario.



**TWO** *New* **MARCONI**  
**R.F. POWER METERS**  
TYPE TF 1020 Series

**POWER RANGE**

**0 to 100 Watts**

**FREQUENCY RANGE**

**D.C. to 250 mc**

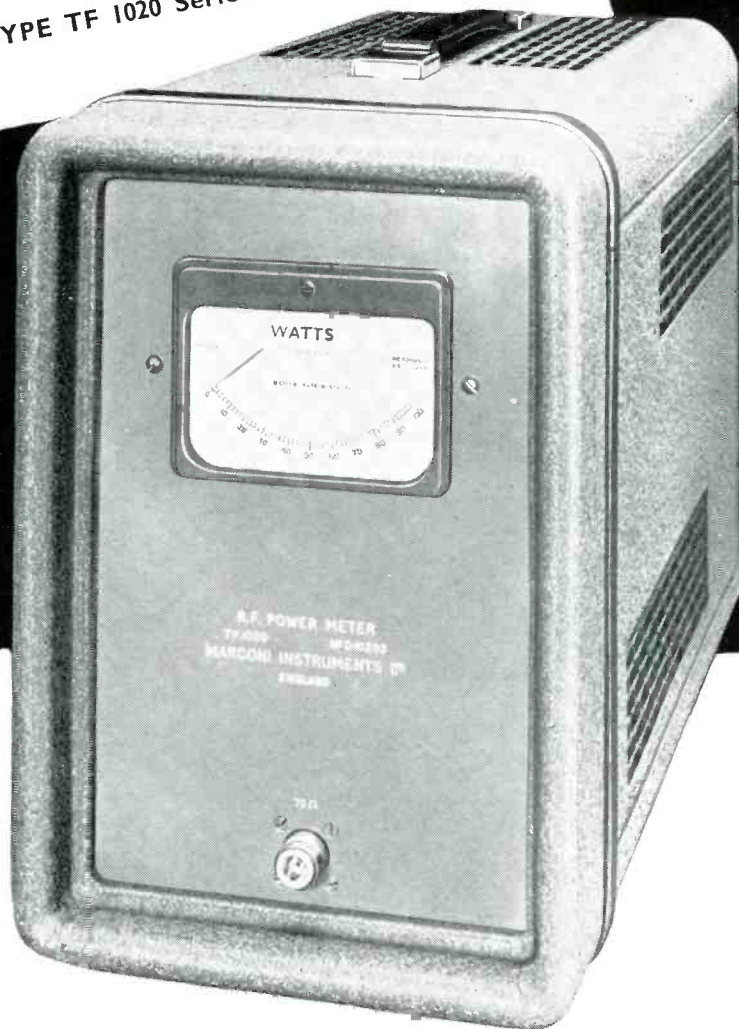

Both instruments have a linear power scale and accurately register mean power input regardless of waveform. The TF 1020 has an input impedance of 75 ohms; the TF 1020/1, an input impedance of 50 ohms.

## **MARCONI INSTRUMENTS**

VACUUM TUBE VOLTMETERS · FREQUENCY STANDARDS · OUTPUT METERS · FM & AM SIGNAL GENERATORS  
DEVIATION METERS · WAVEMETERS · WAVE ANALYSERS · Q METERS · BEAT FREQUENCY OSCILLATORS

44 NEW STREET · NEW YORK 4

ENGLAND: HEAD OFFICE: MARCONI INSTRUMENTS LIMITED, ST. ALBANS, HERTFORDSHIRE

CANADA: CANADIAN MARCONI COMPANY, MARCONI BUILDING, 2442 TRENTON AVENUE, MONTREAL

Managing Agents in Export: MARCONI'S WIRELESS TELEGRAPH COMPANY LIMITED, MARCONI HOUSE, STRAND, LONDON, W.C.2.  
TC 64R

# Eimac

THE WORLD'S  
LARGEST MANUFACTURER  
OF TRANSMITTING TUBES

10kw/cw UHF Klystron

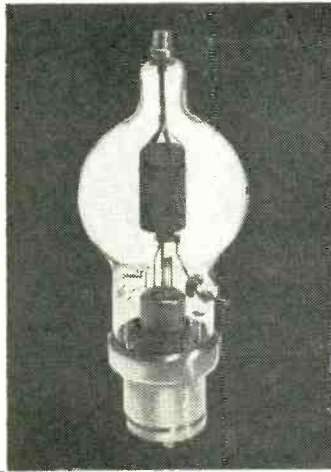
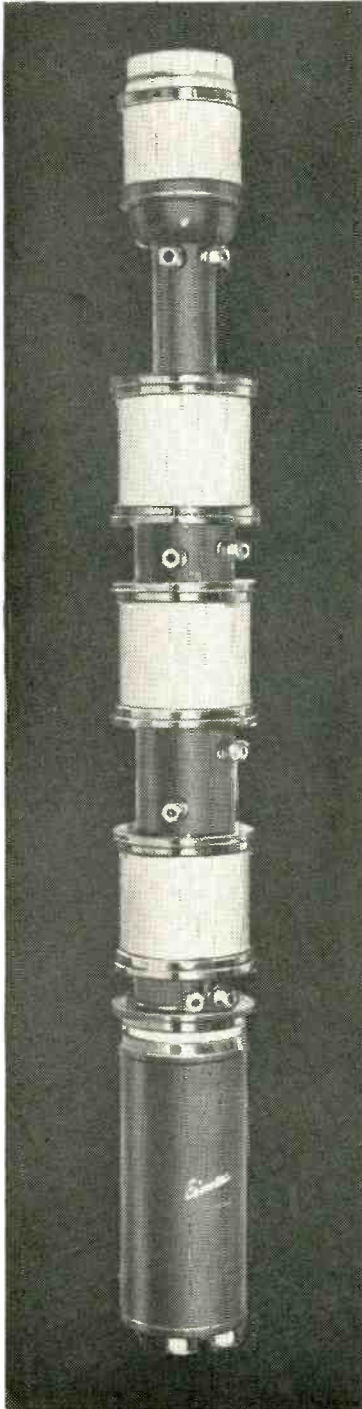

250w Triode



20kw Tetrode

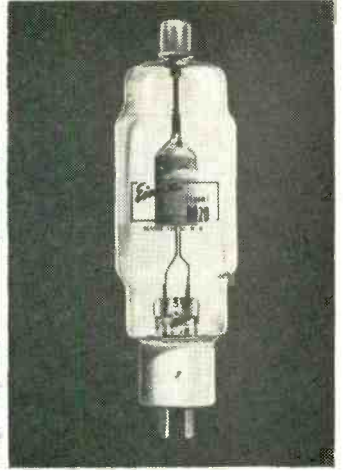

High Vacuum Rectifier

## EIMAC TUBES

### For All Types of Communications, Industrial and Pulse Application!

Eimac offers a complete line of over seventy triode, tetrode, pentode, klystron and rectifier tube types to cover all types of electronic communications, industrial and pulse applications. The versatile Eimac electron-power tube family is second to none in frequency and power coverage. Even at ultra high and microwave frequencies, high power is no problem with Eimac amplifier klystrons. Up through the VHF region, Eimac negative grid tubes have been performance proved in every type of service. Internal or external anode, water or air cooled, metal, ceramic or glass construction, there is an Eimac tube to meet the most exacting requirements.

For further information contact our  
Technical Services Department.

**EITEL-McCULLOUGH, INC.**  
S A N B R U N O • C A L I F O R N I A

Reflex Klystron



5kw Tetrode



250w Tetrode

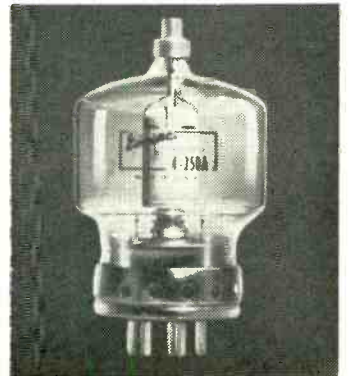

*indispensable for  
measurement and reception*

# MICROWAVE



**MODEL R**

*with these  
special features:*

**EXCELLENT GAIN STABILITY**—Equipped with automatic gain control, as well as "signal-lock" Automatic Frequency Control. Performance stable over entire frequency band.

**HIGH SENSITIVITY**—Achieved with unique double-tuned cavity pre-selector which tracks automatically with local oscillator. Efficient wideband microwave input coupler and crystal mixer maintains sensitivity.

**SELF-CONTAINED**—Complete with electronically regulated low and high voltage power supplies; signal metering circuits; IF, local oscillator, audio-video, and FM plug-in sub-units. Four interchangeable, plug-in microwave tuning units cover frequency range 950-11,260 mc.

**ALL-PURPOSE**—Receives AM, FM, CW, MCW and pulse-modulated signals. Equipped with recorder output, trigger output (constant amplitude), video and audio outputs. Meter reads directly in db.

**UNI-DIAL CONTROL**—Automatically tracks klystron voltages, double tuned pre-selector, oscillator, and linear direct reading frequency dial — all simultaneously.

**POLARAD**

PROVEN RELIABILITY

**ELECTRONICS CORPORATION** 43-20 34th STREET, LONG ISLAND CITY 1, N. Y.

**BROADBAND  
950-11,260 MC**

# FIELD INTENSITY RECEIVER



One of the most complete and versatile measurement instruments ever designed for reception and quantitative analysis of microwave signals in the range 950-11,260 mc.

The Polarad Model R Microwave Receiver is ideal for the reception and monitoring of all types of radio and radar communications within its range. It permits comparative power and frequency measurements, by means of its panel mounted meter, of virtually every type of signal encountered in microwave work.

It is compact and functional, featuring four integrally designed plug-in, interchangeable RF microwave tuning units to cover 950-11,260 mc; non-contacting chokes in pre-selector and microwave oscillator to assure long life and reliability; and large scale indicating meter for fine tuning control.

Call any Polarad representative or direct to the factory for detailed specifications.

## SPECIFICATIONS:

**Basic Receiver:** Model R-B  
**Tuning Unit Frequency Ranges:**  
Model RL-T: 950 — 2,040 mc  
Model RS-T: 1,890 — 4,320 mc  
Model RM-T: 4,190 — 7,720 mc  
Model RX-T: 7,260 — 11,260 mc

**Signal Capabilities:**  
AM, FM, CW, MCW, pulse

**Sensitivity:**  
—80 dbm or better throughout range on all models

**Frequency Accuracy:**  
±1%

**IF Bandwidth:** 3 mc  
**Video Bandwidth:** 1.5 mc  
**Image Rejection:** Greater than 60 db  
**Gain Stability with AFC:** ±2 db  
**Automatic Frequency Control**  
Pull-out range 10 mc off center

**Recorder Output:** 1 ma full scale  
**Trigger Output:**  
10 v. pulse across 100 ohms

**Audio Output:**  
5 v. undistorted across 500 ohms

**FM Discriminator**  
**Deviation Sensitivity:** .7 v./mc

**Skirt Selectivity:**  
60 db — 6 db bandwidth ratio less than 5:1

**IF Rejection:** 50 db

**Input AC Power:**  
105-125 v., 60 cps, 440 watts

**Input Impedance:** (ANT) 50 ohms  
**VSWR:** Less than 4:1 over band  
**Range of Linearity:** 60 db  
**Receiver Type:** Superheterodyne  
**Maximum Acceptable Input**  
Signal Amplitude: 0.1 v. rms without external attenuation

**Video Response:** 20 cps to 1.5 mc  
**Size:** 17" w x 23" d x 19" h  
**Weight:** 180 lbs.

**Price:**

Model R-B (Basic Unit):	\$1,500
Model RL-T:	2,500
Model RS-T:	2,500
Model RM-T:	2,500
Model RX-T:	2,500

**Note:** To the basic cost of \$1,500 add cost of tuning units required.  
Prices subject to change without notice

*for these  
applications:*

- Broadband receiver for AM, FM, CW, MCW, and Pulse Modulated signals
- Field intensity meter
- Frequency measurements
- Leakage, interference and radiation measurements
- Bandwidth measurements
- Measurement of relative power of fundamental and harmonic signal frequencies
- Trigger pulse amplifier
- Noise figure measurements of r-f amplifiers
- Antenna field patterns
- Attenuation measurements
- Propagation studies
- Microwave relay link site selection
- Direction finding
- Filter measurements
- Standing wave measurements

**AVAILABLE ON EQUIPMENT LEASE PLAN**

**FIELD MAINTENANCE SERVICE AVAILABLE  
THROUGHOUT THE COUNTRY**

**CONSULT US ON YOUR MICROWAVE RECEIVER PROBLEMS.**

**REPRESENTATIVES:** • Albuquerque • Atlanta • Baltimore • Bayonne • Bridgeport • Buffalo • Chicago • Dayton • Fort Worth • Los Angeles • New York  
Newton • Philadelphia • San Francisco • Syracuse • Washington, D. C. • Westbury • Winston-Salem • Canada, Arnprior, Toronto—Export: Rocke International Corporation

# G-M Servo Motors

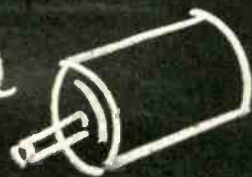

# GUARANTEED

# TO MEET ALL MIL. ENVIRONMENTAL SPECIFICATIONS

By specializing in servo motors only— not systems— G-M gives you these advantages...

- A broader line of servo motors in sizes and types to meet a wide range of applications.
- Servo motors available in all the standard sizes.
- Standard sizes specially modified to meet specific circuit requirements—available on a quick-service basis.
- Creative engineering in designing special motors with special characteristics.
- Faster production—better service.

When reliability under extreme conditions is essential—specify G-M Servo Motors! G-M has long specialized in supplying precision servo motors to the Military Avionic Industry, especially designed to meet

military specifications for humidity, salt spray, temperature, vibration and altitude. Whatever your needs, let G-M build a servo motor with the right characteristics to perform to your specifications.

Write today for G-M charts, specifications, or consultation.



Servo Motors



Motor Generators



Synchronous-Hysteresis Motors



## G-M Servo Motors

manufactured by the Components Division of

**G-M LABORATORIES INC.**

4336 N. Knox Avenue • Chicago 41



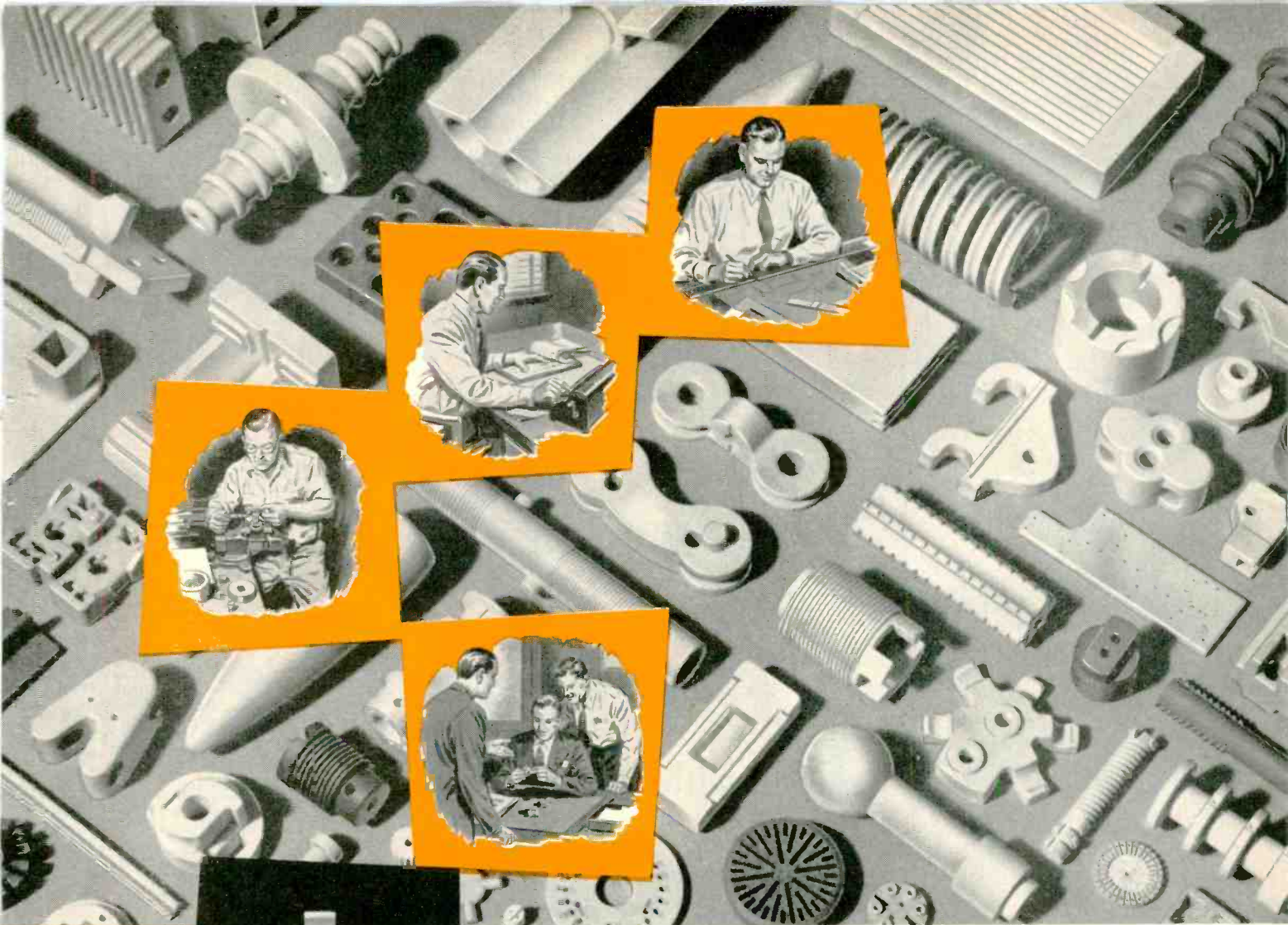

(another ALSiMag Extra)

# ALSiMAG<sup>®</sup>

## Redesign Service

for more **ECONOMICAL CERAMICS**

Our Sample Order Department can quickly make up pieces to any new design that looks promising and let you test them thoroughly. When the final design has been decided upon, parts can be produced to specification in volume to match your requirements.

A blueprint or sample of your present part with outline of operating requirements will bring prompt action . . . which may save you lots of money.

Careful study of designs by our engineering staff (with more than 50 years of specialized experience) often results in recommendations which mean — **Savings** in manufacturing costs, **Savings** in speed and ease of assembly, **Savings** through improved performance, **Savings** from combining two or more parts for still greater economy.

54 TH YEAR OF CERAMIC LEADERSHIP  
**AMERICAN LAVA CORPORATION**  
A SUBSIDIARY OF MINNESOTA MINING AND MANUFACTURING COMPANY  
**CHATTANOOGA 5, TENNESSEE**

Branch offices in these cities (see your local telephone directory): Cambridge, Mass. • Chicago, Ill. • Cleveland, Ohio • Dallas-Houston, Texas • Indianapolis, Ind. • Los Angeles, Calif. • Newark, N. J. • Philadelphia-Pittsburgh, Pa. • St. Louis, Mo. • South San Francisco, Calif. • Syracuse, N. Y. • Tulsa, Okla. • Canada: Irvington Varnish & Insulator Div. Minnesota Mining & Mfg. of Canada, Ltd., 1390 Burlington Street East, Hamilton Ontario, Phone Liberty 4-5735. ALL OTHER EXPORT: Minnesota Mining & Manufacturing Co., International Division, 99 Park Avenue, New York, N. Y.

**marion**  
 advancement  
 in instrument  
 design

**new marion**  
**MEDALIST\***  
 meters

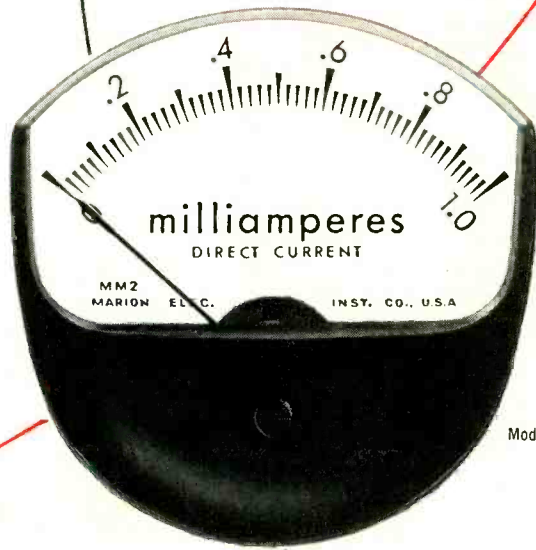

Model MM2 MEDALIST  
 Actual Size

Handsome, modern design and a choice of various colors to enhance the styling of your equipment. Up to 50% longer scale in the same space as ordinary type greatly increases readability. Interchangeable with ASA/IAN 2½ and 3½ inch sizes. Delivery now in all standard ranges.

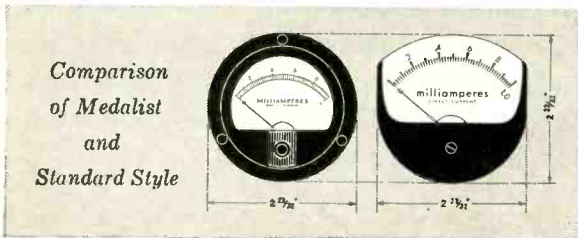

**marion meters**  
 marion electrical instrument company

\*Trademark Patents Pending,  
 copyright 1956 M.E.I. Co.

GRENIER FIELD, New Hampshire's NEW Air-Industry Area  
 MANCHESTER, N.H., U.S.A.



# Something New in Data Coding Devices!

**ACF Model 1002 digital-analog decoder**  
(200,000 codes per second—0.1% precision)

**ACF Model 1050 analog-digital encoder**  
(15,000 ten-bit code groups per second)



*For Details...*

phone, write, or  
see us at WESCON

Booth 1606-1607

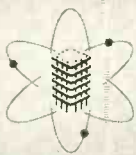

## **ACF Electronics**

a division of ACF Industries, Incorporated  
800 North Pitt Street, Alexandria, Va., KIng 8-4400

*Manufacturers of the ACF Module*



The NEW  
**GRAY** **AUDOGRAPH...**

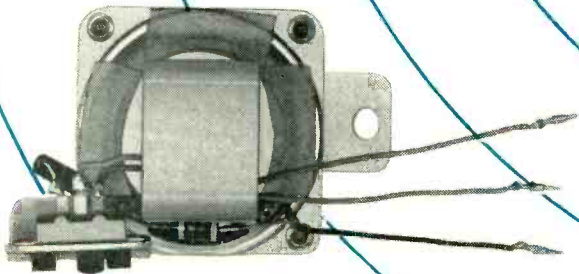
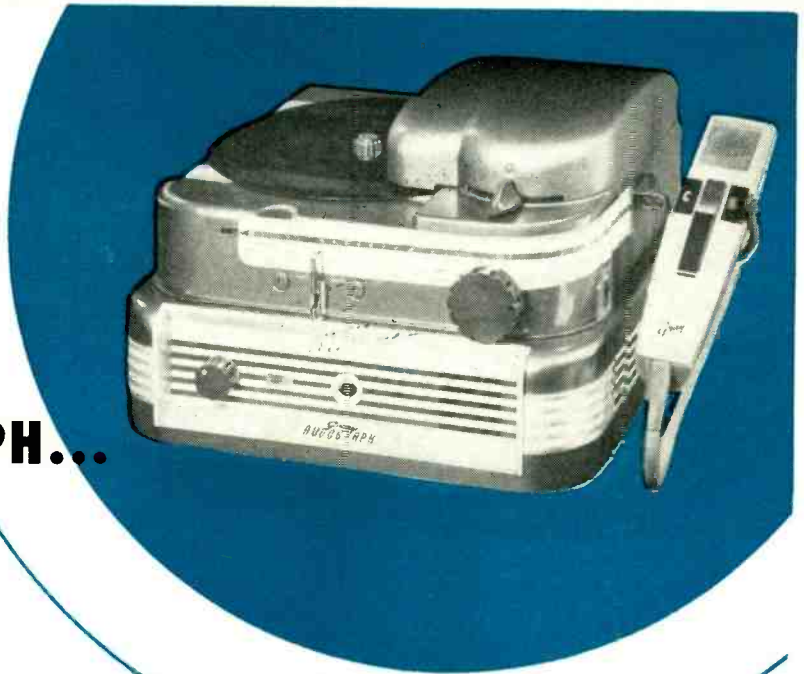

**...GETS A VOICE**

**IN A HURRY...**



**HUBBELL**  
*Interlock* **Sub-Miniature Plugs**  
TRADE MARK

**Eliminate Soldering For Fast Installation Of Speaker Kit!**

Now, one model takes the place of *three* in the new Gray Audograph line. These famous dictation machines are designed with built-in eyelets to receive Type "C" Interlock Plugs. When speaker-equipped models are ordered, specially designed speaker kits, wired with the Sub-miniature Plugs, are quickly and easily plugged in. Hubbell Interlock's exclusive automatic lock-

*ing-quick disconnect* feature makes possible a solderless, low contact resistance connection from the speaker kit to the panel eyelets. The tiny Type "C" Plugs are also easily and quickly disconnected for maintenance or replacement of speaker if necessary. Our Development Laboratory will cooperate with your Engineers to adapt Interlock for your specific applications.

Sub-miniature Plugs: Cat. No. 601C31 • For Further Information, Write Dept. A



**HARVEY HUBBELL, INC.**  
 Interlock Electronic Connector Dept., Bridgeport 2, Conn.

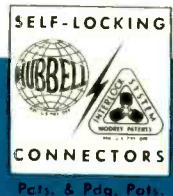

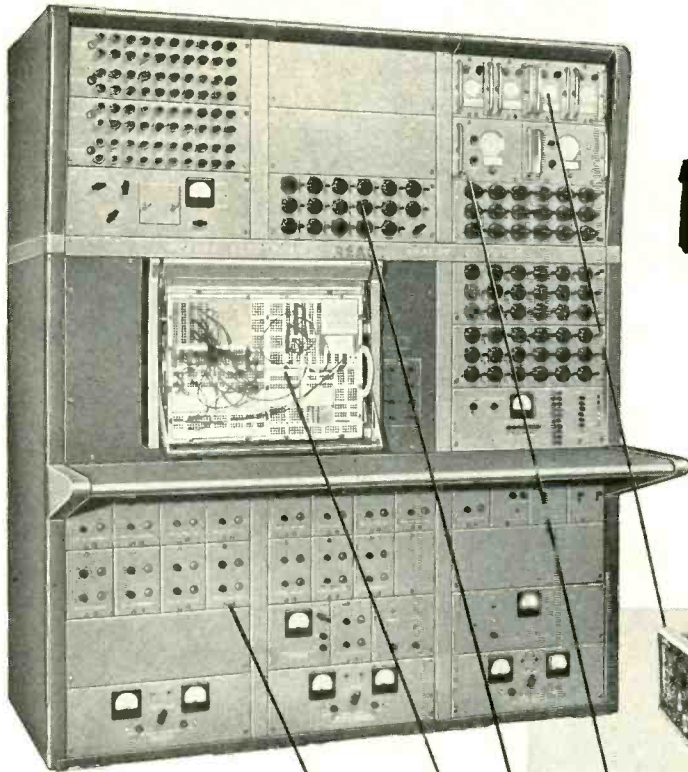

announcing the  
**New REEVES**  
**REAC** HIGH SPEED **400**  
**ANALOG COMPUTER**

**New**  
**BUILDING-BLOCK**  
**CONSTRUCTION**

... an exclusive Reeves design principle that permits assembly of computer elements in any desired combination to form exactly the computer necessary to do a particular job or to expand an existing installation. REAC 400 can be assembled, component by component, to fit specific requirements at minimum cost, time, space and effort. REAC 400 is completely adaptable to the scope and complexity of your control problem, now or in the future.

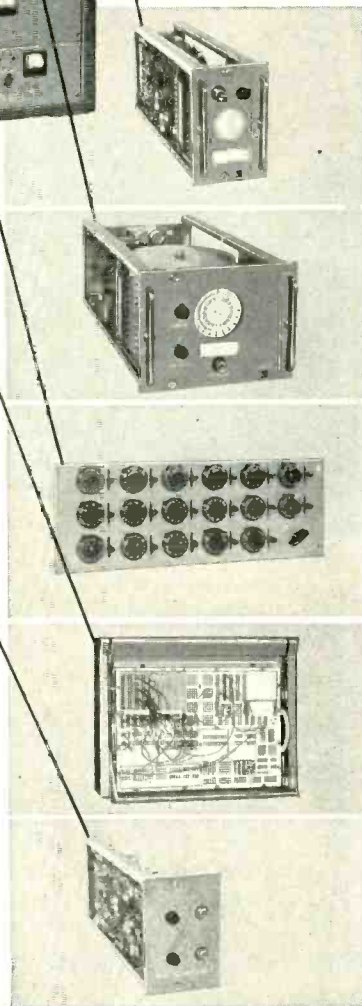

**New** HIGH SPEED SERVOS

Servo multipliers have bandwidth over 50 cps. Velocity 1500 v/sec; acceleration 60,000 v/sec<sup>2</sup>. Six gang pots; two tapped with front panel plug-in turrets for function generation.

**New** HIGH SPEED RESOLVERS

Vastly improved dynamic performance ... 35-cycle bandwidth. Rectangular and Polar operation; Full AGC either mode. Front panel plug-in turrets for easy padding for function generation.

**New** PROBLEM CHECK

New Reeves development permits verification of problem solution directly from equations before problem is run.

Checks { Operation of all components used  
 Patching of problem from diagram  
 Diagramming of problem from equations

**New** CONVENIENT PATCHBAY

Available in units of 1632, 3264 or 4891 holes for maximum flexibility. Color-coded mask aids in patching. Patchboard changes possible during operation.

**New** POWERFUL AMPLIFIERS

New dual amplifier chassis, individually chopper-stabilized. Noise less than 3 mv rms in cabinet. Phase shift 0.025° @ 100 cps. Bandwidth 10KC under cabinet conditions.



**REEVES INSTRUMENT CORPORATION**

A Subsidiary of Dynamics Corporation of America  
 201 East 91st St., New York 28, N. Y.

REAC  
 Analog  
 Computers

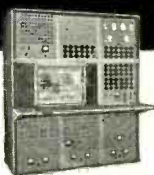

Precision  
 Floated  
 GYROS



Precision  
 RESOLVERS and  
 PHASE SHIFTERS

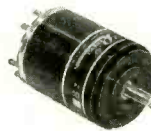

SERVO  
 MECHANICAL  
 PARTS



1RV33



**CRUCIBLE PERMANENT MAGNETS**  
*give maximum energy . . . minimum size*

Crucible *prescription-made* Alnico permanent magnets provide *consistently higher* energy products.

This means greater design freedom . . . more compact products for manufacturers of high-fidelity sound equipment, instruments, controls, motors, and other magnet equipped devices.

Crucible has been a leading producer of

these quality magnets ever since Alnico alloys were first developed. You can get them sand cast, shell molded, or investment cast to meet every size, tolerance, shape and finish need.

Next time you need top quality magnets, or help with magnet applications, call Crucible. *Crucible Steel Company of America, Henry W. Oliver Building, Pittsburgh 30, Pa.*

**CRUCIBLE**

first name in special purpose steels

**Crucible Steel Company of America**

*Tuning Fork Resonators,  
the ultimate in precision audio  
frequency control...*

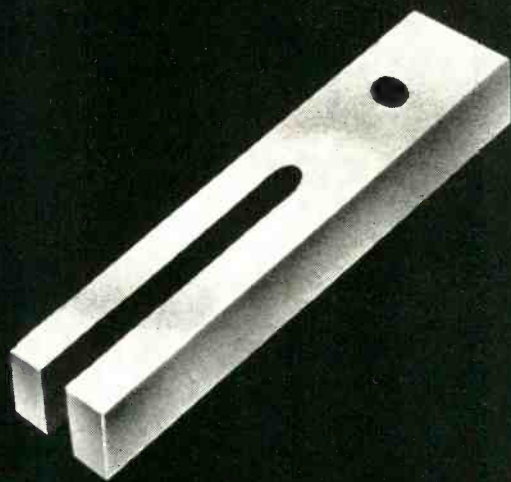

*... phone or write*

for complete information regarding component type  
**Tuning Fork Resonators**, or variously pack-  
aged **Tuning Fork Frequency Standards**.



*Philamon Laboratories Inc.*

90 HOPPER STREET, WESTBURY, LONG ISLAND, N. Y.

EDgewood 3-1700

These successful uses of  
**PHELPS DODGE BONDEZE**

magnet wire . . .

**Suggest**



HOOP-SHAPED  
COIL

# UNLIMITED NEW

## COILS

**Random-wound, Layer or Paper-section** for potentiometers, telephones, brakes and clutches, clocks and timers, hearing aids, instruments, speakers, relays, television, radio and other applications.

## TRANSFORMERS

**Paper-section, Random-wound, Oil-filled, Air-cooled and High Voltage** for distribution, current, X-ray, television, radio and other applications.

## MOTORS

**Windings** for shaded pole, series fields, instruments, induction and others.

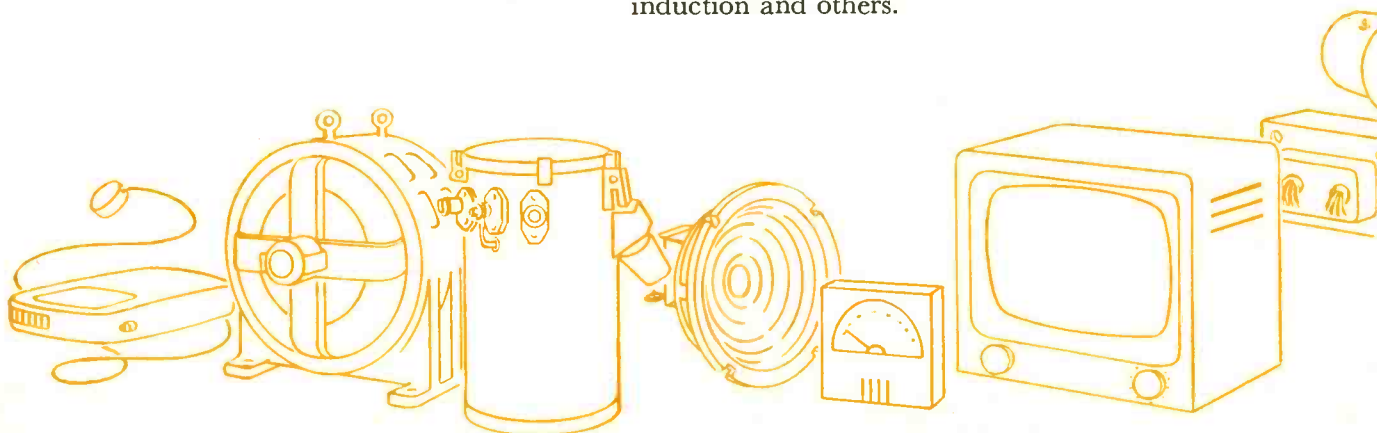

*First for Lasting Quality—from Mine to Market!*





# APPLICATIONS !

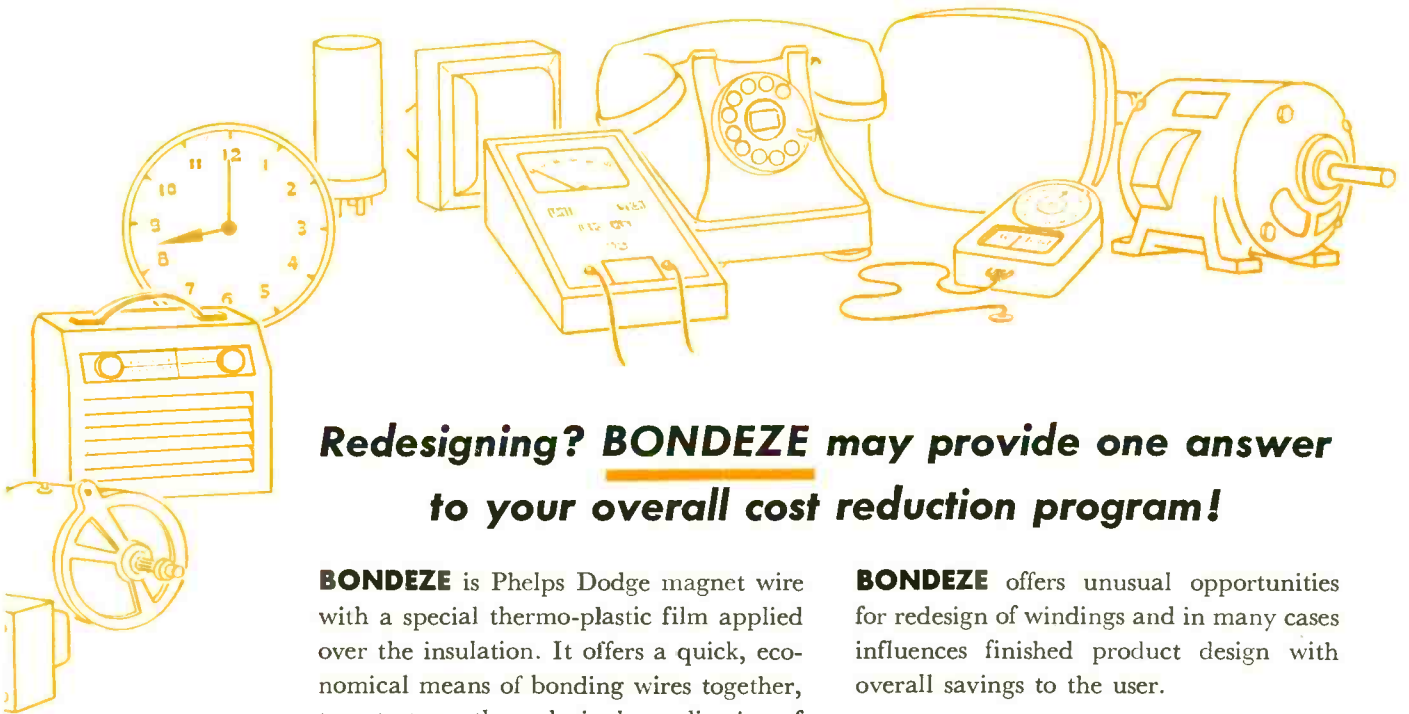

**Redesigning? BONDEZE may provide one answer to your overall cost reduction program!**

**BONDEZE** is Phelps Dodge magnet wire with a special thermo-plastic film applied over the insulation. It offers a quick, economical means of bonding wires together, turn to turn, through single application of heat or solvents.

**BONDEZE** offers unusual opportunities for redesign of windings and in many cases influences finished product design with overall savings to the user.

*Any time magnet wire is your problem, consult Phelps Dodge for the quickest, easiest answer.*

\*BONDEZE is a Phelps Dodge Trademark



**PHELPS DODGE COPPER PRODUCTS CORPORATION**

**INCA MANUFACTURING DIVISION**

FORT WAYNE, INDIANA



**RADIO ENGINEERING LABORATORIES, INC.**

*prove*



*dependability*



(Type J3-01) Askarel immersed high impedance Filament Transformer.



(Type N3-01) Unitized Rectifier askarel immersed for Klystron Bombarding.



(Type L3-01) Askarel immersed Filter Reactor.

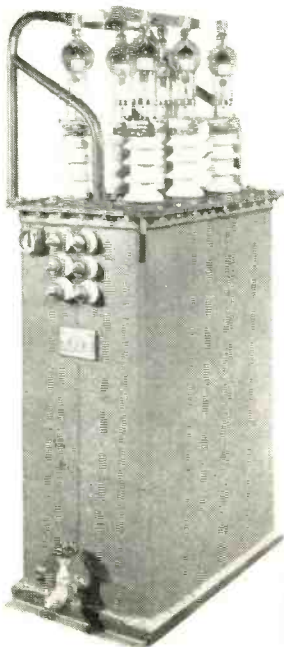

(Type N3-02) Unitized Rectifier askarel immersed Beam Supply.

“Magnatran components have contributed considerably to the fact that REL now makes more beyond-the-horizon FM multiplex relay equipment than all other manufacturers combined. They have been proven in use to be very dependable, both in performance and maintenance.”  
Join the ranks and enjoy reliable Magnatran magnetic components for the electronics industry.

*Write for Catalog*

**MAGNATRAN**  
**incorporated**

**KEARNY, NEW JERSEY, U.S.A.**

# The *All-Metal Multi-directional Mounting\**

# ROBINSON originated

## and universally **APPLIED**



\*This multi-directional mounting, when installed as recommended, protects equipment from imposed vibration and shock emanating from any angle and permits installation and use in any position.

**ROBINSON** Series 9300 plate type double acting multi-directional mount shown here in actual size No. 1, and available in any size required. Load ranges per mount:

Model 9301.....1/2-3 lbs.      Model 9303.....2-7 lbs.  
 Model 9302.....1-6 1/2 lbs.      Model 9304. Up to 15 lbs.

Natural frequencies 12-15 c.p.s.  
 Higher stiffnesses available.  
 Special designs upon request.

# 1955

# 1954

# 1953

# 1952

# 1951

# 1950

# 1949

**ORIGINATED BY ROBINSON** in 1949, the all-metal multi-directional mounting was designed to meet the radically new and different problems of **guided missiles and jet aircraft** requiring protection of electronic equipment from every angle against shock and vibration.

**ENGINEERED AND TESTED** in 1950, in the laboratory under rigorous specifications anticipating actual use, and in field tests far exceeding probable requirements, this mounting was quantity produced only when its performance had been demonstrated.

**SERVICE PROVED AND UNIVERSALLY APPLIED** since 1951, Robinson multi-directional mountings are now preferred for practically all military and commercial aircraft and in the newest of the guided missiles.

**RADICALLY DIFFERENT** from all other shock and vibration control mountings, this Robinson mount furnishes unique performance because of the inherently damped resilient cushions of patented Met-L-Flex, exclusively Robinson. No auxiliary damping means is required or used. Met-L-Flex is unaffected by attitude, extremes of temperature, aging, or the presence of oil, dust or dirt.

**WHEREVER UNFAILING PERFORMANCE** of equipment under maximum environmental difficulties is required, **only Robinson** multi-directional mountings will meet the difficulties involved.

If your need is for complete multi-directional protection of airborne electronic equipment and the assurance of its optimum performance, call on Robinson.

SEND FOR BOOKLET No. 900 "A New Concept in Vibration and Shock Control for Airborne Electronic Equipment."

**ROBINSON AVIATION INC.**  
 TETERBORO, NEW JERSEY  
*Vibration Control Engineers*  
 AIRBORNE DIVISION

**WEST COAST ENGINEERING OFFICE**—Complete engineering design and test service. 3006 Wilshire Blvd., Santa Monica, California.



# DESIGNER'S

## New G-E drawn-rectangular capacitors with seamless cases have standard dimensions to fit existing circuit designs

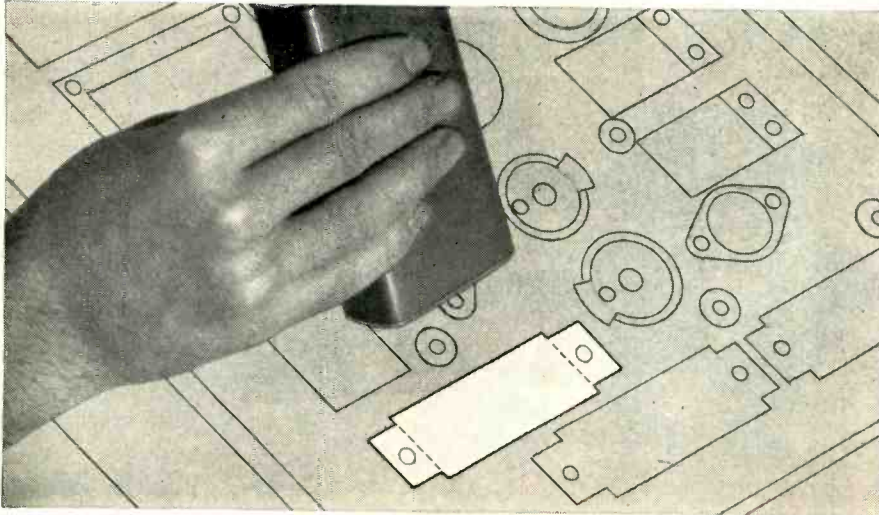

First on the market, G-E drawn-rectangular capacitors can now save you up to 20% in costs, yet are the same size and have the same mounting dimensions as fabricated units. These fixed paper-dielectric capacitors come in seamless,

solderless cases, and in all standard dimensions.

Drawn construction offers three big features: (1) a big saving in production cost is passed on to you, (2) the seamless case is leakproof, and (3) a double rolled



seam between case and cover makes a true hermetic seal.

In addition, suitable bushings for a wide range of design applications are available. For superior performance at lower cost, get the details. Send for Bulletin GEC-809A.

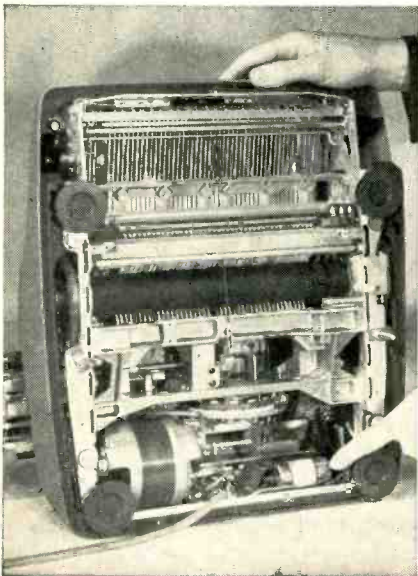

## Save space and weight with G-E drawn-oval capacitors

Besides offering cost reductions up to 20%, G-E drawn-oval capacitors can save as much as 20% of precious space and weight. Their drawn construction offers seamless, leakproof cases, and the covers are hermetically sealed with tough, double rolled seams. All add up to top quality performance in minimum space.

The hot solder-dipped terminals are easy to solder and are welded to the stud for permanent attachment. Both fork-type and quick-connect terminals are available. Silicone bushings maintain effective sealing and high insulation resistance through long operation and temperature variation.

Each drawn-oval capacitor is automatically tested before it leaves the factory for further assurance of maxi-

mum reliability.

Photo at left shows G-E drawn-oval capacitor tucked in minimum space of electric typewriter. For complete list of ratings and data, see Bulletin GEA-5777B.

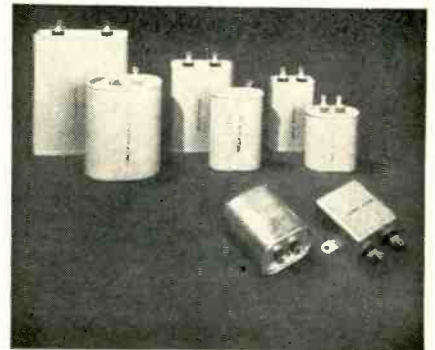

# — GENERAL ELECTRIC —

# DIGEST

## TIMELY HIGHLIGHTS ON G-E COMPONENTS

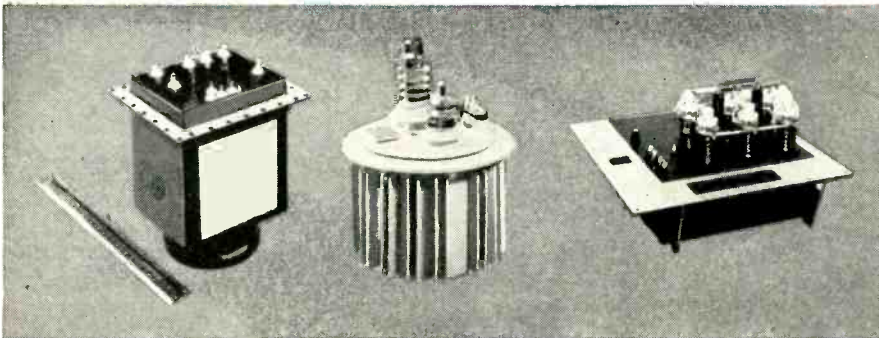

### G-E oil-filled radar components save space, weight

Extremely versatile, G-E high-voltage radar components offer to designers characteristics and features to meet a wide range of requirements. All units are designed to conform to MIL-T-27 specifications. A few examples of the large G-E oil-filled line are shown above.

The "packaged" unit at left combines a rectifier and filament trans-

former, a filter inductor and a resonant charging inductor in the same tank. This unit measures 6 x 6 x 7 inches and weighs only 8 pounds. Any combination of components can be packaged corona-free in one tank; the number of components is restricted only by your installation limitations. This method of

packaging units often reduces installation expenses.

Pulse transformers such as the one shown at the center are manufactured in ratings from 5 to 300 kilovolts or more, up to 40 megawatts peak power. These units are designed for either magnetron or klystron oscillators and their pulse lengths range from 0.1 to 50 microseconds or longer, with repetition rates up to 10,000 pulses per second.

Complete d-c power supplies like the one shown at right are manufactured in ratings from 5 to 25 kilovolts, with current ratings up to 4 amperes. This unit contains a rectifier transformer, filament transformers and a filter inductor making a complete power supply packaged in one oil-filled tank. The sturdy tank is designed with extra bracing to more than withstand shock and vibration tests called for in MIL-T-27 specifications. Your G-E Apparatus Sales office has details.



### Speed soldering of tiny joints with pencil-weight G-E midget iron

As electronics designers work with more and more restricted spaces, G-E midget soldering irons help reduce rejects on assembly work. With a pencil-fine tip, the iron solders delicate joints with little danger of damage to adjacent parts. A G-E Calrod\* heater located in the tip provides fast heat transfer. The copper tip is iron-clad to eliminate need for filing, and to reduce maintenance costs. Weighing only 1 3/4 ounces, the iron has a heat efficiency of 90 per cent. Bulletins GED-2263, GEC-1318.

\*Registered trade-mark of General Electric Co.

### G-E enameled resistors adapt easily in countless designs

Extremely simple control is possible in electronics design with General Electric resistors. These "Blue Sticks," so-called because of their blue vitreous coating, can be ordered unmounted, mounted on a base with a perforated cover, or in perforated, cage-type enclosures. Moisture-resistant enamel forms an airtight case and aids in heat dissipation. Silicate-compound body withstands sudden and extreme temperature changes. Standard  $\pm 5\%$  resistance tolerance makes them adaptable, and nickel alloy wire wound around the ceramic cylinder maintains its consistent resistance characteristic. For the complete story, see Bulletin GEC-817.

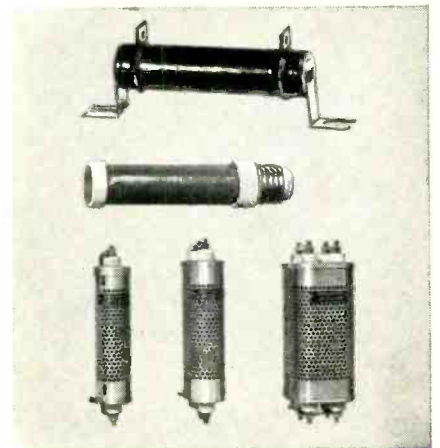

General Electric Company, Apparatus Sales Division,  
Section B667-31, Schenectady 5, New York

Please send me the following bulletins:

for reference only

X for planning immediate project

GEC-809A Drawn-Rectangular Capacitors

GEA-5777B Drawn-Oval Capacitors

GEC-1318 Industrial Soldering Irons

GED-2263 Midget Soldering Iron

GEC-817 Enameled Resistors

GEA-5963 Oil-filled Radar Components

NAME \_\_\_\_\_

COMPANY \_\_\_\_\_

CITY \_\_\_\_\_

STATE \_\_\_\_\_

TURN PAGE FOR MORE G-E COMPONENT HIGHLIGHTS

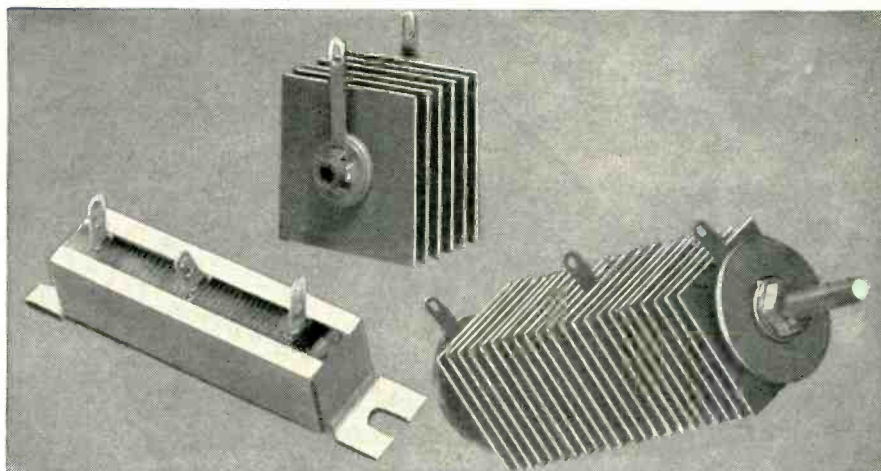

## New *Vac-U-Sel*\* component rectifiers with 3 exceptional performance features

The new Vac-U-Sel trade-mark stands for General Electric's new line of component rectifiers which permit matching performance requirements for life expectancy, ambient temperature, and atmospheric protection, as well as electrical characteristics. *First*, 26-v low-temperature cell has 60,000 hour life

expectancy at normal current rating. Use it in ambient temperatures to 55 C. *Second*, 26-v high-temperature cell meets demands up to 130 C at full voltage. *Third*, 45-v high-temperature cell has a 63-volt peak inverse rating, and a 40,000 hour life. It can be used at ambients up to 110 C. Bulletin GEA-6273.

\*Reg. Trade-mark of General Electric Co.

## New 400-cycle servo motor weighs only 1.2 ounces, develops 21,000 rpm

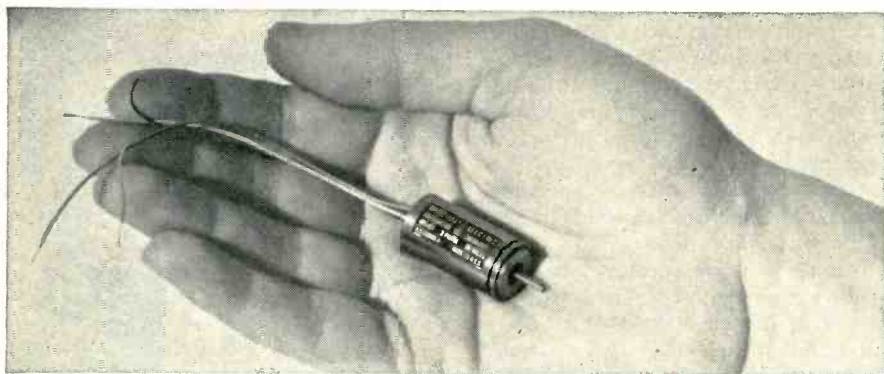

This tiny General Electric induction motor for aircraft applications operates in ambients from  $-55^{\circ}\text{C}$  to  $90^{\circ}\text{C}$ , and in altitudes up to 60,000 feet. Two-pole-wound, with a standard squirrel-cage rotor and precision ball bearings, it features high acceleration, stall torque, and operating efficiency. Some uses: null-method measurements, control power, power failure indication, power-operated brakes. The 1.2-ounce motor has a stainless steel housing 1.2 inches long. For more data contact your nearest G-E Apparatus Sales office.

## Apply G-E specialty heaters when electronic equipment needs thermal conditioning

General Electric engineers have designed and developed a wide variety of specialty heating devices to assure that electronic equipment will operate correctly at low temperatures, and to quickly raise the temperature of equipment to operating levels. These heaters are made in many sizes, shapes and forms. In operation, they are wrapped around electronic equipment, connected to power source. Generally, these de-

vices operate from standard 110-v or 24-v, ac or dc, and can produce thermal conditioning from a watt or two up to 20 watts per square inch. They weigh as little as 4 ounces per square foot, seldom exceed  $\frac{3}{8}$  inch in thickness. They are custom made for servos, gyros, accelerometers, batteries and measuring instruments. Bulletin GEA-6285 gives complete information.

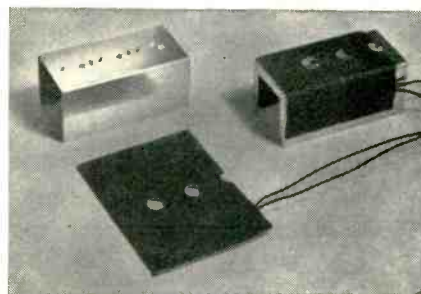

# GENERAL ELECTRIC

### New high-temp. micro-miniature aircraft relay

Two models of General Electric's new micro-miniature aircraft relay are available, standard and current-sensitive. The standard model weighs a third of an ounce, measures .34 x .781 x .81 in. The new relay meets the demand for small size and greater reliability. Materials used assure that no significant amount of gassing occurs inside the enclosure.

The standard model will operate at only 250 milliwatts and the current-sensitive model at only 100 milliwatts. Operation is quick: approximately 1.5 milliseconds with rated voltage on coil. Contact rating is high: 2 amperes resistive load at 30 volts direct current or 115 volts alternating current.

Shock and vibration resistance is also high. Both models will take over 50 G's shock, and vibration of 10-500 cps at 20 G's acceleration. This is achieved

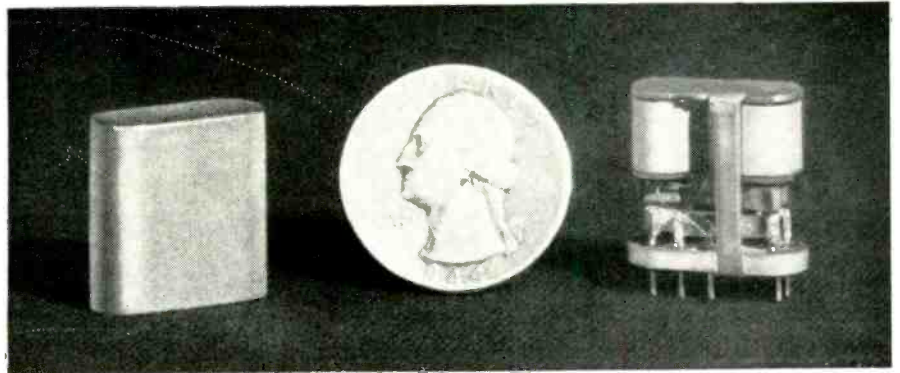

with balanced armature design combined with high tip forces.

The new G-E relays are simply designed, providing easy installation and adjustment for ease of manufacture. This makes it easier to control quality of your product and assures extra reliability. The coil and lead insulation

is Teflon† and the coil spool body is nylon. Contact material is fine silver for low contact resistance and long life. Contact springs are beryllium copper which means they will hold their adjustment indefinitely during temperature cycles or storage. All G-E Apparatus Sales offices have details.

†Reg. Trade-mark of duPont.

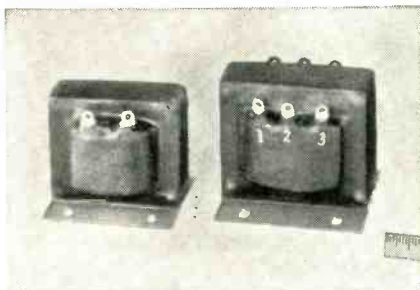

### Encapsulated control transformer resists solvents, shock, humidity

These General Electric control transformers and reactors are encapsulated to provide reliable, long-life operation in corrosive atmospheres. Small, lightweight, and economical, they can be furnished with an epoxy-polyester resin coating to meet humidity, salt spray, thermal shock, and anti-fungus requirements of many government specifications. Equipment designers will appreciate this resin coating because it is impervious to most solvents, oils, greases, and acids encountered in many commercial applications. Sealed-in solder type terminals give added protection wherever they are used. For data, contact your nearest G-E Apparatus Sales office.

### New standard G-E voltage stabilizers save weight and space

Now equipment designers can choose from a complete new line of *standard* G-E automatic voltage stabilizers, rated from 15 va through 10 kva. Because, in many cases, equipments have been installed *before* it was found that stable or "constant" voltage was needed for them, designers are now building automatic voltage correction into voltage sensitive devices *at the design stage*. You, too, will find that usually, a standard, G-E voltage stabilizer, available immediately, will solve your voltage problems. However, special units up to 50 kva can also be designed to your specifications. Your nearest G-E Apparatus Sales Office has details.



General Electric Company, Apparatus Sales Division  
Section B667-31, Schenectady 5, New York

Please send me the following bulletin:

✓ for reference only    X for planning an immediate project

GEA-6273 Vac-U-Sel Rectifiers

GEA-6285 Specialty Heating Equipment

For information on other products contact your nearest General Electric Apparatus Sales office.

NAME \_\_\_\_\_

COMPANY \_\_\_\_\_

CITY \_\_\_\_\_

STATE \_\_\_\_\_



## FOR ALL K<sub>U</sub>-BAND APPLICATIONS SPECIFY THE FINEST KLYSTRON...

### VARIAN'S NEW VA-94



#### TYPICAL OPERATION

Frequency	16.5 kmc
Resonator Voltage	300 v
Resonator Current	38 ma
Reflector Voltage	-150 v
Power Output (VSWR < 1.1)	40 mw
Electronic Tuning	65 mc

Varian now offers the most advanced reflex klystron ever developed for airborne radar local oscillator and beacon service. The VA-94 provides a minimum power output of 20 mw throughout its range of 16 to 17 kmc . . . to give you absolutely reliable operation at any altitude without pressurization.

Exclusive Varian features include a unique brazed-on external tuning cavity . . . to assure you of excellent frequency stability, extremely low microphonics, slow tuning rate and long tuning life. Its single screw tuner adapts easily to motor tuning. The VA-94 weighs only four ounces and mates directly with standard waveguide flanges.

**FOR EXPERIMENTAL APPLICATIONS . . . SPECIFY THE VERSATILE NEW VA-92.** Varian's VA-92 meets all reflex oscillator requirements in the frequency range 14 to 17.5 kmc . . . is especially suitable for signal generators and laboratory testing. It gives you the ease of tuning, ruggedness and reliable performance that has made Varian klystrons the first choice among microwave engineers. Special features include linear reflector voltage tracking, wide tuning range and high altitude operation without pressurization.



**FOR OTHER K-BAND APPLICATIONS . . . SPECIFY V-39, V-40 AND VA-96.**

**FOR COMPLETE SPECIFICATIONS** and technical data on the outstanding new VA-94, and other Varian klystrons, contact our Application Engineering Department.

IN KLYSTRONS,  
THE MARK OF  
LEADERSHIP IS



**VARIAN associates**  
PALO ALTO 1, CALIFORNIA

Representatives in all principal cities



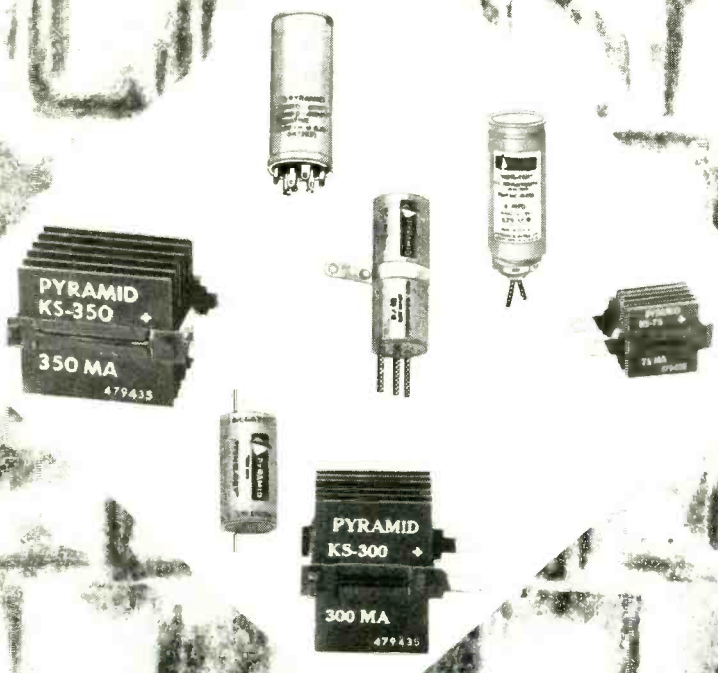

these  
**INDUSTRIAL  
JOBBERs** offer  
A COMPLETE LINE  
of PYRAMID capacitors  
and rectifiers

In your design development and your pilot production even minutes can be important. For your convenience the jobbers listed at the right carry in stock a complete assortment in adequate quantities of Pyramid's line of highest quality electrolytic and paper capacitors, both commercial and MIL-C-25B types, metallized paper capacitors and a complete range of Kool-sel selenium rectifiers, the first new design in over 20 years.

**PYRAMID** ELECTRIC CO.  
1445 Hudson Boulevard, North Bergen, New Jersey

**Allied Radio Corporation**  
100 North Western Avenue, Chicago, Illinois

**Arrow Electronics, Inc.**  
65 Cortlandt Street, New York 7, New York

**Art Electronic Supply Co.**  
145 South Park Street, Tucson, Arizona

**Burstein-Applebee**  
1012-14 McGee Street, Kansas City 6, Missouri

**California Electronic Supply, Inc.**  
11801 W. Pico Boulevard, West Los Angeles 64, Calif.

**Capitol Radio Wholesalers, Inc.**  
2120 Fourteenth Street, N.W., Washington, D. C.

**Cramer Electronics, Inc.**  
811 Boylston Street, Boston 16, Massachusetts

**Dalton-Hege Radio Supply Co.**  
924 W. Fourth Street, Winston-Salem, North Carolina

**Dean's Electronics**  
969 American Avenue, Long Beach, California

**Durrell Distributors**  
222 Mystic Avenue, Medford, Massachusetts

**East Coast Radio & Television**  
1900 N. W. Miami Court, Miami 36, Florida

**Electronics Center, Inc.**  
211 West 19th Street, New York, New York

**Electronic Equipment Distributors**  
1228 Second Avenue, San Diego, California

**Federated Purchaser, Inc.**  
66 Dey Street, New York, New York

**Herbach & Rademan, Inc.**  
1204 Arch Street, Philadelphia 7, Pennsylvania

**Hughes-Peters, Inc.**  
111 East Long Street, Columbus, Ohio

**Interstate Electronics Co.**  
227 Fulton Street, New York, New York

**Kann-Ellert Electronics, Inc.**  
9 South Howard Street, Baltimore, Maryland

**Kierulff Electronics, Inc.**  
820 West Olympic Boulevard, Los Angeles, California

**Lukko Sales Corp.**  
5024 West Irving Park Road, Chicago, Illinois

**Milgray Electronics, Inc.**  
120 Liberty Street, New York, New York

**Milo Radio & Electronics**  
200 Greenwich Street, New York, New York

**Newark Electric Co.**  
233 West Madison Street, Chicago, Illinois

**Niles Radio & Phonograph Co.**  
1254 Arapahoe Street, Denver, Colorado

**Olive Electronics Supply Corp.**  
6711 Olive Boulevard, University City 5, Missouri

**Pearless Radio Distributors**  
92-32 Merrick Road, Jamaica 33, New York

**Fred P. Purcell Company**  
1221-27 N. Washington Ave., Scranton, Pennsylvania

**Radio & Electronic Parts Corp.**  
3235 Prospect Avenue, Cleveland, Ohio

**Radio Specialties Company**  
1946-56 South Figueroa Street, Los Angeles, California

**Srepco, Inc.**  
314 Leo Street, Dayton, Ohio

**Standard Electronic Sales Corp.**  
1505 Main Street, Buffalo 9, New York

**Albert Steinberg & Co.**  
2520 North Broad Street, Philadelphia, Pennsylvania

**Sterling Radio Products Co.**  
1616 McKinney Avenue, Houston 1, Texas

**Walder Radio & Appliance Co.**  
1809 North Second Avenue, Miami 32, Florida

# New Oriented Silicon Steels for LIGHTER-WEIGHT Transformers

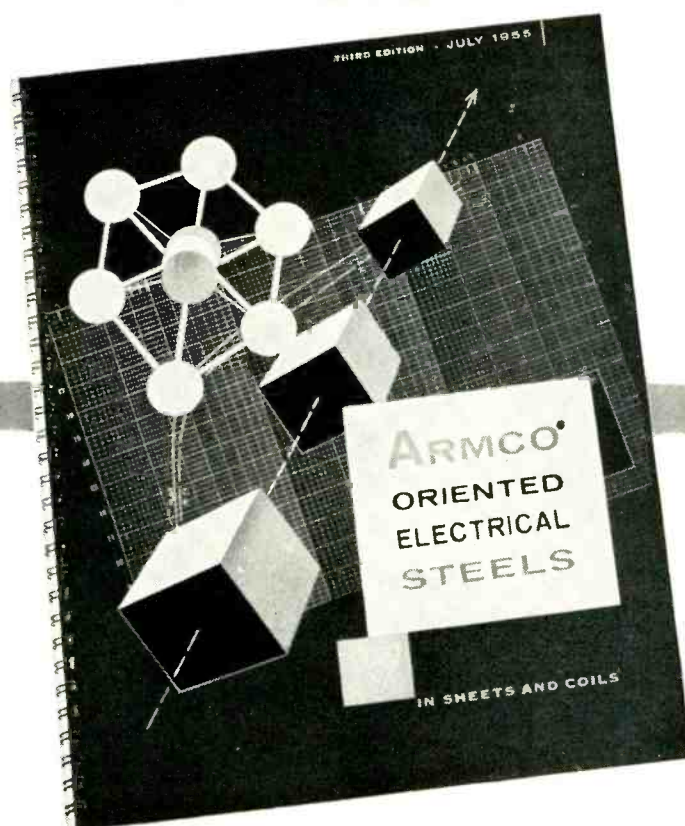

Armco Oriented Electrical Steels have spearheaded revolutionary changes in transformer design for the last 15 years because of these principal advantages:

## Lower Core Loss

These electrical steels give the designer silicon steels with much lower core loss in the rolling direction than any conventional cold-reduced or hot-rolled grades.

## Higher Permeability

The Armco oriented grades have another unique advantage over conventional electrical steels—higher permeability at high inductions combined with lower core loss. Before the introduction of oriented silicon steel, lowered core loss was obtained only at the expense of permeability at high transformer inductions. As core loss improved, the exciting current became the limiting factor in

design. The oriented grades overcame this handicap.

## Other Advantages

In addition to lower core loss and higher permeability in the rolling direction, Armco Oriented Electrical Steels have excellent lamination factors and surface insulations. They are supplied with magnetic properties fully developed at the mill. Only a low-temperature (1475 F) anneal is required for stress-relieving.

## New Information Available

Original grades of Armco Oriented Electrical Steel are long obsolete, replaced by lower core loss grades. Magnetic data now available are more complete.

Write us on your company letterhead for a copy of "Armco Oriented Electrical Steels—Third Edition, July, 1955." This 56-page catalog gives extensive information on the present Armco Oriented grades, M-6W, M-7W, M-6X and M-7X.



**ARMCO STEEL CORPORATION**

1515 CURTIS ST., MIDDLETOWN, OHIO

# SPECIAL STEELS

SHEFFIELD STEEL DIVISION • ARMCO DRAINAGE & METAL PRODUCTS, INC. • THE ARMCO INTERNATIONAL CORPORATION

# ONLY THE LEADER

*always  
sets  
the  
course*

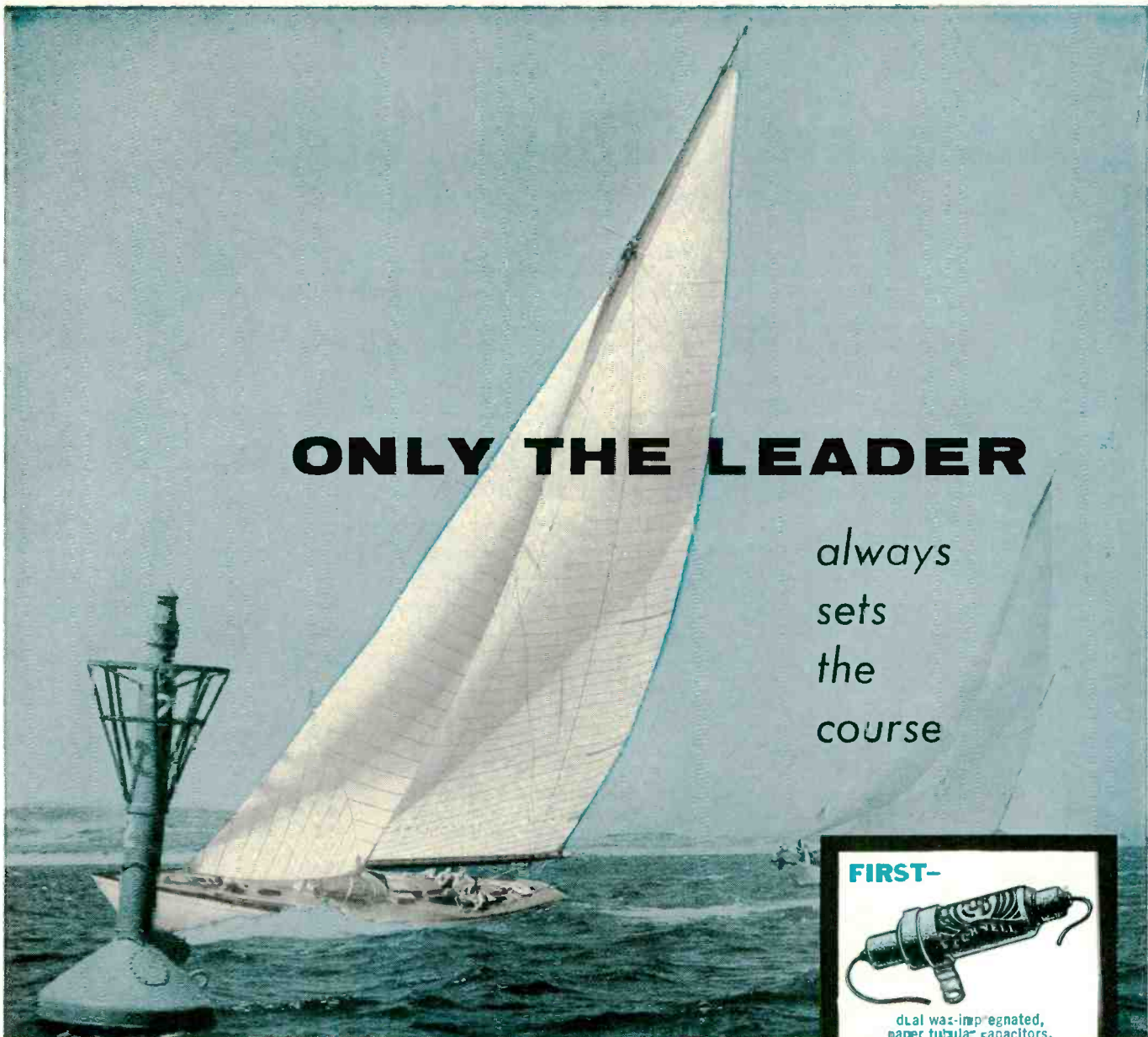

**FIRST-**



dual wax-impregnated,  
paper tubular capacitors.

Charting the course of the future in the manufacture of capacitors has always been the practice at Cornell-Dubilier. Proof of this leadership is that capacitor developments originated at C-D invariably become the standards of comparison for the entire industry.

**FIRST-**



low voltage dry  
electrolytic capacitors.

## C·D...45 YEARS OF FAMOUS FIRSTS

Typical of these "famous firsts" are the three examples shown here . . . proof that whatever your capacitor requirements may be, your needs can be filled by C-D. Write to Cornell-Dubilier Electric Corp., Dept. K-85, South Plainfield, N. J.

**FIRST-**



capacitor used in proximity fuse.



CONSISTENTLY DEPENDABLE  
**CORNELL-DUBILIER CAPACITORS**

PLANTS IN SO. PLAINFIELD, N. J.; NEW BEDFORD, WORCESTER AND CAMBRIDGE, MASS.; PROVIDENCE AND HOPE VALLEY, R. I.;  
INDIANAPOLIS, IND.; SANFORD AND FUYQUAY SPRINGS, N. C.; SUBSIDIARY, RADIART CORP., CLEVELAND, OHIO.

THERE ARE MORE C-D CAPACITORS IN USE TODAY THAN ANY OTHER MAKE

# Collins Mechanical Filters

**SUPERIOR SELECTIVITY, SMALL SIZE**

Collins Mechanical Filters are now available in six series for design needs where superior selectivity and small cubic volume are important. Permanently-tuned, hermetically-sealed and not affected by wide variations in ambient temperature, the Filters have greatly improved the selectivity characteristics of many commercial and military equipments. Mechanical Filters of special design can be supplied for most requirements in the range of 60 kc to 550 kc center frequencies and your inquiry is invited.

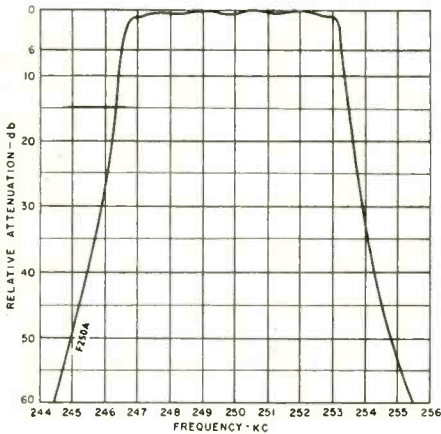

**F250A** A filter for double sideband signals at a center frequency of 250 kc. Bandwidth 6.7 kc at 6 db attenuation. Transmission loss 13 db.

Write for Technical Bulletin 201.

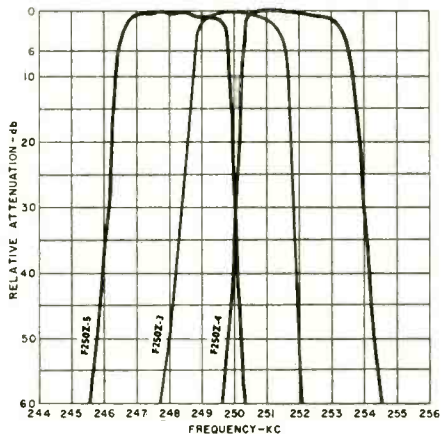

**F250Z** For single sideband signals at a carrier frequency of 250 kc. Bandwidths of 2.7 and 3.2 kc at 6 db attenuation. Transmission loss, 10 db.

Write for Technical Bulletin 202.

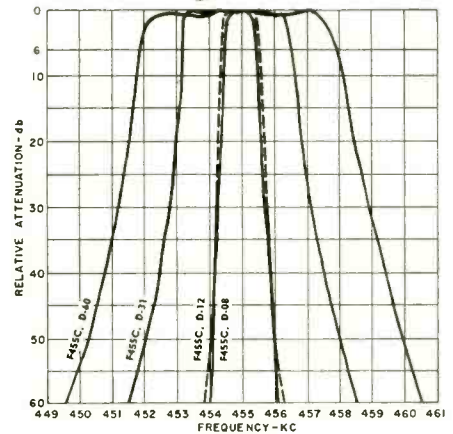

**F455C, F455D** Low insertion loss filters for AM, CW, RTTY and FSK signals at 455 kc. Bandwidth of 0.8, 1.2, 3.1 and 6.0 kc at 6 db attenuation. Transmission loss, 12 db.

Write for Technical Bulletin 203.

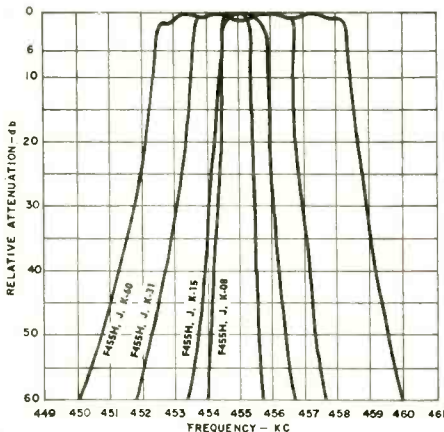

**F455H, J and K** New tubular case mounting, temperature compensated for signals at 455 kc. Bandwidths of 0.8, 1.5, 3.1 and 6.0 kc at 6 db attenuation. Transmission loss, 10 db.

Write for Technical Bulletin 204.

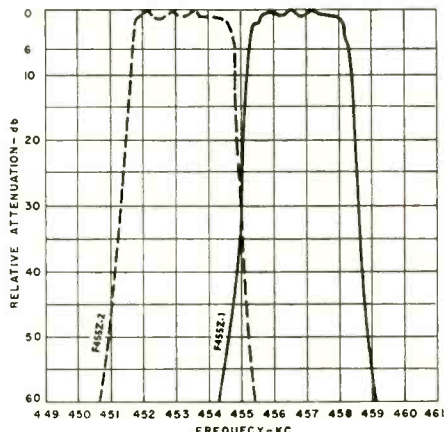

**F455Z** Mechanical Filters for single sideband signals at a carrier frequency of 455 kc. Bandwidth 3.3 kc at 6 db attenuation. Transmission loss, 10 db.

Write for Technical Bulletin 205.

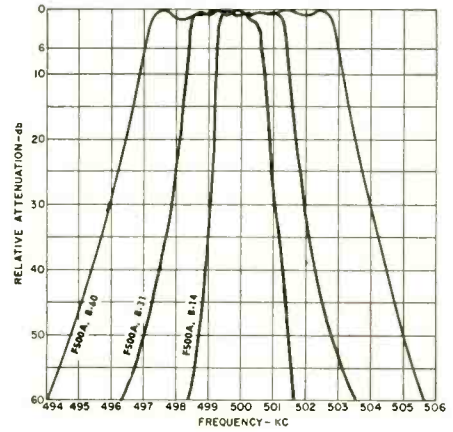

**F500** Mechanical Filters for AM, CW, RTTY signals at 500 kc. Bandwidths of 1.4, 3.1 and 6.0 kc at 6 db attenuation. Nominal transmission loss, 23 db.

Write for Technical Bulletin 206.

Write for a copy of Collins Mechanical Filter Theory and Application Bulletin #200 and for any of the Technical Bulletins described above.

**COLLINS RADIO COMPANY**

**CEDAR RAPIDS, IOWA**

VISIT COLLINS EXHIBIT  
AT WESCON AUG. 24-26  
IN SAN FRANCISCO

261 Madison Avenue, NEW YORK 16, NEW YORK  
1200 18th Street N. W., WASHINGTON, D. C.  
1930 Hi-Line Drive, DALLAS 2, TEXAS  
2700 W. Olive Avenue, BURBANK, CALIFORNIA  
COLLINS RADIO COMPANY OF CANADA LTD.  
74 Sparks Street, OTTAWA, ONTARIO



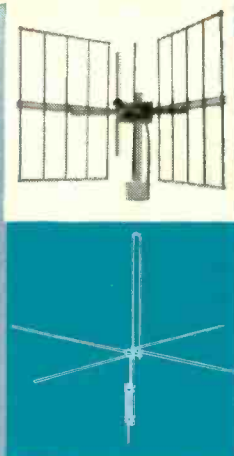

# BARGAINS in POWER

No single piece of radio equipment can equal the antenna for economically increasing effective power.

One of the less expensive components in a radio communications installation is the antenna. Yet the antenna, which usually represents less than ten per cent of the total equipment cost, can multiply the effective power of every transmitter in the system *several hundred per cent.* Equally true, a poorly designed or inappropriate antenna can waste the power produced by the costly equipment behind it.

In planning a new system, selection of the proper antenna often will allow a lower power transmitter to achieve desired signal range. For existing systems, the use of a higher gain antenna will reduce "dead spots."

Andrew is a pioneer in designing and developing antennas. We make over 30 standard types for microwave, broadcast and mobile communications. Special models or adaptations of standard models are readily made to order.

Write or phone Andrew for a dollars-and-cents evaluation of the type of antenna that can give your installation the greatest bargain in power.

**Manufacturers of  
the UNIPOLE,  
High Gain,  
Corner Reflector,  
Parabolic and Yagi  
Antennas**



# Andrew

CORPORATION  
363 EAST 75th STREET • CHICAGO 19

OFFICES: NEW YORK • BOSTON • LOS ANGELES • TORONTO

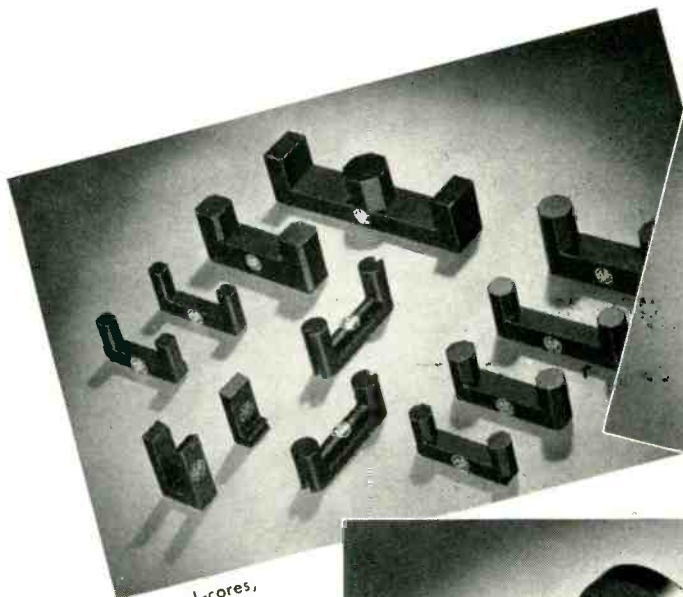

E-cores, L-cores,  
and U-cores

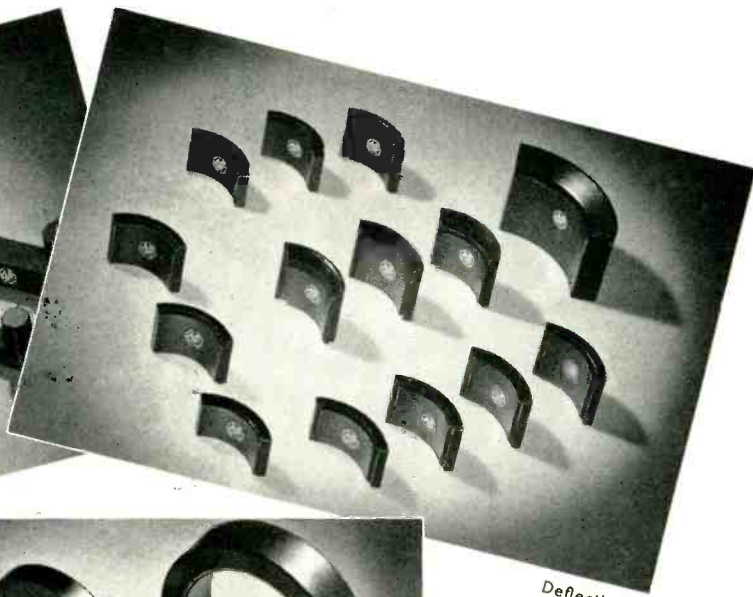

Deflection  
yoke cores  
Quarter-section



Toroid, cylindrical,  
and ring cores

## FERRITE COMPONENTS of HIGH EFFICIENCY for COLOR TV CIRCUITS

A greatly broadened line of Allen-Bradley Quality ferrite parts is now available to electronic and television set manufacturers. Some standard pieces are shown above.

Three performance standards—WO-1, WO-2, and WO-3 have been established for the electrical and magnetic characteristics of Allen-Bradley ferrite component parts:

WO-1 and WO-3 are somewhat more efficient but still interchangeable with other makes of ferrite parts.

WO-2 parts have much lower losses and higher

permeability with greater flux density at maximum operating temperatures. Their higher magnetic efficiency permits reduction in size of these ferrites and the use of less copper. A lower over-all cost is often the result. In some color television circuits, the use of Allen-Bradley WO-2 ferrites has eliminated two tubes and related parts.

Allen-Bradley has grown rapidly as a dependable producer of Quality ferrite parts. It will pay you to investigate the performance of Allen-Bradley ferrites in your electronic circuits.

Allen-Bradley Co.

110 W. Greenfield Ave., Milwaukee 4, Wis.

In Canada—

Allen-Bradley Canada Ltd., Galt, Ont.

### OTHER QUALITY COMPONENTS FOR RADIO, TV & ELECTRONIC APPLICATIONS

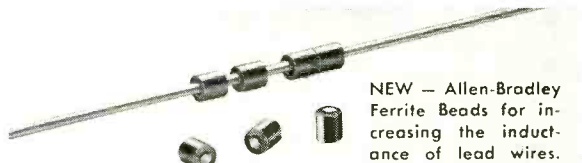

NEW — Allen-Bradley  
Ferrite Beads for in-  
creasing the induc-  
tance of lead wires.

ALLEN-BRADLEY FERRITE BEADS



Ferri-Cap Feed-thru Fil-  
ters are capacitors in  
combination with fer-  
rite material to provide  
"T" filter performance.

ALLEN-BRADLEY FERRI-CAP FILTERS

# ALLEN-BRADLEY

RADIO, ELECTRONIC AND TELEVISION COMPONENTS

★ **AIRCRAFT PUMPS**

Precision-built to rigid government specifications, a broad selection among Eastern pumps offers flexibility to your choice. Modifications can be made, or custom-made units designed to suit your project. Trim in size, light in weight, Eastern Aircraft Pumps give reliable long-term service.



★ **PRESSURIZATION**

Eastern pressurization units for airborne electronic equipment are available in many capacities to handle a broad range of requirements. Units consist of an air pump and motor assembly, pressure switch, check valve, tank valve, and terminal connectors. They meet government specifications and can be modified to your needs.



eliminate the "BUGS"

with Eastern aviation products

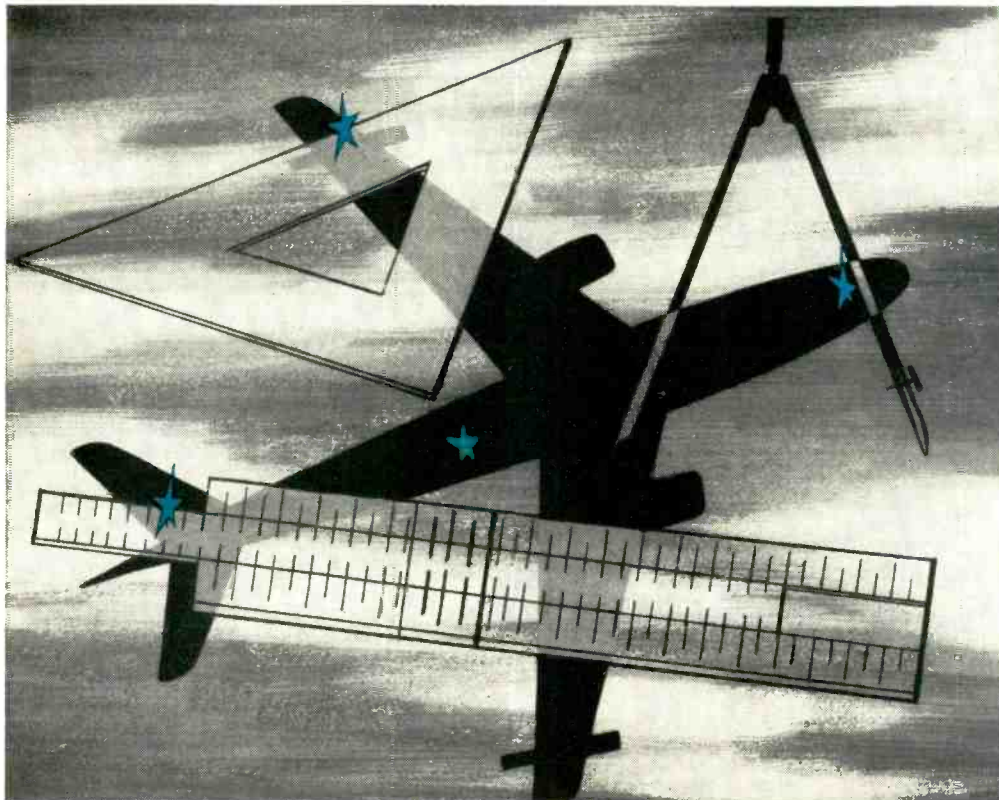
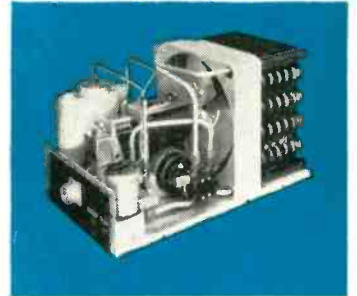

★ **COOLING UNITS**

Hold temperatures to safe operating limits in liquid cooled electronic tubes or similar devices. By virtue of long experience and using standard component parts, Eastern can suit your specific needs at a minimum cost for equipment.

★ **REFRIGERATION-TYPE**

Enable specified components to be held to fairly constant temperatures by use of various types of refrigeration units. Because of the variation in methods possible, Eastern units fill every requirement where the use of a refrigeration cycle is called for.

★ **SPECIAL UNITS**

Eastern's continual research and development program keeps pace with the growing aviation industry. As new problems occur with progress in aircraft development, Eastern units are constantly developed to fill their function as planes fly higher, or faster, or with greater load capacity.

Eastern welcomes the chance to help engineers "take out the bugs" with equipment that cools, pressurizes, or pumps. From the extensive line of existing units, new adaptations, or custom-made designs, Eastern is ready to meet every challenge for equipment that handles your needs *the best today . . . better tomorrow.*



Write for Aviation Products Catalog, Bulletin 330.

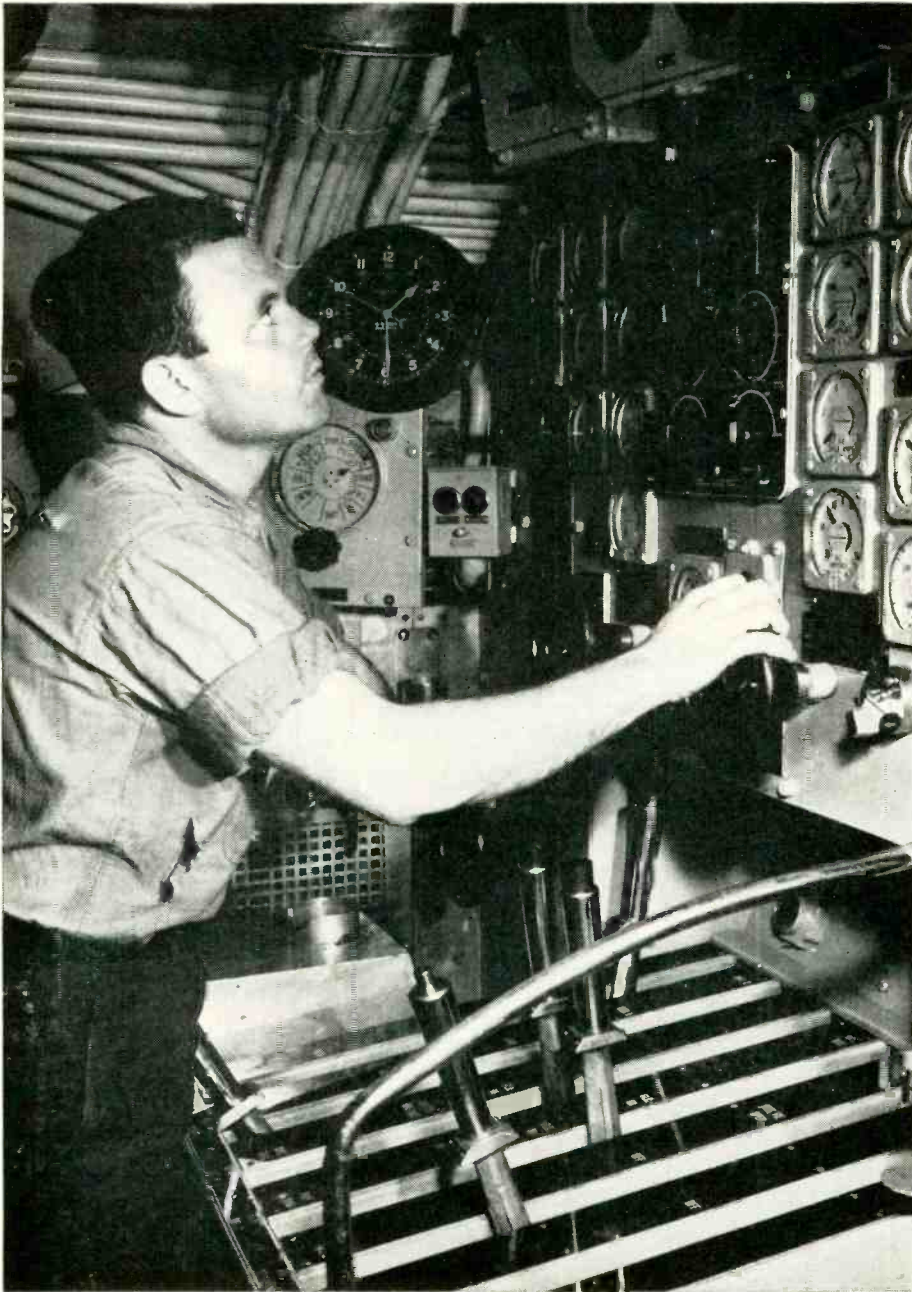

Meters  
 tell the tale  
 but  
**SPECIAL  
 ELECTRICAL  
 ALLOYS**  
 do the  
 work

"Steelmaker to the Electrical Industry" is a title we have earned the hard way . . . by the sweat of research and pioneering development. In this modern world of gauges and instruments, of automation, electronics and atomics, the heart of the design is so often some silicon steel, high-permeability alloy, or other special electrical material that we produce. • When *you* need a steel to do what ordinary steels cannot do—whether electrically or in resisting corrosion, heat, wear or great stress, call on us. *Allegheny Ludlum Steel Corporation, Oliver Bldg., Pittsburgh 22, Pa.*

W&D 4558-B

**PIONEER** in Specialloy Steels  
**Allegheny Ludlum**

Warehouse stocks of Allegheny Stainless carried by all Ryerson plants





# LOOK . . . . TO **Transitron**

## SILICON RECTIFIERS AND DIODES

*designed for specific applications*

### SILICON POWER RECTIFIERS

Rated for 125°C operation, Transitron's silicon rectifiers provide high power handling ability and reliability at high temperature. They are specifically designed for magnetic amplifier and power supply applications. Send for Bulletin TE-1321.

Specifications and Ratings at 125°C					
HIGH POWER TYPES			MEDIUM POWER TYPES		
TYPE	P.I.V.* (volts)	I <sub>dc</sub> ** (amps)	TYPE	P.I.V.* (volts)	I <sub>dc</sub> ** (amps)
1N411	50	10	1N332	400	0.4
1N412	100	7	1N334	300	0.4
1N413	200	5	1N336	200	0.4
			1N338	100	1.0

\* Peak Recurrent Inverse Voltage at full load  
 \*\* Maximum Average Forward Current at full load



### SILICON JUNCTION DIODES

Transitron's silicon junction diodes are characterized by superior forward conductance and reliable operation up to 150°C. They are specifically designed for applications requiring extremely high inverse resistance at high temperatures. Send for Bulletin TE-1322.

TYPE	Forward Current at +1 V (ma)	Inverse Current at Specified Voltage (ua)		Maximum Working Voltage (volts)
		at 25°C	at 125°C	
1N137A	3	.03 at 20V	—	36
1N138A	5	.01 at 10V	—	18
1N137B	20	.03 at 20V	5 at 20V	36
1N138B	40	.01 at 10V	2 at 10V	18
1N350	20	.03 at 60V	5 at 60V	70
1N351	8	.03 at 100V	5 at 100V	120
1N352	5	.05 at 150V	10 at 150V	170
1N353	3	.10 at 200V	20 at 200V	225
1N354	1	.10 at 300V	20 at 300V	325



ACTUAL SIZE

### SILICON BONDED DIODES

Transitron's silicon bonded diodes are specifically designed for high frequency and very fast switching applications at high temperatures. They are particularly useful in detector, discriminator and pulse circuitry. Send for Bulletin TE-1308.

TYPE	Forward Current at +1 V (ma)	Inverse Current at Specified Voltage (ua)	Inverse Breakdown Voltage
S4	1	1 at 10V	15
S5	1	.1 at 10V	20
S6	4	.5 at 5V	10
S7	2	1 at 10V	20
S8	1	1 at 10V	10

Operating frequency range 0-500 mc. Average Shunt Capacitance 0.8 uufd



ACTUAL SIZE

Transitron's special engineering group is available to assist you with specific applications. Inquiries concerning your particular design problems are invited.

**Transitron** electronic corporation • melrose 76, massachusetts



Glass Diodes



Silicon Diodes



Germanium Diodes



Transistors



Silicon Rectifiers

*If you want  
 "Trouble-Free"  
 fuses in all  
 sizes and  
 types —*  
**TURN  
 TO BUSS!**

You can depend on BUSS fuses to operate properly under all service conditions. This means that BUSS fuses will open and prevent further damage to your customers' equipment when there is trouble on the circuit.

And just as important, BUSS fuses won't blow when trouble doesn't exist. Users are not annoyed with useless shutdowns caused by needless blows.

To make sure of this "trouble-free" operation — every BUSS fuse normally used by the Electronic Industries is tested in a sensitive electronic device. Any fuse not correctly calibrated, properly constructed and right in all physical dimensions is automatically rejected.

**A complete line of fuses is available.** Made in dual-element (slow blowing), renewable and one time types . . . in sizes from 1/500 ampere up — plus a companion line of fuse clips, blocks and holders.

When it's a fuse you need — think first of BUSS. You will be protecting both the product and your good name against troubles and complaints often caused by use of poor quality fuses.

*For more information on BUSS and FUSE-TRON small dimension fuses and fuseholders . . . Write for bulletin SFB.*

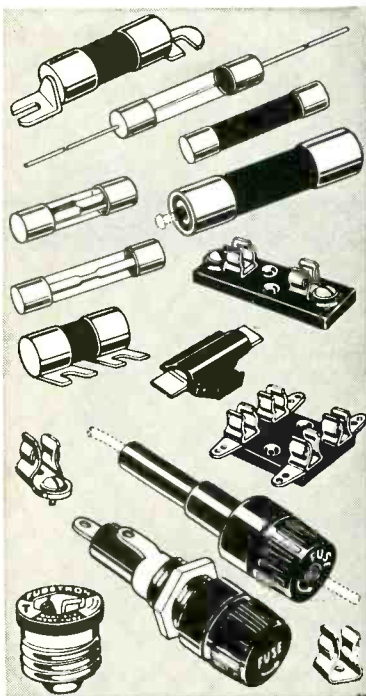

Makers of a complete line of fuses for home, farm, commercial, electronic, automotive and industrial use.

**BUSSMANN MFG. CO.** **FUSETRON** ELRC 856  
 TRUSTWORTHY NAMES IN ELECTRICAL PROTECTION Div., McGraw Electric Co.  
**BUSS** St. Louis 7, Mo.

University at Jefferson

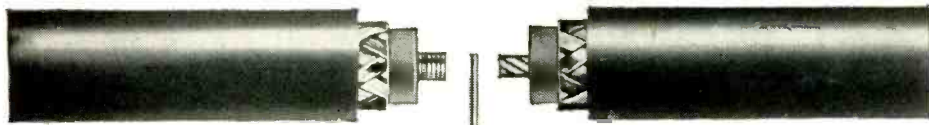

AVIATION



MARINE

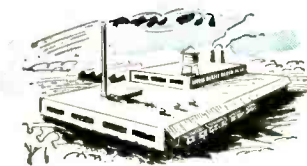

INDUSTRIAL



BROADCASTING



RADIO-TV LEAD-INS



TEST EQUIPMENT



RADAR, PULSE,  
EXPERIMENTAL EQUIP-  
MENT AND SPECIAL TYPES



# TRUSTWORTHY TRANSMISSION

For Every HF • VHF • UHF Application

## With *Federal's* QUALITY-CONTROLLED COAXIAL CABLES

Whatever your field of application . . . whatever your transmission line requirement . . . Federal is ready to serve you. If the cable you need doesn't exist, Federal will cooperate with you in developing and producing it in any quantity!

Federal offers you one of the nation's most diverse stocks of RG type cables—including the Federal-developed low-temperature, non-contaminating thermoplastic jacket.

Quality-controlled throughout the entire manufacturing process, Federal cables bring *trustworthy transmission* to every electronic application . . . *plus* top flexibility and superior resistance to abrasion, weathering and corrosion.

Before you specify cable—or complete cable assemblies—for any general or military application, get the facts and figures from Federal. *We have the answer or we can get it!*

### CALL ON FEDERAL . . .

for cable made to your specifications. Federal engineers will help you with design problems . . .

**CALL NUTLEY 2-3600**



Manufacturer of America's most complete line of solid dielectric cables

## Federal Telephone and Radio Company



A Division of INTERNATIONAL TELEPHONE AND TELEGRAPH CORPORATION  
COMPONENTS DIVISION • 100 KINGSLAND ROAD • CLIFTON, N. J.

In Canada: Standard Telephones and Cables Mfg. Co. (Canada) Ltd., Montreal, P. Q.  
Export Distributors: International Standard Electric Corp., 67 Broad St., New York

# NEW! Job-Tested!

Actual size

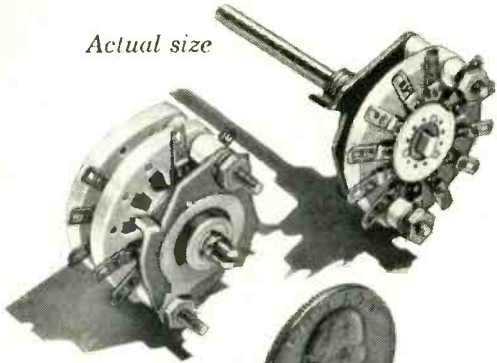

As small as a quarter in diameter



Want further facts?  
Write for detailed engineering  
bulletin EP-SW-1.

## Centralab Series 100 Sub-Miniature Switch

*The only one of its kind*

**Extra Small!** An ultra-miniature switch with the electrical rating of larger switches. Shaft-length up to 2½" from end of bushing—maximum of 3 sections per shaft.

**Field-Tested!** Already proven in day-to-day use on military applications.

**Extra Strong!** Sections are ceramic—Centralab Grade L-5 Steatite (the best!).

**Extra Quality!** Meets the corrosion-resistance requirements—and exceeds the insulation resistance—specified by MIL-S-3786.

**Versatile!** Available up to 12 positions. Make and break, resistance load, 1 ampere at 6 volts d c.; 150 milliamperes at 110 volts a. c.; current-carrying capacity, 5 amperes.

**More proof that  
if it's a job  
for electronic components,  
it's a job for Centralab**

Centralab's  
advanced engineering  
continues to create  
the prototypes  
of the components  
industry

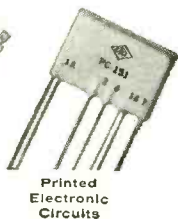
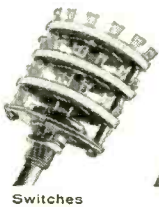
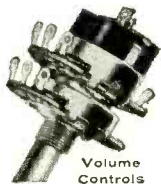

### NEW THIS MONTH! Electroni-Kwiz No.6

**Big, three-in-one  
1st Prize!**

1. Osterizer Liquefier-Blender
2. Wall-type Can Opener
3. Ice Crusher

Wouldn't you like to win? You can try, simply by answering this question in 50 words, more or less:

**What do you want to know about a new product—and how do you like to have the facts presented?**

A leading editor will pick the winner of this month's major prize.

Mail your entry to us before August 30.

\* Nothing to buy. Employees of Centralab and their advertising agency not eligible. Duplicate prizes awarded in case of tie. Entries become the property of Centralab — none can be returned.

D-556

## Centralab

A DIVISION OF GLOBE-UNION INC.

914H E. Keefe Avenue • Milwaukee 1, Wisconsin  
In Canada: 804 Mt. Pleasant Road, Toronto, Ontario

\*Trademark

SINCE 1922, INDUSTRY'S GREATEST SOURCE OF STANDARD AND SPECIAL ELECTRONIC COMPONENTS



# SERAMELITE CAPACITORS

OPERATING TEMPERATURE

-65°C to +125°C



High Heat and Humidity Resistance • Low Cost



## The Trend is to Seramics!

COMPARATIVE SERAMELITE SIZES

CAP MFD.	VOLTS	PAPER Dielectric Dia. Length	"MYLAR" Dielectric Dia. Length
.001	200	5/16 x 1	7/32 x 27/32
.0022	200	5/16 x 1	7/32 x 27/32
.0047	200	5/16 x 1	7/32 x 27/32
.01	200	5/16 x 1	7/32 x 27/32
.022	200	5/16 x 1	7/32 x 27/32
.047	200	3/8 x 1 1/4	5/16 x 1
.1	200	17/32 x 1 1/16	3/8 x 1
.22	200	17/32 x 1 1/16	7/16 x 1 1/4
.47	200	2 1/32 x 1 7/8	1 1/32 x 1 1/16
1.0	200	3/4 x 2 1/4	5/8 x 1 7/8

High performance and low comparative cost make **GOOD-ALL "SERAMELITES"** the number one choice.

Tubular ceramic case and new thermo-setting end seal will not lose its bond under any rated operating temperature.

Seramic plastic combination guarantees tightest possible seal against heat and humidity.

Good-All Seramelites are available with "MYLAR"\* or paper dielectric. "MYLAR" offers the important advantages of high Insulation Resistance, Smaller Size and Higher Operating Temperatures (up to 125°C).

\*Du Pont Trade Mark for its Polyester Film

We welcome the chance to submit data, samples and prices. Write or wire today.



**ELECTRIC MFG. CO.** 120 FIRST ST • OGALLALA, NEBRASKA

# reduce costs

with

**SOUTHCO**

## CAPTIVE PANEL SCREWS *from stock*

Here's a low-cost retractable screw fastener to save you assembly time and to eliminate the frequent need for costly special design fasteners. Unmatched for fast, economical use by assemblers of electronic units and other paneled cabinets.

"Floating" screw insures easy alignment no matter how many screws are engaged in a single panel. No special skills or tools needed; installation fast and simple.

3 head sizes and 3 standard thread sizes available. On special order, slotted heads, stainless steel screws, and extra long screws.

Write for complete information. Southco Division, South Chester Corporation, 233 Industrial Highway, Lester, Pa.

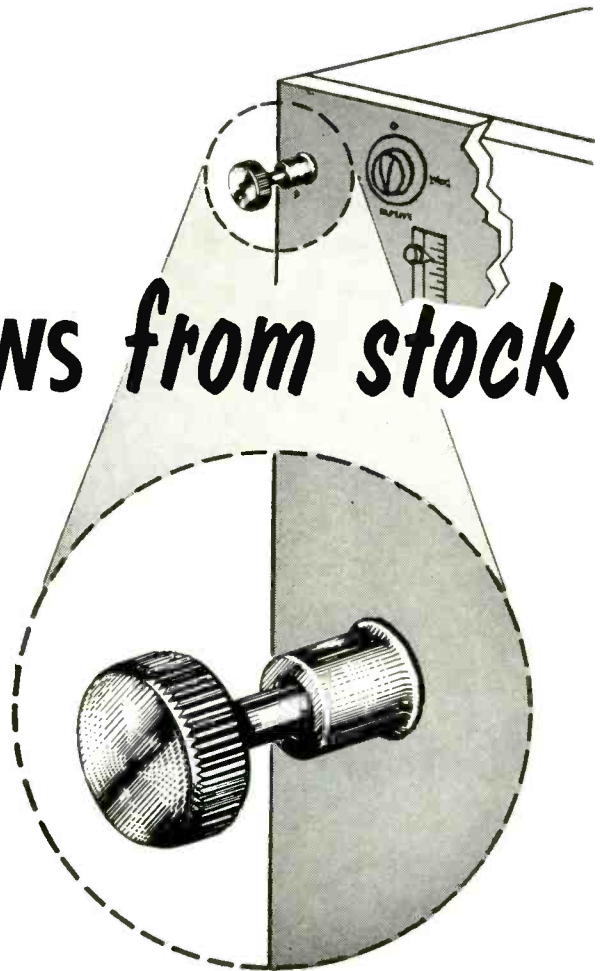

### 3 SIMPLE COMPONENTS

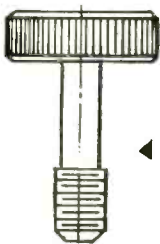

← SCREW



← STAND-OFF



← RETAINING RING

#### EASILY INSTALLED

Stand-off is flanged into panel. Screw is inserted into over-size hole in stand-off and locked in place by retaining ring, which is passed over threads to seat behind last thread.

### A SIZE FOR EVERY NEED

LARGE HEAD  
( $\frac{3}{4}$ " diameter)

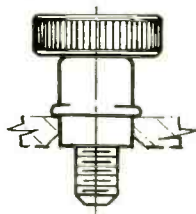

$\frac{1}{4}$ "-20 thread

MEDIUM HEAD  
( $\frac{1}{2}$ " diameter)

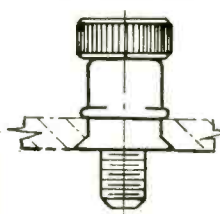

$\frac{1}{4}$ "-20 and  
12-24 thread

SMALL HEAD  
( $\frac{1}{8}$ " diameter)

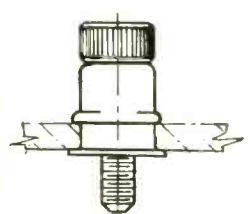

10-24 thread

Screw and stand-off are brass, nickel plated. Retaining ring is durable vinyl plastic.

Choice of stand-offs for each screw size to accommodate panel thicknesses from  $\frac{1}{16}$ " to  $\frac{1}{4}$ ".

**SOUTHCO**

**FASTENERS**

**PAWL • SCREW AND SPRING •  
DRIVE RIVETS • ANCHOR NUTS •  
ENGINEERED SPECIALTIES**

OFFICES IN PRINCIPAL CITIES

WHEREVER TWO OR MORE PARTS ARE FASTENED TOGETHER, STANDARD AND SPECIAL DESIGNS FOR IMPROVED PERFORMANCE AND LOWER PRODUCTION COSTS



# These tubes died young; a G-E Inductrol might have saved them

Fluctuating voltage killed these electronic tubes off young. Over-voltage murdered most . . . a five percent overvoltage cuts tube life by almost 50 percent (see chart below). Undervoltage, which resulted in cathode bombardment of gas or mercury-filled types, ruined more. Even while in use, poor voltage regulation made these tubes perform erratically. And when they died, downtime costs and replacement costs ran high.

Good voltage gives you maximum tube performance. General Electric Inductrols—dry-type induction voltage regulators—are the answer for circuits up to 600 volts, 520 kva. They automatically maintain constant output voltage, assuring accuracy and peak performance of electronic equipment. There are no steps, no brushes to maintain. Wave form distortion is negligible. Regulation is done magnetically, with  $\pm 1\%$  band width. Manufacturers are building Inductrols into induction heating equipment, radar gear, radio and TV transmitters, computers—to get consistent performance wherever voltage is critical.

**TUBE-LIFE AND PERFORMANCE VS VOLTAGE**

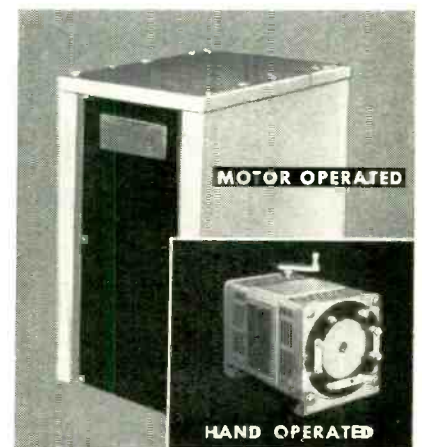
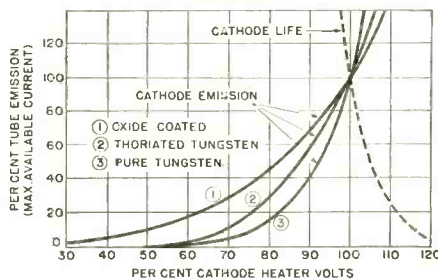

### 3 TYPES AVAILABLE

G-E Inductrols come with manual, motor-operated, or completely automatic controls. See your G-E Apparatus Sales Office or Agent. Or, send us the coupon. General Electric Co., Schenectady 5, N. Y.

**TELL ME MORE!** I'm interested in G-E Inductrols. Please send me these bulletins:

- Voltage Deviation on Electronic Tubes and the Use of Inductrols.....GEA-5936
- Single-phase Inductrols, indoor service, 600 volts and below on circuits up to 240 kva.....GEC-795A
- Three-phase Inductrols, indoor service, 600 volts and below on circuits up to 520 kva.....GEA-5824

**General Electric Company**  
Section B423-211, Schenectady 5, N. Y.

Name .....

Company .....

Address .....

City ..... State .....

*Progress Is Our Most Important Product*

**GENERAL  ELECTRIC**

# Sharper TV Focus at New Low Cost with **INDOX\*** Magnets

There are many applications in the electrical and electronic industry where Indox Ceramic Magnets have helped improve performance . . . without increasing cost. The nation's booming TV industry is a good example. Indox Ceramic Magnets have enabled manufacturers of TV components to produce a magnetic focuser which offers many important advantages. These statements, from TV manufacturers using focusers with Indox Ceramic Magnets, tell an interesting story:

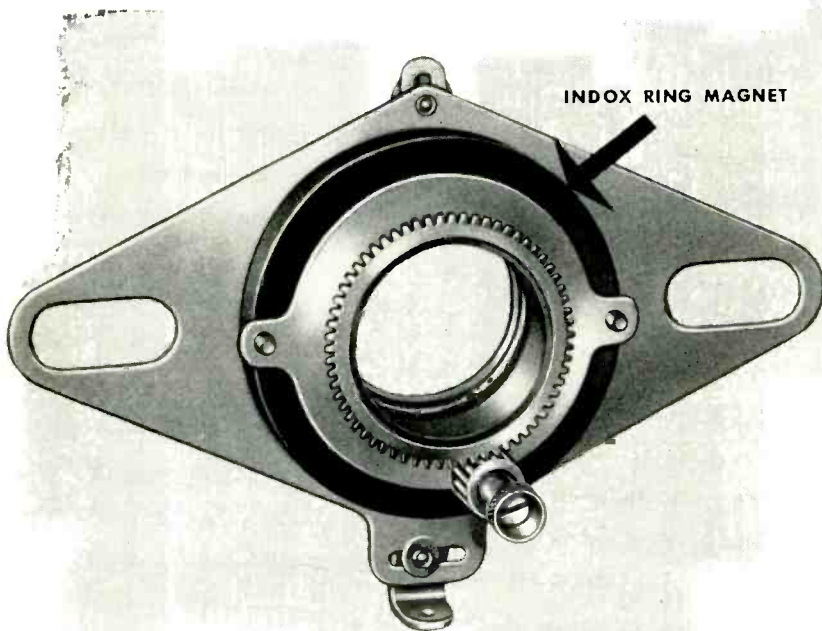

- permits effective focusing over *entire* face of tube—spot size and shape better—no wide variations.
  - time required for factory focusing brief and predictable.
  - consistent quality is predictable . . . inspection cost consequently can be held to a minimum.
  - focus quality remains stable . . . there is no deterioration of focus.
  - eliminates arcing problem, extending tube life.
  - and many others.
- \*INDOX is a new ceramic permanent magnet manufactured by The Indiana Steel Products Company and used by leading makers of magnetic focusers.

**THE INDIANA STEEL PRODUCTS COMPANY**  
VALPARAISO, INDIANA

*World's Largest Manufacturer of Permanent Magnets*

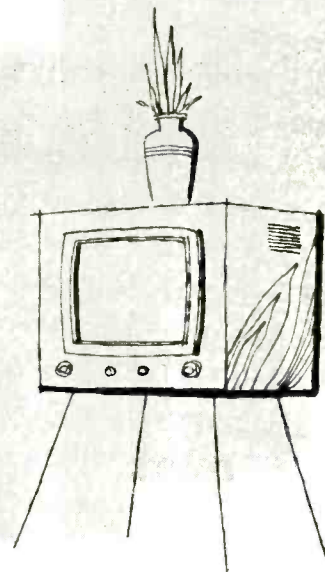

*Can the advantages of Indox Ceramic Permanent Magnets be applied to your product? Investigate these characteristics of Indox Magnets:*

- Higher coercive force than any other commercial permanent magnet material.
- Negligible hysteresis and eddy-current losses in magnetic circuits having an alternating-current component.
- High electrical resistivity.
- No critical materials required.
- Lightweight.
- Magnetization practical prior to assembly.

For additional data on Indox, write to Dept. A-8, The Indiana Steel Products Co., Valparaiso, Indiana

**INDIANA  
PERMANENT  
MAGNETS**





Directional Coupler



Signal Mixer



RF Mixer



Duplexer



Tunable Cavities

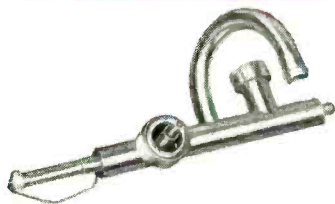

RF Line Section

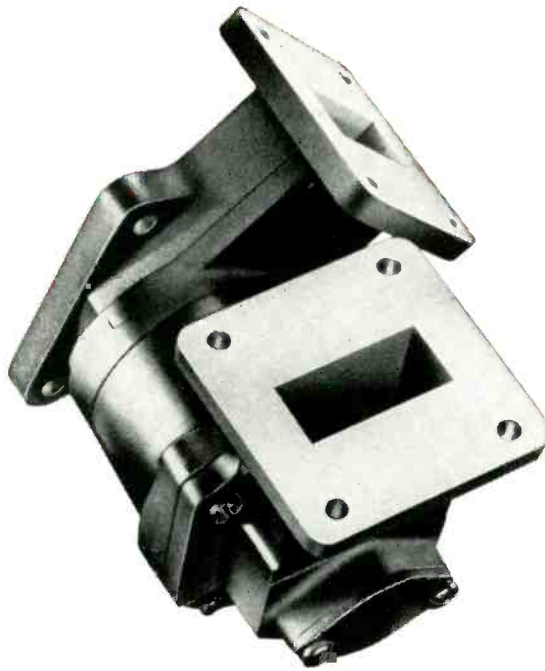

ANTENNA ROTARY JOINT



Antenna Horn



L. O. Mixer and Preamp

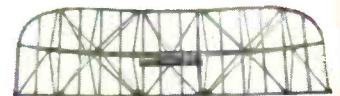

Antenna Reflector

## NEW—Raytheon Microwave Assemblies

**STANDARD—OR PRODUCED  
TO YOUR OWN EXACT SPECIFICATIONS**

Typical of Raytheon's new line of precision microwave assemblies is the Antenna Rotary Joint which handles high power over a wide bandwidth and permits full use of the newer magnetrons' wider tuning ranges.

Raytheon—long a leader in radar and other microwave equipment—now offers to others its unexcelled design, production, and test facilities. Whether you are interested in an entire microwave system or a single component, we would appreciate hearing from you. There's no obligation.

WRITE FOR CATALOGUE NO. 5-200

**Raytheon Manufacturing Company**  
Equipment Marketing Division  
100 River Street, Waltham 54, Mass.



### BROADBAND, HIGH POWER ANTENNA ROTARY JOINT

Couples rotating antenna to X-band microwave system. Power capacity: 250 KW @ .001 duty cycle.

Coaxial rotary section; standard rectangular input and output flanges.

Unique design for transition from rectangular to coaxial section provides greater power-handling capacity and superior electrical performance.

VSWR less than 1.07:1 over 11% bandwidth; VSWR of 1.10:1 maximum over greater bandwidth.

Small size, minimum weight. Can be pressurized to 30 P.S.I.

**Be Sure to Visit Booth 702 and 727 at the Wescon Show August 24-26**

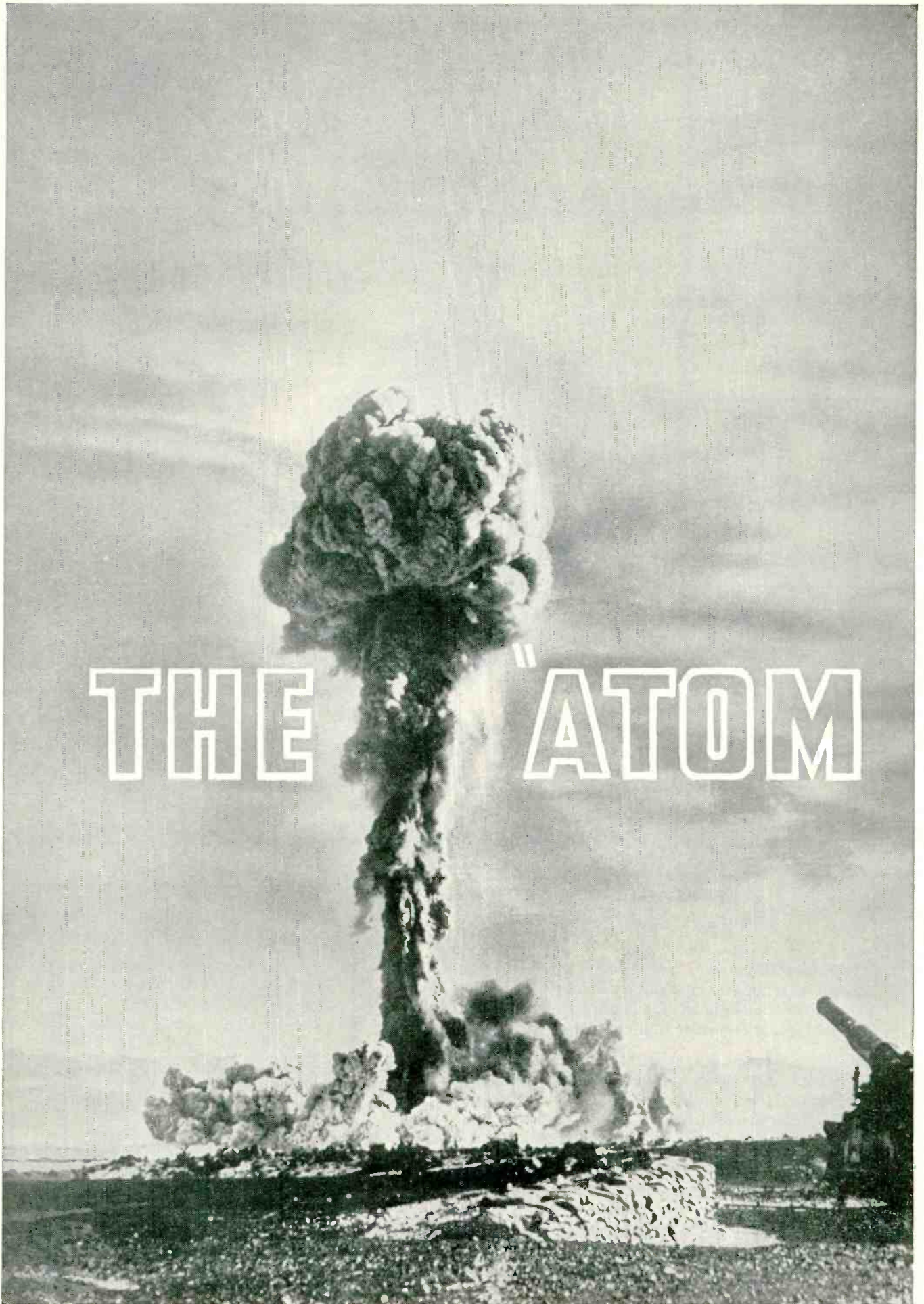

# THE "ATOM"

**ATOM SPAN** is the name that Pye Limited have given to their new military equipment, the W.S. C.12. They have chosen this title to readily convey the role for which the set has been designed. Nuclear warfare demands maximum deployment over large areas with excellent communication facilities between vehicles so that complete co-ordination can be achieved without delay. In the event of atomic attack, vehicular communications must span the area of devastation.



Operating range, vehicle to vehicle, 30-50 miles in normal terrain.

Size and shape similar to the Pye W.S.19.

Now officially adopted for the British Army.

Designed and manufactured by the designers of the W.S.19.

**SPAN**"

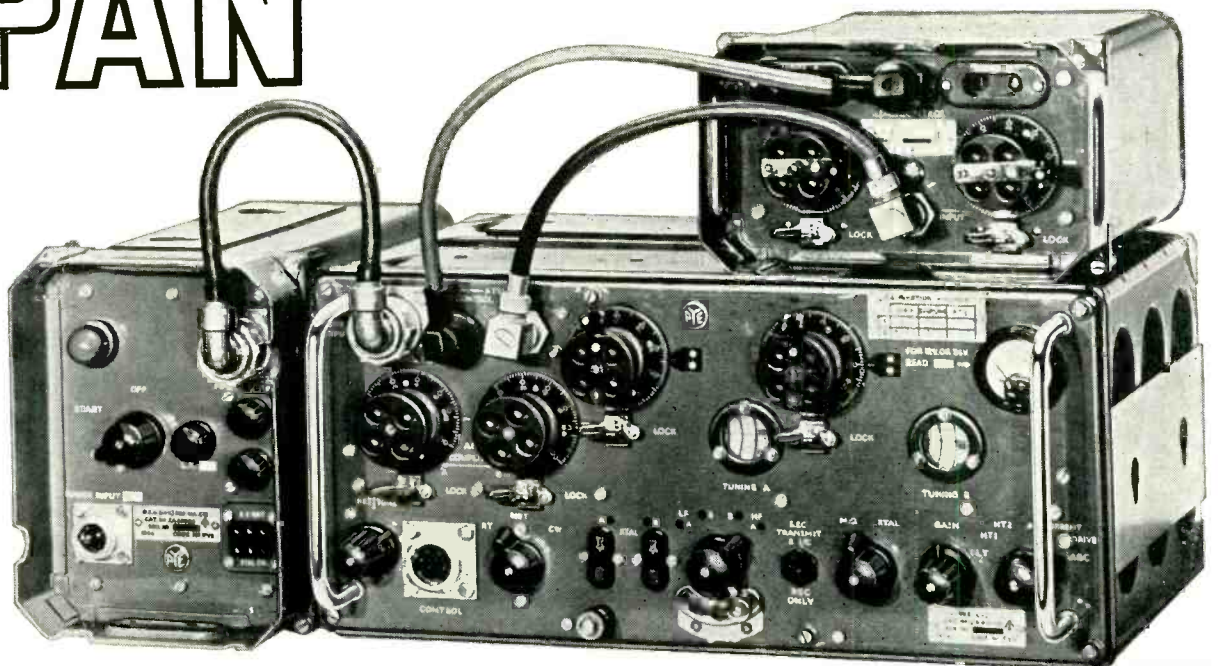

Pye (New Zealand) Ltd.  
Auckland C.I., New Zealand

Pye Radio & Television (Pty.) Ltd.  
Johannesburg  
South Africa

Pye Canada Ltd.  
Ajax, Canada

Pye Limited  
Mexico City

Pye-Electronic Pty., Ltd.  
Melbourne, Australia

Pye Limited  
Tucuman 829  
Buenos Aires

Pye (Ireland), Ltd.  
Dublin, Eire

Pye Corporation of America  
270 Park Avenue, New York

**PYE LIMITED • CAMBRIDGE • ENGLAND**



# this is not something new!

Leading members of the aviation industry have long known about this means of measuring aircraft and missile antenna radiation patterns. In the course of various engineering projects, they have come repeatedly to Airborne Instruments Laboratory with antenna test problems. As always, Airborne's scientists sought to create equipment, singularly perfect in performance yet flexible enough to meet many specific needs. Their efforts resulted in the Type 105 Model Range System, which automatically records polar plots of the relative field strength of aircraft radiation patterns.

The Type 105 System, however, is not only important within itself. Out of its totality have emerged several significant devices, designed for many recording purposes. Among these are the 116R Polar Pattern Recorder, the Type 20 SWR Indicator, and the Type 373 Rectangular Coordinate Recorder.

Here again is an example of creative initiative, by ALL engineers, providing a continuous succession of advanced instruments for America's industrial progress.

*Send for information about the 105 Model Range System and literature on other recording devices.*



Type 116R Polar  
Pattern Recorder

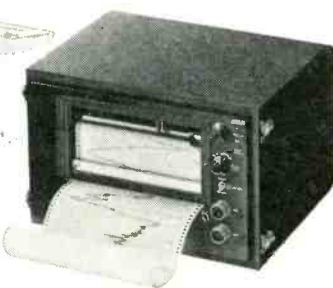

Type 373 Rectangular  
Coordinate Recorder



Type 20  
SWR Indicator



**AIRBORNE  
INSTRUMENTS  
LABORATORY**

I N C.

160 OLD COUNTRY ROAD • MINEOLA, NEW YORK

THERE ARE **NONE FINER!**

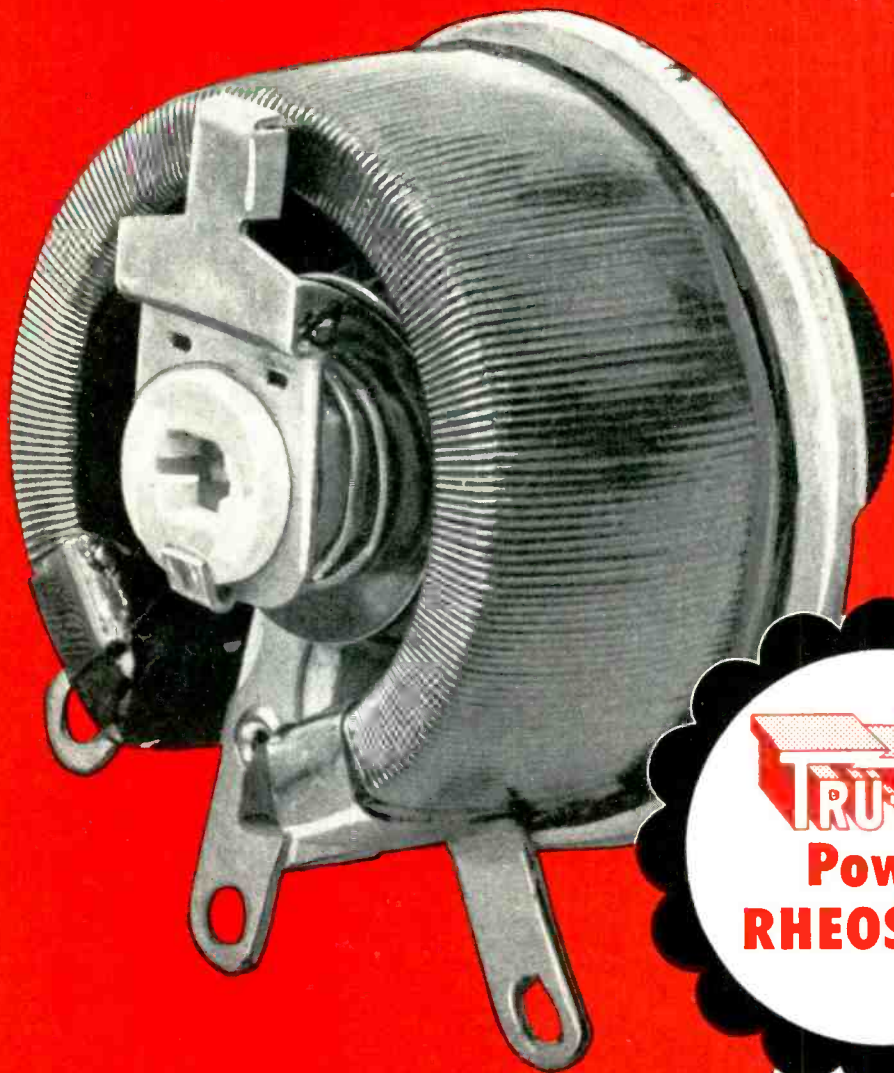

**TRU-OHM**  
Power  
**RHEOSTATS**

**TRU-OHM POWER RHEOSTATS**  
are more and more in demand and  
there are many reasons. These  
include finest quality, better service,  
and delivery; UL approval; variety from  
25 watts up; fairest prices; AND TRU-OHM  
expedites for YOU . . . TRU-OHM ships on time.

We invite your inquiry.  
Have you received our latest catalog? **WRITE TODAY!**



**PRODUCTS**

Division of  
Meadel Engineering  
& Mfg., Inc.

General Sales Office: 2800 N. Milwaukee Avenue, Chicago 18, Ill.

Factory: Huntington, Indiana

"Largest producers of wire-wound resistors in the U.S.A."



MANUFACTURERS: Power Rheostats, Fixed Resistors, Adjustable Resistors, "Econohm" Resistors, "Tru-rib" Resistors

# FOR YOUR AUTOMATION PROGRAM

Barton broun advertising

## VARIABLE RESISTORS FOR PRINTED CIRCUITS



**Type UPM-45**  
For TV preset control applications. Control mounts directly on printed circuit panel with no shaft extension through panel. Recessed screwdriver slot in front of control and 3/8" knurled shaft extension out back of control for finger adjustment. Terminals extend perpendicularly 7/32" from control's mounting surface.

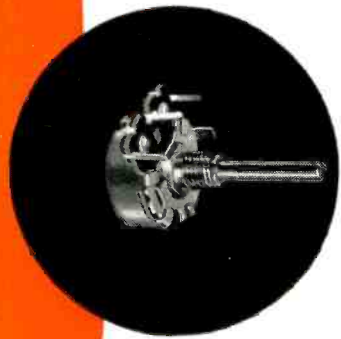

**Type U70 (Miniaturized)**  
Threaded bushing mounting. Terminals extend perpendicularly 5/32" from control's mounting surface.

**Type GC-U45**  
Threaded bushing mounting. Terminals extend perpendicularly 7/32" from control's mounting surface. Available with or without associated switches.

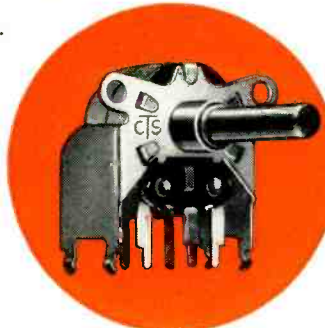
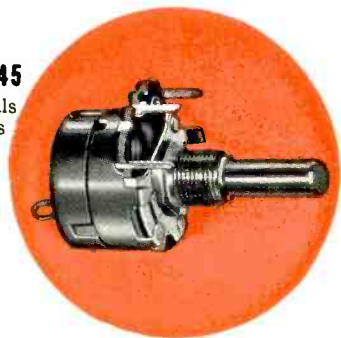

**Type YGC-B45**  
Self-supporting snap-in bracket mounted control. Shaft center spaced 29/32" above printed circuit panel. Terminals extend 1-1/32" from control center.

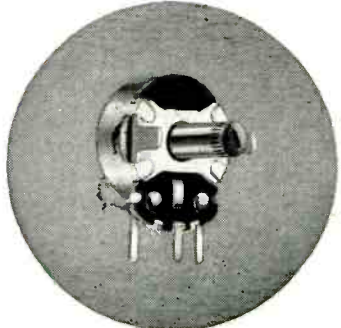

**Type XP-45**  
For TV preset control applications. Control mounts on chassis or supporting bracket by twisting two ears. Available in numerous shaft lengths and types.

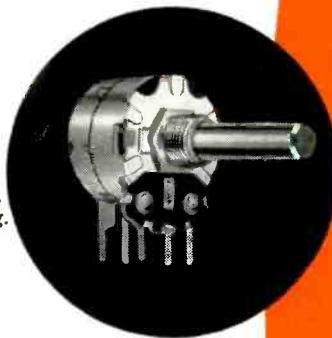

**Type XGC-45**  
For applications using a mounting chassis to support printed circuit panel. Threaded bushing mounting.

## VARIABLE RESISTORS FOR SOLDERLESS "WIRE-WRAP" CONNECTIONS

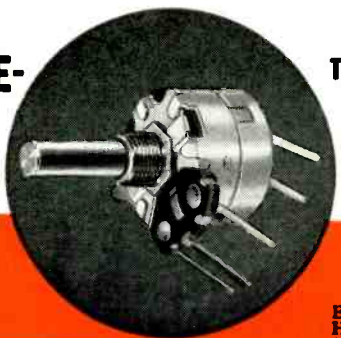

**Type WGC-45**  
Designed for solderless wire-wrapped connections with the use of present wire-wrapping tools. Available with or without switch and in single or dual construction.

The controls illustrated are typical constructions. CTS' years of engineering and technical experience makes available many other types for your automation needs.



**CHICAGO TELEPHONE SUPPLY Corporation**  
ELKHART • INDIANA  
FOUNDED 1896

**EAST COAST OFFICE**  
Henry E. Sanders  
130 North Broadway  
Camden 2, New Jersey  
Phone: Woodlawn 6-1668  
TWX No. Camden NJ 380  
Phila. Phone: Market 7-3129

**SOUTHWESTERN U.S.A.**  
John A. Green Company  
6815 Oriole Drive  
P.O. Box 7224  
Dallas 9, Texas  
Phone: Dixon 9918

**SOUTH AMERICA**  
Jose Luis Pontet  
Buenos Aires, Argentina  
Montevideo, Uruguay  
Rio de Janeiro, Brazil  
Sao Paulo, Brazil

**WEST COAST OFFICE**  
Robert A. Stackhouse  
928 S. Robertson Blvd.,  
Los Angeles 35, Calif.  
Phone: Creatview 4-5931  
TWX No. BEV H 7666

**CANADIAN DIVISION**  
C. C. Meredith & Co., Ltd.  
Streetsville, Ontario  
Phone: 310

**OTHER EXPORT**  
Sylvan Ginsbury  
8 West 40th Street  
New York 18, New York  
Phone: Pennsylvania 6-8239

*The Exclusive Specialists in Precision Mass Production of Variable Resistors*

# Lagging Public Construction — A Spreading National Blight

The most recent editorial in this series dealt with the plans of American industry for expanding and modernizing its plant and equipment over the next four years. These plans call for the expenditure of \$113 billion over that period. There is a good prospect that the money to carry them out will be available. If the plans are carried out, manufacturing capacity at the end of 1958 will be double that which existed at the end of World War II. And this industrial plant will be modernized.

In sharp contrast to this picture is the condition of our *public* plant and equipment — the roads, schools, water supply, health and sanitation facilities upon which industry, as well as the average family, depends. **According to a recent estimate by the Twentieth Century Fund, the people of the United States must spend almost \$100 billion on new public works projects during the next five years merely to meet the minimum needs of our growing economy.**

**Other estimates by the President's Council of Economic Advisers, by state agencies and by private construction economists all show the same condition: a staggering need for public works. Yet no steps have been taken that even offer a promise of closing the gap between the public facilities we are building and the greater facilities we really need.**

How did we come to let our public facilities fall into this sorry state? Here are some of the reasons:

(1) During the years of depression and war, from 1930 to 1945, these facilities were neglected. New construction declined, and even maintenance was cut.

(2) Since the end of World War II, increased construction costs have made it difficult for communities to get the needed construction with the funds budgeted in the past for that purpose.

(3) The great postwar upsurge in population, and the spreading of our population into new areas, has created a huge demand for additional community facilities before the neglect of earlier years could be made up.

## Responsibility Divided

Now the need for more public construction has become apparent to everyone, on jammed highways and in over-crowded schools. But, unfortunately, the responsibility for doing something about this situation cannot be so clearly fixed as can the responsibility for maintaining industrial facilities. A business firm must expand its capacity when markets are growing or lose its trade position. It must modernize its plant and equipment or be undersold by more efficient competitors. In the case of public facil-

ities, there is no such competitive incentive. To be sure, a city or state may lose population and industries if its public facilities are inadequate. But such shifts are very slow to take place and difficult to relate to any specific public program, or lack of it.

Moreover, the responsibility for constructing public facilities is divided between state and local governments and federal authorities. Within each of these governmental units there are specialized bureaus or departments with varying responsibilities. This division of responsibility obviously adds an element of difficulty to the development of an adequate program of public construction.

### **Breaking the Log-Jam**

How can this administrative log-jam be broken and the financial difficulties overcome?

One course would be to have the federal government step in with a nation-wide new program of direct spending on public works. That would utilize the resources of the federal treasury for immediate action. But there are weighty objections to such extensive federal participation. One is that federal spending cannot be greatly enlarged without a corresponding increase in the federal control of decisions that normally have been left to local communities. Another objection is based on the fact that so long as we must maintain a large defense establishment, such an addition to federal spending means either higher taxes or a chronically unbalanced budget.

The other course is to rely primarily on local initiative, but with new and more effective federal aid to local governments. Such aid would help speed up planning and construction, and contribute toward a solution of the most burdensome financing problems, but in amounts sufficiently limited to require that most of the capital be raised locally.

### **No Single Formula**

No one formula can be applied to make such aid effective. The raising of funds for new schools, for example, involves problems very

different from those of financing highways, or water-works, or hospitals. But it does seem clear that, in all these fields, the federal grants must be designed to stimulate more local planning and financing than has prevailed in the past. Among the new ideas that may offer such incentives are federal grants for planning and initial costs and federal guarantees of local bond issues. Such aids have been remarkably effective in the fields of slum clearance and public housing.

While the federal government clearly has a role to play, we cannot afford to postpone inauguration of an adequate public construction program while we seek a formula to apportion governmental participation that would be generally accepted as ideal. Every year about 2½ million more Americans are putting increasing pressure on a public plant already dilapidated and inadequate. The result is an increasing menace to comfort, health, education and safety. It is also an increasing menace to the effective performance of American industry.

**The appropriate public response to this situation is a driving public determination to eliminate this increasingly dangerous lag in public construction. At this juncture, the development of such a determination is basic. Nothing stands in the way of an adequate program of public construction that a determined electorate cannot remove.**

*This message is one of a series prepared by the McGraw-Hill Department of Economics to help increase public knowledge and understanding of important nationwide developments that are of particular concern to the business and professional community served by our industrial and technical publications.*

*Permission is freely extended to newspapers, groups or individuals to quote or reprint all or parts of the text.*

*Donald C. McGraw*

PRESIDENT

McGRAW-HILL PUBLISHING COMPANY, INC.



Johnsonburg, Pa.

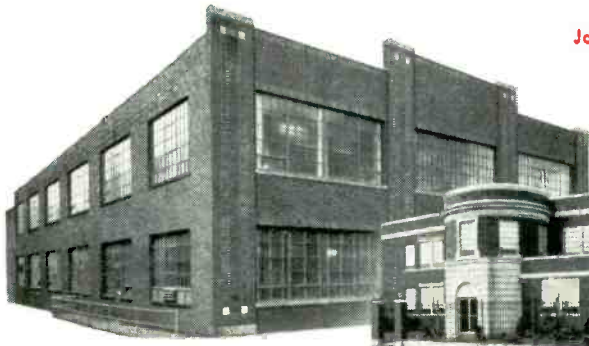

Administration Building  
St. Marys, Pa.



Canadian Stackpole  
Toronto



Plant No. 1  
Kane, Pa.



Plant No. 2  
Kane, Pa.

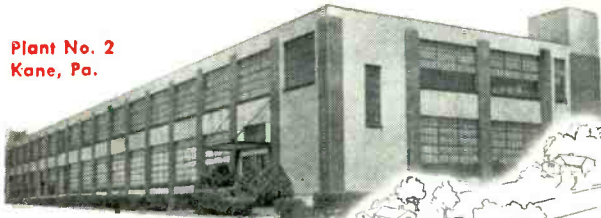

Main plant  
St. Marys, Pa.

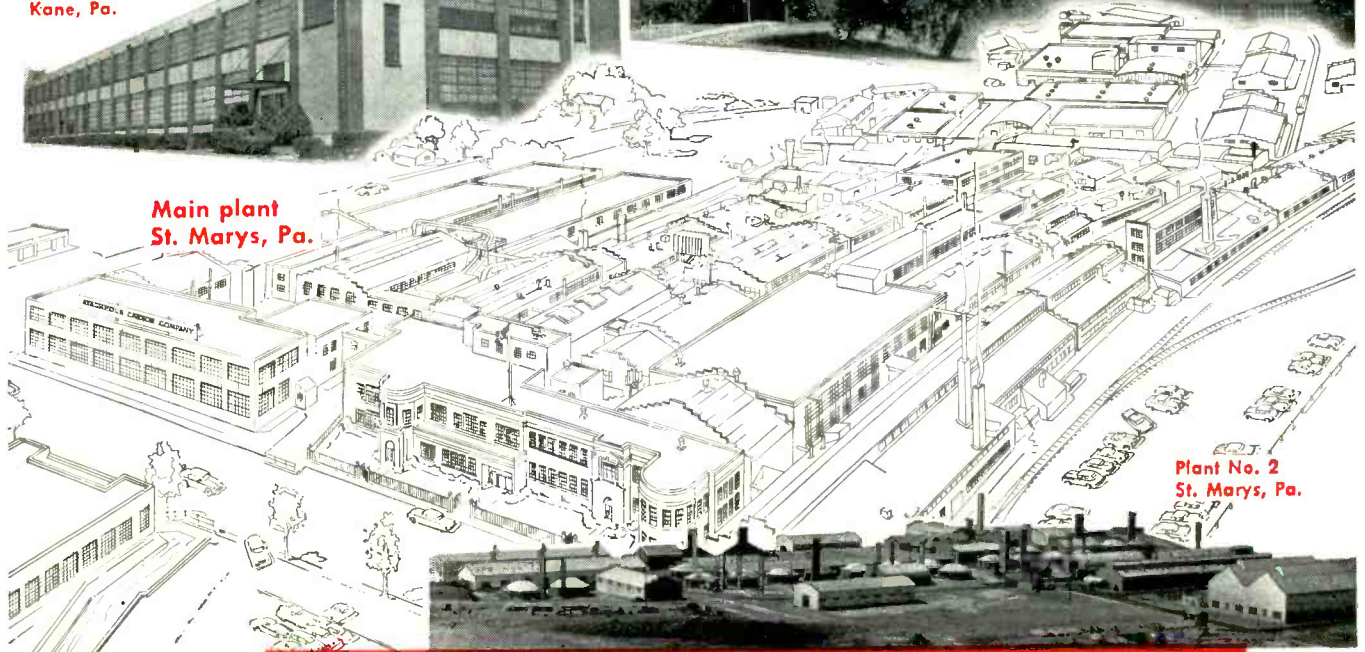

Plant No. 2  
St. Marys, Pa.

# ...THIS IS STACKPOLE

A good source for dependable  
electric-electronic components



- FIXED AND VARIABLE RESISTORS • IRON CORES
- CERAMAG® FERROMAGNETIC CORES • LOW VALUE COMPOSITION CAPACITORS
- SLIDE AND LINE SWITCHES • CERATAB® PRINTED COMPONENTS
- MOLDED COIL FORMS • CERAMAGNET® PERMANENT MAGNETS
- BRUSHES FOR ALL ROTATING ELECTRICAL EQUIPMENT
- ELECTRICAL CONTACTS • POWER TUBE ANODES
- ... and dozens of carbon, graphite and metal powder specialties

Electronic Components Division, STACKPOLE CARBON CO., St. Marys, Pa.

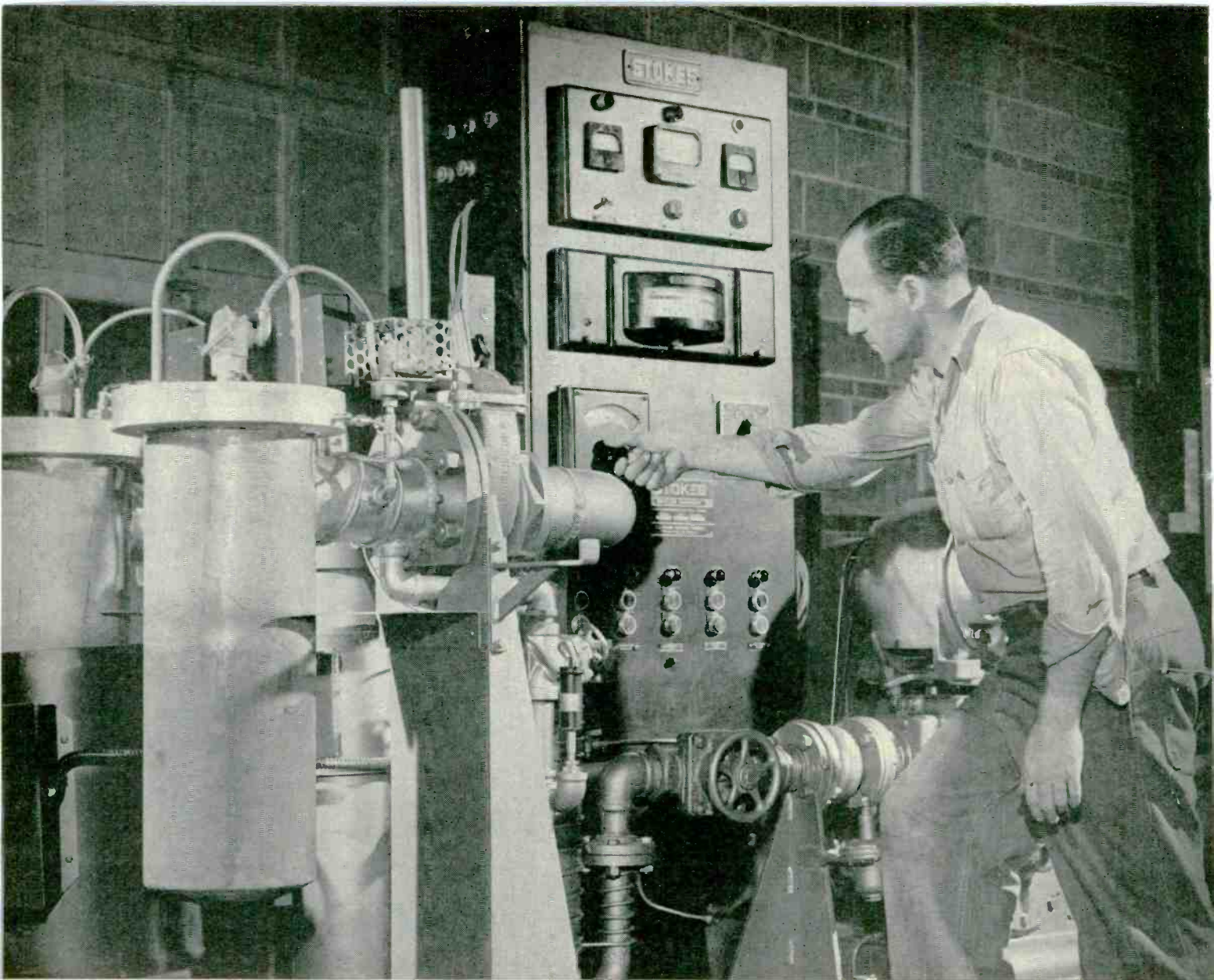

Operator checks pyrometer control of a standard Stokes dual-retort high-vacuum furnace.

## THE COMPLETE LINE OF STOKES

Stokes manufactures a complete line of vacuum pumping equipment. This includes mechanical vacuum pumps, diffusion and booster pumps, vacuum valves and gages, and complete vacuum instrumentation. In engineered high vacuum equipment, Stokes builds vacuum metallizers, vacuum furnaces and other vacuum processing equipment.

Stokes has for many years been active in vacuum research. Vacuum experience among our engineers covers the range from laboratory equipment to some of the largest vacuum equipment in service. This experience is available to help solve your vacuum problems.

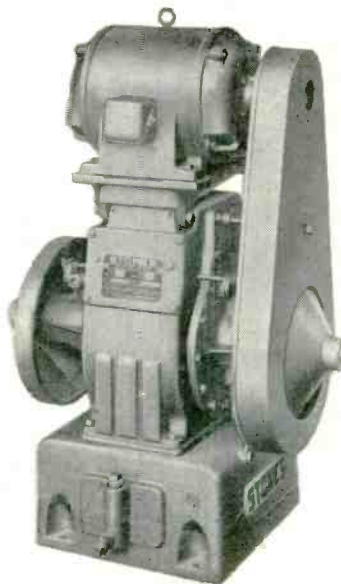

### STOKES MECHANICAL VACUUM PUMPS

For vacuum processing systems and for maintaining low forepressures in high-vacuum systems, the Stokes Microvac pump provides efficient, economical operation. Designed with fully automatic lubrication and a long-lasting exhaust valve assembly, every Microvac pump is assured of smooth, trouble-free operation. Six sizes give capacities from 15 to 500 cfm. Send for catalog listed at right.

# Production vacuum furnaces now available for the Electronics Industry

You can now buy specially designed Stokes vacuum furnaces for all phases of heat treating and outgassing. They are compact . . . give maximum capacity for minimum floor area. Sequence-operated grouped controls permit even unskilled personnel to handle furnace operations.

The basic problems of vacuum design and engineering have been a Stokes specialty for many years. Stokes vacuum furnaces for commercial production have proved their efficiency and earned the respect of manufacturers in numerous fields of technology. Stokes is the leading supplier of vacuum furnaces for industry.

The new Stokes Ring-Jet pumps described below are incorporated in Stokes vacuum systems to assure pumping cycles of maximum speed.

Stokes vacuum furnaces of numerous basic types are made in sizes and with modifications to fit users' requirements.

If you are interested in heat treating, degassing or melting of metals, you'll want to know more about Stokes high-vacuum furnaces. Write for your free copy of Stokes Catalog No. 790, "High-Vacuum Furnaces".

F. J. STOKES MACHINE COMPANY  
5503 TABOR ROAD  
PHILADELPHIA 20, PA.

## SEND FOR TECHNICAL LITERATURE:

Microvac Pumps—Catalog 750  
Diffusion and Booster Pump  
Specification sheets  
and performance curves  
The Story of the Ring-Jet Pump  
Complete Vacuum Processing  
Systems—Catalog 730  
How to Care for Your  
Vacuum Pump—Booklet 755  
Vacuum Impregnation —  
Catalog 760  
Vacuum Drying—Catalog 720  
Vacuum Furnaces —  
Catalog 790  
Vacuum Metallizing —  
Catalog 780  
Vacuum Calculator  
Slide Rule



## VACUUM EQUIPMENT



### STOKES RING-JET DIFFUSION AND BOOSTER PUMPS

The new Stokes Ring-Jet Pumps embody a new concept of the diffusion principle. Size for size, they have pumping speeds of 10% to more than 100% above any other diffusion pump for a given heat input. Ring-Jet Diffusion Pumps are available in sizes of 4, 6, 10, 14 and 16 inches; Booster Pumps in sizes of 4, 6, 10 and 16 inches. Send for information listed.



### STOKES VACUUM VALVES

To control vacuum safely and surely, Stokes vacuum valves are available in 4, 6, 10 and 16-inch standard flange sizes.

### STOKES-McLEOD VACUUM GAGES

For measuring vacuums from fractions of a micron up to 50 mm, Stokes-McLeod gages are the standard of reference. Four sizes available.



OFFICES IN PRINCIPAL CITIES, REPRESENTATIVES THROUGHOUT THE WORLD

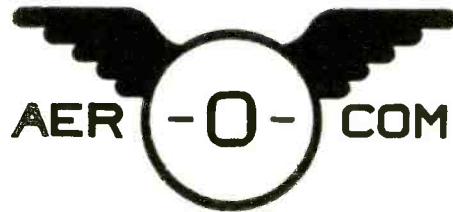

## **DEFINITELY DEPENDABLE!**

# **Aerocom's Dual Automatic Radio Beacon**

Reliability is built into every part of this dual 1000-watt aerophare unit. Ruggedly constructed and conservatively rated, it provides trouble-free unattended service, and at truly low operating and maintenance cost. It operates in the frequency range 200-415 kcs, using plug-in crystal for desired frequency.

Uses single phase power supply, nominal 220 volts, 50 or 60 cycles. Consists of two 1 kw transmitters with keyer (2 keyers if desired), automatic transfer unit and weatherproof antenna tuner. Each transmitter housed in separate standard rack cabinet, with controls in rack cabinet between the transmitters.

Nominal carrier power is 1000 watts. High level plate modulation of final amplifier is used, giving 30%-35% tone modulation. P-T switch interrupts tone, permitting voice operation. Operates in ambient temperatures from  $-35^{\circ}\text{C}$  to  $50^{\circ}\text{C}$ , humidity up to 95%.

Standby transmitter is placed in operation when main transmitter suffers loss (or low level) of carrier power or modulation, or continuous (30 sec.) tone. Audible indication in monitoring receiver tells when standby transmitter is in operation.

Antenna may be either vertical tower or symmetrical T type.

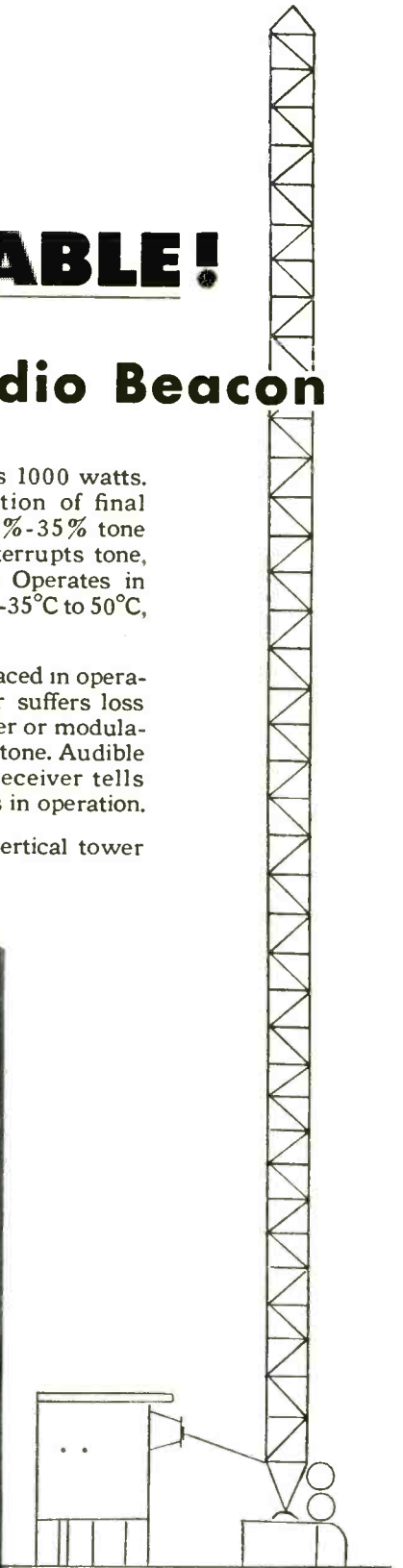
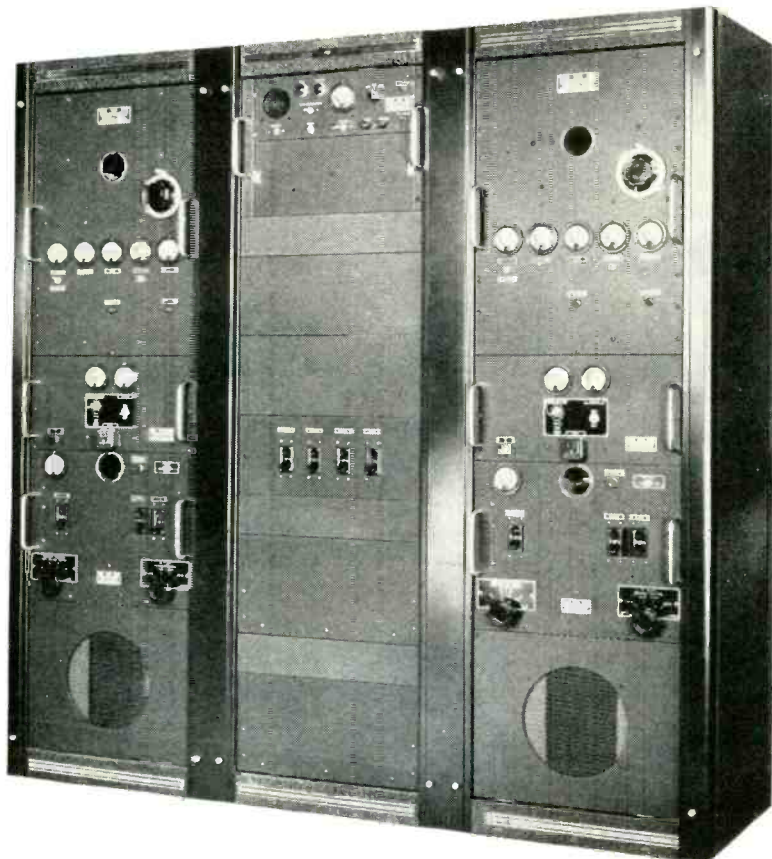

A-101

**3090 S. W. 37th AVENUE • MIAMI, FLORIDA**



# MOUNTING DIMENSIONS OF AIRPAX CHOPPERS

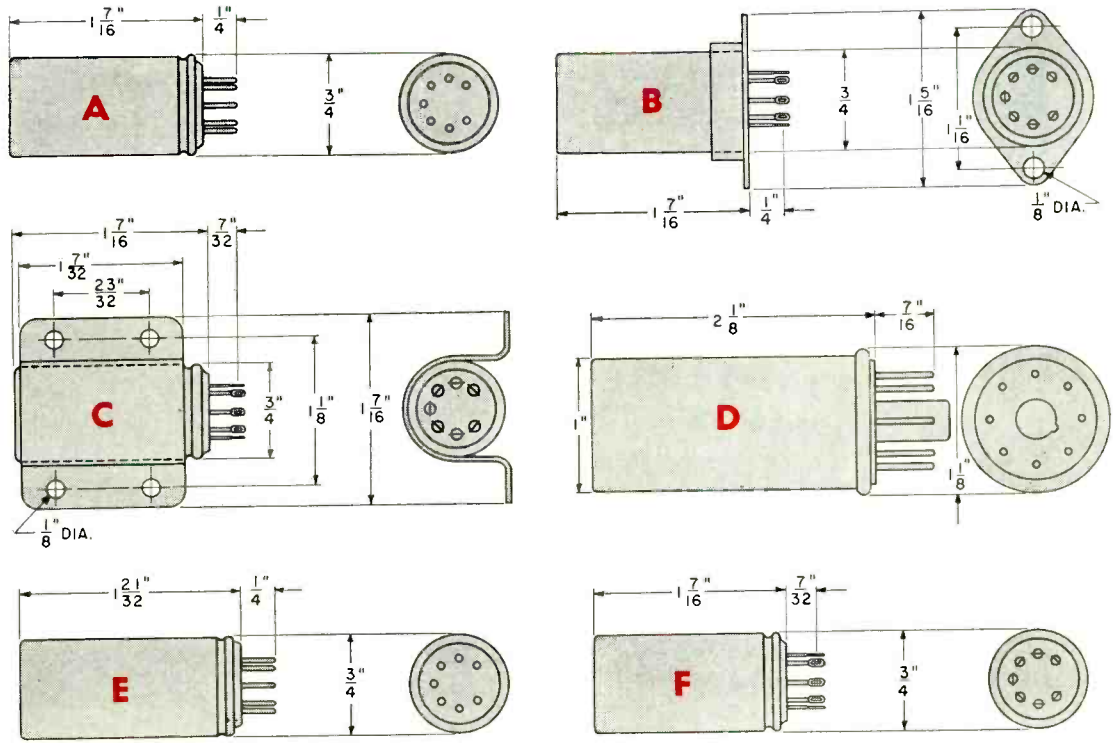

Type	Drive	Frequency	Dwell	Balance	Phase	Temperature	Noise	Contacts	Drawing	
150	6.3	400 ± 20	140 ± 25	15	65 ± 25	- 55 to + 200	3.0P-P	100v, 1ma	A	
170	6.3	60 ± 6	167 ± 10	10	20 ± 5	- 65 to + 100	0.1RMS	100v, 1ma	D	
175	6.3	60 ± 6	167 ± 10	10	20 ± 5	20	0.1RMS	100v, 1ma	A	
300	6.3	400 ± 20	147 ± 18	15	65 ± 15	- 65 to + 100	1.5P-P	100v, 2ma	A	
302	6.3	400 ± 20	147 ± 18	15	65 ± 15	- 65 to + 100	1.5P-P	100v, 2ma	C	
303	6.3	400 ± 20	147 ± 18	15	65 ± 15	- 65 to + 100	1.5P-P	100v, 2ma	B	
304	6.3	400 ± 20	147 ± 18	15	65 ± 15	- 65 to + 100	1.5P-P	100v, 2ma	F	
747	6.3	400 ± 20	140 ± 25	15	65 ± 15	- 40 to + 85	1.0RMS	100v, 1ma	E	
747A	115	applied through external circuit to produce zero phase angle								
		400 ± 20	140 ± 25	15	0 ± 15	- 40 to + 85	1.0RMS	100v, 1ma	E	

**TYPE** number with letter prefix designates a chopper identical to type of same number without prefix. For example, Type A-100 is same as Type 100.

**DRIVE** is rated drive coil voltage in volts RMS; normal tolerance is ± 10%.

**FREQUENCY** is rated drive frequency in CPS with tolerance also given in CPS.

**DWELL, BALANCE, and PHASE** are expressed in electrical degrees of the drive frequency; tolerance is also in electrical degrees.

**TEMPERATURE** is operating range in degrees Centigrade over which performance is within specified tolerances.

**NOISE** is in millivolts peak-to-peak (P-P) or in millivolts RMS produced across one megohm into a circuit having a bandwidth from 20 CPS to 50 KC.

**CONTACTS** are rated for operation with any voltage and current up to the limits given.

**DRAWING** shows outline of chopper and nominal mounting dimensions in inches.

For complete specifications write to



MIDDLE RIVER

BALTIMORE 20, MD.

**MICRO SWITCH Precision Switches**  
A PRINCIPLE OF GOOD DESIGN

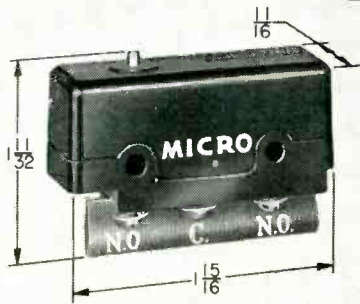

Double-pole,  
double-throw  
basic switch

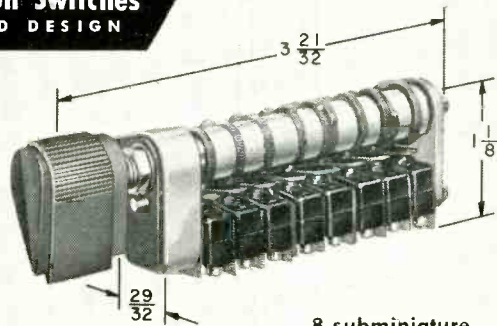

8 subminiature  
SPDT switches with rotary selector actuator

**Here are 6 reliable  
precision switches  
for multiple circuit control**

Whether your requirement is a single switch to control one circuit or an assembly of switches to control many circuits you will find that MICRO SWITCH engineering keeps pace with your needs.

Pictured here are just a few of the many small, sensitive, precision switches MICRO SWITCH has developed to meet specific applications. Push button, toggle and rotary actuators permit extreme versatility of design without any compromise with reliability.

Should your design call for special small switches for use with high temperatures, difficult environments, high inrush currents or unusual circuitry, for instance, MICRO SWITCH engineering can quickly put the proper switch in your hands.

Call MICRO SWITCH engineering today. You'll be glad you did. There are 20 branch offices to bring you quick, intelligent cooperation on every switch problem. There is no obligation.

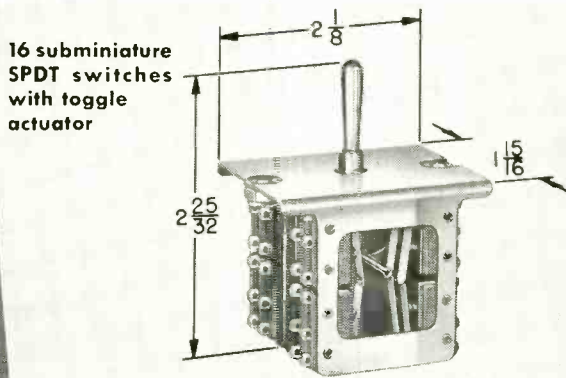

16 subminiature  
SPDT switches with toggle  
actuator

Two-circuit  
double-break switch

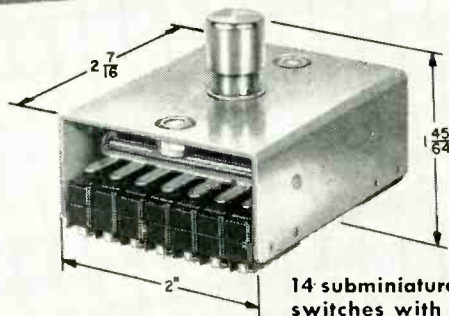
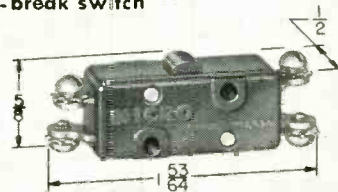

14 subminiature SPDT  
switches with single  
push button actuator

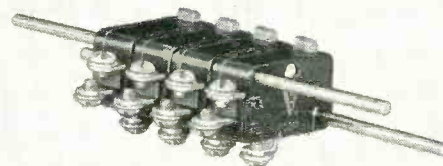

High capacity "V3" switches  
(may be gang-mounted)



A complete line of snap-action and mercury switches

MICRO SWITCH provides a complete line of extremely reliable, small-size, high-capacity, snap-action precision switches and mercury switches. Available in a wide variety of sizes, shapes, weights, actuators and electrical characteristics. For all types of electrical controls.

**MICRO SWITCH**

A DIVISION OF MINNEAPOLIS-HONEYWELL REGULATOR COMPANY

In Canada, Leaside, Toronto 17, Ontario • FREEPORT, ILLINOIS



where 99.9% reliability  
isn't enough—

# Vitrohm resistors take over



## There are cases where you can't play it too safe

In ground-to-air guided missiles, high-powered walkie talkies, radar trucks, experimental rockets, atomic subs, console control panels—any instrument requiring high accuracy and dependability—you'll find Ward Leonard Vitrohm resistors.

You'll also find them in hundreds of commercial and industrial applications where the variety, performance, and uniformity of Vitrohm resistors have added up to

increased customer satisfaction, repeat sales and substantial savings on repairs and returned merchandise.

FOR MILITARY APPLICATIONS, the Vitrohm resistors designed to meet MIL-R-26B specs (characteristics F, G and V) are listed in our TECHNICAL INFORMATION CIRCULAR #1.

FOR ELECTRICAL AND ELECTRONIC APPLICATIONS, our 64-page fact-jammed Catalog #15 gives you the complete Vitrohm story. Write Ward Leonard Electric Company, 31 South Street, Mount Vernon, N.Y.



**WARD LEONARD  
ELECTRIC COMPANY**  
MOUNT VERNON, NEW YORK



RHEOSTATS



RESISTORS



RELAYS



MOTOR CONTROLS



DIMMERS



CHROMASTER

**Result-Engineered Controls Since 1892**

# need quick service on **TIMERS** for automatic control?

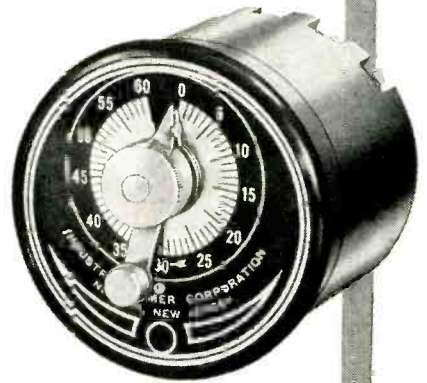

Time Delay Timers

**T**he more automatic control problems we get, the better we like it. For while it's true each automatic control job is a bit different from the rest, the record shows that our 19 years of timer experience has given us the special knowledge it takes to give you the right answers, and in near-record time.

If one of our standard timers won't do your job — or one of the 721 combinations we have thus far developed from our 17 basic units — our engineers will go right to work to develop a new combination that's the one for you. That's the way we grow — and we like it.

We manufacture a complete line of timers in these 4 broad classifications:

**TIME DELAY TIMERS • INTERVAL TIMERS  
RE-CYCLING TIMERS • RUNNING TIME METERS**

And since we maintain large stocks of our 17 basic units, we can assure you of rapid deliveries — of excellent deliveries even on special orders. So whatever your automatic control problem, you have everything to gain by submitting it to our timer specialists. They'll give you a profitable answer — almost with the speed of automatic control itself.



Interval Timers

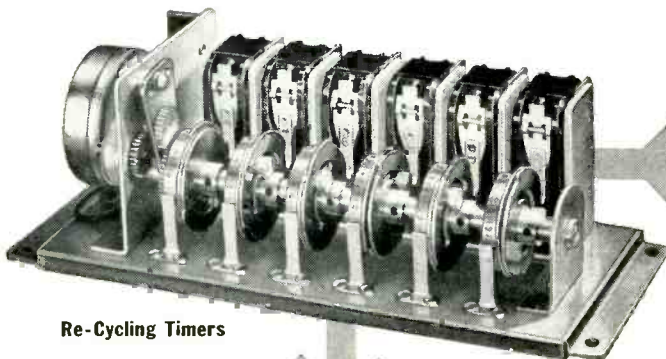

Re-Cycling Timers

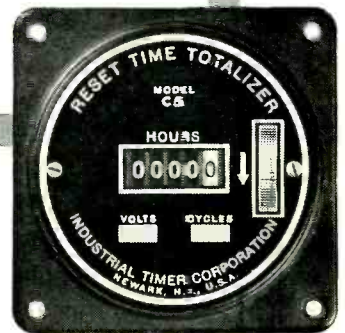

Running Time Meters

*Timers that Control  
the Pulse Beat of Industry*



**INDUSTRIAL TIMER CORPORATION**  
131 OGDEN STREET, NEWARK 4, N. J.



# NEW GERMANIUM POWER RECTIFIERS REDUCE VOLUME AND WEIGHT 75%



TYPE  
4JA3011



...and actually cost less!

## GERMANIUM POWER RECTIFIERS

Ratings to  
**85°C**

Because of the higher efficiency of germanium, these new G-E rectifiers achieve a full 75% saving in size and weight—and yet actually cost less than any conventional type dry rectifier in use today. This sharply-reduced weight and volume is a result of greatly-increased power per cell in G.E.'s unique low-loss rectifier.

*Compare and see!* For new efficiency in your 1955 designs go the limit with new G-E Germanium Power Rectifier. Tell your rectification problem to the G-E application engineer—write today to: *General Electric Company, Semiconductor Products, Section X-485, Electronics Park, Syracuse, New York.*

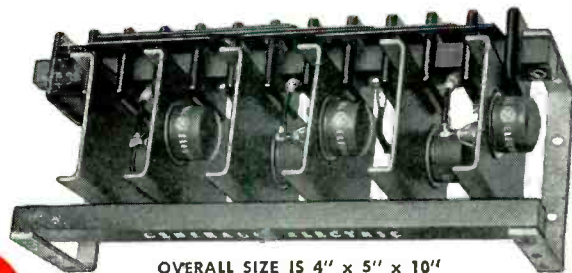

OVERALL SIZE IS 4" x 5" x 10"

### NOW AVAILABLE IN PRODUCTION QUANTITIES

These rectifiers are available in standard combinations consisting of one or more rectifying elements. A few of the typical ratings are listed below.

CIRCUIT	D-C OUTPUT AT 55°C (Resistive Load)
Half Wave	24 amps @ 60 V
	12 amps @ 94 V
	8 amps @ 140 V
Full Wave Center Tap	24 amps @ 60 V
	10 amps @ 140 V
Full Wave Bridge	10 amps @ 125 V
Three-Phase Half Wave	17.8 amps @ 93 V
	11.2 amps @ 139 V
Three-Phase Bridge	11.2 amps @ 188 V

Be "money-wise" and  
"pound-wise" too, with these  
stand-out design features:

- Weight and volume reduced 75%
- Rectifier losses have been reduced to 1/3 or less
- No forward aging effects...no need for age-compensating devices

*Progress Is Our Most Important Product*

**GENERAL**  **ELECTRIC**

U. S. TIME IS NOW DELIVERING IN VOLUME  
ITS NEW MODEL . . .

## SUBMINIATURE PRECISION RATE GYROSCOPES

To Leading Aircraft Companies For Use in Production of Guided Missiles,  
Autopilots, Antenna Stabilization, Fire Control, and Target Drones.

THE WORLD'S SMALLEST—LIGHTEST—MOST RUGGED

Developed by

### SANDERS ASSOCIATES

- Long Life
- Hermetically Sealed
- High Natural Frequency
- Available in Rate Ranges From 40°/Sec. Up.

Motor excitation . . . . . 26 or 6.3V, 400 Cps.  
Damping . . . . . as required  
Starting time . . . . . 15 seconds  
Resolution . . . . . well below earth's rate  
Dynamic range . . . . . 100,000:1  
Linearity . . . . . 0.1% to half scale  
Nominal Full Scale Output . . . . . 5.6 Volts  
Oper. Temperature Range . . . . . -55° to +85°C

Rugged construction enables this gyro to withstand a wide range of environmental conditions in accordance with military specifications.

Performance characteristics of the Gyro can be modified in event one of our standard models does not fulfill your specific requirements.



During the past 14 years U. S. Time has produced more than 327,000 gyroscopes of various types at peak rates of 17,000 per month.

#### STANDARD MODELS NOW AVAILABLE IN PRODUCTION QUANTITIES

Direct inquiries to  
U. S. Time, 500 Fifth Ave., New York, N. Y.

## The United States Time Corporation

Main Plant—Waterbury, Conn. Branches—Little Rock, Ark.; Abilene, Texas; Toronto, Canada; Dundee, Scotland

if  
you  
need to **control heat**



it'll pay you to look into

# Adlake mercury relays

Adlake relays require no maintenance whatever...are quiet and chatterless...free from explosion hazard...dust, dirt, moisture and temperature changes can't affect their operation. Mercury-to-mercury contact gives ideal snap action, with no burning, pitting or sticking. Time delay characteristics are fixed and non-adjustable.



**The Adams & Westlake Company**  
Established 1857 ELKHART, INDIANA • New York • Chicago

the original and largest manufacturers of mercury plunger-type relays



# 3 NEW PRODUCTS

## For Special Applications

For current limiting and for obtaining lagging power factors without wave distortion specify —



### NWL Air Core Reactors

Capacity of 1/4 to 2000 Amperes and 25 to 400 cycles.



For the lowest possible capacitance and non-resonating peaks specify —

### NWL Radio Frequency (R. F.) Chokes

Available in sizes of 1 ampere and larger. In illustration at left terminal is not shown.

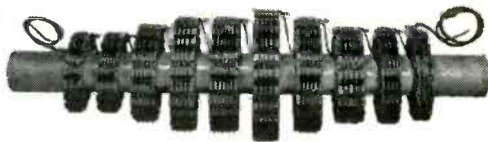

For reduced internal capacitance and better coupling specify —

### NWL Audio Transformers

Transformer shown at left has a range of 5 to 2000 cycles, a capacity of 3.6 KW at 60 cycles, and high voltage windings. Illustration shows sandwiching of the high voltage coils between secondary windings. Available from 2 to 15 KW and up to 10 KV in dry type transformer.

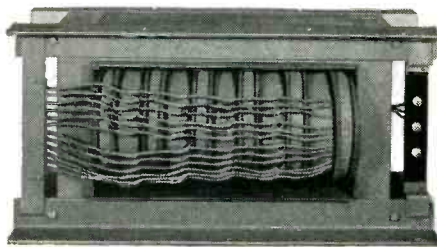

For over 30 years NWL has designed and manufactured custom transformers for every application. The three new transformers shown here are another example of our

constant expansion to serve new applications.

We are proud to have built our business by manufacturing one product — reliable custom transformers.



ESTABLISHED 1920



*Notkefer*

Write for complete information

**WINDING LABORATORIES, INC.**

P. O. Box 455, Dept. 102, TRENTON, N. J.

*hitch your missile to a star . . .*

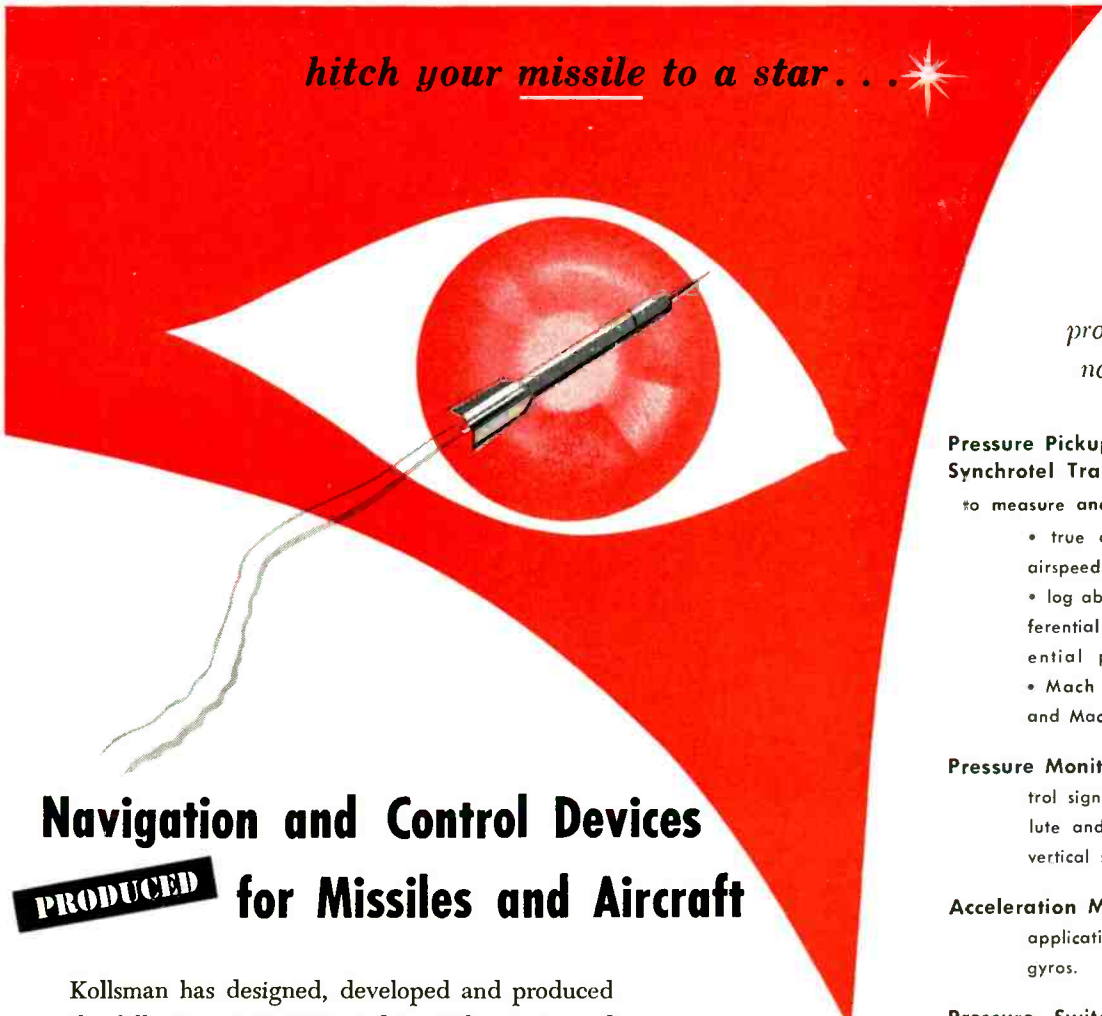

## Navigation and Control Devices

### **PRODUCED** for Missiles and Aircraft

Kollsman has designed, developed and produced the following navigation and control systems and components:

#### FOR NAVIGATION OR GUIDANCE

- CLASSIFIED** Photoelectric Sextants for remote semi-automatic celestial navigation.
- CLASSIFIED** Automatic Astrocompasses for precise automatic celestial directional reference and navigation.

**Photoelectric Tracking Systems** For many years Kollsman has specialized in high precision tracking systems.

**Periscopic Sextants** for manual celestial observations.

- CLASSIFIED** Computing Systems to provide precise data for automatic navigation and guidance, operated by optical, electromechanical, and pressure sensing components.

1955 WESCON  
AUGUST  
24 • 25 • 26

SAN FRANCISCO, CALIF.  
VISIT US IN  
BOOTHS 1621 • 1622

#### FOR CONTROL

*proven components  
now in production*

#### Pressure Pickups and Synchrotel Transmitters

- to measure and electrically transmit
- true airspeed • indicated airspeed • absolute pressure
  - log absolute pressure • differential pressure • log differential pressure • altitude
  - Mach number • airspeed and Mach number.

**Pressure Monitors** — to provide control signals for altitude, absolute and differential pressure, vertical speed, etc.

**Acceleration Monitors** — for many applications now served by gyros.

**Pressure Switches** — actuated by static pressure, differential pressure, rate of change of static pressure, rate of climb or descent, etc.

**Motors** — miniature, special purpose, including new designs with integral gear heads.

#### SPECIAL TEST EQUIPMENT

optical and electromechanical for flight test observations.

*Please write us concerning your  
specific requirements in the field of missile  
or aircraft control and guidance.*

*Technical bulletins are available  
on most of the devices mentioned.*



**kollsman** INSTRUMENT CORPORATION

80-10A 45th AVE., ELMHURST, NEW YORK • GLENDALE, CALIFORNIA • SUBSIDIARY OF *Standard* COIL PRODUCTS CO. INC.

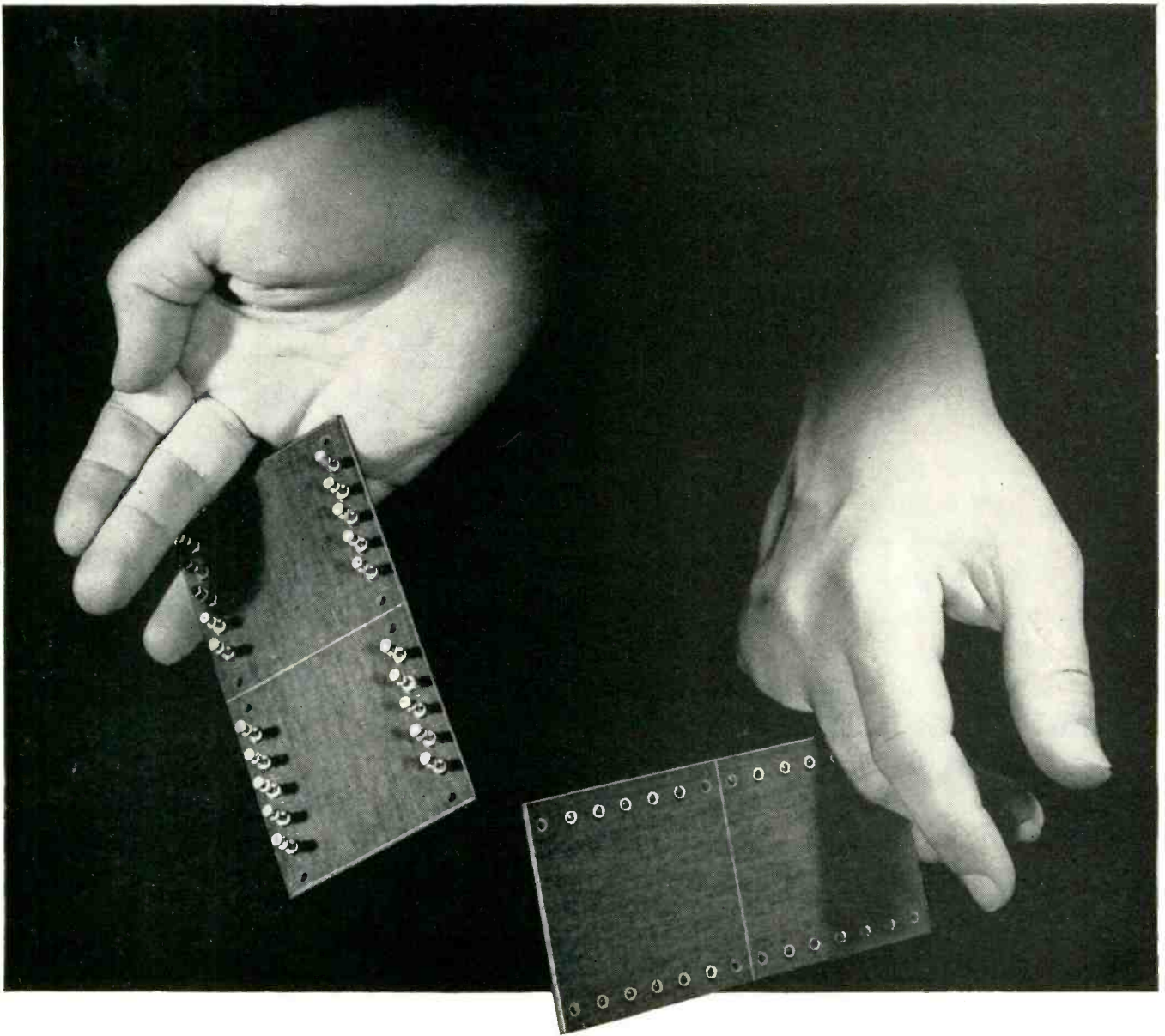

## No cracks, please

You'll find no radial cracks in CTC terminal boards, or "cracked" rivet shanks on terminals. And there's a good reason for this.

Our swaging machines use tools that we designed ourselves in order to prevent just such damage. Terminals are fastened securely — *and carefully*. You benefit from a board that has no "weak spots" — that can give you the service you have a right to expect. And, of course, you also benefit from all the other quality control details that enable us to offer our customers *guaranteed* components — custom or standard. Coatings are smoothly applied — no wrinkles, no heavy deposits. C.T.C. terminals are made from certified stock that is free from defects. And the terminals themselves are guaranteed, even to the thickness of the coatings.

This C.T.C. quality control is given to all C.T.C. products including insulated terminals, coil forms, coils, swagers, terminals and capacitors. For all specifications and prices, write to

Cambridge Thermionic Corporation,  
437 Concord Avenue, Cambridge 38,  
Mass. West Coast manufacturers contact:  
E. V. Roberts, 5068 West Wash-  
ington Blvd., Los Angeles 16 and 988  
Market St., San Francisco, California.

*Terminal Board Data.* CTC makes both standard boards and to your own specifications. Standard boards in cotton fabric phenolic, nylon phenolic or grade L-5 silicone impregnated ceramic. Custom made in cloth, paper phenolic, melamine, epoxy or silicone fibreglas laminates, imprinted as required and lacquered or varnished to specifications MIL-V-173 and JAN-T-152.

See us at Booth 162 WESCON

# CTC

**CAMBRIDGE THERMIONIC CORPORATION**

*makers of guaranteed electronic components,  
custom or standard*

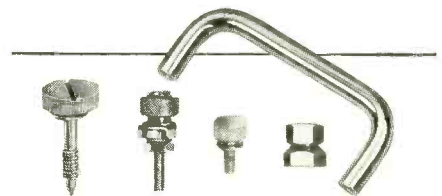

*A wide variety of hardware is available at C.T.C. — all of it quality controlled and guaranteed for durability. This hardware includes terminal board brackets, standoff mounts, spacers, tube clamps, panel screws, thumb screws, dial locks, shaft locks, handles and handle ferrules.*

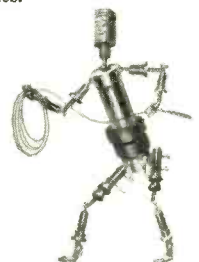



← this mark  
means: "Registered  
U.S. Patent Office."

**SINTERCOTE** <sup>®</sup>

← placed  
after a  
word, like this,  
it identifies a  
registered trademark.



these  
marks together  
mean Los Gatos

Electron Tubes, the  
finest you can get. They  
have Sintercote <sup>®</sup> black-body  
anodes and give truly  
amazing service life. Get  
them from your jobber or  
Lewis and Kaufman Ltd., Los  
Gatos, California. Radio Valve Co.  
distributes them in Canada,  
Minthome International Co. of  
New York exports them.

# This Small Counter Does a Whale of a Big Job!...

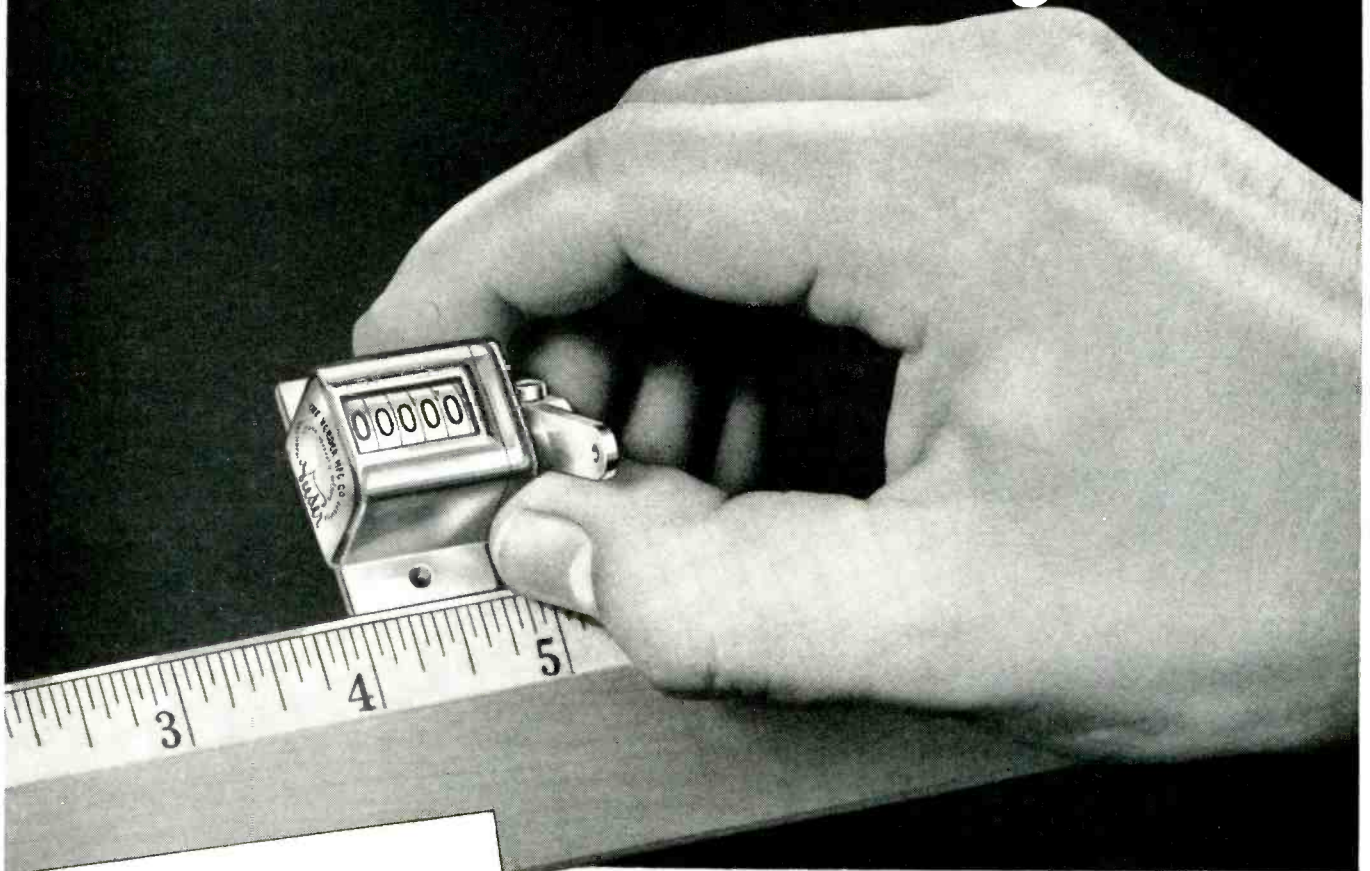

*Added Evidence  
that —*

## Everyone Can Count on **VEEDER-ROOT**

For its size . . . *less than one inch square* . . . this Veeder-Root Small Square-Case Counter is the most rugged instrument of its type, with the longest accurate life. And only Veeder-Root makes it this way . . . square all the way through . . . extra strength built-in, with bearing surfaces on *both* ends of the drive shaft.

What's more, this counter is 100% American . . . made by Connecticut craftsmen to unmatched

standards of quality and precision. And it's the "counter of countless uses" . . . built into everything from office machines and cameras to taxi meters and voting machines. Now what do *you* make that could count its way to bigger sales and profits with a Small Square-Case Counter built-in as a standard part? Write:

**VEEDER-ROOT INCORPORATED  
HARTFORD 2, CONNECTICUT**

Chicago 6, Ill. • New York 19, N. Y. • Greenville, S. C.  
Montreal 2, Canada • Dundee, Scotland  
Offices and Agents in Principal Cities



*"The Name  
that Counts"*



# New Waldes Truarc locking-prong ring functions as spring, shoulder, fastener... and **STAYS PUT!**

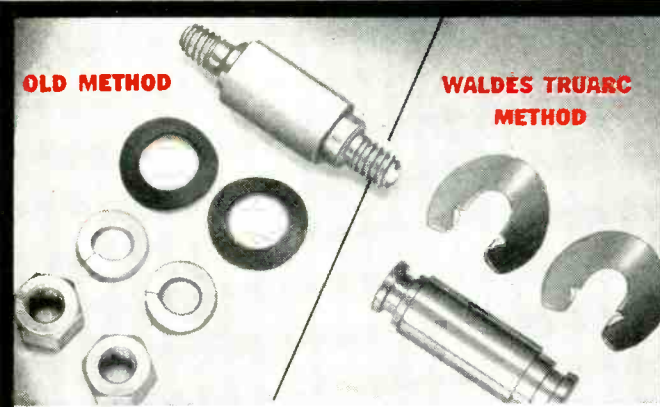

Above assembly shows how 2 Waldes Truarc Locking-Prong Rings (Series 5139) replaced 6 parts... eliminated threading operation... and need for skilled labor.

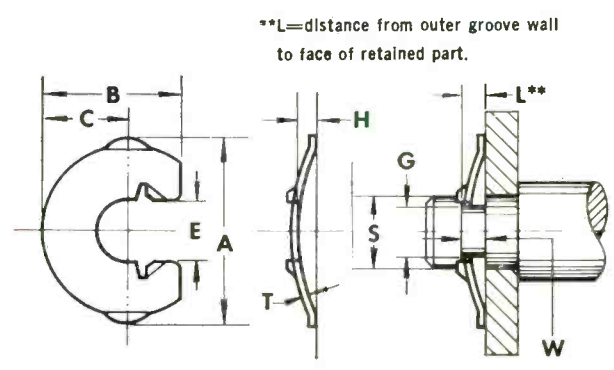

**WALDES TRUARC LOCKING-PRONG RING (Series 5139)**  
U. S. Pat. Pending

Ring No. 5139	SHAFT		RING DIMENSIONS										average ultimate shear strength lbs.*	GROOVE DIMENSIONS					resilient end play take up L max - L min			
	Dia. S	tol.	A	tol.	B	tol.	C	tol.	E	tol.	H	tol.		T†	tol.†	Dia. G	tol.	Width W		tol. - .000	L min.	L max.
12	.125	±.002	.340	±.010	.307	±.010	.166	±.005	.086	±.004	.050	±.010	.010	±.0013	400	.082	±.0015	.045	+-.005	.035	.045	.010
★ 15	.156	±.003	.380	±.010	.330	±.010	.184	±.005	.108	±.004	.055	±.010	.010	±.0013	600	.104	±.002	.050	+ .005	.035	.045	.010
18	.188	±.003	.445	±.010	.390	±.010	.213	±.005	.130	±.005	.060	±.010	.015	±.0015	900	.124	±.002	.065	+ .005	.045	.055	.010
25	.250	±.003	.581	±.010	.500	±.010	.280	±.005	.172	±.005	.070	±.010	.015	±.0015	1000	.165	±.002	.070	+ .005	.050	.065	.015
31	.312	±.003	.744	±.010	.620	±.010	.360	±.005	.234	±.005	.095	±.010	.018	$\frac{+.001}{-.002}$	1300	.228	±.003	.080	+ .005	.080	.095	.015
★ 37	.375	±.003	853	±.015	.740	±.010	.427	±.005	.280	±.005	.130	±.010	.020	±.002	1900	.270	±.003	.105	+ .005	.090	.115	.025
★ 43	.438	±.003	.960	±.020	.820	±.020	.475	±.010	.337	±.010	.130	±.010	.020	±.002	2200	.327	±.003	.105	+ .005	.095	.120	.025

Additional Sizes Under Development      ★Production dies not available as of date of printing      †Applies to unplated rings only      \*Recommended safety factor = 3 to 4.

The Waldes Truarc Locking-Prong Retaining Ring is a new, low cost, radially applied fastener which can be locked positively in its groove and used as a shoulder against rotating parts. It is primarily intended for use in the automotive, electronic and aeronautical industries.

This radially applied ring locks positively in its grooves by means of two prongs at the open end. Because of its high thrust-load capacity the Waldes Truarc Locking-Prong Ring may be used as a shoulder against rotating parts. Its bowed construction provides for end-play take-up in the assembly and makes less critical the tolerances required for the parts being fastened. Since it serves as a spring as well as a shoulder, this ring eliminates the need for springs, washers, and other accessory fastening devices.

Whatever you make, there's a Waldes Truarc Retaining Ring

designed to improve your product...to save you material, machining and labor costs. They're quick and easy to assemble and disassemble, and they do a better job of holding parts together. Truarc rings are precision engineered and precision made, quality controlled from raw material to finished ring.

36 functionally different types...as many as 97 different sizes within a type...5 metal specifications and 14 different finishes. Truarc rings are available from 90 stocking points throughout the U. S. A. and Canada.

More than 30 engineering-minded factory representatives and 700 field men are available to you on call. Send us your blueprints today...let our Truarc engineers help you solve design, assembly and production problems...without obligation.

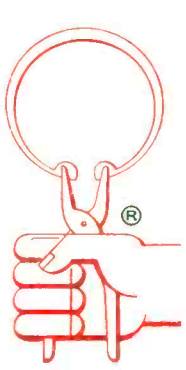

SEND FOR FREE SAMPLES

# WALDES TRUARC®

## RETAINING RINGS

Waldes Kohinoor, Inc., 47-16 Austel Place, L.I.C. 1, N.Y.

Please send me sample Locking-Prong Rings. (please specify shaft size \_\_\_\_\_)

Please send me supplement No. 1 which brings Truarc Catalog RR 9-52 up to date. (Please print)

Name \_\_\_\_\_

Title \_\_\_\_\_

Company \_\_\_\_\_

Business Address \_\_\_\_\_

City \_\_\_\_\_ Zone \_\_\_\_\_ State \_\_\_\_\_

E087

WALDES TRUARC Retaining Rings, Grooving Tools, Pliers, Applicators and Dispensers are protected by one or more of the following U. S. Patents: 2,382,948; 2,411,426; 2,411,761; 2,416,852; 2,420,921; 2,428,341; 2,439,785; 2,441,846; 2,455,165; 2,483,379; 2,483,380; 2,483,383; 2,487,802; 2,487,803; 2,491,306; 2,491,310; 2,509,081; 2,544,631; 2,546,616; 2,547,263; 2,558,704; 2,574,034; 2,577,319; 2,595,787. and other U. S. Patents pending. Equal patent protection established in foreign countries.

**NOW**

**39**

**TUNG-SOL**  
**"Series String"**  
**TV TUBES**

For Luxury-Set Performance  
in the Low-Price Field

This complete line of 600 milliamper tubes, recently augmented by eight *new* types, delivers the performance requirements of present circuit designs as well as any foreseeable new circuitry. Additional tube types are being developed continually.

Rigid standards of quality control insure the same dependable performance from these Tung-Sol Tubes as from the prototypes . . . Experienced Tung-Sol engineering is ready to help you achieve smooth, efficient production . . . Reliable *co-ordinated* deliveries are meshed to meet the exacting schedules of mass manufacturing . . . And your design plans are held in strict confidence.

For additional information, write to Commercial Engineering Department, Tung-Sol Electric Inc., Newark 4, New Jersey.

Sales Offices: Atlanta, Chicago, Columbus, Culver City, Dallas, Denver, Detroit, Montreal (Canada), Newark, Seattle.



**TUNG-SOL "SERIES STRING" TV TUBES**

2AF4	3BZ6	5U8	12B4A
3AL5	3CB6	5V6GT	12BH7A
3AU6	3G56	6AU7	12BQ6GT
3AV6	4BQ7A	6AU8	12BY7A
3BA6	4BZ7	6AX7	12GA5
3BC5	5AM8	6CG7	12L6GT
3BE6	5AN8	6S4A	12W6GT
3BF6	5AQ5	6SN7GTB	19AU4
3BN6	5BK7A	7AU7	25CD6GA
3BY6	5T8	12AX4GTA	

*Tung-Sol also produces aluminized picture tubes for series string sets.*



**TUNG-SOL** RADIO • TV TUBES  
 DIAL LAMPS



Miniature Lamps

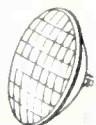

Sealed Beam Headlamps



Signal Flashers



Radio And TV Tubes



Aluminized Picture Tubes



Special Purpose Tubes



Semiconductors

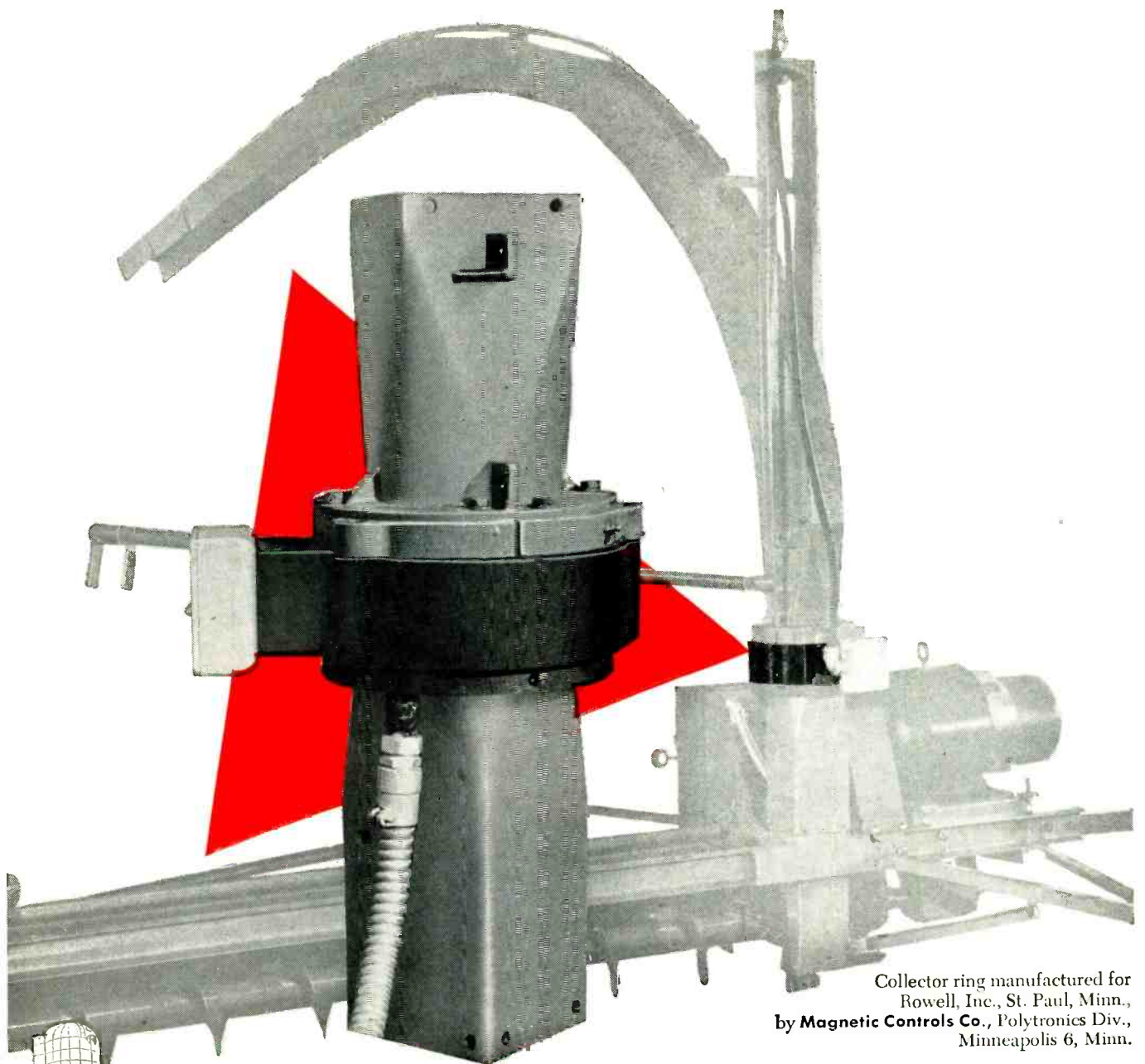

Collector ring manufactured for  
Rowell, Inc., St. Paul, Minn.,  
by **Magnetic Controls Co.**, Polytronics Div.,  
Minneapolis 6, Minn.

## Silo Unloader Collector Ring Brushes Embedded in Epoxy Resin



Electrically powered, this silo unloader revolves over the silage surface, its long augured arm collecting and mixing the corn or grass and discharging it through the gooseneck.

Central point of all this activity is the collector ring, an embedment of copper rings in **BAKELITE** Brand Epoxy Resins reinforced with glass fibers. Here is where power is supplied to the motor while the entire frame rotates. Strong and tough, the resin holds the rings firmly in place, safe from moisture, ice, and dust.

The ring's simple construction, and smooth, dependable operation in any weather are all important factors in farm equipment. They are important in other electrical applications, too.

That's why you'll find **BAKELITE** Epoxy Resins used so widely for potting and encapsulating. They pour as a liquid, cure at room or moderately elevated temperatures, have excellent dielectric and adhesive properties and resist moisture, oils, grease, chemicals, most acids and alkalis. Find out more about them by writing Dept. JF-50.



**BAKELITE COMPANY**, A Division of Union Carbide and Carbon Corporation  30 East 42nd Street, New York 17, N. Y.  
The term **BAKELITE** and the Trefail Symbol are registered trade-marks of UCC

# MAGNETIC TAPE RECORDING

helps **Road-Test** Timken Truck Axles

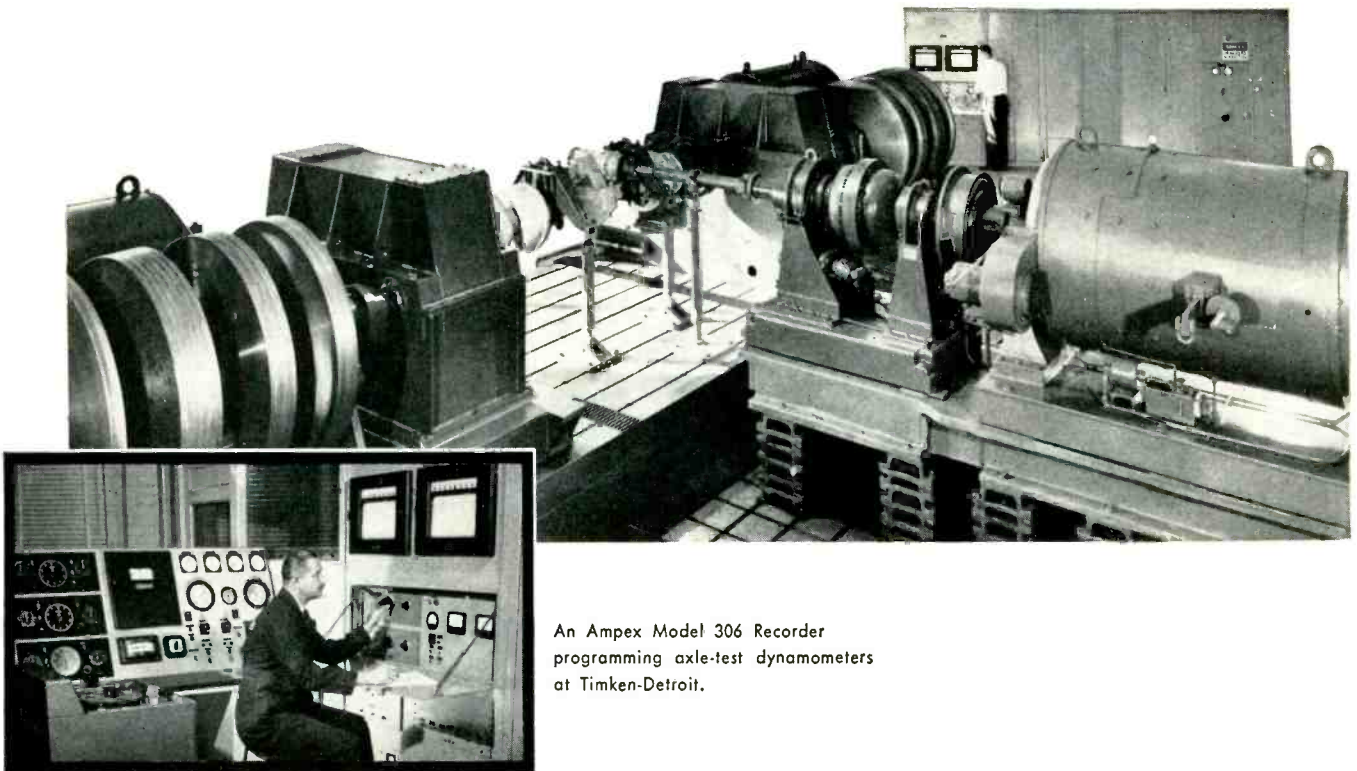

An Ampex Model 306 Recorder programming axle-test dynamometers at Timken-Detroit.

Magnetic tape recordings are now being used to duplicate rugged road-tests at the Timken-Detroit Axle Division of the Rockwell Spring and Axle Company, Detroit, Michigan. A four hour tape cycle is made of actual road surface and driving conditions . . . then played back through torque and speed dynamometers — repeatedly — until a test axle breaks down. Result: more realistic and efficient testing — better axles for today's trucks, buses and trailers.

## WHY TIMKEN CHOSE AMPEX

Timken engineers required a recording and playback medium that could give near-perfect reproduction of the original road test phenomena . . . and would playback indefinitely without introducing errors through wear and speed irregularities. They found that the Ampex F-M recorder best met these exacting requirements. Its extreme stability of tape motion, precise timing and consistent accuracy produced laboratory "road-test" results within 1% of actual conditions.

## LET AMPEX STUDY YOUR REQUIREMENTS

Ampex manufactures the most complete line of magnetic recorders for complex and sensitive automation, communication and data-handling systems. Why not let Ampex application engineers determine what magnetic tape recording can do for you?



For further information, send for our 16-page illustrated bulletin, "Data Recording, Machine Control and Process Regulation." Contact your nearest Ampex representative or write to Dept. E-1897

**AMPEX**  
CORPORATION

ANOTHER APPLICATION BY THE INSTRUMENTATION DIVISION OF

AMPEX CORPORATION • 934 CHARTER STREET, REDWOOD CITY, CALIFORNIA

Branch Offices: New York; Chicago; Atlanta; San Francisco; College Park, Maryland (Washington D.C. area).  
Distributors: Radio Shack, Boston; Bing Crosby Enterprises, Los Angeles; Southwestern Engineering & Equipment, Dallas and Houston; Canadian General Electric Company, Canada.

# Simplify power measurement!

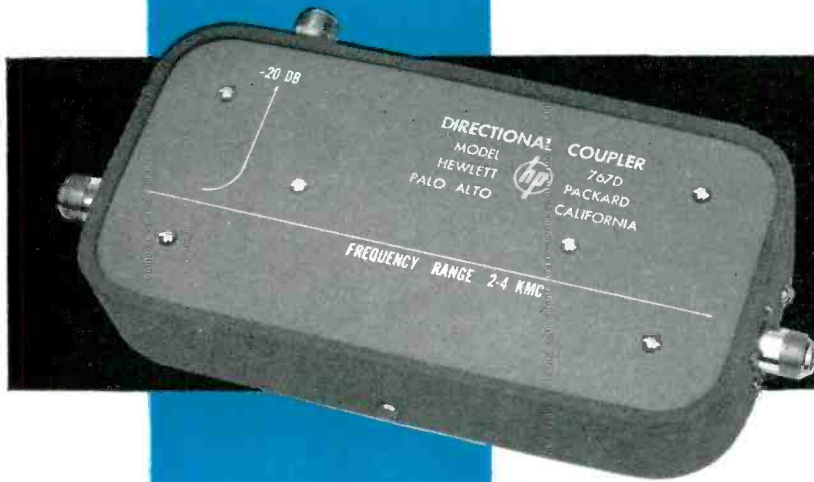

## NEW -hp- 767D COAXIAL DIRECTIONAL COUPLER

Here is a new Coaxial Directional Coupler from Hewlett-Packard that simplifies virtually all your power measurements in the important 2 to 4 KMC range.

The new -hp- 767D permits direct monitoring of powers in coaxial setups. When used with -hp- 477A Coaxial Thermistor Mount and -hp- 430C Microwave Power Meter, powers up to 1 watt can be measured; or with an added output attenuator, measurements can be made up to 30 watts, the CW rating of the -hp- 767D. With a coaxial crystal mount and oscilloscope, Model 767D provides a convenient means of monitoring modulation.

-hp- 767D is a four-terminal precision coupler, with one terminal of the secondary arm equipped with a built-in, replaceable terminating resistor. The coupler is housed in a sturdy, lightweight metal case finished in grey enamel.

### SPECIFICATIONS

- Frequency Range:** 2 to 4 KMC
- Coupling Attenuation:** 20 db
- Coupling Accuracy:** Better than  $\pm 1$  db full range
- Directivity:** At least 20 db
- Power Capacity:** 30 watts CW max., 10 Kw peak max.
- Connectors:** Female Type N jack.
- Primary arm SWR:** Less than 1.3
- Size:** 5½" wide, 10⅞" long, 1⅝" deep;  
Weight: 2 lbs.
- Price:** \$100.00

Data subject to change without notice. Prices f.o.b. factory.

### HEWLETT-PACKARD COMPANY

3335A PAGE MILL ROAD • PALO ALTO, CALIFORNIA, U. S. A.  
Cable "HEWPACK"

Field Representatives in all principal areas

### -hp- POWER METER AND WAVEGUIDE COUPLERS

#### -hp- 430C MICROWAVE POWER METER



No computations! Provides instantaneous automatic power readings *direct* in dbm or mw at all frequencies for which there are suitable bolometer mounts. For CW measurements, uses either 1/100 amp. fuse or Sperry 821 barretter. Also measures CW or pulsed power with negative temperature coefficient thermistor. Provides up to 16 ma bias current. \$250.00

#### -hp- 477A COAXIAL THERMISTOR MOUNT

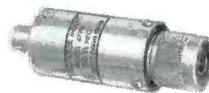

Provides accurate, efficient power measurement from 10 MC to 10 KMC. Fixed tuned, no time-consuming adjustments. SWR less than 1.5. Neg. temp. coefficient thermistors. Range 0.01 to 10 mw. \$75.00

#### -hp- 750 CROSS-GUIDE COUPLERS



For measuring powers up to 1 Kw with attenuator. Comprises two waveguide sections joined on broad faces, providing 4-terminal network. Models cover frequencies 2.6 to 12.4 KMC; coupling factors 20 or 30 db, coupling accuracy better than  $\pm 1.7$  db, directivity 20 db or more. \$100.00 to \$500.00



## ELECTRONIC MEASURING INSTRUMENTS



# DATA FOR



## NEW TEST INSTRUMENT ENABLES ACCURATE MEASUREMENT OF ELECTRON-TUBE TRANSCONDUCTANCE

**RCA-WT-100A MICROHMO METER** . . . unique in design, it makes possible the testing of tubes under actual operating voltage and current conditions. This feature permits direct correlation of test results with manufacturer's published data. Measures true transconductance, both control-grid-to-plate (gm) and suppressor-grid-to-plate. Also measures electrode currents: plate, suppressor-grid, screen-grid and control-grid; ac heater current; voltage drop across electron tubes, dry-disc rectifiers and crystal diodes.

**RCA-WT-100A** is a laboratory-quality instrument designed for production-line and laboratory testing, and circuit design engineering. The versatility and accuracy of the RCA-WT-100A closely approaches that of tube factory equipment for measuring transconductance.

The WT-100A features obsolescence-proof plug-in assemblies, switching for sockets with as many as 14 pins, burnout-proof metering, and electronically regulated, heavy-duty power supply.



## RCA "PREMIUM" TUBES FOR CRITICAL MILITARY APPLICATIONS

**RCA-OA2-WA** (Voltage Regulator), **OB2-WA** (Voltage Regulator), **5751-WA** (High-Mu Twin Triode), **5814-WA** (Medium-Mu Twin Triode), **5727/2D21-W** (Thyratron, Gas Tetrode), **5654/6AK5-W/6096** (Sharp-Cutoff Pentode) . . . six types recently added to the group of RCA "Premium" tubes produced under rigid quality-control standards. For government end use; supplied only against orders giving government contract number.

## HIGH-MU TRANSMITTING TRIODE IS TIME-PROVED RCA ORIGINAL



**RCA-833-A** . . . improved version of the 833 originally developed by RCA more than 15 years ago. The outstanding and continuing popularity of this tube is typical of the many time-proved transmitting, receiving, and special-purpose types originated, developed, and sponsored by RCA. The RCA-833-A is designed for use as an rf power amplifier, oscillator, or class B modulator. It has a maximum plate dissipation rating of 450 watts under ICAS operating conditions with forced-air cooling.

## FOR TECHNICAL INFORMATION . . .

Write RCA, Commercial Engineering, Section H-19-F, Harrison, N. J.  
Use this coupon. Circle types you are interested in.

6161 6383 6448 3RP1-A 6CM7 833-A WT-100A

Name \_\_\_\_\_

Position \_\_\_\_\_

Company \_\_\_\_\_

Address \_\_\_\_\_

Call your RCA representative:

**EAST** \_\_\_\_\_ HUmboldt 5-3900  
744 Broad St., Newark 1, N. J.

**MIDWEST** \_\_\_\_\_ WHitehall 4-2900  
Suite 1181, Merchandise Mart Plaza,  
Chicago 54, Ill.

**WEST** \_\_\_\_\_ MADison 9-3671  
420 S. San Pedro St., Los Angeles 13, Calif.

# DESIGNERS

**ELECTRON TUBES**  
**SEMICONDUCTOR DEVICES**  
**BATTERIES**  
**TEST EQUIPMENT**  
**ELECTRONIC COMPONENTS**

## GENERAL-PURPOSE 3" FLAT-FACE OSCILLOGRAPH TUBE

**RCA-3RP1-A** . . . has small, brilliant, focused spot and high deflection sensitivity for its relatively short length. The screen is of the medium-persistence, green-fluorescence type. This tube provides a trace having high brightness when operated with an ultor voltage near the maximum of 2500 volts, and good brightness at relatively low ultor voltage. The flat face facilitates use of an external calibrated scale and minimizes parallax in readings.

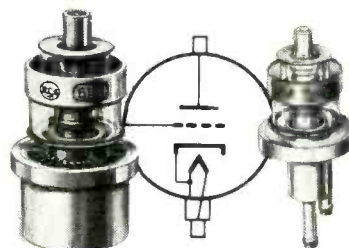
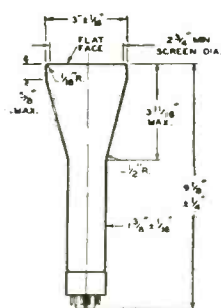

## TWO UHF POWER TRIODES FOR FREQUENCIES UP TO 2000 Mc

**RCA-6383** . . . liquid- and forced-air-cooled for UHF transmitter service. Has 600 watts plate dissipation and can be operated at full input ratings at frequencies up to 2000 Mc. **RCA-6161** . . . forced-air-cooled, with radiating fin construction. For UHF service in TV and cw applications. Has maximum plate dissipation of 250 watts. Operates at full input ratings up to 900 Mc, reduced ratings up to 2000 Mc. Both types for circuits of the coaxial cylinder type. Particularly suited for cathode-drive circuits. For service in aircraft and other applications where light weight, compactness, and high power output are prime design considerations.



## 12 KILOWATTS OUTPUT AT 900 Mc

**RCA-6448** . . . a water-cooled beam power tube with a unique design—is intended for operation as a grid-driven power amplifier at frequencies up to 1000 Mc. In color or black-and-white TV service, it is capable of delivering a synchronizing-level power output of 15 Kw at 500 Mc or 12 Kw at 900 Mc. The 6448 is also capable of giving useful power output of 14 Kw at 400 Mc or 11 Kw at 900 Mc as a cw amplifier in class C telegraphy service.

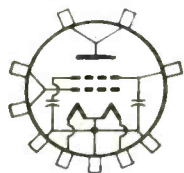

## NEW DUAL TRIODE WITH TWO DISSIMILAR UNITS

**RCA-6CM7** . . . a medium-mu dual triode of the 9-pin miniature type containing two dissimilar triodes in one envelope. Unit No. 2 is a high-perveance triode designed especially for use as a vertical deflection amplifier. Unit No. 1 is designed for use as a conventional blocking oscillator in vertical deflection circuits. The RCA-6CM7 also features a 600-milliampere heater with controlled warmup time, separate cathodes for the two units, and a basing arrangement which facilitates use in printed circuits.

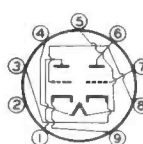

**RADIO CORPORATION of AMERICA**  
 TUBE DIVISION  
 HARRISON, N. J.

## AT YOUR SERVICE

over 2000 scientists, electrical engineers, chemists, physicists, mechanical engineers, mathematicians, designers, technicians and skilled craftsmen who have available over 400,000 square feet of laboratories and manufacturing plants.

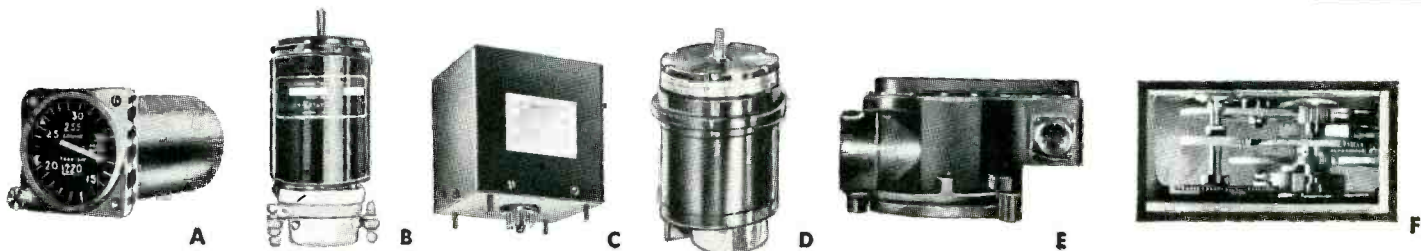

**Look to Norden-Ketay**—leader in research, design, development and mass production of SYNCHROS • SERVO MOTORS • DIGITAL CONVERTERS • RATE GENERATORS • RESOLVERS • MAGNETIC AMPLIFIERS • GEAR TRAINS • POTENTIOMETERS • NAVIGATIONAL SYSTEMS • FIRE CONTROL SYSTEMS • SERVO MECHANISMS • AIRBORNE INSTRUMENTS • BOMB DIRECTOR SYSTEMS • AIR DATA INSTRUMENTS • COMMUNICATION EQUIPMENT • COMPUTERS • PRESSURE GAUGES

# NORDEN-KETAY CORPORATION

99 Park Avenue, New York 16, New York

**RESEARCH & DEVELOPMENT LABORATORY:** *The Norden Laboratories, White Plains, N. Y.*

**MANUFACTURING DIVISIONS:** *Precision Components Division, New York, N. Y.  
Commack, Long Island, N. Y. • Hawthorne, California  
Instrument and Systems Division, Milford, Connecticut*

**SUBSIDIARIES:** *Nuclear Science and Engineering Corporation, Pittsburgh, Pa.  
Vari-obm Corp., Amityville, Long Island, N. Y.  
Scientific Specialties Corporation, Boston, Mass.*



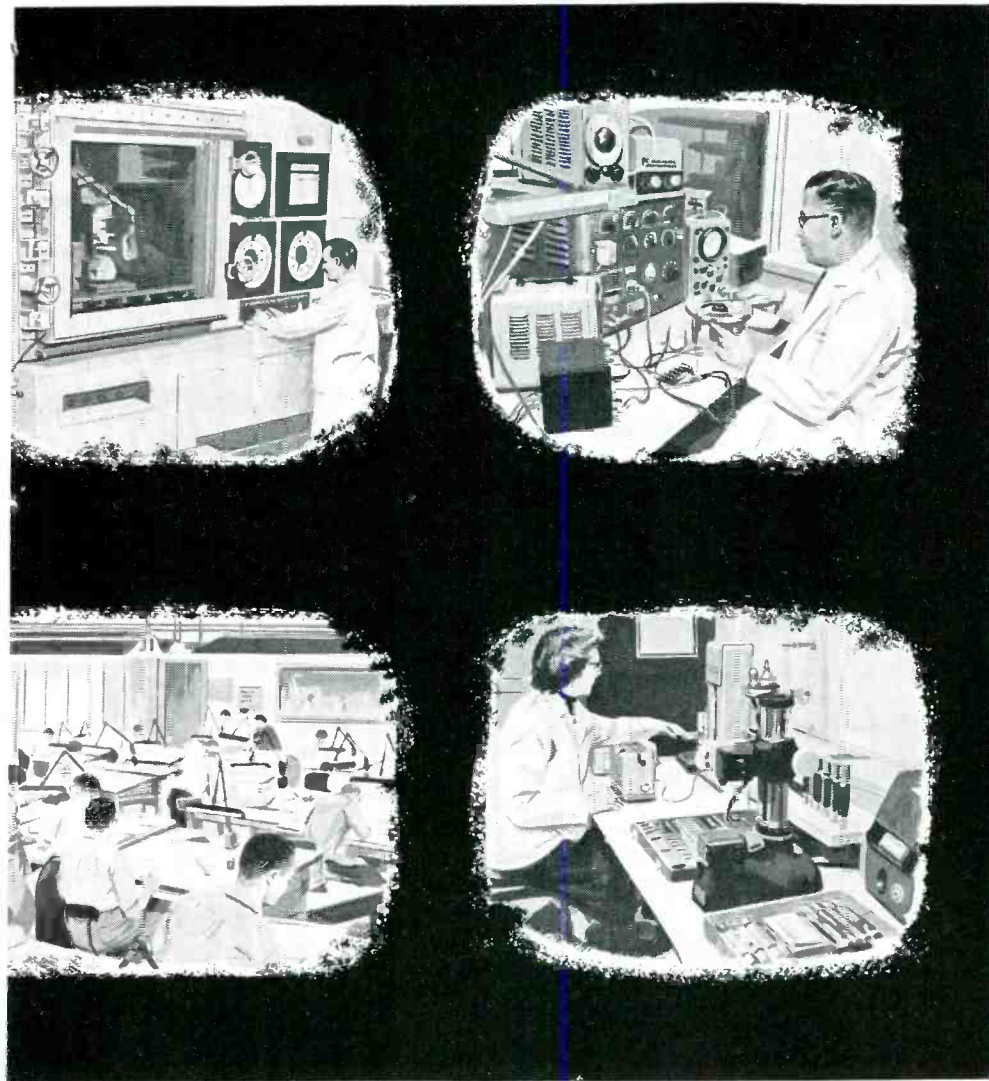

**A...Jet Engine Pressure Ratio Systems.** Noted for low weight, small size, accuracy, stability, sensitivity. Refer to Bulletin #361.

**B...Digital Converter.** Possible rate of 25,000 counts per minute, an unambiguous output of 13 binary digits in natural binary code. Refer to Bulletin #360.

**C...Magnetic and Electronic Amplifiers.** Open, dust-proof or hermetically sealed units. Either standard or to customer specifications. Write for specific data.

**D...Synchros, Servo Motors and Resolvers.** Specifications and characteristics of over 130 sizes and types are given in Bulletin #355.

**E...Fuel Flow Transmitters.** Major instruments, components, and systems for aircraft are available. Write for specific data.

**F...Gear Trains.** Conventional and miniaturized types for use with servo motors and synchros.

**G...Potentiometers.** Linear and non-linear, ten-turn potentiometers, single-turn continuous units and others are described in Bulletin #321.

**H...Acragage Bourdon Tube Gauges.** Pressure, vacuum and compound for the petroleum, chemical, and industrial field. AN types for aircraft. Refer to Bulletin #364.

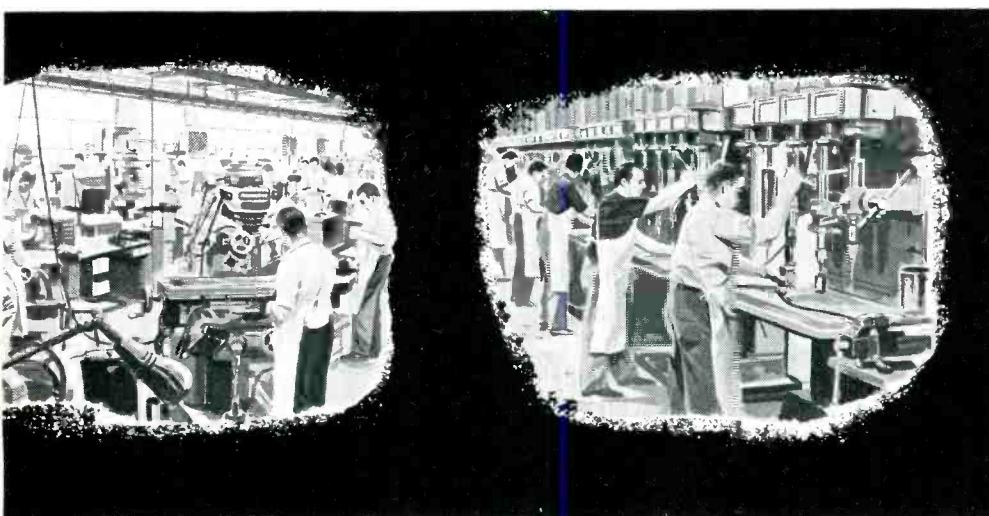
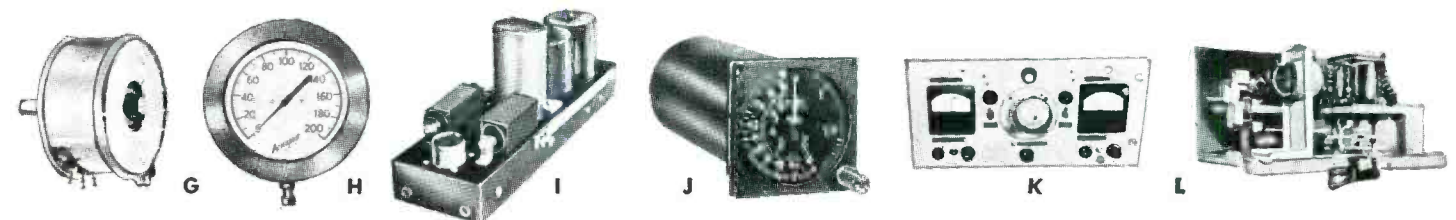

**I...Servomechanisms.** Made to meet extremes of temperature, humidity, and special configuration. Submit your requirements.

**J...Air Data Instrumentation.** Engineers are available to show how our experience in this field can help you in the solution of your problems.

**K...Marine Equipment.** Interior communication equipment, salinity indicators, engine order telegraphs, compass repeaters, and marine equipment. Write for specific data.

**L...Electro-Mechanical Assemblies.** Complete engineering and manufacturing facilities are available for sub-contracts of complete equipments.

From  
wrapping bread  
to  
launching  
missiles...

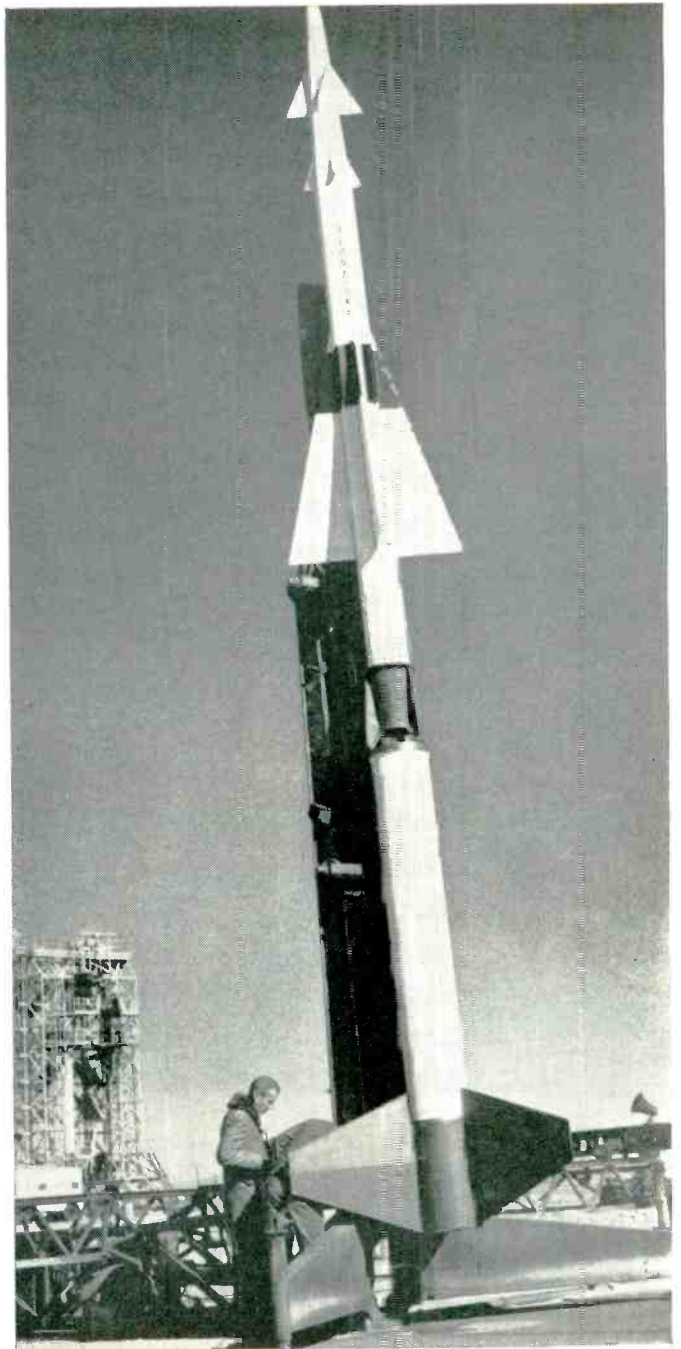
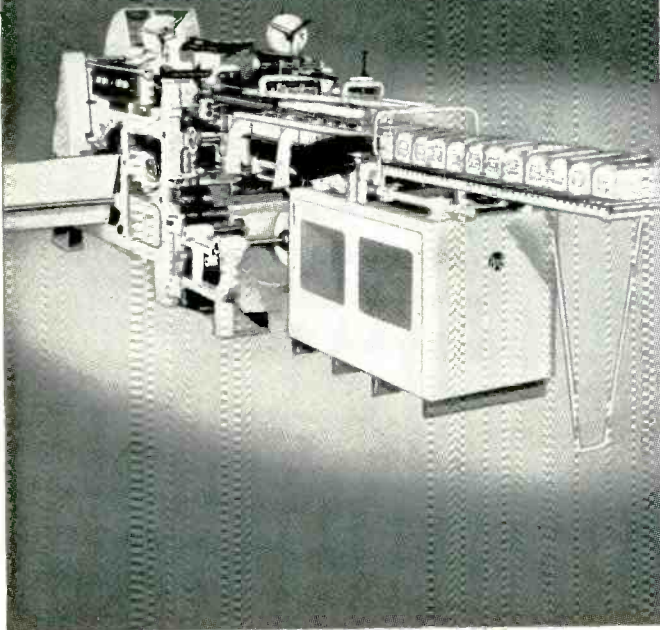

Designing and producing intricate bread-wrapping machinery, or developing guided-missile launching equipment... each demands advanced technology. And these are but two of the *hundreds* of complex tasks the AMF organization performs every day.

The highly specialized yet widely diversified activities of some 35 engineering and production

facilities provide AMF with a wealth of experience that covers nearly every field of industry. And it is immediately available to *you*.

Call upon AMF with your problem. See why this all-around experience in answering the needs of government and industry has made AMF the "can do" company.

## AMF HAS EXPERIENCE YOU CAN USE!



AMERICAN MACHINE & FOUNDRY COMPANY, Defense Products Group, 1101 N. Royal Street, Alexandria, Virginia  
Executive Offices—AMF Building • 261 Madison Avenue, New York 16, N. Y.



# High Voltage Comes of Age!

## Offers *Heavy-Duty* Industrial High Voltage Power Supplies

### The Basic

# 20

No Extras—Every safety and performance feature you need is standard equipment!

- Reversible polarity
- Adjustable over-current trip-out
- Adjustable over-voltage trip-out
- Three-range grounded voltmeter
- Three-range grounded milliammeter
- Automatic output-grounding switch
- Zero-start interlock—with bypass
- Double-interlock protection on doors
- Provision for auxiliary interlock
- Self-holding primary contactor
- Safety resistor in output lead
- Output continuously adjustable, 0 to 100%
- Low corona levels
- FF interference effectively suppressed
- Neon-gap protection on meters, relays
- Three-wire primary circuit
- Six pilot lamps indicate circuit status
- Blown-fuse indicators on all fuses
- All panel elements "dead-front" connected
- Meters are hand-calibrated to 2%

### Off The Shelf—We stock all 23 standard sizes!

Max. Output MA. DC	2.5	5	10	20	30	50	60	120	Max. Output Kilovolts DC
5		H-20 \$415	H-30 \$440	H-40 \$500	H-50 \$590	H-60 \$1,070		H-80 \$1,580	
10				H-41 \$660	H-51 \$740	H-61 \$1,240	H-71 \$1,440		
15						H-62 \$1,420			
20		H-23 \$500	H-33 \$625	H-43 \$900					
35		H-24 \$600			H-54 \$1,000				
50	H-15 \$560		H-35 \$800	H-45 \$1,020					
100	H-16 \$620	H-26 \$740	H-36 \$1,100						
200		H-27 \$900							

All units can be equipped at the factory with line-regulating input transformers and line filters. All units can be supplied with AC/DC output.

**Model H-50**—Highest output voltage in the air-insulated style. This rugged unit develops 0—30 KV at 0—5 ma DC. Ripple is 1% at 2 ma, 2.5% at 5 ma. Regulation is 35% at 30 KV, no load to full load. Input 115V AC 60 cps, 4 amperes, 80% P.F. Safe, stable, Corona-guarded and virtually indestructible.



Write for Catalog H5

For our complete line of electronic power supplies See electronics Pp. 113-120 BU ERS' GUIDE

# NJ&E

## CORPORATION

Electronic Development & Manufacturing

COMPETENT ENGINEERING

REPRESENTATION EVERYWHERE

345 Carnegie Avenue  
Kenilworth, New Jersey

Rapid, complete, competitive custom quotes from 1000 Amperes (low voltage) to 250 KV (low current).

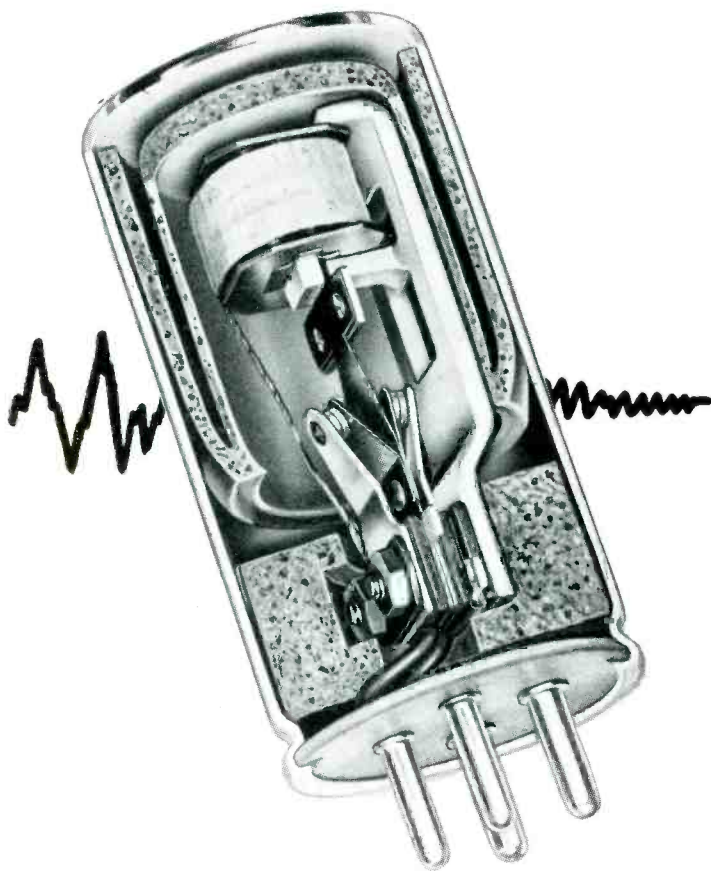

HUM

## SQUELCHED AT ITS SOURCE

—in Mallory's 25th  
Anniversary Vibrator\*

**R**EVOLUTIONARY design improvements in the latest model Mallory vibrator reduce mechanical hum to the lowest level ever attained in a commercial vibrator.

A look inside the vibrator will show you some of the new ideas that have gone into this outstanding product. Most important is a bell-shaped liner which holds the mechanism from the coil end, effectively isolating the vibrations of the reed element from the case and mounting plug. Combined with an improved design for the cup at the plug end, this liner keeps mechanical "shake" from being transmitted to the chassis regardless of the vibrator's mounting position.

*Parts distributors in all major cities stock Mallory standard components for your convenience*

**Serving Industry with These Products:**

Electromechanical—Resistors • Switches • Television Tuners • Vibrators  
Electrochemical—Capacitors • Rectifiers • Mercury Batteries  
Metallurgical—Contacts • Special Metals and Ceramics • Welding Materials

Even the lead wires have been re-designed to minimize transmitted noise.

The result is that this improved vibrator actually produces less mechanical hum than the electrical hum coming from the speaker of most auto radio sets.

Equally important to the designer, this premium performance is available *without* premium cost. Price is identical with previous Mallory models.

Plan to take advantage of this new standard of quietness in vibrator operation, in the new equipment you are designing or in circuits you now have in production. Our Technical Bulletin gives full electrical details . . . write to Mallory for your copy today.

\* Patent Pending

*Expect more . . . Get more from*



# CROSS TALK

► **RUSSIAN ENGINEERS . . .** In America, engineering education is trending more and more toward a broad base that permits the engineer himself to choose his ultimate goal. In Russia it is exactly the opposite.

Engineering education in the USSR today produces men thoroughly trained in narrow specialties. Schools are subdivided into "Institutes" where, for example, only Electrical Engineers are trained. During the first two years all electrical engineering students are taught the same curriculum. In the next three years of a five-year course they specialize. There are no elective courses.

Students are graduated with degrees such as Receiver, Transmitter or Tube Engineer. Such degrees are similar to our Masters. The entire class is then assigned to jobs in industry or government, working pretty much where told and at a government-pegged salary.

Russian engineers considered qualified for advanced degrees are selected, by the Institute, for three years of additional work leading to a Candidate degree, roughly the equivalent of our PhD. Requirements include research, and public defense of the resulting thesis. Further study, leading to the degree of

Doctor of Engineering, entails several more years of work, including teaching and original research of significant value, again with public defense of the thesis. All postgraduate students are selected by the government.

An engineer in industry has access to foreign technical publications, but only those directly related to his specialty. He cannot browse outside his field, but is somewhat compensated for this restriction by being privileged to

read material that might not in the United States be readily available.

Once a member of the engineering profession, a Russian achieves a comparatively high social level. His occupation carries a good deal of prestige and quite a few special privileges, one of which is the right to occupy two rooms with his family.

Nowhere in the two societies, the American and the Russian, is the contrast between systems greater than in engineering.

## LOOKING AHEAD . . .

**History may record 1955 as the year in which the electronics industry turned to truly mechanized production. Fall lines will contain many machine-assembled chassis**

*Expect a sharp increase in the number of cars equipped with automatic headlight dimmers. Adoption of controls made by several manufacturers in our field is likely to be widespread in new automobiles*

**Expect also a rapid swing to transistorized automobile radios. Compactness required by overcrowded dashboards is a major reason**

*As the number of helicopters increases, the need for more and better navigation instruments will also increase, particularly for night or blind flying. The machines are harder for man to handle*



Ribbon-type transducer placed at side of display case sets off alarm if objects are moved

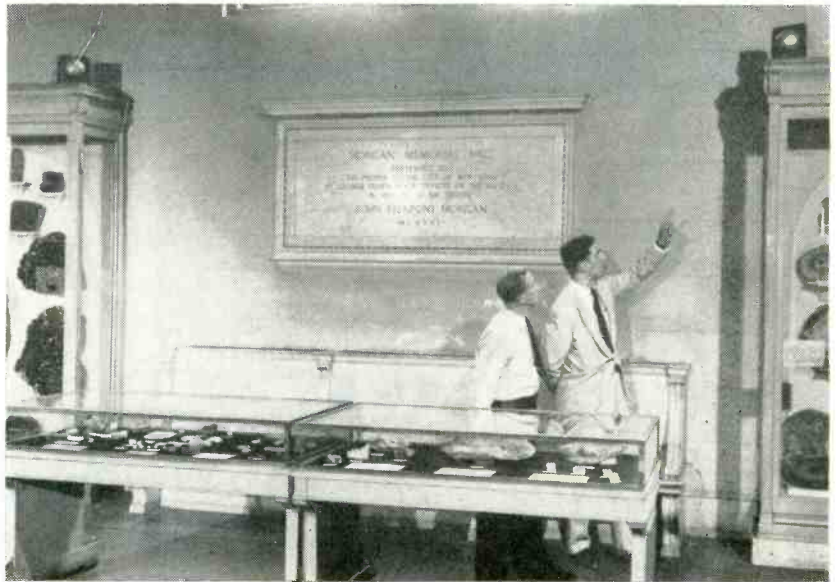

Two transducers placed atop display cases protect museum gems from burglary. Sensitivity of unit is set so that patrol dogs can move through room without setting off alarm

# Designing Ultrasonic

**SUMMARY** — Doppler effect detection system uses filtering and design techniques to eliminate false triggering of alarm by temperature changes and eddy currents in air while retaining sufficient sensitivity to detect fire and broken water pipes as well as burglars

## SONIC SLEUTH AT WORK

The professional dignity of one burglar was seriously injured by an early ultrasonic alarm installation. The alarm system was installed in a jewelry store that had previously been burglarized by cutting through a masonry wall to avoid the wired alarm system then in use. When caught on his second visit while entering through a hole made in the roof, the burglar accused the police of unfair methods, since he had been careful to "case the joint" for photoelectric beams as well as wired detectors.

In another installation, this time a liquor store, an alarm signal brought police to find a fellow member of the force already on the scene. He told how he had climbed through the transom because he thought he saw a burglar inside. His brother officers began to doubt his story when they discovered two bottles of whiskey in his pockets

**B**ASIC principles of burglar detection by ultrasonic radiation have been described in a previous article<sup>1</sup>. Analysis and compensation of effects caused by air turbulence have extended the sensitivity and usefulness of the ultrasonic alarm.

The air of the room to be protected is filled with ultrasonic waves. There is an echo from each object in the room and if an object is moving, the frequency of the echo from the moving object is slightly different from the pitch of the original waves. The original waves and echoes are picked up by a unit acting as a microphone, amplified, and any frequency difference is used to set off an alarm.

The unit also detects the presence of a flame. Because of the low density of the hot air that composes a

flame, it reflects ultrasonic waves in the same manner as a solid object. The flickering of the flame and the cone of hot air above it behave like a moving intruder and set off the alarm.

In general, the size of flame that the instrument will detect depends on the setting of its sensitivity. At any given setting it will detect a flame of about one-quarter the size of the minimum detectable intruder.

### Theoretical Considerations

When ultrasonic waves are radiated into the air they are almost completely reflected by any barrier that would normally keep out an intruder. This can be shown by considering the nature of reflection and the physical constants of the materials involved.

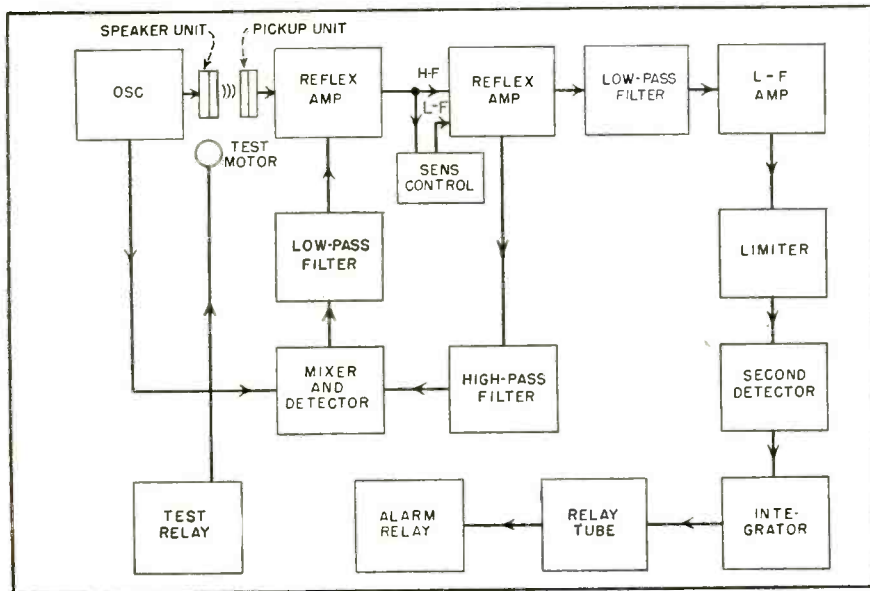

FIG. 1—Ultrasonic intruder detector uses difference frequency caused by body moving in room to trigger alarm system. Sensitivity is sufficient to detect water from broken pipes or fire

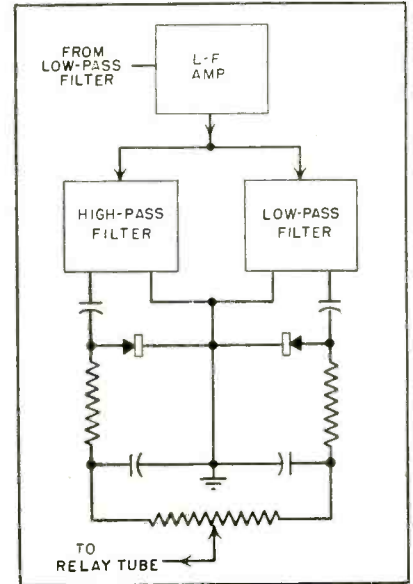

FIG. 2—High and low-pass filter network replaces limiter and second detector for high turbulence areas

# Alarm Systems

The portion of the amplitude reflected from any discontinuity is

$$P = \frac{Z_1 - Z_2}{Z_1 + Z_2}$$

where  $Z_1$  and  $Z_2$  are the mechanical impedances of the materials forming the boundary, and

$$Z = \sqrt{E\sigma}$$

where  $E$  is the elasticity and  $\sigma$  is the density of the material.

Since both the elasticity and density of air are much less than that of any solid, the impedance is less by a ratio of from  $10^4$  to  $10^5$  and the reflection from the boundary of air and any nonresonant solid plane surface is almost complete.

Less than 0.01 percent of the signal amplitude gets through to the solid substance. There is an equivalent loss of energy in going from the solid back to air. This high impedance ratio makes for almost complete reflection and confines the protection.

In the case of resonant or near resonant boundaries the impedance may be very small and a substantial portion of the sound energy may

By **SAMUEL S. BAGNO**

*Electronic Division  
Walter Kidde & Co.  
Long Island City, N. Y.*

get through, as for instance, if a thin section serves as a resonant diaphragm. For that reason it is desirable to make this sound energy of as high a frequency as possible to keep it out of the range of resonance of such surfaces.

## Choice of Frequency

The attenuation constant for a plane wave varies as the square of the frequency if viscosity and thermal conductivity are the factors that attenuate the sound. In actual practice, this frequency square relationship is a useful guide, although other factors, such as humidity, may cause the loss of sound energy in air to be many times that postulated by considering only viscosity and thermal conductivity.

This sound absorption at higher frequencies places a limit on the highest frequency that can be used and still get adequate coverage of

the protected enclosure. In actual practice the 19 to 20-kc range is most effective. A plane sound wave at this frequency would be attenuated to approximately  $\frac{1}{3}$  its energy in 100 feet. For this reason it was not practical to go above 20-kc.

The theoretical limit of sensitivity of the alarm system is a question of ambient noise level and the acoustic power that can be radiated. The steady state power  $P_A$  incident on a moving body of area  $A$  is given by

$$P_A = P \left( \frac{e^{-\alpha r}}{r^2} + \frac{4(1-a)}{as} \right) A$$

where  $P$  = the transmitted power,  $\alpha$  = the attenuation constant for a plane wave in air,  $r$  = the distance between the radiation and receiving surface,  $a$  = the absorption constant of the bounding area of the enclosure and  $s$  = the surface area of the enclosure.

If the sound is incident on a moving area  $A$ , it reflects a Doppler frequency which can be considered a new source of radiation of power  $P_A$  and a microphone at a distance  $r$  will pick up power per unit micro-

phone area  $P_m$  from its motion

$$P_m = P \left( \frac{e^{-ar}}{r^2} + \frac{4(1-a)^2}{as} \right) A$$

For an enclosure 100 by 100 by 20 feet where  $ar$  is taken as 0.5  $\alpha$  as 0.25, the microphone and transmitter are placed 100 feet apart on one wall, the moving object is 100 feet away and moving against the opposite wall and the radiating power is 0.1 watt, an area of 0.03 square feet will produce  $3 \times 10^{-14}$  watts at the microphone. The minimum power detectable by a microphone and amplifier is limited by their inherent noise level of  $2.25 \times 10^{-14}$  watts. Therefore, in an enclosure 100 by 100 by 20 feet a moving object of 0.03 square feet area may be considered the smallest size practically detectable with a two-transducer tenth-watt unit.

### Disturbing Effects

This consideration assumes the noise is minimized by having as the only moving object in the enclosure the one it is desired to detect. Unfortunately this is true only in the most ideal condition. In practice, other noise associated with the Doppler effect is generated. For instance, temperature has such an effect.

At the frequencies used, the wavelength is approximately two-thirds of an inch. In a room 100 feet long, there are approximately

1,800 waves in transit across the room. The velocity of sound in air at any temperature is

$$N_t = N_0 \sqrt{1 + \frac{t}{273}}$$

Where  $N_t$  is the velocity of sound at temperature  $t$  and  $N_0$  is velocity at 0 deg C.

Since the number of waves in the room is proportional to the reciprocal of the velocity, the number in transit changes 0.18 percent per degree C.

In the room under consideration, a uniform temperature change of one degree per second would modify the frequency by 3.2 cps. It is inconceivable for the temperature to change that fast, and in actual practice a uniform temperature change has no effect except as it changes the sound absorption of air.

### Turbulence

Turbulent eddies caused by convection or other currents of air may have an appreciable effect. These effects can best be explained in terms of conservation of momentum.

Consider a miniature pocket of air that has been accelerated by a radiator or fan. As the pocket moves along it grows by diffusion as it transfers its moving energy to other air molecules in its path. Therefore, as the pocket grows its mass increases. However, since the

law of conservation of momentum implies that the product of the mass and velocity of the pocket must remain constant, any increase of mass must likewise mean a decrease in velocity. Since the Doppler frequency follows the velocity of the moving pocket and the Doppler amplitude is dependent on its size, it would be expected that the product of the Doppler frequency and its amplitude would remain relatively constant during the life of the turbulent pocket of air. If such pockets of turbulence are being created at a statistically homogeneous rate such a frequency characteristic is the same for all types of turbulence.

It is for this reason the Doppler frequencies generated by a moving intruder or a flame can be practically separated from the turbulent effects that tend to mask it. The Doppler frequencies can be used to actuate an alarm even when the turbulence is of a very high order.

### Circuit Operation

The circuit of the ultrasonic alarm system is shown in block form in Fig. 1 and schematically in Fig. 3. A Hartley oscillator is used to generate the 19-kc signal and drive the transmitting transducer. The receiving transducer is transformer coupled into a two-stage R-C triode amplifier having a gain of approximately 16,000. The 19-

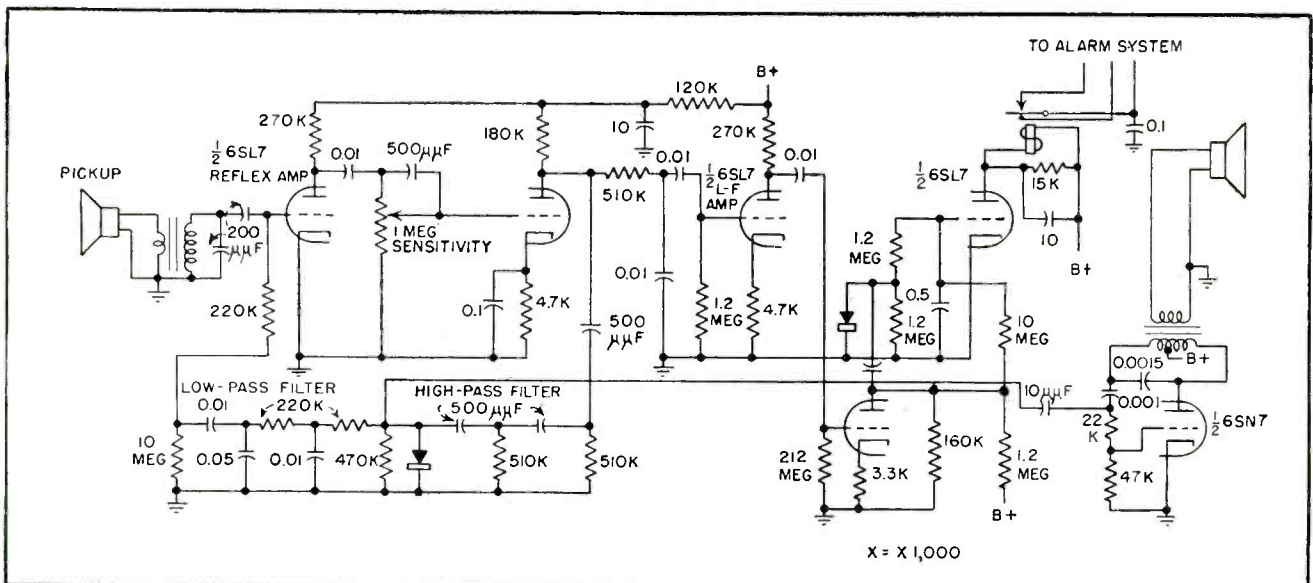

FIG. 3—Doppler difference frequency is reflexed through two-stage amplifier to trigger alarm-relay tube



ke output of the amplifier is passed through a high-pass filter to a selenium diode, mixed with the oscillator signal and detected. After detection the low-frequency Doppler signals are selected by a low-pass filter and reflexed through the preceding two-stage amplifier. The sensitivity control is included in the amplifier to control the Doppler-frequency gain without affecting the 19-kc gain, except at very low sensitivity settings.

The Doppler signal is coupled out of the reflex amplifier through a low-pass filter to a third amplifier stage and thence to a limiter. The limiter output is rectified and fed to an R-C integrator and the grid of the relay tube. The total Doppler signal gain is about 60,000. The limiter and integrator are chosen to require a train of several waves of the Doppler signal to actuate the alarm relay. Thus, the circuit does not respond to random noise pulses and extraneous isolated signals.

### Doppler Spectrum

Tests were made to determine the Doppler spectrums generated by typical signal sources and the feasibility of distinguishing between the various sources by Doppler frequency discrimination.

In these tests the Doppler spectrum caused by temperature and fan turbulences was determined, as well as the spectral response caused by an intruder and that caused by a flame.

An ultrasonic intruder detector unit was modified for a wider Doppler frequency response. The signal output was taken from the last amplifier stage preceding the limiter. As shown in Fig. 4, the Doppler signal was then fed through a constant-decrement filter variable from 1 to 100 cps. The output was then fed through a high-pass filter (adjusted to be 3 db down at the frequency being measured) to a detector. The detector provided a d-c output voltage proportional to the average rms input voltage.

By the constant-decrement filter various Doppler frequencies could be selected from 2 to 90 cps and their average rms amplitude measured. To obtain the curves in Fig. 5, eight to ten frequencies were

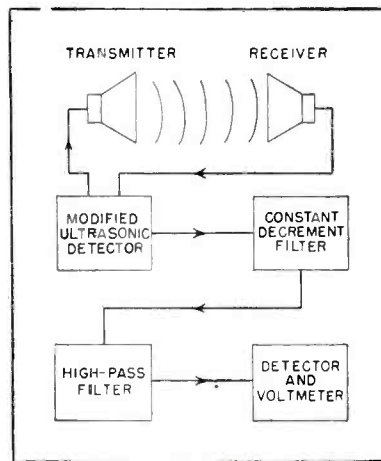

FIG. 4—Test arrangement used to determine ability of alarm system to distinguish sources of Doppler signals

selected throughout the 2 to 90-cps range and the average rms amplitude of each frequency determined over a period of 30 seconds.

The heat source used for thermal turbulence measurements was a small steam radiator having a power input of 1 kw and a surface temperature of 170 deg F. The radiator was located three feet from the transmitting transducer when considered remote and six inches from the transmitting transducer when considered adjacent.

The fan turbulence spectrum was obtained by directing an air stream past the transmitting transducer with a velocity of 5½ ft per sec at a point 6 in. from the transducer.

The intruder spectrum was obtained by having the intruder walk in a 5-foot diameter circle at a linear speed of 2½ feet per second midway between the transmitting and receiving transducers.

### Tests and Results

The experimentally determined Doppler spectrums of turbulence, flame and intruder signals are plotted in Fig. 5. Remote thermal turbulence follows a straight line on the log-log plot, denoting a hyperbolic relationship. The coincidence of the close fan turbulence and the close thermal turbulence curves supports theoretical predictions. If the transducer is located close to the turbulence source the Doppler spectrum contains a greater amount of high-frequency

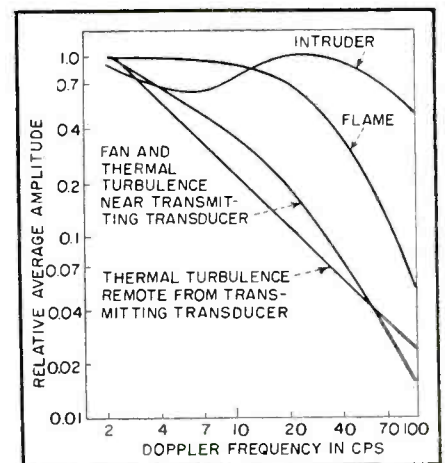

FIG. 5—Signal amplitude from detection system for various sources of Doppler frequency signal

components than when the transducer is located remotely. This indicates high air accelerations at the source.

The intruder spectrum reaches a peak in the region of the Doppler frequency as computed from the average speed of the intruder, merges with the turbulence spectrum at the lower frequencies and contains high-amplitude components of frequencies higher than the Doppler frequency. The air turbulence generated by a person walking would determine the low-frequency end of the spectrum. The high-frequency part of the spectrum would result from the rapid movement of various body parts during walking and the introduction of harmonics by multiple reflection, cross-modulation and distortion. The experimentally determined intruder spectrum plotted in Fig. 5 is consistent with the expected results.

The Doppler spectrum of a flame may be expected to be rich in high-frequency components, as high flame energy dissipated in a low air density causes high velocities and accelerations. It may also be expected to be rich in low-frequency components as a result of the heat turbulence it generates. The experimentally determined flame curve shows these general characteristics. Further experimental data indicates that the flame spectrum may again reach a peak above 100 cps. This gives promise of de-

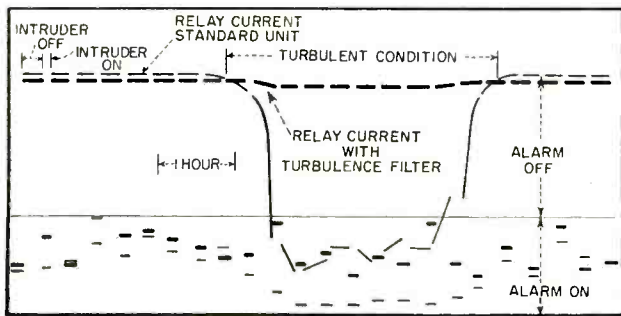

FIG. 6—Response of intruder detector with (heavy line) and without (light line) turbulence filter under turbulent conditions. Intruder was in motion for five minutes out of every fifteen

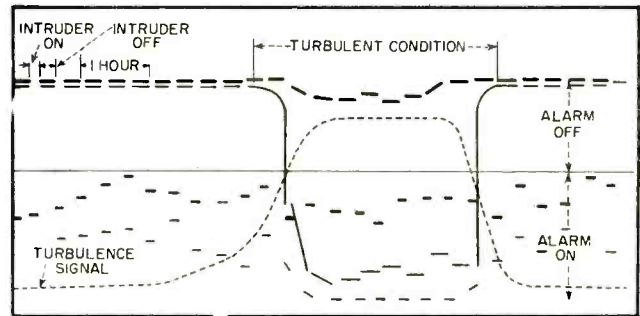

FIG. 7—Operation with automatic turbulence compensation (heavy line) compared with turbulence filter (light line). Compensation signal is dashed line

detecting flame independently of other disturbances.

### Turbulence Filtering

Theoretical consideration and tests showed it was possible to minimize the effects of unwanted turbulences without appreciably affecting the sensitivity of the unit to the type of disturbances the system was made to detect.

Two methods are possible for accomplishing this result. The simplest is the use of a passive linear filter to eliminate the Doppler frequencies below 25 cycles (the Doppler frequencies that result mostly from turbulence). This method is fairly effective. However, it has serious limitations. There are frequency components of turbulence which fall above 25 cycles that can cause false alarms if the turbulent amplitude is great enough. The lowest detectable intruder velocity increases as the cutoff frequency of the filter increases. That makes it easier to beat the system by extremely slow motion. The harmonics of low-frequency disturbances may fall into the sensitive range and give an alarm.

Despite those limitations, such a passive filter may often make an ultrasonic system operative in an otherwise inoperative location simply by raising the low-frequency cutoff.

Figure 6 shows a record comparing the behavior of a unit with a 12-cycle cutoff with that of the same set when the cutoff is raised to 30 cycles by the use of a turbulence filter while the sensitivity is set to the same point as it had been with the 12-cycle cutoff. A two square-foot vane was used as the

moving intruder. This vane was made to rotate continually for five minutes and then to remain still for the next ten.

During the test a steam radiator was turned on for three hours and then permitted to cool off for another two hours. The heat and intruder cycles were then continued. The set with the 30-cycle cutoff remained operative during the entire test while the 12-cycle cutoff condition was completely inoperative, with the relay in the alarm condition during the entire time the radiator was hot.

### Turbulence Compensation

A more satisfactory method of compensating for the effects of turbulence that overcomes most of the passive circuit limitations makes use of the turbulence characteristics shown in Fig. 5. It uses the very low-frequency Doppler components predominant in turbulent eddies to generate a positive bias. The positive bias serves to counteract the negative bias caused by the higher frequency components of the same turbulence. That leaves unaffected the negative bias caused by signals such as would be generated by an intruder or a fire.

The resulting bias is made to operate on the grid of the relay tube so that its plate current is cut off by a wanted signal. However, the low-frequency components of the signal due to turbulence exactly compensate for its higher frequency components and do not affect the plate current.

The low-frequency signal that operates the compensation can also be arbitrarily chosen to suit the best functioning of the system. For

that reason, it can be made so low that it becomes completely impractical for an intruder to beat the system by slow motion.

Figure 7 is a recording showing the comparison of the response to an intruder of a turbulence compensated ultrasonic detection system with one that is not compensated, but includes a 30-cycle high-pass turbulence filter. The method of test is the same as that used in Fig. 4.

The light line on the chart shows the relay current of the filtered unit. The heavy line indicates the relay current in the turbulence compensated unit and the dotted line the positive compensating voltage generated at the compensating diode.

The turbulence compensator has another advantage. The type of distortion generally due to overloading has the frequency characteristic of its generated harmonics that is very similar to that of turbulence. If a sine wave is distorted into a square wave because of a limiting amplifier, the amplitude of harmonics is inversely proportional to its frequency.

The same thing can be said of a single blocked pulse. The frequency function given by its Fourier integral behaves the same way. For that reason any unusual noise disturbance such as a momentary line failure or any electrical shock noises powerful enough to impress themselves on the 19-kc carrier are neutralized in the final detection system.

Figure 2 indicates how turbulence compensation is obtained. The output of the low-frequency amplifier is fed to both high and low-pass

filters. The output from the low-pass filter is fed through a coupling capacitor to a rectifier which generates a positive voltage with respect to ground. This d-c output voltage is filtered by a long-time-constant r-c circuit and fed to one end of a voltage divider. The other end of the voltage divider is fed filtered d-c from a rectifier connected negatively with respect to ground. This rectifier in turn gets its voltage from the high-pass filter that is also fed by the output from the third amplifier.

The voltage divider, therefore, gets voltages from two sources, one positive and the other negative with respect to ground. The tap on the voltage divider is then adjusted so that an incoming signal having the spectral response of turbulence leaves the voltage to ground unaltered. In that way the alarm system is made to respond to the desired motion only.

### Transducer Considerations

The transmitting and receiving transducers are of the magnetostriction type. Nickel is used for the driving element and hard-spun aluminum is used for the diaphragm.

The choice of magnetostriction type transducers was dictated by physical size and electrical impedance considerations. The diaphragm size required for a good mechanical impedance match to air is readily adapted to magnetostriction drive at the frequencies involved. The magnetostriction element may be designed so as to present a low electrical impedance. This permits the transducers to be connected to the control unit with relatively long lengths of shielded cable.

For optimum operation of the alarm system, it is advantageous to use nondirectional transducers having a fairly broad frequency response. The directional characteristics of the transducers may be estimated from their symmetry and consideration of their behavior as a multielement array. This is justified because every nodal region of the transducer diaphragm may be considered a radiating element. These nodal regions are separated by a distance dependent upon the velocity of 19 kc in the radiating

diaphragm. These considerations predict a directional pattern consisting of many lobes emanating at various angles from the face of the diaphragm.

Directional characteristics of the present pan-shaped transducers were obtained in the laboratory by employing pulsed transmissions. This method minimizes the interference of standing waves and permits oscillographic measurement of the direct wave independently of reflections.

The experimentally determined directional patterns of the pan-type transducers were found to be essentially the same for both transmitter and receiver. Patterns were determined in planes perpendicular to the pan face and passing through the center of the pan. It was found that the pattern in a plane perpendicular to the magnetostriction rods was essentially the same as the pattern in a plane containing the magnetostriction rods. Therefore, only receiver directional patterns have been included in Fig. 8.

These patterns were measured in a plane through the center of the pan perpendicular to both the pan face and magnetostriction rod. Figure 8A shows that the pan-type transducer had a nonuniform angular distribution of lobes. To achieve a more uniform distribution, transducers having a hemispherical diaphragm were designed and tested.

A polar directional pattern (taken in the same plane as Fig. 8A) for a hemispherical receiver is

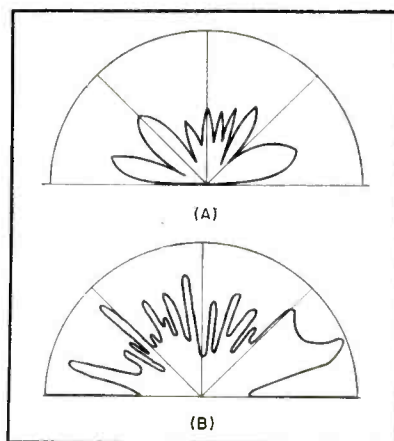

FIG. 8—Directional response characteristics for pan-type (A) and hemispherical (B) magnetostrictive transducers

shown in Fig. 8B. The hemispherical transducer shows lobes of fairly even angular distribution.

The frequency response characteristic of both pan and hemispherical transducers has also been determined. The response was determined by placing the pans at the foci of a hollow ellipsoid and using pulsed transmission to minimize standing waves. The average output of the receiving transducer at various frequencies indicates the relative response of the pair. It has been found that the hemispherical transducers have a bandwidth considerably greater than the pan transducers, indicating a better impedance match to the air.

### Field Experience

In approximately 100 installations the average trouble call per installation per month was 1.5. During the summer months, the average was 0.35, which compared favorably with the average of 0.24 for conventional wiring systems. With the advent of the cold weather the average increased to a peak of 2.58 trouble calls per installation per month. The increase was due largely to the effects of turbulence created when the heating systems were turned on. Most of these trouble calls could have been avoided by eliminating obvious mistakes due to inexperience with the system, such as placing the transducers too close to a source of turbulence. Experience in the proper use of the equipment should considerably reduce the 1.5 average.

The experience figures cited here are now almost two years old. This was done with inexperienced crews and before the development of turbulence compensation. More recent design, as well as the experience gained by the installing companies, has considerably reduced the incidence of trouble.

In another group of 48 installations, five burglaries were prevented, eight arrests made and two fires caught in the incipient stage. The record for conventional wired detection systems is one capture for every 100 installations.

### REFERENCES

- (1) S. Kempner, Ultrasonic System Detects Intruders, *ELECTRONICS*, p 104, April, 1952.

# Decade Counter Employs

**SUMMARY.** — Circuit design which includes a special bias supply enables transistor decade counter to fire ten neon indicator lamps. Total power dissipation is only 3.6 watts. Details of a four-lamp counter are given also

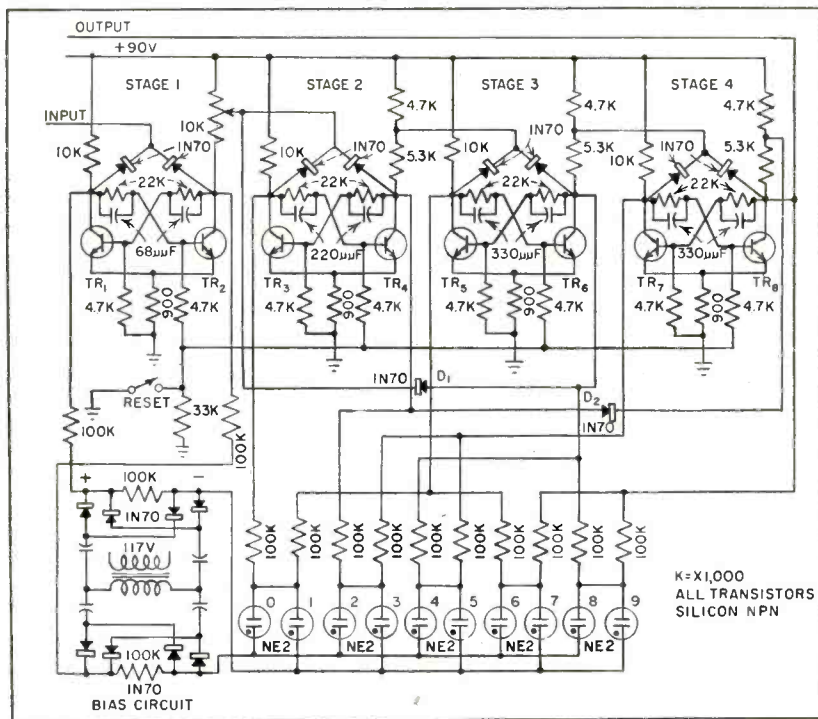

FIG. 1—Complete circuit of 10-lamp scaler with special bias supply

COUNT BY UNITS	TRANSISTOR DESIGNATION							
	TR <sub>1</sub>	TR <sub>2</sub>	TR <sub>3</sub>	TR <sub>4</sub>	TR <sub>5</sub>	TR <sub>6</sub>	TR <sub>7</sub>	TR <sub>8</sub>
0	60	10	60	10	60	10	60	10
1	10	60	60	10	60	10	60	10
2	60	10	10	60	60	10	60	10
3	10	60	10	60	60	10	60	10
4	60	10	60	10	10	60	60	10
5	10	60	60	10	10	60	60	10
6	60	10	10	60	60	10	10	60
7	10	60	10	60	60	10	10	60
8	60	10	60	10	10	60	10	60
9	10	60	60	10	10	60	10	60
0	60	10	60	10	60	10	60	10

COLLECTOR POTENTIAL IN VOLTS

FIG. 2—Collector potentials for 10-lamp unit

COUNT BY UNITS	TRANSISTOR DESIGNATION				LAMPS FIRED
	TR <sub>2</sub>	TR <sub>4</sub>	TR <sub>6</sub>	TR <sub>8</sub>	
0	10	10	10	10	NONE
1	60	10	10	10	1
2	10	60	10	10	2
3	60	60	10	10	1+2
4	10	10	60	10	4
5	60	10	60	10	1+4
6	10	60	60	10	2+4
7	60	60	60	10	1+2+4
8	10	10	10	60	8
9	60	10	10	60	1+8
0	10	10	10	10	NONE

COLLECTOR POTENTIAL IN VOLTS (A)

(B)

FIG. 3—Collector potentials for 4-lamp scaler and 10-lamp scaler waveform

**S**INCE TRANSISTORS are comparatively low-voltage devices, the problem in the design of a transistor decade scaler is to get sufficient voltage swing to light the neon lamps.

A diode clamping decade scaler using *npn* silicon transistors has been devised. The transistors must have collector to base-emitter breakdown voltages of the order of 90 volts or better because a 90-v supply is used.

## Counter Circuit

The circuit schematic of the 10-lamp decade scaler, Fig. 1, shows that the binary stages are conventional flip-flop circuits with two transistors in each stage, one transistor being on when the other is off.

The bases of  $TR_2$ ,  $TR_4$ ,  $TR_6$  and  $TR_8$  are connected to a common bus which goes to the reset switch.

Clamping diode  $D_1$  is connected between the collector of  $TR_2$  (stage 1) and the collector of  $TR_6$  (stage 3). Diode  $D_2$  is connected from the collector of  $TR_8$  (stage 4) to the collector of  $TR_4$  (stage 2). The up-down voltage patterns for this scaler are given in Fig. 2.

When the switch is in reset position, the ground return is opened and a 33,000-ohm resistor placed in series with the bases as shown in Fig. 1. This makes the bases more positive and causes  $TR_2$ ,  $TR_4$ ,  $TR_6$  and  $TR_8$  all to conduct regardless of count.

All even-numbered lamps are connected to a common bus which goes through the bias supply to the collector of  $TR_2$ . All of the odd-

# Silicon Transistors

By PAUL KRENITSKY

Heavy Military  
Electronic Equipment Department  
General Electric Company  
Syracuse, New York

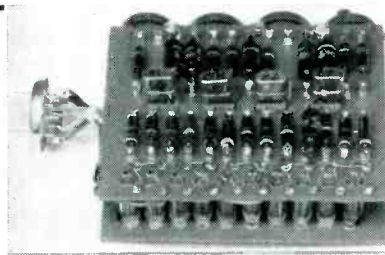

Ten-lamp decade counter employing eight transistors (four on each panel)

numbered lamps connect to a common bus which goes through the bias supply to the collector of transistor  $TR_1$ .

Since stage 1 flips on every count and stages 2, 3 and 4 have the same pattern for two consecutive counts, one side of the odd-numbered lamps can be connected to the collector of  $TR_1$  and one side of the even-numbered lamps can be connected to the  $TR_2$  collector. The other side of lamps 0 and 1, 2 and 3, 4 and 5, 6 and 7 and 8 and 9 can be connected to the other collectors in the manner shown in Fig. 1.

To light the neon lamps reliably, the bias circuit is used. The capacitors block d-c from one collector circuit to another. Thus the collector swings are superimposed on rectified a-c.

Forty silicon transistors were

made available for interchanging in this scaler. No less than one hundred interchanges were made. It was found that a transistor with an alpha of 0.92 or better will work. Transistors  $TR_1$  and  $TR_2$  require an  $h_{22}$  parameter from 0.3 to  $0.4 \times 10^{-6}$  mhos for best operation. All the other transistors must have like parameters except that the  $h_{22}$  parameter may be from 0.5 to  $1.0 \times 10^{-6}$  mhos.

Typical transistor parameters are  $h_{11}$ , 50 to 150 ohms; alpha, 0.94;  $h_{22}$ , 0.3 to  $0.4 \times 10^{-6}$  mhos for  $TR_1$  and  $TR_2$ , and 0.5 to  $1.0 \times 10^{-6}$  mhos for all others;  $h_{12}$ , 1.0 to  $4.0 \times 10^{-4}$  and peak inverse voltage, 90 v.

## Evaluation

Performance figures of the scaler are: frequency range up to 200 kc; minimum input voltage, -10 v pulse; supply voltage, +90 v; sup-

ply current, 40 ma; collector dissipation, 40 to 50 mw; total dissipation, 3.6 watts and operating temperature 20 to 70 C. In comparison, the total dissipation figure for electron-tube decade scalers is about 12 watts.

The up-down voltage pattern for a 4-lamp decade scaler is shown in Fig. 3A. The lamps have the values 1, 2, 4 and 8 and light as indicated on the chart. The circuit schematic is shown in Fig. 4.

Either a-c or d-c can be used although d-c bias will give better brilliance. Through the count of 9, operation is binary. At the count of 10 or 0, the fourth stage is reset by the first and the fourth stage clamps the second stage to prevent it from flipping. Thus, at the count of 0, all of the transistor stages are reset.

The 10-lamp scaler was oven-tested to 80 C, and the scope pattern was correct at 5 kc, 40 kc and 200 kc. Figure 3B is the voltage pattern for the 10-lamp scaler when the scope is placed on the  $TR_1$  collector. With one pulse at a time fed into the scaler for a slow count at 70 C, the voltmeter showed that the circuit was operating properly although the lamps were not lighting. When the temperature was lowered to 50 C, all the neon lamps functioned properly.

## BIBLIOGRAPHY

- John T. Potter, Four-tube Counter Decade, *ELECTRONICS*, p 110, June 1944.
- I. E. Grosdoff, *RCA Rev.*, 7, p 438, 1946.
- V. H. Regener, *Rev Sci Instr.*, 17, p 185, 1946.
- W. C. Elmore, *Rev Sci Instr.*, 22, p 835, 1951.
- R. Parshad and A. Sagar, *Rev Sci Instr.*, 24, p 542, 1953.
- W. C. Elmore, *Rev Sci Instr.*, 22, p 835, 1951.

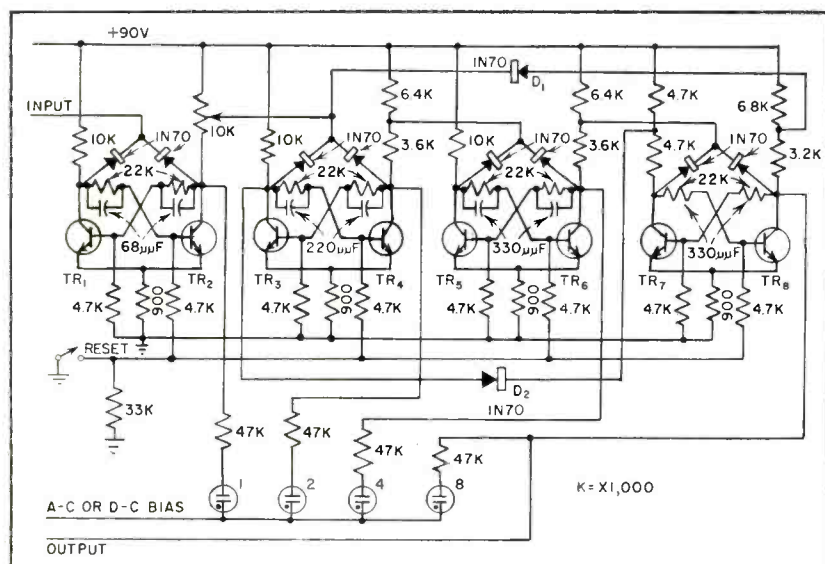

FIG. 4—Circuit of 4-lamp decade scaler. Lamps have values 1, 2, 4 and 8

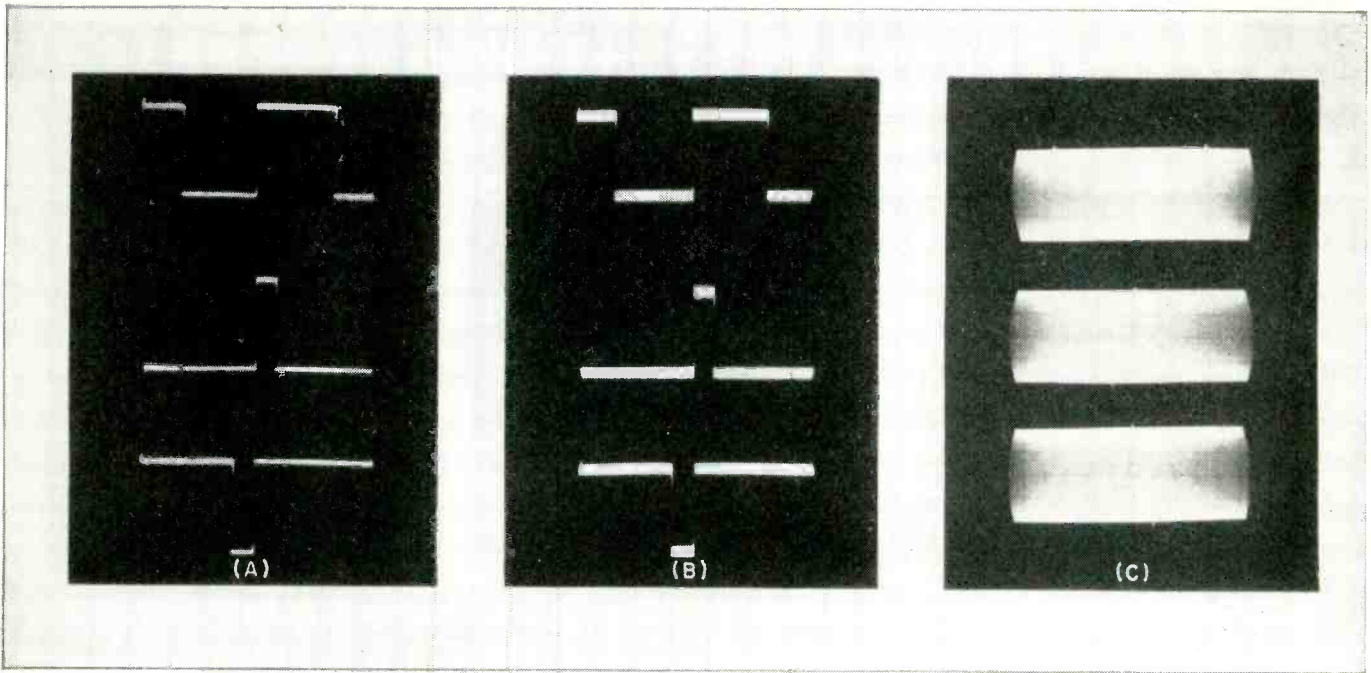
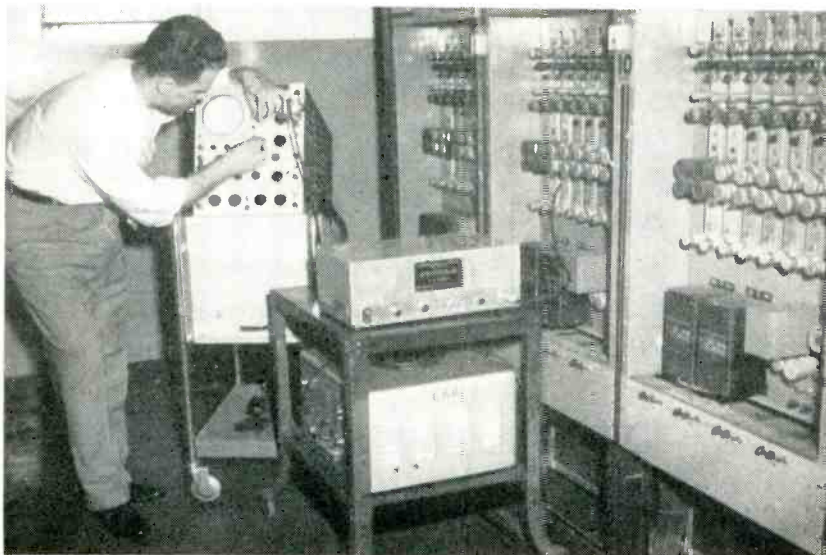

FIG. 1—Waveforms encountered in differential gain testing of video equipment. In each case, the duty cycle is 50, 10 and 90 percent reading from top to bottom waveform. Variable duty cycle pulse for 120 cps (A), with 3.5-mc sine wave added (B) and signal of (P')

# Differential Gain

**SUMMARY** — Modification of the intermodulation testing technique adapted to video employs 120-cps rectangular wave with continuously variable duty cycle mixed with 3.5-mc sine wave having a tenth the amplitude. Nonlinear transfer characteristic of television equipment is shown



Using the test set on the equipment bay for a color studio at WRCA-TV

**S**TRINGENT REQUIREMENTS regarding differential gain for equipment used to handle color television signals made it necessary to develop a means of detecting very small amounts of differential gain distortion.

The seriousness of even the slightest nonlinearity in the input-to-output transfer characteristic of a distribution amplifier becomes apparent when it is realized that the color signal may pass through five to twelve such amplifiers before it is finally fed to the telephone company cable serving the transmitter.

While the test generator described here was designed specifically for testing wide-band video distribution and line amplifiers it

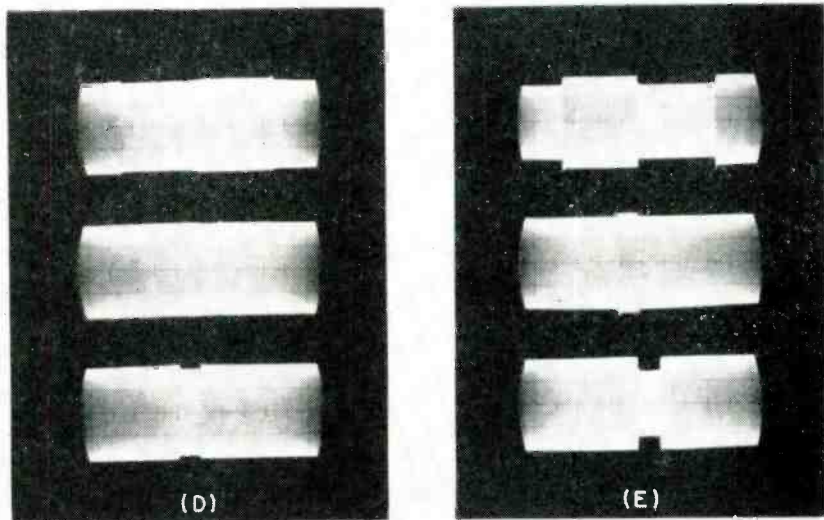

through high-pass filter (C). At (D) is shown the signal of (B) through an amplifier under test and also a high-pass filter, while at (E) a different amplifier is tested

# Tests TV Color

By **JOHN O. SCHROEDER**

*Development Engineer  
Development Group  
National Broadcasting Co.  
New York, N. Y.*

can be used to check other parts of the television system as long as they do not have keyed clamp stages and possess good 120-cycle square-wave response.

## The Test Signal

The technique employed in this instrument is an adaptation of the intermodulation test method used for checking high-quality audio equipment. A small amplitude high-frequency sine wave is mixed with a large-amplitude low-frequency sine wave and the degree of amplitude modulation of the high-frequency signal is determined after separating it with a high-pass or band-pass filter.

This method could be used in tele-

vision, choosing 15 kc for the low frequency and 3.5 mc for the high frequency, except for one important reason. If the system were tested with such an intermodulation signal at a level of 1.4 volts peak-to-peak, a dynamic range from 0.7 volt above to 0.7 volt below the a-c axis only is explored because the test signal is symmetrical. A television picture signal, however, need not be symmetrical but may vary in a-c axis over a wide range depending upon picture content and contrast.

With a picture signal having the same peak-to-peak level of 1.4 volts but with a duty cycle shift of 20 to 80 percent the actual dynamic range of signal handled by an amplifier is

approximately from 1.12 volts above to 1.12 volts below the axis, corresponding to a peak-to-peak symmetrical signal of 2.24 volts.

In this instrument the low-frequency signal consists of a 120-cycle rectangular wave with duty cycle continuously adjustable from 10 to 90 percent. Duty cycle, in this case, refers to the percentage of time the pulse is positive or in the white direction. This signal is shown in Fig. 1A for duty cycles of 50, 10 and 90 percent.

Mixed with this low-frequency signal is a 3.5-mc sine wave of about one tenth the amplitude, the composite test signal as it comes out of the generator appearing as shown in Fig. 1B. This signal with its widely shifting a-c axis and high-frequency carrier is put through the equipment to be checked.

As the signal passes through faulty equipment, any nonlinearity in its transfer characteristic will cause the amplitude of the 3.5-mc sine wave to be dependent upon the instantaneous value of 120-cycle signal. In other words, the high-frequency signal will become amplitude modulated. If the test signal after passing through the equipment to be checked is fed through a high-pass filter that eliminates the large-amplitude 120-cycle signal, the 3.5-mc carrier will appear as shown in Fig. 1C provided there is no differential gain distortion present.

The 3.5-mc signal has constant amplitude regardless of the low-frequency duty cycle. If the equipment under test is not perfect the carrier signal will appear as shown in Fig. 1D, which shows little distortion with the 10-percent duty cycle signal but a considerable amount at 50 and 90 percent. Figure 1E represents a badly overloaded amplifier and the results are indicative of what can be expected of a typical pentode video amplifier stage if it is run at too high a signal level.

Since the transconductance and therefore the gain of such a stage vary with plate current, in the 10-percent duty cycle case when the test signal drives the grid in a positive direction the gain actually increases above its normal no-signal value and causes expansion of whites. In the 90-percent duty

cycle case, the large negative excursion at the grid causes severe black compression as it drives the stage toward plate-current cutoff and into the low transconductance region.

The result of using a series screen-dropping resistor bypassed by a large capacitor to provide d-c screen potential to a pentode amplifier operating at high level is readily apparent when the duty cycle is changed rapidly from one extreme to the other. When this is done, the presentation on the oscilloscope will slowly breathe until it reaches its final steady characteristic. This action results from the slow change in d-c screen voltage caused by the wide shift in a-c axis of the test signal changing the average screen current drawn. Rapidly varying the duty cycle from one extreme to another will also show up any instantaneous grid-current effects in a badly designed amplifier, which might get by unnoticed using less stringent test methods. A good amplifier will show no breathing with rapid changes in duty cycle; this test is therefore a valuable tool for spotting any tendency toward low-frequency instability or bounce in feedback and other types of amplifiers.

### Circuit Description

The composite test signal is developed in a relatively straightforward manner as shown by the schematic diagram, Fig. 3.

The 120-cycle saw-tooth ripple voltage appearing across the input filter capacitor of the power supply is fed to  $V_1$ , a 12AT7 dual triode, which functions as a two-stage limiter and provides a steep-sided 120-cycle square wave at its output. The square wave is then differentiated by the 220- $\mu\text{mf}$  coupling capacitor and the negative pulses clipped off by the 1N100 germanium diode connected from the grid of  $V_2$  to ground. The 6AB4 cathode follower provides further clipping of the negative pulses and provides rapidly rising positive pulses occurring at a 120-cycle rate at a level of about 20 volts peak.

These pulses are then used to trigger  $V_3$ , a 6J6 one-shot multivibrator, which generates one pulse for every

trigger pulse, the duration of the generated pulse being continuously variable by the duty cycle control. The two limit-setting potentiometers allow the circuit to be aligned so that 90 and 10-percent duty cycles are obtained at the two extremes of the duty cycle control with 50 percent falling at midrotation.

### Waveform Slicer

The variable duty-cycle square wave from  $V_3$  is then applied to  $V_4$ , a 12AT7 cathode-coupled clipper that takes a narrow slice of the waveform fed to it and provides a constant amplitude flat-topped output. The rise time of the pulses is purposely slowed down by the 0.001- $\mu\text{f}$  capacitor from plate to ground so that large amplitude spikes are not produced when the signal is viewed on an oscilloscope through a high-pass filter. Such spikes could cause momentary overloading of the scope circuits and thereby cause erroneous presentations. Some low-frequency compensation is also provided at this point by the series 47,000-ohm resistor and 0.5- $\mu\text{f}$  capacitor to ground to make up for a slight amount of tilt occurring in the following circuits.

The output stage comprises  $V_5$ , a 6216 pentode that can handle relatively large plate current swings and develops the 2-volt peak-to-peak output signal across the 200-ohm output potentiometer. The 120-cps level control is used to set this level at 2 volts.

The 3.5-mc high-frequency sine wave that is to be added is generated by oscillator  $V_6$ , a 6AB4 in a

modified Colpitts circuit. A switch is provided so that any externally generated frequency may be fed into the unit and mixed with the 120-cycle waveform if this is desired. Either high-frequency signal is applied to the grid of  $V_7$ , a 12BY7 pentode whose plate load is the same as that of  $V_5$ .

By mixing in the final output no differential gain distortion can be generated by the test generator circuits themselves since there is no amplifier stage common to both the high-frequency sine wave and the 120-cycle square wave. Amplitude of the internal high-frequency sine wave is adjusted by the 350 to 1,180- $\mu\text{mf}$  padder capacitor that forms the shunt element of a capacitive voltage divider and should be adjusted for 0.2 volt peak-to-peak across the output potentiometer. In other words, its amplitude is about 10 percent of that of the 120-cycle square wave.

### Circuit Connection

The test generator has been designed to work into a high-impedance bridging load such as the unterminated input of an amplifier and can be used with at least 3 feet of coaxial output cable with no significant high-frequency loss because of the low source impedance, which never exceeds 200 ohms. It will likewise work into a 75-ohm load with reduction in maximum output level.

The power supply is self-contained and consists of a conventional series regulator tube whose internal resistance is controlled by the pentode amplifier, which derives its control signal from the final B+ output bus. The low-ripple, low-impedance source of regulated 280-volt d-c is developed to provide stable operation of the test generator circuits in the presence of varying line voltages and the varying plate current produced by the large changes in duty cycle.

### Using the Test Generator

Operation of the generator is extremely simple since no external sync or drive pulses are required, the only other equipment necessary being an oscilloscope with reasonable sensitivity at 3.5 mc and a

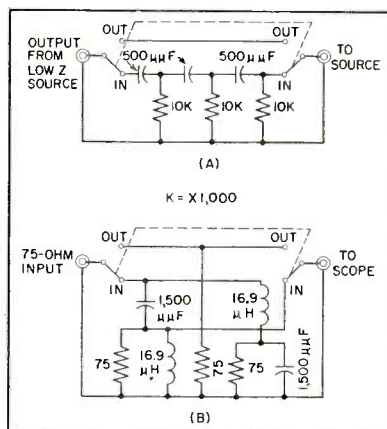

FIG. 2—Simple R-C high-pass filter (A) and a 75-ohm, 1-mc high-pass filter (B)



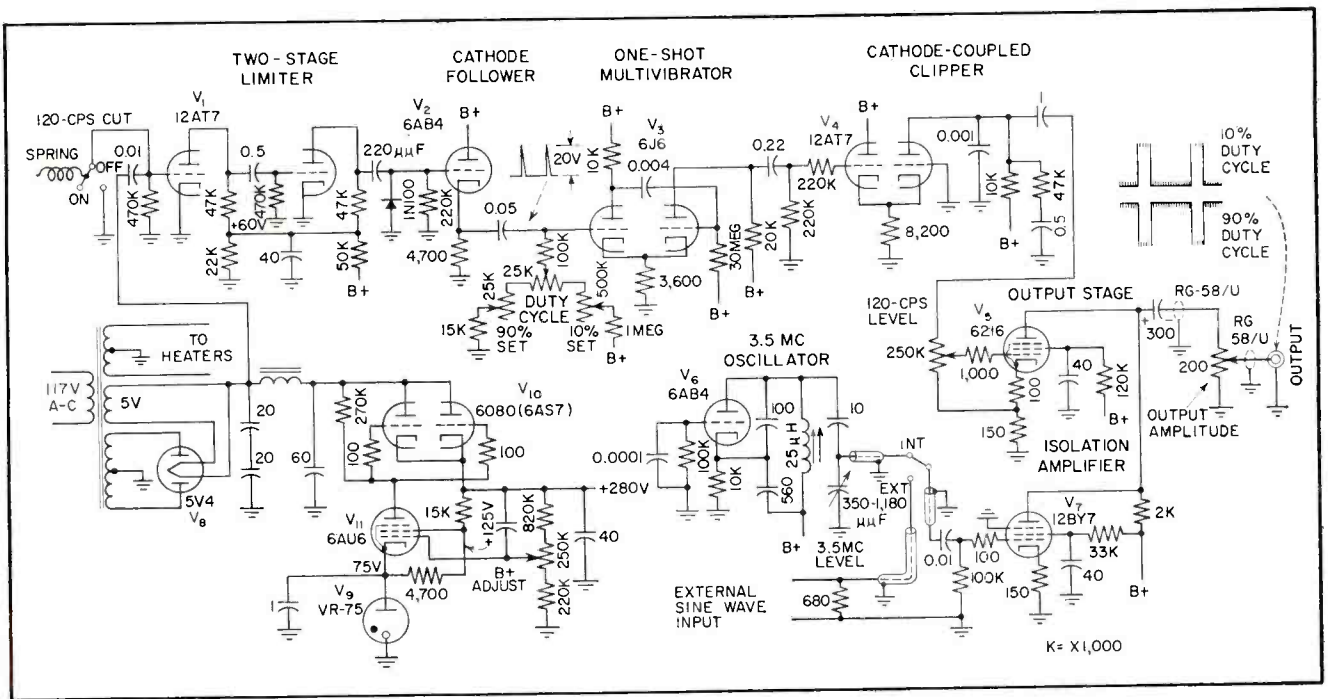

FIG. 3—Complete circuit diagram of the differential gain test generator used for testing color video facilities in network studios

high-pass filter to separate the high-frequency carrier from the low-frequency square wave.

The simple three-section R-C filter of Fig. 2A will work satisfactorily owing to the large separation of frequencies involved. A good filter specifically designed for 75-ohm circuits by R. A. Neis of NBC's Audio-Video Facilities group and shown schematically in Fig. 2B has a nominal low-frequency cutoff at 1 mc.

Output of the test generator is first connected to the input of the amplifier to be tested, the output of the amplifier going through the high-pass filter and then to the vertical deflection input of the oscilloscope. The horizontal sweep is synchronized from the a-c line and adjusted to produce either 60 or 30 sweeps per second.

### Control Settings

With the filter switch in the out position and the duty cycle control of the test generator at approximately 50 percent, the output control and/or the gain control of the amplifier is adjusted for the desired peak-to-peak output voltage from the amplifier using the oscilloscope calibrating circuits for reference.

With the filter switch in, oscilloscope gain is increased until the

carrier produces about 10 divisions of vertical deflection. For fine adjustment, the 120-cps cut push-button switch on the test generator can be depressed to set gain for exactly 10 divisions of deflection. Releasing the 120-cps cut button, percentage of differential gain distortion can be read as the duty cycle control is rotated through its entire range from 10 to 90 percent.

Either compression or expansion is indicated depending on whether the carrier amplitude decreases or increases relative to the 10 divisions as the duty cycle is varied. If the carrier amplitude were 12 divisions during the 10-percent duty cycle pulse this would be read as 20-percent differential gain expansion while if it were 9 divisions, this would indicate 10-percent differential gain compression.

In testing high-level amplifiers such as those intended for driving kinescope grids where large peak-to-peak voltages exist, a simple method of using this test technique is to clip the oscilloscope lead or probe to the insulated high-level signal lead. The capacitive voltage divider thus formed will function satisfactorily as the high-pass filter and also attenuate the high level of carrier to a convenient level, all without imposing any extra load on the

color-video circuit being tested.

The technique described for making measurements constitutes a sensitive and simple method for differential gain tests that will permit measurements of less than 1-percent compression or expansion with easily repeated accuracy.

### Amplifier Requirements

With the present test generator, good 120-cycle square wave response is required of the amplifier under test. The same technique could be used for testing camera preamplifiers (or other types that rely upon a keyed clamp somewhere later in the system to remove tilt) if the first stage were changed to a 15-kc square-wave multivibrator. Appropriate changes in the following stages would permit generating a 15-kc variable duty cycle square wave as the low-frequency signal. Going still further, somewhat more complicated circuits would permit generation of a 15,750-cycle variable duty cycle signal with sync that could be used for testing any type of amplifier including those with keyed clamps.

With other modifications and additions the technique can provide a powerful tool for the measurement of differential phase distortion.

By M. WEISS

and S. R. SIXBEY

Servo Corporation of America  
New Hyde Park, New York

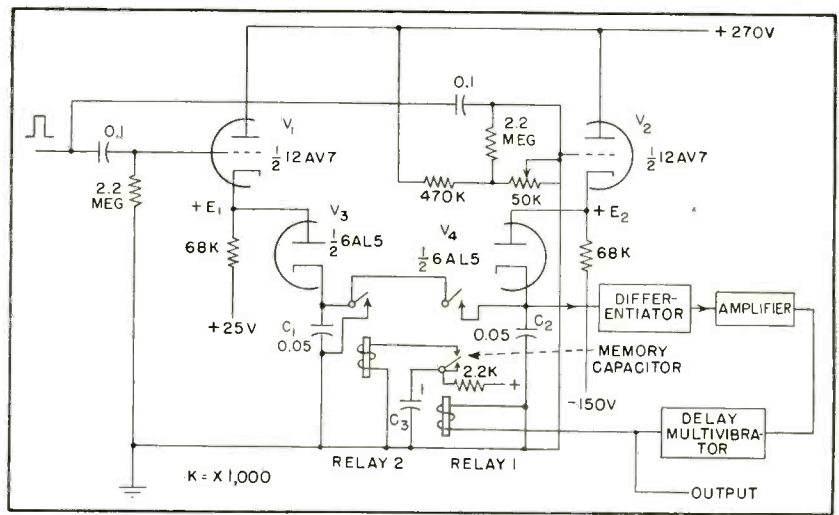

FIG. 2—Schematic diagram of voltage discriminator

# Target Discriminator

**SUMMARY** — Logarithmic amplifier and voltage-difference rejection circuit combine to form an effective voltage-ratio rejection system. Circuits permit countermeasures equipment to concentrate on the stronger signal

A SYSTEM rejecting, outside some desired voltage ratio, signal pulses with a large dynamic signal amplitude range having a varying repetition rate and duration is occasionally required.

Techniques that employ agc and diode peak-charging R-C biasing networks are not suitable here. The varying repetition rate causes blocking of circuits and unacceptable performance in the R-C biasing networks. Both of these prob-

lems have been overcome by using instantaneous compression of the signal and a controlled capacitor-discharge memory circuit.

### Logarithmic Circuits

The requirement of voltage-ratio rejection limits the form of the input-output characteristic of the compression element. The output signal from the compression circuit should have some fixed characteristic for a fixed-input signal-amplitude ratio, which will be independent of signal level, pulse repetition rate and pulse duration. This requirement is met by a logarithmic function of the form  $e_o = k_i e_{in}$ . This function has the unique characteristic that for a fixed-input signal-amplitude ratio the output signal-amplitude difference will be a constant. The rejection circuit can therefore be designed to operate on a fixed-voltage difference basis.

In general, instantaneous signal

compression is accomplished with the aid of nonlinear circuit elements such as vacuum tubes and germanium diodes. The thermionic diode and germanium diode, when operated over a particular current range, produce an output proportional to the logarithm of the input.

The logarithmic characteristic of thermionic diodes varies considerably from tube to tube and no simple way has been found to equalize tubes. The germanium-diode characteristic changes excessively with temperature. Most circuits using multielement vacuum tubes are special circuits that generally have a limited dynamic range. It is therefore concluded that none of these techniques could be employed satisfactorily.

A usable method is that of curve shaping using diodes. Figures 1A and 1B illustrate this method. In Fig. 1A the change of shape in a resistive voltage divider is shown. In Figure 1B, when  $E_{in}$  reaches  $E_c$ ,

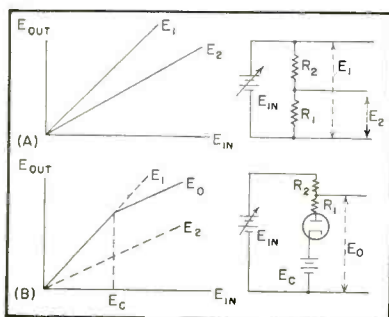

FIG. 1—Change of slope of output curve of a resistive voltage divider (A) and diode shaping characteristic (B)

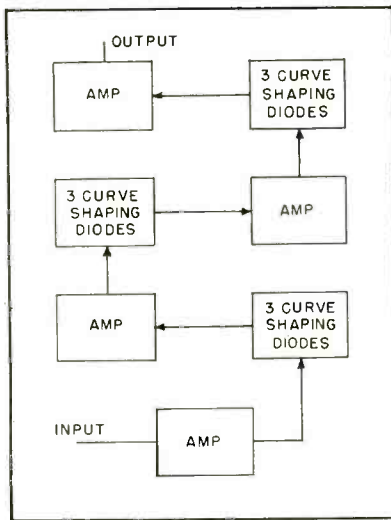

FIG. 3—Logarithmic amplifier

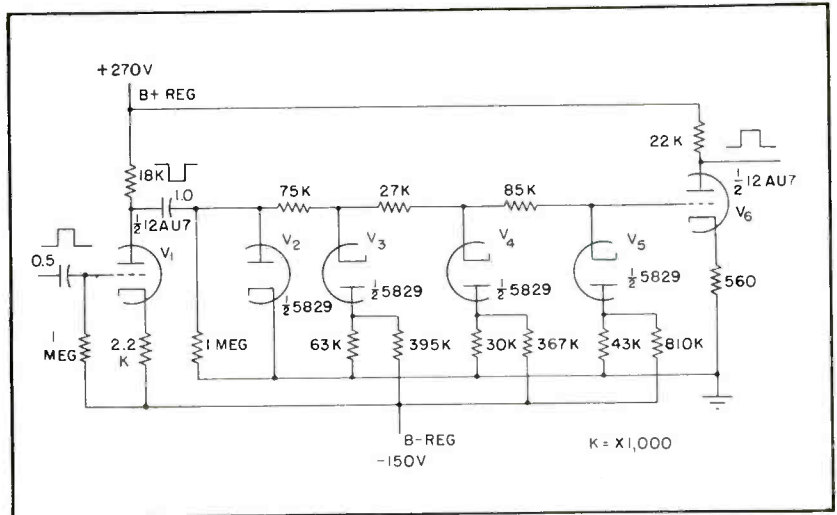

FIG. 4—Typical biased-diode section including input and output amplifiers

# for Countermeasures

the diode conducts, causing the shape of the output curve to change abruptly from the that of  $E_1$  to  $E_2$ .

Any curve of decreasing slope can be synthesized fairly accurately by using enough straight-line sections. Using diodes in this manner has the advantage that the effect of the variability in the diodes is minimized by the presence of the shaping resistors  $R_1$  and  $R_2$ . Except for the transition region from nonconduction to conduction, the diode characteristic does not directly influence the curve shape. This method of curve shaping is well suited to large signal ranges.

## Voltage Discriminator

By proper choice of the parameters of the compression circuit a 1,000-to-1 dynamic signal range can be reduced to a 10-to-1 variation for example. Since the pulse repetition rate is varying, it is not feasible to use a capacitor memory circuit with a fixed leak across the capacitor to obtain discrimination. The charge that leaks off the capacitor will vary with pulse repetition rate and with signal amplitude, which is not linearly related to the voltage-discriminator input signal.

A means of avoiding this diffi-

culty is to charge a memory capacitor through a diode to the pulse amplitude and then remove a fixed amount of voltage from the capacitor between pulses. The remaining voltage on the memory capacitor then acts as a bias on the diode. This blinds the following circuits to all pulses of a lower peak amplitude than the remaining voltage.

A scheme for doing this is shown in Fig. 2. Assume that relays 1 and 2 are released as shown. A pulse impinging on the grids of cathode followers  $V_1$  and  $V_2$  will cause capacitors  $C_1$  and  $C_2$  to become charged through diodes  $V_3$  and  $V_4$ , respectively. Capacitor  $C_1$  will be charged to the amplitude of the pulse plus  $E_1$  volts, the value of the fixed bias shown. Capacitor  $C_2$  will be charged to the pulse amplitude plus  $E_2$  volts. The voltage  $E_2$  is adjusted to be greater than  $E_1$ .

In the process of charging  $C_2$  a step voltage is applied to the differentiator, amplifier and delay multivibrator which operates relay 1 after the pulse has passed. When this relay operates  $C_1$  and  $C_2$  are connected in parallel so that charge flows from  $C_2$  into  $C_1$ . If  $C_1 = C_2$ ,  $C_2$  will lose  $(E_2 - E_1)/2$  volts.

When relay 1 releases relay 2

momentarily operates on the discharge current of capacitor  $C_2$  discharging  $C_1$ . The voltage remaining on  $C_2$  acts as a bias on charging diode  $V_4$ . Unless a subsequent pulse is greater in amplitude than the last pulse minus  $(E_2 - E_1)/2$  volts it will produce no output pulse, hence be rejected.

## Voltage Ratio Discrimination

Combining the logarithmic compression amplifier with the voltage-difference discriminator results in a voltage-ratio discriminator. Referred to the input of the compression amplifier the combined circuits will reject subsequent pulses that are less than a desired voltage ratio. This voltage ratio is determined by the value of the voltage difference  $E_2 - E_1$ .

## Compression Amplifier

To drive the voltage difference discriminator properly, as much signal as possible should be used. This results in a range of output voltage from the logarithmic compression amplifier from 12 to 90 volts. This range corresponds to an input dynamic range of 1,000-to-1.

The accuracy of discrimination required was such that at no time

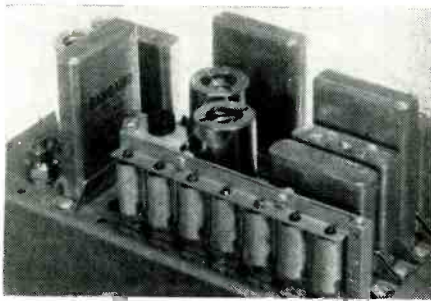

Logarithmic compression amplifier chassis in target discriminator system

should the output voltage from the logarithmic amplifier differ from the theoretical logarithmic curve by more than  $\pm 1$  volt. In order to meet this requirement, it was found necessary to employ nine curve-shaping diodes.

### Diodes

Since the diode contact potential was in the order of 1 volt, it was necessary to arrange the circuit so that the minimum bias voltage applied to any diode would be reasonably large compared to 1 volt. This made the circuit performance independent of variations in contact potential due to tube differences, age and filament-voltage variations.

To accomplish this and still operate within the linear-amplification range attainable with 12AU7 triode amplifiers, the curve-shaping diodes were separated into three groups of three each. Amplifier sections were placed before and after each group, as shown in Fig. 3.

Each amplifier section is required to deliver a maximum peak-pulse amplitude of 100 volts or more. Since these amplifiers must also be linear to within  $\pm 1$  percent, a high value of B supply voltage is required. The amplifier is designed to operate from supply voltages of +270 volts and -150 volts, giving a total effective B supply voltage of 420 volts. Feedback is employed to make the circuit relatively independent of tube variations.

A typical group of three curve-shaping diodes, together with the input and output amplifier stages is shown in Fig. 4. The unbiased diode  $V_2$  clips off the overshoots created by the capacitor coupling. This overshoot problem is serious because two or more stages of R-C coupling will produce an overshoot

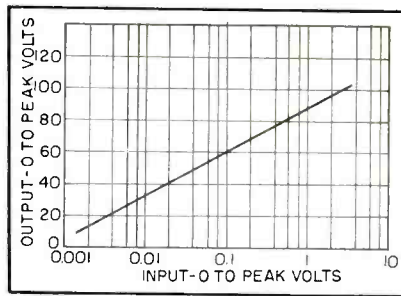

FIG. 5—Output characteristic of the logarithmic compression amplifier

whose polarity is the same as that of the signal pulse. Since the function of the amplifier is compression the amplitude of the signal relative to its overshoot is reduced. This results in the amplitude of the overshoot becoming comparable to that of the signal, yielding a double output pulse.

Using d-c coupling does not offer a solution. Any amplifier drift would change the effective bias on the curve-shaping diodes and thus alter the characteristics of the logarithmic compression amplifier. The only practical solution found was to use clipping diodes. Five such diodes were required, bringing the total diode complement to fourteen. Seven type CK5829 subminiature dual diodes were employed.

### Accuracy

To meet the accuracy requirements, resistors having a 1-percent tolerance were used in the diode biasing and curve-shaping networks and in the amplifier feedback circuits. All other resistors were given a 5-percent tolerance. The theoretical transfer function of the amplifier was

$$e_o = 26.5 \log 2,000 e_{iN}$$

The range of input amplitudes was 0.0014 volt to 1.4 volts.

Several of these units were built and all of them met the accuracy requirement when operated over the above dynamic range. The measured transfer characteristic is shown in Fig. 5.

One of the principal problems encountered was that of obtaining a short charge time constant in the memory circuit. At the same time a long discharge time constant was needed. The required minimum ratio of discharge to charge time constants was  $70 \times 10^6$  to 1.

A discharge time constant of infinity would be ideal. This would permit the pulse amplitude to be remembered indefinitely without loss. If the memory capacitor is made large a long discharge time constant can be obtained but the charge time constant also becomes long. Ultimately a compromise value of capacitance was used.

Cathode followers are used to charge the capacitors because they provide a low source impedance and a convenient means of supplying the fixed bias  $E_1$  and  $E_2$  to  $C_1$  and  $C_2$  respectively. A 12AV7 miniature double triode was chosen as the driving tube because of its high  $g_m$ , medium-high perveance and medium-high  $\mu$ .

To obtain a high-discharge time-constant, a high-quality capacitor and a high-quality hermetically sealed relay were used. The wiring associated with the storage circuit was done carefully. No leak across  $C_2$  was provided. In effect, the total leakage resistance across the memory capacitor is the heater-to-cathode leakage of diode  $V_4$ . This was found to be in the order of 6,000 megohms.

The multivibrator was necessary to provide a standard on time for relay 1. Also a delay in the operation of this relay had to be provided to guarantee passage of the peak of the signal pulse before operation.

By adjusting the bias  $E_2$  the voltage of discrimination can be made almost anything above 1 or 2 volts. The circuit will accept input pulses with peaks as high as 100 volts and with a rise time as short as 1 millisecond.

When a voltage-difference discriminator is driven from the output of a logarithmic compression amplifier the end-to-end result is a ratio discriminator. This particular logarithmic compression amplifier and voltage-difference discriminator were combined. The result was a ratio discriminator capable of discriminating between pulses whose ratios referred to the input were 5-to-4 or less. This performance was independent of the variable pulse width, the varying repetition rate and the absolute amplitude of the input pulses over the 1,000-to-1 dynamic range.

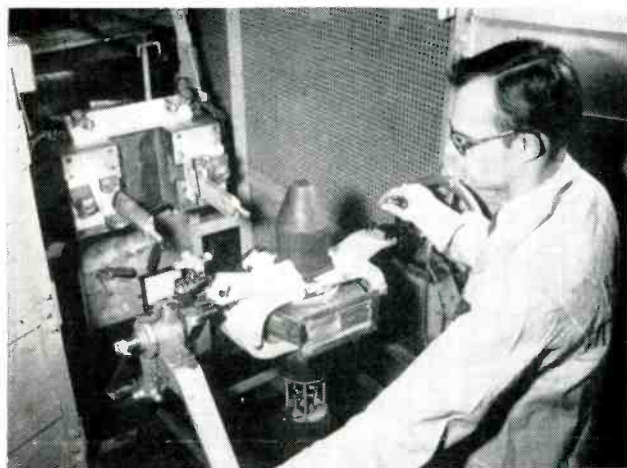

Magnetron on dolly is positioned on two horizontal current conductors shaped to give maximum cross section of copper and heavily silver plated to improve conduction

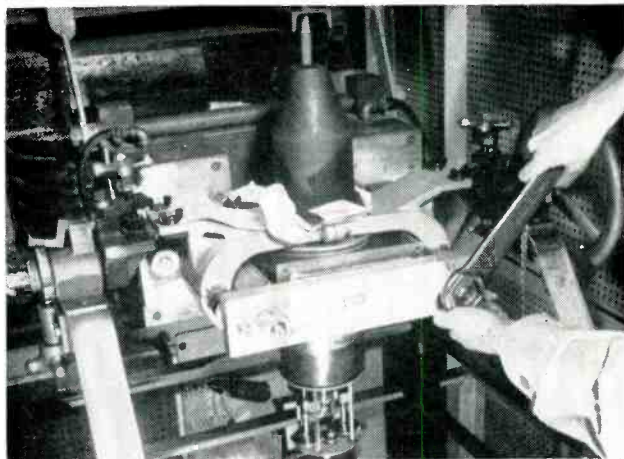

Silver-plated shorting bar is secured to conductors with nonmagnetic nuts and wrench. Insulated pads and jackscrews hold magnetron firmly in place and prevent leakage

# Impulse Magnetizer for Permanent Magnets

**SUMMARY** — Single-turn coil gausses magnetron magnets after assembly. Pulse technique provides 200,000-ampere impulse while drawing no more than 6.6 kva from power line. Capacitor storage bank is used with current step-up transformer and ignitrons in unique circuit to prevent reversal of magnetizing pulse

By **GEORGE M. MOORE**

*Raytheon Manufacturing Company  
Waltham, Massachusetts*

**I**N THE PRODUCTION of certain permanent magnets, conventional magnetizing methods employing solenoids and electromagnets have been found to be unworkable. This has led to the impulse magnetizing technique which uses the stored-energy principle to deliver large pulse currents to a single-turn magnetizing loop. By this method, it is now possible to magnetize magnets which form an almost completely closed loop and those in which the reluctance of the air gap is appreciably less than the

reluctance of the magnetic material.

The principle of impulse magnetization is shown in Fig. 1. Here a ring magnet having a narrow gap is being magnetized. A shorting bar joins two current conductors and passes through the center of the ring magnet. A large unidirectional current is passed through the low-impedance circuit of the shorting bar, creating a circular magnetic field about the bar. This field is concentrated in the iron of the ring magnet and creates permanent north and south poles across the magnetic gap.

The magnetizing force created by a current-carrying conductor is proportional to the product  $NI$ ,  $N$  being the number of conductors

and  $I$  the value of the current. The impulse magnetizer of Fig. 1 has only a single current-carrying conductor thus  $N=1$ . High magnetizing force must therefore be achieved by high values of current  $I$ . These currents are achieved by pulse techniques which concentrate electron flow into extremely high peaks of short duration, but keep peak power demand from the power line to a minimum.

In magnetizing a magnet which has an extremely narrow gap, such as that in Fig. 1, the impulse magnetizer represents the only feasible approach. A toroidal magnetizing coil could be wound around the ring magnet, but this would be time consuming and hardly well adapted

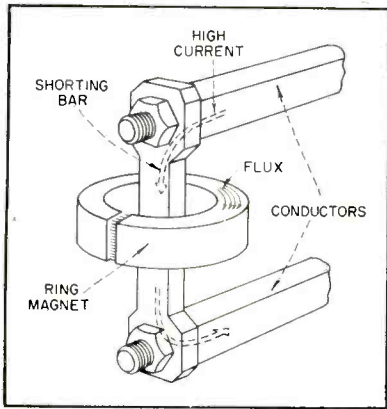

FIG. 1—Principle of impulse magnetization and mounting hardware

to volume production. An electromagnet cannot be used to magnetize such a structure as the ring magnet because its poles cannot be positioned in the gap and the reluctance between the magnetizing poles will be appreciably less than the reluctance of the iron material to be magnetized.

### Magnetizing a Magnetron

The advantages of impulse magnetization are particularly apparent in magnetizing a structure such as an assembled magnetron. Here essentially two ring magnets are joined to provide flux across the single air gap in which the magnetron tube is mounted.

The magnetron is placed on the two current conductors of the impulse magnetizer, as shown in the photographs. A shorting bar is bolted across the two conductors to form a closed circuit of extremely low resistance. A high pulse of current is passed through the two conductors, creating magnetizing flux of sufficient magnitude to saturate the iron of the magnetron magnet. Both magnetic loops are thus magnetized simultaneously in this simple fashion.

### Impulse Magnetizing Equipment

Components of the Raytheon impulse magnetizer include a capacitor rack, output transformer and power supply. The magnetizing loop is attached directly to the secondary of the output transformer.

A block diagram of the impulse magnetizer is shown in Fig. 2. A step-up transformer and rectifier receive a 50 or 60-cps single-phase

voltage directly from the power line. The maximum power demand is 6.6 kva at approximately 70-percent power factor. The transformer and rectifier charge the capacitor bank to a d-c voltage adjustable from 1,000 to 3,000 volts. A feedback charging circuit is used which has a final trickle charging action to hold capacitor voltage to within  $\pm 2$  percent for line voltage variations of  $+10$  percent to  $-20$  percent. By such precise control of capacitor voltage, the magnetizing current pulse is held uniform from pulse to pulse.

A firing tube discharges the stored energy of the capacitor bank through the primary of the output transformer. The transformer secondary is joined directly to the magnetizing loop. This output transformer is a step-down transformer to achieve the desired increase in current level. The transformer turns ratio can be selected by the interconnection of six primary windings, with possible ratios ranging from 100:1 to 600:1. By control of capacitor voltage and transformer turns ratio, peak output current in the transformer secondary can be varied from 40,000 to 200,000 amperes.

By this capacitor discharge method, up to 1,500 kva of peak pulse output power can be provided, even though the maximum demand from the line is only 6.6 kva. Other magnetizing methods, which do not benefit from such pulse power multiplication, must draw their peak power directly from the line at high cost.

The impulse magnetizer provides

Table I—Variables in Impulse Magnetization

	Peak Current ( $I$ )	Time of Rise to Peak Current ( $t_r$ )	Pulse Duration ( $t_d$ )
D-C Voltage Across Capacitor Bank ( $V$ )	$I \propto V$	No effect	No effect
Transformer Turns Ratio ( $TR$ )	$I \propto (TR)^{-1/2}$	$t_r \propto TR$	$t_d \propto TR$
Capacitance of Capacitor Bank ( $C$ )	$I \propto C^{1/4}$	$t_r \propto C^{1/2}$	$t_d \propto C^{1/2}$
Increasing Size of Magnetizing Loop	Decrease	Increase	Increase

a convenient means for the production testing of magnets before they are assembled into the final product. The magnets are mounted on the impulse magnetizer with a keeper usually used to complete the magnetic circuit.

After the current impulse has been applied, a test probe is inserted into a hole provided in the keeper and the gauss value of the magnet read on a ballistic galvanometer. In this manner, both the iron material of the magnet and the accuracy with which the magnet has been machined can be tested.

The magnets are then demagnetized by a reversed current pulse or by ringing down with a decaying alternating current. The magnets are then assembled into the finished product and again magnetized on the impulse magnetizer in a manner such as that shown in Fig. 1.

### Special Shapes

The impulse magnetization technique makes possible the convenient magnetization of a variety of specially-shaped magnetic devices such as a bowl-shaped magnetron magnet. A large copper conductor is permanently mounted within the bowl and carries the high magnetizing current during the gaussing operation. The resulting magnetic flux creates north and south poles at two openings in opposite sides of the structure.

Several cylindrical slotted magnets can be gaussed simultaneously. These magnets are used in wattmeters as eddy current damping devices. A single shorting bar ex-

tends through all of the magnets. Magnetizing flux surrounding the shorting bar creates north and south poles across the narrow air gaps.

### Unidirectional Current Pulses

High unidirectional current pulses can be obtained from a half-wave rectifier operating directly from the a-c power line, by the release of energy stored in an inductor or by the release of energy stored in a capacitor.

The first technique may require an excessive direct demand from the power line of as high as 750 kva rms for one-half cycle. The second and third methods both store energy drawn slowly from the a-c line. The impulse magnetizer makes use of the capacitor storage method.

It is not difficult to obtain a unidirectional current pulse of moderate magnitude from a capacitor bank. The charged capacitor is connected to a low impedance load through a switch device such as an ignitron or a thyatron. Such tubes allow current flow in one direction only.

In impulse magnetization, however, magnetizing currents as great as 200,000 amperes are sometimes required. No discharge tube has yet been designed to handle currents of this size. It is necessary to discharge the capacitor bank into the primary of a step-down transformer and take advantage of the resultant current multiplication.

While the current in the transformer primary is unidirectional, that in the transformer secondary unfortunately is not unless special

measures are taken. Such reversal in current, shown in Fig. 3, would result in undesired demagnetization. Current reversal in the secondary circuit is due to the absence of the magnetizing component of current which is in the primary. Unless the secondary circuit contains no resistance, the secondary current passes through zero before the primary current goes to zero.

However, the primary voltage always passes through zero prior to current reversal in the secondary circuit. Use is made of this fact in the discharge control circuit of Fig. 4.

The capacitor bank is joined to the transformer primary through a thyatron-controlled ignitron firing tube. A switch to positive thyatron bias is sufficient to trigger the thyatron and fire the ignitron.

A second thyatron-controlled ignitron is used to prevent current reversal in the magnetizing loop. The voltage of the capacitor bank, which is initially negative, serves as bias for the thyatron control tube. When capacitor voltage swings positive, the thyatron and ignitron are both turned on.

The R-C network in the thyatron grid circuit delays the positive thyatron grid voltage until there is sufficient voltage drop across the ignitron to maintain conduction. If the delay time of this circuit is made too long, current in the transformer secondary will reverse. If it is made too short, the ignitron will show an undesirable jitter.

The right-hand waveforms in Fig. 3 show the effect of the additional ignitron circuit. All of the waveforms illustrated in the dia-

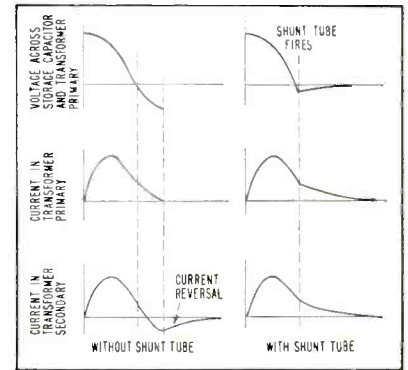

FIG. 3—How shunt tube prevents current reversal and demagnetization

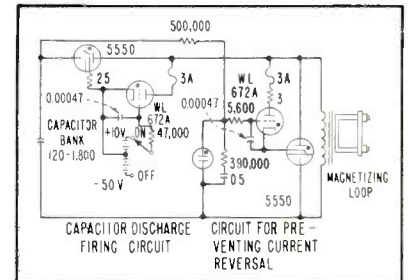

FIG. 4—Discharge control circuit uses two ignitrons

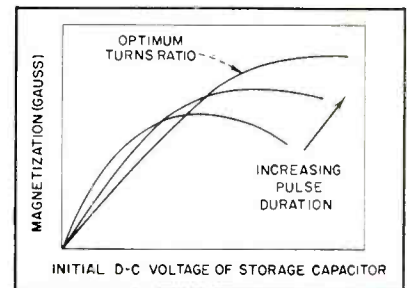

FIG. 5—Effect of d-c voltage and pulse duration on magnetization

gram become exponential after the ignitron shunt tube fires.

### Magnetization Control

In the impulse magnetization of permanent magnets, it has been found that the duration of the current pulse is an important factor and that the optimum pulse length varies with the cross-sectional area of the material to be magnetized. In Fig. 5, the resulting magnetization is shown as a function of initial d-c voltage of the storage capacitor. Three separate curves show the effects of increasing pulse duration. As shown in Table I pulse duration can be increased in several ways, but is usually achieved by increasing turns ratio in the transformer.

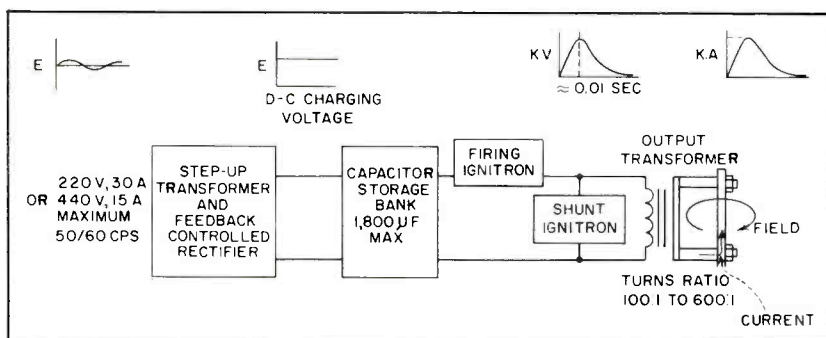

FIG. 2—Main units of impulse magnetization equipment

# Linear Power Amplifier

By **W. B. BRUENE**

Collins Radio Company  
Cedar Rapids, Iowa

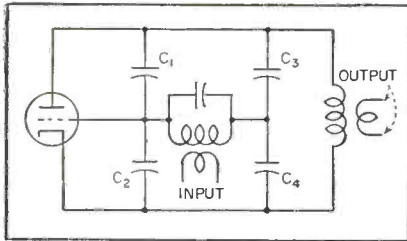

FIG. 1—Simple one-stage neutralized circuit with feedback

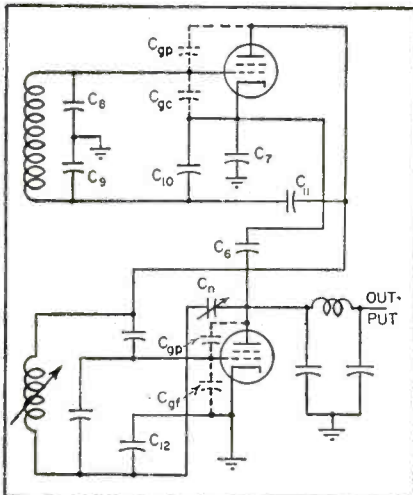

FIG. 2—Two-stage feedback amplifier with neutralization

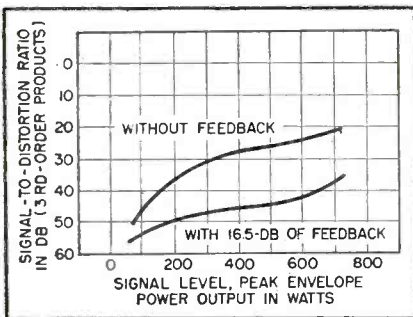

FIG. 3—Curves show distortion reduction in an amplifier with all stages operating class  $AB_1$ .

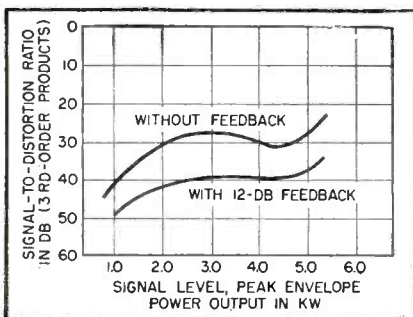

FIG. 4—Plot of distortion reduction with output stage operating class  $AB_2$ .

**H**IGH power gain is required in a single-sideband transmitter because the signal is usually generated at a low power level on the order of 100 milliwatts. Raising the power level to 5 kw, for example, requires a power gain of 50,000 or 47 db. This suggests the use of high-gain tetrode or pentode stages to minimize the number of tubes and associated circuits. Every stage contributes some distortion and it is best practice to confine most of the distortion to the last two stages. Preceding stages must be operated below their maximum power capability if they are to have negligible distortion.

A two-stage power amplifier using high-gain tetrodes and r-f feedback for distortion reduction was developed to meet these requirements. The first stage is operated class  $AB_1$  so the power gain is limited only by the input circuit loss and the loading required to maintain circuit stability. To reduce the distortion of these two stages, r-f feedback is used. With 12 db of feedback, a power gain of 5,000 is still realized and the principal sources of distortion are kept within the feedback loop. A preceding stage operating class A provides the extra power gain of 10.

## Basic Circuit

The basic circuit is a conventional two-stage tetrode amplifier except that r-f is fed back from the plate of the p-a tube to the cathode of the driver tube. This circuit reduces the distortion of both tubes, yet only two tuned circuits are within the feedback loop. These are the interstage and output tank circuits each of which cannot contribute over 90 degrees

of phase shift to the feedback loop.

Additional phase shift appears in the interstage circuit due to lead lengths and tube capacitances, but by care in component layout these are kept relatively small. The use of only 12 to 15 db of feedback, adequate for distortion reduction, leaves a wide margin of stability. Seven different experimental amplifiers using different tube types and physical layouts were built and all were completely stable at frequencies up to 30 mc with as much as 20 db of feedback in some cases.

## Neutralization

Even well screened tetrode tubes are usually neutralized because distortion generated in the stage due to positive feedback is reduced. Also it allows high stage gain because less circuit swamping is required for circuit stability. The circuit shown in Fig. 1, illustrates how any desired amount of feedback can be applied while having the tube properly neutralized.

Neutralization eliminates the coupling from the plate to the input circuit but does not prevent the feedback voltage from appearing on the grid. This requirement is met when the ratio of capacitance values is  $C_1/C_2 = C_3/C_4$ . The amount of negative feedback voltage is determined by the ratio of  $C_3$  to  $C_4$ . Capacitors  $C_1$  and  $C_2$  which include tube interelectrode capacitances, are then brought into the proper relationship for neutralization. In practice, this can be done without applying power to the tube by connecting a signal generator to the output terminals and a sensitive detector such as a receiver to a link coupled to the input coil. Capacitor  $C_1$  or  $C_2$  is then adjusted



# for SSB Transmitters

**SUMMARY** — Use of r-f feedback in two-stage tetrode power amplifier provides high power gain with low distortion in single-sideband transmitters where generation of noise in adjacent speech channels must be avoided

for minimum signal.

In the basic circuit there are two capacitances in the first stage which must be neutralized. One is the grid-to-plate tube capacitance and the other is the cathode-to-grid capacitance. The latter is neutralized to prevent coupling from the feedback to the input circuit.

Figure 2 shows the circuit used to neutralize both capacitances.

The capacitance relationships for neutralizing both circuits are  $C_8/C_9 = C_{gc}/C_{10} = C_{gp}/C_{11}$ . The neutralizing circuit for the output stage is also shown and the capacitance relationship for neutralizing the grid-to-plate capacitance is  $C_n/C_{12} = C_{gp}/C_{g1}$ .

Best performance requires accurate neutralization. For further improvement the input and interstage circuits are loaded with about 5,000 ohms resistance across each circuit. The effective grid loading of a high-power output tube can be further increased by using the interstage capacitive voltage-divider circuit shown in Fig. 2. A 3 to 1 voltage stepdown will cause a 5,000-ohm resistance across the entire circuit to appear like 555 ohms at the grid.

These neutralizing circuits gave excellent performance in amplifiers which covered the frequency range of 2 mc to 30 mc. No neutralizing adjustments were necessary when changing frequency.

For power levels up to 500 watts, tubes can be selected that will operate class AB<sub>1</sub>. Above 500 watts all tubes currently available must be driven into grid current, so means must be provided to avoid excessive distortion due to nonlinear grid-circuit loading. The output impedance of the tetrode driver stage is

quite high so the relatively low source impedance for the output tube grid is provided by loading the interstage circuit with resistance. This is the second purpose of the interstage circuit loading and impedance stepdown that was discussed under neutralization.

Some of the more suitable tubes for the output stage are types 4X150A, 4-400A, 4-1000A, 6076 and 6166. Cathode type tubes are desirable for the driver stage and the 4X150A seems to be the best tube for this application. For low-power applications, a 4X150A operating class AB<sub>1</sub> driven by a 6CL6 will deliver 100 to 300 watts with low distortion.

## Distortion-Reduction

Figures 3 and 4 show distortion curves of two different amplifiers with and without feedback. In the first amplifier with the output stage operating class AB<sub>1</sub>, Fig. 3, 16 db of feedback yields nearly a 16-db reduction in distortion. The second amplifier, Fig. 4, is driven into grid current and as a result some distortion cancellation takes place without feedback. For this reason, the 12 db of feedback did not yield the full 12-db improvement in reducing the third-order distortion products. When cancellation of the third-order distortion products takes place, the fifth and higher-order products are not canceled so the actual overall improvement by feedback is better than the third-order distortion curves alone indicate.

To reduce the static plate-dissipation requirements of the power-amplifier tube r-f feedback can be used. For minimum distortion, a class AB amplifier must be operated with static plate current near

the point of projected cutoff.

In tetrodes, the static current required increases approximately as the 3/2 power of screen voltage. High screen voltage reduces the grid driving power but the resulting high static plate current may cause excessive plate dissipation. Operating with a lower value of static plate current increases the distortion but feedback will reduce distortion to the extent that the static plate dissipation can be reduced by one half. Alternatively, the advantages of lower driving power owing to the use of a higher screen voltage can be realized.

Distortion in linear power amplifiers may also be caused by inadequate dynamic regulation of the power supplies. Feedback will reduce distortion from this cause also so that economies in the power supplies can be achieved.

The use of r-f feedback around a two stage tetrode power amplifier makes high power gain with low distortion practical. One or two low-gain stages which would be required using conventional circuits are eliminated resulting in less circuit complexity, lower cost and better reliability. It also makes possible low distortion that is difficult to achieve by other means.

It has been demonstrated that r-f feedback can be easily used without introducing instability. Trends in voice and code radio transmission indicate increasing usage of linear power amplifiers.

The author acknowledges the contributions of the Collins engineers who had a part in this development, and in particular that of Arthur A. Collins, under whose personal direction this development was conceived and completed.

# Squirrel-Cage Motor

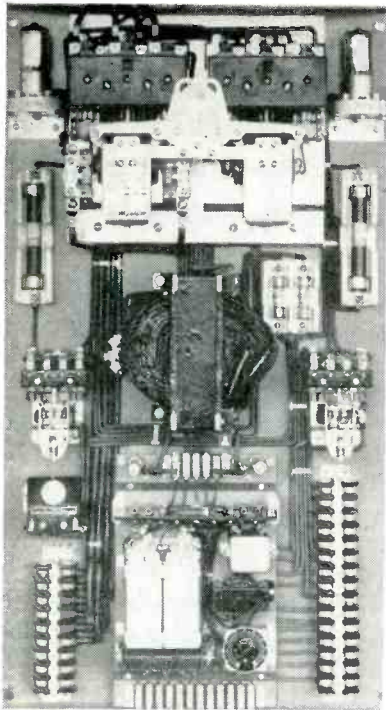

Two-tube control panel for the adjustable speed operation of squirrel-cage induction motors rated 1 to 5 hp

By MILLARD G. SPENCER

Consulting Engineer  
Crocker-Wheeler Division  
Elliott Company, Jeannette, Pa.

**A**DJUSTABLE speed operation of a squirrel-cage induction motor over the entire speed range, with close speed regulation, is now possible.

Saturable-core reactors that are under electronic control are used in the line between the power source and the motor. They automatically adjust motor voltage to the value required to maintain the speed at any preselected value substantially independent of the load.

As the electronic control handles only a small control current its capacity needs to be only a small fraction of the power of the motor. Current for operating the motor flows directly to the motor through the a-c windings of the line reactors and not through the electronic system. Therefore, heavy overload or starting currents cannot damage or burn out the tubes.

## Torque

Ordinarily the speed of a standard squirrel-cage induction motor is not responsive to the motor voltage. The speed-torque curves of

such a motor are shown in Fig. 1. As the stator voltage is reduced the speed of the motor, on a constant torque load as indicated by line A, does not change much. When the voltage has been reduced to about 50 percent the speed collapses and the motor comes to a stop.

However, if the motor-rotor resistance is increased to a high value, speed-torque curves as shown in Fig. 2 can be obtained. Motor speed is responsive to the stator voltage and can now be reduced by reducing the stator voltage. Such a motor can be operated on a constant-torque load, line A Fig. 2, at any speed down to standstill.

In this case the motor speed is stable at all speeds because as the motor slows down with increased load the motor torque increases and tends to maintain speed. The curves of Fig. 2 show that at any particular stator-voltage setting the motor speed regulation is poor. The speed tends to come up to full synchronous speed at no load at any stator-voltage setting.

If the motor stator voltage could be automatically increased the right amount as load is increased, the motor speed-torque curves would be as shown by line B Fig. 2. The motor could thus be given shunt-motor characteristics.

It is possible to obtain such automatic stator-voltage control by connecting direct-current-controlled saturable-core reactors in the line between the power source and the motor-stator winding. Control of the d-c saturating current of these saturable reactors is then effected

by an electronic control circuit.

With no direct current flowing in the d-c saturating windings of these line reactors the impedance of the reactors is high. They absorb practically the entire line voltage and almost no voltage reaches the motor. As direct current in the line reactors is increased the impedance is decreased. They absorb less of the line voltage and more of the line voltage is applied to the motor. When maximum d-c saturating current is reached the impedance of the reactors is reduced to a minimum and practically the entire line voltage is applied to the motor.

The speed-torque curves of a high-resistance, squirrel-cage motor with saturable-core reactors in the line are shown in Fig. 3 for various values of saturating d-c. These curves show that a motor with saturable-core reactors in the line is not as stable at the lower speeds as a motor with reduced but constant stator voltage.

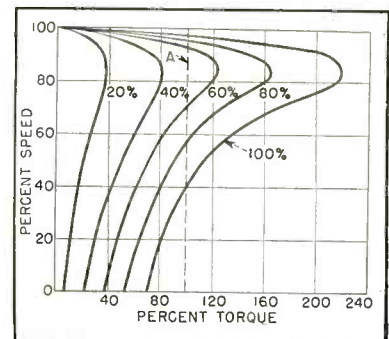

FIG. 1—Speed-torque characteristic of a squirrel-cage induction motor with standard low-resistance rotor

# Speed Control System

**SUMMARY** — Saturable-core reactors in motor leads of induction motor having high-resistance squirrel-cage rotors are connected to two-tube electronic control circuit giving good speed regulation at any speed setting

With reactors in the line, when the motor speed is reduced to about one-half speed the motor speed-torque curves become vertical and coincide with the constant-torque line A in Fig. 3. Under this condition the motor speed becomes unstable on a constant torque load. However, with fast-acting electronic control of the line-reactor saturating current the motor speed can be held substantially constant. Stable operation of the motor is then obtained even on the vertical portion of the speed-torque curves.

## Circuit

A saturable-core reactor shown in Fig. 4 is connected in each line between the a-c power source and the stator winding of the squirrel-cage induction motor. A pair of thyatron-type rectifiers  $V_1$  and  $V_2$ , connected in a single-phase full-wave circuit, supplies the d-c control current to the line reactors. The firing point of these tubes and therefore their d-c output is con-

trolled by a phase-shift circuit connected to the control grids.

This phase-shift circuit is controlled in turn by a small saturable-core reactor  $L$ . The d-c control winding of this reactor is supplied with d-c from the output circuit of amplifier  $V_3$ . Rectifier  $V_4$  supplies the anode voltage for amplifier  $V_3$ . The grid circuit of  $V_3$  is coupled to the output circuit of  $V_5$  in a resistance-coupled amplifier circuit.

Tube  $V_5$  is the primary control tube which is controlled by the algebraic sum of two d-c voltages, a reference voltage and a speed voltage, applied to its grid. A rectifier connected in a full-wave rectifier circuit, supplies the d-c voltage to voltage divider  $R_2$ . An adjustable reference voltage is obtained from potentiometer  $R_1$  which is connected to voltage divider  $R_2$ .

A small inductor-type tachometer generator is driven directly by the squirrel-cage induction motor. The output of this tachometer generator is rectified by  $V_7$  to give a d-c volt-

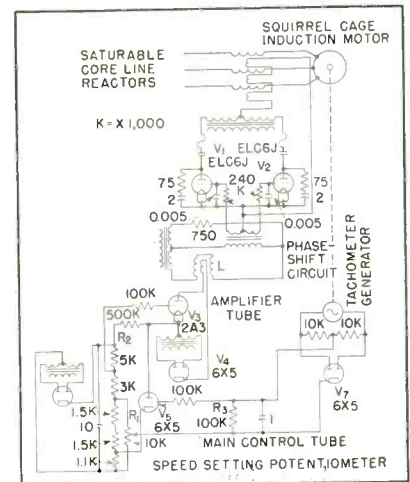

FIG. 4—Control circuit for adjustable speed operation of squirrel-cage induction motors

age which is a direct measure of the motor speed.

## Operation

When speed-setting potentiometer  $R_1$  is set for zero speed a negative voltage from voltage divider  $R_2$  is applied to the grid of the main control tube  $V_5$ , which cuts it off. A negative bias is applied to tube  $V_3$ , cutting off this tube. With  $V_3$  cut off no d-c flows through the control winding of the saturable-core reactor  $L$ . This sets the phase of the phase-shift circuit so that thyatron tubes  $V_1$  and  $V_2$  do not fire and no d-c from these tubes flows through the control circuit of the line reactors.

Under this condition the impedance of the line reactors is high and they absorb practically the entire line voltage. So little voltage reaches the motor stator winding

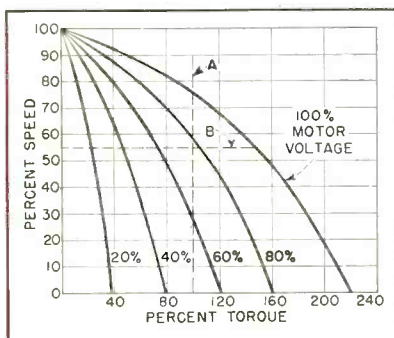

FIG. 2—Speed-torque curves of a squirrel-cage induction motor with a high-resistance rotor

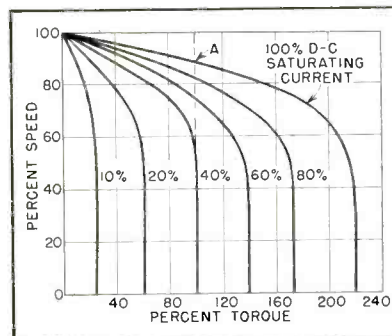

FIG. 3—Motor speed-torque curves. Motor has high-resistance rotor and saturable-core reactors in the line

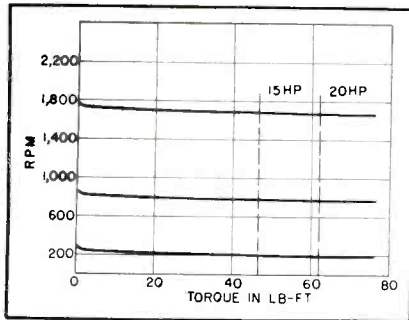

FIG. 5—Speed regulation of a 20-hp squirrel-cage induction motor at reduced speed under electronic control

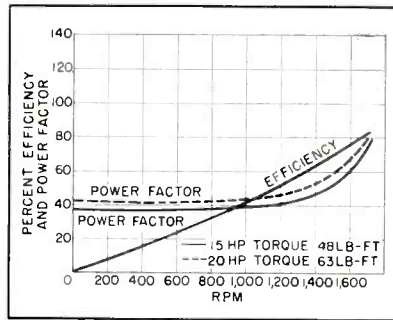

FIG. 6—A 20-hp squirrel-cage induction motor operated over the entire speed range using the control circuit

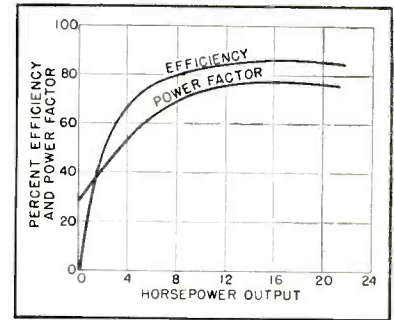

FIG. 7—Power factor and efficiency of 20-hp induction motor operated at maximum speed

that the motor develops practically no torque and stands still. If the speed-setting potentiometer is moved up about half way a positive voltage is applied to the grid of  $V_6$  causing this tube to conduct and, in turn,  $V_3$  conducts. The d-c output current from  $V_3$  partially saturates the core of reactor  $L$  in the phase-shift circuit. This shifts the phase of the grid voltages of  $V_1$  and  $V_2$  so that they fire early and develop considerable d-c output.

Direct current flowing through the d-c windings of the line reactors partially saturates the core of these reactors and reduces the impedance of their a-c windings. This reduces the voltage absorbed by the line reactors and allows a portion of the line voltage to reach the motor-stator winding developing considerable torque.

The motor now starts to rotate. As the motor rotates an a-c voltage is generated by the tachometer generator which is rectified by  $V_7$  and produces a d-c potential across resistor  $R_3$  which is proportional to the speed of the motor. This negative potential is applied to the grid of control tube  $V_6$  in opposition to the reference voltage from speed-setting potentiometer  $R_1$ .

It is the difference between these two voltages which determines the output of control tube  $V_6$ . As the motor speed rises the difference between these two voltages becomes less and the output of the control tube  $V_6$  is reduced. This reduced output of  $V_6$ , through the action of amplifier  $V_3$  and the phase-shift circuit, causes the thyatron tubes to fire later in the cycle thus reducing their output.

This reduced d-c output from the

thyratrons: reduces the saturation of the line reactors; increases the portion of the line voltage absorbed by them; reduces the motor voltage and therefore its torque. Motor speed continues to increase until this action has reduced the motor torque so that is just sufficient to carry the load.

A small difference between the tachometer-generated voltage across  $R_3$  and the reference voltage from  $R_1$  is sufficient to develop enough torque in the motor to carry the load. With increased motor load the motor slows down slightly to decrease the speed voltage across  $R_3$  and increase the difference between this voltage and the reference voltage from the speed-setting potentiometer to cause the motor to develop more torque.

The reverse takes place as the motor load is decreased. When the speed-setting potentiometer is set for a different value of reference voltage the motor speed automatically changes until the tachometer-generated voltage across  $R_3$  again is nearly equal to the reference voltage.

### Motor Rating

Reduction of the speed of an induction motor by the reduction in the applied stator voltage presents a motor-heating problem. As the stator voltage is reduced to cut down the motor speed, the motor field strength is also reduced. The motor torque is proportional to the product of the motor field strength and the in-phase rotor current. This means that as the stator voltage is gradually reduced to reduce the motor speed under a constant-torque load the motor current gradually

increases and becomes a maximum at standstill.

In general, the higher the rotor resistance the less the increase in motor current as the motor is slowed down. But a high rotor resistance means a high slip and low maximum speed at full voltage.

Consider a standard 4-pole motor rated as an adjustable speed motor at  $\frac{1}{3}$  its single-speed rating. A value of rotor resistance is selected which will give a maximum speed of 1,600 rpm at this  $\frac{1}{3}$  rating. This motor will develop this  $\frac{1}{3}$  standard rated torque at any speed down to standstill without exceeding the normal rated current of the motor as a single-speed motor when it is slowed down by stator-voltage reduction.

The advantage of the lowered motor rating is twofold. It enables a high rotor resistance to be used and still obtain a maximum speed of 1,600 rpm. It also allows the motor to be operated at constant torque at any speed down to standstill without exceeding its normal rated current. If normal motor ventilation is maintained by a separate constant-speed blower the motor can be operated continuously at rated torque as an adjustable-speed motor at any speed without exceeding normal stator-temperature rise. If the required speed range is less than the full range down to standstill, or the service is intermittent at the lower speeds, the motor can be given a rating as an adjustable speed motor of more than  $\frac{1}{3}$  its normal rating.

Figure 5 shows the speed-torque curves of a 20-hp squirrel-cage induction motor. This motor had the special rotor construction and was

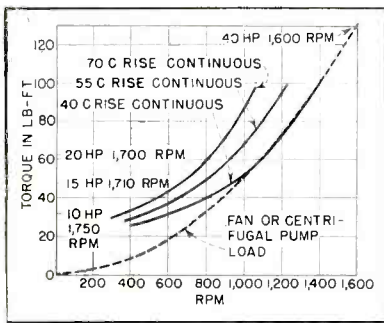

FIG. 8—Heating characteristics, over a wide speed range, of a squirrel-cage induction motor under electronic control

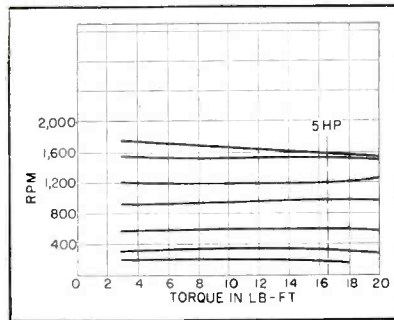

FIG. 10—Speed regulation of a 5-hp induction motor operated at reduced speeds with two-tube electronic control

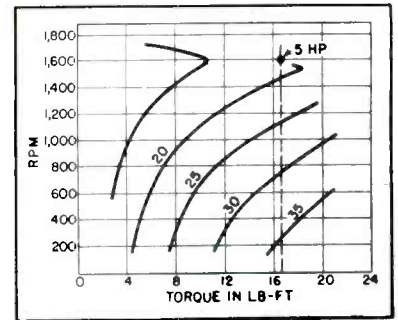

FIG. 11—Speed-torque-current curves of a 5-hp induction motor at reduced speeds with two-tube control

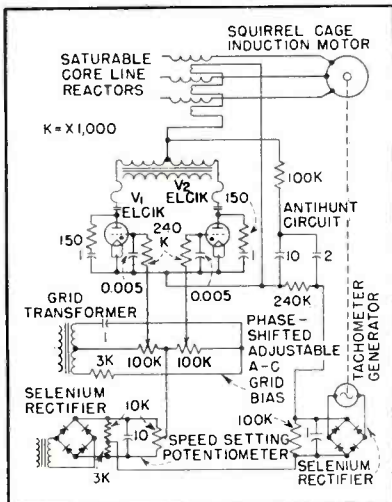

FIG. 9—Schematic diagram of two-tube circuit for the adjustable speed operation of squirrel-cage induction motors

operated as an adjustable speed motor at various speeds using the control system shown in Fig. 4. This motor had good speed regulation

### Operating Characteristics

The efficiency and power factor of this same motor is shown in Fig. 6 and 7 over the entire speed range at two different constant-torque loads and at maximum speed. The efficiency is similar to that of an ordinary slip-ring induction motor.

Temperature rise of this motor is shown in Fig. 8 at various loads and speeds under continuous operation. These curves show how the rating of this motor, for any particular temperature rise, depends upon the speed range and the nature of the load. When used for driving a fan or centrifugal pump where the required torque falls off rapidly as the speed is reduced this motor, as an adjustable speed motor, can

be given practically its entire single-speed motor rating.

### Two-Tube Control

Substituting selenium rectifiers for some of the vacuum-tube rectifiers of the control system of Fig. 4 and eliminating the amplifier stages resulted in the system shown in Fig. 9. Almost as good operating characteristics for an adjustable speed induction motor can be obtained with this control system which uses only two tubes. The same thyatron tubes  $V_1$  and  $V_2$  and main line saturable-core reactors are used with this two-tube control as with the seven-tube control.

Only two thyatron tubes each having a rated output of 1 ampere d-c are required for the speed control of induction motors from 1 hp to 5 hp inclusive. Two 6.4-ampere thyatron tubes are sufficient for speed control of the 7.5-hp to 50-hp induction motors.

Operation of the thyatron tubes in this two-tube control is the same as for the seven-tube control system. However, in this case the thyatron conduction is controlled by the summation in the grid circuit of the thyatron tubes of four voltages. These voltages are: a d-c reference voltage from the speed-setting potentiometer; a d-c speed voltage obtained by rectification from the tachometer generator; a permanently phase-shifted adjustable a-c voltage; and a feedback voltage from an antihunt circuit.

The magnitude but not the phase angle of the a-c grid voltage is adjustable by two potentiometers shown in Fig. 9. These potentiometers are coupled together so that the magnitudes of the a-c grid volt-

ages of  $V_1$  and  $V_2$  are always equal but differ in phase by 180 degrees. The sensitivity of this control system can thus be adjusted.

With small a-c grid-bias voltage this control system is very sensitive. There is little change in motor speed from no load to full load but the system has more tendency to become unstable and hunt. With higher a-c bias voltage the speed regulation is poorer. There is more drop in speed from no load to full load but the system is more stable and there is less tendency to hunt. The best setting for this a-c bias voltage in any particular case depends upon the load.

The speed regulation of a 5 hp adjustable-speed induction motor using the two-tube control is shown in Fig. 10. A standard slip-ring induction motor with a fixed resistor connected to the slip rings was used for this test. The same results could have been obtained with a squirrel-cage induction motor which had the same effective rotor resistance.

Figure 11 shows the speed-current-torque curves for this same motor. These curves enable the torque being developed by the motor under any condition of load and speed to be determined conveniently by reading the line current and the speed of the motor.

The starting current and starting torque of motors with this type of control builds up gradually as the speed-setting potentiometer is turned up from its zero-speed position. This enables smooth starts to be made with a minimum of line current. A maximum starting torque on the order of 300 percent is available if required.

Broadcaster's problem  
is solved by putting . . .

# F-M Antenna

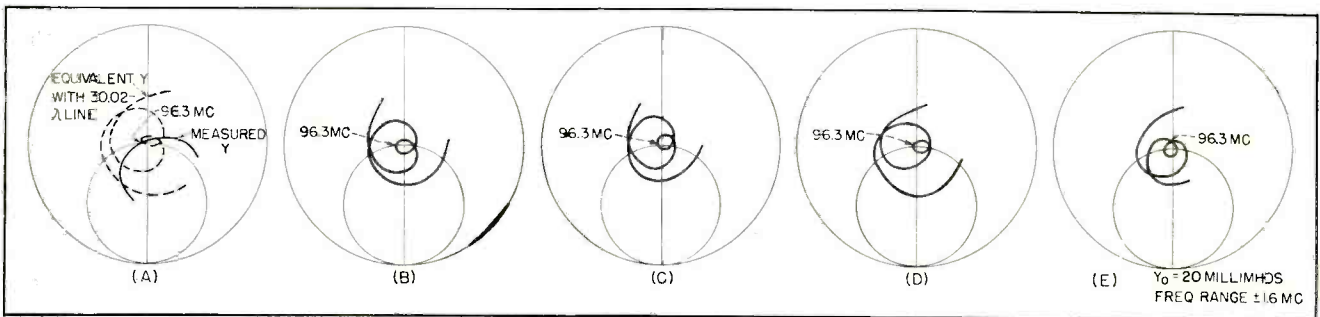
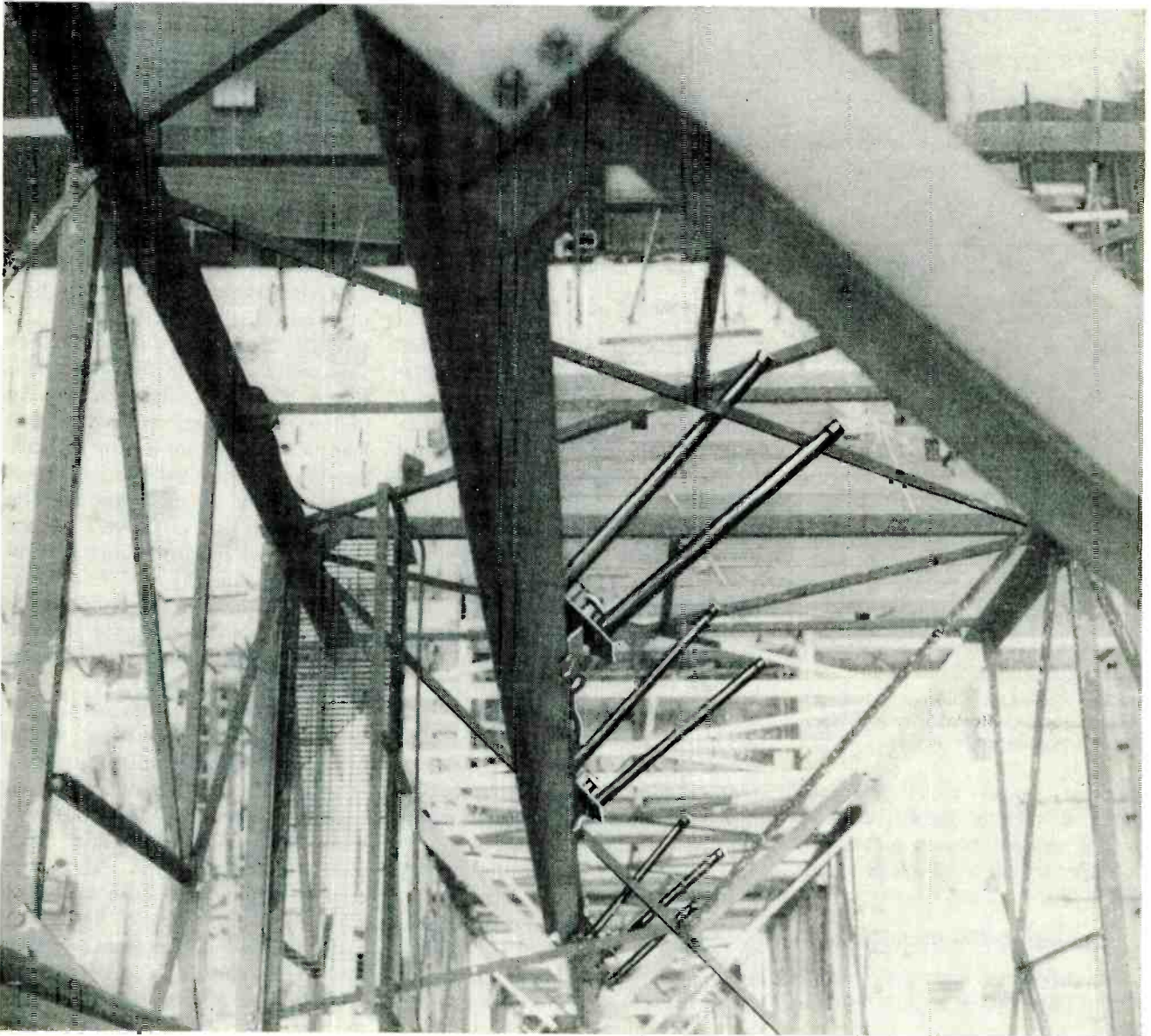

FIG. 1—Smith chart plots of antenna admittance for single-bay element in free space (A) and in each of four operating locations from top to bottom of array

# Inside the A-M Tower

**SUMMARY** — Station WTOP had decided to add f-m service but there was no place for the antenna. There was already a tv array on top of the a-m radiator tower and tower dimensions made outboard mounting impracticable. Answer was to put the f-m antenna inside the tower

By **M. W. SCHELDORF** and **GRANVILLE KLINK, Jr.**

*Andrew Corporation  
Chicago, Illinois*

*Station WTOP  
Washington, D. C.*

WHEN STATION WTOP began plans to add f-m to its broadcasting services, it encountered a serious problem in antenna installation. There was already a tv antenna on top of the tower. The tower itself was so large, even at the upper end, that mounting the antenna outside would have caused serious distortion of the horizontal pattern. The cost and complication of mounting a number of f-m antennas around the tower could not be justified.

A stacked four-bay antenna was mounted within the fabricated tower far enough below the top so the field would penetrate the tower structure lattice without undue distortion.

The scheme was checked at full scale using a single radiator. It was found that an adequately circular antenna pattern was obtained when the tower sides exceeded a half wavelength provided the radiator was positioned vertically to avoid coupling to the horizontal members of the tower. This condition was met for the horizontal pattern by mounting the antenna halfway between horizontal tower members.

For the four-bay WTOP antenna it was necessary to provide phasing sections to feed the antennas in phase even though spaced differently from the normal slightly less-than-a-wavelength spacing. This deviation reduced gain from 3.7 to 3.4.

The overall functioning of the antenna was checked by antenna

admittance measurements. Measurements of the operating admittance of a single bay were made in free space and then made with the antenna element of a single bay mounted successively in each of the operating locations of the four-bay array.

The measurements were made with a General Radio 1602-A admittance meter. One element was measured in a relatively open area and about a wavelength above ground. The measuring setup included approximately two feet of 1½-in., 51.5-ohm transmission line, a reducer and three feet of solid dielectric cable.

The element was then raised in the tower and successively measured in each of the four operating positions. Here the measuring setup included the 1½-in. line, which is a part of the antenna, the reducer, about 54 feet of RG-8/U line, a second reducer, approximately 230 feet of 3¼-in. line, a third reducer and 6 feet of solid dielectric line.

The operating frequency, 96.3 mc, was determined by beating the signal generator output with the signal from the WTOP-FM transmitter. Additional frequencies were obtained from the calibration of the signal generator and covered a range of approximately  $\pm 1.6$  mc.

## Admittance

The free-space measurements were transformed to an equivalent admittance as would exist had the

additional line (30.02 wavelengths at 96.3 mc) been used in the free-space measurements. The original and the transformed free-space admittances are plotted in Fig. 1A. Measurements of admittance in the four operating positions were made at the operating frequency and side frequencies in the range  $\pm 1.6$  mc to establish the shape and position of the admittance curves. These measurements of admittance, from top to bottom, are given in Fig. 1B to 1E.

## Evaluation

The elements in the upper three positions are not affected appreciably from an admittance standpoint by the presence of the tower. Their patterns are essentially the same as the free-space pattern. The element in the bottom position is affected by the proximity of the tower by an increasing amount as the frequency is lowered. At the operating frequency, the admittance is changed by about 17 percent. If this admittance change were caused by a dipole, probably the maximum pattern distortion per unit change in impedance, the effect on the pattern would be about  $\pm 4$  to 6 db.

Since only one bay out of the four is affected by the tower it is reasonable to expect that deviation from the free-space pattern is probably less than 3 db.

Thanks are due Ogden Prestholdt of CBS in New York for measurements and calculations of antenna performance.

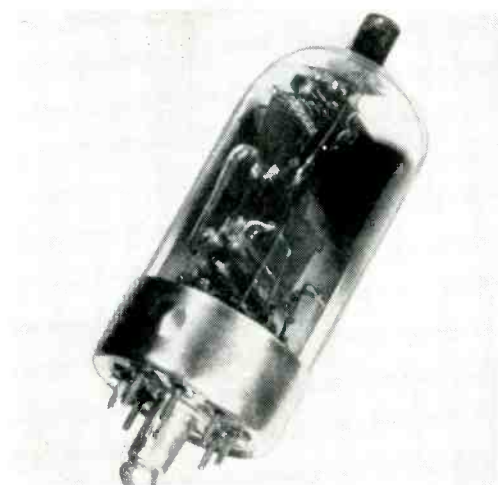

Anodyne tube utilizes T-9 bulb with grid cap

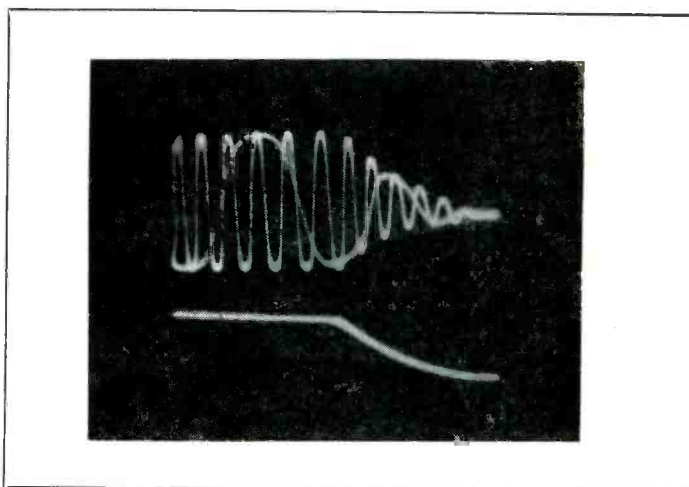

Input to deflection plates is modulated by control-grid

# Anode-Dynode Beam

**SUMMARY** — Zero net operating plate current is achieved in amplifier using composite output element. Anode section gives positive transconductance. Dynode section gives negative transconductance. Tube is useful in gating circuits, difference amplifiers, voltage regulators, multivibrators, binary storage circuits and many others

**C**LASS-A amplification with zero quiescent plate current and other novel and useful operating characteristics may be achieved with the anode-dynode line beam deflection amplifier. The tube's characteristics are obtained by adding primary and secondary electron current through a common output load.

## Zero Quiescent Current

The static anode-dynode currents of the composite output element used in the tube are out of phase producing a net operating plate load current of zero. Dynamic currents obtained with signal variation, how-

ever, are in phase and additive. This mode of operation with zero quiescent current produces a composite output current-deflection voltage curve which is exceedingly linear, giving rise to comparatively constant transconductance for large signals.

On-off switching or coincidence operation of the tube is permitted at the zero current quiescent point without producing any undesirable plate current transient or distortion. Similarly, operation as a balanced modulator is obtained by insertion of inputs both on the deflection system and on the control grid located near the cathode. In addi-

tion, infinite variation of the transconductance of the tube is obtained without sacrificing operational linearity. This characteristic is ideal for automatic gain control.

Plate voltage-current characteristics of the anode-dynode tube can be made to exhibit linear negative as well as positive transconductance. This characteristic can be utilized with suitable interconnection to produce a number of negative resistance devices.

## Basic Tube Structure

Figure 1A illustrates a typical electrode layout employed to obtain zero quiescent current. As indi-



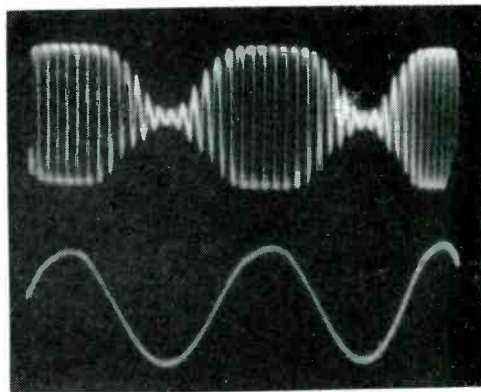
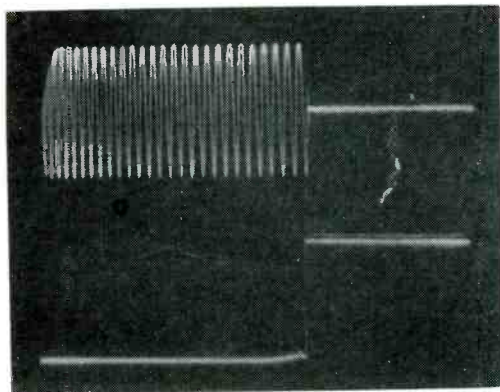

waveforms, bottom. Grid waveforms include saw tooth, left, square wave, center, and sine wave, right

# Deflection Amplifier

By **HERBERT J. WOLKSTEIN**  
and **ALFRED W. KAISER**

*Research Division  
National Union Electric Corp.  
Orange, New Jersey*

cated, a line beam-forming electron gun is utilized with provisions for electrostatic beam focusing and deflection. The target contains an output anode and an output dynode or secondary-emissive surface. The dynode is physically separated from the anode by a suppressor element. This suppressor alters the potential gradient sufficiently to inhibit secondary electrons ejected from the anode.

A grid placed in front of the dynode and overlapping the anode serves as both a secondary electron collector and electron accelerator. The anode and dynode are electrically tied together and utilize a com-

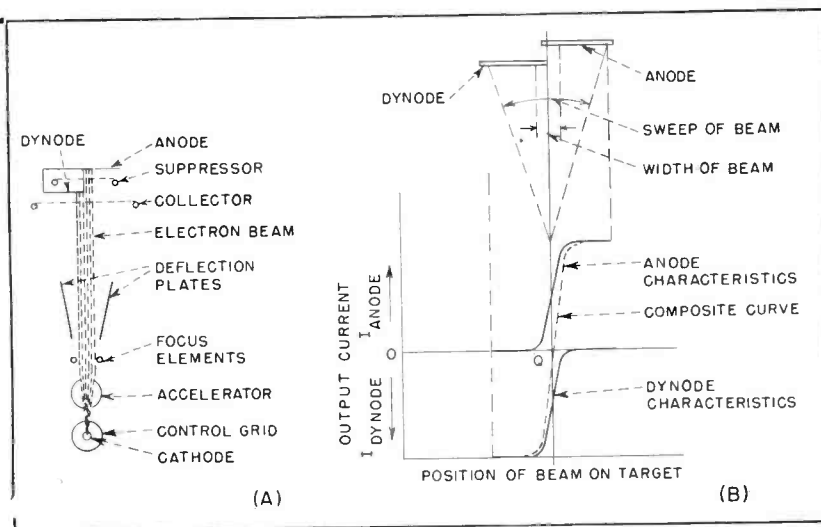

FIG. 1—Tube elements (A) and method of achieving composite anode-dynode characteristics (B)

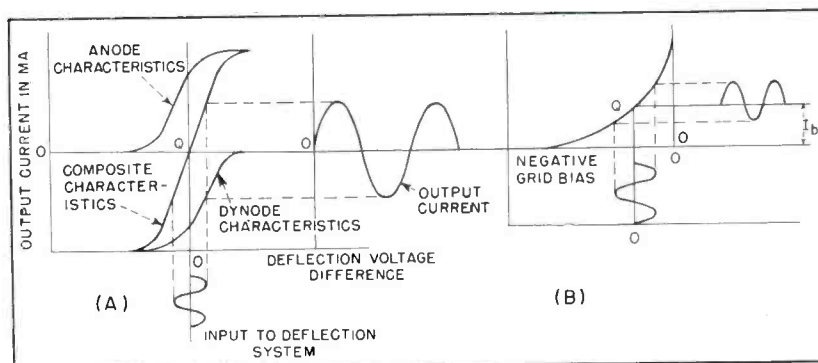
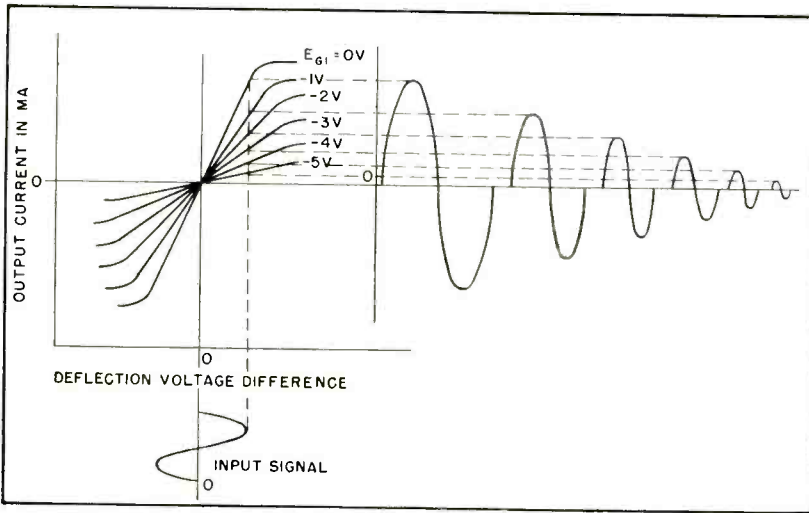

FIG. 2—Anode-dynode characteristics (A) compared with grid-plate transfer characteristic (B) of conventional amplifier

**Table I—Operating Conditions and Electrical Characteristics**

Typical Operating Conditions	
Accelerating anode	300 v
Focusing anode	0 v with adjustment for centering +15 v and -10 v rel to cathode
Control grid (cathode bias)	0 v
Cathode bias resistor	500 ohms
Mean deflection potential	150 v
Anodyne	225 v
Deflection $g_m$	1,200 $\mu$ mho
Cathode current	10 ma
Focusing anode current	10 $\mu$ a max
Control grid voltage for $I_b = 10 \mu$ a	35 v
Electrical Characteristics	
Heater, unipotential cathode	
voltage	6.3 $\pm$ 10v a-c or d-c
current	0.3 amp
Direct interelectrode capacitance	
Deflector plate No. 1 to all other elements, anodyne grounded	3.5 $\mu$ mf
Deflector plate No. 2 to all other elements, anodyne grounded	3.5 $\mu$ mf
Anodyne to deflector plate No. 1, all other elements at ground	0.055 $\mu$ mf
Anodyne to deflector plate No. 2, all other elements at ground	0.055 $\mu$ mf
Anodyne to all other electrodes, deflectors at ground	4.2 $\mu$ mf
Control grid to all other elements, anodyne at ground	3.8 $\mu$ mf
Control grid to anodyne, all other elements at ground	0.0061 $\mu$ mf



**FIG. 3—Output signal for several levels of control-grid bias illustrating almost infinite variation of transconductance**

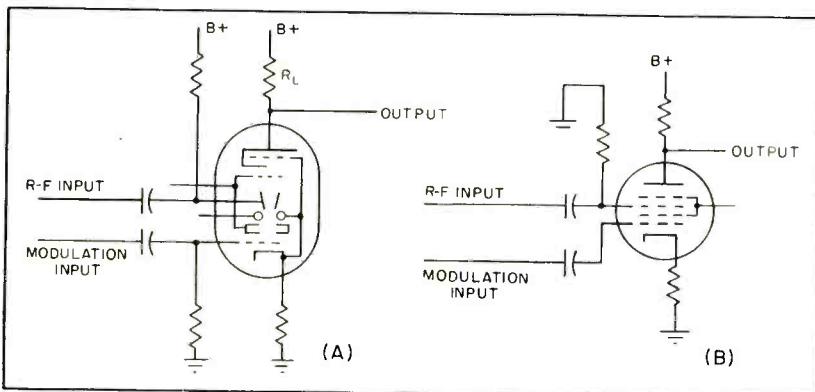

**FIG. 4—Gating or coincidence circuit using anodyne tube (A) and conventional multigrad mixer (B)**

mon output load. The interconnection of these two elements, anode anodyne has suggested the name anodyne which is used to identify the type of tube. The anodyne tube is shown in the photograph.

**Composite Characteristics**

Deflection of the focused line beam across the target produces the waveshape output relative to beam position along the target as indicated in Fig. 1B. The addition of separate out-of-phase currents at the intersection of the target produces a net current of zero for a secondary to primary electron ratio of two.

Dynamic deflection of the beam, however, produces current increments which are in phase and additive through the load. The addition of anode and dynode output forms the composite output curve known as the anodyne characteristic.

The composite curve (Fig. 1B) permits twice the deflection transconductance obtained from beam deflection tubes which do not have anode-dynode characteristics. Typical operating conditions and electrical characteristics of the tube are listed in Table I.

**Operation of the Tube**

For dynamic operation of the tube, the beam is deflection centered so that net current through the output load is zero, point Q of Fig. 1B. Static centering thereby provides compensation if the dynode surface has a secondary emission ratio other than two as suggested. This mode of operation allows signal modulation with no d-c load dissipation.

Figure 2A indicates the transfer characteristics of the tube as a beam deflection amplifier compared to a conventional grid-type amplifier, Fig. 2B. Dynamic transconductance measurements have indicated that the peak transconductance of the beam deflection tube is constant over a larger portion of the working range of the transfer curve. In addition to this property, constant beam current characteristics indicate an exceedingly large constant plate resistance over the same range.

Operation at zero quiescent current produces no degeneration due to d-c output element voltage level

even with large loads. These characteristics provide for decreased output distortion as compared to conventional grid-type tubes.

Published dynamic coefficients for conventional grid-type tubes are generally associated with small-signal operation at a single operating point on the plate characteristic. Variation in tube coefficients for larger signals necessitates the use of graphical solutions. The linearity inherent in line beam deflection amplifiers extends the range over which the published coefficients apply. The equivalent a-c plate circuit theorem, therefore, holds for the anode-dynode tube over a wide variation of input signal amplitude with little or no variation in average tube coefficients.

### Coincidence Gating

In multigrid tubes, where coincidence gating or signal mixing is employed, operating parameters may be shifted from linear small-signal conditions to cutoff or saturation. The shift in operating range is accompanied by a radical departure from quiescent plate conditions where only a change in signal grid transconductance is desired. Rapid changes from quiescent operating conditions to obtain the shift in transconductance gives rise to undesired gating distortion in the output. Voltage increments due to this distortion often overshadow the signal content of the desired intelligence.

For the anode-dynode beam deflection tube, operation about zero quiescent current permits modulation of beam current by the cathode control grid (Fig. 1A) without producing a change in d-c voltage level through the load. At balance, that is, when primary current is equal to secondary current, reduction in total beam current does not affect the conditions of net zero load current.

Figure 3 indicates the relative transfer characteristics obtained at various levels of beam current. Maximum output is obtained at zero grid bias for a given deflection modulating voltage. For smaller values of beam current and the same signal modulation applied less output is obtained. Further increase in negative grid bias de-

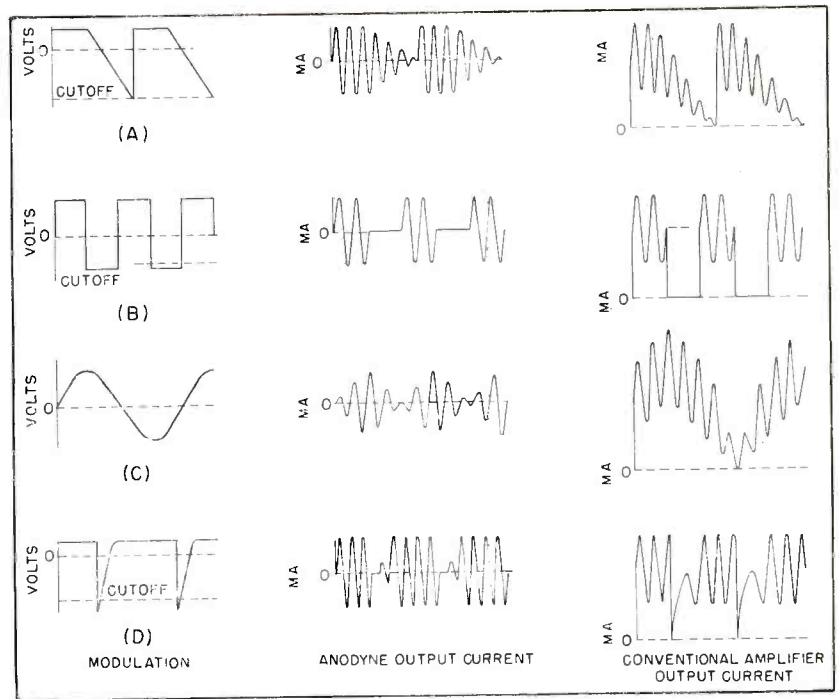

FIG. 5—Response of anodyne and conventional gating circuit to various modulation waveforms

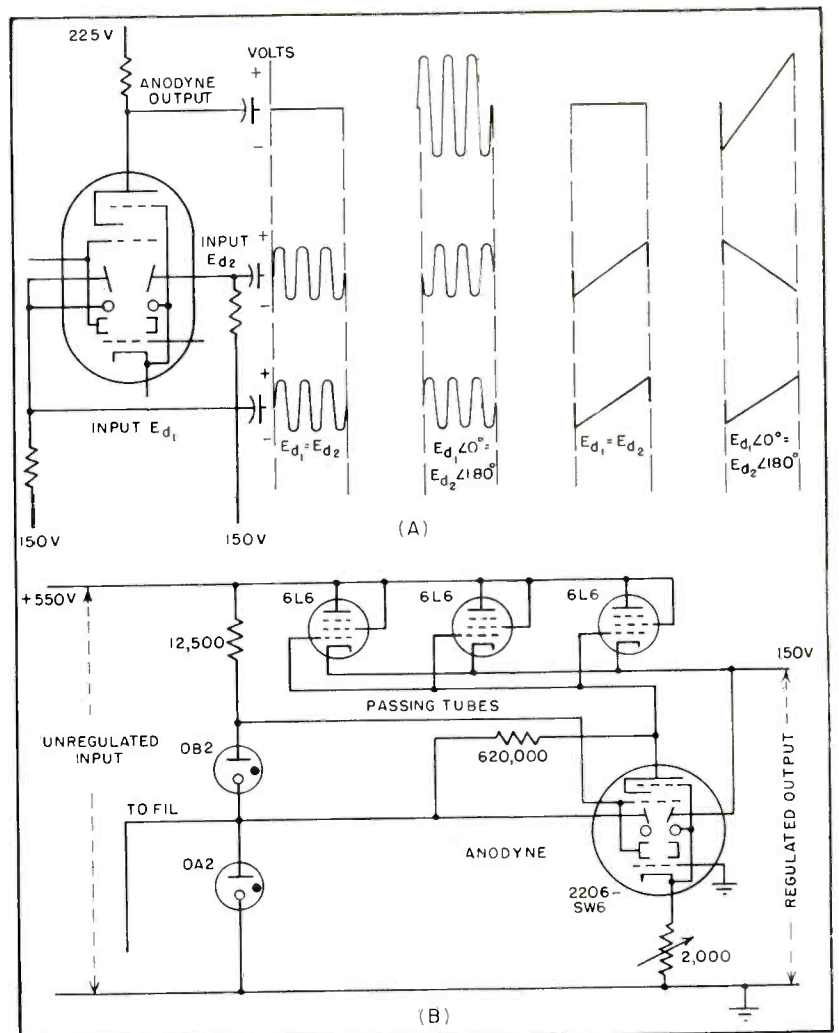

FIG. 6—Circuit and waveforms of anodyne used as difference amplifier (A); circuit of regulated power supply (B)

creases the signal output.

The control of beam current magnitude regulates the transconductance of the tube without shifting the operating point. In conventional tubes, changing the bias changes the operating point. This condition is pronounced when a conventional amplifier is driven from its operating point to cutoff producing a sharp rise in plate potential.

Figure 4A illustrates how the anodyne can be connected in a gating point to cutoff producing a shows a conventional multigrid mixer tube in the same type of circuit. Fig. 5 indicates the output of the anodyne and that of a conventional amplifier in the gating or coincidence circuit. The r-f input to both tubes is of constant amplitude. In addition, the various waveforms shown at the left in

Fig. 5 are applied to the control grids of both tubes. The anodyne provides the output waveforms shown in the center column while the conventional multigrid mixer provides the output waveforms shown at the right.

The important differences conveyed by the output characteristics indicate that the contour of the r-f voltage output from the anodyne essentially follows the waveshape applied to the control member. A square wave *B* applied to the anodyne control grid produces a square wave of r-f voltage while the conventional tube gives rise to an extraneous signal. The application of a sine wave and pulse as indicated in *C* and *D* produce similar results.

Application of a negative linear saw tooth *A* produces a linear variation of transconductance from a maximum value to a value of zero without affecting output linearity. These characteristics are applicable to low-level balanced modulation where the signal applied to the control grid is balanced out in the absence of deflection plate modulation. The oscillograms show anodyne output waveforms, above, and corresponding control-grid waveforms, below.

### Difference Amplifier

The anodyne, because of beam deflection characteristics, can be used as a signal difference amplifier. The deflection transconductance of the device is necessarily common to both deflection plates and transfer balance is maintained at all times. In-phase signals of the same amplitude applied to both deflection plates will produce no output while

out-of-phase signals will yield the sum of both signals. Figure 6A indicates operation of the device as a difference amplifier.

### Other Circuits

The anodyne tube may be used as the control tube in a voltage regulator as shown in Fig. 6B.

The anodyne output characteristic and various modifications of that characteristic have been employed in a number of negative transconductance devices. Proper interconnection of the output to the deflection input terminals produces a two-terminal negative resistance device. This negative transconductance characteristic exhibited by the increase of output current with a decrease of relative deflection potential can be used with suitable load line and deflection plate connection to present two stable levels of circuit current.

The criteria for securing the two stable levels of circuit current are met in the simplified circuit of Fig. 7A. The feedback voltage produced by the current flow through  $R_L$  enables sufficient regeneration to establish two points *A* and *B* of stable equilibrium. The composite curves for this negative transconductance and the points of circuit current stability are indicated in Fig. 7B.

Bistable holding points with separation of less than five volts have been achieved. This small voltage difference as compared to large voltage increments required for conventional grid-type binary-connected devices should be expected to provide fast operation and repetition rates.

### Multivibrator

The negative transconductance characteristics and the associated regeneration provide a means to produce fast multivibrator circuits, monostable flip-flops, counters, oscillators and harmonic generators.

A multivibrator circuit employing the anodyne tube is shown in Fig. 8A while the circuit of a binary storage device is given in Fig. 8B. Most circuits can be employed without the voltage-level coupling problems and the large associated time constants that burden conventional methods.

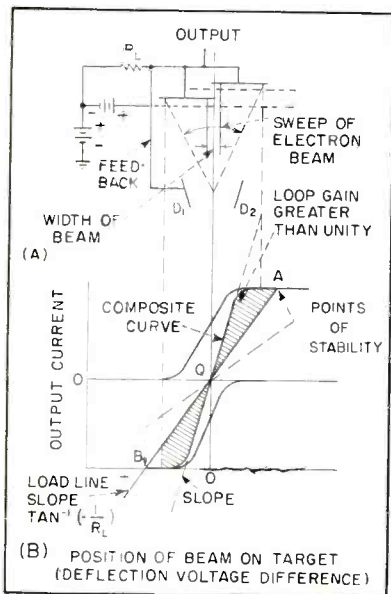

FIG. 7—Beam deflection pattern (A) and corresponding tube characteristic (B) that provide two stable circuit current levels

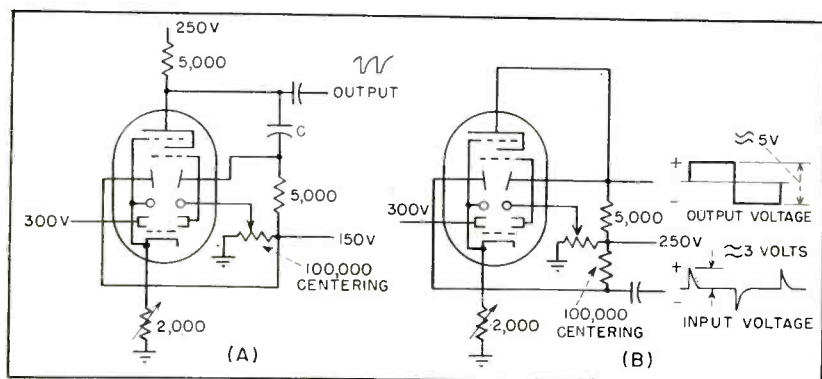

FIG. 8—Multivibrator (A) and binary storage device (B) both using the anodyne tube

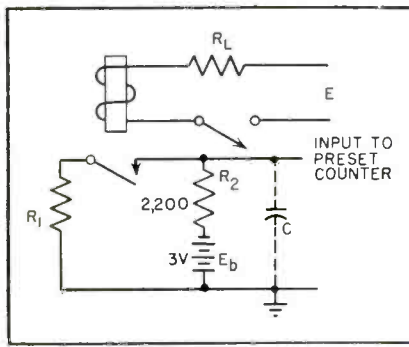

FIG. 1—Transducer circuit for relay measurements with preset counter

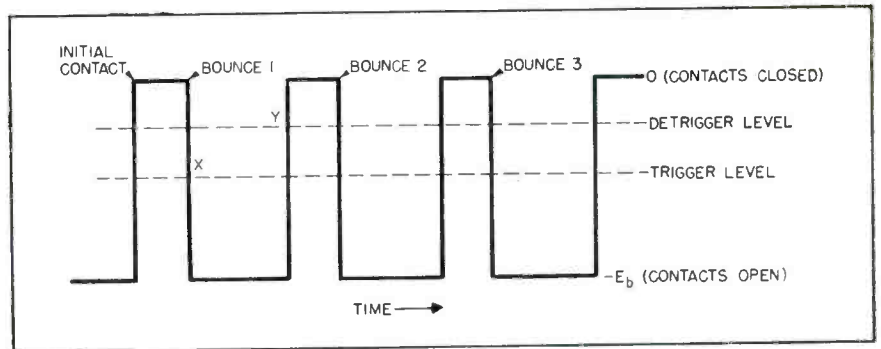

FIG. 2—Waveform generated by contact bouncing, with preset counter input hysteresis voltage superimposed

# Relay Contact-Bounce Measurements

**SUMMARY** — Extent of contact bouncing determined for design or quality-control purposes by using electronic preset counter with simple transducer circuit. For production testing of relays, counter is used as go, no-go device by presetting high and low limits in counter

**B**Y USING a preset counter relay contact-bounce measurements can be made simply and quickly.

Figure 1 illustrates the setup used to count number of contact bounces. When the relay is energized by closing the switch, the battery voltage is applied across load resistor  $R_L$  through the relay contacts. Current-limiting resistor  $R_L$  keeps the relay within ratings. Resistor  $R_1$ , which serves a special function later on, can be considered zero in value. Capacitor  $C$  represents the total stray, cable and input capacitance of the counter.

Bouncing of the contacts interrupts the battery voltage and the fluctuations are applied to a preset counter, which is set for minus polarity to count each negative-going transient. Thus, the number of bounces following initial contact is recorded as shown in Fig. 2.

## Energize Time

Elapsed time between the application of relay energizing voltage

By **RICHARD JIU**

Berkeley Division of  
Beckman Instruments, Inc.  
Richmond, California

$E$  and a particular bounce can be determined with the setup of Fig. 3. Voltage  $E$  simultaneously drives the relay and starts a time-interval meter. Set at a number, the counter gives an output pulse at the preset count to stop the timing meter.

If the number preset is larger than the total bounces, the time-interval meter does not stop and another reading must be initiated. If the number preset equals the total bounces, the time from the application of  $E$  to the start of the last bounce is determined. This time nearly equals the contact quiescent time (Fig. 4).

If the number preset is less than the total bounces, the time interval between the application of voltage  $E$  and the  $n$ th bounce is read directly from the time-interval

meter,  $n$  being the counter total.

Under certain conditions, the time-interval reading can be considered equal to the contact quiescent time, the time from the start of  $E$  to the quiescence of contact bouncing. There is a small error in this consideration. Its magnitude depends on the bounce characteristics of a particular relay. If the time-interval reading is to the last bounce, the error is the difference indicated in Fig. 4.

Because the bouncing rate increases, the loss of one or two counts at the end of the waveform affects the time-interval reading less than proportionately. This rate increase is related to mechanical considerations of the relay. In most cases, the difference is less than 5 percent of the contact quiescent time if counter total  $n$  is 80 percent or more of the total bounces.

Figure 5 shows the bounce characteristics for a particular relay. The interruption rate increases in

time, then ends quite abruptly. Major bouncing, measurable by the counter, subsides in about 1 millisecond. The minor bounces, unmeasurable on the counter, are hardly visible at the end of the waveform. They occur when the bounce rate reaches a point where the time constant of the circuit affects the waveshape. At this point, the spacing between pulses may be less than the 10-microsecond resolution power of the counter.

Normally, bouncing trails off at such a high rate that minor amplitudes are very small if  $R_1$  is zero and  $R_2$  the order of a few thousand ohms. Resistor  $R_2$  is usually made as small as possible, with the contact and battery ratings in mind. This yields a small time constant with  $C$  equal to the sum of the total stray, input and cable capacitances.

### Counter Requirements

The input requirement of the preset counter used depends only on voltage levels. The input amplifier consists of a cathode-coupled phase inverter direct coupled to a Schmitt trigger circuit. Regardless of rise time, polarity or waveshape, the input signal need only cross the two trigger levels between 1 volt and ground level to operate the counter. In all other cases, an input exceeding 1 volt peak in amplitude is applied to the input jack through a large blocking capacitor. Paired-pulse resolution for the counter is ten microseconds or better. Maximum continuous counting rate is 40,000 cycles a second.

A Schmitt discriminator circuit

has at its input grid a hysteresis voltage that is the difference between the trigger and detrigger or recovery values. When the trigger voltage, the higher of the two, is exceeded, the circuit changes state and causes the preset counter to register a count. When the input grid voltage is brought below the detrigger level, the circuit returns to its normal state.

Since the input amplifier of the counter is direct coupled, the hysteresis voltage is reflected back through the phase inverter to the input jack, but with smaller magnitude and lower level. The trigger level at the input can easily be found by slowly increasing the input voltage from ground level up until the counter registers a count. The voltage at which this occurs is +1 volt or lower if the counter polarity is set at plus, -1 volt or higher on minus.

Figure 2 shows the reflected hysteresis voltage superimposed on the counter input waveform. Point  $X$  designates on the transient where the counter operates and  $Y$ , the recovery point. The counter polarity is set at minus.

Trigger level is normally set at 1 volt or less with respect to ground. The detrigger level is about two tenths of a volt below it at the input.

### Bounce Duration

Another possible measurement is the determination of the duration of a particular bounce. Utilization is made of the circuit time constant in Fig. 1 and the fact that the

bouncing rate increases in time. Capacitor  $C$  represents the counter input capacitance, about 40  $\mu\text{f}$ , plus any stray or cable capacitance. If necessary, a capacitor of proper value may be added from input to ground to increase  $C$ .

With the battery resistance negligible, the time constant for the circuit in Fig. 1 is  $R_2C$  with the contacts open and  $R_2C = R_1R_2C / (R_1 + R_2)$  with the contacts closed. Resistor  $R_1$  is approximately zero so that the rise time determined by  $R_1$  in parallel with  $R_2$  is very small. Resistor  $R_2$  is made sufficiently large and variable so that  $R_2C$  causes the negative-going transient to intersect the succeeding transient above the  $E_T$  value (point  $R$  in Fig. 6). With the input trigger level of the counter known,  $R_2$  can be decreased until the negative transient, in the duration  $T$  to be measured, barely intersects the trigger level. Then  $T$  is the time required for the exponential voltage to drop from zero level to  $E_T$  volts with a time constant  $R_2C$ .

The expression for the instantaneous voltage  $y$ , measured from ground level at time  $t$ , decaying exponentially from zero to  $-E_b$  volts with a time constant  $RC$  is

$$y = -E_b[1 - e^{-t/(RC)}] \quad (1)$$

Solving for  $t$  and substituting  $E_T = y$ ,  $R_2C = RC$  and  $T = t$

$$T = 0.434R_2C \log_{10} \left( \frac{E_b}{E_b + E_T} \right) \text{ sec} \quad (2)$$

In Fig. 6, if  $R_2$  should be decreased, point  $R$  drops farther below zero level. When point  $R$  intersects the trigger level, the  $n$ th

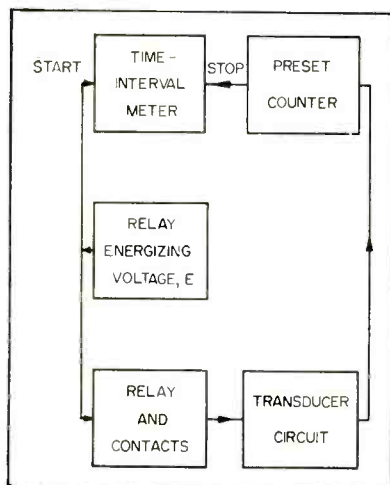

FIG. 3—Setup measures energize time

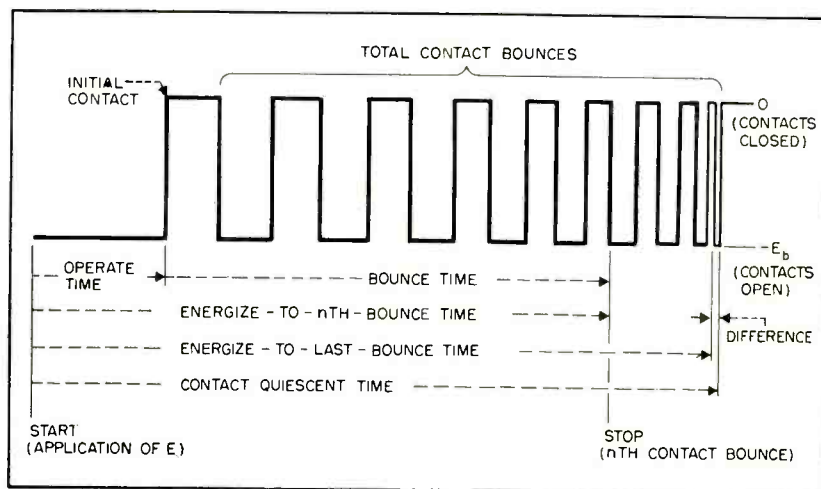

FIG. 4—Waveform considerations when measuring energize-to-nth-bounce time

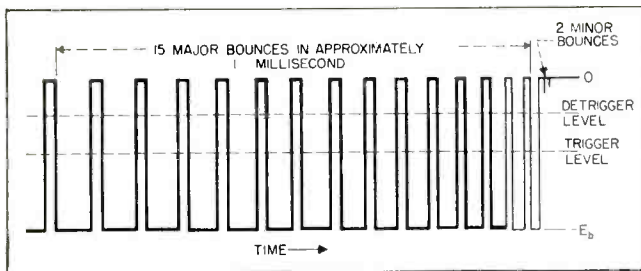

FIG. 5—Bounce waveform obtained with a particular relay

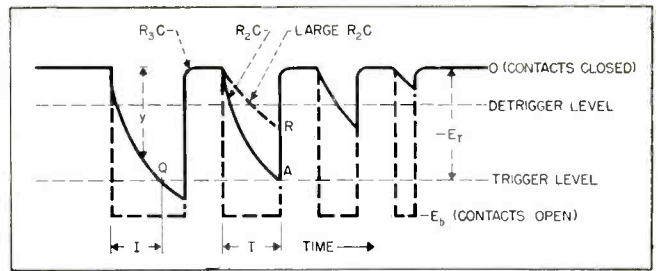

FIG. 6—Effects of circuit resistance and capacitance on waveform

bounce is included in the counter total. Substitution of the known  $E_T$  into Eq. 2 gives the duration of the  $n$ th bounce after initial contact, where  $n$  is the counter reading.

In all cases, the  $R_2 C$  constant of Fig. 6 is decreased from a large enough value so that the exponential barely intersects the trigger level, like point A. If the  $RC$  constant is too small, an intermediate point like Q determines the solution of Eq. 2. The interval  $I$  which results is not the full spacing.

#### Duration of Contact

Similarly, the duration of the  $n$ th contact can be determined if the contact duration between bounces decreases in time. Resistors  $R_1$  and  $R_2$  of Fig. 1 are made sufficiently large and variable, since the time constant with the contacts closed involve the parallel combination of  $R_1$  and  $R_2$  times  $C$ .

For this measurement, the preset counter is set at plus polarity and the battery in Fig. 1 is reversed in polarity. Figure 7 shows an exaggerated waveform where the positive-going transients have time constant of  $CR_1 R_2 / (R_1 + R_2) = R_3 C$ . The equation for this circuit is

$$T = 0.434 R_3 C \log_{10} \left( \frac{E_b}{E_b - E_T} \right) \text{ sec} \quad (3)$$

The solution to Eq. 3 is the duration of the  $n$ th contact. As seen in Fig. 7,  $R_3 C$  is decreased to bring point B up to the trigger level. Since  $E_T$  is a positive value, the  $E_b / (E_b - E_T)$  ratio exceeds one in all cases.

#### Measurement Error

Where the ratio  $R_2 C / (R_3 C)$ , always one or greater, is too large no measurement is possible. Then the amplitude of the waveform may not decrease in time as shown by the

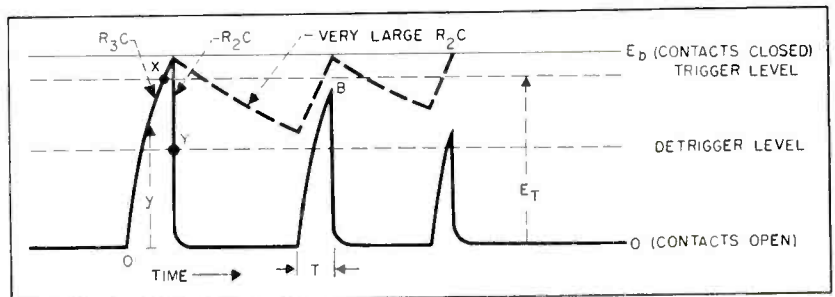

FIG. 7—Effect of circuit time constants on generated waveform when voltage  $E_b$  is reversed in polarity

dotted portion in Fig. 7. Intersection of the exponential curve and the trigger level at a steep angle is desirable. This will give a smaller error,  $\Delta T$  in Fig. 8, for a given change or error in the trigger level,  $\Delta E$ . A smaller  $RC$  value, for instance, will give a steeper exponential and smaller error, but the interval measured is also smaller for a given trigger level. The percentage error,  $\Delta T \times 100/T$ , does not necessarily decrease since  $T$  also decreases. Derivations show that percentage error is minimum if  $T = RC$ . The percentage error is given by

$$M = 100 \frac{\Delta T}{T} = 272 \frac{\Delta E}{E_b} \text{ percent} \quad (4)$$

For instance, if the trigger level can be measured within  $\pm 5$  percent with an oscilloscope, then  $\Delta E / E_b = \pm 0.05$  and the measurement is  $\pm 14$  percent in error, or a total swing of 28 percent.

Equation 4 shows that the larger the battery voltage, the smaller the percentage error. Practically, this is limited by the range of the trigger-level adjustment in the counter to about 4 volts if  $E_T$  is to be near  $E_b$  for a reason stated below. Also, the realization of  $T = RC$  may be difficult. If so, the result in Eq. 4 is low. For instance, if  $T = 2RC$ ,  $M = 370 \Delta E / E_b$ , a 35 percent increase in percentage error over Eq. 4.

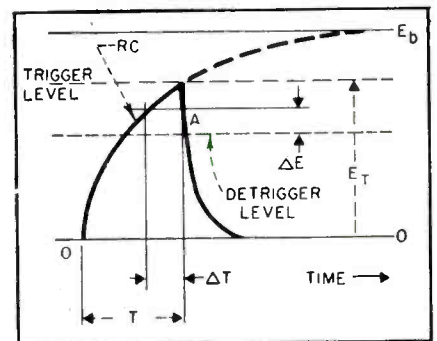

FIG. 8—Diagram illustrates error and percentage error in measurement

If  $T = 4RC$ , the exponential has reached  $0.98 E_b$  or 98 percent of its maximum and the percentage error becomes

$$M = 1,360 \Delta E / E_b \quad (5)$$

Using the same voltage error of  $\pm 0.05$ ,  $M = \pm 68$  percent, a five-fold increase.

However, if the trigger level is shifted to approach the  $E_b$  level, then all the counts registered are caused by amplitudes nearly equal to  $E_b$ , the maximum possible for the arrangement of Fig. 1. For instance, if  $E_T$  is set at  $2.97 \pm 0.03$  volts with a voltmeter, the intersection of  $y$  and  $E_T$  is known to  $\pm 0.03$  volts. Since  $2.97/3.00$  equals 0.99 and approximates the desired value of  $0.98 E_b$  for  $T = 4RC$ , the use of Eq. 5 is justified and  $M$  is recalculated to be  $\pm 13.6$  percent.

# Synchronizing Magnetic

**SUMMARY** — Magnetic drum storage system of digital computer is synchronized with acoustical delay-line system by time difference discriminator circuit that controls drum speed through servo system. Accuracy is  $\pm 0.5$  microsecond with 10-percent line-voltage variation

**S**YNCHRONIZING a magnetic drum-storage system with other storage systems in a computer is often necessary. The following technique was developed to synchronize a drum-storage system to an acoustic delay-line system.

The length of the delay line is nominally 2,500  $\mu\text{sec}$ , making it necessary that the time delay in the drum system also be 2,500  $\mu\text{sec}$ . In this application all the channels on the drum are used as recirculation channels. Two heads per channel are used, one for writing and one for reading.

Since the total storage time in the drum system is 2,500  $\mu\text{sec}$ , actual storage time on the drum itself must be one clock time less than the 2,500  $\mu\text{sec}$ . Thus the output can be held in flip-flop storage for one clock time. The clock rate is 6  $\mu\text{sec}$  so that the delay between write and read must be 2,496  $\mu\text{sec}$ .

The drum used is six inches in diameter with a nominal speed of 6,000 rpm. Spacing between a write and a read head is 90 deg giving a delay time of 2,500  $\mu\text{sec}$ .

## Operation

A simplified block diagram is shown in Fig. 1. A pulse is written on one channel at the time of the synchronizing pulse from the delay-line memory unit; the read-out pulse from this channel is compared in time with the incoming sync pulse. If the drum is rotating at the correct speed the drum output pulse will occur at the time of the next sync pulse. If the drum pulse occurs first, an error signal is generated that increases the field current in the motor to slow down the drum and vice versa.

The error-measuring circuit is a digital version of a conventional time-difference discrimina-

tor. Waveforms are shown in Fig. 2. The top line shows the sync pulses from the delay-line unit. The sync pulses are delayed in a one-shot multivibrator or phantatron circuit to obtain a pulse spaced approximately midway between two sync pulses. A flip-flop is set and reset by these two pulses, the plate waveform is shown as  $U$ . The read pulse from the drum is delayed 2  $\mu\text{sec}$  and 6  $\mu\text{sec}$  by stable electrical delay lines and is used to set up another flip-flop, the outputs of which are shown as  $V$  and  $V'$ .

The outputs of the  $U$  and  $V$  flip-flops are combined in a diode AND circuit, shown in Fig. 3A, to generate  $UV$  and in a diode OR circuit to generate  $(U + V')$ . If the drum pulse occurs exactly 6  $\mu\text{sec}$  ahead of the next sync pulse, the outputs from the diode circuits  $UV$  and  $(U + V')$  will be of the same width (each 2  $\mu\text{sec}$  wide) as shown in

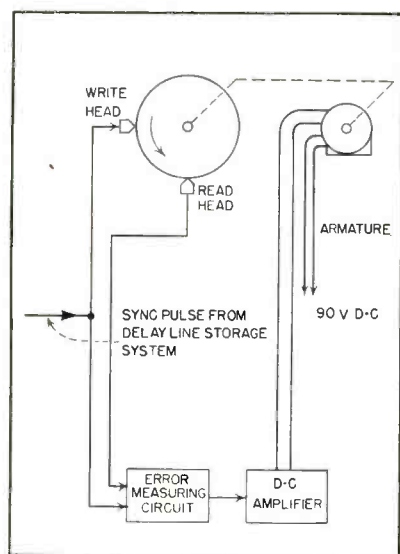

FIG. 1—Simplified diagram of drum synchronizing circuit

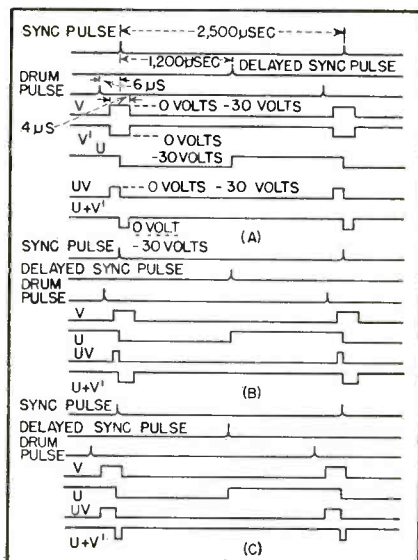

FIG. 2—Timing diagram of the drum synchronizing circuit

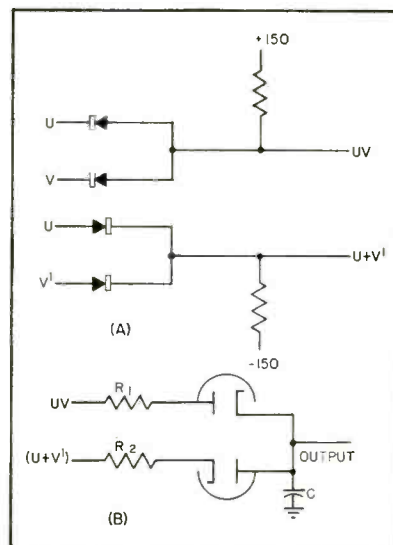

FIG. 3—Product and sum outputs (A) and area difference detector (B)



# Drum Storage Speed

By ERNEST W. BIVANS Lincoln Laboratory  
Massachusetts Institute of Technology  
Lexington, Massachusetts

Fig. 2A. If the drum pulse is less than  $6 \mu\text{sec}$  ahead of the sync pulse,  $UV$  will be less than  $2 \mu\text{sec}$  wide while  $(U + V')$  will be wider as in Fig 2B. Conversely, if the drum pulse is more than  $6 \mu\text{sec}$  ahead of the sync pulse,  $UV$  will be wide and  $(U + V')$  narrow as in Fig. 2C.

When these two pulses are fed to a circuit that measures the difference in area of two pulses, a d-c voltage is obtained that represents the time difference between the sync pulse and the drum pulse. Such a circuit is shown in Fig. 3B. The charge and discharge time constants,  $R_1C$  and  $R_2C$  are adjusted so that when  $UV$  and  $(U + V')$  are of equal width, the output is midway between the two extreme values.

## Control Circuit

Figure 4 is a diagram of the control circuit. The error signal appears at the arm of the potentiometer in the cathode circuit of  $V_{2B}$ . This error signal is applied to the grids of  $V_6$  and  $V_7$  to control the field current in the drum-drive motor. With the circuits thus far described, quasi-synchronization of the drum would be obtained. As the error signal increased, the field current in the motor would change to reduce the error, but the error could never become zero. This, then, is a regulator rather than a servo system.

To make a true velocity servo system it is necessary to continue to change the motor speed until the error is zero. This is accomplished by using the error signal to drive a small two-phase servo motor that turns the  $V_{2B}$  cathode potentiometer. Varying this potentiometer changes the d-c bias to the grids of control tubes  $V_6$  and  $V_7$ .

The d-c error signal which is centered at  $-15$  volts is compared with a  $-15$  volt d-c signal at the cathode of  $V_{2A}$  by a Brown converter. The a-c error signal from the converter is amplified by  $V_{4A}$  and  $V_5$  and is fed to one winding on the motor.

## Speed Response

The storage drum has very high inertia and low friction, so that its effective time constant is very long. To prevent hunting, it is desirable to make the speed of response of this part of the control circuit slow. This is accomplished by using a 256-to-1 speed reducer in coupling the servo motor to the potentiometer. This servo motor-potentiometer loop is equivalent to integral control in conventional servo systems in that it gives a correction proportional to the time integral of the error to make the error zero.

The potentiometer has stops to

prevent more than 360-deg rotation. The gear train is coupled to the potentiometer through a friction drive, so that when the potentiometer hits the stops and an error signal is still applied, the gear train and motor will not be damaged.

A synchronizing accuracy of  $\pm \frac{1}{2} \mu\text{sec}$  is obtained over a  $\pm 10$ -percent change in line voltage with a variation of about  $\pm 3$  percent in the frequency of the sync pulses from the delay-line unit.

Excellent results have been obtained from the system using unregulated but well-filtered voltages. The voltages must be so filtered that rapid changes in the a-c supply will appear in the d-c voltages at a rate much slower than the response of the drum.

Research in this paper was supported jointly by the Army, Navy and Air Force under contract with MIT.

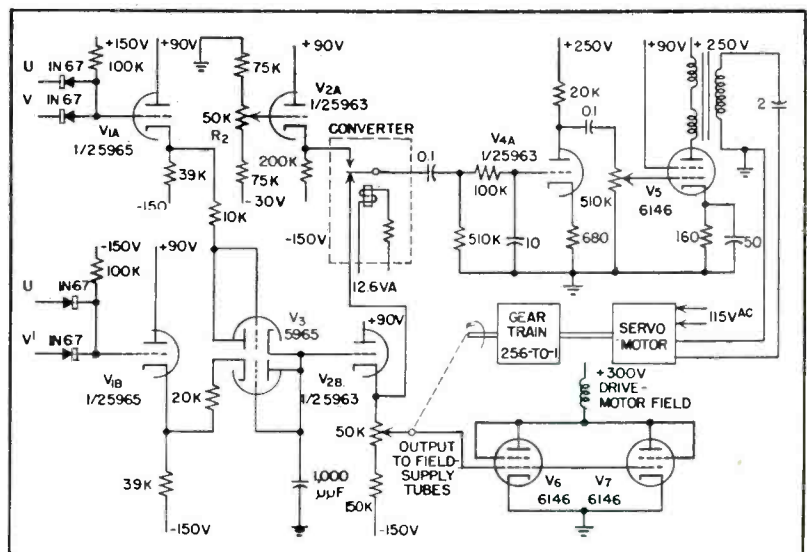
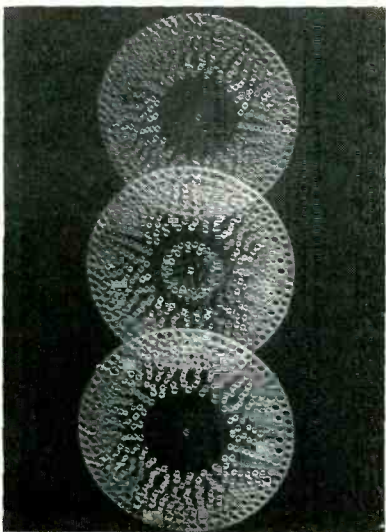
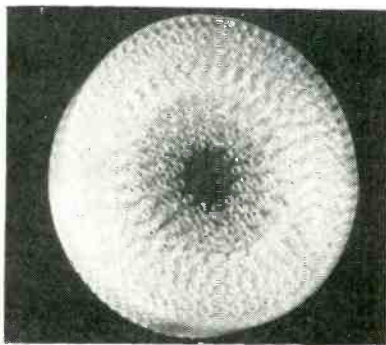
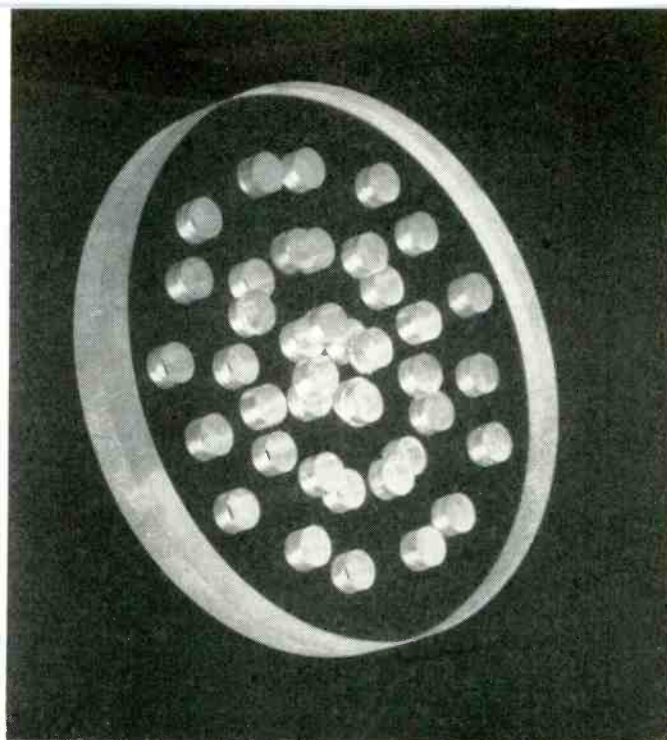

FIG. 4—Control circuit of the drum synchronizer. Error signal appears at the arm of the potentiometer in the cathode circuit of  $V_{2B}$ .



Hole spacing varies refractive index



Variable refractive index is obtained by drilling holes in disk to give cylindrical voids when assembled

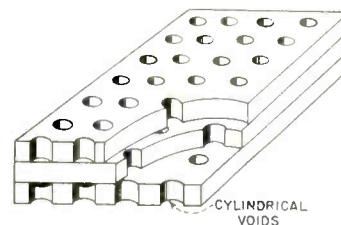

# Dielectric Lens

**SUMMARY** — Size and spacing of holes in laminated disks control index of refraction across face of dielectric lens. Construction is simple and beam-width characteristics are superior to those of conventional radiators

By **K. S. KELLEHER** and **C. GOATLEY**

*Melpar, Inc.  
Alexandria, Va.*

**V**ARIABLE index of refraction to achieve focusing with microwave lenses has become a practical interest to antenna designers within the past decade.

This discussion treats a form of variable index lens which is a microwave analog of the optical magnifying glass. The lens is in the form

of a disk and its optical axis is coincident with its axis of symmetry. For focusing, the dielectric constant of the lens medium is varied such that the index of refraction is a maximum at the center of the lens and a minimum at the edge.

Since this lens has rotational symmetry, it is sufficient to analyze

ray paths in any plane containing its axis. Figure 1 shows such a plane with a coordinate system suitable for the analysis. The distance from the source point to the first lens surface is taken as unity, the lens thickness is  $T$  and a general ray from the feed source makes an angle  $\theta$  with the lens axis.

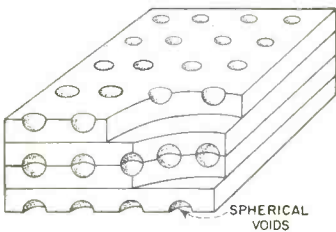
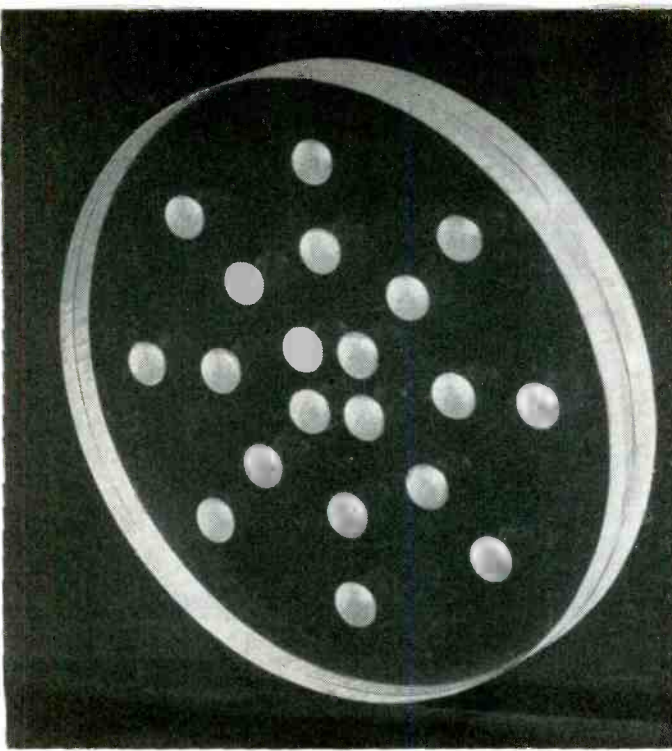

Semicircular indentations provide spherical voids when assembled as shown in cross-section sketch

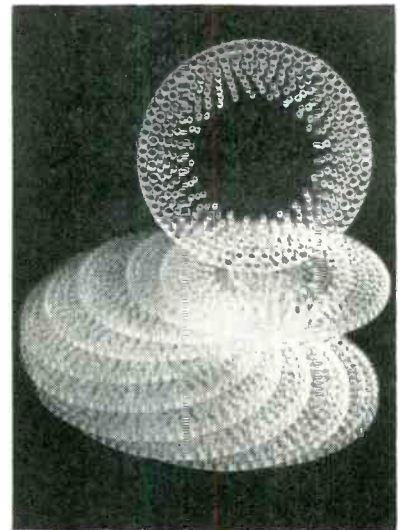
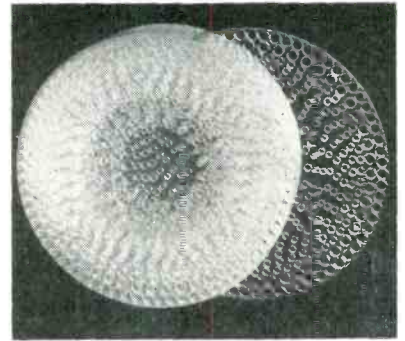

Lens is made up of laminated disks

# for Microwaves

Determination of the required variation in the index of refraction involves equating the optical path length of a general ray to that of the central ray. Where  $n_o$  is the index at the center of the lens and  $n$  is the index at  $P_1$ , this equiphase condition is given by

$$\int_{P_1}^{P_2} n ds = n_o T - (\rho - 1) \quad (1)$$

It is assumed that the dielectric constant varies linearly between points where a ray enters and leaves the lens. Thus it is possible to obtain an expression for  $n$  in terms of  $\theta$ , which becomes the basic design equation for the lens.

$$T(n^2 - \frac{2}{3} \sin^2 \theta) = \frac{2}{3} (n^2 - \sin^2 \theta)^{1/2} (n_o T - \sec \theta + 1) \quad (2)$$

For convenience in design this equation is sometimes given in terms of the dielectric constant.

The lens thickness,  $T$ , is normalized to unit focal length, so that the physical thickness of the lens is the product of  $T$  and  $f$ , the desired focal length.

## Lens Design

The major problem in constructing the lens is that of producing the required radial variation in dielectric constant. Although Eq. 2 shows that  $n$  is a smoothly varying function of  $\theta$ , it is not practical with ordinary shop equipment to produce a lens medium which perfectly satisfies this condition. Practical construction dictates that  $n$  be varied in finite increments so that the variation described by Eq. 2 is approximated by a step function.

This, for example, would permit the lens to be fabricated from a series of concentric cylinders with

each cylinder composed of a different dielectric material. This requires a large variety of dielectric materials.

A more adaptable approach is the placing of spherical voids in a base material of high dielectric constant. Size and spacing of the voids determines the effective dielectric constant which diminishes with increased void size and decreased void spacing. This permits the use of Plexiglas, Teflon and similar rigid base materials.

This method was carried a step farther by utilizing cylindrical voids instead of spherical voids. This was done to eliminate machining complexities. The photographs and cross-section sketches illustrate the difference between a typical sample of a dielectric medium employing spherical voids

and one employing cylindrical voids.

The dielectric constant relationship for spherical voids is

$$\frac{\epsilon}{\epsilon_1} = \frac{n^2}{n_1^2} = \frac{1 + 2FC}{1 - FC} \quad (3)$$

where  $C = (1 - \epsilon_1) / (1 + 2\epsilon_1)$

In these formulas  $\epsilon$  is effective dielectric constant,  $\epsilon_1$  the dielectric constant of the base material and  $F$  is the fractional volume. Fractional volume is the ratio of the volume of the voids in a base dielectric material to the volume of material before insertion of the voids. Dielectric constant  $\epsilon$  depends only on the fractional volume and the void configuration is without significance.

Before Eq. 2 can be applied to lens design, it is necessary to know the maximum value of  $\theta$ , and the minimum value of  $\epsilon$  which can be produced by drilling voids in the base dielectric. Structural considerations limit the minimum value of  $\epsilon$  because the maximum fractional

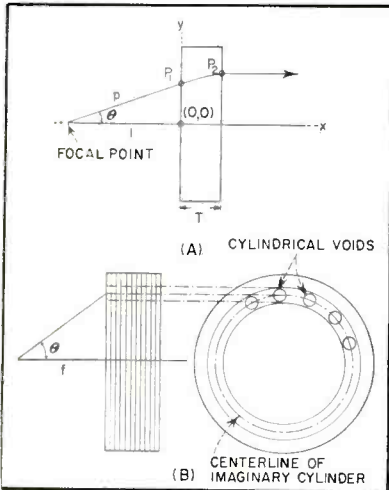
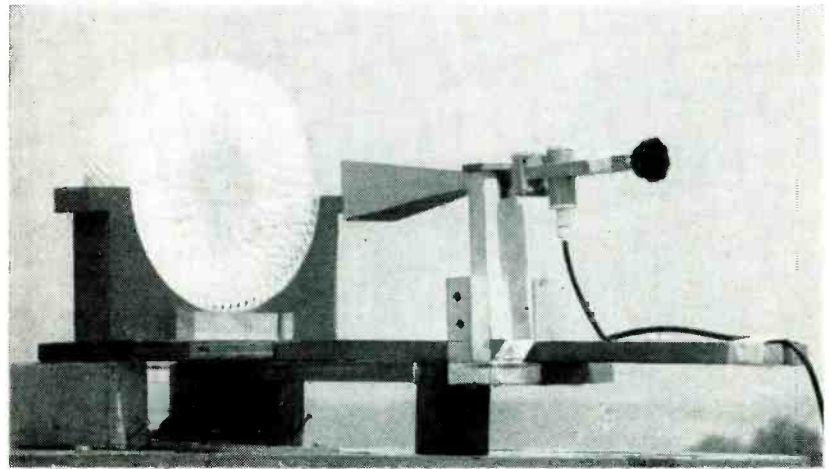

FIG. 1—Analysis of ray path through lens medium (A). Concentric circles (B) are used to compute required variation of refractive index

volume must not become so great as to render the lens medium fragile. Having determined the values of  $\theta_{max}$  and  $\epsilon_{min}$ , Eq. 2 may be solved to find the lens thickness,  $T$ .

For computing the index variation, the lens is imagined to consist of concentric cylinders of discrete radial wall thickness. The dielectric constant is assumed to remain constant within each cylinder wall



Experimental lens setup with illuminating horn on lens axis. Signal strength patterns in Fig. 4 were obtained with this arrangement

and  $\theta$  is measured to the center line of the wall as shown in Fig. 1B. Equations 2 and 3 can be applied to find  $\epsilon$  and  $F$  within each imaginary cylinder.

### Lens Construction

An experimental model of the lens was fabricated by laminating disks cut from 0.25-in. sheet Plexiglas. Cylindrical voids, ranging in diameter from 0.25 in. to 0.375 in. were drilled through these disks to form the lens medium. It was found practical to produce a fractional volume as high as 0.61 with Plexiglas as the base material. This gives a range of 1.53 to 2.6 in the value of dielectric constant, corresponding to a range of 1.24 to 1.61 in the index of refraction. The lens is 10 in. in diameter, 2.75 in. thick and designed to have a focal length of 10 inches.

Since Eq. 2 is fairly complex, design computation can be reduced by calculating  $\epsilon$  for several values of  $\theta$  and passing a smooth curve through

the plotted points. A similar curve may be plotted showing  $\epsilon$  as a function of  $F$ . These curves are shown in Fig. 2 and 3 as plotted for the experimental model. The curves show that fractional volume becomes small near the center of the lens. A combination of the two methods of lens construction will dispense with the limitations imposed by employing either method separately.

As an example, Plexiglas could have been used to form a center section of the experimental lens between zero and 3-in. radius and another base material of lower dielectric constant used for form the annular section between 3 and 5-in. in radius.

### Experimental Data

A series of more than 200 automatically recorded patterns was compiled in a detailed study of the lens. These patterns, measured at several frequencies, are the result of a performance study in which the illuminating horn was located on

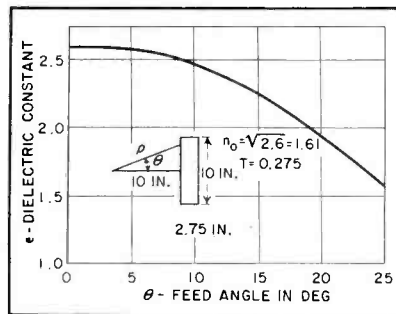

FIG. 2—Plot of variation required in dielectric constant with angle of feed

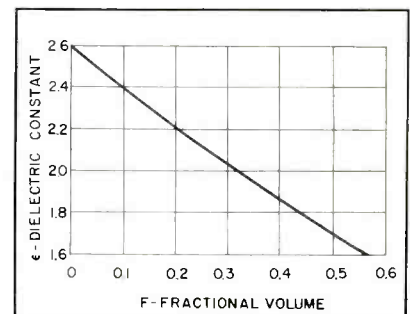

FIG. 3—Dielectric constant obtained with different dielectric-to-void ratios

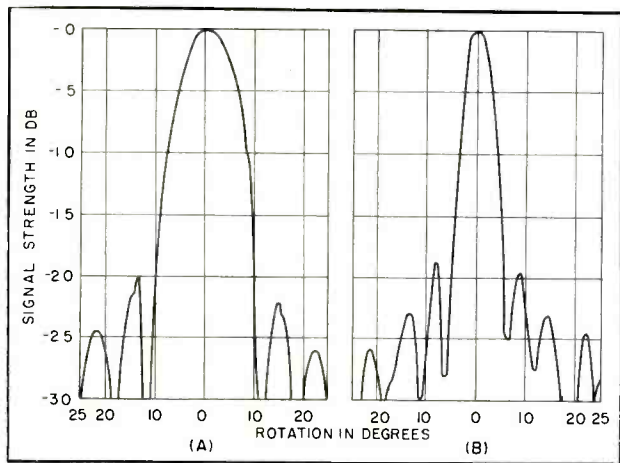

FIG. 4—Pattern of microwave lens with horn on lens axis at 7,000 mc (A) and 15,000 mc (B)

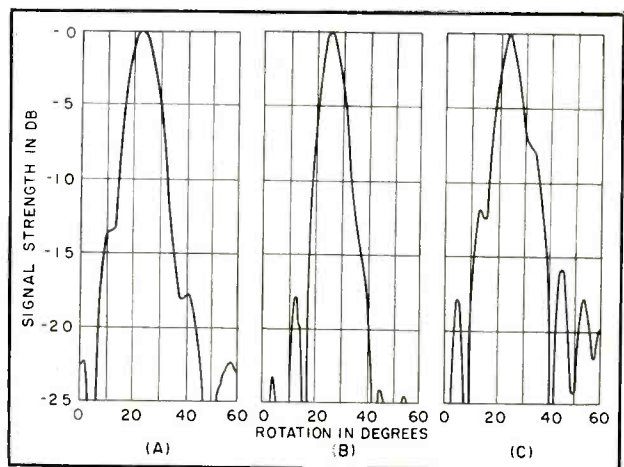

FIG. 5—Lens pattern with horn 5 inches (A), 8 inches (B) and 11 inches (C) off axis of lens

and off the lens axis and at various distances from the lens center.

The horns used at each frequency were designed to provide illumination tapered to  $-10$  db between the center and edge of the lens when the horn apertures are placed at the focal point and the beam directed along the lens axis.

Satisfactory performance over a broad frequency band is obtained when the lens is illuminated by a source on the axis. Patterns measured at 7,000 and 15,000 mc indicate this and are shown in Fig. 4. Note that side lobe levels are down 20 db and 19 db respectively, from the peak signal.

#### Off-Axis Performance

Moving the feed horn off axis has the general effects of shifting the main lobe by a corresponding amount and increasing the side-lobe levels as shown in Fig. 5. Some improvement in off-axis performance may be obtained by moving the feed horn closer to the lens. With the feed horn 25 deg off axis, patterns were measured at 8,000 mc while moving the horn in 1-in. increments between 5 and 14 in. from the lens center. These data show that best performance is obtained at 8 in. and indicate that the focal surface curves from the focal point toward the edge of the lens.

Another interesting effect is the apparent variation in the focal length of the lens with frequency. It is reasonable to expect this result because the diameter of the cylindrical voids becomes an appreciable

fraction of a wavelength at the higher frequencies. This would tend to alter the effective dielectric constant of the lens medium, particularly at those frequencies where the voids approach resonant size.

An overall indication of performance is found by comparing beamwidths obtained with the lens to the H-plane beamwidth of a pyramidal horn is

$$BW = 68\lambda/A \quad (4)$$

where  $A$  is the aperture size measured in the same units as the wavelength. This same formula yields the beamwidth expected from a reflector or lens radiator. As a comparison, the beamwidth in degrees obtained with the variable index lens is closely approximated by

$$BW = 55.7\lambda/A \quad (5)$$

Figure 6 shows a plot of beamwidth versus frequency as measured from the recorded lens patterns and as obtained from Eq. 4 and 5. The dielectric lens yields a narrower beamwidth than can be obtained from a horn.

#### Applications

Although reflectors are commonly utilized for microwave links and radar, the antenna requirements can, in many cases, be fulfilled by lenses. Where a reflector is used, the feed system blocks the reflector aperture. A lens is advantageous where this type of blocking is undesirable.

Since the lens has good off-

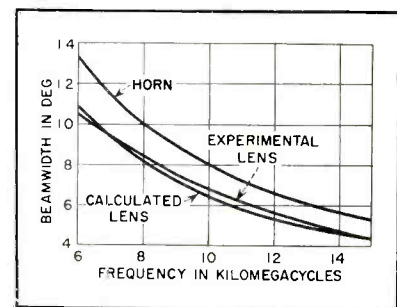

FIG. 6—Calculated and actual beamwidth of lens compared with that of horn

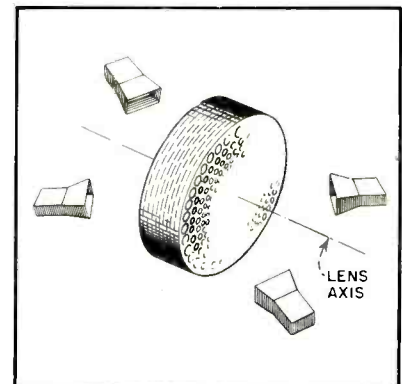

FIG. 7—Good off-axis performance of lens permits use of multiple feed from both sides of lens

axis performance, even greater azimuthal coverage can be achieved by utilizing multiple feeds on both sides of the lens. Figure 7 shows this arrangement and suggests one of the promising applications for this type of focusing objective.

The authors acknowledge the assistance of F. D. Green in obtaining much of the experimental data.

# Dynamic-Diode Limiter

**I**N f-m demodulator applications, the dynamic diode limiter performs better a-m limiting than ratio detectors used in current f-m and television receivers.

Functional and practical versions of the dynamic diode limiter are shown in Fig. 1. The principal requirements for the effective operation of this circuit are that the tuned circuit have fairly high impedance and Q, that the diode be of high or medium permeance, that the time constant of the diode load, RC, be long compared to the lowest modulation frequency which is to be amplitude limited and that the signal level be large compared to the diode contact potential.

The limiting action of this circuit is illustrated in Fig. 2 where

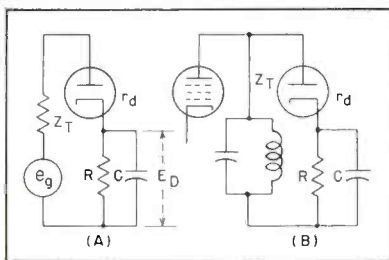

FIG. 1—Functional circuit (A) of dynamic a-m limiter using diode and practical version (B)

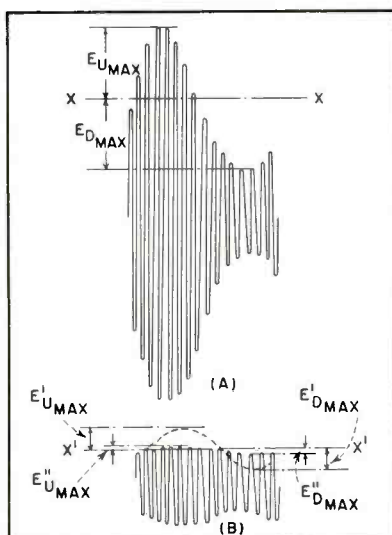

FIG. 2—Input (A) and output (B) waveforms show limiting action of circuit

the waveform before limiting is shown in A and after limiting in B. It should be noted from this figure that there is a reduction of both upward and downward modulation. Bias  $E_D$  developed across the diode load is approximately equal to the peak carrier voltage and remains substantially constant during intervals of amplitude modulation. For positive-upward modulation the diode shunts the tuned circuit with its internal resistance,  $r_d$ , to produce limiting.

For positive-downward modulation, limiting occurs in the same manner since the diode will conduct as long as the a-m variation in Fig. 2A does not go below the diode bias. The downward-modulation reduction is not as effective as the upward-modulation reduction since the diode is operating with lower current and therefore shunting the tuned circuit with a higher value of internal resistance. Also, there is a critical value of modulation index in excess of which no downward a-m reduction is obtained.

Amplitude-modulation reduction in the negative region of the waveform is produced by the filtering action of the tuned circuit.

## Performance Factors

The amplitude reduction factor, expressed in terms of the quanti-

By **FRANK MURAL**

Philco Corporation  
Philadelphia, Pa.

ties used in Fig. 2, is equal to

$$\frac{E''_{U_{max}}}{E'_{U_{max}}} \cong \frac{r_d}{R_o} + \frac{r_d}{R_d} \quad (1)$$

where  $r_d$  is the effective internal resistance of the diode,  $R_o$  is the unloaded resonant impedance of the tuned circuit and  $R_d$  is the loading of the tuned circuit by the diode circuit for an unmodulated carrier and equal approximately to half the diode load resistance  $R$ . The critical amplitude-modulation index, above which there is no limiting, is

$$m_c = 1 - \frac{R_d}{R_d + R_o} \quad (2)$$

Limiting of the negative portion of the waveform of Fig. 2 approaches that in the positive region if the Q of the tuned circuit is high. However, the Q will become rapidly effective above

$$Q_c \cong R_o / (2r_d) \quad (3)$$

The application of a dynamic diode limiter to an f-m demodulator is shown in Fig. 3. Conditioning factors in obtaining a practical circuit are: use of commonly available

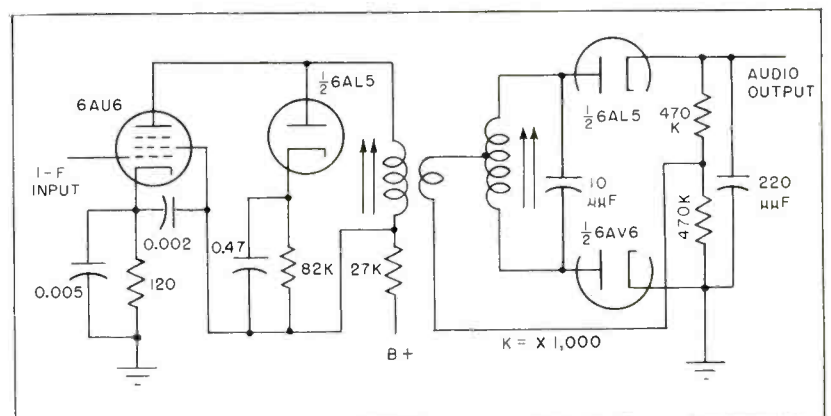

FIG. 3—Dynamic-diode-limiter discriminator is not detuned with changes in signal level and has sensitivity and linearity comparable to that of ratio detector

# for F-M Demodulators

**SUMMARY** — Better performance at lower cost is obtained with diode-limiter and f-m discriminator circuit in comparison with standard ratio detector. Separation of limiting and demodulating functions permits use of any type of f-m demodulator

tube types; use of a given transformer structure and use of a particular carrier frequency. This circuit was used to compare the performance and cost of the dynamic diode limiter against a ratio detector circuit used in a current television receiver.

### Cost Reduction

The tube complement shown replaces a 6T8 tube performing the same functions. This keeps the cost in line but requires that dissimilar diodes be used in the duodiod discriminator.

Some measure of economy can be effected by substitution of a paper capacitor for the electrolytic stabilizing capacitor found in the ratio detector. The discriminator transformer is similar to that used in the ratio detector, but should cost less due to the removal of the primary capacitor and due to a reduction of criticalness of coupling adjustment. There is also a reduction of criticalness in tuning.

The circuit was initially set up to give sensitivity and linearity

comparable to that obtained with the corresponding ratio detectors.

Static a-m rejection characteristics for this circuit are shown in Fig. 4A. The ordinates correspond to the ratio of the demodulated f-m signal for maximum deviation (with carrier at center frequency) to the demodulated a-m signal (with carrier shifted to either side of center frequency by an amount equal to the maximum deviation).

The curves show fall off of a-m rejection with increase in modulation index. This effect becomes more pronounced beyond the critical-modulation-index point beyond which there is no further reduction in downward modulation. At the 100-percent modulation point the curves meet a little below an ordinate of 2, corresponding to no reduction in downward modulation and fairly good reduction in upward modulation.

Amplitude-modulated rejection data for the corresponding ratio-detector circuit is shown in Fig. 4B. Instead of developing a knee at the critical modulation-index

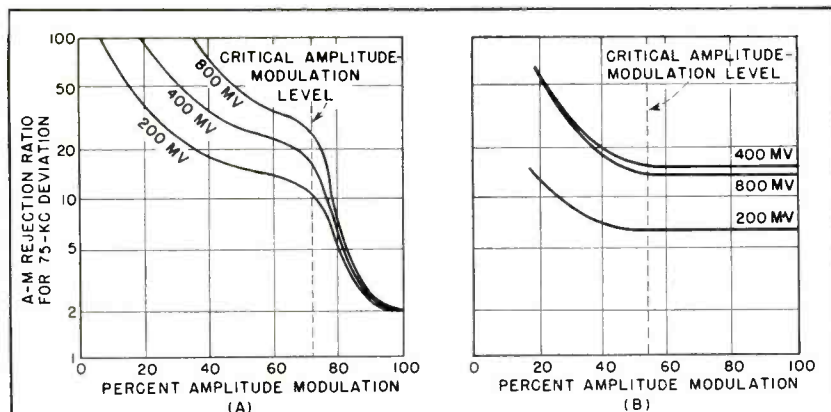

FIG. 4—Diode-limiter static a-m rejection characteristics for various input voltages (A) compared with ratio detector (B)

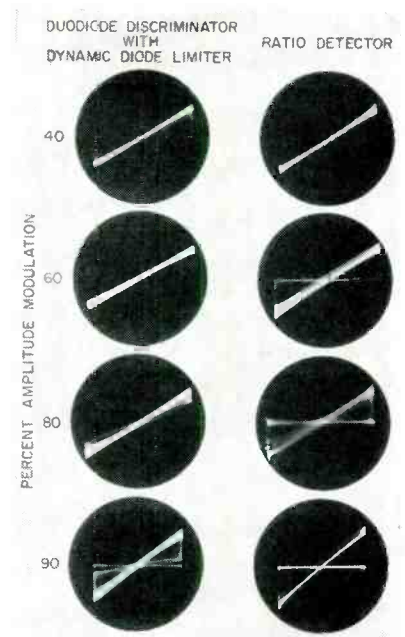

FIG. 5—Demodulated output waveforms for new circuit (left) and ratio detector (right). Numbers indicate percentage of amplitude modulation. Horizontal deflection corresponds to f-m

point, these curves level off. In the ratio detector the diodes, which are both demodulators and limiters, stop conducting so no further a-m variations are recorded. However, this interferes with the desired f-m demodulation process. Because of this, it is necessary to examine the ratio detector by dynamic characteristics using a simultaneously amplitude and frequency-modulated carrier. The data of Fig. 5, in which the horizontal deflection corresponds to the frequency modulation, shows the demodulated signal compared on a dynamic basis.

It was found that this circuit did not have the characteristic detuning with signal level, which is present in the ratio detector.

# Differential Amplifier

DEVELOPMENT of the wide-band differential amplifier described here was undertaken to improve the operation of wide-band bridges<sup>1</sup> for the measurement of junction transistor parameters.

The differential-amplifier circuit has general utility wherever the difference between two wide-band input signals is desired. Thus, the circuit can be used as a preamplifier to convert a standard oscilloscope into a differential oscilloscope.

The two inputs to the differential amplifier are high and equal impedances over the operating range of 0 to 10 mc. The circuit provides a voltage amplification times bandwidth product of about 40 mc. Satisfactory differential operation is obtained for input voltages as large as 2 volts rms.

## Theory of Operation

A differential amplifier accepts two input signals and delivers an output signal which is the difference between the two inputs. The conventional type of differential amplifier as shown in Fig. 1 has been described in some detail in the literature.<sup>2</sup> The tube associated with input  $V_1$  operates as a cathode follower while the tube associated with input  $V_2$  operates as a differential device.

This gives an output signal which is proportional to the difference between the cathode voltage and the grid voltage. Since the cathode follower voltage amplification is less than unity, differential operation is not exact. There will be an output signal even though  $V_1 = V_2$ . This undesired output will be called common-mode output. It becomes even larger when  $R_C$  is made smaller to improve higher-frequency differential operation.

At medium and higher frequencies the common-mode output also increases due to interelectrode capacitances. Capacitive coupling from  $V_2$  to  $V_{out}$  is also a source of trouble.

The deficiencies of the conven-

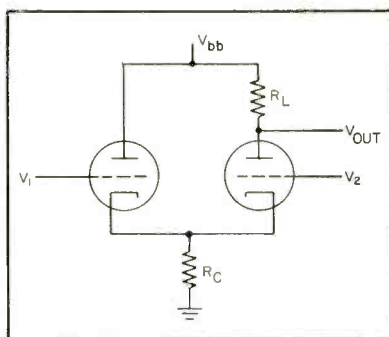

FIG. 1—Basic differential amplifier of conventional design

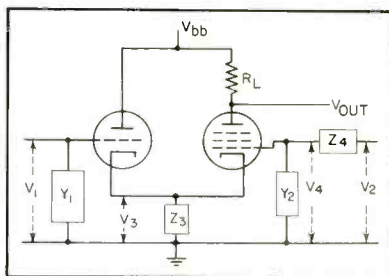

FIG. 2—Null-detector of basic design

tional differential amplifier as shown in Fig. 1 can be largely overcome with the circuit in Fig. 2. To compensate for the fractional voltage amplification of the cathode follower a potential divider consisting of  $Z_4$  and  $Y_2$  is introduced in the grid of the output tube.

Since the functions of the two stages are separate and distinct, there is no necessity that they be identical tubes and they may be individually selected for optimum operation. In particular, the output tube can be a pentode to provide capacitive shielding between  $V_4$  and  $V_{out}$ .

## Design

For  $V_{out}$  to be zero when  $V_1 = V_2$ , it is necessary that  $V_3/V_1 = V_4/V_2$ . For usual bridge operation it is necessary that the input admittances at 1 and 2 be equal,  $Y_{in1} = Y_{in2}$ .

It may be desirable to operate the differential amplifier with unequal input admittances or unequal input voltages. This would be the case when it is employed as a null

By W. E. BARNETTE

and L. J. GIACOLETTO

RCA Laboratories Division  
Radio Corporation of America  
Princeton, New Jersey

detector in a bridge circuit where a standard impedance is to be compared with an unknown impedance that is  $K$  times the standard.

The design formulation to be developed can be modified to accommodate unequal input impedances, for example  $Y_{in1} = KY_{in2}$  or unequal input voltages where  $V_{out}$  is zero when  $V_1 = KV_2$ .

When  $V_3 = V_4$  (null condition), the pentode alternating anode current is zero and the impedance at the cathode of the pentode becomes infinite. The cathode load impedance  $Z_3$  of the cathode follower can therefore be considered as a resistance  $R_3 = 1/G_3$ , shunted by stray capacitance such as wiring capacitance  $C_3$ . Also in shunt with  $G_3$  will be the heater to cathode capacitance of both tubes, lumped together as  $C_{he}$ . Accordingly, the cathode-follower voltage amplification can be written

$$\frac{V_3}{V_1} = \frac{g_m + j\omega C_{gc}}{(g_m + g_a + G_3) + j\omega(C_{gc} + C_{ac} + C_{he} + C_3)} \quad (1)$$

In this equation  $g_m$  and  $g_a = 1/r_a$  are the transconductance and anode conductance of the triode and  $C_{gc}$ ,  $C_{ac}$  and  $C_{ga}$  (employed below) are the grid-cathode, anode-cathode and grid-anode interelectrode capacitances. The voltage-amplification to the pentode grid can be written as

$$\frac{V_4}{V_2} = \frac{Y_4}{Y_2 + Y_4 + j\omega C_i} \quad (2)$$

The quantity  $C_i$  is the pentode input capacitance. At balance, when  $V_3 = V_4$ ,  $C_i$  consists predominantly



# for Null Detection

**SUMMARY** — Single-ended input is delivered to null-balance amplifiers by wide-band differential amplifier that accepts differential output of admittance bridge. Amplifier forms part of measuring instrument for transistor parameters and has additional applications in instrumentation

of the grid-to-screen interelectrode capacitance of the pentode.

The input admittances<sup>3</sup> for both tubes are

$$Y_{in1} = Y_1 + j\omega(C_{ga} + C_{gc}) - \frac{j\omega C_{gc} g_m + j\omega C_{gc}}{(g_m + g_a + G_3) + j\omega(C_{gc} + C_{ac} + C_{hc} + C_3)} \quad (3)$$

$$Y_{in2} = \frac{Y_4(Y_2 + j\omega C_i)}{Y_2 + Y_4 + j\omega C_i} \quad (4)$$

The design problem can now be completed by equating Eq. 1 and Eq. 2 and solving this equation simultaneously with the equation obtained by equating Eq. 3 and Eq. 4. There is no unique solution to this design problem, but a solution that appears reasonably simple can be obtained.

The cathode-follower parameters and  $Z_3$  value are first adjusted so that  $V_3/V_1$  is a constant  $A$  independent of frequency. This requires

$$\frac{g_m}{g_m + g_a + G_3} = \frac{C_{gc}}{C_{gc} + C_{ac} + C_{hc} + C_3} = A \quad (5)$$

Since  $V_3/V_1 = V_4/V_2$ , then

$$\frac{Y_4}{Y_2 + Y_4 + j\omega C_i} = A \quad (6)$$

With this expression the  $Y_{in1} = Y_{in2}$  equation obtained from Eq. 3 and Eq. 4 can be written

$$Y_1 + j\omega[C_{ga} + (1 - A)C_{gc}] = A(Y_2 + j\omega C_i) \quad (7)$$

Without loss in generality  $Y_1$  can be assumed a pure conductance  $G_1$ . Any capacitance in shunt with  $G_1$  can be added to the grid-anode capacitance of the cathode follower. Equation 7 can then be solved for  $Y_2$  and Eq. 6 can be used to determine  $Y_4$ . The results are

$$Y_2 = \frac{G_1 + j\omega[C_{ga} + (1 - A)C_{gc}]}{A} - j\omega C_i \quad (8)$$

$$Y_4 = \frac{G_1 + j\omega[C_{ga} + (1 - A)C_{gc}]}{1 - A} \quad (9)$$

These two equations together with Eq. 5 determine the design of the wide-band differential amplifier. It may sometimes be desirable to pad-out the interelectrode capacitances to either make the admittances  $Y_2$  and  $Y_4$  easily realizable or to make  $Y_2$  a pure conductance.

### Unbalance Condition

When the input voltages to the differential amplifier become unbalanced, the pentode amplifier will then have its grid and cathode fed with unequal voltages. The pentode will amplify this unbalance; the output being dependent on the amount of unbalance.

The actual overall unbalanced

amplification at low frequencies can be determined by considering one of the inputs to the differential amplifier to be electrically at ground potential and the voltage impressed on the other input. Amplification from either input terminal is then the amplification  $A$  of either the cathode follower or the pentode input circuit times the pentode amplification.

The pentode voltage amplification at low frequencies is

$$VA_2 = \frac{R_L}{\frac{1}{g_{m2}} + \frac{1}{g_{equ}}} \quad (10)$$

where  $g_{m2}$  is the pentode transconductance and  $g_{equ}$  represents the cathode conductance seen by the pentode. This conductance is made up of an actual cathode conductance  $G_3$  shunted by a conductance looking back into the output of the cathode follower with its grid elec-

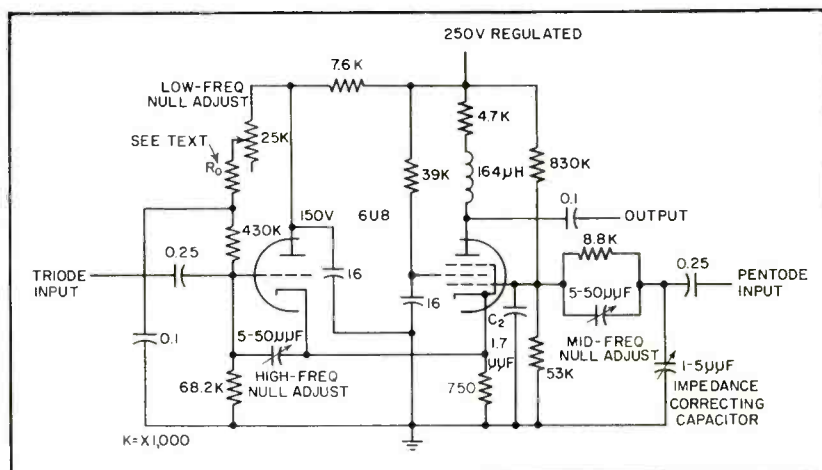

FIG. 3—Complete circuit of differential amplifier for null detection

trically at ground potential.

$$g_{\text{equ}} = G_3 + g_m + g_a \quad (11)$$

The overall voltage amplification at low frequencies may then be written

$$VA = A \frac{R_L}{\frac{1}{g_{m2}} + \frac{1}{G_3 + g_m + g_a}} \quad (12)$$

### Amplifier Construction

Figure 3 shows a complete circuit diagram for a differential amplifier designed in accordance with the above development. The 6U8 triode-pentode was selected for its dual function, high  $g_m$  and low interelectrode capacitances.

The choice of the cathode resistor,  $1/G_3 = 750$  ohms, is somewhat arbitrary. No attempt was made to optimise its value experimentally. With the value of  $G_3$  determined, the low-frequency triode amplification from Eq. 5 is 0.85, using the rated triode  $g_m = 8.5 \times 10^{-3}$  mhos and  $g_a = 1/V_a = 0.2 \times 10^{-3}$  mhos.

To make the high-frequency triode amplification equal to 0.85 it is necessary to pad out  $C_{o1}$  to give a total capacitance of  $22.6 \mu\mu\text{f}$ . The additional capacitance is obtained with a 5 to  $50\text{-}\mu\mu\text{f}$  trimmer capacitor labelled HIGH-FREQUENCY NULL ADJUST.

The value of  $R_1 = 1/G_1 = 59,000$  ohms (parallel combination of 68,200 ohms and 430,000 ohms) was chosen arbitrarily. With the aid of Eq. 8,  $R_2 = 1/G_2 = 50,000$  ohms (parallel combination of 53,000 ohms and 830,000 ohms) was determined.

To determine  $C_2$  is it first neces-

sary to determine  $C_1$  which is mainly the grid-screen capacitance. This capacitance is normally not given in tube specifications; it can be estimated or measured. For the 6U8,  $C_1$  of  $2.8 \mu\mu\text{f}$  was measured. Adding  $2 \mu\mu\text{f}$  to this for wiring capacitance and using the total grid-cathode capacitance of  $22.6 \mu\mu\text{f}$  determined above,  $C_2 = 1.7 \mu\mu\text{f}$ .

The calculation of  $Y_1$  using Eq. 9 results in  $R_1 = 1/G_1 = 8,800$  ohms and  $C_1 = 36.6 \mu\mu\text{f}$ . Capacitance  $C_1$  is provided by a 5 to  $50\text{-}\mu\mu\text{f}$  trimmer capacitor labelled MID-FREQ NULL ADJUST. The values determined in these calculations may differ somewhat from experimentally determined values. Thus, measurement of capacitances after experimentally optimizing the operation indicated a total grid-cathode capacitance of  $32.7 \mu\mu\text{f}$  compared with  $22.6 \mu\mu\text{f}$  computed above  $C_1 = 40.3 \mu\mu\text{f}$  compared with  $36.6 \mu\mu\text{f}$ . These differences may be due to differences in electron tube characteristics. To accommodate these differences between tubes, a potentiometer labelled LOW-FREQ NULL ADJUST is used to adjust the triode  $g_m$  (operating point) to give the desired cathode follower voltage amplification and trimmer capacitors are provided for  $C_{o1}$  padder and for  $C_1$ .

The d-c operating points of the triode and pentode are set by the cathode resistor and the voltage dividers in the grid circuits. These voltage dividers are designed so that they give the proper voltage division and their parallel resistance gives the desired input resistances. The triode grid circuit differs from the

pentode grid circuit in that the resistance to the anode supply voltage is variable. The anode end of the 430,000-ohm resistor is bypassed to ground by a  $0.1\text{-}\mu\text{f}$  capacitor so the proper a-c input resistance is seen as the 430,000 ohm and 68,200 ohm resistors in parallel irrespective of the potentiometer adjustment.

The 25,000-ohm potentiometer in series with the resistor marked  $R_o$  is used to change the triode operating point and thus to set the low-frequency amplification equal to  $A$ . The value of  $R_o$  is determined so that the low-frequency null adjust potentiometer is about in the middle of its operating range when the low-frequency balance is made.

The pentode is operated with a bias of about  $-1.75$  volts and the triode is operated with a bias of about  $-0.75$  volt. The fact that the two cathodes are connected together tends to offset any tube drift due to heater voltage variations. Since the triode grid is connected to its anode through the resistors that set its operating point and since the anode voltage varies with tube current, a feedback path is provided to help stabilize the d-c operation.

### Operational Adjustments

The criteria used for adjusting the differential amplifier is a low rejection ratio over as large a frequency range and as wide an input-resistance variation as possible. The rejection ratio is defined as the ratio of the pentode output voltage, with identical input voltages, to the pentode output voltage when

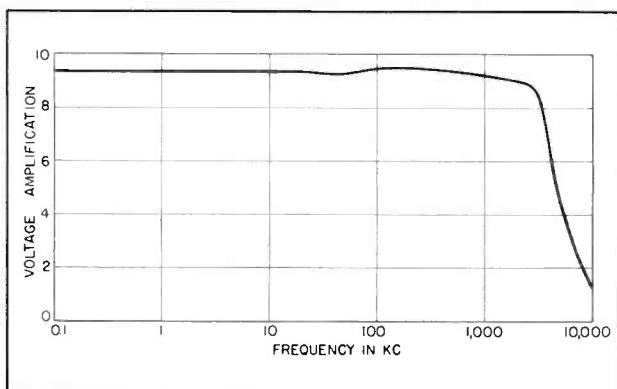

FIG. 4—Response curve of gain versus frequency for the differential amplifier

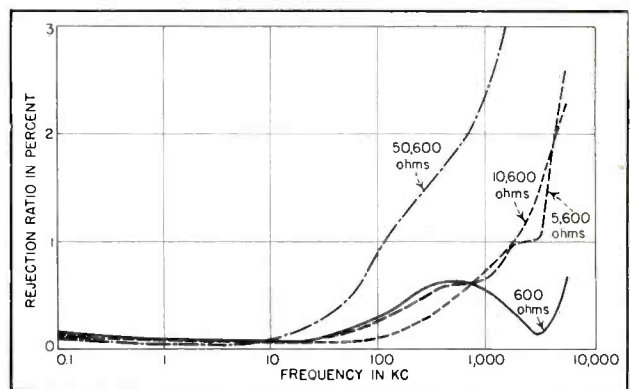

FIG. 5—Curves of rejection ratio versus frequency for indicated generator impedances

one input voltage is removed, but with that input terminated with the same impedance as the generator impedance driving the other input. This ratio is a measure of the differential operation of the amplifier and is useful in determining the accuracy of the circuit for bridge null readings.

The circuit adjustment is carried out as follows.

### Low-Frequency Null Adjustment

After a suitable warmup period, a 1,000-cps signal is supplied to one of the inputs. The other input is terminated with the generator resistance, in this case 600 ohms. Using an a-c voltmeter the input amplitude is adjusted to read a suitable output of about one volt rms. The exact voltage setting is arbitrary as long as it is within the range of linear operation.

The termination is removed from the input and both inputs connected to the same input voltage. The low-frequency null adjust potentiometer and  $R_s$  are adjusted for minimum output voltage. The resulting minimum-output voltage is a direct reading of the rejection ratio provided the output voltage above was set at 1 volt.

The mid- and high-frequency adjustments interact so that the best null adjustment at some mid-frequency will not be the best high-frequency null adjustment and vice versa. The method for making the mid-high null adjustment is to first choose a mid- and high frequency and then to make the adjustments of the mid-frequency and high-frequency null adjust capacitors such that the rejection ratio is near a minimum and the same at both the mid- and high-frequencies. The mid-frequency and high-frequency chosen were 1 mc and 5.5 mc respectively.

### Input-Impedance Correction Adjustment

After the low and mid-high frequency adjustments have been made, two 5,000-ohm 1-percent carbon-deposited resistors placed in shielded coaxial connectors were inserted in series with each of the inputs. The low-mid and high-frequency rejection ratios were then checked.

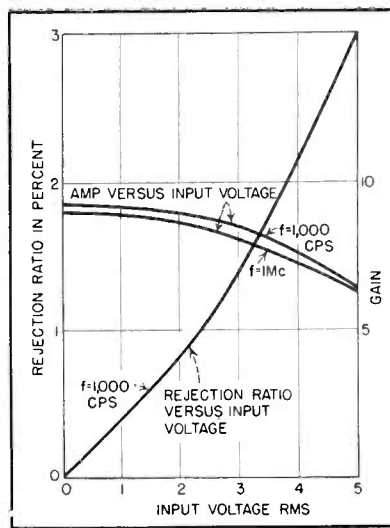

FIG. 6—Curves of gain and rejection ratio versus input voltage

When the output is being measured with a single input, the other input should be terminated with 5,600 ohms if a 600-ohm generator is used. At the low frequencies the rejection ratios should be about the same as when the generator resistance was 600 ohms. High-frequency rejection ratio will generally be worse.

By adding to the pentode input a 1 to 5- $\mu\text{f}$  trimmer marked IMPEDANCE CORRECTING CAPACITOR in Fig. 3 and adjusting for the minimum output voltage at 1 mc, the rejection ratio should become about equal to the low-impedance rejection ratio.

In reality there is a small capacitive term in  $Y_1$  due to wiring capacitance which adds to the grid-anode capacitance and causes an input admittance unbalance. The addition of capacitance on the pentode side makes up for this unbalance. The value of capacitance actually added was about 4  $\mu\text{f}$ . The impedance correcting capacitor is a convenience in adjustment, but it can be eliminated by changing  $C_2$  and readjusting the MID-FREQ NULL ADJUST control.

### Performance

Figure 4 shows a curve of voltage amplification versus frequency for the differential amplifier. The output circuit uses a peaking circuit, shown in Fig. 3, designed to operate into a capacitance of 5  $\mu\text{f}$ . The curve remains fairly flat with

a value of about 9.2 out to about 2 mc. The 3-db-down point occurs at about 4 mc.

The low-frequency voltage amplification calculated using Eq. 2 is 13.45 and is higher than the actual value.

Figure 5 shows curves of rejection ratio versus frequency for various source resistances. The low-frequency rejection ratios are small, being below 0.1 percent over a wide range and independent of source resistance. The desired bridge accuracy determines how high an impedance and over what frequency range that measurements can be made. This amplifier was adjusted for low source resistances. The high-frequency rejection ratios could be improved at higher source resistances by making the initial mid-high frequency balance and the impedance correction somewhere in the desired operating impedance range.

The marked 3-mc dip experienced with the 600-ohm source resistance is due to direct feedthrough from pentode input to its output via the grid-to-plate capacitance. The high-frequency adjustment counteracts this capacitive feedthrough but at the same time causes a dip to occur whose position depends on the mid-high frequency adjustment. The rejection ratios are shown down to 100 cycles. At 30 cycles the measured rejection ratio was about 0.5 percent.

Figure 6 shows curves of voltage amplifications and rejection ratio versus input voltage. The fact that the amplification versus input voltage curve remains fairly constant up to about 2 volts rms indicates that the differential amplifier operates satisfactorily.

The curve of rejection ratio versus input voltage shows that the desired bridge accuracy determines how large an input voltage can be tolerated.

### REFERENCES

- (1) L. J. Giacoletto, Equipments for Measuring Junction Transistor Admittance Parameters for a Wide Range of Frequencies, *RCA Review*, p 269, June 1953.
- (2) G. E. Valley, Jr. and H. Wallman, "Vacuum Tube Amplifiers," p 441, MIT Rad Lab Series, McGraw-Hill Book Co., New York, N. Y.
- (3) L. J. Giacoletto, Terminology and Equations for Linear Active Four-Terminal Networks Including Transistors, *RCA Review*, p 28, March 1953.

# A-M System Tunes

**SUMMARY** — Tuning-servo control signal modulated by aircraft power-line frequency provides fast and accurate tuning at low transmitter power and reduces jitter in frequency-shift modulation systems

**A**UTOMATIC antenna tuning in aircraft is usually accomplished by derivation of the error signals from two bridges measuring antenna impedance as presented to the transmission line. One bridge gives phase error and the other magnitude error. These error signals, amplified, each control at least one variable network element to accomplish correction. Since antenna impedance change is introduced by frequency change, weather conditions, earth proximity or battle damage, speed and accuracy of automatic antenna tuning are desirable.

Systems of the type shown in block form in Fig. 1A involve problems of varying sensitivity with transmitter output power, jitter when used with frequency-shift-modulated transmitters, drift and, for some uses, excessive control system dead-space. In the system shown in Fig. 1B the addition of a continuous modulation to the carrier wave of the transmitter gives a satisfactory solution.

## Modulated Control Signal

Since the equipment may be damaged if turned on when unloaded,

By **DAVID T. GEISER**

*Sprague Electric Co.  
North Adams, Massachusetts*

the transmitter is usually first energized at reduced power. If bridge error signals exceed a predetermined level, the transmitter is interlocked against normal power operation until the bridges indicate safe loading.

The problem of reduced bridge sensitivity at low transmitter power is solved by impressing a constant-power amplitude modulation on the transmitter carrier. An example is shown in Fig. 2. The two transmitter carrier waves have a 4-to-1 power ratio and are modulated by an equal-power signal. When these two modulated waves are demodulated, equal amplitude signals result despite different carrier powers. If the carriers alone had been demodulated, a 4-to-1 power (or 2-to-1 voltage) output ratio would result.

Control signal modulation must not exceed 100 percent of the reduced-power transmitter input. With conventional ratios of normal

to reduced transmitter power this limits control-signal modulation to a maximum value of 5 to 10 percent modulation of the normal transmitter input. With linear demodulating elements, 1 to 2 percent modulation has been used with carrier powers as low as 50 milliwatts.

## Jitter

Aircraft antennas may exhibit many resonances and antiresonances, thus modulation that shifts frequency will often generate an error signal and cause an apparent jitter. When jitter occurs with the tuning network carrying full transmitter power, serious burning of network electrical contacts may occur. Use of control-signal modulation effectively broadens the system bandwidth by selection of adjustment that equalizes bridge response at each of the two control signal sideband frequencies. If the control signal sideband spacing is of the same order as the communication-signal frequency shift, significant, and in certain cases complete, jitter suppression occurs.

Zero-point drift has been minimized by using mechanical or elec-

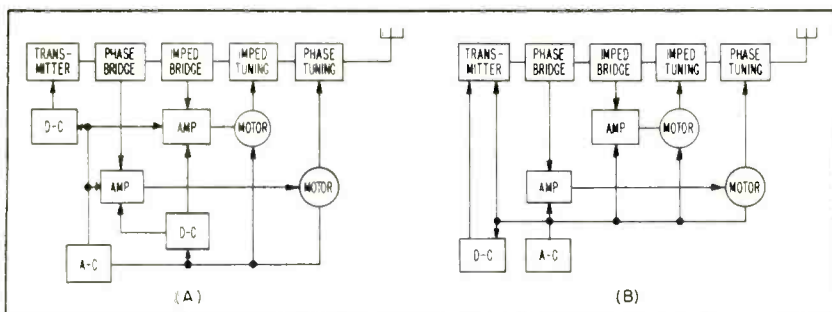

FIG. 1—Conventional antenna tuning system (A) can be simplified by modulation of control signals from aircraft's a-c power supply (B)

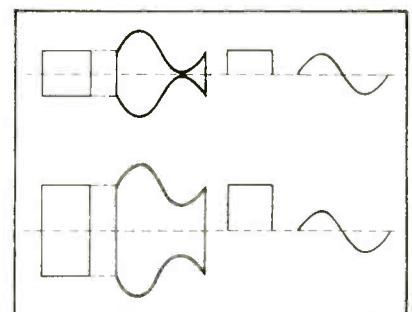
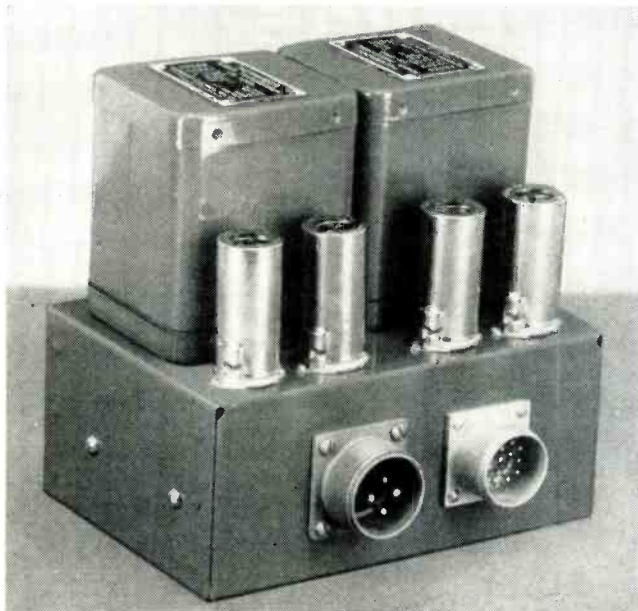

FIG. 2—Sine wave modulating signal maintains constant amplitude

# Aircraft Antennas



Two-channel amplifier for automatic aircraft antenna tuning. Use of modulated control signal increases tuning accuracy

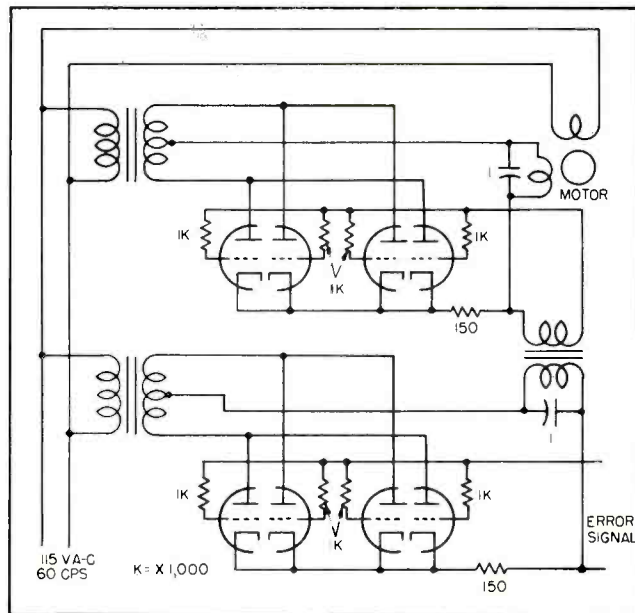

FIG. 3—High-gain two-channel amplifier provides low-delay control signal without use of rectifiers or filters

tronic choppers to convert the error signal to a-c. Such methods are still subject to aging drift and make the use of an inherently a-c control signal desirable. If the control-signal modulation is supplied by the aircraft's a-c bus, the additional advantages of self-rectifying amplifiers may be achieved with reduction of required space and weight of the control amplifier. Reduction of amplifier phase-shift error also results because of the keying action of self-rectification while the detuning effect of extraneous communication signals at the power frequency is cancelled.

Excessive control-system dead space is not a common problem with aircraft automatic-antenna tuning. Considerable maladjustment will cause little loss of transmitter power so detuning is usually important only for its increase of system voltages and currents and consequent effect on tuning components. However, when true duplex operation is attempted, much higher amplifier gains are necessary to permit the accuracy of antenna tuning required. Here the wider effective

bandwidth of the source-modulated servomechanism permits more accurate location of the proper tuning point by permitting drift-free error and anticipation signals.

### Design Considerations

Practical factors involved in system design are the method and amount of modulation, sensitivity of the error-detection bridges, tuning speed and accuracy desired and the type of amplifier and driving motor.

Voice-modulated transmitters pose perhaps the greatest problem in this system of automatic tuning. The major difficulty is not the fact that the added control-signal frequencies degrade speech, but rather that the speech input wiring usually exhibits considerable pickup from the aircraft a-c system. As this pickup in passing through the transmitter modulator can bear any phase relationship to the control-signal modulation, it is important that stray pickup by the speech circuits be minimized.

The modulation percentage of the control signal chosen for tests was two percent. While this level is per-

ceptible under quiet conditions, no deterioration was noticed in typical high percentage modulation speech. The control-signal amplitude modulation is completely unnoticeable on a frequency-shift modulation system.

Beneath the maximum limit of 100-percent modulation of the lowest carrier power, the control-signal modulation percentage has a minimum limit set by desired system sensitivity. The higher the desired sensitivity, the higher the control-signal modulation percentage should be. Maximum bridge sensitivity is obtained when equal potentials are developed in the various bridge legs. This latter condition conventionally introduces high loss and reactance into the transmission network and must usually be compromised.

A simple system amplifier is shown in Fig. 3. This is not the final configuration but is an experimental model successfully used. The two channels have been shown in cascade connection only to indicate one way of producing a high-gain low-delay control-signal amplifier without rectifiers or filters.

# High-Voltage Supply

By VICTOR WOUK

Beta Electric Corp.  
New York, New York

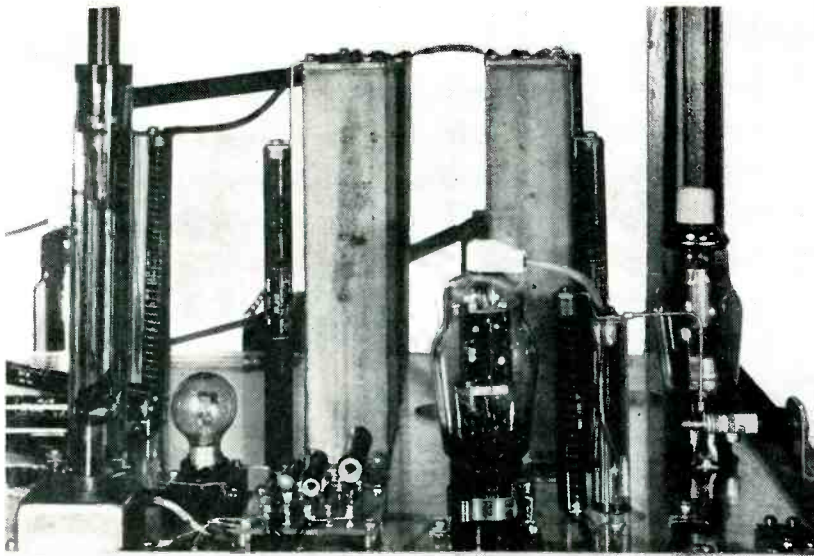

Layout of the high-voltage oil-immersed components of the power supply

INCREASING interest in the possibilities of large-screen theater color television has caused the design problem of a high-quality, high-voltage d-c power supply to become more urgent.

The degree of focusing, registration, color purity and other picture characteristics necessitate a power supply with fairly good regulation, but particularly, with a low ripple factor. Approximately 80,000 volts at 2 milliamperes and 0.005-percent ripple is required.

Ordinary ripple reducing techniques introduce problems concerning size and cost of, and hazardous amounts of stored energy in, the filter capacitors. An electronic filter described in this article eliminates the difficulties.

Ripple is reduced to a low value in the circuit of Fig. 1 employing capacitors comparatively small both in capacitance and size. Only the basic components in the circuit are shown. Tube  $V_1$  is an ordinary amplifier. It is shown as a triode but in practice it is a beam pentode. Capacitors  $C_g$  and  $C_p$  are both high-voltage capacitors. Only the following simplifying assumptions need be made

$$R_g \lll XC_g$$

$$R_i \lll XC_p$$

where  $R_g$  = grid-ground resist-

ance;  $XC_g$  = impedance of  $C_g$  at ripple frequency;  $R_i$  = load resistance; and  $XC_p$  = impedance of  $C_p$  at ripple frequency.

Assume an a-c ripple equal to  $E_i$  exists at point A the output of the full-wave doubling circuit in the 80 kv d-c power supply. This a-c voltage forces current through the internal resistance  $R_i$ , the electronic filter and the high-voltage load. Only the a-c component of output voltage is under consideration. The d-c component cannot affect the amplifier circuits owing to the blocking action of  $C_g$  and  $C_p$ .

At point B the output voltage rises a small amount  $\Delta E$ . This small rise is transmitted to the grid of the tube, since  $R_g$  is much greater than  $XC_g$ . At the plate an amplified voltage change inverted in phase appeared. Thus if voltage at point B were to rise slightly, point G would rise a small amount, but the voltage at point P would drop. This drop would be transmitted through  $C_p$ , and thus maintain the excursions at the output point B rather small. The circuit of Fig. 1 can be replaced by the equivalent circuit shown in Fig. 2;

where  $E_i$  = the a-c voltage generated from a full-wave voltage doubler,

$R_i$  = the internal series resistance in the R-C filter,

$XC_p$  = impedance of the capacitor  $C_p$  and

$E_o$  = output ripple voltage, which also equals the grid voltage  $e_g$ .

In these calculations, the d-c load is a cathode-ray tube and has a high impedance. It can be disregarded.

Then

$$E_i = (R_i + XC_p)I - \mu E_o \quad (5)$$

or

$$E_i - IR_i = IXC_p - \mu E_o$$

but

$$E_i - IR_i = E_o = e_o \quad (6)$$

so

$$E_o = IXC_p - \mu E_o \quad (7)$$

or

$$I = \frac{E_o}{XC_p/(1 + \mu)}$$

Substituting Eq. 7 into Eq. 6

$$E_i - E_o \frac{R_i}{XC_p/(1 + \mu)} = E_o$$

$$E_o = \frac{F_i XC_p/(1 + \mu)}{R_i + XC_p/(1 + \mu)} \quad (8)$$

The output ripple voltage from the electronic filter is equivalent to that which would be present if the capacitance in the plate circuit

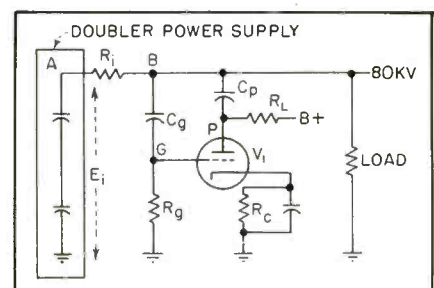

FIG. 1—Basic circuit of electronic filter

# Uses Electronic Filter

**SUMMARY** — Theater color tv requires a high-voltage d-c power supply with a low ripple factor. Simple circuit employs high-voltage capacitors of low capacitance ratings in conjunction with a beam pentode tube to produce a high effective value of C in an R-C filter. Ripple is reduced to 0.005 percent

of the amplifier tube were increased by a factor of  $1 + \mu$ , where  $\mu$  equals the gain of the amplifier circuit. This reduces  $XC_p$ ,  $\mu$ -times, and increases the effectiveness of  $C_p$  in the R-C filter.

This is implicit in Eq. 8 and can be recognized as similar to the Miller Effect. In the electronic filter, the gain of the system and the feedback to the grid through this effective mutual plate-grid impedance is used to advantage.

For a ripple of 1 part in 20,000, which is required for fine registration and color purity

$$E_o/E = 1/200 \quad (9)$$

If  $\mu$  is much greater than 1, then from Eq. 8 and 9

$$1/200 = \frac{R}{XC_p/\mu} + 1$$

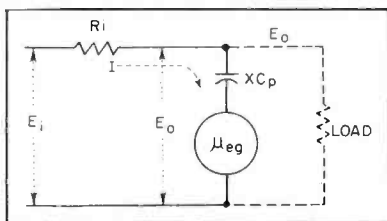

FIG. 2—Equivalent circuit of electronic filter shown in Fig. 1

$$\frac{R}{XC_p/\mu} = 200 \quad (10)$$

A good value of series resistance to employ is 1 megohm, since at 2 milliamperes, this represents only a 2-kv drop and 4 watts dissipation. Excessive regulation is not introduced into the power supply and commercially available types of high-voltage resistors can be employed. Inserting the following values into Eq. 10

$$R = 1 \text{ megohm}$$

$XC_p = 1/2 \pi f \times 4 \times 10^{-9} = 3.3 \times 10^5$  ohms. At  $f = 120$  cps, the fundamental ripple frequency of the output of the doubler circuit,  $\mu$  is approximately equal to 66.

This value of  $\mu$  can readily be achieved with simple tubes so that the overall design of Fig. 1 when converted into a practical engineering problem, is comparatively simple. This is shown in Fig. 3 which illustrates the high-voltage rectifier circuit and electronic filter used for a theatre projection television system, in which a ripple of 1 part in 20,000 was achieved. The feedback capacitor is  $C_1$ , and the deripling capacitor  $C_2$ . The d-c am-

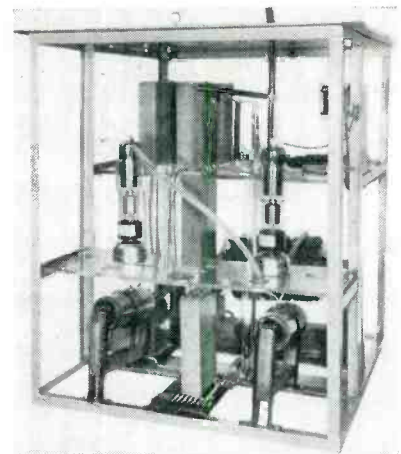

Closeup view of the electronic filter shown in the circuit diagram of Fig. 3

plifier tube is a 6BG6, operating with a plate supply of 4 kv.

The specific example of an electronic filter is for a high-voltage, low-current power supply. The basic circuit has been employed successfully and economically in lower-voltage, higher-current designs, where low ripple is needed. The question to be answered when determining the advantage of the electronic filter is whether the factor of  $\mu$  by which the filter capacitance must be increased to obtain the desired low ripple, can be obtained more economically by using  $\mu$  times as much capacitance, or by employing the amplifier circuit described.

## BIBLIOGRAPHY

- Charles F. Dalsiel, A Study of the Hazards of Impulse Currents, *Trans IEEE*, p 1,032, Oct. 1953.
- Victor Wouk, A Resume of D-C Overpotential Testing, Beta Electric Corp., Feb. 1954.
- B. L. Waidelich, The Full Wave Voltage Doubling Rectifier Circuit, *Proc IRE*, p 554, Oct. 1941.

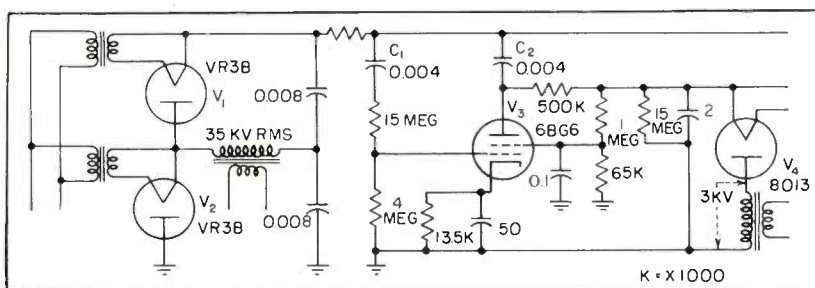

FIG. 3—Electronic filter for 80-kc. 2-ma supply. Ripple reduced to 1 part in 23,000

# How to Design I-F

By **ROGER R. WEBSTER**

*Texas Instruments Inc.  
Dallas, Texas*

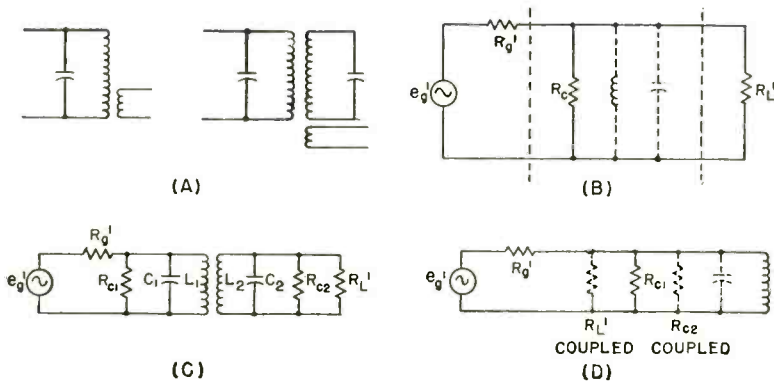

FIG. 1—Single and double-tuned transformers (A), equivalent circuit of single-tuned unit (B); schematic (C) and equivalent circuit (D) of double-tuned unit

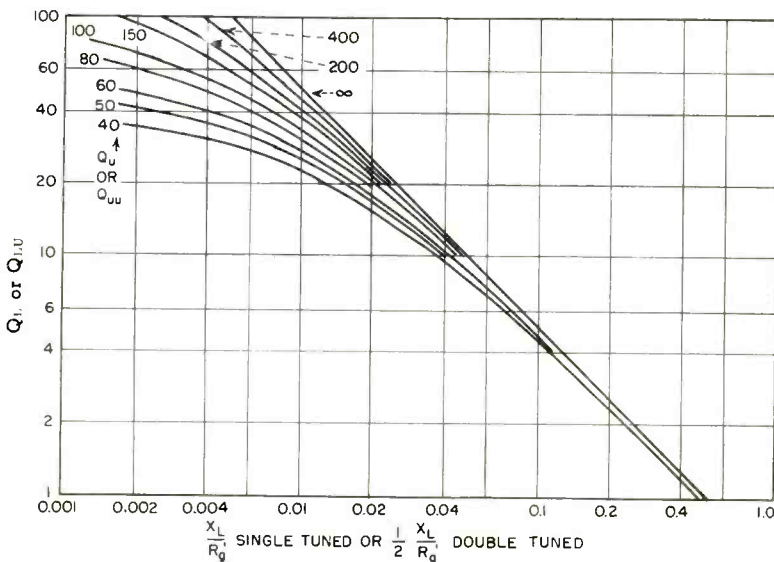

FIG. 2—Ratio of coil reactance to generator impedance vs loaded Q

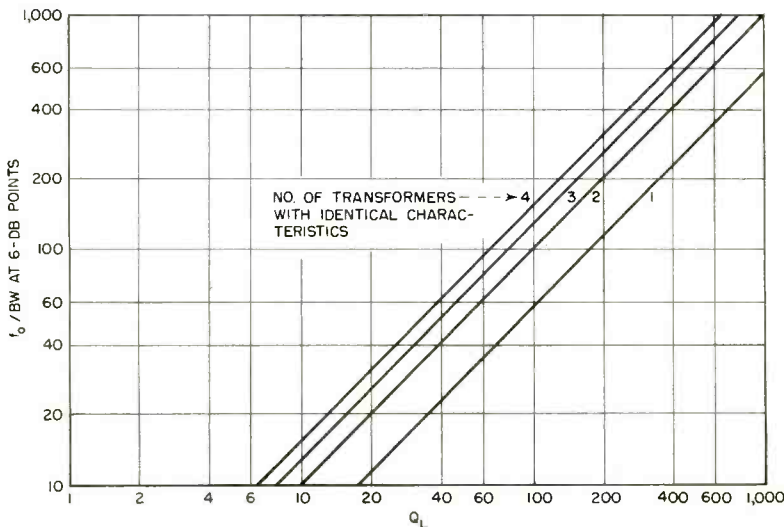

FIG. 3—Loaded Q vs 6-db bandwidth ratio for single-tuned transformers

**I** NTERMEDIATE-FREQUENCY transformers used in vacuum-tube amplifiers are essentially independent of vacuum-tube impedances and the desired band-pass characteristics may be determined independently of vacuum-tube loading at ordinary intermediate frequencies. Grid loading is insignificant and plate loading will often be small enough to be neglected since the plate resistance of many receiving-type pentodes may be  $\frac{1}{2}$  megohm or higher.

Such is not the case with transistors. The collector impedance of a high-frequency transistor such as the Texas Instruments type 225 may be as high as 100,000 ohms or more at 455 kc but the input impedance is low—of the order of 300-500 ohms, grounded emitter. Impedance matching is important to secure maximum power transfer and the band-pass characteristics of the transformer cannot be determined without considering the effects of transistor loading.

Single-tuned transformers have been widely used for transistor i-f amplifiers since for equal 3-db bandwidths they have less insertion loss than double-tuned transformers. However, where adjacent channel rejection is important, double-tuned transformers will often give less insertion loss than single-tuned transformers. Keeping transformer losses low is important with the limited gains available from present-day high-frequency transistors. Figure 1A shows some practical arrangements for both single and



# Transistor Transformers

**SUMMARY** — Designed of tuned coupling networks for i-f transistor transformers requires matching collector and base impedances while meeting bandwidth requirements and providing minimum insertion loss. This article presents detailed procedure and curves of single and double-tuned units

double-tuned transformers.

The design equations for single and double-tuned i-f transformers are easily obtained. Consider the basic tuned coupling networks as transformers with generator and load impedances referred to the primary on a unity-turns-ratio basis and the unloaded resonant impedance of the coil as an equivalent shunt loss resistance.

## Single-Tuned Transformer Design

Refer to Fig. 1B for the equivalent schematic of a single-tuned transformer:

$R_g$  = generator impedance,  $R_g'$  = generator impedance referred to unity turns ratio,  $R_c$  = antiresonant unloaded coil impedance,  $R_L$  = load impedance and  $R_L'$  = load impedance referred to unity turns ratio.

When both  $R_g'$  and  $R_L'$  can be controlled, maximum power will be delivered to the load when  $R_g' = R_L'$ .

From basic theory  $Q_u = R_c/X_L$  where  $Q_u$  = unloaded coil Q and  $X_L$  = coil reactance. Quantity  $Q_L = (\text{parallel resistance of } R_g', R_c \text{ and } R_L')/X_L$  = loaded circuit Q and is determined by bandwidth requirements

$$Q_L = \left[ \frac{1}{\frac{1}{R_g'} + \frac{1}{R_c} + \frac{1}{R_L'}} \right] \left[ \frac{1}{X_L} \right]$$

where  $X_L/R_c = 1/Q_u$  and  $R_g' = R_L'$  for maximum power transfer.

Solving for  $X_L/R_g'$

$$X_L/R_g' = \frac{1}{2}[(1/Q_L) - (1/Q_u)] \quad (1)$$

Figure 2 is a plot of Eq. 1 for

various values of  $Q_L$  and  $Q_u$ . From bandwidth requirements for a single transformer  $Q_L = f_o/2\Delta f$  where  $Q_L$  = loaded circuit Q,  $f_o$  = intermediate frequency and  $\Delta f$  = deviation from  $f_o$  giving 3-db attenuation.

When more than one transformer is involved, each tuned to the same frequency, each transformer will be down 3/T db at the  $\Delta f$  points, where T is the number of transformers and  $\Delta f$  is specified for the entire amplifier.

From a standard text on tuned circuit design<sup>1</sup>

$$\frac{A_o}{A} = \left[ 1 + Q^2 \left( \frac{f}{f_o} - \frac{f_o}{f} \right)^2 \right]^{1/2}$$

where  $A_o/A$  = (voltage at frequency  $f_o$ /voltage at frequency  $f$ ) and Q is the loaded circuit Q.

Letting  $\Delta f = f - f_o$  and rearranging terms

$$Q_L = [(A_o/A)^2 - 1]^{1/2} \left[ \frac{1 + (f_o/\Delta f)}{2 + (\Delta f/f_o)} \right] \quad (2)$$

Figure 3 is a plot of Eq. 2 for values of  $A_o/A$  corresponding to 1, 2, 3 and 4 transformers with identical characteristics. Since in circuit design, bandwidth is usually specified at the 6-db points, Fig. 3 has been plotted for 6-db bandwidth versus loaded Q rather than for 3-db bandwidth.

If transistor impedance, i-f frequency, bandwidth and unloaded coil Q are known, the reactance of the coil may be computed from the value obtained from Fig. 2 or from Eq. 1. For the usual case, the primary will be untapped. When the value of  $X_L$  obtained from Fig. 2

is less than the desired amount any greater  $X_L$  obtained from Fig. 2 is less than the desired amount any greater  $X_L$  may be used provided the driving transistor is matched by tapping down on the primary winding according to

$$n = R_o/R_g' \quad (3)$$

where  $R_o$  = transistor output impedance,  $R_g'$  = value obtained from Eq. 1 or from Fig. 2 and  $n$  = tap to overall primary turns ratio.

The secondary winding may be computed from

$$n' = R_L/R_o' \quad (4)$$

where  $n'$  = secondary to primary turns ratio,  $R_o'$  = generator impedance and  $R_L$  = transistor input impedance.

This involves an approximation, since it assumes unity coupling exists between the primary and secondary. With ordinary close coupled windings the resulting inaccuracies will be considerably less than those caused by transistor impedance variations.

## Double-Tuned Transformer Design

Only the case of critically coupled coils will be considered. Less than critical coupling is not recommended, since additional transformer losses are involved. Over-coupled transformers are not subject to a simple design procedure. The circuit, with resistances referred to a unity-turns-ratio basis, is shown in Fig. 1C.

The coils and external loading are identical, so that  $L_1 = L_2 = L$ ;  $C_1 = C_2 = C$ ;  $R_{e1} = R_{e2} = R_c = QX_L$ , the antiresonant unloaded, uncou-

# How to Design I-F Transistor Transformers

(Continued from page 157)

pled coil impedance, and  $R_g' = R_L'$ .

The equivalent coupled circuit diagram Fig. 1D shows the coupled impedance of  $R_L'$  and  $R_{e2}$  transferred to the primary side of the transformer.

When the coils are critically coupled, the coupled impedance is equal to the loaded primary impedance. The loaded coupled Q of either primary or secondary is  $\frac{1}{2}$  the loaded uncoupled Q. The combined impedance of  $R_L'$  coupled and  $R_{e2}$  coupled is equal to the combined impedance of  $R_g'$  and  $R_{e1}$ .

Since  $R_{e2} = R_{e1}$  and  $R_L' = R_g'$ , then  $R_L'$  coupled =  $R_g'$  and  $R_{e2}$  coupled =  $R_{e1}$ . As in the case of the single-tuned transformer, this represents the minimum insertion loss.

Let  $Q_{uu} = R_c/X_L =$  unloaded, uncoupled coil Q,  $Q_{Lu} =$  parallel impedance of  $R_g'$  and  $R_c/X_L$  and

$$Q_{Lu} = \left[ \frac{1}{\frac{1}{R_g'} + \frac{1}{R_c}} \right] \left[ \frac{1}{X_L} \right]$$

Noting that  $X_L/R_c = 1/Q_{uu}$  and solving for  $X_L/R_g'$  gives  $X_L/R_g' = (1/Q_{Lu}) - (1/Q_{uu})$ .

This is equal to twice the single-tuned transformer value for  $X_L/R_g'$  and is indicated on Fig. 2.

To determine  $Q_{Lu}$ , an equation for coupled circuits from standard texts<sup>1</sup> may be rearranged

$$\frac{A_o}{A} = \left[ \left( 1 - \frac{Q^2 Y^2}{1 + K^2 Q^2} \right)^2 + \left( \frac{2QY}{1 + K^2 Q^2} \right)^2 \right]^{1/2} \quad (5)$$

where  $Y = (f/f_o) - (f_o/f)$  and  $Q = Q_{Lu}$ .

For critical coupling,  $K = 1/Q$  and substituting  $\Delta f = f - f_o$  Eq. 5 can be solved for  $Q_{Lu}$

$$Q_{Lu} = \left( \frac{1}{\sqrt{2}} \right) \left( \frac{f_o}{\Delta f} \right) \left[ \frac{(f_o/\Delta f) + 1}{(f_o/\Delta f) + \frac{1}{2}} \right] \left[ \left( \frac{A_o}{A} \right)^2 - 1 \right]^{1/4} \quad (6)$$

Figure 4 is a plot of Eq. 6 for values of  $A_o/A$  corresponding to 1, 2, 3 and 4 transformers with identical characteristics.

For transformer design, either single or double tuned, the follow-

ing information is required:

Overall amplifier bandwidth,  $f = bw/2$ .

Intermediary frequency,  $f$ .

Number of i-f transformers

Quantity  $Q_u$  or  $Q_{uu}$ , the unloaded uncoupled coil Q. For preliminary determination a value such as 100 may be assumed and when final determination of  $Q_u$  or  $Q_{uu}$  is made the

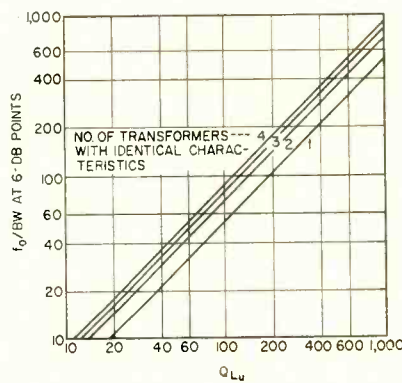

FIG. 4—Loaded circuit Q plotted against 6-db bandwidth ratio for double-tuned transformers

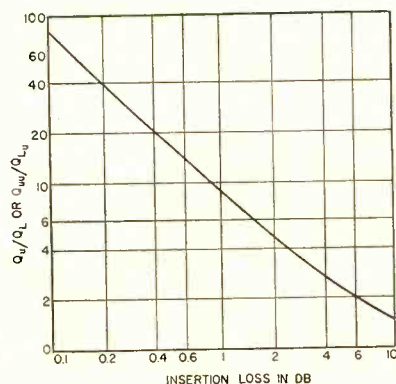

FIG. 5—Insertion loss in db plotted against loaded circuit Q for single and double-tuned transformers

coil  $X_L$  may be adjusted to suit.

Transistor input and output impedances.

Quantities  $Q_L$  or  $Q_{Lu}$ . These may be read directly from Fig. 3 or 4. The adjacent channel attenuation may be specified if the i-f frequency is 455 kc and  $Q_L$  or  $Q_{Lu}$  read from Fig. 6.

Ratio  $X_L/R_g'$ , which may be read directly from Fig. 2.

For an untapped primary,  $R_g = R_g'$  and  $X_L$ . These may be computed directly. For a tapped primary, compute  $N$  from Eq. 3 knowing  $X_L$  and  $R_g'$ .

Compute the secondary for a single-tuned transformer or tertiary for a double-tuned transformer from primary turns and Eq. 4. For double-tuned transformers, critical coupling may be determined easily since the loaded coupled Q of the primary is equal to  $\frac{1}{2}$  the loaded uncoupled primary Q. Adjust the spacing between primary and secondary until this condition exists.

## Transformer Losses

The Q of unloaded coils must be as large as possible if excessive insertion loss is to be avoided. Circuit efficiency is involved rather than the fraction of power coupled through the transformer.

Circuit efficiency is defined as  $\eta =$  power delivered to load/maximum power available from generator =  $P_L/P_g$  where  $P_L = (e_o)^2/R_L$  with  $e_o$  the output voltage and  $P_g = (e_g)^2/4R_g$  with  $e_g$  the generator voltage.

From Fig. 1B, it is found that  $e_o = e_g [R_c/(2R_c + R_g)]$

Substituting these into the equation for  $\eta$  gives

$$\eta = \left[ \frac{1}{1 + (R_g/2R_c)} \right]^2$$

which may be further simplified to give for the single-tuned case

$$\eta = [1 - (Q_L/Q_u)]^2$$

and for the double-tuned case

$$\eta = [1 - (Q_{Lu}/Q_{uu})]^2$$

Figure 5 is a plot of insertion loss for single-tuned and double-tuned transformers. It shows the importance of maintaining a high ratio of  $Q_u$  if reasonable coil losses are to be realized.

While the expression for circuit efficiency is essentially the same for both single and double-tuned transformers, the realizable efficiency depends on  $Q_L$  or  $Q_{Lu}$ . These are in

Continued on page 160

# CINCH <sup>★</sup> STANDARD SOCKETS

The CINCH Sub-miniature socket insures positive electrical contact, holds tubes securely in place, permits easy maintenance and replacement, yields maximum insulation resistance and minimum high frequency loss. And provides manufacturers of electrical

controls, transmitters, receivers, transceivers, airborne equipment,

etc., and hearing aids . . . a labor saving chassis installation which serves terminal board functions

while permitting designers to obtain maximum space afforded by the standard flat base tubes.

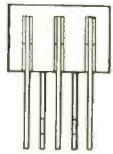

Five pin stem type for mounting tubes parallel to chassis and for printed circuits. (shown enlarged)

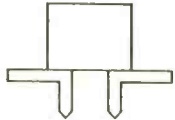
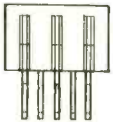

## ★ SUB-MINIATURE SOCKET

FOR "SAVINGS" AND CONVENIENCE IN

**PRINTED CIRCUITS** AND ★ **AUTOMATICALLY**

**MADE SOCKETS FOR  
AUTOMATION**



**Cinch**  
ELECTRONIC  
COMPONENTS

CONSULT CINCH

**CINCH MANUFACTURING CORPORATION**

1026 South Homan Ave., Chicago 24, Illinois

Subsidiary of United-Carr Fastener Corporation, Cambridge, Mass.

★ CINCH components fully perform the service for which they were designed, so that judged by demand and usage, "CINCH is the Standard".



CINCH is producing exactly made components for the exacting requirements of mechanical assembly, automatically made with precision metal and insulation components, insuring the uniformity and quality mandatory for use in AUTOMATION in the end users equipment.

CINCH will design new, or re-design, parts within the category of their manufacture to fit your particular plans, and will also assist in the introduction in the assembly of CINCH's specially designed component in your radio and TV equipment.

CINCH components are available at leading electronic jobbers — everywhere.

# How to Design I-F Transistor Transformers

(continued From Page 158)

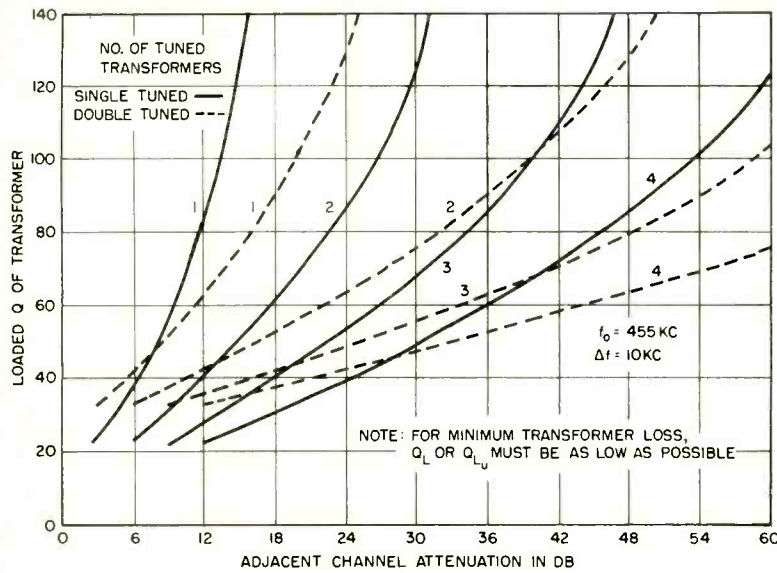

FIG. 6—Adjacent channel attenuation plotted against loaded circuit Q for single and double-tuned transformers

turn dependent on bandwidth, and except for the special case noted in the next section,  $Q_L$  and  $Q_{Lu}$  are not equal for equal bandwidths. Thus  $\eta$  will not be identical in the two cases.

### Single-Tuned vs Double-Tuned Transformers

Ordinarily, the use of single-tuned transformers will result in less insertion loss than the use of double-tuned transformers. However, if skirt selectivity is of greater interest than bandwidth at 3-db points, double-tuned transformers may often result in less insertion loss than single-tuned transformers.

Since the expression for insertion loss involves the loaded and unloaded coil Q's and is identical for both single and double-tuned transformers, Eq. 2 and Eq. 4 may be equated, which sets  $Q_L = Q_{Lu}$  and lets  $Q_u = Q_{uu}$ .

For  $(f_o/\Delta f) > 1$

$$\frac{1 + (f_o/\Delta f)}{2 + (f_o/\Delta f)} \cong \frac{1}{2} \left( \frac{f_o}{\Delta f} \right)$$

and

$$\frac{(f_o/\Delta f) + 1}{(f_o/\Delta f) + 2} \cong 1$$

then

$$A_o/A = \sqrt{5} \quad \text{or} \quad 7 \text{ db} \quad (7)$$

The significance of Eq. 7 is that if the bandwidth is specified at the 7-db points, the insertion losses of the single-tuned and double-tuned transformers are equal, assuming Q of coils equal, since the values of loaded circuit Q are equal.

If the bandwidth is specified at points more than 7 db down from maximum, the double-tuned transformer will have less insertion loss than the single-tuned transformer and conversely

Equation 7 holds for a single transformer. When more than one transformer is used, the db points for equal insertion loss for either single or double-tuned transformers are given by  $T \times 7$  where T is the number of transformers. Thus, if two transformers are used, insertion loss will be equal if bandwidth is specified at the 14-db points. Likewise, for three transformers at the 21-db points etc.

Figure 6 has been computed from Eq. 2 and Eq. 6 and shows  $Q_L$  or  $Q_{Lu}$  versus adjacent channel attenuation in db. This chart is good only for i-f is at or near 455 kc. This figure shows the superiority of double-tuned transformers if large adjacent channel attenuation is required, since much smaller insertion loss is possible than if single-tuned transformers are used.

### Example

A double-tuned transformer design for a grounded-base transistor i-f amplifier was desired, having the following characteristics: number of transformers = 4; bandwidth to 6-db points = 15 kc; maximum insertion loss of transformer = 3 db; i-f frequency  $f_o = 455$  kc; transistor impedances—input = 50 ohms and output = 120,000 ohms.

Calculate  $f_o/BW = 455/15 = 30.4$ .

Determine  $Q_{Lu}$  from Fig. 4,  $Q_{Lu} = 34$ .

Determine  $Q_{uu}/Q_{Lu}$  from Fig. 5,  $Q_{uu}/Q_{Lu} = 3.4$ .

The minimum value of  $Q_{uu} = 3.4 \times 34 = 115$ .

Using the values of  $Q_{Lu}$  and  $Q_{uu}$  read  $\frac{1}{2} (X_L/R_g') = 0.01$ .

No primary tap was desired, so that  $R_g' = R_g = 120,000$  ohms. Therefore,  $E_L = 2 \times 0.01 \times 120,000 = 2,400$  ohms at 455 kc and  $L = 0.85$  millihenry.

After three or four attempts a 0.85-millihenry coil with Q of 115 was wound using 170 turns of No. 5-44 Litz wire with a ferrite cup core and a coil width of  $\frac{1}{8}$  inch. A second identical coil was wound. Both coils were tuned to 455 kc and loaded with 120,000 ohms. By observing the Q on a Q meter, the spacing between coils was adjusted until the Q dropped to  $\frac{1}{2}$  the uncoupled value at which time the coupling was critical. Spacing was  $\frac{3}{32}$  inch. The turns of the tertiary coupling coil to following transistor were computed using Eq. 4,  $N' = R_L/R_g' = 50/120,000 = 0.0205$ . The tertiary winding is equal to  $0.0205 \times 170$  or 3.5 turns. The adjacent channel attenuation for four transformers with  $Q_{Lu}$  of 34 may be read from Fig. 6 and is approximately 14 db.

The author acknowledges the help and suggestions of P. D. Davis and J. L. Nygaard of Texas Instruments Inc.

The author acknowledges the help and suggestions of P. D. Davis and J. L. Nygaard of Texas Instruments Inc.

### REFERENCE

- (1) Radiotron Designers' Handbook.

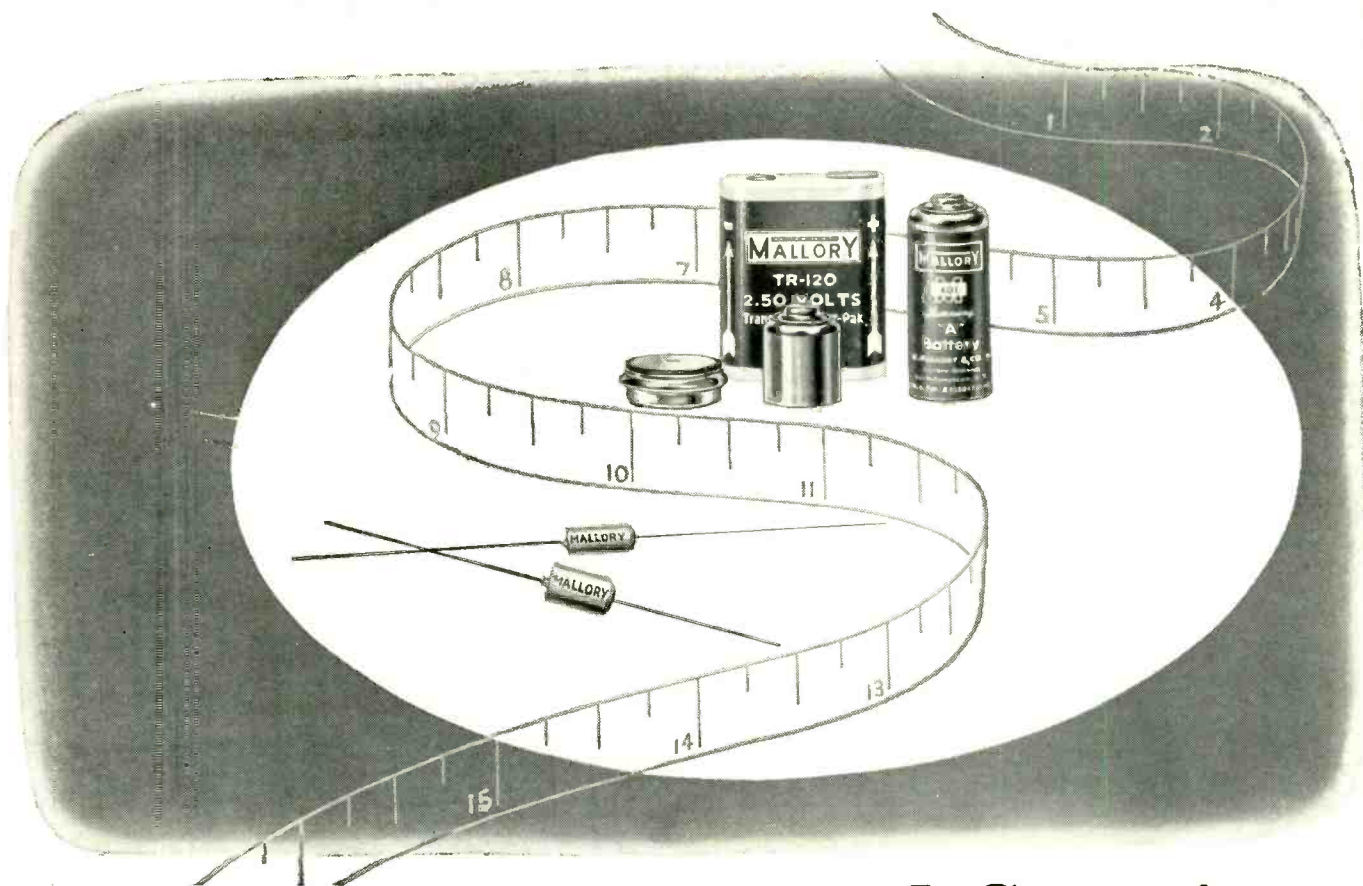

# Miniature Batteries and Capacitors for Transistor Circuits

For the transistor equipment you are designing, it will pay you to investigate Mallory miniature batteries and capacitors. Ideally suited for low-voltage circuits where space is at a premium, these components offer excellent electrical performance in exceptionally small size.

## MALLORY MERCURY BATTERIES

and Power-Paks, developed through Mallory's pioneering research in this field, provide maximum energy in minimum volume. Their constant-voltage, constant-current discharge characteristic makes them the ideal energy source for optimum transistor operation. They are unexcelled for long life... both in service and on the shelf... and withstand extreme ambient temperatures.

Parts distributors in all major cities stock Mallory standard components for your convenience.



## SILVERLYTIC\* CAPACITORS

have the highest capacitance and voltage ratings available in the smallest size case. Type TAP tantalum anode units—only  $\frac{7}{32}$ " in diameter by  $\frac{3}{8}$ " long—are supplied in values from 2 mfd. at 100 volts to 30 mfd. at 6 volts. Even smaller is Type TAW... just 0.145" in diameter and  $\frac{3}{8}$ " long, with a capacity of 4 and 6 mfd. at 4 volts.

Write to Mallory for full technical information and for expert engineering assistance in application.

*Expect more . . .*

Get more from **MALLORY**

Serving Industry with These Products:

Electromechanical—Resistors • Switches • Television Tuners • Vibrators  
Electrochemical—Capacitors • Rectifiers • Mercury Batteries  
Metallurgical—Contacts • Special Metals and Ceramics • Welding Materials

\*Trade Mark

# Electrons At Work

Edited by ALEXANDER A. MCKENZIE

## Geophysical Exploration Speeded By Improved Magnetometer

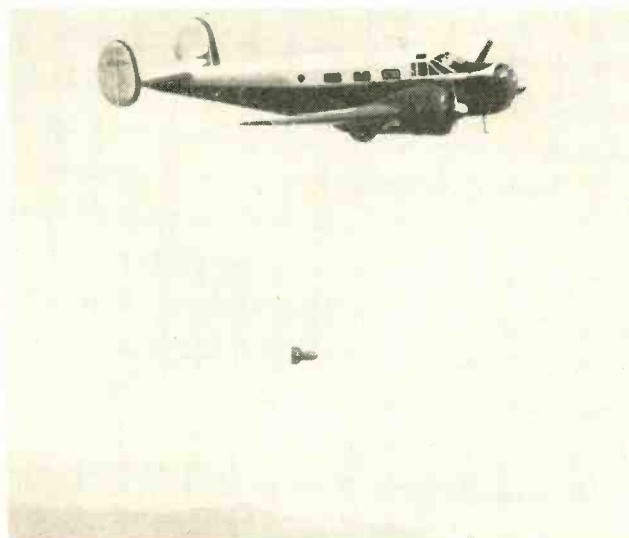

Based upon the phenomenon of nuclear magnetic resonance, a new airborne magnetometer will be used to analyze the earth's natural resources during flights for aerial mapping. The bird that is suspended below the aircraft (left) comprises a jar of water surrounded by a coil of wire housed in a streamlined cone. Use



of the earth's field magnetometer will be carried out by Hycon Aerial Surveys. Ivan Sloan, manager of the survey group and Gunnar Edenquist, senior engineer in charge of aerodynamic design check a magnetometer bird (right). Device needs no gyroscopic stabilization to obtain absolute readings of total field

## Automatic Music-Speech Discriminator Silences Speaker

By J. ROTH  
Vocatrol  
Cambridge, Mass.

AN ELECTRONIC SWITCHING system distinguishes between speech and music by responding to the difference in the nature of audio level changes. Both music and speech contain rapid increases in level. In speech, the level drops more rapidly than in music and deep drops can occur more frequently.

The average rapid drops in level of speech sounds have a rate of decrease about 400 decibels per second, a total drop amplitude of

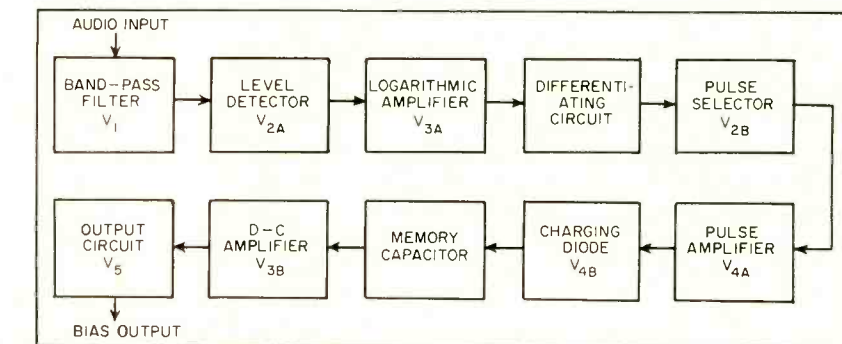

FIG. 1—Essential elements of the audio silencing system

roughly 20 decibels and a duration of roughly 50 milliseconds. Circuits to take advantage of these characteristics are shown in block form in Fig. 1.

Input signal is taken from a first audio stage of the radio. During speech, a negative direct voltage is fed back to the radio and used to cut off a following audio stage to

# KEPCO

## Presents 2 New VOLTAGE REGULATED POWER SUPPLIES

KEPCO Voltage Regulated Power Supplies are conservatively rated. The regulation specified for each unit is available under all line and load conditions within the range of the instrument.

**REGULATION:** As shown in table for line fluctuations from 105-125 volts and load variations from minimum to maximum current.

**SPECIAL FEATURE:** Provision is made for picking up the error signal directly at the load, compensating for the voltage drop in external wiring.



### Model 2600

OUTPUT	VOLTS	CURRENT	REGULATION	RIPPLE
1	0-60	0-2 Amp.	5 Mv.	1 Mv.

### Model 2650

OUTPUT	VOLTS	CURRENT	REGULATION	RIPPLE
1	0-60	0-5 Amp.	5 Mv.	1 Mv.

**30 MODELS**  
AVAILABLE FROM  
STOCK. COMPLETE  
CATALOG ON REQUEST

WRITE DEPT.1



## KEPCO LABORATORIES

131-38 SANFORD AVENUE • FLUSHING 55, N.Y. • INDEPENDENCE 1-7000

silence the speaker. The input signal must not be affected by this bias. Thus the device can continue to monitor the program material and will remove the negative voltage when speech has ceased.

The band-pass filter in the grid and plate circuits of audio amplifier  $V_1$  passes the vowel sounds but rejects hum and sibilant sounds that tend to reduce the depth of the rapid-level drops.

Amplified signal is rectified in the level detector  $V_{2A}$  the direct-voltage output of which is a measure of the signal level. The filtering is such that the output follows the rapid drops of speech but does not respond to impulse noise, which is the most prevalent type of radio static.

The logarithmic amplifier,  $V_{3A}$ , provides an output with constant voltage for each decibel of signal level change, regardless of the program level at which it occurs. A 24-db drop produces twice as much output voltage as a 12-db drop, whereas the corresponding inputs to this amplifier only differ by 25 percent.

The time constant of the differentiating circuit feeding the plate of  $V_{2B}$  is so chosen that the average rapid changes in level of speech sounds are not attenuated but slow changes such as the slower drops, frequently found in music, are greatly attenuated. At the output of this circuit rapid-level drops appear as positive pulses and rapid-level increases appear as negative pulses.

Since rapid-level increases and

rapid drops of small amplitude do occur in music, the pulse selector and threshold circuit  $V_{2B}$  is used to reject pulses from these level changes by passing only positive pulses and only those large enough to overcome the threshold bias.

Since there are types of program material, such as patten songs with faint orchestra, that lie between the two extremes of stentorian speech and symphony music and which might be classified as either speech or music depending on individual preferences, a sensitivity control is provided. This control varies the signal on the grid of pulse amplifier  $V_{4A}$ .

The output of the pulse amplifier is connected through diode  $V_{4B}$  to a memory capacitor. This capacitor charges quickly through the diode

but is discharged slowly through a high resistance. The charge at any time on the capacitor depends on the amplitude and frequency of the pulses that have occurred during the last few seconds. This is a measure of the speech-like character of the signal.

The voltage on the memory capacitor is amplified by  $V_{3B}$  and applied to the multivibrator output circuit  $V_5$ . The output bias is normally applied through a high resistance to the grid of one of the audio amplifiers in the radio.

Connection to the radio is made by use of an adapter. One of the radio tubes is removed from its socket and plugged into the adapter. Then the adapter (plus the tube) is put back into the socket.

(continued on page 166)

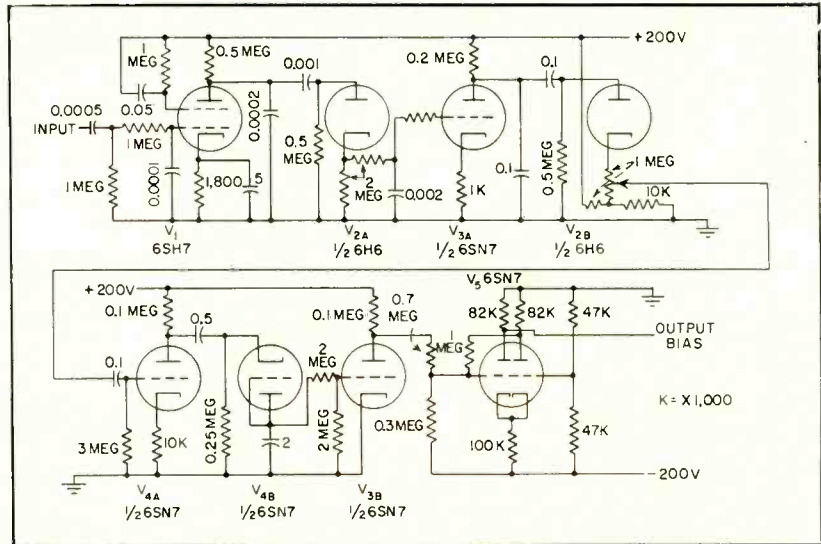

FIG. 2—Speech discriminator takes input from audio output of receiver and feeds back bias to a later stage

## Airborne Wave Propagation Laboratory With Mast

Naval Research Laboratory has converted a DC-4 aircraft for radio and radar research in the air. Four-foot parabolic antennas, transmitters and receiver front ends are carried in four nacelles, two mounted under each wing. Meteorological probing devices are carried in a 15-foot mast that may be raised or lowered above the plane in flight







## time on our hands

Here's a handful of microtime . . . doled out in hundredths of a millimicro-second. It's our new HELIDEL\* delay line.

It's precise . . . wide-band . . . continuously variable. This is not an adwriter's pipedream . . . it's an engineer's, come true.

Which means that definitions are in order.

Precise = delay increments of only  $2 \times 10^{-11}$  sec; resolution 0.01% and better; linearity "better than  $\pm 1\%$ " . . . actually, so fine it can't be measured.

Wide-band = transmission of pulse signals up to 20 mc with negligible phase-distortion, overshoot, or distortion of waveshape.

Continuously variable = a distributed-constant, electromagnetic type . . . dreamed up in 1946 . . . developed in helical form since 1951, by Helipot and DuMont.

The HELIDEL is already used successfully in color-TV broadcasting and oscilloscopes . . . and as a trimmer in transmission systems.

What can you dream up?

 **Helipot** *first in precision potentiometers*

*Helipot Corporation/South Pasadena, California*  
*Engineering representatives in principal cities*  
*a division of BECKMAN INSTRUMENTS, INC.*



*To help you dream,*  
*there's a 10-page technical*  
*paper on the HELIDEL,*  
*presented at the 1954*  
*WESCON . . . and a new data*  
*sheet, with complete specs.*  
*For your copies, write*  
*for Data File 801*

444 \* TRADEMARK

## THE FRONT COVER

**I**N COMMON with other radar systems, the Diana radar comprises a transmitter (shown here) a receiver to detect echoes from the moon and an antenna (described in another article) with means of switching it between transmitter and receiver. The project was appropriately named for Diana, the Greek mythological huntress and moon goddess.

Transmitter and receiver were designed by Radio Engineering Laboratories, Inc. of Long Island City, N. Y. for the U. S. Army Signal Corps and are being installed at Evans Signal Laboratory, Belmar, N. J.

Power stages in the transmitter include a push-pull pair of 4-400's at 75 mc with 1-kw output, four type 4-1000A in push-pull parallel at 75 mc with 10-kw output, a type ML5681 single-ended doubler (foreground of photograph) capable of 25 kw output followed by another (background) working as power amplifier at 50 kw c-w.

Output frequency is 151.11 mc. The high-voltage plate supply can deliver 21 amperes at 9,000 volts. A single crystal holds transmitter and receiver stable to

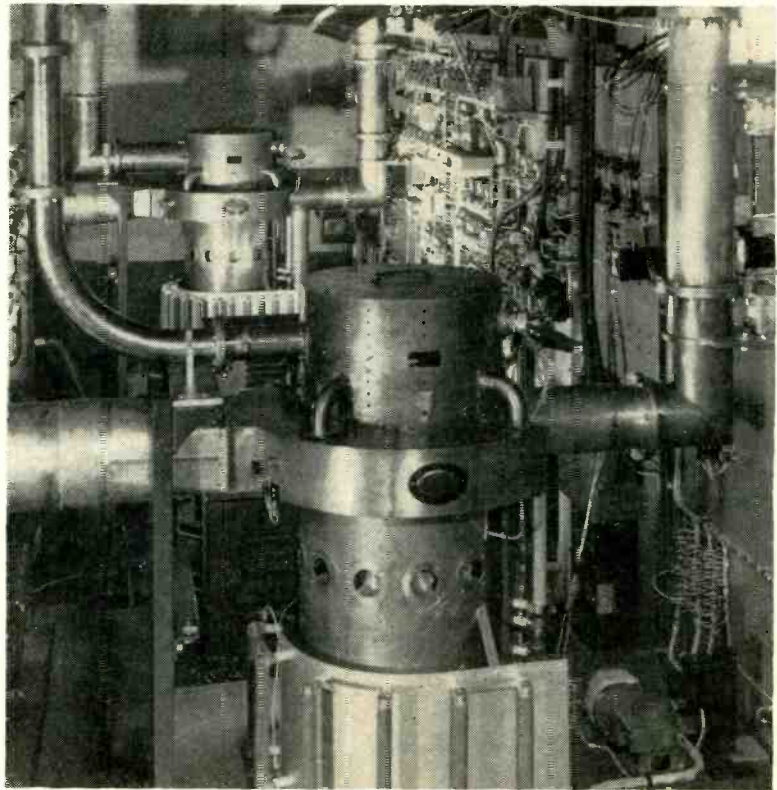

better than one part in  $10^6$ . Modulation can be repetitive pulses or pulse groups. The transmitter is low-level grid-modulated by rectangular pulses at discrete repetition frequencies from 100 cps to  $\frac{1}{2}$  cps. Pulse width is variable from 0.001 second to 50 percent of the pulse interval at the

frequency transmitted from the equipment.

Receiver noise factor is better than 3 db and gain is 170 db. The receiver uses a multiple i-f with high-stability bfo to allow for Doppler shift of  $\pm 500$  cycles. Final i-f bandwidth is selectable at 50, 200 and 1,000 cycles.



## Diana Antenna Tracks Planets

ANTENNA SYSTEM used with the moon-tracking radar is made up of a 50-foot paraboloid reflector with azimuth-elevation mount on a 26-foot steel tower. Position of the antenna may be controlled manually or made to track the moon automatically by an electromechanical computer.

Designed for moving the antenna at the slow rate of speed required for tracking objects such as the moon, the mount weighs 24 tons. Reflector frame is steel with the surface covered by expanded mesh

Giant low-speed antenna will be used to follow moon to test radar reflections

# WIRE

FOR EVERY  
ELECTRONIC  
PRODUCT

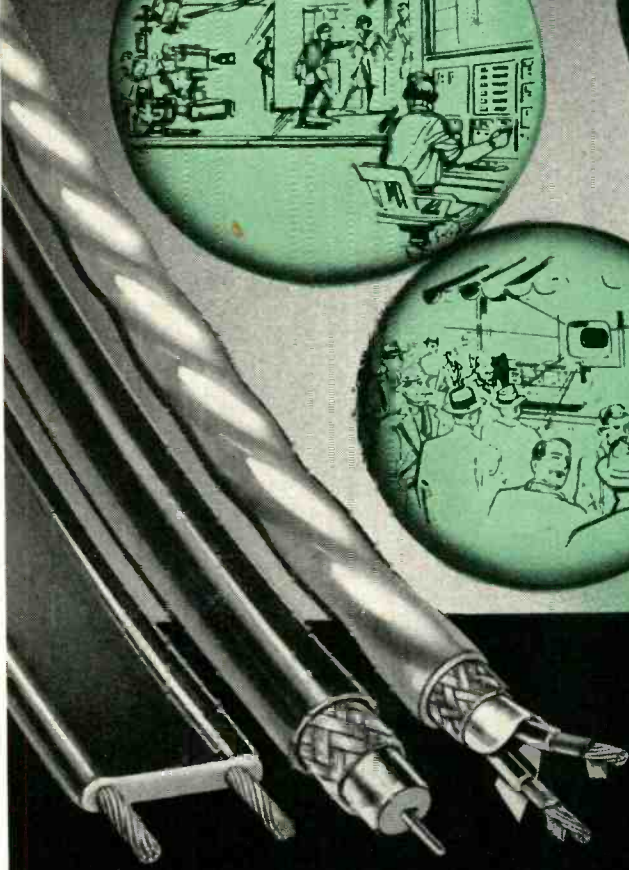
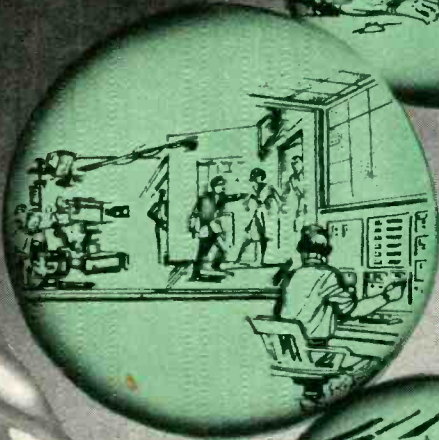
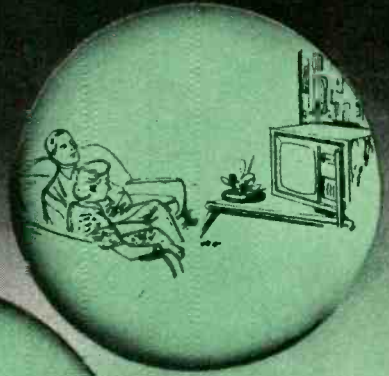

# Belden

WIREFORMER FOR INDUSTRY  
SINCE 1902

BELDEN MANUFACTURING CO. · CHICAGO

3-8

# BETTER PUSH-BUTTON SWITCHES...

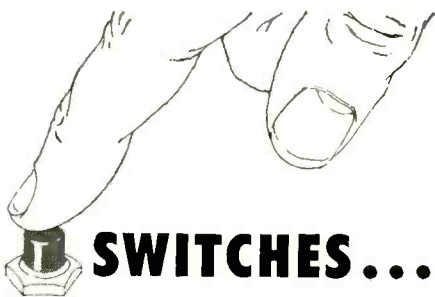

*for a better push-button world*

A good electrical product deserves a good switch—and, for push-button types in the 15 to 50 ampere range that means Hetherington!

Fully proved on the toughest aviation and military assignments, these sturdy, good-looking little units are commercially adaptable to almost any equipment where a few cents more for a really superior switch is recognized as being sound, far-sighted economy.

**HETHERINGTON, INC.**  
SHARON HILL, PA.

(West Coast Division: 8568 W. Washington Blvd., Culver City, Cal.)

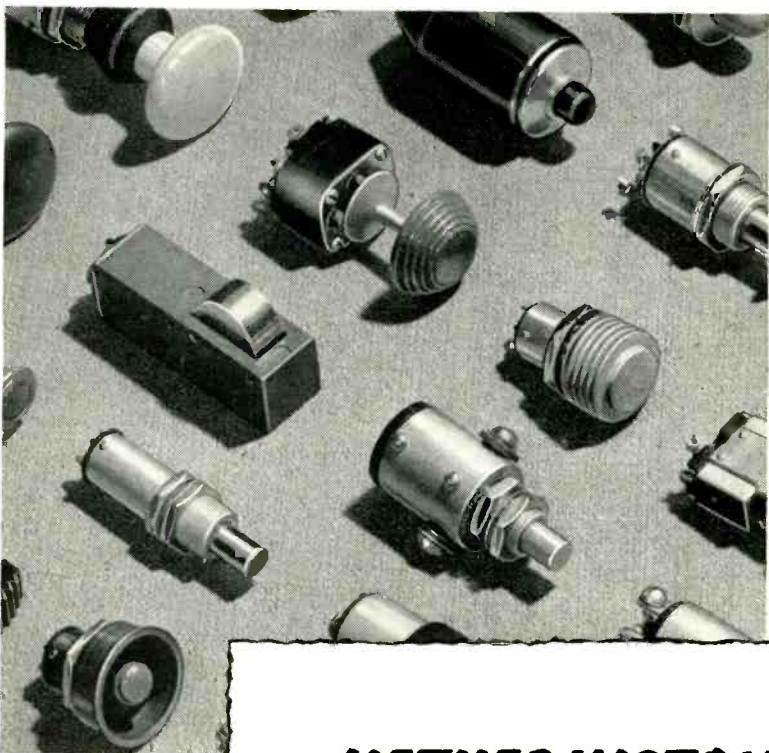

## HETHERINGTON Switches

Fine push-button and snap-action types  
Switch-indicator light combinations  
also  
Panel indicator lights, aircraft and electrical specialties

rolled flat and weighing 14 tons.

Since the dish can be used up to 1,500 mc, the antenna is provided with interchangeable feeds. At 151.11 mc the gain is 25 db and beamwidth is  $8.5 \times 9.5$  degrees. Other primary feeds on hand cover 75.55 mc and 413.25 mc.

The antenna is designed for use with the transmitter shown on the front cover.

## Infinite Impedance Detector-Amplifier

BY H. L. ARMSTRONG

*Clevite-Brush Development Co.  
Cleveland, Ohio*

AN INFINITE IMPEDANCE, cathode-follower, type of detector is sometimes used where it is desired that preceding circuits be loaded negligibly. The circuit described here combines this type of detector with

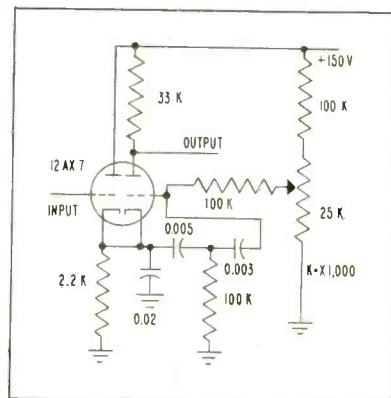

Infinite impedance detector and amplifier with circuit values for 50-kc carrier

an audio-frequency amplifier in a convenient arrangement. Direct coupling extends the range down to d-c, and a 25,000-ohm potentiometer provides bias adjustment for optimum operation with a large carrier and small degree of modulation.

One side of the double triode acts as detector. The output is coupled to the cathode of the other section, which operates as an amplifier with cathode input. A resistor-capacitor network applies to the grid of the amplifier a carrier-frequency signal approximately equal to that applied to the cathode, but little low frequency signal. The output at the plate, since it depends upon the difference of the grid and cathode voltages, thus consists of the low-fre-

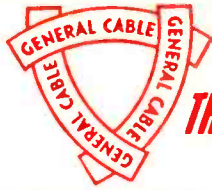

**THE GREATEST NAME IN ELECTRICAL WIRE AND CABLE**



# **SUPER SERVICE**

**HEAVY DUTY MOLD CURED PORTABLE CORDS AND CABLES**

To safeguard the reputation of your product...always specify SUPER SERVICE cords and cables. They are made to exceed IPCEA specifications and will assure a SAFE, DEPENDABLE flow of electricity to your product throughout an extra long service life.

New SUPERTUF neoprene mold cured jacket resists on-the-job hazards far beyond ordinary conditions. It provides excellent resistance to oils, chemicals, flames, impact, cutting, tearing, crushing, and failure due to constant flexing.

New THERMAX heat-resistant insulation protects against dangerous temporary current overloads...

vital extra safety that also extends the life of the cord and cable.

Whether you're making portable electric drills, battery chargers, welding machines, or any type of product that requires heavy duty portable cords and cables...it will always pay you to specify SUPER SERVICE. It performs better...lasts longer.

Also, it will pay you to remember that General Cable is the only manufacturer who can supply *all* your electrical wire and cable needs! Buy from one source.

## **GENERAL CABLE CORPORATION**

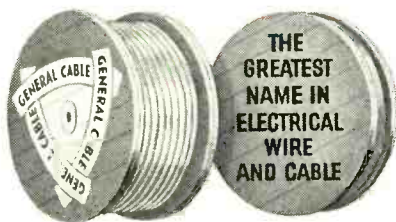

**BARE, WEATHERPROOF, INSULATED WIRES and CABLES FOR EVERY ELECTRICAL PURPOSE**

### **GENERAL CABLE CORPORATION**

*Executive Offices: 420 Lexington Ave., New York 17, N. Y.*

**SALES OFFICES:** Atlanta • Baltimore • Boston • Buffalo • Chicago • Cincinnati • Cleveland • Dallas • Denver • Detroit • Erie (Pa.) • Greensboro (N. C.) • Houston • Indianapolis • Kansas City • Lincoln (Neb.) • Los Angeles • Memphis • Milwaukee • Minneapolis • New Haven • Newark (N. J.) • New York • Philadelphia • Pittsburgh • Portland (Ore.) • Richmond (Va.) • Rochester (N. Y.) • Rome (N. Y.) • St. Louis • San Francisco • Seattle • Springfield (Ill.) • Syracuse • Tampa • Tulsa • Washington, D. C.

PERKIN... HAS A STANDARD POWER SUPPLY FOR YOUR EVERY NEED  
**IMMEDIATE DELIVERY!!**



# PERKIN

TUBELESS!!  
 MAGNETIC AMPLIFIER  
 REGULATED DC  
**POWER SUPPLIES**

MODEL  
 MR 532-15  
 5 TO 32 V.  
 @ 15 AMP.  
 (CONT.)



**REGULATION:**  $\pm 1\%$  (a) from 5-32V DC (b) from 1.5 to 15 amps. (c) from 105-125V AC. (single phase, 60 cps.)

**RIPPLE:** 1% rms @ 32V and full load, increases to max. of 2% rms @ 5V and full load. **RESPONSE:** 0.2 sec.

**METERS:** 4 1/2" AM and VM; 2% accuracy.

**MOUNTING:** Cabinet or 19" rack panel.

**FINISH:** Baked Grey Wrinkle.

**WEIGHT:** 150 lbs.

**DIMENSION:** 22" x 17" x 1 1/2"

MODEL  
 M60 VMC  
 0 TO 32 V.  
 @ 25 AMP.  
 (CONT.)



**REGULATION:**  $\pm 1\%$  (a) at 28V DC; increases to 2% max. over the range 24-32V; does not exceed 2V regulation over the range 4-24V DC (b) from 1/10 full load to full load (c) at a fixed AC input of 115V.

**RIPPLE:** 1% rms @ 32V and full load; 2% rms max. @ any voltage above 4V.

**AC INPUT:** 115V, single phase, 60 cps.

**FINISH:** Baked Grey Wrinkle.

**WEIGHT:** 130 lbs.

**DIMENSIONS:** 22" x 15" x 1 1/2"

MODEL  
 MR 1040-30  
 10 TO 40 V.  
 @ 30 AMP.  
 (CONT.)



**REGULATION:**  $\pm 1\%$  (a) from 10 to 40V DC (b) from 100 to 130V AC (c) from 3 to 30 Amps DC. **RIPPLE:** 1% rms.

**AC INPUT:** 100-130V, 1 phase, 60 cycles.

**RESPONSE:** 0.2 sec. **METERS:** 4 1/2" AM and VM.

**MOUNTING:** Cabinet with 19" rack panel.

**FINISH:** Baked Grey Enamel.

**WEIGHT:** 200 lbs.

**DIMENSIONS:** 22" x 15" x 23"

MODEL  
 MR2432-100X  
 24 TO 32 V.  
 @ 100 AMP.  
 (CONT.)



**REGULATION:**  $\pm 1/2\%$  (a) from no load to full load. (b) from 24-32V DC. (c) from 230\* (or 460) V  $\pm 10\%$ .

**DC OUTPUT:** 24-32V @ 100 amps.

**AC INPUT:** 230 or 460V  $\pm 10\%$ , 3 phase, 60 cycles.

**RIPPLE:** 1% rms. **RESPONSE TIME:** 0.2 sec.

**MOUNTING:** Cabinet or 19" rack panel.

**WEIGHT:** 250 lbs.

**DIMENSIONS:** 25" x 15" x 15"

\*This unit will be supplied for 230V AC Input unless 460V is specified.

ALSO AVAILABLE: Standard 6 and 115 volt models; Ground and Airborne Radar and Missile Power Supplies — Write for Perkin Bulletins.

## PERKIN ENGINEERING CORP.

345 KANSAS ST. • EL SEGUNDO, CALIF. • Oregon 8-7215 or EAstgate 2-1375



quency signals, but practically no carrier frequency.

The carrier frequency in this application is 50 kc. Other frequencies call for proportionally different sizes of capacitors. Tube 12AT7, which was also tried, gave no advantage over the 12AX7; and the 12AU7 was definitely poorer in operation. It is possible that the 12BZ7, with its combination of high amplification factor and relatively high transconductance, would be especially advantageous.

### REFERENCE

(1) F. E. Terman, "Radio Engineer's Handbook," p 563 McGraw-Hill Book Co., New York, N. Y., 1943.

## Regulator for Constant Current Power Supplies

By ROBERT W. DEICHERT

Research Division  
 A. B. DuMont Laboratories  
 Passaic, N. J.

THE PROBLEM often arises in the design of electronic equipment of providing regulated hum-free d-c voltage to a load of substantially constant current demand.

Where rectifiers are used to supply the power and it is impossible to achieve the necessary regulation through control of the a-c input or use of a shunt regulator such as v-r tubes or a lossier tube, a regula-

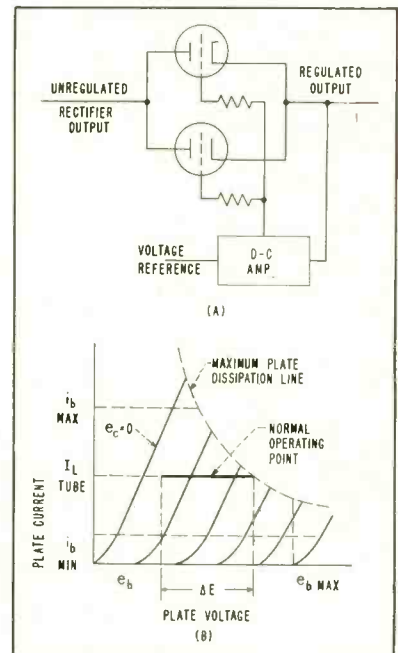

FIG. 1—Conventional series regulator (A) and operating characteristics (B)



WHEN YOU SPECIFY  
Permalloy\*  
POWDER  
CORES  
SPECIFY

**MAGNETICS inc.**  
*Performance-*  
*Guaranteed*

**HERE'S WHY...**

The Magnetics, Inc. "Performance-Guarantee" on molybdenum permalloy Powder Cores is a revolutionary concept in the communications and electronics industries, and opens the way to substantial savings in your production and assembly operations. The guarantee of performance to your specifications is your assurance that these Powder Cores are standardized to meet your circuit requirements.

These Performance-Guaranteed Powder Cores cost no more—indeed, despite the fact that you have a guarantee of performance, they are sold at prices standard in the industry. You can't afford not to investigate Magnetics, Inc. molybdenum permalloy Powder Cores.

**Keep in Mind These Advantages of Powder Cores...**

1. Low hysteresis and eddy current losses;
2. High electrical resistivity;
3. Constant permeability over widely varying flux densities;
4. Magnetic stability with dc magnetization.

**WANT THE COMPLETE STORY?...**

Write us... on your company letterhead... we'll be delighted to send you literature, delighted to answer specific questions. No obligation, of course...

\*Manufactured under a license agreement with Western Electric Co.

**MAGNETICS inc.**

DEPT. E-13 BUTLER, PENNSYLVANIA

# GOT A RELAY PROBLEM?

## USE R-B-M

### GENERAL PURPOSE RELAYS

*Low in Cost — Small in Size — Dependable  
in Performance — AC or DC*

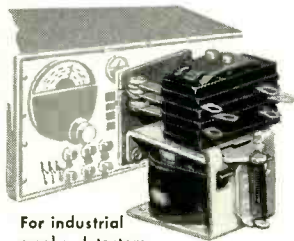

For industrial smoke detectors

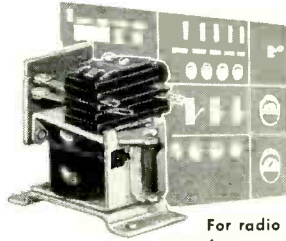

For radio transmitter panels

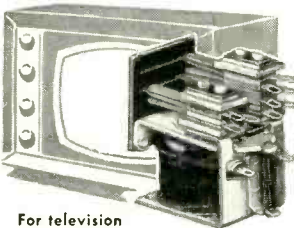

For television screen enlargers

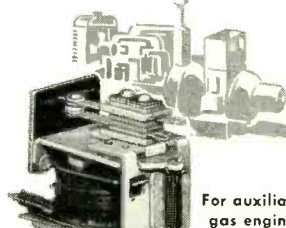

For auxiliary gas engine generators

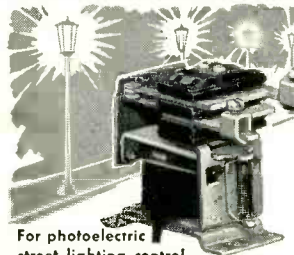

For photoelectric street lighting control

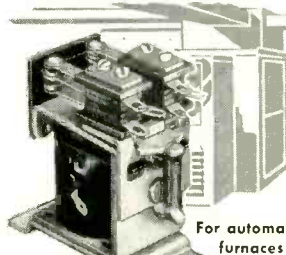

For automatic furnaces

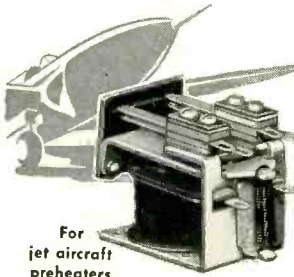

For jet aircraft preheaters

**I**N ADDITION R-B-M General Purpose Relays are used on X-Ray apparatus, permanent wave machines, wire recorders, automotive radio telephone communication equipment, vending machines, coin operated phonographs and many other applications.

Let R-B-M engineering and production facilities serve you. Contact us immediately—Phone 5121

**R-B-M DIVISION**  
**ESSEX WIRE CORPORATION**  
Logansport, Indiana

Controls for Electronic, Refrigeration, Industrial, Appliance, Communication and Automotive Industries



tor element consisting of a vacuum tube driven by a d-c amplifier is placed in series with the rectifier output. If the current demand is substantially constant, the series regulator element may be modified with a resulting saving in the cost and size of the power supply.

The conventional series regulator element is generally of the type

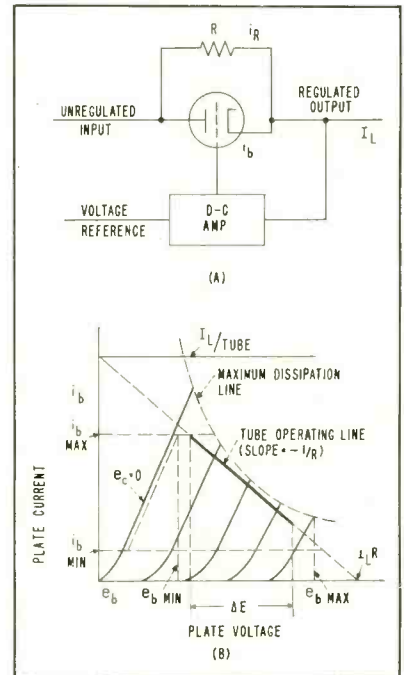

FIG. 2—Circuit (A) and operating curve (B) for regulator with shunt resistor added

shown in Fig. 1A and where the current demand is constant, operates in the manner shown in Fig. 1B. The operating line indicates the variation in the rectifier output  $\Delta E$  (d-c variation with ripple superimposed) which must be absorbed by the regulator element if the output voltage is to remain constant. The magnitude of the current that can be carried by each regulator tube is determined by several factors.

It depends upon the variation in rectifier output voltage  $\Delta E$ , how close it is desired to operate to the zero bias line and the maximum plate dissipation line on the tube plate characteristic. The number of regulator tubes necessary will, therefore, be equal to the quotient of the total load current and the current magnitude just determined.

Variations in rectifier output take place about a point which is somewhere in the range of  $\Delta E$  and



Raytheon — World's Largest Manufacturer of Magnetrons and Klystrons



Excellence in Electronics



**RAYTHEON MANUFACTURING COMPANY**  
Microwave and Power Tube Operations, Section PL-24  
Waltham 54, Massachusetts

Raytheon makes: Magnetrons and Klystrons, Backward Wave Oscillators,  
Traveling Wave Tubes, Storage Tubes, Power Tubes, Receiving Tubes, Transistors

# INFRASONIC

(Ultra-Low Frequency per I.R.E. "Standards on Electroacoustics, 1951")

## Voltage Measurements

with the NEW

# BALLANTINE VOLTMETER

### FREQUENCY RANGE

0.05cps to 30KC  
down to 0.01cps with corrections

### VOLTAGE RANGE

0.02 to 200V peak to peak  
lowest reading corresponds to  
7.07mv rms of a sine wave

### ACCURACY

3% throughout ranges  
and for any point on meter

### IMPEDANCE

10 megohm by an average  
capacitance of 30  $\mu$ f

### OPERATION

Unaffected by line variation  
100 to 130V, 60 cycle, 45 watt

### APPLICATIONS

The Ballantine Infrasonic Voltmeter Model 316 has been introduced to satisfy a growing need for an instrument to facilitate the measurement of ultra-low frequency potentials as are encountered in low frequency servomechanisms, geophysics, biological research, and in loop analysis of negative feedback amplifiers. Among many other uses, it will serve as a very satisfactory monitor for the output of commercially available ULF signal generators most of which are not fitted with an output indicator.

### FEATURES

- Pointer "flutter" is almost unnoticeable down to 0.05cps, while at 0.01cps the variation will be small compared to the sweep observed when employing the tedious technique of measuring infrasonic waves with a dc voltmeter.
- A reset switch is available for discharging "memory" circuits in order to conduct a rapid series of measurements.
- The reading stabilizes in little more than 1 period of the wave.
- Meter has a single logarithmic voltage scale and a linear decibel scale.
- Accessories are available for range extension up to 20,000 volts and down to 140 microvolts.

For further information on this and other Ballantine instruments write for our new catalog.

## BALLANTINE LABORATORIES, INC.

100 FANNY ROAD, BOONTON, NEW JERSEY



MODEL  
316

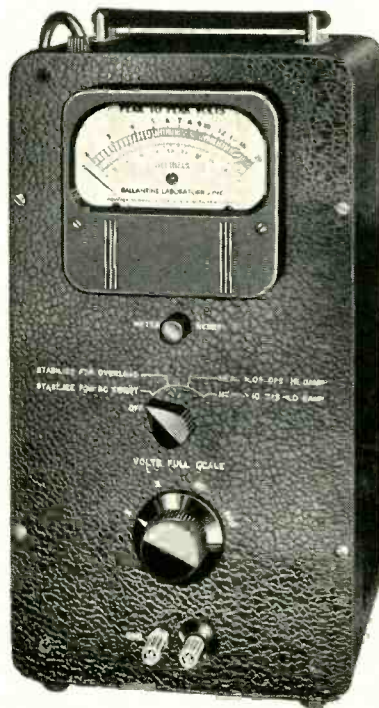

PRICE: \$290

designated as the normal operating point. The plate dissipation of the tube will for the major portion of the time be only 1/2 to 2/3 of the maximum allowable value, the maximum value occurring only at the upper end of rectifier output variation. The majority of tube

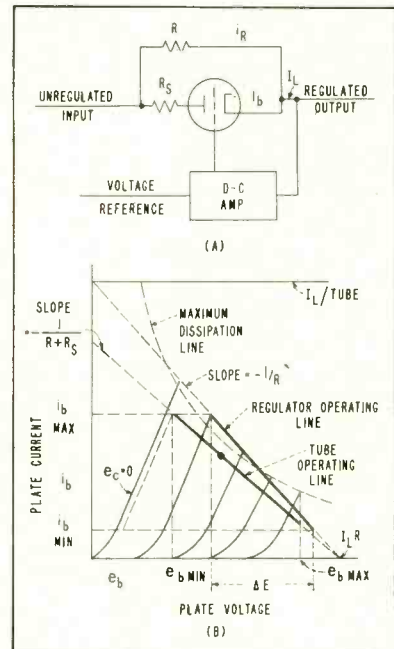

FIG. 3—Circuit of Fig. 2 is modified with series resistor (A) to give operating characteristic shown in (B)

types used as regulator elements have filament dissipations in the neighborhood of half their maximum plate dissipation and require a large filament current.

Maximum utilization of the power-handling capacity of the regulator tube and its filament supply would result if the regulator tube were operated at all times at its maximum plate dissipation. Such operation is closely approached by shunting the tube with a resistor  $R$  as in Fig. 2A. A single tube is shown to present the simplest case. Where several tubes must be used in parallel, standard parallel circuit technique is applied to the single tube result.

An analysis of the circuit of Fig. 2A results in the following equations

$$I_L = i_b - i_R \quad (1)$$

$$i_R = e_b/R \quad (2)$$

$$i_b = [I_L - (1/R)e_b] \quad (3)$$

Equation 3 represents the mode of operation shown on the regula-

# Specify

## **Textolite**<sup>®</sup> copper-clad laminates

for "High-Resistance"  
electrical insulation



**G-E TEXTOLITE** copper-clad laminates made with high-insulation resistance TEXTOLITE Grade 11541, faced one or both sides with copper foil, are completely ready for printing and etching. Famous General Electric research and high engineering standards make TEXTOLITE laminates easy to punch . . . with high bond strength maintained even after severe dip soldering temperatures. They afford a new ease of fabrication and help you achieve simplification or miniaturization of wiring systems with a greater economy of effort and expense.

You should specify **TEXTOLITE**  
for every type of printed wiring!

As a base material, TEXTOLITE 11541 is ideal for all kinds of printed wiring—plated, etched, stamped, embossed. Tough and rigid, yet easy to machine and punch, TEXTOLITE 11541 has excellent electrical insulation properties. A typical high-resistance value of 300,000 megohms\* helps make TEXTOLITE 11541 a superior laminate.

*\*After 96 hours at 35°C in 95% relative humidity.*

**SEND FOR FREE SAMPLE TODAY!**



General Electric Company  
Laminated and Insulating Products Dept.  
Section No. E-8-5, Coshocton, Ohio

Please send me technical data on G-E Textolite 11541 for printed circuits, including ( ) copper-clad sample ( ) sample without copper.

Name \_\_\_\_\_

Firm \_\_\_\_\_

Street \_\_\_\_\_

City \_\_\_\_\_ Zone \_\_\_\_\_ State \_\_\_\_\_

*Progress Is Our Most Important Product*

**GENERAL  ELECTRIC**

for absolute reliability in

**RAYDIST**  
ultra-sensitive  
electronic  
tracking systems

THE  
LOGICAL  
CHOICE  
WAS

**CHICAGO** the World's Toughest  
**TRANSFORMERS**

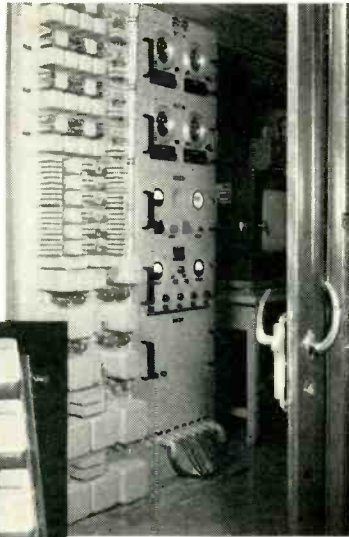

This power supply, shown with the Raydist mobile electronic tracking system, is typical of the use of CHICAGO transformers in Raydist equipment.

Raydist, designed and built by the Hastings Instrument Company, Inc., of Hampton, Virginia, is a remarkably precise and sensitive electronic radio location system. Raydist systems are used for air and marine navigation tracking, marine geophysical surveying, chartmaking, meteorological studies and a host of applications requiring infinitely accurate tracking and plotting.

Because Raydist precision performance is dependent upon the quality of the components used, Hastings specifies and uses CHICAGO MIL-T-27 hermetically sealed transformers.

Wherever absolute reliability and optimum precision are essential, you'll find CHICAGO, truly the world's toughest transformers.



**CHICAGO MIL-T-27**  
Sealed-in-Steel Transformer

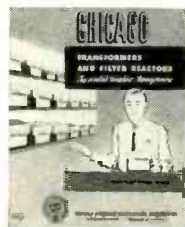

FREE CHICAGO Catalog CT-554, listing over 500 Sealed-in-Steel transformers. Available from your parts distributor.



**CHICAGO STANDARD  
TRANSFORMER CORPORATION**  
Addison and Elston • Chicago 18, Illinois

EXPORT SALES:  
Roburn Agencies, Inc.  
431 Greenwich St.  
New York 13, N.Y.

tor tube characteristic in Fig. 2B. The tube operating line can be seen to have a slope equal to  $-1/R$  and the intersection of the line with the ordinate ( $i_b$  axis) represents the total amount of load current carried by a tube and its shunt resistor. The regulator tube and resistor combination thus carries an amount of current in excess of the tube rating and the tube is operating more efficiently since the ratio of plate dissipation to filament power is more nearly constant and approaches its theoretical limit.

A slight modification of the circuit of Fig. 2 yields a much more useful circuit, which can be classified as the general case and for which a design procedure will be given. Figure 3A shows that the addition of a series resistor in the plate circuit of the regulator tube causes the modified regulator element to operate according to the following equations in a mode shown in Fig. 3B.

$$i_R = \frac{e_b + R_s i_b}{R} \quad (4)$$

Adding Eq. 1 and Eq. 4

$$i_b = \frac{R}{R + R_s} I_L - \frac{1}{R + R_s} e_b \quad (5)$$

While the regulator and its series resistor operate with a dissipation exceeding the tube rating, the plate dissipation of the tube is never in excess of its rated value.

Before presenting the mathematical relationships between the quantities  $\Delta E$ ,  $R$ ,  $R_s$  and  $I_L$ , it should be noted by referring to Fig. 2A and 3A that regulator tube operation must lie within a certain region of its plate characteristic as shown in Fig. 4. The  $i_{b \text{ MAX}}$ ,  $e_{b \text{ MAX}}$  and plate dissipation boundaries are determined from the handbook ratings of the tube type selected. The  $i_{b \text{ MIN}}$  boundary is chosen from inspection of the tube characteristics. The closer cutoff is approached (region of curved grid lines), the poorer will be the regulation for a given amplification of the d-c driving amplifier because of the rapid fall of the regulator tube  $g_m$ . The  $e_{b \text{ MIN}}$  boundary is a line parallel to and displaced to the right of the zero-bias grid line, the amount of displacement depending

# MEASURES IN NUMBERS

## ...NOT VOLTS!

### For FM/FM Telemetry and Multiplexing Systems

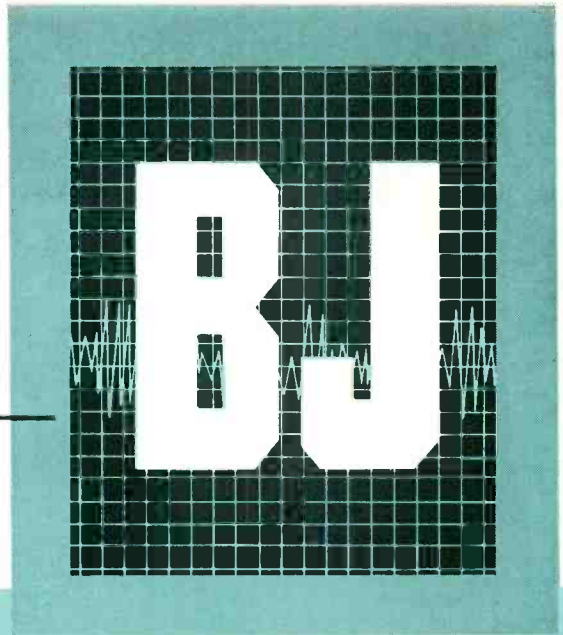

# vibrottron

DIGITAL PRESSURE GAGE



MODEL  
PM 15

MOOEL  
E 3

Model PM 15 Vibrottron Pressure Gage  
and Model E 3 Vibrottron Amplifier, shown actual size

Accurate enough to fit into any telemetry system that requires precise measurement of static or dynamic pressure...and small enough to fit into the palm of your hand...Byron Jackson's new Vibrottron Pressure Gage sets a new standard of accuracy by measuring in numbers, not volts!

**ACCURATE AND RELIABLE** Standard Vibrottron Gages provide accuracies to .1% under the temperature and pressure conditions encountered from sea level to 75,000'.

**DIRECT AND SIMPLE** Utilization of the vibrating wire principle which directly produces a subcarrier frequency eliminates subcarrier oscillators and consequent drift and inaccuracy. The direct digital information is easily handled by tape recording and data handling systems.

**VERSATILE AND STABLE** For altitude measurements, the standard Vibrottron Gages will resolve 60' at sea level. Special gages that cover 0-1 psi absolute ranges or less are also available for better resolution. For air speed measurements, a variety of differential gages have been developed to measure the wide ranges of speeds needed for aircraft and missile work. For pressure measurements, corrosion-resistant gages are being supplied to measure static or dynamic pressure of virtually any medium including fuming acids.

Available in eight pressure ranges from 0-3 psi to 0-2000 psi and in the following RDB Channels.

CHANNEL	CPS	% DEVIATION
8	3000	±7½%
9	3900	±7½%
10	5400	±7½%
11	7350	±7½%
12	10500	±7½%
13	14500	±7½%
14	22000	±7½% or 15%
	40000	±15%
	70000	±15%

# BJ

SINCE 1872

## Byron Jackson Co.

ELECTRONIC DIVISION

492 EAST UNION STREET • PASADENA 1, CALIF. • RYAN 1-5166

PACEMAKER IN PRECISION ELECTRONICS

WRITE TODAY for complete specifications and information on how Byron Jackson engineers can work with you on (1) application of standard Vibrottron models to your measurement problems; (2) special Vibrottron development; and (3) design of complete systems.

VISIT BYRON JACKSON BOOTH NO. 1802 WESCON SHOW—AUGUST 24, 25, 26

# BROAD BAND PULSESCOPE

by

# Waterman

MODEL S-6-A

DC CALIBRATION  
MARKERS 1-1000  $\mu$ S  
0-5 mc

Size:  
8½" x 6¾" x 13¾"  
22 Pounds



## ANOTHER EXAMPLE OF **Waterman** PIONEERING...

The S-6-A BROAD BAND Scope is a PULSESCOPE in performance, POCKETSCOPE in size, and it compares more than favorably with oscilloscopes that are *transportable*, instead of portable. The instrument measures DC as well as AC signals. Unique DC calibration methods permit rapid measurements of either positive or negative AC or DC signals. The scope uses a 3XP1 tube with 1500 volts on the second anode, thus providing a brilliant trace for high speed transients even at low repetition rates. Vertical amplifier sensitivity of 0.2v rms/inch, and response to 5 mc within 3DB . . . pulse rise time of 0.1  $\mu$ s . . . internal intensity markers from 1 to 1000  $\mu$ s . . . repetitive or trigger sweep from 5 cycles to 500 KC with 5X sweep expansion . . . sweep, marker and DC calibrating voltage available externally. Size 8½ x 6¾ x 13¾ in. Weight 22 lbs. Operates from 50 to 400 cycles at 115 volts AC.

## WATERMAN PRODUCTS CO., INC.

PHILADELPHIA 25, PA.

CABLE ADDRESS: POKETSCOPE

### WATERMAN PRODUCTS INCLUDE

S-4-C SAR PULSESCOPE®  
S-5-A LAB PULSESCOPE  
S-6-A BROADBAND PULSESCOPE  
S-11-A INDUSTRIAL POKETSCOPE®  
S-12-B JANIZED RAKSCOPE®  
S-14-A HIGH GAIN POKETSCOPE  
S-14-B WIDE BAND POKETSCOPE  
S-15-A TWIN TUBE POKETSCOPE  
RAYONIC® Cathode Ray Tubes  
and Other Associated Equipment

MEMO...  
Write for details today!

# W

WATERMAN PRODUCTS

on how much reserve regulating range is desired at the lower end of the rectifier output excursion.

The reduction of the theoretical analysis to a practical design procedure results in a graphical method as the best approach and a mathematical equation to determine the limit of the design for a given tube type. The design procedure may be listed as a series of steps as follows:

(1) Select tube type (2A3, 6AS7, 6B4, 6Y6, 807 or 6336) to be used as regulator element. This is generally done on the basis of maxi-

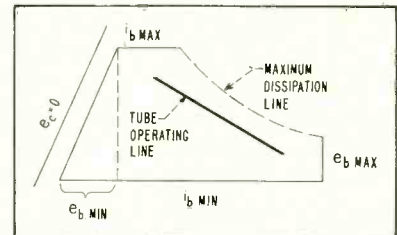

FIG. 4—Operating line of tube must be located within boundaries indicated

imum current handling capacity of tube and the actual d-c plate resistance of the tube at the zero bias line; that is, a low d-c resistance is desirable.

(2) Determine from handbook ratings and tube plate characteristic curves,  $i_{b \text{ MAX}}$ ,  $i_{b \text{ MIN}}$ ,  $e_{b \text{ MAX}}$ , and  $e_{b \text{ MIN}}$  (the limiting point on the  $i_{b \text{ MAX}}$  line in the region of the zero-bias line).

(3) In the design of a regulated power supply,  $\Delta E$  depends on the d-c output of the rectifier, which in turn equals the sum of the regulated output voltage and the operating point of the regulator element. A first approximation of the regulator operating point can be said to equal  $e_{b \text{ MIN}} + \frac{1}{2} (e_{b \text{ MAX}} - e_{b \text{ MIN}})$  and is used in the normal manner to determine the required rectifier output and hence the  $\Delta E$  for a trial design.

(4) Lay out on a set of plate characteristics,  $i_{b \text{ MIN}}$ ,  $i_{b \text{ MAX}}$ ,  $\Delta E$ , the maximum plate dissipation line for the tube and the arbitrarily selected line parallel to the zero bias line as in Fig. 4).

(5) Determine how much of the load current each regulator tube section will have to carry, which generally should not exceed 1½ times  $i_{b \text{ MAX}}$ . Locate this value on

# DU MONT'S **completely new** line of Laboratory Instruments...

In only a year, Du Mont has *revolutionized* its entire line of cathode-ray equipment, introducing nine brand new oscillographs which set new standards for precision, reliability and convenience across the entire range of laboratory applications. Among the instruments listed is one tailor-made for your job.

## 9 new oscillographs

Type 323	Medium-voltage, wide-band (dc to 10 mc) high-precision quantitative oscillograph. \$995.00.
Type 324*	Very-high-sensitivity (1.33 millivolts/inch) high-stability in low-frequency range. \$695.00.
Type 327	Modest cost, high linear; precision measurements from dc to medium-high-frequencies. \$695.00.
Type 329	High-precision, high accelerating potential for the ultimate in high-frequency measurements (dc to 10 mc). \$1090.00.
Type 331	Miniaturized, wide-band, quantitative oscillograph offering superlative performance from dc to 4 mc. Price on request.
Type 333*	High-sensitivity (1.33 millivolts/inch) high-precision dual beam oscillograph. \$990.00.
Type 340*	General-purpose, low-frequency instrument; identical X and Y amplifiers; with negligible phase shift. \$335.00.
Type 341*	Identical X and Y amplifiers with negligible phase shift from dc to 1 mc. \$415.00.
Type 336	Superior instrument for high-precision measurement of signals from dc to beyond 18 mc. \$1125.00.

These new oscillograph record cameras provide unprecedented versatility and convenience for every type of cathode-ray recording.

## 4 new cameras

Type 298	The ultimate for high-speed single-frame recording, f/1.5 lens. \$465.00.
Type 299	Interchangeable backs for versatile, general-purpose, single-frame recording, f/1.9 lens. \$335.00.
Type 302	Polaroid back for finished print in one minute; back interchangeable with Type 299; f/1.9 lens. \$355.00.
Type 321-A	Continuous-motion or single-frame recording over complete range of laboratory applications, f/1.5 lens. \$1050.00.

### NEW QUICK REFERENCE CATALOG

Second edition—brought up to date to include all the latest additions to the new Du Mont line—is just off the press. Get your copy by writing to the address below.



## 7 new accessories

Type 300	Crystal-controlled time calibration pulses for use as accurate and dependable time-marker standard. \$225.00.
Type 325	TV line selector for converting any cathode-ray oscillograph into a video signal monitor. \$235.00.
Type 326	Time-delay generator for high-precision measurements of time with any oscillograph, 0-10,000 usec range. \$375.00.
Type 330	Electronic switch converts any single-channel cathode-ray oscillograph to dual-channel, or any a-c coupled oscillograph to d-c operation, dc to 15 mc. \$225.00.
Type 332	Differential transformer control is complete unit for differential transformer operation. \$245.00.
Type 335	Strain-gage control for use with any commercial strain-gage. \$195.00.
Type 2611	Line control unit provides regulated power from 0 to 135 volts. \$75.00.

\*Rack-mountable versions available.

# DU MONT

Technical Sales Department  
ALLEN B. DU MONT LABORATORIES INC.  
760 Bloomfield Ave., Clifton, N. J.

**CUT**  
YOUR COIL  
PRODUCTION  
COSTS  
with  
**PRECISION COIL BOBBINS**



Our special machinery and high production methods work in combination with rigid quality control to provide you with the finest in coil bobbins at lowest possible cost.

Your specifications are met to the most critical tolerances. Workmanship is precise and carefully inspected. You can order in quantity, in any size or shape, flanges of all types, and be sure of uniformity throughout. Only fine dielectric materials are used—kraft, fish paper, acetate, phenol impregnated or combinations.

With Precision Bobbins you eliminate rejects, waste, loss of time—get better coils at less cost. Prove it to yourself! Send specifications for samples. Ask for literature.

### PRECISION LOW COST PAPER TUBES

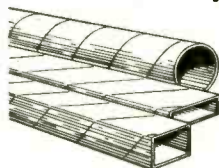

Order in any length, size, shape, I.D. or O.D. and in any quantity. Precision Paper Tubes are crush resistant and light weight, with excellent dimensional stability. They are fabricated to the same high standards governing Precision Bobbins.

Send for samples and Arbor List of over 2000 sizes

Sales Representatives in:

New England: Framingham, Massachusetts, Trinity 3-7091  
Metropolitan New York, New Jersey:  
Jersey City, New Jersey, Journal Square 4-3574  
Upstate New York: Syracuse, New York, Syracuse 4-2141  
Northern Ohio, Western Penn.: Cleveland, Ohio, Atlantic 1-1060  
Indiana, Southern Ohio: Logansport, Indiana, Logansport 2555  
California: Pasadena, California, Sycamore 8-3919  
Canada: Montreal, Quebec, Canada, Walnut 0337

**PRECISION PAPER TUBE CO.**

2041 W. CHARLESTON ST.

CHICAGO 47, ILL.

Plant No. 2: 79 Chapel St., Hartford, Conn.

the  $i_b$  axis of the tube plate characteristic used in step 4 and pass a line through it such that the line also passes through the area enclosed by the boundaries previously located and intersects the vertical boundary lines of  $\Delta E$  (see Fig. 2). In the event that such a condition cannot be met, an auxiliary line must be drawn from the intersection point of the scale on the  $e_b$  axis as in Fig. 3. This auxiliary line should intersect the vertical lines formed by  $\Delta E$ . This juggling operation should be done with the thought in mind that the operating line have as much slope as possible, consistent with proper operation, since the d-c operating point of the regulator will therefore be economically low.

(6) The normal operating point of the regulator can now be determined from the trial constructions. If it is different from the value estimated in step 3, steps 3, 4 and 5 should be repeated until a satisfactory design results.

(7) Measure the slope of the operating line or lines drawn and calculate the value of shunt and series resistors needed per section. For a multisection regulator, the total shunt resistor will be equal to the value per section divided by the number of sections, while the series resistors will equal the value computed.

(8) The wattage ratings of resistors  $R$  and  $R_s$  may be calculated from the maximum voltage that will appear across them during regulator operation; this can be determined from the constructions made in step 5.

Ripple reduction factor of a modified series regulator element is less than for the standard regulator element if both elements are driven by identical d-c amplifiers. This is the result of the ripple current that passes through the shunt resistor. For equivalent ripple reduction, it can be shown that the equivalent loop gain of the modified regulator circuit is related to the gain of the conventional element by the following equation

$$K = K' \left[ \frac{r_p}{R} + 1 \right]$$

(Continued on page 182)







# THIS IS IT

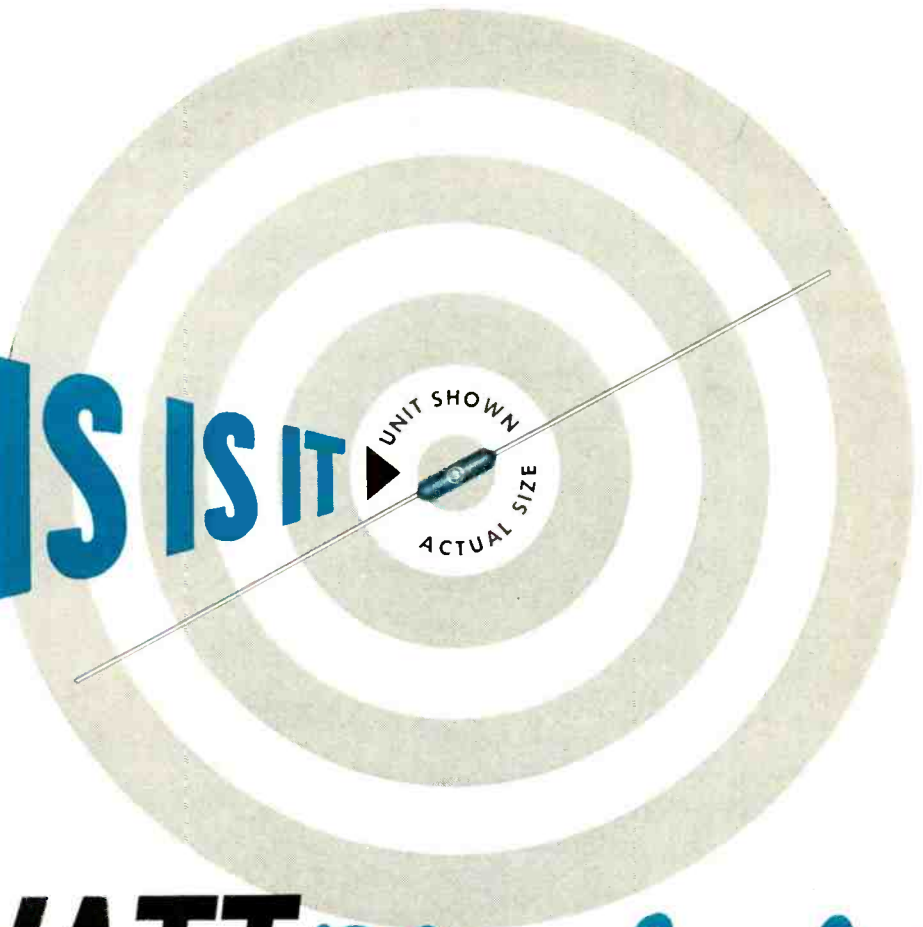

## NEW 3-WATT Blue Jacket<sup>®</sup> miniaturized axial-lead wire wound resistor

This power-type wire wound axial-lead Blue Jacket is hardly larger than a match head *but it performs like a giant!* It's a rugged vitreous-enamel coated job—and like the entire Blue Jacket family, it is built to withstand severest humidity performance requirements.

Blue Jackets are ideal for dip-soldered sub-assemblies . . . for point-to-point wiring . . . for terminal board mounting and processed wiring boards. They're low in

cost, eliminate extra hardware, save time and labor in mounting!

Axial-lead Blue Jackets in 3, 5 and 10 watt ratings are available without delay in any quantity you require. ★ ★ ★

SPRAGUE TYPE NO.	WATTAGE RATING	DIMENSIONS L (inches) D		MAXIMUM RESISTANCE
151E	3	1/2	1/4	10,000 Ω
27E	5	1 1/4	3/8	30,000 Ω
28E	10	1 3/4	3/8	50,000 Ω

Standard Resistance Tolerance: ±5%

# SPRAGUE

WRITE FOR ENGINEERING BULLETIN NO. 111 B



SPRAGUE ELECTRIC COMPANY • 35 MARSHALL ST. • NORTH ADAMS, MASS.

# 1800 Etched PRINTED CIRCUITS

per day

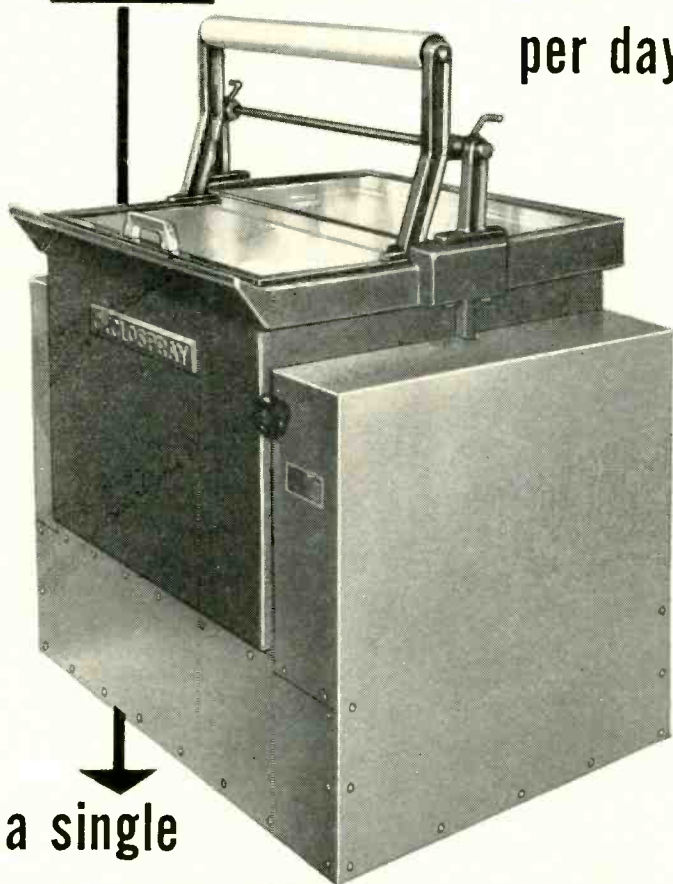

from a single

## CYCLOSPRAY ETCHING MACHINE

The experience of this electronics manufacturer is typical of the many who have standardized on the Cyclo Spray Copper Etching Machine to etch their printed circuits. But fast etching speed is only one of the advantages Cyclo Spray offers: controlled uniform etching depth; simple plate holding device; counterbalanced cover for fatigue-free operation — all the advantages that have made the Cyclo Spray the preferred copper etching machine among photoengravers for many years.

● FACE-DOWN ETCHING PRINCIPLE MEANS FAST UNIFORM ETCHING OVER THE ENTIRE CIRCUIT.

● TWIN PADDLES PROVIDE CONTROLLED FINENESS OF SPRAY

● VARIABLE SPEED CONTROL PER-

MITS CLOSE REGULATION OF SPRAY AND ETCHING SPEED.

● SO SIMPLE THAT ONE OPERATOR CAN HANDLE TWO MACHINES.

● WILL ETCH A PLATE UP TO 23" x 25".

WRITE FOR BULLETIN 84-D



# U. S. STONEWARE

AKRON 9, OHIO

122-E

where

$K$  = loop gain of modified regulator

$K^1$  = loop gain of conventional regulator

$r_p$  = total plate resistance of paralleled regulator tube sections at operating point

$R$  = value of shunt resistor

Thus, a conventional regulator element when modified, must have the loop gain of its regulator circuit increased to maintain its ripple reduction factor.

Since the regulator tube operates over a range where the tube  $\mu$  changes, it can be expected that the degree of regulation and ripple reduction for an upward excursion of the rectifier output will be somewhat less than for the downward excursion. This might be compared with the conventional regulator where a similar condition exists but to a lesser degree since the operating line on the tube characteristic is horizontal.

Regulated power supplies utilizing the modified regulator element described above, designed and built in these laboratories, have performed satisfactorily.

### BIBLIOGRAPHY

R. D. Trigg, Voltage Stabilized with Series Valve Control, *Electronic Eng.*, June 1953.

## Chassis Design for I-F Amplifiers

By DONALD L. LINDEN

Research Department  
Philco Corporation  
Philadelphia, Pa.

L-PLANE chassis construction is an attempt to achieve a high degree of amplifier stability inexpensively using miniature tubes and standard components. It is suited to inductively tuned single-tuned inter-stages but may readily be adapted to other coupling networks.

A schematic of a typical stage with age is shown in Fig. 1. The photographs show two representative stages and details of chassis construction are shown in Fig. 2.

The vertical separating wall shields the B+ and age chains from the signal-carrying components and is constructed as shown in Fig. 2A. Plate and screen bypass capacitors were located on the d-c side of the wall. They could have been kept on the signal side by using feed-through standoffs, at the expense



## PRESSURE OPERATED COMPUTERS to solve simultaneous equations

Compared to Servos, Greenleaf Pressure Operated Computers realize savings of up to 90% in size and weight. They are developed, designed and manufactured to latest military specifications.

For further information and technical data, write, wire or 'phone Greenleaf today.

**ENGINEERING • DEVELOPMENT • PRODUCTION**

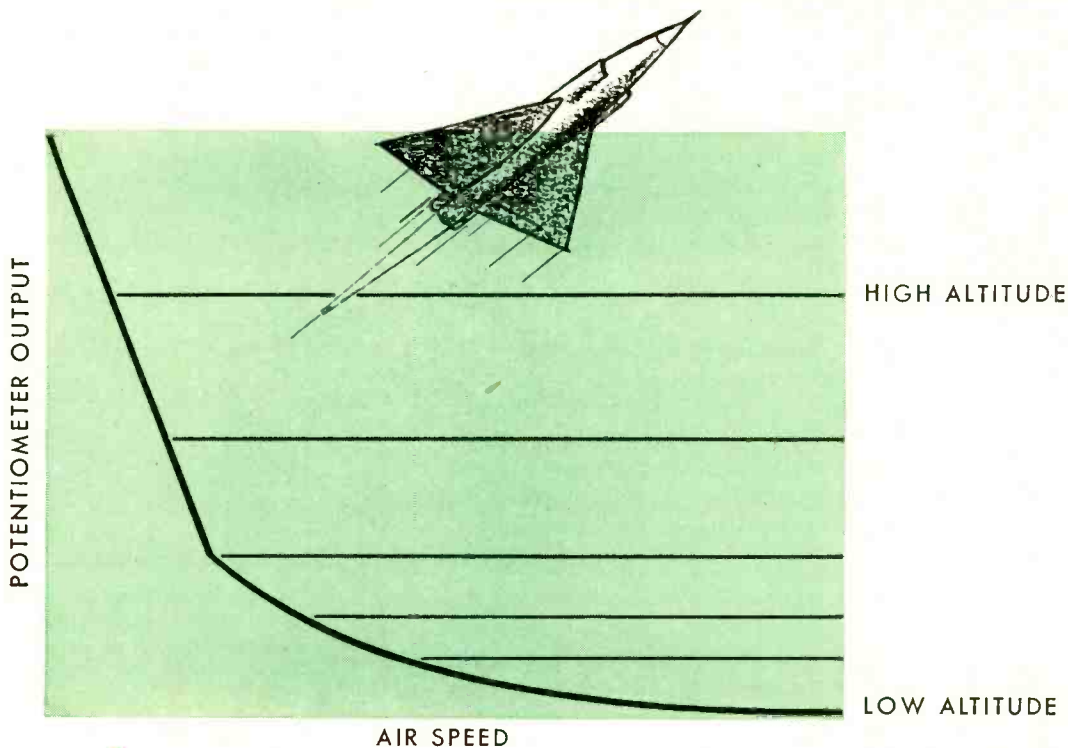

THE **Greenleaf** MANUFACTURING COMPANY  
7814 W. Maplewood Industrial Court • Saint Louis 17, Missouri  
Producers of the HIG-3 and HIG-4 Gyros, Rate and Free Gyros, Differential Pressure Mach Meters, Air Speed Indicators, Computers, Switches and many other precision-built components.

*At Greenleaf Plant No. 2 facilities are available for precision castings*



SINCE 1915 LEADERS IN AUTOMATIC CONTROL

# Smoothing Signal Noise with the DBR\* Integrator

Confronted with the well-known problem of random fluctuations called "noise," Ford engineers have employed the earliest and best-known Ford component — the disk integrator. Used in Ford analogue computers, the disk integrator smooths random fluctuations due to extraneous influences and obtains an average of the received signal. Thus, a device originally designed by Ford for integration is successfully used as a mechanical counterpart of the RC Filter.

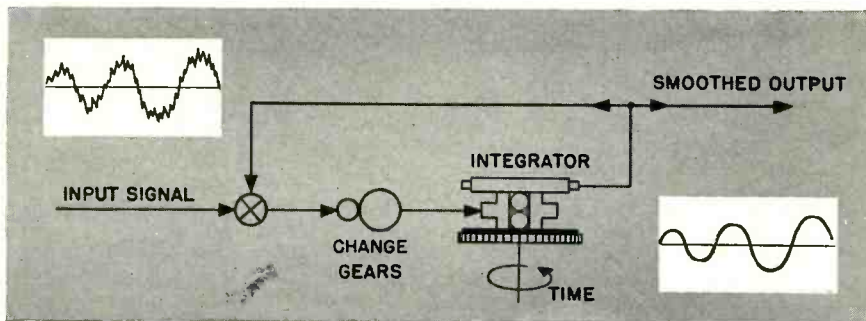

The Ford circuit operates on the premise that the older the data the less important it is. Therefore, data smoothed must be weighted in proportion to its age, so that the weight assigned to it decreases exponentially with time. The output of the circuit then represents the summation of this weighted data and tends to ignore random noises of short time duration.

As shown in the drawing, the incoming signal (with noise superimposed) is the input to the differential. As long as the integrator output (the roller) rotates at the *same rate* as the incoming signal, the differential output (error signal) is stationary and the integrator carriage remains stationary. But any change in the incoming signal produces changes in the *error signal* which tends to displace the integrator carriage and thus restore the system to equilibrium.

This reaction, however, is not instantaneous. It occurs after a certain time-lag which may be adjusted by the gear ratio. If the signal is of brief, random nature, the time-lag of the integrator will prevent its acting on the system. On the other hand, a permanent change in the signal will displace the carriage and change the output of the system.

This use of the Ford disk integrator as a noise smoother exemplifies the flexibility and adaptability of Ford components and ideas.

\*Disk, Balls and Roller Integrator



**FORD INSTRUMENT COMPANY**  
DIVISION OF SPERRY RAND CORPORATION  
31-10 Thomson Avenue, Long Island City 1, N. Y.

**ENGINEERS**

of unusual abilities can find a future at FORD INSTRUMENT COMPANY. Write for information.

ELECTRONS AT WORK

(continued)

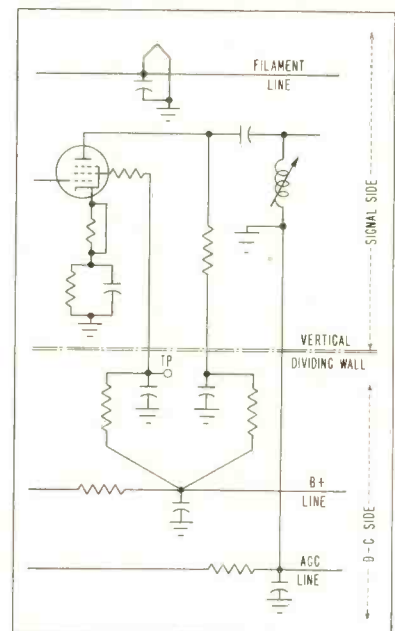

FIG. 1—Intermediate-frequency amplifier using vertical dividing wall to separate signal and d-c circuits

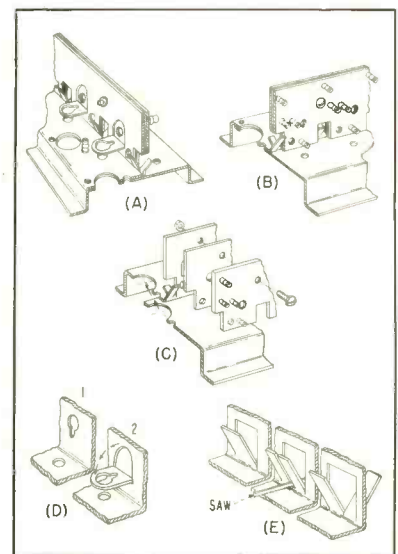

FIG. 2—Signal side (A) and d-c side (B) of amplifier chassis. Detailed views show construction of vertical wall (C) coil shields (D) and ground lugs (E)

of a more complicated lay-out.

Split ground lugs provide one grounding point per stage, thereby keeping chassis currents to a minimum. Each ground lug consists of two adjacent lances punched out of the center wall and bent to provide accessibility from opposite sides of the center plane as shown in Fig. 2E.

Coil shielding, a major factor in avoiding regeneration, is provided by bending semi-circular cut-outs from the center wall as illustrated

# For the most dependable printed circuits, you need the high bond strength, workability, heat-resistance of **C-D-F DILECTO<sup>®</sup> METAL-CLAD LAMINATES**

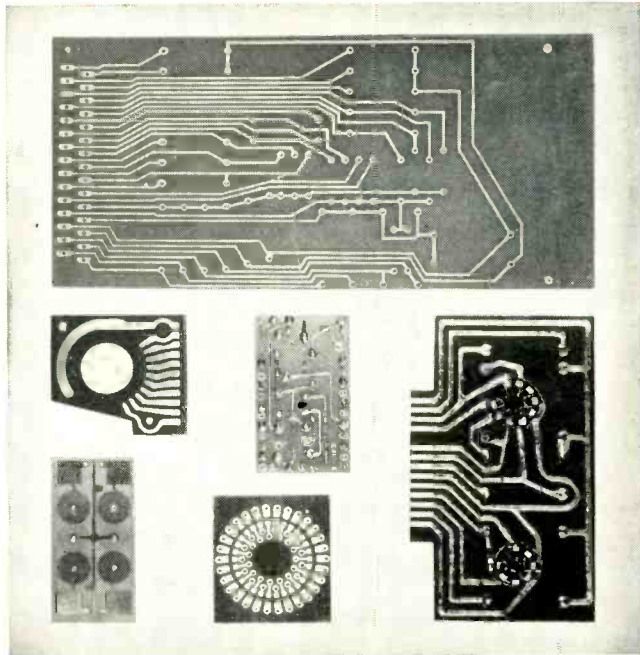

Printed circuits based on C-D-F materials are being used with great success in military electronic equipment, commercial television and radio sets, telephone switchboards—even sub-miniature radioisotope equipment and hearing aids.

Photos courtesy of Photocircuits, Inc., Glen Cove, N. Y.

**HIGH BOND STRENGTH**—C-D-F's special adhesive for metal-clad Dilecto bonds the copper foil to the plastic without affecting the laminate's superior electrical properties. Heat-resistance, dissipation factor, dielectric constant, dielectric strength, and insulation resistance of the Dilecto base remain unaffected. The closely-bonded foil can be etched cleanly and dipped in hot solder to 220°C. (428°F.) for ten seconds with a guarantee of no blistering or separating. Metal-Clad Dilecto can be punched or machined either before or after etching.

**EXCELLENT WORKABILITY**—On all five Dilecto metal-clad grades, you can solder, punch, saw, and assemble components either by hand or automatically. Thanks to the inherently superior workability of the plastics laminate over that of ceramic-type materials, Dilecto can be dropped, jammed into tight chassis, and otherwise treated roughly on the assembly line and in service.

**HIGH HEAT-RESISTANCE**—Metal-Clad Dilecto Laminates are made of phenolic, epoxy, or Teflon<sup>®</sup> resin for various conditions of service and assembly, and have either cellulosic paper or woven glass-fabric base. All are ideally suited to printed-circuit applications in which heat-dissipation is a major problem. Continuous exposure to high ambient operating temperatures in enclosed electronic equipment has no significant effects on Dilecto's electrical and physical properties.

**UNLOAD YOUR HEADACHE HERE!** C-D-F, a big, reliable source of supply, can help you get the most for your printed-circuit money by reducing rejects, lowering fabrication costs, assuring dependable quality every time. Send us your print or problem, and we'll gladly supply appropriate test samples free. See our catalog in the Product Design File (Sweet's) or send for the new 20-page Dilecto catalog. Let your nearby C-D-F sales engineer (listed in Sweet's) help you right from the design stage!

TYPICAL PROPERTY VALUES					
	Copper-Clad PHENOLIC (Grade XXXP-26)	Copper-Clad PHENOLIC (Grade XXXP-24)	Copper-Clad EPOXY (Grade GB-116E)	Copper-Clad EPOXY (Grade GB-181E)	Copper-Clad TEFLON* (Grade GB-116T)
BOND STRENGTH—0.0014" foil (Lbs. reqd. to separate 1" width of foil from laminate)	5 to 8	5 to 8	8 to 12	8 to 12	5 to 8
MAXIMUM CONTINUOUS OPERATING TEMP. (Deg. C.)	120	120	150	150	200
DIELECTRIC STRENGTH (Maximum voltage per mil.)	800	800	700	650	700
INSULATION RESISTANCE (Megohms) 96 hrs. at 35°C. & 90% RH	50,000	50,000	30,000	20,000	Over 10 <sup>6</sup> megohms
DIELECTRIC CONSTANT 10 <sup>6</sup> Cycles	4.20	4.20	4.90	4.95	2.85
DISSIPATION FACTOR 10 <sup>6</sup> Cycles	0.026	0.026	0.019	0.018	0.0006
ARC-RESISTANCE (Seconds)	10	10	60	80	180
TENSILE STRENGTH (psi.)	16,000 x 13,000	14,000 x 11,000	46,000 x 42,000	48,000 x 44,000	23,000 x 21,000
FLEXURAL STRENGTH (psi.)	21,000 x 18,000	19,000 x 16,000	60,000 x 55,000	75,000 x 65,000	13,000 x 11,000
IZOD IMPACT STRENGTH edgewise (ft. lbs. per inch of notch)	0.40 x 0.35	0.40 x 0.35	6.5 x 6.0	13.5 x 11.5	6.0 x 5.0
COMPRESSIVE STRENGTH flatwise (psi.)	28,000	27,000	60,000	62,000	20,000
BASE MATERIAL OF LAMINATE	Cotton rag paper	Cotton rag paper	Fine-weave, medium-weight glass cloth	Medium-weave, medium-weight glass cloth	Fine-weave, medium-weight glass cloth
COLOR OF UNCLAD LAMINATE	Natural greenish	Natural Brown	Natural	Natural	Natural

All these standard grades are available with 0.0014", 0.0028", 0.0042", or thicker electrolytic or rolled copper foil on one or both surfaces. Other metal foils and other resin-and-base combinations can be supplied on special order.

\*duPont Trademark



**Continental-Diamond Fibre**  
CONTINENTAL-DIAMOND FIBRE DIVISION OF THE BUDD COMPANY, INC.

NEWARK 16, DELAWARE

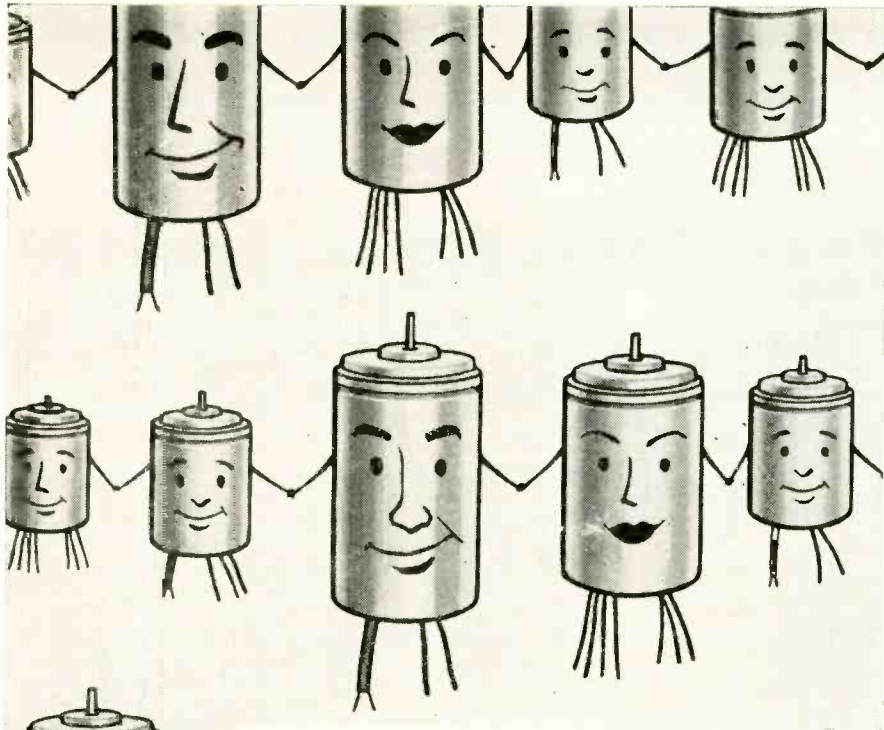

(See you at the Wescon Show, Booth 1417-18)

## WE MAKE ALL TYPES OF SYNCHROS

*and more than anyone else!*

What's your pleasure in synchros? High temperature? High frequency? Linear? Corrosion-resistant? *Whatever* your needs, we either already have a type to fit them . . . or can build a special type for you.

Fine precision synchros have been one of our specialties for over twenty years . . . with more E-P synchros in use today than any other make.

Write, wire or call us for information on standard and special types . . . prices . . . and deliveries. ECLIPSE-PIONEER DIVISION, BENDIX AVIATION CORPORATION, TETERBORO, N. J.

*Eclipse-  
Pioneer*  
DIVISION



West Coast Office: 117 E. Providencia, Burbank, Calif. • Export Sales:  
Bendix International Division, 205 E. 42nd St., New York 17, N. Y.

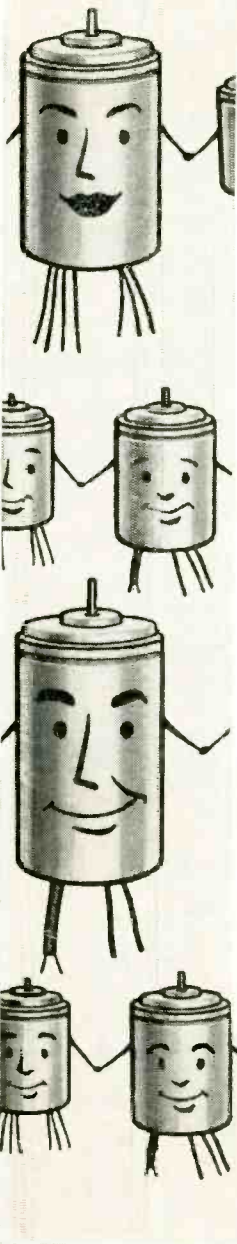

in Fig. 2D.

Tube sockets with short bodies and pins allow components to be mounted close to the chassis and thus help decrease stray capacitive coupling. By riveting the sockets to a double thickness part of the chassis (Fig. 2B), the tops of the lugs are brought within  $\frac{1}{8}$  in. of the ground plane.

In the amplifier of Fig. 1 and



Signal side of i-f amplifier showing coil shields bent from vertical plane

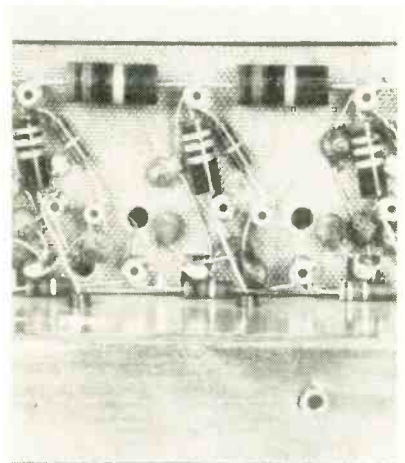

Resistors and capacitors are mounted on terminal board on d-c side of vertical wall

the photographs, a 10-ohm screen resistor is used as a parasitic suppressor and a large screen dropping resistor serves to stabilize the tube transconductance. A voltage rise at the externally accessible test-point indicates tube aging. A Melamine terminal board is used to mount components against the vertical wall. This arrangement was found to be more convenient than the use of standoffs mounted directly on the separating wall. It

At the Mass. Institute of Technology Machine Tool Laboratory the effect of variables such as cutting fluid, tool geometry, speed and feeds, and tool material are measured and recorded, using a dynamometer and Sanborn two-channel System. Such records for various lathe operations, as well as many other cutting operations, provide valuable insight into the whole metal cutting process.



...from  
lathe cutting  
forces  
to telemetered  
aircraft data...  
**SANBORN**  
**Oscillographic**  
**RECORDING**  
**SYSTEMS**  
prove their  
versatility



At Moore Products input and response of their Valve Positioner, a pneumatic instrument widely used on diaphragm top-work valves and power cylinders, are recorded on a Sanborn two-channel System. Impulses from a pneumatic sine wave generator, of frequencies as high as 20 cps, are fed through a transducer to one channel, with valve stem response recorded by the second channel from a strain gage pickup.

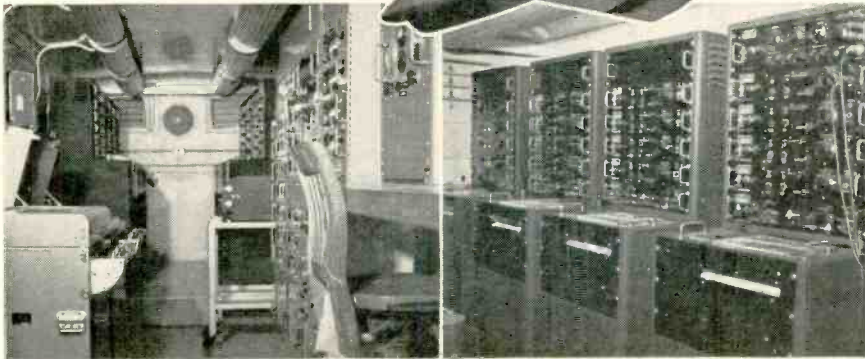

At Edwards Air Force Base, California, this U. S. Air Force telemetering van received and recorded information transmitted from various pickups and transducers in the new delta wing Convair YF-102A during flight. Photos of van interior show eight Sanborn four-channel recording systems in rear, and close-up of four of the systems. Thus equipped, the van could receive data which would affect the design and performance of the YF-102A, a faster-than-sound, all-weather interceptor built by the Convair Division of General Dynamics Corporation.

These typical two- to 32-channel applications of Sanborn oscillographic recording systems give an indication of the tremendous scope of this versatile equipment. Elsewhere, Sanborn 1-, 2-, 4-, 6- and 8-channel systems and components are used in meteorological research... quality control programs... instrument and machinery field testing.

Flexibility of Sanborn design permits interchangeable amplifiers and preamplifiers to meet individual recording requirements with greater over-all efficiency and economy. Other Sanborn features include inkless recording in true rectangular coordinates, high torque galvanometer movement, time and code marking, and numerous chart speeds.



CATALOG AND TECHNICAL DATA  
AVAILABLE ON REQUEST



**SANBORN**  
**COMPANY**

INDUSTRIAL DIVISION  
CAMBRIDGE 39, MASS.

# Do you have source spots?

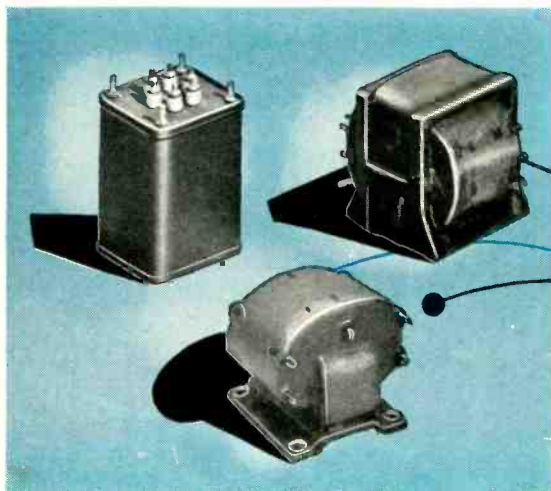

Every design engineer or production man we ever met makes mental notes of good places to get quick aid on needs out of the ordinary.

You might like to know, therefore, that a great deal of the work we do here at Wheeler on transformers, coils, harnesses, custom-built electronic assemblies, and communications components is just that kind of assignment.

We publish no catalog of the everyday standard items . . . they present no problem to anyone. We do serve an increasing group of engineering and production departments that require competent help . . . backed by ample manufacturing facilities . . . in producing components that are "a little (or a lot) different." Call or write us for an interesting story.

TRANSFORMERS • COILS • AMPLIFIERS  
CUSTOM ELECTRONIC AND WIRING ASSEMBLIES  
COMMUNICATIONS EQUIPMENT • MAGNET WIRE

**THE WHEELER**  
INSULATED WIRE COMPANY, INC.  
Division of Sperry Rand Corp.

1101 EAST AURORA STREET  
WATERBURY 20, CONNECTICUT

Wheeler is constantly adding to its staff of engineers. If you are available and qualify in this field, call us now.

was not found necessary to use filament chokes.

This construction was used successfully at frequencies up to 90 mc and gains of the order of 100 db. The writer acknowledges his indebtedness to A. C. Munster, D. E. Sunstein, C. T. McCoy and W. H. Forster of the Philco Research Division for their interest and suggestions.

## Broadband Horn Antennas

HORN REFLECTORS replacing delay lens type antennas are being installed on a new television program

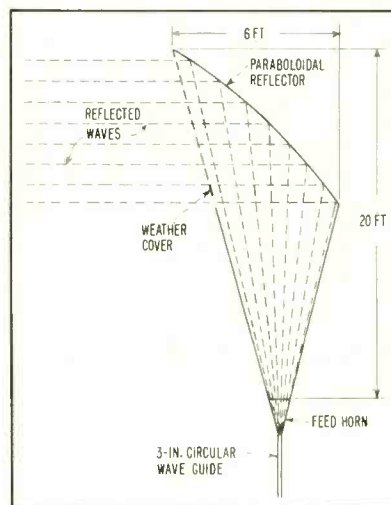

FIG. 1—Cross-section of the horn reflector antenna

route between Dallas, Texas and Jackson, Miss. A single antenna of this type can handle simultaneous transmission in the common carrier band of 3,700–4,000 mc and also in bands in the regions of 6,000 and 11,000 mc.

Capable of transmitting simultaneously both horizontally and vertically polarized waves, the horn will help reduce crosstalk coupling on adjacent channels.

The new antenna shown in Fig. 1 comprises a feed horn, an expanding hornshaped casing and a section of parabolic reflector facing the mouth of the horn. Its aperture has a cross-section of 65 square feet. Energy is transmitted into the feed horn through a circular waveguide that has a smooth transition from the 2.8-in. diameter of the guide to the 11.6-in. square aperture of the feed horn.

Approximate gain of the antenna



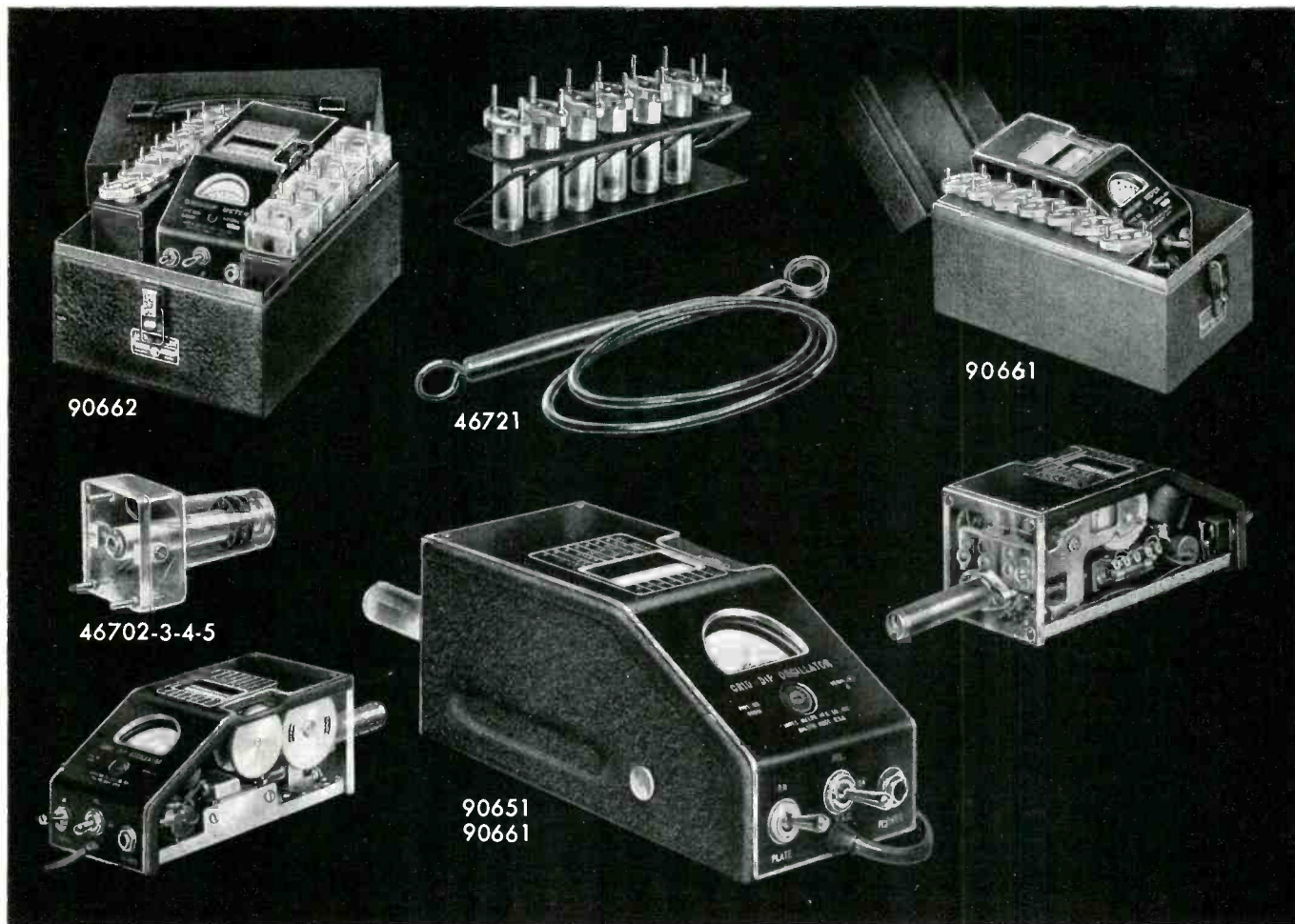

## Designed for Application

### Grid Dip Meters

Millen Grid Dip Meters are available to meet all various laboratory and servicing requirements.

The 90662 Industrial Grid Dip Meter completely calibrated for laboratory use with a range from 225 kc. to 300 mc. incorporates features desired for both industrial and laboratory application, including three wire grounding type power cord and suitable carrying case.

The 90661 Industrial Grid Dip Meter is similar to the 90662 except for a reduced range of 1.7 to 300 mc. It likewise incorporates the three wire grounding type cord and metal carrying case.

The 90651 Standard Grid Dip Meter is a somewhat less expensive version of the grid dip meter. The calibration while adequate for general usage is not as complete as in the case of the industrial model. It is supplied without grounding lead and without carrying case. The range is 1.7 to 300 mc. Extra inductors available extends range to 220 kc.

The Millen Grid Dip Meter is a calibrated stable RF oscillator unit with a meter to read grid current. The frequency determining coil is plugged into the unit so that it may be used as a probe.

These instruments are complete with a built-in transformer type A.C. power supply and internal terminal board to provide connections for battery operation where it is desirable to use the unit on antenna measurements and other usages where A.C. power is not available. Compactness

has been achieved without loss of performance or convenience of usage. The incorporation of the power supply, oscillator and probe into a single unit provides a convenient device for checking all types of circuits. The indicating instrument is a standard 2 inch General Electric instrument with an easy to read scale. The calibrated dial is a large 205° drum dial which provides seven direct reading scales, plus an additional universal scale, all with the same length and readability. Each range has its individual plug-in probe completely enclosed in a contour fitting polystyrene case for assurance of permanence of calibration as well as to prevent any possibility of mechanical damage or of unintentional contact with the components of the circuit being tested.

*The Grid Dip Meters may be used as:*

1. A grid Dip Oscillator
2. An Oscillating Detector
3. A Signal Generator
4. An Indicating Absorption Wavemeter

The most common usage of the Grid Dip Meter is as an oscillating frequency meter to determine the resonant frequencies of de-energized tuned circuits.

Size of Grid Dip Meter only (less probe): 7 in. x 3 $\frac{3}{16}$  in. x 3 $\frac{3}{8}$  in.

JAMES MILLEN



MFG. CO., INC.

MAIN OFFICE

AND FACTORY

MALDEN, MASSACHUSETTS, U. S. A.

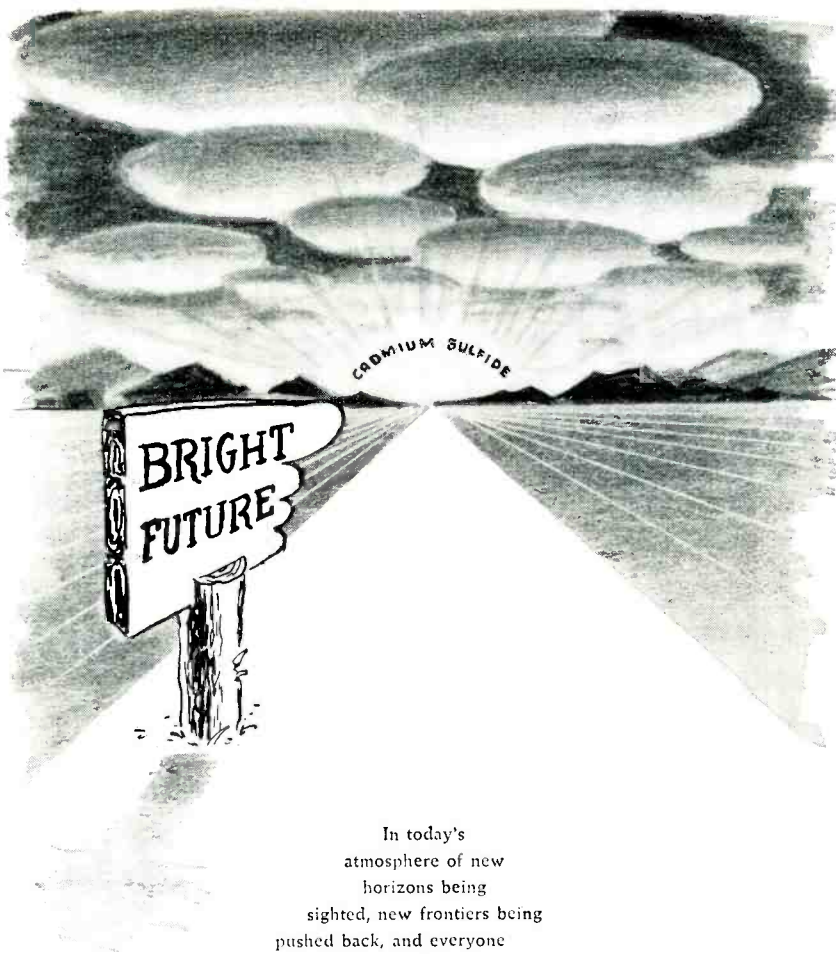

In today's atmosphere of new horizons being sighted, new frontiers being pushed back, and everyone out-pioneering his neighbor, it is pleasant to find that one of our own products has stumbled over the threshold of opportunity, firmly wedging its foot against the door to a whole new world of applications. What especially interests us is that the "product", the AC version of our Series 41 relay, had, until now, lead a notoriously humdrum sales life. (Oh, it has had some perfectly good uses: e.g., it performed admirably in electric blanket controls. It's just that AC applications never seemed to fire anyone's imagination very much.)

But returning to the 41's NEW WORLD—and what it means to YOU . . . (1) commercial development of broad area cadmium sulfide photocells\* of hitherto unheard of (output 2.5 ma. rms at 50 volts, 2 foot-candles) sensitivity, now makes possible the construction of greatly simplified, "amplifier-less" AC photoelectric devices, and (2) the Series 41 is probably the best low cost AC relay available with sufficient sensitivity (0.10-0.15 VA) for such use. Conceivably, such a photoelectric control might consist of simply an AC line cord, broad area CdS cell and a 41. (Of course, if you want to fuss around with rectifiers, we have some capable DC relays for power switching,—but who hasn't?)

At this stage, we know of at least one manufacturer of photoelectric controls already re-designing his devices along the lines indicated, and we suspect this signals some sort of beginning. In case you have some ideas, you can get basic data sheets describing the 41 just by asking. We'll also give you the benefit of what application experience we've had to date, bearing in mind this is a new world.

\*for sale elsewhere, not here.

# SIGMA

**SIGMA INSTRUMENTS, INC.**  
62 Pearl Street, So. Braintree, Boston 85, Mass.

Want more information? Use post card on last page.



FIG. 2—New type of microwave antennas installed on tower near Terrell, Texas. Single antenna can handle 15,000 telephone conversations and 10 tv programs simultaneously

as compared with an isotropic radiator varies from 39 db at 4 kmc to 48 db at 11 kmc. Front-to-back ratio ranges from 71 to 78 db depending on frequency band and polarization. Gain in the 4 kmc range is about the same as for the delay lens antenna.

## Improving Cathode-Follower Frequency Response

By ROBERT W. WOODS

*School of Medicine  
College of Medical Evangelists  
Loma Linda, Calif.*

ATTENTION HAS BEEN called to the possibility of distortion in the operation of cathode-follower circuits.<sup>1</sup>

The conventional follower is illustrated in Fig. 1. The cathode load in this circuit may be considered to be an  $RC$  parallel combination. As such it has a time constant  $RC$  and when a signal is fed in whose period is shorter than  $RC$ , negative clipping results as shown by the waveform.

The signal voltage at the cathode with respect to cathode return in an ideal case is  $E_1 = A - a \sin \omega t$  where  $A$  is the quiescent voltage between cathode and its return,  $a$  is the amplitude of signal and the minus sign is used to start the signal (at  $t = 0$ ) with the maximum negative slope.

We may also represent the volt-

Now!

# International

## Germanium Junction Power Diodes!

Highest rectification efficiency... Minimum leakage...  
 Operating temperature range  $-55^{\circ}\text{C}$  to  $+75^{\circ}\text{C}$   
 Broad application range...

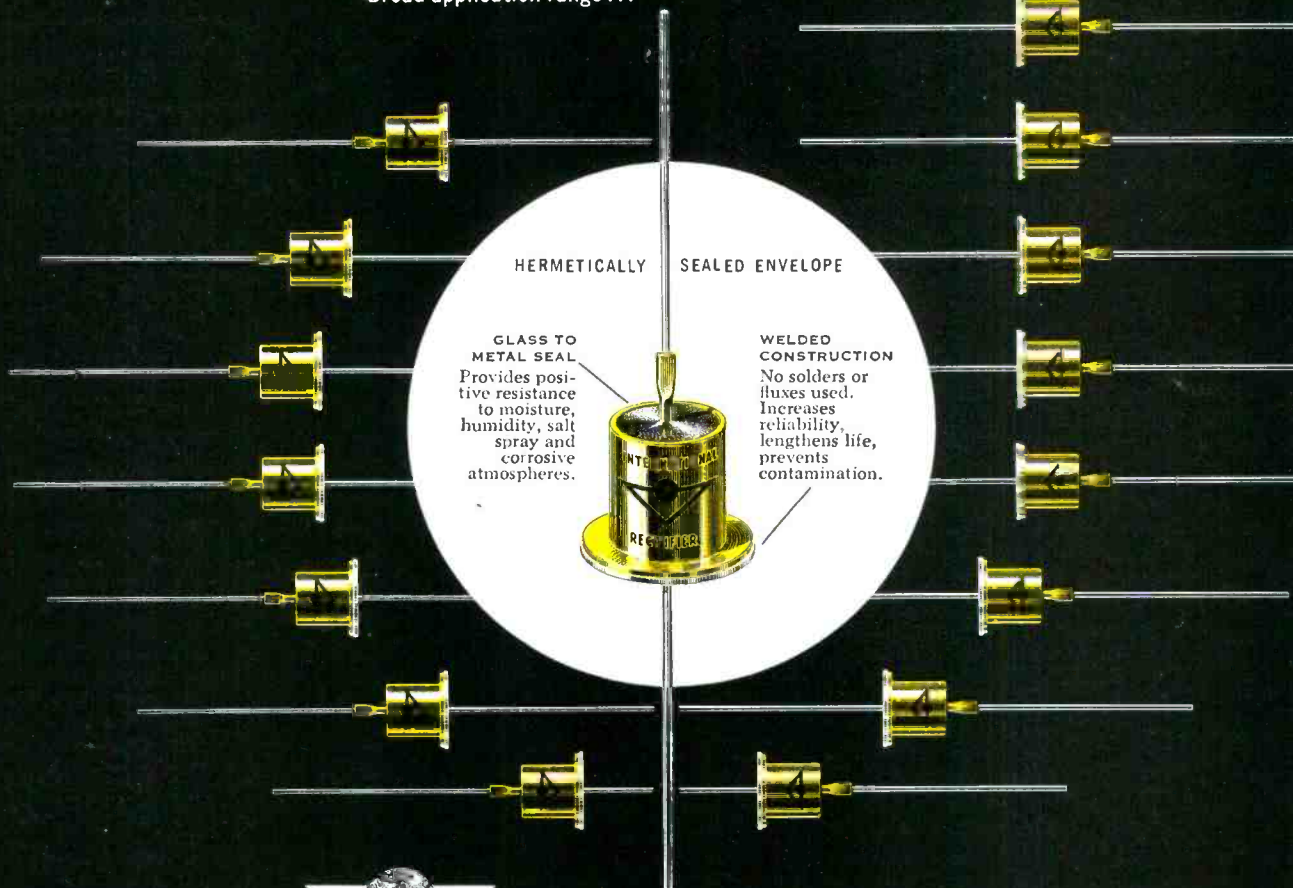

Now available in Standard JETEC 1N91, 1N92 and 1N93 types.  
 For Diodes to meet your special requirements, consult our Semiconductor Division.



# International Rectifier

C O R P O R A T I O N

EXECUTIVE OFFICES: 1521 E. GRAND AVE., EL SEGUNDO, CALIFORNIA • PHONE OREGON 8-6281  
 New York Office: 501 Madison Avenue, Phone PLaza 3-4942 • Chicago Office: 205 West Wacker Drive, Phone FRanklin 2-3889  
 In Canada: Atlas Radio Corp., Ltd., 50 Wingold Ave. W., Toronto, Ontario • Phone RU -6174

WORLD'S LARGEST SUPPLIER OF INDUSTRIAL METALLIC RECTIFIERS

# Still THE WORLD'S BEST HIGH FREQUENCY CAPACITORS

## ERIE BUTTON® SILVER-MICA CAPACITORS

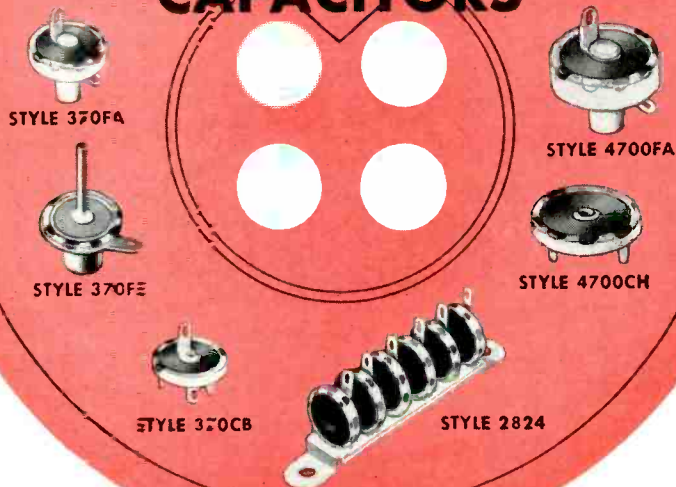

The ERIE BUTTON SILVER-MICA\* capacitor has been and still is known to be the world's finest high-frequency capacitor. Since 1941, when ERIE originally developed the Button capacitor, this compact, efficient unit has been the backbone capacitor of most military and communications equipments.

The ERIE BUTTON SILVER-MICA capacitor is composed of a stack of silvered mica sheets encased in a silver plated brass housing with the high potential terminal connected through the center of the stack. This compact design permits current to fan out in a 360° pattern from the center terminal. ERIE uses short-heavy terminals resulting in minimum circuit inductance. These design features make ERIE BUTTON SILVER-MICA capacitors the best for VHF and UHF applications. They are available in a wide capacity range, a variety of styles and sizes, and have many mounting arrangements.

Standard ERIE BUTTON-MICAS exceed the requirements of characteristics W and X Mil C-10950-A.

\*ERIE BUTTON Capacitors are made under U.S. Patent 2,348,693



Also available at ERIE are the BUTTON CERAMICONS which have the same mounting and terminal arrangements as the Silver-Mica capacitor. These units have a ceramic dielectric rather than the stacked sheets of silvered mica and may be used in applications where extreme temperature stability is not essential.

Write for complete description and specifications.

**ERIE** ELECTRONICS DIVISION  
ERIE RESISTOR CORPORATION  
Main Offices and Factories: ERIE, PA.  
Manufacturing Subsidiaries  
HOLLY SPRINGS, MISSISSIPPI • LONDON, ENGLAND • TRENTON, ONTARIO

age between cathode and its return due to an initial charge across the RC cathode load as

$$E_2 = Ae^{-t/RC}$$

The limiting condition of the threshold of clipping is that the slopes of these two curves close to the point 0, A shall be equal. Application of this condition gives a relationship between the three quantities: frequency  $f$  (or  $\omega$ ) of

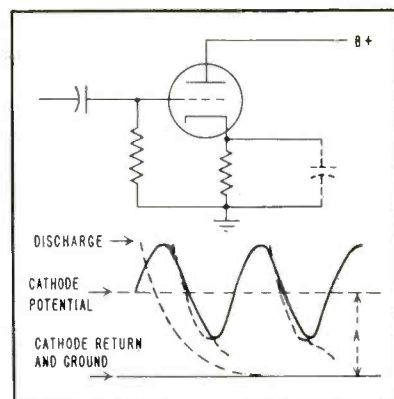

FIG. 1—Conventional cathode-follower with waveforms present in circuit

the signal, time constant  $RC$  of the cathode circuit and the ratio  $a/A$ .

Differentiating

$$E'_1 = -\omega a \cos \omega t$$

$$E'_2 = \frac{-A}{RC} e^{-t/RC}$$

and at  $t = 0$

$$E'_1 = -\omega a$$

$$E'_2 = -\frac{A}{RC}$$

Equating

$$\omega a = A/RC$$

whence

$$\omega = \frac{1}{RC} \cdot \frac{A}{a} \text{ or } f = \frac{1}{2\pi RC} \cdot \frac{A}{a}$$

or

$$RC = \frac{1}{\omega} \cdot \frac{A}{a} = \frac{1}{2\pi f} \cdot \frac{A}{a}$$

or

$$\frac{a}{A} = \frac{1}{\omega RC} = \frac{1}{2\pi f RC} = \frac{1}{2\pi} \cdot \frac{T}{RC}$$

Reducing the time constant of the cathode circuit is the most obvious method of increasing either the frequency response or the signal-handling ability of the cathode follower. However, this procedure encounters limitations.

Distributed capacitance and input capacitance of the load sets the minimum capacitance while re-

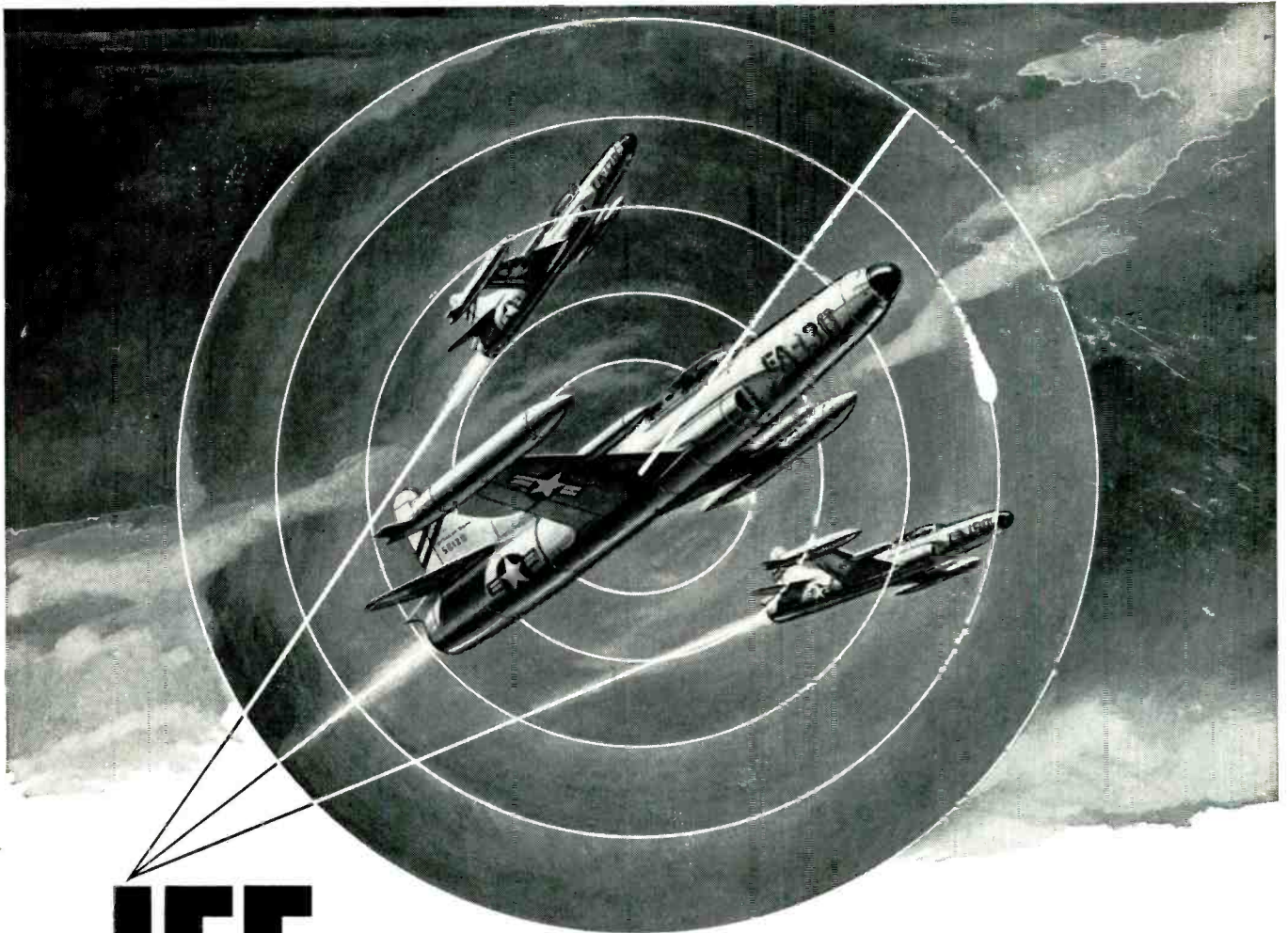

# IFF

(identification, friend or foe)

## the Electronic Sentinel THAT MUST NOT FAIL

A "blip" on the radar screen . . . and IFF goes into action. IFF sends out interrogating signals which automatically trigger an identifying reply signal. That is why IFF dare not fail.

Admiral has been entrusted with the production of IFF equipment now in use on a major portion of all our military aircraft and anti-aircraft defense installations. Admiral production techniques assure unfailing reliability for the equipment, and Admiral advance research is helping to make IFF secure against enemy jamming.

Admiral offers exceptional facilities for research, development and production of electronic or electro-mechanical equipment. Address inquiries to:

**Admiral** CORPORATION  
Government Laboratories Division • Chicago 47, Illinois

**ENGINEERS!** The wide scope of work in progress at Admiral creates challenging opportunities in the field of your choice. Write to Director of Engineering and Research, Admiral Corporation, Chicago 47, Illinois.

LOOK TO **Admiral** FOR  
RESEARCH  
DEVELOPMENT  
PRODUCTION

*in the fields of*

COMMUNICATIONS, UHF and  
VHF airborne and ground.

MILITARY TELEVISION, receiving  
and transmitting, airborne  
and ground.

RADAR, airborne, ship and  
ground.



RADIAC  
MISSILE GUIDANCE  
TELEMETERING  
CODERS and DECODERS  
DISTANCE MEASURING  
TEST EQUIPMENT



Send for Brochure

. . . complete digest  
of Admiral's experience,  
equipment and facilities.

# NOW... you can get a quick-acting quarter-turn Lion Fastener for every need!

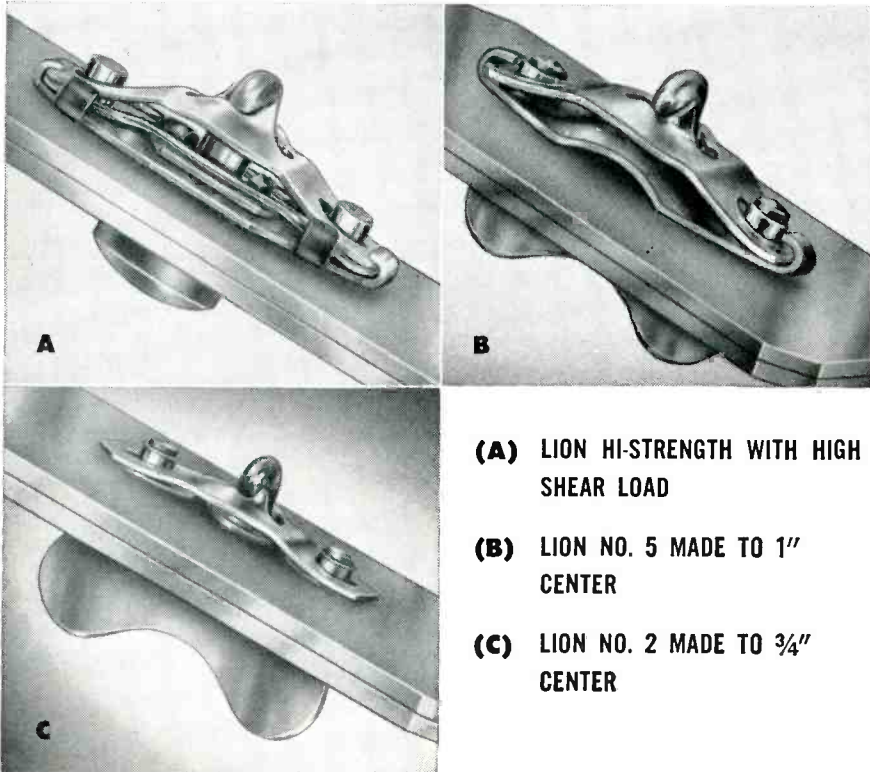

- (A) LION HI-STRENGTH WITH HIGH SHEAR LOAD**
- (B) LION NO. 5 MADE TO 1" CENTER**
- (C) LION NO. 2 MADE TO 3/4" CENTER**

Lion fasteners give you strong, vibrationproof, positive locking for plastic, plywood or metal parts which must be removed repeatedly for inspection, maintenance, etc. Patented Lion cantilever spring-locking designs team fast access with absolute safety.

**Hi-Strength** fastener—takes shear loads up to 4700 lbs. Designed for rugged applications requiring great fastener strength. Takes up no more room than a No. 5 fastener.

**No. 5** fastener—recommended for panels and inspection doors where long life must be combined with easy access.

## SEND FOR **FREE** LION DEMONSTRATOR KIT

Tell us the size and type you are interested in seeing, and we will send you a kit in which there is a mounted working model and unmounted components. A request on your letterhead will bring it to you. Write today.

**No. 2** fastener—used mostly on small panels for electronic telephone and similar equipment. Also frequently used to hold small assemblies which must be removed as units for inspection or service.

**Head styles**—oval, flush, knurled, ring, notched, wing or to your design specifications.

**Delivery**—You can be sure of delivery on the date you specify. We stock over one million fasteners in standard sizes and finishes for same day shipment on most orders. Production facilities are almost always open for custom orders.

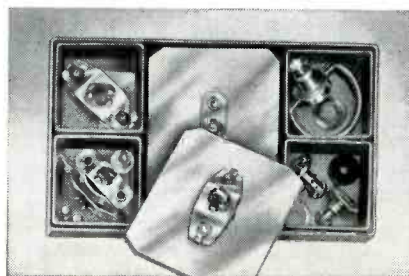

# LION Quarter-turn FASTENERS

one of the **SOUTHCO**

**FASTENERS**

Southco Division  
South Chester Corp  
233 Industrial Highway  
Lester, Pa.

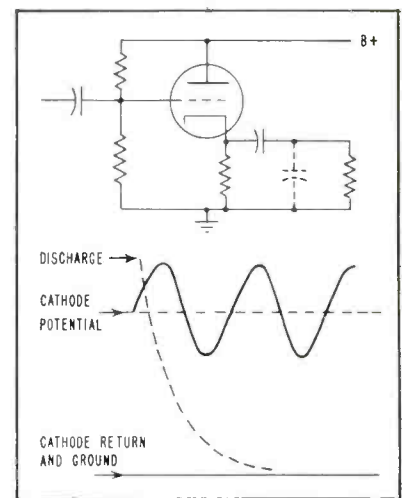

FIG. 2—Amplitude of discharge curve is raised by raising grid voltage with respect to ground

ducing the resistance beyond a certain minimum adversely affects the gain of the cathode follower and will also adversely affect the maximum signal without distortion.

The other method is to raise the value of  $A$  thus increasing  $A/a$  for better frequency response at the same signal amplitude, or alternatively making it possible to handle signals of larger amplitude  $a$  at the same frequency.

Increasing the amplitude  $A$  of the discharge curve relative to the signal amplitude  $a$  may be accomplished either by raising the grid voltage with respect to ground as in Fig. 2 or by lowering the voltage of the cathode return point as in Fig. 3 or both as in Fig. 4.

Since the cathode voltage follows the grid voltage quite closely, either

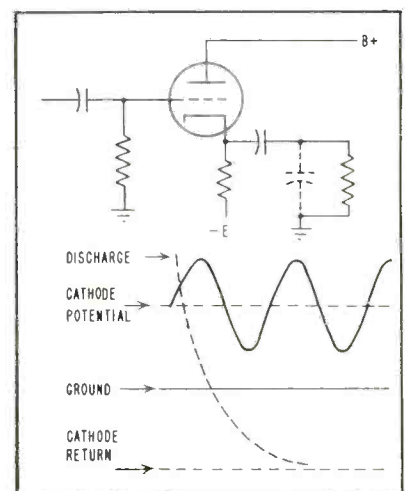
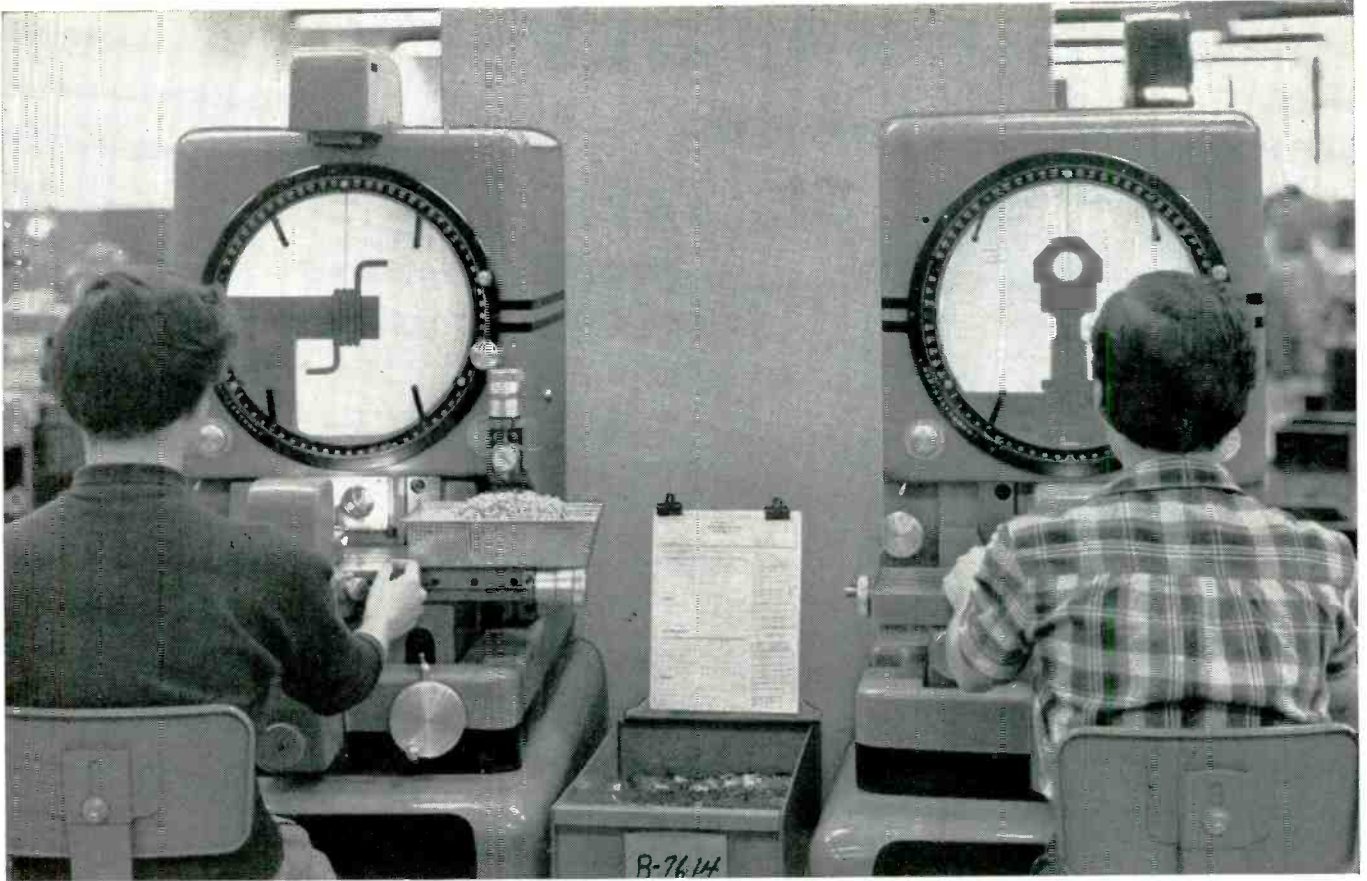

FIG. 3—Discharge curve amplitude can also be raised by lowering voltage of cathode return point



Girls at the Allen-Bradley Company, leading makers of electrical equipment, use Kodak Contour Projectors to inspect incoming precision parts quickly and accurately.

## To speed parts from receiving dock to production . . . Allen-Bradley uses Kodak Contour Projectors

Receiving inspection can be a bottleneck, slowing the production operation when, on an average day, many separate shipments of component parts crowd the receiving room.

To avoid such a bottleneck and keep production lines moving, the Allen-Bradley Company combines statistical sampling methods with modern gaging equipment. Kodak Contour Projectors are used to check more than 400 different items, most having multiple dimensions and sample sizes of 35 or more pieces. Tolerances are held as close as .001".

Because optical gaging affords a check of several dimensions simultaneously, Allen-Bradley has cut inspection time dramatically: a typical part, requiring

minutes to gage mechanically, now is checked in 12 seconds optically.

The result: No unnecessary delays—parts are quickly cleared for production. And quality control has improved.

You'll find that Kodak Contour Projectors are profitable wherever you need fast, accurate, complete inspection or measurement of almost any sort of part—simple or complex, large or small. And there are models to fit every need from the large Model 30 to the bench Model 8. To learn more about optical gaging and how it can help solve your problems, send for our illustrated booklet, "Kodak Contour Projectors." Use the coupon below.

### the KODAK CONTOUR PROJECTOR

#### EASTMAN KODAK COMPANY

Special Products Sales Division, Rochester 4, N. Y.

- Please send me a copy of your booklet, "Kodak Contour Projectors."  
 Put me in touch with your representative.

NAME \_\_\_\_\_ TITLE \_\_\_\_\_

COMPANY \_\_\_\_\_

STREET \_\_\_\_\_

CITY \_\_\_\_\_ STATE \_\_\_\_\_  
(Zone)

**Kodak**  
TRADE-MARK

48

# ADDED SAFETY for the Skyways



RCA's new C-Band air-borne weather mapping radar unit marks a big-step toward all-weather commercial air transport service . . . a major contribution to added efficiency, safety and comfort in flight.

Efficient and safe, too, are the Camloc quarter-turn fasteners that hold the C-Band's electronic assemblies firmly in place. A quarter-turn and the Camloc fastener is opened fast. A quarter-turn and the Camloc fastener is closed fast—to hold fast!

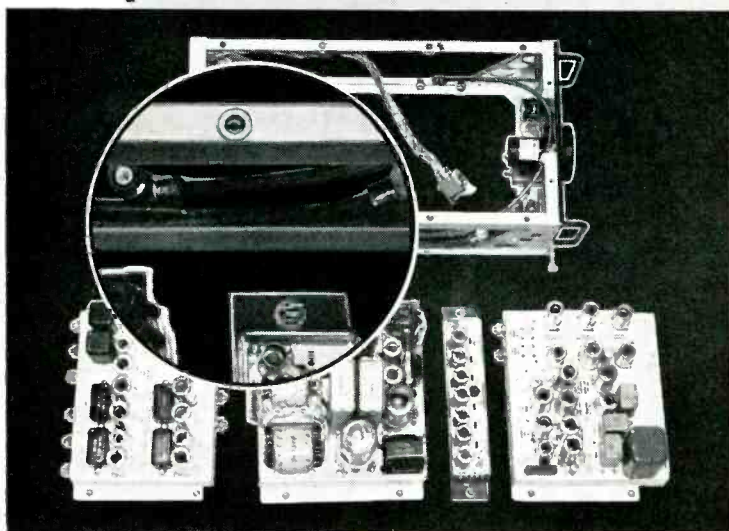

Electronic components in this RCA C-Band radar accessory unit are assembled in groups for quick and easy servicing. Camloc quarter-turn fasteners provide the fast-acting, firm-holding means of insuring quick accessibility on the ground, vibration-proof operation in the air.

Camloc fasteners and latches are serving the aircraft and electronics fields in hundreds of ways. There's a Camloc device to meet your fastening needs, too. Write for complete information.

Visit us at the WESCON Show  
BOOTH 331

# CAMLOC

**FASTENER CORPORATION**

75 Spring Valley Road, Paramus, N. J.

WEST COAST OFFICE: 5410 WILSHIRE BLVD., LOS ANGELES, CAL.



device increases the voltage across the cathode resistor as in the waveform of Fig. 2 and in the presence of a signal of the same amplitude, even though the time constant is unchanged or even longer, the discharge may be made steep enough so that no clipping results until the frequency of the signal rises somewhat higher than the previous

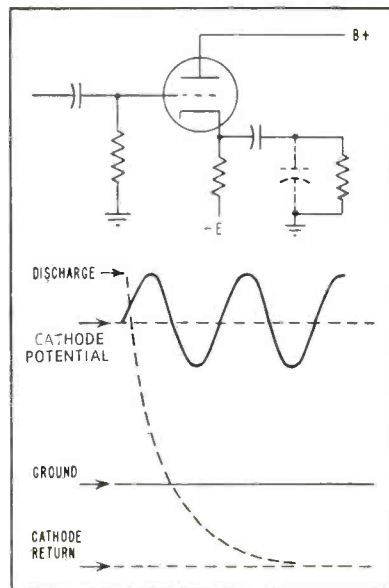

Fig. 4—Combination of raised grid voltage and lowered cathode return voltage produces a high-amplitude discharge curve

threshold of clipping.

Returning the cathode to a negative voltage point usually requires an increase in the cathode resistor thus lengthening the time constant of the cathode circuit and partially canceling the desired effect. However, owing to the increased steepness of the initial portion of the discharge curve the high-frequency threshold of undistorted output is increased.

Since the cathode closely follows the grid but cannot exceed the plate voltage and cannot fall below the voltage of the cathode return point, the quiescent value of grid voltage for maximum signal handling should be approximately at or somewhat above the half-way point between these two limiting values.

To accomplish this the cathode resistor must have a high enough value so the tube current through it produces a drop sufficient to prevent the cathode potential going



## Missile's master

The striking power of Navy surface and submarine forces has been hugely extended by the versatile Regulus, first guided missile to be flown successfully from all the following: a submarine, aircraft carrier, cruiser, guided missile ship, and mobile launcher.

The Regulus can deliver a powerful warhead at transonic speeds over a range of hundreds of miles, guided along its course by a built-in electronic brain. Radio Engineering Laboratories was selected by Chance Vought Aircraft, developers of the Regulus, to design and produce the radio transmitter which successfully directs this missile so important to the nation's defenses.

An inquiry to REL about your specialized radio problem will receive prompt attention.

*Fifth in a series describing REL versatility*

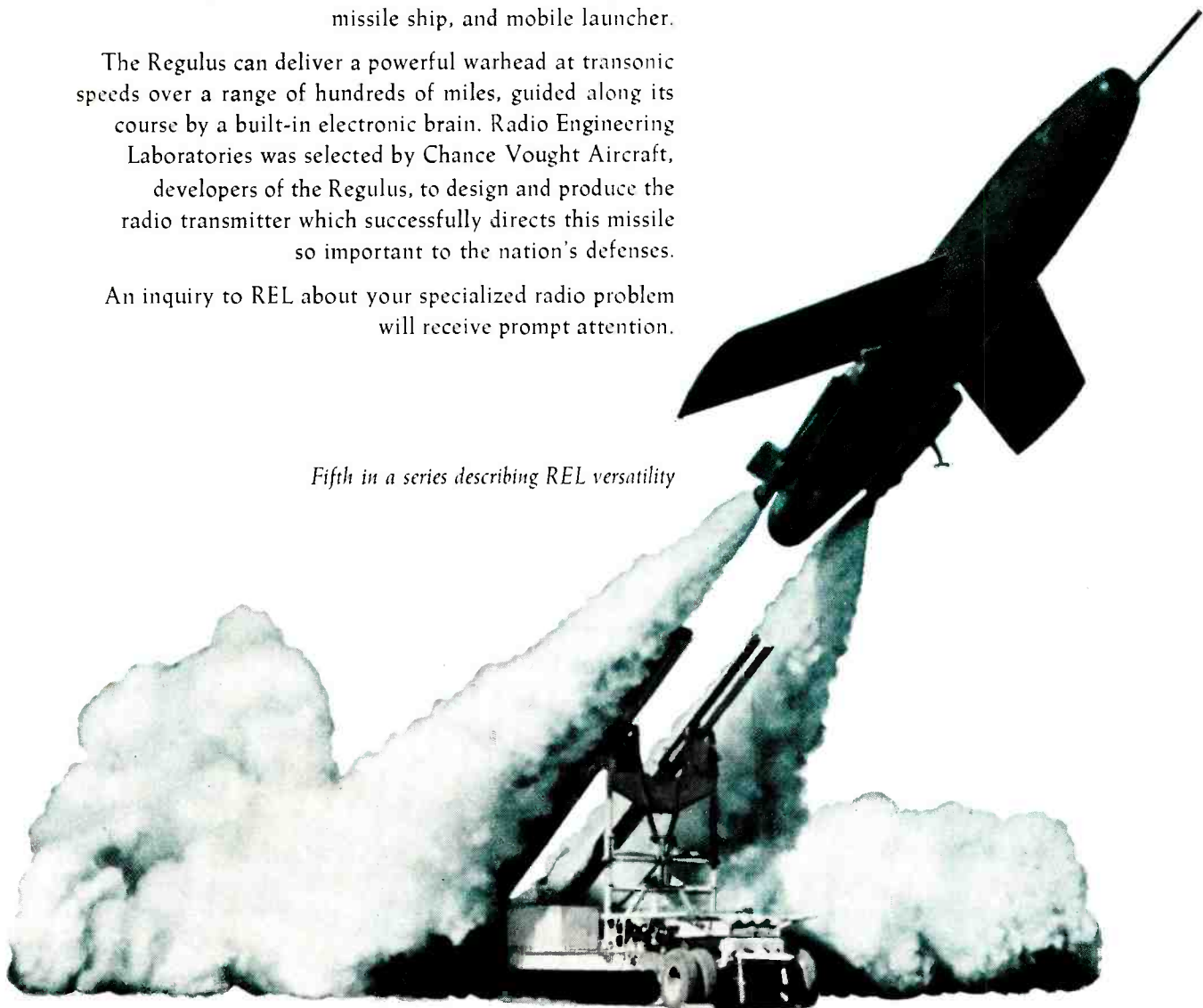

**RADIO ENGINEERING  
LABORATORIES · INC.**

36-40 37th St · Long Island City 1, N. Y.

STillwell 6-2100 · Teletype: NY 4-2816

Canadian representative:

Ahearn & Soper Co., P. O. Box 715, Ottawa



Model A 23 Calivolt



Calivolt now available for immediate delivery

## NEW CALIVOLTER\*

### WHAT THE CALIVOLTER IS

The Calivolt is a precise electrical instrument which provides an accurate voltage output over a wide frequency range. True r.m.s. voltages regardless of waveform, and accuracy of  $\pm\frac{1}{2}\%$  are outstanding features. The Calivolt fills a long recognized need for an extremely accurate but inexpensive voltage standard.

\*Trademark

### WHAT THE CALIVOLTER OFFERS

Here are some of the advantages and features which you get with the Calivolt:

- Accuracy  $\pm\frac{1}{2}\%$  from DC to 10KC — useful to at least 20KC.
- Voltage output from 10 microvolts to 10 volts in 5 continuous ranges.
- Easy operation, simple standardization.
- Low output impedance — max. 1000 ohms.

The Calivolt may be used to measure accurately the e.m.f. of voltage-producing vibration, pressure, and seismic pick-ups, as well as strain-measuring devices. It provides a means for accurately calibrating voltage detectors and voltage-sensitive devices such as Vacuum Tube Voltmeters, Oscilloscopes and Sensitive Relays. It may also be used for over-all calibrations of Recording Systems, and for measuring the frequency-response of Amplifiers, Recording Systems, Transformers, High Impedance Meters, etc.

- No current waveform error.
- Current output — 1 microamp to 10 ma in decade steps.
- A transfer switch and input connection for "unknown" facilitates measurements by substitution.
- Small size (8" x 8½" x 4" o.a.)
- Lightweight (6¼ lbs.), sturdy construction, matchless quality.

Write today for specifications and price.

# THE CALIDYNE COMPANY

120 CROSS STREET, WINCHESTER, MASSACHUSETTS

#### SALES REPRESENTATIVES:

WALTHAM, MASS.  
Robert A. Waters, Inc.  
Waltham, S 8000  
NEW HAVEN, CONN.  
Robert A. Waters, Inc.  
Falcon 7-8760  
NEW YORK CITY AREA  
G. C. Engel & Associates  
Rector 2-0091  
RIDGEWOOD, NEW JERSEY  
G. C. Engel & Associates  
Gilbert 4-0878

PHILADELPHIA, PA.  
G. C. Engel & Associates  
Chambers Hill 8-0392  
NORTHERN NEW YORK  
Technical Services Co., Boston  
Capital 7-9787  
CLEVELAND, OHIO  
M. F. Odell Co.  
Prospect 1-8171  
DAYTON, OHIO  
M. F. Odell Co.  
Oregon 4-441

WASHINGTON, D. C.  
F. E. Jordan, Inc.  
Woodley 8-2613  
SOUTHEAST  
W. A. Brown & Assoc.  
Alexandria, Va.  
Overlook 3 8100  
CHICAGO, ILLINOIS  
Hugh Marling & Co.  
Ambassador 2-1555  
INDIANAPOLIS, INDIANA  
Hugh Marling & Co., Glendale 3803

MINNEAPOLIS, MINN.  
Hugh Marling & Co.  
Calder 7949  
DALLAS, TEXAS  
John A. Green Co.  
Green 9718  
HOLLYWOOD, CALIFORNIA  
G. B. Miller Co.  
Hollywood 9-8205  
SAN FRANCISCO, CALIF.  
G. B. Miller Co.  
Lynch 3-2438

ALBUQUERQUE, NEW MEXICO  
G. B. Miller Co., Albuquerque 5-8606  
SEATTLE, WASH.  
G. B. Miller Co., Lander 3320  
CANADA  
Measurement Engineering Ltd.  
Aurora, Ont., Phone 450  
Toronto, Ont., Mayfair 8800  
EXPORT  
Rohk International Corp.  
13 East 40th St., N. Y. 16, N. Y.  
Murray Hill 9-2900

negative with respect to grid even at the positive peak of grid signal. The exact point will be determined by adjusting the grid voltage until distortion begins to occur on the positive and negative peaks at the same amplitude of signal. The maximum frequency response is attained at somewhat higher value of grid voltage but at the expense of signal-handling ability.

A word of appreciation is due to Gordon Simkin, technical assistant, for his help on this problem.

### REFERENCE

(1) N. H. Crowhurst, Getting the Cathode Follower Straight, *Radio Electronics*, p 50, Dec. 1954.

## Plug-In Rectifier Replaces Tube

SILICON power rectifiers capable of operating at ambient temperatures of 150 C are being packaged for replacement purposes in existing electronic equipment. Bogue Electric Manufacturing Co. of Paterson, N. J. furnishes plug-in units to take the place of types 5R4W and 6X4W vacuum tubes.

Since they are designed for exact replacement, series resistance has been introduced in the common cathode lead. Forward drop of the silicon elements is considerably lower and the output voltage would consequently be more than 10 volts higher than that from the comparable vacuum tube.

## Criss-Cross D-C Amplifier

By HAROLD MORRISON\*

Martinsville, Va.

NEED AROSE for a d-c amplifier that would develop sufficient gain to permit a small d-c input signal to be used as a power control source. One circuit developed to serve this purpose was the criss-cross amplifier, shown in the illustration, the name being derived from the criss-cross pattern of the amplification path between the sides of the a-c line.

This amplifier was designed entirely on the underlying assumption

\* The work described was done while the author was employed by Textile Fibers Division, E. I. du Pont de Nemours & Co., Inc., Wilmington, Delaware.

# FREE TO ELECTRONIC ENGINEERS & DESIGNERS

**A new Superior Tube catalog gives complete facts on cathodes, anodes, grid cups—their characteristics, uses, variety**

For the first time, Superior Tube Company puts all the basic data on its broad line of cathodes and other vacuum tube components into a single catalog. The new CATHALOYS are fully described. Easy-to-read tables give dimensions and tolerances on all standard cathode types, plus detailed chemical and physical properties on 23 different alloys. If you design vacuum tubes or electronic equipment using fabricated tubular parts, don't fail to send for this complete new catalog from Superior Tube Company—world's leading independent supplier of cathodes to the electronics industry.

\*Manufactured under U.S. Patents. †TM Reg. U.S. Pat. Off., Superior Tube Co.  
NOTE. Cathaloy is a trademark of Superior Tube Co., Reg. U.S. Pat. Off.

# Superior Tube

**The big name in small tubing**

All analyses .010" to 3/4" O.D.  
Certain analyses in light walls up to 2 1/2" O.D.



## HOW YOU CAN USE THIS CATALOG



**WHICH ALLOY.** Complete descriptions of Superior Tube alloys make it easier for you to make the right selection.



**WHICH TYPE.** Tabulated dimensional information given on seamless, Lockseam\*, and WELDRAWNT cathodes.



**ANY KIND OF TUBE.** Sections cover receiving tubes, cathode ray tubes, transmitter tubes, other tubing applications.



**SALES POLICY.** Detailed explanation simplifies ordering procedure for you, and shortens your procurement cycle.

## SEND FOR YOUR COPY

Use this handy coupon or write

Superior Tube Company  
2500 Germantown Ave., Norristown, Pa.  
Yes, I want a copy of your new Electronics Catalog #50  
Name \_\_\_\_\_ Title \_\_\_\_\_  
Department \_\_\_\_\_  
Company \_\_\_\_\_  
Street \_\_\_\_\_  
City \_\_\_\_\_ Zone \_\_\_\_\_ State \_\_\_\_\_

**Factory  
pre-setting assures  
high accuracy . . .  
eliminates costly  
pre-installation  
adjustments**

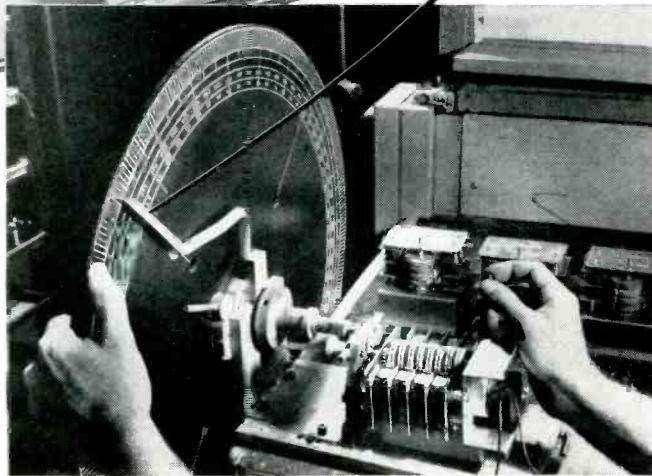
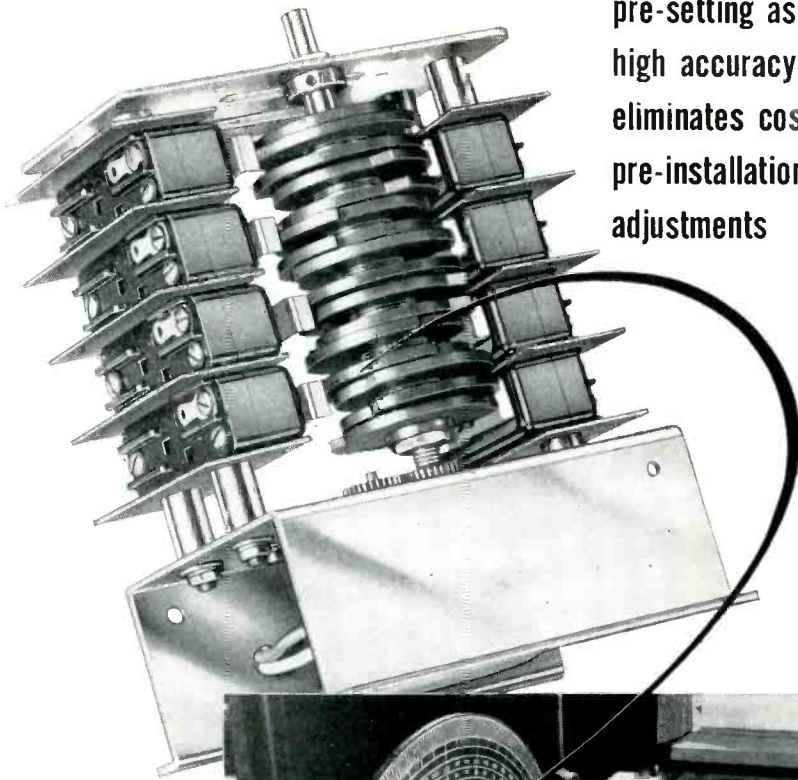

# Cramer CYCLING TIMERS

The accuracy of a cycling timer depends on the exactness of the cam settings. If any one of the driving cams is incorrectly set, even to the minutest degree, the over-all program pattern or sequence of operations is changed.

Cramer cycling timers are normally supplied with all cams pre-set to customer specifications on special calibration equipment like that shown above. This pantographic principle, in effect, produces a sixteen-time enlargement of the cam, permitting extremely close setting accuracies.

While these timers can be adjusted in the field, factory setting assures highest accuracy and eliminates costly pre-installation adjustments.

This is but one of the many Cramer customer services designed to provide greater product usefulness and satisfaction at lower cost.

For full information about Cramer Cycling Timers, write for new Bulletin PB-510.



SPECIALISTS IN TIME CONTROL  
**The R. W. CRAMER CO., Inc.**  
BOX 3, CENTERBROOK, CONNECTICUT

13CR55

Want more information? Use post card on last page.

that if an a-c signal can be amplified by superimposing it on a d-c voltage, amplifying the sum and then discarding the d-c component, it should be possible to amplify a d-c signal by superimposing it on an a-c voltage, amplifying the sum and then discarding the a-c component. Although this is not precisely what the criss-cross amplifier accomplishes, the basis for the design is roughly covered.

Operation of the amplifier is

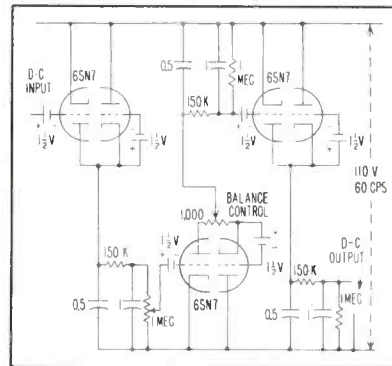

Direct-current input to amplifier changes charging rate of capacitor in plate circuit of each stage. Output after filtering is a d-c signal

based on the balanced charging and discharging of a 0.5- $\mu$ f capacitor on alternate cycles of an a-c wave. Twin triodes are placed in the charging circuit of this capacitor. With no input signal the tubes are biased equally and will charge and discharge the capacitor an equal amount leaving a residual charge of zero. However, if the circuit is unbalanced by the presence of a d-c input signal on the grid of one triode, the capacitor will not be charged and discharged equally and a residual charge will remain. This charge is directly proportional to the input signal and after suitable filtering may be used as the input signal to the next stage. The gain of each stage is a function of the tube characteristics, circuit components and supply voltage.

The amplifier possesses two obvious disadvantages. Frequency response is quite low. For certain process control applications, however, this is not a serious drawback; the top limit may be extended through the use of a high frequency power supply. Drift with power line voltage fluctuations is considerable. A possible remedy

# International

## Selenium Rectifiers



high voltage cartridges

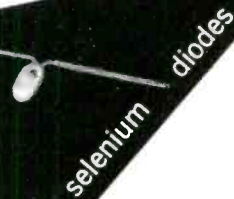

selenium diodes



hermetically sealed cartridges



industrial power rectifiers



selenium color tv rectifiers



selenium tv and radio rectifiers



### The **WIDEST RANGE** in the **INDUSTRY**

- ★ Power Ratings from Microwatts to thousands of Kilowatts!
- ★ Efficiency to 87%

*The most widely used Industrial Power Rectifiers in industry today.*

## International Rectifier

C O R P O R A T I O N

EXECUTIVE OFFICES: 1521 E. GRAND AVE., EL SEGUNDO, CALIFORNIA • PHONE OREGON 8-6281  
New York Office: 501 Madison Avenue, Phone Plaza 3-4942 • Chicago Office: 205 West Wacker Drive, Phone FRanklin 2-3889  
In Canada: Atlas Radio Corp., Ltd., 50 Wingold Ave. W., Toronto, Ontario • Phone RU 1-6174

WORLD'S LARGEST SUPPLIER OF INDUSTRIAL METALLIC RECTIFIERS

Have you seen our...

# ETCHINGS?



By etchings we mean etched circuits

Once you see them, we think you'll agree they're *unusually* good. "Wrap-Around," "Plated-Thru" and "Flush" etched circuits as developed by USECO, give you:

- correct plating • extreme accuracy
- excellent pattern definition • better contact
- easier unplugging • longer service life

These are advantages which guarantee unsurpassed performance. For information, please address Dept. 16

Complete line of electronic hardware, including standard and special terminal boards. World's largest stock of silver plated terminal lugs—over 21 million pieces.

See our complete display at WESCON Show, Booth No. 132

**U. S. ENGINEERING CO., INC.**

A Division of Litton Industries, Inc.

521 COMMERCIAL ST., GLENDALE 3, CALIF.

is the use of two voltage-regulator tubes across the input power line. For particular applications, these disadvantages may be evaded to realize the benefits of high gain and infinite input impedance at a reasonable cost.

## Two-Terminal Push-Pull Oscillator

By E. J. CUDDY  
Romag Associates  
Yonkers, N. Y.

OF THE MANY TYPES of two-terminal oscillators in use at the present time, the Kallitron<sup>1</sup> has the advantage of push-pull action. This circuit has one drawback, however; the fact that the tank is at d-c plate potential and not easily adapted to use with the usual tuning capacitor.

One possibility is an arrangement such as shown in Fig. 1A. When the circuit is redrawn as in Fig. 1B, it is seen to be a bridge-type circuit balanced with respect to the tank until oscillation starts.

This conformation has another advantage over the usual push-pull circuit in that the tube grid-to-plate capacitances are in parallel across the tank as shown in the equivalent

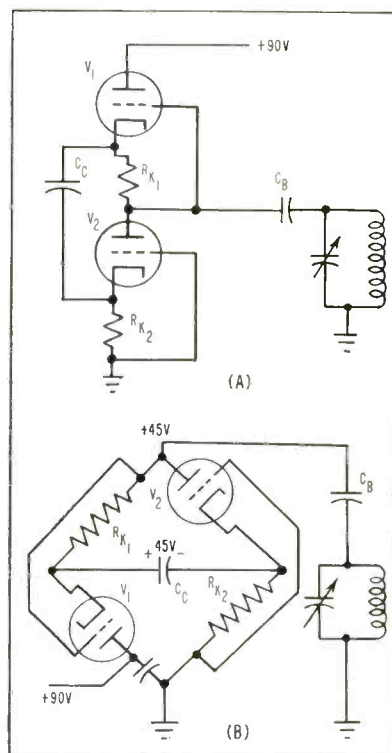

FIG. 1—Push-pull oscillator design (A) can be redrawn to show bridge configuration (B)

# Presenting New MICROWAVE FILTERS AND PRESELECTORS

by  
FREQUENCY  
STANDARD



## Miniature Gang Tuned Filters and Preselectors

These new filters and preselectors feature a wide tuning range, single shaft tuning, TSC response and extreme design. They offer wide temperature range, can be fully sealed, compatible with Frequency Center

(-320° to 390°F.) for critical installations.

**KEL-F® PLASTIC IS UNIQUE.** A polymer of trifluorochloroethylene, its molecular construction produces a combination of outstanding properties headed by excellent electrical characteristics, resistance to chemical attack and negligible deformation under load.

KEL-F Plastic is dense, tough, and readily moldable. It has an operational temperature range of approximately 710°F. (-320°F. to 390°F.) KEL-F Plastic is non-wettable, and moisture absorption is zero! In electrical applications it can be used structurally as well as dielectrically—particularly in the

critical electronic applications encountered in sub-miniaturization, automation, servo-mechanisms, etc. And, as wire insulation, KEL-F Plastic offers outstanding abrasion resistance, so important in aircraft and other critical installations.

KEL-F Plastic is available as a molding compound, or in extruded film, sheeting, rods and tubing from independent fabricators. KEL-F Dispersions for bake-coating of metallic surfaces are also obtainable. The complete story of KEL-F Plastic should be in your "ready" file. Write for special bulletins.



**THE M. W. KELLOGG COMPANY**  
Chemical Manufacturing Division, P. O. Box 469, Jersey City, N. J.  
**SUBSIDIARY OF PULMAN INCORPORATED**

® Registered trademark of The M. W. Kellogg Company's fluorocarbon polymers.

tubes with a change in their grid voltages.

Capacitor  $C_b$  is used to block d-c and is not critical although it should have a small impedance at the lowest frequency used.

Coupling capacitor  $C_c$  should also offer a low impedance at the frequency of oscillation. However, it may be replaced by a series-resonant circuit for fixed frequency operation may be a crystal used at its series-resonant frequency.

The cathode bias resistors,  $Rk_1$  and  $Rk_2$  should be approximately the recommended value for class A operation. Varying  $Rk_1$  and  $Rk_2$  simultaneously tends to affect the frequency stability, possibly owing to a balancing of the Miller effect by the negative feedback inherent in grounded-grid tubes.

The most important factor contributing to good frequency stability and low harmonic content seems to be the class A mode of operation. The simplest method found for adjusting the circuit to these conditions was variation of the plate voltage. This makes it simple to adjust for each range when switching bands, by means of a series resistor simultaneously cut into the plate circuit.

As in other types of oscillators, a high tank Q seems to increase frequency stability but some low-Q tank circuits were made to operate in a satisfactory manner by adjustment of the plate voltage. It should be noted that loading of the tuned circuit can be prevented by taking the output from the cathode of  $V_2$  when amplitude is not important.

When tried in a superhetrodyne receiver this oscillator worked well from 500 kc to 15 mc and over the

Approx. Dimensions:

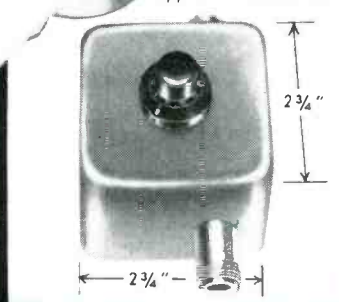

ec-  
range,  
hebycheff  
ely compact  
usable over  
e ranges and  
ished hermetically

ments manufactured by  
Frequency Standards are the ac-  
cepted standard of accuracy in  
the field of microwave frequency  
measurement and control. Engi-  
neering, design and manufac-  
turing facilities are available for  
the solution of problems involv-

ing frequency measurement, fre-  
quency stabilization, frequency  
control and discrimination. Con-  
sult Frequency Standards engi-  
neers on your requirements for  
filters, preselectors, oscillator  
cavities, AFC cavities and fre-  
quency meters for special ap-  
plications.

#### TYPICAL SPECIFICATIONS FOR PRESELECTORS AND FILTERS

	L	S	C	X
Tuning Range (KMC)	1.2-1.5	2.8-3.3	4.8-5.3	8.5-9.6
Bandwidth (MC)	10±2	10±2	10±2	10±2
Insertion Loss (db) (4 sections)	≤2.0	≤2.0	≤2.0	≤2.0
Coupling	TYPE N	TYPE N	TYPE N	WAVEGUIDE

Write for new Catalog containing complete information on Microwave Filters, Preselectors

and Frequency Meters including completely self-contained Field Test Equipment.

# Frequency Standards

ASBURY PARK, NEW JERSEY

Please address  
inquiries to BOX 504 A





**GUARDIAN®**  
*Endurance Tested*  
 MULTIPLE CONTACT  
**RELAYS**  
 BREAKING ALL RECORDS

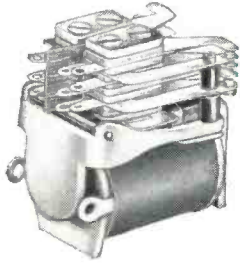

**Guardian Series 595**  
 Up to 4 Pole, Double  
 Throw—3 Amps.

**120 million operations**  
 at 30 pulses per second

This test is equivalent to 100 YEARS of continuous operation in many applications! No visible signs of wear. Ideal for business machines and computers.

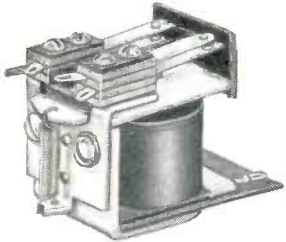

**Guardian Series 615**  
 Up to 4 Pole, Double  
 Throw—10 Amps.

**90 million operations**  
 at 10 pulses per second

A low cost, midget relay with practically unlimited applications. Trouble-free operation! Excellent high quality!

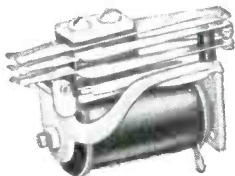

**Guardian Series 415**  
 Up to 8 Pole, Double  
 Throw—3 Amps.

**60 million operations**  
 at 11 pulses per second

Sturdy construction to withstand constant operation at extremely high speed. Meets standard Navy and Signal Corps specifications.

*write* FOR NEW CATALOG NO. 11  
 Switches — Steppers — Solenoids — Complete Control Assemblies  
**GUARDIAN  ELECTRIC**  
 1625-J W. WALNUT STREET CHICAGO 12, ILLINOIS  
 A COMPLETE LINE OF RELAYS SERVING AMERICAN INDUSTRY

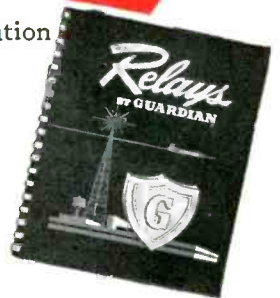

# New hf wave analyzer!

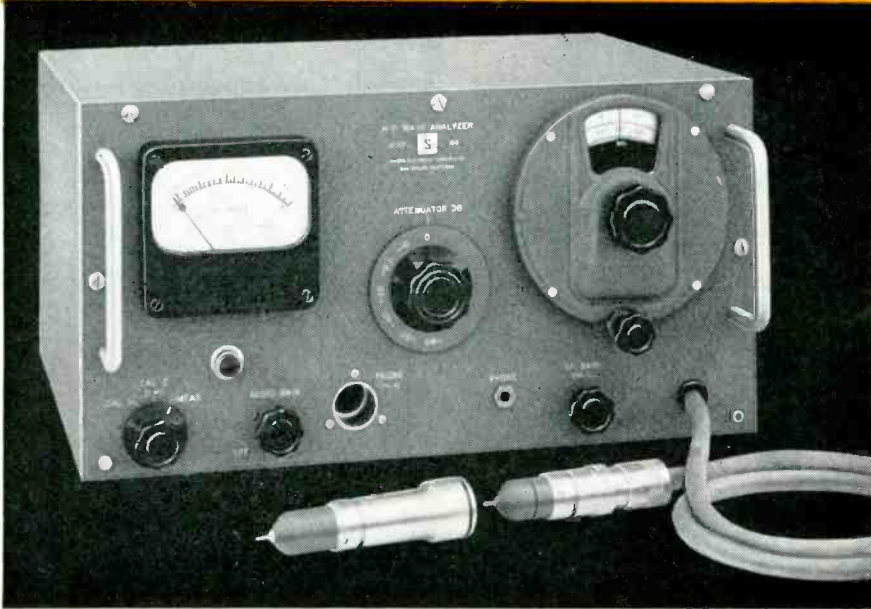

Sierra 158 High Frequency Wave Analyzer

## Fast, convenient, 500 KC to 10 MC!

New Sierra 158 Analyzer is a highly selective, double superheterodyne receiver providing wave analysis data direct in dbm referred to 600 ohms impedance. The instrument uses a cathode follower input probe with two detachable capacity dividers for 20 or 40 db attenuation. It also includes a built-in attenuator adjustable in 10 db steps to a maximum of 60 db. These features, in combination with 22 db usable meter readings, provide a measurement range of 122 db, from  $-80$  to  $+42$  dbm. A measurement accuracy of  $\pm 2$  db is assured for levels above  $-70$  dbm. Spurious components from analyzer circuits are at least 50 db below fundamental. An injection oscillator at 2 mc is provided for rapid voltage calibration. A phone jack is available for aural monitoring. The instrument also includes the Sierra-designed precision spiral-scale frequency dial. *Write for complete data.*

### SPECIFICATIONS

- Frequency Range:** 0.5 to 10 megacycles.
- Signal Measurement Range:**  $-80$  dbm to  $+42$  dbm, referred to 600 ohms. ( $77.5 \mu\text{v}$  to  $97.5 \text{v}$ )
- Selectivity:** 3 db down at 3 kc off; 30 db down at 12 kc off.
- Signal Measurement Accuracy:**  $\pm 2$  db above  $-70$  dbm.
- Spurious Responses:** At least 50 db down.
- Input Impedance:** Greater than 1 megohm shunted by approximately  $8 \mu\text{mf}$ .

**Frequency Calibration Accuracy:** Depends on stability and calibration accuracy of the 22.5 - 32 mc variable oscillator, which is maintained within 0.25%. This results in dial accuracy ranging from  $\pm .056$  mc to  $\pm .080$  mc.

**Operating Power Requirements:** 105 to 125 volts, 50/60 cps, 95 watts drain.

**Cabinet Dimensions:** 17 inches wide, 9 $\frac{1}{8}$  inches high, 13 $\frac{1}{2}$  inches deep.

**Weight:** Approximately 40 pounds.

*Data Subject to Change Without Notice*

### Sierra Electronic Corporation

San Carlos 2, California, U. S. A.

Sales representatives in major cities

Manufacturers of Carrier Frequency Voltmeters, Wave Analyzers, Line Fault Analyzers, Directional Couplers, Wideband RF Transformers, Custom Radio Transmitters, VHF-UHF Detectors, Variable Impedance Wattmeters, Reflection Coefficient Meters.

3235

f-m band using a 7F8 duotriode.

It was also possible to use it as a locked oscillator by feeding a signal between the cathode of  $V_2$  and ground, as long as the method of coupling did not interfere with normal circuit action.

With an antenna attached at the cathode of  $V_2$  and a load in the plate circuit between plate of  $V_1$  and B+ a stable regenerative receiver was formed. By inserting the proper R-C combination between the grid of  $V_2$  and ground it is possible to obtain superregenerative action with this same arrangement.

In the audio range, with a low-Q tank consisting of an output transformer feeding a speaker, a variable tone over a rather wide frequency range could be obtained by changing the value of the capacitor  $C_c$ .

Other uses can probably be devised for this oscillator, such as in a frequency divider circuit. Its main application may be found where a two-terminal oscillator is an advantage, especially when one of these terminals can be at ground potential.

### REFERENCE

- (1) H. J. Reich, *Proc IRE*, 25, p 1,387, Nov. 1937.

## House Analog



Any kind of dwelling or structure can be simulated for the purpose of testing insulating material, heating equipment and accessories such as storm windows with the computer equipment shown. Engineers of the Minneapolis-Honeywell Regulator Co. plan to use the device primarily to measure heat losses and gains as they vary with time. A second of the brain's time is equivalent to 60 days of actual time, giving a time factor of 5 million to 1 in speeding up tests of insulation or build material





Mr. Vincent Sillitta, Traffic Manager of Clarostat Mfg. Co., Inc., discloses

## “How this guided missile gets there on time!”

“... 5, 4, 3, 2, 1, *fire* ... and a Clarostat product helps head the missile for an ‘enemy’ bomber!

“But before its deadly rendezvous, that tiny part of the missile’s ‘brain,’ a Clarostat resistor, had to keep another vital appointment—with the Guided Missile production schedule.

“That date was kept by Air Express!

“We ship up to 15,000 pounds of Clarostat Resistors per month by Air Express. Their sizes range from the one men-

tioned above—finer than a human hair—to shipments weighing one hundred pounds and more.

“With Air Express help, we can meet extremely exacting delivery specifications. Yet most shipments cost *less* than by any other air service. A 25 lb. shipment from Boston to Toledo, for instance, costs \$6.45. That’s 5¢ *less* than the next lowest air carrier—and the service can’t be compared!”

It pays to express yourself clearly. Say Air Express!



# Air Express



GETS THERE FIRST via U.S. Scheduled Airlines

CALL AIR EXPRESS ... division of RAILWAY EXPRESS AGENCY

## Quality Control Panel Shows Variations in Tested Parts

AN INSTANTANEOUS method of determining quality of output in the Chicago plant of Shure Brothers, Inc., uses the actual product to depict frequency distribution curves. At each test position for magnetic recording heads is a rack having vertical channels in which tested heads can be placed. Removable marker strips across the top and bottom of this quality control panel are labeled to cover the range of test readings. A white-tape pointer at the top identifies the channel for the standard reading.

After a head is tested, it is placed in the channel corresponding to its reading. This automatically gives a histogram showing the range of distribution and showing whether it is centered on the standard value. When one channel is filled or at the end of a production run, a quality control engineer transfers the data to the permanent record control chart and then unloads the panel.

The actual-part histogram furnishes quantitative data and qualita-



Quality control panel at left, with magnetic recording heads in channels corresponding to test readings, gives data in convenient form for quick transfer to permanent quality control chart on wall

tive characteristics of distribution for rapid calculations of the average spread and percentage of acceptance. At the same time, the panel provides convenient separation of

unacceptable units for further processing and eliminates the need for the operator to keep elaborate, time-consuming records such as would otherwise be required.

## Induction Generator Bonds Hookup Wire Strands Before Stripping

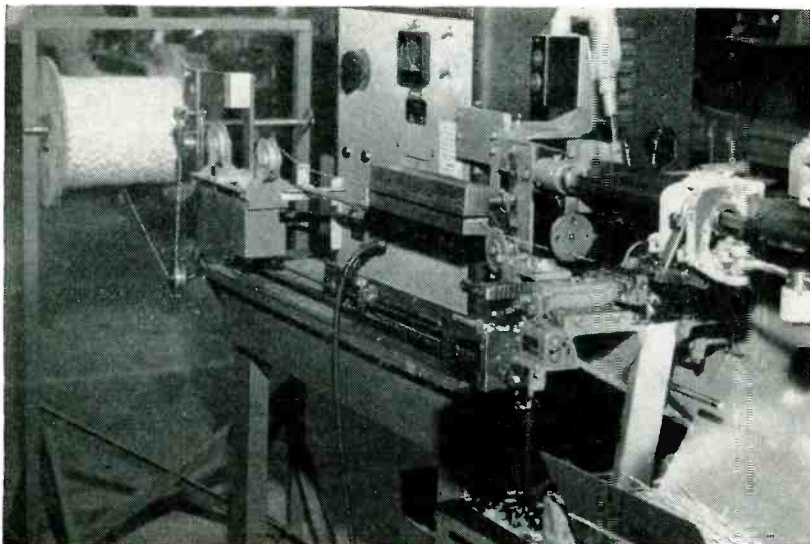

Automatic bonding, cutting and stripping setup. Wire is fed from large spool at left through tension device, water bath (box at right of wire spool), wire guide, induction work coil, cooling fixture and then into Artos machine

AN INDUCTION heating unit combined with an automatic Artos wire cutter and stripper in the Santa Monica, California plant of Lear, Inc., bonds bared wires together automatically at the same instant that cutting and stripping is done. Costly hand operations have thus been eliminated, with an attendant increase in quality and uniformity. This, plus the noticeable reduction in waste, is saving approximately \$40,000 annually in this one operation alone in connection with airborne electronic equipment.

The induction heating generator is set on sliding ways next to the wire cutter, so that the work coil can be set at the correct position for any desired length of wire;



going...

going...



gone!

**KESTER "44" RESIN, PLASTIC ROSIN AND "RESIN-FIVE" FLUX-CORE SOLDERS** owe their production line popularity to the simple fact that they provide the exactly right solder for every soldering application. It's not difficult to realize why Kester is consumed so rapidly ... because of its great adaptability to so many different soldering operations.

**SEND TODAY** for Kester's new 78-page informative textbook "SOLDER ... Its Fundamentals and Usage."

# KESTER SOLDER

**COMPANY** 4204 Wrightwood Avenue, Chicago 39, Illinois; Newark 5, N. J.; Brantford, Canada

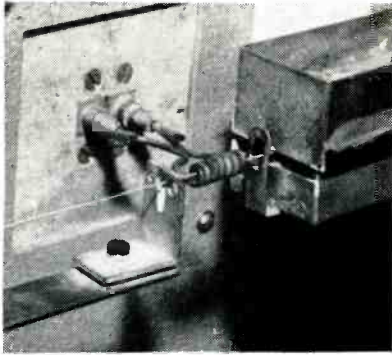

Work coil, with wire guide at left and cooling fixture at right through which wire moves after bonding of strands

this is necessary so fusion of the tinned strands occurs only where the wire is to be cut and stripped. To determine the proper setting, the distance in inches between the two

units should be divisible by the length of wire to be cut. For example, a 30-inch distance would be correct for a 2, 3, 5, 6, 10 or 15-inch wire. For a 4 or 8-inch wire, the distance would be increased to 32 inches, a 7-inch wire would require 35 inches and a 9-inch wire would have a distance of 36 inches. A scale in front of the generator aids adjusting to a new wire length.

A solenoid attached to the Artos is wired to a Micro-Switch, which in turn pulses the induction heating generator for a predetermined length of time. As the cutting blades meet, the solenoid is actuated and the generator is turned on, thus bonding the wire which at the time is passing through the work coil some 30 inches ahead.

The insulated wire is fed from its original spool through a water bath which contains a wetting agent. This tends to keep the insulation cool and prevents it from becoming gummy when the wire is bonded. The wire then enters the induction coil where the strands are bonded together. Immediately after leaving the induction coil, the wire passes between four damp sponges, which have an additional cooling effect on the insulation. It proceeds on to the Artos where it is cut in the center of the bond and stripped. It is of prime importance to keep the insulation as cool as possible during the bonding operation so that most of the heat is retained by the wire strands. This results in a better fusion of the tin.

## Air-Actuated Machine Makes Catwhiskers for Germanium Wafers

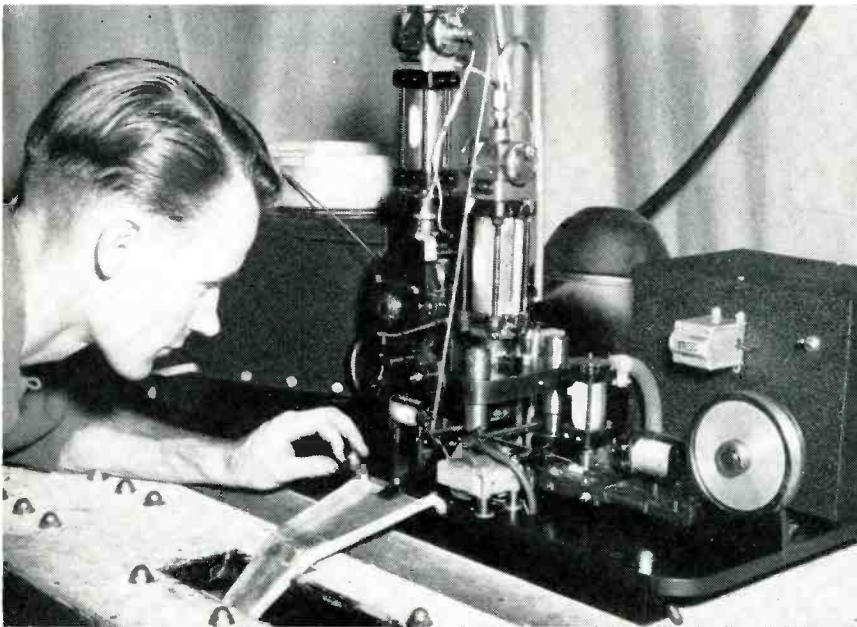

Over 10,000 catwhiskers a day slide down the output chute of the automatic catwhisker machine. Syntron vibrator at left rear feeds in pins. Whiskers come from wire on reel at right

AN AUTOMATIC special-purpose machine built around two Bellows air motors and five Bellows Han-D-Air cylinders produces catwhisker contacts for germanium wafers at Radio Receptor Co. in Brooklyn. A tungsten wire whisker is inserted, staked into a nickel-silver pin and then cut off and formed into an S shape. The finished catwhisker falls down a chute to a conveyor which moves it to the following op-

eration for assembly of wafers.

The cutoff, staking and forming operations are done simultaneously by the BEM-2-25 air motor. On each advance stroke, the cutoff and staking are done at one position and the forming is done at a second position. The pins are moved from position 1 to position 2 by the first air cylinder. A pin moving into position 2 pushes the previously completed pin out to the conveyor

chute, to give automatic ejection.

Pins are continuously fed from the vibrating Syntron hopper into a selector which turns improperly positioned pins 180 degrees to the correct position. Each time the selector ratchet wheel is indexed by the BEM-1C-20 air motor (1½-inch bore, 2-inch stroke), a pin falls into a hopper tube from which it is fed to work position.

A solenoid-controlled gate allows each pin to be released as needed. A pin thus released is fed to work position by one of the air cylinders. When this pin is in proper work position, an electrical circuit is closed, permitting subsequent operations to occur.

A second cylinder feeds the 0.005-inch tungsten wire from the supply reel through a wire guide into the waiting pin. A third cylinder clamps the wire in position. (A solenoid acts as a brake on the reel.) The BEM-2-25 air motor (¾-inch bore, 2½-inch stroke) advances the tools, cutting off the wire and staking it into the pin. The fourth air cylinder swings the wire guide out of the way as the fifth cylinder pushes the pin into the second work position, where it is formed on the next advance of the BEM-2-25 air motor. As each pin moves into position 2, it pushes the previously completed catwhisker

From nursery phonographs . . . to hi-fidelity units

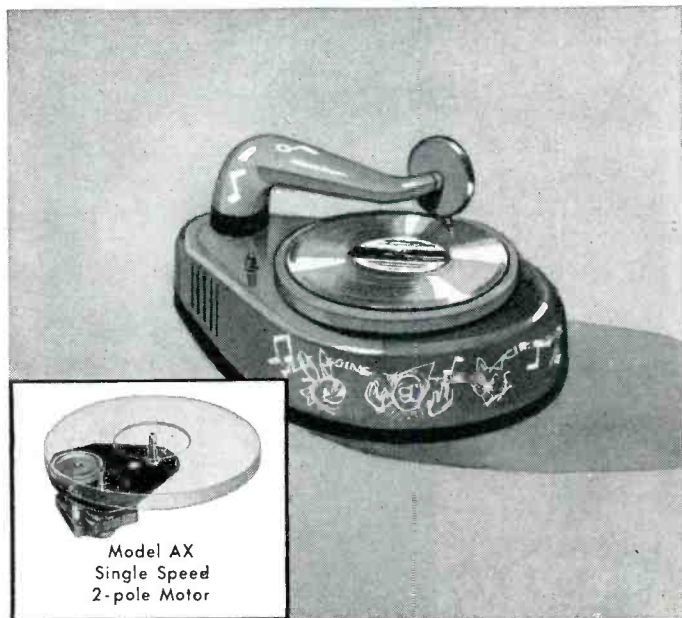

Model AX  
Single Speed  
2-pole Motor

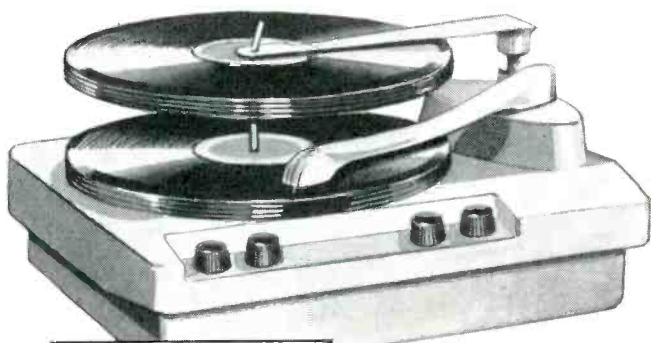

Models DDS  
3-speed, 4-pole motor

## ... ONLY **GI** Makes a Phonomotor for EVERY Application!..

World's only complete line . . . one convenient source for *every* phonomotor need — that's GI! No matter what the application: portables . . . Hi-Fi (2 and 4 pole motors) . . . combinations . . . record changers . . . tape and disc recorders . . . GI has the right motor for the job. First choice of leading original equipment manufac-

turers, first choice for replacement, GI motors through the years have won a reputation for quality and dependability that is unsurpassed anywhere. Write today for a complete catalog giving descriptions and specifications of phonomotors in the famous GI "Smooth Power" Line.



Model DR  
2-speed,  
4-pole motor



Model LC  
Single-speed,  
2-pole motor



Model RM4  
Single speed,  
4-pole motor



Model D-10 — 4-pole,  
shaded pole AC Induction  
type for tape,  
wire or disc recorders.



THE GENERAL INDUSTRIES CO.

DEPARTMENT GA • ELYRIA, OHIO

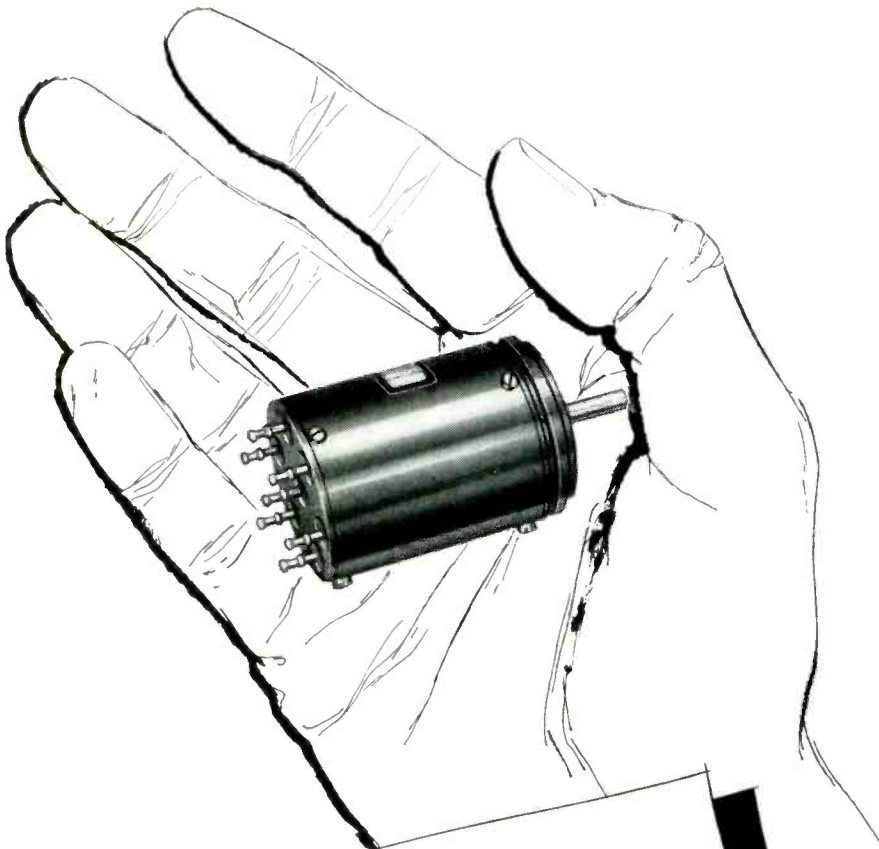

Here is the new  
**GAMEWELL**  
 Miniature Sine-Cosine Potentiometer

This miniature version of the conventional RL-11 and RL-14 sinusoidal potentiometers is 1 1/16" diameter x 1 7/16" long.

Functions of this new Gamewell Precision Potentiometer are accurately and smoothly developed. Four brush contacts move over a uniformly wound rectangular card and pick off output voltages that are proportional to the sine and cosine of the input angle at speeds up to 60 RPM. Standard resistance value is 18K, but resistance from 4K to 25K can be supplied. Accuracy at higher values is ±1%. Power rating: 1 watt ±40°C.

**THE GAMEWELL COMPANY**  
 NEWTON UPPER FALLS 64, MASS.  
 In Canada: Northern Electric Co., Ltd.



For information about this new sine-cosine Gamewell Potentiometer, write today.

**PRECISION POTENTIOMETERS**

Manufacturers of Precision Electrical Equipment Since 1855

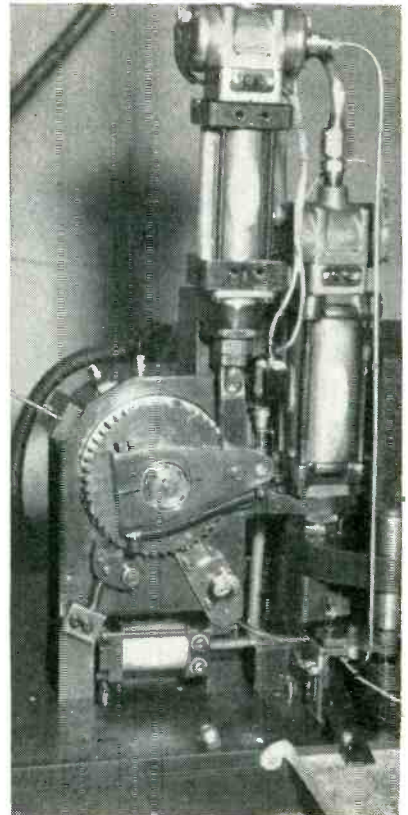

Air motors (with built-in valves) are mounted vertically at top of machine. One indexes the selector ratchet wheel and the other performs the cutting, staking and forming operations. The five small air cylinders transfer and hold the tiny parts

into the conveyor chute. All operations are triggered by eight Micro-Switches operated by eight cams on a time cyeler.

Previously the wires were purchased preformed and assembled by girls using tweezers. The automatic method has jumped output from 3,000 to 10,000 units per day. In addition, worthwhile increases in uniformity have been realized.

### Overhead Conveyor for TV Uses Color-Coded Carriers

COLOR CODING of carriers on the overhead conveyor system in Sylvania's Batavia, N. Y. plant makes it possible to manufacture four different television receiver models simultaneously on four independent production lines. The huge overhead trolley conveyor system was designed and installed by Lamson Corp., Syracuse, N. Y.





Figure 1 illustrates the material-handling setup that serves the two-story manufacturing plant. The



a  
***natfab***  
**First**

**SILICON SOLAR BATTERY\***  
Type S1 Single Cell

\*Licensed by  
Western Electric Co., Inc.

-  Hermetically sealed, weather-proof
-  Compact, 1-3/8" O.D. by 3/16" thick
-  Designed for single cell or bank operation
-  Temperature stability
-  Available for prompt delivery

A lifetime silicon junction solar energy converter with countless applications. Complete characteristics and technical information available on request.

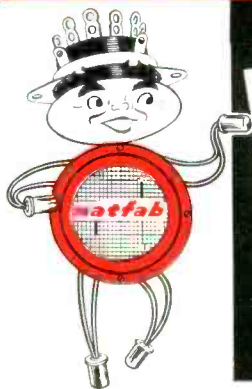

Write for  
Prices  
and  
Quantity  
Delivery!

***natfab***

**NATIONAL FABRICATED PRODUCTS, INC.**  
2650 West Belden Avenue • Chicago 47, Illinois • Phone Dickens 2-2650

**NEED SILICON  
JUNCTION DIODES?**

Wille Semiconductor Division  
**NATIONAL SEMICONDUCTOR PRODUCTS**  
930 Pitner Avenue • Evanston, Illinois

**NEW UNION**

# SELENIUM POWER RECTIFIERS

feature "Solid Stack" assembly

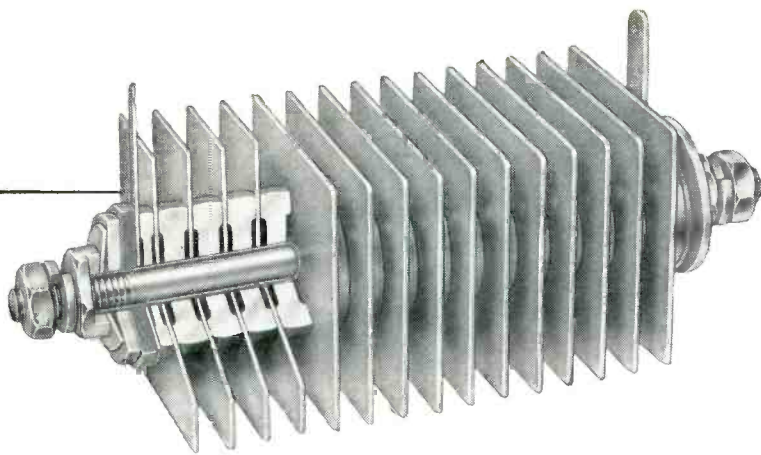

An outstanding feature of the new line of UNION Selenium Power Rectifiers, as shown in this cutaway view, is the "solid stack" assembly. All parts are under constant pressure exerted by Belleville springs at the ends of the stack. Spacer washers are larger than those commonly used and are finished flat to close tolerances to assure high pressure contact. This feature provides utmost rigidity and far more resistance to vibration. It eliminates radial movement and prevents breaks in the paint seal.

The selenium cells are made by a special, carefully-controlled process which assures uniform high quality and better performance. Corners are rounded instead of sharp for safety and to assure an unbroken protective coating. Connectors are made of brass or bronze for long service life.

**SIZES AND RATINGS** — The standard line of UNION selenium rectifier cells ranges in physical size from 1" square to 5" x 6". With convection cooling they are rated from .180 to 10.0 amperes per cell on a single phase fullwave bridge basis. A plurality of cells can be "stacked" in series, parallel or series-parallel combinations to fit practically any current and voltage conversion requirement. The stack assemblies conform to NEMA specifications.

The result of more than 30 years experience, UNION Rectifiers will give years of lasting service in many applications. Write or call any of our distributors listed below for complete information.

VISIT BOOTHS 262-263 at the  
**WESCON SHOW**  
August 24-26, San Francisco, Calif.

GENERAL APPARATUS SALES

## UNION SWITCH & SIGNAL

DIVISION OF WESTINGHOUSE AIR BRAKE COMPANY

PITTSBURGH 18  PENNSYLVANIA

NEW YORK, IVanhoe 3-2424 (Hempstead)

BALTIMORE, VAley 5-3431

ST. LOUIS, JEFFerson 5-7300

CHICAGO, LONgbeach 1-3042

LONDON, OHIO, LONdon 1555

LOS ANGELES, CLinton 6-2255

first of the three overhead conveyors loops around through the tuner assembly and subassembly area (which assembles yokes, power units and rectifier units), picking up completed units for distribution to the chassis-build lines. The flat-bottom carriers, mounted on the conveyor chain at 2-foot centers, have a gross weight capacity of 30 lb each and travel 16 fpm. The 804-foot conveyor dips down at four loading stations in the subassembly

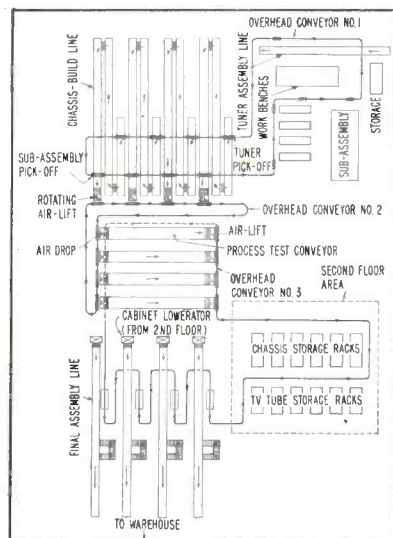

FIG. 1—Floor layout of tv assembly lines and overhead conveyors

area and at two stations in the tuner assembly area, bringing the carrier down to a 4-foot elevation to facilitate loading from the subassembly lines.

Since each of the four main assembly lines usually works on a different model, a color-coding system was devised to make certain that components are routed and taken off at the proper place. Line 1 is designated by brown, 2 by red, 3 by orange and 4 by yellow. Each carrier on the overhead conveyors is marked with one of these colors.

Thus, components that are destined for a model being assembled on line 1 are loaded only onto brown carriers. On the receiving end, the workers on line 1 will pick off from the overhead conveyor only those components on the brown carriers and ignore the rest. The color coding system is in effect in all production sections, from subassembly right through to final assembly. It assures a smooth, uninterrupted flow of components to all work areas

Does a  
**Billion Operations**  
 - with no maintenance -

interest **YOU?**

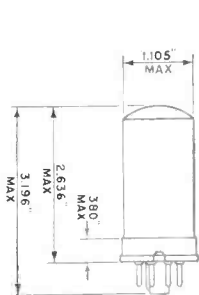

Type HG Relay

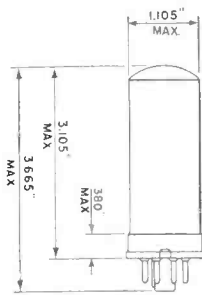

Type HGP Relay

**New CLARE Mercury-Wetted Contact Relays meet ALL requirements of today's high-speed switching devices**

• If you design high speed switching machines or devices which demand accuracy and dependability of the highest order, you should know ALL about the new CLARE Mercury-Wetted Contact Relays.

CLARE Type HG and HGP Relays offer a combination of high speed, high current- and voltage-handling capacity, and extraordinary uniformity of performance over very long periods.

The relays consist of a magnetic switch, hermetically sealed in a high pressure hydrogen atmosphere in a glass capsule, and a coil, enclosed in a steel vacuum-tube-type envelope which has a standard medium-sized octal base. Platinum contact surfaces are continually wetted with mercury by means of a capillary connection to a mercury reservoir below the contacts. Type HGP Relays can be factory-adjusted to provide either biased or polarized operating characteristics.

*For complete information on the new CLARE Type HG and HGP Mercury-Wetted Contact Relays, contact your nearest CLARE representative or address C. P. Clare & Co., 3101 Pratt Blvd., Chicago 45, Illinois.*

Send for CLARE Sales Engineering Bulletin No.120

**CLARE  
 RELAYS**

**FIRST  
 in the  
 industrial  
 field**

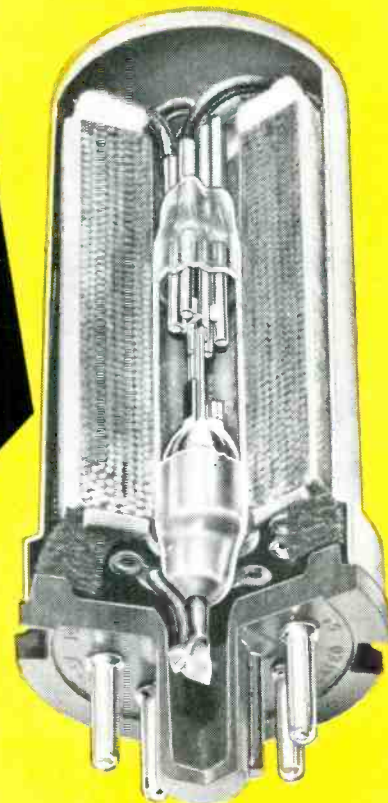

• Cutaway view of HG Relay showing how wick action keeps the mercury at the contacting surfaces continuously replenished.

**CLARE Type HG and HGP Relays are built to meet the exacting requirements for—**

Computing machines	Servo-mechanisms
Sorting machines	Relay amplifiers
Tabulating machines	High-speed keying relays
Totalizers	Signaling devices
All kinds of high-speed switching devices	

**Outstanding features of CLARE Type HG and HGP Relays**

### **ELECTRICAL FEATURES**

**LONG LIFE:** Conservative life expectancy of over a billion operations when operated within ratings.

**HIGH SPEED:** Give consistent performance at speeds up to 60 operations per second.

**HIGH CURRENT**—and voltage-handling capacity (up to 5 amperes, and up to 500 volts).

**UNIFORMITY:** Operating time varies by only about 0.1 millisecond under constant drive conditions.

**NO CONTACT BOUNCE**

### **MECHANICAL FEATURES**

- Small chassis space required
- Convenient plug-in mounting
- Environment-free
- Tamperproof
- High sensitivity
- Maintenance-free
- No contact wear
- Adjustment cannot change

**VERSATILE  
and  
ENDURING!**

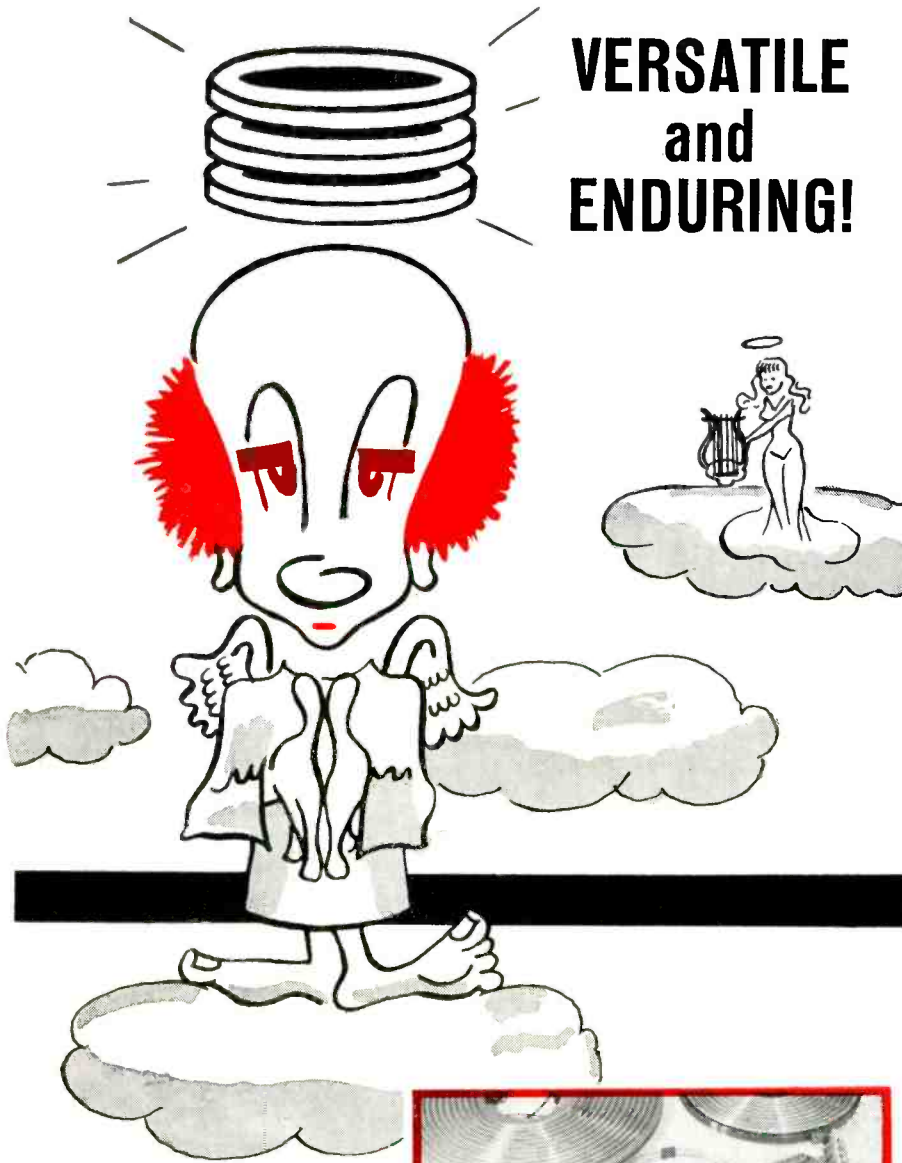

**FOR SLIP RING ASSEMBLIES  
TO LAST A LIFETIME OR  
LONGER . . . CALL PMI**

Our slip ring (collector ring) know-how is adaptable to your problem. Your need for high speed, RF, strain gauge or other slip ring assemblies will be given special attention by our design engineers. Send the details and we will develop and quote on your requirement . . . from sub miniatures to 8 ft. complete installations.



Many of our custom manufactured slip rings, brush blocks, gears, connectors, etc., are adaptable to other slip ring problems at a minimum cost.



**P M INDUSTRIES, INC.**  
270 FAIRFIELD AVENUE  
STAMFORD, CONNECTICUT

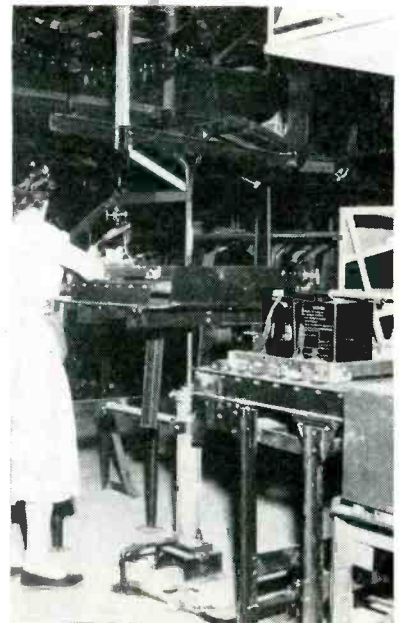

Rotating air lift at end of chassis assembly line raises chassis to level of carrier on overhead conveyor and rotates it 180 degrees so tuning controls cannot bump frame of carrier

in spite of the complexities of supplying four independent assembly lines.

Usually two or three units are placed on the same carrier to enable the take-off operator to build up a small bank of tuners and subassemblies. The overhead conveyor is operated at about double the speed required to satisfy the chassis-build lines, so in case the operator lets a carrier go by, another carrier with her color code will be along in a few minutes.

When the completed chassis reaches the end of the chassis-build conveyor, the operator transfers the chassis to a carrier on the second overhead conveyor, using a roller-bed air lift specially designed by Lamson for the purpose. As the overhead carriers (which also have roller beds) come by the transfer point, they descend onto a short run of parallel rails, which keep the carrier moving level and prevent sway as the operator pushes the chassis onto the carrier.

The carriers approach the operator from the front to aid her in making the transfer. As the air lift rises, it is rotated 180 degrees, so that the chassis rides with tuning controls facing the front of the carrier. This prevents damaging the controls during the loading and un-

# Q Meter Inductors for measurements up to 260 mc!

**INDUCTORS Type 590-A—  
accessories to Q Meter Type 190-A**

TYPE 590-A INDUCTORS					
Type	Inductance $\mu$ h	Capacitance $\mu$ pf	Approximate Resonant Freq. mc	Approximate Q	Approximate Distributed C $\mu$ pf
590-A1	0.05	8.0 — 95.0	70 — 230	320	1.5
590-A2	0.1	10 — 100	50 — 160	350	1.8
590-A3	0.25	8.0 — 80.0	30 — 100	310	2.3
590-A4	0.5	7.5 — 80.0	25 — 70	340	2.4
590-A5	1.0	7.5 — 65.0	20 — 50	300	2.9
590-A6	2.5	9.0 — 25.0	20 — 30	300	2.9

PRICE: \$10.00 each F.O.B. BOONTON, N. J.

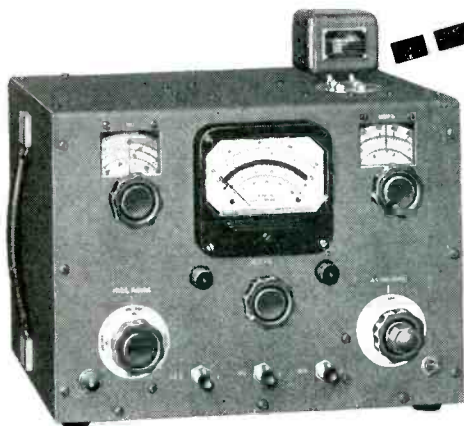
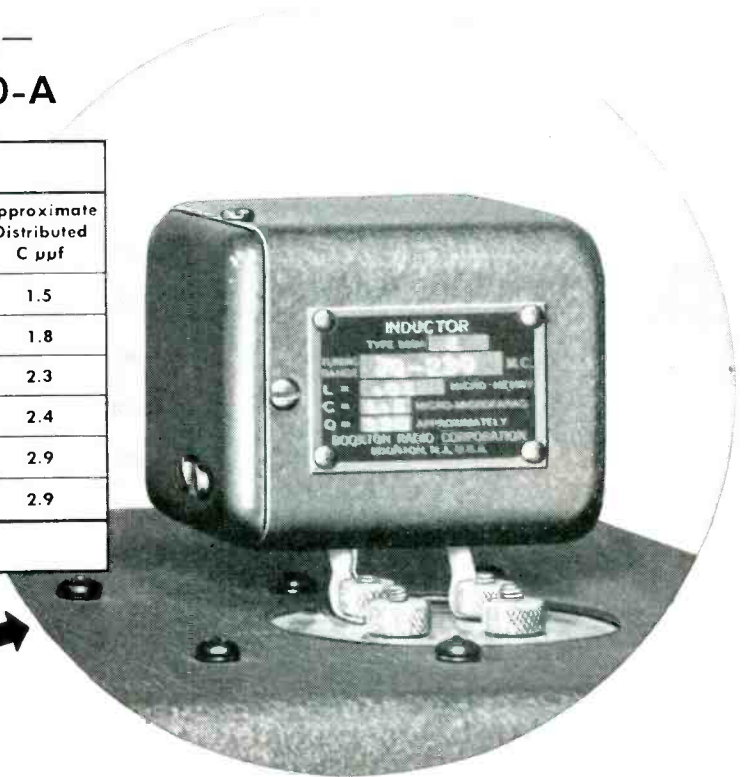

## Q METER Type 190-A

This new 190-A Q Meter measures an essential figure of merit of fundamental components to better overall accuracy than has been previously possible. The VTVM, which measures the Q voltage at resonance, has a higher impedance. Loading of the test component by the Q Meter and the minimum capacitance and inductance have been kept very low.

### SPECIFICATIONS—TYPE 190-A

**FREQUENCY RANGE:** 20 mc. to 260 mc.

**RANGE OF Q MEASUREMENT:**

Q indicating voltmeter	50 to 400
Low Q scale	10 to 100
Multiply Q scale	0.5 to 3.0
Differential Q scale	0 to 100
Total Q indicating range	5 to 1200

**PERFORMANCE CHARACTERISTICS OF INTERNAL RESONATING**

**CAPACITANCE:** Range—7.5 mmfd. to 100 mmfd. (direct reading).

**POWER SUPPLY:** 90-130 volts — 60 cps (internally regulated).

Type 190-A Price: \$625.00 F.O.B. Factory

Inductors Type 590-A are designed specifically for use in the Q Circuit of the Q Meters Type 170-A and 190-A for measuring the radio-frequency characteristics of condensers, resistors, and insulating materials. They have general usefulness as reference coils and may also be used for periodic checks to indicate any considerable change in the performance of the Q Meters.

Each inductor Type 590-A consists of a high Q coil mounted in a shield and is provided with spade lugs for connection to the coil terminals of the Q Meters. The shield is connected to the lugs which connect to the Low Coil terminal in order to minimize any changes in characteristics caused by stray coupling to elements or to ground.

**BOONTON RADIO**

BOONTON · N. J. · U. S. A.

*Corporation*



# Condense and Save!

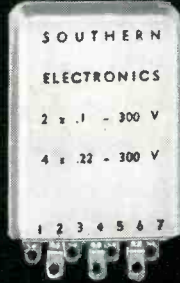

*plastic condenser block capacitors save you Space, Labor, Money!*

Multiple capacitors in one block! Now you can install one capacitor case and use 125% less space as before —at a saving in labor costs of up to 300%.

Available with polystyrene or MYLAR\* dielectric to tolerances as close as 1%.

**NOW!**

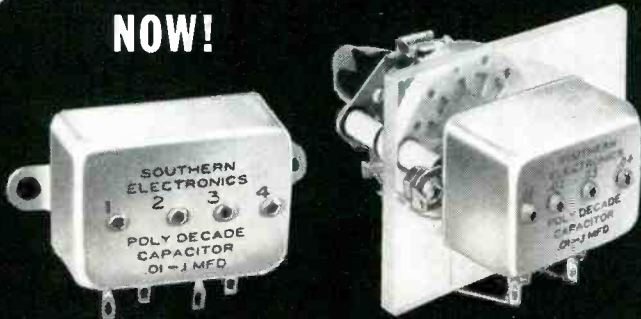

## Precision Decade Capacitors

*with attached rotary switch or completely boxed.*

**CAPACITANCE**  
... FROM .001  
TO 10 M F D

**CHECK THESE OUTSTANDING FEATURES:**

- STANDARD VOLTAGE RATING . . . 200 V. D. C.
- VERY HIGH INSULATION RESISTANCE
- LOW DISSIPATION FACTOR
- LOW DIELECTRIC ABSORPTION
- SMALL SIZES

Available with polystyrene or MYLAR\* dielectric to tolerances as low as 1%.

\*DuPont T.M.

Join America's leading electronic equipment manufacturers in specifying Southern Electronics' precision polystyrene capacitors for your most exacting requirements. Write for complete catalog today!

### SOUTHERN ELECTRONICS



*Corporation*

239 West Orange Grove Ave., Burbank, Calif.

Visit us in Booth #333 Wescon Show Aug. 24-26 San Francisco

loading of the chassis.

As the chassis comes by the head of the test line on the overhead conveyor, the operator removes those units color-coded for his line, using an air drop similar to the lift used for loading the carriers in the chassis-build section.

When the chassis reaches the end of the process test line, the last operator uses an air lift to place the inspected set on a carrier of the third overhead conveyor system, which passes across the end of the four test lines. This conveyor, about 1,200 ft long, has the dual job of delivering inspected chassis to the second-floor storage area and of supplying units and tubes from the storage area to the final assembly section on the first floor.

When the conveyor reaches the second floor, which is primarily a huge storage area where chassis, picture tubes and cabinets are kept until needed for final assembly, it moves along the perimeter of a rectangular chassis-storage area. The inspected chassis are stored on roller conveyor racks 3 tiers high, totalling about 4,150 feet in length. The racks slope 3 inch per linear foot.

As the chassis arrive from the process test line, they are removed from the carriers and slid onto the storage racks where they remain un-

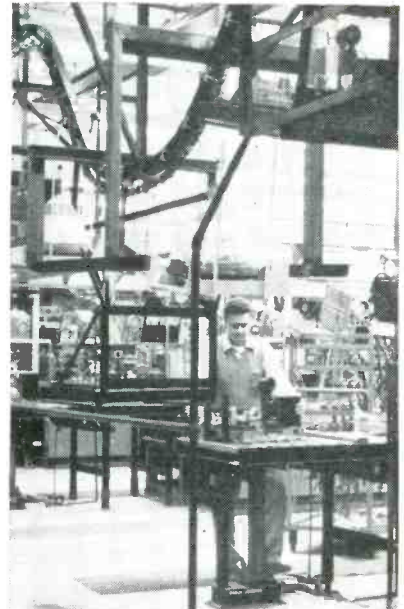

Air lift at end of belt conveyor on tv test line, from which sets are taken to storage area on floor above. Air lift is operated by foot pedal

**KOCH**...World's largest fabricator of moulded Fiberglas products

PRONOUNCED "KOKHE"



## What's going on here?

What's going on here is that carrying cases containing valuable equipment are being shipped without crating or exterior protection of any kind. And cases and contents will arrive undamaged. Thousands upon thousands of actual case histories prove it.

These are Koch Fibreglas carrying cases, the newest and most effective way to protect valuable equipment from damage in shipping, handling and storage.

The Koch Fibreglas case will not dent. It will not corrode. Cushioning material inside the case is moulded to fit perfectly the contours of the equipment, giving maximum protection against vibration and shock.

The Koch case is absolutely airtight, and under

severe tests has maintained a vapor and moisture transmission rate of zero. Equipment is safeguarded from fungus and mildew.

Sixty thousand Koch Fibreglas cases are now in service with the U. S. Air Force and BuAer all over the world. To date there has not been a single casualty to a case or the equipment it contains.

If you manufacture a product that needs this kind of protection, we will be glad to place our knowledge and experience at your disposal. Address Dept. EKB.



**KOCH FIBERGLAS**

*Pioneer in reusable Fibreglas containers*

CORTE MADERA, CALIFORNIA

# QUALITY ASSURED

— through the miracle of  
SPECTROCHEMISTRY



## WILBUR B. DRIVER ALLOYS

- TOPHET A®  
Nickel Chrome
- TOPHET C®  
Nickel Chrome Iron
- EVANOHM®  
Nickel Chrome
- RODAR®  
Nickel, Cobalt, Iron
- CUPRON®  
Copper Nickel
- MANGANIN
- BALCO®  
Nickel Iron
- PURE NICKEL
- FILAMENT WIRE
- GRID WIRE
- CARBONIZED NICKEL
- BERALOY A®  
Beryllium Copper
- STAINLESS STEEL
- MONEL
- COBENIUM®

SPECIFY  ELECTRICAL,  
ELECTRONIC AND MECHANICAL ALLOYS  
IN WIRE, ROD, RIBBON OR STRIP —

A fully equipped Spectrochemical laboratory is the latest addition to the scientific controls used by Wilbur B. Driver to insure quality. Quality checks are now made faster, and with even greater accuracy. The skill and experience of over a quarter century of specialized manufacture is available for the solution of problems involving special alloys.

Visit Booth 1605, Western  
Electronic Show & Convention,  
August 24, 25 and 26, San Francisco

For Over a  
Quarter Century  
Manufacturers  
of Dependable



**WILBUR B. DRIVER CO.**  
McCARTER HWY., NEWARK, NEW JERSEY  
ELECTRICAL, ELECTRONIC, CHEMICAL and MECHANICAL ALLOYS

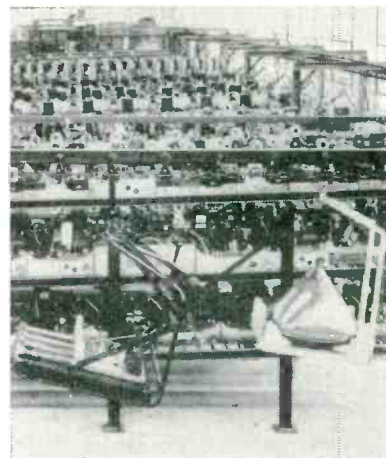

Chassis storage racks

til a production run is scheduled for models calling for that particular type of chassis. Each tier of storage rack has a pair of guide rails at the loading end to facilitate loading and a chassis stop at the unloading end, consisting of a single roll mounted about 1½ inches above the others.

Adjacent to the chassis-storage racks is a picture-tube storage area. When units are drawn from storage for final assembly, the chassis and matching picture tubes are placed on adjacent carriers on the overhead conveyor for transfer to final assembly.

With the overhead lines, little banking and storage is done because these lines serve that function whenever necessary, in addition to their transport function. Units are placed on or removed from the overhead conveyors by persons who have a direct function in assembly work as well. This is made possible because the overhead lines arrive at the points on the production line where the units are actually used and can be absorbed into the production stream with little or no intermediate storage.

### Lint Control Program Reduces Tube Rejects

CONTROL of lint and dust in the manufacture of high-reliability miniature and subminiature tubes at the General Electric receiving-tube plant in Owensboro, Ky. has reduced tube rejects due to lint, dust and dirt. Tube inoperatives, mainly due to intermittent shorts caused by lint and dust, now are one-third





On the ocean floor...life begins at 5000 hours

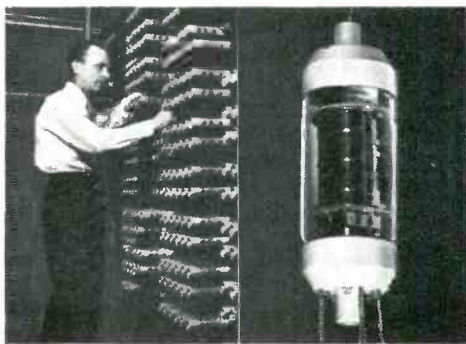

Electron tubes (right) for the Transatlantic Telephone Cable between Newfoundland and the British Isles are being handmade at Bell Laboratories. Life test bank is shown left. The cable system, which can carry 36 simultaneous conversations, is a joint enterprise of the American Telephone and Telegraph Company, the British Post Office and the Canadian Overseas Telecommunications Corporation.

When the world's first transoceanic telephone cable is laid across the Atlantic it will contain hundreds of electron tubes needed to amplify voices. Deep on the ocean floor these tubes must keep on working, year after year, far beyond reach of ordinary repair services.

Bell Telephone Laboratories scientists have developed a tube of unique endurance. Before a tube is even considered for use in the cable it is operated for 5000 hours under full voltage—more than the entire life of many tubes.

But survival alone is not enough. During the test each tube is exhaustively studied for behavior that may foreshadow trouble years later. Tubes that show even a hint of weakness are discarded. For the good ones, a life of many years can be safely predicted.

Bell Telephone Laboratories scientists began their quest for this ocean-floor tube many years ago. Now it is ready—another example of the foresightedness in research that helps keep the Bell Telephone System the world's best.

## BELL TELEPHONE LABORATORIES

*Improving telephone service for America provides careers  
for creative men in scientific and technical fields*



Want more information? Use post card on last page.

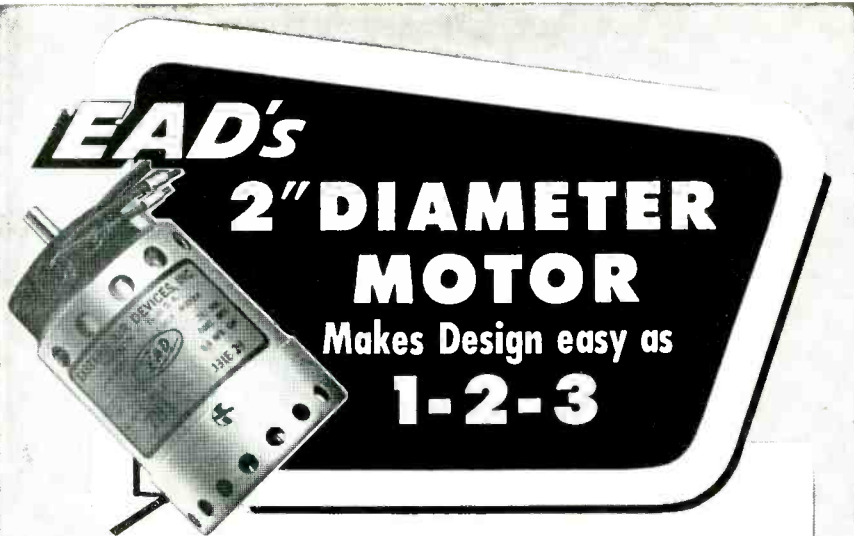

# EAD's 2" DIAMETER MOTOR

Makes Design easy as  
**1-2-3**

- 1** one basic design
- 2** only 2" in diameter
- 3** three frequencies...60, 400 and variable

Here is one basic motor design incorporating the top-quality engineering that's "standard" at EAD . . . and capable of modifications for an unusually broad field of applications. You can order this 2" diameter motor (maximum weight is only 17 ounces) as an induction motor or a hysteresis-synchronous motor. It meets applicable MIL specifications and is available with Class "H" insulation for long life, high temperature operation. Just one more example of how EAD engineering meets the most exacting requirements for rotating electrical equipment.

**INDUCTION MOTOR:** For blowers, fans, automatic devices, business machines, control equipment, antenna drives, etc.

	HP	RPM	AMPS	MODEL
60 cycle, 115 volts	1/100	3,000	0.30	P52QDU
400 cycle 115 volts	1/100	7,200	0.30	P52QFU
	1/30	6,200	0.80	P52LFU
	1/50	22,000	0.75	P50NDU
320-1200 cycle	1/300	4,500 av.	0.60	P52UFU
variable frequency	1/50	4,000	0.80	P52NEU

**HYSTERESIS-SYNCHRONOUS:** For timing devices; stroboscopic work; wherever load inertia is a problem (i.e. recorders, turntables, facsimile equipment, etc.)

	HP	RPM	AMPS	MODEL
60 cycle, 115 volts	1/200	3,600	0.26	P52SRU

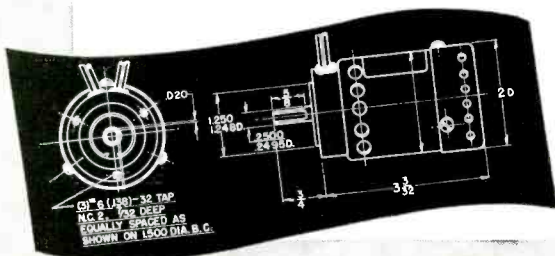

Complete information on EAD's line of small motors and engineering - design service will be sent on request.

## EASTERN AIR DEVICES, INC.

SOLVING SPECIAL PROBLEMS IS ROUTINE AT EAD

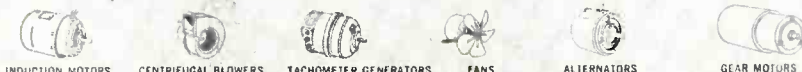

387 CENTRAL AVENUE • DOVER, NEW HAMPSHIRE



Plant visitors must don one of the white lintless coats kept in a locker in air lock. Supervisor at right wears white nylon or dacron shirt and blue dacron trousers



Floors are cleaned alternately with chemically treated cloth, as shown, and with industrial vacuum cleaners continuously throughout working day

of what they were before the Snow-White program started.

Some 750 employees in white lintless uniforms of nylon and dacron assemble these tubes under glass hoods in a glistening white factory pressurized by filtered air.

Air locks approximately 15 feet long and 12 feet wide are installed at the entrances to the 30,000-square-foot assembly area. This area is pressurized with filtered air - 70,000 cfm being pumped into the area and 40,000 cfm taken out through a system of ducts. The difference of 30,000 cfm escapes and effectively dust-seals the air locks

**DEPENDABLE!**

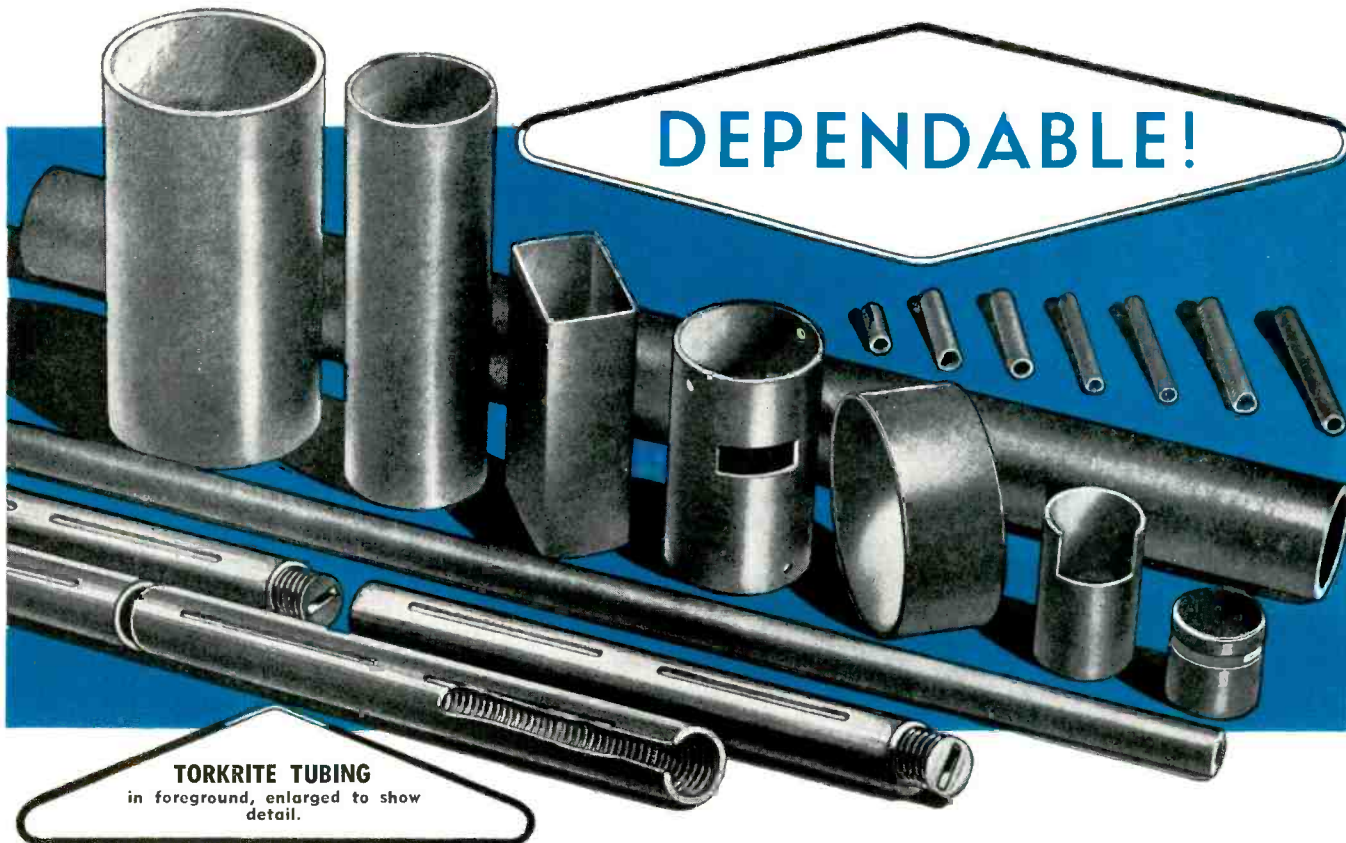

**TORKRITE TUBING**  
in foreground, enlarged to show detail.



**DO YOU HAVE TORQUE PROBLEMS?**

More and more electronic engineers are specifying this newly designed, internally threaded, embossed tubing.

Torkrite permits use of lower torque as it is completely free of stripping pressure.

With Torkrite, torque does not increase after winding. The heavier wall acts to prevent collapse and core bind.

Investigate this outstanding coil form!



Write for your copy of the latest Clevelite brochure.



**CLEVELITE\***  
LAMINATED PAPER BASE PHENOLIC TUBING

is dependable because of its better quality . . . proven performance . . . high insulation . . . uniformity . . . inherent ability to hold close tolerances.

Also, prompt service and dependable deliveries!

These many advantages assure you of greater economy.

WHY PAY MORE? For Good Quality . . . call CLEVELAND!

\*Reg. U.S. Pat. Off.

**THE CLEVELAND CONTAINER COMPANY**  
6201 BARBERTON AVE. CLEVELAND 2, OHIO  
PLANTS AND SALES OFFICES:  
CHICAGO • DETROIT • MEMPHIS • PLYMOUTH, WIS. • OGDENSBURG, N.Y. • JAMESBURG, N.J. • LOS ANGELES  
ABRASIVE DIVISION of CLEVELAND, OHIO  
Cleveland Container Canada, Ltd., Prescott and Toronto, Ont.

**Representatives:**  
NEW YORK AREA: R. T. MURRAY, 604 CENTRAL AVE., EAST ORANGE, N. J.  
NEW ENGLAND: R. S. PETTIGREW & CO., 62 LA SALLE RD., WEST HARTFORD, CONN.  
CHICAGO AREA: PLASTIC TUBING SALES, 5215 N. RAVENSWOOD AVE., CHICAGO  
WEST COAST: IRV. M. COCHRANE CO., 408 S. ALVARADO ST., LOS ANGELES

# REPORTS FROM THE STRATOSPHERE

with  
**Vitramon<sup>®</sup>**  
Capacitors

Almost with the first "whoosh", we groundlings must depend on instruments for guiding and reporting. Here, where only the best of electronic equipment is good enough, RAYMOND ROSEN ENGINEERING PRODUCTS, Inc., specifies Vitramon Capacitors . . . specifies them because *only* Vitramon Capacitors are:

- STABLE
- RUGGED
- LOW LOSS
- LOW NOISE
- MINIATURE
- VAPORPROOF
- WIDE TEMPERATURE RANGE

NOW — Vitramon's New Design adds two additional "plus" values

- Unitized electrode lead construction.
- Complete insulation.

This new series, too, is available in values from 0.5 to 6800  $\mu\text{f}$ . Catalog 55-1 tells the whole story. It's yours for the asking.

CY22C  
500 VDC

**Vitramon**  
INCORPORATED

P. O. Box 544E Bridgeport 1, Connecticut  
Visit Us in Booth 206 at 1955 Wescon Show

and any possible cracks or other openings.

Each person entering receives a mild vacuum cleaning as he or she walks over a floor grating through which air is exhausted. The grating covers the entire width of the door leading into the work area.

To reduce traffic, messengers leave all mail in a rack in the air lock. The mail is then picked up by a Snow-White employee.

Operators are pleased with the special lint-free uniforms which are now required. The women have 12 styles of white nylon and dacron uniforms to choose from. The company issued cash-value certificates to each operator which covered the major part of the cost of two uniforms. Local merchants were given advance notice of the changeover so they would be prepared to fill the demand for special dresses.

Male supervisors wear a uniform consisting of white dacron or nylon shirt and blue dacron pants. The shirt is short-sleeved with a sport-shirt neck. Ties of nylon or dacron are optional. They also wear nylon socks and some wear nylon or dacron belts.

Personnel from other buildings wishing to enter the area must don white lintless coats kept in the air lock.

Maintenance men alternately clean the entire floor with industrial-type vacuum cleaners and with chemically treated cloths. At any time of the day, the floors could pass a white-glove inspection.

Each operator cleans her own work station thoroughly twice



Assembling tube cages under protective hood. Rubber cots worn on fingers are changed every hour. Rubber conveyor belt under hands of operator moves mount along under hood to next operator on the assembly line

# HUGHES

SILICON JUNCTION

# DIODES



Dimensions are maximum for standard Hughes Silicon Junction Diodes.

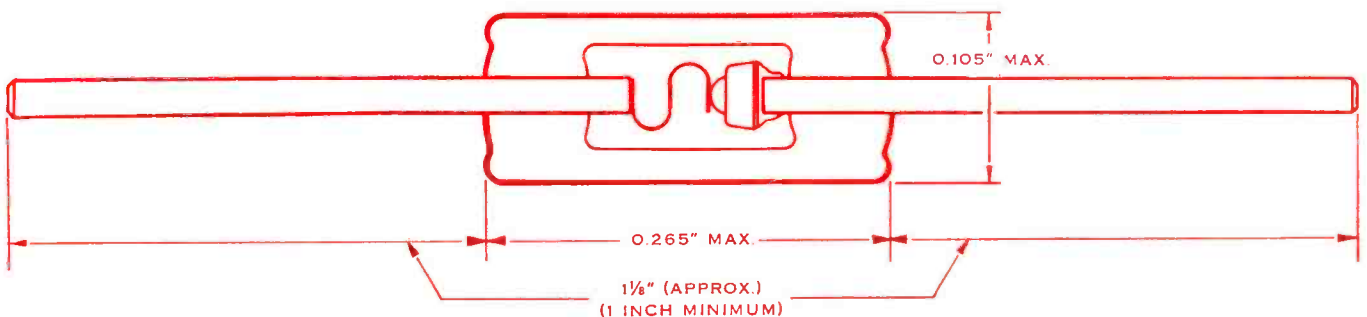

*High  
Temperature Operation\**

*Extremely High  
Back Resistance*

*Exceptionally Stable  
Characteristics*

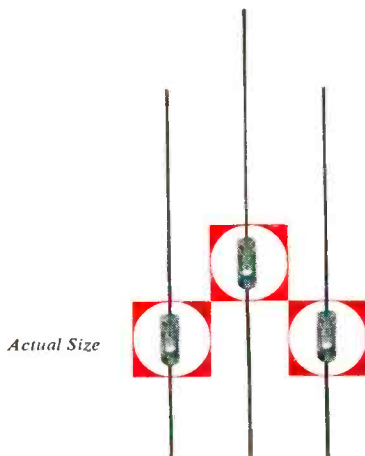

**FEATURES**—High temperature operation . . . *extremely* high back resistance . . . very sharp back voltage breakdown . . . one-piece, fusion-sealed glass body . . . axial leads for easy mounting . . . subminiature size . . . exceptionally stable characteristics.

**TESTED**—All Hughes Silicon Junction Diodes are subjected to rigorous testing procedures. Specific electrical characteristics are measured and, in addition, each diode is temperature-cycled twice in a moisture-saturated atmosphere. When specified, special tests are also performed.

**CONSTRUCTION**—Hughes Silicon Junction Diodes are packaged in the famous fusion-sealed glass body, developed at Hughes. This construction is impervious to moisture penetration—ensures electrical and mechanical stability, and freedom from contamination.

When high temperatures or high back resistance requirements call for silicon, be sure to specify *Hughes Silicon Junction Diodes*. They are first of all—for **RELIABILITY!**

Diode glass body is coated with opaque black enamel, color-coded on cathode end. Available now in nine types: HD6001, HD6002, HD6003, HD6005, HD6006, HD6007, HD6008, HD6009, HD6011. Ask for descriptive Bulletin SP-4.

*\*Characteristics  
rated at 25°C and  
at 150°C.  
Ambient operating range,  
-80°C to +200°C.*

**HUGHES**

Aircraft Company, Culver City, California

SEMICONDUCTOR DIVISION



New York Chicago  
Los Angeles

## 'Diamond H' Miniature, Hermetically Sealed, Aircraft Type Relays



Shown Actual Size

## HAVE A WIDER RANGE OF PERFORMANCE CHARACTERISTICS

**I**F YOU need a relay that will operate consistently under extremely critical or downright adverse conditions, there's an excellent possibility your requirements can be readily met by one of the multitude of variations possible with the basic "Diamond H" Series R relay. Originally designed to meet all requirements of USAF Spec. MIL-R-5757B, they far surpass many. They're adaptable to a wide variety of applications . . . guided missiles, jet aircraft, fire control and detection, radar, communications, high speed camera, geophysical and computer apparatus, for example.

### TYPICAL PERFORMANCE CHARACTERISTICS

<b>Vibration Resistance:</b>	10-55 cycles at 1/16" double amplitude 55-500 cycles at 15 "G" 55-1,000 cycles at 15 "G" 55-2,000 cycles at 10 "G"
<b>Temperature Range:</b>	-55° to + 85°C. -65° to + 125°C. -65° to + 200°C.
<b>Coils:</b>	Resistances—1 ohm to 50,000 ohms Arrangements—single coil; two independent coils, either or both of which will operate unit
<b>Insulation Resistance:</b>	1,000 megohms at room temperature 100 megohms at 200°C.
<b>Dielectric Strength:</b>	450 to 1,250 V., RMS
<b>Operating Time:</b>	24 V. models 10 ms. or less; dropout less than 3ms.
<b>Contacts:</b>	30V., D.C.; 115V., A.C.; 2, 5, 7½ and 10A., resistive; 2 and 5A. inductive. Minimum 100,000 cycles life. Low interelectrode capacitance — less than 5 mmf. contacts to case; less than 2½ mmf. between contacts. Special Ratings: to 350 V., D.C., 400 MA., or other combinations including very low volt- ages and amperages or amperages to 20.
<b>Operational Shock Resistance:</b>	30, 40 and 50 "G" plus
<b>Mechanical Shock Resistance:</b>	up to 1,000 "G"
<b>Mounting:</b>	9 standard arrangements to meet all needs — plus ceramic plug-in socket.
<b>Size:</b>	1.6 cu. in.
<b>Weight:</b>	4 oz. or less

Call on "Diamond H" engineers to work with you in developing a variation to meet your specific requirements.

**THE HART MANUFACTURING COMPANY**  
202 Bartholomew Avenue, Hartford, Connecticut

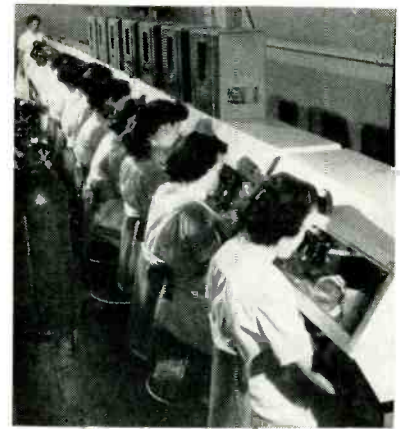

Welding line, with inspection stations in foreground. Eyepieces of binocular microscopes project up through holes cut in windows

daily. Every hour, operators replace the rubber cots they wear on all fingers to protect the tube mounts against moisture and other foreign substances.

Special protective hoods with large windows have been designed to cover all assembly mounts. Here the operator can use her hands with complete freedom.

Conveyors which move the tube mounts along the assembly line are constructed of rubber, which gives off no lint and can be easily cleaned.

All grid subassemblies are put through a special cleaning operation to free them of dirt, dust and lint. After the cleaning, the grids are rinsed once in distilled water and twice in methanol to dry the grids faster. Following the drying process in an electrically heated oven, the grid-filled trays are sorted, inspected



Inserting finished mount in coil for simultaneous demagnetizing and cleaning. Vacuum line is attached to other end of the coil

# These DRIVER-HARRIS alloys do most to improve the quality of

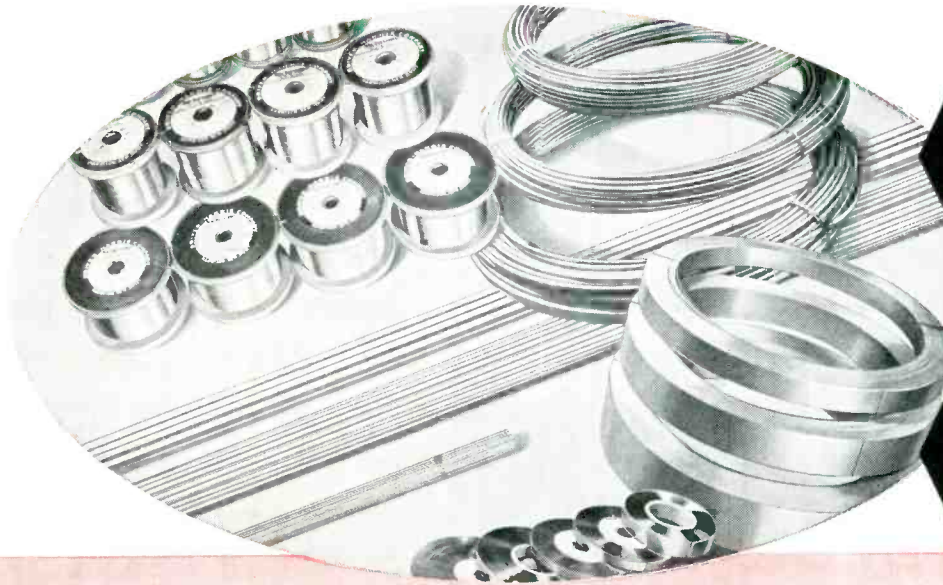

Your Resistors

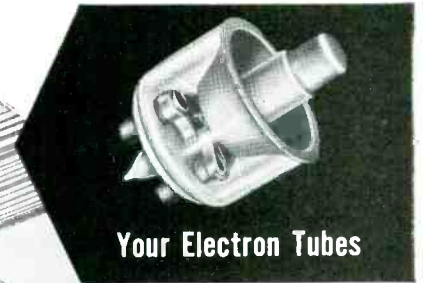

Your Electron Tubes



Your Glass-to-metal Seals

## DRIVER-HARRIS RESISTANCE WIRE ALLOYS

**NICHROME\* V** (Nickel-Chrome) Essential for resistor elements in the higher temperature applications such as electric furnaces, electric ranges, radiant heaters, etc.

**KARMA\*** (Nickel-Chrome-Aluminum-Iron) Permits the manufacture of miniaturized wire wound precision resistors of best temperature coefficient of resistance at low cost per ohm; also resistance standards.

**NICHROME\*** (Nickel-Chrome-Iron) The internationally accepted material for heating devices operating up to 1700°; also industrial applications for rheostats and resistance units.

**CHROMAX\*** (Nickel-Chrome-Iron) A lower cost alloy for electrical heating under conditions less critical than those satisfied by Nichrome.

**ADVANCE\*** (Copper-Nickel Series including MIDOHM\*, 95 ALLOY, LOHM\*, 30 ALLOY) Passes a number of properties which make them useful for winding heavy duty industrial rheostats, precision resistors, thermocouples, and thermocouple leads. Specific resistance range of this series is from 294 to 30 ohms/cm.

**MANGANIN** (Manganese Copper) Most stable resistance wire known at ambient temperature. Indispensable

for resistors used in many types of precision direct current apparatus such as Wheatstone Bridges, National Bureau of Standards type resistance standards, etc.

**HYTEMCO\*** (Nickel-Iron) Combines high temperature coefficient of resistance with high specific resistance; ideal for winding compensating or ballast resistors.

## DRIVER-HARRIS GLASS SEALING ALLOYS

**THERLO\*** (Nickel-Cobalt-Iron). For sealing glasses such as Corning 7052 and 7040.

**142 ALLOY** (Nickel-Iron). For sealing glasses such as Corning 776, also 8160.

**52 ALLOY** Contains 50% nickel. It provides a slightly higher coefficient of expansion than 142 Alloy and seals successfully with 0120 glass.

**146 ALLOY** Contains 46% nickel. It offers special expansion properties, permits seals with ceramic coated resistors.

## DRIVER-HARRIS ELECTRON TUBE ALLOYS

The Driver-Harris Company, since the inception of radio, has been making alloys for this field, supplying the industry with alloys for support wires, plates, grids, cathodes, and lead-throughs.

All Alloys are available in:

- WIRE (Sizes as fine as .0005)
- ROD
- REBBIION STRIP (Foil as thin as .00045)

Insulations:

- ENAMEL
- COTTON
- SILK
- NYLON
- GLASS
- FORMVAR

Singly or in combination

Every Driver-Harris alloy is made to the most precise metallurgical checks and controls known to the industry. And each of these highly specialized alloys is custom-made . . . produced exactly to the specifications of our customers.

Send us your specifications. If your needs are in any way unusual, and cannot be met by one of our current 112 alloys, our engineers will be happy to start tomorrow to devise a new one, custom-made for you. Just tell us exactly what you wish to accomplish.

\*T.M. Reg. U.S. Pat. Off.

Nichrome and Nichrome V are made only by



# Driver-Harris Company HARRISON, NEW JERSEY

BRANCHES: Chicago, Detroit, Cleveland, Louisville, Los Angeles, San Francisco  
In Canada: The B. GREENING WIRE COMPANY, Ltd., Hamilton, Ontario

MAKERS OF THE MOST COMPLETE LINE OF ELECTRIC HEATING, RESISTANCE, AND ELECTRONIC ALLOYS IN THE WORLD

# American Electric Model EPM-1123



## 400 Cycle Laboratory Power Supply

An Electroflow product.

This model, one of the many American Electric power supplies in production, is designed primarily for portable, laboratory quality, 400 cycle requirements. A 115/200 volt, 3 phase output of from 1/2 to 5 KVA capacity is available in various models with voltage regulation within  $\pm 1\%$  and with voltage adjustment of  $\pm 10\%$ . These units are powered from any 220/440 volt, 3 phase, 60 cycle supply.

**ALL CIRCUITS PROTECTED**

Input circuit is equipped with a 60 cycle circuit breaker and motor starter. Output circuit is protected against both current and voltage surges with a circuit breaker and over-voltage relay.

**METERING**

400 cycle instrumentation includes a voltmeter, ammeter, frequency meter and a selector switch by which each phase may be checked individually.

**COMPLETE INTEGRATION**

This rubber tired unit contains the complete system—American Electric Inductor-type Alternator (no wearing parts), electronic exciter and voltage regulator, complete instrumentation and two output connectors for multiple loads.

**MANY OTHER SIZES**

American Electric Power Supplies are available in many high cycle variations... from 1/2 to 75 KVA, fixed or variable frequency, portable or stationary designs.

**WHATEVER YOUR HIGH CYCLE POWER REQUIREMENTS**

There's an American Electric model for your immediate needs. Ask for details!

- Atlanta, Boston,
- Buffalo, Chicago,
- Dayton, Dallas,
- Kansas City (Mo.),
- Los Angeles, Minneapolis,
- Memphis, New Orleans,
- New York City, Rochester,
- San Francisco, Seattle,
- St. Louis, Syracuse,
- Silver Spring (Md.), Tampa,
- Montreal, Toronto.

**American Electric Motors, Inc.**  
Electric Machinery & Equipment Division of

**AMERICAN ELECTRONICS INC.**

2112 Chico Avenue, El Monte, Calif.

and then placed in glassine bags which are stapled shut to keep them lint and dust-free while being transported to the mount line.

Assembly under the lint-protecting glass hoods begins with cage assembly, where components are placed in precision-made jigs. After pin connections are welded, the mount is inspected under a 10-power binocular microscope for chipped micas, weld splashes, mechanical failures such as a break in the wire and for lint and dust.

In the final operations, the mount is placed in a coil which demagnetizes the metal parts while at the same time an air stream blows off any foreign particles which may have caught on the mount. The mount then receives a second complete microscope inspection before being inserted in its glass envelope.

### Numbered Clips Simplify Replacement of Parts

REPLACEMENT of transformers, relays, tube sockets and other multi-terminal components is simplified by attaching a numbered alligator clip to each lead as it is removed from the defective part. This technique is used in the Baltimore plant of The Glenn L. Martin Co. when reworking is indicated after inspection of assembled electronic control units for the Matador guided missile.

Using a terminal identification print for that component as a guide, the operator unsolders connections



Method of using numbered clips as guide for replacing hermetically sealed relay in control amplifier for Matador guided missile



# Using Ceramic Capacitors?

## Specify **RMC DISCAPS**

### Temperature Compensating



These DISCAPS meet all electrical specifications of the RTMA standard REC-107-A. Small size, lower self inductance and greater dielectric strength adapt them for VHF and UHF applications. Type C DISCAPS are rated at 1000 working volts providing a high safety factor. Available in six sizes in all required capacities and temperature coefficients.

### Heavy-Duty

RMC Type B "Heavy-Duty" DISCAPS are designed for all by-pass or filtering applications and meet or exceed the RTMA REC-107-A specifications for type Z5Z ceramic capacitors. Rated at 1000 V.D.C.W., Type B DISCAPS cost no more than lighter constructed units. Available in standard capacities between 470 MMF and 40,000 MMF.



### Type JL

Type JL DISCAPS afford exceptional stability over an extended temperature range. They are especially engineered for applications requiring a minimum capacity change as temperature varies between  $-60^{\circ}\text{C}$  and  $+110^{\circ}\text{C}$ . The maximum capacity change between these extremes is only  $\pm 7.5\%$  of capacity at  $25^{\circ}\text{C}$ .

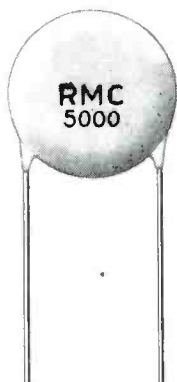

### Wedg-loc

The exclusive wedge design of the leads on these DISCAPS lock them in place on printed circuit assemblies prior to the soldering operation. "Wedg-Loc" DISCAPS are available in capacities between 2 MMF and 20,000 MMF in TC, by-pass and stable capacity types. Suggested hole size is an .062 square.

### High Voltage



Special high voltage DISCAPS are available in a wide range of capacities for color television and other electronic applications. RMC DISCAPS for deflection yokes insure the voltage safety factor required in this application. They are available in all capacities between 5 MMF and 330 MMF.

### Plug-in

RMC Plug-in DISCAPS will speed up production time in printed circuit operations. Leads are constructed of No. 20 tinned copper (.032 diameter) and are available up to  $1\frac{1}{2}$ " in length. Manufactured in TC, by-pass and stable capacity types, Plug-in DISCAPS have all the electrical and mechanical features of standard DISCAPS.



Write today on your company letterhead for expert engineering help on any capacitor problem.

DISCAP  
CERAMIC  
CAPACITORS

# RMC

**RADIO MATERIALS CORPORATION**  
GENERAL OFFICE: 3325 N. California Ave., Chicago 18, Ill.

**FACTORIES AT CHICAGO, ILL. AND ATTICA, IND.**  
Two RMC Plants Devoted Exclusively to Ceramic Capacitors

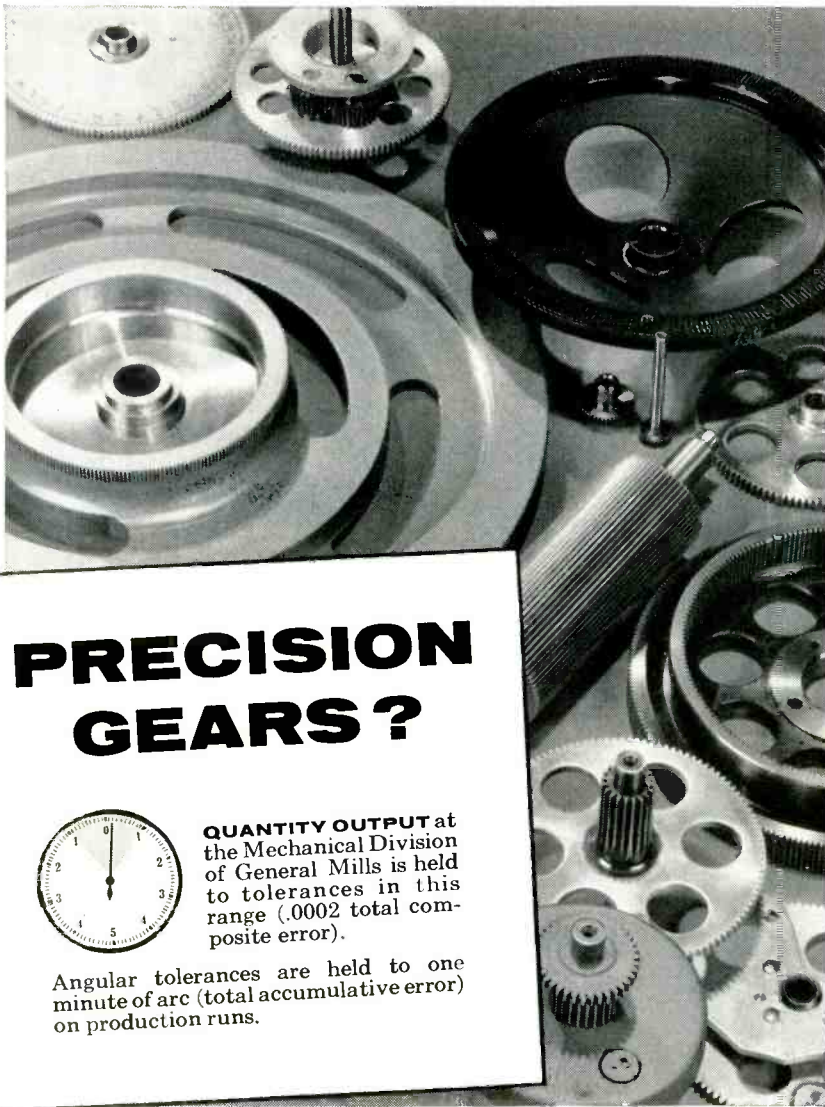

## PRECISION GEARS?



**QUANTITY OUTPUT** at the Mechanical Division of General Mills is held to tolerances in this range (.0002 total composite error).

Angular tolerances are held to one minute of arc (total accumulative error) on production runs.

Individual gears or complete assembled trains—General Mills can produce them for you with a precision that's unsurpassed anywhere. Many of our gear-making machines—hobbers, shapers, shavers, bevel gear generators—were specially built to our standards of precision or rebuilt by us to do finer work than the original designer visualized.

Special inspection devices, many of our own design, maintain precise standards on high-volume work. In addition, our gear assembly specialists are experienced in selecting and matching gears into trains with virtually imperceptible backlash.

*We'd like to quote on your special gear requirements. Write, wire or phone: Mechanical Division of General Mills, Dept. EL-3, 1620 Central Avenue, Minneapolis 13, Minn. GRanville 8811*

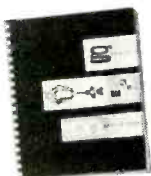

**ILLUSTRATED BOOKLET** gives full details of the facilities, personnel and experience available to you at the Mechanical Division of General Mills. Write for your free copy.

**MECHANICAL DIVISION OF General Mills, Inc.**

one by one and attaches to each a peewee alligator clip on which is the number called for on the print. These numbers are lettered on masking or adhesive tape tabs pressed on the sides of the clips.

After replacing the component, leads are connected one by one while using the treminal diagram as a guide. The numbered leads minimize chances for mistakes.

### Piercing With Squeeze Riveter

AN INGENIOUS attempt to break a production bottleneck produced for Martin a method less costly than the one it was to supplement. Facilities for drilling small holes in contoured sheet-metal parts of housings for airborne electronic equipment were overloaded.

Several surplus rivet squeezers were taken from storage and converted into piercing presses to provide extra capacity. The squeezers were provided with base plates for mounting them vertically on a table, then equipped with anvils and pierce punches. They are used with standard drill templates without drill bushings.

The higher speed of piercing as compared to drilling reduced production costs and a burring operation was eliminated.

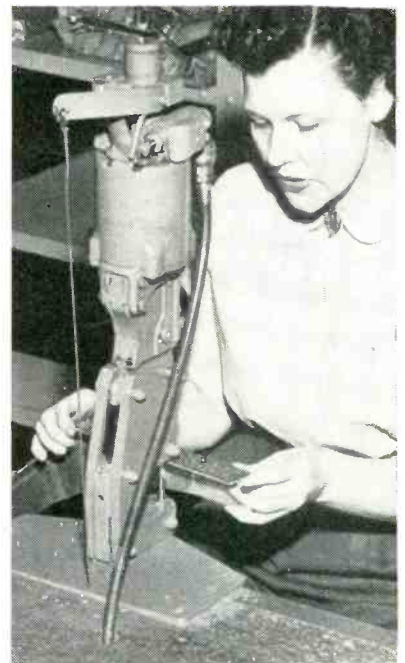

Air-powered squeeze riveter as modified for piercing holes in brackets

WHEN  
SPECIFICATIONS  
CALL FOR



## GLASS-TO-METAL SEALS

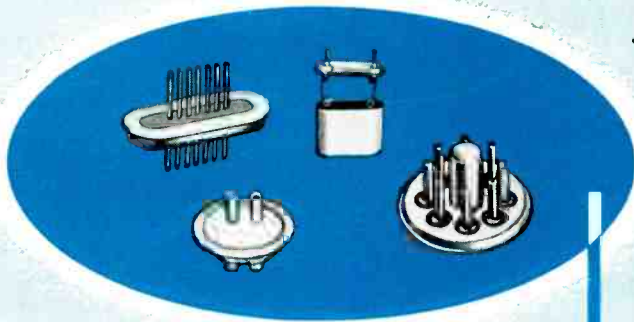

—CONSULT

**E-I**



HEADQUARTERS  
FOR—

Ask E-I hermetic seal specialists for a quick, economical solution to your design problems involving glass-to-metal seals. E-I specialization and standard designing means your specifications can be fulfilled, in most cases, by low cost catalog items. E-I offers fast delivery in reasonable quantities on seals developed for practically every type of electronic and electrical termination. Call, write or wire E-I, today!

**COMPRESSION SEALS  
MULTIPLE HEADERS  
SEALED TERMINALS  
CONDENSER END SEALS  
THREADED SEALS  
TRANSISTOR CLOSURES  
MINIATURE CLOSURES  
COLOR CODED TERMINALS**

PATENT PENDING — ALL RIGHTS RESERVED

— offering 8 important advantages including cushioned glass construction, design standardization, high dielectric strength, miniaturization, vacuum tight sealing, vibration resistant, super durability, maximum rigidity, etc.

One dependable source  
for all hermetically sealed  
terminal requirements!

**ELECTRICAL INDUSTRIES**



Division of Amperex Electronics Corporation • 44 SUMMER AVENUE, NEWARK 4, NEW JERSEY

# New Products

Edited by WILLIAM P. O'BRIEN

99 New Products and 53 Manufacturers' Bulletins Are Reviewed . . . Control, Testing and Measuring Equipment Described and Illustrated . . . Recent Tubes and Components Are Covered

## CATHODE-RAY TUBE

has high brightness

FARNSWORTH ELECTRONICS Co., 3702 E. Pontiac, Fort Wayne, Inc. The Iatron is a charge-controlled c-r tube having unusually good persistence characteristics and high brightness. Operating on the principle of image current control by stored electrical charges on an insulator layer, it possesses two characteristics not common in other

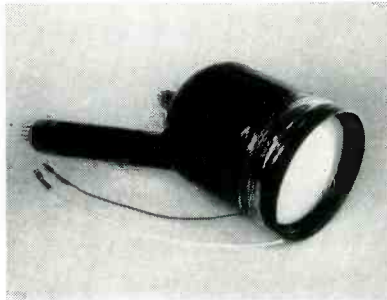

tubes. It permits operator-controllable image persistence from 1 millisecond up to several minutes duration and allows the presentation of a picture at a brightness level of up to 10,000 foot lamberts with relatively low final anode potential. The company has published data sheets giving principles of operation, typical characteristics, maximum ratings, tube base connections and other general information.

## VACUUM GAGE

for research and production

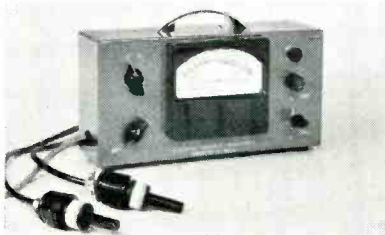

ELECTRONIC RESEARCH LABORATORIES, 85 Surrey St., Brighton 35, Mass., has announced the TC-104 electronically regulated thermocouple vacuum gage. It has a pressure range of from 1 to 1,000 microns, and maintains its accuracy over wide variations of line voltage

(95 to 125 v). It is regularly supplied with two calibrated new type d-c heated thermocouple tubes with standard  $\frac{1}{8}$ -in. IPS male thread. The ruggedized construction of the new tube provides maximum protection from extremes of vibration and shock, and its efficient design provides fast response and minimum exposure of the sensing element to contaminants.

## POWER SUPPLY

for smaller pulse systems

BURROUGHS CORP., Electronics Instruments Division, 1209 Vine St., Philadelphia 7, Pa. Model 9201 regulated power supply is designed for simpler, more economical assembly of small pulse test and control systems containing as many as five units. Though it has numerous other uses, its primary purpose is for use with the company's line of unitized pulse control equipment. This line consists of a number of single-function pulse control panels—such as pulse generators, delays, flip-flops, coincidence detectors and counters—which can be rapidly assembled, building-block style, into

a wide variety of pulse test and control systems. Model 9201 is sized for mounting together with the pulse control units in standard 19-in. relay racks. It provides 6 regulated d-c voltages as well as 6.3 v a-c to as many as 5 different pulse control



units. With line input of  $115\text{ v} \pm 5$  percent, 60 cycles, single phase, the voltage regulation on all d-c outputs is  $\pm 5$  percent. Ripple voltage is less than 0.5 percent. The power supply, costing \$375, measures 7 in. high, 14 in. deep.

## SWEEPING OSCILLATOR

for 2 or 4-band use

KAY ELECTRIC Co., Pine Brook, N. J. The Radaligner, a new 2 or 4-band sweeping oscillator, provides an instantaneous check of the entire passband of any equipment in the 10 to 169-mc range. It offers a choice of four center frequencies for

# EDO

*finest name in*

# SONAR

Ingenuity of design, proven performance and superior range with accuracy are the main reasons why EDO is now regarded and recognized as the outstanding leader in the development of echo-ranging equipment.

From deep depth sounders for navigation, survey, and ocean bottom exploration to a wide variety of under water detection systems, Edo equipment has made its mark and proven its superiority.

That's why when you see the Edo flying fish emblem on a sonar equipment you can confidently recognize it as a product of brilliant engineering and masterful workmanship—reliable beyond question.

*Just off the press! "The Story of Edo"—24 page book describing Edo's diversified facilities and the company's 29-year old history. Send for your copy today.*

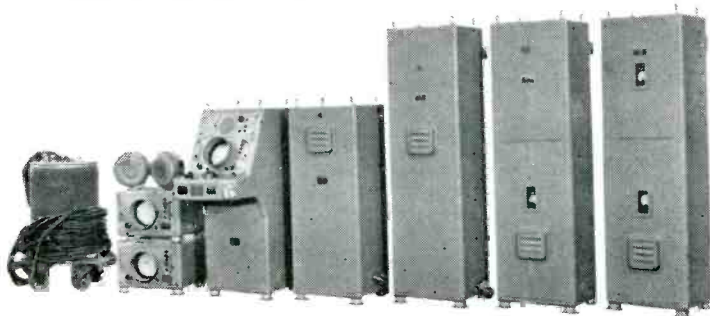

**EDO SCANNING SONAR** a typical example of a complex naval sonar system, developed and built for the U. S. Navy by Edo.

A FEW OF MANY EDO SONAR  
EQUIPMENTS FOR COMMERCIAL AND NAVAL USE



**0 TO 6000 FATHOM DEEP DEPTH SOUNDER** in wide use with U. S. Navy (AN/UQN-1b) now available commercially (Model 185). Gives clear indication of depth on cathode-ray tube in two scales: 0—100 feet; 0—100 fathoms. Records continuously in three scales: 0—600 feet; 0—600 fathoms; 0—6000 fathoms. The finest deep depth sounder available. For complete details send for Model 185 brochure.

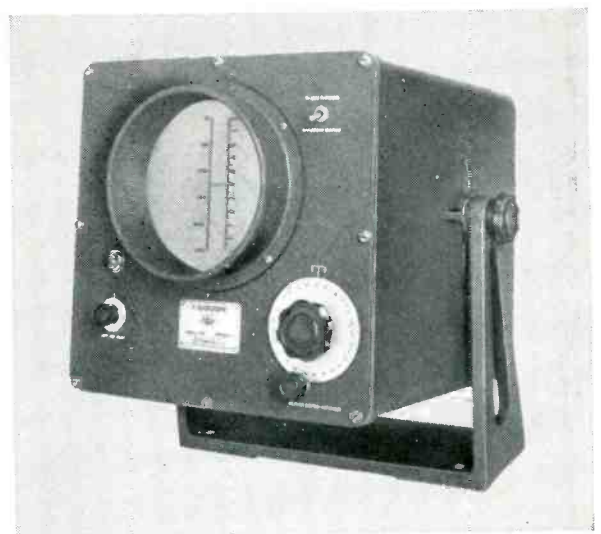

**EDO FISHSCOPE.** Most advanced fish finding device available today. Spots fish on cathode-ray tube in 0—250 fathom range, then magnifies any 10-fathom sector 25 times for clearer view. Commercial fishing boats equipped with the Fishscope report better than average hauls in far less time thanks to this Edo development. For full details send for Fishscope brochure.

**EDO CORPORATION • COLLEGE POINT, L. I., N. Y.**



Since 1925

aligning radar i-f amplifiers. It also provides a variable marker and choice of 10 narrow, plus type crystal-controlled markers, positioned to specification. The Radaligner has extremely low amplitude

modulation while sweeping—less than 0.05 db per mc. The individual marker circuits provide marks independent of test circuit characteristics. The sweeping oscillators are completely electronic, with no

mechanically driven elements. Also, the Radaligner is designed to eliminate phasing, by use of single saw-tooth voltage for deflecting the oscilloscope and driving the sweeping oscillator. Price is \$795.

### 3-IN. OSCILLOSCOPE

available in rack mount

THE HICKOK ELECTRICAL INSTRUMENT Co., 10527 Dupont Ave., Cleveland 8, Ohio. Model 385R is a highly accurate 3-in. oscilloscope available in a rack mount. The instrument features 6-section unitized circuit construction. Circuit sections are available as individual units for replacement. Provision is also made for 2-axis modulation.

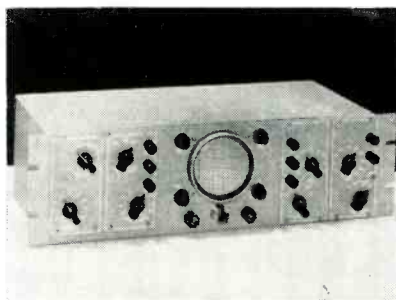

Overall dimensions of the new rack mount are: 19 in. wide, 5½ in. high, 9½ in. deep. Weight is 15 lb. Frequency range is as follows: vertical amplifier—d-c to 4 mc, 3 db down; horizontal amplifier—d-c to 500 kc, 3 db down; sweep circuit oscillator—3 cycles to 50 kc. Vertical and horizontal amplifier input impedances are 2.2 megohms to 25 μmf. Deflection sensitivities for vertical and horizontal amplifier are 0.075 rms v per in.

### RESET RELAY

with spdt or dpdt contacts

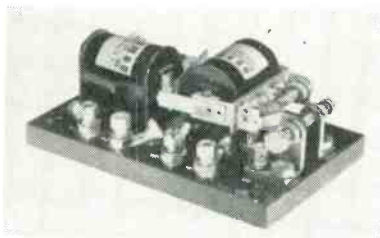

KURMAN ELECTRIC Co., 35-18 37th St., Long Island City, N. Y., is manufacturing a sensitive impulse latching, mechanical locking and electrical impulse reset relay (series 22L). It is highly useful for applications where it is not practical to have the holding coil in constant

service. It consists of two sensitive relays mounted on a phenolic base. Both relays are available in either a-c or d-c or any combination of these. The contacts, rated at 2 amperes, 110 v a-c, are supplied as spdt or dpdt. Many additional features such as tropicalization, varnish impregnated coils and the like, are available for special applications.

### PULSE TRANSFORMER

for printed circuitry use

PCA ELECTRONICS INC., 2180 Colorado Ave., Santa Monica, Calif. A miniature pulse transformer for use in printed circuitry is carried in stock in pulse widths ranging from 0.1 to 16.0 μsec, and in most 2, 3 and 4 winding turns ratios. With unusually low rise times and leakage inductances, the transformers are ideal for use in: (1) blocking oscillators; (2) impedance matching; (3) linear oscillators; (4) as wide-band input and output transformers; (5) 1-v interstage coupling; (6) triggering and counting circuits; (7) d-c isolation; (8) inversion pulse shaping; and (9) pulse transmission circuits. These transformers are ideal for insertion into printed circuit eyelet boards,

and come with standard 7 and 9-pin pattern headers. All transformers are epoxy impregnated in hermetically sealed cans, and will withstand shock, temperature cycling,

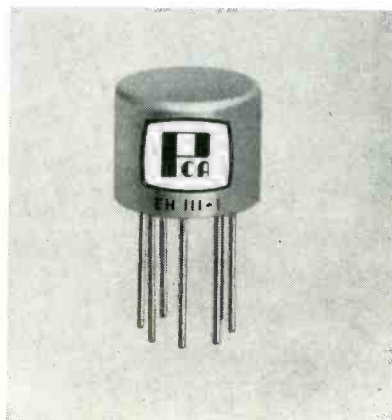

vibration and humidity requirements of MIL-T-27 specification, where applicable.



### PHASE STANDARD provides 0.1-deg accuracy

TECHNOLOGY INSTRUMENT CORP., Acton, Mass., announces the type 706-A ultrasonic phase standard. This generator provides two sinusoidal voltage output signals whose

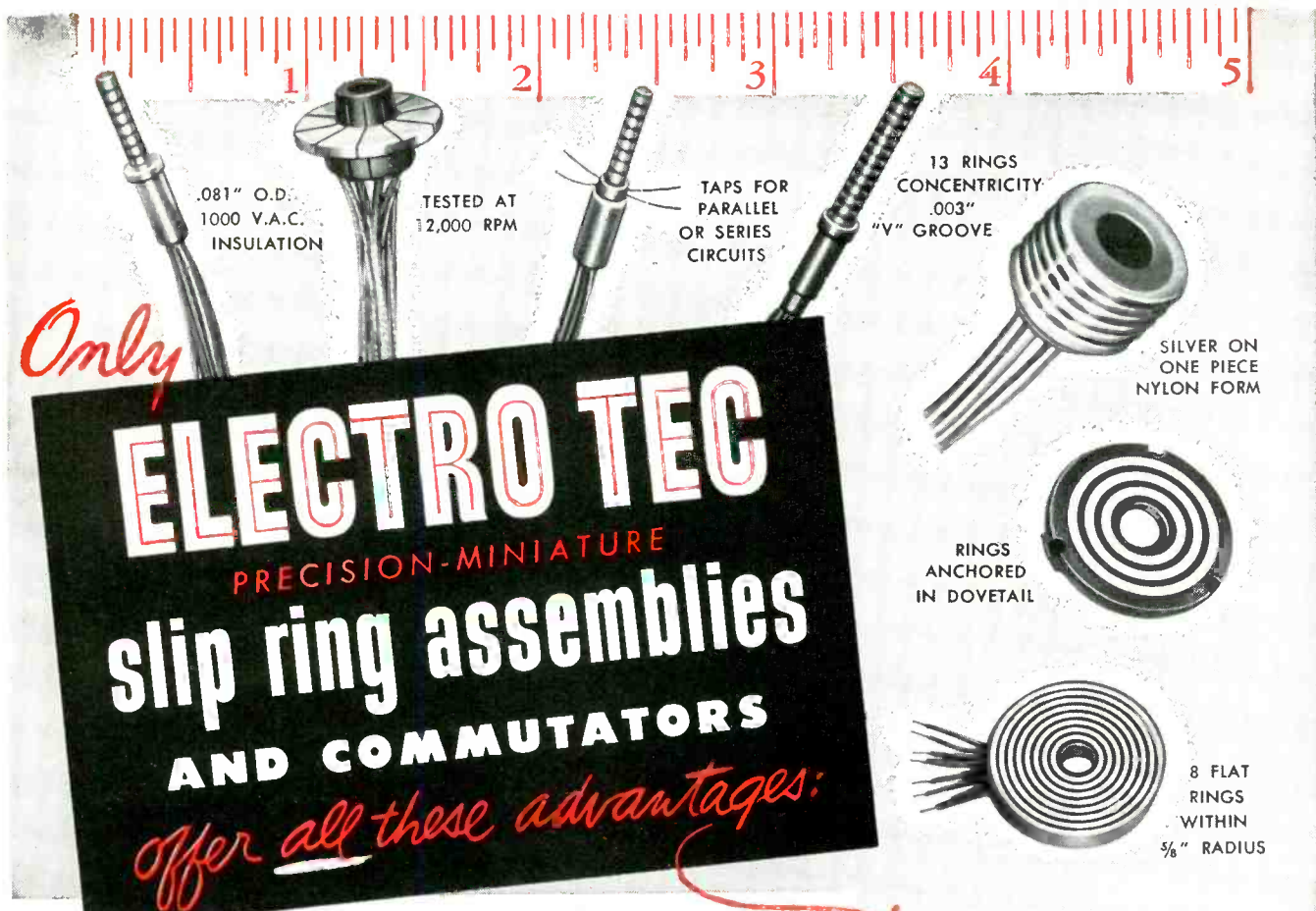

**ELECTRO TEC**  
*PRECISION-MINIATURE*  
**slip ring assemblies**  
**AND COMMUTATORS**

*offer all these advantages:*

**EXCLUSIVE\* ELECTRO TEC TECHNIQUES**  
*insure closer tolerances, absolute uniformity,  
 and the ultimate in miniaturization*

Electro Tec units are the product of an exclusive manufacturing technique that results in accuracy unattainable by conventional fabricating methods. In this process a plastic is moulded around the wire leads. Accurate machining reduces this blank to the proper shape, complete with grooves. Hard silver is deposited into the grooves by electroplating to produce the required rings. Final machining insures concentricity and dimensional accuracy. The result is one-piece, unitized construction with conducting rings of 70 to 95 Brinell hardness.

Diameters of these assemblies range from .045" to 24" cylindrical or flat. Cross-sections may range from .005" to .060" or more. Rings are polished to a jewel-like finish and can be held to 4 micro-inches or better. Even the smallest sizes withstand a 1000 V.A.C. breakdown test. Most types easily withstand rotational speeds up to 12000 rpm.

**ELECTRO TEC Assemblies are Specified by the Nation's  
 Leading Precision Instrument and Equipment Manufacturers for Proven  
 Greater Dependability, Longer Life, Smoother Functioning.**

The uniformly superior performance of Electro Tec slip ring and commutator assemblies in thousands of industrial and governmental applications has resulted in wide adoption of these component units by most leading manufacturers of precision instruments and equipment. Although these products provide improved performance and extra dependability, prices are strictly competitive. Write today for fully illustrated literature.

**ELECTRO TEC CORPORATION**  
 SO. HACKENSACK NEW JERSEY

PRODUCTS OF PRECISION CRAFTSMANSHIP BY A NEW AND REVOLUTIONARY PROCESS

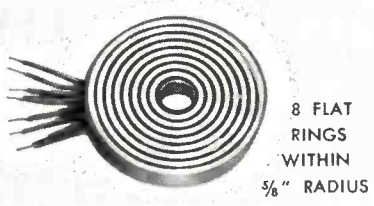

- ONE PIECE, UNITIZED CONSTRUCTION
- ABSOLUTE MINIMUM TORQUE FRICTION
- DIAMETERS FROM .045" TO 24.0"
- MINIMUM 1000 V.A.C. HI-POT INTER-CIRCUIT
- UNIFORMLY HARD SILVER RINGS PLATED INTO GROOVES ON PRECISION MACHINED ONE PIECE PLASTIC FORM
- SPECIAL SURFACE DEPOSITS PREVENT TARNISH, MINIMIZE FRICTION, BRUSH NOISE AND PRACTICALLY ELIMINATE WEAR

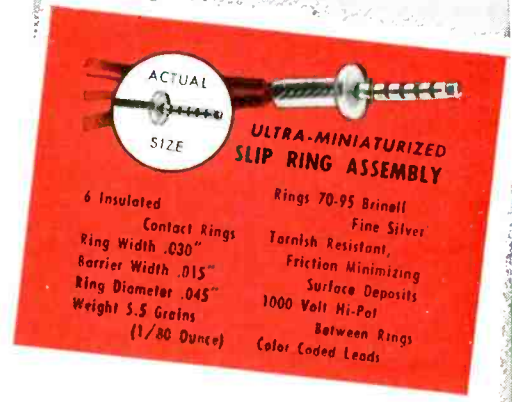

\*PAT. NO. 2,696,570

# "PRINTED CIRCUIT OUTPUT UPPED *when we switched to HUNT R.C.E.*"

( RAPID CIRCUIT ETCH )

## —the FASTEST ETCHING SOLUTION for PRINTED CIRCUITS

Here indeed is good news for all makers of etched printed circuits. Philip A. Hunt Company, world-famous makers of photographic and photo-engraving chemicals, now offers Hunt R.C.E. Solution, a special etching solution with these BIG advantages, guaranteed:

1. Controlled rapid etching speed, permitting standardization of a high production etching schedule
2. Instant and uniform etching over entire circuit
3. Maximum etching capacity
4. Full protection of tops

Contact your nearest Hunt branch, or write us at Palisades Park, N. J., today for full information on Hunt R.C.E. Solution.

*Hunt R.C.E.  
Solution is  
supplied in  
145 lb. rubber  
drums*



**PHILIP A. HUNT COMPANY**  
PALISADES PARK, N. J.

Chicago • Cleveland • Cambridge • Brooklyn • Atlanta • Dallas • Los Angeles • San Francisco

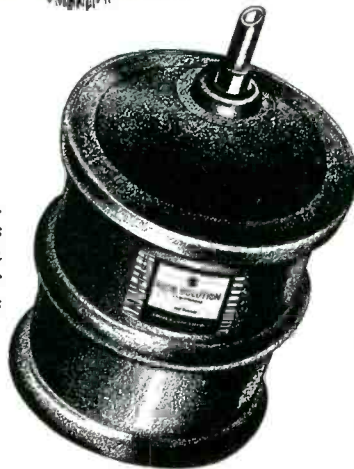
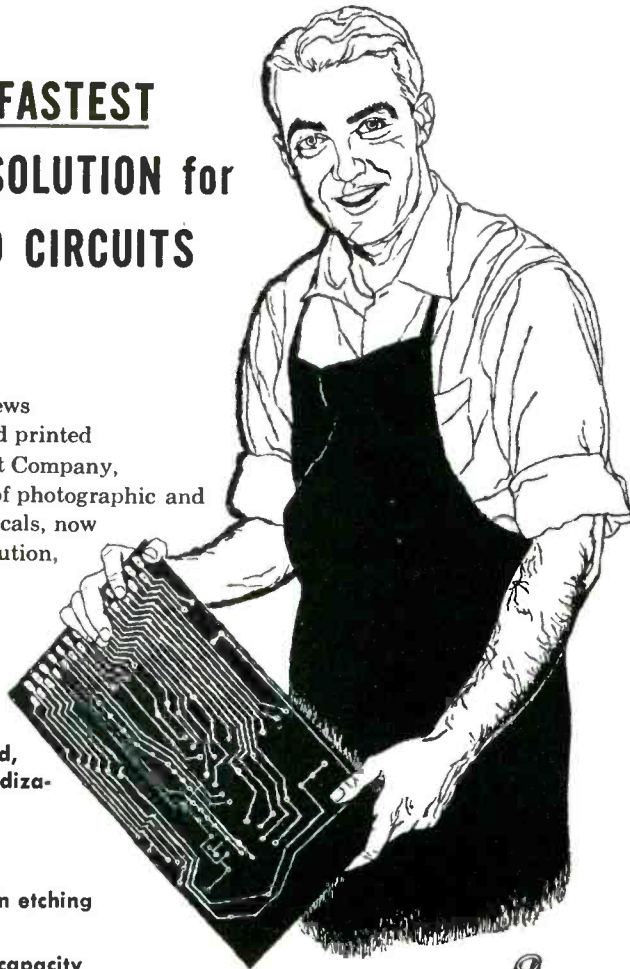

NEW PRODUCTS

(continued)

phase relationship can be continuously controlled from 0 to 360 deg with an accuracy of  $\pm 0.1$  deg. Units can be furnished to supply any single specified output frequency between 20 kc and 200 kc, although the standard frequency is 82 kc. A crystal controlled oscillator generates a frequency 36 times the output frequency. This signal is divided down in two 6-to-1 stages to give the output frequency. Phase stability is  $\pm 0.2$  deg per hr at 25 C, after one hour warmup. Applications of the 706-A ultrasonic give the output frequency. Phase standard include design and measurements on precision phase shifters, phase detector circuits, goniometers, resolvers, threshold circuitry in timing, pulse position and similar determinations.

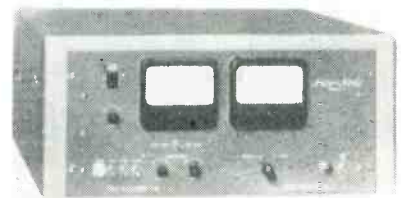

### NOISE FIGURE METER features direct reading

KAY ELECTRIC Co., 14 Maple Ave., Pine Brook, N. J. The Auto-Node will allow automatic noise figure measurement from 5 to 26,500 mc, with continuous interpolation over the vhf, uhf and microwave frequencies. It features direct reading noise figure to facilitate the speed with which measurements can be made. Two models—tv and radar—are available. Both may also be used to work with the Mega-Node Sr., to cover a frequency range of 10 to 3,000 mc.



### MARKER GENERATOR and oscillator

RUTHERFORD ELECTRONICS Co., 3707 South Robertson Blvd., Culver City,



# Adjustoroid®

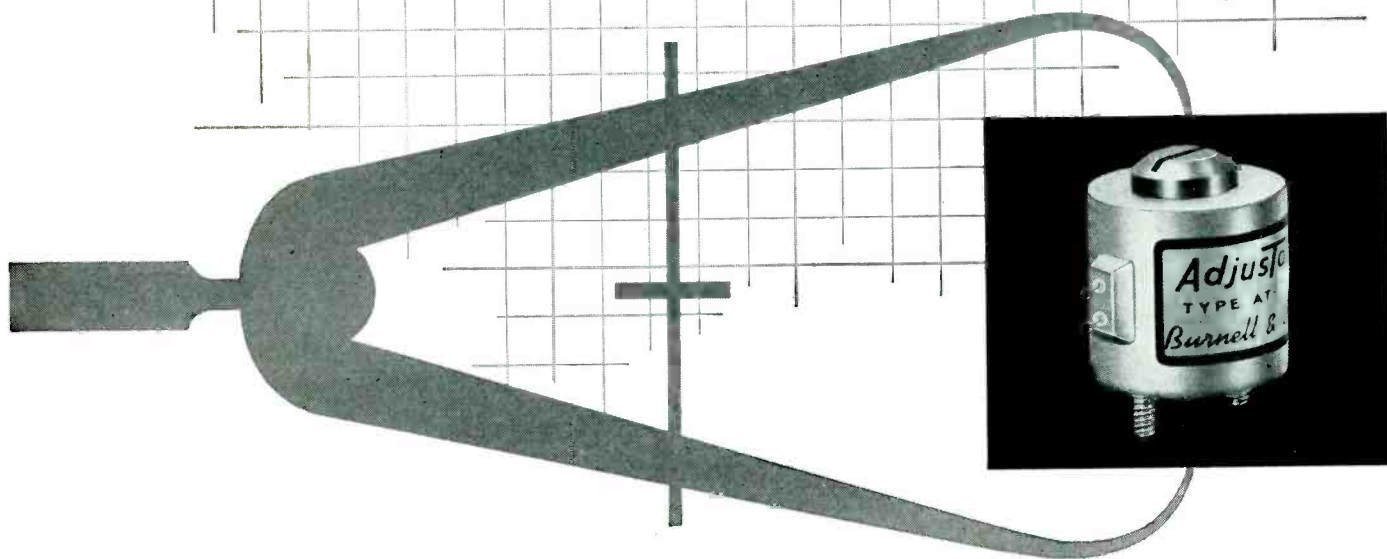

## Introducing **A LOW-COST ADJUSTABLE TOROID**

- precise, instant adjustment
- inductance variation of 10%
- eliminates critical close tolerance capacitors
- high Q
- no external power supply
- truly hermetic sealing
- temperature coefficients same as fixed toroids
- no increase in case diameter
- developed by Burnell, creators of the Rotoroid®

Write for Adjustoroid  
Technical Brochure C

**LET BURNELL ENGINEERS SHOW HOW USE OF ADJUSTOROIDS REDUCES EQUIPMENT COSTS**



Teletype: Yonkers, N. Y. 3633

**BURNELL & CO., INC.**

45 Warburton Avenue  
Yonkers 2, New York

Pacific Division: 720 Mission St., S. Pasadena, Calif.

See us at the WESCON SHOW, Booth 259

Copyright patent applied for

**Custom  
Iron Cores  
to your  
Specifications**

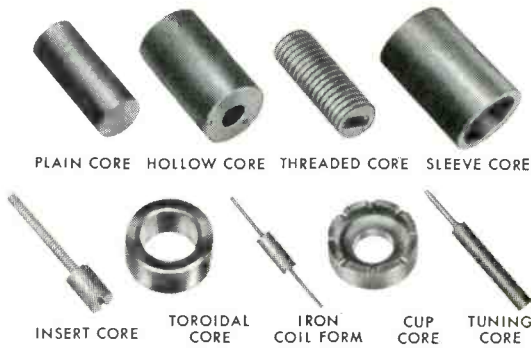

Regardless of your requirement, we can supply a full line of custom iron cores in a variety of sizes and shapes for many applications . . . designed for your needs. Send us your problems.

**RADIO CORES, INC.**

*has Everything  
in Iron Cores*

**The Original  
Engineered  
Economy\*  
Iron  
Cores**



We originated the ways and means of providing ENGINEERED ECONOMY\*IRON CORES at money saving prices and from stock. Over 14 types are available to cover most insert and threaded applications.

\*TRADEMARK

**Complete  
Engineering  
Service**

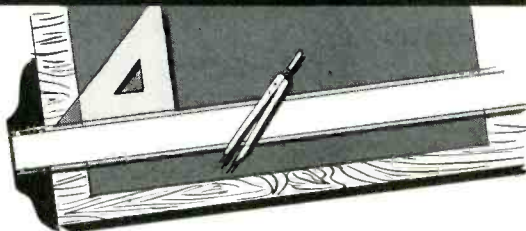

We are the world's largest producers of iron cores because we employ the largest, most experienced and most efficient engineering department to enable us to design, produce and suggest iron cores which will do the best job for you.

Write today . . . tell us your problems . . . you'll be glad you did.

**Radio Cores, Inc.**

9540 Tulley Avenue Oak Lawn, Illinois



Calif., announces two new accessory pulse instruments that measure delay line lengths, rise times, and minute repeated time intervals from a few millimicroseconds to tens of microseconds. The B4-100 marker generator and the B4-200 oscillator when used with the B-2A pulse generator and the required power supply, provide accurate scope markers and pulse delays by means of which time intervals can be measured to  $\pm 1/500 \mu\text{sec}$ . The B4-100 marker generator provides 0.1  $\mu\text{sec}$  and 1  $\mu\text{sec}$  marker signals of either positive or negative polarity. Marker accuracy is 0.01 percent. The B4-200 oscillator consists of a free running blocking oscillator which is phase locked to the 1- $\mu\text{sec}$  marker pulses. Repetition rate can be varied from 1 kc to 10 kc. Literature is available.

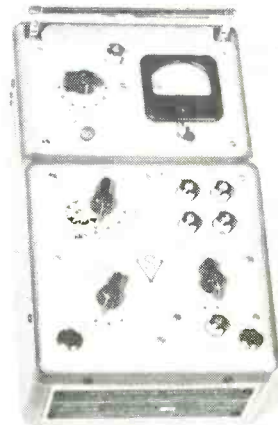

**SCOPE PREAMPLIFIER  
is ultra-low-noise type**

VOLKERS & SCHAFFER MFG. CORP., Box 996, Schenectady, N. Y. The VS-61A oscilloscope preamplifier is a highly sensitive, dual input, adding or differential amplifier, having substantially less than 1  $\mu\text{v}$  rms noise. Its design is based on hushed transistor operation. The amplifier has a stage selector switch which provides a choice of either straight vacuum tube amplification (maximum gain 10, input impedance 100,000 ohms, frequency response 2 cps to 250 kc) or combined transistor and vacuum-tube amplification (available maximum gains 200 and 1,000, input impedance 1,000 ohms, frequency response 2 cps to 60 kc). All frequency responses are given

**Congratulations  
to WCEMA**

*We salute the men and companies  
whose boldness and vision have helped  
build the great West Coast electronics  
industry.*



## WHY California comes to Brooklyn for sheet metal fabrication

West Coast electronic manufacturers reach 3,000 miles across the country to Karp because . . .

- Distance is no barrier to the savings afforded by Karp "one stop service."\*
- Karp-engineering and design service saves you time and solves your problems.
- Karp's stock tools can eliminate costly tooling.
- Karp-quality has set the standard of excellence in sheet metal fabrication for over 30 years.

*We invite your inquiries for chassis, instrument and transit cases, cabinets and enclosures. Estimates promptly submitted.*

The second printing of the "Karp Engineering Data Booklet No. 1" is now available. Write for your free copy today.



**\* METAL PRODUCTS CO. • 215 63rd STREET, BROOKLYN 20, N. Y.**  
Division of H & B American Machine Company, Inc.

**FACILITIES FOR ENGINEERED SHEET METAL FABRICATIONS:** in aluminum or steel • long run or short • spot, arc, gas or heliarc welding • any type finish

- Modern plant—3 city blocks long
- Thousands of dies available
- Most modern of sheet metal fabricating equipment
- U. S. Air Force Certified Welding Facilities
- Air-conditioned spray room. complete baking facilities
- Complete sub-assembly facilities

another filter problem solved . . .



## R-F NOISE ELIMINATED IN BENDIX VALVE ACTUATOR

**PROBLEM:** Bendix Aviation Corporation's Pacific Division, North Hollywood, California, manufactures a series of rotary electric actuators for operating valves in aircraft. But getting a small, lightweight filter to keep the motor from creating radio-frequency interference proved to be a real problem. Any such filter would have to be mounted as an integral part of the square motor actuator, and the required 150°C operating temperature didn't help any.

**APPROACH:** Bendix Pacific engineers took their problem to the Radio Noise Suppression Laboratories of the Sprague Electric Company in Los Angeles. There, Sprague and Bendix engineers cooperated in making radio interference measurements and setting up envelope and mounting provisions for the proposed filter.

**SOLUTION:** A filter was designed by Sprague to meet the envelope, mounting and 150°C performance needs. The filter successfully passed radio interference requirements of MIL-I-6181, MIL-1-6181B, and also, the rigid requirements of MIL-E-5272A. When mounted, the Sprague filter is completely encased in the motor, with the filter terminals utilized as the motor terminal strip.

**PRODUCTION SCHEDULES** for these and many other filters are regularly met by Sprague plants on both coasts. We would like the opportunity to solve your problem too. Write, wire, or phone Sprague Electric Company, 12870 Panama Street, P.O. Box 66507, Los Angeles 66, California (TEXAS 0-7531) or North Adams, Massachusetts (MOhawk 3-5311).

Sprague on request will provide you with complete application engineering service for optimum results in the use of radio noise filters.

YOU CAN DEPEND ON

World's Largest Capacitor Manufacturer

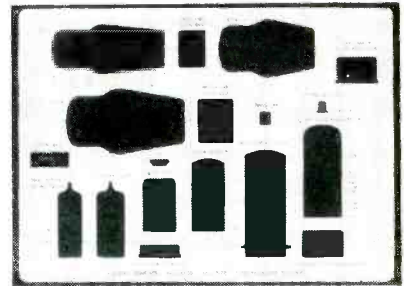
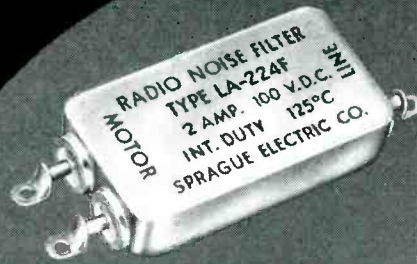

### TEMPLATES for the electronics field

E-Z-WAY TEMPLATES, 2242 South Colby Ave., West Los Angeles 64, Calif., has announced a new template, No. 6116, for electronic engineers, draftsmen and designers. It contains full size cutouts of standard vacuum tube envelopes; useful in three dimensional layout problems. It is made of 0.030 rigid vinyl plastic. Authentic standard dimensions are used throughout with pencil tolerance allowed. Horizontal, vertical and centerline indexes plus necessary nomenclature and sizes are clearly shown. Price is \$4.50.



### VTVM with degenerative network

TECHNOLOGY INSTRUMENT CORP., 531 Main St., Acton, Mass. Type 800-A vtvm combines the inherent accuracy of the basic voltmeter with a highly degenerative amplifier circuit. Designed for rugged field duty as well as precision laboratory work, the compact instrument reads a-c voltage over the frequency range

# Another Advancement by General Ceramics

## Presenting— **SUPER FERRAMICS®**

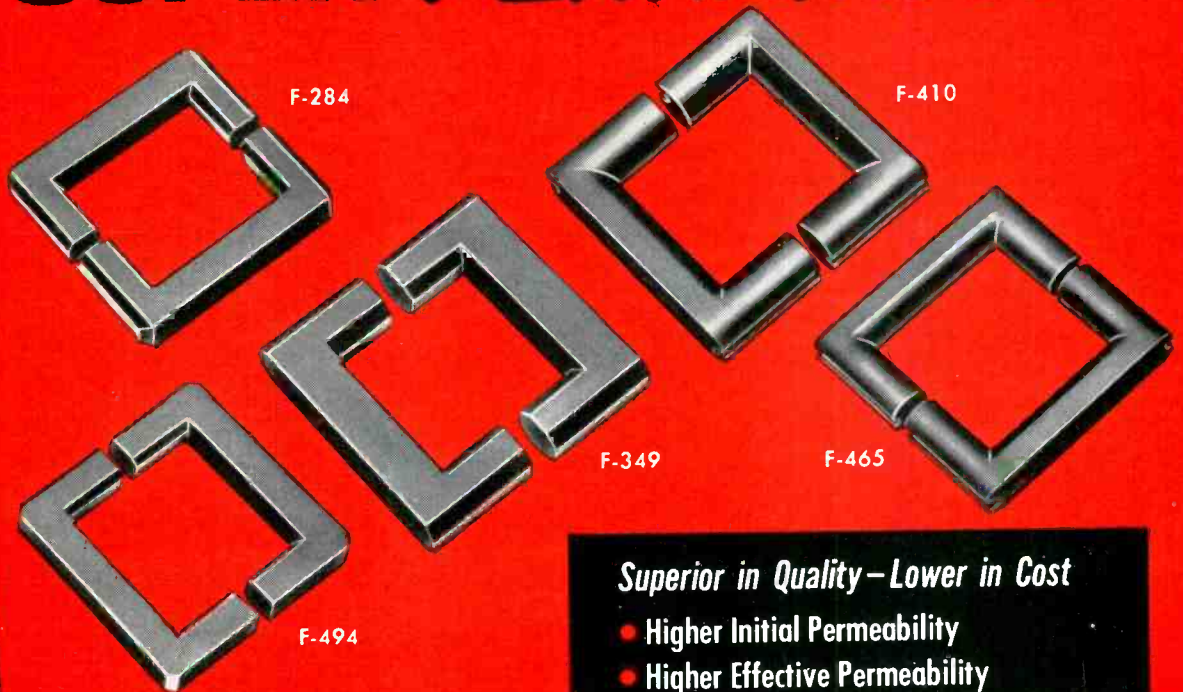

### New Super-Grade Ferrites from the Laboratories of General Ceramics —

New Super-Ferramics are magnetic ferrites with properties once considered beyond the realm of achievement. The first of this series Ferramic O, (see property chart) has been released and is now available in production quantities. Engineers and product designers are invited to request complete information on Ferramic O. Call or write for data today!

#### Superior in Quality—Lower in Cost

- Higher Initial Permeability
- Higher Effective Permeability at Higher Saturation Levels
- Lower Core Loss Resulting in Less Temperature Rise
- Greater Uniformity Through Improved Production Techniques

#### MAGNETIC PROPERTIES OF FERRAMIC O-1

PROPERTIES	UNIT	FERRAMIC O-1
$\mu_0$ at 50 kcs.	—	1200
$\mu_{max}$	—	6000
Saturation Flux Density $B_s$	Gauss	4100
Residual Magnetism $B_r$	Gauss	2500
Coercive Force $H_c$	Oersteds	0.20
Curie Temperature	+ °C.	165
Volume Resistivity	—	Low
Loss Factor at 50 kcs.	$\frac{1}{\mu_0 Q}$	0.000010
Temp. Coeff. of Initial Perm. (50 Kcs)	%/°C.	+0.75



**General CERAMICS CORPORATION**  
TELEPHONE: VALLEY 6-5100  
GENERAL OFFICES and PLANT: KEASBEY, NEW JERSEY

MAKERS OF STEATITE, ALUMINA, ZIRCON, PORCELAIN, SOLDERSEAL TERMINALS, "ADVAC" HIGH TEMPERATURE SEALS, CHEMICAL STONWARE, IMPERVIOUS GRAPHITE, FERRAMIC MAGNETIC CORES

# HOMELITE

1.5 KW 3 phase 400 cycle

# GENERATOR

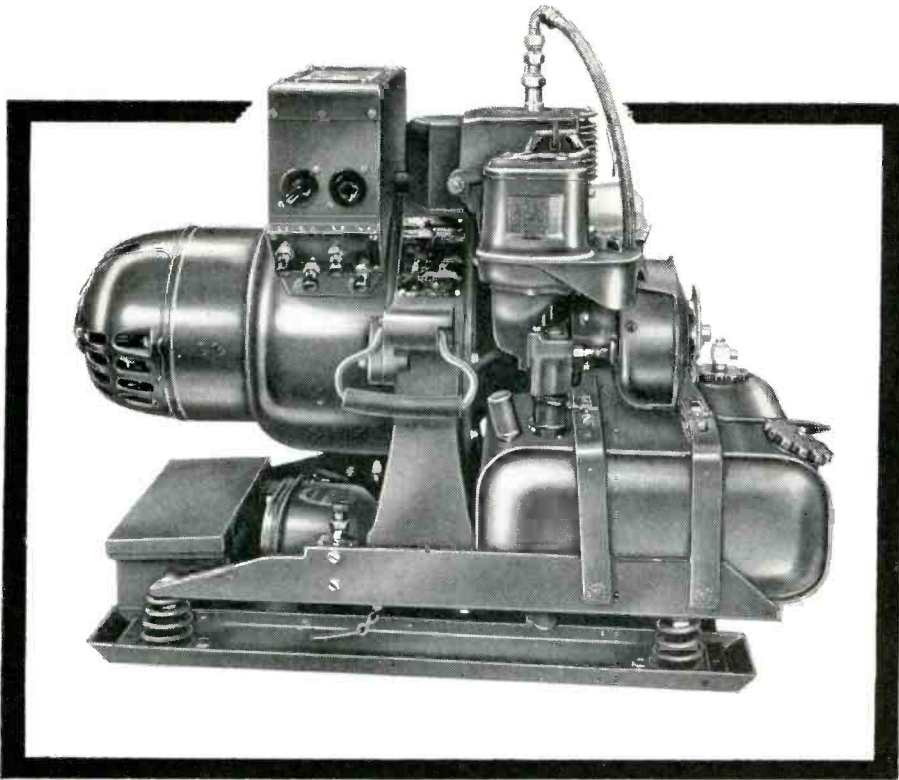

Keeping pace with the latest requirements of the Military, Homelite has developed a 3-phase 400-cycle gasoline-engine-driven generator with a military rating of 1.5 KW . . . weighing only 154 pounds.

When it comes to meeting MIL Specs for lightweight gasoline-engine-driven generators, Homelite . . . with its wealth of experience . . . will solve your problems best. No matter how tough your requirements are . . . why not talk with Homelite engineers?

From Homelite's background of nearly a half century of designing and manufacturing hundreds of thousands of lightweight gasoline engine driven generators, your source of supply is dependable.

Write and you'll hear from us promptly.

Homelite builds generators in sizes from .15 KW up to 5 KW in all voltages and frequencies . . . with either gasoline engine or electric motor drive.

Manufacturers of Homelite  
Carryable Pumps  
Generators • Blowers  
Chain Saws

PERFORMANCE-DEPENDABILITY  
SERVICE

## HOMELITE

CORPORATION

6808 RIVERDALE AVENUE • PORT CHESTER, N. Y.

Canadian Distributors: Terry Machinery Co., Ltd., Toronto, Montreal, Vancouver, Ottawa,

NEW PRODUCTS

(continued)

from 15 cps to 100 mc on 8 full-scale ranges of 0.1 v to 300 v; 9 d-c voltage scales from 0.1 v to 1,000 v; and 9 d-c, full-scale ranges from 0.001  $\mu$ a to 100 ma. Accuracy on a-c voltage is  $\pm 3$  percent of full scale for 1.0 v and higher ranges, and  $\pm 5$  percent of full scale for 0.3 v and 0.1 v ranges. Accuracy on d-c voltages is  $\pm 2$  percent of full scale for 1.0 v and higher ranges, and  $\pm 3$  percent for 0.3 and 0.1 v ranges. Accuracy of d-c is  $\pm 2$  percent of full scale for 0.1  $\mu$ a and higher ranges, and  $\pm 3$  percent for 0.001 and 0.01  $\mu$ a ranges. Detailed bulletins giving further information are available.



### 10-MC AMPLIFIER

for laboratory use

AMERICAN ELECTRONIC LABORATORIES, INC., 641 Arch St., Philadelphia 6, Pa. The 10-mc laboratory amplifier is a versatile instrument designed for application in color tv development, nuclear instrumentation, digital computer circuit development and general wideband circuit problems. Built-in, front panel controlled options of high or low output and input impedances, and continuous variable gain control provide greater versatility and ease in application. Provision is also made for external line terminations. Bandwidth is less than 1 cps to 10 mc (3 db) with overshoot less than 5 percent and compression maximum of 5 percent at maximum output. Tilt is less than 1 percent for 60-cps square wave input. Maximum output is 150 v peak-to-peak with gain of 40 db.

### TRANSISTOR TEST SET

priced at \$950

SCIENTIFIC SPECIALTIES CORP., Show and Union Sts., Brighton Station,

A directly calibrated generator of continuous wave or pulse modulated radio frequency signals, government model TS-419 U.

Modulation - (a) by external or internal pulse generator.  
(b) by synchronization to an external pulse or sine wave generator

Frequency Range - 900 to 2100 MC/S, one band,  $\pm 1\%$ .

Power Output - calibrated 0 to -120 dbm



TS-419/U



## SIGNAL GENERATOR NE-12-20-SG

Attenuation - uncalibrated. Variable 3 to 70 db

Sensitivity to CW - Spectrum Amplified Pos. -- 80 db. below 1 watt for 1 inch deflection.

- Spectrum Position -- 55 db. below 1 watt for 1 inch deflection.

Maximum dispersion of spectra - 1.5 MC/S per inch.

The government model TS-148/UP Spectrum Analyzer:

Frequency-meter Range - 8470 to 9630 MC/S  
 $\pm 5$  MC/S max. error.



TS-148/UP

**NORTHEASTERN  
ENGINEERING, INC.**  
manchester, new hampshire

## SPECTRUM ANALYZER NE-11-20-S

# PRECISION ATTENUATION TO 3000 mc!

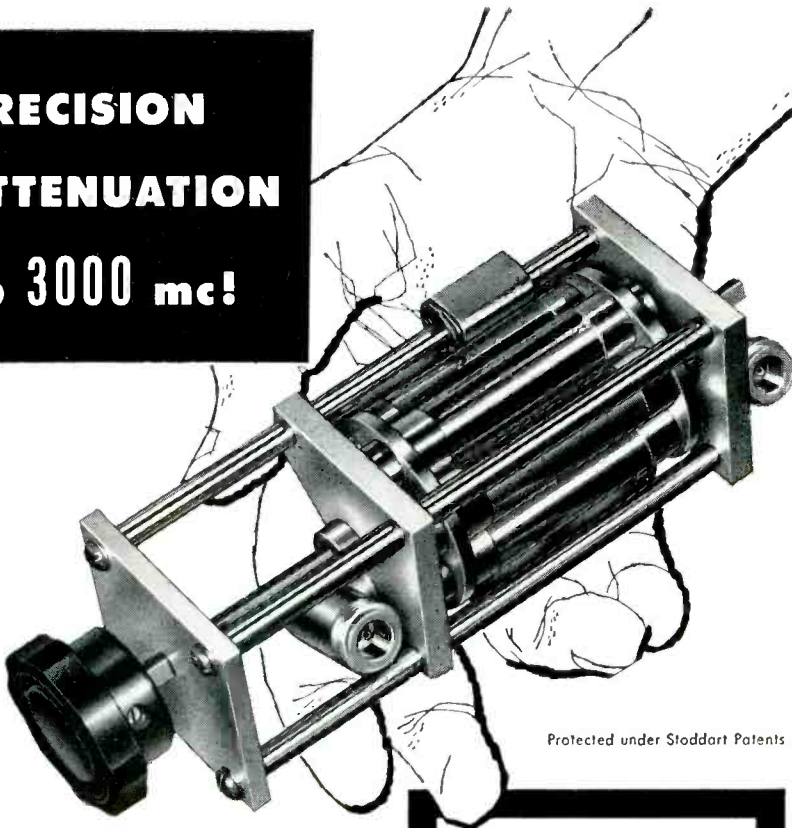

Protected under Stoddart Patents

## six-position TURRET ATTENUATOR

featuring **PULL-TURN-PUSH** action

FREQUENCY RANGE: dc to 3000 mc.

CHARACTERISTIC IMPEDANCE: 50 ohms.

CONNECTORS: Type "N" Coaxial female fittings each end.

AVAILABLE ATTENUATION: Any value from 1 db to 60 db.

VSWR: 1.2 max., dc to 3000 mc/s, values from 10 to 60 db. As value decreases below 10 db, VSWR increases to not over 1.5.

ACCURACY:  $\pm 0.5$  db.

POWER RATING: One watt sine wave power dissipation.

## SINGLE "IN-THE-LINE" ATTENUATOR PADS and 50 ohm COAXIAL TERMINATIONS

This new group of pads and terminations features the popular Type C and Type N connectors, and permits any conceivable combination of the two styles. For example, the two connector types, either male or female, can be mounted on the same attenuator pad, with or without flanges, so that it may serve as an adapter as well as an attenuator. Frequency range, impedance, attenuation, VSWR, accuracy and power rating are as designated above. Send for free bulletin entitled "Measurement of RF Attenuation."

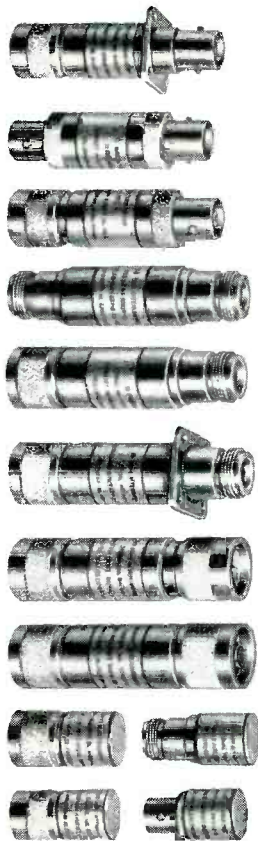

# STODDART AIRCRAFT RADIO Co., Inc.

6644-A Santa Monica Blvd., Hollywood 38, California • Hollywood 4-9294

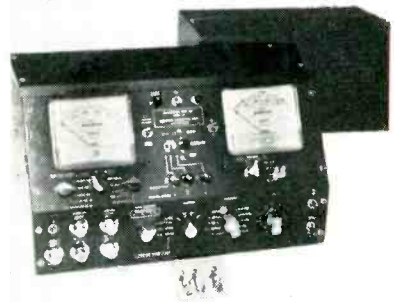

Boston 35, Mass. Model T-62 transistor test set handles point-contact and junction transistors from minute up to high-power types in the grounded base or grounded emitter connection. It features five current bias ranges from 50  $\mu$ a to 500 ma full scale; two collector voltage bias ranges, 0 to 10 v and 0 to 100 v; all power supplies self-contained; and no batteries. Small signal parameters are measured at 270 cps by a powerful and stable self-contained oscillator and locked-in phase-sensitive voltmeter. The T-62 is ideal for those either entering or already working in the field of transistorization of electronic equipment.



## COLOR FILM CHAIN is compact and simple

GENERAL PRECISION LABORATORY INC., Pleasantville, N. Y. The GPL three-Vidicon color film chain, model PA-520, fits into four units everything needed for tv studio pickup of full-color motion picture film and slides for commercial broadcast. It consists of camera



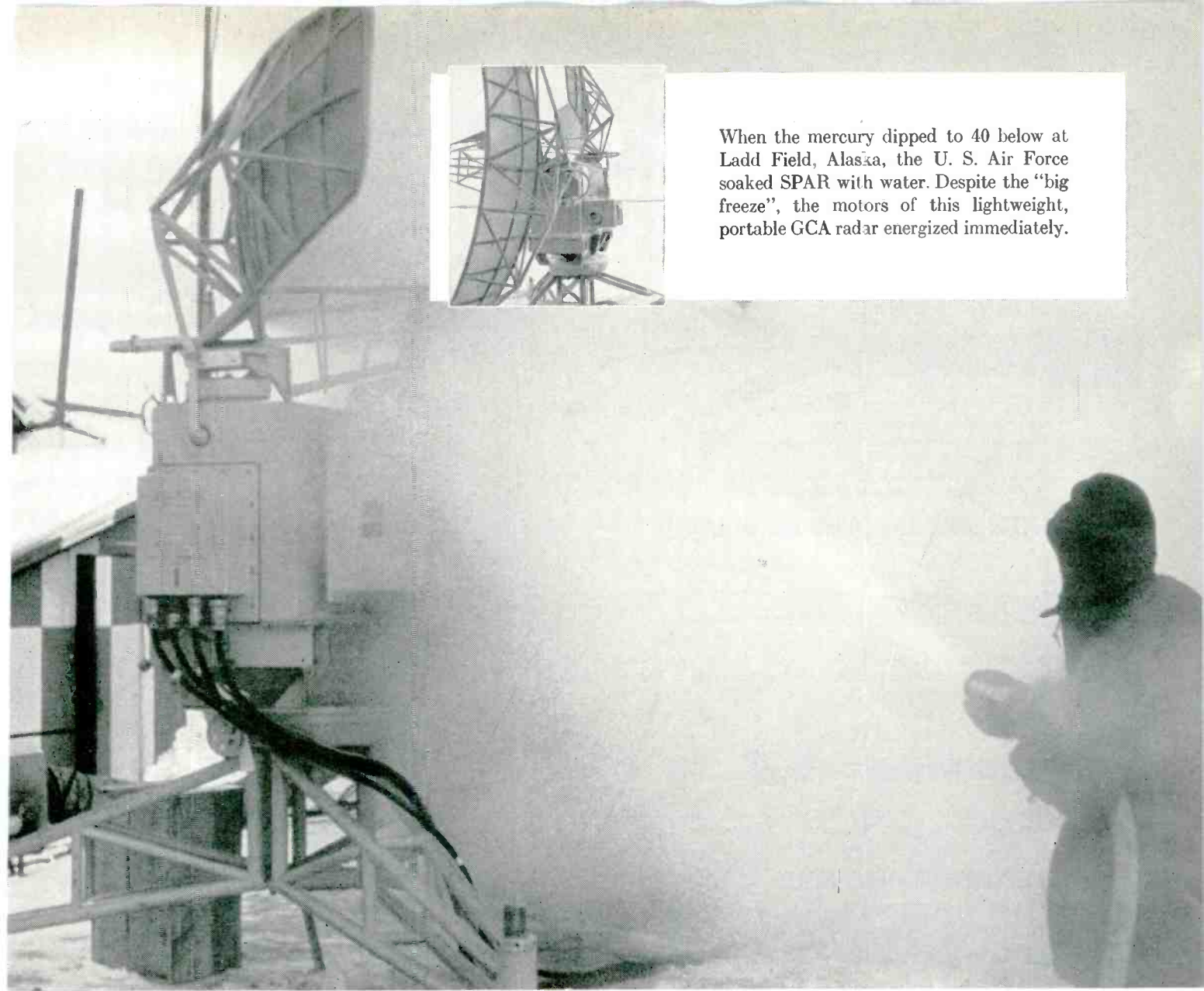

When the mercury dipped to 40 below at Ladd Field, Alaska, the U. S. Air Force soaked SPAR with water. Despite the "big freeze", the motors of this lightweight, portable GCA radar energized immediately.

## **SPAR'S assets can't be frozen!**

More accurate than any comparable GCA landing system, SPAR has come through every rigorous test with flying colors. Neither freezing temperatures, torrid heat, blizzards nor monsoons have lessened its effectiveness. SPAR's accuracy, dependability and durability have been engineered into a unit so light, so easy to use that within thirty minutes of its arrival on the scene, SPAR can "bring 'em in on

the button" in the soupiest weather imaginable. And amazing as it may seem, SPAR costs only  $\frac{1}{5}$ th as much as any other GCA system in production.

No wonder the Air Force, the Navy, European governments, and airport managements are so vitally interested in SPAR—the most revolutionary advance in GCA radar.

Be sure to visit our booth, #318, at the Wescon Show.

*For creative developments in the field of electronics*

**LABORATORY FOR ELECTRONICS, INC.**

75 PITTS STREET, BOSTON 14, MASSACHUSETTS

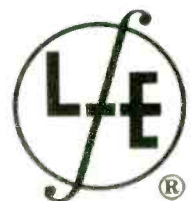

# WHITNEY BLAKE CORD and CABLE



FOR POWER SUPPLY, COMMUNICATIONS AND ELECTRONIC APPLICATIONS  
ADVANCED DESIGN, HIGHEST QUALITY

## MICROPHONE CABLE

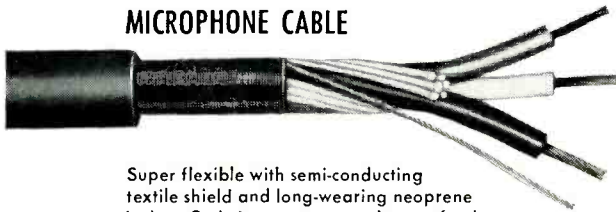

Super flexible with semi-conducting textile shield and long-wearing neoprene jacket. Cadmium copper conductors for long flex life, insulated with high dielectric strength rubber. Noisy circuits are eliminated. Other types also available.

## SPEECH INPUT AND SOUND SYSTEM CABLES



Semi-rigid polyvinyl chloride Types. Solid or stranded conductors with bare or tinned copper shield. And, with cotton braid or Plastite® jacket. Also, Enamel Textile Types.

## SIGNAL WIRES



Bare soft copper conductors insulated with high dielectric strength polyvinyl chloride insulation. Underwriters' Laboratories approved for fire and burglar alarm system internal wiring.

## INTERCOMMUNICATIONS CABLES



TELECABLE® Multiconductor Paired Inside Wiring Cable  
Semi-rigid polyvinyl chloride insulation, brown or ivory polyvinyl chloride jacket. Light weight, easy to install, unaffected by humidity.

## PORTABLE CORDS



Underwriters' Laboratories approved — for power supply on electrical equipment. Neoprene jacketed DYNAPRENE® and rubber jacketed types.

## CORD SETS AND CABLE ASSEMBLIES

Custom-built to customer's requirements. Using either standard cordage or cord designed to fit your particular application, Whitney Blake can furnish regular line cords or special purpose cords having attached or integrally molded rubber or Plastite fittings.

Well Built Wires Since 1899



© 1955  
**WHITNEY BLAKE COMPANY**

New Haven 14, Connecticut

head and pedestal, control console and monitoring unit mounted side by side. A mounting rack houses the video amplifier chassis and power supplies. Maximum stability of optical registration has been achieved. Pickup tubes, field lens and color filtering system are completely aligned in the factory and should remain aligned indefinitely. Realignment necessitated by replacement of a Vidicon is quickly and easily made. Two sets of individual gain controls for each of the three colors enable one control group to be preset in advance, ready to take over when there is a rapid shift to film with appreciably different color balance. The chain has resolution of 600 lines and can be used with and fitted into studio layouts containing monochrome equipment of any manufacturer.

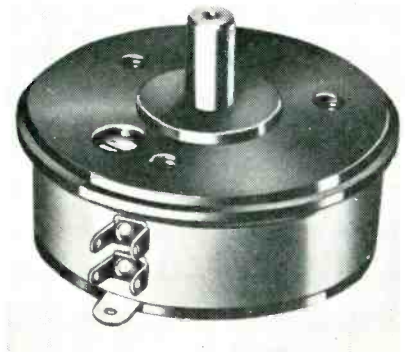

## PRECISION POT is 1-13/16 in. in diameter

HELIPOT CORP., 916 Meridian Ave., South Pasadena, Calif. The series CN ultra-precision potentiometer is 1 13/16 in. in diameter, with linearity as fine as  $\pm 0.075$  percent. The series are fully described in data sheet 54-11. This sheet details construction, specifications, coil characteristics and readily available modifications.

## AMPLIFIER KLYSTRON is forced-air-cooled

EITEL-MCCULLOUGH, INC., San Bruno, Calif., has announced a new high power uhf amplifier klystron, the 3K3000 LQ. In c-w operation at 760 to 980 mc it delivers 2-kw power output with a power gain of

FOR THE APPLICATION OF

# *electronic instrumentation*

TO EVERY REQUIREMENT OF

# *nucleonics*

At El-tronics you will find every facility to meet your needs in the field of nuclear instrumentation. Here are experienced scientists . . . skilled technical personnel . . . fully-equipped laboratories . . . modern production lines . . . the capacity to produce quickly whatever you require.

## **OLD IN A NEW FIELD**

Here, also, is experience, gathered over a twenty-year period, in supplying specialized requirements for the Atomic Energy Commission . . . U. S. Army . . . U. S. Navy . . . General Electric . . . Westinghouse . . . Sloan Kettering Institute . . . Philco . . . RCA . . . Union Carbide and Carbon . . . and many other organizations of this calibre.

## **ONE OR A MILLION**

Whether you need an individual equipment for specialized application or a line of mass-produced instruments, El-tronics is equipped now to serve you.

**CONSULTATIONS ARE INVITED**

# **EL-TRONICS**

*research  
development  
engineering  
production*

## **EXECUTIVE OFFICES:**

1420 Walnut Street, Philadelphia 2, Pa.

## **PLANTS:**

Philadelphia—Scranton

*Visit the EL-TRONICS Exhibit • Atomic Industrial Forum's Trade Fair • Sheraton Park Hotel, Washington, D.C., Sept. 26-29.*

# GET THE FACTS

LOW and constant contact drop  
 LOW electrical noise  
 HIGH current density  
 LONG life...



**HIGH PERFORMANCE**



# BRUSHES CONTACTS SLIP RINGS

**& Slip Ring Assemblies**

BRUSH HOLDERS, CONTACT ASSEMBLIES,  
 BRUSH ASSEMBLIES



USED EXTENSIVELY IN:

**SERVOS • GUN-FIRE CONTROLS  
 TELEMETERING • ROTATING  
 THERMOCOUPLE and STRAIN  
 GAGE CIRCUITS • ROTATING  
 JOINTS • DYNAMOTORS**

Wide range of grades available for standard and special applications. Call on our 40 years of design experience to help solve your problems.

**OTHER GRAPHALLOY**

**PRODUCTS:** Unique (oil-free) self-lubricating Bushings and Bearings (applicable -450° to +700°F.; with expansion coefficient half that of steel will not seize shaft at low temperature); Oil-free Piston Rings, Seal Rings, Thrust and Friction Washers, Pump Vanes.



## GRAPHITE METALLIZING CORPORATION

1055 Nepperhan Ave. • YONKERS, NEW YORK

- Please send data on Graphalloy BRUSHES and CONTACTS.  
 Send data on BUSHINGS.

NAME & TITLE \_\_\_\_\_

COMPANY \_\_\_\_\_

STREET \_\_\_\_\_

CITY \_\_\_\_\_

ZONE \_\_\_\_\_

STATE \_\_\_\_\_

NEW PRODUCTS

(continued)

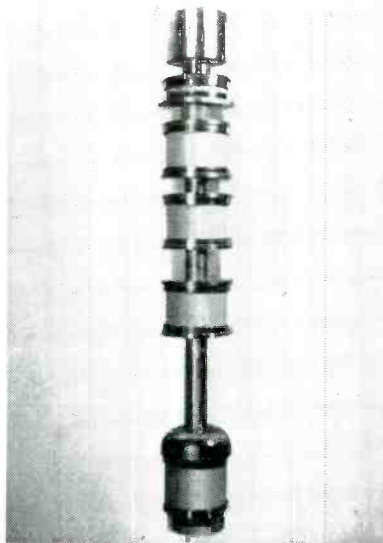

1,000 times and 40-percent efficiency. The forced-air-cooled tube has a long life oxide cathode and rugged ceramic and metal construction. Resonant cavities are completed external to the vacuum system, which is left free of r-f circuitry, enabling wide range tuning, uncomplicated input and output coupling adjustment and ease of installation and maintenance. Price is \$2,360.

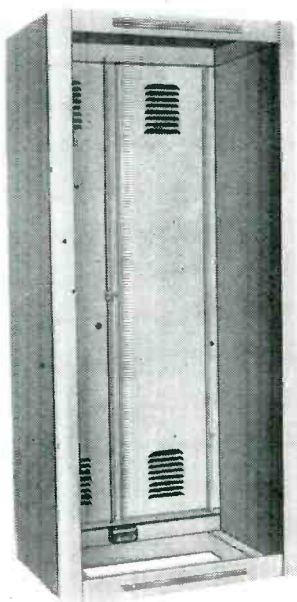

## TRANSMITTER RACKS designed for 30-in. panels

PREMIER METAL PRODUCTS Co., 3160 Webster Ave., New York 67, N. Y., has available a new heavy duty transmitter rack. Features include double rear doors on loose-jointed

# MICROWAVE MULTI-PULSE SPECTRUM SELECTOR

for use with Polarad  
 Spectrum Analyzers



The Polarad Multi-Pulse Spectrum Selector increases the versatility of Polarad Spectrum Analyzers by displaying and allowing selection for analysis a specific train of microwave pulses as well as any one pulse in the train.

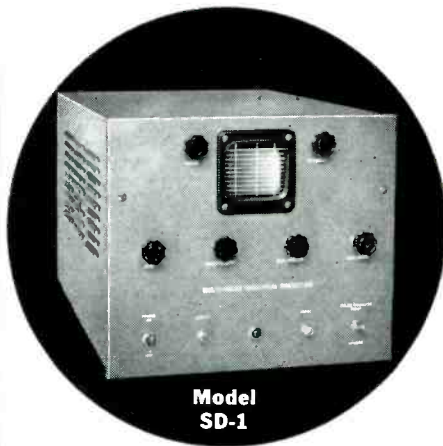

**Model  
 SD-1**

It will select and gate a group of pulses up to 100  $\mu$ sec. in length; is designed to work with fast, narrow pulses; and can be adjusted to gate any pulse including the first at zero time. Special circuitry discriminates automatically once pulses have been selected. The Model SD-1 has been designed to operate with all Polarad Spectrum Analyzers at any of the frequencies they will accept.

- Completely self-powered portable unit.
- High intensity, flat-face CRT for accurate display with:
  - Continuously variable sweep widths; 10 to 100  $\mu$ sec.
  - Continuously variable gate widths for pulse selection; 0.2 to 10  $\mu$ sec.
  - Continuously variable gate delays for pulse selection; 0 to 100  $\mu$ sec.
  - Automatic gating of spectrum analyzer during time of pulse consideration.
  - Intensified gates (brightening) to facilitate manual pulse selection.
  - Triggered sweep on first pulse in any train. No sweep in absence of signal.

**SPECIFICATIONS:**

Maximum Pulse Train Time.....100  $\mu$ sec.  
 Pulse Rise Time.....05  $\mu$ sec. or Less  
 Minimum Pulse Separation.....1  $\mu$ sec.  
 Repetition Rate.....10 -10,000 pps.  
 Minimum Pulse Width.....1  $\mu$ sec.  
 Input Power.....95 to 130 volts,  
 50/60 cps., 350 watts  
 Input Impedance . . . 50 ohms (to match TSA)  
 Output Impedance . . . 50 ohms Spectrum Analyzer

**AVAILABLE ON EQUIPMENT LEASE PLAN**  
**FIELD MAINTENANCE SERVICE AVAILABLE THROUGHOUT THE COUNTRY**



## ELECTRONICS CORPORATION

43-20 34th STREET  
 LONG ISLAND CITY 1, N. Y.

Representatives in all principal cities.

# PORTABLE DIRECT READING SPECTRUM ANALYZER

10 TO 44,000 mcs

5 RF HEADS

UNI-DIAL TUNING



MODEL TSA

Now, a new Polarad spectrum analyzer only 21 inches high that covers the entire frequency range 10 to 44,000 mcs with 5 interchangeable RF tuning heads. The model TSA operates simply—single dial frequency control—with utmost frequency stability. It provides highest accuracy, and reliability for observation and true evaluation of performance over the entire RF spectrum—saving engineering manhours.

This instrument is designed for maximum utility and versatility in the laboratory and on the production line providing an easy-to-read 5 inch CRT display of the RF spectrum.

Model No.	Equipment
Model DSA.....	Spectrum Display and Power Unit
Model STU-1.....	RF Tuning Unit 10-1,000 mc.
Model STU-2A.....	RF Tuning Unit 910-4, 560 mc.
Model STU-3A.....	RF Tuning Unit 4,370-22,000 mc.
Model STU-4.....	RF Tuning Unit 21,000-33,000 mc.
Model STU-5.....	RF Tuning Unit 33,000-44,000 mc.

#### SPECIFICATIONS:

Frequency Range: 10 mc to 44,000 mc.  
 Frequency Accuracy:  $\pm 1\%$   
 Resolution: 25 kc.  
 Frequency Dispersion: Electronically controlled, continually adjustable from 400 kc to 25 mc per one screen diameter (horizontal expansion to 20 kc per inch)

Input Impedance: 50 ohms—nominal

\*Sensitivity:  
 STU-1 10-400 mcs —89 dbm  
 400-1000 mcs —87 dbm  
 STU-2A 910-2,200 mcs —87 dbm  
 1,980-4,560 mcs —77 dbm  
 STU-3A 4,370-10,920 mcs —75 dbm  
 8,900-22,000 mcs —60 dbm  
 STU-4 21,000-33,000 mcs —55 dbm  
 STU-5 33,000-44,000 mcs —45 dbm  
 Overall Gain: 120 db  
 Attenuation:  
 \*\*RF Internal 100 db continuously variable, IF 60 db continuously variable  
 Input Power: 400 Watts  
 \*Minimum Discernible Signal  
 \*\*STU-1, STU-2A, STU-3A

The model TSA Spectrum Analyzer has these exclusive Polarad design and operating features:

- Single frequency control with direct reading dial. No klystron modes to set. Tuning dial accuracy  $\pm 1\%$ .
- Five interchangeable RF tuning units for the entire frequency range 10 to 44,000 mcs.
- Temperature compensation of Klystron Oscillator.
- Swept IF provides 400 kc to 25 mc display independent of RF frequency setting.
- Internal RF attenuator.\*\*
- Frequency marker for measuring frequency differences from 40 kc to 25 mc.

AVAILABLE ON EQUIPMENT LEASE PLAN

FIELD MAINTENANCE SERVICE AVAILABLE THROUGHOUT THE COUNTRY

NEW! Write for Handbook of Spectrum Analyzer Techniques



ELECTRONICS CORPORATION 43-20 34th STREET, LONG ISLAND CITY 1, N. Y.

REPRESENTATIVES: • Albuquerque • Atlanta • Baltimore • Bayonne • Bridgeport • Buffalo • Chicago • Dayton • Fort Worth • Los Angeles • New York • Newton • Philadelphia • San Francisco • Syracuse • Washington, D. C. • Westbury • Winston-Salem • Canada, Amprior, Toronto—Export: Rocke International Corporation

## Practical design engineers prefer REGOHM Regulators...

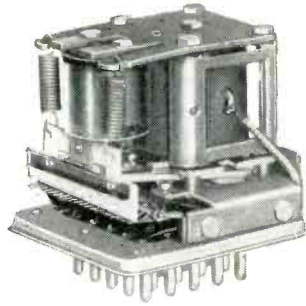

### On Land... Continuous Power Generating Systems

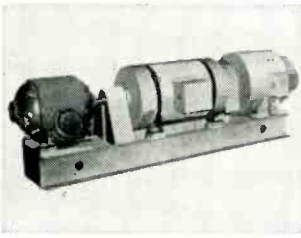

REGOHM regulates the output voltage of this 5KW generating system within a 4% band, independent of load changes and other operating conditions. Used to power control and communications systems, these units must operate every hour of the year. REGOHM's long life and plug-in feature that simplifies replacement makes it a natural for this application.

### On Sea... Hand-Cranked Generators

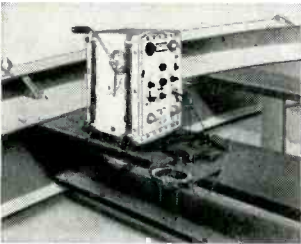

Fast-acting REGOHM maintains constant output voltage on hand-cranked generators powering portable lifeboat radios. Reliable over a wide temperature range, independent of speed of rotation and output loading, REGOHM delivers radio noise-free performance under severe operating conditions. No other equipment equals its size, and low cost advantages.

### In the Air... Control Instrumentation



REGOHM regulates voltage of special control instrumentation in pilotless bombers where precise, reliable control is a *must*. A two-inch cube, weighing under a pound, REGOHM economizes on space and weight. System stabilization is assured by its built-in dashpot, adjustable to match the system's dynamic characteristics. No anti-hunt networks are needed.

Whether your equipment or control system operates on land, sea or in the air...involves power supplies or communications and signal systems, instrumentation or lighting systems...look into the advantages of REGOHM regulation.



Contact Electric Regulator Corporation, 100 Pearl St., Norwalk, Conn. Our Engineering staff will help you design required circuitry...recommend the proper REGOHM type...calculate the resistor network...suggest design modifications for optimum performance...analyze final designs...assist in testing pre-production models...service your requirements. Write or call us today.

**Electric Regulator Corporation**  
Norwalk, Connecticut      Temple 8-4311

hinges and closed by a 3-point locking device. The RM7030 is 76½ in. high, 33 in. wide, 24 in. deep and is designed for 30-in. panels. It is sturdily constructed of No. 16 gage steel with a No. 12 bottom and welded throughout. Panel mounting angles are ⅜ thick and are tapped 12-24 on universal spacings. A rectangular cutout is made in the bottom for leads and a duplex receptacle and outlet box are furnished in the back under the door.

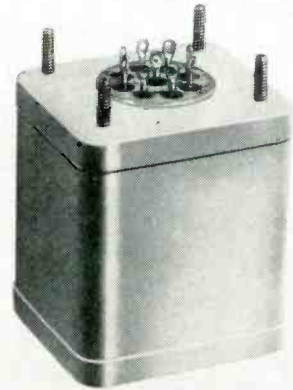

### MAGNETIC AMPLIFIERS with high power gain

HYCOR Co., INC., 11423 Vanowen St., North Hollywood, Calif., announces a standard catalog series of magnetic amplifiers. Stock units are available over wide ranges of impedance, power gain, response time and supply frequency. Toroidally wound reactors are used throughout and the units are available in hermetically sealed cases or plastic encapsulated forms. Type 402, illustrated, is a two-stage amplifier. Power gain is 2,000,000; input impedance, 200 ohms; load impedance, 3,000 ohms; supply frequency, 400 cps at 115 v; response time, one second. All necessary rectifiers are self-contained. Complete information and specifications are given in bulletin MA.

### POTENTIOMETER is precisely adjustable

HELIPOT CORP., 916 Meridian Ave., South Pasadena, Calif. Fast setting to desired value and positive locking are two of the many advantages

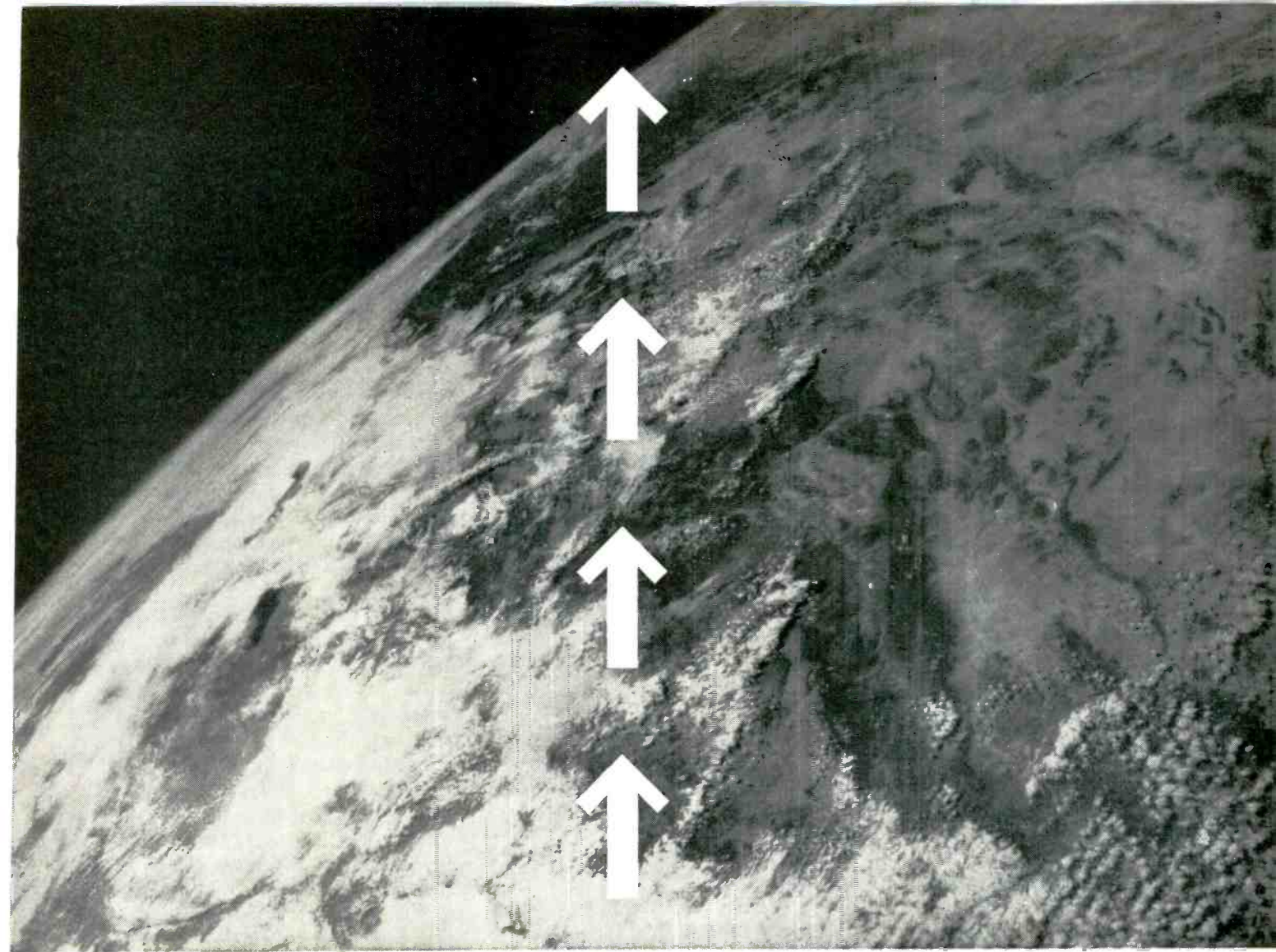

where the future begins

It's a young man's universe!

No other branches of the armed services today – and few businesses – offer more exciting and unlimited opportunities for the future than are available in the military fields of aircraft, missiles, rocketry and space vehicle development.

Shown here is a glimpse of 600,000 square miles of our planet. It was photographed from a Martin Viking research rocket which attained an altitude of 158 miles. This rocket was one of a series de-

veloped by a team of Martin engineers and Navy scientists who have worked together since 1946.

To the young engineer and to the enlistee for military service, this picture says more than words about the immense opportunities to be explored – in uniform or out – in the closely integrated field of military and commercial aviation.

Here, in fact, is one of the biggest futures in the world today.

**MARTIN**  
BALTIMORE · MARYLAND



# STABLE at 120°C



ACTUAL SIZE  
(2 WATTS)

## ...new POLYOHM 1% RESISTOR

—takes full power at ambient temperature three times that specified by MIL-R-10509A

—exceeds all other MIL-R-10509A specifications

DERATING CURVE FOR HIGH AMBIENT TEMPERATURES

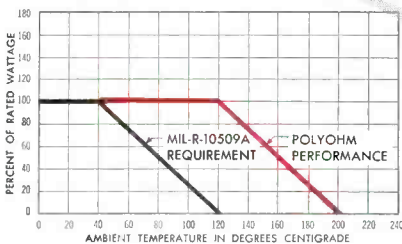

If you need a 1% resistor that is stable at high ambient temperature and humidity, we would like you to test free samples of our newly developed POLYOHMS. They exceed all MIL-R-10509A specifications as you can see from the comparison table below. Note, for example, that they take full power at ambient temperatures up to 120°C instead of only 40°C. Thus, they are ideal for use in aircraft and guided missiles. The same fact, of course, will result in much longer life when they are operated at lower temperatures.

POLYOHMS are well suited to replace bulky, expensive and highly inductive wire-wound resistors.

The resistor will remain well within its 1% tolerance even under the stringent moisture test which allows a 5% change. Its temperature coefficient is always lower than both the R and X characteristics.

POLYOHMS are manufactured in ½, 1, and 2 watt sizes with facilities controlled by the Signal Corps. They are presently available only for government end use. Please request samples on company letterhead.

TABLE OF TEST RESULTS

TEST	MIL-R-10509A Allowable change	POLYOHM Test Results (Median Value)
Temperature cycling	1%	.03%
Low temperature exposure	3%	.08%
Short time overload	.5%	.03%
Load life @ 40°C — 1000 hrs.	1%	.2%
@ 120°C — 1000 hrs.	—	.5%
Temp. coeff. ppm/°C (char. X)	± 500	— 150
(char. R)	± 300	— 150
Moisture resistance test	5%	.3%

# Polytechnic

## RESEARCH & DEVELOPMENT CO. INC

202 TILLARY ST.  
BROOKLYN 1, N.Y.  
Telephone  
ULster 2-6800



Midwest Sales Office:  
1 SO. NORTHWEST HWY., PARK RIDGE, ILL. — TALcot 3-3174  
Western Sales Office:  
737-41, SUITE 7, NO. SEWARD ST., HOLLYWOOD 38, CAL. • HO 5-5287

NEW PRODUCTS

(continued)



of the series T-10-A. This laboratory model, which can be used as either a potentiometer or rheostat, requires only one-fifth the time of a 5-dial decade box. In d-c and low-frequency a-c bridge circuits, it is much faster to use than a series of decade resistors. It is precisely adjustable, with total resistance ranging from 100 to 100,000 ohms. High resolution with extremely fine resistance ( $\pm 1$  percent) and linearity tolerances ( $\pm 0.1$  percent) is provided by a series A 10-turn precision potentiometer. Instantaneous, accurate settings to desired values or reading of unknowns in null-balance circuits are made possible by a model RB Duodial turns-counting dial. The unit has a power rating at 25 C ambient of 6.9 w; 5 w at 40 C ambient. Ambient temperature range is from  $-55$  C to  $+80$  C.



## Q-SWEEP for rapid measurements

KAY ELECTRIC Co., 14 Maple Ave., Pine Brook, N. J., has available the Q-Sweep, which will permit rapid, production line Q measurements. It displays Q by means of 5-percent swept frequency, thereby eliminating the necessity of resetting the oscillator for each component test. Thus it is now possible within a specific tolerance range to measure large numbers of component parts, visually or by meter reading, without readjustment of any control. Frequency range is 20 to 220 mc; range of Q measure, 0 to 125 or 0 to 250; resonating capacitor range,



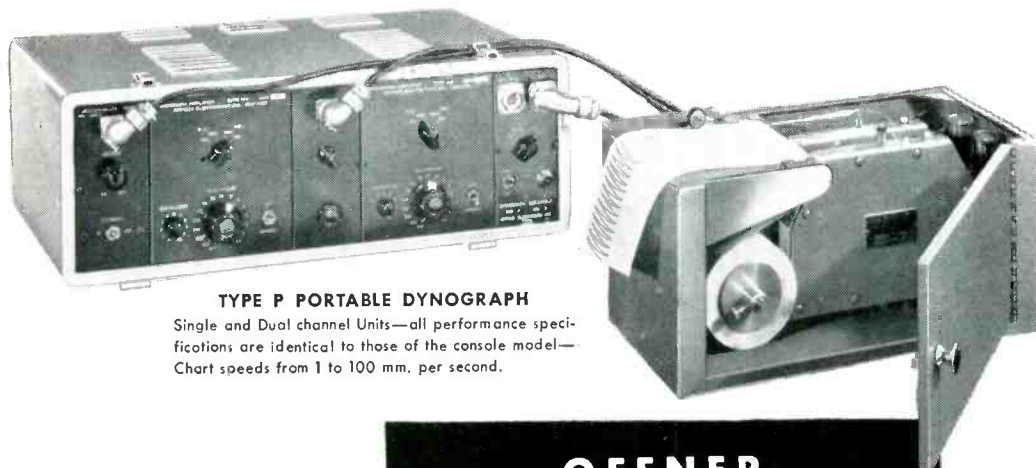

**TYPE P PORTABLE DYNOGRAPH**

Single and Dual channel Units—all performance specifications are identical to those of the console model—Chart speeds from 1 to 100 mm. per second.



**TYPE M CONSOLE**

Six channels—accommodates up to six Type 146 amplifiers with input couplers, uses roll or folded charts—eight chart speeds, 1 to 250 mm. per second.

**OFFNER  
DYNOGRAPH  
RECORDERS**

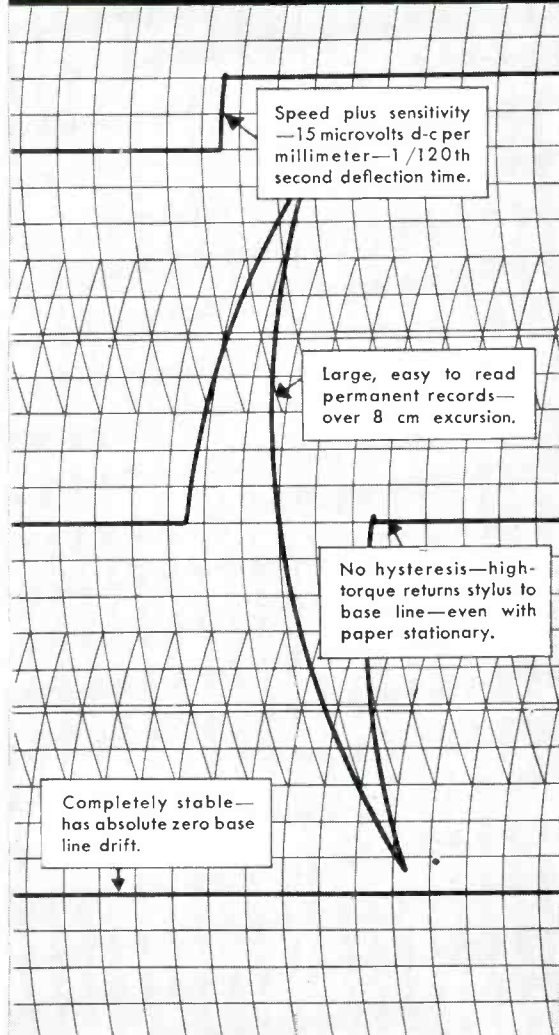

**IF YOU COMPARE—YOU WILL SELECT THE OFFNER DYNOGRAPH!**

Compare the direct writing oscillographs on the market today. If you do, you will select the Offner Dynograph because only the Offner Dynograph has these features:

15 microvolt per millimeter d-c sensitivity . . . Absolute *drift-free* stability . . . One amplifier for d-c amplification, resistance and reluctance gages . . . True differential input, isolated from ground . . . Rugged, low resistance movement.

No other direct writing oscillograph on the market has *any of these features!* The Offner Dynograph *has all these features and many more!*—because the Dynograph uses the exclusive patented Offner *chopper amplifier*. This amplifier must be distinguished from a chopper *stabilized* amplifier, which merely reduces, does not eliminate drift, and provides none of the other features of the Offner Dynograph.

If you want the widest versatility, highest accuracy, greatest reliability in direct writing high speed oscillographs—*compare them all!* You'll select the Offner Dynograph.

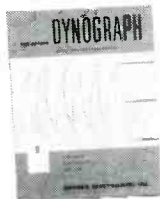

Write for your copy of Bulletin L-742. Get complete details and application information on both Portable and Console Models. Write for a demonstration by our Engineering Representatives in your area. Compare—and you will select the Offner Dynograph.

**OFFNER ELECTRONICS INC.**

5324 N. Kedzie Avenue, Chicago 25, U. S. A.

**Big**  
or  
**LITTLE...**

**McCoy Precision Quartz Crystals**  
deliver the **SAME FINE PERFORMANCE**

You can expect the same precision performance from both the McCoy M-1 and the M-20 "McMite," although the "McMite" is only 1/5th as big. Both crystals are produced up to 110 mc on the 5th overtone. The fact that these two crystals perform equally well in meeting widely varied job specs illustrates the versatility of McCoy design and production facilities. Whatever you need in quartz crystals, McCoy either makes them or can develop them for you. Send for free catalog today on the McCoy line of high quality, precision-made quartz crystals.

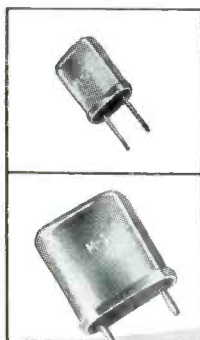

M-20 "McMite" is a sub-miniature hermetically sealed unit, adaptable to multi-channel design for communications and frequency control equipment. Can be wired into a sub-miniature selector switch assembly or soldered to a printed circuit terminal board. Furnished with either .018 inch dia. flexible wire leads or with .040 inch dia. rigid "plug-in" type pins.

M-1 is an hermetically sealed, plated crystal preferred when fundamentals below 5 mc are desired. Easily interchangeable, it plugs into a standard socket. Meets government specification MIL-C-3098A and CAA-R-916; also ARINC No. 401.

**McCoy ELECTRONICS COMPANY**  
MT. HOLLY SPRINGS, PENNA.  
Phone 376 end 377

Licencee under patents of  
Western Electric Company

7.5 to 100  $\mu\text{mf}$ , is displayed on a digital counter dial for easy reading; power supply is 105 to 125 v, 100 w. Price is \$990.

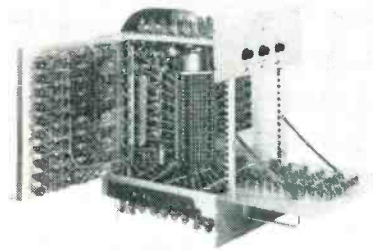

### PULSE ANALYZER a basic research instrument

PACIFIC ELECTRO-NUCLEAR Co., Division of Western Devices, Inc., 8930 Lindblade St., Culver City, Calif. Model PA-3 100-channel pulse height analyzer is used to obtain nuclear energy spectra of radioisotopes. It quantizes the amplitude of pulses from an alpha, beta, or gamma detector into 100 discrete levels or channels; stores counts until the desired statistics are obtained; and then presents the compiled information to the physicist for study and analysis. The unit features coincidence gating of signal pulses when desired; nonvolatile memory storage—complete data may be retained without power; automatic count-stop circuit which terminates data taking when any channel reaches a preset count of 999, 9,999 or 99,999; and built-in memory test routines to localize quickly tube failures or incipient failures.

### IGNITRON with internal cooling coil

NATIONAL ELECTRONICS, INC., Geneva, Ill. The NL-1053 heavy-duty size D ignitron is of stainless steel construction and includes a mounting plate for thermostat to provide thermal protection. It is a repairable welding control ignitron with an internal cooling coil. The increased cooling efficiency permits a greatly increased averaging time: 11 sec at 500 v and 22 sec at 250 v. Simplified construction enables it to be repaired at a cost much below the cost of a new tube. Other ratings

# McGraw-Hill Mailing List Will Help You

- Merchandise your advertising
- Conduct Surveys
- Get leads for your salesmen
- Get inquiries about your product or service
- Pin-point geographical or functional groups
- Sell Direct
- Build up weak territories
- Aid Dealer Relations

Direct Mail is a necessary supplement to a well rounded Business Paper advertising program.

600,000 actual names of the top buying influences in all the fields covered by the McGraw-Hill publications make up our 150 mailing lists. These lists are built and maintained primarily for our own use, but they are available to you for Direct Mail purposes. Pick out a list of YOUR prospects from our Industrial Direct Mail Catalogue.

More and more, progressive companies are using Industrial Direct Mail regularly as an advertising medium. They effectively allocate a portion of their ad budgets to this second medium at the same time as they concentrate on the best business publications.

For complete, detailed information about our service, fill in the coupon or write for your copy of our free Business and Industrial Direct Mail catalogue.

for Results



**Mc GRAW-HILL**  
**DIRECT MAIL LIST SERVICE**

#### Direct Mail Division

McGraw-Hill Publishing Co., Inc.  
330 West 42nd St., N. Y. 36, N. Y.

Please forward my free copy of the McGraw-Hill "Industrial Direct Mail Catalogue."

NAME \_\_\_\_\_

COMPANY \_\_\_\_\_

ADDRESS \_\_\_\_\_

CITY \_\_\_\_\_ STATE \_\_\_\_\_

at last!

# A CALORIMETRIC TYPE RF WATTMETER

0-3000 MCS.

0-300 WATTS

MODEL 641N—an instrument designed to measure RF power with the precision of a Primary Standard.



▶▶▶ **DESIGNED FOR USE** wherever extremely accurate RF Power measurements are needed, the 641N Wattmeter serves as a Primary Standard for such measurements. As such, it can be used to check the accuracy of other types of RF wattmeters, and to determine the actual power output of an RF power source, the approximate magnitude of which is known. Over the entire frequency range of 0 to 3000 megacycles this instrument has an accuracy of better than plus or minus 2 percent of full scale, using the calibration curve supplied. For more accurate measurements, the 641N Wattmeter may be calibrated by the user at DC or 60 cycles. AC-DC wattmeters with an accuracy of 1/4 of 1 percent may be used in this calibration, and the resulting RF power level may be established to an accuracy of better than 1 percent.

## SPECIFICATIONS

Impedance: 52 ohms  
 Frequency Range: 0 to 3000 mcs.  
 Power Range: 0 to 300 watts  
 Power Scales (5):  
 0-3 watts  
 3-10 watts  
 10-30 watts  
 30-100 watts  
 100-300 watts

VSWR (max. over frequency range): 1.1 to 1000 mcs.  
 1.2 to 3000 mcs.  
 RF Connector: Type N, mates with UG21B/U.

Accuracy: Plus or minus 2% of full scale on any scale, using the supplied calibration curves.

This instrument can be calibrated by the user at DC or 60 cycles for more precise measurement at a particular power level.

Repeatability: Within 1%

Time Required for One Reading: 2 minutes.

Recycling Time between Readings: 20 minutes.

Power Required: 3 watts 105-125V  
 60 C.

Size:  
 Indicator Load 5 1/2" x 6" x 13 1/2"  
 Load 5 1/2" x 6" x 14 1/4"

Weight:  
 Indicator Load 8 pounds  
 Load 16 pounds



are the same as the conventional size D ignitron: 2,400 kva maximum demand, 355 amperes d-c maximum anode current per tube, and at any voltage between 250 and 600 v rms at 25 to 60 cycles. Cooling water required is 3 gallons per min at a minimum inlet temperature of 0 deg C.



## PRECISION POT linear within $\pm 0.025$ percent

HELIPOT CORP., 916 Meridian Ave., South Pasadena, Calif. The Helipot series AN precision potentiometers, offering linearity within  $\pm 0.025$  percent, are the subject of data sheet 54-11. The AN series is available in linear and nonlinear versions to which as many as 28 taps can be added, each spot-welded to a selected single turn of resistance wire. Data sheet 54-11 details construction, specifications and coil characteristics.

## UHF ANTENNA for low power to broadcast

PRODELIN INC., Kearney, N. J. Type KTV-2/14-31 Cover-Loop uhf antenna is designed for low power tv broadcasting and satellite stations. It stands 5 ft high, weighs only 90



**M. C. JONES ELECTRONICS CO., Inc.**  
**BRISTOL, CONNECTICUT**



## New Mico XXP Laminate Gives You Much Higher Insulation Resistance

Here at last is a uniform, high-quality material with the higher insulation resistance you need for many applications in radar, television, radio, computers, electronic equipment of all kinds. It's MICO's Radar Grade LAMICOID #6229.

Compare for yourself! Test it together with other laminates under your own test methods for insulation resistance.

Write today for samples—or ask to have a MICO Sales Engineer call.

### Look at these other outstanding values!

#### WATER ABSORPTION, (%)

Precond. E-1/105	
Cond D1-24/23	
$\frac{1}{16}$ " thick	0.57
$\frac{1}{8}$ " thick	0.37

#### SPECIFIC GRAVITY

$\frac{1}{16}$ " thick	1.33
$\frac{1}{8}$ " thick	1.33

#### FLEXURAL STRENGTH, (psi)

Tested flatwise, Cond. A	
$\frac{1}{8}$ " thick	cut lengthwise 21,000
	cut crosswise 16,900

#### DISSIPATION FACTOR AT 1 MEGACYCLE

$\frac{1}{8}$ " thick	Cond. A	.0314
	Cond. D-24/23	.0316

#### DIELECTRIC CONSTANT AT 1 MEGACYCLE

$\frac{1}{8}$ " thick	Cond. A	4.42
	Cond. D-24/23	4.63

#### DIELECTRIC BREAKDOWN, (Kv.)

Parallel to lamination, S/S	
Cond. D-48/50	
$\frac{1}{16}$ " thick	68.8+
$\frac{1}{8}$ " thick	68.0+

#### PUNCHING QUALITY

$\frac{1}{16}$ " thick	Heated 1 min.	Good
	Heated 2 min.	Good
	Heated 3 min.	Good



**MICA** *Insulator* **COMPANY**

Schenectady 1, New York

Offices in Principal Cities

In Canada—Micanite Canada, Ltd., Granby, Quebec

LAMICOID® (Laminated Plastic) • MICANITE® (Built-up Mica) • EMPIRE® (Coated Fabrics and Papers) • FABRICATED MICA • ISOMICA®

# Need A Good Translator



## ...For Custom Cable Requirements?

Look no further! PHALO has established a reputation for translation of exacting custom cable specs which is the envy of the industry.

Dig out those cable "specs" you filed under "Impossible" and put them before a PHALO Custom Cable Man. If anyone can

make that cable, PHALO can.

We may sound a little egotistical here but we have a background of custom cable success which permits us a bit of license for promoting our special abilities.

Anyhow, you can prove it, just by trying our skill!

*Ask For The Complete Phalo Catalog*

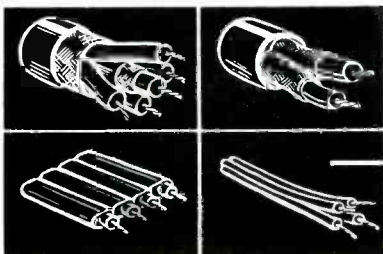

# PHALO

PLASTICS CORPORATION

*The Custom Cable House*

CORNER OF COMMERCIAL STREET  
WORCESTER, MASS.

Insulated Wires, Cables - Cord Set Assemblies

NEW PRODUCTS

(continued)

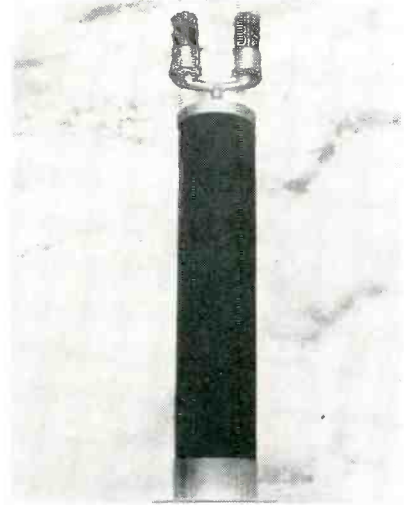

lb and has a power gain of 2. Rated at 500 w, it has a vswr of better than 1.1 to 1. The glass-fiber reinforced plastic cover forms the primary antenna support and also houses, weather proofs and protects the radiating elements within. The antenna is available with power gains of 2, 4 and 8 ranging in height from 3 to 20 ft.

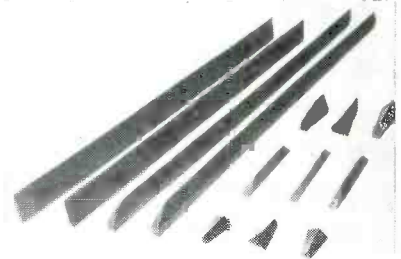
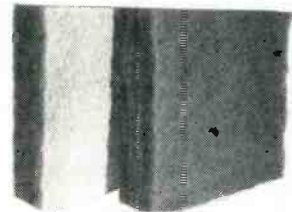

## MICROWAVE ABSORBERS in two new series

EMERSON & CUMING, INC., 869 Washington St., Canton, Mass., announces two new series of microwave absorbers. The ECCOSORB CH is of flexible, rubberized fiber for use in microwave darkrooms. With a maximum energy reflection of 2 percent at all angles of incidence, this absorber permits antenna measurements to be made indoors. Its three types are available in these wavelength ranges: 0.5 cm



6339



6508



6693



5545



6786



857B



5870

# amperex® RECTIFIERS

... the most complete line in the world covering a full range of Voltage and Current Ratings.

# amperex RECTIFIERS

... designed and manufactured by electron tube specialists, in laboratories that are second to none ... with a background of experience that encompasses the entire history of electronic development.

# amperex RECTIFIERS

... are generally lower in initial cost and always lower in cost per operating hour.

Tube Type	Description	Peak Inverse Voltage (PKV)	Average Anode Current (Amps)
6339	H.V.	12‡	0.05‡
AV-3	H.V.	16*	0.065*
AV-1	H.V.	25*	0.05*
866AX	M.V.	140*	0.05*
3B28	M.V.	10	0.25
AVT-14	XENON	10	0.25
AVT-13	H.V.	150*	0.25*
1701	H.V.	125*	0.4*
249B	M.V.-G.C.R.	5	0.5
5869	M.V.	7.5	0.64
4B32	M.V.-G.C.R.	13	1.0
872AX	XENON	10	1.25
8008	M.V.	10	1.25
315AW	M.V.	10	1.25
575A	M.V.	15	1.5
673	M.V.	15	1.5
5559	M.V.	15	1.5
255B	M.V.-G.C.R.	1.5	2.5
869B	M.V.	20	2.5
6508	M.V.	20	2.5
5870	M.V.	21	2.5
6693	M.V.-G.C.R.	27	2.5
5544	M.V.	15	3.0
5545	XENON-G.C.R.	1.5	3.2
AX-105	XENON-G.C.R.	1.5	6.4
6786	M.V.-G.C.R.	2.5	6.4
266B	M.V.-G.C.R.	15	10.0
857B	M.V.	22	10.0
AX255	M.V.	22	10.0
AX260	M.V.	25	12.5
		25	25

HV=High Vacuum Tube  
 MV=Mercury Vapor Tube  
 GCR=Grid Controlled Rectifier  
 \*Oil immersed operation  
 ‡Without cooling (air operation)

← All the listed types are available for immediate delivery! If your local electronic parts distributor does not have the tube you want—write, wire or phone! Simply check your application, ratings and control specifications and select the finest rectifier you can buy.

Equally extensive is the AMPEREX line of power tubes. There's one to suit your need. If you do not have the latest Amperex condensed tube catalog for easy selection of Rectifier and Power tubes, write for it today!

**RETUBE with amperex**

**amperex** ELECTRONIC CORP.

230 Duffy Ave., Hicksville, L.I., N.Y.

In Canada: Rogers Majestic Electronics Ltd.  
 11-19 Brentcliffe Rd., Leaside (Toronto 17)



# Pulse Cable assemblies?



## HHB assemblies prove outstanding in performance

**CORONA-FREE!** . . . up to and including 8 KV and ability to meet 12 KV breakdown test in normal service for most assemblies. Under special conditions they have been produced to meet higher corona-free requirements.

**COMPLETELY APPROVED!** . . . HHB Cable Assemblies embody HHB Connectors. Both are factory-assembled and tested as complete units to provide assurance of outstanding service. Cables supplied in lengths as required.

**NEW!** . . . "pressure correct" connection Bayonet-type connection for HHB Pulse Connectors was recently introduced to permit quick assembly and positive contact without excessive pressure by overtightening.

Write for HHB Catalog Bulletin CA-33-36-53, and data on new Bayonet-type connectors.



Skilled in

- RESEARCH • DESIGN
- ENGINEERING • MANUFACTURING

of Electronic Components and Connectors  
for Communications and Industry

## H. H. BUGGIE, Inc.

726 STANTON STREET

TOLEDO 4, OHIO

Sales-Engineers in All Principal Cities

NEW PRODUCTS

(continued)

through 12 cm; 0.5 cm through 30 cm; 0.5 cm through 60 cm. The second series (ECCOSORB HF) is for use as waveguide terminations and loads. It is produced in standard rods and sheets or molded to specified shapes. Each member of this series is of a different bulk resistivity; the entire range covers from 50 to  $10^{12}$  ohm cm<sup>3</sup>. Write for technical bulletin No. 8-2-1.



## COIL TURN COUNTER is 0.1 percent accurate

SUNSHINE SCIENTIFIC INSTRUMENT, 1810 Grant Ave., Philadelphia 15, Pa. This coil turn counter quickly measures the number of turns on coils wound on nonmagnetic forms with an accuracy of 0.1 percent. It is available in 3 models, with the following ranges: 0 to 11,110, 0 to 31,110, and 0 to 61,110 turns. The coil to be tested is placed over a test rod, and its turn count compared with a standard coil mounted within the equipment. The counter operates from a 115-v 60-cycle source; is easy to use; reads directly in number of turns, and tests a wide range of coil sizes. Catalog No. 16 describes the instrument in detail.

## P-M MOTORS are 1¼ in. in diameter

JOHN OSTER MFG. Co., 1 main St., Racine, Wisc., has available a line of 1¼ in. diameter permanent magnet motors designed for minimum radio noise. Type AM-215 is designed to meet MIL-M-8609 specification. The motor alone weighs only 5 oz. Very high torque is made possible by a simpler magnet



# RUGGEDIZED ADVAC

- Provide Permanent Hermetic Sealing
- Terminal Assembly Complies with MIL-T-27 Requirements
- Withstand Temperatures to 1400°F and Pressures to 2000 P.S.I.

## CABLE END SEALS

HIGH TEMPERATURE HERMETIC SEALS FOR METALLIC SHEATHED CABLES, HEATING ELEMENTS AND OTHER TUBULAR COMPONENTS



The ADVAC metallizing process applied to Hi-Alumina Ceramic produces super rugged hermetic seals. These standard cable end seals operate over extreme excursions of temperature, humidity, shock and vibration. The metal portions provide the ultimate in corrosion resistance and are easily bonded to associated equipment by brazing at temperatures up to 850°C.

For complete information on ADVAC End Seals or Seals for other applications, call or write today!

### D I M E N S I O N S

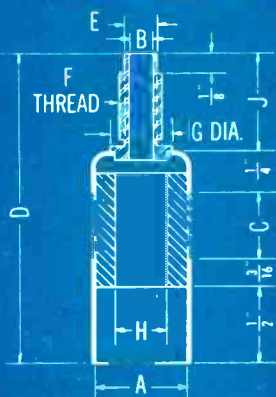

TYPE	A	B	C	D	E	F	G	H	J	Operating Voltage*	Current Rating	Terminal Torque Rating†
250-ES	.250	.082	5/16	1-11/16	.125	8-32	1/4	1/8	7/16	1000	20 A.	15
320-ES	.320	.113	5/16	1-15/16	.148	10-32	1/4	5/32	11/16	1500	30 A.	20
330-ES	.330	.116	1/2	1-7/8	.148	10-32	1/4	5/32	7/16	1500	30 A.	20
375-ES	.375	.116	1/2	1-7/8	.148	10-32	1/4	3/16	7/16	2500	30 A.	20
450-ES	.450	.150	1/2	2-1/8	.203	1/4-28	3/8	1/4	11/16	2500	60 A.	35
500-ES	.500	.150	1/2	2-1/8	.203	1/4-28	3/8	1/4	11/16	2500	60 A.	35
625-ES	.625	.150	1/2	2-1/8	.203	1/4-28	3/8	5/16	11/16	2500	60 A.	35

\*40% R.H. — sea level — 60 cycles R.M.S. per MIL-T-27 Test Method.  
†Rated maximum terminal rotational torque in inch lbs.

DIVISION OF  
GENERAL CERAMICS  
CORPORATION



**ADVANCED VACUUM  
PRODUCTS • INC**

118 Liberty Street, Stamford, Connecticut—Telephone: Davis 4-2148

to suit you best  
**MANSOL** makes  
**GLASS MULTIFORMS**

*Custom Tailored*

to your exact  
 specifications

**GLASS MULTIFORMS**

Did you know that multiforms in glass have greater inherent elasticity to make them more shock resistant than glass tubing or pressed glass? Here are the ideal multiforms for Iron Sealing and Kovar Sealing, matching the expansion of these metals over their entire working range. They resist mercury attack, have ample mechanical strength and seal readily. Our laboratory is prepared to assist you in selecting the proper glass for any metal.

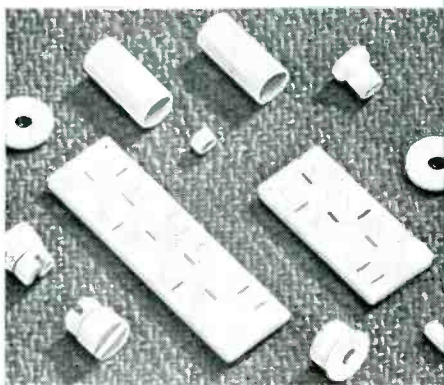

**NOW USED IN MAKING OF:**

Hermetic Seals, Gun Mounts, Thyatron Tubes, Diodes, transistors, Connectors, sealed - TERMINALS, Insulators and Dial Lights.

**MANSOL can produce MULTIFORMS to seal to the following:** Dumet, Kovar, Fernico, Rodar, Molybdenum, Mica, Platinum, #4 Alloy, Tungsten and Stainless Steel.

**MANSOL also makes MULTIFORMS of STEATITE**

We specialize in small die-pressed ceramic parts held to the closest tolerances. All tools and dies are made in our shop to assure quick delivery.

• If you are still making your own multiforms, let Mansol help you with your multiform problems.

• Write to Dept. E for the complete story about Multiforms, Steatite and our production facilities. No obligation, of course.



Cable Address: MANSOL

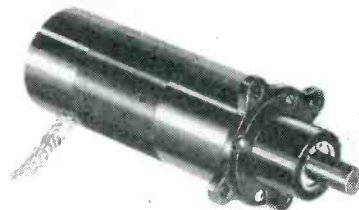

design. Radio noise is minimized by shielded leads. Altitude-treated brushes have very long life. Temperature range is from -55 C to +71 C. Motor speeds range from 6,000 to 20,000 rpm. Speeds are controllable to ±1 percent over a 24 to 29-v range by using a governor. The motor is available with gear train, governor, brake or any combination thereof. When used with gear train, gear ratios range from 6 to 1 to 4,000 to 1.



**DELAY NETWORKS for laboratory use**

E. S. C. CORP., 534 Bergon Blvd., Palisades Park, N. J., has developed a new series of variable delay networks. Designed for laboratory use to facilitate design and development of advanced computer and radar systems, these delay networks are compactly constructed for front panel mounting. They offer a variation of delay from 0 to 0.75 μsec in ten turns of the vernier control shaft.

**TWIN TRIODE for use in tv receivers**

SYLVANIA ELECTRIC PRODUCTS INC., 1740 Broadway, New York 19, N. Y. The 6CG7 general purpose medium twin triode tube is intended particularly for use as a vertical deflection oscillator and horizontal deflection oscillator in tv receivers. It may also be used as a phase inverter, multivibrator, sync separa-

**CHATHAM** advance-designed yesterday

— in  
industry-wide  
use today!



**AMPLIFIERS • REGULATORS • INERT GAS  
AND MERCURY RECTIFIERS • MERCURY,  
INERT GAS AND HYDROGEN THYRATONS**



# CHATHAM SPECIAL-PURPOSE TUBES

• **3B28 RECTIFIER**

Rugged half-wave Xenon filled rectifier. Operates in any position. Ambient temperature range  $-75^{\circ}$  to  $+90^{\circ}$ C. Inverse peak anode voltage 10,000, average current .25 amps. Filament 2.5v., 5 amp.

• **4B32 RECTIFIER**

Ruggedly built, half-wave Xenon filled rectifier. Ambient temperature range  $-75^{\circ}$  to  $+90^{\circ}$ C. Inverse peak anode voltage 10,000, average anode current 1.25 amp. Filament 5v., 7.5 amp.

• **VC-1258 MINIATURE  
HYDROGEN THYRATRON**

for pulse generation. Handles 10 kw peak pulse power.

• **6336 TWIN TRIODE**

for voltage regulation. Features high plate dissipation, hard glass envelope.

• **5R4WGB RECTIFIER**

Full wave rectifier manufactured to MIL-E-1B reliable tube specifications.

• **5651-WA VOLTAGE  
REFERENCE TUBE**

Stable, rugged. Available in both commercial or reliable tube MIL types.



5R4WGB



VC-1258



5651-WA

STANDARD TYPES DIRECT FROM STOCK  
PLUS SPECIAL DESIGNS BUILT TO REQUIREMENTS

Chatham specializes in the development of general and special purpose tubes for both electronic and industrial applications. Many of the tubes originally developed by Chatham to fill a specialized need, now number among the most widely used tubes in the industry. For complete information on Chatham tubes — either stock items or types built to your requirements — call or write today.



## CHATHAM ELECTRONICS CORP.

Executive and General Offices: LIVINGSTON, NEW JERSEY  
Plants and Laboratories: NEWARK and LIVINGSTON, NEW JERSEY

# For Quality TV Tubes

# B&A BARIUM ACETATE

## "ELECTRONIC GRADE"

Granular,  
Reagent A.C.S.

### Rigid Control Assures You Constant, Unvarying Purity!

Lot after lot, Baker & Adamson's "Electronic Grade" Barium Acetate is of the same superior quality . . . ideally suited to TV tube and other electronic equipment needs. Made by an exacting process under rigid controls, it is extremely low in halides, calcium, strontium, and other impurities. The specifications at right are an indication of the high purity requirements to which every lot of B&A Electronic Grade Barium Acetate must conform, *without exception*.

A free-flowing powder, B&A "Quality" Barium Acetate is packaged in 25, 100 and 400-lb. drums with special polyethylene bag liners to protect its purity. B&A warehouses from coast to coast assure prompt supply of your needs.



### B&A Electronic Grade Barium Acetate

#### Maximum Limits of Impurities

Insoluble	0.005%
Chloride (Cl)	0.001%
Iron (Fe)	0.0005%
Copper (Cu)	0.0003%
Nickel (Ni)	0.0001%

### Other B&A Chemicals for Electronic Use

As America's foremost producer of fine chemicals and laboratory reagents, Baker & Adamson is your safe, sure source for chemicals of the guaranteed high purity that means trouble-free performance. Call any B&A office listed below for full information, shipments or quotations.

#### Gaseous Dielectric

Sulfur Hexafluoride

#### Metal Fluoborate Solutions—For plating parts

Fluoboric Acid . . . Copper Fluoborate . . .  
Lead-Tin Fluoborate . . . Indium Fluoborate . . .  
Nickel Fluoborate

#### Mineral Acids, Reagent, A.C.S.

Acetic . . . Hydrochloric . . . Hydrofluoric . . .  
Nitric . . . Phosphoric . . . Sulfuric

#### Solvents, Reagent, A.C.S.

Acetone . . . Isopropanol . . . Toluene . . .  
Xylene

#### Others

Aluminum Nitrate . . . Barium Fluoride . . .  
Barium Nitrate . . . Bromine . . . Calcium  
Carbonate . . . Calcium Fluoride . . .  
Calcium Nitrate . . . Copper Nitrate . . .  
Hydrogen Peroxide . . . Magnesium Oxide . . .  
Manganese Dioxide . . . Mercury . . .  
Nickel Oxide . . . Potassium Fluoride . . .  
Potassium Hydroxide . . . Sodium Carbonate . . .  
Sodium Hydroxide . . . Strontium  
Nitrate . . . Thorium Nitrate . . .

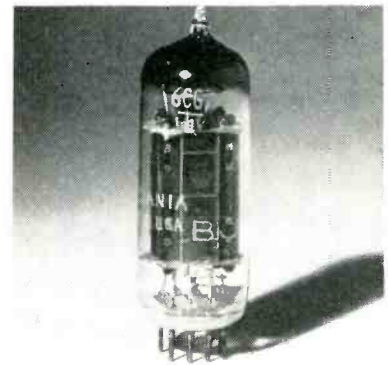

tor and amplifier and resistance-coupled amplifier in electronic equipment. The tube is designed with a 600-ma heater. Design features include a structure which permits cool operation of the grids, with the result that emission from them is minimized. The structure also incorporates an internal shield which provides effective shielding between the triode units that prevents electrical coupling between them.



### MOLDED CONNECTORS replace hand-fabricated type

DEJUR-AMSCO CORP., 45-01 Northern Blvd., Long Island City 1, N. Y. Type XC 145-22 molded, special design connector has been announced. The molding is orlon-filled diallyl phthalate (per MIL-P-4389), a non-hygroscopic material of high dimensional stability and excellent dielectric properties. Precision machined socket contacts with turret terminals are made of spring temper phosphor bronze.

### H-V TUBE SOCKET is safe and reliable

INDUSTRIAL HARDWARE MFG. CO. INC., 109 Prince St., New York 12, N. Y., has designed a new deep shell high-voltage tube socket for safety, reliability and economy purposes. The socket maintains a maximum

# BAKER & ADAMSON *Fine Chemicals*

GENERAL CHEMICAL DIVISION

ALLIED CHEMICAL & DYE CORPORATION

40 Rector Street, New York 6, N. Y.

Offices: Albany\* • Atlanta • Baltimore\* • Birmingham\* • Boston\* • Bridgeport\* • Buffalo\* • Charlotte\*  
Chicago\* • Cleveland\* • Denver\* • Detroit\* • Houston\* • Jacksonville • Kalamazoo • Los Angeles\* • Minneapolis  
New York\* • Philadelphia\* • Pittsburgh\* • Providence\* • St. Louis\* • San Francisco\* • Seattle • Kennewick\*  
and Yakima (Wash.) • In Wisconsin: General Chemical Company, Inc., Milwaukee

In Canada: The Nichols Chemical Company, Limited • Montreal\* • Toronto\* • Vancouver\*

SETTING THE PACE IN CHEMICAL PURITY SINCE 1882

\*Complete stocks carried here

# DAYSTROM INSTRUMENT

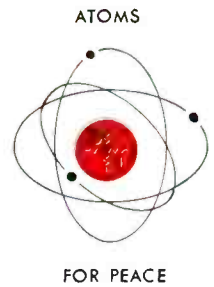
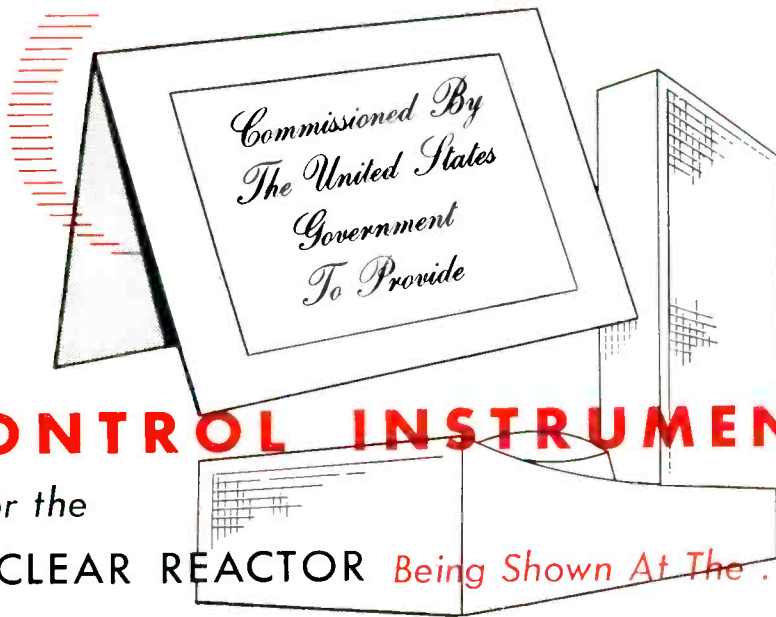

## CONTROL INSTRUMENTATION

for the  
**NUCLEAR REACTOR** *Being Shown At The . . .* **CONFERENCE**  
 UNESCO  
 Geneva, Switzerland

DAYSTROM INSTRUMENT is in full scale production of nuclear instruments for the Atomic Energy Commission and industry . . . and has the facilities, "know-how" and skilled manpower to supply control instruments tailored to your requirements. You can look to Daystrom for instruments of finest quality, utmost precision and top performance.



### *Daystrom Instrument Has Also Supplied:*

Control instruments, computing mechanisms, test equipment for all branches of the Armed Services . . . and many of America's leading industrial concerns—as well as foreign companies.

#### For The AIR FORCE—

Capacitance Testers, All-Altitude Servo Indicators, Transistorized Receivers, R F Switches.

#### For The NAVY—

Radar Fire Control Systems, Mine Detecting Devices, Anti-Submarine Attack Directors, Catapult Speed Indicators, Servo Control Systems, Torpedo Assemblies.

#### For The ARMY—

Mechanical Fire Control Systems, Fuzes, Communication Systems and other instrumentation for all branches of the Army.

#### For INDUSTRY—

Test Equipment, Computing Devices, Radar Equipment, Nuclear Equipment. Gyros, Electronic and Electro-Mechanical Devices.

Write For Our Facilities Report

**DAYSTROM**  **INSTRUMENT**  
 Archbald, Penna. *Div. of Daystrom, Inc.*

Ruggedized  
and aged

# "RELIABLE" DOUBLE TRIODE



Do you have an aircraft or industrial application that requires utmost dependability in increasing or controlling alternating voltages or powers . . . in changing electrical energy from one frequency to another . . . or in generating an alternating voltage?

If so, specify the Red Bank RETMA 6385 "Reliable" Double Triode. For it is specially ruggedized to perform at top efficiency longer, even under operating conditions of severe shock and vibration. And, as further assurance of its extra reliability, each RETMA 6385 is factory-aged with a 45-hour run-in under various overload, vibration and shock conditions, such as it might meet on the job.

Whether you need tubes as amplifiers, mixers, or oscillators, it will pay you to investigate the superior, longer-lasting performance qualities of the Bendix Red Bank RETMA 6385.

### RATINGS\*

Heater voltage—(AC or DC)**	6.3 volts
Heater current	0.50 amps.
Plate voltage—(max.)	360 volts
Max. peak plate current (per plate)	25 ma.
Max. plate dissipation (per plate)	1.5 watts
Max. peak grid voltage	+ 0 volts
	(-100 volts)
Max. heater-cathode voltage	300 volts
Max. grid resistance	1.0 megohm
Warm-up time	45 sec.
(Plate and heater voltage may be applied simultaneously.)	

\*To obtain greatest life expectancy from tube, avoid designs where the tube is subject to all maximum ratings simultaneously.

\*\*Voltage should not fluctuate more than  $\pm 5\%$ .

### PHYSICAL CHARACTERISTICS

Base	Miniature button 9-pin
Bulb	T-6 $\frac{1}{2}$
Max. over-all length	2 $\frac{3}{16}$ in.
Max. seated height	1 $\frac{15}{16}$ in.
Max. diameter	$\frac{7}{8}$ in.
Mounting position	Any
Max. bulb temp.	160° C

### AVERAGE

### ELECTRICAL CHARACTERISTICS

Heater voltage, $E_h$	6.3 volts
Heater current, $I_h$	0.50 amps.
Plate voltage, $E_b$	150 volts
Grid voltage, $E_c$	-2.0 volts
Plate current, $I_b$	8.0 ma.
Mutual conductance, $g_m$	5000 $\mu$ mhos
Amplification factor, $\mu$	35
Cut-off voltage	-10 volts
Direct interelectrode capacitances (no shield)	
Plate-grid (per section)	1.7 $\mu$ $\mu$ f
Plate-cathode (per section)	1.1 $\mu$ $\mu$ f
Grid-cathode (per section)	2.4 $\mu$ $\mu$ f
Plate-plate	0.1 $\mu$ $\mu$ f



EATONTOWN, N. J.

West Coast Sales and Service: 117 E. Providencia, Burbank, Calif.  
Export Sales: Bendix International Division, 205 E. 42nd St., New York 17, N. Y.  
Canadian Distributor: Aviation Electric Ltd., P.O. Box 6102, Montreal, P.Q.

Manufacturers of Special-Purpose Electron Tubes, Inverters, Dynamotors, AC-DC Generators, Voltage Regulators and Fractional H.P. DC Motors.

DIVISION OF



NEW PRODUCTS

(continued)

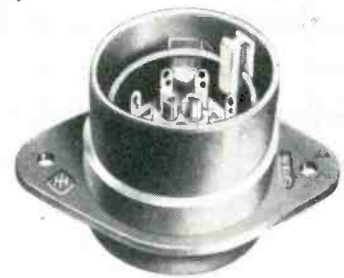

continuous d-c voltage without arc-over to metal chassis. It is molded of natural mica-filled phenolic material and can be supplied for octal, miniature and noval tubes.

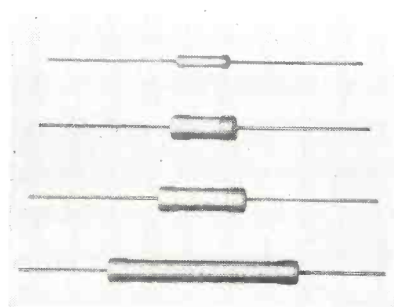

### RESISTORS

are of the carbon film type

CONTINENTAL CARBON, INC., 13900 Lorain Ave., Cleveland 11, Ohio, has available at moderate cost a line of carbon film resistors in  $\frac{1}{4}$  w,  $\frac{1}{2}$  w, 1 w and 2 w ratings. Resistance range is 10 ohms through 20 megohms; tolerance, 1 percent, 2 percent and 5 percent. They are designed to meet the requirements of MIL-R-10509A specifications.



### S-BAND WAVEMETER for 1,800 to 3,800 mc range

AMERAC, INC., 116 Topsfield Road, Wenham, Mass. The C & D S-band wavemeter for the 1,800 to 3,800-mc range features a highly



## *Puts your business on a cash basis*

If you are an electronics manufacturer or a wholesaler with annual or potential sales of \$1,000,000 or more you can profitably use our kind of banking service to provide increased working capital without increased indebtedness or dilution of profits.

Why not investigate this modern approach to your money problems and learn how you can put your business on an all-cash basis, with wider opportunities for sales and profits.

More than four hundred companies in various industries are now profitably using our banking services.



## **Textile Banking Co., Inc.**

*Providing operational financing for manufacturers and distributors of furniture, apparel, electronics, plastics and textiles.*

**55 Madison Avenue, New York 10, N. Y.**

# INVESTIGATE

## This Counseling Service For Frequency Control Engineers

Equipment is being designed every day that creates new applications and new problems for frequency control devices. To help you benefit from the latest developments in this rapidly advancing field, Scientific's Research Department offers this service:

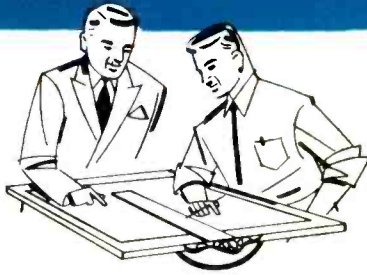

Send Scientific a sketch of your proposed frequency control unit, or of your frequency control problem. Scientific's research and development staff will analyze your data for possible improvements or modifications, and will recommend the standard crystal best adapted to your needs.

This analysis service by Scientific's engineers has helped many manufacturers achieve a design that enabled them to (1) use a standard, less expensive crystal, (2) save many engineering hours at the design level, and (3) produce a circuit that will be far more efficient. It can do the same for you.

To use this service to its fullest advantage, send your sketches while they are still in the design stage — even before comprehensive drawings and prototypes have been made. *Scientific offers you this service at no cost and with no obligation. Address your correspondence to the Research Department.*

### CRYSTALS FOR EVERY PURPOSE

- AIRCRAFT
- AIR FORCE
- AMATEUR
- ARMY-SIGNAL CORPS
- BROADCAST
- CAA CERTIFICATION
- CIVILIAN BANDS
- HOBBY MODELS
- INDUSTRIAL
- LAW ENFORCEMENT
- MARINE
- MOBILE TWO-WAY
- NAVY
- PIPELINE
- RAILROAD
- RAM JET CONTROLS
- TAXI
- TELEVISION



*One of the Oldest Manufacturers  
of Crystals in the United States.*

# Scientific

## RADIO PRODUCTS, INC.

215 SOUTH 11TH STREET.. ATLANTIC 9787. OMAHA, NEBRASKA

sensitive indication of resonance, with a control for setting the sensitivity of the instrument. Its micrometer extends outside the instrument providing easy reading. It has a precision cavity assembly for accurate repeatable readings, with an antibacklash device which gives further accuracy. It has the following specifications: Accuracy at 3,260 mc is  $\pm \frac{1}{2}$ -mc; loaded Q is approximately 1,000; r-f detector is a selected type 1N21-B silicon diode; and overall size is 8 in. long, 7 $\frac{1}{2}$  in. wide and 2 $\frac{1}{2}$  in. deep; net weight is 2 $\frac{1}{2}$  lb. Price is \$225.

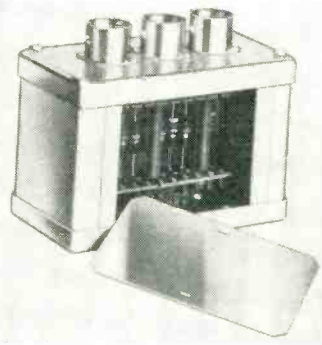

### LIP-LOC CASES for plug-in packages

VECTOR ELECTRONIC Co., 3352 San Fernando Rd., Los Angeles 65, Calif. Designed especially for electronic plug-in packages, these new cases feature snap-open side panels for quick accessibility and attractive appearance. Removal of two screws allows the entire self-locked case to come apart. Center sections may be perforated for ventilation or omitted entirely. Components (such as sockets, plugs and transformers) may be mounted on any four of the six sides with excellent accessibility. Component mounting structures are also available for the inside of the case. Send for the catalog.

### TEFLON TUBING for class H service

HITEMP WIRES, INC., 26 Windsor Ave., Mineola, N. Y., has available the new Temprene nonrigid, Teflon tubing featuring all of the outstanding combination of properties offered by Teflon: noncombustible,



# Transicoil

GEAR MOTORS



And Geared Motor-Driven Induction Generators

.....HERE'S  
YOUR PRACTICAL  
GUIDE TO GEAR-TRAIN  
CONTROL MOTOR  
COMBINATIONS

Now you can design high-quality, precision servo systems with prior knowledge of delivery dates to meet hot production deadlines. Transicoil's new gear motor bulletin gives you, for the first time, complete availability data on the units you need to meet tough space and performance requirements.

The complete list of gear ratios available — for sizes 9, 11, 15, and 18 control motors — is keyed in two ways. One covers "immediate" gear ratios — available within one week of receipt of order. The other is made up of "quick" gear ratios — requiring an additional two weeks.

Also included are a wealth of servo control ideas presented in numerous case histories of custom assemblies designed and manufactured by Transicoil to solve particular problems. Write now for your free copy.

## Transicoil Corporation

WORCESTER, MONTGOMERY COUNTY, PA.

Please send me a free copy of your new gear motor bulletin.

NAME \_\_\_\_\_ TITLE \_\_\_\_\_

FIRM \_\_\_\_\_

ADDRESS \_\_\_\_\_



# a toroid is a shape!

Yes, in the electronics industry a "toroid" is a donut-shaped coil made up of a magnetic core, wire and insulation . . .

but a

# Celco TOROID

## IS AN ENGINEERED SHAPE!

Whether it's a complex 10 winding magnetic amplifier or a simple choke . . . at Celco each toroid is precision-made.

Every job order begins in Celco's Engineering Dept. where toroids are designed to meet customer specifications or operational procedures are prepared to assure proper manufacture of customer designs.

Here at Celco toroidal magnetic amplifiers, transformers and reactors get special handling and testing techniques to realize the advantages of high performance core materials.

Celco's extensive laboratory test and production facilities include modern toroidal winding machines, tool room, machine shop, punch presses, assembly, impregnation, and encapsulating equipment.

Take advantage of the Celco design and production experience in this specialized field. Get a Celco estimate - improve your quality - reduce your cost.

# Celco

*Constantine Engineering Laboratories Co.*

Island Avenue

Mahwah, N. J.

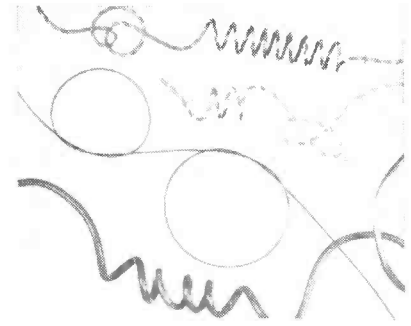

inert to moisture and all known commercial solvents and chemicals, tensile strength of not less than 1,500 psi, minimum breakdown voltage of not less than 5,000 v rms, plus complete flexibility to  $-90^{\circ}\text{C}$ . Inside tubing diameter runs from a minimum of 0.014 to a maximum of 0.112, with wall thicknesses running from 0.008 to 0.012, other sizes on special order. The tubing is ideal for capacitor and resistor leads, junction wire terminals and subminiature tube leads.

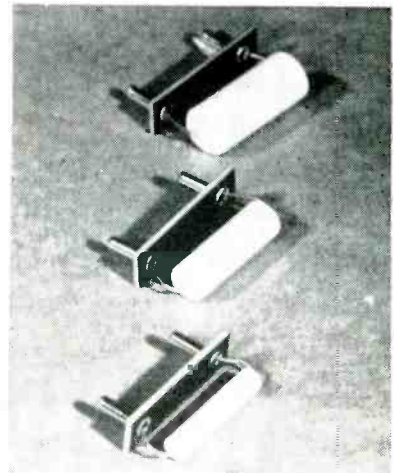

### FUSIBLE RESISTORS are plug-in type units

BRADFORD COMPONENTS, INC., 33-35 Bishop St., Bradford, Pa., have developed a diversified line of fusible resistors known as Fusistors for use in protecting more expensive components in tv and radio circuits. They serve a twofold purpose; a fuse and a resistor. They are constructed of material that will withstand a guaranteed load surge current yet will fuse when the current exceeds a given amperage. Examples are: a 5-ohm unit which will operate continuously at 1 ampere and after 1 hr withstand 1.4 amperes for 1 minute. This type will fuse in less than 2 minutes

## PROGRESS REPORT

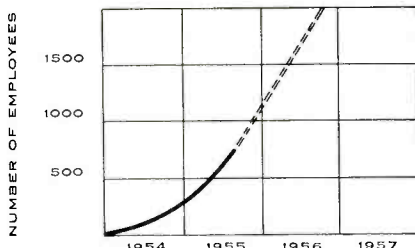

### PROJECTS

Our eight current military contracts support a broad range of advanced development work in the fields of modern communications, digital computing and data-processing, fire-control, and guided missiles. This work is supplemented by non-military activities in the fields of operations research, automation, and data-processing.

### FINANCES

In 1954, our first full year of operation, we showed a good profit. Of greater importance, however, are the arrangements recently completed with Thompson Products, Inc., our corporate associate, whereby we are assured additional funds up to \$20,000,000 to finance our expansion requirements of the next few years, and insure the long-range stability of the company.

### The Future

Our first year and a half of corporate history encourages us in the belief that our future will be one of expanding productivity. But whether we remain a small company or grow large, we plan not to lose sight of the fact that the continued success of The Ramo-Wooldridge Corporation depends on our maintaining an organizational pattern, a professional environment, and methods of operating the company that are unusually well suited to the very technical, very special needs of modern systems development and manufacturing.

## After Twenty-One Months...

### RESEARCH AND DEVELOPMENT PERSONNEL

Total population figures, such as those displayed in the curve, tell only a limited story. Personnel quality factors are most important, in our kind of business. We believe we are doing well in this respect. Of the 90 Ph.D.'s, 65 M.S.'s and 75 B.S.'s or B.A.'s who today make up our professional staff, a gratifyingly high percentage are men of broad experience and, occasionally, national reputation in their fields.

### FACILITIES

By mid-1956 our Los Angeles facility will consist of seven buildings totalling 300,000 square feet of modern research and development space. Two of the three buildings now complete and occupied are shown at bottom of this page; a fourth and fifth are presently under construction, the others are in the design stage.



### MANUFACTURING

We are somewhat ahead of the usual systems development schedule, with some of our projects having arrived at the field and flight-test stages. We are now planning a facility for quantity production of electronic systems. Construction on the initial unit of 160,000 square feet (shown above) is expected to start in late 1955, with manufacturing planned for late 1956.

## The Ramo-Wooldridge Corporation

8820 BELLANCA AVE., LOS ANGELES 45 CALIFORNIA.

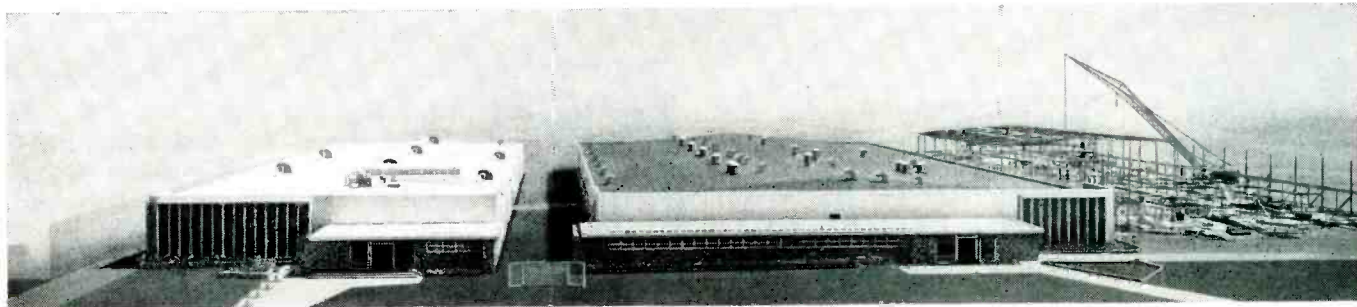

## ELECTRONIC ENGINEERS:

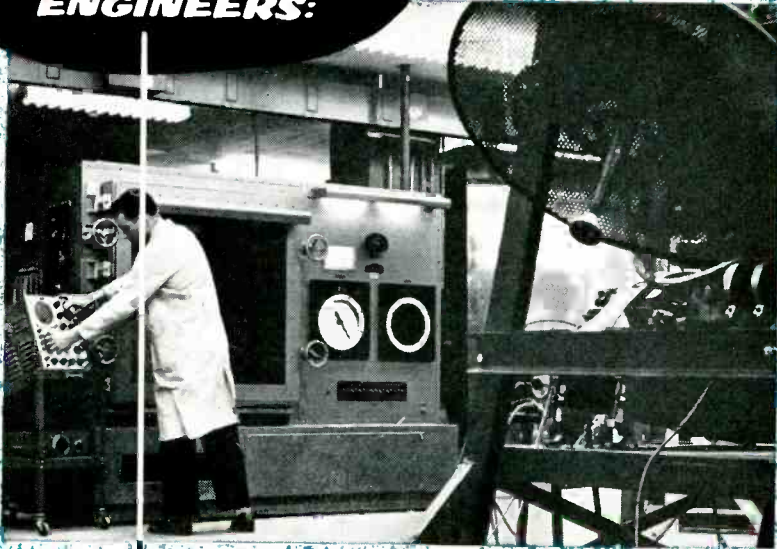

## READ WHAT HAPPENED WHEN WE PUT OURSELVES IN THE "ENVIRONMENTAL TEST CHAMBER"

Both the Electronics and the Air Arm Divisions of the Westinghouse Electric Corporation are expanding. We need experienced electronic engineers for advanced design and development work . . . so we put ourselves in the "environmental test chamber" to see just what we have to offer the people we need.

We found that we have a professional atmosphere that is ideal for the engineer. We offer advanced study at company expense and merit promotions that assure a good future.

Our income and benefit advantages scored high on this test, too. Finally, there were many "extras," like the Westinghouse Patent Award Program, that make investigation of the current openings worthwhile for all electronic engineers.

**APPLY NOW-**

Openings exist in the fields of—

COMMUNICATIONS  
(Microwave)  
FIRE CONTROL  
RADAR  
COMPUTERS

BOMBER DEFENSE  
MISSILE GUIDANCE  
FIELD ENGINEERING  
TECHNICAL WRITING

**TO APPLY-**

Send resume outlining education and experience to:

Technical Director  
Dept. 203  
Westinghouse Electric Corporation  
2519 Wilkens Avenue  
Baltimore 3, Md.

**ILLUSTRATED BROCHURE  
WILL BE SENT TO  
ALL APPLICANTS.**

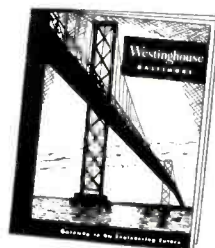

at 3 amperes. The second type, a 4-ohm unit, will carry 1.25 amperes continuously, and after 1 hr will carry 1.75 amperes for 1 minute. It will fuse in less than 3 minutes when passing 2.5 amperes.

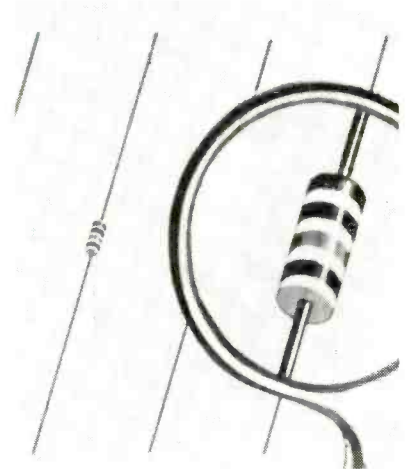

### MOLDED RESISTOR rated at 0.1 watt

ALLEN-BRADLEY Co., 1326 S. Second St., Milwaukee, Wisc. A new miniature molded resistor measuring 0.140 in. long and 0.015 in. in diameter with 1-in. leads and rated at 0.1 w has been announced. Type TR resistor is a molded composition unit with an insulating coating. It is especially suitable for use with transistors, diodes and other small components in miniaturized equipment. The resistors are available in standard RETMA, JAN-R-11 and MIL-R-11 resistance values for standard tolerances of  $\pm 5$  percent, 10 percent, and 20 percent from 10 ohms to 22 megohms. Maximum continuous voltage rating is 150 v rms or d-c. Maximum continuous wattage at 70 C is 0.1 w and at 40 C is 0.2 w. It derates linearly from 0.1 w at 70 C to zero at 100 C.

### POWER AMPLIFIER is 6 in. wide $\times$ 9 in. long

FAIRCHILD RECORDING EQUIPMENT Co., 154th St. and 7th Ave., White-stone, N. Y., has announced a new 25-w power amplifier designated as model 255. Full power output over the complete audio spectrum, minimum noise and distortion, excellent transient response and remarkable

"Okay—we'll reorder by airfreight and keep down our parts supply. Problem now is what carrier do we use?"



"American! Traffic manager says they can give us the best service from our various suppliers. Says American covers more industrial centers than any airline!"



To fully benefit from the advantages of shipping by air, ship American—the airline best qualified to serve your needs. In addition to the best coverage of leading cities throughout the United States, American also leads in:

**CAPACITY**—with the largest cargo capacity of any airline, American assures you of space where it's needed and when it's needed.

**SCHEDULES**—with the greatest number of scheduled departures, American keeps terminal time to a minimum; provides prompt forwarding.

**EXPERIENCE**—with the largest, most experienced personnel force, American is better able to solve shipping problems and provide dependable service.

Find out more about American Airfreight, today. Rates are surprisingly low—even less than some forms of surface transportation. Wire collect to: American Airlines, Inc., Cargo Sales Division, 100 Park Avenue, New York 17, New York.



# **AMERICAN AIRLINES AIRFREIGHT**

—carries more airfreight  
than any other airline in the world

## How SECON Fine Wire is used in critical Government end-use items

SECON'S HIGHLY ENGINEERED FINE WIRE IS BEING USED TO MEET CRITICAL SPECIFICATIONS BY MANUFACTURERS OF IMPORTANT DEFENSE AND MILITARY END-USE ITEMS.

### Precision Wire-Wound Potentiometers

In supplying precious metal alloy wire for these, Secon not only conforms to the physical and electrical characteristics on the manufacturer's specifications, but also winds a prototype potentiometer from each melt, which is tested for life, noise, and other characteristics which cannot be specified on the wire. Roundness of so small a magnitude that it cannot be measured is a carefully controlled characteristic which receives Secon's continuous attention.

### Direct-Heated Cathodes in Electronic Vacuum Tubes

Wire and ribbon for use here are individually prepared for each manufacturer to insure satisfactory operation. Secon sets aside the melts until the manufacturer has ascertained the emission and life characteristics of the melt. Approved Secon melts are then used exclusively to supply the manufacturer who made the tests.

### Electro-Plated Grid Wire for Electronic Vacuum Tubes

Precious metals used for these are carefully selected for purity. Only high purity gold, rhodium, silver and others are employed.

### Strain Gauge Wires

These are most carefully selected, in both precious and base metals. Samples of Secon melts are tested by the manufacturer of the strain gauge for temperature coefficient of resistance, gauge factor, and other important characteristics. To insure uniformity, Secon sets aside approved melts for the exclusive use of the manufacturer who made the tests.

### New Wire Products for Semi-Conductors, Transistors, Diodes, Crystals

Developed through special research for application in these fields, the new products include:

**Gold:** fine gold in purities up to 99.99%; and doped gold alloys.

**Aluminum:** fine aluminum wire in four grades (1) 2S aluminum, 99% pure; (2) EC grade aluminum, 99.4% pure; (3) 99.97% pure aluminum; (4) special high purity aluminum, 99.99% pure.

**Whisker Wires:** in base metals as well as hard platinum alloys, with close tolerances on straightness and hardness in all types.

**Lead-in Wires** of a great variety such as tinned copper wire or ribbon.

Secon specializes in the development, research and production of special alloys and pure metals, processed to very small diameter wire in all shapes—round, oval, flat, ribbon, grooved—for highly engineered applications in electronics, instrumentation, ordnance, aviation, nuclear physics, atomic energy, guided missiles, automotive industry, and other fields.

Close tolerances and controlled specifications can be held on many important characteristics such as: resistance, tensile strength, elongation, surface appearance, special spooling, purity, torque, linearity, composition, cross section, weight per unit length, uniform plating, dependable insulation, temperature coefficient of expansion and resistance, and strain sensitivity.

### Secon end-products include:

- Fine Wire drawn to 0.0003" diameter
- Ribbon rolled to 0.0001" in thickness
- Electro-Plated Wire and Ribbon
- Special Solder
- Enameled and Insulated Wire
- Pirani Gauge Wire
- Electric Primer Ignition Wire
- Galvanometer Suspension Strip
- Etched Wire
- Precision Potentiometer Wire
- Transistor Wire Components
- Electronic Vacuum Tube Wire Components
- Experimental Melts

Secon invites you to discuss your metallurgical problems with its Research and Development Department.

Write for Pamphlet E-8.

## SECON METALS CORPORATION

7 Intervale Street, White Plains, N. Y.  
White Plains 9-4757



stability are among its highlights. Less than 2-percent intermodulation distortion at 25 w with less than 0.5 percent at 22 w results in exceptionally clean reproduction. The amplifier also contains the company's distortion cancelling control for balancing the output stages without the use of external test equipment.

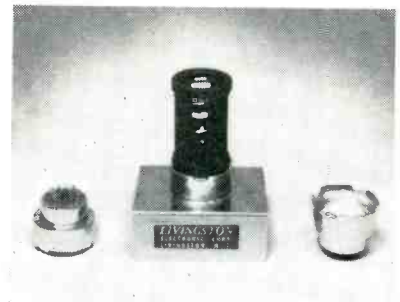

## TUBE SOCKETS are hermetically sealed

LIVINGSTON ELECTRONIC CORP., Livingston, N. J. An hermetically sealed tube socket which mates with I.E.R.C. heat dissipating shields and extends less than  $\frac{1}{2}$  in. below the chassis including solder type terminals has been announced. Made in 7 and 9-pin miniature sizes, these sockets make it possible to seal components for high altitude or other uses and at the same time be able to replace tubes without breaking the seal. Effects of shock and vibration are minimized by firm mechanical support of the tube. Other features of the sockets include: 10,000 megohms minimum insulation resistance, shell and terminals hot tin dipped for ease in soldering, beryllium copper contact sleeves heat treated and heavy silver plated, internal moisture seal effected with silicone rubber, and a temperature range of  $-65$  C to



Announcing **A-MP**®

MINIATURE **TAPER PINS**

FOR MINIATURIZED COMPONENTS!



A-MP's new Miniature Taper Pins, shown here actual size, provide the same uniformly reliable wire connections for your miniature components, as the larger, widely used and accepted A-MP Taper Pins. Miniature Taper Pins are applied to wire with A-MP Automatic Machines at speeds up to 4000 per hour. They are then inserted into components quickly and easily with A-MP CERTI-LOK Insertion Tools. Miniature Taper Pins are available for wire sizes #26 to #20.



©A-MP

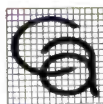

Send today for your copy of "A-MP's Creative Approach to Better Wiring"



**AIRCRAFT-MARINE PRODUCTS, INC.**, 2100 Paxton Street, Harrisburg, Pa.  
In Canada: **AIRCRAFT-MARINE PRODUCTS OF CANADA, LTD.**, 1764 Avenue Road, Toronto 12, Ontario, Canada



# Broader IRC service for your electronic and avionic components

These new IRC subsidiaries specialize in selected fields of advanced electronics. Combined with IRC's leadership in components engineering . . .



they offer dependable, new sources for critical components and broader IRC service in all important electronic centers.



**IN LOS ANGELES, CALIFORNIA,** IRCAL Industries offers specialized experience in Encapsulated Wire Wound Precision Resistors. Convenient West Coast procurement, plus highly developed epoxy techniques offer substantial advantages.



**IN ST. PETERSBURG, FLORIDA,** Circuit Instruments Inc. provides precision potentiometers for critical applications requiring reliability, sturdiness and miniaturization. Write for catalog describing available types, sizes and ratings.



**IN LOS ANGELES, CALIFORNIA,** Hycor Company, Inc. specializes in Precision Wave Filters, Variable Attenuators, Toroid Coils, Audio Components and Magnetic Clutches. Hycor is a consistent pioneer in the development of critical components.



Write for data on the newest electronic and avionic components of IRC and its subsidiaries, or visit **Wescon Show, Booths 818, 819 and 830, August 24-26**



**INTERNATIONAL RESISTANCE CO.**

401 N. Broad Street, Philadelphia 8, Pa.

In **Canada:** International Resistance Co., Ltd., Toronto, Licensee





# Convenient West Coast source for ENCAPSULATED WIRE WOUND PRECISION RESISTORS

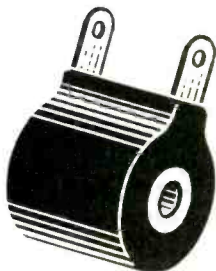

## MIL-R-93A Types

TRU-MITE Encapsulated Wire Wound Precision Resistors offer assured stability and long life under adverse climatic conditions for either high or low ambient temperatures. All exterior surfaces are protected against salt water corrosion and electrolysis. Use coupon for engineering bulletin covering sizes and specifications.



IRCAL INDUSTRIES  
Department B, 2240 S. Sepulveda Blvd.  
Los Angeles 64, Calif.  
Send Engineering Data Bulletin on TRU-MITE Resistors to:

Name \_\_\_\_\_  
Company \_\_\_\_\_  
Address \_\_\_\_\_  
City \_\_\_\_\_ State \_\_\_\_\_



NEW PRODUCTS

(continued)

200 C. The 7-pin socket is conservatively rated at 1,600 v rms, and the 9-pin socket at 2,000 v rms.



## D-C POWER SUPPLIES are high-current units

MODEL RECTIFIER CORP., 557 Rogers Ave., Brooklyn 25, N. Y., announces a series of ten standard low voltage high current d-c power supplies in a space saving portable cabinet design, adaptable to rack panel mounting. Powerunits are available in the 0-15 v, 0-50 ampere range; 0-30 v, 0-27 ampere range, and 0-90 v, 0-9 ampere range. Convection cooled selenium and germanium rectifiers are used for power conversion. Powerunits may be had delivering full wave rectified d-c or filtered d-c in varying degrees to 0.03-percent ripple. Outputs are continuously variable within listed ranges and find use in laboratory, production testing and as battery eliminators.

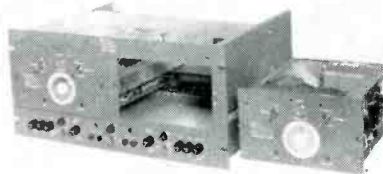

## SERVO MULTIPLIER features speed of response

DYNALYSIS DEVELOPMENT LABORATORIES, INC., 11941 Wilshire Blvd., Los Angeles 25, Calif. Model 123 servo multiplier group consists of two model 123-1 single channel servo multipliers and one model 123-2 power supply. Each servo channel is capable of multiplying 5

# HYCOR TELEMETERING FILTERS

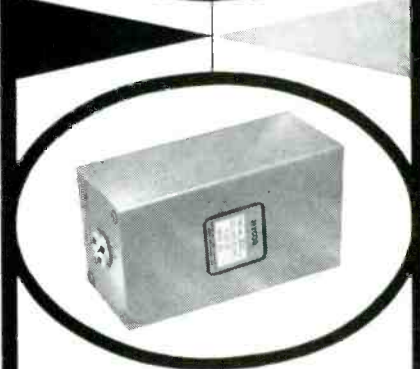
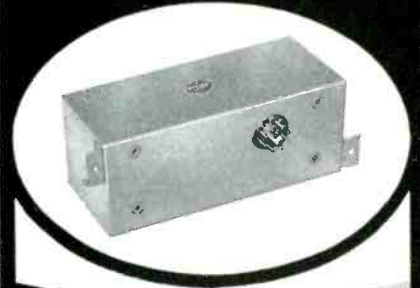

### Features...

- HYCOR telemetering filters have excellent characteristics due to the use of high "Q" toroid inductor elements. The filters may be used in low level circuits with negligible hum pickup resulting.
- In addition, only the finest capacitors are employed to assure stability.
- Available in standard RDB frequencies.

### GENERAL SPECIFICATIONS Impedance 500/500

TYPE	BANDWIDTH	ATTENUATION	FREQUENCY RANGE
1500	± 7½%	-3 db or less	400 cps to 14.5 kc
	± 20%	-30 db or more	
4300	± 7½%	-3 db or less	400 cps to 960 cps 1300 cps to 14.5 kc
	± 20%	-40 db or more	
	± 7½%	-3 db or less	
4000	± 15%	-45 db or more	400 cps to 960 cps 1300 cps to 14.5 kc
	± 15%	-3 db or less	
	± 28%	-45 db or more	

Other frequencies and impedances available on request.

Representatives in  
Principal Cities



Subsidiary of International Resistance Company  
11423 VANOWEN STREET  
NORTH HOLLYWOOD 1, CALIF.

# MICROWAVE POWER MEASUREMENT

## FROM DEGREES...

### SPECIFICATIONS

Av. Power 0-600 watts  
 Peak 600 KW  
 VSWR 1.1 max.  
 Freq. range  
 Basic unit 2.6 to 3.95 kmc  
 With Adapters 2.6 to 18.0 kmc

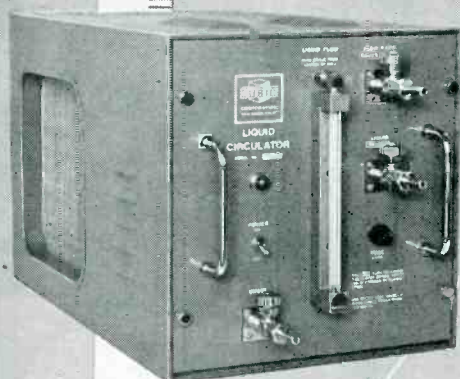

CIRCULATOR

## ...TO WATTS directly!

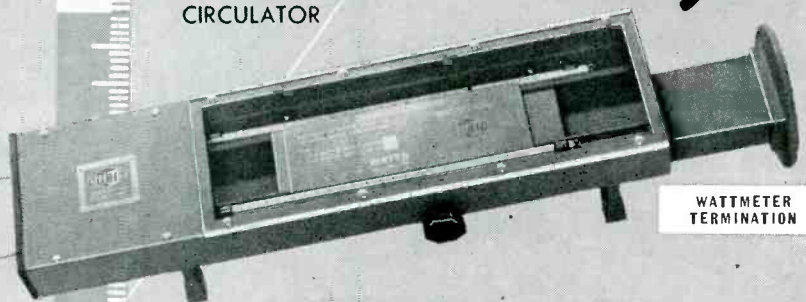

WATTMETER TERMINATION

## CUBIC'S 2-UNIT CALORIMETRIC WATTMETERS

... for obtaining direct power readings in testing electronic equipment—without guessing!

Three of the world's largest producers of electronic equipment have recently made CUBIC Calorimetric Wattmeters standard test equipment in their laboratories and plants.

For very good reason. No other instrument designed for power measurement gives you direct power readings... with such precision, and yet so simple in its application.

The model shown is the MC-1B for power measurement from 2600 to 26,500 MC. Also available are the models MCX-1A (coaxial type) for power measurement from 100 to 3000 MC, and MCL-1A (L-Band waveguide type) for power measurement from 1120 to 2600 MC.

Whether checking field equipment, developing or making acceptance tests on new equipment or magnetrons in the lab, or in production, one of CUBIC'S Calorimetric Wattmeters will be an invaluable addition to your test equipment. Standard laboratories calibrate secondary power devices, especially bridge type bolometer instruments. Exact calibration is provided month to month.

Write for more information, and ask for our catalog of other test equipment and waveguide components. Or if you have a problem in development or engineering, CUBIC offers the services of its engineering staff and facilities in its solution.

variable d-c voltages by a sixth. Servo channels may be provided with sine-cosine, secant, tangent or special nonlinear function potentiometers. Frequency response with 10-percent amplitude is flat to within  $\pm 1$  db to 5 cps; flat to within  $\pm 3$  db to 12 cps. Dynamic accuracy is 0.5 percent at 0.5 cps. Velocity limit is 1,000 v per sec.



## DEVIATION COMPUTER for process, quality control

CEDAR ENGINEERING INC., 5808½ W. 36th St., Minneapolis 16, Minn. Model 6055 is a new dual section analog computer. One section computes the integral of the square or mean square of an a-c or d-c input voltage. The other computes the integral or mean of the a-c or d-c input voltage. If the current is the analog of a thickness, viscosity, density or power, the computer can be used to compute the standard deviation of the process, and it provides electrical analogs for controlling the process. It features automatic rapid reset and no drift. The automatic timer provides a 115-v 60-cycle control signal to drive a recorder and to energize a control mechanism. The integrating time base is adjustable from 1.0 sec to 180 sec. The two answer meters have an absolute accuracy of 0.3 percent. Accuracy of the computer depends upon operating conditions, and can be better than 3 percent.

## AUDIO OSCILLATOR is compact and rugged

SHASTA DIVISION, BECKMAN INSTRUMENTS, INC., P. O. Box 296, Richmond, Calif. Model 301A audio oscillator is a compact rugged and



**CUBIC CORPORATION**

ELECTRONIC EQUIPMENT RESEARCH...DEVELOPMENT  
 2481 CANON STREET,  
 SAN DIEGO, 6, CALIFORNIA



Los Angeles, Cal.

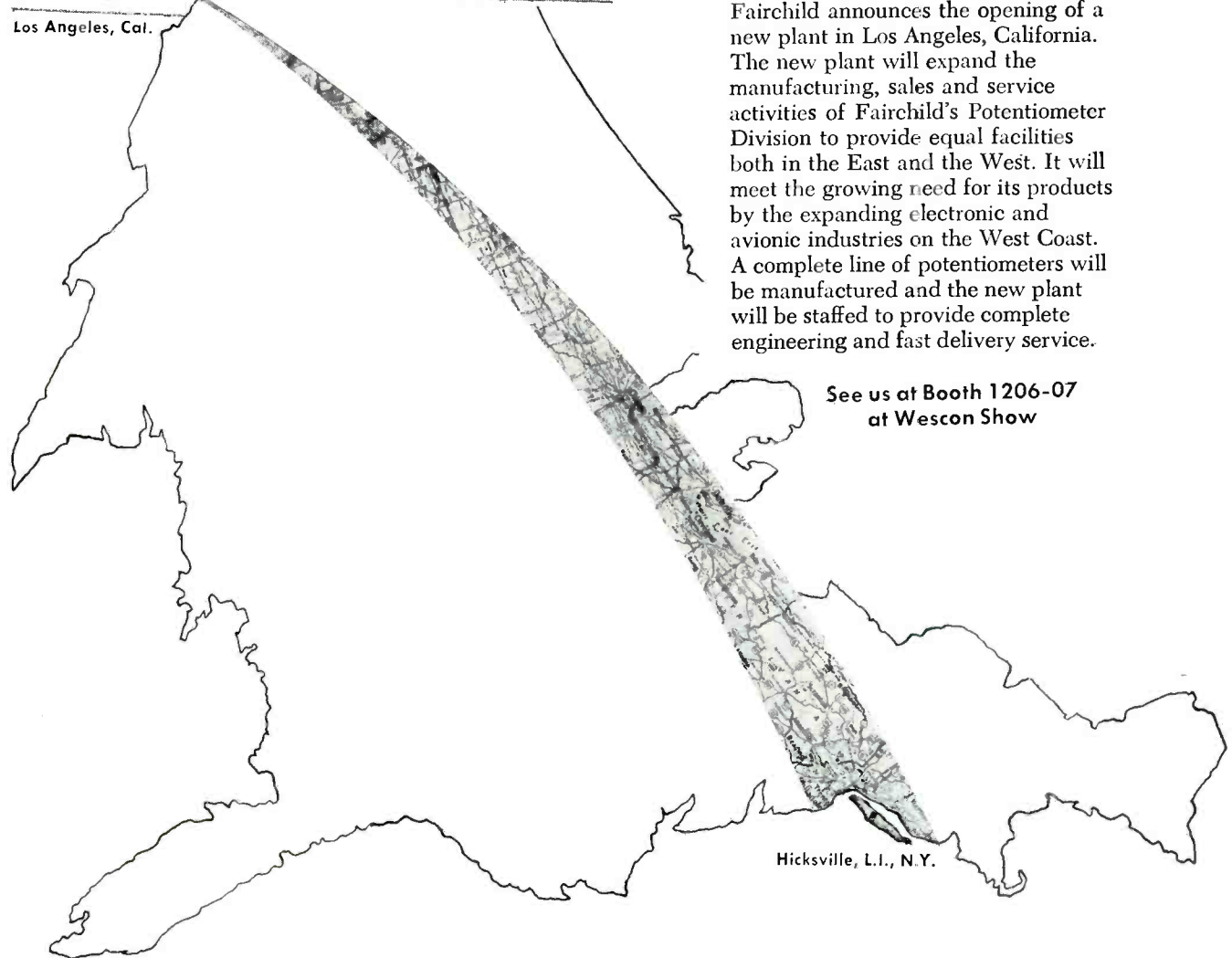

Hickville, L.I., N.Y.

Fairchild announces the opening of a new plant in Los Angeles, California. The new plant will expand the manufacturing, sales and service activities of Fairchild's Potentiometer Division to provide equal facilities both in the East and the West. It will meet the growing need for its products by the expanding electronic and avionic industries on the West Coast. A complete line of potentiometers will be manufactured and the new plant will be staffed to provide complete engineering and fast delivery service.

See us at Booth 1206-07  
at Wescon Show

## AVAILABILITY AND SERVICE

### from L.I. to L.A.

The opening of Fairchild's new West Coast plant means that henceforward the name Fairchild will not only stand for the finest in precision potentiometers . . . it will mean faster delivery and better service, too. You will be able to get complete engineering service, quotations, order handling, delivery and repair from either plant, whichever is most convenient to you.

This is another example of how Fairchild can always give you the answers, no matter what factors govern your choice of precision potentiometers. Write Potentiometer Division, Fairchild Controls Corp., a subsidiary of Fairchild Camera and Instrument Corp., Dept. 140-66A.

**EAST COAST**  
225 Park Avenue  
Hickville, L.I., N.Y.

**WEST COAST**  
6111 E. Washington Blvd.  
Los Angeles, Cal.



# FAIRCHILD

PRECISION POTENTIOMETERS

There is no one "cure all" for system instability. The desired stability of a servo loop is attained through the proper selection of components that satisfy the various conditions under which the loop will operate. Kearfott offers four basic motors and combinations for providing system stability. All feature high speed of response; low inertia and high stall torque.

# SYSTEM STABILITY



(shown  $\frac{2}{3}$  size)



(shown  $\frac{3}{4}$  size)



(shown approximately  $\frac{1}{2}$  size)



(shown  $\frac{1}{3}$  size)

**SERVO MOTORS:** Servo motors with high torque to inertia characteristics possessing (built-in) inherent damping ranging in size from  $\frac{3}{4}$ " to  $1\frac{3}{4}$ " diameter are available. Low speed, low power motors for use in simple instrument servos where high damping and/or low time constant is required can also be provided.

**VISCOUS DAMPED SERVO MOTORS:** Provide integral viscous damping for simple instrument servos. Any degree of damping can be provided. These units reduce no load speed of standard motors to 50% or 75% of normal, providing 70% or 50% of critical damping respectively.

**INERTIAL DAMPED MOTORS:** Integral inertially damped motors for use in high speed and/or high gain servo systems—damping on acceleration or deceleration basis with little loss in normal no load speed. These units make possible system cut off frequencies up to 25 cps using magnetic amplifiers.

**SERVO MOTOR TACHOMETER GENERATORS:** For system stabilization by voltage feedback from an integral tachometer generator. May be obtained as damping generators for use in simple rate servos or as rate damping generators for use in very high gain systems. The latter feature high linearity, high output and maximum output to fundamental null ratios.

These servo motors are suitable for most exacting requirements. Write today for descriptive bulletin giving data of components of interest to you.

## KEARFOTT COMPONENTS INCLUDE:

Gyros, Servo Motors, Synchros, Servo and Magnetic Amplifiers, Tachometer Generators, Hermetic Rotary Seals, Aircraft Navigational Systems, and other high accuracy mechanical, electrical and electronic components.



A SUBSIDIARY OF GENERAL PRECISION EQUIPMENT CORPORATION

## KEARFOTT COMPANY, INC., LITTLE FALLS, N. J.

Sales and Engineering Offices: 1378 Main Avenue, Clifton, N. J.  
Midwest Office: 188 W. Randolph Street, Chicago, Ill. South Central Office: 6115 Denton Drive, Dallas, Texas  
West Coast Office: 253 N. Vinado Avenue, Pasadena, Calif.



reliable instrument designed to fill the need for a wide-range general purpose laboratory audio oscillator. Covering the frequency range from 10 cps to 1.0 mc in 5 steps, this unit will drive impedances as low as 600 ohms with sufficient output to satisfy most general test requirements. Simple, dependable circuitry combined with high quality components assures maximum frequency and amplitude stability and low distortion. The oscillator is packaged in a unit only  $9\frac{1}{2}$  in. high  $\times 7\frac{1}{2}$  in. wide  $\times 8\frac{1}{2}$  in. deep. Frequency range is 10 cps to 1.0 mc in 5 steps. Output level is  $\pm 1$  db from 10 cps to 1.0 mc. Distortion is less than 1 percent. Price is \$140.



## SIGNAL GENERATOR suitable for a-m and f-m

MARCONI INSTRUMENTS LTD., 23-25 Beaver St., New York 4, N. Y., has developed model TF.995A/1 with continuous frequency coverage from 2 to 220 mc. Normal deviation is continuously variable for 0 to 25 kc and 0 to 75 kc on all bands. Modulation distortion is less than 2 percent. Amplitude modulation, both internal or external, is variable up to 50 percent. The r-f level is vari-

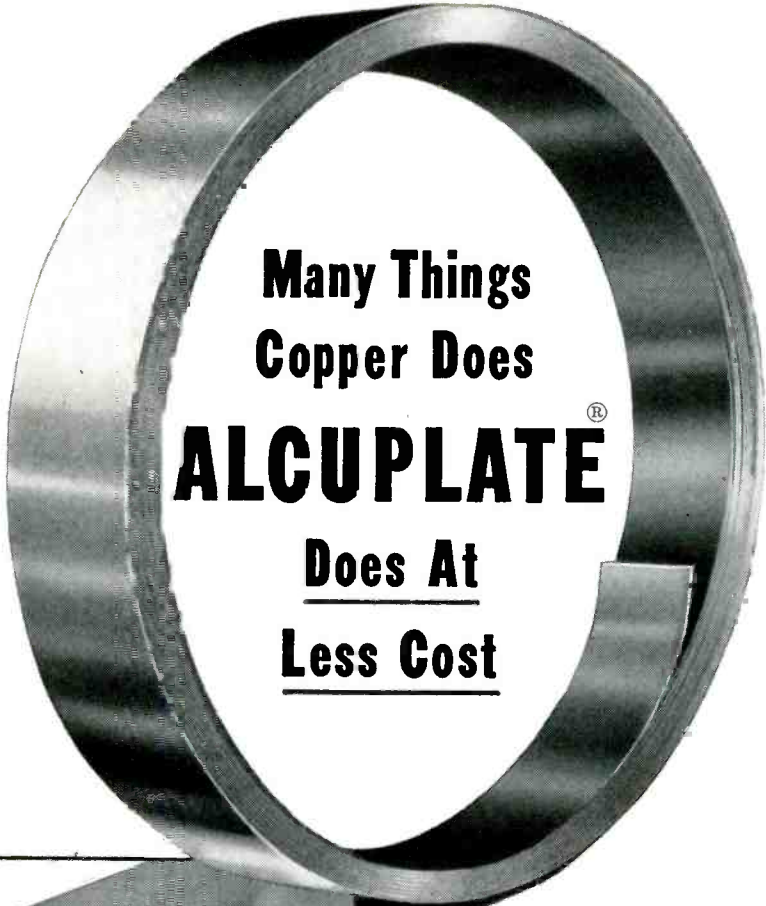

Many Things  
Copper Does  
**ALCUPLATE**<sup>®</sup>  
Does At  
Less Cost



COPPER  
ALUMINUM



COPPER  
ALUMINUM  
COPPER

### ALCUPLATE FEATURES

- Natural copper appearance
- High electrical conductivity
- Excellent heat dissipation
- Soft-soldering surfaces
- Easy fabrication
- Light weight

**Q** How can you reduce the cost of copper or brass in your parts or products?

**A** Get the same copper surface area and natural thickness with less copper.

And that is *exactly* what ALCUPLATE does. ALCUPLATE is a solid layer of copper permanently clad — to one side or both sides of less expensive aluminum.

THUS  ON ONE SIDE

OR THUS  ON BOTH SIDES

**THIS** gives you solid copper performance at a 15 to 30% lower cost over solid copper.

Yet, in addition to this cost reduction, ALCUPLATE provides virtually the same physical and electrical properties as solid copper.

### FABRICATING PROPERTIES

ALCUPLATE can be fabricated by stamping, drawing, spinning and forming. The copper provides an ideal surface for soft-soldering operations, electroplating or other finishes.

### SIZES AVAILABLE

ALCUPLATE is available in coils or flat stock up to 1/16" thick x 13" wide and in a choice of thickness ratios and tempers.

*For further information, write or wire*

**ALCUPLATE**<sup>®</sup>  
METALS & CONTROLS CORPORATION  
GENERAL PLATE DIVISION  
38 FOREST ST., ATTLEBORO, MASS.

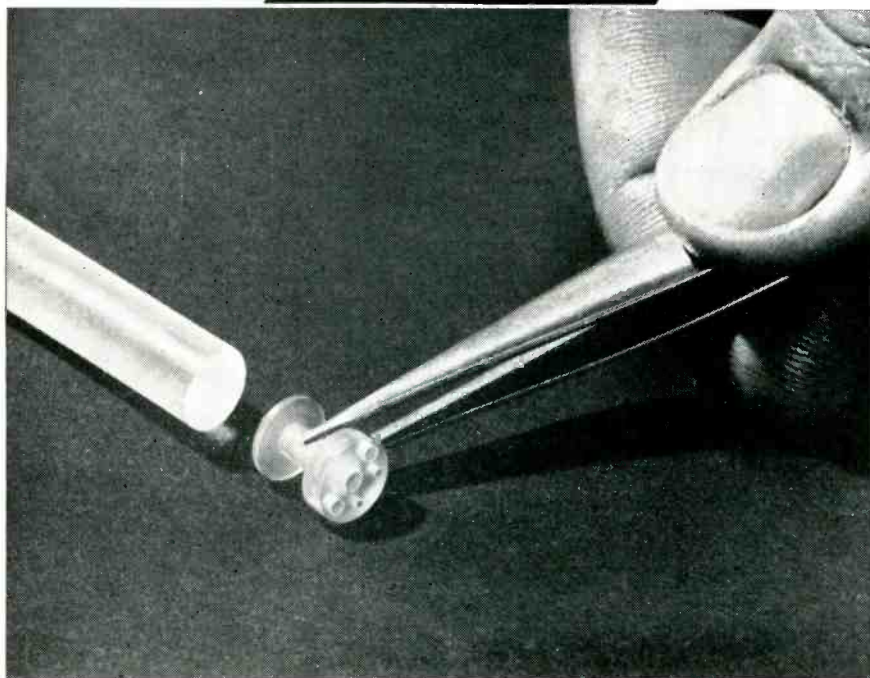

## An outstanding RF and UHF dielectric that's easily machined

The unique properties of POLYPENCO Q-200.5 make this styrene copolymer one of the most important materials available to designers and manufacturers of RF and UHF installation components:

### RIGID AND FORM-STABLE UNDER LOAD

An outstanding characteristic of POLYPENCO Q-200.5 is its very low deformation under load combined with a low power factor. At 160°F., under load of 4000 PSI, deformation is less than 1%! This is extremely important where insulators must withstand compression without yielding and loosening.

### LOW DISSIPATION FACTOR

POLYPENCO Q-200.5 has a constantly low dissipation factor of 0.0002 over practically the entire frequency range. It has a dielectric strength of approximately 350 volts per mil., and a low dielectric constant of 2.5 to 2.6.

### LOW COST FABRICATION

Economical production is assured through rapid machining of POLYPENCO Q-200.5 rod on standard metalworking tools. Coaxial spacers, connector parts, stand-off insulators, coil forms, UHF antennae insulators, etc. can be rapidly fabricated without resorting to extra costs of molding dies.



Write for latest data and technical bulletins on Polypenco Q-200.5.

THE POLYMER CORPORATION of Penna. • Reading, Penna.  
In Canada: Polypenco, Inc., 2052 St. Catherine W., Montreal, P.Q.

**POLYPENCO® nylon, teflon\* and other non-metallics**

\*DU PONT TRADEMARK

able from 0.1  $\mu$ v to 200 mv and the output impedances are 52 and 75 ohms. The generator enables measurements at i-f and carrier frequencies to be made with a single instrument and it is supplied with American tubes and BNC connectors.

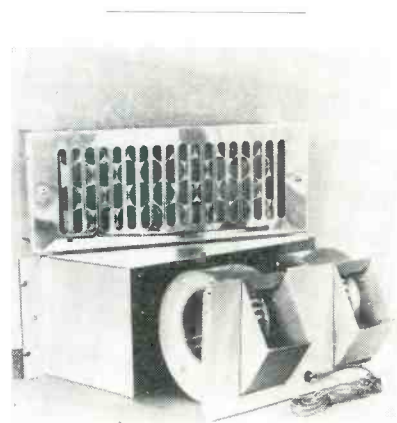

### FAN UNIT cools electronic cabinets

MCLEAN ENGINEERING, Box 228, Princeton, N. J. Model 2E408 cabinet cooling fan is specially designed to fit the standard 19-in. electronic rack. The small packaged unit pressurizes the cabinet with filtered air, preventing dust from entering through cracks and joints of the cabinet. The assembly is rack-mounted the same as other chassis. Standard RETMA notching allows mounting on rack without cutting and fitting. A very desirable feature is that the air is discharged diagonally upward, initiating a revolving air current pattern throughout the electronic rack. With additional inlet area provided in the rear of the cabinet, an induced draft can be created to provide additional cooling. If necessary, the unit may be inverted to drive air downward.

### D-C SOLENOIDS in varied sizes and weights

BRAUNSON ELECTRONICS, INC., 411 Rose Ave., Venice, Calif. The new line of d-c solenoids, including sub-miniatures, high temperature and pressurized units, are manufactured to qualify to military specification MIL-S-4040 for application in automatic controls, switch mechanisms,

# NOPCO<sup>®</sup> LOCKFOAM

## FOAMED PLASTIC

*... that finds an important new  
function almost daily*

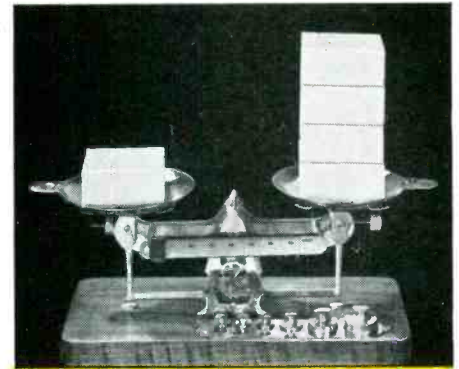
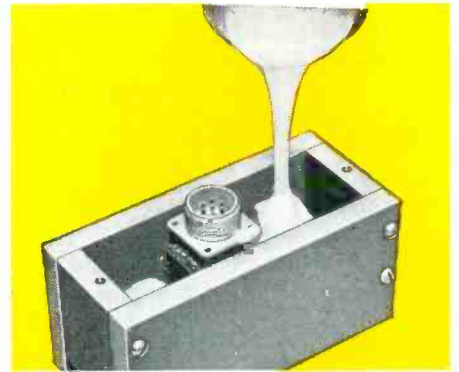

**Choose your density**

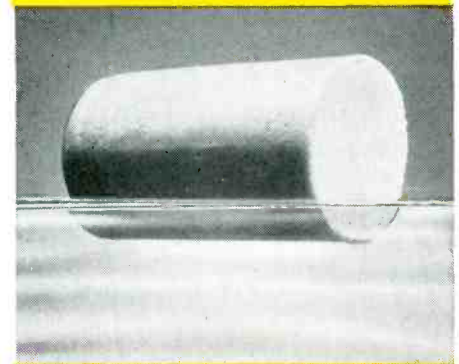

**Resists moisture**



**Rigid or flexible ... as you like**

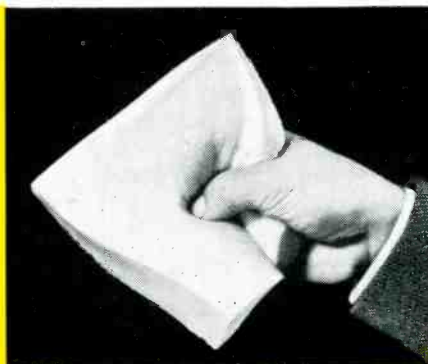

**The properties we  
can't illustrate are  
at least as important  
as those we can**

Near-perfect  
Radar transmission

Ease of Fabrication  
It's "poured-in-place"

Great Strength  
with Light Weight

Wide Range of Densities  
from 2 to 35 lb/cu ft

Good Thermal Insulation  
"K" Factors  
.018 at 8 lb/cu ft  
to .025 at 11 lb/cu ft

Excellent Electrical Properties  
6 lb/cu ft Lockfoam tested  
at 9.375 KMC  
Dielectric Constant 1.05  
Loss Tangent .0005

Available in sheet form

Great versatility  
50 different and  
consistently reproducible  
formulations available

**A few of Nopco Lockfoam's  
present uses**

*Airplane Radomes,  
Potting Electronic Instruments,  
Reinforcing Automobile Doors,  
Automobile Arm Rests, Packaging,  
Shock Panelling, Instrument Cases,  
Insulating Water Coolers and  
Refrigerators, Cushioning,  
Walls for Portable Units, Buoys.*

Our technical staff  
will give you every assistance  
in choosing among  
Lockfoam's 50 different  
formulations, and in making  
its economies *your* economies.

*Write today for the  
Nopco Lockfoam booklet.*

Nopco Chemical Company,  
248 Stier St., Harrison, N. J.

Plastics Division



California Office:  
4858 Valley Blvd., Los Angeles 32

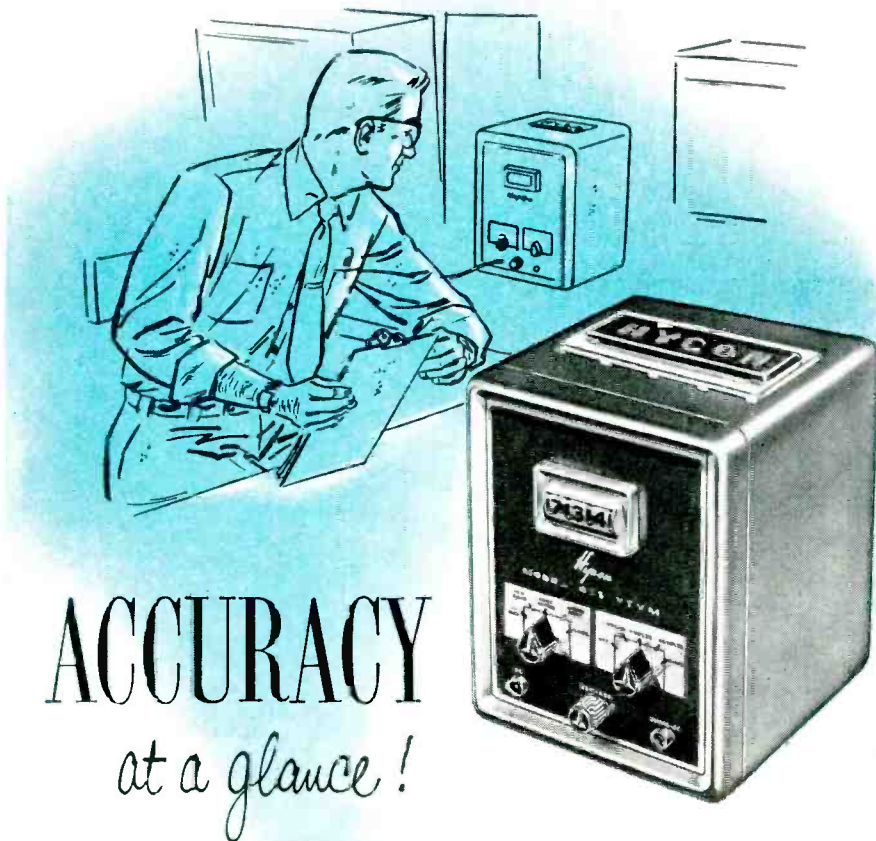

# ACCURACY at a glance!

Just select the range you want... Hycon's new Model 615 Digital VTVM does the rest... gives you a *direct* reading in numerical form, complete with decimal point and polarity sign. There's no interpolation, no chance of reading the wrong scale. Even inexperienced personnel find the Model 615 easy to use... you just *can't* read it incorrectly!

Ideal for both laboratory and production-line testing, here's what the Model 615 offers...

- ... 1% accuracy on DC and of ms; 2% on AC
- ... 12 ranges... 0 to 1000 volts DC and AC; 0 to 10 megohms
- ... Illuminated 3-digit scale, with decimal point and polarity sign
- ... Response (with auxiliary probes) to 250 mc
- ... Shielded case; rugged, bench-stacking design; lightweight

Two more Hycon test instruments... designed for tomorrow's circuitry... ready for color TV...

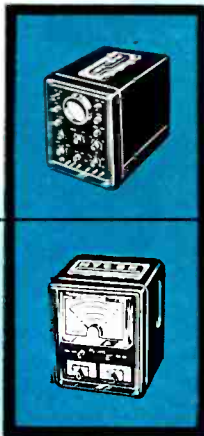

### MODEL 617 3" OSCILLOSCOPE...

Accurate enough for research, rugged enough for servicing. Features high deflection sensitivity (.01 v/in rms) 4.5 mc vertical bandwidth, flat  $\pm 1$  db; internal 5% calibrating voltage. **SPECIAL FLAT 3" CRT FOR UNDISTORTED TRACE FROM EDGE TO EDGE.**

### MODEL 614 VTVM...

Maximum convenience combined with unprecedented low cost. Plus features include: 21 ranges (28 with p-p scales); 6½" meter; 3% accuracy on DC and ohms, 5% on AC; response (with auxiliary probe) to 250 mc. **TEST PROBES STOW IN CASE, READY TO USE.**

Don't Forget

See the complete line  
at the 1955 Wescon show  
Booths 1812 and 1813

## Hycon Mfg. Company

2961 EAST COLORADO STREET  
PASADENA 3, CALIFORNIA

"Where accuracy counts"

BASIC ELECTRONIC RESEARCH • ORDNANCE • AERIAL CAMERAS • ELECTRONIC SYSTEMS  
ELECTRONIC TEST INSTRUMENTS • GO NO-GO MISSILE TEST SYSTEMS • AERIAL SURVEYS

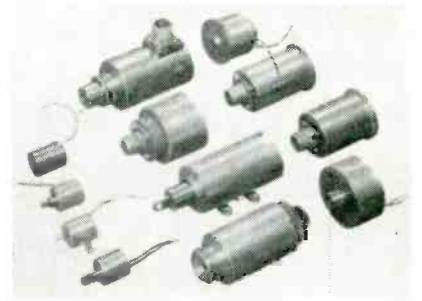

communications, analog and digital computers or wherever precision actuators are required. They feature pressure balanced armatures, adjustable stroke under operating pressure, maximum efficiency in minimum size, high dielectric strength, class H insulation, pressure sealed and high temperature coils. The units pictured range in diameter from 0.781 in. to 1.875 in. and weigh from 1.25 oz to 21 oz. They are capable of providing anywhere from 10 oz to 14 lb to push or pull through a stroke range of 0.025 in. to 0.375 in.

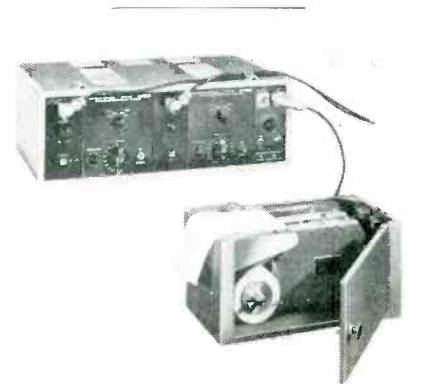

### PORTABLE DYNOGRAPH records transient variables

OFFNER ELECTRONICS, 5320 N. Kedzie Ave., Chicago, Ill. Type P portable Dynograph is a high-speed direct-writing oscillograph recorder providing very high, absolutely stable, d-c or a-c amplification. It may be used with reluctance-type gages without auxiliary equipment. Stability, sensitivity and versatility are made possible by the company's patented chopper amplifier. The Dynograph is used for recording a wide variety of transient variables, such as strain, vibration, temperature and analog computer write-out. Performance specifications are 15  $\mu$ v d-c per mm of pen deflection, with a response time of less than 1/120 sec. The high sensitivity



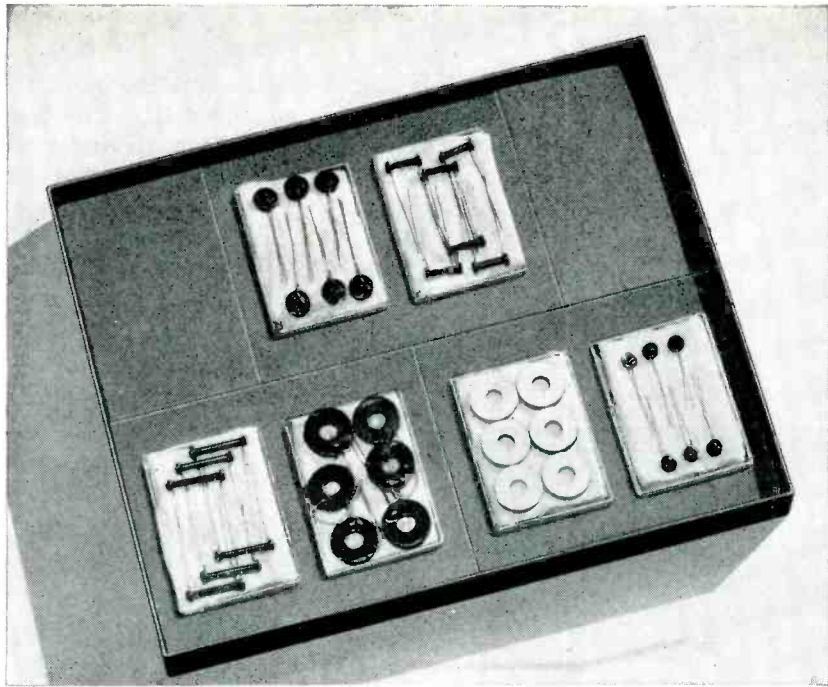

This **NEW TEST KIT** of  
**GLOBAR**<sup>®</sup>  
 Type H THERMISTORS  
*may help solve your circuit problems*

Quantity	Cat. No.	R@25°C	B Constant	Load Watts
6	416	1200	3200	0.7
6	479	1000	3800	1.85
6	373	10	2700	3.0
6	343	20	2700	3.0
6	549	5000	3200	1.5
6	588	11000	3200	2.0

**KIT No. 2** Type H THERMISTORS PRICE **\$24.50**  
*to evaluate use of GLOBAR<sup>®</sup> Type H Thermistors for*

- Providing time delays in relay and solenoid circuits.
- Temperature compensation in field coils.
- Protective resistors in series filament circuits of radio and television receivers.
- Stabilization of television oscillator circuitry during warm-up.
- Temperature compensation in meters.
- Controlling remote temperature-indicating devices.
- Temperature compensation in transistor circuitry.

**OTHER TEST KITS**

of GLOBAR<sup>®</sup> Ceramic Varistors and Thermistors now available for design and application use include:

**KIT No. 1** PRICE **\$29.25**  
 Type F THERMISTORS

- To evaluate series filament circuit applications in radio and television receivers.

Quantity	Cat. No.	R @ 25 C	R @ Rated Current	B Constant	Load Watts
6	763	15		1500	0.5
6	441	880	100 ohms @ 150 ma	1900	2.7
6	341	375	40 ohms @ 300 ma	1950	3.6
6	525	250	20 ohms @ 600 ma	1900	7.2
6	327	460	35 ohms @ 600 ma	1900	12.6
6	421	125	43 ohms @ 600 ma	1100	16.5

**KIT No. 3** PRICE **\$20.00**  
 Type BNR VARISTORS

- To evaluate reduction of surge voltage peaks and contact arcing time; stabilizing speed voltage and amplifier gain.

Quantity	Cat. No.	R @ Calibration Voltage	Load Watts
6	432	100000 @ 10 volts	0.25
6	479	100000 @ 100 volts	0.3
6	328	10000 @ 40 volts	0.5
6	463	24000 @ 40 volts	1.0
6	524	24000 @ 100 volts	1.5
6	430	17500 @ 175 volts	2.7

**KIT No. 4** PRICE **\$18.25**  
 Type F, Type BNR VARISTORS and THERMISTORS

- To evaluate stabilizing rectifier circuits by limiting peak voltages.

Quantity	Type BNR Cat. No.	R @ Calibration Voltage	Load Watts	
6	432	25000 @ 10 volts	0.25	
6	432	100000 @ 10 volts	0.25	
6	432	200000 @ 10 volts	0.25	
Quantity	Type F Car. No.	R @ 25 C	B Constant	Load Watts
6	763	15	1500	0.50
6	763	120	1750	0.50
6	763	330000	2150	0.50

**EACH KIT CONTAINS** 36 resistors — 6 of each specified type, packaged in attractive transparent plastic boxes. Pertinent engineering bulletins giving detailed engineering data are sent with each kit. Kits will be shipped postpaid to any point in the United States and Canada. All resistance values specified carry standard production tolerance.

**ORDER YOUR KITS NOW...**

*use this Handy Coupon*

GLOBAR Division  
 THE CARBORUNDUM COMPANY  
 Dept. EL 87-55, Niagara Falls, New York

Please ship kits as follows:

**No. 1** (Quantity)  **No. 2** (Quantity)  
 **No. 3** (Quantity)  **No. 4** (Quantity)

- Check enclosed (to which we have added applicable local tax)
- Please invoice us.

NAME \_\_\_\_\_ TITLE \_\_\_\_\_

COMPANY \_\_\_\_\_

ADDRESS \_\_\_\_\_

CITY \_\_\_\_\_ ZONE \_\_\_\_\_ STATE \_\_\_\_\_

Please send FREE engineering bulletin on Kit No. \_\_\_\_\_

# Wet... but not worried!



**Stoddart NM-10A Radio Interference and Field Intensity Meter\***  
covering the frequency range of 14 kc to 250 kc.

**CHANCES ARE YOU'LL NEVER SUBJECT YOUR NM-10A TO THIS KIND OF TREATMENT...**

**BUT IT'S NICE TO KNOW THAT IT CAN TAKE IT IF IT HAS TO!**

We turned the hose on the AN/URM-6B — the Navy equivalent of the Stoddart NM-10A — in accordance with Navy specifications. Immediately afterward it was disassembled and found to be dry as a bone inside. And much to our satisfaction, the Navy inspector smiled!

Whether you use this fine, rugged instrument for field intensity measurements of carrier current systems, Navy, maritime or other services... or for surveys of conducted or radiated interference, you'll find that the **NM-10A CAN TAKE IT**... whether in the lab or in the field.

A complete selection of accessories is available, expanding the utility of the NM-10A to make it one of the most versatile instruments you have ever used.

Write today for further information. Learn about the excellent sensitivity... the "hand calibrated" accuracy... the sturdy, dripproof construction, enabling use in driving rain or snow... the A. C. power supply that permits operation from 105 to 125 volts or 210 to 250 volts A. C., 50 to 1600 cps.

The NM-10A is the identical instrument we supply to the Navy as the AN/URM-6B, a Class One instrument, as shown in MIL-I-16910 (SHIPS). It was designed and is manufactured exclusively by Stoddart Aircraft Radio Co., Inc. When you buy the NM-10A you're getting a quality instrument that meets the rugged requirements of the U. S. Navy!

\* Stoddart RI-FI Meters Cover the Frequency Range of 14 kc to 1000 mc

#### NM-20B — HF

15 kc to 25 mc. Commercial equivalent of AN/PRM-1A. Self-contained batteries. A. C. supply optional includes standard broadcast band, radio range, WWW and communications frequencies. Has BFO.

#### NM-30A — VHF

20 mc to 400 mc. Commercial equivalent of AN/URM-47. Frequency range includes FM and TV bands.

#### NM-50A — UHF

375 mc to 1000 mc. Commercial equivalent of AN/URM-17. Frequency range includes Citizens band and UHF TV band.

**STODDART AIRCRAFT RADIO Co., Inc.**  
6644-A Santa Monica Blvd., Hollywood 38, California · Hollywood 4-9294

is obtained with absolute stability —there is no zero drift. The pen excursion is over 8 cm, giving large, easily read records. A feature of the unit is the high-torque pen movement. This provides accurate frequency response at low amplitudes as well as high, and eliminates hysteresis, by completely overpowering pen friction, even with the chart stationary. The type P is supplied with 1 or 2 channels.

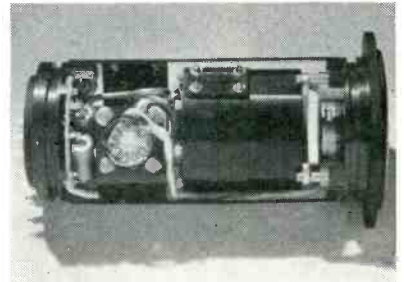

### TRANSDUCER indicates vertical speed

TRANS-SONICS, INC., Bedford Airport, Bedford, Mass., announces a new vertical speed transducer which features a high speed of response. It has a time constant of 2 sec at 50,000 ft. The new instrument employs an Equibar to measure the differential pressure between the pressure in the aircraft's static line and a cavity that is connected to this static line by a small capillary. Difference pressure is proportional to vertical speed. Output voltage varies between 0 and 5 v peak-to-peak and may be telemetered on standard f-m/f-m telemetering systems.

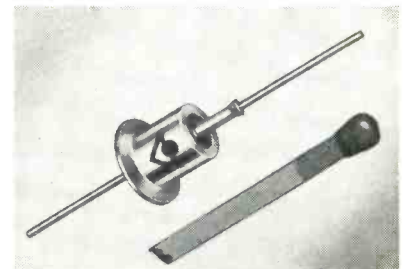

### POWER DIODES feature reliability

INTERNATIONAL RECTIFIER CORP.,  
1521 E. Grand Ave., El Segundo, Calif., has available its new german-

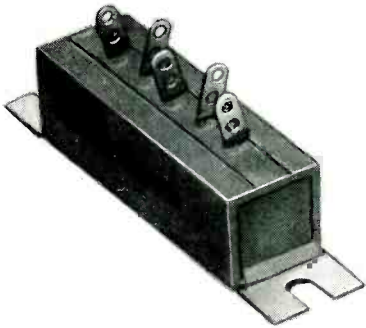

Potted (sealed) Vac-u-Sel rectifier



Vac-u-Sel rectifier with metal-clad housing

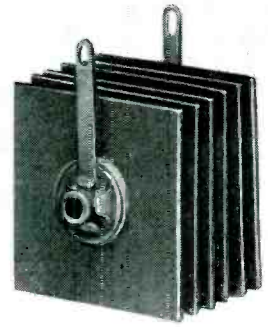

Tube-mounted Vac-u-Sel rectifier

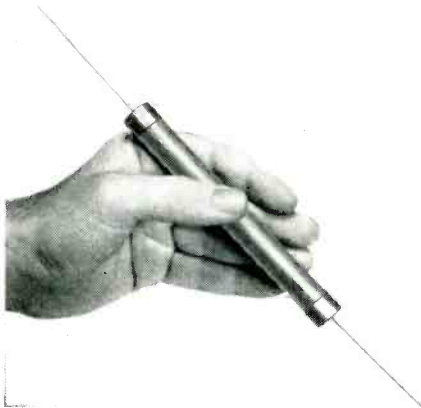

Textolite\* tube construction

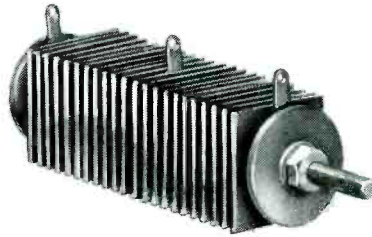

Standard (stud) Vac-u-Sel stack

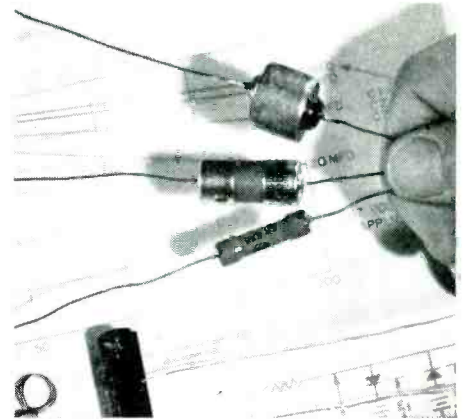

Miniature Vac-u-Sel rectifiers

TO HELP YOU DESIGN QUALITY INTO YOUR PRODUCTS . . .

# NEW G-E Application Approach That Selects The Exact *Vac-u-Sel*\* Rectifier You Need

This new application approach, recently developed by General Electric, assures you of getting the correct Vac-u-Sel rectifier to meet your exact requirements. Now you are assured of getting the full advantage from the long life and outstanding technical characteristics inherent in all the many sizes and types of Vac-u-Sel rectifiers. In addition, in practically all cases, the sales engineer can give you the exact identification and price of your stack on the spot, without the inconvenient delay involved in getting data from the factory.

**THIS NEW APPLICATION APPROACH** brings top quality to your products by permitting complete and efficient utilization of the outstanding electrical characteristics, dependability, and predictable operation found in the many sizes, housings, finishes, and ratings of Vac-u-Sel component rectifiers.

**FOR MORE INFORMATION** on this new application approach, or the outstanding Vac-u-Sel line of rectifiers, contact your nearest G-E Apparatus Sales Office, or write Section 461-38, General Electric Co., Schenectady 5, N. Y.



G-E SALES ENGINEERS are able to determine, on the spot, the exact Vac-u-Sel stack to suit your particular application.

\*Reg. Trade-mark of General Electric Co.

*Progress Is Our Most Important Product*

**GENERAL  ELECTRIC**

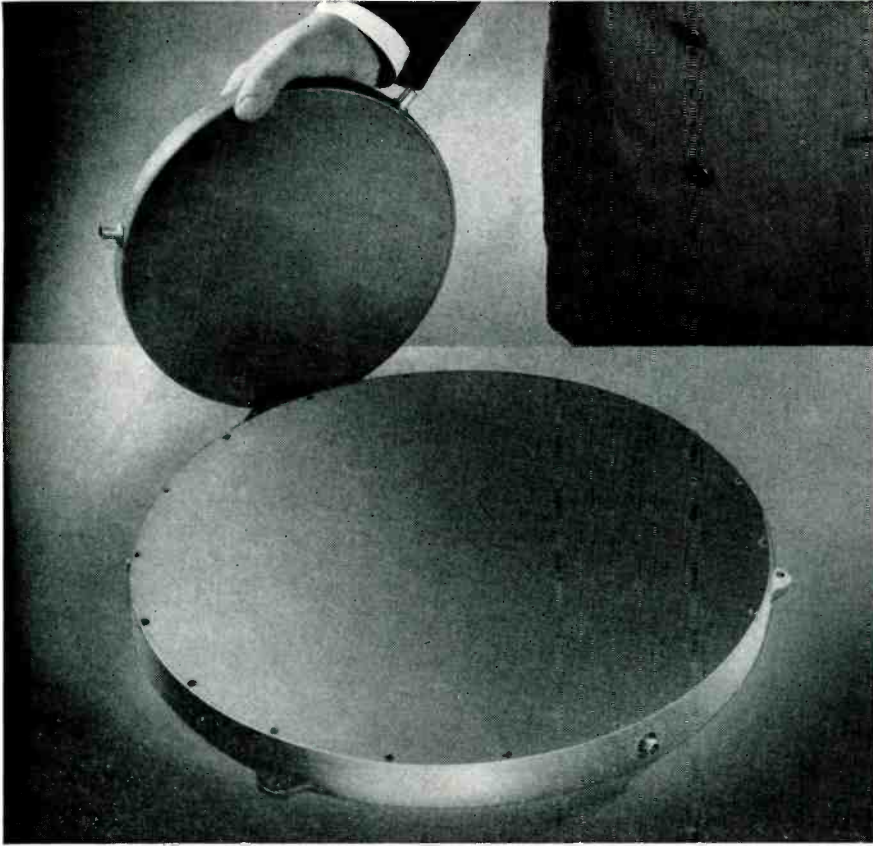

You can get stable Corning Fused Silica Ultrasonic Delay Lines to your specifications within a wide range of characteristics.

## *This ultrasonic delay line ignores cold and vibration*

Corning Fused Silica Ultrasonic Delay Lines give you stability and versatility not found in mercury types. The extremely high purity of the silica used insures superior electrical and ultrasonic properties.

You can depend on Corning Delay Lines for stability of insertion loss of  $\pm 1$  db after cycling over a temperature range from  $-65^{\circ}\text{C}.$  to  $+85^{\circ}\text{C}.$ , vibration of 10 to 55 cps at  $\frac{1}{16}$ " excursion, and operation at 100% humidity. This precision performance is assured after normalizing at center frequency with a suitable case design.

You can get this exceptional stability in ultrasonic delay lines ranging from 50 to 3000 microseconds. Cen-

ter frequencies up to 60 mc are possible with 3 db band widths up to 70% of the center frequency into a 50 ohm resistive termination. Spurious signals range 40 to 60 db below the main output response depending on other performance requirements. Ripples do not exceed  $\pm \frac{1}{2}$  db.

We can produce Corning Fused Silica Ultrasonic Delay Lines to your specifications within a wide range of characteristics. For your convenience in evaluating Corning Ultrasonic Delay Lines we have prepared a Specifications Data Outline Sheet. Send for your copy, fill in the requested information, then mail it to us. Or write, wire or phone us.



*Corning means research in Glass*

**CORNING GLASS WORKS, 36-8 Crystal Street,  
Corning, New York**

NEW PRODUCTS DIVISION

Please send me your Specifications Data Outline Sheet on Corning Ultrasonic Delay Lines.

Name..... Title.....

Company.....

Address.....

City..... Zone..... State.....

ium diffused junction power diodes, which offer very low leakage and high rectification efficiency. Reliability is featured in the design of these diodes as a result of complete hermetic sealing of the housing, consisting of glass-to-metal and welded metal-to-metal seals throughout. Freedom from contamination and long operating life are assured because no solder or fluxes are used in their construction. Standard types such as 1N91, 1N92 and 1N93 diodes are now available from production.

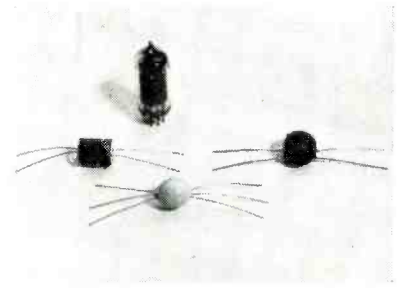

## **TRANSFORMERS** useful to 200 w peak power

CARAD CORP., 2850 Bay Road, Redwood City, Calif. A full line of miniature broadband and pulse transformers for universal application has been announced. The new line consists of two basic styles. One type is encapsulated in epoxy resin and the other, hermetically sealed in a metal can. A choice of silicon ribbon or ferrite as core material is available. For further information on catalogs 19, 50 and 60 write the company.

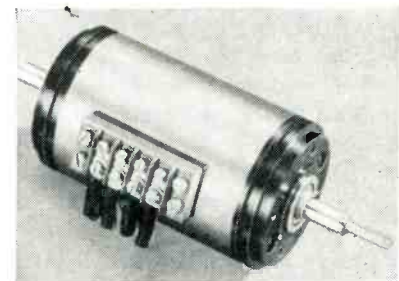

## **ELECTROMECHANICAL UNIT** for servo system uses

STERLING PRECISION INSTRUMENT CORP., 34-17 Lawrence St., Flushing 54, New York, announces a precision, electromechanical component

# Licked *by a Dragon?*



Don't let the problems of miniaturization tie you up!  
Wield your blade on this coupon. It will put you on the mailing list to receive - bi-monthly and without charge - MPB's *Engineering News*, covering the latest developments in the use of MPB's \* such as these



BALL BEARINGS ACTUAL SIZE

CUT ON DOTTED LINE NOW

Miniature Precision Bearings, Inc., 6 Precision Park, Keene, N. H.  
Please put me on your mailing list to receive the MPB "ENGINEERING NEWS"

name \_\_\_\_\_ title \_\_\_\_\_ company \_\_\_\_\_  
street \_\_\_\_\_ city \_\_\_\_\_ zone \_\_\_\_\_ state \_\_\_\_\_



MINIATURE PRECISION BEARINGS, INC., KEENE, N. H.

# THERMOSTATIC DELAY RELAYS

Provide delays  
ranging from  
**2 to 150  
SECONDS**

**A  
M  
P  
E  
R  
I  
T  
E**

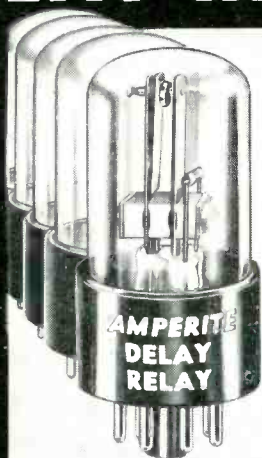

STANDARD

**MOST COMPACT  
MOST ECONOMICAL  
HERMETICALLY SEALED**

- Actuated by a heater, they operate on A.C., D.C., or Pulsating Current.
- *Hermetically sealed.* Not affected by altitude, moisture, or other climate changes.
- Circuits: *SPST only*—normally open or normally closed.

Amperite Thermostatic Delay Relays are compensated for ambient temperature changes from  $-55^{\circ}$  to  $+70^{\circ}\text{C}$ . Heaters consume approximately 2 W. and may be operated continuously.

The units are most compact, rugged, explosion-proof, long-lived, and — *inexpensive!*  
TYPES: Standard Radio Octal, and 9-Pin Miniature.

**PROBLEM? Send for  
Bulletin No. TR-81**

Also—a new line of **Amperite Differential Relays** — may be used for *automatic overload, over-voltage, under-voltage or under-current protection.*



MINIATURE

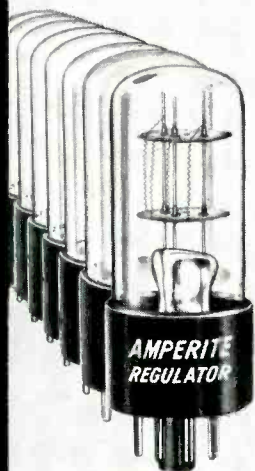

T9 BULB

## BALLAST REGULATORS

- Amperite Regulators are designed to keep the current in a circuit **automatically regulated** at a definite value (for example, 0.5 amp).
- For currents of 60 ma. to 5 amps. Operates on A.C., D.C., or Pulsating Current.
- Hermetically sealed, light, compact, and most inexpensive.

Amperite Regulators are the simplest, most effective method for obtaining *automatic regulation* of current or voltage. *Hermetically sealed*, they are not affected by changes in altitude, ambient temperature ( $-55^{\circ}$  to  $+90^{\circ}\text{C}$ ), or humidity. Rugged; no moving parts; changed as easily as a radio tube.

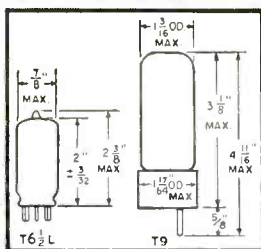
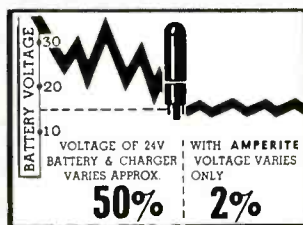

**AMPERITE CO., Inc.**

561 Broadway, New York 12, N. Y.

In Canada: Atlas Radio Corp., Ltd., 560 King St., W., Toronto 2B

Write for 4-page  
Technical Bulletin  
No. AB-51

NEW PRODUCTS

(continued)

designed for servo system applications requiring the possibility of engagement of disengagement of either one or both output shafts from a single input shaft. This is accomplished by enclosing two magnetic coils and two sets of couplings in one housing. The functions of the shafts may be reversed so that outputs can be used as inputs, thus permitting the selection of either of two input rotations to be transmitted to a single output shaft. Mounting is identical to MK8 Mod 0 servo motor.

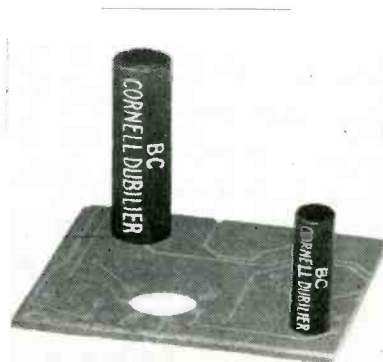

### PLUG-IN TUBULARS for printed circuits

CORNELL-DUBILIER ELECTRIC CORP., South Plainfield, N. J., has developed the new type BC phenolic-cased plug-in paper tubular capacitors especially designed for use with printed circuits. Two parallel lead wire terminals are brought out from the end of the capacitor through a thermosetting plastic end fill compound and are spaced a fixed distance so that they may be plugged directly into printed circuits and dip soldered. Features, ratings, dimensions and test data are given in engineering bulletin No. 162.



### DELAY LINE sealed in epoxy resin

THE GUDEMAN CO. OF CALIFORNIA,  
INC., 2661 South Myrtle Ave., Mon-

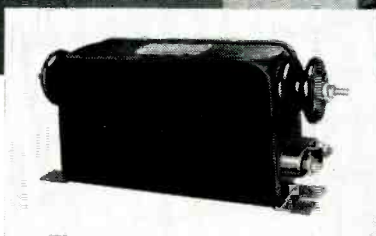

**Battery Of Leesona No. 108 Coil Winders** installed in the plant of Acme Electric Corporation, Cuba, N. Y. The most advanced hand-feed coil winders ever designed, Leesona No. 108's wind 4 to 30 paper insulated coils in stick form simultaneously. Note how conveniently the controls are located for quickly changing to a new coil spec — one of many advantages for speeding production on long or short runs. Inset shows an Acme Electric precision-wound luminous tube transformer which features coils that provide 18 MA 12000 volt secondary.

## At ACME ELECTRIC...Leesona coil winders provide new production advantages

### *Manager credits No. 108 machines with vital share in increasing output*

Transformers made by Acme Electric Corporation are used in a wide range of equipment, including radio, TV and other electronic apparatus, rectifiers, neon signs and fluorescent lighting. To meet increased demands for its products, Acme Electric recently replaced old hand-feed coil

winding equipment with new Leesona No. 108 Hand-Feed Coil Winders. Plant Manager W. F. Koubek of Acme Electric sends the following report:

**"Leesona No. 108 Winders are doing a great job of expanding our production. For short runs on a wide variety of coil types, the quick-change features of these machines are unequalled. We're getting excellent results in both quality and quantity from the accuracy, easy operation and fast winding speed of our new 108's."**

Many similar reports prove how Leesona No. 108 Coil Winders — the most accurate, flexible and economical hand-feed winders ever developed — are bringing important benefits that can save *you* time and money, too.

### *Get the Whole Story*

The coupon below will bring you complete facts on Leesona No. 108 Coil Winders, together with other helpful coil winding information. Why not check and mail it today?

23B.4.6

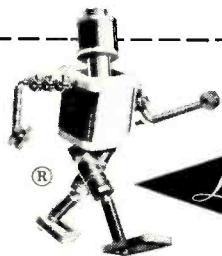

FOR WINDING COILS  
IN QUANTITY...  
ACCURATELY... USE  
LEESONA WINDING MACHINES

## UNIVERSAL WINDING COMPANY

P. O. BOX 1605, PROVIDENCE 1, RHODE ISLAND, Dept. 128

Please send me

- Bulletin on the Leesona No. 108 Hand-Feed Coil Winder.
- Condensed catalog of Leesona Winders.
- Bulletin on the new Leesona Pay-As-You-Profit Plans for purchasing or leasing modern coil winding machinery.

Name.....Title.....

Company.....

City.....Zone.....State.....

new...  
precision

# Continental Connectors

Series  
'GA'

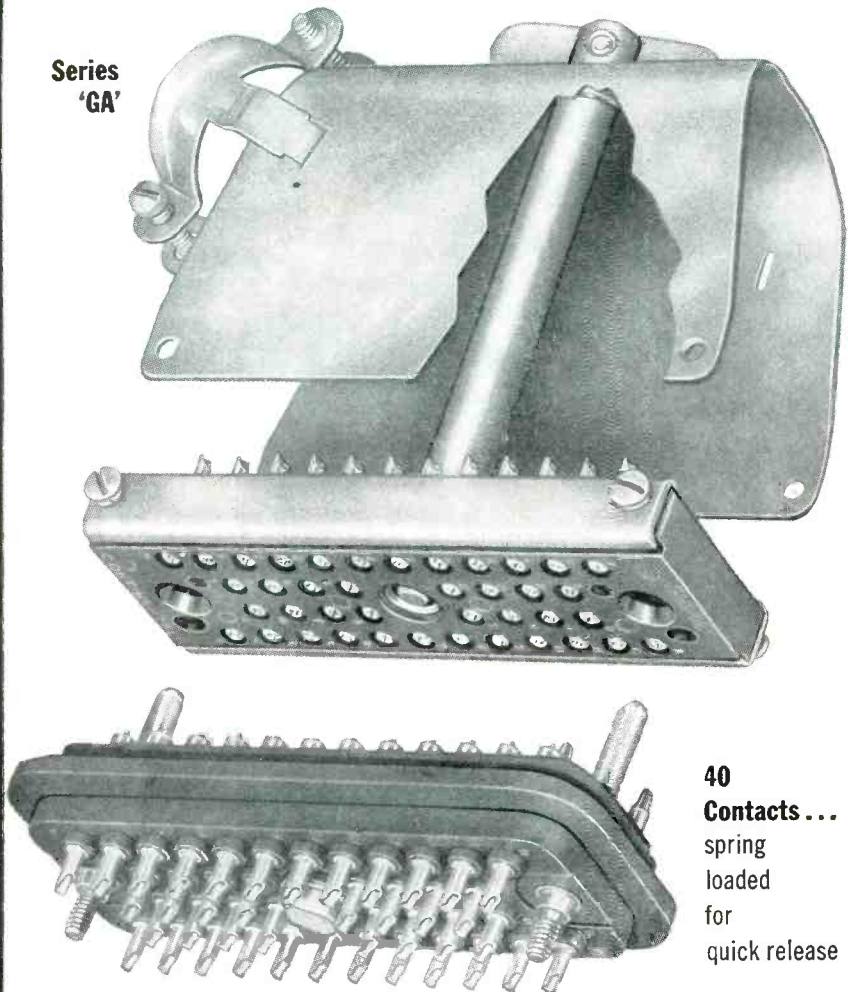

**40**  
**Contacts ...**  
spring  
loaded  
for  
quick release

**Quick  
Release**

## PRESSURIZED CONNECTORS

for guided missile  
and similar  
applications

Here's the connector you can specify for pressurized equipment without fear of dangerous air leakage. The Series "GA" plug is mated from Orlon filled Diallyl Phthalate. When subjected to a pressure differential of 30 PSI at 25° C, leakage is less than 1 cubic inch of air per hour. This series is available with hood and cable clamp. Gold plated, nickel silver contacts take #16 AWG wire, and each is spring loaded for easy release. A spring action center screwlock permits quick, easy release or engagement without damage to the unit.

Write for complete technical data without obligation.

Note: Complete Continental Connector Catalog, covering sub-miniature, printed circuit, hermetic seal, pressurized, high voltage and power connectors, is available on request. Send us your name and title on your company letterhead.

Electronic Sales Division  
DeJUR-Amsco Corporation,  
45-01 Northern Boulevard, Long Island City 1, N. Y.

# DeJUR

NEW PRODUCTS

(continued)

rovia, Calif., offers a new lumped parameter 20- $\mu$ sec delay line, XN-1, with a rise time of 1 microsecond. Impedance is 600 ohms. The unit is hermetically sealed in epoxy resin and operates through the temperature range from -70 C to 135 C. Size is 10 $\frac{1}{4}$  in. (including terminal lugs)  $\times$  3 $\frac{5}{8}$  in.  $\times$  1 $\frac{1}{8}$  in.

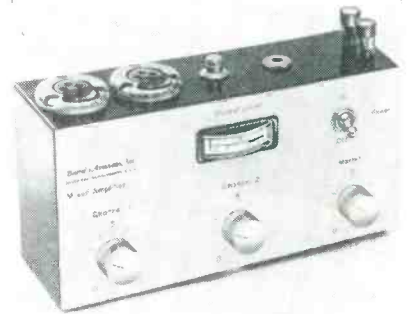

## MIXER-AMPLIFIER is transistorized

BAIRD ASSOCIATES, INC., 33 University Rd., Cambridge, Mass. The new portable transistorized mixer amplifier field pickup unit is designed primarily for broadcasting and recording use. Powered by a two-battery self-contained power supply composed of 10 hearing aid mercury cells, the instrument accomplishes high level mixing by incorporation of two input preamplifiers, followed by two stages of stable amplification. Freedom from dependence on a-c power lines makes this an ideal device for remote pickup recordings and other field programs. The mixer-amplifier is provided with a v-u meter for visual monitoring of program material and as a direct-reading battery voltage monitor. Medium level output of the unit is designed to work directly into a standard 600-ohm load. The lightweight unit has input impedance of either 50 or 250 ohms, balanced and load impedance of 600 ohms, resistive, balanced. Power gain of the device is greater than 90 db.

## GEIGER COUNTER completely transistorized

UNIVERSAL ATOMICS CORP., 19 E. 48th St., New York 17, N. Y. The



**This**  
is just 1/2 the story...

the new **CORE MAGNET MECHANISM**  
by **ROLLER-SMITH**  
master instrument makers

... outperforms conventional mechanisms of much greater weight in a wide variety of applications ... yet it's rugged and "tops" in dependability.

Combining improved efficiency and performance with miniaturization, Roller-Smith's new Core Magnet Mechanism is an outstanding achievement ... a precision, self-shielding movement that can be counted upon to increase the prestige of your product through consistently excellent operation.

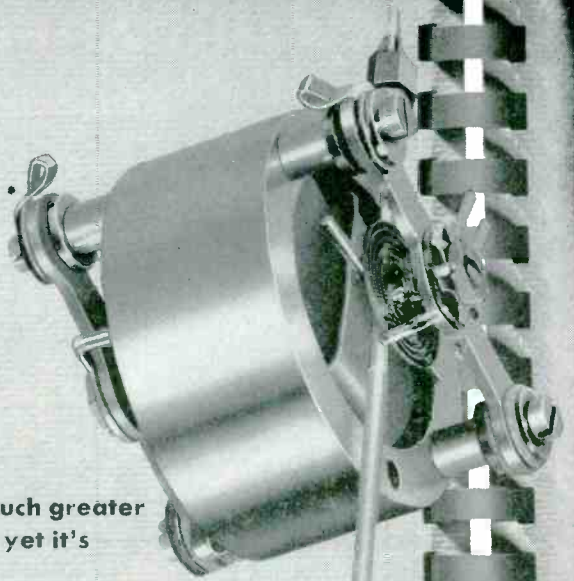

*But furnishing this fine  
Core Magnet Mechanism is only half  
the Roller-Smith story!*

**J**ust as important to you is our ability to furnish the designing skill necessary to incorporate it into your own equipment. The Roller-Smith engineering staff, headed by world-renowned experts and backed by the finest in research and development facilities, will be glad to assist you in arriving at the most practical solution.

**ROLLER-SMITH**  
Instrument Division  
CORPORATION

1825 WEST MARKET STREET  BETHLEHEM, PENNSYLVANIA

Precision Products Since 1908

See these and other outstanding Roller-Smith products featuring the "new-look" at booth 111, WESCON Show, Civic Auditorium, San Francisco, Aug. 24-26, 1955

# KEARFOTT ANNOUNCES

a new rotation-type

# ferrite isolator\*

FERRITE ISOLATOR  
MODEL W152-1A

The new Ferrite Isolator is a useful device with applications such as oscillator isolation with the following advantages to system performance:

- Reduces long-line loading
- Prevents undesired frequency shift
- Insures uniform power output
- Improves transmitted pulse spectrum

*The charts indicate the exceptional performance of this light-weight unit (less than 2 lbs.)*

#### REVERSE ISOLATION

This shows very clearly the good unilateral decoupling effect between the antenna and transmitter.

#### INSERTION LOSS

This illustrates the exceptionally low loss from the transmitter to the antenna.

#### VOLTAGE STANDING WAVE RATIO

The VSWR introduced into the transmission line by the 'Isolator.'

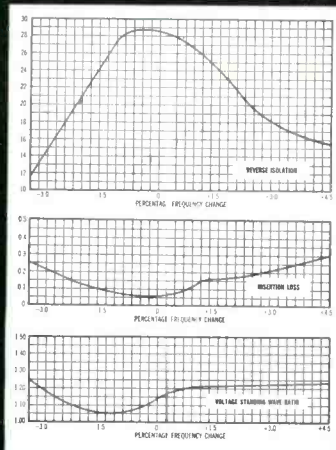

*Special units can be produced by Kearsfott to meet your frequency requirements.*

FERRITE RESONANCE ABSORPTION TRANSVERSE FIELD ISOLATOR for use where high power handling capacity is required. This new model operates over a 10% band width, with these electrical characteristics:

- Greater than 9 db isolation
- Less than 0.4 db insertion loss
- VSWR less than 1.03

*Write or call today for complete detailed information on Kearsfott components and their application to your Radar Systems.*

## Kearsfott COMPANY, INC.

LITTLE FALLS, NEW JERSEY  
WESTERN MANUFACTURING DIVISION  
14844 OXNARD ST. - VAN NUYS, CALIF.  
A SUBSIDIARY OF GENERAL PRECISION EQUIPMENT CORPORATION

#### SALES OFFICES

Eastern Office:  
1378 Main Ave.  
Clifton, N.J.

Midwest Office:  
188 W. Randolph St.  
Chicago, Ill.

South Central  
Office:  
6115 Denton Drive  
Dallas, Texas

Western Area  
Office:  
253 Vinado Ave.  
Pasadena, Calif.



UAC411 gun-type Geiger counter has a completely transistorized audio amplifier built in. The unit operates more than 500 hours on just two 15-cent flashlight batteries. It weighs less than 4 lb. Three mr per hr ranges are 0 to 0.02, 0 to 0.2 and 0 to 2.0. The rate meter reads full scale on background count. Price is \$149.50.

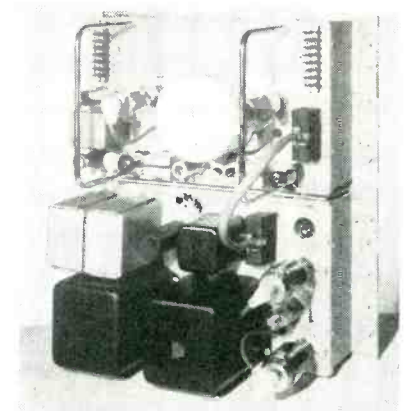

## POWER AMPLIFIER for many applications

GOTHAM AUDIO DEVELOPMENT CORP., 2 W. 46th St., New York 36, N. Y., has developed a new 150-w versatile power amplifier unit adaptable to many applications. The PFB-150WD power amplifier is designed for operations requiring high power output over a wide frequency range and at minimum distortion. It delivers 150 w with less than 0.7 percent rms harmonic distortion from 40 to 15,000 cps, and 10 w with less than 0.15 percent over the range 20 to 20,000 cps. Intermodulation distortion is held below 1 percent at rated power output, while the damping factor exceeds 40. Noise level is 100 db below 150-w output. Instantaneous peak

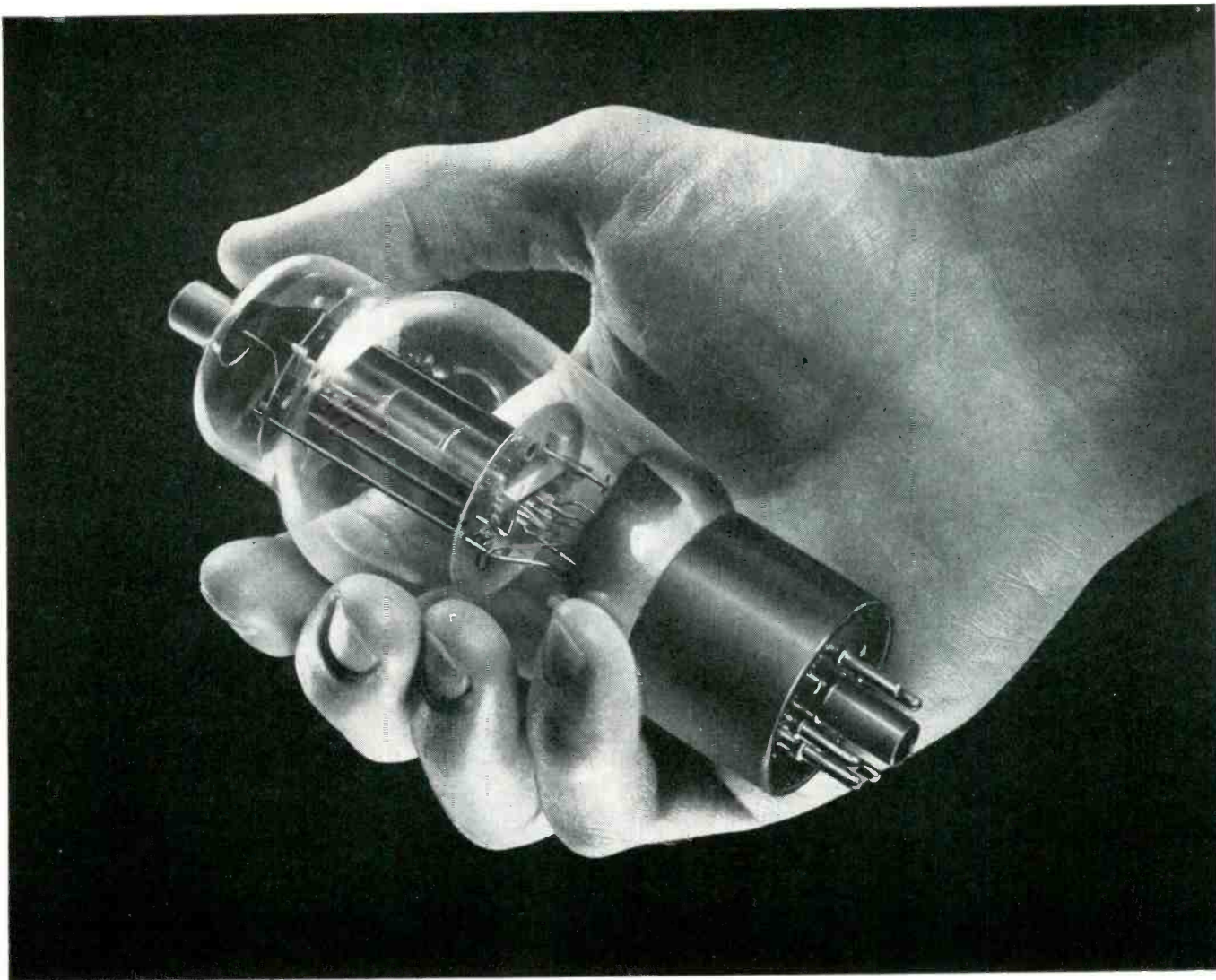

## **vacuum-melted components give long, reliable performance . . .**

Vacuum-melted metals are the answer to the engineer's search for more *reliable* materials. In vacuum tube components, for example, these superior metals mean longer tube life . . . *stable* electrical characteristics even after repeated heatings. For vacuum-melting *removes* undesirable gases *before* they are put in the tube.

*Vacuum-melting literally sucks gaseous impurities and inclusions from the molten metal.* You get high-purity, gas-free metals that far outperform conventional air-melted metals. Cathode nickel alloys, iron, and alloys for metal-glass seals

are held to *uniformly* close standards of composition. Purity and soundness of *any* metal is improved.

Vacuum Metals Corporation, pioneer in development and leading producer of vacuum-melted and cast metals, has available a wide range of these unique metals designed for electrical and electronic uses. If you believe they might improve your product, please write, giving full details. Our engineers will give them careful attention. *Vacuum Metals Corporation, P. O. Box 977, Syracuse 1, N. Y.*



# **VACUUM METALS CORPORATION**

Jointly owned by Crucible Steel Company of America and National Research Corporation

# HIGH RESOLUTION LABORATORY STANDARD DC VOLTMETERS

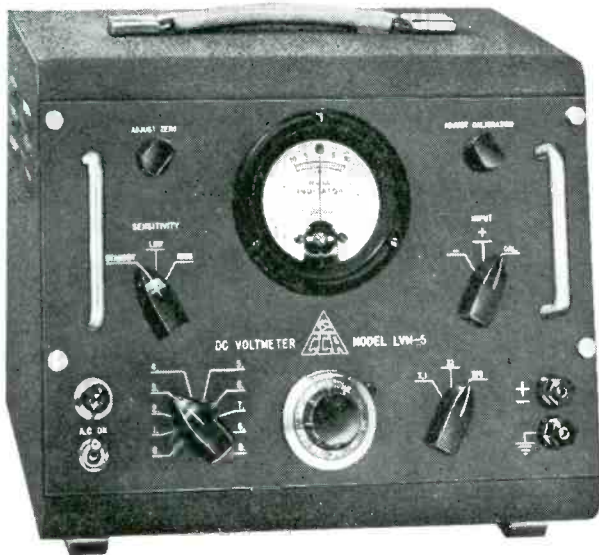

For most applications these rugged portable, self-contained nulling voltmeters replace a potentiometer, voltbox, galvanometer and standard cell combination. They are suitable for laboratory use, production line testing and field service.

## Model LVM-5

Voltage Range: 0-100 Volts DC  
 Resolution: At least 50 microvolts between 0 and 1 volt  
 500 microvolts between 1 and 10 volts  
 5 millivolts between 10 and 100 volts  
 Absolute Accuracy:  $\pm 0.1\%$  of reading  
 Input Impedance: Infinite at null

## Model PVM-4

Voltage Range: 0-600 Volts DC  
 Resolution: At least 5 millivolts between 0 and 10 volts  
 50 millivolts between 10 and 600 volts  
 Absolute Accuracy:  $\pm 0.1\%$  of reading  
 Input Impedance: Infinite at null

*Computer Company of America, Division of Bruno-New York Industries Corp. also manufactures the IDA analog computers and accessories. Their usefulness in the field of dynamics has been proven over the years. A complete line of standard computers, instruments and regulated power supplies is supplemented by the ability to design and manufacture specialized equipment for your particular applications. Your inquiries are invited.*

The Model LVM-5 may also be used as a deflection potentiometer, a sensitive null indicator and a precision millimicroammeter. Write for catalog PL which describes these instruments completely. Address Dept. E8D

COMPUTER COMPANY OF AMERICA  
 Division of BRUNO-NEW YORK INDUSTRIES CORP.  
 460 WEST 34th STREET • NEW YORK 1, N. Y.



power of 400 w is available with perfect stability. Output ranges from 38 v at 4 amperes to 125 v at 1.2 amperes. Balanced and unbalanced inputs of from 150 to 10,000 ohms are available, while output impedances range from 8 to 93 ohms. A gain control adjustable in 2-db steps and direct output tube plate metering are provided.

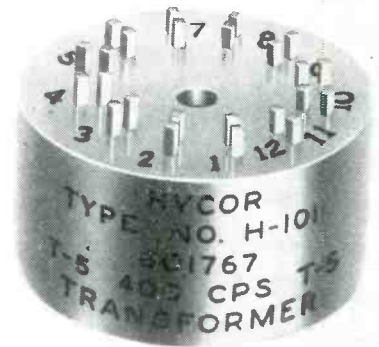

## POWER TRANSFORMERS for 400 cycles and higher

HYCOR Co., INC., 11423 Vanowen St., North Hollywood, Calif., announces a line of miniature power transformers for 400 cycles and higher frequencies. The units are available with output power ratings up to 15 va with multiple windings from 1 v to 500 v. They are available in miniature metal cases or in plastic encapsulated form to satisfy MIL-T-27 requirements. The toroidal construction minimizes external fields and results in extremely high efficiency. Bulletin WT lists stock types and is available upon request.



## TANTALUM CAPACITOR withstands high temperature

CORNELL-DUBILIER ELECTRIC CORP., South Plainfield, N. J., has developed a new Tantalum slug type

# "PIG-TAILORING"

... a revolutionary new mechanical process for higher production at lower costs. Fastest PREPARATION and ASSEMBLY of Resistors, Capacitors, Diodes and all other axial lead components for TERMINAL BOARDS, PRINTED CIRCUITS and MINIATURIZED ASSEMBLIES.

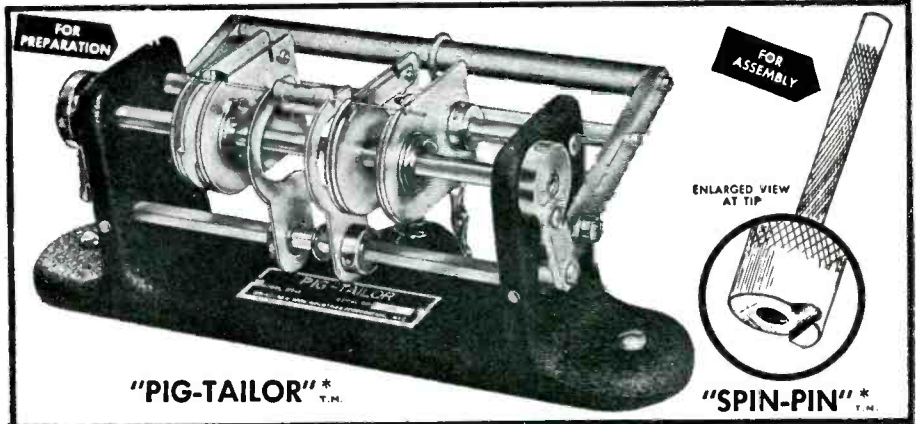

The "PIG-TAILOR" plus "SPIN-PIN" — Accurately Measures, Cuts, Bends, Ejects and Assembles both leads simultaneously to individual lengths and shapes — 3 minute set-up — No accessories — Foot operated — 1 hour training time.

### PIG-TAILORING provides:

1. Uniform component position.
2. Uniform marking exposure.
3. Miniaturization spacing control.
4. "S" leads for terminals.
5. "U" leads for printed circuits
6. Individual cut and bend lengths.
7. Better time/rate analysis.
8. Closer cost control.
9. Invaluable labor saving.
10. Immediate cost recovery.

### PIG-TAILORING eliminates:

1. Diagonal cutters.
2. Long-nose pliers.
3. Operator judgment.
4. 90% operator training time.
5. Broken components.
6. Broken leads.
7. Short circuits from clippings.
8. 65% chassis handling.
9. Excessive lead tautness.
10. Haphazard assembly methods.

\* PATENT PENDING

Write for illustrated, descriptive text on "PIG-TAILORING" to Dept. E8-P

**BRUNO-NEW YORK INDUSTRIES CORPORATION**  
DESIGNERS AND MANUFACTURERS OF ELECTRONIC EQUIPMENT  
460 WEST 34th STREET • NEW YORK 1, N. Y.



# Broadband RF Power Meters

THE CHOICE OF ALL ARMED SERVICES  
FOR MICROWAVE POWER MEASUREMENTS

**POWER:** PULSE and CW —  $5\mu\text{W}$  to 5W average  
**FREQUENCY:** 20MC — 10,000MC  
**ACCURACY:** 5% Absolute at all ranges,  
frequencies, temperatures

- ..... INDICATIONS: Direct Reading
- ..... CALIBRATION: Compensates for All Variables
- ..... R-F COMPONENTS: 3, 6, 10 and 20db Attenuators,  
Bolometer Mount and Elements, R-F Cable
- ..... BOLOMETER: Broadband, High Overload Capacity
- ..... PLUMBING:  $\frac{3}{8}$ " and  $\frac{7}{8}$ " 50-ohm Coaxial
- ..... POWER SOURCE: 115VAC  $\pm 15\%$ , 50-1000 cps
- ..... CONSTRUCTION: Rugged, meets all JAN, MIL re-  
quirements

### TYPICAL APPLICATIONS

Microwave Links . . . Television . . . Communications . . .  
Radar . . . Telemetry . . . Signal Generators . . .  
Laboratory Standards.

Write for descriptive literature to Department E8-M

**Bruno - New York Industries Corporation**  
DESIGNERS AND MANUFACTURERS OF ELECTRONIC EQUIPMENT  
460 WEST 34th STREET • NEW YORK 1, N. Y.

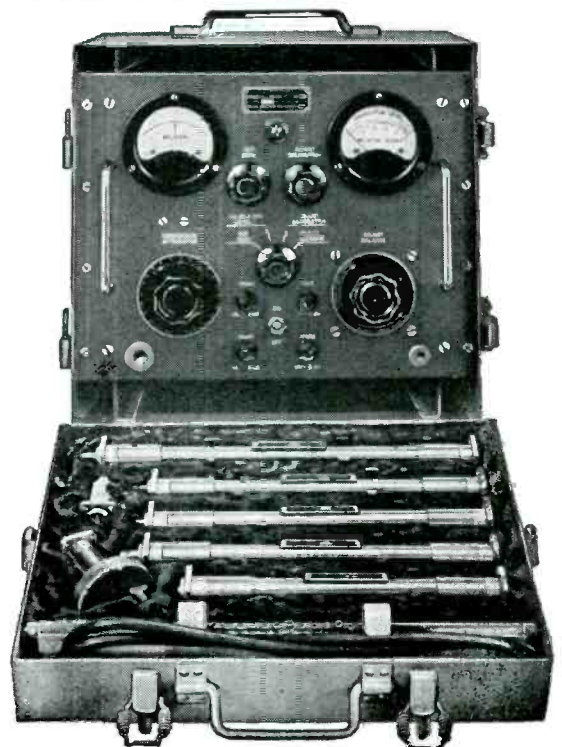

# Standard H.F. R.T.

## STR.18B2 24-Channel Pilot Controlled Airborne Communication Equipment

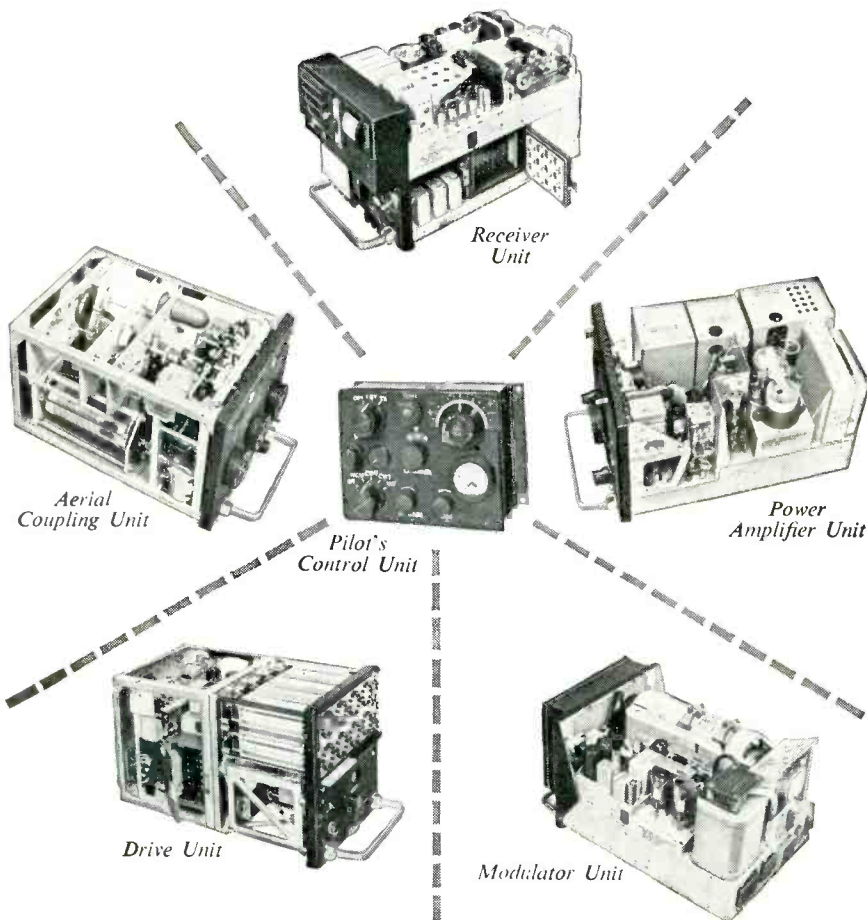

Suitable for use in civil or military aircraft, the STR.18B2 is now in quantity production for the British Ministry of Supply.

- ★ Frequency Band 2.8-18.1 Mc/s.
- ★ 24 Crystal-Controlled Channels
- ★ Full Pilot Remote Control
- ★ Single Knob Selection of both Transmitter and Receiver Channel
- ★ Ample Transmitter Power — 100 watts R.T.
- ★ Receiver Sensitivity less than 1 Microvolt
- ★ Standardized Units for Compact Installation



**Standard Telephones and Cables Limited**

Registered Office: Connaught House, Aldwych, London, W.C.2

**RADIO DIVISION** • New Southgate • London • N. 11 • England



NEW PRODUCTS

(continued)

electrolytic capacitor designed to operate under wide temperature ranges. The TH Tantalums are rated from  $-55^{\circ}\text{C}$  to  $+125^{\circ}\text{C}$ . Standard case size  $\frac{1}{2}$  in.  $\times$   $\frac{3}{8}$  in. to  $120\ \mu\text{f}$  are available; only slightly larger to  $240\ \mu\text{f}$ . Standard units range from 25 to  $120\ \mu\text{f}$  with a working voltage range of 18 to 100 v d-c. Higher capacitances and voltages to 630 v d-c can be supplied. For further information send for engineering bulletin No. 529.

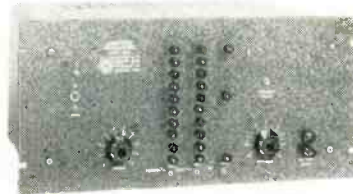

### PRECISION OSCILLATOR covers from 0.5 to 1,000 cps

KROHM-HITE INSTRUMENT Co., 580 Massachusetts Ave., Cambridge 39, Mass. Any of 2,000 different frequencies are available on the model 440-B precision pushbutton oscillator, which covers the frequency range from 0.5 to 1,000 cps in  $\frac{1}{2}$  cps steps. Calibration accuracy is  $\pm 0.05$  percent and then drift per hr is less than 0.005 percent. Distortion and hum are less than 0.1 percent at any output level. Amplitude varies less than  $\pm 0.25$  db over the entire frequency range. Output amplitude is adjustable continuously by a logarithmic output level control with a scale calibrated in rms volts from 0.01 to 10 maximum. Power output is 100 mw into 1,000 ohms. The oscillator is ideal as a secondary standard in laboratory, production and industrial use. Price is \$950.

### H-V RECTIFIER of the mercury vapor type

AMPEREX ELECTRONIC CORP., 230 Duffy Ave., Hicksville, L. I., N. Y. Type 6693 h-v mercury vapor rectifier tube, designed for high and medium voltage rectification, can deliver the higher currents neces-

# UNUSUAL...the dimensional stability of Du Pont "MYLAR"\*



"Mylar" is extremely tough, flexible, transparent, free from fibers, not affected by age, and dimensionally stable, insuring exact register at all times.

"Stabilene" Film is "Mylar" processed by K & E to give drafting, scribing and light-sensitive surfaces, which provide the modern method of making maps, charts, templates, printed electronic circuits and other layouts requiring high precision.

## TYPICAL...the way industry is using "MYLAR" for drafting, map making, template making, printed circuits, comparator work

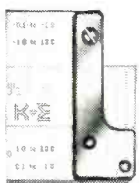

Du Pont "Mylar" polyester film, the base for Keuffel & Esser's new "Stabilene"† Film, provides dimensional stability and extra transparency for precision drafting, scribing and reproduction work. And "Mylar" also gives "Stabilene" Film its exceptional strength and flexibility... for easy handling, shipping, storing.

This is just one example of the way industry is taking advantage of the unique potentials of "Mylar"—a combination of physical, electrical, chemical, and thermal properties never before available in a plastic film—and putting them to profitable use. In a wide variety of fields, "Mylar" is mak-

ing possible better products... lower costs. And the range of valuable applications—from electrical capacitors to acoustical tile—is extended even further because "Mylar" can be slit into yarn, can be metalized, and can be bonded to a variety of other materials.

Only a little research imagination may

\*Du Pont registered trade-mark for its brand of Polyester Film.

†KEUFFEL & ESSER REG. U. S. TRADE-MARK

**DU PONT**

**MYLAR®**

**DU PONT POLYESTER FILM**

Better Things for Better Living...through Chemistry

be needed to show you where this versatile film can be used to your advantage. Find out now what other products are using Du Pont "Mylar." Mail the coupon for your copy of a fact-filled booklet that tells you more about "Mylar"—and the ways it may help you make an improved product.

E. I. du Pont de Nemours & Co. (Inc.)  
Film Department, Room 7E, Nemours Bldg.  
Wilmington 98, Del.

Please send me sample and further information on "Mylar" polyester film.

Name \_\_\_\_\_

Firm \_\_\_\_\_

Street Address \_\_\_\_\_

City \_\_\_\_\_ State \_\_\_\_\_

Even in wide temperature extremes

*S.S. White*  
Flexible Shafts  
meet the toughest  
performance  
standards

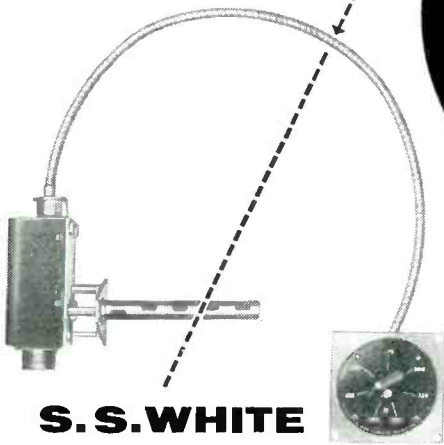

**S.S. WHITE  
FLEXIBLE SHAFTS  
give premium performance**

S.S. White flexible shafts up to 12 feet in length are used to transmit control between a graduated dial and this aircraft thermostat. Operating under all kinds of temperature conditions, the shafts give reliable day-in, day-out performance.

According to the manufacturer, "...the operation of the shaft is satisfactory at temperatures ranging from -65° to +160° F. There is no measurable variation in torque to turn the shaft or in torsional deflection required to initiate cam movement over the temperature range."

Where dependability is essential, you'll find that you can put your confidence in an S.S. White flexible shaft. They're available in both large and small sizes for power drives or remote control.

**Flexible shaft  
information  
for you...**



Bulletin 5306 has basic information and data on selection and application. Send for a copy. Address Dept. E.

**S.S. WHITE INDUSTRIAL DIVISION**  
10 East 40th Street, New York 16, N. Y.

*S.S. White*

**FIRST NAME  
IN FLEXIBLE SHAFTS**

F-1A



sary for use with modern high-current industrial and communications power tubes. Its electrical characteristics and low price make it especially interesting to the original equipment designer. Type 6693 will deliver 9 amperes up to 12 kv in a full-wave, 3-phase power supply. The industrial tube base provides a large contact area for the filament connections. This eliminates difficulties due to oxidation of the base contact surfaces because of the high density. Thus premature tube failure caused by under-heating of the filament is prevented.

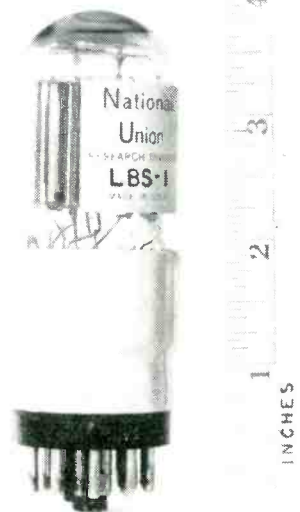

**BEAM SWITCH TUBE  
with 10 output anodes**

NATIONAL UNION ELECTRIC CORP., 405 Lexington Ave., New York, N. Y. The new line beam switch tube is intended for high-speed commutation of a single electron beam source to a multianode target. The beam switching is proportional to the electrostatic deflection and thus permits analog to



# ACCURATE

HIGH RELIABILITY  
HIGH PRECISION  
HIGH QUALITY

LOW WEIGHT  
SMALL SIZE  
ECONOMICAL

# FREQUENCIES

## FREQUENCY STANDARD

240 to 800 Cycles

Type 50 C

$\pm .02\%$  at  $-65^{\circ}$  to  $85^{\circ}\text{C}$

Type R 50 C

$\pm .002\%$  at  $15^{\circ}$  to  $35^{\circ}\text{C}$

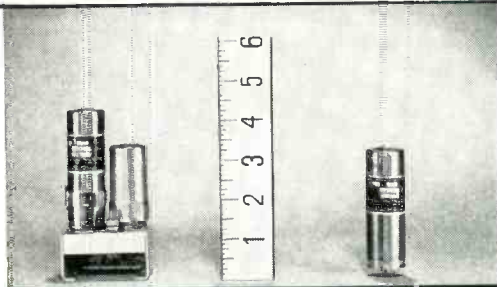

8 oz.

4 oz.

## PRECISION FORK UNIT

240 to 800 Cycles

Type 50

$\pm .02\%$  at  $-65^{\circ}$  to  $85^{\circ}\text{C}$

Type R 50

$\pm .002\%$  at  $15^{\circ}$  to  $35^{\circ}\text{C}$

## FREQUENCY STANDARD

200 to 4000 Cycles

Type 2003 C

$\pm .02\%$  at  $-65^{\circ}$  to  $85^{\circ}\text{C}$

Type R 2003 C

$\pm .002\%$  at  $15^{\circ}$  to  $35^{\circ}\text{C}$

Type W 2003 C

$\pm .005\%$  at  $-65^{\circ}$  to  $85^{\circ}\text{C}$

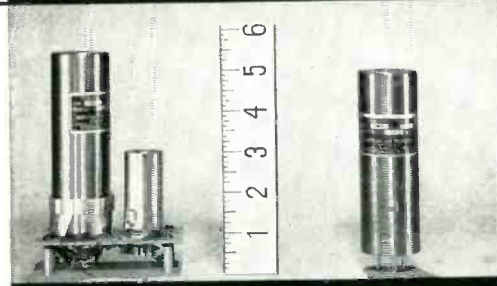

10 oz.

6 oz.

## PRECISION FORK UNIT

200 to 4000 Cycles

Type 2003

$\pm .02\%$  at  $-65^{\circ}$  to  $85^{\circ}\text{C}$

Type R 2003

$\pm .002\%$  at  $15^{\circ}$  to  $35^{\circ}\text{C}$

Type W 2003

$\pm .005\%$  at  $-65^{\circ}$  to  $85^{\circ}\text{C}$

## FREQUENCY STANDARD

200 to 2000 Cycles

Sub-miniature Tube

Type 2007

$\pm .02\%$  at  $-65^{\circ}$  to  $85^{\circ}\text{C}$

Type R 2007

$\pm .002\%$  at  $15^{\circ}$  to  $35^{\circ}\text{C}$

Type W 2007

$\pm .005\%$  at  $-65^{\circ}$  to  $85^{\circ}\text{C}$



6 oz.

8 oz.

## FREQUENCY STANDARD

240 to 1000 Cycles

Transistorized

Type 2007 T

$\pm .02\%$  at  $-65^{\circ}$  to  $85^{\circ}\text{C}$

Type R 2007 T

$\pm .002\%$  at  $15^{\circ}$  to  $35^{\circ}\text{C}$

Type W 2007 T

$\pm .005\%$  at  $-65^{\circ}$  to  $85^{\circ}\text{C}$

## FREQUENCY STANDARD

200 to 3000 Cycles

Type 2001-2

$\pm .001\%$  at  $20^{\circ}$  to  $30^{\circ}\text{C}$

WHEN REQUESTING  
INFORMATION  
PLEASE SPECIFY  
TYPE NUMBER

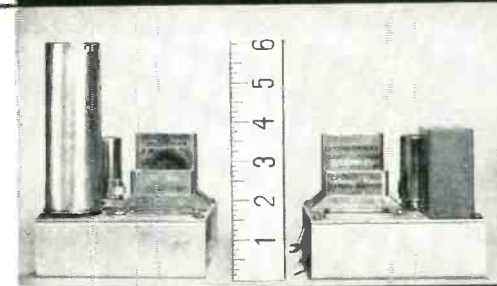

26 oz.

15 oz. av.

## ACCESSORY UNITS

for Type 2001-2

L—for low frequencies,  
multi-vibrator type, 40-200 cy.

D—for low frequencies,  
counter type, 40-200 cy.

H—for high freqs., up to 20 KC

M—Power Amplifier, 2W output

P—Power Supply.

# American Time Products, Inc.

580 Fifth Avenue

New York 36, N. Y.

OPERATING UNDER PATENTS OF WESTERN ELECTRIC COMPANY

# 28 foot TRANS-HORIZON ANTENNAS available **NOW**

Field proven for two years in over 50 installations, this versatile, rugged antenna is currently available from stock.

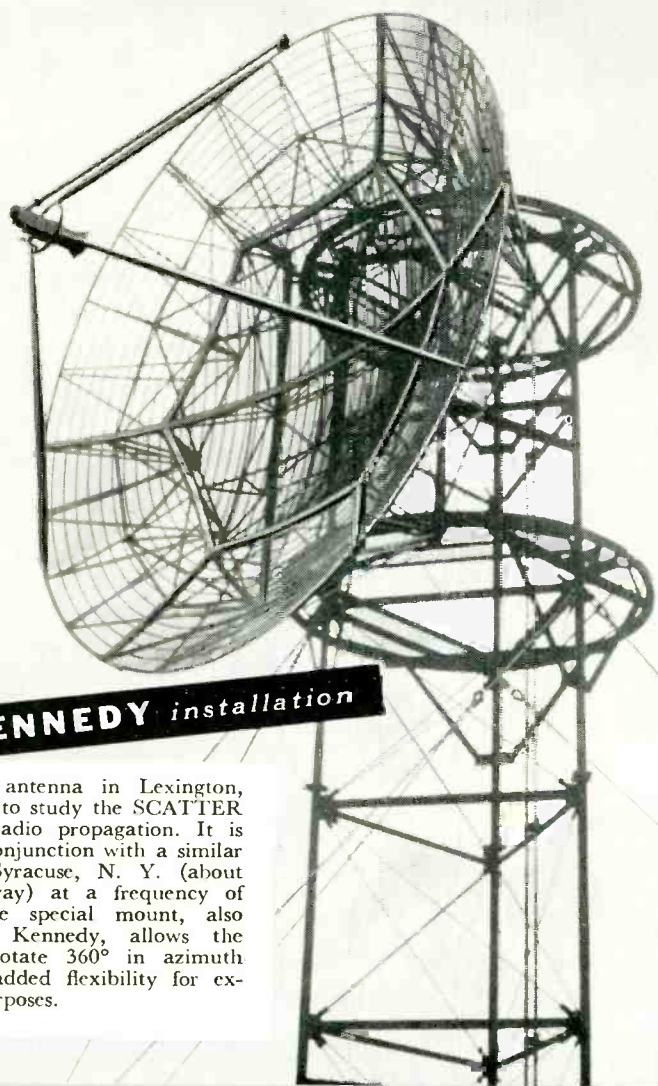

another **KENNEDY** installation

This 28-foot antenna in Lexington, Mass. is used to study the SCATTER principle of radio propagation. It is operated in conjunction with a similar antenna in Syracuse, N. Y. (about 250 miles away) at a frequency of 915 mc. The special mount, also designed by Kennedy, allows the antenna to rotate 360° in azimuth which gives added flexibility for experimental purposes.

ANTENNA EQUIPMENT

**D. S. KENNEDY & CO.**

COHASSET, MASS. — TEL: CO4-0699

digital translation. The output secured from each target anode is of positive polarity and in many applications is of sufficient amplitude to permit gating without preamplification and phase inversion. Ten separate output anodes are provided and outputs of 35 v peak from each anode are obtainable across 100,000-ohm load resistors. Less than 10 anodes may be employed in the operation of the tube by placing the unused anodes at B plus. The LBS-1 tube is in a T-11 bulb and has a maximum overall length of only 4.25 in. Under normal 300-v operation with 6 ma of cathode current the 10 output anodes can be swept with a deflection voltage of 60 v.

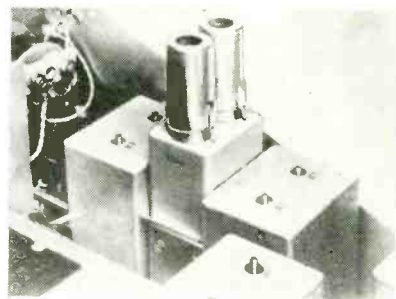

## MECHANICAL FILTER for SP-600 receivers

HAMMARLUND MFG. Co., INC., 460 W. 34th St., New York 1, N. Y. A simple mechanical i-f filter adapter which fits snugly between two i-f cans in a Super Pro-600 communications receiver is now available. This sealed unit consists of an input transducer, a resonant mechanical section comprised of a number of metal disks, an output transducer on which is mounted the replaced i-f tube, and an amplifying tube. The unit, which is available for bandwidths of 0.8, 1.2, 3.1 and 6 kc at 6 db down, can be completely installed in a matter of seconds simply by pulling an i-f tube and replacing it with the permanently tuned mechanical filter adapter.

## COAXIAL TRIODES for 20 to 25-kw equipments

MACHLETT LABORATORIES, Springdale, Conn., announces the ML-6424 and ML-6425 coaxial-terminal tri-

# RELAYS *discriminating* most engineers choose

## Potter & Brumfield

"Your best source for relays" is Potter & Brumfield, because of an enviable reputation earned through a *quarter century* of relay specialization.

Millions of relays of *all styles* and sizes designed and manufactured to meet customer specification.

From small sub-miniature, precision, sensitive relays to heavy duty power types, each fulfilling an exacting requirement.

Enclosed hermetically sealed or open relay structures to meet demands of various environmental conditions.

Priced competitively at all quality levels.

*Samples available for immediate shipment. Send your specification for recommendations and quotations.*

**POTTER & BRUMFIELD MFG. CO., INC.**  
Princeton, Indiana



Automatic Hi-Pot tester developed by P&B

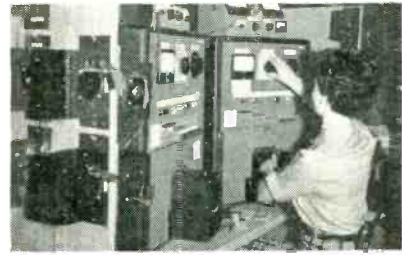

Ultrasonic Cleaning of relay assemblies



3D Microscopic Inspection and assembly



**ALL TYPES—ALL SIZES—FOR ALL APPLICATIONS**

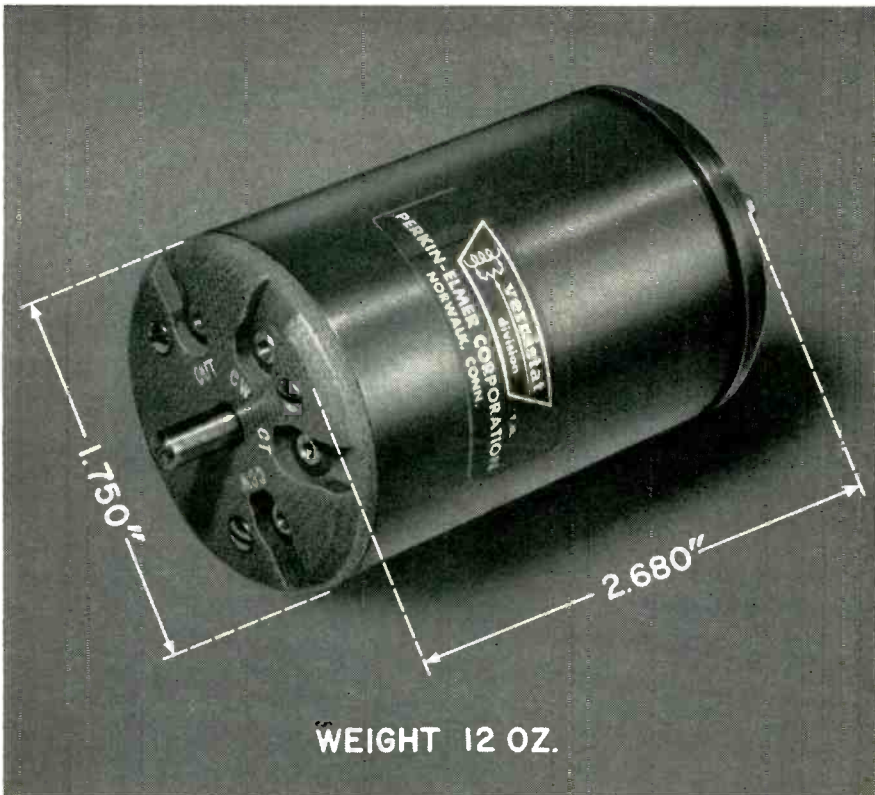

## NEW...the 400 cycle **vernistat**\* a.c. Potentiometer you asked for!

The 400 cycle Vernistat is an a.c. potentiometer-type voltage divider that combines *high* linearity and *low* output impedance. It is essentially a non-dissipative element adaptable to high temperature operation. Size and mounting dimensions are designed to the BuOrd specification for a size 18 synchro.

### Here are the details:

- **high linearity**, inherent in the design principle, is *maintained* over the life of the unit.
- **low output impedance** eliminates need for isolation amplifiers in many applications.
- **high output current capability**.
- **low phase shift** — less than 90 seconds, depending on model.
- **can be coupled with synchros**, resolvers and other components — as well as ganged.
- **nonlinear functions can also be generated**.

Class 5 ball bearings, centerless ground shaft, and an aluminum housing machined to close tolerances combine to make the Vernistat a precision instrument. Shaft seals will be supplied where they are required by environmental conditions.

Write for further information to:

### check these specifications:

Linearity Tolerance .....	$\pm 0.05\%$
Minimum Output Voltage Increment .....	0.01%
Output Impedance .....	less than 130 ohms
Input Voltage .....	130 v max.
Input Impedance .....	up to 75,000 ohms

See the Vernistat at Booth 1408,  
WESCON Show, August 24 to 26,  
Civic Auditorium, San Francisco.

\*Trademark

**vernistat** division  
PERKIN-ELMER CORPORATION  
Norwalk, Connecticut



odes, employing thoriated-tungsten filaments for industrial and broadcast equipments of 20 to 25-kw power output. Featured are high plate and grid current ratings, low terminal inductances and high transconductance characteristics. The ML-6424 is rated for 40-kw input, 20-kw anode dissipation; the ML-6425 is rated for 40-kw input, 12.5-kw anode dissipation. Full ratings on both tubes to 30 mc; reduced ratings to 90 mc. Incorporating a rugged, coaxial terminal structure, heavy-wall anode, self-supporting thoriated filament and large, ring-seal connections, each of these heavy-duty triodes will give excellent performance and low-cost service.

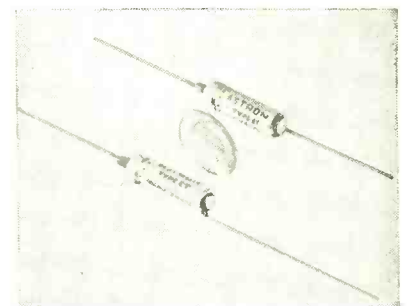

### ELECTROLYTICS for printed circuitry

ASTRON CORP., 255 Grant Ave., East Newark, N. J., has announced a new type ET subminiature electrolytic capacitor. Designed specifically for printed circuitry and automation, it is ideal for applications where space is severely limited. Features include: wide range of values, stable high-gain etch process, low leakage current and low-resistance terminal tab connection. The units

# Foremost protection for **RADAR'S ROVING EYE**

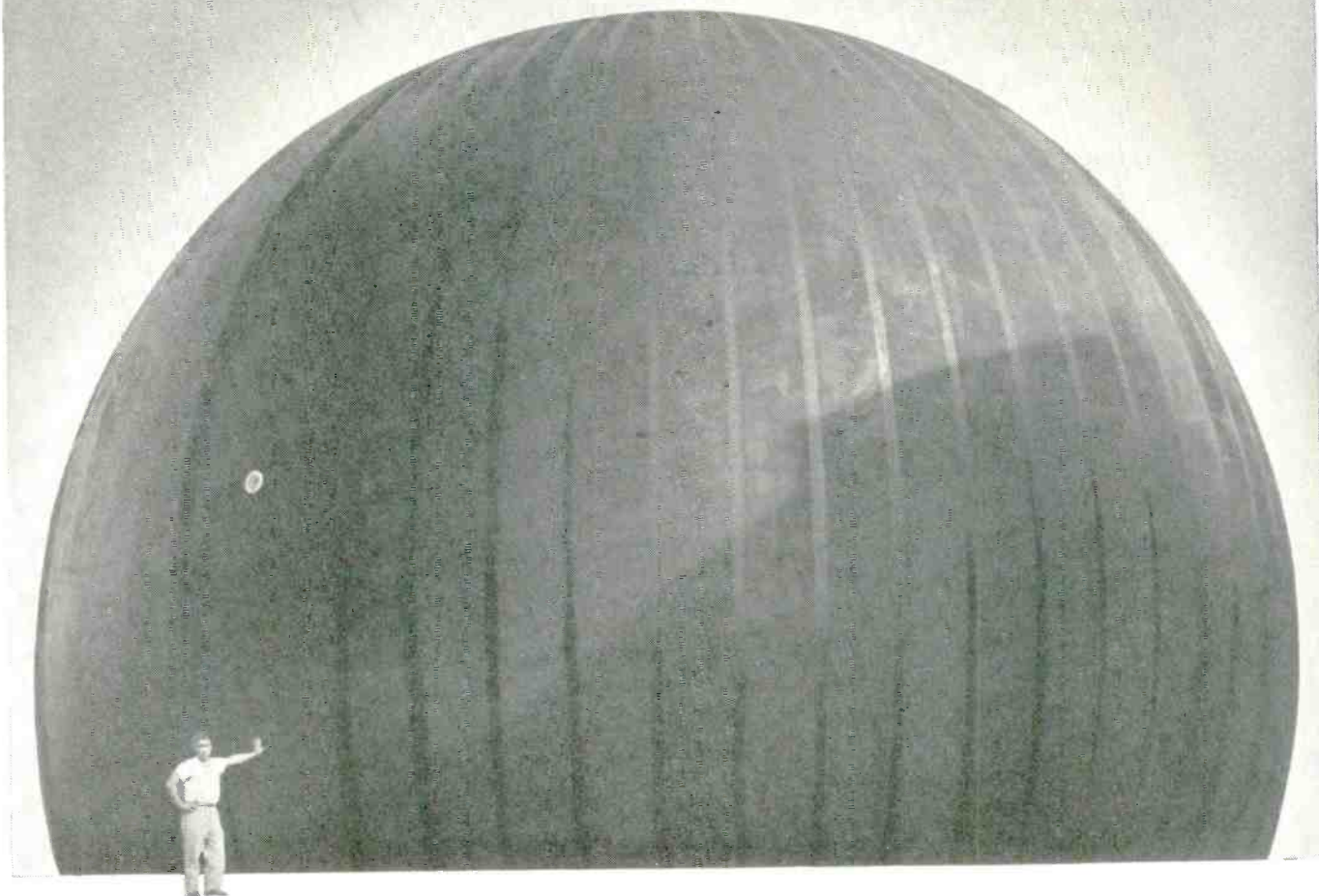

**I**NFLATABLE radomes built by Goodyear are offering the highest transmissibility of any radar housing, and all-weather endurance qualities.

Hundreds are already in successful service in extreme climates throughout the world—in sizes ranging from 10 to 54 feet in diameter. These Goodyear radomes have proved their ability to protect portable, mobile and stationary equipment without hampering its electronic efficiency.

Foremost among their attributes is their high degree of electromagnetic transparency—the result of Goodyear's special skills and technical abilities in working with coated Nylon fabrics and specially compounded synthetic rubbers.

In addition, the radomes can be protected by a special

erosion-resistant coating—which materially reduces the need for maintenance.

This radome-building experience is ready to go to work for you—to design the right housing for your equipment—to give you the *best performance* while giving you the *best protection* against erosion and weather, the *best characteristics* under high and low temperature conditions.

For information, write: Goodyear, Aviation Products Division, Dept. H-1725, Akron 16, Ohio or Los Angeles 54, California.



FACILITIES + ABILITIES = EXTRA *plus* IN PERFORMANCE

**NEW** *Electra*

**Hermetically Sealed  
DEPOSITED CARBON  
RESISTORS**

HC-7

SEVEN SIZES

HC-1

**THEY'RE  
ARMORED!**

**SUPER PROTECTION  
AGAINST:**

**High Temperature—Humidity  
Radical Temperature Change—Abrasion  
Chemical Compounds—Electrical Shock**

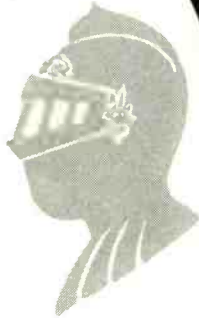

S I Z E  C H A R T	Part No.	Wattage	Maximum Rated Voltage	Resistance Range	Length (A)	Dia. (B)
	HC 1	1/4	250	4 Ohms 250K	15/32"	5/32"
HC 2	1/3	300	5 Ohms 1 Meg	3/4"	3/16"	
HC 3	1/2	350	3 Ohms 2.2 Megs	11/16"	1/4"	
HC 4	1	500	3 Ohms 5 Megs	7/8"	5/16"	
HC 5	1	500	6 Ohms 5 Megs	1"	9/32"	
HC 6	2	500	3 Ohms 10 Megs	1 1/8"	3/8"	
HC 7	3	1000	10 Ohms 50 Megs	2 1/4"	3/8"	

\*All lead lengths are 1 3/8". Resistors supplied in tolerances of 1%, 2%, 5% or 10%.

Electra Hermetically-Sealed resistors are designed for those tough applications calling for a deposited carbon resistor that will really take it. They're rugged and thoroughly insulated, ALSO give you all of the close tolerance characteristics that have made Electra's line of standard deposited carbon resistors the first choice on thousands of blueprints from coast to coast. Choose Electra and know you've got the best.

**FILL OUT AND MAIL THIS COUPON TODAY FOR FULL DETAILS**



Please send Bulletin #60 on Hermetically-Sealed Resistors   
and/or Bulletin #50 on Standard Deposited Carbon Resistors

**ELECTRA  
MFG. CO.  
Electronics Div.  
2537 Madison  
Kansas City, Mo.**

Name \_\_\_\_\_  
Title \_\_\_\_\_  
Company \_\_\_\_\_  
Street \_\_\_\_\_  
City \_\_\_\_\_ State \_\_\_\_\_

NEW PRODUCTS

(continued)

are manufactured with contamination-free assembly of high purity foil and are hermetically sealed in aluminum cases. Stable operation over a wide temperature range and consistent 85 C operation is assured by individual products testing.

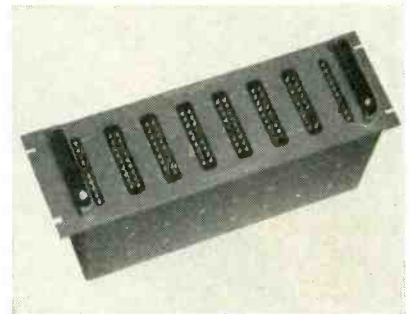

**DELAY LINE  
is a precision unit**

EPSCO INC., 588 Commonwealth Ave., Boston 15, Mass. Model DL0510-400/125 delay line is a precision, low attenuation unit, developed for correlation measurements and wave form analysis covering subaudio and audio frequencies. Overall delay is 5,000  $\mu$ sec; characteristic impedance is 510 ohms; taps are available every 40  $\mu$ sec; calibration accuracy at each of 125 taps is  $\pm 0.1 \mu$ sec; insertion loss is 1.7 db; cut-off frequency, 9 kc; phase linearity is  $\pm 1$  percent up to 5 kc. The unit size is 19 in.  $\times$  6 in.  $\times$  6 in. for relay rack mounting.

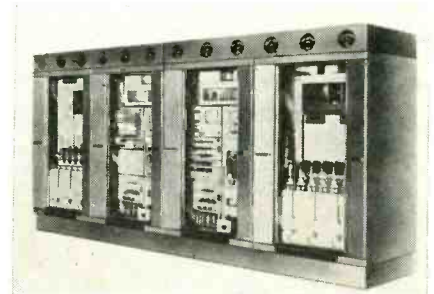

**VHF TV TRANSMITTER  
has built-in sync stretcher**

STANDARD ELECTRONICS CORP., 285 Emmet St., Newark 5, N. J. Model TH-614-2 10 kw vhf tv transmitter features low initial investment, \$55,000; diminished floor space requirements, 187 in.  $\times$  38 1/2 in.; reduced weight, visual and aural

# NRC Rotary Gas Ballast Pumps

...are the only Vacuum Pumps that combine maximum CFM's per dollar with proved ability to pump water vapor, too.



Four of NRC's complete line — Model Nos.: 4D, 4S, 2D, 2S.

**USE CHART FOR PLACING ORDER — OR SEND FOR RGBP BULLETIN**

Remember, *most* systems are wet in humid weather. That makes NRC pumps a *double* value! First, they deliver the finest all around pumping performance you can buy. Second, they *keep* their fast pumping cycles in all types of weather, handling all types of condensable vapors, even up to 100% moisture.

And you get all this at no additional cost! So why buy "conventional" pumps when you can get NRC's dependability and "gas ballast" feature all for the same price?

**NARESCO EQUIPMENT CORPORATION**  
Sales Subsidiary of National Research Corp.  
48 Charlemont St., Newton Highlands 61, Mass.

Sales Offices: Boston • Chicago • Cleveland • Houston  
Los Angeles • New York • Palo Alto • Philadelphia  
in Canada: Toronto • Amprion

## ENGINEERING DATA AND SPECIFICATIONS

Price with base, motor and V-Belt, less just board	Pump Model	Normal Rate Capacity (Cubic Feet Per Minute)	Ultimate Vacuum (1)		Rotor Pump Shaft Speed (R.P.M.)	Motor (2) Horsepower	Approximate Oil Capacity (Pumps)	Connecting Pipe Dimensions		Approximate overall dimensions Pump, Motor and Base (Inches)			Weight Pump, Motor and Base (Lbs.)
			With Gas Ballast	Without Gas Ballast				Pump Inlet	Pump Exhaust	Height	Width	Length	
			mm Hg	mm Hg				inches	inches				
\$ 155	Single Stage NRC 2-S	1.25		3 x 10 <sup>-3</sup>	525	¼	3½ Fl. Oz.	T19/38 <sup>(1)</sup>	¾ <sup>(5)</sup>	16	11	16	68
\$ 225	NRC 4-S	3.3	Less	3 x 10 <sup>-3</sup>	450	¼	3½ Fl. Oz.	T29/42 <sup>(1)</sup>	¾ <sup>(5)</sup>	18	11	19	89
\$ 312	NRC 6-S	6.75	Than	3 x 10 <sup>-3</sup>	400	¼	7 Fl. Oz.	1½ O.D.	1½ O.D.	21	13	24	150
\$ 448	NRC 15-S	11.6		3 x 10 <sup>-3</sup>	305	1	2½ Qts.	1½ O.D.	1½ O.D.	22	18	24	270
\$ 730	NRC 30-S	29.5	One	3 x 10 <sup>-3</sup>	400	1½	2 Qts.	2 <sup>(4)</sup>	3 O.D.	29	19	31	441
\$1350	NRC 100-S	100	Half	3 x 10 <sup>-3</sup>	335	5	5 Qts.	3 <sup>(4)</sup>	4½ O.D.	43	34	45	1430
\$2200	NRC 200-S	202		1 x 10 <sup>-2</sup>	340	15	3 Gal.	4 <sup>(4)</sup>	4½ O.D.	58	43	53	2750
\$3573	NRC 400-S	403		5 x 10 <sup>-3</sup>	340	25	6 Gal.	4 <sup>(4)</sup>	4½ O.D. <sup>(4)</sup>	60	62	66	5775
\$ 215	Compound NRC 2-D	1.25	Less	5 x 10 <sup>-3</sup>	525	¼	3½ Fl. Oz.	T19/38 <sup>(1)</sup>	¾ <sup>(5)</sup>	16	11	16	84
\$ 280	NRC 4-D	3.3		5 x 10 <sup>-3</sup>	450	¼	24 Fl. Oz.	¾ IPS	¾ <sup>(5)</sup>	17	14	20	155
\$ 425	NRC 6-D	6.75	Than	5 x 10 <sup>-3</sup>	400	¼	14 Fl. Oz.	¾ IPS	1½ O.D.	21	18	22	265
\$ 700	NRC 15-D	14.75	2.5 x 10 <sup>-2</sup>	3 x 10 <sup>-3</sup>	400	1	4½ Qts.	1½ O.D.	1½ O.D.	21	20	25	290
\$1080	Combination NRC 30-M	29.5		—	400	1½	2 Qts.	2 <sup>(4)</sup>	3 <sup>(4)</sup>	40	20	35	550
\$1810	NRC 100-M	100	3 x 10 <sup>-3</sup>	—	335	5	5 Qts.	3 <sup>(4)</sup>	3 <sup>(4)</sup>	57	35	46	1600
\$2930	NRC 200-M	202		—	340	15	3 Gal.	4 <sup>(4)</sup>	6 <sup>(4)</sup>	76	43	53	3000
\$4590	NRC 400-M	403		—	340	25	6 Gal.	4 <sup>(4)</sup>	— <sup>(4)</sup>	78	62	89	6400

(1) McLeod gauge, standard test procedure

(2) Requirements for average installation

(3) 1 indicates a standard taper joint, taper

1-10. First figure is the dia. (mm) of large end, second figure is the length (mm) of the ground zone

(4) Standard 150 pound flange

(5) Male pipe thread

(6) NRC 400-S has two exhaust connections

NRC 400-M has two 6" and one 3" 150<sup>lb</sup> flanged exhaust connections

Water Cooling — NRC 100-S, 200-S, 400-S, 100-M, 200-M, and 400-M have water jackets with ½" pipe tap connections.



**Naresco Equipment Corporation**

# CUT CABLE ASSEMBLY COSTS!



## CHECK CABLES WHILE YOU ASSEMBLE - **NEW LINK 209 CABLE CHECKER** SAVES TIME, ELIMINATES COSTLY REWORK!

Now, here's a new production tool that will cut your cable assembly and inspection costs—slash inspection time by as much as one-half!

The new Link 209 Cable Checker is portable, compact and easy to operate—a fool-proof tool that simplifies individual wire identification . . . finds shorts between wires of the cable . . . shorts between any wire and the shell . . . and checks continuity between connectors.

Let the versatile Link 209 Cable Checker save you time and money in cable assembly and inspection. Write today for additional information.

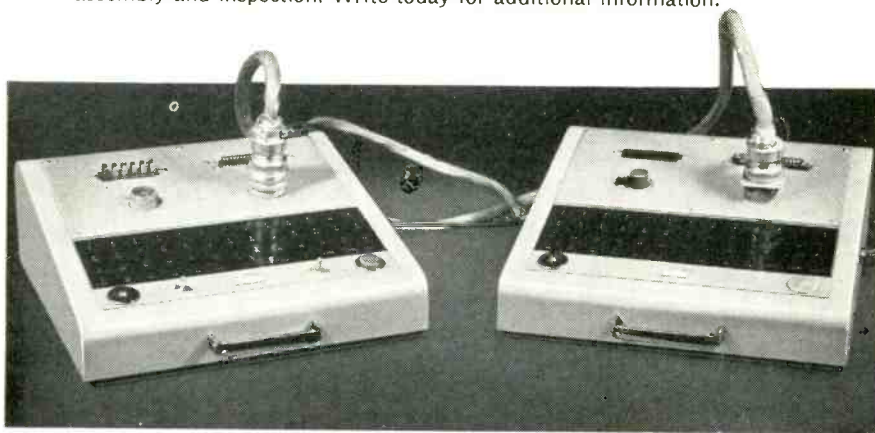

**LOOK  
AT THESE  
OUTSTANDING  
FEATURES!**

- Rapid, positive visual identification
- Low set up time—only minutes to change from one operation to another
- Rugged, durable—reliable performance always, low maintenance
- Easy to operate—just press the button, check connections against wiring list

Only \$575.00

**LINK**  
AVIATION, INC.

BINGHAMTON, NEW YORK

A SUBSIDIARY OF  
GENERAL PRECISION  
EQUIPMENT CORPORATION



cabinets each 3,500 lb; low power consumption, 30.2 kw at 90 percent power factor at black level. Full-length glass doors permit visual inspection of all tubes even when the transmitter is on the air. Single ended coaxial circuits provide exceptional freedom from spurious oscillations and parasitics. A built-in sync stretcher permits adjustment of the sync to-picture ratio of the signal. The transmitter meets all applicable FCC requirements for monochrome and color transmission.

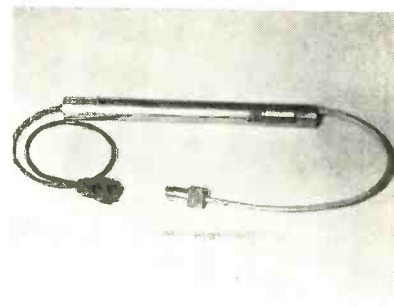

## T-W TUBE AMPLIFIER for X-band use

HUGGINS LABORATORIES, INC., 711 Hamilton Ave., Menlo Park, Calif., has announced an X-band backward-wave oscillator. The t-w tube features broadband electronically tuned oscillations from 7 to 14 mc. This is accomplished by the adjustment of a single voltage without any complementary mechanical adjustments. This type of oscillator would find its greatest field of use in swept signal generators for automatic testing, swept local oscillators and wide band transmitter-receiver applications. The tube is capable of being swept across this band in less than 1  $\mu$ sec. Approximate operating characteristics over this band are 300 to 3,000 v, 12 ma current and 10 mw output. The X-band voltage requirements are 450 to 2,000 v.

## ETCHING SOLUTION for printed circuits

PHILIP A. HUNT Co., Palisades Park, N. J., has announced a new etching solution for use in the field of etched printed circuits for tv, radio and the like. The RCE solu-



# OLD FRIEND!

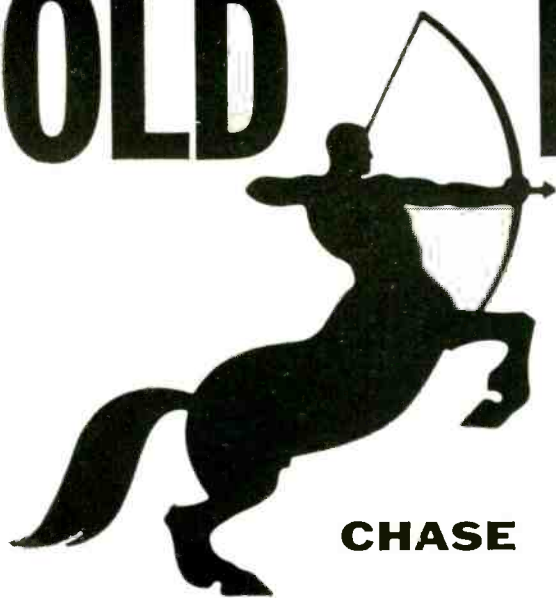

**CHASE**

Since 1876, the name Chase has been the symbol of *top quality in brass and copper*. It also stands for unmatched *service!* Twenty-five Chase warehouses and three Chase mills form the most responsive and efficient source of brass and copper supply in the nation!

# NEW SERVICE!

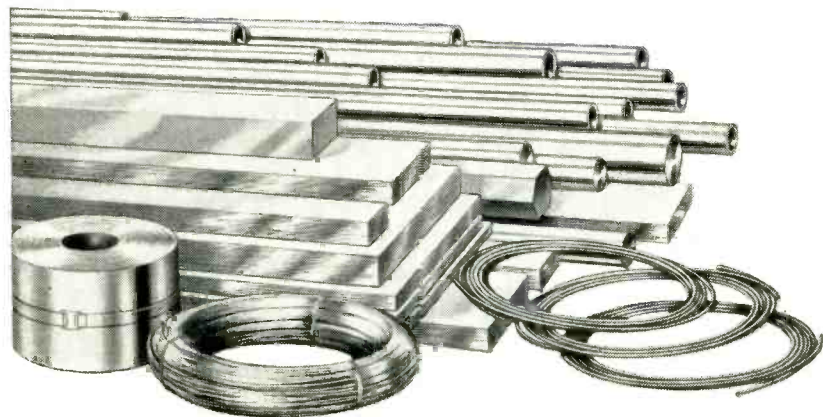

Now the Chase network assures you a dependable source of stainless steel, too! You specify the type, form and quantity. The Chase warehouse near you has it in stock—or will get it to you on the double, direct from another Chase warehouse or the mills. Call Chase today! Get those service experts working for *you* on your stainless steel requirements!

# STAINLESS STEEL!

**Chase**  <sup>®</sup>  
**BRASS & COPPER CO.**

*The Nation's Headquarters for Brass & Copper*

Albany†	Chicago	Detroit	Los Angeles	New York	St. Louis
Atlanta	Cincinnati	Grand Rapids†	Milwaukee	Philadelphia	San Francisco
Baltimore	Cleveland	Houston	Minneapolis	Pittsburgh	Seattle
Boston	Dallas	Indianapolis	Newark	Providence	Waterbury
Charlotte†	Denver	Kansas City, Mo.	New Orleans	Rochester†	(†sales office only)

WATERBURY 20, CONNECTICUT • SUBSIDIARY OF KENNECOTT COPPER CORPORATION

where  
stability is a must . . .

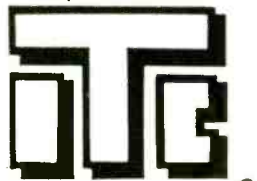

**PRECISION**  
**TRIMMER POTENTIOMETERS**  
small..compact..precise

Engineered to the high standards of TIC Quality . . . a familiar standard of comparison. Environmental tested for MIL-E-5272A. TIC's Trimmer Potentiometers may be used as adjustable resistors or voltage dividers.

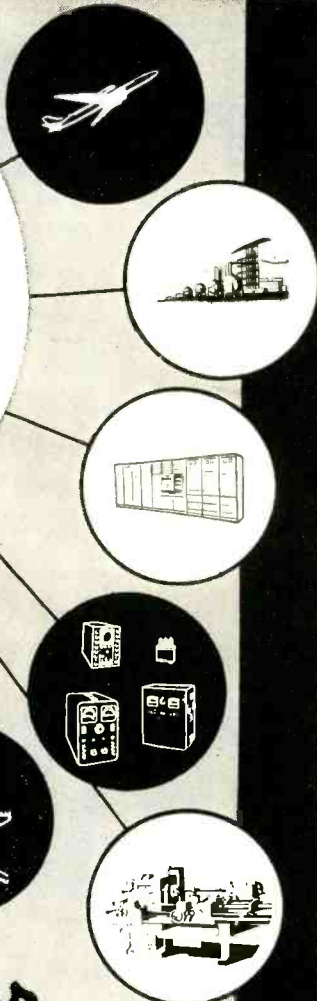

**RV 1/2 SUBMINIATURE TRIMMER**



- 1/2" diameter, threaded bushing mounting, stainless steel case
- Dissipation: 1.5 watts at 25°C
- Resistance values: 50 ohms to 15K
- Temperature range: -55°C to +80°C



**RV 7/8 MINIATURE TRIMMER**

- 7/8" diameter, threaded bushing mounting, aluminum cup construction
- Dissipation: 2.0 watts at 25°C
- Resistance values: 50 ohms to 15K
- Temperature range: -55°C to +80°C



**RFT SUBMINIATURE METALFILM TRIMMER**

- 13/32" x .400 x 1 21/64", rectangular case, 2 screw eyelet mount, 25 turn lead screw adjustment
- Size permits stacking 7 per square inch
- Infinite resolution
- Dissipation: 0.5 watts at 40°C
- Resistance values: 50 ohms to 25K
- Temperature range: -55°C to +125°C



**RVH1 HIGH TEMPERATURE TRIMMER**

- 1" diameter, threaded bushing mounting, aluminum cup construction
- Dissipation: 2 Watts at 25°C, 0.5 w at +130°C
- Resistance values: 100 ohms to 5K
- Temperature range: -55°C to +145°C

*for*

- Adjusting scale factors of functions basically derived by other potentiometers
- Pinpointing circuit values of voltage, current, or resistance
- Balancing adjustments
- Critical magnetic or electric bias
- Padding or fixed reference circuits
- Establishing critical threshold voltages
- Fixed gain adjustments
- Compensation for variable parameters

For further information regarding your trimmer requirements, TIC invites your inquiries.

**TECHNOLOGY INSTRUMENT CORP.**

533 Main St., Acton, Mass., Colonial 3-7711  
West Coast Mail Address: P.O. Box 3941, North Hollywood, Calif., POplar 5-8620

VISIT US AT THE WESCON SHOW BOOTH 1113

tion will be shipped in 145-lb rubber drums. It gives controlled rapid etching speed; instant and uniform etching over the entire circuit; and is a fast etching solution for printed circuits.



**PANEL METERS**  
feature longer scale

MARION ELECTRICAL INSTRUMENTS Co., Manchester, N. H. A new design in panel instruments, permitting up to 50 percent more scale length in the same space as conventional round or square faced meters, has been developed. The Medalist meters are available in 2 1/2-in. and 3 1/2-in. sizes and meet standard ASA/JAN dimensional requirements.

**SHIFT REGISTER**  
of the magnetic type

BUTLER MFG. CORP., 5516 Dorsey Lane, Washington 16, D. C., has announced a magnetic shift register that snaps together without soldering. The BI-MAGSTAT memory units can be quickly and easily plugged together to form any length shift register desired. End plate connectors also plug on to provide terminals for shift pulses and serial input and output signals. Terminals on the top of each unit provide connections for parallel input and output. Each BI-MAGSTAT contains two magnetic cores with associated semiconductor diodes and is capable of storing one binary digit. No electrolytic capacitors are used. A pair of 6L6's can drive more than 100 of these units

# NEW

## plastic lamp socket

### SEALS OUT MOISTURE and DUST



**POLYETHYLENE SKIRT** is flexible . . . seals against mounting surface and wire lead, providing a complete dust and moisture seal.

**SNAP-IN MOUNTING PRONGS** are shaped for easy push-in entry into mounting hole and snap outward to lock socket securely in place. Prongs are firmly anchored in plastic skirt.

**AUTOMATIC GROUNDING** of socket is provided by positive contact between mounting prongs and mounting surface.

*available with springs and washers preassembled*

United-Carr's in-plant plastic molding facilities permit complete control of quality and performance in the manufacture of devices in which metal and plastics are combined. This enables United-Carr to offer truly comprehensive and reliable service on custom-designed fasteners and self-fastening electrical devices. For further information . . . sizes, prices, etc., contact your nearest United-Carr representative or write us direct.

**UNITED-CARR**  
FASTENER CORPORATION

31 Ames Street, Cambridge 42, Massachusetts.

MAKERS OF  FASTENERS

A new standard  
of insulation  
performance

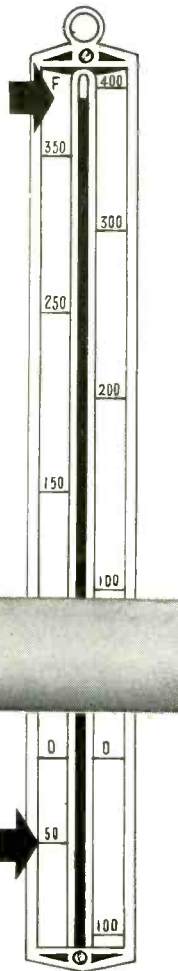

# Resinite<sup>®</sup>

## VINYL GLASS

### ELECTRICAL INSULATION SLEEVING

A superior vinyl impregnated Fiberglas<sup>®</sup> insulation offering dependable performance under extreme conditions is proudly introduced by Resin Industries — leading supplier of vinyl sleeving to the electronics and aircraft industries. RESINITE VINYL GLASS sleeving offers these outstanding characteristics.

- For operation from  $-50^{\circ}$  to  $395^{\circ}$  F (20 hours)
- Won't craze or crack
- Maintains flexibility and dielectric strength after 1000 hrs at  $300^{\circ}$  F
- Grades B-A-1, B-B-1 and B-C-1
- Withstands creasing, pounding, twisting and bending without loss of dielectric strength
- Sizes #24 to  $\frac{5}{8}$ "
- Excellent chemical and oil resistance
- Eleven colors
- Priced comparable to ordinary cotton or rayon base insulations

\*Reg. TM — Owens-Corning Fiberglas Corp.

Ask your Resinite representative or write for samples and performance data.

See the new Resinite Vinyl Glass and other Resinite Sleeving at the Wescon Show, Booth #232, San Francisco, Aug. 24-26.



in series. Rigid quality control assures complete interchangeability of units even when the drive current varies as much as  $\pm 15$  percent. The type C BI-MAGSTAT operates from 0 to 20 kc.

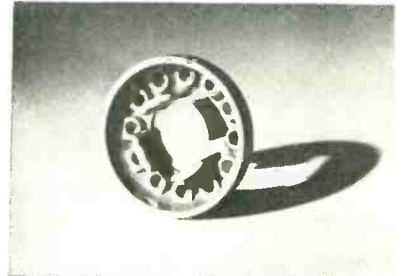

### PROTECTIVE CAP for tv picture tubes

SYLVANIA ELECTRIC PRODUCTS INC., 1740 Broadway, New York 19, N. Y., announces the Pin Cushion, a new plastic protective cap, which fits over the base pins of a tv picture tube. The light weight, durable caps prevent bent or broken pins as the base pins are kept in perfect alignment, especially when tv tubes are being shipped. The cap keeps the pins clean, thus assuring maximum electrical contact, and the Pin Cushion makes it easier to slide the ion trap magnet over the tube base, eliminating the danger of bent pins.

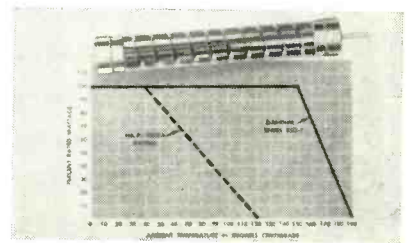

### RESISTORS are the film type

THE DAVEN Co., 191 Central Ave., Newark 4, N. J., announces the Davohm series 850-T resistor. These film type resistors can be used at  $150^{\circ}$  C at full rated power. They derate linearly to zero power at  $190^{\circ}$  C. The temperature coefficient is below  $+400$  ppm per deg C, is always positive in value and is independent of resistance value. Any ohmic value of these resistors will track within approximately

*In servo systems...  
null balance circuits...*

## Choose **BROWN CONVERTERS**

*...for sensitive stable performance*

25, 40, 60 and 400 cycles

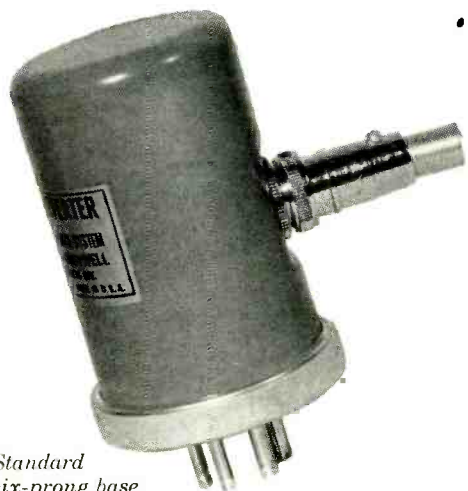

Standard six-prong base with side connection for driving coil.



Standard six-prong base.

DC signals as small as  $10^{-8}$  volt are converted to AC by means of these synchronously-driven SPDT "choppers." Their power capacity is up to 0.1 milliwatt. Each contact closes for 55% of the cycle . . . or other closure cycle as specified. Symmetry is within 2%. Lag of output signal is  $17^{\circ} \pm 5^{\circ}$  behind line voltage. Thermal emf's and pick-up are practically zero.

Brown converters are noted for long life. Thousands of them have been in service on continuous duty for more than 10 years. Their sensitive, stable performance is ideal for radar, computers, servo-mechanisms and balancing circuits. Numerous special features can be provided for individual requirements. All standard models are available for immediate delivery.

- **ORDER NOW!** Prices from **\$35.75**  
(even more favorable costs for quantity purchases)

### Available in these ratings

Nominal frequency, cps	25	40	60	400
Synchronous range, cps	23-28	36-44	45-66	360-440
Driving Coil	6.3 volts, 60 ma.			18 volts, 94 ma.

MINNEAPOLIS-HONEYWELL REGULATOR CO., *Industrial Division*, 4428 Wayne Avenue, Philadelphia 44, Pa.



MINNEAPOLIS  
**Honeywell**  
BROWN INSTRUMENTS

*First in Controls*

for direct measurement  
of electrical, mechanical  
or optical events



new SMALL  
SIZE!

new!  
**DS-6100-T**  
**FREQUENCY COUNTER**

*New Low Cost!*  
*New Light Weight!*

A compact precision frequency counter designed for direct measurement of any electrical, mechanical or optical phenomena which can be converted into a varying voltage. Reads out in direct digital form requiring no interpolation or reference to curves or tables. The all new DS-6100-T is ideal for use by skilled or unskilled personnel. Price \$700.00

**EXCLUSIVE FEATURES**  
at no extra cost...

- TEN CYCLE GATE**  
increases accuracy of period measurement
- MULTI-SAMPLING**  
manually scans the unknown frequency for any multiple of the time base for greater accuracy
- BATCH COUNTING**
- NEW, IMPROVED SENSITIVITY**

THE **Detectron** CORP.

\*Trade Mark

**TECHNICAL REPRESENTATIVES:**

**NEW YORK & NO. NEW JERSEY**  
Gerard G. Leeds Company  
Great Neck, N.Y. HU 2-7784

**SO. NEW JERSEY & EAST PENNSYLVANIA**  
Louis A. Garten & Associates  
Montclair, N.J. MO. 3-0257

**MARYLAND, D.C., VIRGINIA, NO. CAR., TENN.**  
S. S. Lee Associates  
Washington B. D.C. EM. 2-8626  
Branch Office:  
Baltimore 29, Md. AR. 3742  
Branch Office:  
Winston-Salem, N.C. 5-3460

**OHIO, SO. MICH., W. VIR., W. PA.**  
Michael J. Cudaby Company  
Chicago 40, Ill. SU. 4-5858

**NO. ILLINOIS, INDIANA, SO. WIS., E. IOWA**  
Warren B. Cozens Company  
Evanston, Ill. DA. 8-4800

**COLORADO, WYO., E. IDAHO, UTAH, NEBR.**  
Allen I. Williams Co.  
Denver 4, Colo. MA 3-0343

**NEW MEXICO & EL PASO COUNTY, TEXAS**  
Allen I. Williams Company  
Albuquerque, N.M. AL. 5-9632

**WASHINGTON, OREGON, W. IDAHO, MONTANA**  
Testco  
Seattle 8, Wash. MO. 4895

**CALIFORNIA, ARIZONA, NEVADA**  
Koessler Sales Company  
Los Angeles 38, Calif. YO. 6271  
Branch Office:  
San Francisco 18, Calif. JO. 7-0622

**MINN., NO. WIS., NO. MICH., NO. & SO. DAK.**  
Industrial Representatives Company  
Minneapolis 16, Minn. WE. 9-9019

**SO. CAR., GA., ALA. & FLA.**  
Southeastern Industrial Instruments  
Atlanta, Ga. EX. 7801

**SO. ILL. MO., KANS., W. IOWA**  
Engineering Services Company  
St. Louis 5, Mo. VO. 3-3661  
Branch Office:  
Kansas City, Mo. JE. 7765

**CANADA**  
Electromechanical Products  
Agriculture, Ontario. 493-R-2

**EXPORT**  
Frazar & Hansen, Ltd.  
301 Clay St., San Francisco, Calif.

**EXCELLENT LOW FREQUENCY ACCURACY**

The new DS-6100-T has an accuracy of  $\pm 10$  microseconds over the frequency range of 1 to 10,000 events per second. In addition, frequencies of 10,000 to 100,000 events per second can be measured with an accuracy of  $\pm$  one count  $\pm$  one part in 100,000 (one part in 1,000,000 with crystal oven).

**SPECIFICATIONS**

**FREQUENCY MEASUREMENT**

- Frequency Range—10-100,000 cycles per second
- Input Sensitivity—  
0.1 volt RMS: 20-100,000 cps  
0.25 volt RMS: 10-20 cps
- Accuracy— $\pm 1$  count  $\pm$  stability
- Time Base—1 and 10 seconds (0.1 second optional)
- Read-Out—Cycles per second:  
Five digits

**PERIOD MEASUREMENT**

- Frequency Range—1-10,000 cycles per second
- Input Sensitivity—0.1 volt RMS
- Accuracy— $\pm 10$  microseconds
- Gate Time—1 and 10 cycles of unknown frequency. May be increased by multi-sampling (only below 5 cycles per second).
- Read-Out—Tens of microseconds

**GENERAL**

- Stability—1 part in 100,000 (1 part in 1,000,000 with crystal oven)
- Display Time—Automatic: continuously variable from 1 to 10 seconds. Manual: until reset
- Input Impedance—0.5 meg., 0.05 mf
- Power Requirements—117 volts  $\pm 10\%$ , 50-60 cycles (50-400 cycles optional); 150 watts
- Dimensions—14 $\frac{1}{2}$ " wide x 7 $\frac{1}{2}$ " high x 13 $\frac{1}{2}$ " deep
- Weight—28 lbs. net (approximately)

VISIT US IN  
**Booth 824-WESCON**  
Civic Auditorium, S.F.

**COMPUTER-MEASUREMENTS DIVISION**

5528 Vineland, North Hollywood, Calif. Dept. 78-H

+20 ppm per deg C of the normal temperature coefficient value over the temperature range. The hermetically sealed resistors offer excellent moisture resistance and load life stability. Voltage coefficient is below 0.0005 percent per v. The series 850-T resistors are available in  $\frac{1}{2}$  w, 1 w and 2 w.



**POWER SUPPLY**  
is transistorized unit

UNIVERSAL ATOMICS CORP., 19 E. 48th St., New York 17, N. Y. A complete packaged plug-in transistorized power supply with filtered d-c voltage range up to 1,500 v from a single 1 $\frac{1}{2}$ -v flashlight cell at a current of up to 50  $\mu$ a is now available. This lightweight unit can be built into any size or form required—and can be included in any type of printed circuitry. Specifications and prices may be had for the writing.

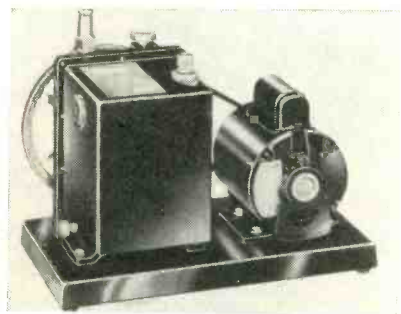

**VACUUM PUMPS**  
with vented exhaust

W. M. WELCH MFG. Co., 1517 Sedgwick St., Chicago 10, Ill. A new feature, vented exhaust, added to models 1397 and 1402 Duo-Seal vacuum pumps, enables these pumps to remove both permanent and condensable gases from a system with-



# MEMO

*Get in touch  
with Budd-Stanley*

for waveguide and microwave transmission equipment:

- ..production skill and experience.
- ..unique manufacturing methods to meet unusual specifications.
- ..unexcelled facilities from model shop to assembly line.
- ..ready to install production-tested components, from 50 to 24,000 mcs.
- ..transmission lines and associated elements manufactured to your specifications.



see us at the Wescon Show—Booth 1610  
August 24-26

Quality  
Economy  
Dependability

*Write, wire or phone*

**BUDD • STANLEY CO. INC.**

43-01 22nd St., Long Island City 1, N. Y.

Phone STillwell 6-1706

Cable Address "BUDDSTAN"

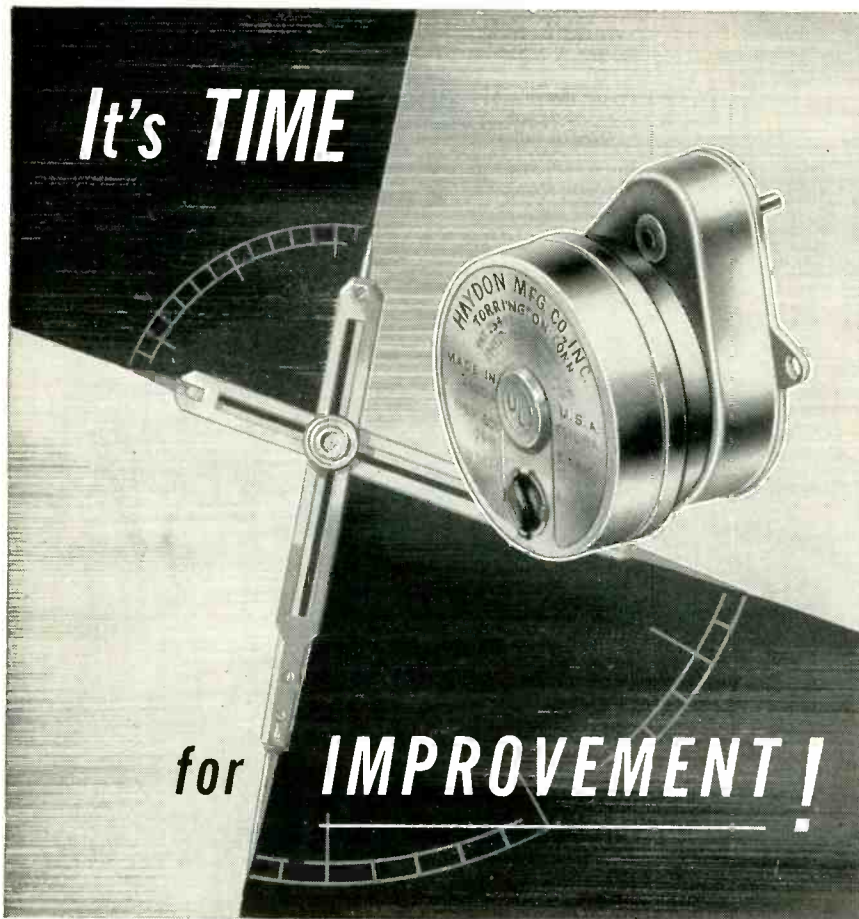

# It's TIME

## for IMPROVEMENT!

when you specify

# HAYDON\* TIMING MOTORS

TIME — and its accurate measure — are vital factors in today's designs. And whatever your timing requirements, you'll find there's a HAYDON Timing Motor that does the job better . . . opens the way to important improvements and advances in your designs.

Take very slow shaft speeds for example. HAYDON 4400 Series Timing Motors offer speeds from 6 hours to 1 week with totally enclosed gearing and at comparatively low cost. You save the extra bulk and expense of external reduction gears . . . achieve greater compactness, dependability and economy.

When it's time for design improvement it's HAYDON every time. Take advantage of our complete Timing Services. HAYDON'S manufacturing facilities and engineering counsel are at your disposal through the nearby HAYDON Field Engineer.



CLIP AND MAIL THE COUPON FOR HIS NAME — AND FOR AN INFORMATIVE CATALOG — TODAY!

A SUBSIDIARY OF GENERAL TIME CORPORATION

**HAYDON Manufacturing Company, Inc.**  
2432 ELM STREET, TORRINGTON, CONN.

- Send me the name of the nearby HAYDON Field Engineer.  
 Send me catalog, "Electric Timing Motors."

NAME \_\_\_\_\_  
POSITION \_\_\_\_\_  
COMPANY \_\_\_\_\_  
CO. ADDRESS \_\_\_\_\_  
CITY \_\_\_\_\_ ZONE \_\_\_\_\_ STATE \_\_\_\_\_

\* Trade Mark Reg.  
U.S. Patent Office

out serious contamination of the oil. Lower pressures are reached in less time and good vacuum performance is possible over longer periods of time without bothersome trapping and excessive oil changes.

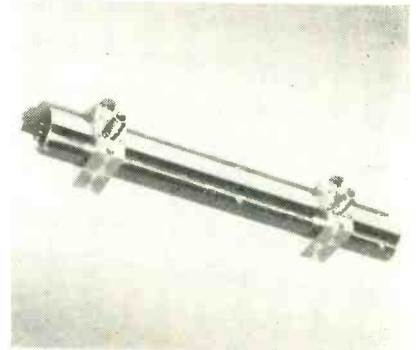

### T-W TUBE

in reduced size and weight

STANFORD LABORATORIES Co., 1619 Broadway, Redwood City, Calif., has available traveling-wave tubes housed in a reduced-size package 1½ in. in diameter × 13 in. long, including the solenoid, and weighing approximately 4 lb. Both dispersive and nondispersive low-level tubes are currently being produced for S-band operation, 2 to 4 kmc. Other features include five-point suspension of the tube stem to provide improved capabilities for rugged-service applications; coaxial input and output terminals conveniently positioned on solid rectangular mounting and heat-dissipation blocks; supply-voltage terminations brought to a convenient end-mounted plug; and corrosion-resistant chromium finish. Gain of the model SL24-10M tube is 35 db; output, 10 mw.

### COAX SWITCH

is 2-pole, 2-position type

BARKER & WILLIAMSON, INC., 237 Fairfield Ave., Upper Darby, Pa. Model 551 two-pole, two-position special purpose coaxial switch makes possible rapid manual switching of devices using 52 or 75-ohm line in or out of series connection. It is particularly useful for switching dummy loads, r-f wattmeters, swr bridges, antenna current meters and tuning networks, in or out of a



# DC-to-30MC Oscilloscopes for FAST RISE applications

**TYPE 545**—This new high-speed laboratory oscilloscope, in combination with the new type 53/54K Fast-Rise Plug-In Unit ...opens the way to quicker, easier analyses of fast-rising waveforms...providing faithful displays and accurate measurement facilities well beyond the range of previous oscilloscopes of its size and cost. The Type 545-Type 53/54K combination offers a vertical-amplifier passband of dc to 30 mc (12-millimicro-second risetime) at calibrated sensitivities to 0.05 v/cm, with a full 4-cm linear vertical deflection. A wide range of calibrated sweeps, with calibrated sweep delay from 1  $\mu$ sec to 0.1 sec, and high accelerating potential, 10 kv, fully complement this greatly extended vertical-amplifier range.

The Type 545 is the most versatile oscilloscope ever made, for it can be quickly converted to many other applications. By merely plugging in the appropriate Type 53/54 Plug In Preamplifier you are ready for wide-band, wide-band high gain, dual-trace, high-gain differential, microvolt-sensitivity, or wide-band differential applications. It's a rare oscilloscope application that isn't easily handled by this modern method.

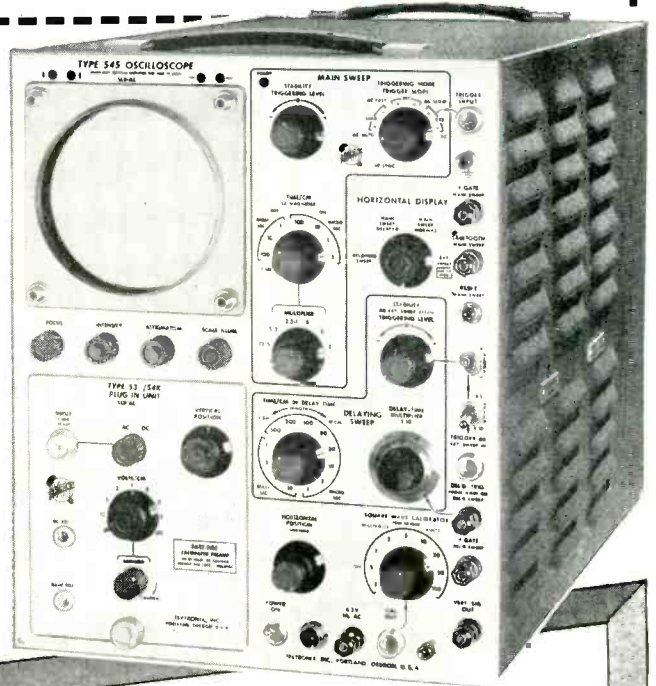
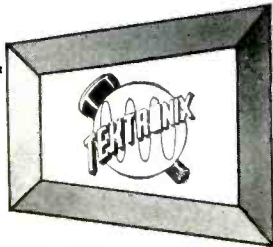

## Type 545 Oscilloscope Characteristics

**Vertical-Amplifier Characteristics with Type 53/54K Unit Plugged In**  
**Transient Response**—Risetime, 12 millimicroseconds.  
**Frequency Response**—Passband, dc to 30 mc (down 3 db  $\pm$  1/2 db at 30 mc, only 6 db at 41 mc.)  
**Input impedance** 20  $\mu$ mf, 1 megohm.  
**Sensitivity**—0.05 v/cm to 20 v/cm in 9 calibrated steps.  
**Price**—\$125

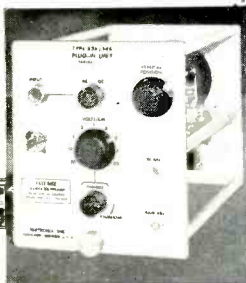

### Wide Sweep Range

24 Calibrated sweeps from 0.1  $\mu$ sec/cm to 5 sec/cm, accurate within 3%. Accurate 5-x magnifier extends calibrated range to 0.02  $\mu$ sec/cm. Continuously variable from 0.02  $\mu$ sec/cm to 12 sec/cm.

### Wide Sweep-Delay Range

Additional delaying-sweep circuitry provides conventional, or triggered jitter-free delay, 1  $\mu$ sec to 0.1 sec in 12 calibrated ranges. Range accuracy within 1%. Incremental accuracy within 0.2% of full scale.

### Versatile Triggering

Internal or external, with amplitude-level selection or AUTOMATIC TRIGGERING. High-frequency synchronization up to 30 mc.

### Square-Wave Amplitude Calibrator

0.2 mv to 100 v in 18 steps, accurate within 3%.

### New Cathode-Ray Tube

Tektronix T54P 5" precision metallized crt provides 4-cm vertical and 10-cm horizontal linear deflection, 10-kv regulated accelerating potential.

### Balanced Delay Network

0.2  $\mu$ sec vertical signal delay.

### DC-Coupled Unblinking

Uniform unblinking at all sweep speeds and repetition rates.

### Electronic Voltage Regulation

All voltages affecting calibrations are fully regulated.

### CRT Beam Position Indicators

**Type 545**—\$1450 plus price of desired plug-in units.

**Type 541**—Same characteristics, less delayed-sweep facility—\$1145 plus price of desired plug-in units.

Prices f.o.b. Portland (Beaverton), Oregon

## LOW INPUT CAPACITANCE

With Accessory Probes for Type 53/54K

Probe	Input Impedance	Maximum Sensitivity
P405	12.0 $\mu$ mf, 5 megohms	0.25 v/cm
P410	8.0 $\mu$ mf, 10 megohms	0.5 v/cm
P420	5.5 $\mu$ mf, 10 megohms	1 v/cm
P450-L	2.5 $\mu$ mf, 10 megohms	2.5 v/cm
P4100	2.5 $\mu$ mf, 10 megohms	5 v/cm

See and try the Type 545 at WESCON, Booths 915 and 916, and at the ISA SHOW, Booths B461 and B462.

Please call your Tektronix Field Engineer or Representative for complete specifications.

# Tektronix, Inc.

P. O. BOX 831 • PORTLAND 7, OREGON  
 CYPRESS 2-2611 • CABLE: TEKTRONIX

# FLEXIBLE but RUGGED

Technicraft Flexible Waveguides offer more electrical and mechanical advantages in combination than other flexible waveguides on the market. For instance the Technicraft Type "V" is the only flexible waveguide that will bend, twist, extend or compress, and shear simultaneously. The Technicraft Type "S" is not only RF leakage-free, but it is the ONLY SEAMLESS flexible waveguide made. Available in Beryllium Copper. Technicraft's Type "L" has a very low VSWR, attenuation and is also capable of carrying higher power than any other flexible waveguide of the same cross sectional size.

*Visit our display—Booth No. 510 at the Western Electronics Show and Convention*

## TECHNICRAFT LABORATORIES

INCORPORATED

1550 THOMASTON RD. • THOMASTON, CONNECTICUT

Designers and Manufacturers of Rigid and Flexible Waveguide Assemblies, Microwave Test Plumbing and Components, Waveguide Systems.

transmitter line at will. Or, it may be used for switching low impedance coupled power amplifiers in or out of a circuit, permitting hook-up of the driver stage to a low impedance antenna circuit or similar load as desired. It is housed in a 2 $\frac{1}{4}$ -in. diameter aluminum case designed for single hole panel mounting, with hook-up accomplished through four S0239 connectors. The switch will handle 1 kw of modulated power with a maximum crosstalk of -45 db at 30 mc.



### PRECISION POTS operate from -55 to +80 C

HELIPOT CORP., 916 Meridian Ave., South Pasadena, Calif. The series Y Helipot precision potentiometer is a single turn, continuous-rotation component designed for servo or bushing mounting. As many as 14 sections may be ganged on a common shaft during manufacture, with as many as 17 taps added to any section. Each tap is spot-welded to a single turn of resistance wire, assuring a strong, trouble-free connection. Measuring 1 $\frac{1}{2}$  in. in diameter by 1 $\frac{1}{2}$  in. long, with a  $\frac{1}{4}$ -in. diameter shaft, the series Y has external clamps for easy, accurate phasing. Operating range is -55 to +80 C. Power rating is 3.4 w at 25 C, 2.5 w at 40 C. Linear models have a standard linearity of  $\pm 0.5$  percent. Standard conformity in models having nonlinear output is  $\pm 1$  percent.

### pH METER with 7-in. scale meter

PHOTOVOLT CORP., 95 Madison Ave., New York 16, N. Y. Model 110 pH meter covers the entire range from 0 to 14 without switching and with-

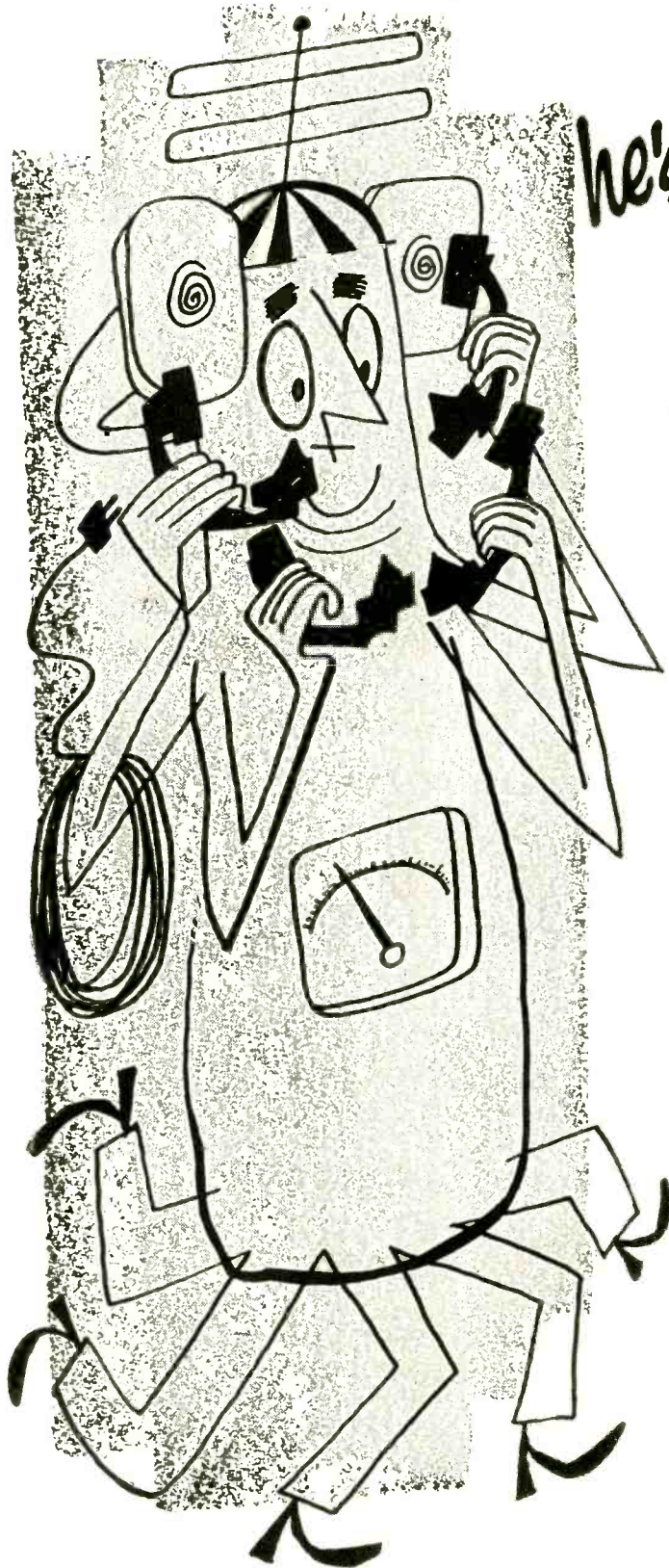

he's working for you

THIS FELLOW IS TRAINED IN YOUR BUSINESS. His main duty is to travel the country — and world — penetrating the plants, laboratories and management councils . . . reporting back to you every significant innovation in technology, selling tactics, management strategy. He functions as your all-seeing, all-hearing, all-reporting business communications system.

THE MAN WE MEAN IS A COMPOSITE of the editorial staff of this magazine. For, obviously, no one individual could ever accomplish such a vast business news job. It's the result of many qualified men of diversified and specialized talents.

AND, THERE'S ANOTHER SIDE TO THIS "COMPOSITE MAN," another complete news service which complements the editorial section of this magazine — the advertising pages. It's been said that in a business publication the editorial pages tell "how they do it"—"they" being all the industry's front line of innovators and improvers — and the advertising pages tell "with what." Each issue unfolds an industrial exposition before you — giving a ready panorama of up-to-date tools, materials, equipment.

SUCH A "MAN" IS ON YOUR PAYROLL. Be sure to "listen" regularly and carefully to the practical business information he gathers.



McGRAW-HILL PUBLICATIONS

# transistor and digital computer techniques

APPLIED TO THE DESIGN, DEVELOPMENT  
AND APPLICATION OF

*AUTOMATIC RADAR DATA PROCESSING,  
TRANSMISSION AND CORRELATION  
IN LARGE GROUND NETWORKS*

## Engineers & Physicists

*Digital computers similar to successful Hughes airborne fire control computers are being applied by the Ground Systems Department to the information processing and computing functions of large ground radar weapons control systems.*

The application of digital and transistor techniques to the problems of large ground radar networks has created new positions at all levels in the Ground Systems Department. Engineers and physicists with experience in the fields listed, or with exceptional ability, are invited to consider joining us.

### FIELDS INCLUDE

TRANSISTOR CIRCUITS • DIGITAL COMPUTING NETS •  
MAGNETIC DRUM AND CORE MEMORY • LOGICAL DESIGN •  
PROGRAMMING • VERY HIGH POWER MODULATORS AND  
TRANSMITTERS • INPUT AND OUTPUT DEVICES •  
SPECIAL DISPLAYS • MICROWAVE CIRCUITS

*Scientific and  
Engineering Staff*

# HUGHES

RESEARCH  
AND DEVELOPMENT  
LABORATORIES

*Culver City, Los Angeles County, California*

NEW PRODUCTS

(continued)



out reversal of the pointer travel. It is perfectly stabilized and can be used on any voltage from 80 to 260 v, 40 or 60 cycles a-c. It offers an accuracy of 0.02 pH unit. Designed for application in laboratory and factory, the unit is priced at \$185.

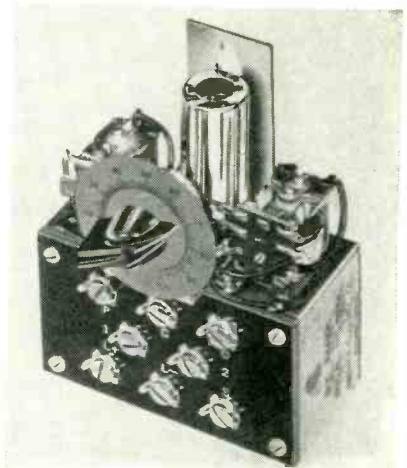

### ELECTRONIC TIMER is self-recycling

FARMER ELECTRIC Co., 21 Mossfield Road, Waban, Mass. A repetitive series of circuit closures can be produced automatically by the model S44 cold-cathode-tube electronic timer of the CK type. The load circuit remains closed for a fixed time of about 60 milliseconds and the time between circuit closures can be adjusted to any value from as low as 0.3 sec to 24 sec. The length of time the load-circuit stays closed can be increased by connecting capacitance to terminals provided for this purpose. Or the hold-in time can be shortened by connecting resistance across those terminals. A maximum current rating of 8 amperes noninductive at 115 v a-c

applies to the two spst contactors of this timer. For high repetition rates some derating is advisable. Model S44 timer is compact, requires no warmup time, and there is no power consumption when the timer is in its off cycle.

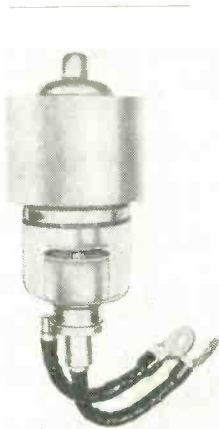

### RECTIFIER is high vacuum type

EITEL-MCCULLOUGH, INC., San Bruno, Calif. The 2X3000F is an external-anode, forced-air-cooled, high-vacuum, high-current rectifier rated at 3.0 amperes average current at 25,000 v peak inverse. Six tubes will deliver 9.0 amperes at 23,000 v d-c in a 3-phase bridge connection. The filament is rated at 7.5 v. The new rectifier is ideal for use in power supply units, voltage multipliers, pulse service or special applications at high frequencies, extreme ambient temperatures and high inverse voltages. It will give reliable performance at high frequencies and high voltages without generating radio frequency transients and will operate over a high ambient temperature range.

### POTENTIOMETERS with high resistances

ACE ELECTRONICS ASSOCIATES, 125 Rogers Ave., Somerville 44, Mass. The new Acepot subminiature precision wire-wound potentiometers feature resistances up to 100,000 ohms. This high resistance should prove ideal in a wide field of government and commercial applications where the characteristics of regular size potentiometers are required, but where minimum size and weight

# News in Analog Computing

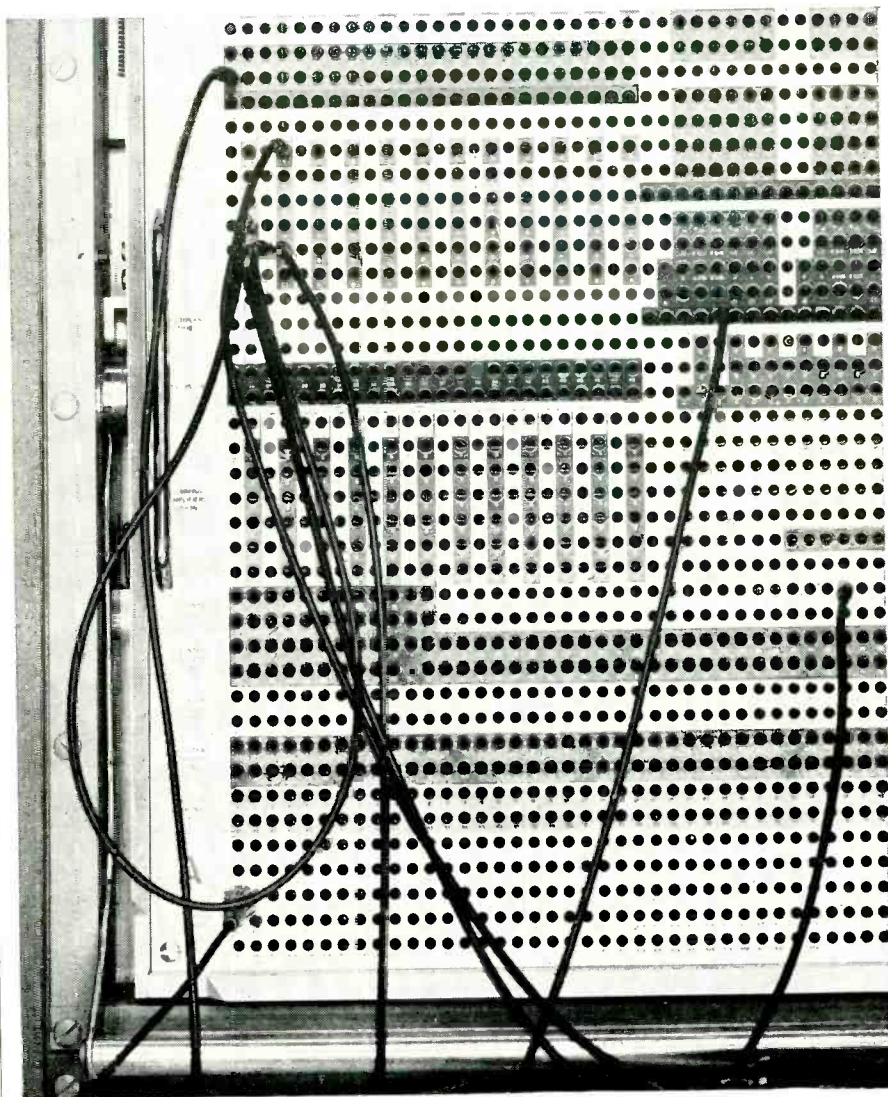

Metal pre-patch panel with shielded cords . . .

Only Electronic Associates' Analog Computing Equipment includes an all metal pre-patch panel with coaxial shielded patch cords. This unique shielding avoids errors caused by inter-terminal leakage. This is just one of the reasons why EAI sets the pace for accuracy and reliability in analog computing equipment. Electronic Associates' PACE Equipment (Precision Analog Computing Equipment) can be purchased at a reasonable price for single purpose use, such as the control of a process—or as a basic general purpose simulator which may be expanded into a large, versatile system—or computing time may be rented at our Princeton Computation Center, completely staffed and equipped to provide fast answers. May we forward you complete details.

WRITE DEPARTMENT EL-10

Booths 1116 and 1117 Western Electronics Conference

**ELECTRONIC  
ASSOCIATES**  
*Incorporated*

EAI SETS THE **P A C E**  
PRECISION ANALOG COMPUTING EQUIPMENT  
LONG BRANCH, NEW JERSEY

# Stupakoff

## PRECISION CERAMICS

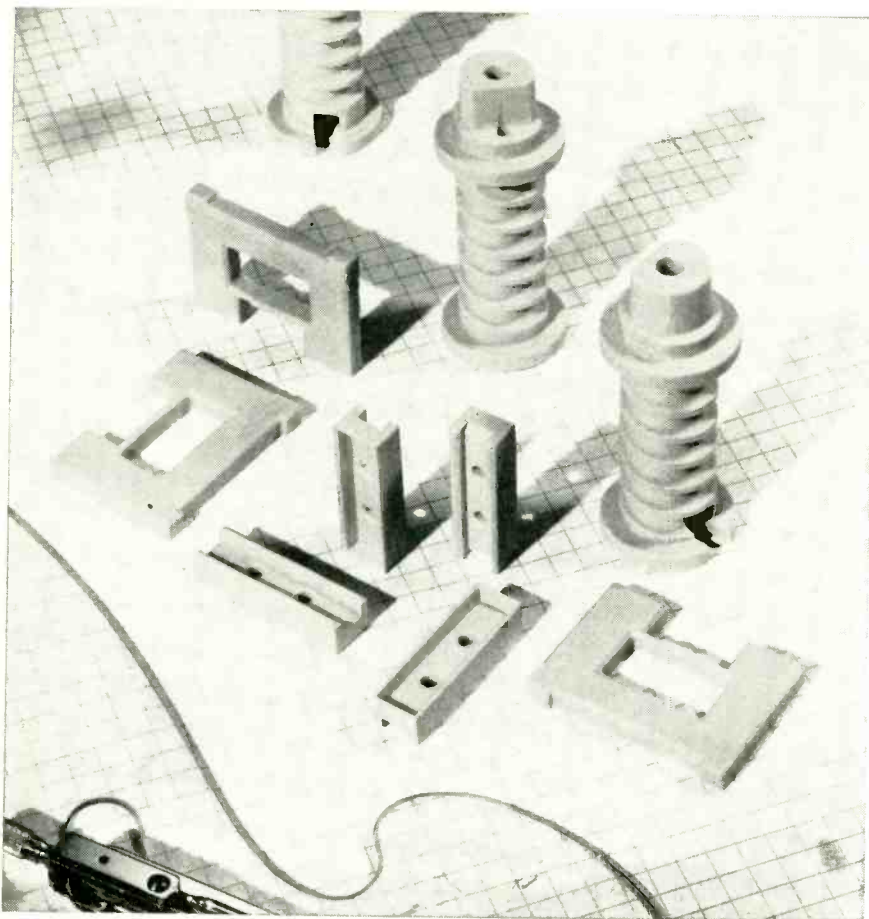

### PRECISION speeds assembly... aids MINIATURIZATION

The high degree of precision maintained by Stupakoff in the manufacture of ceramic parts sharply reduces assembly costs, particularly for miniaturized assemblies. Tolerances of  $\pm 0.001$  in. are not unusual, even in large production quantities.

Stupakoff Precision Ceramics can be made of alumina, steatite, zircon, magnesia, Stupalith® Titanates, and other materials. Parts are formed by modern methods and may be complex, plain, ground, machined, metallized or assembled.

Complete research and engineering facilities are available to assist you in the design and development of your parts.

WRITE DEPT. E  
for CATALOG  
SECTION 301 describing  
Stupakoff  
Precision Ceramics.



Illustration shows a telephone discharge block with precision-made Stupakoff ceramic base. By holding close tolerances on critical dimensions, assembly is speeded and accurate fit assured.

# Stupakoff

CERAMIC & MANUFACTURING COMPANY • LATROBE, PA.

Division of The CARBORUNDUM Company

NEW PRODUCTS

(continued)

are important. Acepots are only  $\frac{1}{2}$  in. in diameter, and now standard models are available from 200 ohms to 100,000 ohms  $\pm 2$  percent. Linearity is 0.3 percent; resolution is high; ambient temperature,  $-55$  C to  $125$  C; power rating, 2 w for 60 C rise; torque, 0.035 oz in. at 20 C. They are available in standard, servo or flush mountings; dual or up to 6-gang units.



### NOISE SOURCE for microwave region

ROGER WHITE ELECTRON DEVICES, INC., 12 W. Island Rd., Ramsey, N. J. The GNW-series instruments are gas tube random noise sources mounted in rectangular waveguide. They provide a noise figure of  $18.0 \pm 0.5$  db at frequencies ranging from 2,600 to 40,000 mc. These noise sources provide additional noise power and increased frequency coverage. They are designed for single-ended operation and require only one power supply cable. The noise tubes are specially designed and processed to insure maximum reproduceability and operating life. The specified noise power is available without warmup time and no correction for ambient temperature is required.

### CRT INDICATOR features high brightness

NATIONAL UNION ELECTRIC CORP., 405 Lexington Ave., New York, N. Y. Type NU-DV1-3 is a high brightness, daylight viewing, 5-in. oscillograph presentation unit that uses electrostatic focusing and magnetic deflection. It presents a small brilliant spot and is capable of providing a sharply focused tv

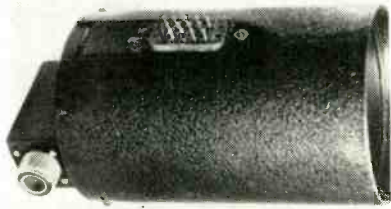

raster at high brightness levels. The unit is designed to withstand MIL shock and vibration tests, and to facilitate mounting on aircraft instrument panels and for similar applications. The crt and other components within the aluminum cylindrical container are treated to prevent corona at high altitudes. It weighs 4 lb 8 oz, has a diameter of 5½ in. and an overall length of 10 in.



### MULTIPLIER UNIT for circuit analyzing

DIT-MCO INC., 505 W. 9th St., Kansas City, Mo., announces a new multiplier unit for complex circuit analyzing. This unit, when used with the model 200 circuit analyzer, will enable the users to test automatically circuits up to 1,600 capacity, for continuity, shorts and leakage resistance. It is available in 6 different models, depending upon the number of circuits to be tested. The four A models are designed to test one wire against 199 in a group of 200, while the B models are designed to test one wire against the complete group of 399 or 799 for shorts. Continuity is closely defined to the point of rejecting ½-ohm continuity resistance as an open circuit at currents up to 2 amperes. Leakage resistance is closely defined to the point of re-

# Stupakoff

## Kovar **HARD GLASS** Seals

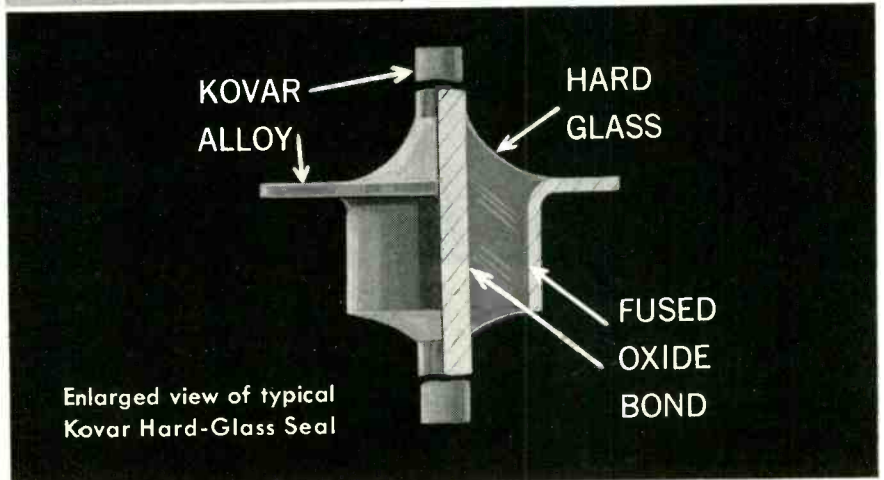

Here are 5 practical reasons why  
**KOVAR AND HARD GLASS**  
make the Best hermetic seals

### BEST for thermal endurance

—because the thermal expansion of Kovar matches exactly that of hard glass over the entire working range.

### BEST for insulating value

—because of the high dielectric strength of hard borosilicate glass. No silicone treatment is required.

### BEST for hermetic tightness

—because the fused oxide bond is a chemical bond, forming a true hermetic seal, free from strains at all working temperatures.

### BEST for miniaturization

—because insulating efficiency and high mechanical strength of hard glass permit the use of seals of minimum size and weight.

### BEST for your product

—because Stupakoff's broad experience, engineering skill and modern manufacturing methods provide hermetic seals that are right for your product. You get all the advantages that can be secured *only with Kovar and Hard Glass.*

WRITE DEPARTMENT E  
for Catalog 453A, which shows  
all the standard and many of the  
special types of Stupakoff Her-  
metic Seals.



# Stupakoff

CERAMIC & MANUFACTURING COMPANY • LATROBE, PA.

Division of The CARBORUNDUM Company

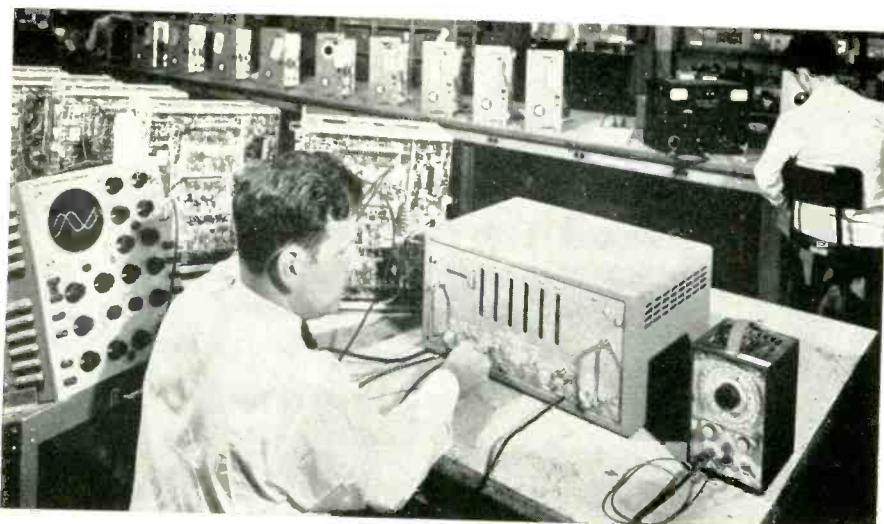

Typical digital phase-shift measurement set-up employing a BERKELEY Model 5510 Universal Counter & Timer, with a Shasta oscillator as reference frequency source and an oscilloscope to provide visual check.

## Now—A Digital Method for Precise Phase Measurements

### ADVANTAGES:

- \* No interpolation required—results displayed in direct-reading digital form (in degrees, mils, or any desired unit of angular measure).
- \* Accuracies to 0.1°
- \* Utilizes standard BERKELEY Universal Counter-Timer or Time Interval Meters.

### APPLICATIONS:

1. Calibration of synchros and resolvers
2. Measurement of gain-phase characteristics of closed-loop servo systems.
3. Low frequency response studies
4. Precise phase measurements at audio and sub-sonic frequencies

### TYPICAL INSTRUMENTATION:

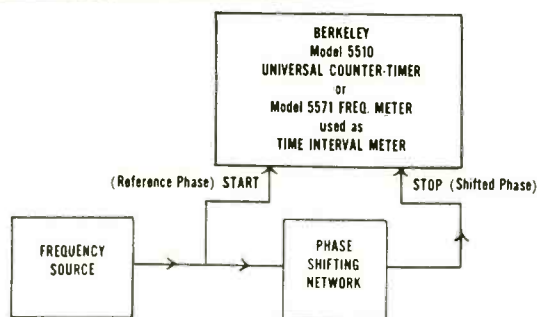

### COMPLETE DATA AVAILABLE

*Data File 107 completely describes the theory and practice of digital phase measurement, including set-up and operational instructions. A copy is yours for the asking; why not write now? Please address Dept. G-8*

# Berkeley

division

63

INDUSTRIAL CONTROL SYSTEMS

BECKMAN INSTRUMENTS INC.  
2200 Wright Avenue, Richmond 3, California

ANALOG COMPUTERS • COUNTERS • TEST & NUCLEAR INSTRUMENTS

SEE OUR DISPLAY—Booths 724-725 WESCON, San Francisco, August 24-26

jecting zero ohms to 200 megohms as a direct short. These values are preset as desired. The multiplier unit provides increased savings for aircraft and missile manufacturers.

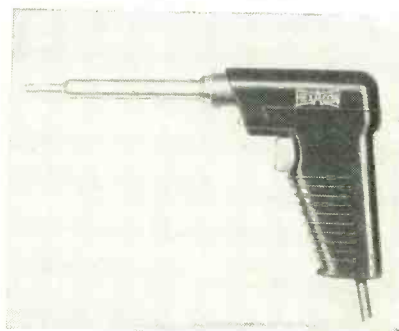

### INSTANT SOLDER GUN weighs only 8 oz

HEXACON ELECTRIC Co., 130 W. Clay Ave., Roselle Park, N. J., announces a new instant solder gun which is soldering-hot in a few seconds, without the use of heavy transformer or fragile thermostats. It weighs but 8 oz compared to 40 oz for equivalent transformer types. The special alloy lifetime tip cannot wear, corrode or bend—thus eliminating tip maintenance. Trigger control gives any degree of heat required without danger of overheating. Rated at 150 w and available for 120 v, it operates identically on d-c as well as a-c, any cycle.

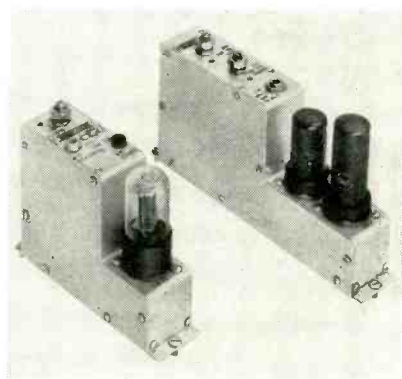

### TONE OSCILLATORS and detectors

BENDIX AVIATION CORP., 11600 Sherman Ways, North Hollywood, Calif., has in production a-f tone oscillators and detectors which are designed for maximum stability under wide variations of voltage and temperature. These standard plug-in assemblies are used in ap-



plications such as remote control, telemetering and selective calling where telephone lines, radio and microwave links are used. One tone oscillator and its companion tone detector comprise a complete tone signaling channel. The tone oscillator employs a modified Weinbridge circuit. The tone detector consists of an isolated, temperature-compensated L-C filter followed by a two-stage v-t amplifier. Any number of tone oscillators and detectors having any combination of different frequencies may be combined in a system. Both units are designed for continuous unattended operation. Available channel frequencies range from 500 to 6,000 cps.

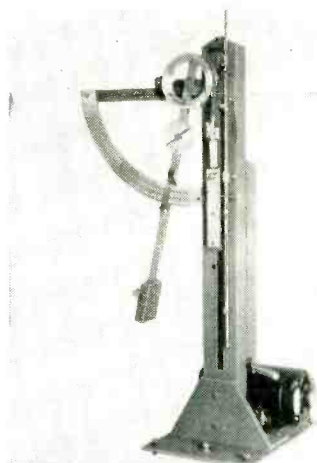

**TESTER**  
shows tensile strength

AMTHOR TESTING INSTRUMENT CO., INC., 45-53 Van Sinderen Ave., Brooklyn 7, N. Y., announces a new tensile strength tester that requires no special skill for performing the test. The instrument gives an absolute correct check on the uniformity of materials such as paper, wire, aluminum foil, plastic film and tapes up to a maximum capacity of 25 lb. It has an easy-to-read 9½-in. radius quadrant, and readings remain fixed after the specimen breaks.

**ANALYZER**  
of capacitance-resistance

CORNELL-DUBILIER ELECTRIC CORP., South Plainfield, N. J., announces the new BF-70 capacitance-resistance analyzer. The 10-pound port-

for your *Specialized*  
applications...

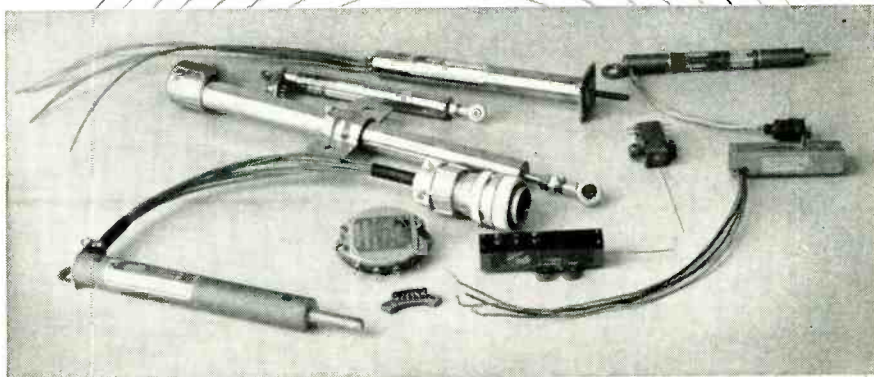

**high temperatures**  
**shock**  
**and vibration**  
**pose no problem with**  
**\* Pacific potentiometers!**

Designed for extra severe applications, and built to rigid military specifications, Pacific Potentiometers provide rugged dependability for any installation.

The wide variety and specification range of Pacific's "standard" potentiometers are actually suitable for many specialized applications. You get the economy of a proven, production design for your own particular requirements!

Precious alloy windings, plus Pacific's precise design and construction, provide clean, sharp signals under the most critical environmental conditions. Whatever *your* needs in linear, rectilinear or rotary potentiometers, Pacific can supply or completely design and build a potentiometer to your exact requirements. Check this wide range of specifications for your needs!

- RESISTANCE: from 10 ohms/inch to 13,000 ohms/inch
- RESOLUTION: from .001" to .005" or 0.10° to 0.25° depending on resistance
- STROKE: (on linear potentiometers) from ¼" to 27½"
- LIFE: at least 1,000,000 cycles
- SHOCK: to 100 g in any direction
- VIBRATION: 15 g from 10 to 1500 cps
- TEMPERATURE: from -65° to 400° F.

**typical range of specifications:**

PACIFIC SCIENTIFIC—pioneer in Aircraft Instrumentation and Accessories since 1919

**Pacific SCIENTIFIC CO.**  
LOS ANGELES • SAN FRANCISCO • SAN DIEGO • SEATTLE • ARLINGTON, TEXAS  
REPRESENTATIVES:  
AERO ENGINEERING CO., Atlanta, Ga. • Baltimore, Md.  
Indianapolis, Ind. • Mineola, L. I., N. Y.  
Columbus, Ohio • St. Louis, Mo.  
GARRETT MFG. CORP., Toronto, Canada



PACIFIC SCIENTIFIC CO.  
1422 Grande Vista Ave.  
Los Angeles 23, Calif.

Please send me free catalog sheets on:

<input type="checkbox"/> Potentiometers	<input type="checkbox"/> Free & Vertical Gyros
<input type="checkbox"/> Rate Gyros	<input type="checkbox"/> Accelerometers

name \_\_\_\_\_  
company \_\_\_\_\_  
address \_\_\_\_\_  
city \_\_\_\_\_ state \_\_\_\_\_

# Leadership

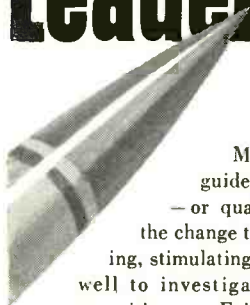

Men now in guided missiles work — or qualified to make the change to this challenging, stimulating field — will do well to investigate the career opportunities at Fairchild Guided Missiles Division.

If you can advance beyond your fellow engineers in such fields as these — if you can do original, imaginative work — there is a place for you at Fairchild!

- Advanced radars
- Countermeasures
- Microwave navigational systems
- Computer circuitry
- Direction finders
- Automatic radar
- Special receivers and transmitters

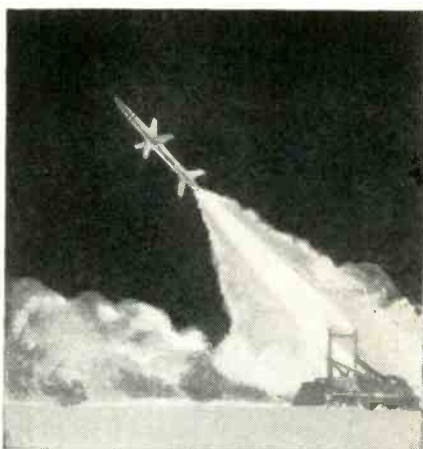

Fairchild's guided missiles plant is situated in a splendid area for living, working and playing. Housing is excellent, recreational facilities superb. Fine beaches, fishing, boating and golfing and other sports.

R. B. Gulliver  
Personnel Manager  
Fairchild Guided Missiles Division  
Wyandanch, N. Y.



NEW PRODUCTS

(continued)



able instrument quickly and accurately measures the important characteristics of essentially all types of capacitors and resistors. Features include a direct-reading calibration scale which provides simplified measurements, avoiding possible errors in using multipliers or charts. The BF-70 quickly locates capacitor opens, shorts and intermittents; high and low capacitances; and detects high leakage and high power factor in electrolytic capacitors, as well as low insulation resistance in paper, mica and ceramic dielectric capacitors. Sensitive capacitance measurements between wires and shielings; transformer windings, cable wire and other similar conditions are also possible. The built-in panel meter is arranged for independent external voltage measurements to 750 v and current measurements to 75 ma.

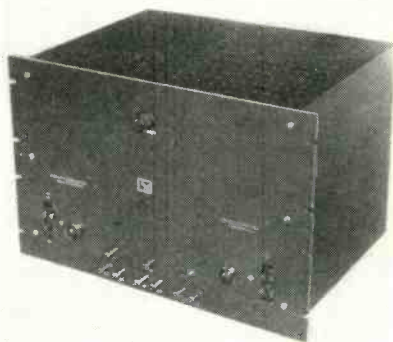

## POWER SUPPLIES meet MIL-E-4158A specs

NJE CORP., 345 Carnegie Ave., Kenilworth, N. J. A new development permits equipment designers to obtain economical, packaged, stock power supplies for any fixed output voltage (adjustable  $\pm 25$  v)

# Leadership

The engineers we're looking for are leaders in their fields. They are able to work far in advance of their contemporaries, and can make genuine contributions in their fields.

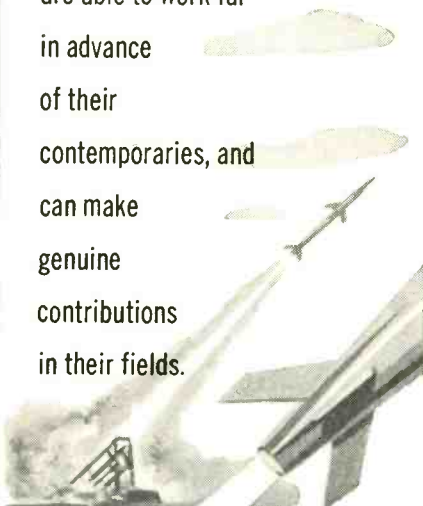

**MISSILES ENGINEERS**  
**AERONAUTICAL ENGINEERS**  
**STRUCTURAL ENGINEERS**  
**ELECTRONICS ENGINEERS**  
**PROPULSION ENGINEERS**

Here is an excellent opportunity for men who *know* they can help advance Fairchild's pace-setting research, design, development programs — men who want to fully utilize their talents and see their good ideas incorporated in missiles.

SEND YOUR RESUME TODAY TO:



R. B. Gulliver  
Personnel Manager  
Fairchild Guided Missiles Division  
Wyandanch, N. Y.

*"where the future is measured in light-years"*

from 0 to 1,200 v in three standard current ranges: 300, 600 or 1,200 ma maximum. Regulation is held to 0.25 percent line or load, and standard ripple is 4 mv, rms. The new power supply employs full fungus-proofing, anti corrosion treatment, MIL-SPEC tubes, 100 percent JAN components, hermetically sealed, ruggedized meters and MIL-T-27 transformers and reactors. A general catalog containing complete technical data on 64 stock models and a supplementary sheet on MIL-SPEC supplies are available.

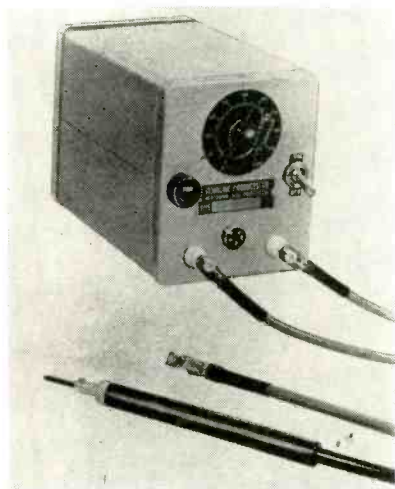

### SOLDERING UNIT is of the resistance type

VEMALINE PRODUCTS Co., P. O. Box 222, Hawthorne, N. J. Model 500 soldering unit was developed for soldering printed circuits, germanium diodes, transistors and all other precision and sensitive parts. The resistance type soldering method will eliminate overheating or burning of the parts. The soldering can be controlled by means of the adjustable heat-controller. The electrode holder, which is extremely light, has a  $\frac{1}{8}$ -in. diameter tip.

### CAPACITANCE BRIDGE for automation purposes

INDUSTRIAL CONTROL Co., Wyandanch, L. I., N. Y. The 601-A is a high precision, automatic capacitance indicator, with counter read-out for both capacitance and dissipation. Operation is from the 117-v 60-cps line. The instrument will measure capacitance from 100  $\mu\mu\text{f}$

# Davies

## AIRBORNE MAGNETIC TAPE DATA RECORDERS

### For Flight Test Instrumentation

When your flight test programs call for magnetic tape (and they should, these days), consult the pioneer producer of airborne recorders—the only manufacturer whose equipment has been in the air for years—aboard Air Force and aircraft manufacturers' planes.

Your requirements, whatever they are, can be fulfilled by one of our units.

If space is limited, the Series 550 is *it*. No multitrack data recorder even approaches its 7" x 7" x 8" dimensions.

If large tape capacity and extreme flexibility are paramount, the Series 540 carries 3600 ft. of tape and 13 FM Carrier Recording channels or 14 Direct or Pulse Recording channels, or any combination of these.

All electronic recording circuitry is incorporated in interchangeable plug-in units—you can use the same recorder for FM carrier and high accuracy on one flight, direct recording and wide frequency response on the next flight, and commutated PWM on a third flight.

Of course, we also furnish laboratory equipment of comparable flexibility, for reproduction of tapes made on our airborne recorders, and for a wide range of recording and reproducing requirements.

As one element of your data reduction system, our Automatic Wave Analyzer provides completely automatic frequency analysis of a number of data sources, such as tape channels.

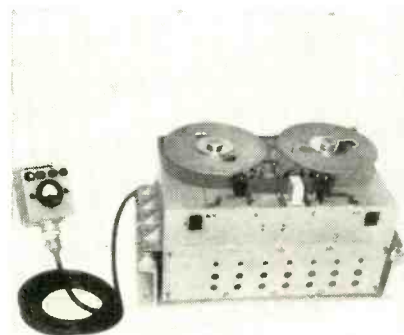

#### THE LARGEST

1½ hours recording time with DC to 1200 cps response, other frequency ranges available. Precision FM Recording 13 or more data channels. Also available in two packages when space allocations dictate.

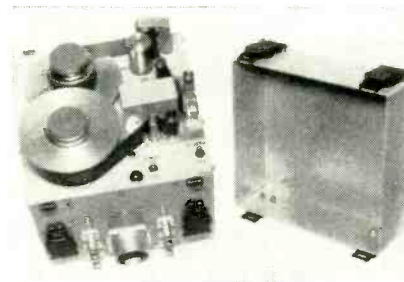

#### THE SMALLEST

About 7" cube for 6 data channels, including electronic circuitry. One hour recording time with 1 to 250 cps frequency response on each channel, FM carrier recording.

- • • • •
- Bulletin 54-D covers tape equipment except the Series 550 Recorder; Bulletin 54-E describes the miniature Series 550; and Bulletin 54-C gives details on the Automatic Wave Analyzer. Bulletin 55-B deals with Davies Multi-Track Magnetic Recording/Reproducing Heads.
- • • • •

THE

# Davies

PIONEER MANUFACTURERS OF AIRBORNE MAGNETIC  
TAPE DATA RECORDING SYSTEMS AND EQUIPMENT

LABORATORIES INCORPORATED

4705 QUEENSBURY ROAD • RIVERDALE, MARYLAND

TELEPHONE: WASHINGTON, D. C., APPLETON 7-1133

## Can you make your transformers smaller, lighter... with Class C encapsulation?

Where a higher hot spot is permissible, you can reduce the ounces and the inches of your transformers by  $\frac{1}{4}$  to  $\frac{1}{2}$ .

How? With *silicone rubber encapsulation*. This allows operation in the 160°C. to 200°C. range at a reduced size.

Silicone rubber encapsulation is one of the many services available to the communications industry at Caledonia. (We provide Class C transformers open and in cases, too.) All encapsulation is done *in our plant*.

For help with this problem, and others involving transformers and related electronic assemblies, contact Caledonia.

*When you have a transformer problem, call on*

# CALEDONIA

ELECTRONICS AND TRANSFORMER CORPORATION

Dept. E-9 Caledonia, N. Y.

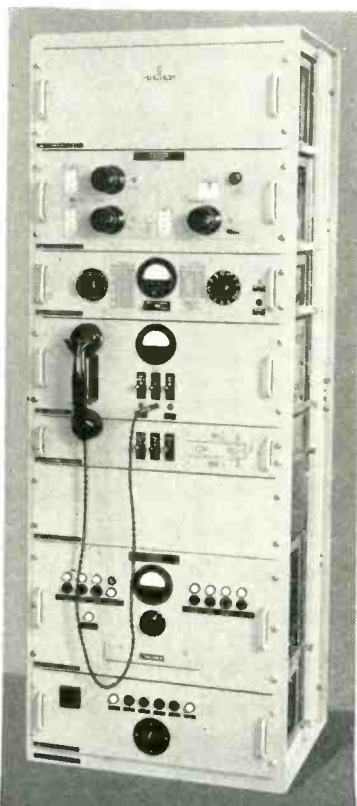

### 24-CHANNEL PULSE-POSITION-MULTIPLEX RADIO SYSTEM OF ADVANCED DESIGN

This equipment provides 24 broad-band telephone channels in the frequency range 2450 to 2700 mc. with toll-grade transmission performance over very long systems. Full provision is made for branching, dropping and inserting channels, and elaborate fault-reporting and automatic changeover features are available. Transmitter has 5 watts average output power. Antennas, transmission line, 4-wire terminating, ringing and dialing sets and test equipment are available to form complete packaged systems of superb performance, reliability and quality.

A similar system is produced for the frequency band 235 to 328 mc.

Type PPM24/2500 Radio Bay is 22" wide by 18" deep by 64" high. The 24-channel multiplex bay has the same dimensions.

## RADIO ENGINEERING PRODUCTS

1080 UNIVERSITY STREET, MONTREAL 3, CANADA

Telephone: UNiversity 6-6887

Cable Address: Radenpro, Montreal

MANUFACTURERS OF CARRIER-TELEGRAPH, CARRIER-TELEPHONE AND BROAD-BAND RADIO SYSTEMS



to 1  $\mu$ f, with dissipation factors up to 6 percent. The 601-A, when combined with suitable handling equipment, can be used to monitor the production of capacitors. It can be modified for digital readout, and to sort capacitors into predetermined value groups. It is useful for incoming component inspection and test, and for unattended monitoring of life and environmental tests. It is a building block for automation.



### SILICON DIODES have selective polarity

BOMAC LABORATORIES, INC., Beverly, Mass. The 1N415 and 1N416 series silicon mixer diodes have selective polarity. Polarity is indicated by the letters REV stamped on one end of the diode. To change the polarity, the position of the end cap is reversed. With the end cap on the unmarked end the polarity is normal and when attached to the other end it is reversed. The complete assembly, with either polarity, is electrically the same as its equivalent type of regular silicon diode. The reversible diodes meet all conditions of JAN 1A specifications.

### CRYSTAL CALIBRATOR aids aviation pilots

EARL W. SPRINGER AIRCRAFT RADIO Co., Route 11, Box 330, Sky Harbor Airport, Indianapolis, Ind. No

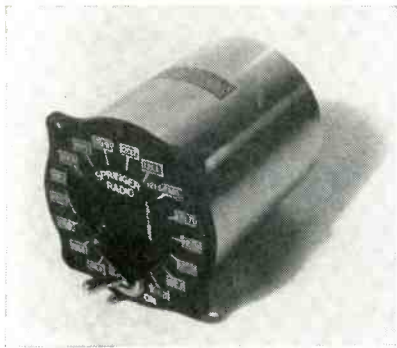

longer is the pilot fully dependent on the dial calibrations of present-day vhf receivers to tune in tower and communication stations. With the model AR16 crystal calibrator device, the desired frequency for reception can be instantaneously selected by a simple switching selector. It has provision for 16 precision calibrated crystals. The basic unit is supplied with 3 crystals for 121.5 mc emergency, 122.8 mc Uni-com, and 126.7 mc communications. The crystal calibrator unit with an installed weight of 1 lb is designed for the standard aircraft instrument hole mounting.



**COLLET KNOBS**  
speed assembly

CAMBRIDGE THERMIONIC CORP., 445 Concord Ave., Cambridge 38, Mass. Molded Tenite II knobs with black satin finish are available for quarter-inch shafts. They are fastened to the shaft by means of a collet that squeezes uniformly rather than by setscrews. A removable cap snaps over the aperture by which access is gained to the tightening nut. The collet insert is brass, nickel plated to a depth of 0.0003 in. Type X2176 Collet Knobs are plain and range in price from 45¢ up depending upon

FAST  
POWER  
PICK-UP  
OR  
STOPS!

Miniature, precision  
**CLUTCH**  
or Clutch Brake

These components provide instantaneous response for use in electro-mechanical control systems, servo-mechanisms, computers, missile instrumentation, and other devices. Energizing the coil magnetically engages input and output shafts. De-energizing disengages shafts, and provides brake action if desired. Energizing or de-energizing will induce no angular displacement error. Through output shafts allow concentric input and output on the same end for use in gear train mounting. Standard coil voltage is 28v dc, but can be modified to requirements. Dia. 1 1/4". Lgth. 1 3/4". Wgt. 6.6 ozs.

WRITE FOR DETAILS TODAY!

ACTUAL SIZE

GLOBE INDUSTRIES, INC.

Motors • Gear Reducers • Fans  
Generators • Governors  
Servos • Blowers • Actuators  
Switches • Gyros • Vibrators

**1793 STANLEY AVE.  
DAYTON 4, OHIO**

MARKEM<sup>®</sup> MACHINES

Solve "IN-PLANT" PRINTING PROBLEMS  
- FASTER - NEATER - AT LOWER COST

The Markem Model 45AF Machine prints trade name, trade mark, specifications, etc., on resistors, condensers, capacitors, diodes, triodes, transistors, etc., at production rates. Feeds, prints, and ejects automatically. Quickly insertable type provides easy change in data being printed.

Write for further information.  
Submit sample of item you wish to mark.

WIRE LEAD  
COMPONENT PRINTING

MODEL  
45AF

MARKEM MACHINE CO.  
KEENE 5, NEW HAMPSHIRE

designed  
for the  
user



**Other Shasta Quality Instruments**  
Expanded Scale Frequency Meters and Voltmeters • Log Scale Voltmeters • Audio Oscillators Square Wave Generators • Power Supplies • Wide Band Amplifiers Bridges • WWV Receivers • Decade Inductors.

S-6

by **Shasta** *division*



## MODEL 202A AC VACUUM TUBE VOLTMETER

*features:*

- ★ Easy-reading 6" meter
- ★ Wide voltage and db range — .001 to 300 v, —60 to + 50 db, full scale
- ★ Wide frequency range — 20 cps to 2 mc
- ★ Simplified range indicator — shows only range in use
- ★ Exclusive SHASTA chassis construction for improved cooling and accessibility, compactness

*description:*

Model 202A is ideally suited to general laboratory use. Accuracy is  $\pm 3\%$  full scale to 100 kc,  $\pm 5\%$  to 2 mc. Its wide voltage span permits sensitive measurements of hum level, balance detection, etc., as well as high-level amplifier gain. Input impedance is 10 meg, 10 mmf. Price is \$190.00 f.o.b. factory.

NOTE: Model 204VTVM similar to above but with 2 cps to 100 kc frequency range, \$175.00. Model 207A Log Scale VTVM, similar to Model 202A but with logarithmic scale for uniform accuracy at any scale point, \$275.00.

Write today for Technical Bulletin 202A; please address Dept. SG-8.

**Shasta**

*division*

BECKMAN INSTRUMENTS INC.

P.O. BOX 296, STATION A • RICHMOND, CALIFORNIA  
TELEPHONE LANDSCAPE 6-7730

NEW PRODUCTS

(continued)

quantity. The type X2180 knob has a skirt and is priced at 52¢ in quantities of more than 500.

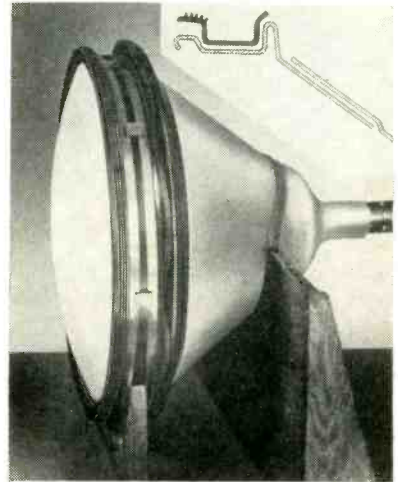

## INSULATING PARTS for 21-in. tricolor tube

ANCHOR INDUSTRIAL CO., 36-36 36th St., Long Island City 6, N. Y., has developed new insulating components for the 21-in. tricolor tube. The 3 parts—consisting of an insulating ring, an insulating cone and a magnet insulator—completely cover the exposed metal shell and flanges of this kinescope tube. Interlocking and overlapping design of the three components assures sufficient creepage path.



## AMPLIFIER for 250 kc to 250 mc

INSTRUMENTS FOR INDUSTRY, INC., Mineola, N. Y. Model 500 distributed amplifier is designed for use as an oscilloscope driver or for general laboratory uses. It has particular application in the field of amplification of narrow pulses such as are found in the nuclear instrumentation field. It is constructed on a plug-in chassis approximately 13½ in. × 2½ in. × 5½ in. overall including tubes. The power supply is a

## U.S.C. HERMETIC SEAL MINIATURE PLUGS

with Insured Protection  
by Double Lead Screw Locking

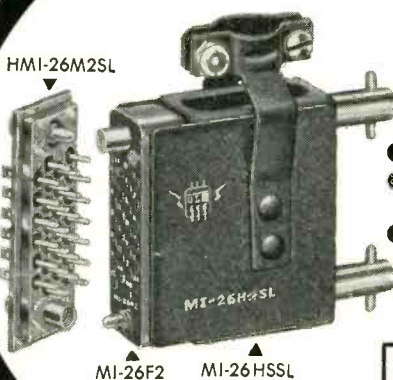

HMI-SL SERIES (HERMETIC SEAL DOUBLE LEAD SCREW LOCK VERSION) USED WITH MI-SL MINIATURE SCREW LOCK CONNECTORS PROVIDE;

- EASE OF ENGAGEMENT
- PROTECTION OF SEALED CONTACTS
- DEPENDABILITY OF ELECTRICAL AND MECHANICAL PERFORMANCE

AVAILABLE IN 7, 8-4, 14, 18, 20, 21, 26, 34, 50 and 75 CONTACTS WITH MATING SCREW LOCK HOOD OR BRACKET ASSEMBLY.

FURTHER INFORMATION ON REQUEST



**U. S. COMPONENTS, Inc.**

Associated with U. S. Tool and Mfg. Co., Inc.

454-462 East 148th Street, New York 55, N. Y. C'press 2-6525-6

separate unit. Bandpass is 250 kc to 250 mc; input impedance, 90 ohms; output impedance, 160 ohms; power output, 3 w; power gain, 12 db; output voltage—22 v rms, 62 v peak to peak.

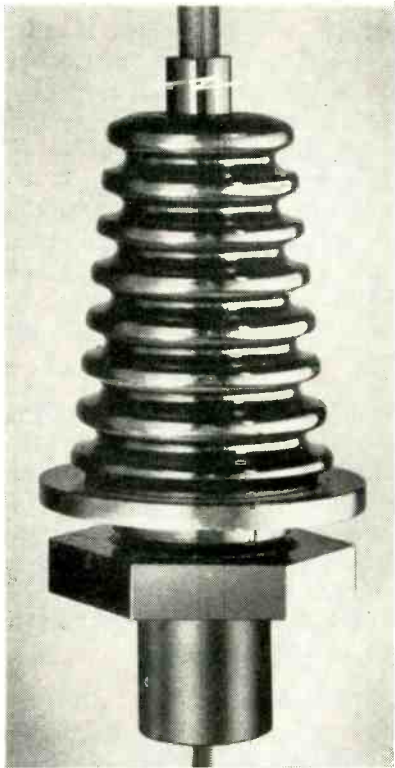

### H-V BUSHINGS with concealed disconnect

MICROTIME LABORATORIES, 7247 Atoll Ave., North Hollywood, Calif., announce new h-v bushings in which connection between h-v source and output lead is wholly concealed deeply within the unit—corona is completely eliminated and maximum safety provided the operator. Units are molded of a tough, flexible resin whose high impact and dielectric strength contribute to their pronounced superiority over ceramic bushings. HVD (60/60 kv) and HVD-100 (100 kv) handle 1.5 kw, but other assemblies accommodate higher wattages. Operating temperatures range from -50 C to 150 C. Height is 5½ in.; base diameter, 3½ in.

## Literature

Ball-Bearing Potentiometers. De-JUR-Amsco Corp., 45-01 Northern

# THE MOSELEY AUTOGRAF

trade mark

## X-Y RECORDER



**MODEL 1**, drum type, accepts 8½"x11" graph paper; traverses each axis in 1 second; has full scale ranges of 5 millivolts to 100 volts; zero set anywhere on the paper; portable, self-contained; available also as a curve follower for electrical read-out of drawn curves.

**AUTOGRAF** Recorders, **MODELS 1 and 2**, provide all the features needed for graphic recording of test data, point plotting, and curve following for readout purposes.



### MODEL 2

Flat bed type, accepts 11"x16½" graph paper; same speeds, sensitivities and ranges as MODEL 1; zero set anywhere on paper plus one full scale length of zero-offset; inputs provided for analog recording, point plotting from digital sources, and curve following for computer or data reduction use.



**MODEL 20 DC VOLTMETER** is a servo-actuated, fast, accurate and sensitive instrument. Has large, easy-to-read scale for general laboratory use where ranges from 3 millivolts to 300 volts are desired. For data handling it is furnished with a built-in Coleman digitizer and delivers digital output for operation of printers, typewriters, tape or card punches, etc.

**MODEL 30 CARD TRANSLATOR** converts information from punched cards into point form for automatic plotting. Handles up to 50 cards per minute, 10 to 200 counts per inch. Plugs directly into MODEL 2 recorder, controls both card reader and recorder for completely automatic operation.



**MODEL 40 KEYBOARD** provides a convenient means for plotting large amounts of tabular data in point-curve form. Self-contained voltage source together with full three column keyboard in both X and Y axes; unit plugs directly into MODEL 2 AUTOGRAF.

*Bulletins describing these instruments are available and we'll be glad to send them to you. Write . . .*

**F. L. MOSELEY CO.**, 409 North Fair Oaks Avenue, Pasadena 3, California

**Pre-assembled partitions...made to exact specifications...for manufacturers of Radio, Electrical and Electronic components and allied products.**

**P**artitions for  
**P**rotective  
**P**ackaging

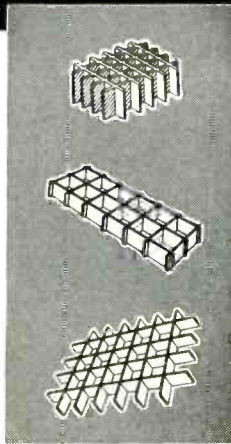

WRITE, PHONE or WIRE  
for QUOTATIONS on  
YOUR REQUIREMENTS

**peter partition corp.**

Manufacturers of Cardboard Partitions

19-21 HEYWARD ST. BROOKLYN 11, N. Y.  
Telephone: TRIangle 5-4033

Blvd., Long Island City 1, N. Y. A 4-page illustrated color bulletin gives features and specifications on the model BC-200 2-in. ball-bearing potentiometers designed for applications requiring exceptional precision. Write for technical bulletin BC200-455.

**Portable Potentiometer.** Barber-Colman Co., Wheelco Instruments Div., Rockford, Ill. Bulletin F5760-1 describes a portable potentiometer capable of providing extreme accuracy to be used for checking installations of temperature measurement and control instruments, both in the laboratory and field. The potentiometer discussed is readable to 0.025 mv. Scale length exceeds 40 in.

**Magnetic Amplifiers.** Hycor Co., Inc., 11423 Vanowen St., North Hollywood, Calif. Catalog bulletin MA illustrates and describes the manufacturer's standard type magnetic amplifiers of toroidal construction, and information regarding special designs to suit individual requirements.

**Multiplier Phototubes.** Allen B. DuMont Laboratories, Inc., 760 Bloomfield Ave., Clifton, N. J., has published a comprehensive catalog of operational theory, data on applications, and specifications for standard and special multiplier phototubes. The 64 pages of this illustrated catalog have been divided into three sections. The first section contains a simplified technical discussion of photo and secondary emissions, and their effect on design and operation of multiplier phototubes. The second section describes the utility of multiplier phototubes for the major sciences and industries with details of specific applications. In the third section, full specifications on standard and special multiplier phototubes are given, together with complete information on their accessories.

**Tube Machinery.** Kahle Engineering Co., 1307 Seventh St., North Bergen, N. J., has available new catalog sheets illustrating and describing significant advances for crystal semiconductors and the Novar head drive, a sealing ma-

These **PILOT LIGHTS**  
give you  
**180° VISIBILITY**  
for the most effective indication  
plus  
**BUILT-IN RESISTORS**  
(a patented Dialco feature)  
for operation on 105-125V. or 210-250V.

The required **RESISTOR** is an integral part of the unit — **BUILT IN** (Pat. No. 2,421,321). Also, simple external resistors for all higher voltages.

Every assembly is available complete with lamp.

SAMPLES ON REQUEST AT ONCE — NO CHARGE



**FREE** Brochure on "Selection and Application of Pilot Lights"

Also write for our latest Catalogues.

**DIALCO**

**For NEON Lamps**

Choice of fluted or clear caps; binding screws or soldering terminals.

Available for both 9/16" and 11/16" mounting clearance holes.

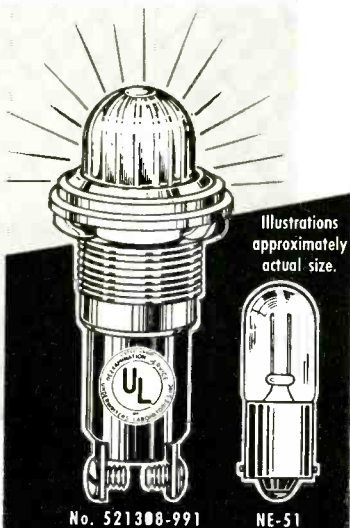

Foremost Manufacturer of Pilot Lights

**DIALIGHT**  
CORPORATION

PLANT AT  
BROOKLYN, N. Y.

60 STEWART AVE., BROOKLYN 37, N. Y. • HYACINTH 7-7600



chine for large tv tubes. Some physical characteristics of glass are given in an appendix sheet.

**Decade Resistance Unit.** Telex, Inc., Telex Park, St. Paul 1, Minn., has published a catalog sheet on its miniature decade resistance unit. Designed for use in analog-computing equipment, circuit development and specialized electrical laboratories, the unit described is approximately one-fifth the size of standard decade resistors, yet is available in maximum resistance values of 1 and 10 megohms. A photograph of the unit and complete product specifications are given in the literature.

**Alarm Contact Tachometer.** Herman H. Sticht Co., Inc., 27 Park Place, New York, N. Y. Bulletin No. 793 illustrates and describes the model SA-6 alarm contact tachometer with electronic control box. The unit discussed not only indicates machine speeds but can control machine speeds, signal and warn visually and audibly by means of signal lights, sirens or bells. It is particularly useful to protect expensive equipment. The bulletin includes ordering information.

**Photoelectric Controls.** Photo-switch Division, Electronics Corp. of America, 77 Broadway, Cambridge 42, Mass., has available a 20-page illustrated bulletin entitled "Proved Answers to Successful Automation." It contains specifications, descriptive data and operational charts of photoelectric controls for numerous industrial uses including high-speed counting, inspection and sorting; smoke-control, high-temperature measurement and control, machinery safeguards and conveyor control.

**Miniature Flat Dielectric Capacitors.** The Gudeman Co., 340 W. Huron St., Chicago 10, Ill. A new 6-page 2-color bulletin (No. 337-8) illustrates and gives complete technical information on miniature flat Mylar dielectric capacitors. Included are tables of capacitance values and voltage ratings, dimensional drawings, explanation of catalog numbers and data on voltage derating for high temperature

# DEPEND ON

## CLIFTON SIZE 10 SYNCHROS for *Consistent* HIGH ACCURACY

**Error Spread Curve for a typical month's production of transmitters.**

- Average Error Spread 7'
- Average Max. Error from EZ about 5'
- Average RMS Error under 3'
- **GUARANTEED** Maximum Error Spread 12'

ACTUAL SIZE



**SEE US AT WESCON!**  
Booth No. 1620  
San Francisco  
Aug. 24, 25, 26

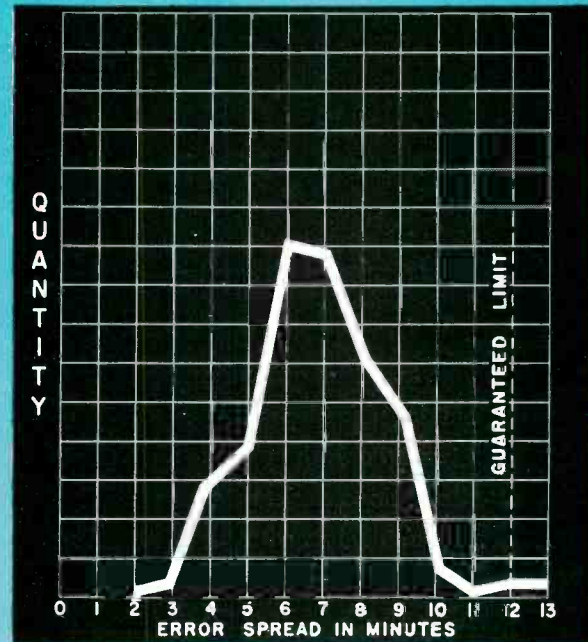

### IMMEDIATELY AVAILABLE

For full engineering information on transmitters, receivers, resolvers, differentials and control transformers, and complete lines of Size 11 and 15 synchros also immediately available, write or telephone T. W. Shoop, Sales Mgr. (Telephone Phila.) MADison 6-2101.

West Coast Rep. Wm. J. Enright, 988 W. Kensington Rd., Los Angeles. MUtual 6573.

LOOK TO CPPE FOR



SYNCHRO PROGRESS

**CLIFTON PRECISION PRODUCTS CO. INC.**  
CLIFTON HEIGHTS  
PENNSYLVANIA

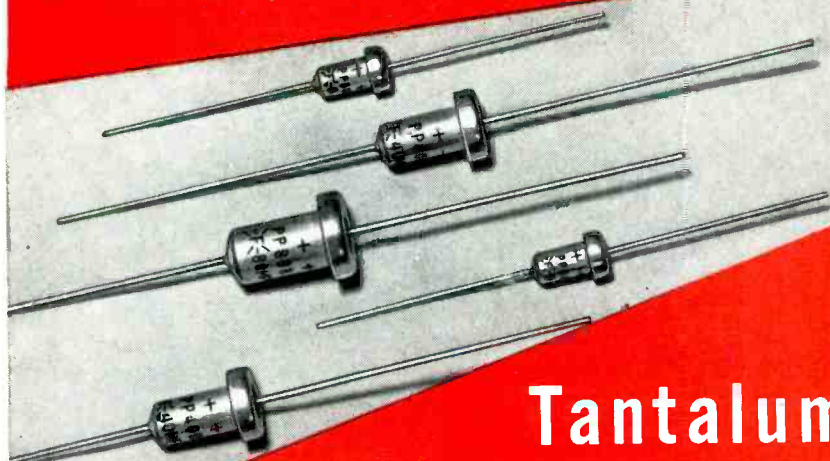
**BIG IN CAPACITY . . . . SMALL IN SIZE****Fansteel** 

## Tantalum CAPACITORS

**30.0 mfd in less than 0.03 cu. in.**

The tantalum oxide film employed in Fansteel Capacitors is the most stable dielectric, chemically and electrically, yet discovered. Fansteel Tantalum Capacitors have a practically unlimited life, either in use or on the shelf; have a maximum d-c leakage of only 0.000008 ampere; and stable characteristics are unchanged over a wide temperature range.

Fansteel offers Tantalum Capacitors in 58 sizes and ratings. A partial listing is shown here. All sizes are available from stock.

Send for  
bulletin 6-100



C564A

**FANSTEEL METALLURGICAL CORPORATION**

North Chicago, Illinois, U.S.A.

**TANTALUM CAPACITORS . . . DEPENDABLE SINCE 1930**

CATALOG NUMBER	CAPACITY MFD*	WORKING VOLTAGE D-C	MAXIMUM D-C LEAKAGE §
PP30B6A1	30	6	1.0
PP25B8A1	25	8	1.0
PP20B10A1	20	10	1.0
PP15B15A1	15	15	1.5
PP10B25A1	10	25	2.0
PP8B30A1	8	30	2.0
PP5B50A1	5	50	3.0
PP4B60A1	4	60	3.0
PP3.5B75A1	3.5	75	3.0
PP2B100A1	2	100	3.0
PP1.75B125A1	1.75	125	3.0
PP140B6A1	140	6	2.0
PP100B10A1	100	10	2.0
PP70B15A1	70	15	3.0
PP40B30A1	40	30	4.0
PP25B50A1	25	50	5.0
PP20B60A1	20	60	5.0
PP15B75A1	15	75	6.0
PP11B100C1	11	100	7.0
PP9B125C1	9	125	7.0
PP325B6A1	325	6	3.0
PP250B10A1	250	10	3.0
PP175B15A1	175	15	4.0

\* ±15% +20% at 120 cps, 25°C

§ Microamperes, at 25°C

operation, dielectric material, end seals, capacitance change, lead specifications, test voltage, life test, power factor, insulation resistance, moisture resistance test, lead pull test, lead bending test and typical curves.

**H-V Test Equipment Instrumentation.** Peschel Electronics, Inc., 13 Garden St., New Rochelle, N. Y. An 8-page general catalog covers 13 instruments. Included are descriptions of: sensitive Hipot testers; h-v test sets; corona test sets; continuous insulation tester; an insulation tester—fault indicator, counter; Audiotone continuity and leakage tester; low resistance ohmmeter; motorized output control; electronic relays; high potential test stick; d-c high potential test set and cable fault set; universal power supply; and electronic rheostats.

**Special Purpose Tubes.** Chatham Electronics, Livingston, N. J., has issued a 4-page folder discussing its development and production of special purpose electronic tubes and equipment. It illustrates and describes a variety of rectifiers, thyratrons, hydrogen thyratrons, twin power triodes, voltage regulator reference tubes and special products.

**Toggle Switches.** Torsion Balance Co., Clifton, N. J., has published specification literature on the new, lightweight subminiature TorBal toggle switches for commercial and military applications. Rated performance and design data are given for the 10 ampere, 50 v d-c switches, which are 50 percent smaller than conventional sizes for comparable ratings. The switches described were designed for applications where conservation of weight and space are important.

**Connector and Cable Catalog.** American Phenolic Corp., Chicago 50, Ill. General catalog B4 provides the electronics industry with a quick reference to thousands of Amphenol components. It catalogs AN and r-f connectors, coaxial cables, Blue Ribbon and miniature connectors. It also contains the only available listing of Amphenol radio sockets and plugs, tv an-

tennas and accessories and microphone connectors.

**Transistor Test Equipment.** Electronic Research Associates, Inc., 67 E. Centre St., Nutley 10, N. J., has available a catalog sheet illustrating and describing transistor test equipment suitable for both laboratory and production applications. Instruments described include an automatic transistor noise figure meter, a transistor alpha tester, and a transistor comparator. Also described is a noise figure calibrator which supplies noise figure values for calibration and reference.

**High Vacuum Pumps.** W. M. Welch Scientific Co., 1515 Sedgwick St., Chicago 10, Ill. A 48-page booklet describes Duo-Seal vacuum pumps which are capable of producing a vacuum of 0.05 micron and better for such applications as the manufacture of radio tubes. The booklet contains construction features, operating principles and instrument selection facts for vacuum gages, diffusion pumps, pump accessories and rheostats. Illustrations, specifications and prices of all instruments are included.

**Hermetic Terminals.** Silicone Seals, Inc., 3125 Milwaukee Ave., Chicago 18, Ill., has available a catalog covering the three basic lines of terminals from which it can make hundreds of different modifications. Included are the single gland terminals which are mounted to covers, cans or brackets in its own plant; the solder type terminals which are mounted on solder flanges for assembly in the purchaser's plant; and the double gland terminals which were designed for assembly at either its own facilities or in the purchaser's plant. For the last group described Silicone Seals, Inc. furnishes the complete terminal hardware and silicone rubber parts. All meet the latest military requirements.

**Universal Meter.** Donald C. Seibert, Box 281, Wilmington, Del., has available descriptive literature on the AEG universal meter. Among the features described are high shock resistance; 15 to 20,000

SMALL IN SIZE . . . **BIG** IN CAPACITY

 **Fansteel**



**150°C**

## Selenium RECTIFIERS

about  $\frac{1}{3}$  the size and  $\frac{1}{4}$  the weight of a comparably rated standard rectifier

CATALOG NUMBER	CIRCUIT	INPUT A-C VOLTS	CONT. D-C OUTPUT AT 100°C	
			VOLTS	AMPS.
TADL35L	1-35-1-H	455	402	0.004 <sup>(1)</sup>
TEUH315 <sup>(2)</sup>	2-8-1-D	132	254	0.020 <sup>(1)</sup>
TBU100L	1-100-1-H	2600	1090	0.020
TEB328 <sup>(3)</sup>	2-31-1-D	363	297	0.150
TEW066L	4-4-1-B	132	108	0.180
TEG070L	4-5-1-B	165	135	0.300
TEX034L	4-1-1-B	33	27.8	1.59
TEC200LN	2-48-1-C-N	214	175	0.600
TBY060L	4-3-1-B	78	62.7	1.0
TBY060L	4-3-1-B	41	62.7	1.0 <sup>(1)</sup>
TEEW334L <sup>(4)</sup>	2-7-1-D	231	295	2.3 <sup>(2)</sup>
TEFW332L <sup>(4)</sup>	2-13-1-D	429	548	4.6 <sup>(2)</sup>
TBC084L	2-1-1-C	13	10.4	5.2
TET050L	4-2-1-B	66	53.9	4.6
TEP514L <sup>(5)</sup>	2-7-2-D	231	189	14.0
TER020L	6-3-1-B	66	79.5	12.9 <sup>(2)</sup>
TER034L	4-1-3-B	33	27.8	25.8
TBR008L	6-1-4-B	26	32.5	51.6 <sup>(2)</sup>

<sup>(1)</sup> Capacitive load. Ratings unmarked are for resistive or inductive loads.

<sup>(2)</sup> Hermetically Sealed.

<sup>(3)</sup> Two stacks required.

<sup>(4)</sup> Three stacks required.

<sup>(5)</sup> Resistive, inductive or capacitive load.

Operating at 100°C (212°F)

Fansteel High Temperature Rectifiers deliver full rated power output, continuously, with no derating whatever. At temperatures up to 150°C (302°F), only moderate derating is necessary.

Fansteel High Temperature Rectifiers are available in all standard cell sizes and all standard circuit arrangements and with all standard protective finishes—moisture resistant, fungus resistant and a salt-spray resistant finish that really works! The table indicates a partial list of over 100,000 available types.

Send for  
bulletin 6.401

FANSTEEL METALLURGICAL CORPORATION

North Chicago, Illinois, U.S.A.



E566A

DEPENDABLE RECTIFIERS SINCE 1924

## Johnson KNOBS and DIALS

DRESS UP YOUR PRODUCT  
THIS EASY WAY...

Attractive equipment often sells better! Now you can give your product that "custom" look simply by installing knobs and dials from Johnson's integrated family line. Dramatic in appearance and functional in design, they are made of tough, scratch resistant black phenolic (to MIL-P-14) with heavy, integral molded brass inserts. Three basic diameters, 1 1/8", 1 5/8" and 2 3/8"—available with matching phenolic skirts or calibrated, satin chromium dial plates.

For more complete information, write to:



**E. F. JOHNSON COMPANY**  
2319 Second Ave. S.W., Waseca, Minn

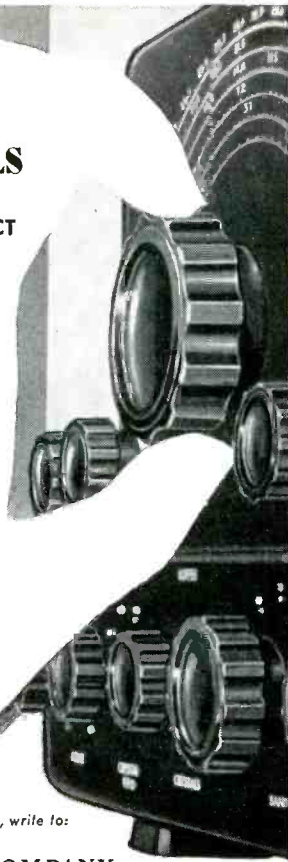

eps rating for a-c ranges by use of a germanium diode; 1-percent accuracy on d-c ranges; 1.5 percent accuracy on a-c ranges. The unit discussed is available with 32 measuring ranges; with up to 25,000 ohms per v a-c; with up to 100,000 ohms per v d-c.

**Computer Tubes.** General Electric Co., Schenectady 5, N. Y., has published a 50-page booklet, ETD-1140-P, on computer tubes. This working guide and reference outlines the company's computer tube program, gives complete technical data on the five types in the GE line, and includes a review of special computer tube design considerations and application notes. The five tubes described in detail are: GL-5844, GL-5915-A, GL-5965, GL-6211 and GL-6463.

**Reagent Catalog.** General Chemical Division, Allied Chemical & Dye Corp., 40 Rector St., New York 6, N. Y. A new catalog lists the more than 1,000 high-purity chemicals offered, and may prove useful from time to time in helping locate a product source for someone making inquiry. One section lists electronic grade chemicals which range from versatile sulfur hexafluoride—used in tv transmitters, radar waveguides and hermetically sealed transformers—to highly specialized reagent quality chemicals for specific applications.

**Tape Catalog.** The Bishop Mfg. Corp., 10 Canfield Rd., Cedar Grove, N. J., has announced publication of an 8-page, 2-color catalog describing major tape products. It provides detailed performance and application information about the company's Bi-Seal self-bonding insulating tape, No. 125 electrical filler tape, Bi-Prene types C and H electrical jacketing tape, general purpose vinyl electrical tape and No. 30 high voltage splicing tape. In addition, several typical applications of these tapes are shown.

**Frequency Counter.** The Detectron Corp., 5528 Vineland Ave., North Hollywood, Calif. A new catalog sheet provides features, description, applications, specifications and block diagram of the latest addition

BE *Sure* with **CORNISH**

*Electronic* **WIRES and CABLES**

<p><b>MICROPHONE CABLES</b></p> <p>Designed for low capacitance, high insulation resistance, low attenuation—in plastic or rubber insulation to stand severe service</p>	
<p><b>T-V LEAD-IN CABLES</b></p> <p>Furnished only in pure virgin polyethylene to insure best electrical properties and long life under severe operating conditions</p>	
<p><b>T-V LEAD-IN CABLES</b></p> <p>Made hollow, of pure virgin polyethylene, for maximum efficiency in receiving Ultra High Frequency signals</p>	
<p><b>INTERCOMMUNICATION CABLES</b></p> <p>These quality cables are made in various constructions, utilizing plastic insulation for both conductors and jacket</p>	
<p><b>SHIELDED INTERCOMMUNICATION</b></p> <p>When installation conditions dictate, shielded cables are recommended. Made with internal or external shield—2 and 3 conductors</p>	

“MADE BY ENGINEERS. FOR ENGINEERS.”

**CORNISH WIRE COMPANY, INC.**

50 Church Street                      New York 7, N. Y.

to the company's line of electronic counters, the model DS-6100-T frequency counter. The unit discussed accurately measures 1 to 100,000 cps of any electrical, mechanical or optical events, with multisampling circuit and 10-cycle gate as standard equipment.

**Signal-to-Noise Ratio Voltmeter.** Millivac Instrument Corp., P.O. Box 997, Schenectady, N. Y. A loose-leaf perforated catalog sheet covers the MV-19A signal-to-noise ratio voltmeter which measures directly, and accurately, rms noise voltages over a frequency range of 20 cps to 200 mc. It illustrates the vtvm which is ideal for production testing and basic research. Chief features, condensed operating instructions and specifications are included.

**Induction Motor.** Dalmotor Co., 1329 Clay St., Santa Clara, Calif. A new publication, form AC-93-355 covers a miniature subfractional 400-cps induction motor featuring good speed regulation at very low slip. Suggested for application to such uses as tape recording, geophysical exploration, or to servo or actuator motor requirements, the type AC-93 motor listed can be supplied in alternative form as a synchronous motor. Illustrated and provided with detailed and dimensioned outlines, the motor is fully described by technical specifications and by performance curves showing rpm, power input and power output.

**Magnetic Components.** Magnatran Inc., Kearny, N. J. A new circular describes, in brief, Magnatran heavy duty magnetic components for the electronic industry. It covers: unitized rectifiers, filter reactors, rectifier, plate transformers, filament transformers, amplifier rectifiers, modulation transformers and reactors.

**Hermetic Seals.** Advanced Vacuum Products Inc., 18 Liberty St., Stamford, Conn. The super-rugged Advac hermetic seals are illustrated and described in a 4-page folder. Metallizing process, assembled brazed terminals, metals and constructions available are described. Standard type terminals

MODEL 80F FEMALE } Size 3 3/8"  
MODEL 80M MALE } x 3/4" dia.

VERY HANDY in lab and production test. At signal generator levels and below 5 watts, this is the last word for low VSWR.

MODEL 82

6" x 8 1/2" x 17"

# TERMALINE COAXIAL LOAD RESISTORS

50 ohms DC to 4000 mc—5 watts to 2500 watts

The constant resistance (Low VSWR) of the TERMALINE resistor make it the ideal dummy load and standard resistor at UHF and VHF. Design is such that normal reactance is put to work producing a pure resistance over an extremely wide frequency range. Acting as a "bottomless pit" for RF energy, thousands of TERMALINE units are in daily use in high frequency applications.

Model	Cont. Power Rating	Input Connector
80F	5 watts	UG-23B/U
80M	5 watts	UG-21B/U
80A	20 watts	UG-23B/U
81	50 watts	UG-23B/U
81B	80 watts	UG-23B/U
82	500 watts	} Adaptor to fit UG-21B/U supplied
82A	500 watts	
82C	2500 watts	

Adapters or cable assemblies for standard coaxial line available.

ALL TERMALINE units, except Model 82C, are self-cooled. Substantial quantity discounts.

LITERATURE UPON REQUEST



**BIRD ELECTRONIC CORP.**  
1800 EAST 38TH ST., CLEVELAND 14, OHIO  
TERMALINE Coaxial Line Instruments

NEELY ENTERPRISES  
Hollywood - San Francisco  
Albuquerque  
RON MERRITT COMPANY  
Seattle

## Borg 900 Series Micropots offer everything you want in a potentiometer



- 1** Versatility — 1 to 5 gang models, single or double shaft, servo or bushing mount.
- 2** Permanent Accuracy — Resistance element integrally molded within housing. Leads, taps and terminals firmly encapsulated.
- 3** Long Life — Scanning action distributes wear across face of bar contact. Rigid, fixed lead screw.
- 4** Dependability — Mechanically and electrically stable. Effectively sealed against dust and moisture.
- 5** Absolute Linearity — Uniform resistance distribution. No external trimming required.
- 6** Specifications — Meets extreme commercial and military requirements for all applications.
- 7** Availability — Quick deliveries on production quantities.

### Borg 1100 Series Micropots

Accurate, dependable, long-lived. Has 9 inch coded leads for easy installation. Offers your products a competitive price advantage.



WRITE FOR CATALOG BED-A15B  
**BORG EQUIPMENT DIVISION**  
GEORGE W. BORG CORPORATION  
JANESVILLE, WISCONSIN



Built by Borg

CO-AX

4 mmf/ft

# ★ ULTRA LOW capacitance & attenuation

WE ARE SPECIALLY ORGANIZED  
TO HANDLE DIRECT ORDERS OR  
ENQUIRIES FROM OVERSEAS

SPOT DELIVERIES FOR U.S.

BILLED IN DOLLARS—  
SETTLEMENT BY YOUR CHECK

CABLE OR AIRMAIL TODAY



**NEW** 'MX and SM' SUBMINIATURE CONNECTORS  
Constant 50 $\Omega$ -63 $\Omega$ -70 $\Omega$  impedances

TYPE	$\mu\mu\text{F/ft}$	IMPED. $\Omega$	O.D.
C 1	7.3	150	.36
C 11	6.3	173	.36
C 2	6.3	171	.44
C 22	5.5	184	.44
C 3	5.4	197	.64
C 33	4.8	220	.64
C 4	4.6	229	1.03
C 44	4.1	252	1.03

TRANSRADIO LTD. 138A Cromwell Rd. London SW7 ENGLAND CABLES: TRANSRAD, LONDON

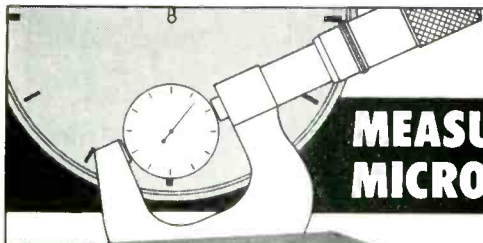

## MEASURE TIME WITH MICROMETER ACCURACY

### MODEL B-4 TIME MEASURING SYSTEM

Direct reading for simple, fast, accurate operation

Measures time intervals to an accuracy of  $\pm 2$  millimicroseconds

Provides marker signals of .1  $\mu\text{s}$  and 1  $\mu\text{s}$  spacing on synchroscope

Incremental control calibrated to  $\pm 1$  millimicrosecond

Complete self-contained integrated system

SEE OUR DISPLAY at:  
WESCON, San Francisco  
National Electronics Conference, Chicago

Write for complete data: our Bulletin E-B-4

WE ALSO MAKE PRECISION WIDE-RANGE PULSE and TIME DELAY GENERATORS—DATA SHEETS AVAILABLE

**Rutherford** ELECTRONICS CO. 3707 S. ROBERTSON BLVD.  
CULVER CITY, CALIFORNIA

and ceramic-to-metal hermetic seals are illustrated and described.

**Counter Switch. Micro Switch,** a Division of Minneapolis-Honeywell Regulator Co., Freeport, Ill. Data sheet 101 illustrates and describes a new heavy duty low force counter switch available in both single and double circuit contact arrangements. Characteristics and dimensional diagram are included.

**Components Catalog.** Erie Resistor Corp., Erie, Pa. Catalog D-55 includes additions to the company's standard lines and two important new lines. Erie Teflon electronic components include stand-off and feed-through insulators, sockets and spaghetti. Also shown are the electronic components of Corning Glass Works, including various types of capacitors and resistors. The catalog is complete with up-to-date listings, illustrations, description and procedure for ordering Erie products.

**Transformers.** Multi-Amp Corp., 10 Third St., Newark 7, N. J. Data sheet 255T illustrates typical examples of the company's transformer engineering. Chief features of the dry type transformers are listed. Transformer problems are invited and quotations are available to suit your purpose, ranging from 5 va to 500 kva.

**Germanium Diodes.** National Union Electric Corp., 350 Scotland Road, Orange, N. J. A recent engineering bulletin illustrates and describes the company's new line of subminiature, hermetically sealed gold-bonded diodes. Such applications as high speed digital computers using transistors or vacuum tubes, where low forward resistance, high back resistance and short recovery time are required, typify the field discussed. Mechanical and electrical specifications are included.

**Dispersions for Industry.** Acheson Colloids Co., Port Huron, Mich. A revised 4-page booklet, listing 44 colloidal and semicolloidal dispersions for electronics and related industries, has been issued. The

products include dispersions of graphite, molybdenum disulfide, mica, vermiculite, zinc oxide and acetylene black. Carriers and diluents are given for each product, along with typical applications and important physical data. Eight new dispersions have been added to this latest revision of the company's product list. These include such varied products as a corrosion-resistant coating for dry-film lubrication, an antiseize compound for oxygen systems and an improved interior wall coating for c-r tubes.

**Metal Products.** Wyco Metal Products, 6918 Beck Ave., North Hollywood, Calif. New literature is now available describing items recently added to the company's line of products for the electronics industry. The items discussed consist of standard relay rack panels, meter panels, metal door rack panels, sloping front cabinets, chassis supporting angles, chassis mounting brackets, rack shelves and cabinet racks with front door and adjustable mounting angles.

**Amateur Equipment.** Radio Corp. of America, Harrison, N. J., has brought out a completely revised edition of "Headliners for Hams." The folder covers 45 types—oscillators, amplifiers, frequency multipliers, voltage regulators, thyatrons, rectifiers, oscillograph types for test equipment, and camera tubes for use in amateur telecasting. It contains ssb tube data and ratings on popular receiving-tube types.

**Capacitance-Resistance Analyzer.** Cornell-Dubilier Electronic Corp., South Plainfield, N. J. A loose-leaf perforated catalog sheet deals with the model BF-70 capacitance-resistance analyzer. The unit illustrated and described detects capacitor defects such as opens and shorts, intermittents, high and low capacitances and high leakage and power factor of electrolytic capacitors, as well as low insulation resistance of paper, mica and ceramic dielectric capacitors.

**Transducer Evaluation.** Crescent Engineering & Research Co., 11632



You can depend on



**HERMETIC-SEAL  
RUGGEDIZED**

## DEPOSITED CARBON RESISTORS

Produced under the most exacting methods of quality control. Ideal for use in UHF equipment where only the optimum of quality may be tolerated.

Completely high temperature alloy solder sealed in newly developed envelope of non-hygroscopic ceramic. Ruggedized for incorporation into "snap-in" clips. Production tested for resistance to thermal shock, salt-water immersion and humidity.

**Three wattage ranges: DCSH-1/2, 1/2 watt;  
DCH-1, 1 watt; DCH-2, 2 watts.**

- Resistance ranges to 200 megohms
- Temperature coefficient 140 PPM to 500 PPM per degree C
- Standard tolerance 1%

Meet MIL-R-10509-A Specifications



WRITE FOR BULLETIN No. R-27  
**DALE PRODUCTS, Inc.**

1300 28th AVE., PHONE 2139 COLUMBUS, NEBRASKA, U. S. A.

Export Dept.:  
Pan-Mar Corp.,  
1270 Broadway,  
New York 1, N.Y.

## HIGHEST PRECISION in low frequency crystals

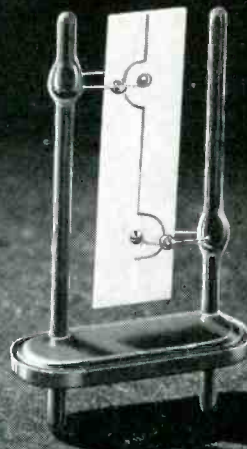

Precision plus, that's what you get with every Reeves-Hoffman low frequency crystal unit. For exact control of all low frequencies from 12 kc to 1000 kc—specify Reeves Hoffman crystals.

Write today for further information and prices.

RI-1

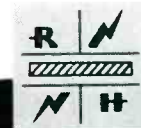

**REEVES - HOFFMAN CORPORATION**  
a subsidiary of Claude Neon, Inc.

**CHERRY AND NORTH STREETS CARLISLE, PENNSYLVANIA**

WHAT  
CLAMP  
TO USE  
WHERE  
TOLERANCES  
ARE LARGE

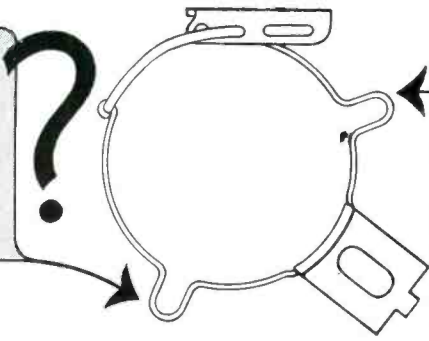

AUGAT'S  
NEW  
TWO TENSION  
LOOP  
CLAMPS

Augat two-tension loop clamps are the long-sought answer for uses where tube base tolerances vary up to .040. The bands of these sturdy clamps are made of Beryllium copper, heat treated to retain original tension and nickel plated to withstand a 96 hour salt spray test with no adverse effect.

The remaining parts of Augat's two-tension loop clamps are made of 18% nickel silver.

Write today for catalog and samples.

**AUGAT BROS. INC.**

31 PERRY AVENUE • ATTLEBORO, MASS.

**THE HOTTEST THING IN  
CARTRIDGE HEATING-UNIT HISTORY**

**THE NEW WATLOW  
FIREROD  
CARTRIDGE**

**5 TIMES  
MORE HEAT**  
*than ANY standard  
cartridge heating unit!*

A New high in Watt Densities and temperatures . . . plus  
l-o-n-g-e-r cartridge life.

For convincing test-proof and other information, write  
for new FIREROD Bulletin.

**WATLOW**

**ELECTRIC MFG. CO.  
1390 FERGUSON AVE.  
SAINT LOUIS 14, MO.**

McBean St., El Monte, Calif. A new 4-page bulletin No. KCE-491 describes and illustrates a simple method of evaluating transducers for absolute linearity, sensitivity phase and frequency characteristics. Accuracies to 0.1 percent are possible with an inexpensive vtm, oscillator and 10-turn potentiometer and the circuitry described operates independent of line voltage fluctuations. A test of linear transducer is reproduced with linearity and sensitivity computations. The same procedure may be employed to evaluate many types of transducers among which are the following: pressure, force, torque, acceleration and flow.

**Portable Millivolt Indicators.** Leeds & Northrup Co., 4934 Stenton Ave., Philadelphia 44, Pa. A 4-page data sheet contains complete information on the company's portable millivolt indicators. It describes how the indicators are being used for temperature and calibration studies involving low voltage measurements both in the plant and in the laboratory. Specifications are arranged in convenient tables. A listing of replacement parts and accessory equipment is included. Ask for data sheet E-33(1).

**Pulse Instruments.** Electro-Pulse, Inc., 11811 Major St., Culver City, Calif. Bulletins are available containing technical data and photographs of new pulse instruments manufactured by the company. Instruments described are the model 1310A long time delay generator, model 3410A pulse oscillator, model 3420A pulse oscillator and model 4120A variable pulse generator.

**Thermistor Heat Detector Cells.** Servo Corp. of America, 2020 Jericho Turnpike, New Hyde Park, N. Y. A new 4-page illustrated brochure covers a group of remote detectors of far infrared energy. Three types are described: a low-price commercial model, No. 1317; a laboratory model, No. 1312, of higher response and accuracy; and a deluxe evacuated model, No. 1340, for use where high ambient vibrations are present. These units are designed for use in heat detec-



# COMPUTER SYSTEMS

make contact with **AMPHENOL** Connectors

Interconnection of the varied elements of computer systems demands equally varied connectors. Only AMPHENOL manufactures all of the different rf and electrical connectors to meet this need.

## BLUE RIBBON

Thousands of these quick connect/disconnect connectors are employed in computer plug-in banks. May be single or gang mounted. Feature proved gold-plated ribbon contacts, blue dielectric.

## 26 SERIES RACK & PANEL

Miniature rectangular or hex, standard rectangulars for interconnection of computer elements.

## SUBMINAX

Sensational new subminiature rf connectors and cable save space and weight in miniaturization programs.

## RF CONNECTORS

AMPHENOL is the foremost manufacturer of every type of rf connector. All popular series immediately available from stock.

## AN CONNECTORS

The 'work horses' of electronics, AMPHENOL AN connectors provide dependability in interconnection of electrical circuits.

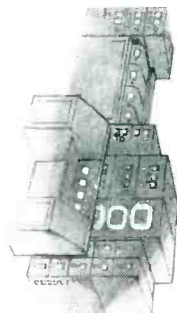

Have you received your copy of the new AMPHENOL Catalog B? It provides the most complete listing of all AMPHENOL products.



AMERICAN PHENOLIC CORPORATION



Chicago 50, Illinois

In Canada: AMPHENOL CANADA LIMITED, Toronto

tion, measurement or control systems where direct contact with the source is inadvisable or impossible. Typical construction of the Servotherm heat detector cells, features and specifications are explained.

**Mica Capacitors.** Cornell-Dubilier Electric Corp., South Plainfield, N. J. Bulletin No. 160 illustrates and describes the Super Micadon miniature encapsulated mica capacitors. Included are a ratings table, a listing of features, a characteristics availability chart, a characteristics description table, four graphs and dimensional drawings.

**Electronic Timer.** Ferrara Inc., 8106 W. Nine Mile Road, Oak Park 37, Mich., has published a catalog sheet on the T-1 electronic timer for interval, delayed action repeat cycle, and two sequence timing. The timer described is supplied in standard maximum times of 25 and 50 seconds. Features, control diagrams and mounting details are given.

**Spectrographic Source Unit.** Baird Associates, Inc., 33 University Road, Cambridge 38, Mass. Bulletin 35A is a 2-color 4-page folder containing detailed information on the 3 circuits available in this apparatus which enable the selection of optimum conditions for a wide range of analytical problems. A selector switch permits quick and easy change from the 3 basic circuits—h-v condensed spark, a-c arc and d-c arc—without physically changing the leads. Other controls on the front panel of the unit allow selection and adjustment of currents and voltages which can be read directly from easily visible meters. Specifications and features of the circuits are presented, together with schematic diagrams of each.

**Stainless Fasteners.** Allmetal Screw Products Co., Inc., 821 Stewart Ave., Garden City, L. I., N. Y. A comprehensive 8-page brochure, PIOA, lists stainless fasteners now available. Included are style and size data about stainless screws, bolts, nuts, washers, rivets,

AN fasteners and the like. Available body and head styles are illustrated.

**Color Studio Scanner Equipment.** Allen B. DuMont Laboratories, Inc., Clifton, N. J. Bulletin TR-888 covers color studio scanner equipment for live color programming. Illustrations, equipment complement listing, space requirements and electrical specifications are included.

**Power Transistors.** Minneapolis-Honeywell Regulator Co., 2753 Fourth Ave. South, Minneapolis 8, Minn., has available a folder on its power transistors that are specially designed for electronic control applications. It contains data sheets giving detailed design information, maximum ratings and typical operating conditions for the types H1, H2, H3, H4 and 2N57 power transistors. Collector characteristics and operating parameters are included.

**Indicating and Recording Instruments.** Barber-Colman Co., Rockford, Ill. Bulletin F5608-1 describes Wheelco indicating and recording instruments designed to provide accurate measurement, indication and permanent record when applied to electrical variables such as voltage and amperage as used in industrial processing, laboratories and generating stations. Wheelco d-c instruments may also be used as tachometers, calibrated in rpm and fpm, for the measurement of speed when used with d-c generators.

**Railroad Radio.** Westinghouse Electric Corp., 401 Liberty Ave., Pittsburgh 30, Pa. Booklet 83-214 deals with the type FE-1 heavy-duty railroad radio equipment. The booklet describes features of the equipment that enable it to readily fulfill the basic needs of railroad radio communications: (1) end to end; (2) train to train; (3) way-side to train; (4) multifrequency operation; (5) talk-back operating positions; (6) intercommunication between control positions; and (7) variety of remote control procedures. The electrical and mechanical description of the equipment

## DELAY LINES

ranging from 0.01 to 200  $\mu$  sec.

from 5 to 10,000 ohms

write for technical literature

COMPONENTS DIVISION

LITTON industries

336 North Foothill Road, Beverly Hills, California • Crestview 4-7344  
215 S. Fulton Ave., Mount Vernon, New York • Mount Vernon 7-6609

Specify



for -  
**PRECISION QUALITY components**

**OF TUNGSTEN, MOLY, NICKEL CLAD WIRE, ALLOYS, KOVAR**

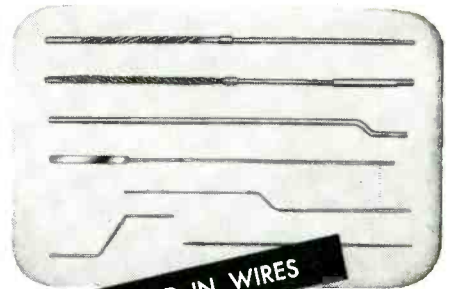

• DKE LEAD IN WIRES

Quality controlled throughout production with Tungsten hard glass leads produced under General Electric Timing Control. Each tungsten lead is micro-specially inspected for flaws. DKE offers highest quality and LOW PRICES now. Send drawings for quotations and let us prove the economy of our prices.



• DKE TUBE BASES

The Engineering Company can give you immediate delivery on following bases: 50 Watt, 3303B, 412 Industrial Base, Giant 7 Pin Bayonet, 4310 Four Pin Jumbo, Tetrode, Hydrogen Thyratron Bases in both Aluminum and Copper up to 6.50 dia etc. All bases to JAN-1A/MIL-E-1B and subjected to weights and strength tests.

### A WORD OF THANKS TO OUR WEST COAST CUSTOMERS!

Western consumers of DKE components can be assured of our continued efforts to provide top quality at lowest prices and service that meets your assembly line schedules!

**THE engineering co.**  
27 WRIGHT ST., NEWARK 5, N.J.

includes rating, dimensions and weights, and power requirements.

**Magnetic Ingot Iron.** Armco Steel Corp., Middletown, Ohio. A revised edition of "Armco Magnetic Ingot Iron for D-C Applications" has been issued. The 24-page illustrated manual covers a wide range of subjects, including magnetic core uses, mechanical and physical properties and magnetic properties. The booklet details and pictures many diverse applications, from telephone and telegraph wire and small relay parts to huge magnetic cores for cyclotrons, beta ray spectrographs and other equipment for nuclear research. Charts, tables, drawings and curves are shown.

**D-C Voltage Regulators.** C. J. Applegate & Co., 1816 Grove St., Boulder, Col. Models 211 and 212 d-c voltage regulators with zero load regulation are covered in a recent bulletin. The Red Line Uni-plugs described require little more chassis area than a 6AS7G. Illustrations, chief features and specifications are included.

**Molded Printed Circuits.** International Resistance Co., 401 N. Broad St., Philadelphia 8, Pa. Catalog data bulletin M-1 covers the type MCR molded printed electronic circuits. Comprehensive data on types, construction, applications, dimensions, design service, leads and terminals, and charts are given in the 1-sheet loose-leaf perforated bulletin.

**Magnetic Amplifiers and Frequency Multipliers.** American Research and Mfg. Corp., 4914 Del Ray Ave., Bethesda 14, Md. A 10-page catalog deals with a newly developed line of high performance magnetic amplifiers and frequency multipliers. The magnetic amplifiers described are of the half wave type, featuring high speed of response, minimum size and maximum reliability in completely self-contained units. The standard frequency multipliers described provide a simple and expedient method of obtaining 180 cps and 1,200 cps where 60 cps and 400

**avoid  
breakdown  
at high power**

WITH A  
**LITTON industries**  
rotary joint!



IT'S GOOD  
FOR  
YOUR SYSTEM

rated at 250 kw, joint carries up to 700 kw without breakdown

Broad band Litton Rotary Joints are engineered to provide a generous extra margin of safety for today's high powered microwave systems. Precision assembly, new methods of construction, and a unique dielectric application permit these components to handle power far in excess of the 250 KW at which they are nominally rated.

Preloaded ball bearings are used to assure maximum mechanical reliability and service life. Full 360° rotation is provided. Joints may be supplied with either a pressure or weather seal, or both.

Litton Mode	frequency	rated power	VSWR	for waveguide
H250R	8.5-9.6 KMC	250 KW	1.10 max.	RG-51/U or RG-68/U
X250R	8.6-9.6 KMC	250 KW	1.15 max.	RG-52/U or RG-67/U

**FLEXIBLE DESIGN** permits ready adaptation to your particular application.

Litton Rotary Joints are compact, rugged, and can be readily modified to solve virtually any antenna packaging problem. You supply the specifications—length, configuration, flange type—and Litton will furnish the waveguide runs as integral parts of the rotary joint. Thus, potential breakdown points are eliminated.

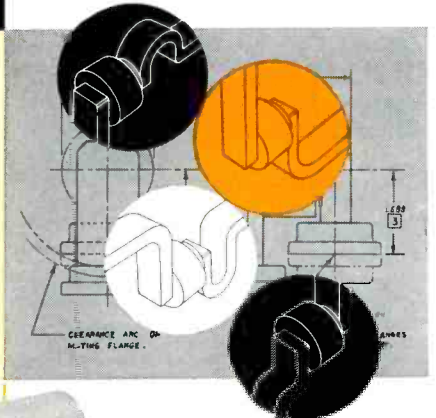

**LITTON INDUSTRIES  
MAGNETRON  
LOAD ISOLATORS**

... insure concentration of energy in the useful pass band of your system. By employing the unidirectional properties of magnetically polarized ferrites at microwave frequencies, Litton Load Isolators permit high power magnetrons or klystrons to operate satisfactorily into long lines terminated in poorly matched loads. They reduce frequency pulling and moding; provide broad band operation with high isolation; present low input VSWR.



**LITTON HIGH POWER ISOLATORS** improve performance in high power radar and other microwave systems.

**LITTON LOW POWER ISOLATORS** for laboratory use, permit you to obtain maximum performance from your X band equipment.

Litton Industries offers an integrated microwave engineering service. We will manufacture waveguide assemblies to your specifications or drawings... or engineer special microwave components to meet your particular requirements.



Write for complete data and name of nearest representative...

336 N. Foothill Road,  
Beverly Hills, California  
CRestview 4-7344  
215 S. Fulton Ave.,  
Mount Vernon, New York  
Mount Vernon 7-6609

Other precision products of the Litton Components Division include: Precision Potentiometers, Metal Film Resistors, Delay Lines

# America's most complete line

## Carter ROTARY POWER SUPPLIES

### ROTARY POWER IS BEST

The "clap-clap" of "Old Bess" gave Grandma's buggy ride more vibration than the smooth Rotary Power of today's modern automobiles. **ROTARY POWER** is best for mobile radio, too . . . and for all DC to AC conversion . . . smoother . . . more dependable.



### DC TO AC CONVERTERS

For operating tape recorders, dictating machines, amplifiers and other 110-volt radio-audio devices from DC or storage batteries. Used by broadcast studios, program producers, executives, salesmen and other "field workers".

### DUO-VOLT GENEMOTORS



The preferred power supply for 2-way mobile radio installations. Operates from either 6 or 12-volt batteries. Carter Genemotors are standard equipment in leading makes of auto, aircraft, railroad, utility and marine communications.

### CHANGE-A-VOLT DYNAMOTORS



Operates 6-volt mobile radio sets from 12-volt automobile batteries . . . also from 24, 32 and 64-volt battery power. One of many Carter Dynamotor models. Made by the world's largest, exclusive manufacturer of rotary power supplies.

### BE SAFE . . . BE SURE . . . BE SATISFIED



AC can be produced by reversing the flow of DC, like throwing a switch 120 times a second. But **ROTARY** converters actually generate AC voltage from an alternator, same as utility stations. That is why **ROTARY** power is such clean AC, so dependable . . . essential for hash-free operation of recorders from DC power.

**MAIL COUPON** for illustrated bulletin with complete mechanical and electrical specifications and performance charts. Carter Motor Co., Chicago 47.

CARTER MOTOR CO.  
2646 N. Maplewood Ave.  
Chicago 47, Illinois



Please send illustrated literature containing complete information on  Carter "Custom" Converters and  Dynamotor Power Supplies

NAME .....

Address .....

City ..... State .....

eps sources are available. They can be utilized in conjunction with magnetic amplifiers where higher carrier frequencies are necessary to meet system requirements.

**Transformer Catalogs.** Triad Transformer Corp., 4055 Redwood Ave., Venice, Calif., has recently released general catalog TR-55 and guide TV-155. Catalog TR-55 lists 685 items, 79 of which are new to the line. Included in the new items are: a series of subminiature audio transformers, available in either hermetically sealed or open frame type; and several additions to the series of high fidelity output transformers, power components and dry disk rectifier transformers. The guide TV-155 lists transformers for tv use, showing Triad items recommended for over 5,800 models of tv receivers.

**Instrument Catalog.** Allen B. DuMont Laboratories, Inc., 760 Bloomfield Ave., Clifton, N. J. The 8-page quick-reference instrument catalog is now available. It covers five new pulse type oscillographs, four new low-frequency oscillographs, and five new accessory items produced within the past 6 months. Illustrations and technical specifications are included.

**Resistor Catalog.** Clarostat Mfg. Co., Inc., Dover, N. H. Catalog No. 55 contains more pages, more items and more listings of resistors, controls and resistance devices than any of the company's previous editions. Notable features are: handy assortments of wire-wound resistors mounted on display cards; fuse-type resistors for the protection of tv components; deposited carbon precision resistors; industrial-type and precision controls designed specifically for laboratory, instrument and other semicritical applications.

**Wiring Catalog.** Columbia Wire & Supply Co., 2850 Irving Park Road, Chicago 18, Ill., has issued its newly enlarged catalog No. 105, featuring a complete line of Permaline products, electrical wire, cord sets, television wire and cable and wire accessories.

let Williams help you apply

**FERRIC OXIDES**

to the manufacture of your

**FERRITES**

You'll be well repaid by getting the facts on a special group of Pure Ferric Oxides, developed by Williams especially for use in the manufacture of ferrites.

Williams Ferric Oxides analyze better than 99% Fe<sub>2</sub>O<sub>3</sub>. They contain a minimum of impurities. They are available in a broad range of particle sizes and shapes. Among them, we're certain you'll find one that's "just right" for your requirements. The proper application of Ferric Oxides to the manufacture of Ferrites is our specialty.

Tell us your requirements . . . we'll gladly send samples for test. Chances are good that our Ferric Oxide "Know How" can save you considerable time and money. Address Dept. 25, C. K. Williams & Co., Easton, Pa.

**WILLIAMS**  
COLORS & PIGMENTS

C. K. WILLIAMS & CO.  
Easton, Pa. • East St. Louis, Ill.  
Emeryville, Cal.

**P.S.** We also produce IRN Magnetic Iron powders for the Electronic Core Industry, the Magnetic Tape Recording Industry and others. Write for complete technical information.

# Beattie

**ELECTRIC CAMERAS**  
For Practically  
Every Industrial Use!

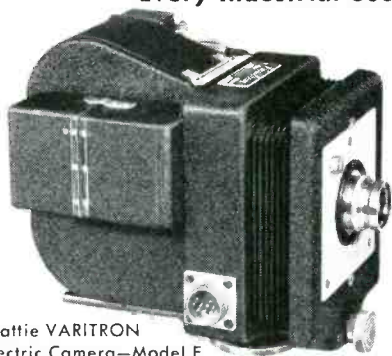

Beattie VARITRON  
Electric Camera—Model E

Data Recording Cameras that save you time... give you a permanent, accurate record. Built to withstand environmental conditions, on land, in the air or at sea. Completely automatic at any time interval. Choice of fifteen models... specially engineered variations can be supplied.

Write for complete detailed literature today

**Photographic Products Inc.**  
1000 NORTH OLIVE STREET  
ANAHEIM, CALIFORNIA

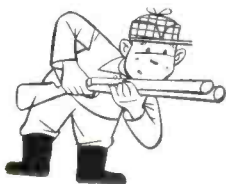

Hunting  
COILS  
For High Temp.  
Application?

## DANO makes them!

For specifications calling for coils to be used for high temperature applications, Dano will supply the exact coils needed.

Dano, makers of a wide variety of coils, is fully equipped to meet the increasing demand for these special coils. Keeping pace with modern design, Dano offers encapsulated coils with tough, molded covers that spell extra electrical insulation with freedom from moisture.

Every Dano Coil is custom-made to your specific requirements. Call or write today, and Dano's quote will be on the way!

- Incapsulated Coils • Form Wound
- Bakelite Bobbin • Cotton Interweave
- Paper Section • Acetate Bobbin
- Coils for High Temperature Applications
- Also, Transformers Made To Order

**The DANO Electric Co.**  
MAIN ST., WINSTED, CONN.

# PHAZOR PHASE METER

Pat. Pend.



MODEL  
200 A

PRICE  
**\$349.50**  
F.O.B.  
NEW YORK

- HIGH ACCURACY
- MEASURES FROM 0 TO 360 DEGREES
- READINGS NOT AFFECTED BY NOISE AND HARMONICS
- PHASE SHIFTS OF THE ORDER OF .01° CAN BE MEASURED EMPLOYING SPECIAL CIRCUIT TECHNIQUES
- MEASURES IN-PHASE AND QUADRATURE COMPONENTS SEPARATELY

For further information contact your nearest representative or write for brochure

**INDUSTRIAL TEST EQUIPMENT CO.**  
55 E. 11th ST. · NEW YORK 3 · GR. 3-4684

Manufacturers of:

- PHASE METERS
- NULL DETECTORS
- IMPEDANCE COMPARATORS
- POWER OSCILLATORS
- VACUUM TUBE VOLTMETERS
- FREQUENCY STANDARDS
- AUTOMATIC HI-POT

Other Electronic  
Test Equipment

# ILSCO CONNECTORS

MAKE  
YOUR  
PRODUCT  
PERFORM  
BETTER

SLU 11 SIZES



# 1000 MCM - # 14

XT 6 SIZES



# 500 MCM - # 14

LO 7 SIZES



# 1000 MCM - # 14

All these... and more... for  
YOUR BEST CONNECTIONS

U/L AND CSA TESTED	HI-RUGGED STRENGTH
PURE COPPER	RE-USABLE
100% CONDUCTIVITY	ALL WIRE SIZES
COOLER OPERATION	ECONOMICAL

WRITE FOR  
80-PAGE CATALOG

**ILSCO CORPORATION**  
5753 Mariemont Ave.  
Cincinnati 27, Ohio

VT 6 SIZES



# 600 MCM - # 14

CAN NEUTRAL



60, 100 & 200 AMPS.

FUSE CLIPS



MANY SIZES AND TYPES

MU 3 SIZES



# 600 MCM - # 6

TERMINAL BLOCKS

# Plants and People

Edited by WILLIAM G. ARNOLD

Western Electronic Show and Convention to open in San Francisco on August 24. Engineers and executives in the industry move to new positions. Manufacturers push plant and facility expansions through acquisitions or new construction

## Western Show And Convention Set For Record Attendance



The officers and committee chairmen of the 1955 WESCON are shown completing plans for the varied program planned for this year's Show and Convention

THE 1955 WESCON (Western Electronic Show and Convention) will open its doors to the nation's electronic engineers and executives this month, Aug. 24-26, in San Francisco at the Civic Auditorium and Fairmont Hotel. On Wednesday, Aug. 24, the show and technical sessions are scheduled concurrently between the hours of 9 am to 6 pm. On Thursday and Friday, Aug. 25, 26, the show's exhibit hours will be 1 pm to 10 pm.

The focal point of the convention is the technical program which will feature 32 sessions of some 160 technical papers highlighting the latest in research and production. The program is published in this issue beginning on page 365.

The special events program of the show will consist of an all-industry cocktail party, on Wednesday evening, Aug. 24, the all-industry luncheon, field trips, a ladies program and an electronics art competition.

Convention headquarters will be the Fairmont hotel atop Nob Hill where all social functions are scheduled. Shuttle bus service is planned between the Civic Auditorium and convention headquarters.

This year there will be 580 exhibits representing more than 650

producers. Attendance is expected to exceed 20,000.

The show is co-sponsored by the West Coast Electronic Manufacturers' Association and the San Francisco and Los Angeles Sections of the Institute of Radio Engineers, representing the Seventh Region.

## Hoffman Elected RETMA President

H. LESLIE HOFFMAN, president of the Hoffman Electronics Corp., of Los Angeles, was elected president of a reorganized board of directors of the Radio-Electronics-Television Manufacturers Association at the conclusion of its 31st annual convention in Chicago.

He will take over the duties performed last year by Max F. Balcom, director-consultant of Sylvania Electric as chairman of the board and Glenn McDaniel, New York attorney, as president. McDaniel will continue as general counsel.

Other officers elected by the



H. Leslie Hoffman

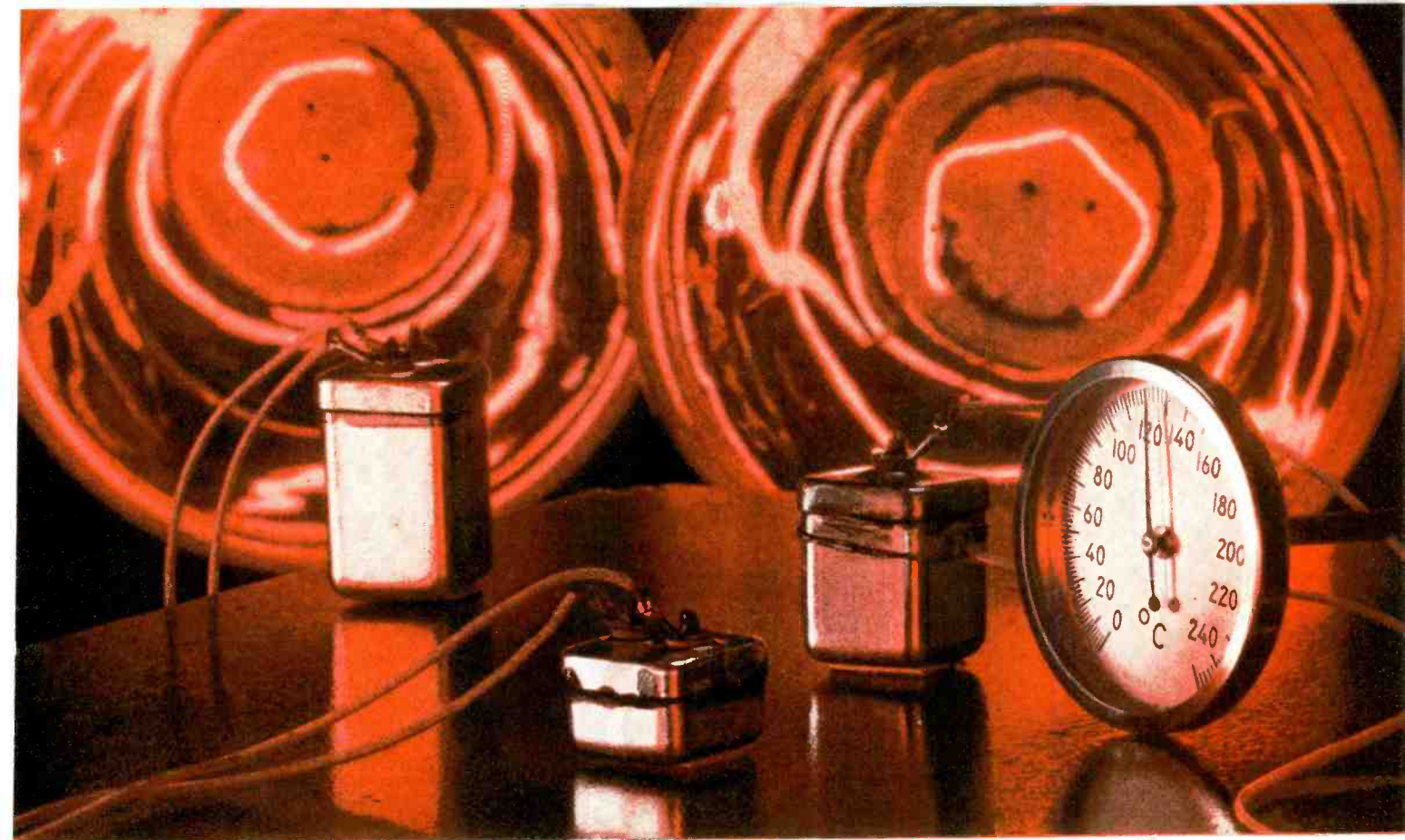

INFRA-RED LAMPS RAISE AMBIENT TEMPERATURE TO +125 C.

# NEW G-E TANTALYTIC\* CAPACITORS OPERATE AT +125°C AMBIENT

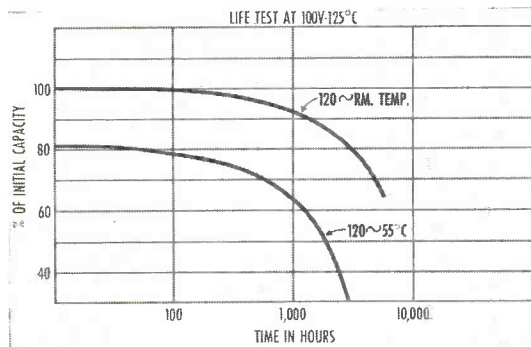

**LONG LIFE** of G-E high temperature Tantalytic capacitors is shown by this graph of life vs loss of capacitance for typical 100 volt d-c unit.

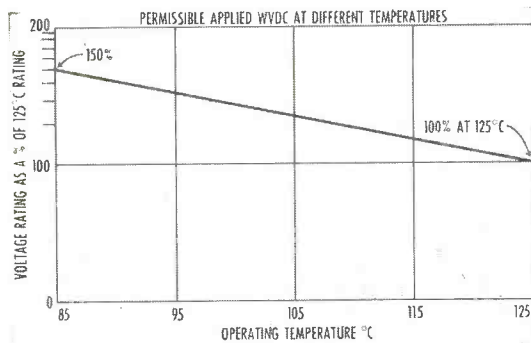

**HIGHER VOLTAGES** than 100 VDC can be applied . . . with no loss of life . . . at ambient temperatures below rated +125 C as shown above.

**Available in ratings from 36 uf at 100 VDC to 180 uf at 30 VDC**

Designed to operate at +125 C for 1000 hours with not more than 20% loss in initial +25 C capacitance, General Electric's new high-temperature Tantalytic capacitors meet the tough requirements of miniaturized military equipment.

**FOIL CONSTRUCTION** assures the same long life, high quality, and stable operating characteristics provided by +85 C Tantalitics. Unlike other types of Tantalytic capacitors, the foil construction also offers:

- Both polar and nonpolar construction.
- Chemically neutral electrolyte . . . minimizes corrosion danger.
- Excellent mechanical stability . . . freedom from electrical noise under shock and vibration.
- Excellent reliability at rated temperatures . . . extended life at temperatures below +125 C.

**AVAILABILITY:** G-E high-temperature Tantalytic capacitors can be obtained now in sample quantities for evaluation and prototype use. Production lots will be available by September in the following standard ratings:

Voltage	uf Case		
	1 3/4" x 3/4" x 1 1/8"	2 3/4" x 3/4" x 7/8"	3 3/4" x 3/4" x 1/2"
30	180	110	55
50	100	60	30
75	60	36	18
100	36	24	12

For more information, see your G-E Apparatus Sales Representative or write for Bulletin GEA-6258, General Electric Company, Section 442-27, Schenectady 5, New York.

\*Reg. trade-mark of General Electric Co.

*Progress Is Our Most Important Product*

**GENERAL  ELECTRIC**

RETMA board include:

Leslie F. Muter, 1955 recipient of RETMA's Medal of Honor and president of the Muter Co., treasurer and chairman of the finance committee; Dr. W. R. G. Baker, vice-president of GE and general manager of its electronics division, as director of the engineering department; Joseph H. Gillies, vice-president in charge of manufactur-

ing of the Philco Corp., as director of the government relations department; James D. Secrest, as executive vice-president and secretary.

In addition to his RETMA activities, Hoffman is a trustee of the University of Southern California and has been California state campaign chairman for the American Cancer Society for the past two years, as well as a member of the

board of directors.

A director of the Los Angeles Chamber of Commerce and chairman of its Electronics Committee, Hoffman is also a director of the California Manufacturers Association, American Red Cross, Norris-Thermador and Clary Corp. He is chairman of Hoffman Laboratories and Television Diablo, Station KOVR in Stockton, Calif.

## General Electric Dedicates Laboratory, Appoints Engineers

GENERAL ELECTRIC dedicated its new microwave laboratory in Palo Alto, Calif. and announced at the ceremony the completion of the first microwave tube developed and built at the new laboratory. Scientists at the lab are shown examining the tube. Also announced was development of a new method of making transistors (Electronics, p 8, July, 1955).

In Syracuse, the firm announced that Harris M. Sullivan has been named manager of the electronics laboratory there. He will be responsible for the technical planning and administrative aspects of the lab.

Dr. Sullivan joined the electronics laboratory in May of this year as supervisor of the dielectric materials unit. Previously, he was vice-president of Central Scientific Co. of Chicago, in charge of research and engineering.

GE also announced that John F.

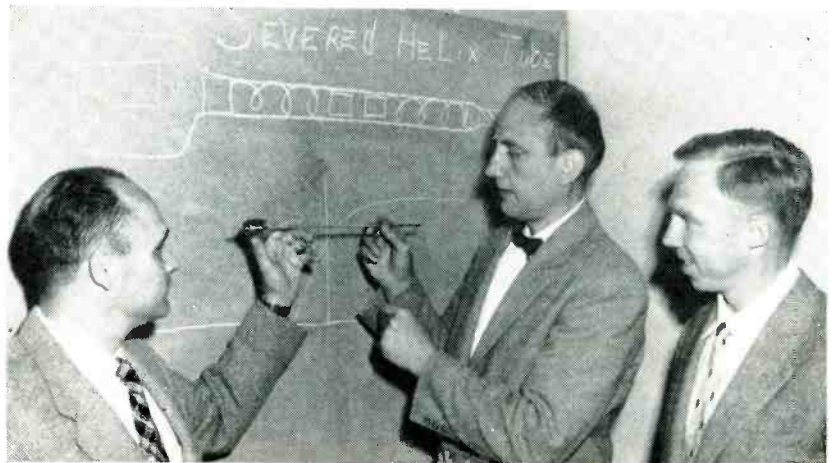

McAllister, Jr., has been named manager of engineering for the radio and television department. He will be responsible for the design and development of all radio and television receivers. He joined GE in 1939. For four years he studied and taught the company's advanced electronic engineering courses. Later, he was assigned to the V-2

rocket project at Schenectady and subsequently at White Sands, New Mexico, where he supervised the installation of electronic equipment.

Since 1951, he has been with the radio and television department, initially as design engineer of receiver components and, in 1953, as manager of product planning, his position prior to promotion.

## Thompson Sets Up \$20 Million For Ramo-Wooldridge

THROUGH PREFERRED stock and long-term revolving credit, up to \$20 million is being made available by Thompson Products to finance the expansion of its affiliate, Ramo-Wooldridge Corp. In less than two years Ramo has grown to an employment level of nearly 1,000, including several hundred scientists and engineers.

While majority ownership and control of Ramo-Wooldridge remains in the hands of its key employees, terms of the new agreement provide Thompson Products with option rights which in the future

could increase its interest in Ramo-Wooldridge to 84 percent.

With 150,000 sq ft of completed laboratory space in Los Angeles, two new buildings under construction and plans drawn for a manufacturing plant in the midwest, Ramo-Wooldridge is moving into commercial and military fields such as automation, electronic computers, guided missiles, transistors and semiconductors, weapon control systems and advanced communications.

"This further cements the close relationship between the two com-

panies," said J. D. Wright, president of Thompson Products. "It is a move designed to broaden the interest and participation of Thompson Products in these highly promising fields."

## Bendix To Expand Radio Facilities

A NEW \$2,000,000 engineering building, devoted to expanded research and development on commercial and military radar and other communications and navigation devices, is being built for the radio



# MISSILE SYSTEMS

## *Research and Development*

Broad interests and exceptional abilities are required of scientists participating in the technology of guided missiles. Physicists and engineers at Lockheed Missile Systems Division are pursuing advanced work in virtually every scientific field.

Below: Missile Systems scientists and engineers discuss future scientific exploration on an advanced systems concept with Vice President and General Manager Elwood R. Quesada. From left to right: Dr. Eric Durand, nuclear physicist, systems research laboratory; Ralph H. Miner (standing), staff division engineer; Dr. Montgomery H. Johnson, director, nuclear research laboratory; Elwood R. Quesada; Dr. Louis N. Ridenour (standing), director, program development; Willis M. Hawkins (standing), chief engineer; Dr. Joseph V. Charyk (standing), director, physics and chemistry research laboratory; Dr. Ernst H. Krause, director, research laboratories.

Western Electronic Show and Convention, San Francisco, August 24-26. Karl E. Zint, C. T. Petrie and senior members of the technical staff will be available for consultation at the convention. For interview phone Exbrook 2-3434 in San Francisco.

*Lockheed*

MISSILE SYSTEMS DIVISION

*research and engineering staff*

LOCKHEED AIRCRAFT CORPORATION • VAN NUYS, CALIFORNIA



... now YOU can buy  
**TRANSFORMERS**

by *Federal*

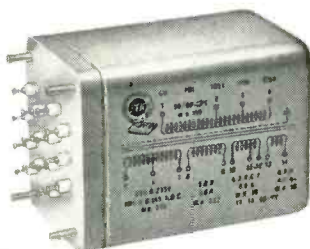

for **COMMERCIAL**  
and **GOVERNMENT** applications!

For years Federal has made many of the iron core components used by divisions of the world-wide IT&T System. Now the engineering, production skill and facilities back of these high-quality, long-life units are available to you... for commercial and government use.

Tell us your needs... we can design and produce to meet the most exacting specifications.

Among the types we manufacture:

- Open frame
- End bell
- Commercial potted
- Encapsulated
- Hermetically sealed
- High temperature
- Miniatures

MIL-T-27 facilities  
ANE-19 compliance  
Complete assembly

Send your requirements to  
Transformer Sales Dept.

**Federal Telephone and Radio Company**

A Division of INTERNATIONAL TELEPHONE AND TELEGRAPH CORPORATION  
COMPONENTS DIVISION • 100 KINGSLAND ROAD • CLIFTON, N. J.

division of Bendix Aviation Corp. The 100,000 sq ft structure is designed to accommodate 500 employees. The two-story modular-type building, to be constructed adjacent to the main radio division plant at Towson, Md., will be completed by July, 1956.

**Bell Labs Promotes Top Engineers**



James B. Fisk



Estill I. Green

JAMES B. FISK, vice-president in charge of research of Bell Telephone Laboratories, has been elected executive vice-president.

In his new post Dr. Fisk will be directly responsible for all technical activities of Bell Laboratories, as well as continuing his present responsibilities in charge of research.

Estill I. Green, director of military communications systems at Bell Laboratories, has been elected vice-president in charge of systems engineering.

At the same time five new general department heads have been named. In the expanded systems engineering area, M. L. Almquist has

**IN-RES-CO**  
**TYPES CX & BX**  
WIRE WOUND  
**RESISTORS**

**FEATHERWEIGHT!**  
—another IN-RES-CO solution  
for CIRCUIT DESIGNERS

**SEALED IN MOLDED BAKELITE PLUS LIGHTWEIGHT**

The dependable resistive elements that combine positive sealing with the important advantage of lightweight. Molded Bakelite core reduces weight by one-half compared to ceramics. Positive seal effectively protects the winding against harmful climatic conditions. Additional IN-RES-CO features include long life stability, hard soldered connections to terminals and extra-sturdy, vibration proof terminal leads. Both CX and BX Resistors include space-saving terminal supported axial terminals of tinned wire.



IN-RES-CO  
TYPE CX  
NON-INDUCTIVE  
RESISTOR



IN-RES-CO  
TYPE BX  
NON-INDUCTIVE  
RESISTOR



ASK FOR THE NEW  
RESISTOR HANDBOOK -  
Contains complete data on  
resistors for every purpose  
and their recommended  
applications. Please  
make request on com-  
pany letterhead.

**INSTRUMENT  
RESISTORS CO.**

COMMERCE AVENUE  UNION NEW JERSEY

APPLICATION-DESIGNED RESISTORS FOR ELECTRONICS AND INSTRUMENTATION

# Aerohm

## Precision wire-wound Potentiometers



"Lo-TORK" POT LT 7/8

For minimum-torque uses in computer, servo, and selsyn service. Stainless-steel precision ball bearings. Maximum torque is 0.01 inch-ounce. Dissipates one watt at 80°C. Resistances—100 to 100,000 ohms. Weight is only 1/2 ounce. Ganging to six decks; internal clamps hold 3/8" diameter. Standard linearity 0.5%; on special order 0.25%; toroidal winding allows winding angles to 360°; standard 354°.

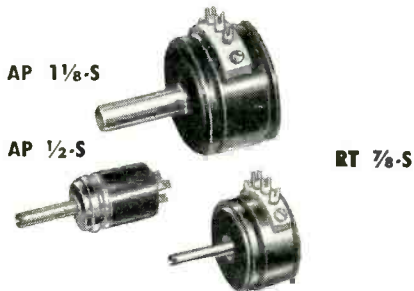

### MICRO-MINIATURE and MINIATURE

**Series AP 1/2-S**—2 watts continuous at 80°C; resistances 10 to 20,000 ohms, 5% tolerance standard; diameter 1/2", depth 5/8", weight 1/4 ounce; sealed well enough for potting.

**Series RT 7/8-S**—3 watts continuous at 80°C; resistances 10 to 100,000 ohms; diameter 7/8", depth 3/8", weight 1/2 oz.; standard linearity 2%.

**Series AP 1 1/8-S**—4 watts continuous at 80°C; resistances 10 to 150,000 ohms; diameter 1 1/8", depth 1/2", wt. less than 3/4 oz.; standard linearity 1%.

All precision-machined, with anodized aluminum bodies, line-reamed phosphor bronze bearings, centerless-ground stainless steel shafts, and gold-plated fork terminals. Fully sealed and fungus-proofed. Can be processed, on special order for use at 125°C. Aerohm potentiometers are individually checked for quality and performance.



Write for copy  
of our new  
catalog.

**WATERS MANUFACTURING, Inc.**  
Waltham 54, Massachusetts

APPLICATION ENGINEERING OFFICES IN PRINCIPAL CITIES

Want more information? Use post card on last page.

ELECTRONICS — August, 1955

PLANTS AND PEOPLE

(continued)

been appointed director of systems engineering I; P. W. Blye has been named director of systems engineering II and F. J. Singer has been named director of systems engineering III.

J. A. Morton has been appointed director of device development under the vice-president in charge of switching and transmission developments and R. R. Hough has been named director of military electronics development II in the area of work for the armed forces.

Dr. Fisk, who joined the Laboratories in 1939, has had a distinguished scientific career, including two years as director of research of the Atomic Energy Commission and simultaneously Gordon McKay Professor of applied physics at Harvard University. He is currently a member of the General Advisory Committee of the Atomic Energy Commission as well as the Science Advisory Committee of the Office of Defense Mobilization.

Green, a veteran of 34 years of service with the Bell System, brings to his new assignment a long record of distinguished engineering experience and achievement, including some 75 patents for his inventions.

He was appointed director of transmission apparatus development in 1948 and in 1953 was named director of military communication systems.

### Westinghouse Builds Semi-Conductor Plant

A NEW WESTINGHOUSE Electric Corporation manufacturing plant, described as "the most highly automatic of any of the company's plants," will be built at Youngwood, Pa., and will employ between 400 and 500 persons by the end of 1956. The multi-million dollar plant is expected to be completed by late 1955. It will be devoted to the manufacture of semi-conductor devices such as transistors, power rectifiers, high frequency detectors and photocells.

The facility will be operated by the company's newly formed semi-conductor department. Manager of the new department and plant will be L. R. Hill.

Other key appointments an-

for  
**PRECISE CONTROL:**  
for  
**AUTOMATIC CONTROL:**  
equip your  
production  
lines with  
**ATOMIC'S**

fast,  
rugged,  
reliable,  
**PRE-SET COUNTER-  
CONTROLLERS**

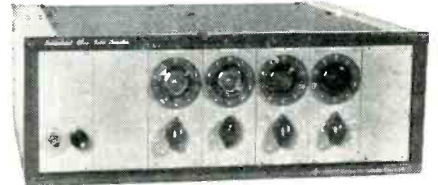

Model 8684

#### features:

- ▶▶▶ Count items, events or units of process flow up to any pre-selected number
- ▶▶▶ Visually display the progress of every count
- ▶▶▶ Provide electrical control of any external function when pre-set count is reached
- ▶▶▶ Handle continuous or random counts
- ▶▶▶ Various counting rates available, up to maximum of 20,000 counts per second, according to model
- ▶▶▶ Available in single or dual pre-set types for control at one or at both of two chosen quantities
- ▶▶▶ Manual or automatic re-cycling

A wide range of models, both pre-set and totalizing, are available through unique unitized design. Models are described in the new Industrial Count and Control Systems Bulletin — write for your copy.

**ATOMIC** INSTRUMENT COMPANY  
CAMBRIDGE 39, MASSACHUSETTS, U. S. A.

Want more information? Use post card on last page.

**You Name It EISLER Makes it...**

**GLASS TO METAL**

**ELECTRONIC GLASS WORKING EQUIPMENT for RADIO, TELEVISION TUBES, INCANDESCENT LAMPS, GLASS LATHES for TELEVISION TUBES**

We make Transformers, Spot and Wire Butt Welders, Wire Cutting Machines and 500 other items. Indispensable in your production. Eisler Engineers are constantly developing New Equipment. If you prefer your own designs, let us build them for you. Write to Charles Eisler who has served The Industry over 34 years.

**IF YOU NEED ANY SPECIAL CAMS WE MAKE THEM**

**INDEXING TURNTABLES**

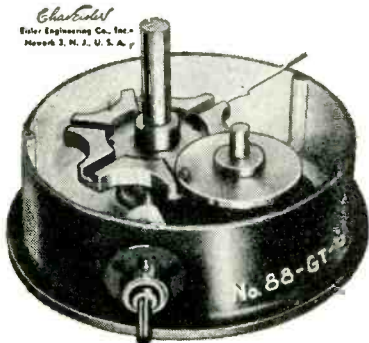

Over  
100  
Different  
Types

Write  
for  
Catalog



CHAS. EISLER JR., PRES.  
**EISLER ENGINEERING CO., INC.**

751 So. 13th St., NEWARK 3, N. J.

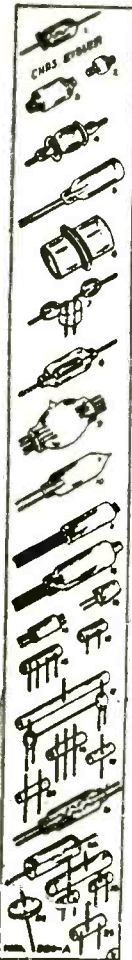

nounced include: Dr. S. J. Angello, manager of engineering; Dr. L. L. Friend, manager of manufacturing; W. L. James, manager of sales and C. H. Hildebrand, purchasing agent.

The new manufacturing facility will be housed in an air-conditioned windowless building one story high and 520 feet long. An adjacent office structure, also air-conditioned, will be two stories tall.

Westinghouse also announced that D. R. Tashjian has been promoted to manager of engineering for the electronics division. He succeeds F. S. Mabry who was named to the newly-created post of engineering consultant to the division manager.

Tashjian, who prior to his present promotion was manager of the division's government engineering department, joined the firm's electronic division in Baltimore in 1941 and has spent his entire career in that division's engineering department which he now heads. Successively his positions have been; design engineer engaged in microwave development, radar design and airborne military communications; 1944, section manager responsible for search radar; 1950, manager of government engineering; 1955, manager of engineering.

Mabry has spent his entire career with Westinghouse, joining the company as a coil winder in 1922. Three years later he went into the then pioneer field of radio engineering and in 1937 became supervisor of that department.

In 1945 he was assigned to the Baltimore division as manager of x-ray engineering. In 1948 he was appointed manager of engineering for the electronics division.

**Du Mont Selects Engineering Director**

RODNEY D. CHIPP has been appointed director of engineering for all manufacturing divisions of Du Mont Laboratories.

Chipp, who has directed engineering for the Du Mont Television Network since 1948, will coordinate the engineering activities of the television receiver division, cathode-ray tube division, communication pro-

**GOLD INLAY KNOBS**  
**IN ANY QUANTITY!**

... and Never a Tool Charge

**NEW Gee-Lar GOLD INLAY KNOBS**

You can get beautiful gold inlay knobs, pointers, instrument controls . . . thousands of styles and varieties . . . in any quantity from GEE-LAR—The House of Knobs. They're available in both knurled and spring types, in either walnut or ivory backgrounds. For faster service and lower cost . . . plus the widest selection . . . get your Gold Inlay Knobs from GEE-LAR!

WRITE TODAY for Gee-Lar Catalog IT'S FREE!



THE HOUSE OF KNOBS

**GEE-LAR MANUFACTURING COMPANY**

821 ELM ST. • Rockford, Illinois



# Couch Rugged



## RELAYS

Specify the COUCH MODEL 2A or 4A relay whenever HIGH SHOCK-HIGH VIBRATION capabilities are required and for DRY-CIRCUIT applications.

**VIBRATION** . . . 5 to 25 cps @ 0.4" peak to peak excursion; 25 to 2000 cps @ 20G acceleration; No contact opening, relay energized or de-energized.

**SHOCK ELECTRICAL** . . . 75G for 10 milliseconds minimum. No contact opening, relay energized or de-energized.

**SHOCK MECHANICAL** . . . 200G minimum . . . no physical damage to relay or change in electrical characteristics.

Models 2A and 4A are subminiature, hermetically sealed, D.C. relays which meet and in several respects exceed the requirements of MIL-R-5757B. They are actuated by a "balanced-armature" rotary motor. Both models are particularly suited to dry-circuit switching applications.

### LEADING PARTICULARS

Ambient Temp.:	-65°C to +125°C
Weight:	3.2 oz. maximum
Height of Case:	1½" maximum
Diameter of Case:	1¾" maximum
Terminals:	Flattened & pierced
Contact	DPDT — Model 2A
Arrangement:	4PDT — Model 4A
Contact Material:	Fine silver to molybdenum
Operation:	Simultaneous operation, simultaneous release, no contact bounce
Pull-in-power (Coil):	¾ watt — Model 2A ½ watt — Model 4A

Test Data and Literature on Request  
**Built-in Dependability**



**NORTH QUINCY 71, MASSACHUSETTS**

Want more information? Use post card on last page.

ELECTRONICS — August, 1955

PLANTS AND PEOPLE

(continued)



Rodney D. Chipp

ducts division, instrument division and government division. He will also serve as liaison between divisional engineering departments and the firm's research laboratories. He will continue to be available to the network for consultation and engineering help.

Chipp has been active in radio and television engineering since 1928. Prior to his association with Du Mont he was radio facilities engineer for ABC and NBC from 1933 to 1941. He has served as consulting engineer to the U.S. Navy, Hazeltine Electronics and a number of broadcasting stations.

### Budd Acquires Continental-Diamond

IN AN ACQUISITION involving a \$9 million stock transaction the Budd Company assumed ownership and management of Continental-Diamond Fibre in July and plans to expand the new division.

Operation of Continental will be carried on by the present working force and management personnel, excepting one or two changes at top executive level. The Continental Diamond Fibre name will be retained.

The division employs a labor force of approximately 2,000 persons. For the present, operations will continue without interruption.

Included in the sale are plants in Newark, Delaware; Bridgeport, Pennsylvania; Valparaiso, Indiana; Spartanburg, South Carolina and subsidiaries in Canada and France. The plant in Marshallton, Delaware and a British subsidiary



**Airflex**  
RIVETERS DIMPLERS  
1/16" diameter  
silver-coated  
terminal board  
pin.

This is typical of the many difficult hand-fed jobs that Airflex® has simplified and made automatic. It can do the same for you as it goes far beyond the limitations of conventional riveting methods.

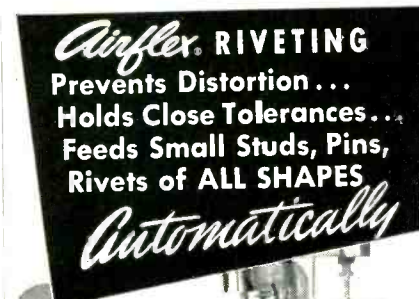

**Airflex RIVETING**  
Prevents Distortion . . .  
Holds Close Tolerances . . .  
Feeds Small Studs, Pins,  
Rivets of ALL SHAPES  
*Automatically*

HOPPER

ESCAPEMENT

TRACK

ANVIL WITH  
LOADING

MECHANISM

**Airflex. DOES IT BY—**

an exclusive, patented principle that combines high frequency blows with spinning action to cold-flow any type of stud, pin, rivet, etc. in any material. Peening tolerances to .002". Rivet capacities of standard automatic machines 1/16" to 1/8", larger capacities special. Also, portable and floor model riveters with capacities up to 5/8" solid steel rivets.

Write for information.

**LEMERT ENGINEERING CO., INC.**  
185 E. JEFFERSON ST., PLYMOUTH, INDIANA

Want more information? Use post card on last page.

  
**GLASS WORKING  
LATHES**

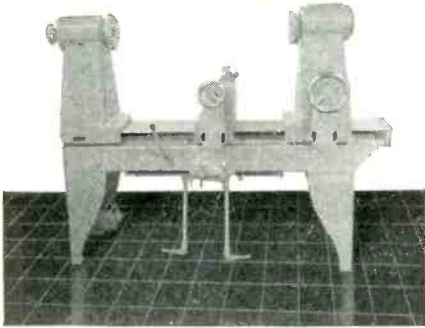

**MODEL ME**

\$3135.00 f.o.b. Grass Valley, Calif.  
Especially useful for handling  
large television Bulbs

**GENERAL SPECIFICATIONS**

Maximum length overall	84"
Maximum width overall	27"
Maximum length, spindle nose to spindle nose	47"
Height, floor to spindle	52 5/8"
Radial clearance above apron	2 1/4"
Spindle hole diameter	3 7/8"
Approximate shipping weight	1800 lbs.
Net weight	1600 lbs.

**STANDARD EQUIPMENT**

- Two face plates
- One collet draw-in bar
- Hand carburetion control
- Foot pedal control of air or nitrogen supply and oxygen-gas volume
- Main air valve controlling air in either or both spindles
- Standard spindle speeds approx. 30-40-60 RPM. (With Adjusto Spede 17 1/2-175 RPM.)
- 1/2 h.p. motor, 220 volt, 3-phase

**DO YOU KNOW?**

- That a first class glassblowing job requires accurate alignment of rotational axes between the headstock and footstock?
- That variable spindle speed gives another dimension to your technique?
- That simple chucking attachments supply versatility for wide varieties of applications?
- That special chucking for your industrial procedures, or laboratory practices are available?
- That Litton jet-mix fires are universally used in glassblowing to prevent reducing conditions?
- That Litton Lathes have been the standard of the vacuum tube industry for 22 years, and have been constantly improved?
- That you can get these precision tools at reasonable cost, in eight sizes, with swing from 8" to 42", and working length from 20" to 75 1/2"?
- Let us send you complete specifications and prices on our line of equipment and tools for the Vacuum Tube industry and for general research and development laboratory use.

3238

  
**Litton Engineering Laboratories**  
Grass Valley, California • P. O. Box 949

Want more information? Use post card on last page.

were not included in the transaction. They will operate under Haveg Industries.

**John Lesser Joins  
Karp Metal Products**

JOHN LESSER, formerly vice-president and general manager of Photo Chemical Products in Santa Monica, Calif., has joined Karp Metal Products in New York as assistant chief executive officer. He will be replaced at Photo Chemical of California by Joseph T. Cain who will assume the title of vice-president and general manager.

**Lavoie Laboratories  
Expands Plants**

LAVOIE LABORATORIES of Morganville, N. J. opened the Lavoie Research Center at Union Beach, N. J. The firm also announced acquisition of Matawan Electronics and Bayshore Electronic Products of Keansburg, N. J.

Stephen D. Lavoie, president, said that the research center will concentrate on the development of new products in the field of radar and communications systems as well as automation, a field which the firm has just entered.

A. M. Schmeling is director of engineering for the firm and Richard J. Griffiths will head up the research center, which is broken down into the following engineering groups:

Kinematics, Dr. Henry G. Giuliani; uhf generation and control, Harry J. Keen; uhf communications, Normand E. Tetreault; automation, John Koch; radar, Charles T. Pierce. Myron Tannenbaum is mechanical staff director.

The acquisition of Matawan and Bayshore will add 42,000 sq ft of space to Lavoie operations. Each of the new plants will continue to operate as separate engineering units with their specialized production of component parts being utilized by Lavoie.

With the new expansion, the firm has a total plant area of approximately 122,000 sq ft and employs about 650 people. In 1942, the company had 500 sq ft of space in a farmhouse and employed 7 people. Its sales in 1942 totaled about

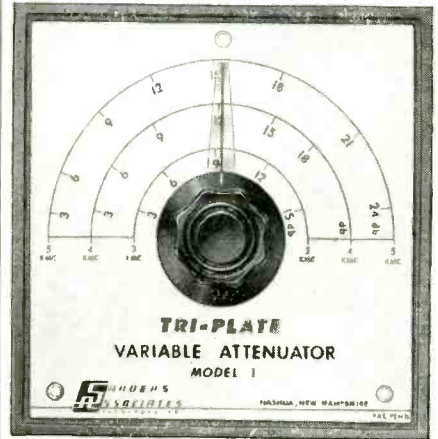
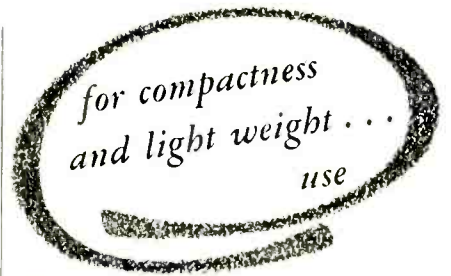

**SANDERS  
TRI-PLATE  
VARIABLE  
ATTENUATOR**

*with a new type of printed  
circuit transmission line  
developed by Sanders Associates, Inc.*

This small, compact attenuator is used in the frequency range of 1000 to 6000 mc. Designed for use with a coaxial cable connection, it has low external leakage and gives broad-band performance.

**Maximum Attenuation** — linear function of frequency (20 db at 4,000 mc)

**Insertion Loss** — less than 1.5 db

**Maximum VSWR** — less than 1.25 at 4,000 mc.

**Characteristic Impedance** — 50 ohms

**Average Power Rating** — 2 watts

**Dimensions** — 5" x 5" x 1/4"

Other Tri-Plate products such as transitions, directional couplers, hybrid rings and special antennae can also be supplied.

Microwave systems will be engineered for conversion to TRI-PLATE and produced to your requirements.

For detailed specifications,  
write to Dept. E

  
**SANDERS  
ASSOCIATES**  
INCORPORATED  
NASHUA, NEW HAMPSHIRE

Want more information? Use post card on last page.

\$200,000. This year, sales are expected to approach \$9 million.

### Condenser Products Names Chief Engineer



HERBERT A. HAWORTH has been named chief engineer for Condenser Products Co., division of New Haven Clock & Watch Co.

Haworth formerly was in charge of research, development and production of plastic film capacitors for Sprague Electric. Prior to that he worked on development of capacitor and transformer dielectrics for GE.

### Sanders Associates Acquire Facilities

SANDERS ASSOCIATES of Nashua, N. H., designers and manufacturers of electronic and hydraulic servo components and systems, have purchased new office and plant facilities totaling almost 500,000 sq. ft of space in Nashua.

The property, which the firm has tenanted for the past several years, was formerly a textile plant.

This acquisition consists of a main, attached brick building and an office building of approximately 325,000 sq ft of space and several near-by brick buildings.

### Curtiss-Wright Purchases Elly

CURTISS-WRIGHT CORP. has purchased the Elly Electronics Corp. in an expansion of its electronics division.

The acquisition includes all of the assets, trade name, patents and



## RHEEM ELECTRONIC EQUIPMENT FOR OUTSTANDING QUALITY

### RHEEM SUBMINIATURE VOLTAGE REGULATOR Model REL-11



Specifications

Size ..... 1-3/4" x 2-5/16" x 4-3/8"  
 Weight ..... 14 ounces  
 Output Voltage ..... Any nominal voltage from 135 to 230 volts, adjustable range  $\pm 10\%$  of the nominal voltage  
 Current ..... Up to 200 milliamperes  
 Ripple Reduction Factor .....  $5 \times 10^{-4}$   
 Output Impedance ..... Will not exceed 2 ohms from 1 cps to 200,000 cps  
 Regulation ..... Within .05% for load variations of  $\pm 25\%$  and input variations of  $\pm 20\%$   
 Minimum DC Input Voltage ..... Equal to 100 volts greater than the regulated output voltage

### AIRBORNE POWER SUPPLY REL-14 (-1, -2, -3)

Special Features  
 \*Size 7" x 7" x 5"  
 Weight 14 lbs.  
 \*REL-14-2 and REL-14-3 have slightly larger dimensions.

ELECTRICAL CHARACTERISTICS

	-1	-2	-3
<b>Regulated output</b>			
Voltage	150 V DC	150 V DC	150 V DC
Current	150 ma	250 ma	300 ma
Ripple	5 MV rms	5 MV rms	5 MV rms
Impedance	2 ohms	2 ohms	2 ohms
Regulation	0.5%	0.5%	0.5%
<b>Unregulated output</b>			
Voltage	250 V DC	250 V DC	250 V DC
Current	100 ma	100 ma	200 ma
<b>Power requirement</b>			
Input voltage	27 V DC $\pm 10\%$	27 V DC $\pm 10\%$	27 V DC $\pm 10\%$
Input current	6 amps	10 amps	14 amps

### RHEEM AIRBORNE POWER SUPPLY Model REL-16

Specifications

Input ..... 115 V, 400 cycle, single phase  
 Regulated Output ..... 150 V, dc at 200 ma  
 Regulation ..... Within 0.05% for Load Variations of  $\pm 25\%$  and input variations of  $\pm 20\%$   
 Ripple ..... 5 MVrms  
 Output Impedance ..... Will not exceed 2 ohms from 1 cps to 200,000 cps  
 Size ..... 8-3/4" x 2-5/16" x 3-1/8"  
 Weight ..... 2 lbs., 13 ounces  
 Environmental Operation ..... Meets existing aircraft and missile environmental specifications of vibration, temperature, acceleration, shock and altitude.

### RHEEM Instrumentation Units are:

- ... Designed to operate under the most rigorous environmental conditions and to meet the most exacting specifications required by modern systems.
- ... Designed to fulfill the demands of industries for increased performance from existing instrumentation units.
- ... Designed for compactness, simplicity, and versatility, and for integration into existing systems.
- ... Designed and built with components of the highest quality for lasting accuracy and dependability.

for complete information on these and other units or on specialized electronic design problems, contact:

### RHEEM Manufacturing Company

Government Products Division  
 9236 East Hall Road, Downey, California

You Can Rely on...





**ATR**  
for A. C.  
current  
**ANYWHERE!**

*To Expand Your  
AC Product Sales!*



**STANDARD and HEAVY DUTY  
INVERTERS**

For Inverting D. C. to A. C. . . . Specially  
Designed for operating A. C. Radios,  
Television Sets, Amplifiers, Address  
Systems, and Radio Test Equipment  
from D. C. Voltages in Vehicles,  
Ships, Trains, Planes and  
in D. C. Districts.



**ATR**

- ✓ NEW MODELS
- ✓ NEW DESIGNS
- ✓ NEW LITERATURE

"A" Battery Eliminators,  
DC-AC Inverters, Auto  
Radio Vibrators

*See your jobber or write factory*

**AMERICAN TELEVISION & RADIO CO.**

*Quality Products Since 1931*

SAINT PAUL 1, MINNESOTA—U. S. A.

machine tools of the company. The firm produces precision thermal time delay relays, thermostats and associated products.

J. George Sauer, president of Elly, has joined the electronics division in the position of manager, thermal devices sales, and all employees of the former company have been retained by Curtiss-Wright.

**Remington Rand-Sperry  
Merger Approved**

THE STOCKHOLDERS of both Remington Rand and Sperry Corp. approved the proposed consolidation of the two firms. The consolidated Sperry Rand Corp. commenced business July 1, 1955.

General Douglas MacArthur is named the chairman of the board of the new corporation and James H. Rand, president of Remington Rand is vice-chairman.

The officers of the new corporation are: president and chief executive officer, Harry F. Vickers, president of Sperry; vice-president and secretary, John Sanderson, senior vice-president of Sperry; vice-president and treasurer, Bernard O. Reuther, executive vice-president of Remington Rand.

Combined assets of the new Sperry Rand Corporation total approximately \$484,000,000.

**Clark And McPherson  
Join Linear Equipment**

HARRY R. CLARK, formerly president of Telechrome Manufacturing Corp. of Amityville, N. Y., has joined the Linear Equipment Laboratories at Copiague, N. Y., as vice-president in charge of sales. David L. McPherson, formerly of the Sperry Gyroscope Co., has joined the company as chief engineer.

**Western Electric  
Completes New Plant**

WESTERN ELECTRIC Co. has completed its newest manufacturing facility at Winston-Salem, N. C. Designated the Lexington Road plant of the radio division's North Carolina Works, the plant is now in full operation and will make communications devices for both the

NEMS-CLARKE  
INCORPORATED  
**167 SERIES  
RECEIVERS**

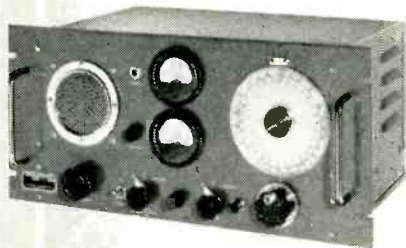

for  
**UNEQUALED  
PERFORMANCE**  
in

- TELEMETERING
- GUIDED-MISSILE MONITORING
- RADIOSONDE RECEPTION

Frequency coverage of 55 to 260 megacycles, AM and FM, without band changing. The 167 series of Special Purpose Receivers are designed for optimum performance in telemetering, guided-missile monitoring, radiosonde reception, television sound rebroadcasting and many other applications calling for superior performance. The superheterodyne circuit assures lowest noise figure possible with an input tube of reasonable cost, ready availability, and reliable performance. Particular care has been exercised to provide for extreme sensitivity and linearity of response, and the 500 ohm impedance of the output circuit permits bridging of many high-impedance devices. Only the finest components are used in their construction. All meters, transformers and chokes are hermetically sealed; all components are operated well within their safe design limits; and the entire assembly is treated to reduce the effect of moisture and fungus. Rigidly inspected and aligned, the Model 167 Receivers reflect the high standards characteristic of the products of this company which for 45 years has been engaged in manufacturing radio-communications equipment and electronic instruments for the rigid requirements of military service.

**NEMS-CLARKE**  
Incorporated

PRECISION  
ELECTRONIC  
INSTRUMENTS

WRITE  
FOR FULL  
SPECIFICATIONS  
DEPT. NO. J

SILVER SPRING  
MARYLAND



Bell Telephone System and the Armed Forces. Located on a 62-acre site on the city's western boundary, the modern facility occupies 625,000 sq ft of floor space and employs 4,000 men and women.

### Consolidated Appoints Transistor Specialist

CONSOLIDATED ENGINEERING CORP. added Richard B. Hurley, a transistor specialist, to its research division as a senior research engineer.

Prior to his present appointment, he spent three years as senior electronics engineer with Convair. Earlier, he was an engineer with Aerojet-General Corp., U. S. Electrical Motors and GE.

He is a part-time lecturer in engineering at the University of California at Los Angeles.

### Dalmo Victor Plans New Plant

DALMO VICTOR Co. of San Carlos, Calif., a wholly-owned subsidiary of Textron American, plans a new \$1.2 million building to bring under one roof all of the electronic firm's present facilities.

The 180,000 sq ft plant will be constructed on 10 acres of land in Belmont, Calif.

The new building is slated for completion next summer and will be ready for occupancy following the 1956 vacation shutdown.

In the span of 33 years, the Dalmo Victor payroll has grown from some 20 employees to approximately 900.

### Webster-Chicago Makes New Moves

TITUS HAFFA, Chicago industrialist, has acquired a substantial block of the stock in Webster-Chicago Corp. held by R. F. Blash, chairman and founder.

This acquisition makes Haffa the largest stockholder in the company.

Haffa owns or controls several Chicago companies, including Dormeyer Corp. and Canfield Manufacturing Co., producers of small kitchen appliances, and Haber

## MANUFACTURERS and FABRICATORS of Printed Circuitry,

Acrylics, Ureas, Fabric and Paper Base Phenolics, Polystyrenes, P.V.C., Fibres, Butyrates and High Pressure Laminates USE and RECOMMEND . . .



# Radialloy-Tipped\* Circular Saw Blades

CHIP-FREE CUTS • CLOSE TOLERANCES • LONG BLADE LIFE

These Super-Finished Blades operate *faster, smoother* and are available for *close tolerance* work, thus eliminating costly trial and error methods. And they *do not vibrate* on "tough sawing" materials. Why? *There's no variation in tooth construction!* They're engineered from the heat-treated shank out as carbide blades—they're not regular saws with carbide tips added!

**RADIAL CUTTER** 839 Bond Street  
MANUFACTURING CORPORATION Elizabeth 4, N. J.

Specialists and Leading Manufacturer of Carbide-Tipped Saw Blades

HERE'S PROOF—  
We'll furnish sample cuts on your materials to illustrate their superior cutting quality.



WRITE for prices and brochure for complete data.

\*Reg. U. S. Pat. Office

# HEAVY DUTY

*Multiple Arm*

## RELAYS by SIGNAL

- Versatile — Rugged
- Cast Aluminum Base
- High Shock and Vibration Resistant
- Available AC — DC
- Contact Capacities Available 10, 35, 50 amp.
- Contact Combinations on Same Base
- Designed to Meet Many MIL Spec's

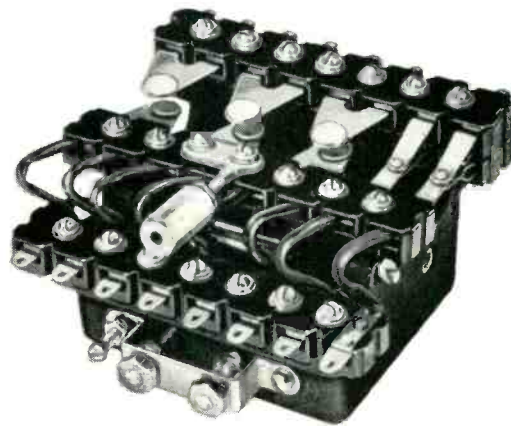

A superior relay that has endured the test of time . . . Specified for many years by America's largest manufacturer of electrical controls and communications equipment.

For complete data, write for Bulletin No. 30-6

Engineering representatives in principal cities

*Wheelock*

**RELAYS  
SIGNAL**  
ENGINEERING & MFG. CO.  
LONG BRANCH, NEW JERSEY

**NEW!**

# Davohm Series 850 Metal Film Resistor

*Perfect compromise between precision wire wound—and composition types*

This new precision film type resistor is hermetically sealed, highly stable, and has a temperature coefficient independent of resistance value. The Davohm Series 850 is available in 1/2, 1 and 2 watt sizes; to tolerances of  $\pm 1.0\%$ ,  $\pm 0.5\%$ ,  $\pm 0.25\%$ ; and, to any desired value.

*Compare these performance figures!*

	MIL-R-10509A ALLOWABLE CHANGE	Series 850 TYPICAL CHANGE
Temperature Cycling	1.0%	0.02%
Low Temperature Exposure	3.0%	0.04%
Short Time Overload	0.5%	0.02%
Effect of Soldering	0.5%	0.02%
Moisture Resistance	5.0%	0.08%
Voltage Coefficient	0.002%	0.00%
Load-Life (per 1000 hours)	1.0%	0.20%
Temperature Coefficient (PPM/°C)	$\pm 500$	$+370 \pm 20$

Write for complete data.

Available Through: THE DAVEN ELECTRONIC SALES CORP.

Associated with:

**THE DAVEN** co. 191 Central Ave.  
Newark 4, N. J.

WORLD'S LARGEST MANUFACTURER OF ATTENUATORS

Corp., manufacturer of components for electronic equipment.

Webster-Chicago also announced that William Brown has been promoted to the newly created post of director of engineering for consumer products.

He has been with Webcor since 1951. He is an acoustic and electronic engineer and has been chiefly engaged in products development. Before joining Webcor he did similar work for Motorola.

## Amperex Appoints New Chief Engineer



PETER JANIS was appointed as chief engineer of Amperex Electronic Corp. He came to Amperex from Sylvania Electric where he was active in the early war development of klystrons, hydrogen thyratrons, magnetrons and photo-sensitive devices. Later, he was put in charge of the microwave and special purpose tube development activities of the product development laboratories, and more recently was heavily involved in the design, development and production of traveling-wave tubes. Prior to his work at Sylvania, he was engaged at RCA in development of special purpose tubes.

## Minnesota Electronics Moves West

MINNESOTA ELECTRONICS Corporation, Librascope subsidiary, has moved its entire operation from St. Paul, Minn. to Burbank, Calif.

Librascope also announced the completion of a new building in Santa Ana, Calif., to house its Mecca division. Commercial prod-

## SHOCK PROOF VACUUM TUBE RETAINERS

These retainers are used to secure Vacuum Tubes and to resist side motion of Vacuum Tubes used in radio equipment which is subject to shock and vibrations. These retainers meet the requirement of all JAN specifications. The insulated portion is made of a melamine base Fibre Glass Phenol which provides 300 volts insulation to ground and withstands a temperature of 350 F. The insulated plate can readily be fastened or released by hand.

Available for envelope types T7, T8, MT8, T9, T12, ST12, T12ZDI, ST14, S14, ST16, T5½, T6½, MT-IC, ST19, T14, ST128CT-9.

*Manufacturers of  
Electronic Components*

# JAMES IPPOLITO & CO., INC.

401 CONCORD AVENUE, BRONX 54, N. Y.

**experience  
pays**

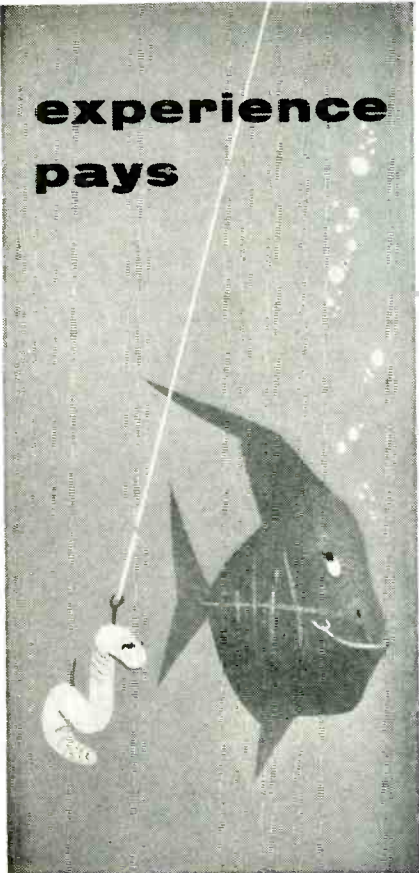

Yes, experience does pay in many ways. Our clients know from experience they have a dependable, responsible source for preparation of better industrial and business literature.

Why not do the job right? It saves time, money and produces results. Let us give you a proposal on your next publication.

We'll do the whole job—from planning to printing—or just those parts that you need.

product literature  
military manuals  
company publications  
training material

Call or write for more information.

**TECHNICAL WRITING SERVICE**  
McGraw-Hill Book Co., Inc. • 330  
West 42nd Street • N. Y. 36, N. Y.

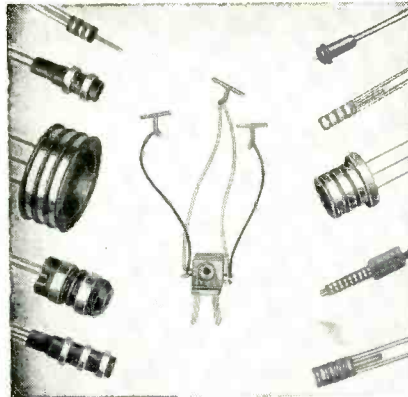

Miniature and Sub-Miniature  
**SLIP RING ASSEMBLIES**  
**BRUSH BLOCK ASSEMBLIES**  
**COMMUTATORS**

and other  
Electro-Mechanical Components

**PRECISION MADE**  
**TO YOUR OWN SPECIFICATIONS**

Precision molded products with exacting tolerances in precious and non-precious solid metals of all alloys. All types of Thermo-Plastic and Thermo-Setting materials.

Slip Ring Assemblies fabricated or one-piece precision molded to your specifications in Nylon, Kel-F, Mineral filled Mellamine, Phenolic, and other materials. Rings and leads spot welded or brazed together for positive electrical circuit.

**Our Swiss methods and techniques are geared to meet exacting requirements. We invite your inquiries.**

**COLLECTRON CORPORATION**

Murray Hill 2-8473 • 216 East 45th Street • New York 17, N. Y.

## Square Wave Generator



**NEW LONDON  
INSTRUMENT**

*Company INC.*

82 Union Street  
New London 1, Conn.

**MODEL 183.** This high-quality precision instrument provides square waves for testing the transient and frequency response of wide band amplifiers, and for accurately measuring their amplitude.

It features an output impedance of 100 ohms at a terminal box at end of 3'-cable; frequency range of 10 cps to 1 mc continuously variable over decade steps; rise time of 0.02 microseconds at the low impedance output.

Write for catalog

**Cunningham**  
ESTABLISHED 1858



**CROSSBAR**

A truly superior switch  
for  
MASTER CONTROL AND  
MONITOR SWITCHING OF  
AUDIO & VIDEO CIRCUITS  
Also

COMPUTERS • TELEMETERING  
TELEPHONY • DELAY LINES  
ETC.

### Advantages

Extreme flexibility  
Fast quiet switching  
Crosstalk down 60 Db at 19 MC  
Any group of setups may be held intact while setting up others  
Provision for spot or remote control  
Strapwiring eliminated  
Excellent HF characteristics  
Palladium contacts  
Reduced cost  
Compact design, small size  
Low operating power—2.5 watts  
Simple "package" installation

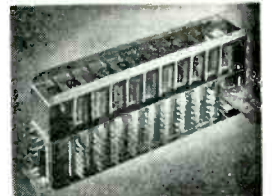

- Individual magnets at each cross-over.
- Maximum, six conductors per circuit
- Life-tested to 100 million operations.

**JAMES CUNNINGHAM, SON & CO., INC.**

33 Litchfield St., Rochester, N. Y.

Tel: Baker 7240

## ENGINEERED

... through  
**EXPERIENCE**  
to Fit Your Needs

Station WOAY-TV is an example of how TOWER'S engineering and experience can solve your unusual tower problems. This 600 ft. tower supports an 83 ft. TV antenna, an FM antenna, an 8 ft. x 12 ft. Microwave Passive Reflector, and serves as an AM radiator. From coast to coast you'll find installations where TOWER'S "know how" has paid off.

## MICROWAVE TOWERS and REFLECTORS

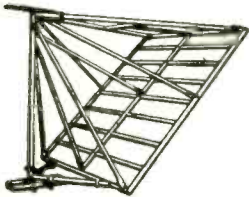

Pioneers in Microwave towers and reflectors, TOWER Microwave Passive Reflectors are used by the U. S. Government, Bell Telephone System and leading manufacturers. For strength, dependability and service . . . you can count on TOWER.

*Tower Fabricators  
And Constructors  
The World Over*

# TOWER

**Construction Co.**  
SIOUX CITY, IOWA

Want more information? Use post card on last page.

PLANTS AND PEOPLE

(continued)

ucts, including a line of automatic food processing machinery, will be manufactured at the new plant.

## Siegler Buys Electronics Firm

THE SIEGLER CORP. of Centralia, Ill. has purchased the entire outstanding stock of the Hallamore Mfg. Co. of Long Beach, Calif.

Hallamore is engaged in the design, manufacture and sale of various electronic devices, used primarily on communication systems and electronic remote control and testing equipment.

The business is being operated by Siegler as a separate division and will be known as Hallamore Electronics Co. Lloyd G. Hallamore, founder of the electronics firm, will continue to head the division.

## Hermetic Seal Appoints Chief Engineer



HERMETIC SEAL Products Co., of Newark, N. J. appointed Philip Sitzer as chief engineer. He will supervise and control all phases of the firm's engineering activity. He joined the company in February, 1950.

From 1936 to 1950, Sitzer was associated with the Tung Sol Lamp Works. He was chief engineer of the flasher division from 1942 to 1950.

## Los Angeles to Survey Parts Needed

THE LOS ANGELES Chamber of Commerce has organized an electronics component development committee.

The committee will conduct a survey to determine the type of

## VHS\* RELAY

(\*Very High Sensitivity)



### Model 266

Sample specs. are:  
0.2 micro-  
amperes, (12,000  
ohms coil) or, 0.1  
millivolts, (5 ohms.)



• The VHS is a balanced armature, Alnico magnet type relay. It is internally shock-mounted and resistant to vibration. The screw-on cover is gasket sealed. It can be opened and resealed. Connections: 9 pin octal style. Dimensions: 1 3/4 diameter x 2 1/4 long. Weight: 4 ounces. Sensitivity: Infinite variations from 0.2 Ua. to 10 Amp. or 0.1 Mv. to 500 volts, self contained. Higher volts or amps with external multipliers. A.C. rectifier types. Trip point accuracies to 1%. Differential 1%. The degree of resistance to shock and vibration primarily depends upon sensitivity and type of action wanted. In general, the relays will not be permanently damaged by shocks of 100 G's and vibrations up to 2,000 cps at 4 G's. The most sensitive relays may close their contacts under these conditions.

Contacts: S P S T or SPDT. 5-25 Ma. D.C. Other ratings to 1/2 Amp. A.C. A locking coil gives high pressure and chatter free contact under shock and vibration. Prices: \$20-\$80.

Delivery 4 to 6 weeks. Assembly Products, Inc., Chesterland 4, Ohio.

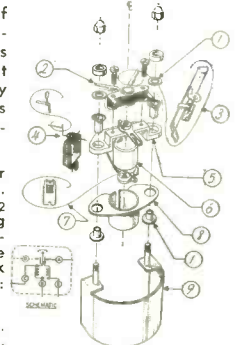

Write for explanation of symbols

BOOTH 416, WESCON SHOW—AUG. 24-26

## MOLYBDENUM

PURE and THORIATED  
TUNGSTEN

For ELECTRONIC APPLICATION

RIBBONS

STRIPS

FORMED PIECES

Your special metals  
rolled to thin sizes  
- close tolerances

## H. CROSS CO.

15 BEEKMAN ST., N. Y. 38, N. Y.  
Worth 2-2044 and Cortlandt 7-0470

Want more information? Use post card on last page.

component manufacturing needed in the Los Angeles area. The study will be used to aid local manufacturers in their expansion programs and as a guide to the Chamber of Commerce in attracting new industry.

Chairman of the new group is Lt. General Harold L. George, senior vice-president of Ramo-Wooldridge, Corp.

### Skeist Elected Vice-President of Polarad

POLARAD ELECTRONICS elected S. Merrill Skeist as vice-president of contracts, and a member of the board of directors. He was formerly vice-president of W. L. Maxson and a member of the board of Langevin Manufacturing Corp. As vice-president he will be in charge of government contract relations and commercial sales.

### Goodyear Expands Electronics Labs

CONSTRUCTION of a new \$3 million engineering and research building in Akron, Ohio has been started for Goodyear Aircraft Corp.

The 400 ft by 125 ft three story building will be used for research and development of new products in the fields of aerophysics and electronics.

It is planned to have the new building ready for occupancy by the summer of 1956.

Currently the company's important products include various types of non-rigid airships for the U. S. Navy; guided missiles; components for numerous military aircraft including wheels and brakes; GEDA analog computers, radar and other electronic devices; plastic items including radomes and canopies; and commercial laminated products.

### Technical Instrument Names Novak

A. J. W. NOVAK has been elected vice-president of Technical Instrument Co. of Houston, Texas, a division of the Clevite Corp. Brush Electronics unit.

Novak moves to TICO from Brush, where he has been general

## compact CRYSTAL TEMPERATURE CONTROL

### with the NEW VALPEY VCO-2 CRYSTAL OVEN

The Valpey type VCO-2 Oven is a very compact temperature controlled housing for two standard mounted crystal units. Oven occupies approximately the space of a single vacuum tube.

The base of the oven contains two 2-pin sockets to receive JAN-HC-6/U, JAN-HC-13/U or Valpey Model VR-6 crystal units, and supports the four watt heater element and its thermostat.

The one-piece, heavy anodized aluminum cover threads onto the base to simplify changing crystals. Base plugs into standard octal socket.

Operating temperature: 75°C ± 1°, from -10°C to +70°C.  
 Operating power: 4 watts, 6.3, 12.6 or 28 volts, AC or DC.  
 (Higher wattage available on special order)  
 Weight: 57.5 grams, exclusive of crystals.  
 Connection brought out for pilot lamp.  
 Isolated crystal connections.

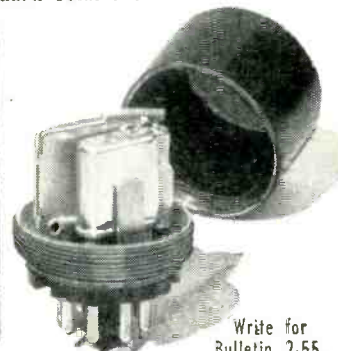

Write for Bulletin 2-55.



**VALPEY** Crystal CORPORATION

1249 Highland Street  
 Holliston, Mass.

Craftsmanship in Crystals since 1931

for service and lab. work

### Heathkit PRINTED CIRCUIT OSCILLOSCOPE KIT FOR COLOR TV!

① Check the outstanding engineering design of this modern printed circuit Scope. Designed for color TV work, ideal for critical Laboratory applications. Frequency response essentially flat from 5 cycles to 5 Mc down only 1½ db at 3.58 Mc (TV color burst sync frequency). Down only 5 db at 5 Mc. New sweep generator 20-500,000 cycles, 5 times the range usually offered. Will sync wave form display up to 5 Mc and better. Printed circuit boards stabilize performance specifications and cut assembly time in half. Formerly available only in costly Lab type Scope. Features horizontal trace expansion for observation of pulse detail — retrace blanking amplifier — voltage regulated power supply — 3 step frequency compensated vertical input — low capacity nylon bushings on panel terminals — plus a host of other fine features. Combines peak performance and fine engineering features with low kit cost!

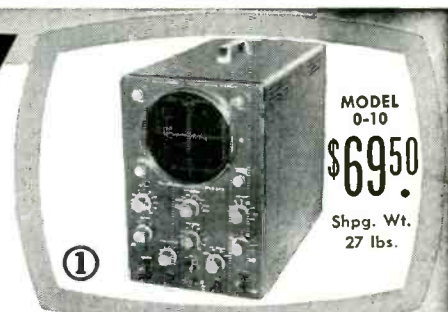

MODEL 0-10  
**\$69.50**  
 Shpg. Wt. 27 lbs.



MODEL TS-4  
**\$49.50**  
 Shpg. Wt. 16 lbs.

### Heathkit TV SWEEP GENERATOR KIT ELECTRONIC SWEEP SYSTEM

② A new Heathkit sweep generator covering all frequencies encountered in TV service work (color or monochrome). FM frequencies too! 4 Mc — 220 Mc on fundamentals, harmonics up to 880 Mc. Smoothly controllable all-electronic sweep system. Nothing mechanical to vibrate or wear out. Crystal controlled 4.5 Mc fixed marker and separate variable marker 19-60 Mc on fundamentals and 57-180 Mc on calibrated harmonics. Plug-in crystal included. Blanking and phasing controls — automatic constant amplitude output circuit — efficient attenuation — maximum RF output well over .1 volt — vastly improved linearity. Easily your best buy in sweep generators.



WRITE FOR FREE CAT  
 ...COMPLETE INFO

*free...*  
**AGF  
BURNER  
CATALOG**

**AVAILABLE NOW!**

The first complete catalog containing technical data on air-gas and oxygen-gas burner equipment is yours for the asking.

Wherever gas burners are used, AGF has been supplying them for 77 years. New Catalog C6A covers:

- Sharp Flame Ribbon Burners
- Fishtail Burners
- Needle Point Glass Fires
- Blowpipes
- Hand Torches
- Mixing Equipment
- Flow Meters
- Fire Checks
- Ball Joints
- Blast Burners
- Oxygen-Hydrogen Burners

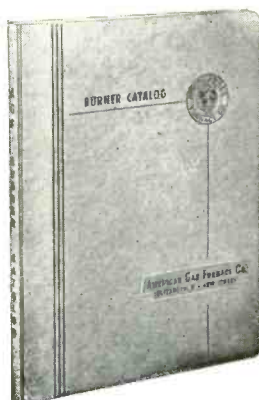

Write for your copy today on your company letterhead.



**AMERICAN GAS FURNACE CO.**  
130 SPRING STREET - ELIZABETH 4, N. J.

**YOKE  
SPECIALISTS**



- Military or special yokes and focus coils designed to your specifications.
- Production yokes for TV sets.

For your answer to yoke problems write Dr. Henry Marcy today.

*syntronic*

**INSTRUMENTS, INC.**

100 Industrial Road • Addison, Ill. • Phone: Terrace 4-6103

sales manager. He joined Brush in 1946 as a magnetic recording production engineer.

**Topp Industries  
Plans New Plant**

TOPP INDUSTRIES of Los Angeles, makers of electronic devices for aircraft, plans to increase its manufacturing facilities by annexing an additional 45,000 sq ft of floor space in an adjoining building. The expansion will be financed by some \$700,000 in new capital, acquired through a public stock issue following a merger with Bonner Machine Works.

The company expects to triple its personnel in the next two years, and anticipates the additional facilities will increase production by 500 percent.

**Electronic Products  
Appoints Biskner**

LYLE J. BISKNER was appointed general manager of Electronics Products Corp. He was manager of customer relations before his promotion.

During the war, he was associated with IT&T and later served as vice-president of engineering with Wells Gardner Co.

Before joining Electronic Products, he was with Sandia Corp. in New Mexico.

**Astron Expands  
Plant Facilities**

ASTRON CORP. of East Newark, N. J. manufacturer of capacitors and filters, is adding 20,000 sq ft of new manufacturing floor space to present production facilities.

**Giannini Names  
Carl Spaulding**

CARL P. SPAULDING has been elected a vice-president of G. M. Giannini & Co. and also appointed general manager of the company's newly formed datex division. Datex manufactures equipment for the conversion of analog data into digital form for use with digital computers.

Spaulding has been with the firm for the past three years and recently

## ALUMINUM DOLLIES



### SCOPE DOLLY MODEL 1

- Convenient Height and Viewing Angle
- Adjustable to Hold Portable Scopes
- Ball Bearing Swivel Rubber Tired Casters
- Lightweight Aluminum Construction
- Recommended by Laboratories Wherever Used

**\$38.50**

FOB Louisville, Ky.

## LAB DOLLY



MODEL A

- 31½" high, 18¾" wide, 27" long.

- 8 Power Outlets with 10 ft. heavy duty extension cord 1500 watts—110 volt A. C.
- Ball Bearing Swivel Rubber Tired Casters
- 2 Shelves for Equipment
- Pan for Test Leads, Notebooks, etc.

**\$49.50**

Price

FOB Louisville, Ky.

**TECHNICAL SERVICE CORP.**  
1404 W. Market St. Louisville 3, Kentucky

## TRANSCONDUCTANCE ANALYZER AND CIRCUIT SIMULATOR

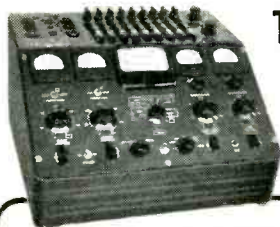

MODEL 901

**NEW LONDON INSTRUMENT**

*Company INC.*

82 Union Street  
New London 1, Conn.

This direct-reading meter measures transconductance under all operating conditions. It has directly calibrated voltage controls and means for connecting components to simulate the circuitry in which a tube will operate. Facilities are provided for measuring both static and dynamic tube characteristics.

Transconductance Range: 0-100, 0-500, 0-1,000, 0-5,000, 0-10,000, 0-50,000 micromhos. Accuracy of measurement:  $\pm 5\%$ .

Write for Catalog

## COILS

### YOKES

Industrial Camera Yokes  
Alignment Yokes  
Image Orthicon Yokes  
Focus Coils Image Orthicon  
Terminal Board Assemblies

Variable R.F.  
Variable I.F.  
Plate Coils  
Oscillator Coils  
Crystal Heater Units

### COIL ASSEMBLIES

Impedance Coils  
Peaking Coils  
R.F. Chokes  
Video Peaking Coils  
Transmitter Coils

**TELE COIL CO., Inc.**

SAMUEL FELDMAN, Pres.  
Camden 5, N. J.

2733 Saunders St.

Phone EMerson 5-7528

which of these  
**CLEANING PROBLEMS**  
are yours?

CHECK\*

- |  |  |
|--|--|
| <input type="checkbox"/> Insulating coatings | <input type="checkbox"/> Radio-active oxides |
| <input type="checkbox"/> Amorphous metal     | <input type="checkbox"/> Dirt                |
| <input type="checkbox"/> Discoloration       | <input type="checkbox"/> Grease              |
| <input type="checkbox"/> Lacquer             | <input type="checkbox"/> Oil                 |
| <input type="checkbox"/> Plastic flash       | <input type="checkbox"/> Rust                |
| <input type="checkbox"/> Rubber flash        | <input type="checkbox"/> Varnish             |
| <input type="checkbox"/> Glass flash         | <input type="checkbox"/> Paint               |
| <input type="checkbox"/> Enamel flash        | <input type="checkbox"/> Plate               |
| <input type="checkbox"/> Imbedded metal      | <input type="checkbox"/> Core sand           |
| <input type="checkbox"/> Lead deposits       | <input type="checkbox"/> Silicate coatings   |
| <input type="checkbox"/> Carbon              | <input type="checkbox"/> Excess solder       |
| <input type="checkbox"/> Brazing flux        | <input type="checkbox"/> Ceramic deposits    |
| <input type="checkbox"/> Weld spatter        | <input type="checkbox"/> Graphite            |
| <input type="checkbox"/> Stains              | <input type="checkbox"/> Slag                |
| <input type="checkbox"/> Heat treat scale    | <input type="checkbox"/> Polishing compound  |

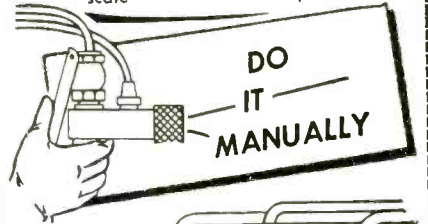

DO IT MANUALLY

OR

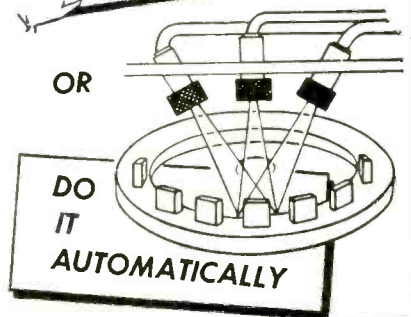

DO IT AUTOMATICALLY

WITH **PRESSURE BLAST WET BLASTING**

TWO SPEED

\* This ad is your coupon. Check off your problem(s) and mail today for free illustrated literature... application data... case history information!

THE **CRO-PLATE COMPANY INC.**

747-A WINDSOR STREET  
HARTFORD 5, CONNECTICUT

# Craig ELECTRONIC SYSTEMS

design • manufacture • installation • servicing

- COMMUNICATIONS SYSTEMS
- NAVIGATION SYSTEMS
- SHELTERS
- TRAILERS
- TRANSIT CASES

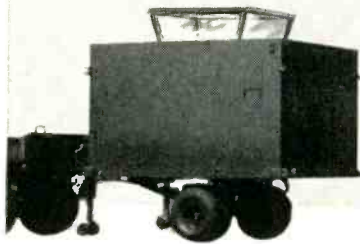

AN/MRN-12  
Air Traffic  
Control  
Central

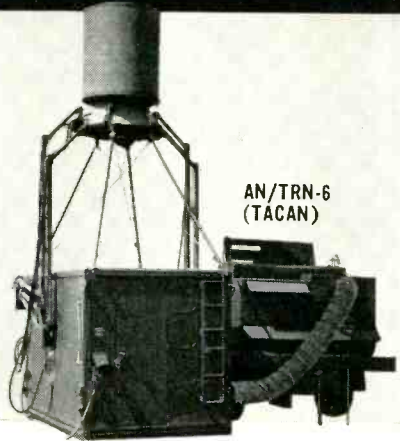

AN/TRN-6  
(TACAN)

BOOTH 1827 - WESCON SHOW

#### other typical Craig installations

- Direction Finder Set AN/TRD-9
- Radio Direction Finder AN/CRD-6
- Air Traffic Control Central AN/MRN-14 (XW-1)
- Radio Receiving Set AN/TRR-7
- Radio Transmitting Set AN/TRT-3
- Radio Set AN/TRC-32
- Radar Set AN/FPN-16

## Craig INC.

Danvers, Mass.

TEL. — DANVERS 1870

## VHF-UHF Noise Source

Long-Lived, Low Cost Tubes  
No Balun Requirements  
No Tuning Required

This simplified noise source operates between 50 and 900 mc. It's fast and accurate, ideal for testing television tuners and receivers in the laboratory and on the production line.

Noise Figure: 0 to 19 db; Accuracy:  $\pm 1$  db max. at 900 mc with equipment having an input impedance of 300 ohms.  $\pm 0.5$  db below 400 mc regardless of input impedance.

Write for Catalog

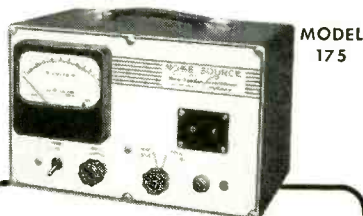

MODEL  
175

### NEW LONDON INSTRUMENT

Company INC.

82 Union Street  
New London 1, Conn.

## Cosmic

CONDENSER SPECIALISTS SINCE 1923  
ELECTROLYTIC & PAPER TUBULAR  
CONDENSERS

For A.C., D.C. Sets - Phonographs etc.

COSMIC CONDENSER CO.  
853 WHITTIER ST., BRONX  
N. Y.

for

performance  
quality  
price

Phone — LU 9-3360



Carl P. Spaulding

was manager of the company's laboratory apparatus division. Prior to coming with Giannini he was staff member of M.I.T.'s Radiation Laboratory and project engineer with Consolidated Engineering Corp.

### New Seal Company Formed

A NEW COMPANY, Silicone Seals, has been formed to engage in the design and production of silicone rubber hermetic terminals.

It has been organized in Chicago by Leonard E. Brown and Robert Shattow, both of whom have experience in engineering, design, production and sales of hermetic terminals.

### Construction Begins On New Honeywell Plant

HEILAND DIVISION of Minneapolis-Honeywell began construction of a new \$1-million manufacturing plant in Denver.

The plant's 45,000 sq ft will house general sales offices and manufacturing facilities. Occupancy is expected in early fall. The division (formerly the Heiland Research Corp. until purchased by M-H last year) produces scientific instruments and photographic products. Approximately 250 persons are employed in the Denver operations.

### Hycon Appoints Electronics Manager

JOHN A. RHOADS has been appointed military and missile electronics



division manager of Hycon Mfg. Co., of Pasadena, Calif. He has been a design engineer on airborne radiotelephone transmitters for the U. S. Navy, supervised the engineering design on airport control tower transmitters and instrument landing systems for the Civil Aeronautics Administration and for the past nine years has been chief engineer and director of engineering for Hoffman Electronics.

## Filtron Opens West Coast Plant



THE FILTRON Co., manufacturers of electronic components, formally opened a new west coast plant in Culver City, Calif. The factory is used for the design and production of radio-frequency interference filters, capacitors, pulse forming networks and delay lines.

Over 10,000 sq ft of floor space will be used for research testing and production.

The company has also purchased 2½ acres of additional property in preparation for further expansion.

## WESCON Sets Technical Program Plans

The technical program of the 1955 WESCON consists of 32 technical sessions and some 160 technical papers. Following is the tentative schedule for the program:

Wednesday Morning, August 24th  
SOLID STATE DEVICES

Transistors Today by J. A. Morton.  
Large Signal Semi-Conductor Devices by John Saby.  
High-Frequency Power Gain of Junction Transistors by R. L. Pritchard.  
Recent Developments in Germanium Alloy Junctions by C. W. Mueller.  
A New High-Ambient Transistor by

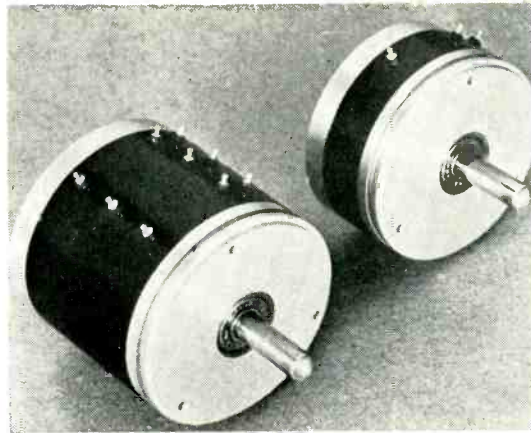

- ★ MINIATURE
- ★ HIGH ACCURACY
- ★ LONG LIFE
- ★ RELIABLE

THE  
ULTIMATE  
IN

## CARBON FILM PRECISION POTENTIOMETERS

- Infinite resolution
- Linearity to 0.05%  
Sine-Cosine conformance to 0.075%
- Compact ganging
- Life in excess of 1 million cycles at speeds as high as 1,000 rpm
- Precision ball bearing servo construction
- Single or ganged units

Prompt delivery of prototype orders and facilities for quantity products are available.

Send for complete details and specifications

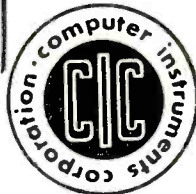

**COMPUTER INSTRUMENTS CORP.**  
1964 UTICA AVE. BROOKLYN 34, NEW YORK

## "INDUSTRIAL"

### SUBMINIATURE AND TRANSISTOR Sockets

Manufactured to RETMA standards for commercial and military applications.

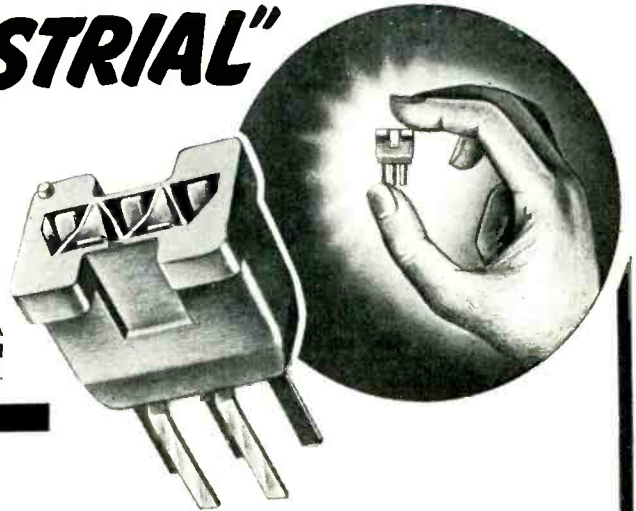

- LAMINATED SOCKETS
- TERMINAL STRIPS
- WIRED ASSEMBLIES
- DUO-DECAL SOCKETS
- ANODE CONNECTORS
- ANTENNA CONNECTORS
- TERMINAL BOARD ASSEMBLIES
- METAL AND BAKELITE STAMPINGS
- PRINTED CIRCUIT SOCKETS
- SUBMINIATURE SOCKETS

INSULATION: Low-loss mica filled phenolic.

CONTACTS: Beryllium copper.

PLATING: Silver coated. Other finishes available.

Novel Chamfer design at the top surface allows easy insertion of delicate tube or transistor leads.  
Generous tail spacing, laterally, provides ample soldering room and greater protection against shorts.  
Can be supplied with retaining rings

Our extensive design and production facilities are available for developing your special requirements and applications. Representatives in principal cities throughout U.S.A.

Precision engineered electronic components and connecting devices for all your needs.

Write for samples and information.



**INDUSTRIAL HARDWARE**  
Manufacturing Company, Inc.  
109 PRINCE ST., NEW YORK 12, N. Y.



**NEW**  
*Allenpoint*  
*Set Screws*

WITH  
**SCIENTIFICALLY-DESIGNED  
SMALLER CUP POINTS**

Smooth, deep point penetration for greater holding power and resistance to vibration; precision formed threads and accurate thread lead for maximum locking action. Comparative tests by leading laboratory prove Allen Set Screws unmatched in performance. Write to Advertising Department for Bulletin C-33A.

When ordering through your local industrial distributor, specify Genuine Allenpoint Set Screws.



**ALLEN**  
MANUFACTURING COMPANY  
Hartford 2, Connecticut, U.S.A.



R. R. Rutherford and J. J. Bowe.

**INFORMATION THEORY**

Limiting Frequency-Modulation Spectra by N. Blachman.

The Definition of a General Metric of Information by N. Abramson.

An Analysis of Optimum Sequential Detectors by J. J. Bussgang and D. Middleton.

Analysis of Automatic Bias Control for Threshold Detectors by E. Ackerlind.

Generating a Gaussian Sample by S. Stein and J. E. Storer.

Proof of the Sampling Theorem for Stationary Processes by A. Rosenbloom and J. Heilfron.

**RELIABILITY AND QUALITY CONTROL**

Engineering and Testing for Reliability by H. G. Romig.

Parts Versus Systems: The Reliability Dilemma, by David A. Hill.

An Effective Reliability Program Based Upon "A Triad for Design Reliability" by F. E. Dreese.

A Basic Study of the Effects of Operating and Environmental Factors on Electron Tube Reliability by W. S. Bowie.

Surface Contamination of Dielectric Materials by Saul Chaikin.

**PROPAGATION**

An Explanation of Fading in Microwave Relay Systems by H. Magnuski.

Some Notes on Propagation over a Spherical Earth by S. J. Fricker.

Radio Power Received via Tropospheric Scatterings by A. Waterman.

Atmospheric Attenuation of Microwave Radiation by G. R. Marner.

Theory of Deviative Absorption in the F<sub>2</sub> Layer and its Relation to Temperature by R. Gallet.

**INDUSTRIAL ELECTRONICS AND NUCLEAR ENGINEERING SYMPOSIUM**

(Program of Invited Papers to be Announced)

Wednesday Afternoon, August 24th

BROADCAST AND TV RECEIVERS  
A Thin Cathode Ray Tube by William R. Aiken.

Beam Focusing and Deflection in the Aiken Tube, by R. Madey.

Radiation Measurements at VHF and UHF, by A. B. Glenn.

An Experimental Automobile Receiver Employing Transistors by L. A. Freedman, T. O. Stanley and D. D. Holmes.

High-Efficiency, Unipotential Post Focus, Tri-Color Picture Tube by Wilfrid F. Niklas.

**CIRCUIT THEORY I TRANSISTORS AND BLOCKING OSCILLATORS**

Advantages of Direct Coupled Transistor Amplifiers by Richard Hurley.

Junction Transistor Blocking Oscillators by J. G. Linville.

The Design of Blocking Oscillators as Fast Pulse Regenerators by F. K. Bowers.

Stability of Multi-Mode Oscillating Systems by R. W. De Grasse.

(Additional paper to be announced.)

**ELECTRONIC INSTRUMENTATION IN AIRCRAFT**

JOINT SYMPOSIUM OF THE PROFESSIONAL GROUP ON AERONAUTICAL AND NAVIGATIONAL ELECTRONICS AND THE INSTITUTE OF AERONAUTICAL SCIENCES

Experiments with Radio Controlled, Dynamically Similar Models by E. G. Stout.

Role of Electronics in Engineering Flight Testing by W. L. Howland.

Instrumentation for Rocket Engine Testing by R. F. Gompertz.

(Additional papers to be announced.)

**ANTENNAS I**

Recent Developments in Microwave Antennas by L. C. Van Atta.

Printed Surface Wave Antennas by H. W. Cooper.

Circularly-Polarized Slot Radiators by A. J. Simmons.

Radiation from Ferrite-Loaded Slot Radiators by D. J. Angelakos and M. Korman.

A Large Aperture Differential Polarization Antenna for Radio Astronomy Use by V. H. Goerke and O. D. Remmler.

**INSTRUMENTATION**

Beamplexer-High Speed Channel Mul-

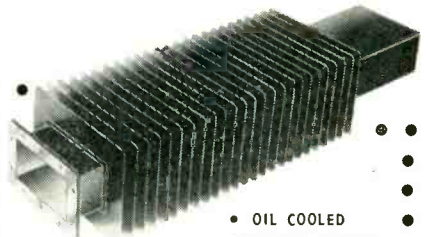

- OIL COOLED
- WATER COOLED
- AIR COOLED

**NEW!**

**High Power  
DUMMY LOADS**

**Waveguide and Coaxial**

**Coaxial Loads:**

up to 10 KW Average Power.

**Waveguide Loads:**

X-Band Loads up to 1000  
Watts Average Power.

S-Band Loads up to 4000  
Watts Average Power.

L-Band Loads up to 6000  
Watts Average Power.

**WRITE FOR NEW CATALOG**

**Electro Impulse Laboratory**

208 River St.

Red Bank, N. J.

Red Bank 6-0404

*For*  
**HIGHEST ELECTRICAL  
& MECHANICAL EFFICIENCY!**  
*New*  
**JONES**

**SERIES 2400  
PLUGS & SOCKETS**

• Improved Socket Contacts—4 individual flexing surfaces. Positive contact over practically their entire length.

• Cadmium plated Plug and Socket, Contacts mounted in recessed pockets, greatly increasing leakage distance, INCREASING VOLTAGE RATING.

• Interchangeable with 400 Series.

Send for complete Catalog No. 20. Plugs, Sockets, Terminal Strips.

See New Developments at the WESCON Show—Booths 712-713



P-2406-CCT



S-2406-SB



**HOWARD B. JONES DIVISION**  
CINCH MANUFACTURING CORPORATION  
CHICAGO 24, ILLINOIS  
SUBSIDIARY OF UNITED-CARR FASTENER CORP.

Want more information? Use post card on last page.

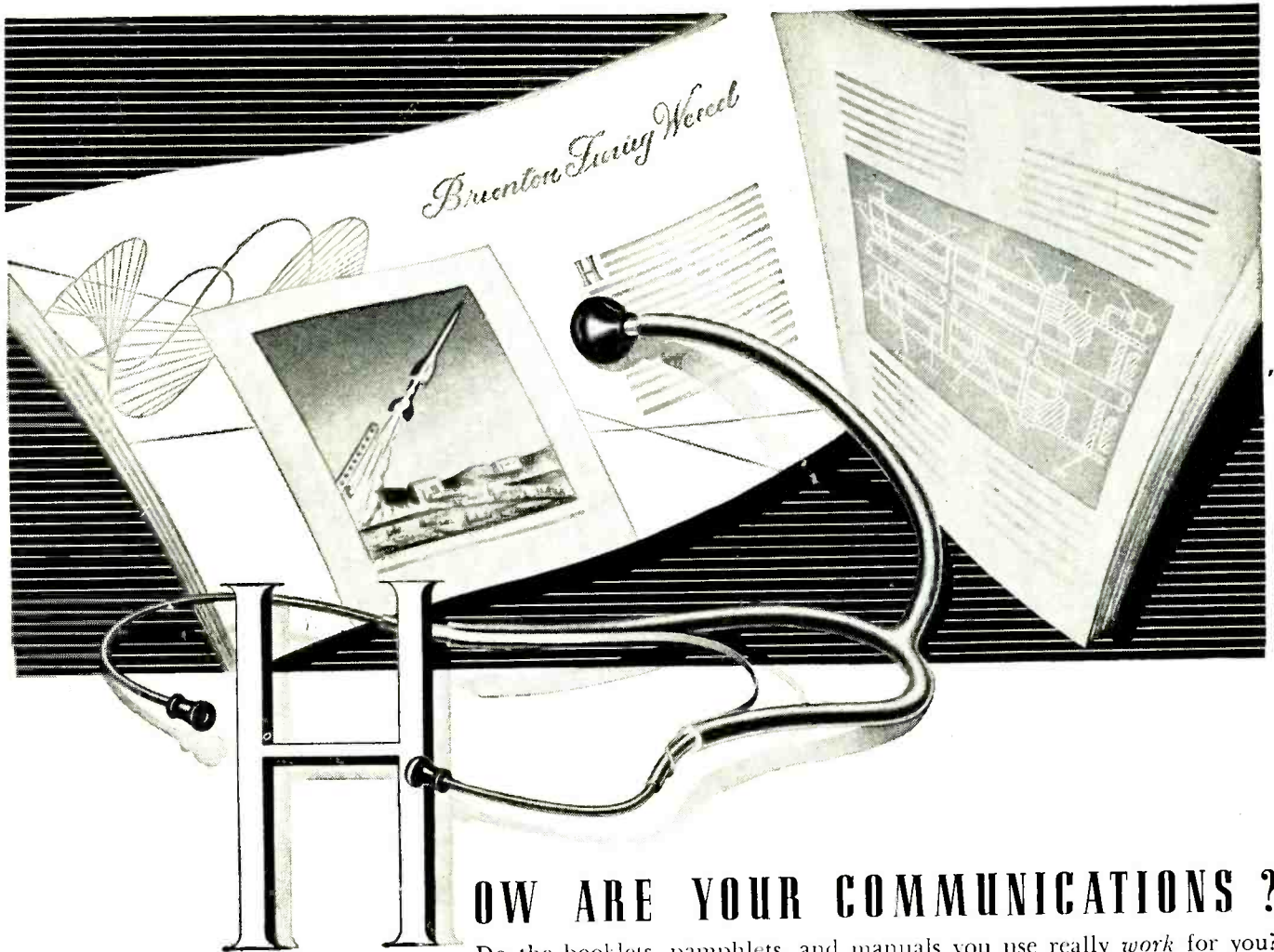

## HOW ARE YOUR COMMUNICATIONS ?

Do the booklets, pamphlets, and manuals you use really *work* for you? Are these vital publications, that tell the story of your products and your company, as effective, readable, well designed and illustrated as they can be? Today more than ever, your entire operation is judged by each annual report, employee manual, and public relations piece that you produce. Have you examined your communications lately? If you have any doubt as to the impact of your instructional and promotional literature, remember . . .

## COMMUNICATION IS OUR BUSINESS

For a good many decades McGraw-Hill has stood for complete coverage in the business literature field. Now the McGraw-Hill TECHNICAL WRITING SERVICE offers a new approach to your publication problems — an *integrated* writing, editing, illustrating, and printing service for the *custom* production of: INSTRUCTION MANUALS, PRODUCT BULLETINS, TRAINING AIDS, INDUSTRIAL RELATIONS LITERATURE, ANNUAL REPORTS, COMPANY HISTORIES, PROCEDURAL GUIDES and other collateral literature. More than 150 editorial and graphic experts are at your disposal, ready to prepare high-quality material to your own or government specifications. Save time, save money . . . and make your communications work! Let *our* staff be your staff for technical and business publications.

## McGraw-Hill Book Co. TECHNICAL WRITING SERVICE

Write or phone Technical Writing Service, McGraw-Hill Book Co., Inc.  
330 West 42nd Street, New York 36, N. Y. • LOngacre 4-3000

*This service is available through ad agencies.*

536K Multimeter Kit \$12.90  
Wired \$14.90  
1000 ohms/volt



425K 5" Scope  
Kit \$44.95  
Wired \$79.95

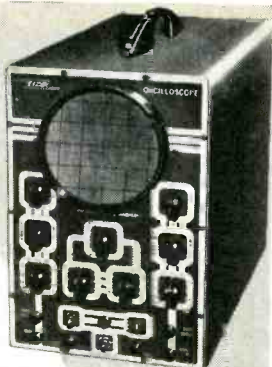

470K 7" Push-Full Scope  
KIT \$79.95 WIRE \$129.50

**YOU BUILD**

**EICO**

**KITS  
IN ONE  
EVENING-**

**but they  
last a lifetime...  
and you  
save 50%**

38 Kits and 42 Instruments —  
the industry's most complete  
line of **MATCHED  
TEST INSTRUMENTS**

1/4-million EICO Instruments are now in use  
the world over! That's the proof  
of EICO's leadership in **Value.**

For latest precision engineering,  
finest components, smart professional  
appearance, lifetime performance  
and rock-bottom economy — see and  
**compare the EICO line at your  
Jobber before you buy any  
higher-priced equipment!** You'll  
agree with over 100,000 others that  
only EICO Kits and Instruments  
give you the industry's greatest  
values at lowest cost.



221K VTVM Kit \$25.95  
Wired \$39.95



505K Multimeter Kit \$24.95  
Wired \$29.95  
20,000 ohms/volt



372K  
Sine & Square-Wave Audio Gen.  
Kit \$31.25. Wired \$49.25

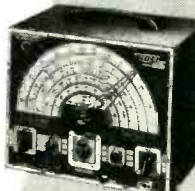

363K Swap Gen.  
Kit \$34.95. Wired \$49.95



1050K Battery Elim.  
Kit \$29.95. Wired \$38.95

625K Tube Tester  
Kit \$34.95  
Wired \$49.95



Write NOW for FREE latest Catalog E-8

**EICO**  
Laboratory Precision at lowest cost

©1954

ELECTRONIC INSTRUMENT CO., Inc.  
84 Withers Street, Brooklyn 11, N. Y.

Want more information? Use post card on last page.

PLANTS AND PEOPLE

(continued)

tiplexing Unit by H. Moss and S. Kuchinsky.  
A Stable Diode Chopper Circuit, by H. Patton.  
A Completely Automatic Impedance Plotter by J. R. Vinding.  
A Broadband Microwave Frequency Meter by P. H. Vartanian and J. L. Melchor.  
An Expanded Scale Frequency Meter by Duane Marshall.  
Measurement of Time Varying Frequencies by Martin Graham.

Thursday Morning, August 25th

ELECTRONIC COMPONENT PARTS

Design and Properties of High Voltage Glass Capacitors by G. P. Smith.  
Characteristics of Modular Electronic Components by W. G. James.  
Simple Electronic Transformer Design by R. Lee.  
Measurement of Parameters Controlling Pulse Front Response of Transformers by P. R. Gillette, K. Oshima and R. M. Rowe  
Development of MIL-T-27-A: Transformers and Reactors by E. M. Wiler.

INTERNATIONAL RESEARCH IN ELECTRONICS AND ALLIED FIELDS SYMPOSIUM I—THE ROLE OF THE IRE AND URSI

(Program to be Announced)

HIGH POWER TUBES

M-Type Backward Wave Oscillators by J. Hull.  
Considerations of Various Structures for High Average Powers in the UHF Region by D. Preist.  
Design Information on Large Signal Traveling-Wave Amplifiers by J. E. Rowe.  
A New Beam Power Tube for UHF Service by W. B. Bennett.  
An Ion Trapped High Voltage Pentode by R. E. Hellers.

AUTOMATIC CONTROL

Non-Linear Compensation of an Aircraft Instrument Servo-mechanism by D. Lebell.  
The Stabilization of Non-Linear Servo-mechanisms Encountered in Antenna Instrumentation by J. Bacon.  
Synthesis of a Non-Linear Control System by I. Flugge-Lotz and C. F. Taylor.  
Theory of Non-Linear Feedback Systems Having a Multiple Number of First-Order Operating Points by J. A. Narud.  
Noise in Non-Linear Servos by G. O. Young and C. J. Savant.

TELEMETRY AND REMOTE CONTROL

Wow and Flutter Compensation in FM Telemetry by W. H. Chester.  
Aliasing Errors in Sampled Data Systems by A. J. Mallinckrodt.  
Air-to-Ground Propagation over Desert Terrain at Telemetering Frequencies by G. L. McCone.  
Pulse Width Data Multiplexing of an FM/FM Subcarrier by A. S. Westnest.  
The Use of A-C Excited Gauges in a PDM/FM Telemetering System by W. F. Carmody.

Thursday Afternoon, August 25th

MICROWAVE THEORY

Periodic Structures for Traveling-Wave Tubes by M. Chodorow.  
Conversion of Maxwell's Equations into Generalized Telegraphist's Equations by S. A. Scheikunoff.  
On the Expansion of Fields in Lossless Microwave Junctions by T. Teichmann.  
Conformal Mapping of Rounded Polygons by a Wave-Filter Analogue by H. A. Wheeler.

BROADCAST TRANSMISSION SYSTEMS

The Perfect Television System by O. H. Schade.  
The Subjective Sharpness of Simulated Color TV Pictures by H. F. Huntsman.  
The Conversion of a Standard TV Mobile Unit for Greater Flexibility and Operating Convenience by H. F. Huntsman.  
High Speed Duplication of Magnetic Tape Recordings by J. M. Leslie.  
Color TV Magnetic Tape Recording System by H. F. Olson.

COMPUTERS I—DIGITAL COMPUTER APPLICATIONS AND DESIGN TECHNIQUES

A Punched Card Method of Evaluating

**CADMIUM  
PHOTOCELLS**

7/16" max Type PC-2

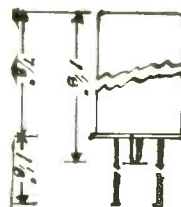

(GLASS)

1/4"

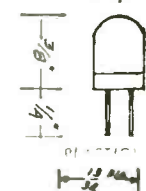

3/16"

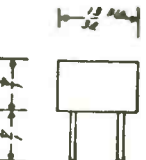

Spectral response in visible and infra-red range. Cell resistances covering a wide range can be supplied. For example, dark resistances of 6 to 8000 megohms down to as low as a few thousand ohms. Different sensitivities can also be supplied over a long range from 10 microamps per lumen to as high as amperes per lumen. Ideal for auto dimmers and the like. Activation from all directions.

Type PC-1

Spectral response in the visible range and X-ray wave lengths, with remarkable response time. Sensitivity comparable with photo-multipliers per unit area. Resistance change is proportional to the light received. Ideal for applications of activating, counting, measuring, etc. End on activation.

Both of these types are extremely sensitive to very low levels of illumination.

**PHOTO-CRYSTALS, INC.**  
15 S. First St. GENEVA, ILL.

**new VIKING  
pressurized  
MINIATURE CONNECTORS**

Note these Viking features:

- FUSED BEAD pressurizing for sealing around contacts
- MS GASKET for panel sealing
- POSITIVE POLARIZATION
- LOCKING DEVICE, simple and fool-proof
- PLATED SHELL... gold over silver
- AUTOMATIC ALIGNMENT



Hex mounting nut  
Lockwasher  
MS Gasket Seal  
Fused Bead Seal

ACTUAL SIZES

Available in 2 shell sizes:  
1-4 CONTACTS AND  
5-9 CONTACTS

**VIKING  
ELECTRIC**

DIVISION OF VIKING INDUSTRIES, INC.  
21343 ROSCOE BLVD., CANOGA PARK, CALIF.

SEE YOU AT THE WESCON SHOW, BOOTH #217, SAN FRANCISCO

Want more information? Use post card on last page.

August, 1955 — ELECTRONICS



**Lean on us for  
HEAT  
TREATING  
SERVICES**

Ultramodern facilities and equipment\*, fast service, unmatched experience, and rigid adherence to specifications make it your best move to lean on us for these services.

Brazing, annealing, and hardening of:

1. Stainless Steels
2. And Now, Tool Steels
3. Up to 5" width strips of stainless steel or high and low carbon steels.

Cycle annealing of Laminations, Silicons, Irons

Phone, write, or wire for information  
Sample processing free



**SARGEANT & Wilbur**  
HEAT TREATING CORP.

170 YORK AVENUE • PAWTUCKET • R. I.

\* U. S. Air Force Certified

**THIS SITE  
WILL ATTRACT  
TOP-FLIGHT  
PERSONNEL**



*NOW* available to Electronic and related industries!

- ✓ 4000 acres for planned industrial development . . . adjacent to double track main line railroad and spur track, U. S. 1 Highway and airport.
- ✓ 5 miles to the "world's most famous beach" and recreational area.
- ✓ More than a location . . . a way of life!

WRITE FOR 58 PAGE FACTUAL ECONOMIC SURVEY.  
**TRAFFIC AND INDUSTRIAL DEPT.**  
CHAMBER OF COMMERCE, DAYTONA BEACH, FLORIDA

DAYTONA BEACH  
RECREATIONAL AREA

HOLLY HILL ORMOND BEACH SOUTH DAYTONA

ELECTRONICS — August, 1955

**MERIT COIL** starts with  
the **FINEST . . . GARFIELD WIRE**

to end with

the **BEST . . . COILS and TRANSFORMERS**

Merit Coil and Transformer Co., of Chicago, is known for precision-engineered coils and transformers. When distributors can't take chances with anything less than the best, they specify MERIT.

And MERIT specifies GARFIELD WIRE every time! They know they can't go wrong with Garfield, whose modern equipment and stringent quality standards produce tolerances closer than NEMA standards.

When you specify Garfield you are SURE of getting UNIFORMITY—and top SERVICE along with QUALITY.

Write for your copy of our specifications chart on bare wire, plain and heavy enamel additions.

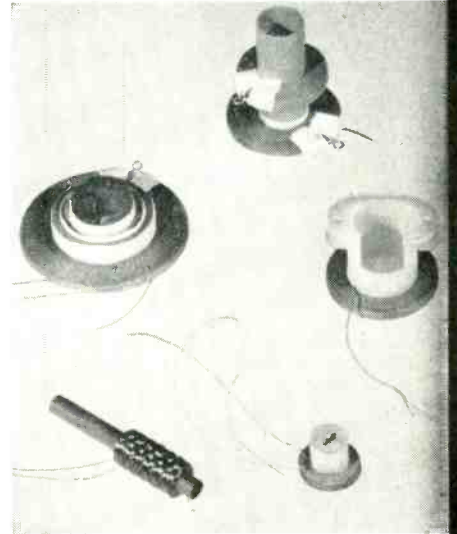

**GARFIELD WIRE DIVISION**

*of The Overlakes Corporation*

142 Monroe St., Garfield, N.J.

GRGregory 2-3661—2

**A 4-POINT PROGRAM FOR TROUBLE-FREE  
TRANSFORMER SERVICE!**

Top quality at competitive prices

①

Complete "in-plant" testing facilities

③

**COMMERCIAL**

**MILITARY**

Immediate delivery of special samples

②

Prompt estimating—rapid service

④

*Let us know your requirements*

**ATLANTIC TRANSFORMER DIVISION**

OF NEW LONDON INSTRUMENT COMPANY, INC.

30 Hynes Ave., Groton 1, Conn.

**RAKEY COIL BOBBINS**



- Design around stock coil forms of injection molded FM-10001 nylon.
- Standard coil forms are available from stock for IMMEDIATE delivery.
- Our unusual facilities also enable us to mold bobbins to your specifications in less than 30 days at a minimum of cost to you.
- Samples of stock forms on request.

**MILMAN ENGINEERING CO.** 957 Lillian Way, Los Angeles 38, Calif. • HO. 95223

Want more information? Use post card on last page.



**\* EPOXY COATED DISC CAPACITORS**

(125 C. Ceramic Bodies)

**\* CERAMIC DISC CAPACITORS**

TEMPERATURE COMPENSATING<sup>1</sup>

A.C. LINE FILTERS

(Conforming to U.L. Specifications)

GENERAL PURPOSE<sup>1</sup>

GENERAL BY-PASS

(Conforming to MIL. C. Specs.)

EXTENDED T.C. SERIES<sup>1</sup>

1. Conforming to RETMA Specifications

ALL ABOVE CERAMIC DISC CAPACITORS MAY BE PHENOLIC COATED, VACUUM SEALED, WAX IMPREGNATED, OR B.T.I. SPECIAL MIX COATED.

**ELECTRONIC DIVISION**

1621 South Maple Ave. Los Angeles 15, Calif.

MAIN OFFICE

**TOOL FABRICATION DIVISION**

14439 S. Avalon Blvd. Gardena, California, Davis 9-4172

"See you at the WESCON show"

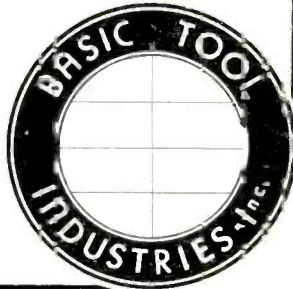

Systems of Boolean Functions with Special Reference to Analysis of Relay Circuits by W. R. Abbott.

The Elecom 50—A New Type of Computer by Eveyln Berezln and Phyllis Hersh.

Logical Design of the Remington Rand High Speed Printer with Emphasis on the Checking and Editing Features by M. Jacoby.

Theory, Principles and Applications of Statistical Computers by H. Blasbalg and W. O'Hare.

A Glow Transfer Shifting Register Utilizing R-F Gas Discharge by D. C. Engelbart.

Ferroelectric Hysteresis in Barium Titanate Single Crystals by H. H. Wieder.

**ENGINEERING MANAGEMENT**

Small Engineering Company Organization—a Philosophy and Method by T. W. Jarmie.

Is the Yardstick for Estimating Individual Engineering and Scientific Potential Reliable? by A. H. Schooley.

Management in Production Engineering by C. Blahna.

Market Development—The Neglected Companion of Product Development by A. D. Ehrenfried.

Cross Functional Engineering Management by C. M. Ryerson.

**AERONAUTICAL AND NAVIGATIONAL ELECTRONICS**

An Improved Simultaneous Phase Comparison Guidance Radar by H. H. Sommer.

Antenna Design Considerations for Helicopters by J. B. Chown.

High Voltage Impulse Generation for Measurement of Receiver Susceptibility to Interference Encountered in Aircraft by A. Newan and J. R. Stahmann.

Experimental Results of Conductive Cooling Tests on Airborne Equipment by R. L. Berner.

Thursday Evening, August 25th

**MEDICAL ELECTRONICS PANEL DISCUSSION**

(Program to be Announced)

Friday Morning, August 26th

**COMPUTERS II—ANALOGUE COMPUTER COMPONENTS AND APPLICATIONS**

Automatic Data Accumulation System for Wind Tunnels by John Wedel.

Data Recorder for Evaluation of a Fire Control System by J. T. Ator and L. P. Retzinger.

Transistors in Current Analog Computing by B. P. Kerfoot.

The Use of Electronic Analog Computers in the Solution of Certain Radar Noise Problems by J. A. Aseltine.

Precision Electronic Switching with Feedback Amplifiers by C. M. Edwards.

**CIRCUIT THEORY II—SYNTHESIS PROBLEMS**

New Methods of Transformerless Driving-Point Impedance Synthesis by Stanley Hurst.

General Synthesis of Quarter-Wave Impedance Transformers with Given Insertion Loss Function by Henry J. Riblet.

The Approximation Problem in the Synthesis of R-C Networks by K. L. Su and B. J. Dasher.

A Precise Method of Designing High-and-Low-Pass R-C Filters with Active Elements by M. McWhorter.

Signal Flow Graphs for Random Signals by W. H. Huggins.

**MEDICAL ELECTRONICS**

Recent Developments in Color-Translating Ultra-Violet Microscopy by R. B. Holt.

Some Theoretical and Practical Aspects of Microscanning by W. E. Tollers, et al.

The Electrocardiophone—A New Surgical Tool by A. J. Morris and J. P. Swanson.

Instrumentation for Spectral Phonocardiography by George N. Webb.

**ELECTRON TUBES**

A UHF Traveling-Wave Amplifier Tube Employing an Electrostatically Focused Hollow Beam by C. B. Crumly.

Design of Solenoids for Traveling-Wave Tubes by J. E. Etter, A. W. Friend and W. Watson.

**Malco** IS YOUR  
**BEST SOURCE**  
for  
**SOLDERING LUGS**  
**SOLDERLESS LUGS**  
**TERMINALS**

● Specialized high production techniques afford lowest possible unit cost.

● Precision tooling, rigid quality control assure tolerances to critical specifications.

● Ample stocks of over 1000 different parts permit prompt delivery.

● Malco specializes in a complete line of small stampings for Radio-TV, electrical/electronic and automotive industries.

Let Malco show you how you can save on production time and costs. Contact us today.



Request handy reference catalog containing specifications on standard and custom-made lugs, terminals, corona rings, pins, contacts and similar stampings.

**Malco** **TOOL and MANUFACTURING CO.**

4023 W. LAKE ST., • CHICAGO 24, ILLINOIS

for that short grid lead

use the Sangamo

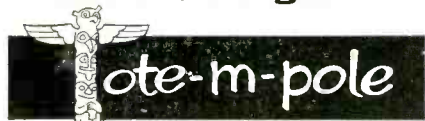

First used in Navy electronic gear, Tote-m-poles are invaluable for "bug-resistant" wiring of models and production units. Advantages: Short leads; high component density; improved ventilation.

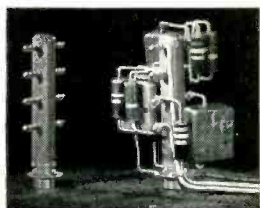

Tote-m-pole supporting "T" network of 5 resistors and 4 capacitors.



Actual Size

CUSTOM COMPONENTS SALES\*  
SANGAMO ELECTRIC COMPANY  
SPRINGFIELD, ILLINOIS

\*H V Power Supplies • Inductive Components  
Servo Instruments • Low-X Resistors

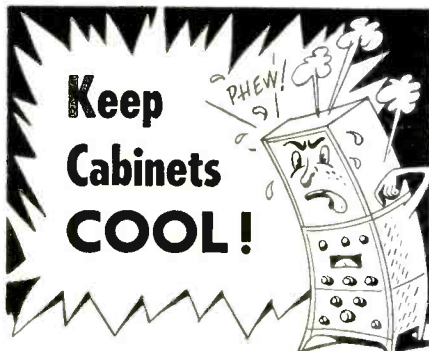

Keep  
Cabinets  
COOL!

### Use McLEAN Electronic Cabinet COOLING FANS

Now for the first time, a rack-mounted, self-contained unit is offered for cooling electronic cabinets. Twin blowers mounted side by side, provide maximum filtered air with minimum panel height. Specially designed to fit standard 19" racks, this unit pressurizes cabinet with filtered air, keeping dust out. Complete in one unit and ready for use. No cutting or fitting necessary. Smart stainless steel grille adds beauty and eliminates matching of cabinet finish. Made in two sizes:

Small Size (7" high x 19" wide with 4 1/4" blower wheels). Delivers 300 CFM.  
Large Size (10 3/4" high x 19" wide with 6" blower wheels). Delivers 600 CFM.  
Send for literature.

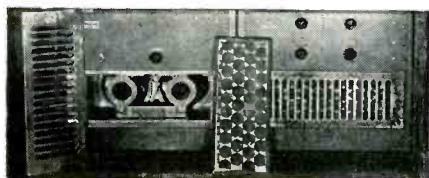

McLEAN ENGINEERING  
PRINCETON, N. J.

Want more information? Use post card on last page.  
ELECTRONICS — August, 1955

## New Books

### Servomechanism Practice

BY WILLIAM R. AHRENDT. McGraw-Hill Book Co., New York, 1954, 349 p., \$7.00.

A BOOK of great value to the engineer and student who is applying the new and ever expanding field of servomechanisms. From the first sentence defining the word servomechanisms to the appendix, it successfully describes and illustrates a part of the family of systems known as feedback control systems as they apply to the positioning of an object. In most cases the engineer and student are familiar with the military and commercial use of servomechanisms in such applications as automatic positioning of guns, radar antennas, gun-fire control, positioning of ships, ship's steering controls, aircraft automatic pilots, computers, remote positioning of valves, the control of machine tools such as contour followers, etc. In this book the author presents to those who are familiar only with the theory of the subject, the opportunity to learn how this theory is applied.

#### Practical Problems

While all automatic feedback control systems are based on a common theory, this book is unique in that it deals with circuitry, electrical and mechanical components and the recent advances in their performance and utilization, plus practical problems encountered in servo design and manufacture.

The prime purpose of the book is to explain in detail the practical aspects of servomechanisms, to describe the many ways in which the essential function of servomechanism components can be accomplished, and to discuss the problems associated with the operation of servos and their components. The author further clarifies this by including many illustrations of actual design procedures used in the servomechanisms described, and their manufacture, a subject related to performance, is treated. Particularly stressed are the departures from idealization of the various components, and more important, what can be done about them to

## H & B 4-channel high-speed PHOTO-TRACE RECORDER

"Lumiscrypt" RLt4



- Instantly visible recording on a special photographic tape which need not be developed.
- Wide selection of measuring systems available with inherent frequencies from 1 up to 570 cps.
- Up to 4 measuring systems can be installed in one instrument.
- Push-button action allowing 3 speeds.
- Sensitive to a speed up to 400" per sec.

Write for literature and prices.

EPIC, inc. 154 Nassau St., N. Y. 38, N. Y.

## ONE SOURCE FOR ALL YOUR METAL HOUSINGS

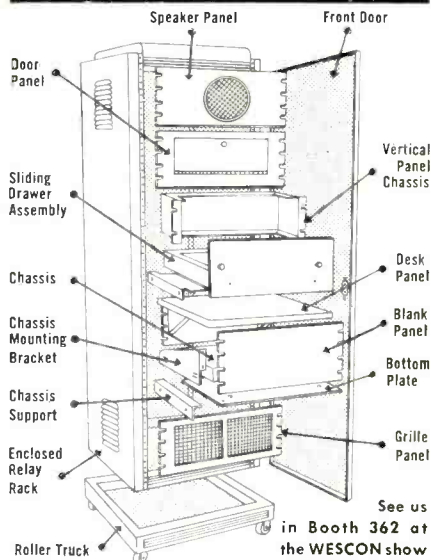

SEND FOR COMPLETE NEW CATALOG

PREMIER METAL PRODUCTS COMPANY  
PRECISION-BUILT METAL HOUSINGS  
3160 WEBSTER AVE., N. Y. 67, N. Y.

Want more information? Use post card on last page.



FOR RELIABLE ASSISTANCE WITH  
SOLDER AND FLUX  
**PROBLEMS**

SEE AN **ALPHA** MAN

a highly trained field SPECIALIST  
ALWAYS available in YOUR  
TERRITORY to give you  
QUALIFIED ASSISTANCE.

**ALPHA METALS, INC.**  
59 Water St., Jersey City, N. J.

**ALPHA** QUALITY CONTROLLED PRODUCTS  
BY SPECIALISTS in Solders, Fluxes, Tin  
& Lead Products FOR OVER 50 YEARS.

offers the facilities of a modern well equipped metallurgical laboratory, competent research staff and trained field specialists to help you solve

**PRINTED  
CIRCUIT  
FLUX or  
SOLDER  
PROBLEMS**

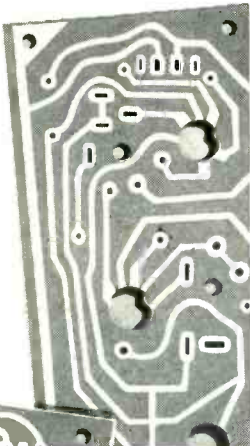

Want more information? Use post card on last page.

NEW BOOKS

(continued)

achieve the limit of their performance.

The book also covers descriptions and detailed design data on all the important servomechanism components, includes many circuit diagrams with component values, and an appendix for those who are interested in reviewing some of the theoretical aspects of the subject either as a background to this book or, for the review of principles as various subjects are discussed or terms are introduced.—WILLIAM KES, *Bethpage, L. I., N. Y.*

### Basic Theory in Electrical Engineering

By R. G. KLOEFFLER AND E. L. SITZ.  
*The Macmillan Co., New York, 1955,*  
134 p., \$5.50.

INTENDED as a text for sophomore electrical engineering students, this book deals with the essentials of electrostatics, electric and magnetic circuits. The final chapter provides an introduction to Maxwell's equations and wave theory.

The book is well illustrated and contains several problems worked out as illustrative examples.

Chapter 5 on conductors, semiconductors and insulators deals with conduction in a vacuum tube and with the flow of electrons and holes in transistors. A point-contact and a *npn* junction unit are used as examples. Also covered are thermistors, metallic rectifiers, gas and ballast tubes.

It is commendable that the authors have chosen to introduce transistors and electron tubes on an equal footing at such an early stage of the students training.—  
J. M. C.

### Elektricitetslara (Fundamentals of Electricity)

By ERIK HALLEN. *Erik Hallén, Stockholm, Sweden, 1953,* 556 p., \$12.00.

THIS BOOK was written by Erik Hallén, professor of theoretical electrical engineering at the Royal Technical Institute, Stockholm, for his classes in electricity and magnetism. It is unusually complete with a coverage of the subject from

DESIGNED AND DEVELOPED  
BY SPECIALISTS FOR  
PRINTED CIRCUIT  
SOLDER OPERATIONS

### VULCAN "EVEN-DIP" SOLDER POTS

- 16 Crucible sizes
- High Fidelity thermostat control — adjustable to 150-600° F.
- Surface Temperatures do not vary beyond  $\pm 2^\circ$  F. Localized Hot Spots completely eliminated.
- Replaceable heavy-duty heating elements.



Send for free  
detailed  
specifications.

**VULCAN ELECTRIC CO.**  
DANVERS 10, MASS.

See 8-page Vulcan catalog in Sweet's  
Product Design File for 1955

### Earn Extra Income in MOBILE-RADIO MAINTENANCE!



It's now a big business  
(650,000 installations) . . .  
fast-growing (70% increase  
just last year) . . . special-  
ized . . . and high-paying!

Learn how to turn this opportunity into cash—write today for free booklet "HOW TO MAKE MONEY IN MOBILE-RADIO MAINTENANCE!" It's published as a service to radio engineers by Lampkin Laboratories, Inc., manufacturers of the well-known 105-B Micrometer Frequency Meter and 205-A FM Modulation Meter.



**LAMPKIN LABORATORIES, INC.**  
Instruments Div., Bradenton, Fla.

At no obligation to me please send "HOW TO MAKE MONEY IN MOBILE-RADIO MAINTENANCE."

Name \_\_\_\_\_  
Address \_\_\_\_\_  
City \_\_\_\_\_ State \_\_\_\_\_

Want more information? Use post card on last page.

August, 1955 — ELECTRONICS



the elementary principles through to applications of Maxwell's equations. Mathematics is the medium in which the subject is developed in a very thorough manner. Vector analysis is used from the outset. The MKSA system of units is employed and both dimensions and units are handled with care and explicitness.

The main topics covered are electrostatics, steady currents, steady magnetic fields of both currents and ferromagnetic materials, induction, steady state alternating currents, and electromagnetic field theory.

*Procedure*

The book raises the reader step-by-step in a systematic manner from the elementary concepts of electricity and magnetism to the more advanced phases of electromagnetic theory. It is well suited as a text or reference book. Professor Hallén is well known for his integral-equation method for the analysis of the cylindrical dipole antenna. In the last part of the book he includes a good discussion of his method. Also included is a short treatment of his reflectionless antenna which is the only non-mathematical section in the book. Unfortunately for most of us the book is in Swedish. However, for those who can read the Swedish language, it is highly recommended as one of the most authoritative and outstanding books ever written on electromagnetic theory. An English edition of the book is planned. —JOHN D. KRAUS, *Ohio State University, Columbus, Ohio.*

**Dielectrics And Waves**

BY A. R. VON HIPPEL. *John Wiley, New York, 1954, 284 p., \$16.00.*

THIS BOOK is a comprehensive survey of dielectric materials and their interaction with waves treated both on a macroscopic basis and on a molecular basis.

*Treatment*

The first part of the book treats the interaction of electromagnetic fields with dielectrics on the basis that certain fundamental parameters can be assigned to dielectric materials without a detailed knowledge of the molecular construction

the pioneer is the leader

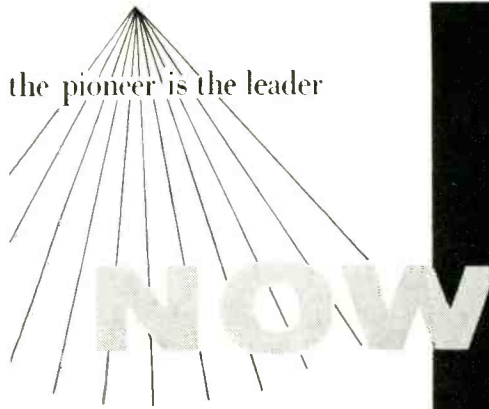

**WAVEFORM ANALYSIS**  
**1 cps to 2000 cps**

with the **NEW PANORAMIC SUB-SONIC ANALYZER**

**MODEL**

**LF-1**

featuring **1/2 cps resolution**

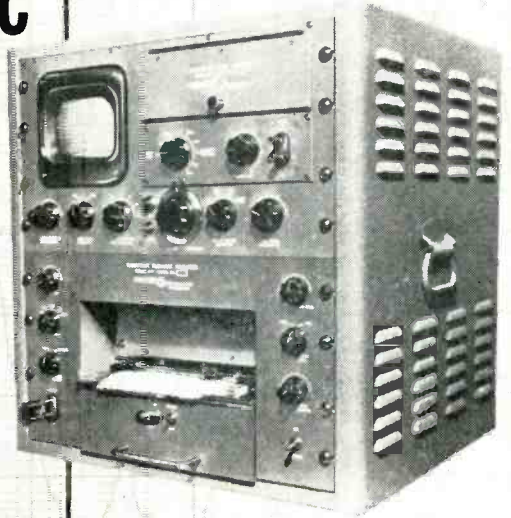

**SUMMARY SPECIFICATIONS:**

Overall Frequency Range: 1 cps—2000 cps.  
Voltage Range: 10 mv to 100 v for full scale linear deflection.  
Voltage Scale: Linear or two decade log.  
Recorder Paper Speed: 4"/min and 16"/min selectable.

**WRITE TODAY** for Complete Specifications.



**FACTS:**

The Model LF-1 Panoramic Sub-sonic Analyzer is designed specifically for applications demanding exceptionally high resolution of waveform components between 1 and 2,000 cps. The LF-1 operates as an adjunct to the widely accepted Panoramic Sonic Analyzer, Model LP-1 which provides detailed magnified views of spectrum segments either 100, 500 or 1500 cps wide anywhere between 20 cps and 20 kc. A calibrated center frequency control permits selection of the mid-frequency of the expanded portion to be examined.

The Panoramic Sub-sonic Analyzer, Model LF-1 features spectral displays which are either 1/10 or 1/100 of the presentation width of the LP-1, that is 10 cps, 50 cps and 150 cps or 1 cps, 5 cps and 15 cps. Scan intervals of 15 seconds or 60 seconds are selectable. Spectral distributions are permanently recorded on paper.

**APPLICATIONS:** • Vibration analysis of large structures or of devices in which members rotate at approximately the same or multiples of the same speed. • Noise analysis. • Medical studies. • Servo analysis. • Geophysical investigations.

**10 South Second Ave.,  
Mount Vernon, New York  
MOUNT VERNON 4-3970**

Made by the makers of Panadaptor, Panalyzer, Panoramic Sonic Analyzer and Panoramic Ultra-sonic Analyzer

**SEE US AT WESCON BOOTH 000**

# DC-AC CHOPPERS

0-500 cycles  
DEPENDABLE



All military specifications met. Liberal factors of safety to meet emergency conditions.

1. Production sampled daily and life tested to check 1,000 hour rating.
2. Every Chopper given not only one but two tests over the full range of military temperatures before shipment.
3. Only gold contacts used for superior operation in the vital 0-1½ volt d-c range.
4. Liberal safety factors to meet emergency conditions.
  - a. 0-500 cps.
  - b. Input voltage  $\pm 30\%$ .

WRITE FOR THESE CATALOGS:  
No. 371, 0-500 CPS.  
No. 370, 60 CPS.

**STEVENS  
ARNOLD**  
INCORPORATED

22 ELKINS STREET  
SOUTH BOSTON 27, MASS.

S/A-11

of these materials. This part of the text essentially covers the whole field of electromagnetic theory, particularly as it pertains to the interaction of fields with dielectric surfaces and boundaries. There is an excellent discussion of the problem of measuring the various properties of dielectrics and their equivalent circuit representation.

### Molecular Phenomenon

The latter part of the book treats the theory of dielectrics on the basis of the microscopic or molecular phenomenon involved. All of the important concepts of physics which have a bearing on the properties of dielectrics are thoroughly discussed in a very readable manner without sacrificing accuracy of treatment.

In this book, dielectrics are not only considered as insulators but also any form of nonmetal including semiconductors, piezoelectric materials and ferromagnetic materials. The phenomena of conduction and breakdown are also treated in considerable detail. The book closes with a series of problems and illustrative examples which are very useful in extending the material treated in the text.

### Broad Scope

Without question, the book under review is the most comprehensive and authoritative treatment of the theory of dielectrics which has appeared to date and is likely to stand as the classic treatment of the subject for some years to come. It is highly recommended to those who have an interest in the basic phenomena relating to dielectrics.—HENRY JASIK, *Consulting Engineer, Mineola, New York.*

### The Physics Of Experimental Method

By H. J. J. BRADDICK. *John Wiley & Sons, Inc., New York, 1954, 404 p., \$7.00.*

THE TYPE of material presented in this book surely should have a place in the curriculum for training research workers. The concept of the book is most commendable. The scope of the problems presented indicates the extensive background of

For consistently high purity...

"LINDE" M.S.C. RARE GASES  
Trade-Mark  
(Mass Spectrometer Controlled)

- Helium
- Argon
- Neon
- Krypton
- Xenon

In radar electronic equipment, nuclear radiation counters, cosmic ray cloud chambers, and thyratrons, where the purest rare gases are demanded, LINDE M.S.C. Grade gases meet the specifications. They are produced under continuous mass spectrometer control to assure you of gases of *known* purity and consistently high quality. LINDE, the world's largest producer of gases from the atmosphere, can meet your individual needs of volume, mixture, and container.

For information on the physical, chemical, and electrical properties of these gases, send for the booklet, "LINDE Rare Gases."



### LINDE AIR PRODUCTS COMPANY

A Division of  
Union Carbide and Carbon Corporation  
30 E. 42nd Street  New York 17, N.Y.

In Canada:  
LINDE AIR PRODUCTS COMPANY, Division  
of Union Carbide Canada Limited, Toronto  
The term "Linde" is a registered trade-mark of Union Carbide and Carbon Corporation.

## Molded BLACK NYLON SCREWS and NUTS



Insulate and fasten without bushings, washers, etc.  
In stock 6-32, 8-32, 10-32

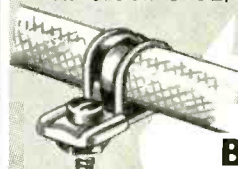

## NyGrip BLACK NYLON Cable Clips

Light-weight non-conducting support for wiring, tubing, etc.  
In stock ¼" to 1½" dia.

Free Samples.. Write  
**WECKESSER CO.**

5267 N. Avondale Avenue • Chicago 30, Illinois

Want more information? Use post card on last page.

August, 1955 — ELECTRONICS

the author, who has had a great deal of experience in experimental research. The author recognizes the difficulties encountered in a host of research areas and is able to offer concrete suggestions and factual material to clarify these difficulties. This broad coverage is desirable and serves to indicate the necessity for a modern-day research worker to have a working knowledge in many fields. However, the consequence of this broad coverage in the book is a lack of a complete treatment of any area. The author's own interests can easily be identified and within these areas the book is considerably more complete.

#### Mathematics

The mathematical tools presented in Chapter II and elsewhere for numerical and statistical analyses are excellent. These are of necessity presented briefly, but the reader is made aware of the existence of the many techniques available. This chapter is aimed toward those with an appreciable acquaintance with statistics since it does not include the elementary and usually most applicable statistics tests.

There is truly a wealth of information in the book which makes it extremely valuable to workers in all branches of engineering as well as physics, chemistry, biology and related fields. Dr. Braddick places special emphasis on the fundamental physical principals of measurement, on a reduction in the number of observations and on the statistical analysis of errors. He also stresses the essential dependence of physical measurement on the properties of various key materials and of their proper use in the construction of apparatus or in the design of instruments.

#### Other Topics

The book includes chapters on Statistics, Mechanical Design, Materials of Construction, Vacuum Techniques, Electrical Measurements, Electronics, Optics and Photography, The Natural Limits of Measurement, and Some Techniques of Nuclear Physics. The book is recommended highly for its coverage on all of these subjects. Of course, it must be recognized



A midwestern electronics manufacturer has cut soldering time a full 60% by changing from cadmium plated to tin-zinc plated parts. As a result they increased assembly production by 250%.

Corrosion-resisting tin-zinc offers many assembly and plating advantages to manufacturers of electronic parts —

**PRODUCTION** — The soldering operation is made easier and considerable assembly time can be saved—parts can be soldered at lower temperatures . . . Embrittlement of fine wire is greatly reduced — solderability is retained longer (*even after 2 years on the shelf tin-zinc plated parts have been soldered without difficulty*) . . . Need for flux is entirely eliminated.

**PLATING** — Tin-zinc plating is economical, easy, and assures a corrosion-resisting finish with good coverage even on difficult metals such as malleable iron.

Tin-zinc plating may solve your production problems, too. For detailed information on the process or technical assistance, write us without obligation.



## METAL & THERMIT CORPORATION

*Chemical & Metals Department*

100 EAST 42nd STREET • NEW YORK 17, N. Y.

# Molded Units Have All-Weather Protection



A Raytheon transformer  
molded with Acme compound

## WITHOUT METAL CASES

For example—

ACME 2002 POTTING COMPOUND is unaffected by climatic changes and assures 100% protection against extremes of temperature ranging from  $-100^{\circ}$  to  $+185^{\circ}$  F.

Developed to withstand elevated and subzero conditions, ACME 2002 forms a hard, moisture-proof seal that will not crack or become brittle when subjected even to sudden changes in temperature. Exterior casings are not necessary.

There are many Acme Compounds for various applications. Let us help you.



Integrated Electrical Products  
of Highest Quality for  
Over Fifty Years

## ACME WIRE CO.

NEW HAVEN, CONN.

MAGNET WIRE • COILS  
VARNISHED INSULATIONS  
INSULATING VARNISHES  
AND COMPOUNDS

Want more information? Use post card on last page.

NEW BOOKS

(continued)

that with a brief work of this nature a considerable amount of supplementary material will be required completely to cover these areas.—JOHN E. BARKLEY, *General Mills, Inc., Minneapolis, Minn.*

### Complex Variable Theory and Transform Calculus— With Technical Applications

By N. W. McLACHLAN, *Cambridge University Press, Cambridge, England, Second edition, 1953, 388 pages, \$10.00.*

DURING use of the first edition this book for several years, as a text for a graduate course in the operational theory of electric circuit analysis, the reviewer became familiar with both its strong and its weak points. Among the principal of these are to be remarked:

1. A concise delineation, in part I, of that portion of complex-variable theory essential to evaluation of inverse transforms through contour integration in the complex plane. This delineation, while generally weak in rigor, was essentially poor in its treatment of the rather elementary Riemann-surface theory essential to integration of multiple-valued functions, which occur in the operational analysis of distributed parameter systems such as transmission-lines and servo-systems incorporating delay lines.
2. A concise account, in part II, of basic aspects of Laplace transform theory: determination of transforms of specified functions, development of certain useful general theorems and inversion of transforms; application of this theory to effect the solutions of lumped-parameter electrical-mechanical systems characterized by ordinary differential equations; and special consideration of the responses of systems excited by step-function, by isolated or repeated pulses and by impulses. While the analysis of part II was satisfactory in general, the particular portion concerned with impulse response was quite meager.
3. Exemplification, in part III, of application of the theory set out in the first two parts through detailed determination of the transient re-

**this is  
important enough  
to read twice!**

Now, for the first time, you can obtain 1, 2, or a dozen prototype high alumina ceramics parts for development work in your own plant . . . at low cost. This new service is available to "custom-make" any small-lot number of ceramic parts to your exacting specifications. Here's an opportunity to "research" high alumina ceramics for new products as well as existing ones, without the barrier of buying production run quantities. Want to know more? Write, outlining your problem. Ask, too, for a copy of our properties chart.

## frenchtown

PORCELAIN COMPANY  
86 Muirhead Avenue • Trenton 9, N.J.

California Representative: Edwin E. Starr, 4101 Rhodes Ave., N. Hollywood, Cal. STanley 7-5879.



## SPADE BOLTS

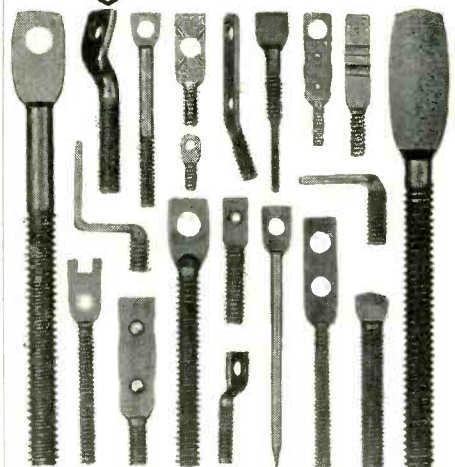

Specialists in designing and manufacturing of all-purpose fasteners and wire forms. Tooled to produce over 1000 styles in any screw size, material, finish, quantity, to your specifications.

Serving Industry for Thirty-five Years  
— OTHER PRODUCTS —

## Simplex

WIRE STRIPPERS & CUTTERS

• TOOLS • DIES • STAMPINGS  
Bulletins on complete line upon request

WENCO MANUFACTURING CO.  
1133 W. Hubbard St., Chicago 22, Ill., U.S.A.

Want more information? Use post card on last page.

August, 1955 — ELECTRONICS





new design possibilities  
new production economy

# GRC

## INJECTION MOLDING TECHNIQUES OFFER WIDE FLEXIBILITY AT IMPORTANT SAVINGS

Gries tiny thermoplastic parts meet simple or intricate specifications precisely uniformly, and economically. We mold all thermoplastics! Nylon, Kel-F, acetates, polystyrene, polyethylene, etc. Quantities of 25,000 to millions.

# SMALL PLASTIC PARTS

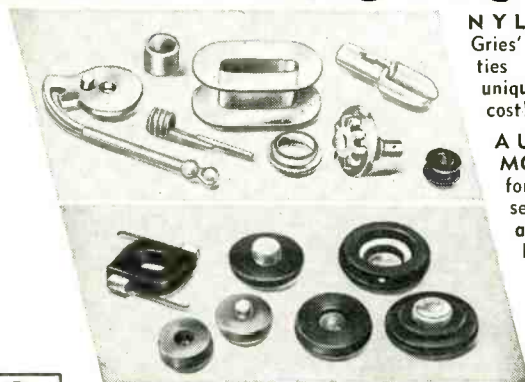

## NYLON A SPECIALTY!

Gries' unique special molding facilities make the most of nylon's unique advantages—at the least cost!

**AUTOMATIC INSERT MOLDING.** Exclusive facilities for individual or continuous inserts; finished parts produced automatically—without manual labor of any kind!

## MAXIMUM SIZE:

.025 oz. 1" long

**NO MINIMUM SIZE!**



Write today for samples and informative bulletins; send prints for quotations.

## GRIES REPRODUCER CORP.

World's Foremost Producer of Small Die Castings

151 Beechwood Ave., New Rochelle, N. Y. • Telephone: New Rochelle 3-8600

**XCELITE Hand Tools**  
PREFERRED BY THE EXPERTS



## IT'S THE NEW "99" JR.

—pocket-size edition of the  
popular XCELITE PR-99

7 nut drivers ( $\frac{1}{8}$ - $\frac{3}{8}$ ), 2 Phillips and 2 slotted screwdrivers with master handle all rolled up in one handy pocket kit—that's the new "99" Jr.! Same fine quality as the big "99" set, but with a smaller handle, same size as our nut driver handles. You'll want to see and own this set that has the tools you need, where you need them! Ask your supplier!

**XCELITE, INCORPORATED**  
Dept. C Orchard Park New York

For Originality  
LOOK TO **XCELITE**

Calculus" by "Transform Calculus".  
2. The treatment, in part I, of basic complex variable theory has—in the author's words—"been rewritten, amplified, and made rigorous enough for all but the pure mathematician, to whom the book is not addressed". Confirmatively the reviewer finds the treatment of basic Riemann-surface theory far more satisfactory than in the first edition.

3. The most conspicuous change in part II is, perhaps, the complete rewrite of chapter X where the treatment of pulse and impulse response has been both clarified and considerably enlarged. Further, new material on a frequency-response analysis, which occupies—for example—a central role in modern filter and servo-system analysis, has been added.

4. Part III has been enlarged through the addition of numerous illustrative examples and, in correction of the shortcoming noted above, the general theory of solution of distributed parameter systems, characterized by partial differential equations, has been reformulated on a sounder basis.

5. Part IV, encompassing the appendixes, has been considerably reworked. In particular, a very useful account of reconvergence of infinite series, much used in the text, has been added.

6. Finally, the number of illustrative examples has been increased; the number and variety of student exercises enlarged; the table of transforms lengthened; and the list of references increased by approximately 25 percent through—largely—inclusion of items published during the last decade or so.

In virtue of these just-mentioned changes, this second edition is—as remarked—an appreciably better text than is the first edition.

—THOMAS J. HIGGINS, *Professor of Electrical Engineering, University of Wisconsin.*

## Thumbnail Reviews

Electronic Business Machines—A New Tool for Management. By Richard W. Appel, Robert B. Carson, Karl G. Heinze, Ray H. Ladendorf, Jacques R.

Masson, Donald Ross and John H. Lindholm, Jr. Electronics Business Machines, 30 Town Way, Winchester, Mass., 1953, 63 p, \$5.00. This book presents a study of developments in electronic business machines and an estimate of their present and future applications to business. Of particular value is the bibliography of 63 articles on the subject of computers which appeared during the years 1949-1952.

**Engineers' Job Directory.** Decision, Inc., Cincinnati, Ohio, 1955, \$2.25. Presents in capsule form information on 129 participating companies including industry, year founded, product, number of employees and whom to contact.

**Standard Samples and Reference Standards Issued by the National Bureau of Standards.** National Bureau of Standards, Government Printing Office, Washington, D. C., 23 p, 25 cents. Descriptive listing of various standard samples issued by the Bureau including a schedule of weights and fees and ordering information.

**Tables of Functions and of Zeros of Functions,** National Bureau of Standards, Government Printing Office, Washington, D. C., 1955, 211 p, \$2.25. Ten tables of specific function including integrals of the Bessel function  $J_0$  and  $Y_0$ , exponential integrals, Struve functions and values of  $x^n/n!$ , and eight tables of zeros of functions.

**MIDAC AND MIDSAC Basic Circuitry.** DeTurk, Garner, Kaufman, Bethel and Hock, University of Michigan Press, 1954, 116 p, \$2.00. The logical, electrical and mechanical specifications of two large-scale computers both of the digital type. Unitized assembly with its advantages from the standpoint of reliability and ease of maintenance is an important part of these machines.

**Lamps for a Brighter America.** Paul W. Keating, McGraw-Hill Book Co., New York, N. Y., 1954, 246 p, \$4.00. A history of the General Electric lamp business with an interesting account of the men, the machines, the methods and the lamps themselves.

**Basic Electricity.** John F. Rider Publisher, Inc., New York, N. Y., 1954, 5 volumes, 608 p, \$9.00. A home study course, without correspondence question-and-answer service, prepared by VanValkenburgh, Nooger & Neville, Inc., for the U.S. Navy and now released for general usage. Exceedingly elementary.

**Deterioration of Materials—Causes and Preventive Techniques.** Edited by Glenn A. Greathouse and Carl J. Wesser, Reinhold Publishing Corp., New York, N. Y., 835 p, 1954, \$12. Prepared under auspices of the National Academy of Sciences and the Department of Defense. A comprehensive analysis of deterioration problems and techniques for material preservation, of value to industry as well as to the military services.

**Television for Radiomen.** Edward M. Noll, the Macmillan Co., New York, revised edition, 1955, 787 p, \$10.00. Text for students; revision chiefly involves adding six chapters on UHF Television, Transistors, Color Television Principles, NTSC Color System, Color Tubes and Color Receiver Circuits, with chapters on color separately numbered as part II of the book.

# "Best"

## VACUO-JUNCTION TUBES

For Thermo-Couple Applications



**STANDARD TYPE**



**U.H.F. TYPE**

**Standard Electrical Types, 1.25 ma to 1,000 ma plus U.H.F. Radio Frequency Types, 5 ma to 1,000 ma plus. Special ranges and outputs made to individual requirements.**

**Insulation:** "Best" Vacuo Junctions are electrically insulated from the heaters, and tested to 100 V., D.C.

**Resistance Tolerances:**  $\pm 10\%$  for heater or thermo-couple.

**Sensitivity Tolerances:** Nominal output all couples, 7 millivolts  $\pm 12\%$ .

**Current Overload:** Current ratings can be exceeded by a 50% overload without damage to the thermo-couple for

continuous running. Heaters withstand transient overloads of 100%.

**General:** All joints are spot welded.

**Temperature Co-Efficient:** Over-all temperature co-efficient does not exceed 0.2% per degree C.

**Dimensions:**  $\frac{3}{8}$ " by  $\frac{3}{8}$ " approx. O. D. "Best" Vacuo Junction Tubes are used by engineering establishments the world over.

For Complete Information and Literature Write the Exclusive Sales Agents,

**BEAM INSTRUMENTS CORP.**

350 FIFTH AVENUE • NEW YORK 1, N. Y.

## HARDWARE FOR ELECTRONICS

ONE SOURCE OF SUPPLY FOR FASTENINGS



We carry in stock thousands of STANDARD and SPECIAL items used in the ELECTRONIC INDUSTRY.

SCREWS—NUTS—WASHERS—TERMINALS—GROMMETS—RIVETS—EYELETS—ACCESSORIES.

SPECIAL Cold Headed Products—Stampings—Screw Machine Parts  
Made to order in all metals.

WRITE FOR CATALOG 54

**FEDERAL SCREW PRODUCTS INC.**

3917 N. KEDZIE AVE. CHICAGO 18, ILL.

For more information circle 124 on inquiry card.

# Broadband Amplifier

- Increases oscilloscope and voltmeter sensitivity
- Amplifies short pulses without objectionable distortion
- Provides high gain—60 db
- Makes ultrasonic delay line measurements

This New London Broadband Amplifier features a maximum gain of approximately 60 db over the entire 15 Kc—50 mc frequency range. Rise time is approximately 0.010 microseconds.

Write for catalog



MODEL 160

**NEW LONDON INSTRUMENT Company INC.**

82 Union Street  
New London 1, Conn.

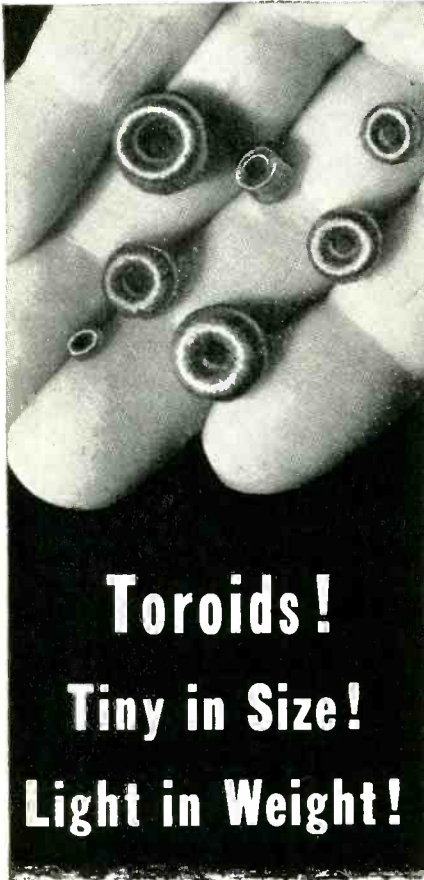

**Toroids!**  
**Tiny in Size!**  
**Light in Weight!**

Envision the potentialities of these bantam coils in solving space and weight problems! Sub-miniature toroids from the BOESCH Model SM reveal a new horizon in equipment design.

Write for detailed information on the NEW Model SM Sub-miniature Toroidal Coil Winding Machine.

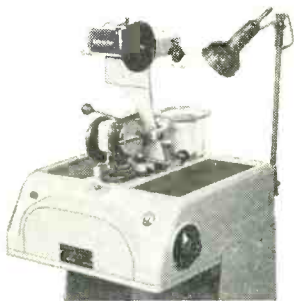

Model SM

Now — no licensing, no royalties required in the sale and use of BOESCH Machines



Want more information? Use post card on last page.

## Backtalk

### About Whistlers

DEAR SIRs:

IN CONNECTION with the item on p 198 of the May, 1955 issue of *ELECTRONICS*, "Observing Whistlers", I would like to call your attention to an interesting bit of history.

Some years ago I had occasion to look up H. Barkhausen's original paper on noises due to the change of magnetization of iron. Your whistler article rang a bell that motivated my checking the library.

In the *Physikalische Zeitschrift*, vol. 20, p 401-03, Sept. 1, 1919 issue there is an article by H. Barkhausen whose title I translate as "Two Phenomena Discovered with the Help of the New Amplifier: Earth Whistles and Noises due to Change of Magnetization of Iron".\*

The magnetization noise now bears Barkhausen's name. The earth whistles seemed, until recently, to have been forgotten.

He tells how the earth whistles were observed during the war when amplifiers were used to pick up telephone conversations by ground currents. The operators of this listening gear said it was "shells flying". Barkhausen suspected the signals to be natural geophysical phenomena. He reported observing them on land and sea.

\*Zwei mit Hilfe der neuen Verstärker entdeckte Erscheinungen.

1. Geräusche beim Ummagnetisieren von Eisen.
2. Pfeiftöne aus der Erde.

FRANK C. ALEXANDER, JR.  
*Gulf Research & Development Company*  
 Pittsburgh, Pa.

Editor's Note: We thank Mr. Alexander for the data on Barkhausen's early work. Frankly, some of us who feel like old timers were somewhat chagrined to find that we had no recollection of earth whistles, nor of new terms—swishes, tweeks or the dawn chorus.

Considering the crude radio equipment available in those World War I years when he observed the phenomena, it seems appropriate to make a low bow to Heinrich Barkhausen for suspecting correctly that the signals were natural geophysical phenomena.

Genisco's New GOH Accelerometer  
**WITHSTANDS VIBRATIONAL  
 ACCELERATIONS**  
*of 15 G's up to 2000 cps*



PHYSICAL DIMENSIONS	
OVERALL HEIGHT	3 1/8"
OVERALL WIDTH	3 1/4"
OVERALL DEPTH	3 3/4"
WEIGHT	38 OUNCES
Hermetically sealed	

This newest Genisco Accelerometer is a rugged, oil-damped, potentiometer-type instrument designed to operate in the most severe missile and aircraft vibrational environment. For example, in a recent production test the GOH performed satisfactorily after vibrational environment of 15 G's up to 2000 cps. As further proof of its ruggedness, the GOH will withstand 40-G shocks of 5 millisecond duration on the sensitive axis, and steady-state accelerations of 30 G's on the non-sensitive axes and 10 G's on the sensitive axis without damage.

**HEATING ELEMENT AVAILABLE**—A thermostat-controlled, internal heater may be installed in the GOH to keep operating characteristics constant between -50° F. and +160° F. However, thermostat operation is limited to 60,000 feet or less, 95% relative humidity at 160° F., and a vibrational environment of 10 G's up to 500 cps.

#### SPECIFICATIONS

- Ranges:** ± 1 G to ± 3 G's inclusive.
- Natural Frequencies:** 7 cps. to 12 cps.
- Nominal Damping:** 0.65 of critical at 75° F. Values between 0.4 to 1 set if desired.
- Resistance:** 14000 ohms (± 5%); center tap at 0 G-point. Other resistances also supplied.
- Potentiometer Voltage:** Up to 60 volts.
- Resolution:** One part in 300 for standard potentiometer.
- Noise Levels:** Less than 10 mv at 0.1 ma brush current.
- Linearity:** Within 1% of full scale from best straight line through calibration points.

Complete technical data on the GOH and other Genisco Accelerometers and Pressure Transducers is available from Genisco, Incorporated, 2233 Federal Avenue, Los Angeles 64, California. Write for your copy today.

#### RELIABILITY FIRST



Want more information? Use post card on last page.



## MANUFACTURER'S REPRESENTATIVES

As a service to readers, ELECTRONICS presents the advertisements for some of the leading manufacturer's representatives in the electronics industry. These firms are qualified to help the Manufacturer with his distribution problems; the Buyer with his product needs.

### S. BOSWORTH & CO.

Engineering Sales Representatives  
PRECISION ELECTRONIC INSTRUMENTATION  
COMPUTERS—CONTROLS

Industrials—Aircraft—Government—Universities  
In Metropolitan New York and Adjoining Areas  
244 Old Country Road, Hicksville, L. I., New York  
Hicksville 4-2232

### PAUL HAYDEN Associates

ENGINEERING

WAREHOUSING

Calling on **JOBBERS**  
**INDUSTRIALS**  
**AUDIO SPECIALISTS**



P. O. Box 331, EAST POINT, GA.  
Telephone (Atlanta): FAirfax 9644  
BRANCH OFFICES AT  
Burlington, N. C. • Birmingham, Ala. • Mt. Dora, Fla.

### SAMUEL K. MACDONALD, INC.

Manufacturers representatives over 25 years  
1531 SPRUCE STREET, PHILA. 2, PA.

Territory: Pennsylvania • New Jersey  
Delaware • Maryland  
Virginia • West Virginia  
District of Columbia

Other Offices:  
Pittsburgh  
Baltimore  
Washington, D.C.



### McGraw-Hill Mailing Lists Will Help You

- Merchandise your advertising
- Conduct surveys
- Get inquiries and leads for your salesmen
- Pin-point geographical or functional groups
- Sell direct
- Build up weak territories
- Aid dealer relations

Direct Mail is a necessary supplement to a well rounded Business Paper advertising program.

Most progressive companies allocate a portion of their ad budgets to this second medium at the same time as they concentrate on the best business publications.

600,000 of the top buying influences in the fields covered by the McGraw-Hill publications make up our 150 mailing lists. Pick YOUR prospects out of our Industrial Direct Mail catalogue.

Write for your free copy of our Industrial Direct Mail catalogue. With complete information.

# CONTACTS

FOR THE FIELD OF ELECTRONICS

## SAUERISEN

### CORROSION-PROOF CEMENTS



offer complete resistance to both acids and alkalis in steel mills, chemical plants and processing industries. Send blue-prints or sketches, so we may recommend proper cement to use. Write for latest catalog.

**TRIAL ORDER**  
**FOR ACID AND ALKALI USERS**  
Handy quart cans for making comparative tests—8 different cements. **\$7.50**

Sauerisen Cements Company • Pittsburgh 15, Pa.

## PLASTIC CUSTOM MOLDING

- Styrene • NYLON • Acetate
- Lucite • Butyrate • Vinylite
- Polyethylene

Highly integrated organization with newest equipment for automatic injection molding your plastic parts, products or packaging from planning stage to finished product. Equipped to produce low cost prototype single cavity molds. Inquiries invited.

### TELL PRODUCTS Corp.

A Division of Tell Mfg. Co., Inc.  
520 Cary St., Orange, N. J.



### EISLER MANUFACTURES COMPLETE EQUIPMENT

WELDERS FOR SPOT & WIRE BUTT  
RADIO, TV TUBE EQUIPMENT & REPAIR UNITS  
INCANDESCENT, FLUORESCENT MFG. EQUIPMENT  
NEON SIGN MAKERS EQUIPMENT, GLASS LATHES  
ELECTRONIC EQUIPMENT, VACUUM PUMPS, Etc.  
Wet Glass SLICING & CUTTING MACHINES for Lab Use  
TRANSFORMERS, SPECIAL & STANDARD TYPES

EISLER ENGINEERING CO., INC.  
751-A So. 13th St. Newark 3, N. J.

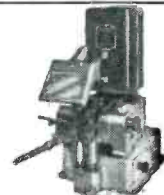

## One inexpensive modern device . . .

can frequently help speed up operation and maintenance or production.

One product advertised in the "Contacts" Section may be the answer to your problem . . . a real money-saver.

To be informed—and reminded—on modern aids to economical operation, maintenance and production, check "Contacts" advertising regularly . . . every issue.

## • PLATING • Precision

Industrial  
GOLD and SILVER  
of all Description  
GOVERNMENT CERTIFIED

### GARREPY PLATERS INC.

11-19 Bartlett St., Worcester, Mass.  
PLeasant 3-6472

### Complete Service FOR SMALL PARTS

- TOOLS
- STAMPINGS
- ASSEMBLIES
- SOLDERING
- PLATING
- PORCELAIN ENAMELING
- BRIGHT ANNEALING

Established 29 Years.

ORBER MANUFACTURING CO.  
DUNNELL LANE PAWTUCKET, R. I.



### World's Only Recorder of its Kind WALKIE-RECORDALL 8-LB SELF-POWERED BATTERY RECORDER

- AUTOMATIC UNDETECTED RECORDING up to 4 hrs.
  - PICKS UP WITHIN 50 FT. RADIIUS
  - VOICE ACTIVATED
  - "SELF START-STOP"
  - NO WIRES OR PLUGS
- Records noiselessly in or out of closed briefcase, containing hidden mike while walking, riding, flying. Conferences, lectures, dictation, 2-way phone. Permanent, unalterable, indexed recording at only 3c per hr.
- MILES REPRODUCER CO., INC.  
812 Broadway, N. Y. 3, N. Y. Dept.

# PROFESSIONAL SERVICES

Consulting—Patents—Design—Development—Measurement

in

Radio, Audio, Industrial Electronic Appliances

## AIRPAX PRODUCTS CO.

Development Division

Specialists in the  
Design and Manufacture of  
UNUSUAL TRANSFORMERS AND RELAYS

Middle River

Baltimore 20, Md.

## WHEN TIME IS SHORT . . . .

put the solution of your problems up  
to a specialized Consultant whose pro-  
fessional card appears on this page.  
His broad experience may save you  
months of costly experimentation.

## PICKARD & BURNS, INC.

Consulting Electronic Engineers

Analysis and Evaluation  
of Radio Systems

Research, Development and Production  
of Special Electronic Equipment

240 Highland Ave.

Needham 94, Mass.

## ANALYSIS INSTRUMENT CO.

Consultants on Magnetic Problems

Magnetic Materials Tested  
Special Magnetic Devices Designed  
Magnetizing & Testing Equipment Supplied

P. O. Box 7

Pequanock, New Jersey

## ERCO RADIO LABORATORIES, INC.

Radio Communications Equipment

Engineering - Design - Development - Production  
Our 27th Year in Air to Ground  
Communications and Radio Beacons  
Garden City • Long Island • New York

## ALBERT PREISMAN

Consulting Engineer

Television, Pulse Techniques, Video  
Amplifiers, Phasing Networks,  
Industrial Appliances

Affiliated with  
MANAGEMENT-TRAINING ASSOCIATES

3224-16th St., N. W.

Washington 10, D. C.

## H. O. BIXBY ASSOCIATES

Consultants to the Electronic Industry

SURVEYS—PROMOTIONS—LIAISON  
PERSONNEL PLACEMENT—TECHNOLOGY

238 Main St.

Cambridge 42, Mass.

ELiot 4-0404

## HANSON-GORRILL-BRIAN INC.

Product & Mfg. Development

ELECTRICAL - ELECTRONIC  
HYDRAULIC - MECHANICAL

One Continental Hill

Glen Cove, N. Y.

Glen Cove 4-7300

## KARL F. ROSS

Registered Patent Agent

(U. S. and Canada)

Specializing in electronic patent matters

305 Broadway, New York 7, N. Y. WOrth 2-3449

## THOMAS H. BRIGGS & ASSOCIATES

Electronics Consultants

Electron Tubes - Automation - Product Surveys  
Tube Materials & Reliability - Servo-mechanisms  
Engineering and production facilities.  
Box 185 RD#2 Norristown, Penn. Tel No. 8-7671

## THE KULJIAN CORPORATION

ELECTRONICS DIVISION

Consulting Electronic Engineers

Research, Development, Production of  
Automatic Controls — Special Instrumentation  
1200 No. Broad St., Philadelphia 21, Pa.  
Stevenson 2-9000

## THE TECHNICAL MATERIAL CORPORATION

Communications Consultants

Systems Engineering

General Offices and Laboratory

700 Fenimore Rd., Mamaroneck, N. Y.

## CROSBY LABORATORIES, INC.

Murray G. Crosby & Staff

Radio - Electronic  
Research Development & Manufacturing  
Communication, FM & TV

Robbins Lane, Hicksville, N. Y.  
Hicksville 3-3191

## Measurements Corporation

Research & Manufacturing Engineers

HARRY W. HOUCK MARTIAL A. HONNELL  
JOHN M. VAN BEUREN

Specialists in the Design and  
Development of Electronic Test Instruments

Boonton, New Jersey

## TELECHROME, INC.

Electronic Design Specialists

COLOR TELEVISION EQUIPMENT

Flying Spot Scanners, Color Synthesizers, Keyers,  
Monitors, Oscilloscopes and Related Apparatus  
J. R. Popkin-Curman, Pres. & Ch. Engr.

88 Merrick Rd.

Amityville, L. I., N. Y.

## EDGERTON, GERMESHAUSEN & GRIER, INC.

Consulting Engineers

Stroboscopy — Transient Oscillography  
Photoelectricity — Pulse Techniques — Timing  
High-Speed and Electronic Flash Photography  
Telemetering - Industrial Television Applications  
160 Brookline Avenue Boston 15, Mass.

## MERCURY ELECTRONIC COMPANY

Power Supplies

Electronic • Magnetic • Static

Red Bank

New Jersey

## WALSH ENGINEERING CO.

Specialists in design of  
ELECTRONIC and MAGNETIC  
Apparatus to solve unusual problems.

Complete Model Shop.

34 DeHart Place

Elizabeth, N. J.  
Elizabeth 2-7600

## Eldico of New York, Inc.

Pioneers of Television Interference Elimination from  
Transmitters, Induction Heaters, Diathermy and etc.

Donald J. S. Merten & Engineering Staff

72 E. Second St. Mineola, L. I., N. Y.  
Pioneer 6-5212

## NEW ROCHELLE TOOL CORP.

FOR CERTIFICATION OF INDUCTION  
AND DIELECTRIC HEATING EQUIPMENT  
IN ACCORDANCE WITH F. C. C. RULINGS

Mobile Test Unit Available Entire U. S.

320 Main St. New Rochelle, New York  
Phone NE 2-5555

## WHEELER LABORATORIES, INC.

Radio and Electronics

Consulting — Research — Development

R-F Circuits — Lines — Antennas

Microwave Components — Test Equipment

Harold A. Wheeler and Engineering Staff  
Great Neck, N. Y.

HUnter 2-7876

## ELECTRONIC RESEARCH ASSOCIATES, INC.

"TRANSISTORIZE" YOUR PRODUCT!

Complete Service in consulting, research, develop-  
ment, and production on Transistor circuitry, prod-  
ucts and instrumentation.

87 East Centre Street

Nutley, N. J.

NUTley 2-5410

## NIAGARA ELECTRON LABORATORIES

CONSULTATION - DESIGN - CONSTRUCTION  
MFG. THE THERMOCAP RELAY

Specializing in solution of problems of electronic  
and electro-physical instrumentation for the re-  
search or analytical laboratory. Industrial plant  
problems also invited.

Andover, New York Cable Address: NIATRONLAB

## YARDNEY LABORATORIES, INC.

Research-Design-Development

Electro-Chemical Generators of Energy

40-46 Leonard Street

Worth 6-3100

New York 13, N. Y.



## EMPLOYMENT OPPORTUNITIES

The Advertisements in this section include all employment opportunities—executive, management, technical, selling, office, skilled, manual, etc.

Positions Vacant  
Positions Wanted  
Part Time Work

Civil Service Opportunities  
Selling Opportunities Wanted  
Selling Opportunities Offered

Employment Agencies  
Employment Services  
Labor Bureaus

### DISPLAYED

The advertising rate is \$91.50 per inch for all advertising appearing on other than a contract basis. Contract rates quoted on request.

An advertising inch is measured 3/4" vertically on a column—3 columns—30 inches to a page.

Subject to Agency Commission.

### RATES

\$2.10 per line, minimum 3 lines. To figure advance payment count 5 average words as a line.

Box Numbers—counts as 1 line.

Discount of 10% if full payment is made in advance for 4 consecutive insertions.

Not subject to Agency Commission.

### UNDISPLAYED

Send NEW ADS to ELECTRONICS, 330 W. 42nd St., N. Y. 36, N. Y., for September issue closing August 4th

## DRAKE PERSONNEL

National Placement Center for  
**EXECUTIVE AND  
TECHNICAL PERSONNEL**

**General and Plant Managers  
Plant Superintendents—Foremen  
Accounting—Staff Personnel  
Engineers—Design—Production  
Sales Managers—Engineers**

Please outline briefly your  
experience or personnel needs to:

**John Cope**  
220 S. State St., Chicago 4, Ill.  
Harrison 7-8600

### PHYSICIST \$7200

Good math background and capable of conducting environmental tests on electronic products. Advancement. For this and other good positions.

**CONTACT BOB POORE**  
O'SHEA EMPLOYMENT SYSTEM  
"America's Largest"

64 E. Jackson, Chicago, Ill. Tel. WAbash 2-1884

### SUPERVISING PROJECT ENGINEER, \$12,000

New division, new factory of dynamic multiple plant electrical manufacturer urgently needs Electronic Engineers with supervisory experience or potential. Unusual fringe benefits and rapid promotion in this growing organization. Company pays agency fees and relocation expense.

**MONARCH PERSONNEL**  
28 E. Jackson Blvd. Chicago 4, Illinois

### ENGINEERS—ADMINISTRATORS —SALESMEN—EMPLOYERS

Confidential, rapid and professional service for nation wide placement in the Electronics field. Write giving age, education and brief experience. Employers send us job description. We will let you know how we can help you by return mail.

**Graebner's Electronics Exchange**  
"The Nation's Largest"  
116 South Michigan Chicago 3, Illinois

### "PHYSICIST"

Heavy math, little chemistry. Supervise small testing lab. Knowledge of instrumentation necessary. Several other good openings.

Contact **BOB POORE**

**O'SHEA EMPLOYMENT SYSTEM**  
"America's Largest"  
64 E. Jackson, Chicago, Ill., Tel. WAbash 2-1884

## When Answering BOX NUMBERS...

to expedite the handling of your correspondence and avoid confusion, please do not address a single reply to more than one individual box number. Be sure to address separate replies for each advertisement.

REPLIES (Box No.): Address to office nearest you  
NEW YORK: 330 W. 42nd St. (36)  
CHICAGO: 520 N. Michigan Ave. (11)  
SAN FRANCISCO: 68 Post St. (4)

### POSITION VACANT

A medium-sized southern New England manufacturer of technical papers used by the electronics industry has a challenging position for an electrical engineer under 35. Some selling or administrative experience is desirable. He must have a strong persuasive personality and be capable of working with both technical and nontechnical people. Salary open. Include resume of personal history, education, and experience with introductory letter to box P-7081, Electronics.

### SELLING OPPORTUNITY OFFERED

**Manufacturers Agent Opportunity:** Pressure sensitive industrial tape line. Exclusive territories open. List current territory, lines carried and biography. Write RW-6926, Electronics.

### POSITION WANTED

**Transformer design engineer.** Presently chief engineer small company. 8 years experience. last 5 in all types electronic transformers. Desires position greater New York area. PW-6968, Electronics.

### ★ MANUFACTURERS

Let us handle technical sales representation of your products

### ★ INVENTORS

We will share the cost of protecting your invention if accepted for commercialization

We Specialize In Electronics, Nucleonics, Instrumentation, Servomechanisms & Cybernetics.

### R. W. HODGSON CO.

Technical Sales Representation & Research & Development Engineering  
3406 W. Washington Blvd. Los Angeles 18, Calif.  
REpublic 2-2651

### LINES WANTED

Engineer desires lines of electronic test equipment and components for North Carolina.

### PAUL MOORE CO

P. O. Box 6003 Five Points Station  
Raleigh, North Carolina

### SALES OPPORTUNITY TO SERVO MOTOR MANUFACTURER

Increase your sales in California and Arizona with an engineering representative specializing in servo systems and components only. Write  
RA-7027, Electronics

1111 Wilshire Blvd., Los Angeles 17, Calif.

### MANUFACTURERS REPRESENTATIVE

Long established highly successful sales organization seeks additional electronic components. Coverage New York State.

RA-6878, Electronics  
330 W. 42 St., New York 36, N. Y.

# ELECTRONIC TECHNICIANS AVAILABLE

Men thoroughly trained in Basic Electronic Circuitry — fast, accurate reading of Schematics, well versed in the use of precision test equipment. Varied backgrounds in formal education, from high school to university level. Mature, qualified men (most have done their hitch in service) who are willing to relocate if necessary. These men have proven their worth to firms both large and small, in the field of electronics as well as automation.

For complete information, contact C. L. Watson, Graduate Placement Division. No obligation.

## The BAILEY Technical SCHOOL

1626 S. GRAND  
ST. LOUIS, MO.  
Prospect 6-7860

Take a look at the record...

**WITHIN THE LAST YEAR,**

**MORE THAN 500**

**EXPERIENCED ENGINEERS AND SCIENTISTS\***

**CHOSE DESIGN AND DEVELOPMENT CAREERS**

**WITH**

**RCA!**



Today... RCA opens  
new opportunities for you to join  
these progressive, creative engineers in...

**NEW EXTENDED  
SYSTEMS  
ENGINEERING  
CONCEPTS**

**NEW,  
MOST ADVANCED  
ELECTRONIC DATA  
PROCESSING  
SYSTEMS**

**AN ENTIRELY  
NEW PROGRAM  
IN  
GUIDED MISSILE  
ELECTRONICS**

**NEW CHALLENGES  
IN  
AVIATION  
ELECTRONICS**

**NEW FIELDS  
IN  
ELECTRON TUBE  
DEVELOPMENT**

**RCA advancement creates opportunities with a future...** openings which are available today for engineers and scientists who can move ahead professionally with the world leader in electronics. At the RCA engineering locations listed in the chart, you'll find the kind of living and working conditions you and your family consider most attractive.

**RCA offers you...** facilities unsurpassed in the electronics industry... everyday association with top engineers and scientists. Plus RCA benefits that include: tuition refund plan, a company-paid insurance program for you and the family, modern retirement plan, relocation assistance. A carefully-planned advancement program helps you move ahead financially and professionally!

\* RCA was also chosen by several hundred recent engineering graduates, field service engineers and other categories of experienced professional engineers or scientists.

... with your future in mind

**Check the chart below for  
positions which interest you most...**

FIELDS OF ENGINEERING ACTIVITY	TYPE OF DEGREE AND YEARS OF EXPERIENCE PREFERRED											
	Electrical Engineers			Mechanical Engineers			Physical Science			Chemistry Ceramics Glass Technology Metallurgy		
	1-2	2-3	4+	1-2	2-3	4+	1-2	2-3	4+	1-2	2-3	4+
<b>SYSTEMS</b> <i>(Integration of theory, equipments, and environment to create and optimize major electronic concepts.)</i>												
<b>AIRBORNE FIRE CONTROL</b>			W						W			
<b>DIGITAL DATA HANDLING DEVICES</b>			C		C				C			
<b>MISSILE AND RADAR</b>			M		M				M			
<b>INERTIAL NAVIGATION</b>			M		M				M			
<b>COMMUNICATIONS</b>			C O						C O			
<b>DESIGN • DEVELOPMENT</b>												
<b>COLOR TV TUBES</b> —Electron Optics—Instrumental Analysis—Solid States (Phosphors, High Temperature Phenomena, Photo Sensitive Materials and Glass to Metal Sealing)	L	L	L	L	L	L	L	L	L	L	L	L
<b>RECEIVING TUBES</b> —Circuitry—Life Test and Rating—Tube Testing—Thermionic Emission	H	H	H		H	H		H	H		H	H
<b>SEMI-CONDUCTORS</b> —Transistors—Semi-Conductor Devices	H	H	H					H	H	H		
<b>MICROWAVE TUBES</b> —Tube Development and Manufacture (Traveling Wave—Backward Wave)		H	H		H	H		H	H		H	H
<b>GAS, POWER AND PHOTO TUBES</b> —Photo Sensitive Devices—Glass to Metal Sealing	L	L	L	L	L	L	L	L	L	L	L	L
<b>AVIATION ELECTRONICS</b> —Radar—Computers—Servo Mechanisms—Shock and Vibration—Circuitry—Remote Control—Heat Transfer—Sub-Miniaturization—Automatic Flight—Design for Automation—Transistorization	X	F X	M C F X	X	F X	M C F X	X	F X	M C F X			
<b>RADAR</b> —Circuitry—Antenna Design—Servo Systems—Gear Trains—Intricate Mechanisms—Fire Control	X	F X	M C F X	X	F X	M C F X	X	F X	M C F X			
<b>COMPUTERS</b> —Systems—Advanced Development—Circuitry—Assembly Design—Mechanisms—Programming	C	C F	M C F	C	C F	M C F	C	C F	M C F			
<b>COMMUNICATIONS</b> —Microwave—Aviation—Specialized Military Systems		F C F	M C F		F C F	M C F		F C F	M C F			
<b>RADIO SYSTEMS</b> —HF-VHF—Microwave—Propagation Analysis—Telephone, Telegraph Terminal Equipment		O O F	M C F		O O F	M C F		O O F	M C F			
<b>MISSILE GUIDANCE</b> —Systems Planning and Design—Radar—Fire Control—Shock Problems—Servo Mechanisms		F F	M C F		F F	M C F		F F	M C F			
<b>COMPONENTS</b> —Transformers—Coils—TV Deflection Yokes (Color or Monochrome)—Resistors		C C			C C			C C				
<b>MACHINE DESIGN</b> Mech. and Elec.—Automatic or Semi-Automatic Machines		H H			H H			H H				

**Location  
Code**

- C—Camden, N. J.—in Greater Philadelphia near many suburban communities.
- F—Florida—on east central coast.
- H—Harrison, N. J.—just 18 minutes from downtown New York.
- L—Lancaster, Pa.—about an hour's drive west of Philadelphia.

- M—Moorestown, N. J.—quiet, attractive community close to Phila.
- O—Overseas—domestic and overseas locations.
- W—Waltham, Mass.—near the cultural center of Boston.
- X—Los Angeles, Calif.—west coast electronics center.

Please send resume of education and experience, with location preferred, to:

**Mr. John R. Weld, Employment Manager**  
Dept. A-15H, Radio Corporation of America  
30 Rockefeller Plaza  
New York 20, N. Y.



**RADIO CORPORATION of AMERICA**

TO THE FINE ENGINEERING MIND  
SEEKING THE CHALLENGING PROJECTS IN

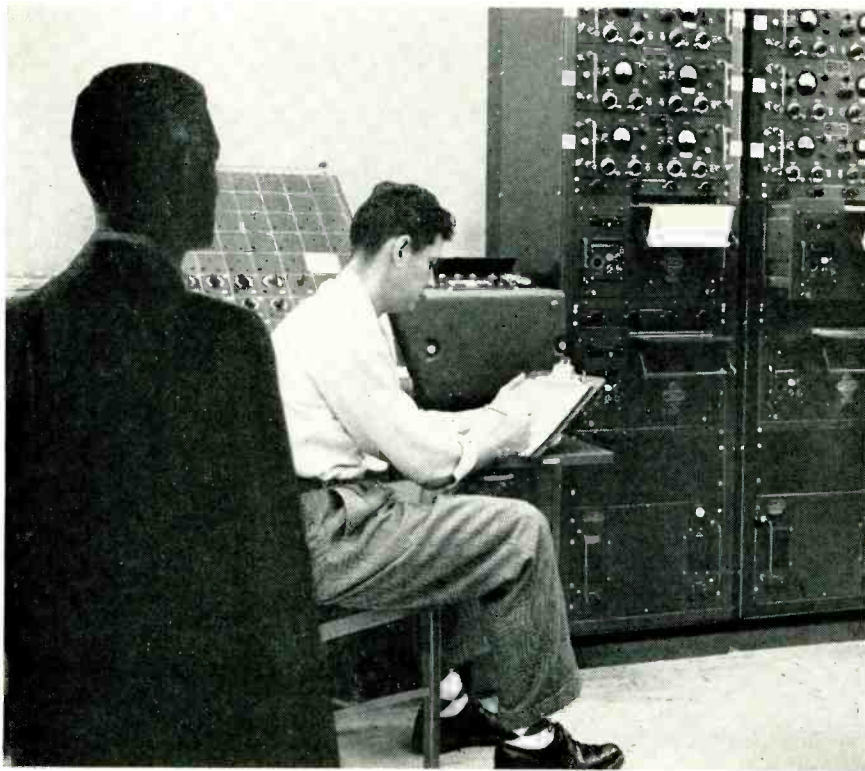

## TELEMETERING

**TELEMETERING ENGINEERS** experienced in research, design and development of all types of static and airborne telemetering systems are offered challenging career opportunities on advanced projects in the rapidly expanding Engineering Department at Convair in beautiful San Diego, California. These responsible positions call for experience in telemetering systems, planning and study; transducer design, selection and application; airborne and ground-based telemetering equipment design and development; and instrumentation systems installation design.

**CONVAIR** offers you an imaginative, explorative, energetic engineering department to challenge your mind, your skills, and your abilities in solving the complex problems of vital, new, immediate and long-range programs. You will find salaries, facilities, engineering policies, educational opportunities and personal advantages excellent.

**SMOG-FREE SAN DIEGO**, lovely, cool city on the coast of Southern California, offers you and your family a wonderful new way of life... a way of life judged by most as the Nation's finest for climate, natural beauty, and easy (indoor-outdoor) living.

Generous travel allowances to engineers who are accepted. Write at once enclosing full resume to:

H. T. Brooks, Engineering Personnel, Dept. 908

# CONVAIR

*A Division of General Dynamics Corporation*

3302 PACIFIC HIGHWAY

SAN DIEGO, CALIFORNIA

## ENGINEERS

## Honeywell

"First In Controls"

OFFERS EXCELLENT  
OPPORTUNITIES IN

### RESEARCH

... including analysis of electronic controls and control systems, using control theory and analog tests. Variety of other applied research activities.

### DEVELOPMENT

... of electronic and electromechanical devices for detection and control of all types of industrial process variables.

... development and design of complex industrial instrumentation systems, data reduction and data handling systems.

... development of pneumatic and mechanical devices for flow measurement and control and other small electromechanical controls and recording instruments.

### APPLICATION

... personal contact with customers, determining exact needs for custom-built devices or systems, determine feasibility of manufacturing special products by estimating engineering time necessary, etc.

### Excellent Opportunities FOR MEN WITH

- 1.—A degree in E.E., M.E. or Physics
- 2.—From 1 to 7 yrs' experience in instrumentation or similar fields.
- 3.—Group or Project Leader Potential

Send a confidential resume of your qualifications for consideration in the area of your interest.

## HONEYWELL

### BROWN INSTRUMENTS

Wayne & Windrim Avenues  
Philadelphia 44, Pa.

# *Bendix* OFFERS

## 3 SENIOR ENGINEERING JOBS

### WELL WORTH LOOKING INTO...

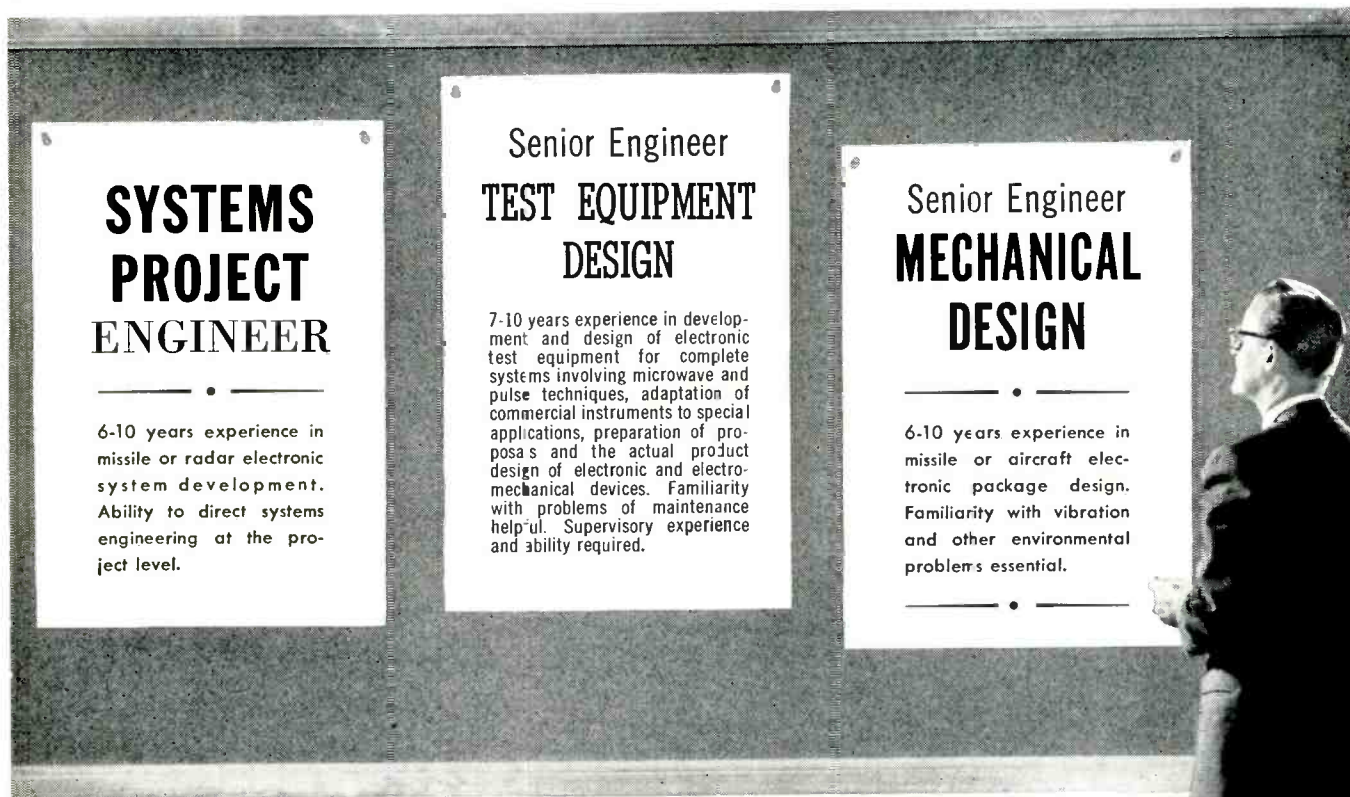

### SYSTEMS PROJECT ENGINEER

6-10 years experience in missile or radar electronic system development. Ability to direct systems engineering at the project level.

### Senior Engineer TEST EQUIPMENT DESIGN

7-10 years experience in development and design of electronic test equipment for complete systems involving microwave and pulse techniques, adaptation of commercial instruments to special applications, preparation of proposals and the actual product design of electronic and electromechanical devices. Familiarity with problems of maintenance helpful. Supervisory experience and ability required.

### Senior Engineer MECHANICAL DESIGN

6-10 years experience in missile or aircraft electronic package design. Familiarity with vibration and other environmental problems essential.

Here are three especially attractive job opportunities for engineers who want to get on the ground floor in the important, interesting, and challenging phase of a new industry—guided missiles.

Qualified men are given real job responsibilities with Bendix and grow with the development of what is not only the nation's most important weapon system, but a project that will undoubtedly lead to new and im-

portant long-range commercial application.

At Bendix you will be associated with top missile authorities and have at your command unexcelled engineering and manufacturing facilities. Salaries for these top jobs and other opportunities are open for discussion. Write today to: Mr. W. L. Webb, General Manager, Missile Section, Bendix Products Division, Bendix Aviation Corporation, 401 North Bendix Drive, South Bend, Ind.

## 23 OTHER ENGINEERING POSITIONS!

Bendix also offers unusual job opportunities for assistant engineers, junior engineers, and technicians, as well as a score of other assignments. A 30-page book describing in

detail every phase of our guided missile operation will be sent to you on request. If you are interested in guided missiles, this book is bound to interest you. Write for it today



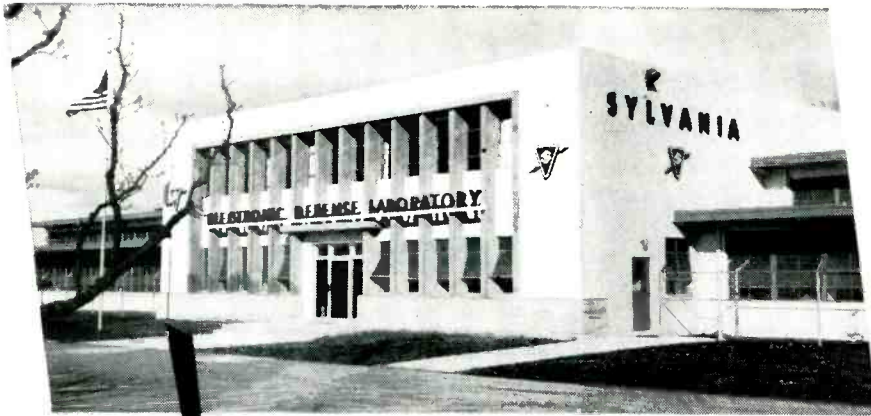

## SYLVANIA'S CALIFORNIA RESEARCH LABORATORY

(San Francisco Bay Area—Near Palo Alto)

*Needs experienced creative engineers for a long range research and development program in microwave electronic systems and components. Also needs experts in design and custom packaging of specialized electronic communications equipment.*

**We have specific openings for  
ENGINEERING SPECIALISTS and SENIOR ENGINEERS in:**

**SYSTEMS ANALYSIS** For weapons systems planning, operational analysis and data handling problems.

**MICROWAVE ANTENNAS** For investigation of new concepts in polarization and pattern control, direction finding and multi-function radiators.

**MICROWAVE CIRCUITS** For advancements in synthesis of filters, broadband mixers, power dividers, etc., involving modern techniques of stripline, ridge guide and periodic structures.

**TRANSMITTER DEVELOPMENT** For research and development involving microwaves and pulse techniques.

**FIELD ENGINEERING** For advanced engineering field tests of prototype equipment.

**COMMUNICATIONS SYSTEMS** For design and development of complex communications systems.

*Sylvania offers the finest facilities and equipment available. We also provide financial support for advanced education, as well as a liberal insurance, pension and medical program.*

*Our Laboratory is located 5 miles from Palo Alto in the San Francisco Bay area, close to excellent schools and universities, unexcelled living conditions, ideal climate and ample housing.*

**RELOCATION EXPENSES PAID**

Please send complete resume to  
**JOHN C. RICHARDS**  
Electronic  
Defense  
Laboratory  
Box 205  
Mountain View,  
California

## ELECTRONIC DEFENSE LABORATORY



**SYLVANIA**  
SYLVANIA ELECTRIC PRODUCTS INC.

*All inquiries  
will be answered  
within two weeks.*

# ENGINEERS

LONG-RANGE  
CONTINUING  
OPPORTUNITY

FOR  
ELECTRICAL  
AND  
MECHANICAL

# ENGINEERS

AT



OPENINGS EXIST FOR . . .

**LIQUID PROPELLANT  
ROCKET CONTROLS**

**ENGINEER**

Mechanical or electrical engineer to supervise the research and development of liquid propellant rocket controls, systems design, component design, development and testing.

**CONTROL ENGINEER**

Requiring an engineering degree in electrical engineering or math and physics, plus at least three years of experience in design analysis of feedback control systems. Should be familiar with frequency response methods as applied to feedback control synthesis. Analog computer and simulator experience highly desirable. Activity is in the field of aircraft and missile power plant controls including gas turbine, ram jet, and rocket types. Controls are largely hydro-mechanical. The fuel metering research facility includes an analog computer and jet engine simulators.

**MAGNETIC AMPLIFIER  
SYSTEMS ENGINEER**

Electrical engineer supervisory capacity on research and development of magnetic amplifier circuitry, control systems, and component design and testing, supervising other engineers and technicians.

The salary of these positions will be determined by your ability and experience.

Send detailed resume listing education, engineering experience, and salary requirement to:

Technical Employment Department S.B.

Bendix Products Division of  
Bendix Aviation Corporation  
401 North Bendix Drive  
South Bend 20, Indiana

We guarantee you an immediate reply





## SHOPPING (shop'ping)

... looking for a job (slang) ... Webster

The wise shopper weighs many things before making an important purchase. You should do no less when considering your future. At Goodyear Aircraft, you'll find **SECURITY** based on a half century of accomplishment and a diversified research and production program; **SALARIES** commensurate with the high level of the aviation industry; **SATISFACTION** in doing the work most interesting to you; **OPPORTUNITY** to grow professionally and financially. We invite qualified persons to inquire about the opportunities now open in the following fields:

- ELECTRO-MECHANICAL
- MICROWAVE
- SERVOMECHANISMS
- ELECTRONIC PACKAGING
- WEAPON SYSTEMS
- PULSE TECHNIQUES
- ANTENNA DESIGN
- MINIATURIZATION

Send a résumé or write for application forms to

C. G. Jones, Salary Personnel Department

GOODYEAR AIRCRAFT CORPORATION

AKRON 15, OHIO



**CHOOSE A CAREER OF**

*Achievement*  
WITH

**Admiral**

← OPPORTUNITIES that offer stability and an assured future. You will work with the most modern electronic equipment and a staff of engineers who are leaders in the field.

To qualify, you must have had previous experience in design and development of communications equipment. Men selected will be given intermediate or advanced level assignments in either a TV, radio or government equipment lab. Positions available for engineers with the following backgrounds:

★ **TEST EQUIPMENT**

Design of electronic test equipment and associated circuits for TV receivers and government electronic equipment.

★ **UHF COMMUNICATIONS**

Applied development and design of military communications apparatus for both transmitters and receivers.

★ **RADAR INDICATOR SYSTEMS**

Development and design to include fire control equipment in the microwave region.

★ **TELEVISION SYSTEMS AND COMPONENTS**

HV Transformers, coils, amplifiers, deflection yokes and tuners as applied to color and monochrome TV

★ **RESEARCH AND DEVELOPMENT**

Engineers with ability to apply fundamental principles of engineering to solving original problems of more than average technical difficulty related to communications projects.

To aid our engineers in their progress, Admiral also provides financial support for advanced education as well as other liberal employee benefits. You will have the opportunity to qualify for excellent salaries commensurate with your ability and experience.

Please forward complete resume to Mr. W. A. Wecker, Personnel Division

**Admiral Corporation**

3800 W. Cortland St.  
Chicago 47, Illinois

**ENGINEERS**

AT LEAR YOU'LL HAVE OPPORTUNITIES IN DESIGN & DEVELOPMENT

MECH ENGRS for design & layout of gyro instrument components for aircraft flight control systems. Will consider topgrade machine designers experienced on intricate precision mechanisms with engineering degree or equivalent education.

ALSO

SR ENGRS for gyro system development projects and electrical engs with experience in design and development of circuitry for airborne gyro mechanisms, servo mechanisms and their related systems.

HYDRAULIC servo design engs for design & development of airborne electro hydraulic servos & manually controlled boost servos. Includes work in manual & electro hydraulic transfer valves, rams, control linkage and regulators. Familiarity with shop practices and ability to design for production a necessity. Knowledge of servo theory desirable.

DESIGN ENGRS for high level complicated layouts E.E. or M.E. degree or equiv in practical engr for layout of intricate mechanisms and/or packaging of electronic components.

We are located in Grand Rapids, Mich., a good clean & modern city of 200,000, where recreational & cultural opportunities are the finest.

Competitive salaries. Generous moving allowance. All replies held confidential.

Interviews arranged at company expense with selected applicants.

Send complete resumes to:

Personnel Manager



**LEAR, INC.**

52 N. Division  
Grand Rapids, Mich.

**FIELD SERVICE ENGINEERS**

We urgently need men with electronic background, and preferably radar or computer experience to supervise, instruct and assist in installation-maintenance of electronic equipment. Excellent starting salary during factory training. Domestic and overseas assignments. Oversea bonus and liberal employee benefits. Continuous per diem allowances. Salary will be commensurate with experience.

Call PI 6-3720 for appt or forward your personal experience record to Personnel Supervisor

**REEVES**  
INSTRUMENT CORPORAT'N  
ROOSEVELT FIELD  
MINEOLA, LONG ISLAND, N. Y.

# Burroughs means Business

## TO Qualified

# ENGINEERS & PHYSICISTS

### ELECTRICAL ENGINEERS

... circuit designers to develop new circuit techniques and/or apply them to advanced systems development that will lead to product design.

### MECHANICAL ENGINEERS

... mechanism and electronic packaging design and development to meet Government and commercial customer acceptance.

### PHYSICISTS

... solid state components, with application directed towards electronic devices.

### LOGICAL DESIGNERS; Senior

... for system design involving inter-connection of basic logical elements to effect arithmetic and logical function of data processing equipment.

### THE ABOVE OPENINGS

— are in the fields of Communications, Data Handling, Electronic, or Electro-Mechanical Business Machines . . . including such specifics as High Speed Mechanisms, Paper Handling Devices, Magnetic-Tape Transport Mechanisms, Magnetic-Drum or Tape Applications, Radar, Telemetering, Guided Missiles, Process Control Instrumentation, Digital and Analog Computers, Transistors and Magnetic Amplifiers, Servo Mechanisms and Electronic Packaging Design.

*Yes . . .* **It Really Pays To Work Where The Best In Everything Is Available To YOU & YOUR FAMILY!**

HERE at Burroughs new Research Center, where highly specialized commercial and government development work is in progress, ENGINEERS and PHYSICISTS who find a special interest in our current openings will discover the opportunity they seek to exercise their keenest creative talents in the field of data handling equipment as well as in the equally challenging allied interests of electronics, automation and instrumentation.

In addition to OPPORTUNITY and RECOGNITION . . . Burroughs offers cooperative educational aid . . . liberal pension plan and all the usual health and hospitalization benefits for you and your family . . . delightfully suburban community life for you and your children, only thirty minutes from Philadelphia.

Paid travel expenses for interview at our NEW Research Center . . . moving and locating expenses.

Write D. A. BOWDOIN, Personnel Section

# Burroughs

RESEARCH CENTER  
PAOLI, PA., ON PHILADELPHIA'S MAIN LINE

# UNIVAC

The FIRST Name

in Complete Electronic Computing Systems

As the UNIVAC takes its place in more and more industries, the REMINGTON RAND DIVISION has greatly expanded its research and development work in order to continue its leadership in electronic computing equipment.

There are many positions recently opened at all levels in all phases of research, design, developments, and application of computing and allied equipment. Even though your training and experience may not be connected with computers, we are willing in many cases to provide the necessary training. Individual cases can be evaluated during interview.

- System Studies
- Logical Design
- New Components
- Solid State Physics
- Semi-conductors
- Magnetic Materials
- Storage Techniques
- Circuit Design
- Pulse Techniques
- Input-Output Devices
- Product Design
- Test Equipment Design
- Computer Development and Design
- High Speed Electro-Mechanical Devices
- System Test and Maintenance

The rapidly expanding engineering program has created many permanent positions paying excellent salaries. These positions offer personal challenge as well as outstanding opportunities for professional development. The possibilities for graduate study in this area are excellent and the company has a liberal plan for reimbursement of tuition expenses. Other company benefits include retirement and group insurance.

**Replies Kept Strictly Confidential**

**FOR INTERVIEW, WRITE TO**

***Remington Rand***

Division of

**SPERRY RAND CORPORATION**

2300 West Allegheny Ave. Philadelphia 29, Pa.

## DEVELOPMENT & FIELD SYSTEMS ENGINEERS

- ANTENNA
- RADIO COMMUNICATIONS
- RADAR
- MICROWAVE
- NAVIGATIONAL AIDS
- TERMINAL EQUIPMENT
- TELETYPE

With a progressive, expanding, well established corporation. Interviews will be arranged for qualified applicants. Send complete biographical resume, experience and education to

Mr. J. E. Richardson  
Personnel Director

MARYLAND ELECTRONIC MFG. CORP.  
5009 Calvert Road  
College Park 9, Maryland

### Engineers

OPPORTUNITIES  
ARE  
POPPING . . .



AT THE NEW, EXPANDING  
ELECTRONIC TUBE DIVISION OF

## Westinghouse

in Elmira, New York

. . . Opportunities to advance in your profession, to receive recognition for your creative talents, to have a secure financial future.

Openings for:

**DESIGN, DEVELOPMENT and APPLICATION ENGRS:** Image orthicon or vidicon, receiving tubes, color television tubes.

**MICROWAVE TUBE DESIGN ENGRS:** Design of magnetrons, traveling wave tubes, TR and ATR tubes, reference cavities, klystrons.

Above openings are for Engrs. & Physicists with B.S., M.S. or Ph.D. degrees. Also . . .

**ELECTRICAL ENGRS for Equipment Design:** Designing, costing and guiding construction of processing and test equipment, e.g. seasoning and test units, induction heaters, X-ray seasoning and test units, wave guide apparatus, high frequency oscillation test units, automatic receiving tube test circuits.

**MANUFACTURING ENGRS:** Electrical & mechanical engineers and physicists to work on microwave, image orthicon, color television tubes.

**SALES ENGRS:** Responsible for sale of electronic tubes to equipment mfrs. Offering technical service involving particular application of tubes, circuiting, etc.

Interviews in your area, or travel expenses paid for interviews in Elmira. Send resume.

**WESTINGHOUSE ELECTRIC CORP.**  
Electronic Tube Div., Elmira, N. Y.

# EXPAND YOUR HORIZON!

ELECTRONIC ENGINEERS  
ELECTRONIC PHYSICISTS

*Bendix Radio has new,  
exceptional opportunities for advancement  
while working on:*

**RADAR**  
**MISSILE GUIDANCE**  
**AIRBORNE COMMUNICATIONS**  
**MOBILE COMMUNICATIONS**  
**AUTO RADIO**

Expand the horizon of your future with Bendix Radio—a leader & pioneer in the electronics field, one that has the knowledge, strength and resources to stay out front during the competitive days ahead! Your part is EASY! Wire, phone, write . . . or send us a post card. Simply state your name, address and phone number, your education and experience. We'll carry the ball from there! All replies held in strictest confidence, and we guarantee speedy action!

*Address: Mr. L. H. Noggle  
Dept. J  
Bendix Radio  
Baltimore 4, Md.  
Phone: Valley 3-2200*

## **Bendix Radio**

DIVISION OF  
BENDIX AVIATION  
CORPORATION

Baltimore 4, Maryland

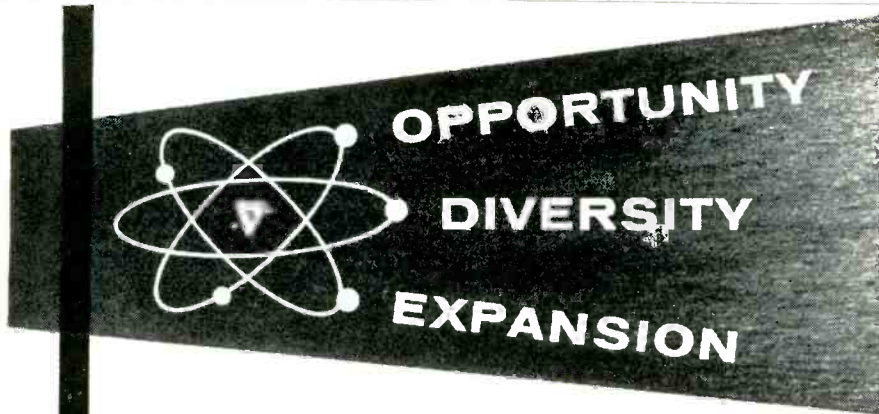

## SPEEDY PATHS TO SUCCESS FOR MEN OF TALENT AT SYLVANIA

### *Career positions with* **ELECTRONIC SYSTEMS DIVISION**

Between 1947 and 1953, the electronics industry grew 24%... Sylvania grew 32%.

That is why Sylvania today offers important paths to quick success for men of talent.

Here, individual achievement is swiftly recognized and rewarded, as witness the fact that the average age of top level executives is only 45. In this stimulating Sylvania atmosphere, original thinkers can and do go far.

#### **BOSTON** Laboratory

Majors in E.E., M.E., Math, Physics. Research & Development experience in—

- Countermeasures
- Systems Analysis
- Transistor Applications
- Noise Studies
- Antenna Res. & Dev.
- Systems Development
- Mechanical Design
- Miniaturization
- Digital Computer Circuits & Systems
- Circuit Design
- Shock & Vibration
- Technical Writing
- Missile Analysis

#### **BUFFALO** Engineering

Majors in E.E., M.E., or Physics. Experience in Product Design and Advanced Development in—

- Circuit Design
- Systems Development
- Pulse Techniques
- F.M. Techniques
- Equipment Specifications
- Components
- Microwave Applications
- Servo Mechanisms
- Subminiaturization
- Mechanical Design
- Shock & Vibration
- Heat Transfer

#### **INTERVIEW AND RELOCATION EXPENSES WILL BE PAID BY SYLVANIA**

Sylvania provides financial support for advanced education as well as liberal insurance, pension and medical programs.

*Please forward resume to:*

**Professional Placement Supervisor**

#### **SYLVANIA ELECTRIC PRODUCTS INC.**

Thomas A. Tierney 100 First St. Waltham, Mass.	Randall A. Kenyon 175 Great Arrow Ave. Buffalo 7, N. Y.
--	---

# SYLVANIA

SYLVANIA ELECTRIC PRODUCTS INC.

*Your inquiries will be answered within two weeks*

## ELECTRONIC ENGINEERS!

- *Big opportunities*
- *await you at*
- *Bendix York!*

To the Engineer who is a recent college graduate, as well as to those with experience in all phases of advanced design, Bendix York offers opportunities outstanding in its field. As a young and expanding division, Bendix York provides fascinating and challenging assignments. Good salaries, all employee benefits, ideal living conditions in a beautiful suburban area are yours.

- Send resume of Education and Experience to: Mr. L. D. Smith, Employment Supervisor

# *Bendix*

**AVIATION CORPORATION**

**YORK DIVISION**

Phone: York 5521 York, Penna.

## Engineers

with experience in

- computers
- microwave
- pulse techniques
- servo-mechanisms
- related circuit design

leading designers and manufacturers of electronic instrumentation offer outstanding opportunity, top pay, moving allowance, benefits, plus the charm of san francisco living.

please send resume.

**Berkeley** *division*  
BECKMAN INSTRUMENTS INC.

2200 WRIGHT AVE., RICHMOND 3, CALIF.

the Key  
to your  
future...

ELECTRONIC **ENGINEERS** MECHANICAL

opportunities better than ever at

*Remington Rand*

ENGINEERING RESEARCH ASSOCIATES DIVISION

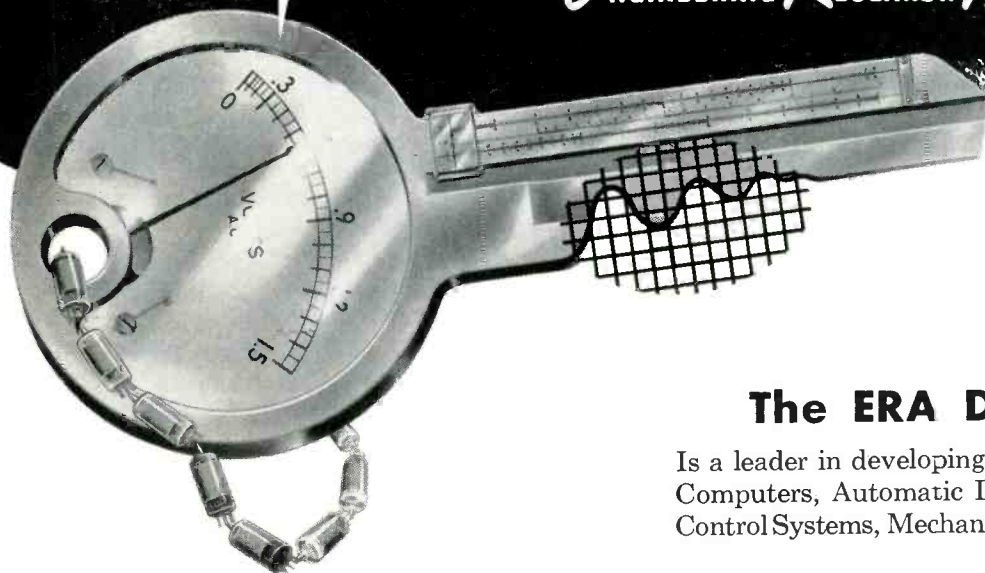

### The ERA Division

Is a leader in developing Electronic Digital Computers, Automatic Data-Handling and Control Systems, Mechanisms, and Weapons.

## Everything you want in a job—

### Stimulating Work

Most of our engineers are having the time of their lives doing creative research and development on important new applications in mechanical and electronic engineering. Men work as project teams, and each man learns all aspects of his project. Pulse circuits, magnetic cores, transistors, printed wiring, miniaturization, and precise mechanisms are used in designing computers, automatic data-handling and control systems, mechanisms, and special weapons. Other excellent engineering jobs are available in production, testing, specifications, quality control, contract administration, and technical writing.

### Advancement

ERA plans to *triple* its staff. Opportunities for promotion are sure to come rapidly for years.

### Good Pay from the Start

We offer the highest starting salary possible considering your qualifications for the job. Experience need not be in computers.

### Good Living

Most ERA engineers own their homes. Within 15 minutes they can drive to work, to downtown shopping, or to the country. The University of Minnesota offers evening courses and Big Ten sports. Minneapolis Symphony concerts are a vital force in the community. Minnesota's forests are dotted with 10,000 cool lakes, many nearby. Hunting, fishing, swimming, and boating are excellent. You will enjoy living in Minnesota's vacation land.

Send an outline of your training and experience to Dept. A4:

*Remington Rand*

DIVISION OF **SPERRY RAND** CORPORATION

ENGINEERING RESEARCH ASSOCIATES DIVISION

1902 W. Minnehaha Avenue  
Saint Paul W4, Minnesota

# ENGINEERS

for immediate placement

## ENGINEERING AT NCR:

1. Immediate, permanent positions in Mechanical and Electrical Engineering Divisions.
2. Engineering project work in Adding Machines, Cash Registers, Accounting Machines, Computers, and related Data Processing Equipment in Dayton, Los Angeles, and Ithaca, New York.
3. Work involving design, development, and production engineering of mechanical, electronic, and electromechanical devices.
4. Some experience in development, design, and application of high-speed, light-weight mechanisms of the intermittent motion type is desirable, but not essential.
5. Ample training and indoctrination is available to all employees.

## MECHANICAL ENGINEERS ELECTRICAL ENGINEERS ELECTRONIC ENGINEERS MECHANICAL DRAFTSMEN

AS AN NCR ENGINEER you, with your family, will enjoy:

1. UNLIMITED OPPORTUNITY in the broad, ever-expanding field of Business Machine Engineering.
2. AN EXCELLENT SALARY, plus exceptional benefits of lifetime value for you and your family.
3. A RECREATIONAL PROGRAM for year-round enjoyment of the entire family including a new Country Club with 36 holes of golf, and a 166-acre park for outings with swimming, boating, and supervised play for the children.
4. LIVING IN DAYTON... considered one of the cleanest and most attractive cities in the Midwest with outstanding school facilities.
5. YOUR WORK AT NCR with its friendly, family atmosphere, with its employee morale at a very high level, and with people who, like yourself, have decided to build their professional future with NCR.

**ACT AT ONCE—Send resume of your education and experience to:  
EMPLOYMENT DEPARTMENT TECHNICAL PROCUREMENT SECTION**

**THE NATIONAL CASH REGISTER COMPANY  
DAYTON 9, OHIO**

# ENGINEERS

*Find Out About GPL's  
INTEGRATED APPROACH  
To Research Engineering*

A continuous flow of stimulating and varied projects are laid before the staff of General Precision Laboratory, Incorporated.

Sometimes research and development engineers work together as a cooperative, specialized professional team. Often one or two devote all their energies to a long-range basic problem. All are engaged in challenging work which encourages them to broaden their interests beyond their immediate fields of concentration. There is particular opportunity for components application engineers of several types.

Your family will enjoy your career at GPL as much as you, for you'll make your home in beautiful Westchester, noted for its high standard of living. Only an hour away is New York City, with all its famous cultural and educational advantages.

## GENERAL PRECISION LABORATORY INC.

A subsidiary of General Precision Equipment Corporation

63 Bedford Road  
Pleasantville, New York

### WHAT GOES ON IN THE GP LAB:

RESEARCH  
& DEVELOPMENT  
WORK IN:

Electronics

Television

Aircraft & Missile Guidance, Control, Simulation

Radar, Microwave, Ultrasonics

Systems Engineering:  
(aeronautical, naval, industrial)

Precision Mechanics,  
Ceramics, Optical Devices

Instruments, Servos,  
Controls:  
(hydraulic, pneumatic, magnetic, electronic)

*Expenses will be paid for qualified applicants, who come for interview. We regret we can consider only U.S. citizens. Please write complete details to Mr. Hollis F. Ware*

## Electronic and Electrical Engineers and Mathematicians

Internationally known research organization seeks experienced engineers and mathematicians for interesting research and development programs in Air Traffic Control and other Communication Systems.

These are permanent positions with initial long term assignments at FORT HUACHUCA, Arizona, offering attractive salaries and excellent opportunities for personal and professional growth.

We will assume the cost of moving and transportation expenses for you and your family.

Positions are also available in Chicago, Illinois in the following fields: Radio and Radar Communications; Electronic Instrumentation; and Electric Machine Components, Measurements.

Interested applicants for positions at either location should write:

Mr. T. E. DePinto

### ARMOUR RESEARCH FOUNDATION

of Illinois Institute of Technology

10 West 35th St.

CHICAGO 16,

ILLINOIS



**ENGINEERS****ELECTRONIC  
and  
MECHANICAL**

The Radio and Television Department of General Electric, situated in beautiful Electronics Park, is expanding its staff of development and product design engineers.

Those graduate engineers who qualify for current openings will find excellent opportunities for professional development through association with the outstanding engineers and scientists concentrating on research, development and design in all branches of the electronics industry.

Electronics Park is headquarters for the Electronics Division of GE, including the Electronics Laboratory, Radio and Television Department, Semi-conductor Products, Communications Equipment, Broadcast Equipment, Cathode Ray Tube Department, Components Department and Government Equipment Department.

Salary scales for engineers are strictly competitive, and based on individual ability and experience. And, in addition to its comprehensive system of benefits, General Electric is noted for its stability.

Current openings include:

**ELECTRONICS ENGINEERS  
ENGINEERING SUPERVISORS  
MECHANICAL ENGINEERS**

VHF and UHF Head-End Design  
Audio and High-Fidelity Products  
Advanced Development  
Deflection Component Design  
Deflection Systems  
Color Television  
Transistor Circuits  
Metal-forming and Plastics

Please send  
complete resume to:  
MR. JAMES STARK

**GENERAL  ELECTRIC**

Electronics Park,  
Syracuse, N. Y.



**ENGINEERING  
OPPORTUNITIES**  
*for you!*

CONVAIR-Pomona is engaged in development, engineering and production of electronic equipment and complex weapons systems. The Convair-Pomona engineering facility is one of the newest and best equipped laboratories in the country. The work in progress, backed by Convair's outstanding record of achievement, offers excellent opportunities for recent graduates and experienced engineers in the following fields:

**ELECTRONICS  
DYNAMICS  
AERODYNAMICS  
THERMODYNAMICS  
OPERATIONS RESEARCH  
HYDRAULICS  
MECHANICAL DESIGN  
LABORATORY TEST ENGINEERING**

Generous travel allowance to engineers who are accepted.

\*For further information on Convair and its fields of interest, write at once, enclosing a complete resume to:  
Employment Department 3-G

\*ENGINEERING  
BROCHURE  
TO QUALIFIED  
APPLICANTS

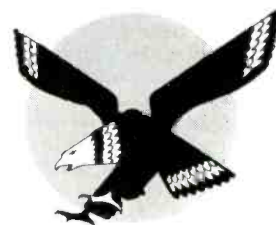

**C O N V A I R**

A DIVISION OF GENERAL DYNAMICS CORPORATION  
POMONA, CALIFORNIA



*has a future for*  
**ELECTRONIC ENGINEERS**  
*in these specialized fields*

Career-minded men with several years specialized experience, and preferably with advanced degrees, are invited to join our rapidly expanding programs in industrial and military electronics.

Address inquiries to:  
 Technical Employment Manager

**TRANSISTOR CIRCUITRY**

Transistorization and subminiaturization of advanced missile guidance and airborne radar systems.

**MICROWAVE ANTENNAS**

Research, development, and design of airborne antennas in C, L, K, S, and X-bands for missiles and radar equipment.

**TEST EQUIPMENT**

Test equipment design for radar and missiles systems and equipment manufacture.

**INDUSTRIAL TELEVISION**

Development, design, and product engineering of closed-loop TV systems, including monitor, camera, and automatic controls.

**RADAR**

Study, analysis, and development in highly advanced radar techniques and electronic counter-measures.

**MISSILES**

Research, analysis, and development in guidance and control systems, components, and systems test equipment.

**FARNSWORTH ELECTRONICS CO.**  
**Fort Wayne, Indiana**

*A division of International Telephone and Telegraph Corp.*

**ENGINEERS**  
 DESIGNERS-DRAFTSMEN  
 Electronic Mechanical

**Keep Your Eye on the Ball**

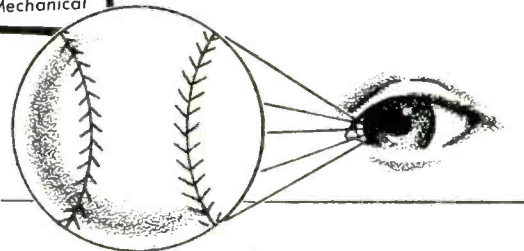

In your career, as in successful baseball, golf or tennis, it pays to keep your eye on the ball. Keep your eye on the advantages only a young, yet securely established company can offer. Melpar is young enough to welcome new ideas, to recognize and award achievement, yet big enough to offer stability and growth to those who look to the future.

Superb new laboratory facilities just completed this year; an engineering staff of the highest calibre; long-range military and industrial research programs; and an ideal family environment in pleasant Fairfax County in northern Virginia . . . these are just some of the many benefits you'll find as a member of the Melpar staff.

Keep your eye on a career with Melpar, leader in electronic research and development.

*For personal interview send resume to*  
 Technical Personnel Representative,



Subsidiary of Westinghouse Air Brake Co.

3000 Arlington Blvd., Dept. E-20,

Falls Church, Virginia or 11 Galen St., Watertown, Mass.

- Network Theory
- Systems Evaluation
- Automation
- Microwave Technique
- UHF, VHF or SHF Receivers
- Analog Computers
- Digital Computers
- Magnetic Tape Handling Equipment
- Radar & Countermeasures
- Packaging Electronic Equipment
- Pulse Circuitry
- Microwave Filters
- Flight Simulators
- Servomechanisms
- Subminiaturization
- Electro-Mechanical Design
- Quality Control & Test Engineers

**SENIOR ELECTRONICS ENGINEERS**

EE degree or equivalent experience. Background in communications and navigation desirable. Permanent positions in design and development. Citizenship required. Position at Rochester, New York. Excellent living and recreational conditions in this area.

ADDRESS:

Chief Electronics Engineer  
**STROMBERG-CARLSON COMPANY**  
 ROCHESTER 3, NEW YORK

**A GOOD WRITER**

is needed by a small electronic company in southern Connecticut. This position can be filled only by an electronic engineer with sufficient imagination and writing ability to do many different tasks in our small company. If you can qualify, you will find this an unusual position with opportunity for advancement limited only by your own ambition and abilities.

P-6970, Electronics  
 330 W. 42 St., New York 36, N. Y.

**ERCO**

Since 1931

an integrated combination  
of men and machines . . .**ELECTRONIC ENGINEERS  
INTERESTED IN  
COMPUTER DEVELOPMENT**

By joining ERCO's progressive organization you can count on your talents being fully utilized on some of the most interesting projects in the computer field. Engineering management constantly stresses individual advancement and recognition.

Since ERCO produces what ERCO designs, for both military and commercial projects, your future will be marked only by the limits of your creative engineering talents.

We need engineers whose experience lies in these fields . . . Analog Computers, Computer Components, Radar, Servo-Mechanisms, Fire Control, Pulse Circuitry, or Systems Engineering

- YOU'LL  
BE  
DELIGHTED  
WITH**
- the fine housing and schools in suburban Washington, D. C.
  - our modern plant located in Riverdale, Md. just 9 miles from the nation's capitol.
  - ERCO's liberal company benefits

Send Resume to

**ENGINEERING  
AND  
RESEARCH**A DIVISION OF **QCF** INDUSTRIES  
INCORPORATED**RIVERDALE  
MARYLAND****COMPUTER ENGINEERS****Can you fill  
these key positions?****Link Aviation, Inc.  
needs top level****electronics engineers**

If you are experienced in computer engineering—and have the ability to direct others in important projects, then Link Aviation Inc. has a top level position for you in its expanding research and development program.

These permanent, key positions are for:

**SENIOR DIGITAL COMPUTER ENGINEERS**—Must be capable of supervising a small group of engineers designing special-purpose digital computers. Should have extensive knowledge of latest digital computer logic and circuit design techniques. Familiarity with transistor pulse circuits, magnetic functional elements, magnetic tape and drum read-write systems and analog digital conversion methods is highly desirable. The position will require complete responsibility for computer project from system design through prototype construction.

**SENIOR ELECTRONICS ENGINEERS**—Qualified to design complex feedback amplifiers, precision regulated power supplies, specialized electronic instruments and advanced systems which require unusual creative and analytical ability. Familiarity with vacuum-tube circuit design, transistor circuits, application of magnetic amplifiers, photo-conductor and photo-transistor circuitry is desirable. Should be capable of directing a small group of engineers engaged in systems and component design in the above fields.

Link's broad scope of activities—including design and development of flight and radar simulators, computer-actuated training devices, electronic instruments and special-purpose computers—presents engineers of executive calibre with an outstanding opportunity for personal advancement in a growing organization.

In addition to these advantages, Link offers an unusually attractive "fringe benefit" program including profit sharing, retirement and liberal vacation and holiday policies. Link is located in Binghamton near the heart of upstate New York's recreationland. Only 180 miles from New York City, Binghamton provides "hometown" comfort with big-city conveniences.

Write full details to Mr. John Hunt,  
Director of Research.**LINK  
AVIATION, INC.****BINGHAMTON, NEW YORK**A SUBSIDIARY OF  
GENERAL PRECISION EQUIPMENT CORPORATION

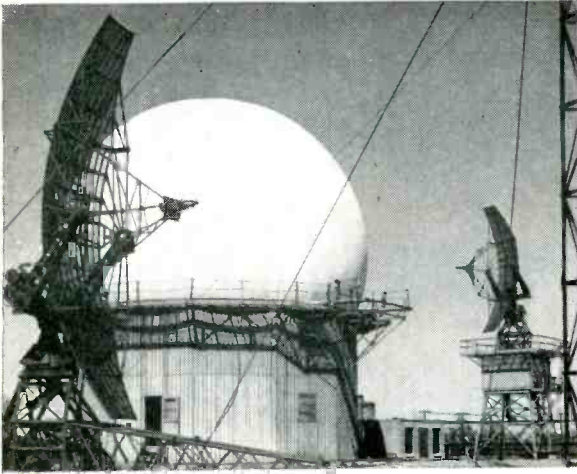

Huge antenna used with new radar height-finder needs a room all its own above the control center in the radome building erected in Arctic climates. Air pressure supports the rubberized glass fabric radome "balloon." Entrance to the radome is through an air lock chamber.

## What Opportunities in Electronics are on the Horizon at GENERAL ELECTRIC?

Advances in electronics are so rapid at General Electric that today's predictions appear tomorrow as equipment bearing the GE symbol.

The opportunities created by the scope and pace of the field are increased at General Electric by the facilities and range of professional advantages which GE engineers enjoy.

This means that GE electronics engineers have incentives, satisfactions and rewards that lead to accelerated personal development and advancement in the company.

*Positions available in the following fields:*

Advanced Development, Design, Field Service and Technical Writing in connection with:

**MILITARY RADIO & RADAR • MULTIPLEX MICROWAVE MOBILE COMMUNICATION • SEMI-CONDUCTORS • ELECTRONIC COMPONENTS • TELEVISION, TUBES & ANTENNAS**

*Bachelor's or advanced degree in Electrical or Mechanical Engineering, physics, and experience in electronics industry necessary.*

## ENGINEERS • PHYSICISTS

*Please send resume to:  
Dept. 8-5-P — Technical Personnel*

**GENERAL  ELECTRIC**

ELECTRONICS PARK, SYRACUSE, N. Y.

### RAYTHEON'S MISSILE and RADAR DIVISION



Bedford  
Mass.

#### CAREER ENGINEERING POSITIONS

- **SENIOR RADAR SYSTEMS ENGINEER**

Attractive opening for engineer capable of advanced systems engineering for airborne radars. Strong background in electronic circuit design required. Experience in radar systems design and allied fields desirable. Long term developments involve application of interesting new techniques.

- **CIRCUIT DESIGN ENGINEERS** ★ **Junior and Senior**  
2 to 3 years electronic circuit design experience required. Must be capable of independent design and analysis. Servo experience desirable.

- **SENIOR SPECIFICATIONS ENGINEER**

5 or more yrs. of experience in electronic design, applications or technical writing required. Familiarity with military specifications desirable.

RAYTHEON'S MISSILE AND RADAR DIVISION is a well-established, progressive organization located 20 miles from Boston in an area offering excellent housing, recreational and educational facilities.

*Please write, or apply in person, giving full particulars concerning education, experience, and salary to Mr. A. H. Nile, Personnel Section.*

**RAYTHEON MANUFACTURING COMPANY**  
190 Willow Street, Waltham, Mass.

**CORNELL AERONAUTICAL  
LABORATORY, INC.**  
of Cornell University  
is seeking

### ELECTRONIC ENGINEERS

for positions in all levels of experience above Junior Engineer

**Communications**  
**Dynamic Control Systems**  
**Aircraft Instrumentation**  
**Radar**  
**Computers**  
**Electrical Measurements**  
**Varied Electronic Circuits**  
**Servo-Mechanisms**  
**Missile Guidance**  
**Microwave**

If you have a B.S. degree and experience, imagination and potential, we invite you to communicate with our Employment Manager

BOX 235

BUFFALO 21, N. Y.

**ENGINEERS:**

Take it from Saul Fast,  
B.S., City College of  
New York '42  
M.E.E., Polytechnic  
Inst. of Brooklyn '50

**your  
creativity pays off  
at National**

Mr. Fast had been a research engineer performing systems engineering on communications, radar, and counter-measure systems when he joined National in 1955. He is now Chief Engineer of National's Communications System Division. He has played an important role here in pioneering the Scatter Communications Systems which promise to strengthen the radar protective screen of the North American continent. Because of National's vigorous program to develop such new and advanced products, he says, an engineer's opportunities at National are limited only by his creativity.

*Opportunities at National Now for . . .*

**PROJECT ENGINEERS  
SENIOR ENGINEERS**

SEND YOUR RESUME TODAY TO Mr. John A. Bigelow

**National**



EST. 1914

**NATIONAL COMPANY, INC.**

58 Sherman St. Malden, Mass.

**Is YOUR FUTURE as  
promising as the ATOM'S?**

If you're not satisfied with your own answer to this question, you should investigate the opportunities at TRACERLAB, foremost company in the field of NUCLEAR APPLICATIONS.

TRACERLAB needs . . .

**NUCLEAR ENGINEERS  
ELECTRONIC ENGINEERS  
ELECTRICAL ENGINEERS  
MECHANICAL ENGINEERS  
PHYSICISTS**

to work in research, development and applications of nuclear instrumentation. Openings are of a permanent and non-military nature, and offer outstanding opportunities for advancement. We would be pleased to have you consider the possibility of joining our successful and forward looking team.

Write in confidence to . . .

**Tracerlab**

130 HIGH ST., BOSTON 10, MASS.

**ENGINEERS  
PHYSICISTS**

**How "TECHNICAL BARRIERS"  
Create Opportunities in SYLVANIA'S  
NEW Missile Systems Laboratory**

Sylvania is opening a new laboratory with facilities for overcoming the many "technical barriers" present in man's effort to perfect guided missile systems. This opens bright new opportunities for engineers and physicists who wish to progress in this field, with a company which has a 54-year history of supplying vital "heart" parts to other manufacturers as well as consumer products to the public. Back of this new laboratory is Sylvania's stability, diversity and continual expansion, as shown by the doubling of its engineering staff and almost tripling of its sales in the past six years.

**Permanent Positions Are Now Open in These Fields:**

- DESIGN, DEVELOPMENT & ANALYSIS OF RADAR SYSTEMS —
 

Transmitters	Servo Systems
Receivers	Data Processing
Antennas	Computers
- OPERATIONAL & DESIGN ANALYSIS OF MISSILE SYSTEMS —
 

Structures	Guidance
Power Plants	Servo Mechanisms
Launchers	Aerodynamics
Controls	Ground Support Equipments
- MATHEMATICAL ANALYSIS & SYSTEM DESIGN OF FIRE CONTROL AND COMPUTER EQUIPMENTS

Relocation and interview expenses will be paid

Please forward complete resume to:

**Erling Mostue**

*Supervisor of Professional Placement*

**missile systems laboratory**

**SYLVANIA**

SYLVANIA ELECTRIC PRODUCTS INC.

100 First Street

Waltham, Massachusetts

# ENGINEERS and DESIGNERS NEEDED

for:

MISSILE GUIDANCE SYSTEMS

BOMBING NAVIGATIONAL COMPUTER SYSTEMS

NEW CIVIL AVIATION PRODUCTS

JET AND TURBO-PROP ENGINE CONTROLS

AIRBORNE FIRE CONTROLS

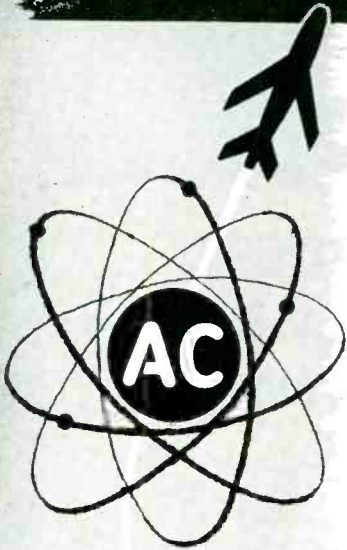

## GM CAREER OPPORTUNITIES IN

Systems Engineering and Analysis  
Experimental Engineering  
Development Engineering  
Project Coordination

Design Engineering  
Product Engineering  
Product Evaluation  
Field Engineering

## AND WE ALSO NEED:

## DESIGNERS • CHECKERS • LAYOUT MEN

Positions Are Permanent

Excellent Advancement Opportunities

Every inquiry treated confidentially and given immediate attention and personal reply.

## WRITE TODAY FOR EMPLOYMENT APPLICATION

Mr. Louis R. Berks  
Supervisor of Employment

AC SPARK PLUG DIVISION  
Precision Instrument Plant

**GENERAL MOTORS CORPORATION**  
Milwaukee 2, Wisconsin

## EXCELLENT OPPORTUNITIES

for

ENGINEERS and  
and  
SCIENTISTS

In Research  
and Development  
of Instruments & Equipment

### QUALIFICATIONS:

BS, MS, or PhD degrees in mechanical, electrical, electronics and chemical engineering, physics and chemistry.



### A CAREER WITH A FUTURE:

Permanent, responsible positions for qualified, creative men to develop, design and apply special instruments and equipment to our pilot plant and process operations.

### EMPLOYEE BENEFITS:

Excellent working conditions, modern facilities, Retirement and Insurance Programs, Company Contributed Savings Plan.

### GOOD LOCATION:

Modern, medium sized Southwestern community. Pleasant surroundings with excellent family recreation, religious and educational facilities.

Reply by letter giving age, experience and other qualifications. All applications carefully considered and kept strictly confidential. Write:

Employee Relations Manager  
Research and Development Department

**PHILLIPS PETROLEUM COMPANY**

Bartlesville, Oklahoma

# electronic ENGINEERS

Excellent, long-range opportunities with a progressive company for top level men of established reputation and experience, and for junior engineers who are seeking an interesting future in design and development of klystrons, magnetrons, semi-conductors, traveling wave tubes, RF microwave components . . . full benefits program.

Write to:

**BOMAC**

Laboratories

Beverly,

Massachusetts



## CIRCUIT ENGINEERS

# Why Not Work in Vacationland?

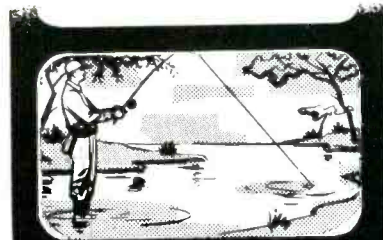

One of the many advantages in working for Sanders Associates, Inc. is the site of the plant itself: Nashua in lovely New Hampshire, New England's most beautiful state. Less than one hour from both the White and Monadnock Mountains, with cool streams, crystal lakes, lush green foliage, Nashua's many natural recreational facilities abound. Or, if you prefer the surf and the sea, you're less than one hour from world-famous Hampton and Rye Beaches.

Of distinct advantage, too, is Sanders' working environment: the small, effective engineering groups working on a variety of projects, the balance of military and commercial work, the realistic management BY engineers FOR engineers make way for quick professional growth and personal advancement.

Noteworthy "firsts" developed at Sanders include printed "strip-line" plumbing, tape resistors, the world's smallest rate gyro. On the staff are some of the top electronics experts in America, and a good many of the most promising junior men — exceptional engineers with the "something extra" that makes the difference between competence and real talent.

To complement this fine team and to permit further expansion, Sanders is adding a few engineers with at least 3 to 5 years experience in missile guidance, pulse and doppler radar, microwave antenna, airborne navigation, printed circuit and component development.

If you are an exceptional engineer — have not only talent, but ambition and drive — Sanders can provide unusual opportunity. Address inquiries to Mr. J. I. Chesterley.



137 Canal St., Nashua, New Hampshire

## ELECTRONIC ENGINEER

### FOR WORK ON CIVILIAN PRODUCTS

in the fields of  
ACOUSTICS and  
ELECTROMECHANICS

Salary commensurate  
with background

## DYNA-LABS INC.

1075 Stewart Avenue  
Garden City, L. I., N. Y.

## UNUSUAL CREATIVE FREEDOM at *Bendix* AVIATION RESEARCH LABORATORIES DIV.

• The center of advanced development activities for the Bendix Aviation Corporation offering excellent opportunities in design, research and development.

### SYSTEMS ENGINEERS

To coordinate and supervise a group of engineers and mathematicians in systems analysis and design.

### MATHEMATICIANS

Evaluation of servo control and guidance systems and components of a system. Analysis of systems and applications.

### MACHINE DESIGNERS

Design of automatic machine tools, machine tool hydraulic servos, and digitally controlled tools.

### CONTROLS ENGINEERS

Analyse and synthesize control system and design, develop and package such systems.

### COMPUTER ENGINEERS

Development of special purpose digital and analog computers for process and business applications.

### MICROWAVE SPECIALISTS

Research and development in advanced microwave techniques.

### MECHANICAL ENGINEERS

Develop mechanical and hydraulic components for servo controls. Systems engineering and dynamic analysis of numerically controlled machine tools.

- Staff will participate in the initial exploration of new fields and the development of new commercial products.

All replies confidential—  
send brief resume to:

**DIRECTOR OF PERSONNEL**  
BENDIX AVIATION CORPORATION  
RESEARCH LABORATORIES DIVISION  
4855 Fourth Avenue • Detroit 1, Mich.



During WESCON SHOW employment interviews will be arranged at your convenience. Please contact Litton Industries' suite, Sir Francis Drake Hotel, San Francisco, or address inquiries to E. Kelly, Personnel Dep't., 336 North Foothill Road, Beverly Hills, California.

## Your Creative Contribution Makes Your Future at . . . LITTON INDUSTRIES

A future of exceptional opportunity developed in an environment of professional challenge, personal responsibility and individual recognition.

Complete lab and test facilities speed your progress.

**RESEARCH PHYSICISTS:** Microwave Systems, Microwave & Storage Tubes, Digital Computer Techniques.

**SENIOR ELECTRONICS ENGINEERS:** Microwave Systems, Circuit Design, Production Design, Packaging, & Qualification of Military Electronic Equipment.

**MECHANICAL DESIGNER:** Precision Mechanisms, Instruments & Transducers.

**LABORATORY ASSISTANTS:** With high vacuum technique experience.

Be sure to visit our booth at the WESCON SHOW . . .  
336 NORTH FOOTHILL ROAD, BEVERLY HILLS, CALIFORNIA

## ELECTRONIC DEVELOPMENT ENGINEERS

CHALLENGING DESIGN & DEVELOPMENT POSITIONS FOR CREATIVE ENGINEERS

These positions are tailor-made for highly imaginative engineers who enjoy problems of more than ordinary difficulty—problems that require a maximum of individual electronic creativity. Men selected will be entrusted with the complete electronic or electro-mechanical design and development tasks (initial circuits, systems, components, or product design) entailed in carrying a prototype project from original conception to its completion.

**REQUIREMENTS:** Senior and Intermediate engineers with degrees and 4 to 8 years' experience; Junior engineers with degrees and 1 to 3 years' experience, capable of growing with our long-range, electronic design and development program in the following fields:

- |                          |                     |
|--------------------------|---------------------|
| (1) ANALOG COMPUTER      | (4) ELECTRO-OPTICS  |
| (2) RADAR BEACONS        | (5) MISSILE SYSTEMS |
| (3) MAGNETIC AMPLIFIERS  | (6) SERVOS          |
| (7) FIRE CONTROL SYSTEMS |                     |

Interviews will be arranged at convenient locations.

Send Resume to:

**AVION DIVISION  
OF ACF INDUSTRIES INCORPORATED**

Route 17, Paramus, N. J.

COlfax 1-4100

## WANTED ENGINEER WITH EXPERIENCE IN VHF OR UHF

Interesting creative work with the most resourceful and progressive firm in the field of television equipment.

This position is permanent. It will offer every opportunity for unlimited advancement and for developing a successful career. The plant is now housed in a newly-acquired larger building, only 22 miles from downtown New York City. The surroundings and atmosphere are stimulating and congenial.

### Attractive Salary

Write stating qualifications.

**BLONDER-TONGUE LABORATORIES**

526-536 NORTH AVENUE  
WESTFIELD, NEW JERSEY



ENGINEERS

**Creative Opportunities  
with Republic Aviation**

Research

**Antenna Engineer**

To conduct pattern studies, design prototype antennas and supervise flight tests of new antenna installations. College graduate in Physics, Math or E. E.

**Electronic Instrumentation Engineer**

Three to five years aircraft instrumentation experience required. Knowledge of transducers, amplifiers and recording equipment used in experimental research testing of hi-speed jet aircraft is essential. Knowledge of servo loop theory as applied to aircraft systems coupled with ability to properly instrument, record and analyze is desirable. Graduate with E. E. degree preferred.

**Electronics Engineer**

Familiar with airborne electronic equipment (communications, navigation I.F.F., Radar and Autopilots), preferably with 2 to 4 years aircraft experience. Should be a college graduate. Duties will include system investigations, establishing test procedures and conducting environment tests on airborne electronic equipment and components.

**Computer Engineer**

To supervise maintenance and to design special circuitry for computers. Experience with either analogue or digital computers required. College graduate preferred.

**Senior Power Plant Engineer**

Three to eight years aircraft power plant experience. Capable conducting power plant testing in conjunction with jet engine and induction system analysis. B.S. in M.E. or A.E.

Please address complete resume, outlining details of your technical background, to:

Assistant Chief Engineer  
Administration  
Mr. R. L. Bortner



**REPUBLIC AVIATION**

FARMINGDALE, LONG ISLAND, NEW YORK

ENGINEERS

The APPLIED PHYSICS LABORATORY of THE JOHNS HOPKINS UNIVERSITY offers an exceptional opportunity for professional advancement in a well-established Laboratory with a reputation for the encouragement of individual responsibility and self-direction.

Our program of

**GUIDED MISSILE  
RESEARCH and DEVELOPMENT**

provides such an opportunity for men qualified in:

- Design and Analysis of Pulse Circuits
- Research and Development in Radar and Microwaves
- Electronic Packaging
- Development of Telemetry, Data Processing, and Special Switching Equipment
- Magnetic Amplifier Design & Analysis
- Development and Application of Printed Circuits
- Servomechanisms and Control-System Analysis

Please send your resume to  
Professional Staff Appointments

**APPLIED PHYSICS LABORATORY  
THE JOHNS HOPKINS UNIVERSITY**  
8621 Georgia Avenue  
Silver Spring, Maryland

PHYSICISTS AND ENGINEERS

for research and development

*We are interested in intelligent men*

When we find them, we offer them mature responsibilities and a broad scope for their abilities in the company of other able men. We offer an opportunity, a challenge and a future.

We want five experienced physicists and engineers for research and development work in the fields of infrared analytical equipment for laboratory and process plant, low signal level electronic circuitry, electro-mechanical devices and analytical instruments for medical use.

We design and manufacture a variety of highly complex instruments and devices employing fine optical, electronic and mechanical skills — such as spectrophotometers and process stream analyzers. We also have designed most of the large aerial photographic objectives in use today. Our bombsights fly in today's jet bombers; our reactor periscopes sail on the Nautilus. We have designed complete computer systems for fire control and bomb direction. Our analytical instruments serve the laboratories of industry and the universities the world over.



If you are interested in becoming associated with Perkin-Elmer, please submit a detailed resume of your qualifications to the Personnel Manager.

**THE PERKIN-ELMER CORPORATION**  
NORWALK, CONNECTICUT

**CAREER OPPORTUNITIES**

**ELECTRONIC and MECHANICAL ENGINEERS  
PHYSICISTS and PHYSICAL CHEMISTS**

Desiring the challenge of interesting, diversified, important projects—  
Wishing to work with congenial associates and modern equipment and facilities—  
Seeking permanence of affiliation with a leading company and steady advancement—  
Will find these in a career here at GENERAL MOTORS.

**Positions now open in RESEARCH, ADVANCE DEVELOPMENT and PRODUCT DESIGN**

COMMERCIAL AUTOMOBILE RADIO

MILITARY RADIO, RADAR and ELECTRONIC EQUIPMENT

ELECTRONIC COMPONENTS

INTRICATE MECHANISMS such as tuners, telemetering, mechanical linkage, controls, etc.

ACOUSTICS—loud speakers, etc.

TRANSISTORS and other SEMICONDUCTORS—with leadership by a physicist with an outstanding record in this field.

TRANSISTOR APPLICATIONS

Salary increases based on merit and initiative. Relocation expenses paid for those hired.

Vacations with pay, complete insurance and retirement programs.

Inquiries invited from recent and prospective graduates as well as experienced men with baccalaureate or advanced degrees in physics, electrical or mechanical engineering, chemistry, metallurgy.

All inquiries held in confidence and answered—Write or Apply to

**Personnel Department DELCO RADIO DIVISION**

**GENERAL MOTORS CORPORATION**

1446 South Home Ave.

Kokomo, Indiana

To

*EMPLOYERS*

*who advertise*

*for MEN:*

WHEN there are many applicants for a single position it frequently happens that the only letters acknowledged are those of the most promising candidates. Others may not receive any indication that their letters have even been received by a prospective employer much less given consideration. These men often become discouraged, will not respond to future advertisements, and sometimes question their bona fide character.

*Every advertisement printed in this Section is duly authorized.*

It will help to keep our readers interested in this advertising if you will acknowledge every application received, even if you merely return the letters of unsuccessful applicants with, "Position filled, thank you" written or stamped on them. If you don't care to reveal your identity, mail them in plain envelopes.

We suggest this in a spirit of cooperation between employers and the men replying to Positions Vacant advertisements.

★

*"Put yourself in the other fellow's place."*

★

*Classified Advertising Division*

**McGraw-Hill Publishing Co., Inc.**

• • • for those  
who qualify

Security

Understanding

Know how

Send resume to



**offers**

**ELECTRONIC  
ENGINEERS**

- HEAVY BACKLOGS
- SOUND FINANCING
- TOP BENEFITS
- MANAGEMENT BY ENGINEERS
- EDUCATIONAL AID
- MINIMIZED RED-TAPE
- VARIED SPECIALIZATION
- FLEXIBLE ORGANIZATION
- VERSATILE PERSONNEL

R. F. LANDER

**Electronic Engineering Company**  
of California



100 SOUTH ALVARADO STREET  
LOS ANGELES 57 - CALIFORNIA

See Us  
At  
Booths  
1102 and 1103  
Wescon,  
San Francisco

	<p><b>new career openings</b></p>	

## ANTENNA AND RADOME DESIGN ENGINEERS

Experience in airborne and/or radome design and development. Advanced degree in E.E.; mathematics or physics desirable. Previous experience in electro magnetic theory, knowledge of di-electric and ferrite materials advantageous. Work to consist of research, development and design of airborne antennas, radomes, and antenna systems for high performance aircraft.

## ELECTRONICS ENGINEERS

Degree in E.E. plus experience in airborne or its associated components. Component development with experience in circuitry and packaging technique advantageous. Work will consist of cooling reliability and evaluation studies of electronic equipment.

*Write or apply*

Engineering Personnel Office  
Dept. A

**NORTH AMERICAN AVIATION**  
COLUMBUS 16, OHIO

# MOTOROLA

## COMMUNICATIONS & ELECTRONICS

**POSITIONS FOR  
ENGINEERS  
PHYSICISTS  
METALLURGISTS  
CHEMISTS**

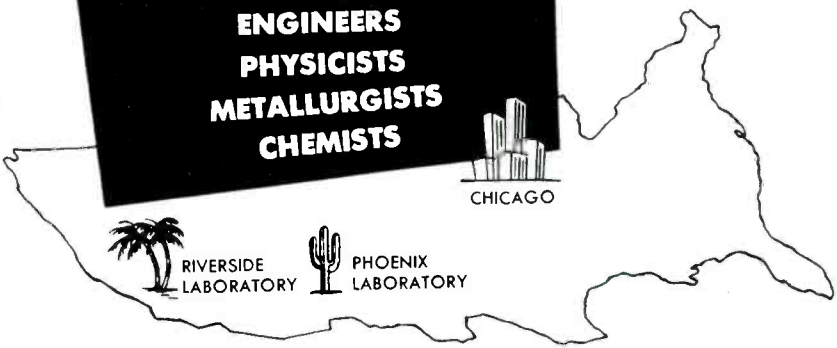

**Immediate, permanent positions in Mechanical and Electrical Engineering Divisions**

- **PHOENIX:** Outstanding opportunities for Metallurgical Physicists, Engineers and Chemists in the development and production of semi-conductor products.
- **CHICAGO:** Challenging positions in Mobile communications, Microwave, Radar and military equipment research, design and production—to all grades of Electronics, Mechanical Engineers and Physicists. Join this rapidly expanding group with unlimited *future and recognition* for you.
- **RIVERSIDE:** This brand new laboratory needs advanced, experienced men in missile and military equipment systems analysis and design. Enjoy superb working and living conditions in California at its best.

▶ Address résumé to **D. E. Noble, Vice Pres. Motorola Inc., C & E Division**  
4501 W. Augusta Blvd., Chicago 51, Illinois

## GRADUATE ENGINEERS and SCIENTISTS

Our expanding Research and Development Department in Minneapolis is a complete and integrated unit in which projects progress from the idea or research stage and into our volume production facilities, for both industrial and military application. It is actively pursuing research programs on military systems and proprietary products, and offers you a stable, permanent organization.

Our ELECTRONICS RESEARCH DEPARTMENT is actively pursuing programs in Electronic controls for automation, special purpose analogue computers, digital circuit applications, instrumentation, micro-wave antennas and equipment; precision servo-mechanisms, and related subjects. Engineers and scientists are needed for advanced development work of a creative nature, who have ability to apply the fundamentals of circuit theory, mathematics and physics.

Pleasant residential communities a few minutes from work. A delightful area of friendly neighbors and recreation. Our extremely low turnover testifies to the pleasant working and living conditions.

You can work closely with prominent scientists on extremely interesting projects where you will be recognized for your contributions. Congenial associates and atmosphere. Alert and progressive organization. Permanent positions. Openings for bachelor, master and doctor degrees. All inquiries will be treated in complete confidence. You are invited to address the Director of Personnel at—

**Mechanical Division of**

**GENERAL MILLS, INC.**

1621 Central Avenue

Minneapolis 13, Minnesota

## PROGRESSIVE ENGINEERS LOOK WEST

Qualified Electronic and Electro-Mechanical engineers find happy association with a Western electronics pioneer and leader.

*design*  
*development*  
*production*

Commercial and military projects. Radar, DME, Communications, Noise, Test Equipment including color T.V. —Many others with real interest & challenge. Relocation expenses—excellent working conditions—Central location. Scheduled reviews & advances. Fine insurance plan. Move should not disturb urgent military projects.

Send complete resume, income history & requirements to engineering employment mgr.

# Hoffman LABORATORIES, INC.

(A SUBSIDIARY OF HOFFMAN RADIO CORP.)

3761 SO. HILL ST.

LOS ANGELES 7, CALIF.

## ELECTRONIC ENGINEERS

Research & Development  
Physicists - Engineers  
(SENIORS)

Experienced in research and development of various radar systems including: beacons, missile guidance and counter measures. Advanced training in applied mathematics, noise theory and probability analysis desirable. EE degree or equivalent required.

## FIELD ENGINEERS

(SENIORS)

Local & Field Assignments

Must have EE degree, with 3-5 years experience in one of the following:

- Flight Simulators
- Radar & Sonar Trainers
- Fire Control Radar
- Electronic installation and maintenance.

### ● EQUIPMENT ENGINEERS

3-5 years experience with at least 3 years in circuit packaging. EE degree with mechanical background.

### ● APPLICATION ENGINEERS

5-10 years experience on coil and transformer development.

Salary and advancement commensurate with ability; liberal vacation, sick leave, 9 paid holidays, group life, sickness and accident insurance plans, and a worthwhile pension system.

## STAVID

Engineering, Inc.

U. S. Highway 22, Watchung, P. O. Plainfield, N. J.—PLainfield 7-1600

## FIELD ENGINEERS

Openings exist for men with Navy fire control & fire control radar experience. Work in U S A only **GOOD SALARY**

Many employe benefits  
Rapidly expanding aggressive company  
Must be U S Citizen

For interview call or write

# REEVES

INSTRUMENT CORPORAT'N

1633 3D AVE. NY 28

EN 9-0660

quality control  
SYSTEMS ENGINEERING  
component design  
ENVIRONMENTAL ENGINEERING  
coordination  
RESEARCH ADMINISTRATION  
production engineering  
DEVELOPMENT packaging

Regardless of which is your ultimate objective the broad practical experience you get in FIELD ENGINEERING will supplement your theoretical training, prepare you to meet the challenge of the future and put you years ahead!

### RAYTHEON FIELD ENGINEERING

is diversified. Radar, Sonar, Guided Missiles, Computers, Microwave and other specialized equipments offer an outstanding opportunity to qualified men to earn excellent salaries while working among authorities in these fields. Your performance regulates your progress. Liberal insurance and retirement plans. Generous travel allowances and other benefits. Grow with a growing organization. Write now:

### RAYTHEON MFG. CO.

Government Service Department  
100 River Street  
Waltham 54, Massachusetts

### ELECTRONIC ENGINEERS

Must have 2-6 yrs. exp. in the design of IF, VHF and/or UHF broad band systems. Progressive firm, many benefits.

Phone or write

MR. G. W. FELLENDORF  
Instruments for Industry, Inc.  
Mineola, N. Y. Pioneer 2-5300

### CHIEF ENGINEER - ELECTRONICS

Prominent eastern Instrument Manufacturer requires graduate E.E. with extensive industrial experience to assume responsibility for all electronic development activities, supervising engineering and laboratory technical personnel, and reporting to Vice President. Instrument background helpful. Please submit complete resume and state approximate salary requirements in first letter to

P-6121, Electronics  
330 W. 42 St., New York 36, N. Y.

## EMPLOYMENT OPPORTUNITIES ADVERTISERS INDEX

Admiral Corp.	390
Allen Organ Co., Inc.	410
Armour Research Foundation of Illinois of Technology	396
Avion Division of ACF Industries Inc.	404
Bailey Technical School	383
Bendix Aviation Corp.	
Pacific Division	409
Products Division	387, 388
Radio Division	393
Research Laboratories Division	403
York Division	394
Berkeley Div., Bechman Instruments Inc.	394
Blonder-Tongue Labs Inc.	404
Bomac Labs Inc.	402
Brown Instruments Div., of Minneapolis Honeywell	386
Burrough Research Center	391
Cardwell Electronics Prod. Corp., Allen D.410	
Convaiv, A. Division of General Dynamics Corp.	
Pomona, Calif.	397
San Diego, Calif.	386
Cornell Aeronautical Laboratory Inc.	400
Drake Personnel Inc.	383
Dyna-Labs Inc.	403
Electric-Auto Lite Co.	409
Electronic Engineering Co. of Calif.	406
Engineering & Research, A Div., of ACF Industries Inc.	399
Farnsworth Electronics Co.	398
General Electric Co., Syracuse, N. Y.	397, 400
General Mills Inc.	407
General Motors Corp.	
Delco Radio Division	406
AC Spark Plug Division	402
General Precision Lab Inc.	396
Goodyear Aircraft Corp.	389
Graebner's Exchange	383
Hodgson Co., R. W.	383
Hoffman Laboratories Inc.	408
Instruments for Industry	408
Johns Hopkins University, Applied Physics Lab.	405
Lear Inc.	390
Link Aviation, Inc.	399
Litton Industries Inc.	404
Maryland Electronic Mfg. Corp.	392
Melpar Inc.	398
Monarch Personnel	383
Moore Co., Paul	383
Motorola Communications & Elec.	407
National Cash Register Co.	396
National Co., Inc.	401
North American Aviation	407
O'Shea Employment System	383
Pennsylvania State University, The	410
Perkin-Elmer Corp., The	405
Philips Laboratories	410
Phillips Petroleum Co.	402
Radio Corp. of America	384, 385
Raytheon Mfg. Co., Waltham, Mass.	400, 408
Reeves Instrument Corp.	390, 408
Remington Rand Inc.	
Engineering Research Associates Div.	395
Sperry Rand Corp., Div.	392
Republic Aviation Corp.	405
Robertshaw-Fulton Controls Co.	409
Sanders Assoc., Inc.	403
Stavid Engineering	408
Stromberg-Carlson Co.	398, 409
Sylvania Electric Products, Inc.	
Buffalo, N. Y.	394
Mountain View Calif.	388
Waltham, Mass.	394, 401
Tracerlab Inc.	401
Transitron Electronic Corp.	409
Trans-Sonics, Inc.	410
Westinghouse Electric Corp., Elmira, N. Y.	392

This index is published as a convenience to the readers. Care is taken to make it accurate but CLASSIFIED assumes no responsibility for errors or omissions.

**Bendix**

needs

**ELECTRONIC  
ENGINEERS**

in

**SOUTHERN CALIFORNIA**

Unusual engineering positions in Radar, Sonar and Telemetry are available at Pacific Division, Bendix Aviation Corporation in North Hollywood, California. These positions, which are directly associated with our long-range projects for industry and for defense, are available at all levels.

Please address inquiries to:

**W. C. WALKER**

Engineering Employment Manager

**Pacific Division**  
Bendix Aviation Corporation  
NORTH HOLLYWOOD, CALIF.

**ELECTRONICS  
ENGINEER OR PHYSICIST**

If you have experience or ability in design, construction and evaluation of high voltage, high frequency circuits, we have an exceptional opportunity in which you will be interested. Position requires applicant capable of designing circuits incorporating transistors, magnetic amplifiers and semi-conductors. Write Director of Personnel, The Electric Auto-Lite Company, Toledo 1, Ohio

**INSTRUMENTATION ENGINEER**

Once in a lifetime opportunity for physicist or electronics engineer with ability to design, construct and install setups used to obtain data on engine ignition and performance. Setups will be diversified so that projects might require mechanical and electronic instrumentation as required to best obtain information. Also included will be design of auxiliary control circuits and writing of operation manual to be used by experimental department personnel. Write Director of Personnel, The ELECTRIC AUTO-LITE COMPANY, Toledo 1, Ohio

**CHIEF ENGINEER**

A well established, midwest company, long engaged in electronic and radiation research and product manufacturing requires a man who can qualify for Chief Engineer. Background in electronic engineering and nuclear science is essential. Experience in administration duties including supervision and co-ordination of project groups is required. Salary will be commensurate with qualifications and ability. Opportunity is unlimited. Give complete resume, with picture, in first letter.

P-7053, Electronics  
520 N. Michigan Ave., Chicago 11, Ill.

**DEVELOPMENT ENGINEERS and PHYSICISTS**

RADIO AND RADAR SYSTEM APPLICATIONS  
TRANSISTORS AND MAGNETIC AMPLIFIERS  
SERVOMECHANISMS AND ANALOGUE DEVICES  
ELECTROMECHANICAL CONTROLS AND ACTUATORS

We are now staffing the new Electronics Laboratory of our Aeronautical Division in Anaheim, California. The selection of associates is based on consideration of their demonstrated abilities and interests in connection with our long-range laboratory plans. Careful attention



Mr. Controls

Aeronautical Division  
**Robertshaw-Fulton**  
CONTROLS COMPANY

SANTA ANA FREEWAY AT EUCLID AVENUE  
ANAHEIM, CALIFORNIA

to engineering and operational planning and to the selection of critical control problems assures opportunities for continuous professional development. The efforts of a relatively small but select staff are being applied on projects requiring engineering ingenuity essential to advancing the art of control in the aeronautical field.

Positions are available at all levels of laboratory work. Please direct inquiries to Vernon Vogel, Electronics Laboratory Director.

**WIRE LINE CARRIER SYSTEMS ENGINEER**

wanted for high-level position with managerial responsibilities in established electronics manufacturing company.

Should have 5 years' experience in wire line carrier telephone work, with at least 2 years spent in applications, either with manufacturer or large carrier operator. Experience in carrier operation in Armed Forces is applicable. Bachelor's degree or professional engineer status required. Travel, about 10% of time, may be necessary.

The right man for this job will find no quibbling about salary. Stromberg-Carlson Company has been pioneering in telephone industry for 60 years, and is known for high quality of products. One of fastest growing companies in the industry, offering excellent opportunities for advancement. Liberal bonus, other benefits. Located in Rochester, New York, in heart of beautiful Finger Lakes Country. Community noted for fine schools, cultural, recreational facilities.

Also have openings for several carrier and microwave sales engineers. Must be free to travel in limited territory. Successful sales experience required. There may be an opening in your area.

If you qualify for either of above positions send resume of experience to General Manager, Telephone Division, Stromberg-Carlson Company, Rochester 3, N. Y.

**SEMICONDUCTOR DEVELOPMENT****DEVICE ENGINEERS****PRODUCTION ENGINEERS****APPLICATION ENGINEERS****SALES ENGINEERS**

Responsible positions are now available with one of the leading and fastest growing semiconductor manufacturers. These are outstanding opportunities for Physicists and Engineers in research, development, or production of advanced germanium and silicon diodes and transistors. Experience in semiconductors or other components such as tubes or capacitors is desirable. Replies held in strict confidence. Send resume or call

**Transitron** electronic corporation

MELROSE, MASS.

MEIrose 4-9600

## ENGINEERS NEEDED FOR RESEARCH AND DEVELOPMENT POSITIONS IN THE

Design of electronic instrumentation for underwater ordnance, including high gain amplifiers, conventional filters, power amplifiers, oscillators and detectors in the ultrasonic range.

Analytical and experimental treatment of scientific research problems in the fields of hydrodynamics, acoustics, electronics, network theory, servomechanisms, mechanics, information theory and noise analysis including analogue and digital computations.

Design of transducers, fundamental problems in underwater acoustics involving transmission, attenuation, reflection, etc. Problems in sound control and noise reduction. Acoustical aspects of systems research including operations research and feasibility studies.

*Opportunities for graduate study*

*Liberal Vacation Policies*

*Excellent Working Conditions*

**THE PENNSYLVANIA STATE UNIVERSITY  
ORDNANCE RESEARCH LABORATORY**

University Park, Pennsylvania

Send Resume to **ARNOLD ADDISON**, Personnel Director

## RECEIVER ENGINEERS With Experience in VHF and UHF Frequencies

Career Opportunities  
With Old Established  
Central Connecticut Firm

Interesting Projects  
Top Salaries  
Suburban Living

Replies Held in Strict Confidence  
Wire or Phone Collect  
Personnel Mgr. **SHERWOOD 7-2741**

**THE ALLEN D. CARDWELL  
ELECTRONICS PRODUCTIONS  
CORPORATION**

Plainville, Connecticut

### ENGINEERS

#### Research Engineers & Physicists

**1. MICROWAVE PHYSICIST**  
For research project on application of ferrites at microwave frequencies and other microwave projects. PhD with experience.

**2. INSTRUMENTATION ENGINEER**  
Electronic and mechanical experience for design of X-ray spectrographic instruments. BS or MS with 3-5 years engineering experience.

**3. TUBE DESIGN ENGINEER**  
To head project on X-ray tube design. BS or MS with 3-5 years' tube design and development experience.

Ideal working conditions in suburban research laboratory. All retirement insurance and other fringe benefits.

Send resume to

**PHILIPS LABORATORIES**

Irvington-on-Hudson, N. Y.

N Y C: LO 2-8703 or Irvington 9-3100

## TRANS-SONICS, INC.

### MICROWAVE ENGINEER

For advance creative design and development work on amplifiers, radomes and components for airborne electronic equipment.

### PROJECT ENGINEER

For leadership and planning of development and engineering programs on airborne electronic and associated ground equipment, industrial experience essential.

These are senior positions which require responsible and professionally competent individuals. Trans-Sonics, Inc. is continuing its expansion program with a new suburban laboratory northwest of Boston in an area of desirable residential and industrial communities.

PLEASE CONTACT:

**ALBERT SACK, TRANS-SONICS, INC., BEDFORD, MASS. CRESTVIEW 4-6600**

## SALES ENGINEER

Aggressive sales engineer to call on military agencies needed by well-known communication equipment manufacturer. Should have knowledge of communication equipment and contacts with military purchasing groups for Army, Navy, and Air Force. Involves travelling out of Washington office. Salary and commission. Send complete details with photo to

SW-6963, Electronics  
520 N. Michigan Ave., Chicago 11, Ill.

## Electronic Organs Engineering - Sales

Challenging opportunities are available in both of the above departments. Send resume.

**ALLEN ORGAN COMPANY**

**MACUNGIE PENNSYLVANIA**

### DISTRIBUTOR WANTED

Importer to handle revolutionary fountain-pen-like pocket voltmeter. Swiss made. U. S. Pat. Importers with contacts among Dealers, Department Stores, etc. Please contact

**MAAG, P. O. B. 103,  
Zurich, 30, Switzerland**

## REPRESENTATIVES WANTED

Manufacturer of electronic test equipment for military and commercial applications needs technically qualified representatives. Write giving qualifications, lines handled, territory covered.

**RW-2178, Electronics  
1111 Wilshire Blvd., Los Angeles 17, Calif.**

## DO YOU NEED ENGINEERS

### EXPERIENCED IN:

Research  
Development  
Design  
Instrumentation  
Servomechanisms  
Missiles  
Audio Systems  
Control Systems  
Radar  
Computers  
Transistors

Place an "ENGINEERS WANTED" advertisement in this EMPLOYMENT OPPORTUNITIES SECTION. It's an inexpensive, time saving method of selecting competent personnel for every engineering job in the electronic industry. The selective circulation of ELECTRONICS offers you an opportunity to choose the best qualified men available throughout the industry.

For Rates and Information

Write:

Classified Advertising Division

**McGRAW-HILL PUBLICATIONS**

330 West 42nd St., N. Y. 36, N. Y.

**UNDISPLAYED RATE:**

\$2.10 a line, minimum 3 lines. To figure advance payment count 5 average words as a line.  
 PROPOSALS, \$2.10 a line an insertion.  
 BOX NUMBERS count as one line additional in undisplayed ads.  
 DISCOUNT of 10% if full payment is made in advance for four consecutive insertions of undisplayed ads (not including proposals).

**DISPLAYED RATE:**

The advertising rate is \$18.50 per inch for all advertising appearing on other than a contract basis. Contract rates quoted on request.  
 AN ADVERTISING INCH is measured 7/8 inch vertically on one column, 3 columns—30 inches—to a page.  
 EQUIPMENT WANTED or FOR SALE ADVERTISEMENTS acceptable only in Displayed Style.

Send NEW ADVERTISEMENTS to N. Y. Office, 330 W. 42nd St., N. Y. 36, N. Y. for September issue closing August 4th

The publisher cannot accept advertising in the Searchlight Section, which lists the names of the manufacturers of resistors, capacitors, rheostats, and potentiometers or other names designed to describe such products.



## AN/APR-4 LABORATORY RECEIVERS

Complete with all five Tuning Units, covering the range 38 to 4,000 Mc; wideband discone and other antennas, wavetraps, mobile accessories, 100 page technical manual, etc. Versatile, accurate, compact—the aristocrat of lab receivers in this range. Write for data sheet and quotations.

We have a large variety of other hard-to-get equipment, including microwave, aircraft, communications, radar; and laboratory electronics of all kinds. Quality standards maintained.

NEW TS-13/AP X-BAND SIGNAL GENERATORS with manual \$575.00; T-47A/ART-13 Transmitters, \$450.00; H-P, Boonton, G-R, Measurements, many others in stock.

## ENGINEERING ASSOCIATES

434 PATTERSON ROAD

DAYTON 9, OHIO

## WESTERN ELECTRIC METERS—NEW!



- A. 80-0-80 amperes. Diam. 5 1/2 in. Individually boxed. With shunt. \$15.00
- B. 100-0-100 Voltmeter. Diam. 3 1/4 in. Basic movement 1 milliamp. Model D-165573 Individually boxed. SPECIAL. \$8.75
- C. 150-0-150 amperes. Diam. 4 1/4 in. Individually boxed. With shunt. \$12.75
- 10-0-10 amperes. Diam. 4 1/4 in. Individually boxed. With shunt. Only. \$10.75
- 20-0-20 amperes. Diam. 4 1/4 in. Individually boxed. With shunt. Only. \$11.50
- 40-0-40 amperes. Diam. 4 1/4 in. Individually boxed. With shunt. Only. \$11.50

### 46 ACJ UHF RECEIVER

13 tube double conversion receivers, frequency range 450-600 MC. This unit employs 446A lighthouse tubes in the RF section, mixer and oscillator circuits. First IF frequency of 55 MC has two stages of amplification, second IF frequency of 16 MC has 4 stages of amplification. Two video stages follow the second detector. With schematic and tubes 8-6AC7, 3-44E, 1-6AG7, 1-6H6 New Condition \$9.95

### ISOLATION TRANSFORMER

For isolating line noise, AC-DC sets, etc. Electrostatic shielding, 2,000 V. breakdown test. 6 ft. cord, female receptacle. Primary 110-120 V. 50/60 cycles. Secondary 110-120 V. Mfg. by UTC. Model No. R-76. 1200 W. \$9.95 New condition

### Q-5'ER NAVY TYPE BEAM FILTER

Can be used same as FL-8, FL-30. This unit has selector knob which will select or reject a 1020 cycle note. Two phone jacks for plugging your headsets in series with the receiver. Wt. 3 lbs. New, with schematic. Ea. \$1.95 2 for \$3.75

### FM WOBULATOR CAPACITOR

Excellent for sweep generator. Frequency modulation unit permanent magnetic field and a moving coil mechanism driving a metal diaphragm supported at its rim. This diaphragm acts as a moving plate of the frequency modulator capacitor. With schematic. See Dec. Radio TV News for data. Brand new. Wt. 3 lbs. \$2.75 TWO FOR \$4.95

### TS-182/UP

Complete. For checking power output, receiver sensitivity, pulse shapes and recovery time. Equipment consists of a pulsed R-F oscillator with calibrated frequency dial, built-in power supply which operates from 110 V. 60 to 1200 cps. Unit has a 2AP1 Scope Tube and 10 other tubes. Freq. range: 150-240 MC. Like new. \$42.50 Weight 50 lbs.

### TS-10C/APN

Latest model for testing FM radio altimeters. Complete with cables and indicator. New condition. P.U.R.

## NEW CATALOG NO. 114

1955 ISSUE  
 LISTS LATEST INVENTORY OF AIRCRAFT, INDUSTRIAL AND MILITARY ELECTRONICS EQUIPMENT. SEND FOR YOUR COPY.

## ARROW SALES INC.

Western Division  
 Mailing Address: P.O. BOX 3878-E, N. HOLLYWOOD, CAL.  
 Office-Warehouse: 7460 VARNA AVE., N. HOLLYWOOD, CAL.  
 Phones: Stanley 7-6005 • Poplar 5-1810  
 Sales-Showroom: 2005 EMPIRE AVENUE, BURBANK, CAL.  
 Phone: Victoria 9-2834  
 Cable Address: ARROWSALES, NORTH HOLLYWOOD  
 Telegraph Address: WUX, NORTH HOLLYWOOD  
 Central Division  
 Mailing Address & Sales-Showroom:  
 2441 S. MICHIGAN AVE., CHICAGO 16, ILLINOIS  
 Phone: CALumet 5-4750

## Component Bargains!

### LARGE QUANTITY

- 3BP1—RCA, Sylvania, Individ. Box. \$1.00
- 6J6—6A05, Unbranded but Guaranteed. 25c
- 3A5—RCA Jan Boxed. 25c
- 5844 Tubes. 30c
- RESISTORS 2 WATT 5% AB, 24K, 560 ohms, 10¢ Each—Min. Order 100 of Each
- CARBON 1/2 W. \$10 per M. Min. Order 100
- RESISTORS 1 W. 20 per M. 100 of
- 2 W. 30 per M. Each
- CONDENSERS 8 mfd 450V. .15
- CONTROLS—1/2 & 1meg w/switch. 28¢
- CERAMIC CONDENSERS — Tubular, All Sizes \$25 per M. Min. order 100
- 70° CONSOLE YOKE WIRED. 1.00
- 90° YOKE UNWIRED. 85¢
- #20 Shielded Wire—Solid. \$7.50 per 1000 ft. 2,000 ft. Spools.

And Many Other Items

We Also Purchase Your Surplus Inventory

## BELVISION, INC

254 Greenwich St., N. Y. 7, N. Y. BA 7-6063

## Specialists in TUBES

All Famous Name Brand Radio and TV Receiving Tubes, Transmitting tubes, Special Purpose Tubes

You get immediate delivery on these high quality, low priced tubes taken from one of the most extensive selection of tubes available. Order now!

We handle such brands as: Hallicrafters, National Union, Zenith, Admiral, Stewart-Warner, Raytheon, RCA, Philco, Sylvania, Crosley, B-E, Motorola, Testron.

### SPECIALS: Transmitting Tubes

5654	\$1.00	3B28	\$2.00
5725	\$2.25	2C46	\$6.00
2D21	.65	6A56	\$1.75
6080	\$2.25	HF200	\$6.00

This is just a partial list of types available. Phone or mail your order. Send for our complete tube listing.

## B & C DISTRIBUTORS COMPANY

180 Spring Street Paterson, N. J.  
 MU berry 4-4010

## TUBE TESTING LABORATORY

TEST YOUR TRANSMITTING, RECEIVING, AND SPECIAL-PURPOSE TUBES TO JAN, MIL-E-1B AND/OR COMMERCIAL SPECS. LAB. CERTIFICATES SUPPLIED  
**BARRY ELECTRONICS CORP.**  
 512 BROADWAY, N. Y. 12, N. Y. WALKER 5-7000

### FOR SALE

Two surplus Eimac Type 2000-T TRANSMITTING TUBES  
 Never used. \$250 each or best offer. Contact: Mr. W. H. Hauser, Chief Engineer, WBZ-TV, 1170 Soldiers Field Road, Boston 34, Mass.

## TELEPHONE RELAYS

See our May Ad for a more complete listing



## Chase

ELECTRONIC SUPPLY CO.  
 105-07 225 St., Queens Village, N. Y. HOLLI 4-6033

2K28 Tubes - Fully 3KP1  
 \$28.50 ea Guaranteed RCA \$550

Write for Quotations on Any Types

## ALLIED ELECTRONIC SALES

74 Courtlandt St.—N. Y. 7, N. Y. BARELAY 7-5839



# COMPASS ELECTRONICS SUPPLY

A Division of Compass Communications Corporation

WE MAINTAIN OUR OWN FULLY EQUIPPED TESTING LABORATORY TO TEST AND GUARANTEE ANYTHING WE SELL  
Wholesale, Industrial and Institutional Sales Only

## Special Announcement

In keeping with our plans for expansion and increased service, we take great pleasure in announcing the removal of our offices and laboratory to a new location. Effective immediately, our new address is:

### 75 VARICK ST. NEW YORK 13, N. Y.

#### TEST SETS

- TS-3A/AP
- TS-10A and B
- TS-12/AP
- TS-13/AP
- TS-14
- TS-16/AP
- TS-35A/AP
- TS-36/AP
- TS-61/AP
- TS-62/AP
- TS-74/UPM
- TS-89/AP
- TS-98
- TS-101/AP
- TS-104
- TS-110
- TS-125/AP
- TS-131
- TS-173/UR
- TS-184
- TS-278
- TS-323
- TS-UPM-1
- OAA
- OAP
- OBU
- LAE
- LM
- LU
- IE-19
- 1-46
- 1-56
- 1-208
- 1-222
- SCR-211
- AND OTHERS
- TRANS-
- MITTERS
- TAJ
- TAQ
- TBL
- TBK
- TBM
- TBN
- TCE
- TCP
- TDE
- TDO
- TDO
- AND OTHERS

#### RECEIVERS

- ARB
- ARC-1
- ARC-3
- ARC-4
- ARC-5
- AR-88
- ART-13
- CR-91
- SLR
- RAK
- RAL
- RAO
- RBB
- RBO
- RBC
- RBL
- RBA
- RBM
- RCM
- BC-224
- BC-312
- BC-314
- BC-344
- BC-348
- BC-348

#### AND OTHERS

#### FIELD EQUIPMENT

- SCR-274
- 284
- 300
- 503
- 399
- 808
- 828
- BC-191
- 375
- 603
- 604
- 610E
- 683
- 684
- 923
- 924
- 1000
- 1306

#### TEST SETS

- TS-13/AP-X BAND RADAR TEST SET—Measures power, freq. signal-to-noise ratio, I.F. Bandpass, etc. Input—115/1/60—800.....WRITE
- TS-35A/AP-X-BAND—Measures transmitted power & frequency of Radar Transmitters, also used for receiver adjustments.....NEW...\$375.00
- TS-100/AP—TEST SCOPE, type A, R, J & X indications, gated & un-gated sweep, Int. or Ext. trigger.....WRITE

#### SPECIAL PURPOSE TUBES

Write for Latest Listing at Great Savings, of New Tubes, Standard Brands Only—Guaranteed!

#### MICROWAVE ACCESSORIES

- 15 LB. ALNICO-V MAGNET—approx 4800 gauss.....\$16.00
- WAVEGUIDE, FLEX, with flanges, 3 cm., 12'1.....\$12.50 ea.
- 3 CM., 24'1.—\$14.00 ea. 10 CM., 60'1.—\$22.50 ea.
- BENDS, E. & H. plane; 3 & 10 CM.....WRITE
- DUPLEXER, Mixer & Preamp Ass'y., 3 CM.....WRITE
- also cavities, klystron mounts, rotating joints, circular waveguide stubs, etc.....WRITE

WESTERN ELECTRIC VARIATORS, THERMISTORS, Res. Networks Relay Ass'y, Precision Potentiometer, #60 A Key Selectors, etc.....WRITE

#### RADAR BEACONS

- YJ and YG.....for shipboard use AN/CPN-8.....10 cm.
  - AN/CPN-6.....3 cm. AN/APS-2, APS-3, APS-4, APS-6, APS-15
- Also SA, SF, SG, SD, SK, SN, SQ—both equipment and spare parts

#### SA-2 RADAR

Used for air traffic control, tracking and search, both land-based and ship-borne, 5 microsec. pulse, PPI indication, operates at 200 mcs, peak power of 150 K.W. Input 110/120 volts a.c. 4 complete installations in stock.—Write for price.

Write for More Details on Any Particular Item in Which You are Interested These are partial listings only of our stock. Please write for other types.

75 Varick St.  
BECKMAN 3-6510

New York 13, N. Y.  
Cable: COMPRADIO, N. Y.

#### MOTOR GENERATORS AND CONVERTERS

50, 60, 400 and 800 cycle and DC Power Supplies

- 28dc to 110/1/800 @ 1kva.....\$49.50
- (Overall length: 12 inches)
- 110dc to 110/1/800 @ 350va.....150.00
- 110ac to 110/1/800 @ 350va.....235.00
- 110dc to 110/1/400 @ 2kva.....395.00
- 110/1/60 to 110/1/400 @ 2kva.....435.00
- 220/1/60 to 110/1/400 @ 2kva.....435.00
- 440/3/60 to 110/1/400 @ 2kva.....435.00
- 32dc to 110/1/60 @ 350va.....100.00
- 110dc to 110/1/60 @ 350va.....100.00
- 110dc to 28dc @ 250va.....95.00
- 110/1/60 to 28dc @ 250va.....115.00
- 220/1, 3/60 to 28dc @ 250va.....115.00
- 110dc to 110/1/60 @ 1.25kva.....135.00
- 220dc to 110/1/60 @ 1.25kva.....145.00

Partial listings write for others

#### SYNCHROS & SELSYNS

- 5F.....\$40.00 7G.....\$70.00
- 5G.....45.00 2J1F1.....10.00
- 5CT.....45.00 2J1G1.....10.00
- 5SDG.....27.50 2J1H1.....10.00
- 6G.....55.00

TORQUE UNIT PIONEER 12602-I-A with CK-5 Motor and AY-43 Autosyn.....\$34.50

#### 115 V AC BLOWER

w/motor, 1/150 h.p. 3000 RPM \$10.00

#### REVERSIBLE GEARED MOTOR

Delco PM-Permanent Magnet Alnico Field Motor



- #5071895 1/4 SHAFT or 11/16 GEAR... \$17.50
  - #5069000.....\$18.50
- Clamps to hold motor: \$1.50 ea.

GRAIN OF CORN LAMPS  
10 for \$3.00—100 for \$25.00



- #328, 6 Volts
- #326 2 1/2 Volts
- #321, 28 Volts

#### TELECHRON Motors

- 4 RPM on 50 cycles or 434 RPM on 60 cycles...2.85
- 2 RPM.....\$2.90
- 3 RPM.....3.90
- 4 RPM.....2.90
- 3.6 RPM.....3.15
- 1 RPM.....3.95
- 3 R.P. 1 Hr.....2.85
- 1 R.P. 2 Hr.....2.80
- 1 R.P. 12 Hr.....3.25
- 60 RPM.....4.85

Laboratory Special 1 of Each Above \$25.00

please include postage

### BLAN



#### BLOWERS 115 Volts A. C. 60 c.

- REDMOND 5" 18 watts.....\$8.95
- DELCO 60 cfm, 40 watts.....\$14.50
- #5062369 used in 584 RADAR
- EASTERN AIR DEVICES 70 watts, 3400 RPM, labeled 80 cfm, but blows like blazes.....\$17.50

HAND WOUND 10 Sec. to 24 Min. TIMER SWITCH...\$1.25

6 Watt Most POWERFUL TELECHRON 1 RPM 110 volts 60 cy.....\$6.50

10 for.....\$50.00



3" Round Elapsed Time Meter \$13.75  
Square Case \$14.50



MARKTIME 5 HOUR SWITCH  
A 10 amp timing device. Pointer moves back to zero after time elapses. Ideal for shutting off radios and TV sets when you go to bed. Limited supply at this special price.....\$4.90  
ALSO available in 15 min., or 30 min. or 1 hr. at \$8.50



HAYDON TIMING MOTORS  
110v. 60 cycle 30 RPM...\$2.60  
110v. 60 cycle 1 RPM...2.85  
230V 1 RPM.....1.00  
60C 2 RPM.....1.00

EST. 1932

64K Dey Street  
New York 7, N. Y.

## FOR SALE

Wholesale to Institutions  
Industrials & Dealers Only

- RELAYS ● METERS
- MOTORS ● BLOWERS
- SWITCHES ● MAGNETS
- SYNCHROS ● RECEIVERS
- I.F. STRIPS ● NETWORKS
- ANTENNAS ● RESISTORS
- DUPLEXERS ● CAPACITORS
- CONNECTORS ● CONTACTORS
- INSTRUMENTS ● WAVE GUIDES
- MODULATORS ● DYNAMOTORS
- TRANSMITTERS ● TRANSFORMERS
- TORQUE UNITS ● SYNCHRONIZERS
- TEST EQUIPMENT ● CONTROL BOXES
- POTENTIOMETERS ● KLYSTRON MOUNTS
- JUNCTION BOXES ● MICROWAVE PARTS

ALL TYPES OF TUBES

WRITE TO

AMBER INDUSTRIAL CORP.  
METALS AND SALVAGE DIVISION  
732 E. Monument Ave. Dayton, Ohio





# FAY-BILL DISTRIBUTING CO.

Partial Listing Only LARGEST SURPLUS TUBE DEALER IN THE COUNTRY—STANDARD BRANDS—TRANSMITTING & RECEIVING

Type	Price	Type	Price	Type	Price	Type	Price	Type	Price	Type	Price	Type	Price	
AB-150	\$2.95	1N22	.39	3B11	3.29	5C22	28.99	286A	7.46	800	1622	1.55	6B6GG	1.99
CEP-224	.94	1N23	2.18	3B22	1.49	5D21	7.99	287A	6.61	801A	1624	1.64	6B6H	.79
CEP-120*ZB	.94	1N27	.89	3B23	3.39	5P1A	6.99	287B	8.93	802	1625	.19	6B6J	.69
CK-507AX	.94	1P28	2.99	3B24	2.49	5P7	1.99	304ATL	9.00	803	1626	.11	6B6K	1.21
CK-521AX	.94	1P30	2.99	3B24A	4.99	5P11	3.99	307A/RK75	.95	805	1629	.69	6B6L	1.29
CRP-72	.79	2B21	1.49	3B25	3.39	5P15	3.99	310A	3.50	807	1630	.69	6B6M	1.21
DG-1290	3.99	2B22	1.49	3B27	11.69	5P19	14.50	316A	4.46	808	1632	.49	6B6N	1.24
EF-50	.39	2B23	3.99	3B27	3.99	5P21	16.50	317A	3.49	809	1633	.59	6B6O	1.39
E-1146	.39	2C21	7.44	3B27	3.99	5P22	16.50	318A	3.00	812	1639	.99	6B6P	1.19
EC1	.39	2C22	3.99	3B27	3.99	5J29	9.00	319A	3.99	813	1641	2.49	6B6Q	1.24
EM3GA	39.99	2C26	.22	3C22	64.95	5J30	16.65	320A	1.49	814	1642	.29	6B6R	1.29
F128A	5.99	2C30	4.95	3C23	7.45	5J31	9.05	321B	1.49	815	1644	.69	6B6S	.49
F129A	5.99	2C33/RX233	1.69	3C24	1.42	5J33	5.90	322A	1.49	816	1645	.39	6B6T	.49
F128A	29.50	2C39A	11.40	3C28	4.99	5P1	1.95	323A	1.49	817	1646	.39	6B6U	.49
FG-105	14.44	2C40	9.99	3C30	3.39	5P11	1.95	324A	1.49	818	1647	.39	6B6V	.49
HF-100	6.99	2C43	12.40	3C45	7.95	5P15	1.95	325A	1.49	819	1648	.39	6B6W	.49
HF-150	1.89	2C44	.85	3C23	4.99	5P19	1.95	326A	1.49	820	1649	.39	6B6X	.49
HF-200	10.99	2C45	.85	3C23	4.99	5P21	1.95	327A	1.49	821	1650	.39	6B6Y	.49
HF-300	19.99	2C51	3.21	3E11	2.99	5P22	1.95	328A	1.49	822	1651	.39	6B6Z	.49
HK-24	3.99	2D1	1.79	3F17	2.99	5P22	1.95	329A	1.49	823	1652	.39	6B6A	.49
HK-45	4.59	2D1W	7.95	3F17	2.99	5P22	1.95	330A	1.49	824	1653	.39	6B6B	.49
HY-114B	.29	2E22	2.49	3MP7	1.77	5P22	1.95	331A	1.49	825	1654	.39	6B6C	.49
HY-615	.29	9E24	3.29	3J21	79.95	5P22	1.95	332A	1.49	826	1655	.39	6B6D	.49
KU-610	4.99	2G-22	1.38	4A-11	.19	5P22	1.95	333A	1.49	827	1656	.39	6B6E	.49
KQ-59	41.50	2J-21	2.49	4B-10	2.99	5P22	1.95	334A	1.49	828	1657	.39	6B6F	.49
QK-61	63.60	2J-22	2.99	4B25/EL6C	8.95	5P22	1.95	335A	1.49	829	1658	.39	6B6G	.49
QK-62	69.00	2J-26	4.99	4B28/CE225	2.99	5P22	1.95	336A	1.49	830	1659	.39	6B6H	.49
QK-185	110.00	2J-27	6.99	4C35	14.99	5P22	1.95	337A	1.49	831	1660	.39	6B6I	.49
RK-34	.29	2J-31	14.99	4C35	14.99	5P22	1.95	338A	1.49	832	1661	.39	6B6J	.49
RK-38	1.89	2J-32	15.99	4C35	14.99	5P22	1.95	339A	1.49	833	1662	.39	6B6K	.49
RK-59	2.49	2J-33	16.99	4D22	19.95	5P22	1.95	340A	1.49	834	1663	.39	6B6L	.49
RK-60	2.49	2J-34	16.99	4D22	19.95	5P22	1.95	341A	1.49	835	1664	.39	6B6M	.49
RK-65	9.95	2J-38	16.99	4D32	19.95	5P22	1.95	342A	1.49	836	1665	.39	6B6N	.49
RX-21A	7.99	2J-40	29.50	4E27A	29.95	5P22	1.95	343A	1.49	837	1666	.39	6B6O	.49
UH-50	1.99	2J-42	69.95	4J22	34.50	5P22	1.95	344A	1.49	838	1667	.39	6B6P	.49
105/VT-25A	1.99	2J-61	15.99	4J24	34.50	5P22	1.95	345A	1.49	839	1668	.39	6B6Q	.49
VR-78	.89	2J-62	8.99	4J25	34.50	5P22	1.95	346A	1.49	840	1669	.39	6B6R	.49
VR-90	.89	2K-22	16.99	4J26	59.50	5P22	1.95	347A	1.49	841	1670	.39	6B6S	.49
VR-105	.89	2K-23	17.95	4J28	59.50	5P22	1.95	348A	1.49	842	1671	.39	6B6T	.49
VR-150	.89	2K-25	12.99	4J29	59.50	5P22	1.95	349A	1.49	843	1672	.39	6B6U	.49
VT-52	.29	2K28	28.99	4J30	49.50	5P22	1.95	350A	1.49	844	1673	.39	6B6V	.49
305/VT-67	2.99	2K-33A	69.50	4J34	49.50	5P22	1.95	351A	1.49	845	1674	.39	6B6W	.49
VT-158	15.99	2K-41	75.00	4J36	69.50	5P22	1.95	352A	1.49	846	1675	.39	6B6X	.49
VU-111	.19	2K45	49.50	5B11	1.96	5P22	1.95	353A	1.49	847	1676	.39	6B6Y	.49
0A2	.86	2K50	29.50	5B11	1.96	5P22	1.95	354A	1.49	848	1677	.39	6B6Z	.49
1B22	1.19	9K54	16.00	5BP4	2.99	5P22	1.95	355A	1.49	849	1678	.39	6B6A	.49
1B24	5.99	9K55	39.95	5CP1	2.29	5P22	1.95	356A	1.49	850	1679	.39	6B6B	.49
1B26	1.19	242/879	.26	5CP7	8.99	5P22	1.95	357A	1.49	851	1680	.39	6B6C	.49
1B29	1.19	2V3	1.29	5CP1A	15.50	5P22	1.95	358A	1.49	852	1681	.39	6B6D	.49
1B32/532A	1.19	3A5	.69	5CP2/C6J	8.49	5P22	1.95	359A	1.49	853	1682	.39	6B6E	.49
1N21	8.69					5P22	1.95	360A	1.49	854	1683	.39	6B6F	.49

We Buy Your Surplus Tubes. Send Us Your List For Highest Quotation LARGEST BUYERS IN THE COUNTRY

Type	Price	Type	Price	Type	Price	Type	Price
7C22	39.50	WL460A	9.99	836	3.20	1MS	69
7C25	89.50	WL464A	2.77	837	.99	1R5	69
7B11	6.99	GL-475A	16.50	841	.26	69	61.6M
7B71	6.99	WL-530	14.99	843	.26	10A	69
9L7	2.19	WL-532	9.99	845	.26	10A	69
10Y	.21	GL-559	9.99	849	49.69	1K2A	69
12X3	1.66	700A/B/E/D	4.99	853	3.99	2A4	69
15E	1.09	701A	1.92	860	.39	3B7	69
18C	.19	702A	1.99	861	.39	3B7	69
19G	1.99	704A	1.59	864	.29	30E	69
257C	4.44	705A	1.96	866A	.99	304	69
53A	2.99	706C	18.95	869B	15.99	354	69
89Y	.10	707A	3.99	872A	1.26	504	69
100TH	6.99	707B	6.99	874	.86	5Y3	69
100TL	8.99	708A	2.45	878	.19	6V6GT	69
203	3.99	708B	2.45	878	.19	6V6GT	69
204A	9.49	709A	1.19	884	.39	6V6GT	69
205B	2.50	710A	1.96	885	1.49	5W4	69
207	36.50	713A	27.99	9-3	.19	6AC7W	69
211	2.89	714Y	6.99	902A	4.99	6AB7	69
215A	3.49	715B	6.99	910A	2.19	6AF4	69
217A	6.99	715C	15.75	927	1.35	6AG5	69
221A	2.29	718A/B/V	.89	931A	2.39	6AG7	69
231D	2.99	719A	21.99	954	.16	6AL5	69
242C	5.99	720A/C/V	11.75	955	.29	6AJ5	69
248B	2.99	721A	29.75	956	.26	6AK5	69
249C	4.99	722	8.10	958	.59	6AN4	69
250TH	19.50	724A/B	1.99	1500T	3.50	6AQ6	69
250L	21.99	725A	7.50	1500T	3.50	6AR6	69
253A	7.99	726A	9.50	CK1006	3.19	6AS5	69
258B	4.49	726B	20.50	1613	1.70	6BA7	69
264C	4.19	726C	26.50	1616	.99	6B8	69
271A	12.99	726C	26.50	1616	.99	6B8	69
274A	1.49	726C	26.50	1616	.99	6B8	69
274B	1.99	726C	26.50	1616	.99	6B8	69
282A/B	4.41	730A	9.99	1616	.99	6B8	69

All boxed and fully guaranteed. Special quantity discount—10% on 100 or more of same type. Minimum order \$10.00. Thousands of other types in stock. Send us your requirements F.O.B. New York. 25% deposit with order if paid in advance save C.O.D. charges. Rated firms net 10 days. Prices subject to change without notice. For fast service ask for Sy.

**FAY-BILL** DISTRIBUTING CO. DEPT. E1  
410 Broome St., N. Y. 13, N. Y.  
Telephone Canal 6-8404

**HIGH VOLTAGE OIL CAPACITORS**  
MFD. Volts Price  
.001 50 KV 22.50  
.01 5 KV 2.50  
.02 8 KV 4.50  
.02 20 KV 2.75  
.025 50 KV 17.95  
.025-.025 50 KV 34.50  
.1 3 KV 1.75  
.1 4.5KV 3.50  
.135 7.5KV 6.95  
.2 20 KV 29.50  
.25 15 KV 13.95  
.25 20 KV 15.95  
.25 50 KV 44.50  
1. 7.5KV 6.95  
1. 15 KV 29.50  
2. 5.5KV 9.50  
2. 6 KV 12.50

**SPECIAL**  
1.0 MFD. 7500 VDC OIL FILLED CAPACITOR.  
Cat. No. 26F681 Only  
**\$6.95**



**RA38 RECTIFIER**  
Variable Output 0-15000 V DC @ 500 MA. Input 115V 60 cy. 1 ph. Size 68 x 53 x 56 in. Write for detailed information.

**HIGH POT TRANSFORMER**  
Westinghouse. Pri: 115, 60 cy. Sec: 15,000V C.T. @ .080A, C.T. ungrounded. Excellent for high potting tests. Size OA 12H x 8 1/2W x 9 1/2D. Weight 87 lbs. Fully enclosed steel case. Price **\$29.50**

**30-10,000 CYCLE MODULATION TRANSF.**  
For RCA, Type 250-K Broadcast Transmitter (M1-7242) P to P Primary Imp. 15,000 ohms. Secondary Loads 5,030 ohms. Size 11 1/4 x 9 1/2 x 13". Wt. 143 lbs. New **\$39.50**

**9 CONDUCTOR CABLE**  
VINYL JACKETS  
SHIELD COV. SERVO  
Army spec. CO-215 Weather-proof 9 Cond. No. 2



Stock No. 130

**Timing Motors: HAYDON — B-5796 20/30 Volts DC — 30 RPM with Chronometric Governor — \$9.95 ea.**



Stock No. 133

**Sensitive Integrating Gyros:** This is the famous HIG gyro which is being used in missile guidance systems, radar stabilization and fine control systems. Gov't cost approx. \$1500.00. Limited quantity available not meeting Gov't Specs \$25 ea.



Stock No. 117

**AY38-D Autosyn:** double shaft; 26 volt; 400 cycle; Has 1/8" shaft extending 1/2" on each side. Pioneer Instrument. \$4.95 each



Stock No. 118

**Delco type 5068571 PM Motor:** 27 1/2 volt DC; 10,000 rpm; measures 1x1 1/2" long; has 1/8" shaft extending 1/2". \$6.75 each



Stock No. 119

**Type CK5 Low Inertia Servo Motor:** 2 phase; 26 volts; 400 cycle; stalled torque .5" oz; speed 3460 rpm; reversing time 0.4 seconds; weight 6 oz.; length 1 1/4"; Pioneer Instrument. \$22.50 each



Stock No. 120

**Type R200-1-A Synchro Control Transformer:** rotor 1 phase; 26 volt; stator 3 phase; 11.8 volts; 400 cycle; OD 1.062; motor length 1 3/4"; weight 3.5 oz.; Kearfott Co., \$15.00



Stock No. 121

**Type R-210-1-A Synchro Transmitter:** rotor 1 phase; 26 volt; stator 3 phase; 11.8 volts; 400 cycle; motor length 1 3/4"; OD 1.062; weight 3.5 oz.; Kearfott Company Inc. \$15.00 each



Stock No. 123

**Type R4-235-3 (high frequency) Synchro Resolver:** input voltage rotor or stator 26 volts; normal, 75 volt maximum; 400 cycle; motor length 1 3/4"; OD 1.062; weight 3.5 oz.; Kearfott Company Inc. \$25.00 each

**RESOLVERS**  
(sine-cosine generators)

**Stock No. 131**  
**Type FJE-43-9 Resolver:** manufactured by Diehl; Designed for 400 cycle excitation at 115 volts, but will operate satisfactorily at reduced 60 cycle voltage. The two outputs (90 electrical degrees apart) give sine-cosine signals of a maximum value of 55 volts at designed input. Shaft 0.125" dia. extends 3/8". Case is 2 1/2" long and 2 1/2" dia. \$25.00 each

**Stock No. 132**  
**Type FPE-43-1 Resolver:** manufactured by Diehl. Identical to type FJE-43-9 (S-7) except has primary-secondary step-up ratio such that 115 volt excitation induces a stator signal of 220 volts maximum.  
\$25.00 each

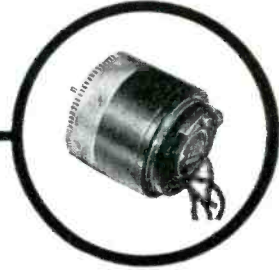

**ELECTRONIC**  
WAR TERMINATION INVENTORIES

WRITE OR WIRE FOR INFORMATION ON OUR COMPLETE LINE OF SURPLUS ELECTRONIC COMPONENTS. ALL PRICES NET F. O. B. PASADENA, CALIF.

**C & H SALES CO**  
2176 East Colorado Street  
Pasadena 8, California • RYan 1-7393



**D-13430 Motor-AC:** 2 phase control; 115 volts; 400 cycle single phase; no load speed 4800 rpm; stalled torque 1.45" oz; weight 8 oz.; length 1 1/2"; OD 1 3/4"; Kearfott Mfg. Corp. \$22.50 each

Stock No. 124

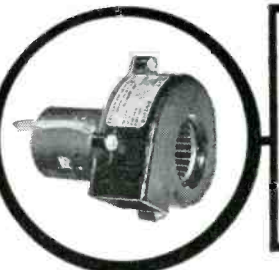

**50 CFM Blower:** 115 volts; 320/1000 cycle; single phase continuous duty; length 4 1/2"; Eastern Air Devices #B302H-1C; \$9.95 each

Stock No. 125

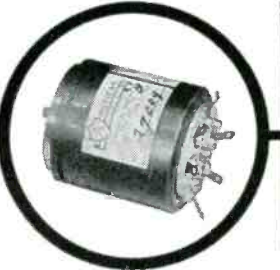

**Model No. 172B Control Motor:** 115 volts; 400 cycle; approximate length 2 3/4"; OD 1 1/2"; American Electronic Mfg. Inc. \$17.50 each

Stock No. 126

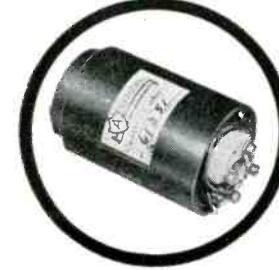

**Model No. 183 Drive Motor:** 115 volts; 400 cycle; single phase; OD 1.675; weight 14 oz.; length 2.625; 1/20 h.p.; speed 10,500; American Electronic Mfg. Inc. \$4.95 each

Stock No. 127

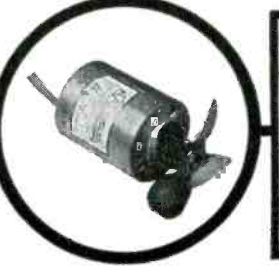

**No. 168A Propeller Fan Blower:** 115 volts; 320/1000 cycle; single phase; Motor OD 1.45; length 1.937"; weight 7 oz; CFM 33 over; speed 11,000; 2 1/8" blade; American Electronic Mfg. Inc. \$15.00 each

Stock No. 128

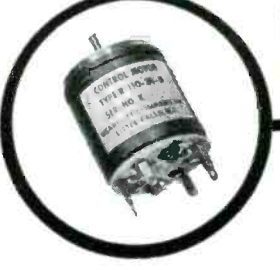

**Type R110-2A-B Control Motor:** 115 volts; 400 cycle; OD 1.437; length 1 1/2"; speed at maximum power output 2800 rpm; Kearfott Company Inc. \$22.50 each

Stock No. 129

**BLOWERS:**



12/24 VDC—AC CAST ALUMINUM BLOWER (Pictured at left)—100 CFM; 3" intake; 2" outlet. Shunt Motor 4"x2"; 3000 RPM @ 24 VDC. \$5.95  
 6 VDC SINGLE—100 CFM—No. 6100 ..... \$4.95  
 6 VDC FLANGE—150 CFM—No. 6150 ..... \$6.95

24 VDC DUAL—20 CFM—Min—No. 2420 ..... \$7.95  
 10 CFM BLOWER (Pictured right) 27.5 VDC; 1/100 HP.; 7000 RPM; Oster Motor C21P-1A; L-R Mfg. Co. Bakelite Blower #2, overall size: 3-1/2" x 4-1/2". Price ..... \$5.95  
 Same as above, 12 VDC operation; Price ..... \$5.95



115 V. 400 CYCLE—10 CFM—Eastern Air Devices Motor 331A—7200 RPM, 1/100 HP. L-R #2 Blower Assy. Overall Size: 4-1/2" x 3-1/2". No. 3110 ..... \$5.95



10 CFM BLOWER (Pictured at left)—28 VDC—6 A; 5000 RPM, Pioneer Motor SS-2345, Aluminum Blower Housing; Overall Size: 4-1/2" x 3-1/2". Price ..... \$5.95

**115 V. 60 CYCLE BLOWERS:**

115-VAC 60 cycle SINGLE TYPE—100 CFM; 2-3/4" intake; 2" outlet. Complete size: 5" x 6" No. 1C939 ..... \$8.95  
 115 VAC 60 cycle DUAL TYPE—100 CFM; 4" intake; 2" Dis. Each Side. Complete size: 8" x 6" No. 1C880 ..... \$13.95

115 VAC 60 cycle COMPACT TYPE—108 CFM; Motor built inside squirrel cage; 4-3/4" intake; 3 3/8" x 3" Dis. Complete size: 4-1/2" W x 8-3/8" H x 8-3/4" D—No. 2C067 ..... \$14.95

115 VAC 60 cycle FLANGE TYPE—140 CFM; 3-1/4" intake; 2-1/2" Dis. Complete size: 7-1/2" W x 7-1/4" H x 6-3/4" D—No. 1C807 ..... \$13.95

115 VAC 60 cycle FLANGE TWIN—275 CFM; 4-1/2" intake; 3-1/4" x 3" Dis. Complete size: 11-3/4" W x 3-3/8" H x 8-1/16" D—No. 2C069 ..... \$21.95

115 VAC 60 Cycle BLOWER—200 CFM; 4" intake; 3" x 5" outlet. Overall size: 8" x 7" x 6". Bodine Motor NSI-33. Removed from New Equipment. #BOD-200 ..... \$14.95

115-VAC 60 Cycle BLOWER—100 CFM; 3-3/4" intake; 2" outlet; Rd. Flange with Flap Director. Overall size with bracket: 8" L x 6-1/2" W x 7" H. Removed from New Equipment. Diehl Motor FB-2106-6 No. FDI-2106. Same as above, but with 12" Curved Director. No. CDBL-2106 ..... \$6.95

115 VAC 60 Cycle BLOWER—200 CFM; 4" intake; 3" x 5" outlet. Overall size: 8" x 7" x 6". Bodine Motor NSI-33. Removed from New Equipment. #BOD-200 ..... \$14.95

115-VAC 60 Cycle BLOWER—100 CFM; 3-3/4" intake; 2" outlet; Rd. Flange with Flap Director. Overall size with bracket: 8" L x 6-1/2" W x 7" H. Removed from New Equipment. Diehl Motor FB-2106-6 No. FDI-2106. Same as above, but with 12" Curved Director. No. CDBL-2106 ..... \$6.95

115 VAC 60 Cycle BLOWER—200 CFM; 4" intake; 3" x 5" outlet. Overall size: 8" x 7" x 6". Bodine Motor NSI-33. Removed from New Equipment. #BOD-200 ..... \$14.95

115-VAC 60 Cycle BLOWER—100 CFM; 3-3/4" intake; 2" outlet; Rd. Flange with Flap Director. Overall size with bracket: 8" L x 6-1/2" W x 7" H. Removed from New Equipment. Diehl Motor FB-2106-6 No. FDI-2106. Same as above, but with 12" Curved Director. No. CDBL-2106 ..... \$6.95

115 VAC 60 Cycle BLOWER—200 CFM; 4" intake; 3" x 5" outlet. Overall size: 8" x 7" x 6". Bodine Motor NSI-33. Removed from New Equipment. #BOD-200 ..... \$14.95

115-VAC 60 Cycle BLOWER—100 CFM; 3-3/4" intake; 2" outlet; Rd. Flange with Flap Director. Overall size with bracket: 8" L x 6-1/2" W x 7" H. Removed from New Equipment. Diehl Motor FB-2106-6 No. FDI-2106. Same as above, but with 12" Curved Director. No. CDBL-2106 ..... \$6.95

**MOTORS:**

24 VDC REVERSIBLE MOTOR — 3.7 RPM, 40 lb. Torque. Motor size: 5-1/2" x 4-1/32" x 3-5/16". Shaft size: 21/32" x 5/16". Also operates 24 VAC. Philco No. 44-1008 ..... \$5.95

27.5 VDC—8000 RPM, 1.5 oz. In Shaft size: 1 1/4" x 1/4". Motor size: 2 1/2" x 1 1/4". No. 5069-267 ..... \$4.95

26 VOLT 60 CYCLE—60 RPM Synchronous Cramer Motor #1147. Shaft size: 1" x 1/4" ..... \$1.95

110 VDC 1/70 HP., 1550 RPM. Motor size: 4" x 2 1/2". Shaft size: 1" x 3/16". Redmond #167 ..... \$4.95

6 VDC 1/20 HP., 4000 RPM. Motor size: 5" x 3". Shaft size: 3/4" x 1/4". Redmond #E-50 ..... \$4.95

12 VDC 1/30 HP., 4500 RPM. Motor size: 3" x 2 1/4". Shaft size: 1" x 3/16". Delco #5047520 ..... \$4.95

27 VDC 1/10 HP., 3500 RPM. Shaft size: 5/8" x 1/4". Motor size: 3 1/2" x 3 1/2". Air Assoc. No. EE-763 ..... \$6.95

80 VDC 1/50 HP., 3000 RPM. Shaft size: 3/8" x 1/4". Motor size: 5" x 3". G.E. #5-PN38HA10 ..... \$8.95

28.5 VDC 1/35 HP., 2200 RPM. Shaft size: 1 1/2" x 1/4". Motor size: 4 1/2" x 3 3/4". Electroflux #16876 ..... \$5.95

27 VDC GEAR HEAD MOTOR—960 RPM; 1/75 HP.; 1.75 A. Size: 5" x 3". Shaft 3/4" x 5/8". Air Assoc. #EF120M ..... \$7.95

27.5 VDC GEAR HEAD MOTOR—324-1 Ratio; 4050 RPM; Right Angle Drive Motor. Size: 5" x 3-1/2". Shaft: 5/16" x 3/4". Bodine Type #V-10L. Price ..... \$7.95

24 V. GENEVA LOC ACTUATOR MOTOR ASSY.—1/25 HP.—15000 RPM, w/Gear Head & Limit Switches. Motor Size: 5-1/2" x 3-1/2". Angle Drive Shaft: 1/2" x 1/4". Bendix #LM-106524. Price: \$7.95

27 VDC MOTOR—1.5 A.; 1/50 HP.; 3000 RPM Shaft: 5/16" x 3/4". Oster #DS-1 or WEVS-5876. Price: \$2.95

27.5 VDC MOTOR—1/100 HP.; 7000 RPM; Motor Size: 3" x 1-3/4"; Shaft: 1/4" x 3/4". L. Oster #C21Y1A—Price ..... \$2.95

27.5 PERMANENT MAGNET ALNICO FIELD MOTOR—0.3 Amp.; 10000 RPM. Size: 1" x 1-1/4" x 2". Shaft: 1/2" x 3/4". Delco #5068571. Price: \$7.95

115 Volt 60 cycle GEARED HEAD MOTOR—24 RPM, 1/100 HP. Right Angle Drive—Size: 7-1/4" x 4" x 4". Shaft Size: 3/16" x 3/4". NEW; \$9.95

24 VDC GEARED HEAD MOTOR—Heavy Duty, 8 Amp, 2-1/2 lb. Torque, 100/200 RPM. Shaft Size: 5/16" x 1". Right Angle Drive. \$8.95

115 VAC 60 Cycle INDUCTION MOTOR—1.9 RPM, 75 Torque oz. in.; 9 Watts—with variable Multi-Disc Control Wheel & Micro Switch, mounted on bracket ass'y. Holtzer Cabot Motor, Type RWC 2505 ..... \$9.95

**METERS:**

**WESTON AC AMMETER**



(Pictured) in portable leather case, with Test Leads, 2 1/2", 0-15 AC and 0-3 AC Scale ..... \$5.95

**DC AMMETER HOYT:**

In portable metal case, with Test Leads, 4 1/4", Fan, Mirrored Scale 0-15 ADC ..... \$4.95  
 0-3 RF AMMETER IS-128 2 1/2" Rd. Flush Mtg. Calibrated R/Non Fan Panel, P/O Bt. 233 Transmitter. NEW; \$2.95  
 0-8 Amp RF w/Thermocouple IS-89; 2 1/2" Rd. \$4.95  
 0-15 AC-DC 2 1/2" Rd.; IS-122 ..... \$4.95  
 0-500 Milliamp DC 2 1/2" Rd.; IS-22 ..... \$4.95  
 0-250 MA DC 3" Sq. Delux ..... \$3.95  
 0-1 MA DC Simpson; 3-1/2" Rd. .... \$3.95  
 0-2 MA DC—Westinghouse; 3-1/2" Rd. .... \$2.95

**INDEX**

**TO THE SEARCHLIGHT ADVERTISERS**

CLASSIFIED ADVERTISING  
 F. J. EBERLE, Ass't Mgr

Allied Electronic Sales.....	411
Alltronics .....	420
Amber Industrial Corp.....	412
Arrow Sales Inc.....	411
Barry Electronics Corp.....	411, 422
B & C Distributors Co.....	411
Beeber Co., Inc., J.....	418
Belevision, Inc. ....	411
Blan .....	412
Chase Electronic Supply Co.....	411
C & H Sales.....	415
Communications Equipment Co.....	419
Compass Electronics Supply Div. of Compass Communications Corp.....	412
Connector Corp. of America.....	414
Dixon, J. C.....	420
Electronicraft Inc. ....	414
Empire Electronics Co.....	414
Engineering Associates .....	411
Fair Radio Sales.....	416
Fay-Bill Distributing Co.....	414
Finnegan, H. ....	418
Florida Aircraft Radio & Marine Inc. ....	418
Green, Gould .....	414
Guided Electronics Co.....	418
Harjo Sales Co.....	420
JSH Sales Co.....	417
Legri S. Co., Inc.....	416
Medical Salvage Co., Inc.....	420
Mitchum, Martin M.....	411
M. R. Co.....	420
North Electronic Supply.....	414
Radalab .....	418
Radio & Electronic Surplus.....	416
Relay Sales .....	420
"TAB".....	413
Universal General Corp.....	420
WBZ-TV .....	411
Western Engineers .....	421

This index is published as a convenience to the reader. Care is taken to make it accurate but Classified assumes no responsibility for errors or omissions.

**FAIR RADIO SALES • 132 SOUTH MAIN ST. LIMA, OHIO**

**SELLING**

- Receivers
- Transmitters
- Radar
- Special Purpose Tubes
- Relays
- Meters
- Switches
- Connectors
- Rectifiers
- Transformers
- Motors & Generators
- Wiring Cable
- Instruments
- and
- All Electronic Components

**WILL BUY ALL**

**New or Used**

- Leach Relay #5059-R
- #5058
- #5055
- #5053-SM
- #5053

- Price Bros. Relay #10
- Relay #5586
- #5587

- Antenna Switching Relay
- Box # CBY 23049
- # BG-AN-198
- # BC -408

- Tubes #53A
- VT-127A
- 357
- WL-530

Highest prices paid for most all types of aircraft sparkplugs any condition

**RADIO & ELECTRONIC SURPLUS**

Wholesale Only

13933-9 BRUSH STREET  
 Detroit 3, Mich. TO 9-3403

Wholesale Only

**FOR ALL BEST RESISTORS POTENTIOMETERS CAPACITORS LEGRI S COMPANY**

Phone: Yonkers 9-6000

391 Riverdale Ave. Yonkers 5, N. Y.

SAVE ON TUBES BRAND NEW TUBES GUARANTEED TUBES

OA2..... 1.00	2E32..... 1.00	3C27..... 1.50	6AJ5JAN. 1.25	282B..... 5.00	715B..... 5.00	922..... 1.25	5657..... 125.00
OA3..... 1.00	2J21A..... 3.00	3C31..... 2.50	6AL5W..... .85	OK283A. 149.50	715C..... 12.50	923..... 1.50	5663..... 1.50
OB2..... .90	2J22..... 3.00	3C33..... 9.95	6AR6..... 1.30	QK284A. 149.50	717A..... .75	927..... 1.40	5667..... 150.00
OC3/VR105 .75	2J26..... 5.00	3C45..... 7.00	6ASTG..... 2.75	287A..... 3.50	719A..... 10.00	SN930..... 4.50	5670..... 2.00
OD3/VR150 .75	2J27..... 5.00	3DP11A... 7.50	6D21..... 200.00	304TH..... 8.95	720AY-EY. 25.00	<b>931A..... 2.75</b>	5672..... 1.25

*This is only a partial inventory. — We stock one of the largest tube inventories in the U. S. Complete inventories purchased. — Quantities large or small — we buy them all!*

1B23..... 3.00
1B24..... 6.00
1B26..... 1.25
1B27..... 15.00
1B29..... 3.00
1B35..... 4.50
1B36..... 4.00
1B40..... 3.00
1B51..... 7.25
1B63A..... 25.00
1C21..... 2.00
1N21..... .75
1N21B..... 1.90
1N23..... .75
1N23B..... 1.75
1N23BM..... 5.00
1N25..... 4.00
<b>1N26..... 4.95</b>
1N34A..... .79
1N35..... 1.50
1N42..... 8.00
1N47..... 4.50
1N63 K63. 1.75
1N69..... .49

2J31..... 15.00
2J32..... 15.00
2J33..... 15.00
2J34..... 15.00
2J36..... 20.00
2J42..... 60.00
2J48..... 45.00
2J49..... 40.00
2J50..... 35.00
2J51..... 150.00
2J55..... 40.00
2J56..... 50.00
2J61..... 15.00
2J62..... 5.00

3D21A..... 4.00
3E29..... 9.50
3GP1..... 1.95
3J30..... 35.00
3J31..... 45.00
3K30..... 125.00
4B23..... 10.00
4B24..... 7.50
4B26..... 3.50
4B27..... 4.00
4-125A..... 17.50
4C22..... 7.50
4C27..... 3.50
4C28..... 25.00
4C35..... 15.00

6F4..... 2.75
<b>6J4..... 3.50</b>
6K4..... 2.50
6L6WGB..... 4.00
6SN7W..... 2.00
7C22..... 50.00
7C23..... 69.50
7C24..... 100.00
15E..... 1.00
NE16..... .35
RK21..... 1.00
HK24..... 3.00
28D7..... .90
T40..... 2.50
D42..... 40.00

<b>304TL. 10.00</b>
305A..... 3.50
307A/RK75 1.00
312A..... 2.95
313C..... 3.00
316A..... .50
323B..... 5.00
327A..... 2.50
336A..... 5.00
338A..... 5.00
349A..... 7.50
350A..... 3.00
<b>350B 3.00</b>
354A..... 15.00
354C..... 5.00
368AS..... 3.00
388A..... 1.50
393A..... 4.50
394A..... 3.00
396A..... 3.25
403B 5591. 2.30
WE417A... 13.50

721A..... 1.00
721B..... 7.50
722A..... .75
723A/B..... 8.50
724A..... 1.00
724B..... .75
725A..... 3.50
726A..... 7.00
726B..... 25.00
<b>726C 25.00</b>
730A..... 10.00
750TL..... 45.00
801A..... .50
802..... 2.75
<b>803 1.50</b>
804..... 9.75
805..... 4.75
806..... 9.50
807..... 1.25
807W..... 4.50
808..... 1.50
809..... 2.75
810..... 10.00
811A..... 3.50
812..... 2.50
813..... 11.00

935..... 4.00
SN944..... 4.50
SN949C..... 4.50
SN953D..... 4.50
954..... .35
955..... .40
956..... .40
957..... .40
958A..... .40
959..... 1.50
SN977CX... 4.50
991..... .35
CK1005..... .35
CK1006..... 2.75

5703..... 1.25
5718..... 3.00
5719..... 2.50
CK5721..... 189.50
5725..... 2.00
5726..... 1.00
5744..... 1.00
5750..... 3.10
5751..... 2.20
5780..... 199.50
CK5787..... 4.95
5814..... 1.60
5842..... 13.50
5844..... 4.50
<b>5851 4.00</b>
5894..... 20.00

**SPECIAL!**  
  
 Vacuum Capacitors  
 6 mmfd. 30 KV. .10.00  
 50 mmfd. 32 KV. .10.00  
 50 mmfd. 40 KV. .14.50  
 75 mmfd. 20 KV. .12.50  
 150 mmfd. 20 KV. .14.00

**SPECIAL!**  
**5" DUAL GUN TUBE**  
 Long persistency face. Value at \$200.00. This tube has been rejected for military use.  
 Tested Before Shipped & Fully Guaranteed. Only **\$17.95**

1P21..... 30.00
1P22..... 6.50
1P29..... 2.00
1P36..... 2.50
1P39..... 1.20
1W5..... 1.25
<b>1Z2 2.00</b>
2AP1..... 5.00
2C21..... .50
2C26A..... .50
2C34..... .35
2C35..... 2.50
2C37..... 30.00
2C39..... 7.50
<b>2C39A 12.50</b>
2C40..... 8.50
2C42..... 15.00
<b>2C43 12.00</b>
2C44..... .50
2C46..... 9.00
<b>2C51 3.25</b>
2C52..... 3.50
2C53..... 12.00
2D21..... 1.00
2D21W..... 1.50
2E22..... 2.50
2E26..... 3.25

2J62A..... 50.00
2JB51..... .50
2K22..... 15.00
2K26..... 45.00
2K28..... 37.00
2K33..... 100.00
2K33A..... 65.00
2K34..... 99.50
2K39..... 125.00
2K43..... 125.00
2K45..... 50.00
2K48..... 90.00
2K54..... 15.00
2K56..... 50.00
2V3G..... 1.50
2X2A..... 1.00
3AP1..... 5.00
3B22..... 1.50
<b>3B24 1.50</b>
3B26..... 3.50
3B28..... 6.00
3B29..... 6.95
C3JA..... 7.50
3C22..... 60.00
3C23..... 6.00
3C24..... 1.50

<b>4E27 9.00</b>
4J22..... 45.00
4J23..... 45.00
4J24..... 45.00
4J26..... 75.00
4J27..... 40.00
4J28..... 40.00
4J29..... 50.00
4J31..... 65.00
4J34..... 50.00
4J42..... 25.00
4J50..... 99.50
4J51..... 150.00
4J52..... 50.00
4J57..... 149.00
4X150A..... 25.00
4X500A..... 60.00
5BP2A..... 6.50
5BP4..... 2.00
5CP1..... 1.75
5CP1A..... 10.00

<b>5C22 29.50</b>
5C30/CSB. 1.50
5CP7..... 7.50
5D21..... 7.00
5D23..... 7.50
5FP7..... 1.50
5FP14..... 5.00
5JP2..... 7.50
5JP4..... 7.50
5JP5..... 7.50
5JP11A... 17.50
5J23..... 20.00
5J29..... 7.00
5J30..... 7.00
5J33..... 5.00
5MP1..... 3.95
5NP1..... 5.00
5R4GY..... 1.00
5R4WGY... 2.40
C6J..... 6.50
C6L/5528 4.00
6AC7W..... 1.25

6F4..... 2.75
<b>6J4 3.50</b>
6K4..... 2.50
6L6WGB..... 4.00
6SN7W..... 2.00
7C22..... 50.00
7C23..... 69.50
7C24..... 100.00
15E..... 1.00
NE16..... .35
RK21..... 1.00
HK24..... 3.00
28D7..... .90
T40..... 2.50
D42..... 40.00
<b>HK54 2.00</b>
QK59..... 30.00
QK60..... 25.00
QK61..... 30.00
QK62..... 29.50
RK60/1641. 1.95
HY65..... 2.50
RK65 5D23. 10.00
FG67 5728. 10.00
RKR72..... .50
RKR73..... .50
75TL..... 5.00
FG104..... 29.50
FG105..... 12.50
F123A..... 4.00
F128A..... 20.00
HF100..... 7.50
FG154..... 17.50
VT158..... 10.00
FG166..... 17.50
FG172..... 17.50
WL200..... 75.00
203A..... 5.00
204A..... 35.00
207..... 50.00
211/VT4C. .50
212E..... 17.50
217A..... 2.00
217C..... 2.00
WL218..... 25.00
220C..... 182.00
QK221..... 125.00
FG235A... 35.00
QK249..... 150.00
249B..... 3.00
249C..... 3.00
250R..... 5.00
250TL..... 15.00
251A..... 50.00
252A..... 10.00
QK253..... 149.50
254A..... 6.50
FG258A... 130.00
271A..... 10.00
274B..... 1.00

434A..... 3.00
446A..... .50
446B..... 2.00
450TH..... 35.00
450TL..... 35.00
WL456..... 59.50
464A..... 2.50
CK512AX... 1.10
527..... 15.00
ML531..... 4.00
559..... .50
<b>KU610 5.00</b>
HY615..... .50
WL616..... 99.50
KU627..... 10.00
631P1..... 7.00
WL651..... 39.50
WL652..... 25.00
WL681/68627.50
<b>701A 1.95</b>
703A..... 1.50
704A..... 1.00
705A..... 1.00
706AY-GY. 15.00
707A..... 3.50
707B..... 5.00
708A..... 1.00
713A..... .50
714A..... 12.50
714AY..... 17.50
715A..... 2.50

<b>814 2.00</b>
815..... 1.50
816..... 1.50
829B..... 8.50
830B..... .95
832..... 4.00
832A..... 6.00
833A..... 34.50
834..... 6.00
836..... 2.00
837..... 1.00
<b>838 1.00</b>
845..... 6.00
846..... 75.00
849..... 24.50
851..... 12.50
852..... 7.50
860..... 3.50
861..... 15.00
865..... .50
866A..... 1.15
869B..... 25.00
872A..... 1.50
874..... .60
878..... .60
884..... 1.25
GL889..... 60.00
GL889A... 74.50
889RA..... 150.00
902A..... 3.50
902P1..... 3.50
919..... 2.50

1500T..... 85.00
1603..... 3.50
1616..... .75
1620..... 3.50
1623..... 2.50
1624..... 1.00
1625..... .30
1626..... .35
1630..... .50
1631..... 1.50
1636..... 1.25
1641..... 1.50
1642..... .50
2050..... 1.00
2051..... .70
ZB3200..... 75.00
5550..... 30.00
5551..... 25.00
5553/655. 135.00
5557..... 3.50
5559/FG57. 12.50
5561..... 29.50
5586..... 150.00
5591/403B. 2.30
5611..... 99.50
5634..... 7.50
<b>5636 4.00</b>
5637..... 8.50
5651..... 1.40
5654..... 1.50
5656..... 7.50
5896..... 6.50
5899..... 5.00
<b>5901 6.50</b>
5902..... 8.00
5905..... 8.95
5907..... 7.90
5908..... 7.95
5910..... 2.25
5932..... 4.50
5933/807W. 4.50
5963..... 1.00
6005..... 2.00
6021..... 4.00
CK6050..... 2.00
6072..... 3.95
6080..... 3.50
6080WA... 4.25
6111..... 6.50
6147..... 4.00
6177..... 79.50
6247..... 8.50
8002R..... 20.00
8005..... 4.95
8012..... 1.00
8013..... 4.95
<b>8025A 2.50</b>
9001..... .90
9002..... .70
9003..... 1.00
9004..... 1.25
9005..... 1.10
9903..... 20.00

THIS IS ONLY A PARTIAL INVENTORY. CHECK WITH US FOR YOUR REQUIREMENTS

Thousands of other types in stock. Send us your requirements. RECEIVING TUBES! We Carry a complete line in stock. Standard brands only.

**Jsh**  
 SALES CO.  
**ELECTRONICS**  
 Dept. ES  
 1108 Venice Blvd.  
 Los Angeles 15  
 California

All prices F.O.B. Los Angeles, subject to change without notice. Minimum order \$5.00. Check with us for items not listed.

## SEARCHLIGHT SECTION

### WANTED

BC-788, T-47A/ART-13,  
BC-348R, R-5/ARN-7,  
RT-18/ARC-1

# RADALAB

87-17 124th STREET  
Richmond Hill 18, New York  
Phone Virginia 9-8181-2-3

Prices FOB NYC. Rated firms  
open account. Prices subject  
to change without notice.

CABLE: Radalab, NY  
TELETYPE: NY-4-4361

**AN/ASQ-1 and 1A MAGNETOMETERS**  
This is an airborne magnetometer used to measure the magnetic flux of the earth and to locate submarines and other metallic objects by their distortion of the magnetic field. Sensitivity 2-3 gamma or better. POR.

**AN/GSQ1-A SPEECH SCRAMBLERS**  
Speech scrambler for use on any com. channel to insure privacy. We can supply complete installations of this equipment 28v DC input. Also 110v 60 cyc.

**SCR-291A DIRECTION FINDER**  
Automatic ground direction finder covering 1.5mc-30mc. Provides instant bearings on a C.R. indicator of any signal in its range. This equipment is transportable and can be set up quickly. 110v 60 cyc. POR.

### P.P.I. REMOTE RADAR REPEATERS

We can supply the following types of remote Radar P.P.I. Repeaters. The main radar provides the Synchronizing, Syncoro, and Video. Pulses to operate the Repeaters. These repeaters may be used with any marine ground or airborne.

VC 7" P.P.I. Upright deck mount Repeater. 4 Ranges are provided from 4-200 miles. Input 110 Volt 60 Cyc.

VD 7" P.P.I. Deck mount Repeater. This unit is very similar to the VC but is completely Waterproof and may be used on deck. The ranges are the same as the VC. Input 110 Volt 60 Cyc.

VE 7" P.P.I. Table mount Repeater. This is a very compact set. 4 ranges are provided from 4-200 miles. Input 110 Volt 60 Cyc.

VF 9" P.P.I. Deck mount Repeater. This is a very late model Repeater enabling 20 radars to be fed into it. 4 Ranges from 4-200 miles are provided. Input 110 Volt 60 Cyc.

VG 12" P.P.I. Plotting Table Projection Repeater. This is a very elaborate Remote Indicator. For use in a plotting center. Up to 20 Radars may be fed into it. This set utilizes a Skiatron tube to provide data that can be retained on the screen and can be erased at will. Input 110 volt 60 Cyc.

Accessories are available such as repeater adaptors enabling the set to be used at a greater distance than normal. Input switches to select the radar to be viewed etc.

### SCR-682-A RADAR

10CM high power long range harbor surveillance and early warning RADAR. This equipment is a 3000 mc mobile search radar that can be transported in a truck. The equipment incorporates a 7" PPI for operation up to 240,000 yards. Azimuth accuracy is  $\pm 1\%$ . Range accuracy is 100 yards at 10,000 yard range and 5000 yards at 240,000 yard range. Trans. output is approx. 225 KW. pulse width is one microsecond. Antenna beam width is 6". Input is 110v 60 cyc. Can be supplied with or without operating shelter or antenna tower. POR.

**We can supply many types of radars, test sets, communications equipments, manufactured after 1947. Write us if you cannot find it.**

### AN/APR-4 38-4000 MC RECEIVER

This is a precision receiver covering 38-4000 mc. The set utilizes 5 tuning units with direct reading dials in megacycles. The receiver has a wide and narrow band-width 30mc. I.F. strip which may be selected at will. An output meter is provided to measure signal strength. Outputs are provided for a pulse analyzer and pan adaptor. Each tuning unit has an automatic sweeping mechanism which enables any portion of the tuning range to be scanned automatically. Input 110v 60 cyc. POR.

### 500-1300 MC SIGNAL GENERATOR

This is a high precision signal generator covering 500-1300 mc. A precision attenuator is built in providing accurate determination of output from 0-100,000 microvolts. Either CW or pulsed carrier output with the following characteristics are provided. Pulse rate 60-2,500 CPS. Pulse length 2-30 microseconds. Output line 50 Ohm impedance. Accuracy better than one percent. Input 110 v 60 cyc. With calibration charts. Price \$249.50

### 90-600 MC SIGNAL GENERATOR

This set covers 90-600 mc. with an accuracy of one percent or better. C.W. or pulse output with the following characteristics are provided. Output from 0-100,000 microvolts 2-30 microseconds long. Pulse rate 60-2,500 cyc. Pulse delay 3-300 microseconds. Output 50 ohm line. Input 110v 60 cyc. Price.....\$249.50

### CF-3A CARRIER REPEATER

This is a transportable 4 wire carrier telephone repeater. This set amplifies all signals when used in an intermediate position on a carrier system to extend the range. DC signaling and telegraph communications can be performed to the terminal equipments or to other repeaters. Monitoring and transmission circuits are built in. Power input 110 or 220v or 12v DC. This set can be used with all CF terminals and commercial equipments. Brand New in original cases. POR.

### AN/APA-17 DIRECTION FINDER

This is an automatic direction finder covering 300-1,000 mc to be used with the APR-1 and APR-4 radar search receivers. The bearing is presented on a cathode ray screen in a cardioid pattern. The set can be used in aircraft or on the ground. Input 110v 400 cyc and 28v DC. POR.

### RADAR BEACONS

X and S Band High and Low Power Beacons

We can supply the following Beacons in Portable and Stationary Models. The X-BAND models will operate with the new Weather Radars AN/CNP-6 X-Band high power Radar Beacon. This is a 40 KW set for use at an Airport. This set will interrogate X-BAND Radars up to 200 miles. Variable Coding is provided as well as monitoring facilities. Input is 110 V 60 CYC.

AN/CPN-8 S-BAND HIGH POWER Airport Beacon. This is a very compact set. This set will interrogate S-BAND Radars up to 200 Miles. Variable Coding and monitoring facilities are provided. Input 110 Volt 60 Cyc.

AN/CPN-17 S-BAND High power version of the CPN-6 with all the latest improvements. Input 110 Volt 60 Cyc.

AN/UPN-4 X-BAND Very lightweight Portable Beacon. This set will interrogate X-BAND Radars up to 60 miles. Variable Coding is provided. Input 12 Volts D.C. Weight Approx. 40 Lbs.

AN/UPN-1 and 2 S-BAND Portable Beacons. This set will interrogate a S-BAND Radar up to 60 Miles. Variable Coding is provided. Input is 12 Volts D.C. and 110 Volts 60 Cyc. Weight Approx 50 Lbs.

# LARGEST STOCK

of UG Connectors in the East! Guided Electronics, distributors of manufacturers' approved connectors, will make immediate delivery of all connectors shown.



UG 88/U & UG 260/U  
..... 39¢ ea.



PL 259 ..... 30c ea.



UG 218/U ..... 76c ea.



UG 290/U  
..... 38c ea.



SO 239  
..... 30c ea.



UG 58/U  
..... 40c ea.

Complete with bullet



UG 43/U & UG 44/U  
..... \$4.95 per set

Complete with bullet



UG 45/U & UG 46/U  
..... \$4.95 per set



UG 39/U  
..... 95c ea.



UG 40/U  
..... \$1.20 ea.



PL 274 ..... 60c ea.

UG 32/U ..... \$10.50 ea.

UG 203/U ..... .46 ea.

UG 212C/U ..... 2.65 ea.

UG 216/U ..... 6.95 ea.

UG 988/U ..... \$59.95 ea.

UG 573A/U ..... \$ 2.25 ea.

UG 625B/U ..... .85 ea.

UG 941A/U ..... 1.10 ea.

UG 943A/U ..... 2.75 ea.

Write for complete listing of our enormous inventory of coaxial cable and connectors.

**guided electronics co.**

Manufacturers' distributor

45 vesey street, n.y. 7, n.y.

Digby 9-2276

FOR SALE

**Transmitter Tubes**  
**Eimac - Machlett - 750TL**  
**List \$137.00. Our price \$32.50**

J. BEEBER CO. INC.  
838 Broadway AL 4-3510 New York

# WANTED

WILL BUY ALL

Art-13 T47A Transmitters BC-348 Rec'r modified \$225.00 \$25.00  
Art-13 T-47 Transmitters BC-348 Rec'r unmodified \$150.00 \$50.  
BC-788C Altimeters \$150.00 ARC-1 Radio complete \$200.00  
RS/ARN7 Radio Compass \$180.00 BC-312 Receiver \$40.00  
ARC-3 Complete \$185.00 BC-342 Receiver \$50.00  
Ship via Express C.O.D. Subject to inspection to:  
H. FINNEGAN  
49 Washington Ave. Little Ferry, N. J.

WANTED

ART-13 transmitters, parts, and components, DY-12 and DY17 dynamotors, CU-25 etc. Also ARC-1 and ARN-7 material.

Advise price, condition first letter.

FLORIDA AIRCRAFT RADIO & MARINE, INC.  
International Airport Branch  
P. O. Box 205 Miami 48, Florida

Wanted

All types of used  
• Electronic test equipment  
• Environmental test chambers and vibration or shock equipment.

Write giving price and description.

W-7043, Electronics  
330 W. 42 St., New York 36, N. Y.

COMMUNICATIONS EQUIPMENT CO.

AUDIO TRANSFORMERS

LVM-11, Multimatch Line Autoformer, rated 30 watts. Will match up to 10 separate 500-ohm lines. Impedances: 500/250/187/125/100/83/71/62/50 ohms. \$3.49  
 G-5603\* Mike-to-Grid, 100-ohm Pri. (with 10 M.A. DC) to 125,000 W. Sec. Response: = 2db. 250-4000~ .69¢  
 G-5604\* Plate-to-Line 20,000  $\omega$  (with 32 M.A. DC) to 600 ohms. Resp. 250/3500 cps. = 2db, 15 mw. Lev. .55¢  
 W-15-21: Hybrid: Input Trans #1: 300 w/300 ohm. Trans. #2: 600 ohm/250,000 ohms. \$1.19  
 W-15-41: Hybrid Output Trans. #1: 300/30 ohm. Trans. #2: 300/13,000 ohm (Plate). \$1.15  
 ● SPECIAL: Set of 2 Transformers: Input Trans. W-15-41 and Output Trans. W-15-21. (Above). \$8.95  
 KS 9496: Output. 9000 ohms P-P. to 9 ohm V.C. 250 watts. 100~ to 10,000 cps = 1db. \$8.95  
 KS 9449: Driver Trans. P-P 6V6 (8000 ohms) to PP Grids CL "B" (805's). 10 watts 1000-10,000 cps = 1db. \$2.45  
 ● SPECIAL: Matched Transformers KS 9449 and KS 9496 (Above). \$9.95  
 AT 071: Interstage: 10,000 ohm pp plates to 80,000 up grids. For BC 614 Speech Amplifier. \$1.35  
 AT 199: Output: 6000 ohm plate to line (200/600 ohms) Response: 200-12 kc. For CFA and CF 3A. \$2.45  
 AT 037: Mike to grid: 75 ohms to 125,000 ohms. \$6.65  
 J-871: Output: Pri: 20,000/16,000 ohms P-P. Or 5,000/4,000 ohms. Sec: 500/167.5/5/3.75/1.25 ohms. Silcor, hi-fi. \$2.75  
 AT SUB Bouncer, Multimatch, 200 ohms to 15 K ohm C.T. and 100 K ohm Grids. \$1.69  
 AT 501 HI-FI Special: PRI: 3000 ohms P-P/Sec: 4716/1250/200 ohms 60-10,000 CY. 1 db 50W. \$3.49  
 AT152 HI-FI Driver Pri: 10,000 ohms Sec: 40,000 ohms PP Grids 50-15 KC/1 db. \$1.49  
 AT602 Output to H. S. or line PRI: 14,200 ohms SEC: 8000/600 ohms \$1.10  
 AT686 Intercom Input: Spkr (-4-8 ohms) to grid (250,000 ohms) \$0.69  
 AT415 Plate (18,000 ohms C.T.) to line (125 ohms) 175 w.-500-600 CY. \$1.95  
 AT858 Plate (10,000 ohms C.T.) to line (125 ohms) (125130 ohms) HI-FI—50 W. \$6.95  
 A-694 HI-FI Output: 3 Watts, 8500 Ohms P-P to V.C. (15 Ohms) 15-15KC PM 1 db. \$1.49  
 AT-1: Mike (35 ohms Carbon) to Line 600 ohm/200 ohm \$1.19  
 AT-148: Line (600 ohms) to V.C. (6 ohms) 17 d.b. Level \$1.19  
 AT-631: Mike-or-Line (200 ohms) To Single or P-P Grids (50K Ohms) \$0.59  
 \*Ouncer Size

COAXIAL R.F. FILTERS

F-29/SPR-2. Hi-Pass, with 1000 mc. Cut-off, Type "N" input and output. 50 Ohms Z. \$9.50  
 F-41/SPR-1. Hi-Pass, with 300 mc cut-off, Type "N" input and output. 50 Ohms Z (As shown) \$10.50



MICROWAVE ANTENNAS

3cm. Horn, 1" x 1/2", with twist and 180 deg. bend. With dielectric window. \$22.50  
 AT49/APR—Broadband Conical, 300-3300 MC. Type N Feed \$8.95  
 Discone Antenna, AS 125 APR, 1000-3200 mc. Stub supported with type "N" Connector. \$14.50  
 length of coax and "N" connectors. \$4.50  
 AS46A/APP-4 Yagi Antenna, 5 element array. \$22.50  
 30" Parabolic Reflector Spun Aluminum dish. \$4.85  
 AN/APA-12—Sector Scan adaptor for APS-2 radar. Complete Kit \$37.50  
 AT-68/UP 3 Cm Horn with type N feed for receiver measurements, etc. New \$7.45  
 AN-154 3 vertical dipoles working against a rectangular mesh approx. 3x7". Freq. 140-200 mc. with lobing switch (115v. 60 cy and portable slatted crate. Extremely rugged \$27.95  
 LP-24 Alford loop, for use with glide-path transmitters 100-108 mc. \$32.50  
 18" PARABOLIC DISHES, spun aluminum. Focus approx. 3 inches \$4.95

POWER TRANSFORMERS

COMBINATION—115V/60~INPUT  
 CT-433 150-0-150V/65MA.6.3V/2.5A.6.3V/0.6A \$1.79  
 CT-427 900V/25MA PK. 5V/2A, 2V/7.5A. 2.79  
 CT-906 350-0-350V/120MA, 5VCT/3A, 2.5VCT/1.5A, 2.5VCT/3.5A 4.39  
 CT-965 125-0-125V/90MA, 5VCT/3A, 2.5VCT/1.5A 1.95  
 CT-004 350-0-350V/90MA, 5VCT/3A, 2.5VCT/12.5A 4.60  
 CT-002 350-0-350V/50MA, 5VCT/2A, 2.5VCT/7.5A 3.65  
 CT-479 7000V/.018V, 2.5V/5A/17,800 V. Test! 22.50  
 CT-013 450-0-450V @ 200MA, 10V/1.5A, 2.5, 3.5A, 5V/3A 4.35  
 CT-403 350VCT .026A 5V/3A 2.75  
 CT-931 585VCT .086A 5V/3A, 6.3V/6A 4.25  
 CT-929 4200V/.001A, 2.5V/2A, 6.3VCT/.6A 5.35

PLATE—115V/60~INPUT

PT-07 400VCT/4.0 AMPS FOR RA43 \$7.50  
 PT 034 125V/45MA (For Preamp) .79  
 PT 371 210-0-210V at 2.12 Amp. 9.45  
 PT 133 1140/1570V. 2.36KVA .79  
 PT 801 22-000V/234 MA. 5.35 KVA 115.00  
 PT 521 7500V/06A, Half Wave. 59.50  
 PT 913 2500V/12 MA H/SLD 4.95  
 PT 12A 280VCT/1.2A. 3.95  
 PT-38-2 37.5/40V AT 750 MA 2.15

FILAMENT—115V/60~INPUT

FT-140 5VCT @ 10A 25KV Test. \$12.50  
 FT-157 4V/16A, 2.5V/2.75A. 2.95  
 FT-101 6V/.25A. 85.00  
 FT-924 6.25A/21A, 2x7.75V/6.5A 14.95  
 FT-824 2x25V/2.5A, 16V/1A, 1.2V/7A, 6.4V/10A 8.95  
 6.4V/2A 8.95  
 FT-463 6.3VCT/1A, 5VCT/3A, 5VCT/3A. 5.49  
 FT-55-2 7.2V/21.5A, 2.5V/6.85A, 5V/6A, 5V/3A. 8.95  
 FT-38A 6.3V/2.5A, 2x2.5V/7A 5KV Test 2.79  
 FT-650 2.5/20A-3KV TEST 1.0-CAP. 7.50  
 FT-025 2.5VCT/10A, 10KV TEST. 6.95

FILTER CHOKES

Stock	Description	Price
CH-914	12HY/250 MA 2500 V. Test 100V	53.25
CH-CEC	117.9-60H/.05-400 MA, 10 KV Test.	14.95
CH-113	2.5H/700 MA, 2.5 KV Test 180V	6.75
CG-044	8.5H/350 MA, 3.5 KV Test 50V	5.35
CH-291	0.1H/12 A. DCR: 0.3 Ohms	2.50
CH-141	Dual 7H/75 MA, 11H/60 MA	4.69
CH-69-1	Dual 120H/17 MA	1.39
CH-8-35	2x.5H/380 MA/25 Ohms.	2.75
CH-776	1.28H/130 MA/75 Ohms.	2.25
CH-344	1.5H/145MA/1200V Test.	2.35
CH-43A	10H/15 MA—850 ohms DCR	1.75
CH-366	20H/300 MA	6.95
CH-999	15H/15 MA—400 ohms DCR	1.95
CH-445	0.5HY/200 MA. 32.2 ohms, 3000 V.T.	1.39
CH-170	2x0.5H/380 MA. 25 ohms.	2.79
CH-533	13.5H, 1.0 AMP DC, 13.5 KVINS.	29.95

Scope XFMR

PRI: 115V/60~, 1 $\phi$ . SEC: 4500V/.005A, 650 VCT, 175A, 5V/3.8A, 5V/3A, 6.4V/10A, 2.5V/3A (9500V. RMS TEST)  
 Size 7"x7"x5 1/4" D. \$7.45



PULSE NETWORKS

H-605: 25 KV, 1.5 usec. Type "E" Network. 400 PPS, 50 ohms Z. \$62.50  
 7-5E3-1-200-67P, 7.5 KV "E" Circuit, 1 microsec. 20.0 PPS, 67 ohms Impedance 3 sections. \$7.50  
 7-5E4-16-50-67P, 7.5 KV "E" Circuit, 4 sections 16 Microsec, 60 PPS, 67 ohms Impedance. \$15.00  
 7-5E3-3200-67P, 7.5 KV "E" Circuit, 3 microsec. 200 PPS, ohms imp. 3 sections. \$12.50  
 H-616 10KV, 2.2 usec., 375 PPS, 50 ohms imp. \$27.50  
 H-615 10KV, 0.35 usec., 750 PPS, 50 ohms imp. \$27.50  
 KS8865 CHARGING CHOKE: 115-150 H @ .02A. 32 40E @ .08A, 21 KV Test. \$37.50  
 G.E. 25E5-1-350-50 P2T, "E", CKT, 1 Microsec. Pulse @ 35 PPS, 50 OHMS Impedance. \$69.50  
 KS9623 CHARGING CHOKE: 16H @ 75 MA, 380 Ohms DCR, 9000 Vac Test. \$14.95  
 G.E. 6E3-5-2000 50 P2T, 6KV, "E" Circuit 0.5 usec /2000 PPS/50 ohms/2 sections. \$7.50

PULSE MODULATORS

MIT. MOD. 3 HARD TUBE PULSER: Output Pulse Power 144 KW (12 KV at 12 Amp.) Duty Ratio: .001 max. Pulse duration: 5, 1.0, 2.0 microsec. Input voltage: 115 v. 400 to 2400 cps. Uses: 1-71B, 4-89-B, 3-72's, 1-73. New. Less Cover—\$135  
 ASD Modulator Units, mfd by Sperry Hard tube pulser delivers Pk. pulse of 144 kw. Similar to Mod 3 unit. Brand new, less tubes. \$85.00  
 Airborne RF head, model A1A, delivers 50 Kw peak output at 9000 mc. at .001 duty. Complete with pulser unit and all tubes. \$185.00

PULSE TRANSFORMERS

RAYTHEON WX 4298E: Primary 4KV., 1.0 USEC. SEC: 16KV-16 AMP DUTY RATIO: 001 400 CYCLE PFL. TRANS. "BUILT-IN" \$42.50  
 WECO D-18327 For Modulator of SCR 720. \$22.50  
 4P37 (West.) Pri: 50 ohms 750V. Sec. 15 KV/1000 ohms .001 Duty. Bifilar: 12.6V/2.5A. \$32.50  
 GE #K-2449A  
 Primary: 9.33 KV, 50 ohms Imp.  
 Secondary: 28 KV, 450 ohms.  
 Pulse length: 1.05/5 usec @ 635/120 PPS. Pk Power Out: 1.740 KW  
 Bifilar: 1.5 amps (as shown) \$62.50  
 GE #K-2748-A, 0.5 usec @ 2000 Pps. Pk. Pwr. out 1.3 KV 32K Impedance 40-100 ohm output. Pri. volts 2.3 KV Pk. Sec. volts 11.5 KV Pk. Bifilar rated at 1.3 Amp. Fitted with magnetron well. \$24.50  
 K-2745 Primary: 3.1/2.8 KV, 50 ohms Z. Secondary: 14/12.6 KV 1025 ohms Z. Pulse Length: 0.25/1.0 usec @ 600/600 PPS. Pk. Power 200/150 KW. Bifilar: 1.3 Amp. Has "built-in" magnetron well. \$32.50  
 K-2461-A. Primary: 3.1/2.6 KV, 50 ohms (line). Secondary 14/11.5 KV—1000 ohms Z. Pulse Length: 1 usec @ 600 PPS. Pk. Power Out: 200/130 KV. Bifilar 1.3 Amp. Fitted with magnetron well. \$29.50  
 K35-45—Pulse Inversion: PRI: 5 KV PK. Pulse Negative. Sec: Pos. Pulse, 4 KV: 1 usec. and .001 DUTY RATIO  
 54318-1-3 w/dgs. Ratio: 1:1:1. 1.18 mh. W/dg. \$6.50  
 5 ohms DCR per section. \$3.50  
 UTAH X-151T-1: Dual Transformer, 2 W/dgs. per section 1:1 Ratio per sec 13 MH inductance 30 ohms DCR \$5.00  
 UTAH X-150T-1: Two sections, 3 W/dgs. per section. 1:1:1 Ratio. MH, 8 ohms DCR per Wdg. \$5.00  
 68G71: Ratio: 4:1 Pri: 200V, Sec. 53V, 1.0 usec Pulse @ 2000 PPS, 0.016 KVA. \$4.50  
 TR1049 Fatio 2:1 Pri. 220 MH, 50 Ohms, sec. 0.75 H. DCR 160 Ohms. \$6.75  
 K-904895-501: Ratio 1:1. Pri. Imp. 40 Ohm. Sec. Imp. 30 Ohms. Passes pulse 0.6 usec with 0.05 usec rise \$8.95  
 RAYTHEON, UX-7350, UX-7307 \$5. ea.

400 CYCLE TRANSFORMERS

(All Primaries 115V, 408 Cycles)  
 KS13101 6.3V/15A, 6.3V/0.9A, 6.3V/0.4A, \$3.85  
 1450VCT/0.283A, 1050VCT/0.217A 7.50  
 KS9615 6.3V/4A, 3V/1A 1.57  
 KS9218 6.3V/4A, P/O R-55/ARO-9 1.35  
 KS968R 12V/35MA, 1140VCT/.07A 1.79  
 152-7102 6.3V/2.5A 1.45  
 M-7472426 1450V/10MA, 2.5V/7.5A, 6.4V/3.9A, 5V/7A, 6.5V/3A, P/O ID-39/APG-13 4.95  
 640VCT @ 380MA, 6.3V/.9A, 6.3V/6A 5V/6A 5.49  
 352-7039 9500/600 @ 32MA 8.95  
 KS9584 5000V/90MA, 5V/10A 22.50  
 KS9607 734VCT/177A, 1710VCT/.177A 6.79  
 352-7273 700VCT/350MA, 6.3V/0.9A, 6.3V/25A, 6.3V/0.8A, 5V/CA 6.95  
 352-7070 2x2.5V/2.5A (2KV TEST) 6.3V/110V/50MA TAPPED 625V 2.5V/5A 7.45  
 352-7196 1140/1.25MA, 2.5V/1.75A, 2.5V/1.75A—5KV TEST 3.95  
 352-7176 320VCT/50MA, 4.5V/3A, 6.3V/CT 20A, 2x6.3VCT/6A 4.75  
 RA6400-1 2.5/1.75A, 6.3V/2A—5KV Test. 2.39  
 901692 13V/9A 2.49  
 901699-501 2.77V @ 4.25A—10KV Test 3.45  
 901698-501 900V75MA, 100V/.04A 4.29  
 UX8855C 900VCT/.067A, 5V/3A 3.79  
 352-7098 2500V/6MA, 300VCT/135MA 5.95  
 KS9336 110V/50MA TAPPED 625V 2.5V/5A 3.95  
 KS7474319 6.3V/2.7A, 6.3V/66A, 6.3VCT/21A. 4.25  
 KS8984 27V/4.3A, 6.3V/2.9A, 1.25V/.02A 3.95  
 52C080 650VCT/50MA, 6.3VCT/2A, 5VCT/2A 2.75

X BAND - 1" x 1/2" WAVEGUIDE

ROTARY JOINT (APS-6) Sperry PT 2658275, 180 deg. rot. choke-to-choke. Has "Built-in" Di-Coupler. 20 DB., with "N" Takeoff. \$22.50  
 PARABOLOID DISH, 18" diam. Spun Aluminum, 8" Focus. For AN, APS-6 \$4.95  
 3 CM. DIPOLE and Feed Assembly. (May be used with above dish.) 8 inches long \$5.00  
 FLEXIBLE SECTION 9 in. long. Cover-to-Cover \$5.50  
 3CM. DIPOLE FEED, 15" L. for APS-15. \$14.50  
 MITRED E-BOW, 1/2" Aluminum, 134" x 5/8" W. W/E Flange "E" Plane. \$3.50  
 3 CM ANTENNA ASSEMBLY: Uses 17" paraboloid dish, operating from 24 vdc motor. Beam pattern: 5 deg. in both Azimuth and elevation. Sector Scan: over 160 deg. at 35 scans per minute. Elevation Scan: over 2 deg. Dht: Over 24 deg. \$35.00  
 Cross-Guide Directional Coupler, UG-40 output flange. Main Guide is 6" Long, with 90 Deg. "E" Plane bend at one end, and is fitted with Std. UG 39/UG 40 flanges. Coupling figure: 20 db Nominal. \$22.50  
 RG52/U Waveguide in 5' lengths, fitted with UG 39 flanges by UG40. Silver plated. Per length \$5.00  
 Rotating-Joints supplied either with or without deck mountings. With UG40 flanges. each \$17.50  
 Bulkhead Feed-thru Assembly \$15.00  
 Pressure Gauge Section with 15 lb. gauge. \$10.00  
 Directional Coupler, UG-40/7" Take off 20db. \$17.50  
 MAGNET AND STABILIZER CAVITY For 2141 Magnetron. \$24.50  
 90 degree elbows. "E" or "H" plane 2 1/2" radius. \$8.50  
 ADAPTER, waveguide to type "N", UG 81-U, P/O TS 12, TS-13. Etc. \$7.50  
 ADAPTER, UG-163/7" round cover to special UG 39 flange. \$2.50 ea.  
 TS-12 SWR Measuring set slotted line accessory amplifier. 8000-10,000 M.C. New. \$425



I. F. AMPLIFIER STRIPS

Model 15: 30 Mc Center frequency. Bandwidth 2.5 Mc. gain figure: 65 db. Uses 3 stages of 6AC7's. Has D. C. Restorer and Video Detector A.T.C. Strip included. Input impedance: 50 Ohms. Less tubes \$17.50  
 60 MC. Miniature IF strip, using 6AK5's 60 Mc center Freq. Gain: 95 db. at Bandwidth of 2.7 Mc. New. Complete with tubes. \$15.00

JAN WAVEGUIDE FLANGES

UG 39/U	\$1.10	UG 51/U	\$1.85
UG 40/U	\$1.25	UG 52/U	\$3.40
UG 40A/U	\$1.85	UG 52A/U	\$3.40

MAIL ORDERS PROMPTLY FILLED. ALL PRICES F.O.B. NEW YORK CITY. M.O. OR CHECK. ONLY SHIPPING SENT C.O.D. RATED CONCERNS SEND P. O. PARCELS IN EXCESS OF 20 POUNDS WILL BE SHIPPED VIA CHEAPEST TRUCK OR RAIL.

131 Liberty St., New York 7, N. Y. Dept. E-8 Chas. Rosen Phone: Dlgby 9-4124

world's largest stock

# RELAYS

immediate delivery!

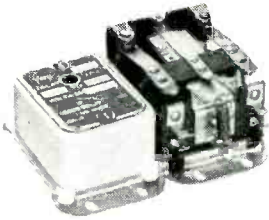

ADJUSTABLE THERMAL TYPE TIME DELAY RELAY

Operates on 115 V.A.C. Continuously adjustable delay from 5 to 20 seconds. 1/4 Inch D.P.D.T. 12 1/2 amp. contacts. Primarily designed for use with radio transmitters but has wide variety of other applications. Catalog No. R 686 Price \$6.10 each

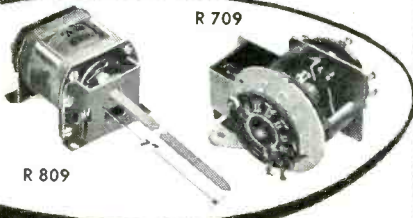

R 709

R 809

### STEPPING UNIT

Operates on 22 to 30 V.D.C. 12 Position driving mechanism operates through 360° in progressive steps. Indexes one position for each momentary current impulse. Attached wafer switch may be used for self interruption. 7 inch flatted shaft will drive pulley, gear or one or more wafer switches. Catalog No. R 809 Price \$2.45 each

### SOLENOID OPERATED RATCHET STEPPER

Operates on 6 V.D.C. Operates three 12 position wafer switches. Most standard wafers are interchangeable with those supplied. Rotates 30° with each impulse. Catalog No. R 709 Price \$3.90 each

### HUNDREDS OF RELAY TYPES IN STOCK

- |                                  |                                   |
|----------------------------------|-----------------------------------|
| Standard Telephone Relays        | Differential and Polarized Relays |
| Short Telephone Relays           | Special Relays BK-Series          |
| Midget Relays                    | Antenna and Ceramic Relays        |
| Timers                           | Motor and Control Relays          |
| Aircraft Contactors              | Relay Assemblies                  |
| Rotary Relays                    | Latching and Interlocking Relays  |
| Western Electric Type "E" Relays | Mechanical Action Relays          |
| Keying Relays                    | Ratchet and Stepping Relays       |
| Hermetically Sealed Relays       |                                   |
| Voltage Regulators and Cutouts   |                                   |

All relays are new, individually inspected and unconditionally guaranteed. They are first line products of leading manufacturers. Special attention given to orders of one or more relays. 24 Hour delivery.

Write for new catalog. Phone, write or wire your requirements.



AUstin 7-0709  
4717 W. Madison St.  
Chicago 44, Ill.

A BARGAIN FOR YOU in a....

# SO LA Constant Voltage TRANSFORMER

## End Fluctuating Line Voltage

SAVE \$147.50

4 inputs! 110 or 220 V. 50 or 60 cycles. SOLA No. 30768 OUTPUT 115 V. ± 1% even if line varies 30% transient or continuous, or if load varies from 0 to 17.4 amps (2,000 VA). Use as step-down 220:115 V. if you wish! Isolated secondary. No moving parts. Self-protecting against overloads. Air Forces overstock, this 4-input unit now \$147.50 LESS than regular price of single-input 2000 VA unit!



Brand new in original wood box. 4 cu. ft. \$97.50 Ship. wt. 254 lbs. F.O.B. Pasco, Wash. Only

(EXPORTERS: Note choice of 50 cycles.)

THE M. R. COMPANY  
P. O. Box 1220-B Beverly Hills, Calif.

## A DEPARTMENT STORE FOR YOUR ELECTRONIC SUPPLIES

WE'RE SELLING YOU RELAYS — WHAT ARE YOUR OTHER NEEDS? Our normal Inventory Includes Over 80,000 Different Items in the Electronic, Radar and Radio Fields

### RELAYS



ALLIED • LEACH • TELEPHONE TYPE  
MINIATURE AIRCRAFT • GUARDIAN  
SIGMA • HERMETICALLY SEALED  
and many others



### SENSITROLS

### STEPPING SWITCHES



SEND FOR OUR LATEST BULLETINS

AND ADD YOUR NAME TO OUR MAILING LIST  
cable address: UNIGENCOR, N. Y.

324 CANAL ST. (Near B'way) N. Y. — WA 5-9642  
Universal general corp.

### INDUSTRIAL X-RAY INSPECTION EQUIPMENT

General Electric OX-200, XRD Diffraction, Picker, Standard, Westinghouse and Keleket units from 100 KV up. Special inspection booths made to order.

MEDICAL SALVAGE CO., INC.  
217 E. 23rd St. N. Y. 10, N. Y.

### RCA TV CAMERA

NEW Surplus

for Labs! Export!  
Industrials!  
Medicine!  
Closed Circuit TV!



Ideal for labs, industry, prisons, TV technicians, swim pools, medics—"mechanical eye" for closed circuit TV. 1846 Iconoscope, 6-stage video amplifier and clipper. THE REAL THING! Send for now free, complete technical data. SOLD AT FRACTION OF REAL VALUE!

Write today! Note our new address!

## Harjo Sales Co.

Mailing Address: Box 1187-E8 MAGNOLIA PARK STATION, BURBANK, CALIF.  
Office-Warehouse: Dept. E-8, 503 N. Victory Blvd., BURBANK, CALIF.

ART-13 APR-4 BC-610-E

BC-348, BC-312, BC-342, RAK, RAX.  
BC-221, TS-174, #241 Scope, LM  
ARC-1, APA-10, DY-17, DY-11

Alltronics, Box 19, Boston 1, Mass  
Telephone: Richmond 2-0048, 2-0916

### FOR SALE

#### UNUSED SURPLUS COMPONENTS

Power Rheostats — Power Resistors — "J" — "JJ"  
Pots — Wire Wound Pots — Glass Ferrule Resistors — Precision Resistors

Send us your requirements and let us quote

J. C. DIXON; Troy, Ind.

### 100 Westinghouse WL-531 50,000 Volt Rectifier Tubes

Input Filament 11.5 V 20 Amps.  
Anode plate 50,000 V.  
750 hr Peak @ 290 Milliamps.

May be used for smoke precipitators. List price over \$35. Best offer takes all or part.

FS-7104, Electronics

330 W. 42 St., New York 36, N. Y.

IF THERE IS

Anything you want

that other readers of this paper can supply

OR—

Something you don't want

that other readers can use, advertise it in the

Searchlight Section



# SPECIAL PURPOSE TUBES

OA9	.75	3BP1	2.00	6Q5G	2.00	WE-121A	3.50	WE-347A	3.50	805	4.00	1625	.35
OA3	1.00	EL-3C	5.50	6SC7GT	2.00	WE-122A	1.50	WE-348A	5.00	806	9.75	1626	.25
OA5	4.00	EL-3CJ	7.50	6SK7Y	.50	F-123A	5.00	WE-349A	7.50	807	1.25	1627	.25
OB2	.75	3C22	60.00	6SN7WGT	2.00	WE-123A	5.00	WE-350A	3.00	807W	4.00	1630	.75
OB3	.75	3C23	3.75	6SU7GT	2.25	WE-124A	3.50	WE-350B	3.00	808	2.00	1631	1.50
OC3	.75	3C24	1.50	7BP7	5.00	VT-127A	1.50	WE-351A	6.00	809	3.00	1632	.50
OD3	.75	3C31	2.50	7CP1	15.00	F-128A	20.00	WE-352A	10.00	810	10.00	1633	.75
EL-C1B	2.50	3033	10.00	7EP4	10.00	HF-130	1.00	F-353A	2.00	811	4.00	1634	1.35
EL-1C	1.50	3C37	30.00	9GP7	5.00	VR-150	.75	WE-353A	3.50	811A	3.00	1635	1.50
1B22	1.50	3C45	7.00	9LP7	3.50	FG-154	17.50	WE-354A	15.00	812	2.25	1636	1.25
1B23	3.50	3D21A	6.00	9MP7	7.50	HK-154	5.00	WE-355A	15.00	813	12.00	1641	1.50
1B24	4.75	3D22	9.75	10Y	.35	VT-158	10.00	WE-359A	3.00	814	1.75	1642	.50
1B27	10.00	3DP1	3.75	CE-11V	2.50	FG-166	25.00	WE-368A	3.00	815	1.50	1644	1.00
1B32	1.00	3DP1A	7.50	12A6	.50	FG-172	20.00	371A	1.00	816	1.50	1649	1.00
1B35	4.75	3E9P	10.00	12DP7A	35.00	QK-181	20.00	371B	1.00	822	10.00	1654	3.50
1B38	30.00	3EP1	2.00	12GP7	15.00	FG-190	7.50	F-375A	15.00	826	1.00	1655	2.00
1B40	3.50	3FP7	2.00	12J5WGT	2.00	HF-200	12.50	WE-388A	1.50	828	7.50	1656	6.50
1B42	4.50	3FP7A	5.00	12K8Y	.75	CE-201	4.00	WE-393A	5.00	829	7.50	1661	6.00
1B59	10.00	3GP1	2.50	12L8GT	1.00	CE-203	5.00	394A	2.50	829B	10.00	1846	50.00
1C21	2.00	3HP7	3.00	LM-15	200.00	203A	5.00	WE-394A	3.50	830B	4.00	1904	10.00
1P21	30.00	3J21	75.00	NE-16	.35	203Z	5.00	WE-396A	3.00	832	5.50	1960	.50
1P23	2.00	3J31	35.00	FG-17	3.50	204A	35.00	WE-404A	10.00	832A	35.00	1984	10.00
1P25	75.00	3K27	150.00	RK-19	1.00	WE-205B	.75	410R	100.00	833A	7.50	2000T	150.00
1P30	2.00	3KP1	7.25	RK-20A	8.00	207	75.00	WE-417A	12.00	834	10.00	2051	1.25
1P32	1.00	3RP1	7.25	TZ-20	2.00	211	.75	WL-417A	4.00	835	2.50	2051	.75
1P34	1.75	4-400A	40.00	CE-21C	3.00	WE-211C	10.00	WE-418A	12.50	836	1.00	2172	12.50
1P36	2.50	KC-4	75.00	RK-21	1.00	WE-211D	8.00	WE-421A	15.00	837	1.00	3183	5.00
1Z2	2.00	4AP10	3.75	RK-22	3.50	WE-212E	25.00	GL-434A	3.75	838	1.00	ZB-3900	75.00
VG-2	10.00	4B22	6.50	CE-23C	1.50	217A	2.00	446A	.50	842	2.50	R-4100	7.50
2AP1	5.00	4B23	15.00	PJ-23	2.00	217C	5.00	446B	2.00	843	5.00	R-4330	10.00
2AP1A	5.00	4B24	5.50	RK-23	2.75	WL-218	25.00	450TH	50.00	845	5.00	3528	3.75
2AS15	6.00	4B25	8.00	HK-24	3.00	CE-220	.75	450TL	45.00	845W	8.50	3550	35.00
2B21	1.00	4B26	3.50	HK-24G	1.00	220C	150.00	451	5.00	846	75.00	3551	40.00
2B26	1.50	4B27	4.00	CE-25A/B	2.00	CE-221	8.00	WL-460	10.00	849	25.00	3553	135.00
2C21	.50	4B28	3.00	RK-25	3.00	CE-222	1.50	464A	2.25	850	25.00	3556	6.75
2C22	.35	4B30	.75	25T	3.00	CE-224	5.50	WL-468	15.00	851	12.50	3557	3.50
2C24	.75	4B32	10.00	25TG	1.00	CE-225	3.00	SS-501	7.25	852	7.50	3560	20.00
2C25	.35	4C22	7.50	FG-27A	2.00	CE-226	3.00	RH-507	35.00	860	3.00	3610	1.25
2C26A	.50	4C25	3.00	CE-28D	2.50	WE-231D	2.00	CK-510AX	.50	861	15.00	3625	75.00
2C33	.75	4C27	3.50	RK-28	2.50	RX-233A	.75	WL-525	10.00	864	.35	3632	7.50
2C34	.35	4C30	1.50	28D7	.75	CE-235A	5.00	527	25.00	865	.50	3645	6.50
2C39A	8.50	4C35	15.00	28D7W	1.50	235R	50.00	WL-530	25.00	866A	1.15	3651	1.50
2C40	7.50	4E27	9.00	CE-29	1.25	WE-242A	5.00	WL-531	7.50	866JR	1.50	3656	7.50
2C42	15.00	4J52	50.00	CE-30C	1.25	WE-242C	8.00	WL-532A	1.00	868	2.00	3670	2.00
2C43	12.00	4X100A	25.00	Twin 30	7.50	WE-249B	3.25	WL-535	10.00	869B	25.00	3687	5.00
2C44	.50	EL-5BHD	15.00	HY-30Z	2.75	WE-249C	3.25	WL-538	.50	GL-872A	2.00	3691	5.00
WE-2C51	3.00	EL-5B2.5	6.50	CE-31V	2.50	250R	5.00	GL-553	2.00	872A	1.00	3696	1.25
2C53	10.00	5AP1	2.00	FG-32	6.00	250TH	20.00	559	.75	874	.75	3703	1.25
2D21	.75	5B21	2.00	FG-33	11.50	250TL	15.00	GL-564	1.50	876	1.50	3720	11.50
2D21W	1.50	5BP1	2.00	RK-33	.50	WE-251A	50.00	575A	15.00	878	1.00	3725	2.00
2E22	2.00	5BP1A	10.00	RK-34	.35	WE-252A	10.00	WL-579B	10.00	879	.35	3728	85
2E24	2.50	5BP2A	10.00	35TG	3.00	WE-253A	5.00	KU-610	7.50	884	1.25	3728	10.00
2E25	3.00	5BP4	2.00	RK-38	6.50	WE-254A	6.00	HY-615	.50	885	1.25	3740	44.00
2E26	3.25	5C21	6.00	RK-39	2.50	HK-257B	9.00	WL-629	1.25	902P1	3.50	3763	1.00
2J21A	3.50	5C22	30.00	T-40	2.50	WE-257A	2.25	WL-630	1.00	905	2.00	3801	2.50
2J26	5.00	5C30	1.00	TZ-40	3.50	FG-258A	135.00	631-P1	7.50	913	15.00	3820	350.00
2J27	5.00	5CP1	3.00	CE-42C	1.50	WE-259A	12.50	WL-632A	17.50	917	2.50	3826	375.00
2J29	15.00	5CP1A	10.00	RK-44	1.00	WE-261A	10.00	WL-655 658		918	2.00	3827	2.50
2J30	25.00	5CP7	7.50	QK-47	50.00	WE-262B	7.00	919	135.00	920	3.00	3829	1.25
2J31	15.00	5D21	7.00	RK-47	1.75	WE-264C	3.00	WL-670A	8.00	921	1.00	3842	12.00
2J32	15.00	5D23	7.50	CE-48	1.75	WE-267B	10.00	WL-681 686	35.00	922	1.25	3847	10.00
2J33	15.00	5F27	1.50	RK-49	3.00	WE-271A	10.00	WE-701A	3.00	923	1.50	3932	4.00
2J34	15.00	5FP14	5.00	HY-51B	1.00	WE-272A	5.00	702A	.50	924	1.35	3933	7.00
2J36	25.00	5GP1	5.00	FP-54	44.00	WE-274A	4.75	702B	1.00	925	2.00	3948	250.00
2J37	5.00	5J26	100.00	HK-54	3.00	WE-274B	3.00	703A	1.50	926	2.50	3963	1.00
2J38	10.00	5J29	7.50	T-55	5.00	274B	.75	WE-704A	1.00	927	1.00	3981 5650	75.00
2J39	10.00	5J30	7.50	RK-57	4.00	WE-275A	5.00	705A	.75	928	2.50	3998	15.00
2J40	15.00	5J32	25.00	RK-58	1.00	276A	3.00	707A	3.50	929	1.25	6011	4.75
2J50	35.00	5J31	15.00	QK-59	35.00	WE-282A	7.50	707B	4.50	930	1.25	6013	10.00
2J51	150.00	5J32	7.50	QK-60	35.00	WE-283A	4.00	WE-708A	1.00	931A	2.75	6031	4.75
2J53	25.00	5J34	7.50	RK-60	1.50	WE-285A	5.00	WE-709A	1.00	934	.35	R-6160	2.00
2J55	50.00	5J35A	7.50	HY-61	1.25	WE-286A	6.00	710A	.50	954	.50	R-6175B	1.00
2J56	75.00	5J31A	25.00	QK-61	35.00	WE-287A	5.00	713A	.50	955	.75	R-6200	.75
2J61	15.00	5LP1	8.00	RK-61	3.00	WE-295A	5.00	714AY	25.00	956	.35	R-6210	15.00
2J62	5.00	5LP1A	25.00	QK-62	35.00	WE-296A	25.00	715A	2.50	957	.75	UX-6653	1.00
2J62A	50.00	5NP1	3.00	RK-62	1.75	HF-300	17.50	WE-715C	15.00	958A	1.75	8001	9.00
2JB51	1.00	5R4GY	1.00	RK-63	20.00	WE-300B	5.00	717A	.50	991	.35	8002R	25.00
2K25	15.00	5R4WGY	2.50	HY-65	3.00	CE-302	1.00	WE-719A	10.00	995	.35	8005	4.25
2K28	30.00	5X3	3.00	RK-65	7.50	EL-302.5	5.00	721A	1.00	1000	2.00	8008	6.00
2K30	100.00	5Z2P7	75.00	FG-67	10.00	CE-303	2.50	721B	7.50	1001	7.50	8011	1.00
2K33A	75.00	5Z4P11	150.00	RK-69	2.00	WE-304B	7.50	722A	1.00	1002	5.00	8012	1.00
2K39	135.00	EL-C6A	6.00	RK-72	.75	304TH	10.00	723A/B	10.00	1003	3.00	8012A	2.50
2K41	100.00	EL-C6B	6.00	RK-73	.75	304TL	10.00	WE-724A	1.00	1004	5.00	8013	2.75
2K54	10.00	EL-C6L	3.75	HY-75	3.00	WE-305A	3.50	WE-724B	1.00	1005	10.00	8013A	3.75
2K55	7.50	EL-C6T	8.00	RK-75	1.00	307A	1.00	WE-725A	3.50	1500T	100.00	8014A	50.00
2P21 (Image orthicon)	100.00	6AC7W	1.00	VR-75	1.00	CE-309	3.50	WE-726A	7.50	1602	2.25	8016	2.50
2V3G	2.25	6AJ5	1.25	75TL	5.00	WE-310A	4.00	WE-726B	30.00	1603	3.50	8020	1.25
2X2	.35	WE-6AK5	1.35	VR-78	.50	WE310B	5.00	WE-726C	25.00	1608	3.75	8021	.75
2X2A	1.00	6AK5W	1.50	VR-90	.75	WE-311A	5.00	WE-730A	7.50	1609	9.25	8022	1.50
3A4	.50	6AL5W	.85	CV-92	3.50	316A	.50	731A	1.50	1610	2.25	8023	1.50
3A5	.50	6AN5	3.00	FG-95	20.00	WE-323A	10.00	WE-732A	2.00	1611	1.50	8025	1.50
3AP1	5.00	6AR6	2.00	C-100D	2.00	323B	5.00	WL-735	2.00	1612	1		

# QUALITY ELECTRONIC TUBES

## GUARANTEED • UNUSED • BOXED

• SPECIALISTS IN JAN, WESTERN-ELECTRIC, SUBMINIATURE, 5000/6000 SERIES AND RECEIVING TYPES

NEW, FREE RECEIVING TUBE CATALOG JUST OFF PRESS!

• Critical Types Lab Tested For Your Protection

0A4G	\$1.00	2J54	35.00	FG67	12.00	GL673	13.00	5702	2.00
0B3/VR90	.85	2K25	22.50	QK69	25.00	703A	1.25	5703	.95
0C3/VR106	.85	2K28	28.50	QK72	25.00	705A	.85	5718	1.90
0D3/VR150	.85	2K45	65.00	RKR-72	.50	707A	4.00	5718	4.25
1B24A	25.00	3B24	1.50	RKR-73	.50	707B	5.00	5726/6AL5W	1.10
1B26	1.50	3B24/W	5.00	FG98A	20.00	708A	2.00	5732	3.00
1B32	2.00	3B27	3.50	100R Surplus	5.00	709A	1.75	5744	1.00
1B35	6.50	3B28	6.00	100TH	6.75	715B	3.00	5751	2.50
1B85A	22.50	3B29	6.00	100TL Surplus	8.50	717A	.50	5762	100.00
1B88	9.95	3C22	62.50	FG105	15.00	721A	.75	5763	1.10
1B86	7.75	3C23	7.50	VT127A	2.50	722B	1.00	5780	250.00
1N21	.06	3C31/C1B	2.25	VXR130	.75	723A/B	9.50	5787WA	5.75
1N21A	.50	3C45	7.95	FG172	45.00	725A	4.50	5795	250.00
1N21B	1.50	3D21A	4.50	QK181	35.00	726B	25.00	5812	2.75
1N22	.50	3J30	45.00	203A	2.50	726C	35.00	5814	1.60
1N23A	.50	3J31	45.00	207	45.00	750TL	50.00	5819	49.95
1N23B	1.50	3BP1	2.95	211	.50	800	2.00	5820	Write
1N26	4.50	3BP11	7.00	227A	2.00	803	1.75	5829	2.00
1N27	.75	3DP1	3.00	249A	3.50	807	1.25	5840	5.00
1N34	.50	3FP7	2.50	251A (WE)	45.00	809	2.25	5841	7.50
1N34A	.65	4B24	5.00	253	5.50	810	8.95	5844	4.00
1N35	1.50	4B28	3.00	266B	45.00	814	2.00	5879	1.40
1N38A	.85	4C35	13.50	274B	1.00	829B	8.75	5881	2.65
1N44/400-B	1.00	4E27	9.50	275A	3.50	838	1.50	5886	2.50
1N45/400-C	1.25	4J21	77.50	276G	8.50	866A	1.25	5890	35.00
1N48	.40	4J36	75.00	287A	3.00	872A (G.E.)	2.75	5899	5.50



### DIRECTION SELENIUM RECTIFIERS

Max. Amps.	18VAC 14VDC	36VAC 28VDC	54VAC 42VDC	72VAC 56VDC	130VAC 100VDC
1	\$1.35	\$2.35	\$3.75	\$4.50	\$7.45
2	2.00	2.75	5.35	5.90	9.15
3	2.95	4.15	5.85	7.85	12.75
4	3.50	6.45	11.35	14.35	21.75
6	4.00	7.75	12.85	17.30	29.75
10	5.90	11.45	19.50	24.80	41.35
12	7.25	14.35	22.10	29.75	44.25
20	13.05	25.05	37.25	48.75	78.50
24	14.25	28.75	44.50	57.65	81.00
30	17.95	34.35	56.50	71.00	109.00
36	22.45	42.35	65.00	86.95	134.00
50	29.50	54.35	105.45	115.75	174.00
100	59.50	119.00			

We build other Selenium Rectifiers, Transformers and Chokes to your specifications. Buy from the Direct Source for Quick Delivery.

### NEW RECTIFIER TRANSFORMERS

Continuous Ratings	1 Amp	\$5.75
115V, 60 cycles input	2 Amps	6.75
SEC: 9, 12, 18, 24, and 36 volts.	12 Amps	16.65
	24 Amps	35.65
	50 Amps	59.00
	100 Amps	108.00

### NEW RECTIFIER CHOKES

Continuous Ratings	1.5 ohm	\$4.95
1 Amp	.1 Hy	5.95
2 Amps	.04 Hy	7.95
4 Amps	.07 Hy	14.95
12 Amps	.01 Hy	29.95
24 Amps	.004 Hy	.025 ohm
50 Amps	.005 Hy	.01 ohm

### FILTER CAPACITORS

Capacity	W. Voltage	Each
500 MFD	200 V.	\$1.95
500 MFD	50 V.	.85
1000 MFD	15 V.	.35
2000 MFD	50 V.	2.25

### NOW AVAILABLE!

**WHITE COATED TUBE CARTONS**  
 SIZE EACH  
 Miniature... \$ .01  
 1"x1"x3"  
 6AU6, 6AL5, etc.  
 GT "2"x3" .0125  
 12"x4"x3"  
 6SN7GT, 6WAGT, etc.  
 5U4G, 6BG6G, etc.  
**Also in Super-Gloss Red and Black**  
 Both types with new safety partitions—they meet U. S. Government specifications! Attractive discounts for quantity users. Minimum order 100 of a size. Be sure to specify white or color when ordering.

### EMITTING TUBE CARTONS

Small Jumbo—White Only  
 Large Jumbo

3"x3"x7 1/2"  
 FOR 805, 866A, etc.  
 \$7.50 PER 100  
 550 TO THE CASE

4"x4"x10"  
 FOR 813, 872A, etc.  
 \$10.00 PER 100  
 300 TO THE CASE

### KILOWATT POWER SUPPLY

Matched, compact, hermetically-sealed components for KW power supply. Ideal for new Collins KWS-1K, etc.  
 • Power xfmr. Pri: 115 v. 60 cy. with taps for 1/2, 1/3, and full power. Sec: 3400 v. @ 400 ma. 39 lbs.—8"x5"x7 1/2"  
 • Choke to match above—12 henries @ 400 ma. 34 lbs. 8"x5"x7 1/2"  
 • Filament xfmr for 4—866A's in bridge circuit. Pri: 115 v. 60 cy. Sec: 2.5 v. @ 5.0 A, 2.5 v. @ .A, and 2.5 v. @ 10 A. Complete set only \$45.00.

Western Electric Model 296  
**STEEL PANELS**  
 10 1/2" x 19"  
 Brand New Telephone Black or Gray  
 75¢ EACH

CL2 WESTINGHOUSE 1990  
**CEASium VAPOR, INFRA RED, LIGHT SOURCE**

**MICRO-CUTTER**  
 Adjustable Circle Cutter. Cuts up to 4" in metals, plastics or wood  
 295

1N54	.80	4J37	75.00	300B	6.00	891	125.00	5963	1.20
1N56	.85	4J63	7.00	304TH Surplus	8.75	931A	3.00	6021	5.00
1N64	.70	4PR60A Surplus	75.00	304TL Surplus	10.75	958A	.50	6073	1.65
1N65	.75	4-125A Surplus	19.00	311A	5.50	1603	3.10	6080	3.25
1N69	.60	4X150A Surplus	30.00	311C	2.50	1619	.30	6080WA	4.25
1N70	1.20	4X500F Surplus	65.00	337A	6.50	1620	4.75	6095	1.25
1N81	.90	5BP4	3.95	50A (WE)	3.00	1851	1.75	6096	1.50
1N82	.70	5C22	29.95	WE355A	19.75	1960	.60	6097	1.50
1N198	1.25	5D21	7.75	359A	2.00	5514	4.50	6098	1.90
1P30	2.00	5JP5	10.00	391A	3.50	5516	6.50	6099	1.50

**GLAS-LINE**  
 Will not shrink, stretch or sag. High tensile strength of over 500 lbs. Non-inductive, non-conducting, non-absorbing. Made with Corning Fibre-glass center. Ideal as guy wire eliminating break-up insulators. Many other antenna and electronic applications.  
 289 Per 100 Ft. Roll

**SNOOPERSCOPE TUBE**  
 Super sensitive tube that converts invisible infra-red rays into a bright image—see in total darkness.  
**TYPE CRI—BARRY SPECIAL... \$4.98**  
**INFRA RED FILTER**  
 Snaps on front of snooperscope tube. Eliminates stray white light for sharper images.  
 Price \$1.02 each  
 Free hook up data supplied with above combination.

1Q22	55.00	6A7	.85	401A/5590	3.10	5634	7.00	6100	4.75
2C39A Surplus	11.95	6J4	3.95	403B/5591	3.15	5641	6.00	6101	1.50
2C40	9.95	7BP7	4.50	404A/5847	12.00	5642	.95	6106	2.90
2C43	12.75	7EP4	12.50	416A	39.95	5651	1.40	6113	1.25
2C46	6.60	7GP4	12.50	416B	79.95	5654	1.55	6146	3.90
2C51	3.75	8D21	455.00	417A	3.00	5656	7.95	6187	4.00
2E30	1.75	12DP7	10.00	417A/5842	12.50	5670	2.15	6189/12AU7WA	3.75
2E31	1.90	FG27A	11.95	422A	9.95	5676	1.00	6201/12AT7WA	2.25

**RCA MODEL REM**  
 DUAL PANORAMIC ADAPTORS  
 New If Frequency 455 KC and 5.25 MC  
**\$15000 EACH**

2E35	1.95	35T 10N Gauge	2.50	429A	8.75	5678	1.15	8020 Surplus	1.25
2J33	10.00	FG41	12.50	464A	2.55	5686	2.00	8008/RCA 872A	4.25
2J36	35.00	RK60	1.00	CK 503AX	1.00	5687	3.00	9001	.75
2J32	15.00	RK61	2.75	GL562	50.00	5691	5.50	9002	.50
2J37	10.00	QK60	25.00	WL651/5552	50.00	5692	5.25	9003	.95
2J42	52.50	QK61	25.00	WL-653B	110.00	5693	4.75	9004	.25
2J49	35.00	QK62	25.00	ZP-653	75.00	5696	1.15	9006	.25

**U. S. ARMY SNOOPERSCOPE** \$16000  
 Complete with IP25. Write for details  
 RCA manual describing above plus history, theory and construction details on other infra-red devices.  
**APPROX. 40 PAGES \$100**

Authorized Tube Distributors of Eimac, CBS, Continental Electric (Cetron), Lewis & Kaufman, Penta, and others.

# BARRY ELECTRONICS CORPORATION

512 Broadway, New York 12, N. Y.

Dept. 8-E

Phone: Walker 5-7000

Terms: F O B—N Y C—25% Deposit with order—  
 or send full remittance to save C O D charges—  
 D & B Rated Firms (F2 1/2 or Better) Net 10 days.  
 CABLE: BARRYELECT, N. Y. TELEGRAPH: BARRY ELECTRONICS, FAX, N. Y.

# INDEX TO ADVERTISERS

A C F Electronics a Div. of A C F Industries, Inc. ....	39
Acme Wire Co. ....	376
Adams & Westlake Company ....	87
Admiral Corp. ....	193
Advanced Vacuum Products, Inc. ....	261
Aeronautical Communications Equipment, Inc. ....	80
Airborne Instruments Laboratory ....	72
Aircraft-Marine Products, Inc. ....	30, 31, 275
Aircraft Radio Corp. ....	426
Alpax Products Co. ....	81
Allen-Bradley Co. ....	58
Allen Co., Inc., L. B. ....	381
Allen Manufacturing Co. ....	366
Allegheny Ludlum Steel Corp. ....	60
Alpha Metals, Inc. ....	372
American Airlines, Inc. ....	273
American Electric Motors, Inc. Electric Machinery & Equipmt. Div. of American Electronics, Inc. ....	228
American Gas Furnace Co. ....	362
American Lava Corporation ....	37
American Machine & Foundry Company. ....	102
American Phenolic Corp. ....	341
American Television & Radio Co. ....	356
American Time Products, Inc. ....	301
Amperex Electronic Corp. ....	259
Amperite Co., Inc. ....	290
Ampex Corporation ....	96
Andrew Corporation ....	57
Armeo Steel Corporation ....	54
Arnold Engineering Co. ....	13
Assembly Products Inc. ....	360
Atomic Instrument Company ....	351
Augat Bros. Inc. ....	340
Bakelite Co., a Div. of Union Carbide and Carbon Corp. ....	95
Baker & Adamson, General Chemical Div. Allied Chemical & Dye Corp. ....	264
Ballantine Laboratories, Inc. ....	174
Barry Controls, Inc. ....	21
Basic Tool Industries, Inc. ....	370
Beam Instruments Corp. ....	379
Belden Manufacturing Co. ....	167
Bell Telephone Laboratories ....	221
Bendix Aviation Corporation, Eclipse-Pioneer Div. ....	186
Red Bank Div. ....	266
Bentley, Harris Mfg. Co. ....	32
Berkeley Division, Beckman Instruments, Inc. ....	324
Bird Electronics Corp. ....	337
Boesch Mfg. Co., Inc. ....	380
Boonton Radio Corp. ....	217

Borg Corporation, George W. ....	337
Bosworth & Co. ....	5, 381
Bruno-New York Industries Corp. ....	296, 297
Byron Jackson Co. ....	177
Budd-Stanley Co., Inc. ....	315
Buggie Inc., H. H. ....	260
Burnell & Co., Inc. ....	237
Bussmann Mfg. Co. ....	62
Caledonia Electronics & Transformer Corp. ....	328
Calidyne Company, The. ....	198
Cambridge Thermionic Corp. ....	90
Camloc Fastener Corp. ....	196
Carborundum Company ....	285
Carter Motor Co. ....	314
Centralab, Div. of Globe-Union Inc. ....	64
Chamber of Commerce, Daytona Beach, Florida Traffic & Industrial Dept. ....	369
Chase Brass & Copper Co. ....	309
Chatham Electronics Corp. ....	263
Chicago Standard Transformer Corp. ....	176
Chicago Telephone Supply Corp. ....	74
Cinch Mfg. Corp. ....	159
Clare & Co., C. P. ....	215
Cleveland Container Co. ....	223
Clifton Precision Products Co. Inc. ....	333
Cohn Corp., Sigmund. ....	424
Collectron Corporation ....	359
Collins Radio Co. ....	56
Computer Company of America, Div. of Bruno-New York Industries Corp. ....	297
Computer Instruments Corp. ....	365
Continental-Diamond Fibre Co. ....	185
Cornell-Dubilier Electric Corp. ....	55
Constantine Engineering Laboratories Co. ....	270
Corning Glass Works ....	288
Cornish Wire Company, Inc. ....	336
Cosmic Condenser Co. ....	364
Couch Company, Inc., S. H. ....	353
Craig Inc. ....	364
Cramer Co., Inc., R. W. ....	200
Cro-Plate Company, Inc. ....	363
Cross Co., H. ....	360
Crucible Steel Co. of America. ....	42
Cubic Corporation ....	278
Cunningham Son & Co., Inc., James. ....	359
Dale Products, Inc. ....	339
Dano Electric Co. ....	345

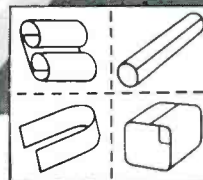
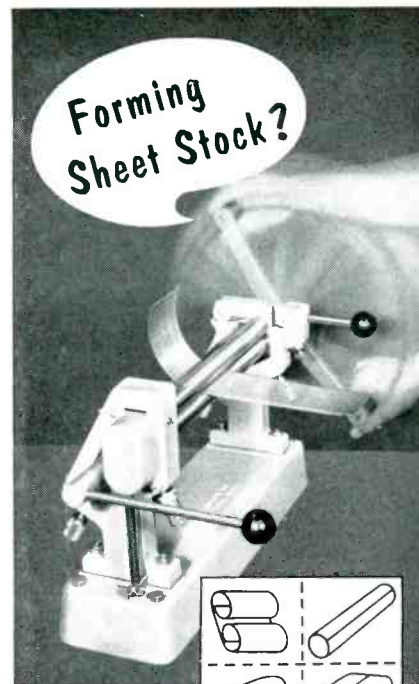

here are **10** "reasons why"

## you'll be interested in DI-ACRO\* ROLLERS

1 Cam actuated idler roll—an exclusive feature—makes it possible to form small circles in one operation.

2 Larger circles are formed in two operations. No limit to maximum radius.

3 Bends are located at any point in metal—with straight sections on both sides of the bend.

4 Material other than sheet is also formed. Special rolls supplied for special forming jobs.

5 Eight models. Rated capacity to 16 gauge. Forming widths from 6" to 42".

6 Di-Acro Rollers are easy to operate.

7 Adjustments can be "locked in"—hundreds of parts precisely duplicated.

8 Long, trouble-free service, all machines backed by warranty.

9 Engineering Service at your disposal for the life of the machines.

10 Delivery is good. Cost is too.

\*pronounced Die-ack-ro



**LIKE MORE INFORMATION?**  
Send for 32-page Catalog

See 2 Di-Acro Exhibits at Chicago Sept. 6-16; Production Eng. Show, BOOTH 125-126, Navy Pier. Metalworking Show, BOOTH 653, Chicago Coliseum

Creators of  
"DIE-LESS  
DUPLICATING"

**O'NEIL-IRWIN**  
MFG. CO.  
321 8th Avenue  
Lake City, Minnesota



Want more information? Use post card on last page.

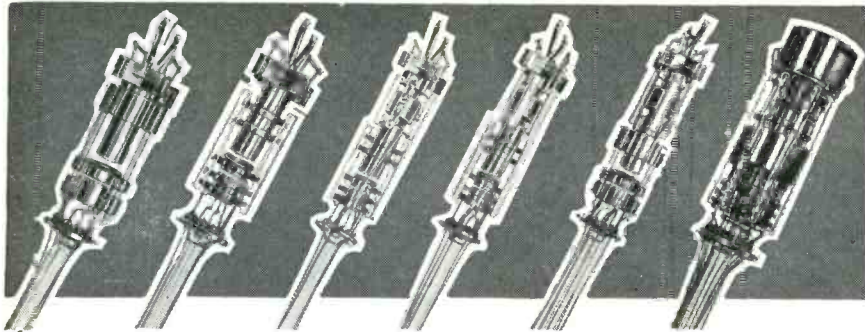

# "SUPERIOR"

manufactures quality electronic

## GUN MOUNTS

SUPERIOR offers the CRT industry a complete line of precision-engineered magnetic, electrostatic and color gun mounts. Electron guns for radar and industrial tube types custom built to your specifications.

You will enjoy dependable service and complete satisfaction when you order from SUPERIOR.

Call upon us to meet your most exacting requirements.

### SUPERIOR ELECTRONICS

CORPORATION

208-212 Piaget Avenue - CLIFTON, N. J. - GR egor y 2-2500

#### IRIDIUM vs. RHODIUM IRIIDIUM THERMOCOUPLE WIRE

The only thermocouple material which may be used at these very high temperatures in an oxidizing atmosphere.

Ductile wire made possible by high purity and our advanced melting and drawing techniques.

Output: Over 10 millivolts at **3700°F.**

UNIFORM • REPRODUCIBLE

Write for List of Products

DIRECT TEMPERATURE MEASUREMENT UP TO

# 3700°F.

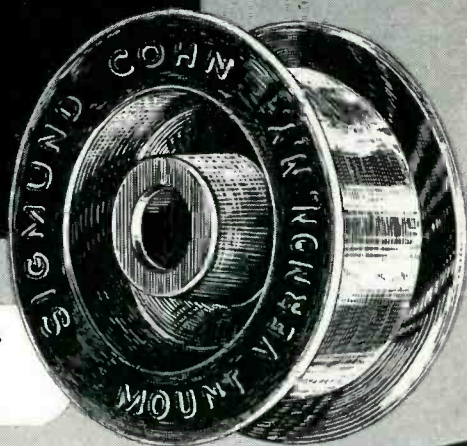

Specialists in the  
*Unusual*



**SIGMUND COHN CORP.** Metallurgists and  
Producers of Small Wire  
121 South Columbus Avenue • Mount Vernon, N. Y.

Daven Company	3rd Cover
Daven Electronic Sales Corp	358
Davies Laboratories, Inc.	327
Daystrom Instrument, Div. of Daystrom, Inc.	265
DeJur-Amseco Corporation	292
Dectron Corporation, Computer-Measurements Div.	314
Dialight Corporation	332
Driver Company, W. B.	220
Driver Harris Company	227
Du Mont Laboratories Inc., Allen B.	179
DuPont de Nemours & Co. (Inc.), E. I., Film Dept.	299

Eastern Air Devices, Inc.	222
Eastern Industries, Inc.	59
Eastman Kodak Company	195
Edo Corporation	233
Fisler Engineering Co., Inc.	352
Eitel-McCullough, Inc.	33
Electra Mfg. Co.	306
Electrical Industries, Div. of Amperex Electronic Corp.	231
Electric Regulator Corp.	250
Electro Impulse Laboratory	366
Electro Tee Corp.	235
Electronic Associates, Inc.	321
Electronic Instrument Co., Inc. (EICO)	308
El-Tronics	247
Engineering Co.	342
EPIC Corporation	371
Erie Resistor Corp.	192
Fairchild Controls Corp. A sub. of Fairchild Camera & Instrument Corp.	279
Fairchild Guided Missiles Div.	326
Fansteel Metallurgical Corp.	334, 335
Federal Screw Products Inc.	379
Federal Telephone & Radio Co.	63, 350
Ford Instrument Co., Div. Sperry Rand Corp.	184
Frenchtown Porcelain Company	376
Frequency Standards	204

G M Laboratories, Inc.	36
Gamewell Co.	212
Garfield Wire Div. of The Overlakes Corp.	369
Garrepy Platers Inc.	381
Gee-Lar Manufacturing Company	352
General Cable Corp.	169
General Ceramics Corp.	241
General Electric Co.	
Apparatus Dept	48, 49, 50, 51, 67, 287, 347
Electronics Dept.	85
Laminated & Insulating Products Dept.	175
Tube Dept.	23

General Industries Co.	211
General Mills, Inc., Mechanical Div.	230
General Radio Co.	17
Genisco Incorporated	380
Globe Industries, Inc.	329
Good-all Electric Mfg. Co.	17
Good Year, Aviation Products Div.	305
Graphite Metallizing Corp.	248
Greenleaf Manufacturing Co.	183
Gries Reproducer Corp.	378
Guardian Electric Mfg. Co.	205

Hammerlund Mfg. Co., Inc.	25
Hart Manufacturing Company	226
Harvey Hubbell, Inc.	40
Hayden Associates, Paul	381
Haydon Manufacturing Co., Inc.	316
Heath Co.	361
Helipot Corp., Div. of Beckman Instruments, Inc.	165
Hetherington, Inc.	168
Hewlett-Packard Co.	97
Homelite Corp.	242
Hughes Aircraft Co.	225
Hughes Research & Development Laboratories	320
Hunt Company, Philip A.	236
Hycor Mfg. Co.	284
Hycor Company, Inc.	277

Ilco Corporation	345
Indiana Steel Products Co.	68
Industrial Hardware Manufacturing Co., Inc.	365
Industrial Test Equipment Co.	345
Industrial Timer Corp.	84
Instrument Resistors Co.	350
International Rectifier Corp.	191, 201
International Resistance Co.	276, 277
Ippolito & Co., Inc., James	358

Johnson Company, E. F.	336
Jones Div., Howard B., Cinch Mfg. Co.	366
Jones Electronic Co., Inc., M. Co.	256
Kable Engineering Co.	15

## INSULATION FOR WATER-COOLED SYSTEMS

For carrying cooling water which must undergo a change in potential, use of Lapp porcelain eliminates troubles arising from

water contamination and conductivity, sludging and electrolytic attack of fittings. Permanent cleanness and high resistance of cooling water are assured—for positive cooling and long tube life.

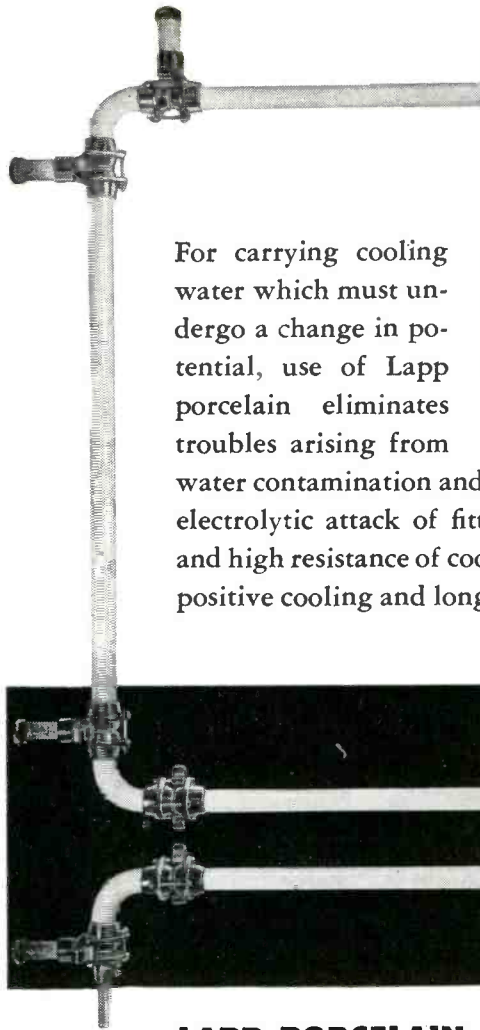

### LAPP PORCELAIN PIPE

Inside diameters  $\frac{3}{4}$ " to 3", in straight pipe, 90° and 180° elbows, fittings. Swivel-type connections. Standoff insulators attach directly to fitting bolts.

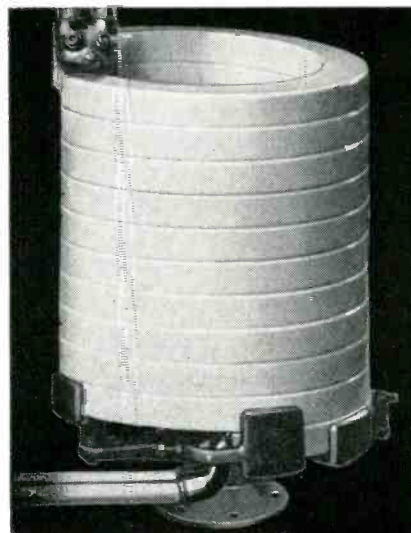

### LAPP PORCELAIN WATER COILS

Twin-hole and single-hole models in sizes to provide flow of cooling water from 2 to 90 gallons per min. Cast aluminum mounting bases; lead pipe or flexible metal hose for attachment.

WRITE for Bulletin 301, with complete description and specification data. Lapp Insulator Co., Inc., Radio Specialties Division, 240 Sumner St., Le Roy, N. Y.

# Lapp



when there's  
**NO** margin for  
**ERROR-**

*you can rely on ARC Test Equipment!*

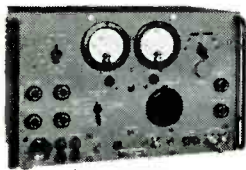

Type H-14A  
Signal Generator



Type H-16  
Standard Course Checker

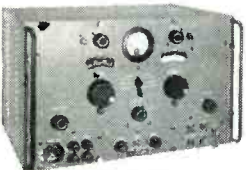

Type H-12  
UHF Signal Generator

The Type H-14A Signal Generator has two uses: (1) It provides a sure and simple means of checking omnirange and localizer receivers in aircraft on the field, by sending out a continuous test identifying signal on hangar antenna. Tuned to this signal, individual pilots or whole squadrons can test their own equipment. The instrument permits voice transmission simultaneous with radio signal. (2) It is widely used for making quantitative measurements on the bench during receiver equipment maintenance.

The H-16 Standard Course Checker measures the accuracy of the indicated omni course in ARC's H-14A or other omni signal generator to better than 1/2 degree. It has a built-in method of checking its own precision.

Type H-12 Signal Generator (900-2100 mc) is equal to military TS-419/U, and provides a reliable source of CW or pulsed rf. Internal circuits provide for control of width, rate and delay of internally-generated pulses. Complete specifications furnished on request.

Dependable Airborne Electronic Equipment Since 1928

## Aircraft Radio Corporation

BOONTON, NEW JERSEY

Omni Receivers • 900-2100 Mc Signal Generators • UHF and VHF  
 Receivers and Transmitters • 8-Watt Audio Amplifiers • 10-Channel  
 Isolation Amplifiers • LF Receivers and Loop Direction Finders



Karp Metal Products Co., Div. of H. & B. American Machine Co. ....	239
Kay Electric Co. ....	27
Kearfott Co., Inc. ....	280, 294
Kellogg Company, M. W. ....	203
Kennedy & Company, D. S. ....	302
Kepeco Laboratories ....	163
Kester Solder Co. ....	209
Koch Fiberglas ....	219
Kollsman Instrument Corp. ....	89

Laboratory for Electronics, Inc. ....	245
Lampkin Laboratories, Inc. ....	372
Lapp Insulator Co., Inc. ....	425
Lemert Engineering Co., Inc. ....	353
Lewis & Kaufman Ltd. ....	91
Linde Air Products Company, Div. of Union Carbide & Carbon Corp. ....	374
Link Aviation, Inc. ....	308
Litton Engineering Laboratories ....	354
Litton Industries ....	342, 343
Lockheed Missile Systems Div. ....	349

MacDonald Inc., Samuel K. ....	381
Magnatran, Inc. ....	46
Magnetics, Inc. ....	171
Malco Tool & Manufacturing Co. ....	370
Mallory and Co., Inc., P. R. ....	104, 161
Mansol Ceramics Co. ....	262
Marconi Instruments, Ltd. ....	32B
Marion Electrical Instrument Co. ....	38
Markem Machine Co. ....	329
Martin Company, Glenn L. ....	251
McCoy Electronics Co. ....	254
McLean Engineering ....	371
Metal & Thermit Corporation ....	375
Metals & Controls Corp., General Plate Div. ....	281
Mica Insulator Co. ....	257
Micro Switch, a Div. of Minneapolis- Honeywell Regulator Co. ....	82
Miles Reproducer Co., Inc. ....	381
Millen Mfg. Co., Inc., James ....	189
Milman Engineering Co. ....	369
Miniature Precision Bearings, Inc. ....	289
Minneapolis-Honeywell Regulator Co., Industrial Div. ....	313
Minnesota Mining & Manufacturing Com- pany ....	32A
Moseley Co., F. L. ....	331
Muirhead & Co., Ltd. ....	5

N J E Corporation ....	103
Naresco Equipment Corp. ....	307
National Fabricated Products, Inc. ....	213
Nems-Clarke Inc. ....	356
New London Instrument Co. ....	359, 363, 364 369, 379
Nopco Chemical Co. ....	283

Norden-Ketay Corp.	100, 101
Northeast Engineering Inc.	243
Nothelfer Winding Labs.	88

Offner Electronics Inc.	253
O'Neil-Irwin Mfg. Co.	423
Orber Manufacturing Co.	381

PM Industries, Inc.	216
Pacific Scientific Co.	325
Panoramic Radio Products, Inc.	373
Perkin-Elmer Corporation	305
Perkin Engineering Corp.	170
Peter Partition Corp.	332
Phalo Plastics Corp.	258
Phelps-Dodge Copper Products Corp. Inca Mfg. Div.	44, 45
Philamon Laboratories, Inc.	43
Photo-Crystals, Inc.	368
Photographic Products Inc.	345
Polarad Electronics Corporation	34, 35, 248, 249
Polymer Corporation of Penna.	282
Polytechnic Research & Development Co., Inc.	252
Potter & Brumfield Mfg. Co.	303
Precision Apparatus Co., Inc.	428
Precision Paper Tube Co.	180
Premier Metal Products Co.	371
Pye Ltd.	70, 71
Pyramid Electric Company	53

R. B. M. Division, Essex Wire Corp.	172
Radial Cutter Manufacturing Co., R. P.	357
Radio Cores, Inc.	238
Radio Corporation of America	98, 99 Fourth Cover
Radio Engineering Laboratories, Inc.	197
Radio Engineering Products	328
Radio Materials Corp.	229
Railway Express Agency, Air Express Div.	207
Ramo-Wooldridge Corp.	271
Raytheon Mfg. Company	18, 19, 29, 69, 173
Reeves-Hoffman Corp.	339
Reeves Instrument Corp.	41
Resin Industries, Inc.	312
Rheem Manufacturing Co.	355
Robinson Aviation Inc.	47
Roller-Smith Corp.	293
Rutherford Electronics Co.	338

Sanborn Company	187
Sanders Associates, Inc.	351
Sangamo Electric Company	371

ELECTRONICS — August, 1955

# NEW CHEMELEC CONNECTORS

**Aluminum Base Type CNA  
Compression Mounted,  
TEFLON-Insulated Terminals**

**2 to 34 Pins**

**Lower Cost . . . High Performance**

These Chemelec Connectors are designed for low loss, high frequency service in interconnection of radio, radar and other electronic equipment—where connectors must be unaffected by a wide range in ambient temperatures, pressure altitudes, humidity and mechanical shock and vibration.

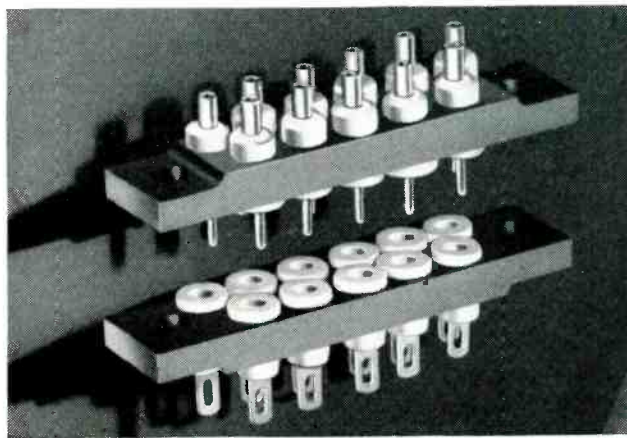

Current rating is 3 amp. for .040 pins and 5 amp. for .063 pins. Voltage rating is 3,300 V. RMS (short time test at sea level).

The TEFLON insulation is serviceable at temperatures from minus 110°F to plus 500°F, for operation in pressure altitudes from 0 ft. to 60,000 ft. Water absorption is zero by ASTM Test.

TEFLON will not carbonize under arcing, and will not support combustion. Its dielectric strength is greater than 500 Volts/Mil.

Lower prices are accomplished by individual compression-mounted, TEFLON-Insulated Terminals in low-cost aluminum bases.

These same terminals are also available for compression-mounting, directly into drilled or punched holes in the chassis itself, without need of additional hardware. (see below).

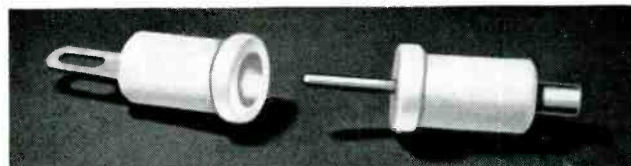

Write for  
Catalog EC-455.

Fluorocarbon Products, Inc. Division of  
**UNITED STATES GASKET CO., CAMDEN 1, NEW JERSEY**



**FABRICATORS OF FLUOROCARBONS  
AND OTHER PLASTICS**

Representatives in principal cities throughout the world

Want more information? Use post card on last page.





*Only*

**DAVEN SWITCHES**

**Have It!**

... The  
"KNEE-ACTION"  
Rotor



**DAVEN's** exclusive, patented, "KNEE-ACTION" Rotor embodies the most advanced principles in switch engineering.

Developed by DAVEN's own staff of switch specialists, it makes possible the fabrication of units with a greater number of switch positions and poles in smaller space than previously possible.

"KNEE-ACTION" insures low contact resistance and uniform contact pressure over the life of DAVEN Switches. Silver alloy contacts, slip rings, and rotor arms are used on all units.

Because a greater number of poles per deck is available, more compactness is possible . . . a feature which is in line with the present trend toward smaller size components which will render maximum performance in minimum space.

DAVEN also offers you every facility for solving your particular switch problems. It stocks a large assortment of standard parts . . . will develop special switches from these standard components . . . or will engineer special switches to meet unusual requirements. DAVEN's Development Engineering Department is at your service to help you. Call on DAVEN today!

*Write for your Free copy of DAVEN's new, 28-page brochure on SWITCHES.*

VISIT DAVEN'S WESCON EXHIBIT AT BOOTH #415

THE **DAVEN** CO. 191 CENTRAL AVENUE, NEWARK 4, NEW JERSEY

