

NOVEMBER • 1954

PRICE 75 CENTS

electronics

A MCGRAW-HILL
PUBLICATION



Testing Microwave Theory
On Navy's Antenna Range

THE STANDARD OF COMPARISON FOR OVER 20 YEARS

HIGH FIDELITY TRANSFORMERS

FROM STOCK... ITEMS BELOW AND 650 OTHERS IN OUR CATALOGUE B.



TYPICAL UNITS

LINEAR STANDARD series

Linear Standard units represent the acme from the standpoint of uniform frequency response, low wave form distortion, thorough shielding and dependability. LS units have a guaranteed response within 1db. from 20 to 20,000 cycles.

Hum balanced coil structures and multiple alloy shielding, where required, provide extremely low inductive pickup.

These are the finest high fidelity transformers in the world. 85 stock types from milliwatts to kilowatts.

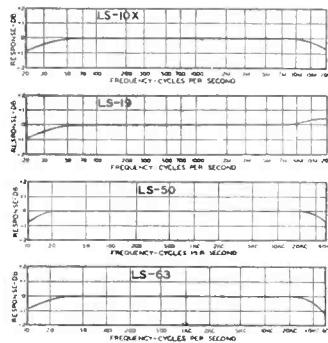

LS-10X Shielded Input

Multiple line (50, 200, 250, 500/600, etc.) to 50,000 ohms ... multiple shielded.

LS-19 Plate to Two Grids

Primary 15,000 ohms. Secondary 95,000 ohms C.T.

LS-50 Plate to Line

15,000 ohms to multiple line ... +15 db. level.

LS-63 P.P. Plates to Voice Coil

Primary 10,000 C.T. and 6,000 C.T. suited to Williamson, MLF, ul-linear circuits. Secondary 1.2, 2.5, 5, 7.5, 10, 15, 20, 30 ohms. 20 watts.

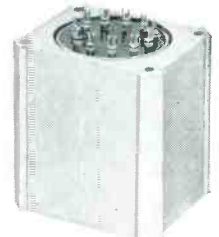

CASE	LS-1	LS-2	LS-3
Length	3 1/8"	4-7/16"	5-13/16"
Width	2 5/8"	3 1/2"	5"
Height	3 1/4"	4-3/16"	4-11/16"
Unit Wt.	3 lbs.	7.5 lbs.	15 lbs.

HIPERMALLOY series

This series provides virtually all the characteristics of the Linear Standard group in a more compact and lighter structure. The frequency response is within 1 db. from 30 to 20,000 cycles. Hipermalloy nickel iron cores and hum balanced core structures provide minimum distortion and low hum pickup. Input transformers, maximum level +10db. Circular terminal layout and top and bottom mounting.

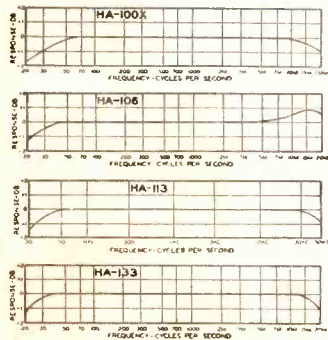

HA-100X Shielded Input

Multiple line to 60,000 ohm grid ... tri-alloy shielding for low hum pickup.

HA-106 Plate to Two Grids

15,000 ohms to 135,000 ohms in two sections ... +12 db. level

HA-113 Plate to Line

15,000 ohms to multiple line ... +12 db. level ... 0 DC in primary.

HA-133 Plate (DC) to Line

15,000 ohms to multiple line ... +15 db. level ... 8 Ma. DC in primary.



Case	H-1	H-2
Length	2 3/8"	3-9/16"
Width	1-15/16"	2-13/16"
Height	3 1/8"	3 1/2"
Unit Weight	2 lbs.	5 lbs.

ULTRA COMPACT series

UTC Ultra Compact audio units are small and light in weight, ideally suited to remote amplifier and similar compact equipment. The frequency response is within 2 db. from 30 to 20,000 cycles. Hum balanced coil structure plus high conductivity die cast case provides good inductive shielding. Maximum operating level is +7db. Top and bottom mounting as well as circular terminal layout are used in this series as well as the ones described above.

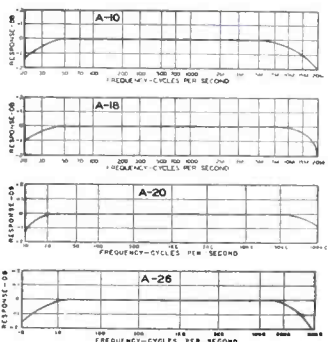

A-10 Line to Grid

Multiple line to 50,000 ohm grid.

A-18 Plate to Two Grids

15,000 ohms to 80,000 ohms, primary and secondary both split.

A-20 Mixing Transformer

Multiple line to multiple line for mixing mikes, lines, etc.

A-26 P.P. Plates to Line

30,000 ohms plate to plate, to multiple line.



A CASE	
Length	1 1/2"
Width	1 1/2"
Height	2"
Unit Weight	1/2 lb.

OUNCER series

UTC Ouncer units are ideal for portable, concealed service, and similar applications. These units are extremely compact ... fully impregnated and sealed in a drawn housing. Most items provide frequency response within 1 db. from 30 to 20,000 cycles. Maximum operating level 0 db. These units are also available in our stock P series which provide plug-in base. The O-16 is a new line to grid transformer using two heavy gauge hipermalloy shields for high hum shielding.

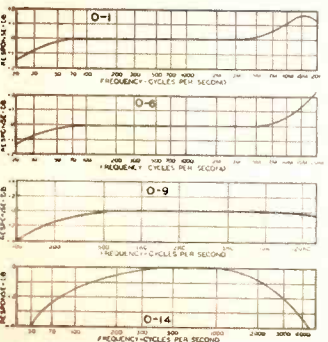

O-1 Line to Grid

Primary 50, 200/250, 500/600 ohms to 50,000 ohm grid.

O-6 Plate to Two Grids

15,000 ohms to 95,000 ohms C.T.

O-9 Plate (DC) to Line

Primary 15,000 ohms, Secondary 50, 200/250, 500/600.

O-14 50:1 Line to Grid

Primary 200 ohms, Secondary .5 megohm for mike or line to grid.



OUNCER CASE	
Diameter	7/8"
Height	1-3/16"
Unit Weight	1 oz.

SPECIAL UNITS TO YOUR NEEDS

If you manufacture high fidelity gear, send your specifications for prices.

UNITED TRANSFORMER CO.

150 Varick Street, New York 13, N. Y. EXPORT DIVISION: 13 E. 40th St., New York 16, N. Y. CABLES: "ARLAB"

TESTING MICROWAVE THEORY ON NAVY'S ANTENNA RANGE—Adjusting horn feed of experimental antenna with unique reflector, mounted on hydraulically-driven pedestal atop 60-foot tower at Navy Electronics Laboratory in San Diego (See p 184).....COVER

Figures of the Month	4		
Industry Report	5		
Color Test Techniques for TV Broadcasters.....by John W. Wentworth	120		
Recorder-Controlled Automatic Machine Tools.....by E. W. Leaver and G. R. Mounce	124		
Feedback Simplifies Transistor Amplifiers.....by Stanley Schenkerman	129		
Helix-Coupled Traveling-Wave Tube.....by Peter D. Lacy	132		
Iron-Core Transformers Run Smaller and Hotter.....by Frank Rockett	136		
Electrostatic Speaker Accents High Frequencies.....by Marvin Hobbs	143		
Radar Offers Solution to Midair Plane Collisions.....by James Q. Brantley	146		
Decode Counter Tube for Accounting Machines.....by R. B. Koehler and R. K. Richards	151		
Welded Joints on Diodes Reduce Computer Bulk.....by S. G. Lutz	154		
UHF Meter Measures Low Power Levels.....by R. L. Bailey and J. B. Quirk	159		
Photoelectric D-C Chopper for Guided Missiles.....by J. Schwartz and R. Solomonoff	162		
Pulse Transmitter for Rocket Research.....by D. G. Mazur	164		
Microwave Applications of Gas Discharges.....by Frank R. Arams	168		
Tunable Audio Filters.....by Geza Zelinger	173		
Reliability Check List for Electronic Equipment Designers.....U. S. Navy Electronics Laboratory	176		
Crosstalk.....119	Electrons at Work.....180	Production Techniques.....228	New Products.....274
Plants and People.....332	New Books.....385	Backtalk.....397	Index to Advertisers.....439

W. W. MacDONALD, Editor; VIN ZELUFF, Managing Editor; John Markus, Alexander A. McKenzie, John M. Carroll, Associate Editors; William P. O'Brien, William G. Arnold, David A. Findlay, Haig A. Manoogian, Edmund B. Palmquist, Assistant Editors; Gloria J. Filippone, Arlene Schilp, Editorial Assistants; Keith Henney, Consulting Editor; Gladys T. Montgomery, Washington Editor; Harry Philips, Art Director; Eleanor Luke, Art Assistant.

H. W. MATEER, Publisher; WALLACE B. BLOOD, Manager; R. S. Quint, Buyers' Guide Manager; Frank H. Ward, Business Manager; H. E. Hilty, Classified Manager; D. H. Miller, James Girdwood, New York; Wm. S. Hodgkinson, New England; James T. Hauptli, Philadelphia; Charles Wardner, Bruce Winner, Chicago; J. L. Phillips, Cleveland; T. H. Carmody, R. C. Alcorn, San Francisco; Carl W. Dysinger, Los Angeles; Wm. D. Lanier, Atlanta



NOVEMBER, 1954

ELECTRONICS
Member ABC and ABP

Vol. 27, No. 11



Published monthly with an additional issue in June by McGraw-Hill Publishing Company, Inc., James H. McGraw (1860-1948), Founder. Publication Office, 99-129 North Broadway, Albany 1, N. Y.

Executive, Editorial and Advertising Offices: McGraw-Hill Building, 330 W. 42 St., New York 36, N. Y. Donald C. McGraw, President; Willard Chevallier, Executive Vice-President; Joseph A. Gerardi, Vice-President and Treasurer; John J. Cooke, Secretary; Paul Montgomery, Executive Vice-President, Publication Division; Ralph B. Smith, Vice-President and Editorial Director; Nelson Bond, Vice-President and Director of Advertising; J. E. Blackburn, Jr., Vice-President and Director of Circulation.

Subscriptions: Address correspondence to Electronics—Subscription Service, 99-129 N. Broadway, Albany 1, N. Y., or 330 W. 42nd St., New York 36, N. Y. Allow one month for change of address. Subscriptions are solicited only from persons engaged in theory, research, design, production, maintenance and use of electronic and industrial control components, parts and end products. Position and company connection must be indicated on subscription orders.

Single copies 75¢ for United States and possessions, and Canada; \$1.50 for Latin America; \$2.00 for all other foreign countries. Buyers' Guide \$3.00. Subscription rates—United States and possessions, \$6.00 a year; \$9.00 for two years. Canada, \$10.00 a year; \$16.00 for two years. Other western hemisphere countries and the Philippines, \$15.00 a year; \$25.00 for two years. All other countries \$20.00 a year; \$30.00 for two years. Entered as second class matter August 29, 1956, at the Post Office at Albany, N. Y., under act of Mar. 3, 1879. Printed in U.S.A. Copyright 1954 by McGraw-Hill Publishing Co., Inc.—All Rights Reserved. BRANCH OFFICES: 520 North Michigan Avenue, Chicago 11, Ill.; 68 Post Street, San Francisco 4; McGraw-Hill House, London, E.C. 4; Washington, D. C. 4; Philadelphia 3; Cleveland 15; Detroit 26; St. Louis 8; Boston 16; 1321 Rhodes-Haverty Bldg., Atlanta 3, Ga.; 1111 Wilshire Blvd., Los Angeles 17; 738-9 Oliver Building, Pittsburgh 22. ELECTRONICS is indexed regularly in The Engineering Index.



power in a package by SORENSEN

THREE PRECISION POWER SUPPLIES IN ONE CABINET, TO HANDLE ALL OF YOUR LABORATORY POWER REQUIREMENTS.

This newest Sorensen concept — *Power in a Package* — is designed to give the research man, technician, or designer a wide range of power outputs, all from one compact cabinet.

The unit illustrated will provide regulated power, simultaneously, as follows: 0-600 volts DC at 0-500 mils, regulated $\pm 0.25\%$; 6 or 7 volts DC at 1.5-15 amps, regulated $\pm 0.2\%$; 110-120 volts AC, 0-1000VA load range, regulated $\pm 0.1\%$.

Many *packaged power* variations are possible, depending on requirements. Practical combinations can include any of the following instruments.

AC Regulators

150VA
250VA
500VA
1000VA
2000VA
3000VA
1000VA at $\pm 0.01\%$ reg.

High-Current DC

6-7 v @ 5, 15, 40 amps
12 v @ 5, 15 amps
28 v @ 5, 10 amps
6/12 v @ 5/10 amps

High-Voltage DC

0-325 v, 0-125 ma
0-500 v, 0-200 ma
0-500 v, 0-300 ma
0-600 v, 0-500 ma
Dual 350 v to 60 ma

In addition, $\pm 0.01\%$ frequency control in an auxiliary unit: 400 cycles at 250VA or 1000VA; 60 cycles at 1000VA.

Consult our engineers for other power packages, comprising such instruments as Rangers, AC meter calibrators, DC voltage reference standards, inverters, higher capacity regulators and power supplies than those indicated above. Sorensen & Co., Inc., Stamford, Conn. In Europe, Sorensen A.G., Gartenstrasse 26, Zurich 2, Switzerland.

Sorensen & Co., Inc.,
375 Fairfield Ave.,
Stamford, Conn.

Please send me further information on
Power in a Package and also a copy
of your latest catalog.

◀ Attach to your business or professional letterhead

SORENSEN

Sorensen & Co., Inc., 375 Fairfield Ave., Stamford, Conn.

Operational Advantages of the Decade Oscillator

Many advantages accrue from this type of RC Oscillator once the operator's initial prejudices towards an unusual system of tuning have been overcome.

IT is a psychological fact that the merits of a new design, measurement technique or apparatus are not appreciated to their full value, if at all, until the new device is withdrawn and the old, which it superseded, is forced upon the user. As a rule it is difficult to persuade him that his old methods were as unsound as this comparison indicates; he will advance a great variety of arguments to demonstrate that he was justified in using his older techniques, that the tests used in the comparison were unreasonable—that, in fact, he does not wish to be persuaded.

This is particularly true of the decade oscillator—a specialized form of resistance-capacitance tuned oscillator. RC oscillators have been in common use for some years, the frequency being altered by means of a two-gang variable air capacitor. In this way a range of 10 : 1 can be covered with reasonable accuracy. The Decade Oscillator, on the other hand, has been designed as a precision instrument: it does not employ calibrated frequency scales: instead the frequency of oscillation is controlled by, and read directly from, a series of 'decade' dials just as resistance is read from the dials of a decade resistance box. This avoids the residual errors introduced in setting a dial to a graduation or in interpolating between graduations. Moreover, there is no 'calibration chart'; the frequency can in general be read to 4 figures direct from the decade dials.

But the full advantages of this type of oscillator do not appear at once



Typical of the best in current design is the Muirhead-Wigan D-650 decade oscillator covering 1c/s to 111,100c/s with a frequency accuracy of $\pm 0.2\%$ or $\pm 0.5c/s$.

to the user, more particularly if he is accustomed to beat-frequency oscillators: he tends to feel hampered by the step-by-step frequency changes. The smooth adjustments possible with the BFO are, of course, absolutely necessary for certain measuring techniques; this field the decade oscillator does not pretend to cover. But once the user has become accustomed to setting a frequency directly from a series of decade dials, and then dismisses from his mind any doubts as to frequency drift, he begins to appreciate the special merits

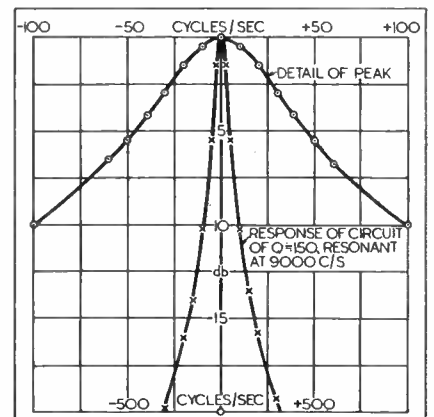

Measurements made on a selective amplifier. Symmetry of R.H. & L.H. curves indicates high accuracy of oscillator settings.

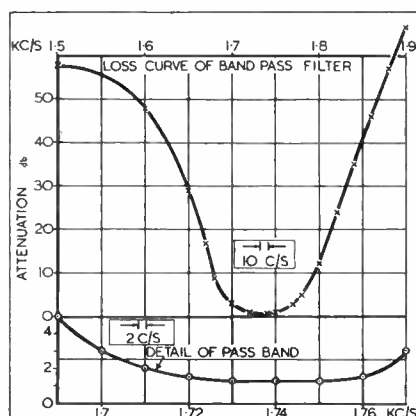

Loss measurements in a filter passband show that ten-cycle or even smaller frequency-increments are needed if exact detail is required.

of the apparatus. If he, further, has occasion to examine, in detail, the cut-off of a filter or the peak of a resonance curve, to take only two cases, he should find the decade oscillator well adapted for the purpose: setting of frequency to 4 figures is a matter of seconds, and highly accurate incremental changes in frequency are available in either minute or large steps as the test may require.

WRITE UNDER YOUR LETTER-HEAD FOR DESCRIPTIVE BROCHURE

131

MUIRHEAD

MUIRHEAD & CO. LIMITED
BECKENHAM · KENT · ENGLAND



FIGURES OF THE MONTH

	Latest Month	Previous Month	Year Ago
RECEIVER PRODUCTION			
(Source: RETMA)			
Aug. '54	July '54	Aug. '53	
Television sets, total ...	633,387	306,985	603,760
With UHF	93,404	57,838	
Color sets	N.R.	32	-----
Radio sets, total	785,499	438,061	991,637
With F-M	15,936	8,622	31,665
Home sets	280,607	150,002	299,939
Clock radios	155,171	57,100	169,301
Portable sets	74,713	39,447	145,460
Auto sets	275,008	191,512	376,937

	Latest Month	Previous Month	Year Ago
RECEIVER SALES			
(Source: RETMA)			
Aug. '54	July '54	Aug. '53	
Television sets, units ...	484,533	368,634	430,101
Radio sets (except auto)	447,025	411,197	491,431

	Latest Month	Previous Month	Year Ago
RECEIVING TUBE SALES			
(Source: RETMA)			
Aug. '54	July '54	Aug. '53	
Receiv. tubes, total units	35,167,272	24,208,512	38,600,494
Receiv. tubes, value ...	\$24,002,391	\$18,082,753	\$26,886,528
Picture tubes, total units	855,191	514,346	879,169
Picture tubes, value ...	\$17,941,034	\$10,102,903	\$21,736,186

	Latest Month	Previous Month	Year Ago
SEMICONDUCTOR SALES			
July '54	June '54	July '53	
Germanium diodes }	608,446	960,112	742,102
Silicon diodes }			

	Quarterly Figures		
	Latest Quarter	Previous Quarter	Year Ago
INDUSTRIAL TUBE SALES			
(Source: NEMA)			
	2nd '54	1st '54	2nd '53
Vacuum (non-receiving)	\$9,851,020	\$8,971,335	\$10,400,000
Gas or vapor	\$3,987,036	\$4,589,239	\$3,300,000
Phototubes	N.R.	N.R.	\$700,000
Magnetrons and velocity modulation tubes ...	\$16,429,553	\$16,135,274	\$10,500,000
Gaps and T/R boxes ...	\$1,914,313	\$1,517,426	\$1,700,000

	Latest Month	Previous Month	Year Ago
TV AUDIENCE			
(Source: NBC Research Dept.)			
Sept. '54	Aug. '54	Sept. '53	
TV Homes, total	31,274,000	31,036,000	25,233,000

	Latest Month	Previous Month	Year Ago
BROADCAST STATIONS			
(Source: FCC)			
Sept. '54	Aug. '54	Sept. '53	
TV stations on air	428	413	288
TV stations CPs—not on air	150	165	246
TV stations—applications*	167	175-r	415
A-M stations on air ...	2,616	2,603	2,488
A-M stations CPs—not on air	121	113	113
A-M stations—applications*	137	133-r	183
F-M stations on air ...	559	561	571
F-M stations CPs—not on air	14	10	21
F-M stations—applications*	2	3-r	5

	Latest Month	Previous Month	Year Ago
COMMUNICATION AUTHORIZATIONS			
(Source: FCC)			
Aug. '54	July '54	Aug. '53	
Aeronautical	40,695	40,708	41,541
Marine	47,360	46,621	42,578
Police, fire, etc.	16,109	15,926	13,966
Industrial	22,132	21,867	18,364
Land transportation ...	6,982	6,925	6,148
Amateur	121,762	120,409	113,341
Citizens radio	8,143	8,093	3,937
Disaster	305	305	251
Experimental	600	592	469
Common carrier	1,699	1,661	1,287

	Latest Month	Previous Month	Year Ago
EMPLOYMENT AND PAYROLLS			
(Source: Bur. Labor Statistics)			
July '54	June '54	July '53	
Prod. workers, comm. equip.	342,700-p	337,500-r	406,800
Av. wkly. earnings, comm. ...	\$67.47 -p	\$68.51	\$65.34
Av. wkly. earnings, radio ...	\$67.03 -p	\$67.32 -r	\$63.50
Av. wkly. hours, comm.	39.0 -p	39.6	39.6
Av. wkly. hours, radio	39.2 -p	39.6 -r	39.2

	Latest Month	Previous Month	Year Ago
STOCK PRICE AVERAGES			
(Source: Standard and Poor's)			
Sept. '54	Aug. '54	Sept. '53	
Radio-tv & electronics	349.4	354.8	265.5
Radio broadcasters	381.6	381.3	263.1

p—provisional; r—revised
N.R.—not reported

FIGURES OF THE YEAR

Television set production	3,785,519
Radio set production	6,110,119
Television set sales	3,658,927
Radio set sales (except auto)	3,269,115
Receiving tube sales	225,084,844
Cathode-ray tube sales	5,326,775

TOTALS FOR FIRST EIGHT MONTHS

	1954	1953	Percent Change	1953 Total
Television set production	3,785,519	4,754,285	-20.4	7,214,787
Radio set production	6,110,119	8,932,638	-31.6	13,368,556
Television set sales	3,658,927	3,546,407	+ 3.2	6,375,279
Radio set sales (except auto)	3,269,115	3,875,293	-15.6	7,064,485
Receiving tube sales	225,084,844	308,222,911	-26.9	437,091,555
Cathode-ray tube sales	5,326,775	6,710,440	-27.3	7,582,835

INDUSTRY REPORT

electronics—November • 1954

Swing To Transistors Gathers Momentum



Pocket-sized set uses four transistors and special miniaturized components

NEW MARKETS for manufacturers of transistors and miniature components opened this month as an all-transistor portable broadcast receiver was introduced. For other transistor applications see p 6.

Scaling $3 \times 5 \times 1\frac{1}{2}$ in., the unit weighs less than 12 oz and sells for under \$50. The manufacturer, Regency of Indianapolis, has promised availability this month.

► **Design**—The receiver uses four *npn* grown junction germanium triodes. One is the mixer oscillator, two are i-f amplifiers and one is the audio amplifier. A germanium diode detector is used. Power gains of 34 and 40 db are achieved in the i-f and audio stages respectively.

Miniaturized components include a tuning capacitor, transformers, volume control, loud speaker and ceramic capacitors.

The receiver is assembled by a semi-automatic process employing printed wiring and dip-soldering techniques. A single miniature battery powers the unit.

Suppliers of special components include: Texas Instruments (transistors and output transformer) Jensen (speaker), Radio Condenser of Camden (tuning capacitor), Vokar Corp. of Dexter, Mich. (i-f transformer), Chicago Telephone

Supply Co. (volume control) and Centralab, a division of Globe Union of Milwaukee (ceramic capacitors).

► **Trends**—Experimental transistorized receivers appeared some years ago and since then several manufacturers have been working on a design for the consumer market.

Principal stumbling block has been cost—largely the cost of the transistors themselves. Several manufacturers indicate that they have all-transistor radios in advanced development stages.

How Manufacturers Use Engineers

Industry has second highest number of engineers per 1,000 employees but uses fewer aides

SOLUTION suggested by some industry observers for the shortage of electronic engineers has been to make more efficient use of graduate engineers by greater utilization of engineering aides.

How the electronics industry compares in this regard with other industries is shown in a recent study by the Labor Department. It shows that while the industry employs more engineers per thousand workers than nearly all other industries surveyed, it utilizes far fewer engineering aides.

► **Chart**—Standing of the industry's engineers compared to those in three other closely allied manufacturing fields is indicated in the chart. For all the industries covered in the study, the ratio of engineers to total employees ranged from 4 engineers per 1,000 employees in the tin can and tin

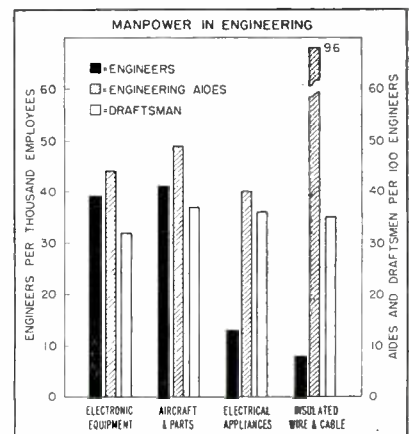

ware industry, to 39 per 1,000 in communications or electronics equipment and 41 per 1,000 in aircraft.

► **Aides**—For all companies surveyed, the number of supporting technicians employed per 100 engineers averaged 120, made up of 55 aides and 65 draftsmen. Communication equipment firms along with electric lamps, electrical generating and related apparatus, aircraft and electrical appliances

were among the fields that employed the fewest technicians relative to the number of engineers employed.

Ship and boat building and repairing was the industry with the highest ratio of technicians to engineers, an average of 103 engineering aides and 181 draftsmen per 100 professional engineers. Only electric lamp companies with 26 engineering aides per 100 engineers and electrical appliances with 40 aides per 100

engineers utilized technicians to a lesser extent than electronic companies.

Other companies in the survey employed from 48 to 103 engineering aides per 100 engineers. In utilizing draftsmen the electronics industry was lowest except for electric lamp makers who employed an average of 12 draftsmen per 100 engineers. All other firms covered in the survey employed from 33 to 181 draftsmen per 100 engineers.

corresponding model using electron tubes.

Introduction of the all-transistor computer marked the opening of IBM's 179,000-square ft research laboratory in Poughkeepsie, N. Y.

► **Other Products**—Other recently announced items using transistors include a transistorized tape recorder and a portable radio receiver. On display at the WESCON show in Los Angeles were three transistorized instruments including a General Radio microphone calibrator using an audio-frequency oscillator—the first commercial instrument application.

Video Tape Recording Makes Headway

Two companies advance plans for commercial debut of the equipment

PROGRESS in the recording of video signals on magnetic tape was indicated last month when the two leading proponents of the method announced plans for the use of the equipment. The Electronics Division of Bing Crosby Enterprises plans to deliver a wide-band recorder to the Air Arm Division of Westinghouse in December for ultimate use by the Air Force in an airborne flight testing program. RCA plans to test its experimental tv tape equipment under actual operating conditions at NBC in December. Results of the tests will be used to make further refinements in the system.

► **Technical**—The recorder for the Air Force is similar to the tv tape recorder that was demonstrated by Bing Crosby Enterprises. It represents the first commercial application of the head construction and drive techniques developed by the company over the last five years for tv tape recording.

Tape speed on the Air Force equipment is higher than that used in the tv tape recorder, although the transport mechanism and head construction for the new machine

(Continued on page 8)

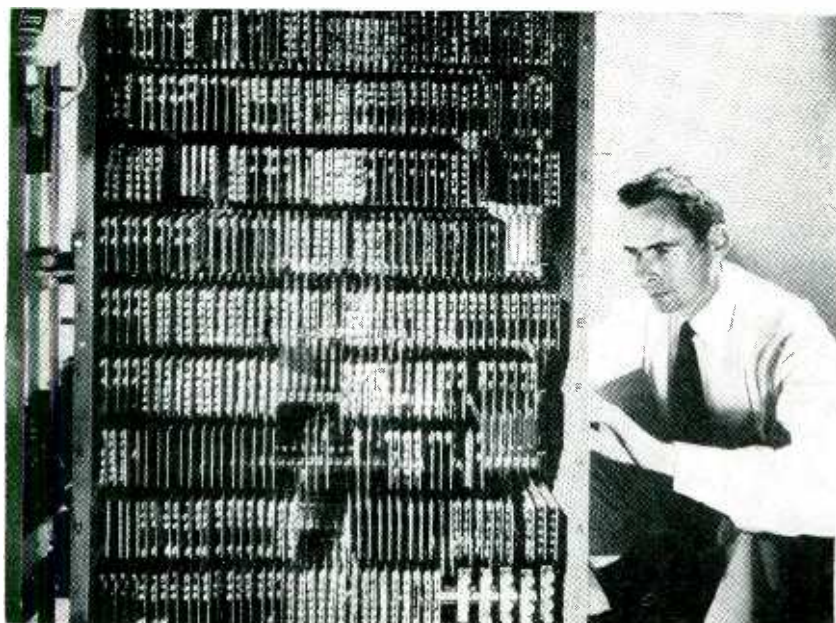

PRINTED wiring boards mounting transistors replace conventional circuits, as . . .

Computer Saves Space and Power

Experimental equipment employs 2,200 junction transistors to replace 1,250 electron tubes

USE of transistors in an experimental electronic calculator indicates a design trend that may develop an even wider market for semiconductor devices.

The all-transistor machine is comparable in function and capacity to the IBM 604—a medium-sized machine of which over 2,000 are in use. The new machine realizes a 50-percent saving in space and a 95-percent saving in power. More than 2,200 *pnp* junction transistors mounted on 595 printed wiring boards replace 1,250

electron tubes used in the standard 604 computer.

► **Advantages**—The all-transistor machine, whose development was noted some six months ago (Engineers Develop New Transistor Uses, *ELECTRONICS*, p 6, Apr. 1954), consumes only 310 watts against 6.2 kw for the electron-tube model. A much smaller power supply is employed and no cooling blowers are required. Use of printed wiring boards permits automatic error-free assembly.

The computer is not presently intended for commercial production. Engineers indicate that the transistorized machine presently costs considerably more than the

Sylvania Offers You . . .

A NEW COMPACT DIODE LINE

Smaller Size . . . Greater Stability . . .

*New improved
Sylvania T-1 Diode.
Actual size only
.125 inches in diameter.*

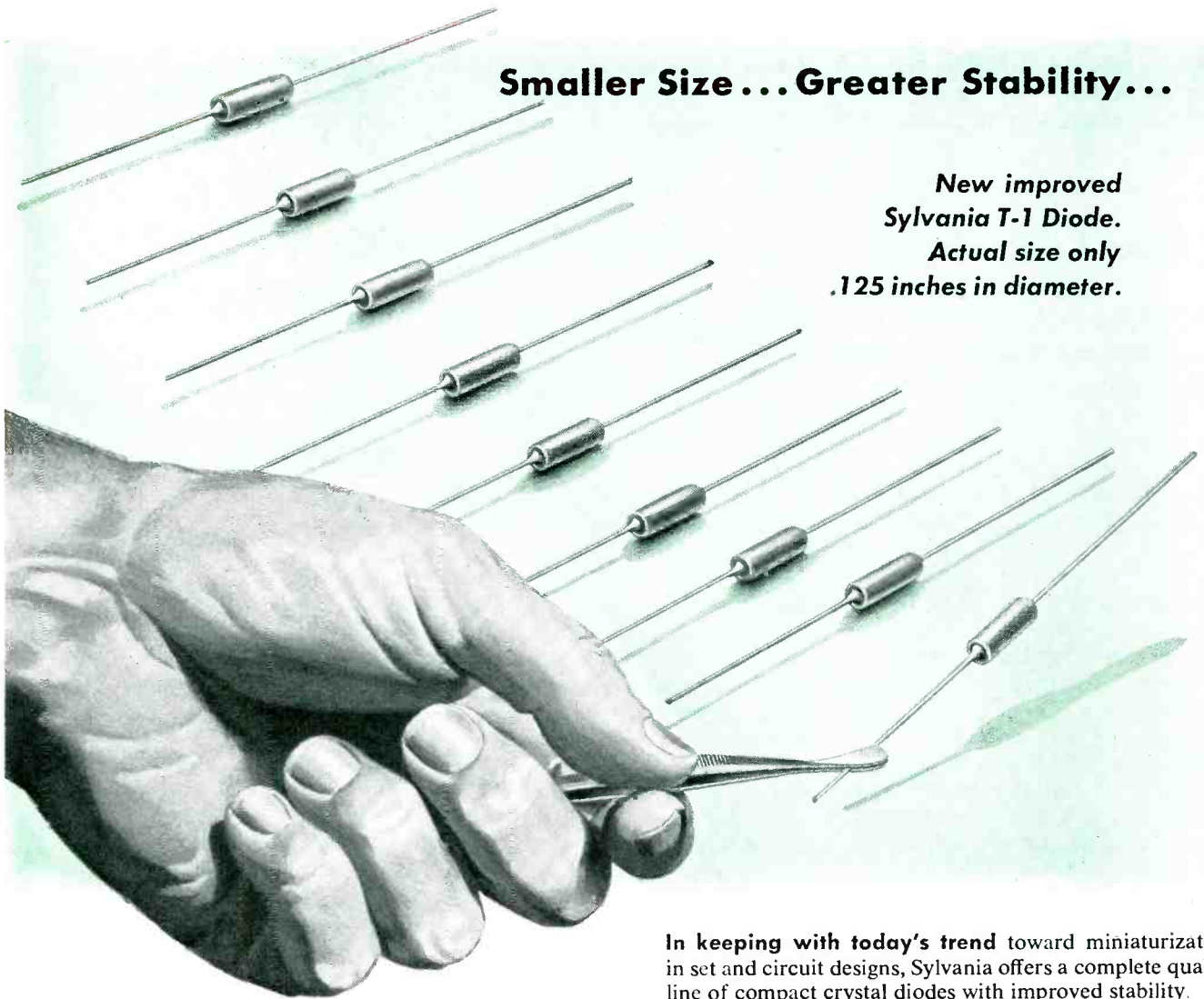

SYLVANIA

Sylvania Electric Products Inc., 1740 Broadway, New York 19, N. Y.



In Canada: Sylvania Electric (Canada) Ltd.
University Tower Building, St. Catherine Street, Montreal, P. Q.

In keeping with today's trend toward miniaturization in set and circuit designs, Sylvania offers a complete quality line of compact crystal diodes with improved stability.

These new components measure only .125 inches in diameter . . . require only 1/6th the space of former units. At the same time, due to advanced manufacturing techniques and Sylvania's new automatic precision equipment, they provide far higher performance records.

With these tiny diodes, you can be assured of more uniform characteristics and closer tolerance limits . . . even on large quantity orders.

This new T-1 Series also has recently passed MIL-E-1B moisture-resistance tests. Now available in capacities for every need. For full details write to Dept. 4E-1611, Sylvania today!

Another reason why it pays to specify Sylvania!

LIGHTING • RADIO • ELECTRONICS • TELEVISION

are basically the same.

According to J. E. Hinds, Jr., eastern sales manager, the wide-band recorder has been designed to meet a growing need for an instrumentation tape recorder to be used in radar evaluation and in pulse spectrum, phase and timing analysis. It uses a total of 5 tracks on one-half inch recording tape. Featuring an extremely accurate

tape transport mechanism, the wide-band recorder also circumvents the effect of tape drop-outs by employment of discriminatory elements in the playback equipment.

► **Parts**—Major units of the airborne wide-band recorder are the tape transport mechanism and power supply for both recording

and playback, recording circuits and playback circuits. The tape transport mechanism is 40 inches high, 17 deep, 19 wide and weighs 160 pounds.

The recorder's power supply measures 16 by 20 by 15 inches and weighs 100 pounds. The recording equipment consists of two units, each 10 by 20 by 13 inches and each weighing 35 pounds.

New Uses Expand Lie Detector Market

Deception tests for employees and job applicants cut petty theft losses in industry

ELECTRONIC techniques for getting right answers without leaving a mark on the body have been used in police labs for many years. Although most courts don't accept such evidence, information obtained has helped narrow lists of suspects and lead police to acceptable forms of evidence.

Leading instrument for detecting deception is the Keeler Polygraph, sold for around \$1,200 by Associated Research, Inc. of Chicago. This uses five tubes and has three separate channels for recording breathing, pulse rate and skin resistance during carefully planned questioning. About 500 of these are in use by state and city police, sheriffs' offices and district attorney offices.

Simpler one-channel instru-

ments, essentially high-range ohmmeters for measuring skin resistance, are also on the market but are rarely used in police work because it is easy to suppress one's emotional response.

► **Accuracy of Tests**—Interpretation of results is the most important factor in accuracy of lie detector tests. The three-channel machines themselves are essentially infallible, but human operators are not. They must phrase special relevant and neutral questions for each particular situation and interpret resulting chart deviations even when a recalcitrant suspect deliberately lies to every question. The limiting factor in expanding the police market is the availability of trained operators.

To get greater accuracy, a research team at State College of Washington recommends use of more elaborate circuitry for monitoring blood volume, pulse wave

velocity through the body and oxygenation of the blood, because these change with emotional stress almost independently of conscious efforts to deceive. The improved sensitivity would give increased accuracy in testing subjects whose responses are inherently weak, but this advantage must be weighted against increased complexity of the equipment.

► **Industrial Uses**—Defense plants used lie detectors routinely during the last war as part of a program for screening out subversives and many have continued this practice. Another use was to reduce thefts of small but costly tools.

Although some plants have their own machines, most utilize the services of some 50 private lie-detecting practitioners who bring in their own machines. A typical test takes 5 to 10 minutes and costs \$10 and up per person, depending on thoroughness and the number of

(Continued on page 10)



Typical industrial polygraph test setup, using pressure cuff, chest band and wrist electrodes



Proposed photoelectric ear clip for monitoring oxygen in blood of suspect to detect lies

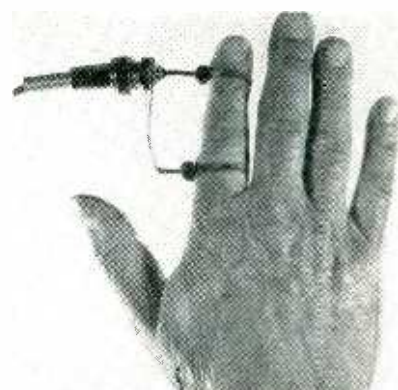

Proposed r-f electrodes for monitoring blood volume changes during emotional reactions

IT'S SPRAGUE FOR Ceramic Capacitors

**EVERY TYPE AND RATING FOR
SMALL OR LARGE PRODUCTION RUNS!**

Sprague can provide you with the best capacitors for your requirements. And when it comes to ceramic capacitors, large plants with adequate production and tooling facilities offer prompt delivery for small or large production runs.

In the East, Sprague ceramic capacitors are made at North Adams, Mass., and Nashua, N. H. The Midwest is served by Sprague's wholly owned subsidiary, the Herlec Corporation of Grafton, Wis.

Some of Sprague's newest developments are shown at right. For future developments in ceramic capacitors, look to Sprague for the ultimate in performance, miniaturization, and reliability.

SPRAGUE ELECTRIC CO.

35 Marshall St., North Adams, Mass.

Sprague, on request, will provide you with complete application engineering service for optimum results in the use of ceramic capacitors, and printed resistor-capacitor networks.

NEW! 'RING' CERAMIC CAPACITORS to clean up chassis



Designed to fit around 7-pin miniature tube sockets, these capacitors may contain 2, 3, or 4 sections. They result in a neat physical layout while reducing space to a minimum. Positive positioning of the ultra short leads between the capacitor and socket terminals eliminates lead dress problems and, consequently, allows "hot" circuit designs. Voltage ratings from 100 to 500 v-d-c. Write for Engineering Bulletin 610.

NEW! FLAT 'PAN' CERAMIC CAPACITORS simplify circuit design



Mounted flat against a chassis with a screw or rivet, these miniature capacitors provide a highly secure mounting. 1 to 4 sections in the shallow pan are insulated and moisture-protected by a phenolic resin. Ideal for military electronics. These units have an unusually high self resonant frequency, and eliminate lead dress problems when mounted adjacent to a miniature tube socket. Available in ratings from 100 to 500 volts d-c. Write for Engineering Bulletin 611.

WIDELY-USED CERAMIC CAPACITORS for electronics, radio, and TV



Shown at left are a few of the many other types of ceramic capacitors available from Sprague. These include:

- Buttons • Discs • Hi-Voltage Moldeds
- Precision Ceramic Trimmers • Plates
- Printed resistor-capacitor networks
- Hermetically sealed, metal cup and tubular precision capacitors

For complete details on any type of ceramic capacitor — it pays to ask Sprague. Write for catalog data on the types in which you are interested.

SPRAGUE

WORLD'S LARGEST CAPACITOR MANUFACTURER

Export for the Americas: Sprague Electric International Ltd., North Adams, Mass. CABLE: SPREXINT

persons examined. From 20 to 30 questions are usually asked, of which only a few are relevant to the goal of the test.

Another widely expanding industrial use for lie detectors is in combatting petty theft by employees in retail stores. Some firms now require job applicants to take the test, which may involve such leading questions as "Have

you ever taken anything from an employer?" To minimize embarrassment and employee rebellion, the examinations are usually called polygraph tests. Where petty theft piles up into major losses or where inside cooperation on a robbery is suspected, the test is given to all employees. Over a hundred of the machines are in industrial use.

Electronics Rides More Rails

Fifteen more railroads install radio equipment. Some roads try television

STEADY growth in the use of electronic equipment on U. S. railroads over the past few years is continuing in 1954. There are now some 145 railroads that have installed and are operating radio and inductive carrier systems compared to 130 roads with equipment in operation last year. Railroad radio transmitter authorizations total over 13,000.

► **Major Buyers**—The leading users of railroad radio are shown in the chart. It lists the number of authorizations issued to each road for fixed and mobile stations. Not all of these authorizations have been translated into operating installations as yet. Up to 1950, most railroad radio allocations were for fixed-station yard and terminal use, but in the last four years the emphasis has shifted to road transmitters. Inductive carrier systems in use account for about 10 percent of total sets.

► **Manufacturers**—There are 12 manufacturers of railroad radio equipment that sell to U. S. railroads. In addition, numerous companies share in the market through test equipment sales. Microwave makers also sell to the market although the number of microwave systems operated by railroads is small. At present there are 2 systems in operation with 11 stations covering 175 route miles.

► **Television**—Railroads continue to experiment with industrial tele-

vision. Southern Pacific recently tested tv as an aid to yard men in watching freight car movements and general switching operations. Other railroads have also tried tv for switching operations but so far none has fully adopted it.

Railroad communications men say one of the difficulties in utilizing the equipment for checking freight car numbers is that the level of car numbers varies making camera readjustments necessary. In other cases, the car numbers may be worn and illegible.

Despite this, roads are continuing to experiment with industrial tv and feel that there is a place for it in railroad operation. Applications of tv in railroad terminals to transmit track information to large screens in waiting rooms, use as an aid to speed customs checking and to see ahead into train tunnels as a safety measure are some of the areas in which tv may find its place.

Electronics Firms Study New Tax Law

Changes made may mean total savings of \$1.3 billion in Federal taxes

COMPANIES in electronics that have paid out a large percentage of annual profits in taxes in recent years are giving close study to the new tax law passed by Congress. It means substantial savings for some firms; the amount depends on individual company conditions.

► **Changes**—According to the American Institute of Accountants, there are over 3,000 technical changes in the tax law. Following are some main changes:

Depreciation write-off is greatly speeded. Some electronic manufacturers have enjoyed fast tax write-offs on defense projects. Under the new law write-offs are speeded for nondefense purposes. A much greater portion of the cost of new, not used, equipment can be written off in the early part of its useful life. Under one new method, for example, double the amount previously allowed can be written off in the first year.

Another change especially important to electronic manufacturers is that research and development costs may now be deducted in the year they are incurred. It is no longer necessary to wait to get a patent or give up an experiment as a failure before deducting costs.

Small electronic companies that are partnerships and proprietorships can elect to report and be taxed as corporations. This can mean lower tax rates at certain levels. Once the method is chosen however, it must be continued unless there is a 20-percent change in ownership.

Also of importance to the electronics industry is the aid given in accumulating earnings for expansion. Under the new law, a 60,000 accumulation-credit can be granted. The penalty tax for over-accumulation is applied only to the

(Continued on page 12)

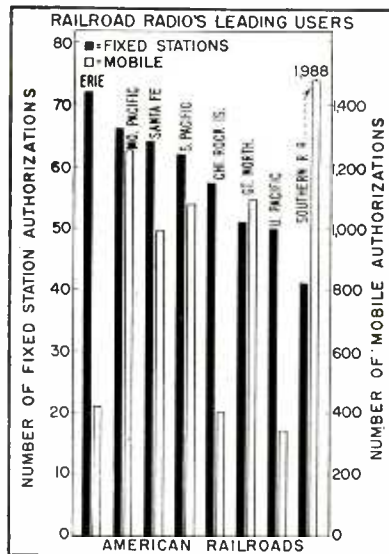

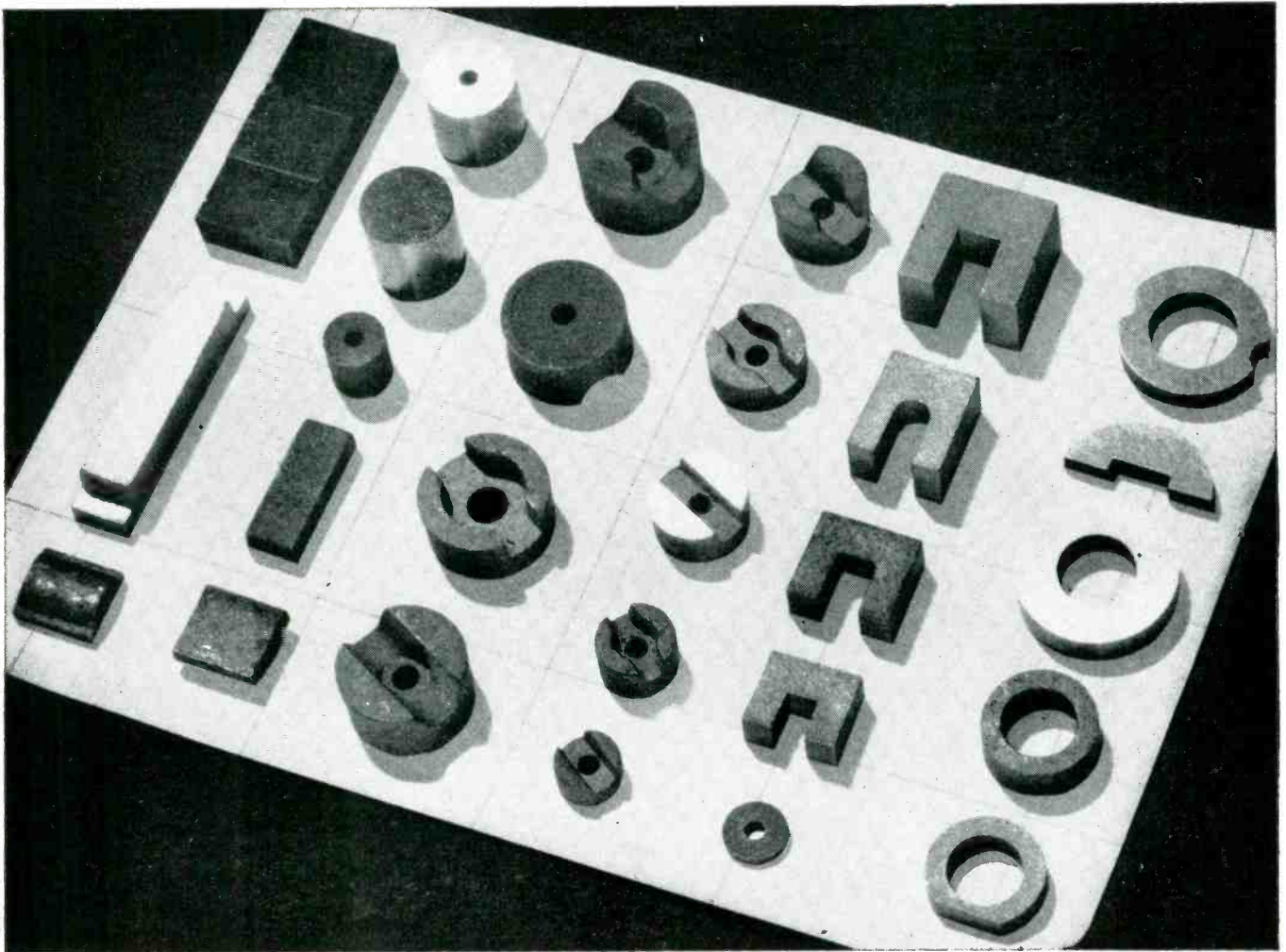

Page-full of ideas for you

on *Sintered Magnets*



"MAGNETIC MATERIALS CATALOG"

Write for your copy

Contains handy data on various types of Alnico Magnets, partial lists of stock items, and information on other permanent magnet materials. Also includes valuable technical data on Arnold tape-wound cores, powder cores, and types "C" and "E" split cores in various tape gauges and core sizes.

ADDRESS DEPT. E-11

**"OFF-THE-SHELF" ITEMS or
SPECIAL SHAPES to suit your needs**

Magnets of sintered Alnico offer endless opportunities to designers who need their useful combination of self-contained power and small bulk. A wide range of sintered Alnico shapes are carried in stock for quick shipment. Special shapes to meet an individual design need can be developed, where the quantity required is large enough to justify the tooling costs. Arnold sintered permanent magnets are fully quality-controlled and accurately held to specified tolerances. • *We'll welcome your inquiries.*

W&D 5280

THE ARNOLD ENGINEERING COMPANY



SUBSIDIARY OF ALLEGHENY LUDLUM STEEL CORPORATION

General Office & Plant: Marengo, Illinois

DISTRICT SALES OFFICES . . . New York: 350 Fifth Ave.

Los Angeles: 3450 Wilshire Blvd.

Boston: 200 Berkeley St.

verage and not to the entire accumulation for the year as was formerly the case.

► **Dates**—Those firms with an anticipated tax liability of \$100,000 or more must make their tax payments earlier in the year. A schedule has been worked out over a five-year period so that by 1959 a firm which uses the calendar year, for example, will pay its tax in equal installments of 25 percent in September and December of 1959 and March and June of 1960. Companies with less than \$100,000 will continue to pay 50 percent in March and 50 percent in June.

Computer Simplifies Paperwork

Data, recorded on tape, are sent to centralized computer location for analysis

INVENTORY control in a manufacturing operation or a sales analysis in a merchandising operation should be much simpler with the use of a new electronic computing system developed by the electronics division of National Cash Register Co. Consolidation of information in the form of stock numbers or sales figures helps the people at management level keep an accurate picture of daily changes.

Part of the system consisting of a large cabinet-like computer, a magnetic tape unit and a control console is kept at the central office and costs about \$150,000 installed. An accounting machine with a paper-tape unit costing approximately \$6,000 is kept at each outlying point (a warehouse for example).

Records of transactions are then kept on the accounting machine tape unit at each remote point. The information is fed by teletype or direct mail to the computer center. Computer results are then printed on paper by means of an electric typewriter unit. These same results can also be recorded on magnetic tape which acts as the computer's memory system. Review can thus be made at any time.

Army Plans 1955 Tube Procurement

Over 4 million tubes will be bought comprising about 300 different types

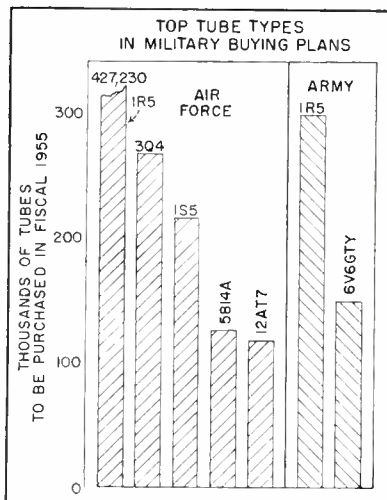

BUSINESS that tube manufacturers can expect from the Army Signal Corps during fiscal 1955 is indicated in procurement plans announced by the Army. The Signal Corps will purchase more than 2.25 million tubes during fiscal year 1955 for the Air Force. The estimate, subject to modification, is expected to include approximately 130 different types of tubes. During the same period, approximately 2 million vacuum tubes will be purchased for Army use. Estimated requirements plan use of 300 different tube types.

► **Types**—Predominant tube types for each of the services are shown in the chart. They represent all types of which over 100,000 will be procured during the year. Amount of each of the hundreds of types required range from as little as 10 of type 6U8 to 427,230 of the 1R5. The chart shows that nearly half of the tubes for Air Force use are battery tubes, that could be used in consumer-type portable radios. The 12AT7 can be used in radar pulse circuits and the 5814A is a ruggedized medium-mu twin triode.

► **Trend**—With some 4 million tubes to be procured by the Army and Air Force in 1955 and assuming about half as many for the

Navy, military sales may account for some 6 million tubes in the year. Receiving tube sales to all government agencies listed by RETMA were 10.0 million in 1953, 29.3 million in 1952, 8.7 million in 1951 and 1.3 million in 1950.

Through July of 1954, unit sales of receiving tubes to the government totaled 2.6 million, half entertainment types and half allied receiving types. Cathode-ray tube sales to the government for the first seven months of this year were 24,539.

Motor Carrier Radio Widens Mobile Use

RULE MAKING by FCC will expand the market for mobile radio equipment among truckers and bus operators. The Federal agency has created a new category of users from three separate groups. Terms of the new regulations will permit greater frequency utilization and provide intracity communication now effectively denied.

Although carriers of people (excluding services such as taxis, school buses and sightseeing tours) can obtain licenses under the new system beginning Oct. 15, carriers of property must wait. Rules applying to trucking are still in the proposal stage and the freight carriers will be given another chance to argue their needs before final action is taken.

► **Precious Channels**—Available to passenger carriers operating between cities are ten channels in the region of 44 mc. Four more channels can be used within a single city. In addition, there are 13 channels around 30 mc to be shared with other services. Developmental channels near 450 mc number eight.

Proposed for common-carrier truckers are nine channels around 43 mc. Three more (now tentatively assigned among the first ten for passenger carriers) are on the block. If the truckers can show a greater need than bus operators,

(Continued on page 14)

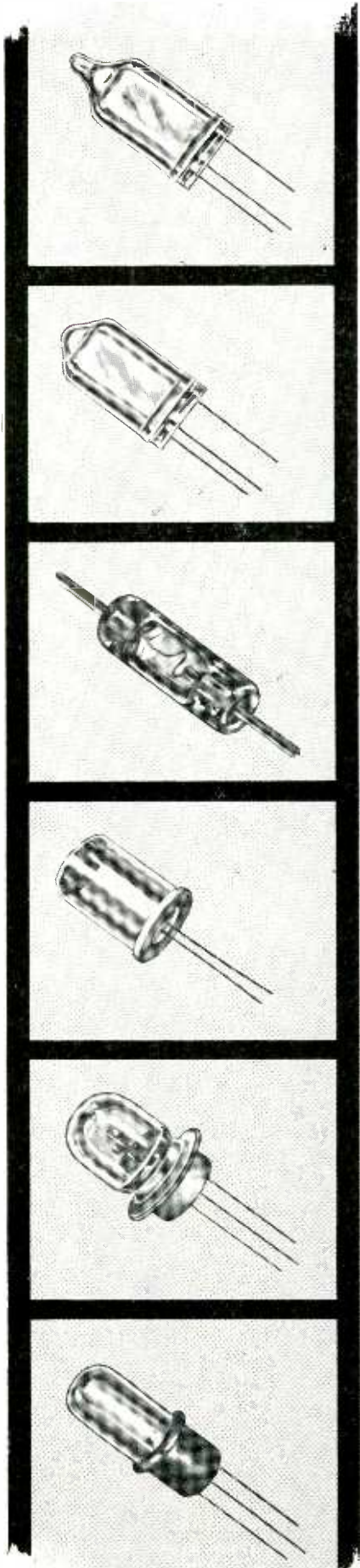

ENCAPSULATION IN GLASS

*of diodes, transistors, and
other crystal semi-conductors*

**is now available with Kahle
equipment and know-how!**

glass has these advantages:

- 1** It offers a true, life-time hermetic seal.
- 2** It offers almost unlimited flexibility as to size and shape. It answers the need for miniaturization.
- 3** It is transparent. In cases where limited transparency, or translucency, or color opacity are desired, glass can be perfectly adapted.
- 4** Glass is available in a wide range of physical and chemical characteristics for special purpose applications.
- 5** It is inexpensive and lends itself to automation.
- 6** It is readily cleansed and sterilized.

*With Kahle machinery and methods
you can obtain high speed, low speed, or
laboratory production to meet any encapsulation
production requirements.*

for complete details write today to

Kahle ENGINEERING COMPANY
1310 SEVENTH STREET • NORTH BERGEN, N. J.

they may get all or part of these channels.

► **Other Issues**—The new allocations have arisen in large part because over-the-road vehicles have found it legally impossible to use their two-way radio within cities—where they often need

communications most. The Commission is suggesting that within-city use of highway-truck radio be limited to common carriers, excluding contract carriers from this privilege. Suggestions as to how in-city use should be permitted is likewise up to the truckers, who had until Oct. 1 to file briefs.

TV Transmitter Market Brightens

FCC proposal would permit higher power in northeast and eastern states

BROADCASTERS have for some time been pushing quietly for a change in the methods of assigning maximum power outputs for television transmitters. In accordance with propagation data and the expected channel occupancy, FCC has until now discriminated against low and high-band vhf tv stations in the region of the United States bounded roughly by the Canadian border, Illinois and a roughly circular line some 175 miles in from the Gulf, excluding the whole of Florida.

In this area, called Zone I, maximum power is assigned as a decreasing function with height of the transmitting antenna above average terrain, starting at 1,000 feet. In all other regions of the U. S., the full value of maximum power is permitted up to 2,000 feet above average terrain. After that, it must be reduced with increasing height.

► **New Plan**—The FCC proposal would equalize the power-height rules. This change would not affect stations with an effective height less than 1,000 feet. It might make a considerable change in other stations. For example, a high-band vhf telecaster 1,300 feet above the surroundings would be able to jump his power from 135 kilowatts to the maximum 316 kw. His signal strength would increase by a factor of 1.54. In other words, a set receiving a 50-microvolt signal would pick up about 78 microvolts—perhaps enough more to give snow-free reception in certain areas.

► **Equipment Market** — Although

there are many high-antenna transmitters with plenty of power just idling along under present rules, most of them are likely to be incapable of making such a jump as that indicated in the example.

Assuming an antenna with a gain of 15 and a transmitter capable of 10-kw output, this station would probably require a transmitter or additional amplifier of 25-kw output to take advantage of the proposed rule change.

Some manufacturers are no surer than dissenting Commissioner Frieda Henneck that the results will be entirely happy. One industry expert says adoption of the new rule would sound the death-knell of uhf television. Interested persons have until November 25, 1954 to file written comments.

Scoops To Replace Dishes In Microwave



Horn-reflector antennas resembling giant sugar scoops have been designed by Bell Labs for use on radio relay routes. The new antennas may eventually handle up to 20,000 telephone circuits or 30 tv programs at one time

Electronic Firms

Profit In Patents

Majority of companies pay and receive substantial amounts in royalties

MANUFACTURERS in the electronics field, probably more than most other producers, build the bulk of their equipment with the use of patents of other firms in the industry. Through cross-licensing agreements, some of the royalty payments are nullified, depending on a firm's patent position. The following list of royalties paid by major manufacturers in the industry in 1953 and 1952 indicates the importance of patents in electronics:

Company	Royalties Paid	
	1953	1952
Admiral	\$1,605,511	\$1,649,333
Avco	1,340,404	1,281,822
GE	3,482,000	3,931,000
Motorola	2,470,483	1,991,298
RCA	8,417,442	7,661,340
Raytheon	951,897	356,089
Stewart-Warner	407,344	285,034
*Sylvania	749,766	601,907
**Westinghouse	12,412,661	9,475,924
Zenith	157,478	238,663
*Royalty income		
**Rents & Royalties Paid		

► **Costs**—The number of patents that are held by individual electronic manufacturers varies widely. Here are three examples as of the beginning of this year: Du Mont, 433; Hazeltine, 1,824, IT&T, 18,000.

Royalty rates vary with the equipment and the licensing company. However, for most equipment, fees are between $\frac{1}{2}$ percent and 2 percent of the amount received by a manufacturer for licensed products. Thus, if the royalty rate on a black-and-white tv set is $1\frac{1}{2}$ percent, the patent holder would receive about one dollar for every 17-inch table model sold by a licensee.

RCA recently reduced its royalty rates on radios and black-and-white tv sets and tubes. Rates were reduced from $1\frac{1}{2}$ percent to $\frac{1}{2}$ percent on sound and auto radios using tubes, and from $1\frac{3}{4}$ percent to $1\frac{1}{4}$ percent on black-and-white tv sets, black-and-white kinescopes and other electron tubes. Sound and

(Continued on page 18)

Barry Engineers Report on Design Methods

Technical articles written by Barry engineers over the past several years on the protection of electronic apparatus against damage by vibration and shock, are now available. The information presented covers both the theoretical and the practical aspects of shock and vibration protection—for aircraft, naval, mobile, and industrial equipment.

Engineers who wish copies of these reports may obtain them by asking for them by number; requests should be addressed to Mr. A. S. Chivers, Barry Corporation, Watertown, Mass.

Designing for Shock Resistance

By Charles E. Crede and Miguel C. Junger. Reprinted from "Machine Design", Jan. 1951.
Bulletin R-511

Shock Testing of Airborne Equipment

By Charles E. Crede. Reprinted from "Tele-Tech", July-August 1951. Bulletin R-518

How to Evaluate Shock Tests

By Charles E. Crede. Reprinted from "Machine Design", Dec. 1951. Bulletin R-521

Toned-Down Noise Tunes Up Operation

By Charles E. Crede. Reprinted from "Steel", Feb. 25, 1952.
Bulletin R-523

Mounting Keeps Vibration in its Place

By William C. Gallmeyer. Reprinted from "Steel", May 18, 1953. Bulletin R-535

Shock or Vibration Isolators?

By J. Markowitz. Reprinted from "Product Engineering" June, 1953. Bulletin R-536

Mock-ups for Vibration and Shock Testing

By Charles E. Crede. Reprinted from "Product Engineering" July, 1953.
Bulletin R-537

Vibration Isolators speed up plant changes

By Harold Wrigley. Reprinted from "Plant Engineering" Jan. 1954. Bulletin R-541

The Role of Shock Testing Machines in Design

By Charles E. Crede. Reprinted from "Mechanical Engineering" July, 1954.
Bulletin R-544

Vibration and Shock Isolators

By Charles E. Crede. Reprinted from "Machine Design", August 1954. Bulletin R-546

Machine Mobility

By E. A. Johnson. Reprinted from "Automation", September, 1954.
Bulletin R-547

for control of

SHOCK and VIBRATION

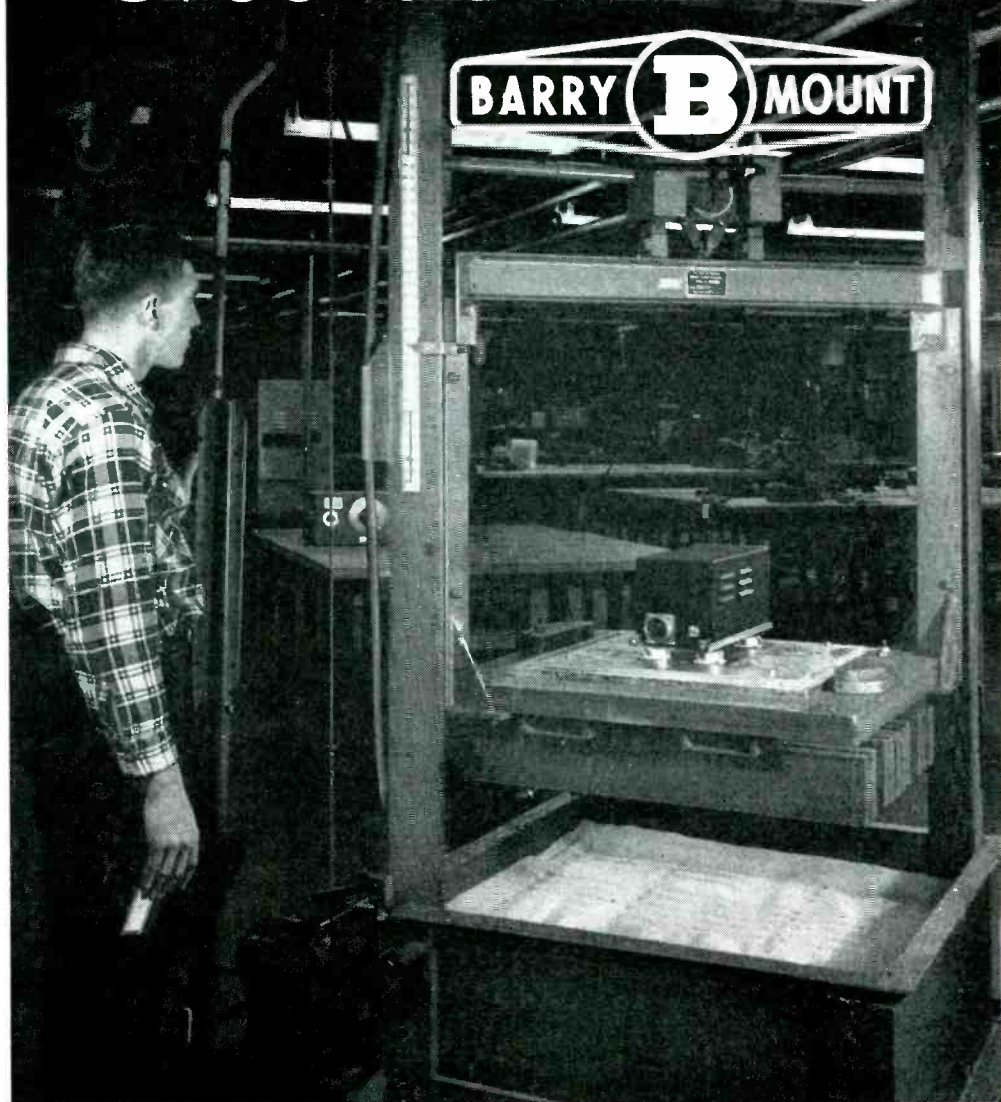
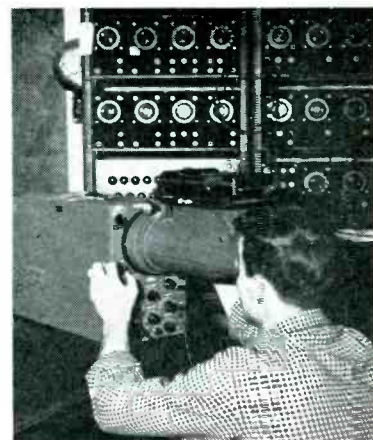

Photo courtesy Bell Aircraft Corporation

How to assure the operation of a pilotless bomber

One way — used by Bell Aircraft Corporation — is to subject every component to a multitude of tests so as to minimize possibility of failure. Barrymounts® that protect delicate electronic equipment, and Barry VD impact-shock machines that provide high accelerations for tests, play an important part in the production of the guided missiles that Bell Aircraft has designed and is manufacturing.

For assured protection of your electronic devices, we can furnish standard Barrymounts® or can develop and manufacture special units for your particular needs. And we can furnish shock-testing equipment for your use or we can conduct your tests in our shock and vibration laboratory. Write for Bulletin BA-54.



THE **BARRY** CORP.

707 PLEASANT STREET
WATERTOWN 72, MASS.

SALES REPRESENTATIVES IN ALL PRINCIPAL CITIES

±0.1% UNIVERSAL BRIDGE for Lab Bench or Production Line

The Type 1604-B Comparison Bridge is a precision Resistance Bridge, Inductance Bridge, Capacitance Bridge . . . and much, much more . . . all in one completely self-contained unit. It will measure impedances, ranging from pure resistive to pure reactive, at any arbitrary phase angle from 0 to ±90°. Accuracy is ±0.1% over the range.

For use in production, it provides rapid and convenient "go"/"no-go" indications with the same basic accuracy. The cathode-ray-tube detector is calibrated at the desired sorting tolerance. As rapidly as each successive component is connected across the unknown terminals, the light band on the scope indicates if the component is acceptable.

With the Comparison Bridge, rapid production testing of ¼% or 1% components is now possible — these precision units need no longer be measured on slower and more expensive laboratory bridges.

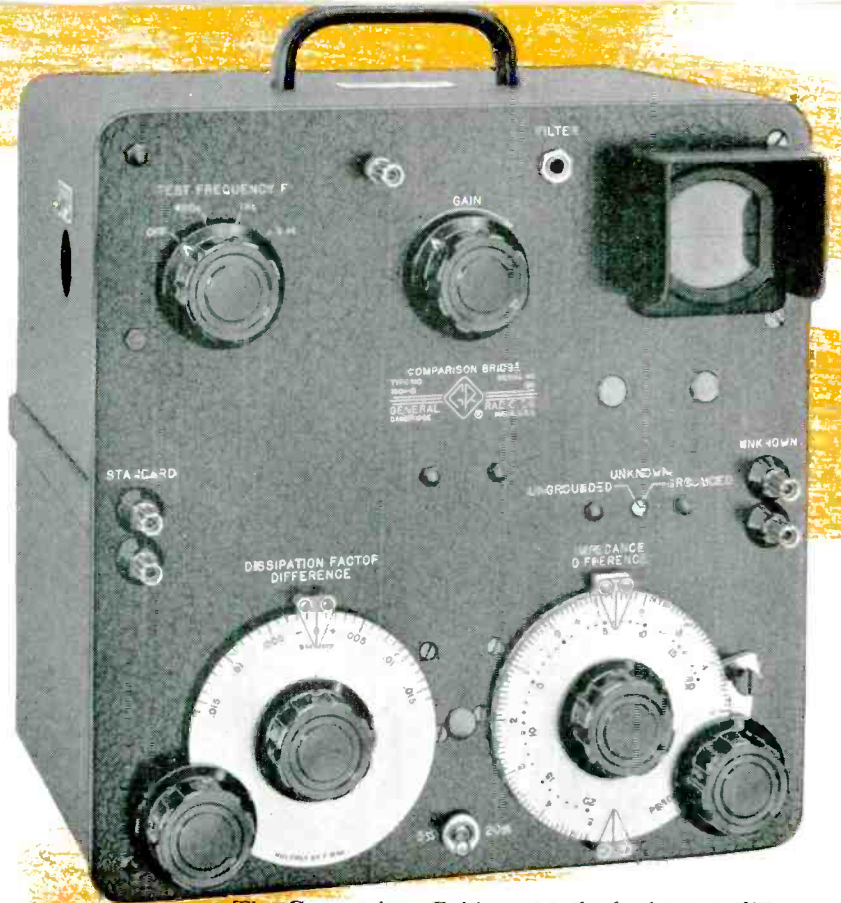

The Comparison Bridge uses the highest quality components, including a specially designed double-shielded bridge transformer, and bridge ratio arms which incorporate the best precision resistors G-R knows how to make.

Type 1604-B Comparison Bridge: Price \$390

Accuracy in Testing . . . Inspecting . . . Adjusting . . .



60/NO-60 Automatic High Speed Sorting

Photo shows G-R Comparison Bridge used in automatic sorting of titinate capacitors for use in Project Tinkertoy. The large error signal available at the plates to the cathode-ray-tube indicator can be used in many ways to operate equipment for automatically rejecting those components whose impedance or dissipation factor are outside the limits set. G-R engineers will recommend a simple external circuit for automatically sorting components. Write, describing your particular requirements.



Precise Measurements in the Development Lab

Where the impedance of a component must be determined with a high degree of accuracy, a precise substitution measurement can be made against a standard whose value is close to that of the unknown.

In the photo, a standard Type 1401 Air Capacitor and a Type 722 Precision Variable Capacitor are connected across the "unknown" terminals — the Comparison Bridge is balanced — the standard is then replaced by the unknown and the Type 722 reset for a detector null. The small difference in the Type 722's readings establishes to ±0.01% the deviation in value of the unknown from that of the standard.



Winding Exact Turns on Precision Inductor

Several manufacturers have rigged up devices to continuously measure impedance of precision inductors as they are actually being produced. One or two excess turns are purposely wound on the core — the "unknown" terminals are connected to the winding ends through a special jig — then, as turns are removed, the cathode-ray-tube continuously indicates the approach to the desired value. Components with 0.1% accuracy are easily wound in this manner.

GENERAL RADIO Company

275 Massachusetts Avenue, Cambridge 39, Mass., U.S.A.

90 West Street NEW YORK 6
 8055 13th St., Silver Spring, Md. WASHINGTON, D. C.
 920 S. Michigan Avenue CHICAGO 5
 1000 N. Seward Street LOS ANGELES 38



The Comparison Bridge is Completely Self-Contained

®

Has Many Basic Advantages

Measures dissipation factor as well as magnitude of impedance, thoroughly checking components tested.

Because small differences in impedance and dissipation factor are compared, measurements are extremely accurate — accuracy is basically limited only by the quality of the standard used — temperature-coefficient errors and residual parameters tend to cancel as a result of careful construction and symmetry.

Wide Impedance Range —

Frequency	R	L	C
400 c	2Ω to 20 MΩ	2 mh to 1500 h	100 μf to 50 μμf
1 kc	2Ω to 20 MΩ	1 mh to 250 h	30 μf to 50 μμf
5 kc	4Ω to 2 MΩ	200 μh to 10 h	2 μf to 50 μμf

The basic ±0.1% accuracy applies over most of the range above; at extreme values of impedance, measurements are slightly less accurate.

Dissipation Factor Range and Accuracy

Frequency	Range	Accuracy
400 c	±.006	±(0.0002 + 0.8% of impedance difference)
1 kc	±.015	±(0.0005 + 2% of impedance difference)
5 kc	±.075	±(0.0025 + 10% of impedance difference)

Three measuring frequencies are provided — 400 cycles, 1 kc or 5 kc — permits a wide range of measurements, and accurate tests under optimum conditions.

Two impedance difference ranges for greater convenience in use: 0 to ±5%, or 0 to ±20% full scale, selected by panel switch.

Instrument is completely self-contained — comprises internal oscillator, bridge circuit, and high-gain amplifier terminated in a cathode-ray-tube visual detector — amplifier is made non-linear to keep indication on scope over wide ranges, permitting bridge balance without continual resetting of gain control.

Visual cathode-ray-tube detector response is instantaneous . . . no meter-ballistics difficulty . . . no waiting.

Any component in lot under test may be used as the standard of comparison — adjustable zero on impedance-difference dial may be offset and locked to correct for selected impedance's deviation from the desired nominal value.

Measurements can be made with unknown grounded or ungrounded, as desired.

Dimensions — 12" x 14¼" x 10"
Net Weight — 22½ lbs.

..... Sorting, Fixed or Variable R-L-C Components

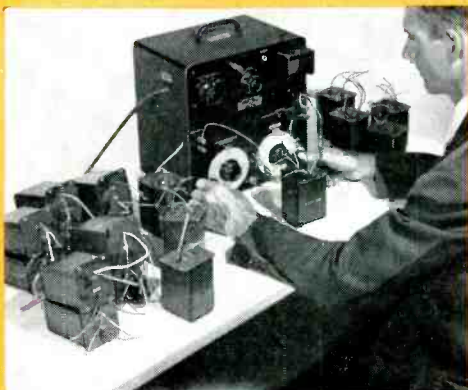

Checking Center-Tapped Windings

Impedances on either side of a center-tapped winding are accurately compared to insure the tap is correctly centered. The winding ends are connected to the "unknown" and "standard" terminals; the center tap goes to either ground terminal. The bridge then directly indicates the extent to which the turns on one side exceed those on the other.



To Check Tracking of Condensers

Ganged potentiometers or condensers which must track each other within a given tolerance can be checked with a high degree of accuracy and ease with the Comparison Bridge. Each section of a two-ganged unit is connected across each pair of terminals — the units are then checked in a second or two by rotating them through their range while watching the cathode-ray-tube. Checking is continuous over the whole range.



Matching Components to Close Tolerances

To select or to check matched pairs of resistors, capacitors or inductors, the pair are simply connected to the two terminals. The bridge directly indicates the difference in impedance and dissipation factor between the two.

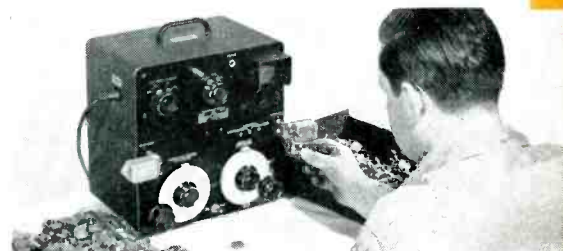

Testing Small Precision Capacitors

To measure small capacitors directly and with high accuracy, large capacitors may be used effectively to re-calibrate the Comparison Bridge in terms of capacitance. For example: 100 μμf capacitors may be placed across each pair of terminals as in the photo, and the unknown placed in parallel with one of the large capacitors. The ±5% impedance difference scale then reads ±5% of 100 μμf or ±5 μμf. Each division represents 0.1 μμf.

Since 1915 — Manufacturers of Electronic Apparatus for Science and Industry

- | | | |
|-------------------------------|----------------------|---------------------------|
| ADMITTANCE METERS | MODULATION METERS | SIGNAL GENERATORS |
| AMPLIFIERS | MOTOR CONTROLS | SOUND & VIBRATION METERS |
| COAXIAL ELEMENTS | NULL DETECTORS | STROBOSCOPES |
| DISTORTION METERS | OSCILLATORS | TV & BROADCAST MONITORS |
| FREQUENCY MEASURING APPARATUS | PARTS & ACCESSORIES | U-H-F MEASURING EQUIPMENT |
| FREQUENCY STANDARDS | POLARISCOPES | UNIT INSTRUMENTS |
| IMPEDANCE BRIDGES | PRECISION CAPACITORS | VARIACS® |
| LIGHT METERS | PULSE GENERATORS | V-T VOLT METERS |
| MEG OHMMETERS | R-L-C DECADES | WAVE ANALYZERS |
| | R-L-C STANDARDS | WAVE FILTERS |

G-P provides a wide variety of resistance, capacitance and inductance standards for use with the Comparison Bridge. These units in conjunction with this bridge make for a flexible and accurate general purpose measuring system.

auto radios using transistors stayed at a royalty rate of 1½ percent and color set and color kinescope rates remained at 1¾ percent.

Hi-Fi Takes The Industry Spotlight

MORE than 60,000 high-fidelity fans attended audio shows in Chicago and New York in the past month attesting to the increasing growth of the audio equipment market. Attendance at the New York show broke all previous records for the event with an estimated attendance of over 31,000. In Chicago over 28,000 fans attended the event.

► **New York**—Exhibitors displayed devices ranging in size from massive loudspeaker systems to tiny record-playing styli. New tape recorders, amplifiers, a-m and f-m tuners, record players and other audio equipments were on display at the show. Held in conjunction with the fair was the annual convention of the Audio Engineering Society under whose sponsorship the show was held. A total of 32 papers were read at 6 technical sessions.

► **Chicago**—Attendance at the three-day event in Chicago also broke all previous records, exceeding the 1953 attendance by more than 7,000 persons. There were 108 firms occupying 132 rooms with equipment on display ranging in price from \$80 for hi-fi kits to \$8,000 for complete home theaters.



At the New York Audio Fair this Midgetape pocket recorder that utilizes 3 hearing aid tubes and printed circuits was shown

Electronics Blooms In Power

More electronic gear is being used with power generation and distribution equipment

INROADS made by electronic equipment into the power field are pointed up by the steady increase in the use of radio, microwave and tv by utilities and the fourth-coming exhibits at the National Power Show to be held in December.

► **New Techniques**—An all-electronic load and frequency control system will be introduced at the show. The system employs continuous pulse-rate telemetering to insure sensitivity and accurate readings and may be installed with any form of transmission, such as wire, controlled carrier or microwave.

A choice of control method is also possible, including frequency, schedule, tie-line bias, manual control and override. It is applicable to a single plant or a system incorporating several plants and network distribution.

The system is based on the module plan for assembling interchangeable standard units and is relatively low in cost because of the resulting installation economy and also because signals to each station require only one channel, whereas older systems required three or four signal wires, or multiple channels to transmit turbine control pulses.

► **Television**—At the power show, one exhibitor of industrial tv plans to show a water-cooled lens system which incorporates along with the camera mount a double glass lens, heat exchanger, pump and blower. With this equipment, furnace and other high-temperature operations up to 3,000 degrees F may be televised. The new cooling system reduces infra red radiation and lens temperatures at the camera below 120 degrees F.

Other exhibitors plan to demonstrate electronic noise measuring instruments, stroboscopes, electronic speed controls, electronic

controls for atomic reactors and computers for robotized power plants.

► **Radio**—Utilities have continued to increase their use of radio. There are over 65,000 transmitters authorized for use by power utilities, an increase of 5,000 in the past year. Biggest increase has been in mobile transmitters which increased from over 56,000 last year to 60,000 this year. In total, the number of transmitters authorized for use in the power field has more than doubled in the past four years and power companies have more transmitters than all other users in the industrial radio services classification.

There are 1,786 licenses issued to utility companies making the average licensee the user of some 36 transmitters. The average number of transmitters per licensee for all industrial services is 27. Today, according to FCC, the most important application of radio by public utilities generally is in connection with restoring service interrupted by fire, storm, flood and accident, although the principal volume of messages concerns routine maintenance activities, not necessarily for emergencies.

Financial Roundup

LOWER net profits for some firms in the electronics industry were indicated in the past month as nine companies in the field issued profit statements. Three manufacturers announced new stock transactions.

Following are the net profit reports of nine firms for the fiscal periods indicated:

Company	Net Profit	
	1954	1953
Am. Cable & Radio 6m	\$906,970	\$526,574
Avco 9m	3,002,843	3,163,343
Du Mont Labs 6m	479,000	913,000
Electronic Eng. 6m	27,142	14,517
Emerson Radio 39w	1,146,676	2,333,227
Garrett 12m	2,817,997	3,084,984
Int'l Resistance 6m	123,080	318,620
Magnavox 12m	2,102,530	2,238,337
Raytheon 3m	1,102,000	884,000

► **Securities**—Clary Multiplier Corp. registered with SEC cover-

(Continued on page 20)

- **COMPUTER**
- **SCALER**
- **MISSILE**

Designers



filamentary

SUBMINIATURE TUBES

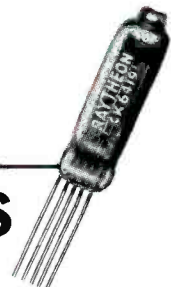

can do the job for you!

Raytheon Filamentary Subminiature Tubes are ideal for Computers, Scalers and Missiles as well as for portable communication equipment.

LOW OPERATING POWER — total input as little as 6.5 milliwatts

SMALL SIZE — as small as 0.06 cubic inches

NEGLIGIBLE HEAT TO DISSIPATE

RUGGED — up to 500G shock — standard fatigue vibration

RELIABLE FILAMENTS — tests indicate only one failure per 500,000 on-off cycles

QUICK HEATING — well under a second

LOW MICROPHONICS — Raytheon CK512AX and CK6419 are extraordinary in this respect

LONG LIFE — combined test data on all types show 58,000 hours of dependable performance for each failure

HIGH EFFICIENCY — mutual conductance (micro-mhos) as much as 4 times greater per watt of filament power as per watt of heater power in comparable heater-cathode tubes

Characteristics of a few representative types of Raytheon Filamentary Subminiatures are charted below. Complete data on all types are available on request.

TYPE	DESCRIPTION	Length (Inches)	Diameter (Inches)	FILAMENT VOLTS MA	PLATE VOLTS	SCREEN VOLTS	GRID VOLTS	PLATE MA.	SCREEN MA.	MUT. COND. UMHOS	VOLT-AGE GAIN	PLATE RESIST. MEG.
1AD4	RF Pentode	1.50	.285-.385	1.25 100	45	45	Rg=2meg.	2.8	0.8	2000		0.5
1AG5	Diode-Pentode	1.50	.285-.385	1.25 30	45	45	Rg=5meg.	0.8	0.25	350		0.26
CK512AX	Ampl.-Pentode	1.25	.285-.385	0.625 20	22.5	22.5	Rg = 5meg. Rl = 1meg. Rc2=2.7meg.				37	
CK5676/6050	UHF Triode	1.50	.285-.385	1.25 120	135		-5.0	4.0		1600		
CK5678	RF Pentode	1.50	.285-.385	1.25 50	45	45	Rg=5meg.	0.8	0.22	820		1.2
CK6088	AF-RF Pentode	1.50	.285-.385	1.25 20	45	-1.25	0.65	0.15	625		†10.5	0.7
CK6092	AF Pentode	1.50	.285-.385	1.25 50	45	45	-4.5	1.4	0.4	600	†25	
CK6286	UHF Triode	1.50	.285-.385	1.25 125	67.5		-2.0	6.0		2100		
CK6397	RF Pur. Pentode	1.625	0.40	1.25 125	125	125	-7.5	7.0	1.1	1800		
CK6418	AF Pentode	1.25	.235-.290	1.25 10	22.5	22.5	-1.2	0.24	0.06	300	†2.2	0.42
CK6419	Ampl. Pentode	1.00	.235-.290	0.625 10	15	15	-0.625	Rl = 2.2meg. Rc2=3.3meg.			27	

†Power output — milliwatts

RAYTHEON MANUFACTURING COMPANY

Receiving Tube Division — Home Office: 55 Chapel St., Newton 58, Mass. Bigelow 4-7500

For Application Information Write Or Call The Home Office Or: 4935 West Fullerton Avenue, Chicago 39, Illinois, NAional 2-2770

589 Fifth Avenue, New York 17, New York, Plaza 9-3900 • 2419 South Grand Avenue, Los Angeles 7, California, Richmond 7-4321

RAYTHEON MAKES ALL THESE:

RELIABLE SUBMINIATURE AND MINIATURE TUBES • SEMICONDUCTOR DIODES AND TRANSISTORS • NUCLEONIC TUBES • MICROWAVE TUBES • RECEIVING AND PICTURE TUBES



Excellence in Electronics

ing 250,000 shares of its \$1 par common stock. Proceeds of the new issue will be applied approximately as follows: \$360,000 for additional working capital; \$340,000 to retire unsecured current loans from the Bank of America, the proceeds of which were used for working capital; \$200,000 for the development of an electronic digital computer expected to sell in the \$10,000 price range; \$200,000 for the development of other products including guided missile control mechanisms and business machines. The balance will be used for tooling and equipment to reduce manufacturing costs.

Daystrom asked holders of Weston Electrical stock to submit tenders of up to a maximum of 35,000 shares of Weston, about 8 percent of the 423,221 shares now outstanding. Daystrom offered to buy the stock at \$25 per share. The firm previously acquired 73,179 shares of Weston and also holds voting rights to 116,000 shares. Daystrom now controls about 44 percent of Weston's outstanding stock.

Eastern Industries offered 100,000 shares of 5-percent cumulative convertible preferred stock at par (\$10 per share). Net proceeds will be added to working capital and are to be used to finance the increase in inventories, work in process and receivables.

Rectangular Tube Shapes Up for Color

ANOTHER ENTRY, in the form of a 21-inch, rectangular, metal-cone color picture tube, has been added to the rapidly growing list of tubes available to color-tv receiver manufacturers. The new tube, recently developed by DuMont, has a picture area of 225 square inches and is of the shadow-mask type.

Final version of tube will be 21 or 22 inch and will have an all-glass envelope. Price to set manufacturers is expected to be about \$175, the same as the price for the company's 19-inch round tube. Samples are expected to go out this year and quantity production is planned next year.

Auto Radio Makers Shift Output

Production is off nearly one-third from last year; one manufacturer leaves the field

CHANGES that have taken place in the auto industry in the past few months go beyond those dependent on variations in the automobile industry.

► **Output**—During the first eight months of this year auto radio production totaled 2.5 million sets compared to 3.7 million sets for the same period in 1953, a decline of 1.2 million sets or a drop of over 32 percent. During the first eight months of 1952 some 1.7 million auto sets were produced and 1951 output totaled about 3.4 million units for the period.

► **Seasons**—Auto radio production is usually at its low point during July and August, not only because of plant vacations but because it is the period when auto makers begin model changeover plans for the coming year. It is also the time when some new auto radio contracts are let. Most of the auto radios produced are made under two-year contracts from auto manufacturers.

Sylvania Electric, which has been producing automobile radio receivers for Ford Motor Co. has decided to drop out of the auto radio business. The firm is not planning to seek any new auto radio business at the present time.

Bendix recently doubled its output of auto sets. The firm has delivered nearly two million sets to Ford since 1948.

► **Transistors**—Delco Radio, one of the largest auto radio manufacturers, recently announced the formation of a new semiconductor department mainly for research and development into power transistors that may eventually be used in auto radios. According to the company, no plans are imminent for the introduction of a transistorized auto radio. However, it has been rumored that an auto set

maker may bring out such a model next year.

► **Future**—Despite the fact that auto radio production is off this year, auto radio manufacturers see expanding business ahead. They point out that auto companies themselves look for a good year in 1955 and expect new passenger car sales to run between 5 million and 5.5 million units. Beyond that, auto makers expect a gradual increase in output for the next ten years.



McConnaughey Named New FCC Chairman

GEORGE C. MCCONNAUGHEY was sworn in as a member and chairman of the Federal Communications Commission in October. He holds a recess appointment as Commissioner to complete the remainder of the term of Commissioner George E. Sterling, who resigned because of ill health. The term expires June 30, 1957. He also succeeds to the chairmanship formerly held by Commissioner Rosel H. Hyde, for a one-year term. The new appointment, subject to Senate confirmation, keeps the Commission make-up at four Republicans and three Democrats.

The new chairman joined the Commission from The Renegotiation Board where he has been chairman since November, 1953. He previously served as chairman

(Continued on page 22)

ELECTRO TEC SLIP RING ASSEMBLIES

*PATENTS PENDING

HIGH TEMP PLASTIC!

NEW ETC-7 (POLYESTER RESIN)
USED ON ILLUSTRATED PART FOR
HIGH TEMPERATURE OPERATION

— for high temp applications!

HARD GOLD RINGS!

24 KT. SOLID GOLD RINGS —
ENTIRE RING THICKNESS ELEC-
TRODEPOSITED* UNIFORM
HARDNESS, 90 to 100 BRINELL.

COURTESY LEAR, INC.

— these two features were incorporated in
the assembly illustrated above, having 45
rings, dia. .180", ring width .020", barrier
width .010". Overall length, less leads 1.763".

Electro Tec Corp., in its constant endeavor to keep pace with the most exacting requirements, has developed these new processes and products. They provide flawless performance under conditions far exceeding the capabilities of other types of construction. Where high temperature is involved, the superiority of these assemblies is so marked, that acceptance has been industry-wide. At the same time, an increasing number of users are specifying these assemblies for the ultimate in dependability under normal operating conditions. Inquiries will receive prompt attention; no obligation.

← 72 rings on integral support — no accumulated tolerances — fulfills electrical, minimum weight and space requirements.



Dual purpose assembly combining "V" grooved signal circuits and wide power rings.

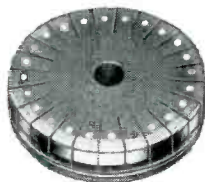

Miniature high speed sampling switch — 24 channels.

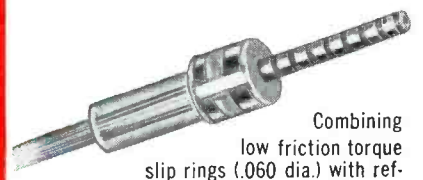

Combining low friction torque slip rings (.060 dia.) with reference switch segments.

NEW ETC-7 (POLYESTER RESIN) WITHSTANDS TEMPERATURE RANGE FROM -60° to $+500^{\circ}$ F.

PRODUCTS OF PRECISION CRAFTSMANSHIP
BY A NEW AND REVOLUTIONARY PROCESS



ELECTRO TEC CORP.

SOUTH HACKENSACK, NEW JERSEY

of the Ohio Public Utilities Commission from 1939 until 1945 and its past president of the National Association of Railroad and Utilities Commissioners. In 1945 he resumed his law practice in Columbus, Ohio until his appointment to the Renegotiation Board last year. The new chairman has stated that he is pretty much on record as believing in as few controls of business as possible.

► **Honor**—The FCC issued a scroll

paying tribute to Commissioner George E. Sterling upon his retirement.

It has also adopted a resolution that reviewed his advancement during his 31 years of Federal service leading in 1948, to the office of Commissioner. "He brought to that office an unprecedented experience in radio which had its beginning in 1908, and as operator, engineer, author and policy maker has played a prominent role in the development of the radio art."

turers in the furniture field failed last year than any other type of manufacturer with a rate of 186 per 10,000 firms. Leather and shoe manufacturers followed with a rate of 175, apparel manufacturers, 129 and transportation equipment, 118. Printing and publishing firms and lumber companies were lowest in failure rate last year with rates of 16 and 13 per 10,000 firms respectively.

The study shows that 58.5 percent of the concerns that failed during 1953 had been in business for five years or less, the period when a business is most vulnerable to failure.

TV Business Failures Analyzed

Leading cause of going out of business due to incompetence or lack of experience

DURING the first eight months of this year business failures in the radio-tv manufacturing field have been more numerous and more costly to creditors than has been the case since 1950. According to Dun & Bradstreet, 32 firms in the field ceased operations during the period and had current liabilities of \$11.7 million, the highest amount in the past four years.

► **Definitions** — Business failures include those businesses that ceased operations following assignment or bankruptcy; ceased with loss to creditors after such actions as execution, foreclosure, or attachment; voluntarily withdrew leaving unpaid obligations; were involved in court actions such as receivership, reorganization or arrangement with creditors. Current liabilities, as used by Dun & Bradstreet, include all accounts and notes payable and all obligations known to be held by banks, officers, affiliated companies, supplying companies or the government. They do not include long-term publicly held obligations and off-setting assets are not taken into account.

► **Why**—According to the survey of 1,857 manufacturing concerns, the underlying cause for over half of the business failures last year,

57.9 percent, was incompetence. Unbalanced experience or experience not well rounded in sales, finance and production on the part of a management unit accounted for 15.2 percent.

Lack of managerial experience and lack of experience in the line of business ranked next, 9.6 and 8.2 percent respectively. Other underlying causes listed were fraud, 3.6 percent, neglect, 3.4 percent, disaster, 1.6 percent and reasons unknown, 0.5 percent.

► **Comparison**—For electrical machinery manufacturing, which includes firms in the electronics field, the failure rate per 10,000 operating concerns in 1953 was 98 compared to 91 in 1952. The field ranked fifth among 14 lines of industry surveyed. More manufac-

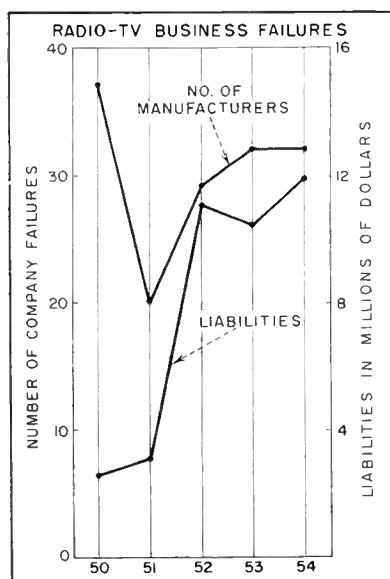

Voluntary Conelrad To Silence Radio Services

CONELRAD, the system of radio silence designed to deny navigational information to enemy aircraft, has recently been extended on a voluntary basis. Amateur, aviation, a-m, f-m and tv are already covered by the system and participation is mandatory. The new memorandum from FCC provides information to assist all other stations operating below 890 mc in maintaining radio blackout.

► **Control**—Actual control of radio silence stems from the Air Force. Certain a-m, f-m and tv stations disseminate the radio alert. Warning is sent out by interrupting the station carrier twice and then broadcasting a 1,000-cycle tone before transmitting the alert message.

Government stations, designated in advance, transmit the alert information by code and radiotelephone on 500 kc and 2.182 kc, respectively.

► **All Stations**—It is possible for almost every station to receive an alert by one or more of these means. Until specific rules can be formulated, FCC is inviting all stations to cooperate voluntarily by monitoring an alerting station and maintaining radio silence thereafter. It is not desirable or neces-

(Continued on page 24)

CENTRALIZED OPERATIONS CONTROL...

- Telemetry
 - Control
 - Report
- On One Circuit

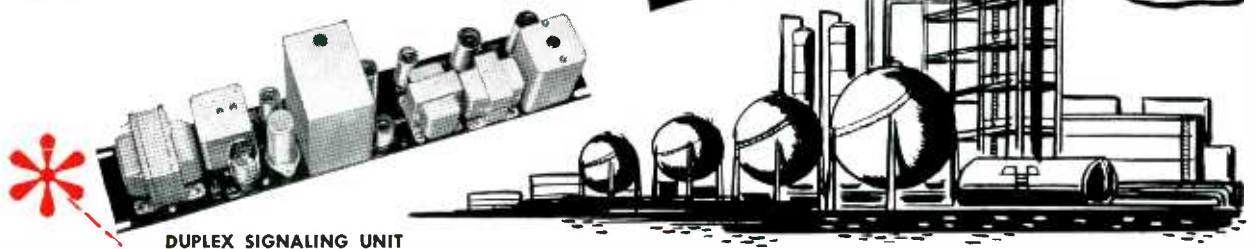

DUPLEX SIGNALING UNIT

Centralized Operations Control is the Hammarlund proven method for remote supervisory control and metering of all your plant operations over a single circuit — telephone line, carrier, radio or microwave. All remote operations can be controlled from one or more main offices.

The system can be built into a new plant or used to modernize existing facilities. You can buy a custom-built COC system, opened to meet future requirements, or you can build one yourself using Hammarlund components. And, most important, *full use can be made of all existing instruments.*

Our growing list of satisfied customers in the petroleum, chemical, transportation, metal working, public utility and other fields reflects and proves the versatility of COC.

No matter which method you select, you take advantage of the Hammarlund COC building-block components that are engineered and built to give long, dependable, trouble-free service. An example of the type of components built by Hammarlund for COC service is the DSU described below.

For further information on COC, write to The Hammarlund Manufacturing Co., Inc., 460 West 34th Street, New York 1, N. Y. Ask for Bulletin 115.

* The DSU is an audio tone generator and frequency receiver in a single package unit that transmits and receives signaling, dialing, telemetry, teleprinting, supervisory controls and other information. It operates over wire lines, telephone or power line carrier, and radio or microwave communications circuits.

HAMMARLUND

SINCE 1910

sary for every station to cease operation, and FCC has spelled out the details to show how participants can function, even during the alert condition, in a publication available from its Washington office.

Industry Flourishes in New York Suburbs

Over 100 plants in Nassau and Suffolk counties employ about 30,000 persons

MANUFACTURE of electronic equipment has become a thriving industry in New York City's fast-growing eastern neighbor. Long Island, which extends nearly 110 miles from the city line to Montauk Point and includes Nassau and Suffolk Counties, is host to 127 electronics plants employing over 30,000 persons.

► **Type of Plants**—Nearly half the plants manufacture some type of electronic equipment as an end product. The remainder are about evenly divided between machine shops producing for the industry, manufacturers of components and laboratories or engineering consultants.

► **Size**—Half the plants have fewer than 10 employees but these account for less than 500 total employees. Eleven concerns account for more than 26,000. Largest of these is the Sperry Gyroscope Co. with about 16,000. Sperry, which makes radar, weapons and navigational systems for government as well as commercial airborne, marine and laboratory equipment, lists 159 local subcontractors and contributes to the income of many of the smaller plants.

► **Location**—The highly industrialized heart of Nassau county, including the villages of Hempstead, Garden City and Mineola, numbers 39 firms including many of the largest. The populous south shore communities contain 45 firms while only 20 firms have located on the north shore.

Tubes Prominent at Business Show

Many dictating and facsimile machines displayed; computers take a back seat this year

ELECTRONIC EQUIPMENT is claiming an increasing share of the businessman's \$2.5-billion annual budget for office machines and equipment. Exhibits at the National Business Show held in New York indicate that a wide range of devices is gaining acceptance. Equipment shown included several types of electronic dictating machines, intercommunication systems and office facsimile devices. Electronic computers were not shown in great numbers because many manufacturers exhibit only alternate years and computers turned out in force last year.

► **Dictating Machines**—Nearly a dozen firms had electronic dictating machines on display. These machines recorded on a variety of mediums including magnetic tape,

belts and disks, wire, plastic disks and belts. Prices ranged around \$300-350.

Use of electronic recorders in business is encouraged by centralized transcribing services fed by intercoms and voice recording via tape recorder of court proceedings.

► **Facsimile**—Electronic scanning devices are entering the business office to prepare master copies for duplication processes, provide rapid communications within the business organization and address mailing pieces.

Miscellaneous electronic devices include an electronically controlled gummed-tape dispenser, electrostatic dry printing process and a telephone amplifier to free busy executives from "holding the phone".

An electronic multiplying punch shown works from 40 or 21-column cards and provides punched-card accounting for small and medium-sized organizations.

Broadcasters Pinpoint Home Sets

TV has moved radio from the living room into the kitchen and bedroom

COMPREHENSIVE survey of radio and tv sets in the nation's homes made for broadcasters by the Advertising Research Foundation shows the place each has in the U. S. household and gives set manufacturers new information on which to base set styling changes. According to the preliminary report, 96.4 percent of U. S. homes have radio sets in working order. More than 45 million homes, representing 94.7 percent of all U. S. households, have a total of 100.9 million radio sets in working order, including 26.1 million car radios. An estimated 27.6 million homes or 58.1 percent of all U. S. households have 28.4 million tv sets that will operate.

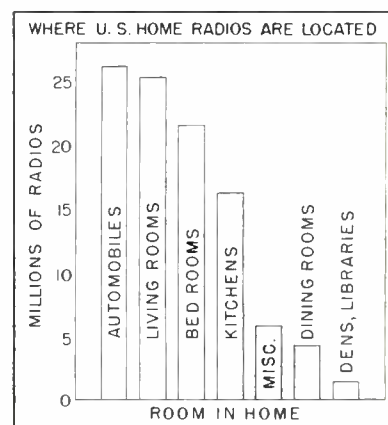

► **Ownership**—It was found that 97.1 percent of the tv households in the U. S. have one or more radio receivers that will work while fewer, 91.3 percent, of non-television homes have a radio set in working order. In the 45 million homes with radio, 26.8 million have tv in operating order and 18.2 million do not.

(Continued on page 26)

In a nutshell

HERE'S THE G-E PICTURE ON—



JUNCTION TRANSISTORS

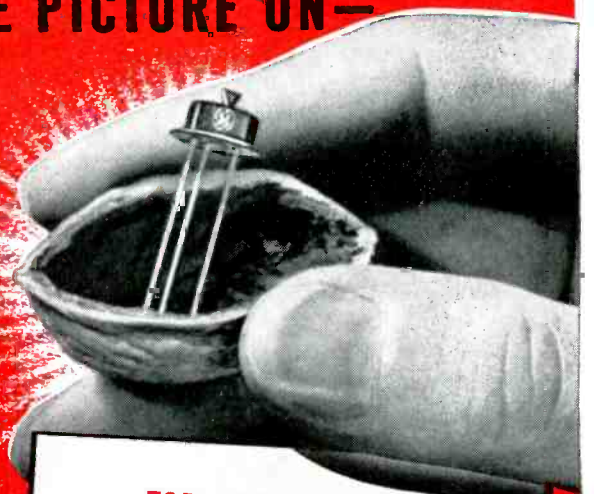

**TOP QUALITY UNITS
ARE NOW BEING SHIPPED**

DESIGN FEATURES:

SEALED JUNCTION ...contaminating gases permanently eliminated!

WELDED SEAM CONSTRUCTION ...free from solder-flux contamination.

HIGH POWER OUTPUT ...case design makes possible a collector dissipation of 150 MW.

HIGH FREQUENCY PERFORMANCE ...specifications cover operation at audio and supersonic frequencies.

HERMETIC SEAL ...unaffected by moisture.

HIGH TEMPERATURE OPERATION ...rated for a maximum junction temperature of 100°C.

LONG LIFE ...designed for long-term, stable performance.

SMALL SIZE ...extremely compact design provides added flexibility for all applications.

G-E recommends these germanium-fused junction transistor triodes (P-N-P units) for low-to-medium power applications, for gains as follows:

2N43 ... HIGH 2N45 ... MEDIUM
2N44 ... INTERMEDIATE

G-E engineering consistently aimed for and *achieved* second-to-none quality in this transistor product. During the past year we refused time after time, to sacrifice quality to the urgency of orders on hand. The thousands of hours invested in development and test laboratories, in field testing and application, earned this most heartening response—every one of our customers has applauded the extreme reliability, the over-all superb quality of these General Electric transistors.

The facts on delivery today are as follows: We're swamped with orders. We can only handle your minimum requirements. Larger orders will be filled as promptly as General Electric's greatly-expanded production lines swing into "high". So place your order promptly. A shipment of G-E junction transistors applied in *your circuits* will save space and power, and reduce weight . . . as they deliver the important design advantages listed at the right.

Progress Is Our Most Important Product

GENERAL  ELECTRIC

We can't tell all in a nutshell—so write today for complete specifications and delivery details. Section X4114, General Electric Company, Electronics Park, Syracuse, N.Y.

► **Location**—Styling and design trends with which set manufacturers may have to contend is evident from the information concerning the rooms in which radio and tv are located. The preliminary report shows that of the 67.8 million radio sets in homes with tv, 53.9 million or about 80 percent are not in the same room as the tv set.

Although 17 of every 20 tv sets are located in the living room, only 5 out of 20 radio sets are found there. Nearly 5 million home sets are portables, according to the study.

Electronic Organ Sales Swell in Volume

PRICED in a competitive range with pianos, electronic organs are making a rapid rise in the home music market. Sales estimates for the present year range from 2 to 40 percent over those for 1953. One company estimates an industry volume of over \$75 million for this year and over \$100-million in 1955. Another organ manufacturer predicts a sales figure for 1954 that will be nearly double the 1952 sales volume.

A major portion of the increased sales are in the home market, although many church pipe organs are being replaced by the more easily serviced electronic type. Home sales have been spurred by the development of chord organs which can provide pleasing music with a minimum of playing skill and training.

► **Kits**—Electronic organs in kit form are now being sold by a West Coast manufacturer. Construction sets for oscillator, shaping circuits, keyboards and sound amplifiers are available from Electronic Organ Arts of Los Angeles. When the units are finished they can be mounted in a console. Object of the kit arrangement is to provide a means of building up a one to four-keyboard organ at a rate governed by the purchaser's time and budget.

MEETINGS

Oct. 27-30: Thirtieth Annual Convention, National Association of Educational Broadcasters, Hotel Biltmore, New York, N. Y.

Nov. 4-5: East Coast Conference on Airborne and Navigational Electronics, IRE, Sheraton-Belvedere Hotel, Baltimore, Md.

Nov. 8-10: Symposium On Modern Advances In Microwave Techniques, Engineering Societies Bldg., New York City.

Nov. 10-11: Conference on Electronic Instrumentation and Nucleonics in Medicine, Morrison Hotel, Chicago, Ill.

Nov. 12-13: National Symposium on Quality Control Methods In Electronics, IRE and American Society for Quality Control, Hotel Statler, New York, N. Y.

Nov. 15-17: Fifth National Conference On Standards, Hotel Roosevelt, New York, N. Y.

Nov. 18-19: Sixth Annual Electronics Conference, Kansas City IRE, Hotel President, Kansas City, Mo.

Nov. 29-DEC. 2: First International Automation Exposition, 244th Coast Artillery

Armory, New York, N. Y.
Nov. 30-DEC. 2: First Electronic Computer Clinic, 244th Regiment Armory, New York, N. Y.

DEC. 8-10: Eastern Joint Computer Conference & Exhibition, Bellevue-Stratford Hotel, Philadelphia, Sponsors, IRE, AIEE, ACM.

JAN 12-15, 1955: World Symposium On Applied Solar Energy, Westward Ho Hotel, Phoenix, Ariz.

JAN. 17-19, 1955: Fourth Biennial Conference On High Frequency Measurements, IRE, AIEE, URSI, NBS, Washington, D. C.

JAN. 20-21, 1955: RETMA Symposium On Printed Circuits, University of Pennsylvania Auditorium, Philadelphia, Pa.

FEB. 4-6, 1955: Los Angeles Audio Fair, Hotel Alexandria, Los Angeles.

FEB. 1955: Western Computer Conference, California, sponsored by IRE, AIEE and ACM.

MAY 2-5, 1955: Third Annual Semiconductor Symposium of the Electrochemical Society, Cincinnati, Ohio.

Industry Shorts

► **Minimum** transmitter power specifications in amendments to FCC rules for ship radiotelephones operating below 25 mc must be met by present users and purchasers of new equipment by July 1, 1959.

► **Custom** tv chassis with all circuits printed on plastic removable strips has been introduced by Walsco Electronics in Los Angeles. The set employs 25 tubes and uses 9 printed circuit units that reduce hand-soldered connections to 56.

► **Increases** in tv set prices have been made by six major manufacturers in the field and more are expected to follow.

► **Soviet** Fishing Authority has placed a substantial radio order with Redifon of London, England for transmitters, all-wave receivers, combined medium and short-wave direction finders and as-

sociated units for installation on 20 deep-sea fishing vessels now under construction for Russia.

► **United Airlines** has authorized an expenditure of up to \$4 million for the installation of C-band airborne radar on 150 of its aircraft.

► **World Series** was telecast live in Cuba through use of a DC-3 flying at 8,000 feet that picked up the signal from Miami and relayed it via microwave to the Cuban national network.

► **Television** programs direct to Cuba from the United States via a high power uhf-tv link may become a reality if an AT&T petition before the FCC is approved.

► **Tape** recorders now in use number approximately one million according to Webcor.

► **Volume** of electronics industry sales, as projected by RCA, is: \$8.8 billion in 1954, \$9.5 billion in 1955, \$10.9 billion in 1956 and \$11.8 billion in 1957.

How would you handle this electrical parts problem?

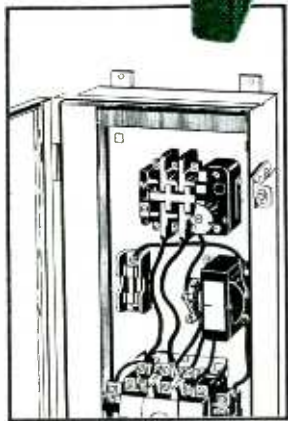

Combination starter, containing parts molded of Monsanto's Resinox 3700 thermosetting material, manufactured by Arrow-Hart & Hegeman Electrical Co.

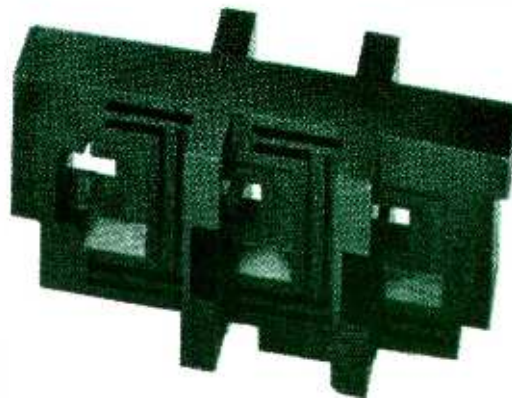

Arrow-Hart
solved it with
new
RESINOX 3700

Arrow-Hart & Hegeman Electrical Company of Hartford, Conn. needed a strong, stable, electrical-grade material with high arc-resistance for important parts of their combination starter shown here. They specified Monsanto's new thermosetting molding powder, Resinox 3700. Result: Complete satisfaction!

Resinox 3700 is the ideal all-around material for magneto ignition, motor control and electronic circuits, and other electrical applications.

- 1** It combines high arc-resistance with outstanding dimensional stability. Eliminates undesirable after-shrinkage.
- 2** It has excellent moldability and relatively good impact resistance, plus good transfer molding properties.
- 3** It offers superior heat resistance.

Perhaps Resinox 3700 is exactly what *you* need to solve an electrical equipment problem. Write today for full information!

Resinox: Reg. U. S. Pat. Off.



SERVING INDUSTRY . . .
WHICH SERVES MANKIND

MONSANTO CHEMICAL COMPANY, Plastics Division, Room 2506, Springfield 2, Mass. Please send me complete information on Monsanto's new Resinox 3700 arc-resistant material.

Name & Title _____

Company _____

Address _____

City, Zone, State _____

AIRPAX

C747 MIDGET

400 CYCLE CHOPPER

PROVEN PERFORMANCE
in large volume production
is your best guarantee
of quality!

*✓ note
these facts...*

- AIRPAX has built nearly 1/4 million choppers
- AIRPAX maintains an engineering staff constantly striving to improve choppers
- AIRPAX has ample capacity for large volume production of choppers
- And AIRPAX choppers have proven performance life and reliability



MIDDLE RIVER BALTIMORE 20, MD.

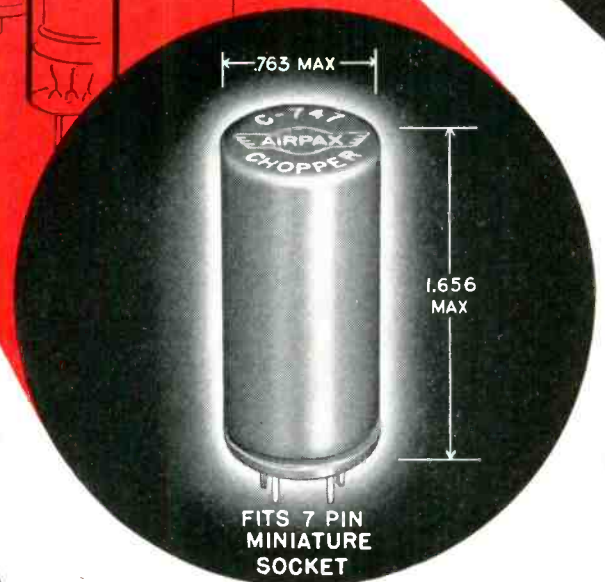

Weights less than 1 oz.

AIRPAX

presents

A NEW 400 CYCLE VIBRATOR

Model A 500, Completely New,
Completely Different, Opens
New Fields of Performance
Offers a High Order of
Reliability with the
Big Saving of Weight
Space and Cost
Resulting From
High Frequency
Operation

Reliable Short
Duty Performance
of as High as
200 Watts From
One Vibrator!

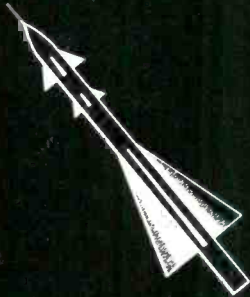

Continuous Duty
Performance of up to
30 Watts for a
Safe 500 Hours!

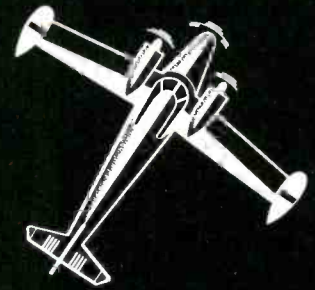

Hermetically Sealed,
Provides an Efficient
Source of 400 Cycle
Power to Handle Small
Motors, Gyros and Selsyns



Provides Ideal
Source of Power
For Mobile
Applications.
Reliability Plus a
Very Small
Power Supply



MIDDLE RIVER BALTIMORE 20, MD.

Federal

introduces a **NEW** line of

insulation-measuring instruments with
500-TRILLION-OHM SENSITIVITY

TERA-OHMMETERS

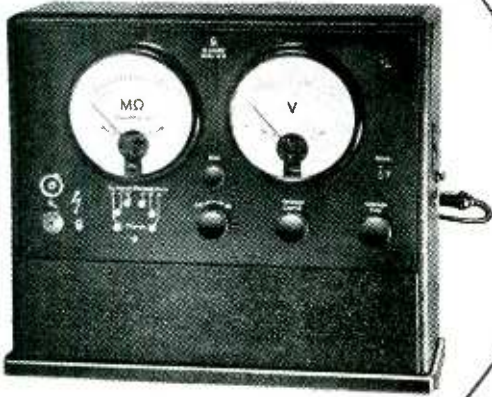

TYPE H



TYPE D

This range is necessary to cover modern insulating materials

Tera-Ohmmeters, by R. Jahre—one of West Germany's leading instrument makers—brings to laboratories, factories and field work the unprecedented sensitivity range of 500 teraohms (500×10^{12} ohms) . . . for thorough evaluation of insulation materials. They are outstanding for high-accuracy measurements . . . $\pm 3\%$ in center of scale for all ranges.

Applications include the testing of resistors, capacitors, cables, switches, tube sockets, transformers and many other components . . . incoming inspection, quality control, engineering . . . also the testing of surface conditions, hygroscopic behavior of materials, insulation of transducers (with 10-volt test voltages). Test samples can be measured grounded, ungrounded, or with guard-ring electrode.

Tera-Ohmmeter sensitivities range from 200,000 ohms to 500×10^{12} ohms. Fixed test voltages of 10, 100 and 500 volts are available; one model provides variable test voltage from 100 to 1000 volts. Operation is from line or self-contained batteries.

For further information on Tera-Ohmmeters—today's most sensitive instruments of their type—mail the coupon to Federal's Instrument Division.

SPECIFICATIONS:

Tera-Ohmmeter—Type H

Range: 2 megohms to 500×10^6 megohms in 6 ranges.
Test Voltage: Adjustable from 100 to 1000 v., dc.
Accuracy: $\pm 3\%$ in scale center.
Power Supply: 115 v., 50-60 cps. Instrument can also be operated from its own battery supply.
Weight: 44 lbs.
Price: \$895 net, FOB, Clifton, N. J.

Tera-Ohmmeters—Type D

Type	Test Voltage	5 Measuring Ranges	Price
D1	100v.	0.2 megohms to 0.5×10^6 megohms	\$499
D2	100v.	2 megohms to 5×10^6 megohms	\$590
D3	100v.	20 megohms to 50×10^6 megohms	\$599

Power Supply: 115 v., 50-60 cps. Instrument can also be operated from its own battery supply.
Weight: 22 lbs.

Note: Other types available to cover ranges from .2 megohm to 250×10^6 megohms—with 2 fixed test voltages of 10 and 100 or 100 and 500 volts.



Federal



Telephone and Radio Company

A Division of INTERNATIONAL TELEPHONE AND TELEGRAPH CORPORATION
 INSTRUMENT DIVISION
 100 KINGSLAND ROAD, CLIFTON, N. J.

Dept. S-213

Federal Telephone and Radio Company
 Instrument Division, Clifton, N. J.

- Please send further information on Tera-Ohmmeters.
 Please send the latest catalog of Federal Test Equipment.

Name _____ Position _____
 Company _____
 Address _____
 City _____ Zone _____ State _____

ERIE

dependable electronic components

ERIE HIGH VOLTAGE CERAMICONS



Erie offers a wide selection of disc and molded-type ceramicons for high voltage service. Available in ratings between 1000 V. and 30 KV. for high potential tuning, by-passing and filtering applications.

ERIE "K-LOK" HIGH STABILITY DISC CERAMICONS



Values up to .0047 mfd at 500 V. are available in tolerances as close as $\pm 5\%$. Capacity variations with temperature, age and voltage are exceptionally small. A truly premium capacitor.

ERIE BUTTON MICA CAPACITORS

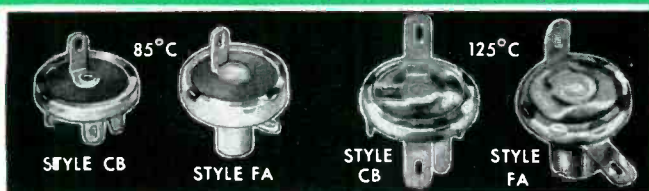

Values from 15 mmf to 8100 mmf are available in tolerances as close as $\pm 2\%$. Rated at 500 VDCW. "Q" value exceeds 1000 for values above 100 mmf. Available for maximum operating temperatures of 85°C. and 125°C. Extremely low inductance makes these very compact capacitors ideal for VHF and UHF applications.

ERIE BY-PASS AND COMPENSATING CERAMICONS

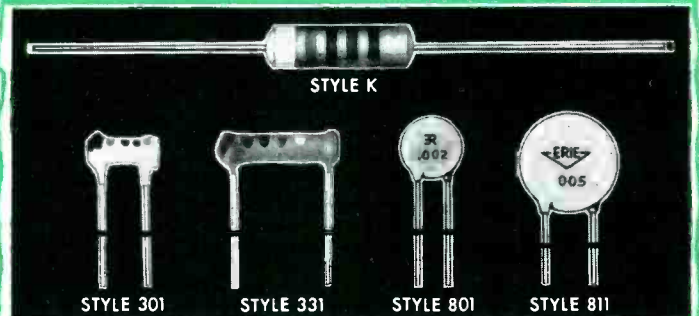

To meet exacting temperature compensation, by-passing, coupling and filtering requirements. Compensating units available from .75 to 1380 mmf. "Hi-K" by-pass units available from 100 mmf to .01 mfd.

ERIE STAND-OFF AND FEED-THRU CERAMICONS



Erie offers a wide selection of chassis—mounting capacitors designed to overcome radiation and critical by-passing problems. Available in both temperature compensating and "Hi-K" materials. Manufactured in values up to 1500 mmf with 500 V. rating.

Ceramicon, Hi-K, K-LOK, GP, Button, and Plexicon are registered trade names of Erie Resistor Corporation



ERIE RESISTOR CORPORATION . . . ELECTRONICS DIVISION

Main Offices and Factories: **ERIE, PA.**

Sales Offices: Cliffside, N. J. • Camden, N. J. • Chicago, Ill. • Detroit, Mich. Cincinnati, Ohio • Fort Wayne, Ind. • Los Angeles, Calif. • Toronto, Ontario

Manufacturing Subsidiaries:

HOLLY SPRINGS, MISSISSIPPI • LONDON, ENGLAND • TRENTON, ONTARIO

NOW AVAILABLE! BROADBAND POWER METERS

THE CHOICE OF ALL ARMED
SERVICES FOR MICROWAVE
POWER MEASUREMENTS

POWER { PULSE and CW
5 μ W to 5W average

FREQUENCY { 20MC — 10,000MC

ACCURACY { 5% Absolute at all ranges,
frequencies, temperatures



- ... **INDICATIONS:** Direct Reading
- ... **CALIBRATION:** Compensates for All Variables
- ... **R-F COMPONENTS:** Included, 3, 6, 10 and 20db Attenuators, Bolometer Mount and Elements, R-F Cable
- ... **BOLOMETER:** Broadband, High Overload Capacity
- ... **PLUMBING:** 3/8" and 7/8" 50-ohm Coaxial
- ... **POWER SOURCE:** 115VAC \pm 15%, 50-1000 cps
- ... **CONSTRUCTION:** Rugged, meets all JAN, MIL requirements

**The Standard Item of Test Equipment for
All Broadband R-F Power Measurements . . .**

TYPICAL APPLICATIONS

Microwave Links . . . Television . . . Communications . . .
Radar . . . Telemetry . . . Signal Generators . . .
Laboratory Standards.

Write for descriptive literature to Department BE-11

Bruno - New York Industries Corporation

DESIGNERS AND MANUFACTURERS OF ELECTRONIC EQUIPMENT
460 WEST 34th STREET • NEW YORK 1, N. Y.

High Resolution Laboratory Standard DC Voltmeters



For most applications these rugged portable, self-contained nulling voltmeters replace a potentiometer, voltmeter, galvanometer and standard cell combination. They are suitable for laboratory use, production line testing and field service.

Model LVM-5

Voltage Range: 0-100 Volts DC
Resolution: At least 50 microvolts between 0 and 1 volt
500 microvolts between 1 and 10 volts
5 millivolts between 10 and 100 volts
Absolute Accuracy: \pm 0.1% of reading
Input Impedance: Infinite at null

Model PVM-4

Voltage Range: 0-600 Volts DC
Resolution: At least 5 millivolts between 0 and 10 volts
50 millivolts between 10 and 600 volts
Absolute Accuracy: \pm 0.1% of reading
Input Impedance: Infinite at null

Catalog PL-4 describes these instruments completely, including their use as deflection potentiometers, null indicators and millimicroammeters. Copy on request.

IDA analog computers and accessories are manufactured by Computer Company of America, Division of Bruno-New York Industries Corp. Their usefulness in the field of dynamics has been proven over the years.

•••••

A complete line of standard computers, instruments and regulated power supplies is supplemented by the ability to design and manufacture specialized equipment for your particular applications. Your inquiries are invited.

•••••

CCA
Computer Company of America
DIVISION OF BRUNO-NEW YORK INDUSTRIES CORP.
460 WEST 34th STREET • NEW YORK 1, N. Y.

NOW.. OHMITE[®] OFFERS

RESISTORS TO MEET MIL-R-26B CHARACTERISTICS

G, F, AND "V"

(HIGH-TEMPERATURE—350° C—CHARACTERISTIC)

IN A
WIDE RANGE
OF SIZES AND
RESISTANCE
VALUES



PATENTED, ALL-WELDED
CONSTRUCTION!

TAB- TERMINAL TYPE

Characteristics
G, F, and V

Style	Over-all length	Diameter	*Watts	††Watts
RW-29	1-3/4"	1/2"	8	11
RW-30	1"	19/32"	8	11
RW-31	1-1/2"	19/32"	10	14
RW-32	2"	19/32"	12	17
RW-33	3"	19/32"	18	26
RW-34	3"	29/32"	30	43
RW-35	4"	29/32"	38	55
RW-36	4"	1-5/16"	60	87
RW-37	6"	1-5/16"	78	113
RW-38	8"	1-5/16"	110	159
RW-47	10-1/2"	1-5/16"	145	210

FERRULE- TERMINAL TYPE

Characteristics
G, F, and V

Style	Over-all length	Diameter	*Watts	††Watts
RW-10	11-7/16"	1-5/16"	140	203
RW-11	9-5/8"	1-5/16"	116	168
RW-12	7-7/16"	1-5/16"	86	125
RW-13	5-1/8"	1-1/16"	50	72
RW-14	4-7/16"	1-1/16"	40	58
RW-15	2-15/16"	3/4"	20	29
RW-16	2-3/8"	3/4"	14	20

FLAT TAB- TERMINAL TYPE

(Stack Mounting)
Characteristic G

Style	Over-all length	Width of Core	Thickness of Core	†Watts
RW-20	2-1/2"	1-3/16"	1/4"	15
RW-21	3-1/4"	1-3/16"	1/4"	22
RW-22	4-3/4"	1-3/16"	1/4"	37
RW-23	6"	1-3/16"	1/4"	47
RW-24	7-1/4"	1-3/16"	1/4"	63

AXIAL- TERMINAL TYPE

Characteristics
G and V

Style	Length of Core**	Diameter	†Watts	††Watts
RW-55	1-3/8"	5/8"	5	7
RW-56	2"	5/8"	10	14

*Watts free air MIL Characteristic "F" or "G" **2-1/2" wire leads
†Watts free air MIL Characteristic "G"
††Watts free air MIL Characteristic "V"

EVEN RESISTORS WITH THE FINEST WIRE SIZE (.00175) MEET THE REQUIREMENTS OF MIL-R-26B, CHARACTERISTIC "V"

The Ohmite resistor types shown at the left can withstand a continuous operating temperature of 350° C—the high temperature requirement of MIL-R-26B, Char. "V". These resistors also meet characteristics "G" and "F"—passing severe moisture-resistance and thermal-shock tests... withstanding sustained vibration applied for five continuous hours... and satisfying the requirements of many other tests.

The Ohmite line of wire-wound resistors is the most extensive on the market. Ohmite also has the most complete line that meets MIL-R-26B specifications. Specify resistors from Ohmite's wide range of types, sizes, and resistance values for your MIL-R-26B requirements and other tough jobs.

OHMITE MANUFACTURING COMPANY
3610 Howard Street Skokie, Illinois
(Suburb of Chicago)

OHMITE[®]

RHEOSTATS • RESISTORS • TAP SWITCHES

OHMITE "Brown Devil"®

RESISTORS have **BALANCED THERMAL EXPANSION!**

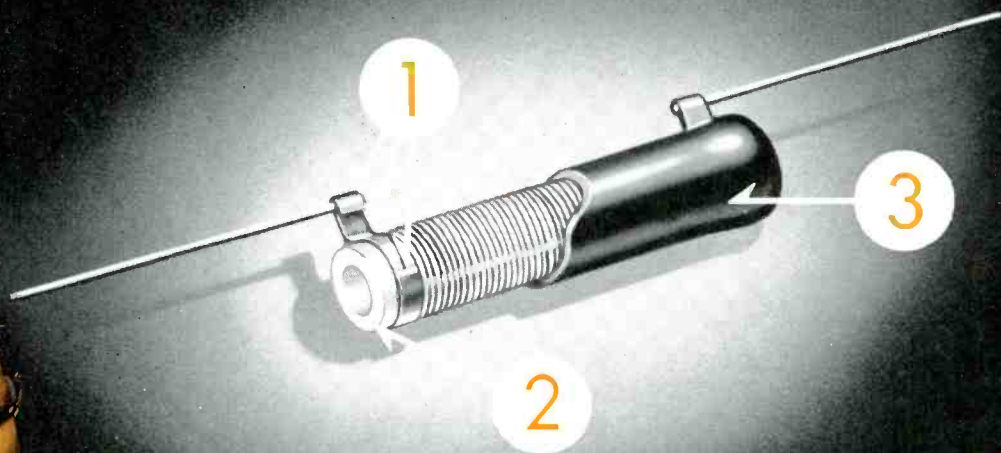

High-quality resistors for your tough jobs!

When you want a resistor that will stand up under high temperatures, specify Ohmite Brown Devils. They have been carefully designed to provide "balanced thermal expansion." All parts—core, resistance wire, vitreous enamel coating, and terminal band—have a thermal expansion that has been carefully matched. As a consequence, "Brown Devil" resistors expand and contract as a unit. This eliminates cracking of the enamel, keeps terminals firmly anchored, and prevents the entrance of moisture.

For many years, these superior Ohmite resistors have proved their reliability under the toughest service. Specify them on your next job.

PATENTED WELDED TERMINALS

1

Ohmite welded terminals provide a perfect and permanently stable electrical connection that is unaffected by vibration or high temperature.

HIGH TEMPERATURE STEATITE CORE

2

This strong, rugged steatite core has excellent electrical characteristics, and a coefficient of thermal expansion that matches the other resistor materials.

EXCLUSIVE HIGH TEMPERATURE VITREOUS ENAMEL

3

This special-formula enamel was developed by Ohmite after extensive research. Its thermal expansion is properly related to that of the steatite core, terminal, and resistance wire.

OVER 100,000,000 SOLD!

Be Right with

OHMITE®

RHEOSTATS

RESISTORS

TAP SWITCHES

OHMITE MANUFACTURING COMPANY, 3610 Howard Street, Skokie, Illinois (Suburb of Chicago)

For Fuses of Unquestioned High Quality



Standardize on BUSS FUSES

BUSS fuses can be relied on for dependable electrical protection, elimination of needless blows and top quality in every detail because . . . every BUSS fuse normally used by the Electronic Industries is electronically tested. A sensitive testing device rejects any fuse that is not correctly calibrated, properly constructed and right in all physical dimensions.

And there is a BUSS fuse to meet your most exacting needs. The complete line includes: dual-element (slow blowing), renewable and one-time types . . . in sizes from 1/500 amperes up — plus a companion line of fuse clips, blocks and holders.

It is just good business to rely on fuses that protect both the product and your reputation. So why not standardize your buying and stock records on genuine BUSS fuses . . . today!

Put the BUSS Engineers on your payroll

Many manufacturers save engineering time when they have special problems in electrical protection by turning to the BUSS engineers. Our engineers are full-time fuse specialists, working in the world's largest fuse research laboratory, well qualified to help determine the right fuse or fuse mounting for the job. If BUSS can be of service to you too, just tell us the problem.

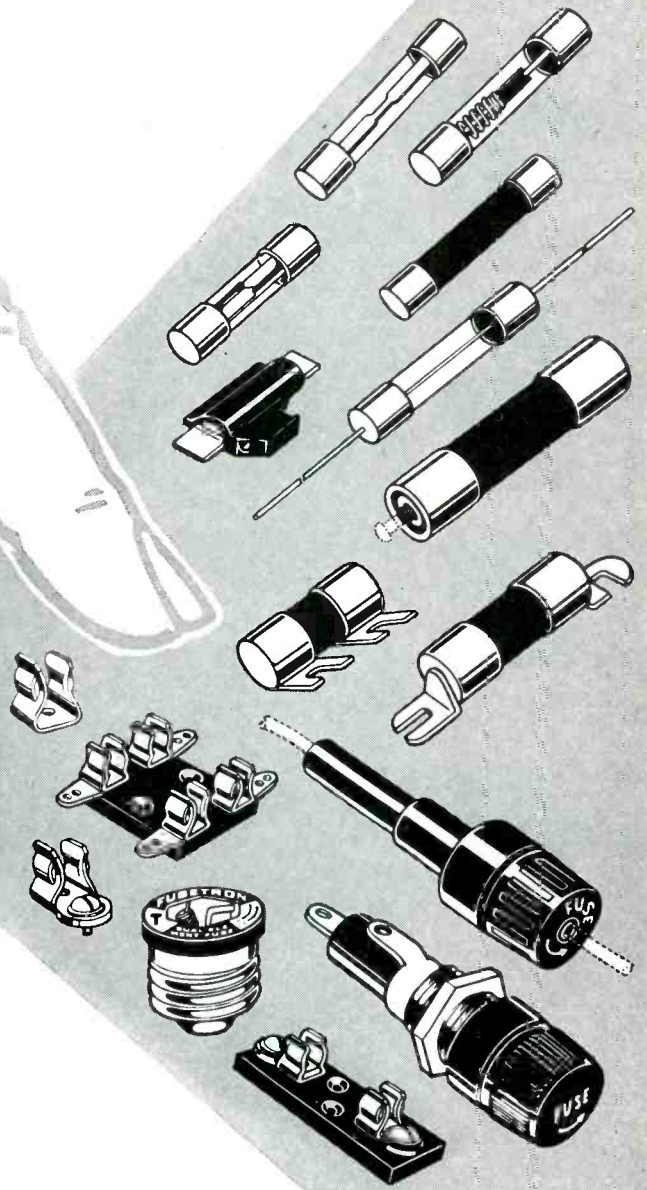

Makers of a complete line of fuses for home, farm, commercial, electronic and industrial use.

For More
Information •
Mail this Coupon



BUSSMANN Mfg. Co. (Div. McGraw Electric Co.)
 University at Jefferson, St. Louis 7, Mo.
 Please send me bulletin SFB containing facts on BUSS small dimension fuses and fuse holders.
 Name.....Title.....
 Company.....
 Address.....
 City & Zone.....State.....EJRC-1154

Announcing

DE CO

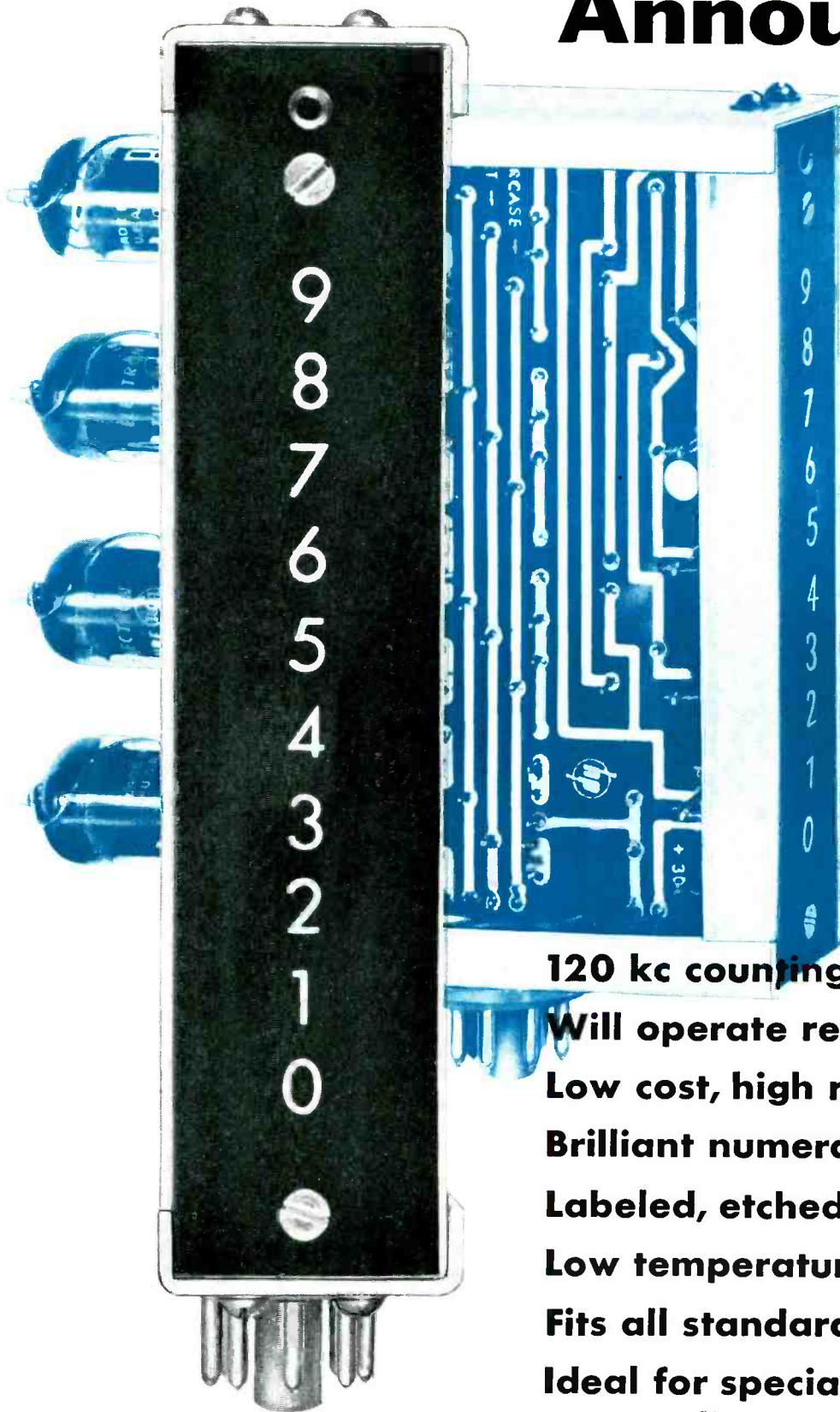

120 kc counting rate
Will operate recorder
Low cost, high reliability
Brilliant numerals
Labeled, etched circuit
Low temperature operation
Fits all standard counters
Ideal for special purpose applications

**COMPLETE
COVERAGE**

HEWLETT-PACKARD



AC-4A

CASCADE COUNTERS

The unique etched circuit in *-hp-* AC-4A Counters sets a new standard of reliability and makes possible high speed counting to 120 kc. A staircase output voltage proportional to count is available to operate recorders or external equipment using coincidence detectors. The circuit is fully visible, accessible, labeled and arranged diagrammatically for simple servicing. Mechanical layout permits maximum ventilation—lower temperatures and longer life. Optically engineered illuminated numerals are clear, bright, easy to read under all light conditions.

AC-4A Counters use binary flip-flop circuitry wherein each input pulse advances the count one numeral, and at "9" an output pulse actuates the next Counter for cascading. A reset terminal restores "0"; or the Counters will reset to "9" for special applications. Etched circuits give excellent balance and uniform incidental capacities for high 120 kc counting rate. Resistors are premium quality 5% tolerance units, coupling condensers are silver mica, and tubes are of the computer type.

-hp- AC-4A Counters are recommended replacement units for *-hp-* 522 and 524 series Electronic Counters; and are ideal for experimental or special applications.

SPECIFICATIONS

Counting Rate: 120 kc max.
Double-Pulse Resolution: 5 μ sec
Input: Approx. 80 v neg.; 1 μ sec rise time
Output: Approx. 80 v neg. to drive succeeding counter
Reset: To 0 or 9

Staircase Output: 135 v at 0, 55 v at 9. Internal resistance 700 K
Size: 5 $\frac{5}{8}$ " deep, 1 $\frac{1}{4}$ " wide, 6 $\frac{1}{8}$ " high. Weight 1 lb.
Mounting: Standard. Fits octal socket
Price: \$45.00.

Data subject to change without notice. Prices f.o.b. factory

HEWLETT-PACKARD COMPANY

3204A Page Mill Road • Palo Alto, California, U. S. A.
 Export: 275 Page Mill Road, Palo Alto, California
 Cable: "HEWPACK"

Sales engineers in all principal areas

Versatile *-hp-* ELECTRONIC COUNTERS



-hp- 524B ELECTRONIC COUNTER

With this revolutionary new all-purpose Counter you buy just the instrumentation you need now—later add other inexpensive plug in units to double or triple the instrument's usefulness. The basic 524B Counter measures frequency 1G cps to 10 mc, and period from 0 cps to 10 kc with stability of 1/1,000,000. Plug in Frequency Converters extend range to 100 or 220 mc while increasing video sensitivity. For low-level work, plug in Video Amplifier unit increases sensitivity to 10 millivolts, 10 cps to 10 mc. Time-Interval plug in permits Counter to measure interval 1 μ sec to 100 days with accuracy of 0.1 μ sec \pm 0.001 %. Readings direct in seconds, milliseconds, microseconds. *-hp-* 524B Counter, (without plug ins), \$1,915.00. *-hp-* 525A/B Frequency Converters, \$225.00. *-hp-* 526A Video Amplifier, \$125.00. *-hp-* 526B Time Interval Unit, \$150.00.

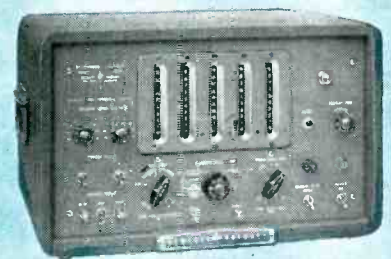

-hp- 522B ELECTRONIC COUNTER

Compact, low cost versatile instrument for frequency, period or time measurements. Range 10 cps to 100 kc. Reads direct in cps, kc seconds or milliseconds. Counts are automatically reset, action is repetitive. Stability of time base is 5/1,000,000. Display length variable at will; or may be "held" indefinitely. Easily used by non-technical personnel. \$915.00.



INSTRUMENTS

COMPLETE COVERAGE







Transitron[®]

NOW . . . FROM
AN OUTSTANDING
ADVANCE IN
SUBMINIATURE
GLASS DIODES

GOLD BONDED CONSTRUCTION

which gives superior electrical characteristics has been combined by Transitron with hermetic sealing in glass to produce a subminiature diode with unsurpassed performance.

These diodes offer the following advantages :

-  — SUPERIOR FORWARD CONDUCTANCE
-  — HIGHER INVERSE RESISTANCE
-  — GREATER RUGGEDNESS
-  — MORE UNIFORM CHARACTERISTICS
-  — GREATER POWER HANDLING
-  — COMPLETE RELIABILITY

All Transitron diodes must pass rigid tests, including shock, vibration, and temperature and humidity cycling between $+135^{\circ}\text{C}$ and -78°C . Strict conformance to all specifications is insured through 100% final electrical testing.

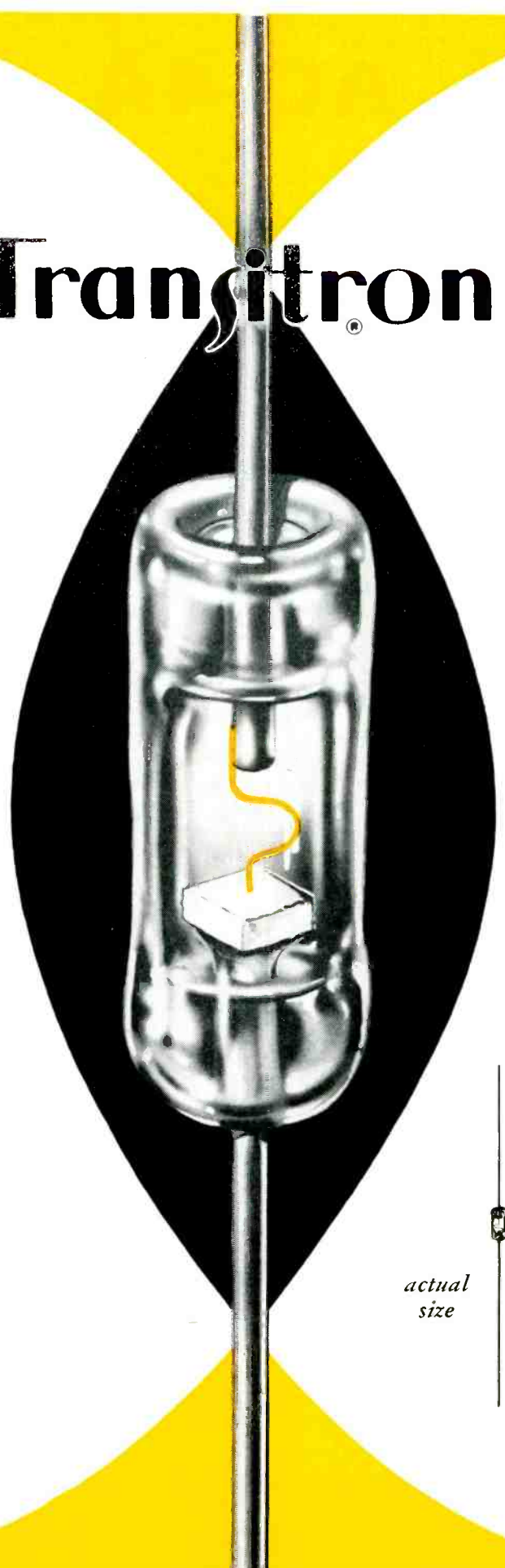

*actual
size*



"The MARK of Quality in Electronics"

WHAT IS GOLD BONDING?

Gold bonding is a process in which a gold whisker is alloyed by low temperature fusion to germanium. At the contact point both the whisker tip and the germanium are melted to form a eutectic alloy. This results in a rectifying subminiature P-N junction. Because the gold wire is dead soft, pressure cannot be transmitted, and mechanical isolation of the junction is achieved. Permanent electrical and mechanical stability is thus assured.

In contrast, the point contact "welded" diode uses a firm whisker wire such as tungsten or platinum ruthenium which does not alloy with the germanium in the forming process. Therefore, rectification depends upon the pressure of the whisker on the germanium. Variations in this pressure can cause variations in diode performance.

WHY ARE GOLD BONDED DIODES BETTER?

Electrically they are many times superior. The subminiature P-N junction formed at the bond provides electrical characteristics that approach those of an ideal diode. The typical Transitor diode offers forward conductance averaging more than five times higher than point contact types. In addition, types such as the T8G feature more than 100 milliamperes for each at +1 Volt, and over 5 megohms at -100 Volts inverse.

Mechanically they are more rugged. The eutectic alloy bond between the gold whisker and the germanium has a strength that is equal to that of the whisker itself. It is virtually impossible to affect the performance of these diodes by shock or vibration.

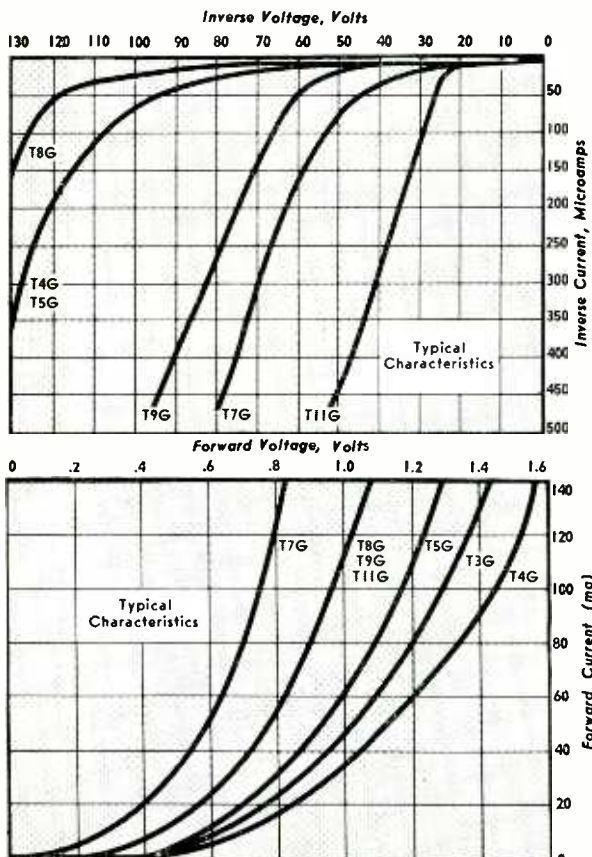

HIGH CONDUCTANCE DIODES

SPECIFICATIONS (At 25°C except as noted)

TYPE	Forward Current at +1V (ma Min.)	Inverse Current at Specified V (ua Max.)	Max. Inv. Voltage (Volts)	DESCRIPTION
T7G T25G	200 200	100 @ -50V 20 @ -10V	75 25	200 MA TYPES
T8G	100	20 @ -100V 5 @ -10V	125	100 MA TYPES
T9G	100	20 @ -50V 2 @ -10V	75	
T11G T6G	100 100	20 @ -20V 200 @ -20V	35 35	
T5G 1N100A	40 40	100 @ -100V 50 @ -50V 5 @ -5V	125 100	
1N98A	40	100 @ -50V 8 @ -5V	100	
1N118A T2G	40 40	100 @ -50V 300 @ -50V	75 75	
T13G T14G	40 40	2 @ -10V 5 @ -10V	25 25	
1N99A	20	50 @ -50V 5 @ -5V	100	
T3G 1N97A	20 20	50 @ -50V 100 @ -50V 8 @ -5V	75 100	20 MA TYPES
1N117A T12G	20 20	100 @ -50V 500 @ -50V 30 @ -10V	75 75	

HIGH RESISTANCE DIODES

1N55B	5	500 @ -150V	190	100 VOLT TYPES
T8G	100	20 @ -100V 5 @ -10V	125	
T5G	40	100 @ -100V	125	
T4G	5	100 @ -100V	125	50 VOLT TYPES
T9G	100	20 @ -50V 2 @ -10V	75	
1N67A	5	50 @ -50V 5 @ -5V	100	20 VOLT TYPE
T3G	20	50 @ -50V	75	
T11G	100	20 @ -20V	35	10 VOLT TYPES
T13G	40	2 @ -10V	25	
T14G	40	5 @ -10V	25	
1N128	5	10 @ -10V	50	

HIGH TEMPERATURE DIODES

T18G	20	125 @ -50V	50	ALL SPECIFICATIONS AND RATINGS ARE AT 75°C
1N198	5	250 @ -50V 75 @ -10V	50	
T19G	200	180K avg. @ 40V RMS	40V RMS	
T20G	20	500 @ -50V 30 @ -10V	50	(T20G at 75°C is electrically equivalent to 1N34A at 25°C)
T21G T22G	20 40	50 @ -20V 20 @ -10V	25 15	ALL SPECIFICATIONS AND RATINGS ARE AT 60°C
T23G	20	200 @ -50V †	50	
T24G	20	300 @ -30V †	35	

COMPUTER DIODES

T15G	125	500K between -20 and -90V	125	Inverse Recovery Time Tested. Forward and Inverse Recovery Time Tested. Inverse Recovery Time Tested.
T16G	40	500K between -10 and -50V	75	
1N191	5	400K between -10 and -50V @ 55°C †	75	
1N192	5	200K between -10 and -50V @ 55°C †	75	
T7G	200	100 @ -50V	75	LOW IMPEDANCE FAST FORWARD SWITCHING TIME. (These types are particularly useful for magnetic core switching)
T25G	200	20 @ -10V	25	
T11G	100	20 @ -20V	35	
T6G	100	200 @ -20V	35	

JAN TYPE DIODES

1N126	5	800 @ -50V 50 @ -10V	75	The above is a partial list of available types. Send for complete details in Bulletin TE1319.
1N127	5	300 @ -50V 25 @ -10V	125	
1N128	5	10 @ -10V	50	
1N198	5	250 @ -50V 75 @ -10V at 75°C		

ADDITIONAL SPECIFICATIONS

Ambient Temperature Range -78°C to +90°C
 Absolute Maximum Storage & Handling Temperature Range -78°C to +150°C
 Avg. Power Dissipation @ 25°C 80 Milliwatts
 Derating above 25°C 10mw/10°C
 Average Shunt Capacitance 0.5 uufd
 † Measured at 0.1 Watt
 ‡ Measured with 60 CPS sweep.



Transitor electronic corporation • melrose 76, massachusetts



HOW CAN AUTOMATIC CONTROL strengthen our defenses

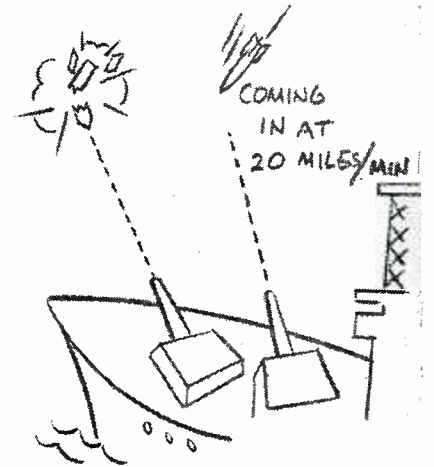
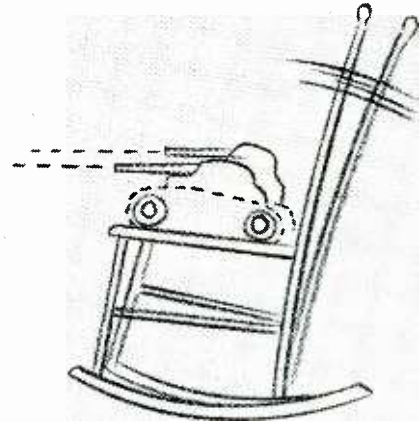
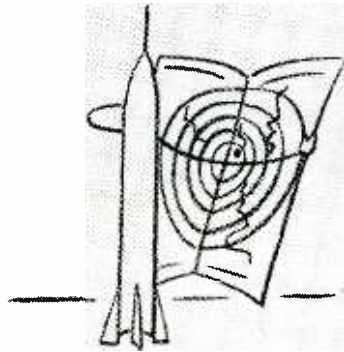

**...and FORD
was asked to find
the answer**

MISSILE GUIDANCE . . . GUN STABILIZATION AIRCRAFT NAVIGATION . . . WEAPONS SYSTEMS

The staff of engineers at Ford Instrument Company are experts in the field of automatic control. Every week, in the laboratories and shops of this large company thousands of men are working on electronic, hydraulic, mechanical and electrical servo-mechanisms, computers, controls and drives to solve problems for the Army, Navy and Air Force. Ever since Hamibal C. Ford started, in 1915, to develop and build the first gunfire computer for the U.S. Navy, Ford Instrument has been leading the way in applying the science of automatic control to America's defensive strength . . . and to American industry.



Each year the Ford Instrument Company is adding to its staff of several hundred engineers. If you are an engineer and can qualify, there may be a position for you.



FORD INSTRUMENT COMPANY

DIVISION OF THE SPERRY CORPORATION
31-10 Thomson Avenue, Long Island City 1, N. Y.

Consistently Dependable

Cornell-Dubilier

electrolytic capacitors



Whether you order 1 or 1,000,000 you can rely on C-D electrolytics.

The consistent demand for C-D, year after year, by the country's leading manufacturers is proof of the uniform quality of C-D ELECTROLYTICS. Whatever your ELECTROLYTIC requirement you will find that Cornell-Dubilier's consistent dependability is unmatched in the field—even to the new, real small (miniature) ELECTROLYTICS.

Engineering samples sent on request. For your special design and application problems, use our Technical Advisory Service. Write to:

*Cornell-Dubilier Electric Corp., Dept. K-114
South Plainfield, New Jersey.*

THERE ARE MORE C-D CAPACITORS IN USE TODAY THAN ANY OTHER MAKE

CORNELL DUBILIER *Capacitors*

PLANTS IN SOUTH PLAINFIELD, N. J.; NEW BEDFORD, WORCESTER AND CAMBRIDGE, MASS.; PROVIDENCE AND HOPE VALLEY, R. I.; INDIANAPOLIS, IND.; FUGUAY SPRINGS AND SANFORD, N. C.; AND SUBSIDIARY, THE RADIART CORPORATION, CLEVELAND, OHIO



ANTENNAS



ROTORS



CAPACITORS



VIBRATORS



CONVERTERS



Look to PHELPS REALISTIC APPROACH TO

PRACTICAL KNOWLEDGE of magnet wire application problems and trends.

CONTINUING INVESTIGATION of existing insulations to improve quality and performance.

EXHAUSTIVE TESTING and evaluation of new organic and inorganic insulation materials to determine fundamental properties and application possibilities.

ENGINEERING ASSISTANCE in selection and use of exactly right magnet wire for specific motor, transformer or coil.

First for Lasting Quality—from Mine to Market

DODGE for a MAGNET WIRE RESEARCH!

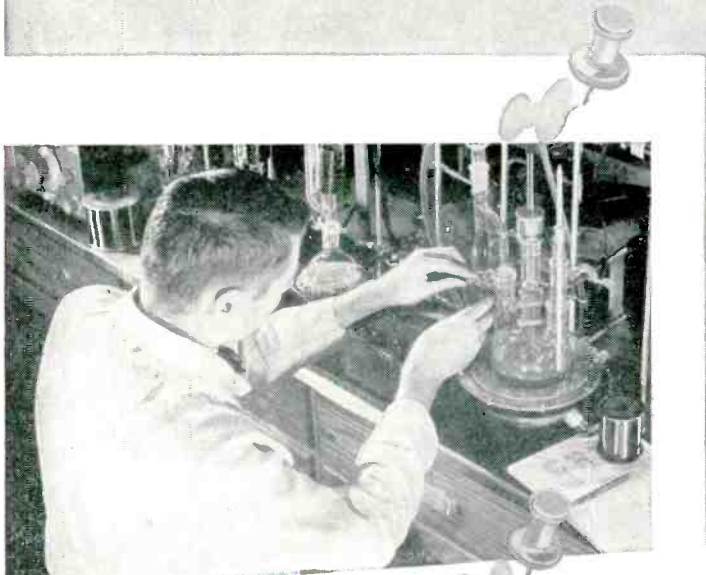

Result: Economical solutions to many varied and complex application problems!

The magnet wires pictured here illustrate the wide range of the Phelps Dodge line. Some of these wires—developed specifically by Phelps Dodge to answer special problems—suggest unlimited new applications for the future with overall savings to the user. Bondeze and Sodereze are examples of this kind of research.

Any time magnet wire is your problem, consult Phelps Dodge for the quickest, easiest answer!

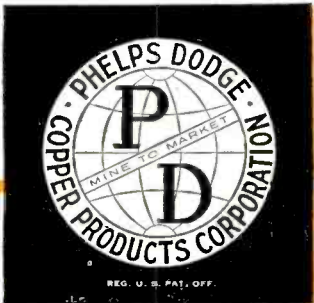
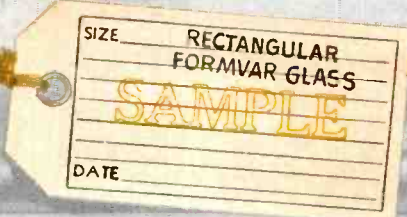

PHELPS DODGE COPPER PRODUCTS CORPORATION

INCA MANUFACTURING DIVISION
FORT WAYNE, INDIANA



DESIGNER'S

Wide selection of G-E specialty motors designed to meet your needs

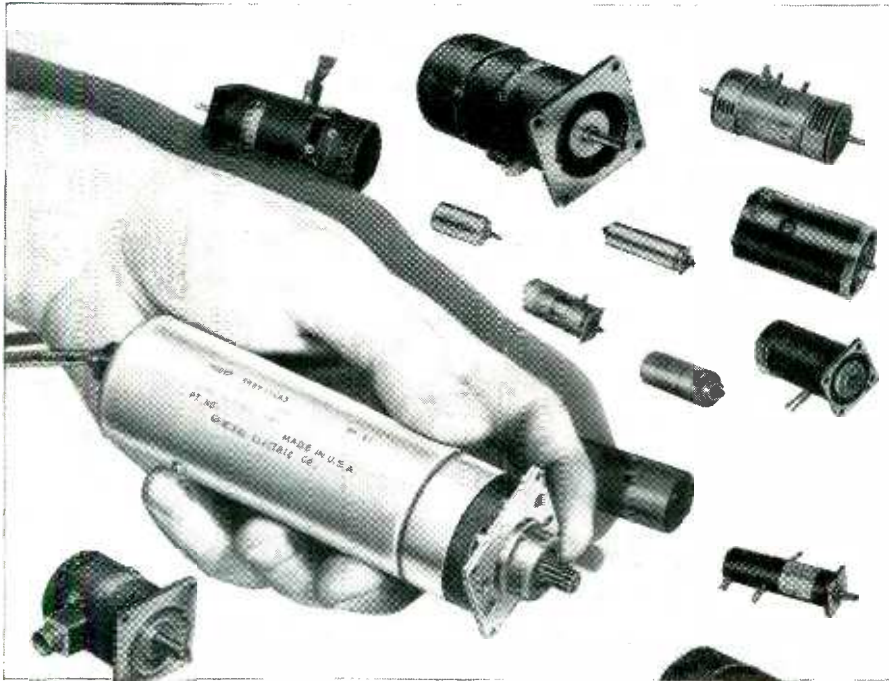

New permanent-magnet, 1 3/8" diameter motors latest addition to aircraft line

Experience gained by General Electric engineers in the design and manufacture of many types of specialty motors is another reason why G.E. is best equipped to supply the aircraft motor you need. In addition, complete testing facilities assure you that your special aircraft motors meet environmental requirements.

Shown at left is one in a series of new permanent-magnet, totally enclosed, shunt motors now part of General Electric's extensive line of aircraft motors. It is rated 1/100 hp, gear-reduced to 130 rpm, and operates on 27.5 volts. Designed for dynamic braking it can be stopped in 1/10 revolution by a fast acting relay. Such performance makes it ideal for radar tuners, actuators, blowers, and similar applications. Write for Bulletin GEC-988.



G-E Hermetically sealed relays feature reliability, high speed

HIGH SPEED RELAY—General Electric's high speed relay can be furnished with contact configurations up to 4 PDT, yet fits in an AN-3304 size can. This versatile relay is more reliable even under severe shock, vibration, extreme temperatures and other adverse conditions. Operating speeds range from 250 microseconds to 1 millisecond. It is available with multiple coils or windings and with multiple independent SPDT units in a single can. Write for Bulletin GEA-6212.

SUBMINIATURE RELAY—Lightweight, reliability, and resistance to shock and high vibration are a few of the important advantages of the G-E subminiature relay. Low capacitance makes it ideal for switching high frequency signals or pulses. Pickup time is 5 milliseconds or less and dropout time is 2 milliseconds or less. It is available with a variety of d-c coil voltages and 400 cycle a-c coil. Write for Bulletin GEA-6211.

GENERAL ELECTRIC

DIGEST

TIMELY HIGHLIGHTS ON G-E COMPONENTS

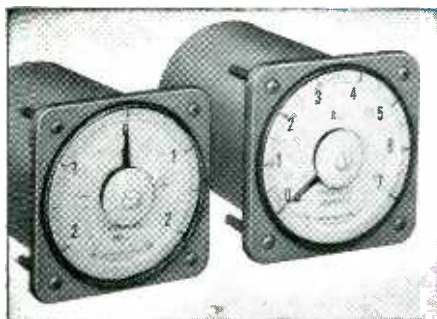

Announcing two new integrating instruments

Mean and standard deviation of variables can now be readily and accurately determined with General Electric's two new direct reading integrating instruments.

Widely applicable, the instruments measure such variables as current, thickness, width, diameter, density, or any other electrical or non-electrical quantity.

Integrating deviation and deviation-squared, the instruments, used with suitable primary detector, reduce statistical analysis of variables to a simple slide-rule calculation. Accuracy of the instruments is about $\pm 3\%$ full scale when integrating over a two-minute period.

For further information about these unique time-saving instruments contact your nearest General Electric Apparatus Sales Office. Write for Bulletin GEC-1230.

Capacitors of many ratings, styles help solve design problems

The variety of case sizes and styles of G-E fixed paper dielectric capacitors makes it easy to select units that meet your needs. Ratings at 236 to 660 volts a-c and at 400 to 100,000 volts d-c are available. All units are treated with Pyranol* impregnating liquid and are hermetically sealed to prevent leakage or contamination. Write for Bulletin GEC-809.

*Reg. trade-mark of General Electric Co.



Electronics easily taught

General Electric's More Power to America program, "Industrial Electronics," offers a practical, easily understood 12-lesson sound slidefilm course on the fundamentals of electronics and its applications in modern industry. It is a particularly interesting method for plant management, production men, and electrical and maintenance staffs to improve their understanding of the operation of industrial electronic equipment. Write for Bulletin GEA-5339.



Inductrols—for automatic or manual voltage regulation

G-E Inductrols end the poor performance and excessive burnouts of electronic tubes due to poor voltage. Compact design of these finely controlled regulators lets you fit them into any location. Models are available for indoor service on circuits 600 volts and below, single phase 3 to 240 kva; three-phase 9 to 520 kva. Bulletin GEC-795 covers single-phase inductrols; GEA-5824, 3-phase models.

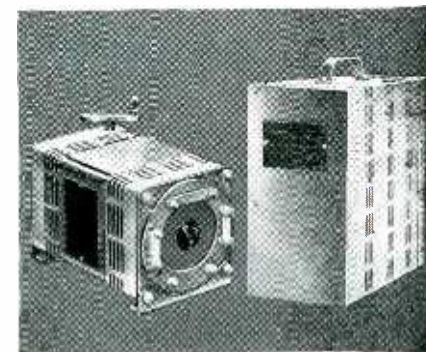

EQUIPMENT FOR ELECTRONIC MANUFACTURERS

Components

Meters, instruments
Dynamotors
Capacitors
Transformers
Pulse-forming networks
Delay lines
Reactors
Motor-generator sets
Inductrols
Resistors
Voltage stabilizers

Fractional-hp motors
Rectifiers
Timers
Indicating lights
Control switches
Generators
Selsyns
Relays
Amplidynes
Amplistats
Terminal boards
Push buttons
Photovoltaic cells
Glass bushings

Development and Production

Equipment
Soldering irons
Resistance-welding control
Current-limited high-potential tester
Insulation testers
Vacuum-tube voltmeter
Photoelectric recorders
Demagnetizers

General Electric Company, Apparatus Sales Division
Section C667-29, Schenectady 5, New York

Please send me the following bulletins:

✓ for reference only X for planning an immediate project

- GEC-988 Aircraft and Ordnance Motors
 GEA-6211 Subminiature Relays
 GEA-6212 High Speed Relays
 GEC-1230 Integrating Instruments
 GEC-809 Paper-Dielectric Capacitors
 GEA-5339 Industrial Electronics Training Course
 GEC-795 Single-phase Inductrols
 GEA-5824 Three-phase Inductrols

Name.....

Company.....

City..... State.....

13 Waldes Truarc Rings Replace Bulky Fasteners... Save \$.23 in 5 Sub-Assemblies of Tape Recorder!



Telectro-Tape Magnetic Recorder

Made lighter, more compact and efficient, and produced at lower cost when Waldes Truarc Rings replace bulkier, more expensive fasteners.

Alternate Design: Pressure Pad Assembly. Collar and set screw secure pressure bar and spring.

Truarc Design: Truarc Grip Ring replaces collar. Reduces size of assembly, saves \$.02/unit.

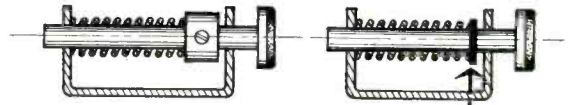

Alternate Design: Wind-rewind unit has collars and set-screws holding shaft in bearing. Rollers are held by flat washer, lock washer and screw. Critical shaft length tolerance required for faultless roller operation.

Truarc Design: Two Truarc Rings (series 5100) replace collars and screws, save \$.04 per unit. Rollers are held by two Truarc Grip Rings. Eliminates tapping and close tolerances, saves another \$.04!

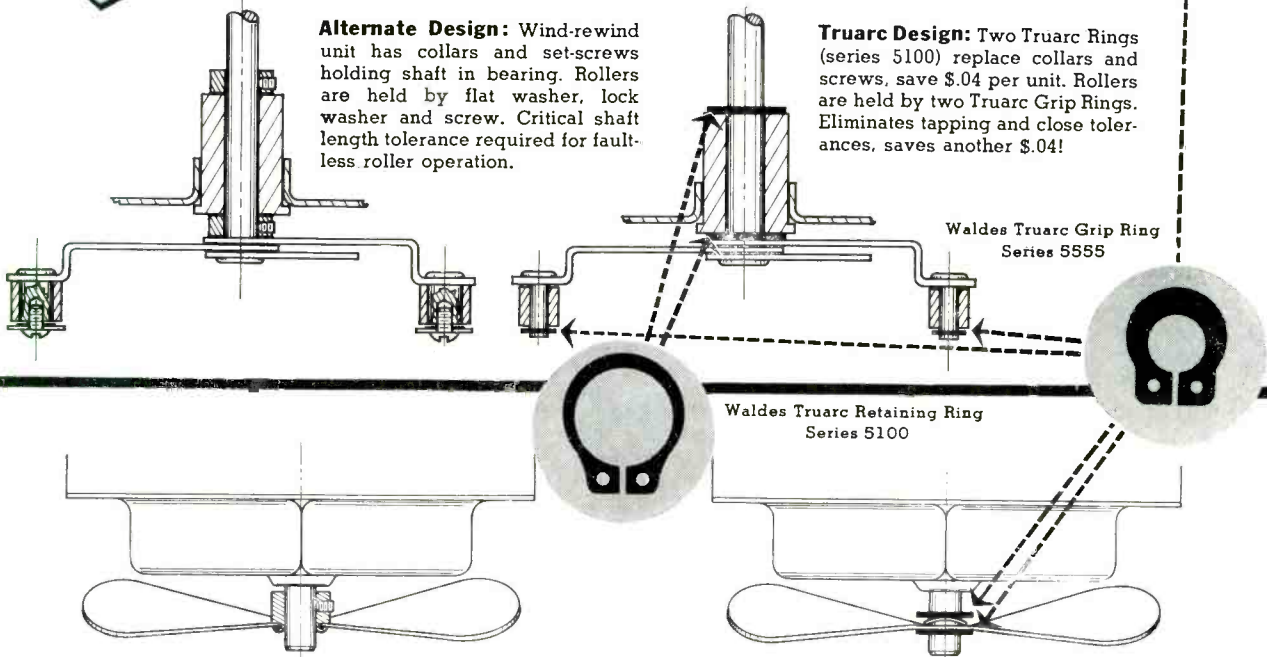

Alternate Design: In motor-fan assembly, hub is secured rigidly to fan blades by staking. Fan assembly is secured to shaft with set screw.

Truarc Design: Two Truarc Grip Rings (series 5555) plus spring-type bowed washer save \$.07 per unit...allow fan to slip if obstructed.

■ By using Waldes Truarc Retaining Rings in five sub-assemblies (three shown above), the Telectrosonic Corp. of Long Island City, N. Y., saves a total of \$.23 per unit...by eliminating material, machining and skilled labor costs.

■ You, too, can cut costs with Truarc Rings. Wherever you use machined shoulders, bolts,

snap rings, cotter pins, there's a Waldes Truarc Retaining Ring designed to do a better, more economical job. Waldes Truarc Rings are precision-engineered...quick and easy to assemble and dis-assemble.

■ Find out what Truarc can do for you. Send your blueprints to Waldes Truarc engineers for individual attention without obligation.

Write for a copy of the latest Truarc catalog.

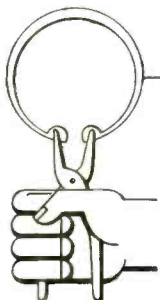

**WALDES
TRUARC**
REG. U. S. PAT. OFF.

■ For precision internal grooving and undercutting... Waldes Truarc Grooving Tool

RETAINING RINGS

WALDES KOHINOOR, INC., LONG ISLAND CITY 1, NEW YORK

WALDES TRUARC RETAINING RINGS AND PLIERS ARE PROTECTED BY ONE OR MORE OF THE FOLLOWING U. S. PATENTS: 2,382,947; 2,382,948; 2,416,852; 2,429,341; 2,439,785; 2,441,846; 2,455,165; 2,420,941; 2,483,380; 2,483,383; 2,487,602; 2,487,803; 2,491,306; 2,509,081 AND OTHER PATENTS PENDING.

*Years of experience
proves to users . . .*



the dependability of



KOVAR

Glass-sealing Alloy

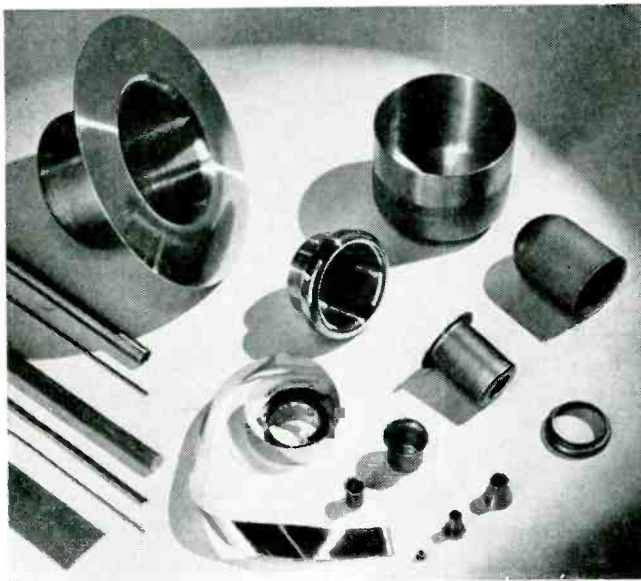

* Westinghouse Trade Mark No. 337,962

The ideal alloy for glass sealing, Kovar matches the expansivity of certain hard glasses over the entire working temperature range. It resists mercury attack, has ample mechanical strength and seals readily. A permanent and impervious bond is obtained by a closely controlled thickness of oxide on Kovar alloy interfused with hard glass.











Kovar is a cobalt, nickel, iron alloy, manufactured under very carefully controlled conditions, and supplied by Stupakoff in the form of: SHEET, ROD, WIRE, FOIL, TUBING, EYELETS, LEADS and FABRICATED SHAPES. The prominent users of KOVAR and the length of time they have employed this metal are convincing proof of satisfaction.

Full information on the use of Kovar is given in Stupakoff Bulletin 145, which we will send upon request.

Stupakoff CERAMIC & MFG. CO.

Latrobe, Pennsylvania

Division of The Carborundum Co.

-  18 YEARS
-  18 YEARS
- Western Electric** 16 YEARS
-  12 YEARS
-  18 YEARS
- Eimac** REG. U.S. PAT. OFF. TUBES 13 YEARS
-  11 YEARS
-  15 YEARS
- Bomac** 6 YEARS
-  18 YEARS
-  5 YEARS
-  18 YEARS
-  7 YEARS
- SPERRY** 13 YEARS



the famous

BLUE RIBBON CONNECTORS

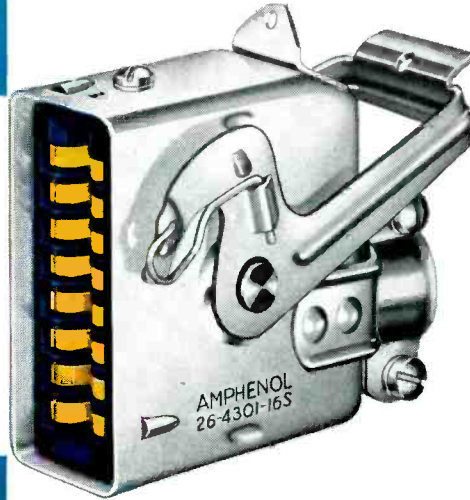
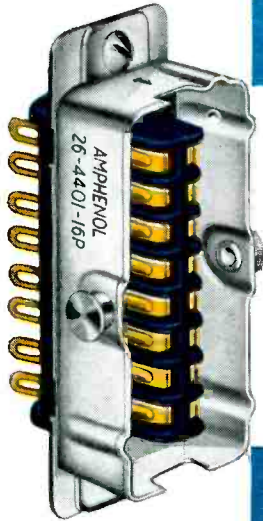

now

available with
Panel & Latch-Lock shells!

AMPHENOL's crack engineering team have completely redesigned the famous *Blue* RIBBON connectors and the results will be of interest to every company engaged in electronics.

The basic improvement has been the design of a new method of polarization. Instead of conventional guide pin and bushing polarization, male and female *Blue* RIBBON connectors are now mated by means of proper matching of the barrier heights between the contacts. Following this first important improvement AMPHENOL's engineers designed a complete line of front panel shells and cable-clamp latch-lock cans to fit the connectors—a step forward that makes the versatile *Blue* RIBBONS even more useful to the electronics industry.

What are the advantages of these design changes to you? Barrier polarization allows increased contact spacing without extending the overall length of the connector—mismatching is impossible. Front panel shells and latch-lock cans are available for *Blue* RIBBONS in a wide variety of keying arrangements, making possible the mounting of large numbers of connectors side by side without the possibility of connector mismatching by untrained personnel. Latch-lock types may be safety-wired and the cans are available with either end or side cable outlets.

Alternate Keying Positions



Receptacle Front Shell



Plug Front Shell

Alternate keying on *Blue* RIBBON shells provide positive insurance against mismatching in side-by-side connector mountings.

Complete details on all AMPHENOL *Blue* RIBBON connectors in CATALOG R1



AMERICAN PHENOLIC CORPORATION *chicago 50, illinois*

In Canada: AMPHENOL CANADA LIMITED, Toronto

AD #1: NOVEMBER 1934

**EIMAC
150-T**

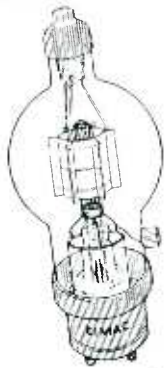

The Tube You Asked For Is Here At Last! IN EVERY IMPORTANT FEATURE— **UNSURPASSED**

HERE is a tube, new and original in design. It fulfills the most severe requirements of amateur practice. High output is obtained with low grid driving power and low plate voltages. Exceptionally high vacuum increases usable filament emission and prolongs tube life. Tantalum grid and plate construction permits maintenance of high vacuum even when overloaded. Extremely low inter-electrode capacitance make for high efficiency at high frequencies. Isolated grid and plate leads, in con-

junction with elimination of internal insulators insure freedom from arc over or break-down. Low voltage filament ruggedness reduces hum, increases mutual conductance, and life and increases mutual conductance. The large NONEX envelope, free from discoloration, allows maximum heat radiation without bulky physical dimensions. Improved 50-watt base insures rigidity and freedom from short-circuiting. "Ghost" grid structure minimizes electronic shadowing effects on the plate.

Characteristics:

EIMAC-150-T Triode

Fil. Voltage	5 V.	Fil. Current	10 A.
Rated Plate Dissipation	150 W.	Max. Amps.	
Factor 13: Max. Plate Current	200 MA.		
Plate Voltage	1000	2000	3000
Plate Resistance	2750	1900	1150
Mutual Conductance	5800	7300	1100
Normal Power Output	150W.	300W.	400W.
(75% eff.)			
PRICE \$24.50. Sold Only by Reputable Dealers.			

More POWER per dollar! Fewer dollars per hour of useful life! The result of six years' experience exclusively building transmitting tubes for ship, mobile, portable and amateur use. Unconditionally guaranteed to be gas-free, and against mechanical defects for two years.

"COMPARE AND REFLECT"

EITEL-McCULLOUGH, INC.
San Bruno, California, U. S. A.

The above advertisement introduced Eimac tubes 20 years ago this month, November 1934. Since then the reliability, performance and quality of Eimac triodes, tetrodes, pentodes and klystrons have made Eitel-McCullough, Inc., the largest manufacturer of transmitting tubes in the world.



EITEL-McCULLOUGH, INC.
SAN BRUNO, CALIFORNIA
The World's Largest Manufacturer of Transmitting Tubes

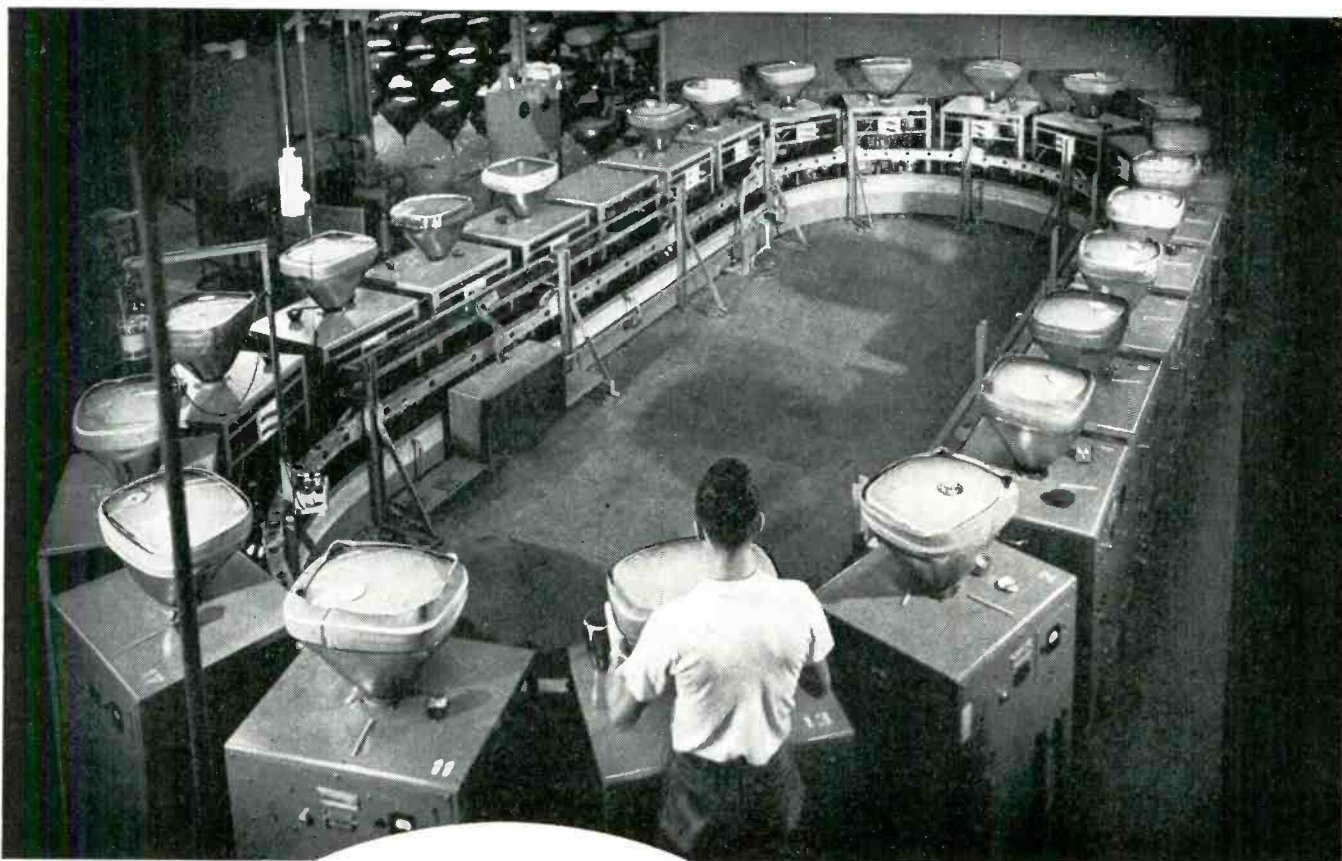

Overall view of Stokes continuous vacuum metallizing dolly system for aluminizing TV tubes at RCA's Marion, Indiana, plant. Operator is required only to load and unload tubes from the carts.

RCA Uses Stokes Vacuum Equipment for Aluminizing TV Tubes

The new Stokes installation at RCA's Marion, Indiana, plant is a valveless, rugged system capable of aluminizing up to 120 TV picture tubes per hour. Low in operating cost, it is by far the least complex continuous aluminizing system available. It is designed without timers, gadgets or intricate accessories, any of which could fail and stall production. The system is so free of vibration that a five-cent piece can be balanced on the dollies while they are in motion.

Operation is simplicity itself: the operator loads one tube to a cart; pressure is automatically reduced to the required vacuum, the filament is automatically flashed and the completed metallized tube delivered to the operator's station.

For metallizing COLOR or BLACK AND WHITE TV tubes, Stokes designs and installs automatic or semi-automatic in-line systems or stationary units, in standard designs or to customer's requirements.

Send for a NEW 28-page technical brochure on vacuum metallizing.



F. J. STOKES MACHINE COMPANY
PHILADELPHIA 20, PA.

STOKES

An Announcement

of the Utmost Importance to Engineers
Doing Research and Design
Work in the Entire Audio
Frequency Range.



Burnell and Co., Inc.
is proud to announce the development
of an entirely new product—

ROTOROID®

a Variable Toroidal Inductor (patent applied for)

ROTOROID will prove to be a valuable aid in the solution of many engineering problems — in research and design — and opens new possibilities for production which were previously impractical or impossible.

ROTOROID

- . . . is a continuously variable, stepless toroidal inductor which can provide a 3:1 range of maximum to minimum inductance in 180° rotation of a shaft.
- . . . employs no mechanical resistance contacts and is therefore free of noise and wear.
- . . . requires no DC saturating currents and thereby eliminates the need for circuitry.
- . . . is applicable over the entire audio range (from approximately 300 cps). ROTOROID is not limited to any stock value of nominal inductance. It is available in any value of inductance now available in regular toroids.
- . . . is hermetically sealed and is virtually vibration and shock-proof, can be chassis or panel mounted.



Write Department C for further information.

Burnell & Co., Inc.

Yonkers 2, New York

PACIFIC DIVISION: 720 Mission Street, South Pasadena, California

An outstanding feature of ROTOROID is that, at maximum inductance, it provides the full Q of the toroid it contains. Thus, the user is at once able to take advantage of the high Q characteristics of toroids while at the same time having available a variable inductor not previously available in a toroid.

Applications: Virtually unlimited. Just a few of the many possible uses of ROTOROID are:

- Tunable Audio Oscillators
- Variable Z Devices
- Servo Systems
- Telemetry
- Adjustable Selective Networks
- Variable Phase Shift Networks
- Variable Filters
- Electro-Mechanical Control Systems

Availability: Immediately available: ROTOROIDS VTI-A and VTI-B which are equivalent in electrical characteristics to Burnell toroids TC-16 and TC-3 in cases 2 1/4" in diameter, 3-1/16" long. Soon to be available: two miniature types, VTI-C and VTI-D, equivalent to Burnell toroids TCO and TC-6.

FIRST IN TOROIDS AND RELATED NETWORKS

3 BIG REASONS

to check

BURNELL

first!

**3 EXTRA REASONS
TO CHECK
BURNELL FIRST!**

- * Proven Top Quality
- * Competitive Prices
- * Prompt Deliveries

Write Department c
for Catalog 102A



BURNELL & CO., INC.
Yonkers 2, New York

PACIFIC DIVISION: 720 Mission Street, South Pasadena, California



ROTOROIDS® A continuously variable, stepless toroidal inductor which can provide a 3:1 range of maximum to minimum inductance in 180° rotation of a shaft. Write for new brochure which gives complete technical data.



TOROIDS Combining the advantages of toroidal type winding with the molybdenum permalloy dust core and other specially selected materials, these toroids provide higher Q than any other structure. They also provide greater stability of inductance vs. temperature and level in a smaller space. Their self-shielding properties permit compact assemblies of coils with a minimum of deleterious effects. Supplied to an inductance accuracy of 1%. Available in standard, miniature and sub-miniature sizes. Also in a wide variety of finishes, including *for the first time toroids molded in a new special material.*



TELEMETERING FILTERS

Band pass filters available for every channel ranging from 400 to 70,000 cycles for band width between 15 - 40%. Low pass filters available for operation in either unbalanced or balanced line, and range in cut off frequency from 6 up to 10,500 cycles. Also, miniaturized filters that do not sacrifice attenuation characteristics, save up to 80% space.

**FIRST IN TOROIDS
AND
RELATED NETWORKS**

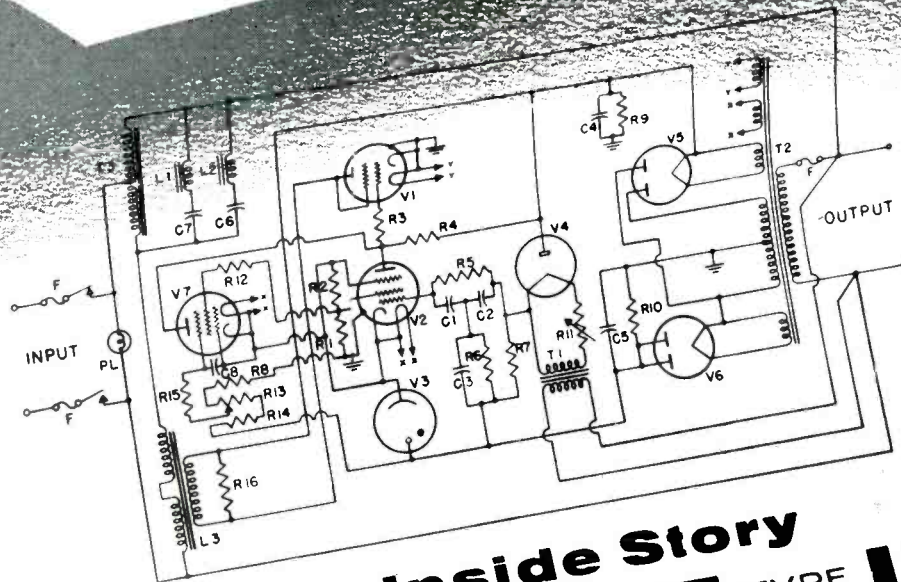

The Inside Story STABILINE TYPE IE

Instantaneous Electronic Automatic Voltage Regulators

- Instantaneous Correction
- Excellent Regulation and Stabilization
- Minimum Waveform Distortion
 - Wide Input Range
- Adjustable Output Voltage
- Insensitivity to Frequency Changes

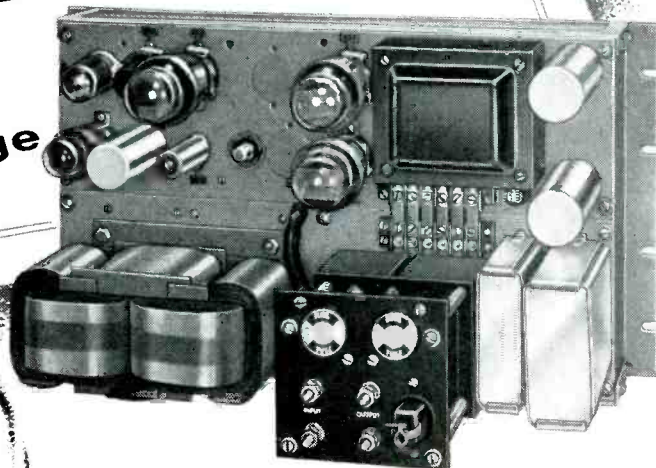

STABILINE Type IE5101R. Rated 95-135 Volts, 60 cycles input; 115 volts, 1.0 KVA output.

The circuit diagram shows how the error detector, the amplifier and power control circuit are combined in a STABILINE Type IE to deliver stabilized and regulated a-c voltage.

You will find a combination of circuit simplicity and mechanical ruggedness in STABILINE Automatic Voltage Regulators Type IE. Send us the details of your specific requirements or use the coupon below. Numerous models are offered in capacities from 0.25 to 5.0 KVA.



Visit Superior Electric's Mobile Display when it visits your area.

THE
SUPERIOR ELECTRIC
COMPANY

211 Clarke Ave., Bristol, Conn.

Manufacturers of: Powerstat Variable Transformers • Stabiline Automatic Voltage Regulators • Voltbox A-C Power Supplies • Powerstat Light Dimming Equipment • Varicall D-C Power Supplies • Superior 5-Way Binding Posts

THE SUPERIOR ELECTRIC CO.
211 Clarke Ave., Bristol, Conn.
Please send Bulletin S351 on STABILINE Automatic Voltage Regulators.

Name.....
Position.....
Company Name.....
Company Address.....
City..... Zone..... State.....



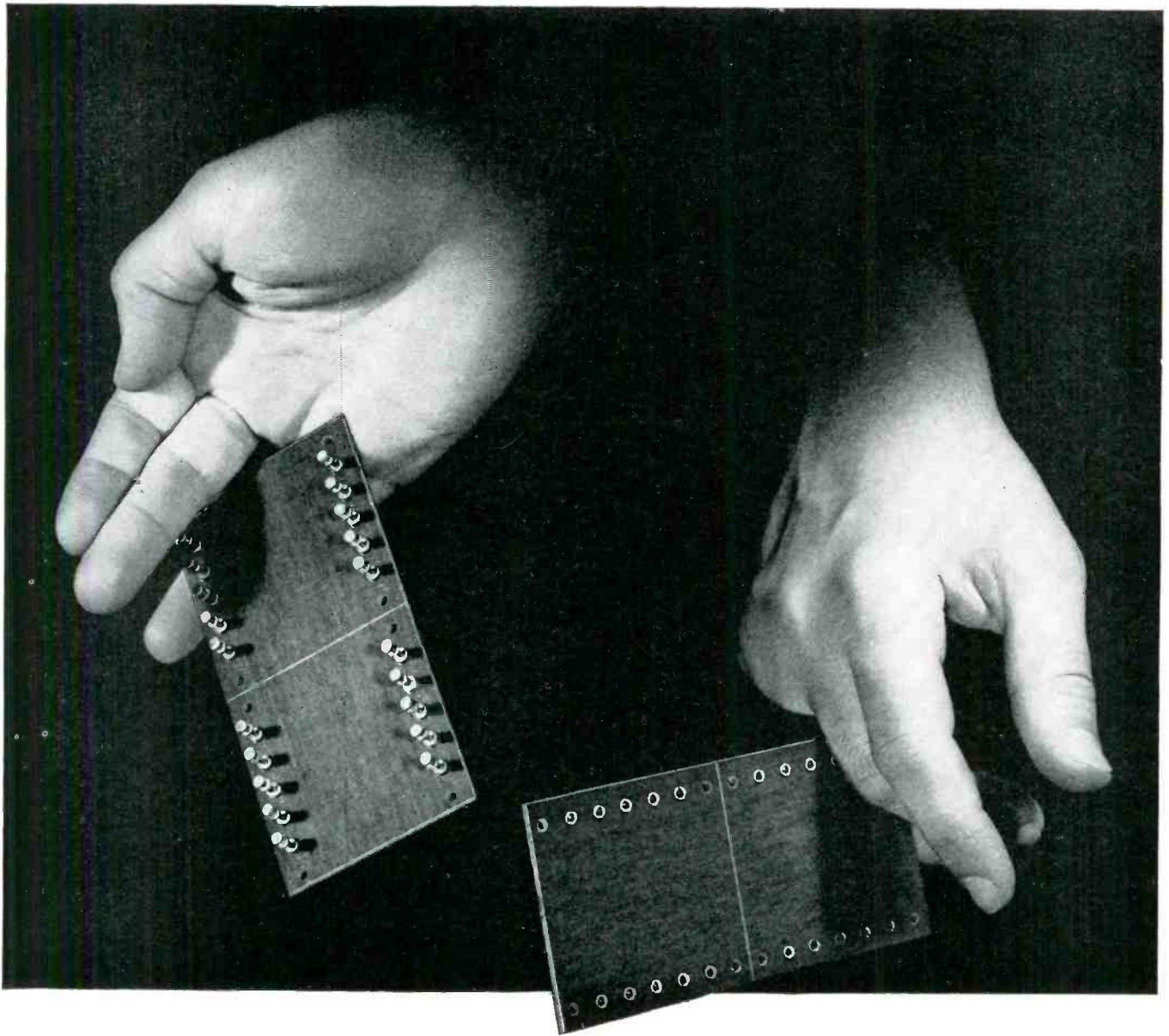

No cracks, please

You'll find no radial cracks in CTC terminal boards, or "cracked" rivet shanks on terminals. And there's a good reason for this.

Our swaging machines use tools that we designed ourselves in order to prevent just such damage. Terminals are fastened securely — *and carefully*. You benefit from a board that has no "weak spots" — that can give you the service you have a right to expect. And, of course, you also benefit from all the other quality control details that enable us to offer our customers *guaranteed* components — custom or standard. Coatings are smoothly applied — no wrinkles, no heavy deposits. C.T.C. terminals are made from certified stock that is free from defects. And the terminals themselves are guaranteed, even to the thickness of the coatings.

This C.T.C. quality control is given to all C.T.C. products including insulated terminals, coil forms, coils, swagers, terminals and capacitors. For all specifications and prices, write to

Cambridge Thermionic Corporation,
437 Concord Avenue, Cambridge 38,
Mass. West Coast manufacturers contact:
E. V. Roberts, 5068 West Washington Blvd.,
Los Angeles 16 and 988 Market St.,
San Francisco, California.

Terminal Board Data. CTC makes both standard boards and to your own specifications. Standard boards in cotton fabric phenolic, nylon phenolic or grade L-5 silicone impregnated ceramic. Custom made in cloth, paper phenolic, melamine, epoxy or silicone fibreglas laminates, imprinted as required and lacquered or varnished to specifications MIL-V-173 and JAN-T-152.

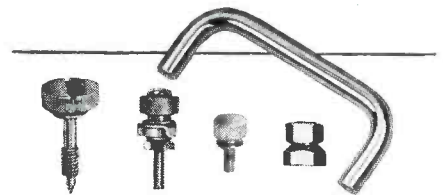

A wide variety of hardware is available at C.T.C. — all of it quality controlled and guaranteed for durability. This hardware includes terminal board brackets, standoff mounts, spacers, tube clamps, panel screws, thumb screws, dial locks, shaft locks, handles and handle ferrules.

CTC

CAMBRIDGE THERMIONIC CORPORATION

*makers of guaranteed electronic components,
custom or standard*

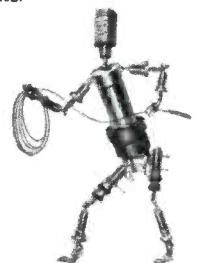

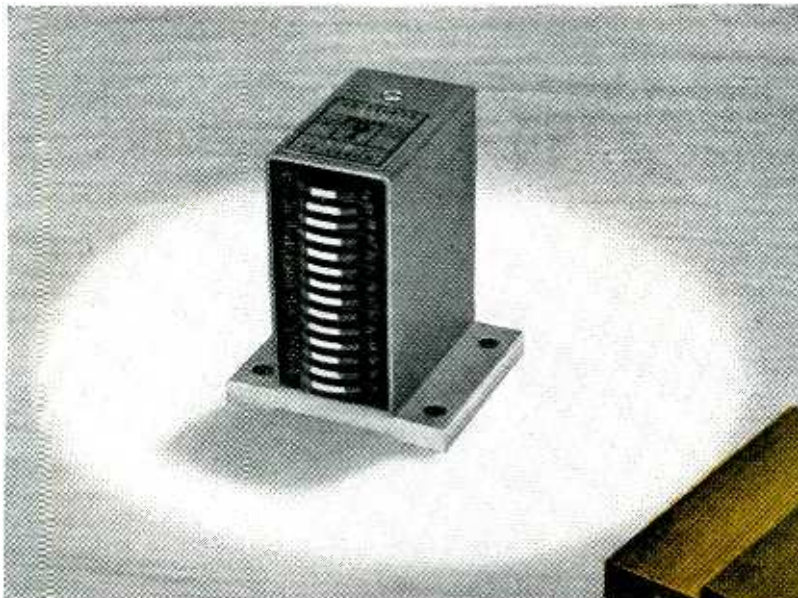

Brush Type BK-1514, a 14-channel recording-reproducing head for use with magnetic tape.



Revere Extruded Shape used for the base of the head.

Revere Extruded Shape

*Saves 15¢
per piece*

For Brush

The base of the magnetic recording-reproducing head shown here is a Revere brass extruded shape. You can see that it is rather simple in design, yet Brush Electronics Co., Cleveland, Ohio, reports that the shape saves 15¢ per piece (1½" long) over the previous method of milling the piece out of solid bar. There were three operations required on the bar, which weighed 1.61 lb. per foot, against 1.22 lb. per foot for the shape. Eliminating the machining operations, and reducing scrap almost to the vanishing point, produced the economy.

The head in question can record and reproduce signals from 14 channels, at frequencies within, below, or above the audible range. Such a head is being increasingly employed to handle information to be used for computation, telemetering, inventory records, process control (automation) and similar purposes.

Extruded shapes by Revere should be looked into if you are doing any extensive machining of raw stock in copper and its alloys, and aluminum alloys. The extrusion process is much like squeezing paste from a tube. Much more intricate shapes than the one shown here are possible. Naturally, all design lines must be parallel to the axis of extrusion. Get in touch with the nearest Revere Sales Office, and see if Revere Extruded Shapes may not save you money.

REVERE

COPPER AND BRASS INCORPORATED

Founded by Paul Revere in 1801

230 Park Avenue, New York 17, N. Y.

*Mills: Baltimore, Md.; Chicago and Clinton, Ill.; Detroit, Mich.; Los Angeles and Riverside, Calif.; New Bedford, Mass.; Rome, N. Y.—
Sales Offices in Principal Cities, Distributors Everywhere.*

SEE "MEET THE PRESS" ON NBC TELEVISION, SUNDAYS

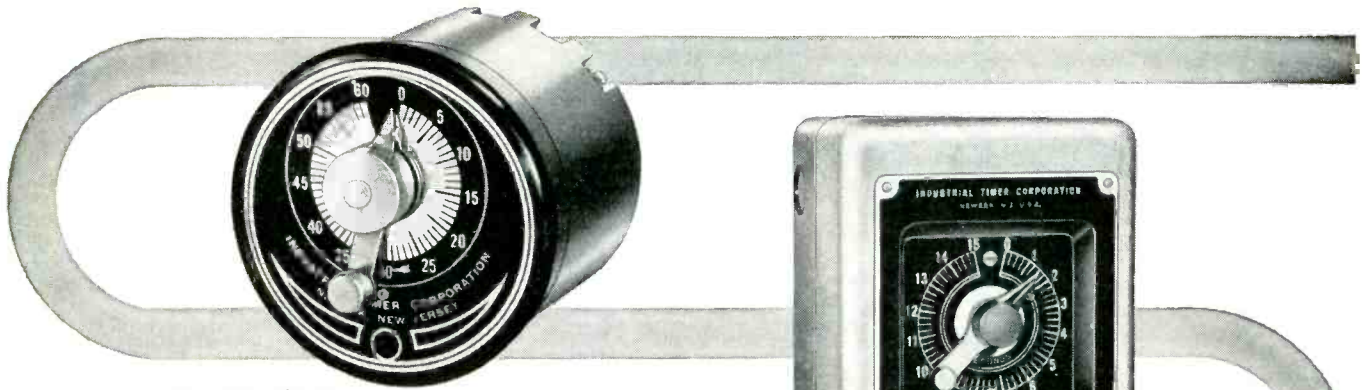

Time Delay Timers

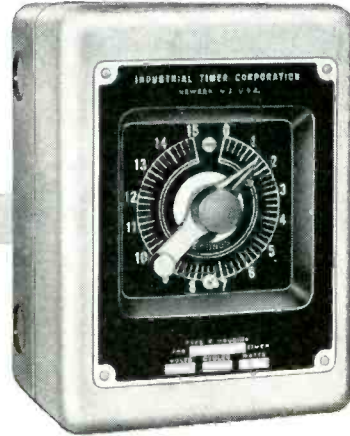

Interval Timers

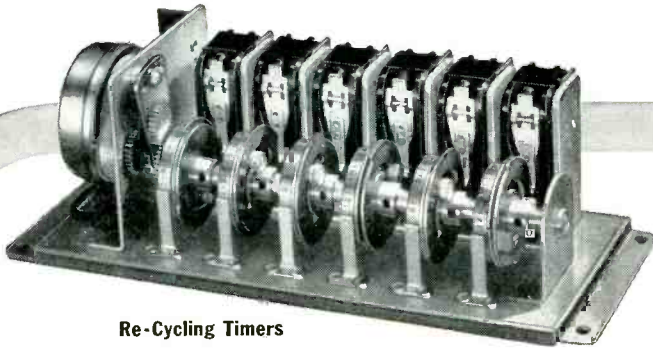

Re-Cycling Timers

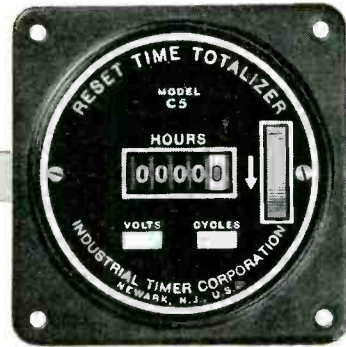

Running Time Meters

MOST COMPLETE LINE OF INDUSTRIAL

TIMERS for automation

The individual requirements of each automation problem are best met by selecting timers designed to perform specific functions. Whatever your timing-control problem, Industrial Timer Corporation can meet it with one of its standard timers, a combination of its standard units, or by designing an entirely new timing element. Our Engineering Department not only originates new designs, but also develops modifications to meet our customers requirements.

We manufacture a complete line of timers in these 4 broad classifications:

**TIME DELAY TIMERS • RE-CYCLING TIMERS
INTERVAL TIMERS • RUNNING TIME METERS**

Our large stocks of 17 basic types from which we have developed over 660 combinations to date, enables us to make rapid deliveries in most cases . . . and excellent deliveries on special orders. Our automation timer specialists will be happy to discuss your automation timer requirements. Your inquiries will receive prompt attention.

*Timers that Control
the Pulse Beat of Industry*



INDUSTRIAL TIMER CORPORATION
131 OGDEN STREET, NEWARK 4, N. J.

Polarad NTSC Color TV Equipment consists of fully integrated units that combine ease of operation with maximum flexibility.

COLOR BAR GENERATOR—PT-203 Provides color TV test signals, NTSC standards, for color TV equipment, networks and components. Supplies complete composite video signal in the form of seven fundamental color bars simultaneously with seven gradations of gamma bars. White dot pattern superimposed on both color and gamma bars. Color test pattern can be used for adjustment of both color transmitter and receiver circuitry. Internal switching permits 19 different test patterns.

COLOR SYNCHRONIZING GENERATOR—PT-201 Furnishes NTSC color TV subcarrier frequency component and contains divider network to yield 31.5 KC signal. Provides driving, blanking and synchronizing pulses, as well as vertical and horizontal dots for linearity checks. Used to drive color bar generators, or any other NTSC color TV generating equipment. Utmost stability assured by driving all pulses from leading edge of crystal controlled oscillator. Unit may be locked to synchronize with 60 cps line. Also available as a separate unit, PT-202 Subcarrier Frequency Generator to modify any existing standard (B/W) synchronizing generator in accordance with NTSC color TV standards.

COLOR TV VIDEO MONITOR—M-200 Compact, rugged instrument consisting of two portable units. Uses 15 inch RCA tri-color Kinescope. Checks quality of NTSC color video signals in studio, on transmission or in factory. Excellent synchronizing stability. Displays highest definition transmitted pictures with exceptionally good color rendition. All controls on front panel. Instrument may be rack mounted or employed as field test equipment.

ALSO AVAILABLE An NTSC color TV Flying Spot Scanner, furnished as a completely packaged unit supplying a standard color video signal. For further information, contact your nearest Polarad representative or write directly to the factory.

Polarad

COLOR

TV

equipment
for studio and
laboratory

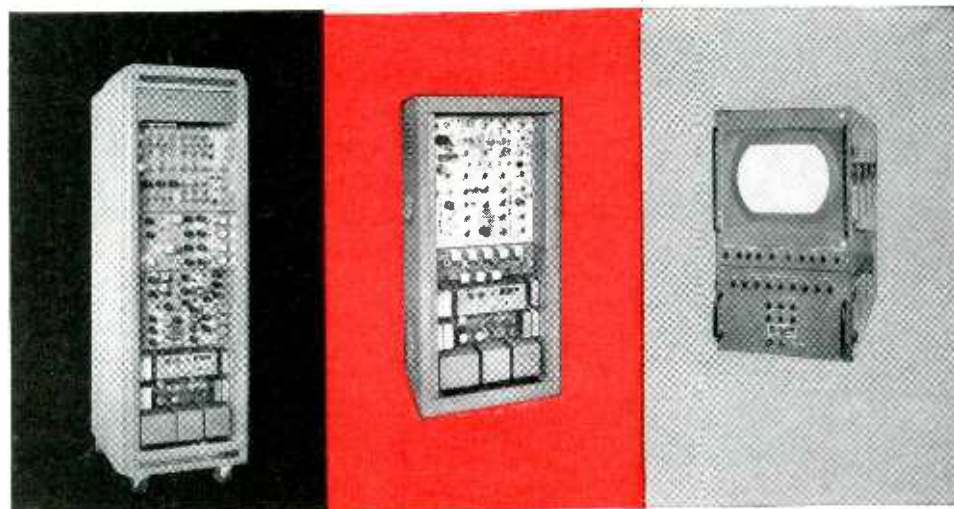

COLOR BAR GENERATOR PT-203
OUTPUT SIGNALS: Composite Video (2 outputs) (Sync negative & positive)
SIGNAL INFORMATION
7 Bars of Color
7 Bars of Gamma Gradations
White Dot Pattern (Vert. and Hor)
EXT. VIDEO INPUT FOR MIXING
2 Volts neg. polarity

COLOR SYNCHRONIZING GENERATOR PT-201
OUTPUT SIGNALS:
Synchronizing Signal (Neg.)
Camera Blanking Signal (Pos., Neg.)
Horizontal Drive Signal (Neg.)
Vertical Drive Signal (Neg.)
Composite Video Output (Neg., Pos.)
NTSC Color Subcarrier Freq. (3.579545 mc/s)

COLOR VIDEO MONITOR M-200
Signal Polarity—Positive, Negative, Balanced
Input Video—0.25 to 2.0 Volts, peak to peak
Input Impedance—66 mmf across
2.2 megohms
Resolution—250-300 lines (Full Utilization of NTSC Color Signal Bandwidth)
Linearity—Better than 2% across raster
Horizontal and Vertical



ELECTRONICS CORPORATION 100 METROPOLITAN AVENUE, BROOKLYN 11, NEW YORK,

REPRESENTATIVES

Albuquerque • Annapolis, Canada • Atlanta • Boston • Chicago • Cleveland • Fort Worth • Kansas City • Los Angeles • New York • Philadelphia • San Francisco
Seattle • St. Paul • Syracuse • Washington, D. C.

IN HOT DIMPLING
HIGH STRESS METALS



WESTON

Sensitrol [®] RELAYS

CONTROL CRITICAL TEMPERATURES
DIRECT FROM
THERMOCOUPLE OUTPUT!



Ultra-Sensitive SENSITROL Relays . . .

- Operate directly on values low as $\frac{1}{2}$ micro-ampere or $\frac{1}{4}$ millivolt.
- Handle substantial wattage at 110 volts on non-chattering magnetic contacts.
- Eliminate need for amplifiers and auxiliary power supplies.
- Available with single or double contacts, fixed or adjustable, manual or solenoid set.

Hot dimpling of high stress materials for flush riveting used in today's airframes requires unfailing control of sheet temperatures within very close limits. Over temperatures might cause annealing and loss of strength, and under temperatures, inter-granular disorder and cracking.

To assure this precise and dependable control, Aircraft Tools, Inc. employ Sensitrol Relays in the Hot Dimpling Press illustrated, as well as in their portable dimpling tools. Operating directly from thermocouple output, these relays render the equipment inoperative should temperatures drop below a specified limit during dimpling; and also are used in the thermocouple break-circuit to prevent heater burn-out in case of thermocouple failure.

This is another instance where Sensitrol Relays have been adopted because they provide a positive means of control direct from feeble input signals . . . *without any amplification*. Some of their outstanding features are listed at the left. The complete story, in bulletin form, is available on request. WESTON Electrical Instrument Corporation, 614 Frelinghuysen Avenue, Newark 5, New Jersey. 8098

WESTON
Instruments



for *Constantin*

for **COMPRESSION**

for **CONNECTORS**

for **CONFIDENCE**

GLASS-TO-METAL

VACUUM-TIGHT

MOISTURE-PROOF

RUGGED CONSTRUCTION

L. L. Constantin & Co.

MANUFACTURING ENGINEERS
Route 46 Lodi, New Jersey



Also manufacturers of Glass-to-Metal

HEADERS • TERMINALS • END SEALS • TRANSISTOR MOUNTS • CRYSTAL BASES & COVERS • VACUUM COATING EQUIPMENT

MILLIONS

OF VARIABLE

COMPLETE MILITARY LINE AVAILABLE.

POPULAR MILITARY TYPES ILLUSTRATED.

CORRESPONDING COMPLETE LINE FOR COMMERCIAL APPLICATIONS ALSO AVAILABLE.

5 acres of plant area . . . over 1000 employees . . . making ALL TYPES of variable resistors by the million. . . for ALL your requirements. CTS SPECIALIZES in precision mass production of variable resistors and associated switches . . . makes nothing else.

Most controls available with switches and in concentric shaft tandems or with two controls operating on one shaft. Also available with locking bushing, water sealed bearing and many other special features not illustrated.

Immediate delivery from stock on many JAN-R-94, JAN-R-19 and other types.



WRITE FOR ILLUSTRATED CATALOG—

Describes Electrical and Mechanical characteristics, Special Features and Constructions of a complete line of variable resistors for military and civilian use. Includes dimensional drawings of each resistor

EAST COAST OFFICE

Henry E. Sanders
130 North Broadway
Camden 2, New Jersey
Phone: Woodlawn 6-1668
TWX No Camden N J 380

WEST COAST OFFICE

Robert A. Stackhouse
928 So. Robertson Blvd.
P. O. Box 35073
Los Angeles 35, California
Phone: Crestview 4-8931
TWX No. BEV H 7666

CANADIAN DIVISION

C. C. Meredith & Co., Ltd.
Streetsville, Ontario
Phone: 310

SOUTH AMERICA

Jose Luis Pontet
Buenos Aires, Argentina
Montevideo, Uruguay
Rio de Janeiro, Brazil
Sao Paulo, Brazil

OTHER EXPORT

Sylvan Ginsbury
8 West 40th Street
New York 18, New York
Phone: Pennsylvania 6-8239

SOUTHWESTERN U.S.A.

John A. Green Company
6815 Oriole Drive
P.O. Box 7224
Dallas 9, Texas
Phone: Dixon 9918

1/2 watt 70°C, 3/4" diameter miniaturized variable composition resistor.

TYPE 65 (Miniaturized)

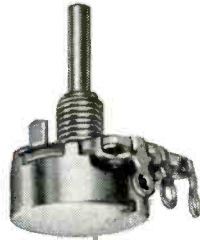

TYPE C90-65 Tandem



UNPRECEDENTED PERFORMANCE CHARACTERISTICS

Types 65, 90 and 95 are specially designed for military communication equipment subject to extreme temperature and humidity ranges: -55°C to +150°C . . . aridity to saturation.

1 watt 70°C, 15/16" diameter variable composition resistor.

TYPE 90



TYPE GC-90 With Switch



TYPE C2-90 Tandem



Meets JAN-R-94 type RV4

2 watt 70°C, 1-1/8" diameter variable composition resistor. Also available with other special military features not covered by JAN-R-94.

TYPE 95

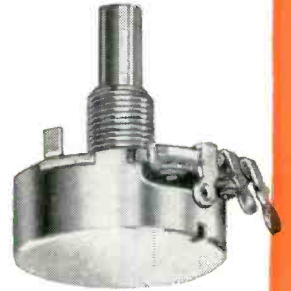

TYPE GC-95 With Switch



TYPE C2-95 Tandem



Burton Browne Advertising

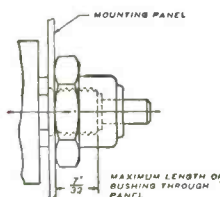

WATER SEALED MOUNTING AND BEARING FOR TYPE 65

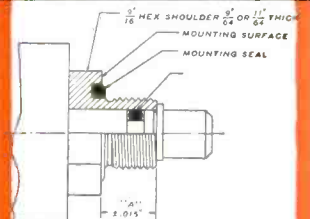
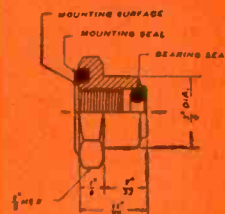

(CAN BE SUPPLIED WITHOUT THE WATER SEALED MOUNTING SHOULDER)

WATER SEALED MOUNTING AND BEARING FOR TYPES 45, 35, 90, 95, 25, 252.

CHICAGO TELEPHONE SUPPLY Corporation

ELKHART • INDIANA

"closer
than
a cat's
whisker"

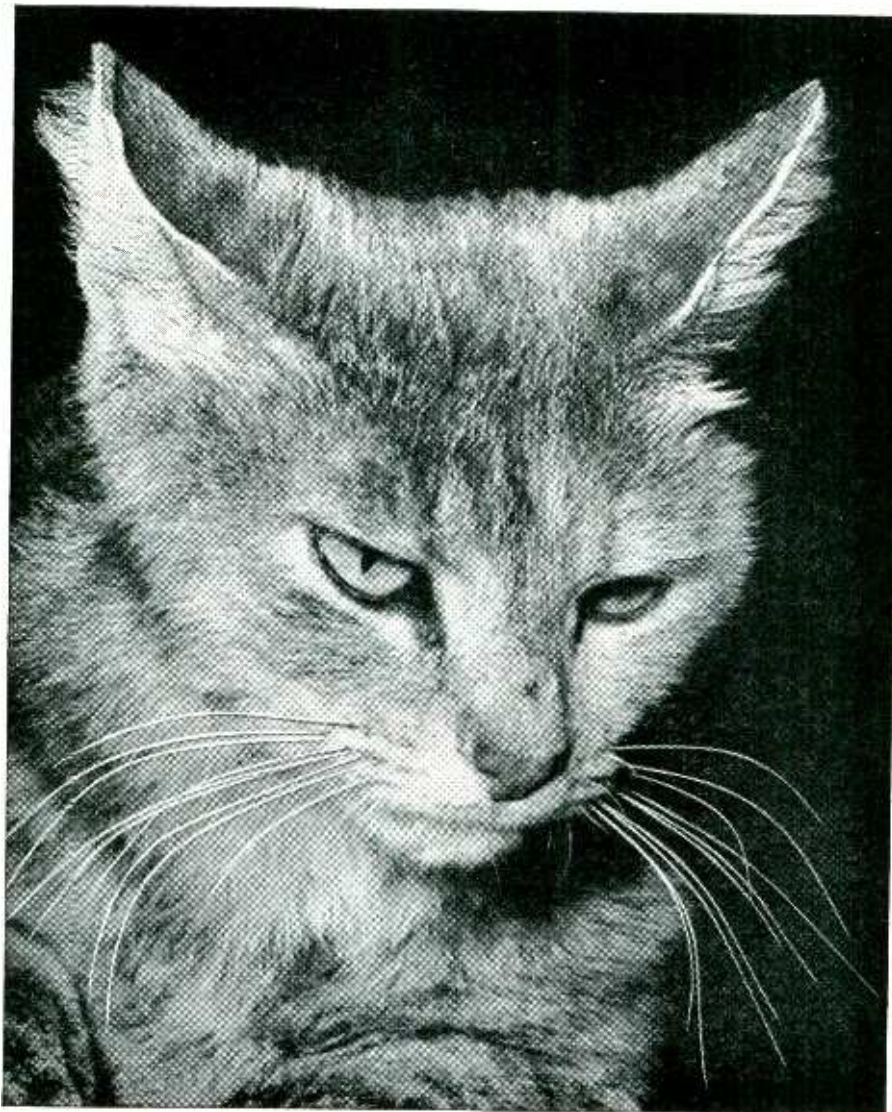

Cat's whisker standards are not good enough for Armco TRAN-COR DI-MAX coils. That's because nature's thickness tolerances are too high. At the end away from the cat, the whiskers measure about 2-thousandths of an inch thick. At the end approaching the cat they measure about 16 thousandths. In other words, heavy ends.

"Heavy ends" are not limited to cat's whiskers. In electrical steels they can cause trouble because of the wide variation in lamination thickness. There are no heavy ends in Armco TRAN-COR DI-MAX welded coils. The ends are rolled the same as the center.

LONGER DIE LIFE TOO

Armco TRAN-COR DI-MAX is also made to standards "closer than a cat's whisker" to improve die life. Customers report twice the average die life, compared with standard hot-

rolled electrical steels. Yet DI-MAX means not only better punching quality but also higher ductility, better flatness and finish.

EXTRA INSULATION IF NEEDED

DI-MAX coils and sheets have adequate insulation for most applications. Where even better interlaminar insulation is required, the steel is supplied with No. 4 Insulation. It withstands annealing temperatures up to 1500 degrees F.

GRADES IN DI-MAX

Armco TRAN-COR DI-MAX, the modernized electrical steel sheet, is available in coils or cut lengths in these hot-rolled, cold-finished grades: M-19, -22, -27, -36 and -43. For complete data write for the new booklet, "Armco Hot-Rolled Electrical Steels."

ARMCO STEEL CORPORATION

4914 CURTIS STREET, MIDDLETOWN, OHIO



SHEFFIELD STEEL • ARMCO DRAINAGE & METAL PRODUCTS, INC. • THE ARMCO INTERNATIONAL CORPORATION

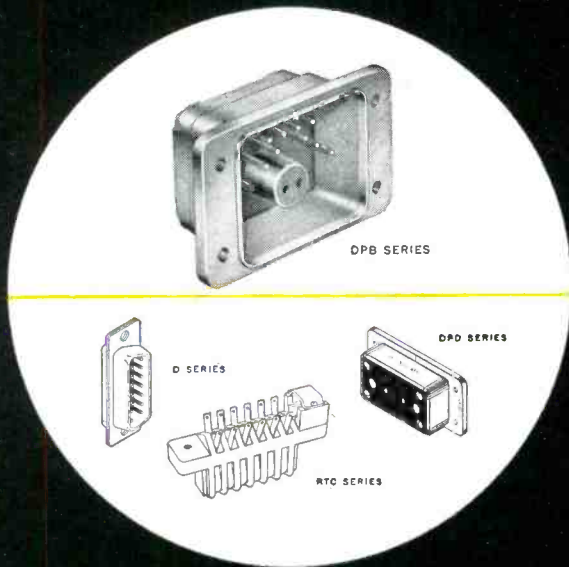

*for rapid disconnect
use cannon
"unit plug-in"
connectors*

speed up inspection...testing...maintenance! facilitate interchangeability!

You can connect, disconnect, interchange, replace, test, and inspect instruments, assemblies, and sub-assemblies easily and rapidly when you use Cannon "Unit Plug-In" multi-contact electric connectors.

You'll find some with shells . . . some without. Shell style units . . . in a wide variety of designs . . . are ruggedly constructed to take the many "in" and "out" operations of rack, panel, chassis, and sub-assembly applications. Varied, simple, but always rigid mounting facilities provided on each connector half. Standard, miniature, sub-miniature sizes.

Either connector half may be made into a plug by use of an end bell. Up to 156 contacts. And . . . an amazing number of combinations of contacts for control, audio, thermocouple, co-ax, twin-ax, as well as pneumatic connections. In single- or double-gang. Special moisture-proofed types. Standby units feature gold-plated contacts to withstand deterioration and corrosion.

Write for full information. Write TODAY!



first in connectors

CANNON PLUGS

Please refer to Dept. 120

CANNON ELECTRIC COMPANY, 3209 Humboldt Street, Los Angeles 31, California. Factories in Los Angeles; East Haven; Toronto, Canada; London, England. Contact representatives and distributors in all principal cities.

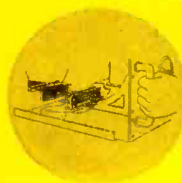

EVERY ELECTRONICS ENGINEER HAS DESIGNED COILS TO UTILIZE **MOLDITE CORE "STANDARDS"**

Consistently dependable, Moldite core "Standards" are in demand wherever electronic engineering requires the finest in precision-manufactured cores with absolute uniformity from first to last.

MOLDITE CORE "STANDARDS" OFFER...

ECONOMY HIGH QUALITY
AVAILABILITY INTERCHANGEABILITY
UNIFORMITY FLEXIBILITY

"The right Moldite core for the right coil" is a byword at National Moldite whose precision production facilities have given the industry a superlative core or coil form for every electronic application.

Design with Moldite Core Standards in Mind.

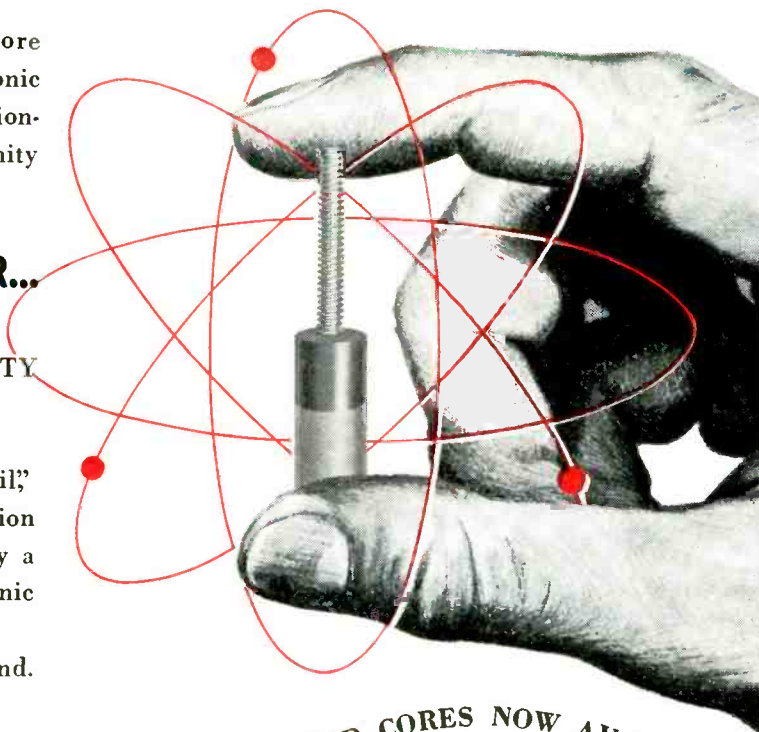

COMPLETE LINE OF MOLDITE ECONOMY-ENGINEERED CORES NOW AVAILABLE

FERRICORES



MOLDED COIL FORMS

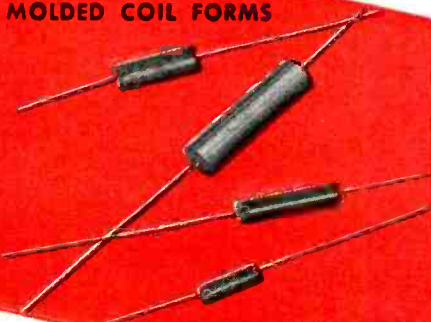

FERRITE CORES
MOLDED COIL FORMS
(iron and phenolic)
MAGNETIC IRON CORES
FILTER CORES
THREADED CORES
SLEEVE CORES
CUP CORES

MAGNETIC IRON CORES



Send for our new Catalog #120

THE MOST COMPLETE LINE OF
CORES IN THE INDUSTRY!

NATIONAL

MOLDITE

COMPANY

1410 CHESTNUT AVE., HILLSIDE 5, N. J.

Robert T. Murray
614 Central Avenue
East Orange, N. J.

Jerry Golten Co.
2750 W. North Ave.
Chicago 22, Ill.

Arnold Andrews
521 Cumberland Ave.
Syracuse, N. Y.

Perlmuth-Coleman & Assoc.
1335 South Flower
Los Angeles, Cal.

Jose Luis Ponte
Cardoba 1472
Buenos Aires

NEW G-E THRU-CON BOARD ASSURES SOLDER CONNECTIONS .. REDUCES PRODUCTION COSTS!

HERE is an advanced printed circuit technique for preferred application in commercial and military equipment. Eye-lets are plated into specified holes at the same time the circuits are plated on one or both sides of each board. Thus, positive front-to-back connections are assured and solder connections to components made easier. Bond strength is outstanding. Remember, General Electric Thru-Con boards are available to your custom specifications. Why not investigate Thru-Con today!



Electronic
COMPONENTS

New General Electric Delay Stick . . .

- ★ The Industry's First, Low-Cost Signal Delay Unit
- ★ Developed Especially For Color Television

Receiver design engineers and purchasing agents take note! This *economical delay stick* can be made to your specifications from 0.2 to 1.0 microseconds delay. Available with or without terminating or compensating networks.

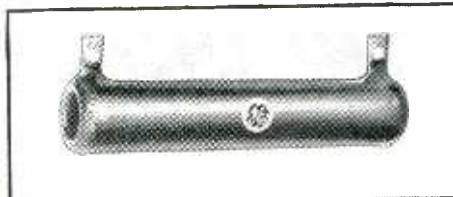

G-E KOR-LES RESISTORS. Famous for reducing resistor weight by as much as 50%. Other outstanding features include high power ratings and small size to make this ideal for new 600 ma. series filament connections. A wide variety of sizes and types for selection.

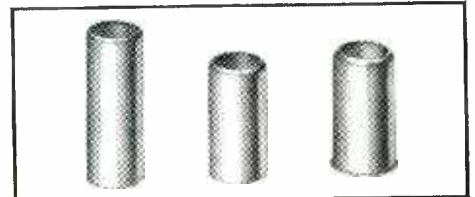

G-E MINIATURE TUBE SHIELDS (for 7 and 9-pin tubes). Miniature wrap-around types for efficient shielding in radio and TV circuits. Sizes 1 7/8", 1 1/4" and 1 3/8". Ideal for those who demand economy of space and cost. Bulk orders promptly delivered.

OUR EXPERT APPLICATION ENGINEERS WILL ADVISE YOU!

General Electric Company, Components Department
1811 LeMoyné Avenue, Syracuse, New York

Please send me literature and further details on your:

- Thru-Con Boards
 Color TV Delay Stick
 Kor-Les Resistors
 Tube Shields
 Have an Application Engineer Call

NAME.....

ADDRESS.....

CITY.....STATE.....

GENERAL  ELECTRIC

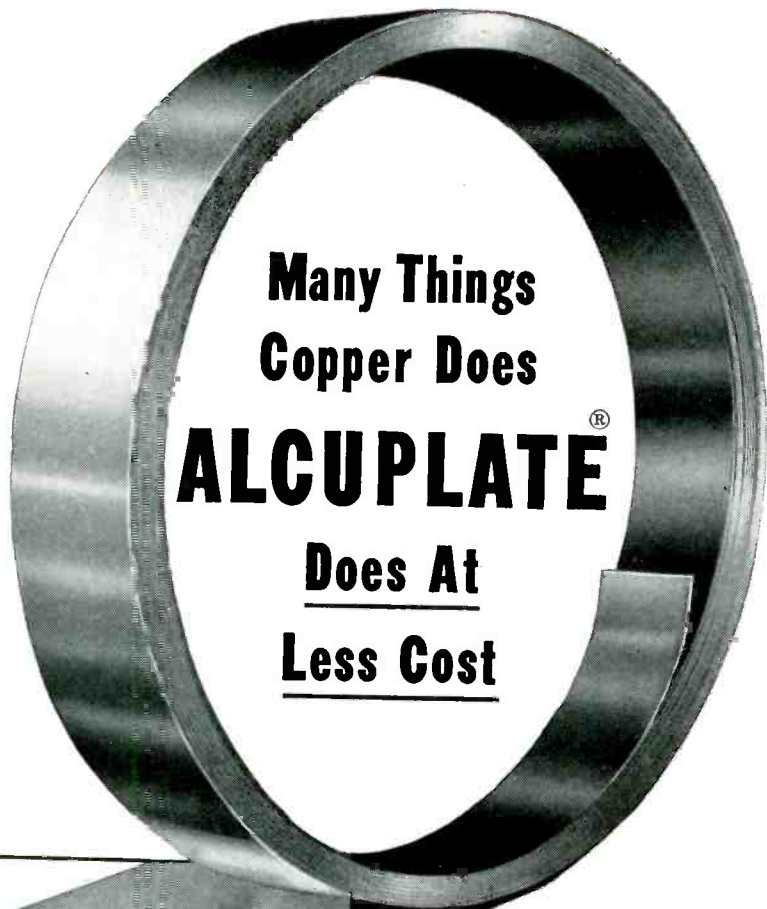

Many Things
Copper Does
ALCUPLATE[®]
Does At
Less Cost

COPPER
ALUMINUM

COPPER
ALUMINUM
COPPER

ALCUPLATE FEATURES

- Natural copper appearance
- High electrical conductivity
- Excellent heat dissipation
- Soft-soldering surfaces
- Easy fabrication
- Light weight

Q How can you reduce the cost of copper or brass in your parts or products?

A Get the same copper surface area and natural thickness with less copper.

And that is *exactly* what ALCUPLATE does. ALCUPLATE is a solid layer of copper permanently clad — to one side or both sides of less expensive aluminum.

THUS  ON ONE SIDE

OR THUS  ON BOTH SIDES

THIS gives you solid copper performance at a 15 to 30% lower cost over solid copper.

Yet, in addition to this cost reduction, ALCUPLATE provides virtually the same physical and electrical properties as solid copper.

FABRICATING PROPERTIES

ALCUPLATE can be fabricated by stamping, drawing, spinning and forming. The copper provides an ideal surface for soft-soldering operations, electroplating or other finishes.

SIZES AVAILABLE

ALCUPLATE is available in coils or flat stock up to 1/16" thick x 13" wide and in a choice of thickness ratios and tempers.

For further information, write or wire

ALCUPLATE[®]

METALS & CONTROLS CORPORATION
GENERAL PLATE DIVISION
311 FOREST ST., ATTLEBORO, MASS.



ELECTRONIC Test and Production INSTRUMENTS

For the producer of electronic or microwave systems, FXR provides a distinctive service . . . with quality components that measure up to the finest standards of design, craftsmanship and performance. The FXR line of Test and Production Microwave Equipment consists of Electronic Instruments and Waveguide Components.

These Electronic Instruments, which include Antenna Pattern Analyzers and High Power Pulse Modulators, were designed throughout by FXR en-

gineers and produced in quantity in our own large plant. The Waveguide Components consist of such units as rotary joints, waveguide switches, horns, cavities, dummy antennas and loads, antenna scanners, and duplexers.

Whether for tube production, radar systems, microwave relay units, or guided missile applications . . . whether the project is large or small . . . FXR has the experience and facilities to produce your special needs accurately, swiftly—at lowest cost.

Custom Engineered and Built

HIGH POWER PULSE MODULATORS

These rugged line type modulators are custom engineered for continuous operation. Ease of operation, minimum of high voltage hazard, and maximum accessibility of all components are uppermost considerations in the design.

14 MEGAWATT UNIT Type Z821A

- Input voltage 440 or 550 volts—3 phase
- Internal signal generator for trigger pulse
- Output pulse for external synchronization
- Motor driven high voltage and heater controls
- Automatic voltage backdown on magnetron sparking
- Output voltage—90 kv at 160 amperes
- Output Z = 560 ohms
- PFN—2.0 microseconds at 500 cycles/sec
- Maximum duty = .001
- Internal pulse voltage and current viewing facilities

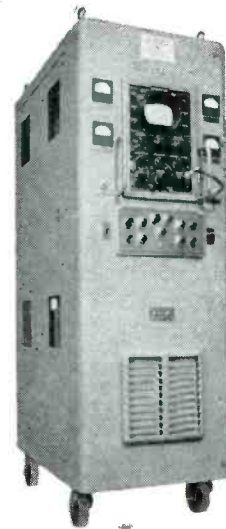
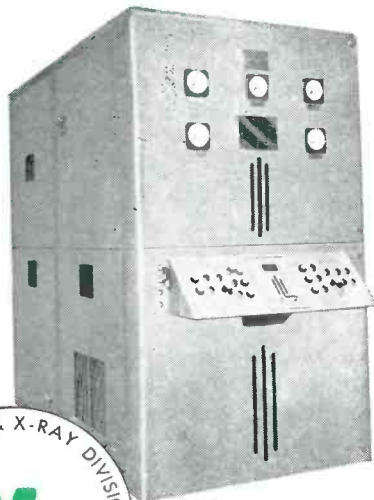

ONE MEGAWATT UNIT Type Z820A

- Input Voltage—190—250 V single phase
- Provisions for mounting internal synchroscope
- Remote control operation
- Motor driven high voltage and heater controls
- Output Z = 1000 ohms
- PFN1—0.5 microseconds at 2000 cycles/sec
- PFN2—2.5 microseconds at 400 cycles/sec
- Internal pulse voltage and current viewing facilities

Data subject to change without notice. Prices on application.

Custom Engineered and Built

ANTENNA PATTERN ANALYZERS

Type T705A

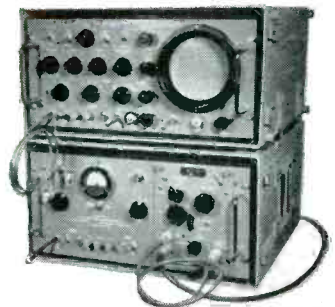

FXR ANTENNA PATTERN ANALYZERS are general purpose test equipments designed for measuring the radiation patterns of rotating antenna systems. The analyzer, a receiver and indicator unit, has the following characteristics:

- Visual pattern display
- Response vs angle of rotation
- 1 to 10 kmc
- Four plug-in r-f heads
- Superheterodyne receiver
- Single knob oscillator control
- CW or pulsed operation
- Field or laboratory use



Electronics & X-Ray Division

F-R MACHINE WORKS, Inc.

26-12 BOROUGH PLACE, WOODSIDE 77, N. Y.

WRITE
TODAY
FOR
COMPLETE
CATALOG

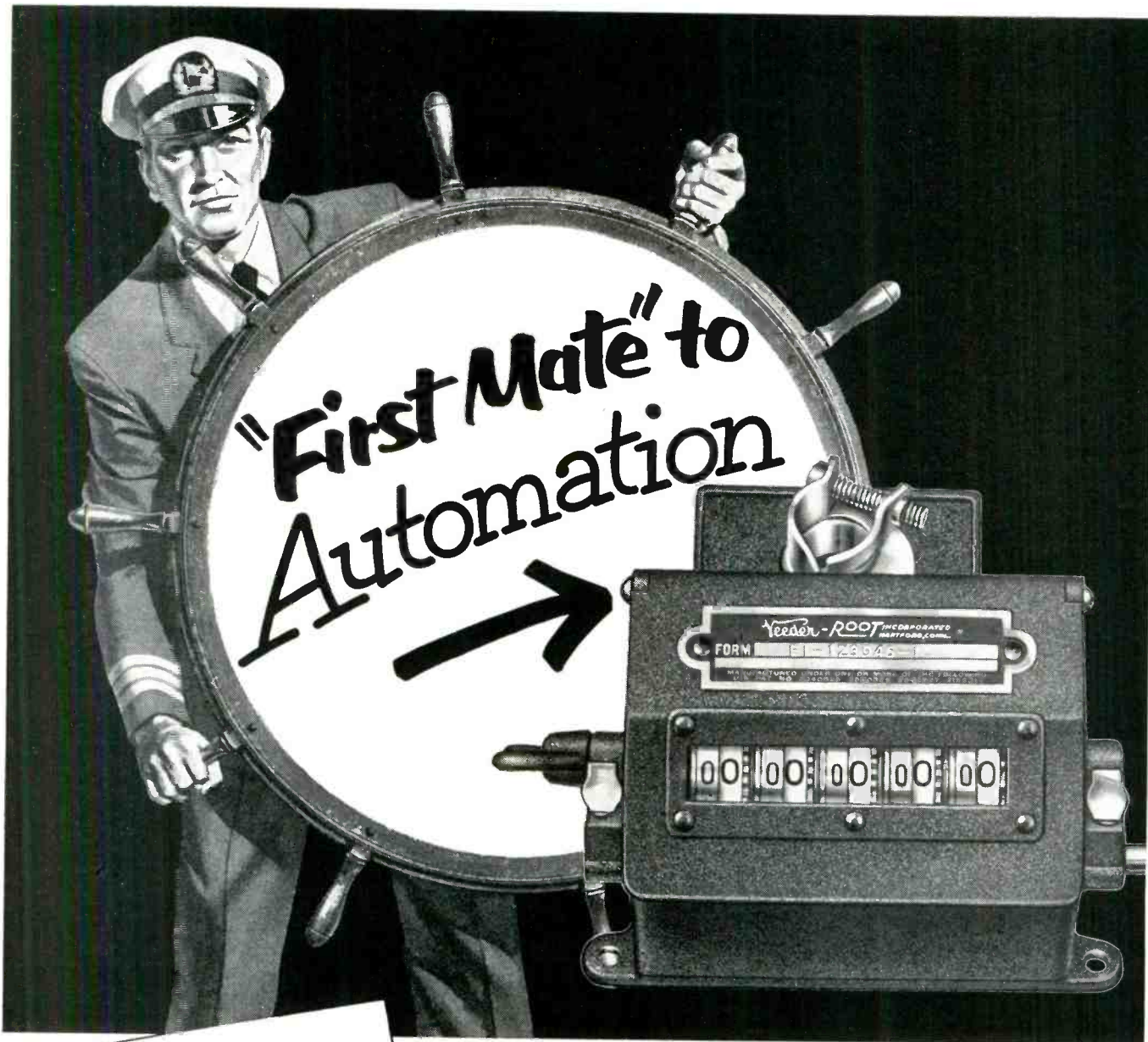

Added Evidence
that . . .

Everyone Can Count on **VEEDER-ROOT**

In figuring out new systems of automatic electrical control, Veeder-Root Control can supply vital connecting links. For instance, this Predetermining Counter can be hooked into such a system to light a light, ring a bell, or actuate a mechanism to stop a machine or process *at any pre-set point*. And there are many other Veeder-Root Counters that can serve as "count-components" in almost any way desired. Or special counters can be designed for specific applications. Engineers in any industry, now engaged in working out automatic control systems, can count on Veeder-Root engineers to work with them on any problem where reliable facts-in-figures are needed.

VEEDER-ROOT INCORPORATED • Hartford 2, Connecticut



Chicago 6, Ill. • New York 19, N. Y. • Greenville, S. C. • Montreal 2, Canada
Dundee, Scotland • Offices and Agents in Principal Cities

"The Name That Counts"

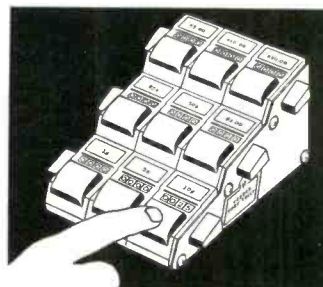

New Vary-Tally Multiple-Unit Reset Counter comes in any combination up to 6 banks high, and 12 units wide. Write for news sheet and prices.

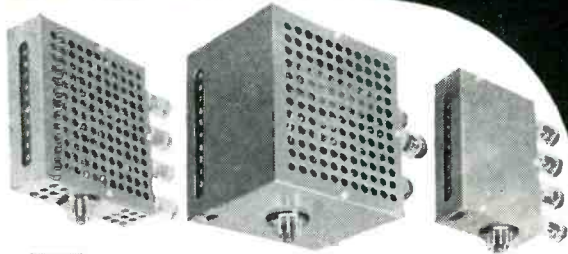

LFE's DECADE SCALERS

Model 1700 Series

- 0-10 Mc covered in four ranges, 40 Kc, 100 Kc, 1 Mc and 10 Mc Max.
- Direct Decimal Display throughout, including 10 Mc
- Individual Stage Outputs available on most types
- Low Power Consumption

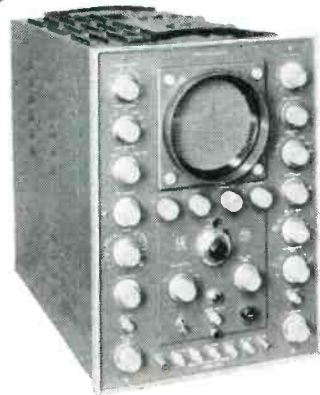

LFE's OSCILLOSCOPE Model 411

- X-Axis Plug-in Adapters for More Uses
- DC to 10 Mc Bandwidth • 15 Mv per Cm Sensitivity, AC or DC • 1 μ Sec. to 1 Second Sweeps

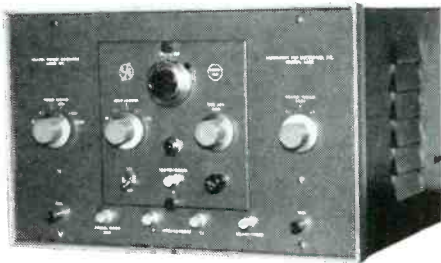

LFE's DELAYED TRIGGER GENERATOR

Model 901

- 1/2 to 100,000 Microsecond Range • 1% Absolute Accuracy • 0.3% Differential Accuracy (short term) • Internal Triggers Available

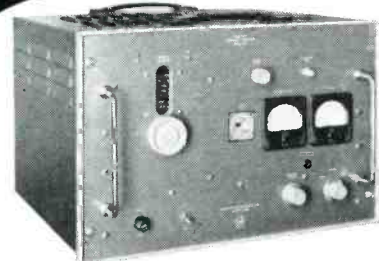

LFE's ULTRA-STABLE MICROWAVE OSCILLATORS

Model 804

- Holds frequency to 1 part in 100,000,000
- Available in X-band, C-band and other microwave frequencies • 15% Modulation when stabilized, 100% without stabilization from 1000 to 24,000 Mc/s
- Calibrated directly in frequency

Outstanding **RECENT**
developments from

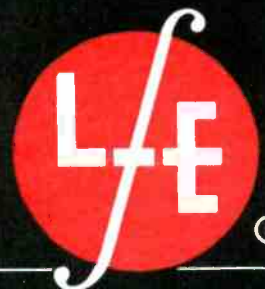

LABORATORY FOR ELECTRONICS, INC.

75 Pitts Street

Boston 14, Mass.

Creative developments in the field of electronics

Inquiries on export sales
should be addressed to:
Andrew S. Szucs, Inc.,
50 Broad Street,
New York 4, N. Y.

Here's what this PULSED-CARRIER GENERATOR does for you...



The RADA-PULSER SR., is a CW, pulsed-carrier and video pulse generator, covering the 12 to 80 mc range in five overlapping bands, with a wide choice of pulse widths and repetition rates. In conjunction with an oscilloscope, or a synchroscope, it may be used to obtain a graphic display of the steady state and transient response of r-f and i-f amplifiers.

RADA-PULSER SR. SPECIFICATIONS

CARRIER FREQUENCY RANGE:

12 to 80 mc in five bands.

OUTPUT:

A—CW: 0.25 volts at 50 ohms.

B—Rectangular Pulsed Carrier: 0.25 volts into 50 ohms.

C—Video Pulse: 0.5 volts negative into 50 ohms.

D—Video Pulse: 5 volts negative into 500 ohms. (10 volts open circuit)

"PULSE OFF" LEVEL:

Minus 80 db.

HARMONIC CONTENT:

$\frac{1}{2}$ x frequency, — 20 db.

$1\frac{1}{2}$ x frequency, — 30 db.

2 x frequency, — 10 db.

PULSE WIDTH:

Calibrated, from 0.2 to 20 microseconds.

PULSE RISE AND RATE OF FALL:

0.03 microseconds.

PULSE REPETITION RATE:

Calibrated, 300 to 3000 pps.

OUTPUT ATTENUATOR:

50 ohms constant impedance. 101 db max. in steps of 0.5 db.

PRICE:

\$745.00, f.o.b. Pine Brook, N. J.

Write for 1954-55 CATALOG

KAY ELECTRIC COMPANY

14 MAPLE AVE. · CALDWELL 6-4000 · PINE BROOK, N. J.

PRECISION TEST AND MEASURING INSTRUMENTS FOR LABORATORY, PRODUCTION AND FIELD

Facts behind the S-1 Timer's extraordinary .005 Sec. ACCURACY

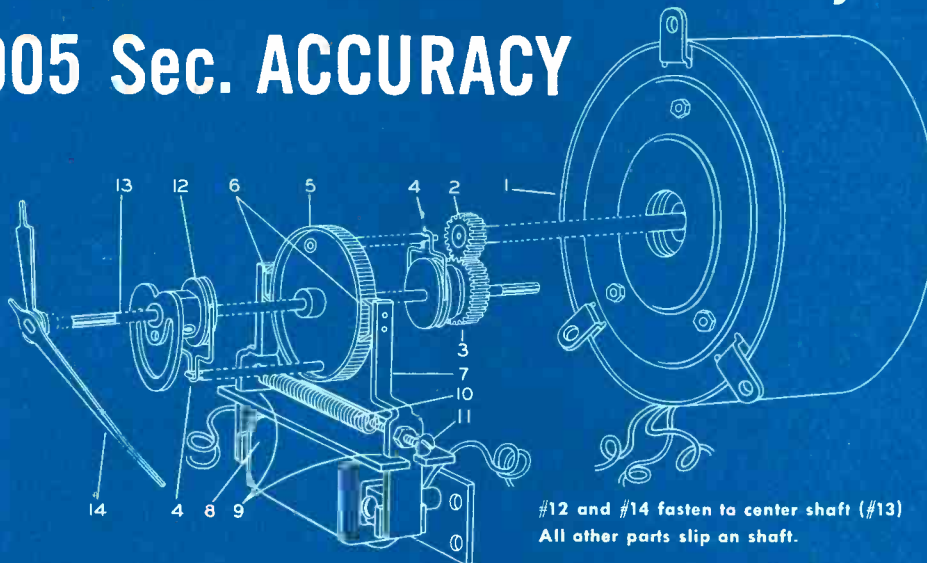

Formula S-1 Expensive high torque, ball bearing motor, low inertia of moving parts, high proportion of precision and ground parts, no thrust bearings as found in ordinary clutches.

- High torque (2 inch-ounce at 100 RPM) industrial grade motor (#1) with no internal gear train so small changes in load due to binds or hand acceleration cause no phase shift between rotor and rotating field . . . runs continuously to eliminate starting error.

- Precision cut gears (#2, #3). Any eccentricity or inaccuracies in gearing reflect directly in timer reading.

- Slip clutch composed of hardened steel spring (#4) riding a V-grooved graphited (for long wear) collet, applies .6 inch-ounces of torque to aluminum (for low inertia) control disc (#5) with 314 tiny teeth in its periphery.

- To hold control disc (#5) at rest, 2 hardened steel brake shoes (#6), ground to square knife edges, grip periphery of control disc in 4 places . . . control disc position to under 1/2 of a degree (1/720 second).

- Electro magnet (#8) pulls brake shoes away from control disc through armatures (#7). Air gaps kept to minimum for speed. Precision made fulcrums prevent stickiness or unequal movement of armatures.

- Adjusting screw (#11) adjusts tension of armature spring (#10) so that time between energizing magnet coil and starting of control disc is same as time between de-energizing magnet coil and stopping of control disc. This compensates for starting and stopping errors.

- Second friction clutch (#12) transfers control disc motion to center staff (#13); allows hands to be reset when control disc is held stationary.

"Gentlemen . . . Let me give you the formula for our astounding final accuracy of .005 sec. obtained with our D-C clutch S-1 Timer."



STANDARD

SINCE 1884

To Split the Split Second with ACCURACY,
Take a Minute Now and Send Us This Coupon

The STANDARD ELECTRIC TIME COMPANY

97 LOGAN STREET • SPRINGFIELD 2, MASS.

PRECISION TIMERS • PIPELINE NETWORK ANALYZERS
LABORATORY PANELS • CHRONO-TACHOMETERS

THE STANDARD ELECTRIC TIME COMPANY

97 Logan Street • Springfield 2, Massachusetts

Gentlemen: Please send me complete
Engineering Data on the S-1 Timer.

Name _____

Firm _____

Street _____

City _____ State _____

Build performance into servo systems — with Honeywell Components



● converters

Compact, durable; proved by years of service in *ElectroniK* recorders. Convert low power d-c signals to alternating voltages for nominal frequencies of 25, 40, 60 or 400 cycles, as specified. Useful for null detection or error voltage measurement. Refinements in design give low phase angle lag and extremely long life. Ask for Data Sheets 10.21-1 and 10.20-5.

● amplifiers

For use with converter and balancing motor, for null detection and error signal correction. See Data Sheets 10.20-3b and 10.20-4.

Amplifier No.	Input Impedance (ohms)	Sensitivity* (volts)	Overall Voltage Gain
357504-20	80,000	3×10^{-6}	1×10^6
357504-21	80,000	1×10^{-6}	3×10^6
357504-5	400	4×10^{-6}	1×10^6
356899	2,200	$.05 \times 10^{-6}$	40×10^6

*Approximate sensitivity, when used with motors listed below.

● balancing motors: 2-phase induction, reversing

Totally enclosed, self lubricated. High torque at low speeds. See Data Sheet No. 10.20-2c.

Ratings for 115 volt, 60 cycle operation†				
Shaft Speed, rpm	27	54	162	33
Maximum Torque, inch-ounces	85	43	19	11
Intermittent Rated Torque, inch-ounces	30	15	5	4
Maximum Power, inch-ounces per minute	5850 at 14-16 rpm	5800 at 30-32 rpm	7550 at 92 rpm	8750 at 190 rpm
Power Required, all speeds	Line Field, 11 watts Amplifier Field, 2.5 watts			

†Motors for 25 and 40 cycle service are also available. Above motors may be used on 50 cycles.

THESE precision-built components, used in *ElectroniK* recorders, are available as separate units or as complete systems for experimental servo circuits. Your inquiry is invited.

MINNEAPOLIS-HONEYWELL REGULATOR Co., Industrial Division, Wayne and Windrim Aves., Philadelphia 44, Pa.



MINNEAPOLIS
Honeywell
BROWN INSTRUMENTS

First in Controls

Exciting New Development

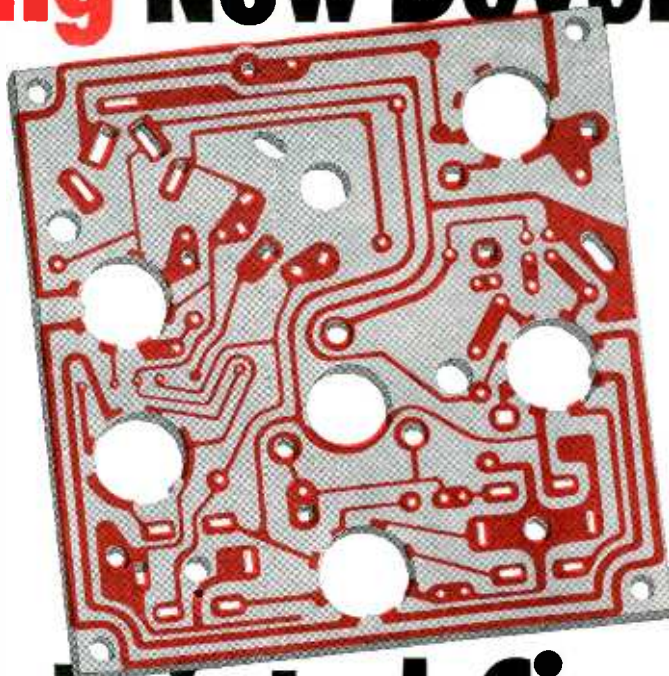

Photo courtesy
Methode Manufacturing Corp.
Chicago, Ill.

in Printed Circuits!

New CuCLAD* copper-clad laminate offers unequalled bond strength, heat resistance, solderability, punchability, electrical performance!

Here's the foil-clad laminate you've been waiting for! It's CuCLAD LAMICOID®—made possible by an entirely new concept in bonding material, specially designed equipment developed exclusively by Mica Insulator Company. This new bond and unique bonding method give you unequalled performance that's consistent and dependable from sheet to sheet, lot to lot. *Trade-mark

You get all these advantages:

- A STRONGER BOND WHICH IMPROVES WITH AGE AND HEAT**
- BETTER HEAT RESISTANCE**
- BETTER REACTION TO HOT SOLDER**
- BOND ELECTRICALLY EQUAL TO LAMINATE**
- IMPROVED ARC RESISTANCE**
- SUPERIOR PUNCHABILITY**
- UNIFORMITY**

and CuCLAD LAMICOID is competitively priced!

CuCLAD LAMICOID is available NOW, in several grades. Tell us your requirements or problems—or ask to have a Mico Sales Engineer call.

LOOK AT THESE TYPICAL PRODUCTION RUN VALUES ON 6028 XXXP CuCLAD LAMICOID:

BOND STRENGTH —Guaranteed min: 6 lb.; avg. 9 lbs. (90° peel at 2 lbs./min.)	
SOLDER TEST —Guaranteed no blisters @ 230-240° C. for 10 seconds, 1" square floated on molten solder	
HEAT RESISTANCE —Guaranteed no change at 150° C. for ½ hour in air-circulated oven, air flow parallel to specimen	
PUNCHABILITY —Excellent	
SURFACE RESISTIVITY, megohms	
C-96/35/90	7.3 x 10 ⁴
VOLUME RESISTIVITY, megohm cm.	
C-96/35/90	3.7 x 10 ⁵
WATER ABSORPTION	
1/16" th., E-1/105 + D-24/23	
copper on	0.1%
1/16" th., E-1/105 + D-24/23	
copper removed	0.7%



MICA *Insulator* **COMPANY**

Schenectady 1, New York

Offices in Principal Cities

In Canada—Micanite Canada, Ltd., Granby, Quebec

LAMICOID® (Laminated Plastic) • MICANITE® (Built-up Mica) • EMPIRE® (Coated Fabrics and Papers) • FABRICATED MICA • ISOMICA®

Look to Cppc for Synchro Progress

FOR IMMEDIATE DELIVERY!



Actual Size
SIZE 10
 .937" diameter



Actual Size
SIZE 11
 1.062" diameter



Actual Size
SIZE 15
 1.437" diameter

Next

SIZE 22

2.161" diameter

Next

SIZE

8

.750"
 diameter

CLIFTON PRECISION now offers these high accuracy, low weight synchros in practically every type of size 10, 11 and 15 as stock, off-the-shelf items for immediate delivery.

Also, virtually any variation of these same units is obtainable. For example:

- Synchros wound to customer's specific requirements
- Special shaft lengths and shapes
- High impedance units
- Feed back windings
- Special core materials
- Linear generators

For customer's special application:

- Flux valve couplers—very low flux levels
- 30~ to 5000~ use (phase shifters)
- Sawtooth wave use—usable up to 100,000~ or higher with special windings
- Computer elements with high accuracy, high linearity

Although we are prepared to serve your special needs, we urge the use of standard units wherever possible for speed of delivery and economy to you.

For full information, drawings etc., write or telephone:
 T. W. Shoop, Sales Mgr., Clifton Heights, Pa. MAdison 6-2101 (Suburban Phila.)
 West Coast Rep. Wm. J. Enright, 988 W. Kensington Rd., Los Angeles. MUtual 6573.

Cppc

CLIFTON PRECISION PRODUCTS CO. INC.

CLIFTON HEIGHTS



PENNSYLVANIA

"PIG-TAILORING"

. . . . a revolutionary new mechanical process for higher production at lower costs. Fastest PREPARATION and ASSEMBLY of Resistors, Capacitors, Diodes and all other axial lead components for TERMINAL BOARDS, PRINTED CIRCUITS and MINIATURIZED ASSEMBLIES.

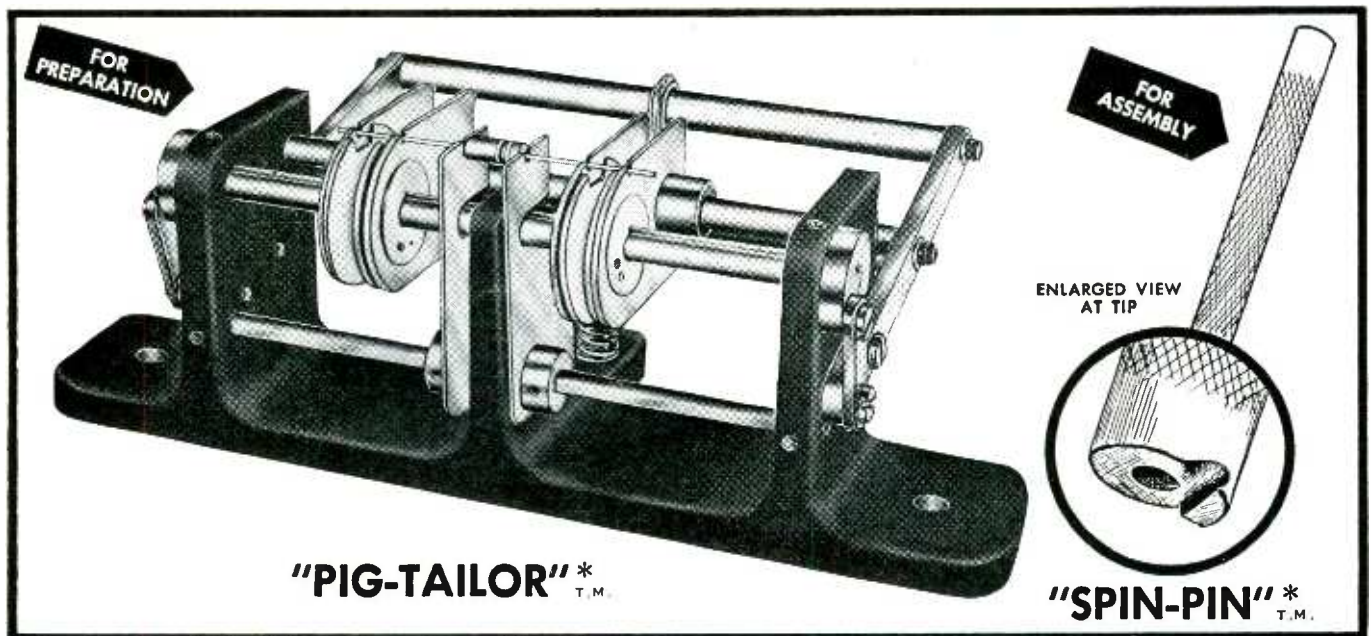

The "PIG-TAILOR" plus "SPIN-PIN" — Accurately Measures, Cuts, Bends, Ejects and Assembles both leads simultaneously to individual lengths and shapes — 3 minute set-up — No accessories — Foot operated — 1 hour training time.

PIG-TAILORING provides:

1. Uniform component position.
2. Uniform marking exposure.
3. Miniaturization spacing control.
4. "S" leads for terminals.
5. "U" leads for printed circuits.
6. Individual cut and bend lengths.
7. Better time/rate analysis.
8. Closer cost control.
9. Invaluable labor saving.
10. Immediate cost recovery.

PIG-TAILORING eliminates:

1. Diagonal cutters!
2. Long-nose pliers!
3. Operator judgment!
4. 90% operator training time!
5. Broken components!
6. Broken leads!
7. Short circuits from clippings!
8. 65% chassis handling!
9. Excessive lead tautness!
10. Haphazard assembly methods!

* PATENT
PENDING

Write for illustrated, descriptive text on "PIG-TAILORING" to Dept. E-11

BRUNO-NEW YORK INDUSTRIES CORPORATION
DESIGNERS AND MANUFACTURERS OF ELECTRONIC EQUIPMENT
460 WEST 34th STREET • NEW YORK 1, N. Y.



new

BACK-MOUNTING TEST JACKS
 permit bench soldering to wiring harness before mounting.

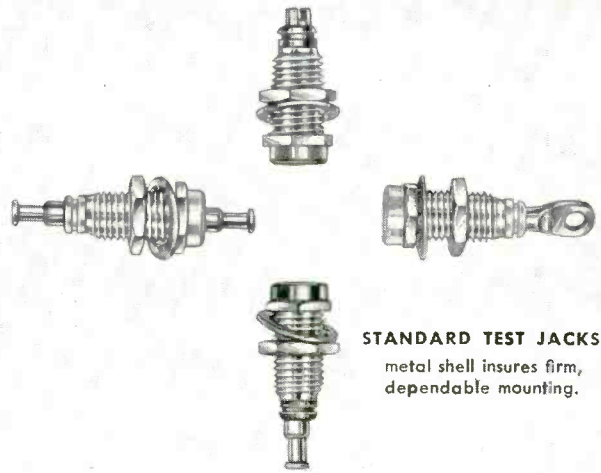
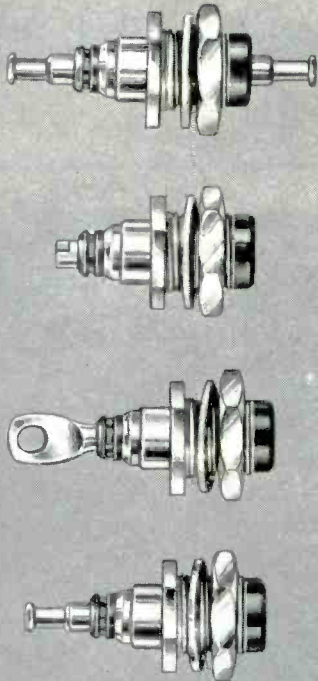

STANDARD TEST JACKS
 metal shell insures firm, dependable mounting.



ALL-NYLON THREADED INSULATOR
 low capacity to panel and high voltage breakdown.

Test Jacks by Ucinite

The introduction of Ucinite's back-mounting jacks makes available for the first time a *complete* line of *high quality* test jacks suitable for use in equipment where long life and dependability are essential.

Ucinite Test Jacks, designed for standard .080 phone tips, are available in a variety of colors ideally suited to coded application. Silver-plated, heat treated beryllium copper contact is made in one piece with large terminal ends for easy solder-

ing. The feed through type is provided with a one-piece brass terminal stud, tin-plated.

The specialized abilities and experience of Ucinite's own staff of design engineers are available for work on new and unusual problems. Volume production facilities ensure fulfillment of the largest requirements.

For full information, call your nearest Ucinite or United-Carr representative or write directly to us.

The
UCINITE CO.
Newtonville 60, Mass.
 Division of United-Carr Fastener Corp.

} **Specialists in**
ELECTRICAL ASSEMBLIES,
RADIO AND AUTOMOTIVE

Costs go tumbling...

when standard
Radio Receptor rectifiers
 do the work of
 specials in magnetic
 amplifier applications

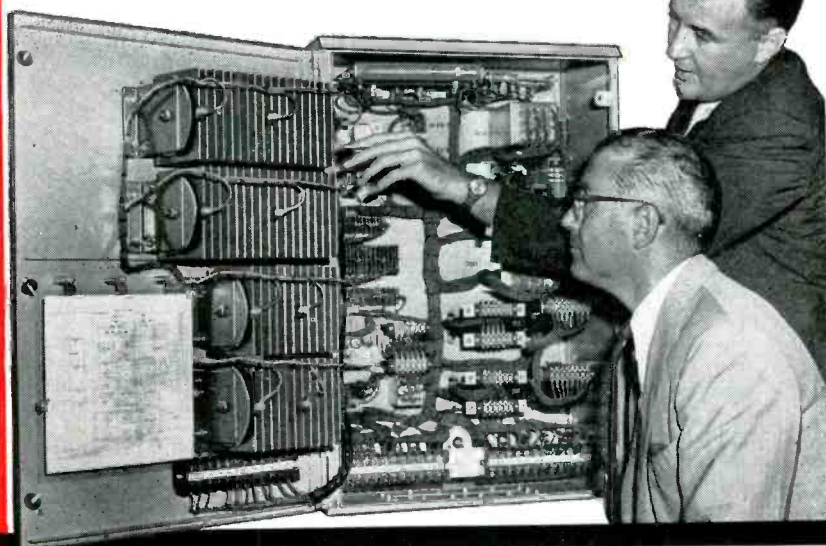

Mr. Dornhoefer (upper right) inspects current production of magnetic amplifier regulator with Mr. J. F. Hysler. Rating of the motor generator set it regulates:

Output: 5KVA, 120 V,
 3 phase, 400 cycles.
 Input: 175 to 345 V, DC.
 Regulation accuracy:
 ±0.5% on both voltage
 and frequency.
 Ambient temperature: 50°C.
 Made for and has passed
 H. I. shock tests.

Here's a magnetic amplifier regulator just off the production line at Regulator Equipment Corp.'s plant in Paterson, N. J. It includes eight RADIO RECEPTOR selenium rectifier types using standard quality cells for a total of 18 units in all, and regulates the voltage and frequency of 400 cycle motor generator sets aboard many of Uncle Sam's submarines.

"The decision to use standard stacks," says Warren Dornhoefer of Regulator Equipment Corp., "is governed by such factors as desired magnetic amplifier performance, reactor core material, ambient temperatures, power supply frequency and many others. Naturally we aim for the right combination to give best overall results."

"It has been our experience," continues Mr. Dornhoefer, "that the standard RADIO RECEPTOR stacks we use perform highly satisfactorily in this mag-amp application and in others we have designed and produced. When we see such excellent results from the regular stacks we prefer to be realistic — particularly when delivery and cost are factors."

Naturally, stock rectifiers are not always the answer for every magnetic amplifier circuit. We can and do supply specials where necessary. We suggest you let us study your specs the next time you require rectifiers for this purpose. Chances are we can save you money — and time!

We also manufacture transistors and silicon and germanium diodes.

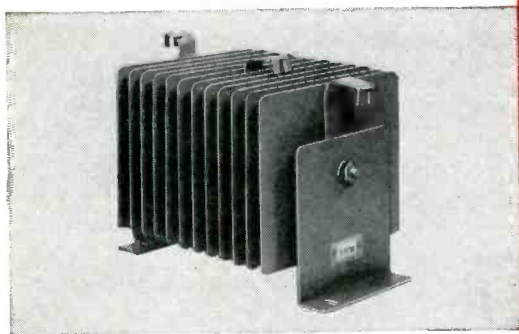

One of the Radio Receptor rectifiers incorporated into Regulator Equipment Corp.'s magnetic amplifier regulator.

Semi-Conductor Division
RADIO RECEPTOR COMPANY, INC.
In Radio and Electronics Since 1922

SALES DEPARTMENT: 251 WEST 19TH STREET, NEW YORK 11 TELEPHONE: WATKINS 4-3633, FACTORIES IN BROOKLYN, N. Y.

Really



Reliable

New!

LAMBDA MODEL 71 PORTABLE POWER SUPPLY

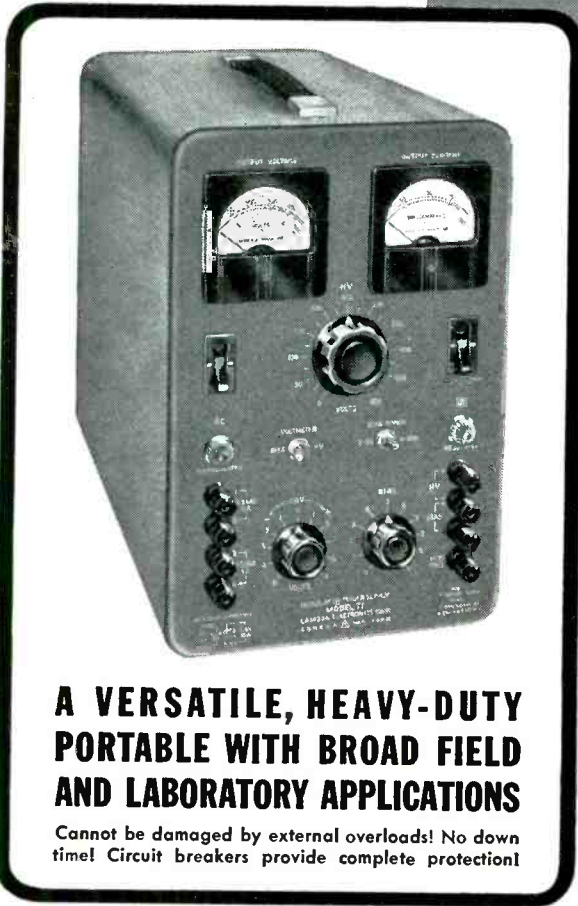

A VERSATILE, HEAVY-DUTY PORTABLE WITH BROAD FIELD AND LABORATORY APPLICATIONS

Cannot be damaged by external overloads! No down time! Circuit breakers provide complete protection!

WIDE RANGE! 0-500 VDC @ 0-200 MA
LIGHT! Weighs only 49 lbs.
COMPACT! 13" high, 8 $\frac{3}{4}$ " wide, 14 $\frac{1}{2}$ " deep

A de luxe unit that combines every good engineering feature with maximum compactness and portability.

\$289⁵⁰

F.Q.B. Factory, Corona, N. Y.

SPECIAL FEATURES

- Overload Circuit Breakers.
- AC and DC Circuit Protection
- No "Down Time" due to External Overloads
- Stable 5651 Reference Tube
- Vernier High Voltage Control
- Hermetically-Sealed, Oil Filled Condensers
- Time Delay Tube Protection
- All-Aluminum Construction
- Made by America's Leading Power Supply Specialists

SPECIFICATIONS FOR LAMBDA MODEL 71 PORTABLE

INPUT..... 105-125 VAC, 50-60 CPS, 475 W (max)

DC OUTPUT NO. 1 (regulated for line and load)

Voltage..... 0-500 VDC (continuously variable)

Current..... 0-200 MA (over entire voltage range)

Regulation (line)..... 0.15% or 0.3 volt (whichever is greater)

Regulation (load)..... 0.15% or 0.3 volt (whichever is greater)

Internal Impedance..... Less than 4 ohms

Ripple and Noise..... Less than 5 millivolts rms

Polarity..... Either positive or negative may be grounded

DC OUTPUT NO. 2 (regulated for line only)

Voltage ranges: Internal Impedances:

(a) 0-50 VDC (no load) 5,500 ohms

(b) 0-200 VDC (no load) 25,000 ohms

Current range:

Any value of external load impedance may be used including continuous low impedance or short-circuit. Insignificant inter-action on Output No. 1 Short Circuit Current: 9 MA (Max.)

Regulation (line)..... Better than 0.1%

Ripple and Noise..... Less than 5 millivolts rms

Polarity..... Positive terminal connected internally to negative terminal of DC Output No. 1.

AC OUTPUTS (unregulated)

Two outputs, isolated and ungrounded. Each is 6.5 VAC at 5A (at 115 VAC input). Allows for drop in connecting leads. May be connected in series for 12.6V (nominal) at 5A, or in parallel for 6.3V (nominal) at 10A.

AMBIENT TEMPERATURE AND DUTY CYCLE:

Continuous duty at full load up to 40°C (104°F) ambient.

OVERLOAD PROTECTION:

External overload protection..... AC and DC magnetic circuit breakers. Trip-Free. Instant manual reset. Front panel.

Internal failure protection..... Fuses, access through rear of cabinet.

INPUT AND OUTPUT CONNECTIONS:

Input..... 8 foot heavy duty rubber covered line cord with integral molded plug, rear of cabinet.

Output..... Sturdy insulated "5-way" binding posts, front panel.

METERS:

Output voltage..... Multi-range 3 $\frac{1}{2}$ " rectangular voltmeter calibrated 0-50 VDC, 0-200 VDC, 0-500 VDC.

Output current..... 3 $\frac{1}{2}$ " rectangular milliammeter calibrated 0-200 MA.

VOLTAGE REFERENCE TUBE:

A stable 5651 reference tube is used to obtain superior long-time voltage stability.

TIME-DELAY RELAY CIRCUIT:

A 30 second time delay circuit is provided to allow tube heaters to come to proper operating temperature before high voltage can be applied.

SIZE AND WEIGHT AND FINISH:

Size..... 13" H x 8 $\frac{3}{4}$ " W x 14 $\frac{1}{2}$ " D

Weight..... 49 lbs.

Finish..... Two-tone gray



LAMBDA Electronics Corp.

THE FIRST NAME IN POWER SUPPLIES

103-02 NORTHERN BLVD. • CORONA 68, NEW YORK • TWINING 8-9400

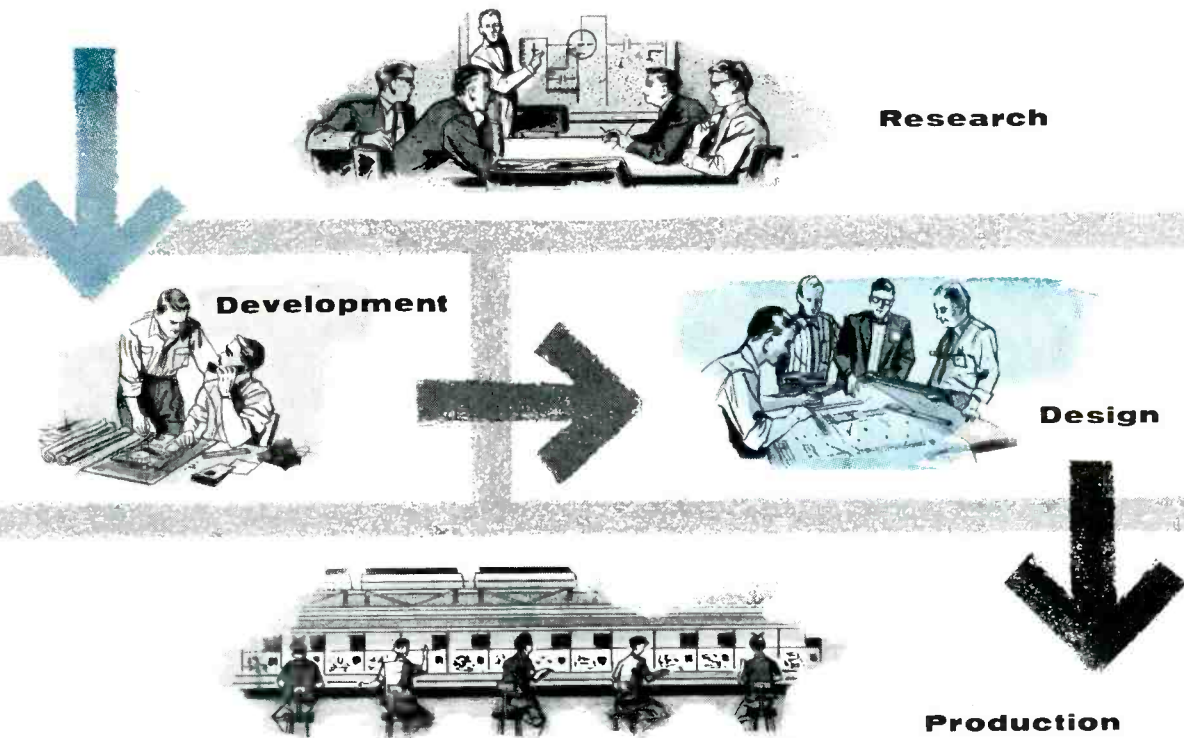

AN INTEGRATED ELECTRONICS OPERATION

Navigational Gear
 Guided Missiles
 Radar
 Noise Rejection
 Countermeasures
 Computers
 Communications
 Terminal Equipment
 Transistors



Hoffman's reputation for getting things done is due, in part, to the unification of Research-Development-Design-Production into one closely integrated electronics operation. At Hoffman — instead of the usual four completely separate operations — one technical director is assigned to co-ordinate each new project from start to finish. Every new project is developed in close cooperation with the divisions ahead, including the practical problems of quantity production. This integration practically eliminates the all-too-common duplications and overlapping of functions, the errors and re-work caused by poor liaison, and materially cuts down the usual time lag between the testing of the prototype and actual production. Hoffman has become a leader in electronics by doing progressively complex jobs — to specifications — to cost estimates — and on schedule.

Write for your copy of a
REPORT FROM HOFFMAN LABORATORIES

HOFFMAN LABORATORIES, INC.
 A Subsidiary of Hoffman Radio Corp.
 3761 South Hill Street, Los Angeles 7, California

Challenging opportunities for outstanding electronics and mechanical engineers. Write Director of Engineering.

▶
**this
 control
 needed
 protection**

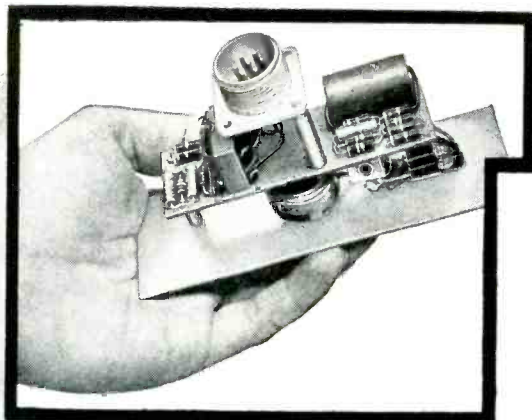

here's the easy way they ▶
 protected it with

NOPCO® LOCKFOAM

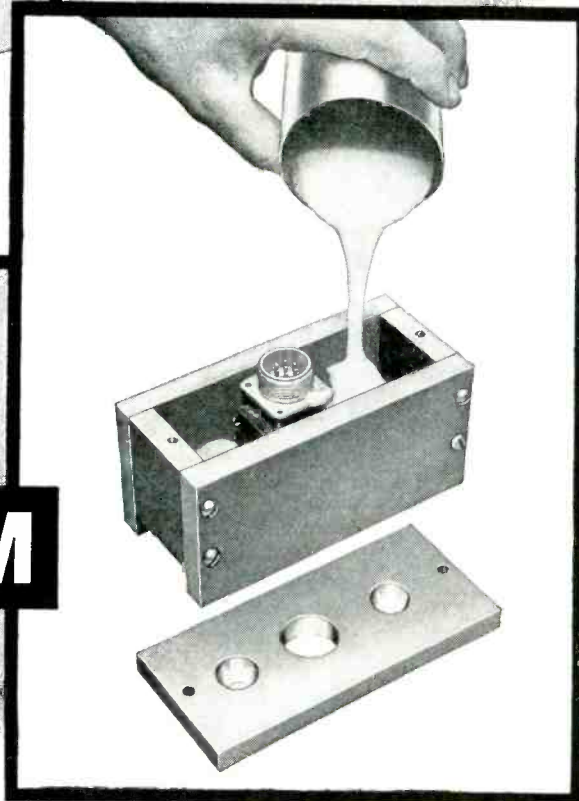

▶
**result: a
 complete
 barrier
 against
 vibration,
 corrosion,
 dampness,
 fungi**

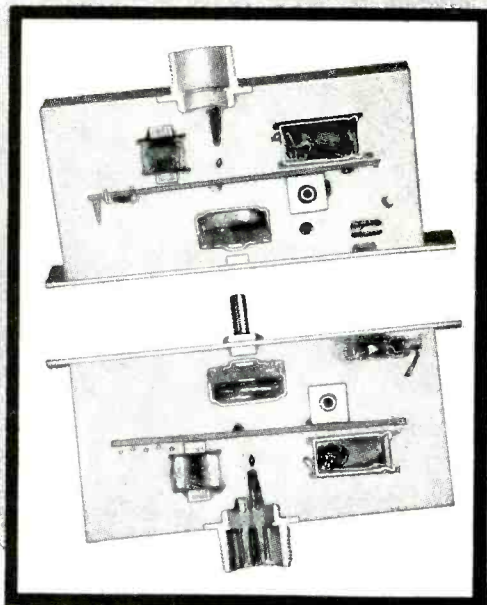

Hamilton Standard Division, United Aircraft Corporation, needed a potting material for the electronic temperature control unit that governs cockpit air-conditioning—found Nopco Lockfoam ideal for the purpose.

Nopco Lockfoam is indeed ideal for this and many other similar tasks because of the absolute protection it affords against damage from severe vibration. Its light-weight closed-cell structure makes a tamper-proof assembly, and gives a high impermeability to dampness, corrosion, and fungi growth. Also, its pour-in-place technique effects great economy of assembly time.

Further, each of the 50 different formulations available is highly consistent and reproducible.

Perhaps the rare combination of properties of this versatile plastic can help with some product you have in mind. *Write today for the Nopco Lockfoam booklet.*

Where Can YOU Best Use These Properties?

Near-perfect Radar Transmission

Ease of Fabrication
 It's "poured-in-place"

Great Strength with Light Weight

Excellent Electrical Properties
 6 lb/cu ft Lockfoam tested at 9.375 KMC
 Dielectric Constant 1.05
 Loss Tangent .0005

Good Thermal Insulation
 "K" Factors
 .018 at 8 lb/cu ft
 to .025 at 11 lb/cu ft

Wide Range of Densities
 From 2 to 35 lb/cu ft

Great Versatility
 50 different formulations available

Plastics Division

NOPCO
CHEMICAL COMPANY

Harrison, New Jersey

4858 Valley Blvd., Los Angeles 32, Calif.



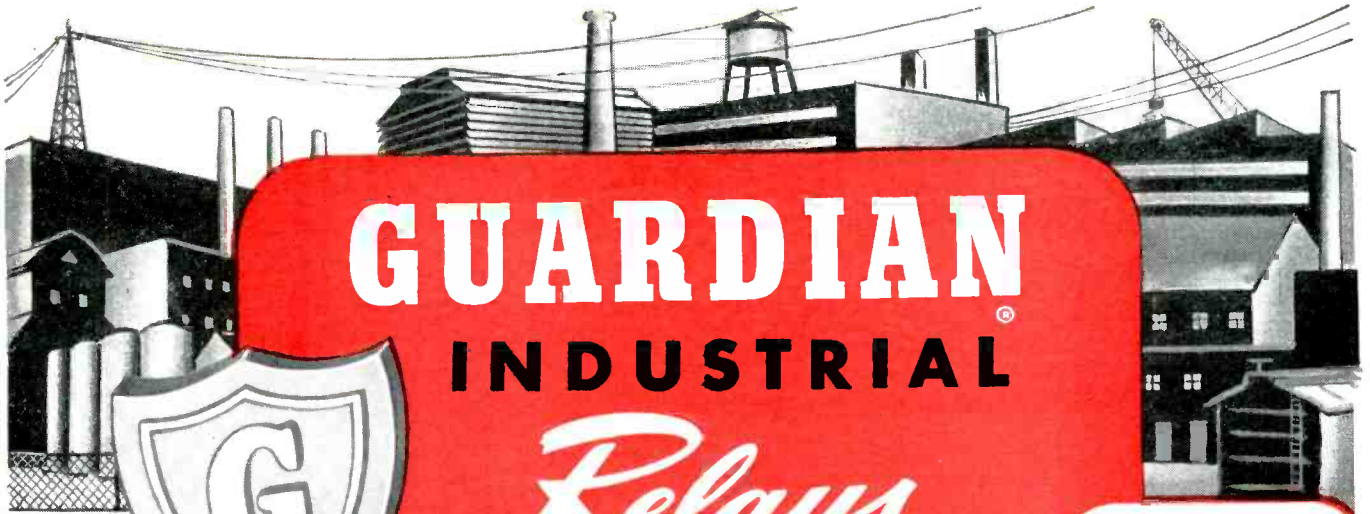

GUARDIAN INDUSTRIAL *Relays*

Versatile — Efficient — Low Priced

CARRYING OFFICIAL UNDERWRITERS LABORATORIES APPROVAL, the Guardian Series 100 and Series 600 Relays are immediately available in production quantities in an unusually wide variety of coil and contact arrangements for either A.C. or D.C. operation. Standard units range from 6 to 230 Volts (also 5000-V. plate circuit coils) with contact combinations up to four pole, double throw.

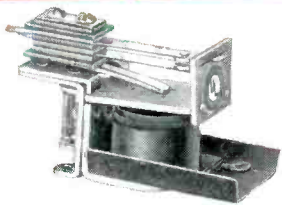

Series 100 A. C.

Simplicity of installation, sturdy, with minimum adjustment. An ideal relay for quantity buyers.

Underwriters Laboratories Approved.



GUARDIAN ENGINEERS KIT

Kit contains supply of various contact switch blades and includes all parts necessary for complete switch assembly. Order yours today!

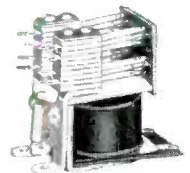

Series 600 A. C.

The Series 600 is a sturdy, compact, lightweight general purpose industrial relay.



Underwriters Laboratories Approved

Guardian Relays Available to Meet  Specifications

POWER TYPE



Series 220 A.C. High current capacity combines with dual contact arrangement to insure long-life. Applications include hand dryers, motor and stoker control.

INSTRUMENT CONTROL

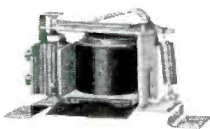

Series 120 A.C. This low cost, compact relay has proved extremely popular for fast-action instrument control for burglar alarms, smoke control systems.

SENSITIVE TYPE



Series 5 D.C. Operates on a minimum of power. Especially suited for electronic timers, high speed counters, telephone dialing and emergency lighting or signaling.

HEAVY DUTY

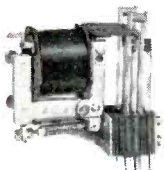

Series 30 A.C. with laminated field piece and armature is ideal for electric scoreboards, elevators, broadcast circuits, public address systems.

TELEPHONE TYPE

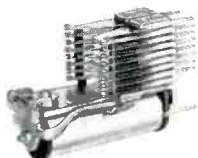

Series 405 D.C. Sturdy, lightweight, carries up to 10 P.D.T. contacts. Vibration resistant. Pin type armature bearing. Frequently used in plate circuit phototubes.

COMMUNICATIONS



Series 595-P D.C. Tiny, powerful. Combines pin type bearing feature with enlarged field piece, longer coil. Also hermetically sealed.

STEPPERS—SOLENOIDS—SWITCHES—COMPLETE CONTROL ASSEMBLIES

Write FOR FREE RELAY CATALOG NO. 10-C
GUARDIAN  ELECTRIC
 1625-M W. WALNUT STREET CHICAGO 12, ILLINOIS
 A COMPLETE LINE OF RELAYS SERVING AMERICAN INDUSTRY

How to measure the depth of D. Jones' locker

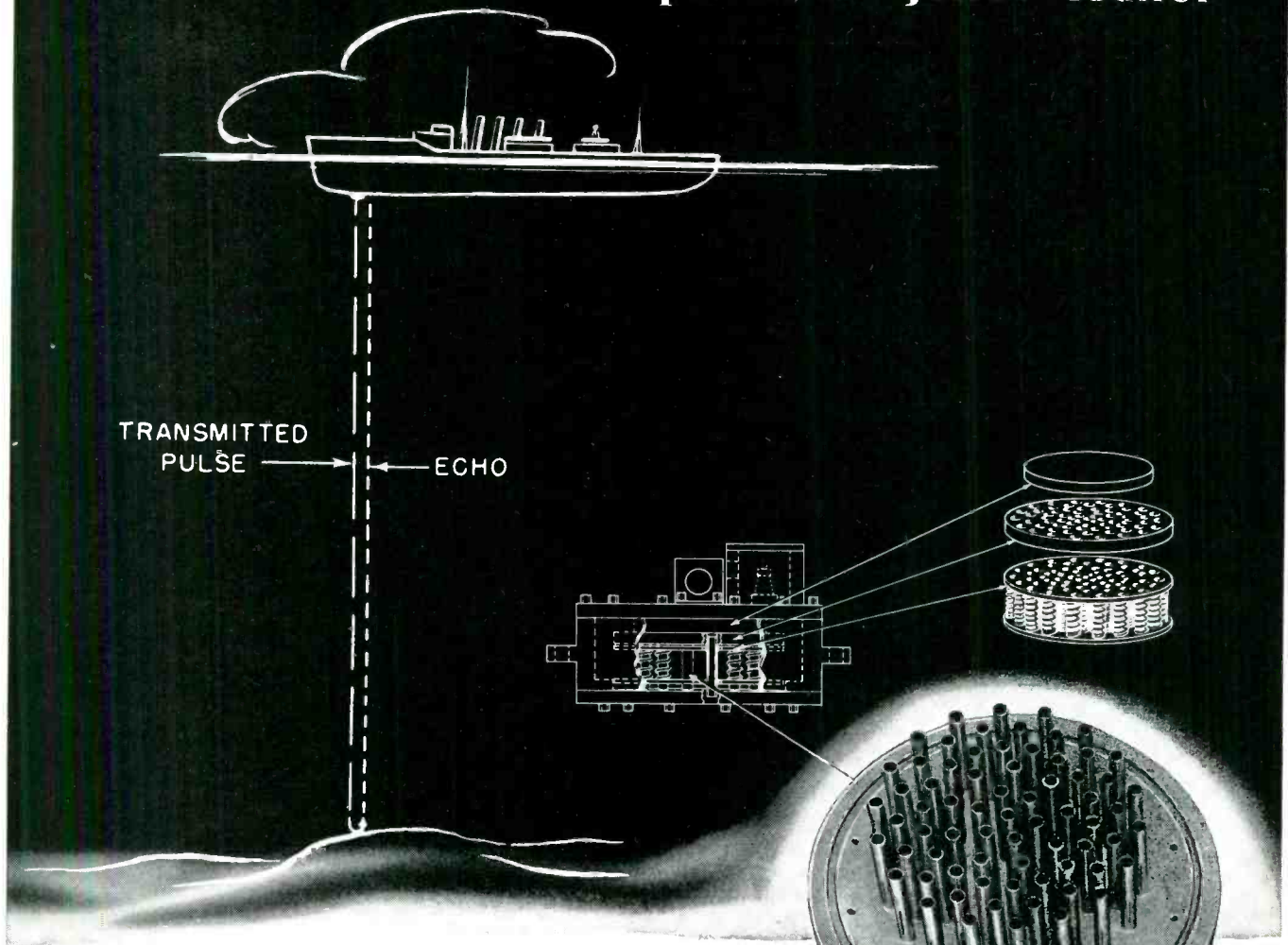

Best insurance against running aground is sonar . . . echo sounding equipment.

RCA Victor Division of Radio Corporation of America uses the phenomenon of magnetostriction to send and receive supersonic pulses and so determine the distance to a submerged object on the ocean's floor.

Magnetostriction—the familiar “Joule Effect” of your textbook days—is the ability of a ferromagnetic metal to change dimensions when magnetized. The metal of RCA echo sounding equipment is Superior Grade “A” nickel tubing.

70 pieces of Superior seamless nickel tubing, cold drawn to $\frac{3}{8}$ ” O.D. x .020” wall thickness and cut to $\frac{1}{4}$ of the wave length of the alternating current signal, are soldered to a plate. Each length is enclosed by a coil.

Energizing the coil with alternating current, the tube expands and contracts, creating a piston effect on plate and diaphragm, sending out a supersonic wave. Likewise, reception of the echo wave by the diaphragm again causes the nickel tubes to pulsate and induce a current in the coil.

RCA Victor looks to Superior for accuracy and uniformity of analysis, precision drawing and cutting in large quantities. For cathodes, anodes, or tubing specialties, and tubing technology—ask Superior. Superior Tube Company, 2500 Germantown Avenue, Norristown, Pa.

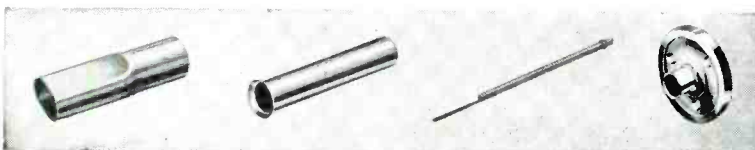

Seamless Nickel Anode. Flattened one end. .500” O.D. x .025” Wall x 1.625” long.

Seamless Nickel Cathode. Round, flanged one end, .070”/.072” I.D. x .0025” Wall. .295” long.

Lockseam* Nickel Cathode. Round, tabbed, single bead, .045” O.D. x .0021” Wall. 27 mm long.

Disc Cathode .121” O.D. .312” long.

Superior
THE BIG NAME IN SMALL TUBING

All analyses .010” to $\frac{3}{8}$ ” O.D.
Certain analyses in Light Walls up to $2\frac{1}{4}$ ” O.D.

Many types of nickel cathodes—made in Lockseam* from nickel strip, disc cathodes, and a wide variety of anodes, grip cups and other tubular fabricated parts are available from Superior. For information and Free Bulletin, address Superior Tube Company, Electronics Division, 2500 Germantown Avenue, Norristown, Pa.

*Manufactured under U.S. Patents.

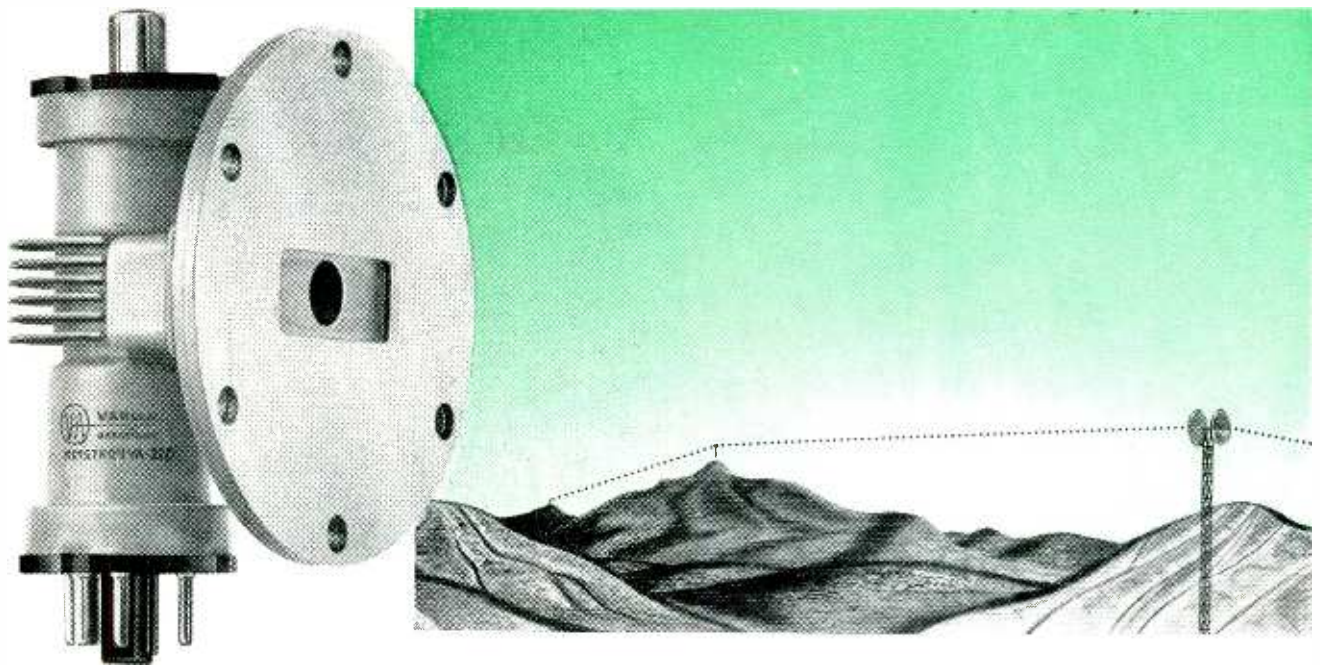

NOW...at **half** the former cost

VARIAN brings you

A NEW, HIGH PERFORMANCE RELAY KLYSTRON

It's the VA-220, another outstanding example of Varian design leadership . . . research and product engineering that brings you the most dramatic cost reduction in the history of high performance klystrons — **with no compromise in quality.**

**UNSURPASSED
FOR EVERY
RELAY APPLICATION**

Microwave relay system designers and equipment buyers have long known that Varian relay klystrons are unmatched for frequency stability, power to override noise, reliability and long life. The VA-220 gives you performance that even exceeds the high standards set by Varian X-26 klystrons . . . at half the cost.

In the 6000-8000 megacycle band, VA-220 klystrons will consistently outperform all others. Here are six reasons why this sensational new klystron is your best buy for all relay applications:

**THESE ADVANTAGES
MEAN TOP PERFORMANCE**

- **Greater Power**—VA-220 high power klystrons are conservatively rated. They will deliver more than rated power without failure.
- **Greater Frequency Stability**—VA-220 klystrons have negligible frequency drift.
- **Greater Uniformity**—Varian mass production techniques assure uniformity — every klystron is as reliable as a nut and bolt.
- **Longer Life**—VA-220 klystrons can be operated at full power for thousands of hours, at low power for years.
- **Less Distortion, Less Noise**—FM distortion and inherent noise are negligible — 60 db below a 1-megacycle deviation.
- **Lower Cost**—VA-220 klystrons cost far less than any other relay klystron with comparable performance characteristics.

TYPE	FREQUENCY RANGE	RESONATOR VOLTAGE	POWER OUTPUT	BANDWIDTH	MODULATION SENSITIVITY
VA-220*	5925 - 7425 mc	750 v	1.2 watts	35 mc	375 kc/v
*VA-220 B, C, D, E and F each cover a frequency range of approximately 300 mc					

FOR COMPLETE SPECIFICATIONS . . . and technical data on the VA-220 and other Varian klystrons, write to the Varian Application Engineering Department today.

IN KLYSTRONS,
THE MARK OF
LEADERSHIP IS



VARIAN associates
PALO ALTO 1, CALIFORNIA

Representatives in all principal cities.

PLUG-IN UNITS

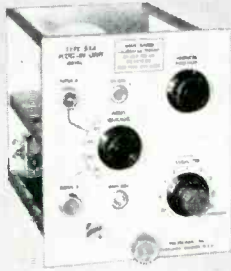

TYPE 53A — DC to 10 mc, 0.035 μ sec risetime; 0.05 v/cm to 50 v/cm, calibrated \$85

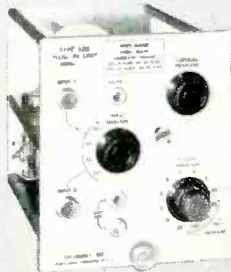

TYPE 53B — Same as Type 53A with additional calibrated ac-sensitivity to 5 mv/cm. . . . \$125

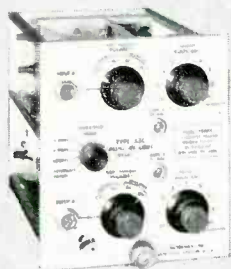

TYPE 53C — Dual-trace unit. Two identical amplifier channels, dc to 8.5 mc, 0.05 v/cm to 50 v/cm. Electronic switching triggered by oscilloscope sweep . . . or free running at about 100 kc. . . . \$275



TYPE 53D — Differential input, high gain, DC to 350 kc at 1 mv/cm — pass-band increasing to 2 mc at 50 mv/cm. Full range — 1 mv/cm to 125 v/cm . . . \$145

EASY?



RIGHT! But there's more here than convenience. There's better performance than you've known . . . over a far wider range than you'd expect. This method of quick conversion provides for the future, too . . . offering adaptability to new work at the moderate cost of a new plug-in unit.

You'll save valuable engineering time and accomplish much more with a Tektronix Type 531 or Type 535. The money you invest will work harder, longer.

OSCILLOSCOPE CHARACTERISTICS

Wide Range of Triggered Sweeps

0.02 μ sec/cm to 12 sec/cm, continuously variable.
24 calibrated sweeps from 0.1 μ sec/cm to 5 sec/cm, accurate within 3%.
Accurate 5-x magnification.

High Writing Rate

10 kv on new precision crt — permits photographing single sweeps at the fastest sweep speed.

Wide-Band Output Amplifier

DC-coupled amplifier designed for use with all Type 53-Series Plug-In Units.

TYPE 531 — \$995 plus price of desired plug-in units.

TYPE 535 — same characteristics — plus delayed sweeps. 1 μ sec to 0.1 sec calibrated delay in 12 ranges, incremental accuracy within 0.2% of full scale. Conventional or triggered operation . . . \$1300 plus price of desired plug-in units.

Balanced Delay Network

0.25 μ sec signal delay in vertical amplifier.

Sensitive Horizontal Amplifier

0.2 v/cm to 20 v/cm sensitivity.

Versatile Triggering

Internal or external, with amplitude level selection or automatic triggering.

Square-Wave Amplitude Calibrator

0.2 mv to 100 v in 18 steps, accurate within 3%.

DC-Coupled Unblanking

CRT Beam Position Indicators

Electronic Power-Supply Regulation

Prices f.o.b.
Portland (Beaverton), Oregon

Your Tektronix Field Engineer or Representative will gladly arrange a demonstration at your convenience . . . Call him today.



Tektronix, Inc.

P. O. BOX 831A • PORTLAND 7, OREGON
CYPRESS 2-2611 • CABLE: TEKTRONIX

THIS RUNDEL-BUILT VARIABLE VOLTAGE CONTROL PANEL is designed for controlling three motors, each with five selective speeds. Major components include Ward Leonard A-C and D-C contactors, starters, relays and resistors.

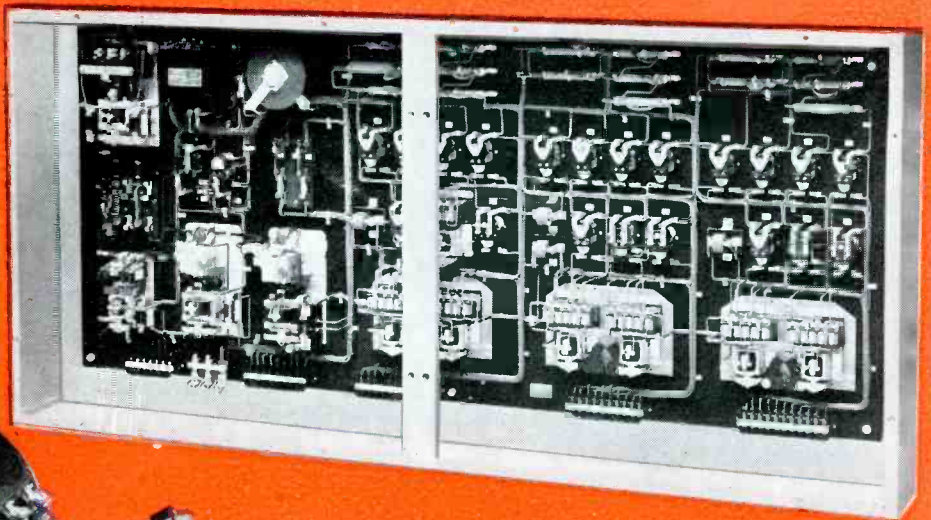

Photo courtesy Rundel Electric Co., San Francisco, Calif.



It's here... one-stop shopping FOR control components

Whether you're building, buying, or using controls, you'll find every A.C. or D.C. component you need at Ward Leonard.

That includes components for automation control, processing machinery, variable voltage speed control (Ward Leonard System of Control), machine tool control, conveyor system, air conditioning and other controls.

Here's what one-stop shopping at Ward Leonard gives you:

- Coordinated design gives matched performance between components.
- Quality-controlled manufacture assures uniformly excellent performance of each component.
- Broad selection cuts shopping headaches, time, costs.
- Ward Leonard design minimizes required panel size.
- Ward Leonard design simplifies engineering requirements.
- See back of page for extreme versatility of W.L. components.

A Ward Leonard engineer will be glad to show you our complete line of coordinated components for your control application. Or write for control catalog to Ward Leonard Electric Co., 600 South St., Mount Vernon, New York.

5 major control components make W. L. line complete

1. A.C. and D.C. CONTACTORS — solenoid type, multi-pole, wide range of accessories.
2. A.C. and D.C. MAGNETIC RELAYS — standard and specialty types like vibrating field, field loss, anti-plugging, etc.
3. A.C. STARTERS — Manual and magnetic, full or reduced voltage, single- or multi-speed.
4. RHEOSTATS — Ring, plate and face plate types, manual or motor driven.
5. RESISTORS — Low, medium or high current for control circuit, motor starting, etc.



**WARD LEONARD
ELECTRIC COMPANY**
MOUNT VERNON, NEW YORK



RHEOSTATS



RESISTORS



RELAYS



MOTOR CONTROLS



DIMMERS



CHROMASTER

Result-**E**ngineered Controls Since 1892

1 contactor... 3 basic models... 6 major variations... 1000 combinations

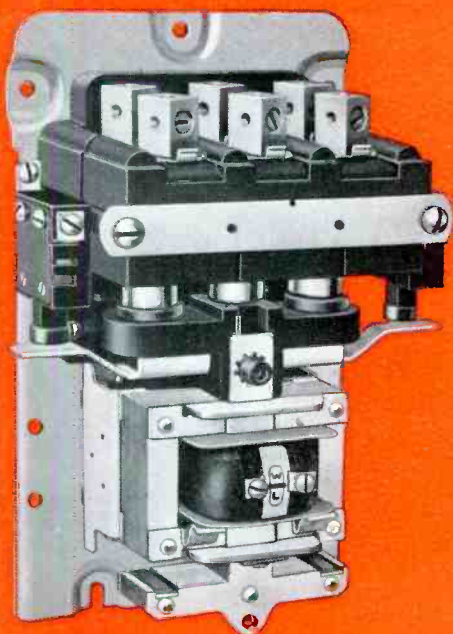

Size 2 A.C. contactor.

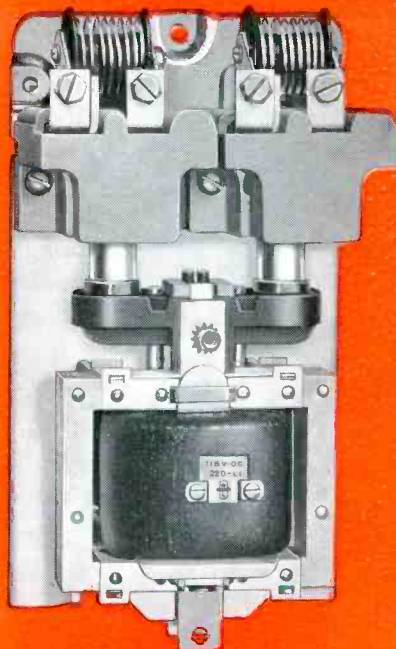

Size 2 D.C. contactor.

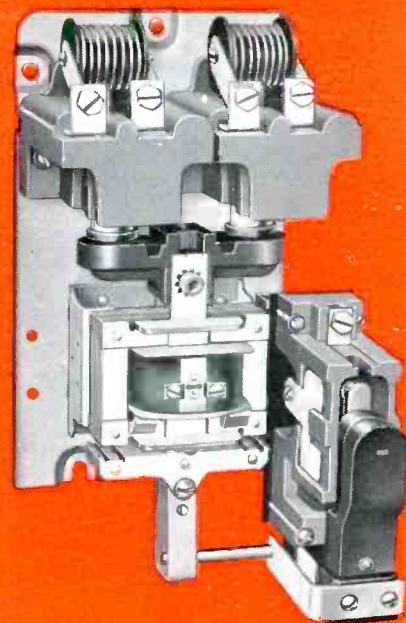

Size 2 D.C. with A.C. power plant and dynamic brake.

Here's what's available from the three basic models illustrated above:

1. Size 2 A.C. solenoid contactor
2. Size 2 A.C. starter
3. Size 2 A.C. solenoid contactor with D.C. power plant*
4. Size 2 D.C. solenoid contactor
5. Size 2 D.C. solenoid contactor with A.C. power plant
6. Contactors above with left- or right-hand integral dynamic brake**
7. Contactors above with: a) base mounted auxiliaries, b) side mounted auxiliaries, c) base mounted low power auxiliaries (precious metal for electronic circuits).
8. Contactors above with mechanical interlocks, either horizontal or vertical types.
9. The size 3 D.C. solenoid contactor (single pole, with or without dynamic brake) has same mounting base plate as the Size 2.

* Equipped with continuous duty D.C. coils.

** D.B. contact can be used as a normally closed power contact.

Here's why you save time and money when you use Ward Leonard contactors in building your controls:

- **Minimum stock** is all you need, thanks to unmatched versatility of Ward Leonard controls.
- **Less panel space** is needed with W.L. designs.
- **Lower assembly costs** with W.L. steel based units (for D.C. too) to eliminate expensive insulating panels.
- **Less layout and drafting time** is required.
- **All D.C. coils are continuous-duty type.**
- **Fewer renewal parts** are needed.

Write for control catalog to Ward Leonard Electric Co., 600 South St., Mount Vernon, New York.

4.9



WARD LEONARD
ELECTRIC COMPANY
MOUNT VERNON, NEW YORK



RHEOSTATS



RESISTORS



RELAYS



MOTOR CONTROLS



DIMMERS



CHROMASTER

Result-**E**ngineered Controls Since 1892

CONFIDENCE

• You can place your orders for printed circuitry and allied electronic sub-assemblies in the hands of Photocircuits Corporation with assurance of satisfaction for these reasons:

SUCCESS. Photocircuits Corporation has produced more printed circuits of the etched foil variety than any other company. It has an unexcelled reputation for reliability of quality and production performance. Photocircuits Corporation has played the largest part in bringing to maturity the young printed circuit industry.

RESEARCH, a never-ending activity at Photocircuits Corporation, does not stop with experimentation on production methods! Many suppliers, as well as its customers, have benefited greatly by Photocircuits' research efforts. Photocircuits Corporation's initiative has been the bulwark and bellwether of the industry's development of a variety of insulator-conductor laminates for printed circuitry.

SPECIALIZATION. At Photocircuits Corporation "printed circuitry" is the sole aim and product. Engineering and production staffs concentrate only on producing the best for each application of electronic and electrical circuitry... extending to switches, commutator discs etc.

TECHNICAL AUTHORITY. Coupled with actual production, the Photocircuits Corporation technical staffs have developed for the trade press authoritative information to aid the entire industry. This is also the product of pioneering, of concentration, of successful achievement. Engineering bulletins, furthermore, have been produced on all phases of design and production of printed circuitry. These are available to all on request.

Photocircuits
CORPORATION

Pioneers in Cost-Cutting Printed Circuit Techniques
Glen Cove 4-4000 • FLushing 3-5050



BOSTON: 25 Huntington Ave. • Commonwealth 6-7705
CHICAGO: 4258 W. Irving Park Rd. • Palisades 5-1170
PHILADELPHIA: 1531 Spruce St. • Kingsley 5-1205
ROCHESTER, N. Y.: 3 Juniper St. • CUlver 7635
LOS ANGELES: 7407 Melrose Ave. • WEbster 3-7276
DAYTON, O.: 1521 Burroughs Drive • RAndolph 5907
KANSAS CITY, MO.: 903 McGee St. • VICTor 8090



The information indicated in the coupon is yours on request.

PHOTOCIRCUITS CORPORATION

Dept. E11, GLEN COVE, N. Y.

Please send us the literature items checked:

- 1954 Engineering Brochure
- P-1 Fabrication
- P-2 Base Materials
- P-3 Platings & Plated-Thru Holes
- P-4 Etched or Plated Conductor Characteristics
- P-5 Printed Components
- P-6 Switch Plates & Commutator Discs
- P-7 Assembly & Dip Soldering
- P-8 Layout & Design

NAME.....

COMPANY.....

ADDRESS.....

CITY.....ZONE.....STATE.....

* Trade Mark

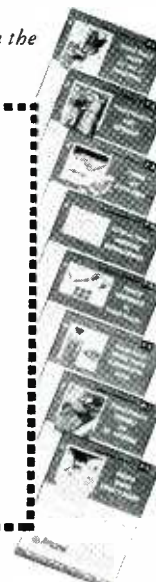



Solid Side Rack Cabinet

Rack Panel And Shelf Assembly

Copper Tubing Inductor

Sectionalized Control Desk From Gates Cabinet Factory

Special Dial Plate

Power Tube Socket

Meter Shorting Switch

Gates
MANUFACTURES MANY THINGS FOR THE *Electronic* INDUSTRY

Yes — many Gates manufactured items are supplied to other manufacturers or directly to users. More and more for quality and fast service, Gates is relied upon for both standard and special design items. Try Gates first whether the need is large or small. You will be pleasantly surprised.

Variable Edgewise Inductor

Solenoid Relay

100KW Transmission Line Bracket

Hi-Power Dummy Antenna

Studio Signal Light

Cast Aluminum Rack Mounting Assembly

Power Meter Shorting Switch

Open Side Rack Cabinet



GATES RADIO COMPANY

QUINCY, ILL., U. S. A.

Manufacturing Engineers Since 1922

Houston, 2700 Palk Avenue
 New York, 51 East 42nd Street

Washington, D. C., Warner Bldg.
 Los Angeles, 7501 Sunset Blvd.
 New York International Div., 13 East 40th St.

Atlanta, 13th & Spring Sts.
 Montreal, Conadiar Marconi Co.

**NOW
AVAILABLE**

BENDIX-PACIFIC MINIATURE ELECTRIC MOTORS

- 1 TIME-TESTED DESIGN** Part 452008. More than 100,000 Bendix-Pacific LM-108 Geneva-Loc rotary electric actuators have been in use over the past 10 years. Split series 24 V-D.C. or 110 V-A.C. Rated at 2.5 oz. inches intermittent duty to 160° F. Weight 13 oz. Reversible and unirotational with or without integral filter.
- 2 VERSATILE, SMALL DESIGN** Part 1007690. Used in Bendix-Pacific LM-128 Square-Motor rotary electric actuator. Split series, 24 V-D.C. Size: 1 inch square by 2 inches long. Rated at 4 oz. inches torque, intermittent duty to 165° F. Can operate satisfactorily up to 300° F. Weight: 6 oz. Reversible or unirotational. Motor designed to AN-M-40 and MIL-E-5272. Can also be obtained with magnetic brake. If motor desired with brake order part 1005940.
- 3 TEMPERATURE COMPENSATED** Part 406046. Used on Bendix-Pacific Position Light Flasher. Shunt field 24 V-D.C. Rated at 1 oz. inch. Continuous duty up to 160° F. Weight: 13 oz. Unirotational. This motor incorporates thermistors in the field to compensate for temperature effect on motor speed.

Modifications to the above assemblies can be made to fit your specific requirements.

PACIFIC DIVISION • Bendix Aviation Corporation
11600 Sherman Way, North Hollywood, California

East Coast Office:
475 5th Ave., N.Y. 17

Export Division: Bendix International
205 E. 42nd St., N.Y. 17

Canadian Distributors:
Aviation Electric, Ltd., Montreal 9



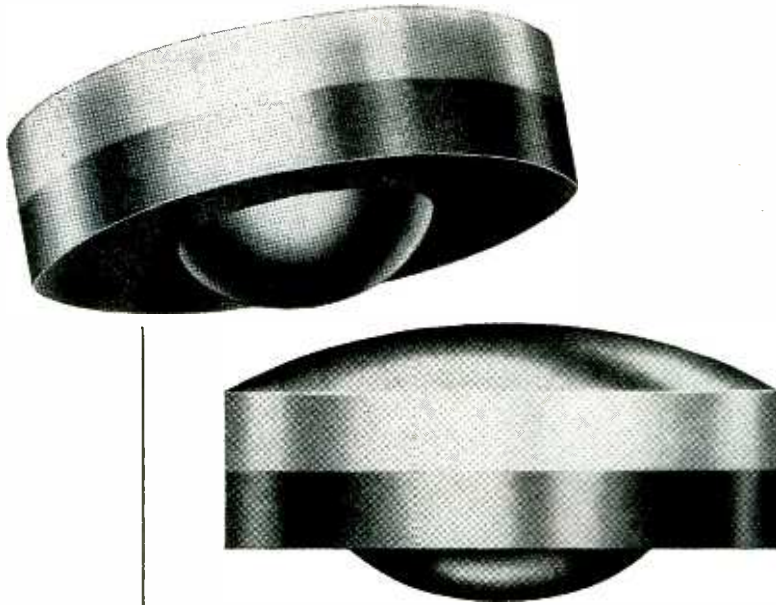

You can save with Monel-backed contacts

Save time and money, too.

Here's why...

If you use contacts like these, chances are that you can save by buying them with Monel-backing. To start with, the manufacturer can usually produce them for just about the same price as steel-backed. He saves plating steps, bonds the Monel-backing to the contact face material more easily.

Then, in turn, *you* can save both time and money in your production. That's because Monel-backed contacts are easier to work with. You can attach them to the contact supports by projection welding quicker; and with no fear that damage to the backing surface will result in rusting later.

You also get a big plus in customer satisfaction. With corrosion-resisting,

solid Monel for the contact backing, he has nothing to fear from scaling rust or formation of corrosion products.

Other Inco Nickel Alloys solve special contact problems, too. Inconel, for example, is excellent for contact springs that must combine good spring properties at high temperatures, corrosion resistance, and weldability.

Several companies produce Monel-backed and other Inco Nickel Alloy electrical contacts. They supply various contact face materials with them. For information, write to Mr. Harold Thompson, The International Nickel Company, Inc. Mention the contact metal you will use with the Monel-backing.

The INTERNATIONAL NICKEL COMPANY, Inc.
67 Wall Street

New York 5, N. Y.



Nickel Alloys

Monel® • "R"® Monel • "K"® Monel • "KR"® Monel
"S"® Monel • Inconel® • Inconel "X"® • Inconel "W"®
Incoloy® • Nimonic® Alloys • Nickel • Low Carbon Nickel • Duranickel®

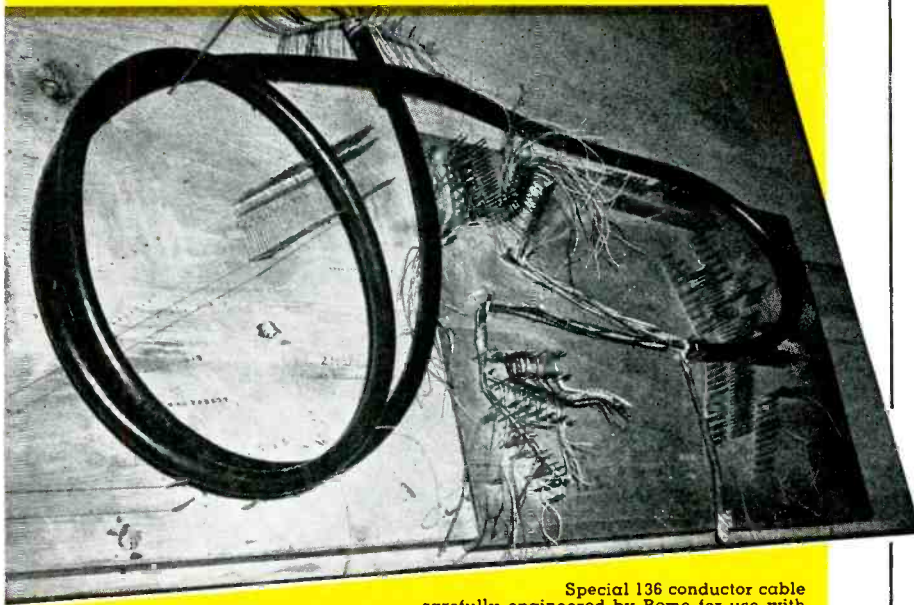

Special 136 conductor cable carefully engineered by Rome for use with IBM electric accounting machines, Types 402 and 403; IBM Reproducing Punch, Type 514; IBM Summary Punch, Type 523; and IBM Accumulating Reproducer, Type 528.

Carefully engineered wires and cables help keep IBM equipment "on the beam"

Equipment manufactured by International Business Machines Corporation has established a record for accuracy and service that's hard to beat.

Much of the reason for this record is the fact that IBM uses only the finest components in their equipment.

This is one of the reasons IBM often comes to Rome Cable for top quality, specially engineered wires and cables. One of these is the 136 conductor cable (pictured top center) which is used in several IBM machines.

Others are various types of hook-up wire, a few of which are shown on the multiple spool rack (top left). Millions of feet of this Rome hook-up wire, manufactured to exacting specifications, are used by IBM every year.

In addition to the constructions shown, Rome manufactures a wide range of military and commercial type hook-up wires, intercommunication cables, coaxial cables, R. F. transmission line, television camera cables and other special constructions, engineered to the application involved.

Commercial type HOOK-UP WIRES

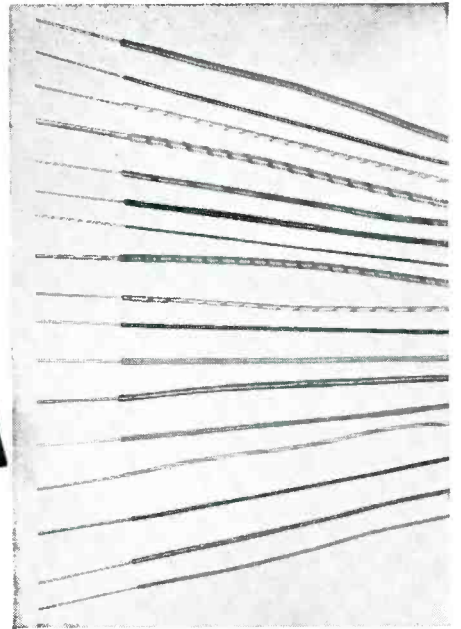

Rome offers commercial hook-up wires with three standard insulations.

Rome Hi-Temp—a rubber insulation with exceptionally high resistance to heat. Underwriters' approved for 75° C.

Rome Synthinol—a polyvinyl chloride thermoplastic compound, highly resistant to acids, oils, alkalis, moisture and flame. Underwriters' approved for 80° C.

Rome Synthinol 901—offers all the advantages of Synthinol plus higher resistance to heat deformation, shrinkage and cracking, also improved solderability. Underwriters' approved up to 105° C.

MILITARY HOOK-UP WIRES

Rome manufactures military type SRIR, SRHV and WL, complying with Army-Navy Joint Specification JAN-C-76, as well as shipboard types SRI and SRIB conforming to Specification MIL-C-915. Insulated with Rome Synthinol, these wires are made in a complete range of specification sizes.



ROME CABLE
Corporation
 ROME • NEW YORK
 and
 TORRANCE • CALIFORNIA

ROME CABLE CORPORATION, Dept. EL-11, Rome, N. Y.
 Please send me the Rome Cable Hook-up Wire Bulletin TR-5.

Name _____
 Company _____
 Address _____
 City _____ Zone _____ State _____

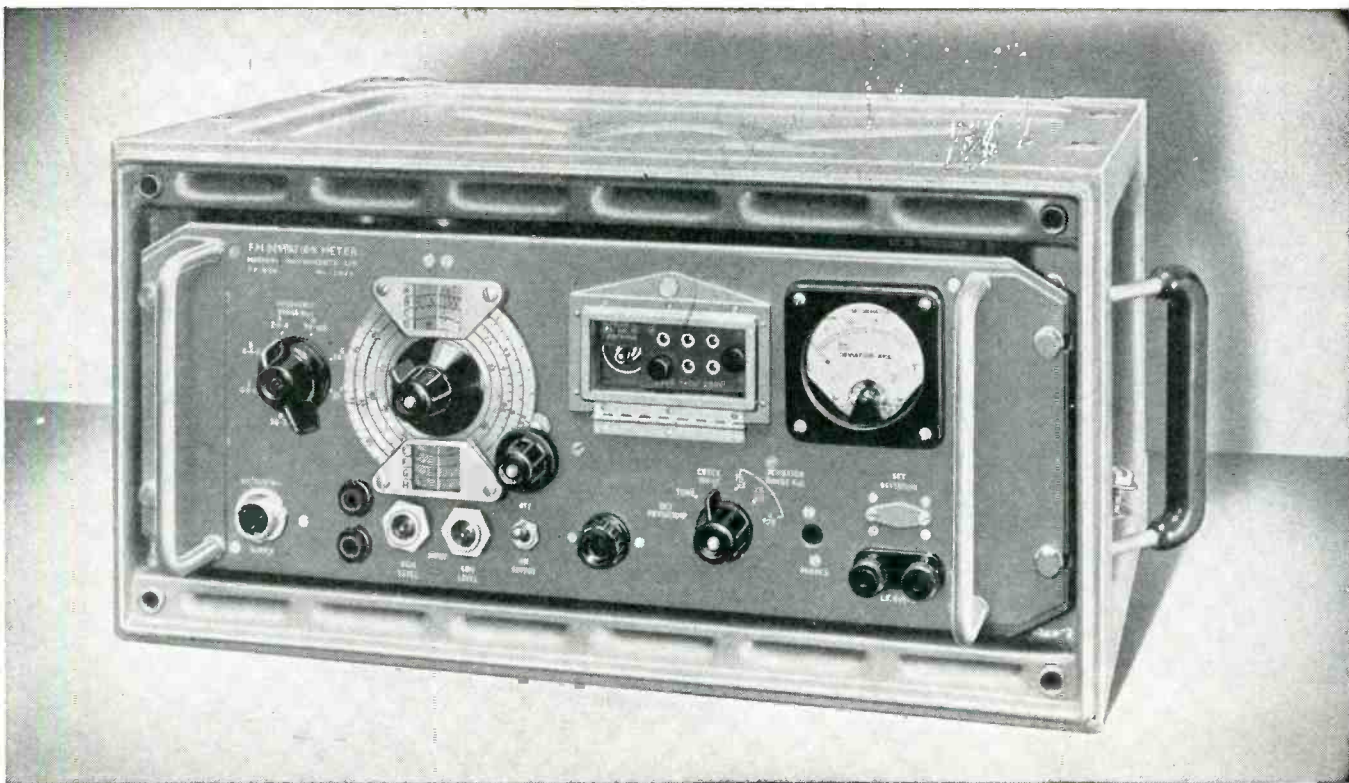

F.M. DEVIATION DIRECTLY MEASURED

THE BESSEL ZERO or "Disappearing Carrier" method of measuring deviation requires complex monitoring equipment, an accurately known modulation frequency, and, finally, mathematical interpretation of results.

With the compact and easy-to-use Marconi Deviation Meter, the modulation frequency need not be known and deviation is directly read on a meter scale.

F.M. DEVIATION METER TYPE TF 934

- Carrier Frequency Range :** 2.5 to 200 megacycles.
- R.F. Input Level :** 55 millivolts to 10 volts.
- Deviation Measurement Ranges :** 0 to ± 5 kc, 0 to ± 25 kc and 0 to ± 75 kc.
- Accuracy of Deviation Measurement :** $\pm 3\%$ from full-scale to half-scale up to 12 kc and $\pm 6\%$ up to 15 kc.

Full data and prices of any of the items listed below will be mailed immediately on request:

F.M. DEVIATION METER TF 934 • UNIVERSAL BRIDGE TF 868
 FM/AM SIGNAL GENERATOR TF 995A • STANDARD SIGNAL GENERATOR TF 867
 Also

VACUUM TUBE VOLTMETERS • FREQUENCY STANDARDS • OUTPUT METERS
 WAVEMETERS • WAVE ANALYSERS • Q METERS • BEAT FREQUENCY OSCILLATORS

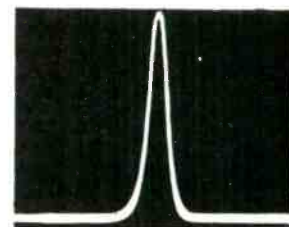

Unmodulated Carrier

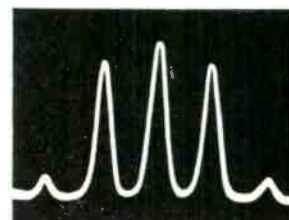

Modulation Index 1.3

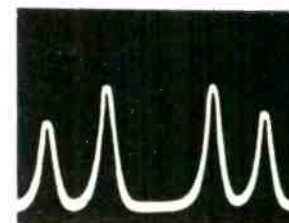

*Modulation Index 2.4
 The Carrier "Disappears"
 BESSEL ZERO METHOD*

MARCONI INSTRUMENTS

23-25 BEAVER STREET • NEW YORK 4

CANADA: CANADIAN MARCONI CO., MARCONI BUILDING, 2442 TRENTON AVENUE, MONTREAL

ENGLAND: Head Office: MARCONI INSTRUMENTS LIMITED, ST. ALBANS, HERTFORDSHIRE

Managing Agents in Export: MARCONI'S WIRELESS TELEGRAPH COMPANY LIMITED, MARCONI HOUSE, STRAND, LONDON, W.C.2

TC40

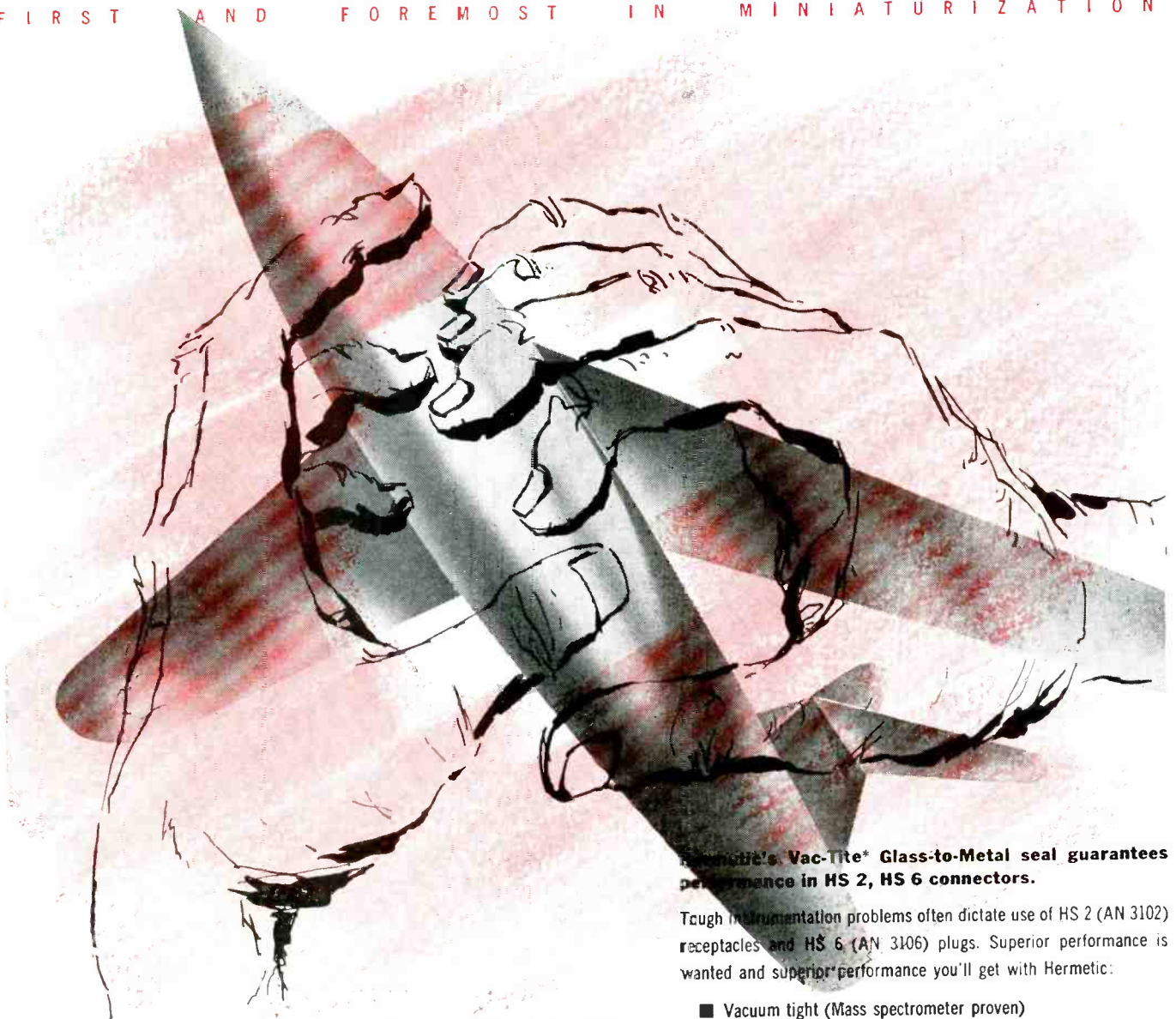

**IN THE "SQUEEZE-PLAY" OF
HEAT & PRESSURE—
HERMETIC'S A-N CONNECTORS
WON'T LEAK!**

Hermetic's Vac-Tite® Glass-to-Metal seal guarantees performance in HS 2, HS 6 connectors.

Tough instrumentation problems often dictate use of HS 2 (AN 3102) receptacles and HS 6 (AN 3106) plugs. Superior performance is wanted and superior performance you'll get with Hermetic:

- Vacuum tight (Mass spectrometer proven)
- Arc-resistance of glass
- High-temperature operation
- Corrosion resistance
- 100% moisture and pressure resistant
- Shock and vibration proof
- Equivalent to MIL-C-5015

In addition to our standard line of HS 2 and HS 6 connectors, special units with particular plating requirements, varied flange style, and extra-high pressure resistance, etc., are being designed and manufactured to meet the most specialized needs.

Let us serve you . . . Write for drawings, engineering data and Hermetic's new catalog.

***Vac-Tite is HERMETIC'S new, vacuum-proof, compression-construction, glass-to-metal seal.**

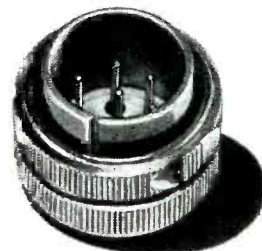

In standard A-N sizes and pin layouts



HERMETIC SEAL PRODUCTS CO.
31 South Sixth St., Newark 7, New Jersey

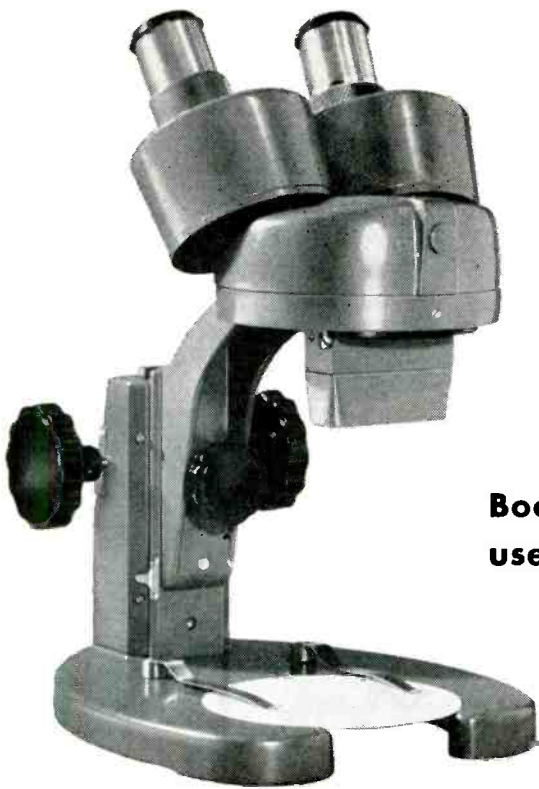

Full 3-D detail for **FASTER, EASIER ASSEMBLY and INSPECTION**

Boost production...save on lifetime trouble-free use...with a Bausch & Lomb Stereomicroscope

SHOCKPROOF . . . for lifetime dependability

Ready whenever you need it . . . in the lab, or mounted in machines or fixtures . . . because prisms *can't* jar loose despite the punishment of year-after-year practical use. Double support locks them into lifelong alignment . . . clamps at the top, gibs at the bottom.

DUSTPROOF . . . for bright, detailed images

Even on production lines, you get "laboratory clean" images. Patented Neoprene ring inside prism housing fits flush on prism surface, seals out contaminants . . . one of the reasons why B&L Stereomicroscopes are *dustproof for life*.

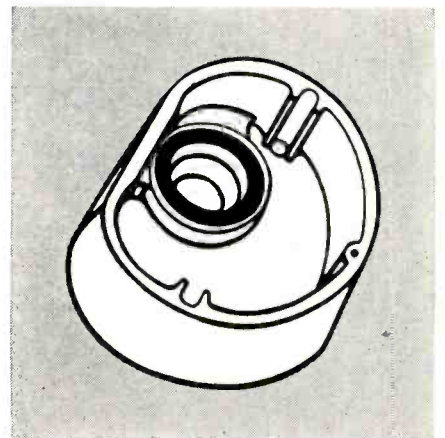
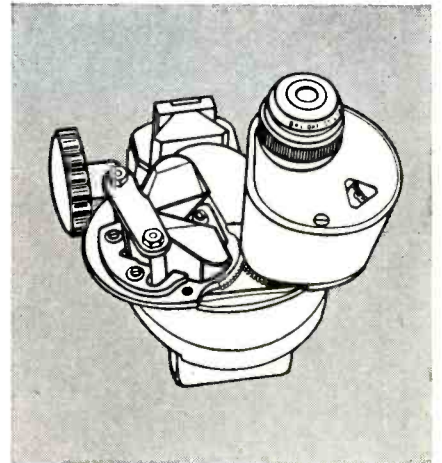

BAUSCH & LOMB



WRITE for Catalog D-15 and demonstration. Bausch & Lomb Optical Co., 61435 St. Paul Street, Rochester 2, N. Y.

STEREOMICROSCOPES

ALSiMAG[®]

metalized hermetic terminals

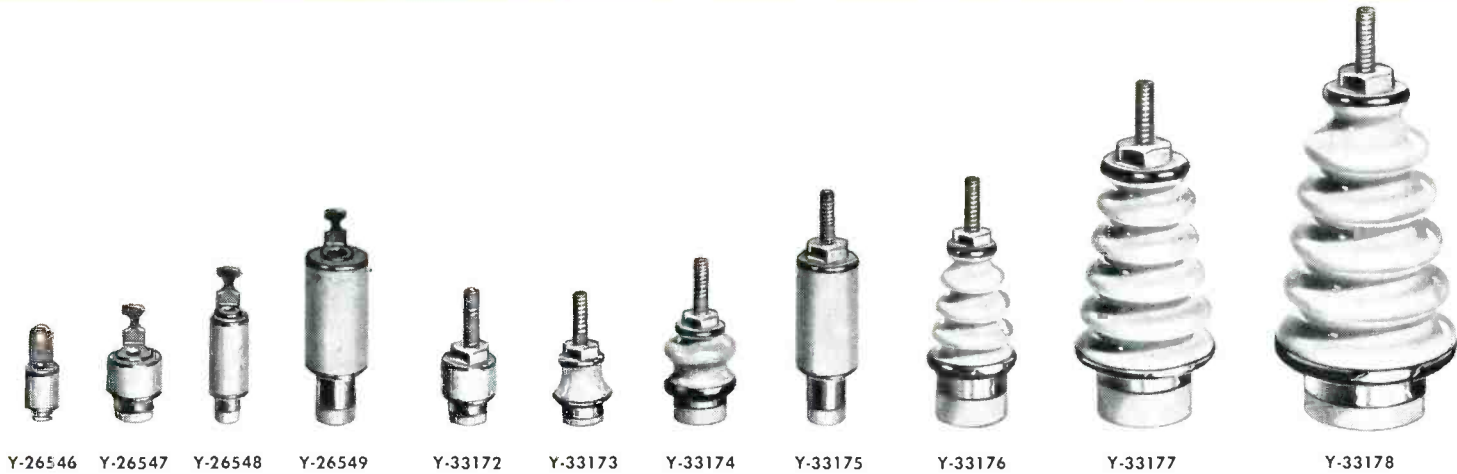

- High strength Alumina ceramic
- Superior electrical properties at high frequencies
- Excellent solder characteristics
- Will not deteriorate with time
- Withstand extreme temperature variations
- Metal permanently bonded to ceramic
- Reduce "leaker" troubles



The standard terminals shown here are in stock for immediate shipment. Bulletin No. 5410, sent on request, gives complete data. If you cannot use one of our many standards, special sizes or types can be custom made to your drawing. (Delivery on specials will take longer, of course.) Send sample or sketch for price and delivery information.

53RD YEAR OF CERAMIC LEADERSHIP

AMERICAN LAVA CORPORATION

CHATTANOOGA 5, TENNESSEE

A SUBSIDIARY OF MINNESOTA MINING
AND MANUFACTURING COMPANY

Branch offices in these cities (see your local telephone directory): Cambridge, Mass. • Chicago, Ill. • Cleveland, Ohio • Dallas-Houston, Texas • Indianapolis, Inc. • Los Angeles, Calif. • Newark, N. J. • Philadelphia-Pittsburgh, Pa. • St. Louis, Mo. • South San Francisco, Calif. • Syracuse, N. Y. • Tulsa, Okla.



KEPCO VOLTAGE REGULATED POWER SUPPLIES



MODEL 750

MODEL	VOLTS	CURRENT	REGULATION	RIPPLE
750	0-600	0-750 Ma.	0.5%	10 Mv.
760	0-600	0-1.5 Amp.	0.5%	10 Mv.
770	0-600	0-2.25 Amp.	0.5%	10 Mv.
780	0-600	0-3 Amp.	0.5%	10 Mv.

DC POWER SUPPLY SPECIFICATIONS

KEPCO Voltage Regulated Power Supplies are conservatively rated. The regulation specified for each unit is available under all line and load conditions within the range of the instrument.

REGULATION: As shown in table for both line fluctuations from 105-125 volts and load variations from minimum to maximum current.

***REGULATION FOR BIAS SUPPLIES:** 10 millivolts for line 105-125 volts. ½% for load at 150 volts.

†All AC Voltages are unregulated.

VOLTS	CURRENT	REGU- LATION	RIPPLE	6.3 V.† AC. CT.	MODEL
0-1500	0-200 Ma.	0.5%	20 Mv.		1520
0-1200	0-20 Ma.	0.1%	10 Mv.	10 Amp.	1220
0-1000	0-500 Ma.	0.5%	20 Mv.		1350
200-1000	0-500 Ma.	0.5%	20 Mv.		1250
0-1000	0-50 Ma.	0.1%	10 Mv.	10 Amp.	1020
0-600	0-3 Amp.	0.5%	10 Mv.		780
0-600	0-2.25 Amp.	0.5%	10 Mv.		770
0-600	0-1.5 Amp.	0.5%	10 Mv.		760
0-600	0-750 Ma.	0.5%	10 Mv.		750
0-600	0-300 Ma.	0.5%	10 Mv.	10 Amp.	615
0-150 Bias	0-5 Ma.	*	5 Mv.		
0-600	0-300 Ma.	0.5%	10 Mv.	10 Amp.	500R
#1 0-600	0-200 Ma.	0.5%	5 Mv.	10 Amp.	800
#2 0-600	0-200 Ma.	0.5%	5 Mv.	10 Amp.	
0-600	0-200 Ma.	0.5%	5 Mv.	10 Amp.	815
0-150 Bias	0-5 Ma.	*	5 Mv.		
#1 200-500	0-200 Ma.	0.5%	5 Mv.	6 Amp.	510
#2 200-500	0-200 Ma.	0.5%	5 Mv.	6 Amp.	
200-500	0-200 Ma.	0.5%	5 Mv.	6 Amp.	245
0-400	0-150 Ma.	0.5%	5 Mv.	10 Amp.	2400
0-400	0-150 Ma.	0.5%	5 Mv.	10 Amp.	
0-150 Bias	0-5 Ma.	*	5 Mv.		
0-400	0-150 Ma.	0.5%	5 Mv.	10 Amp.	400
0-150	0-5 Ma.	*	5 Mv.		
0-400	0-150 Ma.	0.5%	5 Mv.	10 Amp.	141
100-400	0-150 Ma.	0.01%	1 Mv.	10 Amp.	2000
0-350	0-3 Amp.	0.5%	10 Mv.		730
0-350	0-2.25 Amp.	0.5%	10 Mv.		720
0-350	0-1.5 Amp.	0.5%	10 Mv.		710
0-350	0-750 Ma.	0.5%	10 Mv.		700
100-325	0-150 Ma.	0.5%	5 Mv.	10 Amp.	131
0-150 Bias	0-5 Ma.	*	5 Mv.		
0-300	0-150 Ma.	0.5%	5 Mv.	5 Amp.	315
0-150 Bias	0-5 Ma.	*	5 Mv.		
0-150	0-50 Ma.	0.5%	5 Mv.		150
3-30	0-30 Amp.	0.5%	0.1%		3030
1-13	0-10 Amp.	0.5%	10 Mv.		3200

MANUFACTURERS OF ELECTRONIC EQUIPMENT • RESEARCH • DEVELOPMENT

KEPCO LABORATORIES

131-38 SANFORD AVENUE • FLUSHING 55, N. Y. • INDEPENDENCE 1-7000

WORKMANSHIP

Workmanship is of a quality with the highest existing production standards and best instrument electronic practices consistent with the intended use of the item as a continuous duty voltage regulated power supply. Oil filled paper condensers and resistor-board construction are included in the design.

FOR NEW POWER SUPPLY CATALOG — WRITE DEPT. No. 789

AUTOMATIC MANUFACTURING CORPORATION

MANUFACTURERS FOR THE

Radio and Television Industry

85 GOVERNOR STREET NEWARK 4, N. J.
PHONE HUMBOLDT 2-2100

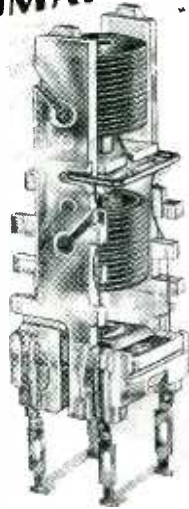

The excellent uniformity and stability of G A & F Carbonyl Iron Powders have enabled us to develop a special process for the production, in extremely large quantity, of a complex tuning core that is the heart of the K-TRAN.

Your product has enabled us to design into our K-TRAN both the high electrical performance and the unparalleled mechanical and climatic stability (otherwise obtainable only in larger and more expensive units) so eagerly sought after by K-TRAN users.

AUTOMATIC MANUFACTURING CORPORATION

Marion H. Benedek
President

WHEN **SIZE** IS A FACTOR

GA & F CARBONYL IRON POWDERS

THE K-TRAN—made by Automatic Manufacturing Corporation—measures only $\frac{3}{4}$ " across. Yet it is available in RF and IF transformers covering frequency ranges from 20 KC to 30 MC and higher! For its size, it covers the widest range of uses in the IF field—and with unsurpassed stabilities. . . . As indicated, the makers credit K-TRAN's success, in large measure, to the controlled uniformity of G A & F Carbonyl Iron Powders.

Today there are ten types of iron powders made by the Carbonyl Iron Process—with the particle sizes ranging from 3 to 20 microns in diameter. The iron content of some types is as high as 99.6 to 99.9%.

With quite different chemical and physical characteristics, the ten types lend themselves to many different uses—to increase Q values, to vary coil inductances, to reduce the size of

coils, to confine stray fields and to increase transformer coupling factors. The Carbonyl Process assures the quality and uniformity of each type.

We urge you to ask your core maker, your coil winder, your industrial designer, how G A & F Carbonyl Iron Powders can increase the efficiency and performance of the equipment or product you make, while reducing both the cost and the weight. We also invite inquiries for powders whose performance characteristics are different from those exhibited by any of our existing types.

This 32-page book offers you the most comprehensive treatment yet given to the characteristics and applications of G A & F Carbonyl Iron Powders. 80% of the story is told with photomicrographs, diagrams, performance charts and tables. For your copy—without obligation—kindly address Department 91.



ANTARA® CHEMICALS

From Research to Reality

A SALES DIVISION OF GENERAL ANILINE & FILM CORPORATION

435 HUDSON STREET • NEW YORK 14, N. Y.



telling the story of 'dag' dispersions

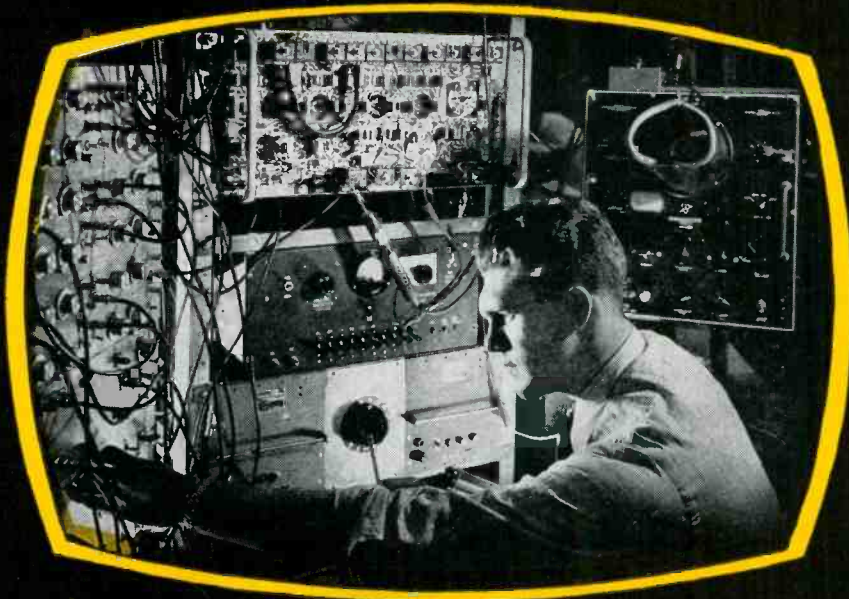

Can This Unique Material Help You?
Check These Properties . . .



'dag' Colloidal Graphite

Chemically inactive, non-fusible, gray-to-black solid.
Electrically conductive, diamagnetic, electrophoretic.
Low in photoelectric sensitivity, resistant to electron bombardment.
Forms tenacious *dry film* which is opaque, conducts heat, adsorbs gas, and has low coefficient of friction.

In Vacuum Tubes—'Aquadag', a dispersion of colloidal graphite in water, applied to grids and plates minimizes secondary emission, "back" emission, and photoelectric effects.

In CRTs—A dispersion of colloidal graphite in distilled water applied to inside walls retards secondary emission, adsorbs gases, and serves as an electrical conductor. And another dispersion, in lacquer, will opaque exterior walls.

In Light-Sensitive Cells—Colloidal graphite does not react with selenium to form selenides; therefore, it is used as an electrode material in photo tubes.

In Other Applications—As a conductive coating on piezo-electric crystals, on high-voltage coils, on suspension-type insulators . . . generally *wherever* a conductive lubricant is required.

Write *today* for more detailed information. Ask for Bulletin No. 433-L2.

Dispersions of molybdenum disulfide are available in various carriers.

We are also equipped to do custom dispersing of solids in a wide variety of vehicles.



Acheson Colloids Company, Port Huron, Mich.

... also **ACHESON COLLOIDS LIMITED, LONDON, ENGLAND**



try 'dag' resin-bonded dry films for permanent lubrication

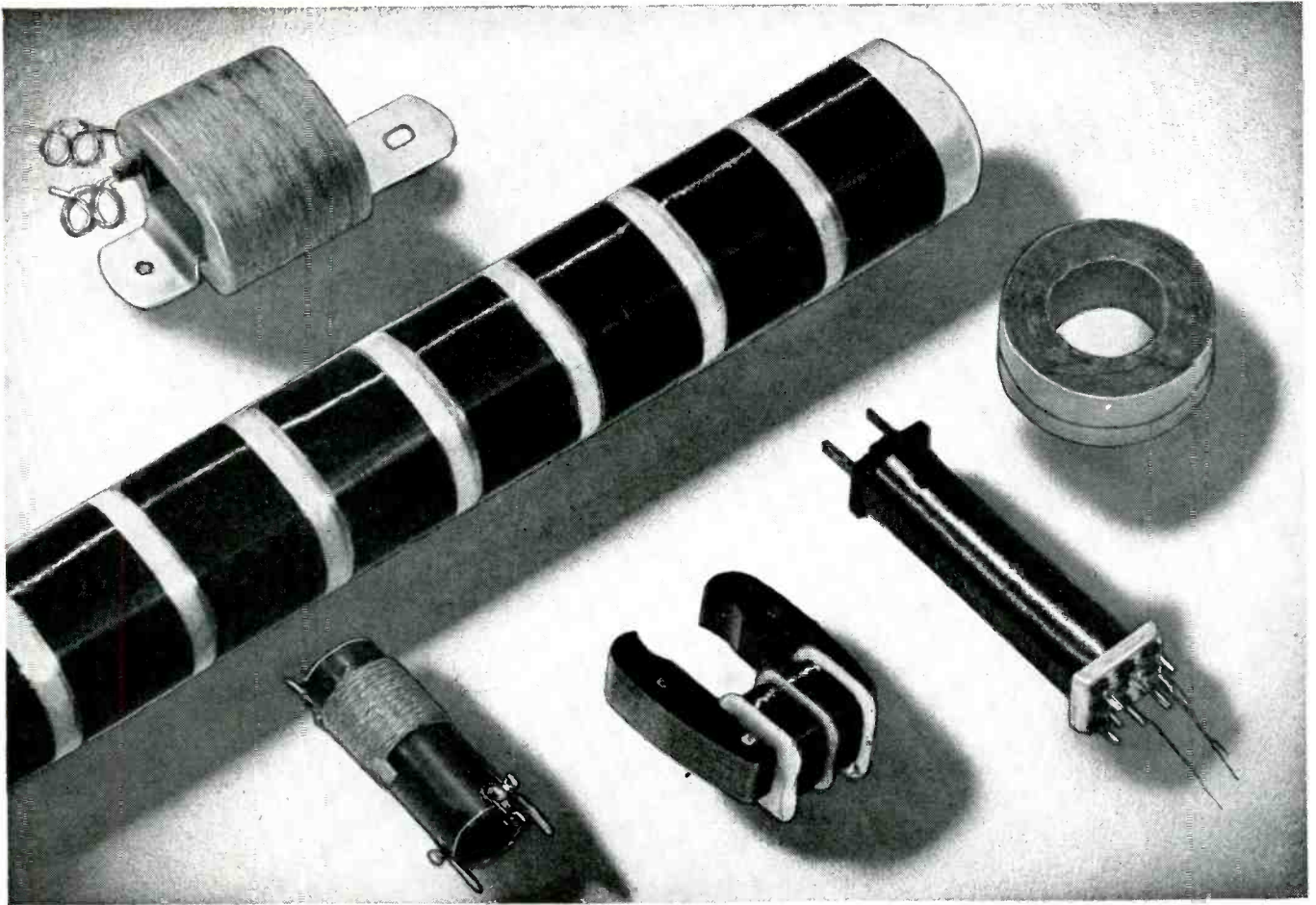

These coils saved winding costs

Each of these coils represents a sizable saving on coil winding costs because it was wound on Universal Coil Winders.

There are Universal machines for a broad range of coil specifications and production requirements — long or short runs. Users report increased output, a higher degree of accuracy, and greater operator satisfaction.

The coupon will bring you information on the complete line — plus any specific data you wish regarding your particular

coil winding requirements.

Also: be sure to visit the Universal Demonstration Room nearest you — in Cranston, R. I. or Chicago, Ill. You'll see winders in operation and have a chance to talk over your coil winding problems with a Universal sales engineer.

To arrange for a visit to the Demonstration Room, write to UNIVERSAL WINDING COMPANY, P. O. Box 1605, Providence 1, R. I., or 9 South Clinton St., Chicago, Ill.

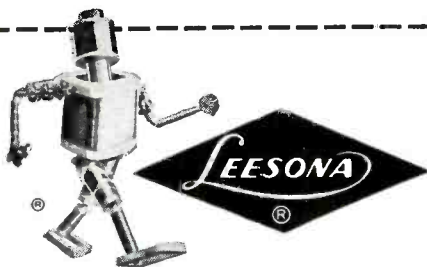

FOR WINDING COILS
IN QUANTITY... ACCURATELY
...AUTOMATICALLY... USE
UNIVERSAL WINDING MACHINES

UNIVERSAL WINDING COMPANY

P. O. BOX 1605, PROVIDENCE 1, RHODE ISLAND

Please send me

- Condensed Catalog of Universal Winders
- Information on Universal Winders for coil types that meet my particular needs. I enclose specifications and production requirements.

Name.....Title.....

Company.....

City.....Zone....State.....



Wire-Wrap Connections

SAVE TIME—CUT COSTS

They're done in half the time. New power tool wraps wire around a terminal to make a permanent electrical connection without soldering. Eliminates costly hand wrapping and cuts material costs, too. Easy to handle... tool is lightweight, nonfatiguing.

SOLDERLESS OR WRAP-AND-SOLDER

Use of the Keller "Wire-Wrap" Tool with recommended terminal and wire size provides a permanent solderless connection that retains low-resistance contact under severe conditions of corrosion, vibration and aging.

When other than recommended terminals are used, the Keller "Wire-Wrap" Tool saves time on wrap-and-solder connections. Bulletin No. 11 gives complete information—send for a copy.

KELLER "Wire-Wrap" TOOLS
Wire-Wrap Division KELLER TOOL COMPANY, 1335 Fulton Street, Grand Haven, Mich.



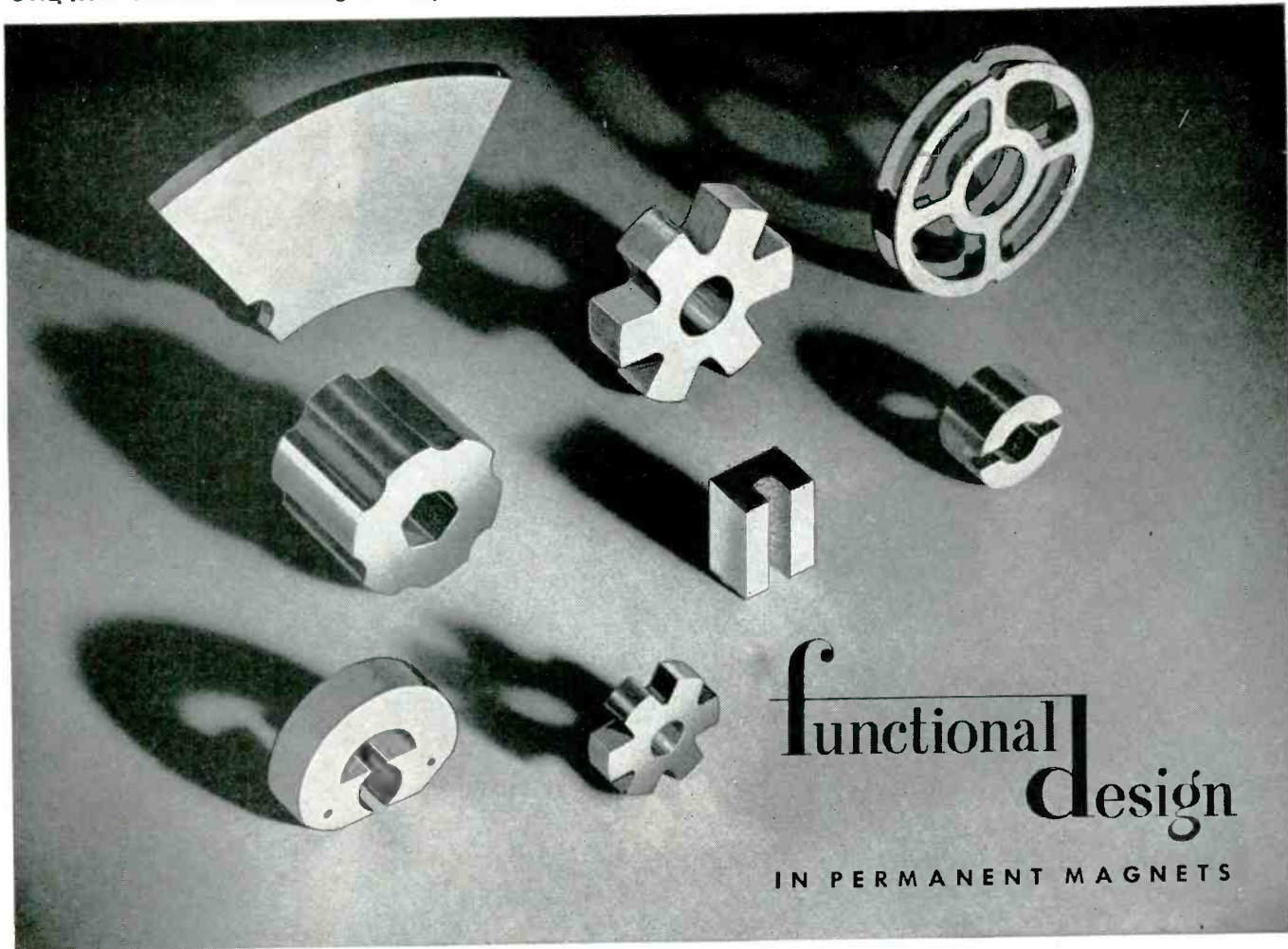

Why SOUND, FUNCTIONAL MAGNET DESIGN guarantees superior product performance

Magnets must be "tailored" to your product . . . tailored in size, shape, and the material used . . . if greatest efficiency, at the lowest possible cost, is to be expected.

The magnet assemblies shown above are typical of such "tailoring." Those used in test meters, for example, are designed specifically to maintain a magnetic field of uniform high energy, so necessary to the precise operation of such meters.

Others—for holding applications—are designed so that their magnetic circuits provide the

greatest possible tractive power. In applications where the magnet acts on moving parts of an assembly, still different designs may be required.

Our engineers—specialists in permanent magnet design and application—welcome the opportunity to assist you with your designs. For their recommendations—without cost or obligation—write us today. Or return the coupon below for a free copy of the helpful article, "Selecting the Proper Permanent Magnet Material for Your Product."

THE INDIANA STEEL PRODUCTS COMPANY
Valparaiso, Indiana

**World's Largest Manufacturer
of Permanent Magnets**

**INDIANA
PERMANENT
MAGNETS**

The Indiana Steel Products Co., Dept. 11A
Valparaiso, Indiana

Please send me a free copy of "Selecting the Proper Permanent Magnet Material for Your Product."

Name _____ Title _____

Company _____

Street _____

City _____ Zone _____ State _____



Air-operated dispensers prove "SCOTCH" Brand tapes can take it!

How does Franklin Electric Co., Bluffton, Indiana, get maximum operating speed and efficiency from their air-operated dispensers for pressure-sensitive paper tapes? By using nothing but "Scotch" Brand Electrical Tapes.

Our quality-control checks on "Scotch" Electrical Tapes insure consistent performance. Tape tensile strength is carefully regulated to prevent snapping by speedy dispenser mechanisms. Tape adhesive strength is controlled for easy unwind, sticking tight

and *holding* tight under specified conditions.

Our field engineer in your area is ready to help you choose the *right* "Scotch" Electrical Tape and the *right* dispenser for your needs. He'll show you how to speed up your production, cut your costs by modifying present tape applying methods—or by putting tape to work where tape has never been used before.

Call or write. There's no charge or obligation, of course.

"SCOTCH" Electrical Tapes

The term "Scotch" and the plaid design are registered trademarks for the more than 300 pressure-sensitive adhesive tapes made in U.S.A. by Minnesota Mining and Mfg. Co., St. Paul 6, Minn.—also makers of "Scotch" Brand Magnetic Tape, "Underseal" Rubberized Coating, "Scotchlite" Reflective Sheeting, "Safety-Walk" Non-slip Surfacing, "3M" Abrasives, "3M" Adhesives. General Export: 122 E. 42nd St., New York 17, N.Y. In Canada: London, Ont., Can.





The BEST ONES are Made by

"Doughnuts" in a most complete variety of sizes and types . . . made to MIL-T 27 specifications. CAC's advanced engineering provides characteristics and performance for every need. This same engineering has made CAC the largest exclusive producers of Toroids in the country today.

LIST OF REPRESENTATIVES

BALTIMORE—Charles R. Hile
Boulevard 1202J
(L. G. Korman) 5006 Kenwood, Baltimore 6, Md.
CHICAGO—Gassner & Clark Co.
Rogers Park 4-6121
6349 N. Clark, Chicago, Ill.
CLEVELAND—Ernie Kohler Associates
Olympic 1-1242
8905 Lake Ave., Cleveland 2, Ohio
HAMBURG—Cooper-Morgan, Inc.
Emerson 3405
P. O. Box 152, Hamburg, N. Y.
KANSAS CITY—E. W. McGrade Co.
Delmar 9242
6315 Brookside Plaza, Kansas City, Mo.
LOS ANGELES—Samuel O. Jewett
State 9-6027
13537 Addison St., Sherman Oaks, Calif.

MERIDEN—Henry Lavin Associates
7-4555
(Henry Lavin) P. O. Box 196, Meriden, Conn.
NEEDHAM—Henry Lavin Associates
3-3446
(Robert V. Curtin) 82 Curve St., Needham, Mass.
NEW YORK—Harold Gray Associates
Lackawanna 4-4258
286 Fifth Avenue, New York City, N. Y.
PHILADELPHIA—Charles R. Hile Co.
Elgin 6-2266
Hillview Road, Box 144, Paoli, Pa.
SYRACUSE—Naylor Electric Co.
2-3894
State Tower Bldg., Room 317, Syracuse 2, N. Y.

FILTERS
SUB-MINIATURE
PULSE TRANSFORMERS
PLASTIC MOLDED
MAGNETIC
AMPLIFIERS
HERMETICALLY
SEALED
DELAY LINES

Ad 4-11-1.10

Write for Additional Information

COMMUNICATION ACCESSORIES COMPANY

Hickman Mills, Missouri

Kansas City Phones: South 5528-5529

**GREATER ARC
RESISTANCE**



**A New
Polyester
Glass Fibre**

**Insulating Sheet - INSUROK[®]
XT-200**

• If you are looking for an insulating laminate that combines excellent electrical properties with good structural strength, consider this new Richardson laminate. INSUROK XT-200 is an excellent material for pole insulators, cable holders and switches, where arc resistance is important, as well as for motor-generators, transformers, switchgear, electroplating equipment, and various kinds of electrical and electronic heating devices. Moreover, INSUROK XT-200 has very satisfactory fabricating qualities. It is available in sheets 34" x 34", in thicknesses of 1/16", 1/8", and 1/4". The Richardson Company will be glad to supply further information and samples.

Send for Data Sheet XT-200

- **GOOD ELECTRICAL PROPERTIES**
- **EXCELLENT STRUCTURAL STRENGTH**
- **HIGH HEAT RESISTANCE**
- **LOW MOISTURE ABSORPTION**
- **PUNCHES COLD TO INTRICATE SHAPES**

The RICHARDSON COMPANY

FOUNDED 1858

2797 Lake Street, Melrose Park, Illinois (Chicago District)



MELROSE PARK,
ILL.

INDIANAPOLIS,
IND.

NEW BRUNSWICK,
N. J.

NEWNAN,
GA.

OGDEN,
UTAH

TYLER,
TEXAS

... another "FIRST BY FANSTEEL"

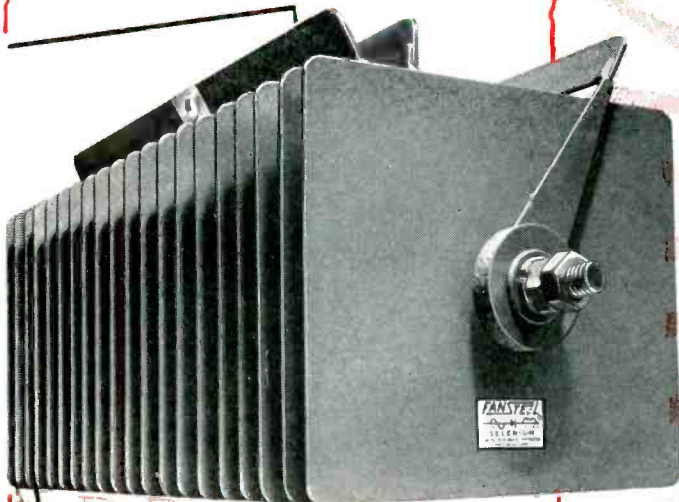

**NEW RECTIFIER
DELIVERS FULL
RATED POWER at
100°C (212°F)**

NORTH CHICAGO, ILL.—A new type of selenium rectifier, intended for operation at temperatures substantially above the limits of conventional, one has been announced at the

Fansteel announces an entirely new Selenium Rectifier:

- 1 Able to operate at 100°C (212°F) and deliver full rated power output, continuously, with no *derating whatever*.
- 2 Able to operate at ambient temperatures up to 150°C (302°F) with only moderate derating.
- 3 Available in all standard cell sizes and all standard circuit arrangements.
- 4 Available with all standard protective finishes—moisture resistant, salt-spray resistant, fungus resistant.
- Now in production for specialized applications. Tell us your problems and we will make recommendations.

302° FAHRENHEIT 150° CENTIGRADE

212° FAHRENHEIT 100° CENTIGRADE

FANSTEEL METALLURGICAL CORPORATION NORTH CHICAGO, ILLINOIS, U.S.A.

30
YEARS
of
DEPENDABLE
RECTIFIERS

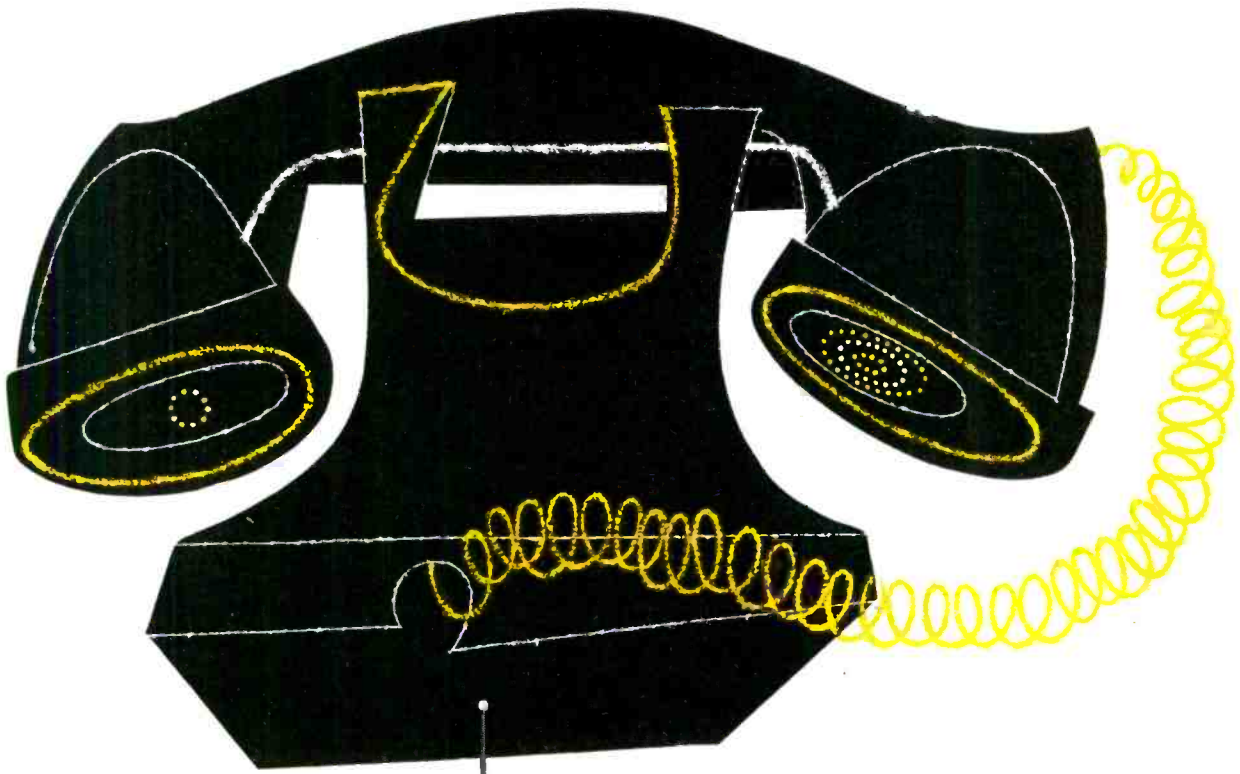

CRUCIBLE PERMANENT MAGNETS

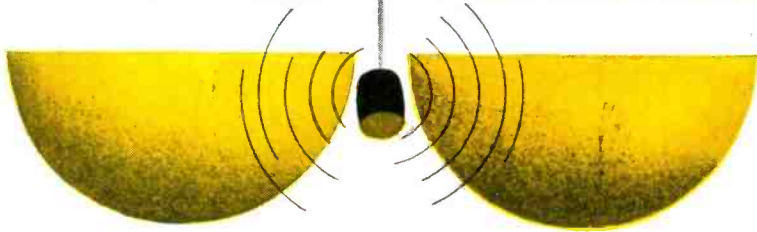

provide maximum energy . . . minimum weight

No matter what your permanent magnet application may be — galvanometer, speedometer, television or telephone — you'll find that Crucible alnico magnets have a *consistently higher* energy product. This means more energy from a smaller magnet.

Since alnico alloys were first developed, Crucible has been a leading producer of this superior type of permanent magnet. And Crucible alnico permanent magnets are made by the nation's foremost specialty steelmaker.

For alnico magnets that are unsurpassed in quality — *call Crucible.*



Join your
Civil Defense Team
NOW!



CRUCIBLE

first name in special purpose steels

54 years of *Fine* steelmaking

ALNICO PERMANENT MAGNETS

CRUCIBLE STEEL COMPANY OF AMERICA, GENERAL SALES OFFICES, OLIVER BUILDING, PITTSBURGH, PA.
 REX HIGH SPEED • TOOL • REZISTAL STAINLESS • ALLOY • MAX-EL • SPECIAL PURPOSE STEELS



GOODMANS

Introduce a
POWER OSCILLATOR
 for **VIBRATION GENERATION**
 and investigation

—provides a stabilized 10-10,000 c/s supply

A vibration generator depends for its accuracy largely upon the suitability of its driving equipment. Goodmans have now produced a self-contained drive unit consisting of oscillator, amplifier and power pack. Although primarily intended for use with Goodmans Model V.47 shaker, it will also find wide application in the laboratory and in industrial processes where a high quality source of audio frequency is required. A brief specification of this latest Goodmans product is given below, and full circuitry details are available on request to "Vibration Dept. W".

**FOR USE WITH
 THE GOODMANS
 SHAKER**

MODEL V.47
 or where small
 scale vibration
 testing is
 involved.



Brief Specification

Frequency range—10-10,000 c/s. in 3 ranges.
 Power output—5 watts into 3 ohms,
 Output Level Stability— ± 0.05 db 10-10,000 c/s.
 Distortion—less than 0.2%.
 Hum level—72 db down on 5 watts
 Power supply—100/115 v, 200/225 v, 225/250 v, 50-60 c/s. 75
 watts.
 Weight—45 lb.
 Dimensions—16½ in. x 13 in. x 11 in.

GOODMANS INDUSTRIES LTD.
AXIOM WORKS • WEMBLEY • MIDDX.
 Cables: GOODAXIOM, WEMBLEY, MIDDX.

MAIL THIS COUPON

**TO GOODMANS INDUSTRIES LIMITED
 AXIOM WORKS, WEMBLEY, MIDDX., ENGLAND**

Please mail me your catalogue and technical data sheets in connection with your PERMANENT MAGNET Shakers.

NAME

COMPANY

CITY..... ZONE..... STATE..... E/U

NOW . . . FIBERGLAS *plus* SILICONE RUBBER

BH "1151"

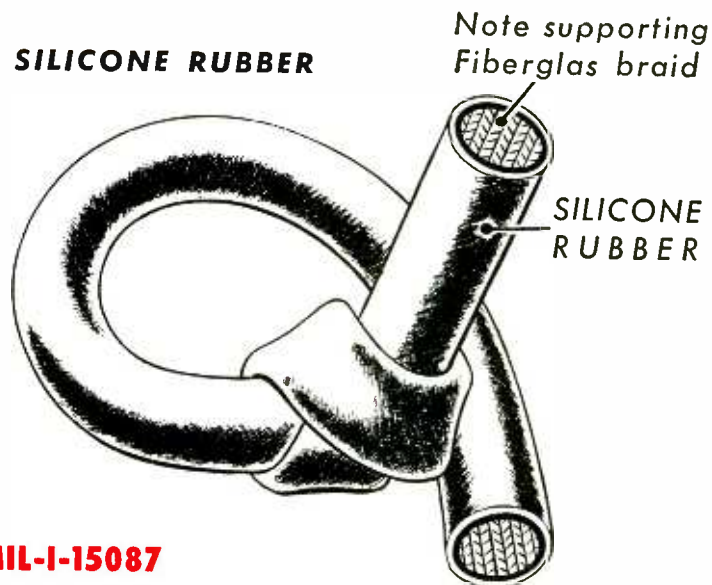

MEETS MILITARY SPECIFICATION NO. MIL-I-15087

. . . for longer electrical equipment life

BH "1151" is a new electrical sleeving that provides the unique combination of permanent flexibility and high dielectric strength at Class "H" temperatures. It offers a long-lasting union of two great inorganic materials — Fiberglas and Silicone Rubber.

BH "1151" shows no change in physical or dielectric properties after 15 minutes at 600°F.; 4 hours at 500°F.; or 96 hours at 450°F. It is applicable for continuous operation through a temperature range of -90°F. to 400°F.

BH "1151" can be twisted, knotted or bent without crazing, cracking, or loss of dielectric strength. Available in rated grades up to 7,000 volts. Electrical

resistance is unusually high. It will not support fungus growth. Offers excellent chemical resistance. Meets all applicable NEMA specifications for Class H insulations.

BH "1151" is available in colors, for circuit tracing and coding, in continuous coils, 36 inch lengths, or in short lengths cut to individual specifications. It is made in Grades H-A-1, H-B-1, H-C-1 and H-C-2. Get all the facts on this superior electrical insulation — write for data sheets today.

Bentley, Harris Manufacturing Co.
1311 Barclay St.
Conshohocken, Pa.

BH *Fiberglass*^{*} SLEEVINGS

*BH Non-Fraying Fiberglass Sleeveings are made by an exclusive Bentley, Harris process (U. S. Pat. No. 2393530). "Fiberglass" is Reg. TM of Owens-Corning Fiberglass Corp.

90%

of those

"SPECIAL DESIGN REQUIREMENTS"

can be obtained
with standard items

from *Ketay*

FOR ECONOMY IN DESIGN... CHOOSE KETAY
... the complete line of synchros, servo motors, and resolvers.

SYNCHROS: From Size 10 to Size 37. There are units for every purpose including dual synchros as a control transmitter or a control transformer. Transolvers*—special purpose devices for use in converting 3-phase data into 2-phase data.

SERVO MOTORS: Ketay offers 400 and 60 cycle Servo Motors. High torque to inertia servos are available as small as a penny and up to Size 23. Torques of 0.1 in.-oz. to 7.5 in.-oz.

RESOLVERS: Another highly developed Ketay specialty, Ketay offers resolvers for all applications... from Coarse $\pm 0.2\%$ to Precision $\pm 0.05\%$. For use in computers, radar sweep circuits, phase shifters, and accurate transmission systems.

Ketay also manufactures a wide selection of aircraft, missile, marine, and ordnance instruments; and control systems.

Ketay has pioneered in the design of rotating precision instruments. For example, as design agent for Frankford Arsenal and the Bureau of Ordnance, Ketay designed the military Size 15, 16, 18, 19, 23, 31, and 37 synchros. The services of the Research and Development Division are available to you!



SIZE 18
TRANSOLVER*
TYPE 108R2E

Voltage Rating	90 90 V.A.C.
Operating Frequency	400 C.P.S.
Input Power	1.42 W
Input Current	133 Ma.
Input Impedance	391.82 Ω
Time Phase Shift thru Synchro	3.8
Moment of Inertia	2.88 x 10 ⁻⁷ slug in. ²
Frictional Torque	0.1 cc. in.
Null Voltage—Total	90 mV
Null Voltage—Fund	90 mV
Electrical Error (max.)	1%
Perpendicularity	2.5



Other Standard Items Include:

Resolver Amplifiers
Magnetic Amplifiers
Gears and Gear Trains
Airborne Instruments

Ketay INSTRUMENT CORPORATION

Executive Offices
555 Broadway, New York 12, N. Y.

Pacific Division
12333 Simms Avenue, Hawthorne, California

*REG. TRADE MARK

USE COUPON FOR COMPLETE INFORMATION ON KETAY PRODUCTS I

Ketay Instrument Corporation, 555 Broadway, New York 12, N. Y.

- Please send me bulletin on synchros, servos, resolvers.
- Please send me information on _____
- Please add my name to your mailing list.
- Please have a representative call.

Name _____

Company _____

Address _____

City _____ State _____

There are 13 paths
that make one direct route
to bring your products



.....to the purchasing influences
of the 1955 expanding electronic market

Alert manufacturers of electronic products get greater results from advertising dollars by getting their product stories told *directly* to the *purchasing influences* of the industry in the sales pages of . . .

12 issues of electronics

where 35,000 subscribers read the editorial pages and re-read them for the very latest developments in product design, circuitry, production techniques and other information vital to their work.



P L U S T H E

1

Electronics Buyers' Guide



* The men who design

* The men who specify

* The men who buy

These important purchasing influences of the electronic industry have, throughout the years, grown accustomed to using the **ELECTRONICS BUYERS' GUIDE** as their sole product reference source . . . for fourteen years they have relied on the "Guide" for its complete, accurate and up-to-date information, serving them year upon year in the exacting manner they require. These technicians of the industry *choose* and *use* the "Guide" as their Breadboard Blue Book . . . that's why manufacturers with electronic products to sell get more results from their advertising dollars by doing a complete year 'round product selling job in 13 issues of **ELECTRONICS**.

BUDGET NOW FOR 13 INSERTIONS IN '55!



electronics

A McGraw-Hill Publication



BUYERS' GUIDE

330 West 42nd Street, New York 36



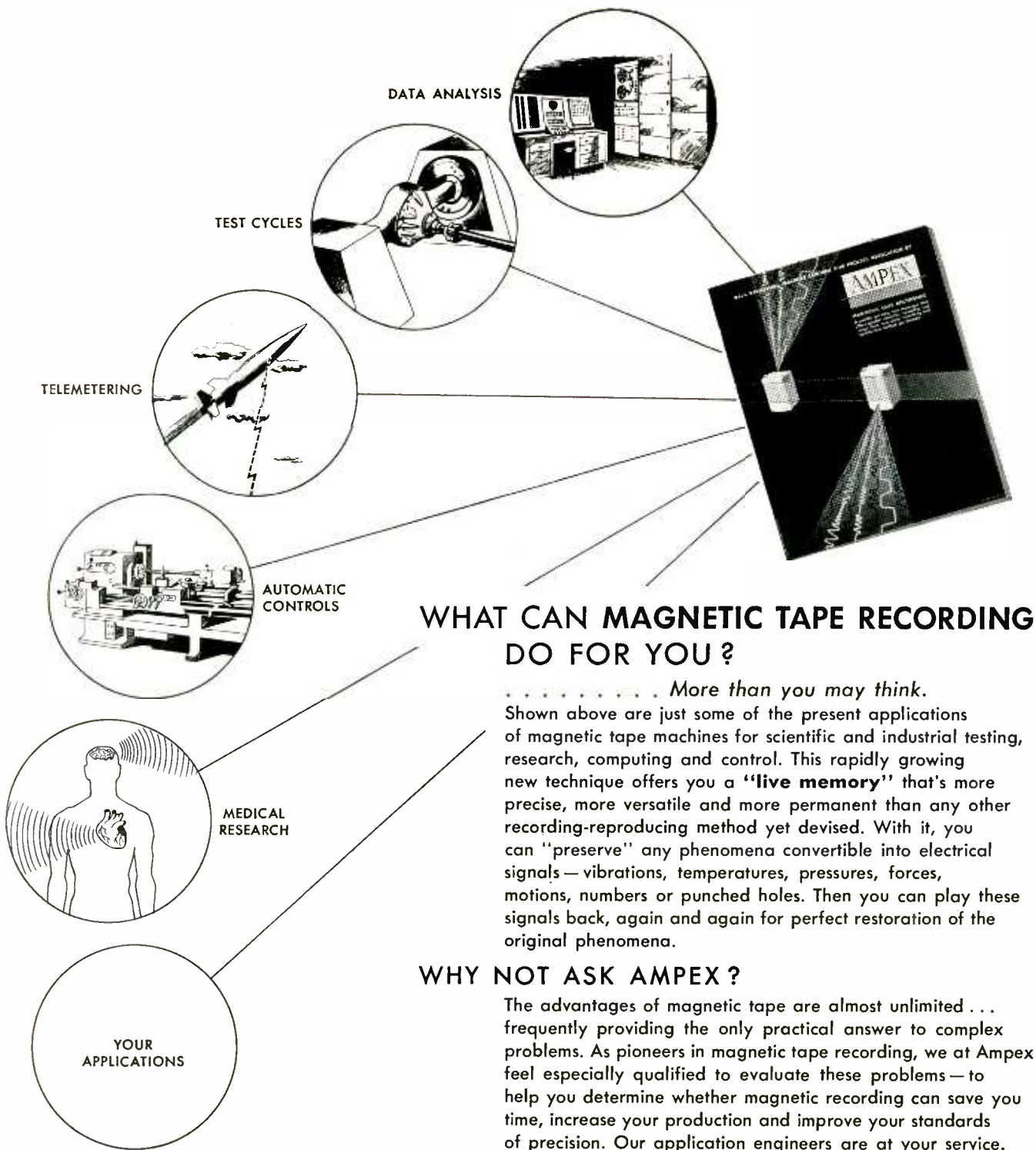

WHAT CAN MAGNETIC TAPE RECORDING DO FOR YOU ?

More than you may think. Shown above are just some of the present applications of magnetic tape machines for scientific and industrial testing, research, computing and control. This rapidly growing new technique offers you a "live memory" that's more precise, more versatile and more permanent than any other recording-reproducing method yet devised. With it, you can "preserve" any phenomena convertible into electrical signals — vibrations, temperatures, pressures, forces, motions, numbers or punched holes. Then you can play these signals back, again and again for perfect restoration of the original phenomena.

WHY NOT ASK AMPEX ?

The advantages of magnetic tape are almost unlimited . . . frequently providing the only practical answer to complex problems. As pioneers in magnetic tape recording, we at Ampex feel especially qualified to evaluate these problems — to help you determine whether magnetic recording can save you time, increase your production and improve your standards of precision. Our application engineers are at your service. Or, if you simply want more information, ask for our 16-page illustrated bulletin: "Data Recording, Machine Control and Process Regulation." There's no obligation in either case.

The Signature of Perfection in Magnetic Tape Machines



934 CHARTER STREET
REDWOOD CITY, CALIFORNIA

Contact your nearest Ampex representative or write-wire Dept. E-1891
BRANCH OFFICES: New York; Chicago; Atlanta; San Francisco; College Park, Maryland (Washington, D.C. area).

DISTRIBUTORS: Radio Shack, Boston; Bing Crosby Enterprises, Los Angeles; Southwestern Engineering & Equipment, Dallas and Houston; Canadian General Electric Company, Canada.

the stiffer the "specs" the better we like it

Virtually every project in the electronics manufacturing field involves operations within the scope of the D. E. Makepeace Company. As specialists, Makepeace is able to supply electronic assemblies for components which meet the most exacting specifications.

WAVEGUIDE TUBING AND MICROWAVE ASSEMBLIES

Long experience in the manufacture of precision drawn waveguide tubing, enables Makepeace to meet tolerances much tighter than specified in MIL-T-85-B. This precision is maintained in the production of components such as rotary joints, crystal mixers, antenna feeds, and many specialized assemblies to meet various requirements.

We shall be glad to confer with you on the design and manufacture of prototypes and production runs. Our exceptional testing facilities are at your disposal.

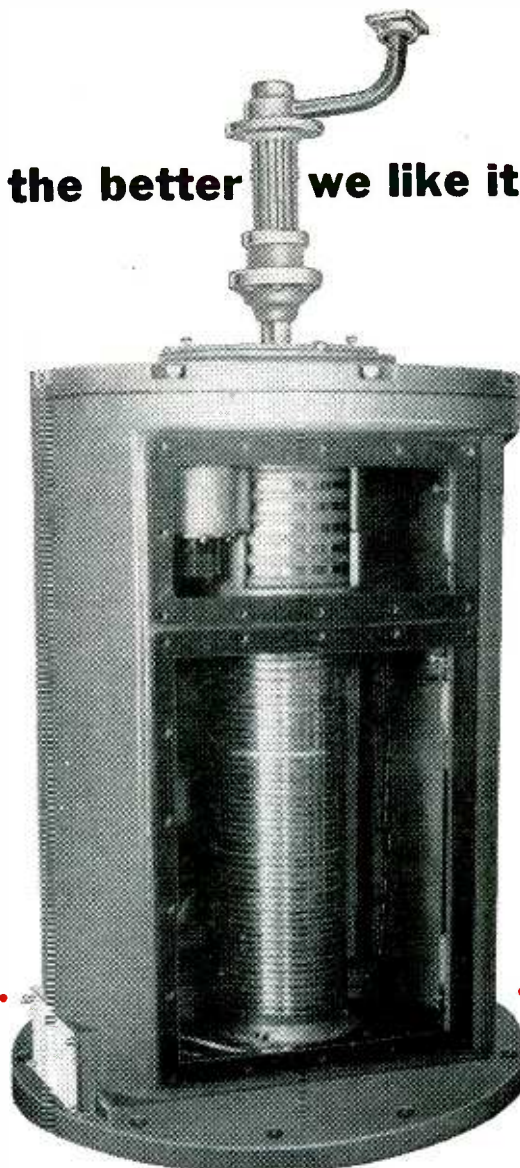

COLLECTOR RINGS AND BRUSHES

Because Makepeace pioneered in the production of solid and laminated precious metal slip rings, a range of sizes and special alloys is available to meet almost any requirement for space, weight, electrical noise, torque, or power handling capability.

In addition to the rings and brushes themselves, Makepeace has utilized its experience in this field in the design and manufacture of complete self contained ring and brush assemblies. The design of such a unit often poses unusual problems. The Makepeace engineering group having met many of these problems, can plan and manufacture a unit to meet your specifications. Before such an assembly is shipped, it is checked out and completely tested for electrical noise, voltage breakdown, impedance matching, power handling capability, and other test specifications as required.

PRECISION RECTANGULAR WAVEGUIDE TUBING
MICROWAVE COMPONENTS • MICROWAVE
TRANSMISSION ASSEMBLIES • ELECTRICAL CONTACT
MATERIAL • FORMED ELECTRICAL CONTACTS
CROSSBAR WELDED CONTACTS • SLIP RING AND
SLIP RING ASSEMBLIES • BRUSH ASSEMBLIES
PRECIOUS METALS CLAD TO BASE METALS
SHEET—TUBING—WIRE AND ASSEMBLIES
SENDZIMIR PRECISION ROLLING

electronic assemblies and components by

Makepeace

D. E. MAKEPEACE COMPANY

Division of Union Plate and Wire Co.

Attleboro, Mass.

Sales Offices: New York • Chicago • Los Angeles • Columbus

WHICH "150"

fits your
oscillographic
recording need?

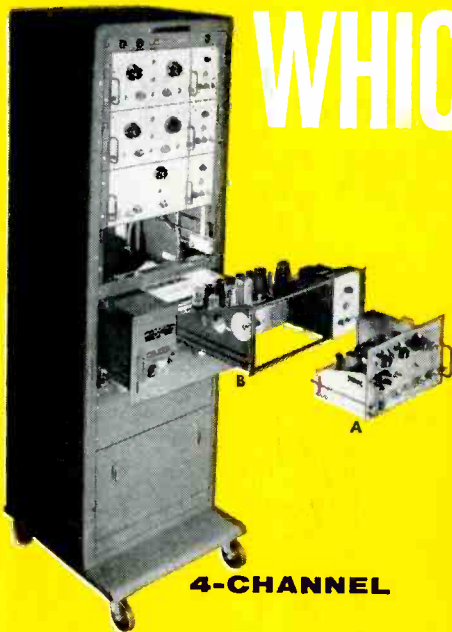

4-CHANNEL

As a graphic example of the design idea that has brought new versatility to industrial recording, a Carrier Preamplifier (A) is shown above in position to plug into a Driver Amplifier in framework with Power Supply (B) which are normally already in place in the Basic Cabinet Assembly.

The identical design principles of the four-channel system are provided in the two-channel, the only difference being the number of channels.



2-CHANNEL

Sanborn "150" Recording Systems that put to use the original design concept of amplifier interchangeability (illustrated at the left) start with either a four-channel or two-channel standard Basic Assembly, to which the user adds whatever selection or combination of preamplifiers (A) are needed for his recording problem. The standard Basic Assemblies comprise a metal Cabinet, Recorder, and a built-in Driver Amplifier and Power Supply (B) for EACH channel. Presently available Preamplifiers are: AC-DC, Carrier, DC Coupling, Servo Monitor, Log-Audio, and Low Level Chopper.

Advantages common to ALL Sanborn Recorders are: inkless recording (by heated stylus) on plastic coated strip chart paper, and in true rectangular coordinates . . . high torque galvanometer movement . . . time and code markers . . . numerous paper travel speeds.

"150"

COMPLETE FOUR-CHANNEL SYSTEM FOR USE WITH ANALOG COMPUTERS

This "150" system consists of a Cabinet Assembly, a four-channel Recorder, and two dual channel DC Amplifiers. Each amplifier is complete with a common power supply. Each measures and records two separate single-ended signals, at sensitivities between one and one hundred volts per centimeter. The two-channel version of this system will comprise Cabinet, two-channel Recorder, and one dual channel amplifier.



Ask, also, for a copy of the *Right Angle* — a Sanborn publication devoted to oscillographic recording in industry.

"150"

SINGLE-CHANNEL RECORDER

A compact, lightweight unit for use when only one channel is required — provides permanent, inkless recording in true rectangular co-ordinates; five paper speeds (5, 10, 25, 50, 100 mm/sec.); extra stylus for either manual or remote timing and coding marks. Designed for simple, patch cord connection to any of the several "150" preamplifiers (plus driver amplifier and power supply), available soon in portable metal cases.

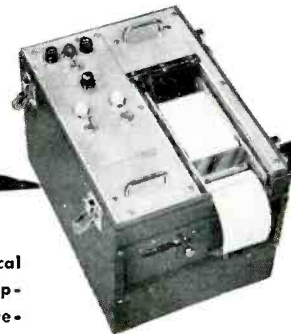

Catalog and technical data on all "150" equipment available on request.

SANBORN COMPANY
Industrial Division
CAMBRIDGE 39, MASS.



Why we choose **WINCO** DYNAMOTORS

"Precision airborne communication equipment must have a dynamotor of consistently reliable quality ... that's why we specify Winco."

says Mr. Paul Wulfsberg,
Ass't. Director Engineering and Research

COLLINS RADIO CO.

Cedar Rapids, Iowa.

WINCO DYNAMOTORS are manufactured on a wide range of rugged frames that allow for broad design applications. Winco engineers have a decade of experience in successfully designing dynamotors to rigid military and commercial specifications. They tackle each power conversion and/or supply problem individually, either modifying a standard Winco machine, or designing a special unit to meet your exact requirements. Winco specialists then plan its manufacture on a production basis to keep costs down and final performance quality at its best.

Winco dynamotors are lightweight, compact and totally enclosed and ventilated. Precise static and dynamic balance is assured by the most modern machines — each dynamotor is thoroughly tested with periodically calibrated precision meters.

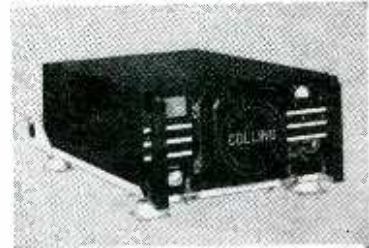

Collins 185 Transmitter/Receiver, used for reliable HF communications in major air-lines and executive aircraft uses a Winco-Engineered Frame 51 Dynamotor.



SEND THIS COUPON TODAY for complete information on how Winco can supply you with reliable, efficient dynamotors and power supplies produced in volume at low cost.



POWER for the Nation's Mobile Communications

WINCHARGER CORPORATION

Sioux City 2, Iowa

Subsidiary of **ZENITH** Radio Corporation

To Wincharger Corp., Sioux City 2, Iowa.

Send me the facts on Winco Dynamotors and Power Supplies

Name _____

Company _____

Address _____

City _____ State _____

Coupon No. 163

YOU can't afford to be without the HATHAWAY S14-C OSCILLOGRAPH

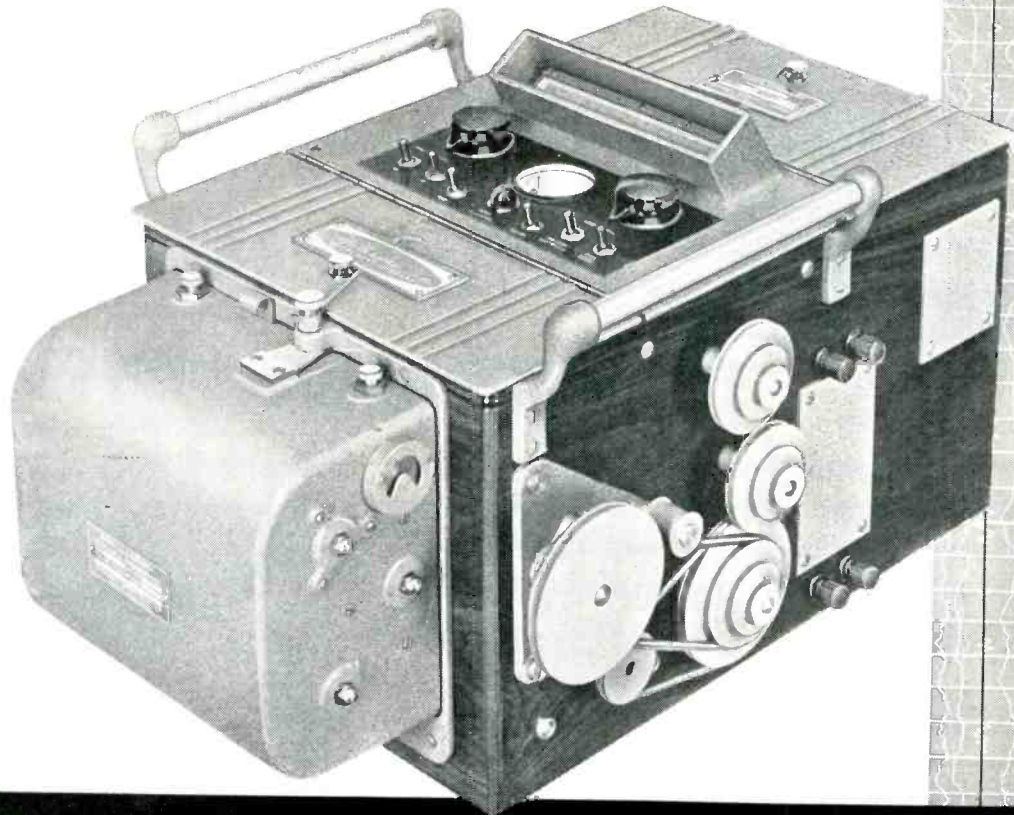

the world's most complete and versatile OSCILLOGRAPH

for recording electrical quantities, processes, flight functions, dynamic pressure, strain, vibration, acceleration, temperature...

for testing relays

for testing welding equipment

for biological recording

for analysis of high-speed engines and compressors

Galvanometers are available for current, voltage, power, covering a most extensive range of characteristics.

Attachments available for almost any recording need—

- automatic transient recording
- wave-shape measurements
- wave-shape scanning
- long records to 100 inches per second
- short records to 1,000 inches per second

PROVE TO YOURSELF THAT THE S14-C IS...

- The Most Versatile ● The Easiest to Maintain ● The Easiest to Operate
- The Finest in Craftsmanship

Write for Bulletin No. 2D-1K and your free copy of Hathaway Engineering News

Hathaway
INSTRUMENT COMPANY
 1315 SO. CLARKSON STREET • DENVER 10, COLORADO

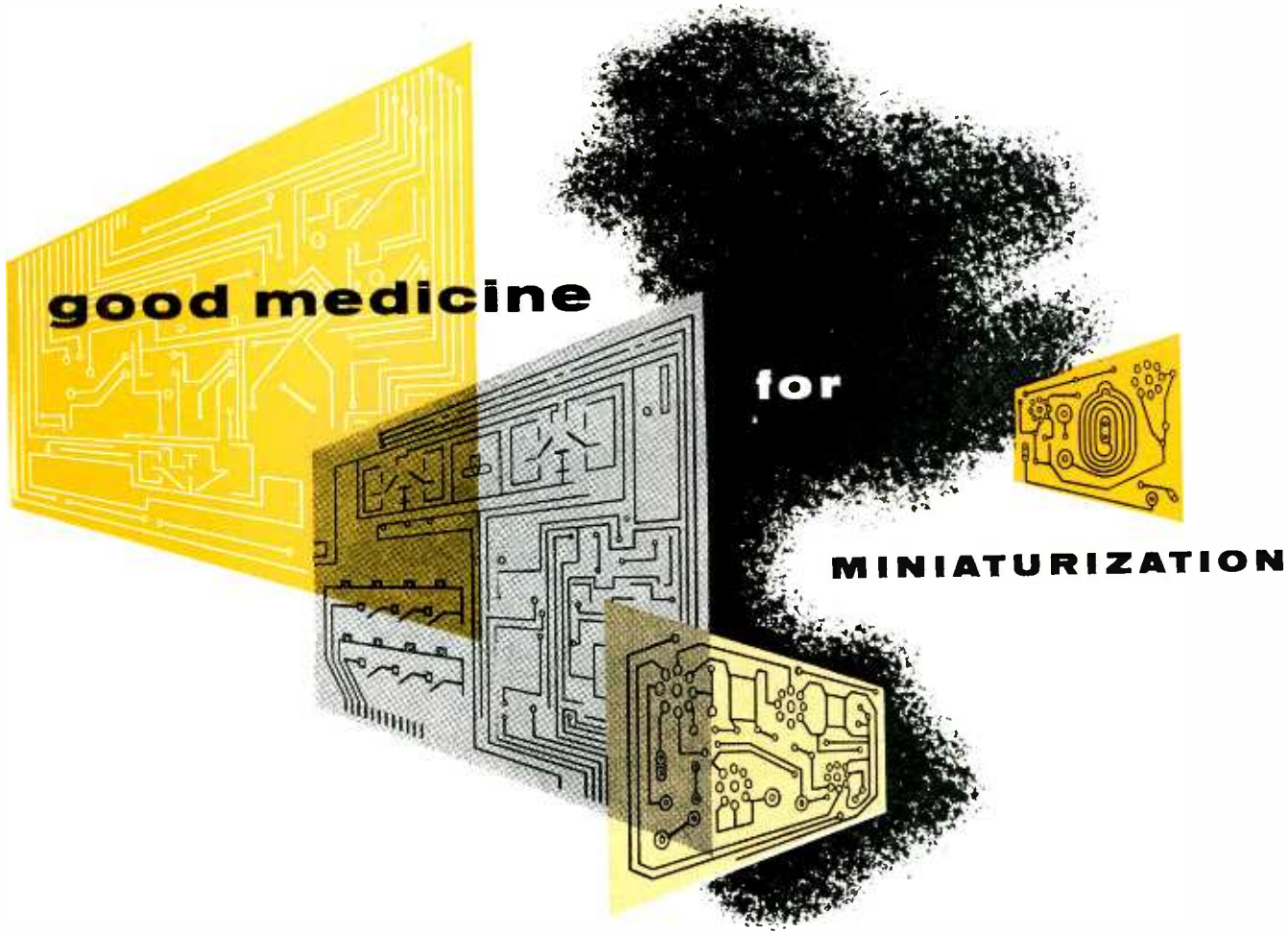

good medicine

for

MINIATURIZATION

By their very nature, *printed circuits* are extremely compact. They open up virtually unlimited possibilities to alert designers concerned with the miniaturization of electrical and electronic devices. From the simplest switches to the most complex computers, printed circuits are proving their versatility and great potential application.

Complicated manual wiring is replaced by a pattern of conductors, coils, resistors, and other components "printed" on a sheet of laminated plastic. Low in cost, uniform in performance, and free of wiring "bugs," such assemblies are speedily mass-produced. Labor costs are drastically cut two ways—far fewer personnel are needed, and lesser-skilled workers can easily assemble (and service) complex devices with less chance of error. Since exact wiring duplication is achieved, inspection is greatly simplified. Assemblies grow small in size, overhead is reduced, less floor space is needed . . . the whole problem takes a big "easy-

does-it" step toward complete automation.

National Vulcanized Fibre Co. is a pace-setter in the development of foil-clad laminates—the basic materials for most printed circuitry. Copper-Clad Phenolite—by National—is recognized as the standard by fabricators everywhere. For Phenolite is a high-quality base laminate that can be *engineered* to fit *your* conditions. It has the high insulation resistance, low electrical loss, and low moisture absorption required in the *right* base material for printed circuits. It is light in weight, easily punched and worked, and withstands effects of the various circuit-printing processes.

No matter which method you use to produce printed circuits, Phenolite clad laminates are the ideal base materials. Whether clad with metal foils, or non-metallic materials (such as rubber, vulcanized fibre, etc.) there is a Phenolite laminate for *your* particular job.

Ask any of our district offices or Wilmington headquarters for details.



HERE'S HELP FOR YOU—our new, fact-filled, 12-page bulletin entitled "Mechanize Your Wiring With Copper-Clad Phenolite." Contains full information and application data on Copper-Clad Phenolite and other metal and non-metal clads. Write for it today! Address Dept. AF-11.



Also manufacturers of Vulcanized Fibre, Vul-Cot Waste Baskets, Peerless Insulation, Materials Handling Equipment and Textile Bobbins



NATIONAL
VULCANIZED FIBRE CO.
 WILMINGTON 99, DELAWARE

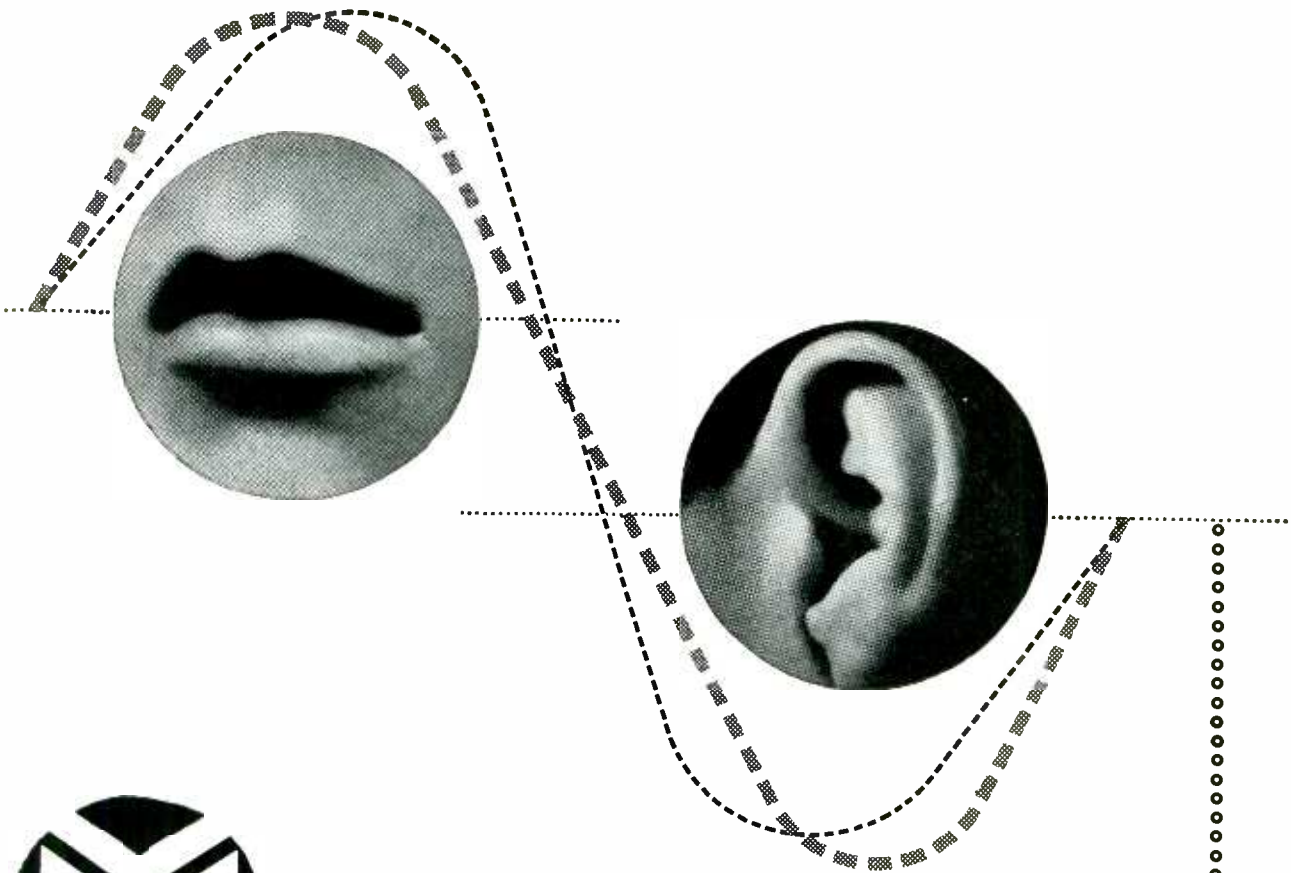

RADIO-TELEPHONE SCHEMES

In more than fifty countries Pye V.H.F. Radio-Telephones are providing an economical and reliable means of instantaneous communication between fixed points, between mobile units, and between fixed points and mobile units. Over two-thirds of the equipment in use in Great Britain alone has been produced by Pye. The Pye Systems Department will be pleased to advise you on your communications schemes whilst Pye agents and representatives overseas will demonstrate, install and maintain the equipment.

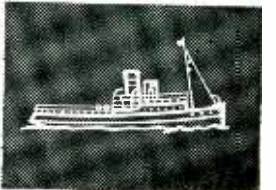
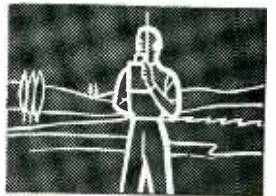

Telecommunications

Pye (New Zealand), Ltd., Auckland C.I., New Zealand. Pye Radio & Television (Pty.) Ltd., Johannesburg, South Africa.	Pye Canada, Ltd., Ajax, Canada. Pye Limited, Plaza de Necaxa 7, Mexico 5.	Pye-Electronic Pty., Ltd., Melbourne, Australia. Pye Limited, Tucuman 829, Buenos Aires.	Pye Ireland, Ltd., Dublin, Eire. Pye Limited, 5th Ave. Building, 200 5th Ave., New York.
PYE LIMITED • • CAMBRIDGE • • ENGLAND			

Want more information? Use post card on last page.

November, 1954 — ELECTRONICS

TUNG-SOL®



6550



a
**completely new
BEAM POWER
AMPLIFIER**

**first in its power
range . . . designed
specifically for
audio service**

see other side for additional information

TUNG-SOL



6550

High Power Capabilities
(Up to 100 watts output in pairs)

- **Low Distortion Output**
- **Extremely Uniform Characteristics**
- **Long Life**

BEAM POWER AMPLIFIER

The Tung-Sol 6550 is a brand new and direct approach to the high power design requirements of high fidelity audio amplifiers. For outputs up to 100 watts, two 6550's in push-pull will provide the same power now attained in most existing designs by the use of four or more tubes. In addition to greater audio output, use of the new 6550 results in simplified electrical balance, reduced maintenance and lower cost. The Tung-Sol 6550 is not directly interchangeable with the 6L6, 5881 or KT66 class of tubes. With proper circuitry, however, the 6550 will provide full power output with approximately the same grid voltage drive as the smaller tubes. The 6550 is produced under laboratory conditions with exhaustive quality control to assure premium performance and long life.

Rugged Construction — The advanced design features which have made the Tung-Sol 5881 so extremely reliable are embodied in the 6550.

- 1 Glass button stem construction is strong and compact and provides a rugged support for the tube structure.
- 2 Micanol wafer and metal shell base provides full lifetime electrical insulation and greater mechanical strength.
- 3 Cathode materials of exceptional stability give more uniform emission with greater life expectancy. Cathode is not poisoned by inactivity during standby periods.
- 4 Maximum control of grid emission achieved by gold plating and carbonizing.
- 5 Triple gettering promotes long, gas-free life. Getters are confined by a spray shield to prevent mica contamination.
- 6 Life tests are made under severe overload conditions to assure adequate safety factor.

MECHANICAL DATA

Coated Unipotential Cathode	
Outline Drawing	Bulb—Short St-16
Base	Large Wafer Octal 8-Pin Mical with Metal Sleeve B8-86
Maximum Diameter	2 1/16"
Maximum Overall Length	4 3/4"
Maximum Seated Height	4 3/8"
Pin Connections	Retma Basing 75
Pin 1—Base Shell	Pin 5—Grid No. 1
Pin 2—Heater	Pin 7—Heater
Pin 3—Plate	Pin 8—Cathode and
Pin 4—Grid No. 2	Grid No. 3
Mounting Position	Any

ELECTRICAL DATA (INTERPRETED ACCORDING TO RETMA DESIGN CENTER SYSTEM)

DIRECT INTERELECTRODE CAPACITANCES — No Shield

Grid #1 to Plate	0.85 μf
Input	14.0 μf
Output	12.0 μf

ELECTRICAL DATA

RATINGS

Heater Voltage (AC or DC)	6.3 \pm 10% VOLTS
Maximum DC Plate Voltage	600 VOLTS
Maximum Plate Voltage (Triode Connection)	450 VOLTS
Maximum Plate Dissipation (Triode Connection)	40 WATTS
Maximum DC Grid #2 Voltage	400 VOLTS
Maximum Grid #1 Voltage	-300 to 0 VOLTS
Maximum Plate Dissipation	35 WATTS
Maximum Grid #2 Dissipation	6.0 WATTS
Maximum DC Cathode Current	175 MA.
Maximum Heater-Cathode Voltage	
Heater Positive (Peak) (DC not to exceed 100V)	+200 VOLTS
Heater Negative (Peak or DC)	-300 VOLTS
Maximum Grid #1 Circuit Resistance (Fixed Bias)	50 KILOHMS
Maximum Grid #1 Circuit Resistance (Self Bias)	250 KILOHMS
Maximum Bulb Temperature	250 °C

HEATER CHARACTERISTICS

Heater Voltage	6.3 VOLTS
Heater Current	1.8 AMP.

TUNG-SOL

ELECTRON TUBES

The TUNG-SOL engineering which has produced the 6550 is constantly at work on a multitude of special electron tube developments for industry. Many exceptionally efficient general and special purpose tubes have resulted. Technical data sheets, or circuitry suggestions for the 6550 may be obtained by writing to Tung-Sol Commercial Engineering Department.



TUNG-SOL ELECTRIC INC., NEWARK 4, NEW JERSEY

SALES OFFICES: ATLANTA, CHICAGO, COLUMBUS, CULVER CITY (LOS ANGELES), DALLAS, DENVER, DETROIT, NEWARK, SEATTLE

TUNG-SOL MAKES ALL-GLASS SEALED BEAM LAMPS, MINIATURE LAMPS, SIGNAL FLASHERS, PICTURE TUBES, RADIO, TV AND SPECIAL PURPOSE ELECTRON TUBES AND SEMICONDUCTOR PRODUCTS.

NOVEMBER, 1954

**HIGH ATTENUATION
CONTINUOUS DUTY
HERMETICALLY SEALED**

FILTRON

SCREEN ROOM FILTERS



FILTRON TYPE FA 736
500 VAC/DC
100 AMPS
Frequency Range 1000 to 15,000 MC

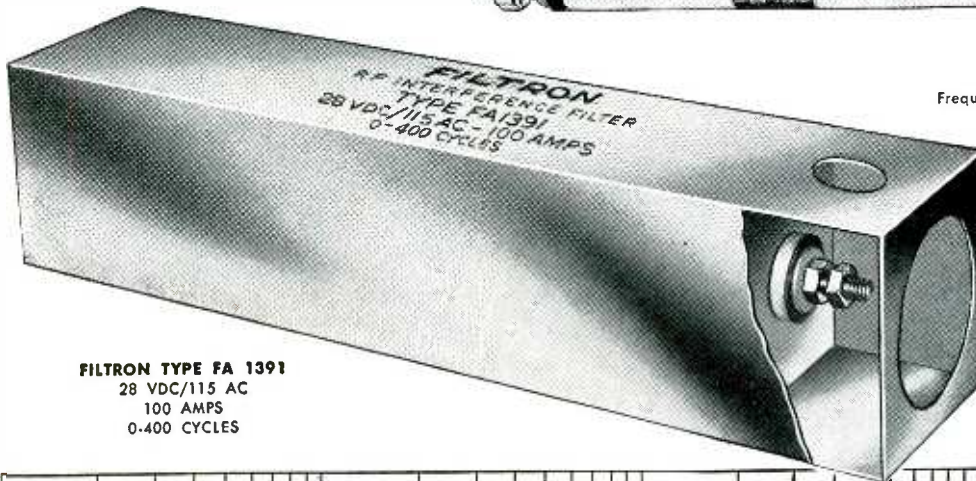

FILTRON TYPE FA 1391
28 VDC/115 AC
100 AMPS
0-400 CYCLES

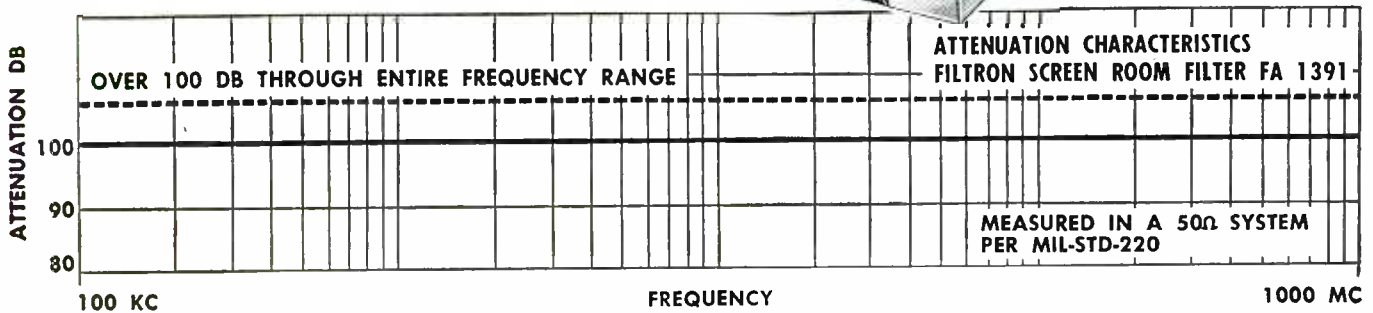

Screen room manufacturers specify and install FILTRON Screen Room Filters as standard equipment.

FILTRON Screen Room Filters are used in the majority of industrial, government and military screen rooms, to meet the requirements of specification MIL-S-4957, and wherever critical RF measurements are required.

FILTRON has over 30 types of Screen Room Filters available, ranging from 1 Amp to 1000 Amps, 28 VDC

to 500 Volt AC/DC, 0 to 1000 cycles. Complete technical information available.

FILTRON RF Interference Filters are also specified in the latest types of Radar, Radio Transmitters, Receivers, Motor Generator Sets, Inverters, Aircraft, Electronic Systems, and numerous other "restricted" equipments.

When you have an RF Interference Filter problem, consult FILTRON — the most dependable name in RF Interference Filters.

SALES REPRESENTATIVES

G. S. Marshall Co., Pasadena, Cal.
Roy J. Magnuson, Chicago, Ill.
Massey Associates, Inc., Narbeth, Pa.,
Washington, D. C.

Holliday-Hathaway, Cambridge, Mass., Canaan, Conn.
Sales Offices at: New York, N. Y., Great Neck, N. Y.
Rochester, N. Y., Binghamton, N. Y.
Wood-Ridge, N. J.

INTERFERENCE FREE

means
FILTERED
by

FILTRON CO., INC. • FLUSHING, LONG ISLAND, NEW YORK

LARGEST EXCLUSIVE MANUFACTURERS OF RF INTERFERENCE FILTERS

An inquiry on your company letterhead will receive prompt attention.

FULL RANGE INSTRUMENTATION!

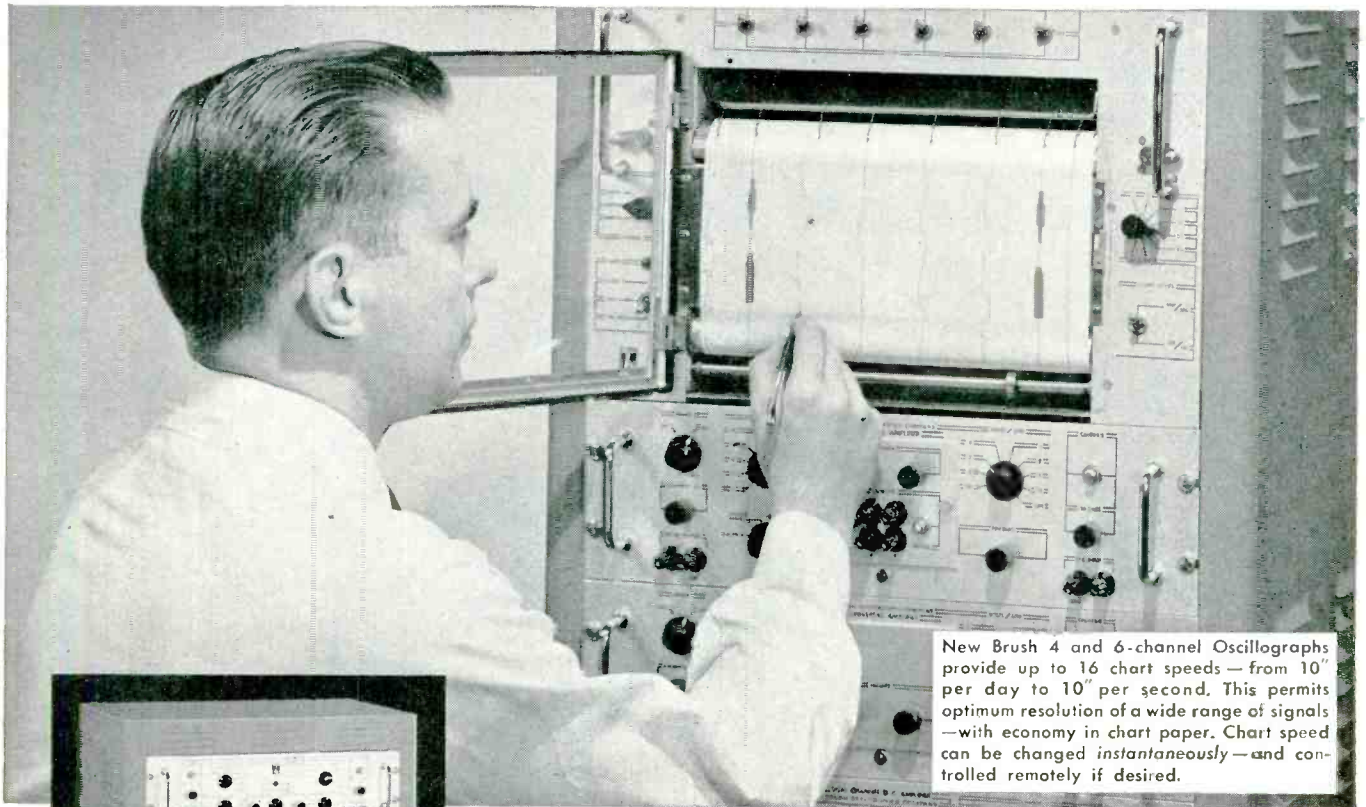

New Brush 4 and 6-channel Oscillographs provide up to 16 chart speeds — from 10" per day to 10" per second. This permits optimum resolution of a wide range of signals — with economy in chart paper. Chart speed can be changed *instantaneously* — and controlled remotely if desired.

NEW BRUSH RECORDING SYSTEMS offer you greatest flexibility in measurements

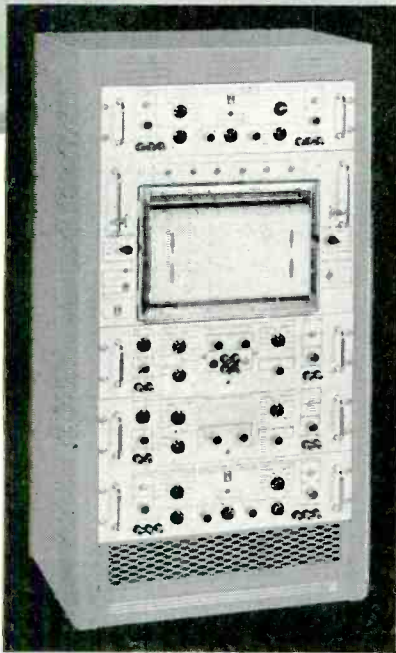

New Brush Recording Systems are designed to meet many mounting requirements — standard 19-inch racks, bench-top, or floor consoles. New Brush Amplifiers are lighter, smaller and can be stacked closely as shown.

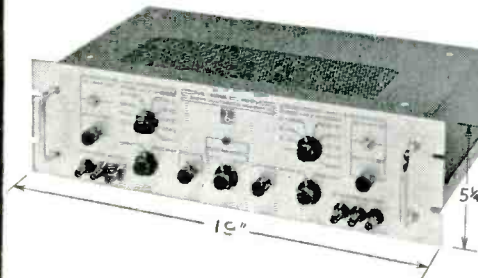

Above: New Brush dual-channel D. C. Amplifier Model BL-530 accepts either single ended or balanced signals, provides a 50 millivolt sensitivity and accurate calibration of the signal to be recorded.

Right: New Brush Universal* Amplifier Model BL-520, when used with the appropriate resistive or inductive transducer, permits measurement and direct recording of physical phenomena: strain, torque, force acceleration, velocity, displacement, pressure, temperature, etc. Maximum sensitivity is equivalent to 1/2 microvolt per chart millimeter; or in strain measurements — .25 microinch per inch. The Amplifier includes a medium gain direct-coupled amplifier section with calibrated attenuator that may be used separately for voltage and current measurements.

*Trade Mark

Brush Recording Systems have an important place in your research and production instrumentation. Write today or call your nearby representative for complete information. Brush Electronics Co., Dept. K-11A, 3405 Perkins Avenue, Cleveland 14, Ohio. In Canada: A. C. Wickman, Ltd., Toronto.

BRUSH ELECTRONICS

INDUSTRIAL AND RESEARCH INSTRUMENTS
PIEZO-ELECTRIC MATERIALS • ACOUSTIC DEVICES
MAGNETIC RECORDING EQUIPMENT
ULTRASONIC EQUIPMENT



COMPANY

formerly
The Brush Development Co.
Brush Electronics Company
is an operating unit of
Clevite Corporation.

Warrants say L. Triplett, of Bluffton, Ohio, assignor to
 Triplett Electrical Instrument Company, of Bluffton, Ohio,
 corporation of Ohio,

In testimony whereof, I have hereunto set my hand and caused the seal of the United Office to be hereunto affixed at the City of Washington this eighth day of September, in the year of our Lord one thousand nine hundred and fifty-three, and of the Independence of the United States of America the one hundred and eighty-eighth.

Robert Winston
 Commissioner of Patents

THESE INSTRUMENTS ARE BACKED BY 63

THE UNITED STATES OF AMERICA
 a corporation of Ohio.

TRIPLET

PATENTS

proof of 50 years research

Bluffton, Ohio, assignor to
 Instrument Company, of Bluffton, Ohio,



MODEL 630—The "Smoothie"
 streamlining expresses advance design features such as selector switch of molded construction, completely enclosed; elimination of harness wiring, etc. AND a single control knob for all 34 ranges affording ease of operation and minimum burn out possibilities.
 Price \$39.50



MODEL 630A ultra-accurate VOM
 designed for the laboratory where you need that PLUS in accuracy—*mirror scales* to eliminate parallax in making readings; $\frac{1}{2}\%$ resistors each mounted in its own insulated compartment; *compensated ohmmeter circuit*, resistance ranges are compensated for greatest accuracy over wide battery voltage variation. Single selector switch feature makes for ease of operation and eliminates possibility of burnouts through incorrect settings.
 Price \$49.50

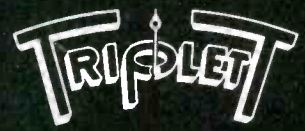

ELECTRICAL INSTRUMENT COMPANY
 Bluffton, Ohio

Burton Browne Advertising



BLINDED BY TEAR GAS but still shooting, a killer, twice-escaped from prison, staggers out of a Los Angeles bungalow into the arms of Sergeant Friday and his partner. Jack Webb,

as Sgt. Friday, stars in this true-to-life series based on actual police cases. With "Badge 714" began a race against time in which millions of dollars are involved. Air Express helps NBC win it.

“DRAGNET!”

How the top detective drama of all TV networks is also seen locally in 152 markets as “Badge 714”

Continuing its highly successful run as the leading program on the NBC-TV Network, “Dragnet” has proved so popular that, in addition, it is being re-run throughout the country as “Badge 714.” This local syndication schedule is made possible only by Air Express.



KHQ-TV, SPOKANE
—\$8.55 less*

POLICE FILES provide the material that keeps about 65 million Jack Webb fans glued to their TV sets each week. A large percentage of them see him under syndicated (locally sponsored) title “Badge 714.” Schedules to the 152 syndicated markets are rigid. Air Express gets the film there on time.



WHO-TV, DES MOINES
—\$3.47 less*

JACK WEBB INSISTS that sets be built to duplicate Los Angeles Police Headquarters, to the very door knobs! It is this passion for realism which attracts audiences for “Badge 714” worth millions of dollars to sponsors. NBC can’t afford to have film arrive late, and so it is shipped regularly by Air Express.



KFEL-TV, DENVER
—\$5.51 less*

FROM BIG CITIES and small towns, people write in to ask whether Sgt. Friday isn’t an actual member of the Los Angeles Police. Many television stations are in cities with no airline connections, but Air Express connects through Railway Express. “Badge 714” films get there on schedule, just the same!



KXLF-TV, BUTTE
—\$4.87 less*

A MADMAN tried to blow up the Los Angeles City Hall. Jack Webb made it into his first NBC “Dragnet” show. Now it’s making history again as “Badge 714,” the hottest syndication property in the industry. “Air Express makes our syndicated operations possible,” says NBC’s Frank Lepore, head of Film and Kinescope Operations.



WLWA-TV, ATLANTA
—29¢ less*

THEY CALL IT “BICYCLING.” Every week, NBC Film Exchanges in New York and Hollywood have 4,000 film or kinescope programs in circulation to and from stations. This method, called bicycling, saves thousands of dollars in film and shipping costs. It is only possible by Air Express, with its ability to pinpoint shipments.



KSD-TV, ST. LOUIS
—63¢ less*

HUMAN ERROR does occur. One film arrived in Springfield, Missouri, addressed to Station WICS. The Air Express Agent wired NBC, “No WICS in city. Please advise.” The film was trans-shipped to Springfield, Illinois (where there is a WICS) and arrived in time! Alert agents protect against error or changing circumstance.

gets there first via **Air Express**



U. S. Scheduled Airlines...call Air Express...division of Railway Express Agency.

*Less than any other air service (from N. Y.) that includes door-to-door pickup and delivery. “These are examples of what we save on 87% of our air shipments by using Air Express. With 97,000 NBC shipments a year, the figure is impressive. The one thing that impresses us more is Air Express service.”—Frank C. Lepore, Mgr., Film and Kinescope Operations and Services.

Need components in a hurry?

Call your nearby
MALLORY
distributor!

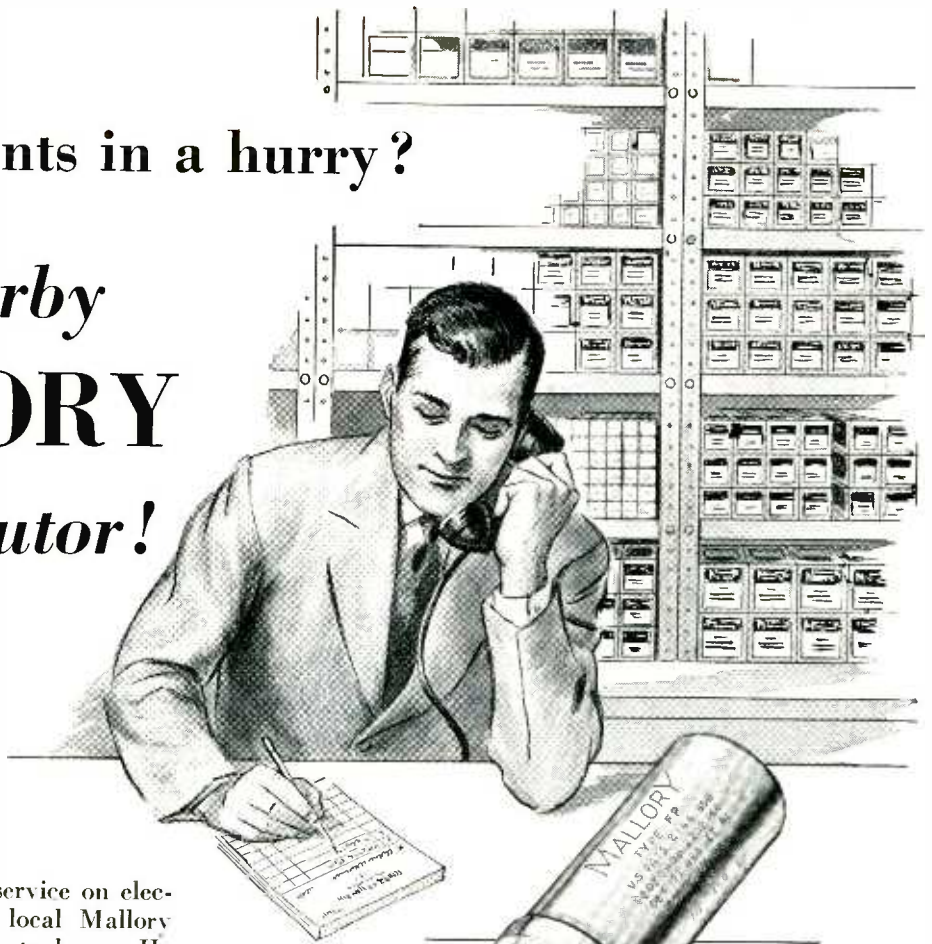

Whenever you need fast service on electronic components, your local Mallory distributor is a good man to know. He stocks an extensive selection of precision-made Mallory resistors, controls, capacitors, switches, batteries, rectifiers and vibrators . . . and many other top quality components, too . . . in a variety of ratings ready for prompt delivery to you.

Anytime you're looking for components to use in experimental "breadboard" circuits, in pilot models, small production runs, or for maintenance purposes, you can save valuable hours by calling on your nearby Mallory distributor. If you do not know the name of your local Mallory distributor or if the particular part you need is not stocked locally, we hope you will contact our nearest District Office or our Home Office in Indianapolis.

Patronizing your local Mallory distributor will assure you of prompt, courteous service . . . and you'll be sure, too, of getting the high standards of quality that have made Mallory components the choice of leading manufacturers of electrical and electronic equipment. Write today for our complete catalog of components, and for the name and address of the Mallory distributor nearest you.



Capacitors

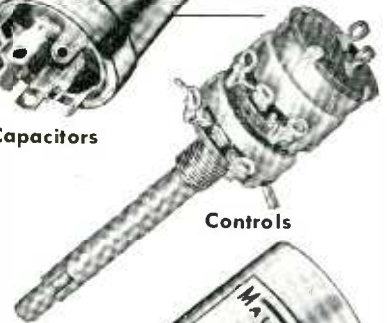

Controls



Vibrators



Resistors

Depend on **MALLORY** for Service!

P. R. MALLORY & CO. Inc.
Distributor Division
P. O. Box 1558
Indianapolis 6, Ind.



... also
Switches
Batteries
Rectifiers

CROSS TALK

► **RELIABILITY . . .** In the early days of radio when we pumped signals into the air it was a matter of conjecture where they would go. Then, largely as a result of experience, transmission paths and distances became reasonably predictable. Now we are entering an era in which it may be possible to determine, by rapid test, precisely where signals will go at any time of day or night and in any season.

Low-frequency signals are influenced to a marked degree by disturbances in the earth's magnetic field. Instruments which measure this field have been developed to a high order of precision. High-frequency signals for the most part travel by reflection from upper-atmosphere layers. A relatively new instrument incorporating the principles of radio, radar and photography presents a quick picture of transmission conditions for various frequencies and directions. Curiously, it draws a blank when aimed north over the polar region.

Sunspots have much to do with communications conditions, and much is known about the sunspot cycle. Still more may soon be known when astronomers, who are themselves now using radio telescopes, evaluate a theory advanced by electronics engineers. According to this theory the observable conjunction of certain celestial bodies produces a "tidal" pull

which may in itself produce sunspots.

► **RETIREMENT . . .** Economic considerations that caused many firms to institute retirement plans several decades ago are even more prominent today. And in some instances the establishment of age as the controlling factor is becoming embarrassing.

Terminating the service of a man who has spent many years in management involves a difficult decision because the proficiency of a management man depends very largely upon the accumulation of experience. It is no less difficult in the case of a physicist or an engineer, who may profit less from experience, because an imaginative technician may come up with an important idea at any age.

History indicates that a preponderance of great inventions were contributed by young men. And yet some truly great inventions have also been contributed by men well along in years. It all depends upon the man, and this is the reason current thinking appears to revolve around carefully considered change in the status of each individual, rather than rigid application of any overall rule.

► **OUTSIDE . . .** Three visitors from Japan questioned us at some length the other day about the

market status of certain electronic devices which have not yet gotten very far here, and exhibited singularly little interest in products about which many American manufacturers are currently quite excited.

This has happened to us before with visitors from other lands so we tried to find the reason. There are, of course, many reasons, including the fact that other countries are in different stages of development. But one stands out. The pressures that cause us to commercially harness new technical developments as quickly as possible are severe enough; in most other countries they are even more severe and in many sheer necessity forces complete sacrifice of long-term objectives.

► **TEMPTATION . . .** A friend of ours is now up to his armpits in the detailed development of an idea which could have an important influence upon the design of electronic gages.

When the idea first occurred to him he put a meter in a circuit and it read backward. It seemed a simple matter to reverse the leads so the meter would read forward, but when he did so it continued to read backward.

Right here, says our friend, is where he should have given up physics and studied music.

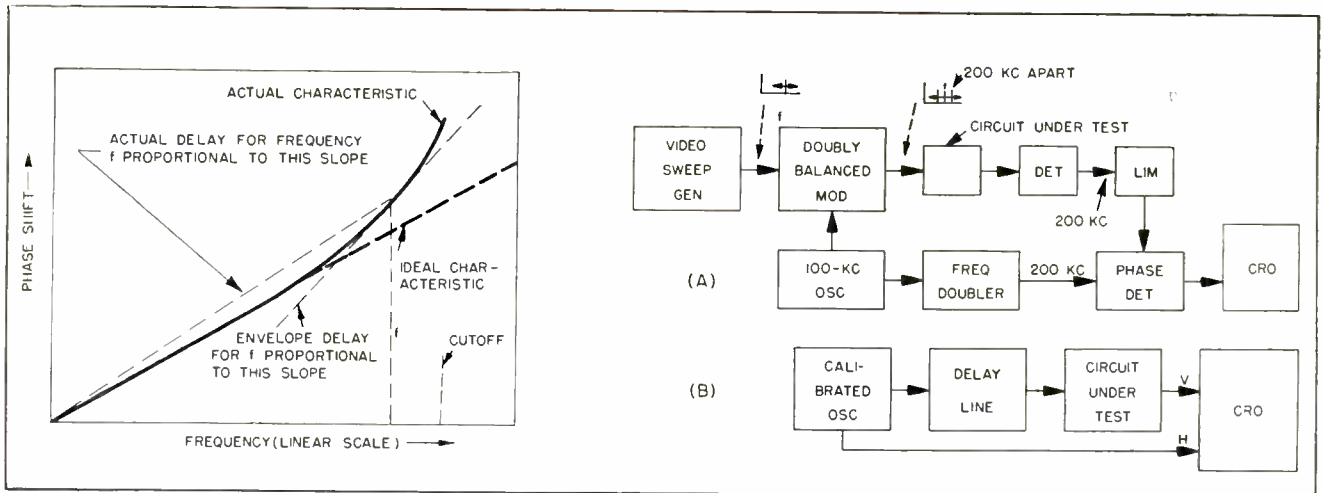

FIG. 2—Graph shows why envelope delay measurements give best indication of phase distortion. Block diagrams, right, give two ways of measuring envelope delay

Color Test Techniques

How to put out the best color signal possible. Key transmission system parameters are discussed together with instruments for checking them. Actual waveform photographs show what to look for in lining up transmitters and studio equipment

By JOHN W. WENTWORTH

*Broadcast Studio Engineering
Engineering Products Division
Radio Corp. of America
Camden, New Jersey*

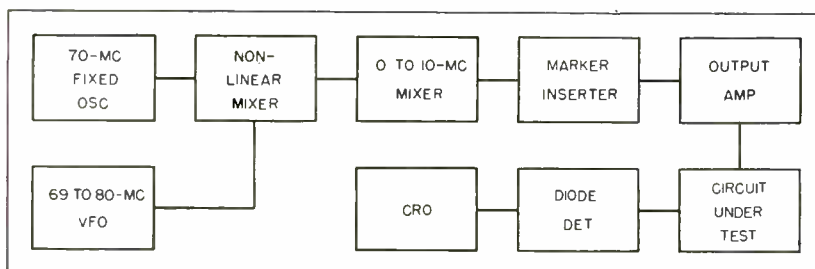

FIG. 1—Test setup for measuring amplitude-versus-frequency characteristic

FOUR TRANSMISSION system parameters require close control for optimum handling of color signals.

The amplitude-versus-frequency characteristic is important because the subcarrier modulated by chrominance information is transmitted near the upper end of the video spectrum, and must pass with the correct level relative to the lower video frequencies in the monochrome component of the signal. Phase or time delay versus frequency is important because the three independent components of a color signal must arrive at the re-

ceiver in time coincidence even though they are transmitted in different parts of the video spectrum. The phase or delay characteristic must be watched particularly in the upper part of the video spectrum where this characteristic is subject to distortion from cutoff effects.

Because the subcarrier is transmitted by adding it to the monochrome component of the signal such that the average level of the subcarrier varies over the black-to-white amplitude range, it is important to maintain good performance with respect to differential gain and

differential phase at the subcarrier frequency.

Amplitude Versus Frequency

A convenient method of measuring amplitude versus frequency involves a video sweep generator that produces a sine-wave test signal varying continuously in frequency over the desired bandwidth—usually at a 60-cycle rate. Typical sweep generators comprise a fixed r-f oscillator whose output is heterodyned against that of a variable oscillator. The test signal at the output of a device under test may be observed either on a wide-band oscilloscope or on a narrow-band oscilloscope equipped with a diode detector. Most video sweep generators provide for adding marker pips or notches for frequency calibration.

A simplified block diagram for a typical video sweep generator and auxiliary equipment is shown in Fig. 1. The fixed oscillator is commonly operated at about 70 mc

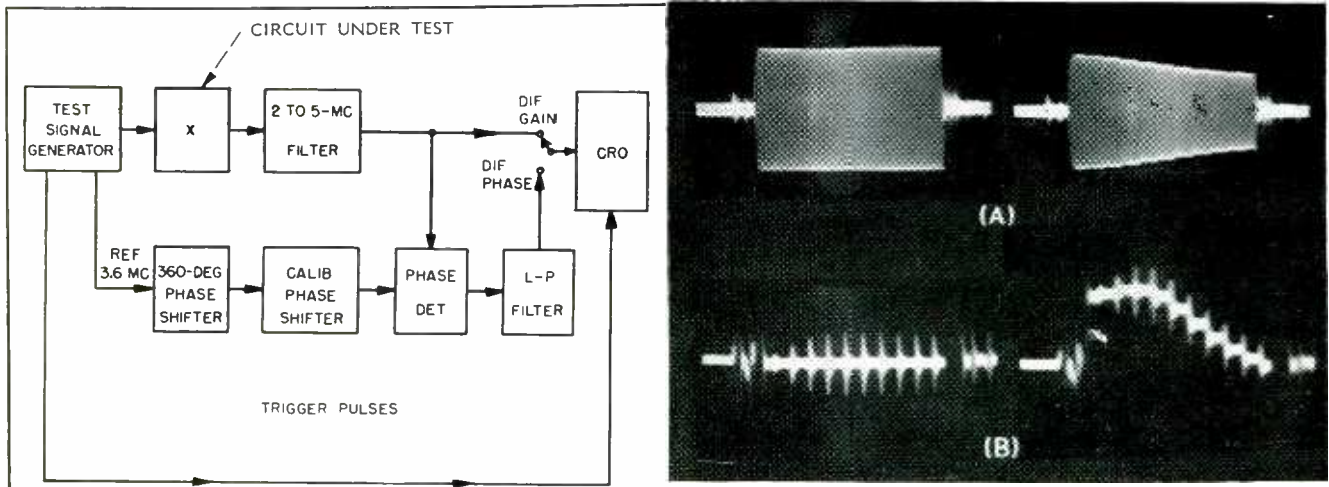

FIG. 4—Equipment for measuring differential gain and phase. Photo (A) shows subcarrier envelope without (left) and with (right) differential gain errors. Photo (B) shows analyzer output without and with phase errors

for TV Broadcasters

while the variable oscillator is swept from perhaps 10 mc away on one side to 1 or 2 mc beyond on the other. The video-frequency beat between these two oscillators produced in a nonlinear mixer is selected by a low-pass filter and after the addition of a suitable marker applied to the unit under test.

Envelope Delay

The time delay introduced by any circuit for a signal of a given frequency is readily determined by dividing the phase shift for that frequency by the angular velocity. In the case of linear-phase-shift networks, the time delay is the same for all frequencies and is proportional to the slope of the phase-versus-frequency characteristic. However, in most cases, there is a tendency for the phase characteristic to rise in the vicinity of cutoff, as indicated in the graph of Fig. 2.

To measure phase distortion which results in delay distortion the concept of envelope delay is frequently employed. Envelope delay is proportional to the incremental slope of the phase characteristic and hence is a somewhat more sensitive indicator of phase distortion than is actual signal delay. The difference between signal delay and envelope delay is indicated in the graph of Fig. 2. Envelope delay may be expressed as $\Delta\theta/2\pi\Delta f$.

A block diagram for a sweep-type instrument for measuring envelope delay is presented in Fig. 2A. This instrument produces a test signal consisting of a pair of frequencies a fixed number of cycles apart—usually about 200 kc—which are swept through the video band. After passing through the circuit under test the test signal is demodulated to recover the 200-kc

component, which is limited and compared in a phase detector with a reference 200-kc signal. Since the frequency separation is small the output of the phase detector is proportional to the envelope delay of the unknown circuit. The phase detector output may be displayed on a cro.

Figure 2B illustrates an alternative method for measuring envelope delay by determining the frequency intervals corresponding to a fixed phase increment, $\Delta\theta$. An oscilloscope can serve as a convenient phase detector for showing 180 or 360-deg increments, since the closing of a Lissajous loop provides a sensitive indication of phase.

Differential Gain and Phase

At least four types of test signals have been proposed for the measurement of differential gain and differential phase. Figure 3A shows a signal consisting of relatively low-level subcarrier sine wave superimposed on a relatively high-level 15.75-kc sine wave. Synchronizing pulses may be added to the trough of each 15.75-kc sine wave to permit the signal to pass through stages with triggered clamps. The most serious disadvantage of this signal is that it has no provision for varying the duty cycle or d-c component.

The signal shown in Fig. 3B con-

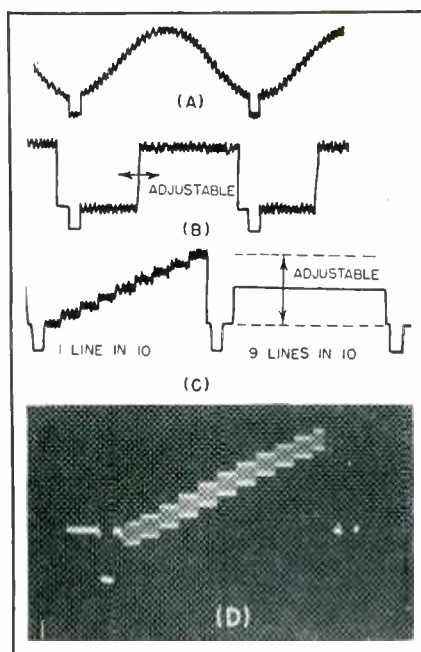

FIG. 3—Three test signals for checking differential gain and phase (A, B and C). Waveform (D) is actual cro photograph of a signal (C)

sists of a variable-width pulse at horizontal frequency with a relatively low-level superimposed subcarrier. The d-c component can be adjusted by varying the width of the pulse and horizontal synchronizing pulses may be added. The most serious disadvantage of this signal is that it shows the conditions only at the limits of the amplitude range.

Figure 3C shows a horizontal-frequency step signal usually comprising 10 steps with a low-level subcarrier sine wave superimposed on each step. If this step-plus-subcarrier signal is presented only during one line out of every ten, the d-c component of the complete signal may be varied by adjusting the level of a blanking pulse transmitted during the remaining nine lines. Sync pulses may be added to this waveform. Figure 3D is a photograph of a test signal of this type. The fourth type of test signal is a color-bar signal.

A typical test setup for making differential gain and differential phase measurements is shown at the left in Fig. 4. Any one of the test signals discussed is passed through the unit under test and then through a high-pass or band-pass filter which rejects the low-frequency components. Variations in the envelope of the separated subcarrier signal correspond to variations in differential gain. Figure 4A shows the subcarrier en-

velope with and without differential gain errors. Distortion is much easier to see in the separated envelope than in the complete test signal.

Differential phase errors can be determined by passing the filtered subcarrier component of the test signal through a phase detector. Here its phase may be compared with that of a reference subcarrier derived from the test signal generator. A 360-deg phase shifter may be employed to zero in on any desired portion of the test signal and an accurately-calibrated phase shifter may be used to determine the phase error between any two amplitude levels in the test signal.

Figure 4B shows the signal at the output of a phase detector. All intervals come to a null simultaneously when there is no differential phase error while only one step at a time can be zeroed in when appreciable distortion is present.

Color Bar Generator

Color patterns produced by combinations of pulses in red, green and blue video channels have two important uses in color television:

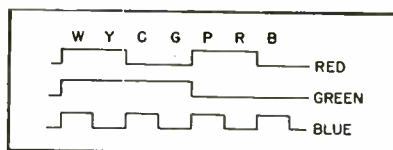

FIG. 5—Waveforms used in producing color bar signal

(1) They provide noise-free, readily recognizable waveforms convenient for the adjustment of encoding equipment, and (2) a composite color bar signal provided by a color bar generator in combination with encoding equipment is useful for aligning monitors and receivers and for making general system checks.

The waveforms in Fig. 5 illustrate a recent color bar generator design which employs only three basic multivibrators—one for each color. The active part of each line period is divided into seven bar intervals, and the circuit arranged so that each multivibrator is on for four of the seven intervals and off for the remaining three. All of the multivibrators are on for the first interval. Thus a white or neutral is produced as the first bar.

Usually the green multivibrator produces only one pulse per line four intervals wide, the red multivibrator produces two pulses per line each two intervals wide and the blue multivibrator produces four pulses per line each one interval wide. The combination of these signals results in a bar pattern with the colors arranged in descending order of luminance.

Evaluating Color Bar Signals

A television oscilloscope with uniform frequency response out to at least 3.6 mc is often sufficient for evaluating a color bar signal to determine if an encoder is set up

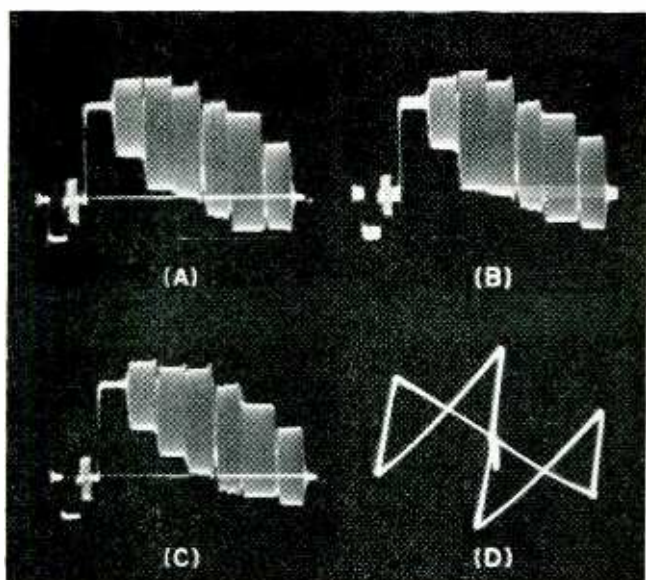

FIG. 6—Color bar signal from encoder in good adjustment (A) and out of adjustment (B and C). Waveform (D) shows vector display

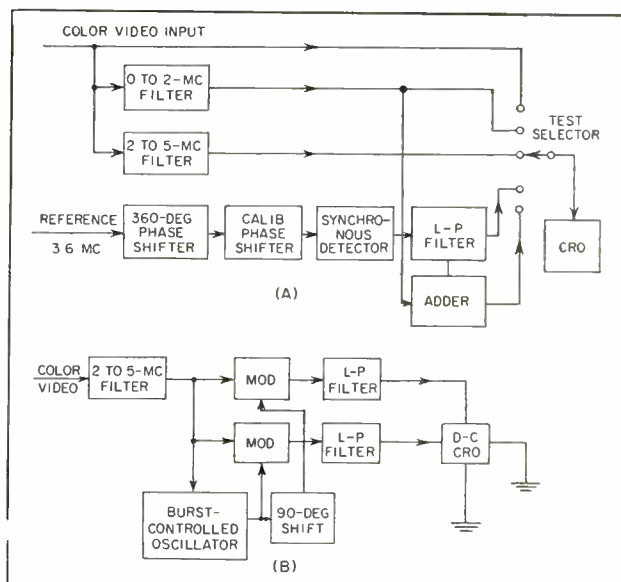

FIG. 7—Block diagram illustrate color signal analyzer (A) and vector display oscilloscope (B)

properly or if distortion has been introduced by equipment handling the composite signal. Figure 6A shows a complete color bar signal produced by an encoder in good adjustment. The trained observer will look for several landmarks in this pattern. A thickening of the black-level trace indicates carrier unbalance while a thickening of the white bar trace when the black trace is of minimum thickness indicates poor white balance. When the relative amplitudes of the monochrome, I and Q signal components are correct, the positive overshoots for yellow and cyan should match, the negative red overshoots should just match the blue overshoots, the negative green subcarrier should just touch the black level and the positive purple subcarrier should just touch reference white.

To indicate possible distortions, Fig. 6B shows a case of poor carrier balance and Fig. 6C shows the pattern that results when the I gain is dropped about 25 percent.

Figure 7A illustrates a color signal analyzer, which provides accurate measurements of the various amplitude and phase relationships in a color signal. A five-position selector switch permits the operator to view on an oscilloscope the complete signal, the low-frequency portion of the signal only (representing luminance information), the high-frequency portion of the signal only (representing subcarrier information), the output of a synchronous detector or the detector output added to the low-frequency information.

The synchronous detector permits the measurements of relative phase angles. An accuracy of better than 1 degree can be achieved.

The vector display oscilloscope, Fig. 7B, gives a complete picture of the phase and amplitude relationships in a color subcarrier signal. This instrument employs a pair of quadrature demodulators comparable to those used in color monitors and receivers and a burst-controlled oscillator for deriving the reference subcarrier from the color synchronizing bursts contained in the signal. The outputs of the two demodulators are applied after suitable filtering to the horizontal and vertical plates of a d-c oscilloscope.

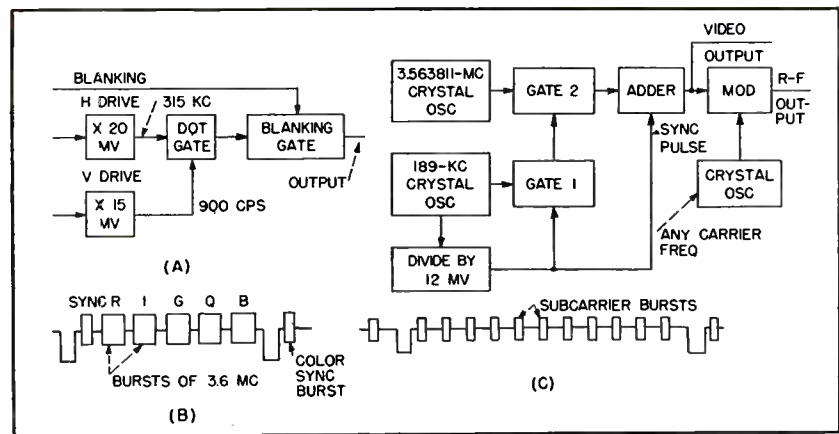

FIG. 8—Dot generator for studio use (A) and waveform from color monitor analyzer (B). Color simulator (C) is for receiving servicing. Its waveform is shown below

When used with color bar signals, the vector display oscilloscope produces a pattern of bright dots corresponding to the tips of the various color vectors, or a pattern of lines corresponding to the transitions between the colors. A typical vector display pattern for the color bar signal of Fig. 6A is shown in Fig. 6D.

The dots or the corners of the line traces can be compared with markings on a transparent overlay. The accuracy of measurement is in the order of 2 or 3 degrees.

Convergence Dot Generators

The dots or the corners of the or registration in tricolor tubes is readily accomplished with a test signal producing a regular pattern of dots. The optimum size for the dots is about 10 to 12 lines square.

A suitable pattern can be generated by two multivibrators or blocking oscillators operating at multiples of the line and field frequencies in combination with a gate circuit that permits pulses to pass through only when pulses from the two multivibrators coincide. For studio use, a dot generator may use the standard horizontal and vertical driving pulses as indicated in Fig. 8A.

Portable Color Signal Generators

The color monitor analyzer was developed specifically for adjusting color monitors. It consists of a crystal-controlled subcarrier oscillator, a free-running horizontal-frequency multivibrator and auxiliary multivibrators, gates and phase standards to produce a simplified

bar signal consisting of a horizontal synchronizing pulse occurring every line, a color synchronizing burst also occurring every line and a group of five test bursts of different phases occurring every other line. See Fig. 8B.

The phases of the test bursts are usually adjusted so that one of them corresponds to zero output at each of the following test points in a color monitor: the red gun, output of the I demodulator, green gun, output of the Q demodulator and blue gun.

The line intervals without test burst provide a convenient zero reference built in to the test signal. To obtain a zero reference line running down the center of the display, it is necessary only to trigger the cathode-ray oscilloscope on any desired odd multiple of the line frequency.

Color Simulator

The color simulator is a portable instrument providing a test signal for checking and adjusting the color oscillators and the phasing and matrixing circuits of receivers. A simplified block diagram and waveform of its signal are presented in Fig. 8C. It consists of a crystal oscillator which operates 15.75 kc below the color subcarrier frequency with a gating circuit for chopping the oscillator output into 12 bursts during each line period. One of these bursts is keyed out to provide a gap for the insertion of a horizontal sync pulse and another serves as the color synchronizing burst. This leaves 10 bursts visible in the picture area.

Recorder-Controlled

Ordinary engine lathe is made automatic by using two channels of magnetically stored information to control carriage feed and cross feed. Synchros provide error correction. System can be applied to more complicated machine tools by employing additional channels

By **E. W. LEAVER** and **G. R. MOUNCE**

*Electronic Associates Limited
Willowdale, Ontario*

MAGNETIC recording combined with servo techniques has been applied to a simple engine lathe to demonstrate the practicability of recorder-controlled machine tool operation. The system uses magnetic tape or wire as the storage element. Electronic (usually thyatron) motor control and synchros on the drive shafts are the prime informational and feedback elements. A block diagram of the system is illustrated in Fig. 1.

Cross-feed and longitudinal feed are both fitted with synchros. They are also arranged so that they can be positioned manually or by means of manual controls on the thyatron drive units. If operation recording is to be used to produce the record, a sample part may be produced by a workman turning out the part in the conventional manner. The motions are recorded on wire or tape.

System Operation

Some of the output of a reference-frequency oscillator is fed into circuits that produce the three-phase supply for the stators of the cross-feed and the longitudinal-feed synchros as shown in Fig. 2A. Voltages appear across the rotor of each of the synchros, but shifted in phase by amounts indicative of the rotational positions of the synchros. These voltages are fed into the two modulators. Also feeding into the modulators are the outputs of two carrier oscillators.

Output

The outputs of the two modulators, together with the original

reference frequency signal (not phase shifted) are all fed into a mixer and then into the recorder. The successive positions of the tool are therefore represented by the phases of the modulations of two carrier frequencies with respect to the reference frequency. These frequencies must lie within the frequency-response capabilities of the recording system and preferably should not be harmonically related (to reduce crosstalk and filter problems).

Playback

In playback, Fig. 2B, the recorder output is fed into a number of filters. When only two synchros are being used three filters will suffice. Two of the filters are designed to accept the phase-modulated signals of the carrier frequencies originally recorded. The outputs are fed into demodulators and then into phase detectors. The reference frequency is easily obtained by a single low-pass filter, the output of which is then fed into the same phase splitters as were used in the original recording and into the stators of the synchros.

The outputs from the synchro rotors are also fed into phase detectors and the resulting voltages are fed into the thyatron controls for the cross and longitudinal-feed drive motors. Velocity-type feedback has been employed from the drive motors to the thyatron control circuits. While either amplitude or frequency modulation could be employed with this system, most success was originally obtained us-

ing an amplitude-modulation system.

Figure 3 is the schematic diagram of an experimental recorder-controlled machine system. On record, the reference frequency of approximately 400 cps is generated by oscillator V_{10} . This oscillator is conventional in design, employing a tuned circuit between the plate and grid, and incorporates a variable cathode resistor to adjust the amplitude of oscillation to a value producing negligible distortion. The output of V_{10} is fed to cathode follower V_6 . Output from V_6 is fed to the PLAY-RECORD switch.

Reference Frequency

The reference-frequency generator output is fed to a circuit through lead A, which produces, from the single-phase output, a three-phase driving voltage for the synchros mounted as information units on the machine tool. The input is fed through a variable attenuator directly to the grid of V_{2A} , a conventional triode amplifier with a matching transformer in the plate circuit. Another input is taken from the common attenuator and fed through a phase shift network to the grid of V_1 . A relatively high capacitance is connected from the grid of V_1 to ground and a high resistance inserted between the input source and grid.

Phase Shift

Since the impedance of the capacitor is low compared to the value of the series resistor, a phase shift approaching 90 deg is produced be-

Automatic Machine Tools

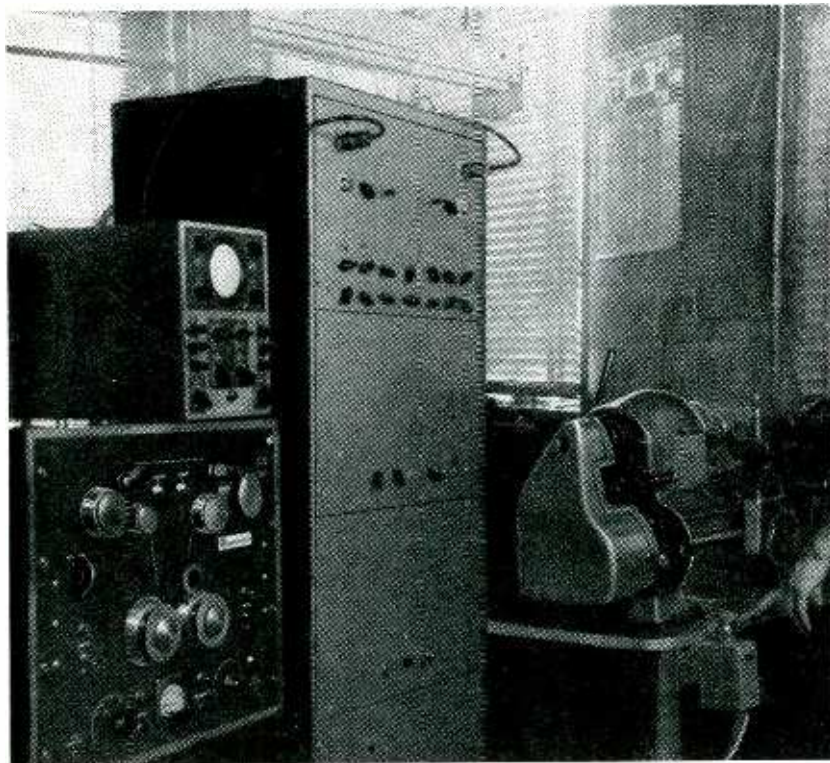

System for automatic operation of a lathe. Recorder is at left, with electronic control rack next to it and controlled lathe at right

tween the signal on the grid of V_{2A} and that fed to the grid of V_1 . Proper adjustment of the series resistor in the phase-shift network is obtained when the attenuation in the phase-shift network is compensated by the gain of V_1 . The signal appearing on the plate of V_1 is therefore equal in amplitude to that on the grid of V_{2A} and nearly 90 deg out of phase with the signal.

The output of V_1 is fed to the grid of V_{2B} , which is a conventional amplifier with a matching transformer in its plate circuit. The secondaries of the two impedance-matching transformers, one in each plate circuit of V_2 , are Scott-connected to produce a three-phase output. This output is connected to the stator of synchro 1.

Tube V_3 is a dual triode connected in a similar fashion to V_2 , driven by the same signals on each grid. A Scott transformer connec-

tion is again used in the plate circuits of V_3 to produce a second source of three-phase voltage for feeding synchro 2.

Synchro Amplifier

The single-phase output from synchro 1 is fed through a matching transformer and a filter to the grid of V_{8A} . The filter, a simple pi-section, is employed to reduce the harmonic content of the signal fed to the grid of V_{8A} . If allowed to pass through amplifier V_8 the harmonics might produce undesirable crosstalk in following circuits. Tube V_{8A} is a conventional amplifier with the output taken from the plate and fed to the PLAY-RECORD switch through lead Y.

With the PLAY-RECORD switch in the RECORD position, the output from the plate of V_{8A} is fed to the grids of V_4 (modulator 1) through a grid-coupling transformer. An inductance is connected from the

center tap of the grid transformer to a variable source of bias and the signal voltage from V_8 is applied across this inductance. A carrier signal is also applied to the grids of V_4 through the grid transformer. The primary of the grid transformer is fed from the oscillator V_6 . This oscillator produces a carrier frequency of approximately 1,300 cps (not harmonically related to the reference frequency generated by oscillator V_{10}).

Modulator 1 (V_4) has a push-pull carrier frequency and an in-phase modulating frequency applied to its grids. A push-pull output transformer with a single-phase secondary applies the output of the modulator stage to the PLAY-RECORD switch. The output consists of the carrier frequency amplitude modulated by the signal obtained from the synchro through the synchro amplifier. The output from this modulator goes to band-pass filter 1. The filter is designed to pass only the carrier frequency and its sidebands. It eliminates the reference frequency, which might pass through to the modulator due to an unbalance condition in the modulator circuit.

Mixer Amplifier

The filter output signal is again passed through the PLAY-RECORD switch to the grid of V_{22B} . Tube V_{22} is a conventional amplifier with considerable cathode feedback to reduce distortion and increase the plate resistance.

The output from synchro 2 is fed through a matching transformer, through V_{8B} and the PLAY-RECORD switch Z, to modulator 2 through lead C, which is also fed from a second carrier frequency having a different frequency from the first carrier frequency oscillator, being approximately 2,700 cps. Modulator 2 output passes through band-pass filter 2 and hence to the grid of V_{22A} .

On RECORD the reference-frequency generator output D is also

applied to the grid of V_{16B} . Amplifier section V_{16B} is exactly similar to the two sections of V_{22} . The two plates of V_{22} and the plate of V_{16B} are tied together to a common plate load. Across this plate load will appear: the reference frequency; the modulated carrier produced by modulator 1; and the modulator frequency produced by modulator 2. This mixture of three signals is fed to the recorder input position.

On PLAY, signals from the recorder output, which will consist of a mixture of two carrier frequencies and a reference frequency, are applied to the grids of V_{17} and the grid of V_{16A} . Each of these tube sections is a conventional triode amplifier.

Output from V_{16A} is applied through a low-pass filter with a cutoff slightly above the frequency of the reference-frequency generator. This filter output, which now consists of only the reference frequency, is fed through the PLAY-RECORD switch to the input A of the three-phase generator circuit exactly as was the output from the reference-frequency generator on the RECORD position. The three-phase generator produces signals for the synchros in exactly the same fashion as on RECORD.

The signal from synchro 1 is fed through a synchro amplifier consisting of V_{9A} through the PLAY-RECORD switch Y to the grid of V_{13B} . Tube V_{13A} is a conventional amplifier. The output is applied to a transformer having a center-tapped secondary with a variable phase-shift network. The output from the phase-shift network is fed to grid of V_{14B} . A transformer in the plate circuit of V_{14B} applies the amplified signal to the center tap of a transformer feeding diode detector V_{15} .

The recorder output is also fed to the grid of V_{17B} which amplifies this signal and feeds it from the plate circuit through the PLAY-RECORD switch to band-pass filter 1. The output from band-pass filter 1 consists of the signal originally produced by modulator 1 at the time of recording. This signal is fed through a transformer to a full-wave detector V_{11} .

The output of V_{11} is passed through a pi-filter, which eliminates

the carrier frequency and its harmonics from the detector output and feeds the remaining signal to the grid of V_{12A} . The output taken from the plate of V_{12A} , a conventional amplifier, is fed to the grid of V_{13A} . Output of V_{13A} is taken from the plate circuit and fed to the grid of V_{14A} . The plate circuit of V_{14A} comprises a matching transformer that acts as a coupling to the diode detector V_{15} .

Phase Detection

Diode detector V_{15} acts as a phase detector. In the absence of signal from V_{14A} , the signal applied through V_{14B} and the coupling transformer to the diode will produce no output signal. The two diode sections are connected back to back so that the current through one diode section cancels the current through the other diode section, resulting in no net signal at the output of the phase detector.

Similarly, with a signal from V_{14A} and no signal from V_{14B} , the current through diode detector V_{15} again cancels, resulting in no output from the phase detector. A signal must therefore be present on both plates of V_{14} for an output from the phase detector to be produced. Furthermore, the amplitude and polarity of the output signal depend on the phase difference between the two signals on the plates of V_{14} . Tube V_{16B} is fed by the reference frequency portion of the recorded signal which has been passed through synchro 1 at time of playback. A signal feeding V_{14A} is produced from demodulation of the carrier frequency produced by modulator 1 at the time of recording. This signal is constant in amplitude but varies in phase, depending upon the position of synchro 1 at the time of recording.

The output from the phase detector, after filtering to remove any reference frequency generator components, is fed to thyatron unit 1, operating that section of the machine tool to which synchro 1 is connected as an information unit.

Thyatron Control

Tracing the operation of the thyatron control in conjunction with the phase detector for synchro 1, if the phase difference between

the two signals applied to detector V_{15} is not 90 deg a d-c signal will be produced at the output of the phase detector and fed to thyatron control 1. Thyatron control 1 operates a motor that adjusts the portion of the machine tool to which synchro 1 is connected as the information unit. As the motor is actuated information synchro 1 will be turned, thereby changing the phase of the signal fed to the phase detector V_{15} from V_{14B} .

When the phase has been adjusted so the signal applied to diode V_{15} from V_{14B} is 90 deg out of phase with that applied from V_{14A} , no d-c output will be obtained from the phase detector. This point is the null position for synchro 1. Phasing of the signal applied to the thyatron control, the output of V_{15} , is such that the system follows in the null.

The null position of synchro 1 must in practice be the same on PLAY as it was for the corresponding portion of the record on RECORD. To fulfill this condition an adjustable phase shift network is provided in the grid circuit of V_{14B} .

The recorder output fed to V_{17A} is amplified by that tube section, passed through band-pass filter 2 and applied to detector V_{18} . Demodulation of the carrier frequency occurs and at V_{18} the recorder output is filtered to remove the carrier

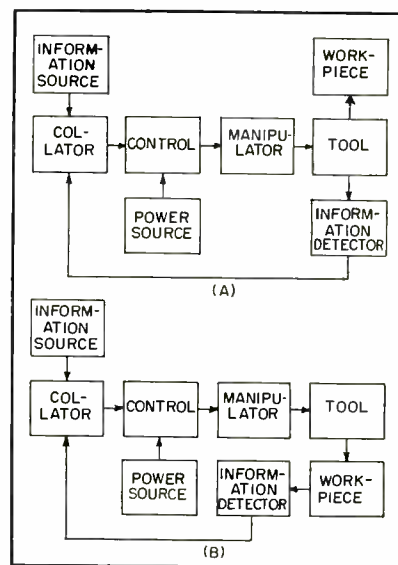

FIG. 1—Automatic machine control using short-loop feedback system (A) and long-loop feedback (B)

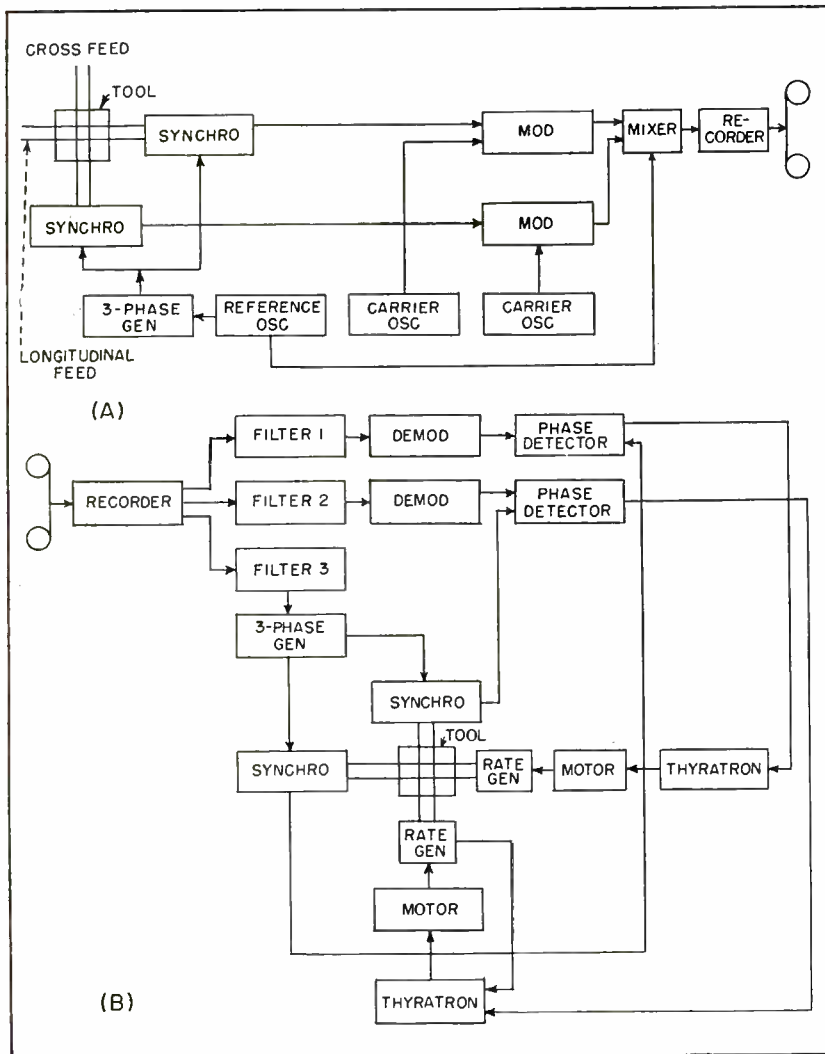

FIG. 2—Block diagram of recorder-controlled machine system during record (A) and playback (B)

frequency. The modulation frequency is passed through an adjustable phase-shift network to the grid of V_{12B} . After amplification by V_{12B} , V_{16A} and V_{20A} , the signal is passed to phase detector V_{21} . Tube V_{21} is also fed by the recorded reference frequency acting through V_{19B} and V_{20B} . Phase detector V_{21} acts in an exactly similar fashion to phase detector V_{15} . In this case, however, the applied signals are the recorded reference frequency and the modulating frequency from synchro 2. The output from phase detector V_{21} , after filtering, is fed to thyatron control unit 2, which operates that section of the machine tool to which synchro 2 is connected.

Thyatron control circuits originally used with the recorder-controlled machine were a conventional arrangement providing a d-c out-

put proportional in magnitude to phase-detector output and having a polarity determined by the same output. The thyatron circuit fed the armature of a shunt-wound motor the field of which was supplied by a separate d-c supply also located in the thyatron control chassis.

The original recorder used wire. Separate recording and playback heads and amplifiers were provided, which was useful in allowing continuous monitoring. Bandwidth was sufficient to allow the use of at least six channels if required.

It may be desirable to provide more than a single channel for each controlled parameter. This will be the case if the travel of the tool is to be large, if accurate work is required and ambiguities are to be avoided. Apart from the history of the operation, there is no electrical

indication of the number of complete revolutions of the synchro. Unless control is lost during a sufficiently large change in the recorder information, the existence of such ambiguities is of little importance.

Tolerances

Apart from the inaccuracies owing to the standard mechanical tolerances of the system, one of the factors limiting precision is the accuracy of the synchros. If this is in the order of one degree and the tool is to be positioned within 0.0005 in., stable positions of the tool during playback will occur at multiples of 0.18 in. from the proper reproducing position.

If the total tool travel is less than 0.18 in. or the accuracy required is less, the problem is less acute and in some cases may not exist at all owing to other limiting factors in the system.

Accuracy

When large tool travels with great positional accuracy are required, the problem may be solved by the use of one or more verniers. The vernier, a second synchro, uses its own carrier, modulator and filter. An automatic switching system may be used, whereby the main synchro is employed to put the apparatus on the right turn of the vernier synchro while the latter determines the accuracy of the system.

Almost any degree of accuracy and tool travel may be obtained by use of this system. This accuracy is subject to the mechanical limitations of the machine being controlled. The increased accuracy is seemingly purchased at the expense of considerable complexity, but accuracy goes up exponentially with only an arithmetic increase in complexity.

Loading

Automatic loading is required if the device is to become a true automaton. Economics and present practice would indicate that, on work requiring a considerable operating time per piece and when a workman has other work that can be done, a workman should be used. When operating time is fairly short,

it is difficult to utilize a workman economically and automatic loading is indicated.

Advantages

Electronic programming, unlike cam and stop-controlled machines, requires little if any set-up time once the record has been made. It is possible to operate a number of machines from a single record where tolerances of machines and product will permit. This allows the multiplexing of machines so that they may be operated simultaneously or sequenced in order that the number of operators needed for a given number of machines may be reduced.

Other advantages accrue to this type of operation, such as the ability to correct by simple wipe-out and in some cases dubbing in portions of the operation that must be changed owing to product changes. The utilization of such machines can lead to the building up of a library of certain operations. Simple operations, to start with, can be combined to produce given

operations and their products without the necessity of going through the recording operation at all.

Where the tolerances of the machine and the product will permit, duplicate records may be used for controlling other machines than the one used for recording purposes. Recordings made in one plant could subsequently be employed in other factories.

It is natural that the system should be compared to others using a digital method of information, storage and handling. The advantage of the former is that it is usually simpler and cheaper to construct, simpler to operate and errors are noncumulative. The employment of sinusoids rather than pulse type information simplifies the circuits required to obtain a given accuracy. The fact that the reference frequency and the phase-shifted frequency are both recorded on the same tape, minimizes errors due to lack of mechanical stability in the recording medium. Feedback is inherent in the system in that, on playback, the motor is di-

rected by an error signal produced by continuously comparing the position of the tool to the recorded information.

The system does not take into account tool wear. In many cases, with new tool materials, the rate of wear is so small that routine inspections can preclude errors on this account. If this is not the case, the start of the work may always be arranged relative to a fixed reference point and the tool cutting edge.

This general technique can offer much to making machines fully automatic without at the same time making them dangerously overspecialized. At the same time, as in the case of all new techniques, whole new areas are opened up for methodical development.

REFERENCES

- (1) U. S. Patent 2,475,245, Method and Apparatus for the Automatic Control of Machinery.
- (2) Tubes Control Milling Cutter, ELECTRONICS, p 172, Nov. 1952.
- (3) T. K. Shallenberger, The Push Button Factory, *Engineering Journal (Canada)*, Nov. 1952.
- (4) E. W. Leaver and J. J. Brown, Machines Without Men, *Fortune*, Nov. 1946.

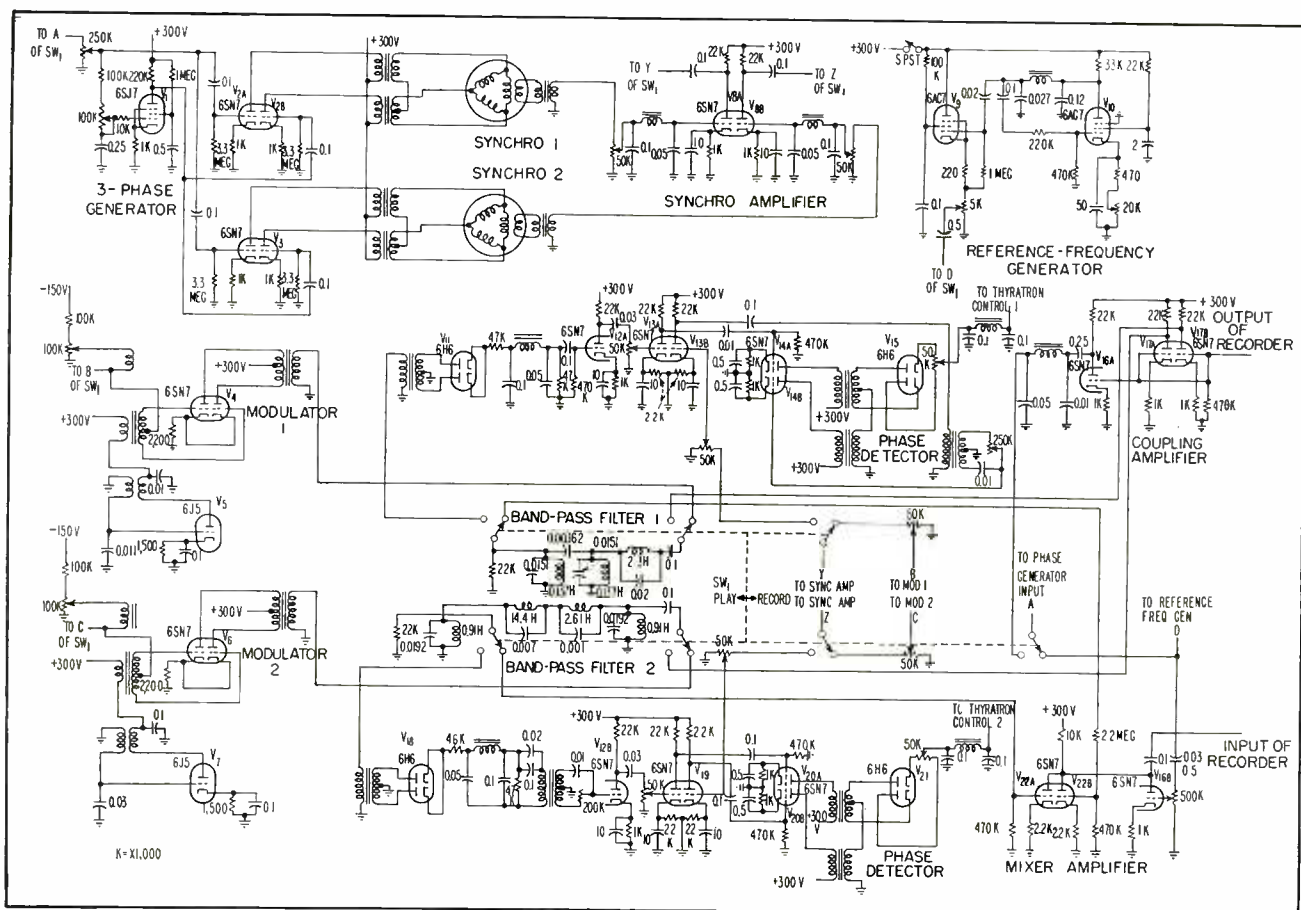

FIG. 3—Dual-channel system as applied to an engine lathe. Circuit shown does not include recorder and thyatron control

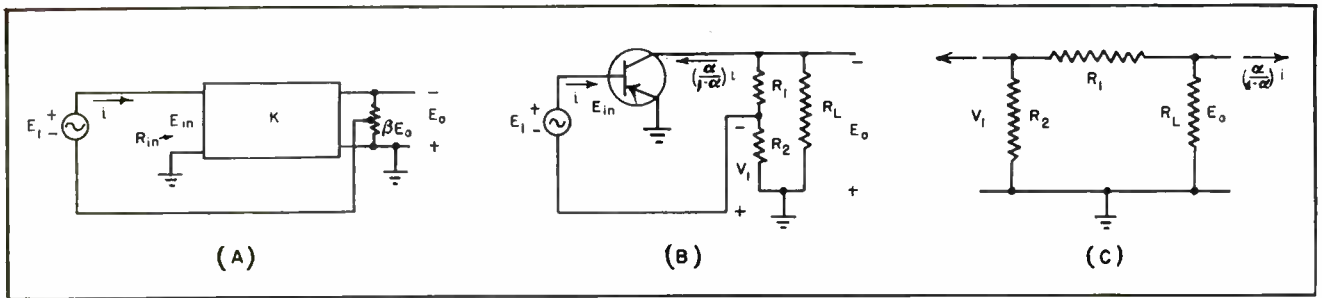

FIG. 1—General shunt-to-series feedback circuit (A) together with common emitter voltage amplifier (B) and its equivalent circuit (C)

Feedback Simplifies Transistor Amplifiers

Voltage amplification in transistor stages is obtained using a degenerative feedback path shunting the output and in series with the input. Use of interstage transformers or grounded-collector stages is avoided

By **STANLEY SCHENKERMAN**

*W. L. Maxson Corp.
New York, New York*

TRANSISTOR AMPLIFIER technology is described quite fully in the literature. However, the circuits discussed are usually power amplifiers. Unlike the vacuum tube, the transistor requires input power and the power gain is, therefore, finite, being about forty decibels for presently available types. For this reason, most workers in the field prefer to employ each stage of a transistor amplifier for power gain instead of following the more conventional practice of relegating the conversion from voltage to power to the output stage.

Voltage Amplification

There are many applications wherein it is more desirable to employ transistors as voltage amplifying elements. However, the characteristics of the transistor, namely its low input impedance and high output impedance, hinder its use

for voltage amplification where the reverse impedance levels are necessary.

Present Systems

To circumvent this difficulty a number of schemes have been suggested. In one approach, transformer interstage coupling is employed to obtain the desired impedance transformations. Another method makes use of input and output common collector (cathode follower) stages for coupling to and from the amplifier proper. This latter scheme suffers from the disadvantage that the common collector stages do not directly contribute to the amplification of the signal.

The technique to be described in this paper makes use of the following properties of negative feedback: (1) shunt feedback reduces the impedance level, (2) series feed-

back raises the impedance level and (3) both increase circuit stability. By employing degenerative feedback in parallel with the output and in series with the input, the impedances required for voltage amplification are obtained. Simultaneously, the circuit is stabilized against component variation.

Theory

Consider the shunt-to-series feedback circuit shown in Fig. 1A. The voltage amplifier of gain K introduces a reversal of phase between input and output so that the instantaneous polarities are as shown. It can be shown that

$$K_f = E_o/E_1 = K/(1 + \beta K) \quad (1)$$

$$R_{inf} = E_1/i = (E_{in}/i)(1 + \beta K) \\ = R_{in}(1 + \beta K) \quad (2)$$

$$R_{outf} = R_{out}/(1 + \beta K) \quad (3)$$

where subscript f refers to the cir-

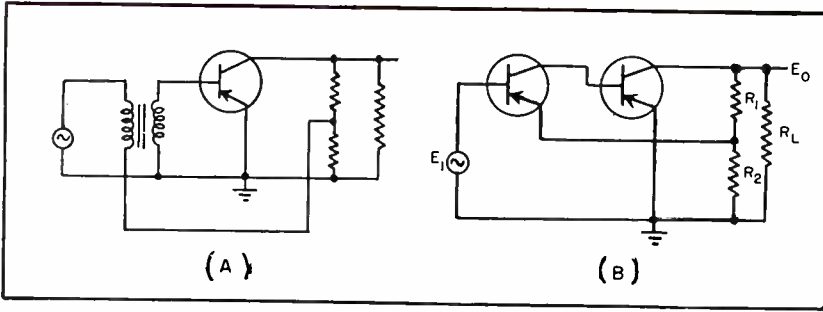

FIG. 2—Transformer coupling scheme for unbalanced input (A) and a two-stage voltage amplifier (B)

circuit with feedback and β is the feedback factor.

The input impedance of the circuit illustrated in Fig. 1B and C is found to be

$$R_{in} = E_1/i = R_2 \{ [R_1 + R_L / (1 - \alpha)] / (R_1 + R_2 + R_L) \}$$

The gain E_o/E_1 of the amplifier may now be found

$$K = E_o/E_1 = [1 / (1 - \alpha)] (R_L / R_2) [(R_2 + \alpha R_1) / (R_1 + R_L / (1 - \alpha))] \quad (4)$$

By considering R_1 as the feedback element several interesting features of this circuit may be observed. Since for this application

$$\alpha R_L / (1 - \alpha) > R_2 \quad (5)$$

the presence of feedback, R_1 finite, decreases the voltage gain and the output impedance and raises the input impedance. A return difference F may be defined that shows the effect of R_1 . Thus

$$F_{R_{in}} = \left\{ \left(R_1 + \frac{R_L}{1 - \alpha} \right) / (R_1 + R_2 + R_L) \right\} \quad (6)$$

$$F_K = \left\{ \left[R_1 + \frac{R_L}{1 - \alpha} \right] / [R_1 + (R_2 / \alpha)] \right\} \quad (7)$$

$$F_{R_{out}} = \left\{ \left(R_1 + \frac{R_L}{1 - \alpha} \right) / R_1 \right\} \quad (8)$$

When R_1 becomes infinite, Eq. 6, 7 and 8 equal unity. These equations are equal only for R_1 infinite whereas the true return difference should be the same for each quantity. This R_1 is not the only feedback element.

Other Elements

To visualize the effect of the circuit elements consider the circuit as indicated. The percentage sensitivity of the gain to changes in α is reduced by the factor F , where

$$F_s = \frac{(R_1 + R_L / (1 - \alpha)) (R_1 + R_2 / \alpha)}{(R_1) (R_1 + R_2 + R_L)} = F_{R_{in}} F_{R_{out}} / F_K > 1 \quad (9)$$

An interesting form of this circuit results if the load resistance is allowed to become infinite

$$R_L \gg R_1 + R_2 \quad (10)$$

The expressions for R_{in} , K and R_{out} become

$$R_{in} = R_2 / (1 - \alpha) \quad (11)$$

$$K = (R_2 + \alpha R_1) / R_2 \approx (R_1 + R_2) / R_2 \quad (12)$$

$$R_{out} = (1 - \alpha) R_1 \quad (13)$$

The feedback factor

$$\beta = V_1 / E_o \quad (14)$$

reduces to

$$\beta = R_2 / (R_2 + \alpha R_1) = 1 / K \approx R_2 / (R_1 + R_2) \quad (15)$$

Both R_1 and R_2 are considered feedback elements and the operation of the circuit is greatly simplified.

Unbalanced Input

Where an unbalanced input is desired, transformer coupling may be employed as shown in Fig. 2A. The secondary of the transformer is returned to ground to increase the bias stability of the circuit. A phase reversal must occur between the primary and secondary of the transformer to obtain degenerative feedback.

A second scheme that provides an unbalanced input is shown in Fig. 2B. The resulting expressions for this circuit are

$$R_{in} = [R_2 / (1 - \alpha)] \quad (16)$$

$$\left\{ \left[R_1 + R_L \left(1 + \frac{\alpha_1 \alpha_2}{1 - \alpha_2} \right) \right] / (R_1 + R_2 + R_L) \right\}$$

$$K = [\alpha_1 \alpha_2 / (1 - \alpha_2)] (R_L / R_2) \quad (17)$$

$$\left\{ \left[R_1 + R_2 \left(1 + \frac{1 - \alpha_2}{\alpha_1 \alpha_2} \right) \right] / \left[R_1 + R_L \left(1 + \frac{\alpha_1 \alpha_2}{1 - \alpha_2} \right) \right] \right\}$$

$$R_{out} = R_L \left\{ R_1 / \left[R_1 + R_L \left(1 + \frac{\alpha_1 \alpha_2}{1 - \alpha_2} \right) \right] \right\} \quad (18)$$

where α_1 and α_2 refer to the first and second transistors, respectively.

Considering R_1 the feedback element the return differences become

$$F_{R_{in}} = \left\{ \left[R_1 + R_L \left(1 + \frac{\alpha_1 \alpha_2}{1 - \alpha_2} \right) \right] / (R_1 + R_2 + R_L) \right\} \quad (19)$$

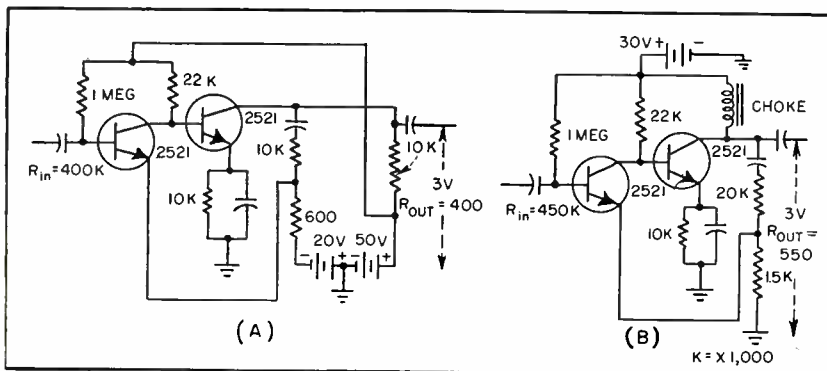

FIG. 3—Two experimental voltage amplifiers. First (A) has gain of 15 and consumes 250 mw. Second (B) has same gain but consumes 150 mw. In both circuits 20-percent bias change produces no change in gain

$$F_K = \left\{ \left[R_1 + R_L \left(1 + \frac{\alpha_1 \alpha_2}{1 - \alpha_2} \right) \right] \right\} \left[R_1 + R_2 \left(1 + \frac{1 - \alpha_2}{\alpha_1 \alpha_2} \right) \right] \quad (20)$$

$$F_{R_{out}} = \left\{ \left[R_1 + R_L \left(1 + \frac{\alpha_1 \alpha_2}{1 - \alpha_2} \right) \right] / R_1 \right\} \quad (21)$$

If R_L is allowed to become infinite that is

$$R_L \gg R_1 + R_2 \quad (22)$$

Eq. 16, 17 and 18 reduce to

$$R_{in} = [R_2 / (1 - \alpha_1)] \{ 1 + [\alpha_1 \alpha_2 / (1 - \alpha_2)] \} \quad (23)$$

$$K = \left[R_1 + R_2 \left(1 + \frac{1 - \alpha_2}{\alpha_1 \alpha_2} \right) \right] \left[R_2 \left(1 + \frac{1 - \alpha_2}{\alpha_1 \alpha_2} \right) \right] \approx (R_1 + R_2) / R_2 \quad (24)$$

$$R_{out} = \left[R_1 / \left(1 + \frac{\alpha_1 \alpha_2}{1 - \alpha_2} \right) \right] \quad (25)$$

Comparison of these expressions with those for the single-stage amplifier with infinite load shows that although the gain and output impedance of the single and double-stage amplifiers are nearly identical, the input impedance of the latter is much greater. This fact, together with the unbalanced input that this configuration affords, indicates that the double-stage amplifier would be preferable for most applications.

Practical Amplifiers

Two experimental double-stage amplifiers have been constructed. Figure 3A is a diagram of the first with a finite load resistance of 10,000 ohms. The circuit is a straightforward realization of Fig. 2B. By returning the 1-megohm base resistor to the supply voltage, larger input signals can be tolerated before the input circuit cuts off. The 22,000-ohm resistor serves as a collector return for the first transistor and a base return for the second. The 10,000-ohm emitter resistor of the second transistor stabilizes the quiescent operating point.

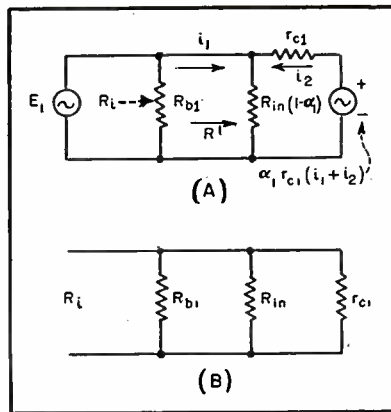

FIG. 4—Two variations of equivalent input circuit of amplifier, showing quantities used in design calculations

The second amplifier, shown in Fig. 3B, is similar to the first except for the infinite load resistance and biasing arrangement. The collector voltage of the second transistor must now be supplied through a source that does not load the output. An audio-frequency choke consisting of the primary of a high-impedance transformer was used for this purpose in the experimental setup.

Calculations

The calculation of the input impedance for practical amplifiers must consider the shunting effects of the first base resistor R_{b1} and the collector circuit of the first transistor. Denoting the actual input impedance by R_i and the input impedance when the first base resistor is infinite by R' the equivalent input circuit is as shown in Fig. 4A when R_{in} is obtained from the previously developed expression. To calculate R' the circuit equations are written as

$$E_1 = R_{in}(1 - \alpha_1)i_1 + R_{in}(1 - \alpha_1)i_2 \quad (26)$$

$$0 = [R_{in}(1 - \alpha_1) - \alpha_1 r_{c1}]i_1 + (R_{in} + r_{c1})(1 - \alpha_1)i_2 \quad (27)$$

Solving Eq. 26 and 27 for i_1

$$i_1 = \frac{E_1 (R_{in} + r_{c1})(1 - \alpha_1)}{[R_{in}(1 - \alpha_1)] \{ [(R_{in} + R_{c1})(1 - \alpha_1)] - [R_{in}(1 - \alpha_1) - \alpha_1 r_{c1}] \}} \quad (28)$$

from which

$$R' = E_1 / i_1 = R_{in} r_{c1} / (R_{in} + r_{c1}) \quad (29)$$

is obtained. Resistance R_i , the parallel combination of R' and R_{b1} , is

$$R_i = R_{b1} R_{in} r_{c1} / (R_{b1} R_{in} + R_{b1} r_{c1} + R_{in} r_{c1}) \quad (30)$$

and the actual equivalent input circuit is shown in Fig. 4B.

Discussion

It is interesting to consider a vacuum-tube amplifier that would provide the same characteristics as the double-stage transistor amplifier with an infinite load resistance. The circuit might employ two tube stages in a negative feedback configuration with an overall gain of 15 and high input and low output impedances. Using a subminiature dual triode such as a type 6112, this amplifier would consume approximately 2.5 w as contrasted with 150 mw for the transistor circuit.

Other Possibilities

The circuits discussed in this article are certainly not exhaustive, but rather, indicate a few general ideas. Of the many possibilities still to be explored, mention might be made of a few. Mixed configurations such as common emitter to common collector should prove useful in obtaining simple biasing arrangements.

Along the same line, *npn* and *pnnp* transistors in symmetrical circuitry look quite promising as does the use of multielectrode transistors, some types of which are just becoming available.

Acknowledgments

The author wishes to express his thanks to William Sollfrey for his invaluable assistance during both the technical investigations and in the preparation of this paper, to Robert S. Sherry for his guidance and encouragement and to Harold D. Ullman who assisted with the actual circuits.

BIBLIOGRAPHY

- Shea, "Principles of Transistor Circuits", John Wiley and Sons, Inc., New York, 1953.
Bode, "Network Analysis and Feedback Amplifier Design", D. Van Nostrand Co., Inc., New York, 1945.

INPUT AND OUTPUT coupling to a traveling-wave tube may be achieved by helices located outside the vacuum envelope. The coupling circuits are thereby accessible and many critical steps in tube fabrication can be performed after the tube is sealed off. Furthermore, the tube can have the simplest internal structure possible.

Using this coupling arrangement, two traveling-wave-tube amplifiers for the 2,000 to 4,000-mc range have been developed. One amplifier has 35-db gain, 20 milliwatts output, a noise figure in the order of 20 db, is capable of modulation and is useful as a low-level amplifier with fast modulation response. The second amplifier has a gain of 30 db, an output of 1 watt and is intended as a power booster for a signal generator or wide tuning range oscillator.

Amplifier Circuit

The common requirements of all traveling-wave-tube amplifier circuits are first to couple to the helix—apply the signal to be amplified at the input and extract the amplified signal—and second to attenuate any wave reflected from the output back to the input. An attenuator is used for isolation of waves traveling in a backward direction along the helix. This attenuator must have sufficient loss to stabilize the tube when imperfect output and input matches are present.

Previous traveling-wave amplifiers have coupled to the helix by a direct lead through the vacuum seal or by a capacitive antenna. In these systems it has been necessary to taper the helix pitch at the terminal to obtain a good match. Where this was done to obtain a match over a broad frequency range, the long electrical length of the helix resulted in a closely spaced fine structure that was difficult to handle.

Spatial Beating

The helix coupler provides for transfer of a traveling wave from one transmission line to another. This phenomenon has been used for some time with waveguides and has been termed spatial beating¹ of coupled transmission lines. If there exists a coupling between the two

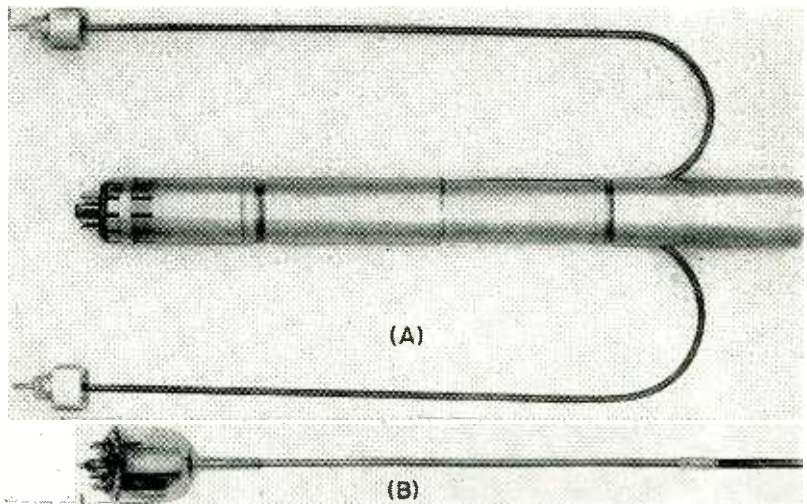

Tube within its capsule (A) and vacuum envelope (B) illustrating construction

Helix-Coupled

By **PETER D. LACY**

*Hewlett-Packard Company
Palo Alto, California*

traveling in one of them induces a wave in the other line that travels in the same direction, the power originally fed to one of the lines will gradually transfer to the other. Then the reverse process starts. Thus the power transfers back and forth between the two lines as shown in Fig. 1A. The two requirements are that the individual transmission lines have the same velocities of propagation and that the

coupling provides a forward wave.

In Fig. 1B, the normal coupling between two conductors of different transmission lines is shown. The electric and magnetic vectors E and H are shown and the resulting Poynting vector S which determines the direction of wave propagation along the wire. The differential induced electric and magnetic fields dE and dH over distance dZ are shown. Here the resulting wave

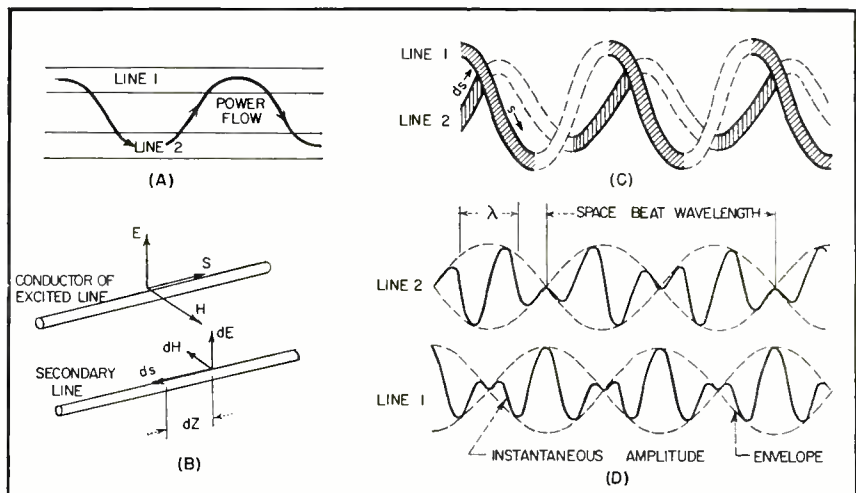
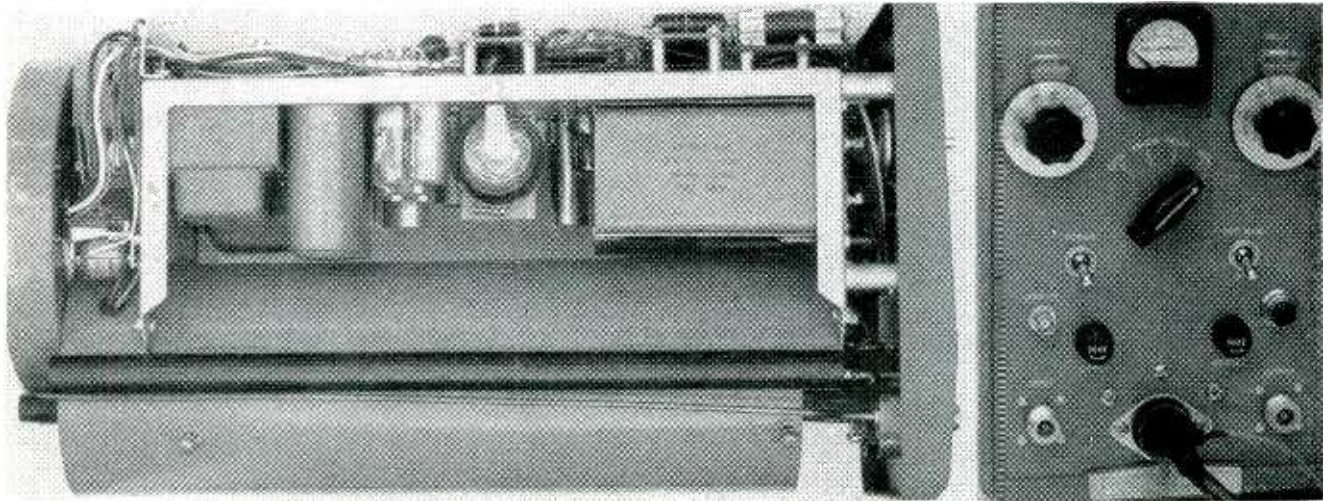

FIG. 1—Principles of transmission-line coupling. Spatial beating (A) and the usual cross coupling (B) are shown for two-wire line. Coupling of helical lines (C) and resulting space-beat patterns (D) are also shown



Side and front views of traveling-wave amplifier unit containing tube, coupling circuits and regulated power supplies

Traveling-Wave Tubes

Fabrication and use of traveling-wave tubes are simplified by putting the coupling circuits outside the vacuum envelope. This development may hasten general use of the tubes in microwave systems. Tubes described have 2,000-mc bandwidth and 35-db gain

travels in the opposite direction as shown by dS so that this coupling does not cause spatial beating.

Energy can, however, be coupled by two parallel helices. Under these conditions spatial beating can occur. This is illustrated in Fig. 1C where a pair of concentric helices are shown wound with opposite senses. A wave impressed on the outer one (line 1) will travel down and to the right. Where the pitch angle is small, a wave will be induced on the near helix that will travel up but again progressing toward the right. This backward coupling over an incremental distance, together with forward coupling in the overall structure, results in spatial beating between oppositely wound helices. Note that it is possible to exchange power between the two helices and that the inner helix may be the traveling-wave-tube helix in the vacuum while the second one may readily be constructed outside the vacuum.

Figure 1D shows the instantaneous amplitudes of the waves on a pair of coupled lines. The coupled wave is always 90 deg out of phase with the induced wave so that the

secondary effect of the induced wave coupled back to the first line gives a 180-deg phase shift to subtract power from the original wave. This is necessary to conserve power. Both the phase and the space-beat wavelengths are shown.

The fields of a pair of transmission lines not too tightly coupled may be approximated by a linear superposition of the individual fields for the isolated transmission lines. Under these conditions, the electric or magnetic coefficients of

coupling for the pair of lines may be defined as the ratio of the cross-field-stored energy to the square root of the product of the self-stored energies of the two lines.

Helical Directional Couplers

If the electric and magnetic coefficients of coupling k are equal in magnitude and the sign of the natural coupling for one of them has been reversed, the space-beat wavelength for transmission lines having the same velocities of propagation

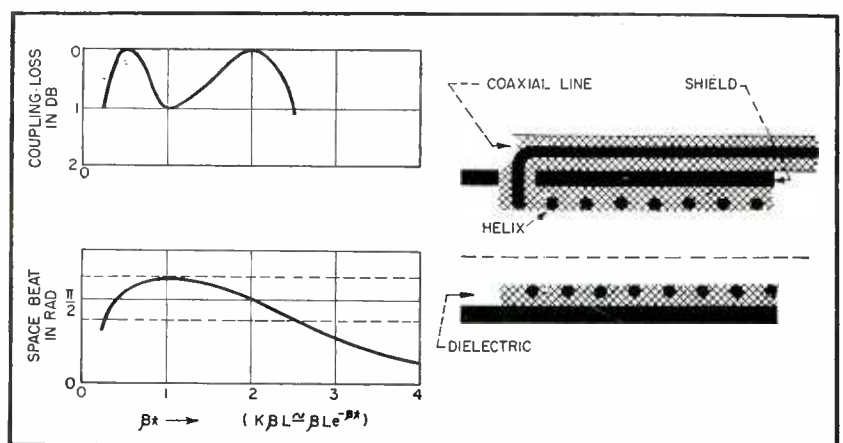

FIG. 2—Coupling-loss, top left, and space-beat, bottom left, characteristics of helical directional coupler together with its mechanical configuration, right

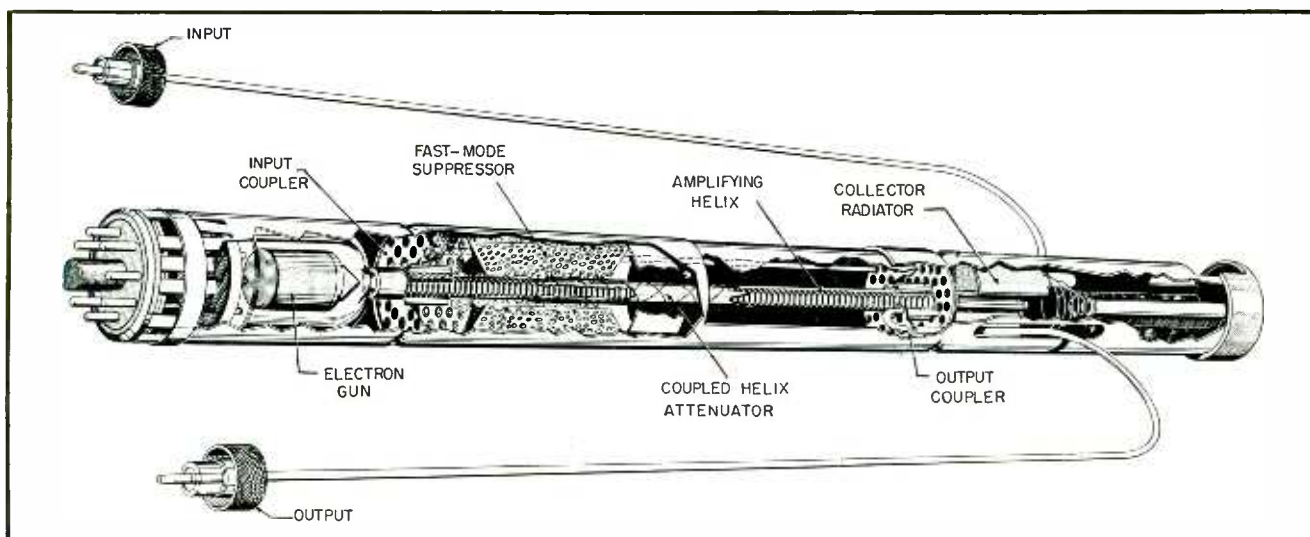

FIG. 3—Cutaway view of helically-coupled traveling-wave amplifier illustrating how coupling circuits are arranged outside of vacuum envelope

is the phase wavelength divided by k . For this condition, the spatial beat envelopes of the two lines are: line 1 = $\cos k\beta Z$ and line 2 = $\sin k\beta Z$.

Thus helical directional couplers can be designed to transfer energy through the vacuum wall to and from the inner helix. A satisfactory directional coupler can be designed using a quarter space-beat-wavelength section. This means $k\beta L$ should be $\frac{\pi}{2}$. Since both k and β change with frequency, complete transfer of power cannot be achieved over a wide band. For helices β increases with frequency and k diminishes. Eventually, the fall-off of k predominates since it is exponential and β becomes linear. The approximate variation of $k\beta L$ is shown in Fig. 2, top left, where $\beta \approx \gamma$ in Pierce's notation.² If the spacing of the helices t is chosen for the desired frequency range and an appropriate coupled length L is used then broadband operation can be achieved. Figure 2, top left, shows a coupler with a 0 to -1-db coupling over a 10-to-1 frequency range. Less than a 1-db fall-off in coupling at the ends of the band has been achieved in a 1-kmc to 4-kmc coupler of a traveling-wave tube. Furthermore outside of this band the coupling falls off gradually and never vanishes.

The matching of the velocities of two helices is not extremely critical. The determining factors are the coefficient of coupling k and the relative velocity difference. When these

quantities are equal, the power transfer is down only one decibel.

Figure 2, left, shows the cross-section of a helical directional coupler with coaxial output. The helix in the vacuum envelope slides through the center of the coil. The outside helix is computed as a 50-ohm single-wire line over a ground plane with a correction for the adjacent wire. The outer helix can feed directly into a coaxial cable.

The coupling helix is embedded in Teflon. The inner radius of the coil and the inner radius of the shield are controlled to determine the wire-to-sheath spacing. For two tubes in the 2 to 4-kmc range operating at 500 to 1,000 volts the couplers are about $\frac{1}{2}$ -inch long.

Attenuators

Previously, loss along a helix or at an end termination was accomplished by resistive films or volume mixtures. Often these had to be put inside the vacuum envelope. The microwave loss of either a lossy film or solid is difficult to control therefore where the loss was in the tube, the shrinkage in production could be very high.

It is desirable first to take the attenuation out of the vacuum region and second to make the loss easily reproducible.

A coupled helix on the outside of the tube removes the energy from the inner helix. This outer coupling helix is wound of resistance wire. Thus, both power transfer and loss are accomplished simultaneously.

A practical helical attenuator is a

multifilar winding. A two or three-conductor helix is necessary to couple tightly to the inner helix at high frequencies. One disturbing feature of the helical couplers compared with previous noncontacting couplers is that since the pickup of these couplers never vanishes, they show up oscillations of the tube far outside the desired operating range. For a 2-to-1 operating frequency range it has been necessary to control the attenuation over a 4-to-1 bandwidth. This control over only 4-to-1 was made possible through helix dispersion at low frequencies causing the tube gain to decrease and increasing loss of the amplifying helix at the high end.

Construction

Figure 3 shows a cutaway view of the traveling-wave tube assembled in its capsule. In the capsule are the input and output helix couplers, a multifilar resistance wire coupled attenuator and a fast-mode suppressor. These components are inserted in the center notch of the capsule. Precision machine operations have virtually been eliminated. The components are fabricated by sawing, rolling, stamping and plastic-molding operations. This unit avoids machine operations without sacrifice of performance.

An electromagnet and the associated power supplies are shown in Fig. 4. The twt capsule mounts in the magnet that is required to prevent the beam from spreading and being lost on the helix. The size and weight of the magnet is undesirable

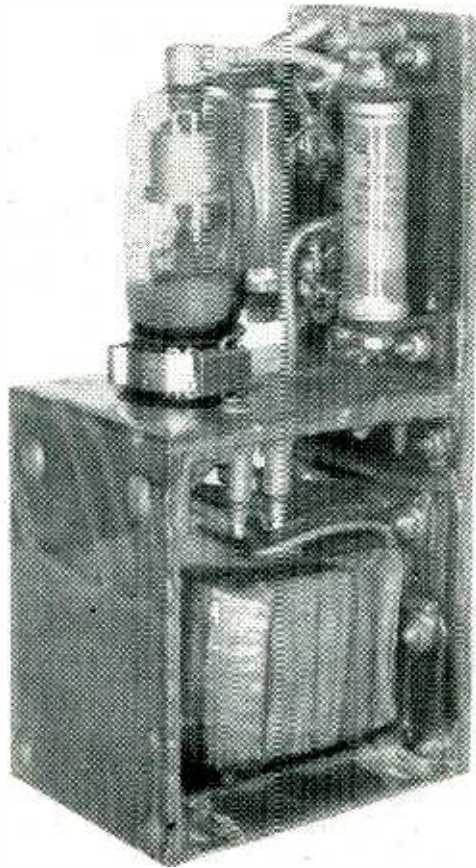

Fig. 1—Packaged power supply for oscilloscope, rated 4 kv at 5 ma, operates from 400-cps source

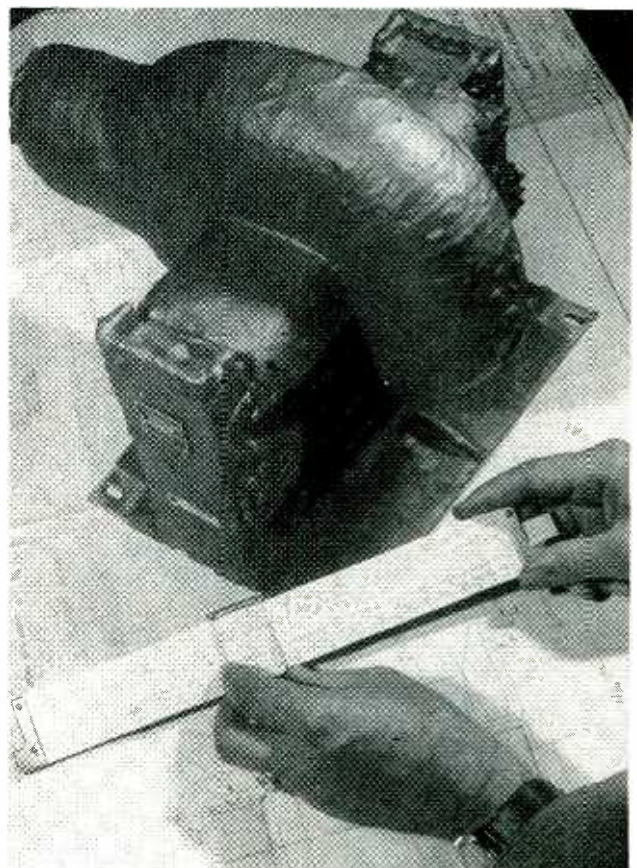

Fig. 2—Filament transformer for 34-kv application was tested at 70 kv peak. Rating is 500 volt-amperes at 60 cps

COMPONENT DESIGN TRENDS

Iron-Core Transformers

By FRANK ROCKETT

Research and Engineering Division, Airborne Instruments Laboratory, Inc., Mineola, N. Y.

TRANSFORMERS and related components, because they are among the bulkier and heavier units in electronic equipment, are frequently manufactured to customer specifications to achieve an optimum design. Some companies, such as Transformers Inc., stock no units but operate a sample department

equipped to manufacture small quantities of unique designs on order.

Others, like Kenyon Transformer Co. and Industrial Transformer Corp., stock a wide selection of standard catalog units, thereby achieving the economy of long production runs and prompt delivery.

Such stock items include multi-tap units for tube testing, current transformers and magnetron pulse transformers, along with standard audio, plate and filament transformers. Most companies follow both practices; even those that began years ago as custom manufacturers today carry in stock units that experience indicates meet a common need.

Techniques reviewed here are being adapted by manufacturers to such products as 60-cps and 400-cps power transformers, audio, matching, interstage and output transformers, microsecond pulse trans-

Previous Articles in Series

Part I: Fixed Capacitors Undergo Miniaturization, p 120, July 1954

Part II: New Variable Capacitors Extend Tuning Range, p 130, Aug. 1954

Part III: Fixed Resistors Show Stability Improvements, p 132, Sept. 1954

Part IV: Precision Potentiometers Use New Materials, p 144, Oct. 1954



Fig. 3—Section of molded-in-resin transformer is examined under microscope for quality control

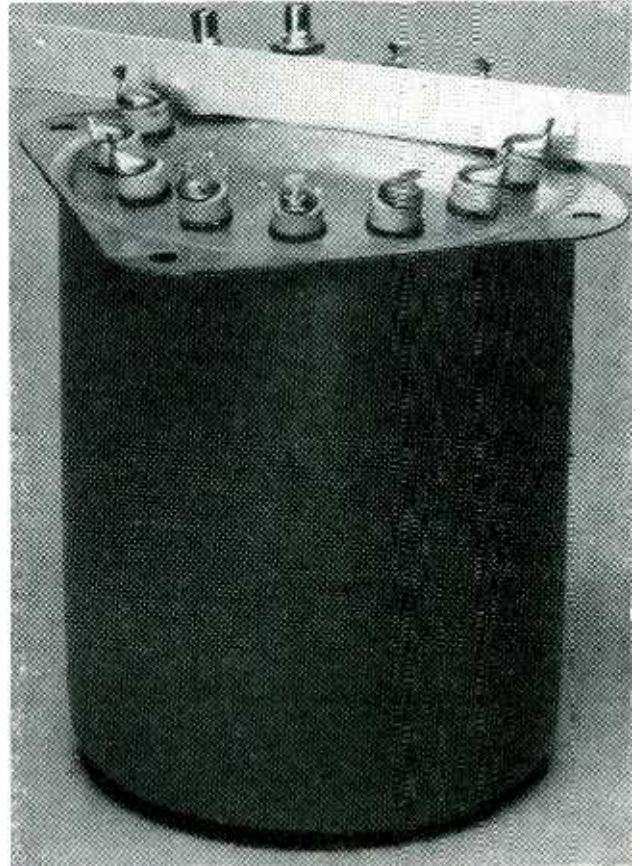

Fig. 4—Although top and bottom of cylindrical transformer bulged out during pressure test, case remains sealed

Run Smaller and Hotter

New core materials, coatings and insulating materials combined with new construction techniques make modern iron-core components about half the size of their counterparts a decade ago and permit operation at much higher ambient and hot-spot temperatures

formers variable reactors and magnetic amplifiers. Although most manufacturers have evolved unique variations of techniques and materials, those cited here by way of example are representative of present industry trends.

Protective Coverings

The case of a transformer, inductor or solenoid protects the windings from damage and holds them in place.

Encapsulation, by which a unit is completely cased by a plastic sheath, permits substantial savings in weight and size over a unit cased

in metal; both constructions hermetically seal the transformer. The Fosterite process, developed by Westinghouse Electric Corp. and licensed by many other manufacturers, is used in the units of Fig. 1 and 2. The packaged power supply fits the same space as an oil-filled unit of the same rating. One advantage of the plastic-cased unit is that it eliminates oil leaks.

Fosterite and other polyester resins and, more recently, the epoxy resins have enabled impregnation and encapsulation to provide the moisture-sealing and insulation required by industrial and military

environments in a light and compact unit.

Experience at Deluxe Coils, Inc. is representative. Their engineers experimented with various polyester resins and with epoxy resins for coil forms and for coverings. On the basis of the required production controls, they developed a formulation of catalyst and liquid base to give a modified epoxy resin and insulation termed Luxolene. This protects coils from moisture as around solenoids for operating refrigerator valves, and also gives protection from vibration in magnetic motor starters. Where the

COMPONENT DESIGN TRENDS

- Most custom manufacturers have changed policy and now carry some high-demand items in stock
- Encapsulation with Fosterite and other polyester resins or with epoxy resins reduces both weight and size
- Silicone-impregnated glass-fiber insulations increase operating temperatures of encapsulated units

plastic is molded about the coils, the enhanced dimensional stability provides closer fits that ease assembly and help heat transfer. Furthermore, molded coils withstand heat better than varnish-impregnated coils; Luxolene is rated for continuous operation at 105 C.

To be effective, encapsulation must fill the transformer and the resin must cure completely. Standard sampling procedures used at United Transformer Co. involve slicing and examining randomly chosen units as in Fig. 3; maximum data is obtained from each transformer thus destroyed.

Plastic-encapsulated transformers such as those produced by Telectro Industries Corp. to meet military requirements are, in some cases, considerably less effective than conventional hermetically sealed units, weigh less, are easier to install (partly because leads are a part of the assembly) and can be made in odd shapes rather than conform to a standard steel case.

Performance requirements of government specifications can be met for hermetically sealed units in eleven sizes of drawn steel cases with silicone or other leak-proof bushings. Units in drawn cases, because of their predictable performance especially under overload, offer great mechanical protection. For example, the UTC cylindrical unit of Fig. 4 withstood an internal pressure of over 500 psi; the top and bottom bulged only 0.25 inch.

Where other factors dominate, General Electric casts Permafil around core and coil assemblies to provide a shatter-resistant structure approximately 20 percent smaller and lighter than metal-clad units of comparable ratings. For applications where size and weight are critical, open core and coil units are protected from moisture by a

coat of Permafil covering material.

Toward increasing the operating temperature of such encapsulated transformers, Central Transformer Co. is developing insulations of Teflon and of silicone-impregnated glass fiber. A high-voltage insulated filament transformer sealed in glass provides complete immunity from moisture and operates experimentally at temperatures close to

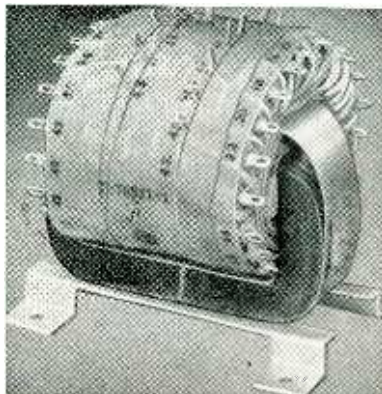

Fig. 5—Multiple-winding high-temperature aircraft transformer is vacuum-impregnated with silicone resin

those of vacuum-tube envelopes.

The success of such molding practices has stimulated improvements in older practices. At Sylvania Electric Products, Inc., the seals of oil-filled units are inspected using the Veeco mass spectrophotometer just as is done in the vacuum-tube and lamp bulb industries. By substituting this method for the oven or immersion test, Sylvania locates pinholes and cracks that may possibly be filled with resin and thus not show in the conventional test. Even minute areas of porous or cold solder seals are revealed.

Together with other advances directed at automatic production of transformers, such as winding sheets of copper foil and insulation into a roll and slicing the roll into wafers, for automatic assem-

bly into coils, Sylvania is molding a variety of components. These include interstage audio transformers, reactors, small pulse transformers and a 100-va low-capacitance filament transformer. This unit, rated for 35 kv breakdown, has a capacitance less than 20 μmf because the low dielectric constant of the resin minimizes capacitance between windings while its mechanical and dielectric strength combine to produce a durable insulated unit.

Compactness and light weight are features of airborne transformers. Examples made by Laboratory for Electronics are shown in Fig. 5 and 6.

Design techniques for airborne transformers have been adapted by Electro Engineering Works to high-power transformers (1 to 100 kva) such as plate and modulation transformers and filter

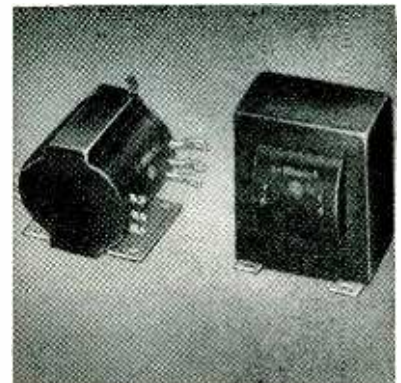

Fig. 6—Immersion-resistant light-weight transformers are vacuum-molded in thermosetting polyester resin

reactors. In this open-frame core-type construction, two coils are used to obtain thinner coils with consequent greater exposed surface per volume than in the more common shell-type construction. Heat transfer is improved with a resulting smaller size for a given power rating, greater overload capacity and more response to forced air cooling. Over-all reductions in size and weight exceed 50 percent in many applications. The coils are protected by a fiber layer with its ends sealed against dust and moisture.

Wire and Wire Insulation

Impregnation and encapsulation inherently provide insulation within coils; these techniques augment but do not replace the insulation of the

wire and the insulation introduced within the coils during winding. For example, to prevent turns of one layer from pulling between turns of a lower layer, insulating yarn is wound into the coil simultaneously with the wire by Chicago Standard Transformer Corp., giving the matrix of Fig. 7.

Before coils are impregnated they are usually wrapped. In lieu of the normal Kraft paper outer wrapper, the UTC coil of Fig. 8 is wrapped with Mylar pressure-sensitive tape. This tape, in addition to its advantageous electrical properties, is transparent and thus permits 100-percent inspection of the location of wires and insulation after the coil is completed. More important, the operator can see the unit as he wraps it, to maintain a high quality of workmanship. The numerous small power and audio transformers

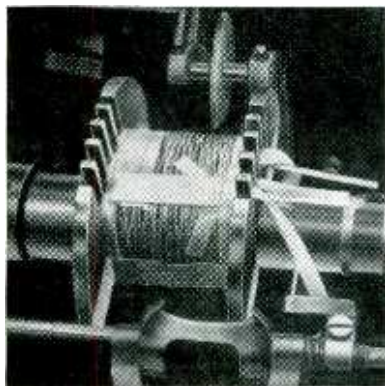

Fig. 7—Glass yarn serves as matrix and glass tape insulates terminal lugs in high-temperature open transformer

of radio receivers are benefiting from such advances in internal insulation. Mylar as interlayer and interwinding insulation and silicone enamel as wire insulation make such UTC units as the one shown in Fig. 9 more compact.

Much of the advance in transformers is resulting from improved techniques for handling wire. The trend continues to smaller wires; for example, Universal Manufacturing Co. winds toroids for magnetic amplifiers, pulse transformers and filter coils in experimental or production quantities with wire sizes No. 10 (0.1019 inch) to No. 42 (0.00249 inch), the latter wire being wound to an inside diameter of less than 0.25 inch. Torwico Electronics offers to wind special miniaturized toroids with No. 48

wire. It is difficult to remove the tendency to kink from drawn wire much smaller than this.

Lead wires used in small control transformers are wound at Control Corp. with Lenz Co. Plascot stranded wire. This sort of wire has advantages over previously used wires inasmuch as it does not crack after being coated with impregnating varnish. These machine-tool transformers are engineered for operation on both 50-cps and 60-cps lines with export trade in mind, as are many other power transformers.

Reduced Size

The steady reduction in transformer size over the past decade is demonstrated by the UTC 90 to 150 cps radio navigation filter of Fig. 10, which now retains original performance in a quarter of the

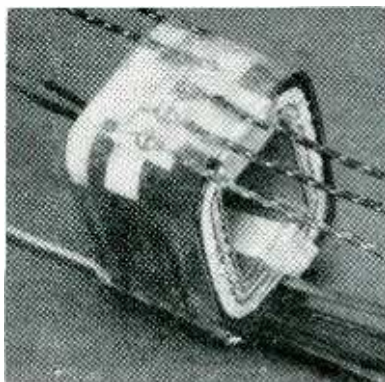

Fig. 8—Mylar-wrapped coil can be visually inspected after completion for location of wires and insulation of wires

original volume. This has been accomplished for the most part by improved core materials.

As another example, even the terminals of the line matching transformer of Fig. 11 were redesigned by Audio Development Co. to realize the utmost in miniaturization.

Extreme reduction in size, even though core losses may also be cut down, reduces the outside area available for cooling. Were it not that the smaller units shorten the thermal conduction path to the case, heat dissipation would prohibit further significant reduction in size. Even so, miniature units are frequently engineered for higher hot spots than were feasible a few years ago. Experience at New York Transformer Co. indicates that

polyester resin is satisfactory to a hot spot of 185 C, silicone varnish to 200 C, and silicone rubber holds possibilities for surpassing these limits.

The extreme in miniaturization illustrated by the UTC unit in Fig. 12, although possibly giving an exaggerated impression of what is being done, is pioneering the way for the future. With Ferroxcube as a Potcore material, inductors are made by Micro Instrument Co. in miniature uncased units weighing less than 0.5 oz that are suitable for mounting on terminal boards by their own leads. In phenolic-cased units, these are adaptable to direct mounting on the chassis. The high permeability of Ferroxcube, which it retains better at high temperatures than do older core materials, gives these inductors a high Q in relation to their size. Standard units



Fig. 9—New materials make small radio and amplifier transformers more compact and improve performance

range in inductance from 2.2 to 220 mh rated for operation from 5 to 500 kc; special units have been manufactured with inductances over 1 h for operation from 400 cps to over 1 mc. For frequencies above 75 kc, inductors are wound preferably on Ferroxcube-core toroids.

At Telex, Inc., hearing-aid transformers having a substantially flat response from 150 to 1,500 cps are wound using 1-mil wire. These units are designed to plug into standard miniature sockets for printed-circuit construction or to be wired directly into the circuit as in hearing aids. Units operate at power levels up to 20 mw and d-c primary currents up to 1 ma.

The trend toward miniaturization has been considerably accelerated

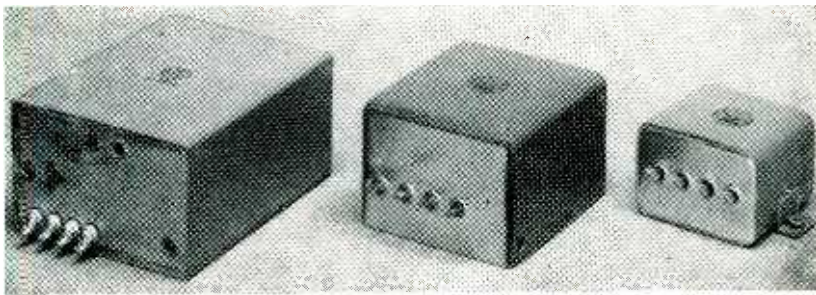

Fig. 10—Radio navigation filter (left) as manufactured during the war, (center) as produced around 1950, and (right) as made today using new insulating materials, new core material and new miniaturizing techniques for construction



Fig. 11—More compact construction of miniaturized impedance-matching transformer that equals performance of earlier unit

COMPONENT DESIGN TRENDS

- New winding techniques improve electrical performance characteristics
- Use of transparent Mylar pressure-sensitive tape aids inspection of coil leads
- Miniature uncased units having Ferroxcube cores can be supported by own leads
- Tape-wound, punched or powdered-iron toroidal cores cut losses

by the transistor. Union Electric Products Co. has, for example, decreased the weight of a standard subminiature transformer from 5 grams to 2.25 grams. Size is now $\frac{3}{16} \times \frac{3}{16} \times \frac{1}{8}$ inch, compared with $\frac{7}{16} \times \frac{1}{4} \times \frac{5}{8}$ inch for the older model. The new units are available as chokes and input, output or inter-stage transformers. Nickel alloy is used for laminations, which are annealed specially; the wire is wound on a bobbin completely free of acid.

Improved Cores

Tape-wound cores, especially toroids, minimize air gaps. These are made up by transformer manufacturers or by suppliers such as Magnetics, Inc. which winds toroids with inside diameters from 0.375 to 4.500 inch, outside diameters from 0.500 to 6.500 inch and heights from 0.125 to 4.500 inch, using tape from 1 to 6 mils thick of such materials as Hy-Mu 80 (79% Ni, 17% Fe, 4% Mo), 48 Alloy (48% Ni, 52% Fe), Orthonol (50% Ni, 50% Fe), Magnesil (97% Fe, 3% Si) and others of similar composition.

Flat laminations stamped as rings, EE and IE shapes continue to fill many needs. Arnold Engineering Co., for example, winds cores of grain-oriented silicon Silec-

tron steel as cut C and E cores and uncut rectangles and toroids weighing from less than an ounce to hundreds of pounds. Moly-Permalloy powder cores are produced for loading coils, filters and broadband carrier networks operating up to 200 kc. Such cores cast as toroids possess low eddy current and hysteresis losses and constant permeability over a wide range of flux density.

Continuing development between Armco Steel Co. and Westinghouse has produced a 4-mil grain-oriented Hipersil steel core material for transformers operating at high inductances and high temperatures. It has been used successfully in the Westinghouse 400-cps three-phase cores illustrated in Fig. 13. Faces of the cut core are flat to give a small air gap. This material can be operated at an induction of 16 kilogauss with only 1 oersted magnetizing force and a core loss of 8.5 w per lb, or 18 kilogauss with 10 oersteds and a loss of 15.5 w. Such developments account for much of the miniaturization accomplished in the past five years.

Significant advance in transformer design has come about as the result of military-sponsored development. One such program of

the Department of the Army Signal Corps, carried out by Chicago Transformer Division of Essex Wire Corp., had as its objective the design of hermetically sealed and open transformers for both 60 and 380-2,400 cps operation; the units were to be of as small a size and weight as practical while using commercially available materials.

A comparison of sealed and open-type transformers developed under this project shows that each hermetically sealed transformer can have an electrically equivalent design in the open-type construction. The choice of construction to be used depends upon the environmental conditions under which the transformer is to be operated and upon such considerations as weight and space.

Heat Problems

Some hermetically sealed transformers are able to dissipate more power than an equivalent open-type transformer due to their greater radiating surface afforded by the

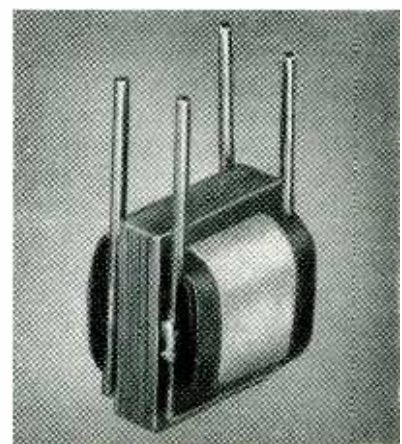

Fig. 12—Subminiature transformer less than 0.5 inch cube has nylon coil form

case. From this it follows that, for those designs which are limited by temperature rise, the coil and core of a sealed transformer can be made smaller than the coil and core of an open transformer of equal rating.

Designs which are limited by voltage regulation cannot always take advantage of this condition. In some cases, the regulation is critical enough to require the same core size for both sealed and open types.

A comparison of core and coil weights and completed weights for plate transformers limited by temperature rise shows that the increase in weight of a sealed unit compared to its equivalent open type is less than the weight of case, cover assembly and filling material by an amount equal to the difference between core and coil weights. Some variation in this generalization is necessary if the transformer is mounted in a standard case appreciably bigger than that strictly necessary.

Core Design Factors

Among the considerations on which these results are based is a comparison of wasteless laminations and C cores. Two transformers were designed to have as nearly as possible the same finished weight. Both cores were made from Armco 4-mil material. The same winding buildup on a percentage basis was used for both designs. Because previous tests had proved that at least in the size used for this comparison (1.6-lb weight of core and coil), magnetizing current was the

paramount factor in determining the operating flux density. The transformers were designed for 400-cps operation so that the results could be applied to 60 cps. The C core has the smaller core section. The copper to core ratio is 0.28 for the lamination design and 0.73 for the C design.

The two transformers were run simultaneously in a test chamber at a series of primary voltages to operate the cores at different densities. A series of secondary currents were drawn at each primary voltage. Output voltage and temperature rise were measured. The data show that, at any specified temperature rise, the C-core transformer provides about 14 percent more va per pound and reaches its optimum at a higher density than the wasteless transformer.

The matching core surfaces of the C core were carefully polished. The laminated core was constructed with unannealed punchings, with centered holes at its corners. Thus, with an improved wasteless lamination, the difference between production units might be less than that observed here.

The mounting dimensions for sealed and open-type transformers can be identical for equivalent units; therefore, the chassis area required for mounting is substantially the same for both types. The open construction requires less height above the chassis and, in general, more depth below to accommodate the exposed portion of the coil.

Hermetically sealed transformers may be operated at high altitudes

(barometric pressures as low as 1.32 inches of mercury) by reducing the load current to 90 percent of its rated value. Modification of the terminal bushings may be necessary, however, to prevent arcovoltages at the reduced pressures. Open-type transformers with terminal voltages in excess of 750 volts are not generally used in unpressurized equipments.

Audio Transformers

Recent effort in audio transformers has been directed toward tighter coupling between sides of push-pull output transformers. Acro Products Company has developed a special arrangement of split windings to obtain tight coupling that permits essentially equivalent response in performance on all taps. Production techniques and equipment, such as multiple traverse winding machines which permit production facility and economy even with extensively interleaved and pi-wound designs, have been developed. This special coupled tertiary winding supplies d-c voltage for the screen grids of push-pull tetrodes and at the same time provides a-c loading on the screens to assure linear operation. One such transformer having a primary impedance of 6,600 ohms has a power rating of 100 w from 20 cps to 20 kc, a frequency response within 1 db from 7 cps to 70 kc, occupies a volume of about 100 cu in. and weighs 14 lb.

Grain-oriented strip-wound C cores are used by Partridge Transformer Ltd. of England in a line of high-fidelity transformers. Design

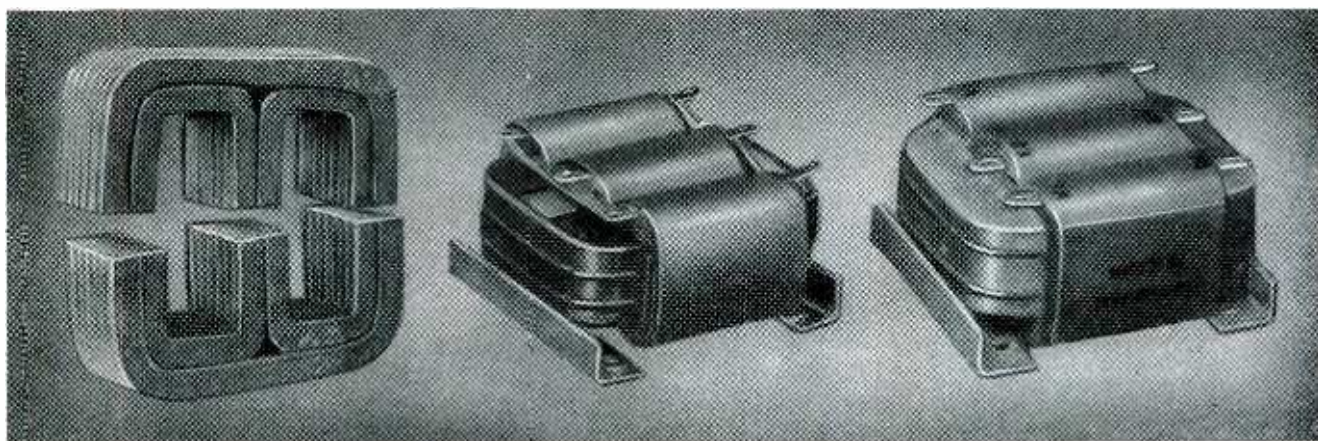

Fig. 13—Core, assembled unit and coated three-phase transformer with secondary rated 25 volts line to neutral at 3 amperes. Faces of cut core are precisely machined to give small air gap.

COMPONENT DESIGN TRENDS

- Hermetically sealed transformers can be smaller than open units because of improved heat dissipation from case
- Thermostats and heating elements improve stability of miniaturized inductors
- Split windings give tighter coupling to improve frequency response of audio units
- Plated tracks and improved brushes make life of variable transformers equal to that of corresponding fixed-ratio transformers

is such that considerable negative feedback can be taken from the secondary and injected into the circuit three or four stages back. Transformer insulation is adequate for a 500-volt supply line with full class-B swing.

Use of Toroidal Cores

Toroidal chokes, such as produced by Communication Accessories Co. and others, provide, for example, a Q of 200 at 6 kc for a 36-mh unit in molded plastic 2 inches in outside diameter and 1 inch high, or a Q of 60 at 800 cps for a similar 36-h unit. Where necessary, such units are readily hermetically sealed in high-permeability cases that also minimize stray coupling.

The tight coupling available from the toroidal core has been used by General Radio Co. in an impedance-matching or bridging transformer and in the output transformer shown in Fig. 14. For tightest coupling, each half of the primary winding covers the complete circumference of the toroid, giving

thereby extremely tight coupling between the two halves of the primary. Switching transients which occur with class AB operation in conventional push-pull amplifiers are thereby minimized.

Where low capacitance between windings and a more extended high frequency range is desired, the loose-coupled connection is used in which each half of the primary winding is on a separate semicircumference of the toroid. Such arrangement gives more leakage reactance between the two halves of the primary. The 6,600-ohm primary has an inductance of about 24 h at initial permeability. This cylindrical transformer is rated at 90 w continuous with an ambient temperature of 35 C and no d-c on the windings; it occupies about 60 cu in., weighs 7 lb and is insulated for 200 v between individual windings and between each winding and case.

For the utmost in stability the UTC miniaturized inductor of Fig. 15 combines in one case a high-Q toroid for use in an oscillator or

filter, a mica capacitor, a thermostat and a heating element to provide high stability over a wide temperature range.

The techniques and materials reviewed here are applicable to all types of magnetic inductance devices, such as saturable reactors and magnetic amplifiers, and are being adapted to motors and relays. They are also being used in continuously variable autotransformers such as the General Radio Variac and the Superior Electric Co. unit of Fig. 16.

Variable-Transformer Life

Life of such units depends greatly on the durability of the track. To achieve a life under rated load essentially the same as that of a fixed-ratio power transformer, General Radio coats the track with a corrosion-resistant silver alloy that prevents deterioration of the copper wire under the brush. The elevated temperature which inevitably occurs under the brush had, in older units, accelerated the formation of high-resistance copper oxide which caused failures in units left without maintenance or at one setting for long periods of operation. The silvered track should be cleaned occasionally with an alcohol-moistened rag. The commutator of the unit shown in Fig. 16 is rhodium-plated for a similar purpose.

Acknowledgments

The contributions of many individuals and companies to this survey, in addition to those mentioned specifically in the text, are hereby acknowledged.

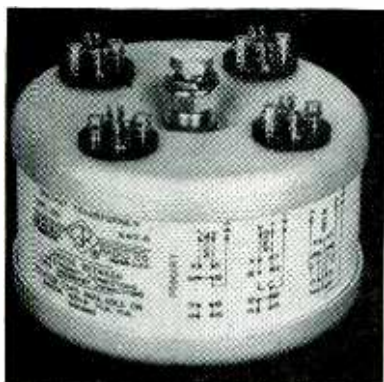

Fig. 14—Toroid output transformer structure provides tight coupling between windings and efficient use of core



Fig. 15—Where utmost temperature independence is required, toroid unit includes thermostat and heater

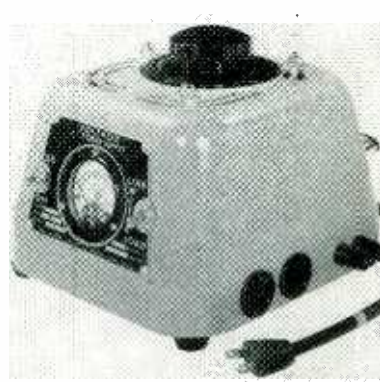
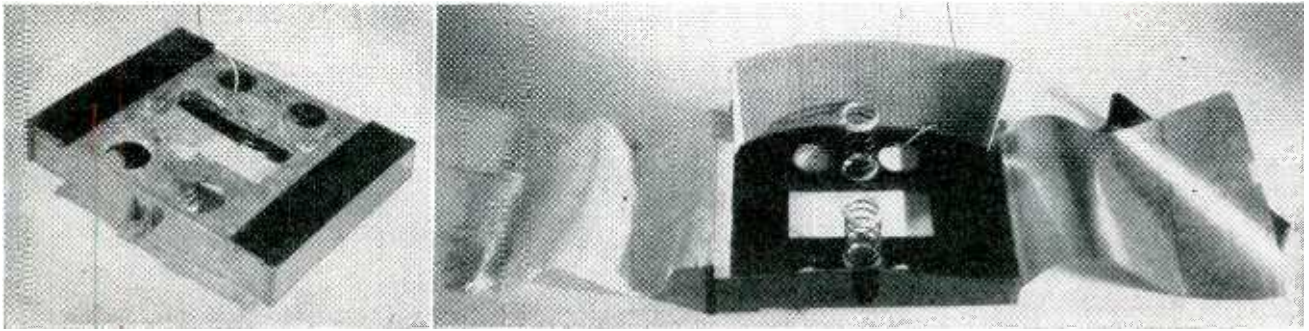

Fig. 16—Variable autotransformer is convenient laboratory tool, widely applicable for voltage control



Rear and exploded views of electrostatic speaker. Electrodes consist of cylindrical diaphragm and gold foil on polyethylene dielectric, 0.0012 in. thick. Perforations in the diaphragm reduce back-loading and prevent nonlinear movement. Sound is generated by movement of dielectric and gold foil

Electrostatic Speaker Accents High Frequencies

Inexpensive capacitor-type speaker has range of 7,000 to 15,000 cycles per second, with good polar response in horizontal plane, permitting design of economical radio receivers and phonographs capable of wide-range audio reproduction

By **MARVIN HOBBS***

*Vice-President and Director of Engineering
Harvey-Wells Electronics, Inc.
Southbridge, Mass.*

USE of an electrostatic loud-speaker to reproduce only the higher audio frequencies is not new. The unit to be described is designed to provide better distribution of the higher frequencies. It also has a relatively uniform response throughout its range and a low degree of distortion when fed through the proper network.

As shown in the photographs the speaker consists of a stiff curved perforated copper-backed plate, firmly mounted in a molded-plastic housing with a gold-sprayed insulated foil tensely stretched over it. The sieve-like copper plate serves as one electrode and the gold film serves as the other. The electrodes and insulating foil form a capacitor of approximately 4,000 μf . The gold electrode, which is at the front of the speaker, is at ground potential and is protected by

a thin wide-mesh cloth covering. Acoustical reproduction results from the forces established in the dielectric due to the variations of potential between the plates.

Early models of electrostatic speakers had two major disadvantages: sufficient movement to reproduce the full audible-frequency range at any reasonable power level could not be attained

without high driving power and a high polarizing potential; physical properties of dielectric materials were such that voltage breakdown was a common occurrence.

The first problem is solved by confining operation of the capacitor speaker to the approximate range of 7,000 to 15,000 cycles. This keeps the energy content of the signals fed to the speaker at a low level eliminating the requirement for a large movement of the diaphragm. Thus, both the driving voltage and the polarizing potential are kept within the bounds of values available in an inexpensive amplifier. In the same way, the problem of voltage breakdown is minimized by the low polarizing potential. An additional safety factor is provided through the use of Styroflex or polyethylene dielectrics giving a unit having a breakdown limit of 1,000 volts, which is four times the average polarizing

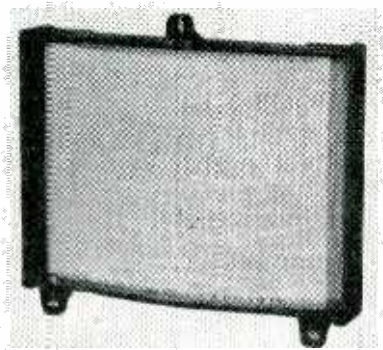

Front view of electrostatic speaker

* Now consulting engineer, Southbridge, Mass. and Chicago, Ill.

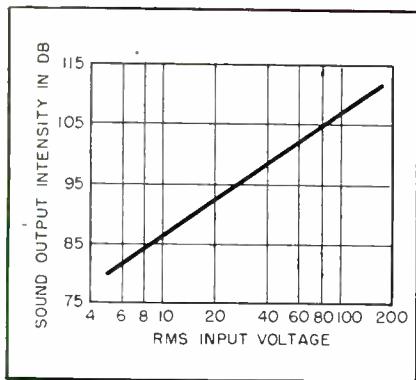

FIG. 1—Speaker input versus output at 12,000 cps with 250-v dc polarization

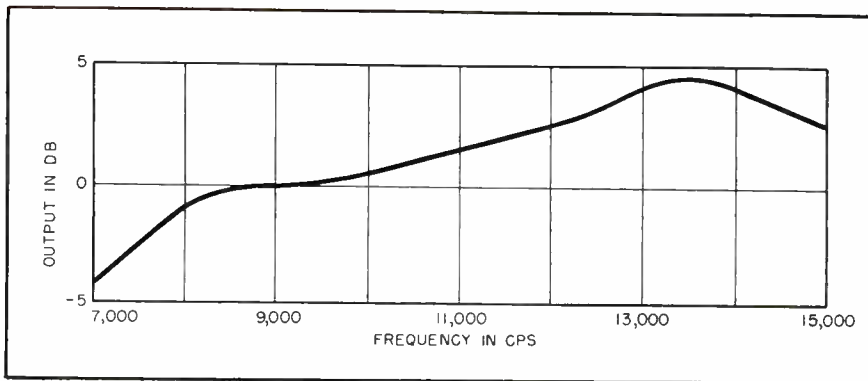

FIG. 2—Electrostatic speaker response curve. Output is flat plus or minus 4 db over range of 7,000 to 15,000 cycles per second

potential of 250 volts required by the speaker described here.

Polarizing Voltage

The electrostatic speaker is a voltage-operated device. To handle any given value of a-c input voltage, it is recommended that a d-c polarization potential of twice the value of the highest value of peak a-c modulation voltage occurring in practical use be applied to the unit in conjunction with the audio voltage. A polarizing potential of +250 volts is a typical value. However, the speaker can handle an audio input voltage up to a maximum of 150 volts peak.

Potentials of 250 to 300 volts are readily obtainable from the B+ supply of most audio amplifiers using transformer power supplies.

The relationship between the speaker input and output at 12,000 cycles is shown in Fig. 1. Zero db

is taken in this case as a sound intensity of 10^{-16} watts per sq cm. It can be seen that a low level of distortion will be realized from this linear characteristic. The response curve of the speaker throughout the range of 7,000 to 15,000 cycles is shown in Fig. 2. Note that the output is relatively free of peaks and quite uniform throughout the upper register.

Frequency Distribution

Most past designs of electrostatic speakers utilized flat electrodes. Such configurations when driven by higher audio frequencies usually produced a concentrated pattern of radiated energy and was not the most suitable for covering more than a very limited angle directly in front of the unit. The photographs show how the speaker being described is curved in the horizontal plane to provide a wider distribu-

tion of higher audio frequencies.

Figure 3 shows the speaker's polar pattern in the horizontal plane at 12,000 and 15,000 cycles. Although the pattern is somewhat restricted in the vertical plane (30 degrees at 12,000 cycles), the speaker is physically at such a level in a table model radio that the pattern covers the listener quite well, particularly when seated. In console models where the cabinet design requires that the speaker be located below the ear level of the seated listener, the tweeter may be tilted upward at a sufficient angle to provide excellent ear-level response within the limits of the horizontal pattern indicated by the curves.

Circuits

A typical audio-amplifier output circuit for driving the electrostatic speaker in conjunction with a

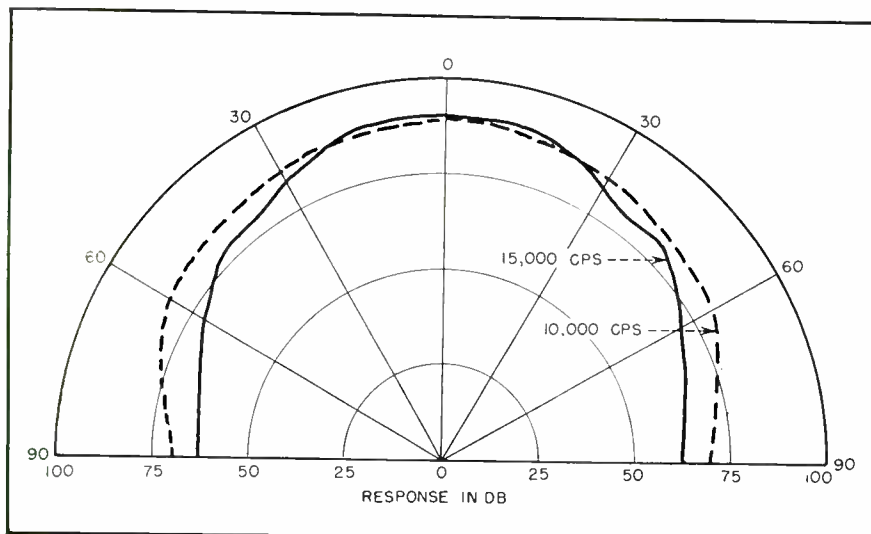

FIG. 3—Polar-distribution pattern of electrostatic speaker at two frequencies

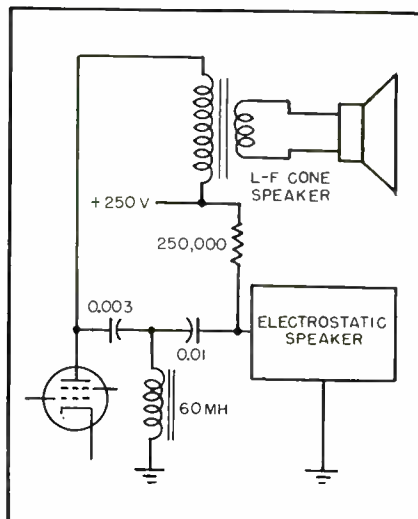

FIG. 4—High-pass coupling network

standard low-impedance cone speaker is shown in Fig. 4. The circuit for a push-pull output stage utilizes component values similar to those of a single-ended output stage. However, the network feeding the tweeter is connected across only one-half of the output-transformer primary in the push-pull case.

The loss in high-frequency drive by this arrangement is adjusted by increased high-frequency compensation within the amplifier or by using a less efficient cone speaker to achieve the required tonal balance between highs and lows. In either case the electrostatic speaker is fed through a low-cost network, consisting of 0.003- μ f and 0.01- μ f capacitors and a 60-millihenry inductance. This circuit attenuates the audio voltages below 7,000 cycles, with the shunt inductance keeping the impedance high in the operating range of the speaker.

All of these coupling network components, including the resistor feeding the polarizing voltage, are low-cost items and contrast in this respect with the large capacitors and inductances associated with crossover networks of low-impedance cone and compression-type tweeters. An even simpler network consisting of capacitors and resistors is sometimes employed.

An interesting aspect of this circuit design is the possibility of reducing the output transformer cost. The problems of providing an adequate output transformer are normally complicated by the necessity for it to pass both ends of the audio spectrum with equal fidelity. The transformer design may be simplified and its cost reduced if the transformer can sacrifice performance at either end of the frequency range. Since the tweeter is fed from the primary, the output transformer need not be capable of passing the highest frequencies with full fidelity. In fact it can provide an artificial crossover in so far as the low-frequency speaker is concerned, if it favors the low and middle frequencies and allows the higher frequencies to diminish. This situation may be exploited fully if the negative-feedback volt-

the primary instead of the secondary.

Efficiency

The fact that the efficiency of this electrostatic tweeter is somewhat less than the average expensive high-frequency loudspeaker might appear to offer serious limitations to its satisfactory performance. However, upon viewing the application of this tweeter in a complete system, such as a packaged phonograph to be produced by one organization with all of the design parameters under control, the situation is somewhat different. Modern microgroove recordings have high-frequency preemphasis of the order of 12 to 18 db (0 db at 1,000 cps) in the frequency range of 10,000 to 15,000 cycles. Also, f-m transmissions have a 75-microsecond preemphasis resulting in a boost of about the same magnitude as that on the new microgroove records. It is standard practice in high-fidelity equipment to attenuate this boost of high frequencies either at the front end of the audio amplifier in the record compensator or to attenuate them after the detector in the f-m case. However, if these highs are allowed to feed through to the output circuits of the complete system to the extent required for a given degree of fidelity, the high-frequency speaker can be much less efficient than a so-called ideal loudspeaker and still provide high-frequency response at a level comparable with that of such an ideal unit driven by an amplifier system preceded by conventional arrangements for preemphasis attenuation.

Life Expectancy

With regard to life of operation, in a typical test 6 watts of 10,500-cycle audio were applied to the speakers for more than 2,000 hours without interruption, while the unit was simultaneously acoustically vibrated by the 50-cycle output of two large cone speakers mounted on the same baffle. The speakers tested withstood this test without deterioration and without changes in the measured values of their characteristics.

This test indicates that these

speakers have useful life characteristic for the amplifier is taken from statistics not unlike those of dynamic cone speakers.

When the speaker was driven beyond the 1,000-volt breakdown limit, occasional flashovers healed without permanent damage. Also, tests conducted in a humidity of 96 percent showed satisfactory performance. With polarizing potential applied, the resistance of the insulation dropped from 100 megohms for dry air to a few megohms under high humidity conditions. Without polarizing potential applied, the resistance dropped to a value as low as 1 megohm under high humidity, but returned to normal, when the unit was removed from the test room. No permanent damage resulted from high humidity even when the speaker was operated under these conditions.

Application

Using the electrostatic speaker, overall tonal balance will depend to a large extent upon the care with which the cone speaker is chosen. It should have as good low-frequency response as is consistent with the price class of the unit into which it is designed and should have a middle and high-frequency response that blends with the characteristic of the tweeter. It must also be carefully designed to minimize intermodulation distortion and frequency-doubling. For the listening levels required in the average living room, with proper volume-control compensation, it has been found that excellent tonal balance and a low level of distortion are realized with the design described.

In the Western zone of Germany, electrostatic tweeters are most widely used in table model radios and in conjunction with 8-inch cone loudspeakers whose resonance characteristics are established at the lowest frequency consistent with cost considerations, in cabinets of limited volume.

The courtesy of the Korting Radio Werke in furnishing their receivers as well as some of the performance data for the electrostatic speaker is acknowledged.

Radar Offers Solution

Continuous-wave Doppler technique provides advance recognition of collision threats. Evaluation of collision potential is obtained automatically by measurement of closure rate, deviation of closure rate and deviation of closure angle

By **JAMES Q. BRANTLEY**

*Cornell Aeronautical Laboratory, Inc.
Buffalo, New York*

PREVENTION OF COLLISIONS between airplanes in flight constitutes one of the air transportation industry's most acute growing pains. Between 1946 and 1953, airline airplanes were involved in 15 midair collisions. In addition, hundreds of near misses have been reported and numerous others have no doubt gone unnoticed or unrecorded in many instances.

One approach to the collision problem embodies the use of some form of airborne radar to provide recognition of collision threats in advance. This article describes the means whereby prior recognition of such threats can be achieved and discusses the applicability of pulse and continuous-wave radar techniques.

Recognition Criteria

Determination of present position involves distance (range) and angular position (closure angle). Estimation of future position necessitates, in addition, a knowledge of the speed of approach (closure rate) and the rate-of-change of closure angle.

The behavior of closure rates and closure angles of two converging aircraft is related to the collision potential present.^{1,2} An approaching plane whose closure angle remains constant is on a collision course; the more slowly the angle changes the closer the approach to a collision course. Concerning closure rate, a constant rate is a definite collision indication; the more slowly it varies, the closer the approach to collision conditions. For example, as the planes in Fig. 1A approach the collision point, the

closure angle and the closure rate remain constant. In the near-miss case in Fig. 1B, the range does not decrease uniformly and plane X arrives at the course intersection before plane Y. The greater the miss-distance the larger the rate-of-change of closure rate and closure angle.

Means must be provided whereby more than one aircraft may be detected and the most dangerous one singled out. In this respect, the concept of closure time is useful. Closure time is the ratio of range to closure rate and is defined as the time it would take an aircraft to arrive if it were to continue at a constant closure rate.

Figure 1C shows how closure time can be used for target discrimination. The closure time of X (closing on Z) is 12 seconds and the closure time of Y (also closing on Z) is 36 seconds. We can therefore conclude that the closest target is not necessarily the most dangerous since A will be the first to arrive at a collision point.

In the past, all fatal midair collisions involving air carriers have occurred when visibility was good. In many cases the accidents could have been prevented had either pilot known of the presence of the other aircraft. An approach to the collision problem which would take advantage of the eye's remarkable capabilities when visibility is good and simultaneously make up for its deficiencies when visibility is poor, would be very effective. A radar, by merely alerting the pilot, would be effective in preventing an appreciable number of collisions. In addition, the radar could

serve as an all-weather warning device by supplying essential information to the pilot under instrument conditions.

Radar Collision Prevention

Tests have indicated that ordinary search radars are inadequate for collision prevention. Large echoes from the ground can mask weaker aircraft echoes, making it difficult to detect and identify airplanes on a plan position indicator. The requirement for constant surveillance of the radar scope would be unrealistic even if aircraft echoes were discernible. Estimation of future position is relatively difficult and uncertain from a presentation of present position. Finally, extraction of a target's closure rate from a pulse radar requires complicated techniques.

Some of the disadvantages associated with pulse radar in the collision warning application can be largely overcome by utilization of continuous-wave Doppler techniques. One important aspect of c-w radar is its ability to measure closure rates accurately by use of the Doppler effect.

The Doppler phenomenon appears as an apparent carrier frequency change in radar echoes from moving targets. When detected in the radar receiver, the frequency of energy thus reflected differs from the frequency at transmission by an amount accurately proportional to target closure rate. By measuring this difference, closure rate can be determined. With a c-w radar it is only necessary to compare the frequency of the received signal

to Midair Plane Collisions

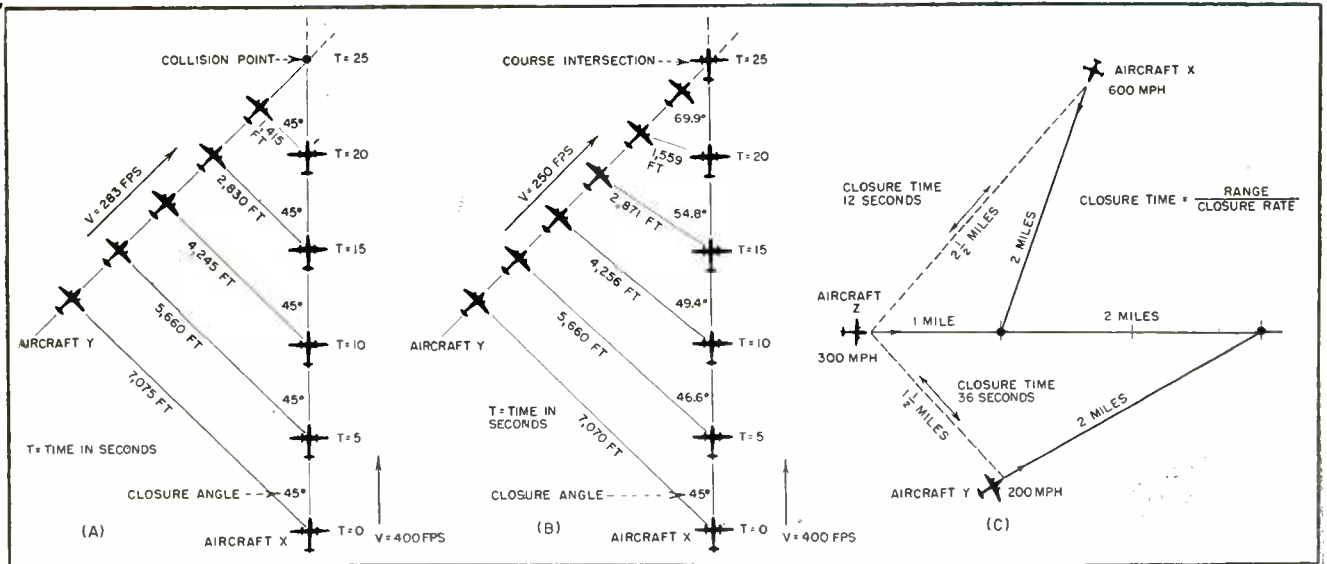

FIG. 1—Two aircraft at identical altitudes converging and on collision courses have constant closure angles and closure rates (A). Aircraft flying near-miss courses have changing closure angles and rates (B). Hypothetical case of double collision threat shows that closest plane is not most dangerous (C)

with that of the transmitter; with pulsed radar this is more difficult because of the on-off character of its transmission. Ranging can be accomplished with c-w radar if carrier modulation is used.³

Search by Closure Rate

A radar system's maximum range capabilities at low altitudes are improved by an ability to categorize targets by their closure rates. Figure 2 illustrates how a search by closure rate system is superior to search by range. In Fig. 2A, echoes from the ground, received from a wide spectrum of ranges, tend to smother reflections

from other aircraft. In Fig. 2B, however, ground echoes are distributed about the aircraft's ground speed of 300 mph. The target's closure rate of 600 mph. places its echo beyond the ground return, effectively reducing ground clutter and permitting detection of aircraft at ranges exceeding those obtainable with search by range systems.

For closure rates which place aircraft echoes in the ground clutter, a loss in maximum range results. This condition is not as serious as one might at first suppose, since for lower approach rates early detection is not as imperative

as for higher rates. For high-speed targets, the search by closure rate method is at its best.

Antennas

Measurement of closure angles, whether by pulse or c-w radar, is generally accomplished through use of special antenna configurations. Such systems are complex if large regions are to be searched and complications result from air frame space limitations. Further, if high angular resolution is desired, antenna physical dimensions are large. Therefore, it is necessary to restrict measurement of closure angles to rough approxima-

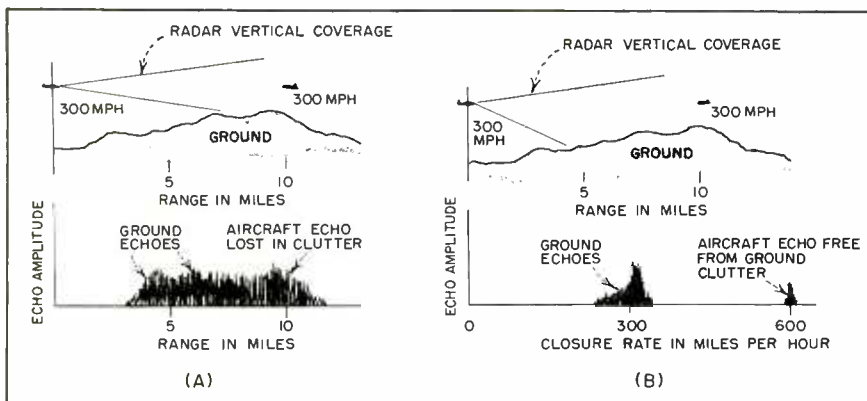

FIG. 2—Aircraft echoes are smothered by ground clutter in search by range method used by most pulse radars (A). Masking of echoes is avoided by using search by closure rate method employed by c-w radar (B)

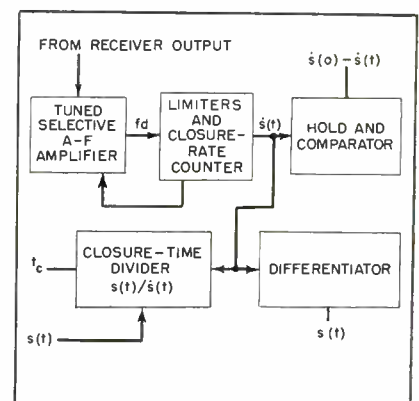

FIG. 3—Block diagram shows basic configuration of experimental single-target computer

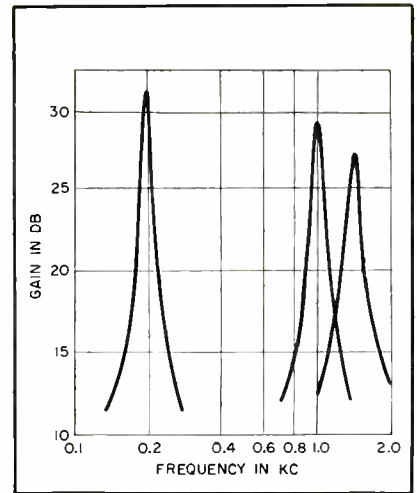
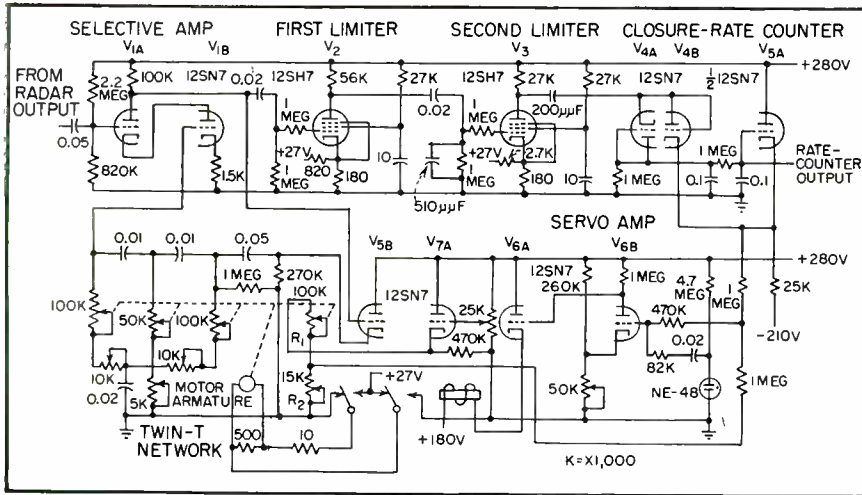

FIG. 4—Automatically tuned amplifier, limiters and closure-rate counter. Twin-T network sharply peaks amplifier gain at its center frequency

FIG. 5—Amplifier response at three different frequencies

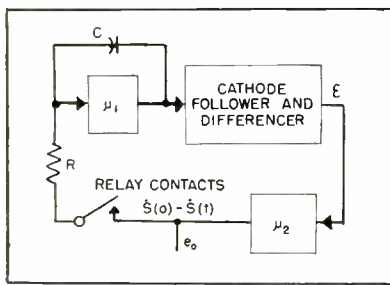

FIG. 6—Block diagram of hold and comparator

tinuously, a combination radar-computer type system is desirable. Evaluation of the collision potential is then accomplished automatically by measurement of closure rate, deviation of closure rate and observations of closure angle deviation if technically feasible. The appropriate data and decisions of the computer would then be displayed in the cockpit by a suitable indicating device.

changes in accordance with a changing closure rate. The difference, $ds(0)/dt - ds(t)/dt$, is obtained in a comparator and in addition, the closure rate signal is differentiated to determine $\dot{d}s(t)/dt$.

Assuming the availability of range information $s(t)$, closure time t_c is determined by division of $s(t)$ by $ds(t)/dt$.

Figure 4 is the complete circuit of an automatically tuned amplifier, limiters and closure rate counter. The tuned amplifier contains a twin-T feedback network phased to peak the amplifier gain sharply at its center frequency.

Amplifier V_{1A} , drives the twin-T network through a cathode follower and the feedback signal is injected through series-connected triode V_{1B} . Response curves for three frequencies are shown in Fig. 5.

The three variable resistance arms of the twin-T network are

tions and to rely on these measurements primarily for determining the appropriate turn direction for avoidance of an impending collision. Future development of improved techniques for angle measurement may make possible the use of the constant-angle criterion for prior collision recognition.

To reduce the pilot's work load and to relieve him of the necessity for watching the radar output con-

Computing Circuits

A block diagram of the computer is shown in Fig. 3. The tuned a-f amplifier automatically locks upon the received signal's frequency and its output is amplitude-limited and injected into a counter, which supplies a voltage proportional to closure rate $ds(t)/dt$. Holding circuits establish the closure rate at initial instant of lock-on $ds(0)/dt$, maintaining it while the signal

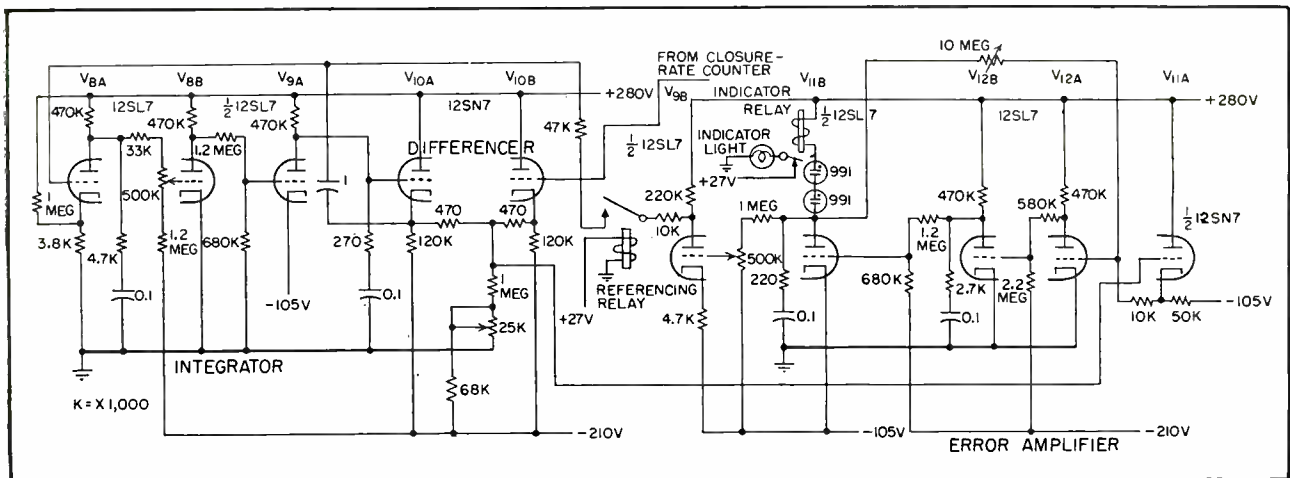

FIG. 7—Experimental hold and comparator. Integration amplifier, consisting of triodes V_{8A} , V_{8B} and V_{9A} has a voltage gain of 10^4

ganged with a fourth potentiometer, which is used to supply a reference voltage proportional to the amplifier's resonant frequency. The reference voltage at the junction of R_1 and R_2 is subtracted from the output of the closure rate counter to obtain an error signal which, when amplified by V_6 , drives a follow-up servo motor on the potentiometer shaft.

Introduced in series with the input of V_6 is a 5-cps alternating voltage obtained from the NE-48 relaxation oscillator. The a-c signal causes alternate forward and reverse motor connections; the dwell in each position is dependent on

the differencing circuit (including μ_2) yields a voltage $e_o = \epsilon\mu_2 = ds(0)/dt - ds(t)/dt$. The smaller e_o , the greater the probability of collision.

The circuit of an experimental hold and comparator is shown in Fig. 7. The integration amplifier consists of triodes V_{8A} , V_{8B} and V_{9A} and has a voltage gain of approximately 10^4 . The integrator output is connected through cathode follower V_{10A} into a T-type differencing network the other arm of which is connected to a voltage proportional to $ds(t)/dt$.

The difference voltage is taken from the series arm of the T-network and fed into the amplifier

is approximately 2 miles.

The amplifiers of Fig. 7 have a drift rate of about 0.025 volt per minute over a period of 10 minutes. The measurable change of 0.04 volt occurs in about 1 second and renders the 0.025-volt-per-minute drift rate negligible.

Differentiator

The differentiator and d-c amplifier are shown in Fig. 8. Differentiation is achieved with an R-C feedback circuit.

A wide variety of dividing methods are applicable for the closure-time computer. Accuracies of about 5 percent are required for this ap-

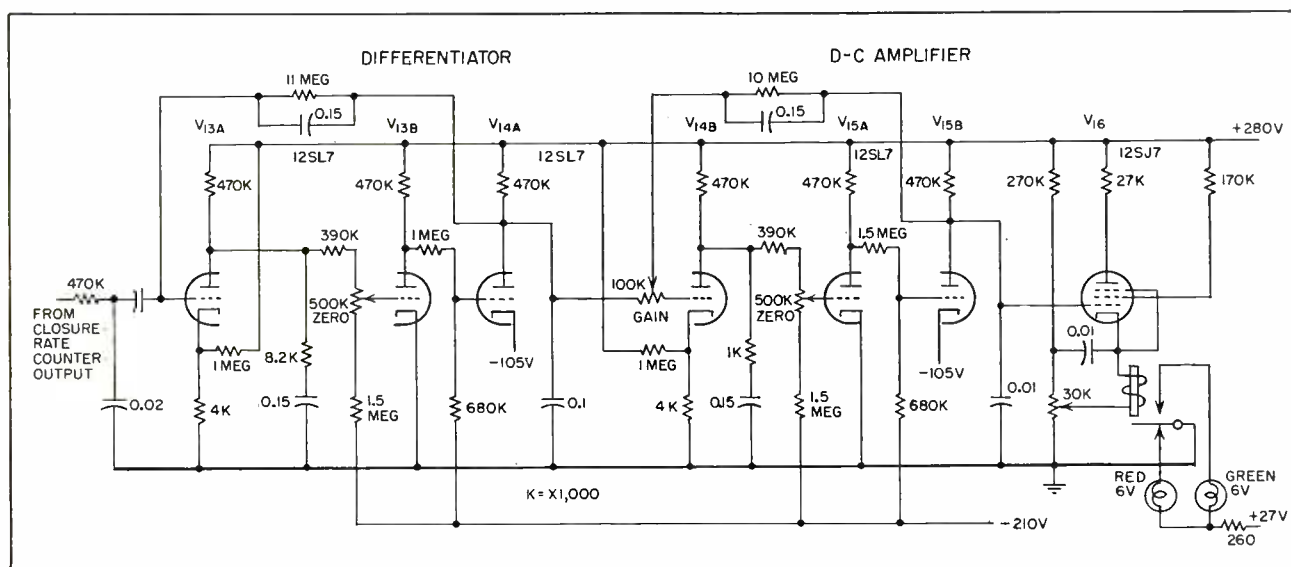

FIG. 8—Differentiator and d-c amplifier. Differentiation is obtained with R-C feedback circuit

the amplitude of the d-c error. A d-c error produces a predominance of armature current flow in the direction for proper correction. Introduction of the a-c signal results in smoother servo operation and more precise tracking.

Stages V_2 and V_3 limit the audio signal, providing V_4 and V_{8A} with a constant-amplitude square wave.

Hold and Comparator

The hold and comparator is shown in Fig. 6. Polarities of the elements are such that in the closed loop connection the integrator output balances the input voltage from the closure-rate counter. Opening the feedback loop at $t = 0$ leaves a reference potential across the integrator terminals proportional to $ds(0)/dt$. Henceforth, the output of

comprised of V_{12A} , V_{12B} and V_{11B} through cathode follower V_{11A} . The error signal is then inverted by V_{9B} and integrated. This action continues until the error vanishes.

In the open loop or hold position, the grid-to-ground leakage resistance of V_{8A} is greater than 10^8 ohms and the circuit will retain a reference voltage to a high degree of precision for several minutes.

With this circuit, variations in speed voltage of 0.04-volt are detectable. A 0.04-volt change corresponds to a speed frequency change of about 1.3 cps or, at a carrier frequency of 1,500 mc, a change of closure rate of approximately 0.44 fps. This is about the sensitivity needed to detect a potential 1,000-foot miss when the range of the approaching aircraft

plication and special circuitry is not required.

To assess the range capabilities of a continuous-wave radar, ground tests were conducted using a 1,500-mc radar. Average transmitter output power of the unit was approximately 1 watt. An antenna system having horizontal and vertical beam widths of 66 and 74 degrees was employed; separate antennas were used for transmission and reception.

The radar equipment was installed in a panel truck and the antennas were placed on a rotary mount. The movable antenna assembly made it possible to direct the antennas toward any target desired from a control position within the truck.

Receiver output signals were re-

recorded on magnetic tape. Oscillographs of some of these recordings are shown in Fig. 9 and 10. Figure 9 displays echoes received from a DC-3 making a straight-in approach with the radar situated just off the runway and near the point of touchdown. The intervals shown are of $\frac{1}{3}$ -second duration. Average relative speeds in feet per second were computed from the Doppler equation

$$\frac{ds}{dt} = \frac{1}{2} \lambda f_a$$

where f_a is the Doppler frequency in cps and λ is the carrier wavelength in feet.

Considerable amplitude and frequency modulation of the signal is in evidence in Fig. 9. The amplitude modulation results largely from specular reflections from the propeller and the frequency variations are caused by propeller motion. Over a period of time long compared to the period of the amplitude bursts, the Doppler shift arising from motion of the aircraft will experience little displacement from propeller f-m effects if the receiver frequency response curve is symmetrical. Because of the alternate increases and decreases in f_a , a cancellation occurs which prevents the accumulation of large errors.

An aircraft stationary with respect to the radar, but with motors running, would not be detected if it were situated head-on to the radar. In that attitude, at a reasonable range, relative motion of the propellers is almost negligible and practically no Doppler shift is present. Results which substantiate this are illustrated in the oscillographs of Fig. 10. From the top down, the first recording illustrates the Doppler return from a side-on view of an idling Convair 240. The second recording was taken of the same airplane as it was turning into takeoff position and head-on to the radar. The third was taken from the forward quarter as the takeoff run began. In the first and last recordings propeller modulation is evident, but in the head-on attitude it is considerably reduced.

Airplanes such as the DC-3 and Convair 240 were consistently detected at ranges from 2 to 2.5 miles (measured optically) and private

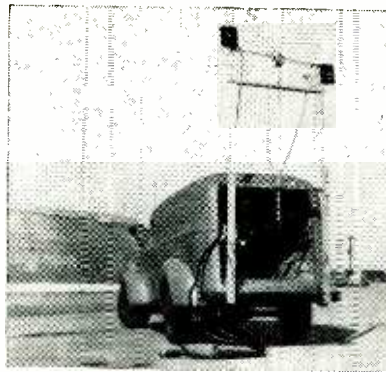

Radar truck, showing antenna assembly used for ground testing collision-preventing equipment and techniques

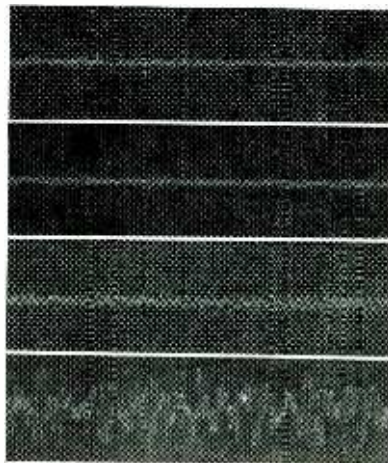

FIG. 9—Doppler recordings of DC-3 on final approach. Time in seconds after signal amplitude became steady, from top to bottom is: 10; 30; 50; 65. Closure rates of last two waveforms are 115 and 148 fps for Doppler frequencies of 351 and 450 cps

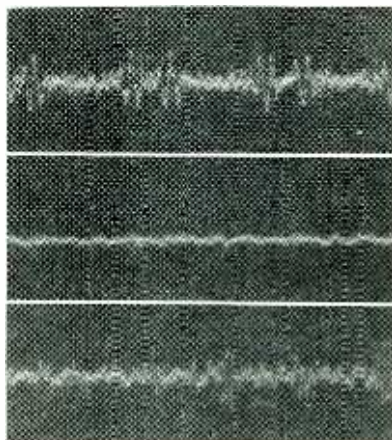

FIG. 10—Doppler recordings of Convair 240 taxiing into takeoff position

craft were normally detectable at ranges just over one mile.

These results, achieved with low transmitter power and low antenna gain, indicate strongly that sufficient detection ranges for adequate

collision warning are attainable with more appropriate equipment. Furthermore, echo waveforms from sufficiently strong signals are such that accurate speed data are obtainable.

From what has been said, some readers may assume that c-w radar for collision warning can be made immediately available. This is not the case. Even if the methods described should prove their usefulness, they would be for the projected future and could not be instrumented from on-the-shelf components. Perhaps, also, improved techniques which permit extraction of accurate Doppler information from pulse-type radars will appear. A pulse-Doppler system capable of finding bad-weather areas, serving in a terrain avoidance capacity and capable of preventing mid-air collisions, while retaining a reasonable degree of simplicity, could constitute the optimum solution to the collision problem.

The assumption has been made here that the solution to the collision problem will be a self-contained system. While this is not necessarily the case, there are reasons why such a system seems desirable. Among these reasons are freedom from dependence upon ground facilities, freedom from dependence upon equipment carried in other aircraft and the flexibility of operation which such a system would allow.

The author is indebted to the Cornell Aeronautical Laboratory and the members of its staff for sponsorship of this work. In particular the contributions of Frank M. Pelton were of major importance. Credit is due the Guggenheim Aviation Safety Foundation, the Air Transport Association, the Civil Aeronautics Administration and the Air Line Pilot's Association for their interest and cooperation in supplying much valuable information.

REFERENCES

- (1) An Analysis of the Problem of Aircraft Collision Prevention, Airborne Instruments Lab. Inc., Report No. 508-1, Sept. 1946.
- (2) J. Q. Brantley, Jr., A Study of the Aircraft Collision Problem with Particular Emphasis on the Possible Application of Continuous Wave Radar Techniques, Cornell Aeronautical Lab., Report No. JA-774-P-1.
- (3) D. G. C. Luek, "Frequency Modulated Radar", McGraw-Hill Book Co., Inc., 1949.

Decade Counter Tube for Accounting Machines

Gas-discharge tube fitting into 9-pin miniature envelope provides decade counter that replaces mechanical and electromechanical units. Construction and basic circuits are given together with circuit values, operating voltages and their allowable variation

By **R. B. KOEHLER** and **R. K. RICHARDS**

*International Business Machines Corp.
Poughkeepsie, New York*

RECENTLY need has arisen for an electronic counter that is faster and less costly than the mechanical and electromechanical counters now employed in accounting machines. Use of a cold-cathode glow discharge that can be stepped from one electrode to the next has been recognized as a possible solution to this problem and descriptions of many such counter tubes have appeared.¹⁻¹⁰ In at least one instance a complete computer has been assembled with gas-tube counters as the basic arithmetic and storage elements.¹¹ Some of the schemes by which a glow can be caused to step along have been summarized and explained.¹²

The counter tube to be described differs from previously known tubes in that the transfer of the glow in the desired direction is secured through the use of cathodes comprised of two different materials. Appropriate cathode configuration, cathode coating and shielding from mica supports are additional factors that insure positive operation over a wide range of parameters.

The entire structure fits into a standard T-6½ miniature bulb and the position of the glow may be determined by viewing the tube from the side. The tube contains a self-complementing feature whereby the digit stored in the tube may be transposed to its 9's complement—its value subtracted from 9—by application of a single

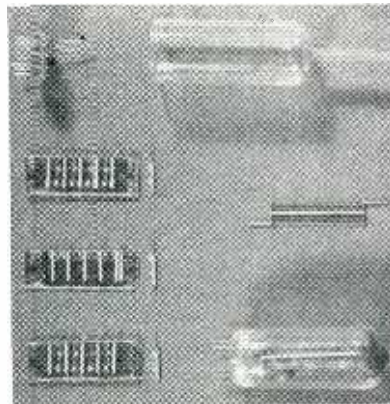

Mica support plates, left center, with U-shaped cathodes attached are sandwiched to form desired structure. Wire-mesh anode, right, is mounted above this assembly

pulse to an appropriate set of cathodes.

Arithmetic Operation

In accounting machine applications the counter system should be capable of both addition and subtraction. One way to gain both of these functions is by counters capable of counting either forwards or backwards.

However, subtraction can be simplified by using counters that count in one direction only and creating the effect of subtraction by adding the 9's complement of the number to be subtracted.

With the self-complementing counter both subtraction and read-out of all balances in true form are accomplished with a minimum of extra equipment. For subtraction, the number initially stored in the

counters is transposed to its 9's complement representation and the number to be subtracted is added with an end-around carry if necessary. If the difference is positive, the result will appear in 9's complement form but it may be converted to true form by a second complementing action of the self-complementing counters.

Illustrative Example

Assume that 0785 is stored in a four-digit accumulator and 0493 is to be subtracted from it. By the application of a single pulse to all self-complementing counter tubes 0785 is converted to its 9's complement—9214. The number 0493 is then added. No end-around carry occurs in this example

9214
0493

9707

The result is the 9's complement of the correct answer, 0292, which can be obtained by applying a second complementing pulse to the counters.

If the number to be subtracted from 0785 were 0905, an end-around carry would result

9214
0905

0119
1

-0120

The result is the true representa-

tion of the difference, which is negative in this case. The end-around carry may be obtained from the carry signal in the highest-order counter. The presence or absence of this carry can be used to indicate negative or positive balance.

Description

The basic counting process in the gas-discharge counter may be explained with the aid of Fig. 1. Four hollow, cylindrical cathodes K_1 , K_2 , K_3 and K_4 are shown with K_1 and K_3 connected together and grounded and K_2 and K_4 connected to an external lead C . Attached to these cathodes are the transfer wires T_1 , T_2 , T_3 and T_4 each having a work function higher than that of the cathodes. A common anode A is spaced equally from each cathode structure. This assembly is sealed in an envelope containing a gas at a pressure such that the voltage required to start a glow discharge will be considerably higher than necessary to maintain the glow.

The positive terminal of the power supply is connected through a series resistance R to the anode and the negative terminal is grounded. A glow discharge is then established between K_1 and the anode. When a voltage source initially positive with respect to ground is connected to C and reduced to a negative value, sufficient voltage will exist between K_2 and K_1 and the anode to maintain a glow discharge on T_2 or T_4 . Since the free end of T_2 extends into the ionized region between K_1 and the anode, a glow will begin on T_2 and not T_4 because the high ion density in the region of K_1 will reduce the initiating voltage for T_2 .

Action of Glow Discharge

As the voltage becomes more negative this glow will spread until it covers the entire surface of T_2 . Additional voltage change will force the glow to spread onto the main body of K_2 . Since the outer surface is covered with an insulating material, the glow will locate on the inside surface of the cylinder. The cylinder material has a lower work function than that of the transfer wire so that when the glow reaches K_2 the voltage drop between K_2 and

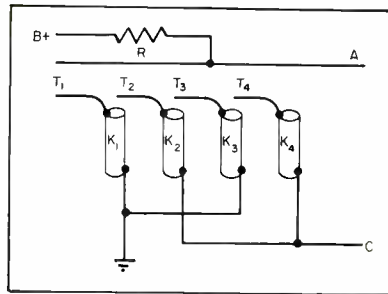

FIG. 1—Basic cathode configuration

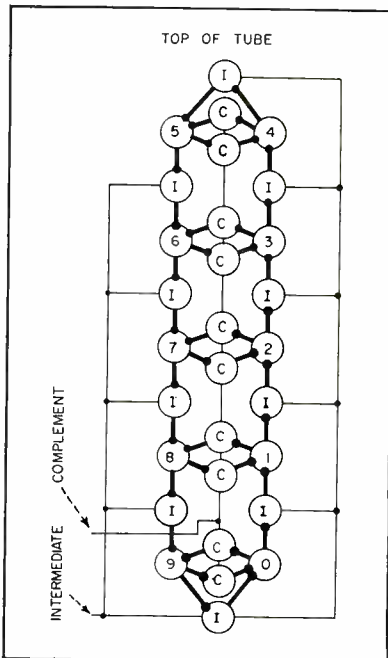

FIG. 2—Top view of basic cathode arrangement

Table I—Typical Voltage and Component Values

Voltage or Component	Typical Value	Allowable Variation
E_A	500 v	
E_K	135 v	
$E_A - E_K$	365 v	315 to 405 v
E_I and E_C	15 to 75 v
Driving Pulse	-100 v	-60 to -110 v
Output Pulse	70 v	57 to 88 v
R_A	68,000 ohms	
R_K	36,000 ohms	
R_1 and R_3	680,000 ohms	
R_2 and R_4	390,000 ohms	

the anode will be less than the voltage required to maintain a glow on T_2 . Thus the glow on T_2 will be extinguished.

Further change of the voltage on C will be accompanied by a decrease in the anode voltage, since the voltage difference between the anode and K_2 will remain constant. This action will reduce the voltage between K_1 and the anode to a value less than its sustaining voltage.

Therefore the glow on K_1 will be extinguished also.

If the voltage applied to C is allowed to return to its original positive value, the anode voltage will rise with the voltage on K_2 until it is sufficiently positive to maintain a glow on T_1 or T_3 . The tip of T_3 will pick up the glow because it is in an ionized region. From there it will spread into K_3 and leave T_3 . The anode voltage will now be stabilized at a potential above ground equal to the drop from the anode to K_3 . Further increase of voltage on C will decrease the voltage between anode and K_2 until the glow on K_2 extinguishes.

If K_1 is called the 0 position and K_3 the 1 position and if a negative pulse of voltage of sufficient duration is applied to cathodes K_2 and K_4 at C , the glow will count the pulse by moving from K_1 to K_2 to K_3 . By interspersing ten digit cathodes and ten intermediate cathodes to extend the configuration in a closed loop, a ten-position counter can be constructed.

Construction

Platinum transfer wires and aluminum cathode cylinders, anodized on the outside surface, together with pure argon gas at a pressure of 70 mm of mercury yield a reliable and long-life tube at counting speeds up to 2,000 pulses per second.

In the IBM 78 ten additional cathodes are added to the array to provide the self-complementing function and are referred to as complementing cathodes. The basic cathode arrangement is shown in Fig. 2. The circles represent the thirty cathodes and the heavy lines are their transfer wires. The other lines show electrical connections between the intermediate cathodes labelled I and the complementing cathodes C . The digit cathodes are numbered as shown.

Positions 1 through 8 are connected to an external lead and 9 and 0 are separately connected to two additional leads. A glow starting from 0 will travel up the right row of cathodes, over the top, down the left row and around the bottom to its starting position when ten negative pulses are applied to the intermediate cathodes.

Each digit cathode is located directly opposite its 9's complement digit cathode and between each set is a pair of complementing cathodes with transfer wires so arranged that a glow can be transferred from one digit position to the other in either direction by a negative pulse applied to these complementing cathodes. This tube is thus able to convert a digit to its 9's complement in addition to functioning as a decade counter.

The photograph shows the construction of the counter. The U-shaped cathodes are fastened to mica support plates sandwiched to form the desired structure. A wire-mesh anode is located above this assembly and the entire unit is mounted on a standard nine-pin miniature button base and sealed into a T-6½ glass bulb. The tube is ¾ inch in diameter with an overall length of 2⅝ inches.

Basic Circuit

Figure 3 shows the counter tube in its basic operating circuit. Tubes V_1 and V_2 represent the drivers for counting and complementing.

Any tube type may be used in either position if it is capable of driving the cathodes to which it is connected to the required voltage level when in full conduction. Resistors R_1 and R_c must be inserted when the plate voltages of the drivers during conduction are lower than the voltages to which the connected cathodes must be driven. The voltage divider R_1 and R_2 establishes the potential E_i at which the intermediate cathodes are held between driving pulses. Resistors R_3 and R_4 act similarly in the complementing circuit.

Potentials E_i and E_c should be the same and the driving pulses applied to the intermediate and complementing cathodes should have equal amplitudes. Switches S_1 and S_2 reset the glow to its zero position. Switch S_1 is first opened to extinguish the glow if it is in any position but zero. Switch S_2 is momentarily closed to apply the full anode voltage between the anode and zero cathode to establish a glow. Then S_1 is closed. An output signal is available from the 9 cathode for carry initiation and

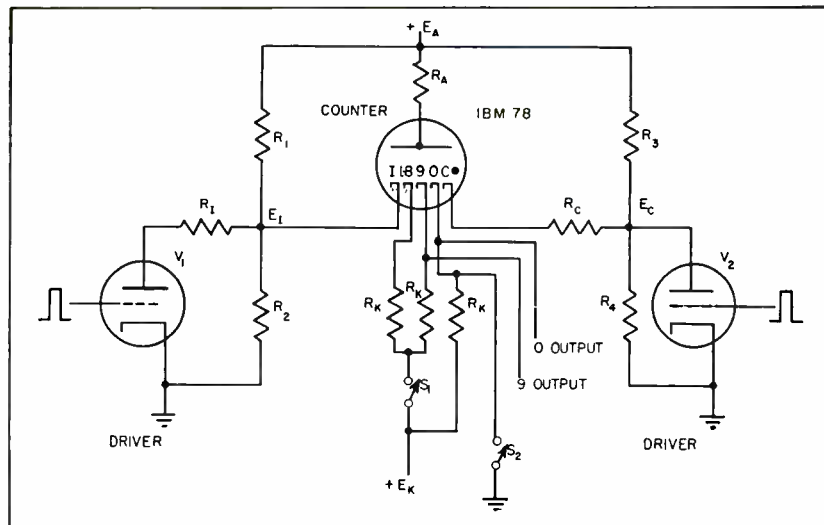

FIG. 3—Basic counting circuit in which gas-discharge tube may be operated

the read-out signal is taken from the 0 cathode.

Some typical values of resistance and voltage for this circuit together with allowable voltage variations are given in Table I.

The voltage required to initiate a glow discharge within a tube is from 325 to 450 volts while the voltage drop across such a discharge is 150 volts. An average tube operating in this circuit will count reliably over relatively wide potential variations.

Transfer-Voltage Values

The operational reliability of this tube is determined by the magnitude of the difference between the voltages required to cause a glow transfer in the backward and forward directions. In the circuit illustrated and with the component and voltage values listed, typical transfer voltage values are as follows:

A forward direction glow transfer from a digit cathode to an intermediate or complementing cathode will occur when the latter has been driven to 120 volts. In the absence of such a transfer, a backward direction movement of the glow will not occur until this voltage has been reduced to 25 volts.

A forward direction glow transfer from an intermediate or complementing cathode to a digit cathode will occur when the voltage on the former has risen to 175 volts at the end of a driving pulse. In the absence of a forward transfer, a backward transfer will not

occur until this voltage has increased to 320 volts.

Life tests were conducted with fifty experimental tubes and thirty-three of these were still operating satisfactorily after 17,000 hours. Most failures were caused by the sputtering of cathode material that eventually builds up conductive deposits on insulator surfaces.

The authors acknowledge the help of W. H. Dass who did part of the mechanical design, E. J. Rabenda who subjected the self-complementing counter to tests in practical accounting machine applications and J. B. Little, W. E. Mutter and A. L. Samuel.

REFERENCES

- (1) J. J. Lamb and J. A. Brustman, Polycathode Glow Tube for Counters, *ELECTRONICS*, p 92, Nov. 1949.
- (2) G. H. Hough and D. S. Ridler, Multicathode Gas-Tube Counters, *Electrical Communication*, p 214, Sept. 1950.
- (3) M. A. Townsend, Construction of Cold-Cathode Counting or Stepping Tubes, *Electrical Engineering*, p 810, Sept. 1950.
- (4) R. C. Bacon and J. R. Pollard, The Dekatron, *Electronic Engineering*, p 173, May 1950.
- (5) J. R. Acton, The Single-Pulse Dekatron, *Electronic Engineering*, p 48, Feb. 1952.
- (6) J. H. L. McAuslan, A Dekatron CRO Time Marker, *Electronic Engineering*, p 567, Dec. 1952.
- (7) G. H. Hough and D. S. Ridler, Cold-Cathode Glow Discharge Tubes, *Electronic Engineering*, p 152, April 1952; p 230, May 1952 and p 272, June 1952.
- (8) J. McAuslan and K. J. Brimley, A Dekatron Timer, *Electronic Engineering*, p 408, Sept. 1952.
- (9) D. S. Peck, A Ten-Stage Cold-Cathode Stepping Tube, *Electronic Engineering*, p 1,136, Dec. 1952.
- (10) J. H. L. McAuslan and K. J. Brimley, Polycathode Counter Tube Applications, *ELECTRONICS*, p 138, Nov. 1953.
- (11) R. C. M. Barnes, E. H. Cook-Yarborough and D. G. A. Thomas, An Electronic Digital Computer Using Cold Cathode Counting Tubes for Storage, *Electronic Engineering*, p 286, Aug. 1951 and p 341, Sept. 1951.
- (12) A. B. Thomas, The Principles and Method of Operation of Some Modern Gas-Filled Counter Tubes, *Jour Brit IRE* p 414, Aug. 1953.

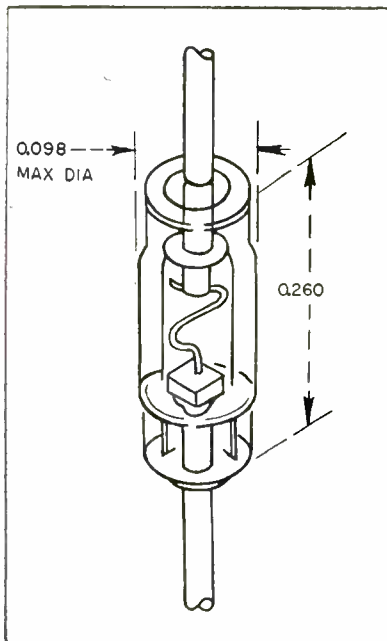
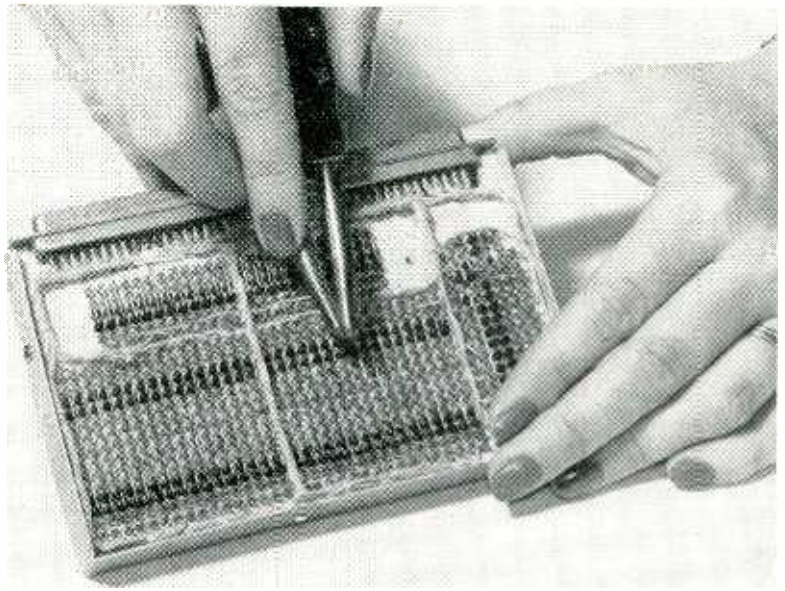

FIG. 1—Miniature diode has maximum component density of over 400 per cu in.



Capacitor-discharge spot-welder permits connection to short leads of germanium diodes without danger of heat damage to components

Welded Joints on Diodes

Spot-welding techniques for assembling complex computer equipment reduce size of equipment and give optimum accessibility for repairs. Honeycomb type arrangement of grain-of-wheat diodes permits component densities up to 128 per cubic inch

REDUCING COMPONENT SIZE does not generally lead to a corresponding size reduction of equipment. The tendency to mount and wire such components in the same manner as larger components results in mounting hardware and wiring consuming a disproportionate share of the volume.

One reason for the wiring occupying so much of the volume is that connections cannot safely be soldered closer to small components than to large ones. Soldering closer than about a quarter-inch from miniature diodes introduces the risk of effecting a permanent change in diode characteristics if the crystal is heated above 150 deg C.

Realizing good size-reduction from the use of miniature components requires breaking away from conventional practices to the

BY S. G. LUTZ

*Hughes Aircraft Co.
Culver City, Calif.*

extent necessary to miniaturize wiring along with the components. Etched wiring is a step in this direction, but it involves soldering and its two-dimensional inflexibility often results in waste space.

Spot-welding offers an attractive means of making connections near components, because capacitor-discharge welds are made in milliseconds, with much less heat than is required for a soldered joint. Mounting axial-lead components on end, rather than laying them flat on etched-wiring boards or on terminal strips, also aids in miniaturizing the wiring by shortening the interconnections.

Figure 1 shows the general construction and nominal dimensions

of a Hughes germanium diode. Its glass envelope provides humidity protection. The leads are copper-clad nickel having a coefficient of expansion identical with that of the glass. The nickel core in this wire makes it easier to spot-weld than would be the case with a solid copper wire.

If a 1/4-inch spacing is maintained

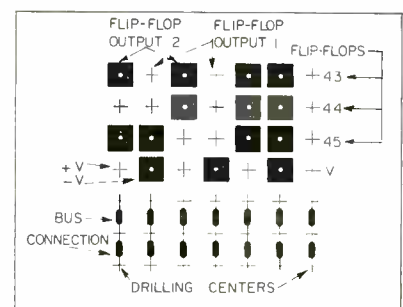
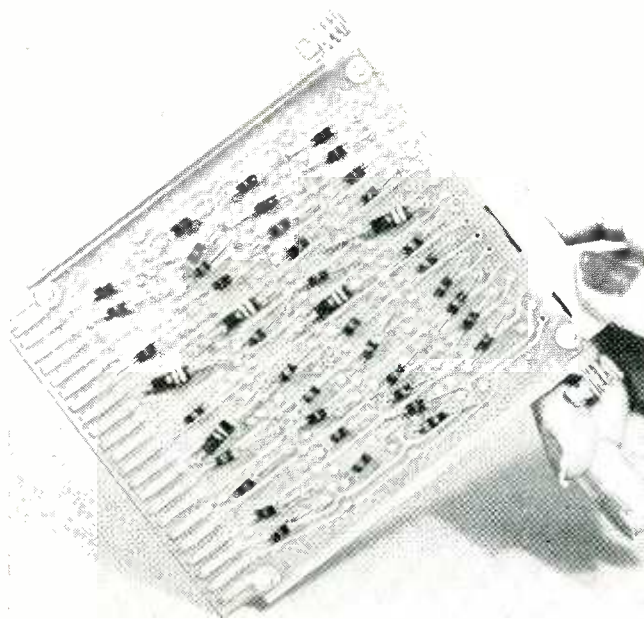
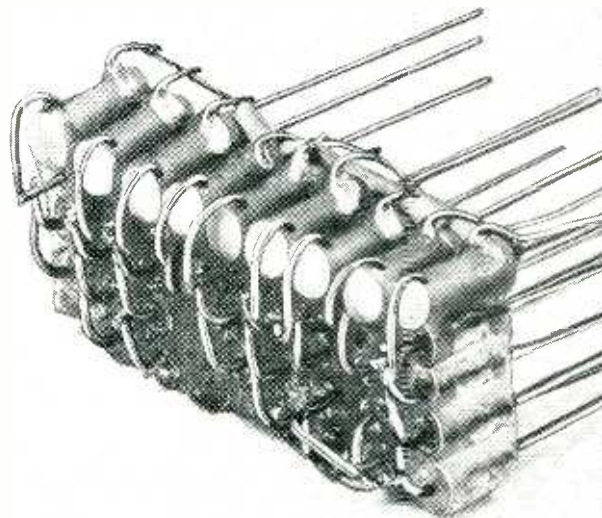

FIG. 2—Section of photographic wiring guide, showing symbols used to identify connections



Use of etched-wiring board limits component placement to two dimensions. Component density is about 13 per cubic inch



Cemented assembly provides high component density of 180 per cubic inch but does not allow for replacement of components

Reduce Computer Bulk

between the solder joint and the body of the diode, the mounting centers must be spaced about three times the length of the diode body as a minimum. Closer spacing cannot be used unless rapid soldering is possible on each joint. If an energy-discharge welder is used, connections can be made as close to the seal as desired.

Etched Wiring Matrices

Large numbers of these diodes, along with a lesser number of resistors, are employed in digital computer gating systems. Matrices composed of these gate circuits account for much of the wiring complexity of such a computer and often account for an appreciable portion of its volume.

In the etched-wiring matrix shown in the photograph, some space was wasted by employing a universal etched-wiring pattern, so the same basic pattern could be used for many different matrices. Its density of 13 components per cubic inch or 22,464 components per cubic foot, is not much below the maximum generally obtainable

with etched-wiring. Thirty times as many components the size of these diodes could be packed into the same volume if their leads could be clipped off.

This is a good example of the deterioration in volumetric efficiency, or ratio of component volume to total volume, which generally is encountered as the size of

components is reduced without miniaturizing the wiring along with the components.

Spot-Welded Matrix

One approach to increased volumetric efficiency of a unit is that of fitting the required components together as closely as possible with a minimum additional volume

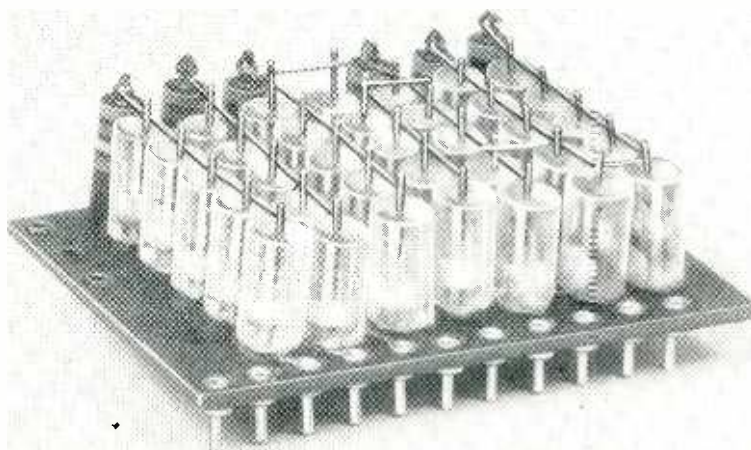

Stick capsule containing up to five diodes simplifies production and replacement but has only one-sixth component density of cemented type construction

used for the wiring. With computer matrices, it is logical to pack the diodes and their associated resistors into a rectangular block, with the leads extending in opposite directions. One characteristic of gate circuits is that they have a common connection between the resistor and all its diodes, so it is logical to make these common connections on top of the block, to make ties between gates having the same inputs at the bottom of the block and to employ the remaining bottom leads for the external connections.

A matrix was built in this manner as a test to establish the maximum component density, to investigate the feasibility of spot-welded wiring in such cramped quarters and to demonstrate the short leads required when such a unit is wired from both ends in this manner. This matrix contains 32 diodes, 9 Gload resistors and 4 vacant positions where diodes could have been placed if required. The unit occupies only $\frac{1}{8}$ cubic inch, measured over the wiring but excluding the input and output leads which normally would connect to a plug. Maximum component density with this construction is 180 per cubic inch. The cemented construction of this matrix is impractical in that the entire unit would have to be discarded if one component failed.

Stick-Capsuled Matrix

A matrix design directed toward achieving ease of production uses diodes molded in long sticks. Notches are molded between each pair of diodes so that the desired number can be broken off. This feature permits the assemblers to handle the diodes in convenient groups of five or less. In the matrix shown, the diodes were molded in epoxy resin but tests have established that they can withstand the temperature and pressure required for alkyd molding, the latter being far more rapid.

With this construction, etched wiring is used for the gate interconnections and for the input and output connections, while the common top connections can be made by a multiple-welding operation prior to inserting the diode sticks into the etched-wiring card.

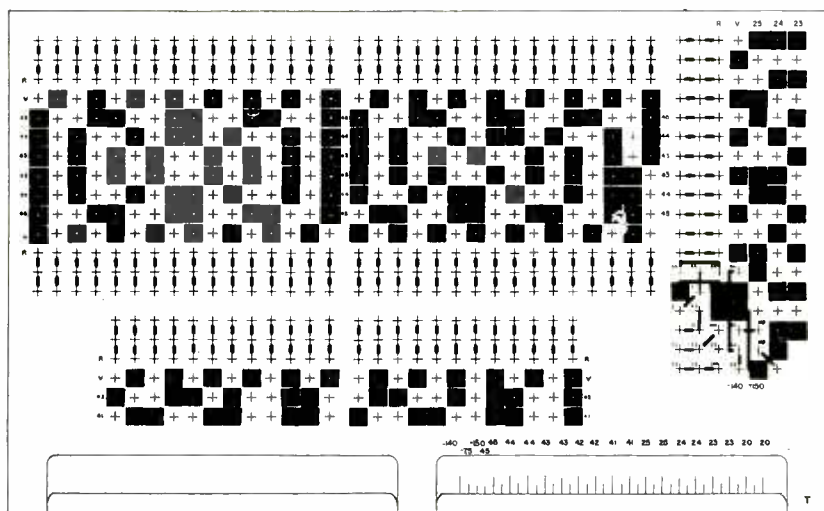
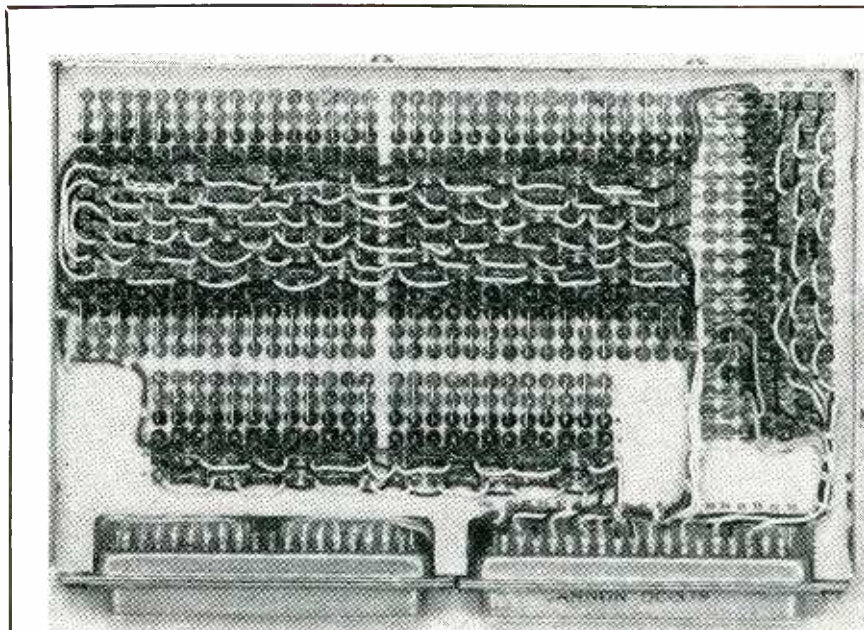

Top view of diode matrix using honeycomb construction, together with photographic pattern used for printing wiring guides

Top connections to the resistors have been soldered, because of the uncertainty of welding to their solid copper leads. These connections also could be welded if resistors with weldable leads were available. All connections to the bottom board are dip-soldered simultaneously. There is only an eighth of an inch between the glass seal and this soldered joint. Thermal shunting action of the plastic and the low temperature of the soldering bath prevent damage to the diodes.

In the event of a diode failure, the stick of diodes containing the defective one is unsoldered and re-

placed. As many as four good diodes may be discarded with the bad one but their cost generally will be less than the labor cost of this replacement. If desired, the defective diode may be broken out of its stick and be replaced. A special soldering tool has been developed for removing and replacing sticks of components and consists of a 200-watt iron with a long grooved tip.

With this construction, the spacing between components is $\frac{1}{8}$ inch, this spacing being determined by the minimum clearances required for the etched wiring. The height of the unit is $\frac{1}{16}$ inch, so its peak

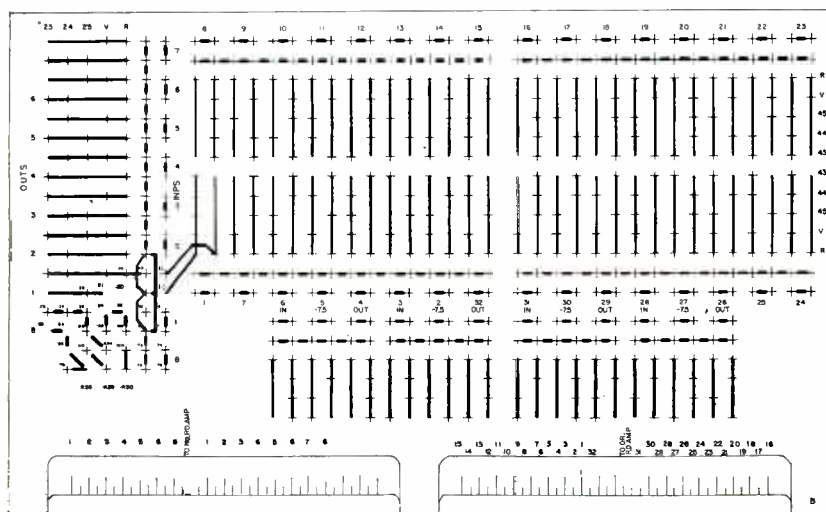
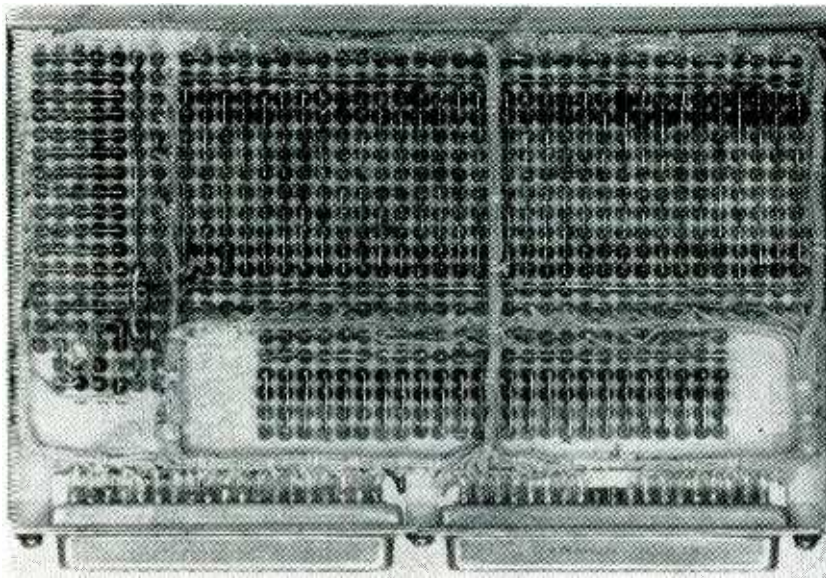

Bottom view of honeycomb diode matrix with photo printing pattern. Maximum component density is 128 per cubic inch

component density is 30 per cubic inch. Thus, these units are twice as compact as the flat etched-board units, as well as being much cheaper to assemble. Compared with the cemented matrix, this repairability and ease of assembly have been purchased at the cost of a six-time reduction in component density.

Honeycomb Technique

Diodes and associated components can also be cemented into a honeycomb of holes in a supporting board and individual components can be replaced by softening the adhesive with a suitable solvent.

Preliminary tests showed that the diodes could be spaced $\frac{1}{8}$ inch on centers or 64 per square inch of mounting board and that the wiring could be spot-welded easily despite this close spacing. No difficulty was experienced in removing and replacing components. It was only necessary to clip the leads obstructing component removal and later weld around the clipped-out section. The diode leads were cut to a length of $\frac{1}{8}$ -inch from the seal, thus holding their overall length just under $\frac{1}{2}$ -inch, so the peak component density was 128 per cubic inch, or 71 percent of the density with the cemented matrix construction.

The honeycomb technique has been tried on typical large sections of the computer gate circuits. The sections selected were the reading gate circuits for the magnetic memory drum and the gate circuits for a conversion control unit. Fully wired but nonoperating units were decided upon, since these units were to be built as a packaging study only.

Reading-Gate Matrix

Reading-amplifier gates are ideally suited for honeycomb technique. Their nearly repetitive nature and simple binary coding under the control of a small number of flip-flops, leads to simple and systematic wiring.

One problem encountered was the need for a resistor suitable for use with this honeycomb mounting technique. Axial leads and dimensions comparable to those of the diodes were the chief requirements, with weldable leads being desirable. Use of the Globar resistors was ruled out because of wrapped-around radial leads, which prevented their insertion in the mounting holes.

Dummy resistors were fabricated from $\frac{3}{32}$ -inch wood dowel rod, using 0.020-inch nickel wire for the axial leads. There is no apparent reason why resistors of this size cannot be produced commercially whenever the demand for them justifies their development and there seems to be a steadily increasing need for such resistors for transistor circuits and other such applications in which a tenth-watt dissipation would be adequate.

Microfilmed Wiring

A feature that has contributed greatly to the ease of wiring these small honeycomb units has consisted of microfilming the essential wiring information on the dural mounting plates. These plates were coated with a white lacquer, over which a photographic emulsion was applied. This emulsion was printed in contact with a negative obtained by photographing a large ink drawing to the desired scale. Use of a $\frac{1}{8}$ -inch dural mounting plate provides excellent heat equalization and dissipation and leads to extremely rugged units.

Figure 2 is an enlarged view of a

small section of the wiring and drilling pattern for the reading matrix unit. The regularly spaced crosses and white centers of black squares mark the centers of the component holes to be drilled. The heavy lines between crosses denote bus connections. Most of the rows of black and white squares denote rows of diodes to be connected to the two outputs of the same flip-flop; the particular flip-flop is designated by the number beside each such row. Similar black and white squares also are used to indicate the connection of resistors to positive or negative bias voltages.

Flip-flop 1 leads and positive bias leads are insulated with white vinyl sleeves. Negative bias and flip-flop 0 leads have black sleeves. Thus, most of the wiring consists of running black wires to black squares and white wires to white squares and of making common connections to bus wires as indicated. The remaining wiring, cabled connections to the plugs, is designated by correspondence of numbers or letter at the plug and at the circuit. This use of black and white squares simplifies inspection, since a white lead to a black square is conspicuous.

Spot-Welded Wiring

A capacitor-discharge welder with extension tweezer electrodes was employed for the wiring. The tweezer points are brought together by a spring, so that they serve as a clamp to hold the wires being welded and pressure always is the same. These tweezer electrodes were found more convenient and produced more consistent welds than the normally open type of tweezers with which the welding pressure depends upon the operator's grip. Nickel wire of 0.010 inch diameter was used for all connections. Welded connections can be made as close to the glass seals as desired. Even though the metal is fused at the weld, the capacitor discharge is so rapid that the quantity of heat is negligible.

The dimensions of the unit, exclusive of the plugs and frame, are $5\frac{1}{4} \times 3\frac{1}{4} \times \frac{1}{2}$ inches. The unit contains 504 diodes and 209 resistors, so its average density is 94.5 components per cubic inch. The com-

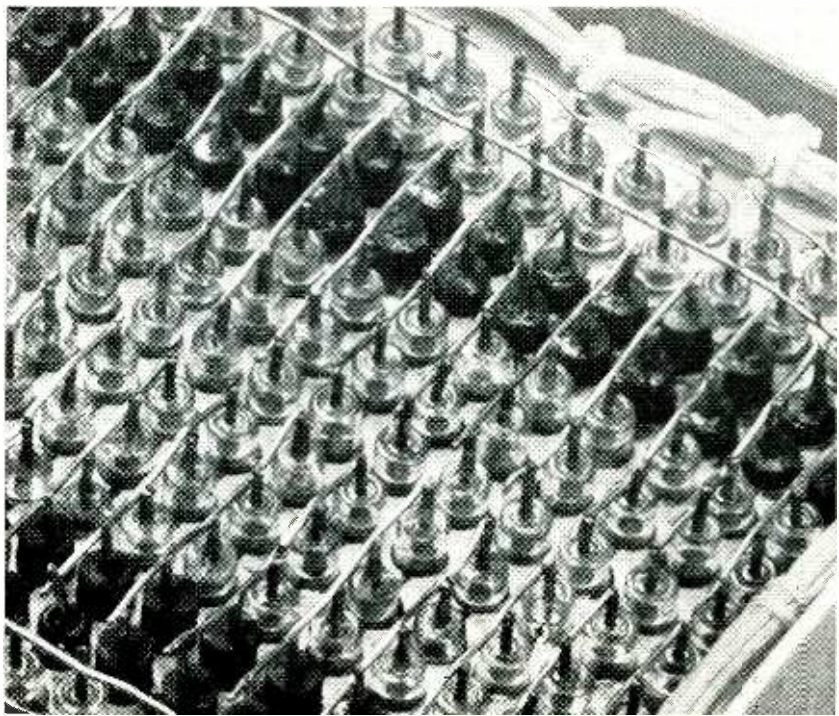

Close-up of spot-welded honeycomb construction. Use of welded joints permits cutting leads within $\frac{1}{8}$ inch of diode seal

plete unit weighs slightly over a quarter-pound, plugs and frame included.

The unit is rugged and may be dropped without damage because the plugs and the aluminum frame that surround the dural plate serve to protect the components and leads. Components have been removed and replaced many times.

Conversion-Control Unit

Conversion-control matrices afforded a better test of the applicability and versatility of honeycomb packaging because their circuits are more diversified, they involve connections to many more flip-flops and cathode followers and are typical of the arithmetic and control matrices of a computer. The dimensions of this unit are $8\frac{3}{4} \times 2\frac{1}{4} \times \frac{1}{2}$ inches. The unit contains 587 diodes, simulated resistors and ceramic capacitors, so its average density is 62.3 per cubic inch.

This reduced density resulted from separating the individual matrices and from leaving space down the center for the large interconnecting cable. No more time is required to wire this unit than to wire a standard-size unit of equal complexity. Spot-welded wiring actually should be faster and cheaper than soldered wiring.

Many variations of the above technique have been proposed and some have been tried. In general, variations that tend to simplify the assembly and wiring also tend to reduce the component density correspondingly, so the technique to be chosen for any specific application will be a compromise of size and weight with desired simplification.

As long as tubes are used in digital computers, there is little to be gained from miniaturizing the diode matrices to the extent made possible by these techniques. Honeycomb component mounting, spotwelded wiring and microfilmed wiring information should become useful techniques as soon as it becomes feasible to miniaturize other parts of computers by replacing tubes with transistors and by replacing magnetic drums with more compact memory devices. When component densities of the order of 100 per cubic inch become applicable throughout the computer, it should become possible to reduce their volume and weight to approach that of mechanical desk calculators.

Many members of the Hughes Miniaturization Group contributed to this work but mention should be made of Carmen Livesay who built and wired the first gate unit.

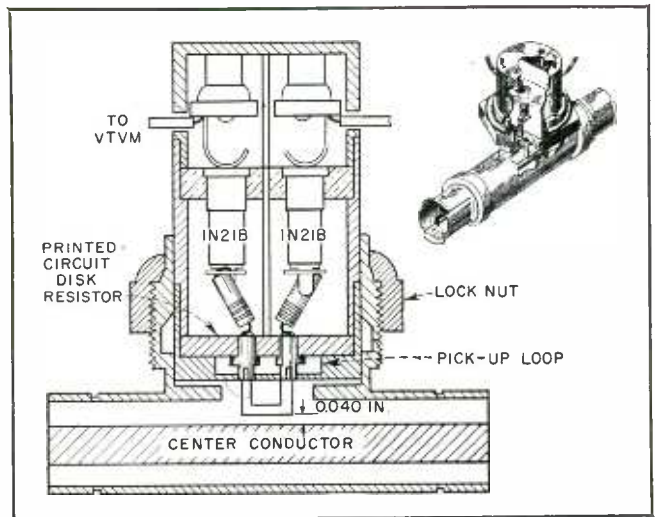
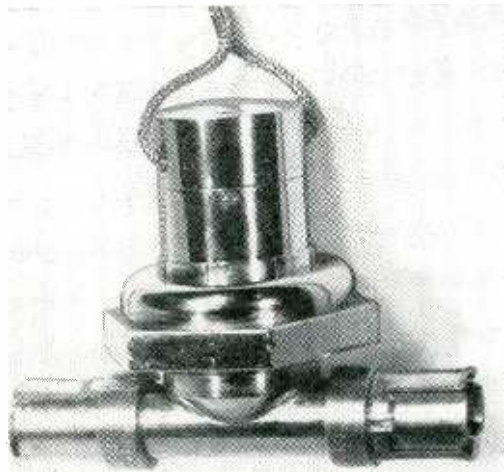

Coaxial wattmeter for range of 10 to 100 microwatts has attenuation of equivalent length of waveguide. Cross-section shows internal construction with printed-circuit disk resistor used to minimize inductive effects

UHF Meter Measures Low Power Levels

Coaxial-type indicator covers 10 to 100 microwatt range at frequencies up to 900 mc with an insertion loss of less than 0.8 db. Power gain measurements in uhf receiving tubes and matching of lines to load are among applications

By **R. L. BAILEY** and **J. B. QUIRK**

*Circuit Development Section
General Electric Co.
Owensboro, Ky.*

DEVELOPMENT and evaluation of uhf receiving tubes requires a directional coupler that will measure the low-level input power to the tube under test independent of the standing-wave ratio of the input.

The wattmeter shown in the photograph and cross-section drawings gives accurate indications of incident and reflected power in a 50-ohm coaxial line transmitting power as low as ten microwatts at 900 mc independent of swr or position of insertion of the wattmeter in the line.

The wattmeter has the additional advantage that accurate power measurements can be made with it over a very wide band of

frequencies up as high as 900 megacycles.

In the section of line in Fig. 1A, a small coupling loop is inserted through a hole in the side of the outer conductor and the ends of the loop are connected to R_1 and R_2 . The equivalent circuit for this arrangement is shown in Fig. 1B.

Field Relations

The voltages which appear across R_1 and R_2 are caused by the electric field and the magnetic field which are in time phase but in space quadrature.

The electric field causes a conduction current to flow through R_1 and R_2 in parallel of a magnitude $J_{\omega} A_0 K_0 E$ (1)

where $\omega = 2 \pi f$ and A_0 is the area of that portion of the loop parallel to the center conductor (normal to the E field), K_0 is a constant and E is electric field strength.

If $R_1 = R_2$, the current given by Eq. 1 divides equally between the two resistors. This current is shown as I_2 in Fig. 1C. This current can lead the E -field by approximately 90 degrees only if R_1 and $R_2 \ll X_{e1}$ (the reactance due to the capacitance between the loop and the center conductor). The currents in R_1 and R_2 due to the electric field are shown as I_e in the equivalent circuit.

The voltage induced in the closed loop consisting of R_1 , L and R_2 in series caused by the rate of

change of magnetic flux linked by the loop is

$$e_m = -JA_1(\cos \theta)\omega H\mu_o \quad (2)$$

where θ = angle between the planes of the loop and the axis of the coaxial line

- A_1 = area of the loop normal to the transverse magnetic field H
- H = magnetic field strength
- μ_o = constant.

This voltage is e_m in Fig. 1D. The voltage e_m lags the current I in the center conductor by 90 deg and I_1 is in phase with the H field. If the series inductance of the loop, L , is zero, e_m causes a current I_2 to flow around the loop circuit. This current is shown as I_m , and will be in phase with e_m if L is zero.

The total current through either resistor is now the vector sum of the two currents I_m and I_e . By proper selection of the dimensions and spacing of the loop, I_m and I_e can be made equal in magnitude. For this condition the current through R_1 is simply $2I_e$, while that through R_2 is zero since the cur-

rents subtract. By reversing the position of the generator and the load, the currents through R_1 and R_2 become zero and $2I_e$, respectively since only the current due to the magnetic excitation changes sign. The device then affords outputs across R_1 and R_2 which are sensitive to the direction of current flow in the center conductor and hence sensitive to the power flow through the wattmeter in either direction.

Loop Inductance

This explanation is somewhat simplified since it neglects the effects of the loop inductance L and the capacitance of the loop to ground C_2 . The loop inductance causes the current I_m resulting from the induced voltage e_m to lag e_m by some angle α_1 , as shown in Fig. 1D. This angle of lag has been shown to be

$$\alpha_1 = \arctan \omega L/2R \quad (3)$$

If X_{c2} is much greater than $\omega L/2$

it can be shown that the angle α_2 caused by the shunting effect of C_2 is

$$\alpha_2 = \arctan \frac{R}{2} \omega C_2 \quad (4)$$

The angles α_1 and α_2 are therefore equal when

$$R_1 = R_2 = \sqrt{L/C_2} \quad (5)$$

When this condition is satisfied, I_m and I_e will either be exactly in phase or 180 deg out of phase in R_1 or R_2 . For this condition the equal-

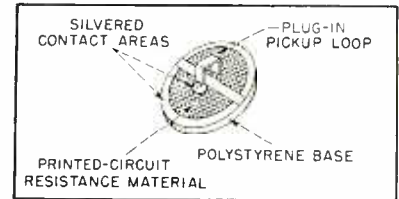

FIG. 3—Use of printed-circuit resistors reduces inductance in pickup loop

ity of the angles α_1 and α_2 is dependent only on circuit constants and is independent of frequency.

For loads other than the matched case, the absolute resultant current through R_1 is an indication of the incident power while the absolute resultant current through R_2 indicates reflected power.

If the coupling loop is not to introduce an appreciable discontinuity in the coaxial system, the power absorbed by the device must be small compared to the power transmitted by the coaxial line. The resulting voltages across R_1 and R_2 for very low power flow through the wattmeter are minute. To measure such voltages, the signal generator is sinusoidally modulated at a constant frequency and percent modulation. The modulation is then extracted by 1N21B silicon diodes as shown in Fig. 2, followed by amplification and rectification to a d-c current for indicating purposes. The resistance of R_3 and R_4 is made high compared to R_1 and R_2 so that when crystals are replaced a change in crystal impedance will not materially alter the balance of the system. A value of 300 ohms for R_3 and R_4 is sufficiently high for isolation without sacrificing too much sensitivity.

The modulation voltages across R_1 and R_2 , detected by the square-law diodes are proportional to the power in R_1 and R_2 and therefore proportional to the incident and re-

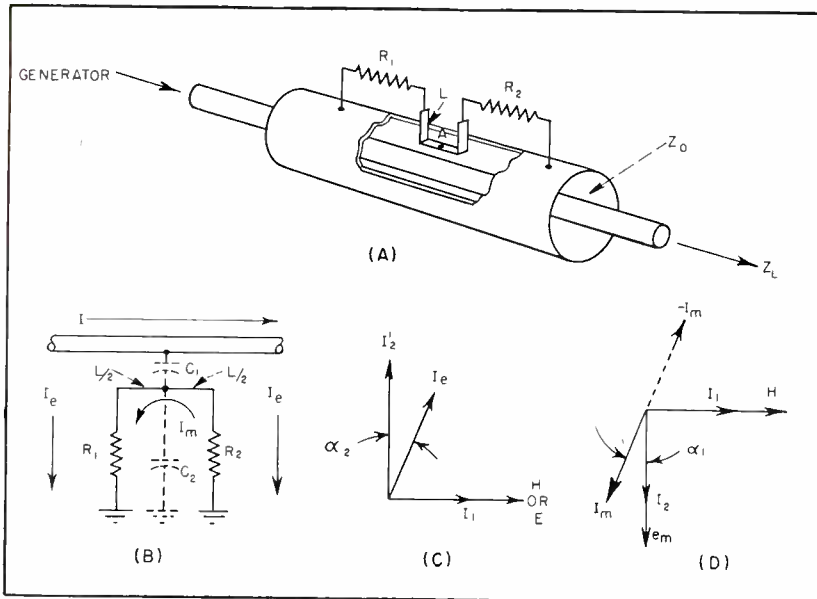

FIG. 1—Simplified wattmeter circuit (A) has equivalent circuit (B). Vector diagrams show current relationships in R_1 and R_2 for electric (C) and magnetic (D) fields

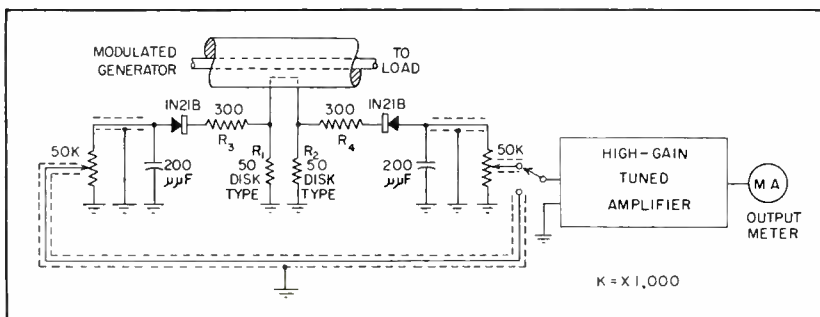

FIG. 2—Modulated signal is picked up by loop and detected by rectifiers. Vacuum-tube voltmeter circuit provides meter indication of power

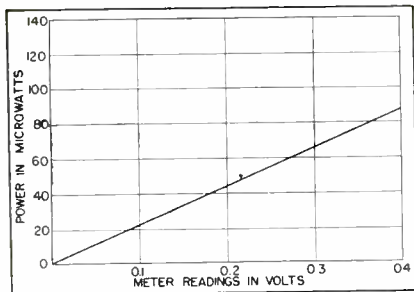

FIG. 4—Meter calibration curve at 900 mc for 30-percent modulated signal feeding 50-ohm load

flected power respectively. These voltages are amplified by a tuned linear amplifier having high gain with low-noise output. The output is monitored by a vacuum-tube voltmeter calibrated in microwatts. The difference between incident and reflected power is the net power flow to the load.

Loop Construction

Perfect cancellation of I_e and I_m in R_2 for a matched load can occur only if I_e and I_m are equal in magnitude and if $\alpha_1 = \alpha_2$. It was previously stated that the operation of the coupler is independent of frequency, that is, $\alpha_1 = \alpha_2$, only if $X_{c2} \gg \omega L/2$. Lead inductance of ordinary resistors would add to the loop inductance resulting in too high a value. A distributed resistance of low inductance was made for R_1 and R_2 using printed-circuit resistance material painted on a polystyrene disk as shown in Fig. 3. At 900 mc this type of distributed resistance presents an almost perfect 50-ohm resistive load to each end of the loop.

In practice the theoretical conditions required for the perfect operation of the wattmeter can not be realized but by careful design these theoretical conditions for directional properties may be approached. Loop dimensions must be kept small compared to a quarter wavelength and each end of the loop must be terminated in a pure resistance. The inductive reactance of the loop must be small compared to the terminating resistors.

In addition, the geometry of the loop must be so proportioned that probe currents due to magnetic and electric excitation will be equal in magnitude and phase for a matched load.

As shown in Fig. 2 the 50,000-

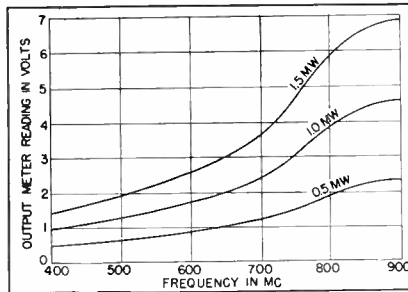

FIG. 5—Increase in sensitivity of wattmeter indications with frequency at three power levels with 50-ohm load

ohm potentiometers serve to equalize the outputs of the 1N21B silicon diodes so that only one calibration curve is required for incident or reflected power. This calibration curve, shown in Fig. 4, is linear and it is necessary only to change the gain of a linear amplifier in order that the power range of the coupler be changed.

The initial calibration can be made by placing the wattmeter between an r-f generator and a bolometer matched to the 50-ohm line. The generator output is turned up to the desired power level indicated on the bolometer and then the audio output of the indicator amplifier is noted. Repeating for different power levels establishes the calibration.

In the wattmeter being calibrated the self inductance of the pickup loop, though small, has a finite value. This gives rise to imperfect cancellation because α_1 does not equal α_2 . This imperfect cancellation can be found by measuring and plotting the ratio of the voltages monitored across the load resistors for a matched load. It is important that the load be matched exactly to 50 ohms in order to have no reflected power.

Currents in the load resistors due to both electric excitation and magnetic excitation are proportional to frequency. The measured variation is shown in Fig. 5. To compensate for this variation a gain control calibrated in terms of frequency must be provided on the indicator amplifier. Lowest sensitivity is at the frequencies where the minimum detectable power is limited by the first-stage noise of the audio amplifier.

The discontinuity caused by the insertion of the wattmeter in a transmission line is less than 0.8

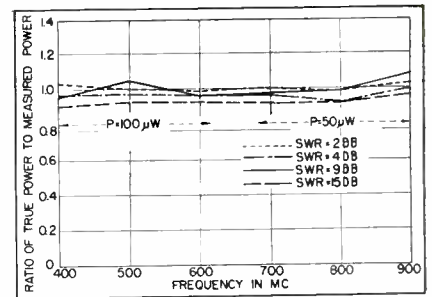

FIG. 6—Relation of the true power to measured power over frequency range of coaxial wattmeter

db swr over the region from 400-900 mc. In most cases insertion of the wattmeter is equivalent to inserting a section of transmission line equal to the length of the wattmeter.

Sensitivity

The accuracy of the wattmeter over a wide frequency range for loads of different swr is shown in Fig. 6. The lowest frequency at which measurements were made was 400 mc. Power sensitivity is limited by the sensitivity and noise of the tuned amplifier. Maximum power is limited by the ability of the loop resistors to dissipate the power extracted by the loop without changing their resistance values.

The device has the disadvantage that the calibration is dependent upon the percentage modulation of the generator. This is not serious since a bolometer must be used to calibrate the coupler. Calibration will change for different modulating waveforms but most standard tests are made at 30-percent sinusoidal modulation which is a convenient calibration condition for the wattmeter.

Since the 1N21B crystals are temperature sensitive, the wattmeter should be at a relatively constant temperature if the highest accuracy is to be obtained.

The authors acknowledge the many helpful suggestions given by Hsiung Hsu during the course of this development.

BIBLIOGRAPHY

- H. C. Earley, A Wide-Band Directional Coupler for Wave Guide, *Proc. IRE*, 34, p 883, Nov. 1946.
- B. Parzen and A. Yalow, Theory and Design of the Reflectometer, *Elect Comm*, 24, p 94, 1947.
- H. R. Allen and C. D. Curling, The Reflectometer, *Proc. IEE*, Pt. III, p 25, Jan. 1949.
- A. F. Boff, Power Meter and Mismatch Indicator, *Wireless Eng.* Sept. 1951.

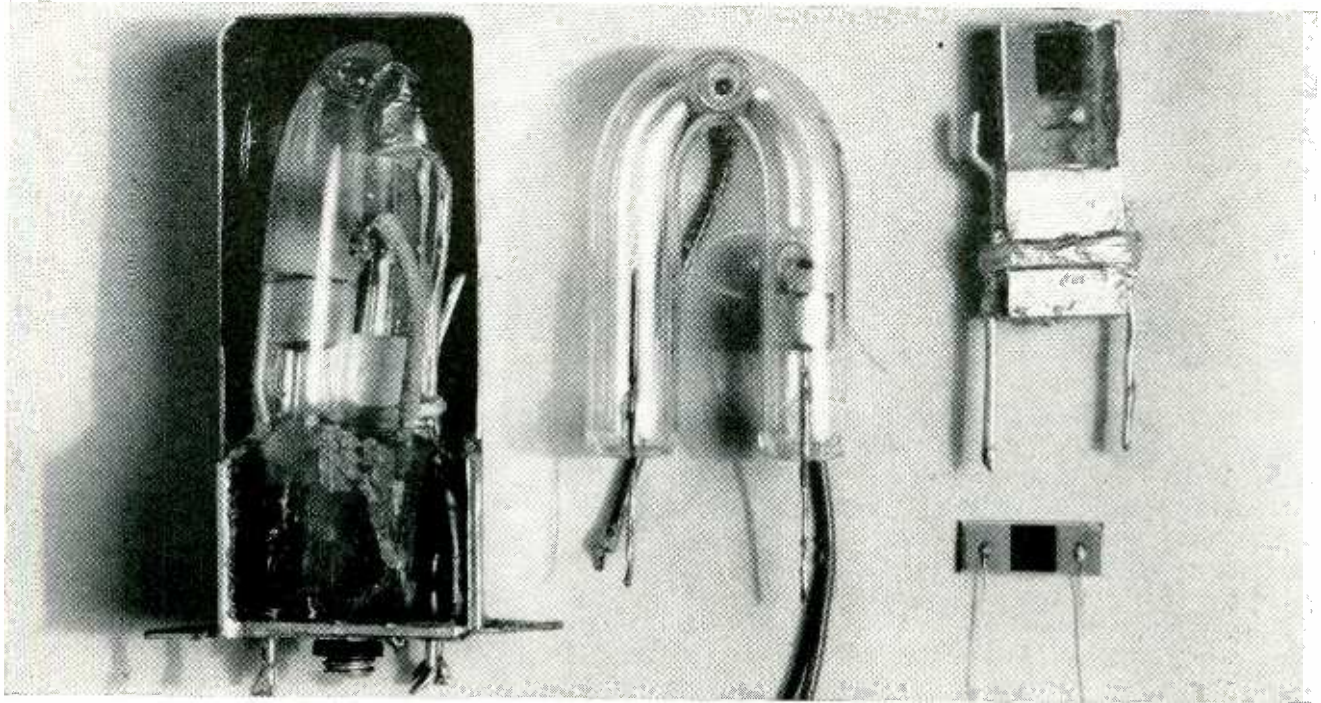

Cutaway view of chopper mounted in housing only two inches long, with U-shaped neon flash tube at center, mounted photocell alongside and lead sulfide cell itself at lower right

Photoelectric D-C Chopper

Optically driven ruggedized miniature chopper converts high-impedance d-c millivolt signals to a-c signals for airborne d-c analog computers such as are used in guided missiles. Neon tube flashing at 400 cps surrounds lead sulfide photocell in signal circuit

FOR some time there has been a need in ruggedized d-c analog computers for a chopper that would convert d-c high-impedance millivolt signals into a-c signals. The associated requirements of stability, long life, low noise level, small size and light weight are all satisfactorily met by the unit to be described.

Principle of Operation

Referring to Fig. 1, the d-c input voltage is applied to a voltage divider consisting of a lead sulfide photoconductive cell in series with a 200,000-ohm resistor. As the intensity of the neon light source is modulated, the resistance of the lead sulfide cell changes from 300,000 ohms, with no illumination, to 140,000 ohms with full

illumination. For a 1-v d-c input signal, the output has a peak-to-peak amplitude of about 0.25 v. A typical output waveshape at a 400-cps modulating frequency is shown in Fig. 2.

Figure 3 is a typical graph of resistance of the lead sulfide cell as a function of incident light flux. In the present unit, light flux reaches a peak of about 200 foot-candles, driving the cell into saturation and obtaining close to the maximum possible swing of cell resistivity.

The unit is particularly applicable to ruggedized d-c analog computers, such as those used in aircraft systems, missiles and portable ground equipment. It may be used to stabilize the zero and gain of an ordinary direct-coupled am-

plifier or, if a wide bandwidth is not required, it may be used in a d-c amplifier having none of the difficulties inherent in direct coupling, as shown in Fig. 2.

The unit is also applicable in d-c servos, and in many applications where vibrating-reed choppers have been used. At present, the variation in gain of the signal conversion with temperature permits most satisfactory performance in circuits employing large amounts of feedback.

Modulated Light Source

For the modulated light source, the energy at about 6,300A in the spectrum of a neon gas discharge tube proved sufficient to saturate the cell.

To obtain the most efficient util-

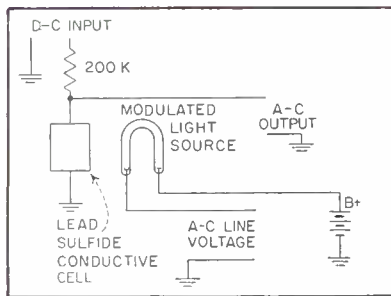

FIG. 1—Method of using flashing neon tube to vary resistance of photocell

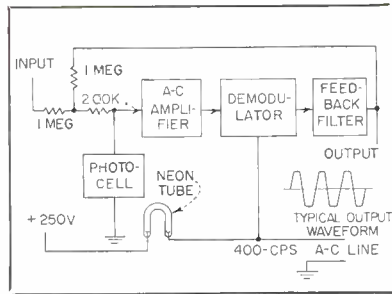

FIG. 2—Chopper in stabilized d-c amplifier having no direct-coupled stages

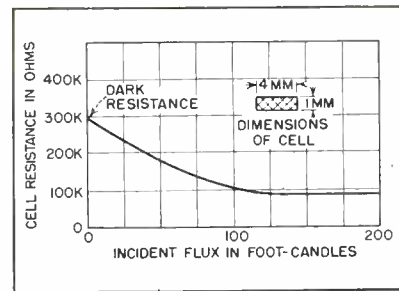

FIG. 3—Variation of resistance with incident light flux of lead sulfide cell

By **J. SCHWARTZ**
and
R. SOLOMONOFF

Avion Instrument Corp.
Paramus, N. J.

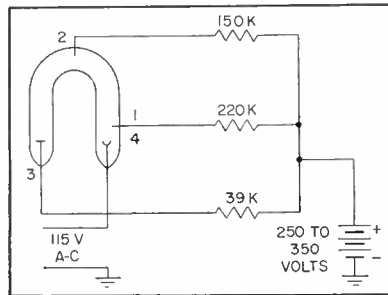

FIG. 4—Circuit used with multiple-anode neon tube to cut d-c voltage needed

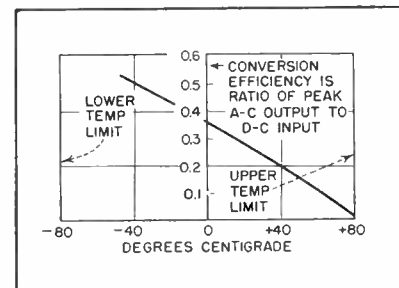

FIG. 5—Temperature characteristic and operating limits of typical photocell

for Guided Missiles

ization of the neon tube, it was bent into a U shape, and placed so as to illuminate the photocell from both sides. Illumination of the cell was further increased by packaging the entire assembly in an enclosure covered with a reflecting material on its inside surface.

The neon tube of Fig. 4 would require an ignition voltage of about 1,000 v if exciting voltage were placed between electrodes 3 and 4 only. However, by introducing several intermediate electrodes and exciting them successively, the final ignition voltage of anode 3 may be reduced to as low as 250 v. This low ignition voltage makes it possible to drive the chopper with readily available 250 v d-c in series with a 115-v a-c line. Average current drain is only about 3.5 ma.

The various anodes begin to draw current successively as the voltage between the cathode (electrode 1) and the point at B+ is increased. Anode 1 begins to draw current when the voltage difference is 125

v. Anode 2 fires at 175 v and anode 3 fires at 250 v.

A limiting factor in the use of a signal converter will be noise which will tend to obscure small signals. An important factor at low signal levels is a-c pickup due to capacitive coupling between the lead sulfide cell and the tube anodes.

A second source of noise is caused when the d-c voltage on the neon tube is lowered so that the neon actually extinguishes. In this case a sharp noise peak is produced each time the gas changes from dark to light condition. The effect of this noise can be eliminated by using intermediate starting anodes in the tube and operating at a sufficiently high B+ voltage (about 350 v) to prevent the tube from becoming totally dark at any portion of its cycle. The noise peak is substantially higher in frequency than a 400-cps flicker voltage, hence simple filter networks are effective. The a-c pickup has been reduced to a satisfactory level by enclosing

the photocell in a glass shield covered with a transparent coating having a surface resistivity of approximately 300 ohms per square inch.

To achieve maximum signal-to-noise ratio, it is wise to use a 400-cps bandpass amplifier. If the quadrature component is a source of error, the demodulation with an in-phase reference is an effective quadrature filter.

Ambient Temperature Range

Elevated temperatures reduce the light-dark conductivity ratio of lead sulfide cells and hence reduce the d-c to a-c conversion efficiency, as shown in Fig. 5. Saturating the photocell at the light input peaks reduces this effect considerably.

When the unit is operated at room temperature, the chief limitation on the life of the unit is set by sputtering of the cathode of the neon tube. Tests indicate an expected life of 10,000 hours.

Pulse Transmitter for

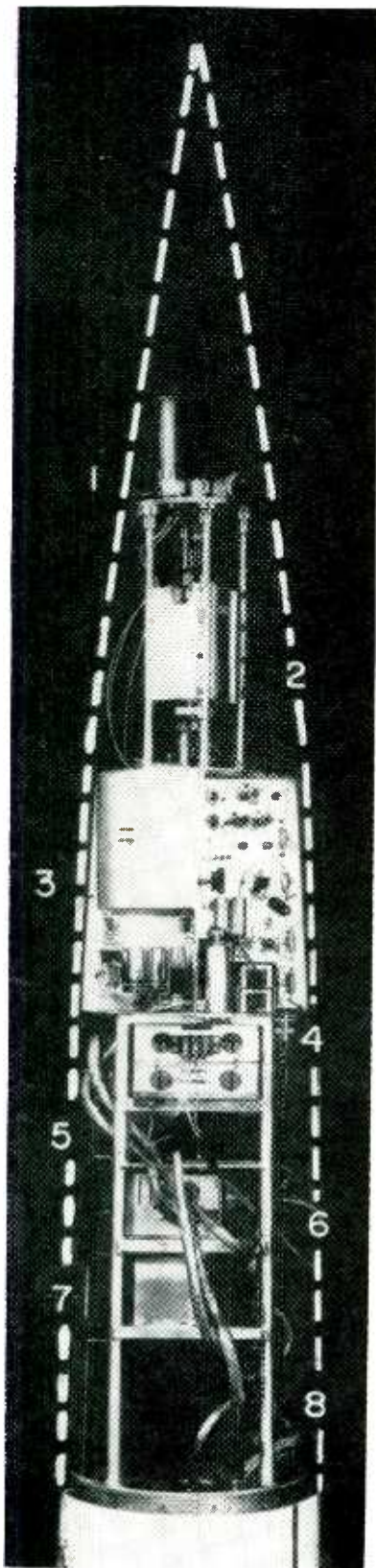

SINCE 1946, a program of upper-atmosphere research has been carried on using V-2, Viking and Aerobee rockets launched at White Sands Proving Ground, Las Cruces, New Mexico. Vital to this program has been development of pulse position-modulation telemetering systems to meet the requirements for relaying research measurements—accuracy, reliability and high-percentage recovery of noise-free data.

This paper describes the 15-channel AN/DKT-7 telemetering transmitter designed primarily for use in the Aerobee rocket and compatible with existing NRL ground recording station (AN/FKR-1) equipment.

The AN/DKT transmitter has been flown in ten Aerobee rockets. A typical nose installation is shown in the photograph. Peak altitudes have ranged from 50 to 86 miles depending on the instrumentation payloads. Maximum accelerations encountered are approximately 15g. There have been no failures to date. Recovery of completely noise-free data has been better than 96 percent of the total flight time on each flight, with most of the losses occurring as a result of antenna shadowing while the rocket rose through the launching tower.

Every transmitter prepared for flight has been flown and in no case has a spare transmitter been resorted to.

Requirements

Specifications of the transmitter are: 15 channels each with a normal sampling rate of 312.5 cps, overall intelligence rate 4,700 samples per second, input range 0 to +5 volts, r-f pulse width 3 μ sec,

Nose cone of Aerobee (left) contains (1) break-off mechanism and actuator, (2) spectrometer, (3) spectrometer power supply, (4) lead-acid batteries, (5) timer and calibrator, (6) distribution box, (7) cutoff receiver and (8) telemetering transmitter

r-f frequency 227 mc, peak power output 10 watts, channel deflection range 150 μ sec and one-percent accuracy with in-flight calibration.

The transmitter has 15 triode-duodiode data tubes. Each triode section acts as a cathode follower with the data fed to its grid. However, when either diode plate is held sufficiently positive current flow to the diode plate raises the cathode potential of the tube until plate current cutoff results (Fig. 1A). Gating voltages on the diode plates thus permit the triode sections to be turned on and off in sequence. The sequence is achieved by using combinations of a scale-of-16 counter output as gating voltages. The resultant data current is collected at a common point and transformed into a voltage which is compared with a saw tooth to provide pulse-width modulation.

Gate Circuits

Gating is done in two steps. Channels 1, 5, 9 and 13 have a common output. Similarly channels 2, 6, 10 and 14 have a common connection. There are four such groups, the last having only three data tubes. Simultaneously, the first-channel tubes of each group are allowed to conduct for 800 μ sec by grounding their diode plates during the period. Then the second-channel tubes of each group are allowed to conduct for 800 μ sec and so on.

Each of the four groups is connected to its collector tube which is similarly gated. However, collector-tube gating is such that the first tube of the first group conducts, then the first tube of the second group and so on. Figure 1B shows a mechanical analogy of the commutation process. By this cascade arrangement, sequential turn-on of the data tube current is obtained and by tying the collector plates to a common resistor, the current derived from the voltage applied to each channel may influ-

Rocket Research

By D. G. MAZUR
Naval Research Laboratory
Washington, D. C.

Airborne telemeter for medium-sized instrumentation jobs provides 15 data channels. Sampling rate is 312.5 cps, but one high-speed channel with a 1,250-cps rate may be obtained. Equipment has performed reliably during 10 rocket flights and is compatible with existing ground-station equipment

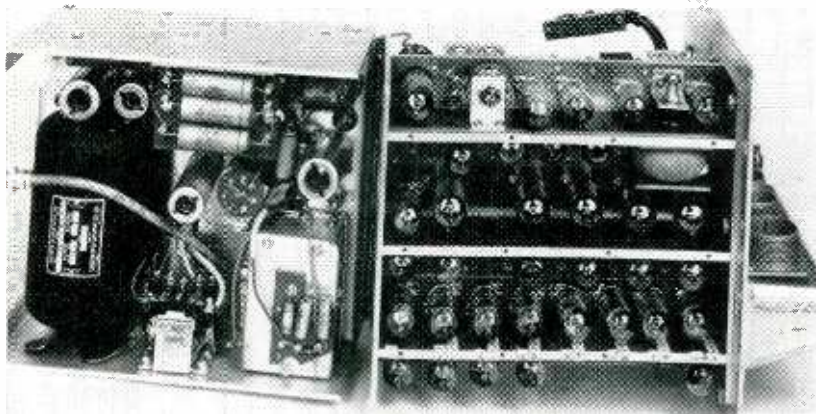

Transmitter is hinged for ease of servicing; T-plate construction dissipates heat while right-angle connectors conserve space

ence sequentially the operation of the pulse-width modulator.

Figure 2 displays the interconnections of the data and collector tubes and the gating combinations applied to the diode plates. The potential at the data-tube plate is set by the fixed grid potential of the collector tube. This permits the data tube to act as a cathode follower during sampling time.

Gating utilizes the complementary outputs shown in Fig. 3A of a scale-of-16 triode counter in various combinations. Each data tube has its diodes connected to the scale-of-8 and 16 counter outputs while each collector tube has its diodes connected to the scale-of-2 and 4 counter outputs.

The maximum time allotted for each channel is 200 μ sec. This spacing is derived from a free running 5-kc Clapp oscillator. The oscillator drives a thyatron saw-tooth generator arranged to generate both a saw tooth and a counter-

drive pulse. The counter drive pulse occurs in coincidence with the discharge of the saw tooth giving synchronism between data-tube switching and the saw tooth.

Modulator

Pulse-width modulation is accomplished in a regenerative, diode-coupled, voltage comparator illustrated in Fig. 3B. The saw tooth is coupled into a pentode and causes its cathode potential to rise. Meanwhile the triode has been conducting and its plate voltage is low. The saw tooth eventually reaches an amplitude sufficient to raise the cathode potential of the triode and initiate cutoff. Cutoff is regeneratively aided by the plate voltage drop of the pentode coupled back to the triode. The triode remains cut off until the saw-tooth discharge, when initial conditions reassert themselves.

The data current is introduced into the plate-grid coupling net-

work and modifies the voltage at which the triode will cut off. Large data currents will lower the grid potential of the triode and result in turn-off at lower values of saw-tooth voltage. Conversely, small data currents will raise the triode's grid potential, and result in turn-off at higher values of saw-tooth voltage. In practice, the saw-tooth voltage and an adjustable resistor in the triode grid circuit are varied so that there is a finitely wide triode output-pulse for each channel tube at zero input.

High-Speed Data

Of the 200 μ sec allotted for channel spacing, only 150 are used for 100-percent modulation. Part of the remainder is left for guard bands and part for the deionization time of the saw-tooth generator. Some of the period is wasted by poor rise time of the switching currents.

A data tube may have its sampling rate quadrupled by removing the connections from the scale-of-8 and 16 counters normally tied to its diodes. Thus the data tube conducts four times during each frame instead of once. The remaining three data tubes normally connected to the common point must be removed and the single high-speed channel conducts during its own as well as their time periods. If channel three is made a high-speed channel, conduction will occur during periods 3, 7, 11 and 15.

Thus at a sacrifice of three channels, a high-speed channel may be created with a sampling rate of 1,250 cycles. This is not the same as connecting four normal chan-

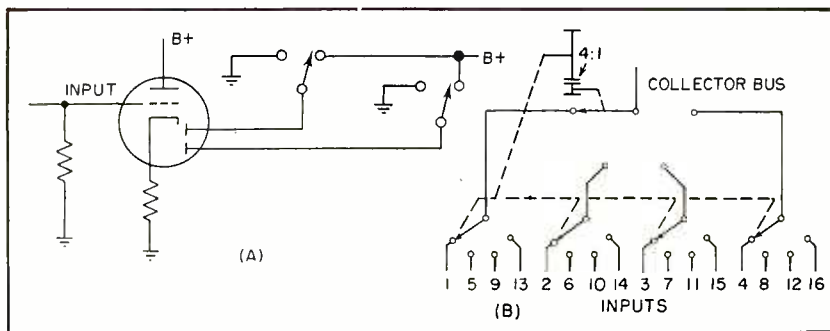

FIG. 1—Basic data-tube circuit (A) and mechanical analogy of commutation process (B)

nels to the same input since due to variations in channel guard bands four normal channels would have different zero positions while the high-speed channel has the same zero each time it conducts. Removal of the 8 and 16 counts is easily effected by clipping the diode pins of the data tube. Recording the high-speed channel must be done by an oscilloscope with a repetitive synchronized trigger to gain the advantage of the increased sampling rate.

Synchronization

The pulse-width modulation output of the voltage comparator circuit is differentiated and mixed with frame synchronization pulses in a common stage. The frame synchronization, necessary for locking the ground decoding and recording equipment to the airborne pulse pattern, is obtained from a triple-pulse code consisting of three pulses spaced approximately 7.9 μ sec apart. This code is required by the design of ground equipment already in existence when the airborne unit was developed. (See N. R. Best, Matrix Telemetry System, *ELECTRONICS*, p 82, Aug. 1950.) Generation of the triple pulse in the transmitter is adjusted to occur 100 μ sec following a channel reset. The delay prevents any data pulses combining to give false synchronization and gives the ground station a clear period where nothing but the synchronizing signal is transmitted.

The synchronizing code is initiated by the scale-of-16 positive-counter output. The scale-of-16 positive output triggers a phantastron delay generator adjustable to 100 μ sec. The phantastron output pulse triggers a self-restoring mul-

tivibrator having in the plate of the normally conducting tube an L-C resonant circuit. Upon being triggered, the tube shuts off and shock excites the L-C circuit, producing a damped sine wave whose peaks are separated by 7.9 μ sec. The multivibrator constants may be varied to produce two, three or four cycles of sine wave before restoring itself. The sine wave is then shaped into pulses and mixed with the differentiated pulse-width modulation in a video amplifier.

Since the whole channel period following counter reset is used for the triple pulse, only 15 intervals remain for data pulses. The second interval is called channel 1, the third channel 2 and so on.

The combined video is fed to a blocking oscillator having a 3- μ sec delay line to shape the pulses. A self-excited 227-mc Colpitts oscillator is grid pulsed by the blocking oscillator output. A simplified version of the r-f oscillator is shown in Fig. 4A. Driving pulses applied to the grid overcome the self bias developed by previous pulses. The time constant is adjusted to hold the oscillator off between pulses. In the absence of modulation, the oscillator will squeak at a low rate. The output r-f pulse is nearly square. Peak power during the pulse is 10 watts with a average power of 0.2 watt.

Calibration

The accuracy of the unit is enhanced by in-flight calibration. The transmitter provides a source of constant current to the calibration circuit shown in Fig. 4B. This source consists of a regulated cathode follower having its grid and plate potentials set by v-r tubes. An adjustable resistor in

the calibrator connected in series with the cathode of the cathode follower permits 10 ma to flow through five, precision, 100-ohm resistors resulting in one-volt tap points from zero to five volts.

The calibrator includes a set of motor-operated cams controlling microswitches that sequentially disconnect the data from each channel. The channel is then connected to a commutator sampling the divider tap points.

A complete calibration period for each channel lasts $\frac{1}{3}$ sec. During this period every channel has applied to it briefly zero, 1, 2, 3, 4 and 5 v. All 15 channels are calibrated in sequence and it is possible to omit calibration of any channel if desired. The calibration cycle repeats every 16 seconds; about two percent of the data is lost during calibration. The circuit is stable to better than one percent over conditions of widely varying input voltage.

Primary power sources are an 8-v battery that furnishes filament voltage and a 28-v battery that

Table I—Electrical Characteristics

(1) 5-kc oscillator drift ± 1 cps with 10-v plate variation, ± 5 -cps drift after operating 15 min in case
(2) Modulation linearity — within 1 percent of straight line up to 4v, within 2 percent from 4-5v
(3) Maximum crosstalk — 0.5 μ sec or 0.3 percent of total deflection
(4) Channel noise (jitter) — less than 0.3 μ sec or 0.2 percent of total deflection
(5) Calibration accuracy — within 0.2 percent using 0.1 percent calibrator resistors
(6) Variation of pulse position with input impedance — about 0.3 percent
(7) Normal channel time constant — 500 μ sec
(8) Repeatability (obtained by plotting successive calibration points throughout several flights) — within $\frac{1}{2}$ percent.
(9) Variation of pulse position with heat (15 min) — within 1 percent
(10) Overall accuracy — about 2 percent without calibration, better than 1 percent with calibration
(11) Over-voltage protection required only for positive voltages greater than 5-6 \times normal input voltage
(12) Battery operation time — 44 min on lead-acid batteries, 38 min with Silvercels

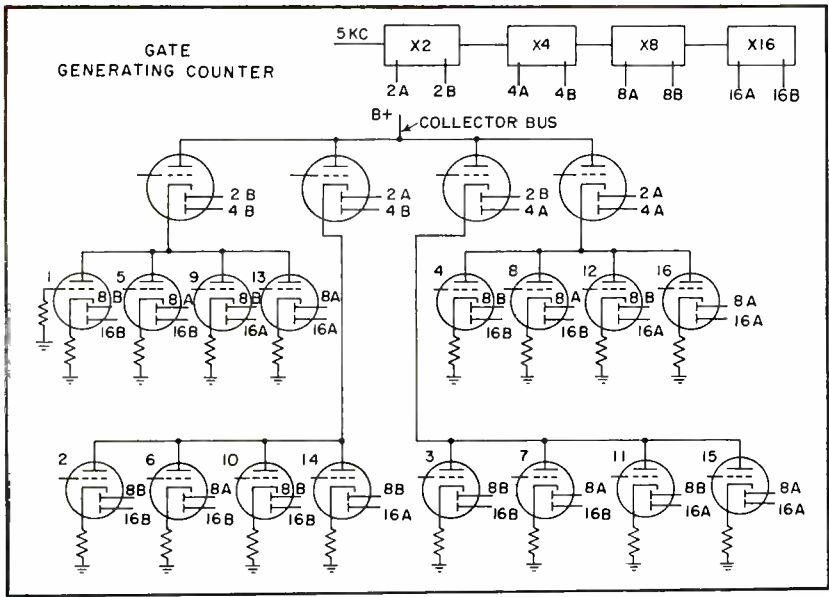

FIG. 2—Electronic commutator connections showing place of gate-generating counter

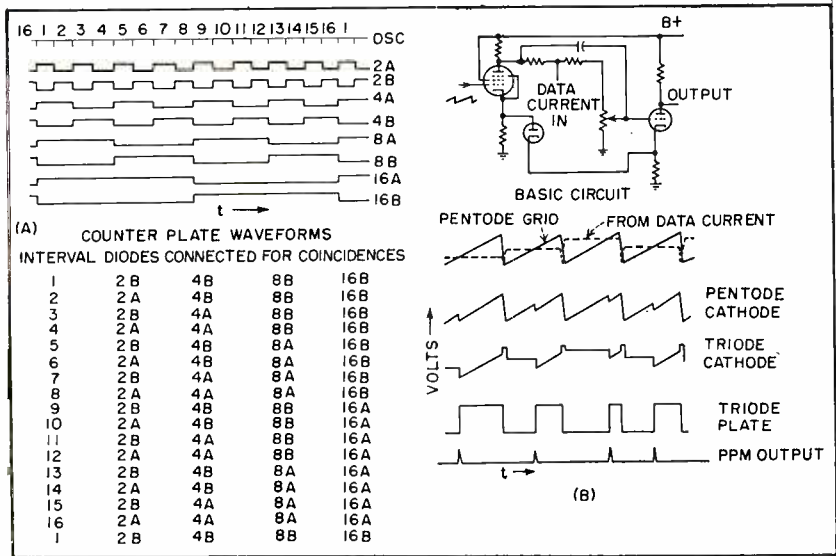

FIG. 3—Counter plate waveforms (A) and basic voltage comparator circuit and its waveforms (B)

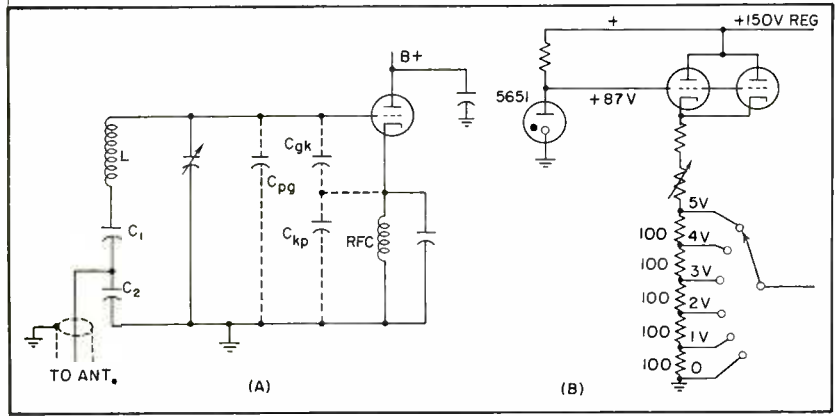

FIG. 4—Simplified circuit of i-f oscillator (A) and circuit of in-flight calibrator (B)

runs both a dynamotor and a calibrator motor. The dynamotor supplies a nominal 320 volts d-c which is dropped to provide plate voltage. Critical circuits are operated from a regulated 150-v bus.

Mechanical Design

The transmitter is approximately 9 in. high, 9 in. wide and 12 in. deep. It is housed in a pressure-tight case having all panel holes sealed with gaskets or O-rings; AN connectors for power, control and input leads are mounted at right angles to the front panel to conserve space.

The transmitter weighs 18 pounds, the external calibrator 3½ pounds and, when powered with lead-acid batteries, the complete installation, less antenna and interconnecting cables, weighs about 43 pounds. Use of Silvercels instead of lead-acid batteries reduces the overall weight to about 32 pounds.

Commercial Version

The transmitter's electrical characteristics are given in Table I.

A commercial model of the transmitter is approximately the same size and weight as the NRL unit and utilizes the same type of construction. However, the former employs a 5687 trigger amplifier and blocking oscillator and a 5687 modulator amplifier. A 5703 is used as the overtone crystal oscillator at 75.833 mc and is tripled to 227.5 mc using another 5703. A third 5703 tube constitutes a driver feeding two 6021 push-pull r-f amplifiers. The tripler, driver and final amplifiers are plate pulsed by the 5687 modulator amplifier. Peak-power output is better than 40 watts and pulse shaping reduces radiation at points 1.5 mc from the carrier 30 db.

Development and production of the AN/DKT-7 transmitter was carried on under the direction of J. T. Mengel. Those responsible for design, development, construction and field use were K. M. Uglow, N. R. Best, R. Lowell, R. Freudberg, J. B. Flaherty, J. Y. Yuen and L. F. Schmadebeck. Assistance has been provided by members of P.S.L., New Mexico College of Agriculture and Mechanic Arts under contract to NRL.

Microwave Applications

High electron densities in low-pressure gases provide means for electronically controlling microwave signals. Switches, modulators, phase shifters, oscillators and microwave gyrators are among devices that can be based on this phenomenon

By FRANK R. ARAMS

*Tube Division
Radio Corp. of America
Harrison, N. J.*

GAS DISCHARGE PHENOMENA are presently used in two principal microwave applications, gaseous microwave noise sources¹ and gaseous t-r and atr radar switch tubes². However, because gas discharges can be varied and controlled electronically, they have potential utility in a variety of other microwave devices such as electronically variable reactances, attenuators, phase shifters, electronic switches and couplers, electronically tunable resonant cavities and oscillators and the microwave gaseous gyrator.

In the discussion of the various devices, the mathematical expressions are given first and then the applications are derived logically. For the equations presented, the gas discharge is assumed to be an unbounded infinite medium consisting of equal concentrations of electrons and positive ions. This medium, called a plasma, strongly resembles the brightly glowing region, called the positive column, of a d-c or low-frequency a-c gaseous discharge. Plasmas also occur in nature in the earth's ionosphere, the sun's atmosphere and interstellar space. The expressions for free space also describe, at least qualitatively, the properties of a plasma in a bounded transmission line such as a waveguide.

The mathematical expressions included in this article indicate that all the effects observed in gas discharges are a function of the electron volume density. In a gas discharge, it is possible to realize electron volume densities having orders of magnitude many times

larger than those realizable in a vacuum.

As a result, many effects that are small when an electron cloud or beam is used in a vacuum become large enough in a gas-discharge plasma to be of practical magnitude. In addition, because electron volume density is proportional to the current flowing through the gas discharge, the control of discharge current offers a means for electronic control of the device. Although this feature of electronic control is an important advantage to the designer, the possible presence of disadvantages such as drop of gas pressure with life (gas cleanup), instability, generation of noise and possibly limitations to the attainable speeds of control of electron densities must also be considered.

Gas-Discharge Plasma

Maxwell's laws of electromagnetism show that gas-discharge plasma, as far as an electromagnetic wave that is propagating through the plasma is concerned, can be represented by a dielectric having a relative dielectric constant³

$$\epsilon_r = 1 - \frac{e_n^2 N_n}{\epsilon_0 m_n \omega^2} - \frac{e_p^2 N_p}{\epsilon_0 m_p \omega^2} \quad (1)$$

The middle term of the right-hand factor represents the contribution due to electrons and the last term is the contribution due to positive ions. The subscripts n and p refer to negatively and positively charged particles, respectively. In the equation, N is

the number of particles per cubic meter (volume density), and e and m are the charge and mass of the particles, respectively, ϵ_0 is the dielectric constant of free space and $\omega = 2\pi f$ is the angular frequency of the electromagnetic wave propagating through the plasma.

The ions are not present as far as the electromagnetic wave is concerned. Even for the lightest element, hydrogen, the mass of the positive ion (which is then merely a proton) is 1,837 times the mass of an electron. Therefore, because e_p equals e_n and N_p equals N_n , the last term in Eq. 1, representing the contribution due to the positive ions, is negligible in comparison to the term representing the contribution due to the electrons. Equation 1 may be reduced to

$$\epsilon_r = 1 - \frac{e_n^2 N_n}{\epsilon_0 m_n \omega^2} \quad (2)$$

Thus, the gas-discharge plasma appears to the electromagnetic wave as an electron gas, except that the space-charge forces of the electrons are largely neutralized by the positively charged ions, diffusion of the charged particles is slow and very large electron densities are realizable.

Tunable Circuit

The relative dielectric constant of a plasma, unlike that of ordinary materials, is less than unity. In addition, the value of ϵ_r depends on N_n , the electron volume density. If the plasma exists between two capacitor plates, the dielectric constant and capacitance can be

of Gas Discharges

varied. The connection of an inductance to this capacitance forms a resonant circuit, the resonant frequency of which can be varied electronically.

Such a tunable resonant circuit and the results⁴ obtained at a frequency of 375 mc are shown in Fig. 1A and 1B. A practical arrangement might be like that shown in Fig. 1C.

Phase Shifting

As the dielectric constant of a region is varied, the phase-constant β of the wave traversing the medium is also varied because β is proportional to $1/\sqrt{\epsilon_r}$. In the electronic phase shifter shown in Fig. 2A, the waveguide has a gas-filled tube at least as long as one guide wavelength.

The gas-discharge tube has a pointed end to reduce reflections. Results obtained with similar tubes⁵ in a small X-band rectangular waveguide at 8,500 and at 12,000 megacycles are shown in Fig. 2B. At a discharge current of 16 ma, the d-c power input to the discharge was 2.72 watts and the attenuation was only 0.5 db. Increased phase shift may be obtained by lengthening the discharge tube. The application of a modulating voltage to the input of the tube phase-modulates the microwave signal.

For combinations of high values of N_n and low frequencies, ϵ_r will go through zero and become negative. Under such conditions the phase constant β becomes imaginary, propagation ceases and the wave is reflected near the point where the dielectric constant becomes negative. This condition is analogous to that of a waveguide beyond cutoff. The plasma appears to the propagated wave as a metallic conductor.

This effect has been used in the coaxial switch⁶ shown in Fig. 3A. Attenuation is high at zero discharge current in this device because the gap section of coaxial

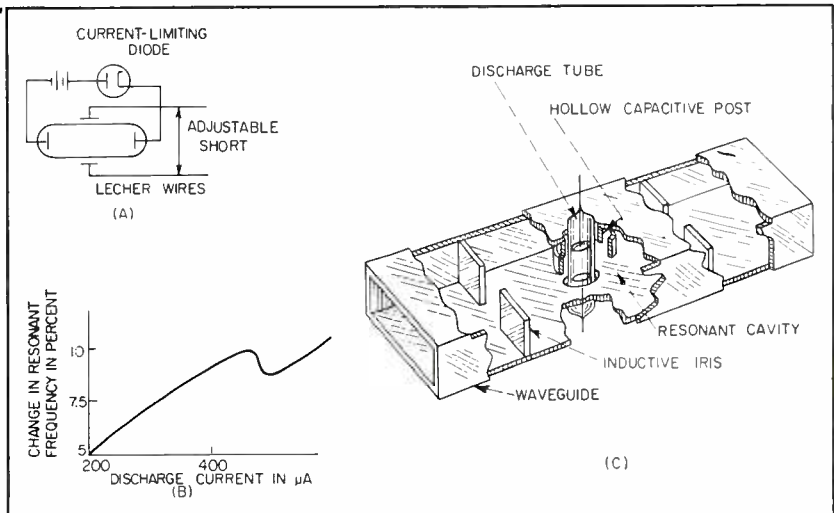

FIG. 1—Resonant circuit (A) tuned by gas-discharge current over range shown in (B). Typical waveguide structure (C) for resonant tuning

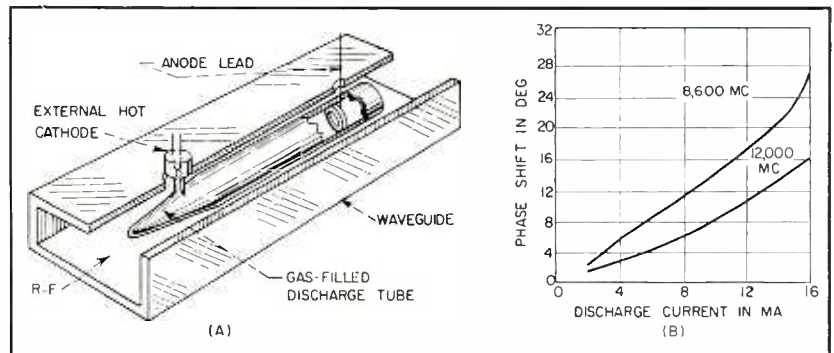

FIG. 2—Electronic phase-shifter for X-band (A) with phase-shift characteristics (B) using argon gas at a pressure of 0.5 mm mercury

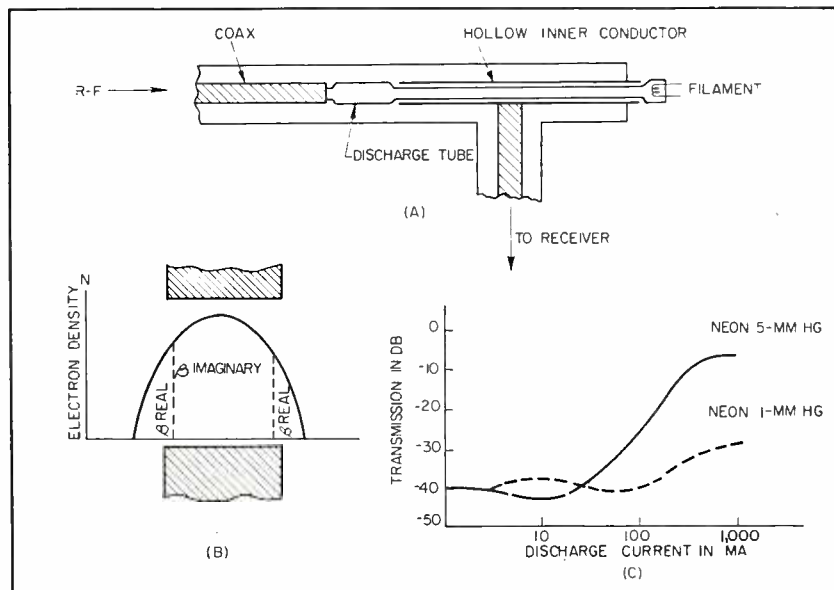

FIG. 3—Gas-discharge controlled coaxial switch (A), electron density distribution (B) and attenuation characteristics (C)

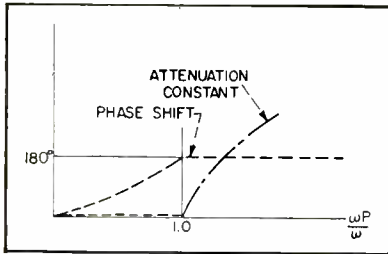

FIG. 4—Filter characteristics for ideal plasma without collisions

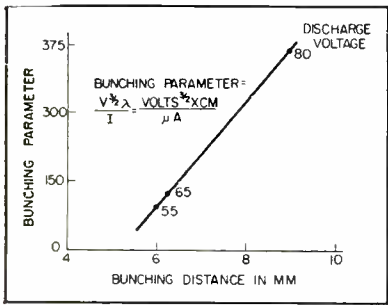

FIG. 5—Bunching distance compared to bunching parameter for sheet of oscillating electrons in gas-discharge plasma

line appears as a waveguide beyond cutoff. With a large discharge current, however, the electron density is such that ϵ_r becomes negative and the wave will not propagate inside the plasma; the inner conductor appears continuous and attenuation is low. Figure 3B shows the relative electron density distribution in the discharge tube.

A curve of the attenuation as a function of discharge current is shown in Fig. 3C. Switching rates can be as high as 10 kc. Residual attenuation is 2 db at 5,000 mc for a pressure of neon equal to 5 millimeters of mercury. Attenuation in the order of 1 db or less is attainable. A possible application for this coaxial switch might be in antenna switching.

High-Pass Filter

Because ϵ_r is also sensitive to the angular frequency ω , the plasma has the properties of a high-pass filter, as shown in Fig. 4. In addition, the cutoff frequency can be varied by varying the electron density, N_n .

The cutoff frequency of such a filter would fall in the microwave region for practical values of N_n . The cutoff frequency, f_p , in cycles per second, is obtained by setting

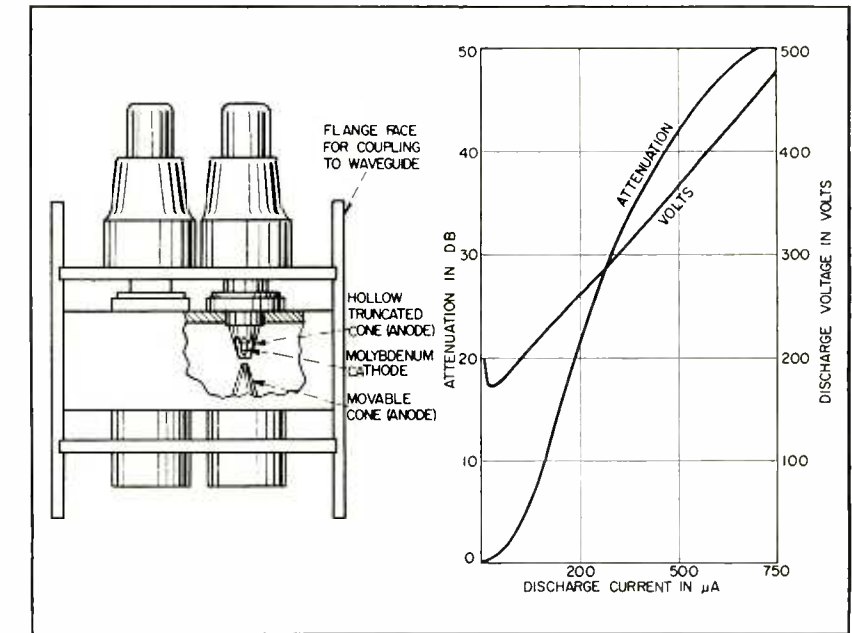

FIG. 6—Gas-discharge microwave attenuator can be used as modulator to provide 100-percent modulation with practically no distortion. Attenuation characteristic is controlled by discharge current

ϵ_r equal to zero in Eq. 2, thereby obtaining the expression

$$f_p = 8.98 \times 10^3 \sqrt{N_n} \quad (3)$$

where the value of N_n is given in electrons per cubic centimeter. Some sample values of N_n and f_p are shown in Table I.

The cutoff frequency, f_p , has a fundamental significance⁷. Known generally as the plasma-electron oscillation frequency, f_p is the frequency at which the electrons oscillate in phase with the exciting electromagnetic field. At or near this frequency, electrons move in a group in an oscillatory motion, thereby setting up very strong oscillatory fields within the plasma.

If, due to a random disturbance, one region in the plasma has a slight excess of electrons, the electrons repel one another and move

apart in such a direction as to re-establish neutrality in the plasma. However, the electrons gain momentum and keep on moving, creating a region in which there is a deficiency of electrons. Because this region then attracts the electrons, their motion is reversed and a coherent oscillation is set up.

Electron oscillations in the plasma produce fields closely analogous to the oscillatory electric fields in a cavity resonator.⁸ An oscillating sheet of plasma may be only a few tenths of a millimeter thick. A beam of primary electrons passing through such a sheet would be velocity modulated and the electrons bunched after drifting for a suitable distance. This effect is similar to that produced in a klystron. Figure 5 shows the straight-line relationship between the bunching distance and the bunching parameter for a gas discharge. This curve is similar to the relationship obtained for a klystron.

The lower-frequency oscillations in plasmas have been shown to correspond to the plasma-ion oscillation frequency.

Plasma With Collisions

The devices discussed thus far utilize plasmas employing selected

Table I—Cutoff Frequencies for Gas-Discharge High-Pass Filters

Electron Volume Density N_n in electrons per cc	Cutoff Frequency f_p in mc
10^8	9
10^9	90
10^{10}	898
10^{11}	2,810
10^{12}	8,980
10^{13}	28,400

gases at low pressure to minimize the frequency of collisions of electrons with neutral or ionized gas molecules. Under different conditions, losses due to such collisions cannot be neglected and the expression for the relative dielectric constant of the plasma includes a damping term and becomes a complex quantity.

$$\epsilon_r = 1 - \frac{\omega_p^2}{\omega^2 + f_c^2} - j \left(\frac{f_c}{\omega} \right) \frac{\omega_p^2}{\omega^2 + f_c^2} \quad (4)$$

In this expression, f_c is the average frequency of collision of an electron with neutral or ionized gas molecules and $j = \sqrt{-1}$.

Attenuator and Modulator

The lossy property of the plasma was utilized in the construction of an electronically variable hot-cathode attenuator⁹ in rectangular waveguide. At X-band frequencies, attenuations as high as 30 db were obtained with this device. The attenuator is wide-band and can be used for c-w or pulse applications. Attenuation was observed to be independent of incident power up to the point where the incident power produced ionization.

Several types of cold-cathode gas-discharge microwave attenuators for use at X-band frequencies have been described.¹⁰ When an attenuator such as that shown in Fig. 6 was operated in an automatic gain-control circuit, a variation in microwave power output as small as 0.5 db could be obtained for a 20-db variation in power input. The maximum

power input used in these measurements was about 10 milliwatts.

The tube shown in Fig. 6 was also used as a modulator of microwave signals. It was possible to obtain practically undistorted 100-percent amplitude modulation at frequencies up to about 50 kc and reasonably undistorted 20-percent modulation up to 500 kc. The attenuation and voltage characteristics of the tube are also shown.

Direct-current tests indicate that the life of this tube is in the order of 500 hours. The vswr of the tube varies from about 1.2 to 1.5 when attenuation is varied from 0 to 40 db.

In another type of attenuator, a resonant element such as that shown in Fig. 1C is detuned, thereby varying the fraction of the microwave signal that is transmitted to the load through the resonant element.¹¹

Plasma in Magnetic Field

For a wave propagating in a direction parallel to the magnetic-field vector, the dielectric constant of the plasma splits into two values

$$\epsilon_r = 1 - \frac{\omega_p^2}{\omega(\omega \pm \omega_H)} \quad (5)$$

where $\omega_H = [(e_n/m_n) B] = (1.76 \times 10^{11} B)$, the angular velocity of an electron rotating in a magnetic field, in radians per second and B is the magnetic-field density in webers per sq meter.

Upon entering the plasma, therefore, a plane-polarized wave splits

into two components that are circularly polarized negatively and positively and have different phase constants. The two components, called ordinary and extraordinary waves, have different velocities in the plasma. Upon emerging from the plasma they unite to form a plane-polarized wave whose plane of polarization has been rotated with respect to the incident polarization. This phenomenon is known as the Faraday effect.

Rotation of the plane of polarization is shown as a function of magnetic field density in Fig. 7A. The device used in obtaining these results¹² is shown in Fig. 7B. For a fixed value of magnetic field, a variation in discharge current produces a variation in angle of rotation of the plane of polarization.

Gyrator

The process described above is unusual in that it is nonreciprocal. If a wave traveling in one direction is rotated clockwise, a wave traveling in the opposite direction is also rotated in the same clockwise direction. This effect makes it possible to design a gas-tube microwave gyrator. Figure 8 shows a gas-tube microwave gyrator for decoupling two waveguides. Even when a short circuit is present at the end of waveguide B , waveguide A appears to be terminated in a matched load because a wave reflected at the short circuit is absorbed in the gyrator and never reaches waveguide A .

Waveguide B is at an angle of 45 degrees to waveguide A . The gas pressure and current of the plasma and the magnetic field are adjusted to produce a rotation of 45 deg in the plane of polarization so that a wave traveling from A to B is rotated the necessary amount to enter guide B in the dominant mode and continue to the load. A wave traveling from B to A , however, is also rotated 45 degrees. This wave cannot enter waveguide A and is absorbed in the resistance card.

The Faraday effect can be utilized in various other designs including the use of ferromagnetic materials.¹³

In the gyrator it is desirable that the value of ω should not approach

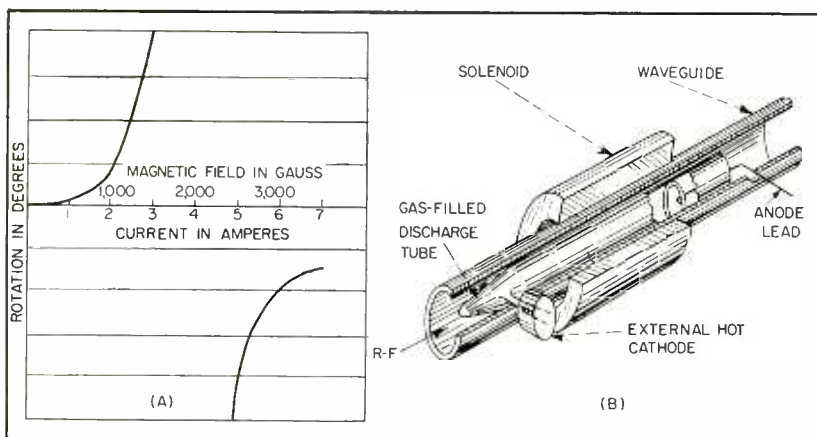

FIG. 7—Rotation characteristic (A) of gas-discharge tube controlled device for rotating plane of polarization and (B) Faraday polarization rotator

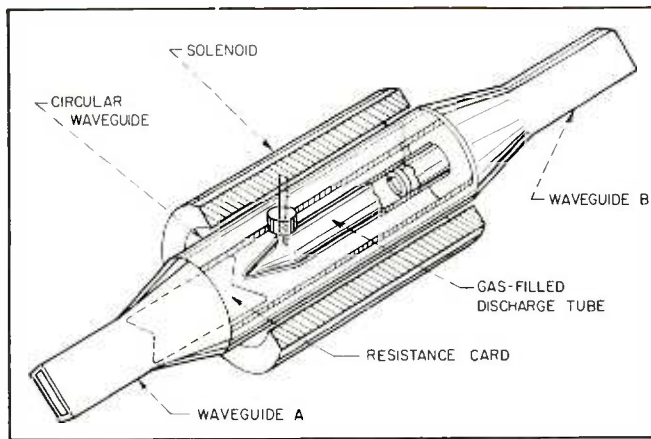

FIG. 8—Microwave gyrator for decoupling two waveguides uses Faraday effect to rotate plane of polarization of unwanted wave so that it will be attenuated by resistance card

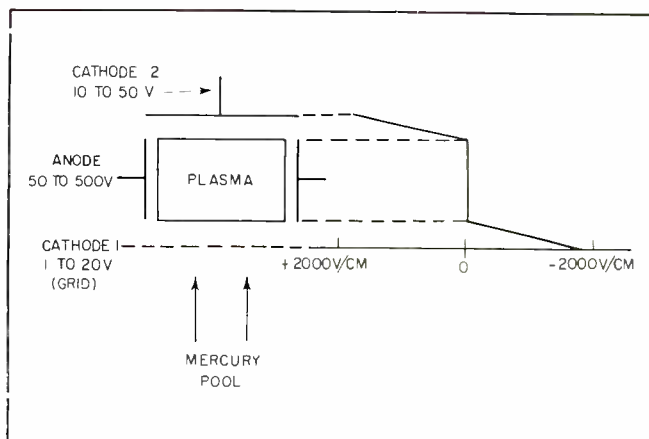

FIG. 9—Gas-discharge oscillator with graph of electric field potentials. With a pressure of one micron of mercury, oscillator will cover range from 1,200 to 3,000 mc

the value of ω_H so that attenuation will remain low. If ω is equal to ω_H the circularly polarized wave components rotate at the same angular velocity as the electrons rotating as a result of the presence of the magnetic field ($\omega_H = \frac{e_n}{m_n} B$). This is gyromagnetic resonance.

The wave component rotating in the same direction as the electrons is completely absorbed while the wave component rotating in the opposite direction passes through unattenuated.

As a result of this, a circularly polarized wave emerges from the plasma at a power level 3 db lower than that of the plane-polarized wave entering the plasma. For the case of ω not quite equalling ω_H , varying degrees of elliptical polarization will result. This situation also exists in nature in the ionosphere and is in part responsible for the familiar fading of sky-wave radio signals. In this case, B is the magnetic field of the earth.

Gas-Discharge Oscillator

Figure 9 is a schematic diagram of a gas-discharge oscillator.¹⁴ This device, operating at a pressure near one micron of mercury vapor, can oscillate over a frequency range from 1,200 to 3,000 mc at an output power of one to several watts. No tuned circuits are involved. Frequency is changed electronically by varying different potentials. The electric field in the tube is distributed as shown in the graph,¹⁵ and the device, therefore, is analogous to a double-cavity klystron tube.

There seems to exist in the two space-charge regions strong oscillating movements of masses of charged particles whose frequency of oscillation corresponds approximately to the plasma-electron oscillation frequency. The central plasma region corresponds to the drift space of the klystron. This device can also be analyzed as a growing-wave tube. The central plasma is then considered to be a cylindrical dielectric resonator containing a dispersive medium.

Tunable Resonant Cavity

In the tunable resonant-cavity system¹⁶ shown in Fig. 10, an electron gun shoots a beam into a resonant cavity at gas pressure in the order of 10 microns of mercury. With the magnetic field adjusted so $\omega/\omega_H = 1.10$, changes in frequency from 3,280 to 4,300 mc (30 percent) were obtained for an S-band cavity and from 9,170 to 10,800 mc

(18 percent) for an X-band cavity.

The author is grateful to M. Lampert of the RCA Laboratories Division in Princeton, N. J. for his kind encouragement in connection with the preparation and writing of this article.

REFERENCES

- (1) W. W. Mumford, A Broad-Band Microwave Noise Source, *BSTJ*, 28, p 608, 1949.
- (2) A. L. Samuel, J. W. Clark and W. W. Mumford, The Gas-Discharge Transmit-Receive Switch, *BSTJ*, 25, p 48, 1946.
- (3) H. R. Mimno, The Physics of the Ionosphere, *Rev Mod Phys*, 9, p 1, 1937, and E. Everhart and S. C. Brown, The Admittance of High Frequency Gas Discharges, *Phys Rev*, 76, p 839, 1949.
- (4) K. K. Darrow, *BSTJ*, 11, p 576, 1932, and Appleton and Chapman, *Proc Phys Soc*, 44, p 246, 1932.
- (5) L. Goldstein, M. A. Lampert and R. H. Geiger, Determination of Electron Density and Collision Frequency in a Gaseous Discharge by Microwave Propagation Measurements, *Elect Comm*, p 243, 1952. Presented at Conference on Gaseous Electronics, Pittsburgh, 1949.
- (6) L. Goldstein and L. Cohen, Radio-frequency Conductivity of Gas-Discharge Plasmas in the Microwave Region, *Phys Rev*, 78, p 83, 1948.
- (7) L. Tonks and I. Langmuir, Oscillations in Ionized Gases, *Phys Rev*, 33, p 195, 1929, and D. Gabor, Plasma Oscillations, *Brit Jour App Phys*, 2, p 209, 1951.
- (8) T. R. Neill, Plasma-Electron Oscillations, *Nature*, 59, p 163, 1949.
- (9) Hawkins and Costain, *Nature*, (London), 164, p 356, 1949. Presented at Conference on Physical Electronics, MIT, 1950.
- (10) D. H. Pringle and E. J. Whitmore, private communication, also Gas Discharge Tubes for Control of Microwave Attenuation, *Jour Sci Inst*, 30, p 320, 1953.
- (11) F. A. Jenks and D. F. Folland, U. S. Patent 2,425,328.
- (12) L. Goldstein, M. Lampert and J. Heney, Magneto-Optics of an Electron Gas with Guided Microwaves, *Phys Rev*, 82, p 956, 1951 and 83, p 1255, 1951.
- (13) C. L. Hogan, Ferromagnetic Faraday Effect at Microwave Frequencies and its Applications—The Microwave Gyrator, *BSTJ*, 31, p 1, 1952.
- (14) G. Wehner, Plasma Oscillator, *Jour App Phys*, 21, p 62, 1950.
- (15) J. H. Bryant, Ph.D. Thesis, University of Illinois, "Some Studies of Electrical Oscillations in a Mercury Vapor Gas Discharge at Low Pressure". Presented at Conference on Gaseous Electronics, Pittsburgh, 1949.
- (16) H. K. Jenny and F. R. Arams, Wide-Range Electronic Tuning of Microwave Cavities Using Gas Atmospheres. Presented Electron Tube Research Conference, Orono, Maine, 1954. To be published in *Proc IRE*.

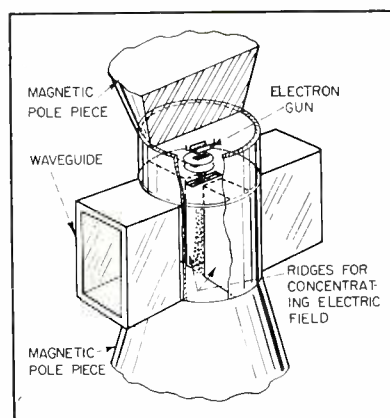

FIG. 10—Wide-range tunable resonant cavity

Tunable Audio Filters

Clamped resonant bar as an electromechanical filter can be tuned within a spectrum of 5 percent using an electromagnet energized from a source of variable direct current. For frequencies from 60 to 700 cycles, factors of Q range between 100 and 400

By **GEZA ZELINGER**

*Royal Institute of Technology
Stockholm, Sweden*

OWING to their inherently high Q factor, tuning forks are extensively used in precision low-frequency timing generators^{1,2} and as interstage coupling filter networks in certain types of selective audio amplifiers³. Their applications are somewhat restricted, on the other hand, by Q 's between 2,000 and 10,000 as well as by inherently long time constants and critical balancing requirements.

To permit construction of inexpensive selective low-frequency, fast-response amplifiers and stable oscillators, with the additional feature of electronically tuning the resonant frequency over a considerable spectrum, a new kind of electromechanical filter of the resonant-reed variety has been developed.

Filter Characteristics

These new filters are characterized by moderate Q factors when compared with those of tuning forks, but the Q is readily variable within a broad range. Experimental filters with operating frequencies from below 60 to over 700 cycles per second have been used with reasonable success for mobile selective signaling, remote supervisory control and switching applications.

A remarkable similarity of behavior has been observed between these new electromechanical filters and a shorted quarter-wavelength transmission line section.

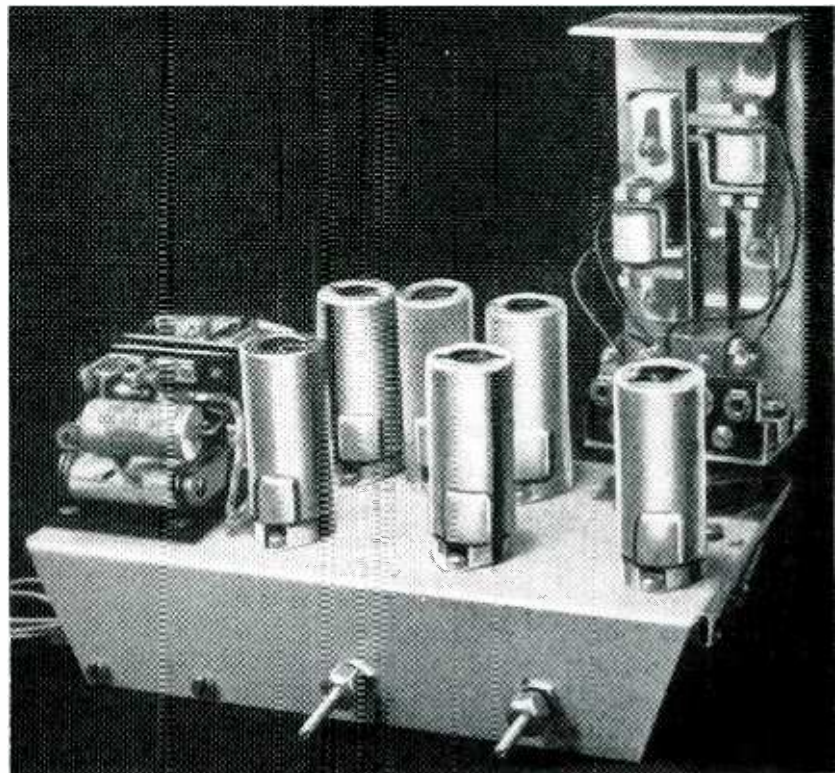

Remote selective switching equipment for telemetering uses filter (right rear). Variable tuning coil not used here

The fundamental resonant frequency of a rectangular elastic bar clamped at one end⁴ as shown in Fig. 1 is given by the equation

$$f_0 = \frac{0.5596}{l^2} \left(\frac{Y_m K^2}{\rho} \right)^{1/2} \quad (1)$$

where f_0 is fundamental resonant frequency in cycles per second, l is length of the bar in centimeters, Y_m is Young's modulus of elasticity in

dynes per square centimeter, K denotes radius of gyration and ρ is specific density of the bar per cubic centimeter.

In rectangular bars, $K = a/(12)^{1/2}$ where a is thickness of the bar in the direction of vibration in centimeters.

From tables of physical constants⁵ for wrought iron and steel $Y_m = 20 \times 10^{11}$ dynes per square centi-

meter and $\rho = 7.9$.

Solving Eq. 1 for l

$$l = \left(\frac{0.5596}{f_0} \right)^{1/2} \left(\frac{Y_m K^2}{\rho} \right)^{1/4} \quad (2)$$

The width dimension of the bar does not enter as a factor into Eq. 1 and 2. Therefore the width of the resonant member may be chosen arbitrarily in accordance with mechanical or electrical requirements.

Basic Filter

If clamped bar B is provided with a set of input and output coil assemblies C and D as shown on Fig. 2, the bar may be excited into resonant transverse mechanical vibrations by applying alternating current of the correct frequency across input coil terminals D .

The electromotive force resulting from the vibration at C is proportional to the rate of change of the magnetic flux in the air gap and to the number of turns of the output coil⁶. The generated voltage is sinusoidal, since the mechanical displacements of the vibrating bar are, in practice, very small. Length required for an experimental 118-cycle filter using flat steel bar of 0.7-millimeter thickness can be computed from Eq. 2.

$$l = \left(\frac{0.5596}{118} \right)^{1/2} \times \left[20 \times 10^{11} \left(\frac{0.07}{\sqrt{12}} \right)^2 \frac{1}{7.9} \right]^{1/4}$$

$l = 6.87$ centimeters

Constructional details of an electromechanical filter built on these principles is illustrated. The working mechanical elements of the filter may be represented as an equivalent lumped-parameter electrical network⁷. When this is done the electromechanical filter assembly as a whole may be replaced by the equivalent lumped-parameter network of Fig. 3.

The frequency response of such a network may be conveniently measured by connecting a constant-voltage variable-frequency generator across the input terminals and a vacuum-tube voltmeter across the output terminals. Frequency response of experimental filters for 118.5 and 709 cycles was similarly

measured. Results are shown in Fig. 4 and 5, respectively.

By definition

$$Q = \frac{f_0}{\Delta f} \quad (3)$$

where f_0 is resonant frequency and Δf is bandwidth at 0.707 times maximum response. Figure 4 shows the Q factor of this particular filter to be $Q = 118.5/0.7 = 170$.

By definition

$$Q = \omega_0 L / R \quad (4)$$

where ω_0 is the angular resonant frequency, L the equivalent inductance and R the equivalent resistance of the filter.

From Eq. 4

$$Q = (2L/R) \pi f_0 \quad (5)$$

But from the theory of lumped parameter LCR circuits⁸

$$2L/R = T_0 = \text{time constant} \quad (6)$$

Therefore Eq. 5 may be put into the form

$$Q = T_0 \pi f_0 \quad (7)$$

$$T_0 = \frac{Q}{\pi f_0} \quad (8)$$

For the sample filter under consideration; $T_0 = 170/\pi 118.5 = 0.457$ second

When a third coil assembly F (Fig. 6) is added to the simple electromechanical filter, the filter acquires further useful features. If this third control coil is energized from a variable direct-current source, the resonant frequency of the system varies almost linearly with the applied control current.

The mechanism of this phenomenon may be better visualized with the equivalent lumped-parameter electrical network (Fig. 3). Resulting from the action of the direct-current excited control coil, the elastance of the clamped resonant bar is influenced, which is synonymous with a change of capacitance C_1 . The resonant frequency of the system therefore changes.

Control Characteristics

Figure 7A shows measured frequency shift of a 118.5-cycle filter as a function of control current. The mechanical stiffness of the resonant bar increases with current. It follows from reasoning that

the insertion loss of such a frequency-controlled electromechanical filter should also increase. This has been experimentally verified and

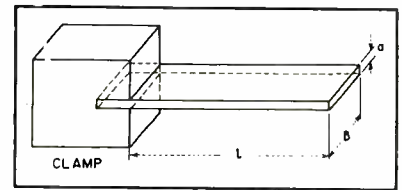

FIG. 1—Basis of the electromechanical filter is the clamped resonant bar with important dimensions marked

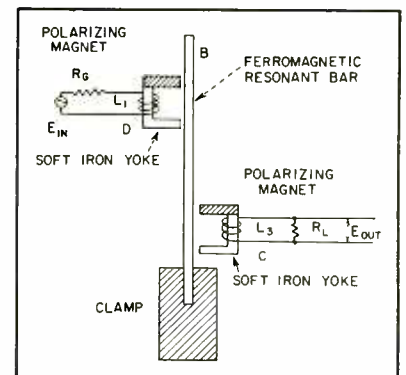

FIG. 2—Basic elements of the electromechanical filter with fixed resonant frequency

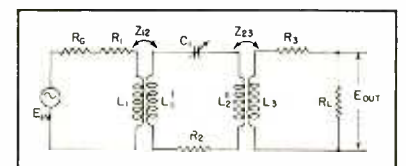

FIG. 3—The electromechanical device shown in Fig. 2 is represented by a lumped-parameter electrical network

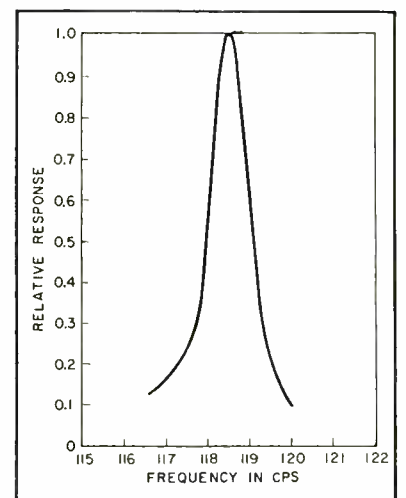

FIG. 4—Frequency response of the experimental fixed-frequency 118.5-cycle electromechanical filter

Fig. 7B shows measured insertion loss as a function of control current. For completeness, a plot of the measured input-output voltage

ratios of the same filter with zero control current is shown in Fig. 7C. The graph of Fig. 7D shows how the control current reduces de-

pendence of the resonant frequency upon the magnitude of the applied a-c input drive voltage.

Control coils of the experimental filters were wound with 8,500 turns of 0.05-millimeter diameter enamel-insulated copper wire. Total resistance is approximately 2,500 ohms. The sliding coil assemblies are positioned between 0.15 and 0.7 millimeters from the clamped resonant bar.

Applications

One application of the filter is shown in Fig. 8 where it is used as an electronically tunable interstage filter network. Control coil *F* is energized from a constant-current source through a control tube. The plate current passed by this tube is set by the potentiometer, thus providing manual frequency control. The resonant frequency of the filter may be further shifted from the preset value by the application of incremental d-c signals across the grid-cathode terminals of the regulator tube.

The electromechanical filter can be used as a tunable frequency-determining element in a feedback oscillator. In this case, coil *C* would be connected to the input and coil *D* to the output of a suitable amplifier.

Development work on the electromechanical filters described has been carried out by the writer since 1949 at the Electronics Laboratory of the Department of Scientific Research and Development, Ministry of Defence of the State of Israel. Credit is due to Ernst D. Bergman, director of the Department, for his encouragement to prepare and permission to publish this paper.

REFERENCES

- (1) A. B. Wood, "A Textbook of Sound," p 121, G. Bell and Sons, London 1949.
- (2) Fritz Vilbig, "Lehrbuch der Hochfrequenztechnik", p 551, Akademischer Verlagsgesellschaft, Leipzig 1937.
- (3) Karl N. Wulfsberg, A Tuning Fork Filter, *Journ Acous Soc Am*, 22, No. 6, p 847, Nov. 1950.
- (4) Harry F. Olson, "Elements of Acoustical Engineering", second edition, p 52, D. Van Nostrand Company, New York 1947.
- (5) Same as reference 4, p 8.
- (6) M.I.T. Staff, "Magnetic Circuits and Transformers", p 115, John Wiley & Sons, New York 1943.
- (7) Same as reference 4, p 67.
- (8) M.I.T. Staff, "Electric Circuits", p 220, John Wiley & Sons, New York 1943.

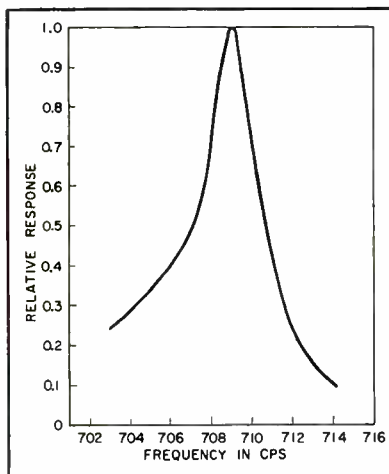

FIG. 5—Frequency response of experimental electromechanical filter operating at 709 cycles

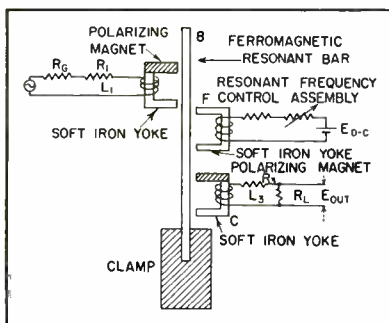

FIG. 6—Constructional details of the experimental variable-frequency electromechanical filter showing the method of polarization

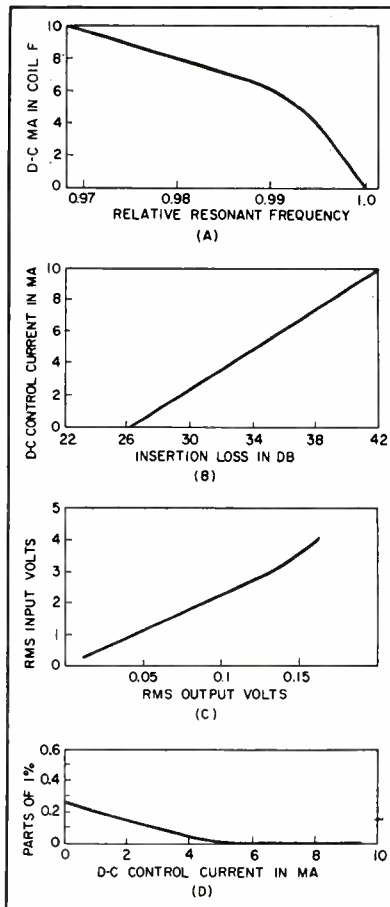

FIG. 7—Various characteristics of adjustable filters under several conditions of operation as explained in the text of the article

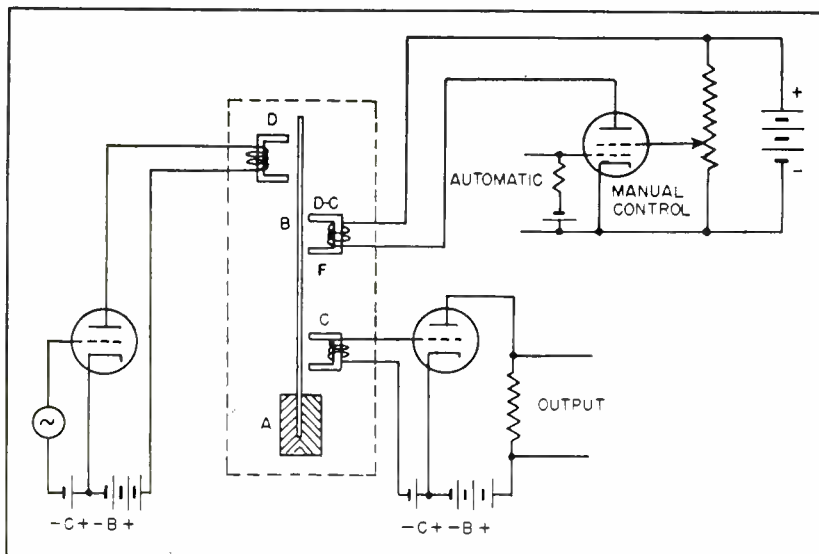

FIG. 8—Electromechanical filter used as tunable interstage selective coupling network. Control coil *F* is energized through a control tube

RELIABILITY Check List for Electronic Equipment Designers

*By The Engineering Division
U. S. Navy Electronics Laboratory
San Diego, California*

One-hundred points that engineers and others responsible for design, production and use of electronic equipment should consider while planning military gear. Many of the requirements are applicable also to products intended for civilian use

CIRCUITRY

Use tubes from the Armed Services Preferred List of Electron Tubes. Do NOT use selected tubes under any circumstances.

Provide 10 percent (at least 2) spare terminals on terminal strips and boards.

Undesired radiation must be within the limits specified by MIL-I-16910.

Provide protection from damage due to overload, excessive heating, etc.

Fuse or otherwise protect both sides of the line, and provide spare fuses in a convenient location.

Conductors shall be bound into a cable and held by means of lacing twine or other acceptable means. Long conductors or cables should be secured to the chassis by cable clamps.

Allow sufficient slack in the ends of flexible conductors to preclude breakage due to vibration.

Keep use of relays to a minimum.

Wires and cables run through holes in metal partitions must be protected from mechanical damage by grommets or other acceptable means.

All soldering lugs, studs, and terminals must be provided with a means for mechanically securing the wire lead prior to soldering.

Do not use solderless lugs unless specifically approved.

Do not use acid or corrosive soldering fluxes.

Do not depend on soft solder for mechanical strength.

Do not join leads without a support at their junction.

Keep "parts peculiar" to an absolute minimum.

CONTROLS

Controls infrequently required shall be accessible when the equipment is open for maintenance pur-

poses. Maintenance controls shall be screwdriver adjusted.

All controls should be clearly labeled with standard nomenclature and marked, indexed, or metered such that the control position can readily be identified.

Controls shall be arranged to facilitate smooth and rapid manipulation.

Adequate end stops shall be provided on all controls with limited degree of motion.

All control shafts and control shaft bushings shall be grounded.

Provide control locks where specified.

Glass windows shall be secured to the panel by means of clips or other devices. Do NOT use cement alone.

Provide dimmer control for all dial and indicating lights.

Light leakage shall be prevented.

Control knobs should be kept to a minimum and have standard shape and color. Control knobs should be secured by means of 2 setscrews.

Controls and indicators which are only occasionally required should be mounted behind hinged doors.

All moving parts shall operate smoothly and quietly without introducing objectionable electrical noise.

Backlash and torque-lash shall be kept to a minimum.

Tuning instructions and calibration charts shall be mounted on the equipment when such instructions and charts are required.

Pilot lights should be of the lock type and replaceable from the front. Do not series-connect pilot lights.

SAFETY

Provisions shall be made to prevent personnel from coming into contact with voltages in excess of 50 volts while installing, operating, or interchanging assemblies or plug-in parts.

All external metal parts shall be at ground potential. Antenna and transmission line terminals shall be at ground potential except with regard to the energy to be radiated.

Provide safety covers for potentials from 50 to 400 volts where interlocks are not provided. Interlocks and automatic discharging devices must be provided. Interlocks and automatic discharging devices must be provided where potentials exceed 400 volts.

Provide personnel protection from moving machinery.

Provide crt with safety glass.

Adequate safety factors and derating must be used in order to insure maximum reliability of equipment in service.

Use miniature parts and sub-assemblies where possible, coordinated with cognizant Bureau of Ships codes.

Doors or hinged covers should be rounded at the corners and provided with slip hinges and stops to hold them open.

Plugs and connectors should not expose "hot" leads.

MAINTENANCE

All circuits must be readily accessible for servicing.

Make provision to lock assemblies in the maintenance position.

A servicing power outlet, separately fused, shall be provided on each major unit.

Built-in test equipment (meters, etc.) should be used, to determine qualitatively whether the equipment is operating normally.

Do not provide portable test equipment.

Provide test points for checking essential wave forms and voltages where terminals are not otherwise accessible.

(Continued on p 178)

CINCH PRODUCES

A LARGE VARIETY OF SMALL COMPONENTS...IN *STANDARD USE

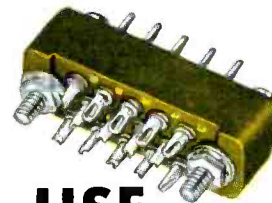

THIS IS A LIST OF CINCH COMPONENTS
(INCLUDING THOSE OF-CINCH-JONES DIVISION):

SOCKETS: TUBE (RECEIVER, TRANSMITTER AND SPECIAL): BATTERY, ALL TYPES • C-R TUBE • CRYSTAL • ELECTROLYTIC • GLASS TYPE; 4 TO 7 PRONG LAMINATED • INFRA-RED RAY TUBE • HIGH ALTITUDE AIRBORNE TYPES • KINESCOPE; MAGNAL, DUODECAL, DIHEPTAL • LOKTAL-MINIATURE-MULTIPLUG-NOVAL OCTAL (MOLDED BAKELITE, STEATITE, TEFLON, KEL-F AND LAMINATED) • PLEXICON • PRINTED CIRCUIT • SPECIAL SOCKETS TO SPECS • SUB-MINIATURE; HEARING AID TYPES • TV; 110V CIRCUIT BREAK-AWAY • VIBRATOR • PENCIL TUBE TRANSISTOR • DIODE

ANTENNA JACKS • METAL STAMPINGS • BANANA PINS AND JACKS • MICRO-CONNECTORS • BARRIER TERMINAL STRIPS • MOUNTING DEVICES • FANNING STRIPS • PHONO TIP JACKS • BATTERY PLUGS & SOCKETS • PRINTED CIRCUIT, CONNECTORS SHIELDS, TUBE-MINIATURE & NOVAL & BASES SOLDERING LUGS—200 VARIATIONS • BINDING POSTS • DIODE SOCKET • CONNECTORS, MULTI CONTACT • FUSE STRIPS, BLOCKS & BOARDS • GRID CAPS • STRAP NUTS • GRID CAP SHIELDS • TRANSISTOR SOCKET • TUBE HOLDERS—SPRING TYPE • HERMETICALLY SEALED TUBE SOCKETS • VIBRATOR PLUGS AND SOCKETS

TERMINAL ASSEMBLIES: BLOCKS, BOARDS IN LAMINATED AND MOLDED, ASSEMBLED WITH LUGS, PINS, SCREW TERMINALS, CONTACTS, CLIPS, TURRET LUGS AND OTHER HARDWARE TO SPECIFICATIONS.

Centrally located plants
at Chicago, Shelbyville,
Indiana and St. Louis.

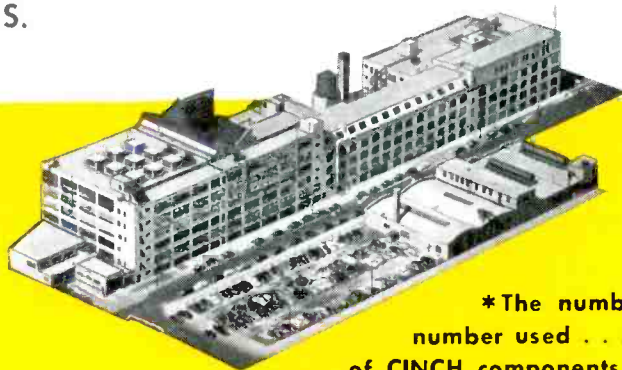

Cinch components are
available at leading
electronic jobbers —
everywhere

*The number of users and the
number used . . . testify to the choice
of CINCH components as Standard. Ample
physical properties, space and production facilities is
producing many variations of these standard elec-
tronic components for military, and commercial, use.



Cinch
ELECTRONIC
COMPONENTS

CONSULT CINCH'
CINCH MANUFACTURING CORPORATION

1026 South Homan Ave., Chicago 24, Illinois

Subsidiary of United-Carr Fastener Corporation, Cambridge, Mass.

Provide voltage dividers with test points for measurement of voltages in excess of 1,000 volts.

Insure complete interchangeability of all removable units, maintenance parts, etc.

Provide means for by-passing interlocks and have warning indicator.

Special tools must be mounted in a convenient place in the equipment. Minimize need for special tools.

Parts mounted on terminal strips and boards must be accessible for servicing.

All terminal strips and boards shall be marked by a standard system. Publication NavShips 250-916 may be used as a guide.

Rear of plug connectors must be accessible for test and service.

Range indicators should be of large counter types suitably placed with provision for transmission to remote positions (or as required by the equipment specification).

Provide running-time meters where required by the specifications.

MARKING

Conductors should be color coded in accordance with standard MIL-STD-122.

Noninsulated leads should be color coded by means of color spots near all terminals.

Part reference designations shall be located adjacent to each part. Type designation of each tube and the reference designation shall be marked on the tube side of the chassis adjacent to the socket.

Markings shall be permanent and legible.

Transmission line terminals shall be marked with the characteristic impedance of the line.

Positive identification of scales in use shall be provided.

Clearly mark all "non-tamper" factory adjustments.

Indicate parts which MUST be replaced at specified intervals.

Transformers, chokes, capacitors, etc., shall have circuit diagrams with current, voltage, and impedance ratings stenciled on the outside (MIL-T-27).

Lubrication points shall be accessible and clearly marked.

ASSEMBLY

Electron tubes, ferrule-type resistors and fuses, and other plug-in items must be secured by easily released positive holding clamps.

Mounting of parts shall be compatible with the size and weight of

the parts so as to preclude lead breakage from fatigue under conditions of vibration.

Leave adequate (1/16 inch) pig-tail on leads and do not mount more than three wires on one terminal.

Threaded devices shall conform with Specification MIL-S-933 or MIL-B-857 and Handbook H 28. For bushings or collars for mounting variable resistors, toggle switches, etc., Specification 16E7 applies.

Screws, studs, nuts, etc., shall be of nonferrous material. Corrosion-resistant steel or nickel-copper alloy may be used where required for reasons of strength.

Avoid threading aluminum alloy into aluminum alloy parts.

Self-tapping screws should not ordinarily be used. If used, approval must be obtained from the bureau or agency concerned.

Devices for retaining panels and cover plates shall be of captive types with slotted or knurled and slotted heads.

Use external tooth-type lock washers.

Provide rotating antenna assemblies with local power safety switch and means for hand training for maintenance.

Removable side and back plates for terminal tube mounting shall be provided.

All set screws shall have one type of head.

Do not use flat-head screws on thin panels.

Center - of - gravity mounting should be employed where possible.

Do not mount components on tube socket lugs except where required for performance reasons.

MATERIALS

Do not mount parts with rivets.

Do not use wood, magnesium, inflammable materials, fungus supporting materials, toxic materials, hygroscopic materials, dissimilar metals in contact, and electrical tape.

Use glareproof and shatterproof glass.

Iron and steel shall not be used except where required for electromagnetic or strength reasons.

Plate or otherwise treat metals to protect them from corrosion.

Materials for embedding electronic parts in assemblies shall be in accordance with Specification MIL-C-16923.

Finish enamel shall conform with Specification MIL-E-15090 or TT-E-485, as indicated.

Operating conditions (may be modified by equipment specification MIL-E-16400):

- a. -54° to $+85^{\circ}\text{C}$ (nonoperating)
- b. -54° to $+65^{\circ}\text{C}$ (operating)
- c. 95 percent relative humidity
- d. For certain equipment, wind 90 knots operating and 150 knots nonoperating
- e. Ice loading as specified by equipment spec.
- f. Shock and vibration (MIL-S-901, 40T9, MIL-T-17113, etc.)
- g. Line voltage and frequency (excursions per equipment spec.)
- h. Salt spray (for external finishes and materials)

Avoid use of friction or pressure contacts where possible.

Equipment shall be dripproof, splashproof, or waterproof as required by the equipment specification. See Standard MIL-STD-108.

LAYOUT

Equipment shall be of the lightest weight consistent with sturdiness, safety, and reliability.

Provide suitably labeled lifting-eyes on equipment weighing more than 150 pounds.

Provide adequate ventilation facilities. Do not provide openings in top.

Restrict use of liquid cooling.

When forced-air cooling is used, provide suitable dust filters. Mounting and size to be coordinated with bureau or agency concerned.

Electronic equipment should use as few lubricants as practicable.

Size restrictions:

- a. Surface vessel installation—
 - (1) Height 72 inches
 - (2) 30-inch-by-30-inch hatch with round corners on $7\frac{1}{2}$ -inch radius.
 - (3) 26-inch-by-45-inch door with round corners on 8-inch radius.
- b. Submarine installation—
 - (1) 72 inches high
 - (2) 25-inch diameter circular hatch
 - (3) 20-inch-by-38-inch door with round corners on 10-inch radius.

Use of cable plugs and connectors should be kept to absolute minimum.

Avoid cable entrances on front panels.

Provide space heaters where necessary.

See Specification MIL-E-16400 for more detailed requirements.



New Taylor laminates are premium in everything but price

YOU'LL LIKE everything about this new family of Taylor paper-base laminates—including their price. They're a new kind of hot-punch laminate, uniform all the way through, with no surface overlay of resin.

In insulation resistance, water absorption, power factor, flame retardance and dimensional stability, they'll meet or exceed your strictest specifications. And they punch and stake so well . . . with smooth surfaces and clean edges . . . that you can produce complex parts with maximum utilization of each sheet.

Four different grades are available in production quantities, in standard sheet size of approximately 49" by 49":

XXXXP-301 . . . *the top grade laminate* with unusually high insulation resistance, lowest water absorption . . . excellent punching and staking.

XXP-351 . . . a high grade laminate with most of the properties of XXXP-301, at lower price.

Grade 353 . . . a quality grade laminate priced for economy, with outstanding electrical and physical properties.

Grade 354 . . . an easily fabricated grade having low water absorption and good stability . . . priced for real savings.

Taylor Fibre Co. Plants in Norristown, Pa.; and La Verne, Calif. *Branch offices in Atlanta; Boston; Chicago; Cleveland; Dayton; Detroit; Indianapolis; Los Angeles; Milwaukee; New York City; Philadelphia; Rochester; San Francisco; St. Louis; and Tolland, Connecticut. Distributors in Grand Prairie and Houston, Texas; Jacksonville, Florida; New Orleans, Louisiana; and Toronto, Ontario.*

WRITE TODAY FOR FULL SPECIFICATIONS, AND FOR ENGINEERING ASSISTANCE IN APPLICATION

TAYLOR
Laminated Plastics
Vulcanized Fibre

ELECTRONS AT WORK

Edited by ALEXANDER A. McKENZIE

Microwaves Carry Television Across The Alps	180	Accurate Beat-Frequency Measurements	196
Simple Circuit Stabilizes Transistor	182	Four-Megawatt Klystron	200
Photocell Records Marine Luminescence	182	High-Speed Film Marker	202
Measuring Microwave Antenna Patterns (The Front Cover)	184	Robot Speeds Oil Research	208
Cane Guides Sightless	186	Improved Recording Heads	210
UHF R-F Power Meter	188	Pertinent Patents	212

OTHER DEPARTMENTS

featured in this issue:

	Page
Production Techniques	228
New Products	274
Plants and People	332
New Books	385
Backtalk	397

Microwaves Carry Television Across The Alps



Sole trans-Alpine microwave television link employs antennas like this one, which is mounted on the side of the Jungfrau



Relay station equipment undergoing tests prior to installation in the Alps

EUROPEAN TELEVISION program exchange depends upon microwaves to connect Italian and German networks. A link 125 miles long runs from Chasseral in northern Switzerland through a relay station high on the 15,000-foot Jungfrau to Monte Generoso in southern Switzerland.

The Alpine link provides a one-

MEASURES

A Completely Self-Contained

RF BRIDGE

500 kc to 250 mc

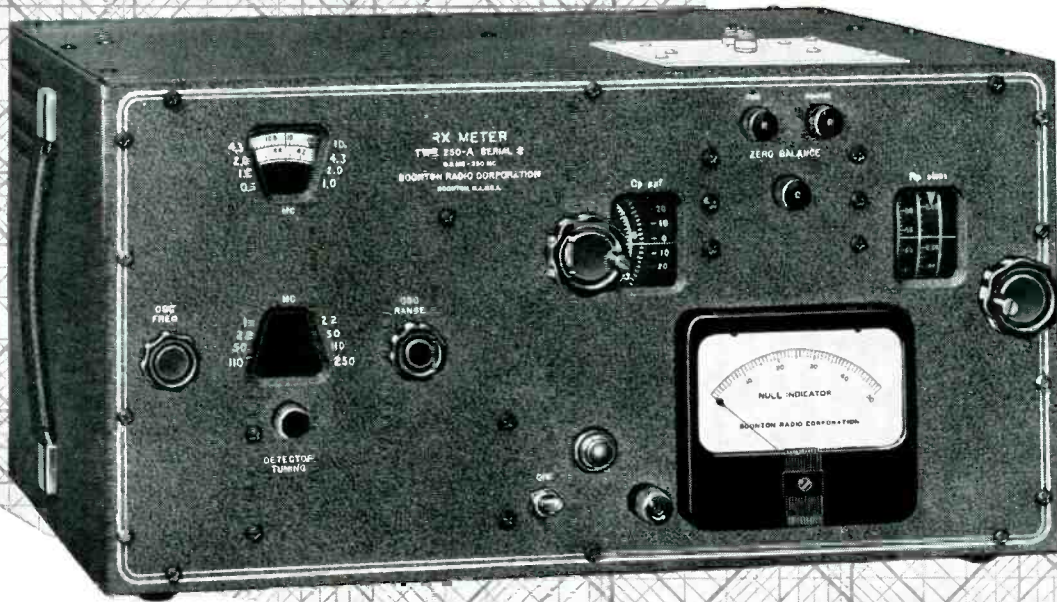

RX METER TYPE 250-A

- SAVES valuable engineering labor: makes RF bridge measurements a "means to an end" rather than an end in themselves.
- INCLUDES self-contained test oscillator, local oscillator, Schering bridge, detector, and null indicator.
- INDICATES directly equivalent parallel resistance and capacitance (or inductance) of any two-terminal network.
- MEASURES dynamic and static systems under actual operating conditions.
- CONNECTS to unknown from convenient binding posts or Type N coaxia (with use of accessory adapter).

SPECIFICATIONS

FREQUENCY RANGE: 500 KC to 250 MC in eight ranges.

FREQUENCY ACCURACY: $\pm 1\%$.

RESISTANCE RANGE (Rp): 15 to 100,000 ohms.

RESISTANCE ACCURACY (Rp): $\pm \left\{ 2 + \frac{Fmc}{200} + \frac{Rp}{5000} + \frac{Q}{20} \right\} \% \approx 0.2$ ohms.

CAPACITANCE RANGE (Cp): -100 mmf to +20 mmf.

CAPACITANCE ACCURACY (Cp) $\pm \left\{ 0.5 - 0.0002 F^2 mc \right\} \approx 0.15$ mmf.

TEST VOLTAGE: 0 volts D. C. (Up to 50 ma. may be passed through unknown terminals).

0.1-0.5 volts R. F. (may be conveniently reduced to 20 mv.).

POWER REQUIREMENTS: 105-125 volts, 50/60 cps, 60 watt. (internally regulated).

MEASUREMENT APPLICATIONS

Resistors
Transistors
Tubes
Tuned Circuits
Diodes
Transmission Lines
Antennas
Coils
Capacitors
Chokes
Receivers
Filters
Transmitters
Attenuators
Pads



RESISTORS



DIODES



COILS



TUBES



CAPACITORS



TRANSISTORS

BOONTON RADIO

BOONTON, N. J. U.S.A.

Corporation



Price: \$1250.00 F.O.B. Boonton, N. J.

way reversible television channel capable of handling a bandwidth of 5.5 mc suitable for 625-line pictures. The Jungfrauoch relay station, 12,000 feet above sea level, is 60 miles from Chasseral and 65 miles from Monte Generoso.

Operating in the band of 1,700 to 2,300 mc on specific assignments of 1,776 and 1,848 mc, the system is frequency modulated. The two car-

rier frequencies are used to reduce the problems arising when transmitter and receiver must operate on the same frequency.

Paraboloidal reflectors 12-feet in diameter, spun from aluminum, are used at all locations. The antennas have an effective bandwidth of 150 mc over which range the vswr does not exceed 1.15. A gain of 34 db relative to an isotropic radiator is ob-

tained at 2,000 mc. Beam angle is 2 degrees at the half-power points. Input impedance is 75 ohms, which facilitates connection of air-spaced coaxial feeders.

Signals are passed through the repeater system at a 60-mc intermediate frequency so that demodulation and subsequent modulation are not required. This technique reduces distortion.

Simple Circuit Stabilizes Transistor

By FRED E. BARRON

Associate Chief Engineer
E. A. Myers & Sons, Inc.
Pittsburgh, Pa.

FOR A GIVEN SET of operating conditions in a particular stage of a transistor amplifier, optimum performance is realized with a particular operating current. This seems to be generally true from one transistor to another of the same type, but bias requirements to obtain a particular collector current vary greatly from one unit to another. Collector current likewise varies markedly with temperature when the bias on a particular transistor is constant. This effect occurs because I_{co} , the cutoff current (or collector-base current with the emitter open), varies with tempera-

ture. The following equations give collector current for the common-emitter connection of the transistor shown in Fig. 1A. The desired operating point is usually reached by adjusting the value of base bias resistor R_1 so that collector current,

$$i_c = I_{co} + \alpha i_e$$

$$i_c + i_{R1} = i_e$$

$$i_{R1} = E/R_1$$

$$i_c = I_{co} - \alpha i_e$$

$$i_c + i_{R1} = i_e$$

$$i_{R1} = E/R_1$$

where R_1 is large compared to the d-c resistance in the emitter circuit, E is the voltage supplied to R_1 , I_{co} is collector cutoff current and α is

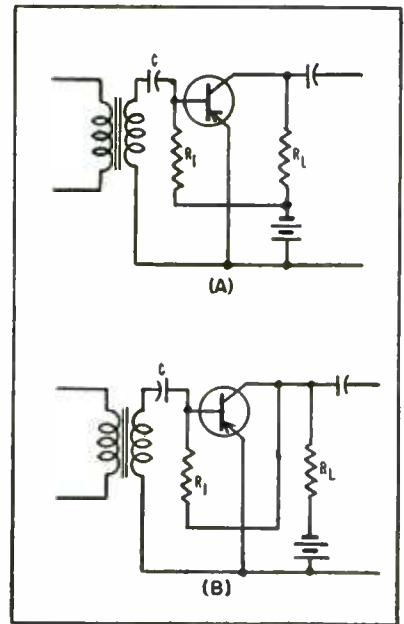

FIG. 1—Stabilization of transistor amplifier (A) is obtained by returning bias resistor to the collector (B)

current amplification factor.

$$\text{From this } I_{co} + \frac{\alpha E}{R_1}$$

$$i_c = \frac{I_{co} + \frac{\alpha E}{R_1}}{1 - \alpha}$$

where R_1 is the base bias resistor.

The stabilization factor S is equal to the derivative of collector current with respect to cutoff current.

$$S = \frac{di_c}{dI_{co}} = \frac{1}{1 - \alpha}$$

For a typical high-quality junction transistor, $\alpha = 0.98$, and S therefore is equal to 50. This means that the collector-current change will be fifty times the cutoff current change in the common-emitter connection of the transistor. It is therefore desirable to design a circuit in which S is small, if such can be done without loss of gain or addition of too many components.

The circuit of Fig. 1B shows the basic stabilized circuit. This is

Photocell Records Marine Luminescence



Princeton University research scientist E. N. Harvey uses photoelectric recorder in study of cold light from sea animals at Marine Biological Laboratory at Woods Hole, Mass. Mechanism of light production is being studied in the hope of applying similar principles to artificial synthesis of illumination

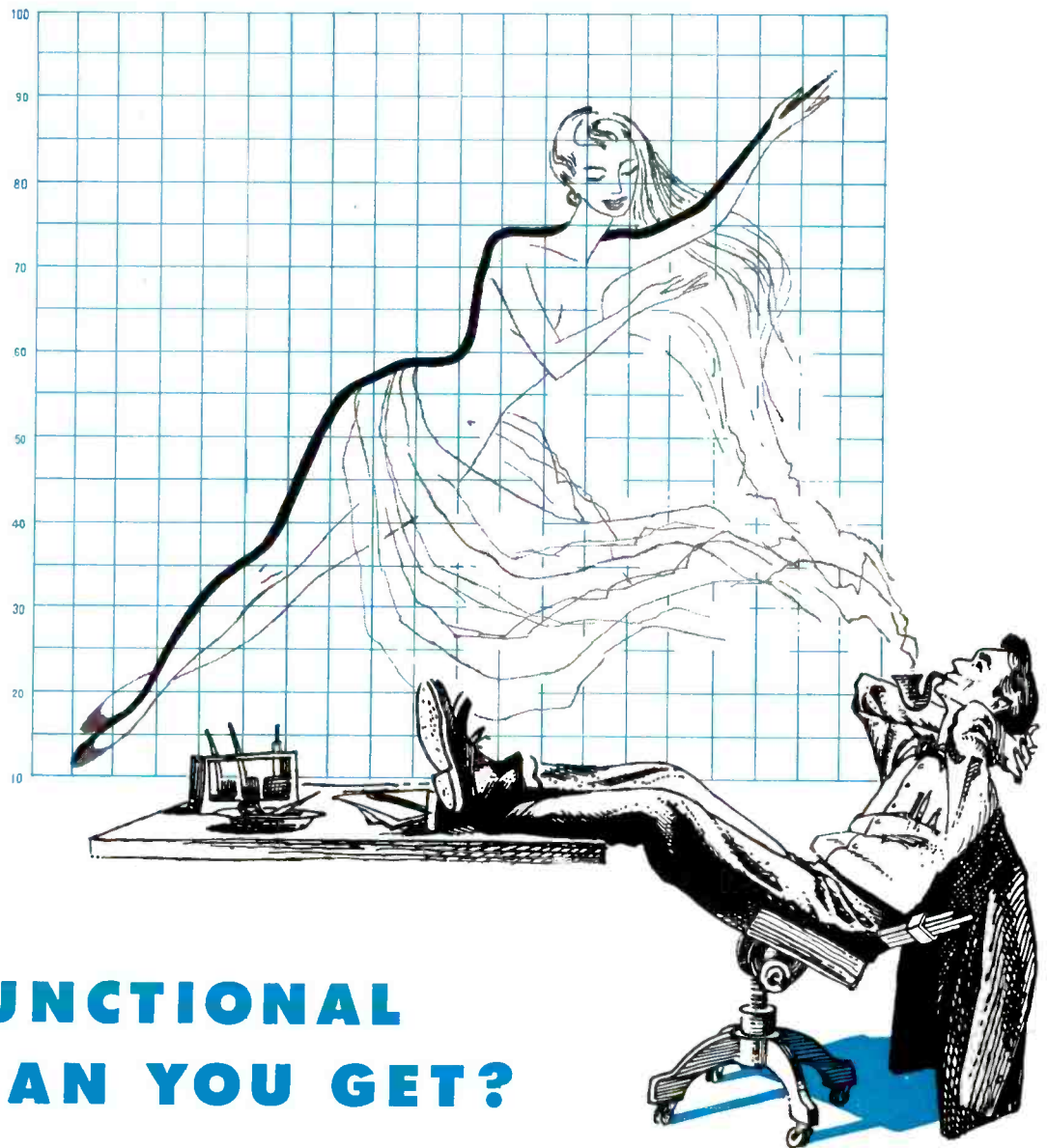

HOW FUNCTIONAL CAN YOU GET?

Need a sine-cosine pot?...or one that will solve $Y = x^2 + \sqrt{x}$... or do you desire those dreamy curves above?

Whatever your need...there's a HELIPOT* precision potentiometer to put out the curve you want...to do computations for you...or to compensate for inequalities of input.

Small or large...continuous-rotation or multi-turn...single units or ganged up to 25 sections (and each can produce a different function) on a common shaft. You get an extremely wide choice of resistances...with extremely close conformities...and a choice of mounting styles. Helipot makes non-linear potentiometers to your exact specifications.

Helipot's manufacturing methods also afford you the widest choice of coil-winding techniques for functional potentiometers.

If the curve you need is most precisely and economically reproduced by spacewinding on a copper mandrel...by a shaped card...by padding and tapping...or by a combination...come to Helipot first!

And, of course, we have non-linear HELIPOTS in a variety of

standard functions...available for prompt delivery.

Write for detailed information and specifications of HELIPOT functional potentiometers.

Ask for Data File 1101



14-gang Series YN non-linear HELIPOT

Helipot

first in precision potentiometers

*Helipot Corporation/South Pasadena, California
Engineering representatives in principal cities
a division of BECKMAN INSTRUMENTS, INC.*



*REG. U.S. PAT. OFF. 346

THE FRONT COVER



Measuring Microwave Antenna Patterns

By BERNARD I. SMALL
and C. M. HATCHER
Navy Electronics Laboratory
San Diego, Calif.

MICROWAVE ANTENNA pattern measurements at NEL are made on the 60-foot wooden tower at the right, equipped with a hydraulically driven pedestal. The antenna under test is used as a receiver and the pattern recorded automatically as the pedestal is rotated.

The 50-foot transmitting tower at the left contains modulated transmitters and associated antennas covering the major part of the microwave spectrum. The testing range spans a canyon 150 feet below the line of sight. The natural low brush cover on the hillsides provides scattering and absorption to such a degree that ground reflections are not observable.

The line-of-sight distance between towers is 650 feet. This provides a sufficiently flat phase front at the receiving site (where the antenna under test is located) over any normal aperture for a shipboard antenna at 200-mc and the higher bands. Apertures of at least 20 feet at 200 mc to at least 3 feet at 9,000 mc are covered without question and larger apertures can be handled with negligible error.

Patterns are taken with the test antenna mounted on a pedestal having three degrees of freedom. Rotation in azimuth and elevation is produced and controlled by a hydraulic system; rotation about the third axis (for

change of polarization) is accomplished manually. The patterns are recorded automatically on a rectangular co-ordinate automatic pattern recorder developed at the Naval Research Laboratory, Washington, D. C. This recorder, with its associated amplifier and square-law detector, is capable of recording over a 40-db power range, with angular accuracy of about ± 0.1 degree. Even a highly diffracted pattern can be recorded accurately over the full 360 degrees in the order of 30 seconds.

The test pedestal is mounted at a corner of the top deck of the tower. A hydraulically operated hoist on top of the tower handles large antennas efficiently and safely. This hoist is mounted on a collapsible boom to minimize local sources of reflection that could cause serious errors in back patterns. Wooden railings, required for minimum personnel protection, are the remaining major source of reflections. At certain frequencies, in cases where extremely clean patterns (side and back lobes more than 30-db down) are under investigation, reflections from this source are noticeable, and must be taken into account when patterns are being analyzed. The recorder, hydraulic pumps, controls and a small work space are housed one flight below the top deck.

shown for a stage having transformer-coupled input and resistance-capacitance coupled output such as might be found in the second stage of a three-stage amplifier. Bias resistor R_1 , instead of being returned directly to the negative connection of the battery, is returned to the collector of the transistor. Then, if the collector current tends to increase there is additional voltage drop across load resistor R_L so there will be less voltage supplied to the bias resistor R_1 and, as a result of the reduced bias current in R_1 , there will be less collector-current flow. This partially compensates for the initial collector current change.

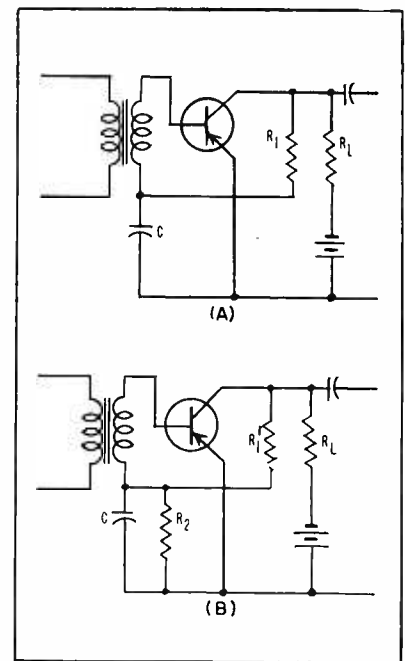

FIG. 2—Alternate stabilizing connection (A) eliminates audio degeneration due to negative feedback. Circuit with added resistor (B) provides further stabilization

The novelty of this circuit lies in the fact that no components in addition to those required by the basic circuit of Fig. 1A are needed and in the fact that there is no decrease in efficiency of the transistor stage owing to increased battery drain. The collector current is now equal to

$$i_c = \frac{I_{co}(1 + R_L/R_1) + \alpha E/R_1}{1 - \alpha + R_L/R_1}$$

$$S = \frac{1 + R_L/R_1}{1 - \alpha + R_L/R_1}$$

In a typical example $\alpha = 0.98$, R_L



THIS IS IT!

This is the actual size of the newest, smallest Blue Jacket — ready now to help solve your production problems!



NEW... a 3-watt Blue Jacket[®] miniaturized axial-lead wire-wound resistor

This power-type wire wound axial-lead Blue Jacket is hardly larger than a match head *but it performs like a giant!* It's a rugged vitreous-enamel coated job — and like the entire Blue Jacket family, it is built to withstand severest humidity performance requirements.

Blue Jackets are ideal for dip-soldered sub-assemblies . . . for point-to-point wiring . . . for terminal board mounting and processed wiring boards. They're low in cost, eliminate extra hardware, save time and labor in mounting!

Axial-lead Blue Jackets in 3, 5 and 10 watt ratings are available without delay in any quantity you require. ★ ★

SPRAGUE TYPE NO.	WATTAGE RATING	DIMENSIONS L (inches) D		MAXIMUM RESISTANCE
151E	3	1 ¹¹ / ₃₂	3 ¹ / ₈	6,000 Ω
27E	5	1 ¹ / ₂	3 ¹ / ₈	30,000 Ω
28E	10	1 ⁷ / ₈	3 ¹ / ₈	50,000 Ω

Standard Resistance Tolerance: ±5%

WRITE FOR ENGINEERING BULLETIN NO. 111'B

SPRAGUE

SPRAGUE ELECTRIC COMPANY • 35 MARSHALL ST. • NORTH ADAMS, MASS.

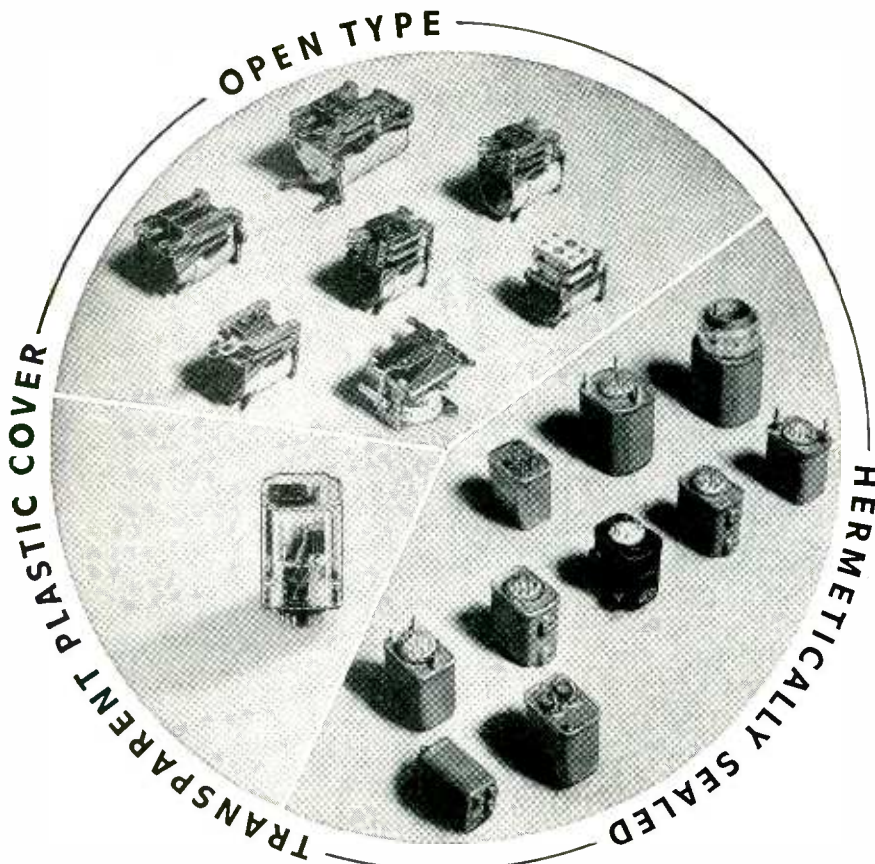

R-B-M Relays

**FOR EVERY ELECTRONIC
APPLICATION**

Meeting Commercial and Government Requirements

OPEN TYPE. Circuit switching—power and dynamotor loads—plate circuit—low capacitance.

HERMETICALLY SEALED. Stud or bushing mounting—solder or plug-in headers—circuit switching—power—low loss applications.

TRANSPARENT PLASTIC COVER. Most R-B-M relays now available in low cost transparent plastic cover.

OTHER PRODUCTS: Motor starting relays and overload protectors for refrigeration, appliance and general purpose motors. Industrial contactors and across-the-line starters. NEMA size 1 and smaller. Low cost general purpose relays. Low voltage D.C. manual and magnetic devices.

Let R-B-M engineering and production facilities serve you. Contact us immediately—Phone 5121

R-B-M DIVISION
ESSEX WIRE CORPORATION
Logansport, Indiana

Control for Electronic,
Refrigeration, Industrial,
Appliance, Communication and
Automotive Industries



= 2,200 ohms, $R_1 = 33,000$ ohms and $S = 13$.

This is an improvement of 3 $\frac{1}{2}$ -to-1 over the circuit of Fig. 1A.

The circuit of Fig. 2A shows an alternate connection of bias resistor R_1 that eliminates any audio degeneration owing to negative feedback present in the circuit of Fig. 1B. For the same bias resistor R_1 , the stabilization of the circuits of Fig. 1B and Fig. 2A will be identical.

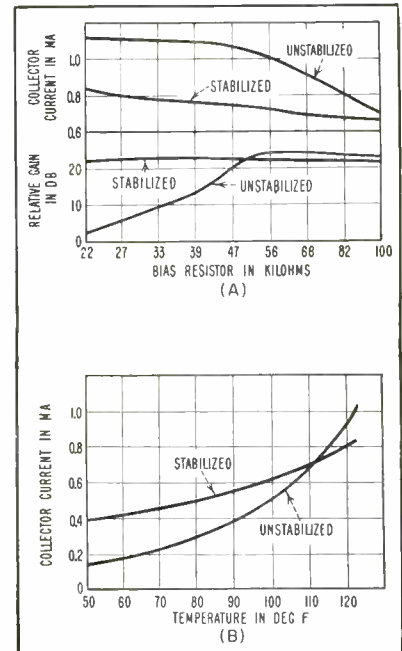

FIG. 3—Collector current and gain for range of bias resistor values (A). Effect of temperature on collector current (B) is given for stabilized and unstabilized circuits

In the circuit of Fig. 2B, an additional resistor R_2 has been added across capacitor C . Such a resistor indirectly improves the stabilization properties of the circuit because it permits a smaller value of R_1 to be used for a particular desired operating current. Improvements of 9-to-1 in stability may be realized by this circuit.

Figure 3 shows the experimental results obtained with the basic simple stabilized circuit of Fig. 1B compared to the unstabilized circuit of Fig. 1A.

Cane Guides Sightless

EXPERIMENTAL BLIND-GUIDANCE aid developed at the Franklin Institute Laboratories in Philadelphia uses a special cane. At the upper end, a

FREED MAGNETIC AMPLIFIERS

Series MAFS

Designed for high-performance control systems

TWO CYCLE RESPONSE TIME — DRIFT-FREE

The Freed MAFS series of Magnetic Amplifiers is characterized by

- FAST RESPONSE — 2 cycles of power frequency delay for 100% response to step input signal.
- PHASE REVERSIBLE A.C. OUTPUT WITH ZERO DRIFT OF NULL POINT

The MAFS series includes the units described below. Engineering and development facilities are available for the design and development of Magnetic Amplifiers having special performance characteristics.

FAST-RESPONSE MAGNETIC AMPLIFIERS — DRIFT-FREE								
1 ϕ Supply Voltage and Frequency	Full Power Output	Max. Voltage Output	Signal Req. for full output	Max. Power Gain	Mfr. and Type No.	Typical Motor Stall Torque	Load No Load Speed	FREED Type No.
115V., 60	15 watts	115V. AC phase reversible	.IV. AC (10,000 ohms input impedance)	1.5×10^7	Diehl FPE 25-11	5.5 in-oz	3500 RPM	MAFS-1
115V., 400	5	57.5V. AC phase reversible	.IV. AC (10,000 ohms input impedance)	5×10^6	Kearfott R 110-2	1.5	5300	MAFS-2
115V., 400	10	57.5V. AC phase reversible	.IV. AC (10,000 ohms input impedance)	1×10^7	Kearfott R 111-2	2.4	5300	MAFS-3
115V., 400	50	115V. AC phase reversible	.IV. AC (10,000 ohms input impedance)	5×10^7	Bendix CK-3000	14	3700	MAFS-4

SEND FOR LATEST DETAILED BULLETINS AND CATALOGS

FREED RESEARCH, Engineering and Production Facilities Combine to Produce Transformers and Instruments of Top Performance.

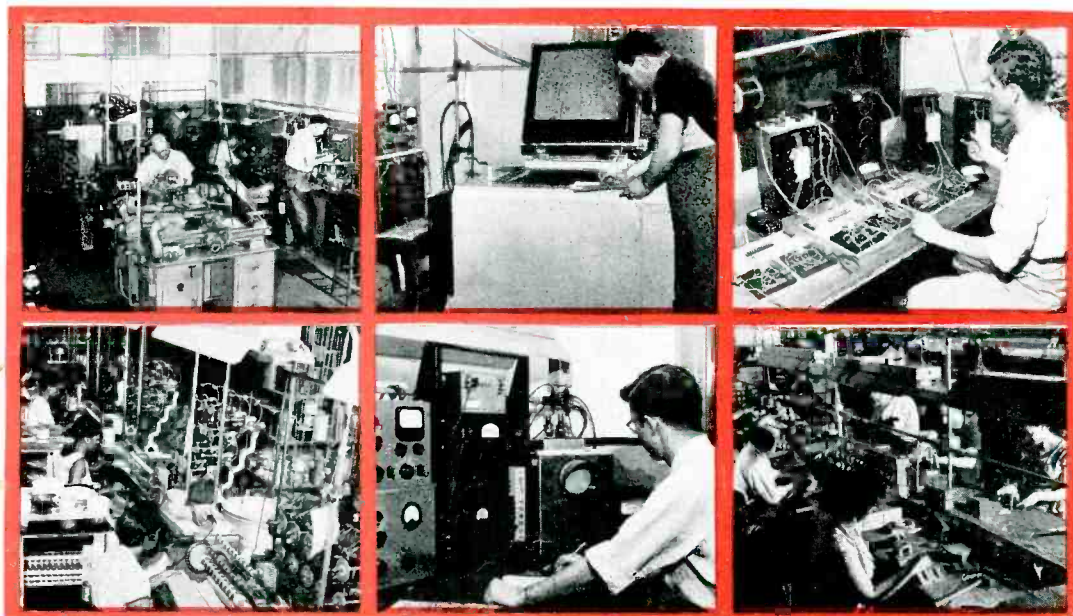

FREED TRANSFORMER CO., INC.

1722 WEIRFIELD ST., BROOKLYN (RIDGEWOOD) 27, N. Y.

Freed Magnetic Amplifiers, Saturable Transformers and Reactors are designed for efficient operation and long life. They can be used wherever reliable, rugged and maintenance free systems are required.

The types of amplifiers listed are designed to control AC servomotors.

Development facilities are available for the design of magnetic amplifiers to meet specific requirements.

All standard units are hermetically sealed and meet MIL-T-27 Specifications.

SATURABLE TRANSFORMERS — Controlled with dual triode; plate supply can be either DC or AC; no rectifiers; AC or DC control signals.

PUSH-PULL MAGNETIC AMPLIFIERS — AC or DC control signals; high gain; may be used with magnetic or vacuum tube preamplifiers if needed.

FAST-RESPONSE MAGNETIC AMPLIFIERS — High gain; half-cycle per stage response time; AC or DC control signals; RC feedback networks for control system stabilization can be used directly; preamplifier not needed.

HIGH TEMPERATURE MAGNETIC AMPLIFIERS — Designed to operate in ambient temperatures as high as 200°C.; AC or DC control signals.

DRIFT-FREE MAGNETIC AMPLIFIERS — For rigid drift-free requirements of control systems; designed to meet specific requirements.

OTHER FREED PRODUCTS TRANSFORMERS

- High Fidelity
- High Level Pulse
- High Q Toroids
- Power
- Slug-Tuned
- Hermetically Sealed
- Step-down
- Miniature Transistor
- High Q Reactors
- High Temperature
- Miniature Audio
- Charging Reactors
- Sub-miniature
- Precision Reactors
- Precision Filters

INSTRUMENTS

- Comparison and Limit Bridges
- Low frequency "Q" Indicators
- Incremental Inductance Bridges
- Universal Bridges
- Null Detectors and V.T. Voltmeters
- Power Supplies
- A.C. Bridges and Accessories
- Differential Voltmeters
- Harmonic Distortion Meters.
- Wide Band Amplifiers
- Decade Amplifiers
- Decade Inductors
- Decade Capacitors
- Megohmmeters
- Filters
- Magnetic Voltage Regulators

✓ UP to 4800 HOURS

average
self time constant
under
normal conditions



For
precision
circuitry
in:

Meter Damping Circuits
Peak Load Control Devices
Voltage Stabilizers
Countless Other Electronic
and Industrial Uses

Industrial Condenser Corporation's experienced engineering staff can help you in the selection or design of capacitors for your particular application. Send for our Catalog 1117. You need this valuable information containing performance curves, characteristics and applications, as a source of ready reference.

INDUSTRIAL
CONDENSER CORPORATION



3249 North California Avenue

Chicago 18, Illinois

Outstanding Operating Characteristics

Insulation resistance at +20° C. after three minutes charge: 90,000 megohm microfarads

Insulation resistance at +75° C.: 78,000 megohm microfarads

Insulation resistance at -75° C.: In excess of one million megohm microfarads

Change in capacitance from +25° C. to -80° C.: +0.76%

✓ **Self time constant** of 10 mfd. capacitor: 4800 hours
Q at 50 kilocycles: 10,000

Power Factor at 1 kc: 0.00025

housing is provided for batteries and the electronic components. The bottom end comprises a special capacitor used to sense difference in levels, such as a curbing.

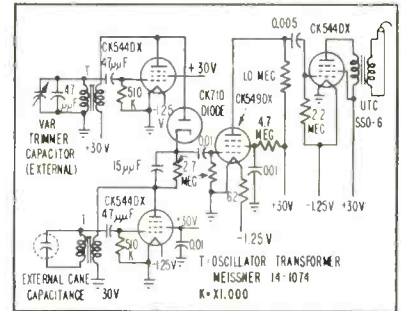

Beat-frequency oscillator interprets curbing or holes as an audible tone for sightless user who carries it as a cane. Sensing capacitor is at cane tip

The circuit shown, using subminiature tubes, employs two oscillators, a mixing diode and two stages of amplification with a gain of 1,500 to drive a miniature head-phone. One oscillator is adjustable to obtain zero-beat with that connected to the cane. That associated with the cane tip varies in frequency as the cane changes its distance from the ground. The resultant frequency difference causes an audio tone in the headset.

No signal is produced until the cane tip is four inches or more above the ground. The equipment requires three small batteries costing about a dollar for the set. They last over a month in normal usage. It is expected that the cane itself will cost around \$50 when mass produced.

The research was sponsored by the W. K. Kellogg Foundation.

UHF R-F Power Meter

BY HAROLD REED
Chief Engineer
Radio Station WOL
Washington, D. C.

OF THE METHODS that can be employed in r-f power measurements, the one commonly used converts r-f output into heat in the resistance of the filament of an incandescent lamp. A bulb of wattage rating close to the expected output of the apparatus under test is used. The brilliancy of the lamp, serving as an r-f output load resistor, can be

New G-E ELECTROSTATIC-FOCUS GUN GIVES NEEDLE-SHARP TV PICTURES!

- Spot is smaller, rounder.
- Greatly improved focus at high picture brightness.
- Better edge-to-edge picture detail.

GENERAL ELECTRIC's electrostatic picture tubes with new high-resolution gun—most recent product of G-E Tube Design Service—enable designers and builders to increase TV sales by offering *superior fringe-area reception*, as well as improved pictures under all conditions.

Because the gun gives substantially better focus at high picture brightness, snow and interfering-signal excitations in TV fringe areas will not "bloom" to the same extent as before . . . marring the picture less. Also, the screen image has superior detail, helping to maintain picture quality.

Better fringe reception is only one of many improvements you can build into your TV sets by specifying G-E picture tubes with the new gun. Wire or write for complete information! Tube Department, General Electric Company, Schenectady 5, N. Y.

ALL G-E electrostatic picture tubes are equipped with the new high-resolution gun. Types include:

17RP4/17HP4	21ALP4-A	21FP4-A	21YP4
17VP4/17LP4	21ATP4	21FP4-C	21YP4-A
21ALP4	21AUP4-A	21XP4-A	

Nominate a candidate for the Third Annual Edison Award for radio amateurs! Help honor outstanding public service! Entries close January 3, 1955. Write General Electric Tube Department for the rules!

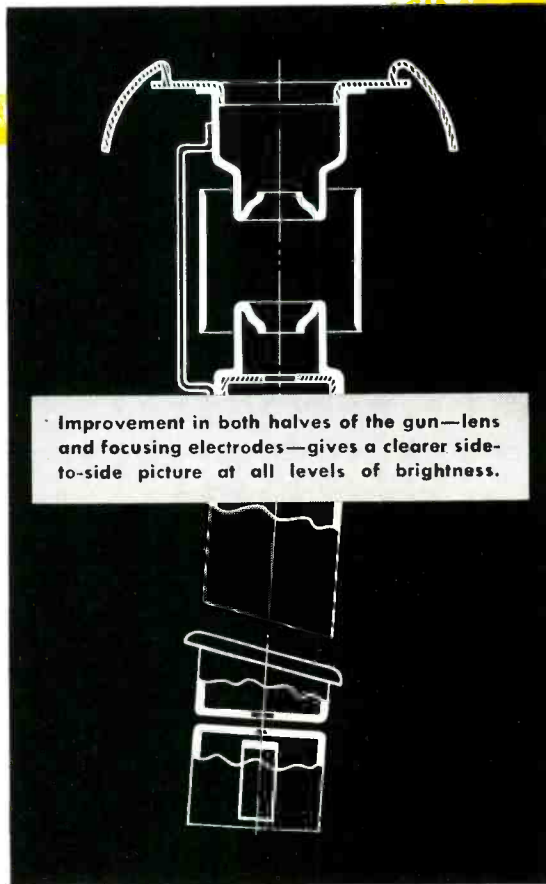

Check these standout design features of General Electric's new gun:

- Lens structure (lower half) has new spacings and dimensions that give a much smaller electron beam with the sharper resolution this makes possible. Also, Grid 1 now is "coined" or pressure-formed for utmost dimensional accuracy. In addition to creating a smaller beam with sharper resolution, the new spacings reduce grid-cathode shorts.
- Grid-1 drive characteristics now provide a much more desirable relationship between brightness and drive voltage.
- Bushings of the focusing electrodes (upper half) are new and advanced in design. Beam distortion over the entire picture area is held to a minimum, and focusing characteristics are more uniform, tube to tube.

Progress Is Our Most Important Product

GENERAL ELECTRIC



The tape and parts pictured are typical of R/M Teflon manufacture



gives you the plus of R/M's unmatched skill, experience, facilities

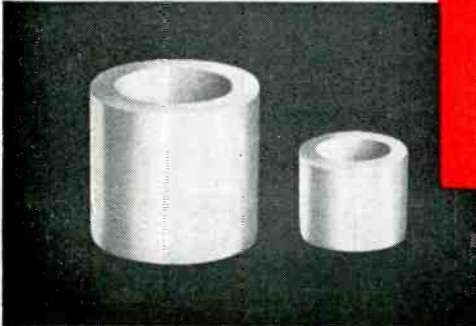
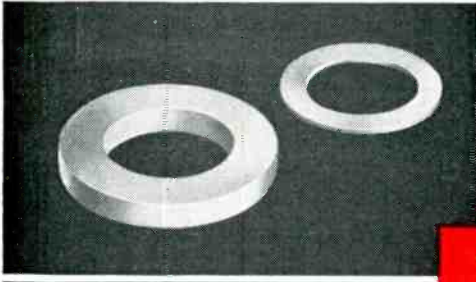
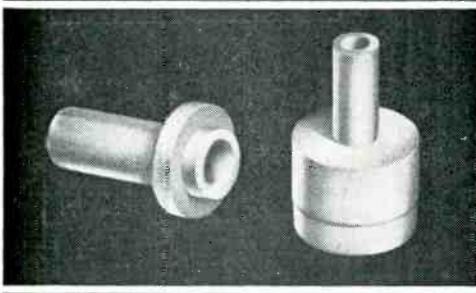
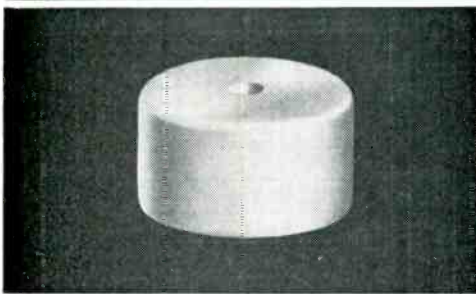
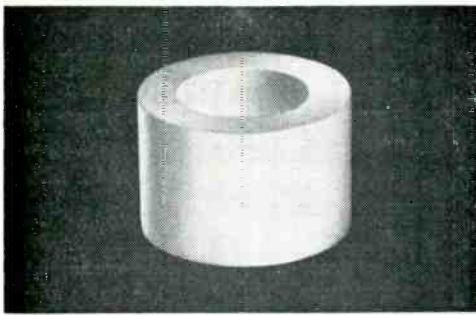

It is difficult to write about Teflon without appearing to exaggerate. For in many different ways this almost magic plastic—the most important derivative of the new wonder chemical fluorocarbon—is making the seemingly impossible possible. Parts made of R/M Teflon have already brought many startling improvements to the electronics and electrical manufacturing fields. And everyone working with it senses that the surface has barely been scratched—that hundreds of applications remain to be revealed.

There undoubtedly are ways in which Teflon can be profitably put to use in your own plant. So we have this suggestion to make to you: consider the properties of Teflon listed below—then get in touch with us if you think that any of them might make a contribution to your operation. We will fabricate parts to your own specifications or supply you with Teflon in the form of rods, sheets, tubes or tape.

Properties

High resistance to acids and gases even at high temperatures • Moisture absorption zero • Unaffected by weather • Excellent heat stability up to 500°F. in continuous operation • As tape, leaves no carbon residue along discharge path • High impact resistance • Nonadhesive • Stretches easily • Tensile strength 1500-2500 psi

**Du Pont's trade-mark for its tetrafluoroethylene resin*



RAYBESTOS-MANHATTAN, INC.

ASBESTOS TEXTILE DIVISION

MANHEIM, PA.

FACTORIES: Manheim, Pa.; No. Charleston, S. C.; Passaic, N. J.; Neenah, Wis.; Crawfordsville, Ind.; Peterborough, Ontario, Canada

RAYBESTOS-MANHATTAN, INC., Asbestos Textile • Packings • Brake Linings • Brake Blocks • Clutch Facings • Fan Belts • Radiator Hose • Rubber Covered Equipment • Industrial Rubber, Engineered Plastic, and Sintered Metal Products • Abrasive and Diamond Wheels • Bowling Balls

... for aircraft

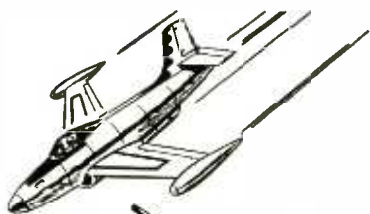

... for gunfire control



... for
servo-mechanisms

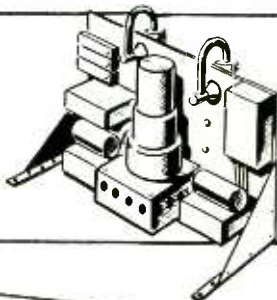

get the
facts about



PRECISION POTENTIOMETERS

For prompt service on prototypes that meet your specifications, get in touch with Gamewell.

Linear and non-linear Gamewell Precision Potentiometers can be made to meet your exact requirements. And they are made by a firm with over 98 years of experience in the manufacture of precision electrical products.

Write today for a copy of the Gamewell Precision Potentiometer booklet. It contains a convenient glossary of terms used in working with precision potentiometers.

THE GAMEWELL COMPANY
NEWTON UPPER FALLS 64, MASSACHUSETTS



GAMEWELL



PRECISION POTENTIOMETERS

Manufacturers of precision electrical equipment since 1855

clip-on type found in most radio receivers. In order to hold capacitance and inductance values to a minimum, the clip was cut off leaving only the screw shell and solder lugs.

The uhf power meter may be used for quantitative measurements or calibration curves can be plotted from various meter readings and power inputs to the miniature lamp bulbs used. A curve for the unit described, operating with a type 48 lamp, is shown in Fig. 2. A wide range of low-power inputs is available with the few lamps tested.

In operation, sensitivity control P_1 should initially be at its highest value placing all the resistance in the circuit to protect the meter.

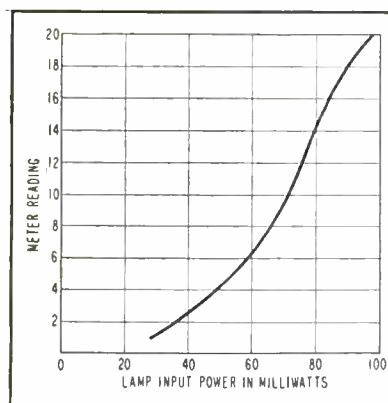
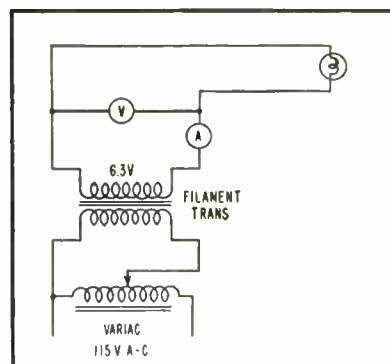

FIG. 2—Calibration curve using lamp type 48 in uhf power meter

When making quantitative measurements, the power meter is coupled to the apparatus to be tested and the control is turned to increase meter indication results. The coupling loop is removed and the known power source connected in place. The setting of the sensitivity control of the power meter must not be disturbed after being set. Care should be exercised to make certain at this point that all



Alternate circuit that can be used for power calibration

Bomac

SILICON DIODES

Bomac Silicon Diodes are manufactured to exceptionally high standards to assure electrical uniformity and mechanical stability. New design considerations and improved manufacturing techniques have resulted in X- and S-band crystals of increased burnout resistance and higher humidity resistance.

- TOP PERFORMANCE
- UNIFORMITY
- STABILITY

Band	Type	Freq. (MC)	Max. Conversion Loss db	Noise Ratio (Times)	Max. VSWR	IF Impedance (Ohms)
S	1N21B	3060	6.5	2.0	—	—
S	1N21BR	3060	6.5	2.0	—	—
S	1N21C	3060	5.5	1.5	—	—
S	1N21CR	3060	5.5	1.5	—	—
X	1N23B	9375	6.5	2.7	—	—
X	1N23BR	9375	6.5	2.7	—	—
X	1N23C	9375	6.0	2.0	1.50	325-475
X	1N23CR	9375	6.0	2.0	1.50	325-475
X	1N149	9375	5.5	1.5	1.25	325-475
X	1N23D	9375	5.0	1.7	1.25	350-450
X	1N23DR	9375	5.0	1.7	1.25	350-450

The above diodes may be supplied in pairs wherever their characteristics are matched as follows:

Conversion Loss $\pm 10\%$
 IF Impedance ± 15 ohms
 Rectified Current $\pm 10\%$
 RF Impedance (VSWR) Such that unbalance $\leq 10\%$ of available power

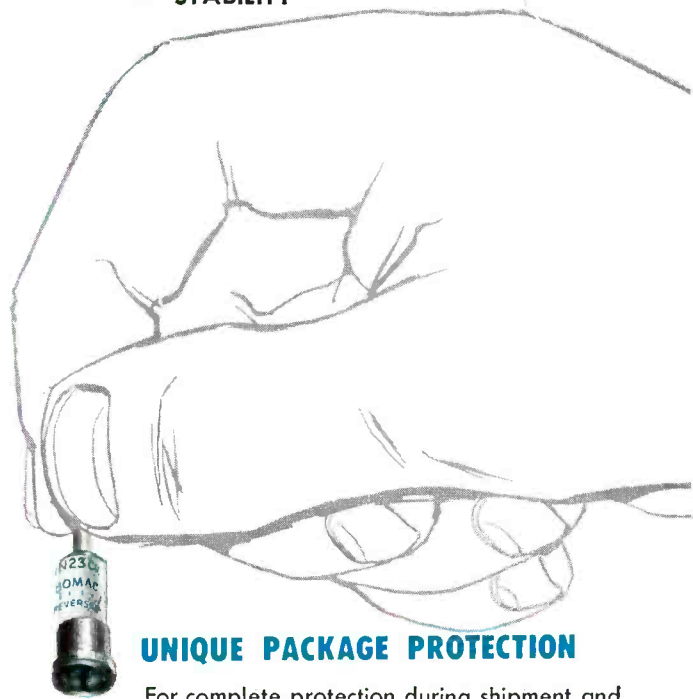

UNIQUE PACKAGE PROTECTION

For complete protection during shipment and storage Bomac has designed a reusable RF Protective Package* which conforms with MIL-E1B specification. Diodes stored in this package are completely protected no matter how many times they are handled after the original seal is broken.

*Pat. applied for

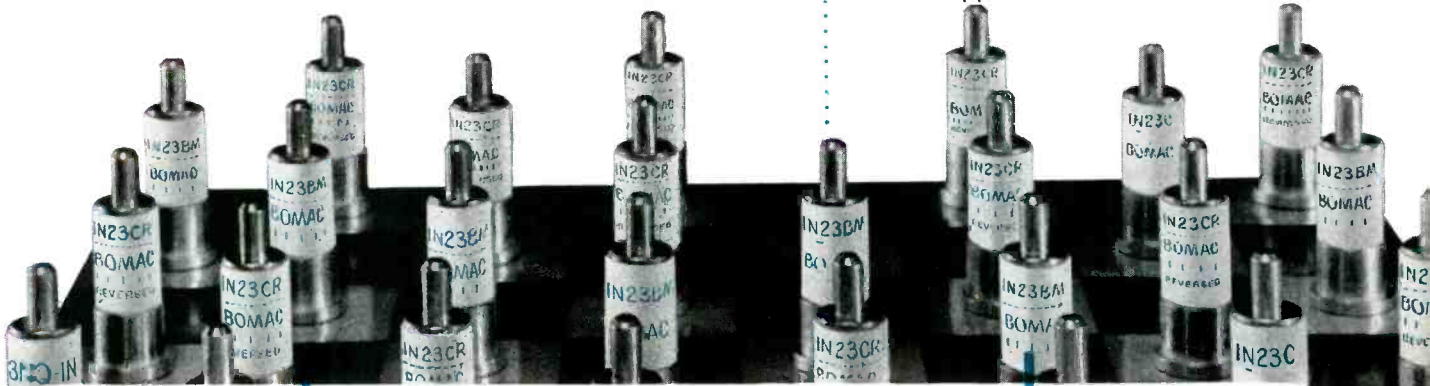

We invite your inquiries regarding

- ENGINEERING
- DEVELOPMENT
- PRODUCTION

Bomac Laboratories, Inc.

BEVERLY, MASSACHUSETTS

GAS SWITCHING TUBES · DIODES · HYDROGEN THYRATRONS · DUPLEXERS · MAGNETRONS
 MODULATORS · CAVITIES

Catalog on request.
 Write (on your company letterhead)
 Dept. E-11 BOMAC
 Laboratories, Inc.
 Beverly, Mass.

the resistance of potentiometer P_1 , in the power source is in the circuit.

The resistance of P_2 is then decreased until the meter produces the same reading as was obtained when the power meter was coupled to the oscillator or amplifier being measured. The power input to the lamp and therefore the r-f power output picked up from the circuit under test, is equivalent to the product of the voltmeter and ammeter readings in the known power source circuit.

Table I—Lamp Power Inputs

Lamp 46 Blue Bead			
Volts	Amps	Watts	Milliwatts
6	0.260	1.56	
5	0.210	1.2	
4	0.220		880
3	0.180		540
2	0.110		280
1	0.100		100
Lamp 41 White Bead			
Volts	Amps	Watts	Milliwatts
2.5	0.50	1.25	
1.5	0.40		600
0.5	0.26		130
Lamp 42 Green Bead			
Volts	Amps	Watts	Milliwatts
3.2	0.35	1.12	
2.2	0.28		616
1.2	0.20		240
Lamp 40 Brown Bead			
Volts	Amps	Watts	Milliwatts
6	0.160		960
5	0.140		700
4	0.120		480
3	0.100		300
2	0.080		160
1	0.060		60
Lamp 48 Pink Bead			
Volts	Amps	Watts	Milliwatts
2	0.060		120
1.8	0.050		90
1.7	0.019		83
1.6	0.017		75
1.5	0.016		69
1.3	0.012		55
1.0	0.038		38
0.8	0.035		28

To calibrate the power meter for various type lamps, the unit is connected to the known power source with sensitivity control P_1 set as before. The power-source control P_2 is then adjusted until the voltmeter and ammeter indicate that the lamp is running at rated power. Sensitivity control P_1 is then adjusted for maximum reading on the meter and the meter reading and power input to the lamp are recorded. No further adjustment of P_1 should be made during the cali-

CUT

YOUR COIL

PRODUCTION

COSTS

with

PRECISION

COIL

BOBBINS



Our special machinery and high production methods work in combination with rigid quality control to provide you with the finest in coil bobbins at lowest possible cost.

Your specifications are met to the most critical tolerances. Workmanship is precise and carefully inspected. You can order in quantity, in any size or shape, flanges of all types, and be sure of uniformity throughout. Only fine dielectric materials are used—kraft, fish paper, acetate, phenol impregnated or combinations.

With Precision Bobbins you eliminate rejects, waste, loss of time—get better coils at less cost. Prove it to yourself! Send specifications for samples. Ask for literature.

PRECISION LOW COST PAPER TUBES



Order in any length, size, shape, I.D. or O.D. and in any quantity. Precision Paper Tubes are crush resistant and light weight, with excellent dimensional stability. They are fabricated to the same high standards governing Precision Bobbins.

Send for samples and Arbor List of over 2000 sizes

Sales Representatives in:

New England:
Framingham, Massachusetts, Framingham 7091
Metropolitan New York, New Jersey:
Jersey City, New Jersey, Journal Square 4-3574
Upstate New York:
Syracuse, New York, Syracuse 76-8056
Northern Ohio, Western Pennsylvania:
Cleveland, Ohio, Atlantic 1-1060
Indiana, Southern Ohio:
Logansport, Indiana, Logansport 2555

Missouri, Southern Illinois, Iowa:
St. Louis, Missouri, Sterling 2318
Maryland:
Baltimore, Maryland, Plaza 2-3211
Philadelphia, Camden:
Philadelphia, Pa., Chestnut Hill 8-0282
California:
Pasadena, California, Sycamore 8-3919
Canada:
Montreal, Quebec, Canada, Walnut 2715



PRECISION PAPER TUBE CO.

2041 W. CHARLESTON ST.

CHICAGO 47, ILL.

Plant No. 2: 79 Chapel St., Hartford, Conn.

Keystone announces...

a new tubeless
MOTO MAG

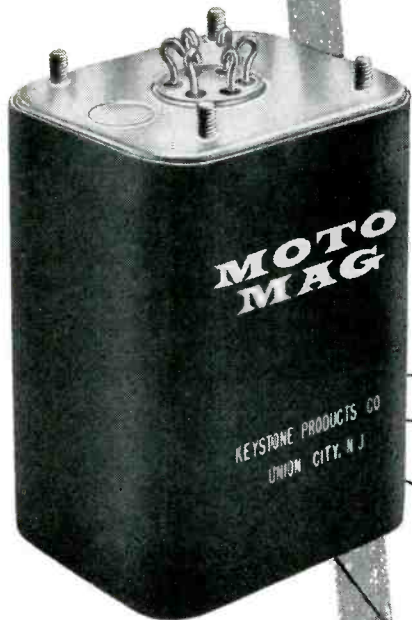

Now, from the world's leading producer of magnetic amplifiers... a new tubeless two-stage magnetic amplifier of saturable transformer type

3 3/8" high x 2 1/4" deep x 2 5/8" wide • mounting dimensions 1 5/8" x 1 3/4" chassis cutout 1" diameter weight 1 3/4 lbs.

remote control devices

computers

positioning servos

any 2-phase motor

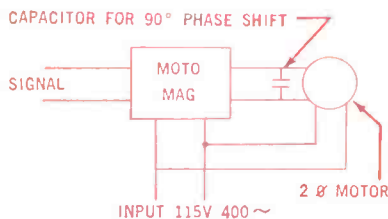

power input 115 volts 400 cycles
output 115 volts 6 watts
AC phase reversible • output at zero signal 1.5 volts maximum
signal for full output 800 microamps • control circuit resistance 2800 ohms • response 63% .06 seconds • phasing capacitor .4 microfarads
temperature range -40°C. to +100°C. • AC control available on special order

Newest members of the famous MOTO MAG family, these improved models offer several unique advantages:

- In many applications they eliminate use of a pre-amplifier
- Smaller size — fit into more installations
- Operate on a smaller signal
- Self-contained phase detector
- Incorporate high-temperature germanium diodes for high operating temperatures

These hermetically sealed units provide precision variable phase power control with a minimum of size and weight. Six standard models available — each can be quickly and economically adapted to meet your individual specifications.

PRICES:

1-24, \$58 ea.; 25-49, \$40 ea.; 50-99, \$35 ea.; 100-299, \$32 ea.; 300-499, \$30 ea.; 500-999, \$28 ea.; 1000-2500, \$27 ea.

Write today for complete specifications, performance data, and quotes to meet your specific application.

keystone



PRODUCTS COMPANY

908 23RD. STREET • UNION CITY, 2. N. J. • UNION 6-5400

CONTI



Precision WHEATSTONE BRIDGES

Highest Accuracy... Minimum Size for Field, Lab, and Production Use

There's a Shallcross Bridge for measuring resistance to any desired precision—indoors or out. Field models have aluminum cases with controls easily adjustable even with a gloved hand. Models for lab, production, and school use feature high readability and simple operation—even for unskilled users.

Accuracy, Stability, and Ruggedness—unsurpassed in any instrument of comparable price.

Selections from the complete Shallcross line are described below. Additional specifications on these, and many other types, are available from SHALLCROSS MFG. CO., 522 Pusey Ave., Collingdale, Pa.

WHEATSTONE—FAULT LOCATION BRIDGE No. 6100: 5-dial field model. Locates grounds, crosses, opens, and shorts by Murray, Varley, Hilborn, or Fisher Loop and Capacitance tests. Range: 1 to 1,011,000 ohms. Accuracy: $\pm 0.1\%$, $+ 0.01$ ohm. $8\frac{7}{8}'' \times 7\frac{3}{8}'' \times 5\frac{3}{4}''$. 8 lbs. Price: \$175.

KELVIN-WHEATSTONE BRIDGE No. 638-R: Shallcross has pioneered this compact combination of two bridges in one. Range: 0.001 to 11,110,000 ohms. Accuracy: $\pm 0.3\%$ - 1 to 111,100 ohms. $12\frac{1}{2}'' \times 10\frac{1}{2}'' \times 6\frac{3}{4}''$. 9 lbs. Price: \$260.

WHEATSTONE-LIMIT BRIDGE No. 6320: Combines 5-dial Wheatstone and Percent-Limit features. Range: 0.1 to 111,110,000 ohms. Accuracy—Ratio resistors: $\pm .01\%$, Rheostat: $\pm (.01\%$ to $.05\% + .005$ ohms). $15\frac{3}{4}'' \times 9\frac{1}{4}'' \times 5\frac{1}{2}''$. 15 lbs. Price: \$700.

Deliveries
from
Stock

Shallcross

brating procedure and the dial reading of this control is recorded along with each plotted curve. As many lower power inputs and meter readings may now be taken as necessary to plot a curve for this particular lamp.

A curve may also be plotted by reversing the above procedure. That is, hold the dial reading of the sensitivity control P_1 at maximum, which removes all the resistance of this control from the circuit, and starting with minimum setting of P_2 , increase this control, thereby increasing the power input to the lamp, until a readable indication is observed on the meter. Numerous inputs and meter readings may then be recorded in this way, up to the maximum of the meter scale.

Each coupling loop should be cut and tuned to resonance at the frequency of the oscillator or amplifier being measured. Tuning can be done capacitively, with a shorting bar, or otherwise.

Accurate Beat-Frequency Measurements

BY H. M. SCHLICKE

*Consultant Engineer
Allen-Bradley Co.
Milwaukee, Wis.*

MEASURING FREQUENCY DRIFT by the beat-frequency method is potentially extremely accurate. The relative accuracy, denoted by the significant digits within the order of magnitude, may be off several hundred percent under certain unfavorable conditions unless corrections are made. These deviations are larger as the beats become less symmetrical.

The reason for this error is the inherent indeterminacy of every self-excited oscillator whose frequency is conditioned upon the phase relation of the feedback path. In spite of buffer stages and shielding, a small amplitude of the reference frequency will intrude in the oscillator under the test. A non-linearity, necessarily present for amplitude limitation of the oscillator, will produce a difference frequency whose vector rotates about

**Uniformity
Ruggedness
Reliability
make the**



MACHLETT 2C39A

**Preferred Choice of Equipment Manufacturers,
Military and Commercial Users**

**New Standard for
Electrical Uniformity**

The ML-2C39A sets the highest standard of electrical uniformity for UHF planar triodes.

Close tolerance parallelism between electrodes prevents uneven heating at high frequencies, minimizes arcing.

Uniquely processed grid, mechanically stable at high temperatures, assures frequency stability over broadest range of operating conditions.

Machined emitter surfaces with extremely uniform oxide deposit assure optimum cathode emission as well as freedom from uneven, grid distorting, heat.

400% More Rugged

Average strength of the ML-2C39A is over 400% greater than *any other* 2C39A, as measured in torque and pry tests.

Unmatched Reliability

Quality in design, materials, and production techniques build superior reliability into the ML-2C39A.

Final inspection includes r-f oscillation in both test oscillators, and prototypes of field equipments, to assure tubes of high power output and long, trouble-free life.

**Electrical Characteristics
of ML-2C39A***

Heater voltage, 6.3 volts	Grid-plate capacitance, 2.0 uuf
Amplification factor, 100	Maximum frequency, 2500 mc/sec
Transconductance, 22,000 umhos	Useful power output, 12-35 watts

*Manufactured to JAN specifications.

Also made by Machlett to highest quality specifications: ML-381 for pulsed applications (3500 V peak; 3 microsecond pulse; 1/2% duty cycle) and the ML-322 clipper diode.

**For complete data write to:
MACHLETT LABORATORIES, INC.
Springdale, Connecticut**



Over 55 years of electron tube experience!

BALLANTINE

STILL THE FINEST IN ELECTRONIC VOLTMETERS



Ballantine Model 300
SENSITIVE
ELECTRONIC
VOLTMETER
 Featuring a Logarithmic
 Voltage Scale and
 Uniform Decibel Scale

PRICE... \$210.

- Measures 1 millivolt to 100 volts over a frequency range from 10 to 150,000 cycles on a single logarithmic scale by means of a five decade range selector switch.
- Accuracy: 2% at any point on the scale over the ENTIRE RANGE.
- Input Impedance: 1/2 megohm shunted by 30 mmfds.
- Generous use of negative feedback assures customary Ballantine stability.
- Output jack and output control permit voltmeter to be used as a flat high gain (70DB) amplifier.
- Available accessories permit range to be extended up to 10,000 volts and down to 20 microvolts.
- Available Precision Shunt Resistors convert voltmeter to microammeter covering range from 1 to 1000 microamperes.

For additional information on this Voltmeter and Ballantine Battery Operated Voltmeters, Wide-Band Voltmeters, Peak to Peak Voltmeters, Decade Amplifiers, Inverters, Multipliers and Precision Shunt Resistors, write for catalog.

BALLANTINE LABORATORIES, INC.

100 FANNY ROAD, BOONTON, NEW JERSEY



the vector of the oscillator frequency. Since this changes the phase condition, the oscillator is quite nonuniform.

The momentary circumferential velocity is proportional to the difference of the interfering reference frequency and the momentary

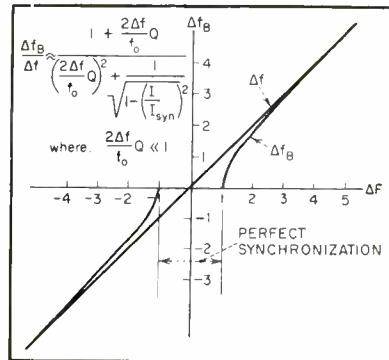

FIG. 1—Relationship of Δf and Δf_b in terms of half the bandwidth of synchronization range

frequency of the oscillator conditioned by the momentary vector addition of oscillator and difference frequency. The resulting distorted beat frequency may have any value between zero (complete synchronization) and the actual difference of the two oscillators having no interaction. In other words, the beat frequency Δf_b is not identical with the actual difference frequency Δf .

Figure 1 shows the correlation between Δf and ΔB . The units are expressed in terms of Δf of half the bandwidth of the range of synchronization, depending primarily on the ratio of two amplitudes of the difference frequency, namely the actual I and the one required for synchronization I_{SYN} . These two quantities are not required to be known if properly converted to the

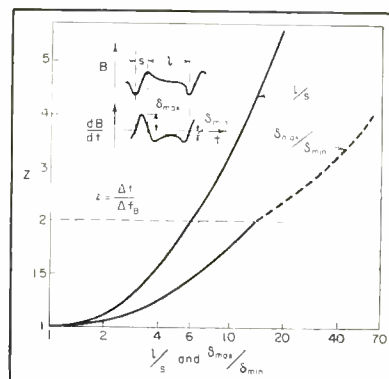

FIG. 2—Measurement of portions of waveform as described in text gives correction factor for obtaining actual beat-frequency difference

NEW

HUGHES

MINIATURE

GOLD JUNCTION*

GERMANIUM

DIODES

High Forward Conductance

High Back Resistance

Excellent Transient Response

Stable Characteristics

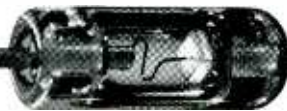

Actual size, diode body: 0.265 by 0.130 inches, maximum.

Developmental gold junction diodes have been made at Hughes for some time. Their commercial introduction, however, has been withheld until stability equal to that of the reliable Hughes Point-Contact devices was firmly established. Now, these superior diodes, in a variety of types, are available to meet your particular requirements. They combine high forward conductance with high back resistance—characteristics necessary for many circuit applications—yet offer the *assured*

reliability that has made Hughes Diodes the standard. Like the *original* Fusion-Scaled Germanium Diodes, the new line of Miniature Gold Junction Diodes is housed in the famous Hughes one-piece glass body—impervious to moisture, fumes, and external contaminating agents. This means that you can specify—and confidently use—these Gold Junction Diodes in applications such as magnetic amplifier circuits . . . clamps . . . d-c restorers . . . logical gate circuits.

The ORIGINAL Glass-Body, Fusion-Sealed Germanium Diodes.

* These are true junction diodes, with the miniature junction being formed by manufacturing processes at the end of the catwhisker. The envelope is the same sub-miniature package used in Hughes Point-Contact Diodes.

Hughes

SEMICONDUCTOR SALES DEPARTMENT

Aircraft Company, Culver City, Calif.



New York Chicago

Simul-Scopic* Signals

TAKE THE GUESSWORK OUT OF SCOPES

It's all done by combining any number of electron guns up to ten in a single cathode ray tube. Then, when you have to measure simultaneous phenomena, you've actually got a number of oscilloscopes in one—all operating continuously without the disadvantages of electronic-switching or an optical system. And only ETC multi-channel scopes and multi-gun tubes make Simul-Scopic signals available to meet such a wide variety of individual needs.



MULTI-CHANNEL SCOPES

... with the combination you need of band width, gain, sensitivity, frequency response, with or without film strip recording. Separate intensity, focus, and axes controls for each channel.



MULTI-GUN TUBES

... with 2 to 10 guns ... round or square face ... 3 to 12 inches. Special purpose tubes made to specification, including every type capable of commercial manufacture.



THIS FREE CATALOG

... entitled "Oscillography—Key To The Unknown", shows why there is no other equipment so easy to use, so comprehensive in its presentation, and so economically practical for simultaneous oscillography. Write for your copy.

***Simul-Scopic** — Two or more simultaneous events which can be observed on a cathode ray tube (Reg. Applied for)

ETC

electronic tube corporation

1200 E. MERMAID LANE, PHILADELPHIA 18, PA.

readily obtainable magnitudes shown in Fig. 2.

The simplest procedure is to avoid the necessity of correction by making the measurements far off the region of unsymmetry (keep away from range of synchronization).

In many practical cases, operation in regions of distorted beats cannot be prevented. Depending on the measure of distortion, two methods may be used.

Measure and compare the long falling-off part l with the short ascending part, s , of the beats, as shown in Fig. 2 and multiply the measured beat frequency Δf_b by z to obtain actual difference frequency Δf .

For small unsymmetry the beats may be differentiated. This can be done graphically or electrically. The ratio of the maximum positive slope and the minimum negative slope permit also the reading of z from Fig. 2. This second method, however, is only applicable when the beats are derived directly from the grid circuit of the oscillator under test.

Example

The frequency drift of a transmitter is to be determined. First reading: $\Delta f_b = 1,750$ cps; $l/s = 2.1$. Reading after 5 min: $\Delta f_b = 500$ cps; $l/s = 7.7$. Without correction the frequency drift would have been read $1,750$ cps $- 500$ cps = $1,250$ cps. By using the correction factors from Fig. 2, however, the actual frequency drift is found to be $1,750$ cps $\times 1.13 - 500$ cps $\times 2.5 = 730$ cps.

Four-Megawatt Klystron

HIGH-POWER KLYSTRON amplifier developed by Sperry for the Air Force (Rome Air Development Center) is designed to power an advanced type of radar. Eight feet tall, the new tube produces four megawatts of power. Frequency control is claimed by Air Force scientists to be 20 to 200 times closer than the frequency limits of ordinary radio or tv transmitters.

Concentration of electrons into the beam that passes through the rhumbatrons (hollow copper doughnuts) by a special focusing

now!

BENDIX·SCINFLEX

waterproof plugs

*for use with
multi-conductor
cables*



These new Bendix*·Scinflex *waterproof* plugs are a modification of our standard AN type "E" (environment resistant) connector. They are designed to meet all "E" performance requirements when used with multi-conductor cables. Each plug includes a modified AN3057B cable clamp which provides inward radial compression on multi-conductor cables. This unique feature completely eliminates cable strain—a common source of circuit trouble.

In addition, there are gaskets at all mating surfaces and an accessory sleeve is available to accommodate an extreme range of cable sizes. A folder describing this new waterproof plug—and the various sizes in which it is manufactured—may be obtained by writing our Sales Department.

* TRADE MARK

THESE BUILT-IN FEATURES ASSURE TOP PROTECTION AGAINST CIRCUIT FAILURE:

Shock and Vibration Resistant • Die Cast Aluminum Shell
• Cadmium Plate—Olive Drab Finish • Moisture-Proof,
Pressurized • High Arc Resistance, High Dielectric
Strength • Silver-Plated Contacts • Resilient Inserts

SCINTILLA DIVISION

Bendix
AVIATION CORPORATION

SIDNEY, NEW YORK

Export Sales: Bendix International Division
205 East 42nd St., New York 17, N. Y.

Factory Branch Offices: 117 E. Providencia Avenue, Burbank, California • Brouwer Building, 176 W. Wisconsin Avenue, Milwaukee, Wisconsin • Stephenson Building, 6560 Cass Avenue, Detroit 2, Michigan • 512 West Avenue, Jenkintown, Pennsylvania • 8401 Cedar Springs Rd., Dallas 19, Texas • American Building, 4 South Main Street, Dayton 2, Ohio

Bendix

**Save Time, Reduce Errors...
Determine and Record Data
Automatically with These Two
Versatile Berkeley Instruments**



Model 5510 Universal Counter and Timer offers direct-reading digital display of count, frequency or microsecond time interval. Time bases from 1 mc. to 1 cps; gate times from .00001 to 10 sec. Accuracy ± 1 count, \pm crystal stability (1 part in 10^6). Price \$1,100.00 f.a.b. factory.

1. **UNIVERSAL COUNTER AND TIMER, Model 5510**, combines the functions of four instruments in one single, compact unit. It will:

- a. Count at speeds to 1 million per second.
- b. Count events occurring during a selectable, precise time interval.
- c. Measure time intervals in 1 microsecond increments, from 3 microseconds to 1 million seconds.
- d. Determine frequencies or frequency ratios from 0 cps to 1 megacycle.
- e. Operate directly the BERKELEY printer (below), BERKELEY digital-to-analog converter, or BERKELEY data processor to drive IBM card punches, typewriters or teletype systems.

2. **BERKELEY DIGITAL RECORDER, Model 1452**, combines scanner and high speed printer in a single unit; prints up to 10 digits on standard adding machine tape. Can be modified to print "Time" or "Code" information simultaneously with count data on same tape.

Model 1452 prints 6 digits (8 or 10 on special order) on standard adding machine tape. Is only 19" wide x 10 1/2" high x 14" deep, weighs 60 lbs. Price, \$750.00 f.o.b. factory.

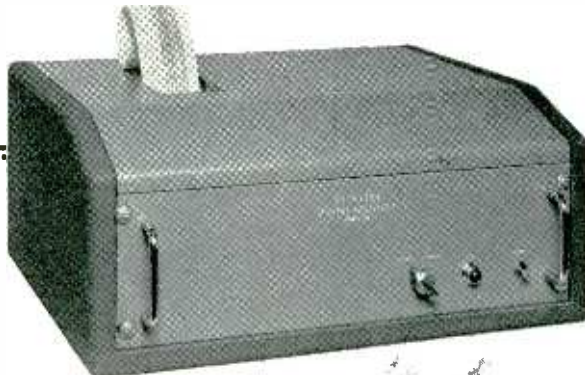

Write for complete specifications and data; please address Dept. G-11

Berkeley

division

BECKMAN INSTRUMENTS INC.
2208 WRIGHT AVE., RICHMOND, CALIF.

INDUSTRIAL INSTRUMENTATION AND CONTROL SYSTEMS • COMPUTERS • COUNTERS • TEST INSTRUMENTS • NUCLEAR SCALERS

method was made possible through the work of C. C. Wang and C. E. Rich. In a prototype unit, electrons are so tightly packed that a one-inch beam now transmits more current through a vacuum than a 1/8-inch copper wire can safely carry, according to Sperry engineers.



Tests show that the klystron has a power gain of 38 db. Plate efficiency of 43 percent has been measured with as high as four megawatts of peak power output. Research carried on from 1948 to 1950 has recently been declassified.

High-Speed Film Marker

By F. I. STRABALA

Edgerton, Germeshausen and Grier, Inc.
Boston, Mass.

NEON AND ARGON glow lamps have been used for some years to put timing markers on fast film with reasonably good results. However, slower films provide greater resolution, minimum grain and greater latitude of usable light levels and may be used successfully for high-speed photography when there is sufficient light available. Argon and neon glow lamps have not been found satisfactory when using slow film in a high-speed camera, as the marks produced are not dense enough and leading edges of the marks are difficult to ascertain, making accurate measurement difficult.

In the high-speed film marker, the light is produced by a spark gap rather than by a glow tube. The light emitted by the marker is



PERHAPS WE'LL HAVE TO ADD A PINCH, FOR YOU . . .

Just ask us for an alloy we haven't got — we'll be delighted.

Because that's how each of the more than 80 resistance and electronic alloys Driver-Harris makes had its beginning. Each of these highly specialized alloys is custom-made — produced exactly to the specifications of our customers.

The physical and chemical properties of an electrical resistance alloy can be altered greatly by a minute difference in its constituents. Often just a few ounces to the ton can make the difference you need.

One thing you can always rely on in any Driver-Harris alloy: it is made to the most precise metallurgical checks and controls known to the industry. It is these exclusive quality controls that have made Nichrome V and Nichrome* the standard for over 50 years by which all other electrical resistance alloys are measured.

Perhaps in a sense Nichrome is *too* well known. For we don't want people to forget that we make many other resistance alloys of sustained high quality to meet other special needs. And that, as we said at the outset, our engineers will be more than delighted to start afresh tomorrow to devise a new one, custom-made for you. Just tell us as exactly as you can what you wish to accomplish.



NICHROME V and NICHROME
are manufactured only by

**Driver-Harris
Company**

HARRISON, NEW JERSEY

**BRANCHES: Chicago, Detroit, Cleveland, Louisville,
Los Angeles, San Francisco**

**In Canada: The B. GREENING WIRE COMPANY, Ltd.,
Hamilton, Ontario.**

*T. M. Reg. U. S. Pat. Off.

MAKERS OF THE MOST COMPLETE LINE OF ELECTRIC HEATING, RESISTANCE, AND ELECTRONIC ALLOYS IN THE WORLD

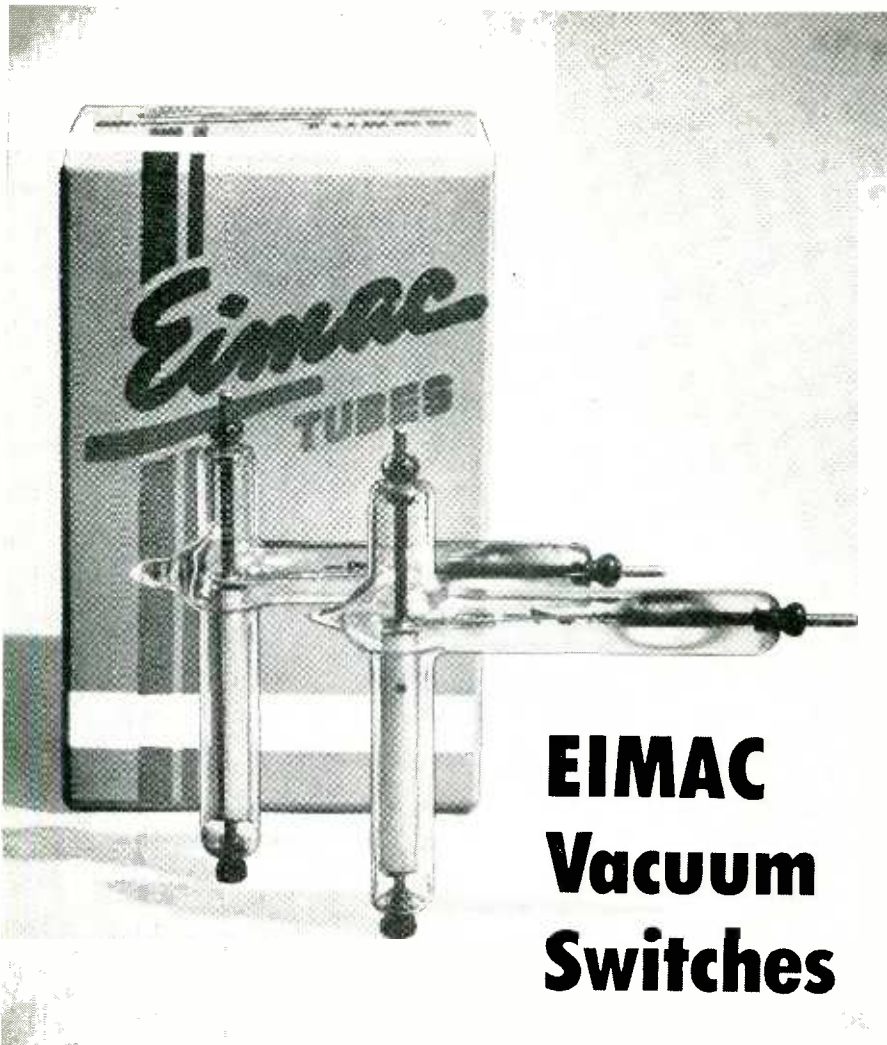

EIMAC Vacuum Switches

for high voltage, airborne service

Compact, fast action Eimac vacuum switches are custom designed for high voltage application. Single pole, double throw action contacts are precision spaced in high vacuum, permitting reliable performance regardless of ambient atmospheric conditions. In antenna switching service, RF peak potentials as high as 20kv may be applied between the switch terminals. Eimac vacuum switches are not limited to this service, however, as they will handle 1.5 amps at 5kv in DC switching. Efficient operation in severe airborne conditions, small size and instant response give these switches a distinct advantage over conventional relays. Now available are four Eimac switch types, including one for pulse service.

*For further information contact our
Application Engineering department*



EITEL-McCULLOUGH, INC.
SAN BRUNO, CALIFORNIA

The World's Largest Manufacturer of Transmitting Tubes

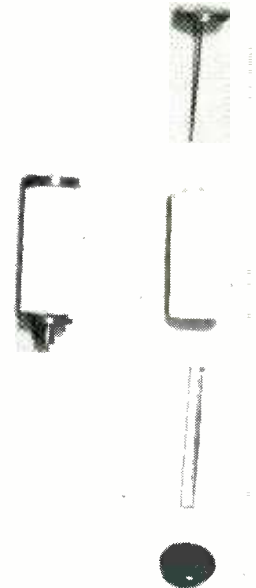

Assembly of spark-gap marker. Probe electrode is at top with outer and inner insulators below and ground electrode at bottom. Assembled unit is at left

bright enough to mark film with an ASA rating of one, or any faster film, very clearly with a spot about 0.020 inch diameter. Normally the marks are put on the film at a rate of 200 per second. From the spacing of the marks on the film, the velocity and acceleration of the film is determined.

The light to put the marks on the film is produced by a spark in a coaxial gap shown in Fig. 1 and in the photograph. The spark occurs between the probe electrode and the ground electrode. The spark, in jumping between the two electrodes, illuminates the film running

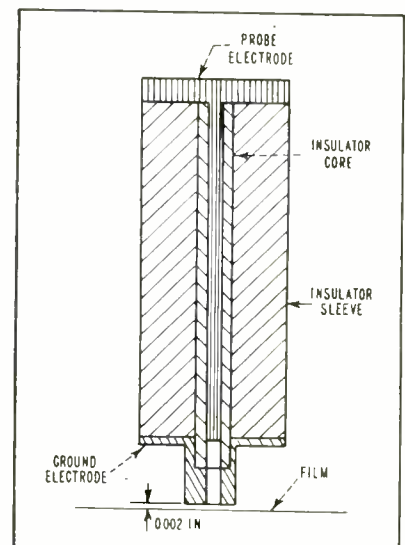
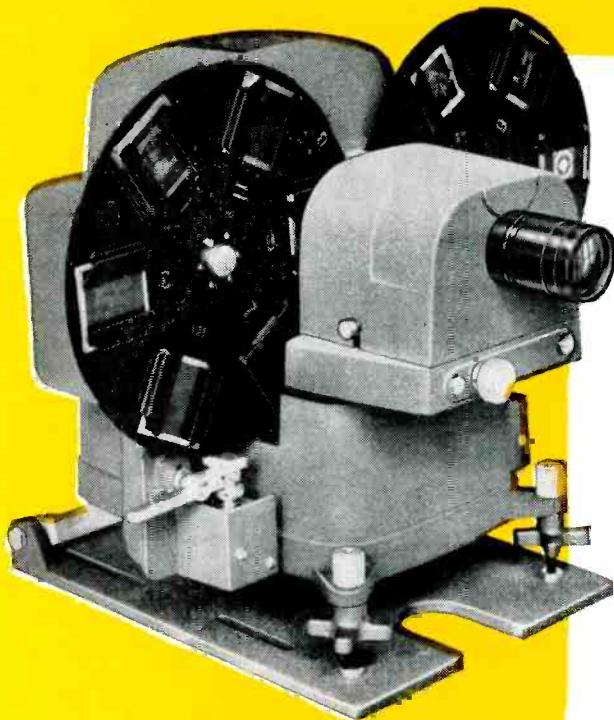

FIG. 1—Spark-gap marker for timing marks on slow-speed films

NEW SINGLE LENS

GRAY TELOJECTOR

STAR PERFORMER....



Complete Projection System

The New Gray 3B Telojector (2" x 2" Transparency Slide Projector) utilizes a single lens—permits superposing of two images on an optical axis... eliminates any need for external registration adjustment. The improved unit provides positive focusing of images on the camera tube with an uninterrupted sequence of slides for television commercials, news flashes and photographs or station and sponsors' identification.

**for TV
commercials**



Precision Projection

BETTER Commercials at **LOWER COST**

Yes... **now** you can use better 2" x 2" transparencies in uninterrupted sequence at lower cost. Important too, Gray Telojector is low in initial cost... ideal for budget-minded program directors. Telojector is compact, light weight, trouble-free. Two turrets take up to 12 slides at one loading. Additional loaded turrets are substituted in a matter of a few seconds... providing unlimited continual sequence. Controlled locally at the unit or remotely at the master video console. Also, can be used with the Gray 35B Manual Control Box to produce superposition, laps, fades and slide changes at any desired rate.

GRAY RESEARCH

AND DEVELOPMENT CO., Inc., Hilliard St., Manchester, Conn.
Division of the GRAY MANUFACTURING COMPANY
Originators of the Gray Telephone Pay Station and the
Gray Audiograph and PhonAudiograph.

WRITE FOR:

Illustrated, detailed information on the NEW, SINGLE LENS GRAY TELOJECTOR and complete line of Gray Television - Broadcasting Equipment.

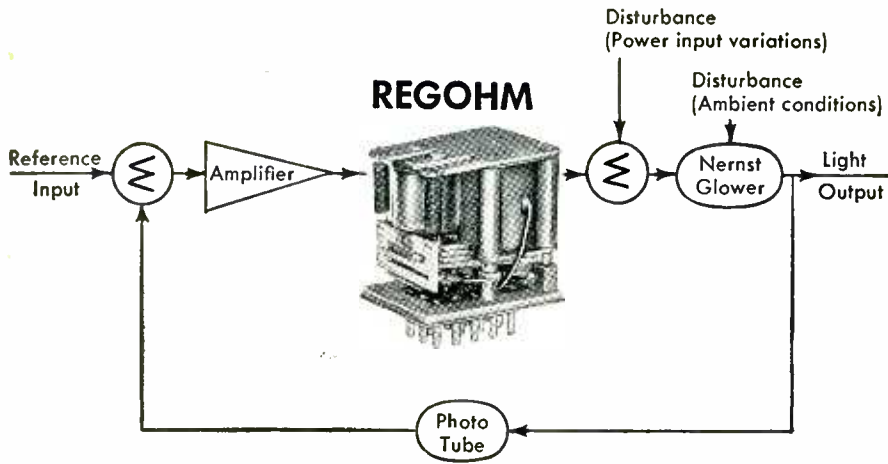

Regohm keeps radiation energy constant for new infrared spectrometers

Since infrared analysis must be able to record changes as slight as 1 part in a million of a chemical substance, the energy source must be kept constant. The above block diagram shows how Regohm does this for a Perkin-Elmer Infrared Spectrometer.

In most applications, Regohm directly senses what it controls. Here, however, Regohm serves as a power amplifier. A photo tube acts as the sensing device. Its output is electronically amplified, using a balanced DC amplifier to raise the power level of signal and eliminate the effects of drift.

The photo tube is constantly sensitive to changes from the Nernst glower by delivering current output proportional to changes in radiation. Output from the Reference Balanced Amplifier changes above and below fixed voltage.

Reacting to milliwatt output changes in the amplifier, Regohm produces large changes in power input to the Nernst glower. Hence, the Regohm circuit adjusts for all variations in source intensity, counteracting disturbance from power input changes and ambient temperature conditions. Regohm's dashpot stabilizes the control system.

Electric Regulator takes pride in the fact that high performance alone was the reason for P-E's choice of Regohm for equipment that is the "Cadillac" in its field.

7 Reasons why Regohm can simplify your control problem

- 1. Regohm is small in size**—It is compact, lightweight, position-free.
- 2. Regohm is a high-gain power amplifier**—Milliwatt variations in signal energy control energy changes millions of times greater.
- 3. Regohm's isolated signal and control circuits**



Assembling a Perkin-Elmer Infrared Spectrometer

eliminate impedance matching problems—Signal coils may have ratings from 0.01 to 350 amperes. Control resistance range unlimited.

4. Regohm will correct system instability—A reliable, sturdy dashpot aids system damping.

5. Regohm's effect can be calculated in advance—Its response is independent of rest of servo system.

6. Regohm assures continuous control—In "closed loop" systems a high-speed averaging effect occurs.

7. Regohm has long life—Plug-in feature simplifies replacement when necessary.

Regohm can be applied to your control system or regulation problem. Our engineering and research facilities are always at your service. Write for Bulletin 505.00, analyzing Regohm's characteristics and applications. Address Dept. E., Electric Regulator Corporation, Norwalk, Conn.

REGOHM



CONTROL COMPONENT IN: Servo systems • battery chargers • airborne controls • portable and stationary generators • marine radar • inverters • locomotive braking systems • mobile telephones • guided missiles • signal and alarm systems • telephone central station equipment • magnetic clutches • railroad communication systems • magnetic amplifiers.

about 0.005 inch from the end of the ground electrode. Since the gap is driven by a pulse of approximately 12,000 volts maximum amplitude, care must be taken to prevent arcing to ground at any other point than through the gap.

The driver unit is designed to produce marks on the film at a rate of 200 ± 0.001 percent a second with a jitter of less than two microseconds between any two successive marks.

A simplified schematic of the driver and its associated pulse transformers is shown in Fig. 2. A

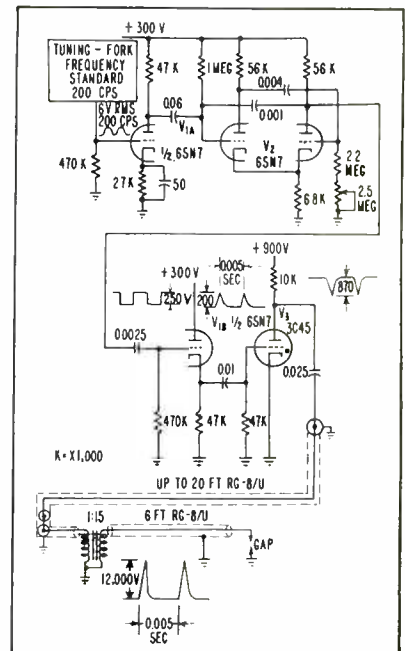

FIG. 2—Film-marker drive circuit uses tuning-fork frequency standard to trigger multivibrator

tuning-fork controlled oscillator is used as a frequency standard. The output of the oscillator is amplified by one section of V_{1A} . The output of the amplifier drives the multivibrator. This multivibrator is biased so that it will not operate unless driven by V_{1A} . Therefore the driver does not operate unless the frequency standard is controlling its input frequency.

The square-wave output of this multivibrator is applied to the cathode follower V_{1B} . Output from the cathode follower is differentiated and drives a 3C45 hydrogen thyratron. When the thyratron fires, it discharges the 0.025- μ f capacitor, charged to 900 volts, through the primary of the 1-to-15 pulse transformer. The secondary of the pulse

DEPEND UPON



FOR THE
ULTIMATE

in

ACCURATE PRECISION MULTITURN POTENTIOMETERS

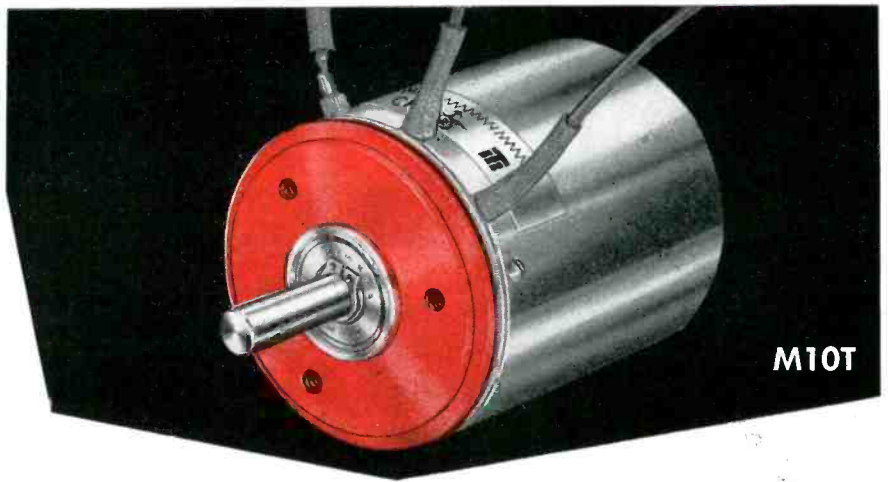

M10T

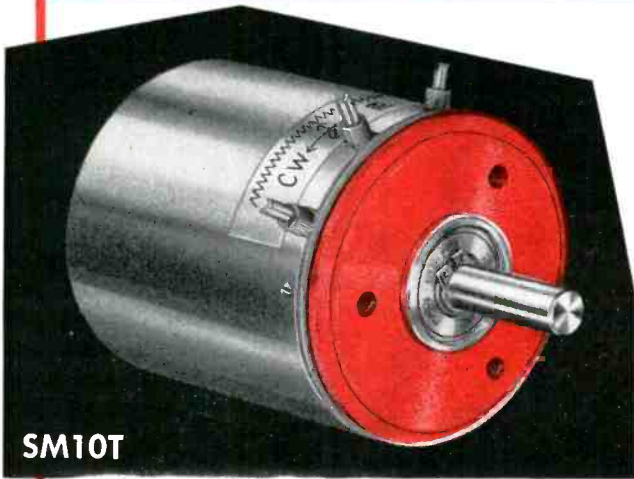

SM10T

TYPE SM10T Slide Wire Precision Multiturn Potentiometer with **INFINITE RESOLUTION** .05 % Linearity

Slide wire construction of resistance element firmly bonded to supporting drum. Essentially zero end resistance.

Res. Range: 0-1000 ohms \pm 5%
Ind. Linearity: \pm .05% standard

SPECIFICATIONS COMMON TO BOTH TYPES SM10T AND M10T

Effective Electrical Angle: $3600^\circ + 1^\circ - 0^\circ$
Ambient Temperature Range: -55°C to $+ 80^\circ\text{C}$

Base and Bearings: One-piece machined aluminum base houses spring-loaded ball bearings in a single through bore for rigid, low-friction shaft support.

Finish: Base is red alumilite, corrosion resistant per AN-QQ-A-696A. Cover stainless steel.

Mounting: Universal-type mounting offers choice of synchro or tapped hole mount with two high-precision pilots.

Shaft: Centerless ground stainless steel .2500" \pm .0000-.0003 diameter.

ELECTRICAL SPECIFICATIONS

Res. Range: 1,000 ohms to 10,000 ohms \pm 5%
Ind. Linearity: \pm .05% Std. \pm .025% or better, special.

ELECTRICAL

Equivalent Noise Res: 100 ohms maximum @ 4 rpm
Temperature Coeff. of Res. Wire: .00002 $^\circ$ /C nominal

MECHANICAL

Mechanical Angle between stops 3660°
Rotation: $\pm 2.5^\circ$

Stops: Rugged mechanical stops of lead screw type withstand torques exceeding 100 inch pounds.

Dimensions: Diameter 1.820", Length 2-1/16".

For full details write, wire or call

TECHNOLOGY INSTRUMENT CORP.

533 Main St., Acton, Mass.
C0lonial 2-7711

PLANTS .

11020 Sherman Way, Sun Valley, California
Mail Address — Box 3941, North Hollywood, Calif. POlar 5-8620

Jennings
RADIO[®]
 VACUUM ELECTRONIC COMPONENTS

**HIGHER
 CAPACITY
 OR**

**HIGHER
 FREQUENCY**



ECS

VMMC
 VMMHC

WHATEVER THE DESIGN REQUIREMENT
 for vacuum fixed or variable capacitors, JENNINGS can
 meet the need with a large selection of capacities, sizes,
 and voltage ratings.

High capacity units up to 5000 mmfd at 10 kv and 1000
 mmfd at 45 kv are now being made in both variable and
 fixed types.

Small vacuum capacitors such as the one shown above are
 currently being used in VHF and UHF applications. The ECS,
 for example, has capacity ranges of either 2 to 8 mmfd or
 3 to 30 mmfd and a voltage rating up to 15 kv.

*Send for our catalog summary describing over 300 types, sizes, and
 ratings of vacuum capacitors and switches.*

**JENNINGS RADIO MANUFACTURING CORPORATION • 970 McLAUGHLIN AVE.
 P.O. BOX 1278 • SAN JOSE 8, CALIFORNIA**

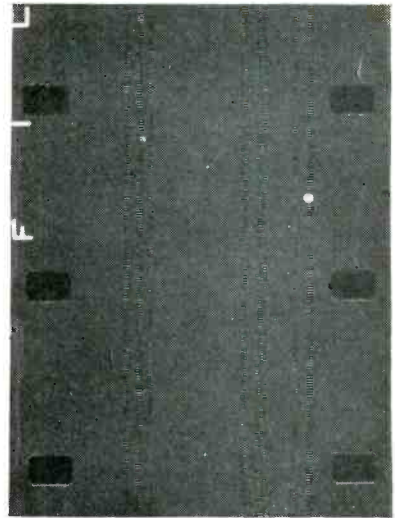
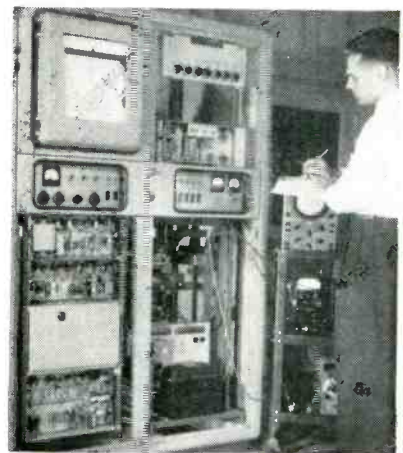

FIG. 3—Timing mark (white dot) re-
 corded on 16-mm film

transformer is connected by means
 of six feet of RG-8/U cable to the
 marker gap.

The length of the cable connect-
 ing the secondary of the pulse
 transformer to the gap is critical.
 Since the capacitance of the cable
 must be charged to the breakdown
 voltage of the gap, the cable length
 cannot be too great or the gap can-
 not be bridged and no arc occurs. If

Robot Speeds Oil Research



Laboratory technique employing a mass
 spectrometer at Baton Rouge, La., au-
 tomatically sorts and identifies oil mol-
 ecules for Esso research chemists. Such
 work was formerly done manually,
 which required obtaining samples and
 testing them individually. Adapted to
 operate as a robot, this electronic as-
 sembly now provides a continuous,
 graphic analysis of petroleum prod-
 ucts. The general approach is said to
 hold promise for future use in actual
 refinery operations

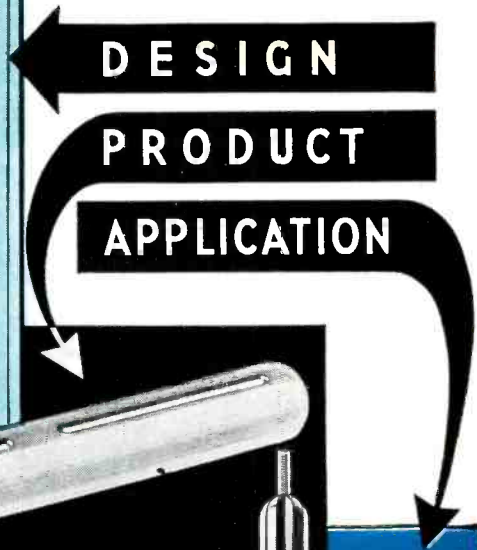
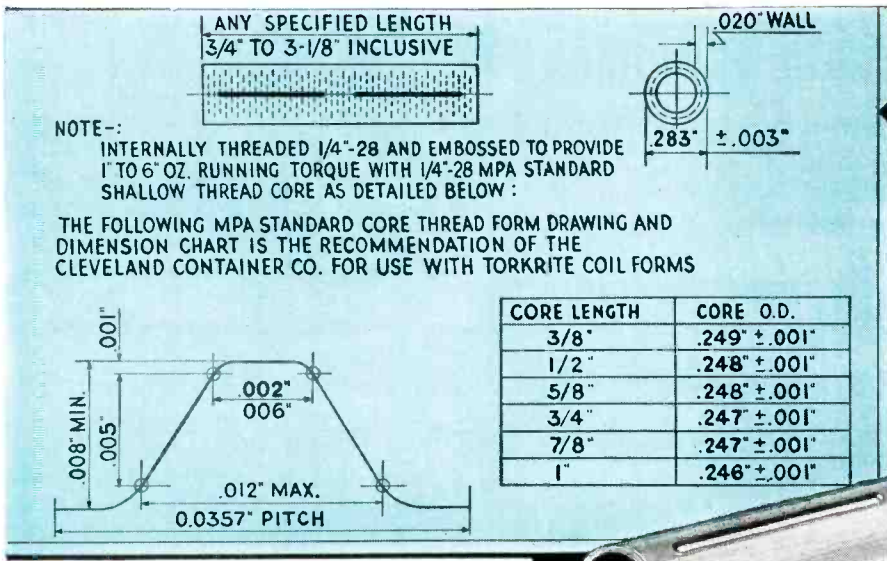

TORKRITE

BY THE MAKERS OF CLEVELITE* PHENOLIC TUBING
Torkrite coil forms eliminate torque and stripping problems and are rapidly replacing other coil forms because Torkrite:

- withstands more than required stripping pressure.
- requires no revision other than reduced winding arbor diameter.
- is round and concentric; winds coils at higher speed without wire breakage or fallen turns.
- permits use of lower torque since it is completely independent of stripping pressure.
- recycling ability is unmatched.
- is stronger mechanically because of heavier wall.
- provides 1-6" oz. running torque when used with MPA standard shallow thread core.
- has no holes or perforations thru tube wall which eliminates cement leakage locking cores.
- has smooth adjustment of core without lubricant.
- torque increases less after winding as heavier wall reduces any tendency to collapse and bind core.
- maximum stability results as core cannot move in relation to winding after peaking as it is engaged in internal threads.
- embossings are evenly spaced, with a lead at each end of the form to permit easy insertion of core.

INVESTIGATE this outstanding coil form.

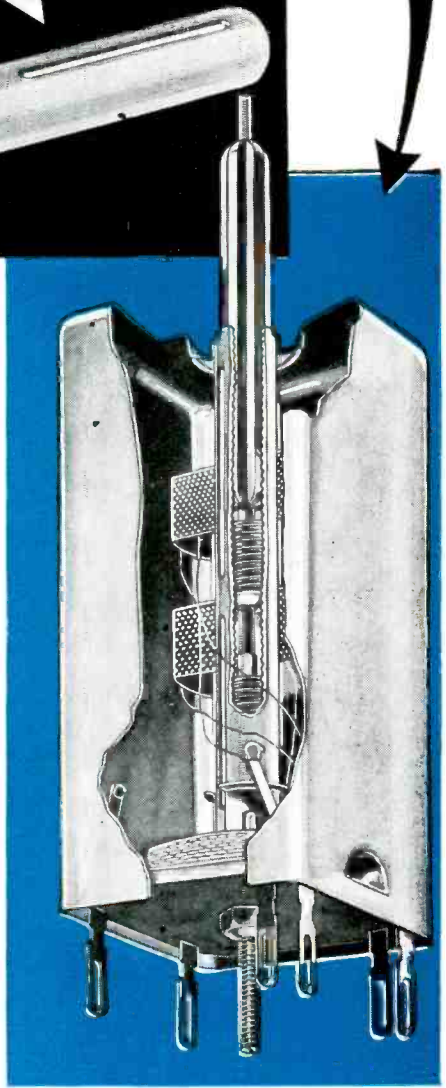

Why pay more? For good Quality . . . Call CLEVELAND!

Improved new Torkrite is now available in various diameter tubes. Lengths from 3/4" to 3-1/8" are made to fit 8-32, 10-32, 1/4-28 and 5/16-24 cores.

*Reg. U. S. Pat Off.

The CLEVELAND CONTAINER Co.
6201 BARBERTON AVE. CLEVELAND 2, OHIO

PLANTS AND SALES OFFICES at Chicago, Detroit, Memphis, Plymouth, Wisc., Ogdensburg, N. Y., Jamesburg, N. J.
ABRASIVE DIVISION at Cleveland, Ohio
CANADIAN PLANT: The Cleveland Container, Canada, Ltd., Prescott, Ontario

- REPRESENTATIVES
- NEW YORK AREA R. T. MURRAY, 604 CENTRAL AVE., EAST ORANGE, N. J.
 - NEW ENGLAND R. S. PETTIGREW & CO., 62 LA SALLE RD., WEST HARTFORD, CONN.
 - CHICAGO AREA PLASTIC TUBING SALES, 5215 N. RAVENSWOOD AVE., CHICAGO
 - WEST COAST IRV. M. COCHRANE CO., 408 S. ALVARADO ST., LOS ANGELES



for complex electronic equipment

ERCO

Engineering and Research Corp.
Riverdale, Maryland

chose

CHICAGO

THE WORLD'S TOUGHEST TRANSFORMERS

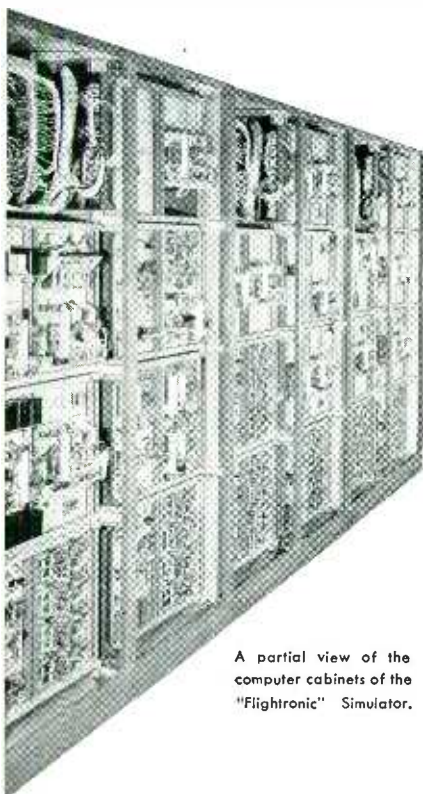

A partial view of the computer cabinets of the "Flightronic" Simulator.

The "Flightronic" Simulator, designed and produced by ERCO, trains Air Force pilots in cockpit checks, navigation, interception and emergency procedures of the famed F86D "Sabre" Jet Interceptor.

The "brains" of the Simulator are intricate computers containing complicated electronic and electro-mechanical systems. To insure accurate, uninterrupted duplication of flight conditions, only the most dependable components can be used. That's why ERCO chose CHICAGO transformers: to be sure of reliable, trouble-free service.



One of the many electronic units using CHICAGO transformers.

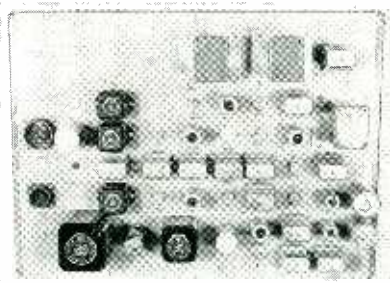

Despite the specialized nature of this equipment, all of the CHICAGO transformers used were shipped from stock. These transformers were all cataloged units, listed in CHICAGO Catalog CT-554 and available for immediate delivery. This valuable publication is available FREE from your CHICAGO distributor or from Chicago Standard Transformer Corporation.

CHICAGO STANDARD TRANSFORMER CORPORATION

ADDISON AND ELSTON
CHICAGO 18, ILLINOIS



EXPORT SALES:
Roburn Agencies, Inc.
431 Greenwich Street
New York 13, N. Y.

the cable is too short, the energy stored in the cable when the gap fires is not enough to produce the required amount of light. About six feet of RG-8/U cable has been found to be a good compromise between the two extremes. A shorter length of cable with a capacitor across the gap may also be used.

This marker gap with its driver has been used successfully to put timing marks on many types of film. It produces a small round dot on the film at 0.005 second intervals. The dot has sharp edges that allow accurate measurement. The light is confined to a small portion of the film outside the frame area and therefore it does not interfere with pictures being taken. Figure 3 shows an enlargement of the mark produced on 16-mm film operating at 2,000 frames per second. Tests have shown that the marks may be projected on the film through a lens to give even smaller spot sizes, but the space required for the installation is greater and a high-aperture lens must be used.

Improved Recording Heads

ALFENOL, a magnetic material previously described (ELECTRONICS, p 222, August 1953) has been successfully applied to magnetic recording and reproducing heads.

The material possesses extreme physical hardness while, at the same time, being magnetically soft. Since it is produced in a cold-rolled sheet, heads can be fabricated from it in conventional stacked laminated form. Other advantages include high electrical resistivity and lack of permeability loss under physical strain imposed in normal fabrication techniques.

There are no measurable eddy-current losses up to the testing limit of 60 kc. Recording units show a reduction of more than 50 percent in the amount of 200-kc bias power required over that of conventional heads.

Alfenol heads permit direct contact with the recording medium since wear is minimized by the hardness of the material. Resolu-

NEW *Uniline* MODELS

RUGGEDIZED

Now, completely new design extends the field of utility to applications where severe shock and vibration are prevalent.

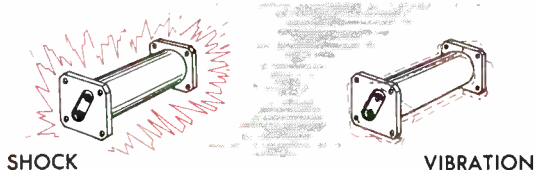

SHOCK

VIBRATION

WIDER RANGE OF OPERATING TEMPERATURES

Range from -55°F to $+180^{\circ}\text{F}$ permits use in high temperature environments.

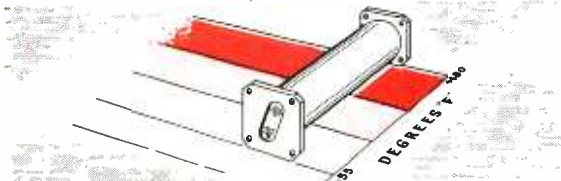

PERFORMANCE CHARACTERISTICS SAME AS STANDARD MODELS

All new ruggedized models retain the desirable performance characteristics of their standard, equivalent frequency range, counterparts.

FIVE MODELS AVAILABLE

MODEL R88-96: 8.8 to 9.6 mcms.

MODEL R96-104: 9.6 to 10.4 mcms.

MODEL R69-74: 6.9 to 7.4 mcms.

MODEL R64-69: 6.4 to 6.9 mcms.

MODEL R59-64: 5.9 to 6.4 mcms.

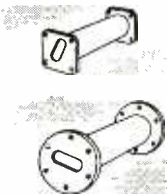

SMALLER...

Substantial reduction in physical size compared to standard models . . . readily installed in existing microwave systems.

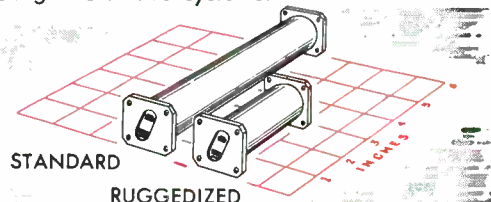

STANDARD

RUGGEDIZED

AVAILABLE FOR USE IN PRESSURIZED SYSTEMS

These new models can be supplied, modified, for use in pressurized systems.

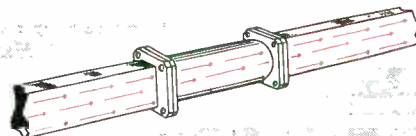

GREATLY EXTENDED FIELD OF APPLICATION

For use in aircraft and missiles, for mobile and fixed microwave communications equipment.

OTHER CASCADE FERRITE DEVICES

Other CASCADE microwave ferrite devices include: UNILINES for other frequency ranges, and for high power applications..GYRALINE, the microwave amplitude modulator. Complete information on request.

Uniline MICROWAVE LOAD ISOLATOR

A practical application of the Faraday rotation properties of ferrites at microwave frequencies. By its use, highly effective isolation is provided between source and load without the requirement of external power source or supplementary equipment and with negligible loss of transmitted microwave power.

Write for descriptive bulletins.



CASCADE RESEARCH
CORPORATION
53 VICTORY LANE, LOS GATOS, CALIF.

silicon



semiconductor

devices

available

now in

production

quantities

HIGH VOLUME PRODUCTION of *silicon* semiconductor devices enables Texas Instruments to offer you an enlarged line of five types of silicon transistors and two types of silicon junction diodes . . . all available for immediate delivery in production quantities!

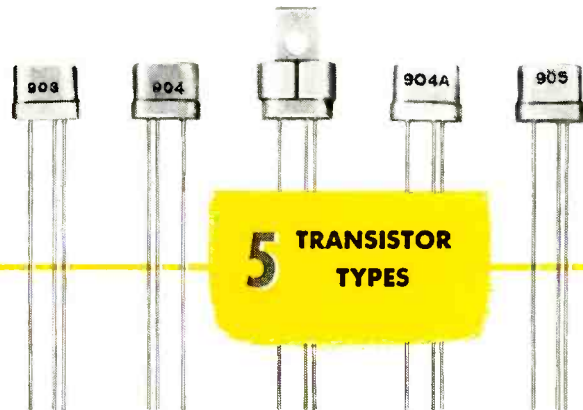

SILICON TRANSISTORS—produced commercially by and available *only* from Texas Instruments — are now available with alpha (current amplification factor) to over 0.975 and with alpha cutoff frequency to over 8 megacycles . . . stable to 150° Centigrade (302° F)!

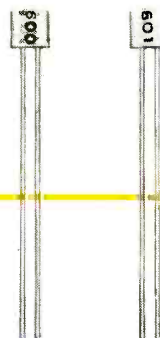

SILICON JUNCTION DIODES are also manufactured by Texas Instruments from grown single crystals and feature back currents as low as 0.001 microamp and safe operation to 150° Centigrade! All TI semiconductor devices — *silicon* or germanium; diodes, triodes and tetrodes — are made with glass-to-metal hermetic seals.

WRITE FOR LITERATURE on semiconductor devices in the widest range available today!

TEXAS INSTRUMENTS
INCORPORATED
6000 LEMMON AVENUE DALLAS 9, TEXAS

MINNEAPOLIS
Honeywell*Heiland* OSCILLOGRAPH**Series
700C**MODEL
708C**The Key to Better Product Design - Performance**

This new Recording Oscillograph enables the testing engineer and scientist to solve a wide variety of industrial and laboratory problems involving the measurement and correlation of strains, stresses, vibrations, accelerations, pressures, impacts, temperatures, etc.

The 700C Oscillograph provides up to 60 separate recording channels, has record widths of 8 to 12 inches, record speeds as high as 144 inches per second and as low as .030 inches per second. The 700C accommodates our new Sub-Miniature Galvanometers and temperature controlled magnet assemblies in which a new high in stability and sensitivity has been attained.

*Heiland*

A DIVISION OF MINNEAPOLIS-HONEYWELL

130 EAST FIFTH AVE., DENVER 3, COLORADO

steel when the steel is a core material in a coil. As shown in Fig. 1, dynamometers are used to determine the eddy-current losses. The first dynamometer shows the eddy-current variation or resistance of the steel. A second dynamometer is adjusted to read voltages in quadrature to the current. The voltages in the second channel are affected by changes in stresses present in the specimen and are unaffected by changes in the first dynamometer. The system indicates two factors that are encountered in fatiguing of steel. These are the change in hardness and in its internal resistance.

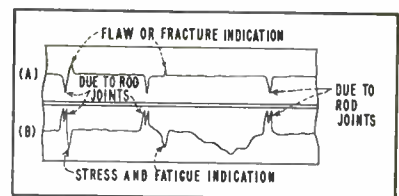

FIG. 2—Records produced by pipe tester. Joints cause discontinuities

It has been observed that there are several distinct stages in fatigue failure. First, internal stress increases without change in internal resistance. An apparent change in hardness is indicated by the out-of-phase dynamometer, no change being indicated on the in-phase dynamometer. Further fatigue results in a change in internal resistance, indicating strain.

The test specimen is fed through a primary and secondary coil assembly. The primary is excited with 60-cycle current into the balanced primary windings. When the test specimen is uniform and unfatigued there is no change in the secondary residual voltage, which has been nulled by a 3-phase 60-cycle current. The dynamometers, which are connected to the secondary, drive writing pens of a recorder that produces the graphs shown in Fig. 2. The record has been marked to show the meanings of various indications obtained. Figure 3 shows a general view of the test set-up with selection bins where the pipe is stored by the values of fatigue shown on the indicator.

Magnetron Coupling

A problem that has existed in the operation of magnetrons is due to

Get this 56-page Guide to

STACKPOLE ELECTRONIC COMPONENTS



Electronic Components Division
STACKPOLE CARBON COMPANY
St. Marys, Pa.

FIXED RESISTORS

RETMA and special types

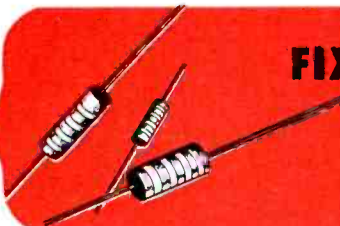

VARIABLE RESISTORS

0.5 and 0.6 watt bushing, tab mounting, printed circuit, and special types



LINE SWITCHES

10 types—circuit arrangements and current capacities for every need



SLIDE SWITCHES

Over 22 low-cost miniature styles for radio and TV receivers, small motors, toys, etc.



LOW-VALUE CAPACITORS

46 stable values in fixed composition types from 0.10 to 10.0 mmf with RETMA 4-band color code

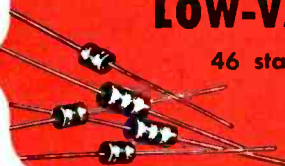

POWDERED IRON CORES

Standard, cup, sleeve, side-molded, and screw core types in any grade



FERROMAGNETIC CORES

Samples and production runs to your exact specifications



Ceramag[®]

MOLDED COIL FORMS

Molded phenolic types with or without iron core sections; powdered iron choke cores



AVAILABLE THROUGH PARTS DISTRIBUTORS:

For name of nearest distributor stocking Stackpole resistors, switches and "EE" iron cores write Distributors Division, Stackpole Carbon Co., 26 Rittenhouse Place, Ardmore, Pa.

LOWER YOUR SET COSTS WITH THIS LOWER-PRICED DEPENDABLE SPEAKER

A line of 4" and 5" speakers designed for peak performance. Break off or cast magnet may be used.

Low priced only because of unusually efficient manufacturing techniques.

Produced under rigid quality control. Metal stampings completely manufactured in our own Tool, Die and Punch Press Departments. Exceptionally thorough final inspection.

Plugs, transformers and/or brackets to your specifications.

Lower your set costs with this dependable speaker. Write for further information TODAY.

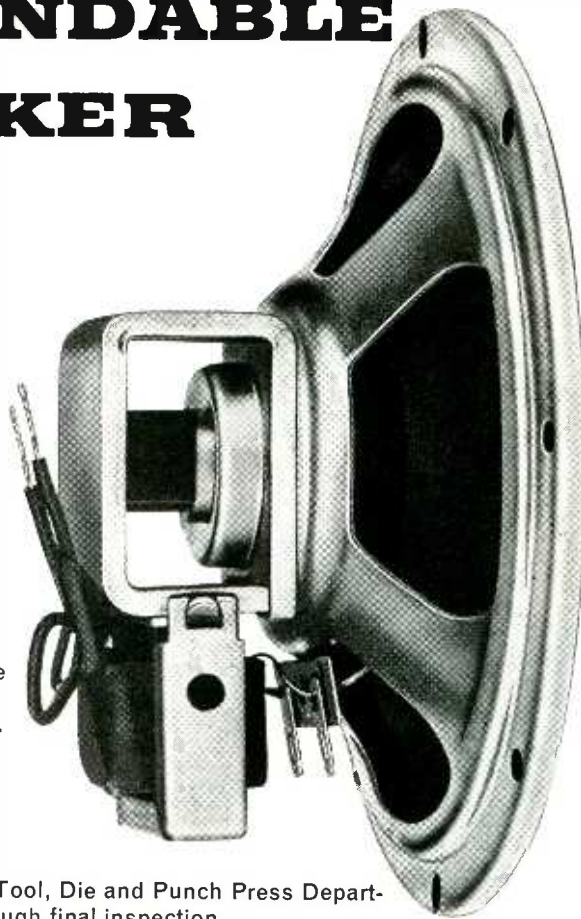

OTHER HEPPNER PRODUCTS:
Ion Traps, Centering Devices, Fly-Back Transformers and Focomaggs.

HEPPNER

MANUFACTURING COMPANY
ROUND LAKE, ILLINOIS
(50 Miles Northwest of Chicago)
Phone: 6-2161
Specialists in Electro-Magnetic Devices

Representatives:

JAMES C. MUGGLEWORTH, 324 Haddon Avenue, Collingswood 7, New Jersey • RALPH HAFEEY, R.R. 1, U.S. 27, Coldwater Rd., Ft. Wayne 8, Indiana • IRV. M. COCHRANE CO., 408 So. Alvarado St., Los Angeles, Calif. • JOHN J. KOPPLE, 60 E. 42nd St., New York 17, N. Y.

the cavities wherein there is a tendency to oscillate in a number of modes other than the desired ones. Thus when pairs or groups of magnetrons are connected together for high power there are the tendencies of each to oscillate both at these spurious modes and the combination of frequencies that are possible from them.

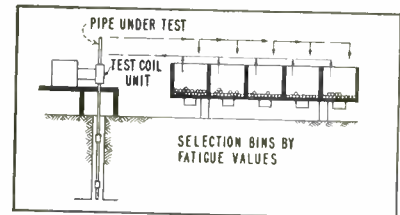

FIG. 3—Equipment is tested and stored according to results

Patent 2,667,580 was granted C. V. Litton of Redwood City, California for a "Magnetron with Valence Electrode", which overcomes this problem by providing an arrangement of magnetrons such that they will oscillate only at the desired frequency.

In Fig. 4 two cavity resonators are shown of two separate but similar magnetrons. These are connected together by a transmission line that is a wavelength or an integral multiple of one wavelength long at the operating frequency. If the magnetrons are operating at the same frequency and there is no phase inversion in the coupling, there will be no net exchange of energy between the resonators when they are in phase.

The arrows show current flow at instant of time t_0 . Actually there will be no current flow because the resonators are in phase and operating in parallel. The high-frequency voltages across both ends of the wave path are of the same magnitude and phase. Any current of energy from resonator 1 transmitted to resonator 2 would be balanced by current from resonator 2 that would be otherwise transmitted through the coupling path.

Figure 5A shows the two resonators of separate but similar magnetrons directly connected together. The transmission line of Fig. 4 acts just as the closely coupled units shown in Fig. 5A.

Figure 5B shows a one-half wave transmission line between reson-

Get better printed circuits . . . lower costs . . . fewer rejects

with **NEW C-D-F METAL CLADS**

All manufacturers of metal clad stock for printed circuitry have made considerable progress in improving their product—a material with a metal foil surface bonded to a non-conducting base. How this has been done by one leading manufacturer, the Continental-Diamond Fibre Company, illustrates some of the problems involved in buying this type of material and in understanding its design potentials.

C-D-F CONSOLIDATED GRADES

At first, small test lots of Dilecto laminated plastic with copper surfaces were made. Almost every core material was used. Finally the number of practical grades for printed circuit work narrowed down to these few grades which retained to a large degree the inherent electrical qualities of their base material and resin at high temperatures:

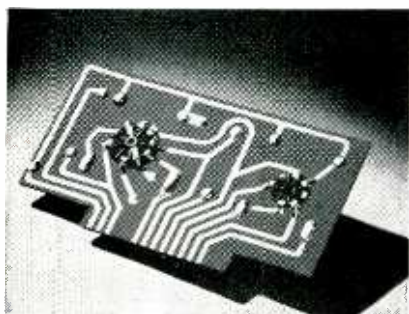

**COPPER CLAD
GRADE XXXP-26**

A laminate with excellent electrical and mechanical properties. High moisture resistance and dimensional stability. Recommended for applications where

high heat and high insulation resistance plus low dielectric loss under high humidity is needed. Low cold flow characteristics. Can be hot punched to 1/8". Good flexural strength. Natural green color.

This is one of the *improved C-D-F Dilecto laminates*. Advances in resins and manufacturing techniques makes this grade almost homogeneous, with improved impregnation of the filler. Thorough impregnation eliminates entrapped moisture and air, giving greater moisture resistance and better dielectric properties.

Any metal clad is no better than its base and the care taken in laminating. With the cost of material high, compared to labor and inspection, the purchase of a *uniform* metal clad material, like this C-D-F grade, becomes vital.

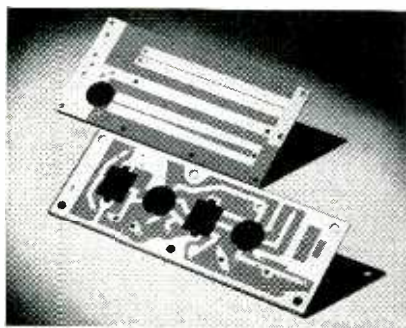

**COPPER CLAD
GRADE XXXP-24**

Similar to grade XXXP-26 in electrical and moisture resistance properties, but not quite as strong mechanically. Equal cold flow and punching characteristics. Natural brown.

COPPER CLAD GRADES GB-112S AND GB-261S

These silicone grades use a glass fabric laminate with a copper foil surface on one or both sides. Recommended where high heat resistance and low dielectric loss properties are required. For certain tuners and inductances the

low dielectric loss factor of this grade makes its higher cost acceptable. A continuous filament (Grade GB-112S) is used for thicknesses 1/32 to 1/16". A staple filament (Grade GB-261S) is used for thicknesses over 1/16".

COPPER CLAD GRADE GB-116T

A glass base laminate using duPont's tetrafluoroethylene resin, Teflon, for outstanding resistance to high heat with extremely low dielectric loss properties. A fine weave continuous filament glass fabric cloth is used for superior mechanical strength and good machining qualities. In spite of its high cost, this C-D-F grade has demonstrated that it can save money and do a job that no other single material can in microstrip high-voltage, high-frequency circuit elements. Remember, C-D-F is a major supplier of sheets, tapes, rods, tubes of Teflon, has valuable experience in its manufacture and fabrication. Write for samples.

C-D-F INCREASED BOND STRENGTH

By developing a special thermo-setting adhesive particularly suited for metal clads, C-D-F was able to increase the bond strength of their laminates considerably above their original figures. Bond or peel strength, the amount of pull required to separate the foil from the core material, is one of the most important physical properties. Therefore, the purchaser should compare his source of supply with these C-D-F average test values:

BONDING STRENGTH—FOIL TO LAMINATE	
MATERIAL	Average or Typical Value Lbs. pull per 1" width of foil to separate
XXXP-24 or XXXP-26 plus 0.0014" copper	5 to 8
XXXP-24 or XXXP-26 plus 0.0028" copper	7 to 9
GB-116T plus 0.0014" copper	5 to 12
GB-112S plus 0.0014" copper	6 to 8
GB-261S plus 0.0014" copper	7 to 10

These values are based on tests at prevailing room temperature (20-30°C.)

C-D-F INCREASED HEAT RESISTANCE

Special efforts by C-D-F technicians to increase the heat resistance of all C-D-F Metal Clads have resulted in certain special grade variations able to withstand higher soldering temperatures without damage. As production methods change, C-D-F offers materials to meet your requirements.

NOW . . . HOW ABOUT YOUR STORY?

Notice how we have talked about C-D-F and what we have done to improve quality and uniformity of metal clad products. Much of this has been accomplished with the guidance and cooperation of leading users of printed circuit stock. No one company knows all the answers . . . but C-D-F, a big reliable source of supply, can help you get better printed circuits . . . lower costs . . . fewer rejects. Look up the address of your nearest C-D-F sales engineer in Sweets Design File, write us for samples you can test in the lab and on the production line, technical bulletins, help on your specific project. We want to work with you!



Continental-Diamond Fibre

CONTINENTAL-DIAMOND FIBRE COMPANY
NEWARK 16, DELAWARE

ator 1 and resonator 2 with no phase inversions in the coupling. In this case there is no net exchange of energy where the currents are 180 deg out of phase. The transmission line here must be

$$\frac{2n-1}{2}$$

If for any reason one of the magnetrons drifts or otherwise changes frequency, the interconnected sys-

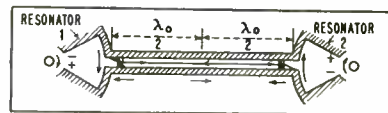

FIG. 4—Two cavities of separate magnetrons

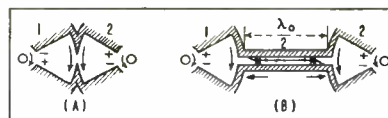

FIG. 5—Junction of cavities directly (A) or via half-wave line (B)

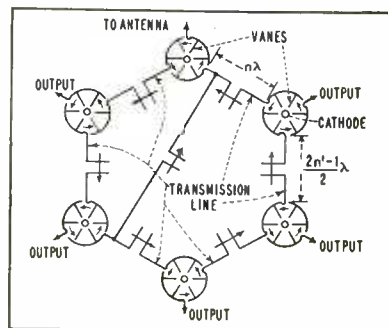

FIG. 6—Interconnection of six magnetrons

tems of Fig. 4 or 5 will be unbalanced and an energy exchange will occur until the system is stabilized.

Thus the resonators will remain locked in with one another.

Interconnection of six magnetrons in accordance with the invention is shown in Fig. 6. They are connected by adjustable transmission lines. These may be adjusted to provide no net interchange of energy between any pair connected together. A transmission line is connected across the loop. The result is that each of a connected pair will lock in the other

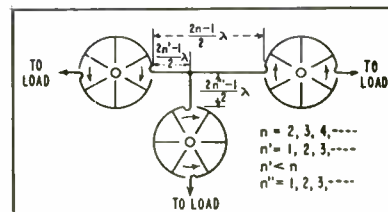
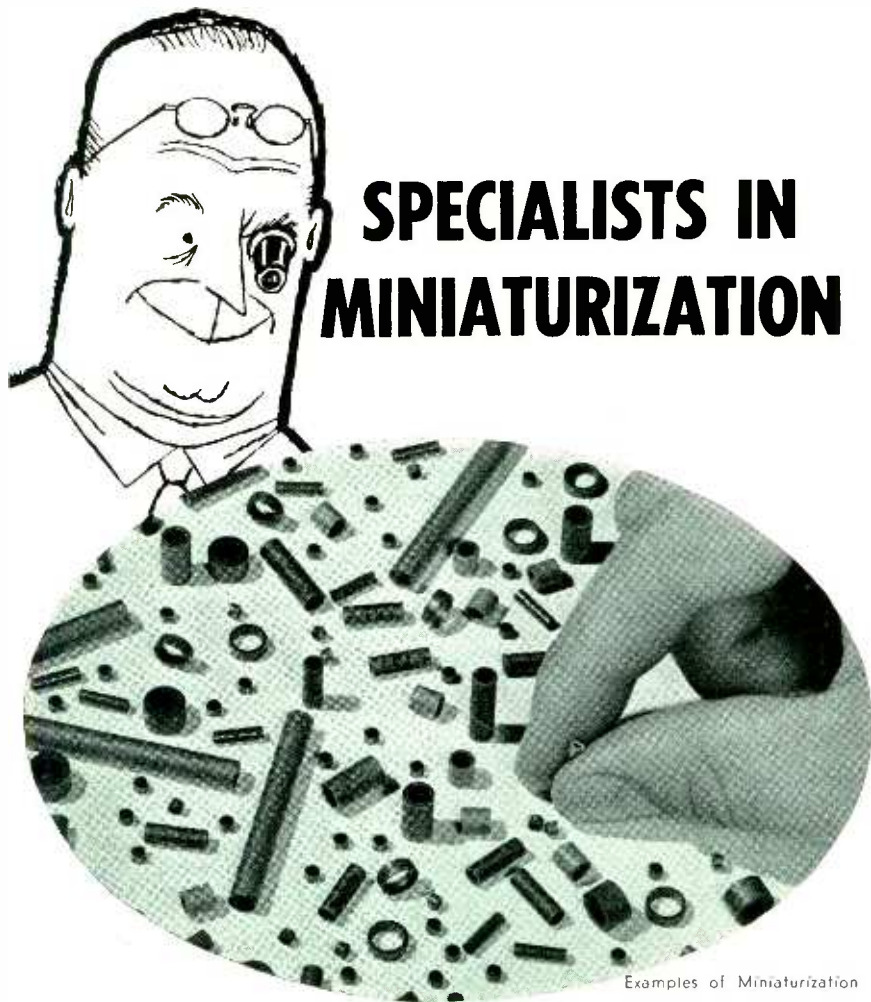

FIG. 7—Coupling three resonators



SPECIALISTS IN MINIATURIZATION

Examples of Miniaturization by Stonized

Thirty years' experience in the precision manufacture of small diameter spiral wound paper tubes gives Stone a decided advantage in the important movement to miniaturization now going on in the electronics and electrical fields.

Stonized, our phenolic impregnated tube, when used as a *coil form*, has low moisture absorption characteristics (5% after 24-hour immersion), low power factor, and good insulation resistance.

Stonized bushings combine extremely high compression strength with resiliency.

Stonized thin wall insulating tubes can be precision engineered and manufactured down to walls of .006" with ID's ranging from .046" to 1/4".

These examples of Stone's craftsmanship positively illustrate what you may expect when your order calls for a *rigid* meeting of your specifications.

Write or phone us directly. We will be happy to have one of our conveniently located representatives call on you.

Stone PAPER TUBE CO.

AFFILIATED WITH

STONIZED PRODUCTS CO. INC.

900-922 Franklin Street, N.E., Washington 17, D. C.

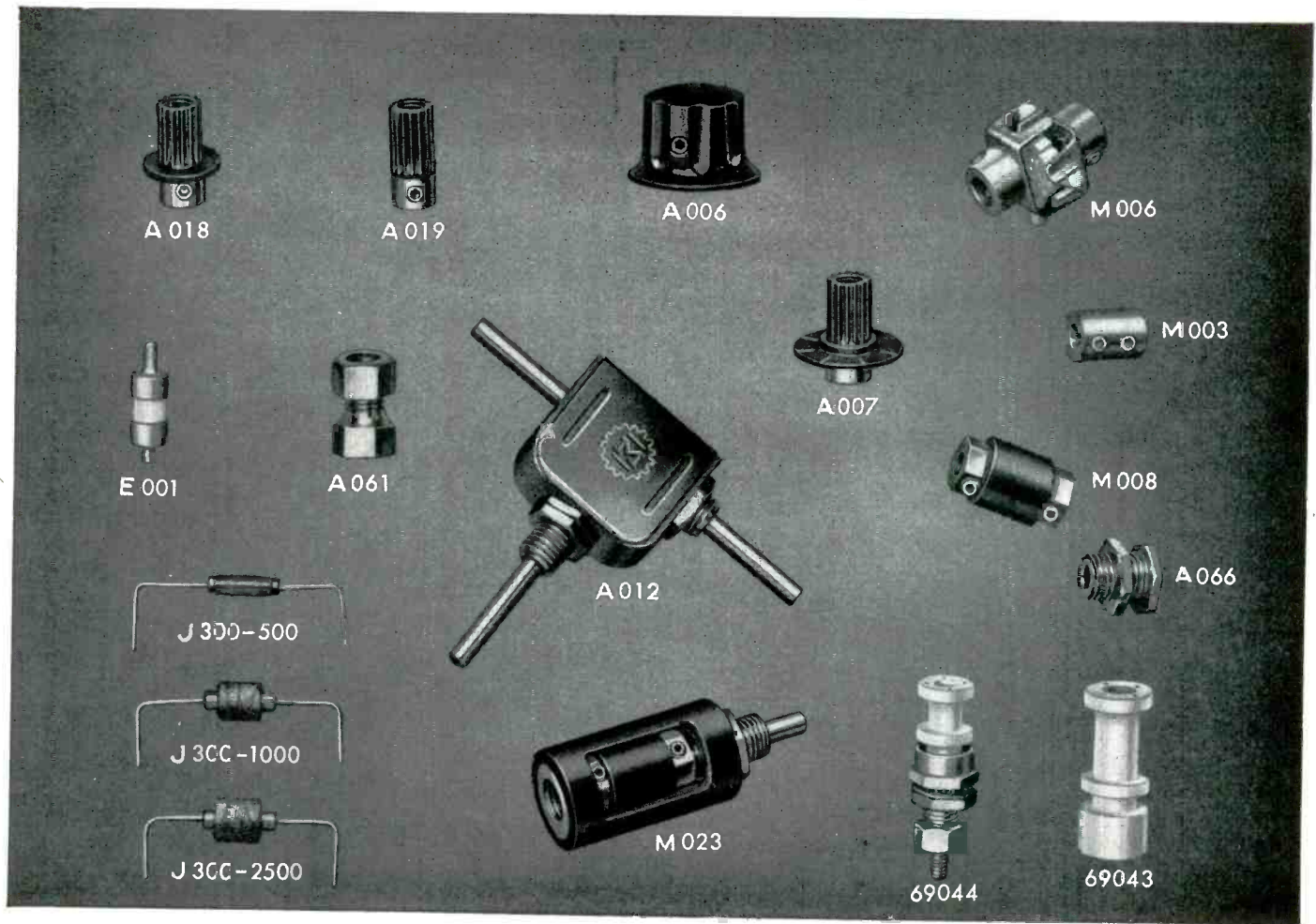

MINIATURIZED COMPONENTS

DESIGNED for APPLICATION miniaturized components developed for use in our own equipment such as the 90901 Oscilloscope, are now available for separate sale. Many of these parts are similar in most details except size with their equivalents in our standard component parts group and in certain devices where complete miniaturization is not paramount, a combination of standard and miniature components may possibly be used to advantage. For convenience, we have also listed on this page the extremely small sized coil forms from our standard catalogue. Additional miniature and subminiature components are in process of design and will be announced shortly.

CODE	DESCRIPTION	NET PRICE
A006	Matches standard knobs in style. Black plastic with brass insert. For $\frac{1}{8}$ " shaft. Overall height $\frac{1}{2}$ ". Diameter $\frac{3}{4}$ ".	\$.42
A007	Same as A018 except for $\frac{3}{8}$ " diameter plastic dial with 5 index lines.	.48
A012	Right angle drive. $\frac{1}{8}$ " diameter shafts. Single hole mounting bushing $\frac{1}{4}$ "-32 diameter.	3.90
A018	$\frac{1}{8}$ " diameter black plastic knob with brass insert for $\frac{1}{8}$ " shaft. Skirt diameter $\frac{3}{4}$ ". Overall height $\frac{3}{4}$ ". Unique design has screwdriver slot in top.	.39

CODE	DESCRIPTION	NET PRICE
A019	Similar to A018, but without flange.	\$.36
A061	Shaft lock for $\frac{1}{8}$ " diameter shaft. $\frac{1}{4}$ "-32 bushing. Nickel plated brass.	.39
A066	Shaft bearing for $\frac{1}{8}$ " diameter shafts. Nickel plated brass. Fits $\frac{1}{4}$ " diameter hole.	.36
E001	Steatite standoff or tie-point integral mounting eyelet. .205 overall diameter. Box of five.	.90
J300-500	Iron core RF choke 500 uh.	.42
J300-1000	Iron core RF choke 1000 uh.	.42
J300-2500	Iron core RF choke 2 $\frac{1}{2}$ mh.	.42
M003	Solid coupling for $\frac{1}{8}$ " diameter shaft. Nickel plated brass.	.30
M006	Universal joint style flexible coupling. Spring finger. Steatite insulation. Nickel plated brass for $\frac{1}{8}$ " diameter shafts.	.75
M008	Insulated coupling, with nickel plated brass inserts for $\frac{1}{8}$ " diameter shafts.	.48
M023	Insulated shaft extension for mounting sub miniature potentiometer with $\frac{1}{8}$ " diameter shafts and $\frac{1}{4}$ "-32 bushing.	1.35
69043	Steatite coil form. Adjustable core. Top tuned. Tapped 4-40 hole in case for mounting. Winding space $\frac{1}{4}$ " diameter x $1\frac{1}{2}$ " length.	.84
69044	Steatite coil form. Adjustable brass core. Bottom tuned. Mounting by No. 1D-32 brass base. Winding space .187 diameter by $\frac{3}{8}$ " length.	.84

JAMES MILLEN

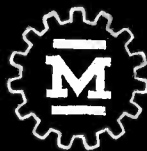

MFG. CO., INC.

MAIN OFFICE

AND FACTORY

MALDEN, MASSACHUSETTS, U. S. A.

Magnecord ...

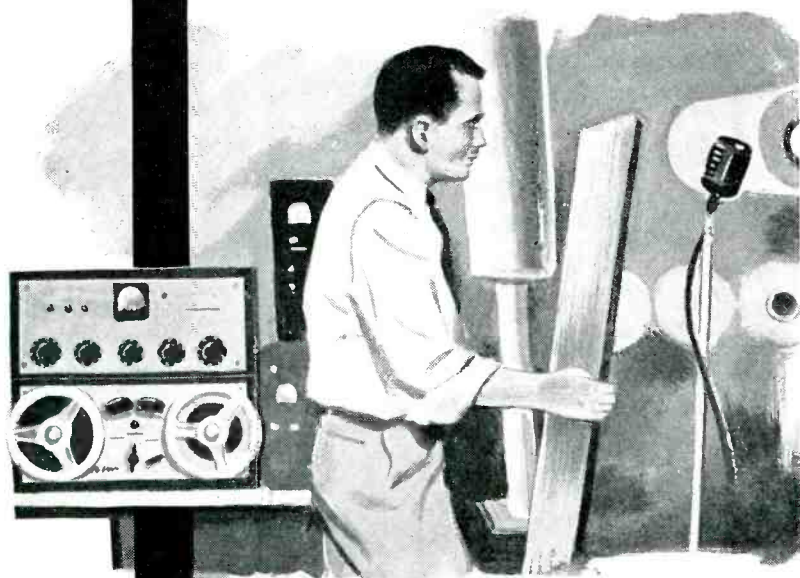

*the truth
on tape*



BASIC PT6



BINAURAL

THE
NEW M80

Every day, industry finds important new applications for Magnecorders — in testing, research, data recording, or other fields. If you have a particular application — there is a Magnecord unit to fit your specifications.

The unwavering *truth* is on every Magnecord tape. That's why Magnecorder is the most widely used professional tape recorder in the world.

Look under "Recorders" in your classified telephone directory, or write, phone, wire . . .

INSTRUMENTATION DIVISION

magnecord, inc.

1101 S. KILBOURN AVENUE

CHICAGO 24, ILL.

DEPT. E-11

and should any one magnetron of the loop start to drift it will be pulled in by the others.

The separate output connections may be connected to individual loads or to a common load.

The inventor shows, as in Fig. 7, that three resonators may be coupled in accordance with his invention and that it is not limited to coupling in pairs.

X-Ray Protector

A "Protecting Device for X-ray Apparatus", which was awarded U. S. Patent 2,667,587, was invented by Alfred Kuntke and Heinz Mester of Hamburg, Germany. The patent is assigned to Hartford National Bank and Trust Company as trustees.

There is a considerable difference between the no-load and normal operating voltages in the high-voltage system of an X-ray diagnostic apparatus. In the absence of emission from the heated cathode of an X-ray tube there is no reliable means of determining that emission has ceased, other than observation of the filament illumination, which may not be visible in most X-ray tube enclosures.

These inventors observe that whereas in the absence of cathode emission an X-ray tube has an almost infinite impedance, when the cathode is emitting, the impedance is in the order of 1 to 2 megohms. This difference may be detected to provide means of operating a relay tube circuit, protecting the X-ray tube by opening up the ground return of the high-voltage circuit.

The ratio of primary-to-secondary impedance of an X-ray high-voltage transformer is in the order of 150 to 200. Variation in the secondary side owing to operation or nonoperation of the X-ray tube would result in a variation of from 10^9 to about 200 ohms. This is sufficient to provide for protection of the primary side by the use of an a-c relay.

Two circuits for accomplishing the protective operation in accordance with the invention are shown in Fig. 8. Figure 8A shows a protective circuit in the primary side of the high-voltage transformer. Figure 8B shows a protective cir-

designs
circuitry
NEW
applications
types

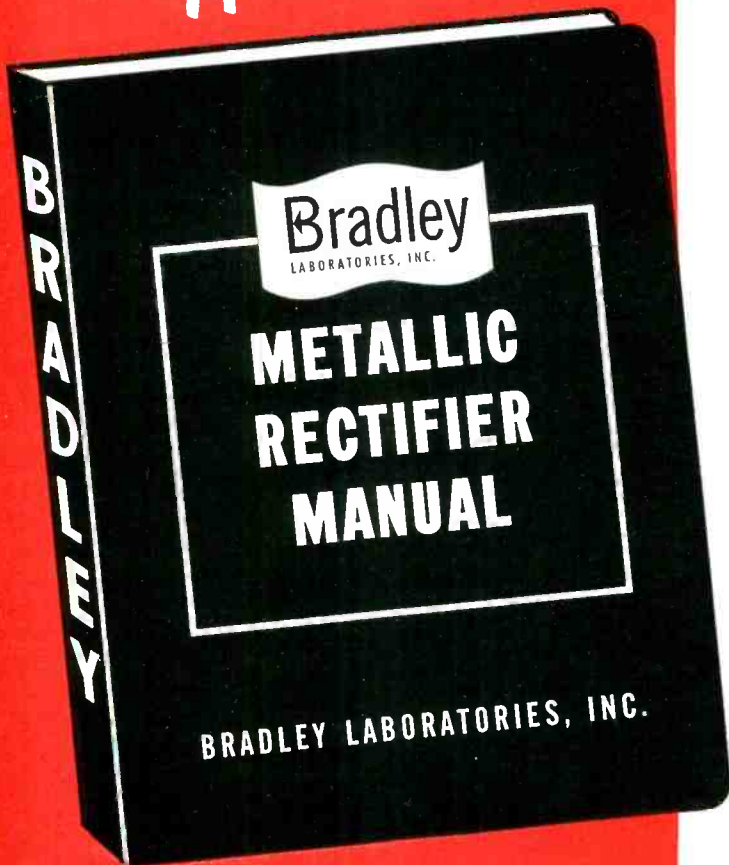

complete
concise

The **BRADLEY METALLIC RECTIFIER MANUAL**

An Invaluable Tool for the Engineer . . .
A Workable Guide for the Purchasing Agent . . .

The Bradley METALLIC RECTIFIER MANUAL is the most comprehensive and up-to-date handbook on Selenium and Copper-Oxide Rectifiers. It's a real "must" for every design and development engineer using rectifiers.

Into its 144 pages are packed the facts and figures you need on — types, designs, circuitry, applications, characteristics. Included too, are new, previously unpublished curves showing the characteristics of the latest developments in selenium rectifiers.

Included in the initial low price of \$2.00 a copy is the revision service that will keep your manual always in step with progress. As changes and developments occur, additions and revisions will be mailed automatically to all manual owners.

Fill out the coupon and mail it today. Your copy of the Bradley METALLIC RECTIFIER MANUAL will be delivered promptly.



BRADLEY LABORATORIES, INC.
 168E Columbus Ave., New Haven 11, Connecticut

Please send me _____ copies of the Bradley METALLIC RECTIFIER MANUAL at \$2.00 each. Check for \$_____ is enclosed.

NAME _____

FIRM _____

ADDRESS _____

CITY _____ ZONE _____ STATE _____

WIND YOUR COILS FASTER, CHEAPER, EASIER

on a Geo. Stevens Winder

- MORE OUTPUT... LOWER COSTS... from EXCLUSIVE SPEED FEATURE
- MUCH FASTER CHANGING OF SET-UPS
- MUCH LOWER ORIGINAL COST
- LONGER LIFE
- EASIEST TO OPERATE
- MORE GEO. STEVENS WINDERS USED THAN ALL OTHER MAKES COMBINED

MODEL 319-AM

ADJUSTABLE LENGTH BOBBIN WINDER

- NEW Oil Bath Lubricated Internal Gears.
- Winds all types of random wound bobbin coils, solenoids, repeater coils, resistors and precision, non-inductive coils.
- Instant Re-Setting Automatic Counter.
- Extra Economy Positive Stopping Magnetic Brake.

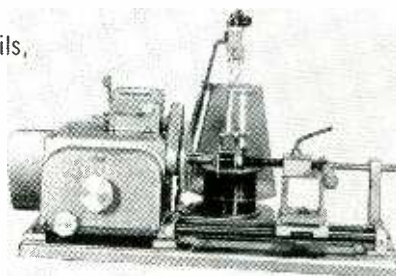

MODEL 225-AMVP

VARIABLE PITCH PROGRESSIVE UNIVERSAL WINDER

- NEW Oil Bath Lubricated Internal Gears.
- Winds variable pitch progressive universal coils and variable pitch solenoids. Also winds universal, progressive universal, pi-windings and single layer close or space wound solenoids.
- Instant Re-Setting Automatic Counter.
- Extra Economy Positive Stopping Magnetic Brake.

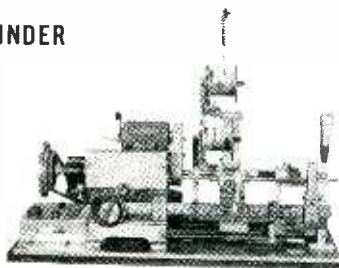

MODEL 105

HIGH SPEED WIRE SCRAPER

- Special analysis high carbon Steel Brushes cleanly strip insulation from multistrand wire.
- Medium grit Cloth Brushes cleanly strip No. 20-29 Formvar or Enamel Wire.
- Fine grit Cloth Brushes cleanly strip No. 30-40 Formvar or Enamel Wire.
- Wire can be cleaned to within 1/4" of coil.



NEW GEO. STEVENS CATALOG

—describes machines that wind practically every kind of coil for production line or laboratory. Write for your copy today.

REPRESENTATIVES

FRANK B. TATRO, 6022 N. Rogers Ave., Chicago 30, Ill.
INSULATION & WIRES, Inc.
2040 E. Washington Blvd., Los Angeles 21, Calif.
1077 Howard St., San Francisco, Calif.
R. A. STAFF & CO., 1213 W. 3rd St., Cleveland 13, Ohio
RICHARD H. WHITEHEAD, 150 Church St., Guilford, Connecticut
HARRISON BLIND, 1508 Winton Ave., Indianapolis, Ind
ALLIED INTERNATIONAL, INC., 230 Park Avenue, New York 17, N.Y.

Geo Stevens
MANUFACTURING COMPANY, INC.
Pulaski Road at Peterson, Chicago 30, Illinois
WORLD'S LARGEST MANUFACTURER OF COIL WINDING MACHINES

circuit designed for secondary side.

In the 0 position of the control switch (Fig. 8A) relay R_1 is not energized and the system is inoperative. In the 1 position relay R_1 is energized and its contacts S_1 are closed to complete the circuit of the low-voltage winding of the autotransformer to the primary of the high-voltage transformer. The hv transformer receives a lower voltage than it would otherwise.

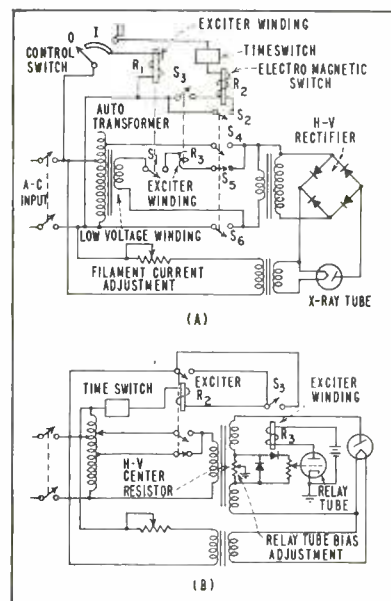

FIG. 8—Protective circuit in primary (A) and alternative method (B)

If there is cathode emission in the X-ray tube, the low-voltage secondary winding is loaded, exciting the coil of R_3 to close contacts S_3 going to relay R_2 and a time switch control. In the 2 position of the control switch relay R_2 is closed and its contacts S_2 , S_4 , S_5 and S_6 actuated. Contact S_5 is opened as all others are closed upon excitation of R_2 . This applies the normal high voltage to the transformer. If the incandescent cathode of the X-ray tube is not operating and doesn't emit, insufficient current is developed in the low voltage secondary circuit to excite R_3 and no operation occurs to supply normal high voltage.

In Fig. 8B the a-c voltage drop across a high-voltage winding center resistor is rectified to provide a bias on a relay tube that may be adjusted to a predetermined firing level. If, when current is applied, there is no emission, no change occurs in the bias and the

THE MOST CRITICAL CONTROL

PROBLEMS are
solved at

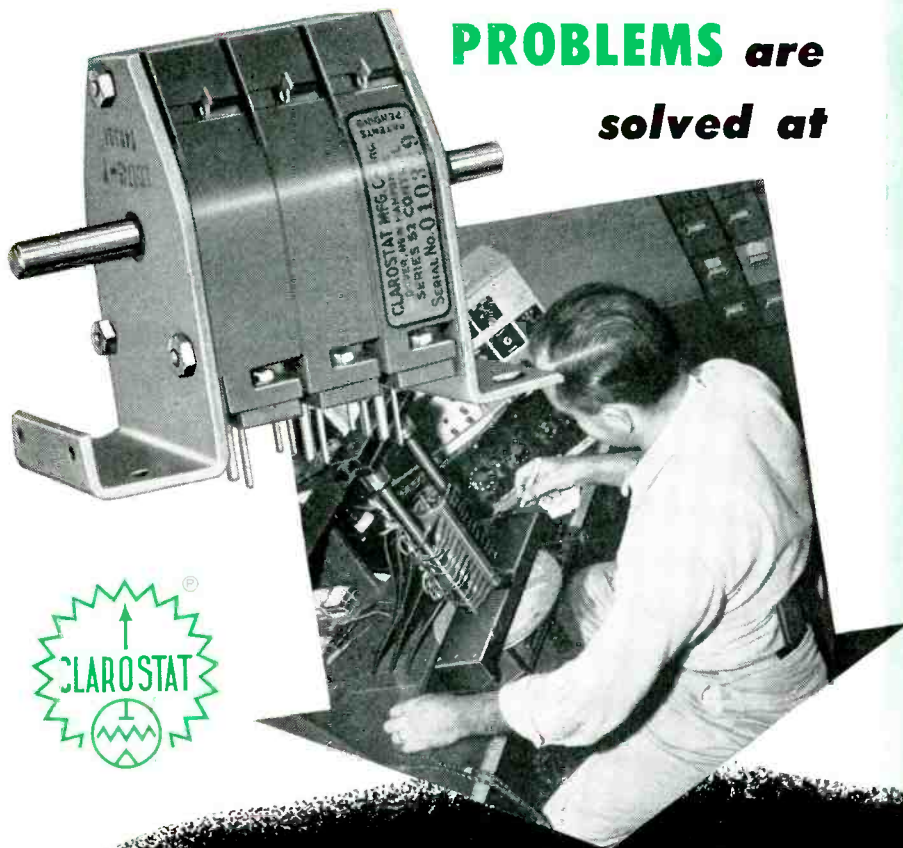

FEATURES...

Individual sections or tandem assemblies up to 18 sections.

Resistance tolerance: Standard overall, plus/minus 5%. Plus/minus 0.5% available where resolution permits.

Linear and non-linear within plus/minus 0.5%, or a voltage ratio accuracy of 0.005 where resolution permits.

Resistance range of 10 to 100,000 ohms. Non-linear, maximum of 350 ohms per degree of rotation.

One or more taps available. Taps can be located to within one winding convolution.

Power rating: 3 watts at 40° C. Non-linear, approximately 0.01 watt per degree of rotation.

Rotation: Effective up to maximum of 358°. Mechanical, any value up to 360°.

ULTRA-PRECISION CONTROLS HEADQUARTERS

For applications requiring *ultra-precision* controls, again you can "stand pat with Clarostat."

Originated by Clarostat, such ultra-precision potentiometers are now used in intricate and critical assemblies such as servo-mechanisms, range finders, fire-control systems, computing devices, and so on.

And now the latest, further-refined, plug-in version, Series 52, is available. Arch-shaped low-loss phenolic casing. Prong terminals engaging with corresponding sockets for plug-in circuitry. Side terminal lugs on each unit facilitate checking section voltages. Heavy metal end brackets insure rigid mounting.

Built by craftsmen working under instrument-shop conditions, these Clarostat Series 52 units are *the finest controls ever offered*.

Torque: 1 oz.-in. maximum per section.

Insulation: 1000 V.A.C. at atmospheric pressure.

End brackets and other types of mountings meet any mechanical considerations.

These units exceed applicable JAN-R-19 specifications.

Section-by-section assembly of tandem controls, with critical checkups of mechanical and electrical factors at each step insure *ultra precision*.

STAND PAT WITH
CLAROSTAT

Data on request. Let us collaborate on your ultra-precision control requirements.

CLAROSTAT Controls & Resistors

CLAROSTAT MFG. CO., INC., DOVER, NEW HAMPSHIRE
In Canada: Canadian Marconi Co., Ltd., Toronto, Ontario

SPECIALS may match the prices of STANDARDS

If ordered in fair quantities, recessed hex head screws cost no more than standard machine screws, and actually much less than trimmed hex head screws.

The saving results from elimination of one production operation, without loss of mechanical values. The difference is in appearance. And even that may be in favor of the recessed head.

To order only, made to standard dimensions in sizes to suit your needs or to your specifications.

Get our prices and deliveries on your requirements. In fact write us about special upset, and rolled thread products of any kind. The cost may be lower than you think.



MACHINE SCREWS AND SPECIAL FASTENERS ARE OUR BUSINESS



WRITE FOR
OUR CATALOG

THE PROGRESSIVE MANUFACTURING COMPANY

50 NORWOOD ST., TORRINGTON, CONN.

relay in its plate similar to R_2 of Fig. 1 is not energized and its contacts S_3 are not closed. If emission does occur, the relay tube is energized and normal high-voltage operation of the X-ray is effected.

Dough Consistency

The rheological properties of materials are measured by a device for "Consistency Determination", the invention of C. N. Kimball of Detroit, Michigan and W. R. Lewis, of Kansas City, Missouri. Patent 2,673,463, which they were granted, is assigned to C. J. Patterson Co., a corporation of Missouri.

The elasticity, viscosity or plasticity of materials have been discovered by these inventors to have a definite relationship to certain proportionate parts of the energy it takes to mix or stir a material and its consistency. It is pointed out that a recording wattmeter will

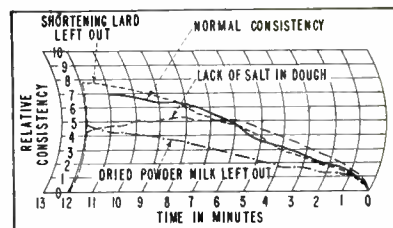

FIG. 9—Graph of dough consistency

produce a curve indicative of the power required to drive the motors of a stirring and mixing equipment, but that the resulting serrated curve cannot be analyzed.

Accordingly, these inventors have provided a circuit by means of which these power factors can be

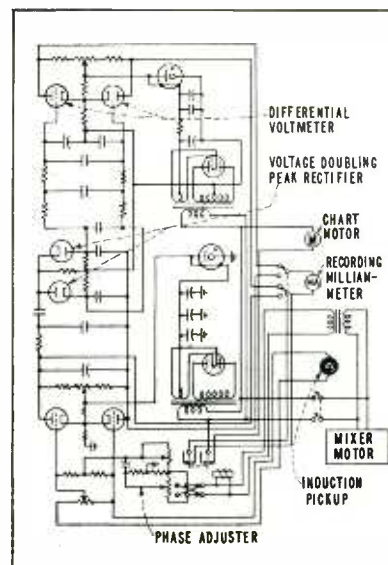
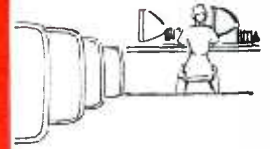

FIG. 10—Circuit integrates power curve

WHY

do leading TV makers specify **RMC DISCAPS**

Manufacturers specify DISCAPS because they provide faster assembly line production and lower over-all costs.



WHY

do engineers specify **RMC DISCAPS**

Engineers specify DISCAPS for their uniform quality, low inherent inductance, high working voltage and greater mechanical strength.

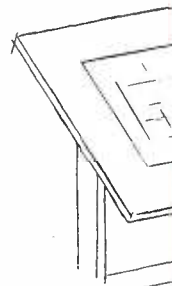

WHY

do purchasing agents specify **RMC DISCAPS**

Purchasing agents specify DISCAPS because they can depend on RMC to make delivery when scheduled.



Why don't you specify...

RMC DISCAPS, the proved money saving replacement for mica and ceramic tubular capacitors. They are widely used by leading manufacturers of TV sets and tuners, radio receivers and high frequency electronic equipment. RMC offers a full line of by-pass, high voltage, and temperature compensating DISCAPS. If you are interested in improving the quality and uniformity of your products you will be interested in RMC DISCAPS.

RMC
.005

RMC
100

RMC
3KV
68

DISCAP
CERAMIC
CAPACITORS

RMC

RADIO MATERIALS CORPORATION

GENERAL OFFICE: 3325 N. California Ave., Chicago 18, Ill.

FACTORIES AT CHICAGO, ILL. AND ATTICA, IND.

Two RMC Plants Devoted Exclusively to Ceramic Capacitors

MINIATURIZING YOUR EQUIPMENT?

Specify **SIMPLEST, MOST COMPACT**

AMPERITE THERMOSTATIC DELAY RELAYS

MOST ECONOMICAL, HERMETICALLY SEALED



STANDARD



MINIATURE

Provide delays ranging from 2 to 120 seconds.

- Actuated by a heater, they operate on A.C., D.C., or Pulsating Current.

- Hermetically sealed. Not affected by altitude, moisture, or other climate changes.
- Circuits: SPST only — normally open or normally closed.

Amperite Thermostatic Delay Relays are compensated for ambient temperature changes from -55° to $+70^{\circ}\text{C}$. Heaters consume approximately 2 W. and may be operated continuously. The units are most compact, rugged, explosion-proof, long-lived, and — inexpensive!

TYPES: Standard Radio Octal, and 9-Pin Miniature.

PROBLEM? Send for Bulletin No. TR-81

BALLAST-REGULATORS

- Amperite Regulators are designed to keep the current in a circuit *automatically regulated* at a definite value (for example, 0.5 amp).
- For currents of 60 ma. to 5 amps. Operates on A.C., D.C., Pulsating Current.
- Hermetically sealed, light, compact, and most inexpensive.

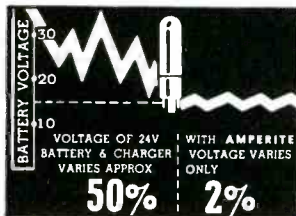
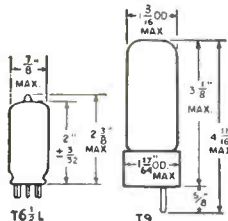

Maximum Wattage Dissipation: T6 1/2 L—5W. T9—10W.

Amperite Regulators are the simplest, most effective method for obtaining *automatic regulation* of current or voltage. Hermetically sealed, they are not affected by changes in altitude, ambient temperature (-55° to $+90^{\circ}\text{C}$), or humidity. Rugged; no moving parts; changed as easily as a radio tube.

Write for 4-page Technical Bulletin No. AB-51

AMPERITE CO. Inc., 561 Broadway, New York 12, N. Y.

In Canada: Atlas Radio Corp., Ltd., 560 King St. W., Toronto 2B

analyzed to provide a smooth curve from which the determination and control is possible.

Figure 9 shows a series of relative consistency curves drawn by the instrument of this invention for a mix batch of dough. The differences in the curve when various ingredients are left out is clearly evident.

The electrical circuit for integrating the power curve to provide the recording curve is shown in Fig. 10. This circuit is actually a recording electronic wattmeter. Figure 11 is a modification of the circuit to act on a proportional value of the positive and negative power peaks.

The circuit generally is a type familiar to the electronic engineer, comprising a push-pull amplifier

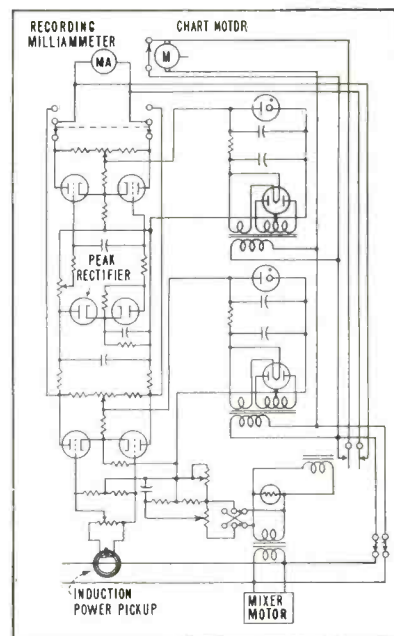

FIG. 11—Circuit modification acts on positive and negative peaks

that receives indications of current variations from the induction pick-up device in the power lines and voltage variations from the secondary side of a transformer. These are connected to the line-voltage system that operates the mixing motor.

The transformer output is phase adjusted to provide properly phased components to the amplifier. The amplified resultant is an alternating-current watts-consumed indication. This is smoothed by the action of a peak voltmeter that drives a differential amplifier whose output in turn drives a recording milliammeter.

*Third in the series of
important new instruments
by DuMont type 327*

- Vertical bandwidth, D-C to 5 MC; rise time of 0.07 usec
- Distortion-free, mono-accelerator cathode-ray tube
- Direct, accurate, reliable time measurement
- Measures signal amplitude accurately from calibrated screen



Continuing the pace set by the now-famous Du Mont Types 323 and 329, the new Type 327 provides the truly modern approach to the broad "middle range" of oscillography, offering superb performance characteristics from DC to 5MC. At modest price — not a major investment in any sense — the Type 327 features accurate, time and amplitude calibration. And, measuring facilities are not degraded by the cathode-ray tube since a virtually distortion-free mono-

accelerator tube is used.

Useful from DC through the low-frequency spectrum and for many applications in the high-frequencies as well, the Type 327 is expected to find more actual use than any other single instrument.

By combining the best features of low- and high-frequency oscillographs this new instrument provides a uniquely efficient and practical tool for production as well as research.

MAJOR SPECIFICATIONS

VERTICAL AMPLIFIER: Frequency response, flat from zero (d.c.) to down not more than 30% at 5 mc; Rise time, 0.07 usec; Deflection factor, 0.25 volts peak-to-peak per inch; Signal delay, 0.4 usec allows sweep to start before signal is applied.

CALIBRATED SWEEPS: (1) High-level calibrated, 19 steps from 1 sec/inch to 1 usec/inch; Accuracy $\pm 5\%$; (2) Calibrated expansion, by factors of 2, 3, 4, or 5

with full positioning and accuracy of 15%; (3) Continuously variable, uncalibrated.

AMPLITUDE MEASUREMENT: Calibrating voltage, 0.5 volts p-p internal; Range, 10 full scale ranges from 0.5 to 500 volts full scale.

CATHODE-RAY TUBE: Distortion-free Mono-accelerator Type 5AMP—; Accelerating potential, 2500 volts, equivalent to operation at 3 kv on post-accelerator types.

DU MONT

ALLEN B. DU MONT LABORATORIES, INC.

TECHNICAL SALES DEPARTMENT • 760 BLOOMFIELD AVENUE • CLIFTON, N. J.

Production Techniques

Edited by JOHN MARKUS

Sandwich-Type Corrugated Cardboard Protects Relays	228	Ultraviolet Inspection of Picture Tube Screens	248
Washing Machine Cleans Insides of Picture-Tube Bulbs	228	Checking 4,000-Mc Radio Relay Tubes	252
Cutting and Forming Pigtail Leads for Printed Circuits	230	Vibrator Shakes Leads Into Printed-Circuit Holes	256
Stripping Coax	236	Probe Light Aids Inspection of Wiring	266
Masking Tape for Plating	238	Quality Control Test Set for Picture Tubes	268
Automatic Assembly Line for Printed TV Chassis	240	New Shipping Crate Protects Amplifiers	270
Vacuum Bag Supports Irregularly Shaped Parts	246	Tube-Cooling Tunnel	272

OTHER DEPARTMENTS

featured in this issue

	Page
Electrons At Work.....	180
New Products	274
Plants and People.....	332
New Books	385
Backtalk	397

Sandwich-Type Corrugated Cardboard Packaging Protects Relays

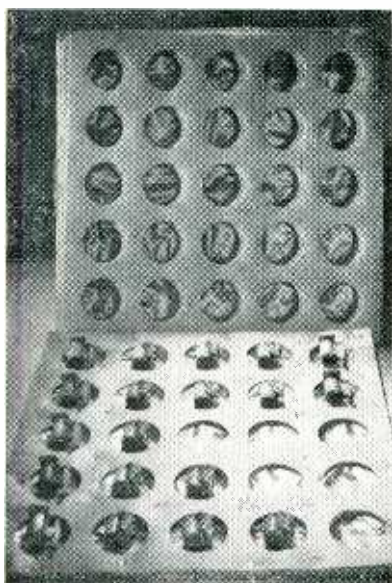

Sheets of corrugated cardboard stapled together give low-cost protection to relays during shipment

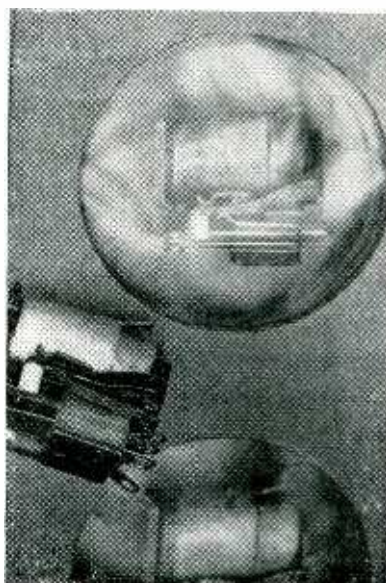

Polyethylene sheets between cardboard serve as dust-tight windows for compartments of relay container

SENSITIVELY calibrated relays are protected from possible damage during shipment and handling by the use of a unique packaging method developed by RBM Division, Essex Wire Corporation, Logansport, Indiana.

Each relay is individually nested between two sheets of clear polyethylene plastic. The overall dimensions of the various types of relays determine the number of spacers necessary to insure proper size and depth of the package unit. Twenty-five relays are packaged in each container and three to five containers are placed in a carton. In some instances the containers are returned by the customer.

In addition to protecting the relays during shipment and handling, this packing method reduces inspection time and facilitates counting.

Washing Machine Cleans Insides of Picture Tube Bulbs

TO ACHIEVE the high degree of cleanliness required inside a picture tube prior to depositing the screen, an automatic bulb washing machine is used in Raytheon's Quincy, Mass. plant. This machine automatically sprays a solution of hydrofluoric acid into the bulb, moves the bulb to the next position and sprays in water, moves to the next position for another hydrofluoric acid wash and continues in this manner until four hydrofluoric acid washes followed

by four water rinses have taken place. In each position the acid spray or the water rinse continues for half a minute.

Hydrofluoric acid is used in the washing process because it actually removes a very thin layer of glass and thus definitely removes all dirt which might otherwise adhere to the glass. During this washing process, the rinse water is discarded but the acid is reused. A circulating system pumps acid back through the storage tank, at which point

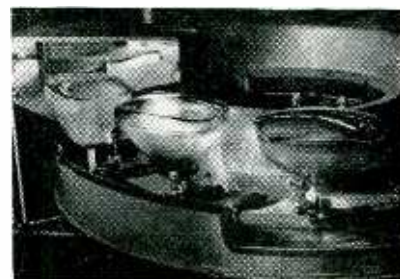

Loading position in bulb washing machine. Neck of each tube fits into rubber cone through which cleaning fluid and rinse water are forced under pressure as shown at left

**REMEMBER, MERLIN,
WAND WAVING IS
STRICTLY HOCUS-POCUS!**

Pulling a rabbit out of a hat is fine for entertainment, we agree. But not even a magician can make good on the fantastic claims attributed to cheaper solders, *the mystery alloys with a secret ingredient*, that are supposed to equal the performance of higher tin content solders. Today, as always, Kester believes, the quality of the soldered connection is what counts . . . *not* an infinitesimal saving. That's why Kester Solder has been a "star performer" for more than 50 years!

For your specific solder requirements, remember Kester "44" Resin, "Resin-Five" or Plastic Rosin-Core Solder . . . with exact core size or flux-content "tailored" to every job.



KESTER

S O L D E R C O M P A N Y

4204 Wrightwood Avenue, Chicago 39, Illinois
Newark 5, New Jersey • Brantford, Canada

WRITE TODAY for Kester's **NEW** 78-Page
Informative Textbook, "SOLDER . . . its fundamentals and usage"

the strength of the acid mixture is maintained at the proper value.

The final rinse which is given in the above acid wash process uses special deionized water which is also filtered and temperature-controlled.

Water for bulb washing and screen making is used at the rate of 30 gallons per minute. At this rate of usage, it would be impossible to supply the water by a distillation process without using an exorbitant amount of power for heating the water to the boiling point. It was therefore necessary to set up a water purifying system which would result in equally pure water but without the huge power requirement. This has six steps:

(1) A coagulation process is used to trap all suspended material which is in the water as it comes into the plant from the city water system.

(2) The water is super-chlorinated to remove bacteria.

(3) The water is filtered to remove the chlorine and other residues from steps 1 and 2.

(4) A deionizing process is used to remove all dissolved ions from the water.

(5) The water is filtered again in order to remove all of the residues from the deionizing process.

(6) The temperature of the water is controlled to within 1 deg F by passing the water through a heat exchanger. The water then goes into the solutions room.

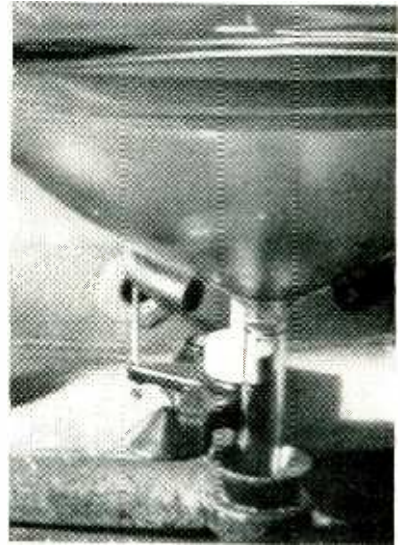

Details of valve-actuating trip and rubber-funnel seal for neck of tube

Cutting and Forming Pigtail Leads for Printed Circuits

By IRVING STRAUSS

*President
Bruno-New York Industries Corp.
New York, N. Y.*

LEAD-TAILORING involves accurately measuring, cutting and bending leads or pigtails to permit uniform assembly on wrap-around terminals or in printed-circuit punched holes. The preparation of component leads prior to assembly minimizes total assembly time, increases quality of workmanship and improves appearance.

As an aid in preparing axial leads

for assembly, a small foot-operated machine is now available from Bruno-New York Industries Corp. under the trade name Pig Tailor. It is capable of simultaneously and accurately measuring, cutting and bending both axial leads of any component at the average rate of 750 units per hour.

Both axial leads of a component can be cut to any individual length and bent at any desired point at right angles to the axis, either in the form of a U or an S. No acces-

sory fittings or attachments are required. The machine is completely flexible and adjustable to any cut, bend and shape within a maximum set-up time of 3 minutes. Any component of 1-inch diameter or less and not exceeding 6 inches overall, including uncut leads, can be processed.

The body of the resistor, capacitor or other axial-lead component is placed between the two guide supports, which are adjustable to any body length. The component leads



Foot-operated installation of lead-tailoring machine on assembly bench in typical electronic assembly plant

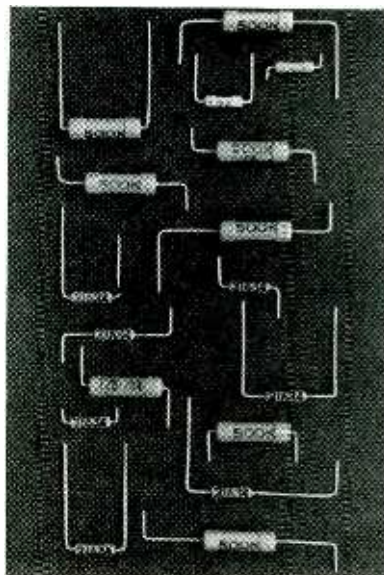

Examples of lead configurations obtainable, all with any desired orientation of printed value on component

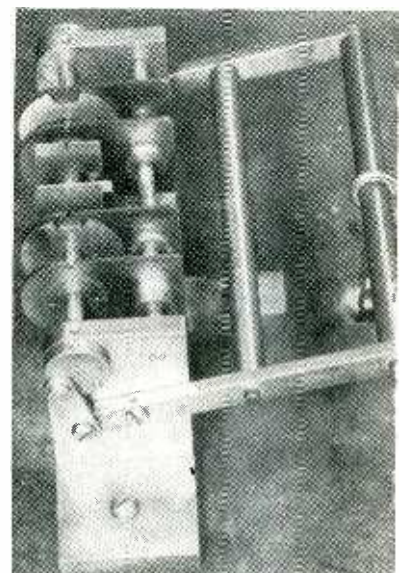

Closeup view of machine, showing how slots align in readiness for insertion of axial-lead component

From **VERY SMALL**...to **LARGE CAPACITY**

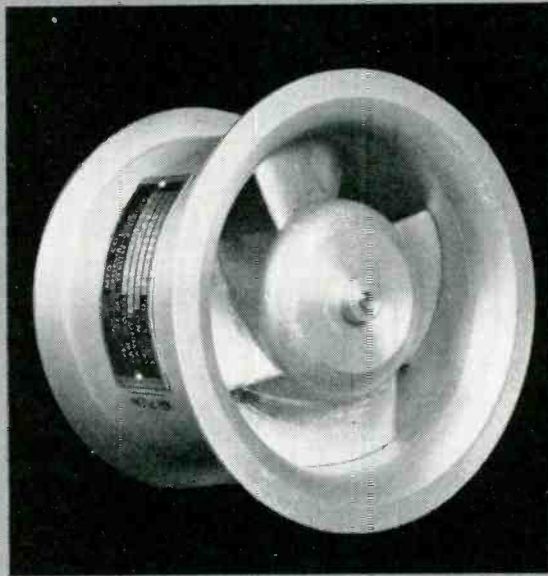

JOY AXIVANE[®] FANS

are available to meet any
ELECTRONIC COOLING NEED

Joy AXIVANE Electronic Cooling Fans are expressly designed to meet the needs of this exacting field of service. They are built in a complete range to suit any requirements, such as: spot cooling of ventilated units where local high-temperature conditions arise; heat removal from pressurized or hermetically-sealed units; or heat removal where space is so restricted that natural ventilation through the unit or over its surface is insufficient. Important operating advantages of these fans are their strength, high resistance to shock and vibration, and efficiency in low or high-pressure service. Aluminum and magnesium construction keeps weight at a minimum.

Available in sizes from 2" I.D. up, these Joy Fans are built to meet all present Air Force and Naval electronic specifications. They can be furnished with totally enclosed or explosion-proof motors, if desired.

In general, keep these facts in mind: that the light, compact design, low power consumption and high overall efficiency of Joy AXIVANE Fans provide more satisfactory cooling for electronic equipment in either air-borne or surface units.

If you have a problem in heat dissipation from electronic units, let us place at your disposal JOY'S experience as the world's largest manufacturer of vaneaxial-type fans. • Write *Joy Manufacturing Company, Oliver Building, Pittsburgh 22, Pa.* In Canada; *Joy Manufacturing Company, (Canada) Limited, Galt, Ontario.*

Consult a Joy Engineer



W&I 5375

JOY

WORLD'S LARGEST MANUFACTURER
OF VANE-AXIAL FANS

Now Available . . .



MICROPHONE CORD

with newly-developed
TEXTILE SHIELD for

longer service life, improved flexibility



This is a completely new cable design in which a close semi-conducting textile wrap and a stranded flexible drain wire replace the conventional braided copper shield. Conductors are cadmium copper for improved flex life. This new construction is not subject to damage by twisting or by the pressure of heavy equipment rolling over it. The shield will not break as a result of continued flexing.

Additional Features

- Super Flexible
 - Light weight
 - Long Flex Life
 - Excellent Electrical Characteristics
 - Tough, abrasion-resistant brown neoprene jacket

This improved construction is the result of years of development work by Whitney Blake laboratory to find the best answer to the needs of the broadcasting companies and equipment manufacturers. The semi-conducting textile shield construction has already been used successfully for over a year on nationally famous dictating machine microphones where extreme flexibility, long flex life and freedom from noise are cord essentials.



Available in 2 conductor, #18 A.W.G. and 3 conductor, #20 A.W.G. Order some and take advantage of the newest development in microphone cords.

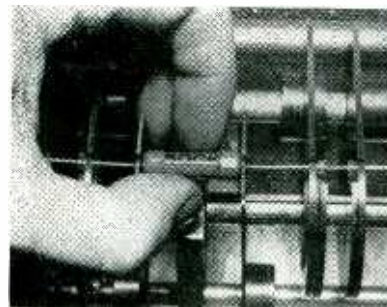

Method of placing component between centering guides of machine



Cutting blades at extreme right and left are starting to cut into leads



Bending blades are here completing the lead-forming operation

fall into the aligned notches of both sets of shearing and bending elements, before the foot pedal is depressed. Depressing the foot pedal drives the keyed drive shafts, on the left and right sides of the center support, through a double reversible linkage, thus rotating both sets of shearing and bending elements.

The direction that each keyed shaft drives is dependent upon the position of one drive link at each end of the machine. It is the independent direction change of these two links that provides for the S or U formed leads. Shifting of one or both links by relocation of a screw in the eccentric drive collar at each end will provide complete direction change.

Each of the shearing and bending elements has key-slotted bushings that enable sliding adjustment from the center to each end of the machine. A single Allen setscrew fixes their ultimate cutting and bending positions.

Each of the shearing and bending elements consists of notched fixed and rotary members. Due to the relative positions of the leading edges of the shearing elements to the leading edges of the bending elements, the shearing is accomplished first, followed by the bending.

Production models of the lead-tailoring machine include an ejection

Well Built Wires Since 1899



WHITNEY BLAKE COMPANY

New Haven 14, Connecticut

**The Only
All Band**

**10 mc
to
33,000 mc**

**Direct Reading
Single Control**

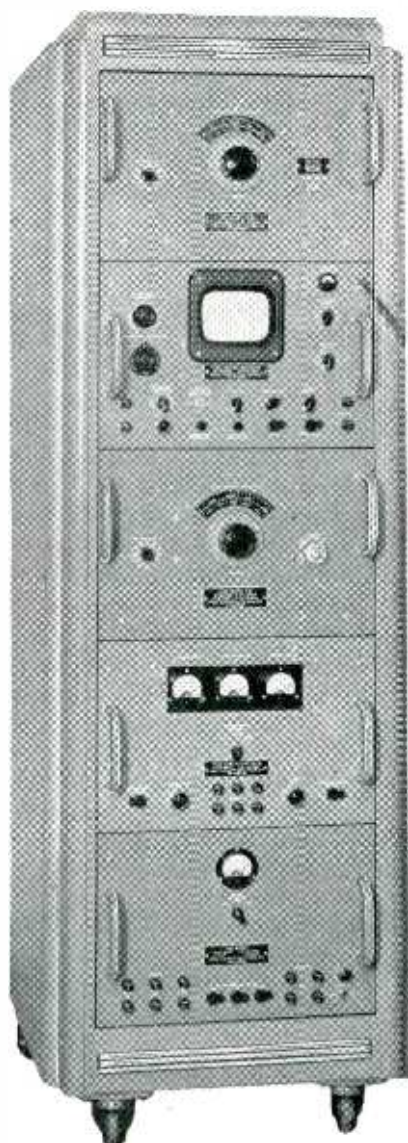

The Model LSA provides direct means of rapid, accurate measurement of spectral display of r. f. signals from 10 to 33,000 MCS

SPECTRUM ANALYZER

Model LSA

Saves Engineering Manhours

The Model LSA Spectrum Analyzer is Polarad's answer to rising engineering costs when high performance and economy are essential.

This unique engineering tool helps get results faster with fewer personnel and in less space. Because of its ultra simplicity, tremendous frequency coverage and remarkable instrumentation the Model LSA can handle almost any problem in the radio spectrum (10 mc to 33,000 mc) with the greatest of ease, reliability and accuracy.

How The Model LSA Cuts Production Costs

In the factory, Model LSA's simplicity of operation, direct reading and "GO-NO-GO" electronic display speeds production and cuts costs. Uniform quality and high performance of your complete equipment is assured by checking it with a Polarad Spectrum Analyzer.

Expensive personnel training programs are eliminated by the Model LSA, which often actually takes the place of the microwave specialist and frees engineers for other work. For further details contact your nearest Polarad representative or write direct to us.

FEATURES:

Frequency Range 10 mc-33,000 mc; 5 tuning heads
Accuracy Frequency Calibration—1%
Spectrum Display variable from 250 kc to 25 mc
Frequency Marker for measuring frequency differences of 0-25 mc
Broad Band R.F. Attenuators 10 mc-12,000 mc
Automatic Voltage selector for each tuning head
Single Dial Control
Direct Frequency Reading
Spectrum Displayed on 5" cathode ray tube

USES:

Examine pulse spectrum of magnetrons and klystrons
Measure noise and interference spectrum
Act as broad band receiver from 10 mc to 33,000 mc
Observe and measure harmonic frequency differences
Measure band width of microwave cavities
Calibrate microwave oscillators and preselectors

PROVEN RELIABILITY



Available on Equipment Rental Plan

Polarad Electronics Corporation

100 Metropolitan Avenue, Brooklyn 11, N. Y.

REPRESENTATIVES • Albuquerque • Atlanta • Boston • Chicago • Cleveland • Fort Worth • Kansas City • Los Angeles • New York • Philadelphia • San Francisco • Seattle • St. Paul • Syracuse • Washington, D. C. • Canada, Arnprior—Export: Rocke International Corporation

Engineered Economy Iron

CORES

from

STOCK

EE5002

SPECIFICATIONS

$\frac{1}{32} \times \frac{1}{32}$ SLOT

4-40 BRASS INSERT

Material: Radio Cores No. 10
 Test Frequency: 1 MC
 Q Tolerance: $\pm 7\frac{1}{2}\%$
 Perm Tolerance: $\pm 2\%$

Concentricity of Screw and Core:
 .015 Maximum at $\frac{3}{4}$ " from end of core
 .007 Maximum at end of core

tion device which will remove the component and allow it to drop into a tray in front of the machine.

The lead-tailoring operation can be taught to an unskilled operator within one hour. With less than one day's experience a production rate such as mentioned above can be expected. The device can easily be mounted for air operation and equipped with a counter.

Lead-Spinning Tool

Uniform spinning of tailored component leads around standard turret-type terminals is easily achieved with a special tool also developed by this firm. It eliminates the need for longnose pliers and the contingent training and skill required for their use. Within one hour, a trainee can be taught to use the pigtail-spinner at a production rate and uniformity considerably superior to former methods.

The use of the spinner with pre-cut and preformed leads of components eliminates excessive lead tautness, broken leads and broken components. Chassis handling is greatly minimized; positional accessibility of the terminal, essential for application of a pigtail with longnose pliers, is of negligible importance with the spinner. The tailored lead wire can be completely spun on the terminal, leaving no protruding end to be clipped. Either clockwise or counterclockwise turns can be applied since the tool is double-ended.

The important element in the de-

Engineered Economy means:

- HIGHEST PERFORMANCE
- HIGHEST QUALITY MATERIALS
- UNIFORM HIGH QUALITY
- LOWEST COST
- STANDARDIZATION

DELIVERY FROM STOCK:

We maintain an inventory of EE Cores, thus increasing speed of delivery, increasing your inventory turnover, cutting your investment, and eliminating expensive down-time on lines because of inventory "outs."

ENGINEERED ECONOMY IRON CORES . . . AT MONEY SAVING VOLUME PRICES . . .

ARE NOW AVAILABLE FROM STOCK. Two years of research and planning have produced the first concrete approach toward mass production in the iron core field. The EE cores illustrated are based on the most commonly used electrical and mechanical standard specifications, therefore design engineers may adapt them easily to a wide variety of uses.

Literature is available upon request . . . please write for our EE specification sheets.

If your needs are not covered in the above group, ask about our "Custom Engineered Cores", made to your exact specifications.

Radio Cores, Inc.

9540 Tulley Avenue Oak Lawn, Illinois

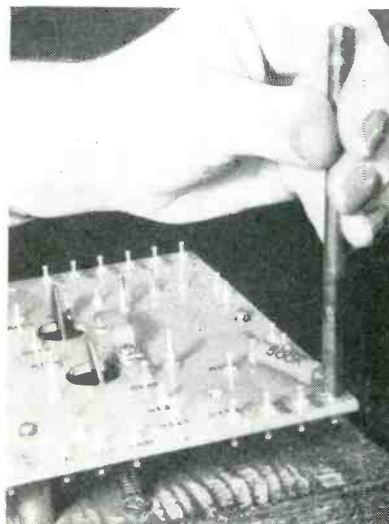

Method of using lead-spinning tool on turret-type terminals



Q: How can you build greater reliability into your electrical spring parts?

A: With **BRIDGEPORT PHOSPHOR BRONZE**



Parts made from Bridgeport Phosphor Bronze (Alloys 35 and 36) retain their resiliency and high flexural strength year after year. The inherent characteristics of these rugged Bridgeport alloys also make them corrosion and wear resistant. And their excellent electrical properties increase the operating efficiency of parts.

For technical help in specifying the right alloy for electrical parts and prompt service on your metal needs, call your nearest Bridgeport Sales Office.

◆ One of the many Bridgeport Metals with High I.Q. (Inner Quality) for economical fabrication and improved products.

BRIDGEPORT BRASS
COMPANY ◆ BRIDGEPORT, CONNECTICUT



Serving Industry with a Nationwide Network of Conveniently Located Sales Offices and Warehouses
 Mills in Bridgeport, Conn., Indianapolis, Ind., and Adrian, Mich.
 In Canada: Noranda Copper and Brass Limited, Montreal

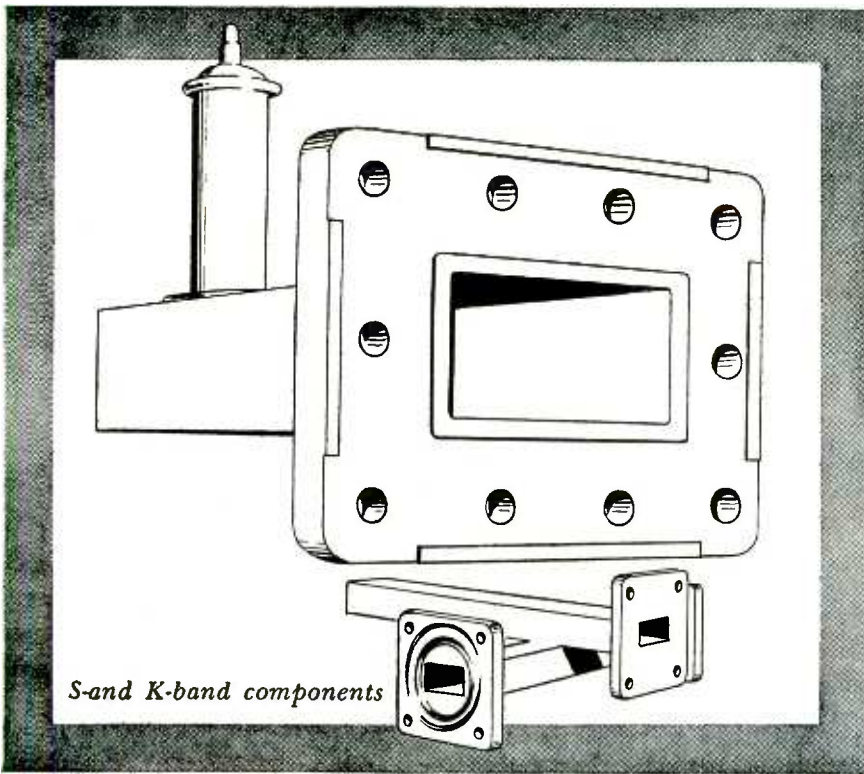

S-and K-band components

how
small
can a
wave
guide
get?

Well, alongside some of the stuff we're working with now, the radar plumbing we used during World War II gets to look like air-conditioning duct. What's more, some of our boys here seem to regard anything below S-band as practically pure D.C. Naturally, we're up to our hips as usual in work on military equipment. However, we do occasionally have some extra creative capacity available, so if you have a problem involving something special in wave guide components (real small ones, too) and like that, maybe we can help. Drop us a line.

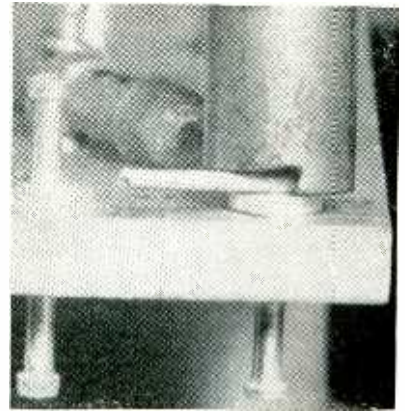

Closeup view of tool as it is placed over terminal, on top of preformed lead

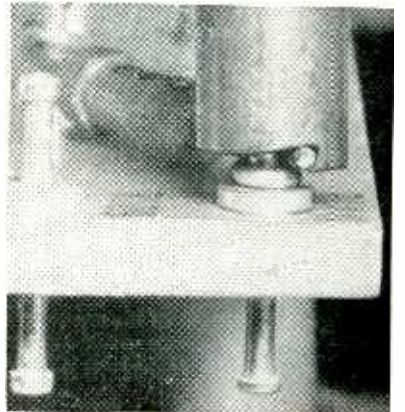

Appearance of tool as it nears completion of joint. End of lead will be snug against terminal when tool is rotated another 90 degrees

sign and operation of the lead-spinning tool is the spiralling of the end of the lead over the adjacent section of the same lead, as shown in the photos.

The tailoring and spinning tools together eliminate the need for diagonal cutters and longnose pliers, both of which require unnecessary skill and judgment factors, costly handling and waste motions. The further elimination of many broken components and pigtailed due to excessive lead tautness is accomplished.

Stripping Coax

TWO TYPES of wire strippers have been developed to meet the special problems encountered in removing a precise length of outer insulation from coaxial cable, in the Palo Alto, Calif. plant of Hewlett-Packard Co. Both meet operator preference for seeing the cutting mechanism at all times, and both minimize chances of cutting the braided

L. H. TERPENING COMPANY
DESIGN • RESEARCH • PRODUCTION
Microwave Transmission Lines and Associated Components
16 West 61st St. • New York 23, N. Y. • Circle 6-4760

HUBBELL *Interlock*

TRADE MARK



automatic locking — quick disconnect
low contact resistance connection for
METERS

Meter leads cannot disconnect accidentally

Bruno Multimeters take advantage of Hubbell Interlock's exclusive contact and locking features. Leads lock automatically when plugged into meter — disconnect only when intended. Contact resistance is extremely low, and stays constant because of unchanging coil spring pressure. Exclusive design and nylon insulation make Interlock jacks waterproof and weatherproof.

Another Hubbell Interlock Development!

4 in 1 Test Prod Kit



This complete 10-piece kit, consisting of two prod couplers, one black and one red, and two each of four basic attachments, makes it possible to change from one tip to another without changing the entire test lead. Wired with Interlock Type S Plugs for a perfect, low contact resistance connection at the meter, Hubbell's versatile test kit gives an accurate reading every time. Basic attachments are: Phone Tip, Phono Needle, Alligator Clip and Spade Terminal. Extra attachments also available in black or red.

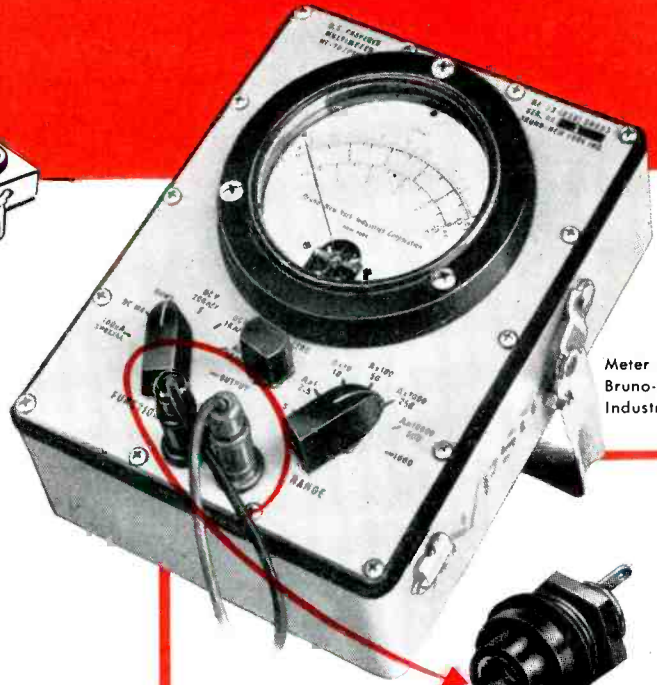

Meter Mfrd. by
Bruno-New York
Industries Corp.

Hubbell Interlock connectors, shown, are nylon insulated . . . color-coded in black and red with a terminal wire connection.

The Type S connectors used in Bruno Multimeters accommodate wire sizes #14 to #18 with 15 amps. capacity.

Hubbell Interlock connectors may be put to a multiplicity of uses for both electrical and electronic devices. Our development laboratory will cooperate with your engineers to adapt Interlock for your specific applications.



For Further Information, Write Dept. AC

HARVEY HUBBELL, Inc.

Interlock Electronic Connector Dept., Bridgeport 2, Conn.

QUAKER CITY GEAR...

... producing gears of every description for the Electronic Industry... including ground thread worms and spiral bevel gears.

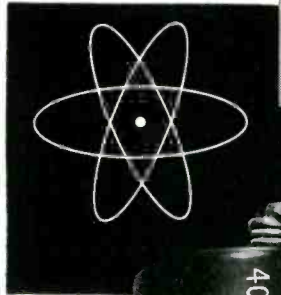

We invite your inquiry



RED LION AND PHILMONT ROADS
BETHAYRES, PA., CHAPEL HILL 0800

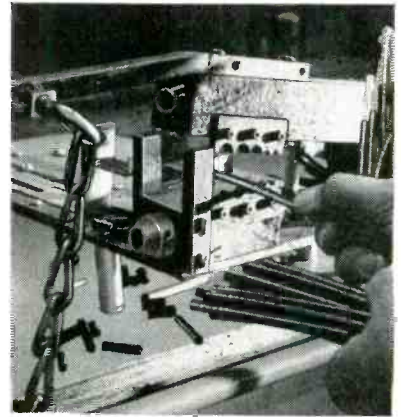
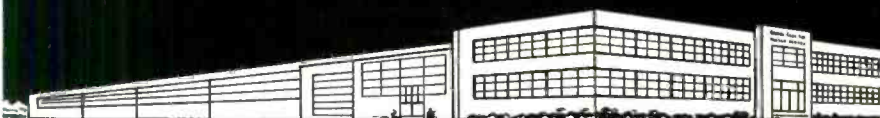

Manually operated coax stripper. Chain goes to foot pedal

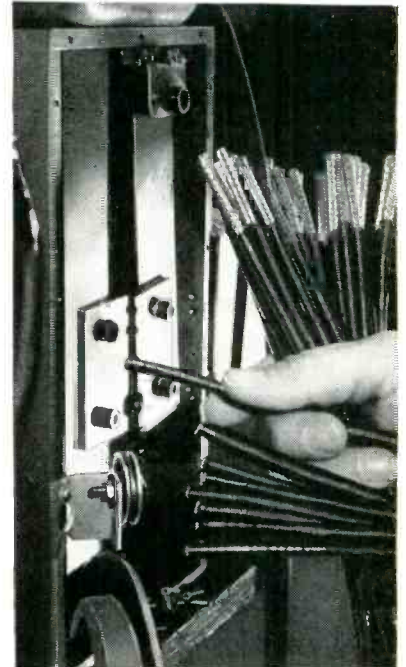

Solenoid-operated coax stripper. Heated jaws are moved together by solenoid

metal outer shield. One type cuts through the insulation of various diameters of coax when actuated by a foot pedal. The other utilizes heat and pressure through use of a solenoid tripper, also operated by foot pedal.

Masking Tape for Plating

IN electroplating a part or an assembly, a portion of the item to be plated must often be masked either to protect that portion from the bath or to prevent it from being plated.

Pressure-sensitive tape, applied manually with a great deal of pressure, has been found an effective mask; negligible plating fringes under the edges of this mask. The

... El Menco First Again
Announces Production of the...

the "DuraMike" dm15...

Smallest
Mica
Capacitor



*does more jobs — in less space — better!
the first and only miniature mica
capacitor with parallel leads*

the DuraMike gives you . . .

1. **SUPERIOR PERFORMANCE:** The *DuraMike* El Menco Capacitors range from 1 to 390 mmf. at 500vDCw. 1 to 510 mmf. at 300vDCw. Made to meet all the humidity, temperature and electrical requirements of MIL-C-5 Specifications.
2. **SUPERIOR CONSTRUCTION:** The *DuraMike* El Menco Capacitor is phenolic coated, durable and tough. Temperature co-efficient and stability *equal to or better than* characteristic F. Will operate efficiently at temperatures as high as 125° Centigrade.
3. **GREATER VERSATILITY:** The *DuraMike* El Menco Capacitor is ideally suited for all military as well as civilian electronic applications . . . Parallel leads means that the El Menco *DuraMike* can be used in positions heretofore impractical. Has wide application in transistor circuits and other miniature electronic equipment. The *DuraMike* El Menco Capacitor is ideal for use in printed wiring circuits.
4. **GREATER ECONOMY:** The *DuraMike* El Menco Miniature silvered mica capacitor sells at prices even lower than our famous CM-15. Provides economy of size with maximum performance and widest application.

*To solve your space problems
to fit your needs!*

Test the El Menco DuraMike capacitor for yourself! Write for free samples and catalog on your firm's letterhead.

Jobbers and distributors write to Arco Electronics, Inc., 103 Lafayette St., New York, N. Y.



El-Menco
Capacitors

THE ELECTRO MOTIVE MFG. CO., INC.
WILLIMANTIC CONNECTICUT
molded mica · mica trimmer

plant-location news

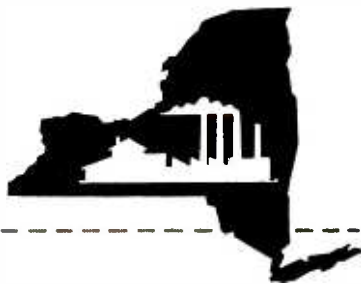

Find the labor you need . . . where you need it

"I want cross-helical-coiler operators for my new plant. As well as tufters and grommeters to work on finished assembly. Can you tell me where to find them?"

Chances are your labor requirements for a new plant location won't be as unusual as these. But they'll probably need just as much specialized information and fact finding. You'll have to know where the right labor force is located or can be recruited, prevailing rates for a wide range of job titles, age, sex, and skills of available workers and up-to-the-minute details on union-management relations. Our Industrial Location Service knows *all* these facts—and many more—for every locality in New York State. And we'll be glad to send you exactly the information you need quickly and without cost, on sites that meet your particular requirements.

Facts and figures . . . tailor-made

ILS labor specialists prepare reports giving a detailed breakdown of the labor force. You'll get an accurate estimate of the percentage of the labor force now available at new sites.

And ILS can also supply rates for various labor skills, or ranges of rates for more general labor requirements. Along with this you can get data on the availability of male and female workers, the number of people adapt-

able to precision work, and facts on recognized training schools for workers.

The ILS labor team constantly studies new developments in the industrial-labor field. As a result, we're in a position to offer the best possible facts on labor at specific New York State locations.

One other thing about this free ILS service—all inquiries are handled in strictest confidence, so that no undue interest or speculation is aroused in the field.

Other free plant-site services

Labor won't be your only concern when you're looking for a new plant location. But no matter what factors are involved, ILS can be of help. Reports are available on transportation, markets, raw materials, water, buildings and sites, and local laws and regulations—to mention just a few. These surveys are tailored to meet your requirements, and sent to you quickly without cost or obligation—and in strictest confidence.

Our booklet called "Industrial Location Services" shows how you can put this valuable plant location data to work. To get your free copy, just drop me a card, care of the New York State Department of Commerce, Room 876, 112 State Street, Albany 7, New York.

Ronald B. Peterson

Director, Industrial Location Service

technique has been used successfully by the Applied Physics section at Airborne Instruments Laboratory on such critical parts as grid-support wafers for electron tubes, where the gold plating bath is chiefly hydrochloric acid. This tape, manufactured by Minnesota Mining & Mfg. Co. as Scotch tape No. 470, is a transparent vinyl plastic film with adhesive. The yellow adhesive appears to resist a variety of plating baths yet peels clear of the work after the plating operation. In this way, rather complex masks are quickly formed directly on the work.

Automatic Assembly Line For Printed TV Chassis

ELECTRONICALLY-CONTROLLED automatic assembly equipment for television circuits has been designed and built by Admiral engineers working under the direction of C. S. Rossate, vice-president-production (Industry Report, p 5, Oct. 1954 ELECTRONICS). Thousands of man hours were devoted to research work on this development. To put the machinery into production required an investment of hundreds of thousands of dollars in tools and equipment. It also required the re-designing of components so they would fit into the feeding chutes.

The machines utilize photo-etched and stamped printed-circuit boards. Stacked boards are automatically



Inspecting etched wiring boards, produced twelve per sheet, and retouching where needed. Sheets are later cut, trimmed and punched. Molded plastic supports hold the sheets at top and bottom while drying

MARION COAXIAL* MECHANISMS MAKE NEW AIRCRAFT INSTRUMENTS LIGHTER, SMALLER, MORE STABLE

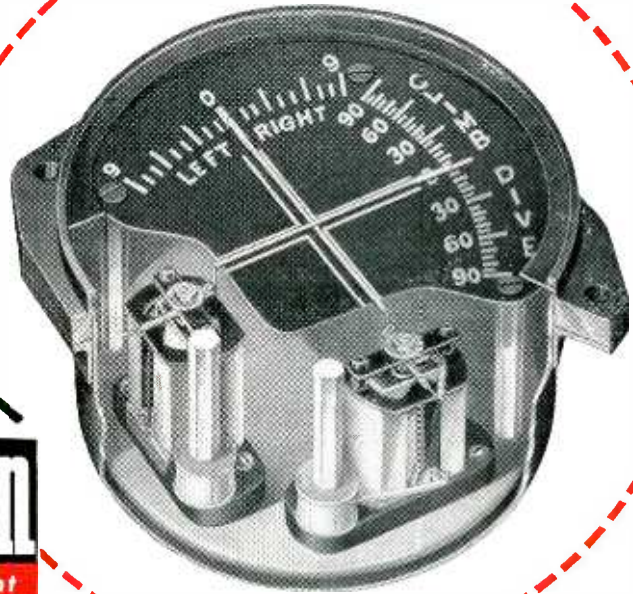

marion
advancement
in instrument
design

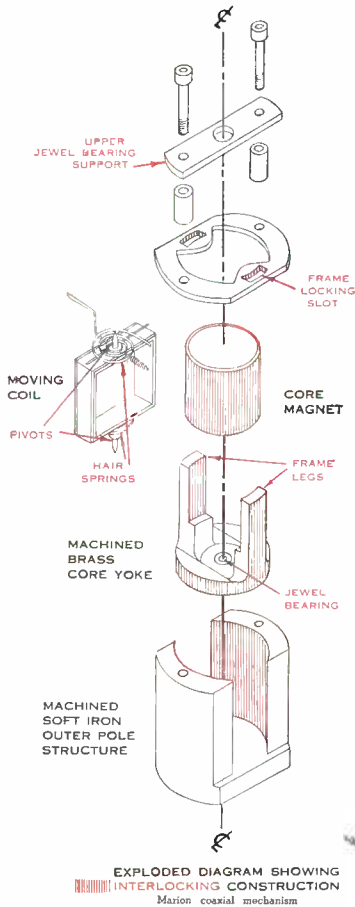

A new AN type multi-element aircraft instrument, incorporating recently developed Marion Coaxial Mechanisms, has greater durability and performance stability than many existing instruments of much greater size and weight. Applications of the new instrument, available with two, three or four elements, include ammeters, voltmeters, temperature indicators and radio navigational instruments. They meet the requirements of Army-Navy Aeronautical Design Standard AND10401 for 2 3/4" dial instruments.

The Coaxial Mechanism making these improvements possible represents a new Marion concept in the mechanical design of moving coil mechanisms. The Coaxial assembly provides a self-shielded magnetic field of great strength, uniformity and stability. Ruggedness and stability are inherent in the basic simplicity of the design. Only two fasteners hold the rigid, interlocked assembly together. All critical dimensions are machined from a common center (the bearing axis), facilitating precise alignment of parts.

MECHANISMS BY MARION

The Coaxial Mechanism typifies the way each Mechanism by Marion is designed to meet the particular requirements of a specific application — and to provide substantially improved performance, with large reductions in cube and weight. They are not adaptations or variations of standard, conventional mechanisms.

Marion Electrical Instrument Company
401 Canal Street, Manchester, New Hampshire

*Trade Mark Patents Pending



marion meters

Reg. U.S. Pat. Off.

MANUFACTURERS OF RUGGEDIZED AND "REGULAR" METERS AND RELATED PRODUCTS

Copyright 1954 Marion

MORE ACTION IN SMALLER SNAP-ACTION SWITCHES

To Hetherington engineers, snap-action in a switch means a whole lot more than a little detent action accompanied by a loud "click". Thus, in every Hetherington snap-action switch, whether for push button, toggle, or rotary operation, the patented beryllium mechanism shown here provides four definite advantages:

- ... an exceptionally positive snap-action that makes it impossible to "tease" the switch ON or OFF contact.
- ... lightning-fast contact make or break for reduced arcing. (Hetherington switches are smaller, carry higher ratings because of this unusually fast action.)
- ... the "snap" and the contact make or break are simultaneous. (Deceptive "clicks" or "snaps" just can't occur with the Hetherington snap-action mechanism).
- ... highest quality construction—polished taper, beryllium copper springs, contacts and terminals of copper with heavy silver overlay—all designed for a minimum life of 50,000 cycles under rated load.

Today more and more appliance and equipment manufacturers recognize that using dependable, space-saving Hetherington switches is really far-sighted economy. Send details of your application for a prompt recommendation by Hetherington switch specialists.

also...

- Indicator lights • Switch-in-
- indicator light combinations •
- Relays • Aircraft and
- Electrical Equipment
- Assemblies

HETHERINGTON

SHARON HILL, PA.

West Coast Division: 8568 W. WASHINGTON BLVD.
CULVER CITY, CALIF.

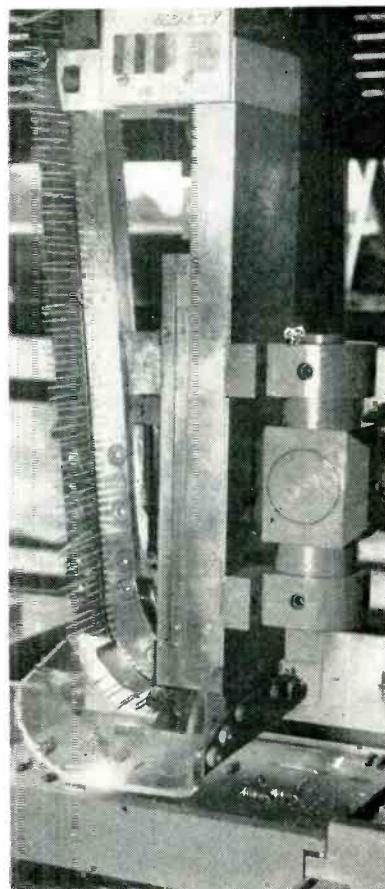
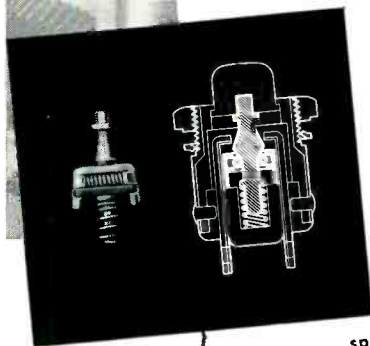

Resistor-inserting head on machine. Adjustable mount permits positioning head to insert resistor at any angle between any two holes on sheet. Air cylinder mounted above head provides actuating power for the operation

moved from machine to machine down the 30-foot line.

Fifty assorted resistors and wire jumpers are automatically inserted in the board, some singly, some two at a time and some three at a time;

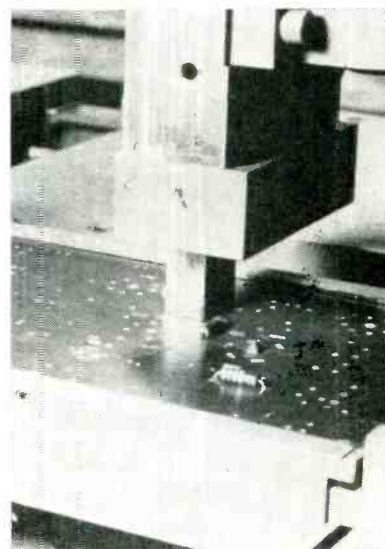

Head used for inserting wire jumpers

A MESSAGE TO RADAR MODULATOR DESIGNERS

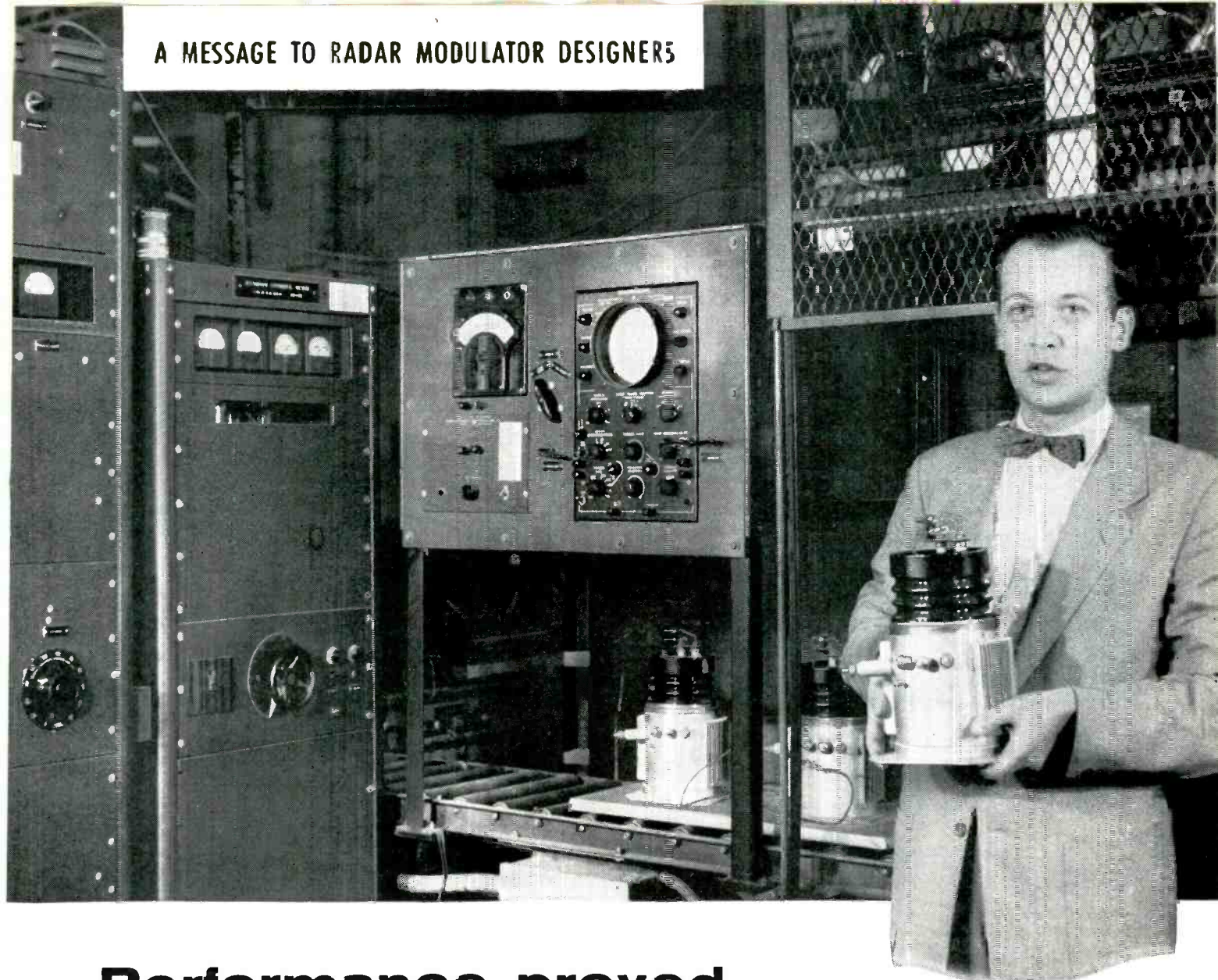

Performance proved . . . to your exact specification

Here's why Westinghouse Pulse Transformers are performance proved—100% production line testing. Every Westinghouse Pulse Transformer must pass tests under simulated actual operating conditions. The pulse permeability test, for instance, besides giving control over normal parameters, includes pulse overvoltage tests and pulse exciting current measurements.

Here's why they can be produced in quantity to your exact specification—Wide core selection. The largest range of Hipersil® C core sizes in the world is available to Westinghouse Engineers. Wave shape performance need never be sacrificed by limited core stocks.

Engineering experience. Westinghouse has for many years been the leader in the design and manufacture of transformers of all types and sizes. Wide engineering experience assures you of coordinated parameters, circuit familiarity and advanced pulse transformer designs.

Why not let us prove that your specialty transformer problem can be solved—to meet your precise specification under any operating conditions. Call your nearby Westinghouse Representative—or, if you prefer, write direct for CS-44-250 to Westinghouse Electric Corporation, 3 Gateway Center, P. O. Box 868, Pittsburgh 30, Pennsylvania. J-70718

YOU CAN BE SURE... IF IT'S
Westinghouse 

RESINITE

EMBOSSED COIL FORMS

*... can
increase
efficiency
of your
iron core
insertion
production
by 20%*

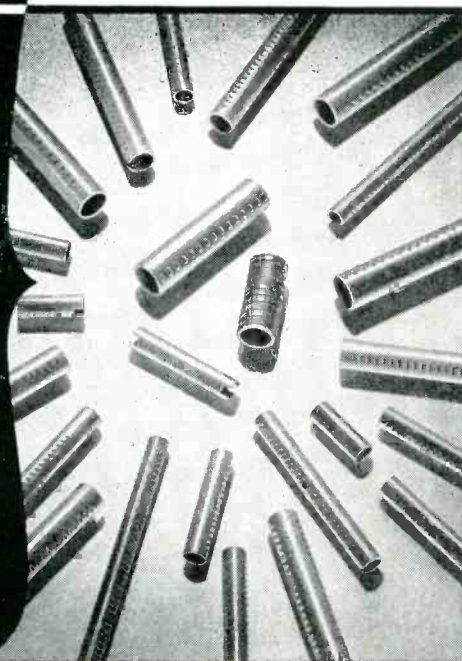

Special embossed construction eliminates torque control problems and stripping . . . prevents breakage or freezing of cores due to cross threading or improper starts.

Custom fabrication to your exact specification assures correct dimensions to within the most critical tolerances, plus uniformity throughout.

Threads are positioned in accordance with your requirement — full thread, each end, one end, center only.

We will furnish—without charge—a pilot production run of custom-made embossed forms to fit your particular application. We will also send a winding mandrel made to the specifications you supply.

Contact us now for full details about this special offer. Request technical bulletin, *Use of Threaded Tubes, Threaded Iron Cores VS. Torque Control.*

**RESINITE
CORPORATION**

▼ ▼ ▼
Sales Representatives in:

New England:
Framingham, Massachusetts, Framingham 7091
Metropolitan New York, New Jersey:
Jersey City, New Jersey, Journal Square 4-3574
Upstate New York:
Syracuse, New York, Syracuse 76-8056
Northern Ohio, Western Pennsylvania:
Cleveland, Ohio, Atlantic 1-1060
Indiana, Southern Ohio:
Logansport, Indiana, Logansport 2555

Missouri, Southern Illinois, Iowa:
St. Louis, Missouri, Sterling 2318
Maryland:
Baltimore, Maryland, Plaza 2-3211
Philadelphia, Camden:
Philadelphia, Pa., Chestnut Hill 8-0282
California:
Pasadena, California, Sycamore 8-3919
Canada:
Montreal, Quebec, Canada, Walnut 2715

Division
of.

PRECISION PAPER TUBE COMPANY

2035E W. CHARLESTON ST. • CHICAGO 47, ILLINOIS

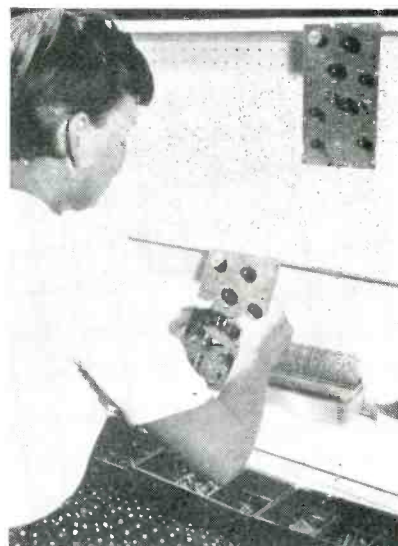

Inserting additional large resistors, tube sockets and capacitors by hand to complete assembly of printed-circuit chassis

before inserting the resistors, the machines trim the wire leads to size and bend them at right angles to the shape of staples. After insertion, dies under the panel crimp the projecting leads flush against the panel to contact the copper circuit pattern, so as to improve the mechanical strength of the dip-soldered joints.

The equipment is so constructed that whenever any part fails to feed from the chute a red light goes on at that machine. The entire line is automatically halted until adjust-



Dip-soldering assembled boards manually. Solder pot has positioning pegs to insure correct depth of immersion

ADVANCED CAPACITOR DESIGN

...Especially adaptable to your own requirements and specifications

Good-ALL
CAPACITORS

MYLAR* Dielectric

METAL ENCLOSED

Hermetically Sealed,
Miracle X Impregnated.



Types 612 and 613 extended foil construction

612 One End Grounded • 613 Both Ends Insulated

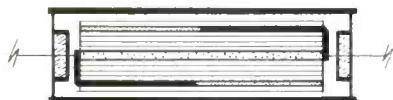

Types 614 and 615 tab construction

614 One End Grounded • 615 Both Ends Insulated

This MIFILM capacitor is unaffected by severe climatic changes—retains extreme high insulation resistance over complete temperature range of -65°C to $+150^{\circ}\text{C}$. SUBMINIATURE SIZES OVER THE ENTIRE CAPACITANCE AND VOLTAGE RANGE. Special sizes can be made to withstand even higher temperatures. Tolerances as low as $\pm \frac{1}{2}$ of 1%. Special shapes available to meet your space requirements.

MYLAR* Dielectric

Commercial Type Construction

Enclosed in thermo-setting plastic
impregnated tube or ceramic case.

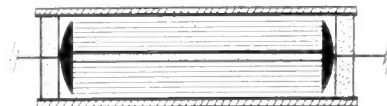

Type 620 extended foil construction

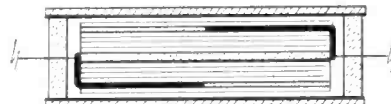

Type 621 tab construction

A high quality, lower cost capacitor with the same excellent properties obtained in our hermetically sealed metal enclosed Mi-film Capacitor. Miracle X Impregnated (high temperature synthetic oil). Marbelite plastic end seal. Excellent humidity resistance. High insulation resistance. Low capacitance change with temperature. Operating temperature -65°C to $+125^{\circ}\text{C}$. Power factor less than .5%.

*Du Pont trade-mark for its Polyester film.

We custom-build to your specified sizes. Our engineers are always ready to work with you on any capacitor problem. We invite sample orders for your evaluation. Write for complete catalog covering these any many other types of Good-All long life capacitors.

Good-ALL
CAPACITORS

SO SUPERIOR they are being specified and used extensively by Electronics, Radio and TV Manufacturers throughout America.

GOOD-ALL ELECTRIC MFG. CO.

114 West First Street • Good-All Building • Ogallala, Nebraska
Phone 112 or 113

HOMELITE

Gasoline-Engine-Driven Generators
designed and built to meet
toughest specifications

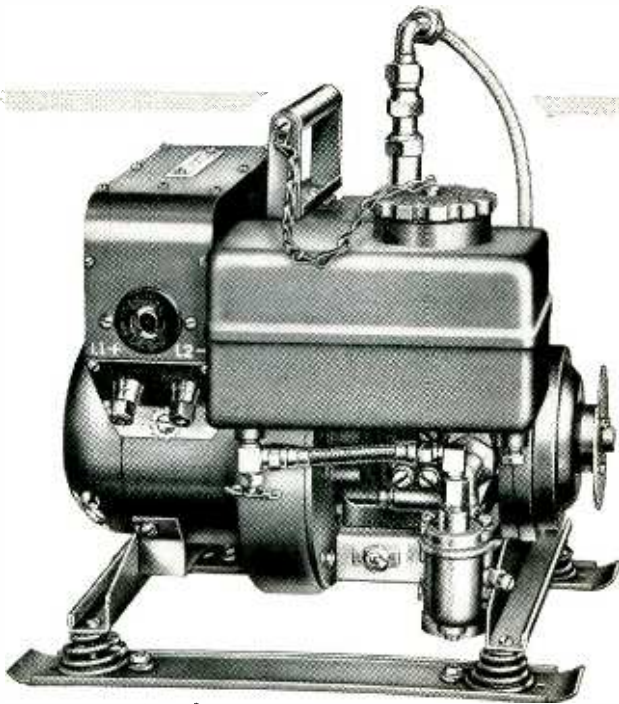

Another Typical Homelite Example

This is the first generator of this size procured to meet the requirements of MIL-G-10286A(CE) and the requirements of the reference engine specification MIL-E-11275A (CE). Only 22 pounds complete, it has a military rating of .15 KW, 120 V., 60 cycle, 1 Phase, 1.0 P.F. reconnectable to 120 V. DC. One gallon of fuel will operate this generator more than 11 hours at full load.

What's your problem? If it involves meeting MIL specifications for lightweight generators, get in touch with Homelite.

With more than thirty years' experience in designing and building hundreds of thousands of lightweight, dependable gasoline-engine-driven units, Homelite's engineering and manufacturing facilities are in a position to find the best solution to your toughest problem, quickest.

Write and you will receive prompt, competent and confidential service.

Homelite builds generators in sizes from .15 KW up to 5 KW in all voltages and frequencies . . . with either gasoline engine or electric motor drive.

Manufacturers of Homelite
Carryable Pumps
Generators • Blowers
Chain Saws

PERFORMANCE • DEPENDABILITY
SERVICE

HOMELITE
CORPORATION

6811 RIVERDALE AVENUE • PORT CHESTER, N. Y.

Canadian Distributors: Terry Machinery Co., Ltd., Toronto, Montreal, Vancouver, Ottawa

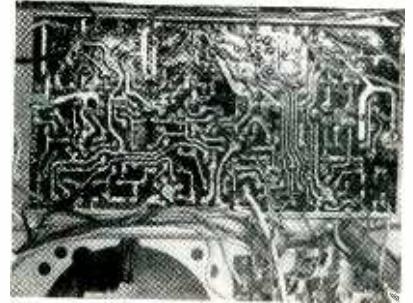

Machine-assembled chassis as installed in receiver after dip-soldering

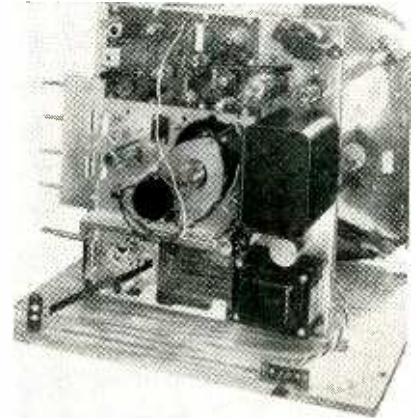

Rear of receiver using printed-circuit board having 69 resistors, capacitors, tube sockets and other components all wired in one solder-dipping operation

ments are made and the components again feed smoothly.

Two other machines—one approximately 100 feet long—are under construction and will be in use early in 1955. Eventually the machines will be able to insert such complex items as tube sockets and tubes.

Advantages of using a machine-assembled printed chassis include more uniform production, trouble-free soldering, greater resistance to extremes of temperature and humidity, more flexibility of engineering and lower production costs.

Vacuum Bag Supports Irregularly Shaped Parts

A THIN-WALLED rubber bag filled with fine plastic granules is used in conjunction with a portable electric vacuum pump in place of special jigs or supports for holding odd-shaped parts during x-ray examination. Normally the bag is limp. When air is partially evacuated from the bag, it becomes pliable like putty, and can be easily molded to any desired shape. Finally, when air is further exhausted, the bag

WHY generate when you can convert?

GET DC DIRECTLY FROM AC

Cut costs, maintenance and replacements with

Federal SELENIUM RECTIFIER EQUIPMENTS

famous for steady, long-life industrial power supply



FEDERAL'S
FTR-3152-AS
POWER
SUPPLY

RATINGS

CODE NUMBER	A-C INPUT			D-C OUTPUT	
	VOLTS	PHASE	CYCLES	VOLTS	AMPS.
FTR 3115-JS	115	1	50/60	115	1
FTR 3116-BS	115	1	50/60	115	5
FTR 3117-HS	115	1	50/60	115	10
FTR 3117-JS	230	1	50/60	115	10
FTR 3152-AS	220 or 440	3	50/60	115 230	4.4 2.2
FTR 3153-AS	220 or 440	3	50/60	115 230	4.6 3.3
FTR 3154-AS	220 or 440	3	50/60	115 230	8.8 4.4
FTR 3155-AS	220 or 440	3	50/60	115 230	13 6.5
FTR 3228-BS	220 or 440	3	50/60	115 230	26 13

NO costly, bulky, moving equipment to buy ... no expendable parts to replace frequently ... virtually no maintenance!

No wonder Federal's compact, silent, rugged, ever-dependable selenium rectifiers are the economical and efficient way to get DC ... for chucks, brakes, clutches, drums, pulleys, relays, circuit-breakers, motors and many other applications ... for all DC needs of the machine tool industry.

Federal Equipments are ready to connect to your AC source ... ready to deliver uninterrupted service. Powered by Federal's completely inert selenium rectifiers, their life is practically unlimited. All are conservatively rated ... with a wide margin of safety to withstand momentary heavy overloads.

If the DC output you need is not listed in the table, Federal will gladly design and build to meet any specific requirements. Fill out and mail the attached coupon today!

MAIL COUPON TODAY for data on available FTR equipments, or any desired rating:

"America's first and largest manufacturer of selenium rectifiers"

Federal
Telephone and Radio Company

A Division of INTERNATIONAL TELEPHONE AND TELEGRAPH CORPORATION
Components Division: 100 Kingsland Road, Clifton, N. J.
In Canada: Federal Electric Manufacturing Company, Ltd., Montreal, P. Q.
Export Distributors: International Standard Electric Corp., 67 Broad St., N.Y.

Federal Telephone and Radio Company
Components Division, Clifton, N. J. Dept. E-313A

Send complete data on FTR code numbers indicated below:

Send preliminary data on the following rating:

FTR.....

FTR.....

Company.....

Address.....

Signature.....

We'll Help You Put More "Automatic" In Your Automation!

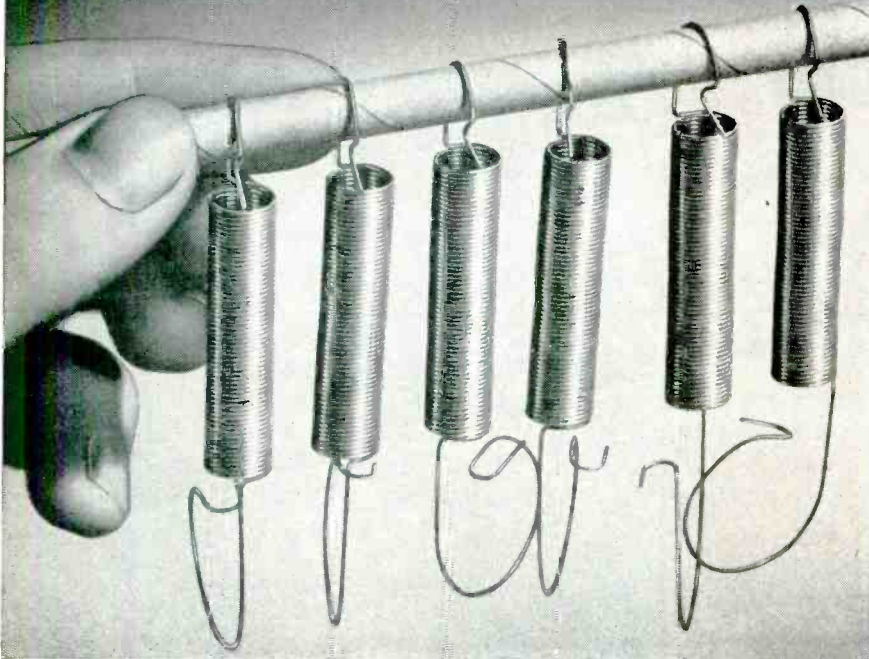

● There is an "extra" Lewis Service many spring users don't know about... it might be called: "packing for production" or "arranged for automation." It's simply the way in which Lewis Springs and Wireforms may be shipped to reach the production line ready for quick, time-saving handling and the most efficient assembly operation... by hand or automatic equipment.

Working with customer's production men, Lewis Engineers devise the packing method best suited to the job: Perhaps threaded on a rod... on special holders... in envelopes... tied or grouped in bundles... and in many other different ways.

If you use springs and wireforms, and have plans to further "automate" production we'd like to help you with our "extras" in Lewis Service. And, of course, top quality springs and wireforms are our business. Send us your problem.

LEWIS SPRING & MANUFACTURING COMPANY
2656 W. NORTH AVE. CHICAGO 47, ILL.

Lewis  **PRECISION SPRINGS**

The Finest Light Springs and Wireforms of Every Type and Material

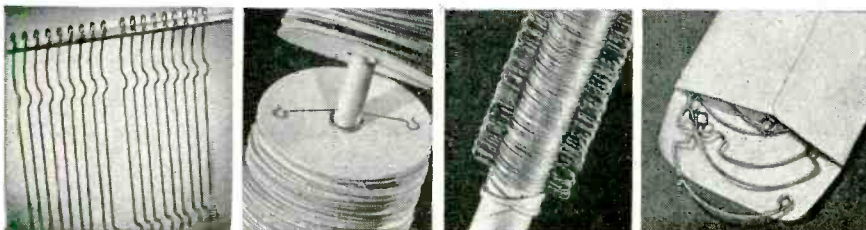

Method of using bag as fixture for supporting x-ray film and tube or other part under industrial x-ray equipment

and its contents become extremely rigid, holding any previously molded shape. The bag can thus be made to serve as a universal holding fixture. It is known as Flexi Cast, was developed by the Picker X-ray Corp., and is in regular use at the Des Moines plant of Solar Aircraft Co.

Ultraviolet Inspection of Picture Tube Screens

SCREENS of picture tubes are checked for evenness of illumination before installation of electron guns by running the tube conveyor through an inspection booth hav-

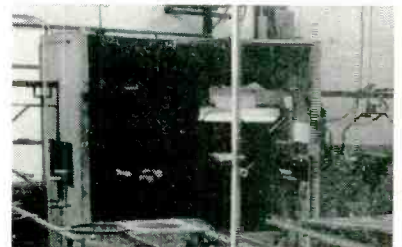

Ultraviolet inspection booth for screens of picture tubes. Wheel-type conveyor and wood pallet for picture tubes can be seen in foreground

WHEN YOU SPECIFY...

TAPE WOUND CORES

SPECIFY ♦♦♦

MAGNETICS inc.

*Performance -
Guaranteed*

HERE'S WHY

Only Magnetix, Inc. "Performance-Guaranteed" Tape Wound cores are *guaranteed* to meet *your* performance specifications. These are truly the most economical tape wound cores offered to industry today, for their guaranteed performance effects major savings on your production line. *They are sold to you at no increase over standard core prices.*

When you specify "Performance-Guaranteed" Tape Wound Cores from Magnetix, Inc., you have your choice of the largest selection of standard tape wound cores offered by any manufacturer. In addition, the nationally renowned Magnetix Engineering and Development Department will design cores to meet your product needs as a completely free service.

Why not write us today, and put Guaranteed Performance to work for you?

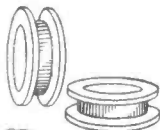

Performance - Guaranteed **BOBBIN CORES, TOO**

Tiny Bobbin Cores made with ultra-thin tape down to 0.000125" in thickness, and possessing very rectangular hysteresis loops under pulse conditions, are now available for the first time with the famous Performance-Guarantee. If temperature stability, low coercive value, high saturation density, and ability to switch from positive to negative saturation in a very few microseconds, are of value to you, it will pay you to investigate Magnetix, Inc. Bobbin Cores.

WANT THE COMPLETE STORY?

It's easy to get the detailed story . . . simply write on company letterhead. We'll send complete literature, containing specifications and design information.



DEPT. E-15, BUTLER, PENNSYLVANIA

... Masterpieces in crystal craftsmanship

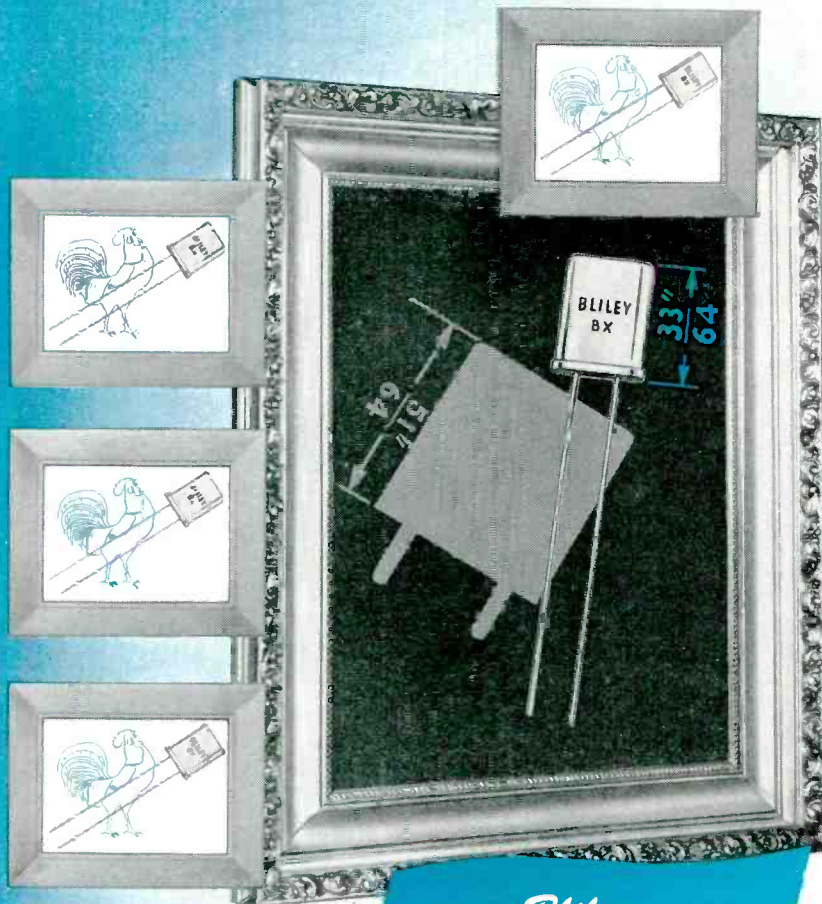

Bliley
**BANTAM BX
CRYSTAL UNIT**

**BANTAM IN EVERY WAY—
BUT PERFORMANCE!**

The **BANTAM BX** is precision in pint-size! Meets all of the demanding specifications dictated by space limitations in portable and pocket size gear.

In design, if the sub-miniature assembly calls for multi-character operation, **BANTAM BX** crystals with wire leads may be conveniently mounted in a sub-miniature selector switch. Or, the **BANTAM BX** can be directly wired to printed circuitry.

BANTAM BX crystals meet all performance requirements of larger units such as the Bliley BH6A. Supplied in frequency ranges: 10 mc - 100 mc. Hermetically sealed.

More technical information may be secured by requesting our Bulletin No. 46-A. Send your prints for a prompt quotation.

Bliley
ELECTRIC COMPANY
UNION STATION BUILDING
ERIE, PENNSYLVANIA

**TECHNICAL LITERATURE
AVAILABLE:**

- Bulletin No. 47—Crystals, Ovens, Frequency Standards, Mill-type Specifications Index
- Bulletin No. 45-A—Solid Ultrasonic Delay Lines
- Bulletin No. 46-A—"Bantam BX" Crystals
- Bulletin No. 44-B—"Anokur", Standard Frequency, Ship-to-shore, and TV Service Crystals

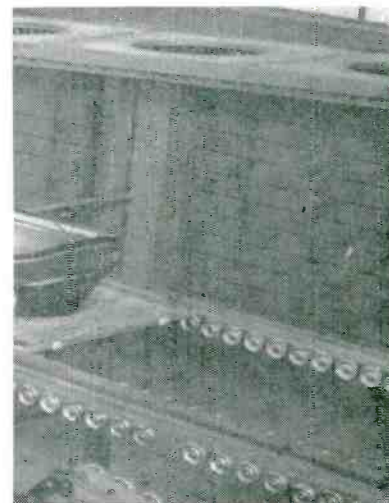

Conveyor details, showing how picture tube rides in pallet. Empty pallets are traveling down from right to left by gravity on upper conveyor

This radiation causes the screen to fluoresce, giving an indication of the evenness of illumination that will be obtained from these screens under electron bombardment. Tubes having screen defects can be thrown out at this point for re-processing, thereby cutting production costs appreciably. This inspection supplements a visual inspection with fluorescent lamps im-



Method of using vacuum lifting aid for loading 27-inch picture tubes into 8-tube automatic sealing machine

Another G-E Capacitor First for the Electronics Industry

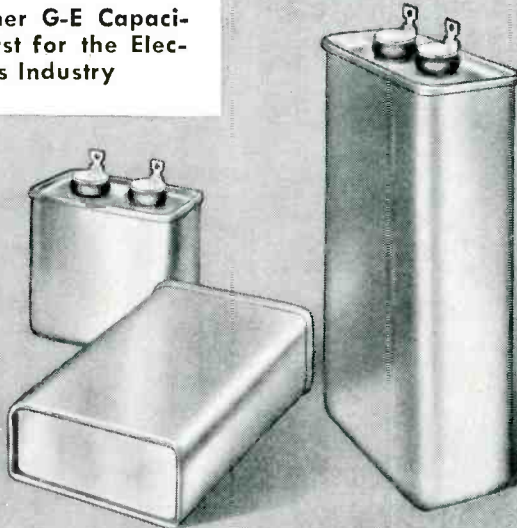

DRAWN-RECTANGULAR CASE has no soldered seams, does not depend on solder for mechanical strength and effective sealing.

new . . . G-E CAPACITORS IN DRAWN-RECTANGULAR CASES

- Solderless, double-rolled cover seam
- Seamless case with standard dimensions

General Electric is now producing fixed paper-dielectric capacitors in seamless, solderless cases with standard dimensions that comply with or exceed MIL specifications. For complete information contact your G-E Apparatus Sales Office or write for Bulletin GEC-809A to Section 442-24, General Electric Co., Schenectady 5, N. Y.

Progress Is Our Most Important Product

GENERAL  ELECTRIC

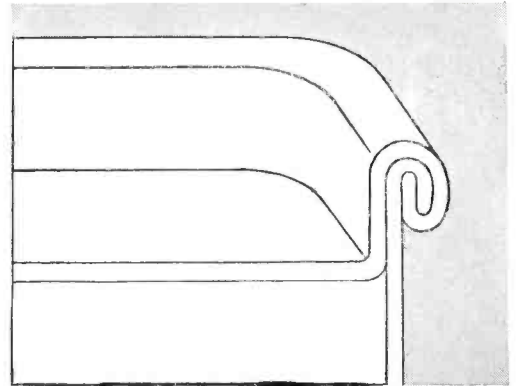

SOLDERLESS DOUBLE-ROLLED COVER SEAM makes a mechanically strong, hermetic seal.

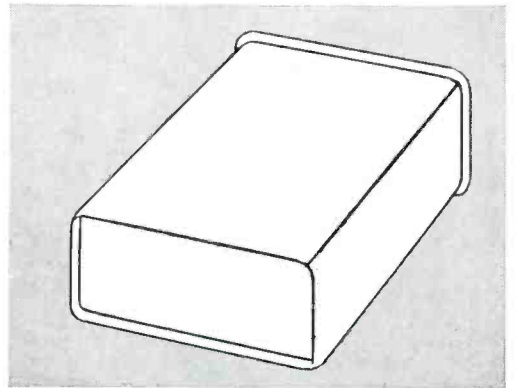

BOTTOM OF CASE IS INDENTED to permit mounting in inverted position.

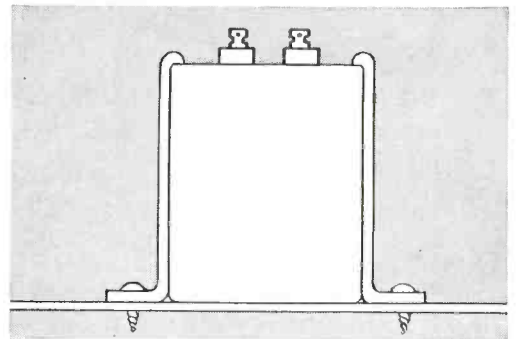

UPRIGHT OR INVERTED MOUNTING is possible using either spade lug, or footed brackets (above)

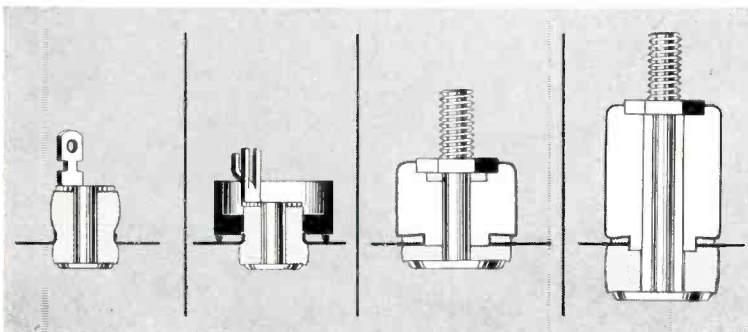

FOUR BUSHINGS STYLES are available for applications below 2000 volts d-c, special skirted bushings for higher voltages.

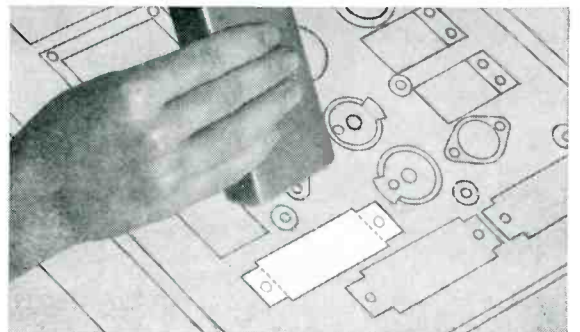

STANDARD CASE SIZES are interchangeable, making it unnecessary to change drawings or circuit layouts.

Available Now! YOUR PERSONAL COPY
OF THIS INFORMATIVE NEW CATALOG—

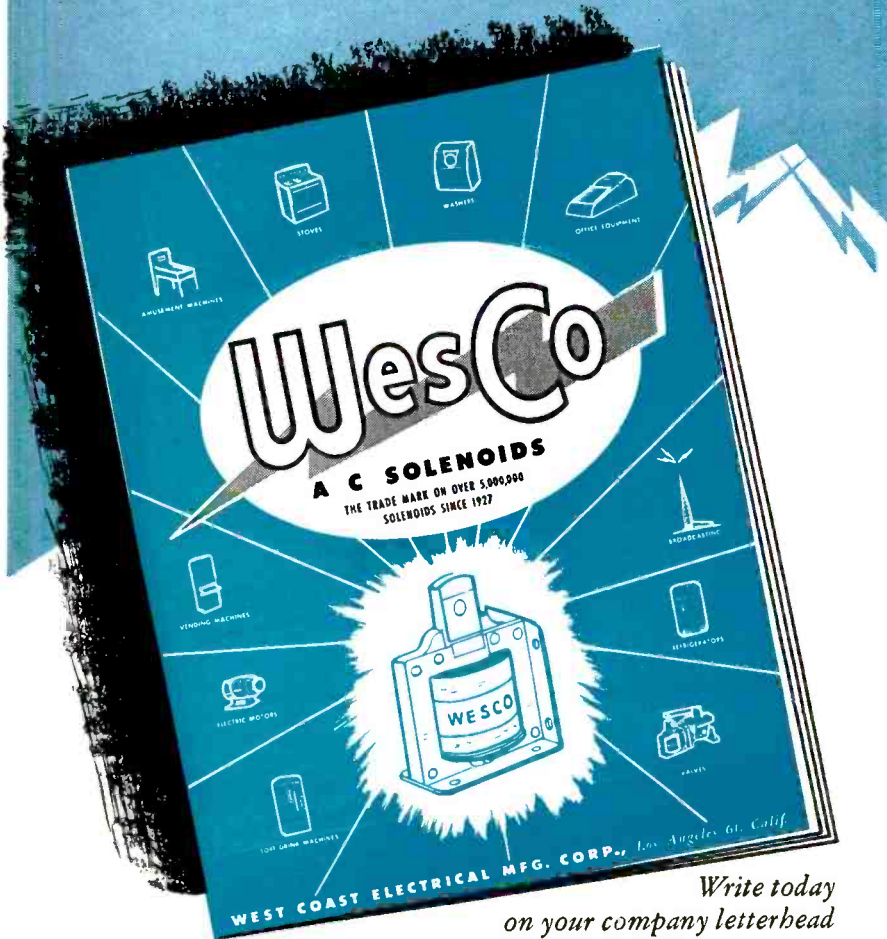

Write today
on your company letterhead

THE NEW WESCO AC CATALOG is off the press—request your copy now. The catalog gives design information to help you order the right solenoid for your application. It gives engineering drawings, solenoid performance charts, work and temperature curves in easy to follow form.

Since the WesCo trademark is on AC solenoids used everywhere, you can be sure the WesCo catalog gives you real help on your solenoid problems. A request on your company letterhead brings your AC catalog promptly. Write today.

NOTICE:

If you specify DC aircraft solenoids for your company, you will find the WesCo DC solenoid catalog helpful. The pages are filled with easy to read information to help you choose the **right** solenoid. Sent only to requests on company letterhead.

mediately after the bulbs are taken from the settling machine. The rejects found by ultraviolet inspection do not ordinarily show up when the screen is inspected under ordinary light.

The inspection booth also serves as the unloading position for the overhead conveyor. Good bulbs are lifted out of the U-shaped arms of the conveyor and set into the circular holes of wood pallets that run on wheel conveyors. The two sides of the conveyor ride on roller skate wheels attached to the conveyor frame, so that the neck of the picture tube can hang down far below the pallet without hitting anything.

At the other end of the wheel-type conveyor, the operator lifts tubes out with the aid of an overhead vacuum lifter, for transfer to an eight-tube automatic sealing machine. This accommodates tubes up to 27 inches in size and seals in the glass stem containing the electron gun. Tubes coming off this sealing machine are ready for exhaust. These techniques are in use in the new Quincy, Mass. plant of Raytheon Mfg. Co.

Checking 4,000-Mc Radio Relay Tubes

A TEST set employing waveguide plumbing in conjunction with a 4,000-mc klystron oscillator, attenuators, wavemeters, a crystal converter, an oscilloscope and a power-measuring thermistor is used in Western Electric's Allentown tube plant for 100-percent checking of

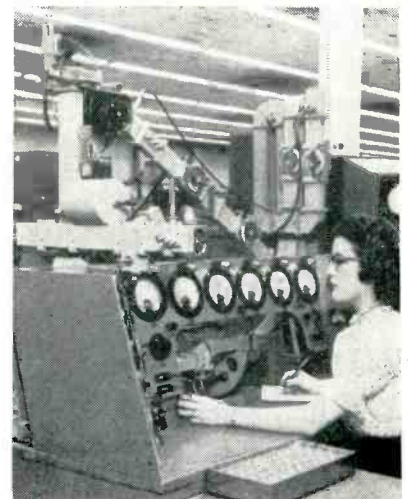

Production test set for microwave tubes



THE TRADE MARK ON OVER 5,000,000 SOLENOIDS SINCE 1927

WEST COAST ELECTRICAL MFG. CORP.

233 W. 116th PLACE, AC DIV. 107 • LOS ANGELES 61, CALIF. • PL. 5-1138

For inventories with more variety...less depth

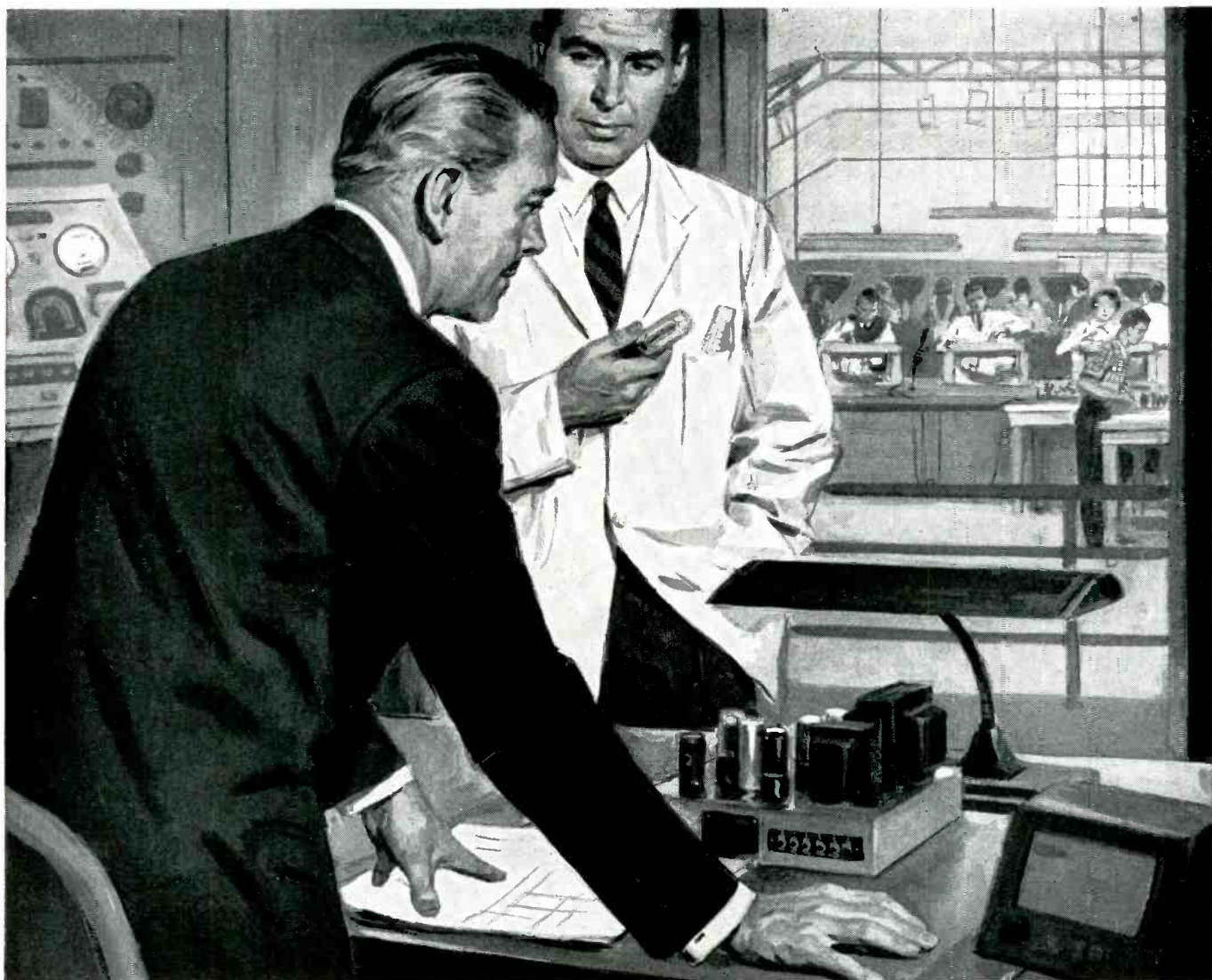

Ship American Airlines AIRFREIGHT

With More Space at More Places, American Provides Prompt Delivery of Component Parts

To keep up with the rapid progress of the electronics industry many manufacturers are turning to airfreight. With supplies just hours away, they can maintain production with only a fraction of the inventories once required. Less capital is tied up and quicker engineering modifications are possible without out-dating huge stocks of component parts.

If you'd like to apply these benefits to your business, be sure to specify *American Airlines Airfreight*. With more flights to more industrial centers than any other Airline, American is your best assurance of prompt forwarding, dependable on-time deliveries. American Airlines, Cargo Sales Division, 100 Park Ave., N.Y.C. 17.



AMERICAN AIRFREIGHT ALSO LEADS IN

SPEED — American's own terminals, special handling techniques assure prompt forwarding, on-time deliveries.

COVERAGE — American serves more leading retail and industrial centers than any other Airline.

EXPERIENCE — first with scheduled airfreight service, American has the experience to provide expert handling.

America's Leading Airline

AMERICAN AIRLINES INC.

THIS IS T/SGT [REDACTED] COMMUNICATIONS CENTER MAINTENANCE
[REDACTED] AFB [REDACTED] WOULD LIKE T SPEAK
SOME ONE IN YOUR RESEARCH AND DEVELOPMENT SECTION PLS

WITH REGARD TO WHAT TZEV

IN REGARDS TO SIGMA RELAYS I WHICH WE REC THIS STATION
THE ARE NUMBERS 157 158 AND 159

MIN PLS
RITE
SORRY TO KEEP YOU WAITING SO LONG WILL BE HERE IN A SEC
RITE THAT IS OK
OK I HAVE A MAN HERE NOW WHAT IS YOUR QUESTION

WELT WE HAD A MISFOURTYONE ON ONE OF TE RELAYS
WE WERE USING IT
YOU ARE WRITING ON THE END OF LIEXXX LINE AND I KXXX DIDNT GET
ANYTHING AFTER WE WERE USING IT
GA PLS

WE WERE USING IT ON A 75 WPM CIRCUIT AND THE MARKING CONTACT
SPRING BROKE
MD WAS WONDERING IF WE COULD GET A COUPLS FM YOU
AS WE HAVE NO STOCK NUMBERS OR ANY WAY TO ORDER ANY THRU AIR FORCE CHA

RPT AIR FORCE SUPPLY CHANNELS
MIN PLS

DO YOU KNWO THE TYPE OF RELAY THAT YOU HAVE
RGR THEY ARE UR NEW TYPE ADJUSTABLE
RELAY THAT REPLACED THE SEALED OCT BASE
DID YOU RECEIVE THEM FROM [REDACTED] A F B AND ARE THEY SERIES 72 RELAYS

MIN PLS I KNOW WE GOT THEM FM [REDACTED] A F B
AND THE ERAL NUMBERS OF THE RELAYS ARE 157 158 AMD159
OK THAT IS ALL WE NED TO KNOW
WE WILL SEND YOU THE 2 CONTACTS THAT YOU WANT
GA

WILL THEREBE ANY CHARGE ON THEM AS WE HAVE NO
OPERATING ACCOUNT THIS TATION

THEY WILL GO OUT TO YOU NO CHARGE
RITE CAN YOU SEND A ME A LIST OF STOCK NUMBERS
FOR THAT TYPE RELAY SO WE CAN ORDER THEM THRU

NORMAL AIR FORCE SUPPLY CANAEIEEE CHANNELS ALSO
A MORE DETAILED INSTRUCTION ON THEM AS
ALL [REDACTED] GAVE US WERE THE
MECH ADJUSTMENTS ON THEM GA
UES WE WILL DO THAT WE WILL GET IT OUT TO YOU BY NEXT WEEK
GA

RITE THEY HAVE TE OLD RELAY BEAT BY ABOUT 1000 PERCENT
WEM WERE HAVING A LOT OF TROUBLE ON 75 AND 100 WPM TILL THGESE
IN AND NOW NO BIAS OR DISTIRTION ON THE CKT AT ALL.

QUERY WOULDYOU LIKE TO HAVE A PERFORMANCE REPORT ON THISE RELAYS
IN OPERATION AT 75 AND 100 WORD SPEED
GA

YES WE WOULD LIKE TO HAVE A PERFORMANCE REPORT
JUST TO GET THE RECORDS STRAIGHT THE OLD EXXX RELAYS WERE NOT
INTENDED FOR MORE THAN 60 WPM
GA PLS

RITE WILL DO WHERE CAN WE SEND THE REPORT
PLEASE SEND IT TO
MR LAURENCE B STEIN
SIGMA INSTRUMENTS INC

RITE WILL DO AND NOW ON THE PARTS IF YOU WILL

PLS END THEM TO
T/SGT [REDACTED]

OK [REDACTED] WILL DO AND THX FOR THE COMPLIMENTS ON OUR 72 RELAYS
WE THINK THAT THEY ARE PRETTY GOOD TOO

WELL FM THE EXPERIENCE I HAVE TN HAD WITH THEM I KNOW THEY RE GOOD
AND NIS A MILLION AND WILL GET THE REPORT OUT BEFORE 1 OCTOMBR
THIS IS [REDACTED] OUT

OK THX END AND BYE

the production line output of type 416 tubes used in microwave relay systems. Eight separate tests are involved. Six conventional meters are connected to read the applied voltages and the currents drawn by the tube under test. This tube is placed in the amplifier cavity, located in the panel opening directly

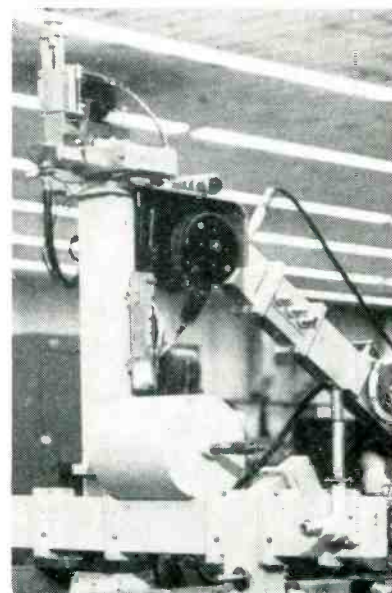

Oscillator is at top left, with attenuator below. Variable wavemeter is in cylindrical housing, with couplers, matching sections and fixed wavemeter below

in front of the operator. After installing a tube and bolting the amplifier cavity section back in position, the operator reads each meter in turn and records the results.

The 4,000-mc test signal originates in the oscillator at the top left on the test set. The oscillator signal is transmitted through a vertical section of waveguide to an attenuator which controls its magnitude, and its frequency is then checked by means of wavemeters. From here a continuation of the waveguide conducts the signal to the amplifier cavity. A sample of this input signal is fed through a crystal converter to a cathode-ray oscilloscope.

Output Indication

The output of the cavity is similarly fed through attenuators, a matching section and a crystal converter to the oscilloscope. When attenuators have been adjusted for equal-height presentations on the scope, the amplification of the tube

Tech. Sgts., though obviously not so hot at operating teletype machines, are, in our opinion, the ones who keep the military wheels going around. We wish there were more of them using our relays (Tech. Sgts. and teletype machines).



This is a picture of the Sigma Series 72 polar telegraph relay to which the Sgt. referred. Neither major carrier of telegraph traffic regularly use it. They should not however be criticized for this. Each makes, or is responsible for someone else making, one of their own design, and although there is nothing "modern" about either, each has the virtue of thirty or so years of service proof. Like the DC3 Airplane, against which let nothing be said!

What we hope is that by making a pulse relay that can "copy" at 500 cps (1200 wpm) and "rattle" at 1500 cps, we may succeed rather well at normal speeds. Also, while service life of these admittedly new relays seems to be exceptionally good, we have even this aspect well hedged. All vital parts can be changed by the user like phonograph needles.

SIGMA

SIGMA INSTRUMENTS, INC.
12 PEARL STREET
50. BRAIN FREE, BOSTON 85, MASS.

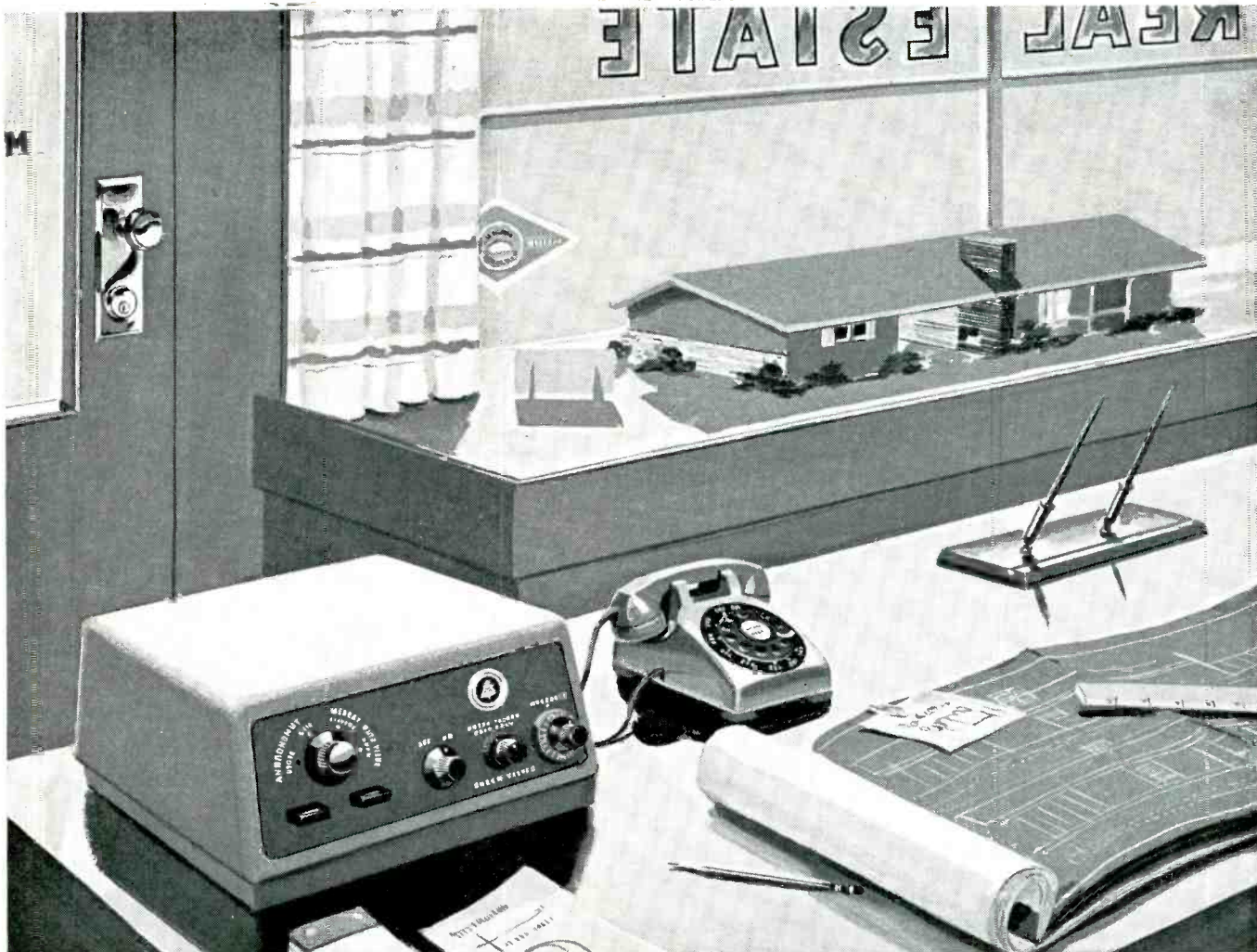

Bell's new Telephone Answering Set. In use, the machine tells the caller when to start talking, and when his time—thirty seconds—is up.

*He's out . . .
but he's answering his telephone!*

This newly designed Bell Telephone Answering Set makes it possible for you to go out—but leave your voice behind.

Before you leave you twist a knob, dictate a message into your telephone, then switch the machine to "Automatic Answer." When somebody calls, the machine starts up and the caller hears your voice telling who you are, requesting his name and telephone number, repeating whatever you have said. The reply is recorded too. On your return you play back all the calls that have come in, as often as you please.

The new machine features "talking rubber," a Laboratories-developed recording medium made of rubber-like plastic and iron oxide which can be used over and over again millions of times. It is another example of how Bell Laboratories research works to help your local Bell Telephone Company serve you.

**Bell Telephone
Laboratories**



*Improving telephone service for America provides
careers for men in scientific and technical fields*

Want more information? Use post card on last page.

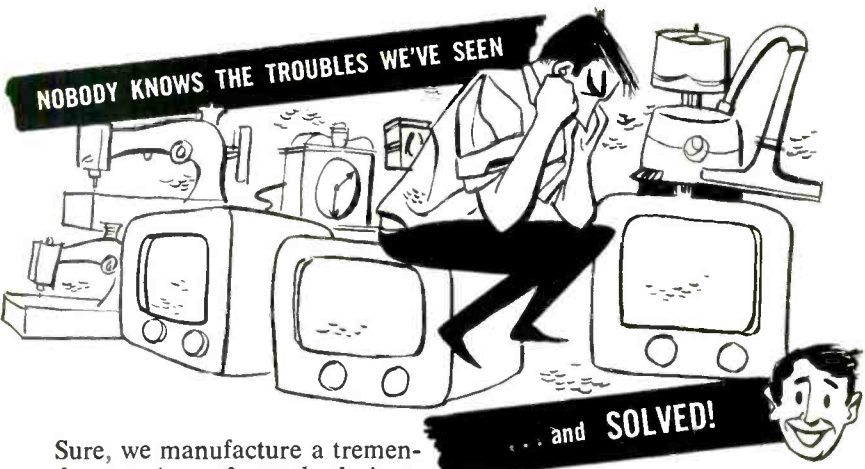

Sure, we manufacture a tremendous variety of standard rivets that have helped many of our customers. Yet, frequently a customer is confronted with a specific fastening (or electrical contact) problem requiring something special. Here are a few of the thousands of unique designs created to give a customer what he needs.

CONTACT STUD FOR RADIO AND TELEVISION

Here is one of the many former screw machine items now being successfully produced by our cold heading process, thereby rewarding the user with substantial cost savings.



CAPACITOR RIVETS

Our capacitor rivets are recognized nationally. We have successfully developed a product which not only prevents any leakage but also facilitates soldering the connection — sometimes by passing the terminal wire through the rivet.

SILVER AND SILVER ALLOY CONTACTS

These silver and silver alloy contacts minimize electrical switch failure wherever long cycle life is a requirement. Made in both tubular and solid styles.



BI-METAL CONTACTS

If the proportion of shank to head size results in a prohibitive cost in solid silver, the advantage of a silver disc on a bronze base rivet provides the desirable cycle life with greater economy.

AUTOMATIC RIVETING MACHINES

TUBULAR has a wide selection of Automatic Feed — single and multiple setting — bench or floor models — pneumatic, motorized or foot powered machines. Standard models or Special design — *for your work.*



Our Sales Engineering Staff is prepared to discuss your problems, and furnish recommendations promptly. Please send blueprints or a sample assembly to Dept. E at the office nearest you.

Tubular Rivet

E. STOD COMPANY
 WOLLASTON 70, MASSACHUSETTS
 BRANCH OFFICES: Buffalo, Chicago, Dallas, Detroit, Indianapolis,
 Los Angeles, Nashville, New York City, Philadelphia, San Francisco, St. Louis

is read directly from the attenuator dials.

A power-measuring thermistor in the output waveguide is used to check the power level at which the amplification is measured.

Vibrator Shakes Leads Into Printed-Circuit Holes

By JAMES E. HUGGINS, JR.
*Ordnance Corps, Frankford Arsenal
 Philadelphia, Pennsylvania*

ASSEMBLY of standard components in a plastic catacomb between two printed wiring plates has been very difficult in the past. Component leads can be easily inserted into the holes of one plate. They can then be threaded through the remaining plate one by one, but this is quite time-consuming and far from automatic assembly.

In the assembly technique developed as a solution to this problem, vibration is used to shake component leads into the plate holes. The shaft of a small a-c motor rides in an eccentric rigidly attached to the vibrator platform which is shock-

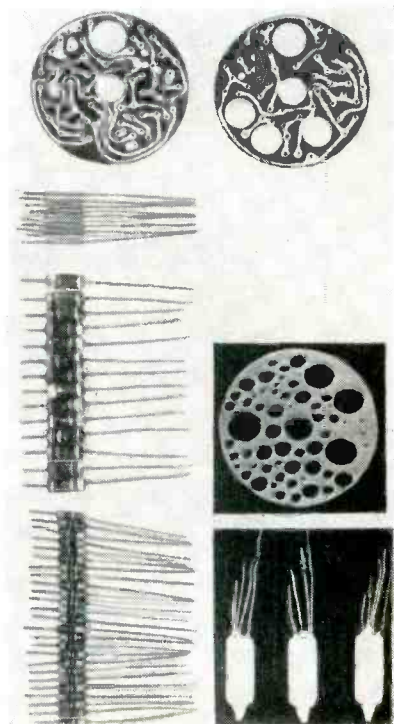

Parts used in three-tube sandwich-type assembly. Conductor plates with etched wiring are at top. Through wires, just below, have sleeves that prevent wires from slipping through plates after assembly. Resistor and capacitor leads are clipped short at one end only. At right center is plastic catacomb

Dimensions:

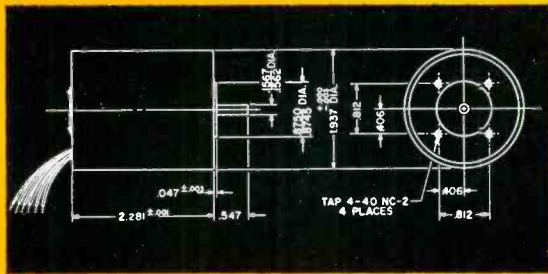

Tabulated Performance Data:
(For continuous operation)

Type	370A-1	370A-2	370A-3	370A-4
Frequency (CPS)	0-1000	0-500	60	400
Voltage (RMS)	20-1000*	20-1000*	115	115
No. Phases	2	2	2	2
No. Poles	4	4	4	4
Synch. Speed (RPM)	30X Freq.	30X Freq.	1800	12000
Max. Synch. Torque (oz.-in.)	0.9	2.0	1.8	2.3
Stall Torque (oz.-in.)	0.9	0.6	1.6	3.2
Max. Efficiency (%)	*	*	33	62

*Dependent upon excitation frequency and driver tubes. 370A-1 and 370A-2 may be driven by 4-6146's (4-6CM6's at reduced torque).

Synchronous Performance Curves:



SYNCHRONOUS AND STALL TORQUE (370A-1)

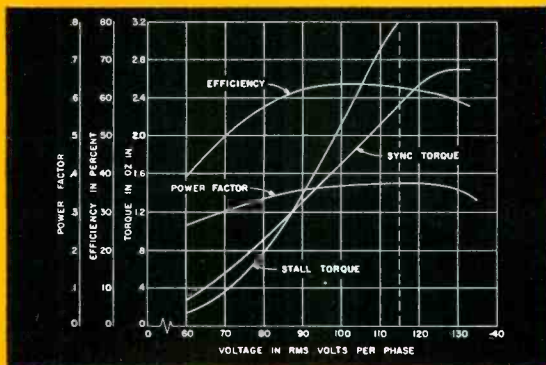

TORQUE, EFFICIENCY, POWER FACTOR (370A-4)

Compact, efficient

Collins

HYSTERESIS MOTORS



Absolutely synchronous and independent of line and load fluctuations

The Collins Hysteresis Synchronous Motor is the answer to the need in the electronic industry for a high efficiency instrument-type motor having the added capacity of operation from vacuum tube amplifiers. The precision construction of Collins Hysteresis Motors yields high starting and synchronous running torques, produces absolutely synchronous rotation, and minimizes power consumption.

The hysteresis synchronous motor is useful for driving timing devices, facsimile equipment, commutators, recorders, or any device which must rotate at an absolutely constant speed regardless of load or line voltage variations. Because a Collins 370A Series Hysteresis Motor operates *directly* in the plate circuits of two push-pull direct coupled amplifiers, output transformers and the attendant poor low frequency response are eliminated and power and space economies are achieved.

The Collins Type 370A-1 Wide-Band Motor can be employed in automatic frequency control systems having error signals as high as 1000 cps. Speed of synchronous rotation is 30 times input frequency, ranging from 0—30,000 rpm.

Type 370A-2 Motor, with split windings similar to Type 370A-1, is designed for operation over a narrower frequency band in the range of 0—500 cps, with higher torque. Types 370A-3 and 370A-4 motors have standard two phase windings for operation at 60 cps and 400 cps respectively. Synchronous motors for use with other voltages and frequencies are available on special order.

Write today for complete information.

COLLINS RADIO COMPANY CEDAR RAPIDS, IOWA

261 Madison Ave., NEW YORK 16
1930 Hi-Line Dr., DALLAS 2
2700 W. Olive Ave., BURBANK

Collins Radio Company of Canada, Ltd., 74 Sparks Street, OTTAWA, ONTARIO





"Your Blueprint In Plastics"

ALL MATERIALS • ALL PROCESSES

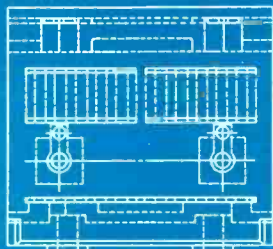

Custom Molding

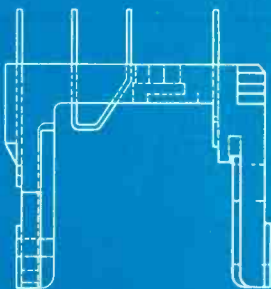

CONSOLIDATED MOLDED PRODUCTS CORPORATION

SCRANTON 2, PENNA.

WAVEGUIDES FOR RADAR & MICROWAVE LINK SYSTEMS

We offer complete facilities for manufacturing Waveguide components from your drawings and specifications—or expert design and development to meet your needs.

- Precision Cast Waveguides
• Aluminum Dip Brazing & Heliarc Welding
• Broadband Waveguide Components
• Mixers • Duplexers
• Rotating Joints
• Hybrid Junctions
• Crystal Mounts
• Bends

Write for Illustrated Brochure

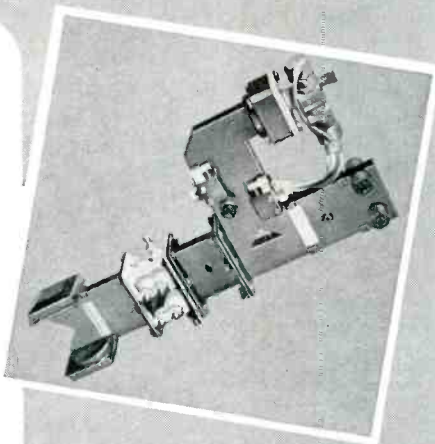

PREMIER INSTRUMENT CORP.

52 West Houston Street New York 12, N. Y.

THE WAVEGUIDE HOUSE SINCE 1943

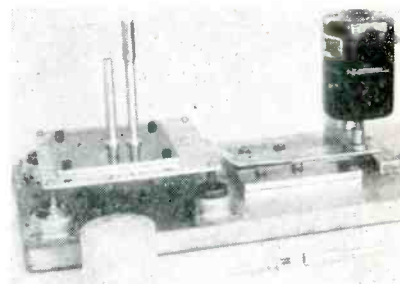

Vibrator setup, with pilot catacomb and guide pins in foreground

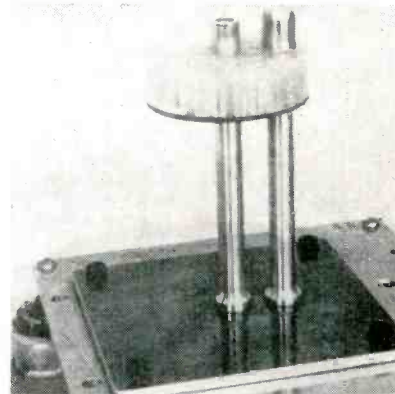

Vibrator table, with pin 1, one conductor plate and permanent assembly catacomb on shafts

mounted to the base. The vibration is produced in a horizontal circular direction. A Variac provides control of motor speed. Assembly with this equipment is not fully automatic, but additional or full-automatic production is feasible.

Two shafts mounted on the vibrating platform provide orientation of the conductor plates and catacomb. One is threaded for adding two shouldered pin sections.

Assembling is begun by placing one extra pin in the shaft. A conductor plate is then slipped down over the two shafts so it rests atop the narrow shoulder of the added pin (called pin 1). Next, the assembly catacomb is placed in such a position that all holes are in alignment with those of the conductor plate.

A pilot catacomb, identical to the other catacomb but of greater length, is now placed in position and loaded with components by hand. Automatic loading here can be accomplished by gravity feeding of components through tubes. Vibration of the unit causes the component leads to drop into the holes of the conductor plate, after which the pilot catacomb is removed.

The assembly is now complete ex-

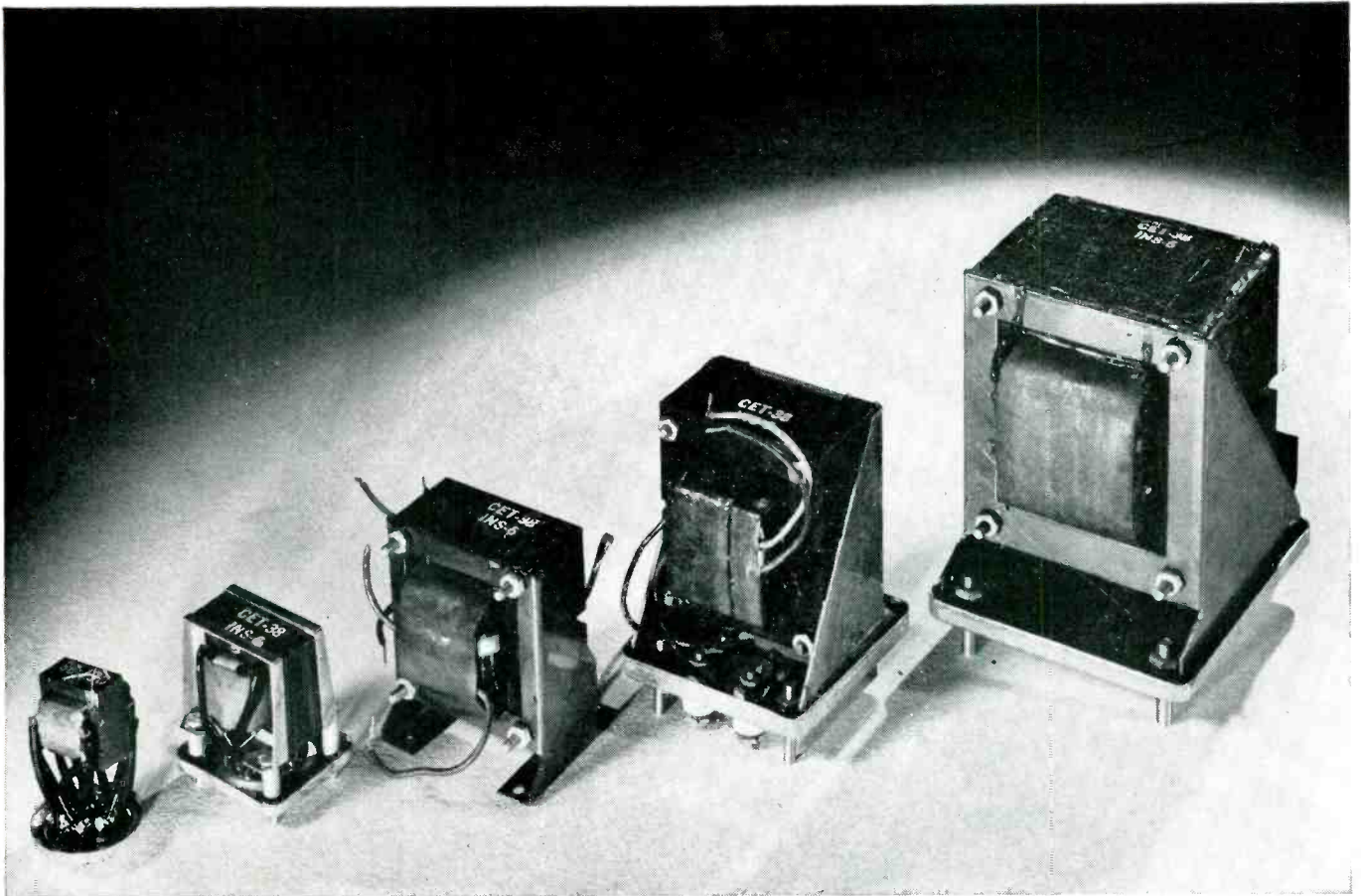

A Transformer becomes a precision device with Allegheny Magnetic Materials in the core



Write for your Copy
"TRANSFORMER LAMINATIONS"

84 pages of valuable technical data on standard and custom-made laminations from all grades of Allegheny Ludlum magnetic core materials. Prepared from carefully checked and certified laboratory and service tests — includes standard dimensions, specifications, weights, etc. Sent free on request . . . ask for your copy.

ADDRESS DEPT. E-59

- ★ ALLEGHENY SILICON STEEL
- ★ ALLEGHENY 4750
- ★ ALLEGHENY MUMETAL

The operation of a transformer is no better than the magnetic core around which it is built. With Allegheny magnetic materials in the core, you get the *best* — uniformly and consistently.

Sure there are reasons why! For one thing, there's the long experience of a pioneer in development and quality control of electrical alloys. But most important, the A-L line offers complete coverage of any requirement you may have, any service specification. It includes all grades of silicon steel sheets or coil strip, as well as Allegheny Silectron (grain-

oriented silicon steel), and a wide selection of special high-permeability alloys such as Allegheny 4750, Mumetal, etc.

In addition, our service on magnetic materials includes complete lamination fabrication and heat treatment facilities. What's more, this extensive experience in our own lamination stamping department is a bonus value for all users of A-L electrical sheets or strip. ● Let us supply *your* needs. *Allegheny Ludlum Steel Corporation, Oliver Bldg., Pittsburgh 22, Pa.*

STEELMAKERS to the Electrical Industry
Allegheny Ludlum

W&D 5333



Versatility Plus!

The New PRD DC POWER SUPPLY

- for general laboratory and production line use
- power supply for many low voltage klystrons

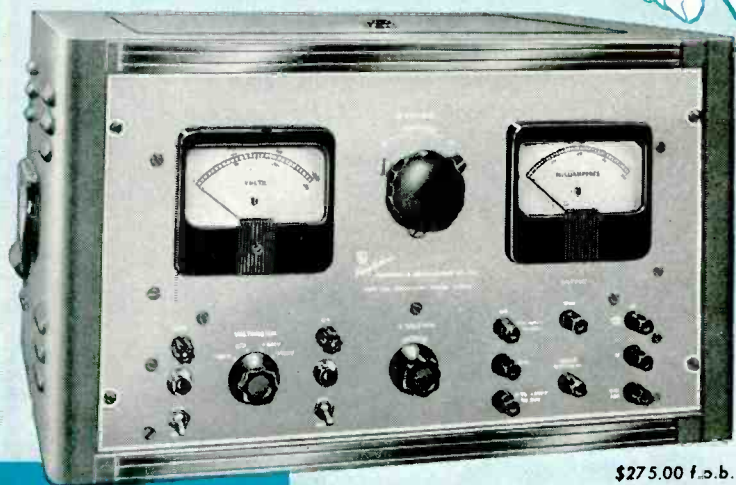

\$275.00 f.o.b. N. Y.

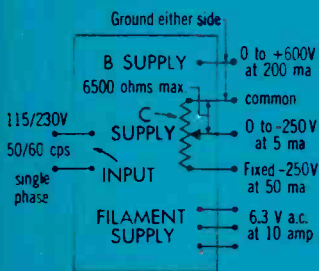

Flexible ground permits stacking of supplies to provide up to -600V. cathode voltage and an additional 0 to -250V. for the reflector of low voltage klystrons.

Features:

- Wider than usual output range: "B" supply 0 to $\pm 600V.$ at 200 ma. "C" supply 0 to -250V. at 5 ma.
- Additional fixed supply -250V. at 50 ma.
- Unregulated 6.3V., 10A. C.T. filament supply
- Excellent voltage regulation (only $\pm .25V.$)
- Low ripple (less than 4 mv.)
- Input 115/230 Volts ac, 50/60 cps, single phase

The PRD Type 807 is a general purpose, constant voltage power supply, competitively priced to fit any instrument budget. It is conservatively rated for continuous service. Panel voltmeter monitors either supply voltage; milliammeter indicates "B" supply current. Write for bulletin.

Polytechnic RESEARCH

& DEVELOPMENT CO. Inc

202 TILLARY ST.
B'KLYN 1, N.Y.
Telephone:
ULster 2-6800



Chicago Sales Office:
1 SO. NORTHWEST HWY., PARK RIDGE, ILLINOIS-TAIcol 3-3174
Los Angeles Sales Office:
741 1/2 NO. SEWARD ST., HOLLYWOOD 38, CAL.-Hollywood 5-5287

cept for the second plate. This is placed atop the component leads in oriented position and the other extra pin (pin 2) is threaded into pin 1. The catacomb is now pulled up flush against the upper plate to bring each component lead near its own hole in the plate. The whole unit is removed from the shafts of the vibrator, inverted and placed on the vibrator again. For automatic assembly the vibrating mechanism itself would be inverted.

Vibration now causes all the component leads to drop into their holes in the conductor plate that is now at the bottom. This plate, through which the shorter leads protrude, is

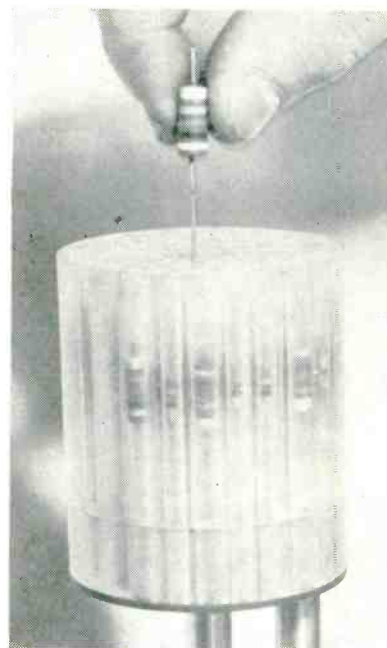

Loading resistor into pilot catacomb

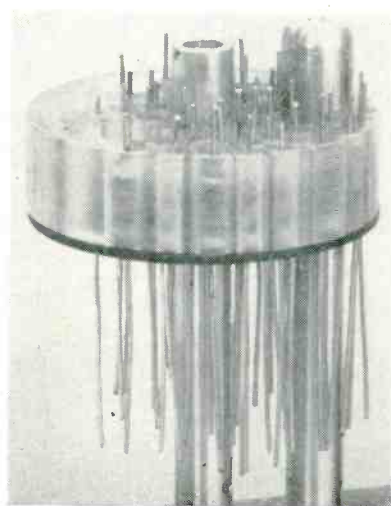

Appearance after components have been vibrated into first plate and pilot catacomb removed

AUDIO PRODUCTS MODULAR SYSTEM

equipped with  Quality Resistors

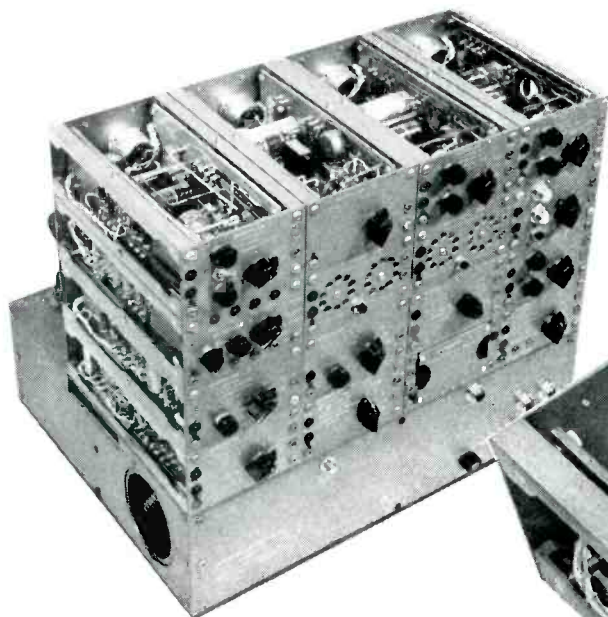

A typical array of Modular units assembled upon the power supply base.

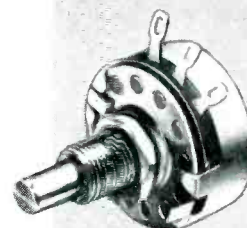

BRADLEYOMETERS

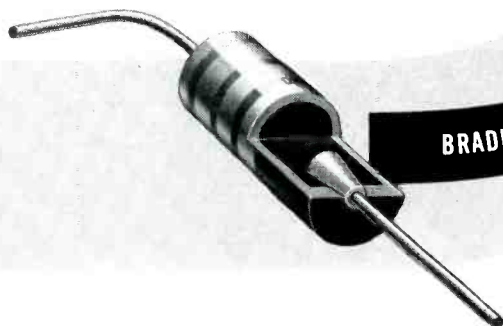

BRADLEYUNITS

The Modular system, developed by Audio Products Corporation of Los Angeles, consists of 16 Modular units of various electronic functions which may be interconnected to perform most basic pulse operations. With this system of compatible units, research engineers can think and work in "block diagram" terms, and thus be freed of many circuit details.

Bradleyunit fixed resistors and Bradleyometer adjustable resistors are used in the various Modulares to assure stability of performance.

Bradleyunits are ultra-conservatively rated at 70C ambient temperature—not the usual 40C. Their resistance values exhibit no erratic changes . . . nor do they open circuit.

Bradleyometers have solid molded resistor elements that are not affected by temperature or humidity, and improve with use.

Get the data on these QUALITY products by sending for Allen-Bradley electronic fixed and adjustable resistor bulletins, today.

Allen-Bradley Co., 110 W. Greenfield Ave., Milwaukee 4, Wis. • In Canada—Allen-Bradley Canada Limited, Galt, Ont.

ALLEN-BRADLEY
FIXED AND ADJUSTABLE RADIO RESISTORS

QUALITY

a masterpiece of accuracy

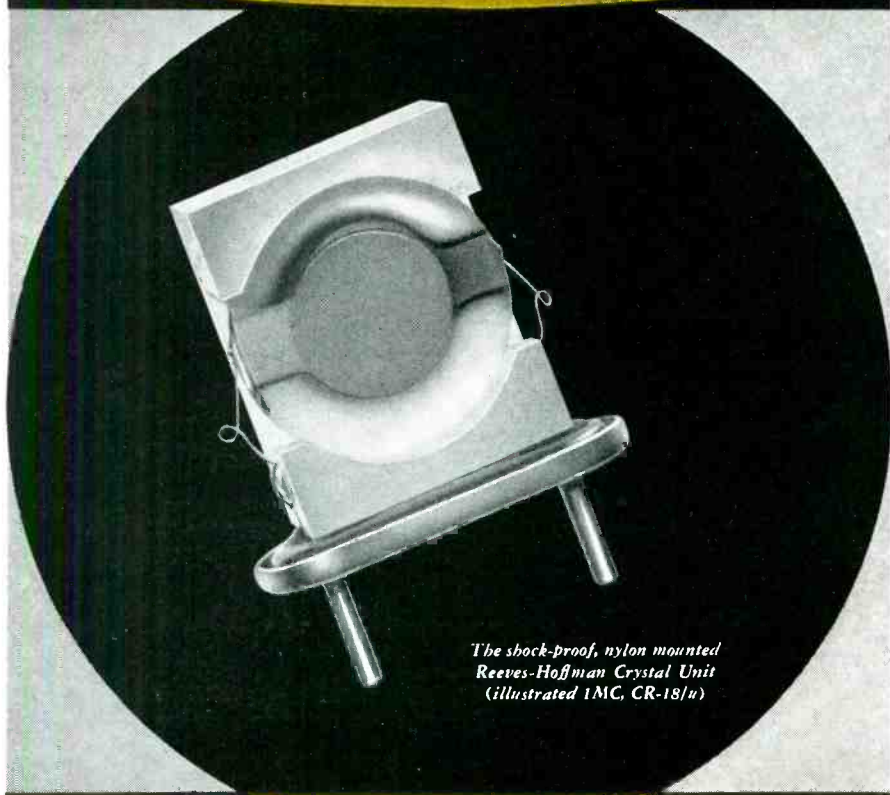

*The shock-proof, nylon mounted
Reeves-Hoffman Crystal Unit
(illustrated 1MC, CR-18/u)*

The RH-7N utilizes one of the latest electronic developments to come out of Reeves' laboratory—the new nylon nest mount for crystals. This nylon nest permits Reeves to go down to 500 kc with an AT cut in an HC-6 holder, with remarkable stability in frequency control.

The RH-7N is built to meet the requirements for MIL types: CR-18, 19, 27, 28, 35, 36 and 48/u. Write today for further information.

REEVES-HOFFMAN CORPORATION

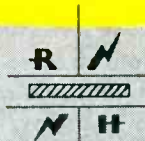

A SUBSIDIARY OF CLAUDE NEON, INC.

**CHERRY AND NORTH STREETS
CARLISLE 2, PENNSYLVANIA**

fluxed and dip-soldered first. After dip-soldering, the leads are clipped flush against the plate, the three subminiature tubes are manually inserted in the remaining plate and

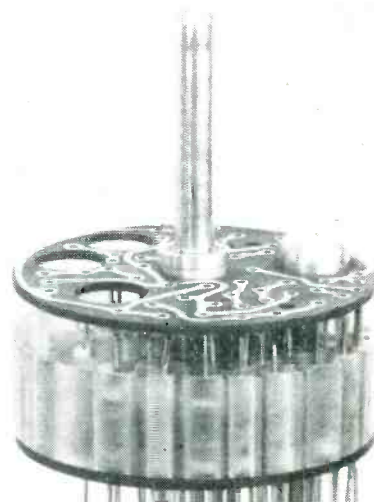

Top plate is now in position and pin 2 threaded into pin 1



Holding catacomb up against top plate prior to inverting assembly

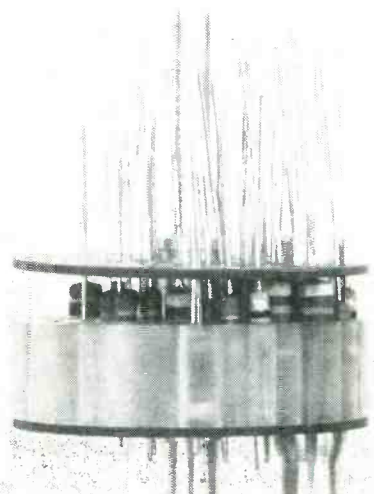

Assembly after inversion, with some leads already down into their holes

For Research, Production, and Servicing specify RCA WR-86A UHF Sweep Generator

only
\$275

(suggested user price)



CHECK THESE FEATURES:

- ***Frequency range**—continuous from 300 to 950 Mc.
- ***Wide sweep range**—continuously adjustable up to 10% of indicated dial frequency for frequencies up to 750 Mc; continuously adjustable up to at least 75 Mc. for frequencies from 750 to 950 Mc.
- ***Flat-output**—maximum voltage amplitude variation 0.1 db/Mc over swept range.
- ***High output voltage**—0.6 volt across 50 or 300 ohms.
- ***Wide-range attenuation**—continuously adjustable over a range of 60 db.
- ***Electro-mechanical sweep** of rugged, time-tested design.
- ***Phased blanking circuit** provides essential zero-reference line.
- ***Phased horizontal deflection** voltage for oscilloscope.
- ***50- and 300-ohm outputs**—balanced 300-ohm output provided by shielded, padded 50- to 300-ohm balun (WG-296).
- ***Portable, lightweight**—only 14 pounds.

The new WR-86A UHF Sweep Generator is recommended for continuous production-line testing and for general service applications on color and black-and-white TV receivers, converters, tuners, filters, antennas, transmission lines, and other equipment operating in the range from 300 to 950 Mc.

The sweep oscillator in the WR-86A uses an RCA-6AF4 uhf oscillator triode in a specially designed circuit which provides excellent sweep linearity, wide sweep width, and flat output voltage (maximum amplitude variation is only 0.1 db/Mc).

The oscillator compartment of this instrument and its associated components are specially designed and sturdily constructed to assure stability and reliable performance under continuous use on production lines. Critical parts are silver plated, and the entire oscillator sec-

tion is enclosed in a silver plated compartment to minimize leakage and to insure high electrical efficiency.

A blanking circuit is included to provide a reference base line on an oscilloscope. Horizontal sweep for the 'scope can be obtained from front-panel terminals.

The RCA WR-86A comes equipped with 4-foot rf-output cable, 50- to 300-ohm padded balun (WG-296), and instruction book. The balun is also available as an accessory for use with RCA WR-40A, WR-41A, and WR-41B UHF Sweep Generators. (Suggested User Price, \$13.50).

VSWR Measurements

New! The RCA WG-298A UHF Demodulator for 300 to 950 Mc facilitates measurement of voltage standing-wave ratios of receiver inputs, antennas, and other uhf loads utilizing 300-ohm transmission lines. It is designed for use with the WR-86A and other uhf generators having 50-ohm BNC-type output connector. The WG-298A matches a 50-ohm unbalanced to a 300-ohm balanced termination, and provides a terminal for connecting the demodulated output to an oscilloscope.

Suggested User Price **\$37.50**

See your RCA Distributor
for complete details.



RADIO CORPORATION of AMERICA
TEST EQUIPMENT

HARRISON, N. J.

PRECISION components

tuned to tomorrow

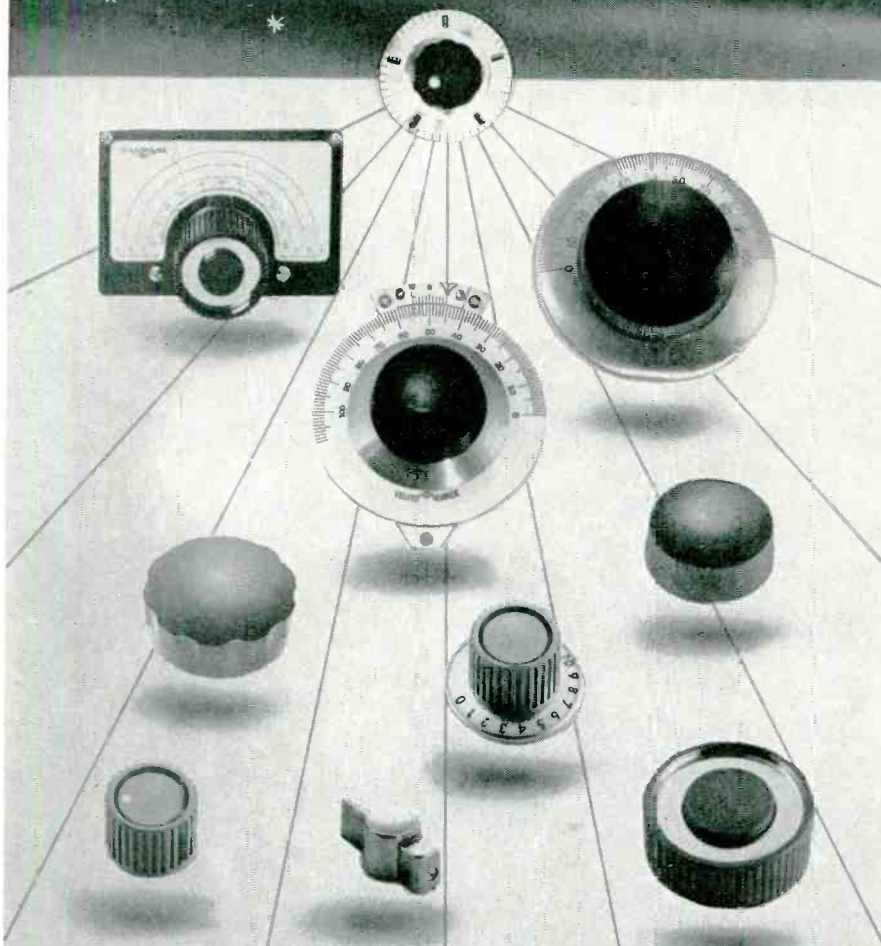

POPULAR DIALS AND KNOBS

For years, NATIONAL dials and knobs have been the popular choice of amateurs, experimenters, and commercial users.

NATIONAL dials feature smooth, velvety action, easily-read scales and quality construction. Many dials, like the N and ACN dials shown, can be specially calibrated or supplied with blank scales for commercial applications.

NATIONAL knobs — distinguished by their clean, functional, chrome and plastic styling and sturdy construction — are the most popular of their type ever produced. All fit 1/4" shafts. For commercial applications, they can be supplied in special colors and with special calibrations.

Write for new NATIONAL catalog of dials and knobs to Dept. E-1154

National

NATIONAL COMPANY, INC., 61 SHERMAN ST., MALDEN 48, MASS.

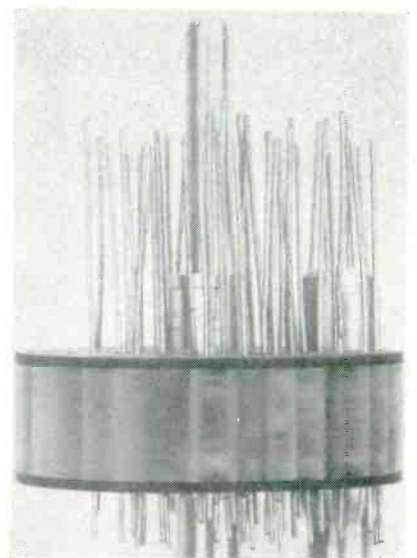

All leads are now in position

the same dip-soldering procedures followed to complete the unit.

No machinery changes are required to change from one size of component body to another. Components of widely varying lengths and diameters may be handled with equal ease because catacombs can be made any size, and at relatively low cost once the die is made. A removable-type catacomb can be designed and used if desired.

Complex electronic equipment can be subdivided into small units which can be designed and assembled in this manner. These units would be disposable when found to be faulty in the field. Repair during manufacture would be unnecessary, with adequate inspection of components and controlled manufacturing processes, as a result of the virtual elimination of the possibilities of human error. The design is even more attractive when the unit is to

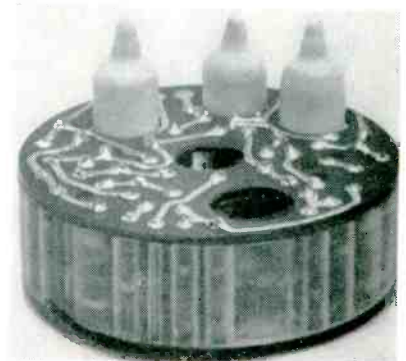

Completed assembly after dip soldering and removal of excess leads. Vibrator shaft holes can be used for cabling when stacking many assemblies

When pennies make production sense...

Check your hermetic seal problems with standard

E-1

MINIATURE CLOSURES & TERMINALS*

*PATENT PENDING
ALL RIGHTS RESERVED



TWO ELECTRODE TERMINAL FOR MINIATURE ASSEMBLIES (SUPPLIED WITH CASE)



MINIATURE THREE ELECTRODE COMPONENTS (AVAILABLE WITH CASE)

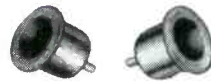

SINGLE WIRE COMPRESSION TYPE MINIATURE SEALED TERMINALS

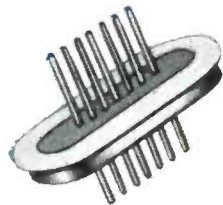

HERMETICALLY SEALED TERMINAL WITH CUSHIONED GLASS CONSTRUCTION

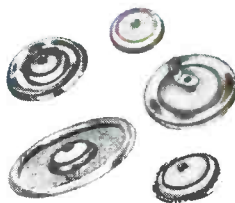

COMPLETELY STRAIN-FREE END SEALS FOR CONDENSERS, RESISTORS, TUBULAR ASSEMBLIES

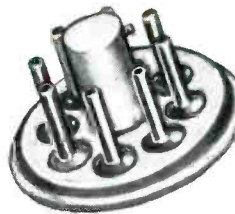

OCTAL HEADERS WITH SOLID METAL BLANKS FOR MAXIMUM RIGIDITY AND MECHANICAL STRENGTH

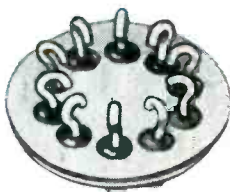

SUPER DURABLE COMPRESSION TYPE HEADERS OFFER MAXIMUM RESISTANCE TO SHOCK AND VIBRATION



SILICONE TREATED, STRAIN-FREE, VACUUM TIGHT MULTIPLE HEADER



LUG TYPE, LEAD THRU INSULATORS FOR VOLTAGE RATINGS FROM 2,000 TO 4,000 (rms.)

E-1 Standard Types — Samples and quotations on standard terminals and closures will be supplied promptly on request.

Require Custom Types? Special components for unusual requirements can be supplied quickly and economically in reasonable quantities.

Catalogs Available — Including specifications, diagrams and optional features. Call or write for copies, today!

MEMO
E-1... Headquarters for Multiple Headers, Sealed Terminals, Octal Headers, End Seals, Compression Type Headers, Lug-Type Lead-thru Insulators, Miniature Closures, etc.

DIVISION OF AMPEREX
ELECTRONIC CORP.



ELECTRICAL INDUSTRIES

44 SUMMER AVENUE, NEWARK 4, NEW JERSEY

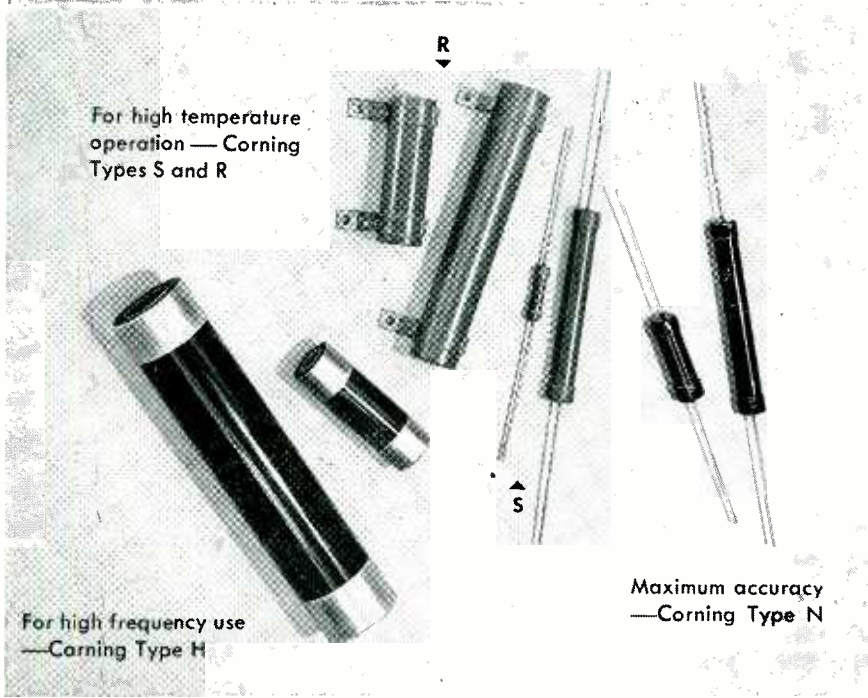

5 reasons why Corning film-type resistors meet your most exacting circuit needs

1. They're Stable • The resistive element of Corning Resistors is so stable it can be cycled from near absolute zero to red heat without impairing its electrical properties. These resistors withstand high-ambient and high-operating temperatures.

2. They're Moisture-proof • Corning Resistors are impervious to moisture. They meet specifications for maximum resistance change under moisture resistance tests of MIL-R-10509A and MIL-R-11804A.

3. They're Durable • No need to coddle Corning Resistors. Drop them or scratch them. Neither affects them. The film material is fired in at a red heat and makes an integral contact with the heat-resist-

ant base. You end special handling and assembly costs.

4. They're Quiet • No need to use oversize resistors to overcome solder heat noise. Fired-in-silver bands afford low-load resistance, low-noise termination. These resistors are so quiet, noise is difficult to measure. Excellent for signal-level, high-gain amplifier stages.

5. They're Space-Saving • You can couple Corning Resistors close—without damage or fear of creating noise.

That's not all! Corning Resistors have other important characteristics to help you. And there are 16 different types, covering a resistance range from 10 ohms to 1 megohm; ratings from ½ watt to 150 watts. Write today for technical descriptions of all of them.



CORNING GLASS WORKS • CORNING, N. Y.

New Products Division

Corning means research in Glass

function only once, as in guided missiles.

The method described herein will result in large savings because of the decreased manual labor required in the assembly of electronic equipment. Further advantages lie in the fact that automatic machinery for this method will be relatively inexpensive and flexible. Less indirect labor is required in that components are not formed, sleeving is not required, and inspection can be readily accomplished.

Appreciation is expressed to the Army Ordnance Corps and to the military and civilian personnel of Frankford Arsenal for cooperation and assistance.

Probe Light Aids Inspection of Wiring

COMBINING a pen-size flashlight with a clear plastic probe and a dentist-type magnifying mirror gives a handy tool for final sampling inspection of finished equipment. The tool is particularly useful for looking under wiring harnesses and for checking parts not directly visible. The clip-supported mirror can be

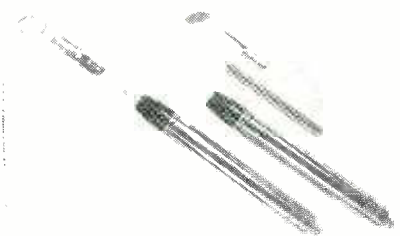

New three-way inspection light



Inspecting top of transformer without removing chassis from cabinet. Mirror provides 1½-times magnification



THE ONLY COMPLETE LINE OF COLOR TV BROADCASTING EQUIPMENT



Chromoscope
(Signal
Certification)



Phase Slope
(Envelope Delay)
Curve Tracer

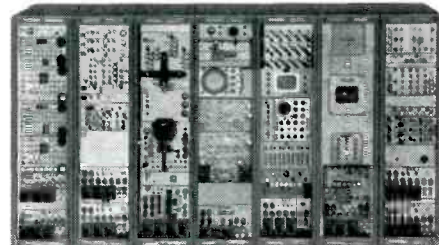

Full facilities — Transmits, receives, monitors,
analyzes composite color pictures

In Color TV broadcasting, no other name means as much as Telechrome . . . because no organization can match Telechrome's 3 years of experience in providing color TV generating, testing and broadcasting equipment to these and other prominent manufacturers, laboratories and broadcasters.

Complete equipment for generating color bars; creating encoded and composite pictures from transparencies; color signal certification: transmission, reception, monitoring, and analysis of color pictures — literature on these and more than 100 additional instruments for color TV by TELECHROME are available on request.

DELIVERY 30 DAYS



The Nation's Leading Supplier of Color TV Equipment
88 Merrick Road Amityville, N. Y.
AMITYVILLE 4-4446

slid off easily to use the probe tip. Similarly, the probe can be pulled out when the flashlight alone is desired. The new three-way light is available through Moore Manufacturing Co., Swedesboro, New Jersey.

Quality Control Test Set for Picture Tubes

AS A CHECK on production line test operators, sample tubes are taken from each day's production of Raytheon's picture tube plant in Quincy, Mass. for special analysis and a complete performance check in a quality control test set. These tubes are held for seven days and again tested to determine if any changes occurred during that period. Quality control data is plotted daily to insure that the averages of the important picture tube characteristics do not drift toward the limits allowed in specifications. This insures that the majority of the tubes have characteristics which are well centered. In addition this method helps to insure a minimum of rejects in production; as soon as an engineer notes that a characteristic is drifting away from the center of its range, he can immediately take



PROTECTED UNDER STODDART PATENTS

NOW

Precision Attenuation to 3000 mc!

TURRET ATTENUATOR featuring "PULL-TURN-PUSH" action



SINGLE "IN-THE-LINE" ATTENUATOR PADS and 50 ohm COAXIAL TERMINATION

- FREQUENCY RANGE:**
dc to 3000 mc.
- CHARACTERISTIC IMPEDANCE:**
50 ohms
- CONNECTORS:**
Type "N" Coaxial female fittings each end
- AVAILABLE ATTENUATION:**
Any value from .1 db to 60 db
- VSWR:**
<1.2, dc to 3000 mc., for all values from 10 to 60 db
<1.5, dc to 3000 mc., for values from .1 to 9 db
- ACCURACY:**
±0.5 db
- POWER RATING:**
One watt sine wave power dissipation

Send for free bulletin entitled "Measurement of RF Attenuation"

Inquiries invited concerning pads or turrets with different connector styles



Special test set for picture tubes. Operator swings crank arm on table to 18 different detent positions in turn and observes screen or reads meters

STODDART AIRCRAFT RADIO Co., Inc.
6644-A Santa Monica Blvd., Hollywood 38, California • Hollywood 4-9294

AT LAST . . . Something really **NEW** in **RELAY DESIGN!**

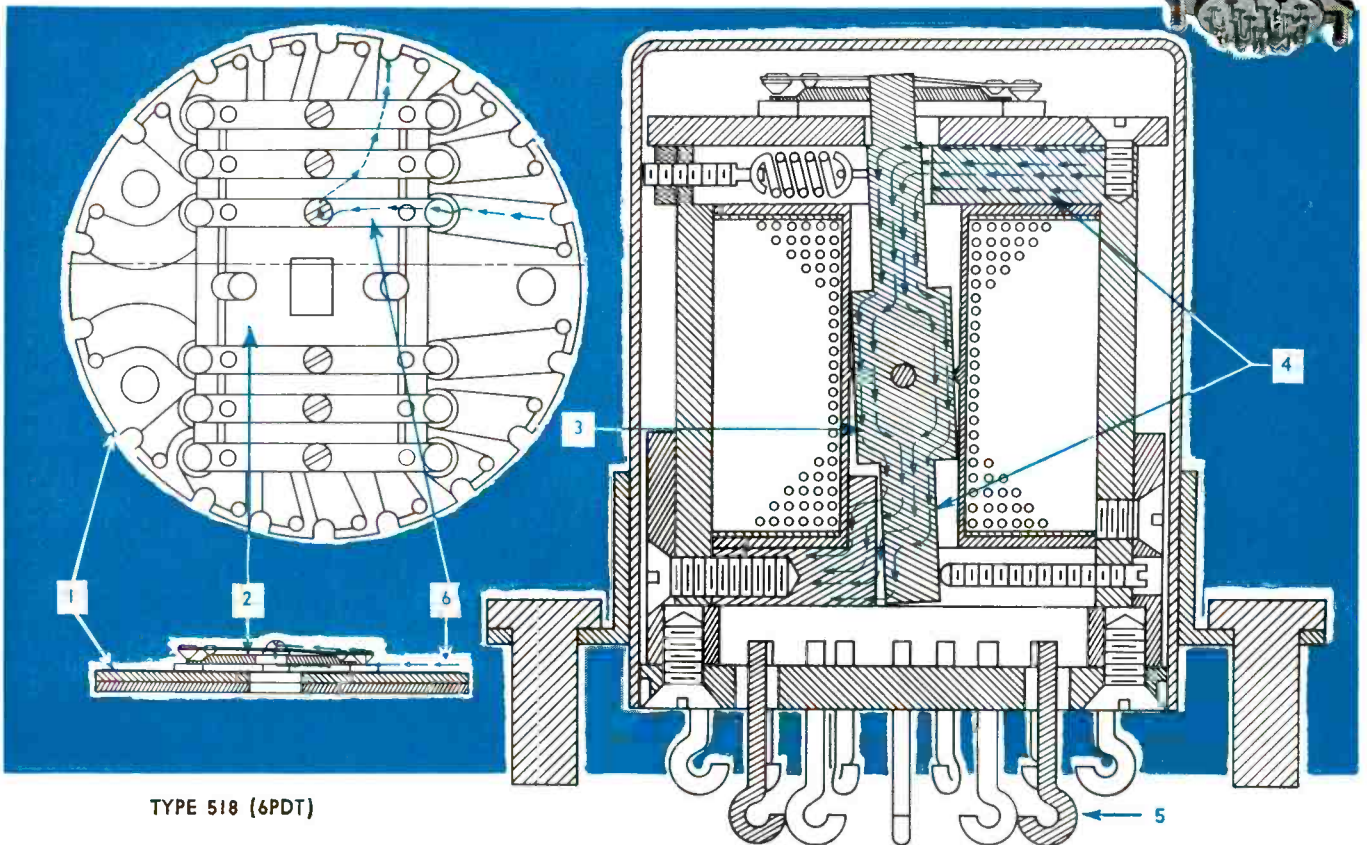

TYPE 518 (6PDT)

HUSKY SUB-MINIATURE INCORPORATES MANY EXCLUSIVE PATENTED FEATURES!

DESIGN FEATURES

1. Printed circuit contact carrier. Saves space and simplifies wiring.
2. Sliding interrupter leaf opens contacts, assures ultimate resistance to shock and vibration. This achieves high insulation resistance and contributes toward increased arc suppression and diminishing contact "bounce".
3. Balanced armature, center-pivoted, prevents failures due to shock, vibration and acceleration.
4. Powerful magnetic circuit.
5. Terminal location not dependent on contact arrangement. Can be adapted to any customer requirement.
6. Unique contact circuits. (Shown normally closed.)
7. Exceeds requirements of latest military specifications.

SPECIFICATIONS

OPERATING VOLTAGES: Up to 150 VDC
 COIL RESISTANCE: Up to 10,000 Ohms
 SENSITIVITY: As low as 0.080 Watts
 ALTITUDE: Up to 85,000 feet
 SHOCK: 50 G's Operating
 250 G's Mechanical
 VIBRATION: 30 G's up to 2,000 c.p.s.
 POLE COMBINATIONS: 2 PDT to 6 PDT
 TEMPERATURE RANGE: MIL-R-5757B
 Class A . . . — 55 C to + 85 C
 Class B . . . — 65 C to + 125 C
 Class C . . . — 65 C to + 200 C

**SEND TODAY FOR COMPLETE DATA
ON THE NEW HUSKY SUBMINIATURES!**



Price Electric
CORPORATION

**1500 CHURCH
FREDERICK, MARYLAND**

Introducing— THE MYCALEX PARTS KIT

- * For design projects
- * For experimental use
- * For emergency repairs

To acquaint engineers with the superior qualities of Mycalex glass-bonded mica—the world's most nearly perfect insulation—a conveniently packaged kit containing more than 30 Mycalex products has been assembled.

This assortment includes 46 miniature and sub-miniature tube sockets, terminal boards, rods and strips of fabricated Mycalex 400 and various Mycalex 410 injection-molded products such as connector sleeves, coil forms, stand-off terminals, rotors and rings, motor slot wedges and switch wafers. A handy reference table compares the superior physical and electrical properties of Mycalex glass-bonded mica with those of other insulating materials.



MYCALEX

- * withstands extreme operating temperatures
- * offers high arc resistances
- * possesses low loss and power factors
- * for permanent dimensional stability

The Introductory Mycalex Kit is being offered to qualified engineers and others who are interested.

Mycalex Corporation of America, Dept. T14
Clifton Boulevard, Clifton, New Jersey
Please send me the new Mycalex Parts Kit at the introductory price of \$10.00.
Enclosed find Check.....Cash.....Money Order.....
Name..... Title.....
Company.....
Street.....
City..... Zone..... State.....



Executive offices:
30 Rockefeller Plaza
New York 20, New York

MYCALEX CORPORATION OF AMERICA
World's largest manufacturer of glass-bonded mica products

steps to correct the situation in production.

The control box of a handling aid is shown on the top of this test set. The handling aid enables the female operator to lift the largest picture tubes into position in the test set. When the tube is lowered into position, connections are made automatically and thus the operator does not have to reach underneath to plug the socket onto the tube and connect the high-voltage leads.

New Shipping Crate Protects Amplifiers

A CLEATED panel box designed to permit continuous visual inspection of stabilized amplifiers and other electronic equipment resulted in 100-percent reduction in concealed damage and a 20-percent saving in labor when adopted by Allen B. DuMont Laboratories, Inc. in Clifton, N. J. The two sides of the box are covered with metal screen backed by a sheet of transparent plastic film to provide mechanical protection and keep out dust while still permitting a clear view of both the top and bottom of the equipment.

Strips of rubberized wood are combined with extruded rubber molding to act as shock absorbers while holding the chassis in position between wood cleats nailed to the inner sides of the box. The extruded rubber strips also serve to protect the edges of the chassis dur-

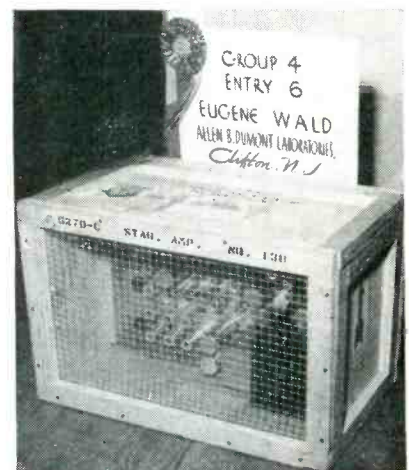

Amplifier crate devised by Eugene Wald of DuMont. This was awarded first prize in its class in the Annual Protective Packaging and Materials Handling Competition

MINIATURE K-TRANS
 TELEVISION K-TRANS
COLOR K-TRANS
 K-TRANS FOR PRINTED
 CIRCUITS
 TRANSISTOR K-TRANS

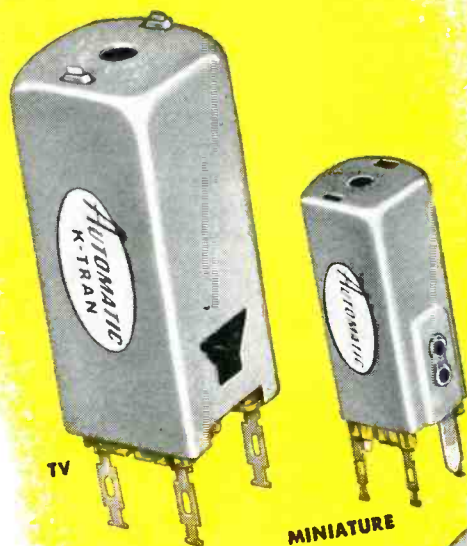

TV

MINIATURE

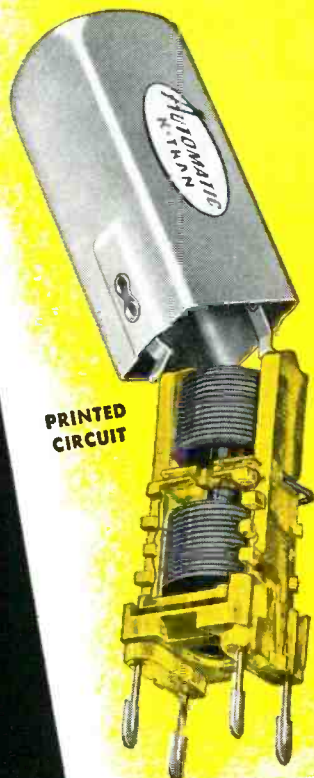

PRINTED
 CIRCUIT



TRANSISTOR

K-TRANS

There is a K-TRAN for
 every design and every
 purpose . . . ask us

K-TRAN® K-CAP®

MASS PRODUCERS OF
 ELECTRONIC COMPONENTS



65 GOVERNEUR ST., NEWARK 4, N. J.

FULL VIEW FULL VALUE

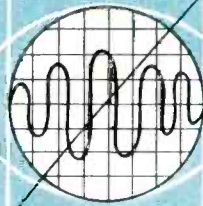

WITH A
HYCON
OSCILLOSCOPE
MODEL 617

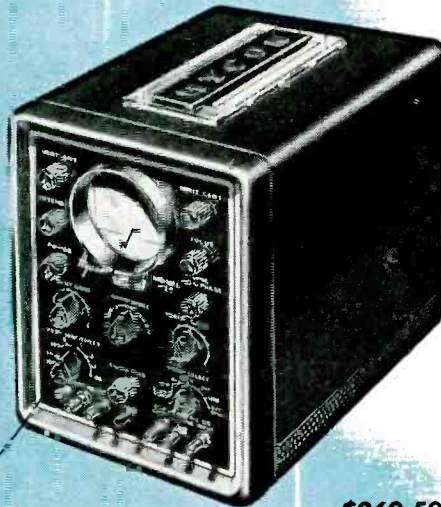

\$269.50

SHARP UNDISTORTED TRACE EDGE TO EDGE

The Model 617 Oscilloscope is a quality instrument, designed and constructed to laboratory standards. The special flat face 3-inch CRT provides a sharp, undistorted trace for the full width of the scope. Other features—such as high deflection sensitivity and 4.5 MC vertical bandpass—make the Model 617 ideal for general laboratory use, and for color TV testing and servicing. So before ordering new or replacement scopes, try the Hycon Model 617... for any application "where accuracy counts."

- 4.5 MC BANDPASS WITHIN ± 1 DB (VERTICAL AMPLIFIER)
- HIGH DEFLECTION SENSITIVITY (.01 V/RMS PER INCH)
- INTERNAL CALIBRATING VOLTAGES
- EDGE LIGHTED BEZEL
- STURDY, LIGHTWEIGHT CONSTRUCTION



Hycon's line of matching, bench-stacking test instruments includes the Model 615 Digital VTVM and the Model 614 Standard VTVM. Distributed through Electronic Parts Jobbers.

Service facilities in your area.

Hycon Mfg. Company

2961 EAST COLORADO STREET PASADENA 8, CALIFORNIA

"Where Accuracy Counts"

ing assembly of the equipment.

Another advantage of the technique is that it permits identification of a unit without uncrating, to facilitate setting up complete broadcast stations that involve a large number of crates.

Tube-Cooling Tunnel

TELEVISION picture tubes are cooled to proper temperature in a sheet-metal tunnel which surrounds the overhead chain conveyor, after baking the screen in General Electric's tube plant at Electronics Park, Syracuse, N. Y. Adequate process control in picture-tube manufacture requires closely controlled temperatures at certain processing stations.

Aluminum foil caps pressed over tube necks prevent contamination of the interior during cooling. The foil is removed prior to processing at subsequent stations, and may be reused.

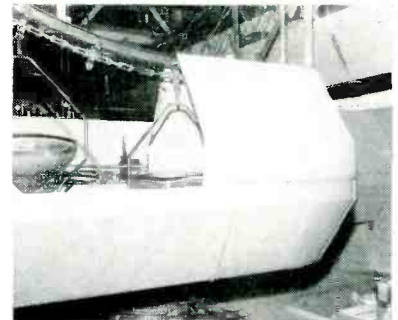

Entrance of cooling tunnel, with tubes traveling from left to right

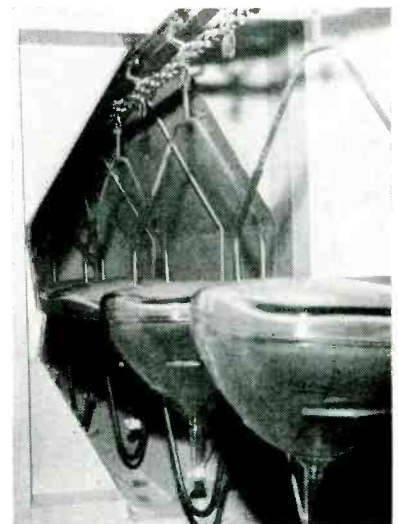

Output end of cooling tunnel, showing use of aluminum foil over the necks to keep out dust

PROGRESS REPORT—

after one year

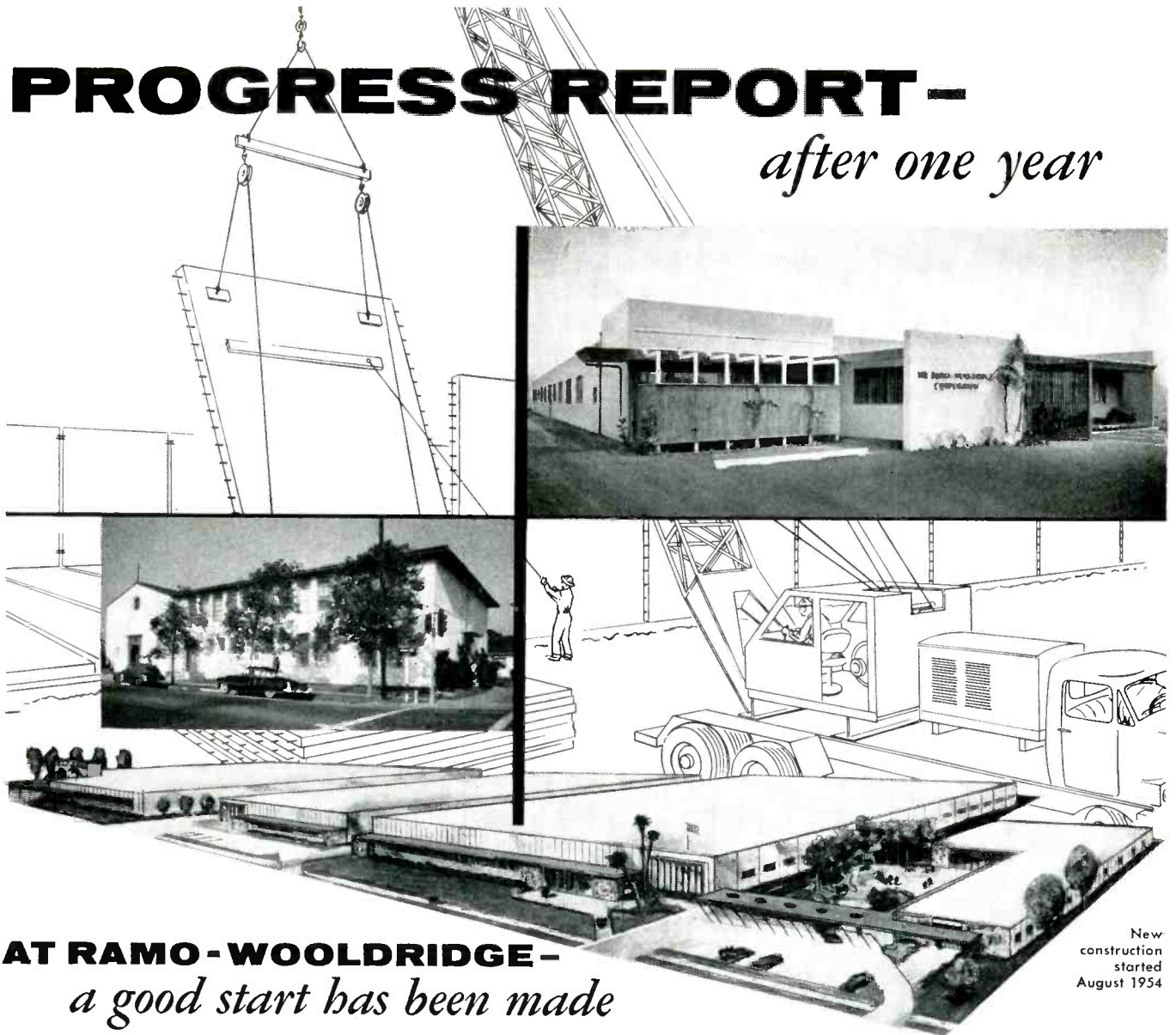

AT RAMO-WOOLDRIDGE— *a good start has been made*

New
construction
started
August 1954

Progress during a new company's first year can be measured in terms of plant and equipment, contract back-log, or quality and quantity of personnel.

By any of these standards the first year's experience of THE RAMO-WOOLDRIDGE CORPORATION has confirmed the soundness of the basic theses on which the company was established:

1. Competence in systems analysis, engineering and development, a relatively scarce commodity, is one of the most salable articles in America today.
2. Scientists and engineers find unusual satisfaction in participating in the development of a company in which, from the outset, all features of the organization and of the operational procedures are designed to be as appropriate as possible to their special needs.

Today, research and development activities are being conducted by an organization of approximately two hundred people, which will more than double within

twelve months. Urgent project responsibilities have led to the temporary use of such quarters as the former school and church shown in the photograph, but construction is complete on 20,000 and well along on an additional 80,000 square feet of the 200,000 square foot permanent laboratory building program. Orders have been placed for \$1,500,000 worth of digital and analogue computers that will be installed the end of this year to facilitate the extensive analyses required by current projects.

In the light of the first year's progress THE RAMO-WOOLDRIDGE CORPORATION anticipates expanding opportunities to perform major research, development and—a little later—manufacture in the fields of commercial and military electronic systems, and in guided missiles.

The Ramo-Wooldridge Corporation

8820 BELLANCA AVENUE, LOS ANGELES 45, CALIF. • DEPT. E-1

- Guided Missile Research and Development
- Digital Computer Research and Development
- Business Data Systems Development
- Radar and Control Systems Development
- Communication Systems Development

**POSITIONS ARE
AVAILABLE FOR SCIENTISTS
AND ENGINEERS IN
THESE FIELDS OF
CURRENT ACTIVITY**

NEW PRODUCTS

Edited by WILLIAM P. O'BRIEN

67 New Products and 52 Manufacturers' Bulletins Are Reviewed . . . Control, Testing and Measuring Equipment Described and Illustrated . . . Recent Tubes and Components Are Covered

OTHER DEPARTMENTS

featured in this issue:

	Page
Electrons At Work	180
Production Techniques	228
Plants and People	332
New Books	385
Backtalk	397

ELECTRONIC RELAY

for industrial use

MACHINERY ELECTRIFICATION, INC., Northboro, Mass. The MEK-2403 electronic relay is designed for those applications requiring a compact, inexpensive electronic relay suitable for industrial use. This relay offers advantages over ordinary magnetic relays in that it will operate dependably with a relatively poor initiating contact. It has been called a contact amplifier because it allows the presence of a high resistance in its control or initiating circuit. Contact resist-

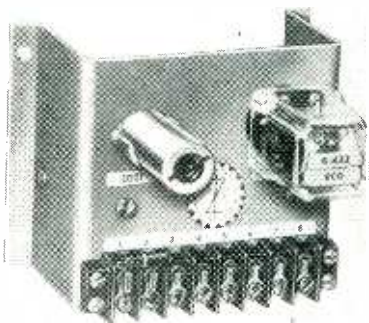

ance of up to almost 1 megohm can be allowed across the initiating contacts. Load contacts are provided for control of external circuits. The MEK-2403 is a medium sensitivity relay. It is recommended for stop-motion applications, gaging operations, control of various devices from contact-making instruments, and many other applications where positive-acting, trouble-free operation is desired.

CASTING RESIN

has wide temperature range

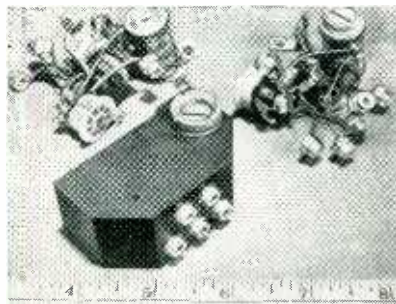

EMERSON & CUMING, INC., 869 Washington St., Canton, Mass. Sty-cast 2850 GT is a newly developed casting resin for producing electronic embedments. It has an extremely wide temperature range of usefulness extending from -100 F to +400 F. For short periods it can be used at 500 F. The cured plastic has a low thermal coefficient of expansion. It is approximately the

same as that of aluminum and brass. This means that even large metallic inserts can be embedded without cracking on temperature cycling. Other important features of Sty-cast 2850 GT are low shrinking during cure, good adhesion to a variety of materials and the possibility of a room temperature cure. It has been found useful in embedding such diverse components as power transformers and transistors as well as complete electronic circuits.

POWER SUPPLIES

are constant-current units

DRESSEN-BARNES CORP., 250 N. Vinedo Ave., Pasadena 8, Calif. Model CC-503-B constant current d-c power supply is designed and built to withstand rugged treatment. Output current ranges from 0 to 500 ma in 5 steps with vernier control of 100 ma between steps. The voltage across the load may vary from 100 to 250 v, depending on load resistance. Regulation is



0.3 percent for 10-v line variation, 0.03 percent for load change. The unit is designed to operate in temperatures ranging from -50 F to +130 F. It is built for standard rack panel mounting.

PLATE CIRCUIT RELAY

is long life unit

POTTER & BRUMFIELD, Princeton, Ind. Series LB long-life plate cir-



What are your
**Aluminized
 Picture Tube**
 Problems?

**Better Contrast!
 Longer Life!
 Availability!**

Now Sylvania offers a full line!

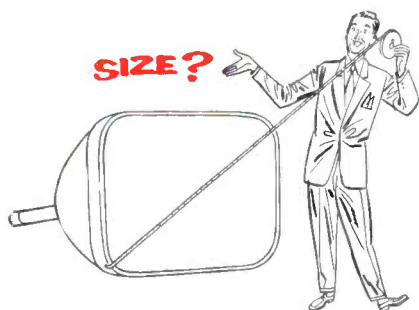

TODAY, because of greatly increased facilities and improved manufacturing techniques, Sylvania is in a position to offer you perfect answers to your aluminized picture tube problems.

And, much more than your physical spec requirements, Sylvania Aluminized Tubes also offer the finest *performance!* These tubes give whiter whites and blacker blacks . . . a 6-times better picture contrast.

This means Sylvania's new aluminized tubes make your sets stand out ahead of competition. The improvement is obvious . . . and immediate. And the low prices will amaze you!

For the full story concerning Sylvania's complete aluminized tube line, and how they can help your future sales, write a note on your letterhead to Dept. 4R-1611 at Sylvania TODAY!

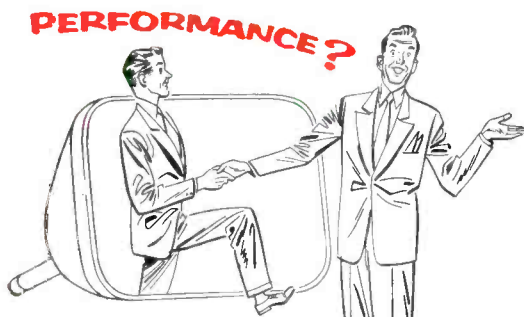
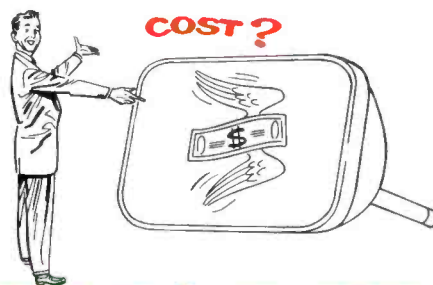

SYLVANIA

Sylvania Electric Products Inc.  1740 Broadway, New York 19, N. Y.

In Canada: Sylvania Electric (Canada) Ltd.
 University Tower Building, St. Catherine Street, Montreal, P. Q.

LIGHTING • RADIO • ELECTRONICS • TELEVISION

cuit relay is available in coil resistances up to 34,000 ohms with a pull-in rating of 3 ma (approximately 0.09 w). The LB is equipped with a one-piece back spring and contact arm which can be adjusted for desired pull-in. A permanent air armature gap eliminates residual sticking. Contacts are silver—spdt (1 Form C), rated 5 amperes,

($\frac{3}{4}$ hp) 115-v a-c noninductive load. Coil is varnish impregnated, centrifugally. Insulation will withstand 500 v, rms breakdown. Base is laminated phenolic, easily adapted to screw or rivet mounting. Terminals are tinned for easy soldering. Dimension are $2\frac{5}{8}$ in. \times 1 in. \times $1\frac{3}{4}$ in. high, with $2\frac{1}{4}$ in. mounting centers.



12-CHANNEL SWITCH

extends cro usefulness

CENTURY GEOPHYSICAL CORP., 1333 North Utica, Tulsa, Oklahoma. Model 19 electronic switch provides a convenient, economical method for displaying 12 separate signals on a conventional single-channel crt. Designed to work into any commercially available oscilloscope, it greatly extends the laboratory usefulness of the cro. The switch

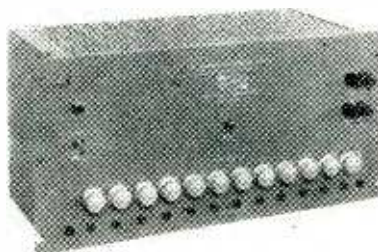

consists of 12 individual d-c amplifiers gated sequentially by a ring oscillator. Each gate is open about 25 μ sec at a sampling rate of 2,300 cps. The gated amplifiers, being d-c, have a band-pass from d-c to about 100 kc. Thus, the highest frequency which can be displayed is limited only by the sampling rate. Each base line may be individually positioned on the screen, permitting maximum flexibility in the use of the switch.

TINY CAPACITOR

for high-temperature use

GUDEMAN Co., 340 W. Huron St., Chicago 10, Ill., has announced a line of tubular high-temperature hermetically-sealed miniature capacitors designed for continuous operation from -65 C to $+165$ C.



The type XC line has insulation resistance of 50,000 megohm-microfarads minimum at $+25$ C, 100 megohm-microfarads minimum at $+125$ C and 20 megohm-microfarads minimum at $+165$ C. The new units are offered for any high temperature military or industrial application.

PULSE MAGNETRON

operates at high altitudes

GENERAL ELECTRIC Co., Schenectady, N. Y., has announced the type GL-6527 3-cm pulse magnetron designed for reliable operation without pressurization up to 60,000 ft. The tube is designed primarily for use in airborne radar gun-sights. It is a forced-air cooled, fixed frequency, pulsed-type oscillator, with 9-kw peak power output and operates at frequencies between 9,345 and 9,405 mc. The tube weighs 3 lb. Electrically and mechanically it is interchangeable with the type 2J42 magnetron. Feature of the GL-6527 which allows nonpressurized reliable operation at high altitudes is its evacuated waveguide. Maximum ratings and

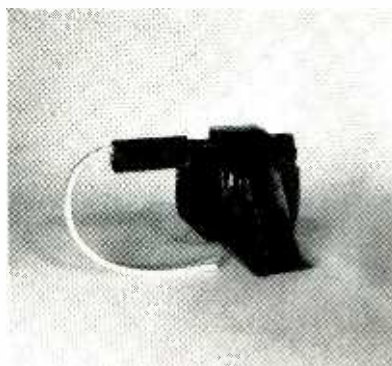

typical operating conditions include: duty cycle, 0.0025; heater voltage, 7.0 maximum volts; heater current, 0.60 maximum amperes; peak anode voltage, 6,000 maximum volts; peak anode current, 5.5 maxi-

imum amperes; average power input, 82.5 maximum watts; pulse duration, 2.5 maximum μ sec; rate of rise of anode voltage, 60 maximum kv per μ sec.

DELAY LINE

for permanent installation

CONTROL ELECTRONICS Co., INC., 1925 New York Ave., Huntington Station, N. Y. Model V103-A delay line provides a variable delay of 0 to 3.1 μ sec. It is designed for permanent installation in equipment such as computers, radar and tv test equipment. The delay is obtained with a lumped-constant circuit consisting of 60 coil and capacitor sections. A shorting-type rotary

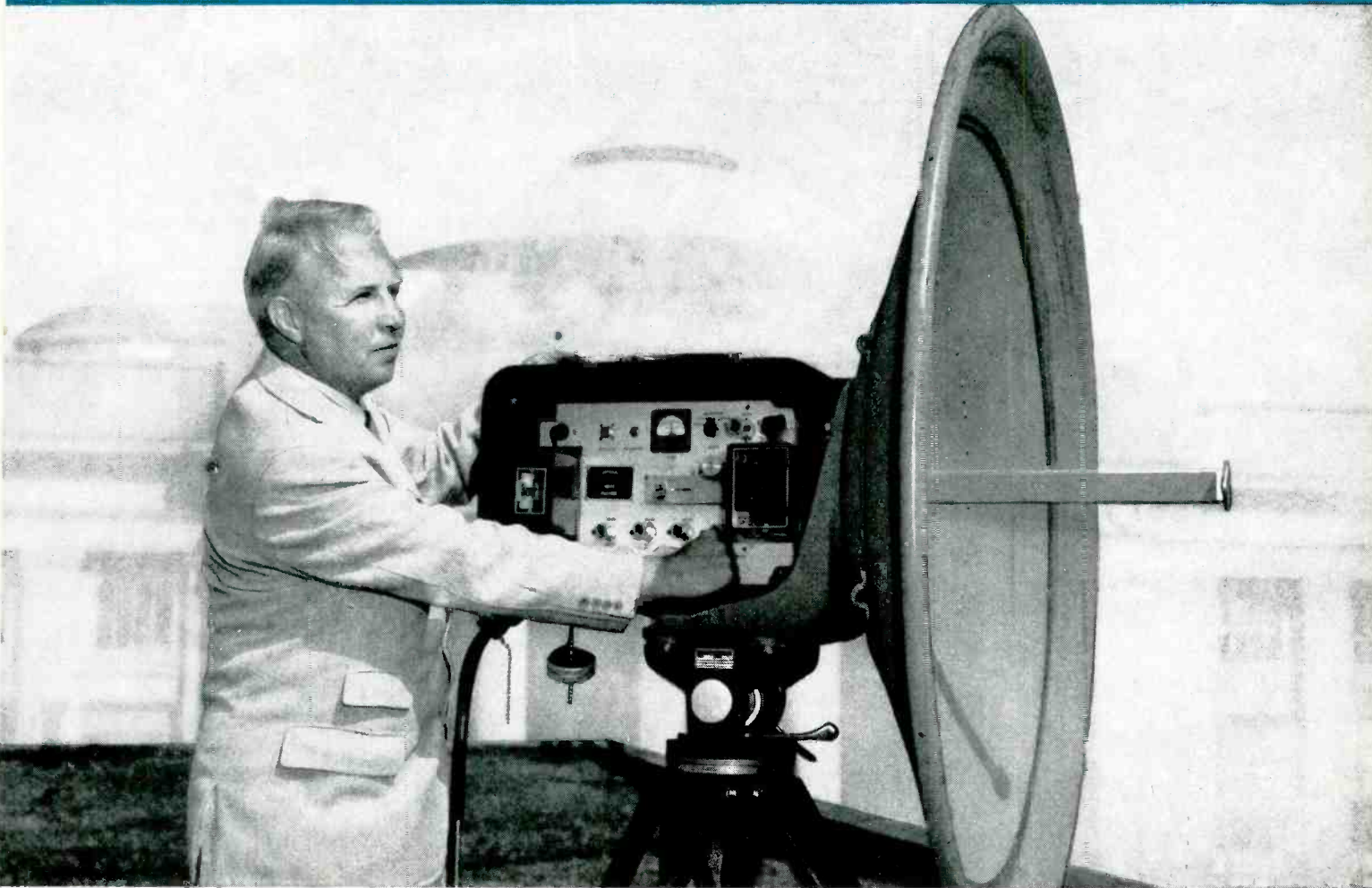

Arthur W. Richardson, Chief Engineer, Station WCBH-TV, Boston, Mass., at station's Raytheon KTR-100 microwave relay which transmits picture and sound simultaneously.

More than 75 TV stations using this equipment for STL, remotes, and network intercommunication have proved the performance of the 5976 Klystron.

Color TV relay uses Raytheon 5976 Klystrons

The new, compact Raytheon KTR-100 microwave relay is a good example of the use of the long-life Raytheon 5976 in regular and color TV relay equipment. This reliable Klystron has also been selected for additional applications by other leading manufacturers—for these five reasons:

Over 22,000 hours of life—many users report more than 22,000 hours (over 2½ years) of continuous service.

Low temperature coefficient—temperature need not be held to close tolerance. No forced air cooling.

Low power requirements—only 300 volts at 25 mA. Easy to install.

Low initial cost—lowest cost Klystron in its class. Immediate delivery in any quantity.

Low maintenance cost—long life means absolute maximum of trouble-free operation...ideal for isolated installations.

Condensed Operating Data—5976 Klystron

	3¾ Mode	2¾ Mode
Power output	110 mW av. (6750 Mc)	150 mW av. (6750 Mc)
Frequency range	6200-7425 Mc	6200-7425 Mc
Reflector voltage	-78 to -158 Vdc	-200 to -285 Vdc
Resonator voltage	300 Vdc	300 Vdc
Current	25 mA	25 mA
Modulation sensitivity	1.0 Mc/v	0.5 Mc/v
Temp. coefficient	-10 to +10 Mc/C°	-10 to +10 Mc/C°
Pulling figure	0.2% of operating freq.	0.1% of operating freq.

Write for valuable Data Booklets on Raytheon Magnetrons and Klystrons, including the stable, reliable 5976. Our Application Engineer Consultation Service is also available to you without cost or obligation. Call us when you have a microwave tube problem.



RAYTHEON MANUFACTURING COMPANY
Microwave and Power Tube Operations, Section RM-01
WALTHAM 54, MASSACHUSETTS

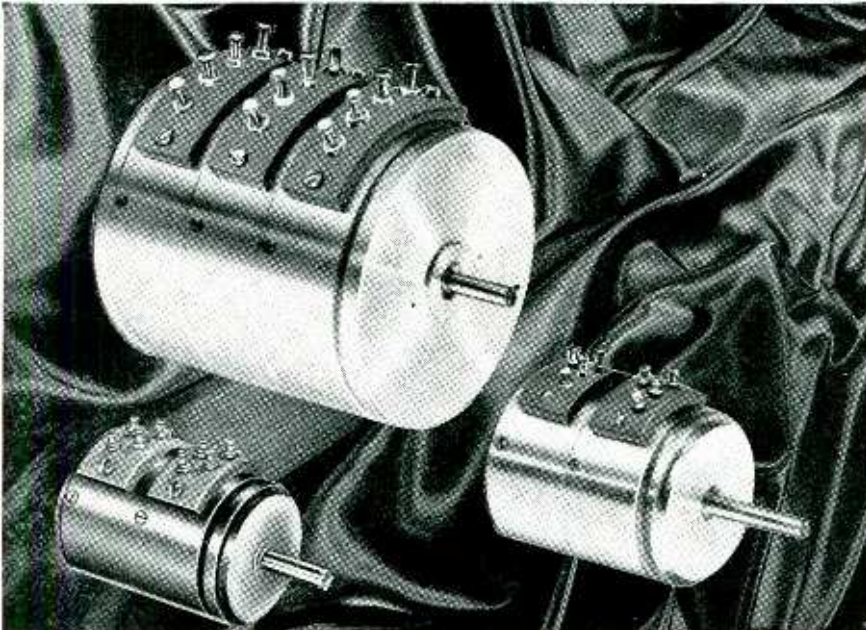

Three **NEW**

Fairchild Precision Potentiometers

TYPE 751 7/8"

TYPE 741 1 1/8"

TYPE 754 2"

LINEAR

Type 751, resistance range 400 to 20,000 ohms, linearity $\pm 0.5\%$ or better; Type 741, resistance range 500 to 25,000 ohms, linearity $\pm 0.5\%$ or better; Type 754, resistance range 800 to 100,000 ohms, linearity $\pm 0.15\%$ or better. All are extremely compact and are available with servo mounts. Internal clamp rings permit ganging without increasing overall diameter. All have gold-plated terminals for reduced contact resistance and easier soldering. Standard resistance values Types 741 and 751—500, 1000, 5000, 10,000, 20,000 ohms; Type 754—1000, 5000, 10,000, 20,000, 50,000 ohms.

Three more reasons why Fairchild can supply ALL your precision potentiometer needs

Fairchild makes a complete line of precision potentiometers to fill all your needs—linear and nonlinear potentiometers, single or in ganged combinations . . . single-turn, helical and linear motion . . . with servo or threaded bushing mounts . . . and with resistance elements to meet your requirements.

Fairchild guarantees accuracy of $\pm 1\%$ in nonlinear types and $\pm 0.5\%$ in linear types. Highly accurate production methods and close mechanical tolerances, plus thorough type-testing and quality control, assure high resolution, long life, low torque and low electrical noise level in every Fairchild potentiometer. For more information, or for help in meeting your potentiometer problems, call on Fairchild Camera & Instrument Corp., Potentiometer Division, 225 Park Avenue, Hicksville, L. I., N. Y., Department 140-53A 2.



switch selects the desired delay from 120 steps of $0.025 \mu\text{sec}$ per step. Overall accuracy is 5 percent. Rise time varies from $0.04 \mu\text{sec}$ to $0.14 \mu\text{sec}$ according to delay. Nominal impedance is 2,700 ohms.

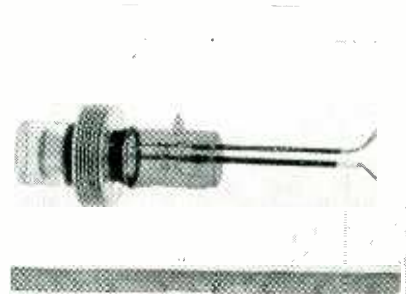

PULSE TRIODE for vhf applications

CENTRAL SALES & MFG. CORP., Denville, N. J., has announced the JAN-4C28 pulse triode. It is designed for applications in the vhf range in ground and airborne Shoran equipment. Improved cathode processing results in higher available total emission, more stable operation and longer life.

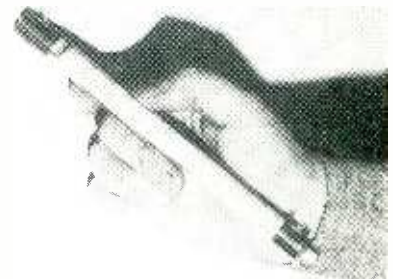

DELAY MECHANISM for color television

GENERAL ELECTRIC Co., Syracuse, N. Y. The delay stick has been engineered to meet the require-



**INSTRUMENT CORPORATION
OF AMERICA**

slip ring & commutator assemblies

**One-piece construction*
assures high accuracy and
super-dependability to the
most rigid specifications.**

*Proven for
performance in
precision instruments
and equipment including
SYNCHROS, GYROS, RADAR,
FIRE CONTROL, TEST TABLES
and other CRITICAL APPLICATIONS*

Specify Instrument Corporation of America Slip Ring and Commutator Assemblies for closer tolerances, absolute uniformity and the ultimate in miniaturization. Wherever extreme dimensional precision, accurate concentricity and high dielectric qualities, are required, Instrument Corporation of America assemblies are specified with confidence. One-piece, unitized construction eliminates dimensional variation due to accumulated errors, provides jewel-like finish, uniform ring hardness and reduced weight. Engineering "know-how" resulting from years of specialization and continuous collaboration with leading manufacturers all over the world is at your immediate service.

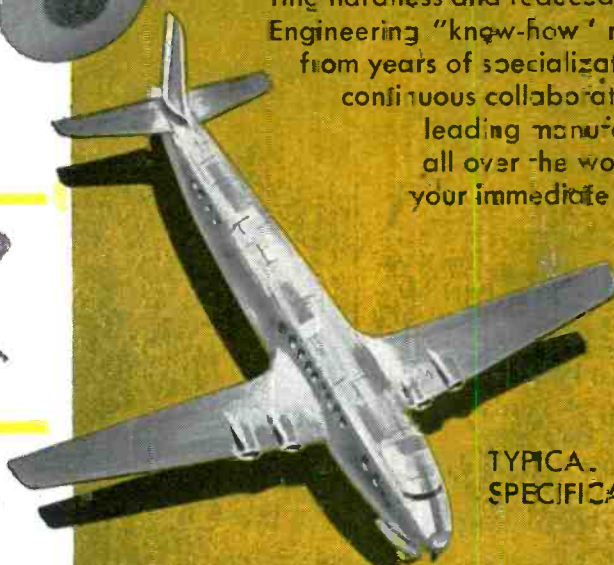
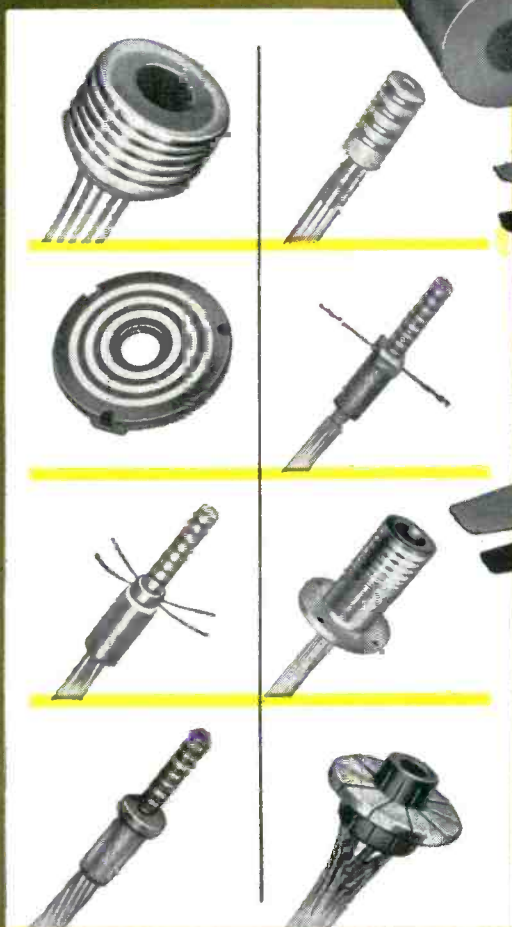

TYPICAL SPECIFICATIONS

- SIZES: .035" to 24" Diameter, Cylindrical or Flat
- CROSS-SECTIONS: Ring Thickness .005" to .060" or More
- FINISH: 4 Micro-Inches or Better
- BREAKDOWN: 1000 V or More Hi-Pot Inter-Circuit
- RING HARDNESS: 75 to 90 Brinell
- SURFACE PROTECTION: Palladium and Rhodium, or Gold Prevent Tarnish, Minimize Wear & Noise

INSTRUMENT CORPORATION OF AMERICA
BLACKSBURG • VIRGINIA

*ELECTRO DEPOSITION PROCESS AVAILABLE UNDER EXCLUSIVE LICENSE AGREEMENT WITH ELECTRO TEC CORP.



Not Only a Time Delay Relay...

G-V THERMAL RELAYS

*Advanced
Engineering
Features!*

- Miniature and Octal Sizes
- Hermetically Sealed in Metal Shell
- Adjustable and Non-Adjustable
- Heater Voltages up to 230 Volts
- Fully Temperature Compensated
- Suitable for Military and Industrial Use
- Unequaled for Ruggedness and Precision

Greatly expanded production facilities assure prompt deliveries.

Write for bulletin and help with your particular problems.

G-V CONTROLS INC. 32 Hollywood Plaza
East Orange, New Jersey

U. S. and Foreign Patents Pending

...with performance features never before possible

More and more engineers are finding other uses for these precise and rugged units—jobs which thermal relays of the usual bi-metal design often cannot do... such as:

- TUBE HEATER VOLTAGE REGULATION
- POWER SUPPLY OVERLOAD PROTECTION
- OVER- OR UNDER-VOLTAGE ALARM OR CUT-OFF
- LOW OR HIGH FREQUENCY CUT-OFF



Only G-V offers complete technical data and helpful engineering cooperation on THERMAL TIME DELAY RELAYS.

ments of mass-production color tv. Among its advantages are neater and simpler assembly in the receiver with smaller space requirements, and simplified manufacturing which permits a cost reduction over conventional delay assemblies. It consists of a core $7\frac{1}{2}$ in. long and $\frac{1}{2}$ in. in diameter, around which are wound wire and tape to form the solenoid and dielectric. A delay mechanism is essential to color tv in order to slow down the black and white picture signal (which comes through faster than the basic color signals) so that all three signals arrive simultaneously.



MAGNETIC AMPLIFIER for use in servo systems

KETAY MFG. CORP., 555 Broadway, New York 12, N. Y. The SMA 4-103 magnetic amplifier is designed for use in servo systems employed 2-phase, 400-cps low inertia induction motors. Input impedance is 10,000 ohms; input signal is a-c, d-c or pulse. Power gain at 0.5 v signal is approximately 50,000. Response time is approximately $1/200$ sec.

STUDIO MICROPHONE is omnidirectional type

ELECTROVERT INC., 489 Fifth Ave., New York 17, N. Y. The 60K studio microphone is a pressure receiver of the moving coil type having an aperiodic spherical response characteristic and uniform sensitivity over a wide range of frequencies. It is also suitable for close talking as, contrary to the tendency of directional microphones to over-emphasize the lower frequencies at

AEROCOM'S 1046 H. F. TRANSMITTER



POWER + STABILITY

1000 WATTS

WITH

.003% STABILITY

Rugged, versatile general purpose H. F. transmitter—Aerocom's 1046 packs 1000 watts of power and high .003% stability under normal operating conditions (0° to +50°C.). Excellent for point-to-point or ground-to-air communications.

Multi-channel operation on telegraph A1, or telephone A3 with GM-8A modulator... new Aerocom 1046 can be *remotely controlled* with TMC-R at control position and uses only one pair of telephone lines. In A3 operation, the local dial control panel is located in modulator cabinet.

Transmitter cabinet has 8 $\frac{3}{4}$ inch panel space available for either local dial control panel or frequency shift keyer.

Model 1046 operates on 4 crystal-controlled frequencies (plus 2 closely spaced frequencies) in the band 2.0—24 Mcs. Operates on one frequency at a time; channeling time 2 seconds. Operates into either balanced or unbalanced loads. Operates in ambient -35° to +50° C. Power supply: nominal 220 volts, 50-60 cycles, single phase.

Complete technical data on request

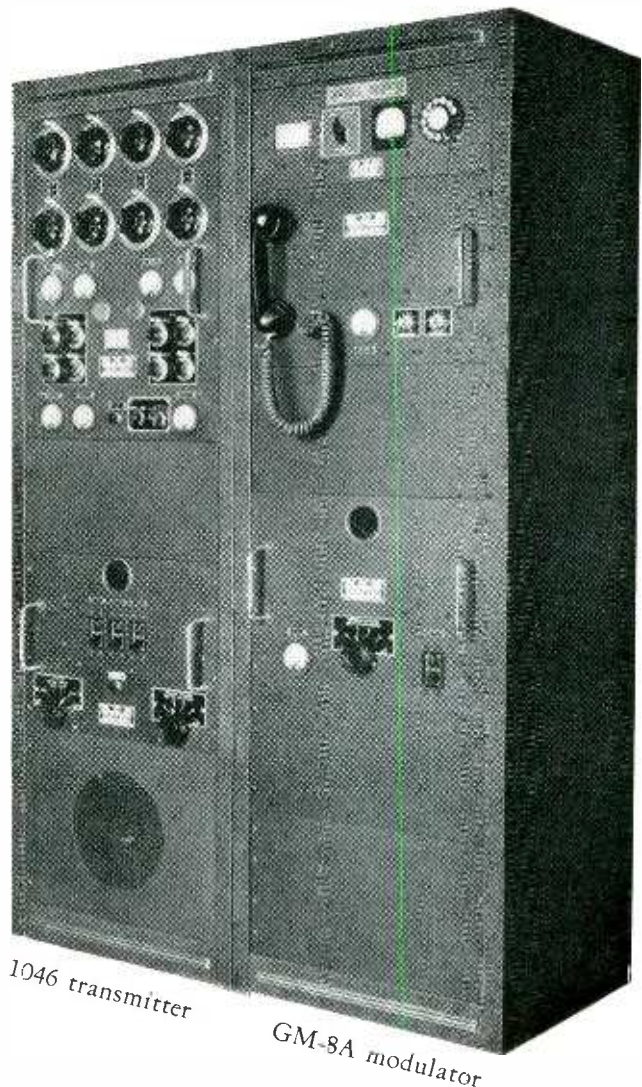

1046 transmitter

GM-8A modulator

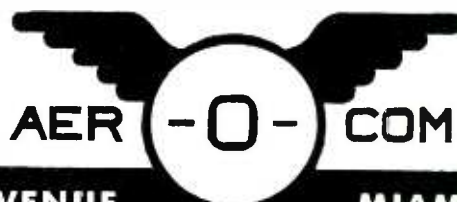

3090 S. W. 37th AVENUE

MIAMI 33, FLORIDA

Volkert stampings insure fidelity of millions of radio and TV sets

PRECISE COMPONENTS GO INTO VOLUME CONTROLS FOR IRC

Volkert—leading independent supplier of electron gun parts—is also helping to moderate millions of radio and television sets across the nation.

International Resistance Company of Philadelphia calls on Volkert for all vital stamped components of their volume controls and switches.

Here's why electronics industry leaders like IRC look to Volkert for precision stampings:

Volkert's skill in designing and building its own dies assures them of accurate, volume production. Volkert progressive dies feature interchangeable sections for wider adaptability and economy. Volkert has the most modern automatic production equipment in the industry. These factors, plus Volkert's rigid inspection of stampings at every production stage, hold rejects to a minimum and lower manufacturing costs.



ACCURATE DIES—Volkert-built multi-stage dies like this "13-stage progressive" for stamping control covers assure uniformly high quality in long production runs for many manufacturers.



QUICK, EASY ASSEMBLY—The pay-off on precision comes when components hit the IRC high-speed assembly line. They're accurate; they fit.

KEEP ON TOP of the latest precision stamping news in the electronics industry! Write for fact-packed, picture-filled **VOLKERT VIEW** quarterly. It's free!



Volkert

for design... tooling... production and assembly of precision stampings

VOLKERT STAMPINGS, INC.

222-34 96th Avenue, Queens Village 29, L. I., N. Y.

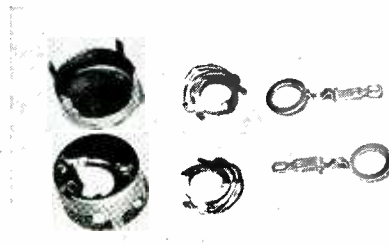

PRECISION STAMPINGS—These covers, contact springs and center terminals were Volkert-made on modern automatic production equipment for International Resistance Company.

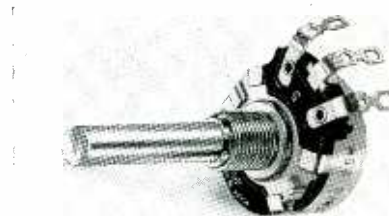

TOP PERFORMANCE—Volkert precision stamped parts contribute to rugged construction and superior performance of this IRC "Q" control.



short distances, speech is reproduced without distortion, regardless of range. The actual plotted curve of its frequency response is included with each instrument supplied. Because of its uniform sensitivity over a wide range of frequencies (50 to 15,000 cps) and its aperiodically omnidirectional response, this microphone is highly suitable for sound measurement purposes.

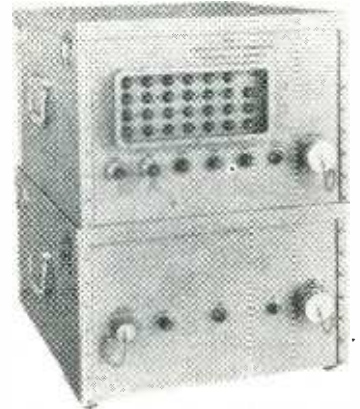

SPLIT- μ SEC TIMER for radar field testing

POTTER INSTRUMENTS CO., INC., 115 Cutter Mill Road, Great Neck, N. Y. The 8-mc counter chronograph, model 471, illustrated, meets demands for a rugged instrument for field testing radar and sonar equipment. Hitherto, calibration and other detailed tests were impossible under field conditions due to the delicacy of instruments capable of measuring short time intervals with the split microsecond accuracy required. Housed in two drip-proof heavy-gage reinforced aluminum cabinets, the timer contains a temperature-compensated crystal-controlled 8-mc oscillator that produces

*For the big difference
in size
and weight
use*

*Astron Metalite®
Hy-Met*.....*

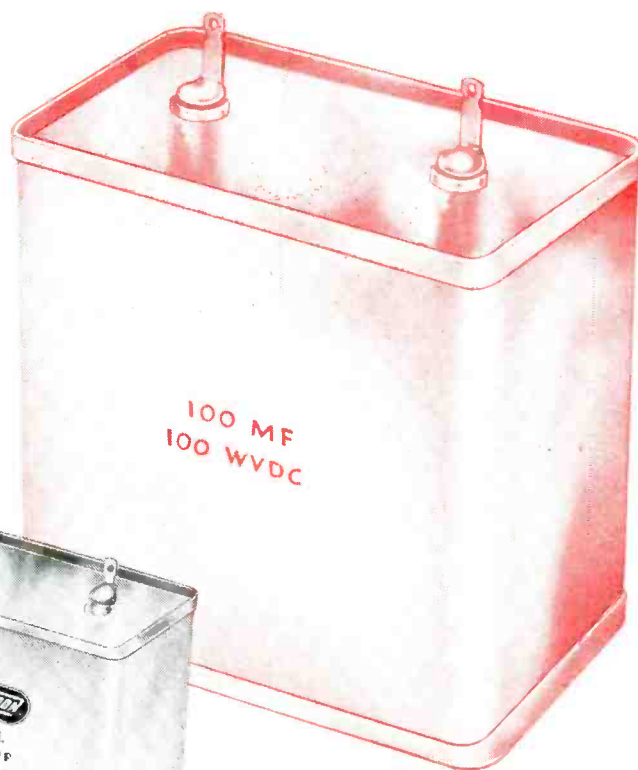

ONLY 1/7 the size and weight of equally rated, high capacitance, low voltage, paper and foil capacitors. Astron Metalite Hy-Met utilizes lacquer coated dielectric tissue on which an aluminum film approximately 50 millimicrons thick has been deposited . . . to eliminate the bulky windings necessary in larger conventional paper and foil capacitors. The all important space and weight saved enables Astron to build a dependable high temperature Metalite Hy-Met (operation up to 125° C) smaller and lighter . . . so small and light that every miniaturizing requirement, no matter how exacting, can easily and efficiently be met.

Modern electronic designs require tiny but tough capacitors able to withstand severe environmental and electrical conditions. This is where ultra-small Metalite Hy-Met "fits in!"

Astron uses an extremely pure thermosetting impregnant in Metalite Hy-Met insuring high capacitance stability over the entire operating temperature range -55°C to +125°C . . . units have low R.F. impedance due to small size and short circuit path . . . hermetically sealed . . . positive glass to metal seals . . . a wide variety of case styles and mounting brackets . . . self-healing properties to add extra protection against overvoltages or momentary surges . . . higher insula-

tion resistance . . . metal cased Metalite Hy-Met meets all MIL humidity, thermocycle immersion and vibration requirements. Designing miniaturized electronic equipment, noise suppression circuits, or other devices where space and weight are vital such as airborne units? Then you should have all the details about Astron Metalite Hy-Met . . . for complete design characteristics and physical information write to Astron for your free copy of Bulletin AB-19A TODAY!

ASTRON
CORPORATION



225 GRANT AVENUE, E. NEWARK, N. J.

Export Division: Rocke International Corp. 13 E. 40 St., N. Y., N. Y.
In Canada: Charles W. Pointon 6 Alcina Ave., Toronto 10, Ontario

©NTI

*Trademark

dependable operation up to 125° C



MDL



MQL



MEL



MTL



MKL

INTERNATIONAL RECTIFIER

C O R P O R A T I O N



Here's more data about INTERNATIONAL'S

NEW
HIGH TEMPERATURE



RED • DOT

Germanium Diodes

100° C

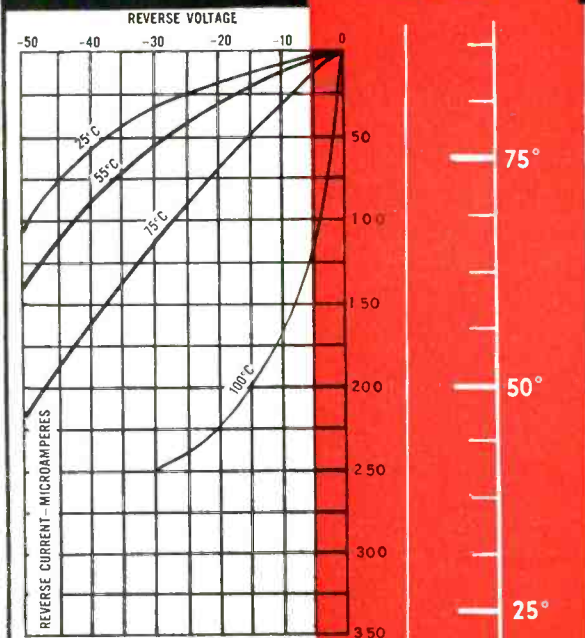

Note These
RED • DOT
Characteristics
at 100° C . . .

- TYPE G66
REVERSE CURRENT (MAX.)
12 μa AT -2 V
FORWARD CURRENT (MIN.)
5 MA AT +1 V
- TYPE G71
REVERSE CURRENT (MAX.)
50 μa AT -10 V
FORWARD CURRENT (MIN.)
5 MA AT +1 V
- TYPE G75
(85° C)
REVERSE CURRENT (MAX.)
300 μa AT -60 V
FORWARD CURRENT (MIN.)
4 MA AT +1 V

● TYPE G44
REVERSE CURRENT (MAX.)
300 μa AT -30 V
FORWARD CURRENT (MIN.)
5 MA AT +1 V

WRITE FOR
RED DOT BULLETIN
ER 191

INTERNATIONAL RECTIFIER

C O R P O R A T I O N

1521 E. Grand Ave., El Segundo, Calif • Phone: ORegon 8-6281
CHICAGO: 205 W. Wacker Drive • Phone: Franklin 2-3889
NEW YORK: 501 Madison Avenue • Phone: Plaza 5-8665

timing pulses exactly $\frac{1}{2}$ μsec apart. These pulses are gated into a high-speed electronic counter during an unknown interval. Maximum interval range is 1 sec and measuring accuracy is $\pm \frac{1}{2}$ μsec. The cabinet shown on top in the photo contains the 8-mc crystal oscillator, the electronic counter stages and the necessary control circuits; the bottom cabinet houses the three separate power supplies employed.

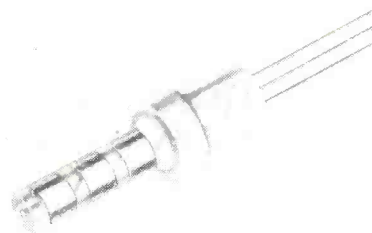

INSULATION MATERIAL for slip ring assemblies

ELECTRO TEC CORP., South Hackensack, N. J., has developed an insulation material for high temperature slip ring assembly applications. The company is manufacturing slip ring assemblies with its new plastic, ETC-7, which withstands -60 F to + 500 F and has other desirable properties such as low water absorption, high surface resistivity and excellent impact strength and dielectric properties.

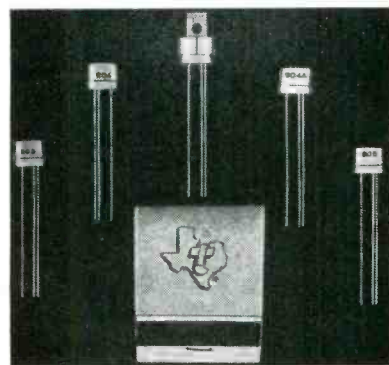

SILICON TRANSISTORS in 5 different types

TEXAS INSTRUMENTS INC., 6000 Lemmon Ave., Dallas 9, Texas, has expanded its line of silicon transistors from three to five types. Grown junction silicon transistors operate with little change at 150

SHOPPING FOR

LOW COST

CLASS B

Insulation?

**Nothing on the market today excels the
low priced Class B protection of Varflo Tubing and Sleeving**

Flexible Varflo is solvent-, oil-, moisture-, flame-, and fungus-resistant. Passes the NEMA heat endurance test of 15 minutes at 225°C. Also passes 100 hours at 125°C. Will not lose dielectric strength when subjected to severe handling, bending and twisting. Has good shelf life.

Available in Grades A-1 and B-1 tubing and Grades C-1 and C-2 sleeving.

Let us help you with your problem. Describe it in a letter—no cost, no obligation.

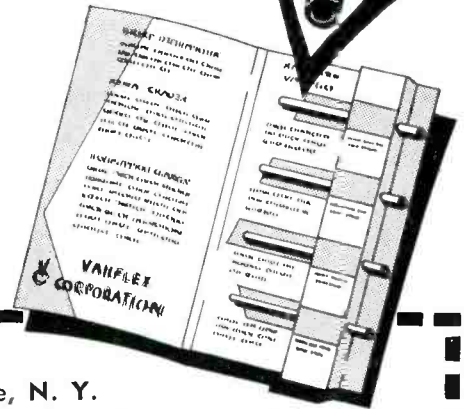

Varflex
CORPORATION

Makers of
Electrical Insulating
Tubing and Sleeving

VARFLEX CORPORATION
506 W. Court St., Rome, N. Y.

Please send me free folder containing description and samples of Varflo Tubing and Sleeving.

I am particularly interested in insulation for _____

Name _____

Company _____

Street _____

City _____ Zone _____ State _____

FREE SAMPLES... Mail Coupon Today!



SERIES "E-Z 16" EASY RELEASE



SERIES "16" POWER



SERIES "14" POWER

new...
precision

Continental Connectors*

simplify your connector problems



18 CONTACT
SERIES "E-Z 16"

(Pat. Pend.)



SERIES "20" MINIATURE



SERIES "SM-20" SUBMINIATURE



SERIES "P-C" PRINTED CIRCUIT



SERIES "H-20" HERMETIC SEAL



SERIES "C-20" HEXAGONAL

Power Connectors with COAXIAL CONTACTS

Plugs and receptacles can be used with RF Cables RG/55, 58, 59 and 71/U, where non-constant impedance is required. The two coaxial contacts serve both as a means of polarization and as self-aligning guide pins and guide sockets. Individually spring loaded pin contacts permit fast, easy release with practically no disengagement force. This feature eliminates the forcing and prying often encountered when separating conventional multi-contact connectors.

These connectors are available in 12, 18, 24 and 34 contacts, in Mineral filled Melamine, Ploskon reinforced (glass) Alkyd 440A or Diolyl Phthalate molding materials.

For illustrated technical literature E-Z 16, and assistance on special or unusual connector problems, write Dept. E, Electronic Sales Division, DeJUR-Amscc Corporation, 45-01 Northern Blvd., L. I. C. 1, N. Y.

Electronic
Sales
Division

DeJUR

45-01 NORTHERN BLVD., LONG ISLAND CITY 1, N. Y.

*World's largest manufacturers of miniature precision connectors

C (302 F) compared to an equivalent limit of 65 C (149 F) for germanium transistors. Average alpha cutoff frequency is 3 mc for three of the types, with alpha guaranteed to be from 0.90 to 0.95 with type 903, 0.95 to 0.975 with type 904, and 0.975 or better with type 905. Type 904A has an alpha cutoff frequency of 8 mc or better and an alpha of 0.95 or better. The type X-15 large signal unit gives a power gain of 14 db with collector dissipation of 1 w in class B operation. Detailed information is contained in bulletin DL-S 426.



LINE AMPLIFIER for color video signals

LINEAR EQUIPMENT LABORATORIES, INC., Brightwater Place, Massapequa, L. I., N. Y. Model LA-2 line amplifier was designed for the transmission and distribution of color tv video signals in the laboratory and on the production line. It will deliver several times the output of black-and-white line amplifiers at less than 5-percent compression, permitting simulation of color receiver detector output. Polarity reversing switch, regulated power supply and input-output termination connectors are incorporated.

DYNAMIC MICROPHONE employs single transducer

ELECTROVERT INC., 489 Fifth Ave., New York 17, N. Y. The D20 dynamic cardioid microphone is a high-fidelity microphone for use in broadcast and tv studios. The instrument employs a single transducer only, incorporating one moving coil and one diaphragm, as against the many combinations of pressure and ve-

TAKE A LOOK INSIDE

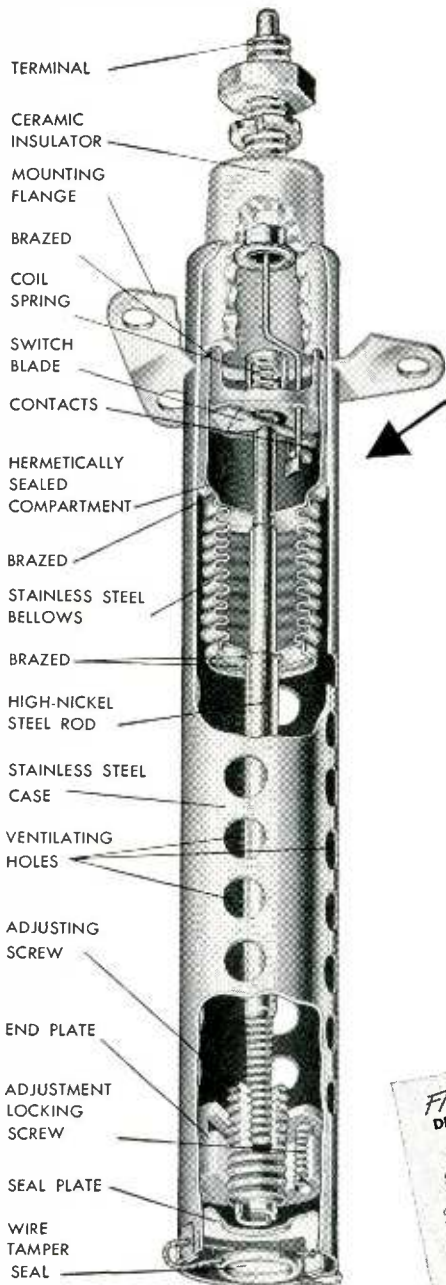

Iron Fireman FIRE and HEAT DETECTORS

These are basically high-temperature thermostatic switches. They work like this: The differing expansion rates of the high-nickel steel rod and the stainless steel case cause the rod to pull away from the switch blade as the temperature rises. The contacts will finally close at a temperature determined by the setting of the adjusting screw (-65°F to +1000°F). The contacts are located in a hermetically sealed compartment, protected from dust, fungus, moisture, etc. A stainless steel bellows permits the relative movement of the rod without breaking the hermetic seal.

This rugged design is resistant to shock and vibration—yet so precisely made that it is sensitive to small changes in temperature. These characteristics make it well suited to applications where sensitive temperature control is required under severe operating conditions.

This same combination, rugged design and precision manufacture—is characteristic of the other Iron Fireman components shown below:

- Vertical Gyros • High Speed Relays
- Sensitive Relays • Special Motors
- Slip Rings and Brushes



Send for informative literature

IRON FIREMAN ELECTRONICS DIVISION
2800 S.E. 9th Ave., Portland 2, Oregon

Please send me the specification sheets checked below:

- Fire and Heat Detectors
- Vertical Gyroscopes
- High Speed Relays
- Sensitive Relays
- Choppers
- Slip Rings and Brushes
- Special Motors

Name _____

Address _____

City _____ State _____

Firm Name _____

Products _____





OVER 12 YEARS EXPERIENCE

in Specialization and Standardization

Ask "OLYMPIC" to apply its Accumulated Knowledge, Skills and Techniques to YOUR Design Problems.

Use OLYMPIC'S "complete coordination" from design to delivery. It's to your advantage now to consolidate your speculations or your specifications with OLYMPIC.

- **ENGINEERING and DESIGNING** . . . of housings and hardware.
- **PRODUCTION** . . . with prompt, scheduled deliveries.
- **FINISHING** . . . centrifugal hot-tin dipping, cadmium plating, and black oxide finish.
- **SAMPLE SHOP FACILITIES** . . . in addition to production facilities.
- **TOOL and DIE SHOP** . . . fully equipped.

*****OLYMPIC Plans Today for Your Products of Tomorrow*****

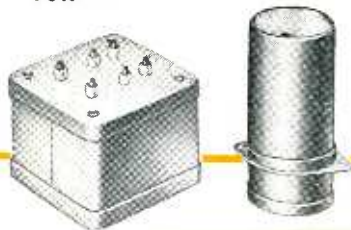

OLYMPIC

**METAL PRODUCTS COMPANY, INC.
ALPHA, NEW JERSEY**

Want more information? Use post card on last page.

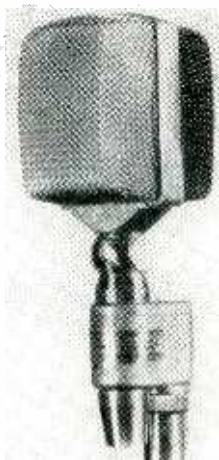

locity receivers hitherto used to obtain a unidirectional sensitivity pattern. A new principle, based on the effect of velocity transformation in thin short tubes, makes possible the extension of the frequency range down to 30 cps and the reduction of blast and vibration sensibility. The unusually rugged D20 is practically immune to the effects of moisture and vibration. Frequency range is 30 to 15,000 cps. Frequency response is $\pm 3\text{db}$ maximum.



UHF GRID DIP METER has varied applications

BOONTON ELECTRONICS CORP., Boonton, N. J. The 101-B uhf grid dip meter incorporates a series-tuned circuit capable of efficient operation in the uhf region from 300 to 1,000 mc. This circuit accommodates much higher values of external coupling inductance than would normally be used in an oscillator at these frequencies. It is thus possible to utilize plug-in coils of practical size that permit adequate coupling to test circuits. The instrument may be operated either

Digital Communication Engineers

with experience in the fields of

- Systems Engineering
- Miniaturization
- Circuit Development
- Electromechanical Development
- Digital Techniques

Long-Range Information Transmission

New advancements in the field of long-range information transmission are being made at Hughes with digital techniques.

Areas of Work

To further expand work in this area, Hughes Research and Development Laboratories are interested in people with experience in airborne communication systems, digital storage, low frequency measurements, modulation systems, miniaturized packaging, audio, IF and RF circuitry in the HF range, analog to digital—and other data conversion methods.

Scientific and Engineering Staff

Hughes

RESEARCH AND DEVELOPMENT LABORATORIES

CULVER CITY, LOS ANGELES COUNTY, CALIFORNIA

Relocation of applicant must not cause disruption of an urgent military project.

Want more information? Use post card on last page.

NOW... DU PONT MYLAR offers you a new world of opportunity in electrical design

REG. U. S. PAT. OFF.



"MYLAR" COMBINES THESE PROPERTIES:

- **DIELECTRIC STRENGTH**
4000 volts/mil . . . highest of any flexible insulating material.
- **THINNESS**
Gauges: 0.00025—0.0075 in.
- **IMPACT STRENGTH**
90 KGM.—cm. Strongest of all plastic films.
- **CHEMICAL RESISTANCE**
Less than 0.5% moisture absorption
. . . inert to solvent attack.
- **THERMAL STABILITY**
Operating range: -60°C. to 150°C.

"Mylar" polyester film—a new product of Du Pont research—offers you a combination of physical, electrical, chemical, and thermal properties never before available in a plastic material.

This versatile film is already bringing about new concepts and improvements in the field of electrical design. The slot liner shown above is one example of the increased efficiency made possible with "Mylar." Some of the properties of "Mylar" which combine to make a better slot liner are high dielectric strength, thinness and toughness that allow trouble-free insertion of a superior liner. The thermal stability and chemical resistance of "Mylar" increase its operating life over a wide temperature range.

"Mylar" is ideal for a wide

variety of insulating purposes . . . permits smaller electrical equipment . . . makes possible improved electrical products and lower costs. Evaluate the possibilities of "Mylar" polyester film for improving your own products; send for your copy of a new booklet that gives you the facts and figures...shows you where this versatile film's properties can be used to advantage. Write to: E. I. du Pont de Nemours & Co. (Inc.), Film Department, Room 5-E, Wilmington 98, Delaware.



BETTER THINGS FOR BETTER LIVING
... THROUGH CHEMISTRY

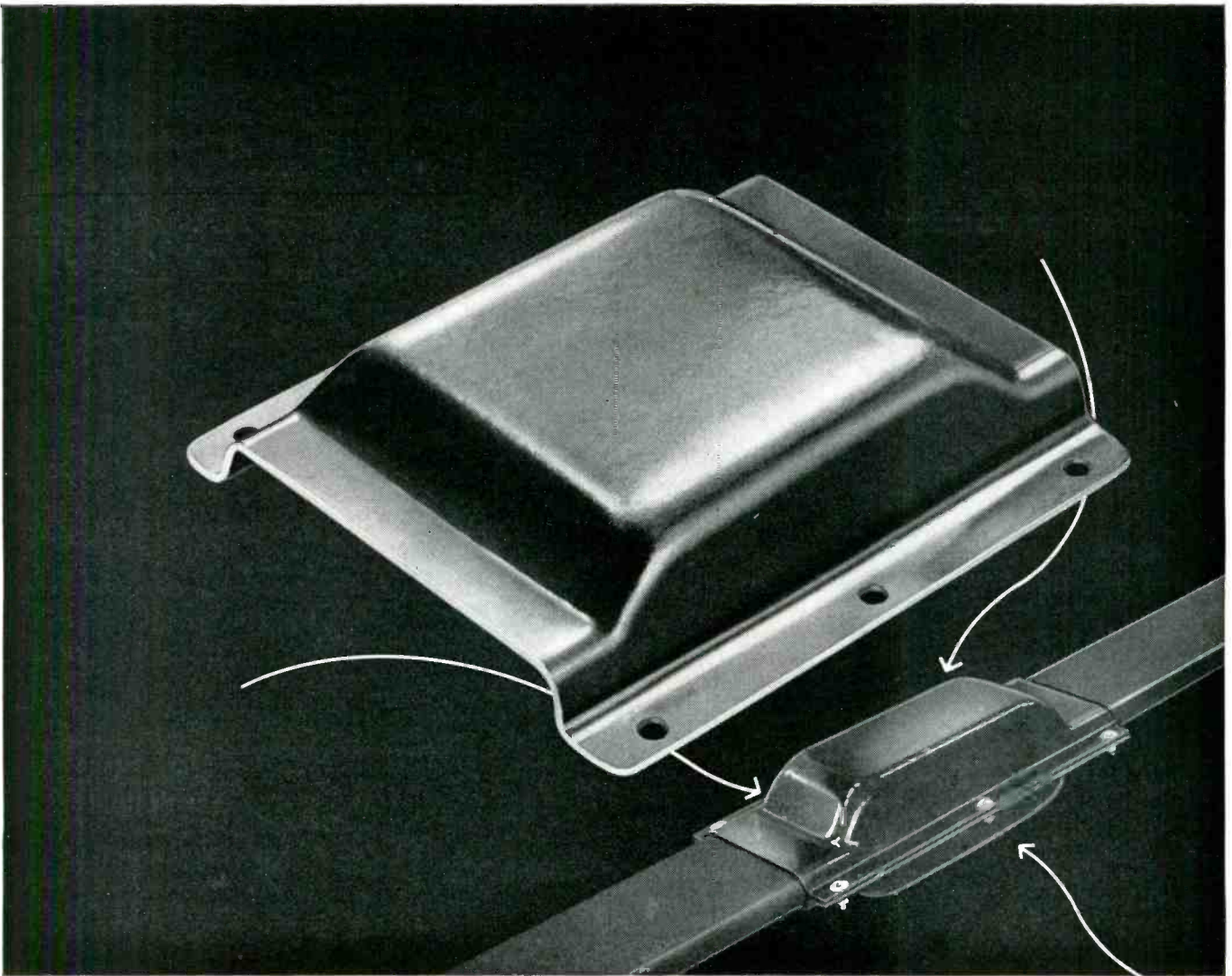

Because 5,000 volts like to jump— Copper teams up with Synthane

Properties of Synthane

In addition to those mentioned in the text, Synthane has the following important properties:



Light weight. Synthane is a dense material, but light in weight. Synthane is only about one-half the weight of aluminum.



Low moisture absorption. Most grades of Synthane are highly moisture resistant. Special grades are available for applications where absorption must be at a minimum.



Thermosetting. Synthane will hold its shape under elevated temperatures; some grades resist up to 400° C. Synthane cannot be reheated and re-shaped. (If this must be done, special post-forming grades are available.)



Availability. In addition to more than 33 grades of sheets, Synthane is also supplied in many grades of rods, tubes and special shapes. Molded-laminated and molded-macerated parts are also manufactured. A complete fabricating service is available.

● Insulating high-voltage bus bars and covering the flexible joints between them presents problems. The insulation must have high dielectric strength and high mechanical strength combined. *Synthane* laminated plastics supply these properties—and a few more. For instance, the postforming properties of paper-base *Synthane* made it possible to make the two halves of the cover economically. And *Synthane* is easily sprayed with, or laminated to, a conductive coating for corona protection.

The high dielectric strength of *Synthane* sees service in hundreds of electrical applications. *Synthane* is used in toasters, in the world's largest power shovels, and for components of TV

cameras and sets. It is also used in radio transmitters and receivers, ignition systems, household appliances, electrical measuring instruments and x-ray machines.

But this is only part of the *Synthane* story. The many chemical, mechanical and electrical properties of *Synthane*—in combination—have widened its field of usefulness. If you have need of a material with many different properties in combination, *Synthane* may be your answer. The *Synthane* catalog supplies full information on the grades and kinds of *Synthane* sheets, rods, tubes, special shapes and fabricated parts. Write for your copy to Synthane Corporation, 12 River Road, Oaks, Pa.

Our 25th Year

SYNTHANE CORPORATION, OAKS, PA.

SYNTHANE
LAMINATED **S** PLASTICS

as an oscillating grid dip meter for locating resonance frequencies of passive networks, or as a diode detector for measuring both the frequency and the relative level of an oscillating circuit. Either internal or external modulation may be applied as desired and a phone jack is provided to permit audible detection of modulated signals and beats. Bulletin U-1 10M354 gives chief features, applications and specifications.



COAXIAL PADS designed for a 10-w input

WEINSCHEL ENGINEERING CO., INC., 10503 Metropolitan Ave., Kensington, Md., has available high-precision coaxial pads designed for a 10-w input. Their power sensitivity is below 0.001 db per db per watt; for example, a 10-w input to a 10-db pad changes the insertion loss less than 0.1 db. Here is microwave equipment offered with accuracies usually found at audio frequencies. The 3 and 10-db pads are within ± 0.1 db of nominal between d-c and 1,000 mc. A calibration, accurate to 0.05 db, is furnished for 400, 750 and 1,000 mc and to 0.02 db at d-c. The long-term stability of these precision pads is commensurate with the accuracy of calibration.

D-C POLYRANGER is sensitive and accurate

SENSITIVE RESEARCH INSTRUMENT CORP., 9-11 Elm Ave., Mt. Vernon, N. Y. Model C reference standard Poly ranger is novel because of its 14 ranges of current and voltage and its high accuracy of 0.25 percent with its 6-in. scale length. It

has been designed to meet very rigid requirements insofar as accuracy and ruggedness are concerned. One of the new features is an exceed-



ingly high torque-weight ratio that eliminates pivot friction as a factor. The instrument is a milliammeter down to 1 ma full scale; an ammeter, up to 10 amperes full scale; and a voltmeter, down to 1 v full scale and up to 1,000 v full scale. A 4-page folder, entitled "Electrical Measurements," Vol. 21, No. 7, gives complete technical data.



MINIATURE RESISTOR is deposited carbon type

MEPCO, INC., 37 Abnett Ave., Morristown, N. J., announces a new miniature carbon deposited resistor for transistor and hearing aid circuits. Type C-5 resistor has a diameter of 0.032 in. and is just $\frac{1}{16}$ in. long. It is rated at $\frac{1}{8}$ w with a minimum resistance of 5 ohms and a maximum resistance of 500 kilohm. It has a power rating of full load at 70 C derate to zero 160 C. Voltage rating is 150 v d-c. Peak voltage is 500 v; temperature coefficient is negative—180 ppm to 400 ppm per deg C, depending upon resistance value. The new resistor is coated with one coat clear varnish and two coats resin. The resin coats make the resistor scratch resistant and moisture resistant. It meets the requirements of MIL-R-10509A. The

SYNTHANE

laminated plastics at work

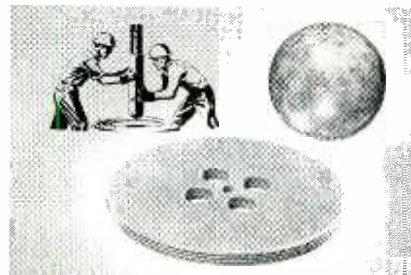

In the oil fields Synthane's toughness, dimensional stability and chemical resistance are all utilized in underground equipment for cementing oil wells. Synthane piston rings are widely used.



In business offices Synthane is a favored material for casters which are tough, durable and kind to various types of flooring. Many business machines, big ones and little ones, are mounted on molded-macerated wheels and casters of Synthane.

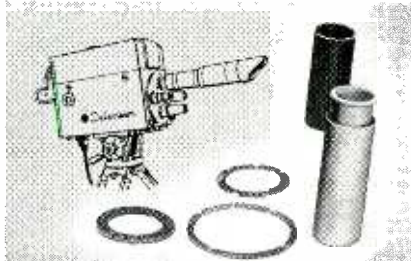

In television studios TV cameras use many Synthane parts. The mechanical strength, dielectric strength and ease of fabrication of Synthane all fit it for use in TV cameras, transmitters and home receivers.

What's Your PROBLEM?
MAIL COUPON FOR FREE FOLDER

Our 25th Year
SYNTHANE CORPORATION
12 River Road, Oaks, Pa.
Please send me your free folder describing advantages, properties, uses and kinds of Synthane plastics.

Name _____
Title _____
Company _____
Address _____
City _____ State _____ Zone _____

Want more information? Use post card on last page.

coating will not dissolve in potting compounds.



CERAMIC CAPACITOR for color television

SPRAGUE ELECTRIC Co., 35 Marshall St., North Adams, Mass. A new h-v ceramic capacitor with integral corona shield is being used in early model color tv receivers. Rated at 500 μ f, 30,000 v, it resembles a child's toy "top" in appearance. Complete description of the encapsulated capacitor, together with data on other units being furnished for color tv applications, are given in Engineering Bulletin 609, available upon letterhead request.



CALIBRATOR for use with strain gages

ALEGANY INSTRUMENT Co., 1000 Oldtown Road, Cumberland, Md. Type C calibrator is designed for use with one, two and four-arm active strain gages and transducers. By means of shunt and series resistors, a calibration is obtained directly in pressure, force and acceleration. Calibration may be either by the constant current or constant voltage method in which a factor of millivolts per volt of



Open Type 380
**AVAILABLE
FROM STOCK**

Delay Lines

**... STOCK TYPES FOR QUICK DELIVERIES
... SAMPLES AND "SPECIALS" TO
EXACT SPECIFICATIONS**

As engineering specialists in both wire winding and electronic equipment assemblies, Shallcross offers complete facilities for the design and large-scale production of delay lines in a variety of open and encapsulated styles for both highly critical as well as commercial uses.

Typical applications include use as compensating delays for color television, in signal delays for TV synchronizing signal generators, and in wideband distributed-type amplifiers.

Now available for prompt delivery is the Shallcross open-type 380 described below. This is a typical lumped parameter delay line using silvered mica capacitors conforming to JAN Style CM-15, Characteristic E. Many other types can be readily designed for specific applications. Quick delivery of prototypes! Send your specifications for prompt consideration by Shallcross engineers. SHALLCROSS MFG. CO., 522 Pusey Avenue, Collingdale, Pa.

SHALLCROSS TYPE 380 DELAY LINE

SIZE: Open Type: $2\frac{1}{4}'' \times 1\frac{1}{2}'' \times \frac{5}{16}''$
Encapsulated Type: $2\frac{1}{4}'' \times 1'' \times 1''$

ELECTRICAL CHARACTERISTICS:
Maximum pulse voltage: ± 100 volts
Rise time: 0.04 microseconds
Total delay: 0.3 ± 0.03 microseconds
Impedance: 500 ohms
Cut-off frequency: 8.5 megacycles

Shallcross

Our
25th Year 1929-1954

bridge voltage is obtained. Accuracy of measurement is 0.1 percent.



VTVM
is a high-impedance unit

FREED TRANSFORMER CO., INC., 1715 Weirfield St., Brooklyn 27, N. Y. Model 1060 high-impedance vtvm is especially useful when making tuned circuit measurements at audio and supersonic frequencies. It combines these features: input impedance of 50 megohms in parallel with 25- μ f capacitor; accuracy of 2.0 percent on all ranges, with full-wave average reading meter calibrated in rms; and frequency range, 10 cps to 300 kc. Voltage range is 0.001 v to 100 v in 5 ranges. Effect of variation in line voltage from 100 to 125 v is less than 2.0 percent, while effect in changes of tubes is less than 0.5 percent. Logarithmic voltage scale is calibrated from 1 to 10 plus a linear decibel scale calibrated from 0 to 20 db. Meter is 4 in., suppressed zero protected against overload.

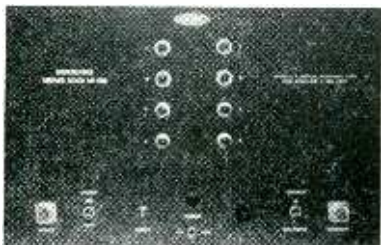

DECADE SCALER
for high-speed counting

ELECTRICAL AND PHYSICAL INSTRUMENT CORP., 42-19 27th St., Long Island City 1, N. Y. Model 412 fast decade scaler has been designed to allow convenient and precise high-speed counting of the fast pulses encountered in nuclear work, com-

talk about Vibration!



WHEN SENSITIVE RECORDING MECHANISMS OR CONTROL DEVICES MUST WITHSTAND SEVERE VIBRATION . . . CALL P M I.

Electro-mechanical devices made by P M I withstand severe shock, vibration and water test conditions of government specs. Miniature one circuit slip ring assemblies or giant 500 circuit installations, to exact requirements.

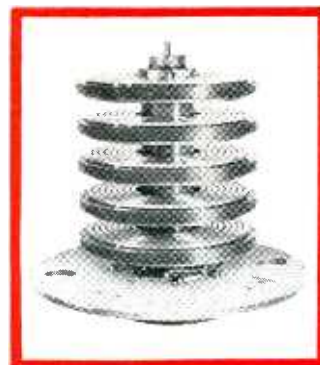

PROJECT 12AC278

50 ring S.R.A. for strain gauge. Made for Bell Aircraft for helicopter mast. Subject to vibration and whip at 300 RPM. Current, 15 milliamps. No contact resistance or electrical noise detectable.



P M INDUSTRIES, INC.
270 FAIRFIELD AVENUE
STAMFORD, CONNECTICUT

There is no one "cure all" for system instability. The desired stability of a servo loop is attained through the proper selection of components that satisfy the various conditions under which the loop will operate. Kearfott offers four basic motors and combinations for providing system stability. All feature high speed of response; low inertia and high stall torque.

SYSTEM STABILITY

SERVO MOTORS: Servo motors with high torque to inertia characteristics possessing (built-in) inherent damping ranging in size from $\frac{3}{8}$ " to $1\frac{1}{4}$ " diameter are available. Low speed, low power motors for use in simple instrument servos where high damping and/or low time constant is required can also be provided.

VISCOUS DAMPED SERVO MOTORS: Provide integral viscous damping for simple instrument servos. Any degree of damping can be provided. These units reduce no load speed of standard motors to 50% or 75% of normal, providing 70% or 50% of critical damping respectively.



(shown $\frac{3}{8}$ size)

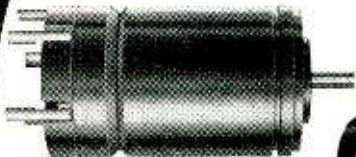

(shown $\frac{1}{4}$ size)



(shown approximately $\frac{1}{2}$ size)

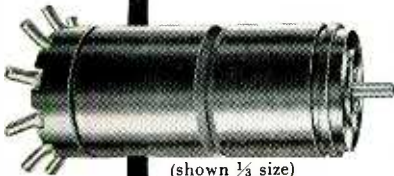

(shown $\frac{1}{2}$ size)

INERTIAL DAMPED MOTORS: Integral inertially damped motors for use in high speed and/or high gain servo systems—damping on acceleration or deceleration basis with little loss in normal no load speed. These units make possible system cut off frequencies up to 25 cps using magnetic amplifiers.

SERVO MOTOR TACHOMETER GENERATORS: For system stabilization by voltage feedback from an integral tachometer generator. May be obtained as damping generators for use in simple rate servos or as rate damping generators for use in very high gain systems. The latter feature high linearity, high output and maximum output to fundamental null ratios.

These servo motors are suitable for most exacting requirements. Write today for descriptive bulletin giving data of components of interest to you.

KEARFOTT COMPONENTS INCLUDE:

Gyros, Servo Motors, Synchros, Servo and Magnetic Amplifiers, Tachometer Generators, Hermetic Rotary Seals, Aircraft Navigational Systems, and other high accuracy mechanical, electrical and electronic components.

A SUBSIDIARY OF GENERAL PRECISION EQUIPMENT CORPORATION



KEARFOTT COMPANY, INC., LITTLE FALLS, N. J.

Sales and Engineering Offices: 1378 Main Avenue, Clifton, N. J.
 Midwest Office: 188 W. Randolph Street, Chicago, Ill. South Central Office: 6115 Denton Drive, Dallas, Texas.
 West Coast Office: 253 N. Vineland Avenue, Pasadena, Calif.

puter and pulse control problems, h-f measurements (to 10 mc), and small, time interval measurements (to 0.1- μ sec accuracy). The scale factor of 100 and the output pulse characteristics have been chosen so that almost all slow, conventional commercial scalars, (approximately 10^5 counts per sec) and frequency counting equipment, can be operated from the output pulse with ease. Chief technical features and applications are available from the company.

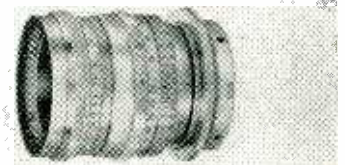

TV LENS has added focal length

PONDER & BEST, 814 North Cole Ave., Hollywood 38, Calif. Exhaustive tests in actual studio presentations have proven the value of these 75-mm lenses as compared to the standard 50-mm lenses. The additional focal length, although the angle of view is slightly reduced, provides faster focusing and higher resolving power. Although the speed of these lenses is f/1.9, the iris diaphragm permits stopping down to the speed (f stop) desired for maximum depth of field. Priced at \$132.25, these imported German lenses may be ordered on a 10-day trial basis.

FREQUENCY STANDARD for precision measuring

NEW LONDON INSTRUMENT CO., P.O. Box 189, New London, Conn. Model 701 frequency standard provides a source of highly stabilized frequencies covering the range from 10 kc to 50 mc at intervals of 10 kc, 100 kc or 1 mc. Stability of one part in 10^7 per 24 hours has been achieved by means of a unique method of temperature stabilization. Frequency dividers and multiplication are used to develop the range of frequencies available. A warning light is provided to give an indication of temperature sta-



bilizing oven failure. There is also a fine frequency control for adjusting the standard oscillator frequency at $1 \text{ mc} \pm 10 \text{ cps}$.

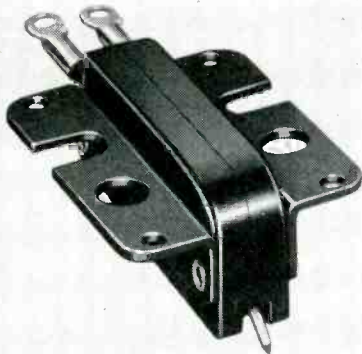

CERAMIC CARTRIDGE
withstands heat and humidity

WEBSTER ELECTRIC Co., 1900 Clark St., Racine, Wisc., has added a new ceramic cartridge to its Featheride line. Model GX is a lightweight, single-needle cartridge that will withstand heat and humidity. It develops 0.6 v at $33\frac{1}{2}$ rpm and 0.8 v at 45 rpm with 7 grams tracking pressure and a cutoff frequency of 10,000 cps. It fits any standard $\frac{1}{2}$ -in. RETMA mounting, the RCA 45-rpm or the Columbia $33\frac{1}{2}$ rpm record players. Further information is given in bulletin Y-F4.

RESISTORS
have tiny dimensions

RESISTANCE PRODUCTS Co., 714 Race St., Harrisburg, Pa., announces new subminiature type J precision wire-wound resistors. An improved method of terminating the winding to the wire leads eliminates one of

THESE RUGGED PLASTIC COATINGS
—are Super-durable!
—Easier Working!



“HLT 500 B”
← 120 C WIRE

← MIL-W-76A
WIRES and CABLES
TYPES LW, MW,
HW, FX and HF
(Formerly JAN-C-76
WIRES SRIR,
SRHV, SRRF, WL)



NYLON JACKETED WIRES



TV LEAD-IN WIRES



LACQUERED WIRES



SHIELDED WIRES & CABLES



INSTRUMENT WIRES



COAXIAL CABLES



UL LISTED APPLIANCE WIRES
FOR 80 C, 90 C AND 105 C



SPECIAL WIRES & CABLES
TO SPECIFICATIONS

These quality-engineered plasticord and plasticote constructions are available in types to meet all military and commercial wiring specifications. Chester super-durable plastic coatings offer easier-working qualities that speed wiring production . . . and extra strength that adds years to wiring life. For complete wiring dependability — connect it with Chester, the name for quality in wires and cables!

CALL OR WRITE TODAY FOR LITERATURE AND SAMPLES!

Check your wiring needs with Chester, now Complete information on standard constructions will be sent promptly. If you need custom constructions, Chester can build them quickly and economically.



“Chester”
says —
Connect it
with Chester
—the wiring
that lasts!

CHESTER
plasticord-plasticote
WIRES & CABLES



CHESTER CABLE CORP.
CHESTER, NEW YORK

MEN WITH BS, MS, and PhD DEGREES

*This is where
you can get*

FREEDOM FOR INITIATIVE

AIRBORNE INSTRUMENTS LABORATORY has challenging design and development problems that will excite the engineering talents of men with B.S., M.S. and Ph.D. Degrees. If you have initiative and the desire to express it without reservation, you'll find AIRBORNE INSTRUMENTS LABORATORY the place best suited for your professional advancement . . . with job security assured by a wide variety of commercial and government contracts. We are presently seeking qualified men in the following fields:

Radar Systems
Microwave Components
I.F., R.F. and Video Circuitry
Navigation
and Communication Devices
Analog and Digital Computers
Transistor Circuit Development
Servo Mechanisms
High Speed Data Processing

Ideally situated on Long Island for suburban living with access to graduate study . . . and still close enough to reach New York City in less than an hour . . . AIRBORNE INSTRUMENTS LABORATORY might prove to be "the spot you are looking for." Employee benefits include paid vacations and holidays, insurance, pension and hospital plans, tuition refunds, etc.

Howard Gresens,
Director of Personnel

Pioneer 2-0600



AIRBORNE INSTRUMENTS LABORATORY INC.

160 OLD COUNTRY ROAD, MINEOLA, L. I., N. Y.

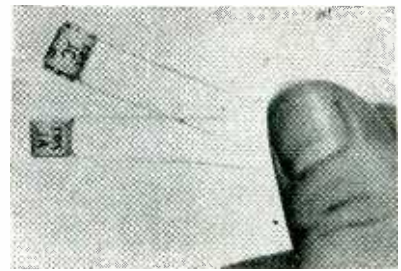

the serious weak points present in most subminiature resistors. Type JA is $\frac{1}{4}$ in. in diameter \times $\frac{1}{4}$ in. long. Maximum resistance is 125,000 ohms; military power rating, 0.1 w. Type JC is $\frac{1}{4}$ in. in diameter \times $\frac{3}{8}$ in. long. Maximum resistance is 250,000 ohms; power rating, 0.15 w. Tolerance of 1 percent is standard, with tolerances to 0.05 available. Type J resistors have a mounting hole for a No. 2 machine screw. Leads are of heavily tinned copper wire. These resistors are finding extensive use in electronic equipment for guided missiles, aircraft and many applications where space is extremely limited and highly accurate performance is required.

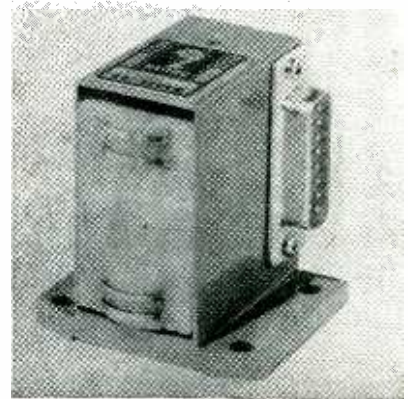

CINEMASCOPE HEADS are record-reproduce units

BRUSH ELECTRONICS Co., 3405 Perkins Ave., Cleveland 14, Ohio, announces two additions to its line of magnetic record-reproduce heads. One is the record head, model BK-1544-R and the other, its reproduce head companion, model BK-1544. They were especially designed to meet the specifications of Cinemascope applications. Chief features include: balanced magnetic structure with gaps at front and back; all gaps in precise alignment; complete assembly nonmagnetic and impervious to mois-

ture; mu-metal shields between individual channels and cast in specially selected high-temperature resin.

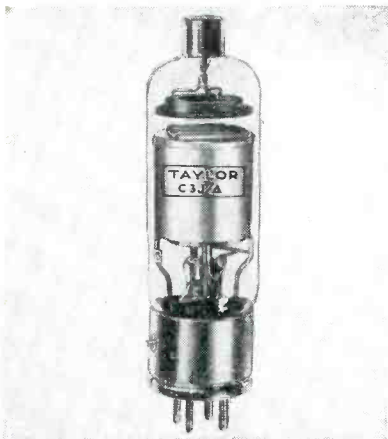

XENON THYRATRON

measures 6¼ in. × 1 9/16 in.

TAYLOR TUBES, INC., 2312 W. Wabansia Ave., Chicago 47, Ill. The 5684/C3J/A xenon thyratron tube features grids constructed with the Gold Flow process which assures sharp cutoff characteristics throughout tube life. Other construction features include: arc resisting high-emission cathode, nickel brazed anode assembly, automatic gettering action and metalized graphite anode. The tube features a 3-ampere average anode current and a low average arc drop of 8 v. Ambient temperature limits are -55 to +85 C. Warmup time is 30 seconds. The tube also features a substantial overload capacity and a low deionization time of less than 500 μsec. Life expectancy is over 2,000 hr when operated within ratings.

AMPLIFIERS

have 3 control windings

ATLAS ENGINEERING Co., Roxbury, Mass. Three new magnetic amplifiers, the RG-60-D series, can be used to improve the performance, life and reliability of many circuits by eliminating costly maintenance and reducing replacement part costs. They have three control windings, one of which may be used to provide a lead (anticipation) signal when fed from a conven-

RELAYS

TO *Exactly* FIT YOUR REQUIREMENTS



Comar Custom Engineering Gives You—
✓ THE PHYSICAL SIZE YOU NEED
✓ THE CHARACTERISTICS YOU WANT
 —yet you pay no more!

Comar specializes in designing and manufacturing relays to fit all types of requirements. Our engineers will assist you in determining the correct relay, with the right physical size and electrical characteristics to exactly fit your specific needs. We invite you to submit your relay problems for our recommendations. No obligation.



3349 ADDISON STREET
 CHICAGO 18, ILLINOIS

RELAYS • SOLENOIDS • COILS • TRANSFORMERS • SWITCHES • HERMETIC SEALING

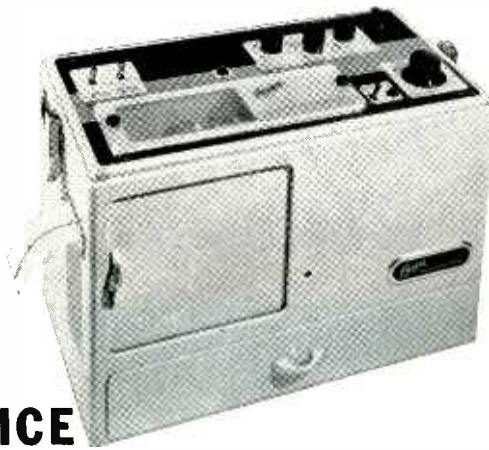

**MAKE IT LOOK
 WORTH THE PRICE**

with **STANDARD
 CONTROL
 KNOBS**



70 Series
 Round



90 Series
 Skirted Round



90 Series
 Pointer



90 Series
 Skirted Pointer



125 Series Dial
 Skirted Round



175 Series Crank



Fine electric and electronic equipment is easier to sell when it looks like the money it represents.

Raytheon standard control knobs add the appeal of custom styling at standard cost — make the *outside* reflect the quality of the *inside*.

These injection molded knobs are available in an integrated family of 54 items — in a choice of *six* basic types and *five* widely used sizes.

Made of tough, durable "Tenite II" (cellulose acetate butyrate) with anodized aluminum inserts and dual setscrews. All types and sizes available in black with gleaming *mirror finish* or with non-reflecting *matte finish* for government equipments. Also available in color or with knob parts assembled in striking color combinations.

Write for complete information. Address Dept. 6120 KA Raytheon Manufacturing Company, Equipment Sales Division, Waltham 54, Massachusetts.

DRESS UP YOUR PRODUCT



**STANDARD
 CONTROL
 KNOBS**



tional differentiating network. The other control winding may be used to provide a positive feedback signal to compensate for load line voltage drop. The three models provide maximum d-c output current of 4.5 amperes, 1.2 amperes and 225 ma; mean output voltage of 6.0 v, 27 v and 115 v. Size of all 3 units is 4 $\frac{1}{8}$ in. \times 3 $\frac{1}{8}$ in. \times 4 $\frac{1}{2}$ in. high. Four mounting studs, 8-32 \times $\frac{3}{8}$ in. are provided, and unit weight is 2 lb, 3 oz.



**FREQUENCY METER
 for 1,000-3,000 mc range**

AIRCOM INC., 354 Main St., Winthrop 52, Mass. Model 410 frequency meter was designed for laboratory, production and field test use. It measures 2 $\frac{1}{8}$ in. \times 5 $\frac{1}{4}$ in. \times 6 $\frac{1}{8}$ in. excluding the connectors. It also features a wide frequency range without spurious responses, being useful with reduced accuracy down to 500 mc; direct reading, with each unit individually calibrated; and versatility, being useful as a direct-reading frequency meter, as a reaction-type frequency meter, as a coaxial line band-pass filter with adjustable output coupling, and as a modulation monitor with output for oscilloscope viewing of amplitude or pulse modulation. Accuracy varies between 0.25 per-

cent at 1,000 mc and 0.05 percent at 3,000 mc.

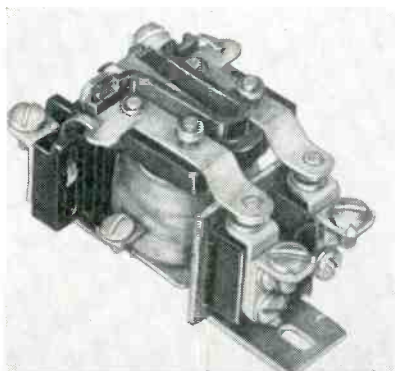

RELAYS

for control applications

LEACH RELAY Co., 5915 Avalon Blvd., Los Angeles 3, Calif. Part numbers 9094 and 9194 heavy-duty relays are designed for electrical and electronic commercial and industrial control applications. The new compact, lightweight, rugged relays are capable of handling heavy contact loads with low coil power requirements. Insulation, spacing and contact life exceed UL requirements for industrial control equipment. Coils are vacuum varnish impregnated. Multiple mounting holes in bracket allow relays to be mounted from above or below mounting surface as required. A new catalog is available on request.

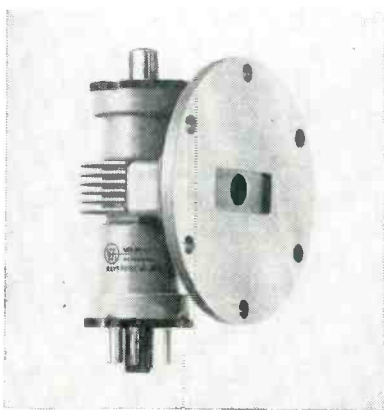

RELAY KLYSTRON

for 5,925-7,425 mc range

VARIAN ASSOCIATES, Los Angeles, Calif. Exemplifying the most advanced techniques in klystron design and construction, the VA-220 relay klystron offers significant advantages for all relay applications

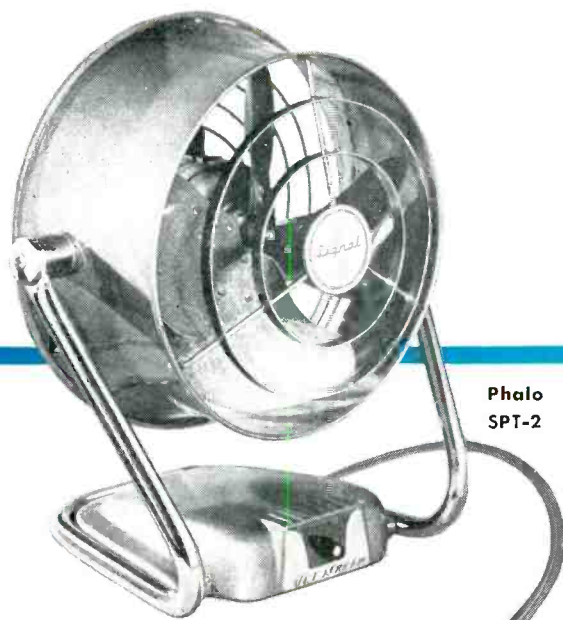

Phalo
SPT-2

Take The Signal—
From *Signal* Fans

and go

PHALO Cord

for

**POWER SUPPLY
DEPENDABILITY!**



Phalo
M-64-A



IN THE CURRENT
PICTURE TO STAY!

The newest of the fine line of portable SIGNAL FANS, the SIGNAL Jet Stream shown here features the famous Stout Heart motor and is built for quality performance over a long fan life right down to the power supply cord which is, of course, a PHALO Cord!

Take this production signal from SIGNAL . . . get the PHALO Cord story from your PHALO representative . . . ask us for his name.

Remember PHALO is in the current picture to stay!

PHALO PLASTICS CORPORATION

CORNER OF COMMERCIAL STREET, WORCESTER, MASSACHUSETTS

Southern Plant; Monticello, Miss.

Insulated Wire and Cables — Cord Set Assemblies

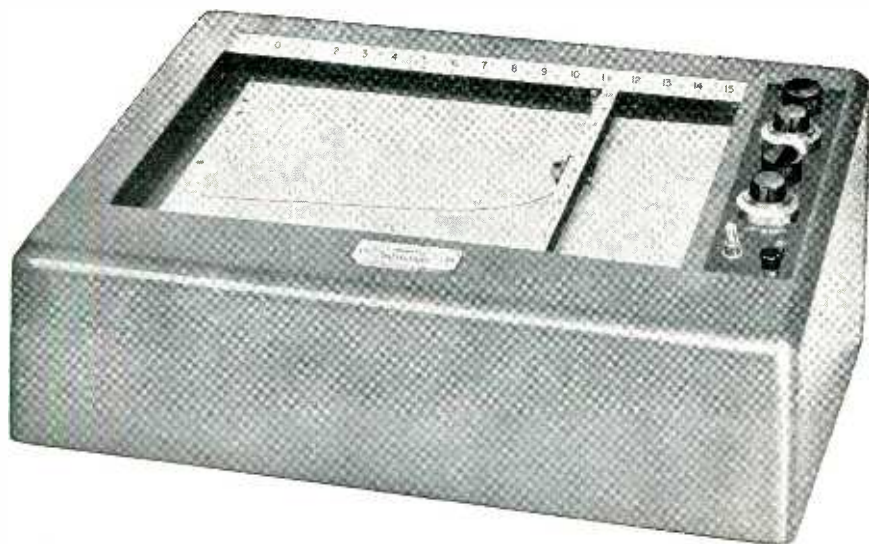

*A new, large size,
flat bed,
versatile
2-axis recorder...*

AUTOGRAF
trademark
MODEL 2



Curves are available for observation and labeling while they are being drawn.

The versatility and labor-saving convenience of the original portable Autograf have now been built into an instrument which handles standard 11" x 16½" graph papers. Model 2 has the same scales and ranges as Model 1 (0-5 millivolts to 0-100 volts each axis); same speed (full scale X and Y in one second); same input impedance (200,000 ohms per volt). In addition, depressed zero available each axis, larger recording area (twice as big), flat bed, easy-reading design.



THE AUTOGRAF MODEL 1

general purpose 8½" x 11" X-Y recorder — is doing duty in hundreds of laboratory applications: chemical, electrical, electronic, wind tunnel, computer... And on production lines: measuring motors, filters, tubes, transistors, airfoils, amplifiers, rectifiers, magnetic circuits and materials, nuclear devices, etc. . . .



AUTOGRAF CURVE FOLLOWER plots or reads out Y vs. X. Either Model 1 or Model 2 can be furnished as a recorder/curve follower.



AUTOGRAF POINT PLOTTER Models 1 and 2 may be fitted for point plotting from keyboard or other digital sources.

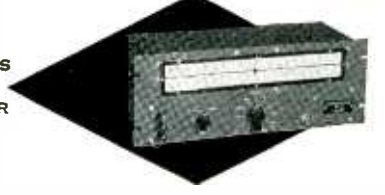

A new high accuracy, easy-to-read, multi-range servo-voltmeter with fast response. Scales 0-3 millivolts to 0-300 volts. Zero left or zero center. Designed for indication, control, or analog to digital conversion.

Bulletins describing these instruments are available, and we will be glad to send you the ones you want. Write...

F. L. MOSELEY CO., 409 NORTH FAIR OAKS AVENUE, PASADENA 3, CALIFORNIA

in the 6,000-8,000 mc band. Features include ample power to override noise, negligible frequency drift, easier tuning, f-m distortion and inherent noise 60 db below a 1-mc deviation and production uniformity—at a cost far less than other relay klystrons of comparable performance. Resonator voltage is 750 v; power output, 1.2 w; bandwidth, 35 mc; and modulation sensitivity, 375 kc per v.

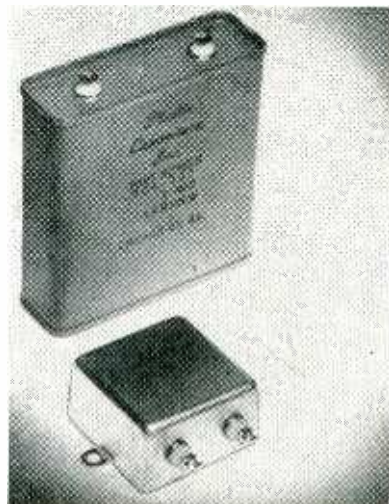

CAPACITORS
are the coefficient type

PLASTIC CAPACITORS, INC., 2511 W. Moffatt St., Chicago 47, Ill., announce a new line of zero temperature coefficient capacitors with plastic film dielectric for use in integrating circuits, tuned filters and timing oscillators. The type GC capacitors feature a temperature coefficient of ±330 ppm per deg C and are available in capacitance from 0.1 µf to 10 µf. Voltage range is from 100 to 1,000 v. Other characteristics are the excellent capacitance retrace, stability with life, temperature range from -60 C to 85 C and hermetic sealing.

OSCILLATOR
for extended-range use

WAVEFORMS, INC., 333 Sixth Ave., New York 14, N. Y. Model 512 oscillator features 0.1-percent distortion, 2-w output, and frequency range to less than 1 cycle. A 4-step attenuator provides calibrated output from 50 v to 5 mv, with a

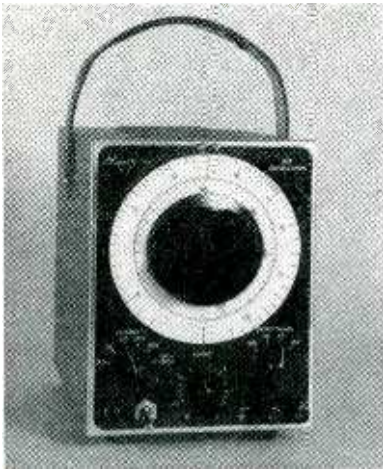

maximum power of 2 w into a 600-ohms load. Source impedance is less than 50 ohms. Tuning range from 0.9 cycle to 500 kc is covered in 5 decade ranges, with an additional bandspread range for ease of tuning at high frequencies. Vernier drive provides 14 in. of scale length per range, a total scale length of 6 ft. Calibration accuracy is ± 2 percent and stability is ± 0.5 percent for normal line voltage and temperature variations. Output remains constant within 0.5 db throughout the tuning range. Model 512 weighs 12 lb and measures 7½ in. high, 6¼ in. wide and 8 in. deep. It is rated for operation from 50 to 400-cycle lines.



30-MC ATTENUATOR has counter-type indicator

AIRBORNE INSTRUMENTS LABORATORY, INC., 160 Old Country Road, Mineola, N. Y., has developed a precision 30-mc attenuator for use as a linear standard of attenuation in the frequency range 25 to 35 mc. Attenuation is continuously variable over a range of 80 db above a minimum insertion loss of 25 db. A counter-type indicator, calibrated in tenths of a db, reads at-

PRECISION PARTS TO PRODUCTS WEIGHING TONS—

... A Range of Unusual Versatility

FROM DRAWING BOARD TO FINISHED PRODUCT—

... All Under One Roof

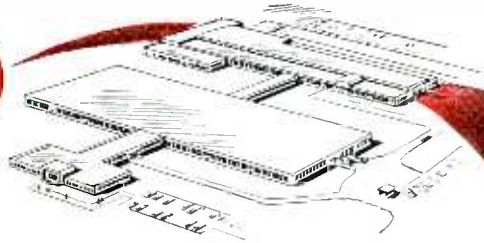

Servo Amplifiers
Electronic Chassis
Gear Assemblies
Instrumentation
Sheet Metal Cabinets

In Daystrom's 350,000 sq. ft. plant the very finest modern machinery and equipment has been acquired for the manufacture, assembly and test of these products. Daystrom's research, development, engineering and manufacturing specialists have a collective experience that embraces electronics, nuclear instrumentation, computing and electro-mechanical devices. To supplement these creative skills Daystrom also has specialists in metallurgy and welding, as well as organic and plated finishes. Daystrom Instrument has earned its place in the expanding Daystrom Incorporated family.

Gyros
Radar
Computers
Radio
Servo Controls

Gun Fire Control Systems
Ordnance Telescope Mounts
Nuclear Instrumentation
Precision Potentiometers
Electrical Test Equipment

DAYSTROM INSTRUMENT

ARCHBALD, PENNA

Division of Daystrom, Incorporated

WRITE TODAY FOR OUR FACILITIES REPORT



Lapp



ANTENNA STRAIN INSULATORS



● The largest of the porcelain rod insulators shown in the illustration develops 12,000 lb. strength. It is available, if specified, with rain shield and/or corona rings. All hardware is silicon aluminum alloy. Smaller units, in porcelain or steatite, are suited to lighter duty for strain or spreader use. Engineering and production facilities are also available for design and manufacture of units to almost any performance specification. Write for Bulletin 301, with complete description and specification data. Lapp Insulator Co., Inc., Radio Specialties Division, 231 Sumner St., Le Roy, N. Y.



Lapp

tenuation directly with an accuracy of ± 0.2 db. Frequency error is negligible from 25 to 35 mc. Input and output impedances are 50 ohms. The instrument weighs only $3\frac{1}{2}$ lb and is supplied in a case 11 in. long by 4 in. wide by $3\frac{3}{4}$ in. high. The type 30 precision attenuator can also be made available with a standard 19-in. rack panel, or unmounted for use as a built-in component of a complete equipment.

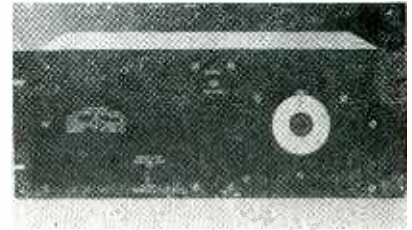

VOLTAGE REGULATOR for both 115 and 230 v

GENERAL RADIO Co., 275 Massachusetts Ave., Cambridge 39, Mass. Type 1570-A automatic voltage regulator has a 6-kva capacity, 0.25-percent accuracy, an efficiency of 98 percent, excellent transient response, and no power-factor restrictions or waveform distortion. Basically, the regulator consists of a Variac autotransformer that adjusts the output voltage, a buck-or-boost step-down transformer that multiplies the power rating of the Variac, and a servomechanism that positions the Variac. Output voltage is adjustable over a range of ± 10 percent from a base value of 115 v. Models are available for both 115 and 230 v in three types of mounting: metal cabinet for bench use, metal cabinet with relay-rack fittings, and metal box for wall or switchboard mounting. All models of this automatic voltage regulator are priced at \$465.

COUNTER adds and subtracts pulses

PHOTOCON RESEARCH PRODUCTS, 421 No. Foothill Blvd., Pasadena 8, Calif., is introducing a new model MC-505AS lightweight high-speed precision counter developed to add and subtract magnetic pulses in a digital control system. The MC-505AS is a 5-digit electrically actu-



ated counter that adds or subtracts from 0000.0 to 9999.9 when magnetic pulses are applied to add or subtract terminals respectively. Each wheel may be individually set to any predetermined number. Typical applications of this continuous-duty-cycle counter are for net pulse counting in pulse guidance systems, and for the remote indication of net totals in any reversible system.



BEAM POWER AMPLIFIER with hard glass bulb

BENDIX AVIATION CORP., Red Bank Division, Eatontown, N. J. Type 6094 beam power amplifier is run-in tested and aged under vibration with all operating voltages applied for 45 hours. This run-in serves to reduce early failures in actual operation. The tube is designed for use in equipment in which high ambient temperatures and high levels of vibration, shock and other accelerations are encountered. A hard glass (nonex) bulb and stem with tungsten pins are used. This, along with careful exhaust to a very low vacuum, permits operation of the 6094 at bulb temperatures up to 300 C. The tube is specifically designed for aircraft, military and industrial applications where freedom from early failures, long aver-

For greater performance at lower cost...

DURAMICS*

AEROVOX Type P84 CM Ceramic-Cased Paper Tubulars

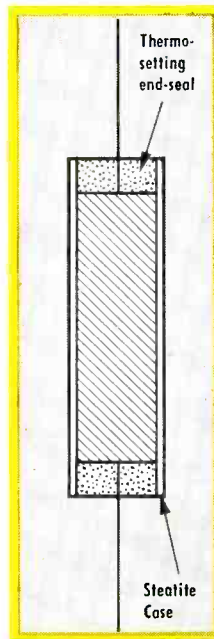

Ceramic-cased tubulars for engineers and designers seeking performance above that of conventional cardboard tubulars.

Dense steatite casing, with specially-developed end-sealing material, provides exceptional protection against humidity. End-seals firmly adhered to the ceramic tubing, will not soften or flow at any rated temperature. Terminal lead wires will not loosen or pull out even with severe handling.

Operating temperature range of from -55°C to $+85^{\circ}\text{C}$. Life test for Type P84 CM Duramics is $1\frac{1}{2}$ times rated voltage at 85°C . for 250 hours. These units meet requirements of RETMA Specification REC-118, high-temperature range, Class M capacitors, and withstand the 250-hour humidity resistance test. Excellent power factor, insulation resistance, temperature-coefficient.

GET THE FACTS!

Ask for Bulletin NPA-200 containing detailed information and standard numbers. Write on business stationery for sample which best tells its own story of superlative performance.

*TRADE-MARK



AEROVOX CORPORATION
NEW BEDFORD, MASS.

Hi-Q DIVISION
OLEAN, N. Y.

ACME ELECTRONICS, INC.
MONROVIA, CALIF.

CINEMA ENGINEERING CO.
BURBANK, CALIF.

In Canada: AEROVOX CANADA LTD., Hamilton, Ont.

WANT TO CUT INSPECTION COSTS ELIMINATE CIRCUIT DEFECTS



Automatic quality control with the CTI *Supertester*

Here is the answer to the problem of maintaining high standards of inspection and reliability with the ever-increasing complexity of modern equipment.

The CTI Supertester is an automatic precision instrument for production testing, fault analysis, and preventive maintenance. It checks electronic and electrical products more completely and in a fraction of the time required by present methods.

Profit three ways by reduced labor costs, higher efficiency, and improved customer relations.

Here are a few widely varied applications. Others will suggest themselves immediately. Completely automatic checking for:

electronic and electrical assemblies
aircraft-engine nacelles
equipment in routine maintenance
guided missile pre-flight tests
computers
cable harnesses

The CTI Supertester automatically programs any combination or sequence of these measurements:

Impedance
Resistance
A-C Voltage
D-C Voltage
Leakage
Continuity

COLOR TELEVISION INCORPORATED



SAN CARLOS 1, CALIF.

age service life and uniform operating characteristics are extremely important.

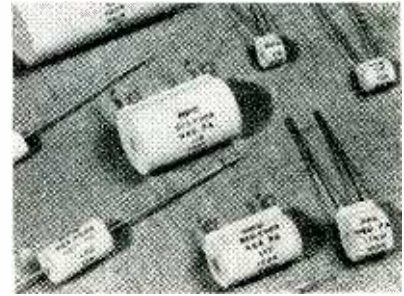

RESISTORS defy shock and vibration

RESISTANCE PRODUCTS CO., 714 Race St., Harrisburg, Pa. Type L encapsulated precision wire-wound resistors are specifically designed to perform accurately in extreme humidity, altitudes and corrosive influences. They will also withstand severe shock and vibration. By winding on steatite bobbins, dimensional stability is assured. Type L resistors perform in accordance with U. S. Government specifications MIL-R-93A and withstand the salt water immersion test for Characteristic A in JAN-R-93. They are furnished with lug type terminals or wire leads, in a complete line of standard, midjet and subminiature sizes. They feature a wide range of performance.

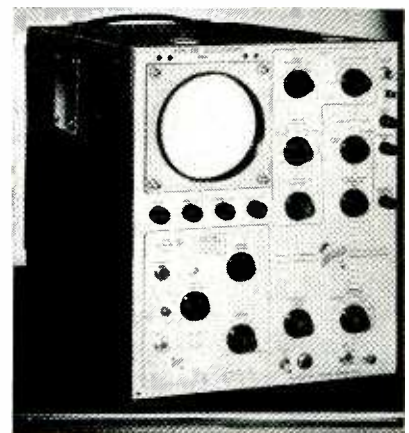

C-R OSCILLOSCOPE uses plug-in preamplifiers

TEKTRONIX, INC., P. O. Box 831, Portland 7, Ore. Type 531 oscilloscope is designed to use plug-in vertical preamplifiers. Four cali-

brated plug-in units are available for use with the type 531, providing vertical amplifier characteristics for wide-band applications (d-c to 10 mc), high d-c sensitivity applications (1 mv per cm) and dual-trace applications. Basic oscilloscope characteristics include: wide-range sweep circuit—0.1 μ sec per cm to 12 sec per cm continuously variable with 24 calibrated steps; trigger amplitude selection or automatic triggering; d-c coupled unblanking, 10-kv accelerating potential on new metallized crt with helical post-accelerating anode; horizontal input amplifier sensitivity 0.2 v per cm to 20 v per cm continuously variable; 0.25- μ sec vertical signal delay; and square-wave amplitude calibrator—0.2 mv to 100 v. Price is \$995 plus price of desired plug-in units.



POWER SUPPLY is an adjustable unit

BECKMAN INSTRUMENTS, INC., Shasta Division, P.O. Box 296, Richmond, Calif. The model 701 is an unregulated supply, providing d-c voltages from 0 to 250 at maximum load of 90 ma (360 v, open circuit), and a-c filament power, 6.3 v at 3 amperes, center tapped. Ripple has been kept to the low value of 20 mv rms by use of a two-section choke input filter. An auto-transformer in the primary permits the adjustment of d-c output to any desired value from zero to maximum. Output voltage is constantly monitored by a front-panel meter that can be switched to indicate current when desired. Sepa-

NO DERATING
even at
50° C
ambient

NEW HIGH AMBIENT
Vickers Selenium Rectifier

40°
30°
20°
10°
0°
-10°

New Vickers rectifiers give you more watts per dollar initial cost ... lower annual cost.

HIGH VOLTAGE

- 40-volt inverse cell rating
- Leakage and inverse loss are one-half that of ordinary rectifiers
- High dielectric—withstands surges up to twice rated voltage

LONG LIFE

Vickers' newly-developed inorganic barrier is inherently stable, gives longer rectifier life. Inverse characteristics actually improve with use.

WRITE TODAY FOR COMPLETE INFORMATION



WRITE TODAY FOR COMPLETE INFORMATION

VICKERS ELECTRIC DIVISION

VICKERS INC.
 A UNIT OF THE SPERRY CORPORATION

1801 LOCUST STREET • SAINT LOUIS 3, MISSOURI

Want more information? Use post card on last page.

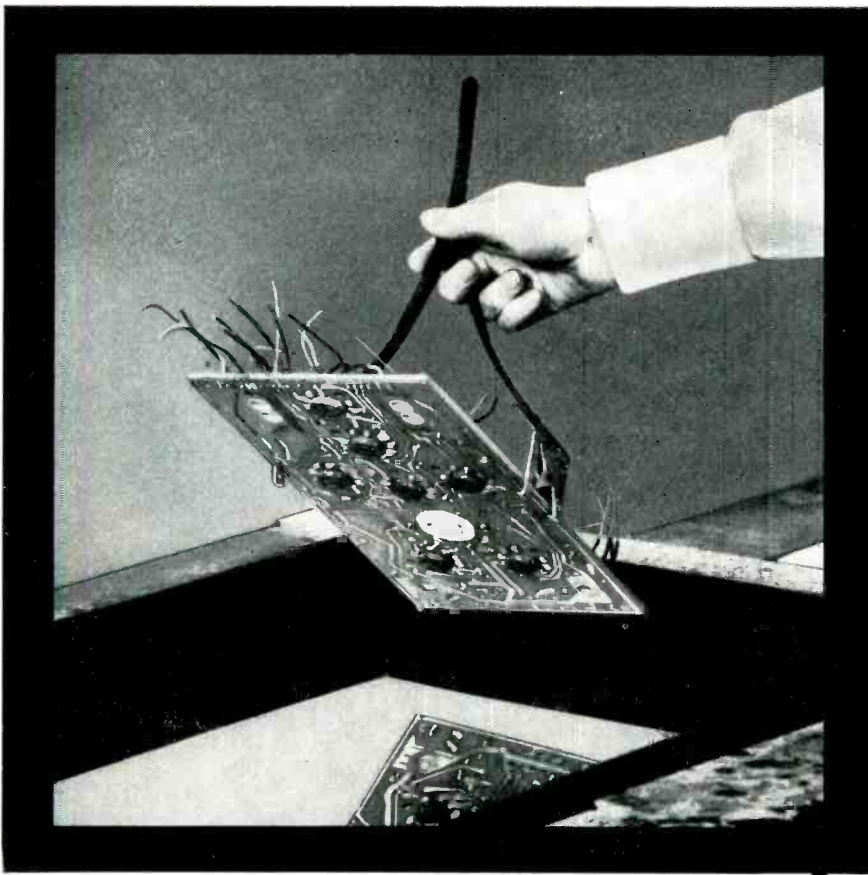

Subject: solder

As far as cost is concerned, solder is a relatively small item in any manufacturing operation.

But solder does a big job. You should have the best solder you can buy... Federated solder.

For printed circuits — Federated CASTOMATIC® bar solder, the machine-cast solder with *no dross*, with *uniform composition* throughout each bar.

For joining work — Federated Rosin Core (RTS 200) wire solder in all commercial gauges and compositions.

Photo courtesy Photocircuits Corp., Glen Cove, N. Y.

Federated Metals Division

AMERICAN SMELTING AND REFINING COMPANY
120 BROADWAY, NEW YORK 5, N. Y.

In Canada: Federated Metals Canada, Ltd., Toronto and Montreal

Aluminum, Magnesium, Babbitts, Brass, Bronze, Anodes, Zinc Dust,
Die Casting Metals, Lead and Lead Products, Solders, Type Metals



rate terminals for positive, negative and ground are provided.

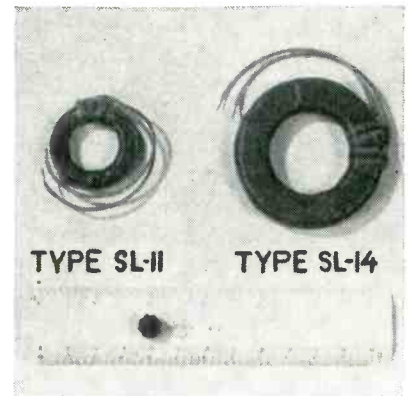

TOROID INDUCTORS use Ferroxcube cores

MICO INSTRUMENT Co., 80 Trowbridge St., Cambridge 38, Mass. A new line of toroid inductors utilizes Ferroxcube 3C cores. They are particularly suited to applications requiring small size, wide range of inductance values, high Q and high astaticism. They are well suited for use as inductor elements in v-t and transistor circuits as well as in wide-range filter networks and other applications requiring a compact, stable and durable inductor. A bulletin is available providing special features, specifications and ordering data.

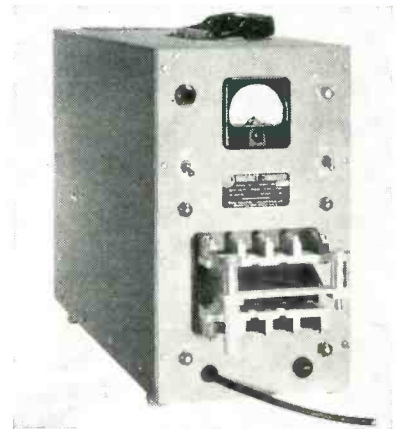

MAGNET CHARGER is versatile and portable

RADIO FREQUENCY LABORATORIES, INC., Boonton 3, N. J. The improved model 107-A magnet charger is a capacitor discharge impulse type capable of charging practically all permanent magnets in common use. Weighing only 75

Andersen offers
**SOLID
 ULTRA-SONIC
 DELAY LINES**
to meet your
CRITICAL spec.

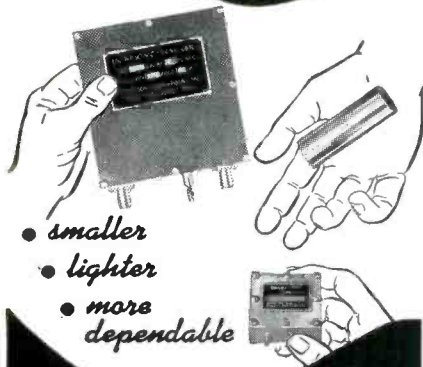

- smaller
- lighter
- more dependable

for RADAR and COMPUTERS

Delay Time	From 1 to 3500 microseconds.
Delay Tolerance	\pm 0.01 microsecond.
Carrier Frequency	From 5 to above 65 megacycles, transducer fundamental for moderate delays.
Bandwidth	Up to 60% of carrier frequency.
Attenuation	Zero to 60 decibels (depending on termination).
Dynamic Range	Up to 60 decibels.
Line Terminations	50 to 2500 ohms (depending on bandwidths and attenuation requirements).
Temperature Range	Dimensionally and functionally stable from -60 to $+100$ degrees Centigrade. (Temperature controlled cases available).

Whatever your vital requirement in ultra-sonic delay lines, Andersen Laboratories, specialists in the research, design, and manufacture of fused quartz lines, can provide you better performance characteristics at lower cost. Write for general bulletin #54 or send details of application for advisory service.

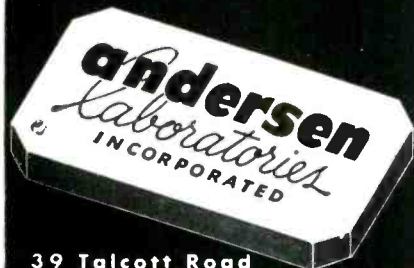

39 Talcott Road
 West Hartford 10, Conn.

Want more information? Use post card on last page.
 ELECTRONICS — November, 1954

NEW PRODUCTS

(continued)

lb, the unit is completely portable and convenient to use from any 110 or 120-v outlet. Charging current is controlled by a simple pushbutton switch on the front panel. A minimum amount of time is required to mount and charge the magnet. Multiplied by many operations this represents a large saving in time and labor cost. It consumes only 25 w. Special adapters are available for many charging requirements, including all popular aircraft instruments.



DIGITESTER
 needs no accessories

TELECOMPUTING CORP., 133 E. Santa Anita Ave., Burbank, Calif. Type 48A Digitester measures resistance, voltage and current with laboratory standard accuracy and supplies a direct-reading digital output. It has an accuracy of 0.1 percent and 0.8 second speed. Visual readout is in decimal numbers instead of analog form. Wide measuring ranges are an important feature. One can measure up to 10 megohms in 7 ranges, 1,000 v in 6 ranges, or 1 ampere in 6 ranges. Maximum accuracies (lowest scales) are ± 0.01 ohm; ± 0.0001 v; -0.01 μ a. Operation does not involve any manual adjusting or balancing. One simply presses a panel button to get decimal readout. No accessories or external references are necessary.

TIMER
 with synchronous motor

BRISTOL MOTOR DIVISION, Vocaline Co. of America, Inc., Old Saybrook, Conn. The series PB push-button type timer complete with Circle B synchronous motor is rated for 25 amperes at 115 v 60-cycle. The lightweight unit fea-



CRYSTALS

FOR EVERY PURPOSE



- AIRCRAFT
- MOBILE TWO-WAY
- LAW ENFORCEMENT
- TAXI
- RAILROAD
- BROADCAST
- AIR FORCE
- ARMY — SIGNAL CORPS

- NAVY
- HOBBY MODELS
- AMATEUR
- TELEVISION
- PIPELINE
- MARINE
- INDUSTRIAL
- CAA Type Certification



CONSULT OUR RESEARCH AND ENGINEERING LABORATORY. IT IS AT YOUR SERVICE.

One of the Oldest Manufacturers of Crystals in the United States.

ORDERS PROMPTLY FILLED



SCIENTIFIC RADIO PRODUCTS, INC.

215 South 11th St.,
 Omaha, Nebr., U.S.A.

Be Specific - Say Scientific

Want more information? Use post card on last page.

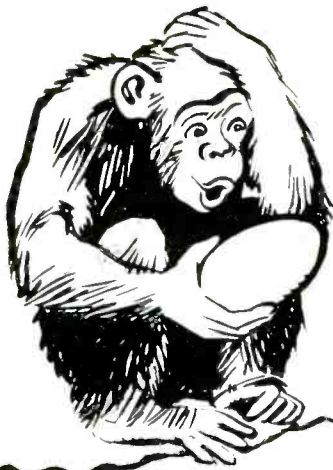

Penny Foolish

Columbus, Ohio, July 28 (AP)—It cost the state 36 cents yesterday to collect one cent in sales tax revenue. Furniture dealer John Glancy of Goshen sent a check for a penny by registered mail. State Treasurer Tracy had to pay 36 cents postage due.

PLENTY FOOLISH

Somebody lays an egg every now and then . . . but the wise engineer avoids this by not being penny foolish . . . by not seeking cheaper materials, especially where dependability over long periods is a major factor in the proper performance of their product. To be economical . . . to keep costs down, is being thrifty, provided quality is not sacrificed at any point along the production line. At DUMONT there are skilled, efficient personnel and precision equipment to fill your needs with speed and economy. DUMONT'S reputation for quality capacitors has been established thru years of experience, experiment and research. It's thrifty to bring your problems to DUMONT . . . NOW!

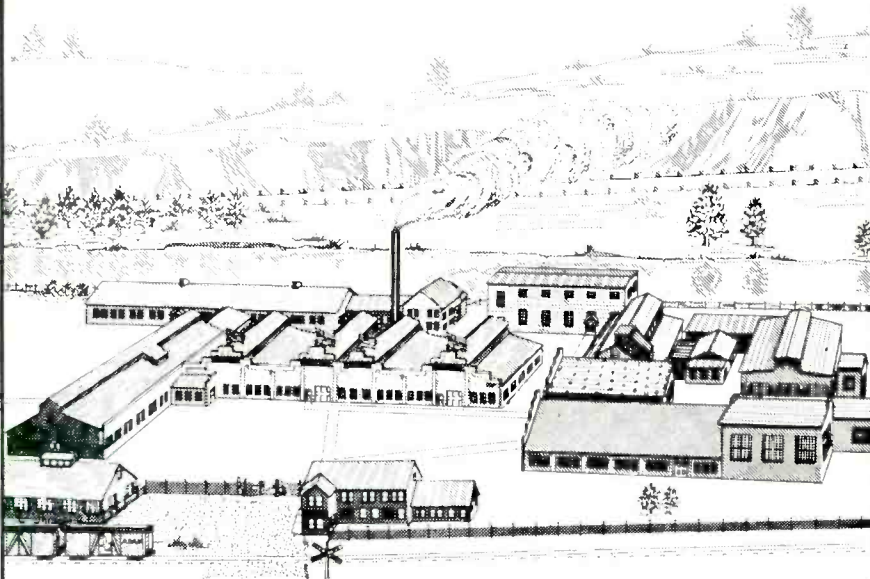

DUMONT-AIRPLANE & MARINE INSTRUMENTS, Inc.

OFFICE
15 William Street
New York 5, N. Y.

FACTORY
Clearfield
Pennsylvania

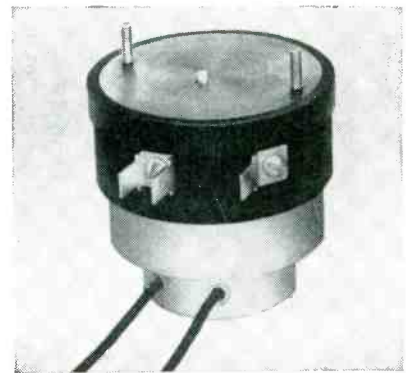

tures a dust-tight housing, and can be easily mounted to operate in any position. Featured also are quick connect terminals, heavy-duty solid silver contacts, nylon cam, latch and operating button. When the actuating button is depressed the timer switch turns on the load, then turns it off after the factory set time interval. With a maximum diameter of 2½ in. × 2½ in. deep, the timer is designed for use in equipment requiring a pushbutton actuated electrical time switch.



H-V MULTIPLIER serves as potential divider

BALANTINE LABORATORIES, Boonton, N. J. Model 620 extra-high-voltage multiplier allows measurement of alternating potentials up to 60 kv peak with all types of Ballantine voltmeters and with many other makes also, and serves as a potential divider with most cro's for displaying high potential waveforms. A voltage applied to the model 620 is attenuated 10,000 to 1 with an accuracy of 2 percent between 60 cps and 6 mc. Connection is made to an associated in-

strument through a 6-ft cable allowing for observations at a point safely remote from a high-voltage source. Input capacitance is 3.8 μf and shunt resistance is about 10^9 megohms. The model 620 can be used for extremely high impedance bridging purposes to measure down to 1 v or less when used in conjunction with sensitive types of electronic voltmeters.



PRECISION RESISTORS of carbon deposit type

ALLIES' PRODUCTS, INC., 1023 Conn. Ave., N.W., Washington 6, D. C., introduces a complete line of precision deposit carbon resistors, featuring high temperature operation (up to 250 C), a wide range of values in 1-w to 5-w sizes, with tolerances as close as 0.1 percent. The new line is being offered at prices which make it especially attractive for replacement of wire-wound resistors. Engineering catalog No. 537A gives all design specifications.

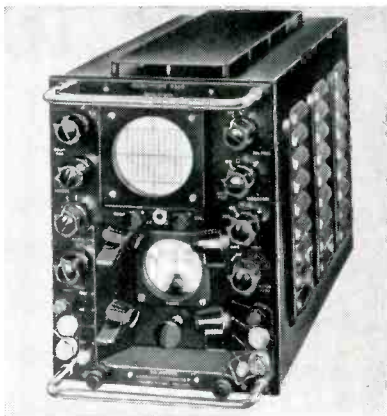

OSCILLOSCOPE can be used with radar

SOLARTRON LABORATORY INSTRUMENTS LTD., Thames Ditton, Surrey, England. The D.300 oscilloscope has a direct-coupled deflection amplifier with a bandwidth of 6 mc, and a time-base with a maximum sweep speed of 1 μsec with facilities for delaying the start up to 10 milliseconds. An internal sine-wave calibrator provides a trace at 1 mc, 100 kc or 10

The Tandem-Rotor BELL HSL-1 Helicopter

A Bell-designed autopilot enables this submarine hunter and killer to hover motionless for long periods of time while crewmen maneuver its dipping sonar.



NORDEN Precision Reduction Gear Box

vital to the performance of
a Bell autopilot.

When ultra-precision at maximum performance and minimum weight is a mandatory speed reduction requirement in computers, servomechanisms, or other instrumentation systems, select a Norden Precision Reduction Gear Box.

PERFORMANCE

Reduction ratios to 20,000:1 have been attained without sacrificing performance. Friction is almost without identity since the greatest reduction requires less than .01 in.-oz. of input torque. Acceptance tests of units now in production indicate backlash of less than 0.25° at the output. All gearing for a gear box with a 20,000:1 reduction weighs only 6.5 ounces and is contained within an area $2\text{-}3/32" \times 2\text{-}3/32" \times 7/8"$ exclusive of mounting flanges.

COMPONENTS

Materials used for gears and pinions are dependent upon the respective requirements for such factors as average life expectancy, reduction ratio, operational speed, and torque. The same consideration of requisites is given in determining bearing materials and/or the size and type of precision anti-friction ball bearings to be incorporated. Lubricants are selected for specific temperature range operation and maximum protection against corrosion. Die cast, stamped sheet metal or machined housings are chosen for maximum durability, minimum weight and relative costs.

With the ever increasing demand for precision products ranging from the smallest, most sensitive element to expansive Navigational, Fire Control and Bomb Director systems, the name Norden has become more and more familiar. To the Norden people, no challenge is too great!

Precision Instruments and Precision
Control Systems are our Business

THE
NORDEN
LABORATORIES CORPORATION
MILFORD, CONNECTICUT



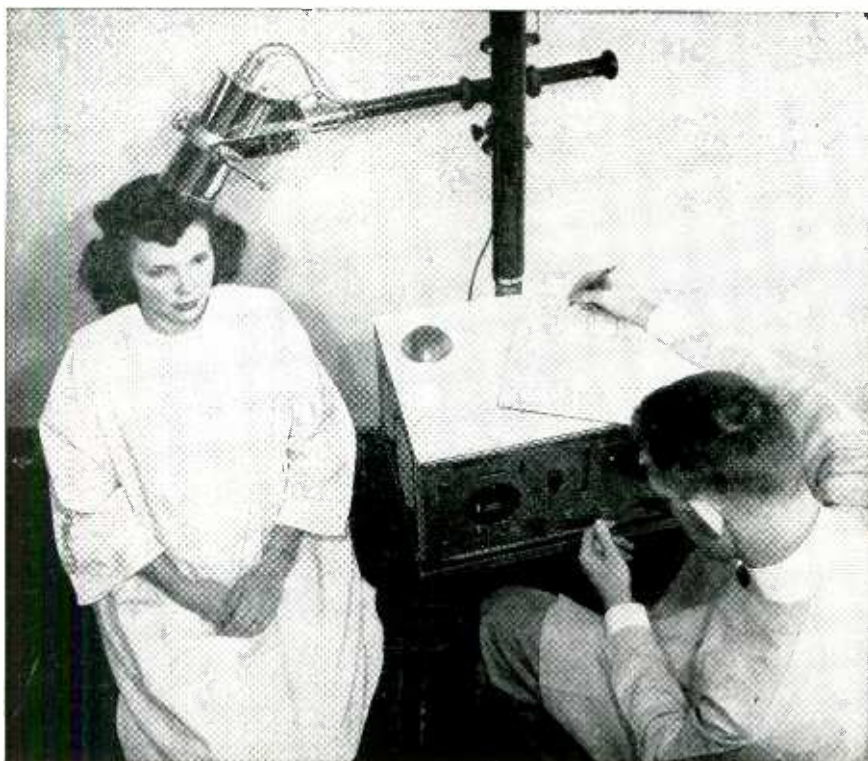

WHERE PRECISE MEASUREMENT
OF TIME IS ESSENTIAL . . .

Specify **Cramer** RUNNING TIME METERS

"The Cramer running time meter plays an extremely important part in our equipment . . .," reports R-C Scientific Instrument Company, Inc., Playa Del Rey, California, manufacturers of high-quality radiation detection instruments.

"The *Scintistand*, shown here, is designed for medical tracer studies, such as brain tumor location, which require precise determination of small differences in counting rate. The quoted accuracy of our apparatus is based on a statistical formula for computing the probable error in sampling a series of pulses randomly spaced in time. Since no allowance is made in this formula for the running time meter, it must be extremely accurate. We've used Cramer devices on all our scalers for the past five years with no failures."

Regardless of application or type of timing device needed, it will pay you to consult the R. W. Cramer Company, specialists in time control. An experienced engineering staff is available to help you solve your timing problems.



Running time meter with reset feature for flush panel mounting. Complete line of time control equipment available to fit every installation requirement.



SPECIALISTS IN TIME CONTROL

The R. W. CRAMER CO., Inc.

BOX 3, CENTERBROOK, CONNECTICUT

ke for measuring time-base velocities and linearity. Facilities for input signal measurement and signal delay are provided. The oscilloscope is particularly suitable for use with all types of radar systems as well as for general purposes.

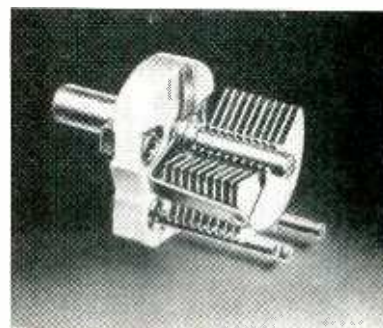

VARIABLE CAPACITOR
with extended shaft

THE HAMMARLUND MFG. CO., INC., 460 W. 34th St., New York 1, N. Y. The APC and MAPC type variable capacitors are now being made available with a half-inch shaft extension for knob control. The APC trimmer is used in all classes of equipment where a compact high-quality air dielectric trimmer is needed. The MAPC is similar to it except that it is a miniaturized version.



GAS PHOTOTUBE
for industrial use

RADIO CORP. OF AMERICA, Harrison, N. J. The gas phototube 6405/1640 is designed for use in industrial applications critical as to microphonics and sensitivity gradient. Among such applications are electronic beverage-inspection equip-

ment and ampul-inspection equipment. The spectral response of the 6405 is characterized by high sensitivity to red and near-infrared radiant energy. Because of its spectral response it is especially suitable for use with an incandescent light source. A 4-page folder is available giving complete technical data, installation and application information, characteristics curves, dimensional outline and socket connections.

PARALLELING SWITCH
features self-cleaning

INDUSTRIAL INSTRUMENTS, INC., 89 Commerce Road, Cedar Grove, N. J. The type SW switch is designed for additive switching whereby each position brings in circuitry in parallel with circuitry switched in by previous setting. Primarily designed for use in capacitance decade work, the switch has many other applications in laboratory work due to its low resistance and capacitance and self-cleaning features.



POWER SUPPLY
has 0.01 percent stability

JOHN FLUKE MFG. CO., INC., 1111 W. Nickerson St., Seattle 99, Wash. Model 300R is a super-regulated, ultrastable d-c supply capable of delivering 0.3 ampere of current at any output voltage from 0 to 1,514 v. Four decade switches permit selection of output voltage in 1-v steps while a 1.1-v vernier calibrated in 0.1-v increments affords

BROAD BAND PULSESCOPE

by **Waterman**

MODEL S-6-A

DC CALIBRATION MARKERS 1-1000 μ S
0-5 mc

Size:
8½" x 6¾" x 13¾"
22 Pounds

ANOTHER EXAMPLE OF **Waterman** PIONEERING...

The S-6-A BROAD BAND Scope is a PULSESCOPE in performance, POCKETSCOPE in size, and it compares more than favorably with oscilloscopes that are *transportable*, instead of portable. The instrument measures DC as well as AC signals. Unique DC calibration methods permit rapid measurements of either positive or negative AC or DC signals. The scope uses a 3XP1 tube with 1500 volts on the second anode, thus providing a brilliant trace for high speed transients even at low repetition rates. Vertical amplifier sensitivity of 0.2v rms/inch, and response to 5 mc within 3DB . . . pulse rise time of 0.1 μ s . . . internal intensity markers from 1 to 1000 μ s . . . repetitive or trigger sweep from 5 cycles to 500 KC with 5X sweep expansion . . . sweep, marker and DC calibrating voltage available externally. Size 8½" x 6¾" x 13¾" in. Weight 22 lbs. Operates from 50 to 400 cycles at 115 volts AC.

WATERMAN PRODUCTS CO., INC.

PHILADELPHIA 25, PA.

CABLE ADDRESS: POKETSCOPE

WATERMAN PRODUCTS INCLUDE

- §-4-C SAR PULSESCOPE®
- §-5-A LAB PULSESCOPE
- §-6-A BRC ADBAND PULSESCOPE
- §-11-A INDUSTRIAL POCKETSCOPE®
- §-12-B JANIZED RAKSCOPE®
- §-14-A HIGH GAIN POCKETSCOPE
- §-14-B WIDE BAND POCKETSCOPE
- §-15-A TWIN TUBE POCKETSCOPE
- RAYONIC® Cathode Ray Tubes and Other Associated Equipment

MEMO...
Write for details today!

WATERMAN PRODUCTS

**20
TO
200 D.P.**

**SEND YOUR
PRINTS FOR
QUOTATION**

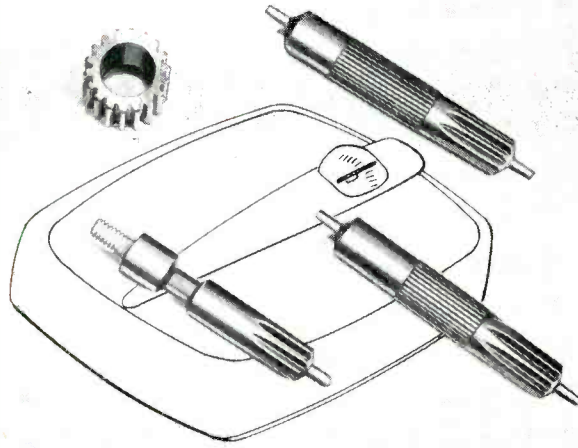

SPURS • HELICALS • WORM AND WORM GEARS • STRAIGHT BEVELS
LEAD SCREWS • RATCHETS • CLUSTER GEARS • RACKS • INTERNALS • ODD SHAPES

THE *Finest* IN GEARS



Beaver Gear Works Inc.

1021 PARMELE STREET, ROCKFORD, ILLINOIS

**sub-miniature
AND
moisture-proof**

THE ECONOMICAL SOLUTION where moisture proof resistive elements of comparatively small size are required for commercial applications. Type S-15 is $\frac{3}{8}$ " long by $\frac{1}{4}$ " diameter; type S-30 measures $\frac{3}{4}$ " by $\frac{1}{4}$ " diameter. Both types are moisture proof and capable of high performance over long periods of continuous service. IN-RES-CO Resistors for every ordnance or civilian requirement are available at a cost that solves circuit design problems both performance-wise and cost-wise. Check up now, on the complete line of IN-RES-CO quality wire wound resistors.

**IN-RES-CO
S-15 & S-30
WIRE WOUND
RESISTORS**



TYPE S-15
 $\frac{1}{4}$ " DIA. x $\frac{3}{8}$ " LG.



TYPE S-30
 $\frac{1}{4}$ " DIA. x $\frac{3}{4}$ " LG.

**INSTRUMENT
RESISTORS CO.**

COMMERCE
AVENUE



UNION
NEW JERSEY

APPLICATION-DESIGNED RESISTORS FOR ELECTRONICS AND INSTRUMENTATION

FOR JAN SPECIFICATION RESISTORS — consult the new illustrated literature describing the complete In-res-co line. Write for your copy today!



resolution of 2 mv at any output voltage. Calibration accuracy is better than 0.25 percent. Regulation is 0.002 percent for 20-percent change in line voltage and 0.002 percent for load current change from no load to full load. These figures obtain over the entire output voltage range. Long term stability is 0.01 percent or better.

**JUNCTION TRANSISTOR
has 500 mw dissipation**

CBS-HYTRON, a Division of Columbia Broadcasting System, Danvers, Mass., has announced a new *pn-p* power junction transistor. This CBS-Hytron development device, known as the HD-197, is of germanium construction and is capable of 500 mw collector dissipation without the use of a heat sink. Because of its high current gain the development type HD-197 transistor is suitable for switching circuits, class B circuits, and servo-mechanisms.

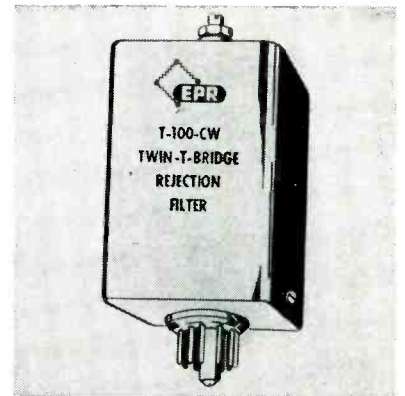

**REJECTION FILTER
in plug-in type can**

EASTERN PRECISION RESISTOR CORP., 130-11 90th Ave., Richmond Hill, N. Y. The use of high stability accurate precision wire-wound resistors, coupled with selected silver mica capacitors has resulted in the development of a stable twin-T bridge type 60-cycle rejection filter, with attenuation greater than 50 db. Encased in a plug-in type can, measuring 2 in. x 2 in. x 3 in. with a tube socket base for easy mounting, the T-100-CW filter can be made with mechanical design variations. It is available also for

rejection of other frequencies when requested on special order.

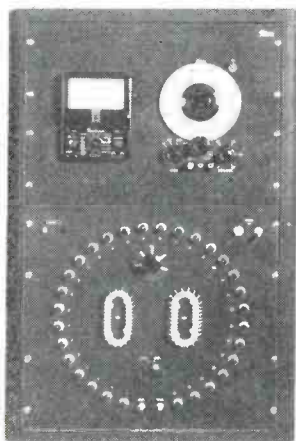

IMPEDANCE BRIDGE
is an automatic unit

CAL-TRONICS CORP., 11307 Hindry Ave., Los Angeles 45, Calif., has produced a new type of automatic impedance bridge. This unit is used to test a specific multicircuit electronic assembly, which checks all circuits completely, including extraneous wiring. A built-in audio oscillator furnishes bridge excitation. Provision is made for front-panel selection of percentage limit tolerance. The unit can be readily adapted to test similar electronic assemblies. The illustrated unit accommodates 30 circuits that can be redesigned to handle any required number of circuits.

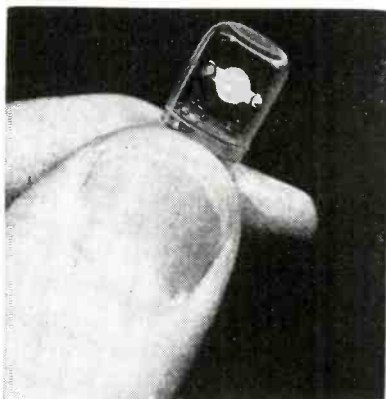

TINY CRYSTAL
offers a high Q

JAMES KNIGHTS Co., Sandwich, Ill., has announced a new miniaturized, high-stability Glasline crystal. The JK-G3, along with extreme com-

NEW NEW



Advanced Design...
MODEL DS-6100

FREQUENCY COUNTER

All new electronic pulse indicator with a completely different circuitry approach that reduces size and weight without sacrificing accuracy. Direct read out in events per second to 100,000.

Inherent accuracy is ± 1 event.

Time base — 100 KC crystal controlled oscillator circuit. Easily portable and weighs only 28 pounds. Price — \$675.00

New MULTI-SAMPLING

... 3 to 60 second manual

Greater STABILITY

... lower power consumption allows continuous, accurate operation without excessive heat

Improved CIRCUITRY

... by utilizing a new and different approach in design

Less WEIGHT

... advanced design offers ready portability

Smaller SIZE

... unit size reduced by unique design. Uses less bench space.



MODEL DS-660 FREQUENCY COUNTER

Designed for portability and low cost as well as accuracy, this new Detectron unit will count and display electrical or mechanical events which can be converted to a varying voltage of sufficient amplitude. Direct read out in events per second to 10,000. Accuracy — approximately .1%. Weighs only 16 pounds. Price — \$425.00

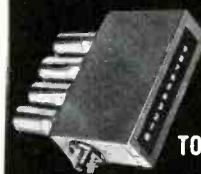

**DECIMAL
DECADE
TOTALIZERS**

New, improved Totalizers designed for use where a number of pulsations are to be counted. Direct read out. Standard octal plugs assure adaptability to most existing scaling equipment.

For more detailed information, please write...

COMPUTER-MEASUREMENTS Division of

The **Detectron** Corp.

5420 Vineland Avenue North Hollywood, California

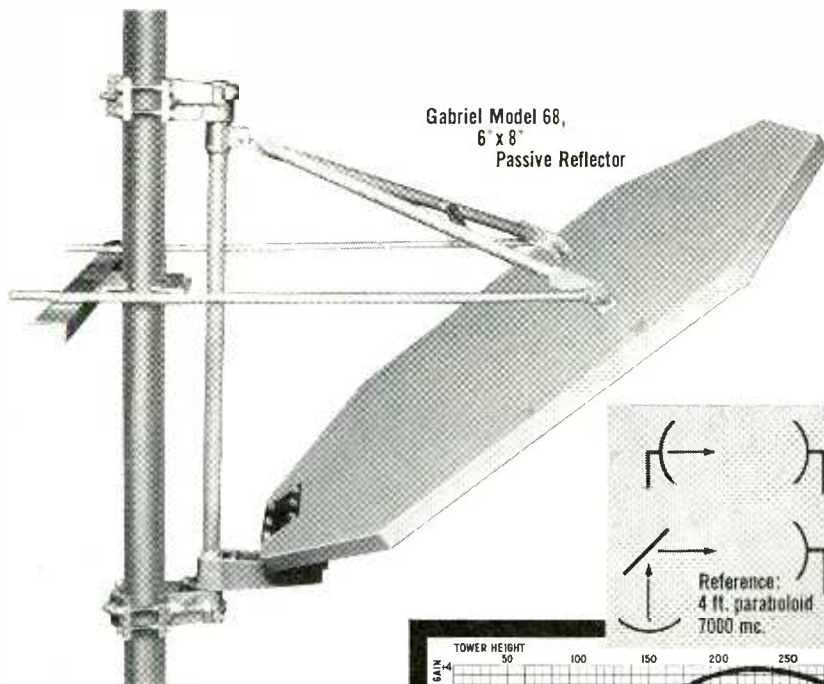

Gabriel Model 68,
6' x 8"
Passive Reflector

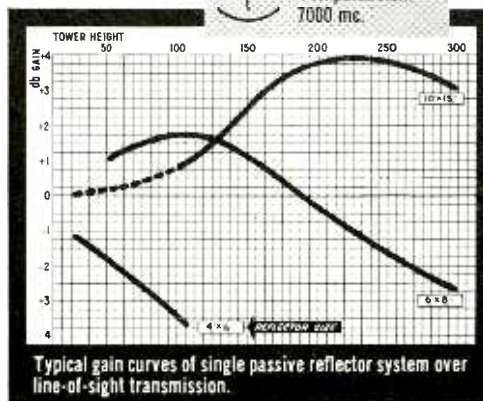
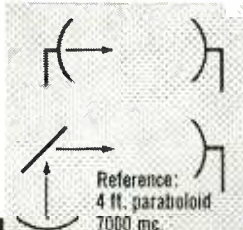

gain
“PEAK”
 performance at lower cost
 with
GABRIEL passive reflectors

Fast . . . accurate . . . easy adjustment permits peaking Gabriel Passive Reflectors in microwave relay links to gain maximum point-to-point transmission at lower overall cost. Gabriel's new design offers increased system efficiency that can out-perform line-of-sight transmission.



Adjusting elevation done
by one man on tower.

- Two lead-screw systems permit continuous, stepless adjustment in azimuth and elevation by one man on the tower with only a hand wrench.
- Mounting on the tower can be done usually by a two-man crew, with total man-hours cut as much as 50%.
- Increased gain over line-of-sight transmission is obtainable with optimum size reflector for various tower heights.

Ask for Gabriel recommendations for your system.

Write for Bulletin PR-11 for complete mechanical and electrical systems data.

Gabriel Electronics Division
 THE GABRIEL COMPANY, Endicott Street, Norwood, Mass.



pactness, offers a high Q for maximum performance and minimum aging drift. It is available in a frequency range from 10 mc to 100 mc. Vacuum sealing the JK-G3 in glass provides protection against shock and contamination and permits extremely high stability. Because the glass provides insulation there is no risk of wiring shorts even in the most compact assemblies.

PICTURE TUBES are the rectangular type

CBS-HYTRON, Danvers, Mass., has announced two new types of spherical-face, rectangular, 90-deg deflection, all-glass picture tubes—the 21ALP4 and 21ALP4A. Both are electrostatically focused, magnetically deflected, direct-view picture tubes designed for use in tv receivers. Both tubes incorporate a new bulb design that provides 263 sq in. of screen area. Both contain electron guns designed for use with single-field, external ion-trap magnets.

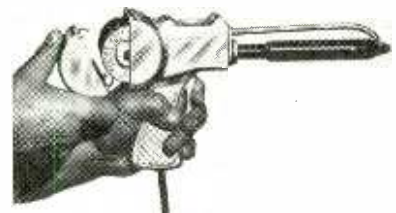

SOLDERING GUN is self feeding

SCOTCO PRODUCTS Co., Beverly, Mass. The Scotty electric soldering gun feeds solder (acid, rosin or plain type) through the upper tube to the hot soldering tip. The solder strip ($\frac{1}{16}$ in. or $\frac{3}{32}$ in. diameter) is accurately controlled by trigger action allowing a small or large quantity, as required, to be fed to the tip. The illustration with the snap-on back plate partially removed shows the solder spool in position. A new spool replaces the used one in a few seconds. The Scotty comes equipped with either a wedge shape, half round for copper tubing or pointed

soldering tip, the latter for use with explosion rivets. It is also furnished with either 50, 100 or 150-w heating elements. The Scotty is of lightweight aluminum construction.

pH CONTROLLER is Free-Vane type

THE BRISTOL Co., Waterbury 20, Conn., has announced a new electronic indicating pH controller available with a variety of electric control actions. Featuring a newly developed high-torque, jeweled, millivoltmeter-type movement, the instrument has an easy-to-read 7-in. mirror scale, and a dust- and vapor-proof case. It is available in the following electric control actions: two-position, two-position with normal zone, two-position with proportional input and three-position control. It will actuate a wide variety of final control devices, permitting pH control with any type of reagent, whether liquid, gaseous or solid. Complete specifications and illustrations are included in the new 36-page bulletin Q1304.

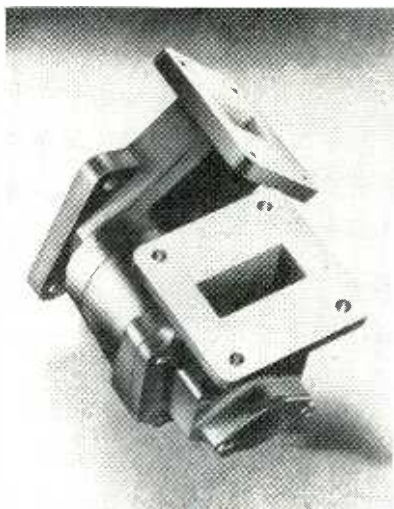

ROTARY JOINT for X-band antenna systems

RAYTHEON MFG. Co., 150 California St., Newton 58, Mass., is producing a new design of rotary joint for antenna systems in the X-band frequency range. The device employs a coaxial rotary section with standard rectangular waveguide input and output, eliminating the bandwidth limiting factors and



GABRIEL L-band components

*for
your
special
job . . .*

Now, a complete line of large-size microwave components is available from the Gabriel Laboratories. Whatever L-Band components you need . . . stub tuners, power dividers, waveguide components, rotary joints, hybrid junctions, adjustable phase shifters . . . Gabriel can supply them. If you have a special problem, our staff of designers and engineers is ready to meet your most exacting specifications. Extensive testing equipment and complete production facilities operated by highly-skilled personnel insure exceptional electrical performance and mechanical strength.



Let us solve your microwave problem. Write, or phone NEEDHAM 3-0005

The Gabriel Laboratories

THE GABRIEL COMPANY 135 Crescent Street, Needham Heights, Mass.



TIME and TIME again

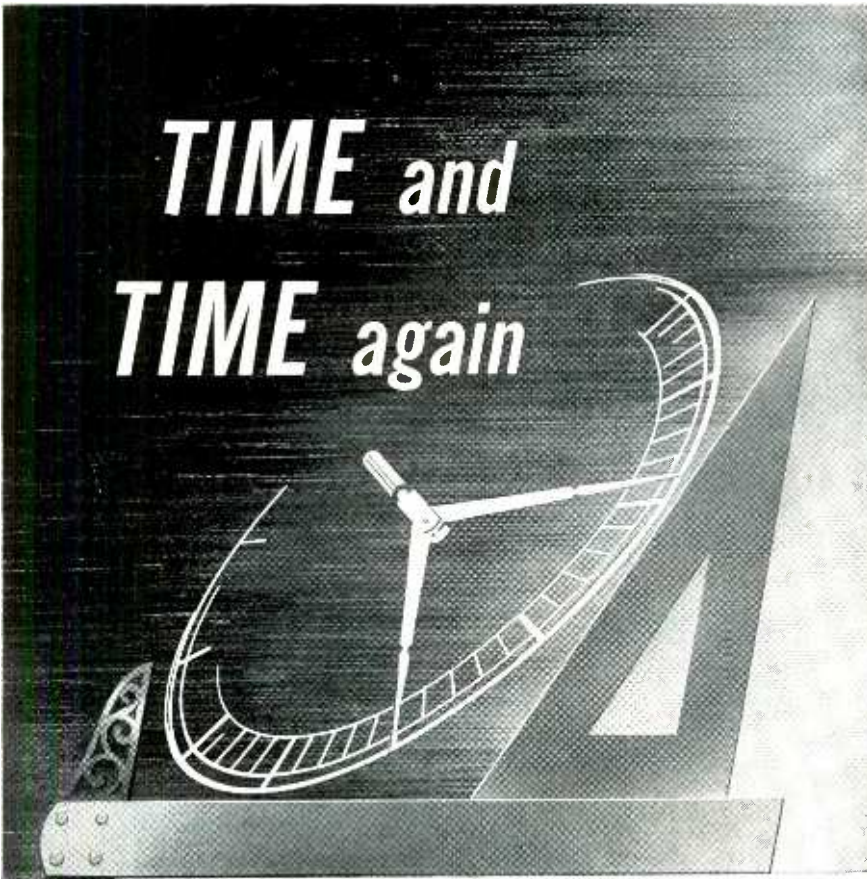

Designers find a better way

When better performance depends on unexcelled timing components, it pays to look to HAYDON*. Engineers can rely on HAYDON Timing Motors and Timing Devices to give products precise, exacting control of Time to better serve the user.

Whether it's product diversification or refinement, your HAYDON Timing Engineer can provide complete engineering information. Write for his name now.



resonances usually associated with standard designs utilizing circular waveguide sections. The rotary joint is constructed of aluminum and utilizes a unique design of transition from rectangular to coaxial section permitting peak power up to 250 kw at a duty cycle of 0.001 at atmospheric pressure over an 11-percent bandwidth with a maximum vswr of 1.07. Total weight of the unit is 1.5 lb.

SELENIUM DIODES of the subminiature type

INTERNATIONAL RECTIFIER CORP., 1521 E. Grand Ave., El Segundo, Calif., has added to its line four new subminiature selenium diodes. The new additions, types 4V1, 5V1, 2Y1 and 3Y1, are rated for a maximum a-c input voltage (rms) from 52 v to 130 v and for maximum d-c output voltage of 60 v to 80 v. They will deliver an output current from 5 ma to 11 ma. Each diode is completely encapsulated within a thermosetting plastic and may be operated in an ambient temperature range of -50°C to 100°C . Applications for these selenium diodes include their use to provide bias for tubes in military and commercial electronic equipment.

IMAGE ORTHICON for color tv cameras

RADIO CORP. of AMERICA, Harrison, N. J. The 6474/1854 is a tv camera tube for use in color tv cameras utilizing the method of simultaneous pickup of the studio or outdoor scene to be televised. It has exceptional sensitivity combined with a spectral response approaching

HAYDON
AT TORRINGTON

A SUBSIDIARY OF GENERAL TIME CORP.

HEADQUARTERS FOR
TIMING

HAYDON Manufacturing Company, Inc.
2435 ELM STREET, TORRINGTON, CONN.

- Put me in touch with the Haydon Timing Engineer.
 Send me catalog, "Electric Timing Devices".

NAME _____
TITLE _____
COMPANY _____
CO. ADDRESS _____
CITY _____ ZONE _____ STATE _____

*Trade Mark Reg.
U. S. Patent Office

that of the eye, and good resolution capability. With a color camera employing a suitably designed optical system and utilizing efficient color filters, commercially acceptable color pictures can be obtained with about 350 foot-candles of incident incandescent illumination on the scene and a lens stop of $f/5.6$. The photocathode utilized is characterized by a relatively wide spectral response having high blue and green sensitivity, good red sensitivity and practically no infrared sensitivity. This spectral characteristic enables the tube to translate colors very accurately when operated in a color camera with appropriate color filters and optical arrangements.



VSWR AMPLIFIER is multiple-function device

WAVELINE, INC., Caldwell, N. J., has perfected a new microwave vswr amplifier with multiple test functions. Incorporated are these features: crystal current measurement for monitoring c-w levels; 100- μ a Weston meter; dual channel inputs that eliminate continuous cable changes; a sensitivity of 0.3 μ v for full-scale deflection; a 60-db range calibrated to ± 0.1 db per 10-db step; crystal or bolometer inputs; and plug-in filter units from 250 to 2,500 cps.

UHF DEMODULATOR for use in measuring swr

RADIO CORP. OF AMERICA, Harrison, N. J., has announced the WG-298A uhf demodulator for use as an accessory with uhf tv test equipment operating in the frequency range from 300 to 950 mc. It facilitates measurements of vswr's of receiver

can you put **TIME**
to work
at **400 cycles?**

at **60 cycles?**

on **Direct Current?**

If time is an element in the operation of your product or process, be sure to call in your factory-trained HAYDON* Sales Engineer. HAYDON Timing Motors utilize time, control time, master time . . . precisely, quietly . . . bettering performance and opening new horizons to product and process use.

Put time to work now by writing for the name of your HAYDON timing specialist, and for the catalog, "Electric Timing Motors."

*Trademark Reg. U.S. Patent Office

HAYDON
AT TORRINGTON

A SUBSIDIARY OF GENERAL TIME CORP.

HEADQUARTERS FOR
TIMING

HAYDON Manufacturing Company, Inc.

2435 ELM STREET, TORRINGTON, CONN.

- Send me the name of my HAYDON Sales Engineer
 Send me the catalog, "Electric Timing Motors"

NAME _____
POSITION _____
COMPANY _____
CO. ADDRESS _____
CITY _____ ZONE _____ STATE _____





USE *New* DIEHL INSTRUMENT SERVO MOTORS

Designed for use on recording instruments where rapid acceleration and deceleration are of primary importance.

DIEHL Instrument Servo Motors feature a novel construction with an integrally molded stator and housing. Liberal design characteristics are built-in so that long life can be expected even under severe ambient temperature conditions.

While intended primarily for commercial use, these Servo motors meet pertinent JAN specifications for resistance to humidity, salt spray, fungus, shock and vibration.

SPECIFICATIONS	DIEHL NUMBER	
	FPE21L-27-1	FPE25L-92-1
Output (Watts)	1	5
Frequency (Cycles)	60	60
Poles	2	2
Reference Phase (Volts)	115	115
Control Phase (Volts)	50	115
Reference Phase (Watts)	10	17
Control Phase (Watts)	3.5	17
Control Phase Impedance (Ohms)	555	575
Locked Torque (Oz.-In.)	1.5	5.5
Theoretical Acceleration (Rad/sec. ²)	9650	19000

Our engineering staff will gladly help you select the motors best suited to your specific requirements. A request on your letterhead will bring you a copy of Technical Manual No. EL-1154 describing Diehl Servo Motors and related equipment.

Other Available Components:

D.C. SERVO SETS • RESOLVERS
MINIATURE PERMANENT MAGNET D.C. MOTORS

DIEHL MANUFACTURING COMPANY

Electrical Division of THE SINGER MANUFACTURING CO.
Finderne Plant, SOMERVILLE, N. J.

inputs, antennas, and other uhf loads operating from 300-ohm transmission lines. A plug-in type, with a built-in germanium diode, the demodulator operates between a 50-ohm single-ended source and a balanced 300-ohm transmission line. It provides a terminal for connection to an oscilloscope for observation and measurement of vswr patterns. Oscilloscope display of these swr patterns permits constant observation of effects produced by adjustment of load.

Literature

Connector Bulletin. DeJUR-Amsco Corp., 45-01 Northern Blvd., Long Island City 1, N. Y. A 1-page, 2-color bulletin gives voltage breakdowns, contact availabilities, schematic drawings and detailed specifications on the new series G-20 miniature side-mounting Continental connectors. The reverse side describes the series HC-20 hexagonal hermetic plug with solid glass insulation.

Signal Source Generators. Electric Indicator Co., Inc., Springdale, Conn., has prepared a comprehensive 24-page catalog on its line of instrument and signal source generators. Complete electrical and physical specifications are listed along with performance curves and dimensional drawings for all of the company's permanent-magnet and wound-field d-c, a-c and sine wave generator types. The brochure, EI-1A, is clip-bound for easy inclusion of supplementary data.

Audio Equipment. General Electric Co., Syracuse, N. Y., has published a 40-page, pocket-size catalog on audio equipment for radio and tv broadcasting stations. Some 21 different items, ranging from amplifiers to jack strips, cables, mounting trays and transformers, are illustrated. Pertinent mechanical and electrical specifications and price are included for each item.

H-V Connectors. DeJUR-Amsco Corp., 45-01 Northern Blvd., Long Island City 1, N. Y. A 2-page,



illustrated data sheet covers the series 800 high-voltage precision Continental connectors, with 15 contacts, for AN-36 shell. It gives specifications, schematic drawings, electrical and mechanical ratings, and molding compounds.

Delay Lines. Richard D. Brew and Co., Inc., Airport Road, Concord, N. Y. Included in general catalog 54 are illustrations, descriptions and technical data covering the lumped constant, distributed constant and ultrasonic delay lines offered by the company. Design, engineering and manufacturing facilities are described and the plant is illustrated. Also of interest is a description of the test procedure used by the company as part of their strict quality control measures.

Replacement Guide. The Merit Coil & Transformer Co., 4427 North Clark St., Chicago, Ill., has published a new replacement guide, No. 407. The guide includes about 7,000 television models and chassis, and lists the replacements for transformers, yokes, fly-backs, and i-f and r-f transformers.

Microwave Power Measurements. The Hewlett-Packard Co., 395 Page Mill Road, Palo Alto, Calif. Volume 5, No. 11 of the *Journal* deals with a number of new thermistor mounts that have been developed for simplifying measurements of microwave power levels. The mounts described include both waveguide and coaxial styles. Included in the bulletin are illustrations, specifications and arrangement drawings.

Precision Potentiometers. Ace Electronics Associates, 125-129 Rogers Ave., Somerville 44, Mass. A recent single-sheet loose-leaf perforated bulletin illustrates and describes the No. 500 Acepot, a new standard in subminiature wire-wound precision potentiometers. The unit discussed features 0.5-in. diameter; special precision winding equipment and assembly process that produce a higher tpi resulting in linearity of ± 0.3 percent on standard models; low dielectric constant and power factor; very low torque and availability in threaded bushing, servo or tapped hole

DC TO DIGITAL TO DC CONVERSION

$\pm 0.035\%$ ACCURACY
OVER 2000 MILES
OF TELEPHONE LINE

...Converts 3 dc voltages to 11 digit binary code and back to dc.

...Samples each voltage 10 times per second.

...Insensitive to transmission system variations and noise.

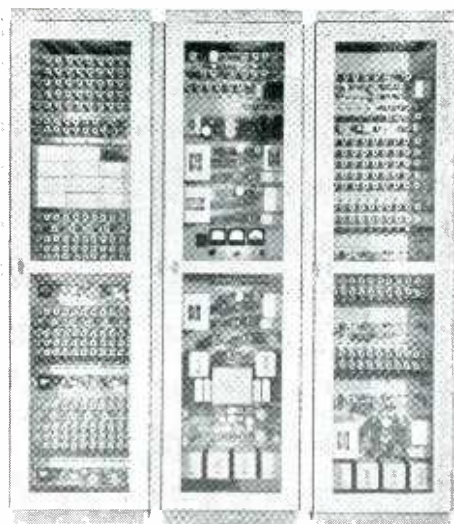

Data Transmission Equipment

EECO Data Transmission Equipment has operated successfully over 2064 miles of carrier telephone circuit passing through 60 filters and 32 sections of carrier terminal equipment -- all without loss of accuracy. By using only half of the equipment, DC data may be transmitted from a remote point for use in digital form, or digital data may be converted to analog form by using the receiving half of the equipment.

PRINCIPLES OF OPERATION

The equipment accepts three separate dc data input voltages, encodes them into 11 digit binary codes, and decodes the received binary number to produce duplicate dc output voltages at the receiving end of the system.

In addition, six auxiliary on-off circuits are available. These auxiliary circuits may be used singly or as binary code groups. If used as six-digit binary code, 64 combinations are possible, one at a time.

TRANSMITTER

The three data and six auxiliary channels are each sampled 10 times per second.

ENCODING METHOD

A stable encoding method employs a modification of the self-balancing potentiometer principle. By means of a relay controlled summing network, 11 successive subtractions of $1/2$, $1/4$, $1/8$... $1/2048$ of full scale voltage are made from the input data.

OUTPUT SIGNAL

The binary codes from the input channels, the auxiliary codes, and the receiver synchronizing signals are multiplexed to permit transmission over a single communication circuit with a frequency band from 920 to 2920 cycles.

MODIFICATIONS

Many different modifications can be economically worked out because the various circuit functions are generally self-contained on separate panels.

RECEIVER

Master or frame synchronizing signals together with channel synchronizing signals are used. The multiplexed serial codes are separated and stored in transfer registers. On completion of the sample, the code numbers in the registers are transferred in parallel form to decoders.

DECODING METHOD

Resistance summing networks are used for decoding. The output from control relays in the encoder are summed by means of a chopper stabilized direct coupled amplifier.

REFERENCE VOLTAGE

Either a self-contained standard cell or external voltage can be used as the dc reference.

DUNKIRK 2-7353



Electronic Engineering Company of California

180 SOUTH ALVARADO STREET...LOS ANGELES 57, CALIFORNIA

For further information, please send attached coupon.

R. B. Bonney, Chief Engineer
 Electronic Engineering Co. of Calif.
 180 South Alvarado Street
 Los Angeles 57, California

Data Sheet on Data Transmission Equipment
 ZA-11210, please.

Name _____
 Company _____
 Address _____
 Title _____

A new source of high performance instrumentation!

DONNER SCIENTIFIC COMPANY



analog computer \$995

MODEL 30 f.o.b. Berkeley, California
(with one 30-3 problem board as illustrated)

Here is a compact, economically priced analog computer designed for service as a personal tool of the engineer, mathematician, and scientist. Model 30 computers make electronic computation economically possible wherever differential equations are used. Typical applications include analysis and synthesis of physical systems and simulation of transfer characteristics. Flexibility and economy make the computer ideal for instructional use in schools and colleges and for individual use of the industrial scientist.

features

- A** "Slide Rule" versatility and simplicity — anyone who can translate physical problems into corresponding differential equations can use the Model 30 . . . even without specialized knowledge of electronics.
- B** Accuracy of solutions to better than 1% is determined by the precision of components selected.
- C** Two types of inexpensive plug-in problem boards . . . **Model 30-3** with solder terminals for components . . . **Model 30-4** with plug-in connectors for components.

D Ten stable, high gain, single pentode D.C. amplifiers.

E Five isolated power supplies to set initial condition voltages.

PHYSICAL SPECIFICATIONS

Computer — height 19", width 21",
depth 12", weight 75 lbs.
Problem Boards — height 2", width 21",
depth 13".

Write for technical bulletin #301-A

DONNER

SCIENTIFIC COMPANY

2829 Seventh Street • Berkeley 10, California

mountings. Electrical and mechanical specifications are included.

Toroidal Inductors. Lenkurt Electric Sales Co., 1113 County Road, San Carlos, Calif. Bulletin TL2-P4 lists two types of precision-wound toroidal inductors, both available in 6 different sizes with various Q's and inductance ranges. One coil type described is wound on Carbonyl iron cores for h-f applications with inductance values from 0.15 mh to 1.0 henry. The other is wound on Molybdenum-Permalloy cores for l-f applications with inductance values from 2.0 mh to 9.0 henries. The bulletin includes Q curves, dimensions and other data fully describing each type of coil. All coils are specially wound to within 1 percent of specified inductance value.

Electrical Insulations. Johns-Manville, 22 East 40th St., New York 16, N. Y., has issued three descriptive sample folders to introduce a new series of composite asbestos electrical insulations recently added to the Quinterra and Quinorgo line. The folders contain good sized samples for testing and experimentation plus descriptive information covering application, packaging, physical and electrical properties and pyrolysis resistance.

Servo System. Richardson Scale Co., Van Houten Ave., Clifton, N. J., offers a new 4-page technical reference that pictures and describes a recently-developed servomechanism system. Components of the system are a synchro mechanism, control transformer (balancing synchro), servo amplifier and servo motor. Besides describing construction features and listing the operating characteristics of the system, the technical reference includes photographs and engineering drawings of key parts. It also contains a diagrammatic layout showing how parts are hooked up. Ten new uses for the system are listed.

Antenna Filters. Ortho Filter Corp., 196 Albion Ave., Paterson 2, N. J. A single-sheet bulletin illustrates and describes a line of specialized type ANF filters. Built in accordance with MIL specifications, the filters discussed are designed to cover the r-f, vhf and uhf spectrums. Included is a table covering

6 different types, giving information on pass band, stop band, impedance, vswr and power handling.

Remote-Control Wiring Manual. General Electric Co., Bridgeport 2, Conn., announces a revised, up-to-date edition of the remote-control wiring manual. The new manual includes new components recently added to the line, such as relay gang boxes; motor-driven master switch; and new locking switches, both flush and surface types; and the new twisted construction, color-coded remote control wire. Manual 16-284 contains complete technical and installation data on this modern low-voltage system of wiring. Wiring diagrams, wiring layouts, suggested specifications and much other useful information are included.

Sound Catalog. Shure Brothers, Inc., 225 W. Huron St., Chicago 10, Ill. General catalog 55 covers microphone accessories, magnetic tape and wire recording heads, crystal and ceramic pickup cartridges, crystal phonograph pickups and phonograph needles. Two special features are the replacement charts for pickup cartridges and magnetic recording heads. Introduced in the catalog is the company's Concert-Line family of high fidelity studio microphones. Also introduced are the Slendvne probe-type nondirectional microphone and the RK-54 phono cartridge replacement kit.

Instrumentation Bulletin. Minneapolis-Honeywell Regulator Co., Industrial Division, Wayne and Windrim Aves., Philadelphia 44, Pa. Round-the-clock production techniques are described in the current issue of "Instrumentation", the company's technical publication. The article on the manufacture of gamma globulin describes how electronic instruments are harnessed to monitor extremely exacting processing operations. Also included are articles on boiler tube measurement, a report on the use of a new servo analyzer, electronic burnout protection for a 60-ft rotary press and controls to regulate start-up procedures in an open hearth furnace.

Wires and Cables. Chester Cable Corp., Chester, N. Y. A 6-page fold-

**YOU WANTED IT
HERE IT IS**

EM-BED-IT

**THE FIRST AND ONLY
POTTING COMPOUNDS
FORMULATED EXPRESSLY FOR
ELECTRONIC COMPONENTS**

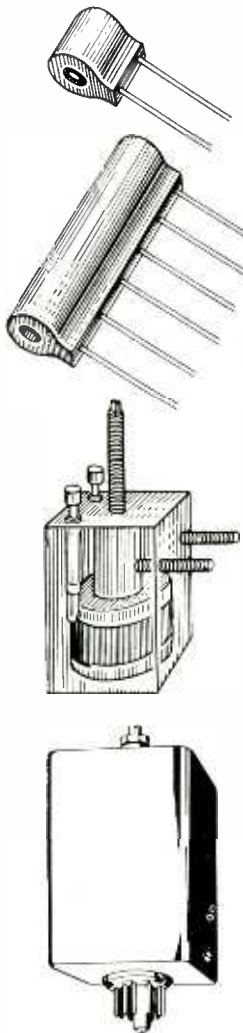

Designed for the armed forces specifically to solve the problems encountered in the encapsulation of delicate electronic components, EM-BED-IT has "come-through with flying colors." Now, at last we are permitted to make EM-BED-IT available for general use. EM-BED-IT offers several vital advantages. It will be well worth your while to investigate the possibilities of EM-BED-IT for your applications, today!

Check the Advantages of EM-BED-IT

- ✓ EM-BED-IT sets in minutes instead of hours.
- ✓ EM-BED-IT requires inexpensive molds . . . its setting speed eliminates need of costly multiple molds.
- ✓ EM-BED-IT saves up to 50% as compared to Epoxy resins.

EMBEDDING SERVICE

We have established facilities for custom embedment of your components if desired. Our service is fast, efficient and low in cost. We will be glad to have an engineer discuss it with you.

Write for new illustrated literature

EP ELECTRONIC PLASTICS CORP.
130th St. & 90th Ave. Queens 18, N. Y.

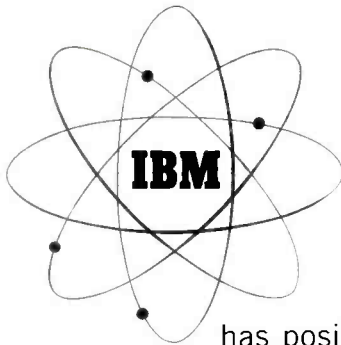

WORLD'S LEADING PRODUCER
OF ELECTRONIC ACCOUNTING
AND COMPUTING MACHINES

has positions open in
Development and Manufacturing
for
Electronic and Electro-mechanical
ENGINEERS

FOR WORK IN THE DIGITAL COMPUTER FIELD

**FUNCTIONAL TESTING AND ANALYSIS
PROGRAM DEVELOPMENT
SYSTEMS PLANNING**

BS, MS, or PhD degree and experience in the fields of computers or weapons systems are required.

**ELECTRONIC & ELECTRICAL CIRCUIT DESIGN
TEST EQUIPMENT DESIGN
PRODUCTION TESTING**

BS degree or equivalent experience is required. Experience in the following fields is desirable. Radar—Servo-mechanisms—TV—Analog Computers—Audio Systems—Instrumentation—Data Handling Systems.

Replies will be held in strict confidence. Write giving full details of education and experience to:

Mr. W. M. Hoyt, Dept. 686 (A)

INTERNATIONAL BUSINESS MACHINES
590 Madison Ave., New York 22, N. Y.

**What an Engineer
—and his family—
should know about IBM**

* You'll be working with the great teams of engineers that created and developed the world's most advanced digital computers—IBM's 701 and 702 data processing machines.

* Your future will be as big as you make it, with your advancement depending on your own merits.

* You'll be joining a company with a 40-year record of growth and stable employment and with one of the very lowest employee turnover records in the entire country.

* Your salary will be excellent, and IBM's exceptional employee benefits will be a life-long advantage for you and your family.

* You can continue your engineering education through IBM's education program.

* Family recreational facilities including golf courses, swimming pools and supervised children's activities are of the finest at IBM's Country Clubs.

Your moving expenses will be paid to Poughkeepsie or Endicott, N. Y., where IBM's plants and laboratories are located and living conditions are excellent.

er covers the company's Plasticord-Plasticote wires and cables for the radio, electronic and tv industries. Included are information on appliance wire, hookup wire, tv lead-in wire, rotor cable, coaxial cable, multiple conductor cable, miniature wire and cable, h-f lead wire and test lead, among many others. Descriptions and illustrations of all types are included.

Regulated Voltage Supply. Keithley Instruments, 3868 Carnegie Ave., Cleveland 15, Ohio. Latest issue of *Engineering Notes* covers a new regulated voltage supply. The paper gives full specifications on the new supply, which features 0.01-percent line regulation, a series of accurate fixed voltage outputs up to 500 v, and an output of 0 to 1 ma. The publication includes diagrams of several typical uses, showing the new supply in conjunction with the company's electrometer equipment measuring ultrahigh resistances, furnishing excitation voltage to photocells, supplying a buckout potential for precise voltage measurements, and in checking d-c amplifier gains.

Constant Voltage Principle. Sola Electric Co., 4633 W. 16th St., Chicago 50, Ill., has available a publication dealing with the theory of design and operation of its constant voltage transformer. It contains schematic diagrams, vector diagrams, performance curves, and photographs illustrating typical assemblies. Following an extended treatment of the basic principles, there are discussions of modifications for harmonic neutralization, compensation for variable frequency, and modifications for regulated multiple output for electronic supply.

Self-Sticking Tapes. Insulation Manufacturers Corp., 565 W. Washington Blvd., Chicago 6, Ill., has published a 20-page catalog containing revised and added technical data, descriptions, photos and application information on Permacel pressure-sensitive electrical tapes, and nonelectrical Texcel and Permacel tapes. Permacel self-sticking electrical tapes covered in the catalog are acetate cloth, acetate film, acetate film cloth combination, flat-

back and crepe paper, vinyl film, cotton cloth, glass cloth and Mylar polyester film. The catalog also covers about 9 nonelectrical tapes.

Pressure Meter. Decker Aviation Corp., 1361 Frankford Ave., Philadelphia, Pa. Instrument data sheet 303-1 covers a pressure meter that features one micron mercury resolution at atmospheric pressure, with 7.5 v output available for recording at 1 mm Hg differential. With the instrument described the determination of volume and temperature variations, fluid flow, expansions, absorption, adsorption, chemical alterations, altitude and vacuum measurements may be made. Complete technical specifications are given.

Industrial Control Counters. Potter Instrument Co., Inc., 115 Cutter Mill Road, Great Neck, N. Y. A new 20-page booklet contains detailed descriptions of equipment and techniques for controlling industrial equipment by means of predetermined electronic counters. Over a dozen typical applications are explained and illustrated in detailed diagrams. Equipment described includes counters capable of being preset to apply control after any desired number of counts from 1 to a million, and a complete line of count detectors for converting physical increments into electrical impulses for counting.

Measurement Instruments. Hewlett-Packard Co., 3000 Page Mill Road, Palo Alto, Calif., has available a short form catalog outlining details on the company's major measuring instruments for manufacturing, industrial and scientific research, equipment maintenance, communications and military use. Included are illustrated descriptions, prices and tables of technical data.

Antenna - Mounted Preamplifier. Jerrold Electronics Corp., 26th and Dickinson Sts., Philadelphia, Pa., announces a 4-page illustrated brochure on its De-Snower preamplifier that improves the performance of modern cascade tuner tv sets by mounting a lower noise cascade amplifier at the antenna. The preamplifier described, which uses low-noise

Now Available!

New M-21 "McMite" Sub-Miniature Quartz Crystal



Latest addition to the McCoy line of high quality, precision quartz crystals is the new M-21 "McMite" . . . with .040" dia. pins. The new M-21 supplements its twin brother, the M-20 "McMite" which has wire leads. Together, these two crystals offer extreme adaptability to designers of multi-channel communications and frequency control equipment. The M-21 plugs into a sub-miniature socket while the M-20 can be wired or soldered to a printed circuit terminal board. Both may be incorporated into miniature selector switch assemblies. The M-20 and M-21 crystals are sub-miniature, hermetically sealed units which deliver the same performance as larger, regular size crystals, yet require only one-fifth as much space. Both meet military specification requirements for fundamental operation above 5 mc. and overtone operation above 15 mc. Neither sacrifices stability or dependability but meets the same characteristics and performance requirements as the conventional larger crystal units.

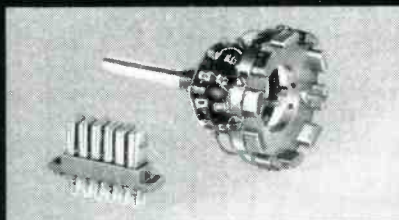

Six M-21 units plugged into a 1 3/4" strip of sockets (left) and ten M-20 units wired into a 2" dia. switch assembly (right) illustrate the space saving qualities of the McCoy "McMite" crystals.

McCoy ELECTRONICS CO.

MT. HOLLY SPRINGS, PA.

Phone 376 and 377

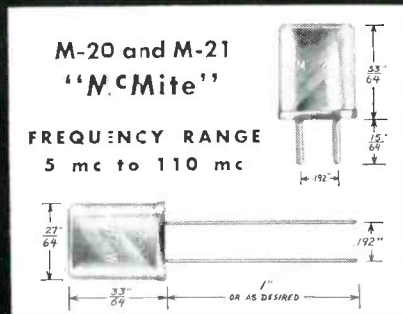

The New **SHURE** "TWIN-LEVER"
CERAMIC PICKUP CARTRIDGE
for High Fidelity systems



PC Series for 33 $\frac{1}{3}$, 45, 78 r.p.m.

AN "AB" LISTENING TEST WILL PROVE THAT THIS CARTRIDGE
SURPASSES ANY OTHER HIGH QUALITY
COMMERCIAL CARTRIDGE!

A new frontier for the Ceramic principle has been crossed by the development of this cartridge. Designers of high fidelity phonograph systems and hi-fi radio or tv phono combinations, who have been "test piloting" this new "Twin-Lever" ceramic development, report an amazing superiority in tone quality that can be easily heard before the cartridge is even measured!

This "Twin-Lever", high fidelity ceramic cartridge represents the ultimate in commercial high fidelity reproduction—**without compensating preamplifiers!** Smooth, wide range response from 50 to 12,000 c.p.s., plus or minus 3 db. Other features which help to make this new cartridge so outstanding in performance are: high compliance that virtually eliminates tracking distortion . . . extremely low effective mass provided by new specially-designed needles and new coupling . . . tailored needles on separate needle shafts, functioning independently for best 78 rpm response, too—as well as the superior microgroove performance.

The new unique design eliminates "turnover" of either the cartridge or the needles. Both needles are in the same plane, and an ingenious, lever-operated shift mechanism gently moves each needle in and out of playing position.

RADICAL NEW DESIGN FOR NEEDLE REPLACEMENT!

Needle replacement is now so simple it can be done blindfolded!! This is a feature that will be of special interest to the ultimate users of your original equipment. Anybody can replace the needle, without tools, in a few seconds—while the cartridge remains in the pickup arm!

TECHNICAL DATA for MODELS PC4 and PC5

Output Level at 1,000 c.p.s.	.40 volts (33 $\frac{1}{3}$, 45 rpm)
Output Level at 1,000 c.p.s.	.65 volts (78 rpm)
Frequency Response	50-12,000 c.p.s.
Compliance	1.30 x 10 ⁻⁶ cm/dyne
Tracking Force	5 to 8 grams
Net Weight	7.3 grams
Dimensions	1 $\frac{3}{4}$ " overall length; $\frac{3}{8}$ " wide $\frac{1}{8}$ " high

ALSO . . .

New High Output Ceramic Cartridges NO LESS OUTSTANDING IN THEIR CONTRIBUTION TO LOW COST. FINE QUALITY REPRODUCTION ARE THE HIGH-OUTPUT CARTRIDGES, MODELS PC2 and PC3.

SHURE

The Mark of Quality

For further information on these remarkable new cartridges, write
SALES DIVISION—SHURE BROTHERS, INC., 225 W. HURON STREET, CHICAGO 10, ILL.

6BQ7A's ahead of 6AK5 and 6CB6 tubes, provides a 25-db gain on all vhf channels. A detailed description covering the De-Snow'er's operation along with information on inputs, output, tube complement, size, shipping weight and list price is fully treated in the booklet.

Solder Products. Enthoven Solders Ltd., Enthoven House, 89, Upper Thames St., London, E.C.4, England, has available an 8-page catalog dealing with its line of flux cored solder wire, cored and solid solder preforms, solid solder wire, solid solders, Entoloy for centrifugal casting, solder paints and soldering fluxes. The section on Super-speed flux cored solder wire mentions the stellate core which is the secret of faultless fluxing because it gives six points of rapid solder collapse and the flux is liberated immediately heat is applied. The catalog includes specifications and typical applications.

Industrial Relays. Automatic Electric Sales Corp., 1033 W. Van Buren St., Chicago 7, Ill. Detailed descriptions on a complete line of industrial relays, plug-mounted for advantages in assembly, inspection, servicing and maintenance, are available in recently published data sheets, circulars 1801-1805. Dimensional drawings, wiring diagrams and specifications are provided for plug-mounted classes A, B, F, S and Z relays.

Comparator Micrometer. Decker Aviation Corp., 1361 Frankford Ave., Philadelphia, Pa. A recent data sheet illustrates and describes the model 103 comparator micrometer, an instrument using the T-42 ionization transducer which makes capacitive gaging practical. The instrument discussed, designed to aid the quality control program, features full scale meter deflection for $\pm 20 \mu$ in. and measures 0.000001 to 0.0002 in. Chief applications and complete specifications are given.

Ceramic Spacers. American Lava Corp., Chattanooga 5, Tenn. Bulletin 549 illustrates and describes a line of internal insulators for electron tubes. Mechanical and dielectric requirements are listed. Also

included are complete technical properties of lava and AlSiMag for use inside electron tubes.

Germanium Diodes. Hughes Aircraft Co., Culver City, Calif. An 8-page brochure illustrates and describes a line of germanium diodes especially designed to meet the requirements of both commercial and military applications. Some features of the diodes discussed are moisture resistance, thermal and electrical stability, subminiature size and thorough dependability. Included are application hints, characteristics charts and electrical specifications.

Frequency Deviation Meter. Budelman Radio Corp., 375 Fairfield Ave., Stamford, Conn. A single-sheet bulletin covers the type 17A versatile frequency deviation meter and test oscillator for the land-mobile services. Included are an illustrated description, principal characteristics and specifications, and ordering information.

Stepping Relay Bulletin. Guardian Electric Mfg. Co., 1621 W. Walnut St., Chicago 12, Ill., has available a 12-page stepping relay bulletin. It contains illustrations, dimensional drawings, technical chart data and general informative copy featuring 12 types of Guardian steppers including midget, high speed, vibration resistant and interlock types. Write for bulletin P-84.

Connectors. Whitney Blake Co., New Haven 14, Conn. Catalog No. 674-2 describes a completely new AU type connector that meets all the requirements of the latest issue of MIL-C-5015 and is interchangeable with connectors now in use. The connectors described will reduce weight considerably; reduce size in all styles; reduce numbers of types required; improve ease of mating and unmating; simplify wiring and servicing; permit use of solderless terminals; make potting unnecessary; and add a high reliability factor. The catalog is fully illustrated.

Chromacoder Color TV Broadcasting System. General Electric Co., Syracuse, N. Y., has published a 4-page, illustrated brochure on the Chromacoder color tv broadcasting



New KU slotted section and probe
Easy, accurate operation . . . rugged construction . . . simple convenient drive adjustments . . . highly efficient probe and crystal tuning for exceptional sensitivity

New KU slide and variable screw tuners
Stable adjustments . . . easy, precise settings . . . no backlash . . . no R. F. leakage

New KU precision attenuator
Attenuation to 40 DB . . . accurate to ± 0.3 DB . . . no backlash . . . smooth precision control

New KU fixed and tunable crystal mounts
Highest sensitivity . . . optimum impedance matching . . . very efficient convenient tuning adjustments

Ku frequency range 12,400 to 18,000 Mcs.

FOR ACCURATE MEASUREMENT
over the entire microwave spectrum
RELY ON WAVELINE

... for highly engineered multi-function instruments (newest in the Ku band are pictured at the right) . . . to carefully craft these instruments to the highest degree of precision . . . for the most dependable operation yet achieved. Rely on Waveline as many, many engineers working on exacting projects in Ku, Ka and all other microwave bands have for years . . . for a complete line of advanced instruments including VSWR amplifiers, noise generators, power, measurement and related equipment—the basic tools of more efficient microwave research and communication.

Rely on Waveline for fast, economical deliveries on every project large and small . . . new expanded plant facilities enable Waveline to better execute all orders including large quantity deliveries of brass or aluminum waveguides for radar, communications or other industrial or government applications.

Rely on Waveline's field sales engineers to give immediate professional attention to all your microwave problems . . . cutting your costs while saving valuable engineering time.

For microwave reference catalogs containing technical information and the name of the nearest Waveline sales engineer — WRITE TODAY!

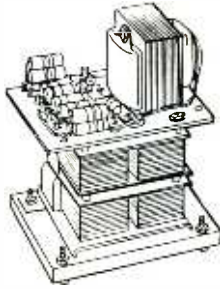
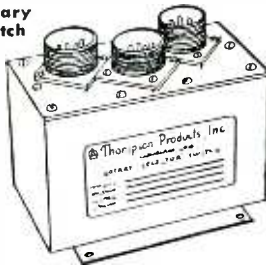

CALDWELL, NEW JERSEY

Thompson's
Magnetic
AmplifierThompson's
Airborne Rotary
Selector Switch

ideas...

facilities...

experience

Thompson has all three

It's no accident that more and more manufacturers are turning to Thompson to solve tough electronics problems.

Thompson has ideas! Thompson engineers will not admit "it can't be done" for they are continually finding the answers to tough research, development and production problems.

Thompson has facilities! Complete development and testing laboratories, and modern production equipment are available to the skilled electronics engineers who make up the highly successful Thompson team!

Thompson has experience! For 52 years, Thompson has been blazing trails and making vital contributions to the automotive, aircraft and general industries of the nation. The highly valuable skills and experience of the entire Thompson organization are at your service for research, development and production of all things electronic.

FOR COMPLETE INFORMATION on how Thompson's Electronics Division can work for you, write to Thompson Products, Inc., Electronics Division, 2196 Clarkwood Road, Cleveland 3, Ohio. You will receive details of Thompson ideas... facilities... experience.

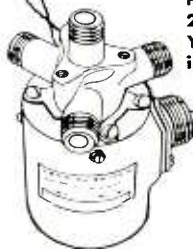
One of the
many
Thompson
Coaxial
Switches

Electronics Division

Thompson Products, Inc.

2196 CLARKWOOD RD., CLEVELAND 3, OHIO

system. The brochure explains what the Chromacoder is, how it functions, and its advantages over other types of live color broadcasting systems. The booklet includes a detailed explanation of the use of the Chromacoder with color-modified black and white cameras to obtain an NTSC color signal. A simplified block diagram of the Chromacoder illustrates how the simultaneous color signal, as required by the FCC, is obtained from the sequential signal produced by the pickup cameras in the studios. A rack layout diagram of the Chromacoder is also included in the brochure.

Instrument Packaging. Skydyne, Inc., River Road, Port Jervis, N. Y., has issued a pamphlet that tells in capsule form the company's story of specialized packaging as it applies to the problem of the electronic field. Included among the tests which the shipping containers described have withstood are: drop, vibration, shock, impact, submersion, altitude, pressure resistance, salt spray, heat and cold transfer, thermal shock and fungicide. The products discussed are designed according to Government specifications.

Electrical Connectors. IlSCO Copper and Tube Products, Inc., Mariemont, Cincinnati 27, Ohio, has issued a 72-page catalog on its line of connectors, crimp terminals, fabricated tubes, fuse clips, neutral bars, shading coils, stampings and terminal blocks. The booklet is well illustrated and indexed. Specifications and prices are included.

Reference Guide for Miniature Electron Tubes. CBS-Hytron, a division of Columbia Broadcasting System, Inc., has announced the 7th edition of its reference guide for miniature electron tubes. It is complete, accurate, and contains all miniature tubes, regardless of make. Twelve pages of data include 329 miniature types of which 79 are new, and 134 basing diagrams of which 27 are new. Larger prototypes are also listed.

Radio Communications Antennas. The Antenna Specialists Co., 12435 Euclid Ave., Cleveland 6, Ohio, has issued a 6-page catalog describing

approved and accepted mobile communication and ground plane antennas available from stock. The company offers specialized production antennas designed for the two-way radio communication industry. A guarantee covering the characteristic of its antenna rod is an innovation unveiled in this illustrated catalog now available.

Metallized Hermetic Terminals. American Lava Corp., Chattanooga 5, Tenn. Bulletin No. 5410 gives the latest information on AlSiMag metallized hermetic terminals. The terminals illustrated and described meet L5A requirements of JAN-1-10 specifications for such hermetically-sealed electrical components: transformers, capacitors, relays, controls and motors. A property chart of AlSiMag 576 is included.

Electrical Ceramics. General Ceramics Corp., Keasbey, N. J. A 4-page folder tabulates electrical and mechanical properties of standard grades of electrical ceramics with recommended applications. Included is a mention of the company's engineering staff, with complete facilities for both development and production, that is available for recommendations on specific requirements without obligation.

Miniature Repeat Cycle Timers. A. W. Haydon Co., 230 N. Elm St., Waterbury, Conn. Bulletin RC200 contains complete information on a new line of miniature hermetically-sealed repeat cycle timers. It describes cycling time, timing accuracy, detail characteristics and determination of timing tolerances.

Germanium Diodes. International Rectifier Corp., 1521 E. Grand Ave., El Segundo, Calif. A new 4-page bulletin, GD-1A, lists ratings and specifications on the company's germanium diodes. Included is a complete replacement guide of International germanium diodes for replacing RETMA type diodes, and ratings and characteristics for new Red Dot germanium diodes for 100 C applications.

Product Catalog. Trimm Inc., 400 Lake St., Libertyville, Ill., has issued a new 4-page catalog describing the company's line of headsets,

Burton browne advertising

James is the complete source for all vibratory products!†
THE ENGINEER'S STANDARD SINCE 1936

*Send your engineering problems to us

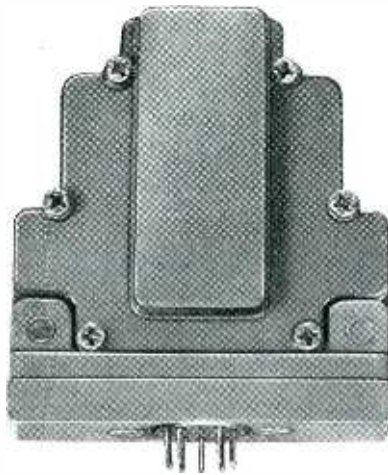

Introducing the first instrument-type double-pole, double-throw chopper featuring complete coaxial isolation of all contacts, low residual noise, 60 c.p.s., and meeting military environmental specifications for temperature, humidity, shock and vibration. The JAMES engineering department will be happy to analyze the application of this device to your specialized electronic circuitry.

JAMES
VIBRAPOW
4038 N. Rockwell St. • Chicago 18, Ill.

AUTO VIBRATORS • COMMUNICATIONS VIBRATORS • VIBRATOR POWER SUPPLIES • CHOPPERS • VIBRATORY COAXIAL SWITCHES

Whatever Your Application...

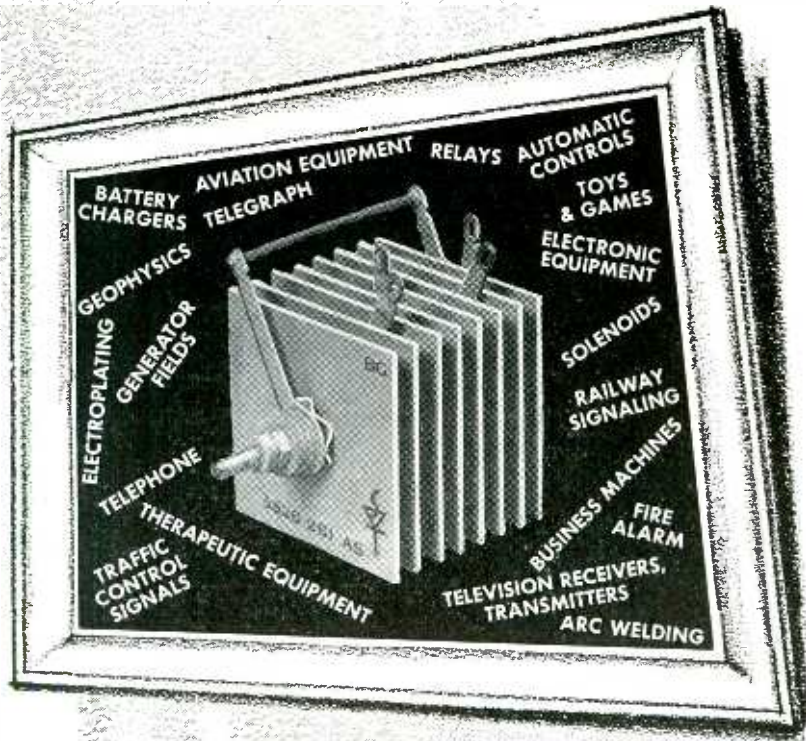

- • • Sarkes Tarzian Centre-Kooled Selenium Rectifiers give years of trouble-free, maintenance-free service. Write for complete information.

Sarkes Tarzian, Inc., RECTIFIER DIVISION

DEPT. E-5, 415 N. COLLEGE AVE., BLOOMINGTON, IND.
In Canada: 700 Weston Rd., Toronto 9, Tel. Murray 7535
Export: Ad Auriema, Inc., N. Y. C.



"Centre-Kooled"
SELENIUM RECTIFIERS

plugs and jacks, jack panels and patch cords. The bulletin includes illustrated descriptions of all major components.

Telemetry Equipment. Minneapolis-Honeywell Regulator Co., Wayne and Windrim Aves., Philadelphia 44, Pa. Instrumentation data sheet No. 9.1-9a describes improved electric telemetry equipment for high-speed transmission of system variables to a central location. Details are given on how ElectroniK indicating, recording and totalizing instruments can be incorporated at various points in the system. Transmitter and receiver are interconnected by microwave equipment, power line carrier facilities or a two-wire connecting line. Specifications of the Freq-O-Tron transmitter and receiver and the ElectroniK recorders are given.

Precision Servo Computer Potentiometers. Helipot Corp., 916 Meridian Ave., South Pasadena, Calif. A 12-page technical paper, No. 341, entitled "Characteristics of Precision Servo Computer Potentiometers," discusses linearity and sets forth data on research, development and trends in precision potentiometers. The paper was originally presented at the AIEE Conference on Feedback Control Systems.

Antenna Brochure. JFD Mfg. Co., 6101-16th Ave., Brooklyn 4, N. Y., has printed a 6-page, 2-color brochure complete with charts, diagrams and photographs detailing the development of the new Jet-Helix antenna. The configuration of the antenna described is a radical departure from former broad-band types, utilizing a new flat plane helical concept for highest vhf-uhf gain. The Jet-Helix antenna is tested according to the signal-to-noise figure of merit rating system.

Products Catalog. The Staver Co., Bay Shore, L. I., N. Y., has available a new catalog covering products manufactured by the company. Included are tube shields, spring tube holders and clips, for miniature tubes, as well as data on stamping specialties, electronic components

and assemblies that are manufactured to customer specifications. Unique feature is the format of the catalog, which is designed as a file folder, with a pocket to contain the data sheets that are currently included as well as sheets on future products. The brochure also illustrates the company's plant facilities.

A-C Rate Generator. Ford Instrument Co., 31-10 Thomson Ave., Long Island City 1, N. Y. A 4-page, 2-color bulletin illustrates and describes a line of extremely stable, linear, a-c rate generators with high functional voltage output. The units discussed are offered in 60 and 400-cycle models and are available with temperature compensation for a wide environmental operating range. Information on construction, applications and design features, and characteristics and specifications are provided. Also included is a section on rate generator-servo-motor packages, which combine, in single-shaft units, rate generators and high-precision servo motors.

Electronic Controls. Barber-Colman Co., Rockford, Ill. A 24-page booklet "The Electronic Control Story," F6437, aids the understanding of the fundamentals of electronic temperature controls and their application. Dealing with the basic elements of electronic control the following points are explained: the bridge circuit, sensing elements, type of control and control applications. The booklet also delves into on-off temperature control, humidity control, and outdoor reset hot water control.

Bearings Catalog. The Kaydon Engineering Corp., Muskegon, Mich. A 24-page well-illustrated booklet covers the company's line of Reali-Slim standard and special bearings. The listing with its charts and data is to act as general guide for the designer and the layout engineer. Included is a page of required application data to be filled in for complete information.

Equipment for Radio-Interference Measurement. Empire Devices Products Corp., 38-15 Bell Blvd., Bayside 61, N. Y. Timed to aid manufacturers of all types of elec-





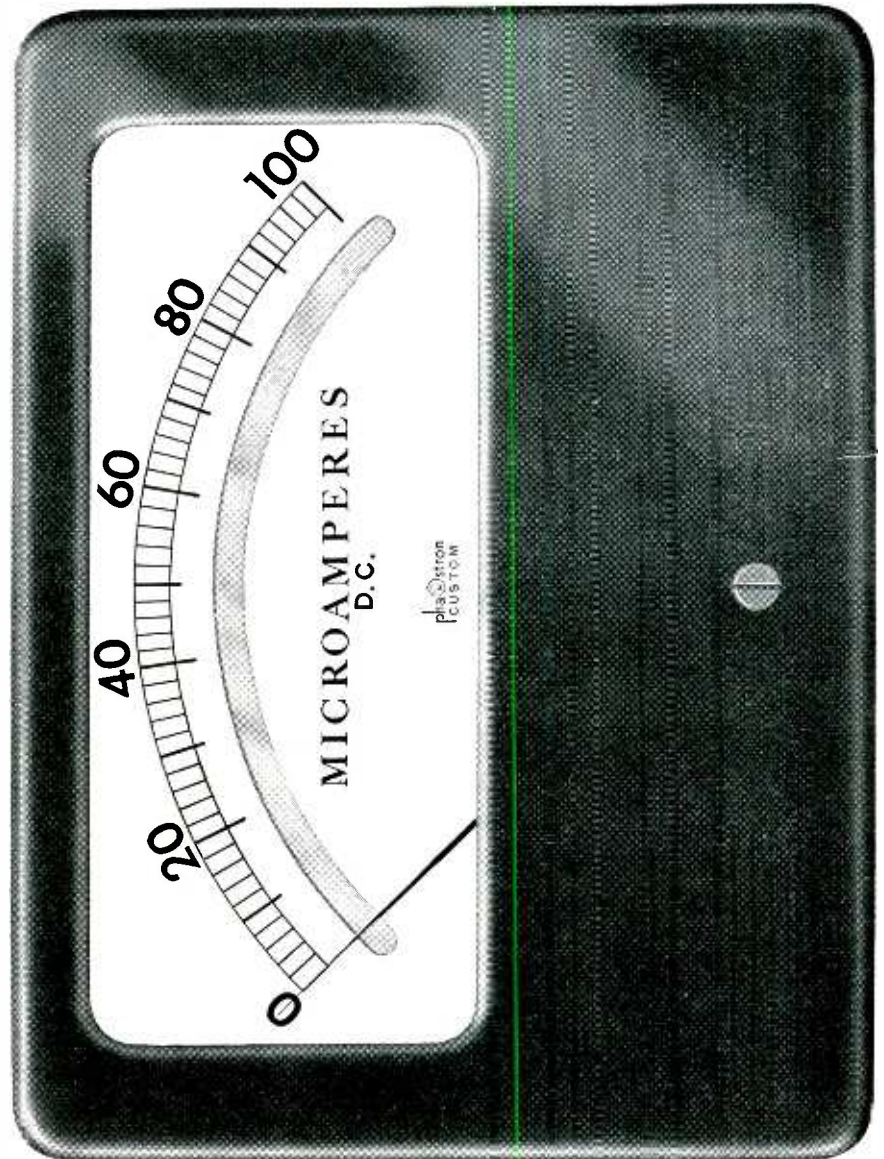

the KEY
to your problems

6" CUSTOM panel instruments

METAL-CASED TO INSURE THEIR CONTINUED INTEGRITY

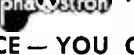
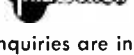

We don't recommend mounting the instrument in this position
this **FULL SIZE ILLUSTRATION**
will be better appreciated by turning the magazine

-  TIME PROVEN MOVEMENTS
-  ANTI-MAGNETIC SHIELDING
-  LARGE, EASY-TO-SEE SCALES
-  1% ACCURACY
-  MIRROR SCALES
-  PRICE — YOU CANNOT BUY BETTER

Inquiries are invited and catalogue sheets are available on this
NEW LINE of CUSTOM INSTRUMENTS which also include 2½" & 3½" sizes.

PHAOSTRON CO. • 151 PASADENA AVE. • SO. PASADENA, CALIF.

VHF

... Very High Frequencies



**RADIO INTERFERENCE
and FIELD INTENSITY*
measuring equipment**

Stoddart NM-30A • 20mc to 400mc

Commercial Equivalent of AN/URM-47

PRINTED CIRCUITRY... Modern printed circuits offer many advantages over conventional wiring, lighter weight, more compact units and freedom from many of the troubles normally encountered in conventionally-wired electronic equipment. Vibration becomes even less of a problem with printed circuits, adding to the many portable features already available with Stoddart equipment.

ADVANCED DESIGN... Specialized engineering and modern production techniques have produced one of the most advanced instruments for the accurate measurement, analysis and interpretation of radiated and conducted radio-frequency signals and interference ever manufactured. Designed to laboratory standards, rugged, and with matchless performance, the versatile NM-30A is an outstanding example of modern instrumentation. Its frequency range includes FM and TV bands.

SMALLER SIZE... A wider frequency range and higher standard of performance is incorporated into an equipment whose size is one-third that of any similar equipment ever manufactured.

SENSITIVITY... Sensitivity ranges from one to ten microvolts-per-meter, depending upon frequency and antenna in use.

APPLICATIONS... Field intensity surveys, antenna radiation pattern studies, interference location and measurement for checking radiation from virtually any mechanical or electrical device capable of generating or radiating radio-frequency signals or interference.

Stoddart RI-FI* Meters cover the frequency range 14kc to 1000mc

VLF

NM-10A, 14kc to 250kc
Commercial Equivalent of
AN/URM-6B. Very low frequen-
cies.

HF

NM-20B, 150kc to 25mc
Commercial Equivalent of
AN/PRM-1A. Self-contained
batteries. A.C. supply optional.
Includes standard broadcast
band, radio range, WWV, and
communications frequencies.
Has BFO.

UHF

NM-50A, 375mc to 1000mc
Commercial Equivalent of
AN/URM-17. Frequency range
includes Citizens band and
UHF color TV band.

tromechanical products in meeting the stricter radio-interference regulations now imposed by government agencies, a new 6-page catalog describes noise meters, distortion analyzers, impulse generators, attenuators and crystal mixers. The comprehensive catalog is fully illustrated, and details for each product data on design specifications, operating ranges, recommended applications and lists of accessories.

Thermosetting Laminated Plastics. Synthane Corp., Oaks, Pa., has published a chart giving a complete tabulation of the latest military and government specifications for 24 grades of thermosetting laminated plastics. It is a completely revised and up-to-date version of several bulletins that have been very helpful to manufacturers of government purchased equipment, designers, engineers, purchasing and production men.

Precision Carbon Deposit Resistors. Allies' Products, Inc., 1028 Conn. Ave., N. W., Washington 6, D. C., announce a new catalog No. 537A giving full engineering specifications for their line of high-temperature deposit carbon resistors. Temperature characteristics, humidity, and temperature coefficient characteristics described meet the exacting requirements of computer and missile manufacture. The resistors listed are usable over ambient temperatures from -70 C to $+250\text{ C}$ and tolerances as close as ± 0.1 percent.

D-C Indicating Amplifier. Doelcam Corp., 1400 Soldiers Field Road, Boston, Mass. Bulletin 1A includes in two pages engineering data and performance curves on the type 2HLA-3 d-c indicating amplifier. The instrument discussed is designed as a polarity-sensing microvoltmeter for the direct measurement of low-level d-c signals and as an amplifier to provide flat response to greater than 20 cps suitable for driving most commercial pen motor or galvanometer recorders. Also included are a photographic illustration, detailed description, typical applications and a discussion of the principle of operation.

STODDART AIRCRAFT RADIO Co., Inc.

6644-A Santa Monica Blvd., Hollywood 38, California • Hollywood 4-9294

thirty
times
as
sensitive

yet drift-free



TYPE M

THE OFFNER DYNOGRAPH

0.001 volt input d-c gives 70 mm. deflection with this high-speed direct writing oscillograph, as compared to only 2 mm. with the most sensitive competitive unit—and with zero drift.

The Dynograph with *one amplifier* is used for all types of inputs—d-c, a-c, or reluctance gauges for measuring speed, temperature, position, vibration, and other variables. Exclusive, patented, chopper amplifier design makes it sensitive, stable, and versatile—greatly increasing the scope of direct writing oscillographs.

Get bulletin L742—compare the Dynograph with all competitive models—it's thirty times as sensitive.

OFFNER ELECTRONICS INC.

5324 N. Kedzie Avenue
Chicago 25, U. S. A.

ZOPHAR

WAXES

COMPOUNDS

Zophar Waxes, resins and compounds to impregnate, dip, seal, embed, or pot electronic and electrical equipment or components of all types; radio, television, etc.

Cold flows from 100°F. to 285°F.

Special waxes non-cracking at -76°F.

Compounds meeting Government specifications plain or fungus resistant.

Let us help you with your engineering problems.



ZOPHAR MILLS, INC.
112-130 26th Street,
Brooklyn 32, N. Y.

free

send for the
most widely used
Electronic Supply Guide

**ALLIED'S
COMPLETE 308-PAGE
1955 CATALOG**



**your guide to the world's largest stocks of
ELECTRONIC SUPPLIES FOR INDUSTRY**

We specialize in
Electronic
Equipment
for Research,
Development,
Maintenance
and Production
Operations

Simplify and speed the purchasing of *all* your electronic supplies and equipment. Send your orders to us at ALLIED—the reliable one-supply-source for *all* your electronic needs. Depend on us for fast shipment from the world's largest stocks of electron tubes (all types), test instruments, audio equipment, electronic parts (transformers, capacitors, controls, etc.) and accessories—*everything* for industrial and communications application. Let our expert Industrial supply service save you time, effort and money. Send today for your FREE copy of the 1955 ALLIED Catalog—the *complete* up-to-date guide to the world's largest stocks of quality Electronic Supplies for Industrial and Broadcast use.

One complete
dependable source
for everything
in electronics

ALLIED RADIO

100 N. Western Ave., Dept. 11-L-4
Chicago 80, Illinois

SEND FOR
FREE
CATALOG

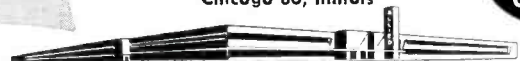

PLANTS AND PEOPLE

Edited by WILLIAM G. ARNOLD

Industry associations report on conventions and elect new officers . . . Manufacturers build new plants, promote personnel . . . Engineers are honored by technical societies . . .

OTHER DEPARTMENTS

featured in this issue:

	Page
Electrons At Work	180
Production Techniques	228
New Products	274
New Books	385
Backtalk	397

International Group Sets Parts Specs

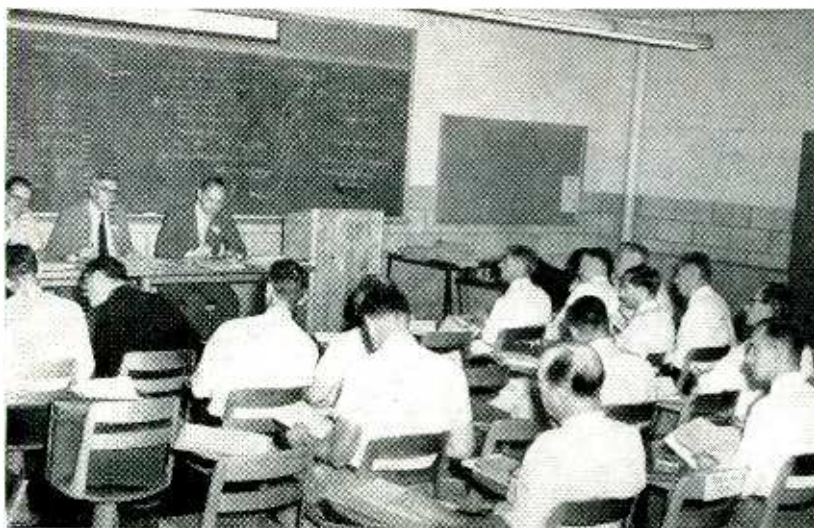

Delegates from twelve foreign nations work on electronic standards. Officers of the group are, left to right on platform: L. Van Rooij and N. A. J. Voorhoeva of the Netherlands and chairman E. F. Seaman of U. S. A.

COMMITTEE 12-3 on electronic components completed work on four major specifications at its recent meeting in Philadelphia. The group is a subcommittee of Technical Committee 12 on Radio Communication of the International Electrotechnical Commission, which met in Philadelphia during the Golden Jubilee meeting of the IEC. In addition to the four specifications, a draft proposal for one additional specification was also completed.

Among the accomplishments of the committee was basic agreement on revision of a fundamental standard covering the procedures to be used in testing electronic component parts, known as BCMT. This specification had previously been approved and was in use in other nations in the world but was found unacceptable to many United

States engineering committees.

United States delegates meeting with Committee 12-3 resolved these differences and established agreement for modification of this document.

Agreement was reached on specifications for paper dielectric capacitors, electrolytic capacitors, ceramic dielectric capacitors and carbon composition resistors. Specification on these items will be circulated to the various nations for a six-month trial approval period.

Work was also completed on a draft specification on mica-dielectric capacitors which will now be circulated in trial form for further comment.

The U. S. position on these specifications was prepared by six committees working during the past year. The chairman of each of

these committees was a member of the U. S. working delegation to Committee 12-3, under the leadership of Leon Podolsky, Sprague Electric Company, who acted as technical advisor to the U. S. delegation.

These committee chairmen and U. S. delegates were J. D. Stacy of GE; J. W. Maxwell of P. R. Mallory; J. D. Heibel of Erie Resistor; Jesse Marsten of International Resistance and E. W. Bisson of GE.

RCA Honors Zworykin At Science Seminar

A SEMINAR covering Thirty Years' Progress in Science and Technology was held in Princeton, N. J. in September in honor of Vladimir K. Zworykin on the occasion of his retirement as vice-president and technical consultant of RCA Laboratories. He has been appointed an honorary vice-president, the first in the corporation's history, and will continue as a technical consultant to the company.

At the seminar, I. I. Rabi, professor of physics at Columbia University, discussed nuclear physics; Hugh Taylor, dean of the graduate school of Princeton University, discussed synthetic materials; Jerome C. Hunsaker, head of the department of aeronautical engineering of MIT, discussed aviation and James Hillier, director of the research department of Melpar (who has since rejoined RCA), discussed medical electronics. The seminar was followed by a social hour and a dinner in Dr. Zworykin's honor.

Dr. Zworykin's life has been



New General Electric "fleaweight" aircraft transformers 50% lighter

New insulation and coil winding process make possible smaller, lower-priced transformers, rated 50 to 500 va

With space and weight so much a premium in today's aircraft, you'll want to take advantage of the savings offered by the new G-E "fleaweight" transformers. Here's a line of transformers that are up to 60% smaller and 50% lighter . . . save you mounting space and materials . . . cost you less than existing units.

Combining silicone insulation and a new method of coil winding, the new "fleaweights" are especially suitable for operation in the higher ambient temperatures of today's high-speed aircraft. Use them for a wide range of 400-cycle aircraft applica-

tions including landing lights, navigation lights, and instruments. The "fleaweights," featuring a low center of gravity and strong vibration-resistant mounting, give you power reliability.

Like other units in the G-E line of electronic and aircraft transformers, the "fleaweights" are tailored to your particular, specialized requirements. If you need application engineering assistance, contact your nearest G-E Apparatus Sales Office. For literature on G-E transformers, write General Electric Company, Section 412-114, Schenectady 5, New York.

Progress is our most important product

GENERAL  ELECTRIC

largely devoted to the problem of seeing-at-a-distance. The achievement of practical television stems to a large extent from his conception and development of the iconoscope. In addition, in the broad field of electronics, he holds approximately 100 U. S. patents on developments ranging from gunnery controls to devices for reducing the twinkling of the stars. The electron microscope was developed under his leadership.

Born in Russia in 1889, Dr. Zworykin received his undergraduate training at Petrograd Institute of Technology, where he worked with professor Boris Rosing. He attended the College of France in Paris, where he engaged in x-ray research under professor Paul Langevin. He served as an officer in the Signal Corps of the Russian



Vladimir K. Zworykin

Army during World War I. At the close of the war he came to the U. S. and became a citizen. He received his Ph D from the University of Pittsburgh in 1926.

Soon after his arrival in the U. S. Dr. Zworykin joined the research staff of Westinghouse, began investigations in the field of photoelectric emission and research in television.

In 1930, Dr. Zworykin became associated with RCA. For many years he was director of the electronic research laboratory and, in 1947, was elected vice-president and technical consultant of the Laboratories.

Dr. Zworykin's various honors received in recognition of his work include the Navy Certificate of Merit, the Chevalier Cross of the French Legion of Honor, the Medal of Honor of the IRE and the Edison Medal of the AIEE.

I-T-E Produces Metal Color TV Bulb



W. M. SCOTT JR., (center) president of I-T-E Circuit Breaker Co., W. S. Hubbs, (left) gen. sales mgr. of special products division, and W. H. Harman Jr., mgr. of television sales, discuss construction details of new I-T-E 21-inch metal color tv bulb for the new RCA 21-inch color tube.

The bulb was developed in conjunction with RCA and is a metal envelope specifically designed for

color for the television tube industry. It is designed for use with a curved aperture mask and 3-beam electron gun.

The metal part of the bulb is fabricated of type 430 stainless steel to which a face plate and neck assembly of glass are sealed. I-T-E is continuing research on tv bulbs aimed toward fabrication from cold rolled steel.

Parts Show Elects Officers For 1955



NEWLY ELECTED OFFICERS of the 1955 Electronic Parts Show receive congratulations of outgoing President Harry A. Ehle of International Resistance. They are, left to right, Leon B. Ungar of Ungar Electric Tools in Venice, Calif., the new president; Elliott Wilkinson of

Wilkinson Bros. in Dallas, vice-president; Karl Jensen of Jensen Industries in Chicago, secretary and Bernard L. Cahn of Insuline Corp. of America in Manchester, New Hampshire, re-elected treasurer of the group.

Ungar, in succeeding Ehle as

Heldor

quality, service and economy
in precision-made
SHEET METAL CABINETS
to your specifications!

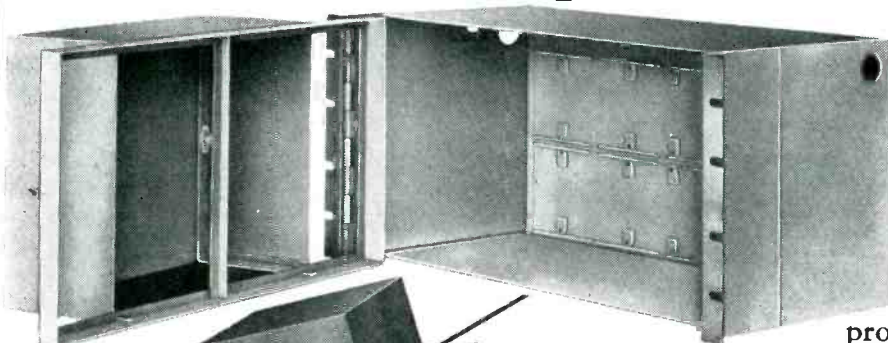

A typical
Heldor
Custom-
Built
unit

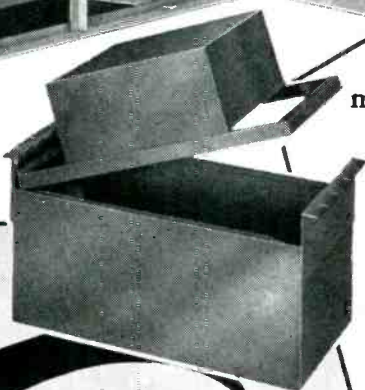

TAKE advantage of Heldor's technical and production background in sheet metal fabrication of cabinets, panels and racks. It will save you both time and money. You're assured of a precision-made product to your own specifications—finished as you want it: painted, zinc chromate, unpainted, etc.

Heldor's skilled craftsmen, trained to work to close tolerances on modern equipment, produce sheet metal products that set new standards for quality, economy and service.

Avail yourself of Heldor's engineering staff for consultation, at no obligation, on your cabinet design problems; or, send Heldor your specifications or prints for a money-saving quotation today.

SAVE MONEY
on *Heldor*
CANS and COVERS—
Compression-Type TERMINALS—
complete ASSEMBLY SERVICE—

Send your specifications for a quotation today!

HELDOR MANUFACTURING CORPORATION



HELDOR HERMETIC SEAL COMPANY, INC.



238 Lewis Street • Paterson, N. J.

Available NOW in quantity...

POWER TRANSISTORS



Transistor uniformity and high performance are assured with the constant temperature, humidity and dust-free conditions provided for our production line.

THE Honeywell 2N57 power transistor is now available in quantities from 1 to 10,000 with new low prices and quantity discounts.

The remarkable high power 2N57 has now moved from the pilot line stage to mass production. Operating from a standard DC supply the 2N57 will deliver watts to a load while still providing maximum power gain.

Already driving servo motors and tripping relays in airborne applications, the 2N57 offers a solution to your weight, space, reliability and vibration problems.

Write for full information on your business letterhead to Transistor Division, Dept. ED-24, Honeywell, Minneapolis, Minnesota.

REAL POWER—2N57 POWER TRANSISTORS

Collector current 800 ma max.

Collector voltage 60 volts max.

Collector dissipation—20 watts max. at 70° F. mounted on adequate heat sink.

Frequency Range—Audio

Sinusoidal power outputs 5 watts max.

Push-pull output 10 watts (2 units) max.

DC switching 40 watts max.

Power gains for ordinary applications 15-25 db.

Maximum temperature—will operate at conservative output levels up to 165° F.

Vibration resistance 30 G up to 1000 cycles/sec.

Hermetically sealed.

MINNEAPOLIS
Honeywell

Transistor Division



112 OFFICES ACROSS THE NATION

president, is the first member of the West Coast Electronics Manufacturers Association, co-sponsor of the show, to be elected to head the group. Other co-sponsoring associations are the National Electronic Distributors Assn.; the Radio-Electronic-Television Manufacturers Assn; Association of Electronic Parts & Equipment Manufacturers and the Sales Managers Club, Eastern Group.

Audio Engineering Society Elects Officers

ALBERT A. PULLEY, manager of general recording for RCA Victor Records, has been elected president of the Audio Engineering Society. He succeeds Jerry B. Minter, president of Components Corp. of Denville, N. J.

The new president joined the test department of GE in 1920. He was transferred to the radio department, working first on radio transmitters and then on the GE disc recording system. When RCA assumed these interests in 1930, Pulley shifted to Camden, N. J. where he did design engineering work on electrical-mechanical devices, including disc recording systems. He subsequently transferred to New York, and was appointed manager of recording in 1938. He was promoted to his present post in March of this year.

A member of the Society since its founding, Pulley was advanced to fellow in 1952. He was elected executive vice president a year ago. He presided as general chairman at the organization's Sixth Annual Meeting, held in New York City



Albert A. Pulley

INDUSTRY WANTED

Are you thinking of re-locating or establishing a branch unit? Locate in Lakeland, Florida, now offering unusual industrial advantages:

- | | |
|---|--|
| 1. Friendly labor supply. | 6. Industrial sites available. |
| 2. Unbelievable city, county and state tax advantage. | 7. Good banking facilities. |
| 3. Excellent water and power. | 8. Promise of full cooperation. |
| 4. Good transportation facilities. | 9. Perfect geographical location, 227 ft. elevation. |
| 5. Abundant housing availability. | 10. Ideal year-round climate. |

We solicit inquiries from small and medium-size industries.

For Full Information Write or Wire:

**Industrial Development Committee of 100
Lakeland Terrace Hotel, Lakeland, Florida**

Oh Yes! LAKELAND is an ideal place for a year around vacation.



Speeding X-Ray Photography

with EEMCO-DESIGNED MOTORS

Manufacturing X-Ray equipment calls for precision and dependability in every part. That's why, when the nation's three leading manufacturers of X-Ray machines chose the motor that moves the delicate negative holders, they selected motors designed and built by EEMCO.

These tiny motors of 1/500 h.p. (intermittent service) provide the reliable, steady source of power that revolves the negative changing mechanism. After a photo is made, the exposed negative with its lens and shutter, are automatically moved aside and a new unit moved into the ready position. Handling this task demands an even, slow application of power to avoid damage to the delicate mechanism. This is typical of the many unusual applications to which EEMCO-designed motors have been put.

If your particular problem calls for special design, or merely for standard motors that can handle the toughest service, you'll find that EEMCO is the source on which to depend. Out of the many unusual requirements filled by EEMCO engineers has come experience unsurpassed in industry and always at your disposal.

Equally important, the EEMCO plant is well-equipped and staffed to turn out motors for you on a mass-production, low-cost basis when necessary.

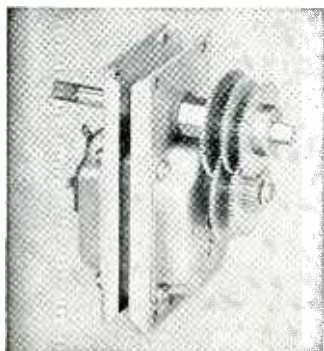

Write today for complete details and catalog information



ELECTRO ENGINEERING PRODUCTS CO.
609 W. LAKE STREET, CHICAGO 6, ILLINOIS

- P-M DC MOTORS & GENERATORS • CAPACITOR TYPE MOTORS • UNIVERSAL MOTORS
- DC MOTORS & GENERATORS • SHADED POLE MOTORS (2-4 Pole) • P-M AC GENERATORS



**Dependable • Precision
Wire Forming and
Stamping Specialists**

Precision Parts to meet your Production and Engineering needs. From .002" dia. to .125" dia. Radio tube parts—Stampings—Drawings. Modern facilities, high-production equipment.

Send sketch or print for quotation.



MANUFACTURING CO., Inc.
24A Bedford Street
Newark 3, New Jersey

STAINLESS fasteners in STOCK

All types and sizes of screws (slotted, Phillips, socket, hex head), bolts, nuts, washers, rivets, keys and pins

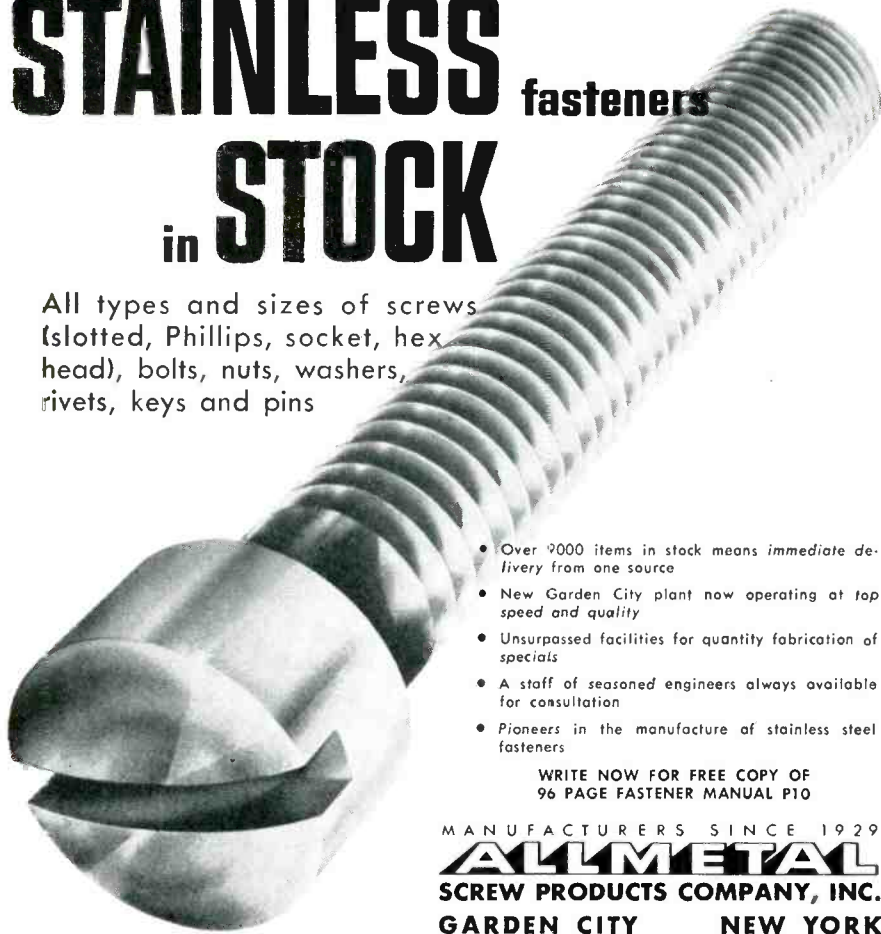

- Over 9000 items in stock means immediate delivery from one source
- New Garden City plant now operating at top speed and quality
- Unsurpassed facilities for quantity fabrication of specials
- A staff of seasoned engineers always available for consultation
- Pioneers in the manufacture of stainless steel fasteners

WRITE NOW FOR FREE COPY OF
96 PAGE FASTENER MANUAL P10

MANUFACTURERS SINCE 1929
ALLMETAL
SCREW PRODUCTS COMPANY, INC.
GARDEN CITY NEW YORK



Veco Thermistors also are sensitive to temperature!

These versatile sensing elements are resistors with a high negative temperature coefficient of resistance — temperature goes up — resistance goes down. This characteristic makes thermistors useful components in electronic circuits as temperature compensators, surge suppressors, voltage regulators, automatic gain controls, etc.

They are used also as sensing elements in high speed thermometry and temperature control for which they are available in a multiplicity of forms such as small beads, rods, discs, washers, glass, plastic or metal probes, or even embedded in the tips of hypodermic needles! Because of their extremely small size, they assist in miniaturization.

Victory is the important name to remember in thermistors. This company has done most to perfect the materials and employ precise quality control in their manufacture. You can depend on "VECO" thermistors for absolute uniformity and efficiency.

To find out how "VECO" thermistors can improve your products, write for free information. New M-168 kit of 6 thermistors and 1 varistor with suggested circuitry. \$5.00 postpaid, or available at electronics parts wholesalers.

Victory Engineering Corporation

101 Springfield Road, Union, New Jersey
Tel. UNIONVILLE 2-7150



THEMISTORS • VARISTORS
TEMPERATURE SENSING DEVICES
ELECTRONIC AND THERMAL
CONTROL INSTRUMENTS

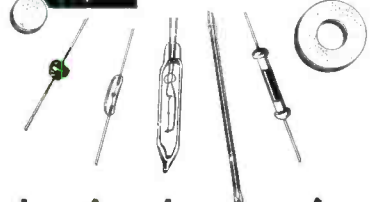

PERIPHERAL
MULTISTAGE BLOWERS
AIR-FILTER
HIGH
STATIC PRESSURE
LOW VOLUME
LOW NOISE LEVEL
60 CPS — 400 CPS
and DC



ROTRON MODEL M multistage blowers direct-driven by INDUCTION motors, incorporate 3 to 9 cascaded impellers. Static pressures as high as 15 inch water column (at 60 CPS, 3400 RPM) and 80 inch water column (at 400 CPS, 7000 RPM) are obtained at air volumes ranging from 3 to 35 CFM. Also available with DC commutator motors. Extremely low noise level and low power consumption.

MODEL M blowers are available with integrally fitted filters of 3 different types. Shown above is Type 10016 down-filter, which removes finest dust particles. Also available with integral activated-carbon filters for use on silverplated microwave cavities.

SHOWN ABOVE is dual blower assembly combining multistage high-pressure blower and a conventional centrifugal blower, driven by one single induction motor, representing special assembly for use with General Electric air-cooled tetrode transmitting tubes.



ROTRON MFG. CO.
Schoonmaker Lane Woodstock, N. Y.

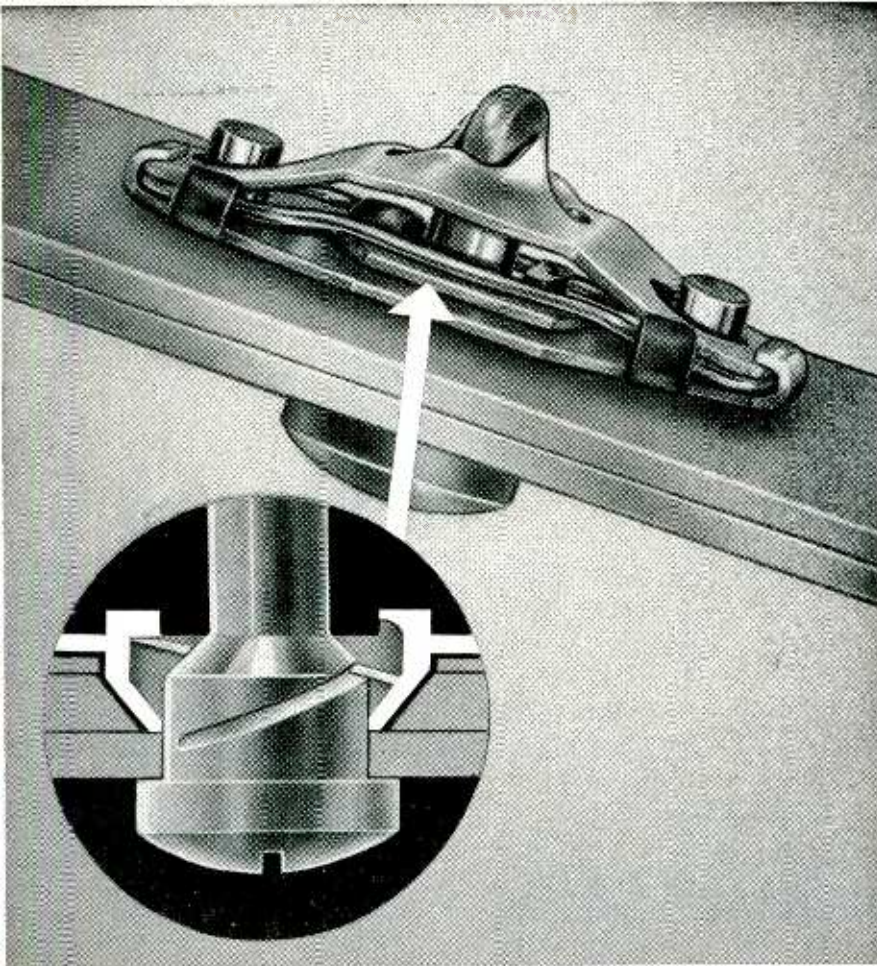

New Lion "Hi-Strength" fastener completely assembled. Cutaway shows the beveled counter sink. Beveling substantially increases the area over which stress is distributed.

NOW! Shear strength twice that of any other fastener!

New Lion "Hi-Strength" design fills every need for parts that must be fastened, taken apart, buttoned tight quickly

Here's a new and better answer to your problem of metal-to-metal fastening where high shear stress and vibration are factors.

It's the Lion "Hi-Strength" fastener, combining speedy quarter-turn opening and closing with a shear strength of 4750 lbs!

This "Hi-Strength" fastener is remarkably strong because shear load is distributed evenly over the area of the fastened parts. The secret lies in the *beveled* counter sink in the sheet and the nut. It's the same high shear prin-

ciple used for years by the automotive industry for wheel lugs.

In addition to high shear strength, its tensile strength is 3000 lbs. Sheet separation is zero up to 4750 lbs. Misalignment is as much as .125 with high shear qualities. Regardless of the number of times it's opened or closed, there is no wear. It cannot be overtorqued (up to 3750 lbs.). It cannot be fastened incorrectly. It is no larger than a standard No. 5!

To test it yourself, write for a free mounted working sample. Just drop us a line on your company letterhead.



500 Main St., Honeoye Falls, N.Y.

In Canada: A. T. R. Armstrong Co., 50 St. Clair Ave. West, Toronto

Award was awarded to Dr. John B. Smyth, of the U. S. Naval Electronics Laboratory in San Diego and the annual WCEMA Scholarship Awards were made to outstanding students of eleven West Coast Colleges and Universities.

A discussion of "Problems in Vehicular Communications" was moderated by FCC Commissioner E. M. Webster. Members of the panel were Douglas Anello, FCC; C. E. Ludekens, Southern California Edison Company; M. E. Kennedy, Dept. of Communications, Los Angeles County; C. E. Donaldson, Radio Communications Service; Ray Meyers, Lockheed Aircraft Corp; R. J. Stratton, FCC and Fred Crowder, Los Angeles Police Department.

Vice-chairmen for the show were C. Frederick Wolcott and Thomas P. Walker. Other members of the 1954 WESCON board of directors were secretary-treasurer, Leon B. Ungar, Noel E. Porter, Richard A. Huggins, Joseph H. Landells and Walter E. Noller.

GE Names Young, Gable And Sutter

CHARLES M. YOUNG has been named manager of engineering for GE's industrial and transmitting tube sub-department.

Young, who joined G. E. in 1937, comes to his new position following 13 years with the GE aeronautics and ordnance systems division engineering staff at Schenectady. He holds five patents on automatic flight control equipments.

Young succeeds Albert C. Gable, who has been appointed manager of product planning for the sub-



Charles M. Young

UNIVERSAL meets exacting DESIGN REQUIREMENTS

in

TOROIDAL COILS

Our specially designed machines now wind Toroidal Coils quicker and with more accuracy than other standard methods. Universal Toroidal Coils in any size wire to your specifications—are economical in materials and possess the smallest external leakage field of all other shapes.

Universal Toroids wound to Mil-T-27 specs.

Wire sizes #42 (.00249 mils) to #10 (.1019 mils).

Excellent Delivery in small or large quantity.

Engineering Service Available.

"ACCURACY IS A UNIVERSAL WORD"

UNIVERSAL  **MANUFACTURING COMPANY, INC.**
410 Hillside Ave., Hillside, N. J.

ABOVE ALL... U. S. C. CONNECTORS



<p>HEAVY DUTY CONNECTORS</p> <p>980-34F2 980-34HRSL 980-34M2SL</p>  <p>For use on rack and panel type equipment in communication and power circuits. U. S. C. heavy duty multi-contact connectors offer</p> <ul style="list-style-type: none"> • Maximum number of heavy current contacts • Mechanical and electrical dependability of operation in a minimum of space. • available 7 to 34 contacts 	<p>PRINTED CARD RECEPTACLES</p> <p>UPCR - 18</p>  <p>U. S. C. Printed Card Receptacles offer</p> <ul style="list-style-type: none"> • Channel Strength and Snap-in Contacts • Dependability of operation over range of printed card thickness • Available - Single and double Row, Wire Solder and Wire Wrap - From 6 to 44 contacts 	<p>MINIATURE CONNECTORS</p> <p>MI-34F MI-34M</p>  <p>For Multi-Contact Plug-in</p> <ul style="list-style-type: none"> • Maximum Strength • Dependable Electrical Performance • Minimum of Space • Available 5 to 75 contacts <p>Over 1000 types available</p> <p>Write us for information on your connector problems</p>
--	---	--

U. S. COMPONENTS, Inc.
Associated with U. S. Tool and Mfg. Co., Inc.
454-462 East 148th Street, New York 55, N. Y. CYPress 2-6525-6

Pioneers of modern crystal development

- more widely used for military applications
- more widely used by the world's leading airlines
- more widely used for critical frequency control for practically any application

NEW CRYSTAL CATALOG . . . just off press . . . listing all standard crystal types. Write for your copy today.



STANDARD PIEZO COMPANY
Carlisle, Pa.

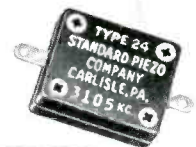

STANDARD PIEZO CRYSTALS

The world's largest, most complete line





Are Your
Components
Guilty of
**RADIO
NOISE?**

POTTER can tell you "why"

POTTER can tell you "how"

and **POTTER** can make
the **FILTER** that will
confirm that "how"



Once it's stated completely and correctly,
a problem is half solved.

Potter can put the facts and figures of
your problem on paper . . . can
chart its limits in laboratory tests . . . can
engineer the solution. And Potter
can embody that solution in
subsequent design and production.

Call Potter to engineer, design and
produce the filter to solve your
radio interference problem.

Write for Bulletin 41



THE
potter
COMPANY

SPECIALISTS IN
FIXED PAPER
CAPACITORS
SINCE 1925

1950 SHERIDAN ROAD
NORTH CHICAGO, ILL.



Albert C. Gable

department's new marketing section.

Walter E. Sutter has been appointed manager of sales for instruments and industrial electronic products of the commercial equipment department of the company.

Sutter joined GE in 1946 in the company's engineer test program. From that time until his present appointment, he has been associated with the company's microwave application and sales section serving in various positions including that of commercial engineer. He holds two patents on microwave equipment.



NBC Color Studio Is Dedicated

MOTION PICTURE studio located in Brooklyn, formerly a Warner Brothers soundstage, has been modernized and equipped at a cost of \$3,500,000 as an NBC color tv studio.

There will be 33 90 minute programs produced at the location.

The studio is 178 feet long, 88 feet wide and over 35 feet high. The lighting consists of 900 cir-

For consistently high purity...

"LINDE" M.S.C. RARE GASES
Trade-Mark (Mass Spectrometer Controlled)

- Helium
- Argon
- Neon
- Krypton
- Xenon

In radar electronic equipment, nuclear radiation counters, cosmic ray cloud chambers, and thyratrons, where the purest rare gases are demanded, LINDE M.S.C. Grade gases meet the specifications. They are produced under continuous mass spectrometer control to assure you of gases of *known* purity and consistently high quality. LINDE, the world's largest producer of gases from the atmosphere, can meet your individual needs of volume, mixture, and container.

For information on the physical, chemical, and electrical properties of these gases, send for the booklet, "LINDE Rare Gases."



LINDE AIR PRODUCTS COMPANY

A Division of
 Union Carbide and Carbon Corporation
 30 E. 42nd Street **UCC** New York 17, N.Y.

In Canada:
 Dominion Oxygen Company, Division
 of Union Carbide Canada Limited, Toronto
 The term "Linde" is a registered trade-mark of Union Carbide and Carbon Corporation.



YOU CAN TAKE IT WITH YOU

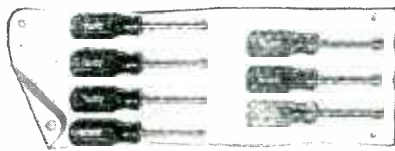

New No. 77 Nut Driver Set

Closed, it's a compact carrying case. Open, it's ready to use anywhere! 7 nut driver sizes, 3/16" to 3/8". Famous XCELITE color-coded handles flash you the size! Ask your supplier for this newest timesaver. While you're at it, check your screwdriver and plier needs—XCELITE makes the right tool for your job!

XCELITE INCORPORATED
 (Formerly Park Metalware Co., Inc.)
 Dept. C
 Orchard Park, N. Y.



you could raise your own steak . . .

But it won't pay unless you're set up for cattle raising.

It's the same way with coils. You *can* make them, and perhaps you do. But in most cases we at Coto-Coil can make them for you faster, better and at less cost. We have nearly 40 years of coil design and manufacturing experience. We know the best types of materials for each type of coil. We have automatic production equipment, the most modern testing devices.

Find out what this cost-saving combination can do for *you*.

Coto-Coil Company, 65 Pavilion Avenue, Providence 5, R. I.
 New York Office: 10 E. 43rd Street, New York 17.



if you're looking for SOMETHING SPECIAL in STEATITE call on.....



PORCELAIN COMPANY

49 Muirhead Avenue • Trenton 9, N. J.

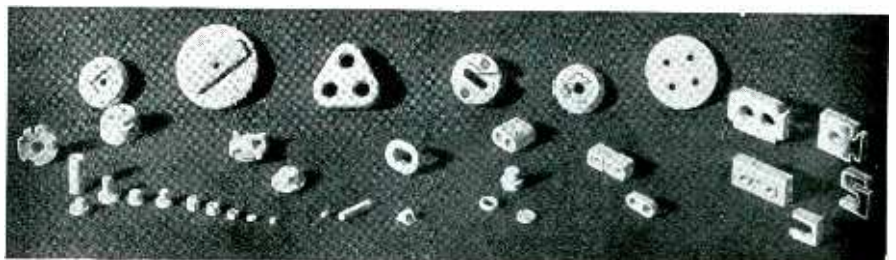

**IMMEDIATELY AVAILABLE
FROM STOCK ...**

magnetic servo amplifier series

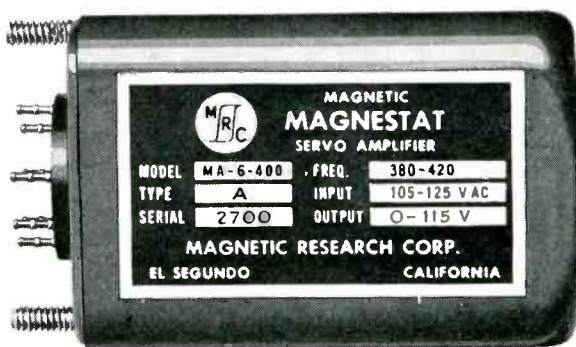

Shown above Model MA-6-400
Actual size: 2-9/16" x 1-3/4" x 1-7/16". Wt. less than 12 oz.
Hermetically Sealed • 7-Pin Header

MODELS

400 cps Series

MA-3-400
MA-6-400
MA-10-400
MA-15-400
MA-18-400
MA-40-400

This complete series of precisely engineered Magnetic Servo Amplifiers is immediately available from stock, as standard components for servo systems application. Furnishes in compact form all the salient features of a high quality, hermetically sealed transformer.

OUTSTANDING PERFORMANCE CHARACTERISTICS ...

- Sinusoidal Phase Reversing Output
- Transistor or Tube Control ... AC or DC Input
- Ambient Temperature Range -55°C. to +100°C.
- Low Cost, Rugged, Compact, Efficient, Long Service Life
- Meets Military Specifications

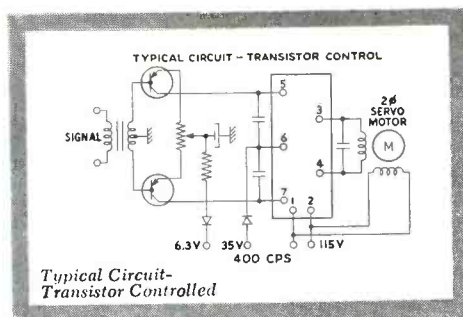

MAGNETIC SERVO AMPLIFIER SERIES

400 cps Models*

MA-3-400
MA-6-400
MA-10-400
MA-15-400
MA-18-400
MA-40-400

Applications

MK-14 (3-watt)
MK-7 (6-watt)
MK-8 (10-watt)
16-watt
18-watt
40-watt

* Equivalent 60 cps Series also available

If you are confronted with circuitry design or engineering problems involving magnetic components for servo system or other application, your inquiry directed to our engineering staff for information will receive prompt, courteous attention.

For complete technical data and performance curves ... request Engineering Bulletin on Magnetic Servo Amplifier Series.

MAGNETIC RESEARCH CORP.
200 CENTER STREET • EL SEGUNDO, CALIFORNIA

Mfrs. of Magnetic Amplifiers and Converters, Magnetically Regulated DC Power Supplies, Magnetic Pulse Generators.



uits with a capacity of 960,000 watts, sufficient to light a community of 3,000 homes. Nine thousand amperes of current are required for the system.

The components of the lighting grid can be raised or lowered by electric hoists remotely-controlled from the lighting bridge. There are 126 such hoists, with a capacity of 75,000 pounds of lighting equipment. This push-button hoist system, permitting individual height adjustment of 63 groups of lights, allows pre-setting of heights for 10 scenes.

The Lumi-Tron lighting board with some 2,000 controls, permits the pre-setting of lighting for 10 scenes and 10 changes of lighting within any one scene.

To convert the lighting system for color, it was necessary to increase the light capacity 7.5 times, which in turn meant a heavy reinforcement of the overhead girders to handle the increase in weight.

The color television equipment permits the handling of 10 video sources including four studio cameras and effects such as triple dissolves.

A smaller studio will be built in what is now a rehearsal hall just off the main studio. It will be used for commercials.

The installation includes a carpentry shop, an artists' lounge, remodelled dressing rooms, makeup rooms and storage space for props and equipment. A Quonset hut, 40 by 60 feet, is being erected as additional storage space.

A new type of demountable seating arrangement will provide facilities for a studio audience of 360 and a lobby is being added.

Ralph Batcher Joins Hudson Wire

RALPH R. BATCHER has joined Hudson Wire Company as technical consultant.

Until recently the chief engineer of RETMA, Batcher has been associated with the radio industry for many years, as well as in the educational and publishing fields. In his new capacity he will assist Hudson Wire in the development of new types of magnet wire and associated

SLASH

**PRODUCTION COSTS
WITH HIGH SPEED**

**SPECIAL
ENGINEERING
SERVICE**

If your assembly problem involves staking or riveting, let High Speed experience provide the solution. Just send us parts to be assembled, with prints. In less than one week we return sample assembly with complete production analysis covering tooling, set-up, procedure, costs and a firm quotation on the High Speed equipment to do the job. **ABSOLUTELY NO OBLIGATION.** We've helped thousands of manufacturers—large and small. We can help you.



HIGH SPEED STAKERS AND RIVETERS

... are designed for rugged, high speed production line service. Complete line of bench and pedestal models, foot and air operated, and backed by the finest tooling program in the industry. Write or Wire Today.

SEND FOR COMPLETE CATALOG

HIGH SPEED HAMMER CO., INC.
315 NORTON ST., ROCHESTER 21, N. Y.

**WWV
IS
FREE — Why Not Use It?**

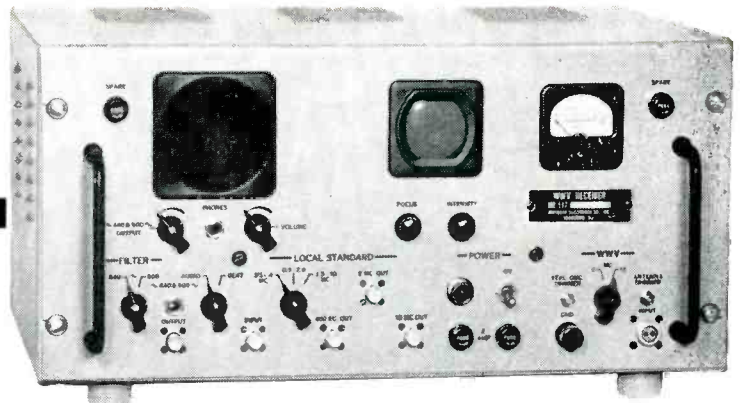

The WWV frequency standard, as transmitted by the U. S. Bureau of Standards, is the most accurate frequency standard of any in the world.

By using the new Marawan WWV receiver, this frequency standard, with all its information (standard audio frequencies, time signals, propagation notices) is now available to your laboratory. The WWV carrier, after elimination of its modulation, by means of a narrow band pass crystal filter, monitors your local HF standard. The rotative pattern on the screen of the cathode ray tube gives sense and amount of the frequency deviation.

Either the 5MC WWV or the 15MC WWV may be received. The receiver will accommodate any local frequency in the range from 50kC to 10MC equal to a subharmonic of 10MC, 2 MC or 400 kC. A second channel receives the audio modulation and time signals of the WWV-Standard.
Four Models Available.

Fully descriptive, illustrated spec. brochure available on request.

**PHILLIP H.
HARRISON & CO.**
Route 34, Matawan, N. J.
Matawan 1-3113

	WWV Input	
	50 MC	5 and 15.0 MC
Audio Modulation on Speaker Phone Jacks	Model ME-117A \$865	Model ME-117C \$910
Additional Filter for 440/600 CPS	Model ME-117B \$940	Model ME-117D \$985

Versatility

with a
**GREEN
ENGRAVER**

ENGRAVES

PANELS

DIALS

PLATES

Widely used in electronic and plastic fields. In machine tool shops and wherever permanent marking is needed. The GREEN ENGRAVER engraves equally well on metals, plastic, wood, hard rubber and glass. ✓ Fact-filled folder on request... showing how economies in costs, labor and time are achieved with the GREEN ENGRAVER.

Mark your own symbols, numbers, lettering, on your small parts, tools, identification and name plates... easily, simply, quickly tracing from a master with the GREEN ENGRAVER.

✓ Routes ✓ Models
✓ Profiles ✓ Engraves
Etching attachment and other special equipment for industrial uses are available.



GREEN

INSTRUMENT COMPANY
363 PUTNAM AVE., CAMBRIDGE, MASS.



NEW MULTIMETER KIT
\$26.50



SIGNAL TRACER KIT
\$23.50



NEW SCOPE KIT
\$59.50



CONDENSER CHECKER KIT
\$19.50



VACUUM TUBE VOLTMETER KIT
\$24.50



TUBE CHECKER KIT
\$29.50



SIGNAL GEN. KIT
\$19.50



GRID DIP METER KIT
\$19.50

Heathkit
TEST EQUIPMENT

BUILD YOUR OWN — INCREASE KNOWLEDGE — SAVE MONEY — BUY DIRECT FROM MANUFACTURER... Top quality instruments in kit form featuring latest design and circuit developments. Completely detailed step-by-step construction manual — clear pictorials — complete schematics. All sheet metal work punched, formed and finished. Low kit prices include tubes, chassis, cabinet and all necessary constructional components.
Kits for the school — service shop — industrial laboratory — hobbyist, etc.

Write for free catalog for further information.

HEATH COMPANY
BENTON HARBOR 14,
MICHIGAN

PRECISION GLASS ENCLOSED CRYSTALS over a complete range of 800 cycles to 5 mc.



JK G-12A — with a proven stability potential of one part in 100 million at 1000 kc.

MINIATURE PRECISION GLASS ENCLOSED CRYSTALS over a complete range of 10 mc to 100 mc.

JK G-3
ACTUAL SIZE



No need to insulate the G-3 case even in the most compact wiring assemblies.

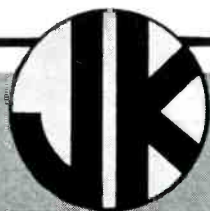
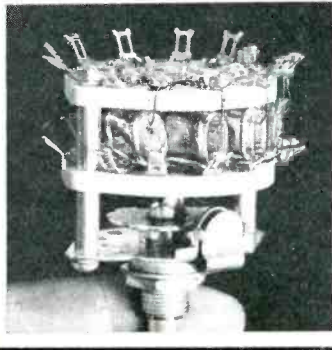

PRODUCTS

FREQUENCY MANAGEMENT SPECIALISTS

MILITARY TYPES

Hermetic sealed, metal cased, in frequency ranges from 16 kc to 100 mc.

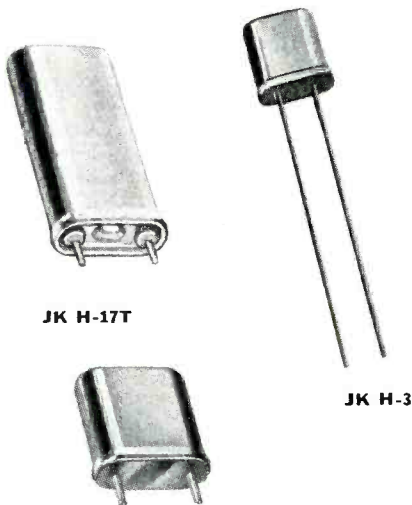

JK H-17T

JK H-3

JK H-17



JK 07E

A Wide Range of **TEMPERATURE CONTROL OVENS**

JK 09T

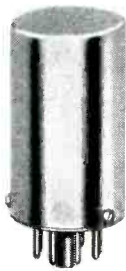

JK 09



- ▶ Custom Oscillators, Crystal Filter Networks.
- ▶ Suppliers of Quartz for Ultra Sonic Transducers.
- ▶ Complete customer engineering service provided for quartz crystal applications.



Write for technical catalog

THE JAMES KNIGHTS COMPANY
SANDWICH, ILLINOIS

products called for by recent trends and development requirements.

Batcher was chairman of the board of directors of the National Electronics Conference this year.

Admiral Expands Engineering Labs

THE ENGINEERING AND RESEARCH STAFFS of Admiral have been consolidated in new and larger quarters at the company's general offices in Chicago.

The consolidation provides 20 per cent additional floor space under one roof for the electronic engineering and research functions of the company. A separate color tv laboratory is maintained at Palo Alto, Calif.

The move also provides enough additional space for two new laboratories. One of these labs is devoted to color tv work and the other to printed circuit television.

Altogether 10 laboratories, including four tv, two color tv, two advanced development, one radio and high fidelity and one printed circuit lab are situated in the new engineering and research section.

Several military engineering groups, now occupying space in this section, are to be moved to make room for five new advanced development laboratories.



Miller Instruments Opens Computer Center

WILLIAM MILLER INSTRUMENTS of Pasadena has opened a computer laboratory to make its MILAC analog computer available on a rental basis for solving general industrial and engineering problems.

Operating on a commercial basis,

NO VACUUM TUBES...NO POWER SUPPLY

allison continuously variable Passive Network audio frequency filter

... offers highest performance characteristics for
a wide range of laboratory and production applications.

The first audio frequency filter to combine the advantages of passive network and continuously variable control. The continuously variable control feature on the Allison low-pass, high-pass and band-pass filter is made possible by incorporating a tested and proven variable inductor. This facilitates filter tuning at audio frequencies as simply and easily as a variable condenser tunes radio frequencies.

FEATURES:

- Passive networks... NO VACUUM TUBES, NO POWER SUPPLY
- Maximum input 5 watts
- Continuously variable over audio frequency band
- Frequency range from 60 to 20,160 cps.
- Low loss... approximately 1 db. in the pass band
- High attenuation outside pass band... 30 db/octave
- Designed for 600 ohm circuits
- Compact and lightweight

\$295.00

F.O.B. Factory

\$297.00

F.O.B. New York



Model 2-B Filter



allison laboratories

14187 SKYLINE DRIVE • PUENTE, CALIFORNIA

Write for Engineering Bulletin with Complete Technical Data

highly efficient source of
BLACK LIGHT
for fluorescence tests and
analyses



**HANOVIA
INSPECTOLITE**

A lamp of high intensity capable of illuminating large areas, the Hanovia Inspectolite is proving invaluable equipment for many industrial and laboratory uses. May be employed for the differentiation and classification of numerous materials, including chemicals, oils, drugs, food products and textiles. Oil filled transformers and capacitors may be effectively tested for leakage by the fluorescence of seepage.

Identification and analysis by fluorescence is rapidly becoming a valuable technique in industrial and engineering practice. Quickest and easiest method of examination is by observation and fluorescence comparison. For closer study or permanent recording, the Hanovia Inspectolite provides excellent light source for ultraviolet photography.

Of sturdy, practical construction, the Hanovia Inspectolite is flexible in usage with supporting upright that permits vertical adjustment of direction of light radiations over an arc of 180°

Yours on Request: Complete application data and details on Hanovia Inspectolite #16106.



DEPT. E-11, Newark 5, New Jersey

Thor

**WINDING FORMS
ARE OUR BUSINESS!**

SAVE money, get prompt deliveries on custom-made Steatite and Epoxide Winding Forms.

Thor also custom-produces Steatite coils and pressed parts to Commercial or JAN-1-10 specifications

Leading companies specify THOR let us quote on your requirements.

Thor Ceramics, Inc.
225 Belleville Avenue, Bloomfield, New Jersey

PRECISION... STABILITY...

Signposts of Quality that make F.C.I. Capacitors ideal for exacting applications.



POLYSTYRENE CAPACITORS

For applications where low power factor, low soakage, high insulation resistance and high capacitance stability are of vital importance. Voltage ranges from 100 volts up; temperature to 85° C. Types satisfying MIL-C-25A specifications available.



TEFLON CAPACITORS

Electrical characteristics equal to those of polystyrene at operating temperatures up to 200° C. Highest possible I.R. at any temperature. Ideal for applications where high electrical qualities are required at ambient temperatures above 125° C.

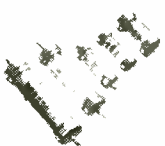

HIGH VOLTAGE CAPACITORS

Employ a "high-breakdown" plastic film producing capacitors remarkably smaller and lighter than previously available. Operation at temperatures to 125° C, with voltages from 2 to 60 KV. Hermetic glass or plastic tube housings with wire leads or threaded stud mountings.



MINIATURE CERAMIC CAPACITORS

Mylar* dielectric capacitors housed in ceramic jackets with thermosetting plastic end fill. Specially impregnated to minimize temperature coefficient. Insulation resistance is maintained under the most severe conditions of temperature and humidity.

*Du Pont trademark

ELECTRICAL CHARACTERISTICS

	POLYSTYRENE	TEFLON	H.V.	MINIATURE MYLAR
Operating Temp. Range	-55°C to +85°C	-55°C to +200°C	-55°C to +125°C	-55°C to +125°C
Voltage Range, D.C.	100 to 30,000	100 to 30,000	2 KV to 60 KV	100-600V
Capacitance Range	.001 to 20 MF	.001 to 20 MF	.0001 to 0.1 MF	.0001 to 1.0 MF
Power Factor	.02% @ 1 KC	.02% @ 1 KC	0.3% @ 1 KC	0.3% @ 1 KC
Dielectric Absorption	.01%	.01%	0.1%	0.1%
Voltage Derating at 85°C	none	none	30%	none
Voltage Derating at 125°C	not operable	none	66%	30%
Voltage Derating at 150°C	not operable	none	not operable	60%
Voltage Derating at 200°C	not operable	33%	not operable	not operable
Temperature Coefficient	-100 PPM/°C	-100 PPM/°C	+500 PPM/°C	+60 PPM/°C up to 70°C
I.R. at Room Temperature	10 ⁶ megohms/MF	10 ⁶ megohms/MF	10 ⁶ megohms/MF	10 ³ megohms/MF
Capacitance Stability	0.1%	0.1%	0.5%	0.2%

When your industrial capacitors specs. call for precision and stability, specify F.C.I.

Excellent delivery on standard or special types—Capacitors made to your specifications.

For more complete technical data, write for catalog.

film capacitors, inc.

3400 Park Ave., New York, N.Y.
Telephone CYpress 2-5180

the laboratory will undertake solution of either an individual problem or an entire development program.



Charlton Chosen By Testing Society

ERNEST E. CHARLTON, consultant in nucleonics and radiation at the GE research laboratory in Schenectady, has been chosen as the Mehl Honor Lecturer for the annual convention of the Society for Nondestructive Testing, to be held in Chicago, November 1-4 at the Morrison Hotel.

In 1920 he became a research engineer in the GE research laboratory. He worked on vacuum tubes, the sodium lamp, the use of alkali metal vapors in vacuum tubes in general, including the caesium photocell. In 1928, when the organization of the research laboratory was changed, he was put in charge of the x-ray section.

Under his direction, the use of hard glass in x-ray tubes and other vacuum tubes was introduced. When Dr. W. D. Coolidge developed the method of securing high-voltage x-rays by a multiple tube in which the electrons were accelerated in several stages, Dr. Charlton was instrumental in applying these ideas. It was found that there was a difference in the operation of these multiple tubes, depending on whether they were oriented in east-west or north-south direction, which he showed to be due to the effect of the earth's magnetic field upon the electron beam. He found that this could be corrected by the use of a small permanent magnet near the cathode to compensate for



Now, with the addition of the new model BD4, Ledex Rotary Solenoids are available in seven basic sizes with various degrees of rotation and torque values up to 54 pound-inches. This new BD4 model offers the same compactness, ruggedness, versatility and dependable snap action as all the previously available sizes of Ledex.

Torque values for normal intermittent duty and 45° stroke.

Model No.	2	3	4	5	6	7	8
Diameter inches	1 1/8	1 5/16	1 9/16	1 7/8	2 1/4	2 3/4	3 3/8
Torque lbs.-inches	.4	1.0	1.7	4.0	7.5	25.0	54.0

WRITE FOR DESCRIPTIVE DATA TODAY!

G. H. LELAND, INC.

123 WEBSTER ST., DAYTON 2, OHIO

NEY'S SMALL PARTS PLAY A BIG PART IN PRECISION INSTRUMENTS

The accurate transmission of electrical impulses through a movable contact is dependent solely upon the properties of that contact. Illustrated at the right is a Ketay Synchro, which is the heart of many precision indicating, communicating and control devices. Ketay is noted for Synchros and Resolvers capable of extreme accuracy. Therefore, Ney Precious Metal Contacts have been selected because of their practically ideal physical and electrical properties.

Ney Precious Metal Alloys have high resistance to tarnish, are unaffected by most industrial corrosive atmospheres, and are fabricated into slip rings, brushes, commutator segments, wipers, contacts and similar components for use in electrical instruments. Call on the Ney Engineering Department for help in selecting the right Ney Precious Metal Alloy which will improve and prolong the life and accuracy of your instruments.

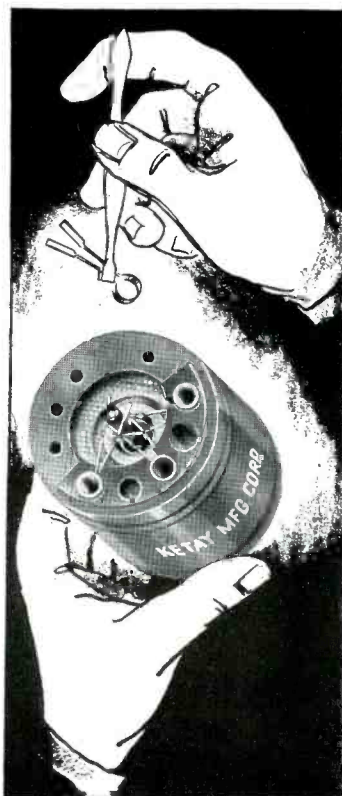

THE J. M. NEY COMPANY
179 ELM STREET, HARTFORD 1, CONN.
Specialists in Precious Metal Metallurgy Since 1812

7NY54B

ELECTRONICS — November, 1954

Want more information? Use post card on last page.



ONE DAY SERVICE

on
**QUARTZ
CRYSTALS**

throughout the range of frequencies from 1500 kilocycles to 50 megacycles. Fundamental Crystals — 1500 KC - 15000 KC. Overtone Crystals — 15 MC - 50 MC.

All orders of less than five units of any one frequency in the range 1500 KC - 50 MC - will be mailed within 24 hours from the time received.

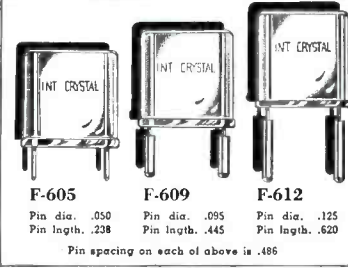

F-605 Pin dia. .050 Pin lgth. .238
F-609 Pin dia. .095 Pin lgth. .445
F-612 Pin dia. .125 Pin lgth. .620

Pin spacing on each of above is .486

WHEN ORDERING SPECIFY:

- (1) Frequency
- (2) Holder Type*
- (3) Circuit Data (32 mmf load, series resonance, etc.)
- (4) End Use (Equipment type & manufacturer, development, etc.)

* Adaptors can be supplied for 3/4" pin spacing.

Calibration

All fundamental crystals are calibrated into 32 mmf unless otherwise specified. All overtone crystals are calibrated for series resonance, unless otherwise specified.

All units are calibrated to .0025% or better of their nominal frequency at 25° C.

For further information write, wire or call:

**International
CRYSTAL Mfg. Co., Inc.**

18 N. Lee

OKLAHOMA CITY, OKLA

Phone FO 5-1165



They tell us this relay is **TOPS!**



ELECTRONICS engineers have been giving these UNION Miniature Relays a real "going over"—and they like what they found. They tell us the relays have come out "tops" in every test—especially for high-vibration resistance and they meet and exceed MIL-R-5757 A&B. They resist shock, vibration, corrosion, heat, cold, and have a life expectancy of 1,000,000 operations!

Contacts are available to function down through the micro-ampere and millivolt range. Coil resistance, contacts, voltage requirements, means of mounting, etc., can vary to suit your circuits.

We don't pretend to know all the possible applications, but if you have relay problems, call in our nearest sales representative. He can help you to a satisfactory solution. In the meantime, write for descriptive literature now.

GENERAL APPARATUS SALES

UNION SWITCH & SIGNAL

DIVISION OF WESTINGHOUSE AIR BRAKE COMPANY

PITTSBURGH 18



PENNSYLVANIA

NEW YORK
Ivanhoe 3-2424
(Hempstead)

BOSTON
Jackson 9-3122
(Wethersfield, Conn.)

BALTIMORE
Valley 5-3431

ST. LOUIS
Jefferson 5-7300

LOS ANGELES
Michigan 9719

the earth's magnetism. Under his direction, there were developed x-ray outfits of 300,000 volts, 400,000 volts and up to 1,000,000-volt equipments for hospitals and the 1,400,000-volt outfit for the National Bureau of Standards. The million-volt industrial unit, now extensively used in industry for x-raying of thick castings, represented a product of his department along with the 2,000,000-volt apparatus which was completed in 1944.

While serving as manager of the x-ray section of the Research Laboratory's electron physics research department, he was directly responsible for construction of GE's 100,000,000-volt electron accelerator.



Pierson Heads Airborne Conference

C. D. PIERSON, JR., chief engineer of the electronics systems section at Martin Aircraft, has been elected president of the Baltimore section, Institute of Radio Engineers for the year 1954-55. Dr. Pierson will also serve as chairman of the east coast conference on Airborne and Navigational Electronics which will be held at the Sheraton-Belvedere Hotel, Baltimore, Nov. 4 and 5.

RETMA Plans Industry Actions, Names Chairmen

AT RETMA'S three-day conference in New York City, president McDaniel was authorized to work for removal of the 10-percent excise tax on all color tv receivers and for the reduction of the tax from 10 to 5 percent on black and white tv and radio re-

Star Performers



"QUALITY-PLUS"

TRANSFORMERS

For Industrial and Electronic Equipment

DESIGNED TO COMMERCIAL & MILITARY SPECIFICATIONS (MIL-T-27 and AN-E-19). ALSO CLASS A, B, H, AND MINIATURES.

Sample, Short and Long Runs. Let us quote on your specifications. No obligation.

Delivery as promised!

EPCO
PRODUCTS, INC.
2500 ATLANTIC AVE.
BROOKLYN 7, N. Y.

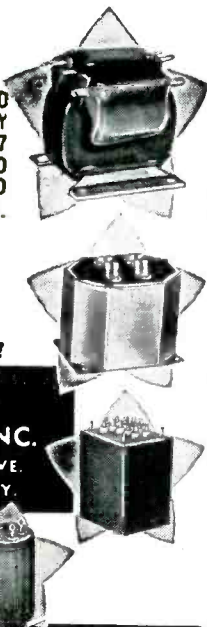

for all applications requiring exceptionally high insulation resistance and unusual stability at high temperature

HOPKINS
"HY-THERM"

New sub-miniature high temperature

CAPACITOR

Hermetically sealed and metal encased, new HY-THERM capacitors have been designed to meet or exceed military requirements (Mil-C-25A). Example: At 125°C the minimum insulation resistance is 20 megohm-microfarads and maximum insulation resistance is 500 megohms. Available in all standard values and tolerances. Variety of mounting and circuit combinations. Special units designed to meet individual requirements.

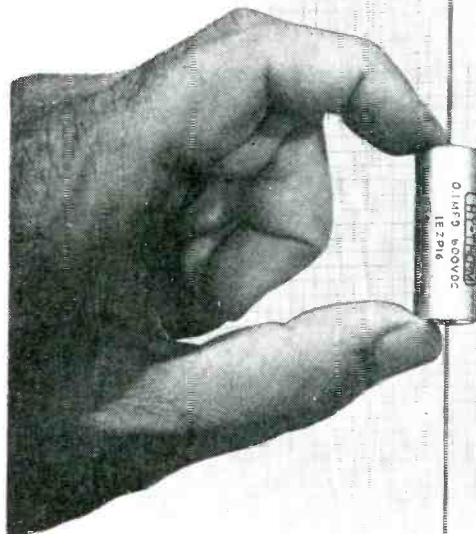

HOPKINS
Engineering Co.

Have a special problem? Write, wire or phone for details, TODAY! Catalog available.

2082 Lincoln Ave.,
Altadena, Calif.
SYcamore 8-1185
Offices in
WASHINGTON, D.C.
and DETROIT

NOW

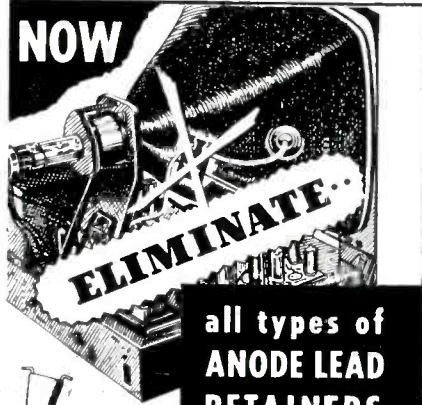

ELIMINATE

all types of
**ANODE LEAD
RETAINERS**

with

"INDUSTRIAL"

"FISH HOOK" pat. pending
ANODE CONNECTORS

Designed specifically to eliminate any supporting harnesses which were necessary in the past to prevent dangerous "Buggy Whip". This unit is absolutely slipproof once connected to the picture tube. The connector is manufactured from tempered steel, hot tinned, with vinyl insulation, and is wired to customer specifications.

Further information and samples will be sent on request.
Dept. E-11

INDUSTRIAL HARDWARE 109 PRINCE ST. NEW YORK 19, N. Y.
Manufacturing Company, Inc.

Metal Joints & Specialists in Small Wire
Serving Industry—FOR OVER 53 YEARS



BASE METAL WIRES
Very small diameter—for filaments, thermo couples, resistance units. Available bare or enameled.



PRECIOUS METAL WIRES
Produced in Platinum, Gold, alloys and pure metals—small diameter. Platinum alloy resistance wire bare or enameled.



COATED WIRES
Comprising an extensive range of wires, electroplated with various metals such as Gold, Silver, Rhodium, Platinum, Copper, Gallium, Indium and others. Enamel insulated wires for precision resistors and potentiometers.

Write for latest list of Products

SIGMUND COHN CORP. 126 So. Columbus Avenue • Mount Vernon, N. Y.



Dynacord[®]
the magnificent
 by Pentron

Now
for the
first time

... a professional tape recorder that offers both
MAXIMUM OPERATING CONVENIENCE
plus **UNMATCHED DEPENDABILITY**

Dynacord is engineered to exceed the rigid requirements of broadcast stations, sound studios, industry and government. Its wide dynamic range and many convenient operating features amaze engineers and audiophiles alike. Compare it in every way with any other professional tape recorder and see why Dynacord sets the new standard of professional recording.

Model DTM Tape Transport Mechanism, \$350 net.
Model DP-100 Broadcast Amplifier, \$150 net.
Model DS-10 Audiophile Amplifier, \$75 net.

Write for
details and
bulletin

Exclusive 2-speed, inside-out Hysteresis synchronous motor. Direct capstan drive.

Exclusive dynamic braking, fast, positive, fool-proof.
 Frequency Response: 50-15,000 CPS at 15 in./sec. \pm 2DB
 Signal to Noise Ratio: better than 55 DB

THE PENTRON CORPORATION
 777 South Tripp Avenue, Chicago 24, Illinois, Dept. E-11
 Canada: Atlas Radio Corp., Ltd., Toronto
 Largest exclusive makers of tape recorders and accessories

SEND FOR FREE DETAILED BULLETIN TODAY!



Want more information? Use post card on last page.

ceivers. He also was authorized to cooperate with other trade associations in seeking administrative tax reforms involving radio, tv and electronic communications products.

The Association will try to convince Congress that the excise tax on color receivers should be removed, at least for a few years, in conformance with the policy of waiving the tax for a limited period on new industries and products. Congress also will be told that a reduction in the tax on black and white television and radio sets to 5 percent will place these products on a competitive basis with household appliances on which the tax was reduced last spring and eliminate present discrimination.

In response to an invitation from the Federal Civil Defense Administration, RETMA endorsed participation of member-companies in a test of electronic equipment and components during an atomic blast test at the Nevada Proving Grounds next spring. The Board authorized Dr. W. R. G. Baker, director of the engineering department, to utilize the facilities of the department in coordinating the industry's participation in the test.

Engineering

To provide additional services for RETMA members engaged in military production, the RETMA Engineering Department will add to its staff an engineer who will devote his time entirely to military engineering problems and specifications.

The status of the West Coast branch of the engineering department is to be changed to a full-fledged regional operation under the direction of RETMA headquarters.

Dr. Baker, as chairman of the special committee on spurious radiation, reported on recent developments in the Association's program to limit spurious radiation of television receivers.

The great majority of set manufacturers, Dr. Baker said, have agreed to conform to RETMA intermediate frequency and radiation engineering standards. The FCC, however, will again be asked to postpone until Feb. 1, 1955, its deadline for receiving comments on



BRANSON MINIATURE RELAY

... for aircraft and missile applications
Branson Type MRH relay is about the size of a miniature tube. Occupies a volume of .75 cubic inches and weighs 1.4 ounces. All contact insulation is ceramic and glass, which makes the relay extremely useful for high frequency switching applications where low, high quality capacities are required.

Branson Type MRH relay provides 2 amp. contacts in double-pole, double-throw combination. Withstands 50g shock and 20g vibration up to 500 cps. Built for ambients of 85° C or up to 200° C for special purposes. Coil resistances up to 10,000 ohms are available. Can be supplied with a plug-in arrangement or new ferrule mounting.



Write for complete information

BOONTON, NEW JERSEY

ELECTRONIC ENGINEERS

North American's Aviation Missile and Control Equipment Department offers unusual opportunities for engineers in the following fields:

FIRE CONTROL SYSTEMS

RADAR

ANALOG AND DIGITAL COMPUTERS

INSTRUMENTATION

TRANSISTOR CIRCUITRY

SERVOMECHANISMS

SYSTEM TESTING

Openings exist at both senior and junior levels. BS, MS or PhD in Mathematics, Physics or EE required. Junior engineers with this educational background, without experience, will be accepted for training in the above openings.

For additional information please forward resume to:

Missile & Control Equipment Dept.,
Engineering Personnel
NORTH AMERICAN AVIATION, INC.
DOWNEY, CALIFORNIA

In the N. Y. area, pls. contact our representative, Mr. G. W. Benedict; 19 Rector St. Rm. 1609, N. Y. 6, N. Y.

NOW... *Insulated* DEPOSITED CARBON RESISTORS

After intensive study of the many special requirements arising in modern resistor applications, Welwyn has succeeded in developing a resistor-encapsulating process employing a new, insulating material. When thus applied, this material will withstand an applied potential of 8000 volts. Its insulating effectiveness is in excess of 100,000 megohms.

Welwyn insulated resistors can be placed contiguous to each other without the need for additional insulating material. In all other respects, these new insulated resistors offer the same performance and quality advantages generally associated with Welwyn Deposited Carbon resistors. Available in 1/4, 1/2, 1 and 2 watt ratings.

Manufactured in
England and Canada

For complete data
and specifications
write to Dpt. KL-7

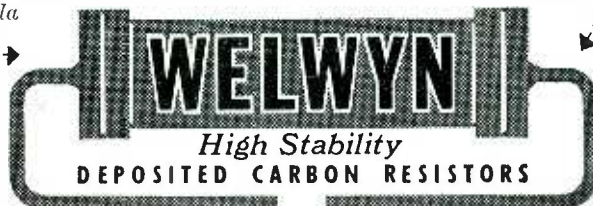

ROCKBAR CORPORATION 215 East 37th Street, New York 16, N. Y.

NOISE and FIELD INTENSITY METER Model NF-105

(Commercial Equivalent of AN/URM-7)



CONFORMS TO

MIL-I-6181B

MIL-I-16910

ENGINEERING DATA

- Frequency range 20 MC to 1000 MC by means of three quick-change tuning heads. At least one RF amplifier with tuned input is employed for each tuning range.
- Easy frequency scanning by means of single tuning knob.
- Built-in impulse noise calibrator flat to 1000 MC (Output externally available).
- 4 1/2" logarithmic indicating meter reads carrier or true peak.
- Aural slideback operation.
- Input VSWR better than 1.2 to 1.
- Built-in regulated "A" and "B" supply.
- Complete line of accessories available.

Write today for additional information and our complete catalog

edp **EMPIRE DEVICES PRODUCTS CORPORATION**
38-15 BELL BOULEVARD • BAYSIDE 61, NEW YORK

MANUFACTURERS OF
FIELD INTENSITY METERS • DISTORTION ANALYZERS • IMPULSE GENERATORS • COAXIAL ATTENUATORS • CRYSTAL MIXERS

its proposed radiation rules to permit the task committee to complete its work.

L. W. Teegarden, executive vice-president of RCA, was elected a director from the set division and a member of the executive committee to fill vacancies created by the resignation of J. B. Elliott. L. G. Haggerty, president of Capehart-Farnsworth Co., was elected a member of the executive committee to replace Fred D. Wilson, who has transferred to IT&T. E. Alschuler, president of Sentinel Radio, who is a member of the board of directors, was elected a member of the executive committee.

W. R. G. Baker of GE has been appointed chairman of the RETMA's Television Committee for the fiscal year 1954-55.

Applications for membership from nine companies were approved by RETMA.

Following is the list of new members: The Antenna Specialists Co., Cleveland, Ohio; General Mills, Inc., Mechanical Division, Minneapolis 13, Minn.; General Products Corp., Union Springs, N. Y.; Germanium Products Corp., subsidiary of Radio Development & Research Corp., Jersey City 4, N. J.; Jerrold Electronics Corp., Philadelphia 46, Pa.; Kay Lab, San Diego 10, Calif.; Resitron Laboratories, Inc., Los Angeles 25, Calif.; Richardson Co., Hollywood 28, Calif.; Technical Training Institute, Portland, Ore.



Sylvania Names Broker Plant Head

EUGENE E. BROKER has been appointed manager of the Sylvania radio tube plant at Shawnee, Okla. Broker succeeds Charles W.

EPR N-CAPS[®]

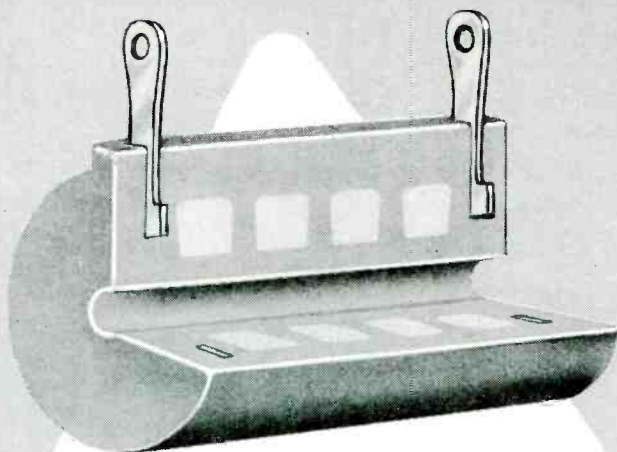

HERMETICALLY SEALED SURPASSES SPEC. MIL-R-93A

Amendment # 2 Characteristic B

Withstands Effects
of Salt Water

Resistance to
Mechanical Shock

Maximum Stability
for
Longest Periods

All Military Styles Available

THE SUPERIOR ENCAPSULATED

Precision

WIRE WOUND RESISTORS

New illustrated catalog containing valuable engineering data.

Write for it today.

Sales Engineers in Principal Cities

EASTERN PRECISION RESISTOR CORP.

Richmond Hill 18, New York

EPR

JORDAN

HEALTH AREA MONITOR

*Measuring continuously
and intermittently . . .*

GAMMA BETA NEUTRON

Models RAMS-1 and RAMS-2, are

ADAPTABLE

RELIABLE

INEXPENSIVE

WRITE FOR DATA FILE 30-47



Jordan Electronic Mfg. Co., Inc.
119 East Union Street • Pasadena 1, California

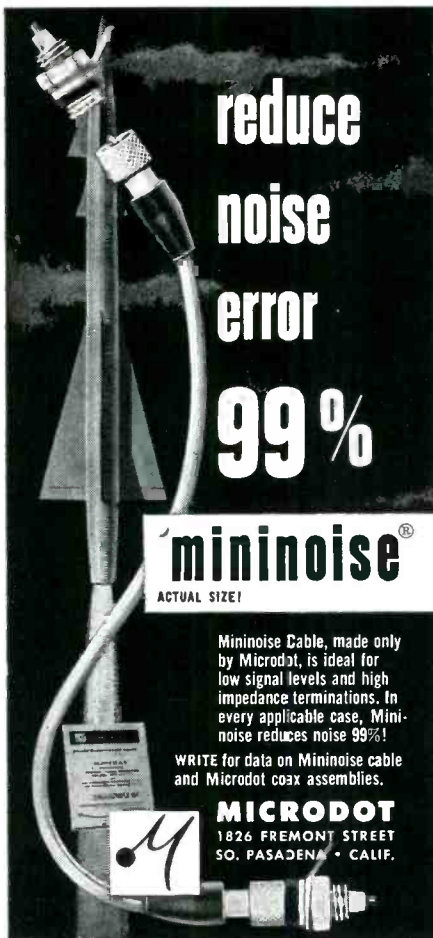

**reduce
noise
error
99%**

mininoise[®]
ACTUAL SIZE!

Mininoise Cable, made only by Microdot, is ideal for low signal levels and high impedance terminations. In every applicable case, Mininoise reduces noise 99%!

WRITE for data on Mininoise cable and Microdot coax assemblies.

MICRODOT
1826 FREMONT STREET
SO. PASADENA • CALIF.

FOR MARKING...



PLASTIC • METAL
GLASS • PAPER
RUBBER • CERAMIC
CARDBOARD

*in such products as
Resistors, capacitors,
valves, tubes, labels,
sleeves, spark plugs, car-
tons, etc., etc.*

**THESE PRODUCTS
AND MANY OTHERS
OF ALMOST ANY
MATERIAL AND SHAPE
CAN BE IMPRINTED**

ON THE

REJAFIX MARKING MACHINE

Why not send us samples of your products? They will be test-printed and returned to you for your examination!

- REJAFIX HAND-OPERATED MODELS FOR SMALL RUNS. FULLY AUTOMATIC MODELS FOR MASS PRODUCTION.

EST. 1922

POPPER & SONS INC. 300 FOURTH AVENUE
NEW YORK 10, N. Y.

NOW...SOLVE YOUR HIGH VOLTAGE PROBLEMS with BETTER EQUIPMENT



34 KW 17,000 V.D.C.



Our years of experience gives you MAGNATRON Heavy Duty High Voltage products . . . built for longer life and rugged performance

← NEW UNITIZED RECTIFIERS

For high voltage D.C. sources . . . lower initial cost . . . minimum upkeep . . . convenient — ready to connect to AC. line and D.C. load . . . compact — requires minimum floor space.

AIR . . . OIL . . . ASKAREL

Plate Transformers . Filament Transformers . Filter Reactors . Modulation Transformers . Distribution Transformers . Pulse Transformers . Testing Transformers . Precipitation Transformers . General Purpose Transformers . Hi-Voltage Transformers.



Askarel Immersed Filter Reactor
50,000 Volt Test

WRITE FOR DETAILED INFORMATION

MEETS STANDARDS OF AIEE-NEMA

A NAME SYNONYMOUS WITH EXPERIENCE

MAGNATRON INCORPORATED

TRANSFORMERS AND ELECTRICAL EQUIPMENT
WALTER GARLICK, JR., PRESIDENT
246 SCHUYLER AVE., KEARNY, NEW JERSEY



BARORESISTOR PRESSURE TRANSMITTER

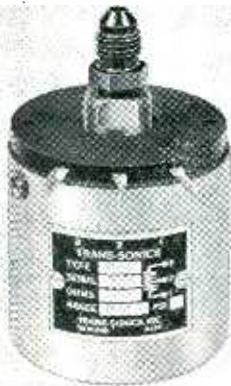

The Trans-Sonics® Baroresistor is a rugged pressure actuated potentiometer designed and field tested for use in operational aircraft. This pressure transmitter provides a simple and reliable means of varying fire control equipment and autopilot performance as a function of pressure (altitude).

**TRANS-SONICS TYPE 71-5
BARORESISTOR**



CONDENSED DATA

Type 71-5 Baroresistor	Maximum voltage: 75 volts
Range: 0-14.7 psi, absolute	Resolution: $1/3^{\circ}C$
Resistance: 7500 ohms	Accuracy: 2% of full scale
Shock: No discontinuity under 30g shock	

MEMO TO PURCHASING OFFICIALS

You will get the deliveries promised you of Trans-Sonics Baroresistors. Shown in the photo is an automatic calibrator which enables Trans-Sonics, Inc. to calibrate this precision instrument in production quantities and on schedule.

TYPICAL APPLICATIONS

Servos — Vary servo loop gain as a function of altitude.
 Fire Control — Air density measurements. Telemetering — Pressure transducer.
 Computers — Voltage divider, P total/P static. Recording — Pressure transducer.

MEMO TO ENGINEERS You can specify Trans-Sonics Baroresistor with confidence because:

1. The instrument is immune to dust, fungi, moisture, oil vapors, ice, etc. The potentiometer and moving parts are hermetically sealed in the reference vacuum with the measured pressure admitted into the bellows only.
2. Every instrument is subjected to a detailed performance inspection. Shown in the photo is a special calibrator which automatically records the increasing and decreasing resistance ratio versus pressure plot of the instrument's performance. In addition, this calibration provides an inspection of each turn of the potentiometer winding.

Write for
Bulletin No. 71-5
for further details.

TRANS-SONICS, INC.
5 Forest Street, Bedford, Mass.

Price
\$225.00
Delivery: from stock.

Hosterman, who recently was named to the newly-created post of assistant general manager of Sylvania's electronics division.

Manufacturing superintendent of the company's radio tube plant at Burlington, Ia., since 1951, Broker joined Sylvania in 1929 and served in various supervisory capacities in the filament department at the company's division headquarters in Emporium, Pa., until 1942 when he became supervisor of a feeder plant at Galeton, Pa. In early 1951, he was transferred to the division's plant in Huntington, W. Va., and shortly afterward he was appointed manufacturing superintendent of the company's subminiature tube plant in Burlington, Ia.

Thermal To Buy American Quartz

AMERICAN FUSED QUARTZ COMPANY of Dover, New Jersey will be purchased outright on November 1 by the Thermal Syndicate of Wallsend-on-Tyne, England.

The new company will be known as Thermal American Fused Quartz Company, Dover, New Jersey, with branch offices in Lynbrook, Long Island, New York.



Guhl Joins National Vulcanized Fibre

HENRY C. GUHL, formerly manager of engineering for the Micarta division of Westinghouse, has been named manager of process engi-

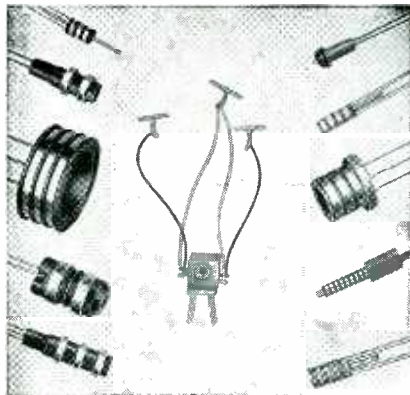

Miniature and Sub-Miniature
SLIP RING ASSEMBLIES
BRUSH BLOCK ASSEMBLIES
COMMUTATORS

and other
 Electro-Mechanical Components

PRECISION MADE
TO YOUR OWN SPECIFICATIONS

Precision molded products with exacting tolerances in precious and non-precious solid metals of all alloys. All types of Thermo-Plastic and Thermo-Setting materials.

Slip Ring Assemblies fabricated or one-piece precision molded to your specifications in Nylon, Kel-F, Mineral filled Mellamine, Phenolic, and other materials. Rings and leads spot welded or brazed together for positive electrical circuit

Our Swiss methods and techniques are geared to meet exacting requirements. We invite your inquiries.

COLLECTRON CORPORATION

MUrray Hill 2-8473 • 216 East 45th Street • New York 17, N. Y.

SUBMINIATURE
RELAY-Plus!



ACTUAL SIZE

Compact . . . Rugged . . .
Light weight . . .

6 PDT arrangement.

All these features are achieved by the use of an extremely efficient rotary motor, precision built, with hydrogen annealed parts.

COMPACT—One inch diameter, with 1-5/16" long enclosure.

HEIGHT—above chassis is only 1.216 inches.

RUGGED—Withstands operational shock of 50 G's and operational vibration of 5-500 C.P.S. at 10 G's. Altitude to 80,000 feet. Ambient temperature range of -65°C to +125°C.

LIGHT WEIGHT—Only 2.6 ounces (even with mountings interchangeable with larger relays of other manufacture).

Tests of production relays, under USAF supervision, have proven that this relay meets or exceeds the requirements of MIL-R-5757B.

Based on 1,000,000 operations, contacts are rated at 3 amperes at 26.5 V.D.C. or 115 V.A.C., 60 to 400 CPS.

Coil resistance values range from 6 ohms to 14,000 ohms. Relay pictured above has 1-9/16" mounting centers but can be supplied with other mounting styles requiring less chassis space.

Other standard contact arrangements are 2 PDT, 3 PDT and 4 PDT. All are available in the plug-in construction.

FILL IN COUPON
FOR CATALOG

FILTORS, Inc.
 30 Sagamore Hill Drive
 Port Washington, L. I., N. Y.

Please send data sheets on your subminiature relays.

Name

Title

Company

City Zone State



MINIATURE
Magnetic Servo Amplifier
 Size: 1 Cu. Inch — Weight: 50 Gr.

Here's the perfect miniature magnetic amplifier, designed by Atlas engineers to match the Oster Company, 18V, 400 cycle, 2 phase servo motor type 2 ET-123 Model 2. The SA-427 occupies only 1 cubic inch of space; weighs but 50 grams. It is available with either a high impedance control winding to work with a vacuum tube pre-amplifier, or a low impedance control winding to operate with a transistor pre-amplifier. The Atlas SA-427 has a gain of 1,000 and a response time of less than one-and-one-half cycles of supply frequency. **FREE FOLDER . . . contains complete electrical and mechanical specifications. Write today for Booklet SA-427.**

ATLAS

ATLAS ENGINEERING CO., Inc.

3 EDGEWOOD ST., ROXBURY, MASS.

In Canada

CANADIAN ATLAS TRANSFORMER CO. LTD., 17 CARLAW STREET, TORONTO, CANADA



Electronic Associates Computation Center near Princeton, N. J.

PRECISION ANALOG COMPUTERS... rapidly and accurately solve complex engineering problems

At the EA Computation Center you may solve complex problems in Applications Engineering, Simulation, and Engineering Design by renting EA Analog Computation Equipment by the hour, week, or month.

Scientists, engineers, and mathematicians experienced in the use of analog computers are available to assist in problem solution.

PRECISION ANALOG COMPUTATION EQUIPMENT IS ALSO AVAILABLE FOR PURCHASE.

Throughout the design of this computing equipment the objective was to produce the most accurate, versatile and dependable equipment possible at a reasonable price. In achieving this end, many of the latest advances in the art have been incorporated which contribute to the superiority of this equipment.

If you state your interest, we will be glad to send you applicable data. Write to Dept. EL.

Visit our booth at the first international automation exposition in New York Nov 29 through Dec. 2.

PRECISION ANALOG COMPUTING EQUIPMENT
FOR SOLVING PROBLEMS IN DYNAMICS

ELECTRONIC ASSOCIATES



LONG BRANCH • NEW JERSEY

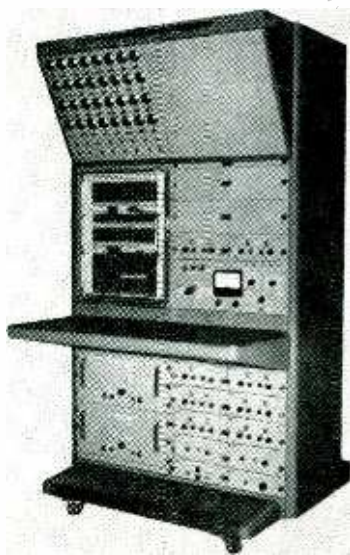

EA Precision Analog Computer, Type 16-31R

PLANTS AND PEOPLE

(continued)

neering by National Vulcanized Fibre Co. He has been placed in charge of manufacturing specifications and control and quality control.

Guhl was associated with National's president, Eugene R. Perry, for 16 years in the Micarta division. Perry was division manager before joining National as executive vice-president in 1952. He was elected president last year.

Guhl has had 20 years of experience in the making of laminated plastics. He was named manager of engineering for Micarta in 1943.

His initial efforts will be devoted to process and quality control procedures in National's Phenolite division, a part of the Kennett plant in Kennett Square, Pennsylvania.



Thomas Electronics Appoints Schmalz

HENRY SCHMALZ has been appointed manager of color tube engineering and development of Thomas Electronics. The move was made in anticipation of translating color tube engineering into production techniques.

Schmalz formerly served with RCA, Rauland, and Sarkes Tarzian. Just prior to joining the Thomas organization, he was associated with the Crosley division of Avco as chief of color development and engineering at their Batavia, Illinois cathode-ray tube plant.

Admiral Clarke Elected British IRE President

REAR-ADMIRAL SIR PHILIP CLARKE has been elected president of the British IRE for 1954-55. He has been a vice-president of the group

IF YOU NEED IT —

Dage can make it!

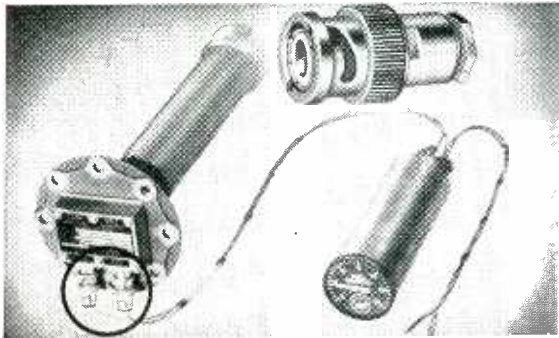

LEFT: DAGE Type BNC Connectors are used in this Avion capacitor type two unit fuel gage.



Dage CBSN-552 Snap-on BNC Connector

Dage Radio Frequency Connectors

Your *special* RF Connector requirements receive *special* attention at DAGE... masters of custom design and manufacture.

DAGE makes all standard connectors, including new sub-miniatures, to precise military and commercial specifications.

DAGE invites your request for details,

quotations, recommendations, and your order for standard or *special* RF Connectors.

DAGE MAKES RF CONNECTORS FOR—

- Federal Telephone & Radio Corp.
 - The Magnavox Company
 - Capehart-Farnsworth Company
 - Radio Receptor Company, Inc.
 - Bendix Aviation Corp.
 - Motorola Inc.
 - Federal Telecommunication Laboratories
 - Boeing Airplane Company
 - Lavoie Laboratories, Inc.
 - Thompson Products, Inc.
 - Western Electric Company
 - Stamford Electronics Company
- AND MANY OTHERS

Write DAGE today!



DAGE ELECTRIC COMPANY, INC. • BEECH GROVE, INDIANA

EVERY USER OF

SOLDERING LUGS
•
TERMINALS
•
SMALL STAMPINGS

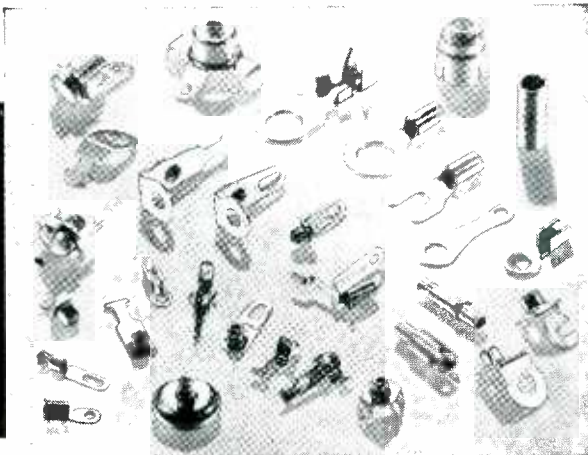

Can Profit Through MALCO'S Low Cost, Quantity Production

We manufacture a complete line of standard and custom-made solder and solderless lugs, terminals, corona rings, and small stampings for radio, television and industrial electrical/electronic use.

Precision tooling and rigid quality control insures tolerances to your most critical specifications. High production techniques, plus stocks of over 1000 different parts permit prompt delivery at lowest possible unit cost.



Let us know your requirements. Request our new 38 page, convenient reference catalog.

Malco

TOOL and MANUFACTURING CO.

4023 W. LAKE ST., • CHICAGO 24, ILLINOIS

Negative temperature and voltage coefficients



White 80X MOLDED RESISTORS

RATING — 3 watts — 100 to 100,000 megohms

SERVICE — High voltage equipment such as electrostatic generators, atomic energy equipment, etc.

CHARACTERISTICS

- Negative temperature coefficients
- Negative voltage coefficients
- Good stability, durability, mechanical strength
- Non-deterioration of values due to age
- Non-hygroscopic base specially processed against humidity
- Compactness

BULLETIN 4906 has full details. Send for a copy. Attention Dept. R



THE White INDUSTRIAL DIVISION
DENTAL MFG. CO.



10 EAST 40th ST.
NEW YORK 18, N.Y.

Western District Office • Times Building, Long Beach, Calif.

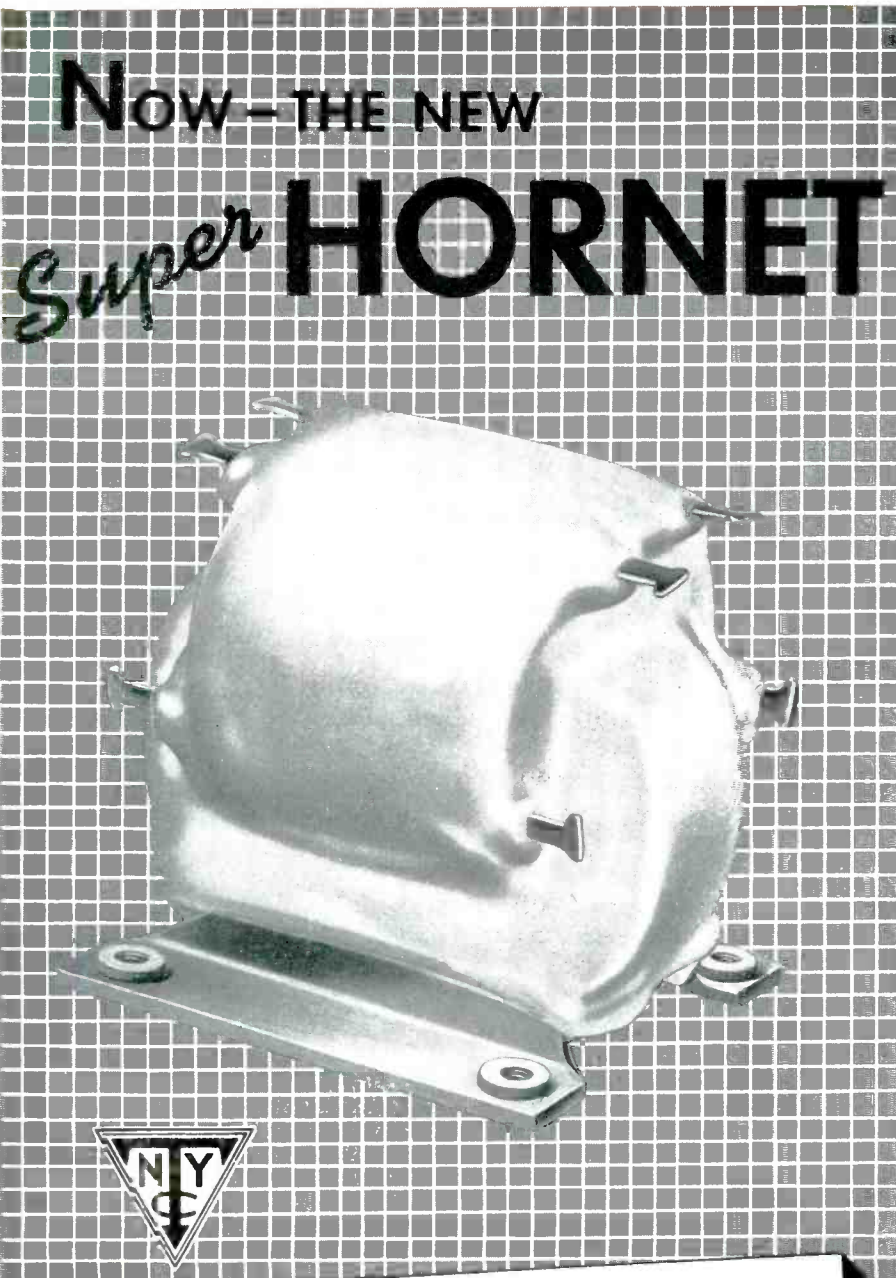

Now — THE NEW

Super HORNET



The Super Hornet has all of the features which made the Hornet the pace-setter of the industry — small size, light weight, high heat resistance and dependability, *plus*

A radically different type of coating used for encapsulation, which increases resistance to environmental conditions far beyond other coated Class H units.

Specify the Super Hornet for Superior Service

**NEW YORK
TRANSFORMER CO., INC.**
ALPHA, NEW JERSEY

since 1952. He had been with the Navy since 1914.

He was appointed to his present post of Director of the Naval Electrical Department in 1951.

General Ceramics Acquires Advanced Vacuum

GENERAL CERAMICS CORP. of Keasbey, N. J., has acquired Advanced Vacuum Products of Stamford, Conn., producer of high-temperature metal to ceramic seals.

The Advanced Vacuum plant will be operated as a division of General Ceramics. The management staff and production personnel have been retained intact with additional personnel and plant facilities listed among current expansion moves.



Dunn Resigns To Join Ramo-Wooldridge

LOUIS G. DUNN resigned as director of the jet propulsion laboratory at California Institute of Technology to join The Ramo-Wooldridge Corp. in Los Angeles as associate director of the new guided missile research division.

Dr. Dunn will work with Simon Ramo, who, in addition to his duties as executive vice-president of Ramo-Wooldridge, will be director of the division and with Ralph P. Johnson, vice-president for research and development.

The new division, which will occupy the first 50,000 sq ft of laboratory space in the firm's new buildings, has a backlog of \$4 million from the Air Force for advanced guided missile research and

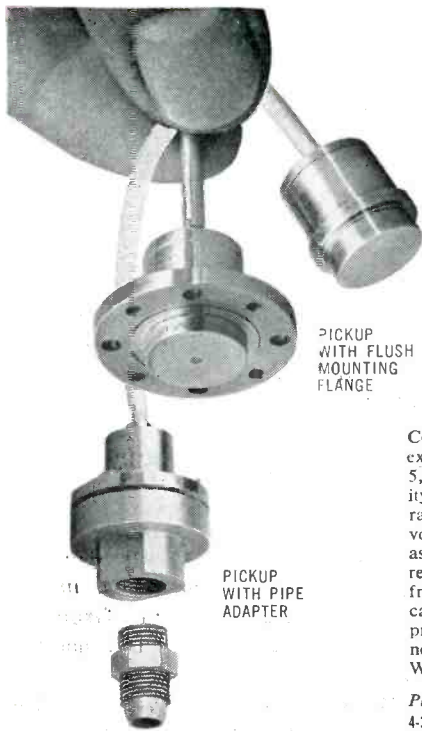

PICKUP ONLY

PICKUP WITH FLUSH MOUNTING FLANGE

PICKUP WITH PIPE ADAPTER



FLUSH MOUNTING DIAGRAM

These CEC miniature precision instrument-type

pressure pickups

cover a wide performance range

Consolidated pressure pickups feature a-c or d-c excitation—full-scale pressure ranges from 5 to 5,000 PSI—linearity within 1%—negligible sensitivity to acceleration and vibration—wide temperature range from -65°F to +250°F—output 20 millivolts with 5-volt excitation—flush-type diaphragm as standard construction—stainless steel, corrosion-resistant construction—overload protection—high frequency response—variable-resistance types—calibration certificate with each pickup. Electrical principle is unbonded strain-gage windings connected in a four-arm bridge as the active element. Write for Bulletin CEC 1552-X2 and price list.

Pickup Type	Range	Dimensions
4-310 gage pressure pickup	5 to 250 PSI	0.5" diam. x 0.7"
4-311 gage pressure pickup	5 to 5,000 PSI	0.625" diam x 0.875"
4-312 absolute, differential, or gage pressure pickup	5 to 250 PSI	0.5" diam x 0.7"

Consolidated Engineering CORPORATION

300 North Sierra Madre Villa, Pasadena 15, California

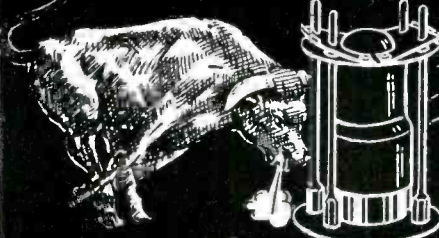

SHOCK PROOF

VACUUM TUBE RETAINERS

These retainers are used to secure Vacuum Tubes and to resist side motion of Vacuum Tubes used in radio equipment which is subject to shock and vibrations. These retainers meet the requirement of all JAN specifications. The insulated portion is made of a melamine base Fibre Glass Phenol which provides 300 volts insulation to ground and withstands a temperature of 350 F. The insulated plate can readily be fastened or released by hand.

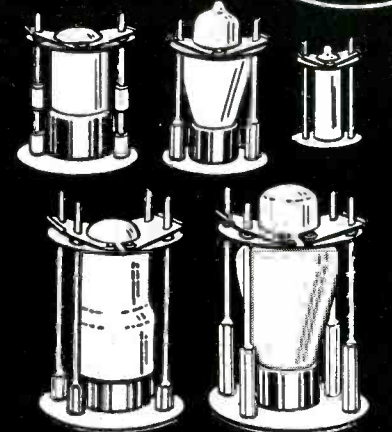

Available for envelope types T7, T8, MT8, T9, T12, ST12, T122DL, ST14, S14, ST16, T5½, T6½, MT-1C, ST19, T14, ST128CT-9.

Manufacturers of
Electronic Components

JAMES IPPOLITO & CO., INC.

401 CONCORD AVENUE, BRONX 54, N. Y.

536K Multimeter Kit \$12.90
Wired \$14.90
1000 ohms/volt

425K 5" Scope Kit \$44.95
Wired \$79.95

470K 7" Push-Pull Scope
KIT \$79.95. WIRED \$129.50.



YOU BUILD EICO KITS IN ONE EVENING- but they last a lifetime... and you save 50%

38 Kits and 42 Instruments — the Industry's most complete line of MATCHED TEST INSTRUMENTS

¼ - million EICO Instruments are now in use the world over! That's the proof of EICO's leadership in Value.

For latest precision engineering, finest components, smart professional appearance, lifetime performance and rock-bottom economy — see and compare the EICO line at your Jobber before you buy any higher-priced equipment! You'll agree with over 100,000 others that only EICO Kits and Instruments give you the industry's greatest values at lowest cost.



221K VTVM Kit \$25.95
Wired \$39.95



565K Multimeter Kit \$24.95
Wired \$29.95
20,000 ohms/volt



377K Sine & Square Wave Audio Gen. Kit \$32.95. Wired \$49.95



360K Sweep Gen. Kit \$34.95. Wired \$49.95



1050K Battery Elim. Kit \$29.95. Wired \$38.95



625K Tube Tester Kit \$24.95
Wired \$49.95

Write NOW for FREE latest Catalog E-11

EICO

Laboratory Precision at lowest cost

©1954

ELECTRONIC INSTRUMENT CO., Inc.
84 Withers Street, Brooklyn 11, N. Y.

SOME STRAIGHT TALK TO ELECTRONIC ENGINEERS



William W. Wood, Jr.
Vice Pres. — Engineering

Here at Link Aviation, we're making substantial contributions to the field of automation. Quite possibly, there's a spot for you in our group of Senior Electronic Engineers — if you can assume full responsibility for completing electronic component or systems design problems — or can direct and coordinate the technical activities of other persons assigned to assist you.

To qualify, you must have proven ability in at least one of the following areas:

ANALOG COMPUTATION
SERVO SYSTEMS
PULSE CIRCUITRY
DIGITAL COMPUTATION

Imaginative management provides an ideal working environment for our creative engineers — and hand in hand with this progressive spirit go maximum employee benefits.

Write to
William W. Wood, Jr.
Vice President — Engineering,
if you'd like to set up an exploratory interview.



LINK AVIATION
BINGHAMTON - NEW YORK

A SUBSIDIARY OF GENERAL PRECISION EQUIPMENT CORPORATION

Manufacturers of the world famous Link Flight Simulators • computer-actuated training devices • helicopter trainers • servomechanisms • graphic recorders • friction and over-drive clutches • ratio voltmeters • precision potentiometers • spur gear differentials • index dials • phase angle meters • radar simulators and other classified products.

development work. Dean E. Woolbridge, president of the corporation, states that the new division is being set up because of the large growth of guided missile activities of the company.

Dr. Dunn, as director of the jet propulsion laboratory since 1947, has been in charge of the recently completed development program for the Corporal, the Army's guided missile.

Sprague To Head U. S. Parts Group

JULIAN K. SPRAGUE, president of Sprague Electric, has been named chairman of the Advisory Group on Electronic Parts of the Defense Department.

Serving with Sprague on the group will be Leslie J. Woods, vice-president in charge of engineering at Philco; Estill I. Green, director of transmission apparatus development at Bell-Lab; A. W. Rogers of the Spier Signal Laboratory at Fort Monmouth, N. J., Edward Mroz of the electronics division of the U. S. Navy Bureau of Ships and Amos Petit of the U. S. Air Force Wright Development Center at Dayton, Ohio.

Sprague has been in the electronic parts business since 1926 and has served from time to time on various committees of the old War Production Board and of the military establishment. He is at present a member of the steering committee of the Technical Advisory Panel on Electronics of the Dept. of Defense. Woods and Green are also members of the Panel.

The Advisory Group is being organized on a permanent basis with a full time secretariat to perform many of the functions of the panel on components of the former Research and Development Board of the Department of Defense. Under Sprague's direction, the new group will be responsible for achieving a sound, coordinated, and integrated research and development program in the field of electronic parts and materials.

The Advisory Group will continuously survey research and development activities in the fields of electronic parts and materials, both in commercial organizations and in



SPADE BOLTS

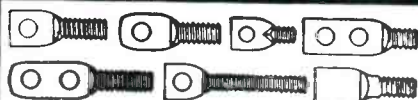

Specialists in designing and manufacturing All-Purpose Fasteners and Mounting Lugs. Tooled to produce over 1,000 sizes and styles of Spade Bolts in any finish, material or quantity.

OTHER PRODUCTS

Simplex WIRE STRIPPERS & CUTTERS

- TOOLS AND DIES
- METAL STAMPINGS
- WIRE SPECIALTIES
- REPLACEMENT TIPS for Electric Soldering Irons

Send samples or specifications for quotations. Descriptive bulletin on request.

WENCO MANUFACTURING CO.
1133 W. Hubbard St., Chicago 22, Ill., U.S.A.

Pre-assembled partitions...made to exact specifications...for manufacturers of Radio, Electrical and Electronic components and allied products.

P P P Partitions for Protective Packaging

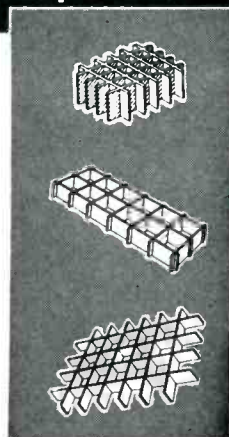

WRITE, PHONE or WIRE for QUOTATIONS on YOUR REQUIREMENTS

peter partition corp.

Manufacturers of Cardboard Partitions

19-21 HEYWARD ST. BROOKLYN 11, N. Y.
Telephone: TRIangle 5-4033

BE SAFE WITH

Q-max A-27

LOW-LOSS LACQUER & CEMENT

- Q-Max is widely accepted as the standard for R-F circuit components because it is chemically engineered for this sole purpose.
- Q-Max provides a clear, practically loss-free covering, penetrates deeply, seals out moisture, imparts rigidity and promotes electrical stability.
- Q-Max is easy to apply, dries quickly and adheres to practically all materials. It is useful over a wide temperature range and serves as a mild flux on tinned surfaces.
- Q-Max is an ideal impregnant for "high" Q coils. Coil "Q" remains nearly constant from wet application to dry finish. In 1, 5 and 55 gallon containers.

Communication
Products Company, Inc.

MARLBORO, NEW JERSEY
(MONMOUTH COUNTY)
Telephone: FReehold 8-1880



MINIATURE PULSE TRANSFORMERS

The wealth of experience that Acme Electric engineers have gained in more than 37 years of transformer designing, becomes apparent in the performance and high quality construction of this line of Miniature Pulse Transformers. Send us your specifications.

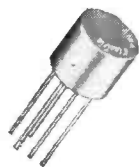

ACME ELECTRIC CORPORATION
1375 WEST JEFFERSON BLVD. • LOS ANGELES, CALIF.

WRITE FOR
CATALOG
PT-301

Acme  Electric
TRANSFORMERS

Corrections of Product Listings for the 1954-1955 Electronics Buyers' Guide

The additions and corrections listed below apply to the current issue of the GUIDE.

PETER PARTITION CORP.

19-21 Heyward St.
Brooklyn 11, N. Y.

ADVERTISING PAGE 667

PACKAGING MATERIALS
not PACKAGING—Electronic
Equipment

ELECTRO-SEAL CORP.

946 North Ave.
Des Plaines, Ill.

ADVERTISING PAGE 206

(Addition as follows:)

SEALING SERVICE—Hermetic

ROCKBAR CORP.

211 E. 37th St.
New York 16, N. Y.

ADVERTISING PAGE 488

(Additions as follows:)

MULTIPLIERS—Meter
POTENTIOMETERS
RESISTORS

4. High Megohm

5. High Voltage

13. 4 to 35 Watts

RESISTORS—Deposited
Carbon



BOLD FACING AND ADVERTISING PAGE NUMBER ARE OMITTED IN THE FOLLOWING:

P M INDUSTRIES, INC.

Stamford, Conn.

ADVERTISING PAGE 452

ANTENNA PEDESTALS—Gear Driven
Radar

BRUSHES—Metal-Graphite

CONTROLS—Servo

HARNESSES—Wire

HOUSINGS—Antenna

MOUNTS—Antenna

PLATING—Metal on Plastic

RINGS—Collector

SLIP RING ASSEMBLIES

SWITCHES—Rotary and Band Change

SWITCHES—Telemetering

RUTHERFORD ELECTRONICS CO.

3737 S. Robertson Blvd.
Culver City, Calif.

ADVERTISING PAGE 573

CALIBRATORS—Radar Range

CALIBRATORS—Sweep

GENERATORS—ELECTRONIC

Pulse

Square Wave

STANDARDS—Laboratory Time

TIMERS—Electronic

SOUTHERN ELECTRONICS CO

239 W. Orange Grove Ave.
Burbank, Calif.

ADVERTISING PAGE 528

CAPACITORS—

2. Decade

4. Energy Storage

9. High Voltage

13. Plastic Dielectric



In the following, the correct address should be:

ALLIED RADIO CORP.

100 N. Western Ave.
Chicago 80, Ill.

ADVERTISING PAGE 464

AMPLIFIERS—Audio Frequency

AMPLIFIERS—Power

DISTRIBUTORS LIST

MANUFACTURERS INDEX



ABC **electronics** ABP

BUYERS' GUIDE

A MCGRAW-HILL PUBLICATION, 330 WEST 42nd ST. NEW YORK 36, N. Y.

laboratories of the Dept. of Defense. It will act as a clearing house for collating and distributing pertinent commercial and military data on a need-to-know basis. It will also consider measures to improve the reliability of electronic parts and materials used in the expanding field of military electronics.

Responsibilities of the group include the setting of major goals for research and development programs, components and a continuing review of current and proposed projects to insure adequacy and proper balance among various technical areas. The group will also promote effective interchange of information among all interested parties and will coordinate development work of various groups active in the component field, both in government and in private industry.

The Advisory Group will also serve as advisor to the assistant secretary of defense for research and development concerning funds and facilities needed to carry on developmental work on electronic parts and materials.



New Haven Clock Appoints Henrich

WILLIAM H. HENRICH has been named assistant to the general manager in charge of production and sales of the Condenser Products Co., a division of New Haven Clock and Watch Co.

Henrich formerly was chief development engineer for Sorensen & Co. of Stamford, Conn. and prior to that was an electronic engineer

IMMEDIATE DELIVERY!

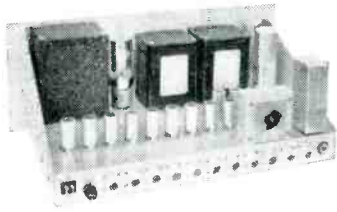

S178A

ANTENNA MULTICOUPLER

Operates 10 Receivers from One Antenna

- Antenna Impedance 50-1000 ohms
- Frequency Range 2-20 Mc
- Rack Mounting
- Used and Approved by many Government Agencies
- \$308.00 FOB Washington, D. C.



SCHUTTIG and CO.
INCORPORATED
5005 Calvert Road
College Park, Md.

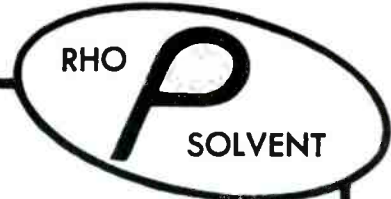

NEW!

FOR
ENCAPSULATING RESINS
EPOXIES—POLYESTERS

- Permits recovery of valuable cores, sub-min tubes, etc.
- Non-corrosive chemical action cleans parts like new.
- Non-inflammable—may be used safely anywhere.
- Effective on most encapsulating resins now used.
- Requires minimum of labor and equipment.
- Cleans printed circuits, molds, and tools.
- Write for free literature now.

The Rho Company

Box 101 — Mar Vista,
California

PLASTIC DIALS



Printloid has been supplying dials to the leaders in the electronic industry for 18 years. Printing, die cutting, forming and machining.

COMPLETE PLASTIC PRODUCTION FACILITIES . . . ALL UNDER ONE ROOF



Including machining of Nylon, Kel-F, and Teflon. Specializing in dials, dial windows, and printed circuits.

All custom work to your specification.

Write for brochure



Dept E 93 Mercer St.
New York 12, New York

TAKE NO CHANCES WITH VITAL EQUIPMENT... *Specify*

SERIES 6918 or 6924

RACKS
by **PAR-METAL**

18½" or 24" DEEP, for 19" WIDE PANELS

- Panel Spaces: 61¼", 70", or 77" high.
- Finished in Prime Coat, Black Wrinkle, Grey Lacquer, Grey Wrinkle.
- Series 6918 or 6924 Racks may be used in "rows" or "gangs," as corner trims are removable from front of cabinet.
- Standard shelves and roller trucks are manufactured by us for use with these Racks.

THESE RACKS ARE MODERATELY PRICED and AVAILABLE FOR SHIPMENT FROM STOCK

Planning an electronic product? Consult Par-Metal for

**RACKS • CABINETS
CHASSIS • PANELS**

Remember, Par-Metal equipment is made by electronic specialists, not just a sheet metal shop.

Made by
Electronic Specialists!



WRITE FOR CATALOG!

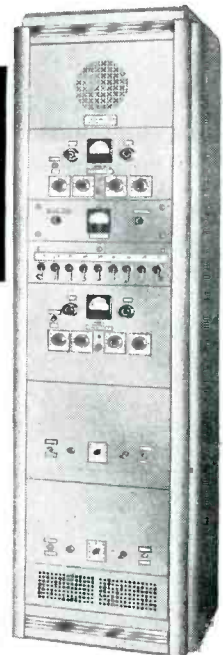

Our P-6924 Rack as used by Gat-Tronics, Inc., Reading, Pa.

PAR-METAL
PRODUCTS CORPORATION

32-62 — 49th ST., LONG ISLAND CITY 3, N. Y.
Tel.: Astoria 8-8905
Export Dept.: Rocke International Corp.
13 East 40 Street, New York 16, N. Y.

MEECO
Instruments



SWEEPMASTER Sweep Frequency Generators give you these outstanding advantages . . .

- Frequency Marker with an accuracy independent of Sweep Width. Inserted after external detection, it eliminates erroneous interpretation—eliminates possibility of undesirable transient distortion or limiting actions. The Marker is adjustable in amplitude and after adjustment remains independent of other controls.
- An attenuator whose performance is free of Frequency, assuring you that the Output Envelope is the same as that indicated by the Internal Monitor.
- A simple switching operation to permit examination of either Envelope of the Swept Frequency Signal.
- Durable, compact, lightweight Output and Detector Probes, either of which can be detached easily and replaced by cables having standard connectors.

SPECIFICATIONS

MODEL	CENTER FREQUENCY	RF OUTPUT 50 ohm * TERMINATION	SWEEPWIDTH CONTINUOUS ADJUSTMENT	FREQUENCY MARKER
SM I	100 KC to 11 MC	1 volt RMS	150 KC to 14 MC	100 KC to 11 MC
SM II	500 KC to 50 MC	0.2 volt RMS	150 KC to 20 MC	500 KC to 50 MC
SM III	500 KC to 75 MC	0.1 volt RMS	150 KC to 20 MC	500 KC to 75 MC

FLATNESS: LESS than 1 DB variation over maximum sweepwidth range.
FREQUENCY MARKER: Engraved calibration accurate to $\pm 2\%$.

* 75 ohm available when specified

HORIZONTAL DEFLECTION: A 60 cps sine wave for application to horizontal input of oscilloscope is supplied.

BLANKING: The RF signal may be operated

continuously or blanked out for $\frac{1}{2}$ of each 60 cycle period.

EXTERNAL DETECTOR: Blocking capacitor of 400 volt breakdown capacity.

Write for complete information

MANUFACTURERS ENGINEERING & EQUIPMENT CORP.
15 Sunset Lane • Hatboro, Pa.

for the Laboratory of Advanced Research of Remington Rand. He has been a lecturer in physics at the University of Bridgeport, Conn. and holds patents on electronic controlled high speed printing mechanisms and voltage regulators.

Eisenhower Dedicates New NBS Labs

FIVE HUNDRED engineers and scientists participated in technical meetings that preceded the dedication by President Eisenhower of the National Bureau of Standards new laboratories at Boulder, Colo., near the University of Colorado.

The Boulder laboratories, 30 mi. northwest of Denver, comprise the second principal campus of NBS. They supplement the research and development facilities in Washington, D. C. The Boulder campus includes the Bureau's Central Radio Propagation Laboratory and the Cryogenic Engineering Laboratory, operated jointly by the Bureau and the Atomic Energy Commission.

Laboratory buildings are located on a 217-acre site in the foothills of the Rocky Mountains. The Central Radio Propagation Laboratory (CRPL) is the nation's chief research enterprise studying troposphere and ionosphere as media for the propagation of radio waves. It also develops and maintains the national primary standards for radio frequency measurements.

The CRPL observations, services and research bear on radio communications from long waves to microwaves.

The Cryogenic Engineering laboratory is developing and testing equipment for use at temperatures near absolute zero. The Bureau said "liquid hydrogen and liquid nitrogen have been produced in unusually large quantities since March 1952 and this work is supported by a vigorous program of research in the fields of low temperature physics and engineering."

The Central Radio Propagation Laboratory is housed in the main building that includes the library, auditorium, lecture halls and administrative offices. This structure, completed this year, has a central unit that tapers from four stories

Priced Right!

WIRE FORMS

& Metal Stampings

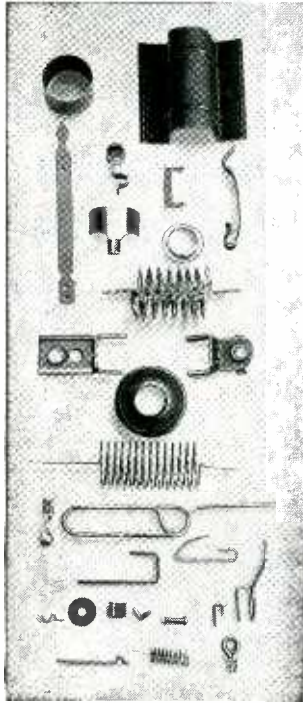

High-speed, quality production with custom-made precision. Wire formed to any shape for every need.

WIRE FORM

.0015 to .125 diameter

STRAIGHTENING CUTTING

Perfect straight lengths to 12 ft.

.0015 to .125 diameter

SMALL METAL STAMPINGS

.0025 to .035 thickness

.062 to 3 inches wide.

Specializing in Production of Parts for Electronic, Cathode Ray Tubes & Transistors

Write for illustrated folder.
Send Blueprints or Samples for Estimate.



ART WIRE and STAMPING

COMPANY
1 BOYDEN PLACE
NEWARK, 2, N. J.

Amazingly Versatile crystal mike

TURNER MODEL 80

Intercom

On the matching Turner C-4 Stand—ideal mike arrangement for intercom operation in industry, radio and TV stations. Is conveniently small—only 4½" without stand.



Model 80 \$15.95
C-4 Stand 5.75

Built-in Applications



Model 81 — same specs as the 80 only smaller in size. For built-ins, sound reinforcers, dictograph and detective work. Has a PC1M Amphenol connector.

Model 81 \$13.95

Demonstrations

Model 82-3H—factory-adapted for use on Turner's famous "Third Hand." Ideal for window demonstrations, carnival and sideshow work, switchboard operators, wherever hands need to be free. Holds microphone close to mouth for excellent volume without feedback.

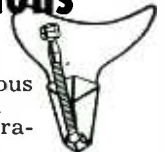

Model 82-3H Complete with "Third Hand" \$22.75

Hand Held

(Model 83) Perfectly balanced, hide it in your palm or pocket . . . handle only 4" long. For paging systems, parking lots, recording, dictating, etc.



Model 83 \$15.95

Whichever version of the Turner 80 you require, you can count on superior voice and music reproduction. Response is 80 to 7000 cps, level is about -54 db. The high quality Bimorph moisture sealed crystal is blast and mechanical shock proofed.

Send this coupon for full information

The TURNER Company

905 17th street N.E., Cedar Rapids, Iowa

Gentlemen: Please send me complete information on the Turner Model 80

Model 81 Model 82-3H

Model 83

Name

Address

City

State

MEASURE VSWR AND RF POWER

0.5 to 225 MCS 0 to 1 KW

MicroMatch

Compact, sensitive and accurate, the MicroMatch 260 Series monitors both incident and reflected power without the necessity of removing the coupler or reversing its connections. Three models of this equipment are available.



MODEL 263 Laboratory type complete coupler and indicator. Coupler equipped with N connectors. Indicator provided with 3 scales calibrated in watts, 0-10, 100, 1000. \$85.00

MODEL 261 Coupler (only) similar to Model 263 coupler but with 83-1R Connectors, complete instructions to build #262 Indicator included. \$22.50

MODEL 262 Indicator (only), provides relative power measurements when used with #261 coupler. \$14.50



M.C. JONES ELECTRONICS CO. Inc.
BRISTOL, CONNECTICUT

Leading a brand new line...

1000°
OF CALIBRATED BANDSPREAD!

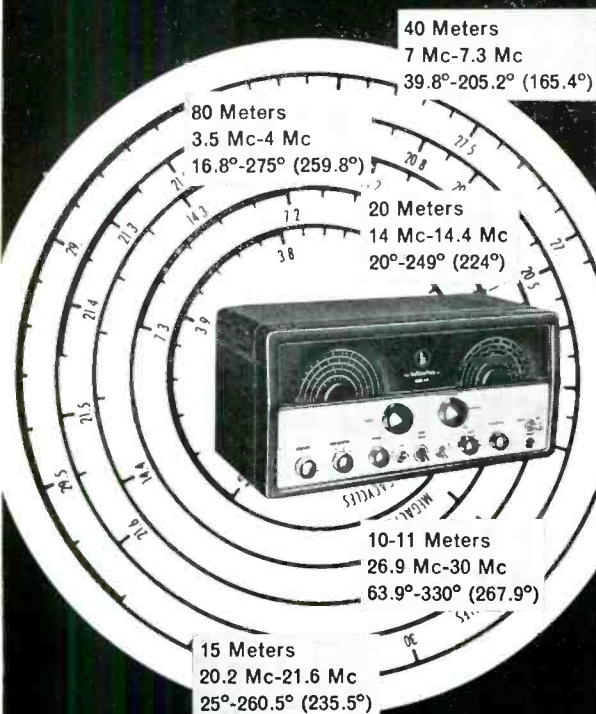

MODEL S85

S-85 Receiver (AC)
S-86 Receiver (AC-DC)
105/125 V. 50/60 cycle
Either \$119.95

We here at Hallicrafters are proud of our new communications line, especially the new S-85 receiver with over 1000° of calibrated bandsread. Broadcast band 540-1680 Kc and three short-wave bands 1680 Kc—34 Mc on large easy to read dial. Separate bandsread tuning condenser and built-in speaker. Seven tubes plus rectifier. Coupon below brings complete specifications.

Used by 33 governments,

Sold in 89 countries.

hallicrafters
Chicago 24, Illinois



MAIL THIS COUPON

FREE World-wide time converter
Specification sheet S-85(S-86)
 S-95(S-94) S-38D

Name _____
Address _____
City _____ Zone _____ State _____
 Ham (call letters _____) Listener
Occupation _____

to one story on the sloping ground. Two pairs of one-story wings extend outward at ground level. There are 170,000 sq ft of working area. An additional pair of wings are planned for later expansion.

Two principal buildings of the Cryogenic Engineering Laboratory were completed in 1952. One is for liquefaction and the other is for all-purpose experimental laboratories.

There are a half-dozen isolated sites within 20 miles of Boulder where testing and special radio experiments are carried out with a minimum of man-made interference.

The Boulder laboratories are headquarters for a dozen field stations extending from Guam to Alaska and Greenland where NBS scientists are carrying out scientific services and special experiments.

Lear Expands Plant Facilities



Lear's new Santa Monica plant

LEAR, manufacturers of electrical and electronic devices for aircraft instrumentation, has completed a \$350,000 building in Santa Monica, Calif., part of a long-range expansion program. The 52,000 sq ft facility comprising offices, manufacturing, and laboratories, houses LearCal and research and development divisions. It brings Lear's total plant space to 363,400 sq ft.

Lear also plans a 40,000 sq ft hangar at Santa Monica Airport for its aircraft service division and a new building at Kent County Airport, Michigan for its Grand Rapids division.

K. M. Miller has been named assistant general manager of the research and development division of Lear. Miller has been with Lear

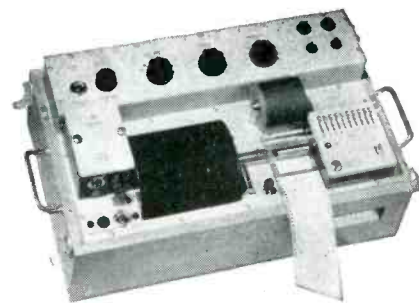

FOR HIGH SPEED RECORDING OF VOLTAGE LEVELS

LEVEL RECORDER, MODEL BL-2304

With this precision instrument you can make high speed recordings of signal level variations. The level of A.C. voltage from 20 to 200,000 cycles per second is accurately recorded. It simplifies recording frequency response curves for microphones, loudspeakers, filters, amplifiers, hearing aids, and other audio equipment. It is useful in recording reverberation decay curves, noise levels, and electrical voltage levels.

With this recorder you have a choice of nine recording speeds and ten chart speeds. Recording accuracy is within 1%. Calibration is made quickly with an internal standard signal.

For complete specifications on this and other Bruel & Kjaer instruments, write Brush Electronics Company, Dept. K-11, 3405 Perkins Avenue, Cleveland 14, Ohio.

ACOUSTIC AND TEST INSTRUMENTS

Bruel & Kjaer instruments, world famous for their precision and workmanship, are distributed exclusively in the United States and Canada by Brush Electronics Company.

- BL-1012 Beat Frequency Oscillator
- BL-1502 Deviation Test Bridge
- BL-1604 Integration Network for Vibration Pickup BL-4304
- BL-4304 Vibration Pickup
- BL-2002 Heterodyne Voltmeter
- BL-2105 Frequency Analyzer
- BL-2109 Audio Frequency Spectrometer
- BL-2304 Level Recorder
- BL-2423 Megohmmeter and D. C. Voltmeter
- BL-3423 Megohmmeter High Tension Accessory
- BL-4002 Standing Wave Apparatus
- BL-4111 Condenser Microphone
- BL-4120 Microphone Calibration Apparatus and Accessory
- BL-4708 Automatic Frequency Response Tracer

BRUSH ELECTRONICS COMPANY

formerly The Brush Development Company. Brush Electronics Company is an operating unit of Clevite Corporation.



Want more information? Use post card on last page.

November, 1954 — ELECTRONICS



PYRAMID



① Glass-sealed hermetically sealed sub-miniature paper tubulars. Manufactured to the highest commercial standards and engineered to the exacting performance requirements of Military Specification MIL-C-25-A.

② Oil paper capacitors of finest possible commercial quality, meeting MIL-C-25A and Jan-C-25 standards of precision.

③ Electrolytics of superior commercial performance characteristics, meeting Jan-C-62.

Write for Catalog J-8 for further detailed information. Or call your local Pyramid Sales Representative or write to:

PYRAMID ELECTRIC COMPANY
Dept. 123, 1445 North Hudson Blvd., North Bergen, New Jersey

JELLIFF

ALLOY 800 RESISTANCE WIRE

for miniaturized precision-instrument components

the ideal resistance wire for

fixed and variable resistors of high ohmage — resistance boxes and bridges — voltmeter and wattmeter multipliers — and other miniature wire-wound units.

Where space is at a premium and performance is a "must" — these outstanding qualities of Jelliff Alloy 800 will assure that your products conform to the tightest specs.

High resistivity, 800 ohms/cm — Low Temperature Coefficient, ± 20 ppm per $^{\circ}\text{C}$ — Non-Magnetic — Highly Stable Electrically and Mechanically — Diameters from 0.0009" to 0.0056" — Bare, enameled or oxidized, or insulated with silk, Nylon or cotton — Solders and Winds easily.



For Complete Data Address
Department 17

THE C. O. JELLIFF

MANUFACTURING CORP. SOUTHPORT, CONN.

Over 85% of the torque wrenches used in industry are

STURTEVANT

TORQUE WRENCHES

Read by Sight, Sound or Feel.

- Permanently Accurate
- Practically Indestructible
- Faster—Easier to use
- Automatic Release
- All Capacities

in inch grams...inch ounces...inch pounds...foot pounds
(All sizes from 0-6000 ft. lbs.)

Every manufacturer, design and production man should have this valuable data. Sent upon request.

PA **STURTEVANT CO**
ADDISON, ILLINOIS

ANALOG-DIGITAL CONVERTER

**NO AMBIGUITY
FAST RESPONSE**

A shaft position to digital conversion component for data handling systems and digital computers. Multi-brush pick-offs eliminate ambiguity. Adapted to be used in digital to analog conversion systems and closed loop systems. Standard unit handles 13 digits; 7, 17, and 19 digit models also available. Multi-channel converters designed to be time-shared with one scan network. Custom models may be ordered to your specifications.

SPECIFICATIONS:
Dia. 2 in. Wt. 8 oz.
Length: 2-3/4 to 5", according to model
Torque: Under 0.2 oz. in.
Meets applicable military specifications

Write for catalog information.

Computers and Controls

LIBRASCOPE

A SUBSIDIARY OF GENERAL PRECISION EQUIPMENT CORPORATION
808 WESTERN AVE. • GLENDALE • CALIF.

for eight years, previously holding the position of manager of engineering of the LearCal division.

The research and development division of Lear now comprises 125 engineers working in laboratories housed in the new Lear plant in Santa Monica.

RCA Promotes Smith, Forms Color Section

Douglas Y. Smith was elected vice-president and general manager of the tube division of RCA. Smith had been general marketing manager of the division since October, 1953.

Joining the firm in 1930, Smith has held positions of increasing responsibility in engineering and sales. He has served as manager of RCA tube plants in Harrison, N. J., and Lancaster, Pa., tube merchandise manager and manager of tube sales operations.

A special color kinescope operations department, devoted exclusively to the engineering and manufacturing of color television picture tubes, has been established by the company.

Harry R. Seelen, associated with RCA tube engineering and manufacturing for nearly 25 years, has been appointed manager of the new department which will have its headquarters at the company plant in Lancaster, Pa.

For the past 10 months, Seelen has been engineering manager of the cathode ray and power tube operations department, which incorporated color tube engineering and manufacturing. That department, under the management of C. E. Burnett, will continue to have responsibility for RCA power tubes, oscilloscope tubes, phototubes, microwave and pick-up tubes, television camera tubes, and black-and-white kinescopes, which are produced at Lancaster and at the Marion, Indiana, plant.

Seelen has been associated with the development of many RCA tube types, including acorns, miniatures, phototubes, and cathode-ray tubes. He joined the company as an engineer at the Harrison, N. J., plant in 1930. He has held numerous executive engineering posts,



★ ULTRA LOW capacitance & attenuation

TYPE	$\mu\text{mf}/\text{ft}$	IMPED. Ω	O.D.
C1	7.3	150	.36'
C11	6.3	173	.36'
C2	6.3	171	.44'
C22	5.5	184	.44'
C3	5.4	197	.64'
C33	4.8	220	.64'
C4	4.6	229	1.03'
C44	4.1	252	1.03'

WE ARE SPECIALLY ORGANIZED TO HANDLE DIRECT ORDERS OR ENQUIRIES FROM OVERSEAS
SPOT DELIVERIES FOR U.S.
BILLED IN DOLLARS—SETTLEMENT BY YOUR CHECK
CABLE OR AIRMAIL TODAY



NEW MX and SM SUBMINIATURE CONNECTORS
Constant 50 Ω -63 Ω -70 Ω impedances

TRANSRADIO LTD. 138A Cromwell Rd. London SW7 ENGLAND CABLES: TRANSRAD, LONDON

ANOTHER Rutherford PRECISION TIMING INSTRUMENT



MODEL (A-5) TIME DELAY GENERATOR

An instrument of small size which provides accurate and variable time delays from 1 μs to 1,000 μs in three ranges.

- low jitter (.008%) • linear scales • highly stabilized power supplies • small repetition rate effects • blocking oscillator output • trigger type input • separate calibration adjustments for each range.

Get complete data : our Bulletin E-A-5

Other Rutherford precision Time Delay Generators { Model A-2 (.8 μs to 100,000 μs): Bulletin E-A-2
Model A-4 (10 μs to 10 secs): Bulletin E-A-4

Rutherford ELECTRONICS CO. Telephone: TEXAS 0-4362
3707 S. ROBERTSON BLVD. CULVER CITY, CALIFORNIA

RELAYS

POWER AND SENSITIVE TYPES

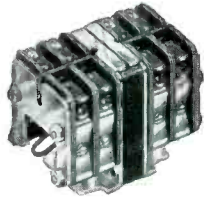

COILS • SOLENOIDS



WOUND
TO YOUR
SPECIFICATIONS

LIGHT
AND MINIATURE
TYPES



Send us your prints
and specifications for
prompt quotations.
Literature available
on request.

THE FIVE STAR COMPANY

10 WEST MAIN STREET
PLANTSVILLE, CONN.



1 MFD. 2" x 2" x 1"



0.5 MFD. 1 3/4" x 1 1/4" x 1 1/8"



0.25 MFD. 1 3/4" x 1 1/4" x 7/8"



0.1 MFD. 1 3/4" x 1" x 7/8"



0.05 MFD. 1 3/4" x 7/8" x 1 1/16"

ULTRA-HIGH PRECISION POLYSTYRENE CAPACITORS

as low as 0.1%
tolerance in most values

CAPACITANCE AVAILABLE—0.05 to 10.0 MFD.

VOLTAGE AVAILABLE—100 to 400 VDC

INSULATION RESISTANCE—10⁹ MEG./MFD.

TEMP. COEFF.—100 P.P.M. per °C (—20°
to 140°F)

DIELECTRIC ABSORB.—.015%

DISSIPATION—.0002

Special Values to
Close Tolerances—Our Specialty

Write for new, complete catalog to Dept. IA

SOUTHERN ELECTRONICS CORP.

239 W. Orange Grove Avenue, Burbank, Calif.

for the ELECTRONIC
INDUSTRIES

Quality

Ribbons

STRIPS

**MOLYBDENUM
TUNGSTEN
TANTALUM
FORMED PIECES**

•
*Your Special
Metals Rolled
to Thin Sizes &
Close Tolerances*

•
YOUR INQUIRIES WILL
RECEIVE PROMPT ATTENTION

H. CROSS CO.

15 BEEKMAN ST., N. Y. 38, N. Y.
WRth 2-2044 and COrtlandt 7-0470



"HOW MEYERCORD
SERVES INDUSTRY"
No. 2 of a Series

MEYERCORD Nameplate DECALS Cut MANUFACTURING EXPENSE

Your brand name and trademark are powerful sales weapons in today's competitive market. Prominently and attractively displayed on your products, they're an immediate identification of high quality to the consumer.

Meyercord Nameplate Decals offer you a better way to identify your product most effectively while cutting labor, time and material costs. There's a Meyercord Decal for every commercial surface, every temperature condition—in fact wherever product branding, instructions or identification are in order.

Meyercord Nameplate Decals can be applied with speed and ease on your present production line . . . whether your run is short or long. Let an expert Meyercord Decal Engineer unfold cost-cutting proof and make recommendations all without obligation.

**FREE! "Mark-It" Manual
of Decal Nameplates**

Send today, on your company letterhead, for this valuable full-color guide to every industrial problem in marking, identification, instruction, and information.

THE MEYERCORD CO.

World's Largest Decalomania Manufacturers

Dept. B-303
5323 WEST LAKE ST.
CHICAGO 44, ILLINOIS

YOU CAN'T SHAKE 'EM LOOSE!



BIRTCHER TUBE CLAMPS



BIRTCHER TYPE 22 TUBE CLAMP

...will securely hold tubes throughout the entire range of JAN base tolerances.

Even *unusual* jarring or vibration will not shake a tube loose when secured by a BIRTCHER CLAMP! Made of *stainless steel*, BIRTCHER CLAMPS are wear-and-weather resistant, made for all types of tubes: glass or metal—chassis or sub-chassis mounted.

There's a Birtcher Clamp For Every Purpose

CATALOG AND SAMPLES SENT BY RETURN MAIL

Send this coupon today

The BIRTCHER CORPORATION

4371 Valley Blvd.
Los Angeles 32, California

Dept. E-11-4



Please send Bulletin which describes and illustrates Tube Clamps in detail.

Company.....
Attention of.....
City..... State.....

Want more information? Use post card on last page.

including manager of engineering services, Lancaster plant, 1943; chief engineer of the Lancaster plant, 1949 and engineering manager, cathode ray and power tube operations department since 1953.

Arnold E. Linton has been appointed manager of the RCA tube manufacturing plant at Woodbridge, N. J.

Linton had been manufacturing manager at the plant since November, 1952. The Woodbridge plant produces RCA glass and special-purpose electron tubes for use in home entertainment, communications and industrial electronic equipment.

Linton joined RCA in 1934 as a production supervisor in the Harrison, N. J., plant. From June, 1950, until his transfer in November, 1952 to the new Woodbridge installation, he was manufacturing supervisor for glass and special-purpose tubes in Harrison, N. J.



Beckman Sets Service, Names Ortino

AN ENGINEERING service for the design, construction and installation of industrial recording and control systems has been established by the Berkeley division of Beckman Instruments in Richmond, California.

Headed by Wallace E. Rianda, an engineering group has been drawn from the organization's research and development, applications engineering, production, and service departments.

Leonard J. Ortino has joined the special products department of the

let Williams help you apply



to the manufacture of your

FERRITES

You'll be well repaid by getting the facts on a special group of Pure Ferric Oxides, developed by Williams especially for use in the manufacture of ferrites.

Williams Ferric Oxides analyze better than 99% Fe₂O₃. They contain a minimum of impurities. They are available in a broad range of particle sizes and shapes. Among them, we're certain you'll find one that's "just right" for your requirements. The proper application of Ferric Oxides to the manufacture of Ferrites is our specialty.

Tell us your requirements . . . we'll gladly send samples for test. Chances are good that our Ferric Oxide "Know How" can save you considerable time and money. Address Dept. 25, C. K. Williams & Co., Easton, Pa.



P.S. We also produce IRN Magnetic Iron powders for the Electronic Core Industry, the Magnetic Tape Recording Industry and others. Write for complete technical information.

Want more information? Use post card on last page.

November, 1954 — ELECTRONICS

2 Fungus Resistant NYLON FLAT-BRAIDED LACING TAPES

WAX FINISH

GUDELACE*

Easy on Hands
Easy to tie

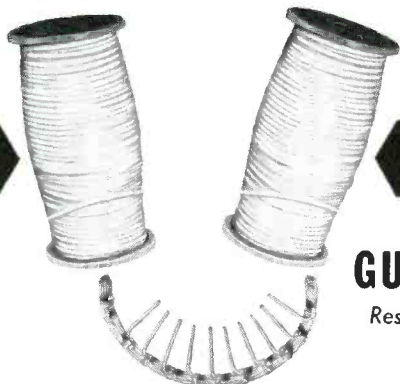

WAX FREE

**All-Nylon
GUDE-NYLACE***

Resists High Temperature

Both tapes save time and money — and cut down rejects. Neither will bite through insulation. Gudelace ties easier, tighter and cuts down

knot slippage. Gude-Nylace is the perfect product where the use of wax is not indicated.

*Patent Applied For

WRITE FOR COMPLETE INFORMATION AND A FREE TRIAL SUPPLY TODAY!

GUDEBROD BROS. SILK CO., INC.

ELECTRONICS DIVISION
225 W. 34th Street, New York 1, N.Y.

EXECUTIVE OFFICES
12 S. 12th Street, Philadelphia 7, Pa.

Have you seen
CORNING'S NEW PRICES
on Film-Type Resistors?

Stycast Hi-k

Plastic Rod and Sheet Stock
for RF and Microwave.

Any Dielectric Constant **3 through 20**

DISSIPATION FACTOR below 0.001
TEMPERATURE RANGE -75°C to $+125^{\circ}\text{C}$
MACHINEABILITY Excellent



Emerson & Cuming, Inc.
PLASTICS for ELECTRONICS

869E Washington Street, Canton, Mass.

Write for More
Information on
Other Stycast
Plastics for Electronics

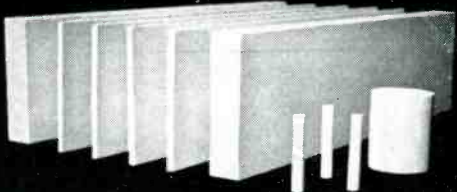

**COMPACT
DEPENDABLE
EFFICIENT** *Rotary Power*
by **Carter**

THE NEW
Custom

DC-AC CONVERTER

These latest of all Carter DC to AC Converters are specially engineered for professional and commercial applications requiring a high capacity source of 60 cycle AC from a DC power supply. Operates from storage batteries, or from DC line voltage. Three "Custom" models, delivering 300, 400, or 500 watts 115 or 220 V. AC. Wide range of input voltage, 12, 24, 32, 64, 110 or 230 V. DC. Unequaled capacity for operating professional recording, sound movie equipment and large screen TV receivers. Available with or without manual frequency control feature.

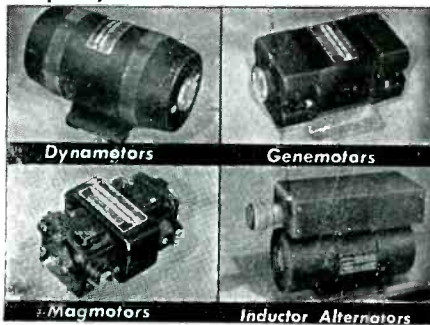

Dynamotors Genemotors
Magmotors Inductor Alternators

MAIL COUPON FOR CATALOG

Carter Rotary Power Supplies are made in a wide variety of types and capacities for communications, laboratory and industrial applications. Used in aircraft, marine, and mobile radio, geophysical instruments, ignition, timing, etc. MAIL COUPON NOW for complete Dynamotor and Converter Catalogs, with specifications and performance charts on the complete line.

Carter MOTOR CO.
2646 N. Maplewood Ave.
Chicago 47

Carter Motor Co.
2646 N. Maplewood Ave., Chicago 47
Please send new catalogs containing complete information on Carter "Custom" Converters and other Rotary Power Supplies.

Name _____
Address _____
City _____ State _____

For PILOT LIGHTS

CONSULT

DIALCO

Your product benefits 3 ways from the use of a DIALCO Pilot Light:

Enhanced appearance: The glow of light and sparkle of a lens add colorful visual attraction.

Greater safety: A timely warning flashed by a pilot light can prevent damage to equipment.

Added service: Discs inserted behind lenses can be used to deliver specific messages, such as "FUEL LOW", "ON", "OFF", etc.

Let the Dialco engineering department assist you in selecting the right lamp and the most suitable pilot light for your needs.

Dialco offers the complete line of pilot lights, from sub-miniature types to giant units with 1½" lenses.

Every assembly is available complete with lamp.

SAMPLES ON REQUEST AT ONCE — NO CHARGE

Illustrations are approx. 70% actual size
 (A) No. 8-1930-111 sub-miniature pilot light... (B) No. 521308-991, with multi-vue cap... (C) No. 922210-111, dimmer type... (D) No. 47901 with light shield cap.

Write for Catalogues L-151, L-153, and L-154



Foremost Manufacturer of Pilot Lights

DIALIGHT CORPORATION

60 STEWART AVE. • BROOKLYN 37, N. Y.

HYACINTH 7-7600



PLANT AT BROOKLYN, N. Y.

PLANTS AND PEOPLE

(continued)

Beckman division of Beckman Instruments as chief mechanical engineer.

Ortino was with the elevator and special products divisions of Westinghouse for six years and for the past four years was project engineer with IBM at Poughkeepsie, N. Y. From 1944 to 1947 he served as fire control officer at the Army's Ordnance School at Aberdeen Proving Grounds, Md.

Ortino's efforts will be directed toward the development of new electromechanical systems.

Honeywell Buys Heiland, Retains Dean

HEILAND RESEARCH CORP. of Denver has been purchased by Minneapolis-Honeywell Regulator Co. The price was reported at more than \$1 million. Heiland, manufacturer of photoflash equipment and precision instruments, had a sales volume of nearly \$3 million for the year ended Jan. 31, 1953.

Paul B. Wishart, Honeywell president, said the Heiland plant in Denver would be operated as a new division of the corporation.

S. A. Keller, general manager of the firm's valve division in Philadelphia, will become general manager of the Denver division. A. W. Johnson, vice-president and general manager of Heiland, will remain as Keller's adviser.

The major part of Heiland's production is photoflash synchronizers and other photoflash equipment. It also makes instruments for geophysical exploration and for testing strain and vibration in aircraft and guided missiles.

In another action Athelstan Spilhaus, dean of the Institute of Technology at the University of Minnesota, was retained by Honeywell as a consultant in the fields of engineering and research.

Dr. Spilhaus will assist in the formulation of broad engineering and research policies aimed at the continued expansion of development work in the many branches of technology in which the firm is active.

Honeywell is intensifying its development work in transistor development, sonar and nuclear energy.

Dr. Spilhaus, who has been dean



STOP RF LEAKAGE

ON THE

DRAWING BOARD

... WHEN YOU DESIGN METEX ELECTRONIC WEATHERSTRIPPING INTO YOUR EQUIPMENT YOU GET ITS POSITIVE SHIELDING EFFECTIVENESS — AT MAXIMUM OVERALL ECONOMY

Plan now to take full advantage of *Metex Electronic Weatherstripping's* unusual effectiveness in shielding all types of electronic equipment. Because it is made of *knitted wire mesh*, *Metex Electronic Weatherstripping* is both conductive and resilient. It assures positive metal-to-metal contact between all mating surfaces. And being resilient it accommodates itself positively to surface inequalities.

In reality, *Metex Electronic Weatherstripping* can do more for you than just shield RF leakage. It can cut the cost of machining mating surfaces to close tolerances. It can eliminate the need for extra fasteners and many other costly means of making joints RF tight.

Applications in which *Metex Electronic Weatherstripping* has already proved its effectiveness include pulse modulator shields, wave-guide choke-flange gaskets, local oscillators on TV sets, dielectric heaters, etc.



For detailed information on METEX ELECTRONIC PRODUCTS, write for FREE copy of "Metex Electronic Weatherstrips" or outline your SPECIFIC shielding problem — it will receive our immediate attention.

METAL TEXTILE CORPORATION



ROSELLE, NEW JERSEY

Want more information? Use post card on last page.

November, 1954 — ELECTRONICS

Want more information? Use post card on last page.

of Minnesota's Institute of Technology since 1949, also is consultant to a number of government and military agencies including the Department of Defense and the Weather Bureau.

Ampex Elects Dean Terman

FREDERICK E. TERMAN, dean of the school of engineering at Stanford University, was elected to the board of directors of the Ampex Corp. in Redwood City, Calif., manufacturer of magnetic recording equipment.

Dr. Terman replaces Charles McSharry, who relinquished his membership to become secretary of the board.

Formation was announced of two product divisions corresponding to the two broad classifications of use for Ampex recorders—recording of sound and recording of laboratory and industrial data.

Robert Sackman was named manager of the instrumentation division, responsible for industrial and research applications of Ampex equipment and Phillip L. Gundy, manager of the audio division, responsible for sound recording equipment.

Erie Resistor Opens Plants

FRYLING ELECTRIC PRODUCTS, a subsidiary of Erie Resistor, recently opened its new manufacturing plant in Holly Springs, Mississippi. The new plant produces electronic components and custom molded plastic parts.

Erie Resistor also opened its new enlarged plant in Trenton, Ontario, Canada. At present, about 75 people are employed there and further expansion is planned.

Instrument Firm Begins Production

MASON INSTRUMENT COMPANY has been organized in New Rochelle, N. Y., and is producing an optical pyrometer designed for the ceramic industry. A line of photographic and medical instruments is planned for future development.

The new organization is headed

MODEL 80F FEMALE
MODEL 80M MALE } Size 3 3/8" x 3/4" dia.

MODEL 82
VERY HANDY in lab and production test. At signal generator levels and below 5 watts, this is the last word for low VSWR.

6" x 8 1/2" x 17"

TERMALINE COAXIAL LOAD RESISTORS

50 ohms DC to 4000 mc—5 watts to 2500 watts

The constant resistance (Low VSWR) of the THERMALINE resistor make it the ideal dummy load and standard resistor at UHF and VHF. Design is such that normal reactance is put to work producing a pure resistance over an extremely wide frequency range. Acting as a "bottomless pit" for RF energy, thousands of THERMALINE units are in daily use in high frequency applications.

Model	Cont. Power Rating	Input Connector
80F	5 watts	UG-23B/U
80M	5 watts	UG-21B/U
80A	20 watts	UG-23B/U
81	50 watts	UG-23B/U
81B	80 watts	UG-23B/U
82	500 watts	} Adaptor to fit UG-21B/U supplied
82A	500 watts	
82C	2500 watts	

Adapters or cable assemblies for standard coaxial line available.

ALL THERMALINE units, except Model 82C, are self-cooled. Substantial quantity discounts.

LITERATURE UPON REQUEST

BIRD ELECTRONIC CORP.
1800 EAST 38TH ST., CLEVELAND 14, OHIO
THERMALINE Coaxial Line Instruments

NEELY ENTERPRISES
Hollywood • San Francisco
Albuquerque

EARL LIPSCOMB ASSOCIATES
Dallas • Houston

DIMCO-GRAY SNAPSLIDE FASTENERS

PROVIDE VIBRATION-PROOF HOLDING AND QUICK, FOOL-PROOF RELEASE!

APPROVED UNDER ARMY-NAVY STANDARDS

Here's a simple, easy means of securely fastening assemblies to withstand shock or vibration, and yet allow quick removal for inspection or repair. Instant snap action engages or releases fastener... no tools are required! After installation, fasteners never need adjustment... even with repeated use.

Three sizes available for different load requirements. Large and medium sizes are made of corrosion-resistant stainless steel. Small size is made of nickel-plated brass. Stock parts fit various thicknesses of flanges and mounting plates... special parts can also be supplied.

WRITE FOR FULL DETAILS TODAY!

DIMCO-GRAY COMPANY

204 E. SIXTH STREET DAYTON, OHIO



Square Wave Generator

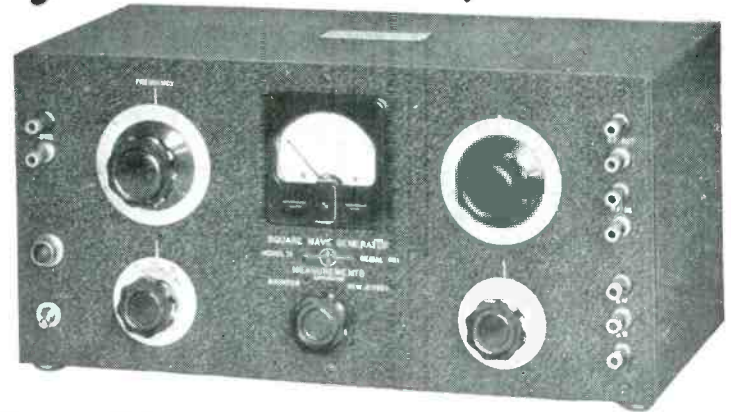

MODEL 71

SPECIFICATIONS

FREQUENCY RANGE: 5 to 100,000 cycles.
WAVE SHAPE: Rise time less than 0.2 microseconds with negligible overshoot.
OUTPUT VOLTAGE: Step attenuator giving 75, 50, 25, 15, 10, 5 peak volts fixed and 0 to 2.5 volts continuously variable.
SYNCHRONIZING OUTPUT: 25 volts peak.
R. F. MODULATOR: 5 volts maximum carrier input. Translation gain is approximately unity—Output impedance is 600 ohms.
POWER SUPPLY: 117 volts, 50-60 cycles.
DIMENSIONS: 7" high x 15" wide x 7 1/2" deep overall.

MANUFACTURERS OF
 Standard Signal Generators
 Pulse Generators
 FM Signal Generators
 Square Wave Generators
 Vacuum Tube Voltmeters
 UHF Radio Noise & Field Strength Meters
 L-C-R Bridges
 Megohm Meters
 Megacycle Meters
 Intermodulation Meters
 TV & FM Test Equipment

MEASUREMENTS CORPORATION
 BOONTON NEW JERSEY

by Albert C. Mason, for many years a project engineer with the Far-ram Optical Co. of New York.

Electro Dynamics Changes Its Name

ELECTRO DYNAMICS CORP., of Beverly Hills, Calif. has changed its name to Litton Industries. Charles B. Thornton, former vice-president and assistant general manager of Hughes Tool Co., is chairman of the board of the firm.

It has three California plants and one in Mount Vernon, New York totaling 300,000 sq ft. The 165,000 sq ft facility in Beverly Hills was recently purchased from Free Sewing Machine Co.

Magnecord Appoints Carroll Hoshour

CARROLL W. HOSHOUR has been named products manager for Magnecord. Hoshour will be in charge of sales engineering, quality control, product service and technical sales promotion for all divisions of the company.

Most recently Hoshour was director of sales engineering and service for Raytheon in Chicago. Previously he operated his own television service business in Omaha, Neb. and held service manager positions with several firms in the electronics field.

Conrac Builds Plant Addition

CONRAC, manufacturers of Fleetwood custom tv sets, is building a new addition to the main manufacturing plant at Glendora, California. Present facilities will be expanded by about 20% with the completion of this new addition.

Vidaire Organizes As A Corporation

VIDAIRE ELECTRONICS MFG. Co. has been incorporated under the name of Vidaire Electronics Mfg. Corp. It was formerly organized as a partnership.

The corporation will handle the manufacture and sale of electronic components and accessories for-

NOW... A RELAY 20 G UP TO 2000 CPS



ACTUAL SIZE



Limited quantity of model shop samples available — submit your specifications and requirements with your inquiry.

DIMENSIONS:
 1 1/2" diam. x 1 3/4" long
WEIGHT:
 less than 1 oz.
OPERATING POWER:
 100 MW Max.
CONTACTS:
 spdt—2 amp. at 24 V DC
 Resistive load
VIBRATION RESISTANCE:
 20 G up to 2000 CPS
 (cycles per sec.)

PHOTO
 Martin Matador, courtesy
 The Glenn L. Martin Company

RELAYS
Wheelock SIGNAL
 ENGINEERING & MFG. CO.
 LONG BRANCH, NEW JERSEY

VALPEY

symbol of craftsmanship
for over 23 years

Quartz
Crystals

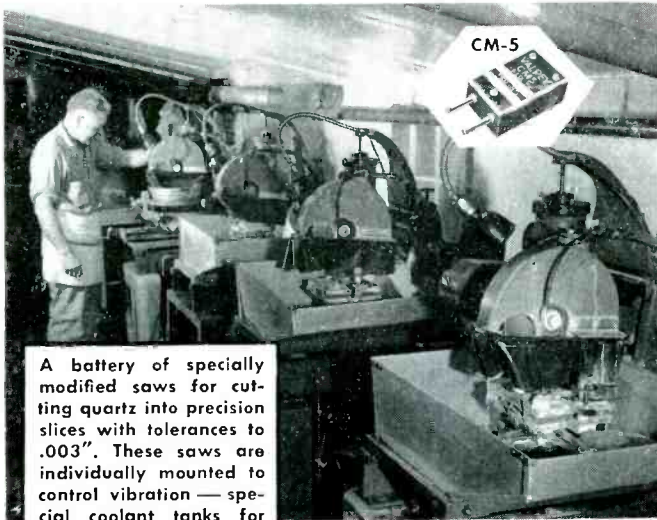

A battery of specially modified saws for cutting quartz into precision slices with tolerances to .003". These saws are individually mounted to control vibration—special coolant tanks for each saw prevent contamination.

Control is the key to the superior quality of Valpey Crystals. Step-by-step inspection guarantees precision crystals, right for your needs. From 40 Kc. to 100 Mc., there's a Valpey Crystal for all applications. Bulletin FE-1 describes all conventional types; write for your copy today.

VALPEY
Crystal
CORPORATION
1244 Highland Street
Holliston, Mass.

Craftsmanship in Crystals since 1931

Model 3 Calibrator



- A Precision Calibrator for quality control of Vacuum Tube Voltmeters used in production and Laboratory tests.
- Will provide AC output voltages in the audio frequency range from .0005V to 7.5 V.
- Specially developed Weston Iron Vane Meter assures permanency of calibration and incorporates a mirror scale.
- Relay Rack or Portable Mounting—Immediate delivery from stock

For additional information write:

Northeast Electronics Corp. Municipal Airport, Concord, N. H.

PROBE-SCOPE

The Newest and Handiest
Waveform Analyzers.

For the first time a Cathode Ray Tube is incorporated into a probe small enough to be held in the palm of a hand . . . only 1 1/2" round by 7 1/2" long. The waveform is even sharper and clearer than on larger scopes. The control cabinet is small and compact occupying less than 1/2 sq. foot on the bench and is connected to the Probescope by a 3 1/2 ft. shielded cable. The back of the cabinet is provided with a holder for the probe and cable.

SPECIFICATIONS: INPUT IMPEDANCE: 2.2 megohms shunted by cap. of 100 MMFD. with Cathode Follower Input.
SENSITIVITY: 100 MV full scale, vertical input only.
FREQUENCY RESPONSE: Flat to 60 KC — 3 db point.
SWEEP RATE: 20 cycles to 30 KC in 5 steps.
SIZE: 9" w., 6" h., 5" d.
Model PD-1

Price \$77.95 F.O.B. N.Y.C.



MINIATURE OSCILLOSCOPE Model M0-1
The smallest and most compact oscilloscope on the market yet an industrial giant.

SPECIFICATIONS:
INPUT IMPEDANCE: Horizontal and vertical. 2.2 megohms shunted by approximately 15 MMFD.
SENSITIVITY: 100 MV vert. full scale; 1 volt horiz. full scale.
FREQUENCY RESPONSE: Vert. 7 cycles to 200 KC — 3 db; Horiz. 4 cycles to 100 KC — 3 db.
SWEEP RATE: 20 cycles to 30 KC in 5 steps.
SIZE: 9" high, 6" wide, 5" deep.

Price \$79.95 F.O.B. N.Y.C.



PROBESCOPE CO.

44-05 30th AVENUE
LONG ISLAND CITY 3, N. Y.

ATTENTION !!
Executives and Salesmen!

Shave in the
Comfort of
Your Own Car,
Boat or Plane!

WITH

ATR

SHAV-PAK



Specially Designed for
Operating Standard A.C.
Electric Shavers in
Automobiles, Buses,
Trucks, Boats, and
Planes.

Keep in
Glove
Compartment



PLUGS INTO
CIGARETTE LIGHTER
RECEPTACLE
ON DASH

\$12.95

LIST PRICE

TYPE	INPUT D.C. VOLTS	A.C. OUTPUT 60 CYCLES	OUTPUT WATTAGE	LIST PRICE
6-SPB	6	115 volts	15	12.95
12-SPB	12	115	15	12.95

Dictate Reports
Accurately—Promptly!

make your car, boat or plane
a "rolling office"

WITH

ATR

INVERTERS



for changing your
storage battery
current to A. C.

Household
ELECTRICITY

Anywhere
in your own car!

Plugs into
Cigarette Lighter
Receptacle on Dash

\$2250
AND UP
LIST PRICE



ATR INVERTERS . . .

especially designed for operating
standard 110 volt A. C. . . .

- TAPE RECORDER
- WIRE RECORDERS
- DICTATING MACHINES
- ELECTRIC RAZORS

See your jobber or write factory today
for complete information

ATR

AMERICAN TELEVISION & RADIO CO.
Quality Products Since 1931
SAINT PAUL 1, MINNESOTA—U. S. A.

The Shaft Shows the Holding Power of Allenpoint Set Screws

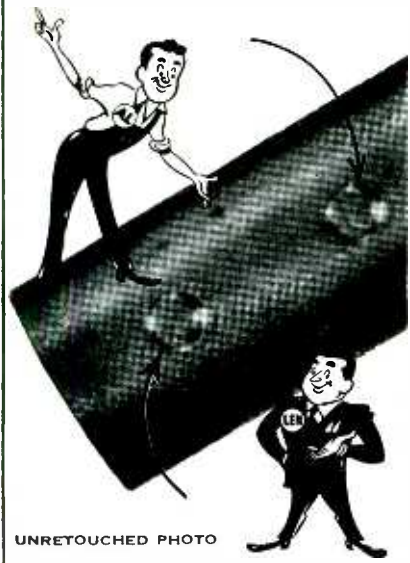

Loosen a set screw and look at the shaft it's pressing against. The set screw must make a full circle impression with no rough edges in order to give maximum holding power.

Allenpoint Set Screws drive smoothly and deeply into the shaft. Their even bearing surface gives increased resistance to rotation and sliding motion. Even on shafts of small diameter, Allen's smaller cup point assures top holding power.

Sold only through leading Industrial Distributors—specify Genuine Allenpoint Set Screws



Want more information? Use post card on last page.

merly handled by the partnership. The same partnership interest will control the corporation and the same management and personnel will be retained.

Clear Beam Combines And Expands



Harry Lieb, left and Harold Florence, president of Tempo TV and Clear Beam Antenna, respectively, inspect plant model

CLEAR BEAM ANTENNA CORP. plans to combine operations with Tempo TV Sales Corp.

The combined firms will open a new 63,000 sq ft antenna plant in Canoga Park, Calif.

The new organization plans to employ approximately 225 persons and estimates that the facilities will enable them to produce 12,000 antennas and 3,000 telescoping masts per day. A warehouse stock will be set up on the property to house 45,000 antennas. Following the opening of their Canoga Park, California plant, another Clear Beam plant will open this year in Chicago, Illinois.

Lion Appoints Color TV Chief Engineer

HAROLD J. ADLER has been named chief engineer in charge of the color television development program of Lion Manufacturing in Chicago.

The program currently being carried out will result in the fall introduction of Lion color television featuring remote control.

Adler was formerly vice-president in charge of engineering of E. I. Guttman. He coordinated the

GREATER RESOLUTION

SLOWER SWEEP RATE



PANADOPTOR SA-8a PANALYZOR SB-8a

More Valuable Than Ever!

New Panoramic engineering achievements embodied in these improved instruments open important new applications involving modulation and interference problems.

SA-8a and SB-8a enable spectrum analysis of signals so close in frequency that their corresponding indications would normally mask one another.

- IMPROVED RESOLUTION down to 50 cps for RF spectrum analysis where maximum resolution is a "must"
 - LOW SWEEP RATES down to 1 scan per second for analysis of pulsed RF signals with low p.r.f.'s
 - LONG PERSISTENCE DISPLAYS
 - CONTINUOUSLY VARIABLE SCANNING WIDTH
- 3 types available with maximum sweepwidths of 200 KC., 1 MC. and 10 MC.

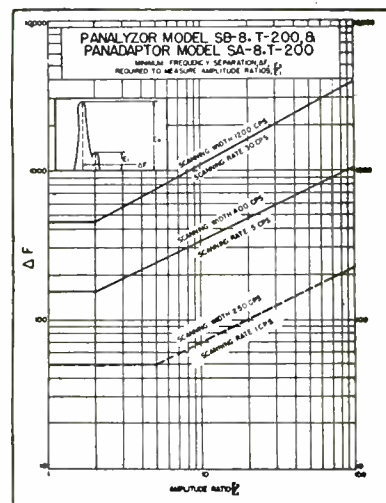

WRITE TODAY FOR COMPLETE SPECIFICATIONS AND PRICES



- Makers of
- Panadaptor
- Panalyzer
- Panoramic Sonic Analyzer
- Panoramic Ultrasonic Analyzer

10 South Second Avenue, Mount Vernon, N. Y. MOUNT VERNON 4-3970

Want more information? Use post card on last page.

company's activities in the manufacture of delay lines, coils, yokes, flybacks and other electronic components.

He also served as director of engineering for Hallicrafters and as chief engineer for Sentinel Radio.

Gulton Industries Expands Plant

TWO NEW BUILDINGS with a total of 6,000 sq ft of space have been added to the Metuchen plant of Gulton Industries, a group of associated companies who are manufacturers of the Glennite line of products. These include Gulton Mfg., Glenco Corp., Vibro-Ceramics, Greibach Instruments and Thermistor Corp. of America.

The new facilities will house the specifications and drafting department, machine shop and stock and supply areas and will permit expansion of development, production and test operations.

Shewhart To Receive Holley Medal

WALTER A. SHEWHART, research statistician with the Bell Laboratories in Murray Hill, New Jersey has been named to receive the Holley Medal.

The award, which is administered by the Board of Honors of The American Society of Mechanical Engineers, is conferred, when warranted, to "one who by some great and unique act of genius of an engineering nature has accomplished a great and timely public benefit." The "Deed of Gift" which established the award directs the attention of the Board of Honors to the act of the recipient, and not to his personal, educational or business qualifications.

Dr. Shewhart began his career as an engineer with the Western Electric Company. Since 1925 he has been associated with Bell Laboratories as a member of the technical staff and later as research statistician.

He was a pioneer in the application of statistical methods to standardization, specification and inspection in manufacturing processes. The citation accompanying the Holley Medal honors him for "leading

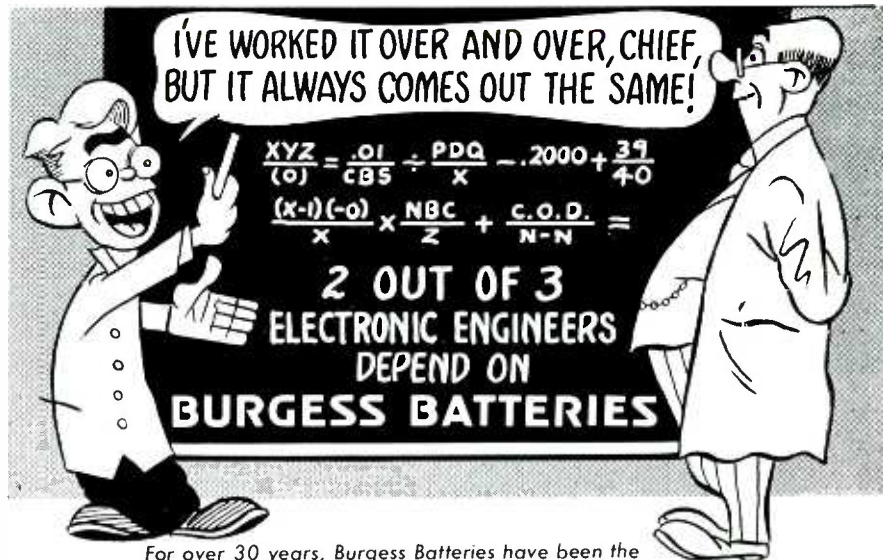

For over 30 years, Burgess Batteries have been the popular favorite of electronic engineers, due to their uniform operation and consistently high quality. You'll find a Burgess Battery to fit every need... including the all-new transistor types.



No. 4FH



No. Z30NX



Write for FREE engineering manual listing the complete line of BURGESS BATTERIES and specifications, the FREE check sheet to enter new battery specifications, and the new transistor battery sheet.

BURGESS BATTERIES
BURGESS BATTERY COMPANY
 FREEPORT, ILLINOIS

MANSOL makes

GLASS MULTIFORMS

custom-molded to exact specifications.



FORMULA 800 MULTIFORMS

Extracted from epoxy resins. "800" can be used in multiforms and for conductive or non-conductive small parts welding at 400° F. It possesses extremely high bonding strength, with no shrinkage, on metals to metals and metals to non-metals.

MULTIFORMS OF STEATITE

We specialize in small die-pressed ceramic parts held to closest tolerances. All tools and dies are made in our shop to assure quick delivery.

GLASS MULTIFORMS — The ideal multiforms for Iron Sealing and Kovar Sealing, matching the expansion of these metals over their entire working range. They resist mercury attack, have ample mechanical strength, and seal readily. Our laboratory is prepared to assist you in selecting the proper glass for any metal.

- If you are still making your own multiforms, Mansol would like to show you how to save money and eliminate rejects.

- Write to Dept. N for the complete story about multiforms, Formula 800 and our production facilities. No obligation of course.



CABLE ADDRESS: MANSOL



Resinite

specify...

VINYL TUBING

The tougher the operating conditions, the more important it is to specify Resinite Specification Vinyl Tubing. Resinite Tubing meets or exceeds military specifications for performance under extremely low and high temperatures, for dielectric strength, for fungus, and corrosion resistance and inflammability.

This superior quality of Resinite Tubing has been achieved through many years of specializing in vinyl tubing. It is maintained through constant research, accurate compounding, skillful workmanship, rigid quality control and thorough inspection. That's why more Resinite Specification Vinyl Tubing than any other is used by the aircraft and electronics industries.

Write today for samples and performance data.

Resinite
RESIN INDUSTRIES, INC.
315 Olive St. • Box 1589 • Santa Barbara, Calif.
SPECIALISTS IN VINYL SLEEVING AND TUBING FOR THE
AIRCRAFT ELECTRONICS AND PHARMACEUTICAL FIELDS

Want more information? Use post card on last page.

his colleagues in the applications of the latent but potent methods of statistics to the problems of the hitherto unscientific and quantitatively lacking domain of manufacturing and industrial research."

Ruge-deForest Names Koch

PAUL KOCH has been appointed assistant general manager of Ruge-deForest of Cambridge, Mass.

Koch was formerly retained as a consultant by the firm. Before that, he was works manager of Norden Instruments in Milford, Conn. His experience includes ten years with the Pioneer Instrument division of Bendix Aviation and eleven years with Manning, Maxwell & Moore, where he organized and managed the electronics division.

Recording Association Appoints Leon

ROBERT LEON of Brush Development has been appointed chairman of the standards and engineering committee of the Magnetic Recording Industry Association.



Brach Manufacturing Promotes Kamen

IRA KAMEN has been named vice-president in charge of engineering, research, and development for the Brach Manufacturing Corp., a division of General Bronze. Kamen was formerly vice-president in charge of sales. While continuing to direct contract sales, his new responsibility will place Brach's engineering, research, and development facility

NEW!

UHF GRID DIP METER

300 TO 1000 MEGACYCLES



FEATURES:

- ★ Exceptionally wide frequency range in three bands.
- ★ High sensitivity for both capacitive and inductive coupling.
- ★ No wiping contacts.
- ★ May also be used as a sensitive high Q absorption frequency meter.
- ★ Frequency accuracy: $\pm 2\%$ (individually calibrated dial.)
- ★ 18 inches total dial scale readable to $\frac{1}{4}\%$ anywhere on dial.
- ★ High stability RF circuit. Short term stability approximately .01% after initial warm up.
- ★ Provision for internal or external modulation.

PRICE \$275
F.O.B. Boonton, N. J.

BOONTON
ELECTRONICS CORP.
BOONTON, NEW JERSEY

BOONTON 8-3603

Want more information? Use post card on last page.

Specify

Cryco
QUARTZ
CRYSTALS

for unsurpassed quality and proven performance in the most exacting military, aviation and industrial communications applications. Ultrasonically cleaned, hermetically sealed.

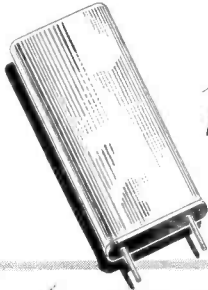

*MIL-C-3098A

✓
CR-37/U

Frequency range: 90 — 250 KC
Temperature range: —40 to +70° C
Frequency tolerance: ± .02%
Load capacity: 20 mmf.
Holder type: HC-13/U

SALES REPRESENTATIVE: JOHN RICHARDT CO.
BOX 267, WHIPPANY, N. J.



Write for
catalog sheet
1138 Mission St.
South Pasadena, Calif.

A licensee of Western Electric Co.

FOR PUBLIC
ADDRESS, RADIO,
and kindred fields,
JONES 400
SERIES
PLUGS & SOCKETS

of proven quality!

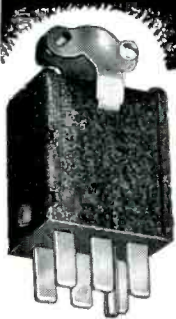

P-406-CCT

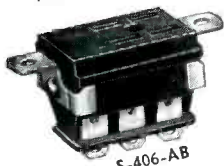

S-406-AB

Socket contacts phosphor bronze cadmium plated. Plug contacts hard brass cadmium plated. Insulation molded bakelite. Plugs and sockets polarized. 2, 4, 6, 8, 10, 12 contacts. Steel caps with baked black crackle enamel. Catalog No. 20 gives full information on complete line of Jones Electrical Connecting Devices — Plugs, Sockets and Terminal strips. Write

Howard B. Jones Division
CINCH MANUFACTURING CORPORATION
CHICAGO 24, ILLINOIS
SUBSIDIARY OF UNITED-CARR FASTENER CORP.

When Instruments Must Be Accurate...

The Burlington Meter was chosen for this Bendix-Friez Laboratory Temperature Indicator because they found it met their requirements for an accurate, yet low cost, meter and enabled them to set a desirable price on their instrument. Other famous-name manufacturers have made their selection from the wide ranges, styles and sizes offered by Burlington. Or, let Burlington build a meter to your specifications.

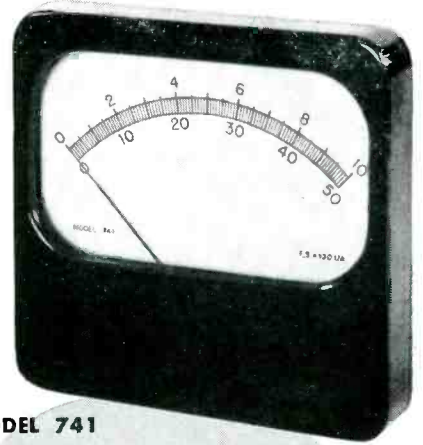

MODEL 741
SQUARE
SEMI-FLUSH



WRITE FOR
CATALOG N1

BURLINGTON INSTRUMENT CO.
127 N. Third St., Burlington, Iowa



CUSTOM BUILT TO SPECIFICATION

DC-7

NEVER BEFORE
such Magnificence . . . such Power
such Performance!



and NEVER BEFORE
has the A. W. HAYDON COMPANY
been so proud of its contribution . . .



DOUGLAS DC-7, the ultimate in comfortable and safe air travel. Swift, luxurious, dependable — the new DOUGLAS DC-7 justly deserves the accolades it is receiving.

In the never-ending conquest of the vast barriers of space and time, Douglas goes ever forward meeting every challenge that men and machines must face. The newest — and brightest — star in the aviation firmament, the Douglas DC-7, is truly a miracle of the mastery of men over machines . . . and in this great work sixteen A. W. Haydon timing devices play an important part. We at A. W. Haydon take pride in our contribution toward bringing a mass of metal and machinery into integrated performance which meets Douglas' high standards. Integrated performance is born of a multitude of small component parts, working in perfect mechanical and electrical coordination. The A. W. Haydon precision timing instruments are a vital part of this vast network.

A. W. Haydon Time Delay Relay is a very important component of the automatic prop feathering system.
A. W. Haydon Time Delay Relay times duration of prop feathering.
A. W. Haydon Repeat Cycle Timer is a vital part of the prop deicing equipment.
A. W. Haydon D.C. Timing Motors are used in the cabin pressurization systems.

when timing poses a problem — consult

(Catalog sent on request)



The
A.W. HAYDON
COMPANY

235 NORTH ELM STREET
WATERBURY 20, CONNECTICUT

Design and Manufacture of Electro-Mechanical Timing Devices

PRECISION PHASE MEASURING INSTRUMENTS .0001 CPS to 500 MEGACYCLES

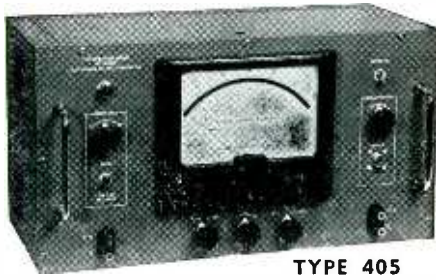

TYPE 405

- 0.3 VOLT SENSITIVITY
- NO AMBIGUITY AT ZERO DEGREE
- 0.25° RELATIVE ACCURACY
- PHASE READING INDEPENDENT OF SIGNAL AMPLITUDES

Type 405 Phase Meter has a frequency range of 8 cps to 100 kc, phase range 0-36, 0-90, and 0-180 degrees; a switch is provided for 180-216, 180-270, and 180-360 degrees. The accuracy is 1/2 degree relatively and 1 degree absolute in any range. The input impedance is 2.7 megohms shunted with 20 uf on both channels. The meter scale is 6 1/2" long, thus, a fraction of 1/2 degree can be read easily. Price \$485. FOB, Passaic, N. J. For 0.0001 cps to 1000 cps, use our N-L Phase Counter.

TYPE 205—100 KC TO 15 MEGACYCLES:

Type 205 Phase Detector was developed to measure envelope delay, time delay, phase shift with error of less than 0.1 degrees or 1% in communications systems such as color television. 5 x 10⁻¹⁰ seconds resolution time. 0.01 volts full scale sensitivity. Price \$445.00.

TYPE 213—100 KC TO 500 MEGACYCLES:

Type 213 H-F Phase and Vector Voltage Meter measures phase angle between two voltages, vector difference of two voltages, and others. It is based on a new differential rectifier circuit developed exclusively by this company. Price \$228.00.

WRITE FOR DATA!

ADVANCE ELECTRONICS CO., INC.

451 HIGHLAND AVE.

PASSAIC, N. J.

NEW Chassis Slides INVERT CHASSIS Quickly and Easily



Carry 100 lbs.; easily fitted to standard relay rack. Rugged, cadmium plated, iridized steel pins, nylon bushings. Meet Gov't specs. Write for data sheet.

Part No. H-5798



NEW ELECTRICALLY INSULATED Handle With Mounting Plate

Designed for portable electronic equipment; conforms to MIL-T-915A. Comfortable, hinged grip is black anodized aluminum coated with black vinyl; swings 180°—lies flat when not in use. Lifts 125 lbs.

Part No. H-5371

3 BASIC RFL Sealnuts* FOR NEARLY EVERY APPLICATION

Here's Why:

Each SEALNUT has three parts—a black silicone sleeve, a nickel plated brass nut, and a silicone O-ring. The sleeve seals the switch handle and the nut bears against the control panel, sealed by the O-ring. SEALNUTS are the only switch seals that provide rigid, metal-to-metal contact for positive, secure mounting.

WRITE FOR DATA SHEET AND SAMPLES

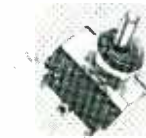

TOGGLE SWITCH

TYPE H-1267 fits 15/32 thd. is equal to Boot AN 3223-1. Also types for 1/2-20, 1/4-32 and 1/4-40 thds.



CONTROL SHAFT

TYPE H-1268 fits 3/8-32 thd. Also types for 1/2-20 and 15/32-32 thd. with larger shafts.

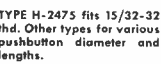

PUSH BUTTON

TYPE H-2475 fits 15/32-32 thd. Other types for various pushbutton diameter and lengths.

NOW SEAL OUT MOISTURE, DIRT and FUMES at Switches and Control Shafts

SEALNUTS have operated without leaking at external hydraulic pressures of 200 lbs./in. stay flexible at -65°C. meet requirements of MIL-B-5423. Over a million have been used to protect military electronic equipment.

*U.S. Patent 2162023

Radio RFL Frequency

LABORATORIES, INC. BOONTON 3, NEW JERSEY, U.S.A.
MANUFACTURERS OF ELECTRICAL EQUIPMENT AND APPARATUS SINCE 1922

We also manufacture instrument calibration standards, crystal impedance meters, magnet chargers, frequency meters and teletypewriter terminals. See ad in June BUYER'S GUIDE.

under his general cognizance.

He has been with General Bronze since 1950 where he began as director of tv development and promotion. In 1952 he became a vice-president. Kamen joined Brach after having served as a consultant to the L. S. Brach Co. prior to its purchase by General Bronze.

From 1948 to 1950 Kamen was the manager of the tv department for Commercial Radio Sound Corporation.

From 1946 to 1948 he served as a consultant to Workshop Associates, Vertrod Antenna Corporation, Transmitter Equipment Manufacturing Corporation, and other organization. He also served as an officer of the Intravideo Corporation where he directed the development of the first tv master antenna system.

From 1945 to 1946 he was director of electronics for the Conlan Electric Corp.

Standard Telephone Appoints Tube Head

C. H. FOULKES has been appointed by Standard Telephones and Cables as head of the company's tube division and location manager at Dowlis Ford Mills, Ilminster, Somerset. This division is responsible for the development and manufacture of all of the company's special tubes except broadcast receiver tubes.

Foulkes joined the company in 1936 as a laboratory assistant, assembling cathode ray tubes.

In 1940 he was moved with the tube division of Standard Telephones and Cables Limited to Ilminster in Somerset and throughout the War was engaged in the development of micro-wave tubes.

Hess, Goldsmith Form Research Division

A SPECIAL fiber glass research and development division has been established by Hess, Goldsmith & Co., weaver of glass fabrics.

Jayanti Dharma Teja, former vice-president of Mystik Adhesive Products Co., has been appointed director of the new division.

The division will work on new ap-

lications of glass textiles in decorative and industrial use.

New Instrument Firm Organized

THE INDIKON CO. has been formed in Belmont, Mass. by Haskell Ginns, formerly vice-president in charge of electronics for Ruge-deForest. The new company will manufacture instruments and systems for industrial measurement and process control. Special emphasis will be given systems involving transducers.



Adler Labs Names Friedman

THOMAS B. FRIEDMAN, tv engineer and consultant, joined Adler Communications Laboratories of New Rochelle, New York. He will assist in the development and application of satellite television stations and television station systems.

Friedman was previously with Empire Coil as chief tv engineer.

Norton To Receive Ballantine Medal

A STUART BALLANTINE MEDAL, awarded by The Franklin Institute of Pennsylvania for outstanding achievement in the field of communication, will be presented to Kenneth A. Norton, chief of the radio propagation engineering division of the National Bureau of Standards. He has been in government service since 1929.

Norton is being honored "In consideration of his contributions over a period of twenty-five years in the field of radio propagation through which our knowledge has been considerably increased by his



Technology Instrument Corp. Presents a Compactly-Built Wide-Band Decade Amplifier

Featured by its wide band response, high input impedance, low output impedance, and compact dimensions, TIC's Type 500-A wide band decade amplifier is excellent as a general purpose laboratory instrument. Here is an instrument for special applications requiring a zero phase shift and high stability of gain. TIC increases the general utility of this amplifier by including a self-contained power supply and cabinet or rack mounting.



SPECIFICATIONS:

Amplification: 10, 100 and 1000 times, selected by 3-position rotary switch.
Frequency Response: Flat to $\pm .5$ db from 5 cycles to 2 mc on gain of 10; Flat to $\pm .5$ db from 5 cycles to 1.5 mc on gain of 100; Flat to $\pm .8$ db from 5 cycles to 1 mc on gain of 1000.

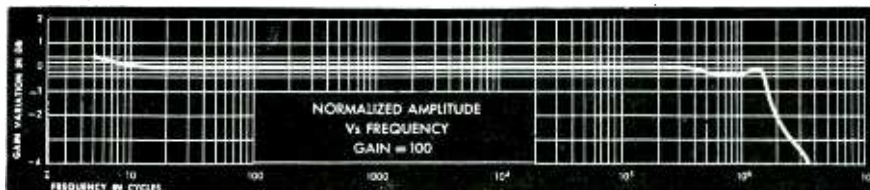

Amplification Accuracy: $\pm 2\%$ of nominal — dependent on precision resistors only; Unaffected by normal tube characteristics or line variations.

Phase Shift on All Ranges: 0 to $\pm 2^\circ$ from 20 cycles through 100 kc
Gain Stability on All Ranges: Constant with line voltages of 105 to 124 volts.
Noise and Hum: 60 db below maximum output voltage with input shorted.
Input Impedance: Approximately 160 megohms shunted by $7 \mu\text{mf}$.

Output Impedance: Approximately 200 ohms.
Output Voltage on All Ranges: 20 volts maximum output across a load of 20 k Ω or greater.

Power Supply: 105-125 volts, 50-60 cycles self-contained power supply requiring approx. 30 watts. (230 volt, 50-60 cycles models available).

Mounting Dimensions: Single, in cabinet: 13 $\frac{1}{4}$ " wide x 5" high x 9 $\frac{3}{8}$ " deep. (11 $\frac{1}{4}$ " x 3 $\frac{1}{2}$ " panel) Single, for rack: 19" wide x 3 $\frac{1}{2}$ " high x 8 $\frac{1}{2}$ " deep.

The low distortion is a feature much desired in amplifiers of this type.

Further information and details gladly sent upon request.

ENGINEERING REPRESENTATIVES

- New York, N. Y. — Murray Hill 8-5858
- St. Paul, Minn. — Prior 4955
- Binghamton, N. Y. — Binghamton 3-1511
- Arlington, Ont., Can. — Arnprior 400
- Utica, N. Y. — Utica 2-1602
- Dallas, Texas — Dixon 9918
- Rochester, N. Y. — Monroe 3143
- Hollywood, Cal. — Hollywood 9-6305
- Woodridge, N. J. — Webster 9-7217
- Belmont, Cal. — Lytell 3-3438
- Great Neck, L. I., N. Y. —
- Seattle, Wash. — Lander 3320
- Great Neck 2-9406
- Albuquerque, N. M. —
- K.L.N. Trading Co., Ltd.
- Albuquerque 3-1998
- Stockholm, Sweden
- Chicago, Ill. — Uptown 8-1141
- Dayton, Ohio — Michigan 8721



533 Main St., Acton, Mass. CO 3-7711
 West Coast Mail Address P. O. Box 3941 North Hollywood, Calif., Poplar 5-8620
 Plant, 11020 Sherman Way, Sun Valley, California

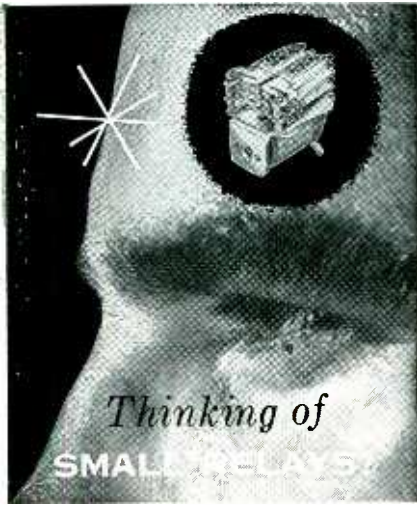

ADVANCE builds 'em for heavy loads and long service!

Cramped quarters don't cramp the style of ADVANCE midgets and miniatures. You can use them on loads up to 5 amperes continuously... and at three times their rating intermittently—with complete safety. They'll resist shock and vibration... stand up under temperature extremes. You'll find them readily adaptable to any mounting need... any type of duty. Here are a few examples:

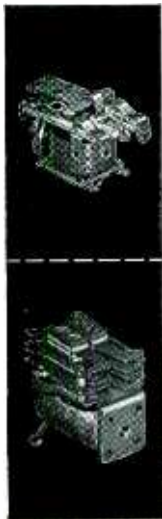

"TINY MITE"

MM & MP SERIES

This ultra-small d-c relay occupies less than 1/2 cu. in. mounting space! It's stable under vibration and shock... plated to prevent corrosion. Operate time is 5 milliseconds. Contact rating: .5 amp. or 1 amp.

MINIATURE TELEPHONE TYPE TQ SERIES

Only .94 cu. inches in size, yet this relay carries 5-amp. loads in any combination up to 4 PDT. Mechanically secured throughout, it's extremely efficient. No gassing or bubbling. Withstands 10G vibration. Temperature range: -55° to +125° C.

Hermetic enclosures on these types are impervious to varying climatic conditions... are sealed and carefully checked against leakage.

Write for literature on any of the above series, or the complete ADVANCE line.



ADVANCE ELECTRIC AND RELAY CO.

2435-F NORTH NAOMI STREET
BURBANK, CALIFORNIA

Sales Representatives in Principal Cities of U.S. and Canada

Want more information? Use post card on last page.

measurements; our insight broadened by his theoretical work; our engineering calculations made easier by his charts and our broadcasting frequency allocations above 50 mc established more effectively through his guidance."

Sands Establishes Tech Writing Service

TECHNICAL WRITING SERVICE for manufacturers of electronic equipment is being offered by a newly formed firm, Sands Associates in Santa Barbara, Calif.

The new firm is headed and was founded by Leo G. Sands who has been a sales executive for such firms as RCA, Bogue and Langevin, and who was director of public relations and advertising for the radio division of Bendix Aviation. He was also associated with Philco where he worked on the practical application of microwave radio relay systems.

Insulation Firm Forms New Division

CHENEY BROTHERS of New York has formed a new Textiglass division to be headed by Emile J. Van Dyck.

Van Dyck was formerly partner of the Textiglass division of Madagascar Graphite and Mica in New York City. The new division will stress engineering sales service operations in reinforced plastics.

R S Electronics Moves Into New Plant

R S ELECTRONICS CORP., a division of Selective Cam Transmission Co. of San Bruno, Calif., has moved into a new 10,000 sq ft plant in Palo Alto, Calif.

The firm manufactures radar scanners with selective cam transmission drive and works on electronic miniaturization, product design, electronic automatic production and etched and printed circuits.

New vice-president and chief engineer of the firm is Robert K-F Scal, who worked on the development of miniaturized airborne radar while working for the National Bureau of Standards.

DC-AC CHOPPERS

0-500 cycles
DEPENDABLE



All military specifications met. Liberal factors of safety to meet emergency conditions.

1. Production sampled daily and life tested to check 1,000 hour rating.
2. Every Chopper given not only one but two tests over the full range of military temperatures before shipment.
3. Only gold contacts used for superior operation in the vital 0-1 1/2 volt d-c range.
4. Liberal safety factors to meet emergency conditions.
 - a. 0-500 cps.
 - b. Input voltage $\pm 30\%$.



WRITE FOR THESE CATALOGS:
No. 371, 0-500 CPS.
No. 370, 60 CPS.

STEVENS ARNOLD INCORPORATED

22 ELKINS STREET
SOUTH BOSTON 27, MASS.

S/A-11

Want more information? Use post card on last page.



MAILING LISTS THAT WORK...

McGraw-Hill Industrial Mailing Lists are a direct route to today's purchase-controlling executives and technicians in practically every major industry.

These names are of particular value now when most manufacturers are experiencing constantly increasing difficulty in maintaining their own lists.

Probably no other organization is as well equipped as McGraw-Hill to solve the complicated problem of list maintenance during this period of unparalleled changes in industrial personnel. These lists are compiled from exclusive sources, based on hundreds of thousands of mail questionnaires and the reports of a nation-wide field staff, and are maintained on a twenty-four hour basis.

Investigate their tremendous possibilities in relation to your own product or service. Your specifications are our guide in recommending the particular McGraw-Hill lists that best cover your market. When planning your industrial advertising and sales promotional activities, ask for more facts or, better still, write today. No obligation of course.

**McGraw-Hill
Publishing Co., Inc.**

DIRECT
MAIL
DIVISION

330 WEST 42nd STREET
NEW YORK, 18, N. Y.

Want more information? Use post card on last page.
ELECTRONICS — November, 1954

NEW BOOKS

Faster Than Thought

By B. V. BOWDEN, EDITOR. *Sir Isaac Pitman and Sons, Inc., London, 1953, 416 p., \$8.50.*

THE ART of designing and of using digital computing machines is still advancing so rapidly that it cannot be properly caught on paper, particularly not in the form of a printed and bound book. What Bowden and his co-authors have to say about computing machines, therefore, is already out of date and will soon be ludicrous.

The great strength of "Faster Than Thought" is that its interest and its worth are not to be measured by the currency of the computer lore that the book has to offer. While much that is said is still pertinent, the principal attraction of the book lies in its unusual attention to the pre-history of modern computing machines and the breadth of its approach to applications.

Historical

Bowden has made a personal project of tracing out the life and achievements of Babbage and of his principal disciple, Ada Augusta, the Countess of Lovelace and the daughter of the poet Byron. This is a fascinating story. Babbage was a gifted eccentric, Ada was an accomplished mathematician, and both of them were clearly ahead of their time.

After a section devoted to the history and the theory of computing machines, we come to nine chapters devoted to describing "Electronic Computing Machines in Britain and America". This leads into the final section, which is devoted to "Applications of Electronic Computing Machines". This last section includes chapters describing logical calculators, applications of digital computers to meteorology, to crystallography, to ballistics, to structural engineering, to problems of government, to business and commerce, to economics, to dynamical astronomy, to games and to the type of problem for whose solution



VSWR Calibrator



PRECISE WAVEGUIDE DEVICES



Precision Slide
Tuner



Hi Power Movable Short



Unequaled experience in producing simple or complex test components that combine laboratory precision with production ease. Get the most quality values your dollars can buy — consult our field Engineers or send us your specifications for microwave test components.

Make Technicraft your source for flexible waveguides and custom built microwave plumbing also.



TECHNICRAFT LABORATORIES

1550 Thomaston Road
THOMASTON, CONNECTICUT

West Coast Office | Westron, 6907½ Melrose Ave.,
Los Angeles 38, California

Want more information? Use post card on last page.

where **LESS**
is **MORE**
international
instruments



1" and 1½"
ELECTRICAL METERS
and 1½"
RUGGEDIZED
To Spec. Mil-M-10304 (Sig. C.)
METER



**FOR AIRCRAFT, GUIDED MISSILES,
ELECTRONIC and ATOMIC DEVELOPMENTS,
COMMUNICATIONS and INDUSTRY**

Wherever less weight and smaller size are vital, these sub-miniature and miniature meters allow more savings. They not only provide accuracy and dependability equal to that of larger models, but, in addition, the inherently strong construction withstands shock and vibration far better than conventional sized instruments. A D'Arsenal type movement of excellent design, precision workmanship and materials of selected quality permit miniaturization while retaining high performance standards.

Meters, testing devices and allied equipment are available for a wide variety of requirements and can be adapted for use wherever it is desired to measure quantities electrically. Instruments are engineered for unusual applications by our staff of skilled technicians. Efficient production insures good delivery and low cost on both regular and special jobs.

If smaller size and lighter weight can help solve your instrument problems, fill in and mail the attached coupon today.

**i international
instruments**
INCORPORATED
P. O. BOX 2954, NEW HAVEN 15, CONN.
LIAISON ENGINEERS IN PRINCIPAL CITIES

Please send me engineering data sheets covering the International line of instruments.

NAME _____
POSITION _____
CO. NAME _____
ADDRESS _____
CITY _____
ZONE _____ STATE _____

Want more information? Use post card on last page.

NEW BOOKS

(continued)

human thought has heretofore been regarded as essential.

Conclusions

This reviewer confesses to a weakness for the chapters that have been written by Bowden. Chapter 26, on "Thought and Machine Processes" is especially good. The author has mastered and is able to communicate such recondite and interesting lore that the effect is altogether charming.

In sum, this book contains so much that is timeless that its description of an early state of the computing-machine art becomes no handicap. It is a work that everyone who is interested in electronic computers will want to own and have available. Bowden has now left Ferranti to become the principal of the Manchester Technical College. If his lectures are as interesting as his writing, and as well informed by the results of personal research, one cannot doubt that his students will benefit.

"Faster Than Thought" is a book that everyone interested in the computer field will want to own.—
LOUIS N. RIDENOUR, *International Telemeter Corp., Los Angeles, Calif.*

**Books on
Elliptic Functions**

Cauer—Filter Theory

ELLIPTIC functions are much used in all domains of modern electrical engineering. Thus, to cite two instances in current telecommunication theory: rigorous determination of the electrical parameters of coaxial rectangular tubular waveguides, or of microstrip uhf transmission lines, hinges on intricate analysis couched in terms of elliptic functions. Again, Cauer's powerful (very limitedly known or taught in the U. S.) approach to filter theory based on the Tschebyscheff extremal problem (W. Cauer, *Theorie der linearen Wechselstromschaltungen*, Akademische Verlagsgesellschaft, Leipzig, Germany, 1941, 548 pages; J. W. Edwards, Ann Arbor, Michigan, 1948, 614

**NEWLY DEVELOPED
SUB MINIATURE TYPE 10**

HYCOR

**TYPE 10
PRECISION
RESISTOR**



**TYPICAL
1 WATT
CARBON
RESISTOR**

H-SERIES

*Hermetically
SEALED*

PRECISION WIRE-WOUND

RESISTORS

The new Hycor "H" Series Precision Resistors incorporate unique design features that make it possible for the resistors to meet performance requirements far beyond those required by military specification.

The "H" Series Precision Resistors are encapsulated in a tough plastic compound; The result is a solid, homogeneous unit with unparalleled ruggedness, impervious to the effects of moisture, thermal shock and mechanical shock. The plastic is filled with heat conducting mineral which dissipates the heat and equalizes the "hot spots" in the resistor winding. The sealed-in terminal connections are welded.

SPECIFICATIONS...

MILITARY SPECIFICATIONS: Performance characteristics satisfy all requirements of MIL-R-93A and JAN-R-93.

TEMPERATURE COEFFICIENT: ±0.0022% per deg. C.

OPERATING TEMPERATURE: -65°C. to +125°C.

RESISTANCE ACCURACY: Standard resistance tolerances are 1%, 0.5%, 0.25% and 0.1%.

Type 10 (illustrated):
1/4" dia x 1/2" long;

Resistance range: 1.0 ohm - 0.35 meg.

Send for Bulletin H for complete description on other physical sizes and wattage ranges.

DISTRIBUTOR
Hycor Sales of California
11423 Vanowen St., Na. Hollywood, Calif.

REPRESENTATIVES
Beebe Associates
1155 Waukegan Road, Glenview, Illinois
Burlingame Associates
103 Lafayette Street, New York City
Harrison J. Blind, 1616 Card St.
Indianapolis 24, Indiana
G. M. Howard & Associates
734 Bryant St., San Francisco 7, Calif.

EXPORT DIVISION
Morhan Exporting Corporation
458 Broadway, New York 13, N. Y., U. S. A.
Cable: "MORHANEX"

HYCOR
Company Inc.

Want more information? Use post card on last page.

November, 1954 — ELECTRONICS

IMMEDIATE DELIVERY!



REGULATED OUTPUT AMPLIFIER

S190A

Holds output level constant despite 40 db input level variations

- Adjustable noise threshold
- 75 db gain
- Low distortion
- 25/50/250/600 Ohms input
- 600 Ohm output
- \$295.00 FOB Washington, D. C.



SCHUTTIG and CO.
INCORPORATED
5005 Calvert Road
College Park, Md.

**Constant Current or Constant Voltage
DUAL PURPOSE REGULATED
DC POWER SUPPLY**



Model PS-110

Continuously variable thru zero from full output of either polarity to full output of opposite polarity

- Constant current to 50 ma, 100 volts max.
- Constant voltage to 200 volts, 50 ma max.
- Wide range selection permits fine control to zero
- Provisions for modulation by external signal
- Voltage regulation 1/4% or 0.3 volts, no load to full load
- Current regulation 1/4% or 0.2µa, all scales, except 1/2% for 50 µa and 100 µa scales, max. voltage to short circuit



TELETRONICS LABORATORY, INC. 54 KINKEL STREET
WESTBURY, L. I., N. Y.

**LO-C
OSCILLOPROBE***



Permits examination of any signal under observation without the amplitude loss or waveform distortion generally experienced with conventional R-C probes. The low input capacitance [less than 2 MMF] results in a minimum of loading, particularly on high impedance circuits. Invaluable for operational checks on computers, TV sync amplifiers, and pulse circuitry.

- FEATURES: MODEL HF-3**
- Less than 2 MMF input capacitance.
 - Input Impedance: 4.5 megohms.
 - Output Impedance: 60 ohms.
 - Band Width: 10 cps to 10 mc.
 - Regulated supply: D.C. on filament.
 - 0.25 MV noise level.

*TM Reg WRITE FOR CATALOG
LINEAR EQUIPMENT LABORATORIES INC
MASSAPEQUA, L. I., N. Y.

**electronic engineers
physicists**

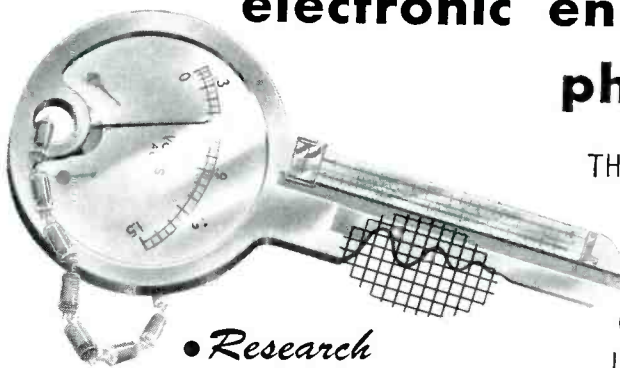

THE KEY TO YOUR
future IN
AUTOMATIC
DATA HANDLING
COMMUNICATIONS
INSTRUMENTATION

- Research
- Development
- Field Engineering • Technical Writing

Our electronic computer program is providing unequalled opportunities for qualified individuals to participate in the dynamic field of computer technology. Write now for additional information.

INTERVIEWS ARRANGED AT OUR EXPENSE HOUSEHOLD GOODS, MOVING EXPENSES PAID

LIBERAL EMPLOYEE BENEFITS

You Will Enjoy Living in Minnesota

**REMINGTON RAND
INC.**
1902 West Minnehaha

**ENGINEERING RESEARCH
ASSOCIATES DIVISION**
St. Paul W 4, Minnesota

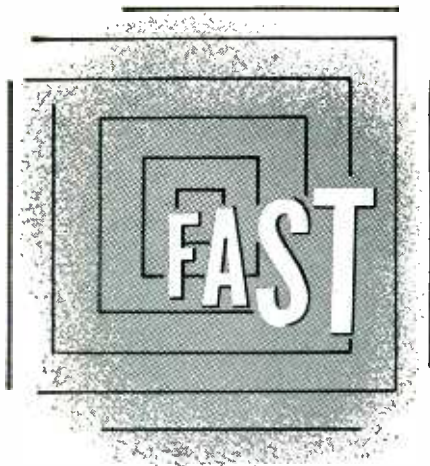

SQUARE PULSE GENERATORS by EPIC



Model 100: Single Pulse Generator, Model 200: Double Pulse Generator, Model 300: Three or more pulse outputs. Rise time .001 usec. Pulse width .001 usec. to several usec. Pulse amplitude from 0.006 volts to 100 volts into low impedance cables (50 ohms or more).

A new, more accurate method of pulse generation for Nuclear, Radar, TV, UHF and other fields where fast pulse circuits are employed. EPIC pulse shaping provides practically ideal square pulses of rise time of one millimicrosecond and of widths which can be varied from one millimicrosecond to several microseconds. A push button control is included for single pulse operation. Double, triple and multiple pulse output generators or adaptations are available to meet your individual requirements.

EPIC FAST PULSE GENERATORS ARE USEFUL IN THE FOLLOWING APPLICATIONS:

- As a basic test instrument for use in development, design, calibration and servicing of fast pulse circuits.
- Testing nuclear counting systems, analyzers, scalars, and amplifiers.
- Calibrating fast oscilloscopes and timing equipment.
- EPIC multiple output Pulse Generators are of immeasurable value, where one or more trigger impulses of definite amplitude and timing relative to signal pulse are required, or in testing resolution and dead time of counting equipment.

Write for detailed engineering bulletin No. 202. Inquire also about our 10 mc counting and timing equipment, and custom designs.

EPIC

**ELECTRICAL AND PHYSICAL
INSTRUMENT CORP.**
42-19 27th Street • Long Island City, N. Y.

Want more information? Use post card on last page.

388

pages) is couched in terms of Weierstrass' elliptic functions.

Greenhill—Practical Applications

Despite, however, this rapidly increasing use of elliptic function theory in applied electrical theory—as well as in numerous other branches of engineering, particularly in modern aerodynamic and hydrodynamic theory—it is only recently that books especially suited to study by engineers or physicists (who wish a text that both details those portions of the theory most useful in practice and illustrates application of this theory to the solution of technical problems by advance of numerous selected examples) have become available. Thus, of the several score of texts published before 1948, only a half dozen or so were in the English language; of these, only one could be cited as other than an essentially massive compendium of pure mathematical theory—namely, that by G. Greenhill (*The Applications of Elliptic Functions*, Macmillan and Co., London, England and New York, 1892, 357 pages), longtime professor of applied mathematics in the Artillery College at Woolwich; and even this is of limited value to an engineer or physicist; for most of the illustrative problems stem from the domain of nineteenth century classical mechanics and the context is yet essentially a mass of pure theory.

Oberhettinger & Magnus—Text on Theory

The just-mentioned lacuna, the increasingly significant role of elliptic function theory in engineering analysis and synthesis, and the pressing need of an appositely-written text were respectively noted, appreciated, and—in 1949—partially fulfilled by F. Oberhettinger and W. Magnus through publication of their very excellent German text: *Anwendung der Elliptischen Funktionen in Physik und Technik*, Springer-Verlag, Berlin, Cöttingen, Heidelberg, Germany, 1949, 126 pages. This book, comprising five chapters and pertinent tables, encompasses basic theory and carefully selected illustrative content which is easiest epitomized, perhaps, by citing (in

Complete Testing Equipment for

OMNI and LOCALIZER RECEIVERS

A.R.C. Type H-14 Signal Generator

For a quick and accurate check by pilot before take-off, or for maintenance on the bench, this is the favored and dependable instrument. Checks up to 24 omni courses, omni course sensitivity, to-from and flag-alarm operation, and left-center-right on localizer. For ramp check, RF output 1 volt into 52 ohm line; for bench checks, 0-10,000 microvolts.

The H-16 Standard Course Checker is a companion instrument to the H-14. It makes possible a precise check on the course-accuracy of the H-14 or of any other omni signal generator. Just as a frequency meter is necessary in connection with a variable frequency signal generator, the H-16 Standard Course Checker is required in connection with a VOR signal generator for a precise measurement of phase accuracy.

These instruments sold only direct-from factory.

Write for detailed literature



Dependable Airborne Electronic Equipment Since 1928

Aircraft Radio Corporation
BOONTON NEW JERSEY

Want more information? Use post card on last page.

November, 1954 — ELECTRONICS

translation) the chapter headings: I. Basic Theory; II. Conformal Mapping and Green's Function; III. Applications of Elliptic Functions to Problems of Electrostatics; IV. Applications in Hydrodynamics and Aerodynamics; V. Mixed Problems: The Mathematical Pendulum, the Charged Ellipsoid, The Stressed Beam, Questions of Tschebyscheff Approximation; Tables.

Careful study and assimilation of this text will (in the reviewer's opinion, stemming from work during the past decade on numerous problems involving intricate elliptic function analysis) afford one seriously interested in modern communication theory a basic mastery of elliptic function theory sufficient to cope with most of the pertinent published literature or original research involving elliptic theory.

Bowman—Jacobian Elliptic Functions

Those who desire such mastery, yet lack the necessary reading knowledge of German, will find a very excellent substitute in the recently-published, concisely-written, and elegantly-framed text by F. Bowman (Introduction to Elliptic Functions with Applications, English Universities Press Ltd., London, England, and John Wiley & Sons, New York, 1954, \$2.50). This text, by the Head of the Department of Mathematics, College of Technology, Manchester, England, provides "a short, practical account of the Jacobian elliptic functions, intended for the physicist or engineer who wishes to make himself familiar with the properties which are most useful in application". Illustration of use is provided by solution of numerous two-dimensional problems in electric and magnetic field theory, in hydro-dynamics and in the theory of elasticity.

A particular feature marking the illustrative problems set out in Bowman's book is the associated account of effective use of certain available tables of elliptic functions. Such discussion is of especial value in that practical application of the general solution of a specified problem hinges on being able to effect numerical calculation in terms of assigned numerical data. Now fulfillment of such necessity entails

COST-SAVING IDEAS  FOR DESIGN ENGINEERS

HOW AN S.S. WHITE FLEXIBLE SHAFT CUTS THE COST OF CONTROLLING AN INACCESSIBLE PART

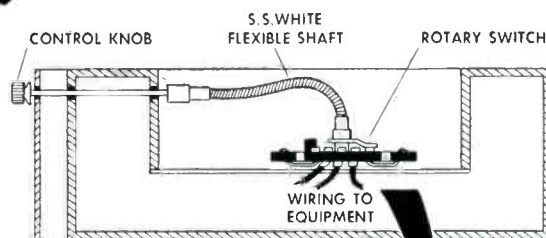

Note how simply and easily an S.S. White flexible shaft solved this problem—that of controlling an inaccessible rotary switch from a convenient operating point. Despite the 90° turn, only one shaft was needed, a fact which meant important savings in space, parts and weight and which in turn resulted in lower costs.

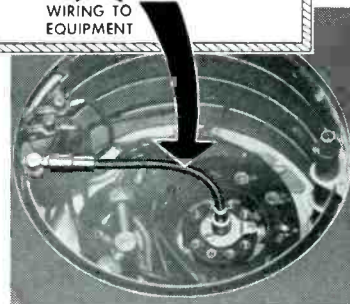

Here's how you'll save with S.S. White Flexible Shafts

Whenever a design calls for remote control, it will pay you to consider the cost-saving advantages of an S.S. White flexible shaft. You'll be able to eliminate problems created by alignment or vibration—you'll be able to save parts—you'll reduce assembly time and costs—and will be able to meet critical space requirements with greater ease.

We invite you to submit your problems to our staff of experienced flexible shaft engineers for recommendations. There's no obligation.

BULLETIN 5306 has basic information and data on flexible shaft application and selection. Send for a free copy. Address Dept. E



R-6

THE S.S. White INDUSTRIAL DIVISION
DENTAL MFG. CO.  10 East 40th Street
 NEW YORK 16, N. Y.

Western District Office • Times Building, Long Beach, California

DEPEND ON



RELIABLE ELECTRON TUBES



With electronic controls taking over more and more operational functions in military and industrial applications, it is becoming increasingly important that the electron tubes used be dependable under extremely severe conditions. This applies particularly to installations in aircraft where tubes must operate reliably at high altitudes, while subjected to continuous vibration, varying voltages and frequent shock. Because of their advanced design and construction . . . born of never-ceasing research and special production skills . . . Bendix Red Bank Reliable Electron Tubes have the dependability necessary to meet these severe operating conditions. You can depend on our long, specialized experience to give you the right answer . . . for all types of regular as well as special-purpose tube applications. Tubes can be supplied to both commercial and military specifications. Call on us for full details.

Manufacturers of Special-Purpose Electron Tubes, Inverters, Dynamators, Voltage Regulators and Fractional D. C. Motors

DESIGNATION AND TYPE					TYPICAL OPERATING CONDITIONS		
Type	Proto-type	Bendix No.	Description	Base And Bulb	Heater Voltage	Plate Voltage Per Plate	M.A. Load
5838	6X5	TE-3	Full Wave Rectifier	Octal T-9	12.6	350.	70.
5839	6X5	TE-2	Full Wave Rectifier	Octal T-9	26.5	350.	70.
5852	6X5	TE-5	Full Wave Rectifier	Octal T-9	6.3	350.	70.
5993	6X4	TE-10	Full Wave Rectifier	9-Pin Miniature	6.3	350.	70.
6106	5Y3	TE-22	Full Wave Rectifier	Octal T-9	5.0	350.	100.

Type	Proto-type	Bendix No.	Description	Base And Bulb	Heater Voltage	Plate Voltage	Screen Voltage	Grid Voltage	Gm	Plate Current	Power Output
5992	6V6	TE-8	Beam Power Amplifier	Octal T-9	6.3	250.	250.	12.5	4000	45. MA	3.5 W
*6094	6AQ5 6005	TE-18	Beam Power Amplifier	9-Pin Miniature	6.3	250.	250.	12.5	4500	45. MA	3.5 W
6385	2C51 5670	TE-21	Double Triode	9-Pin Miniature	6.3	150.	—	—2.0	5000	8. MA	—

*Tube Manufactured with Hard (None) Glass for High Temperature Operation (Max. Bulb Temp. 300°C.)



DIVISION OF



West Coast Sales and Service: 117 E. Providencia Ave., Burbank, Calif.
 Export Sales: Bendix International Division, 205 East 42nd St., New York 17, N. Y.
 Canadian Distributor: Aviation Electric Ltd., P.O. Box 6102, Montreal, P. Q.

—in general—a knowledge of the sources and relative merits of the numerous tables of elliptic functions in the literature.

Fletcher—Guide to Tables

In such thought, the reviewer would direct attention to that very excellent guide to such tables: A. Fletcher, "Guide to Tables of Elliptic Functions," Mathematical Tables and Other Aids to Computation (MTAC), volume 3, 1948, pages 229-281.

Milne—Function Tables

Attention may also be directed to the useful little volume, L. M. Milne, Jacobian Elliptic Function Tables, Dover Publications Inc., New York, N. Y., 1950, 132 pages, and to the exhaustive, recently-computed, mimeographed tables effected by the Numerical Analysis Section of the National Bureau of Standards.

Kober—Conformed Mapping

In particular, the solution of numerous problems in electromagnetic, electronic, and communication theory depends on being able to effect the function which conformally maps a certain plane area on a standard area (such as the unit circle or upper-half plane). It is of interest to note that such effort can often be obviated through use of the lengthy and well-detailed table of transformations provided by H. Kober (Dictionary of Conformal Representations, Dover Publications, New York, N. Y., 1952, 208 pages).

Byrd & Friedman—Handbook of Elliptic Integrals

Tables of elliptic functions facilitate numerical computation of, and tables of mapping functions facilitate effecting transformation with, general formulas couched in terms of elliptic functions. Obtaining such general formulas, however, often turns on a ready ability to evaluate integrals whose nonelementary integrands encompass, or whose integration results in, elliptic functions. In consequence, need has long existed for "a handbook embodying in convenient form a comprehensive table of elliptic integrals together with auxiliary

Spectrum Analyzer

TS-148/UP

EQUAL TO OUR
GOVERNMENT TYPE DESIGNATION
UPM—33



- NEW AND IMPROVED DESIGN
- OUTSTANDING PERFORMANCE
- MORE RUGGED CONSTRUCTION

Specifications . . .

Attenuation (Spectrum Amplitude): 3—70 db uncal.

Frequency range: 8430 Mcs—9660 Mcs.

Frequency sweep: 10—30cps continuous.

Frequency swing (FM sawtooth) of analyzer r-f oscillator: 40—50 Mcs.

Maximum error: ± 4 Mcs.

Maximum dispersion of spectrum: 1.5 Mcs per inch.

Overall i-f bandwidth at half power point: 50 Kcs.

Sensitivity to CW:

a. Spectrum amplified position: 80 db below 1 W per inch deflection on oscilloscope screen.

b. Spectrum position: 55 db below 1 W per inch deflection on oscilloscope screen.

Weight: 86 pounds (complete in armored case with all accessories).

Write or wire for prices
and delivery schedule

G&M EQUIPMENT Co., Inc.

"Where Hi-Quality Is Fundamental"



7309 VARNA AVENUE
NORTH HOLLYWOOD, CALIF.
Phone: **POplar 5-4185**

0 to 5000 Volts

CALIBRATED DC • PRECISE POWER SUPPLIES

- Calibrated Accuracy 0.1% or Better
- Voltage Resolution 0.002 Volt
- Line Regulation 0.002%
- Load Regulation 0.002%
- Stability, Long Term 0.01%

The Series 300 Supplies comprised of 12 models include: (Pictured at right)

Model 301C Instrument Calibrator

Voltage: 1 to 1000 volts

Current: 0 to 400 ma.

Calibration: 100, 10 and 1 volt steps, calibrated 1.1 volt vernier

Mounting: Panel 19" x 21", depth 16"

Price: \$895.00 FOB Seattle

Model 300N Calibrated Supply

Voltage: 700 to 3000 volts

Current: 0 to 30 ma.

Calibration: 100, 10 and 1 volt steps, calibrated 1.1 volt vernier

Mounting: Panel 19" x 29 $\frac{3}{4}$ ", depth 16"

Price: \$1425.00 FOB Seattle

The Series 300 Supplies are ideal for fast, accurate instrument calibration; for computer work; for use as secondary standards. Custom models for special needs.



The Series 400 Nuclear Supplies (not pictured) feature the following:

- Calibration accuracy 1% or better
- Line and Load Regulation 0.01%
- Stability 0.01% short term, 0.1% long term
- Ideal for scintillation spectrometer and detector applications
- Models available covering the range of 500 to 5000 volts, currents from 0 to 20 ma.
- Prices \$475.00 to \$615.00 FOB Seattle



JOHN FLUKE MFG. CO., INC.

1111 West Nickerson Street,

Seattle 99, Washington

Represented by

YEWELL ASSOCIATES, Bridgeport & Waltham; HORMAN ASSOCIATES, Washington, D. C.; GERALD B. MILLER CO., Hollywood, San Francisco, Albuquerque, Seattle; M. P. ODELL CO., Cleveland, Dayton, Detroit, Pittsburgh; HUGH MARSLAND & CO., Chicago, Indianapolis, Minneapolis; RMC ASSOCIATES, New York, N. Y., Bogota, N. J.; THE I. E. ROBINSON CO., Upper Darby, Pa., Asbury Park, N. J., Harrisburg, Pa.; J. D. RYERSON, Syracuse, N. Y.

MINISEL HG



Selenium Rectifiers



MINISEL HW



MINISEL HW BRIDGE



NPS



NRS



PLASTIC SEALED



OIL FILLED



RECTISEL



POWERSEL

MINISELS — high voltage, low current, subminiature, encased selenium rectifiers. Minisel HG is glass encased, hermetically sealed. Minisel HW is a Bakelite encased cartridge, half-wave and full wave (bridge or center tap) types.

RECTISEL — Conventional open construction.

NPS — Sealed in plastic, pigtail leads.

NRS — Fully insulated, no center mounting, no hot spots.

POWERSEL — Industrial stack, power rectifier.

HERMETICALLY SEALED — Oil-filled, metal container, or plastic sealed, plastic cased.

Carefully engineered, built, tested. Fully guaranteed. Many JAN types.

Our engineering facilities are at your disposal. Phone, wire, write for complete data.



Electronic Devices, Inc.

429-12th St., Brooklyn 15, N. Y.

Manufacturers of long life Selenium Rectifiers

Aerohm Precision Potentiometers



**"HOT-
POT"**

Designed for high-temperature use
Dissipates 1 watt at 200°C
Dissipates 5 watts at 80°C
Resistances - 1000 to 25,000 ohms
Compact - 1 in. diameter x 11/16" depth behind panel
Stainless steel case and shaft
Teflon insulated terminals

**"LO-
TORK"
POT**



Designed for minimum-torque uses
0.01 inch-ounce maximum torque
Dissipates 1 watt at 80°C
Resistances - 100 to 100,000 ohms
Compact - 7/8 in. dia., 4/5 in. depth
Weighs only 1/2 oz.
Ganging up to 6 sections, internal clamps maintain 7/8" dia.
Stainless steel ball bearings
Anodized aluminum case

These potentiometers have standard linearity of .5%—on special order .25%; precision toroidal winding allows winding angles up to 360°—standard is 354 degrees.



Write today for data sheets and price information.

WATERS MANUFACTURING, inc.

Waltham 54, Massachusetts

APPLICATION ENGINEERING OFFICES IN PRINCIPAL CITIES

NEW BOOKS

(continued)

formulas and numerical tables of values". Such need is satisfied by the recently-published volume by Byrd and Friedman, *Aeronautical Research Scientists with the NACA. (Handbook of Elliptic Integrals for Engineers and Physicists, by P. F. Byrd and M. D. Friedman; Springer-Verlag, Berlin, Göttingen and Heidelberg, Germany; Lange, Maxwell and Springer, Ltd., London and New York, 355 pages, 1954).*

This book is not a textbook; hence it complements, rather than parallels, the German and the English texts reviewed above. Accordingly, though, as the authors remark, "an attempt has been made to write it in elementary terms so that no previous knowledge of theta functions or elliptic integrals is needed", the average user thereof will find it both desirable and helpful to preface use of it by knowledge equivalent to at least that encompassed in Bowman's book.

This volume comprises a collection of over 3,000 integrals and formulas; selected to suffice most needs originating in practice and couched in terms of Legendre's and Jacobi's notation.

The necessities of numerical calculation are met by inclusion of short tables of the elliptic integrals of the first and second kind. Numerical evaluation of integrals of the third kind is afforded by tables of Jacobi's q -function, of Heuman's Λ_0 -function, and of Jacobi's (K-multiplied) zeta-function.

An excellently-delineated preface; a well-detailed table of contents; a most useful three-page list of the prime symbols and abbreviations employed in the text; a page of errata and addenda; a seven-page introduction which provides historical background, a detailed plan of the text and evidence of typical uses of the formulas therein; a bibliography of some forty well-chosen items and a carefully compiled index round out the content.

The binding is sturdy; the paper of excellent grade; the typography superlative; the formulas and tables well displayed.

In recapitulation, the reviewer

**experience
pays**

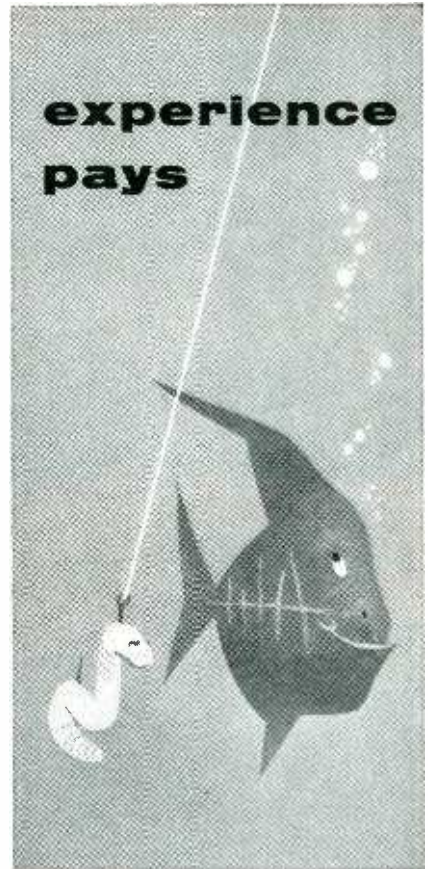

Yes, experience does pay in many ways. Our clients know from experience they have a dependable, responsible source for preparation of better industrial and business literature.

Why not do the job right? It saves time, money and produces results. Let us give you a proposal on your next publication.

We'll do the whole job—from planning to printing—or just those parts that you need.

product literature

military manuals

company publications

training material

Call or write for more information.

TECHNICAL WRITING SERVICE
McGraw-Hill Book Co., Inc. • 330
West 42nd Street • N. Y. 36, N. Y.

Want more information? Use post card on last page.

Want more information? Use post card on last page.

would rate each of the four major items discussed above as "must" items for an up-to-date library maintained by an engineering college or industrial research laboratory. Further, as they encompass the theory, tables, formulas and integrals which will resolve most phases of elliptic function theory that will be encountered in the usual course of modern electrical engineering work—particularly in communication, applied electronic or automatic control engineering—these books merit a careful scrutiny and study by the analytically-capable engineer particularly interested in research or development.—THOMAS J. HIGGINS, Professor of Electrical Engineering, University of Wisconsin.

Physics and Applications of Secondary Electron Emissions

BY DR. H. BRUINING. McGraw-Hill Book Co., Inc., New York, N. Y., 1954, 178 pages, \$5.50.

ABOUT fifty years ago scientists learned that when electrons strike the surface of a solid with sufficient energy, the latter emits electrons. This phenomenon, called secondary emission, has intrigued physicists and engineers ever since.

Physicists want to know why this happens, and to correlate their observations with the latest developments in the theory of solids; engineers want to know how to employ the phenomenon in building better and more useful tubes, or to suppress the effect where it is not wanted.

Attempts to make full use of secondary emission in practical devices have been nearly continuous since about 1917, when Hull introduced the dynatron. Much of the work that followed ended in disappointment, because the secondary-emissive properties of materials are difficult to maintain, due largely to the contaminating influence of the ordinary thermionic cathode. This problem was overcome in large measure in the de-

CHECK DIODES

- Instantly • Visually
- In Operation



You can tell good diodes from bad — at a glance — when you check them with this compact, self-contained, visual tester.

- Shows dynamic characteristics of point-contact-type germanium diodes on a cathode-ray tube.
- Calibrated scale allows direct reading of voltage on horizontal axes and current on vertical axes.
- Can be used by unskilled operators, for production-line testing and stock maintenance.
- Pays for itself in a short time by spotting rejects and units having insufficient shelf life.
- Shows forward and backward characteristics between 10 ohms and 20 megohms.
- Operates on 115 volts 50/60 cycles.
- Overall size, 11 x 12 x 9 inches
- Price\$400.00

Data sheet giving detailed information on the Model 1003-A Crystal Diode Curve Tracer will be sent on request.



WATERS MANUFACTURING, inc.
Waltham 54, Massachusetts
APPLICATION ENGINEERING OFFICES IN PRINCIPAL CITIES

NEW

LOW-RANGE INCREMENTAL INDUCTANCE BRIDGE

fast • simple • accurate



For production or laboratory testing of toroids, filters, relay coils, and chokes under actual operating conditions.

- 1 millihenry to 5 henries
- ± 3% accuracy
- Direct-reading at 60, 400, 1000 cps.
- Visual balance indication
- DC adjustable, 0 to 500 ma.
- AC continuously variable, shown on panel meter
- Self-contained for 60-cycle measurement; permits external frequencies to 1000 cps.

HIGH-RANGE BRIDGE

- 1 to 200 henries
- Direct-reading at 120 cps.
- ± 3% accuracy
- DC adjustable, 0 to 500 ma.
- Sensitivity increases toward null for fast, easy, visual balance

These two instruments are designed for mounting in standard relay racks; panel area is 19" x 8 3/4" for each bridge. Units are wholly self-contained for operation at 115 volts 50/60 cycles.



Write for data sheet describing both instruments.

WATERS MANUFACTURING, inc.
Waltham 54, Massachusetts
APPLICATION ENGINEERING OFFICES IN PRINCIPAL CITIES

Want more information? Use post card on last page.

SECON

PRECISION POTENTIOMETER WIRE
Bare and insulated. A complete range of precious metal potentiometer winding alloys from 37 ohms per circular mil foot to over 600 ohms per circular mil foot.

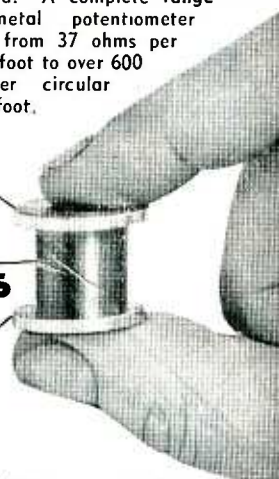

- round
- oval
- flat
- grooved
- ribbon

precision small wire

- bare
- insulated
- plated

for highly engineered applications

- all metals
- all alloys

Round Wire to 0.00015" diameter. Ribbon rolled to 0.0001" in thickness. Close tolerances held on all specifications.

SECON

... wherever the element calls for PRECISION

development and production metallurgists
SECON METALS CORPORATION
7 Intervale Street, White Plains, New York
White Plains 9-4757

Write for Pamphlet E

sign of the orbital beam tube, but no application involving the handling of large amounts of power has met with marked success.

In more recent years the applications of secondary emission have resulted in a number of practical devices. For example, the multiplier phototube, or photomultiplier, depends upon secondary emission for the enormous gain it is able to provide. The signal-to-noise ratio for weak light signals is far greater than could be obtained with a phototube requiring a separate amplifier.

The more spectacular applications are, of course, in television camera tubes and other storage tubes. In these devices the difficulties inherent in earlier attempts to use secondary emission are quite readily circumvented while, at the same time, performance is achieved that could not be attained by any other means.

Those who have known the pleasures and discouragements that result from working with secondary emission are fully aware of Dr. Bruining and of the work he and his associates have been doing at Eindhoven. My own efforts on an application of secondary emission during the war was immeasurably facilitated by having had available the series of papers by Bruining and DeBoehr published in *Physica* between June 1937 and October 1939. Most of this work is included in the new volume.

While "Secondary Electron Emission" contains only 157 pages of text, the subject is covered more completely than one would expect in such a small book. About twenty pages are devoted to a good outline of measurement techniques, two chapters review the results obtained with both metals and compounds, and three chapters cover the theory of observed results.

The applications of secondary emission in special tubes are outlined in two chapters, including brief descriptions of multiplier phototubes, image converters, the dynatron and the various kinds of storage tubes including television pick-up tubes. These descriptions, while obviously not intended to provide a full working knowledge of

DANO COILS

Serve Modern Industry

Behind the scenes come Dano Coils—made to exact customer specifications to perform an exact electrical function . . .

- Molded Coils
- Form Wound
- Paper Section
- Acetate Bobbin
- Bakelite Bobbin
- Cotton Interweave
- Coils for High Temperature Application

Also, Transformers Made to Order

The **DANO Electric Co.**
MAIN ST., WINSTED, CONN.

HIGH SPEED TV LENSES



WORLD'S LARGEST STOCK
(Shown)

Coated Hi-resolution Lenses for every TV need
... Wide-Angle, Normal, Telephoto—1 1/4 to 20"
... COOKE, Zeiss, Ektar, Carl Meyer, B & L, Wollensak, Ross, Astro, etc. Featuring all Accessories . . . Baffle Rings, Counterbalances, Fittings. Foc. Mounts fit RCA, DuMont, G.E. Image Orth. **Special Mounts** for G P I and others. Expert Fitting Service.

15-day FREE TRIAL
Unconditional GUARANTEE

Write for Free TV LENS BULLETIN #754 TV
Serving TV since 1936



Also available — **FREE 96 pg. Photo-Tools Catalog** — Geared to Industrial & Scientific Uses. Write Mr. Elec Today!

BURKE & JAMES, INC.
321 South Wabash Ave.
Chicago 4, Ill. U.S.A.

SECONDARY FREQUENCY STANDARD

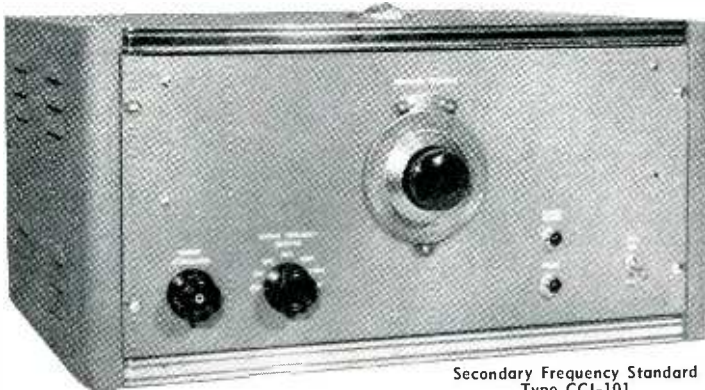

Secondary Frequency Standard
Type CCI-101

Seven Years *PROVEN* Performance

Compare these outstanding features:

- Stability 1 part/10 million over period of hours
- Standard oscillator variable 40 PPM with dial calibrated in parts per million and directly readable to 0.1 part per million
- Resetability to within 0.1 PPM
- 1 KC Harmonic to 15 Mc
- 10 KC Harmonics to 100 Mc
- 50 KC Harmonics to 150 Mc
- 100 and 250 KC Harmonics to beyond 250 Mc
- Low output impedance
- Low cost

First Time Available! A sliding secondary frequency standard with direct reading in parts per million up to 40 PPM.

Eng. Prod. Div. **ORDER NOW! WRITE IMMEDIATELY!**

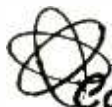

Continental Communications, Inc.

452 WEST CHICAGO AVENUE, CHICAGO 10, ILLINOIS

FEATHERWEIGHT CLASS H (200°C) TRANSFORMERS

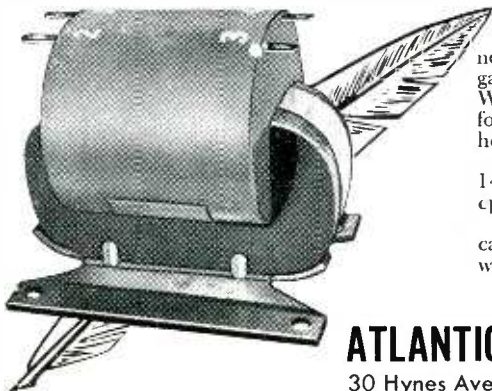

Atlantic Transformer Corporation is now producing units designed with thin gauge C-loops, Asbestos Insulation, Teflon Wire and Silicone Varnish. These transformers are conservatively rated for 5000-hours life.

The transformer illustrated here weighs 14 ounces, and is rated at 220 watts, 400 cps, 100°C heat rise.

On special order, these transformers can be supplied in sizes ranging from 1/8 watt to 750 watts.

Let us know your requirements.

ATLANTIC TRANSFORMER CORP.

30 Hynes Ave., Groton, Conn. Hilltop 5-0353

Have you seen

CORNING'S NEW PRICES

on Fixed Glass Capacitors?



CEN-TRI-CORE

"ENERGIZED or PLASTIC"

ROSIN-FILLED

SOLDER



STANDARD
FOR RADIO,
TELEVISION,
AND FINE
ELECTRICAL WORK.
PRINTED CIRCUITS
NON-
CORROSIVE

Available in six different flux percentages.

Surpasses Federal Specifications. Guaranteed against rosin voids or skips.

Write for informative booklet

ALPHA METALS, INC.

59 Water St., Jersey City, N. J.

SPECIALISTS IN
LEAD & TIN PRODUCTS, SOLDER & FLUXES
FOR OVER 50 YEARS

SQUARE WAVE GENERATOR

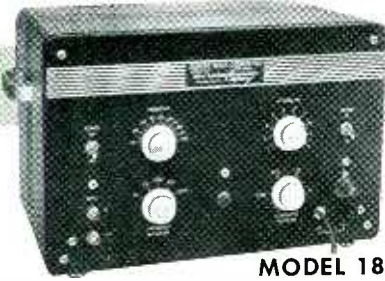

MODEL 183

Combined Voltage Calibrator and Source of Square Waves

This precision instrument provides square waves suitable for testing the transient and frequency response of wide band amplifiers, and for accurately measuring their amplitude. A wide range of output levels is available. Attenuator settings do not affect the output wave shape.

SPECIFICATIONS — Frequency Range: 10 cps to 1 mc continuously variable over decade steps; Rise time: 0.02 μ sec for 100 ohms output, 0.05 μ sec for 1200 ohms output; Max. output: 10 volts p-p across 100 ohms, 100 volts p-p across 1200 ohms.

VHF-UHF NOISE SOURCE

Accurate, Simplified Operation

Ideal for measuring receiver noises in television tuners, receivers and other applications between 50 and 900 mc. Designed for operation with 300 ohm receivers with less than 0.5 db error. Noise figure 0-19 db.



MODEL 175

Write for specifications and catalog on our complete line of measuring equipment.

NEW LONDON INSTRUMENT Company

P. O. BOX 189E
NEW LONDON, CONN.

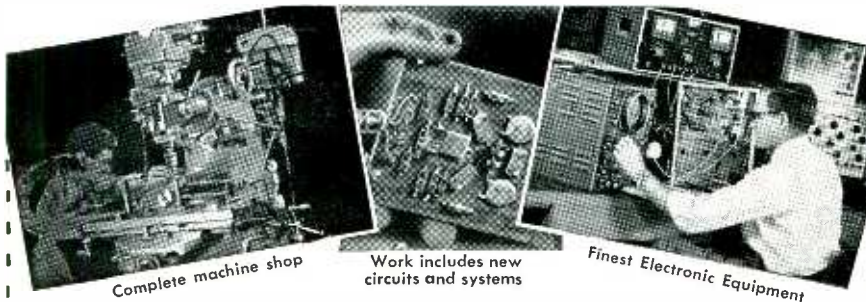

Complete machine shop

Work includes new circuits and systems

Finest Electronic Equipment

Leaders and
Specialists in

"ENGINEERING"

offered splendid opportunities in Boston Engineering Laboratory!

Men qualified to handle high level assignments in electronics are offered a challenging opportunity in Boston, under ideal working conditions divorced from production. The laboratory provides stimulating projects, an atmosphere of scientific progress and provides assistance towards your personal advancement or professional recognition. You will work with a top level technical staff possessing the finest facilities. Administrative positions are open to men qualified to guide the efforts of others.

MICROWAVE ENGINEERS

Senior engineers to handle design and development projects and provide technical direction of other top-level engineers working on microwave circuits and microwave plumbing in the development of military airborne electronic equipment. Should have 5 years' experience in such work and at least a BS degree.

RADAR SYSTEMS AND CIRCUIT ENGINEER

To assume responsibility for electronic circuit design for major elements of complex airborne electronic equipment. Should have a BS degree and about 5 years' experience.

Sylvania provides financial support for advanced education as well as a liberal insurance, pension and medical program. Investigate a career with Sylvania.

INTERVIEWS BY APPOINTMENT

Tom Tierney, Personnel Manager, Boston Engineering Lab. Dept. B

SYLVANIA ELECTRIC PRODUCTS INC.

70 FORSYTH STREET • BOSTON, MASSACHUSETTS • KEnmore 6-8900

the devices, are entirely adequate as illustrations of the ways in which secondary emission is usefully employed.

Tube engineers whose duties include the design or manufacture of tubes in which unwanted secondary emission is a problem will be interested in the chapter entitled "Some Examples of Secondary Electron Emission Causing Disturbing Effects." While only ten pages in length, it summarizes rather well what is known of the subject.

The bibliography at the end of the book gives 393 references, covering the important work from Austin & Starke in 1902 through the 1952 literature.

The author is a member of the research staff of the Philips Laboratories, Eindhoven, Holland, and the book was edited by Dr. D. W. Fry of the Harwell Laboratory in England. —GEORGE D. O'NEILL, *Sylvania Electric Products Inc., Bay-side, New York*

THUMBNAIL REVIEWS

Bibliography on the Submarine. National Research Council, Washington, D.C., 1954, 261 pages, \$1.50. Prepared by the Committee on Undersea Warfare, divided into 8 sections covering the period 1557 to 1953 and giving many hundreds of citations with many brief abstracts of the contents of the individual papers.

Alternating-Current Machines, 3rd Edition. By Puchstein, Lloyd and Conrad, John Wiley, New York, N. Y., 1954, 721 pages, \$8.50. About one-fifth larger than the previous edition; a text on transformers, rotating machinery, and mercury-vapor rectifiers.

TV Manufacturers' Receiver Trouble Cures, Vol. 1, 2, 3 and 4. John F. Rider Publisher, Inc., New York, N. Y., 1953, \$1.80 each. Compilation of trouble cures recommended by manufacturers of television receivers to clear up initial design defects or to give improved operation in areas of high humidity, low signal strength or abnormally high signal strength. Volume 1 covers Admiral through DuMont; Vol. 2—Emerson through Jackson; Vol. 3—Kaye-Halbert through Philco; Vol. 4—Philharmonic through Shaw.

Subminiaturization Techniques for Low-Frequency Receivers. By Gustave Shapiro. National Bureau of Standards Circular 545, 1954, 64 pages, 50¢, U. S. Government Printing Office, Washington, D. C. Complete data on a 12-tube receiver for 190-550 kc, contained in 55 cu. in., made possible by development of 14 new components.



precision resolvers
SIZES 11, 15, 23



400~ servo motors
SIZES 11, 15, 18



brushless induction
potentiometers
SIZE 15



RELIABLE
AND STABLE
PERFORMANCE
•
servo components,
instruments,
synchros

Let us quote on your
detailed requirements.

American Electronic Mfg., Inc.

9503 W. JEFFERSON BLVD., CULVER CITY, CALIF.

TELEPHONE: TEXAS 0-5471

Want more information? Use post card on last page.
ELECTRONICS — November, 1954

BACKTALK

More On Teachers' Problems

DEAR SIRs:

PERMIT ME to contribute to *Backtalk* on teacher vs engineer. According to C. Radius, Mr. McMurtrey's figures would have engineers earning from \$12,000 to \$24,000 per year. . . .

It makes little difference to an instructor that he gets paid for 10 months work, if it means that he is paid at a rate which requires that he engage in summer work to live comfortably. Teachers have always figured their pay as an annual stipend paid in twelve equal amounts.

One of the ideals in teaching that Mr. Radius did not elaborate on is the need to keep abreast of the latest developments. The summer time is ideal for such activities. He would not seriously have it otherwise if he were interested in the long-range improvement of teaching.

I am a supervisor of science and mathematics in one of New York City's vocational high schools and I can speak authoritatively of the difficulties being encountered in recruitment of properly trained personnel. At the moment, our school is faced with the prospect of having no teachers for its mathematics classes. This sort of situation has been plaguing us for years.

Recently, a retiring superintendent mentioned in his farewell address that his son had earned as much as \$160 in one week selling ice cream from a car. We note that young engineers, just out of college, are being offered \$6,000 a year. Mr. Radius uses the average salary of his colleagues, \$500 a month, to project up to the \$12,000 level mentioned previously.

A young man, thinking of entering teaching, does not think in terms of averages. He wants to know the starting salary first. Second, he wants to know how fast he can increase his rate of pay. Third, he wants to know how long it will take him to reach the salary he feels he will need to suit a desirable standard of living. Fourth,

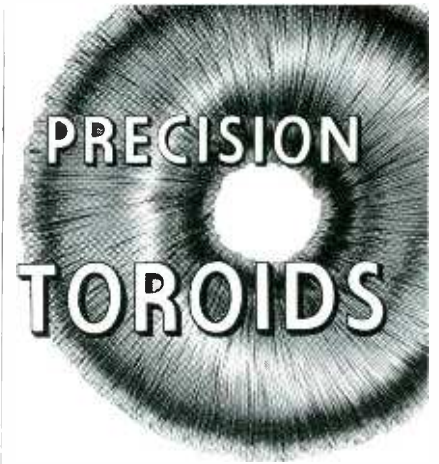

in less time with BOESCH TW-201!

Set up and start winding a new design in 30 seconds! Start winding the next coil in 5 seconds or less!

Coil sizes . . .

.218" I. D. through 5" O. D.!

Wire sizes . . .

#20 through #42 AWG!

Winding speeds . . .

through 600 RPM!

The BOESCH Semi-Automatic Coil Winding Machine lends itself ideally to both research and production. Write today for detailed information on the BOESCH TW-201 and other BOESCH winding machines.

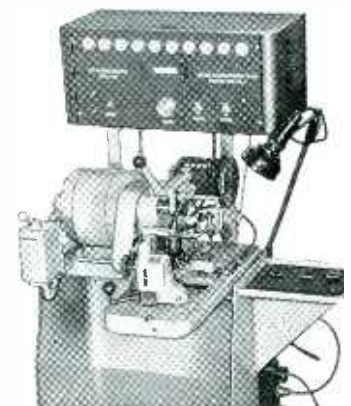

Model TW-201

Makers of the world's most
Versatile winding machines



Want more information? Use post card on last page.

New!

Stepless Spiralpot

HIGH ACCURACY

LOWER PRICE

In response to many requests, G. M. Giannini & Co., Inc. now offers a new LOWER PRICED model in the high performance SPIRALPOT. Having the same infinite resolution and noiseless slide wire operation as the other SPIRALPOT models, the new Model 85175A is available with a bushing mount, sleeve bearings, and linearities of $\pm 0.1\%$ and $\pm 0.05\%$.

FEATURES:

MODEL
85175

Weight: .13 Lbs., Dia.
1.5" Resist. 2 ohms/360° to
250 ohms/360°, 3 &
10 turns standard.
Rated: 5 watts
per 10 turns.

MODEL
85171A

1 to 10 turns Linearities:
 $\pm 0.1\%$ to $\pm 0.025\%$.
Resistances: 2 to 2500
ohms. Ball Bearing
Synchro-
mount.

OTHER
MODELS
AVAILABLE
11 to 40 turns.

Giannini

Product of Electromechanical Division
EAST ORANGE, NEW JERSEY

for information write

G. M. GIANNINI & CO. INC.
PASADENA 1, CALIFORNIA

European Sales Office via ALBERTO DA GIUSSANO
15 MILANO, ITALY

Want more information? Use post card on last page.

398

BACK TALK

(continued)

he considers seriously whether the security or tenure (a phantom in actuality) will compensate him for the relatively lower standard in the early years. Fifth, he considers how inflexible teachers salaries are in the face of rising living costs, rising taxes, lowered educational budgets, and so on.

Modern Methods

To my mind, the shortage of engineering teachers can be attributed also to the current educational philosophy. We are in the grip of a most vocal and numerous group of English and social studies teachers who have sold our schools a philosophy of education based on the assumption that all learning must be directly experiential, personally motivated and should result in discovery. This has led to a watering down of courses of study, and even the elimination of courses of study. Pupils are given to substitute "discussion" for simple application to the acquisition of facts and generalizations, and to problem solving.

Our classes are made up of pupils of abilities ranging from the near-illiterate to the very bright. There is no money for laboratory equipment for pupil experimentation, to say nothing of properly equipped demonstration laboratories, laboratory assistants, clubs and special classes for the bright. As a result, our output of suitable engineering students and teachers is limited.

The vocational schools, which should be the fountainhead of engineering school prospects, are populated with pupils whose average intelligence quotient is well below the national average of 100. College pupils should average 120. My own vocational high school, a typical one, has an average less than 80.

Other Problems

Permit me to discuss some tangential items. It is highly desirable for pupils to see, if not experience, industrial and commercial activities which can lend meaning to classroom instruction. It is very difficult to obtain cooperation of industry. A good program, perhaps subsidized by government, could do much for stimulation of interest in engineering.

Industry would do itself a service

Digital Computer Techniques

Applied to the
design, development and
application of

Military Radar Fire Control Systems

Aircraft Control and Navigation Systems

Electronic Business Systems

The successful application of Hughes airborne digital computers to high speed aircraft fire control problems has opened up an entire new area for these digital computer techniques.

Similar equipment is now under development in the Advanced Electronics Laboratory to apply such digital systems to modern business information handling.

Areas include

LOGICAL DESIGN
COMPONENT DEVELOPMENT
PROGRAMMING
MAGNETIC RECORDING
CIRCUIT DESIGN
INPUT & OUTPUT DEVICES
SYSTEMS ANALYSIS

Engineers and Physicists

Computer activities embrace systems planning and analysis, design and development, system engineering and component development. Experience in these areas, as well as in application of electronic digital computers, is desirable but not essential. Analytically inclined men with backgrounds in systems work are required for this phase.

Scientific and
Engineering Staff

Hughes

RESEARCH AND DEVELOPMENT
LABORATORIES

Culver City, Los Angeles County, Calif.

Assurance is required that relocation of applicant will not disrupt an urgent military project.

Want more information? Use post card on last page.

November, 1954 — ELECTRONICS

VACUUM DEVICES

Our modern well equipped plant with 60 employees is currently manufacturing medium power transmitting tubes for the Armed Services and industrial use. We also custom manufacture a diversified line of laboratory and production, high vacuum equipment incorporating complex electronic circuitry.

Our Engineering Department consists of five men, each with a minimum of 15 years experience in this field.

Your inquiries are invited for design, development or production of high vacuum equipment, vacuum seals, high and low vacuum measuring equipment, medium and high power vacuum tubes and special purpose tubes.

CENTRAL SALES & MFG. CORP.
Denville, New Jersey

new designs on the board?

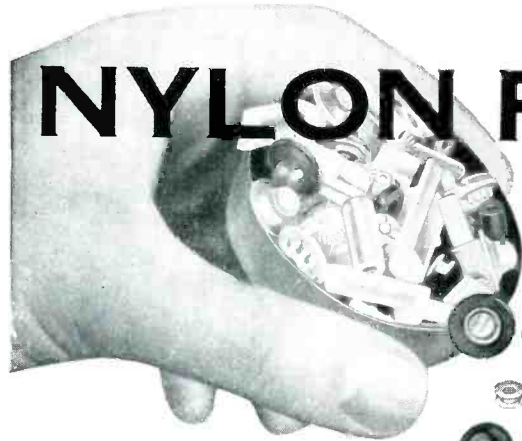

Gries' unique single cavity molding facilities are *flexible*—provide the practical answer to countless problems of product design and improvement. No matter how tiny, or how intricate. GRC molds nylon parts to meet your exact specifications, with precise tolerances and uniform quality. And because GRC methods are completely automatic, costs are surprisingly low—GRC tiny nylon parts are produced completely trimmed and ready for use, in one high-speed, money-saving operation!

Write today for Bulletin and Samples.

Send prints for quotation.



GRIS REPRODUCER CORP.

World's Foremost Producer of Small Die Castings

151 Beechwood Ave., New Rochelle, N. Y. Phone: New Rochelle 3-8600

GRC

TINY MOLDED

NYLON PARTS

may be the difference between "problems" and profits!

GRC MOLDS ALL THERMOPLASTICS SWIFTLY, DEPENDABLY, ECONOMICALLY!

Automatic Continuous and Individual Inserts! Single Parts!

Quick deliveries on quantities of 25,000 to millions.

NO SIZE TOO SMALL!

MAXIMUM SIZE .025 oz — 1" long
NO MINIMUM SIZE!

LOW MOLD COSTS!

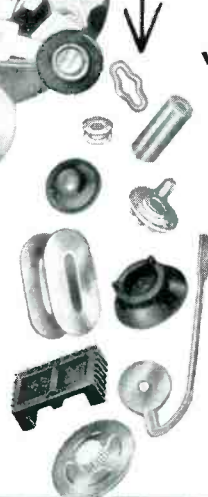

PRECISION

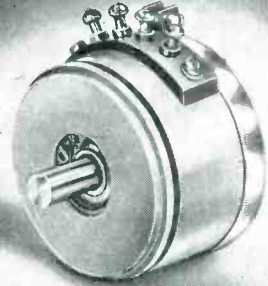

POTENTIOMETERS

LINEAR — NON-LINEAR

Ratray precision potentiometers have a wide scope and cover many types and sizes, in the field of wire-wound units of high accuracy, long life and stability.

If you have a requirement involving procurement of precision potentiometers, in small or large quantities — see us first for the best in standard and special designs.

Model 162-C shown here is typical of our compact design, with mechanical and electrical capabilities of highest quality, as shown by comparative tests.

Technical Bulletin 3-54 Now Available

RATRAY & CO., Inc.
116-08 MYRTLE AVENUE
RICHMOND HILL 18, N. Y.

quality
"precision" LEADS

of
TUNGSTEN
MOLYBDENUM
NICKEL
NICKEL-CLAD
COPPER
and ALLOYS

quality
hand-wound COILS

of Tungsten and Molybdenum

quality
MACHINED TUBE COMPONENTS
to customers' specifications

Your products can only be as good as the parts you put into them!

Electronic Parts Manufacturing Co., Inc.
508 25th St., Union City, N. J.
Send me copy of your brochure.
Name.....
Address.....

EPM

SEND US YOUR BLUEPRINTS or SPECIFICATIONS FOR QUOTATIONS!

ELECTRONIC PARTS MANUFACTURING CO., Inc.
508 25th St., Union City, N. J.



MILLI-MICROSECOND PULSE GENERATOR

Model PG-215

- Practically ideal rectangular pulses 60 or 120 per second recurrence rates.
- ⊙ Rise and decay times down to 1.2 μs . Minimum width 1.2 μs Max. unlimited.

- Amplitude 0 to 35 volt with 93Ω load may be read directly on DC voltmeter.
- Sync output isolated from main pulse with provisions for main pulse delay.

The Model PG-215 Pulse Generator is a mercury-relay plus pulse-forming-line type of generator producing rectangular waveforms having rise, duration, and decay times in the millimicrosecond range. It also furnishes a trigger signal, advanced in time with respect to the main pulse, for synchronizing associated equipment. All of the time parameters are determined by sections of standard coaxial cable supplied by the user or contained in the Model PGA-220 Width and Delay Unit available as a separate accessory.

WIDTH AND DELAY UNIT

Model PGA-220



by engaging young men and women on a part-time, work and learn program. Any engineer will vouch for the reality of the situation wherein his own work problem suddenly lends meaning to formulas, facts and generalizations learned previously, and wherein he frequently feels that he could have done better in his math, kinematics, etc., if he had had the stimulation of a real problem from industry.

I suggest that much of our educational system's troubles could be avoided by attaching teacher's salaries to the cost of living index, or some other index to avoid the alternations of adequate and inadequate teacher supply. The dollar value of school supplies and services should also be attached to some index to give needed stability. This is just one step in a broad program needed to stimulate good teaching and good engineering prospects.

LESTER LEVY

Chairman Related Technical Subjects Dept.
Metropolitan Vocational H. S.
New York, N. Y.

DEAR SIRs:

A LETTER from Mr. C. Radius in July issue of *ELECTRONICS*, p 344, comments upon and questions my letter in the May issue.

First, I wish to point out that I gave *no* opinions for or against either teaching or industrial employment. In short, I like both (this leaves me philosophically neutral).

Second, I gave *no* salary figures in dollars—only a 2 to 4 ratio of present salaries to former teaching salaries. Therefore, the salary range of 12,000 to 24,000 dollars, which Mr. Radius invites *ELECTRONICS'* readers to doubt, must be recognized as an invitation to doubt his own figures, not mine.

Teachers at Cal Poly with Mr. Radius are fortunate to average \$500 per month, twelve months per year, for only nine months work. The *average* figure I had in mind was nearer \$350 per month, nine months per year, for nine months work. These figures give a salary range of 6,300 to 12,600 dollars.

The group of ex-teachers mentioned in my previous letter closely approximate the mean value of the latter range. But in all fairness to the doubtful salary range of 12,000



TELETRONICS LABORATORY, INC. 54 KINKEL STREET WESTBURY, L. I., N. Y.

Bird

COMPLETE JEWEL ASSEMBLIES
WILL SPEED YOUR PRODUCTION

You'll be time and money ahead if you specify Bird complete jewel assemblies for your product. Rejects are eliminated, jewel breakage is minimized, and Bird jewel assemblies will keep your production running smoothly.

Bird Jewel Assemblies are furnished in the right mounting, rigidly inspected according to your specifications, ready for your assembly operations. Make a test — find out how Bird Jewel Assemblies can help your production. Send us a print of your specifications, and we'll provide samples for your own testing.

Our engineering staff is at your service for all small bearing problems.

Over 40 years of serving industry with Quality jewel bearings

Richard H. Bird & Co., Inc.

Sapphire and glass jewels • Precision glass grinding • Ferrite precision products • Sapphire styli
1 Spruce Street, Waltham 54, Mass.

MISSILE SYSTEMS

Research
and
Development

PHYSICISTS
AND ENGINEERS

Inquiries are invited from those who can make significant contributions to, as well as benefit from, a new group effort of utmost importance.

Lockheed

MISSILE SYSTEMS DIVISION

research
and
engineering
staff

LOCKHEED AIRCRAFT
CORPORATION

VAN NUYS • CALIFORNIA

Want more information? Use post card on last page.
ELECTRONICS — November, 1954

BACK TALK

(continued)

to 24,000 dollars, as supplied by Mr. Radius, a number (greater than one) of the ex-teachers are in this range right up to the middle of the range at least; this may seem strange to teachers and engineers alike, though true.

Last, two weeks vacation would not be long to spend "all that dough"—if one had it to spend on vacation. However, in line with an old American custom of exchanging money for goods and services, not much is left of all that dough and hence no difficulty in spending it on vacation. Personally, I believe that one could force himself to face this particular difficulty bravely if (ever) it should arise; in fact, this is probably the least likely of all occupational hazards, whether in teaching or in industry.

With regard to schools' qualifications requirements for teachers, I refer readers of *ELECTRONICS* to the recent article in *Life* concerning the teacher who was a professor in seven colleges and universities through the use of false statements relating to qualifications. This could not readily happen in a company holding government contracts, if only because of security investigations.

A. W. McMURTRY

Senior Aerophysics Engineer
Consolidated Vultee Aircraft Corp.
Fort Worth, Texas

Early Silicon Diode

DEAR SIRS:

AS EARLY as 1925, we manufactured a rectifier known as the "A" cartridge, which was used in some of the earliest A-battery eliminators. This rectifier utilized silicon and could be accurately described as a silicon barrier type diode. An electrolyte enabled the rectifier to operate at higher currents than without the electrolyte but, even with the electrolyte completely used, reduced current operation was possible.

Page 5 of your August, 1954 issue refers to a high-current silicon diode. . . .

C. W. MARTFL

Technical Information Service
Raytheon Manufacturing Company
Newton, Massachusetts

Editor's Note: Receipt of this letter caused us to sit back and reminisce; not often done nowadays. We remember the cartridge.

KINESCOPE RECORDING
with
Guaranteed Results!
OR YOUR MONEY BACK

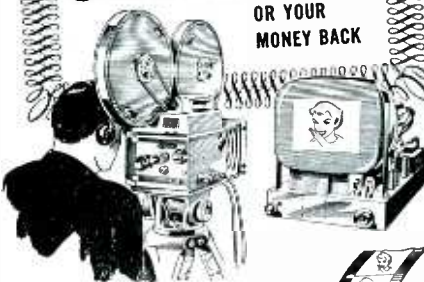

**NOW, A DUAL-PURPOSE
AURICON
"SUPER 1200" CAMERA**
with TeleVision-Transcription
"TV-T" Shutter...

...designed for Kinescope Recording...and also shoots regular Live Action 16 mm Sound-On-Film Talking Pictures with no Camera modification! The "Super 1200" Camera with "TV-T" Shutter (Pat. Appl'd. for 1949) can Kinescope Record a 30 minute continuous show using 1200 foot film magazines. Write today for information and prices.

USE AURICON "TV-T" KINESCOPES FOR:

- ★ DELAYED RE-BROADCASTING
- ★ SPONSOR PRESENTATIONS
- ★ COMPETITION CHECKS
- ★ PILOT KINESCOPES
- ★ SHOW-CASE FILMS
- ★ "HOT KINES"
- ★ AIR CHECKS

Auricon 16 mm Sound-On-Film Cameras are sold with a 30-day money-back guarantee. You must be satisfied!

Auricon 50 ft. Kinescope "TV-T" Demonstration Films are available on loan to TV Stations and Film Producers. Please request on your letterhead.

Auricon
Hollywood

BERNDT-BACH, INC.

6924 Romaine St., Hollywood 38, Calif.

MANUFACTURERS OF SOUND-ON-FILM
RECORDING EQUIPMENT SINCE 1931

Want more information? Use post card on last page.

CONTROL-SYSTEM DYNAMICS

Just Published!

Demonstrates techniques for determining response of linear control systems, emphasizing the new Root Locus Method invented and developed by the author which is particularly useful for complicated systems or those requiring complete solution. Method develops from basic fundamentals, stressing physical understanding of the problem rather than memorized routines for solving particular problems. Each solution establishes a concept which permits a simpler technique to be applied to the next more complicated problem. By W. R. Evans, Systems Group Leader, Electromechanical Eng. Dept., North American Aviation, Inc. 380 pp., 140 illus., \$7.00



MAGNETIC-AMPLIFIER CIRCUITS

A practical treatment of fundamental principles, characteristics, and applications. Logically develops the various kinds of basic and more complex magnetic amplifier circuit arrangements without extended mathematical considerations. Material is systematically classified according to circuit functions so you can compare and select solutions best suited to your special problem. By William A. Geyger, U. S. Naval Ord. Lab. 277 pages, 135 illus., \$6.00

basic and more complex magnetic amplifier circuit arrangements without extended mathematical considerations. Material is systematically classified according to circuit functions so you can compare and select solutions best suited to your special problem. By William A. Geyger, U. S. Naval Ord. Lab. 277 pages, 135 illus., \$6.00

MODERN PHYSICS FOR THE ENGINEER

Just Published!

Broadens the viewpoint of the engineer by showing the fundamental physical laws on which all engineering is ultimately based. Main sections cover the laws of nature, man's physical environment, and information and its communication, including topics on relativity, atomic structure, magnetism, astrophysics, electrons and waves, and computing machines. Edited by L. N. Ridenour, Vice President, International Telemeter Corp. 490 pp., 211 illus., \$7.50



FREQUENCY MODULATION

Well organized, engineering treatment of frequency modulation, covering both basic principles and design of commercial apparatus. Describes phenomena and features of frequency and phase modulation in a thorough approach that includes comparison with customary amplitude modulation. Applications in FM transmitters, receivers, auxiliary apparatus, and antennas are fully discussed. Uses tables and curves to simplify information on design. By A. Hund, Consulting Engineer. 375 pp., 113 illus., \$6.75

SEE THESE BOOKS TEN DAYS FREE

McGraw-Hill Book Co., Dept. L-11
330 W. 42 St., NYC

Send me book(s) checked below for 10 days' examination on approval. In 10 days I will remit for book(s) I keep, plus few cents for delivery, and return unwanted book(s) postpaid. (We pay for delivery if you remit with this coupon—same return privilege.)

- Evans—Control-System Dynamics—\$7.00
- Geyger—Magnetic-Amplifier Circuits—\$6.00
- Ridenour—Modern Physics for the Engr.—\$7.50
- Hund—Frequency Modulation—\$6.75

(Print) Name

Address

City

Company

Position

For price & terms outside U. S. write McGraw-Hill Int'l., N. Y. C.

CONTACTS

FOR THE FIELD OF ELECTRONICS

CINEMA'S TAPE AND FILM Degausser

CLEAN ERASURE OF MAGNETIC TAPE & FILM



TYPE 9205 DEGAUSSER

Noise & program erasure. Use the best. Cinema's Bulk-Tank Type Degausser 9205. Economically priced. Buy yours today

CINEMA ENGINEERING CO.
DIVISION AEROVOX CORPORATION
1100 CHESTNUT STREET • BURBANK, CALIF.



HAVE YOU PROBLEMS IN METAL TO GLASS SEALS?

Name it, We'll make it!
TERMINALS, HEADERS
END SEALS, SPECIAL ITEMS

QUALITY Products Co.

387 CHARLES STREET
PROVIDENCE, R. I.

ASK FOR BULLETIN NO. 1

Toroidal Winder

REX RHEOSTAT COMPANY
BALDWIN, L. I. N. Y.
Telephone: Baldwin 3-5160

Precision
BLACK ANODIZING

Specializing in black anodizing, both sulphuric and chromic, on all alloys and castings.

All other colors as well.

GOVERNMENT CERTIFIED
Contact us for special service.

HENRY and MILLER INDUSTRIES, INC.
675 Garfield Ave., Jersey City, N. J.
HENDERSON 4-4200

COILS

2uH—2MH in Stock for Immediate Delivery
SPECIAL COILS DESIGNED AND WOUND
NORTH HILLS ELECTRIC CO., Inc.
203-18E 35th Ave., Bayside 61, L. I., N. Y.

Shorted Turn Indicator
now \$175 f.o.b.

Kartron

HUNTINGTON BEACH, CALIF.

BUILD IT YOURSELF
Mod. EC-100-A ELECTRONIC TIMER

Control both off & on times; continuously variable range 0.02 sec. to 1 min. Laboratory tested circuit. Many satisfied users.

1 Comp. data & drawings \$3. p.p.
2 Comp. Kit of components \$30. F.O.B.

3 Comp. wired & tested \$60. F.O.B.

PARKS LABORATORY
104 S. E. 57th Ave., Portland 15, Oregon

G-C INDUSTRIAL ADHESIVES

A Cement for Every Purpose . . . for

METALS PLASTICS
WOODS FABRICS
RUBBER RUBBER TO METAL
PAPER FIBRE

Write to Dept. X for complete catalog
GENERAL CEMENT MFG. CO., 911 Taylor Ave., Rockford, Illinois

FLUXES

SODERING
BRAZING & WELDING

L. S. ALLEN CO. INC. Chicago 21, Ill.
6751 BRYN MAWR AVE.

MAKERS OF META-MAGNET suggest Electromagnet for non-ferrous metals in Automation, Sorting, and Handling. Electromagnetic Levitation for Reducing Friction, Aid to Metallurgy.

META-MAGNET ASSOCIATES
P. O. Box 775
Sanford, Florida

World's Only Recorder of its Kind
WALKIE-RECORDALL
8-LB SELF-POWERED BATTERY RECORDER

- AUTOMATIC UNDETECTED RECORDING up to 4 hrs.
- PICKS UP WITHIN 60 FT. RANGE.
- VOICE ACTIVATED "SELF-START-STOP"
- NO WIRES OR PULS.

Records noiselessly in or out of closed briefcase, containing hidden mike while walking, riding, flying. Conferences, lectures, dictation, 2-way phone. Permanent, unalterable, indexed recording at only 3c per hr.

MILES REPRODUCER CO., INC.
812 Broadway, N. Y. 3, N. Y. Dept. E

MICROMETER FREQUENCY METER

Measures center frequency of any number of transmitters, AM or FM, 0.1 to 175 MC, and crystal-controlled transmitters to 500 MC. Accuracy 0.0025%. Price \$220.00.

LAMPKIN LABORATORIES, INC.
BRADENTON, FLORIDA

PROFESSIONAL SERVICES

Consulting—Patents—Design—Development—Measurement
in
Radio, Audio, Industrial Electronic Appliances

ANNIS ELECTRIC RESEARCH LABORATORY, INC.

CONSULTING — RESEARCH — DEVELOPMENT
AND DESIGN OF RADIO AND ELECTRONIC
EQUIPMENT
Antennas, Wave Propagation, Information Storage,
Computers, Impedance Matching and Variable
Speed A-C Motors.
P. O. Box 581 1401½ S. Nell St.
Champaign, Ill. Tel. 6-1780

Professional Assistance

*in solving your most difficult
problems in the specialized
field of electronic devices is
offered by consultants whose
cards appear on this page.*

NIAGARA ELECTRON LABORATORIES

CONSULTATION - DESIGN - CONSTRUCTION
MFG. THE THERMOCAP RELAY
Specializing in solution of problems of electronic
and electro-physical instrumentation for the re-
search or analytical laboratory. Industrial plant
problems also invited.
Andover, New York Cable Address: NIATRONLAB

CROSBY LABORATORIES, INC.

Murray G. Crosby & Staff
Radio - Electronic
Research Development & Manufacturing
Communication, FM & TV
Robbins Lane, Hicksville, N. Y.
Hicksville 3-3191

PICKARD & BURNS, INC.

Consulting Electronic Engineers
Analysis and Evaluation
of Radio Systems
Research, Development and Production
of Special Electronic Equipment
240 Highland Ave. Needham 94, Mass.

EDGERTON, GERMESHAUSEN & GRIER, INC.

Consulting Engineers
Stroboscopy — Transient Oscillography
Photoelectricity — Pulse Techniques — Timing
High-Speed and Electric Flash Photography
Telemetering - Industrial Television Applications
160 Brookline Avenue Boston 15, Mass.

INTERFERENCE MEASUREMENT LABORATORY

Interference Study per Government Specifications
Shielded Space for Interference Investigation
Field Surveys for F.C.C. Certification of Induction
and Dielectric Heating Equipment
907 East 51st Street • Brooklyn 3, New York
Ingersoll 9-1765

ALBERT PREISMAN

Consulting Engineer
Television, Pulse Techniques, Video
Amplifiers, Phasing Networks,
Industrial Appliances
Affiliated with
MANAGEMENT-TRAINING ASSOCIATES
3224-16th St., N. W. Washington 10, D. C.

Eldico of New York, Inc.

Pioneers of Television Interference Elimination from
Transmitters, Induction Heaters, Diathermy and etc.
Donald J. S. Merten & Engineering Staff
70 E. Second St. Mineola, L. I., N. Y.
Garden City 7-0383

THE KULJIAN CORPORATION

Consultants • Engineers • Constructors
Electronic Control
Specialists
Utility • Industrial • Chemical
1200 N. Broad St. Phila 21, Pa.

JOSEPH RACKER COMPANY

Radar Consultants & Editors
Technical Manuals
Research and Development
140 Nassau Street New York 38, N. Y.
Worth 4-1463

ELECTRONIC RESEARCH ASSOCIATES, INC.

"TRANSISTORIZE" YOUR PRODUCT!
Complete Service in consulting, research, develop-
ment, and production on Transistor circuitry, prod-
ucts and instrumentation.
715 Main Street North Caldwell, N. J.
Caldwell 6-6729

G. LEWIN

Consulting Physicist
ELECTRON TUBES
development, design and manufacture
21 Yale Terrace West Orange, N. J.
ORange 4-6994

THE TECHNICAL MATERIAL CORPORATION

Communications Consultants
Systems Engineering
General Offices and Laboratory
700 Fenimore Rd., Mamaroneck, N. Y.

ERCO RADIO LABORATORIES, INC.

Radio Communications Equipment
Engineering - Design - Development - Production
Our 25th Year in Air to Ground
Communications and Radio Beacons
Garden City • Long Island • New York

ROBERT McCABE

Radio Noise Measurement and Elimination
Field Intensity Surveys
1781 Bide-a-Wee Park Columbus 5, Ohio

TELECHROME, INC.

Electronic Design Specialists
COLOR TELEVISION EQUIPMENT
Flying Spot Scanners, Color Synthesizers, Keyers,
Monitors, Oscilloscopes and Related Apparatus
J. R. Popkin-Curman, Pres. & Ch. Engr.
88 Merrick Rd. Amityville, L. I., N. Y.

HANSON-GORRILL-BRIAN INC.

Product & Mfg. Development
ELECTRICAL - ELECTRONIC
HYDRAULIC - MECHANICAL
One Continental Hill Glen Cove, N. Y.
Glen Cove 4-7300

Measurements Corporation

Research & Manufacturing Engineers
HARRY W. HOUCK MARTIAL A. HONNELL
JOHN M. VAN BEUREN
Specialists in the Design and
Development of Electronic Test Instruments
Boonton, New Jersey

WHEELER LABORATORIES, INC.

Radio and Electronics
Consulting — Research — Development
R-F Circuits — Lines — Antennas
Microwave Components — Test Equipment
Harold A. Wheeler and Engineering Staff
Great Neck, N. Y. HUnter 2-7876

R. W. HODGSON CO.

*Technical Sales Representation &
Research & Development Engineering.*
Specializing in Electronics, Nucleonics,
Instrumentation, Servomechanisms &
Cybernetics. Let Us Handle Your New
Product or Invention.
2406 W. Washington Blvd. Los Angeles 18, Calif.
REpublic 3-0322

NEW ROCHELLE TOOL CORP.

FOR CERTIFICATION OF INDUCTION
AND DIELECTRIC HEATING EQUIPMENT
IN ACCORDANCE WITH F.C.C. RULINGS
Mobile Test Unit Available Entire U. S.
320 Main St. New Rochelle, New York
Phone NB 2-5555

YARDNEY LABORATORIES, INC.

Research - Design - Development
Electro-Chemical Generators of Energy
40-46 Leonard Street Worth 6-3100
New York 13, N. Y.

CHEMICAL and ELECTRICAL ENGINEERS PHYSICISTS and METALLURGISTS

With
WESTINGHOUSE

you can be SURE . . .

Of Excellent Living Conditions . . . Of Professional Progress

DESIGNERS: Micro-wave, TV pickup, and receiving tubes; solid state devices and traveling-wave tubes.

APPLICATION ENGRS: Circuit experience helpful in radio, TV, VHF, and semi-conductors.

PRODUCT ENGRS: Knowledge and/or exp. in cathode design and fabrication of magnetrons and klystrons.

Recent graduates in Electrical, Chemical and Mech'l Engineering, Physics, Chemistry & Metallurgy are also urged to apply. Expenses paid if invited to Elmira for interview. Send resume:

WESTINGHOUSE
ELECTRONIC TUBE DIV.
P.O. Box 284, Elmira, N. Y.



DESIGN ENGINEERS

The Pacific Division, Bendix Aviation Corporation has openings for design engineers in development of radar, sonar and telemetering offering excellent opportunities for growth with the corporation and the opportunity to live in Southern California. Positions are open at several levels.

Please Address Inquiries to

W. C. WALKER

ENGINEERING EMPLOYMENT MANAGER

11600 Sherman Way

North Hollywood, California

RECEIVER ENGINEERS With Experience in VHF and UHF Frequencies

Career Opportunities
With Old Established
Central Connecticut Firm
Interesting Projects
Top Salaries
Suburban Living
Replies Held in Strict Confidence
Wire or Phone Collect
Personnel Mgr. SHerwood 7-2741

**THE ALLEN D. CARDWELL
ELECTRONICS PRODUCTIONS
CORPORATION**
Plainville, Connecticut

COMMUNICATIONS ENGINEERS and TECHNICIANS

EXCELLENT SALARIES
MINIMUM PREREQUISITES

ENGINEER
TECHNICIAN

EE Graduate with 3 years
experience
2 years technical school in
communications and 3 years
experience.

Require installation adjustment and maintenance experience with communication receivers and associated terminal equipment. Also, men with similar experience with high-powered transmitters, antennas, transmission lines.

Must be willing to travel in United States and Overseas.

Page Communications Engineers, Inc.
710 Fourteenth St., N.W., Washington 5, D.C.

FOR LEASE ELECTRONICS LAB

Adjacent Pentagon Bldg., in Arlington, Va., 18,000 sq. ft. in one floor masonry bldg.; Offices, 440 volt current, fluorescent lighting, partly air conditioned, long lease. See Mr. Norris

WEAVER BROS., INC.—REALTORS
Washington Bldg. Wash. 5, D. C.

ADMINISTRATIVE CAREERS FOR TECHNICAL MEN

We have a number of excellent positions for graduate or experienced Electrical Engineers who prefer a position combining technical knowledge and general management administration. Starting salaries are higher than for straight technical work and potential is much greater. COMPLETELY CONFIDENTIAL, NATIONWIDE.

**DRAKE ENGINEERING
PERSONNEL SERVICE**
7 W. Madison St. Chicago 2, Ill.
Financial 6-2100

HAVE YOU A BETTER MOUSETRAP?

Let us introduce it at **GRIFFISS AFB**, center for all AF ground electronic equipment and see that you no longer miss any AF business.

WRIGHT ASSOCIATES
Manufacturer's Representatives
127 W. Liberty St. Rome, New York

REPLIES (Box No.): Address to office nearest you
NEW YORK: 330 W. 42nd St. (36)
CHICAGO: 520 N. Michigan Ave. (11)
SAN FRANCISCO: 68 Post St. (4)

POSITIONS VACANT

FLORIDA POSITIONS, \$5,000 to \$25,000. For Electrical & Electronic Engineers & technicians, physicists, mathematicians, optical techs, research electronic scientists, inventors, aeronautical engineers, technical writers and communication specialists, etc. Send resume; Tech-Associated Agencies, P. O. Box 1324, Orlando, Florida.

TECHNICAL WRITERS . . . For preparation of operation and maintenance manuals, engineering reports on audio and instrumentation magnetic tape recorders. Minimum two years experience. BSEE or Physics preferred. Knowledge MIL specs, and familiarity with photographic and reproduction processes required. Send resume to Ampex Corporation Dept. 502 934 Charter Street Redwood City, Calif.

POSITIONS WANTED

COMMUNICATIONS SPECIALIST — 18 years exp. Engineering Sales Installation Maintenance communication electronic equipment all types, FCC First Fone/Telz Licence. Fluent linguist Spanish, Portuguese. Long resident Brazil. Available immediately. Hawken 4855 Lakeshore Road, Port Huron, Michigan.

NEW PRODUCTS for several markets. Engineer of long experience seeks connection with manufacturer Los Angeles area. PW-4234, Electronics.

SUPERVISING SEMICONDUCTOR Project Engineer with 14 years experience in development, production, and sales, interested in establishing and operating integrated manufacturing program in solid state devices. 8 years in semiconductor field with major corporations including transistors, tetrodes, rectifiers, and thermistors. College graduate in physics and math with additional training in industrial engineering and business. Age 39. Married. PW-4128, Electronics.

ELECTRICAL ENGINEER, B.S.E.E., licensed, 5 years experience, electronics and communications, desires technical sales position. Dayton, Ohio area. PW-4292, Electronics.

BUSINESS OPPORTUNITY

New Tape Player. Electrical engineer 20 years USA-Europe experience radio, instruments development, design, sale, has idea for public appealing tape player. Wants to head development. BO-4194, Electronics.

CONTRACT WORK WANTED

Electronics firm recently organized desires sub-assembly or special design work. Standard Electric & Manufacturing Company, Investment Building, Pittsburgh 22, Pa.

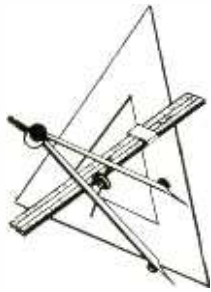

Help Build Tomorrow's World TODAY!

GOODYEAR AIRCRAFT CORPORATION, pioneer and leader in lighter-than-air craft, offers you a new employment opportunity with a well-established and fast-growing company where "careers are planned."

DESIGN AND DEVELOPMENT engineering opportunities are available for capable and imaginative men and women in the field of airships, aircraft and aircraft components.

RESEARCH AND DEVELOPMENT projects — missiles, electric and electronics systems, servomechanisms, new special devices, fiber resin laminates — all present an urgent need for engineers with fresh talent, aptitude and ambition.

POSITIONS ARE OPEN at several levels in various fields with salaries based on education, ability and experience.

Physicists	Civil engineers
Mechanical engineers	Electrical engineers
Aeronautical engineers	Technical editors
Welding engineers	Technical illustrators

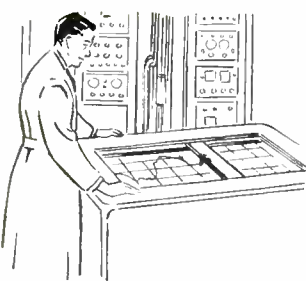

AKRON, THE HOME OF GOODYEAR AIRCRAFT, is located in the lake region of northeastern Ohio. Cosmopolitan living, year-round sports and recreation, cultural and educational advantages make this thriving city an ideal spot for a pleasant home.

YES, BUILD YOUR FUTURE — TODAY! Write, giving your qualifications, or requesting an application form.

C. G. Jones, Salary Personnel Department

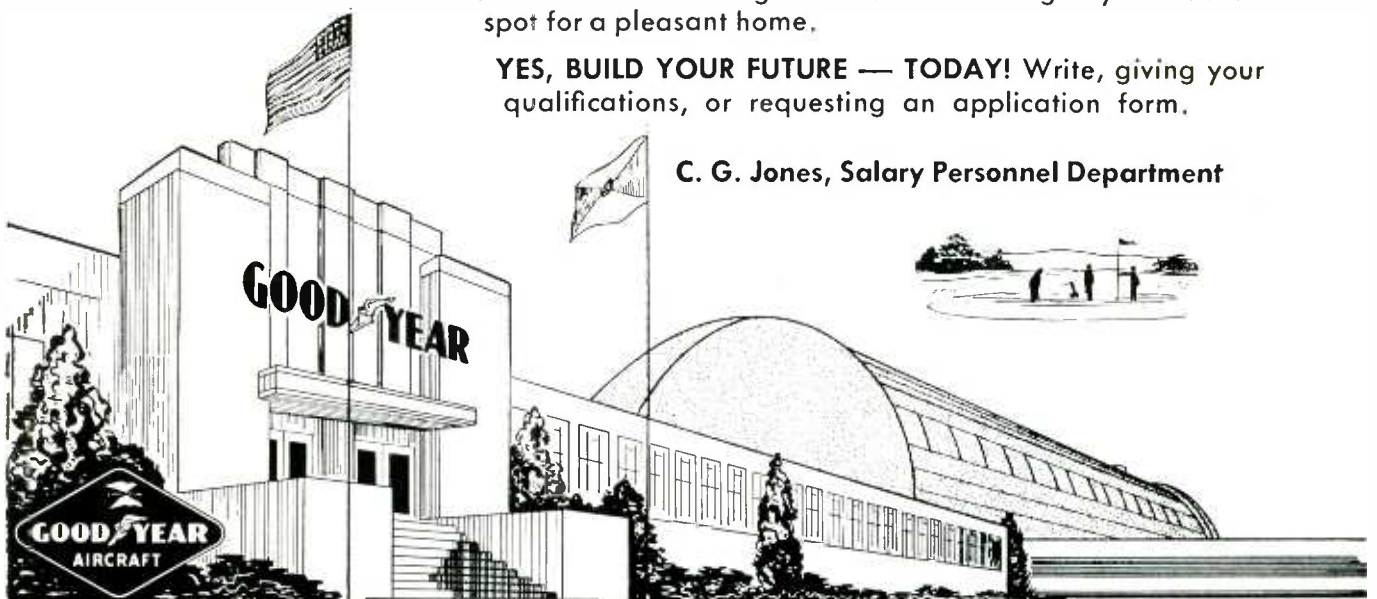

GOODYEAR AIRCRAFT CORPORATION, 1210 MASSILLON RD., AKRON 15, OHIO



YOUR CALLING CARD FOR A BRILLIANT FUTURE...

Bendix Missile Section is a major contractor in the U. S. Navy's guided missile program -- a part of the "new look" in our defense plan. Our expanding program has many opportunities for senior engineering personnel: Electronics Engineers, Dynamicists, Servo-Analysts, Stress Analysts, Project Coordinators, and Designers. Take time now to look into the opportunities which Bendix can offer you. Write Employment Dept. M, 401 Bendix Drive, South Bend, Indiana.

ENGINEER

MAGNETIC RECORDING

Minimum of 5 years
Experience specializing
in design of
transducers and
associated equipment
for high fidelity
magnetic recording

Mail detailed resume to:
Personnel Dept, Room 1201

COLUMBIA BROADCASTING SYSTEM, INC.

485 Madison Ave,
NY 22, NY

ENGINEERS

- | | |
|------------------|-----------|
| ■ ADMINISTRATIVE | ■ PROJECT |
| ■ SENIOR | |
| ■ INTERMEDIATE | ■ JUNIOR |

LONG RANGE PROGRAMS IN . . .

◀ RESEARCH

◀ DEVELOPMENT

◀ DESIGN

- | | | |
|------------------------|-----------------|---------------|
| • Fire Control Systems | • Radar Systems | |
| • Communications | • Navigation | • Transistors |
| • Guided Missiles | • Telemetry | |

DIRECT INQUIRIES TO—

Director of Engineering
Government Products
CROSLEY DIVISION
AVCO Manufacturing Corporation
Cincinnati 15, Ohio



ENGINEERS

Have you developed a
"Success Perspective"?

If a year or two of practical experience has given you the youthful maturity that demands more than just a job, you may be interested in our "career opportunities" in color TV, crystal products and electronic tubes.

Submit resume or address request for personal interview to D. Bellat, Personnel Director.

TUNG-SOL ELECTRIC INC.

200 Bloomfield Avenue
Bloomfield, N. J.

ENGINEERS:

**DOES YOUR
PRESENT JOB
GIVE YOU**

ALL THESE

RCA

CAREER

ADVANTAGES?

**POSITIONS NOW OPEN FOR
SENIOR DEVELOPMENT
AND DESIGN ENGINEERS:**

- ✓ ELECTRONIC . . .
- ✓ COMMUNICATIONS . . .
- ✓ MECHANICAL . . .
- ✓ COMPUTER . . .
- ✓ ELECTRON TUBE . . .

**PERSONAL INTERVIEWS ARRANGED
IN YOUR CITY.** A copy of our booklet
"Challenge and Opportunity," describing the role of the
engineer in RCA, will be mailed upon request. Please
send a complete resume of your education and
experience to:

MR. JOHN R. WELD
Employment Manager, Dept. 300K
Radio Corporation of America
30 Rockefeller Plaza
New York 20, N. Y.

Tmk.



RADIO CORPORATION of AMERICA

CHECK SHEET

Yes No

- PROFESSIONAL RECOGNITION AND PRESTIGE?
- ADVANCEMENT IN STATUS?
- SECURITY AND STABILITY?
- CHALLENGE AND OPPORTUNITY?
- HIGH SALARY SCALE AND OPPORTUNITIES FOR PROMOTION?
- EXCELLENT SUBURBAN HOUSING AT REASONABLE COST?
- FACILITIES FOR PROFESSIONAL ADVANCEMENT?
- UNEXCELLED TECHNICAL AND LABORATORY FACILITIES?
- ASSOCIATION WITH TOP SCIENTISTS?
- TUITION REFUND PLAN FOR ADVANCED STUDY?
- MILITARY OR COMMERCIAL OPPORTUNITY?
- MODERATE COST OF LIVING?
- MODERN RETIREMENT PLAN?
- COMPANY-PAID LIFE INSURANCE?
- COMPANY-PAID LIBERAL HOSPITAL, SURGICAL AND DISABILITY PLAN (FAMILY BENEFITS)?
- LIBERAL VACATION PLAN?
- LIBERAL HOLIDAY SCHEDULE?
- PROFESSIONAL STATUS AND UTILIZATION OF YOUR EDUCATION AND EXPERIENCE?

CAREER BUILDING THROUGH RESEARCH

The Cook Research Laboratories, one of the Nation's most progressive research and development laboratories, has openings for qualified engineers and physicists at both Senior and Junior levels.

**A Growing Company
Outstanding Personnel
High Starting Salaries
Excellent Working Conditions**

There are immediate openings in the following fields:

**Radar
Pulse Systems
Microwave Techniques
Servomechanisms
Operations Research**

Contact

MR. D. M. HALLIDAY

COOK RESEARCH LABORATORIES

8100 Monticello Avenue Skokie, Illinois
KE 9-2060

A Division of
Cook Electric Company
Chicago

Electrical and Mechanical Engineering and Manufacturing
Since 1897

Electronics Engineers and Applied Physicists

For a long-range research and development program in air armament. Interested in both senior and junior men for work on:

Infrared systems and components.
Simulators and computers.
Solid State Physics.
Ordnance and ordnance test equipment.
Instrumentation for aircraft and missile test ranges. (Locate in Chicago or Florida.)

Complete, modern laboratory and shop facilities. Professional atmosphere on a university campus, with salaries equivalent to industry. Liberal vacation and other benefits. U. S. citizenship required. Send brief resume with request for application form to:

Scientific Personnel Office

CHICAGO MIDWAY LABORATORIES
The University of Chicago
6040 South Greenwood Ave.,
Chicago 37, Illinois

Electronic Engineers *Your Move*

The men we seek are experts in their specialized fields; capable of filling responsible engineering positions with MELPAR, a leader in research and development. Perhaps one of these men may be you. We invite you to learn about our long-range military and industrial programs.

If you are experienced in one or more of the fields listed, write us during a personal interview about our past record of success and how you can successfully fit into our future plans.



- Network Theory
- Microwave Techniques
- UHF, VHF or SHF Receivers
- Digital Computers
- Magnetic Tape Handling Equipment
- Radar and Countermeasures
- Microwave Filters
- Flight Simulators
- Subminiaturization Techniques
- Electro-Mechanical Design
- Small Mechanisms Design
- Pulse Circuitry



Technical Personnel Representative

melpar, inc.

A Subsidiary of the Westinghouse Air Brake Co.

452 Swann Ave., Dept. E-11, Alexandria, Virginia
or 11 Galen St., Watertown, Mass.

NEW HORIZONS

Today's horizons in electronic engineering are limited only by the vision of the individual himself. To those qualified men who desire to stand on the constantly changing frontiers of electronic development, we offer a chance to pioneer and grow with a soundly-established, yet young and progressive company.

• Electronics Field Engineers

Local & Field Assignments
Available

At least 5 years' experience in any one of these fields: Servo Mechanisms; Special Weapons; Microwaves; Antennas; Circuit Design; Flight Simulators; Radio Propagation; Electronic Computers and Communications.

Qualified to instruct in the operation and supervise installation, maintenance and repair of Radar, Sonar, Flight Simulators and allied electronic equipment in the field.

Salary and advancement commensurate with ability; liberal vacation, sick leave, 9 paid holidays, group life, sickness and accident insurance plans, and a worthwhile pension system.

STAVID ENGINEERING, INC.

Personnel Office, 312 Park Avenue
Plainfield, N. J.—PLainfield 6-4806

ELECTRONIC ENGINEERS . . .

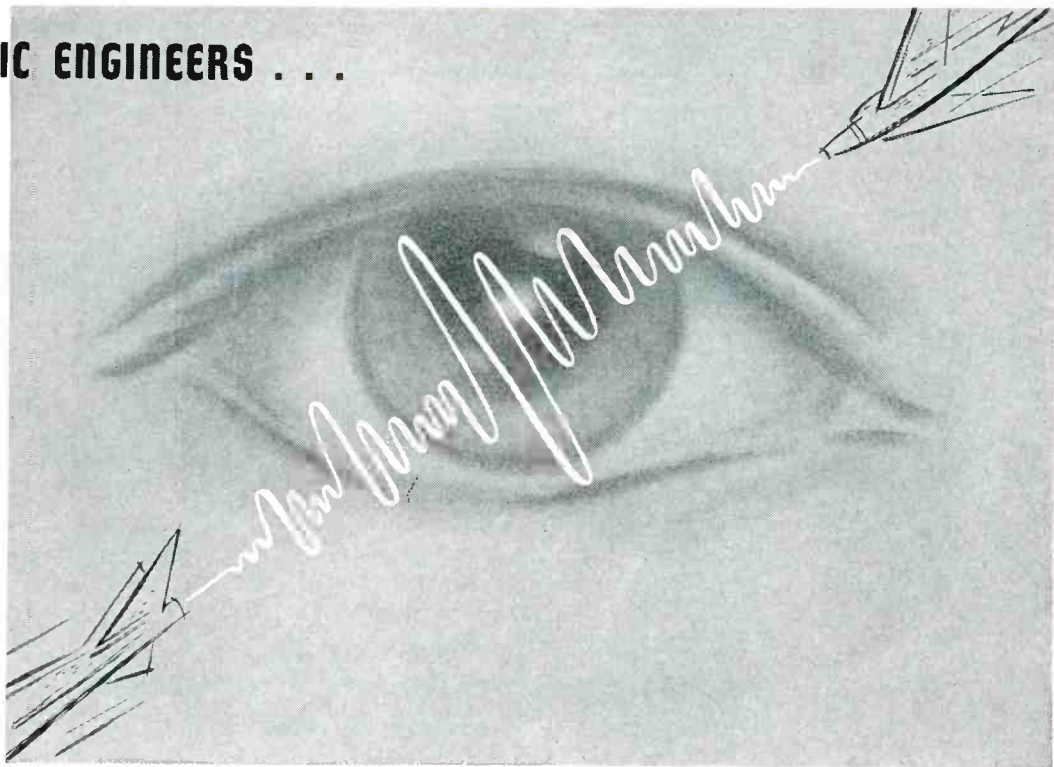
CREATE!

**IF YOU VALUE CREATIVE SUCCESS
YOUR ROLE AT AIR ARM
WILL BE A VITAL ONE!**

The need is for electronics to give America air superiority! Can you fill a top-level design and development position? At Westinghouse Air Arm you will find unlimited opportunities for creative engineering, in spacious and excellently equipped quarters. Income and benefits are very attractive! Act now—this is the type of opportunity that all creative engineers are looking for! Openings exist in the fields of . . .

Radar • Radar Antennas • Radar Circuitry • Magnetic Amplifiers • Computers

And many other phases of aviation-electronics work.

For Confidential Interviews... Send Resume And Salary Expectations To:

R. M. SWISHER, JR.
EMPLOYMENT SUPERVISOR, DEPT. 12
WESTINGHOUSE ELECTRIC CORP.
2519 WILKENS AVENUE
BALTIMORE 1, MARYLAND

Illustrated brochure will be promptly forwarded to all applicants.

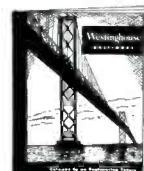

YOU CAN BE SURE...IF IT'S **Westinghouse**

M. I. T.

LINCOLN LABORATORY

Staff research positions available for exceptional **electrical engineers** with advanced training or experience in **electronics** as applied to . . . Radar, Communications and High Speed Digital Computers.

Please reply to:
Personnel Department, P. O. Box 73,
Lexington 73, Mass.

Transformer Engineers

A Midwestern Electronics Manufacturer

has openings for qualified electronic engineers experienced in design and development of radio transformers and components.

Applicants must have BS degree in Electrical Engineering, Electronics, or Physics, and at least two years experience in Magnetics or Electro-Magnetics including high permeability steel applications.

Qualified applicants write, giving educational and experience resume to:

P4179 ELECTRONICS
520 N. Michigan Ave., Chicago 11, Ill.

Electrical Engineers and Physicists

- Radar Simulation
- Advanced Circuitry
- Analog Computers
- Ballistics
- Mapping
- Telemetry

Senior and Junior Engineers

Join a Firm with a Future

Our future is bright . . . we're small but we're growing. We offer you the opportunity to grow with us . . . to gain individual recognition by working closely with technical management . . . to advance rapidly. You will work and live in a delightful suburban community . . . associate with other top-notch engineers, and with them, develop yourself by contact with a complete project, not just a segment of a project. If you are interested in allying your future with a firm with a future . . . write:

Industrial Research Laboratories
 Dept. A-11, Hilltop & Frederick Rds.
 Baltimore 28, Maryland

Engineers & Physicists

Permanent positions in the Vitro Laboratories for career-minded men providing challenging assignments in missiles, radar, sonar, fire control and ordnance systems.

LAYOUT SYSTEM DESIGN
FIELD INVESTIGATIONS
ORDNANCE SYSTEMS EVALUATION
SYSTEMS & CIRCUIT
ANALYSIS STUDIES

This modern laboratory provides a professional environment in a quiet residential community accessible to metropolitan New York City. Please submit resumes to Personnel Dept.

VITRO LABORATORIES

Division of Vitro Corporation of America
 200 Pleasant Valley Way, West Orange, N. J.

ELECTRICAL—ELECTRONICS DESIGN ENGINEERS

Long Range Program—Aircraft Trainers
 Challenging, creative assignments in an expanding and progressive organization. BSEE plus experience in electro-mechanical devices, servo-mechanisms or analogue computers desirable. Send complete resume to:
STANLEY AVIATION CORPORATION
 Buffalo Municipal Airport
 Buffalo 25, New York



SENIOR ELECTRICAL ENGINEER

Five to ten years' experience in the electrical engineering field required. Experience to have been gained in the area of controls, servo-mechanisms, magnetic amplifiers or electronics. A degree in electrical engineering necessary.

The activity will consist in leading a group of junior and intermediate engineers in the design and development of controls involving magnetic amplifiers, transistors and other electro-mechanical devices; design, testing and fabricating into systems for turbo-jet, ram-jet engine controls and other developmental propulsion systems. To propose and develop new control systems.

COMPUTER ENGINEER

Requiring an engineering degree plus a minimum of three years of computer activity.

Must be capable of handling programming in the simulation and study of jet and reciprocating engine fuel systems, and aircraft shock strut and brake systems. Problems involved would be linear and non-linear in nature and applied to product design as well as research into basic phenomena. No maintenance ability necessary.

The salary of both positions will be commensurate with ability and experience.

Send resume to
Technical Employment Department
**BENDIX PRODUCTS DIVISION OF
BENDIX AVIATION CORPORATION**
401 Bendix Drive
South Bend 20, Indiana

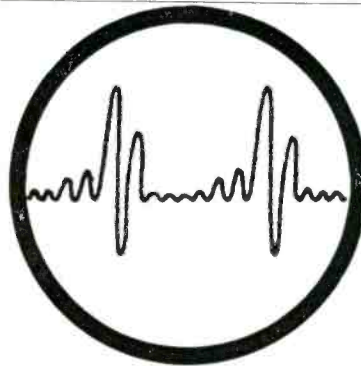

SPECIAL OPPORTUNITIES FOR ELECTRONIC ENGINEERS

Convair in beautiful, sunny San Diego invites you to join an "engineers" engineering department. Interesting, challenging, essential long-range projects in missiles, engineering research and electronics development. Positions open in these specialized fields:

Microwave Antennae	Dynamics Testing
Microwave Components	Telemetry
Electronic Packaging	Servomechanisms
Mathematical Physics	Electron Tubes
Electronic Components	Radome Design
Electronic Systems	Digital Computers
Applied Mathematics	Test Equipment
Transmitters & Receivers	Miniature Circuits

Generous travel allowances to those accepted. For free brochure, write Mr. H. T. Brooks, Engineering Dept. 900

CONVAIR IN BEAUTIFUL SAN DIEGO

Division of General Dynamics
3302 PACIFIC HIWAY
SAN DIEGO 12, CALIFORNIA

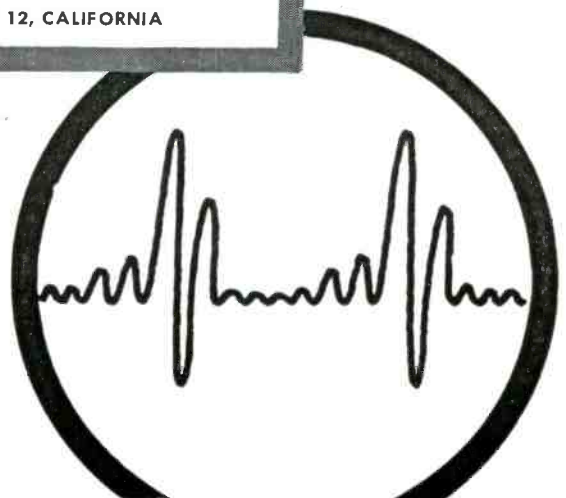
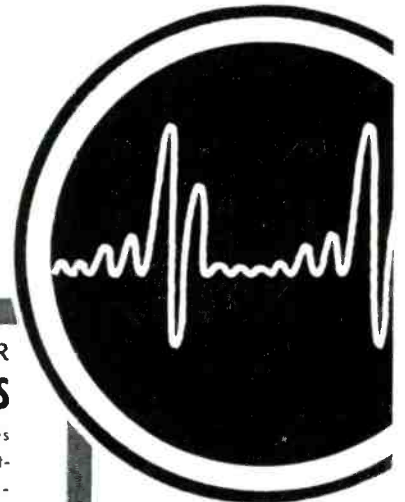



ENGINEERING OPPORTUNITIES

Engineers: Choose an Outstanding Career at Emerson-Electric.
Challenging Opportunities for:

- ELECTRONIC ENGINEERS
- STRESS ENGINEERS
- ELECTRONIC PACKAGING ENGINEERS
- SERVO ENGINEERS
- MECHANICAL ENGINEERS

You can select a key position in a comprehensive, long-range program developing and manufacturing turrets, radar, fire control systems, computers, servo mechanisms, instruments, guided missiles and rocket launchers. Attractive benefits include modern plant and facilities, suburban location, promotion-

from-within policy, group insurance, pension plans, paid holidays and vacations. Salaries are commensurate with training, experience and ability. Transportation and moving expenses paid to St. Louis. Please send resume, salary requirements and availability to:

Technical Employment Supervisor, Station 483-E

THE EMERSON ELECTRIC MFG. CO.

8100 Florissant • St. Louis 21, Missouri
LEADERS IN THE ELECTRICAL INDUSTRY SINCE 1890

ELECTRONIC AND MECHANICAL ENGINEERS!

Motorola Research Laboratories, located in the healthful climate of Arizona's Valley of the Sun, has several openings for experienced engineers in the following fields:

Electronic research and development for missile guidance, radar and VHF communications.

Mechanical design of missile-borne and vehicular electronics equipment.

Analysis and laboratory work involving development of new types of airborne and ground radiators and waveguide components.

VHF and microwave antenna waveguide circuitry.

Transistor development.

Desire men with B.S. degree or above. Salary commensurate with education and experience. Free health, accident and life insurance. Free hospitalization. Profit Sharing. Paid holidays. Sick leave. Vacations. Ideal working conditions. Plenty of housing, reasonably priced. Excellent schools. Exceptionally mild and dry winter climate.

WRITE: J. A. Chambers, Manager
Motorola Research Laboratory
3102 North 56th Street
Phoenix, Arizona

WHITE-RODGERS ELECTRIC CO. NEEDS MICRO-WAVE and SERVO ENGINEERS TO JOIN AN OUTSTANDING RESEARCH and DEVELOPMENT GROUP NOW

Developments of Inertial Guidance and Control Systems and Automatic Flight Formation Systems Accomplished By White-Rodgers Armament Engineering Divisions Are Commanding Wide-Spread Attention and Interest In The Guided Missile and Drone Aircraft Fields

Long Term Expansion of this Permanent and Well-established Organization offers UNLIMITED OPPORTUNITY for Qualified Technical Personnel

All Offices and Laboratories Completely Air Conditioned
All Laboratories Fully Equipped

POSITIONS ALSO AVAILABLE FOR ENGINEERS EXPERIENCED IN

Systems Analysis
Mechanical Design
Test Instrumentation
Electronics Packaging
Circuit Design

SEND RESUME TO EMPLOYMENT MANAGER, 1201 CASS AVENUE, ST. LOUIS 6, MO.

Exceptional OPPORTUNITY for Engineer

Long established manufacturer of temperature, humidity and pressure control instruments requires engineer with sound electronics education and background to work on design projects. Midwest location. Excellent prospects for the future. Age, preferably between 28 and 35. Apply by letter giving age, education, experience and salary requirements. All letters will be answered, and all held confidential.

P-4202, Electronics
520 N. Michigan Ave., Chicago 11, Ill.

ELECTRONIC ENGINEERS

Unique opportunity to get in on ground floor of young successful company applying atomic energy to industrial uses (non-government).

Graduate engineers are needed in two major functions: sales and applications engineering, and development and design engineering. Rapid expansion of company offers promotion opportunities found in few organizations. Only men with top academic and work records who desire and are capable of hard work and rapid promotion will be considered.

INDUSTRIAL NUCLEONICS CORP.
1205 Chesapeake Ave., Columbus 12, Ohio

A leader in Nuclear Instrumentation and Automation Equipment.

ENGINEERS

*have you considered
what a career at
General Precision Laboratory
can mean to you?*

Electronics, systems, analogue computer, field, senior micro-wave research and related engineers will find few opportunities which can match the advantages at General Precision.

It's a growing research laboratory, subsidiary of the large and diversified General Precision Equipment Corporation. Work is on a variety of interesting long-range projects, and men with initiative and ability are given prompt recognition for their achievements.

Living and working conditions are of the best. The modern laboratory is located in New York's Westchester County, known throughout the country for its beautiful surroundings and high standard of living . . . and only one hour from metropolitan New York city with its wealth of cultural and educational activities.

If you're interested in a permanent, satisfying career, send your resume to Mr. Hollis F. Ware, Personnel Director. Expenses will be paid for qualified applicants who come for interviews. We regret we can consider only U. S. citizens.

GENERAL PRECISION LABORATORY INCORPORATED

A subsidiary of
General Precision Equipment Corporation
63 Bedford Rd

Pleasantville

New York

Micro-Wave Specialists

The growing importance of micro-wave applications to aircraft has created a staff opening for a Micro-Wave Specialist at Lockheed Aircraft Corporation.

The position requires a specialist who couples at least three years' practical experience in airborne radar applications with a strong theoretical background. An advanced degree in Physics is preferred.

Duties will involve keeping abreast of latest developments in the field of micro-waves, redesigning micro-wave systems for application on Lockheed Aircraft, and acting in a staff advisory capacity on micro-wave subjects.

Lockheed offers you a high salary commensurate with the importance of the position; generous travel and moving allowances; an opportunity to enjoy Southern California life; and an extremely wide range of employee benefits which add approximately 14% to each engineer's salary in the form of insurance, retirement pension, sick leave with pay, etc.

Address inquiries to E. W. Des Lauriers,
Dept. E-M-11.

Lockheed

Aircraft Corporation

Burbank, California

**JOIN RCA
ENGINEERING
MANAGEMENT**

RCA has two engineering management openings in its expanded electronics engineering program:

Manager Aviation Systems Electronics Development (to supervise circuit development engineering and systems analysis of precision navigation, fire control and communications equipments).

Manager Airborne Fire Control Product Design (to supervise design engineering of airborne electronic equipments).

These positions require the ability to manage a comprehensive design and development engineering organization and to plan broad engineering programs. Your ability should be substantiated by proven supervisory experience and a degree in EE, ME, or Physics.

Send a complete resume of your education and experience to:

Mr. John R. Weld, Employment Manager
Dept. B-454K, Radio Corporation of America
Camden 2, New Jersey



RADIO CORPORATION OF AMERICA

**ENGINEERS
ELECTRONIC**

**WORK FOR THE LEADER
IN THE INDUSTRY**

E. E. Degree required. Experience helpful in any of the following:

**MILITARY ELECTRONICS
TWO WAY RADIO
ADVANCE CIRCUIT DESIGN
MICROWAVE
FIELD ENGINEERING**

High starting salary plus many company benefits including profit sharing

WRITE, GIVING COMPLETE RESUME OR APPLY IN PERSON 8 TO 5 DAILY.

MOTOROLA
4545 W. Augusta
Chicago 51, Illinois

ENGINEERS

with

EXPERIENCE

in electronic development

with experience comes progress

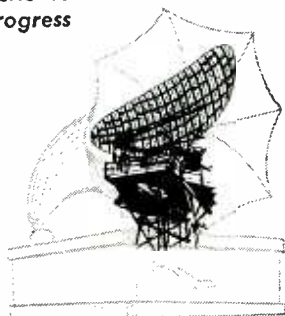

are you EXPERIENCED in
RADAR - MISSILE CONTROL
AIRBORNE COMMUNICATIONS
MOBILE COMMUNICATIONS
AUTO RADIO

... does an analysis of your background show that—at present—you are employed at THE HIGHEST LEVEL OF YOUR SKILL?

... Send us a resume of your background. We may have a higher level position open for you!

Send resume to Mr. L. H. Noggle, Dept. J

BENDIX RADIO

Division of Bendix Aviation Corp.

Baltimore 4, Md.

SALES ENGINEER

Well established (since 1934) small manufacturer of precision electronic instruments requires a Sales Engineer. We are located in a pleasant, active, rural community and our business is primarily commercial. Our personnel policies are modern and forward looking.

You will need a degree in EE and 3 to 5 years of engineering experience with electronic equipment or equivalent. Sales experience would be helpful but is not required.

Your work will include home office and field duties; demonstration of our instruments, customer technical assistance, and evaluation of customer needs. You will be paid a salary commensurate with your ability.

Please forward complete resume to

BOONTON RADIO CORPORATION
BOONTON, NEW JERSEY

advanced electronics developments
create new opportunities for engineers
at General Electric

▶ **ENGINEERS
PHYSICISTS**

New revolutionary developments are under way at General Electric. Behind each advance are the General Electric engineers . . . working with the finest facilities . . . exploring the most challenging aspects of their field . . . knowing the sense of stability and progress their work provides.

And, with each new advance, broadening the scope of electronics . . . new challenges, new opportunities constantly arise.

The opportunity is ever-growing at General Electric. And, an excellent salary and liberal benefits are other advantages worth knowing about.

Experience required in the following fields:

*Advanced Development, Design, Field Service
and Technical Writing in connection with:*

**MILITARY RADIO & RADAR MULTIPLEX MICROWAVE
MOBILE COMMUNICATION COMMUNICATIONS
ELECTRONIC COMPONENTS
TELEVISION, TUBES & ANTENNAS**

Bachelor's or advanced degrees in Electrical or Mechanical Engineering, Physics, and/or experience in electronics industry necessary.

Please send resume to: Dept. 11-4-E, Technical Personnel

GENERAL  ELECTRIC

ELECTRONICS PARK, SYRACUSE, N. Y.

An Opportunity

is offered for intelligent, imaginative engineers and scientists to join the staff of a progressive and self-sustaining, university-affiliated research and development laboratory. We are desirous of expanding our permanent staff in such fields as electronic instrumentation, missile guidance, microwave applications, design of special-purpose electronic computers, and in various other applied research fields of electronics and physics.

Salary structure and benefit programs are on a par with industry. In addition, there are many tangible advantages, such as our self-sponsored internal research policy, of interest to men with ingenuity and initiative.

**CORNELL AERONAUTICAL
LABORATORY, INC.**

BUFFALO 21, NEW YORK 

Stability and opportunity for
ELECTRONIC ENGINEERS
at the "Laboratory in the Sky"

One of America's leading centers of long-range radio and electronic developments offers outstanding opportunities for accomplishment, advancement and stability. Write for booklet describing projects, facilities and employee benefits.

INTERESTING ASSIGNMENTS IN:

Microwave Links • Pulse Networks • Radar
Direction Finders • Air Navigation Systems
Television Transmitters and Studio Equipment
Antennas • Computers • Guided Missiles
Telephone and Wire Transmission Systems
Microwave and Gas Discharge Tubes • Dielectrics

MAIL THIS COUPON TODAY

*Federal
Telecommunication
Laboratories* 

A Division of International Telephone
and Telegraph Corporation



Federal Telecommunication Laboratories ES-11
500 Washington Ave., Nutley, N. J.

Please send me a copy of "Your future is with FTL."

Name _____
Address _____
City _____ Zone _____ State _____

PHYSICISTS and ENGINEERS

Electronic
Mechanical
Chemical

Interested in *Research, Advanced Development and Product Design* involving

TRANSISTORS AND SEMI-CONDUCTOR DEVICES
COMMERCIAL AUTOMOBILE RADIO
MILITARY RADIO AND ELECTRONIC EQUIPMENT
ELECTRONIC COMPONENTS
INTRICATE MECHANISMS (tuners, mechanical linkages, controls, etc.)

Diversified and challenging work in an informal friendly atmosphere with congenial associates and modern equipment and facilities. Liberal employee benefits. Opportunities available for recent graduates and for experienced men with Bachelor or advanced degrees.

All inquiries treated confidentially and given prompt attention. Relocation expense allowed for those employed.

WRITE OR APPLY

DELCO RADIO DIVISION

GENERAL MOTORS CORPORATION

Kokomo, Indiana

PROGRESSIVE ENGINEERS LOOK WEST

Qualified Electronic and Electro-Mechanical engineers find happy association with a Western electronics pioneer and leader.

design
development
production

Commercial and military projects. Radar, DME, Communications, Noise, Test Equipment including color T.V. — Many others with real interest & challenge. Relocation expenses — excellent working conditions — Central location. Scheduled reviews & advances. Fine insurance plan. Move should not disturb urgent military projects.

Send complete resume, income history & requirements to engineering employment mgr.

Hoffman LABORATORIES, INC.

(A SUBSIDIARY OF HOFFMAN RADIO CORP.)

3761 SO. HILL ST.

LOS ANGELES 7, CALIF.



Electronic Engineering Company of California

The Electronic Engineering Company of California is an independent firm engaged in the design, development and fabrication of electronic equipment for private industry and the Armed Forces. Founded and managed by electronic engineers, the Electronic Engineering Company offers a broad background of experience, highly trained personnel, excellent facilities plus a well integrated, expanding organization.

The Electronic Engineering Company has openings for engineers with experience and background in industrial and military electronics.

Please send resume of experience and education with salary requirements to:

Electronic Engineering Company of California
100 SOUTH ALVARADO STREET
LOS ANGELES - 57 - CALIFORNIA

Bendix Aviation Corporation

YORK Division . . .

This NEW division of our nationally-famous corporation has openings for

ENGINEERS PHYSICISTS

Top-flight men in advanced fields of electronic research, development and product engineering are needed for challenging work under ideal conditions in our new, modern plant.

You benefit at Bendix York from our location in the heart of a beautiful suburban area, from high wages, paid vacations and holidays . . . and excellent opportunities for advancement.

Openings at all levels.

Write, Wire or Phone
Department Y-1



AVIATION CORPORATION
YORK DIVISION

Phone: York 5521

York, Penna.

REPRESENTATIVES' OPPORTUNITY

Five Territories Still Available for a broad new line of electronic laboratory test and measurement equipment; analog computers; aviation instruments.

Area A	Area B
Missouri	Texas
Kansas	Oklahoma
Nebraska	Arkansas
Western Iowa	Louisiana
	Area C
Virginia	Alabama
Eastern Kentucky	Georgia
Tennessee	Florida
Mississippi	North Carolina
	South Carolina

Area D: Southwestern Ohio

Area E: Canada

This is an unusual opportunity for technically competent, well-supported manufacturers agents to join a strong distribution network. For full information on products and facilities, contact Sales Manager

DONNER SCIENTIFIC COMPANY

2829 Seventh Street • Berkeley 10, California

REPRESENTATIVES WANTED

Manufacturer of electronic test equipment for military and commercial applications needs technically qualified representatives. Write giving qualifications, lines handled, territory covered.

RW-2178, Electronics
1111 Wilshire Blvd., Los Angeles 17, Calif.



Engineering Careers with a *FUTURE . . .*

- Positions are available in our organization at all levels for qualified personnel in the following fields:

- | | |
|--------------|---------------------------|
| • TELEVISION | • MILITARY COMMUNICATIONS |
| Commercial | • COMMERCIAL RADIO |
| Military | • RADAR |
| Monochrome | |
| Color | |

Our rapidly expanding interests in these and other fields opens many opportunities for experienced electrical engineers as well as recent graduates.

Chicago location offers excellent opportunities for further study and graduate work in the electronics field.

Personal interviews will be arranged at the convenience of qualified applicants

We suggest you write Mr. Walter Wecker, Personnel Department to get more information on career opportunities, advanced educational plans, and other advantages.

Admiral Corporation

3800 W. Cortland St.
Chicago 47, Illinois

DEVELOPMENT & FIELD SYSTEMS ENGINEERS

- ANTENNA
- RADIO COMMUNICATIONS
- RADAR
- MICROWAVE
- NAVIGATIONAL AIDS
- TERMINAL EQUIPMENT
- TELETYPE

With a progressive, expanding, well established corporation. Interviews will be arranged for qualified applicants. Send complete biographical resume, experience and education to

Mr. J. E. Richardson
Personnel Director

MARYLAND ELECTRONIC MFG. CORP.
5009 Calvert Road
College Park 9, Maryland

ENGINEERS

E.E.

MECHANICAL

DESIGNERS

. . . who are interested in the development, testing or field servicing of new precision airborne navigational systems. Some previous experience with electronic and electro-mechanical computers and instruments necessary.

Among the advantages at Kollsman are a congenial atmosphere, the most modern facilities and interesting and diversified assignments in the design and development of America's finest aircraft instruments.

*A few
unusual
opportunities
for
young,
bright
engineers . . .*

For Appointment, Please Write
Employment Manager

KOLLSMAN Instrument Corp.
80-08 45th Ave., Elmhurst, Long Island, N. Y.



Calvert Electronics
INCORPORATED

The Switch is to CALVERT



SPECIAL PURPOSE

KC4	19.00	RKR73	.77
KC5-3	19.00	101L WE	.99
1B32	.44	F-127A	17.75
1B35	3.35	FG-172	17.50
1B56	24.00	205B	.55
1P23	.55	207	47.50
2C33	1.25	249B	3.75
2C43	12.75	249C	3.75
2E24	1.75	250R	5.00
2J21	1.95	311A WE	2.75
2J22	1.75	311B WE	3.75
2J26	4.75	CAA-322	9.45
2J27	6.75	407A WE	2.50
2J32	12.50	408A WE	2.95
2K28	20.00	416A WE	write
2K31	99.50	416B WE	wtire
2K56	48.00	421A WE	2.75
2X2 879	.92	422A WE	2.75
3BP1	2.75	CK507AX	.65
3B24W	9.45	717A	.45
3E29	9.45	722	.77
4B28	3.75	730A	12.50
4J25	99.50	826	.55
5AP1	2.00	832A	7.50
5BP1	.99	841	.19
5BP4	1.75	851	20.00
5B21	3.75	880	250.00
5CP1	3.75	889R	99.50
5D21	7.75	891	77.50
5FP7	1.75	921	.39
5R4WGY	1.25	931A	3.35
7BP7	2.75	954	.14
7C4 1203A	.12	955	.24
9GP7	3.75	957	.24
10	.19	CK-1006	1.25
10Y	.19	CK-1089	.80
12GP7	9.45	1616	.49
15R	.99	1619	.22
180	2.00	1625	.19
191	2.00	1626	.19
23D4	.44	1629	.10
30 Spec.	.92	1630	.55
FG32	2.95	5702	3.25
35T Ion Gauge	1.75	5800 Victoreen	3.50
39 44	.92	5803 Victoreen	1.75
T40	2.00	5881	2.75
HY40Z	2.00	5964	.77
RK62	2.00	6035	10.00
RK72	.77	6038	3.85
		6099	.90

7193	.14	6K7	.44
8011	.44	6K8G	.65
8025	2.45	6L5G	.50
8025A	3.75	6L6GAY	.75
9004	.19	6L7G	.39
9006	.24	6N7GT	.44
		6Q7G	.39
		6S5	.55
		6SL7GT	.55
		6T8	.65
		6V6G	.39
		6Y6G	.75
		7A6	.22
		7C4	.12
		12A8GT	.39
		12B8GT	.29
		12SK7GT	.48
		12SL7GT	.55
		12SR7	.45
		14A4	.45
		14C7	.45
		19	.55
		25L6G	.39
		25L6GT	.45
		26	.44
		30	.60
		37	.17
		38	.17

RECEIVING TYPES

01A	.99
1F7G	.69
1H6G	.55
1LA4	.55
1LA5	.60
1LC5	.75
1LC6	.75
1LH4	.33
1P5GT	.60
1Q5GT	.55
2A3	.65
2A6	.45
2A6G	.39
2X2 879	.26
5X4	.30
5Y4G	.55
5R4WGY	1.25
6AG5	.53
6A57G	3.35
6B7	.39
6F6	.50
6F8G	.45
6H6	.22
6K7	.44
6K8G	.65
6L5G	.50
6L6GAY	.75
6L7G	.39
6N7GT	.44
6Q7G	.39
6S5	.55
6SL7GT	.55
6T8	.65
6V6G	.39
6Y6G	.75
7A6	.22
7C4	.12
12A8GT	.39
12B8GT	.29
12SK7GT	.48
12SL7GT	.55
12SR7	.45
14A4	.45
14C7	.45
19	.55
25L6G	.39
25L6GT	.45
26	.44
30	.60
37	.17
38	.17

Individually
Boxed
•
Standard
Brands
•
R. M. A.
Guarantee

Export packing facilities and deliveries to pier

Calvert Electronics
INCORPORATED

59 Fourth Ave., New York 3, N. Y.
Oregon 4-3027 Cable Address: Calvertron

SAVE UP TO...

85%

SURPLUS ELECTRONIC EQUIPMENT

INVERTERS

DMF 3506M CONTINENTAL ELECTRIC
24-30 volts input; 5.5-4.5 amps; cont. duty. OUTPUT: 115 volts; .44 amps; 400 cyc; 1 phase; P.F. 1.0; 50 wats \$39.50

10563 LELAND ELECTRIC
Output: 115 VAC; 400 cycle; 3-phase; 115 VA; 75 PF. Input: 28.5 VDC; 12 amp. \$39.50

PIONEER 12117
Output: 26 volts; 400 cycles; 6 volt amperes, 1-Phase. Input: 24 VDC; 1 amp. \$19.95 ea.

ALTERNATOR, CARTER
Mfg. Carter Motor Co.; output: 7 VAC; 9.7 amp.; 650 cycles, and 295 VDC. 200 amps. Input: 26.5 VDC; 10.5 amps; 6500 rpm. \$29.50 ea.

PE 218 LELAND ELECTRIC
Output: 115 VAC; Single Phase; PF 90; 380/500 cycle; 1500 VA. Input: 25-28 VDC; 92 amps; 8000 rpm; Exc. Volts, 27.5. BRAND NEW \$39.95 ea.

PE 109 LELAND ELECTRIC
Output: 115 VAC, 400 cyc; single phase; 1.53 amp.; 8000 rpm. Input: 13.5 VDC; 29 amp. \$65.00

MG 153 HOLTZER-CABOT
Input: 24 VDC; 52 amps. Output: 115 volts—400 cycles, 3-phase, 750 VA and 26 Volt—400 cycle, 250 VA. Voltage and frequency regulated \$95.00 ea.

PIONEER 12130-3-B
Output: 125.5 VAC; 1.5 amps. 400 cycle single phase, 141 VA. Input: 20-30 VDC, 18-12 amps. Voltage and frequency regulated. \$69.50

12116-2-A PIONEER
Output: 115 VAC; 400 cyc.; single phase; 45 amp. Input: 24 VDC, 5 amp. \$39.95

10285 LELAND ELECTRIC
Output: 115 Volts AC, 750 VA, 3 phase, 400 cycle, 90 PF. and 26 volts, 50 amps, single phase, 400 cycle, 40 PF. Input: 27.5 VDC, 60 amps, cont. duty, 6000 rpm. Voltage and frequency regulated \$89.50

10486 LELAND ELECTRIC
Output: 115 VAC; 400 cycle; 3-phase; 175 VA; .80 PF. Input: 27.5 DC; 12.5 amp; Cont. Duty. \$90.00 ea.

PIONEER 10042-1-A
DC input 14 volts; output: 115 volts; 400 cycle, 1-Phase; 50 watt \$39.50

10339 LELAND ELECTRIC
Output: 115 volts; 190 VA; single phase; 400 cycle; 90 PF. and 26 volts; 60 VA; 400 cycle, .40 PF. Input: 27.5 volts DC 18 amps cont. duty, voltage and freq. regulated \$49.50

PIONEER 12147-1
Output: 115 VAC; 400 cycle; single phase. Input: 24-30 VDC; 8 amps \$49.50

MG 149F HOLTZER CABOT
Output: 26 VAC @ 250 VA; 115V @ 500 VA; single phase; 400 cycle. Input: 24 VDC @ 36 amps \$49.50

EICOR CLASS "A" NO. 1-3012/08-7
Output: 125 VAC; 400 cycle; single phase; 100 VA. Input: 24-30 VDC; 11 amps; Duty int. Voltage and Frequency Regulator. \$49.50

SYNCHRONOUS SELSYNS

110 volt, 60 cycle, brass cased, approx. 4" dia. x 6" long. Mfg. by Diehl and Bendix. Quantities Available. REPEATERS \$20.00 ea. TRANSMITTERS \$20.00 ea. We Stock a Wide Range of Synchro Motors, Generators, Differential Generators, Transformers and Repeaters.

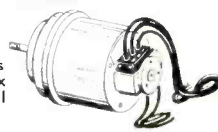

Write or Wire for Information on our Complete Line of Surplus Electronic Components • Immediate Delivery • All Equipment Fully Guaranteed • All Prices Net F.O.B. Pasadena, Calif.

C & H SALES CO.

2176-E E. Colorado Blvd., Pasadena 8, Calif.

SELLING

- Receivers
- Transmitters
- Radar
- Special Purpose Tubes
- Relays
- Meters
- Switches
- Connectors
- Rectifiers
- Transformers
- Motors & Generators
- Wiring Cable
- Instruments
- and
- All Electronic Components

Wholesale Only

WILL BUY ALL

New or Used

- Leach Relay #5059-R
- #5058
- #5055
- #5053-SM
- #5053

- Price Bros. Relay #10
- Relay #5586
- #5587

- Antenna Switching Relay
- Box # CBY 23049
- # BG-AN-198
- # BC -408

- Tubes #53A
- VT-127A
- 35T
- WL-530

Highest prices paid for most all types of aircraft sparkplugs any condition

Wholesale Only

RADIO & ELECTRONIC SURPLUS
13933-9 BRUSH STREET
Detroit 3, Mich. TO 9-3403

New Sola Const. Volt. Transformers

Input 95-125VAC. Output 118VAC 60 cycle 165VA. \$24.95. 225VA \$32.95. 310VA \$42.50. 500VA (115V out) \$47.50. Raytheon 120VA (115V out) \$19.95

LAPIROU BROS.

1649 Hoffner St. Kirby 1285 Cincinnati 23, Ohio

NEW CATALOG

Large stock of tubes, electronic and TV components available for sale to manufacturers and wholesalers only. Write for catalog No. 954 on company letterhead.

Dept. SSE, Mid-America Co., Inc.
2412 S. Michigan Ave., Chicago 16, Ill.

TREMENDOUS SAVINGS IN ELECTRONIC

WAR TERMINATION INVENTORIES
 SAVE UP TO 85% • IMMEDIATE DELIVERY • EQUIPMENT FULLY GUARANTEED

SIMPLE DIFFERENTIAL

Size: 2-5/32" long x 1/4" dia.; bearing one end 1/2" O.D.; Shaft Size: 1" long, threads 8-32-3/4" long, with bearing shaft 3/8" dia. x 1/4" long. Gear on shaft end 1-7/16" dia., gear on bearing end 1 1/4" dia. Drive gear 25/32" dia.



Stock No. 101

\$3.95 ea

FOUR GEAR SPIDER DIFFERENTIAL

2"-96 teeth-48 pitch gear; 4" of 48 pitch, 12 teeth pinon wire. Size: 8 1/2" long x 4 3/8" wide x 2" high.



Stock No. 102

\$3.00 ea.

TRANSCOIL CORP. TYPE 2900

115 vclt, single phase, 400 cycle. 115 volt, 2-phase, 400 cycle, 5500 R.P.M. Size: 1 1/2" dia., 2" long. Shaft size: 1/8" dia., 9/16" long. 3/8" O.D. index ring.



Stock No. 103

\$25.00 ea.

PIONEER TORQUE UNITS

Type 12602-1-A. Includes CK 5 Servo motor coupled to output shaft thru 125:1 gear reduction train. Output shaft coupled to autosyn follow-up (AY-43). Ratio of output shaft to follow-up autosyn is 30:1. Includes base mounting type cover for motor and gear train . . .



Stock No. 104

\$34.95 ea.

SPIDER DIFFERENTIAL

Three spur gears. Size: 7 1/2" long x 1 3/4" wide x 2 3/4" high.



Stock No. 105

\$5.00 ea.

SIMPLE DIFFERENTIAL

1:1 reverse ratio, 60 teeth on large gear; 1/4" shaft. Size: 3" long with 1-15/16" dia.



\$3.95 ea.

Stock No. 106

**SAVE UP TO 85%
 EQUIPMENT FULLY
 GUARANTEED
 IMMEDIATE DELIVERY**

C&H

SALES CO.

2176-E East Colorado St.
 Pasadena 8, California
 RYan 1-7393

WRITE OR WIRE FOR INFORMATION ON OUR COMPLETE LINE OF SURPLUS ELECTRONIC COMPONENTS. ALL PRICES NET F. O. B. PASADENA, CALIFORNIA.

SPIDER DIFFERENTIAL

Size: 6 1/2" long x 1 3/4" wide with 3/16" shaft.



Stock No. 107

\$2.50 ea.

GEAR DRIVE SPIDER DIFFERENTIAL

System includes seven gears and spider. Size: 5 1/4" long x 3 1/2" wide x 3" high.



Stock No. 108

\$5.00 ea.

INDUCTION MOTOR, KOLLSMAN

TYPE 1515B-0410
 26 volt, 400 cycle, 2-phase. Size: 1-1/64" long; 15/16" dia. Shaft size: 1/8" dia.



Stock No. 109

\$22.50 ea.

DUAL SIMPLE DIFFERENTIAL

1:1 reverse ratio on both. Size: 3 1/4" long x 1-7/16" dia. Shaft size: 1/8" and 5/32".



Stock No. 110

\$7.50 ea.

SIMPLE DIFFERENTIAL

1:1 reverse ratio. Size: 6 3/4" long x 2 3/4" dia. Shaft size: 11/32".



Stock No. 111

\$7.50 ea.

SIMPLE DIFFERENTIAL

Size: 5 1/2" long x 2 1/4" dia. Shaft size: 3/8" on one end and 11/32" on other end. Hub is 1-3/32" dia. on each end.



Stock No. 112

\$7.50 ea.

BENDIX ALTERNATOR

100 V.A.; 115 volt; 1 P.F.; 3 Phase; 400 Cycle; 2400 R.P.M.; Bendix Type 1631; Model 5; Style A Mounting; Flange 4 1/4" sq. 5/16" holes; 3 1/4" O.D. Ring for Centering; Unit is 7" long; Spline Shaft 12 T.; 5/8" dia.; 1-1/16" long; 10.5 lbs.



Stock No. 113

\$49.50

PRECISION PLANETARY DIFFERENTIAL

1:1 reverse ratio, ring gear 3" dia., 120 teeth. Overall length 5 1/4", shaft dia. 11/32", 3/8" key on one end.



Stock No. 114

\$7.50 ea.

RADAR ANTENNAS

SO-1 (1CM) assembly with reflector, waveguide nozzle and drive motor. New\$279.50
 SO-3 (3CM) Surface Search type with reflector and drive motor, but less plumbing. New in original cases.\$89.50
 SO-13 (10CM) Complete assembly with 24" dish, dipole, drive motor and gearing. New\$89.50

RADAR SETS

MODEL SQ. Portable radar set, 10CM. Operates on 90-130 volt, 60 cy., 1 Ph. "A", "B", and "PPI" presentation. Complete with tech manual and full set of operating spare parts. Used but in good condition\$495.00

RA38 RECTIFIER

Variable output 0-15000 V DC @ 500 MA. Input 115V 60 cy. 1 ph. Size 63 x 53 x 56 in. Write for detailed information.

SCR-545A RADAR

Removed from trailer. Includes: Azimuth and Elevation Control Units; 214A and 154A Indicators; Input and Output Servo Amplifiers; Three BC-1035A Scopes; Power Pack and IIA-65A Power Supply; Range Cont. Unit; Range Converter; Search Rec. and Cont. Unit; Search Trans; Track Rec. and Control Unit; Track Trans; Range Unit; Auto. Controller; No Antenna included. In good condition. A terrific value at.....\$975.00
 Only one set available.

G. E. SERVO AMPLIFIERS

Used in H29 planes for Central Station Fire Control Systems B2, B3 and B4. Used to drive Amplidyne 5AM31N19A and Control Motor 5BA50L2A listed in 1st column. New less tubes.....\$29.50

SHOCK MOUNTINGS

Type A—3 x 3 x 1-3/4 in.....\$30
 Type B—2-3/4 x 2-3/4 x 1-1/4 in.....\$20
 Type C—1-1/4 x 1-1/4 x 1-1/4 in.....\$10

NEW SCR-522A EQUIPMENT

Complete BC-624C receivers and BC-625AM Transmitters including mounting racks, plugs, connectors, dynamotor. Brand new equipment with instruction manuals. Write for full details.

REPAIR PARTS FOR BC-348

(Models H, K, L, R.)
 Also BC 224 Models F, G. Coils for ant., r.f., det., osc., I.F., c.w. osc. rital filters, 4 gang cond. front panels, dial assemblies, vol. controls, etc. Write for complete list and free diagram.

SPECIALS

ATTENUATOR. Daven Type T-800 Circuit. TPE. Imp. 50,000. 0.5 D.B. per step. New\$2.75
 CRT Shields for 3" Tubes.....\$2.75
 FIRE DETECTOR. Designed for use on aircraft, tanks, armored vehicles. Heating of outside casing as by fire causes inside snap blade switch to close. Good Experimenters Item\$1.00
 JACK BOX. BC-1366M. Brand New \$5.65
 PARABOLOIDS. 17 1/2" dia. spun magnesium, 4" deep. 1 1/2 x 1 1/2" opening at apex. Per pair.....\$12.50
 SAWTOOTH POTENTIOMETER. Continuous winding, 2 rotating and 2 take-off brushes. GE251X95.....\$2.75
 SOLENOID. 24V DC, 2 lb. pull, 3/4" stroke. New\$1.45
 SWEEP GENERATOR CAPACITOR. 5/10 mfd., split stator coax type. Hi-speed ball bearings.....\$1.95

PLUG IN RELAYS

Clare octal base 75 ohm coil, 115 V, 60 Cy. Make two breaks one New.....\$1.95
 Western Electric D163781 Octal Base 2400 Ohm coil 10 MA operating. Makes one. Normally open. New.....\$4.95

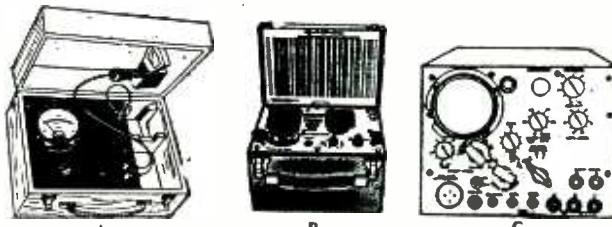

Fig. A FLUXMETER. Measures field strength of magnets from 500 to 4000 gauss. Indicates polarity. Probe gap 1/4". British handcraft in fine hardwood case with hinged cover. Operating instructions on underside of cover. Size 12-3/4 x 9 x 6 in. A lab instrument. Also ideal for classroom magnetics instruction. \$24.50

Fig. B FREQUENCY METER 375 to 725 Mcs. Model TS-127/U. Compact. Self-contained, precision (± 1 Mc). Sturdily constructed Hi-"Q" resonator has average "Q" of 3000. Uses 357, 186 and 354 tubes. Requires standard 1 1/2 V "A" and 45V "B" battery, not supplied. Brand new with instruction book, probe and spare kit of tubes.....\$47.50

Fig. C PANORAMIC ADAPTER AN/APA-10. A combined Panoramic Adapter and Scope. Has 3 inputs for feeding in receiver I.F.'s of 455Kc, 5.2Mc or 30Mc. Designed also to be used as regular scope for testing other equipment. Has both vertical and horizontal push-pull amplifier inputs, etc. Complete with 21 tubes including 3" CR tube and instruction manual. For operation on 115V 60 Cy. \$145.00

SPECIAL OFFER! 80 page Tech. Manual for Panoramic Adapter AN/APA-10. Full of circuitry, descriptive data, theory, etc. Postpaid in U. S. A. \$100

TEST OSCILLATOR TS-47/APR, 40-2000+ Mc. Fundamental coverage 40-500 Mc in two ranges. Harmonics above 2000 Mc. Provides a calibrated (dial accuracy ± 0.7 per cent) H.F. source for testing receiving equipment. Output 3MW or more up to 400 Mc. less on harmonics. C.W. mod. pulse or sine wave output. Operates on 115/230 60 Cy. or batteries. Part of APR countermeasures equipment. \$169.50

FREQUENCY STANDARD TELRAD 18A. Provides 1000, 100, and 10 Kc. check points from 100 to 45,000 Kc. Employs dual 100/1000 Kc Billey Crystal. \$239.50

Calibrates with WWV. Operates 110/220, 60 Cy. New with instructions. TS-16/APN TEST SET. For calibrating various radio altimeters. Measures modulator sweep frequency and band width of transmitter. Excellent condition. Price \$29.50

AN/APR-1 RECEIVER. For use with tuning units TN-1, and N-2, and N-3. Range 38-1000 megacycles. \$149.50
 Price with tubes less tuning units.....\$149.50
 156-210 Mc RECEIVER BC-1068A. Has 2 tuned RF stages, tuned converter and oscillator, 5 IF stages, diode detector, tuning eye, and 2 stages of audio. Tuning coils may be altered for lowering or increasing coverage. Operates from 115V. 60 Cy. Gov't. cost estimated at \$700.00. Our special price including 14 tubes. \$29.50

Shipping Weight Approx. 100 lbs.
 300-1200 Mc TRANSFORMER T85/APT5. Nominal output 10 to 30 watts. Tunable cavity provides range from 300-1200 Mc. Filament transformer operates from 115 V 60 Cy. Uses 8 tubes: 1-831A, 2-6AC7, 2-6AG7, 1-6L6G, 2-829B, 1-3C22 (oscillator). Price with tubes.....\$139.50

HIGH POT TRANSFORMER

Westinghouse. Pri: 115, 60 cy. Sec: 15,000V C.T., @ .060A. C.T. ungrounded. Size OA 12H x 8 1/2 W x 9 1/4 D. Weight 67 lb. Price \$29.50

PLATE TRANSFORMER

Pri: 115V., 60 cy. 1 Ph. Sec: 1470V. C.T. @ 1.2A tested at 6500V RMS. Raytheon. Size 12 1/2 x 10 x 10 in. Shipping wt: 150 lbs. New. Special \$19.50

G.E. BATTERY CHARGER

Charges 54 Cell Battery at from 1 to 10 ampere rate
 Input 115V., 60 cy. 1 Ph. Sec.
 T8 model 6RC89F16 Copper Oxide battery charger consists of a transformer, a secondary reactor, a copper oxide rectifying element, a ventilating fan, control circuits and auxiliary equipment necessary for proper operation. Transformer tapped for various supply voltage. Eight secondary taps for adjusting charging rate. Built into metal cabinet. Metered. Complete with spare fan and fuses. New in original packing cases. Shipping weight approx. 305 lbs. Price.....\$149.50

SOUND POWERED CHEST SETS

U. S. Instrument Co. No. A-280 Combination headset and chest microphone. Brand new, including 20 ft. of rubber covered cable and plug\$17.50 each
 HEADSET ADAPTER. MC-385C Matches hi to lo imp., for HS-33 or 38 phones. New in original cartons.....\$6.65
 TRANSMITTER CAPSULE for TS-13 headset. New in original cartons.....\$1.75

9 CONDUCTOR CABLE

VINYL JACKETS
 SHIELD COY. SERVE
 Army spec. CO-215 Weatherproof 9 Cond. No. 20 AWG stranded tinned copper, plastic ins., color coded, double vinyl jackets with tinned copper braid between. Dia. 9/16" made by G.E. Available 1000, 1500, 2000 ft. coils.....Price \$1.12 ft. Sample 100 ft. Coil.....\$15.00

FIELD TELEPHONES

RM29A Complete with carrying cases and TS-13 handsets. New in original cartons \$17.50

TERMS: Rated Concerns Net 30, FOB Bronxville, New York. All Merchandise Guaranteed. Prices Subject to Change.

INVERTERS

Onan MG-215H. Navy type PU/13. Input 115/230, 60 cy., 1 Ph. Output: 115, 480 cy., 1 Ph., 1.2KW and 28 V DC at 4 amps. New\$295.00
 Onan MG-0-75. Navy type PU/11. Input 115/230, 60 cy., 1 Ph., Output: 115, 480 cy., 1 Ph., 3.3 amps. and 28 VDC @ 3.8 Amps. New\$225.00
 Leland Elec. Co. PE206A. Input: 28DC at 38 Amps. Output 80V, 800 cy., 1 Ph., 485W. New\$16.50
 PE218H. Input: 28DC. Output: 115, 400 cy., 1 Ph., 1.5KVA. New.....\$32.50
 G.E. 5AS131111A. Input: 28DC. Output: 115, 400 cy., 1 Ph., 1.5 KVA. Regulated. New\$89.50
 Elcor. 32VDC to 110AC, 60 cy., 1 Ph. at 2.4 Amps. New\$29.50
 Navy type PU-7/AP 2800 VA Input 160 Amps. @ 28 V. Output 115 V, 400 Cy., 1 Ph. (1.00 PF) 2500 W. Continuous. Both voltage and freq. regulated. New. Price\$98.50

DYNAMOTORS

Navy type CA10-21144H. Input: 105 to 130VDC. Output: either 28VDC at 20 amps. or 13VDC at 40 amp. Radio filtered and complete with line switch. New\$69.50
 Type PE94CM. For SCR-522. Brand new in overseas cases. Has wide band input and output filters.....\$14.95

AMPLIDYNES

5AM21J17. Input 27 VDC @ 15 A. Output 60 VDC @ 2.5A 4600 RPM. New\$34.50
 5AM31N19A. Input 27 VDC @ 44 A. Output 60 VDC @ 8.8 A., 7500 RPM. New\$23.50
 5AM31N18A. Input 27 VDC @ 44 A. Output 60 VDC @ 8.8 A., 8300 RPM. New\$12.50

HIGH VOLTAGE OIL CAPACITORS

Mfd.	Volts	Price
.001	50 KV	\$22.50
.01	5 KV	1.25
.02	8 KV	2.69
.02 1/2	20 KV	9.75
.025	50 KV	25.50
.05-.05	50 KV	34.50
.1	3 KV	.95
.1-1	4.5 KV	3.50
.135	7.5 KV	6.35
.25	50 KV	19.50
.25	50 KV	15.50
.25	20 KV	17.50
.25	50 KV	44.50
1.	7.5 KV	6.35
1.	15 KV	39.75
2.	5.5 KV	9.50
2.	6 KV	12.50

1MFD 7500 VOLTS D.C. SPECIAL \$6.95

OIL FILLED CAPACITOR

.02 mfd. 20KV. Size OA-10 1/2" x 2 1/2" Dia. Special \$9.95

SMALL DC MOTORS

G.E. 5BA50L2A. Armature 60VDC at 8.3 Amps. Field 27.5VDC at 2.3A RPM 4000. H.P. 0.5. New.....\$27.50
 G.E. 5BA50L22. Armature 60 VDC at 8.3 Amps. Field 27.5 at 2.9 Amps. RPM 4000. H.P. 0.5 Gear Box No. T8254261-G1. Has two 160 RPM and one 120 RPM take-off. Gov't. Cost \$207.00. Our price\$29.50
 Oster E-7-5. 27.5DC. 1/20 HP, 3600 RPM Shunt Wound. New\$9.50
 Dumore Co. type ELBG, 24 VDC, 40-1 gear ratio. For type B-4 Intervalometer. New\$2.75

400 CY. BLOWERS

Westinghouse Type FL. 115V, 400 cy., 6,700 RPM. Airflow 17CFM. New \$3.95

SYNCHROS

Ford Inst. Co. Synchro Differential Generator. Mod. 3 Type 5SDG. 90/90V. 400 cy., Ord. Dr. 173029. New.....\$4.50
 Armor. Synchro Differential Generator. Type 6DG. New\$29.50
 Hobart Mfg. Co. Synchro Dif. Generator Type XIX 115V, 60 Cy. New \$4.95
 5F, 5G, 5CT Also in Stock

MOTOR GENERATORS

2 KVA O'Keefe and Merritt 15DC to 120AC, 50 cy., 1 Ph. Export Crated. New\$25.00
 MOTOR GENERATOR. TYPE CGU-2 Unit of U. S. Navy TCK-7 Transmitter Motor: 2 H.P. 280V. D.C., 10 amps. Generator: 180V. D.C. 0.4 A., 500V. D.C., 0.35A, 115V. D.C., 1.5A, 12 V. D.C., 2A. 3480 R.P.M. Self excited. Brand new including spare armature. \$95.00
 ALLIS-CHALMERS 230DC to 115AC. 60 cy., 1 Ph., 1.25 KVA.....\$149.50

IMMEDIATE SHIPMENT from one of the **MOST COMPLETE** inventories of **SPECIAL PURPOSE, TRANSMITTING, RADIO and TV RECEIVING TUBES. FULLY GUARANTEED, STANDARD BRANDS** at the **LOWEST PRICES** consistent with **HIGHEST QUALITY.**

WE SPECIALIZE IN WESTERN ELECTRIC, SUBMINIATURE and NEW JAN RUGGEDIZED TYPES.

DIRECTRON



FULL-WAVE BRIDGE TYPE

SELENIUM RECTIFIERS

Max. Amps	18/14 Volts	36/28 Volts	54/42 Volts	72/56 Volts	130/100 Volts
1	1.40	2.40	3.80	4.60	8.50
2	2.30	3.00	5.40	6.00	10.50
2 1/2	3.00	4.20	6.00	8.00	13.00
4	3.75	7.50	11.50	14.50	25.25
6	4.50	9.00	13.00	17.50	33.00
10	6.00	12.75	20.00	25.00	42.50
12	8.20	16.25	22.50	30.00	46.00
20	13.25	25.50	38.00	49.00	79.50
24	16.25	32.50	45.00	58.00	86.50
30	20.00	38.00	57.50	72.00
36	25.00	48.50	66.00	88.00
50	32.00	62.50
100	60.00	120.00

We Build other Selenium Rectifiers, Transformers and Chokes to your specifications. Buy from the Direct Source for Quick Delivery.

NEW RECTIFIER TRANSFORMERS

PR1: 115 V., 60 cycles in., 4 Amps. \$8.75
 SEC: 9, 12, 18, 24, and 36 12 Amps. 16.75
 Volts 24 Amps. 35.75
Continuous Ratings 30 Amps. 45.00
 50 Amps. 59.75
 New—1&2 amp. Write for Prices, Specs.

FILTER CAPACITORS

Capacity	W. Voltage	Each
500 MFD	50 V.	\$.85
1000 MFD	15 V.	.35
2000 MFD	50 V.	2.25
6000 MFD	15 V.	1.50

NEW RECTIFIER CHOKES

4 Amps.07 Hy. 6 ohm \$7.95
 12 Amps.01 Hy.1 ohm 14.95
 24 Amps.004 Hy.025 ohm 29.95
 New—5&2 Amp. Write for Prices, Specs.

MALLORY VIBRAPACKS 12 v DC input: 300 v DC @ 125 MA output. Brand new. Complete with vibrator. **1095**

SPECIALS

1B24	Sylvania Jan Box	\$3.80
1B32	1.50
1P25	77.00
2C33	1.80
2K28	27.50
3B24	Sylvania Boxed	3.60
3B26	W.E. and Raytheon Box	2.75
3B29	Raytheon Jan	9.00
3C22	Raytheon Box	66.66
3J21	G.E. Boxed	59.50
3J30	55.00
RI131	Sylvania Wood Box	8.50
6AK5	Sylvania Jobb. Box	.49
803	1.95
838	1.95
750TL	Unused, Surplus in Orig. Carton	49.50

Authorized distributors for Eimac, Westinghouse (WL), CBS-Hytron (CBS), Cetron, Lewis & Kaufman and Penta Tubes.

Terms: F O B—N Y C—25% Deposit with order— or send full remittance to save C O D charges— D & B Rated Firms (F2 1/2 or Better) Net 10 Days. CABLE BARRYLECT, N. Y.

WESTERN ELECTRIC

• NEW • ORIGINAL-BOXED •

2C51/396-A	\$3.85	348-A	\$4.95	416-A	\$60.00
2K45	75.00	359-A	3.50	416-B	66.50
2K55	29.50	373-A	3.50	417-A/5842	write
271-A	16.00	374-A	4.50	418-A	18.00
274-A	4.95	387-A	4.00	421-A	15.00
274-B	1.95	394-A	3.00	422-A	15.00
275-A	12.00	403-A/6AK5	1.25	705-A	1.20
310-A	1.50	403-B/5991	3.45	709-A	2.50
311-B	4.50	404-A/5847	12.90	5780	350.00
313C, CA, CA	2.50	407-A	2.50	5795	350.00
337-A	6.00	408-A	2.50		

We maintain on our premises a **TEST LABORATORY** with complete facilities **CERTIFIED ELECTRONIC TUBE TESTING**

- We can test your tubes to: Jan I-A or Mil I-EB Specs or Commercial Specs.
- We do specialized and qualitative testing on magnetrons, klystrons, ignitrons, diodes, transmitting, power tubes, etc.

SUBMINIATURE TYPES

	EACH		EACH		EACH
5633	\$6.90	5646	\$6.90	5829	\$1.75
5634	6.90	5647	3.75	5829WA	5.80
5635	6.90	CK-5676	1.15	5840	6.90
5636	6.90	CK-5702	2.20	5896	6.90
5637	3.50	CK-5703	1.25	5899	6.90
5638	7.90	CK-5703WA	4.50	6021	5.95
5639	7.90	CK-5704	2.20	604	2.50
5641	3.50	CK-5744	1.25	6K4	2.75
5642	.95	CK-5744WA	4.50		
5643	6.00	CK-5784	3.25		

AND MANY [OTHERS] IN STOCK

NOVEMBER SPECIAL

NEW UNUSED SURPLUS GUARANTEED

304TH—304TL

ORIG. BOX LABORATORY TESTED AT 2,000V!

675 EACH

Popular Types and Crystal Diodes

DIODES			
1N21	\$.35	1N48	\$.45
1N21-B	1.85	1N52	.55
1N22	1.00	1N63	1.90
1N23	1.15	1N69	.75
1N23A	1.75	1N70	.80
1N23B	1.85	2C40	7.25
1N25	6.50	2C43	11.90
1N34	.60	2E24 (RCA)	2.20
1N34-A	.60	7C25	120.00
1N38-A	.75	QK60	55.00
1N44	1.10	QK61	85.00
1N45	1.20	QK62	75.00
		707-B	9.95
		725-A	\$5.90
		807 (Jan)	1.20
		829-B	9.95
		832-A	6.95
		866-A (RCA)	1.20
		869-B	30.00
		872-A (G.E.)	2.75
		1616	.80
		5816	4.20
		5625/KC-4	55.00
		8020	2.00
		OTHERS	

POPULAR, NEW RUGGEDIZED TYPES Jan. and Commercial

2D21	\$1.00	5763	\$.95
6J4 (RCA)	4.50	5814	1.75
6AK5-W	1.70	5879	1.00
5654/6AK5-W	1.85	6073	1.75
6AS6	1.75	6080	3.25
5656	14.75	6080 WA	5.50
5670	2.75	6082	3.35
5725/6AS6W	2.45	6096	1.90
5726/6AL5-W	1.15		
5751	1.75	and others.	

TUBE CARTONS

Two-Colored Cartons With New Safety Partitions— Super-Glass Red and Black Carton is the Most Distinctive Box Available Today.

SIZE	EACH	SIZE	EACH
Miniature	5.01	LARGE GT	.015
6AU6, 6AL5, etc.		1B3, 6BQ6GT, etc.	
GT	.0125	LARGE G	.02
6SN7, 6W4, etc.		5U4G, 68G6G, etc.	

"Quantity Users—Buy These Cartons by the Case. Write for Quantity Discounts.—"

BARRY ELECTRONICS CORP.

136-C Liberty St., New York 6, N. Y. Phone: Rector 2-2562

All Merchandise Fully Guaranteed

Harjo

From the West's Greatest Source for Surplus Electronic Values . . .

APS-4 X BAND RADAR SETS

It took months to bring you this sensational value—but here it is—ready to go at an unheard-of low price! Original Government cost over \$15,000.00! Ideal for small boats, planes, experimental work—dozens of uses!

\$299
COMPLETE!

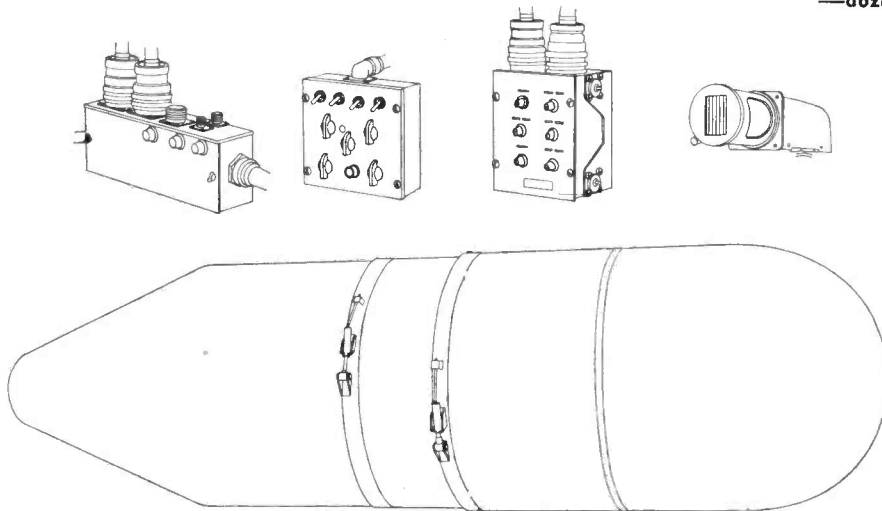

SEPARATE COMPONENTS ALSO AVAILABLE:
INDICATOR AMPLIFIER AM-5/APS-4 complete with tubes . . . \$9.95
CONTROL BOX C-12/APS-4 7.95
INDICATOR ID-11/APS-4 7.95
JUNCTION BOX J-5/APS-4 24.95
D-151426 I.F. STRIP for above less tubes . . . 9.95
RANGE AND ALARM UNIT less tubes . . . 14.95
ANTENNAS for above . . . 49.50
WRITE FOR BROCHURE GIVING COMPLETE INFORMATION ON ABOVE EQUIPMENT . . . PLUS LIST OF AVAILABLE INDIVIDUAL PARTS AND PRICES!

TURBO AMPLIFIERS
 New including 2-7C5 1-7Z4. Ideal for pre-amps mobile equipment and lab supplies
\$10.95 value here \$2.95

TEST EQUIPMENT

TS-11	\$45.00	TS-268	37.50
TS-13	650.00	IE-19	200.00
TS-34	250.00	I-222	89.50
TS-47/APR	200.00	I-139A	12.50
TS-34	250.00	I-183A Freq. Meter	22.50
TS-89	32.50	I-185A Oscillator	24.50
TS-100	85.00	LZ Sig. Gen	15.00
TS-101	7.50	(S Band)	85.00
TS-126	75.00	LW	
TS-131	14.35	BC-221 Meter	89.50
TS-184	45.00		

TSX-4SE PULSE ANALYZER
 A 3CM Spectrum analyzer. This is similar to TS-148, but has greater sensitivity. Frequency range 8500 to 9600 MC. Features: Absorption wavemeter, waveguide—beyond attenuator, 20 mc I.F. Strip, 120 db gain. Operates from 115 V/200 V—50-1200 CPS. PRICE ON REQUEST. Write for complete information!

RELAY ASSY BENDIX BC-640-B, DRAWING C-58363 227695 2-3 \$6.50
POTENTIOMETERS wire-wound resistors all sizes. Write for complete list!
OIL CONDENSERS bath-tub channel and hi-voltage type. Write for complete list!
RESISTORS, insulated, std. brands, 5%, 10%, 1/2 & 2 watt asst., 100 for \$1.79 postpaid
TV TUNER standard coil, cascade with 6BQ7, 6J6 new, 13.95
CERAMIC CONDENSERS, kit of 100 asst. brand new, standard brands, \$30 value . . . \$1.00

METER BARGAINS
 Removed from New Equipment
 0-4 AMPS r f GE 3" round enclosed in aluminum case. For accurate X-mtr. output readings. \$2.95
COMBINATION: Choice of 3" Black dialface 0-750 MA, 500-0-500 Microamp 3" panel meters, round or Weston 0-2.5 amps, DC \$3.95
 60-0-60 MICRO AMPS, Weston Electric \$4.95
WESTON FREQ. METER 400 cy \$14.95
TS-24/ARR-2 TEST SET, Gold plated oscillator circuit with 6 channel modulator, small whip antenna. Can be used as portable transceiver test set in other ranges and freq. \$3.95

701A TRANSMITTER TUBES
 A real screen-grid xmtr. tube for new final AM or SSB. Brand new, original boxes. Comes complete with dope sheet. \$2.95 ea. or 7 for \$5
FILAMENT TRANSFORMERS FOR ABOVE
 8 Volts @ 7 1/2 amps \$2.95
SOCKET FOR 701A XMTR. TUBE \$2 postpaid

Check Our Prices On **PANORAMIC ADAPTERS**

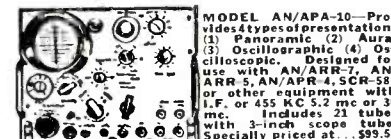

MODEL AN/APA-10—Provides 4 types of presentation:
 (1) Panoramic (2) Aural
 (3) Oscillographic (4) Oscilloscopic. Designed for use with AN/ARR-7, AN/ARR-5, AN/APR-4, SCR-587 or other equipment with I.F. or 455 KC 5.2 mc or 30 mc. Includes 21 tubes with 3-inch scope tube. Specially priced at \$89.50

- **MODEL AN/APA-6** . . . \$85.00
- **MODEL AN/APA-23** . . . \$95.00
- **ID80 APA-17 NEW, Boxed** . . . \$75.00

TS-24/ARR-2 TEST SET
SHV. WT. Gold-Plated Special \$3.95
 15 LBS. Complete with 6 channel modulator from 540 to 830°C. Comes in sturdy metal carrying case with handle, many parts including small whip antenna with coax connector. Battery compartment has room for AC supply if needed. Can be modified to portable transceiver, test set in other ranges and frequencies A or ce in a life-time buy. Orig. Gov't cost over \$350—brand new only

WESTINGHOUSE OIL CAPACITOR Model 1313852
 120 MFD @ 3000V. Made for DC welding service, single side band, power supplied and other industrial uses. Contains 1.7 gallons of non-inflammable liquid Brand new \$175. Value \$69.50

COLLINS AUTOTUNE ASSEMBLY
 with 110V, 60cy, AC Motor. Tunes automatically to any of 10 preset positions. For tuning xmtrs., instrument devices, etc. Orig. gov't cost \$300—Zew boxed. Shp. wt.—5 lbs. \$39.50

RCA Surplus TV CAMERA
Special \$225
 Comes complete with 24E6 Iconoscope and 6-stage video amplifier & clipper. They're selling fast for movie pickup training and experimental work. Complete information on request. Perfect for Closed Circuit Industrial Uses.

NETWORK SECTIONS

- **D138435**—Used in TS-24. \$9.50 ea.
- **D133331**, 330 ohms, 1 micro second. Used in SCR-545 rcar. \$25.00
- **D133594** Filter network. Contains stais for use Western Elect. Carrier Control phone system \$25.00
- **D123211**—Used in IE-57A Test Equipment \$15.00

POWER SUPPLIES INVERTERS

- MC-149's Rotary Converters certified. \$45.00
- RA-34 HI-Voltage for BC-191 etc. \$49.50
- RA-62 HI-Voltage for SCR-522. \$50.00

COAX SPECIALS!

- 51.5 OHM COAXIAL CABLE 500 ft. roll . . . \$24.95
- 100 ft. roll . . . 4.50
- RG-34/U 71 OHM COAXIAL CABLE 1625 dia. 5 MW rating. 95 ft. roll with PL-173 plug at one end. New 7.95
- SO-153 CHASSIS PLUG to match PL-17398
- RG-59 COAX. 25 ft. length with PL-259A at each end . . . 1.95

GENERATOR HAZELTINE PULSE

Model No. 1017
 With Schematic and Complete Instructions . . . \$49.50

Electrical characteristics: Pulse frequency: Initiating and sliding pulse—external. Pulse width: Initiating and sliding pulses, plus 150V. Sliding pulse delay: variable over full trace length. Sweep duration: 50, 200 and 1000 microseconds. TUBES: Sixteen 65J7's, three 6L6's, two 6J5's, two 6SN7's, one 5U4G, one 6SK7, one 6Y6G, one 991, one 9002. Power input: 150-125W, 90 cy, single phase. Dimensions 13 1/4" x 20 1/2" x 23". Wt. 85-lbs.

NEW POWER TRANSFORMER 110v. 60cy. primary 150v. 30ma. secondary 6.3-1 amps. Fil. FB for grid dip kts, test equipment, etc. . . . 79c each or 4 for \$3

CONTROL RECTIFIER
 Input 115 V., #1 phase, 400 cycles 1.8 amps, 175 watts. Output 115V. DC. 0 to plus or minus 5 amps. Originally used with model SF Radar equipment. Xlnt. condition, less tubes. A steal at just **\$14.95**

SAVE ON OUR COMPLETE STOCK OF TRANSMITTERS AND RECEIVERS!

- ARC-3 complete, certified. \$580.00
- BC-640 & BC-639, RA-42. 750.00
- AN/RT-1 Mine Trans. 100.00
- AR-13 350.00
- BC-797 Ground Stations. 750.00
- SCR-284 100.00
- BC-1333 Marker Receivers, Certified. 75.00
- BC-732D CAATC 35.00
- ASB-7 Xmtrs with tubes. For 420 MC and TV relay work. Write for our complete list! 7.95

CHECK THESE VALUES!

- **ANDREW TYPE 876 D AIR PUMPS** for use with coax transmission lines. New \$9.95
- **WESTERN ELECTRIC HANDSET** Standard telephone type complete with cord. Ideal for mobile and home phone systems. These are in xlnt. condition \$2.95

SAVE ON TRANSFORMERS! MINIATURE LINE MATCHING TRANSFORMERS \$1 (plus 25c for postage & handling)
 For blocking oscillators on TV Revers. TV camera input circuits, monoscillator trans for use for detector organ, for digital computer systems, transistor circuits, 1000's other uses. Only 4oz. 4 windings—2 input 150 ohms, 2 output of 1 at 105 ohms & 1 at 600 ohms. Rated 6 MW 200-5 cy. 500 V. RMS test.
NEW POWER TRANSFORMERS 110 V. 60 cy. Primary, 150 V. 30 ma. secondary 6.301 amps. Fil. BC-640 grid dip kits, test equip. etc. \$25.00
24 V. TRANSFORMER & RECTIFIER COMB., a basic 24 V. DC power supply of 110 V. AC primary 24V. secondary and Rectifier. Operates intermittently up to 3 or 4 amps.
POWER TRANSFORMER 110V. 60 cy. primary. Secondary 24 V. 36 amp and 1st amp \$1.00
NEW POWER TRANSFORMER 110 V. 60 cy. primary 150 V. 30 ma. secondary 6.3-1 amps. Fil. FB for grid dip kits, test equipment, etc. 79c each or 4 for \$3

ORDER BY MAIL—OR VISIT OUR RETAIL SHOWROOMS

All orders will receive prompt attention. Minimum order \$3.00. Please send check with order (credit to rated firms only). No COD's please. All shipments FOB warehouse.

ORDER DIRECT FROM

Harjo Sales Co.

Dept. EK
 4109 BURBANK BLVD.
 BURBANK, CALIFORNIA
 Phone: Victoria 9-2411
 Cable Address: HARJO

SAVE ON TUBES BRAND NEW TUBES GUARANTEED TUBES

OA2	.85	2C46	10.00
OA3/VR75	1.00	2C51	3.69
OA5	3.50	2C52	3.00
OB2	.85	2D21	.95
OC3/VR105	.90	2D21W	2.49
OD3/VR150	.80	2J31	17.50
1B23	4.00	2J32	17.50
1B24	6.75	2J33	17.50
1B26	1.75	2J34	17.50
1B27	12.50	2J36	79.50
1B35	5.50	2J42	105.00
1B49	8.25	2J49	59.50
1B51	7.50	2J51	175.00
1B63A	28.50	2J56	89.50
1D21/SN4	3.75	2J61	24.50
1N21B	2.00	2K22	17.50
1N23B	2.00	2K25	20.00
1N26	4.95	2K26	45.00
1N34A	.79	2K28	25.00

3K30	199.50
4C27/CV92	7.50
4C35	17.50
4J26	79.50
4J28	79.50
4J29	79.50
4J30	99.50
4J31	79.50
4J34	79.50
4J36	79.50
4J42	79.50
4J50	99.50
4J51	149.50
4J52	160.00
4J57	149.00
4-65A	14.00
4-125A	19.00

6B6	45.00
6C21	24.50
6F4	3.00
614	3.25
7C22	99.50
7C25	135.00
12GP7	17.50
15E	1.75
35TG	5.95
D42	write
QK60	35.00
RG60/1641	1.95
FK67/5728	15.00
RK72	.75
RR73	.95
75T	6.95
75TL	7.95

312A	2.95
316A	1.25
323B	8.95
327A	4.50
328A	3.95
336A	write
337A	6.00
349A	8.50
350A	3.50
368AS	4.00
383A	write
394A	3.50
412A	write
417A	6.50
418A	15.00
434A	9.95
438A	50.00

708A	1.95
713A	.95
715B	6.00
715C	14.00
717A	.90
719A	10.00
720CY	99.50
720EY	99.50
721A	1.50
721B	12.50
722A	1.95
723A	7.95
723A/B	12.00
724B	1.00
726A	8.00
726B	32.00
730A	15.00

922	1.25
923	1.30
931A	3.75
935	5.00
957	.49
958A	.49
959	1.50
CK1006	1.75
1616	.75
1620	2.95
1623	1.65
1625	.30
1630	.89
1636	1.25
2050	1.00
2051	.80
ZB3200	68.00
5516	5.50
5544	16.50
5545	18.95

5718	3.75
5719	6.95
RK5721	179.50
5727	1.75
5744	1.30
5750	3.10
5780	199.50
CK5787	4.95
5814	1.30
5837	67.50
5844	4.50
5851	4.00
5902	7.95
5904	7.95
5905	8.95
5907	7.95
5908	7.95
5916	7.95
5932	21.95

NOW-NEW LOW PRICES

4X150A	27.50
4-400A	39.50
4X500A	75.00
5AP1	2.95
5BP2A	2.95
5BP4	2.50
5CP1A	14.50
5C22	29.50
5D21	9.50
5FP14	7.50
5HP1	3.95
5HP4	3.95
5JP1	17.50
5JP2	17.50
5JP4	17.50
5JP5	17.50
5J23	29.50
5J26	85.00
5J29	10.00
5J30	19.95
5J33	7.50
5LP1	9.95
5MP1	3.95
5R4G	1.10
5R4WG	1.60
C6J	6.50
6AL5W	1.60

FG95/5560	19.50
HF120	9.95
FG104	29.50
FG105	17.50
V1-127A	2.75
V1158	17.50
QK159	149.60
FK172	22.50
HF200	14.50
WL200	write
207	65.00
21-VT4C	.98
21A	.98
FG-935	35.00
QK221/6002	199.50
QK235	149.50
QK249	200.00
QK253	149.50
949B	6.95
950R	6.95
950TH	14.50
950TL	12.50
951A	49.50
974B	2.75
304TH	6.95
304TL	6.95
307A/RK75	1.95

446A	1.19
446B	3.50
WL456	59.50
464A	3.50
CK512AX	1.30
WL530	16.95
CK536AX	.95
GL605	write
WL616	99.50
GL623	150.00
KU627	14.50
KU628	14.50
WL651	39.50
WL652	35.00
F660	150.00
700 B/C/D	16.50
701A	2.95
702A	1.95
703A	1.75
705A	1.60
706AY	27.50
706BY	27.50
706CY	27.50
706DY	27.50
706EY	27.50
706GY	29.50
707B	13.55

750TL	49.00
803	1.95
805	2.95
807	1.50
811A	3.50
813	9.95
815	2.50
829	6.00
839B	9.50
830B	1.10
832A	6.00
836	2.95
837	1.00
838	1.95
846	write
851	35.00
852	7.50
860	3.50
861	10.00
865	.98
866A	1.00
869B	35.00
872A	1.75
874	1.10
878	.95
884	1.00
GL893A	295.00

SPECIAL!
5" DUAL GUN TUBE
Long persistency face. Valued at \$200.00. This tube has been rejected for military use.
Tested Before Shipped & Fully Guaranteed. Only **\$17.95**

5586	200.00	6005	2.75
5591/403B	3.00	6080	4.50
5611	99.50	6110	8.95
5633	8.95	6121	8.95
5634	8.95	6147	4.30
5636	6.25	8005	4.95
5637	4.00	8012	1.95
5643	6.95	8013	4.95
5647	5.95	8014A	65.00
5651	1.75	8020	1.25
5654	1.75	8025A	3.75
5656	14.95	9001	.90
5670	3.50	9002	.98
5672	1.29	9003	1.15
5678	1.00	9005	1.50
5696	1.10	902A	6.50
5702	2.95		
5703	1.15		
5704	2.50		

WRITE FOR FREE CATALOGUE

Jsh ELECTRONICS
SALES CO. Dept. EJ
7552 Melrose Ave.
Los Angeles 46, California

Thousands of other types in stock. Send us your requirements. RECEIVING TUBES! We carry a complete line in stock. Standard brands only.

All Prices F.O.B. Los Angeles, subject to change without notice. Minimum order \$5.00. Check with us for items not listed.

K-RK-ARC-UG-PL-AN

CONNECTORS

In Stock for Immediate Delivery

Connector Corporation

OF AMERICA

137 Hamilton St., New Haven 11, Conn. Phone: Spruce 7-2513

New York Phone: Lexington 2-6254

FOR SALE

HEADSETS, HS-30/U
REMOTE CONTROL UNITS, RM-29
ANTENNA EQUIPMENT, RC-175
DYNAMOTORS, DY-12
DYNAMOTORS, DM-32A
DYNAMOTORS, DM-36
DYNAMOTORS, PE-86

VICTOR-BERNARD INDUSTRIES, INC.
1511 N. 26th St., Phila. 21, Pa.

INDUSTRIAL X-RAY INSPECTION EQUIPMENT

General Electric OX-200, XRD Diffraction, Picker, Standard, Westinghouse and Keleket units from 100 KV up. Special inspection booths made to order.

MEDICAL SALVAGE CO., INC.
217 E. 23rd St. N. Y. 10, N. Y.

Built TV-FM-AM Sweep Generator

You can build "Versatile Sweep Frequency Generator" with APN-1 magnetic units\$5.95

AN/APR5A Airborne superhet radar search rec. Freq. range 1000 to 3000MC. Rec. has a 10MC 1F band width operating from 80/115VAC, single phase 60 to 2600 cps. and one amp. at 26VDC complete with tubes like new \$250.00

AN/APT5 TRANSMITTER operates over a freq. of 300 to 1400 MC; output 30 watts. The carrier freq. is noise-modulated with effective random noise freq. up to 2MC. Complete with tubes like new \$99.50

I-122 SIGNAL GENERATOR RF signal 15 to 25 MC and 90 to 125 MC; modulated at 400 cps. or 625 cps. Power Supply 100 to 135 VAC, 25 to 60 cps. like new...\$39.50 Spare parts kit for above...\$5.95 (new)

AN/APN 9 Loran long range navigation system as used in ships and aircraft. Brand new—original cartons Ea. \$295.00

AN/APN4 - "B"—Brand new—Complete \$129.50 per set

I.D. 6A/APN-4 Loran Indicator, BRAND NEW, complete with 5CP1 tube and 100 KC crystal at\$29.50

R-9A/APN4-4—160 meter Loran Receiver, less tubes, Brand New. Complete with conversion diagrams \$14.50

Both I.D. 6A and R-9A—\$41.50

Write for prices and bulletin

26% Deposit on orders. Shipments F.O.B. Chicago

RW Electronics

Dept. EL
2430 S. Michigan Ave. Chicago 16, Ill.
Phone: CALumet 5-1281

COMMUNICATIONS EQUIPMENT CO.

MICROWAVE COMPONENTS

10 CM.—RG 48/U Waveguide

10 CM ECHO BOX: Tunable from 3200-3333 Mc. For checking out radar transmitters, for spectrum analysis, etc. Complete with pickup antenna and coupling devices. \$27.50

10 CM ANTENNA ASSEMBLY: 3000-3300 Mc. Parabolic Dish, 29 inch Diam. Fed from dipole. Rotation: 360 Deg. Azimuth at speeds of 20 and 10 RPM. Tilt: 20 deg. above and below horizontal. Motor-Driven by 2-28V motors. 4.5 A Total Drain. Azimuth info. is fed to seism mechanism, and elevation data is obtained from Azimuth potentiometer. Net weight 65 lbs. \$78.50

POWER SPLITTER for use with type 726 or any 10 CM Shepherd Klystron. Energy is fed from Klystron antenna through dual pick-up system to 2 type "N" output connectors. \$22.50 EACH

LHTR. LIGHTHOUSE ASSEMBLY. Parts of 1M39 APC 5 & APC 15 Receiver and Trans. Cavities w/ assoc. Tr. Cavity and Type N CILG. To Recv. Uses 2C40, 2C43, 1B27, Tunable approx. 2400-2700 MCS. Silver Plated. \$22.50

BEACON LIGHTHOUSE cavity p/o UPN-2 Beacon 10 cm. Mfg. Bernard Rice, each. \$27.50

MAGNETRON TO WAVEGUIDE Coupler with 721-A Duplex Cavity, gold plated. \$45.00

721A TR BOX complete with tube and tuning plungers. \$12.50

MENALLY KLYSTRON CAVITIES for 707B or 2K28 2700-2900 Mc. \$4.00

WAVEGUIDE to 7/8" rigid coax "Doorknob" Adapter Choke Flange Silver Plated Broad Band. \$32.50

AS14A AP-10 CM Pick up Dipole with "N" Cables \$4.50

HOLMDELL-TO-TYPE "N" Male Adapters. W. E. #D187284. \$2.75

I. F. AMP. STRIP: 30 MC. 30 db. gain, 4 MC Bandwidth, uses 6AC7-8-less. \$24.00

BEACON ANTENNA, AS31/APN-7 in Lucite Ball. Type "N" feed. \$22.50

ANTENNA, AT49A/APR: Broadband Conical, 300-3300 MC Type "N" Feed. \$12.50

"E" PLANE BENDS, 90 deg. less flanges. \$7.50

DYNAMOTORS

	INPUT		OUTPUT		Price
	VOLTS	AMPS	VOLTS	AMPS	
35X 059	19	3.8	405	.095	\$4.35
POSX-15	14	2.8	220	.08	8.95
DA-7A	23	27	1100	.400	15.00
DM33A	28	7	540	.250	3.95
23350	27	1.75	285	.075	3.95
B-19	12	9.4	275	.110	6.95
DA-3A*	28	10	300	.260	6.95
			150	.010	
PE 73 CM	28	19	1000	.350	22.50
BD 89	14	2.8	220	.08	8.95
DAC-33A	18	3.2	450	.06	4.49
DM 251	12	2.3	250	.05	6.95

Less Filter. * Replacement for PE 94.
Used, Excellent.
PE 94-C, Brand New. 6.95

DELAY NETWORKS

D-168184: 0.5 usec. up to 2000 PPS. 1800 ohms. \$4.00

D-170499: 0.25/5/75/usec. 8 KV. 50 ohms. \$12.50

D-165997 Delay .25 usec. \$6.50

RCA #255686-502: 1.7 usec. 1400 ohm impedance. \$2.00

D-162311. Delay of 0.5 usec. 72 ohms with 4 MC. Bandwidth. \$4.75

D-168435. Delay 0.5 usec. 555 ohms. 5mc. BW. \$4.50

D-172579. 416 ohms imp. 0.22 usec. Delay. \$4.75

D-150979: Oscillating network. Oscillates at 81.955 kc. When normal current of 10ma. is interrupted. Has built-in temperature control for stability. Assembled in shielded can 4" L x 4" Diam. \$7.50

PULSE NETWORKS

15A-1-400-50: 15 KV. "A" CKT, 1 microsec. 400 PPS. 50 ohms imp. \$22.50

G.E. #3E (3-84-810) (8-224-405) 50P4T; 3 KV "E" CKT Dual Unit: Unit 1, 3 sections, 0.84 Microsec. 810 PPS. 50 ohms imp; Unit 2, 8 Sections, 2.24 microsec. 405 PPS 50 ohms imp.

7-5E3-1-200-67P. 7.5 KV "E" Circuit, 1 microsec. 200 PPS. 67 ohms impedance 3 sections. \$7.50

7-5E4-16-60. 67P. 7.5 KV "E" Circuit, 4 sections 16 microsec. 60 PPS. 67 ohms impedance. \$15.00

7-5E3-3-200-67P. 7.5 KV. "E" Circuit, 3 microsec. 200 PPS. ohms imp. 3 sections. \$12.50

H-616 PK. 2.2 usec. 375 PPS. 50 ohms imp. \$27.50

H-615 10KV. 0.85 usec. 750 PPS. 50 ohms imp. \$27.50

K8865 CHARGING CHOKE: 115-150 II @ .02A. 32 -40H @ .03A. 21 KV Test. \$37.50

G.E. 25E5-1-350-50 P2T. "E" CKT, 1 Microsec. Pulse @ 350 PPS. 50 OHMS Impedance. \$69.50

K5623 CHARGING CHOKE: 16H @ 75 MA, 380 Ohms P.C.R. 1000 Vac Test. \$14.95

G.E. 6E3-5-2000 50 P2T: 6 KV. "E" Circuit 0.5 usec /2000 PPS/50 ohms/2 sections. \$7.50

INVERTERS

800-1B Input 24 vdc. 62 A. Output: 115 V, 800 cy. 7A. 1 phase. Used, excellent. \$18.75

PE-218H: Input: 25/28 vdc. 92 amp. Output: 115V. 350/500 cy 1500 Volt-ampere. NEW \$37.50

PE206: Input: 28 vdc. 36 amps. Output: 80 V 800 cy. 500 volt-amps. Dim. 13 x 5 1/2 x 10 1/2 \$22.50

TEST EQUIPMENT

IE19	TS34 A	TS100
IE36	TS35 A	TS110
I-104	TS56 A	TS159 TPX
TS10 A	TS56 A	TS268/U
TS16	TS47 APR	TSX 4SE

JAN/UG CONNECTORS

UG 9/U	\$1.15	UG 27A/U	2.50	UG 188/U	1.20
UG 10/U	1.25	UG 29/U	.95	UG 254/U	1.35
UG 22/U	1.25	UG 58/U	.65	UG 261/U	1.10
UG 22B/U	1.20	UG 85/U	1.25	UG 290/U	1.15
UG 24/U	1.25	UG 102/U	1.85	UG 306/U	2.35
UG 27/U	1.20	UG 176/U	.25		

THERMAL DELAY RELAYS

Stock No.	Heater V	Contact*	Delay (Sec)	Price
30120	6.3	NC	30	\$2.25
B-1608	6.3	NO	25	2.40
B-1612	6.3	NO	5	1.85
6C10	6.3	NC	10	1.85
12C10	12	NC	5	1.75
12C10	12	NC	10	1.85
12C45	12	NC	45	2.45
26N05	24-28	NO	5	2.25
26N010	24-28	NO	10	2.25
26N015	24-28	NO	15	2.40
26N020	24-28	NO	20	2.40
26N030	24-28	NO	30	2.40
26N060	24-28	NO	60	2.40

* NO—Normally open, NC—Normally closed. All contact ratings are 3A at 115 VDC or 250 VAC, and are SPST. Units are enclosed in glass tube envelope with octal base.

ECHO BOX RF 3/AP

Cavity has a "Q" of 30,000 and is tuned by means of an internal 24 vdc motor. Unit is tunable over a range of 80 mc. When motor is left on, the tuning plunger goes thru the tuning range three times per minute. During the tuning motion, an eccentric cam on the mechanism causes an additional flutter action of the tuning disk at approximately 200 cycles per minute. This flutter raises curves about 15 mc. This eliminates need of stopping the motor at the peak of the signal, and also gives a characteristic pattern to the echo signal. Input is to type "N" input jack. \$125.

JAN WAVEGUIDE FLANGES

UG 38/U	\$1.10	UG 51/U	\$1.65
UG 40/U	\$1.25	UG 52/U	\$3.00
UG 40A/U	\$1.85	UG 52A/U	\$3.40

THERMISTORS

D-164699 Bead Type DCR: 1525-2550 Ohms @ 75 Deg. F. Coefficient: 2% Per. Deg. Fahr. Max. Current 25 MA. AC/DC. \$2.50

D-167332 Bead Type DCR is 1525-2550 Ohms. Rated 25 MA at .825-1.175 VDC. \$1.35

D-167613 Disk Type DCR: 355 Ohms @ 75 Deg. F.P.M. 2.5% I. Watt. \$1.35

D-166228 Disk Type 7120 Ohms @ 60° F. 4220 Ohms @ 80° F. 2590 Ohms @ 100° F., 1640 Ohms @ 120° F. \$1.35

VARISTORS

D-167208	\$1.35	D-171812	\$1.63
D-171858	\$1.42	D-172155	\$1.50
D-168687	\$1.35	D-167176	\$1.25

CATHODE RAY TUBES

3FP7*	\$1.50	5FP7*	\$1.50
3EP1*	\$2.50	*Mfrs. Quantity	

MAGNETRONS

Type	Freq. Range (MC)	Peak Power Out (KW)	Duty Ratio	Price
2121A	3345-9405	50		58.75
2122	3267-3333	265		7.50
2126	2992-3019	275	.002	7.49
2127	2965-2992	275	.002	13.50
2129	2914-2939	275	.002	44.95
2131	2820-2860	285	.002	21.50
2132	2780-2820	285	.002	24.50
2138*	3249-3263	5		8.50
2139*	3267-3333	8.7		8.50
2148	9310-9320	50	.001	24.50
2149	9000-9160	50	.001	54.50
2156*	9255-9275	50	.001	132.50
2162*	2914-3010	35	.002	32.50
3131	24-27KMC	50	.001	85.00
4J34	2740-2780	900	.001	87.50
4J38	3550-3600	750	.001	125.00
4J42*	670-730	30	.003	169.50
5J23	1044-1056	475	.001	42.50
700B	690-700	40	.002	22.50
700D	710-720	40	.002	39.75
706EY	3038-3069	200	.001	32.50
706CY	2976-3007	200	.001	32.50
QK259*	2700-2900	800	.001	249.50
QK601*	2840-3005	100	CW	65.00
QK611*	2975-3170	100	CW	65.00
QK621*	3135-3350	100	CW	65.00

* Packaged with magnet.
† Tunable over indicated range.

PULSE TRANSFORMERS

K35145—Pulse Inversion: PRI: 5 KV PK. Pulse Negative Sec; Pos. Pulse. 4 KV; 1 usec. and .001 duty ratio. \$6.50

549318-1 3 wds. Ratio: 1:1:1, 1.10 uh/wdg, 2.5 ohms DCR. \$3.50

Westinghouse 4P37: Primary: 50 ohms imp. 750 v. Sec. 15 kv. 1000 ohms imp. Bilateral filament trans. built-in deliveries 12.8 c at 2.5 amp. (pri. 115v. 400 cy.) \$37.50

RAYTHEON WX 4298E: Primary 4KV. 1.0 USEC. SPO, 16KV-16 AMP DUTY RATIO: .001 400 CYCLE FIL. TRANS. "BUILT-IN". \$42.50

WECO: KS 9948: Primary 700 ohms; Sec. 50 ohms. Plate Voltage: 18KV, Part of APQ-13. \$12.50



GE #K-2449A

Primary: 9.33 KV. 50 ohms Imp.
Secondary: 28 KV. 450 ohms.
Pulse length: 1.0/5 usec @ 635/120 PPS, Pk Power Out: 1.740 KV
Bifilar: 1.5 amps. (as shown) \$62.50

GE #K2748-A. 0.5 usec @ 2000 Pps. Pk. Pwr. out is 32 KW; Impedance 40:100 ohm. Pri volts 2.3 KV Pk. Sec. volts 11.5 KV Pk. Bifilar rated at 1.8 Amp. Fitted with magnetron well. \$39.50

K-2745 Primary: 3.1/2.8 KV, 50 ohms Z. Secondary: 14/12.6 KV 1025 ohms Z. Pulse Length: 0.25/1.0 usec @ 600/600 PPS. Pk. Power 200/150 KV. Bifilar: 1.3 Amp. Has "built-in" magnetron well. \$42.50

K-2161-A. Primary: 3.1/2.8 KV—50 ohms (line). Secondary: 14/11.5 KV 1000 ohms Z. Pulse Length: 1 usec @ 600 PPS. Pk. Power Out: 200/130 KV Bifilar: 1.3 Amp. Fitted with magnetron well. \$39.75

UTAH X-151T-1: Dual Transformer, 2 Wdgs. per section 1:1 Ratio per sec 13 MH Inductance 30 ohms DCR. \$5.00

UTAH X-150T-1: Two sections of 3 Wdgs. per section. 1:1:1 Ratio. 3 MH. 6 ohms DCR per Wdg. \$5.00

68G711: Ratio: 4:1 Pri: 200V. Sec. 53V. 1.0 usec Pulse @ 2000 PPS. 0.016 kVA. \$4.50

TR1049 Ratio 2:1 Pri. 220 MH. 50 Ohms. sec. 0.75 H. DCR 100 Ohms. \$6.75

K-904695-501: Ratio 1:1. Pri. Imp. 40 Ohms. Sec. Imp. 40 Ohms. Passes pulse 0.6 usec with 005 usec rise \$8.95

RAY UX 7896—Pulse Output Pri. 5v sec. 41v. \$7.50

RAY UX 842—Pulse Inversion 40v + 40v. \$7.50

PHILCO 352-7250, 352-7251, 352-7287.

RAYTHEON: UX8693, UX5986, UX-7307. \$5 ea.

W.E.: D-166310, D-166638, K89800, D-163247

UTAH #9262, with Cracked Beads, but will operate at full rated capacity. \$5.00

UX 8693 (SCS #229027-54); 3 Wdgs. 32 turns #18 wire. DCR is: 362/372/4 ohms. \$5.00

D-166173: Input: 50 ohms Z. Output: 900 ohms 3 Wdgs. Freq. range 10 kc-2mc. P/O AN/APQ-13. \$12.50

K-2450 Pulse-inversion auto-transformer: primary 13 kv, 4 usec. Output: 14 kv @ 100 kw peak. \$34.50

PULSE EQUIPMENT

MIT. MOD. 3 HARD TUBE PULSER: Output Pulse Power 144 KW (12 KV at 12 Amp.) Duty Ratio: .001 max. Pulse duration: 5, 1.0, 2.0 microsec. Input voltage: 115 v. 400 to 2400 cps. Uses: 1-71B, 4-89-13, 3-72's, 1-73. New. Less Cover—\$135

ASD Modulator Units, mfd. by Sperry. Hard tube pulser delivers Pk. pulse of 144 kw. Similar to Mod 3 unit. Brand new, less tubes. \$85.00

Airbrone RF head, model A1A, delivers 50 Kw peak output at 900 mc. at .001 duty. Complete with pulser unit and all tubes. \$185.00

MAIL ORDERS PROMPTLY FILLED. ALL PRICES F.O.B. NEW YORK CITY. 25% DEPOSIT WITH ORDER. BALANCE C.O.D. RATED CONCERNS SEND P.O.

131 Liberty St., New York 7, N. Y. Dept. E-11 Chas. Rosen Phone: DIgby 9-4124



COMPASS ELECTRONICS SUPPLY

A Division of Compass Communications Corporation

WE MAINTAIN OUR OWN FULLY EQUIPPED TESTING LABORATORY TO TEST AND GUARANTEE ANYTHING WE SELL

TEST SETS

TS-35A/AP—(Late Model) X-Band Signal Generator and Power Meter—Input 115/150-1200 CPS. Generates and measures RF power. Produces (CW or pulsed, int. or ext. synchronized) signal of known frequency and power. Generates FM signal for trouble shooting radar. **NEW \$375.00**

TS-69/AP Frequency Meter, Range 340-1,000 mcs. Uses 0-200 microammeter; Excellent. **\$75.00**

TS-100/AP Test Scope with typ A, R, J and X Indicators. Gated and ungated sweeps, int. or ext. triggering. **\$195.00**

also

- TS-3A/AP
- TS-10A and B
- TS-12/AP
- TS-13/AP
- TS-16/AP
- TS-36/AP
- TS-62/AP
- TS-74/UPM
- TS-89/AP
- TS-101/AP
- TS-125/AP
- TS-173/UR
- TS-278
- TS-323
- OAA
- OAP
- OBU
- LAE
- LM
- LU
- IE-19
- I-46
- 1-56
- 1-208
- 1-222
- SCR-211

AND OTHERS

SPECIAL RADAR AND MICROWAVE ACCESSORIES

RADAR BEACONS

- AN/CPN-6 3 cm.
- AN/CPN-8 10 cm.
- YJ and YG for shipboard use
- AN/CPN-6 3 cm.
- also
- AN/CPN-8 10 cm.
- AN/APS-2, APS-3, APS-4 and APS-15
- SA, SF, SG, SD, SJ, SK, SN, SQ—both equipment and spare parts

SN—RADAR—10 cm—Compact, light and portable, ranges of 5 and 20 miles. Uses SCPI scope. Operation is from 115 volts, 60 cycle, but we can supply converter for dc operation. **\$850.00 ea**

ANTENNA ASSEMBLY—10 cm Radar—Reflector is a light-weight parabolic cylinder, Ass'y has both manual and motor drive. Ideal unit for labs, classroom demonstration, small craft, etc. **\$99.50 ea**

MAG—10 cm, remarkable link radar, portable, operated from 6 volt battery, uses folding antenna and tripod. A pair set. **\$1,750.00**

APS-3—3 cm—Airborne radar for search and homing, 5-in scope. 10 brand new sets at **\$700.00 ea**

APQ-13—Very late model airborne radar set, complete and new. One only at **\$2,950.00**

SCR-545—Complete radar set, less vehicle, antenna and power plant, pretty fair condition, sold as-is at **\$1,375.00**

SA-2 RADAR

Used for air traffic control, tracking and search, both land-based and ship-borne. 5 microsec. pulse, PPI indication, operates at 200 mcs, peak power of 150 KW. Input 110/120 volts a.c. 4 complete installations in stock.—Write for price.

393 Greenwich St., New York 13, N. Y.
BEEKMAN 3-6510 Cable: COMPRADIO, N. Y.

Wholesale, Industrial and Institutional Sales Only

RECEIVERS

- ARB
- ARC-1
- ARC-3
- ARC-4
- ARC-5
- AR-88
- CR-91
- SLR
- RAK
- RAL
- RAO
- RBB
- RBO
- RBG
- RBL
- RBA
- RBM
- RCH
- BC-224
- BC-312
- BC-314
- BC-344
- BC-348

FIELD EQUIPMENT

- SCR-274
- 300
- 399
- 536
- 808
- 828
- BC-191
- 654
- 603
- 604
- 610E
- 683
- 684
- 923
- 924
- 1000
- 1306

MARINE TRANSMITTERS

- TAJ
- TAQ
- TBL
- TBK
- TBM
- TBN
- TCE
- TCP
- TDE
- TDO

These are partial listings only of our stock. Please write for other types.

TELEPHONE RELAYS

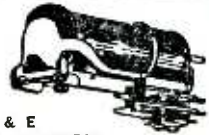

Large Stock of CLARE, TYPES O D & E COOKE, AUTOMATIC—ELECTRIC ALL TYPES OF COILS and PILE-UPS

Send Us Your Specs. for Our Quote

CLARE TYPE G HALF SIZE SENSITIVE TELEPHONE RELAYS			
Coil	Contacts	Operates at	Price
1) 6500 ohms	2A	10 MA	\$2.50 ea.
2) 5800 ohms	3A	4 MA	2.50 ea.
3) 5300 ohms	2B-1C	5 MA	2.50 ea.
4) 4350 ohms	1C	4 MA	2.50 ea.
4) 3600 ohms	1C	6 MA	2.00 ea.
5) 4850 ohms	1A	5 MA	2.00 ea.
6) 3300 ohms	(None)	ACTUATOR	1.50 ea.
7) 3300 ohms	1A	Micro-Switch	2.50 ea.

All *o/s* R lays may be used for continuous duty operation on 110V. D.C.

OTHER TYPE G TELEPHONE RELAYS			
Coil	Contacts	Operates at	Price
1) 1300 ohms	1A-1C	24 or 48V	\$2.50 ea.
2) 400 ohms	1A	24V	1.65 ea.
3) 500 ohms	1D	24V	1.65 ea.
4) 200 ohms	1A	24V	1.50 ea.

CLARE TYPE G STANDARD SIZE D.C. TELEPHONE RELAYS			
Coil	Contacts	Operates at	Price
1) 1300 ohm	1B	24 to 85V	\$2.25 ea.
2) 1300 ohm	2A-1B	24 to 85V	2.75 ea.
3) 1300 ohm	2C-1A	24 to 85V	3.00 ea.
4) 1300 ohm	4C-2A	30 to 85V	3.50 ea.
5) 1300 ohm	2A-1B-1C-1D	24 to 85V	3.00 ea.
6) 1300 ohm	6C	30 to 85V	4.50 ea.
7) 2000 ohm	2C-1A	24 to 110V	3.00 ea.
8) 2000 ohm	4C-2A	30 to 110V	4.00 ea.
9) 2000 ohm	6C	30 to 110V	4.50 ea.
10) 2000 ohm	8A	30 to 110V	3.50 ea.
11) 3000 ohm	3A	24 to 150V	2.75 ea.
12) 3600 ohm	2C-1A	24 to 150V	3.00 ea.
13) 110V. AC	2C-1A	110V. AC 60cy	3.50 ea.

CONTACT SYMBOLS
A=Norm. Open B=Norm. Closed C=S.P.D.T.
D=Make Before Break

Allied Type LKX-58 Tel. Relay. Coil-5,000 ohm Contacts-3A Operates at 6 MA. Price—\$2.50 ea.

Signal Wheelock Relays #KS9665 Coil—2,000 ohms Contacts-1A, 1B, 1C Oper. at 9 MA. Price—\$2.75 ea. GM #13017 Relays, 24 volts 150 ohm, Contacts-3PDT 10 Amp. Price—\$2.00 ea. MINIATURE TEL. RELAY, 300 ohm, 24 volt SPDT Price—\$1.65 ea. FIVE Plug CR-2791 G.E. Plug In Relays, 1) C-103C95 2200 ohms SPDT 4.5 MA. Price—\$4.00 ea. 2) C-104B28 700 ohms SPDT 6 MA. Price—\$3.00 ea.

Bulletin #700 Allen Bradley Contactors 110V AC 60 cy. D.P.S.T. N.O. 25 Amps \$7.50 ea.

ALLIED BJ6D36 MINIATURE RELAYS		
Coil	Contacts	Price
1) 24V.	260 ohms	\$1.25 ea.
2) 24V.	100 ohms	DPST NO 1.00 ea.

Clare SK-4032 (Herm. Sealed) Plug-In Relays. Coil—30 ohms 6 volts Contacts—DPDT. Price \$4.00 ea.

SIGMA TYPE 5F SENSITIVE RELAYS. Has two 70 ohm coils. Contacts—SPDT. Price—\$3.00 ea.

Leach Relays Type 1025-SN-BF. Coil—24V. 425 ohms. Contacts—D.P.S.T. Norm. closed. Rated at 10 Amps Price—\$1.25 ea.

STROM. CARL. TEL. RELAY Coil—100 ohm 6 Volts. Contacts—1A Price—\$1.35 ea.

Chase Electronic Supply Co.
105-07 225 St.
Queens Village, N. Y.
HOLLIS 4-5033

AN/APR-4 LABORATORY RECEIVERS



Complete with all five Tuning Units, covering the range 38 to 4,000 Mc.; wideband discone and other antennas, wavetraps, mobile accessories, 100 page technical manual, etc. Versatile accurate, compact—the aristocrat of lab receivers in this range. Write for data sheet and quotations.

We have a large variety of other hard-to-get equipment, including microwave, aircraft, communications, radar; and laboratory electronics of all kinds. Keleket alpha scalars and chambers, dosimeters and other nucleonics now in stock. Quality standards maintained.

NEW TS-13/AP X-BAND SIGNAL GENERATORS with manual \$575.00; TS-175/U Frequency Meter 85-1,000 Mc. \$485.00; H-P, Boonton, G-R, Measurements, many others in stock.

ENGINEERING ASSOCIATES

434 PATTERSON ROAD

DAYTON 9, OHIO

TEST CHAMBER

We have, for sale, one slightly used 18 cu.ft. dry ice Chamber complete with control instrument. Temperature range: -80° F to +200°F. Perfect condition

ETCCO

24 Dogwood La. Glen Head, N. Y.

APR-4 TN-17 TN-18 \$675.00

T47A/ART-13, Dy-17, Dy-12, ATC Be-312, BC-342, BC-348, SCR-694-C ARC-1, I-208, Dumont #241

ALLTRONICS,

Box 19, Boston 1, Mass.
Telephone S. Richmond 2-0048, 2-0916

OVER 1 MILLION RECEIVING INDUSTRIAL AND NEW TYPE TUBES AT LOWEST PRICES—AVAILABLE ANYWHERE—ALL GUARANTEED, ALL SPECIALLY PRICED—AVAILABLE FROM STOCK FOR IMMEDIATE DELIVERY—WRITE, CALL OR WIRE FOR QUOTATIONS; THYRATRONS, KLYSTRONS, CATHODE RAY, VOLTAGE REGULATORS, MAGNETRONS, LIGHTHOUSE

➔ SUPER SPECIAL FOR THIS MONTH ONLY ➔
WESTERN ELECTRIC IN ORIGINAL PACKING, 725A Fully Guaranteed \$4.75 each

ALLIED ELECTRONIC SALES

74 Cortlandt St. N.Y.C., N. Y.
Phone Barclay 7-5839, 5840

Surplus - Airline - Military Communication & Navigation Equipment

Bought and Sold
AIRBORNE ELECTRONICS, INC.
155 First St., Minoia, N. Y.
Cable: Airteltron Minoia
Tel: Pioneer 6-6410

FAMOUS B-29 BOMB SIGHT

ASSEMBLED BY SPERRY GYROSCOPE CO.

Comes in three units—the main body and two attachable periscopes, 22 and 68 inches high, alternate parts of an intricate optical system made by Eastman-Kodak Co. Main body is 35x25x14 inches. Contains at least 27 VDC motors, electric heater and temp. control, precision sextant, dozens of switches and controls, hundreds of fine gears and driving rods all types. Shipping wt. 250 lbs.

Cost to U.S. Govt. \$21,000
Your Cost **\$12950**
Brand New



It's MURRY'S FOR MONEY-SAVING BUYS!

FAMOUS SCR-522 VHF RECVR-XMITTER

Terrific Buy! 100 to 156 Mc VHF Transmitter-Receiver. 4 channels. Crystal-controlled. Amplitude modulated voice. Complete with tubes. Excellent condition only.



\$7950

New Complete I.F.F. Equipment RC-188-A

Originally cost about \$20,000

... now buy it for a tiny fraction of cost! Easily converted for Television. Complete assembly consists of Control unit with 5" C.R. Tube transmitter and receiver assembly (157 to 185 Mc). Indicator unit, and Power Supply (450 watts), operating on 110 volts, 60 cycles AC. All assembled, ready to operate. 62 Tubes included: 8-6V6GT, 9-6SL7GT, 14-6SN7GT, 1-5CP1, 2-9006, 1-8Y6G, 2-6E5, 1-100TH, 2-6J5, 2-2C2A, 1-3E29, 1-6H6, 7-6AG5, 3-6AK5, 1-6C4, 3-2X2, 1-6X8GT, 3-5U4GT. Overall size 55" high 28" wide, 20 1/2" deep. Shpg. weight 855 lbs. Your cost, complete, BRAND NEW in original packing.



\$14950

CATHODE RAY TUBES



BRAND NEW

Type	Lets of 3 Each	Type	Lets of 3 Each
SCP1	1.25	5BP1	2.65
3FP7	1.25	5BP4	2.75
5FP7	1.45	7BP7	1.95
6CP1	2.95	9LP7	2.24

TELEGRAPH KEYS



All Brand New Special Low Prices!
J-37 Navy Type.....85c
J-38 Sig. Corps Type.....74c



LORAN APN-4

FINE QUALITY NAVIGATIONAL EQUIPMENT
Determine exact geographic position of your boat or plane! Complete, BRAND NEW installation consists of: 1D-6B/APN-4 Indicator; 1D-9B/APN-4 Receiver; PE-206 Inverter; Set of Plugs; Visor for Indicator; Operation manual; Brand New, export packed.

COMPLETE **\$12950**

R-65/APN-9 LORAN Receiver-Indicator

Furnishes position data at greater distances from transmitting stations than is possible by any other methods. Accurate to within 1% of distance from ground transmitters. Operates entirely by radio. Complete in one case. BRAND NEW, export packed.

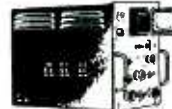

\$29500

MAGNETRON TUBES

All brand new and perfect! SPECIAL LOW PRICES!

BC-221 FREQ. METER

Limited quantity, first come first served! Range 125 to 20,000Kc with crystal check points in all ranges. Complete with tubes, crystal, calibration charts. Excellent condition.

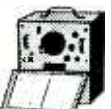

\$12950



DYNAMOTORS

Compare Murry's Low Prices!

Type	Input	Output	BRAND NEW
DM-40	14V 3.4A	172V 138A	3.95
DM-42A	14V 46A	515/1030/2/8	12.95
		MA 215/260	16.95
DM-43A	28V 23A	515/1030/2/8	29.50
		MA 215/260	
DM-32A	28V 1.1A	250V .05A	2.95
DM-34D	12V 2.8A	220V .080A	11.95
DM-35D	12V 5.7A	5V AC 1.12A	9.95
DM-36	28V 1.4A	220V .080A	9.95
DM-37	25.5V 9.2A	625V 225A	12.95
DM-28	28V 1.4A	220V .08A	1.95
DM-53A	28V 1.4A	220V .080A	2.95
DM-33A	28V 5A	575V .16A	3.95
	28V 7A	500V .25A	1.95
PE-73C	28V 20A	1000V .350A	9.50
PE-101C	13V 12.6A	400V .135A	3.75
	28V 7A	5V AC 1.12A	4.85
PE-94A	28V 10A	300V .200A	7.50
PE-94C	28V 10A	150V .101A	3.95
PE-103	6V	800V .160A	12.75
	12V	800V .160A	24.50
PE-98	14V 21A	300V .200A	32.50
PE-86	28V 1.25A	150V .101A	22.50
PE-135AX	with filter 24V 12A	500V .200A	5.24
BD-77	12V	1000V .350A	24.95
			22.50

Terrific Transmitter-Receiver Buy!



FAMOUS BC-645 450 Mc.—15 Tubes

BRAND NEW!

Makes wonderful mobile rig for 420-500 Mc. Easy to convert for phone or CW 2-way communication. CONVERSION DIAGRAM INCLUDED. This swell rig originally cost over \$1000—factory carton, BRAND NEW, complete with 17 tubes, less power supply. **\$2950**

PE-101C DYNAMOTOR for BC-645, has 12-24V input (easy to convert for 6V Battery operation instructions included)..... **\$4.85**

UHF ANTENNA ASSEMBLY, for BC-645..... **\$2.45**

CONVERSION BOOKLET. Instructions for most useful surplus rigs..... **\$2.50**

BC-375 TRANSMITTER

A famous transmitter, originally cost \$1800. Yours, for a small fraction! Shpg wt 275 lbs. Complete with tubes, Brand New... **\$49.50**

Used, Excell. **\$29.50**

TUNING UNITS FOR BC-375

Type	Excellent BRAND NEW	Cond.	BRAND NEW	Type	Excellent BRAND NEW	Cond.
TU-10	\$2.25	2.95	TU-7	2.25	2.95	
TU-9	2.25	2.95	TU-6	3.95	4.95	
TU-8	2.25	2.95	TU-5	3.95	4.95	

GOULD 6-VOLT STORAGE BATTERY

15 Amp. Hour Rating Navy Standard Black Rubber Case, BRAND NEW **\$5.95**



WILLARD 6-VOLT Midget Storage Battery 3 Amp. Hour. BRAND NEW. 3 3/4" x 1-13/16" x 2 3/8". Uses Standard Electrolyte only **\$1.85**



WILLARD 2-VOLT STORAGE BATTERY 20 Amp. Hour. BRAND NEW. Transparent plastic case **\$1.95**

1-QUART ELECTROLYTE enough for two cells. Bottle..... **\$1.45**



HEADPHONES

Smashing price reductions!

Model	Description	Excellent BRAND NEW Used	BRAND NEW
HS-23	high impedance	\$2.25	\$4.35
HS-33	low impedance	1.75	4.65
HS-30	low imp. (featherwt)	1.49	1.85
H-16/U	high imp (2 units)	2.75	7.95
CD-307A	cords, with PL55 plug and JK26 jack		.88

MICROPHONES

Model	Description	Excellent BRAND NEW Used	BRAND NEW
T-17	Carbon hand mike	\$5.45	\$7.95
T-30	Carbon Throat Mike	.33	.69
T-45	Navy Lip Mike	1.95	1.25
ES-38	Navy	1.95	5.95
T-24	Carbon mike		3.95

PHONE PLUGS & JACKS

PL-54 Plus	BRAND NEW	14c
PL-54 Plus	BRAND NEW	22c
PL-58 Plus	BRAND NEW	47c
JK-26 Jack	BRAND NEW	18c

BEACON RECEIVER BC-1206-C

Complete with 5 tubes. Tunes 195 KC to 420 KC. IF Frequency—135 KC. Receiver Sensitivity—3 Microvolts for 10 Milliwatts output. Output Impedance—300 Ohms and 400 Ohms. Volume Control—RF Gain Control, Power Supply—24-28 Volts Aeroplane Battery, Current—75 Amperes. **\$1195**

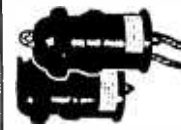

SELSYN 2J1F1

Operates from 5 1/2 volt 400 cycles. New, tested. Conversion diagram for 110 volt AC operation included. BRAND NEW.....EACH **\$3.75**

EE-8 FIELD PHONES

Talk as far as 17 miles. Dependable 2-way communication at low cost. Ideal for home, farm, field. Up to six phones can be used on one line. Each phone complete with ringer. Originally cost govt. \$65.00 each.



Excellent Condition Your cost..... **\$17.95**

MINE DETECTOR SET

Model SCR-625. Complete portable outfit, detects all types of metals. Has many uses in agriculture, mining, etc. Complete BRAND NEW **\$5550**

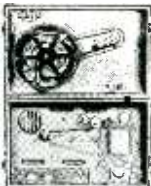

CODE KEYS TG-34A

Self-contained automatic unit, reproduces code practice signals recorded on paper tape. By use of built-in speaker, provides code-practice signals to one or more persons at speeds from 5 to 25 WPM. BRAND NEW, in or- **\$18.95**

Used, Excellent Condition **\$12.95**

TG-10 CODE KEYS, complete with 7 tubes and electric eye. 65 lbs. BRAND NEW..... **\$17.50**



McElroy Automatic KEYS BRAND NEW

Suitable for keying transmitter, or for code practice. Has photoelectric cell and sensitive relay. Variable speed motor operates on 110 volts 60 cycles AC or DC, complete with 2-117L tubes your cost **\$1495**

MURRY'S RADIO

"Serving the Electronics Industry Since 1920"

enough for two cells. Bottle..... **\$1.45**

Dept. E-11
51 VESEY STREET
NEW YORK 7, N. Y.
Phone: Cortlandt 7-4605

GIGANTIC MAIL SALE WAR SURPLUS EXCESS INVENTORY BANKRUPT STOCK

AUTOMATIC REMOTE CONTROL SWITCHES

Amazing electro magnetic switch. Complete with dial. Any circuit from 1 to 100 can be selected simply by dialing the number, uncertainty response. Will work over lines up to 20 units. Used, excellent. Fine for inter-coms. Private automatic phone systems, remote control, experimental, etc. New Cost Over \$200.00. Sale, \$13.95 Prepaid

MULTI-SPEED A-C MOTOR

Unique 110-v, 60-c. multi-speed motor. Has separate shaft speeds of 8,32,320 and 4000 r.p.m., all simultaneously. Hundreds experimental uses. List \$38.75 Sale, \$8.75

ELECTRONIC AUTOMATIC TIMER

Genuine Telechron 15-volt, 60-cycle Clock Timer. Has beautiful red onyx case. Will handle 1000-watt load. Set for any time 0 to 15 minutes. Turns power off at proper time. Has pilot light and alarm buzzer. Many experimental and laboratory uses. Use for photography, sun lamps, timing studies. List \$19.95 Sale, \$4.95 Prepaid

FIRE-FREEZE ALARM UNIT

Remarkable ultra-sensitive mercury alarm. Closes circuit at 105° F. Opens circuit at 32° F. Use for sensitive precision fire alarm, or freeze warning. List \$5.50 Sale, 99c

MAGNETO TELEPHONES

Compact oak case phones. Complete with signaling generator, bells, etc. Makes wonderful indoor or outdoor inter-com. sets. Connect as many as desired to same line. List \$32 Sale, \$9.95

EMERGENCY POWER PLANTS

Genuine new condition Hobart 60-c, 115-v AC power plant. Output 3000 to 4000 watts. Consists of Hercules 4-cylinder water-cooled 12 H.P. engine, direct coupled to generator. Complete instrument panel with cct. breaker, ammeter, voltmeter, frequency meter, etc. Ideal plant or emergency power for home or business. Govt. cost over \$900 Fully Guar. Sale \$349.50 Prepaid

POWER PLANT CLOSEOUTS

We Pay All Freight Charges
Plants, 2000-w, 115-v, 60-c \$289
Plants, 1000-w, 115-v, 60-c \$189
Plants, 7500-w, 115-v, 60-c \$799
Generator, 3000-w, 115-v, DC \$8
Generator, 6000-w, 30-v, 200 amp DC, 115-v, 800-c, AC \$29.48

WESTON METERS

Finest Model 643 expensive 4 1/2" meters. A wonderful buy. (A) DC ammeter (0-300 amps) \$7.92 (B) DC Voltmeter (0-150 volts) \$3.79 (C) DC Basic milliammeter (0-2 m. uncalibrated) \$2.19 (D) Laboratory Type (8" dial) ohmmeter \$12.95

PHOTO PAPER AND FILM

Eastman Kodak film and paper purchased from the Govt. Outdated but guaranteed good. Save to 70%. Write for bargain sheet on surplus paper and film.
SHEET FILM—SAVE TO 70%
11 x 14—Super Pan-Press Sports Type — 10 sheets per box \$3.15
11 x 14—Super Pan-Press Type B 10 sheets per box \$3.21
8 x 10—Replithol Ortho 25 sheets per box \$3.09
11 x 14—Super Ortha Press 10 sheets per box \$3.09

PHOTO PAPER—SAVE TO 65%

13"x13"—Contact paper sing. wt. glossy 250 sheets per box contrast 1, 2 or 3 \$9.07
10" x 10"—Enlarging paper S W 100 sheets per box contrast 1, 2, 3 or 4 \$3.49

SPECIAL OF THE MONTH

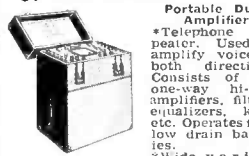

Portable Dual Amplifier
Telephone repeater. Used to amplify voice in both directions. Consists of two one-way hi-gain amplifiers, filters, equalizers, keys, etc. Operates from low drain batteries. Wide variety uses including telephone amplifier, wire tapping, audio oscillator, etc. Excellent experimental laboratory unit. Brand new and with Govt. data book. Cost over \$295 Sale, \$29.95 ppd.

ELECTRONIC MISCELLANEOUS

Experimental instruction sheets furnished with all items.
W. E. Photo Cell (\$6.50) \$.49
Black Light Tube (26-watt) .48
Thyratron Trigger Tube (\$4.95) .98
Hi-volt. Miniature Rectifier Tube .24
Phone Type 400 Ohm Relays .69
Ouncer Type Trans. 100-4000 ohms
Tripping Fire-Burglar Alarm .59
Laboratory 25-amp. Cct. Breaker .99
Laboratory Misc. Electronic Assortment (6 pieces). Guaranteed to please or money back \$3.49
Airway Beacon Bulbs (1000-watt, 110-volt) .97
Selenium Rectifier Lab. Asst. (3) .95
Experimental G.E. Selsyn Amplifier, 110-v, 60-r. Remarkable unit. Cost \$145 \$15.91
Ultra-Violet Fluor. Tube, 4-watt .98
Army Pole Climbers \$1.79
Small 110-v, 60-r. motor 1.89
Lab. Adj. Micrometer Relay \$2.97
Army Hip Waders, pair 6.97

ORDER FROM AD or Write For FREE CATALOG!

Thousands of items. Tools, electronics, watches, transits, tarps, microscopes, etc. Get finest Govt. items at fraction of original cost.

BURDEN SALES COMPANY
842 "O" St. Lincoln, Nebraska

REVERSIBLE GEARED-MOTOR
Delco-PM-Permanent Magnet Alnico Field Motor



#5071895 1/4 SHAFT or 11/16 GEAR... \$17.50
#5069600... \$18.50
Clamps to hold motor: \$1.50 ea.

GRAIN OF CORN LAMPS
10 for \$3.00 — 100 for \$25.00

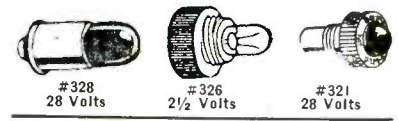

1/2" Ford Spark Coil by Delco-Remy... \$2.75

Smallest Buzzer Made!
EDWARDS BUZZER \$145
Size "O"—1"x1 1/4"

Diehl PM Motor 10,000 RPM \$595
FD621

HAYDON TIMING MOTORS

110v. 60 cycle 80 RPM... \$2.60
110v. 60 cycle 1 RPM... 2.85
230V { 1 RPM... 1.00
60C { 2 RPM... 1.00

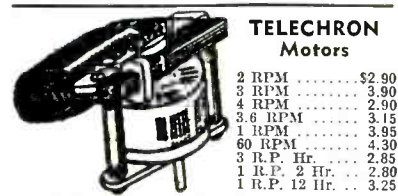

TELECHRON Motors
2 RPM \$2.90
3 RPM 3.90
4 RPM 2.90
3.6 RPM 3.15
1 RPM 3.95
60 RPM 4.30
3 R.P. Hr. 2.85
1 R.P. 2 Hr. 2.80
1 R.P. 12 Hr. 3.25

4 RPM on 50 cycles or 4 1/2 RPM on 60 cycles... 2.85
Laboratory Special 1 of Each Above \$25.00

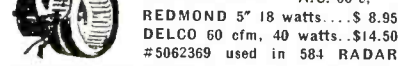

BLOWERS 115 Volts A.C. 60 c.
REDMOND 5" 18 watts... \$ 8.95
DELCO 60 cfm, 40 watts... \$14.50
#5062369 used in 584 RADAR

EASTERN AIR DEVICES 70 watts, 3400 RPM, labeled 80 cfm, but blows like blazes!... \$17.50

10 Seconds to 24 Minutes Timer

A hand wound electric TIMING SWITCH. Pointer moves back to ZERO and shuts off RADIO-TV—Electric Mixer—Photographic Devices—Time Delay etc. Furnished with Calibration Chart and Pointer Knob. Biggest bargain we ever had. \$1.25



3" Round Elapsed Time Meter 1375

MARKTIME 5 HOUR SWITCH
A 10 amp. timing device. Pointer moves back to zero after time elapses. Ideal for shutting off radios and TV sets when you go to bed. Limited supply at this special PRICE \$4.90
Also available in 15 min., 30 min., 1 hr. at \$9.90
ALL PRICES F.O.B. N. Y.

EST. 1923 **BLAN** EST. 1923
64H Dey Street. New York 7, N. Y.

At the height of our busiest season, we've CUT OUR PRICES on popular Industrial, Receiving, Special-Purpose Tubes!

TUBES

Free!

Stock Up! Save \$\$\$

New 1955 electronic parts mail-order catalog just published! Better than ever!

OB3/VR-90* \$0.90	5CP1* 4.49	388A 1.39	813 9.95
OC3/VR-105* .85	5D21 9.95	3948A 2.45	814 2.25
OD3/VR-150 .69	5FP7* 1.65	417A* 11.95	815 3.00
1B22* 1.11	5JP1 14.95	GL-434A 11.50	816* 1.10
1B23* 4.50	5JP2 12.50	GL-446A 1.39	826 85
1B27 8.95	7BP7* 4.95	450TL* 38.75	830B 1.75
1B32 1.49	7CP1 9.95	464A 4.90	832* 6.95
1P23 1.95	9LP7 1.89	CK-501LX 1.49	832A* 8.95
2A1 6.90	10 Special .88	HY-615* .49	838 2.50
2B22 1.50	10Y .69	ZP-653 24.50	866/866A 1.00
2C33 2.45	15R .30	702A 1.15	872A 1.95
2C40 8.50	CE-22 55	705A 1.49	874* .95
2C44 .89	23D4 1.10	706B* 16.95	884 1.00
2E22 1.50	24G 1.49	707A* 5.95	954 .29
2J21 4.45	2K-25* 1.95	708A* 3.25	VR59/955 .35
2J21A 4.90	FG-27-A 4.90	710A* 6.50	956* .35
2J22 4.90	30 Special .32	714A* 8.45	957 .29
2J27 8.95	45 Special .30	715A* 2.85	958A* .59
2J50 49.50	HK-54 3.95	715B 3.95	959* 1.40
2J54* 49.50	OK-65* 19.95	721A 1.50	1616 .75
2J55 59.45	OK-72 50.00	723A 8.95	1619* .39
2J61A* 21.95	VR-92 .39	723A/B 14.95	1625 .35
2K55 24.50	VR-78* .65	724A* 1.25	1626 .30
2X2 1.20	227A 2.98	724B* 2.90	1629 .40
3A1* 7.50	RX-233A 6.75	725A* 6.75	1638* .89
3BP1* 3.45	274B 1.49	726A* 9.95	1655 .75
3C23 6.75	304TH 8.95	801 .75	2051* 1.00
3C24 1.49	316A .98	803 3.10	UX6653 .65
3CP1 1.69	327A 3.50	805 2.50	8011 .95
3DP1* 3.50	350A 2.49	807 1.40	9001 .95
3FP7 1.69	359B 4.75	810 .95	9002* .90
3HP7* 3.50	371B .69	811 2.45	9003 .99
3JP12 3.99			9004 .35
4B22/EL-5B 3.25			9006 .30
4B25/EL-6-CF 3.25			
4C27* 8.95			
4J36 90.00			
4J37 90.00			
5BP1 2.99			
5BP4 3.25			

* limited quantity

RADIO SHACK CORPORATION

167 WASHINGTON ST., BOSTON 8, MASS.

SPECIAL 304TH Just \$8.95

FOR SALE
Radio Receivers, manufactured by Air Communication, #1A1, TC#830 Used Good—\$30.00 each
Automatic Radio Direction Finders—manufactured by Sperry MKF, part #844490, CAATC 445, Used Good \$37.50 each.
Midwest's Largest Surplus Dealer.
NATIONAL SURPLUS SALES COMPANY
723 East 18th Street
Kansas City, Missouri

Biggest & Best in Surplus Communications

JUST RECEIVED

LARGE QUANTITY: SCR-300 (BC-1000) Walkie-Talkies; SCR-536 (BC-611) Handy-Talkies. SPARE PARTS for both eqpts. All units re-conditioned to **LIKE NEW**, thoroughly tested.

BIGGEST & BEST STOCK IN: TCS Transmitters & Receivers with 12, 24, 110 DC or 110 AC Power Supplies.

BEACHMASTER & OTHER BATTLE ANNOUNCING PA SYSTEMS. SCR-284; BC-224; BC-312; 342 & 348. SCR-510, SCR-511, SCR-610, SCR-508 & 608, SCR-543, RBS, RBM, RAK, RAL, TBK, TBL, TAJ, BC-447, ETC.

UHF & VHF EQUIPMENT:

SCR-522, BC-797, SCR-624, TDQ, RCK, VHR-401A RECEIVERS, SCR-619 FM TRANS-RCVR EQPT., RCA MOBILE FM TRANSMITTERS & RECEIVERS, WESTERN ELEC. 2-20 MC 30 CHANNEL 250 WATT RADIO TELEPHONE EQPT., FRC EQPT., COLLINS BC-460 250 WATT 10 CHANNEL AUTOTUNE X'MTTRS, LINK 70-100 MC FM TRANS-RECVG. EQPT., ETC.

FINEST STOCK OF X'MTTRS & RADIOTELEPHONES FOR FIXED STATION INSTALLATION, 50 WATTS TO 10 KW.

Dynamotors & Power Supplies:
DY-2/ARR-2, DM-28 (For BC-348)
DM-35, DM34, DM-36, DM-53,
TCS 12v., 12/24v., 24v., 110
V.D.C., and 110/220 V.A.C. Also
32 V.D.C. to 110 v. AC (250 w.)
Rotary Converters.

PE-218 (A to H) Inverters, New,
\$14.95 each

Write for Prices & Literature

EXPORTERS, GOVERNMENT AGENCIES, INDUSTRIALS!

We have a large stock of Transmitters, Receivers, Walkie-Talkies, VHF Equipment, Ship & Shore Communications, FM Broadcast Stations, Radar, Accessories, etc. Write and tell us of your requirements. Descriptive literature and prices available upon request.

ALL MATERIAL SUBJECT TO PRIOR SALE!
CABLE ADDRESS: TELEMARINE, N. Y.

**—TELEMARINE—
COMMUNICATIONS CO.**

3030 W. 21st St., Brooklyn 24, N. Y.
Phone: ES 2-4300

TEST EQUIPMENT

X Band VSWR Test Set, TS-12, complete with linear amplifier, direct reading VSWR meter, slotted waveguide with gear driven traveling probe, matched termination and various adapters, with carrying case.

TS-13, X Band Signal Generator.

TS-33 A/AP, X Band frequency meter and video detector.

TS-34, Synchroscope

TS-35 A/AP, X Band Signal Generator with power and frequency meter.

TS-36 A/AP, X Band power meter .1 to 1000 milliwatts meter.

TS-45, X Band signal generator with power and frequency meter.

TS-89, Voltage divider 1:10 or 1:100 ratio flat ± 2 DB from 150 cps to 5 mc.

TS-110, S Band echo box

TS-125, S Band power meter

TS-155 A/AP, S Band signal generator with attenuators and power meter

TS-184, Test Set

TS-226, Peak reading power meter 0-1KW-400mc range.

TS-230, X Band frequency and power meter .1 to 1000 milliwatts.

TS-231, X Band dummy load.

TS-234, L Band dummy load.

TS-278, APS 13 test set

TS-305, Peak reading power meter 30 to 600 mc, 0-50 KW

X Band, 90° E plane and H plane bends and 90° twists

R. F. Power Meter, 1 to 600 MC 0-15 and 0-60 Watt scales. May be used as dummy load for 0-1000 MC.—100W maximum. VSWR less than 1.1 from 0-600 MC. less than 1.3 from 600 to 1000 MC.

X Band Pick up Horn, AT48/UP with coaxial fitting.

30 MC I.F. Strip, Video and Audio Amplifier and 115 volt 60-2600 cps Power Supply. Bandwidth 10 MC. new part of SPR-2 receiver.

High Pass Filter, F-29/SPR-2 Cuts off at 1000 MC. and below; used for receivers above 1000 MC.

Attenuator L101-A, UHF connectors at each end. calibration 30-199db.

TAA-16 Tuned Linear Audio Amplifier, 300 to 3000 cps output meter reads direct in VSWR or Power DB. Regulated power supply, 110 V 60 cps.

T85/APT 5, 300 to 1600 MC, 40 watt noise modulated transmitter.

110-330 MC Oscillator Butterfly.

80-300 MC Mixer Butterfly with socket for 955 (used as diode).

Mark 5, "S" Band Signal General—2.4 to 3.4 KMC 2C40 Oscillator Motor tuned.

Synchroscope—Model P4
Sweep Speed Calibrator, 200KC, 1 MC 5 MC.

Tuning Units P/O APR-4, TN16 30-86 MC. TN17 80-300 MC., TN18 300-1000MC., TN19 1000-2200 MC., TN54 2200-4000 MC.

AN/APR 1 Receiver used with above tuning units. 100 V 60 cycle. Rotary Joints. Coaxial, S Band Antenna. Coaxial, pressurized S Band. Can be used with parabolic reflector.

F.M. Test Set—X Band, with wavemeter and wattmeter, 110V 60 cycle AC.

Recording Ammeter—Esterline Angus 0-5MA.

Impedance Bridge—Type TBX-1BR 8.5 to 9.6 KMC-CRT Indicator.

Video Amplifier, 25 watts

Klystron Power supplies with or without modulation

Calibrator Model 3 (MIT).

Standard Signal Generator, Measurements Model 75, 124 to 510 mc, calibrated output 0 to 200,000 microvolts.

Standard Signal Generator, Measurements Model 84, 300 to 1000 mc, calibrated output 0-100,000 microvolts cw, pulse, sine-wave or external modulation.

UHF Radio Noise and field strength meter, measurements 15 to 150 mc—calibrated 0 to 100,000 microvolts input. Model 58

Field Intensity meter, RCA Model TMV-75-B 500 kc to 20 mc range 5 voltmeter to 20 microvolt meter 10 to 20 mc coils included.

Capacitance Test Bridge General Radio type 1611A 0 to 10,000 micro farad, dissipation factor 0 to 60%.

Q. Meter, Boonton Model 160 A 50 kc to 75 mc.

Q. Meter, Boonton Model 170 A 30 to 200 mc.

Cathode Ray Oscillograph, Dumont type 248 with power supply.

W Bridge, Electra Voice TBN-3EV 100 microwatt or 1000 microwatt sensitivity.

Pulse Generator, measurements Model 79B

Frequency modulated Generator Boonton 150A, 1 to 10 mc and 41 to 50 mc. Spectrum Analyser—Electro Impulse Laboratory Model 4X-X Band and Model 4S-S Band, superhetrodyne circuit, may also be used as a signal generator with internal or external modulation.

Tuned VSWR Amplifier, Electro Impulse Laboratory, Model A-12. 500 to 10,000 cycle range, 10 microvolt sensitivity.

R.F. Standard Signal Generator Unit—Federal Model 605CS 9.5 kc to 50 mc with calibrated output.

S Band Crystal Mixer—tuned and adjustable coupling. Uses 1N21 crystal. type "N" input. U.H.F. output connector.

K Band Crystal Mixer—18000 to 26500 mc uses 1N26 crystal, mounts on RG 96/U waveguide. Coaxial output.

HIGH POWERED DUMMY LOADS

X Band, 1 1/4" x 5/8" guide, choke or plain flange, dissipates 350 watts average power continuously in still air. VSWR less than 1.15 between 7 and 10 KMC. weight 5 1/4 pounds.

X Band 1/2" x 1" guide, choke flange, dissipates 250 watts average power continuously in still air, VSWR less than 1.15 between 8.2 x 12.4 KMC, weight 3 1/4 pounds.

X Band 1 1/4" x 3/8" guide, plain flange, dissipates 200 watts average power continuously in still air. VSWR less than 1.15 between 7-10 KMC, weight 3 1/4 pounds.

X Band 1 1/4" x 3/8" guide, plain flange, dissipates 250 watts average power continuously in still air, weight 2 pounds ounces.

S Band, 1 1/2" x 3" guide dissipates 1,500 average power in still air, VSWR less than 1.15 between 2.5 to 3.7 KMC. choke flange, weight 13 pounds.

K Band, VSWR less than 1.15 dissipates 50 watts average power.

CALORIMETER WATER LOADS—X Band—VSWR does not exceed 1.02 at any specified frequency within the band, less than 1.05 for 10% frequency change. These loads are made with both RG51/U and RG52/U waveguide and will adequately handle any power within the limits of the waveguide.

CALORIMETER WATER LOADS—S Band—VSWR does not exceed 1.05 over its band, this termination is designed for use on pressurized waveguide systems using up to 3KW average power, and also has provision for two sampler probes for spectrum analysis or frequency measurements.

NIBUR SALES CORPORATION

P. O. Box 811

Red Bank, New Jersey

Telephone: Red Bank 6-5810

METER SPECIALS
 Lab. type . . . 0-300 Amp. DC. \$19.95
 Mfr. Roller Smith Steel Six Line
 0-40 Mills R.F. 3" Meter. . . \$12.95
 Many Other Meters in Stock

RADALAB
 87-17 124th STREET
 Richmond Hill 18, New York
 Phone Virginia 9-8181-2-3

Prices FOB NYC. Rated firms open account. Prices subject to change without notice.
 CABLE: Radalab, NY
 TELETYPE: NY-4-4361

AN/TPS-3—AN/TPQ-3
 Early warning and mortar tracking radar. This equipment is completely portable and can be set up for field use very quickly. 600 mc freq. 7" PPI 5" A scope. Range 20-120 miles. Very accurate ranging. P.O.R.

AN/APS-2—AN/APS-15
 10 and 3CM nav. and bombing radar. Has 5" PPI and 3" A scope.

AN/CPN-6 & AN/CPN-17
 3 cm & 10 cm. High Pwr. Airport Radar Beacon. Output approx. 40 kw. Complete installation available. P.O.R.

VE-VF-VG-VC-VD
 We can supply many remote PPI indicators for use with various ground and marine radars. These sets are driven by synch-video-synchro pulses from the main radar. P.O.R.

AN/ASQ-1 and 1A MAGNETOMETERS
 This is an airborne magnetometer used to measure the magnetic flux of the earth and to locate submarines and other metallic objects by their distortion of the magnetic field. Complete sets available. P.O.R.

SA-SF-SG-SJ-SL-SO-SP-SQ NAVY AND MARINE RADARS
 We can supply many types of Navy Radar sets for all uses. We can deliver complete installations of the above and also of the MK series fire control sets in many input voltages. Write for quotations.

SCR-206
 Portable direction finder. Frequency 200kc-18mc. complete sets available consisting of BC-470 receiver, LP-22 loop, sense antennae, power supply, operates from 6v. DC. Mounted in a transporting trunk.

COUNTERMEASURES
 We specialize in and can supply search and jamming equip. to cover 30mc-10,000mc for Air Ground and Marine use. We can deliver complete installations of the following and many others. Write

SEARCH-DETECTION
 AN/APR-4 38-400mc
 AN/APR-2 300-1000mc
 AN/APR-5 1000-3100mc
 AN/APR-6 3000-1000mc

DIRECTION FINDING
 AN/APA-17 300-500mc
 AN/APA-24

INDICATING
 AN/APA-10 Pan-adaptor
 AN/APA-11 Pulse analyzer
 AN/APA-38 Pan-adaptor
RECORDING
 AN/APA-23 Signal & time rec.

JAMMING
 AN/APT-1, 2, 3, 4, 5, 10
 AN/APQ-1, 2, 3, 9
 AN/APQ-1-20
 Misc. Equip.
 TDY, MRQ, SPT, SPQ, TPQ-1

AN/APN-3 SHORAN EQUIPMENT
 This equip. is used for navigation and surveying. Operates in conjunction with AN/CPN-2 ground beacons. Operating freq. is 290mc. Accuracy is plus or minus 10 feet up to its range of 300 miles. Spares available. AN/CPN-2 ground beacons available. P.O.R.

AN/GSQ-1A
 Speech scrambler for use on any comm. channel to insure privacy. We can supply complete installations of this equipment 28v DC input. Very compact. P.O.R.

SCR-508-528-608
 10 channel freq.-modulated mobile military radio set. 20-27.9mc. Output 25 watt transmitter is crystal controlled. Receiver is tuneable. Input 12 or 24v DC.

SCR-291A
 Automatic ground direction finder covering 1.5mc-30mc. Provides instant bearings on a C.R. indicator of any signal in its range. This equipment is transportable and can be set up quickly. 110v 60 cyc. P.O.R.

SCR-300A
 Walkie talkie FM. covering 40-48 mc in 41 channels. This is the standard set of most of the nations of the world. Provides reliable communications up to 10 miles. 6, 12 volt vibropacks RC-291G.P. and spares also available. P.O.R.

FIELD RADIO AND COMMUNICATIONS
 SCR-284 Field Radio
 SCR-536 Handi-Talkie
 SCR-694-C Field Radio
 SCR-506 Mobile Radio
 SCR-808 Mobile Radio
 SCR-188, 193 Mobile Radio
 SCR-206 Direction Finder
 AS-81-GR Direction Finder

AIRBORNE COMMUNICATIONS
 RA-1B, ART-13, ARN-6, ARN-7, RTA-1B, ARC-1, 3, APN-9, DY-17, CRN-2 glide path ground station.

AN/APR-4
 38-4000 mc precision receiver consists of receiver and five tuning units to cover the full range. Each tuning unit is calibrated directly in mc. Input 115v 60 cyc. P.O.R.

SURPLUS BARGAINS

TRIP RELAY—



Instantaneous class
 9005 Type N. 23-47
 Amp range; 600 Volts
 Max. Ship. wgt. 3 1/2
 lbs. Brand new —
 \$1.35 ea.

ALPHA HAND MONITOR—



Mfd. for the Atomic Energy Commission, at a cost of several hundred dollars. Indication of radiation is made on 0-20 micro-amp. meter in panel. No technical data available. Size 13 1/2" H. x 12 1/2" W. x 8" D. Brand new.....\$27.95

CIRCUIT BREAKER—



2163M4 1.25 amp. 117.5
 V. 2 pole AC. Curve 3
 size 5 1/4" x 4" x 3".
 Ship wt. 2 1/2 lbs. Brand
 newPrice \$2.70 ea.

VARIABLE VOLTAGE REGULATOR—



Type TH 115 V. Input
 50-60 cy. Output
 57.5-0-57.5 or may be
 connected for 0-125
 V. output @ 45 amps.
 max. Brand new —
 \$45.00

New Surplus 400 Cycle 115 V. Transformers

- (a) Delca #7249009, 115 V. 400-2600 cycles 2.6 A. Tapped 75, 80, 85, 105, 125 Volts. Sec. 680 V Ct. 300 Ma. Size 6-3/4" H x 4" D x 4 1/2" W. Quantity price—\$1.75 ea. Unit price—\$2.75 ea.
- (b) GE229619-44, 115 V. 400 cy. pri. Sec. 13.5 KV @ 13 Ma. Quantity price—75¢ ea. Unit price—\$1.95 ea.

All Merchandise Guaranteed to Satisfy or may be returned prepaid for Cash refund.

ESSE RADIO CO.

40 W. South St. Indianapolis 25, Ind.

TS-10 SOUND POWERED HANDSET
 Used, Excellent Condition



INCLUDES 6 FT CORD.
 USES NO BATTERIES OR EXTERNAL POWER SOURCE.....\$6.50 PER PAIR

TALLEN CO., INC.
 159 Carlton Ave., Brooklyn 5, N. Y.

Boonton Model 202-B FM/AM Signal Gen. \$750 00
 Boonton Model 100-A "Q" Meter.....\$250.00
 General Radio 722-D Precision Condenser. \$120.00
 General Radio 805 Signal Generator.....\$720.00
 General Radio 503-A Output Meter.....\$ 80.00
 General Radio 726-A Vac Tube Voltmeter. \$ 95.00
 Gen. Rad. 530-A 400 cps Band Pass Filter. \$ 25.00
 RCA 160B 5-inch Oscilloscope.....\$ 60.00
 RCA 69C Distortion and Noise Meter, Rack Mounting, Less Case.....\$130 00
 Hewlett-Packard 200B Audio Oscillator....\$ 65.00
 Hewlett-Packard 200BR Audio Oscillator. \$ 65 00
 Hewlett-Packard 400A Vac Tube Voltmeter \$110.00
 Dumont 224A 3-Inch Oscilloscope.....\$120.00
 BC639A VHF Receiver 100-156 mcs. complete with RA-42 Power Supply.....\$190.00
 Ferris 22A Signal Generator 85-25000 kc. 1 volt output.....\$155.00
 Weston 904 1/2% A.C. Voltmtr. 0/150/300 V. \$ 50.00
 Weston 904 1/2% A.C. Voltmtr. 0/7.5/15 V. \$ 50.00
 Weston 901 1/2% D.C. Voltmeter 0/3/150/300 5000 ohms per volt.....\$ 70.00
 Weston 280 Milliammeters (four) 0/30/120/600 Milliampers, each.....\$ 18.00
 Weston VOR Indicator ID-48.....\$ 60.00
 Spencer Compound Microscope Cat.—No. 13-MAH (new) comp with 1.8 mm., 4 mm. objectives and X6 and X10 eyepieces.....\$140.00
 DI-Acro #4 Shear 24-inch.....\$185.00
 DI-Acro #4 Radius Break.....\$195.00
 DI-Acro #2 Punch 12-inch throat with 35 Punches and Dies, Other Accessories.....\$385.00

All Apparatus In Excellent or New Condition
 PRICES F.O.B. KATONAH, NEW YORK

W. P. HILLIARD
 Deer Park Road Katonah, New York

world's largest stock

RELAYS

immediate delivery!

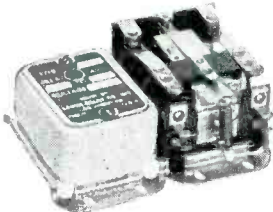

ADJUSTABLE THERMAL TYPE TIME DELAY RELAY

Operates on 115 V.A.C. Continuously adjustable delay from 5 to 20 seconds. 1/4 Inch D.P.D.T. 12 1/2 amp. contacts. Primarily designed for use with radio transmitters but has wide variety of other applications. Catalog No. R 686 Price \$6.10 each

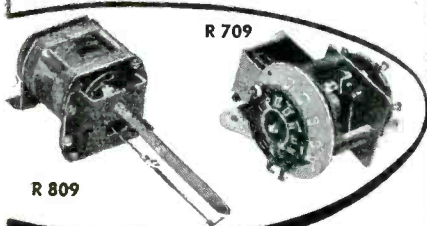

STEPPING UNIT

Operates on 22 to 30 V.D.C. 12 Position driving mechanism operates through 360° in progressive steps. Indexes one position for each momentary current impulse. Attached wafer switch may be used for self interruption. 7 inch flatted shaft will drive pulley, gear or one or more wafer switches. Catalog No. R 809 Price \$2.45 each

SOLENOID OPERATED RATCHET STEPPER

Operates on 6 V.D.C. Operates three 12 position wafer switches. Most standard wafers are interchangeable with those supplied. Rotates 30° with each impulse. Catalog No. R 709 Price \$3.90 each

HUNDREDS OF RELAY TYPES IN STOCK

- | | |
|----------------------------------|-----------------------------------|
| Standard Telephone Relays | Differential and Polarized Relays |
| Short Telephone Relays | Special Relays |
| Midget Relays | BK-Series |
| Timers | Antenna and Ceramic Relays |
| Aircraft Contactors | Motor and Control Relays |
| Rotary Relays | Relay Assemblies |
| Western Electric Type "E" Relays | Latching and Interlocking Relays |
| Keying Relays | Mechanical Action Relays |
| Hermetically Sealed Relays | Ratchet and Stepping Relays |
| Voltage Regulators and Cutouts | |

All relays are new, individually inspected and unconditionally guaranteed. They are first line products of leading manufacturers. Special attention given to orders of one or more relays. 24 Hour delivery.

Write for new catalog. Phone, write or wire your requirements.



AUstin 7-0709
4717 W. Madison St.
Chicago 44, Ill.

Save up to 70% of Wholesale Cost

All Components 1st Quality and 100% Guaranteed

Production Quantities

Immediate Delivery

From One of the Largest and Most Diversified Inventories in the U.S.

We Invite Your Inquiries for All Your Electronic Needs

Write for a Complete List of Surplus Equipment

SYNCHROS

Complete stock of U.S. Navy Ordnance size 1, 3, 5, 6, 7, and 8 Generators, Motors, Control Transformers, Differential Generators and Differential Motors.

Guaranteed to meet Specs. Quotations on Request.

OIL FILLED CONDENSERS

All voltage ratings from 400V to 50 KV in stock

Typical Values

4 mfd 600 VDC TLA (round) \$1.25
4 mfd 600 VDC TJU (rectangular) 1.25
Send for complete listing

PRECISION POTENTIOMETERS

HELIPOT TYPE C1—5KΩ 3W.—3 TURNS—0.1% LINEARITY \$9.50
HELIPOT TYPE CCI—DUAL SECTION—5KΩ and 10KΩ 3W. each SECTION—3 TURNS—0.1% LINEARITY \$11.50
HELIPOT TYPE D1—10KΩ 15W.—25 TURNS—0.1% LINEARITY \$19.50
T.I.C. TYPE RVC2—10KΩ 2% 4W.—0.5% Linear \$5.75
T.I.C. TYPE RVC2—40KΩ 2% 4W.—0.5% Linear \$5.75
T.I.C. TYPE RV3—10KΩ 2% 8W.—1% Linear \$3.60
T.I.C. TYPE RV3—20KΩ 4% 12W.—1% Linear \$4.75

Send for Complete Listing.

PULSE TRANSFORMERS

IN STOCK for IMMEDIATE DELIVERY over 50 different types Manufactured by Utah, General Electric, Raytheon, Westinghouse, Western Electric

Send us your Inquiries

TACH GENERATOR

Elinco T PM-1-M

D.C. permanent magnet generator. 2.0 volts output per 100 RPM.
Each \$27.50
In lots of 10 25.00

TYPE J POTENTIOMETERS

Single "J" Units \$3.95 ea.
Dual "JJ" Units 2.95 ea.
Triple "JJJ" Units 3.95 ea.

Send for complete listing.

COAXIAL CABLE

RG-8/U \$100.00 per M ft.
RG-9/U 250.00 per M ft.
RG-11/U 100.00 per M ft.
RG-58/U 60.00 per M ft.
RG-59/U 55.00 per M ft.

Full line of JAN approved cable in stock

COAXIAL CONNECTORS

PL-259 \$0.40
80-239 .40
M-359 .30
UG-88/U .75
UG-260/U .70
UG-280/U .70

Send for complete listing of JAN approved connectors at similarly low prices.

TUBES GUARANTEED STANDARD BRANDS TUBES

Over 1100 Different Types in Stock

RECEIVING—TRANSMITTING—SPECIAL PURPOSE

TYPICAL VALUES

6AC7 \$0.85	5BP1 \$5.50	725A \$12.95
6AK5 .79	EG-32 6.75	837 1.45
6SN7GT .73	FG-172 20.00	1625 .39
12A6 .64	723A/B 18.50	8020 1.25

Full stock of Magnetrons, Klystrons, Crystal Diodes.

Send for complete listing of types and prices.

2 PHASE SERVO MOTORS

MINNEAPOLIS-HONEYWELL

115 V, 60 cy, 13.5 W. Used in many Brown Instr. recorders.

Part #76750-2-54 RPM #76750-3-27 RPM

Either type \$19.50
KOLLSMAN—45 V, 60 cy, 4 W, 1500 RPM \$22.50
DIEHL FP 25-2-20V, 60 cy, 1600 RPM, 0.85A \$27.50
DIEHL FP 25-3-20V, 60 cy, 3200 RPM, 0.5 A \$27.50
DIEHL FPE 25-11-75V, 60 cy, 4 W, 0.11A \$34.50
DIEHL FPE 25-14-20V, 60 cy, 2.5W, 0.5 A \$27.50
PIONEER 10047-2-3—26V, 400 cy. with 40:1 reduction gear \$14.50
PIONEER CK-5—400 cycle. Only \$29.50

MERCURY RELAY

W.E. D171584 Contacts SPDT Coil: 86 VDC, 4500 ohms. Glass-sealed, mercury-wetted contacts; hermetically-sealed standard octal plug-in-tube-base. Each \$8.75 In lots of 10 \$7.75

Special Discounts on Quantity Purchases

ELECTRONIC RESEARCH LABORATORIES

715-19 Arch St., Phila. 6, Pa. • Market 7-6771-2-3

CABLE ADDRESS: ELECTRONIC, PHILADELPHIA

Terms—25% cash with order. Bal. C.O.D. unless rated. All prices Net F.O.B. PHILA., PA. subject to change without notice.

NEW ITEMS:

NEW ITEMS BEING RECEIVED ALL THE TIME! WRITE AND TELL US YOUR NEEDS!

METERS:

WESTON AC AMMETER:

(Pictured) In portable leather case, with Test Leads, 2 1/2", 0-15 AC and 0-3 AC Scale. \$4.95



DC AMMETER HOYT:

In portable metal case, with Test Leads, 4 1/2", Fan, Mirrored Scale—0-15 ADC. \$4.95

0-3 RB AMMETER IS-128—2 1/2" Rd. Flush Mtg. Calibrated P/Non Mag. Panel, P/O BC-233 Transmitter. NEW: \$2.95

0-500 MICROAMMETER—TRIPLET, 2 1/2" Sq. \$4.95

0-5 MA DC WESTINGHOUSE, 2 1/2" Sq. \$3.95

D-B METER—10 to Plus 6, G.E., 3 1/2" Ltd. \$4.95

TS-291/U VOLTOHMETER—Meter 3" square, 1000 ohms per volt, D'Arsonval Movement—0/300/600 VDC Scale and 0-1 Meg. Case size: 3 1/2"x5 1/2"x 2 1/4". W/Test Leads P/O 1-56 Test Set NEW: \$7.95

MOTORS:

24 VDC REVERSIBLE MOTOR—3.7 RPM, 40 lb. Torque. Motor size: 5 1/2" x 4-1/32" x 3-5/16". Shaft size: 2 1/32" x 5/16". Also operates 24 VAC. Philco No. 441-1008 \$5.95

27.5 VDC—6000 RPM, 1.5 oz. in Shaft size: 1 1/2" x 1/2". Motor size: 2 1/2" x 1 1/2". No. 5069-267. \$4.95

26 VOLT 60 CYCLE—60 RPM Synchronous Cramer Motor #1147. Shaft size: 1" x 3/8". \$4.95

110 VDC 1/70 HP., 1550 RPM. Motor size: 4" x 2 1/2". Shaft size: 1" x 3/16". Redmond #157. \$4.95

6 VDC 1/20 HP., 4000 RPM. Motor size: 5" x 3". Shaft size: 3/4" x 1/4". Redmond #E-56. \$4.95

12 VDC 1/30 HP., 4500 RPM. Motor size: 3" x 2 1/2". Shaft size: 1" x 3/16". Delco #5047520. \$4.95

27 VDC 1/10 HP., 3500 RPM. Shaft size: 3/4" x 1/4". Motor size: 5" x 3". G.E. #5-PN38HA10. \$8.95

80 VDC 1/50 HP., 3000 RPM. Shaft size: 3/4" x 1/4". Motor size: 5" x 3". G.E. #5-PN38HA10. \$8.95

28.5 VDC 1/35 HP., 2200 RPM. Shaft size: 1 1/2" x 1/4". Motor size: 4 1/2" x 3 3/4". Electrolux #10876 \$5.95

115 VAC 60 Cycle INDUCTION MOTOR—1.9 RPM, 75 Torque oz. in; 9 Watts—with variable Multi Disc Coder Wheel & Micro Switch, mounted on bracket assy. Holtzer Cabot Motor Type RWC 2505 \$9.95

GEARED HEAD MOTOR—Heavy duty, 24 VDC 8 Amp, 2 1/2 lb. Torque, 100/200 RPM. Shaft size: 5/16" x 1". Right Angle Drive. \$8.95

BLOWERS:

BLOWER AND HEATING ELEMENT

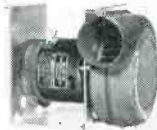

110 Volt 60 cycle; Blower 100 CFM, Heating element can be turned on & off separately from blower. Used to pre-heat Transmitter Tubes. Gov't. Surplus. #2570 Price \$10.95

115 V/60 100 CFM—Single, #1C939	\$ 8.95
115 V/60 100 CFM—Dual, #1C880	13.95
115 V/60 108 CFM—Pancake #2C067	14.50
115 V/60 140 CFM—Single Flange, #1C807	13.95
115 V/60 275 CFM—Dual Flange, #2C069	21.95
6 VDC 100 CFM—Single, #6100	7.50
6 VDC 150 CFM—Flange, #6150	9.95
24 VDC 10 CFM—Min.—Single #2410	5.95
24 VDC 20 CFM—Min.—Dual, #2420	7.95

TRANSFORMERS—115 V. 60 Cycle Pri.:

600 VCT/100 MA—6.3 V/5 A; 5 V/3 A	\$ 4.95
650 VCT/50 MA—6.3 V/2.5 A; 6.3 V/6 (Rect. 6x5)	1.95
4500 VC/75 MA—2.5 V @ 2 A	7.95
350 VCT/40 MA—6.3 V/2.4 A; 6.3 V/6 (Rect. 6x5)	1.75
2500 V/015 A; 2.5 V/1.75 A; 6.3 V/6 A	5.95
1890 V/12.6 MA Tapped 2.5 V/2 A	5.95
1100 V/80 MA; 7.5 VCT/3.25 A	5.95
5 Volt CT-25 A; 10,000 V. Inc. Open Frame	7.95
9 Volt 35 A. Tapped @ 4.5 V	7.95
12 Volt—Two Separate Windings—4 Amp each	5.95
28 Volt 8 A. Tapped @ 4 V	5.95
5 V/2 A; 5 V/2 A; 5 V/2 A; & 5 V/6 A	2.95

CHOK 12.5 Hy/100 MA	\$ 1.95
CHOK 12 Hy/250 MA, 180 Ohm	4.95
CHOK 15 Hy/165 MA, 125 Ohm	1.95
CHOK 5 Hy/150 MA, 85 Ohm	1.50

COAXIAL CABLE: Prices Per Foot:

	100	500	1000
RG-8/U 51.5 Ohm (Special)	.07	.06 1/2	.06
WC-547 95 Ohm—Solid Cond.	.05	.04 1/2	.04
WC-549 52 Ohm—Solid Cond.	.05	.04 1/2	.04
WC-550 95 Ohm—Twin Solid Cond.	.08	.07 1/2	.07
RG-34 71 Ohm—145 Ft. Length	\$15.00 per Lgth.		

INVERTERS & GENERATORS:

5D21NJ3A—27 VDC input; 115 Volt 400 cycle output. 1 Phase 485 VA	\$39.50
PE-109D—Input 13.5 VDC 29 A; output 115 Volt 400 cycle. 1 Phase 1.53 Amps	\$59.50
PU-7/AP—Input 28 VDC 160 A; output 115 Volt 21.6 A, 400 cycle, 2500 VA	\$89.50
PE-218—Input 28 VDC 100 A; output 115 V 400 cycle 1 Phase 1500 VA... USED: \$24.95... NEW: \$49.95	
PE-115 or PE-206—Input 28 VDC 36 A; output 80 Volt 800 cycle 7.2 Amps. Like New \$ 9.95	
TYPE 800-1-D—Input 28 Volt 62 A; output 115 Volt 7 Amp, 1 Phase 800 cycle Used: \$19.95 New: \$75.00	

IF NOT LISTED, PLEASE WRITE. MOST ITEMS PREVIOUSLY ADVERTISED ARE STILL AVAILABLE!

**RADIO - RADAR - INSTRUMENTS
AIRCRAFT - PHOTO EQUIPMENT**

AIRLINES • GOVERNMENTS RESEARCH • LABORATORIES

We carry a large inventory of NEW and Guaranteed overhauled U.S. Signal Corps and U.S. Navy Surplus Equipment.

We solicit your inquiries.

TRANSMITTERS RECEIVERS RADAR DYNAMOTORS INSTRUMENTS SELSYNS. PLUGS AERIAL PHOTO EQUIPMENT SPARE PARTS

WE WILL NOT BE UNDERSOLD!

Send for FREE catalogues on

- Communication Equipment
- Inverters - Dynamotors
- Radio-Radar Test Equip.
- Aerial Photographic Equip.

EQUIPMENT WANTED

Semler Industries, Inc.

6853 Lankershim Blvd., North Hollywood, Calif.

FAIR RADIO SALES • 132 SOUTH MAIN ST. LIMA, OHIO

SPECIALISTS JAN, RUGGEDIZED SPECIAL PURPOSE TUBES

1B24	6.75	3B28	3.75	100R	15.00	DY	10.00	5705	1.50	6082	3.25
1B24A	24.50	9Y5	6.25	F123	25.00	EY	8.25	5718	1.30	6111	2.25
1B26	1.50	3CP1(51)	2.00	1527M	25.00	FY	10.00	5719	4.50	6096	1.50
1B33	7.50	3C24	.95	211	.75	800	3.00	5719	4.50	6097	1.50
1B35A	7.50	3HP4	6.00	215	2.25	837A	7.75	5725	3.00	6098	3.95
1B42	7.00	4D22	20.50	249C	7.00	836	3.00	5728	1.25	6099	1.50
				2507L	17.50	837	.90				
				305A	4.25	855	5.00				
				316A	.55	HM953D	75.00				
				TR317	10.00	CM1090	6.00				
				412A	9.00	1620	4.25				
				416A	75.00	1636	2.50				
				416R	75.00	1654	4.00				
				434A	9.00	2050	1.00				
				464A	6.00	5635	9.00				
				471A	2.00	5636	5.50	5744	1.00	6101	1.50
				512	3.25	5641	7.50	5744WA	5.00	6110	11.00
				700A/B/C/D	7.50	5643	8.00	5749	1.60	6111	8.25
				701A	3.75	5644	11.50	5751	1.75	6112	9.75
				702A	1.50	5645	7.00	5784	5.00	6136	1.75
				705A	1.00	5646	7.00	5787	5.00	6146	4.65
				706C	15.00	5654	1.45	5787	1.45	6201	3.75
				CK705	15.00	5651	1.75	5814	1.75	6201	3.75
				706B	15.00	5651WA	2.50	5814A	1.75	6216	1.25
				707A	2.00	5670	1.00	5829	4.20	6217	1.75
				708A	4.00	5670	1.00	5840	5.50	1N21A	1.80
				709A	1.75	5676	1.00	5875	1.40	1N21B	2.20
				717B	17.50	5678	1.15	5875	1.40	1N23A	2.25
				CK721	7.50	5691	2.00	5881	2.50	1N23B	1.75
				722A	4.40	5692	1.15	5902	8.00	1N34A	4.75
				722A	1.25	5693	6.75	5910	.75	1N35	2.10
				728AY	10.00	5696	1.75	5932	8.50	1N38A	.95
				BY	10.00	5702	2.50	5937	3.20	1N44	1.10
				CY	10.00	5702WA	5.00	5964	1.35	1N45	1.20
								5985	3.50	1N51	3.50
								5995	6.00	1N55A	2.65
								6005	2.50	1N63	1.80
								6023	1.65	1N70	2.80
								6074	3.75	1N72	.85
								6080	6.00	1N73	1.50
								6080WA	5.00	1N92	2.30
										1N93	3.50
										1N94	3.50
										2N34	10.00

HANOVER ELECTRONICS 125 CEDAR ST. NEW YORK 6, N. Y. RECTOR 2-1296

SPECIAL FOR NOVEMBER!

- G.E. DD 6 Surface Mounted D.C. Ampmeters. 50 M.V. Any scale or range (shunts extra) @ \$12.50
 - DD 6 0-150 or 300 V.D.C. @ \$17.50
- These are used meters but look and are guaranteed like new.
- ### MARITIME SWITCHBOARD
- 336 CANAL STREET
NEW YORK 13, N. Y.
Worth 4-8216-7

CARRIER EQUIPMENT

Western Electric CF-1A 4-channel carrier telephone terminals.

EE-101-A 2-channel 1000/20 cycle carrier ringers.

CFD-B 4-channel carrier pilot regulated telephone terminals complete with four channels 1000/20 cycle ringing.

CFD-B 4-channel pilot regulated telephone repeaters.

C-42-A V. F. telegraph in from 2- to 12-channel terminals.

FMC 1 or 2 channels carrier telephone terminals, automatic regulation, duplex signaling each channel. Carrier frequencies above 35 KC. Ideal for adding channels above type "C".

Complete engineering and installation services offered.

RAILWAY COMMUNICATIONS, INC.
Raytown, Missouri
Telephone: F Lenig 2121

CONDENSERS

GUARANTEED—CONDENSER—SPECIALS—GUARANTEED

24 mfd—500 V..... \$1.95
3—8 mfd sects.—4 terms

4 mfd—600 V..... \$.99

2 mfd—600 V Rd. Can. \$.45

1 mfd—6 KV..... \$6.25

2 mfd—7500 V... \$23.95
Pyranol #F135—Orig. Carth.

DIESEL GEN.

25 KW 3 phas 60 cy. Hill diesel, G.E. gen. Complete with control panel & starting batteries. Ready for immediate operation. Guaranteed. P.U.R.

115 mfd—2 KV Mica \$4.65

20 a. @ lmc. Qua. Disc.

1 mfd—25 KV..... \$59.50

7 mfd—600 V..... 1.25

1 mfd—1500 V..... .90

TRANS MICA CONDENSERS

Mfd.	Wvdc	Price	Mfd.	Wvdc	Price
.000015	2500	.35	.001	1200	.32
.000024	2500	.38	.001	2500	.49
.000025	1200	.30	.001	4500	1.70
.00003	600	.24	.001	5000	2.50
.00003	1200	.28	.001	6000	2.25
.00003	2500	.37	.0015	600	.23
.00003	2500	1.30	.0015	2500	.53
.00004	600	.23	.0015	5000	2.50
.000047	2500	.31	.002	600	.27
.00005	600	.23	.002	1200	.39
.00005	1200	.29	.002	2500	1.95
.00005	2500	.33	.002	5000	2.95
.00005	2500	1.29	.002	6000	2.40
.000051	5000	1.49	.0024	5000	2.25
.00008	5000	1.35	.0025	5000	.28
.00008	2500	.27	.0025	1200	.43
.00007	500	.27	.003	600	.30
.000075	5000	1.49	.003	1200	.31
.00008	1200	.29	.003	2500	.74
.00008	2500	.33	.003	3000	1.95
.00009	3000	1.35	.003	8000	5.95
.0001	600	.23	.004	600	.29
.0001	1200	.29	.004	1500	.49
.0001	2500	.36	.004	2500	2.84
.0001	5000	1.75	.004	5000	2.75
.00015	600	.23	.005	600	.35
.00015	2500	.33	.005	1200	.45
.00015	5000	1.95	.005	2500	.99
.0002	600	.23	.005	5000	1.90
.0002	1200	.29	.005	8000	2.40
.0002	2500	.36	.006	600	.36
.00025	600	.23	.006	1200	.59
.00025	1000	.16	.0068	1200	1.55
.00025	1200	.20	.0075	5000	1.65
.00026	2500	.40	.008	800	.35
.00025	5000	1.95	.01	1000	.48
.00027	1200	.28	.01	1200	.73
.00027	2500	.36	.01	2500	1.15
.0003	600	.23	.012	1200	.70
.0004	600	.23	.014	1200	.72
.0004	2500	.29	.015	600	.55
.00047	2500	.40	.015	1200	.78
.0005	600	.23	.015	2500	1.25
.0005	1200	.29	.02	600	.57
.0005	2500	.43	.02	600	.21
.0005	3000	1.35	.02	1200	11.5
.0006	2500	.43	.02	2000	1.50
.00062	3000	1.25	.02	2000	1.50
.00068	2500	.43	.02	600	.67
.00075	5000	1.90	.03	1200	1.34
.0008	1000	.16	.4	800	4.95
.00089	1200	.28	115	2000	4.65
.001	600	.23			

TUBULAR COND.

Mfd.	Wvdc	Price	Mfd.	Wvdc	Price
.0025	200	.11	.02	400	.14
.0025	400	.15	.02	600	.17
.005	800*	.10	.02	600*	.14
.005	600*	.12	.03	400	.14
.005	1600*	.12	.03	600	.16
.006	1000*	.12	.05	200	.10
.01	300	.12	.05	600	.18
.01	600	.13	.05	1000	.20
.01	1500	.23	.05	600	.22
.01	1000	.20	1	1000	.29
.01	2000	.20	1	600*	.19
.02	100	.09	5	600	.25
.02	100	.09	5	200	.29

* Case Graded

Type "G" Mica CONDENSERS

Mfd.	Volts	Price	Mfd.	Volts	Price
.00005	2KV	5.95	.0013	15KV	34.95
.00005	3KV	6.95	.002	8KV	4.25
.00005	4KV	8.95	.002*	6KV	5.95
.00005	10KV	19.95	.002	20KV	37.50
.0001	6KV	12.50	.0024	8KV	11.95
.0001	10KV	15.95	.0025	12KV	35.95
.0001	20KV	31.50	.0025	15KV	35.95
.00015	35KV	45.95	.0025	25KV	59.95
.00015	10KV	9.95	.0025	25KV	59.95
.0002	6KV	9.95	.003*	6KV	6.95
.00024	6KV	9.95	.003	6KV	9.95
.00024	8KV	11.95	.003	15KV	37.50
.0003*	20KV	32.95	.00575	6KV	11.95
.00032	25KV	44.50	.00575	10KV	37.50
.00035	20KV	31.95	.03	2KV	9.95
.0005	6KV	11.50	.045	2KV	37.50
.0005	20KV	28.95	.08	1.5KV	7.95
.0005	35KV	49.95	.09	1.5KV	6.95
.0008	30KV	59.50	.115	2000V	4.95
.001	6KV	12.50	.115	2500	39.50
.001	25KV	57.50		* Paradox	

MICA CONDENSERS

6, 10, 15, 27, 30, 34, 39, 50, 81, 60, 70, 75, 85, 100, 140, 150, 200, 230, 240, 250, 300, 350, 380, 400, 500, 610, 690, 850, 750, 1000, 1200, 1400, 1000, 1600, 2000, 2400, 2500, 3000, 3300, 3700, 3900, 4000, 4700, 5000, 5100, 6000, 6200, 6500, 7900, 8000 & 9100 mfmfd

6 to 750 mfmfd 5c | 2000 to 5100 mfmfd 10c
1000 to 1600 mfmfd 6c | 9000 to 9100 mfmfd 13c

Special Mica Kit... 100 @ \$2.95

SILVER MICA CONDENSERS

7, 8, 10, 15, 24, 25, 27, 35, 50, 75, 100, 120, 150, 170, 200, 240, 250, 300, 330, 400, 450, 500, 750, 1000, 1100, 1200, 1300, 1450, 1500, 2000, 2200, 2500, 2700, 2900, 3000, 3300, 3600, 4300, 4700, 5100, 5500, 6200, 7500, 8200 & 9100 mfmfd

7 to 75 mfmfd 8c | 2200 to 5100 mfmfd 22c
100 to 750 mfmfd 9c | 500 to 8200 mfmfd 24c
1000 to 2000 mfmfd 17c | 8100 mfmfd 30c

BATHTUB CONDENSERS

Mfd.	Volts	Price	Mfd.	Volts	Price
.01-01	600	.25	2x.25	1000	.59
.02-02	600	.25	3	400	.21
.04-04	600	.25	5	400	.27
.05	600	.25	5	400	.38
.05-05	600	.25	5	600	.45
.05-05	1000	.44	5	1000	.52
.08-08	600	.25	2x.5	600	.55
			3x.5	600	.68
1	1000	.45	1	100	.32
1	1200	.47	1	300	.35
1-1	400	.12	1	400	.45
1-1	600	.35	1	600	.57
3x.1	600	.42	2x.1	230AC	.35
2	1000	.19	2	600	.75
.25	800	.12	2	400	.58
.25	600	.32	2	600	.85
.25	600	.42	4	50	.48
.25	1000	.49	4	100	.53
2x.25	600	.49		other types available	

CHENNEL CONDENSERS

Mfd.	Volts	Price	Mfd.	Volts	Price
.025	500	.19	.25	1000	.45
.05	400	.21	4	600	.25
.05	1000	.32	15	400*	.15
2x.05	600	.30	15	500	.13
1	600	.23	5	500	.32
1	600	.32	5	600	.45
1	1000	.52	5	400	.39
1	2500	1.25	2x.5	600	.55
2x.1	400	.34	1	25KV	59.50
2x.1	600	.38	5-1	600	.29
3x.1	400	.39	1	400	.45
3x.1	600	.45	1	500	.55
.25	400	.26	1	600	.59
.25	600	.39		*Top Terms	

CERAMICON CONDS.

5, 10, 27, 56 & 100 mfmfd @05
1000 & 5000 mfmfd @07

Mfd.	Volts	Price	Mfd.	Volts	Price	
.016	15KV	\$5.75	2	2500V	3.95	
.0023	15KV	5.95	3	3000V	4.75	
.005-005-			2	4000V	8.75	
.01	10KV	4.75	2	5000V	12.50	
.012	25KV	19.95	2	7500V	75.00	
.02	10KV	12.95	2	25KV	98.50	
.02	20KV	17.90	2	10KV	39.95	
.025-.025-			2-2	600V	1.05	
.025	60KV	34.50	2	1000V	1.60	
.03	7500V	4.50	3	2000V	2.95	
.03	10KV	10.95	3	4000V	11.95	
.035	10KV	12.95	3	8KV	17.95	
.05	5KV	2.49	3-3	150V	.35	
.05	7500V	2.95	3-3	400V	1.05	
.08	12.5KV	12.50	3-3	400V	3.25	
1	1500V	.59	4	600VTLA	1.39	
1	2000V	.49	4	600VTLAD	1.39	
1	2500V	.117	4	1000V	1.89	
1	3000V	1.39	4	1500V	2.65	
1	500V	1.95	4	2000V	3.95	
1	7500V	1.39	4	2500V	5.95	
1	7500V	3.50	4	3000V	7.55	
1	10KV	9.50	4	4000V	13.95	
1	10KV	12.50	4	4000V	14.95	
1	12KV	14.95	4	7500V	52.50	
1	25KV	29.50	4-4	600V	.98	
1-1	2000V	1.17	5	250V	1.39	
1-1	7500V	3.50	5	330VAC	1.75	
15-15-			5	600V	1.69	
2	6000V	3.85	5	1000V	1.95	
2	10KV	9.95	5	1500V	2.40	
2	15KV	17.95	5-5	600V	1.32	
2	2500V	1.39	5	330VAC	1.49	
2	1500V	.79	6	600V	1.75	
2	2000V	1.19	6	1000V	2.49	
2	2500V	1.59	6	1500V	3.65	
2	2500V	1.49	7	300V	.79	
2	6000V	3.25	7	300V	1.45	
2	3000V	2.25	7	600V	1.99	
2	3000V	15.95	7	5000V	32.95	
2	20KV	19.95	8	110VAC	1.29	
2	25KV	24.50	8	200V	1.35	
2	25KV	67.50	8	600V	2.25	
2	200V	.32	8	600V Rd	1.79	
2	300V	.35	8	1000V	3.25	
2	400	.45	8	1500V	3.98	
2	4-4	4	8	2000V	7.25	
2	10KV	19.95	8	1000V	1.89	
2	2000V	1.49	8	50VAC	.69	
2	2000V	2.20	10	50VAC	2.50	
2	3000V	2.39	10	600V	5.90	
2	400	.58	10	1000V	3.95	
2	5000V	4.15	10	1500V	5.95	
2	7500V	6.95	10	2000V	9.50	
2	5-1	2000V	.89	12	600VAC	6.25
2	5-5	600V	.58	12	3X10 90VAC	2.95
2	5-5	9KV	16.50	12	1000V	4.25
2	25KV	54.50	10	1500V	4.95	
2	400V	.39				

TIME ELECTRONIC SALES IS THE MOST COMPLETE SOURCE OF CONNECTORS IN THE COUNTRY

The Following UG Connectors are in STOCK—by the Country's Leading Manufacturers at These LOW, LOW Prices!

UG 7/A/P..... 35.95	UG 83/U..... 1.25	UG 201A/U..... 1.95	UG 291B/U..... 1.25	MX 564A/U..... .95
UG 8/A/P..... 5.50	UG 83/U..... 2.95	UG 202/U..... 2.95	UG 294/U..... 1.60	UG 564/U..... 1.75
UG 9/U..... 1.05	UG 86/U..... 1.85	UG 203/U..... 2.75	UG 299/U..... 5.25	UG 565/U..... 2.20
UG 10/U..... 1.70	UG 87/U..... 1.15	UG 204A/U..... 2.45	UG 307/U..... 1.75	UG 566/U..... 4.75
UG 11/U..... 1.60	UG 88/U..... 1.75	UG 206/U..... 1.75	UG 309/U..... 2.35	UG 567/U..... 3.60
UG 12/U..... 2.10	UG 88B/U..... .90	UG 207/U..... 19.50	UG 318/U..... 3.75	UG 568/U..... 1.50
UG 13/U..... 1.05	UG 88C/U..... 1.00	UG 210/U..... 14.50	UG 334A/U..... 2.00	UG 572/U..... 2.00
UG 14/U..... 2.95	UG 89/U..... 1.25	UG 212A/U..... 2.35	UG 333A/U..... 3.50	UG 570/U..... 2.00
UG 15/U..... .75	UG 89A/U..... 1.25	UG 212B/U..... 3.75	UG 334/U..... 7.50	UG 571/U..... 1.75
UG 16/U..... 2.10	UG 90/U..... 1.40	UG 213A/U..... 3.25	UG 348A/U..... 1.75	UG 572/U..... 2.00
UG 17/U..... 1.00	UG 92A/U..... 1.50	UG 215/U..... 3.65	UG 335/U..... 2.70	UG 573/U..... 2.20
UG 18/U..... 1.50	UG 91A/U..... 1.10	UG 216/U..... 9.50	UG 347/U..... 1.95	UG 574/U..... 2.50
UG 18A/U..... 1.50	UG 92/U..... 1.30	UG 217/U..... 4.75	UG 348/U..... 1.75	UG 575/U..... 2.00
UG 18B/U..... 1.00	UG 92A/U..... 1.50	UG 218/U..... 8.50	UG 349/U..... 2.50	UG 585/U..... 4.50
UG 19/U..... 1.50	UG 93/U..... 1.40	UG 219/U..... 4.95	UG 349A/U..... 2.25	UG 589/U..... 1.10
UG 19A/U..... 1.50	UG 93A/U..... 1.50	UG 220/U..... 9.25	UG 350/U..... 2.00	UG 592/U..... 1.65
UG 19B/U..... 1.00	UG 94/U..... 1.40	UG 221/U..... 26.00	UG 352/U..... 4.95	UG 602/U..... 2.45
UG 20/U..... 1.65	UG 94A/U..... 1.20	UG 222/U..... 4.25	UG 352A/U..... 4.50	UG 603/U..... 2.00
UG 20A/U..... 1.85	UG 95/U..... 1.20	UG 223/U..... 1.20	UG 361/U..... 2.10	UG 604/U..... 1.00
UG 20B/U..... 1.00	UG 95A/U..... 1.20	UG 224/U..... 1.20	UG 362/U..... 2.25	UG 625/U..... .90
UG 21/U..... .75	UG 96/U..... 1.45	UG 225/U..... 14.50	UG 400/U..... 21.00	UG 626A/U..... .90
UG 21A/U..... 1.20	UG 96A/U..... 1.10	UG 226/U..... 14.50	UG 402/U..... 21.00	UG 627/U..... 3.50
UG 21B/U..... 1.00	UG 97A/U..... 1.00	UG 227/U..... 10.50	MT 412..... .70	UG 628/U..... 3.50
UG 21C/U..... 1.00	UG 98/U..... 1.75	UG 228/U..... 8.00	UG 413/U..... 26.00	UG 629/U..... 3.50
UG 21D/U..... 1.35	UG 100/U..... 1.25	UG 229/U..... 17.00	UG 414/U..... 1.30	UG 630/U..... 3.85
UG 22/U..... 1.00	UG 101A/U..... 1.00	UG 230/U..... 10.50	UG 419/U..... 1.30	UG 631/U..... 3.85
UG 22A/U..... 1.50	UG 102/U..... 2.25	UG 241/U..... 2.35	UG 421/U..... 2.65	UG 632/U..... 3.65
UG 22B/U..... 1.00	UG 103A/U..... 3.50	UG 242/U..... 2.85	UG 422/U..... 2.65	UG 633/U..... 2.70
UG 22C/U..... 1.00	UG 104A/U..... 2.95	UG 243/U..... 3.25	UG 423/U..... 5.00	UG 634/U..... 3.65
UG 22D/U..... 2.35	UG 107B/U..... 2.60	UG 244/U..... 2.95	UG 425/U..... 2.25	UG 635/U..... 3.65
UG 23/U..... 1.10	UG 108A/U..... 2.50	UG 245/U..... 2.50	UG 448/U..... .75	UG 636/U..... 3.75
UG 23A/U..... 1.00	UG 109A/U..... 2.00	UG 246/U..... 14.50	UG 482/U..... 26.00	UG 637/U..... 3.65
UG 23B/U..... 1.00	UG 110/U..... 10.25	UG 249/U..... 14.50	UG 479/U..... 26.00	UG 642/U..... 3.95
UG 23C/U..... 1.00	UG 114/U..... 1.65	UG 250/U..... 14.50	UG 482/U..... 26.00	UG 643/U..... 3.95
UG 23D/U..... 1.75	UG 115/U..... 1.80	UG 251/U..... 14.50	UG 483/U..... 2.40	UG 648/U..... .35
UG 24/U..... 1.00	UG 119/UP..... 6.50	UG 252/U..... 4.95	UG 484/U..... 4.75	UG 657/U..... .95
UG 27B/U..... 2.10	CW 123A/U..... .30	UG 253A/U..... 5.20	UG 485/U..... 1.80	UG 692/U..... .75
UG 27C/U..... 2.10	UG 115/U..... 1.80	UG 254/U..... 7.10	UG 486/U..... 1.80	UG 693/U..... .75
UG 28/U..... 2.10	UG 146/U..... 1.95	UG 255/U..... 1.80	UG 488/U..... 1.95	UG 697/U..... .75
UG 29/U..... .75	UG 148A/U..... 5.50	UG 256/U..... 12.25	UG 491/U..... 2.10	UG 698/U..... .75
UG 29A/U..... 1.10	UG 149A/U..... 3.95	UG 257/U..... 12.25	UG 492/U..... 2.50	UG 700/U..... .90
UG 29B/U..... 1.30	UG 154/U..... 4.85	UG 259/U..... 4.75	UG 492A/U..... 2.50	UG 701/U..... 9.30
UG 30/U..... 1.60	CW 155/U..... .30	UG 260/U..... 4.75	UG 493/U..... 5.95	UG 702/U..... 5.75
UG 30C/U..... 2.50	CW 155A/U..... .40	UG 260A/U..... 1.00	UG 494/U..... 3.35	UG 703/U..... 5.75
UG 32/U..... 1.00	UG 155/U..... 5.75	UG 260B/U..... 1.00	UG 495/U..... 5.75	UG 704/U..... 2.95
UG 33/U..... 20.00	UG 156/U..... 4.65	UG 261/U..... .80	UG 496/U..... 1.30	UG 705/U..... 4.95
UG 34/U..... 9.50	UG 157/U..... 4.65	UG 261A/U..... 1.30	UG 497/U..... 13.00	UG 706/U..... 4.10
UG 35A/U..... 2.10	UG 158/U..... 39.00	UG 261B..... 1.25	UG 499/U..... 1.85	UG 707/U..... 4.95
UG 36/U..... 11.00	CW 159/U..... .65	UG 262/U..... .90	UG 503/U..... 26.00	UG 708/U..... 6.95
UG 37A/U..... 13.00	UG 159A/U..... 3.70	UG 262A/U..... 1.25	MX 504..... .50	UG 709/U..... 2.95
UG 38A/U..... 18.00	UG 160/U..... 1.25	UG 262B/U..... 1.25	UG 505/U..... 26.00	UG 710/U..... 5.75
UG 39/U..... 1.10	UG 160B/U..... 1.30	UG 264/U..... 10.00	UG 506/U..... 26.00	UG 711/U..... 7.50
UG 40/U..... 1.80	UG 165/U..... 39.00	UG 265/U..... 1.00	UG 507/U..... 26.00	UG 809/U..... 1.50
UG 43/U..... 2.10	UG 167/U..... 3.00	UG 268/U..... 5.00	UG 507A/U..... 26.00	MX 910/U..... 1.50
UG 46/U..... 2.10	UG 167A/U..... 3.25	UG 269/U..... 2.85	UG 516A/U..... 1.25	MX 913/U..... .50
UG 48/U..... 15.00	UG 167B/U..... 5.00	UG 270/U..... 7.10	UG 519/U..... 21.00	UG 913/U..... 2.95
UG 49/U..... 15.00	UG 174/U..... 3.25	UG 271/U..... 7.10	UG 528/U..... 2.85	UG 914/U..... 1.25
UG 57B/U..... 1.60	UG 174A/U..... 14.00	UG 272/U..... 16.00	UG 530/U..... 3.35	UG 923/U..... 2.50
UG 58/U..... .65	UG 178/U..... 1.10	UG 273/U..... 9.00	UG 531/U..... 3.95	UG 924/U..... 1.95
UG 58A/U..... 1.00	UG 178A/U..... 1.10	UG 274/U..... 2.25	UG 532/U..... 4.90	UG 931/U..... 2.40
UG 59/U..... 1.70	UG 180A/U..... 5.25	UG 274A/U..... 2.50	UG 533/U..... 4.25	UG 932/U..... 2.40
UG 59A/U..... 1.60	UG 181A/U..... 5.25	UG 275/U..... 4.95	UG 535/U..... 1.75	UG 935A/U..... 1.75
UG 59B/U..... 1.00	UG 182A/U..... 5.65	UG 276/U..... 4.95	MX 536/U..... 1.45	UG 940A/U..... 2.10
UG 60/U..... 1.75	UG 185/U..... .75	UG 276A/U..... 4.65	MX 539/U..... .60	UG 941/U..... 2.35
UG 60A/U..... 1.50	UG 188/U..... 1.00	UG 281/U..... 3.60	MX 541/U..... 3.75	UG 941A/U..... 1.85
UG 60B/U..... 1.50	UG 192/U..... 16.00	UG 287/U..... 5.75	MX 543/U..... .60	UG 982/U..... 3.50
UG 61/U..... 1.75	UG 192A/U..... 52.00	UG 290/U..... 7.70	MX 554/U..... 1.50	UG 982A/U..... 6.00
UG 61A/U..... 2.00	MX 197/U..... .80	UG 291/U..... 1.00	UG 557/U..... 2.95	
UG 61B/U..... 2.10	UG 201/U..... 3.70	UG 291A/U..... .85	UG 560/U..... 2.45	
UG 62/U..... 22.00	UG 201A/U..... 1.50	UG 291A/U..... 1.25	MX 564/U..... .50	

Make Time Electronics Your Headquarters for AN Connectors. Discounts from 50% to 80% Off List Send For Free Connector Catalog—E55.

LAVOIE TYPE 105 FREQUENCY METER

VHF. 2 tubes. Battery operated portable frequency meter designed to measure frequencies for 300-600 MC. This unit is used for a variety of measurements on the VHF circuit. Complete unit with 0-200 micro amp meter, time switch, instruction book, all in metal carrying case. New condition. **\$29.50**

SCR-503

Complete Radio Direction Finder. Freq. range: 100-300 Kc. Receiver detects AM and CW signals. NEW with all cables and power supply. Operates from 12 V. battery. Write for descriptive data. P.U.R.

HANDSET & MIKE SPECIALS

- M1-2040 RCA sound powered. With mounting rack. New Ea. \$14.95
- TS-9 Handset with switch and cord. New Ea. 8.50
- TS-10 Sound powered handset. Used. Ea. \$5.50. 2 for \$10.00
- TS-12 Handset. Complete with cord and mounting hook. New Ea. 8.50
- TS-14 Handset. With cord and PL-204 Plug. New Ea. 9.95
- T-17D Mike. Military approved, cord and plug. New Ea. 8.25

MOTOROLA FSTR-250

250 W. Crystal Controlled FM Transmitter. With one receiver for communication. Freq. range: 30-40 MC. Complete with 120 VAC power supply. Like new P.U.R.

SIGNAL GENERATOR 1-208

Complete, crystal controlled, for testing FM receivers. Freq. range: 1.9-4.5 MC. 19-45 MC. Operates from 12 VDC or 120 V 60 cps P.U.R.

UHF FM TRANSCEIVER APG-17

2 watt FM transmitter-receiver radar set. Frequency range 1475-1525 MC. The antenna system consists of 2 double-bay cylindrical parabolas to operate in the above frequency. Electronic computer unit has air cooled power supply for the transceiver. Complete installation. Brand new. P.U.R.

NEW CATALOGUE NO. 114

LISTS LATEST INVENTORY OF AIR-CRAFT, INDUSTRIAL AND MILITARY ELECTRONICS EQUIPMENT. SEND FOR YOUR COPY TODAY!

Time Electronic Sales

368 BROADWAY NEW YORK 13, NEW YORK BARclay 7-3922

ARROW SALES INC.

Mailing Address: P. O. BOX 7878-E, HOLLYWOOD, CALIF.
Office: WASHINGTON, 7480 VARNIA AVENUE, HOLLYWOOD, CALIF.
Phone: 3-1818 • ST. LOUIS 7-5005 • Cable Address: ARROWSALES

TIME DELAY

Haydon relay 115v 60 cy adjustable in 5 sec. steps to 40 seconds max. 3 1/2 x 3 1/2 x 2 1/2 \$4.50

4PDT RELAY

- Midget 12 vdc 70Ω \$1.65 425Ω 24vdc \$2.75
- 3PDT Clare K 250Ω 24vdc 1.95
- SPDT 6 vdc 35Ω cer. insul. Dunco 181 1.25
- 115 vac 60 cy SPDT P. & B. #MR5A 1.95
- ERIE #557 silver trimmer 3-12 NPO .16
- Transistor or 5 pin submini socket .13

All material is from excess inventories & is new and guaranteed. Write for Bulletin

EMPIRE ELECTRONICS CO.

409 Ave. L Brooklyn 30, N. Y. CL 2-4000

JAN SOCKETS & SHIELDS

JAN S28A1

Stock Delivery—All Quantities

SAUL SCHWARTZ, Owner

Enmar ELECTRONICS CO.

CO 7-5850 120 Liberty St., N. Y. 6, N. Y.

WANTED

BC-221s, particularly BC-221AKs. Highest possible prices paid. Your instrument must be complete with original calibration book and bear the original name-plate. Write, wire, or phone:

THE OVERBROOK COMPANY
Overbrook, Massachusetts

WANTED

WANTED VIBRATION MACHINE

Late model L.A.B. Type. RVH 30-300 or equal.

Box E 1147,
221 W 41 St., New York 36, N. Y.

WILL BUY ALL

- Art-13 T-47A Transmitters BC-348 Rec'r modified \$200.00 \$35.00
- Art-13 T-47 Transmitters BC-348 Rec'r unmodified \$150.00 \$50.00
- BC-788C Altimeters \$100. ARC-1 Radio complete \$150.00
- RS/ARN7 Radio Compass \$125 BC-312 Receiver \$40.00
- ARC-3 Complete \$250.00 BC-342 Receiver \$50.00

Ship via Express C.O.D. Subject to Inspection to: H. FINNEGAN Little Ferry, N. J.

WANTED ENVIRONMENTAL TEST CHAMBER

late model, capable of testing electronic components in accordance with Mil-T Specifications. Box E 1148, 221 W. 41 St., N. Y. 36, N. Y.

WANTED

Type R19/TRC-1 Receivers.

W-3652, Electronics
330 W. 42 St., New York 36, N. Y.

WANTED

WE NEED YOUR SURPLUS ELECTRONIC EQUIPMENT

WE PAY TOP \$\$\$ FOR:

- * TUBES
- * TRANSFORMERS
- * COILS & PLUGS
- * ARC-1
- * ARC-3
- * ART-13
- * CLAMPS
- * RELAYS
- * RESISTORS
- * CONNECTORS
- * RADIO RECEIVERS
- * TRANSMITTERS
- * CONTROL BOXES
- * INDICATORS
- * CORDS
- * TELEPHONE MATERIALS

WE BUY ANYTHING!

TALLEN CO., Inc.
159 Carlton Ave., Brooklyn 5, N. Y.

HAVE YOUR ELECTRONIC TUBES TESTED UNDER QUALIFIED ENGINEERING SUPERVISION to JAN 1A, Mil E 1B, Commercial or Special Specification

Magnetrons, klystrons, special purpose, transmitting, receiving, sub-miniature, etc. Prompt service on small runs and production quantities. Report on test conditions and results issued if desired. Write or phone for price and delivery data.

RESEARCH ASSOCIATES, Inc.

1121 FLUSHING AVENUE
BROOKLYN 37, N. Y.
Hyacinth 7-2142

FOR SALE—SAVE 33-1/3%

- 30 1/4 HP 250 V DC geared head shunt motors 155 RPM GE 5BC46AB986 Gear 7GW120RY2
- 22000 ft. 1/2" brass flexible shielding conduit Titeflex 152-32. 900 ft. reels.
- 1383 lbs. MU metal transformer laminations F shape Allegheny Ludlum part F-20. 1.500"x1.263"x.014" thick.
- 824 ft. Micarta tubing 9/16" ID x 1/16" wall.

MILROY COMPANY
72 N. Arlington St. Akron 5, Ohio
Phone JE 5-3841

TO HELP YOU... find equipment you need "Searchlight" Advertising

RELAYS

RELAYS

OVER 400,000 IN STOCK
1200 DIFFERENT TYPES

\$2,000,000 inventory of Sensitrols and Steppers!

WESTON TYPE 705 SENSITROL

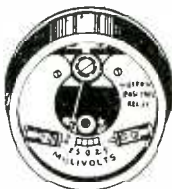

Operation is as follows: The stationary contact is a small powerful permanent magnet and movable contact is iron "rider" mounted on pointer which travels over relay scale. Operating torque moves pointer into magnetic field of stationary contact. This contact then draws movable contact and holds it firmly. Perfect contact is assured and chattering is eliminated. Contacts remain closed until reset. Accuracy in general may be considered as within 5% of the range. Operates directly from a photocell or a group of thermocouples. Net weight 14 oz.

Weston Model 705 Type 6

Double contact with Solenoid Reset
Sensitivity 7.5 Microamps
Reset coil 6-24 DC or 24 V AC
Makes contact on increasing or decreasing values.
Contacts: "Twincontacts", Capacity 100 ma at 110 volts
Nickel plated, Brass cover; #1560.....\$18.75
10 for \$170.00

Weston Model 705 Type 6

Same as #R560 but with glass face; #R561...\$19.75
10 for \$180.00

Weston Model 705 Type 4

Single contact (Normally Open), Solenoid Reset
Sensitivity: 10 Microamperes
Reset coil: 6-24 V DC or 24 V AC
Contact: "Twincontact", capacity 100 ma at 110 volts
Glass Face: #R523.....\$17.75
10 for \$160.00

Production Quantities Available... Call Us for Prices

STEPPING SWITCHES



STEPPING SWITCH S55:

Mfg by Western Electric, Automatic Electric Sales
Minor Switch
10 steps and off
Single Level
Contacts: Gold plated brass;
Bridging Wiper
Operating Voltage 6.0 to 12.0 V. DC

Resistance:
Oper. coil 6 ohm
Reset Coil 9 ohm
Net Weight: 1 lb.; #R960.....\$11.95
10 for \$100.00

STEPPING SWITCH S56:

Mfg by Western Electric Co., Automatic Electric Sales
22 step; 5 levels; Bridging Wipers;
Contacts: Gold plated brass
Operating Voltage: 5.5 to 12 V. DC;
Coil Resistance: 4.0 ohm
Interrupter Switch: 1 Break-Make
Net Weight: 2 lb. 2 oz.; #R926.....\$14.75
10 for \$120.00

STEPPING SWITCH S57:

Mfg by Western Electric Co., Automatic Electric Sales
44 step; 2 levels; Bridging Wipers;
Contacts: Gold plated brass
Operating Voltage: 5.5 to 12 V. DC;
Coil Resistance: 4.4 ohm
Interrupter Switch: 1 Break-Make
Net Weight: 1 lb. 14 oz.; #R927.....\$14.75
10 for \$120.00

AUTOMATIC ELECTRIC

TYPE 13; 25 POSITION; 3 levels;
1 Bridging, 2 non-bridging wipers;
Operating Voltage: 24 V DC, Max 36.
Resistance: 30-ohm
Net Weight: 2 lb.; AE No. RA92; Our #R900...\$17.75
CLAIRE L35631; 25 Position; 10 Levels;
1 Bridging, 9 Non-Bridging wipers;
Operating Voltage: 36 to 110 V. DC.
Resistance: 160 ohm
Net Weight: 2 lb. 6 oz.; #R898.....\$27.50

Production Quantities Available in Most Types... Call Us For Quotes.

Orders Under \$10 Remittance Order. Plus Approximate Shipping Charges (overage will be returned.)

MANUFACTURERS—JOBBER—EXPERIMENTERS—LABORATORIES

WRITE OR PHONE WALKER 5-9642 FOR YOUR RELAY REQUIREMENTS

Ask for Mr. Greenberg or Mr. Herzog

We have a large variety of standard types of relays and solenoids for a multiplicity of uses which for various reasons are not listed in our advertising. When inquiring concerning your needs give as much information as possible. Catalog numbers are not sufficient. Give coil voltage; specify AC or DC; give current or resistance; contact current and arrangement.

Get your name on our mailing list—something new and interesting in the near future.

AUTOMATIC ELECTRIC JACK-IN BASES



Simplify mounting, assembly and maintenance. Provide standardized mounting on which equipment units may be added, removed or rearranged, while presenting neat appearance. Made of sheet steel, durably finished, and punched to mount Class "B" or Class "A" relays, and other apparatus as desired. Equipment mounted on each base is connected to a jack on back of base, which engages a similar jack on mounting. Bases slip into place on standard mounting, bayonet slots engaging mounting pins, and jacks simultaneously engaging, to complete electrical connections.

"Jack-in" bases are all 4 1/2 inches wide, but of varying lengths, as listed below, for various quantities of relays. Relays are mounted in two parallel rows, with springs outward; relays in one row have contact springs on one side, and those in other row have springs on other side. Relays in left-hand row have not more than 9 springs; those in right-hand row may have a maximum of 13 springs. In addition, each row provides for one double-arm Class "A" relay, with two pile-ups of 9 to 13 springs each, respectively.

Each base is supplied with a 24 point jack—(Cat. No. BC-68), providing for a maximum of 24 outgoing connections from equipment on base. Front covers (enclosing the relays) and rear covers (enclosing relay terminals and wiring) are also provided.

No. of Relays	Length	A. E. Cat. No.	Price Ea.
10	7 13/16"	RB-63	3.00
14	1' 1 1/2"	RB-64	3.50
16	1' 2 3/8"	RB-65	4.00
18	1' 4"	RB-66	4.50

PHASE SHIFT CAPACITORS

W.E. #D150734 S.C. Stock No. 2C6996-1053A/C2. As used in BC1053A, SCR-545, Mark 34 and other Radar equipment. New, in original boxes.



\$25.00 each
10 for \$225.00

H-F TIE POST



Low-Loss Yellow Melamine insulation, pictured actual size (4-40 Thread).....\$7.50/C \$67.50/M

TERMS:—All Prices F.O.B. Our Plant. Rated Firms Net 10 Days; All Others Remittance with Order.

324 CANAL ST., N.Y.C., 13, N.Y. Walker 5-9642

Universal general corp.

INDEX TO ADVERTISERS

Acheson-Colloids Company	92
Acme Electric Corp.	363
Advance Electric & Relay Co.	384
Advance Electronics Co., Inc.	382
Aeronautical Communications Equip- ment, Inc.	281
Aerovox Corporation	303
Airborne Instruments Laboratory	296
Aircraft Radio Corporation	388
Airpax Products Co.	28, 29
Alleghany Ludlum Steel Corp.	259
Allen-Bradley Co.	261
Allen Co., Inc., L. B.	402
Allen Manufacturing Co.	378
Allied Radio Co.	331
Allison Laboratories	347
Allmetal Screw Products Company, Inc.	339
Alpha Metals, Inc.	395
Amerac, Inc.	190
American Airlines, Inc.	253
American Electronic Mfg., Inc.	397
American Lava Corporation	89
American Phenolic Corp.	46
American Television & Radio Co.	377
Amperite Co., Inc.	226
Ampex Corporation	106
Andersen Laboratories, Inc.	307
Antara Chemicals, a Sales Div. of General Aniline & Film Corp.	91
Armeo Steel Corp.	58
Arnold Engineering Co.	11
Art Wire & Stamping Co.	367
Astron Corporation	283
Atlantic Transformer Corp.	395
Atlas Engineering Co., Inc.	357
Automatic Mfg. Corporation	271

Ballantine Laboratories, Inc.	198
Barry Corp.	15
Bausch & Lomb Optical Co.	88
Beaver Gear Works, Inc.	312
Bell Telephone Laboratories	255
Bendix Aviation Corporation	
Pacific Div.	83
Red Bank Div.	390
Scintilla Div.	201
Bentley Harris Mfg. Co.	102
Berkeley Div., Beckman Instruments, Inc.	202
Berndt-Bach, Inc.	401
Bird & Co., Inc. R. H.	400
Bird Electronic Corp.	375
Bircher Corporation	372
Bliley Electric Company	250
Boesch Mfg. Co., Inc.	397
Bomac Laboratories, Inc.	193
Boonton Electronics Corp.	380
Boonton Radio Corp.	181
Bradley Laboratories, Inc.	221
Branson Corp.	353
Bridgeport Brass Co.	235
Bruno-New York Industries Corp.	32, 71
Brush Electronics Co.	114, 368
Burgess Battery Co.	379
Burke & James, Inc.	394
Burlington Instrument Co.	381
Burnell & Co., Inc.	48A, 48B
Bussmann Mfg. Co.	33

Cambridge Thermionic Corp.	50
Cannon Electric Co.	59
Carter Motor Co.	373
Cascade Research Corp.	211
Central Sales & Mfg. Corp.	399
Chester Cable Corp.	295
Chicago Standard Transformer Corp.	210
Chicago Telephone Supply Corp.	56, 57
Cinch Mfg. Corp.	177

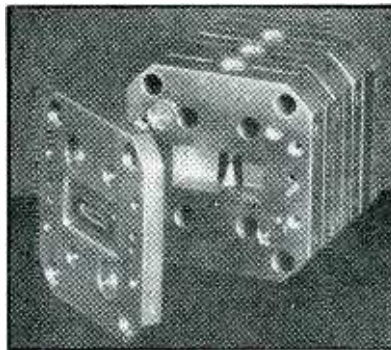

MICROWAVE DEVELOPMENTS

Wheeler Laboratories is an engineering organization offering consulting, research and development services in the fields of communications and radar.

Shown above is a demountable dummy TR tube designed for use as a comparison standard in the factory tuning of TR tubes to cover the 12-percent X-band. This standard features several sections individually pretuned within 1/3000 of 9 KMc, which requires adjusting the .006" gap to its correct value within ± 12 micro-inches.

At present, Wheeler Laboratories comprises a staff of twenty engineers under the personal direction of Harold A. Wheeler, with supporting facilities including a group of designers and a model shop.

A brief summary of our work will be sent on request, and comprehensive engineering reports on some of our developments are available. Inquiries are welcomed regarding your particular problems in microwave design and development.

Wheeler Laboratories, Inc.

122 Cutter Mill Road, Great Neck, N. Y.
HUunter 2-7876

PHAZOR PHASE METER

Pat. Pend.



MODEL
200 A

PRICE
\$34950
F.O.B.
NEW YORK

- HIGH ACCURACY
- MEASURES FROM 0 TO 360 DEGREES
- READINGS NOT AFFECTED BY NOISE AND HARMONICS
- PHASE SHIFTS OF THE ORDER OF .01° CAN BE MEASURED EMPLOYING SPECIAL CIRCUIT TECHNIQUES
- MEASURES IN-PHASE AND QUADRATURE COMPONENTS SEPARATELY

For further information contact your nearest
representative or write for brochure

REPRESENTATIVES

KITTLESON CO., 416 No. La Brea Ave., Los Angeles 36, Calif.
BROGER INSTRUMENT SALES CO., INC., 739 Boylston St., Boston 16, Mass.
F. R. JODON, INC., 2902 Porter St., N.W., Washington 8, D. C.
G. G. WILLISON CO., 1821 W. Alabama, Houston 6, Texas
LEEMARK ASSOCIATES, P. O. Box 8467, Kansas City 14, Mo.
RON MEREDITH CO., 2410 Beacon Ave., Seattle 44, Washington

INDUSTRIAL TEST EQUIPMENT CO.
55 E. 11th ST. · NEW YORK 3 · GR. 3-4684

Manufacturers of:

PHASE
METERS

•
NULL
DETECTORS

•
IMPEDANCE
COMPARATORS

•
POWER
OSCILLATORS

•
*Other Electronic Test
Equipment*

VICTOREEN can supply your needs for...

BETA and GAMMA COUNTER TUBES



Victoreen offers the most complete line of geiger tubes, developed for every type of application from the extremely accurate laboratory units to the heavy duty, portable, field type.

In every application where counter tubes are used — Victoreen has set the standard of comparison.

ELECTROMETER TUBES

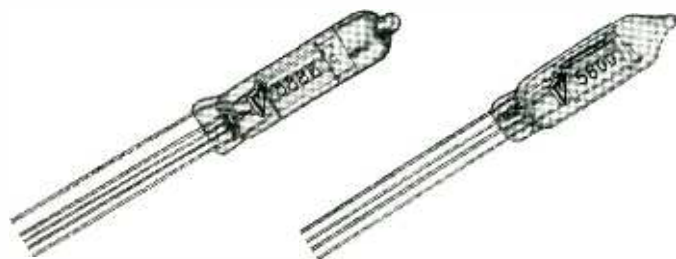

Victoreen has every facility for making tetrode, pentode and triode tubes to standards of operating performances that will inherently improve the performance of their application. In addition to exceptional quality, Victoreen offers engineering skill to assist in solving your problems and production facilities to meet your requirements. Send specifications of your needs.

For further information, write for catalog.



The Victoreen Instrument Co.

COMPONENTS DIVISION: 3810 Perkins Ave. • Cleveland 14, O.

Cinema Engineering Co.	402
Clarostat Mfg. Co., Inc.	223
Cleveland Container Co.	209
Clifton Precision Products Co., Inc.	70
Cohn Corp., Sigmund	351
Collectron Corp.	357
Collins Radio Company	257
Color Television, Inc.	304
Comar Electric Co.	297
Communication Accessories Co.	97
Communication Products Co., Inc.	363
Computer Co. of America	32
Computer-Measurements Div. of The De-	
tector Corp.	313
Consolidated Engineering Corp.	361
Consolidated Molded Products Corp.	258
Constantin & Co., L. L.	55
Continental Communications, Inc.	395
Continental-Diamond Fibre Co.	217
Cornell-Dubilier Electric Corp.	39
Corning Glass Works	266, 373, 395
Coto-Coll Co.	343
Cramer Co., Inc., R. W.	310
Cross Co., H.	371
Crucible Steel Co. of America	100
Cryco, Inc.	381

Dage Electric Co., Inc.	359
Dano Electric Co.	394
Daven Company	3rd Cover
Daystrom Instrument, Div. of Daystrom	
Inc.	301
DeJur-Amsco Corporation	286
Dialight Corporation	374
Diehl Manufacturing Company	318
Dimco-Gray Co.	375
Donnor Scientific Co.	320
Driver-Harris Co.	203
Dumont Airplane & Marine Instruments,	
Inc.	308
Dumont Laboratories, Inc., Allen B.	227
Du Pont de Nemours & Co., (Inc.) E. I.	
Film Dept.	289

Eastern Precision Resistor Corp.	354
Eitel-McCullough, Inc.	47, 204
Electrical Industries, Div. of Amperex	
Electronic Corp.	265
Electrical & Physical Instrument Corp.	388
Electric Regulator Corp.	206
Electro Engineering Products Co.	337
Electro Motive Mfg. Co., Inc.	239
Electro Tec Corp.	21
Electronic Associates, Inc.	358
Electronic Devices, Inc.	391
Electronic Engineering Co. of California	319
Electronic Instrument Co., Inc. (EICO)	361
Electronic Parts Mfg. Co., Inc.	399
Electronic Plastics Corp.	321
Electronic Tube Corporation	200
Emerson & Cuming Inc.	373
Empire Devices Products Corp.	353
Engineering Research Associates, Div. of	
Remington Rand, Inc.	387
Epo Products, Inc.	351
Erie Resistor Corp.	31

F-R Machine Works, Inc.	63
Fairchild Camera & Instrument Corp.	278
Fansteel Metallurgical Corp.	99
Federal Telephone & Radio Co.	30, 247
Federated Metals Div., American Smelt-	
ing & Refining Co.	306
Film Capacitors, Inc.	348
Filtors, Inc.	357
Filtron Co., Inc.	113
Five Star Company	371
Fluke Mfg. Co., Inc., John	391
Ford Instrument Co.	38
Freed Transformer Co., Inc.	187

G & M Equipment Co., Inc.	391
G-V Controls, Inc.	280
Gabriel Electronics, Div. of Gabriel Co.	314
Gabriel Laboratories, Div. of Gabriel Co.	315
Gamewell Co.	192
Gates Radio Co.	82
General Cement Mfg. Co.	402

General Electric Co.	
Apparatus Dept.	42, 43, 251, 333
Electronics Dept.	25, 61
Tube Dept.	189
General Radio Co.	16, 17
Giannini & Co., Inc., G. M.	298
Good-all Electric Mfg. Co.	245
Goodmans Industries, Ltd.	101
Gray Research & Development Co., Inc.	205
Green Instrument Co.	345
Gries Reproducer Corp.	399
Guardian Electric Mfg. Co.	77
Gudebrod Bros. Silk Co., Inc.	373

Hallcrafters	368
Hammarlund Mfg. Co., Inc.	23
Hanovia Chemical & Mfg. Co.	347
Harrison & Co., Philip H.	345
Harvey Hubbell, Inc.	237
Hathaway Instrument Co.	110
Haydon Co., A. W.	381
Haydon Manufacturing Co., Inc.	316, 317
Heath Co.	345
Helland a Div. of Minneapolis Honeywell	214
Heldor Mfg. Company	335
Helipot Corp., Div. of Beckman Instruments, Inc.	183
Henry & Miller Industries, Inc.	402
Heppner Mfg. Co.	216
Hermetic Seal Products Co.	87
Hetherington, Inc.	242
Hewlett-Packard Co.	31, 35
High Speed Hammer Co., Inc.	345
Hoffman Laboratories, Inc.	75
Homelite Corp.	246
Hopkins Engineering Co.	351
Hughes Aircraft Co.	199
Hughes Research & Development Laboratories	288, 398
Hycon Mfg. Company	272
Hycor Company, Inc.	386

Indiana Steel Products Co.	95
Industrial Condenser Corp.	188
Industrial Hardware Manufacturing Co., Inc.	351
Industrial Test Equipment Co.	439
Industrial Timer Corp.	52
Instrument Corp. of America	279
Instrument Resistors Co.	312
International Business Machines	322
International Crystal Mfg. Co., Inc.	349
International Instruments, Inc.	386
International Nickel Co., Inc.	84
International Rectifier Corp.	284
Ippolito & Co., Inc., James	361
Iron Fireman Electronics Division	287

James Vibrapowr Co.	327
Jelliff Mfg. Co., C. O.	369
Jennings Radio Mfg. Corp.	208
Jones Div., Howard B., Cinch Mfg. Co.	381
Jones Electronics Co., Inc., M. C.	367
Jordan Electronic Mfg. Co., Inc.	355
Joy Manufacturing Co.	231

Kahle Engineering Co.	13
Kartron	402
Kay Electric Co.	66
Kearfott Co., Inc.	294
Keller Tool Co.	94
Kepco Laboratories	90
Kester Solder Co.	229
Ketay Instrument Corp.	103
Keystone Products Co.	195
Knights Co., James	346

Laboratory for Electronics, Inc.	65
Lakeland, Florida Industrial Development Committee of 100	337
Lambda Electronics Corp.	74
Lampkin Laboratories, Inc.	402
Lapp Insulator Co., Inc.	302
Leland, Inc., G. H.	349
Lewis Spring & Mfg. Co.	248

DC MILLIVOLTMETER GROWS WINGS



America's oldest, most reliable, sensitive DC-VTVM, the Millivac MV-17 C, is now available for 400 cycle operation in aircraft. An important new tool has thus been provided for aviation research.

These 400 cycle Aviation Models may, in addition, be used on any odd frequency over a range of 40 cps to 500 cps, including, of course, 60 cps.

Standard 60 cycle models (100-125 V, 59-61 cps):

MV-17 C	DC Millivoltmeter, 100 uV-1 KV	\$295.00
MV-17 CX	Identical with MV-17 C but has Int.-Ext. Meter Change-Over Switch for use as d.c. amplifier (1,500 gain, 3 V-2 mA output corresponding to full scale int. meter reading)	\$360.00
RM-17 B	Rack-mounted version of MV-17 C	\$320.00
RM-17 BX	Rack-mounted version of MV-17 CX	\$385.00

New "Aviation" models (100-125 V, 40 cps-500 cps):

MV-17 CP	DC Millivoltmeter, 100 uV-1 KV	\$390.00
MV-17 CPX	Corresponds to MV-17 CX	\$455.00
RM-17 BP	Rack-mounted version of MV-17 CP	\$415.00
RM-17 BPX	Rack-mounted version of MV-17 CPX	\$480.00

TIME PROGRESSES—SO DO WE

MILLIVAC INSTRUMENT CORPORATION

444 SECOND ST.

SCHENECTADY 6, N. Y.

Librascope, Inc.	369
Linde Air Products Company Div. of Union Carbide & Carbon Corp.	343
Linear Equipment Laboratories	387
Link Aviation, a Sub. of General Precision Equipment Corp.	362
Lion Fastener, Inc.	340
Lockheed Missile Systems Div.	401

Machlett Laboratories, Inc.	197
Magnecord, Inc.	220
Magnetic Research Corp.	344
Magnetics, Inc.	249
Magnatran, Inc.	355
Makepeace Co., D. E.	107
Maleo Tool & Manufacturing Co.	359
Mallory and Co., Inc., P. R.	118
Mansol Ceramics Co.	379
Manufacturers Engineering & Equipment Corp.	366
Marconi Instruments, Ltd.	86
Marion Electrical Instrument Co.	241
Maxson Corp. W. L.	213
McCoy Electronics Co.	323
McGraw-Hill Book Co., Inc.	402
McGraw-Hill Book Co., Technical Writing Service	392
Measurements Corporation	376
Mega-Magnet Assoc.	402
Metal Textile Corporation	374
Metals & Controls Corp., General Plate Div.	62
Meyercord Co., The	371
Mica Insulator Co.	69
Microdot Div. of Felts Corp.	355
Miles Reproducer Co., Inc.	402
Millen Mfg. Co., Inc., James	219
Millivac Instrument Corp.	441
Minneapolis-Honeywell Regulator Co. Industrial Div.	68
Transistor Div.	336
Minnesota Mining & Mfg. Co.	96
Monsanto Chemical Company	27
Moseley Co., F. L.	300
Muirhead & Co., Ltd.	3
Myalex Corporation of America	270

National Company Inc.	264
National Moldite Co.	60
National Vulcanized Fibre Co.	111
New London Instrument Co.	396
New York State Dept. of Commerce	240
New York Transformer Co., Inc.	360
Ney Company, J. M.	349
Nopco Chemical Co.	76
Norden Laboratories Corp.	309
North American Aviation, Inc.	353
North Hills Electric Co., Inc.	402
Northeast Electronics Corp.	377

Offner Electronics Inc.	331
Ohmite Manufacturing Co.	32A, 32B
Olympic Metal Products Co., Inc.	288

PM Industries	293
Panoramic Radio Products, Inc.	378
Parks Laboratory	402
Par-Metal Products Corp.	365
Pentron Corporation	352
Peter Partition Corp.	363
Phalo Plastics Corp.	299
Phaotron Co.	329
Phelps Dodge Copper Products Corp. Inca Mfg. Div.	40, 41
Photocircuits Corp.	81
Pix Manufacturing Co., Inc.	337
Polarad Electronics Corporation	53, 233
Polytechnic Research & Development Co., Inc.	260
Popper & Sons, Inc.	355
Potter Company, The	342
Precision Apparatus Co., Inc.	444
Precision Paper Tube Co.	194
Premier Instrument Corp.	258
Price Electric Corp.	269
Printloid, Inc.	365

miniatures of

U.S.G. Stand-off and Feed-through Insulators made with tough TEFLON, are fast supplanting units made with brittle glass

TEFLON's superior insulating characteristics made these miniatures possible. Here are their features:



UNITED STATES
 FLUOROCARBON PRODUCTS INC. DIVISION
 CAMDEN 1, NEW JERSEY

Mighty Importance

Better for high frequency, high temperature service. Higher surface and volume resistivity. Lower loss factor. Higher dielectric strength. Wider service temperature range (-110°F. to +500°F.). Zero water absorption (A.S.T.M. Test). Won't carbonize under arcing or DC-plate. Non-flammable, non-gassing, chemically inert.

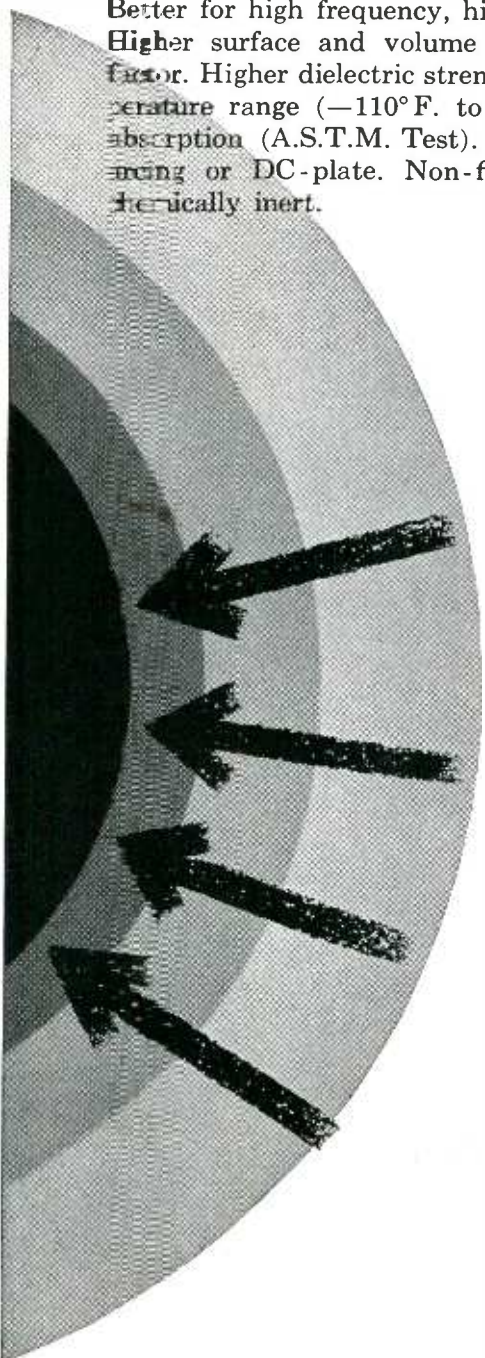

Read these Points for Assembly Savings and Service Satisfaction.

COMPRESSION MOUNTING

impossible with glass. Fits like a cork. Also withstands shock and vibration in service. Assembly costs greatly reduced. No additional mounting hardware or soldering required.

PLASTIC MEMORY

securely locks insulator permanently in place. Minimum pull test 10 lbs., insulator to hardware, insulator to deck.

MINIATURIZATION

is easily accomplished.

NINETEEN STOCK SIZES

including sub-miniatures, in Stand-off and Feed-through types. Other dimensions feasible.

• Write for Catalog
No. EC-1153

GASKET COMPANY
FABRICATORS OF *du Pont* TEFLON, Kellogg KEL-F
AND OTHER PLASTICS



Probescope Co.	377
Progressive Mfg. Co.	224
Pye, Ltd.	112
Pyramid Electric Company.	369

Quaker City Gear Works, Inc.	238
Quality Products Co.	402

R-B-M Div. of Essex Wire Corp.	186
Radio Cores, Inc.	234
Radio Corporation of America. 4th Cover,	263
Radio Frequency Laboratories Inc.	382
Radio Materials Corp.	225
Radio Receptor Co., Inc.	73
Railway Express Agency, Air Express Div.	116, 117
Ramo-Woolridge Corp.	273
Ratray & Company, Inc., George.	399
Raybestos-Manhattan, Inc.	191
Raytheon Mfg. Company.	19, 277, 298
Reeves-Hoffman Corporation.	262
Resin Industries, Inc.	380
Resinite Corp., Div. of Precision Paper Tube Co.	244
Resistance Products Co.	338
Revere Copper & Brass Inc.	51
Rex Rheostat Co.	402
Rho Company.	365
Richardson Company.	98
Rockbar Corp.	353
Rome Cable Corp.	85
Rotron Mfg. Co.	339
Rutherford Electronics Co.	370

Sanborn Company.	168
Sarkes Tarzian Inc., Rectifier Div.	328
Schuttig & Co., Inc.	365, 387
Scientific Radio Products, Inc.	307
Scintilla Div., Bendix Aviation Corp.	201
Secor Metals Corp.	394
Shalleross Mfg. Co.	196, 292
Shure Bros., Inc.	324
Sigma Instruments, Inc.	254
Signal Engineering & Mfg. Co.	376
Sorensen & Co., Inc.	2
Southern Electronics Co.	371
Sprague Electric Co.	9, 185
Stackpole Carbon Co.	215
Standard Electric Time Co.	67
Standard Piezo Co.	341
Star Porcelain Co.	343
Stevens Arnold Inc.	384
Stevens Mfg. Co., Inc., George.	222
Stoddart Aircraft Radio Co., Inc.	268, 330
Stokes Machine Co., F. J.	48
Stone Paper Tube Co.	218
Stupakoff Ceramic & Mfg. Co., Div. of the Carborundum Company.	45
Sturtevant Co., P. A.	369
Superior Electric Co.	49
Superior Tube Co.	78
Sylvania Electrical Products, Inc.	7, 275, 396
Synthane Corporation.	290, 291

Taylor Fibre Co.	179
Technicraft Laboratories, Inc.	385
Technology Instrument Corp.	207, 383
Tektronix, Inc.	80
Teledrome, Inc.	267
Teletronics Laboratory, Inc.	387, 400
Terpening Company, L. H.	236
Texas Instruments, Inc.	212
Thompson Products Inc.	326
Thor Ceramics, Inc.	347
Transradio, Ltd.	370
Transitron Electronic Corp.	36, 37
Trans-Sonics, Inc.	356
Triplett Electrical Instrument Co.	115
Tubular Rivet & Stud Co.	256
Tung-Sol Electric, Inc.	112A, 112B
Turner Company.	367

Uclnite Company.	72
Union Carbide & Carbon Corp. Div. of Linde Air Products Co.	343
Union Switch & Signal, Div. of Westing- house Air Brake Company.	350
U. S. Components, Inc.	341

PRECISION

ANNOUNCES THE

Model E-300

SINE-SQUARE WAVE SIGNAL GENERATOR

(AUDIO-VIDEO RANGE)



The Series E-300 provides sine and square wave signals of high accuracy and stability for direct-performance testing of:

- ▶ High Fidelity Audio Amplifiers
- ▶ TV Video Amplifiers
- ▶ Carrier Current Systems, etc.

GENERAL SPECIFICATIONS

- ★ Variable-Frequency Sine Wave Ranges:
20 Cps. to 200 KC. in Four Bands.
- ★ Variable Frequency Square Wave Ranges:
20 Cps. thru 20,000 Cps. In Three Bands.
- ★ Four Fixed, High-Frequency Square Waves:
for analysis of wide-band amplifiers
up to 20 MC band width:
50 KC.—100 KC.—250 KC.—500 KC. steps.
- ★ Output Characteristics:
Variable Frequency Ranges:
0-2000 ohms, 0-10 volts RMS, ± 1 db.
Accuracy: $\pm 2\%$ from 50 cycles to 200 KC.
 ± 1 cycle from 20 cycles to 50 cycles.
Distortion: Less than 1% from 20 cycles
through 200 KC.
20 KC Square Wave Rise Time:
.5 microseconds.
Fixed High Frequency Square Waves:
0-250 ohms, 0-5 volts P-P
Rise Time: .05 microsecond
Overshoot: Negligible
- ★ Tube Complement:
1-5879, 1-6CL6, 1-6J6, 2-6AU6,
1-6BL7, 1-6AH6, 1-6X4.
- ★ Separate Output Circuits:
for the variable and fixed frequency ranges.
- ★ Terminated, Low-Loss, High Frequency
Coaxial Output Cable
- ★ External 'Sync' Terminal Post:
for synchronizing scope to H.F. square wave.
- ★ Etched-Anodized Tuning Dial and Panel

MODEL E-300: in black, ripple finished, portable steel case—10½ x 12 x 6". Complete with tubes, coaxial, output cable and operating manual. Net Price \$175.00

PRECISION APPARATUS CO., INC.

70-31 84th Street, Glendale 27, L. I., N. Y.

Export: 458 Broadway, New York 13, U. S. A.
Canada: Atlas Radio Corp., Ltd., 560 King St., W., Toronto 28

Want more information? Use post card on last page.

United States Gasket Co.	442, 443
United Transformer Co.	2nd Cover
Universal Manufacturing Co., Inc.	341
Universal Winding Co.	93

Valpey Crystal Corp.	377
Variflex Corporation	285
Varian Associates	79
Veeder-Root, Inc.	64
Vickers Electric Div., Vickers, Inc.	305
Victoreen Instrument Co.	440
Victory Engineering Corp.	339
Volkert Stampings Inc.	282

Waldes Kohinoor, Inc.	44
Ward Leonard Electric Co.	80A, 80B
Waterman Products Co., Inc.	311
Waters Manufacturing Inc.	392, 393
Waveline, Inc.	325
Wenco Manufacturing Co.	363
West Coast Electrical Mfg. Corp.	252
Westinghouse Electric Corp.	243
Weston Electrical Instrument Corp.	54
Wheeler Laboratories, Inc.	439
White Dental Mfg. Co., S. S.	359, 389
Whitney Blake Company	232
Williams & Co., C. K.	372
Wincharger Corp.	109

Xcelite, Incorporated	343
-----------------------	-----

Zophar Mills, Inc.	331
--------------------	-----

PROFESSIONAL SERVICES	403
-----------------------	-----

SEARCHLIGHT SECTION

(Classified Advertising)

H. E. HILTY, Mgr.

EMPLOYMENT

Positions Vacant	404-417
Selling Opportunities Offered	416
Positions Wanted	404

BUSINESS OPPORTUNITIES

Offered	404
---------	-----

EQUIPMENT

(Used or Surplus New)	
For Sale	418-438

WANTED

Equipment	436
-----------	-----

ADVERTISERS INDEX

Admiral Corporation	417
Airborne Electronics Inc.	428
Allied Electronic Sales	428
Alltronics	428
Arrow Sales, Inc.	436
Barry Electronics Corp.	423
Bendix Aviation Corp., Missile Section Products Div.	411
Bendix Aviation Corp., Pacific Div.	404
Bendix Aviation Corp., Radio Div.	414

Bendix Aviation Corp., York Div.	416
Blair	430
Boonton Radio Corp.	414
Burden Sales Co.	430
Cadillac Electronics Inc.	435
Calvert Electronics	418
Cardwell Electronics Prod. Corp., Allen D.	404
C & H Sales Co.	418, 419
Chase Electronics Supply Co.	428
Chicago Midway Laboratories	408
Columbia Broadcasting Inc.	406
Communications Devices Co.	420
Communications Equipment Co.	427
Compass Communications Co.	428
Connector Corp. of America	426
Cook Research Laboratories	408
Convair	411
Cornell Aeronautical Laboratory Inc.	415
Crosley, Div. of Avco Manufacturing Corp.	406
Delco Radio Division, General Motors Corp.	416
Donner Scientific Co.	416
Drake Engineering Personnel Service	404
Electronic Engineering Co. of Calif.	416
Electroncraft, Inc.	421
Emerson Electric Mfg. Co.	412
Empire Electronics Co.	436
Engineering Associates	428
Enmar Electronics	436
Esse Radio Co.	432
Etcco	428
Fair Radio Sales	434
Fay-Bill Distributing Co.	420
Federal Telecommunications Labs.	415
Finnegan, H.	436
General Electric Co., Syracuse Div.	415
General Precision Laboratory	413
Goodyear Aircraft Corp.	405
Harjo Sales Co.	425
Hanover Electronics	434
Hilliard, W. P.	432
Hoffman Laboratories Inc.	416
Industrial Nucleonics Corp.	412
Industrial Research Labs.	410
Instrument Service	424
JSH Sales Co.	426
Kollsman Instrument Corp.	417
Lapirow Bros.	418
Lectronic Research Labs.	433
Liberty Electronics	422
Lockheed Aircraft Corp.	413
Maritime Switchboard	434
Maryland Electronic Mfg. Corp.	417
Massachusetts Institute of Technology	410
Medical Salvage Co., Inc.	426
Melpar, Inc.	408
Mid-America Co., Inc.	418
Milroy Co.	437
Mogull Co., Inc., A.	424
Monmouth Radio Labs	435
Motorola Research Laboratories	414, 419
Murry's Radio	429
National Surplus Sales Co.	430
Nibur Sales Corp.	431
Overbrook Company	436
Page Communications Engineers Inc.	404
Photocon Sales	420
Radalab	452
Radio Corp. of America	407, 414
Radio & Electronic Surplus	418
Radio Shack Corp.	430
Railway Communications, Inc.	434
Relay Sales Inc.	433
RW Electronics	426
Semler Industries Inc.	434
S & R Electronics Inc.	422
Solo Electronics Sales Corp.	424
Stanley Aviation Corp.	410
Stavid Engineering Inc.	408
"TAB"	438
Tallen Co., Inc.	432, 437
Time Electronic Sales	436
Tung-Sol Electric Inc.	406
Telemarine Communications Co.	431
Universal General Corp.	437
Victor-Bernard Industries Inc.	426
Vitro Corp.	410
Weaver Bros. Inc.	404
Westinghouse Electric Co.	409
Westinghouse Electronic Tube Div.	404
White-Rodgers Electric Co.	412
Wright Associates	404

This index is published as a convenience to the readers. Every care is taken to make it accurate, but ELECTRONICS assumes no responsibility for errors or omissions.

New

Switch on

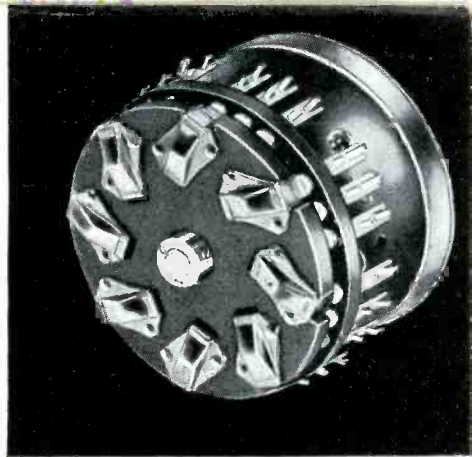

SWITCHES

by **DAVEN**

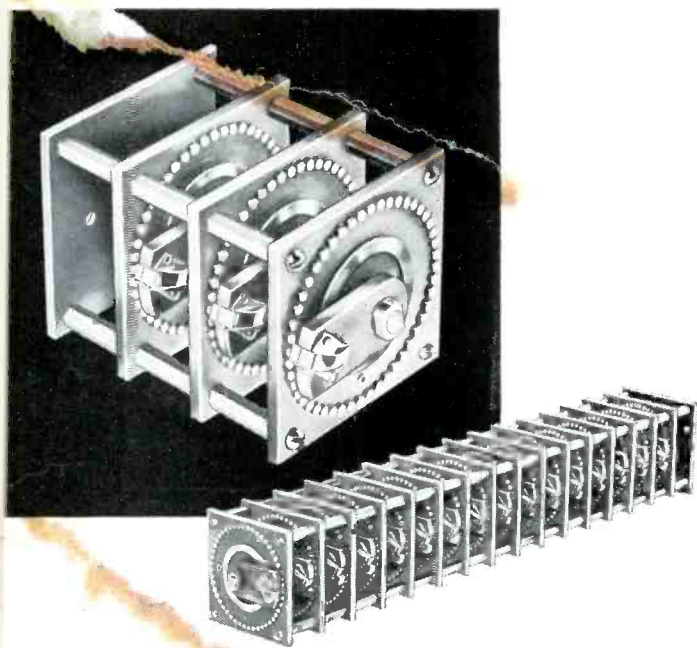

DAVEN not only supplies switches from its hundreds of standard units, but can also effect quick changes from standard units to special switches by using components at hand.

As a result, you are able to select, from thousands of variations, the right switch for your particular requirements.

And . . . here's a new switch for problems that defy solution with standard components. If your prototype is that of an unusual piece of equipment and requires a switch not yet developed, DAVEN will engineer it for you.

This is a service which DAVEN is singularly well qualified to perform by reason of its skilled engineering staff and exceptional facilities. For more than a generation, DAVEN has built up a Development Department that is second to none in solving difficult switch problems.

Furthermore, because only DAVEN has the patented "knee-action" rotor, units can be produced with a greater number of switch positions and poles in a smaller space than was ever possible before.



THE **DAVEN** CO.

191 CENTRAL AVENUE
NEWARK 4, NEW JERSEY

Why not call on DAVEN today to assist with your development project, especially if you need switches that must render maximum performance in minimum space.

It's FREE Write for your copy of DAVEN's new, 28-page brochure on SWITCHES.

FOR "SERIES-STRING" TV

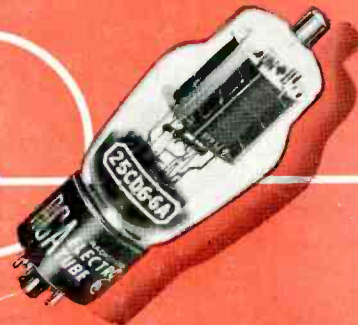

SPECIFY

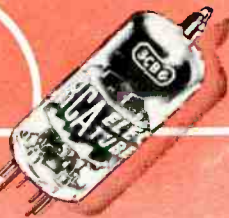
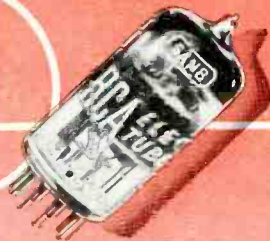

RCA TUBES

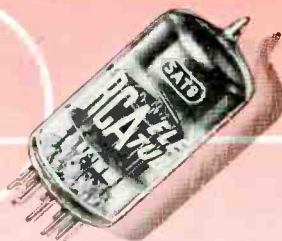

RCA "SERIES-STRING" TUBES

"SERIES-STRING" TYPE	PROTO-TYPE	"SERIES-STRING" TYPE	PROTO-TYPE
2AF4-A	6AF4	5J6	6J6
3AL5	6AL5	5U8	6U8
3AU6	6AU6	5X8	6X8
3AV6	6AV6	6AU7	12AU7
3BC5	6BC5	6S4-A	6S4
3BY6	6BY6	6SN7-GTB	6SN7-GT
3CE6	6CE6	12AX4-GTA	12AX4-GT
3CF6	6CF6	12BH7-A	12BH7
4BQ7-A	6BQ7-A	12BQ6-GTB	6BQ6-GT
4BZ7	6BZ7	12BY7-A	12BY7
5A48	6A48	12L6-GT	25L6-GT
5A25	6A05	12W6-GT	6W6-GT
5A18	6A18	25CD6-GA	6CD6-G
5AT8	6AT8		

If you're making—or planning to make—'series-string' TV receivers, spark your designs with *new* RCA tube types!

Designed to withstand increased heater-cathode ratings where necessary, these new RCA tubes meet the demands of 'series-string' TV applications.

Controlled heater warm-up time minimizes voltage unbalance during starting—adds dependability to your receiver designs.

RCA's ever-careful attention to technical detail and product quality assures you of high calibre "series-string" tube performance.

For technical data, call your local RCA Field Representative. Or write RCA, Commercial Engineering, Section K19Q, 415 South Fifth St., Harrison, N. J.



RADIO CORPORATION of AMERICA

ELECTRON TUBES

HARRISON, N. J.